



Full wwPDB X-ray Structure Validation Report ⓘ

Nov 5, 2023 – 01:46 PM EST

PDB ID : 6PXK
Title : 3.65 Angstroms resolution structure of HslU with an axial-channel plug
Authors : Baytshtok, V.; Grant, R.A.; Sauer, R.T.
Deposited on : 2019-07-26
Resolution : 3.65 Å(reported)

This is a Full wwPDB X-ray Structure Validation Report for a publicly released PDB entry.

We welcome your comments at validation@mail.wwpdb.org

A user guide is available at

<https://www.wwpdb.org/validation/2017/XrayValidationReportHelp>

with specific help available everywhere you see the ⓘ symbol.

The types of validation reports are described at

<http://www.wwpdb.org/validation/2017/FAQs#types>.

The following versions of software and data (see [references ⓘ](#)) were used in the production of this report:

MolProbity : 4.02b-467
Mogul : 1.8.5 (274361), CSD as541be (2020)
Xtriage (Phenix) : 1.13
EDS : 2.36
buster-report : 1.1.7 (2018)
Percentile statistics : 20191225.v01 (using entries in the PDB archive December 25th 2019)
Refmac : 5.8.0158
CCP4 : 7.0.044 (Gargrove)
Ideal geometry (proteins) : Engh & Huber (2001)
Ideal geometry (DNA, RNA) : Parkinson et al. (1996)
Validation Pipeline (wwPDB-VP) : 2.36

1 Overall quality at a glance i

The following experimental techniques were used to determine the structure:

X-RAY DIFFRACTION

The reported resolution of this entry is 3.65 Å.

Percentile scores (ranging between 0-100) for global validation metrics of the entry are shown in the following graphic. The table shows the number of entries on which the scores are based.

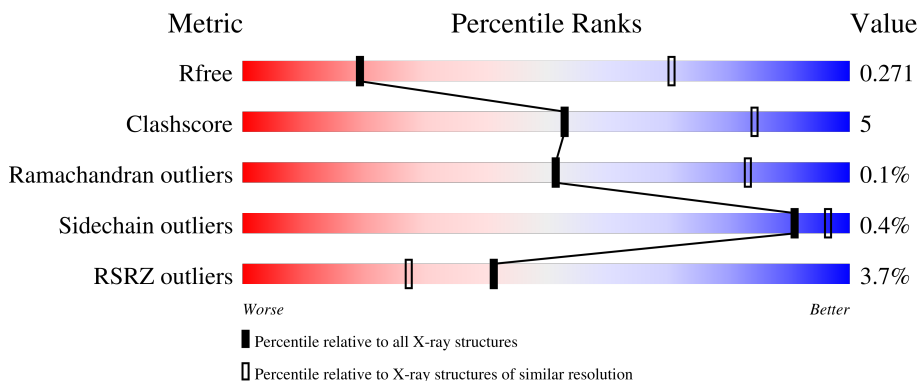

Metric	Whole archive (#Entries)	Similar resolution (#Entries, resolution range(Å))
R_{free}	130704	1341 (3.78-3.50)
Clashscore	141614	1439 (3.78-3.50)
Ramachandran outliers	138981	1391 (3.78-3.50)
Sidechain outliers	138945	1391 (3.78-3.50)
RSRZ outliers	127900	1242 (3.78-3.50)

The table below summarises the geometric issues observed across the polymeric chains and their fit to the electron density. The red, orange, yellow and green segments of the lower bar indicate the fraction of residues that contain outliers for ≥ 3 , 2, 1 and 0 types of geometric quality criteria respectively. A grey segment represents the fraction of residues that are not modelled. The numeric value for each fraction is indicated below the corresponding segment, with a dot representing fractions $\leq 5\%$. The upper red bar (where present) indicates the fraction of residues that have poor fit to the electron density. The numeric value is given above the bar.

Mol	Chain	Length	Quality of chain
1	A	448	<div style="display: flex; align-items: center;"> <div style="width: 5%; height: 10px; background-color: red; margin-right: 5px;"></div> <div style="width: 80%; height: 10px; background-color: green; margin-right: 5px;"></div> <div style="width: 13%; height: 10px; background-color: yellow; margin-right: 5px;"></div> <div style="width: 6%; height: 10px; background-color: grey;"></div> </div> <p style="text-align: center;">5% 80% 13% 6%</p>
1	B	448	<div style="display: flex; align-items: center;"> <div style="width: 3%; height: 10px; background-color: red; margin-right: 5px;"></div> <div style="width: 76%; height: 10px; background-color: green; margin-right: 5px;"></div> <div style="width: 12%; height: 10px; background-color: yellow; margin-right: 5px;"></div> <div style="width: 11%; height: 10px; background-color: grey;"></div> </div> <p style="text-align: center;">3% 76% 12% 11%</p>
1	C	448	<div style="display: flex; align-items: center;"> <div style="width: 4%; height: 10px; background-color: red; margin-right: 5px;"></div> <div style="width: 81%; height: 10px; background-color: green; margin-right: 5px;"></div> <div style="width: 13%; height: 10px; background-color: yellow; margin-right: 5px;"></div> <div style="width: 5%; height: 10px; background-color: grey;"></div> </div> <p style="text-align: center;">4% 81% 13% 5%</p>
1	D	448	<div style="display: flex; align-items: center;"> <div style="width: 2%; height: 10px; background-color: red; margin-right: 5px;"></div> <div style="width: 66%; height: 10px; background-color: green; margin-right: 5px;"></div> <div style="width: 9%; height: 10px; background-color: yellow; margin-right: 5px;"></div> <div style="width: 25%; height: 10px; background-color: grey;"></div> </div> <p style="text-align: center;">2% 66% 9% 25%</p>
1	E	448	<div style="display: flex; align-items: center;"> <div style="width: 5%; height: 10px; background-color: red; margin-right: 5px;"></div> <div style="width: 77%; height: 10px; background-color: green; margin-right: 5px;"></div> <div style="width: 18%; height: 10px; background-color: yellow; margin-right: 5px;"></div> <div style="width: 5%; height: 10px; background-color: grey;"></div> </div> <p style="text-align: center;">5% 77% 18% 5%</p>

Continued on next page...

Continued from previous page...

Mol	Chain	Length	Quality of chain
1	F	448	<p>4% 75% 11% 13%</p>
1	G	448	<p>3% 72% 11% 17%</p>
1	H	448	<p>% 75% 12% 12%</p>
1	I	448	<p>6% 79% 13% 8%</p>
1	J	448	<p>% 63% 8% 28%</p>
1	K	448	<p>% 83% 12% .</p>
1	L	448	<p>3% 75% 12% 12%</p>
2	X	16	<p>100%</p>

2 Entry composition

There are 4 unique types of molecules in this entry. The entry contains 37523 atoms, of which 0 are hydrogens and 0 are deuteriums.

In the tables below, the ZeroOcc column contains the number of atoms modelled with zero occupancy, the AltConf column contains the number of residues with at least one atom in alternate conformation and the Trace column contains the number of residues modelled with at most 2 atoms.

- Molecule 1 is a protein called ATP-dependent protease ATPase subunit HslU.

Mol	Chain	Residues	Atoms						ZeroOcc	AltConf	Trace
			Total	C	N	O	S	Se			
1	G	374	Total 2932	C 1834	N 512	O 573	S 2	Se 11	0	0	0
1	H	392	Total 3090	C 1933	N 549	O 598	S 2	Se 8	0	0	0
1	I	411	Total 3217	C 2010	N 568	O 624	S 2	Se 13	0	0	0
1	J	321	Total 2517	C 1575	N 444	O 489	S 2	Se 7	0	0	0
1	K	429	Total 3368	C 2106	N 596	O 651	S 2	Se 13	0	0	0
1	L	394	Total 3113	C 1948	N 554	O 601	S 2	Se 8	0	0	0
1	A	420	Total 3304	C 2068	N 582	O 639	S 2	Se 13	0	0	0
1	B	397	Total 3129	C 1958	N 558	O 603	S 2	Se 8	0	0	0
1	C	425	Total 3339	C 2090	N 588	O 646	S 2	Se 13	0	0	0
1	D	335	Total 2633	C 1649	N 464	O 511	S 2	Se 7	0	0	0
1	E	426	Total 3338	C 2089	N 587	O 647	S 2	Se 13	0	0	0
1	F	388	Total 3059	C 1916	N 544	O 589	S 2	Se 8	0	0	0

There are 72 discrepancies between the modelled and reference sequences:

Chain	Residue	Modelled	Actual	Comment	Reference
G	-4	HIS	-	expression tag	UNP C3SIX7
G	-3	HIS	-	expression tag	UNP C3SIX7
G	-2	HIS	-	expression tag	UNP C3SIX7
G	-1	HIS	-	expression tag	UNP C3SIX7
G	0	HIS	-	expression tag	UNP C3SIX7

Continued on next page...

Continued from previous page...

Chain	Residue	Modelled	Actual	Comment	Reference
G	1	HIS	-	expression tag	UNP C3SIX7
H	-4	HIS	-	expression tag	UNP C3SIX7
H	-3	HIS	-	expression tag	UNP C3SIX7
H	-2	HIS	-	expression tag	UNP C3SIX7
H	-1	HIS	-	expression tag	UNP C3SIX7
H	0	HIS	-	expression tag	UNP C3SIX7
H	1	HIS	-	expression tag	UNP C3SIX7
I	-4	HIS	-	expression tag	UNP C3SIX7
I	-3	HIS	-	expression tag	UNP C3SIX7
I	-2	HIS	-	expression tag	UNP C3SIX7
I	-1	HIS	-	expression tag	UNP C3SIX7
I	0	HIS	-	expression tag	UNP C3SIX7
I	1	HIS	-	expression tag	UNP C3SIX7
J	-4	HIS	-	expression tag	UNP C3SIX7
J	-3	HIS	-	expression tag	UNP C3SIX7
J	-2	HIS	-	expression tag	UNP C3SIX7
J	-1	HIS	-	expression tag	UNP C3SIX7
J	0	HIS	-	expression tag	UNP C3SIX7
J	1	HIS	-	expression tag	UNP C3SIX7
K	-4	HIS	-	expression tag	UNP C3SIX7
K	-3	HIS	-	expression tag	UNP C3SIX7
K	-2	HIS	-	expression tag	UNP C3SIX7
K	-1	HIS	-	expression tag	UNP C3SIX7
K	0	HIS	-	expression tag	UNP C3SIX7
K	1	HIS	-	expression tag	UNP C3SIX7
L	-4	HIS	-	expression tag	UNP C3SIX7
L	-3	HIS	-	expression tag	UNP C3SIX7
L	-2	HIS	-	expression tag	UNP C3SIX7
L	-1	HIS	-	expression tag	UNP C3SIX7
L	0	HIS	-	expression tag	UNP C3SIX7
L	1	HIS	-	expression tag	UNP C3SIX7
A	-4	HIS	-	expression tag	UNP C3SIX7
A	-3	HIS	-	expression tag	UNP C3SIX7
A	-2	HIS	-	expression tag	UNP C3SIX7
A	-1	HIS	-	expression tag	UNP C3SIX7
A	0	HIS	-	expression tag	UNP C3SIX7
A	1	HIS	-	expression tag	UNP C3SIX7
B	-4	HIS	-	expression tag	UNP C3SIX7
B	-3	HIS	-	expression tag	UNP C3SIX7
B	-2	HIS	-	expression tag	UNP C3SIX7
B	-1	HIS	-	expression tag	UNP C3SIX7
B	0	HIS	-	expression tag	UNP C3SIX7

Continued on next page...

Continued from previous page...

Chain	Residue	Modelled	Actual	Comment	Reference
B	1	HIS	-	expression tag	UNP C3SIX7
C	-4	HIS	-	expression tag	UNP C3SIX7
C	-3	HIS	-	expression tag	UNP C3SIX7
C	-2	HIS	-	expression tag	UNP C3SIX7
C	-1	HIS	-	expression tag	UNP C3SIX7
C	0	HIS	-	expression tag	UNP C3SIX7
C	1	HIS	-	expression tag	UNP C3SIX7
D	-4	HIS	-	expression tag	UNP C3SIX7
D	-3	HIS	-	expression tag	UNP C3SIX7
D	-2	HIS	-	expression tag	UNP C3SIX7
D	-1	HIS	-	expression tag	UNP C3SIX7
D	0	HIS	-	expression tag	UNP C3SIX7
D	1	HIS	-	expression tag	UNP C3SIX7
E	-4	HIS	-	expression tag	UNP C3SIX7
E	-3	HIS	-	expression tag	UNP C3SIX7
E	-2	HIS	-	expression tag	UNP C3SIX7
E	-1	HIS	-	expression tag	UNP C3SIX7
E	0	HIS	-	expression tag	UNP C3SIX7
E	1	HIS	-	expression tag	UNP C3SIX7
F	-4	HIS	-	expression tag	UNP C3SIX7
F	-3	HIS	-	expression tag	UNP C3SIX7
F	-2	HIS	-	expression tag	UNP C3SIX7
F	-1	HIS	-	expression tag	UNP C3SIX7
F	0	HIS	-	expression tag	UNP C3SIX7
F	1	HIS	-	expression tag	UNP C3SIX7

- Molecule 2 is a protein called unidentified alpha helical sequence.

Mol	Chain	Residues	Atoms			ZeroOcc	AltConf	Trace	
			Total	C	N				O
2	X	16	80	48	16	16	0	0	0

- Molecule 3 is ADENOSINE-5'-DIPHOSPHATE (three-letter code: ADP) (formula: $C_{10}H_{15}N_5O_{10}P_2$).



Mol	Chain	Residues	Atoms					ZeroOcc	AltConf
			Total	C	N	O	P		
3	G	1	Total	C	N	O	P	0	0
			27	10	5	10	2		
3	H	1	Total	C	N	O	P	0	0
			27	10	5	10	2		
3	I	1	Total	C	N	O	P	0	0
			27	10	5	10	2		
3	J	1	Total	C	N	O	P	0	0
			27	10	5	10	2		
3	K	1	Total	C	N	O	P	0	0
			27	10	5	10	2		
3	L	1	Total	C	N	O	P	0	0
			27	10	5	10	2		
3	A	1	Total	C	N	O	P	0	0
			27	10	5	10	2		
3	B	1	Total	C	N	O	P	0	0
			27	10	5	10	2		
3	C	1	Total	C	N	O	P	0	0
			27	10	5	10	2		
3	D	1	Total	C	N	O	P	0	0
			27	10	5	10	2		
3	E	1	Total	C	N	O	P	0	0
			27	10	5	10	2		
3	F	1	Total	C	N	O	P	0	0
			27	10	5	10	2		

- Molecule 4 is SULFATE ION (three-letter code: SO4) (formula: O₄S).



Mol	Chain	Residues	Atoms			ZeroOcc	AltConf
4	G	1	Total	O	S	0	0
			5	4	1		
4	H	1	Total	O	S	0	0
			5	4	1		
4	H	1	Total	O	S	0	0
			5	4	1		
4	I	1	Total	O	S	0	0
			5	4	1		
4	I	1	Total	O	S	0	0
			5	4	1		
4	J	1	Total	O	S	0	0
			5	4	1		
4	J	1	Total	O	S	0	0
			5	4	1		
4	K	1	Total	O	S	0	0
			5	4	1		
4	K	1	Total	O	S	0	0
			5	4	1		
4	L	1	Total	O	S	0	0
			5	4	1		
4	A	1	Total	O	S	0	0
			5	4	1		
4	B	1	Total	O	S	0	0
			5	4	1		
4	D	1	Total	O	S	0	0
			5	4	1		
4	D	1	Total	O	S	0	0
			5	4	1		

Continued on next page...

Continued from previous page...

Mol	Chain	Residues	Atoms			ZeroOcc	AltConf
4	E	1	Total	O	S	0	0
			5	4	1		
4	F	1	Total	O	S	0	0
			5	4	1		

3 Residue-property plots [i](#)

These plots are drawn for all protein, RNA, DNA and oligosaccharide chains in the entry. The first graphic for a chain summarises the proportions of the various outlier classes displayed in the second graphic. The second graphic shows the sequence view annotated by issues in geometry and electron density. Residues are color-coded according to the number of geometric quality criteria for which they contain at least one outlier: green = 0, yellow = 1, orange = 2 and red = 3 or more. A red dot above a residue indicates a poor fit to the electron density ($RSRZ > 2$). Stretches of 2 or more consecutive residues without any outlier are shown as a green connector. Residues present in the sample, but not in the model, are shown in grey.

- Molecule 1: ATP-dependent protease ATPase subunit HslU

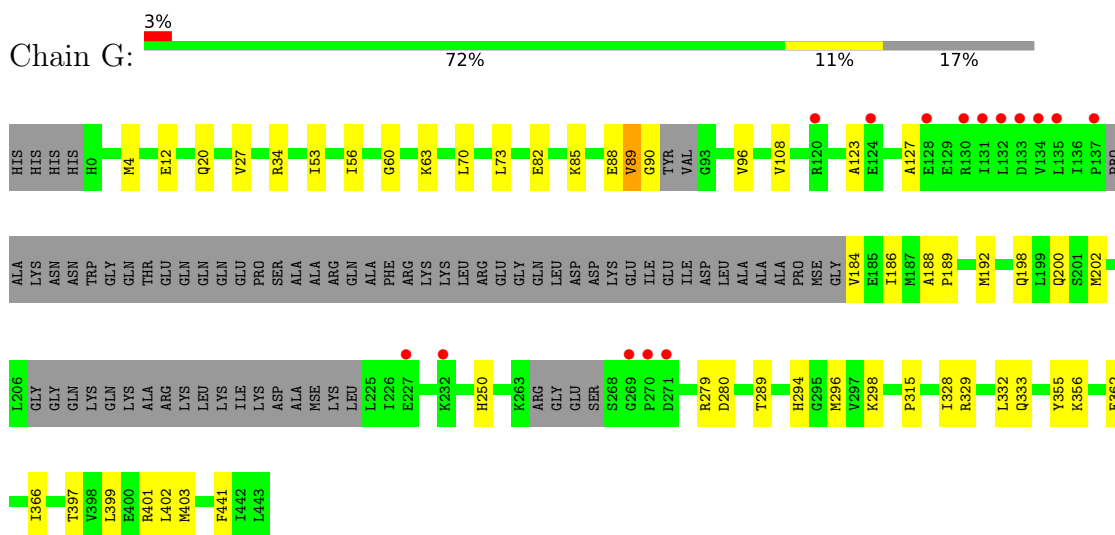

- Molecule 1: ATP-dependent protease ATPase subunit HslU

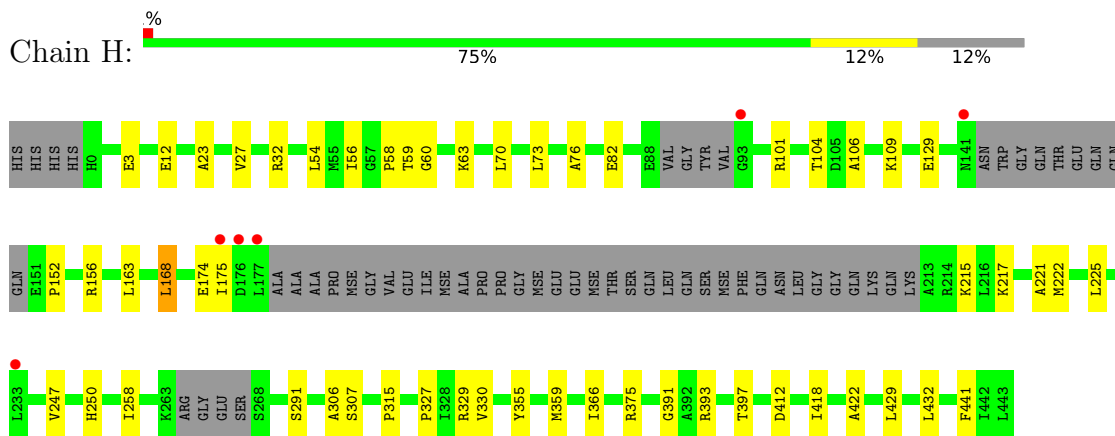

- Molecule 1: ATP-dependent protease ATPase subunit HslU

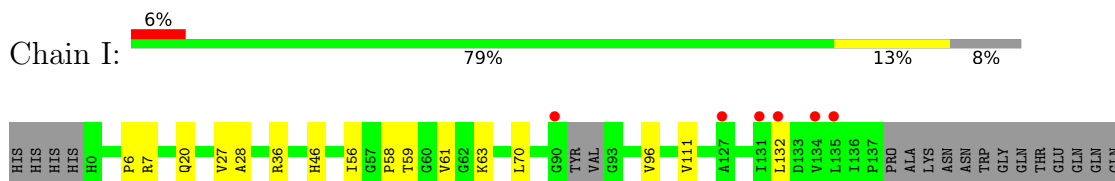

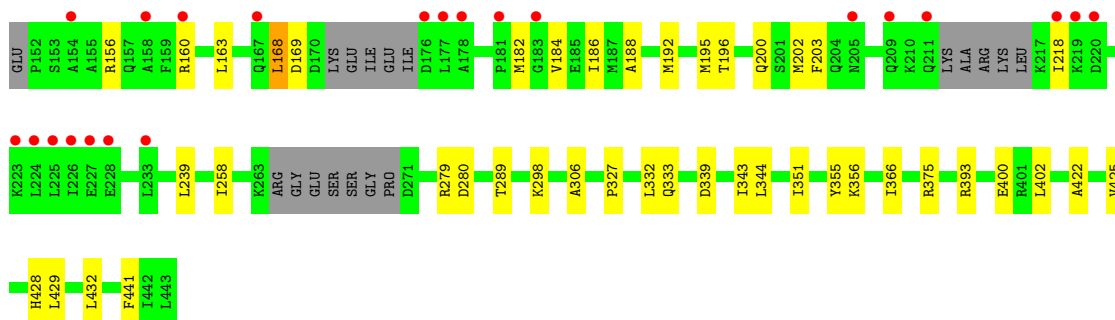

- Molecule 1: ATP-dependent protease ATPase subunit HslU

Chain J: 63% 8% 28%

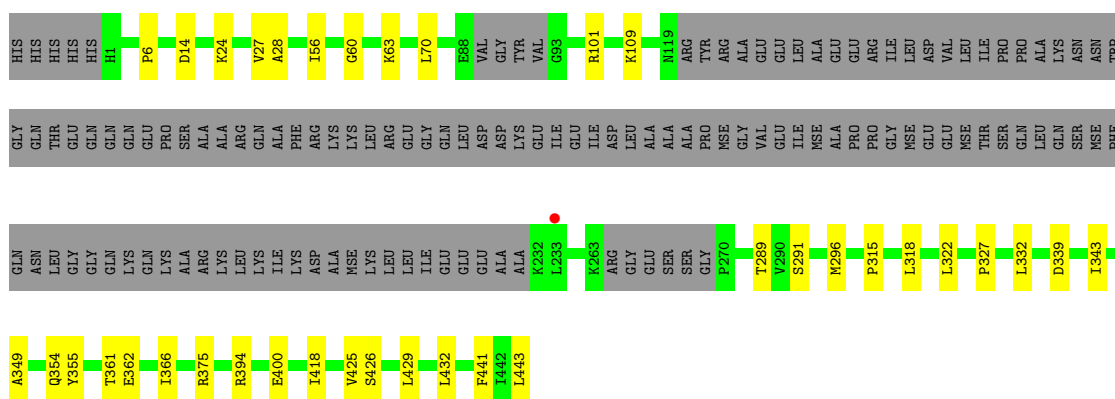

- Molecule 1: ATP-dependent protease ATPase subunit HslU

Chain K: 83% 12% 5%

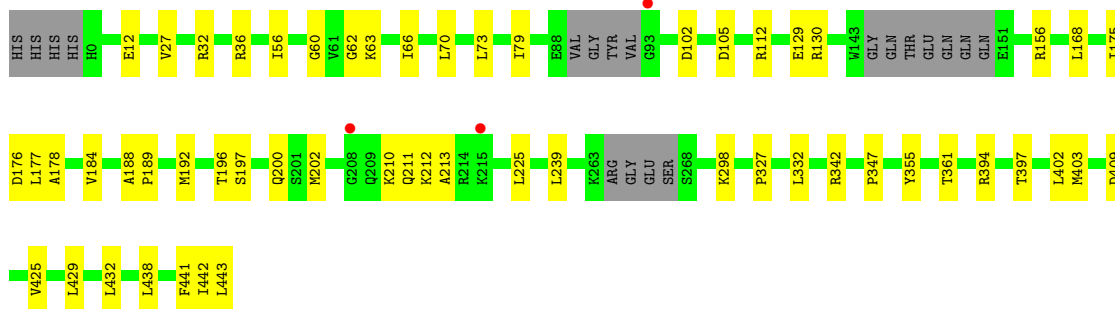

- Molecule 1: ATP-dependent protease ATPase subunit HslU

Chain L: 3% 75% 12% 10%



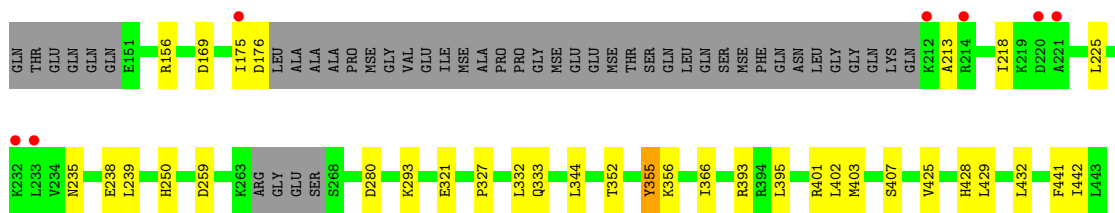

• Molecule 1: ATP-dependent protease ATPase subunit HslU

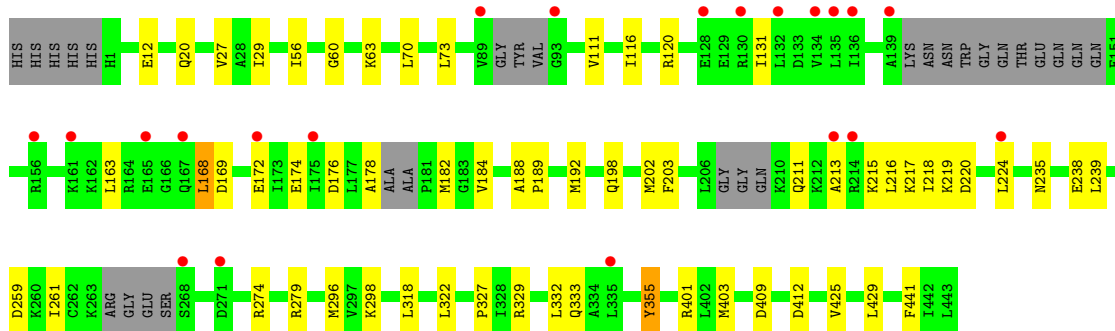
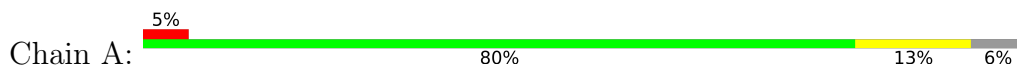

• Molecule 1: ATP-dependent protease ATPase subunit HslU

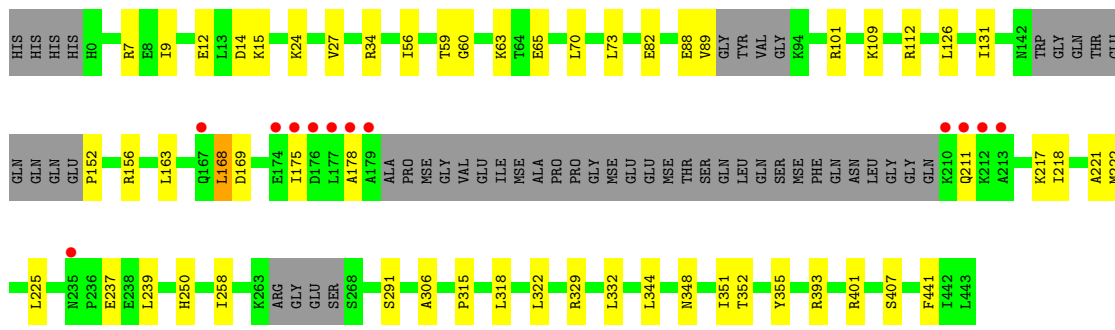
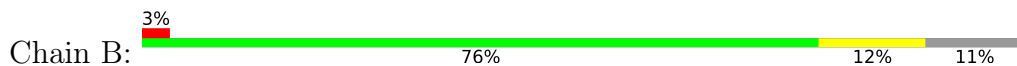

• Molecule 1: ATP-dependent protease ATPase subunit HslU

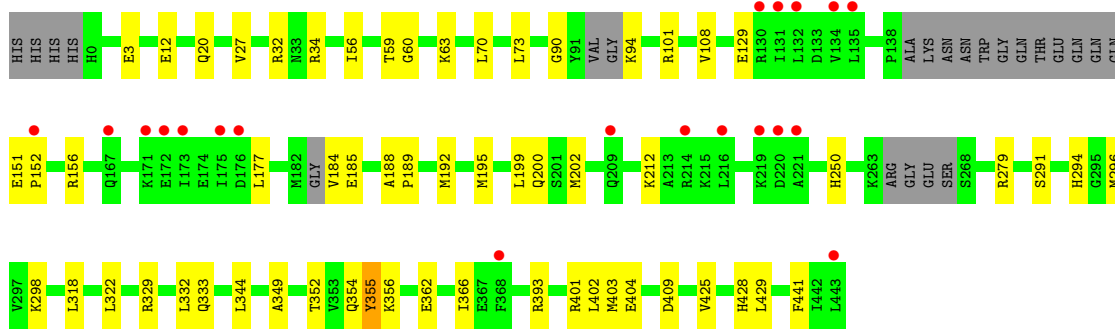
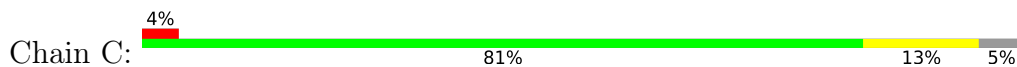

- Molecule 1: ATP-dependent protease ATPase subunit HslU

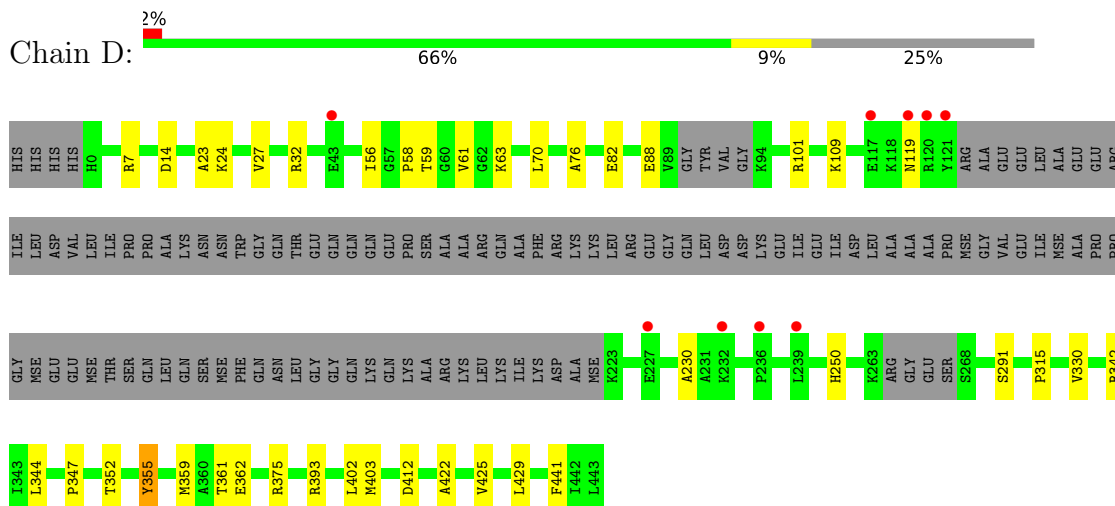

- Molecule 1: ATP-dependent protease ATPase subunit HslU

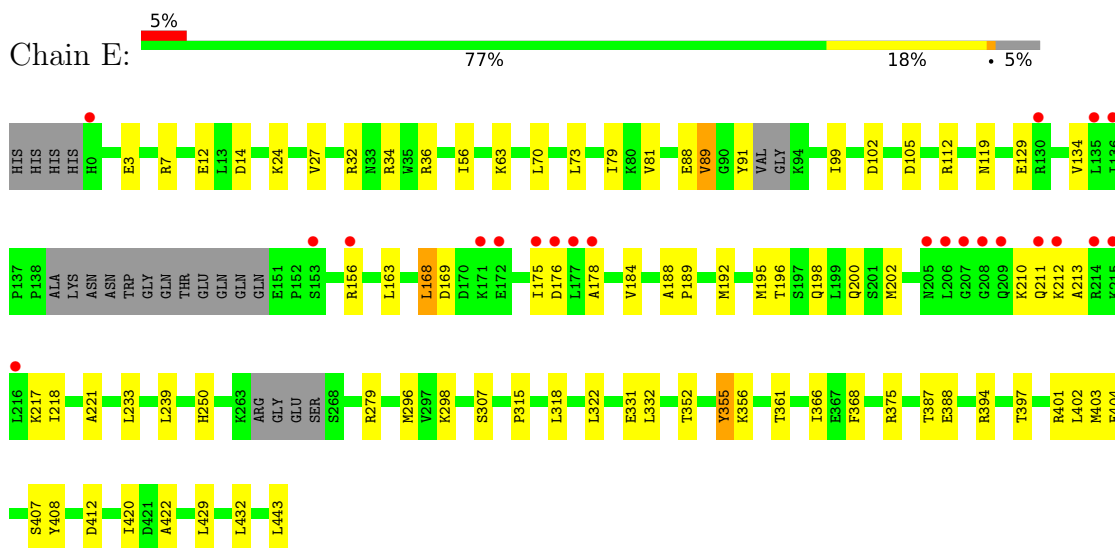

- Molecule 1: ATP-dependent protease ATPase subunit HslU

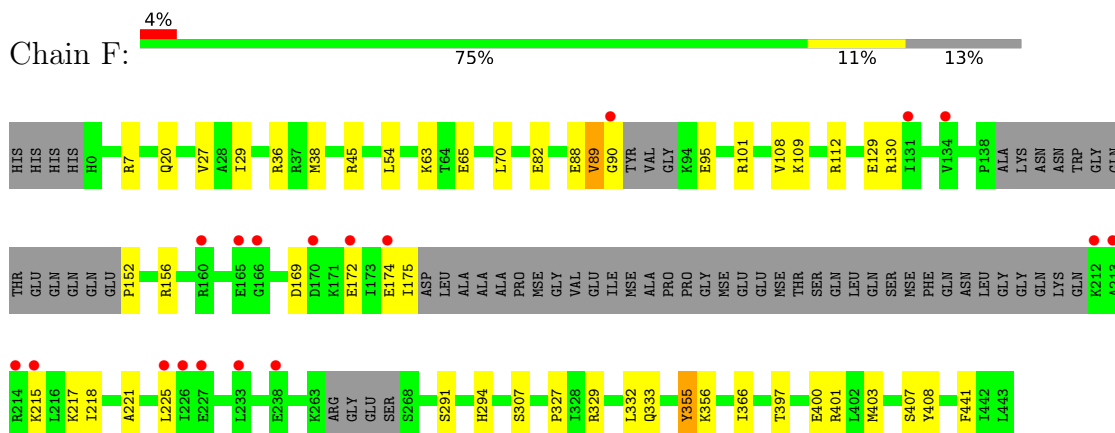

- Molecule 2: unidentified alpha helical sequence

Chain X:  100%

There are no outlier residues recorded for this chain.

4 Data and refinement statistics i

Property	Value	Source
Space group	P 1 2 1	Depositor
Cell constants a, b, c, α , β , γ	200.03Å 91.20Å 201.80Å 90.00° 99.43° 90.00°	Depositor
Resolution (Å)	47.69 – 3.65 47.69 – 3.65	Depositor EDS
% Data completeness (in resolution range)	98.6 (47.69-3.65) 98.7 (47.69-3.65)	Depositor EDS
R_{merge}	0.10	Depositor
R_{sym}	(Not available)	Depositor
$\langle I/\sigma(I) \rangle$ ¹	1.94 (at 3.67Å)	Xtrriage
Refinement program	PHENIX 1.13_2998	Depositor
R, R_{free}	0.230 , 0.271 0.230 , 0.271	Depositor DCC
R_{free} test set	3890 reflections (4.88%)	wwPDB-VP
Wilson B-factor (Å ²)	144.4	Xtrriage
Anisotropy	0.385	Xtrriage
Bulk solvent k_{sol} (e/Å ³), B_{sol} (Å ²)	0.28 , 88.6	EDS
L-test for twinning ²	$\langle L \rangle = 0.44$, $\langle L^2 \rangle = 0.27$	Xtrriage
Estimated twinning fraction	0.036 for l,-k,h	Xtrriage
F_o, F_c correlation	0.94	EDS
Total number of atoms	37523	wwPDB-VP
Average B, all atoms (Å ²)	162.0	wwPDB-VP

Xtrriage's analysis on translational NCS is as follows: *The largest off-origin peak in the Patterson function is 2.51% of the height of the origin peak. No significant pseudotranslation is detected.*

¹Intensities estimated from amplitudes.

²Theoretical values of $\langle |L| \rangle$, $\langle L^2 \rangle$ for acentric reflections are 0.5, 0.333 respectively for untwinned datasets, and 0.375, 0.2 for perfectly twinned datasets.

5 Model quality [i](#)

5.1 Standard geometry [i](#)

Bond lengths and bond angles in the following residue types are not validated in this section: SO4, ADP

The Z score for a bond length (or angle) is the number of standard deviations the observed value is removed from the expected value. A bond length (or angle) with $|Z| > 5$ is considered an outlier worth inspection. RMSZ is the root-mean-square of all Z scores of the bond lengths (or angles).

Mol	Chain	Bond lengths		Bond angles	
		RMSZ	# $ Z > 5$	RMSZ	# $ Z > 5$
1	A	0.23	0/3328	0.40	0/4456
1	B	0.23	0/3155	0.40	0/4233
1	C	0.23	0/3365	0.40	0/4509
1	D	0.23	0/2657	0.39	0/3573
1	E	0.24	0/3364	0.42	1/4509 (0.0%)
1	F	0.23	0/3085	0.40	0/4139
1	G	0.24	0/2955	0.40	0/3968
1	H	0.23	0/3116	0.40	0/4182
1	I	0.24	0/3239	0.41	0/4337
1	J	0.24	0/2539	0.40	0/3413
1	K	0.24	0/3396	0.42	1/4552 (0.0%)
1	L	0.24	0/3141	0.41	0/4216
All	All	0.24	0/37340	0.40	2/50087 (0.0%)

There are no bond length outliers.

All (2) bond angle outliers are listed below:

Mol	Chain	Res	Type	Atoms	Z	Observed(°)	Ideal(°)
1	K	105	ASP	CB-CG-OD2	5.21	122.99	118.30
1	E	105	ASP	CB-CG-OD2	5.19	122.97	118.30

There are no chirality outliers.

There are no planarity outliers.

5.2 Too-close contacts [i](#)

In the following table, the Non-H and H(model) columns list the number of non-hydrogen atoms and hydrogen atoms in the chain respectively. The H(added) column lists the number of hydrogen

atoms added and optimized by MolProbity. The Clashes column lists the number of clashes within the asymmetric unit, whereas Symm-Clashes lists symmetry-related clashes.

Mol	Chain	Non-H	H(model)	H(added)	Clashes	Symm-Clashes
1	A	3304	0	3384	43	0
1	B	3129	0	3215	42	0
1	C	3339	0	3411	40	0
1	D	2633	0	2684	28	0
1	E	3338	0	3410	63	0
1	F	3059	0	3142	41	0
1	G	2932	0	2974	41	0
1	H	3090	0	3164	38	0
1	I	3217	0	3278	41	0
1	J	2517	0	2568	26	0
1	K	3368	0	3437	38	0
1	L	3113	0	3182	43	0
2	X	80	0	18	0	0
3	A	27	0	12	1	0
3	B	27	0	12	3	0
3	C	27	0	12	2	0
3	D	27	0	12	1	0
3	E	27	0	12	0	0
3	F	27	0	12	2	0
3	G	27	0	12	2	0
3	H	27	0	12	2	0
3	I	27	0	12	1	0
3	J	27	0	12	2	0
3	K	27	0	12	2	0
3	L	27	0	12	3	0
4	A	5	0	0	0	0
4	B	5	0	0	0	0
4	D	10	0	0	0	0
4	E	5	0	0	0	0
4	F	5	0	0	0	0
4	G	5	0	0	0	0
4	H	10	0	0	0	0
4	I	10	0	0	0	0
4	J	10	0	0	0	0
4	K	10	0	0	0	0
4	L	5	0	0	0	0
All	All	37523	0	38011	408	0

The all-atom clashscore is defined as the number of clashes found per 1000 atoms (including hydrogen atoms). The all-atom clashscore for this structure is 5.

All (408) close contacts within the same asymmetric unit are listed below, sorted by their clash

magnitude.

Atom-1	Atom-2	Interatomic distance (Å)	Clash overlap (Å)
1:G:89:VAL:HG12	1:G:90:GLY:H	1.02	1.14
1:G:89:VAL:HG12	1:G:90:GLY:N	1.66	1.06
1:G:89:VAL:CG1	1:G:90:GLY:H	1.68	1.06
1:E:91:TYR:CE1	1:F:95:GLU:OE2	2.09	1.04
1:D:88:GLU:OE2	1:E:89:VAL:HG11	1.58	1.01
1:F:89:VAL:HG12	1:F:90:GLY:N	1.84	0.93
1:G:296:MSE:HE1	1:L:105:ASP:HB3	1.60	0.84
1:F:89:VAL:HG12	1:F:90:GLY:H	1.43	0.84
1:D:109:LYS:HB2	1:E:296:MSE:HG2	1.64	0.80
1:F:89:VAL:CG1	1:F:90:GLY:H	1.94	0.80
1:F:89:VAL:CG1	1:F:90:GLY:N	2.47	0.78
1:C:184:VAL:O	1:C:200:GLN:NE2	2.18	0.77
1:L:355:TYR:OH	1:L:407:SER:HB2	1.85	0.76
1:G:188:ALA:HB1	1:G:192:MSE:HB2	1.68	0.74
1:B:88:GLU:O	1:B:89:VAL:HB	1.86	0.74
1:F:101:ARG:NH1	1:F:291:SER:O	2.21	0.74
1:A:188:ALA:HB1	1:A:192:MSE:HB2	1.70	0.72
1:I:188:ALA:HB1	1:I:192:MSE:HB2	1.71	0.72
1:F:27:VAL:HB	1:F:70:LEU:HD22	1.71	0.72
1:H:175:ILE:HD13	1:H:225:LEU:HD11	1.71	0.71
1:H:82:GLU:HG3	1:I:279:ARG:HB3	1.72	0.71
1:H:63:LYS:N	3:H:501:ADP:O1B	2.24	0.70
1:C:188:ALA:HB1	1:C:192:MSE:HB2	1.73	0.70
1:A:182:MSE:HE3	1:A:203:PHE:HB3	1.73	0.69
1:D:109:LYS:HE2	1:E:298:LYS:HB2	1.74	0.69
1:B:109:LYS:HB2	1:C:296:MSE:HG2	1.74	0.69
1:I:184:VAL:O	1:I:200:GLN:NE2	2.26	0.69
1:H:175:ILE:CD1	1:H:225:LEU:HD11	2.23	0.68
1:B:175:ILE:CD1	1:B:225:LEU:HD11	2.24	0.68
1:H:258:ILE:HG22	1:H:307:SER:O	1.92	0.68
1:E:352:THR:HB	1:E:368:PHE:CE2	2.29	0.68
1:E:352:THR:HB	1:E:368:PHE:HE2	1.58	0.68
1:K:79:ILE:CD1	1:K:102:ASP:HB2	2.24	0.67
1:K:184:VAL:O	1:K:200:GLN:NE2	2.28	0.67
1:B:27:VAL:HB	1:B:70:LEU:HD22	1.76	0.67
1:G:329:ARG:O	1:L:401:ARG:NH2	2.27	0.67
1:K:188:ALA:HB1	1:K:192:MSE:HB2	1.76	0.67
1:K:63:LYS:HG2	1:K:332:LEU:HD22	1.77	0.65
1:K:189:PRO:HG2	1:K:192:MSE:HG2	1.77	0.65
1:E:188:ALA:HB1	1:E:192:MSE:HB2	1.78	0.65
1:F:63:LYS:N	3:F:501:ADP:O3B	2.29	0.65

Continued on next page...

Continued from previous page...

Atom-1	Atom-2	Interatomic distance (Å)	Clash overlap (Å)
1:B:101:ARG:NH1	1:B:291:SER:O	2.30	0.65
1:K:27:VAL:HB	1:K:70:LEU:HD22	1.78	0.65
1:L:356:LYS:NZ	1:L:366:ILE:O	2.30	0.64
1:K:409:ASP:OD1	1:L:7:ARG:NH2	2.31	0.64
1:A:172:GLU:HG3	1:A:217:LYS:HE2	1.79	0.64
1:K:129:GLU:OE1	1:K:156:ARG:NH1	2.31	0.63
1:G:63:LYS:HG2	1:G:332:LEU:HD22	1.80	0.63
1:I:59:THR:OG1	1:I:393:ARG:NH2	2.32	0.63
1:H:27:VAL:HB	1:H:70:LEU:HD22	1.80	0.63
1:H:258:ILE:HG21	1:H:306:ALA:HB1	1.81	0.62
1:C:63:LYS:N	3:C:501:ADP:O1B	2.32	0.62
1:G:279:ARG:HB3	1:L:82:GLU:HG3	1.82	0.62
1:L:112:ARG:HA	1:L:239:LEU:HD11	1.82	0.62
1:G:184:VAL:O	1:G:200:GLN:NE2	2.32	0.62
1:A:401:ARG:NH2	1:B:329:ARG:O	2.33	0.62
1:F:129:GLU:OE1	1:F:156:ARG:NH1	2.33	0.61
1:G:88:GLU:O	1:G:89:VAL:HB	2.00	0.61
1:L:129:GLU:OE1	1:L:156:ARG:NH1	2.33	0.61
1:G:89:VAL:CG1	1:G:90:GLY:N	2.35	0.60
1:K:397:THR:HG22	1:L:327:PRO:HA	1.83	0.60
1:F:355:TYR:OH	1:F:407:SER:HB2	2.02	0.60
1:A:169:ASP:HA	1:A:218:ILE:HB	1.82	0.60
1:E:88:GLU:O	1:E:89:VAL:HB	2.01	0.60
1:I:356:LYS:NZ	1:I:366:ILE:O	2.33	0.60
1:A:318:LEU:HD22	1:A:322:LEU:HD23	1.84	0.60
1:L:63:LYS:N	3:L:501:ADP:O3B	2.32	0.60
1:I:111:VAL:HG23	1:I:239:LEU:HD11	1.83	0.60
1:J:60:GLY:N	3:J:501:ADP:O2B	2.25	0.60
1:C:189:PRO:HG2	1:C:192:MSE:HG2	1.84	0.60
1:C:59:THR:OG1	1:C:393:ARG:NH2	2.35	0.59
1:G:401:ARG:NH2	1:H:329:ARG:O	2.35	0.59
1:G:96:VAL:HG21	1:G:280:ASP:HB3	1.84	0.59
1:B:401:ARG:NH2	1:C:329:ARG:O	2.35	0.59
1:L:169:ASP:HA	1:L:218:ILE:HB	1.84	0.59
1:J:101:ARG:NH1	1:J:291:SER:O	2.35	0.59
1:B:175:ILE:HD13	1:B:225:LEU:HD11	1.85	0.59
1:J:27:VAL:HB	1:J:70:LEU:HD22	1.84	0.59
1:A:296:MSE:HG2	1:F:109:LYS:HB2	1.84	0.59
1:E:184:VAL:O	1:E:200:GLN:NE2	2.35	0.58
1:E:189:PRO:HG2	1:E:192:MSE:HG2	1.85	0.58
1:F:88:GLU:O	1:F:89:VAL:HB	2.02	0.58

Continued on next page...

Continued from previous page...

Atom-1	Atom-2	Interatomic distance (Å)	Clash overlap (Å)
1:G:189:PRO:HG2	1:G:192:MSE:HG2	1.86	0.58
1:D:27:VAL:HB	1:D:70:LEU:HD22	1.85	0.58
1:B:88:GLU:O	1:B:89:VAL:CB	2.52	0.58
1:C:185:GLU:O	1:E:198:GLN:NE2	2.35	0.58
1:C:27:VAL:HB	1:C:70:LEU:HD22	1.86	0.57
1:E:79:ILE:CD1	1:E:102:ASP:HB2	2.34	0.57
1:J:375:ARG:NH1	1:J:426:SER:OG	2.33	0.57
1:B:63:LYS:N	3:B:501:ADP:O1B	2.38	0.57
1:E:408:TYR:HB2	1:F:29:ILE:HD11	1.86	0.57
1:A:27:VAL:HB	1:A:70:LEU:HD22	1.85	0.57
1:E:355:TYR:OH	1:E:407:SER:HB2	2.04	0.57
1:J:109:LYS:HE2	1:K:298:LYS:HB2	1.85	0.57
1:J:349:ALA:O	1:J:354:GLN:NE2	2.38	0.57
1:B:178:ALA:HA	1:B:211:GLN:HA	1.86	0.57
1:I:184:VAL:HG13	1:I:200:GLN:HE22	1.68	0.57
1:G:441:PHE:HD2	1:H:56:ILE:HD13	1.70	0.57
1:B:163:LEU:HD21	1:B:222:MSE:HE1	1.87	0.57
1:G:441:PHE:HA	1:H:315:PRO:HG2	1.87	0.56
1:G:12:GLU:HG2	1:G:73:LEU:HD13	1.87	0.56
1:K:402:LEU:HG	1:K:403:MSE:HE3	1.88	0.56
1:L:175:ILE:HD13	1:L:225:LEU:HD11	1.88	0.56
1:A:412:ASP:OD2	1:B:7:ARG:NE	2.37	0.56
1:A:56:ILE:HD13	1:F:441:PHE:HD2	1.71	0.56
1:K:60:GLY:N	3:K:501:ADP:O2B	2.32	0.56
1:B:258:ILE:HG21	1:B:306:ALA:HB1	1.88	0.56
1:H:441:PHE:HD2	1:I:56:ILE:HD13	1.71	0.55
1:G:296:MSE:HE2	1:L:105:ASP:O	2.06	0.55
1:G:20:GLN:NE2	1:G:333:GLN:O	2.36	0.55
1:A:189:PRO:HG2	1:A:192:MSE:HG2	1.87	0.55
1:A:235:ASN:HD22	1:A:238:GLU:HB2	1.71	0.55
1:I:441:PHE:HD2	1:J:56:ILE:HD13	1.71	0.55
1:H:101:ARG:NH1	1:H:291:SER:O	2.39	0.55
1:C:3:GLU:O	1:C:32:ARG:NH1	2.39	0.55
1:L:60:GLY:N	3:L:501:ADP:O2B	2.33	0.55
1:J:63:LYS:N	3:J:501:ADP:O3B	2.38	0.55
1:G:198:GLN:HG3	1:G:202:MSE:HE3	1.88	0.54
1:C:101:ARG:NH1	1:C:291:SER:O	2.40	0.54
1:C:441:PHE:HA	1:D:315:PRO:HG2	1.89	0.54
1:G:27:VAL:HB	1:G:70:LEU:HD22	1.88	0.54
1:C:20:GLN:NE2	1:C:333:GLN:O	2.31	0.54
1:C:63:LYS:HG2	1:C:332:LEU:HD22	1.88	0.54

Continued on next page...

Continued from previous page...

Atom-1	Atom-2	Interatomic distance (Å)	Clash overlap (Å)
1:G:289:THR:HG22	1:G:296:MSE:HE3	1.89	0.54
1:I:163:LEU:HA	1:I:168:LEU:HD11	1.89	0.54
1:L:355:TYR:CZ	1:L:403:MSE:HB3	2.42	0.54
1:F:174:GLU:HA	1:F:215:LYS:HA	1.89	0.54
1:G:402:LEU:HG	1:G:403:MSE:HE3	1.89	0.54
1:I:27:VAL:HB	1:I:70:LEU:HD22	1.89	0.54
1:K:175:ILE:HD13	1:K:225:LEU:HD11	1.88	0.54
1:A:29:ILE:HD11	1:F:408:TYR:HB2	1.90	0.54
1:F:63:LYS:HG2	1:F:332:LEU:HD22	1.89	0.54
1:I:156:ARG:HD2	1:I:160:ARG:HH21	1.71	0.54
1:A:174:GLU:HA	1:A:215:LYS:HA	1.90	0.54
1:J:361:THR:HG21	1:K:36:ARG:HA	1.90	0.53
1:K:178:ALA:HA	1:K:211:GLN:HA	1.90	0.53
1:A:215:LYS:NZ	1:B:126:LEU:HD13	2.23	0.53
1:A:441:PHE:HD2	1:B:56:ILE:HD13	1.74	0.53
1:B:63:LYS:HG2	1:B:332:LEU:HD22	1.90	0.53
1:C:318:LEU:HD22	1:C:322:LEU:HD23	1.90	0.53
1:J:441:PHE:HD2	1:K:56:ILE:HD13	1.74	0.53
1:K:361:THR:HG21	1:L:36:ARG:HA	1.90	0.53
1:B:65:GLU:HG3	3:B:501:ADP:H2'	1.90	0.53
1:H:163:LEU:HD21	1:H:222:MSE:HE1	1.91	0.53
1:F:356:LYS:NZ	1:F:366:ILE:O	2.37	0.53
1:E:178:ALA:HA	1:E:211:GLN:HA	1.91	0.53
1:E:134:VAL:HG21	1:E:175:ILE:HG12	1.91	0.53
1:G:56:ILE:HD13	1:L:441:PHE:HD2	1.74	0.52
1:K:79:ILE:HD12	1:K:102:ASP:HB2	1.91	0.52
1:C:199:LEU:HA	1:C:202:MSE:HE3	1.91	0.52
1:E:12:GLU:HG2	1:E:73:LEU:HD13	1.90	0.52
1:E:129:GLU:OE1	1:E:156:ARG:NH1	2.43	0.52
1:J:291:SER:HA	1:J:296:MSE:HG2	1.90	0.52
1:A:116:ILE:O	1:A:120:ARG:N	2.43	0.52
1:J:394:ARG:NH1	1:J:443:LEU:O	2.43	0.52
1:K:63:LYS:N	3:K:501:ADP:O3B	2.38	0.52
1:C:441:PHE:HD2	1:D:56:ILE:HD13	1.75	0.52
1:C:402:LEU:HD12	1:C:428:HIS:HB2	1.92	0.51
1:E:397:THR:HG22	1:F:327:PRO:HA	1.92	0.51
1:K:188:ALA:HB2	1:K:196:THR:HG21	1.92	0.51
1:D:412:ASP:OD2	1:E:7:ARG:NE	2.43	0.51
1:E:356:LYS:NZ	1:E:366:ILE:O	2.41	0.51
1:E:361:THR:HG21	1:F:36:ARG:HA	1.92	0.51
1:D:361:THR:HG21	1:E:36:ARG:HA	1.93	0.51

Continued on next page...

Continued from previous page...

Atom-1	Atom-2	Interatomic distance (Å)	Clash overlap (Å)
1:I:182:MSE:HE2	1:I:203:PHE:HB3	1.92	0.51
1:L:425:VAL:HG13	1:L:429:LEU:HD12	1.93	0.51
1:G:60:GLY:N	3:G:501:ADP:O1B	2.36	0.51
1:K:176:ASP:HA	1:K:213:ALA:HA	1.93	0.51
1:C:12:GLU:HG2	1:C:73:LEU:HD13	1.93	0.51
1:D:375:ARG:HD2	1:D:422:ALA:HB1	1.93	0.51
1:I:192:MSE:HB3	1:I:195:MSE:HE2	1.93	0.51
1:G:289:THR:CG2	1:G:296:MSE:HE3	2.41	0.50
1:A:198:GLN:HG2	1:A:202:MSE:HE3	1.93	0.50
1:I:63:LYS:N	3:I:501:ADP:O1B	2.42	0.50
1:L:20:GLN:NE2	1:L:333:GLN:O	2.43	0.50
1:D:14:ASP:OD1	1:D:24:LYS:NZ	2.30	0.50
1:G:315:PRO:HG2	1:L:441:PHE:HA	1.93	0.50
1:C:349:ALA:O	1:C:354:GLN:NE2	2.44	0.50
1:F:217:LYS:O	1:F:221:ALA:N	2.41	0.50
1:D:441:PHE:HD2	1:E:56:ILE:HD13	1.77	0.50
1:H:375:ARG:HD2	1:H:422:ALA:HB1	1.94	0.50
1:H:54:LEU:HB3	1:H:329:ARG:HD3	1.94	0.50
1:H:412:ASP:OD2	1:I:7:ARG:NE	2.40	0.50
1:I:441:PHE:HA	1:J:315:PRO:HG2	1.94	0.50
1:A:111:VAL:HG23	1:A:239:LEU:HD11	1.94	0.50
1:E:176:ASP:HA	1:E:213:ALA:HA	1.92	0.50
1:F:169:ASP:HA	1:F:218:ILE:HB	1.93	0.50
1:H:60:GLY:N	3:H:501:ADP:O3B	2.36	0.49
1:E:412:ASP:OD2	1:F:7:ARG:NE	2.45	0.49
1:B:60:GLY:N	3:B:501:ADP:O3B	2.37	0.49
1:B:217:LYS:O	1:B:221:ALA:N	2.41	0.49
1:H:359:MSE:HE1	1:I:36:ARG:NH1	2.28	0.49
1:D:101:ARG:NH1	1:D:291:SER:O	2.45	0.49
1:E:63:LYS:HG2	1:E:332:LEU:HD22	1.94	0.49
1:H:59:THR:OG1	1:H:393:ARG:NH2	2.45	0.49
1:L:63:LYS:HG2	1:L:332:LEU:HD22	1.93	0.49
1:J:400:GLU:HG3	1:K:327:PRO:HB2	1.95	0.49
1:A:63:LYS:HG2	1:A:332:LEU:HD22	1.93	0.49
1:C:192:MSE:HB3	1:C:195:MSE:HE2	1.94	0.49
1:E:163:LEU:HA	1:E:168:LEU:HD11	1.94	0.49
1:L:402:LEU:HD12	1:L:428:HIS:HB2	1.93	0.49
1:D:82:GLU:HG3	1:E:279:ARG:HB3	1.95	0.49
1:G:298:LYS:HB2	1:L:109:LYS:HE2	1.94	0.49
1:H:60:GLY:HA3	1:H:391:GLY:HA3	1.93	0.49
1:H:366:ILE:HD13	1:H:418:ILE:HB	1.95	0.49

Continued on next page...

Continued from previous page...

Atom-1	Atom-2	Interatomic distance (Å)	Clash overlap (Å)
1:I:63:LYS:HG2	1:I:332:LEU:HD22	1.95	0.49
1:K:441:PHE:HD2	1:L:56:ILE:HD13	1.77	0.48
1:E:27:VAL:HB	1:E:70:LEU:HD22	1.95	0.48
1:K:425:VAL:HG13	1:K:429:LEU:HD12	1.94	0.48
1:G:397:THR:HG22	1:H:327:PRO:HA	1.96	0.48
1:J:425:VAL:HG13	1:J:429:LEU:HD12	1.94	0.48
1:L:402:LEU:HD13	1:L:429:LEU:HG	1.95	0.48
1:E:184:VAL:HG13	1:E:200:GLN:HE22	1.78	0.48
1:I:344:LEU:HD23	1:I:351:ILE:HD11	1.95	0.48
1:L:176:ASP:HA	1:L:213:ALA:HA	1.94	0.48
1:C:60:GLY:N	3:C:501:ADP:O3B	2.44	0.48
1:A:327:PRO:HA	1:F:397:THR:HG22	1.94	0.48
1:A:327:PRO:HB2	1:F:400:GLU:HG3	1.95	0.48
1:G:356:LYS:NZ	1:G:366:ILE:O	2.46	0.48
1:A:20:GLN:NE2	1:A:333:GLN:O	2.36	0.48
1:B:355:TYR:OH	1:B:407:SER:HB2	2.14	0.48
1:D:344:LEU:O	1:D:352:THR:OG1	2.23	0.48
1:E:318:LEU:HD22	1:E:322:LEU:HD23	1.95	0.48
1:G:63:LYS:N	3:G:501:ADP:O3B	2.45	0.48
1:A:298:LYS:HB2	1:F:109:LYS:HE2	1.96	0.48
1:E:192:MSE:HB3	1:E:195:MSE:HE2	1.96	0.48
1:E:368:PHE:CE1	1:E:403:MSE:HE3	2.49	0.48
1:A:224:LEU:HD13	1:B:237:GLU:HG2	1.95	0.47
1:B:59:THR:OG1	1:B:393:ARG:NH2	2.43	0.47
1:L:235:ASN:HB3	1:L:238:GLU:HB3	1.95	0.47
1:D:23:ALA:HA	1:D:330:VAL:HG21	1.96	0.47
1:E:352:THR:CB	1:E:368:PHE:HE2	2.26	0.47
1:K:197:SER:HB3	1:L:293:LYS:HA	1.95	0.47
1:G:4:MSE:HE1	1:G:73:LEU:HG	1.96	0.47
1:A:425:VAL:HG13	1:A:429:LEU:HD12	1.97	0.47
1:B:109:LYS:HE2	1:C:298:LYS:HB2	1.95	0.47
1:I:186:ILE:HG12	1:K:202:MSE:HE1	1.96	0.47
1:A:131:ILE:HD13	1:A:218:ILE:HD12	1.96	0.47
1:D:63:LYS:N	3:D:501:ADP:O1B	2.44	0.47
1:G:96:VAL:HG21	1:G:280:ASP:CB	2.44	0.47
1:J:318:LEU:HD22	1:J:322:LEU:HD23	1.97	0.47
1:L:27:VAL:HB	1:L:70:LEU:HD22	1.97	0.47
1:A:169:ASP:HB2	1:A:219:LYS:N	2.29	0.47
1:C:362:GLU:OE2	1:D:32:ARG:NE	2.41	0.47
1:D:441:PHE:HA	1:E:315:PRO:HG2	1.97	0.47
1:A:355:TYR:CE2	1:A:403:MSE:HB3	2.50	0.47

Continued on next page...

Continued from previous page...

Atom-1	Atom-2	Interatomic distance (Å)	Clash overlap (Å)
1:E:63:LYS:HD2	1:E:307:SER:HB2	1.97	0.47
1:A:215:LYS:HZ1	1:B:126:LEU:HD13	1.79	0.46
1:C:356:LYS:NZ	1:C:366:ILE:O	2.47	0.46
1:I:169:ASP:HA	1:I:218:ILE:HB	1.97	0.46
1:L:130:ARG:HH21	1:L:225:LEU:HD22	1.80	0.46
1:B:82:GLU:HG3	1:C:279:ARG:HB3	1.97	0.46
1:C:129:GLU:OE1	1:C:156:ARG:NH1	2.48	0.46
1:E:217:LYS:O	1:E:221:ALA:N	2.44	0.46
1:L:65:GLU:HG2	3:L:501:ADP:H5'2	1.97	0.46
1:B:152:PRO:O	1:B:156:ARG:HB3	2.15	0.46
1:C:425:VAL:HG13	1:C:429:LEU:HD12	1.96	0.46
1:A:163:LEU:HA	1:A:168:LEU:HD11	1.96	0.46
1:C:344:LEU:O	1:C:352:THR:OG1	2.19	0.46
1:E:3:GLU:O	1:E:32:ARG:NH1	2.48	0.46
1:L:58:PRO:HG2	1:L:61:VAL:HG11	1.97	0.46
1:D:402:LEU:HG	1:D:403:MSE:HE3	1.98	0.46
1:F:20:GLN:NE2	1:F:333:GLN:O	2.40	0.46
1:A:409:ASP:OD1	1:B:7:ARG:NH2	2.48	0.46
1:C:177:LEU:O	1:C:212:LYS:N	2.47	0.46
1:E:401:ARG:NH1	1:E:404:GLU:OE2	2.49	0.46
1:I:96:VAL:HG21	1:I:280:ASP:HB3	1.98	0.46
1:I:425:VAL:HG13	1:I:429:LEU:HD12	1.97	0.45
1:A:279:ARG:HB3	1:F:82:GLU:HG3	1.98	0.45
1:B:169:ASP:HA	1:B:218:ILE:HB	1.99	0.45
1:E:89:VAL:HG12	1:E:89:VAL:O	2.16	0.45
1:A:329:ARG:O	1:F:401:ARG:NH2	2.49	0.45
1:C:108:VAL:HG21	1:C:294:HIS:CE1	2.50	0.45
1:E:176:ASP:OD2	1:E:211:GLN:HG3	2.16	0.45
1:F:63:LYS:HD2	1:F:307:SER:HB2	1.98	0.45
1:I:375:ARG:HD2	1:I:422:ALA:HB1	1.98	0.45
1:D:119:ASN:HB3	1:D:230:ALA:HB1	1.98	0.45
1:E:368:PHE:CZ	1:E:403:MSE:HE3	2.52	0.45
1:A:441:PHE:HA	1:B:315:PRO:HG2	1.98	0.45
1:E:198:GLN:HG2	1:E:202:MSE:HE3	1.98	0.45
1:K:394:ARG:NH1	1:K:443:LEU:O	2.46	0.45
1:H:76:ALA:HB1	1:H:250:HIS:O	2.16	0.45
1:E:210:LYS:HD3	1:E:212:LYS:HE2	1.99	0.45
1:H:217:LYS:O	1:H:221:ALA:N	2.47	0.45
1:K:130:ARG:HG2	1:K:175:ILE:HD11	1.98	0.45
1:C:409:ASP:OD1	1:D:7:ARG:NH2	2.50	0.45
1:B:12:GLU:HG2	1:B:73:LEU:HD13	1.99	0.45

Continued on next page...

Continued from previous page...

Atom-1	Atom-2	Interatomic distance (Å)	Clash overlap (Å)
1:L:59:THR:OG1	1:L:393:ARG:NH2	2.49	0.45
1:B:14:ASP:OD1	1:B:24:LYS:NZ	2.35	0.45
1:C:90:GLY:O	1:C:94:LYS:N	2.50	0.45
1:F:175:ILE:HD12	1:F:221:ALA:HB1	1.99	0.45
1:A:259:ASP:OD1	1:A:259:ASP:N	2.50	0.44
1:I:402:LEU:HD12	1:I:428:HIS:HB2	1.99	0.44
1:B:318:LEU:HD22	1:B:322:LEU:HD23	1.99	0.44
1:F:130:ARG:HH21	1:F:225:LEU:HD22	1.82	0.44
1:C:401:ARG:NH1	1:C:404:GLU:OE2	2.50	0.44
1:F:108:VAL:O	1:F:112:ARG:HG3	2.18	0.44
1:H:104:THR:HA	1:H:247:VAL:HG21	1.98	0.44
1:J:429:LEU:O	1:J:432:LEU:N	2.51	0.44
1:F:108:VAL:HG21	1:F:294:HIS:CE1	2.53	0.44
1:L:344:LEU:O	1:L:352:THR:OG1	2.22	0.44
1:G:53:ILE:HG23	1:G:328:ILE:HG22	1.99	0.44
1:H:129:GLU:OE1	1:H:156:ARG:NH1	2.51	0.44
1:H:397:THR:HG22	1:I:327:PRO:HA	2.00	0.44
1:G:399:LEU:HD23	1:G:399:LEU:HA	1.90	0.43
1:E:210:LYS:HE2	1:E:210:LYS:HB3	1.80	0.43
1:I:258:ILE:HG21	1:I:306:ALA:HB1	2.00	0.43
1:J:63:LYS:HG2	1:J:332:LEU:HD22	1.99	0.43
1:A:216:LEU:HD11	1:A:220:ASP:HB2	2.00	0.43
1:H:174:GLU:HA	1:H:215:LYS:HA	2.01	0.43
1:K:112:ARG:HA	1:K:239:LEU:HD11	2.00	0.43
1:B:131:ILE:HD13	1:B:218:ILE:HD12	2.00	0.43
1:G:362:GLU:OE2	1:H:32:ARG:NE	2.48	0.43
1:L:76:ALA:HB1	1:L:250:HIS:O	2.18	0.43
1:E:403:MSE:HE1	1:E:420:ILE:HG13	2.00	0.43
1:I:111:VAL:HG23	1:I:239:LEU:CD1	2.46	0.43
1:I:132:LEU:HD13	1:I:156:ARG:HG3	2.01	0.43
1:K:184:VAL:HG13	1:K:200:GLN:HE22	1.84	0.43
1:B:344:LEU:O	1:B:352:THR:OG1	2.21	0.43
1:J:362:GLU:OE2	1:K:32:ARG:NE	2.44	0.43
1:K:438:LEU:HD21	1:K:442:ILE:HG13	1.99	0.43
1:L:344:LEU:HD21	1:L:395:LEU:HD22	2.00	0.43
1:E:375:ARG:HD2	1:E:422:ALA:HB1	2.00	0.43
1:K:210:LYS:HD3	1:K:212:LYS:HE2	2.00	0.43
1:E:394:ARG:NH1	1:E:443:LEU:O	2.52	0.43
1:E:34:ARG:NH1	1:E:250:HIS:HA	2.34	0.43
1:K:342:ARG:O	1:K:347:PRO:HD3	2.19	0.42
1:D:355:TYR:O	1:D:359:MSE:HG2	2.18	0.42

Continued on next page...

Continued from previous page...

Atom-1	Atom-2	Interatomic distance (Å)	Clash overlap (Å)
1:H:58:PRO:O	1:H:63:LYS:NZ	2.52	0.42
1:D:76:ALA:HB1	1:D:250:HIS:O	2.19	0.42
1:E:91:TYR:HE1	1:F:95:GLU:OE2	1.84	0.42
1:F:152:PRO:O	1:F:156:ARG:HB3	2.20	0.42
1:A:176:ASP:HA	1:A:213:ALA:HA	2.01	0.42
1:B:441:PHE:HD2	1:C:56:ILE:HD13	1.84	0.42
1:E:188:ALA:HB2	1:E:196:THR:HG21	2.01	0.42
1:L:321:GLU:OE2	1:L:321:GLU:N	2.46	0.42
1:L:96:VAL:HG21	1:L:280:ASP:HB3	2.00	0.42
1:B:15:LYS:HB3	1:B:348:ASN:ND2	2.35	0.42
1:D:362:GLU:OE2	1:E:32:ARG:NE	2.47	0.42
1:E:119:ASN:HB3	1:E:233:LEU:HD12	2.01	0.42
1:F:65:GLU:HG2	3:F:501:ADP:H5'2	2.01	0.42
1:A:12:GLU:HG2	1:A:73:LEU:HD13	2.02	0.42
1:B:163:LEU:HA	1:B:168:LEU:HD11	2.00	0.42
1:H:152:PRO:O	1:H:156:ARG:HB3	2.20	0.42
1:K:62:GLY:O	1:K:66:ILE:HG13	2.20	0.42
1:K:177:LEU:O	1:K:212:LYS:N	2.51	0.42
1:C:355:TYR:CE1	1:C:403:MSE:HB3	2.55	0.42
1:J:289:THR:CG2	1:J:296:MSE:HE2	2.50	0.42
1:E:56:ILE:O	1:E:331:GLU:HA	2.19	0.42
1:E:387:THR:OG1	1:E:388:GLU:N	2.50	0.42
1:F:38:MSE:O	1:F:45:ARG:NH2	2.53	0.42
1:L:175:ILE:CD1	1:L:225:LEU:HD11	2.49	0.42
1:G:108:VAL:HG21	1:G:294:HIS:CG	2.55	0.42
1:I:188:ALA:HB2	1:I:196:THR:HG21	2.02	0.42
1:K:12:GLU:HG2	1:K:73:LEU:HD13	2.02	0.42
1:B:34:ARG:NH1	1:B:250:HIS:HA	2.35	0.42
1:D:58:PRO:HG2	1:D:61:VAL:HG11	2.01	0.42
1:D:425:VAL:HG13	1:D:429:LEU:HD12	2.02	0.42
1:H:12:GLU:HG2	1:H:73:LEU:HD13	2.02	0.41
1:A:178:ALA:HA	1:A:211:GLN:HA	2.02	0.41
1:C:184:VAL:HG13	1:C:200:GLN:HE22	1.84	0.41
1:E:14:ASP:OD1	1:E:24:LYS:NZ	2.36	0.41
1:J:289:THR:HG22	1:J:296:MSE:HE2	2.02	0.41
1:A:60:GLY:N	3:A:501:ADP:O1B	2.38	0.41
1:K:429:LEU:O	1:K:432:LEU:N	2.52	0.41
1:B:9:ILE:HG23	1:B:73:LEU:HD23	2.02	0.41
1:H:3:GLU:O	1:H:32:ARG:NH1	2.52	0.41
1:H:23:ALA:HA	1:H:330:VAL:HG21	2.02	0.41
1:I:429:LEU:O	1:I:432:LEU:N	2.54	0.41

Continued on next page...

Continued from previous page...

Atom-1	Atom-2	Interatomic distance (Å)	Clash overlap (Å)
1:L:131:ILE:HD13	1:L:218:ILE:HD12	2.03	0.41
1:B:344:LEU:HD23	1:B:351:ILE:HD11	2.03	0.41
1:E:88:GLU:O	1:E:89:VAL:CB	2.68	0.41
1:E:169:ASP:HA	1:E:218:ILE:HB	2.02	0.41
1:F:54:LEU:HB3	1:F:329:ARG:HD3	2.01	0.41
1:F:172:GLU:HG2	1:F:217:LYS:HE2	2.02	0.41
1:J:339:ASP:O	1:J:343:ILE:HG13	2.21	0.41
1:C:151:GLU:HB3	1:C:152:PRO:HD3	2.03	0.41
1:E:112:ARG:HA	1:E:239:LEU:HD11	2.03	0.41
1:L:402:LEU:HG	1:L:403:MSE:HE3	2.01	0.41
1:G:82:GLU:HB2	1:G:85:LYS:HG3	2.02	0.41
1:G:186:ILE:HG12	1:I:202:MSE:HE1	2.02	0.41
1:I:339:ASP:O	1:I:343:ILE:HG13	2.20	0.41
1:I:6:PRO:HA	1:I:28:ALA:HB1	2.02	0.41
1:I:58:PRO:HG2	1:I:61:VAL:HG11	2.02	0.41
1:L:432:LEU:HD23	1:L:442:ILE:HG21	2.02	0.41
1:D:342:ARG:O	1:D:347:PRO:HD3	2.21	0.41
1:F:355:TYR:CE1	1:F:403:MSE:HB3	2.56	0.41
1:H:429:LEU:O	1:H:432:LEU:N	2.50	0.41
1:I:184:VAL:HG13	1:I:200:GLN:NE2	2.35	0.41
1:I:400:GLU:HG3	1:J:327:PRO:HB2	2.02	0.41
1:A:184:VAL:HG11	1:C:202:MSE:SE	2.71	0.41
1:H:109:LYS:HE2	1:I:298:LYS:HB2	2.01	0.41
1:J:6:PRO:HA	1:J:28:ALA:HB1	2.02	0.41
1:J:366:ILE:HD13	1:J:418:ILE:HB	2.03	0.41
1:E:81:VAL:HG21	1:E:99:ILE:HD13	2.02	0.41
1:A:261:ILE:O	1:A:274:ARG:HB3	2.21	0.40
1:C:34:ARG:NH1	1:C:250:HIS:HA	2.35	0.40
1:H:163:LEU:HA	1:H:168:LEU:HD11	2.02	0.40
1:J:14:ASP:OD1	1:J:24:LYS:NZ	2.37	0.40
1:B:112:ARG:HG3	1:B:239:LEU:HD11	2.03	0.40
1:E:429:LEU:O	1:E:432:LEU:N	2.54	0.40
1:G:34:ARG:NH1	1:G:250:HIS:HA	2.36	0.40
1:H:106:ALA:HA	1:I:289:THR:HG21	2.03	0.40
1:E:402:LEU:HD23	1:E:403:MSE:HE2	2.03	0.40
1:G:123:ALA:O	1:G:127:ALA:N	2.49	0.40
1:L:259:ASP:OD1	1:L:259:ASP:N	2.55	0.40
1:I:20:GLN:NE2	1:I:333:GLN:O	2.46	0.40
1:D:59:THR:OG1	1:D:393:ARG:NH2	2.54	0.40

There are no symmetry-related clashes.

5.3 Torsion angles [i](#)

5.3.1 Protein backbone [i](#)

In the following table, the Percentiles column shows the percent Ramachandran outliers of the chain as a percentile score with respect to all X-ray entries followed by that with respect to entries of similar resolution.

The Analysed column shows the number of residues for which the backbone conformation was analysed, and the total number of residues.

Mol	Chain	Analysed	Favoured	Allowed	Outliers	Percentiles	
1	A	408/448 (91%)	401 (98%)	7 (2%)	0	100	100
1	B	387/448 (86%)	380 (98%)	7 (2%)	0	100	100
1	C	415/448 (93%)	407 (98%)	8 (2%)	0	100	100
1	D	327/448 (73%)	322 (98%)	5 (2%)	0	100	100
1	E	418/448 (93%)	408 (98%)	9 (2%)	1 (0%)	47	79
1	F	378/448 (84%)	371 (98%)	6 (2%)	1 (0%)	41	74
1	G	364/448 (81%)	357 (98%)	6 (2%)	1 (0%)	41	74
1	H	382/448 (85%)	374 (98%)	8 (2%)	0	100	100
1	I	399/448 (89%)	391 (98%)	8 (2%)	0	100	100
1	J	313/448 (70%)	308 (98%)	5 (2%)	0	100	100
1	K	421/448 (94%)	412 (98%)	9 (2%)	0	100	100
1	L	384/448 (86%)	375 (98%)	9 (2%)	0	100	100
All	All	4596/5376 (86%)	4506 (98%)	87 (2%)	3 (0%)	51	83

All (3) Ramachandran outliers are listed below:

Mol	Chain	Res	Type
1	G	89	VAL
1	E	89	VAL
1	F	89	VAL

5.3.2 Protein sidechains [i](#)

In the following table, the Percentiles column shows the percent sidechain outliers of the chain as a percentile score with respect to all X-ray entries followed by that with respect to entries of similar resolution.

The Analysed column shows the number of residues for which the sidechain conformation was analysed, and the total number of residues.

Mol	Chain	Analysed	Rotameric	Outliers	Percentiles	
1	A	361/369 (98%)	359 (99%)	2 (1%)	86	94
1	B	340/369 (92%)	339 (100%)	1 (0%)	92	97
1	C	363/369 (98%)	362 (100%)	1 (0%)	92	97
1	D	289/369 (78%)	288 (100%)	1 (0%)	92	97
1	E	362/369 (98%)	360 (99%)	2 (1%)	86	94
1	F	333/369 (90%)	332 (100%)	1 (0%)	92	97
1	G	322/369 (87%)	321 (100%)	1 (0%)	92	97
1	H	336/369 (91%)	334 (99%)	2 (1%)	86	94
1	I	349/369 (95%)	346 (99%)	3 (1%)	78	89
1	J	277/369 (75%)	276 (100%)	1 (0%)	91	96
1	K	365/369 (99%)	363 (100%)	2 (0%)	88	95
1	L	338/369 (92%)	337 (100%)	1 (0%)	92	97
All	All	4035/4428 (91%)	4017 (100%)	18 (0%)	91	96

All (18) residues with a non-rotameric sidechain are listed below:

Mol	Chain	Res	Type
1	G	355	TYR
1	H	168	LEU
1	H	355	TYR
1	I	46	HIS
1	I	168	LEU
1	I	355	TYR
1	J	355	TYR
1	K	168	LEU
1	K	355	TYR
1	L	355	TYR
1	A	168	LEU
1	A	355	TYR
1	B	168	LEU
1	C	355	TYR
1	D	355	TYR
1	E	168	LEU
1	E	355	TYR
1	F	355	TYR

Sometimes sidechains can be flipped to improve hydrogen bonding and reduce clashes. All (5) such sidechains are listed below:

Mol	Chain	Res	Type
1	I	75	ASN
1	K	200	GLN
1	A	354	GLN
1	C	200	GLN
1	E	200	GLN

5.3.3 RNA [i](#)

There are no RNA molecules in this entry.

5.4 Non-standard residues in protein, DNA, RNA chains [i](#)

There are no non-standard protein/DNA/RNA residues in this entry.

5.5 Carbohydrates [i](#)

There are no monosaccharides in this entry.

5.6 Ligand geometry [i](#)

28 ligands are modelled in this entry.

In the following table, the Counts columns list the number of bonds (or angles) for which Mogul statistics could be retrieved, the number of bonds (or angles) that are observed in the model and the number of bonds (or angles) that are defined in the Chemical Component Dictionary. The Link column lists molecule types, if any, to which the group is linked. The Z score for a bond length (or angle) is the number of standard deviations the observed value is removed from the expected value. A bond length (or angle) with $|Z| > 2$ is considered an outlier worth inspection. RMSZ is the root-mean-square of all Z scores of the bond lengths (or angles).

Mol	Type	Chain	Res	Link	Bond lengths			Bond angles		
					Counts	RMSZ	# $ Z > 2$	Counts	RMSZ	# $ Z > 2$
4	SO4	I	503	-	4,4,4	0.15	0	6,6,6	0.05	0
3	ADP	E	501	-	24,29,29	0.96	1 (4%)	29,45,45	1.49	4 (13%)
3	ADP	D	501	-	24,29,29	0.97	1 (4%)	29,45,45	1.50	4 (13%)
3	ADP	K	501	-	24,29,29	0.96	1 (4%)	29,45,45	1.48	5 (17%)
4	SO4	H	502	-	4,4,4	0.14	0	6,6,6	0.04	0
4	SO4	B	502	-	4,4,4	0.15	0	6,6,6	0.04	0
4	SO4	D	502	-	4,4,4	0.14	0	6,6,6	0.05	0
3	ADP	G	501	-	24,29,29	0.94	1 (4%)	29,45,45	1.47	4 (13%)
4	SO4	F	502	-	4,4,4	0.13	0	6,6,6	0.07	0

Mol	Type	Chain	Res	Link	Bond lengths			Bond angles		
					Counts	RMSZ	# Z > 2	Counts	RMSZ	# Z > 2
3	ADP	L	501	-	24,29,29	0.98	1 (4%)	29,45,45	1.51	4 (13%)
3	ADP	B	501	-	24,29,29	0.96	1 (4%)	29,45,45	1.37	4 (13%)
4	SO4	A	502	-	4,4,4	0.14	0	6,6,6	0.06	0
4	SO4	L	502	-	4,4,4	0.14	0	6,6,6	0.06	0
3	ADP	F	501	-	24,29,29	0.97	1 (4%)	29,45,45	1.51	4 (13%)
4	SO4	I	502	-	4,4,4	0.13	0	6,6,6	0.09	0
3	ADP	H	501	-	24,29,29	0.94	1 (4%)	29,45,45	1.50	4 (13%)
4	SO4	H	503	-	4,4,4	0.14	0	6,6,6	0.07	0
4	SO4	J	503	-	4,4,4	0.14	0	6,6,6	0.05	0
4	SO4	E	502	-	4,4,4	0.14	0	6,6,6	0.05	0
4	SO4	J	502	-	4,4,4	0.15	0	6,6,6	0.06	0
3	ADP	A	501	-	24,29,29	0.97	1 (4%)	29,45,45	1.49	4 (13%)
4	SO4	K	503	-	4,4,4	0.14	0	6,6,6	0.06	0
3	ADP	J	501	-	24,29,29	0.95	1 (4%)	29,45,45	1.47	4 (13%)
3	ADP	C	501	-	24,29,29	0.95	1 (4%)	29,45,45	1.46	4 (13%)
4	SO4	D	503	-	4,4,4	0.14	0	6,6,6	0.04	0
4	SO4	K	502	-	4,4,4	0.15	0	6,6,6	0.05	0
4	SO4	G	502	-	4,4,4	0.13	0	6,6,6	0.06	0
3	ADP	I	501	-	24,29,29	0.95	1 (4%)	29,45,45	1.50	4 (13%)

In the following table, the Chirals column lists the number of chiral outliers, the number of chiral centers analysed, the number of these observed in the model and the number defined in the Chemical Component Dictionary. Similar counts are reported in the Torsion and Rings columns. '-' means no outliers of that kind were identified.

Mol	Type	Chain	Res	Link	Chirals	Torsions	Rings
3	ADP	G	501	-	-	5/12/32/32	0/3/3/3
3	ADP	A	501	-	-	1/12/32/32	0/3/3/3
3	ADP	E	501	-	-	1/12/32/32	0/3/3/3
3	ADP	D	501	-	-	3/12/32/32	0/3/3/3
3	ADP	L	501	-	-	4/12/32/32	0/3/3/3
3	ADP	J	501	-	-	4/12/32/32	0/3/3/3
3	ADP	B	501	-	-	2/12/32/32	0/3/3/3
3	ADP	K	501	-	-	1/12/32/32	0/3/3/3
3	ADP	F	501	-	-	3/12/32/32	0/3/3/3
3	ADP	C	501	-	-	0/12/32/32	0/3/3/3
3	ADP	I	501	-	-	3/12/32/32	0/3/3/3
3	ADP	H	501	-	-	4/12/32/32	0/3/3/3

All (12) bond length outliers are listed below:

Mol	Chain	Res	Type	Atoms	Z	Observed(Å)	Ideal(Å)
3	A	501	ADP	C5-C4	2.60	1.47	1.40
3	D	501	ADP	C5-C4	2.57	1.47	1.40
3	L	501	ADP	C5-C4	2.57	1.47	1.40
3	H	501	ADP	C5-C4	2.54	1.47	1.40
3	J	501	ADP	C5-C4	2.51	1.47	1.40
3	B	501	ADP	C5-C4	2.51	1.47	1.40
3	E	501	ADP	C5-C4	2.50	1.47	1.40
3	F	501	ADP	C5-C4	2.49	1.47	1.40
3	I	501	ADP	C5-C4	2.48	1.47	1.40
3	C	501	ADP	C5-C4	2.47	1.47	1.40
3	K	501	ADP	C5-C4	2.46	1.47	1.40
3	G	501	ADP	C5-C4	2.46	1.47	1.40

All (49) bond angle outliers are listed below:

Mol	Chain	Res	Type	Atoms	Z	Observed(°)	Ideal(°)
3	L	501	ADP	C3'-C2'-C1'	3.75	106.63	100.98
3	F	501	ADP	C3'-C2'-C1'	3.74	106.60	100.98
3	L	501	ADP	PA-O3A-PB	-3.73	120.02	132.83
3	H	501	ADP	C3'-C2'-C1'	3.71	106.57	100.98
3	I	501	ADP	PA-O3A-PB	-3.71	120.10	132.83
3	B	501	ADP	C3'-C2'-C1'	3.67	106.50	100.98
3	D	501	ADP	PA-O3A-PB	-3.67	120.24	132.83
3	F	501	ADP	PA-O3A-PB	-3.58	120.54	132.83
3	J	501	ADP	PA-O3A-PB	-3.56	120.60	132.83
3	D	501	ADP	C3'-C2'-C1'	3.52	106.28	100.98
3	K	501	ADP	C3'-C2'-C1'	3.51	106.27	100.98
3	G	501	ADP	C3'-C2'-C1'	3.43	106.15	100.98
3	C	501	ADP	PA-O3A-PB	-3.43	121.05	132.83
3	E	501	ADP	C3'-C2'-C1'	3.43	106.14	100.98
3	A	501	ADP	C3'-C2'-C1'	3.41	106.12	100.98
3	A	501	ADP	PA-O3A-PB	-3.35	121.31	132.83
3	I	501	ADP	C3'-C2'-C1'	3.34	106.00	100.98
3	H	501	ADP	PA-O3A-PB	-3.30	121.50	132.83
3	E	501	ADP	PA-O3A-PB	-3.27	121.60	132.83
3	G	501	ADP	PA-O3A-PB	-3.26	121.65	132.83
3	C	501	ADP	C3'-C2'-C1'	3.24	105.86	100.98
3	J	501	ADP	C3'-C2'-C1'	3.23	105.85	100.98
3	H	501	ADP	N3-C2-N1	-3.21	123.66	128.68
3	I	501	ADP	N3-C2-N1	-3.21	123.67	128.68
3	J	501	ADP	N3-C2-N1	-3.18	123.70	128.68
3	G	501	ADP	N3-C2-N1	-3.17	123.73	128.68

Continued on next page...

Continued from previous page...

Mol	Chain	Res	Type	Atoms	Z	Observed(°)	Ideal(°)
3	K	501	ADP	N3-C2-N1	-3.14	123.78	128.68
3	C	501	ADP	N3-C2-N1	-3.12	123.80	128.68
3	A	501	ADP	N3-C2-N1	-3.11	123.81	128.68
3	F	501	ADP	N3-C2-N1	-3.11	123.81	128.68
3	D	501	ADP	N3-C2-N1	-3.10	123.83	128.68
3	B	501	ADP	N3-C2-N1	-3.10	123.83	128.68
3	E	501	ADP	N3-C2-N1	-3.10	123.83	128.68
3	L	501	ADP	N3-C2-N1	-2.97	124.03	128.68
3	K	501	ADP	PA-O3A-PB	-2.88	122.96	132.83
3	A	501	ADP	C4-C5-N7	-2.61	106.68	109.40
3	D	501	ADP	C4-C5-N7	-2.60	106.69	109.40
3	L	501	ADP	C4-C5-N7	-2.60	106.69	109.40
3	H	501	ADP	C4-C5-N7	-2.57	106.72	109.40
3	K	501	ADP	C4-C5-N7	-2.56	106.73	109.40
3	G	501	ADP	C4-C5-N7	-2.53	106.77	109.40
3	E	501	ADP	C4-C5-N7	-2.49	106.81	109.40
3	B	501	ADP	C4-C5-N7	-2.46	106.84	109.40
3	I	501	ADP	C4-C5-N7	-2.39	106.91	109.40
3	F	501	ADP	C4-C5-N7	-2.36	106.94	109.40
3	K	501	ADP	C5'-C4'-C3'	-2.35	106.36	115.18
3	J	501	ADP	C4-C5-N7	-2.34	106.96	109.40
3	C	501	ADP	C4-C5-N7	-2.24	107.06	109.40
3	B	501	ADP	PA-O3A-PB	-2.11	125.59	132.83

There are no chirality outliers.

All (31) torsion outliers are listed below:

Mol	Chain	Res	Type	Atoms
3	G	501	ADP	C5'-O5'-PA-O2A
3	G	501	ADP	O4'-C4'-C5'-O5'
3	H	501	ADP	C5'-O5'-PA-O1A
3	H	501	ADP	C5'-O5'-PA-O3A
3	H	501	ADP	O4'-C4'-C5'-O5'
3	H	501	ADP	C3'-C4'-C5'-O5'
3	I	501	ADP	C5'-O5'-PA-O1A
3	J	501	ADP	C5'-O5'-PA-O1A
3	L	501	ADP	C5'-O5'-PA-O3A
3	L	501	ADP	O4'-C4'-C5'-O5'
3	L	501	ADP	C3'-C4'-C5'-O5'
3	A	501	ADP	C5'-O5'-PA-O1A
3	D	501	ADP	C5'-O5'-PA-O1A
3	E	501	ADP	C5'-O5'-PA-O1A

Continued on next page...

Continued from previous page...

Mol	Chain	Res	Type	Atoms
3	F	501	ADP	O4'-C4'-C5'-O5'
3	F	501	ADP	C3'-C4'-C5'-O5'
3	J	501	ADP	O4'-C4'-C5'-O5'
3	J	501	ADP	C3'-C4'-C5'-O5'
3	G	501	ADP	C3'-C4'-C5'-O5'
3	I	501	ADP	O4'-C4'-C5'-O5'
3	I	501	ADP	C3'-C4'-C5'-O5'
3	D	501	ADP	C3'-C4'-C5'-O5'
3	D	501	ADP	O4'-C4'-C5'-O5'
3	G	501	ADP	C5'-O5'-PA-O3A
3	L	501	ADP	C5'-O5'-PA-O2A
3	J	501	ADP	C5'-O5'-PA-O3A
3	B	501	ADP	C5'-O5'-PA-O3A
3	F	501	ADP	C5'-O5'-PA-O3A
3	B	501	ADP	O4'-C4'-C5'-O5'
3	G	501	ADP	C5'-O5'-PA-O1A
3	K	501	ADP	C5'-O5'-PA-O1A

There are no ring outliers.

11 monomers are involved in 21 short contacts:

Mol	Chain	Res	Type	Clashes	Symm-Clashes
3	D	501	ADP	1	0
3	K	501	ADP	2	0
3	G	501	ADP	2	0
3	L	501	ADP	3	0
3	B	501	ADP	3	0
3	F	501	ADP	2	0
3	H	501	ADP	2	0
3	A	501	ADP	1	0
3	J	501	ADP	2	0
3	C	501	ADP	2	0
3	I	501	ADP	1	0

The following is a two-dimensional graphical depiction of Mogul quality analysis of bond lengths, bond angles, torsion angles, and ring geometry for all instances of the Ligand of Interest. In addition, ligands with molecular weight > 250 and outliers as shown on the validation Tables will also be included. For torsion angles, if less than 5% of the Mogul distribution of torsion angles is within 10 degrees of the torsion angle in question, then that torsion angle is considered an outlier. Any bond that is central to one or more torsion angles identified as an outlier by Mogul will be highlighted in the graph. For rings, the root-mean-square deviation (RMSD) between the ring in question and similar rings identified by Mogul is calculated over all ring torsion angles. If the

average RMSD is greater than 60 degrees and the minimal RMSD between the ring in question and any Mogul-identified rings is also greater than 60 degrees, then that ring is considered an outlier. The outliers are highlighted in purple. The color gray indicates Mogul did not find sufficient equivalents in the CSD to analyse the geometry.

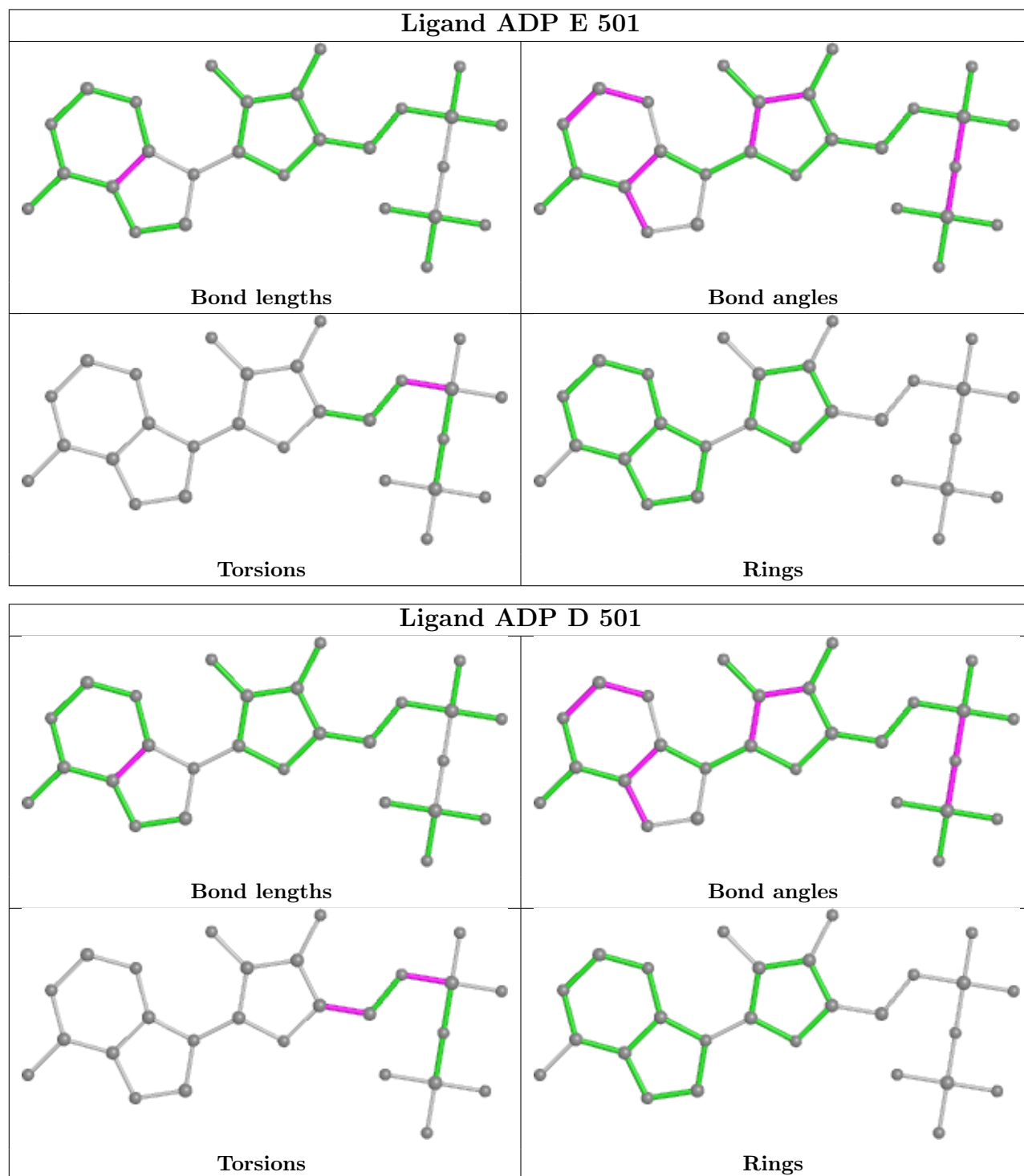

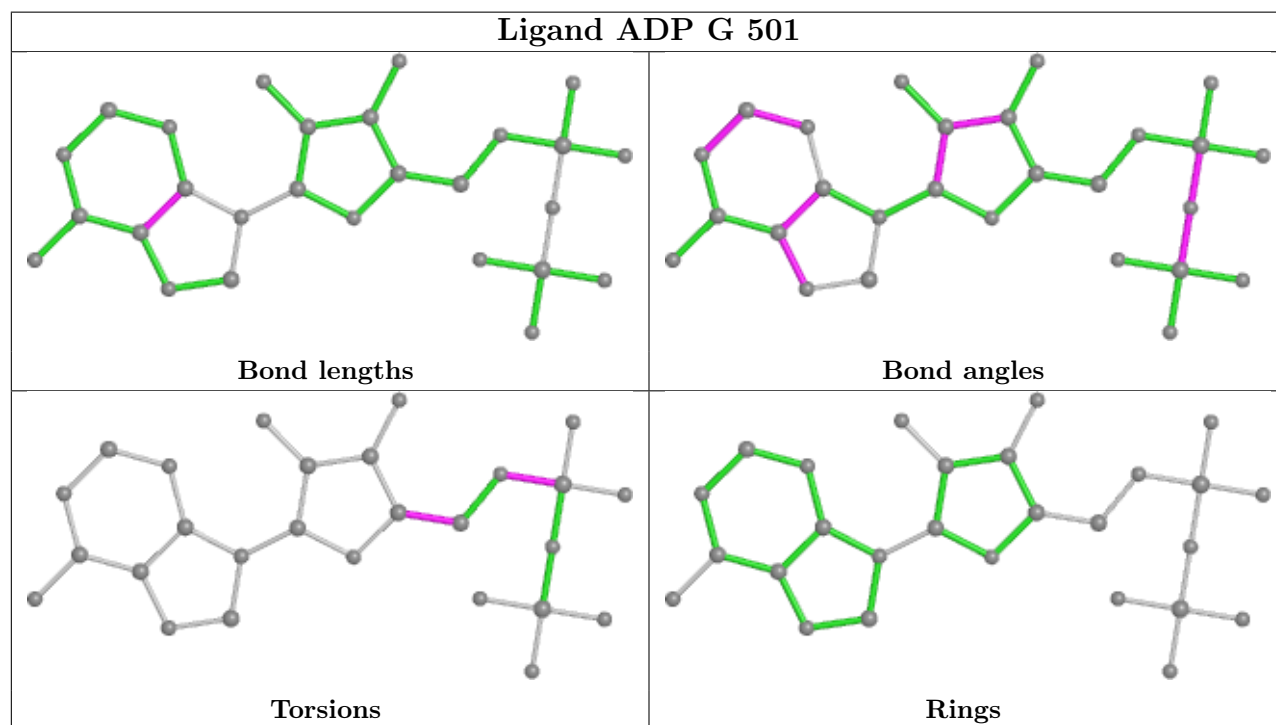
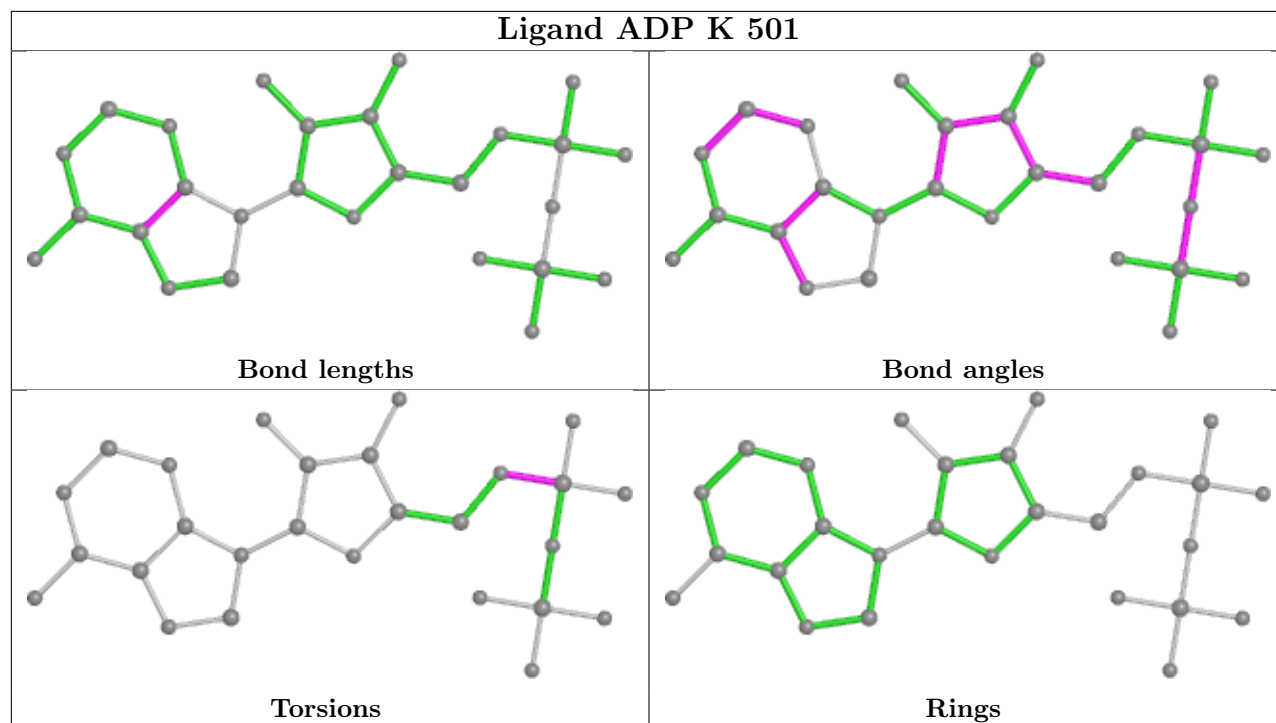

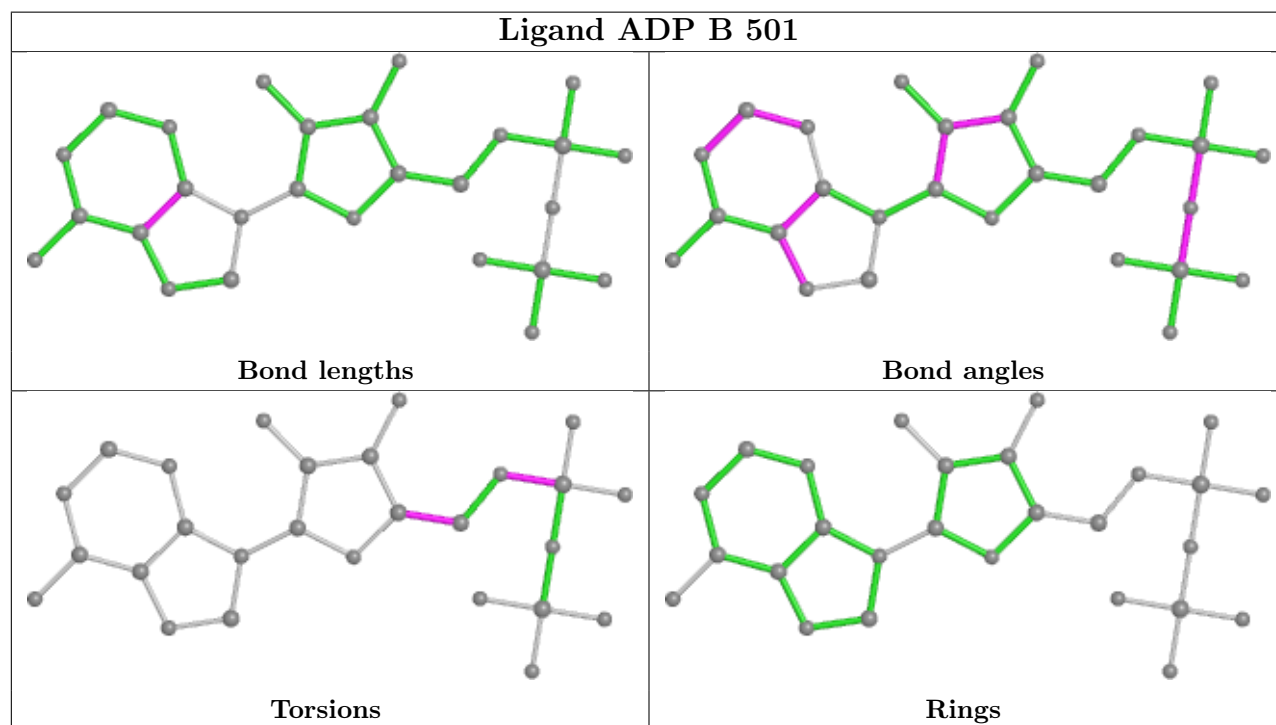
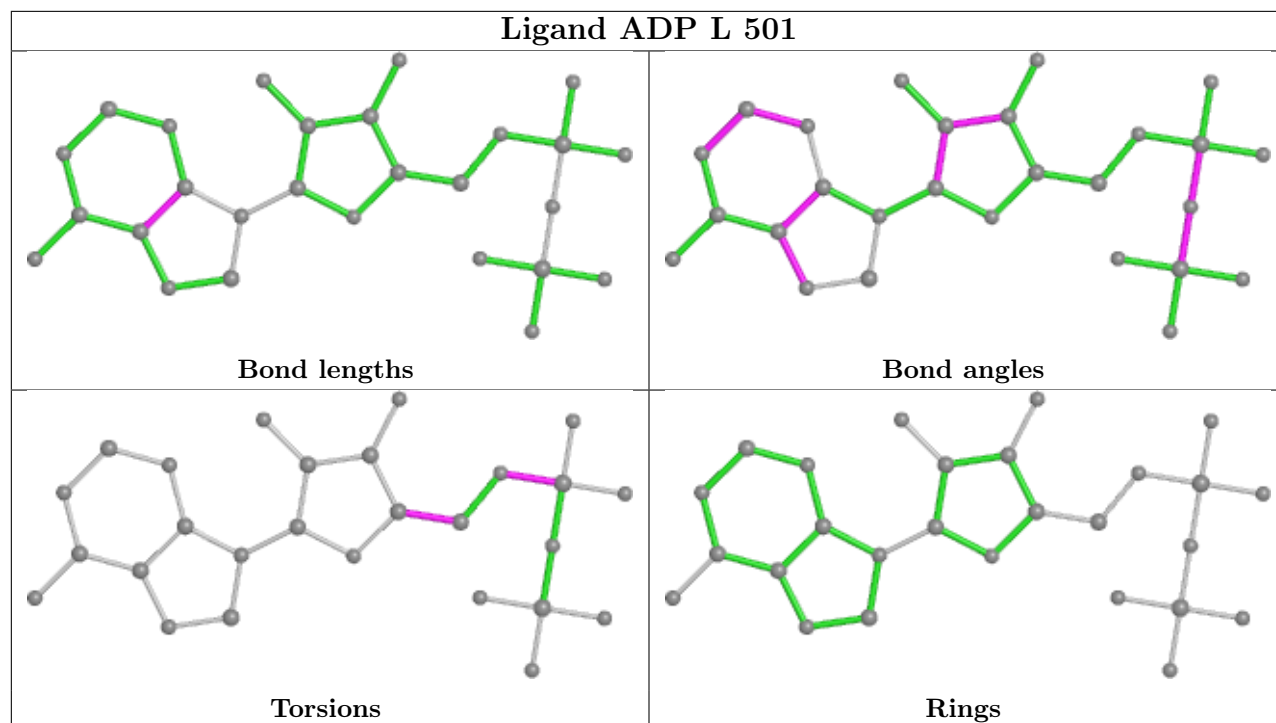

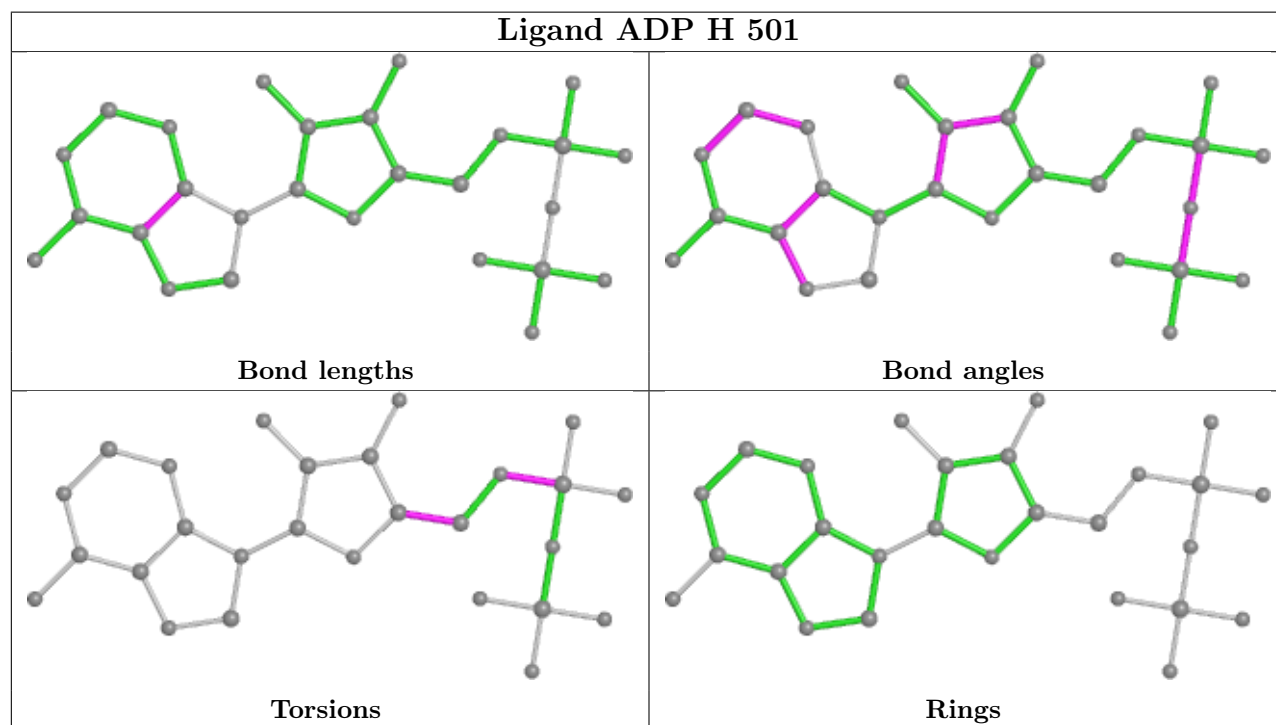
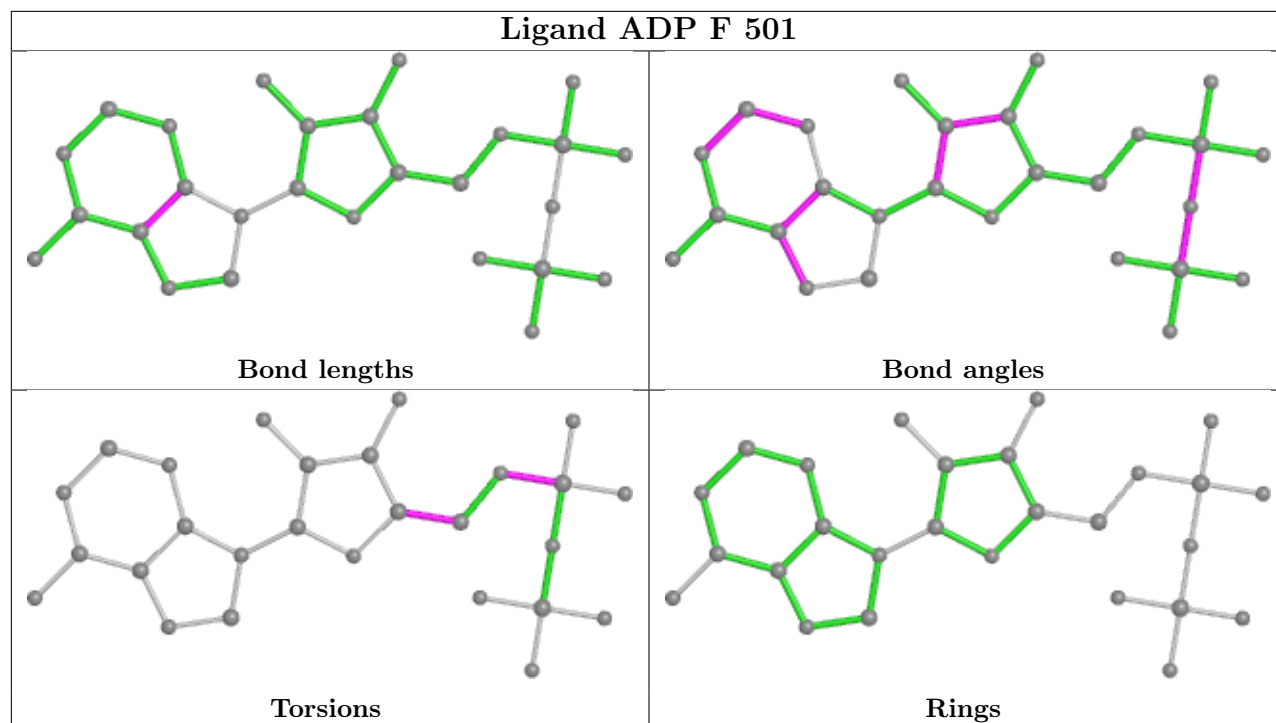

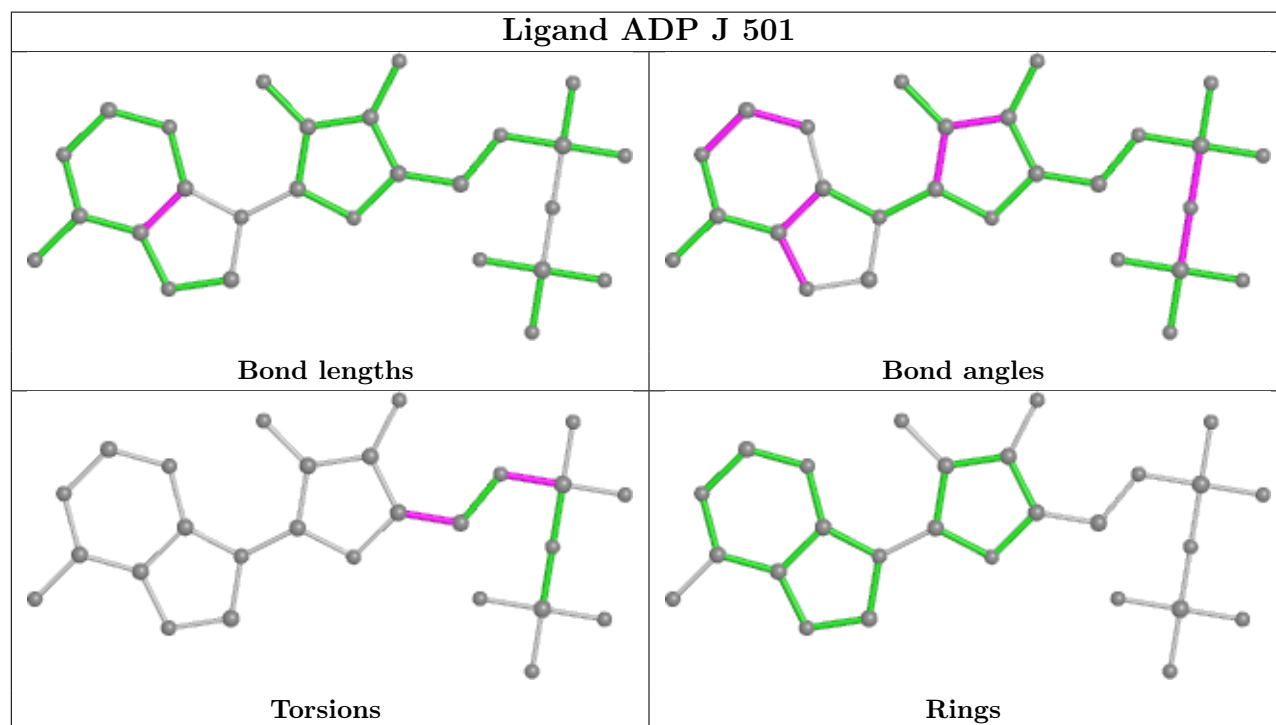
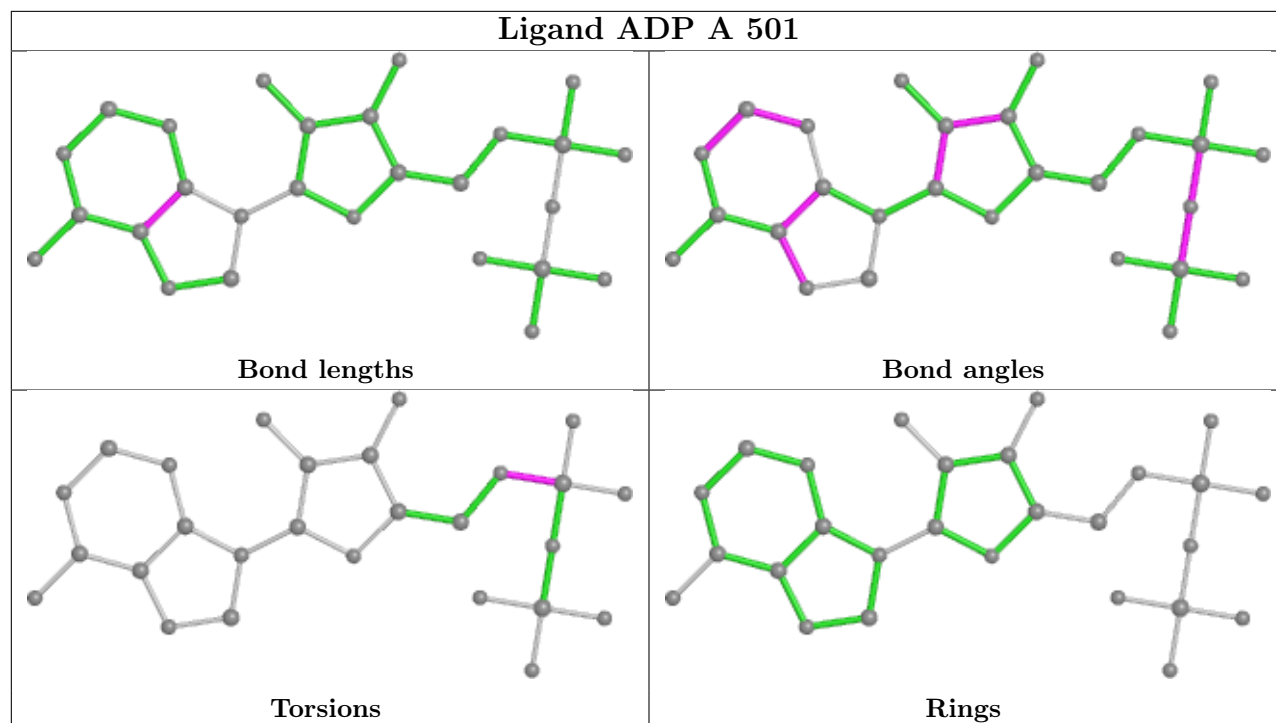

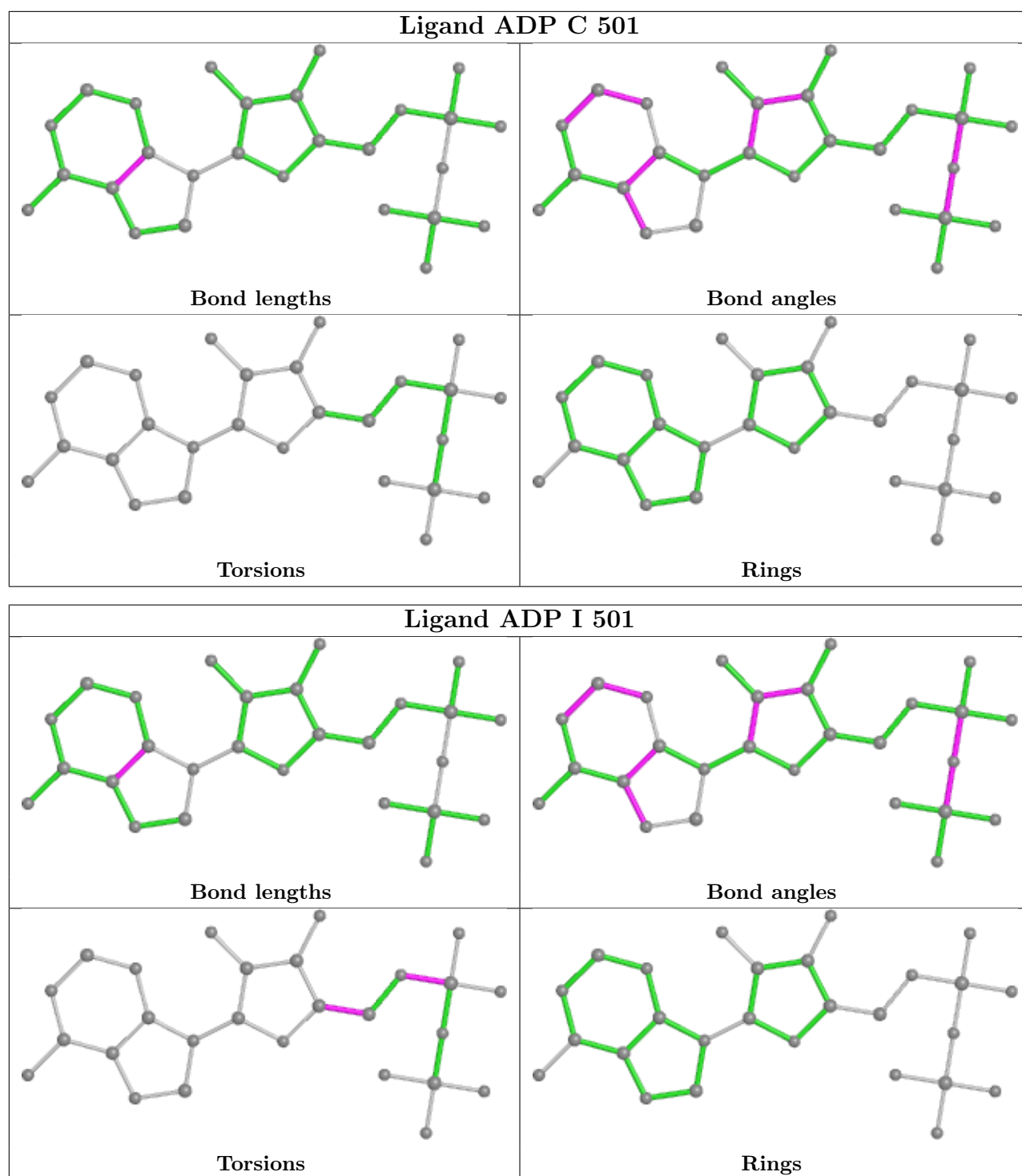

5.7 Other polymers [\(i\)](#)

There are no such residues in this entry.

5.8 Polymer linkage issues

There are no chain breaks in this entry.

6 Fit of model and data [i](#)

6.1 Protein, DNA and RNA chains [i](#)

In the following table, the column labelled ‘#RSRZ > 2’ contains the number (and percentage) of RSRZ outliers, followed by percent RSRZ outliers for the chain as percentile scores relative to all X-ray entries and entries of similar resolution. The OWAB column contains the minimum, median, 95th percentile and maximum values of the occupancy-weighted average B-factor per residue. The column labelled ‘Q < 0.9’ lists the number of (and percentage) of residues with an average occupancy less than 0.9.

Mol	Chain	Analysed	<RSRZ>	#RSRZ>2	OWAB(Å ²)	Q<0.9
1	A	407/448 (90%)	0.10	21 (5%) 27 18	118, 176, 228, 247	0
1	B	389/448 (86%)	-0.09	12 (3%) 49 33	122, 161, 207, 228	0
1	C	412/448 (91%)	0.12	20 (4%) 29 19	127, 183, 278, 290	0
1	D	328/448 (73%)	-0.03	9 (2%) 54 38	134, 170, 237, 263	0
1	E	413/448 (92%)	0.09	22 (5%) 26 17	113, 145, 212, 240	0
1	F	380/448 (84%)	-0.00	18 (4%) 31 20	101, 149, 239, 256	0
1	G	363/448 (81%)	0.04	15 (4%) 37 24	108, 155, 254, 348	0
1	H	384/448 (85%)	-0.15	6 (1%) 72 58	110, 145, 204, 220	0
1	I	398/448 (88%)	0.15	28 (7%) 16 9	99, 147, 275, 288	0
1	J	314/448 (70%)	-0.20	1 (0%) 94 89	101, 136, 192, 244	0
1	K	416/448 (92%)	-0.04	3 (0%) 87 79	91, 130, 191, 218	0
1	L	386/448 (86%)	-0.05	13 (3%) 45 31	87, 141, 251, 263	0
2	X	0/16	-	-	-	-
All	All	4590/5392 (85%)	0.00	168 (3%) 41 27	87, 154, 241, 348	0

All (168) RSRZ outliers are listed below:

Mol	Chain	Res	Type	RSRZ
1	I	135	LEU	8.8
1	G	132	LEU	7.8
1	C	220	ASP	7.7
1	K	93	GLY	7.2
1	C	135	LEU	6.8
1	G	135	LEU	6.5
1	A	132	LEU	6.0
1	G	131	ILE	5.8
1	C	132	LEU	5.8
1	E	207	GLY	5.4

Continued on next page...

Continued from previous page...

Mol	Chain	Res	Type	RSRZ
1	E	208	GLY	5.2
1	I	220	ASP	5.1
1	G	137	PRO	4.7
1	C	131	ILE	4.6
1	D	119	ASN	4.6
1	L	220	ASP	4.4
1	I	90	GLY	4.4
1	D	121	TYR	4.4
1	G	133	ASP	4.2
1	J	233	LEU	4.2
1	I	181	PRO	4.2
1	C	175	ILE	4.1
1	B	210	LYS	4.1
1	E	215	LYS	4.0
1	H	175	ILE	4.0
1	C	172	GLU	4.0
1	C	219	LYS	3.9
1	H	177	LEU	3.9
1	F	212	LYS	3.9
1	A	93	GLY	3.8
1	G	120	ARG	3.8
1	C	173	ILE	3.8
1	C	221	ALA	3.7
1	L	175	ILE	3.6
1	I	211	GLN	3.6
1	A	165	GLU	3.5
1	B	211	GLN	3.4
1	C	214	ARG	3.4
1	B	212	LYS	3.3
1	A	213	ALA	3.3
1	F	131	ILE	3.3
1	E	175	ILE	3.3
1	F	215	LYS	3.3
1	F	226	ILE	3.2
1	G	227	GLU	3.2
1	D	43	GLU	3.2
1	G	270	PRO	3.2
1	I	177	LEU	3.1
1	I	160	ARG	3.1
1	B	177	LEU	3.1
1	I	219	LYS	3.1
1	C	443	LEU	3.1

Continued on next page...

Continued from previous page...

Mol	Chain	Res	Type	RSRZ
1	I	233	LEU	3.1
1	A	135	LEU	3.0
1	E	206	LEU	3.0
1	B	178	ALA	3.0
1	I	178	ALA	3.0
1	H	141	ASN	3.0
1	I	227	GLU	3.0
1	L	214	ARG	2.9
1	G	124	GLU	2.9
1	I	209	GLN	2.9
1	A	136	ILE	2.9
1	I	224	LEU	2.9
1	B	167	GLN	2.9
1	I	127	ALA	2.9
1	I	158	ALA	2.9
1	C	134	VAL	2.9
1	I	176	ASP	2.8
1	I	132	LEU	2.8
1	I	134	VAL	2.8
1	L	221	ALA	2.8
1	E	177	LEU	2.8
1	D	120	ARG	2.8
1	A	175	ILE	2.8
1	K	208	GLY	2.8
1	E	176	ASP	2.8
1	A	89	VAL	2.8
1	A	156	ARG	2.8
1	E	136	ILE	2.7
1	C	368	PHE	2.7
1	F	134	VAL	2.7
1	A	335	LEU	2.7
1	G	134	VAL	2.7
1	D	117	GLU	2.7
1	F	233	LEU	2.6
1	F	227	GLU	2.6
1	E	0	HIS	2.6
1	B	174	GLU	2.6
1	C	216	LEU	2.6
1	A	161	LYS	2.6
1	H	176	ASP	2.6
1	F	170	ASP	2.6
1	F	172	GLU	2.6

Continued on next page...

Continued from previous page...

Mol	Chain	Res	Type	RSRZ
1	B	179	ALA	2.6
1	A	130	ARG	2.6
1	I	228	GLU	2.6
1	E	172	GLU	2.6
1	F	90	GLY	2.6
1	L	233	LEU	2.6
1	C	167	GLN	2.6
1	G	130	ARG	2.5
1	D	236	PRO	2.5
1	L	119	ASN	2.5
1	D	239	LEU	2.5
1	I	226	ILE	2.5
1	G	232	LYS	2.5
1	I	154	ALA	2.5
1	E	178	ALA	2.5
1	K	215	LYS	2.5
1	E	130	ARG	2.5
1	I	183	GLY	2.5
1	F	160	ARG	2.5
1	F	165	GLU	2.5
1	A	172	GLU	2.5
1	C	171	LYS	2.4
1	G	271	ASP	2.4
1	I	167	GLN	2.4
1	E	156	ARG	2.4
1	F	238	GLU	2.4
1	A	271	ASP	2.4
1	I	223	LYS	2.4
1	L	130	ARG	2.4
1	F	214	ARG	2.4
1	F	225	LEU	2.4
1	I	205	ASN	2.4
1	A	214	ARG	2.4
1	A	224	LEU	2.4
1	B	176	ASP	2.4
1	I	131	ILE	2.3
1	A	139	ALA	2.3
1	D	232	LYS	2.3
1	E	209	GLN	2.3
1	C	176	ASP	2.3
1	A	268	SER	2.3
1	E	214	ARG	2.3

Continued on next page...

Continued from previous page...

Mol	Chain	Res	Type	RSRZ
1	L	122	ARG	2.3
1	F	213	ALA	2.3
1	A	167	GLN	2.3
1	G	128	GLU	2.3
1	L	131	ILE	2.3
1	E	135	LEU	2.3
1	F	174	GLU	2.2
1	H	93	GLY	2.2
1	B	213	ALA	2.2
1	A	134	VAL	2.2
1	B	175	ILE	2.2
1	F	166	GLY	2.2
1	A	128	GLU	2.2
1	C	209	GLN	2.2
1	G	269	GLY	2.2
1	E	205	ASN	2.2
1	E	153	SER	2.2
1	L	232	LYS	2.2
1	L	126	LEU	2.2
1	H	233	LEU	2.1
1	C	130	ARG	2.1
1	B	235	ASN	2.1
1	L	212	LYS	2.1
1	E	216	LEU	2.1
1	E	211	GLN	2.1
1	I	218	ILE	2.1
1	D	227	GLU	2.1
1	E	212	LYS	2.1
1	E	171	LYS	2.0
1	C	152	PRO	2.0
1	L	140	LYS	2.0
1	I	225	LEU	2.0

6.2 Non-standard residues in protein, DNA, RNA chains [i](#)

There are no non-standard protein/DNA/RNA residues in this entry.

6.3 Carbohydrates [i](#)

There are no monosaccharides in this entry.

6.4 Ligands

In the following table, the Atoms column lists the number of modelled atoms in the group and the number defined in the chemical component dictionary. The B-factors column lists the minimum, median, 95th percentile and maximum values of B factors of atoms in the group. The column labelled 'Q< 0.9' lists the number of atoms with occupancy less than 0.9.

Mol	Type	Chain	Res	Atoms	RSCC	RSR	B-factors(Å ²)	Q<0.9
4	SO4	H	502	5/5	0.73	0.31	183,183,183,183	0
4	SO4	L	502	5/5	0.79	0.20	165,165,165,165	0
4	SO4	A	502	5/5	0.79	0.20	198,198,198,198	0
4	SO4	B	502	5/5	0.79	0.38	192,192,192,192	0
4	SO4	D	503	5/5	0.81	0.32	190,190,190,190	0
4	SO4	J	503	5/5	0.82	0.40	181,181,181,181	0
4	SO4	F	502	5/5	0.83	0.30	180,180,180,180	0
3	ADP	C	501	27/27	0.85	0.24	142,167,176,178	0
4	SO4	D	502	5/5	0.85	0.30	205,205,205,205	0
4	SO4	I	503	5/5	0.86	0.18	177,177,177,177	0
4	SO4	G	502	5/5	0.86	0.19	187,187,187,187	0
4	SO4	K	502	5/5	0.86	0.31	183,183,183,183	0
4	SO4	J	502	5/5	0.87	1.03	197,197,197,197	0
4	SO4	K	503	5/5	0.87	0.23	146,146,146,146	0
4	SO4	H	503	5/5	0.88	0.18	166,166,166,166	0
3	ADP	E	501	27/27	0.88	0.29	110,142,155,158	0
3	ADP	A	501	27/27	0.88	0.24	134,161,170,172	0
3	ADP	G	501	27/27	0.88	0.31	115,143,150,151	0
3	ADP	L	501	27/27	0.89	0.28	100,117,123,125	0
3	ADP	I	501	27/27	0.90	0.32	108,127,135,138	0
3	ADP	J	501	27/27	0.90	0.26	107,125,136,138	0
4	SO4	I	502	5/5	0.91	0.20	170,170,170,170	0
3	ADP	B	501	27/27	0.91	0.26	130,142,153,155	0
3	ADP	K	501	27/27	0.91	0.30	96,107,111,112	0
3	ADP	F	501	27/27	0.92	0.25	112,133,141,145	0
3	ADP	D	501	27/27	0.92	0.23	141,165,180,182	0
3	ADP	H	501	27/27	0.93	0.24	117,135,142,145	0
4	SO4	E	502	5/5	0.95	0.15	155,155,155,155	0

The following is a graphical depiction of the model fit to experimental electron density of all instances of the Ligand of Interest. In addition, ligands with molecular weight > 250 and outliers as shown on the geometry validation Tables will also be included. Each fit is shown from different orientation to approximate a three-dimensional view.

Electron density around ADP C 501:

$2mF_o-DF_c$ (at 0.7 rmsd) in gray
 mF_o-DF_c (at 3 rmsd) in purple (negative)
and green (positive)

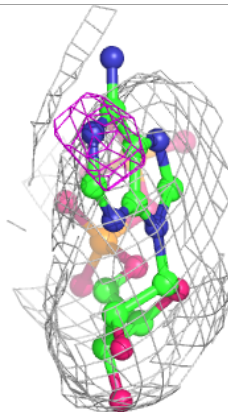
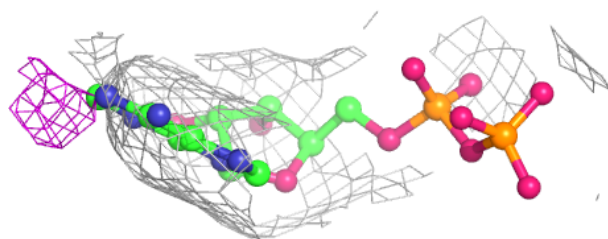
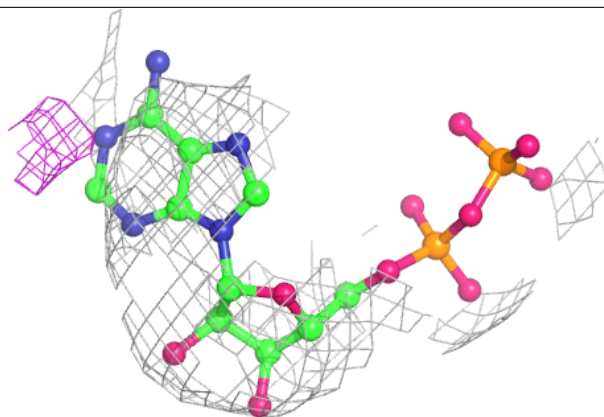
**Electron density around ADP E 501:**

$2mF_o-DF_c$ (at 0.7 rmsd) in gray
 mF_o-DF_c (at 3 rmsd) in purple (negative)
and green (positive)

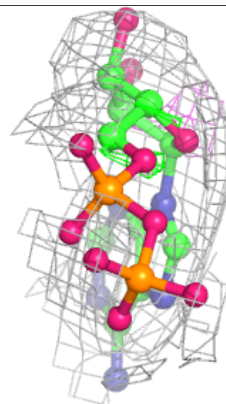
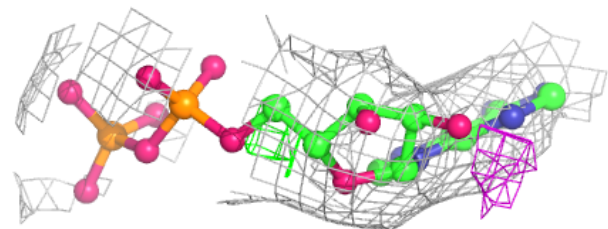
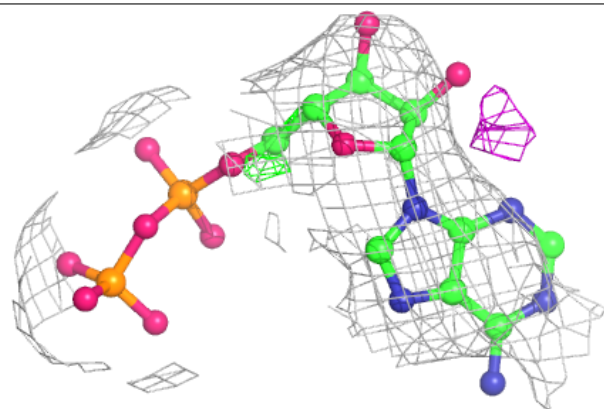

Electron density around ADP A 501:

$2mF_o-DF_c$ (at 0.7 rmsd) in gray
 mF_o-DF_c (at 3 rmsd) in purple (negative)
and green (positive)

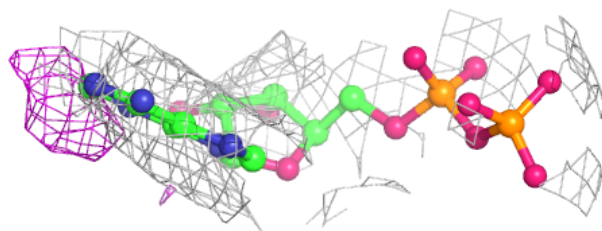
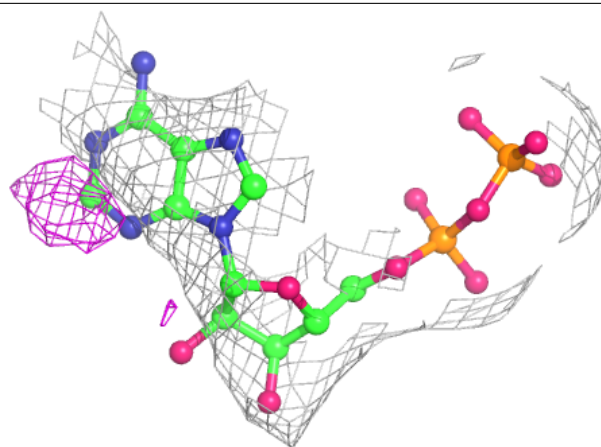

Electron density around ADP G 501:

$2mF_o-DF_c$ (at 0.7 rmsd) in gray
 mF_o-DF_c (at 3 rmsd) in purple (negative)
and green (positive)

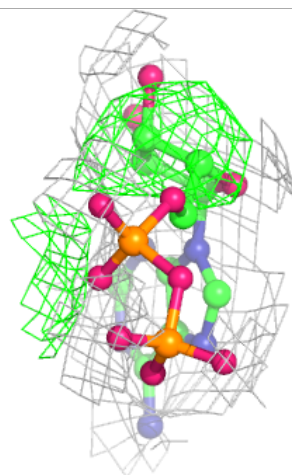
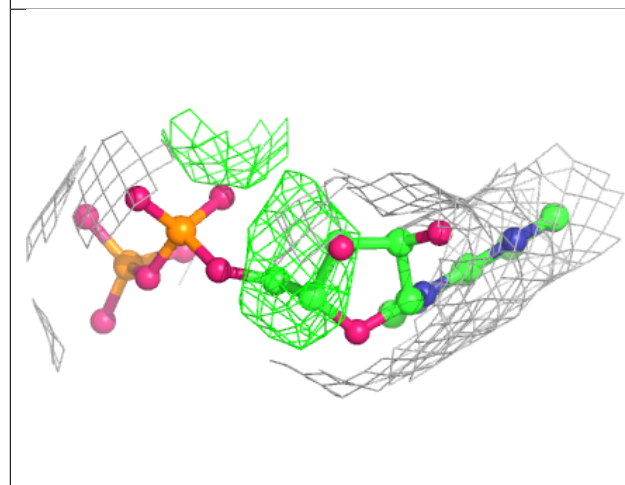
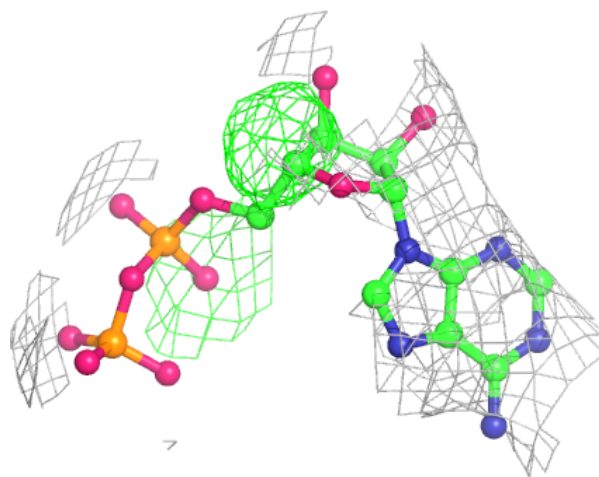

Electron density around ADP L 501:

$2mF_o-DF_c$ (at 0.7 rmsd) in gray
 mF_o-DF_c (at 3 rmsd) in purple (negative)
and green (positive)

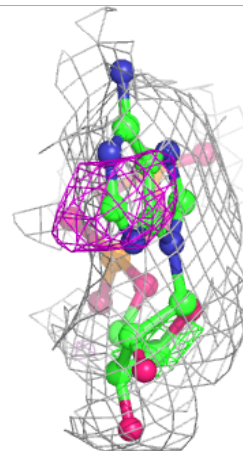
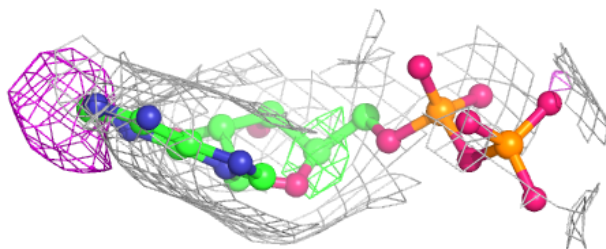
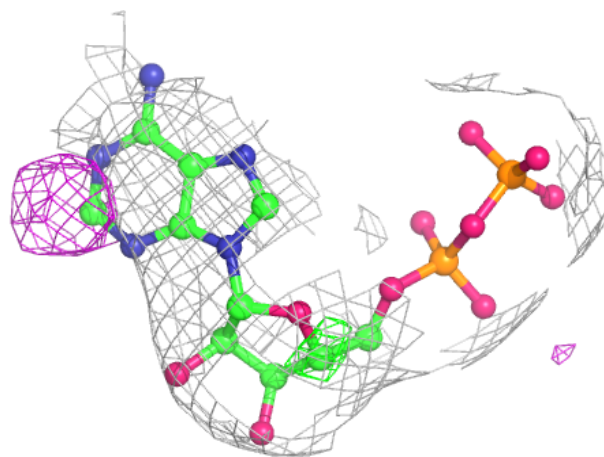

Electron density around ADP I 501:

$2mF_o-DF_c$ (at 0.7 rmsd) in gray
 mF_o-DF_c (at 3 rmsd) in purple (negative)
and green (positive)

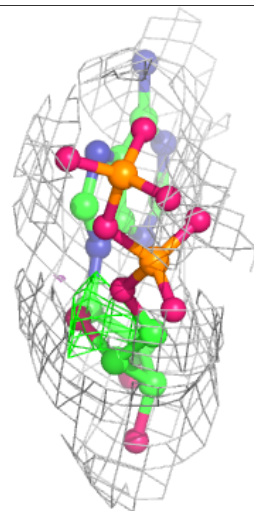
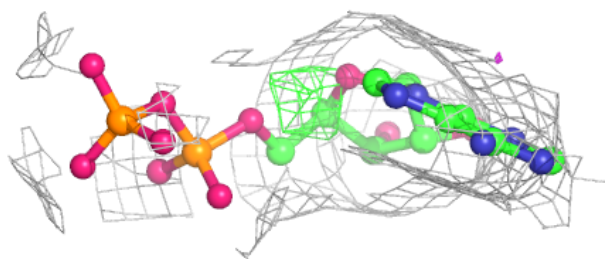
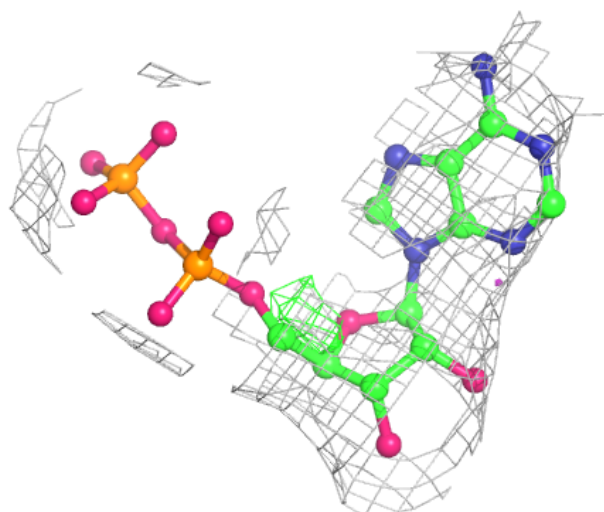

Electron density around ADP J 501:

$2mF_o-DF_c$ (at 0.7 rmsd) in gray
 mF_o-DF_c (at 3 rmsd) in purple (negative)
and green (positive)

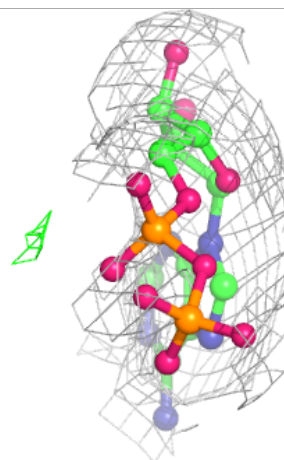
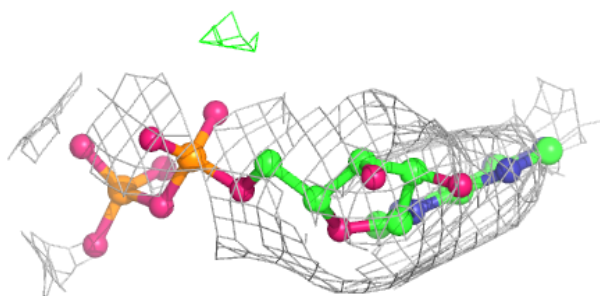
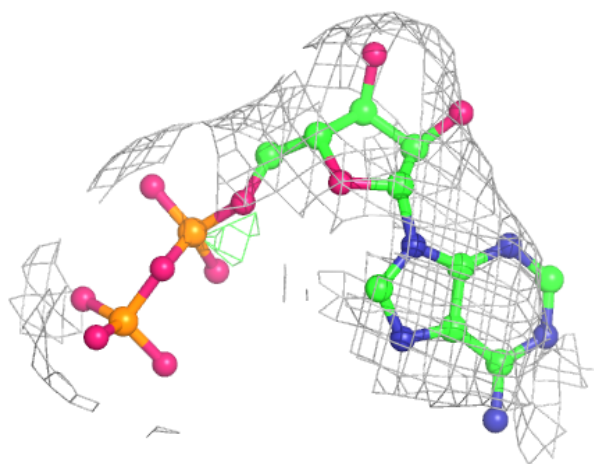

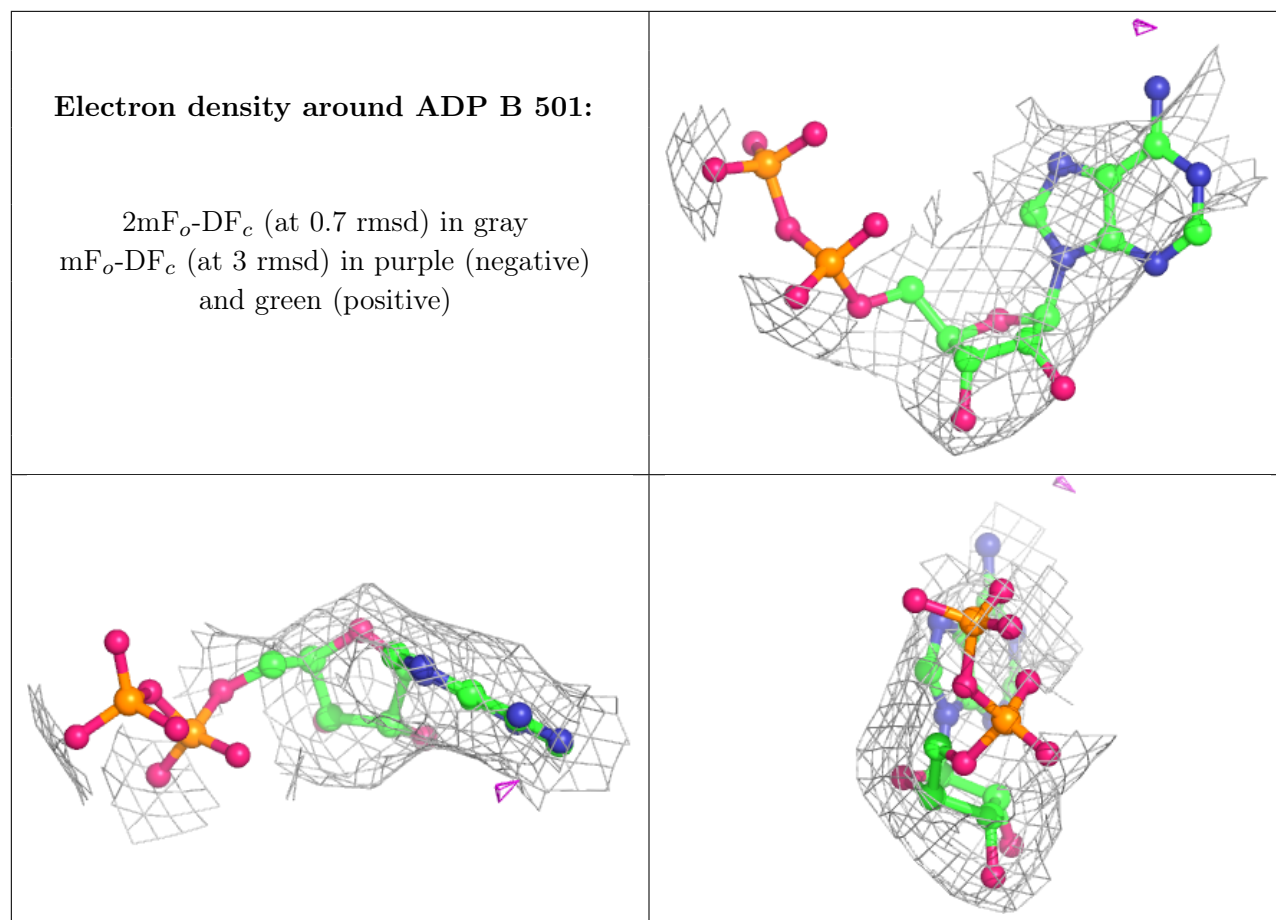

Electron density around ADP K 501:

$2mF_o-DF_c$ (at 0.7 rmsd) in gray
 mF_o-DF_c (at 3 rmsd) in purple (negative)
and green (positive)

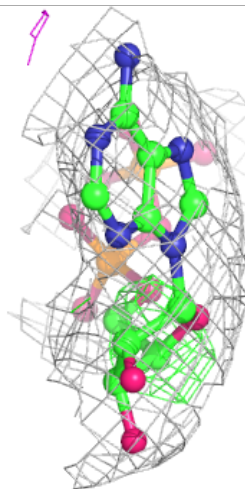
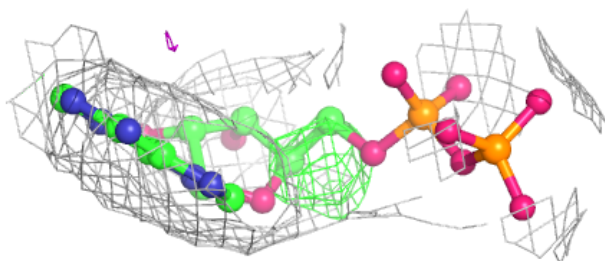
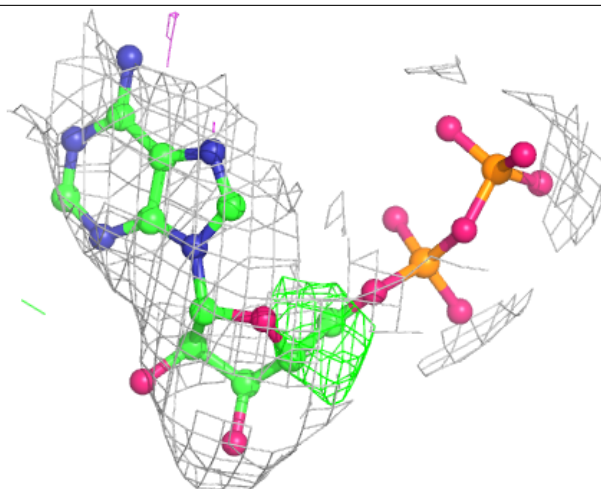

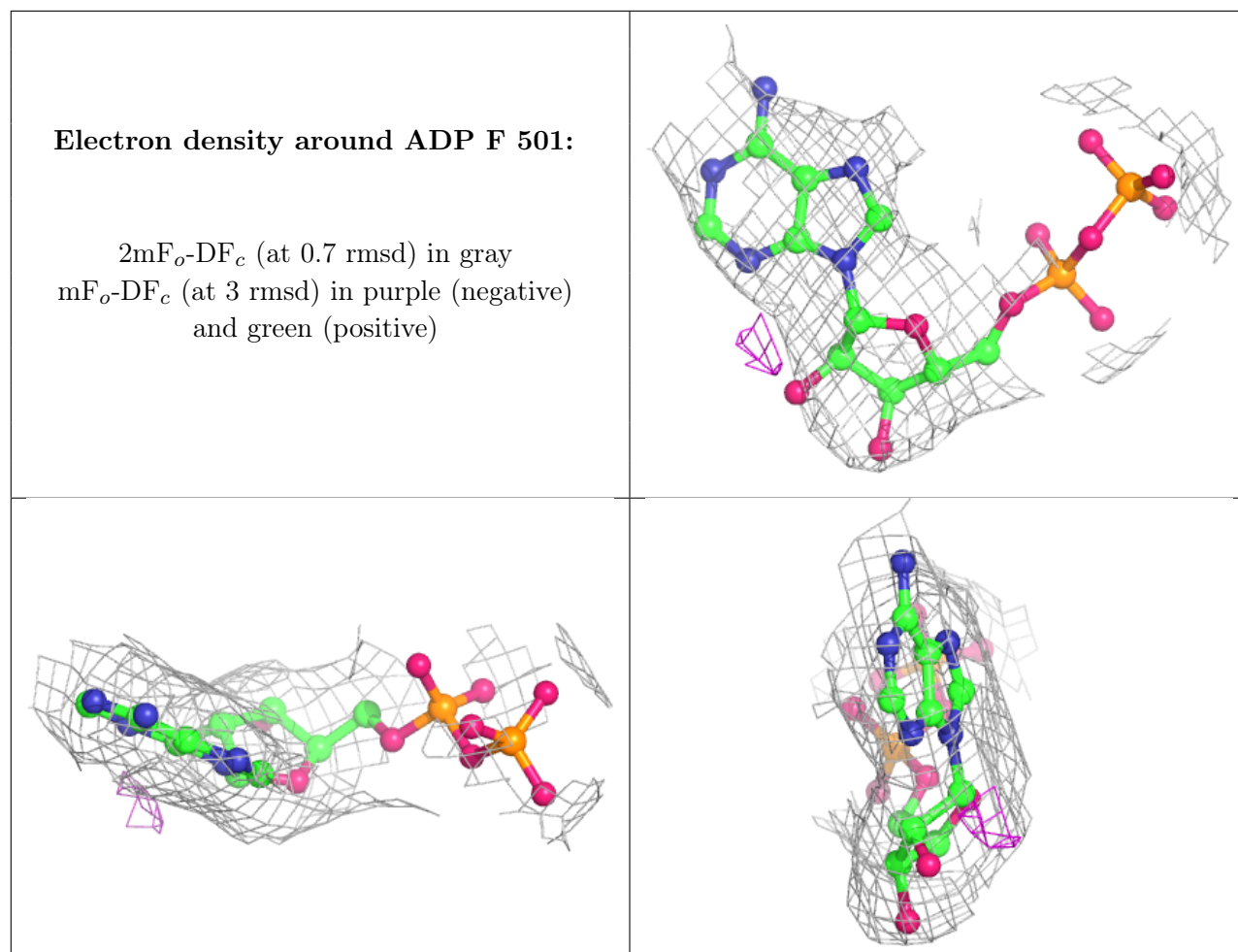

Electron density around ADP D 501:

$2mF_o-DF_c$ (at 0.7 rmsd) in gray
 mF_o-DF_c (at 3 rmsd) in purple (negative)
and green (positive)

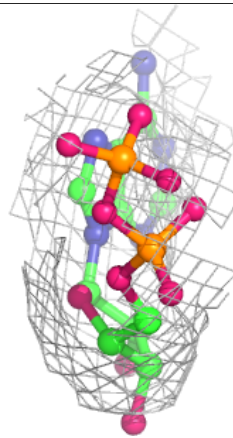
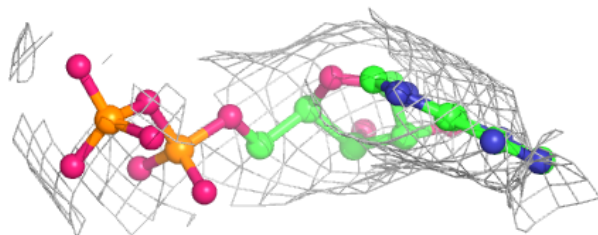
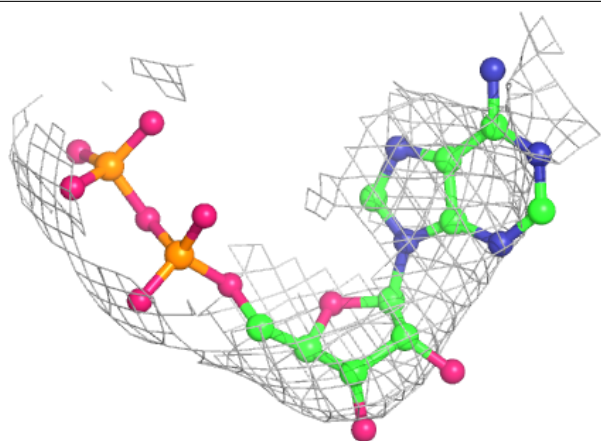

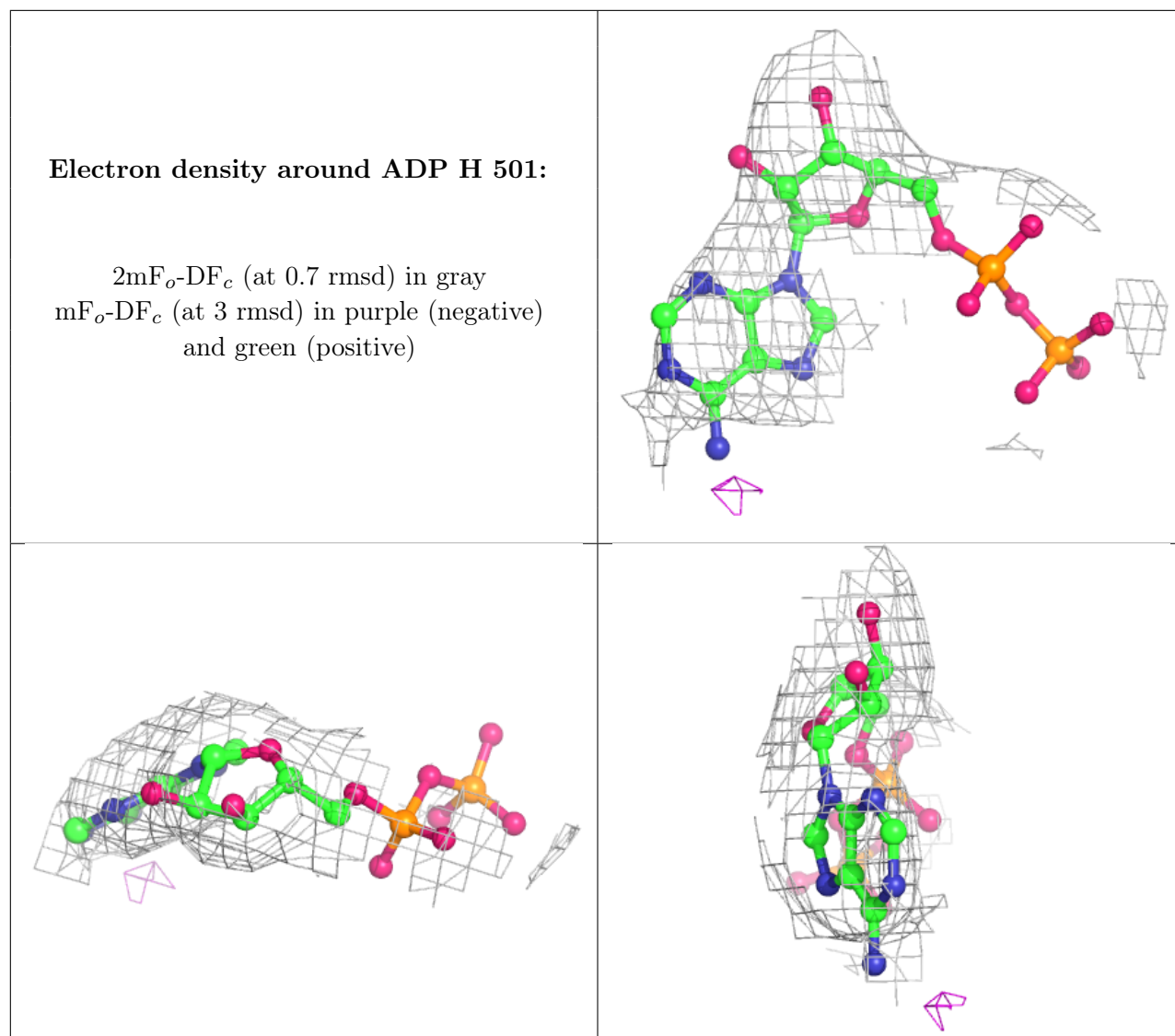

6.5 Other polymers [\(i\)](#)

There are no such residues in this entry.