



wwPDB EM Validation Summary Report ⓘ

Nov 20, 2022 – 01:49 pm GMT

PDB ID : 6QC5
EMDB ID : EMD-4497
Title : Ovine respiratory complex I FRC closed class 1
Authors : Letts, J.A.; Sazanov, L.A.
Deposited on : 2018-12-26
Resolution : 4.30 Å (reported)
Based on initial model : 5LNK

This is a wwPDB EM Validation Summary Report for a publicly released PDB entry.

We welcome your comments at validation@mail.wwpdb.org

A user guide is available at

<https://www.wwpdb.org/validation/2017/EMValidationReportHelp>

with specific help available everywhere you see the ⓘ symbol.

The types of validation reports are described at

<http://www.wwpdb.org/validation/2017/FAQs#types>.

The following versions of software and data (see [references ⓘ](#)) were used in the production of this report:

EMDB validation analysis : 0.0.1.dev43
Mogul : 1.8.4, CSD as541be (2020)
MolProbity : 4.02b-467
buster-report : 1.1.7 (2018)
Percentile statistics : 20191225.v01 (using entries in the PDB archive December 25th 2019)
MapQ : 1.9.9
Ideal geometry (proteins) : Engh & Huber (2001)
Ideal geometry (DNA, RNA) : Parkinson et al. (1996)
Validation Pipeline (wwPDB-VP) : 2.31.2

1 Overall quality at a glance

The following experimental techniques were used to determine the structure:

ELECTRON MICROSCOPY

The reported resolution of this entry is 4.30 Å.

Percentile scores (ranging between 0-100) for global validation metrics of the entry are shown in the following graphic. The table shows the number of entries on which the scores are based.

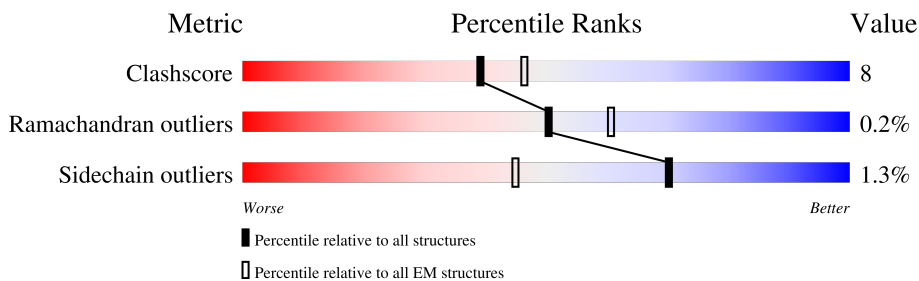

Metric	Whole archive (#Entries)	EM structures (#Entries)
Clashscore	158937	4297
Ramachandran outliers	154571	4023
Sidechain outliers	154315	3826

The table below summarises the geometric issues observed across the polymeric chains and their fit to the map. The red, orange, yellow and green segments of the bar indicate the fraction of residues that contain outliers for ≥ 3 , 2, 1 and 0 types of geometric quality criteria respectively. A grey segment represents the fraction of residues that are not modelled. The numeric value for each fraction is indicated below the corresponding segment, with a dot representing fractions $\leq 5\%$. The upper red bar (where present) indicates the fraction of residues that have poor fit to the EM map (all-atom inclusion $< 40\%$). The numeric value is given above the bar.

Mol	Chain	Length	Quality of chain
1	V1	445	
2	V2	217	
3	S1	704	
4	S2	430	
5	S3	228	
6	S7	179	
7	S8	176	
8	V3	75	

Continued on next page...

Continued from previous page...

Mol	Chain	Length	Quality of chain
9	S6	96	26% 76% 23%
10	S4	133	26% 77% 18% 5%
11	A9	338	32% 71% 21% 8%
12	A2	98	20% 63% 20% 16%
13	A5	115	23% 79% 17%
14	A6	127	30% 79% 11% 10%
15	A7	112	44% 57% 27% 15%
16	AL	145	47% 60% 25% 15%
17	AA	88	51% 69% 22% 9%
17	AB	88	44% 86% 13%
18	AM	143	31% 80% 17%
19	D3	115	67% 84% 16%
20	D1	318	48% 68% 31%
21	D6	175	57% 88% 12%
22	4L	98	67% 81% 17%
23	D5	606	53% 78% 21%
24	D4	459	40% 81% 19%
25	D2	347	39% 77% 23%
26	AK	140	66% 88% 11%
27	B5	143	36% 80% 17%
28	A8	171	31% 80% 20%
29	BJ	175	34% 74% 23%
30	AJ	320	43% 82% 17%
31	S5	105	31% 73% 20% 6%
32	A3	83	36% 72% 17% 11%

Continued on next page...

Continued from previous page...

Mol	Chain	Length	Quality of chain
33	B3	97	
34	C2	120	
35	B4	128	
36	B6	127	
37	B7	136	
38	B9	178	
39	B2	72	
40	B8	158	
41	BK	125	
42	C1	49	
43	B1	57	
44	A1	70	

2 Entry composition [i](#)

There are 52 unique types of molecules in this entry. The entry contains 65691 atoms, of which 0 are hydrogens and 0 are deuteriums.

In the tables below, the AltConf column contains the number of residues with at least one atom in alternate conformation and the Trace column contains the number of residues modelled with at most 2 atoms.

- Molecule 1 is a protein called NADH dehydrogenase [ubiquinone] flavoprotein 1, mitochondrial.

Mol	Chain	Residues	Atoms					AltConf	Trace
			Total	C	N	O	S		
1	V1	430	3312	2086	593	613	20	0	0

- Molecule 2 is a protein called NDUFV2.

Mol	Chain	Residues	Atoms					AltConf	Trace
			Total	C	N	O	S		
2	V2	212	1647	1052	277	308	10	0	0

- Molecule 3 is a protein called NADH:ubiquinone oxidoreductase core subunit S1.

Mol	Chain	Residues	Atoms					AltConf	Trace
			Total	C	N	O	S		
3	S1	688	5275	3301	922	1011	41	0	0

- Molecule 4 is a protein called NDUFS2,NADH:ubiquinone oxidoreductase core subunit S2.

Mol	Chain	Residues	Atoms					AltConf	Trace
			Total	C	N	O	S		
4	S2	430	3455	2205	594	631	25	0	0

- Molecule 5 is a protein called NADH:ubiquinone oxidoreductase core subunit S3.

Mol	Chain	Residues	Atoms					AltConf	Trace
			Total	C	N	O	S		
5	S3	208	1726	1112	296	315	3	0	0

- Molecule 6 is a protein called NADH:ubiquinone oxidoreductase core subunit S7,NDUFS7.

Mol	Chain	Residues	Atoms					AltConf	Trace
			Total	C	N	O	S		
6	S7	156	1248	795	225	214	14	0	0

- Molecule 7 is a protein called NDUFS8.

Mol	Chain	Residues	Atoms					AltConf	Trace
			Total	C	N	O	S		
7	S8	176	1415	889	243	271	12	0	0

- Molecule 8 is a protein called NDUFV3.

Mol	Chain	Residues	Atoms					AltConf	Trace
			Total	C	N	O	S		
8	V3	41	345	215	63	66	1	0	0

- Molecule 9 is a protein called NDUFS6.

Mol	Chain	Residues	Atoms					AltConf	Trace
			Total	C	N	O	S		
9	S6	95	737	451	139	144	3	0	0

- Molecule 10 is a protein called NADH:ubiquinone oxidoreductase subunit S4.

Mol	Chain	Residues	Atoms					AltConf	Trace
			Total	C	N	O	S		
10	S4	126	1025	646	182	194	3	0	0

- Molecule 11 is a protein called NADH:ubiquinone oxidoreductase subunit A9.

Mol	Chain	Residues	Atoms					AltConf	Trace
			Total	C	N	O	S		
11	A9	311	2512	1614	451	442	5	0	0

- Molecule 12 is a protein called NADH dehydrogenase [ubiquinone] 1 alpha subcomplex subunit 2.

Mol	Chain	Residues	Atoms					AltConf	Trace
			Total	C	N	O	S		
12	A2	82	665	419	124	120	2	0	0

- Molecule 13 is a protein called NDUFA5.

Mol	Chain	Residues	Atoms					AltConf	Trace
			Total	C	N	O	S		
13	A5	111	901	583	151	165	2	0	0

- Molecule 14 is a protein called NADH:ubiquinone oxidoreductase subunit A6.

Mol	Chain	Residues	Atoms					AltConf	Trace
			Total	C	N	O	S		
14	A6	114	969	619	180	166	4	0	0

- Molecule 15 is a protein called NDUFA7.

Mol	Chain	Residues	Atoms					AltConf	Trace
			Total	C	N	O	S		
15	A7	95	757	473	144	137	3	0	0

- Molecule 16 is a protein called NADH dehydrogenase [ubiquinone] 1 alpha subcomplex subunit 12.

Mol	Chain	Residues	Atoms					AltConf	Trace
			Total	C	N	O	S		
16	AL	123	1044	676	182	182	4	0	0

- Molecule 17 is a protein called Acyl carrier protein.

Mol	Chain	Residues	Atoms					AltConf	Trace
			Total	C	N	O	S		
17	AA	80	645	416	96	128	5	0	0
17	AB	87	702	451	103	143	5	0	0

- Molecule 18 is a protein called NDUFA13.

Mol	Chain	Residues	Atoms					AltConf	Trace
			Total	C	N	O	S		
18	AM	139	1143	733	200	201	9	0	0

- Molecule 19 is a protein called NADH-ubiquinone oxidoreductase chain 3.

Mol	Chain	Residues	Atoms					AltConf	Trace
			Total	C	N	O	S		
19	D3	115	923	621	133	162	7	0	0

- Molecule 20 is a protein called NADH-ubiquinone oxidoreductase chain 1.

Mol	Chain	Residues	Atoms					AltConf	Trace
			Total	C	N	O	S		
20	D1	318	2529	1704	384	422	19	0	0

- Molecule 21 is a protein called NADH-ubiquinone oxidoreductase chain 6.

Mol	Chain	Residues	Atoms					AltConf	Trace
			Total	C	N	O	S		
21	D6	175	1345	904	192	236	13	0	0

- Molecule 22 is a protein called NADH-ubiquinone oxidoreductase chain 4L.

Mol	Chain	Residues	Atoms					AltConf	Trace
			Total	C	N	O	S		
22	4L	98	748	489	112	132	15	0	0

- Molecule 23 is a protein called NADH-ubiquinone oxidoreductase chain 5.

Mol	Chain	Residues	Atoms					AltConf	Trace
			Total	C	N	O	S		
23	D5	606	4805	3187	746	828	44	0	0

- Molecule 24 is a protein called NADH-ubiquinone oxidoreductase chain 4.

Mol	Chain	Residues	Atoms					AltConf	Trace
			Total	C	N	O	S		
24	D4	459	3646	2428	571	607	40	0	0

- Molecule 25 is a protein called NADH-ubiquinone oxidoreductase chain 2.

Mol	Chain	Residues	Atoms					AltConf	Trace
			Total	C	N	O	S		
25	D2	347	2724	1808	416	460	40	0	0

- Molecule 26 is a protein called NDUFA11.

Mol	Chain	Residues	Atoms					AltConf	Trace
			Total	C	N	O	S		
26	AK	140	1025	654	175	190	6	0	0

- Molecule 27 is a protein called NADH:ubiquinone oxidoreductase subunit B5.

Mol	Chain	Residues	Atoms					AltConf	Trace
			Total	C	N	O	S		
27	B5	139	1156	761	194	199	2	0	0

- Molecule 28 is a protein called NADH dehydrogenase [ubiquinone] 1 alpha subcomplex subunit 8.

Mol	Chain	Residues	Atoms					AltConf	Trace
			Total	C	N	O	S		
28	A8	171	1404	889	253	252	10	0	0

- Molecule 29 is a protein called NDUFB10.

Mol	Chain	Residues	Atoms					AltConf	Trace
			Total	C	N	O	S		
29	BJ	171	1441	905	266	262	8	0	0

- Molecule 30 is a protein called NADH dehydrogenase [ubiquinone] 1 alpha subcomplex subunit 10, mitochondrial.

Mol	Chain	Residues	Atoms					AltConf	Trace
			Total	C	N	O	S		
30	AJ	319	2583	1653	430	490	10	0	0

- Molecule 31 is a protein called NADH:ubiquinone oxidoreductase subunit S5.

Mol	Chain	Residues	Atoms					AltConf	Trace
			Total	C	N	O	S		
31	S5	99	822	520	154	142	6	0	0

- Molecule 32 is a protein called NADH:ubiquinone oxidoreductase subunit A3.

Mol	Chain	Residues	Atoms					AltConf	Trace
			Total	C	N	O	S		
32	A3	74	582	379	96	105	2	0	0

- Molecule 33 is a protein called NADH:ubiquinone oxidoreductase subunit B3.

Mol	Chain	Residues	Atoms					AltConf	Trace
			Total	C	N	O	S		
33	B3	73	578	378	100	98	2	0	0

- Molecule 34 is a protein called NADH dehydrogenase [ubiquinone] 1 subunit C2.

Mol	Chain	Residues	Atoms					AltConf	Trace
			Total	C	N	O	S		
34	C2	119	997	647	174	172	4	0	0

- Molecule 35 is a protein called NADH:ubiquinone oxidoreductase subunit B4.

Mol	Chain	Residues	Atoms					AltConf	Trace
			Total	C	N	O	S		
35	B4	128	1059	675	189	194	1	0	0

- Molecule 36 is a protein called NDUFB6.

Mol	Chain	Residues	Atoms					AltConf	Trace
			Total	C	N	O	S		
36	B6	95	804	530	135	138	1	0	0

- Molecule 37 is a protein called NADH:ubiquinone oxidoreductase subunit B7.

Mol	Chain	Residues	Atoms					AltConf	Trace
			Total	C	N	O	S		
37	B7	119	1026	641	196	181	8	0	0

- Molecule 38 is a protein called NADH:ubiquinone oxidoreductase subunit B9.

Mol	Chain	Residues	Atoms					AltConf	Trace
			Total	C	N	O	S		
38	B9	176	1515	970	278	261	6	0	0

- Molecule 39 is a protein called NADH:ubiquinone oxidoreductase subunit B2.

Mol	Chain	Residues	Atoms					AltConf	Trace
			Total	C	N	O	S		
39	B2	64	555	368	92	94	1	0	0

- Molecule 40 is a protein called NADH dehydrogenase [ubiquinone] 1 beta subcomplex subunit 8, mitochondrial.

Mol	Chain	Residues	Atoms					AltConf	Trace
			Total	C	N	O	S		
40	B8	157	1324	855	217	243	9	0	0

- Molecule 41 is a protein called NDUFB11.

Mol	Chain	Residues	Atoms					AltConf	Trace
			Total	C	N	O	S		
41	BK	102	853	547	141	161	4	0	0

- Molecule 42 is a protein called NDUFC1.

Mol	Chain	Residues	Atoms				AltConf	Trace
			Total	C	N	O		
42	C1	46	391	258	67	66	0	0

- Molecule 43 is a protein called NDUFB1.

Mol	Chain	Residues	Atoms				AltConf	Trace
			Total	C	N	O		
43	B1	52	449	296	79	74	0	0

There are 3 discrepancies between the modelled and reference sequences:

Chain	Residue	Modelled	Actual	Comment	Reference
B1	16	VAL	GLY	conflict	UNP W5QG39
B1	35	ALA	THR	conflict	UNP W5QG39
B1	38	ARG	TRP	conflict	UNP W5QG39

- Molecule 44 is a protein called NDUFA1.

Mol	Chain	Residues	Atoms					AltConf	Trace
			Total	C	N	O	S		
44	A1	70	577	369	106	97	5	0	0

- Molecule 45 is IRON/SULFUR CLUSTER (three-letter code: SF4) (formula: Fe₄S₄).

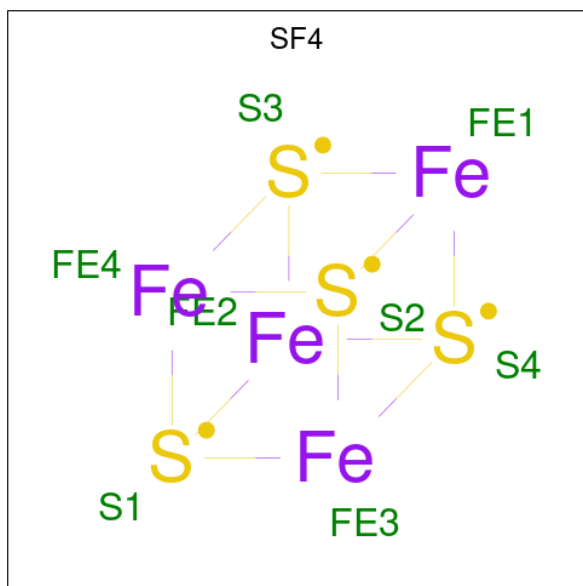

Mol	Chain	Residues	Atoms			AltConf
			Total	Fe	S	
45	V1	1	8	4	4	0

Continued on next page...

Continued from previous page...

Mol	Chain	Residues	Atoms			AltConf
			Total	Fe	S	
45	S1	1	16	8	8	0
45	S1	1	16	8	8	0
45	S7	1	8	4	4	0
45	S8	1	16	8	8	0
45	S8	1	16	8	8	0

- Molecule 46 is FLAVIN MONONUCLEOTIDE (three-letter code: FMN) (formula: C₁₇H₂₁N₄O₉P).

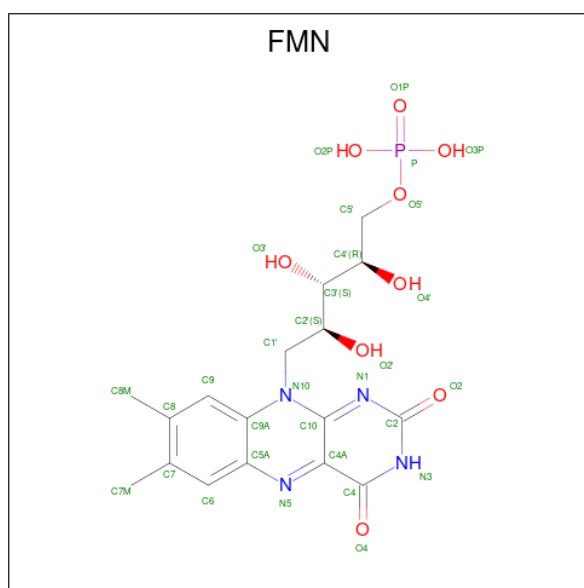

Mol	Chain	Residues	Atoms					AltConf
			Total	C	N	O	P	
46	V1	1	31	17	4	9	1	0

- Molecule 47 is FE2/S2 (INORGANIC) CLUSTER (three-letter code: FES) (formula: Fe₂S₂).



Mol	Chain	Residues	Atoms			AltConf
47	V2	1	Total	Fe	S	0
			4	2	2	
47	S1	1	Total	Fe	S	0
			4	2	2	

- Molecule 48 is 1,2-DIACYL-SN-GLYCERO-3-PHOSPHOETHANOLAMINE (three-letter code: 3PE) (formula: C₄₁H₈₂NO₈P).

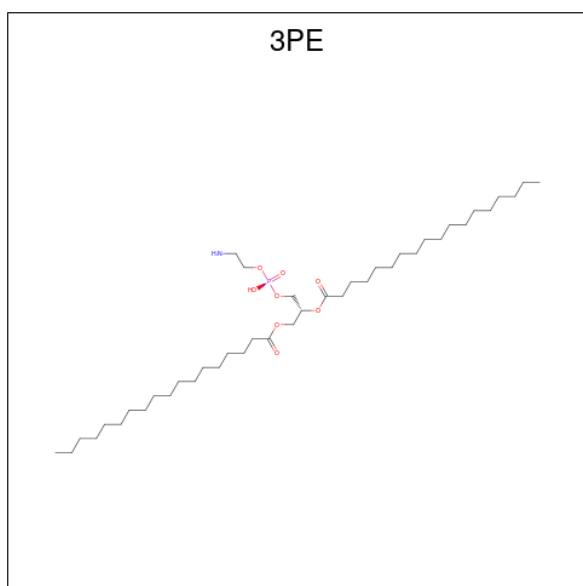

Mol	Chain	Residues	Atoms				AltConf	
48	S2	1	Total	C	N	O	P	0
			40	30	1	8	1	

Continued on next page...

Continued from previous page...

Mol	Chain	Residues	Atoms					AltConf
			Total	C	N	O	P	
48	D5	1	38	28	1	8	1	0

- Molecule 49 is ZINC ION (three-letter code: ZN) (formula: Zn).

Mol	Chain	Residues	Atoms		AltConf
			Total	Zn	
49	S6	1	1	1	0

- Molecule 50 is NADPH DIHYDRO-NICOTINAMIDE-ADENINE-DINUCLEOTIDE PHOSPHATE (three-letter code: NDP) (formula: C₂₁H₃₀N₇O₁₇P₃).

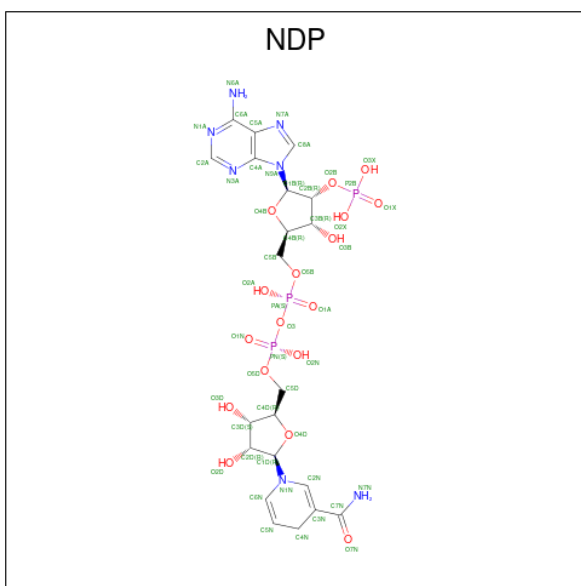

Mol	Chain	Residues	Atoms					AltConf
			Total	C	N	O	P	
50	A9	1	48	21	7	17	3	0

- Molecule 51 is S-[2-({N-[(2S)-2-hydroxy-3,3-dimethyl-4-(phosphonoxy)butanoyl]-beta-alanyl}amino)ethyl] tetradecanethioate (three-letter code: ZMP) (formula: C₂₅H₄₉N₂O₈PS).

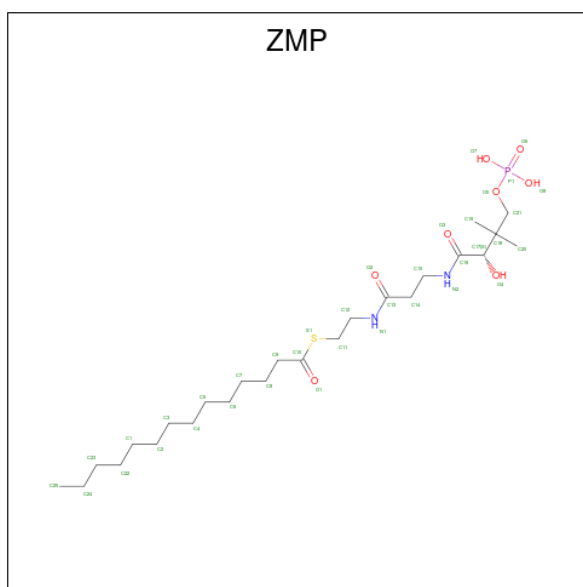

Mol	Chain	Residues	Atoms					AltConf	
			Total	C	N	O	P		S
51	AA	1	34	23	2	7	1	1	0
51	AB	1	31	20	2	7	1	1	0

- Molecule 52 is 1,2-DIACYL-SN-GLYCERO-3-PHOSPHOCHOLINE (three-letter code: PC1) (formula: C₄₄H₈₈NO₈P).

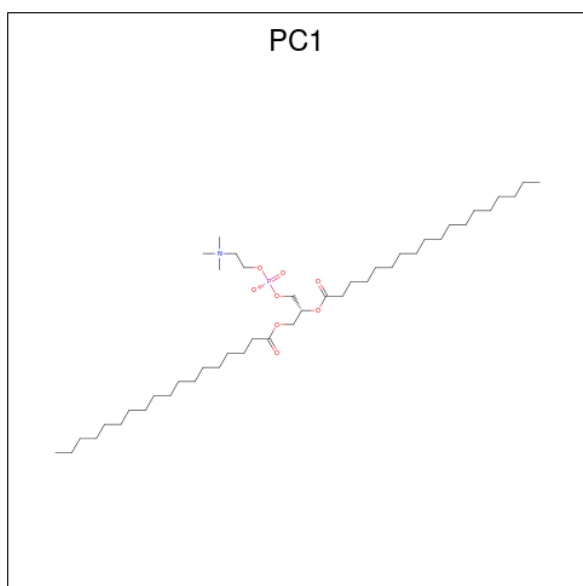

Mol	Chain	Residues	Atoms					AltConf
			Total	C	N	O	P	
52	AK	1	28	18	1	8	1	0

3 Residue-property plots

These plots are drawn for all protein, RNA, DNA and oligosaccharide chains in the entry. The first graphic for a chain summarises the proportions of the various outlier classes displayed in the second graphic. The second graphic shows the sequence view annotated by issues in geometry and atom inclusion in map density. Residues are color-coded according to the number of geometric quality criteria for which they contain at least one outlier: green = 0, yellow = 1, orange = 2 and red = 3 or more. A red diamond above a residue indicates a poor fit to the EM map for this residue (all-atom inclusion < 40%). Stretches of 2 or more consecutive residues without any outlier are shown as a green connector. Residues present in the sample, but not in the model, are shown in grey.

- Molecule 1: NADH dehydrogenase [ubiquinone] flavoprotein 1, mitochondrial



- Molecule 2: NDUFV2

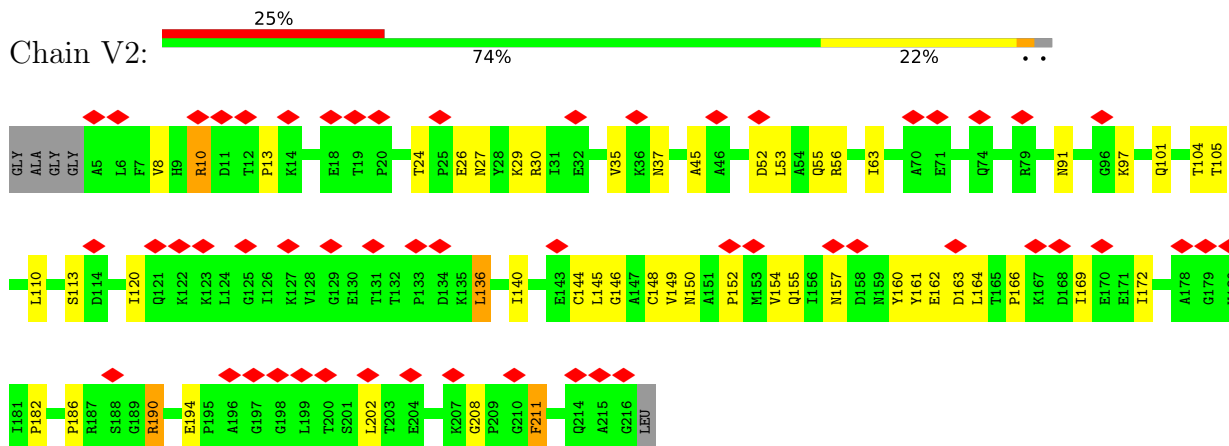

- Molecule 3: NADH:ubiquinone oxidoreductase core subunit S1

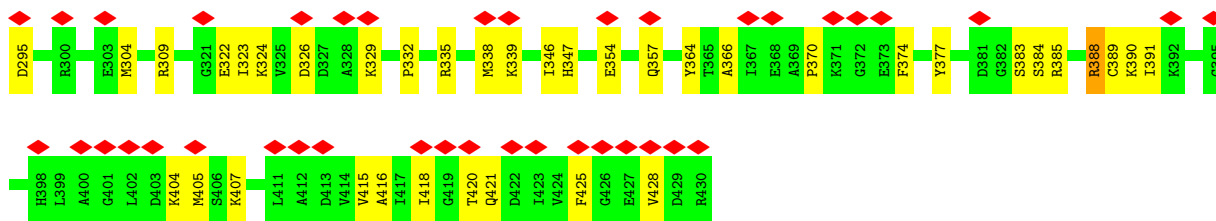

- Molecule 5: NADH:ubiquinone oxidoreductase core subunit S3

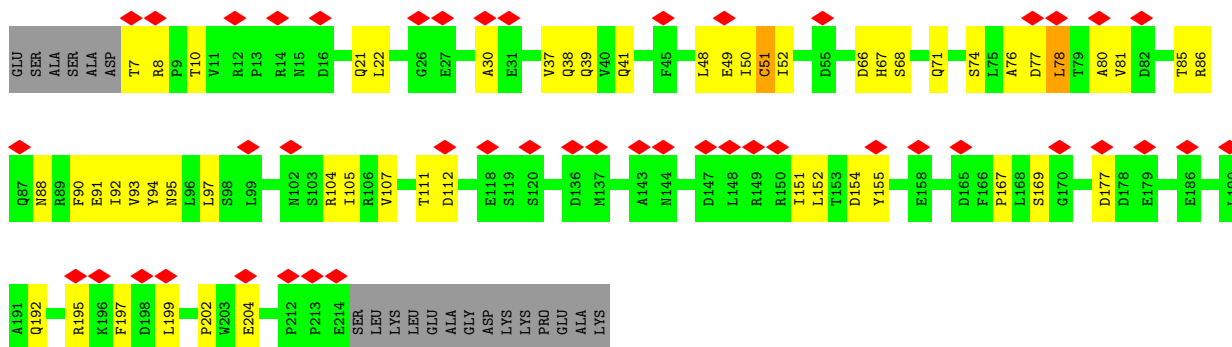

- Molecule 6: NADH:ubiquinone oxidoreductase core subunit S7, NDUFS7

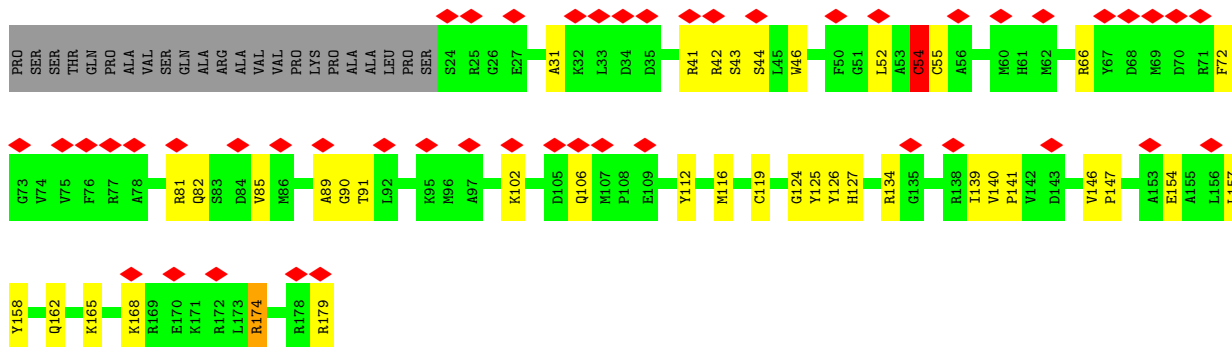

- Molecule 7: NDUFS8

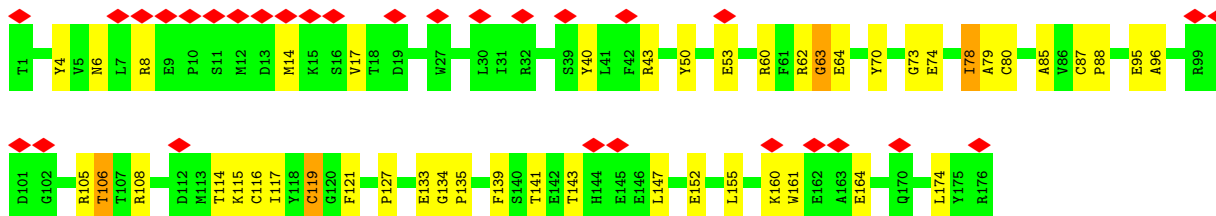
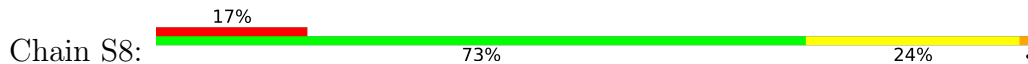

- Molecule 8: NDUFV3

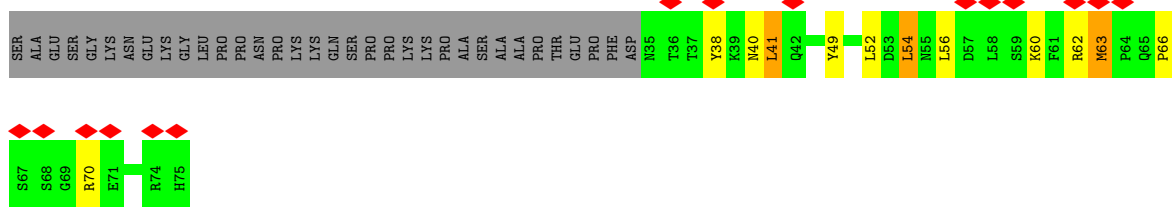
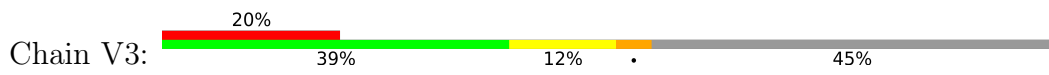

• Molecule 9: NDUFS6

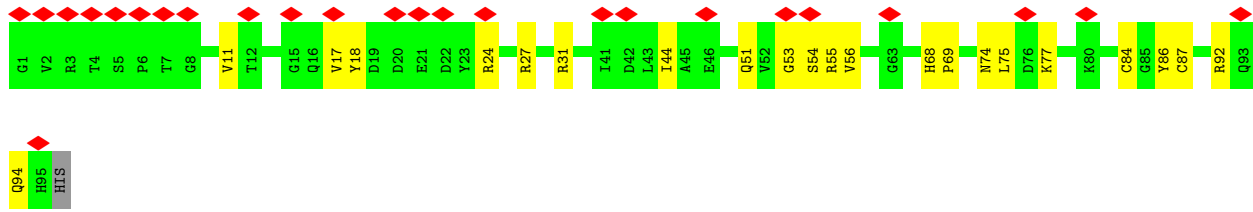
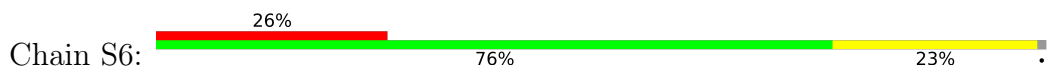

• Molecule 10: NADH:ubiquinone oxidoreductase subunit S4

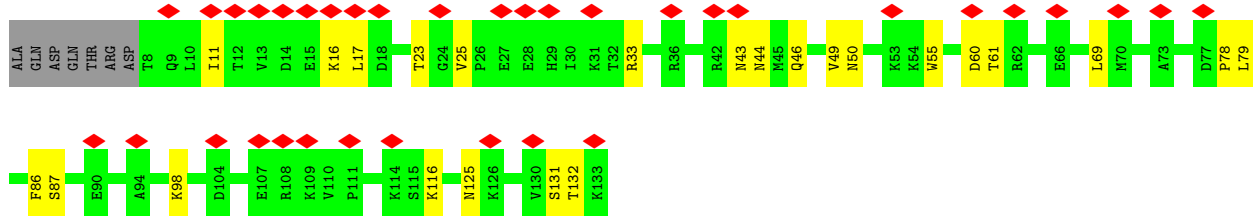
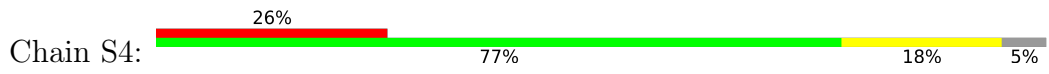

• Molecule 11: NADH:ubiquinone oxidoreductase subunit A9

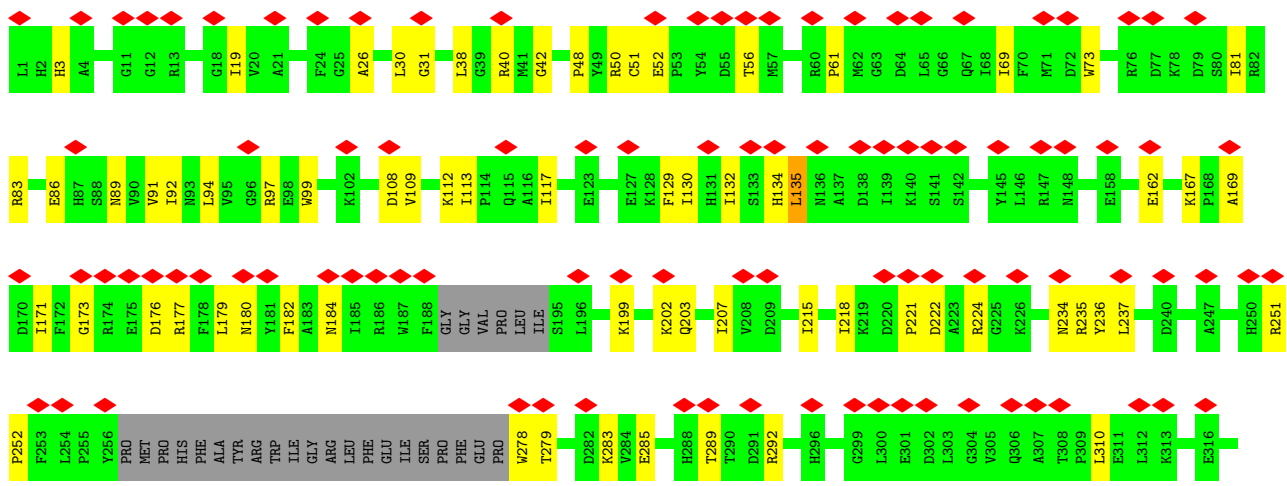
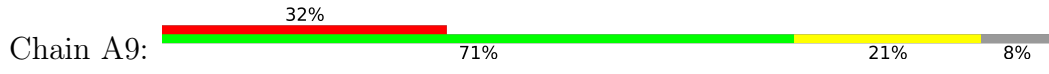

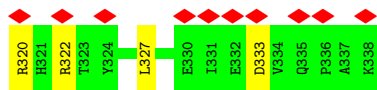

- Molecule 12: NADH dehydrogenase [ubiquinone] 1 alpha subcomplex subunit 2

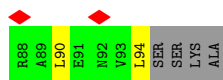
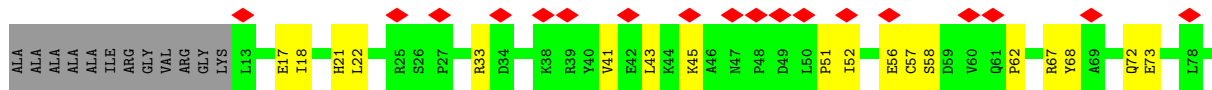

- Molecule 13: NDUFA5

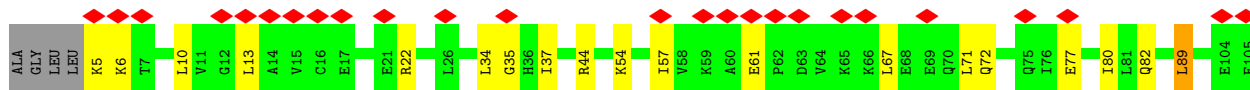
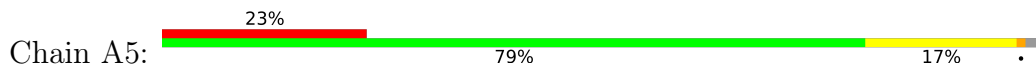

- Molecule 14: NADH:ubiquinone oxidoreductase subunit A6

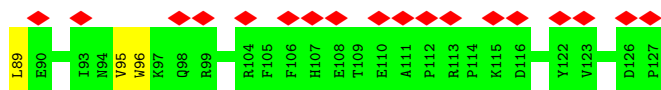
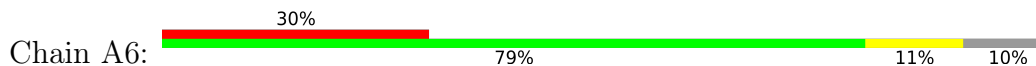

- Molecule 15: NDUFA7

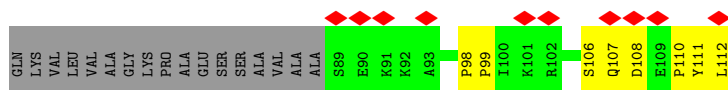
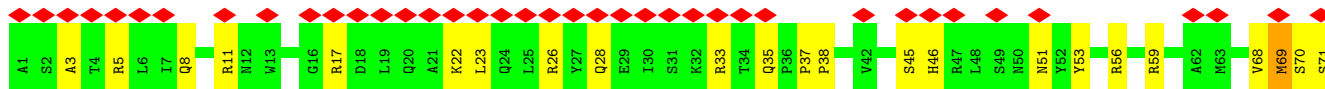

- Molecule 16: NADH dehydrogenase [ubiquinone] 1 alpha subcomplex subunit 12

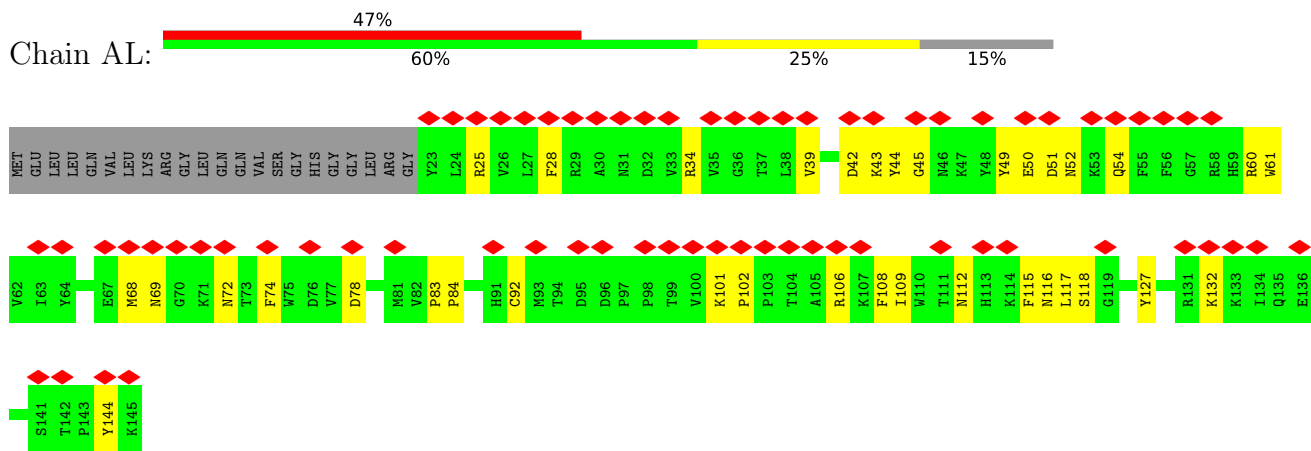

• Molecule 17: Acyl carrier protein

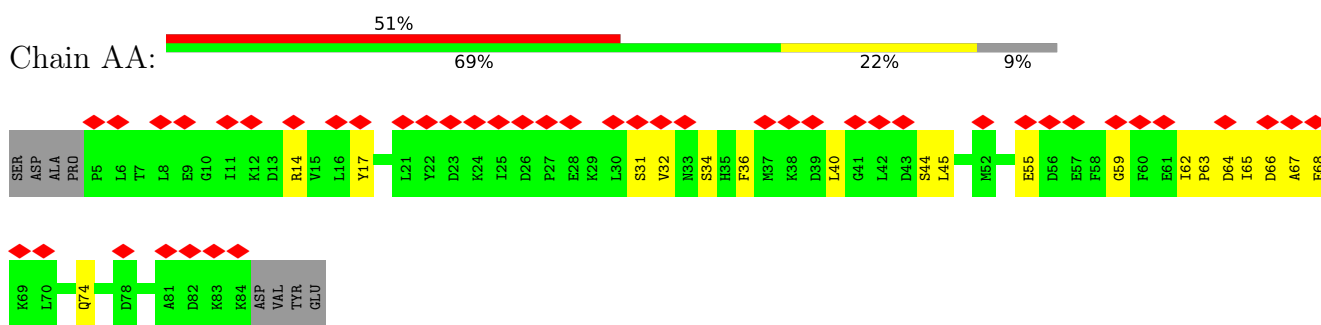

• Molecule 17: Acyl carrier protein

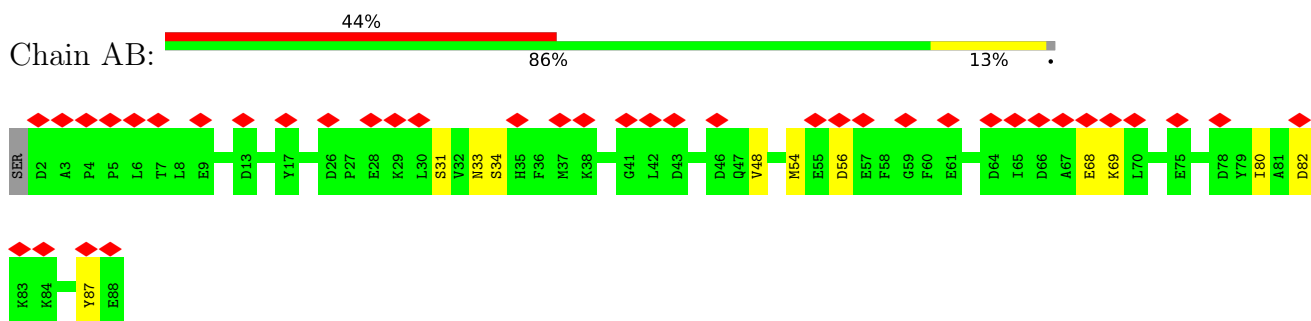

• Molecule 18: NDUFA13

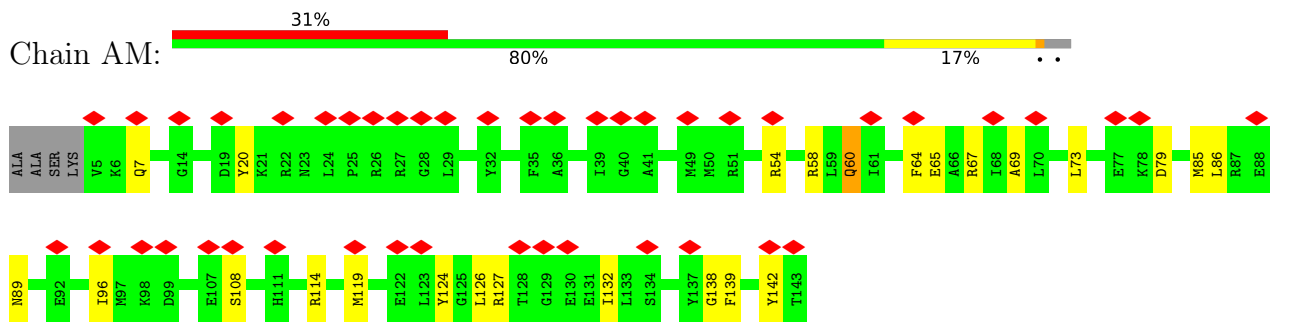

• Molecule 19: NADH-ubiquinone oxidoreductase chain 3



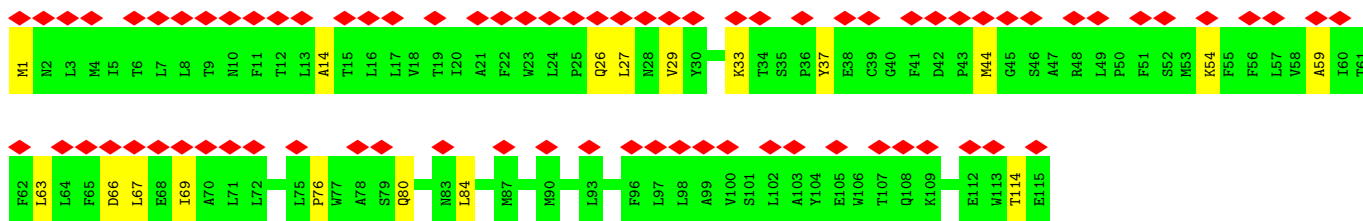

- Molecule 20: NADH-ubiquinone oxidoreductase chain 1

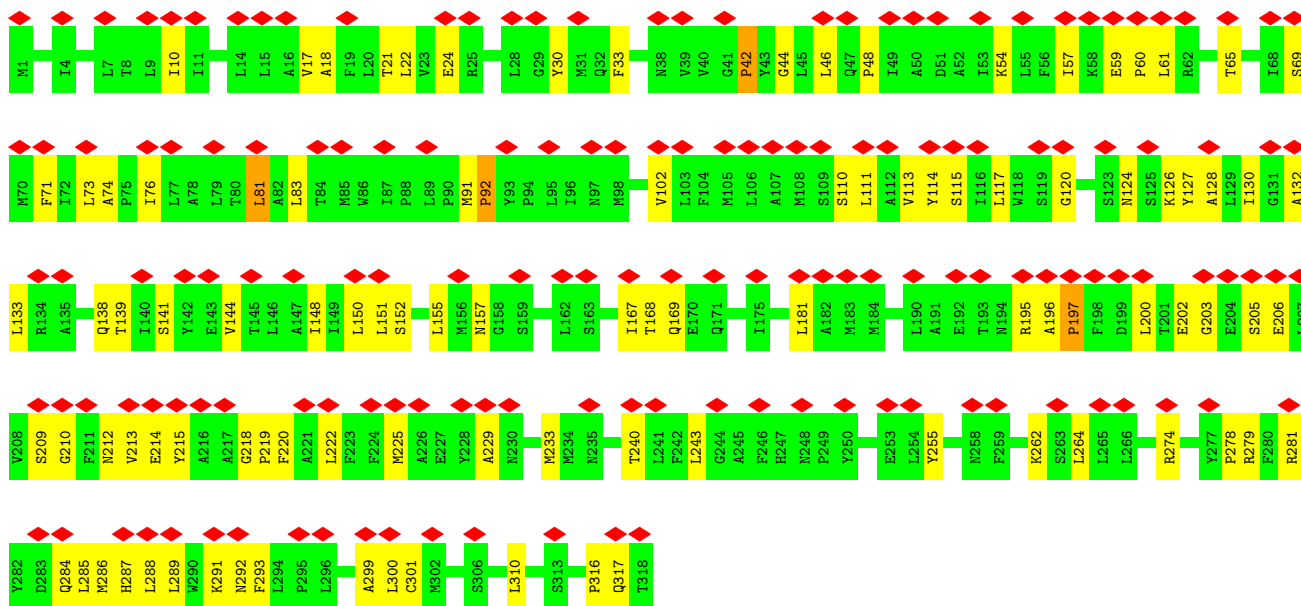

- Molecule 21: NADH-ubiquinone oxidoreductase chain 6

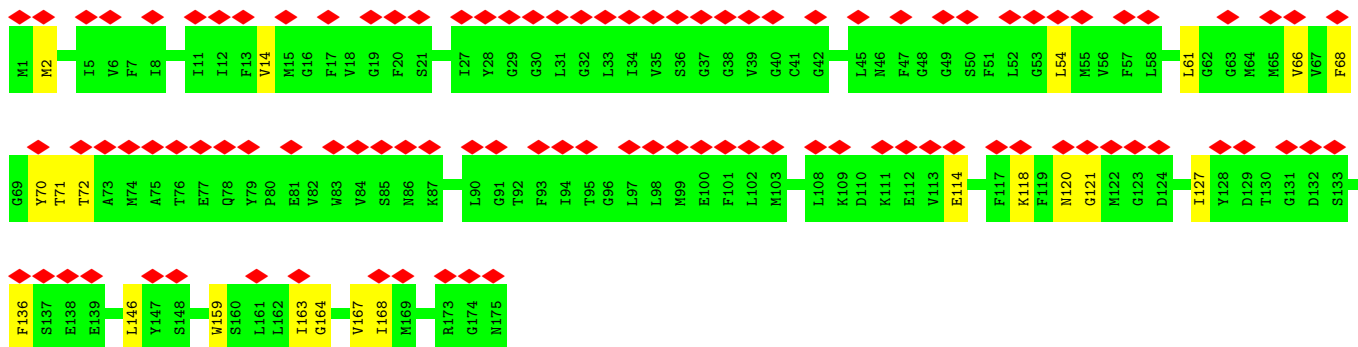
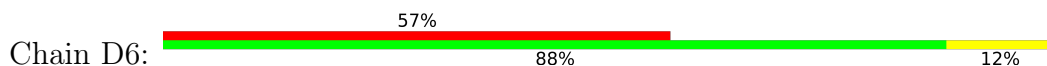

- Molecule 22: NADH-ubiquinone oxidoreductase chain 4L

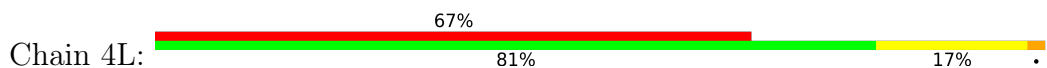

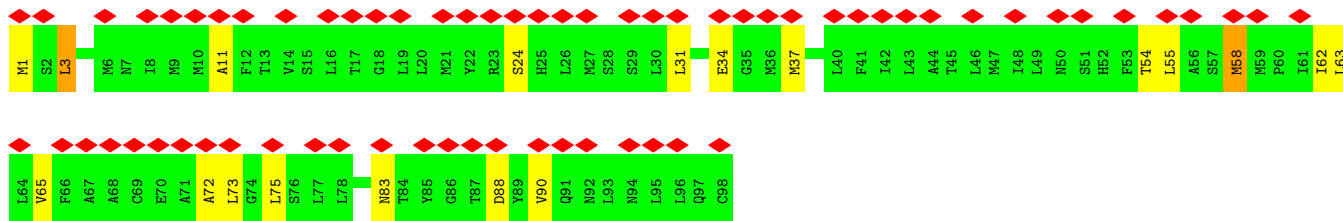

• Molecule 23: NADH-ubiquinone oxidoreductase chain 5

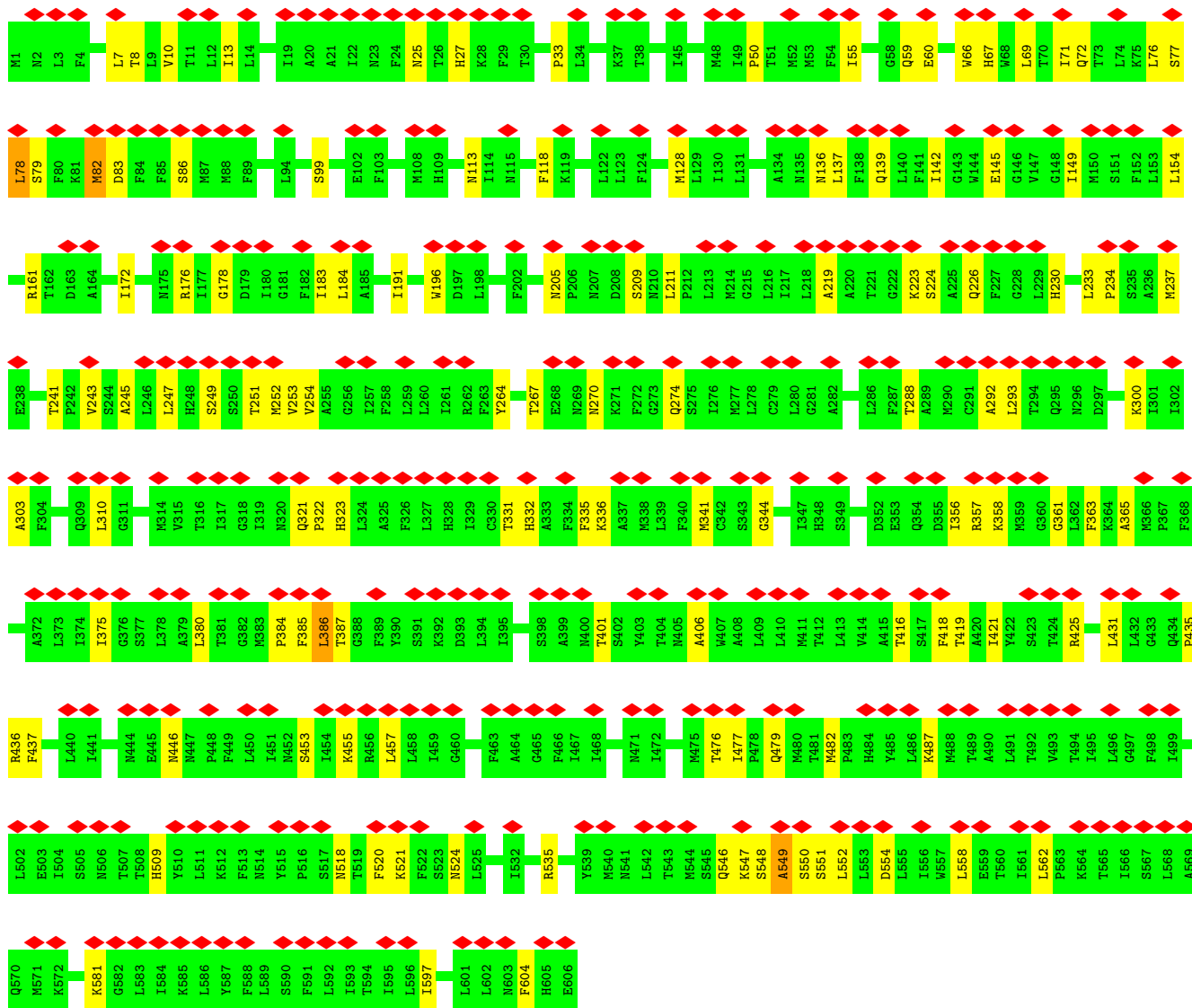
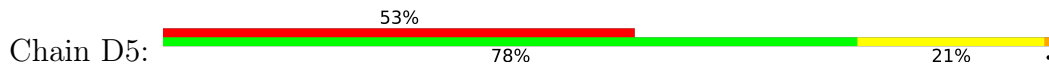

• Molecule 24: NADH-ubiquinone oxidoreductase chain 4

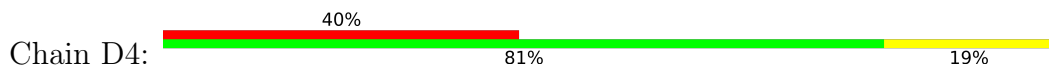

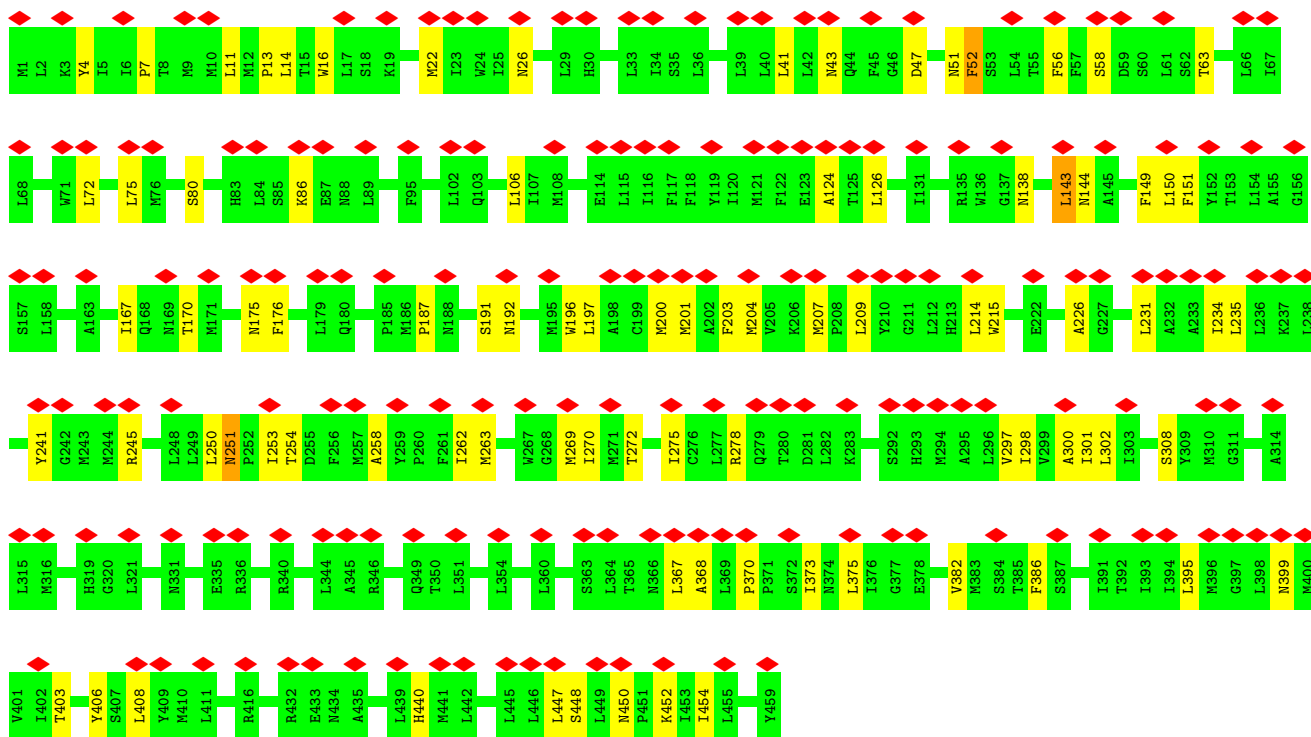

• Molecule 25: NADH-ubiquinone oxidoreductase chain 2

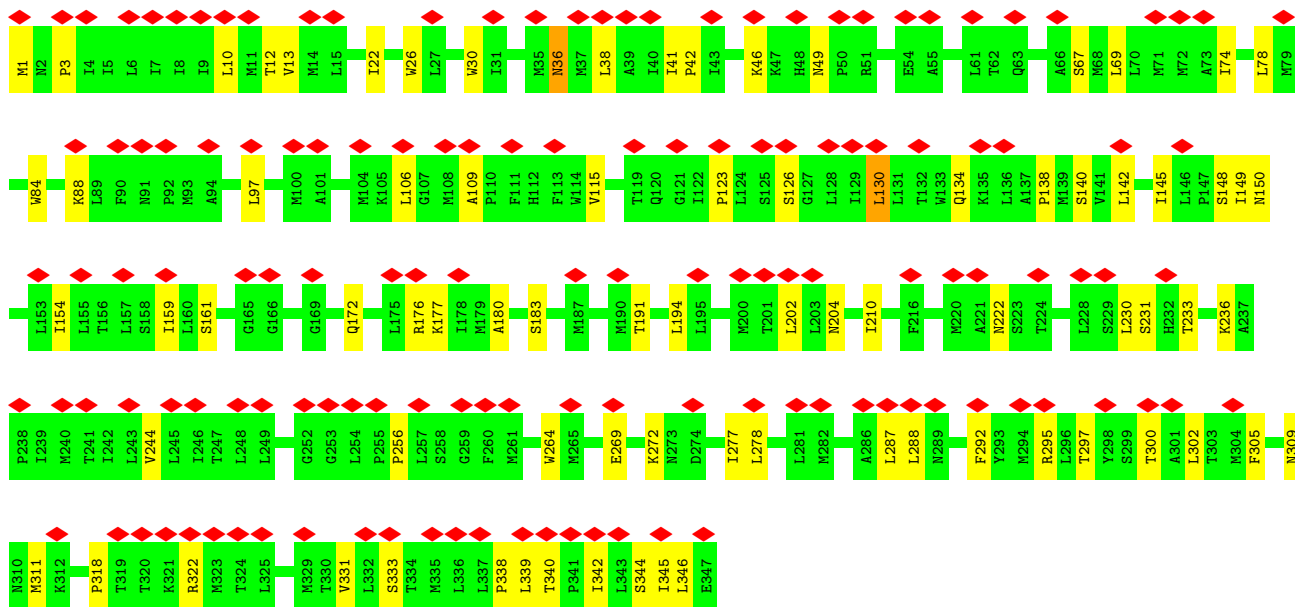
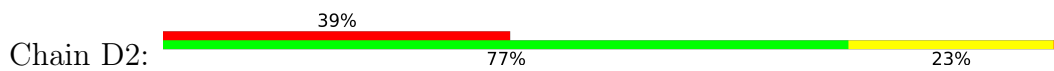

• Molecule 26: NDUFA11

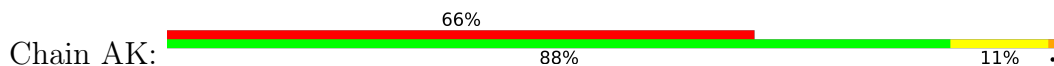

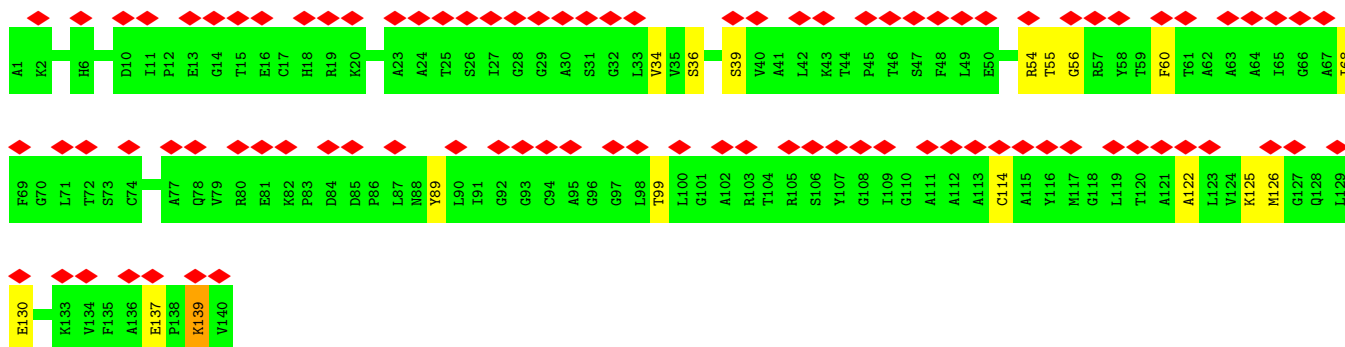

- Molecule 27: NADH:ubiquinone oxidoreductase subunit B5

Chain B5: 36% 80% 17%

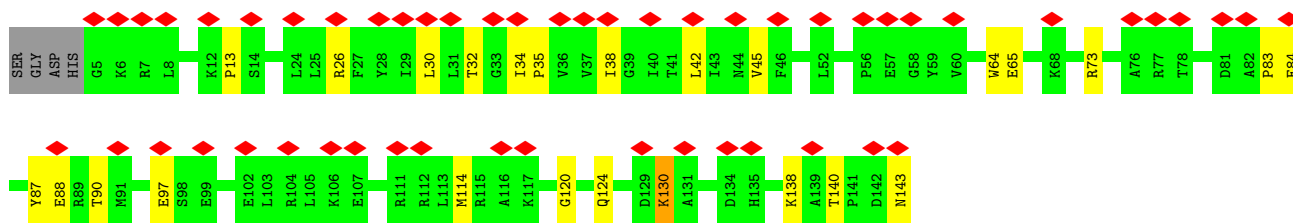

- Molecule 28: NADH dehydrogenase [ubiquinone] 1 alpha subcomplex subunit 8

Chain A8: 31% 80% 20%

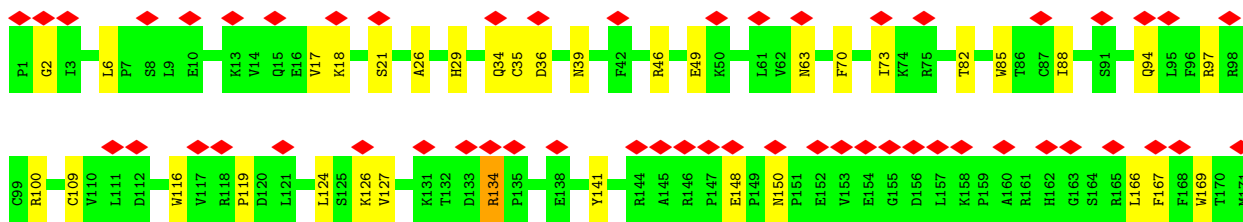

- Molecule 29: NDUFB10

Chain BJ: 34% 74% 23%

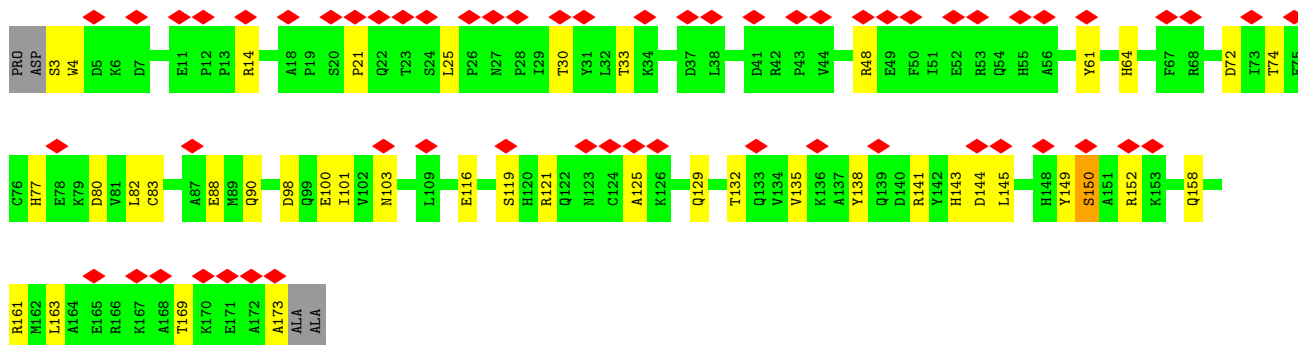

- Molecule 30: NADH dehydrogenase [ubiquinone] 1 alpha subcomplex subunit 10, mitochondrial

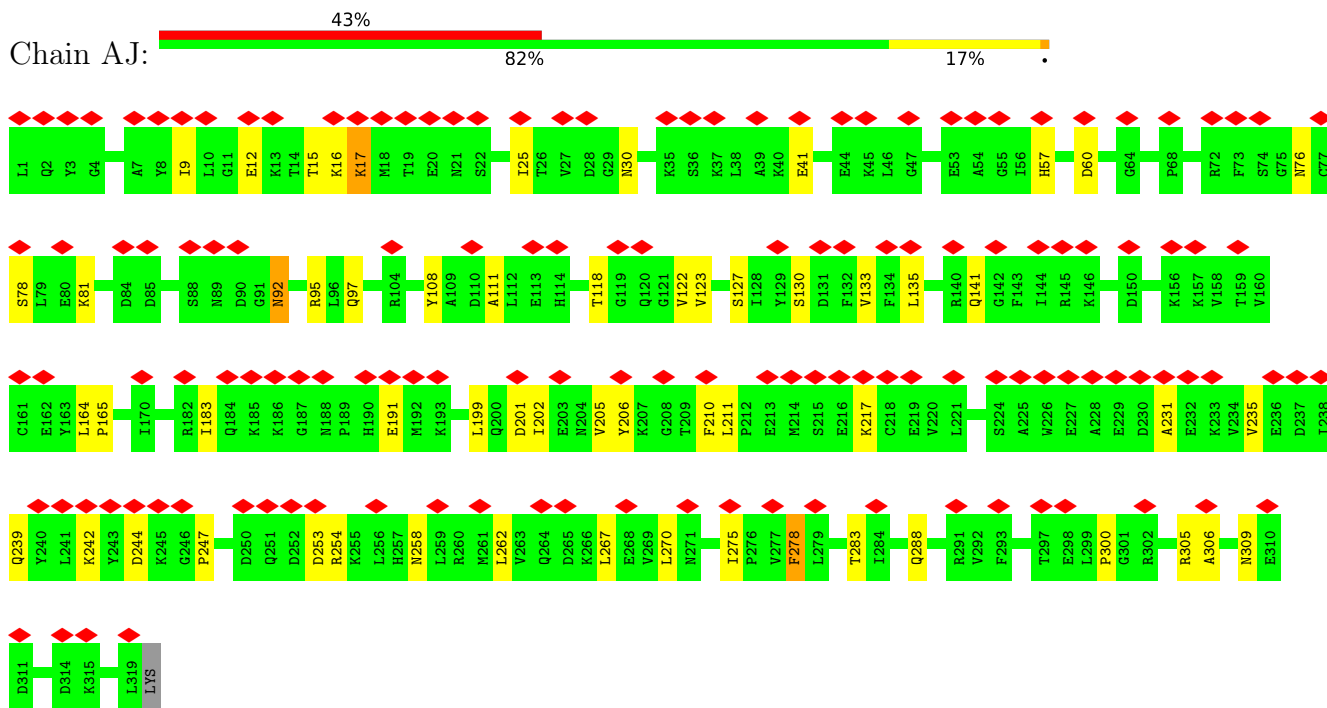

• Molecule 31: NADH:ubiquinone oxidoreductase subunit S5

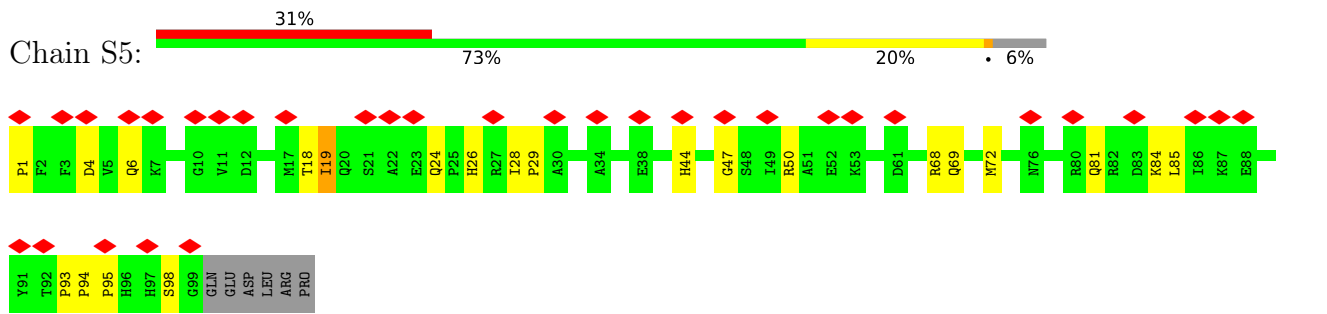

• Molecule 32: NADH:ubiquinone oxidoreductase subunit A3

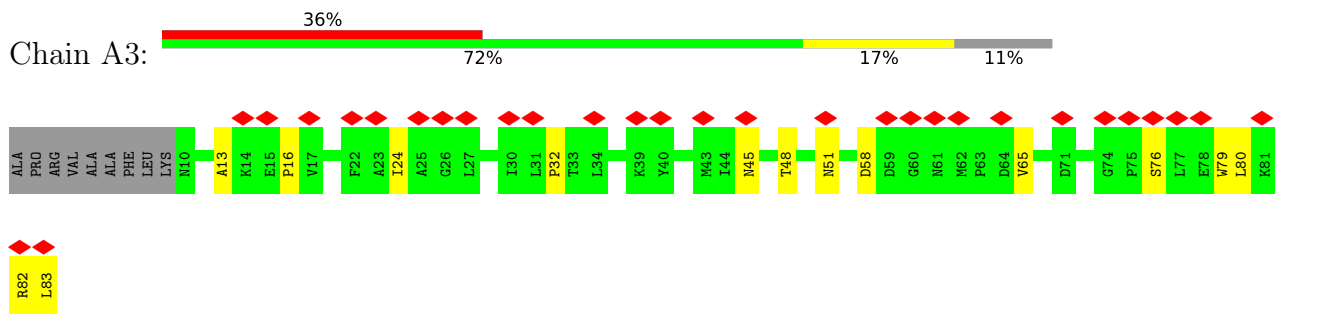

• Molecule 33: NADH:ubiquinone oxidoreductase subunit B3

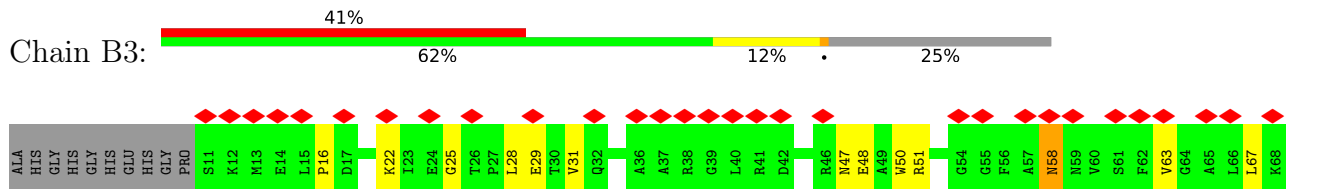

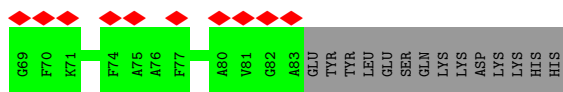

- Molecule 34: NADH dehydrogenase [ubiquinone] 1 subunit C2

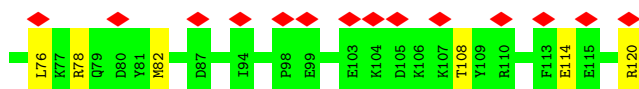
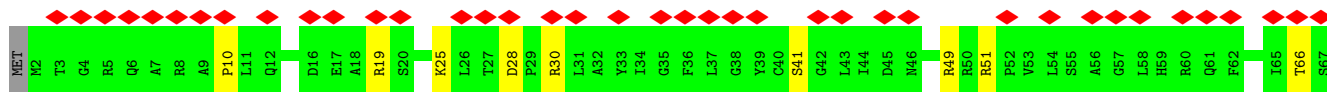
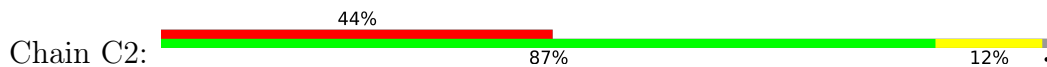

- Molecule 35: NADH:ubiquinone oxidoreductase subunit B4

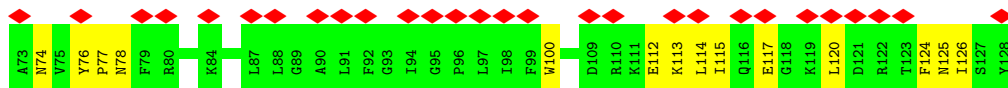
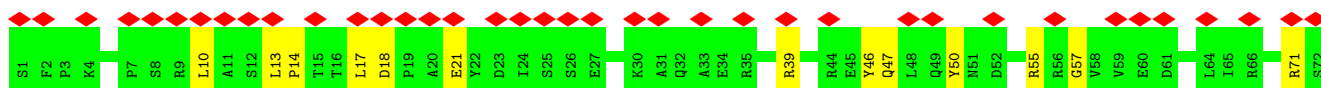
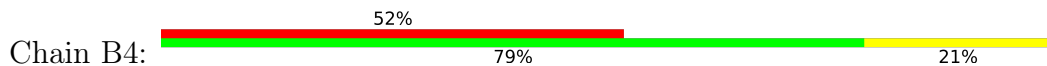

- Molecule 36: NDUFB6

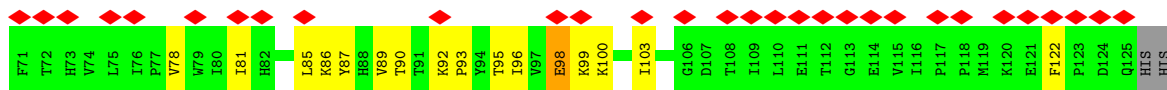
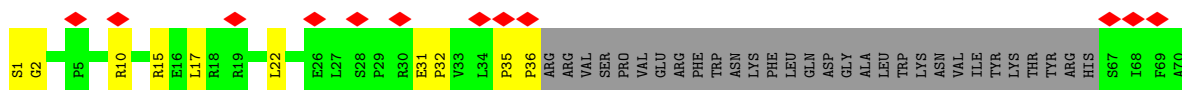

- Molecule 37: NADH:ubiquinone oxidoreductase subunit B7

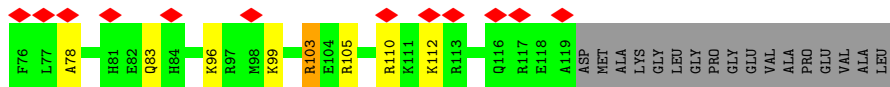
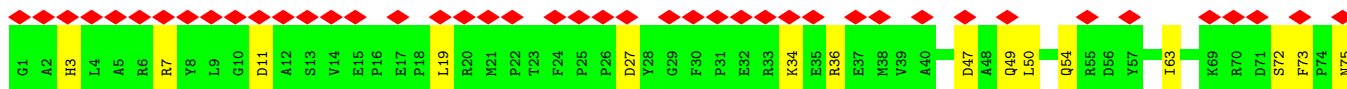
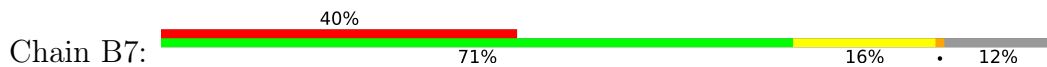

- Molecule 38: NADH:ubiquinone oxidoreductase subunit B9

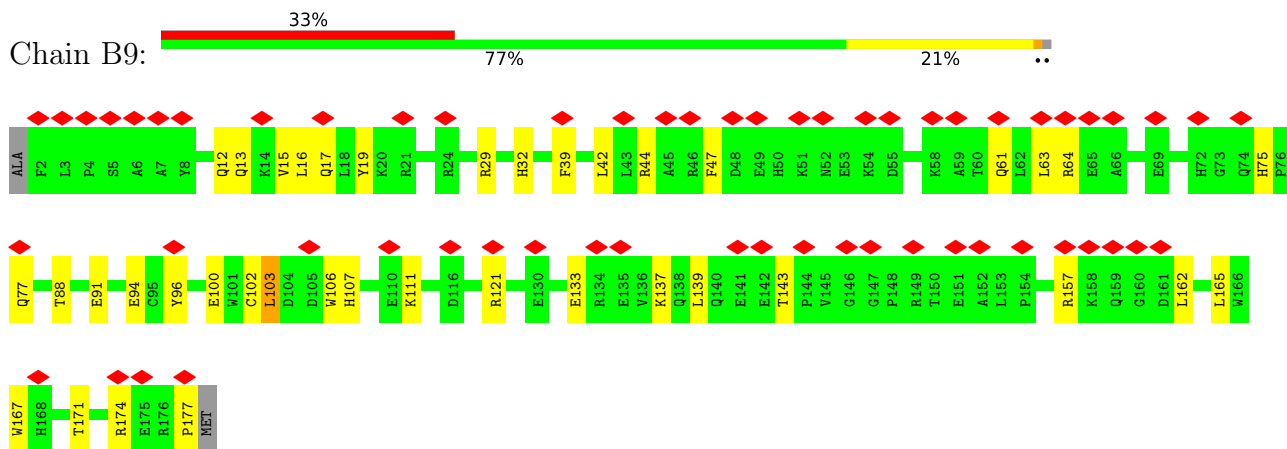

• Molecule 39: NADH:ubiquinone oxidoreductase subunit B2

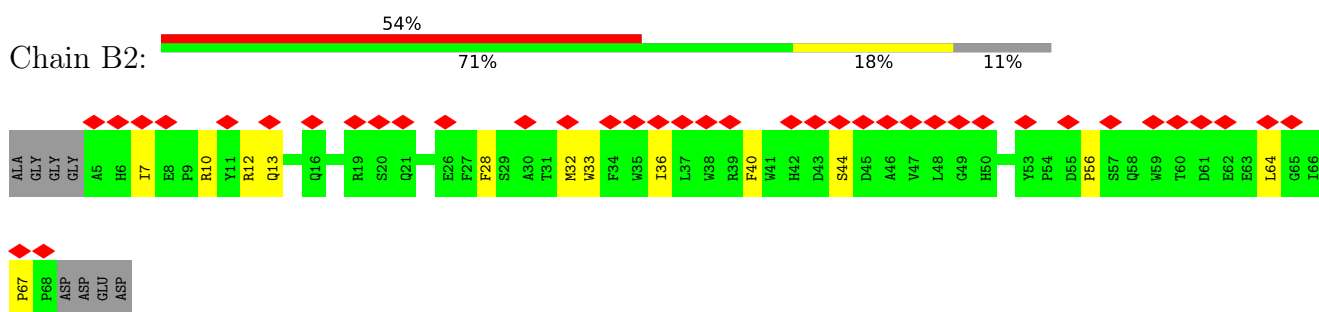

• Molecule 40: NADH dehydrogenase [ubiquinone] 1 beta subcomplex subunit 8, mitochondrial

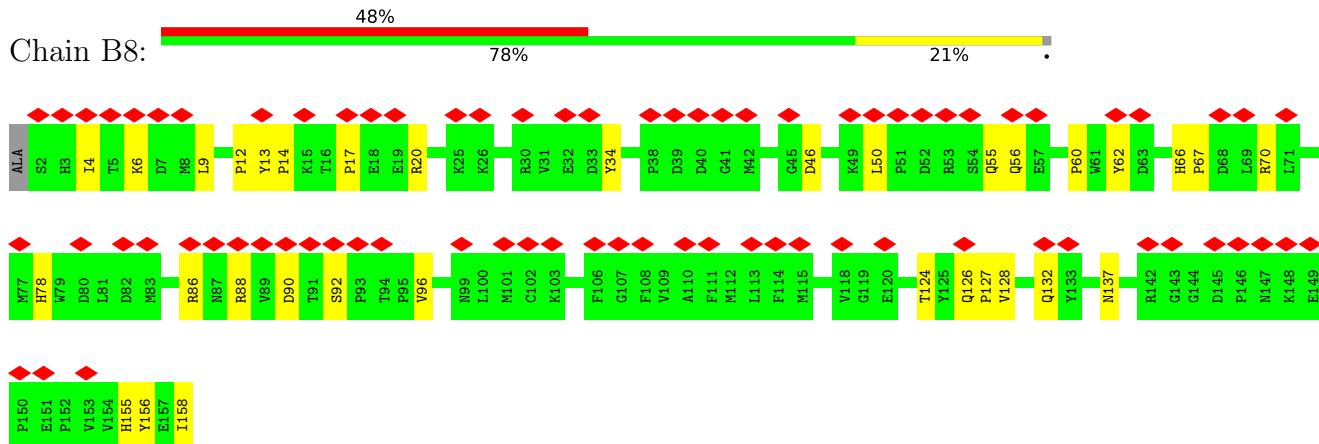

• Molecule 41: NDUFB11

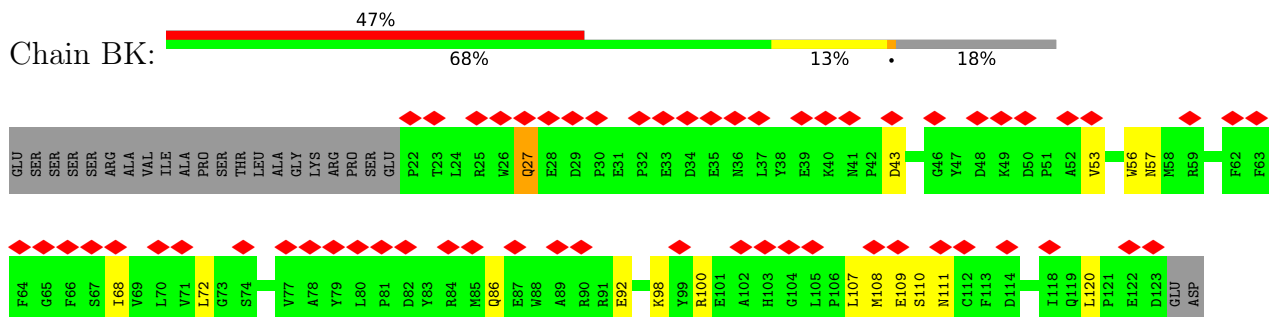

- Molecule 42: NDUFC1

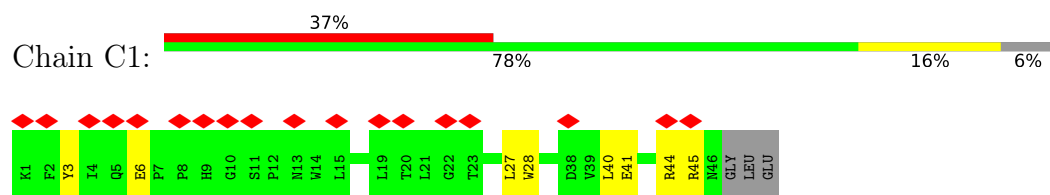

- Molecule 43: NDUFB1

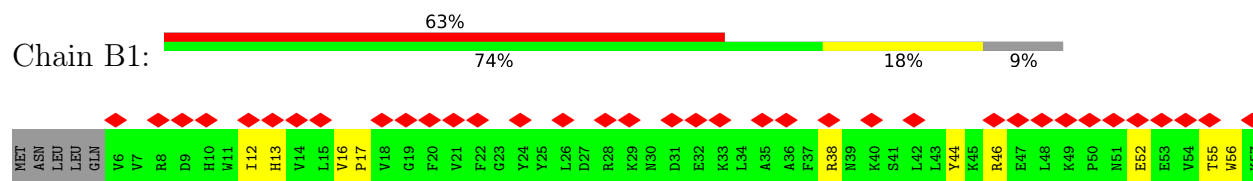

- Molecule 44: NDUFA1

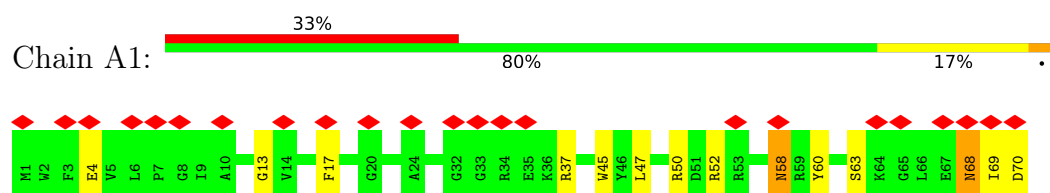

4 Experimental information

Property	Value	Source
EM reconstruction method	SINGLE PARTICLE	Depositor
Imposed symmetry	POINT, C1	Depositor
Number of particles used	22107	Depositor
Resolution determination method	FSC 0.143 CUT-OFF	Depositor
CTF correction method	PHASE FLIPPING AND AMPLITUDE CORRECTION	Depositor
Microscope	FEI TITAN KRIOS	Depositor
Voltage (kV)	300	Depositor
Electron dose ($e^-/\text{\AA}^2$)	51	Depositor
Minimum defocus (nm)	1500	Depositor
Maximum defocus (nm)	3000	Depositor
Magnification	100000	Depositor
Image detector	FEI FALCON II (4k x 4k)	Depositor
Maximum map value	1.214	Depositor
Minimum map value	-0.283	Depositor
Average map value	0.000	Depositor
Map value standard deviation	0.022	Depositor
Recommended contour level	0.15	Depositor
Map size (Å)	716.8, 716.8, 716.8	wwPDB
Map dimensions	512, 512, 512	wwPDB
Map angles (°)	90.0, 90.0, 90.0	wwPDB
Pixel spacing (Å)	1.4, 1.4, 1.4	Depositor

5 Model quality i

5.1 Standard geometry i

Bond lengths and bond angles in the following residue types are not validated in this section: PC1, NDP, FMN, ZMP, 3PE, ZN, FES, SF4

The Z score for a bond length (or angle) is the number of standard deviations the observed value is removed from the expected value. A bond length (or angle) with $|Z| > 5$ is considered an outlier worth inspection. RMSZ is the root-mean-square of all Z scores of the bond lengths (or angles).

Mol	Chain	Bond lengths		Bond angles	
		RMSZ	# $ Z > 5$	RMSZ	# $ Z > 5$
1	V1	0.45	0/3386	0.65	0/4575
2	V2	0.43	0/1687	0.73	1/2295 (0.0%)
3	S1	0.44	0/5362	0.66	1/7266 (0.0%)
4	S2	0.50	0/3547	0.68	1/4808 (0.0%)
5	S3	0.49	0/1776	0.65	0/2417
6	S7	0.50	0/1279	0.65	0/1728
7	S8	0.56	1/1446 (0.1%)	0.69	1/1956 (0.1%)
8	V3	0.35	0/355	0.69	1/480 (0.2%)
9	S6	0.47	0/749	0.62	0/1009
10	S4	0.43	0/1048	0.62	0/1415
11	A9	0.42	0/2574	0.67	2/3483 (0.1%)
12	A2	0.39	0/676	0.65	0/911
13	A5	0.40	0/921	0.71	2/1249 (0.2%)
14	A6	0.42	0/993	0.61	0/1336
15	A7	0.38	0/775	0.67	0/1048
16	AL	0.42	0/1084	0.66	0/1478
17	AA	0.36	0/655	0.69	0/881
17	AB	0.39	0/714	0.66	0/963
18	AM	0.42	0/1172	0.63	1/1579 (0.1%)
19	D3	0.44	0/948	0.74	0/1296
20	D1	0.48	0/2604	0.72	2/3561 (0.1%)
21	D6	0.46	0/1379	0.66	0/1868
22	4L	0.43	0/758	0.81	2/1024 (0.2%)
23	D5	0.42	0/4933	0.73	3/6710 (0.0%)
24	D4	0.45	0/3740	0.74	3/5095 (0.1%)
25	D2	0.46	0/2788	0.71	2/3795 (0.1%)
26	AK	0.37	0/1046	0.67	0/1419
27	B5	0.43	0/1189	0.60	0/1607
28	A8	0.42	0/1441	0.72	0/1942
29	BJ	0.40	0/1475	0.62	2/1989 (0.1%)
30	AJ	0.42	0/2644	0.65	1/3579 (0.0%)
31	S5	0.43	0/843	0.69	1/1128 (0.1%)

Mol	Chain	Bond lengths		Bond angles	
		RMSZ	# Z >5	RMSZ	# Z >5
32	A3	0.38	0/602	0.74	0/828
33	B3	0.41	0/595	0.69	0/803
34	C2	0.45	0/1028	0.61	0/1388
35	B4	0.42	0/1085	0.65	1/1467 (0.1%)
36	B6	0.42	0/830	0.72	1/1130 (0.1%)
37	B7	0.35	0/1051	0.68	2/1408 (0.1%)
38	B9	0.43	0/1568	0.63	1/2123 (0.0%)
39	B2	0.44	0/582	0.68	1/799 (0.1%)
40	B8	0.45	0/1379	0.72	1/1884 (0.1%)
41	BK	0.41	0/880	0.65	0/1196
42	C1	0.39	0/404	0.60	0/548
43	B1	0.37	0/462	0.63	0/624
44	A1	0.40	0/592	0.65	0/795
All	All	0.44	1/67045 (0.0%)	0.68	33/90883 (0.0%)

Chiral center outliers are detected by calculating the chiral volume of a chiral center and verifying if the center is modelled as a planar moiety or with the opposite hand. A planarity outlier is detected by checking planarity of atoms in a peptide group, atoms in a mainchain group or atoms of a sidechain that are expected to be planar.

Mol	Chain	#Chirality outliers	#Planarity outliers
1	V1	0	3
2	V2	0	4
3	S1	0	5
4	S2	0	2
5	S3	0	1
7	S8	0	2
10	S4	0	1
11	A9	0	2
13	A5	0	1
15	A7	0	2
16	AL	0	2
20	D1	0	5
23	D5	0	1
24	D4	0	2
28	A8	0	1
29	BJ	0	1
30	AJ	0	1
32	A3	0	1
33	B3	0	3
35	B4	0	2
36	B6	0	2

Continued on next page...

Continued from previous page...

Mol	Chain	#Chirality outliers	#Planarity outliers
39	B2	0	1
40	B8	0	1
42	C1	0	1
43	B1	0	1
44	A1	0	1
All	All	0	49

All (1) bond length outliers are listed below:

Mol	Chain	Res	Type	Atoms	Z	Observed(Å)	Ideal(Å)
7	S8	119	CYS	CB-SG	-5.61	1.72	1.81

The worst 5 of 33 bond angle outliers are listed below:

Mol	Chain	Res	Type	Atoms	Z	Observed(°)	Ideal(°)
23	D5	69	LEU	CA-CB-CG	8.46	134.75	115.30
13	A5	89	LEU	CA-CB-CG	7.84	133.33	115.30
2	V2	136	LEU	CA-CB-CG	7.63	132.84	115.30
37	B7	19	LEU	CA-CB-CG	7.57	132.70	115.30
23	D5	78	LEU	CA-CB-CG	7.26	132.00	115.30

There are no chirality outliers.

5 of 49 planarity outliers are listed below:

Mol	Chain	Res	Type	Group
1	V1	28	ARG	Peptide
1	V1	331	THR	Peptide
1	V1	99	GLU	Peptide
2	V2	10	ARG	Peptide
2	V2	13	PRO	Peptide

5.2 Too-close contacts [i](#)

In the following table, the Non-H and H(model) columns list the number of non-hydrogen atoms and hydrogen atoms in the chain respectively. The H(added) column lists the number of hydrogen atoms added and optimized by MolProbity. The Clashes column lists the number of clashes within the asymmetric unit, whereas Symm-Clashes lists symmetry-related clashes.

Mol	Chain	Non-H	H(model)	H(added)	Clashes	Symm-Clashes
1	V1	3312	0	3266	68	0

Continued on next page...

Continued from previous page...

Mol	Chain	Non-H	H(model)	H(added)	Clashes	Symm-Clashes
2	V2	1647	0	1657	37	0
3	S1	5275	0	5300	121	0
4	S2	3455	0	3395	84	0
5	S3	1726	0	1676	48	0
6	S7	1248	0	1256	30	0
7	S8	1415	0	1371	41	0
8	V3	345	0	323	9	0
9	S6	737	0	710	16	0
10	S4	1025	0	1023	18	0
11	A9	2512	0	2527	43	0
12	A2	665	0	678	12	0
13	A5	901	0	936	17	0
14	A6	969	0	980	10	0
15	A7	757	0	771	30	0
16	AL	1044	0	1001	22	0
17	AA	645	0	649	10	0
17	AB	702	0	692	7	0
18	AM	1143	0	1137	21	0
19	D3	923	0	952	19	0
20	D1	2529	0	2641	65	0
21	D6	1345	0	1364	20	0
22	4L	748	0	794	18	0
23	D5	4805	0	4950	97	0
24	D4	3646	0	3850	59	0
25	D2	2724	0	2930	56	0
26	AK	1025	0	1033	10	0
27	B5	1156	0	1177	18	0
28	A8	1404	0	1384	25	0
29	BJ	1441	0	1417	29	0
30	AJ	2583	0	2547	36	0
31	S5	822	0	820	21	0
32	A3	582	0	583	12	0
33	B3	578	0	570	6	0
34	C2	997	0	983	13	0
35	B4	1059	0	1062	16	0
36	B6	804	0	824	20	0
37	B7	1026	0	995	18	0
38	B9	1515	0	1469	26	0
39	B2	555	0	505	9	0
40	B8	1324	0	1219	22	0
41	BK	853	0	800	13	0
42	C1	391	0	391	6	0

Continued on next page...

Continued from previous page...

Mol	Chain	Non-H	H(model)	H(added)	Clashes	Symm-Clashes
43	B1	449	0	453	8	0
44	A1	577	0	570	9	0
45	S1	16	0	0	1	0
45	S7	8	0	0	0	0
45	S8	16	0	0	1	0
45	V1	8	0	0	1	0
46	V1	31	0	19	4	0
47	S1	4	0	0	0	0
47	V2	4	0	0	1	0
48	D5	38	0	50	1	0
48	S2	40	0	54	3	0
49	S6	1	0	0	0	0
50	A9	48	0	26	4	0
51	AA	34	0	40	1	0
51	AB	31	0	34	1	0
52	AK	28	0	30	1	0
All	All	65691	0	65884	1025	0

The all-atom clashscore is defined as the number of clashes found per 1000 atoms (including hydrogen atoms). The all-atom clashscore for this structure is 8.

The worst 5 of 1025 close contacts within the same asymmetric unit are listed below, sorted by their clash magnitude.

Atom-1	Atom-2	Interatomic distance (Å)	Clash overlap (Å)
5:S3:80:ALA:HA	5:S3:91:GLU:O	1.19	1.26
5:S3:78:LEU:HA	5:S3:93:VAL:O	1.34	1.21
5:S3:38:GLN:O	15:A7:70:SER:HA	1.41	1.20
3:S1:449:PRO:O	3:S1:489:VAL:HA	1.51	1.11
12:A2:21:HIS:O	12:A2:62:PRO:HA	1.66	0.95

There are no symmetry-related clashes.

5.3 Torsion angles [i](#)

5.3.1 Protein backbone [i](#)

In the following table, the Percentiles column shows the percent Ramachandran outliers of the chain as a percentile score with respect to all PDB entries followed by that with respect to all EM entries.

The Analysed column shows the number of residues for which the backbone conformation was analysed, and the total number of residues.

Mol	Chain	Analysed	Favoured	Allowed	Outliers	Percentiles	
1	V1	428/445 (96%)	382 (89%)	46 (11%)	0	100	100
2	V2	210/217 (97%)	175 (83%)	35 (17%)	0	100	100
3	S1	686/704 (97%)	604 (88%)	80 (12%)	2 (0%)	41	76
4	S2	428/430 (100%)	369 (86%)	57 (13%)	2 (0%)	29	68
5	S3	206/228 (90%)	181 (88%)	25 (12%)	0	100	100
6	S7	154/179 (86%)	135 (88%)	18 (12%)	1 (1%)	25	65
7	S8	174/176 (99%)	155 (89%)	19 (11%)	0	100	100
8	V3	39/75 (52%)	32 (82%)	7 (18%)	0	100	100
9	S6	93/96 (97%)	85 (91%)	8 (9%)	0	100	100
10	S4	124/133 (93%)	108 (87%)	16 (13%)	0	100	100
11	A9	305/338 (90%)	268 (88%)	37 (12%)	0	100	100
12	A2	80/98 (82%)	70 (88%)	10 (12%)	0	100	100
13	A5	109/115 (95%)	96 (88%)	13 (12%)	0	100	100
14	A6	112/127 (88%)	104 (93%)	8 (7%)	0	100	100
15	A7	91/112 (81%)	73 (80%)	17 (19%)	1 (1%)	14	52
16	AL	121/145 (83%)	97 (80%)	24 (20%)	0	100	100
17	AA	78/88 (89%)	65 (83%)	13 (17%)	0	100	100
17	AB	85/88 (97%)	77 (91%)	8 (9%)	0	100	100
18	AM	137/143 (96%)	122 (89%)	15 (11%)	0	100	100
19	D3	113/115 (98%)	90 (80%)	23 (20%)	0	100	100
20	D1	316/318 (99%)	269 (85%)	45 (14%)	2 (1%)	25	65
21	D6	173/175 (99%)	150 (87%)	23 (13%)	0	100	100
22	4L	96/98 (98%)	86 (90%)	9 (9%)	1 (1%)	15	54
23	D5	604/606 (100%)	544 (90%)	59 (10%)	1 (0%)	47	81
24	D4	457/459 (100%)	422 (92%)	35 (8%)	0	100	100
25	D2	345/347 (99%)	315 (91%)	30 (9%)	0	100	100
26	AK	138/140 (99%)	128 (93%)	10 (7%)	0	100	100
27	B5	137/143 (96%)	124 (90%)	12 (9%)	1 (1%)	22	62
28	A8	169/171 (99%)	137 (81%)	32 (19%)	0	100	100
29	BJ	169/175 (97%)	155 (92%)	14 (8%)	0	100	100

Continued on next page...

Continued from previous page...

Mol	Chain	Analysed	Favoured	Allowed	Outliers	Percentiles	
30	AJ	317/320 (99%)	274 (86%)	43 (14%)	0	100	100
31	S5	97/105 (92%)	84 (87%)	13 (13%)	0	100	100
32	A3	72/83 (87%)	61 (85%)	11 (15%)	0	100	100
33	B3	71/97 (73%)	58 (82%)	13 (18%)	0	100	100
34	C2	117/120 (98%)	107 (92%)	10 (8%)	0	100	100
35	B4	126/128 (98%)	109 (86%)	17 (14%)	0	100	100
36	B6	91/127 (72%)	78 (86%)	12 (13%)	1 (1%)	14	52
37	B7	117/136 (86%)	99 (85%)	18 (15%)	0	100	100
38	B9	174/178 (98%)	145 (83%)	29 (17%)	0	100	100
39	B2	62/72 (86%)	57 (92%)	5 (8%)	0	100	100
40	B8	155/158 (98%)	118 (76%)	36 (23%)	1 (1%)	25	65
41	BK	100/125 (80%)	85 (85%)	15 (15%)	0	100	100
42	C1	44/49 (90%)	40 (91%)	4 (9%)	0	100	100
43	B1	50/57 (88%)	37 (74%)	13 (26%)	0	100	100
44	A1	68/70 (97%)	64 (94%)	4 (6%)	0	100	100
All	All	8038/8509 (94%)	7034 (88%)	991 (12%)	13 (0%)	50	81

5 of 13 Ramachandran outliers are listed below:

Mol	Chain	Res	Type
4	S2	293	CYS
6	S7	54	CYS
22	4L	3	LEU
15	A7	69	MET
4	S2	73	VAL

5.3.2 Protein sidechains [i](#)

In the following table, the Percentiles column shows the percent sidechain outliers of the chain as a percentile score with respect to all PDB entries followed by that with respect to all EM entries.

The Analysed column shows the number of residues for which the sidechain conformation was analysed, and the total number of residues.

Mol	Chain	Analysed	Rotameric	Outliers	Percentiles	
1	V1	344/354 (97%)	340 (99%)	4 (1%)	71	84

Continued on next page...

Continued from previous page...

Mol	Chain	Analysed	Rotameric	Outliers	Percentiles	
2	V2	182/183 (100%)	180 (99%)	2 (1%)	73	85
3	S1	578/588 (98%)	574 (99%)	4 (1%)	84	90
4	S2	371/371 (100%)	368 (99%)	3 (1%)	81	89
5	S3	189/204 (93%)	188 (100%)	1 (0%)	88	93
6	S7	132/150 (88%)	130 (98%)	2 (2%)	65	80
7	S8	151/151 (100%)	149 (99%)	2 (1%)	69	82
8	V3	40/68 (59%)	36 (90%)	4 (10%)	7	28
9	S6	79/80 (99%)	79 (100%)	0	100	100
10	S4	113/119 (95%)	112 (99%)	1 (1%)	78	88
11	A9	269/292 (92%)	266 (99%)	3 (1%)	73	85
12	A2	73/81 (90%)	72 (99%)	1 (1%)	67	81
13	A5	99/101 (98%)	99 (100%)	0	100	100
14	A6	107/113 (95%)	107 (100%)	0	100	100
15	A7	83/94 (88%)	82 (99%)	1 (1%)	71	84
16	AL	114/131 (87%)	110 (96%)	4 (4%)	36	60
17	AA	74/81 (91%)	73 (99%)	1 (1%)	67	81
17	AB	80/81 (99%)	77 (96%)	3 (4%)	33	58
18	AM	119/121 (98%)	115 (97%)	4 (3%)	37	61
19	D3	103/103 (100%)	102 (99%)	1 (1%)	76	86
20	D1	278/278 (100%)	277 (100%)	1 (0%)	91	94
21	D6	144/144 (100%)	142 (99%)	2 (1%)	67	81
22	4L	87/87 (100%)	85 (98%)	2 (2%)	50	70
23	D5	539/539 (100%)	534 (99%)	5 (1%)	78	88
24	D4	412/412 (100%)	406 (98%)	6 (2%)	65	80
25	D2	315/315 (100%)	309 (98%)	6 (2%)	57	75
26	AK	101/101 (100%)	99 (98%)	2 (2%)	55	73
27	B5	122/125 (98%)	121 (99%)	1 (1%)	81	89
28	A8	154/154 (100%)	150 (97%)	4 (3%)	46	67
29	BJ	155/157 (99%)	154 (99%)	1 (1%)	86	92
30	AJ	283/284 (100%)	280 (99%)	3 (1%)	73	85
31	S5	88/94 (94%)	88 (100%)	0	100	100

Continued on next page...

Continued from previous page...

Mol	Chain	Analysed	Rotameric	Outliers	Percentiles	
32	A3	65/71 (92%)	65 (100%)	0	100	100
33	B3	55/75 (73%)	53 (96%)	2 (4%)	35	60
34	C2	106/107 (99%)	106 (100%)	0	100	100
35	B4	114/114 (100%)	113 (99%)	1 (1%)	78	88
36	B6	91/121 (75%)	89 (98%)	2 (2%)	52	71
37	B7	108/119 (91%)	104 (96%)	4 (4%)	34	59
38	B9	159/160 (99%)	156 (98%)	3 (2%)	57	75
39	B2	58/62 (94%)	58 (100%)	0	100	100
40	B8	142/142 (100%)	139 (98%)	3 (2%)	53	72
41	BK	93/112 (83%)	91 (98%)	2 (2%)	52	71
42	C1	42/44 (96%)	42 (100%)	0	100	100
43	B1	48/53 (91%)	48 (100%)	0	100	100
44	A1	59/59 (100%)	56 (95%)	3 (5%)	24	51
All	All	7118/7395 (96%)	7024 (99%)	94 (1%)	70	82

5 of 94 residues with a non-rotameric sidechain are listed below:

Mol	Chain	Res	Type
25	D2	204	ASN
30	AJ	17	LYS
25	D2	322	ARG
17	AB	80	ILE
33	B3	58	ASN

Sometimes sidechains can be flipped to improve hydrogen bonding and reduce clashes. 5 of 98 such sidechains are listed below:

Mol	Chain	Res	Type
25	D2	204	ASN
30	AJ	204	ASN
25	D2	316	GLN
29	BJ	77	HIS
31	S5	81	GLN

5.3.3 RNA

There are no RNA molecules in this entry.

5.4 Non-standard residues in protein, DNA, RNA chains [i](#)

There are no non-standard protein/DNA/RNA residues in this entry.

5.5 Carbohydrates [i](#)

There are no monosaccharides in this entry.

5.6 Ligand geometry [i](#)

Of 16 ligands modelled in this entry, 1 is monoatomic - leaving 15 for Mogul analysis.

In the following table, the Counts columns list the number of bonds (or angles) for which Mogul statistics could be retrieved, the number of bonds (or angles) that are observed in the model and the number of bonds (or angles) that are defined in the Chemical Component Dictionary. The Link column lists molecule types, if any, to which the group is linked. The Z score for a bond length (or angle) is the number of standard deviations the observed value is removed from the expected value. A bond length (or angle) with $|Z| > 2$ is considered an outlier worth inspection. RMSZ is the root-mean-square of all Z scores of the bond lengths (or angles).

Mol	Type	Chain	Res	Link	Bond lengths			Bond angles		
					Counts	RMSZ	# Z > 2	Counts	RMSZ	# Z > 2
46	FMN	V1	501	-	33,33,33	0.37	0	48,50,50	0.49	1 (2%)
51	ZMP	AB	101	17	24,30,36	0.74	1 (4%)	29,37,45	0.87	0
51	ZMP	AA	101	17	27,33,36	0.68	1 (3%)	32,40,45	1.02	2 (6%)
48	3PE	D5	701	-	37,37,50	0.34	0	40,42,55	0.35	0
47	FES	V2	300	2	0,4,4	-	-	-	-	-
45	SF4	S1	802	3	0,12,12	-	-	-	-	-
50	NDP	A9	401	-	45,52,52	0.74	2 (4%)	53,80,80	0.57	1 (1%)
52	PC1	AK	201	-	27,27,53	0.40	0	33,35,61	0.37	0
45	SF4	S1	801	3	0,12,12	-	-	-	-	-
45	SF4	S8	202	7	0,12,12	-	-	-	-	-
47	FES	S1	803	3	0,4,4	-	-	-	-	-
45	SF4	S8	201	7	0,12,12	-	-	-	-	-
45	SF4	S7	300	6	0,12,12	-	-	-	-	-
48	3PE	S2	501	-	39,39,50	0.34	0	42,44,55	0.36	0
45	SF4	V1	500	1	0,12,12	-	-	-	-	-

In the following table, the Chirals column lists the number of chiral outliers, the number of chiral centers analysed, the number of these observed in the model and the number defined in the Chemical Component Dictionary. Similar counts are reported in the Torsion and Rings columns. '-' means no outliers of that kind were identified.

Mol	Type	Chain	Res	Link	Chirals	Torsions	Rings
46	FMN	V1	501	-	-	5/18/18/18	0/3/3/3
51	ZMP	AB	101	17	-	8/35/37/43	-
51	ZMP	AA	101	17	-	9/38/40/43	-
48	3PE	D5	701	-	-	10/41/41/54	-
47	FES	V2	300	2	-	-	0/1/1/1
45	SF4	S1	802	3	-	-	0/6/5/5
50	NDP	A9	401	-	-	16/30/77/77	0/5/5/5
52	PC1	AK	201	-	-	7/31/31/57	-
45	SF4	S1	801	3	-	-	0/6/5/5
45	SF4	S8	202	7	-	-	0/6/5/5
47	FES	S1	803	3	-	-	0/1/1/1
45	SF4	S8	201	7	-	-	0/6/5/5
45	SF4	S7	300	6	-	-	0/6/5/5
48	3PE	S2	501	-	-	9/43/43/54	-
45	SF4	V1	500	1	-	-	0/6/5/5

All (4) bond length outliers are listed below:

Mol	Chain	Res	Type	Atoms	Z	Observed(Å)	Ideal(Å)
51	AA	101	ZMP	C9-C10	2.37	1.53	1.50
50	A9	401	NDP	P2B-O2B	2.35	1.63	1.59
51	AB	101	ZMP	C9-C10	2.28	1.53	1.50
50	A9	401	NDP	C8A-N7A	-2.08	1.31	1.34

All (4) bond angle outliers are listed below:

Mol	Chain	Res	Type	Atoms	Z	Observed(°)	Ideal(°)
50	A9	401	NDP	C5A-C6A-N6A	2.44	124.06	120.35
46	V1	501	FMN	P-O5'-C5'	2.42	124.96	118.30
51	AA	101	ZMP	C15-C14-C13	-2.30	108.53	112.36
51	AA	101	ZMP	O1-C10-C9	-2.21	121.38	123.99

There are no chirality outliers.

5 of 64 torsion outliers are listed below:

Mol	Chain	Res	Type	Atoms
46	V1	501	FMN	C4'-C5'-O5'-P
46	V1	501	FMN	C5'-O5'-P-O2P
46	V1	501	FMN	C5'-O5'-P-O3P
48	S2	501	3PE	C11-O13-P-O12
48	S2	501	3PE	O13-C11-C12-N

There are no ring outliers.

11 monomers are involved in 19 short contacts:

Mol	Chain	Res	Type	Clashes	Symm-Clashes
46	V1	501	FMN	4	0
51	AB	101	ZMP	1	0
51	AA	101	ZMP	1	0
48	D5	701	3PE	1	0
47	V2	300	FES	1	0
50	A9	401	NDP	4	0
52	AK	201	PC1	1	0
45	S1	801	SF4	1	0
45	S8	202	SF4	1	0
48	S2	501	3PE	3	0
45	V1	500	SF4	1	0

The following is a two-dimensional graphical depiction of Mogul quality analysis of bond lengths, bond angles, torsion angles, and ring geometry for all instances of the Ligand of Interest. In addition, ligands with molecular weight > 250 and outliers as shown on the validation Tables will also be included. For torsion angles, if less than 5% of the Mogul distribution of torsion angles is within 10 degrees of the torsion angle in question, then that torsion angle is considered an outlier. Any bond that is central to one or more torsion angles identified as an outlier by Mogul will be highlighted in the graph. For rings, the root-mean-square deviation (RMSD) between the ring in question and similar rings identified by Mogul is calculated over all ring torsion angles. If the average RMSD is greater than 60 degrees and the minimal RMSD between the ring in question and any Mogul-identified rings is also greater than 60 degrees, then that ring is considered an outlier. The outliers are highlighted in purple. The color gray indicates Mogul did not find sufficient equivalents in the CSD to analyse the geometry.

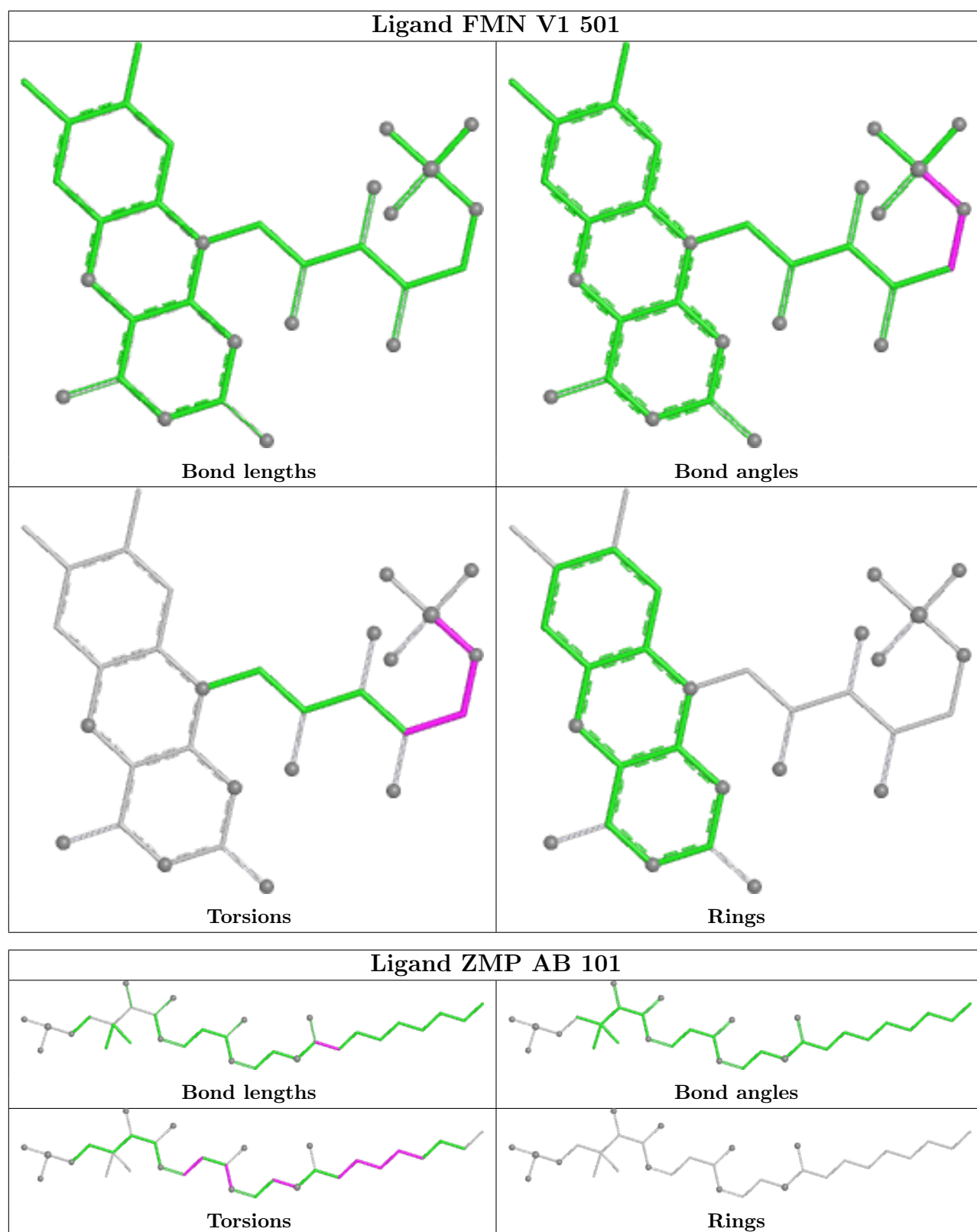

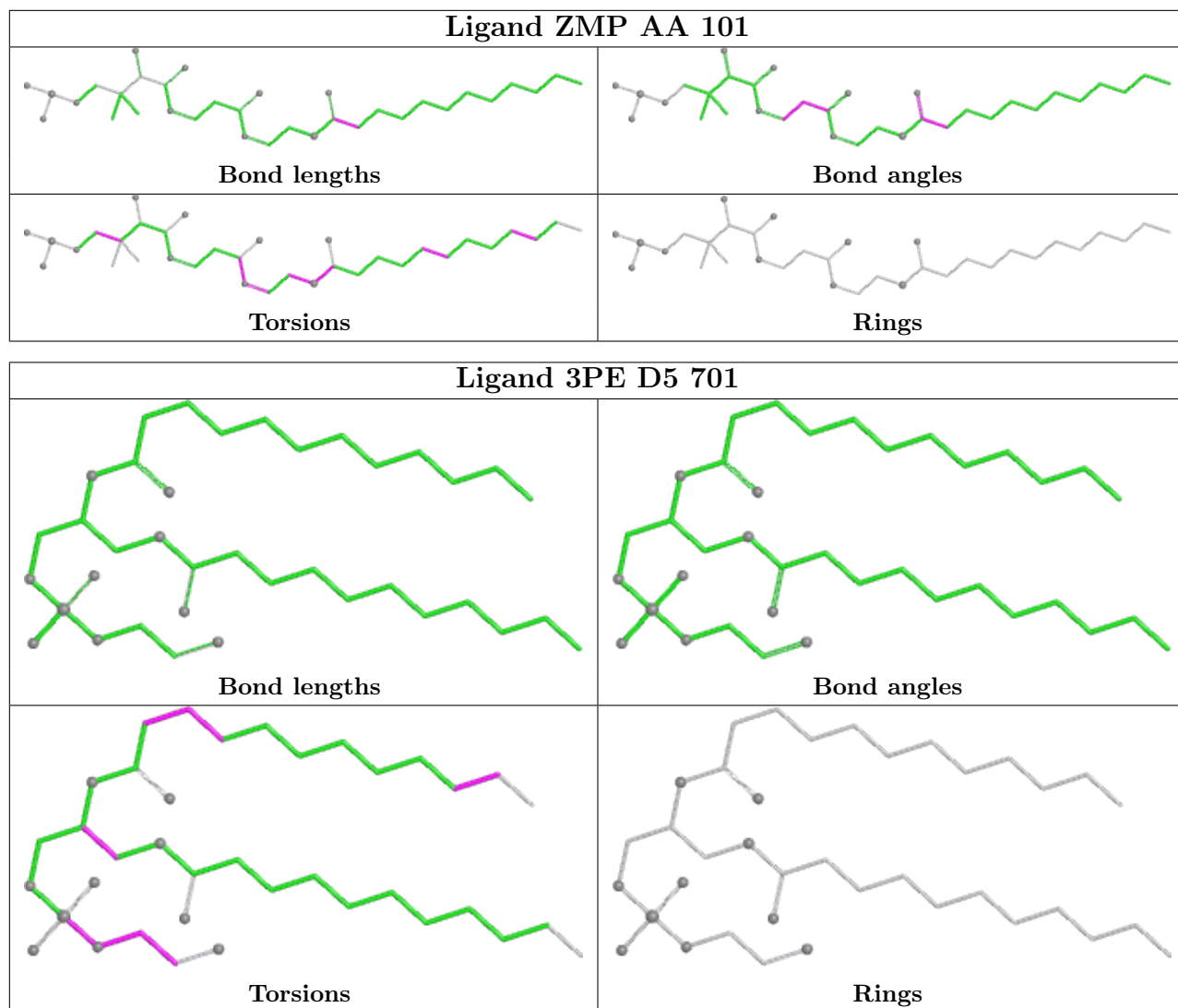

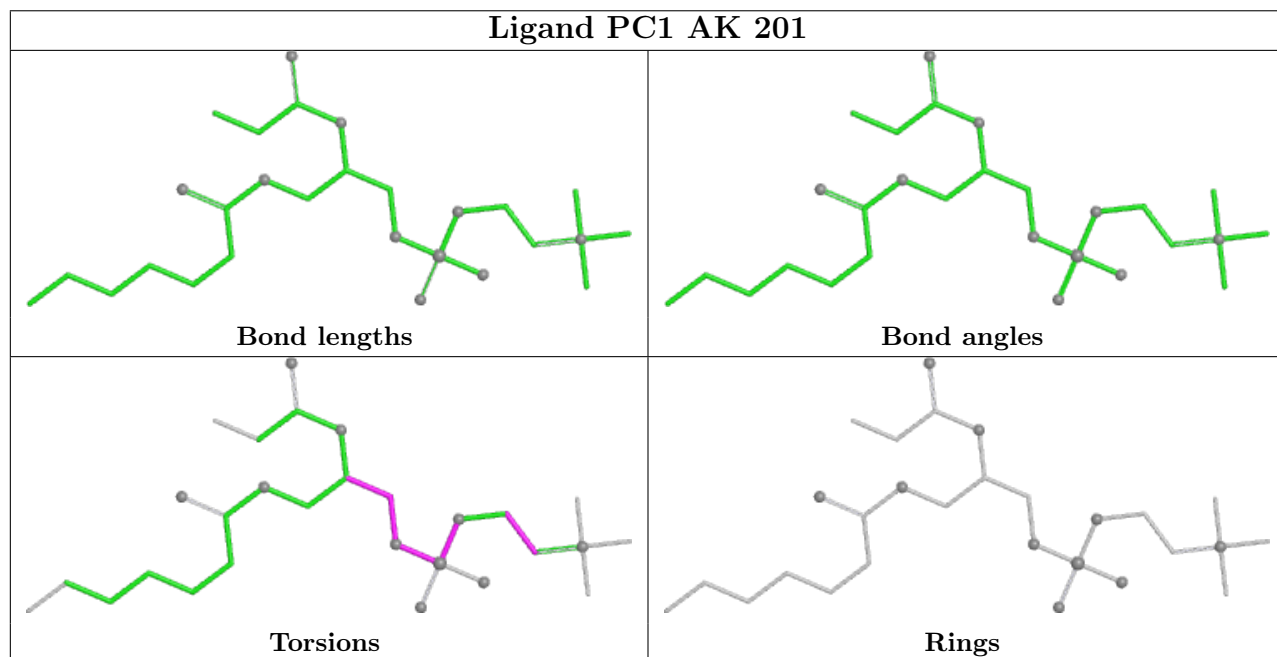
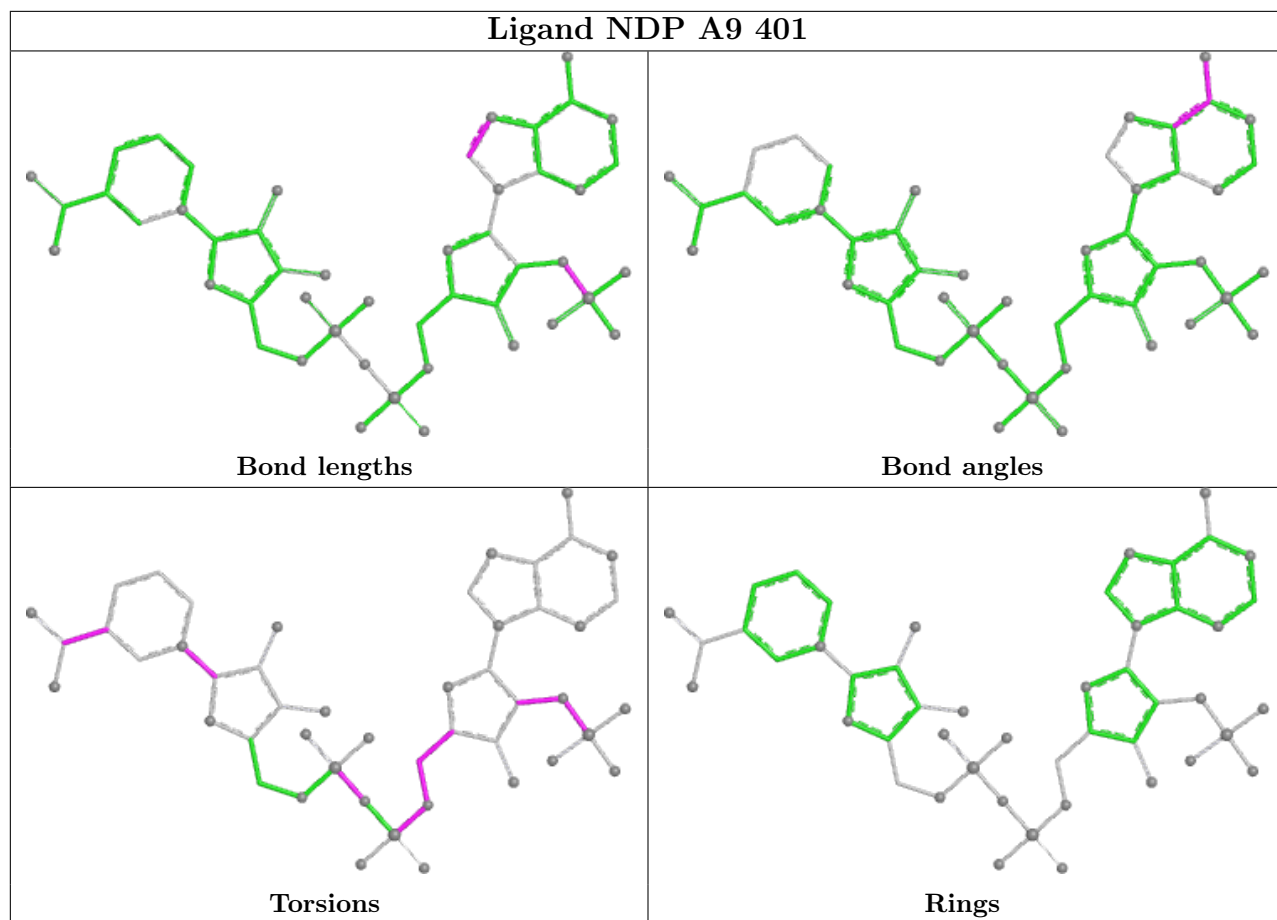

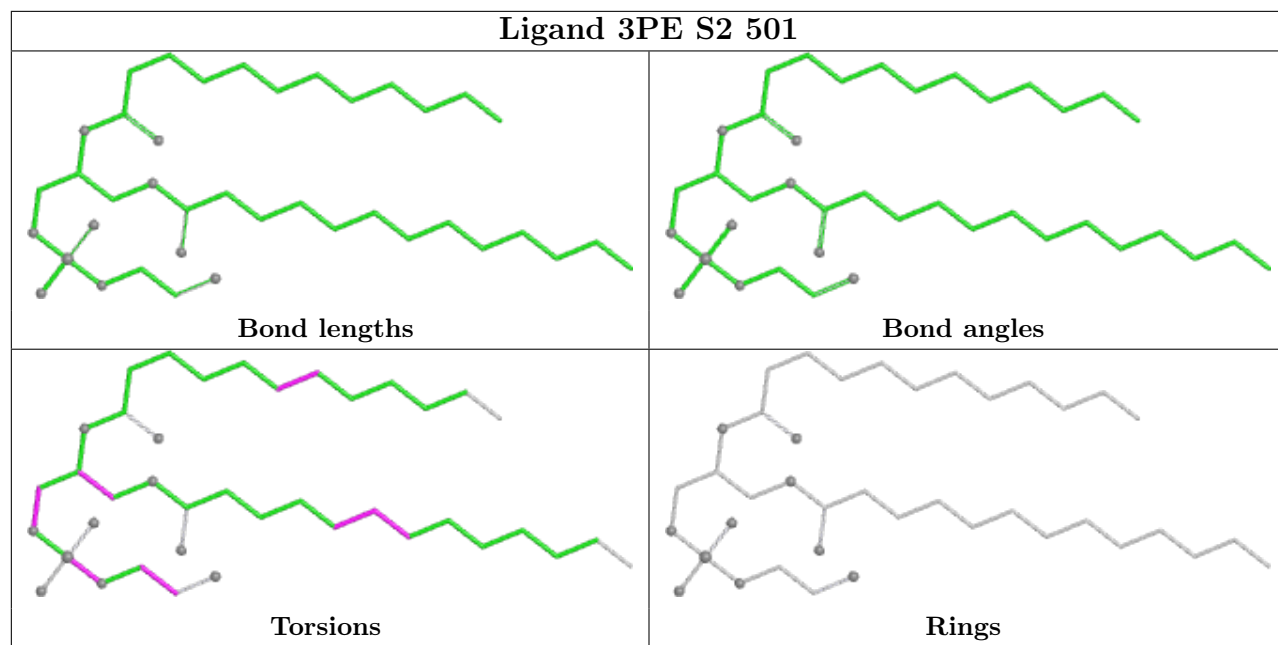

5.7 Other polymers [i](#)

There are no such residues in this entry.

5.8 Polymer linkage issues [i](#)

There are no chain breaks in this entry.

6 Map visualisation [i](#)

This section contains visualisations of the EMDB entry EMD-4497. These allow visual inspection of the internal detail of the map and identification of artifacts.

Images derived from a raw map, generated by summing the deposited half-maps, are presented below the corresponding image components of the primary map to allow further visual inspection and comparison with those of the primary map.

6.1 Orthogonal projections [i](#)

6.1.1 Primary map

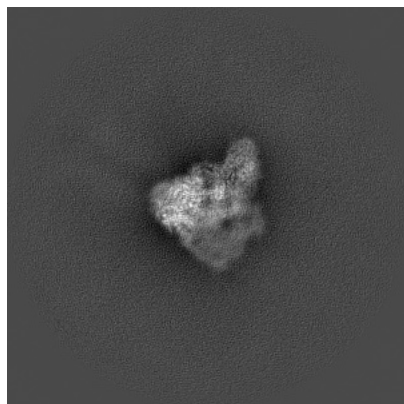

X

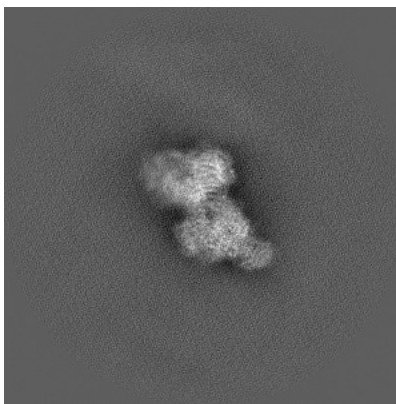

Y

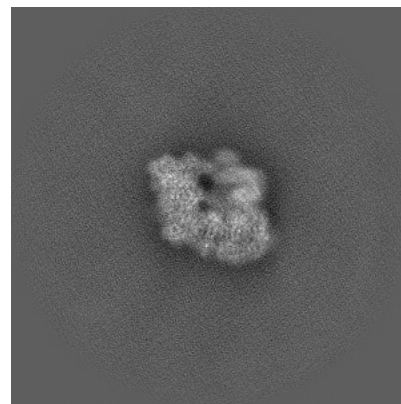

Z

6.1.2 Raw map

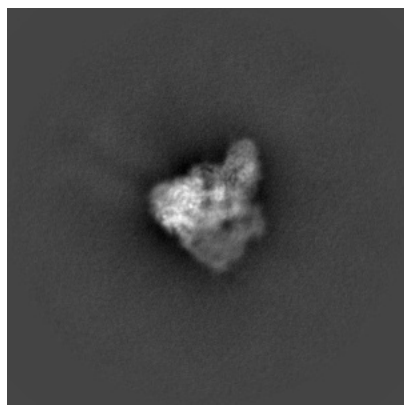

X

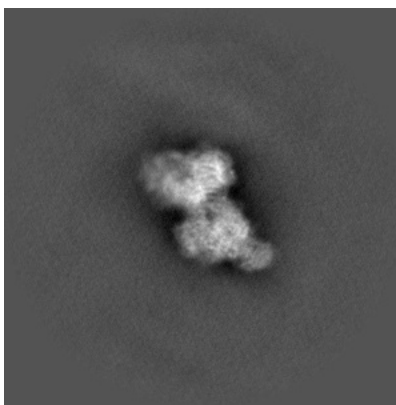

Y

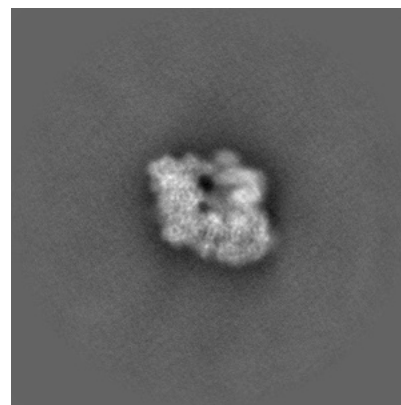

Z

The images above show the map projected in three orthogonal directions.

6.2 Central slices [i](#)

6.2.1 Primary map

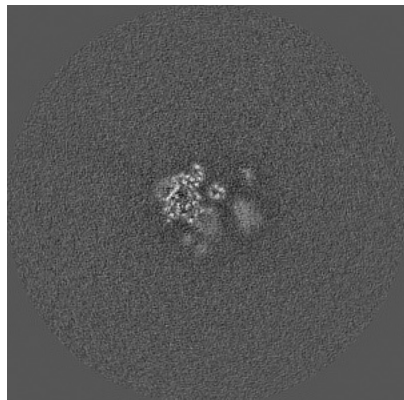

X Index: 256

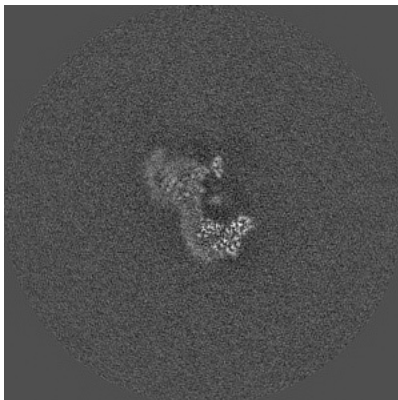

Y Index: 256

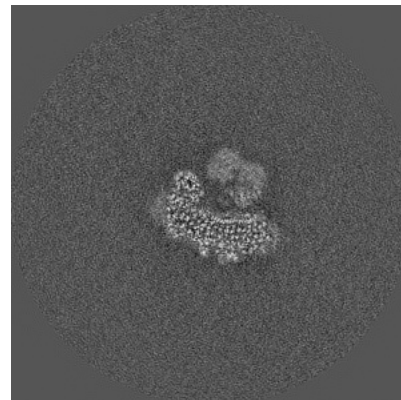

Z Index: 256

6.2.2 Raw map

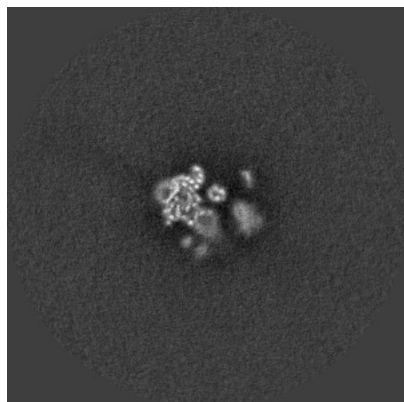

X Index: 256

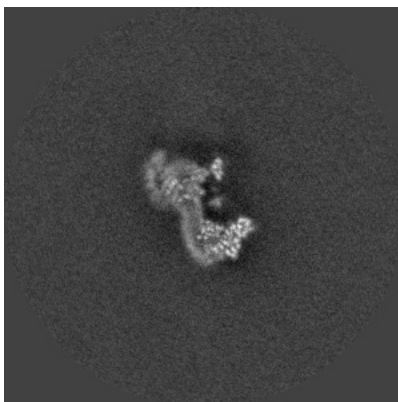

Y Index: 256

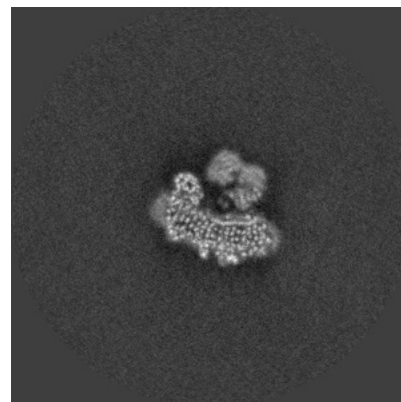

Z Index: 256

The images above show central slices of the map in three orthogonal directions.

6.3 Largest variance slices [i](#)

6.3.1 Primary map

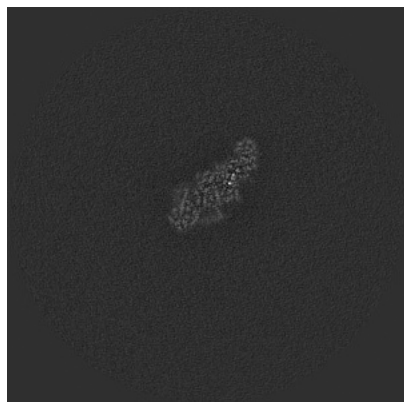

X Index: 205

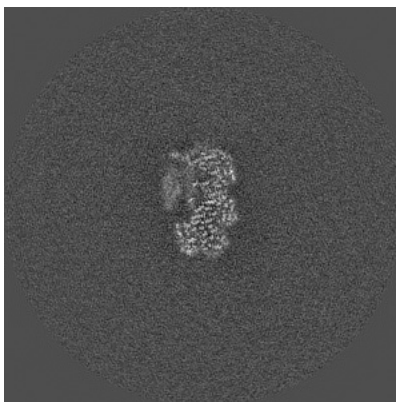

Y Index: 229

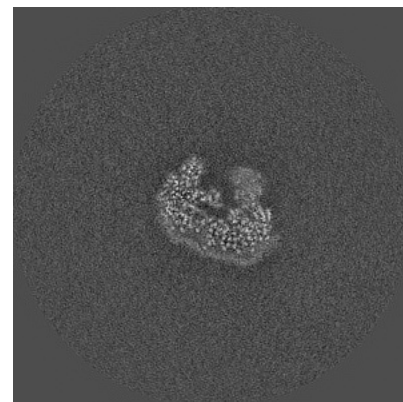

Z Index: 272

6.3.2 Raw map

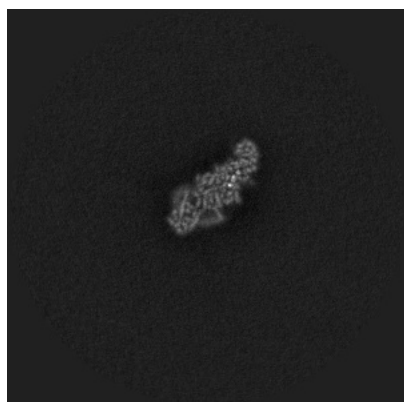

X Index: 205



Y Index: 296

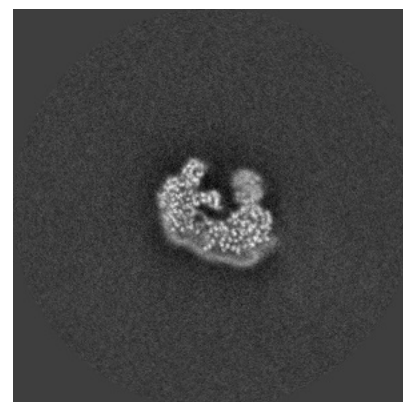

Z Index: 274

The images above show the largest variance slices of the map in three orthogonal directions.

6.4 Orthogonal surface views [i](#)

6.4.1 Primary map

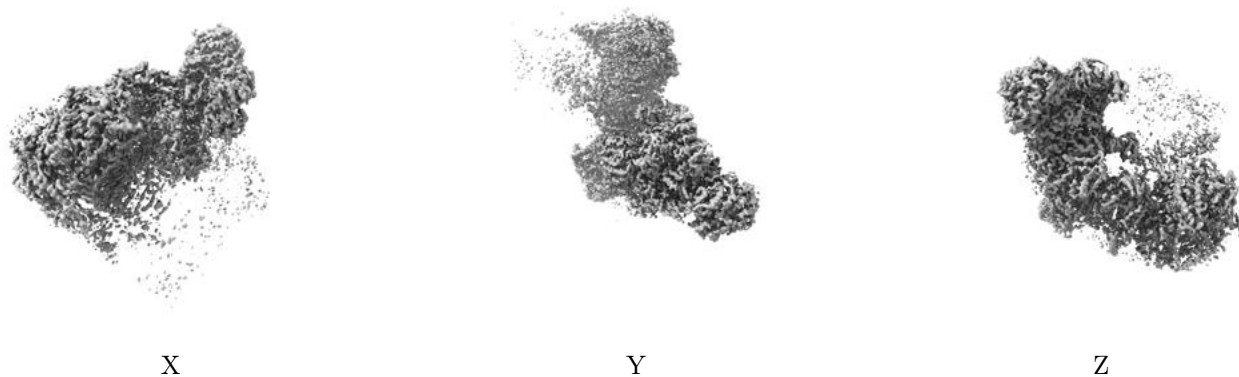

The images above show the 3D surface view of the map at the recommended contour level 0.15. These images, in conjunction with the slice images, may facilitate assessment of whether an appropriate contour level has been provided.

6.4.2 Raw map



These images show the 3D surface of the raw map. The raw map's contour level was selected so that its surface encloses the same volume as the primary map does at its recommended contour level.

6.5 Mask visualisation [i](#)

This section shows the 3D surface view of the primary map at 50% transparency overlaid with the specified mask at 0% transparency

A mask typically either:

- Encompasses the whole structure
- Separates out a domain, a functional unit, a monomer or an area of interest from a larger structure

6.5.1 emd_4497_msk_1.map [i](#)

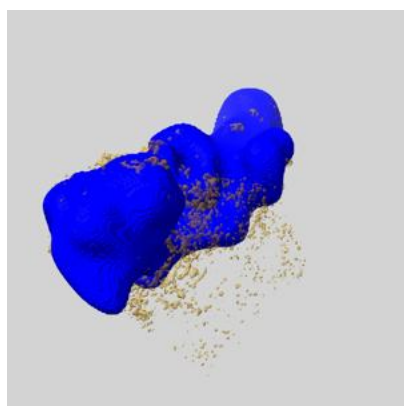

X

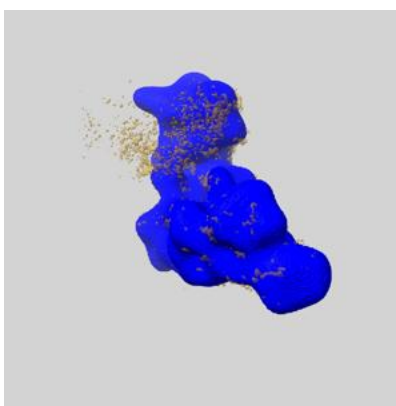

Y

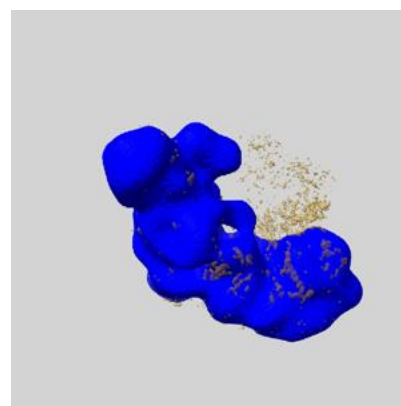

Z

7 Map analysis [i](#)

This section contains the results of statistical analysis of the map.

7.1 Map-value distribution [i](#)

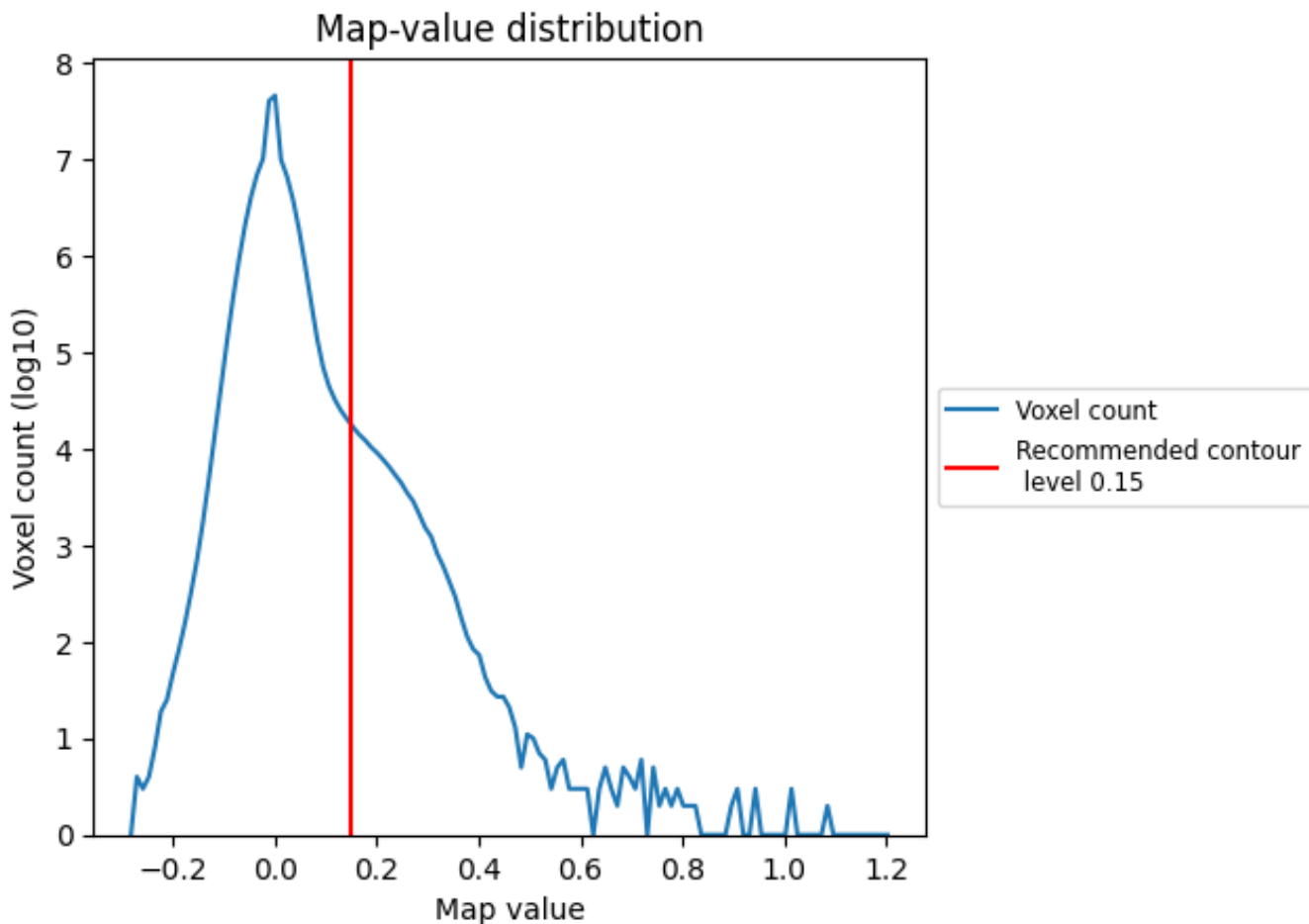

The map-value distribution is plotted in 128 intervals along the x-axis. The y-axis is logarithmic. A spike in this graph at zero usually indicates that the volume has been masked.

7.2 Volume estimate [\(i\)](#)

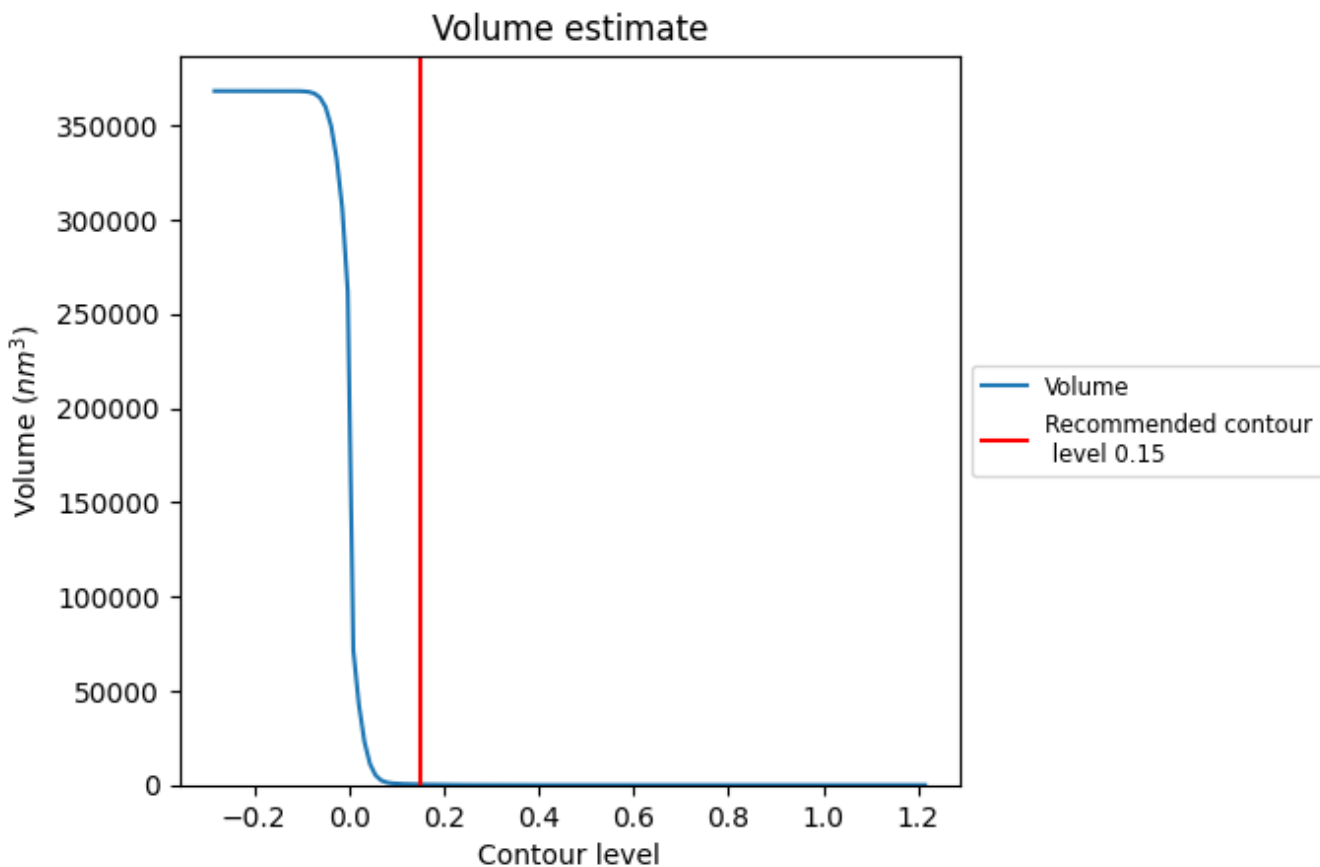

The volume at the recommended contour level is 291 nm^3 ; this corresponds to an approximate mass of 263 kDa.

The volume estimate graph shows how the enclosed volume varies with the contour level. The recommended contour level is shown as a vertical line and the intersection between the line and the curve gives the volume of the enclosed surface at the given level.

7.3 Rotationally averaged power spectrum i

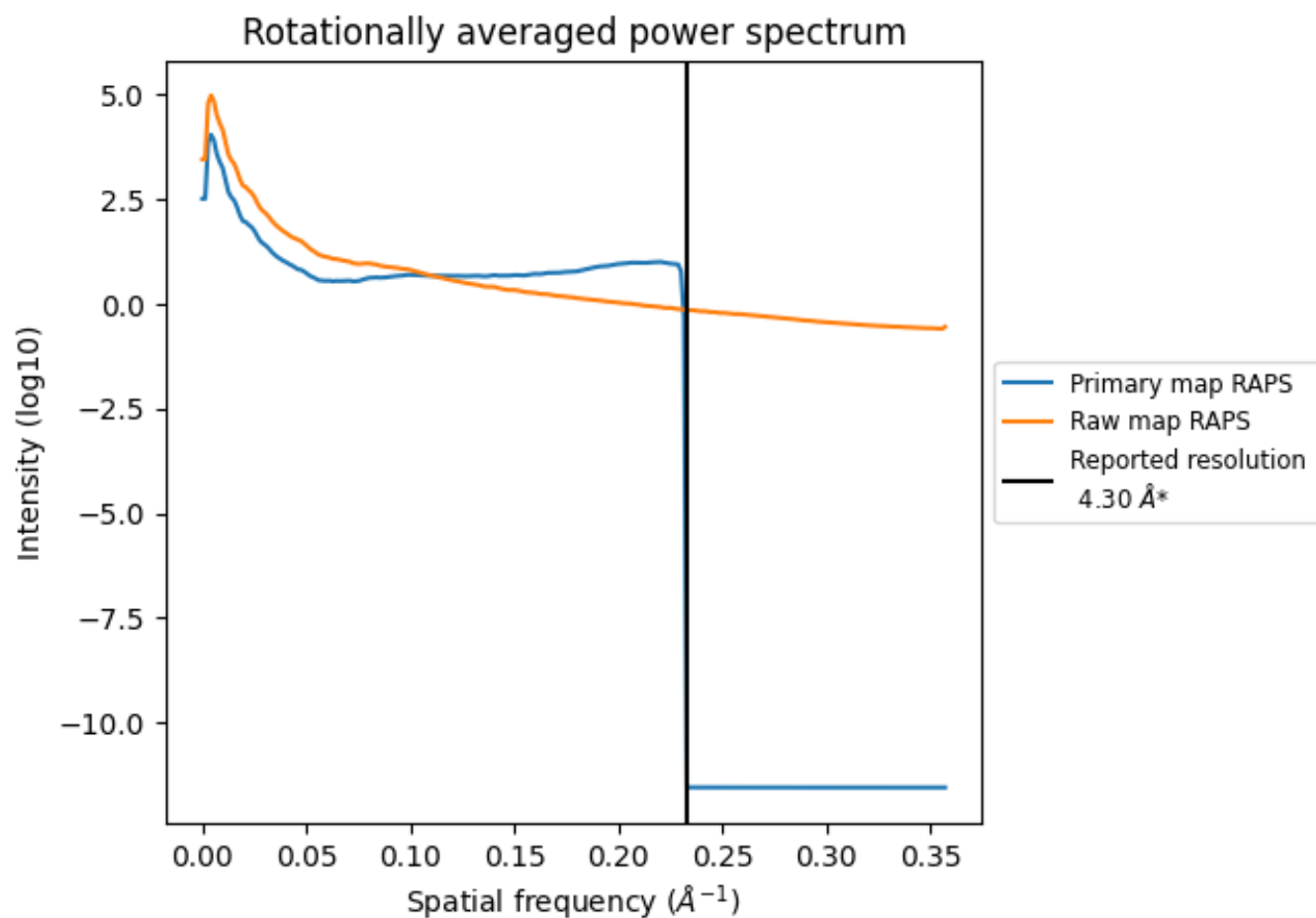

*Reported resolution corresponds to spatial frequency of 0.233 Å⁻¹

8 Fourier-Shell correlation [i](#)

Fourier-Shell Correlation (FSC) is the most commonly used method to estimate the resolution of single-particle and subtomogram-averaged maps. The shape of the curve depends on the imposed symmetry, mask and whether or not the two 3D reconstructions used were processed from a common reference. The reported resolution is shown as a black line. A curve is displayed for the half-bit criterion in addition to lines showing the 0.143 gold standard cut-off and 0.5 cut-off.

8.1 FSC [i](#)

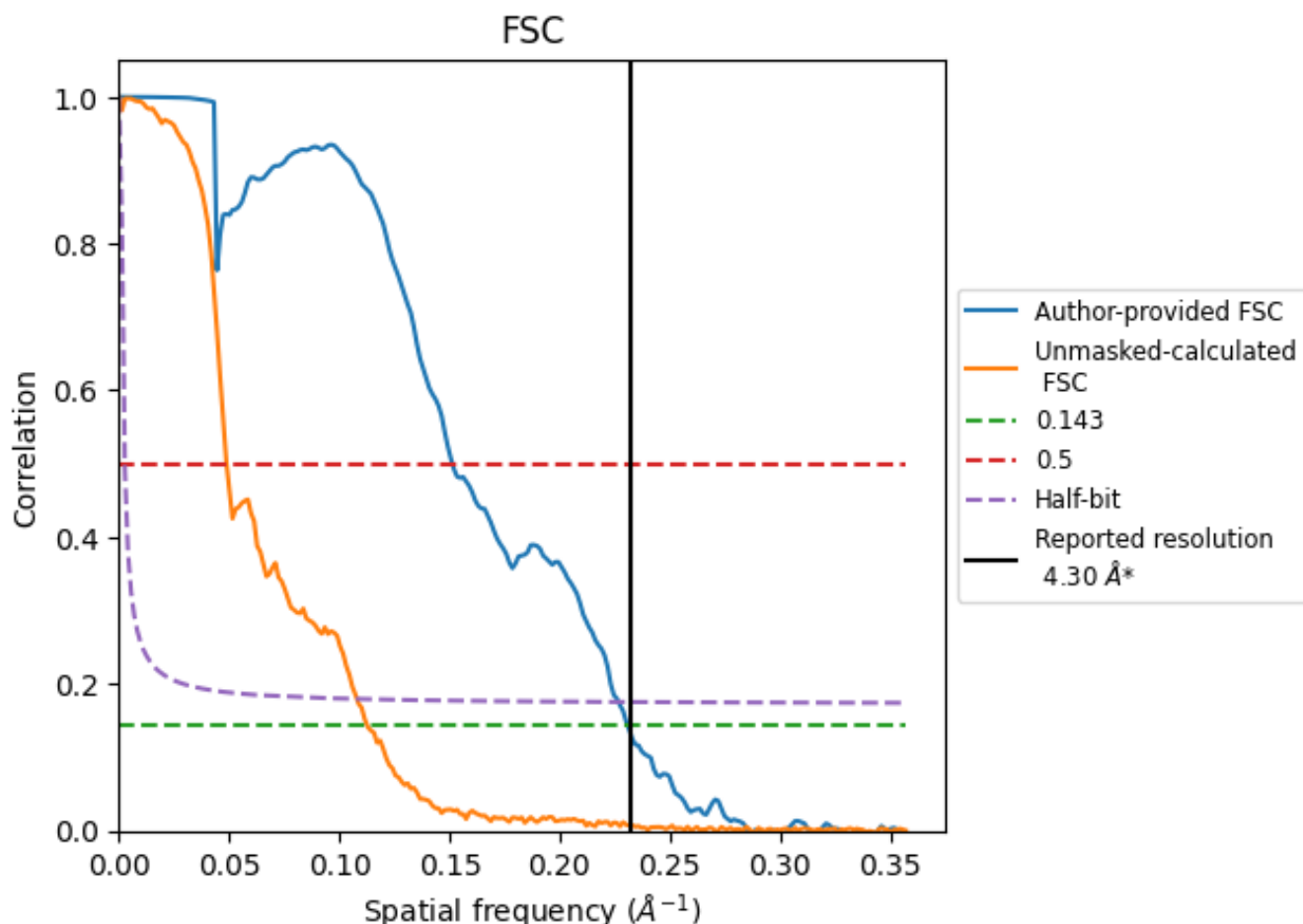

*Reported resolution corresponds to spatial frequency of 0.233 Å⁻¹

8.2 Resolution estimates [i](#)

Resolution estimate (Å)	Estimation criterion (FSC cut-off)		
	0.143	0.5	Half-bit
Reported by author	4.30	-	-
Author-provided FSC curve	4.33	6.61	4.41
Unmasked-calculated*	8.87	20.45	9.25

*Resolution estimate based on FSC curve calculated by comparison of deposited half-maps. The value from deposited half-maps intersecting FSC 0.143 CUT-OFF 8.87 differs from the reported value 4.3 by more than 10 %

9 Map-model fit [i](#)

This section contains information regarding the fit between EMDB map EMD-4497 and PDB model 6QC5. Per-residue inclusion information can be found in section 3 on page 16.

9.1 Map-model overlay [i](#)

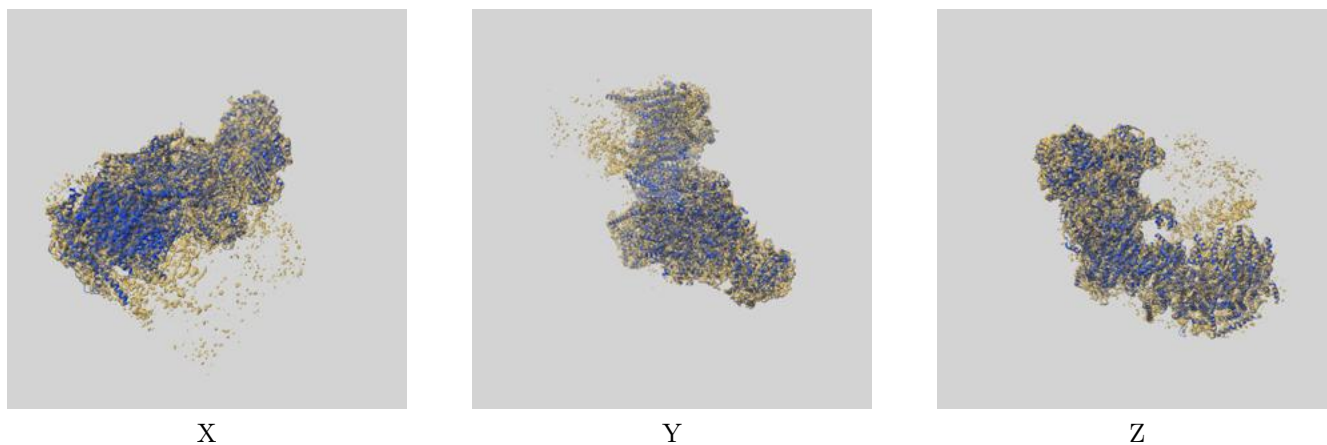

The images above show the 3D surface view of the map at the recommended contour level 0.15 at 50% transparency in yellow overlaid with a ribbon representation of the model coloured in blue. These images allow for the visual assessment of the quality of fit between the atomic model and the map.

9.2 Q-score mapped to coordinate model [i](#)

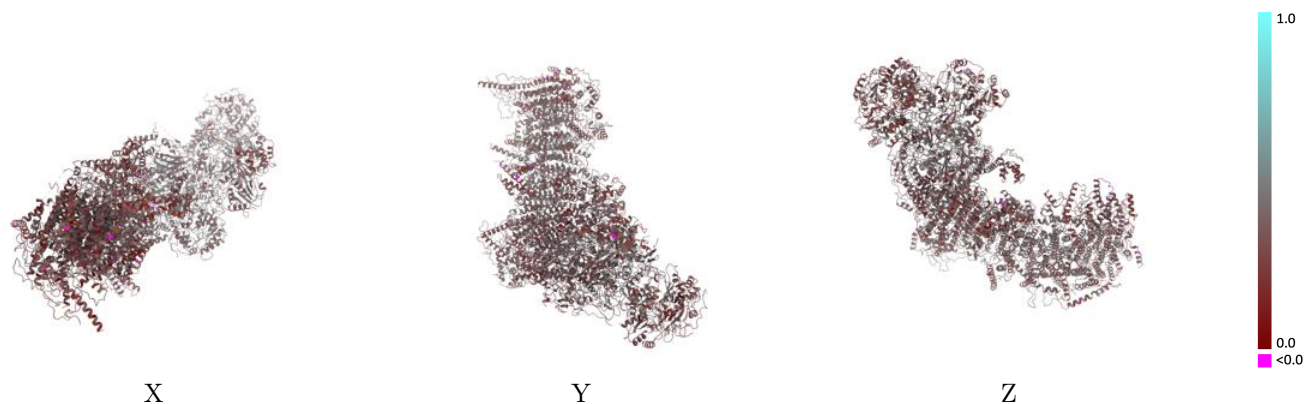

The images above show the model with each residue coloured according to its Q-score. This shows their resolvability in the map with higher Q-score values reflecting better resolvability. Please note: Q-score is calculating the resolvability of atoms, and thus high values are only expected at resolutions at which atoms can be resolved. Low Q-score values may therefore be expected for many entries.

9.3 Atom inclusion mapped to coordinate model [i](#)

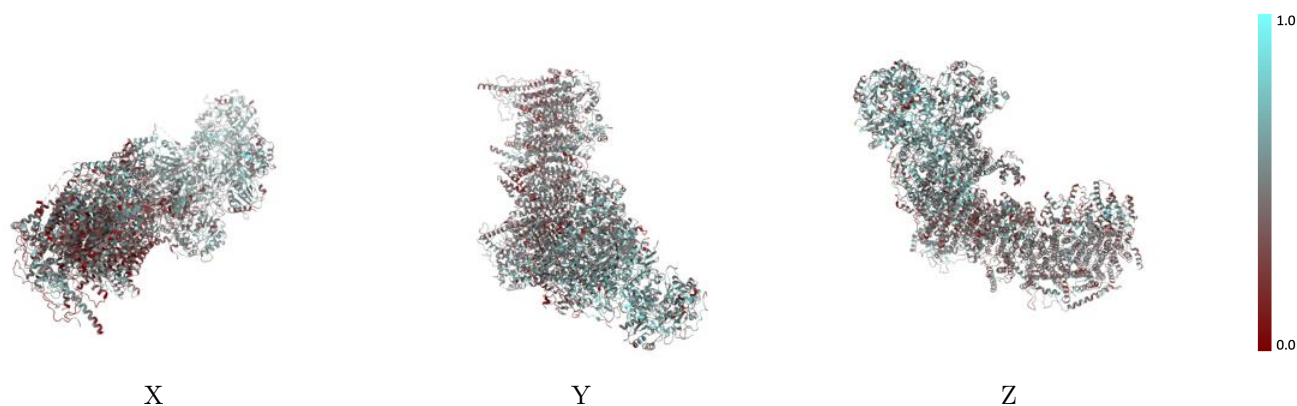

The images above show the model with each residue coloured according to its atom inclusion. This shows to what extent they are inside the map at the recommended contour level (0.15).



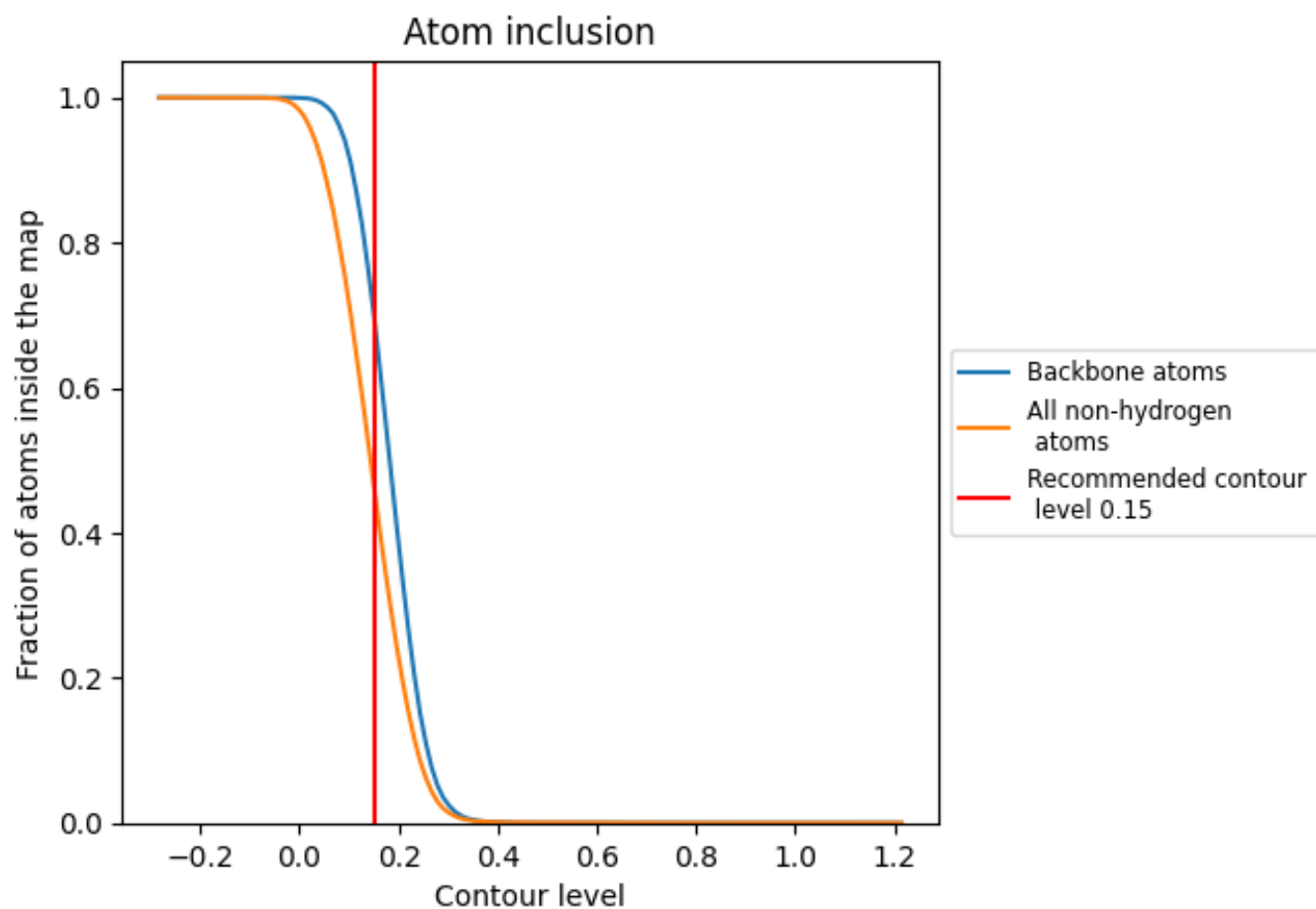



































































9.4 Atom inclusion [i](#)



At the recommended contour level, 70% of all backbone atoms, 47% of all non-hydrogen atoms, are inside the map.

9.5 Map-model fit summary























The table lists the average atom inclusion at the recommended contour level (0.15) and Q-score for the entire model and for each chain.

Chain	Atom inclusion	Q-score
All	 0.4657	 0.3510
4L	 0.3491	 0.3440
A1	 0.5072	 0.3460
A2	 0.5588	 0.3490
A3	 0.4386	 0.3500
A5	 0.5304	 0.3450
A6	 0.4628	 0.3730
A7	 0.3639	 0.3590
A8	 0.5066	 0.3490
A9	 0.4946	 0.3750
AA	 0.3635	 0.2980
AB	 0.4237	 0.3280
AJ	 0.4353	 0.3390
AK	 0.3110	 0.3090
AL	 0.3708	 0.3460
AM	 0.4896	 0.3360
B1	 0.3257	 0.3270
B2	 0.3722	 0.3100
B3	 0.4007	 0.3040
B4	 0.4163	 0.3360
B5	 0.4747	 0.3440
B6	 0.4240	 0.3170
B7	 0.4154	 0.2910
B8	 0.4146	 0.3400
B9	 0.4884	 0.3340
BJ	 0.4710	 0.3260
BK	 0.4043	 0.3230
C1	 0.4084	 0.3240
C2	 0.4461	 0.3620
D1	 0.4230	 0.3500
D2	 0.4514	 0.3620
D3	 0.3315	 0.3330
D4	 0.4364	 0.3600
D5	 0.3929	 0.3360
D6	 0.3469	 0.3390



Continued on next page...

Continued from previous page...

Chain	Atom inclusion	Q-score
S1	 0.5461	 0.3700
S2	 0.5139	 0.3810
S3	 0.5456	 0.3900
S4	 0.5090	 0.3890
S5	 0.5044	 0.3610
S6	 0.5446	 0.3820
S7	 0.5463	 0.3760
S8	 0.5830	 0.3820
V1	 0.5638	 0.3440
V2	 0.5554	 0.3580
V3	 0.5030	 0.3200