



# Full wwPDB X-ray Structure Validation Report ⓘ

Feb 10, 2024 – 07:22 PM EST

PDB ID : 2QYN  
Title : Crystal structure of PDE4D2 in complex with inhibitor NPV  
Authors : Ke, H.  
Deposited on : 2007-08-15  
Resolution : 1.57 Å(reported)

This is a Full wwPDB X-ray Structure Validation Report for a publicly released PDB entry.

We welcome your comments at [validation@mail.wwpdb.org](mailto:validation@mail.wwpdb.org)

A user guide is available at

<https://www.wwpdb.org/validation/2017/XrayValidationReportHelp>

with specific help available everywhere you see the ⓘ symbol.

The types of validation reports are described at

<http://www.wwpdb.org/validation/2017/FAQs#types>.

---

The following versions of software and data (see [references ⓘ](#)) were used in the production of this report:

MolProbity : 4.02b-467  
Mogul : 1.8.5 (274361), CSD as541be (2020)  
Xtriage (Phenix) : 1.13  
EDS : 2.36  
buster-report : 1.1.7 (2018)  
Percentile statistics : 20191225.v01 (using entries in the PDB archive December 25th 2019)  
Refmac : 5.8.0158  
CCP4 : 7.0.044 (Gargrove)  
Ideal geometry (proteins) : Engh & Huber (2001)  
Ideal geometry (DNA, RNA) : Parkinson et al. (1996)  
Validation Pipeline (wwPDB-VP) : 2.36

# 1 Overall quality at a glance

The following experimental techniques were used to determine the structure:

*X-RAY DIFFRACTION*

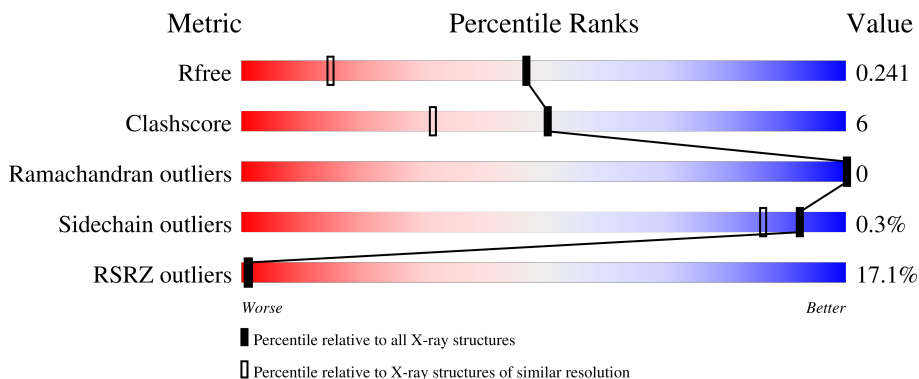

The reported resolution of this entry is 1.57 Å.

Percentile scores (ranging between 0-100) for global validation metrics of the entry are shown in the following graphic. The table shows the number of entries on which the scores are based.



Metric	Whole archive (#Entries)	Similar resolution (#Entries, resolution range(Å))
$R_{free}$	130704	5534 (1.60-1.56)
Clashscore	141614	5861 (1.60-1.56)
Ramachandran outliers	138981	5708 (1.60-1.56)
Sidechain outliers	138945	5703 (1.60-1.56)
RSRZ outliers	127900	5431 (1.60-1.56)

The table below summarises the geometric issues observed across the polymeric chains and their fit to the electron density. The red, orange, yellow and green segments of the lower bar indicate the fraction of residues that contain outliers for  $\geq 3$ , 2, 1 and 0 types of geometric quality criteria respectively. A grey segment represents the fraction of residues that are not modelled. The numeric value for each fraction is indicated below the corresponding segment, with a dot representing fractions  $\leq 5\%$ . The upper red bar (where present) indicates the fraction of residues that have poor fit to the electron density. The numeric value is given above the bar.

Mol	Chain	Length	Quality of chain
1	A	328	
1	B	328	

## 2 Entry composition [i](#)

There are 5 unique types of molecules in this entry. The entry contains 5694 atoms, of which 0 are hydrogens and 0 are deuteriums.

In the tables below, the ZeroOcc column contains the number of atoms modelled with zero occupancy, the AltConf column contains the number of residues with at least one atom in alternate conformation and the Trace column contains the number of residues modelled with at most 2 atoms.

- Molecule 1 is a protein called cAMP-specific 3',5'-cyclic phosphodiesterase 4D.

Mol	Chain	Residues	Atoms					ZeroOcc	AltConf	Trace
			Total	C	N	O	S			
1	A	326	Total 2638	C 1668	N 450	O 506	S 14	0	0	0
1	B	325	Total 2631	C 1664	N 450	O 503	S 14	0	0	0

- Molecule 2 is 4-[8-(3-nitrophenyl)-1,7-naphthyridin-6-yl]benzoic acid (three-letter code: NPV) (formula: C<sub>21</sub>H<sub>13</sub>N<sub>3</sub>O<sub>4</sub>).

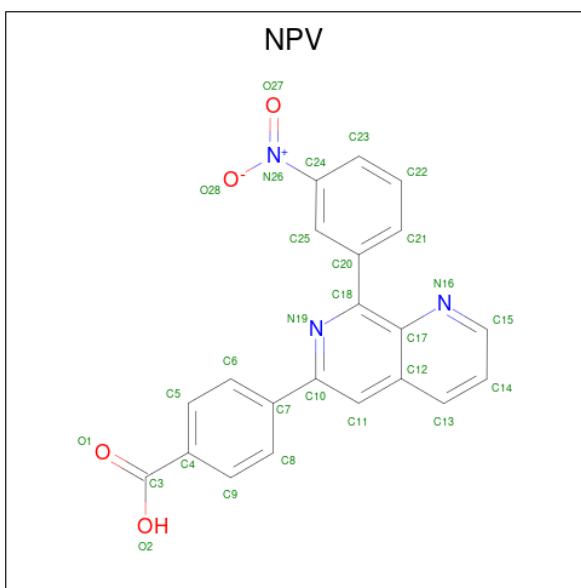

Mol	Chain	Residues	Atoms				ZeroOcc	AltConf
			Total	C	N	O		
2	A	1	Total 28	C 21	N 3	O 4	0	0
2	B	1	Total 28	C 21	N 3	O 4	0	0

- Molecule 3 is ZINC ION (three-letter code: ZN) (formula: Zn).

Mol	Chain	Residues	Atoms		ZeroOcc	AltConf
3	A	1	Total 1	Zn 1	0	0
3	B	1	Total 1	Zn 1	0	0

- Molecule 4 is MAGNESIUM ION (three-letter code: MG) (formula: Mg).

Mol	Chain	Residues	Atoms		ZeroOcc	AltConf
4	A	1	Total 1	Mg 1	0	0
4	B	1	Total 1	Mg 1	0	0

- Molecule 5 is water.

Mol	Chain	Residues	Atoms		ZeroOcc	AltConf
5	A	225	Total 225	O 225	0	0
5	B	140	Total 140	O 140	0	0

### 3 Residue-property plots [i](#)

These plots are drawn for all protein, RNA, DNA and oligosaccharide chains in the entry. The first graphic for a chain summarises the proportions of the various outlier classes displayed in the second graphic. The second graphic shows the sequence view annotated by issues in geometry and electron density. Residues are color-coded according to the number of geometric quality criteria for which they contain at least one outlier: green = 0, yellow = 1, orange = 2 and red = 3 or more. A red dot above a residue indicates a poor fit to the electron density ( $RSRZ > 2$ ). Stretches of 2 or more consecutive residues without any outlier are shown as a green connector. Residues present in the sample, but not in the model, are shown in grey.

- Molecule 1: cAMP-specific 3',5'-cyclic phosphodiesterase 4D

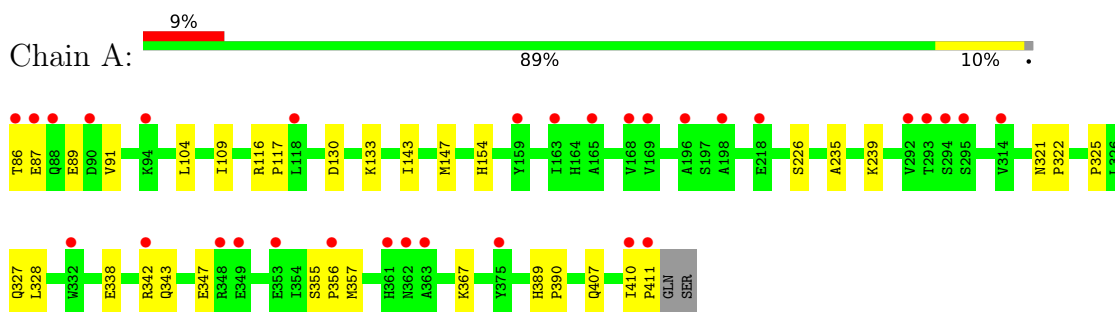

- Molecule 1: cAMP-specific 3',5'-cyclic phosphodiesterase 4D

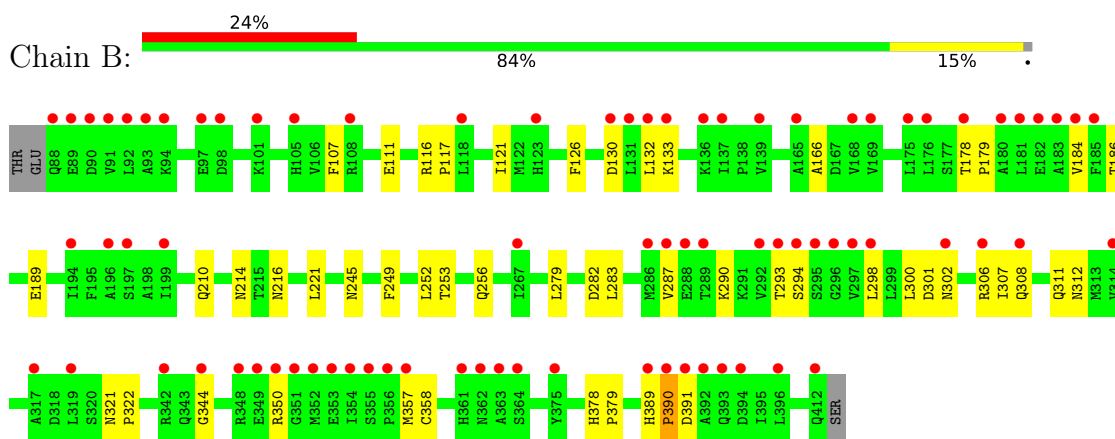

## 4 Data and refinement statistics

Property	Value	Source
Space group	P 21 21 21	Depositor
Cell constants a, b, c, $\alpha$ , $\beta$ , $\gamma$	58.10Å 80.63Å 163.31Å 90.00° 90.00° 90.00°	Depositor
Resolution (Å)	30.00 – 1.57 32.40 – 1.57	Depositor EDS
% Data completeness (in resolution range)	(Not available) (30.00-1.57) 92.6 (32.40-1.57)	Depositor EDS
$R_{merge}$	0.05	Depositor
$R_{sym}$	(Not available)	Depositor
$\langle I/\sigma(I) \rangle$ <sup>1</sup>	2.32 (at 1.57Å)	Xtrriage
Refinement program	CNS 1.2	Depositor
R, $R_{free}$	0.225 , 0.248 0.217 , 0.241	Depositor DCC
$R_{free}$ test set	10439 reflections (10.05%)	wwPDB-VP
Wilson B-factor (Å <sup>2</sup> )	19.3	Xtrriage
Anisotropy	0.325	Xtrriage
Bulk solvent $k_{sol}$ (e/Å <sup>3</sup> ), $B_{sol}$ (Å <sup>2</sup> )	0.39 , 52.3	EDS
L-test for twinning <sup>2</sup>	$\langle  L  \rangle = 0.50$ , $\langle L^2 \rangle = 0.33$	Xtrriage
Estimated twinning fraction	No twinning to report.	Xtrriage
$F_o, F_c$ correlation	0.95	EDS
Total number of atoms	5694	wwPDB-VP
Average B, all atoms (Å <sup>2</sup> )	26.0	wwPDB-VP

Xtrriage's analysis on translational NCS is as follows: *The largest off-origin peak in the Patterson function is 4.02% of the height of the origin peak. No significant pseudotranslation is detected.*

<sup>1</sup>Intensities estimated from amplitudes.

<sup>2</sup>Theoretical values of  $\langle |L| \rangle$ ,  $\langle L^2 \rangle$  for acentric reflections are 0.5, 0.333 respectively for untwinned datasets, and 0.375, 0.2 for perfectly twinned datasets.

## 5 Model quality

### 5.1 Standard geometry

Bond lengths and bond angles in the following residue types are not validated in this section: ZN, NPV, MG

The Z score for a bond length (or angle) is the number of standard deviations the observed value is removed from the expected value. A bond length (or angle) with  $|Z| > 5$  is considered an outlier worth inspection. RMSZ is the root-mean-square of all Z scores of the bond lengths (or angles).

Mol	Chain	Bond lengths		Bond angles	
		RMSZ	# Z  >5	RMSZ	# Z  >5
1	A	0.30	0/2692	0.53	0/3658
1	B	0.27	0/2685	0.50	0/3648
All	All	0.28	0/5377	0.51	0/7306

There are no bond length outliers.

There are no bond angle outliers.

There are no chirality outliers.

There are no planarity outliers.

### 5.2 Too-close contacts

In the following table, the Non-H and H(model) columns list the number of non-hydrogen atoms and hydrogen atoms in the chain respectively. The H(added) column lists the number of hydrogen atoms added and optimized by MolProbity. The Clashes column lists the number of clashes within the asymmetric unit, whereas Symm-Clashes lists symmetry-related clashes.

Mol	Chain	Non-H	H(model)	H(added)	Clashes	Symm-Clashes
1	A	2638	0	2591	23	0
1	B	2631	0	2586	39	0
2	A	28	0	12	1	0
2	B	28	0	12	1	0
3	A	1	0	0	0	0
3	B	1	0	0	0	0
4	A	1	0	0	0	0
4	B	1	0	0	0	0
5	A	225	0	0	2	0
5	B	140	0	0	3	0
All	All	5694	0	5201	60	0

The all-atom clashscore is defined as the number of clashes found per 1000 atoms (including hydrogen atoms). The all-atom clashscore for this structure is 6.

All (60) close contacts within the same asymmetric unit are listed below, sorted by their clash magnitude.

Atom-1	Atom-2	Interatomic distance (Å)	Clash overlap (Å)
1:B:293:THR:HG22	1:B:294:SER:H	1.30	0.93
1:A:226:SER:HB2	5:A:661:HOH:O	1.75	0.87
1:A:239:LYS:HG2	1:B:221:LEU:HD21	1.55	0.86
1:B:184:VAL:HG11	1:B:300:LEU:HD12	1.69	0.73
1:B:210:GLN:HG3	1:B:214:ASN:HD21	1.55	0.71
1:A:239:LYS:HG2	1:B:221:LEU:CD2	2.21	0.69
1:B:282:ASP:HB3	1:B:308:GLN:NE2	2.07	0.69
1:A:104:LEU:HD11	1:A:109:ILE:HD11	1.75	0.68
1:A:154:HIS:NE2	5:A:660:HOH:O	2.27	0.67
1:B:321:ASN:HB2	1:B:322:PRO:HD3	1.79	0.64
1:B:293:THR:HG22	1:B:294:SER:N	2.10	0.63
1:A:356:PRO:HB2	1:A:357:MET:HE2	1.79	0.63
1:B:179:PRO:HD2	1:B:391:ASP:CG	2.19	0.63
1:B:302:ASN:O	1:B:306:ARG:HG3	1.98	0.62
1:A:389:HIS:CE1	1:A:390:PRO:HB3	2.37	0.60
1:B:178:THR:HG23	1:B:391:ASP:OD2	2.02	0.59
1:B:210:GLN:HG3	1:B:214:ASN:ND2	2.18	0.58
1:B:283:LEU:O	1:B:287:VAL:HG23	2.04	0.58
1:B:301:ASP:OD1	5:B:606:HOH:O	2.17	0.58
1:B:107:PHE:O	1:B:111:GLU:HG3	2.02	0.57
1:B:253:THR:OG1	1:B:256:GLN:HG3	2.07	0.55
1:B:282:ASP:HB3	1:B:308:GLN:CD	2.28	0.54
1:A:343:GLN:O	1:A:347:GLU:HG3	2.06	0.54
1:B:184:VAL:CG1	1:B:300:LEU:HD12	2.37	0.54
1:A:235:ALA:O	1:A:239:LYS:HG3	2.08	0.53
1:B:189:GLU:OE1	1:B:306:ARG:NH2	2.41	0.53
1:B:186:THR:HG23	1:B:306:ARG:HH22	1.73	0.52
1:B:121:ILE:HD12	1:B:166:ALA:HB1	1.93	0.51
1:B:186:THR:OG1	1:B:189:GLU:HG3	2.10	0.50
1:A:130:ASP:OD1	1:A:133:LYS:HD2	2.11	0.50
1:B:357:MET:SD	2:B:1:NPV:C23	3.01	0.49
1:A:321:ASN:HB2	1:A:322:PRO:HD3	1.93	0.49
1:B:130:ASP:OD1	1:B:133:LYS:HD2	2.13	0.49
1:B:389:HIS:CE1	1:B:390:PRO:HB3	2.47	0.49
1:A:87:GLU:O	1:A:91:VAL:HG23	2.13	0.49
1:B:344:GLY:HA3	1:B:358:CYS:O	2.12	0.49
1:A:86:THR:HA	1:A:89:GLU:OE2	2.14	0.48

*Continued on next page...*



Continued from previous page...

Atom-1	Atom-2	Interatomic distance (Å)	Clash overlap (Å)
1:B:307:ILE:O	1:B:311:GLN:HG3	2.13	0.47
1:A:410:ILE:HB	1:A:411:PRO:HD3	1.95	0.47
1:B:293:THR:CG2	1:B:294:SER:H	2.11	0.47
1:B:179:PRO:HD2	1:B:391:ASP:OD2	2.15	0.47
1:B:290:LYS:HG3	1:B:298:LEU:CD1	2.44	0.46
1:B:378:HIS:HB3	1:B:379:PRO:HD3	1.97	0.46
1:A:355:SER:HB3	1:A:356:PRO:HD2	1.98	0.46
1:A:357:MET:SD	2:A:1:NPV:C23	3.04	0.46
1:B:126:PHE:HB3	1:B:132:LEU:CD1	2.46	0.45
1:A:116:ARG:N	1:A:117:PRO:CD	2.80	0.45
1:B:249:PHE:HA	1:B:252:LEU:HD13	1.98	0.45
1:A:407:GLN:O	1:A:411:PRO:HD3	2.17	0.45
1:B:389:HIS:HA	1:B:390:PRO:HA	1.71	0.45
1:A:143:ILE:O	1:A:147:MET:HG3	2.16	0.44
1:B:116:ARG:N	1:B:117:PRO:CD	2.80	0.44
1:B:350:ARG:HD3	5:B:577:HOH:O	2.18	0.44
1:A:327:GLN:NE2	1:A:328:LEU:HG	2.33	0.43
1:B:216:ASN:HA	5:B:637:HOH:O	2.19	0.42
1:B:279:LEU:HG	1:B:312:ASN:OD1	2.20	0.41
1:A:367:LYS:HG2	1:A:410:ILE:HD13	2.03	0.41
1:A:338:GLU:OE2	1:A:342:ARG:NH2	2.55	0.40
1:A:325:PRO:HB2	1:A:327:GLN:HE22	1.86	0.40
1:B:132:LEU:H	1:B:132:LEU:HD12	1.87	0.40

There are no symmetry-related clashes.

## 5.3 Torsion angles [i](#)

### 5.3.1 Protein backbone [i](#)

In the following table, the Percentiles column shows the percent Ramachandran outliers of the chain as a percentile score with respect to all X-ray entries followed by that with respect to entries of similar resolution.

The Analysed column shows the number of residues for which the backbone conformation was analysed, and the total number of residues.

Mol	Chain	Analysed	Favoured	Allowed	Outliers	Percentiles	
1	A	324/328 (99%)	316 (98%)	8 (2%)	0	100	100
1	B	323/328 (98%)	312 (97%)	11 (3%)	0	100	100

Continued on next page...

Continued from previous page...

Mol	Chain	Analysed	Favoured	Allowed	Outliers	Percentiles	
All	All	647/656 (99%)	628 (97%)	19 (3%)	0	100	100

There are no Ramachandran outliers to report.

### 5.3.2 Protein sidechains [i](#)

In the following table, the Percentiles column shows the percent sidechain outliers of the chain as a percentile score with respect to all X-ray entries followed by that with respect to entries of similar resolution.

The Analysed column shows the number of residues for which the sidechain conformation was analysed, and the total number of residues.

Mol	Chain	Analysed	Rotameric	Outliers	Percentiles	
1	A	298/300 (99%)	298 (100%)	0	100	100
1	B	297/300 (99%)	295 (99%)	2 (1%)	84	72
All	All	595/600 (99%)	593 (100%)	2 (0%)	92	86

All (2) residues with a non-rotameric sidechain are listed below:

Mol	Chain	Res	Type
1	B	245	ASN
1	B	390	PRO

Sometimes sidechains can be flipped to improve hydrogen bonding and reduce clashes. All (11) such sidechains are listed below:

Mol	Chain	Res	Type
1	A	127	GLN
1	A	242	GLN
1	A	362	ASN
1	B	210	GLN
1	B	214	ASN
1	B	242	GLN
1	B	245	ASN
1	B	258	GLN
1	B	302	ASN
1	B	308	GLN
1	B	362	ASN

### 5.3.3 RNA [i](#)

There are no RNA molecules in this entry.

## 5.4 Non-standard residues in protein, DNA, RNA chains [i](#)

There are no non-standard protein/DNA/RNA residues in this entry.

## 5.5 Carbohydrates [i](#)

There are no monosaccharides in this entry.

## 5.6 Ligand geometry [i](#)

Of 6 ligands modelled in this entry, 4 are monoatomic - leaving 2 for Mogul analysis.

In the following table, the Counts columns list the number of bonds (or angles) for which Mogul statistics could be retrieved, the number of bonds (or angles) that are observed in the model and the number of bonds (or angles) that are defined in the Chemical Component Dictionary. The Link column lists molecule types, if any, to which the group is linked. The Z score for a bond length (or angle) is the number of standard deviations the observed value is removed from the expected value. A bond length (or angle) with  $|Z| > 2$  is considered an outlier worth inspection. RMSZ is the root-mean-square of all Z scores of the bond lengths (or angles).

Mol	Type	Chain	Res	Link	Bond lengths			Bond angles		
					Counts	RMSZ	# Z  > 2	Counts	RMSZ	# Z  > 2
2	NPV	A	1	-	28,31,31	1.61	2 (7%)	34,44,44	1.50	5 (14%)
2	NPV	B	1	-	28,31,31	1.62	2 (7%)	34,44,44	1.47	4 (11%)

In the following table, the Chirals column lists the number of chiral outliers, the number of chiral centers analysed, the number of these observed in the model and the number defined in the Chemical Component Dictionary. Similar counts are reported in the Torsion and Rings columns. '-' means no outliers of that kind were identified.

Mol	Type	Chain	Res	Link	Chirals	Torsions	Rings
2	NPV	A	1	-	-	0/6/16/16	0/4/4/4
2	NPV	B	1	-	-	0/6/16/16	0/4/4/4

All (4) bond length outliers are listed below:

Mol	Chain	Res	Type	Atoms	Z	Observed(Å)	Ideal(Å)
2	B	1	NPV	C4-C3	-5.07	1.38	1.49

*Continued on next page...*

*Continued from previous page...*

Mol	Chain	Res	Type	Atoms	Z	Observed(Å)	Ideal(Å)
2	A	1	NPV	C4-C3	-5.05	1.38	1.49
2	B	1	NPV	C24-N26	-4.83	1.33	1.45
2	A	1	NPV	C24-N26	-4.82	1.33	1.45

All (9) bond angle outliers are listed below:

Mol	Chain	Res	Type	Atoms	Z	Observed(°)	Ideal(°)
2	A	1	NPV	C18-N19-C10	5.67	122.43	116.77
2	B	1	NPV	C18-N19-C10	5.48	122.25	116.77
2	A	1	NPV	C15-N16-C17	2.54	121.65	117.12
2	B	1	NPV	C15-N16-C17	2.50	121.59	117.12
2	A	1	NPV	C11-C10-N19	-2.21	119.82	121.83
2	A	1	NPV	C14-C15-N16	-2.10	120.72	123.94
2	A	1	NPV	C11-C12-C17	2.08	119.74	117.70
2	B	1	NPV	C11-C10-N19	-2.08	119.94	121.83
2	B	1	NPV	C14-C15-N16	-2.06	120.78	123.94

There are no chirality outliers.

There are no torsion outliers.

There are no ring outliers.

2 monomers are involved in 2 short contacts:

Mol	Chain	Res	Type	Clashes	Symm-Clashes
2	A	1	NPV	1	0
2	B	1	NPV	1	0

The following is a two-dimensional graphical depiction of Mogul quality analysis of bond lengths, bond angles, torsion angles, and ring geometry for all instances of the Ligand of Interest. In addition, ligands with molecular weight > 250 and outliers as shown on the validation Tables will also be included. For torsion angles, if less than 5% of the Mogul distribution of torsion angles is within 10 degrees of the torsion angle in question, then that torsion angle is considered an outlier. Any bond that is central to one or more torsion angles identified as an outlier by Mogul will be highlighted in the graph. For rings, the root-mean-square deviation (RMSD) between the ring in question and similar rings identified by Mogul is calculated over all ring torsion angles. If the average RMSD is greater than 60 degrees and the minimal RMSD between the ring in question and any Mogul-identified rings is also greater than 60 degrees, then that ring is considered an outlier. The outliers are highlighted in purple. The color gray indicates Mogul did not find sufficient equivalents in the CSD to analyse the geometry.

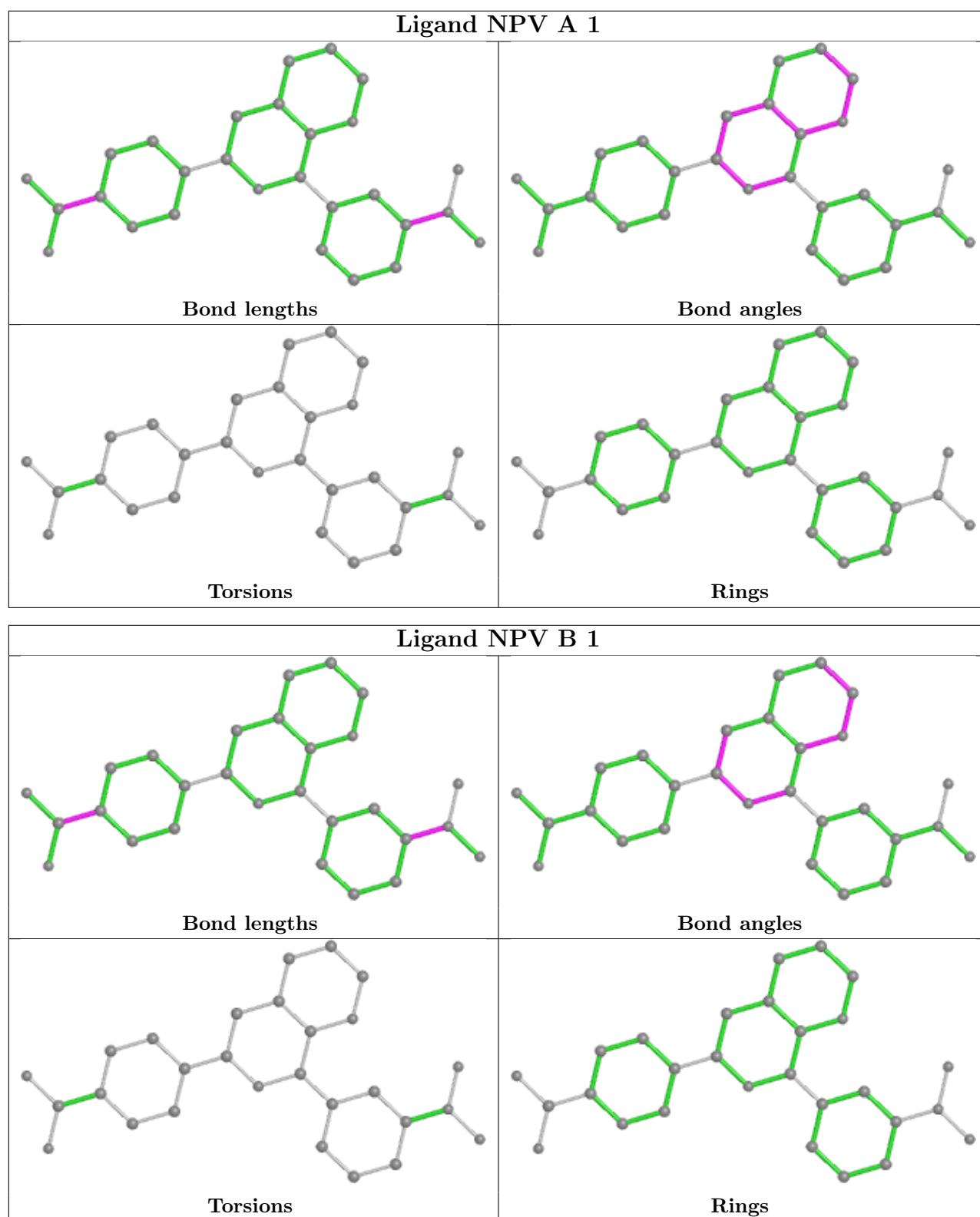

## 5.7 Other polymers [\(i\)](#)

There are no such residues in this entry.

## 5.8 Polymer linkage issues

There are no chain breaks in this entry.

## 6 Fit of model and data

### 6.1 Protein, DNA and RNA chains

In the following table, the column labelled ‘#RSRZ > 2’ contains the number (and percentage) of RSRZ outliers, followed by percent RSRZ outliers for the chain as percentile scores relative to all X-ray entries and entries of similar resolution. The OWAB column contains the minimum, median, 95<sup>th</sup> percentile and maximum values of the occupancy-weighted average B-factor per residue. The column labelled ‘Q < 0.9’ lists the number of (and percentage) of residues with an average occupancy less than 0.9.

Mol	Chain	Analysed	<RSRZ>	#RSRZ>2	OWAB(Å <sup>2</sup> )	Q<0.9
1	A	326/328 (99%)	0.53	31 (9%) <b>8</b>   <b>8</b>	11, 21, 41, 50	0
1	B	325/328 (99%)	1.36	80 (24%) <b>0</b>   <b>0</b>	13, 29, 51, 58	0
All	All	651/656 (99%)	0.94	111 (17%) <b>1</b>   <b>1</b>	11, 24, 46, 58	0

All (111) RSRZ outliers are listed below:

Mol	Chain	Res	Type	RSRZ
1	A	86	THR	9.1
1	B	294	SER	7.1
1	B	412	GLN	6.9
1	B	354	ILE	6.9
1	B	295	SER	6.7
1	B	353	GLU	6.0
1	B	293	THR	5.9
1	A	294	SER	5.7
1	B	296	GLY	5.7
1	B	91	VAL	5.6
1	B	363	ALA	5.6
1	B	314	VAL	5.3
1	B	183	ALA	5.2
1	A	87	GLU	5.1
1	B	94	LYS	5.0
1	B	88	GLN	4.9
1	B	348	ARG	4.6
1	B	90	ASP	4.6
1	B	356	PRO	4.4
1	A	90	ASP	4.4
1	B	297	VAL	4.4
1	B	139	VAL	4.4
1	B	89	GLU	4.3
1	B	375	TYR	4.3

*Continued on next page...*

*Continued from previous page...*

<b>Mol</b>	<b>Chain</b>	<b>Res</b>	<b>Type</b>	<b>RSRZ</b>
1	B	181	LEU	4.2
1	B	137	ILE	4.0
1	B	168	VAL	4.0
1	B	288	GLU	3.9
1	B	93	ALA	3.8
1	B	391	ASP	3.8
1	B	389	HIS	3.7
1	A	168	VAL	3.7
1	B	169	VAL	3.7
1	B	362	ASN	3.7
1	B	133	LYS	3.6
1	B	92	LEU	3.6
1	B	349	GLU	3.5
1	B	298	LEU	3.5
1	B	130	ASP	3.5
1	B	287	VAL	3.5
1	B	289	THR	3.5
1	B	319	LEU	3.4
1	B	292	VAL	3.4
1	B	182	GLU	3.3
1	B	390	PRO	3.3
1	B	396	LEU	3.3
1	A	362	ASN	3.2
1	B	194	ILE	3.2
1	B	108	ARG	3.2
1	B	199	ILE	3.1
1	B	355	SER	3.1
1	A	292	VAL	3.1
1	A	363	ALA	3.0
1	A	410	ILE	2.9
1	B	317	ALA	2.9
1	B	350	ARG	2.9
1	B	98	ASP	2.9
1	A	353	GLU	2.9
1	B	184	VAL	2.9
1	A	293	THR	2.9
1	A	165	ALA	2.9
1	B	357	MET	2.8
1	B	392	ALA	2.8
1	A	169	VAL	2.8
1	B	180	ALA	2.8
1	B	197	SER	2.8

*Continued on next page...*



*Continued from previous page...*

<b>Mol</b>	<b>Chain</b>	<b>Res</b>	<b>Type</b>	<b>RSRZ</b>
1	B	352	MET	2.7
1	B	105	HIS	2.7
1	B	176	LEU	2.7
1	A	356	PRO	2.6
1	B	342	ARG	2.6
1	A	88	GLN	2.6
1	A	295	SER	2.6
1	B	178	THR	2.6
1	A	361	HIS	2.5
1	A	349	GLU	2.4
1	A	411	PRO	2.4
1	A	196	ALA	2.4
1	B	165	ALA	2.4
1	A	348	ARG	2.4
1	A	314	VAL	2.4
1	B	97	GLU	2.4
1	B	306	ARG	2.4
1	B	302	ASN	2.4
1	A	218	GLU	2.3
1	B	361	HIS	2.3
1	B	136	LYS	2.3
1	A	163	ILE	2.3
1	A	375	TYR	2.3
1	B	123	HIS	2.3
1	B	308	GLN	2.3
1	A	94	LYS	2.3
1	B	101	LYS	2.2
1	B	132	LEU	2.2
1	A	342	ARG	2.2
1	B	351	GLY	2.2
1	A	198	ALA	2.2
1	B	118	LEU	2.2
1	B	175	LEU	2.2
1	B	364	SER	2.1
1	B	393	GLN	2.1
1	B	185	PHE	2.1
1	A	118	LEU	2.1
1	B	267	ILE	2.1
1	A	159	TYR	2.1
1	B	394	ASP	2.1
1	A	332	TRP	2.1
1	B	196	ALA	2.1

*Continued on next page...*

*Continued from previous page...*

Mol	Chain	Res	Type	RSRZ
1	B	131	LEU	2.1
1	B	344	GLY	2.0
1	B	286	MET	2.0

## 6.2 Non-standard residues in protein, DNA, RNA chains [i](#)

There are no non-standard protein/DNA/RNA residues in this entry.

## 6.3 Carbohydrates [i](#)

There are no monosaccharides in this entry.

## 6.4 Ligands [i](#)

In the following table, the Atoms column lists the number of modelled atoms in the group and the number defined in the chemical component dictionary. The B-factors column lists the minimum, median, 95<sup>th</sup> percentile and maximum values of B factors of atoms in the group. The column labelled 'Q< 0.9' lists the number of atoms with occupancy less than 0.9.

Mol	Type	Chain	Res	Atoms	RSCC	RSR	B-factors(Å <sup>2</sup> )	Q<0.9
2	NPV	B	1	28/28	0.66	0.18	22,25,40,41	0
2	NPV	A	1	28/28	0.80	0.14	17,21,38,41	0
3	ZN	B	501	1/1	0.99	0.05	18,18,18,18	0
4	MG	A	502	1/1	0.99	0.13	12,12,12,12	0
4	MG	B	502	1/1	0.99	0.14	14,14,14,14	0
3	ZN	A	501	1/1	1.00	0.07	14,14,14,14	0

The following is a graphical depiction of the model fit to experimental electron density of all instances of the Ligand of Interest. In addition, ligands with molecular weight > 250 and outliers as shown on the geometry validation Tables will also be included. Each fit is shown from different orientation to approximate a three-dimensional view.

**Electron density around NPV B 1:**

$2mF_o-DF_c$  (at 0.7 rmsd) in gray  
 $mF_o-DF_c$  (at 3 rmsd) in purple (negative)  
and green (positive)

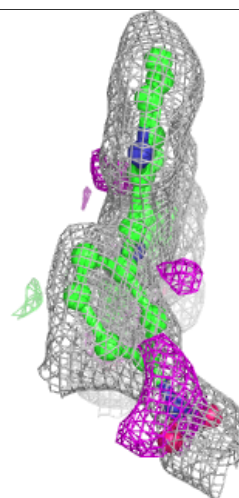
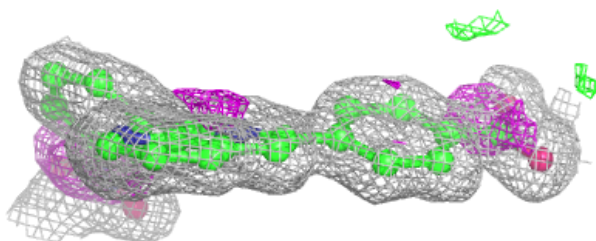
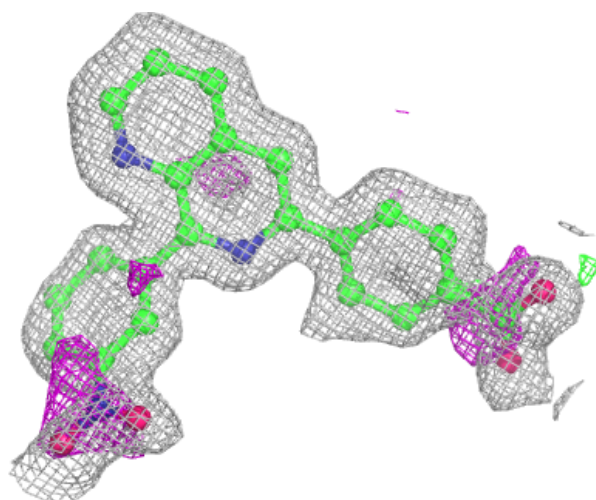

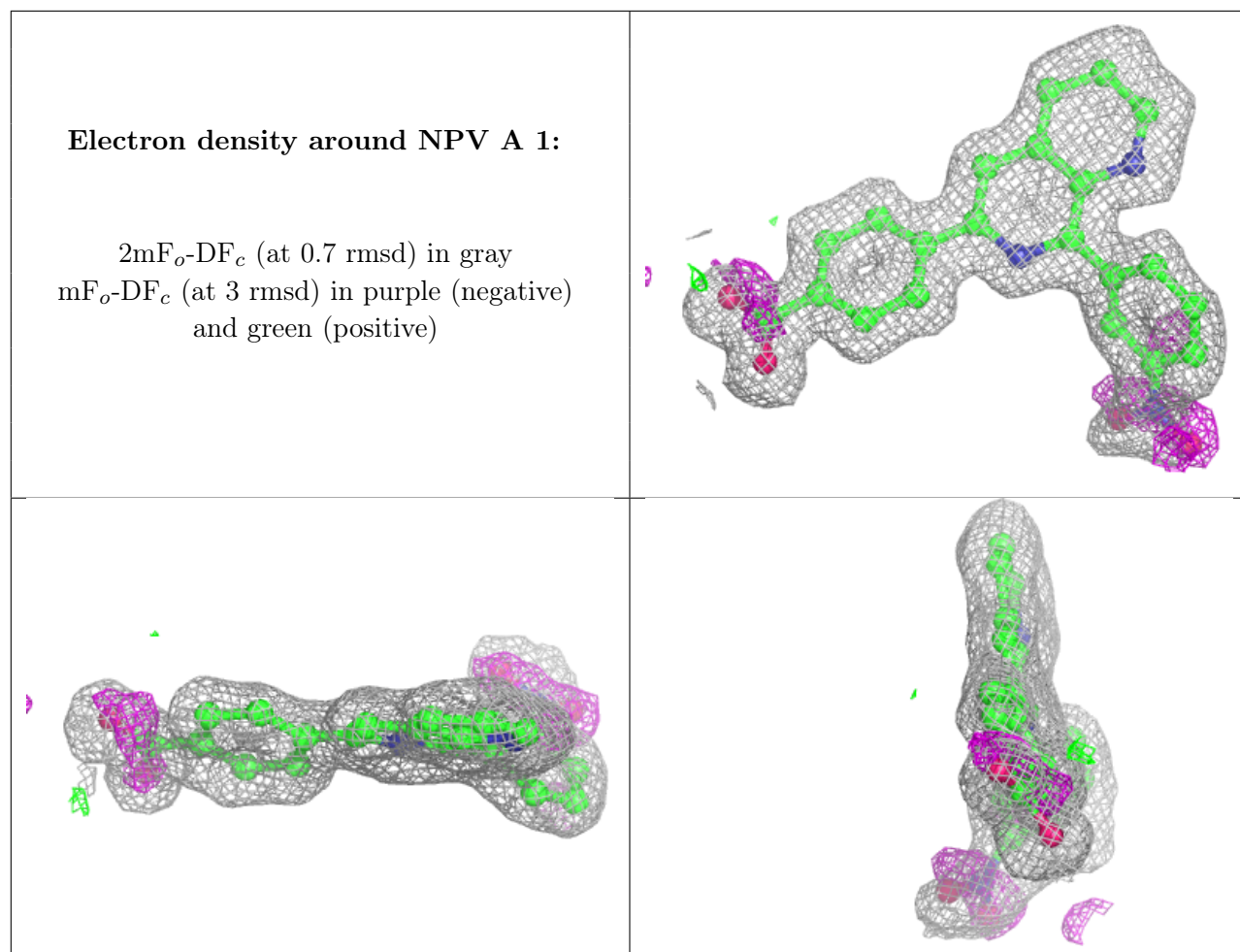

## 6.5 Other polymers [i](#)

There are no such residues in this entry.