



Full wwPDB EM Validation Report ⓘ

Dec 11, 2022 – 01:29 am GMT

PDB ID : 6R6G
EMDB ID : EMD-4735
Title : Structure of XBP1u-paused ribosome nascent chain complex with SRP.
Authors : Shanmuganathan, V.; Cheng, J.; Braunger, K.; Berninghausen, O.; Beatrix, B.; Beckmann, R.
Deposited on : 2019-03-27
Resolution : 3.70 Å(reported)

This is a Full wwPDB EM Validation Report for a publicly released PDB entry.

We welcome your comments at validation@mail.wwpdb.org

A user guide is available at

<https://www.wwpdb.org/validation/2017/EMValidationReportHelp>

with specific help available everywhere you see the ⓘ symbol.

The types of validation reports are described at

<http://www.wwpdb.org/validation/2017/FAQs#types>.

The following versions of software and data (see [references ⓘ](#)) were used in the production of this report:

EMDB validation analysis : 0.0.1.dev43
MolProbity : 4.02b-467
Percentile statistics : 20191225.v01 (using entries in the PDB archive December 25th 2019)
MapQ : 1.9.9
Ideal geometry (proteins) : Engh & Huber (2001)
Ideal geometry (DNA, RNA) : Parkinson et al. (1996)
Validation Pipeline (wwPDB-VP) : 2.31.3

1 Overall quality at a glance

The following experimental techniques were used to determine the structure:
ELECTRON MICROSCOPY

The reported resolution of this entry is 3.70 Å.

Percentile scores (ranging between 0-100) for global validation metrics of the entry are shown in the following graphic. The table shows the number of entries on which the scores are based.

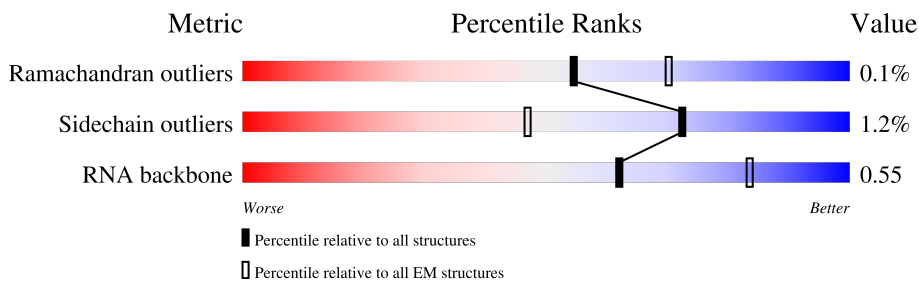

Metric	Whole archive (#Entries)	EM structures (#Entries)
Ramachandran outliers	154571	4023
Sidechain outliers	154315	3826
RNA backbone	4643	859

The table below summarises the geometric issues observed across the polymeric chains and their fit to the map. The red, orange, yellow and green segments of the bar indicate the fraction of residues that contain outliers for ≥ 3 , 2, 1 and 0 types of geometric quality criteria respectively. A grey segment represents the fraction of residues that are not modelled. The numeric value for each fraction is indicated below the corresponding segment, with a dot representing fractions $\leq 5\%$. The upper red bar (where present) indicates the fraction of residues that have poor fit to the EM map (all-atom inclusion $< 40\%$). The numeric value is given above the bar.

Mol	Chain	Length	Quality of chain
1	0	68	
2	1	24	
3	2	75	
4	3	75	
5	4	6	
6	5	3544	
7	6	313	
8	7	120	

Continued on next page...

Continued from previous page...

Mol	Chain	Length	Quality of chain
9	8	151	7% 74% 25%
10	9	55	27% 100%
11	A	248	98%
12	AA	55	40% 96%
13	B	394	5% 99%
14	BB	189	38% 97%
15	C	362	97%
16	CC	206	22% 99%
17	DD	185	29% 98%
18	D	293	6% 99%
19	EE	151	16% 93% 5%
20	E	251	8% 85% 14%
21	FF	62	31% 98%
22	F	225	100%
23	GG	100	56% 99%
24	G	240	15% 95%
25	H	190	7% 98%
26	HH	83	30% 99%
27	I	213	5% 94%
28	II	144	24% 99%
29	JJ	83	35% 99%
30	J	170	5% 100%
31	K	1698	12% 76% 22%
32	KK	132	41% 100%
33	L	210	9% 100%

Continued on next page...

Continued from previous page...

Mol	Chain	Length	Quality of chain
34	LL	101	16% 99%
35	M	138	99%
36	MM	136	21% 99%
37	N	203	100%
38	NN	124	31% 99%
39	O	199	99%
40	OO	75	33% 100%
41	P	153	99%
42	PP	141	30% 99%
43	Q	187	99%
44	QQ	149	11% 99%
45	R	180	12% 98%
46	RR	117	79% 99%
47	S	176	100%
48	SS	96	58% 98%
49	T	159	5% 99%
50	TT	129	18% 100%
51	UU	142	42% 99%
52	U	99	19% 99%
53	VV	141	15% 99%
54	V	131	98%
55	W	121	28% 88% 12%
56	WW	120	33% 98%
57	X	118	8% 99%
58	Y	134	6% 99%

Continued on next page...

Continued from previous page...

Mol	Chain	Length	Quality of chain
59	Z	135	12% 100%
60	a	147	99%
61	b	116	27% 88% 10%
62	c	98	9% 99%
63	d	107	8% 98%
64	e	128	99%
65	f	109	99%
66	g	114	10% 98%
67	h	122	8% 100%
68	i	102	7% 99%
69	j	86	99%
70	k	69	23% 100%
71	l	50	6% 98%
72	m	52	8% 100%
73	n	25	8% 100%
74	o	104	11% 99%
75	p	91	8% 99%
76	q	217	29% 99%
77	r	124	98%
78	s	196	93% 100%
79	t	153	99% 100%
80	u	213	22% 99%
81	v	221	25% 99%
82	w	228	60% 97%
83	x	262	25% 98%

Continued on next page...

Continued from previous page...

Mol	Chain	Length	Quality of chain
84	y	191	
85	z	237	
86	AB	431	
87	AF	206	
88	AC	105	
89	AI	195	
90	AD	74	
91	AE	94	
92	AG	12	

2 Entry composition [i](#)

There are 94 unique types of molecules in this entry. The entry contains 227187 atoms, of which 0 are hydrogens and 0 are deuteriums.

In the tables below, the AltConf column contains the number of residues with at least one atom in alternate conformation and the Trace column contains the number of residues modelled with at most 2 atoms.

- Molecule 1 is a protein called eS31.

Mol	Chain	Residues	Atoms					AltConf	Trace
			Total	C	N	O	S		
1	0	68	555	351	103	94	7	0	0

- Molecule 2 is a protein called X-box-binding protein 1.

Mol	Chain	Residues	Atoms					AltConf	Trace
			Total	C	N	O	S		
2	1	24	204	137	35	30	2	0	0

There is a discrepancy between the modelled and reference sequences:

Chain	Residue	Modelled	Actual	Comment	Reference
1	255	ALA	SER	conflict	UNP P17861

- Molecule 3 is a RNA chain called P-tRNA.

Mol	Chain	Residues	Atoms					AltConf	Trace
			Total	C	N	O	P		
3	2	75	1594	713	285	522	74	0	0

- Molecule 4 is a RNA chain called E-tRNA.

Mol	Chain	Residues	Atoms					AltConf	Trace
			Total	C	N	O	P		
4	3	75	1597	714	287	522	74	0	0

- Molecule 5 is a RNA chain called mRNA.

Mol	Chain	Residues	Atoms					AltConf	Trace
			Total	C	N	O	P		
5	4	6	127	57	21	43	6	0	0

- Molecule 6 is a RNA chain called 28S ribosomal RNA.

Mol	Chain	Residues	Atoms					AltConf	Trace
			Total	C	N	O	P		
6	5	3543	75972	33833	13910	24686	3543	0	0

- Molecule 7 is a protein called ribosomal protein RACK1.

Mol	Chain	Residues	Atoms					AltConf	Trace
			Total	C	N	O	S		
7	6	313	2436	1535	424	465	12	0	0

- Molecule 8 is a RNA chain called 5S ribosomal RNA.

Mol	Chain	Residues	Atoms					AltConf	Trace
			Total	C	N	O	P		
8	7	120	2558	1141	456	842	119	0	0

- Molecule 9 is a RNA chain called 5.8S ribosomal RNA.

Mol	Chain	Residues	Atoms					AltConf	Trace
			Total	C	N	O	P		
9	8	151	3208	1432	564	1062	150	0	0

- Molecule 10 is a protein called uS14.

Mol	Chain	Residues	Atoms					AltConf	Trace
			Total	C	N	O	S		
10	9	55	459	286	94	74	5	0	0

- Molecule 11 is a protein called uL2.

Mol	Chain	Residues	Atoms					AltConf	Trace
			Total	C	N	O	S		
11	A	248	1898	1189	389	314	6	0	0

- Molecule 12 is a protein called 40S ribosomal protein S30.

Mol	Chain	Residues	Atoms					AltConf	Trace
			Total	C	N	O	S		
12	AA	55	443	274	97	71	1	0	0

- Molecule 13 is a protein called uL3.

Mol	Chain	Residues	Atoms					AltConf	Trace
			Total	C	N	O	S		
13	B	394	3172	2020	597	542	13	0	0

- Molecule 14 is a protein called 40S ribosomal protein S7.

Mol	Chain	Residues	Atoms					AltConf	Trace
			Total	C	N	O	S		
14	BB	185	1488	952	271	264	1	0	0

- Molecule 15 is a protein called uL4.

Mol	Chain	Residues	Atoms					AltConf	Trace
			Total	C	N	O	S		
15	C	362	2883	1812	577	480	14	0	0

- Molecule 16 is a protein called 40S ribosomal protein S8.

Mol	Chain	Residues	Atoms					AltConf	Trace
			Total	C	N	O	S		
16	CC	206	1686	1058	332	291	5	0	0

There is a discrepancy between the modelled and reference sequences:

Chain	Residue	Modelled	Actual	Comment	Reference
CC	47	ARG	GLY	conflict	UNP G1TJW1

- Molecule 17 is a protein called Ribosomal protein S9 (Predicted).

Mol	Chain	Residues	Atoms					AltConf	Trace
			Total	C	N	O	S		
17	DD	185	1525	969	306	248	2	0	0

- Molecule 18 is a protein called 60S ribosomal protein L5.

Mol	Chain	Residues	Atoms					AltConf	Trace
			Total	C	N	O	S		
18	D	293	2391	1512	438	427	14	0	0

- Molecule 19 is a protein called Ribosomal protein S11.

Mol	Chain	Residues	Atoms					AltConf	Trace
			Total	C	N	O	S		
19	EE	143	1175	749	222	198	6	0	0

- Molecule 20 is a protein called 60S ribosomal protein L6.

Mol	Chain	Residues	Atoms					AltConf	Trace
			Total	C	N	O	S		
20	E	216	1729	1115	329	282	3	0	0

- Molecule 21 is a protein called Ribosomal protein S28.

Mol	Chain	Residues	Atoms					AltConf	Trace
			Total	C	N	O	S		
21	FF	62	488	297	97	92	2	0	0

- Molecule 22 is a protein called uL30.

Mol	Chain	Residues	Atoms					AltConf	Trace
			Total	C	N	O	S		
22	F	225	1875	1205	358	303	9	0	0

- Molecule 23 is a protein called Ribosomal protein S20.

Mol	Chain	Residues	Atoms					AltConf	Trace
			Total	C	N	O	S		
23	GG	100	795	498	152	141	4	0	0

- Molecule 24 is a protein called eL8.

Mol	Chain	Residues	Atoms					AltConf	Trace
			Total	C	N	O	S		
24	G	233	1879	1199	361	315	4	0	0

There is a discrepancy between the modelled and reference sequences:

Chain	Residue	Modelled	Actual	Comment	Reference
G	244	GLY	CYS	conflict	UNP G1STW0

- Molecule 25 is a protein called uL6.

Mol	Chain	Residues	Atoms					AltConf	Trace
			Total	C	N	O	S		
25	H	190	1516	954	284	272	6	0	0

- Molecule 26 is a protein called 40S ribosomal protein S21.

Mol	Chain	Residues	Atoms					AltConf	Trace
			Total	C	N	O	S		
26	HH	83	636	393	117	121	5	0	0

- Molecule 27 is a protein called Ribosomal protein L10 (Predicted).

Mol	Chain	Residues	Atoms					AltConf	Trace
			Total	C	N	O	S		
27	I	205	1664	1056	321	274	13	0	0

- Molecule 28 is a protein called uS13.

Mol	Chain	Residues	Atoms					AltConf	Trace
			Total	C	N	O	S		
28	II	144	1190	746	241	202	1	0	0

- Molecule 29 is a protein called 40S ribosomal protein S27.

Mol	Chain	Residues	Atoms					AltConf	Trace
			Total	C	N	O	S		
29	JJ	83	651	408	121	115	7	0	0

- Molecule 30 is a protein called Ribosomal protein L11.

Mol	Chain	Residues	Atoms					AltConf	Trace
			Total	C	N	O	S		
30	J	170	1362	861	254	241	6	0	0

- Molecule 31 is a RNA chain called 18S ribosomal RNA.

Mol	Chain	Residues	Atoms					AltConf	Trace
			Total	C	N	O	P		
31	K	1698	36249	16180	6508	11864	1697	0	0

- Molecule 32 is a protein called eS17.

Mol	Chain	Residues	Atoms					AltConf	Trace
32	KK	132	Total	C	N	O	S	0	0
			1068	670	199	195	4		

- Molecule 33 is a protein called 60S ribosomal protein L13.

Mol	Chain	Residues	Atoms					AltConf	Trace
33	L	210	Total	C	N	O	S	0	0
			1702	1065	354	279	4		

There are 9 discrepancies between the modelled and reference sequences:

Chain	Residue	Modelled	Actual	Comment	Reference
L	47	ALA	-	insertion	UNP G1TPV0
L	48	PRO	-	insertion	UNP G1TPV0
L	49	ARG	-	insertion	UNP G1TPV0
L	50	PRO	-	insertion	UNP G1TPV0
L	51	ALA	-	insertion	UNP G1TPV0
L	52	ALA	-	insertion	UNP G1TPV0
L	53	GLY	-	insertion	UNP G1TPV0
L	54	PRO	-	insertion	UNP G1TPV0
L	55	ILE	-	insertion	UNP G1TPV0

- Molecule 34 is a protein called 40S ribosomal protein S26.

Mol	Chain	Residues	Atoms					AltConf	Trace
34	LL	101	Total	C	N	O	S	0	0
			814	507	170	132	5		

- Molecule 35 is a protein called Ribosomal protein L14.

Mol	Chain	Residues	Atoms					AltConf	Trace
35	M	138	Total	C	N	O	S	0	0
			1137	727	221	182	7		

- Molecule 36 is a protein called 40S ribosomal protein S14.

Mol	Chain	Residues	Atoms					AltConf	Trace
36	MM	136	Total	C	N	O	S	0	0
			1016	621	199	190	6		

- Molecule 37 is a protein called Ribosomal protein L15.

Mol	Chain	Residues	Atoms					AltConf	Trace
37	N	203	Total	C	N	O	S	0	0
			1701	1072	359	266	4		

- Molecule 38 is a protein called 40S ribosomal protein S24.

Mol	Chain	Residues	Atoms					AltConf	Trace
38	NN	124	Total	C	N	O	S	0	0
			1011	640	198	168	5		

- Molecule 39 is a protein called 60S ribosomal protein L13a.

Mol	Chain	Residues	Atoms					AltConf	Trace
39	O	199	Total	C	N	O	S	0	0
			1630	1051	319	255	5		

- Molecule 40 is a protein called ribosomal protein eS25.

Mol	Chain	Residues	Atoms					AltConf	Trace
40	OO	75	Total	C	N	O	S	0	0
			598	382	111	104	1		

- Molecule 41 is a protein called uL22.

Mol	Chain	Residues	Atoms					AltConf	Trace
41	P	153	Total	C	N	O	S	0	0
			1242	777	241	215	9		

- Molecule 42 is a protein called eS19.

Mol	Chain	Residues	Atoms					AltConf	Trace
42	PP	141	Total	C	N	O	S	0	0
			1097	688	211	195	3		

There is a discrepancy between the modelled and reference sequences:

Chain	Residue	Modelled	Actual	Comment	Reference
PP	119	GLY	TRP	conflict	UNP G1TN62

- Molecule 43 is a protein called eL18.

Mol	Chain	Residues	Atoms					AltConf	Trace
			Total	C	N	O	S		
43	Q	187	1515	946	315	250	4	0	0

There are 16 discrepancies between the modelled and reference sequences:

Chain	Residue	Modelled	Actual	Comment	Reference
Q	6	ARG	LEU	conflict	UNP G1TX70
Q	14	ARG	TRP	conflict	UNP G1TX70
Q	23	ILE	MET	conflict	UNP G1TX70
Q	24	TYR	CYS	conflict	UNP G1TX70
Q	38	ARG	HIS	conflict	UNP G1TX70
Q	57	ASN	LYS	conflict	UNP G1TX70
Q	66	MET	VAL	conflict	UNP G1TX70
Q	74	GLY	ASP	conflict	UNP G1TX70
Q	75	ARG	PRO	conflict	UNP G1TX70
Q	86	VAL	ILE	conflict	UNP G1TX70
Q	110	ARG	HIS	conflict	UNP G1TX70
Q	117	GLY	GLU	conflict	UNP G1TX70
Q	124	ASP	HIS	conflict	UNP G1TX70
Q	150	ARG	GLN	conflict	UNP G1TX70
Q	172	ARG	GLY	conflict	UNP G1TX70
Q	184	ARG	TRP	conflict	UNP G1TX70

- Molecule 44 is a protein called ribosomal protein uS15.

Mol	Chain	Residues	Atoms					AltConf	Trace
			Total	C	N	O	S		
44	QQ	149	1202	770	228	203	1	0	0

- Molecule 45 is a protein called 60S ribosomal protein L19.

Mol	Chain	Residues	Atoms					AltConf	Trace
			Total	C	N	O	S		
45	R	180	1508	933	328	238	9	0	0

- Molecule 46 is a protein called 40S ribosomal protein S12.

Mol	Chain	Residues	Atoms					AltConf	Trace
			Total	C	N	O	S		
46	RR	117	908	570	161	169	8	0	0

- Molecule 47 is a protein called eL20.

Mol	Chain	Residues	Atoms					AltConf	Trace
			Total	C	N	O	S		
47	S	176	1462	930	285	236	11	0	0

- Molecule 48 is a protein called eS10.

Mol	Chain	Residues	Atoms					AltConf	Trace
			Total	C	N	O	S		
48	SS	96	810	530	143	131	6	0	0

- Molecule 49 is a protein called eL21.

Mol	Chain	Residues	Atoms					AltConf	Trace
			Total	C	N	O	S		
49	T	159	1298	823	252	217	6	0	0

- Molecule 50 is a protein called Ribosomal protein S15a.

Mol	Chain	Residues	Atoms					AltConf	Trace
			Total	C	N	O	S		
50	TT	129	1034	659	193	176	6	0	0

- Molecule 51 is a protein called Ribosomal protein S16.

Mol	Chain	Residues	Atoms					AltConf	Trace
			Total	C	N	O	S		
51	UU	142	1128	717	213	195	3	0	0

- Molecule 52 is a protein called 60S ribosomal protein L22.

Mol	Chain	Residues	Atoms					AltConf	Trace
			Total	C	N	O	S		
52	U	99	809	519	141	147	2	0	0

- Molecule 53 is a protein called Ribosomal protein S23.

Mol	Chain	Residues	Atoms					AltConf	Trace
			Total	C	N	O	S		
53	VV	141	1098	693	219	183	3	0	0

- Molecule 54 is a protein called eL14.

Mol	Chain	Residues	Atoms					AltConf	Trace
54	V	131	Total	C	N	O	S	0	0
			979	618	184	172	5		

- Molecule 55 is a protein called Ribosomal protein L24.

Mol	Chain	Residues	Atoms					AltConf	Trace
55	W	106	Total	C	N	O	S	0	0
			860	538	174	144	4		

- Molecule 56 is a protein called uS19.

Mol	Chain	Residues	Atoms					AltConf	Trace
56	WW	120	Total	C	N	O	S	0	0
			997	635	187	168	7		

- Molecule 57 is a protein called uL23.

Mol	Chain	Residues	Atoms					AltConf	Trace
57	X	118	Total	C	N	O	S	0	0
			967	618	181	167	1		

- Molecule 58 is a protein called Ribosomal protein L26.

Mol	Chain	Residues	Atoms					AltConf	Trace
58	Y	134	Total	C	N	O	S	0	0
			1115	700	226	186	3		

- Molecule 59 is a protein called 60S ribosomal protein L27.

Mol	Chain	Residues	Atoms					AltConf	Trace
59	Z	135	Total	C	N	O	S	0	0
			1107	714	208	182	3		

- Molecule 60 is a protein called uL15.

Mol	Chain	Residues	Atoms					AltConf	Trace
60	a	147	Total	C	N	O	S	0	0
			1162	734	239	185	4		

- Molecule 61 is a protein called eL29.

Mol	Chain	Residues	Atoms					AltConf	Trace
61	b	104	Total	C	N	O	S	0	0
			848	527	189	129	3		

- Molecule 62 is a protein called eL30.

Mol	Chain	Residues	Atoms					AltConf	Trace
62	c	98	Total	C	N	O	S	0	0
			761	481	134	140	6		

- Molecule 63 is a protein called eL31.

Mol	Chain	Residues	Atoms					AltConf	Trace
63	d	107	Total	C	N	O	S	0	0
			888	560	171	155	2		

- Molecule 64 is a protein called eL32.

Mol	Chain	Residues	Atoms					AltConf	Trace
64	e	128	Total	C	N	O	S	0	0
			1053	667	216	165	5		

- Molecule 65 is a protein called eL33.

Mol	Chain	Residues	Atoms					AltConf	Trace
65	f	109	Total	C	N	O	S	0	0
			876	555	174	143	4		

- Molecule 66 is a protein called eL34.

Mol	Chain	Residues	Atoms					AltConf	Trace
66	g	114	Total	C	N	O	S	0	0
			906	566	187	147	6		

- Molecule 67 is a protein called uL29.

Mol	Chain	Residues	Atoms					AltConf	Trace
67	h	122	Total	C	N	O	S	0	0
			1013	640	204	168	1		

- Molecule 68 is a protein called 60S ribosomal protein L36.

Mol	Chain	Residues	Atoms					AltConf	Trace
68	i	102	Total	C	N	O	S	0	0
			830	520	176	129	5		

- Molecule 69 is a protein called Ribosomal protein L37.

Mol	Chain	Residues	Atoms					AltConf	Trace
69	j	86	Total	C	N	O	S	0	0
			705	434	155	111	5		

- Molecule 70 is a protein called 60S ribosomal protein L38.

Mol	Chain	Residues	Atoms					AltConf	Trace
70	k	69	Total	C	N	O	S	0	0
			569	366	103	99	1		

- Molecule 71 is a protein called eL39.

Mol	Chain	Residues	Atoms					AltConf	Trace
71	l	50	Total	C	N	O	S	0	0
			447	286	96	64	1		

- Molecule 72 is a protein called 60S ribosomal protein L40.

Mol	Chain	Residues	Atoms					AltConf	Trace
72	m	52	Total	C	N	O	S	0	0
			429	266	90	67	6		

- Molecule 73 is a protein called 60s ribosomal protein l41.

Mol	Chain	Residues	Atoms					AltConf	Trace
73	n	25	Total	C	N	O	S	0	0
			239	145	64	27	3		

- Molecule 74 is a protein called eL42.

Mol	Chain	Residues	Atoms					AltConf	Trace
74	o	104	Total	C	N	O	S	0	0
			851	533	174	138	6		

- Molecule 75 is a protein called ribosomal protein eL43.

Mol	Chain	Residues	Atoms					AltConf	Trace
75	p	91	Total	C	N	O	S	0	0
			708	445	136	120	7		

- Molecule 76 is a protein called uS2.

Mol	Chain	Residues	Atoms					AltConf	Trace
76	q	217	Total	C	N	O	S	0	0
			1710	1086	300	316	8		

- Molecule 77 is a protein called eL28.

Mol	Chain	Residues	Atoms					AltConf	Trace
77	r	124	Total	C	N	O	S	0	0
			994	616	205	167	6		

- Molecule 78 is a protein called 60S acidic ribosomal protein P0.

Mol	Chain	Residues	Atoms					AltConf	Trace
78	s	196	Total	C	N	O	S	0	0
			1507	959	263	276	9		

- Molecule 79 is a protein called uL11.

Mol	Chain	Residues	Atoms					AltConf	Trace
79	t	153	Total	C	N	O	S	0	0
			1160	722	218	217	3		

- Molecule 80 is a protein called 40S ribosomal protein S3a.

Mol	Chain	Residues	Atoms					AltConf	Trace
80	u	213	Total	C	N	O	S	0	0
			1729	1098	309	308	14		

- Molecule 81 is a protein called uS5.

Mol	Chain	Residues	Atoms					AltConf	Trace
81	v	221	Total	C	N	O	S	0	0
			1716	1111	295	301	9		

- Molecule 82 is a protein called Ribosomal protein S3.

Mol	Chain	Residues	Atoms					AltConf	Trace
			Total	C	N	O	S		
82	w	228	1768	1126	318	316	8	0	0

- Molecule 83 is a protein called 40S ribosomal protein S4.

Mol	Chain	Residues	Atoms					AltConf	Trace
			Total	C	N	O	S		
83	x	262	2076	1324	386	358	8	0	0

There are 4 discrepancies between the modelled and reference sequences:

Chain	Residue	Modelled	Actual	Comment	Reference
x	25	GLY	SER	conflict	UNP G1TK17
x	51	ARG	LYS	conflict	UNP G1TK17
x	78	THR	ALA	conflict	UNP G1TK17
x	156	VAL	MET	conflict	UNP G1TK17

- Molecule 84 is a protein called Ribosomal protein S5.

Mol	Chain	Residues	Atoms					AltConf	Trace
			Total	C	N	O	S		
84	y	185	1471	921	277	266	7	0	0

- Molecule 85 is a protein called 40S ribosomal protein S6.

Mol	Chain	Residues	Atoms					AltConf	Trace
			Total	C	N	O	S		
85	z	237	1923	1200	387	329	7	0	0

- Molecule 86 is a protein called Signal recognition particle 54 kDa protein.

Mol	Chain	Residues	Atoms					AltConf	Trace
			Total	C	N	O	S		
86	AB	403	3126	1978	532	592	24	0	0

- Molecule 87 is a RNA chain called 7S RNA.

Mol	Chain	Residues	Atoms					AltConf	Trace
			Total	C	N	O	P		
87	AF	206	4551	2026	836	1477	212	6	0

- Molecule 88 is a protein called Signal recognition particle subunit SRP19.

Mol	Chain	Residues	Atoms					AltConf	Trace
			Total	C	N	O	S		
88	AC	105	844	534	152	152	6	0	0

- Molecule 89 is a protein called Signal recognition particle subunit SRP68.

Mol	Chain	Residues	Atoms					AltConf	Trace
			Total	C	N	O	S		
89	AI	179	1497	939	280	271	7	0	0

- Molecule 90 is a protein called Signal recognition particle 9 kDa protein.

Mol	Chain	Residues	Atoms					AltConf	Trace
			Total	C	N	O	S		
90	AD	74	608	388	105	110	5	0	0

There are 3 discrepancies between the modelled and reference sequences:

Chain	Residue	Modelled	Actual	Comment	Reference
AD	37	ASN	SER	conflict	UNP F1Q0Z5
AD	40	VAL	ILE	conflict	UNP F1Q0Z5
AD	52	LYS	ARG	conflict	UNP F1Q0Z5

- Molecule 91 is a protein called Signal recognition particle 14 kDa protein.

Mol	Chain	Residues	Atoms					AltConf	Trace
			Total	C	N	O	S		
91	AE	76	604	382	105	113	4	0	0

There are 2 discrepancies between the modelled and reference sequences:

Chain	Residue	Modelled	Actual	Comment	Reference
AE	22	THR	LEU	conflict	UNP P16255
AE	27	TYR	PHE	conflict	UNP P16255

- Molecule 92 is a protein called Signal sequence (HR2).

Mol	Chain	Residues	Atoms				AltConf	Trace
			Total	C	N	O		
92	AG	12	96	72	12	12	0	0

- Molecule 93 is MAGNESIUM ION (three-letter code: MG) (formula: Mg).

Mol	Chain	Residues	Atoms		AltConf
93	5	202	Total 202	Mg 202	0
93	7	6	Total 6	Mg 6	0
93	8	4	Total 4	Mg 4	0
93	A	1	Total 1	Mg 1	0
93	B	1	Total 1	Mg 1	0
93	I	1	Total 1	Mg 1	0
93	K	79	Total 79	Mg 79	0
93	P	2	Total 2	Mg 2	0
93	V	1	Total 1	Mg 1	0
93	a	1	Total 1	Mg 1	0
93	j	1	Total 1	Mg 1	0

- Molecule 94 is ZINC ION (three-letter code: ZN) (formula: Zn).

Mol	Chain	Residues	Atoms		AltConf
94	g	1	Total 1	Zn 1	0
94	j	1	Total 1	Zn 1	0
94	m	1	Total 1	Zn 1	0
94	o	1	Total 1	Zn 1	0
94	p	1	Total 1	Zn 1	0

3 Residue-property plots [i](#)

These plots are drawn for all protein, RNA, DNA and oligosaccharide chains in the entry. The first graphic for a chain summarises the proportions of the various outlier classes displayed in the second graphic. The second graphic shows the sequence view annotated by issues in geometry and atom inclusion in map density. Residues are color-coded according to the number of geometric quality criteria for which they contain at least one outlier: green = 0, yellow = 1, orange = 2 and red = 3 or more. A red diamond above a residue indicates a poor fit to the EM map for this residue (all-atom inclusion < 40%). Stretches of 2 or more consecutive residues without any outlier are shown as a green connector. Residues present in the sample, but not in the model, are shown in grey.

- Molecule 1: eS31

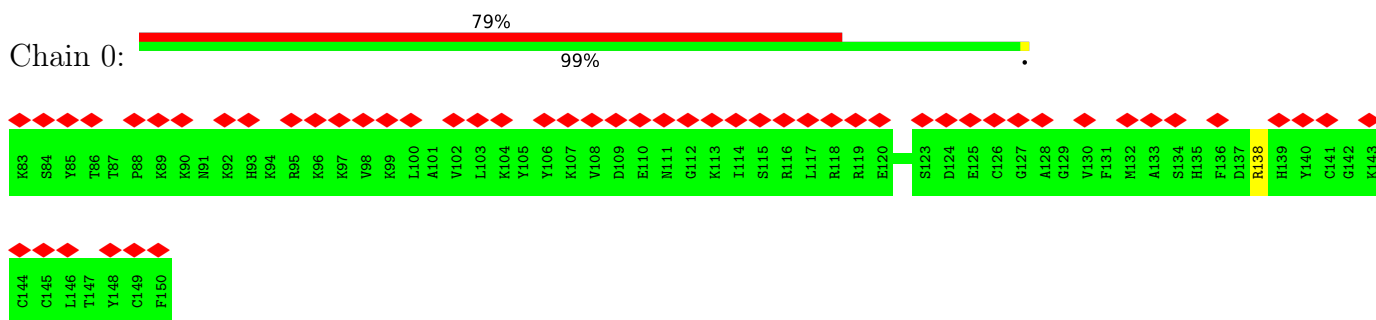

- Molecule 2: X-box-binding protein 1

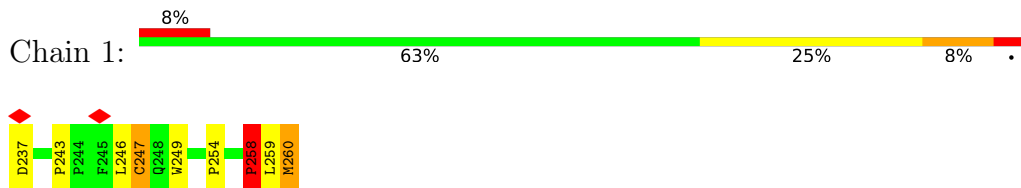

- Molecule 3: P-tRNA

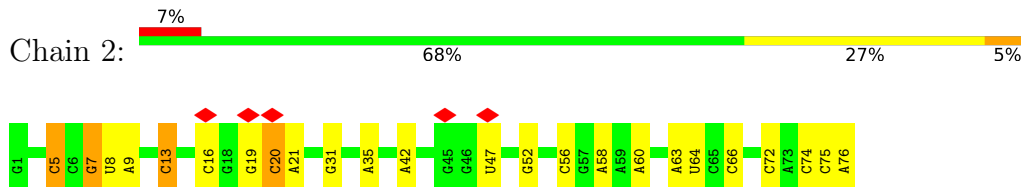

- Molecule 4: E-tRNA

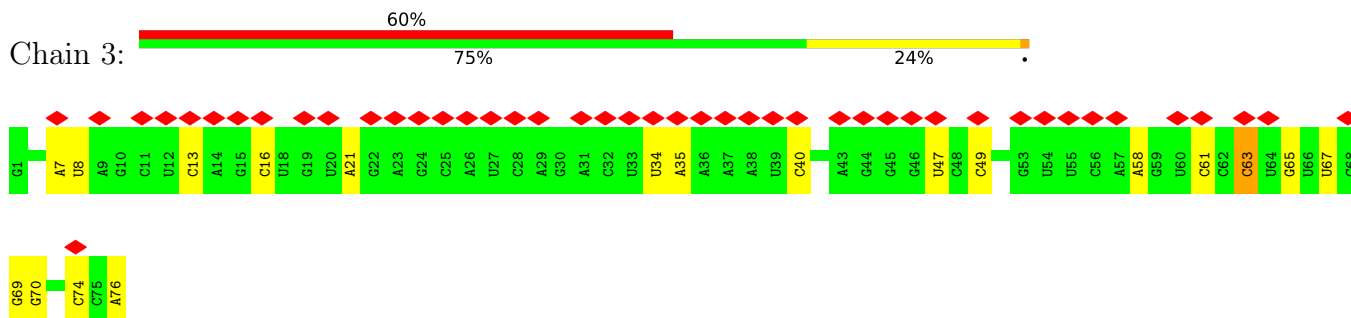

• Molecule 5: mRNA



• Molecule 6: 28S ribosomal RNA

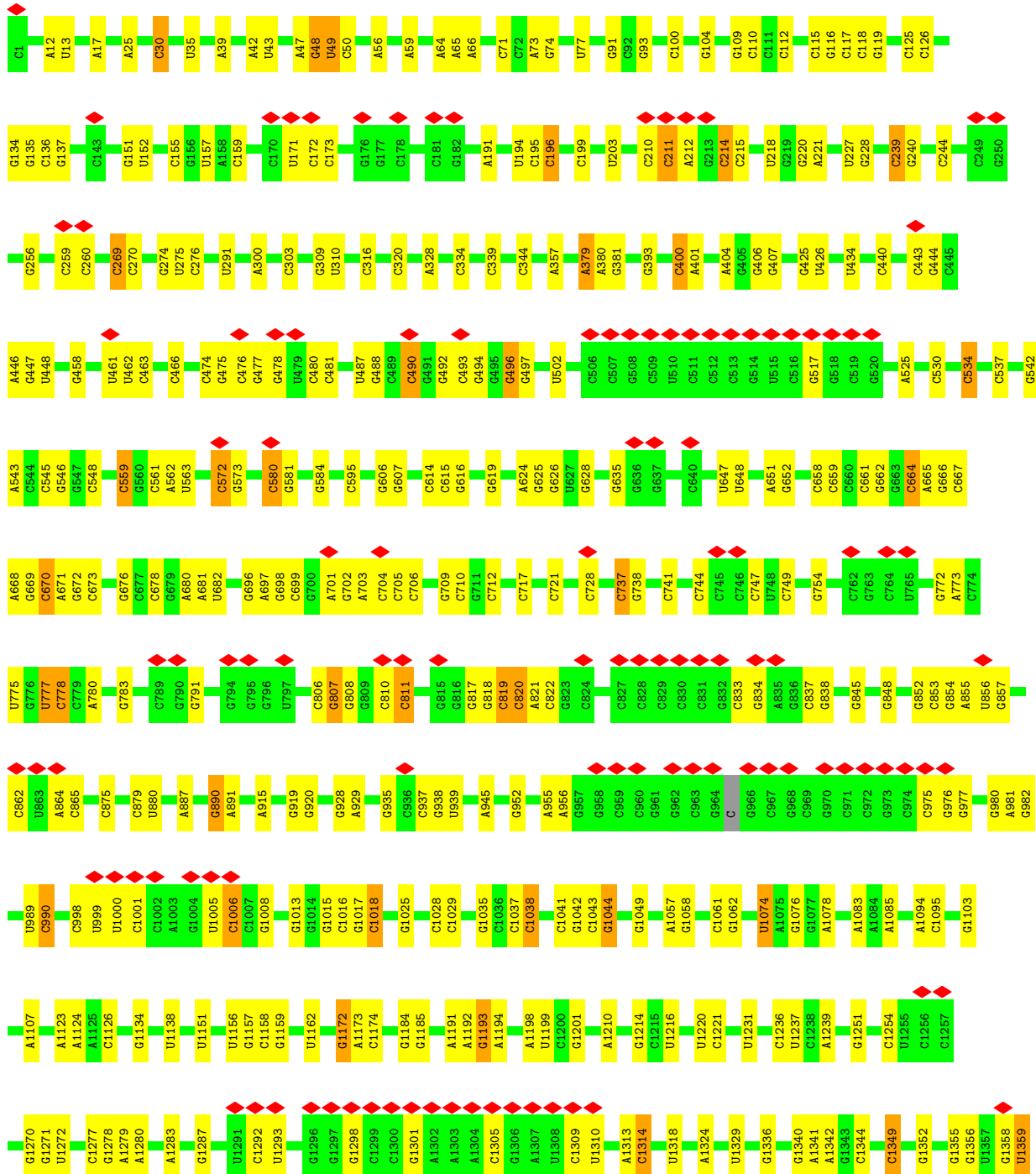
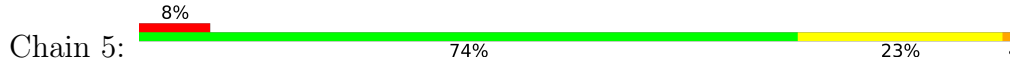

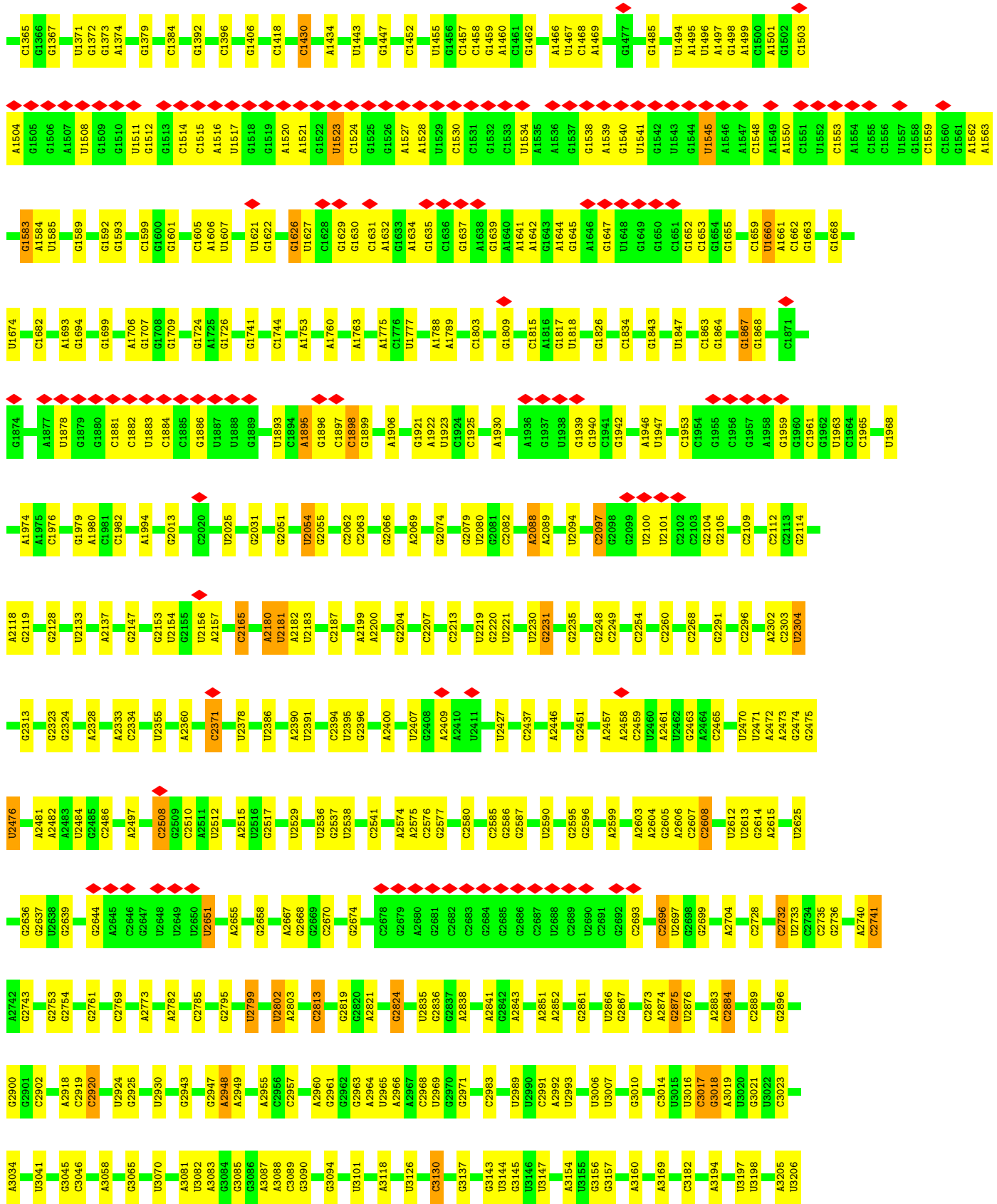

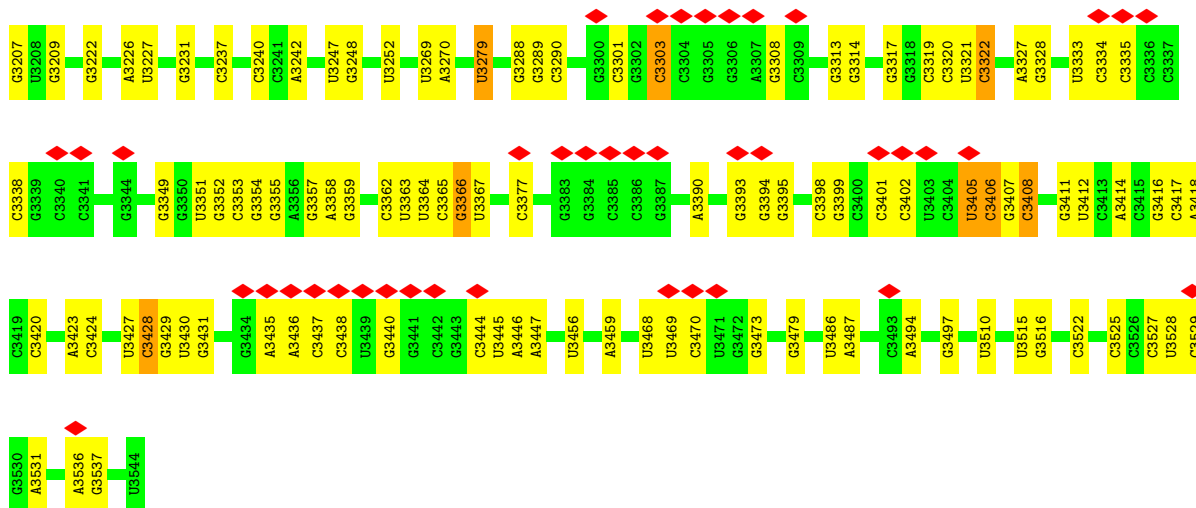

• Molecule 7: ribosomal protein RACK1

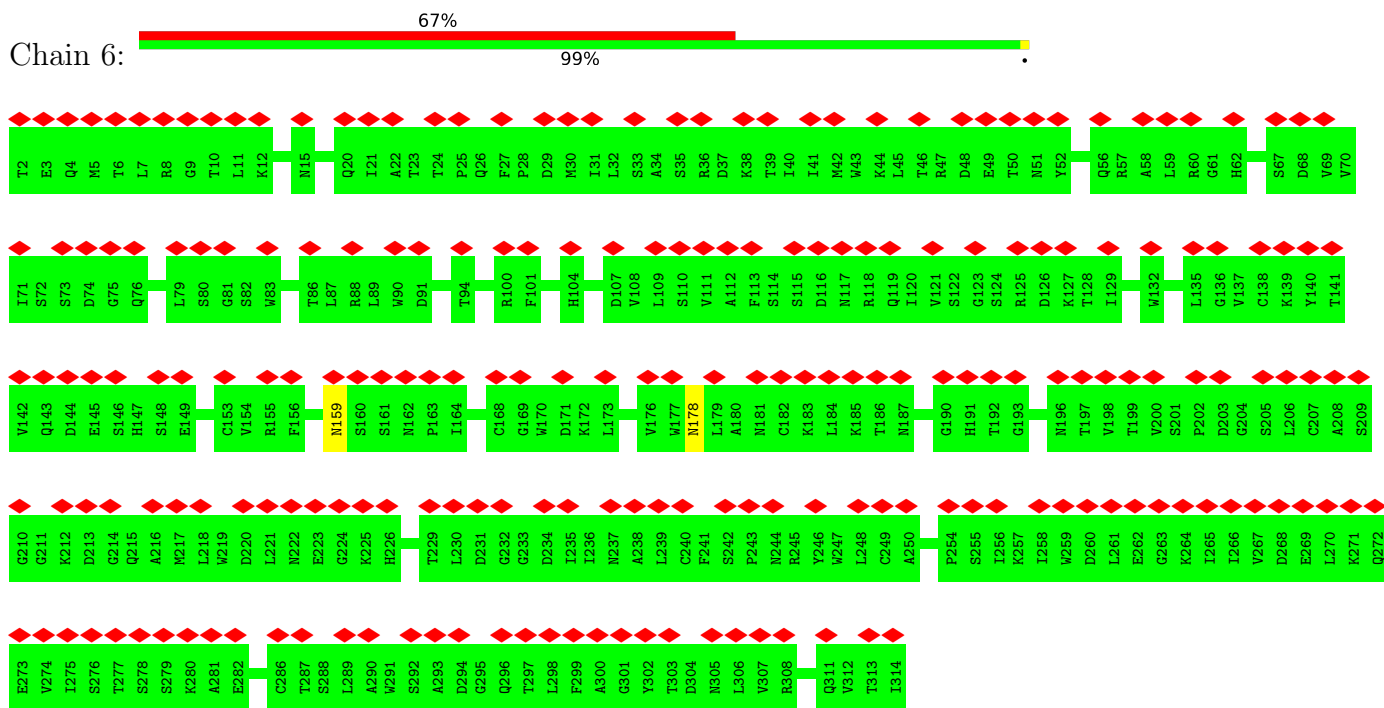

• Molecule 8: 5S ribosomal RNA

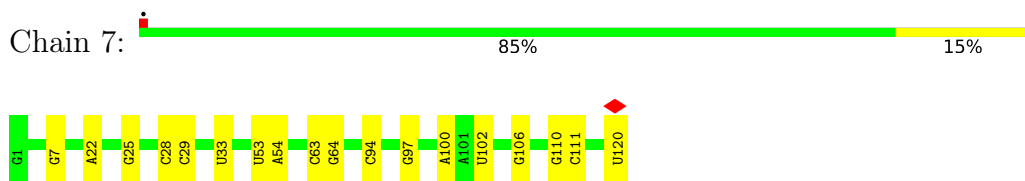

• Molecule 9: 5.8S ribosomal RNA





• Molecule 10: uS14

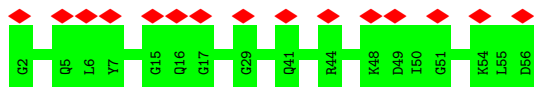

• Molecule 11: uL2

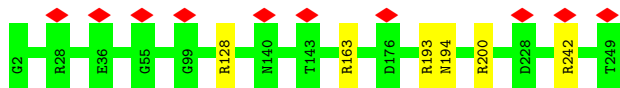

• Molecule 12: 40S ribosomal protein S30

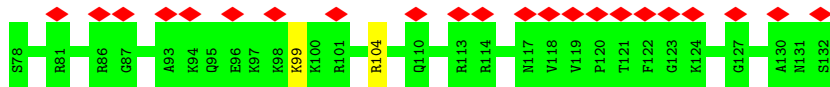
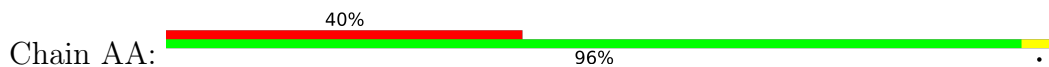

• Molecule 13: uL3

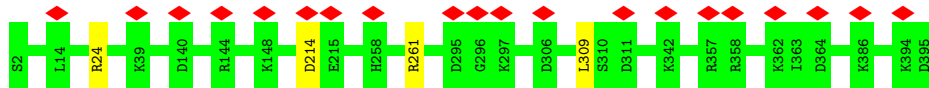

• Molecule 14: 40S ribosomal protein S7

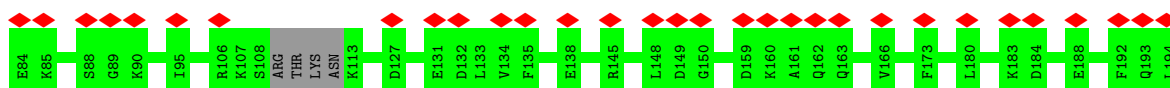
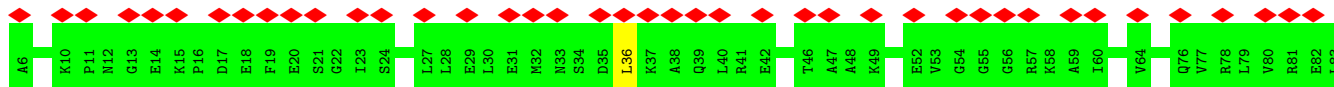
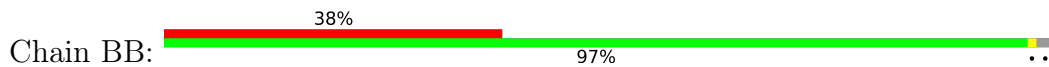

• Molecule 15: uL4

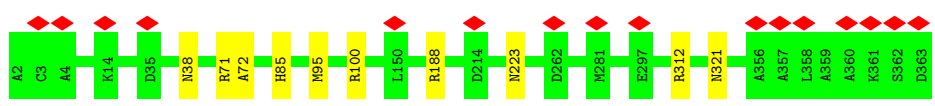

• Molecule 16: 40S ribosomal protein S8

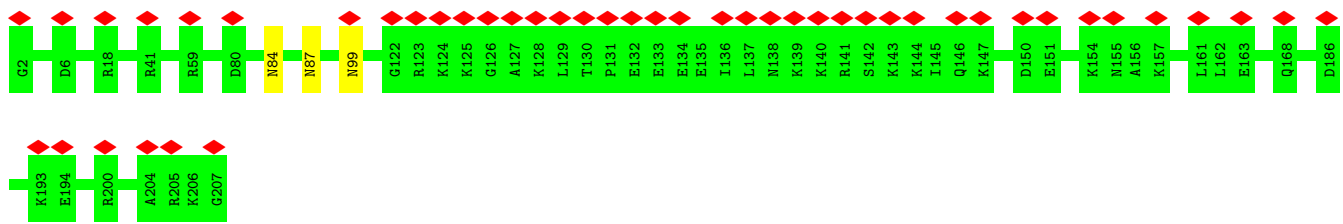

• Molecule 17: Ribosomal protein S9 (Predicted)

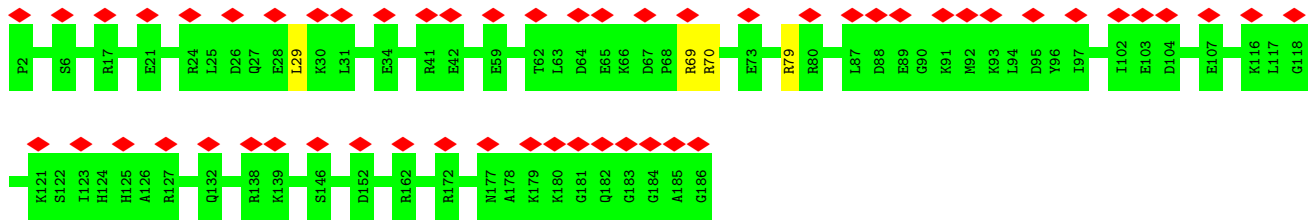

• Molecule 18: 60S ribosomal protein L5

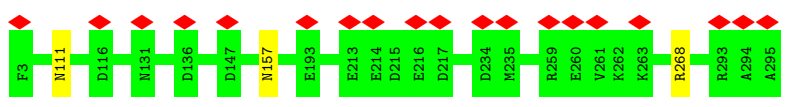

• Molecule 19: Ribosomal protein S11

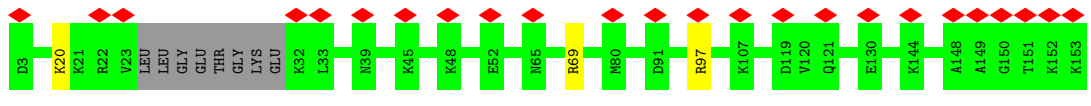
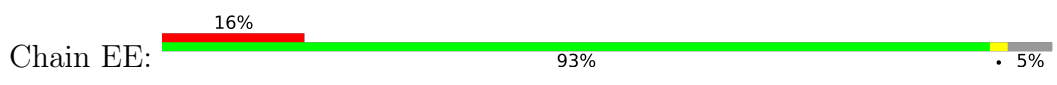

• Molecule 20: 60S ribosomal protein L6

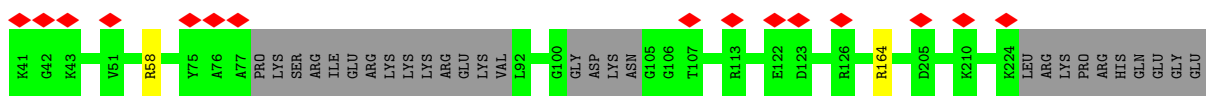
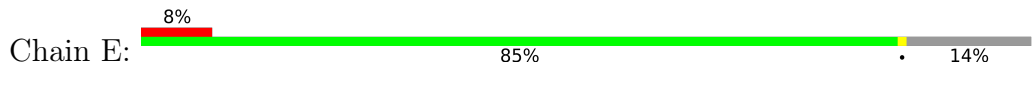

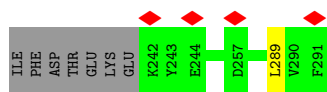

- Molecule 21: Ribosomal protein S28

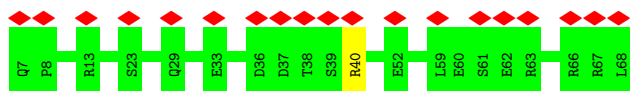

- Molecule 22: uL30

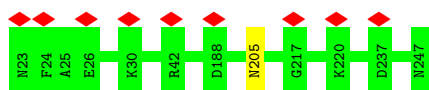

- Molecule 23: Ribosomal protein S20

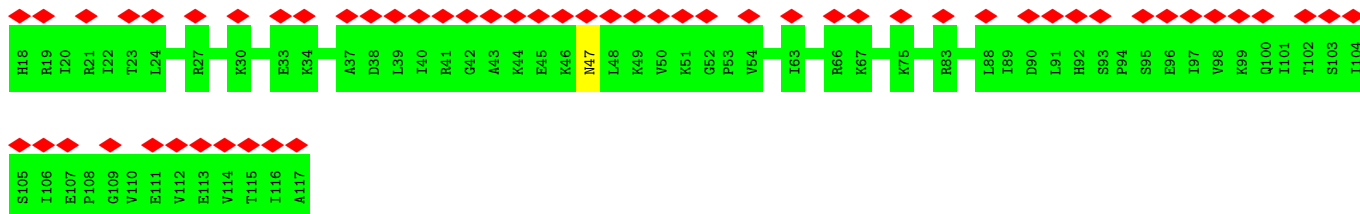

- Molecule 24: eL8

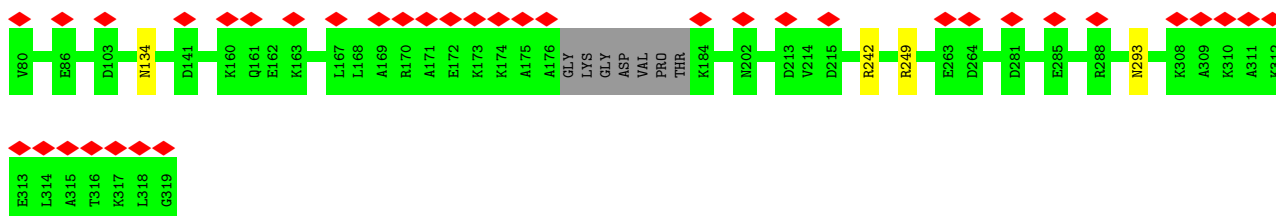

- Molecule 25: uL6

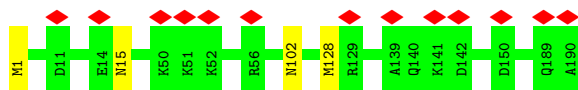

- Molecule 26: 40S ribosomal protein S21

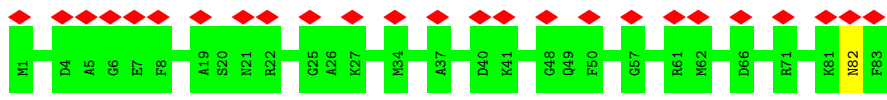

• Molecule 27: Ribosomal protein L10 (Predicted)

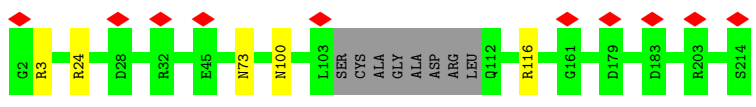
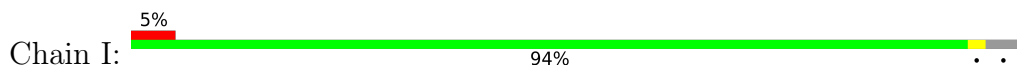

• Molecule 28: uS13

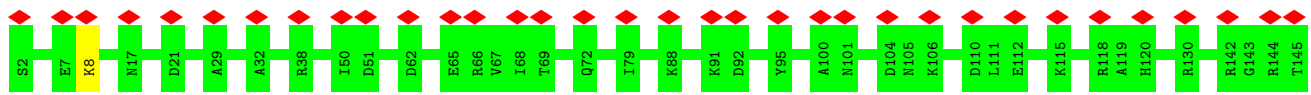

• Molecule 29: 40S ribosomal protein S27

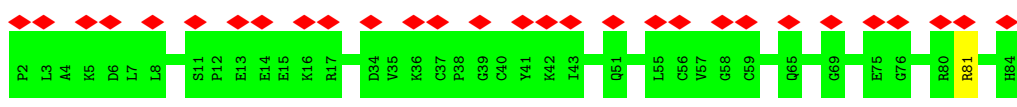

• Molecule 30: Ribosomal protein L11

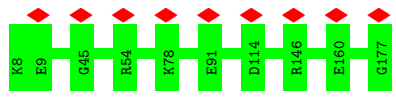

• Molecule 31: 18S ribosomal RNA

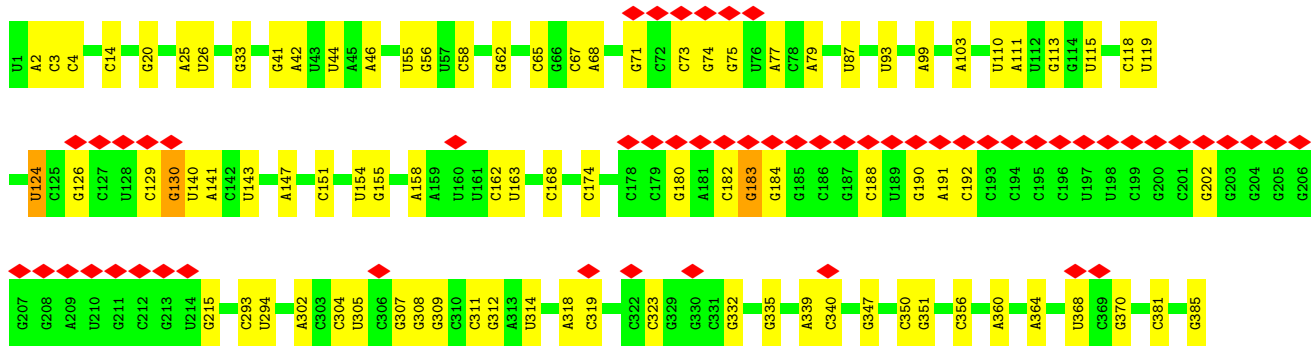
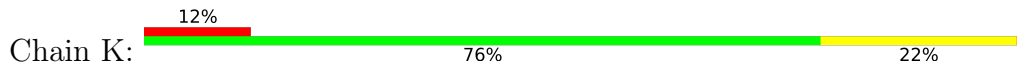

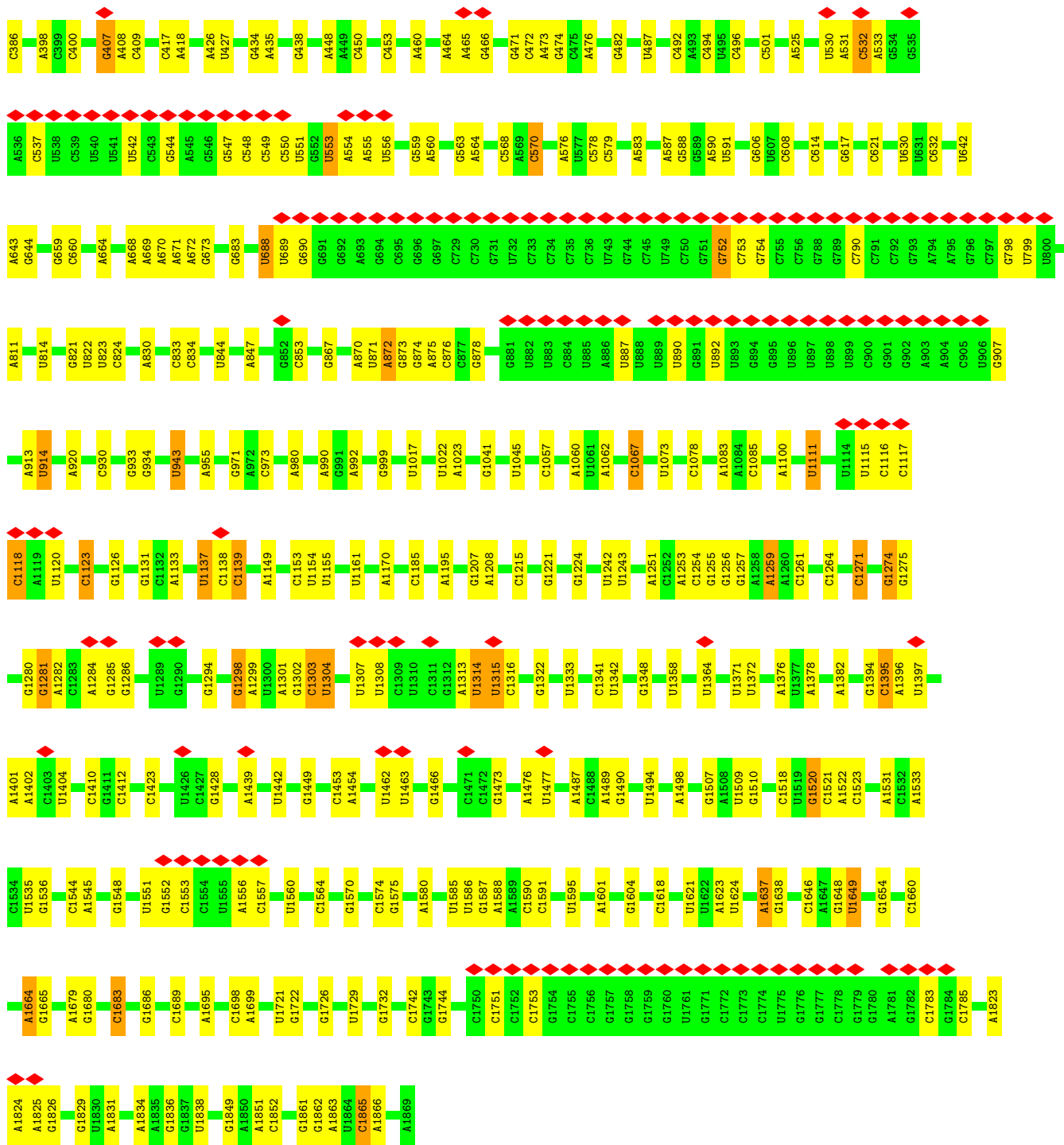

• Molecule 32: eS17

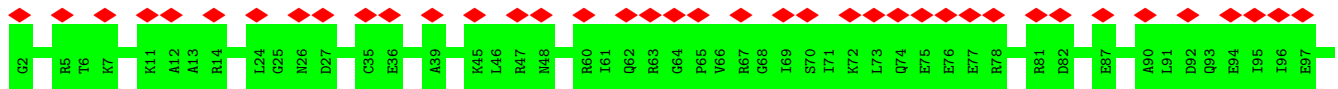
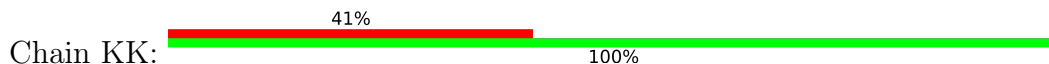

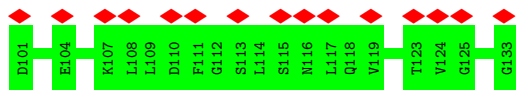

- Molecule 33: 60S ribosomal protein L13

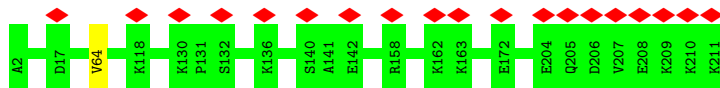

- Molecule 34: 40S ribosomal protein S26

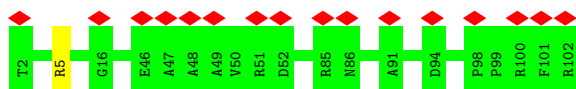

- Molecule 35: Ribosomal protein L14

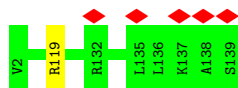

- Molecule 36: 40S ribosomal protein S14

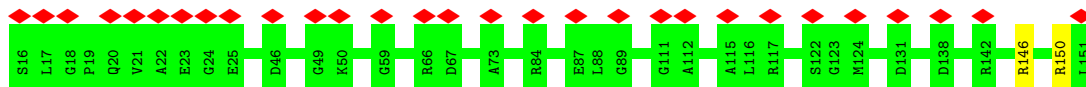

- Molecule 37: Ribosomal protein L15

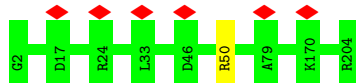

- Molecule 38: 40S ribosomal protein S24

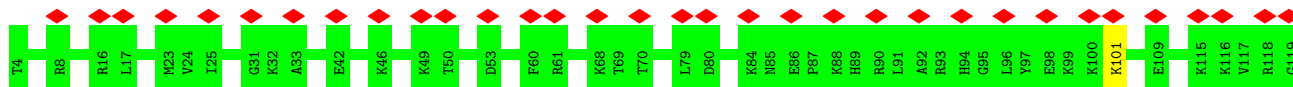

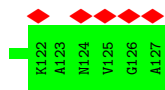

- Molecule 39: 60S ribosomal protein L13a



- Molecule 40: ribosomal protein eS25

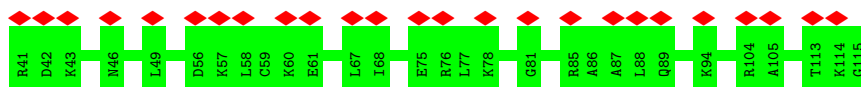

- Molecule 41: uL22

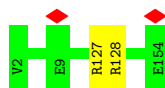

- Molecule 42: eS19

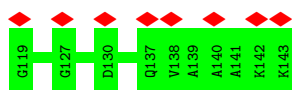
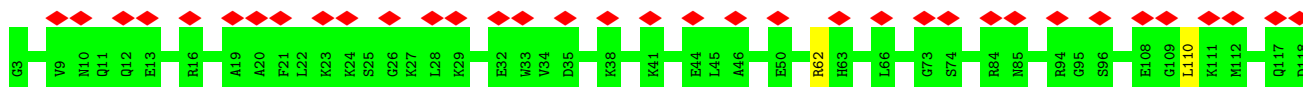

- Molecule 43: eL18

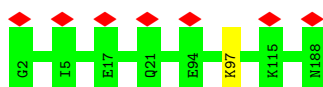

- Molecule 44: ribosomal protein uS15



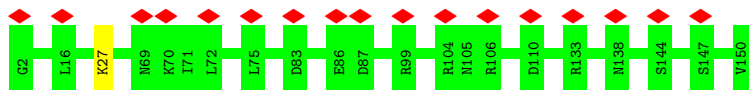

- Molecule 45: 60S ribosomal protein L19

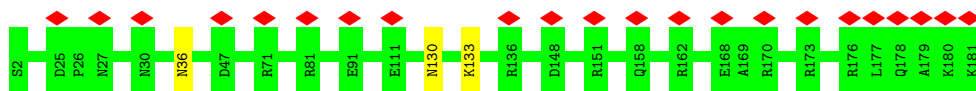

- Molecule 46: 40S ribosomal protein S12

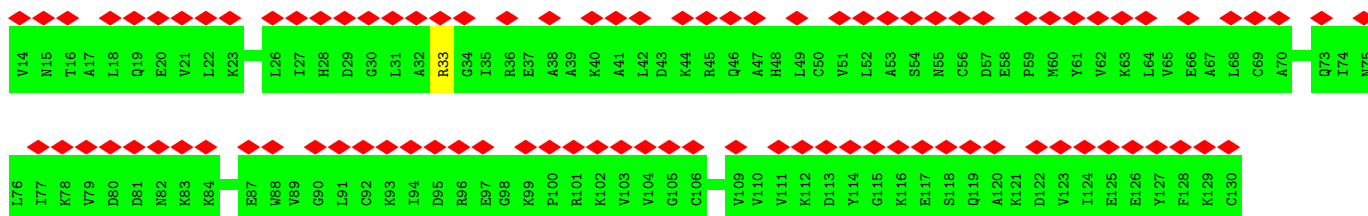
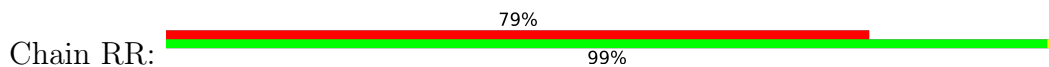

- Molecule 47: eL20

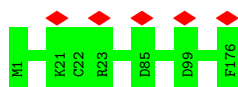

- Molecule 48: eS10

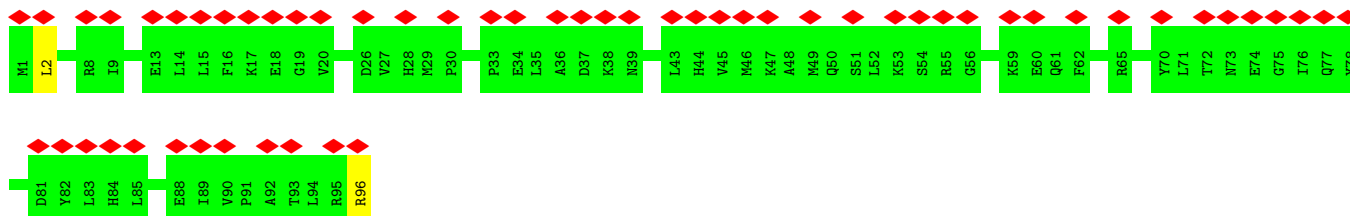

- Molecule 49: eL21



- Molecule 50: Ribosomal protein S15a

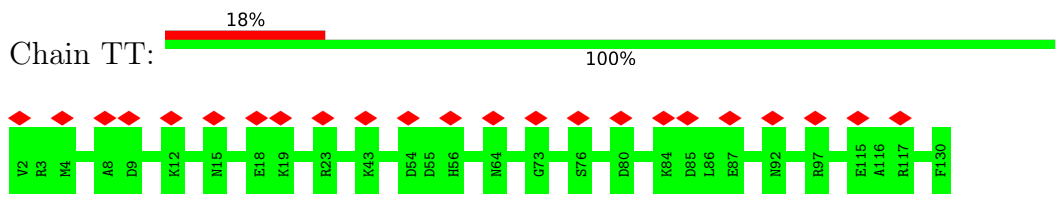

• Molecule 51: Ribosomal protein S16

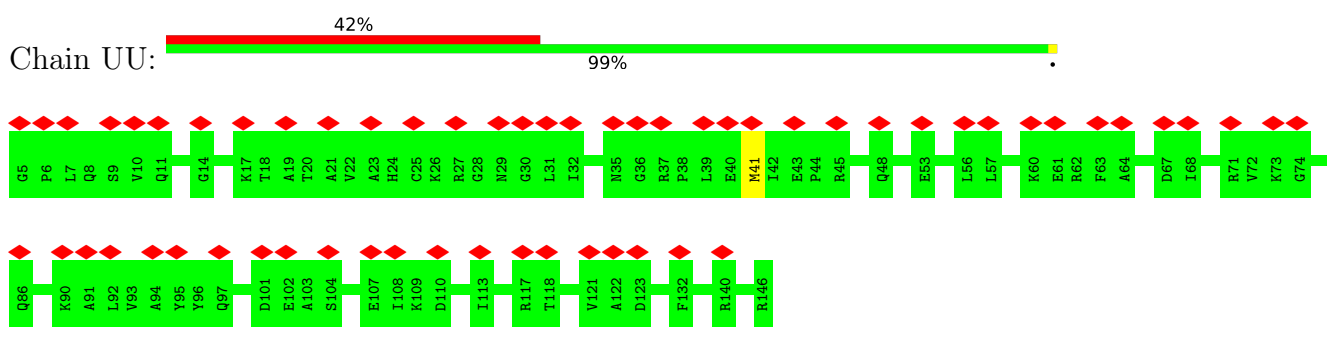

• Molecule 52: 60S ribosomal protein L22

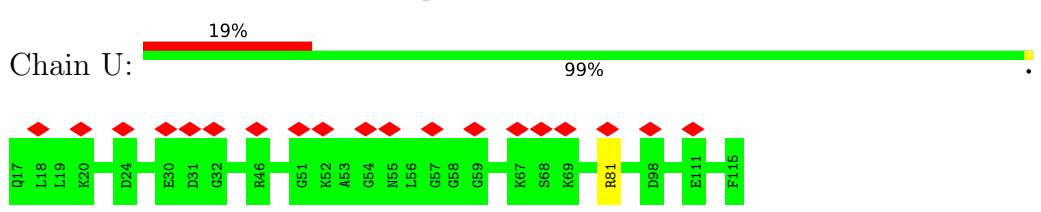

• Molecule 53: Ribosomal protein S23

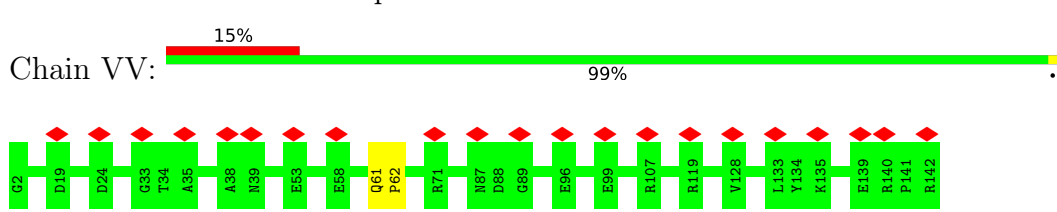

• Molecule 54: eL14

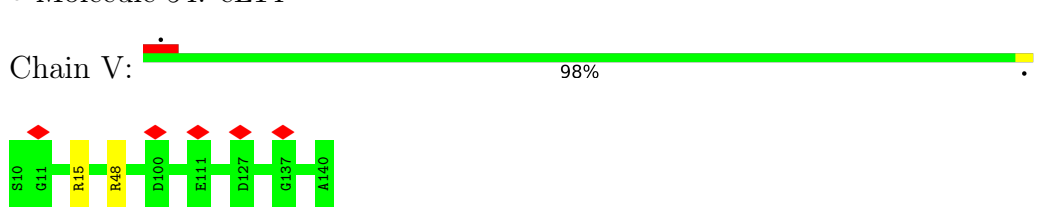

• Molecule 55: Ribosomal protein L24

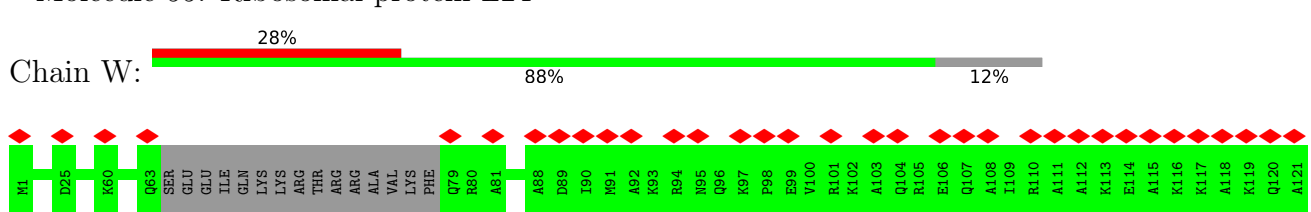

• Molecule 56: uS19



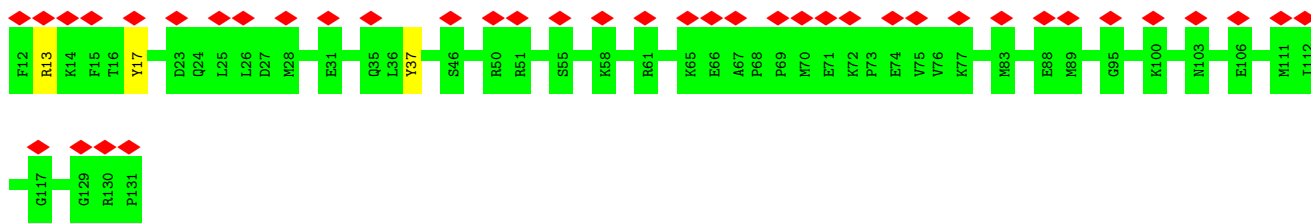

- Molecule 57: uL23

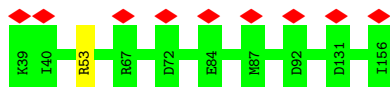

- Molecule 58: Ribosomal protein L26

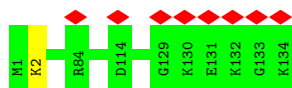

- Molecule 59: 60S ribosomal protein L27

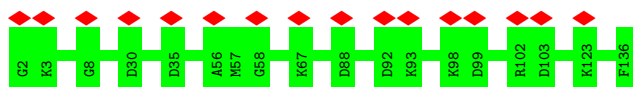

- Molecule 60: uL15

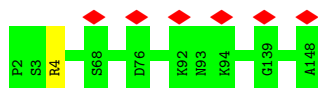

- Molecule 61: eL29

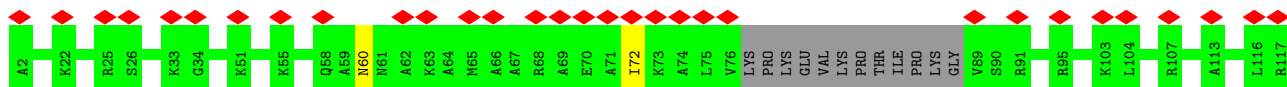
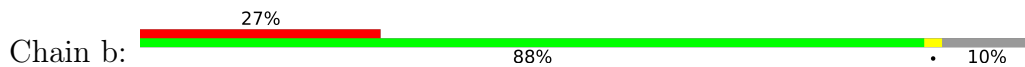

- Molecule 62: eL30



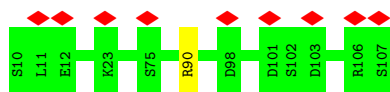

- Molecule 63: eL31

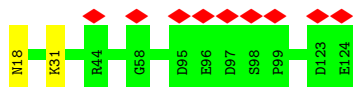

- Molecule 64: eL32

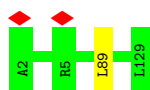

- Molecule 65: eL33



- Molecule 66: eL34

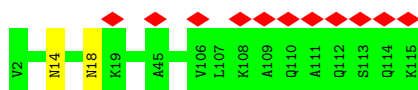

- Molecule 67: uL29

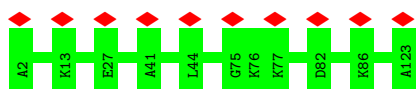

- Molecule 68: 60S ribosomal protein L36

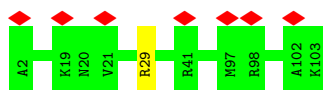

- Molecule 69: Ribosomal protein L37

Chain j:  99%

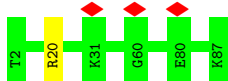

- Molecule 70: 60S ribosomal protein L38

Chain k:  23%  100%

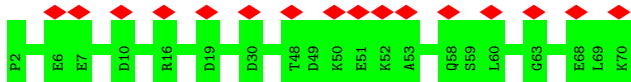

- Molecule 71: eL39

Chain l:  6%  98%

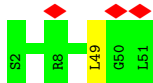

- Molecule 72: 60S ribosomal protein L40

Chain m:  8%  100%

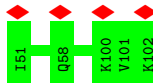

- Molecule 73: 60s ribosomal protein l41

Chain n:  8%  100%

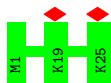

- Molecule 74: eL42

Chain o:  11%  99%

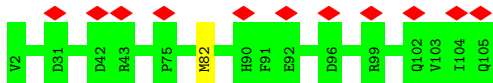

- Molecule 75: ribosomal protein eL43

Chain p:  8%  99%



• Molecule 76: uS2

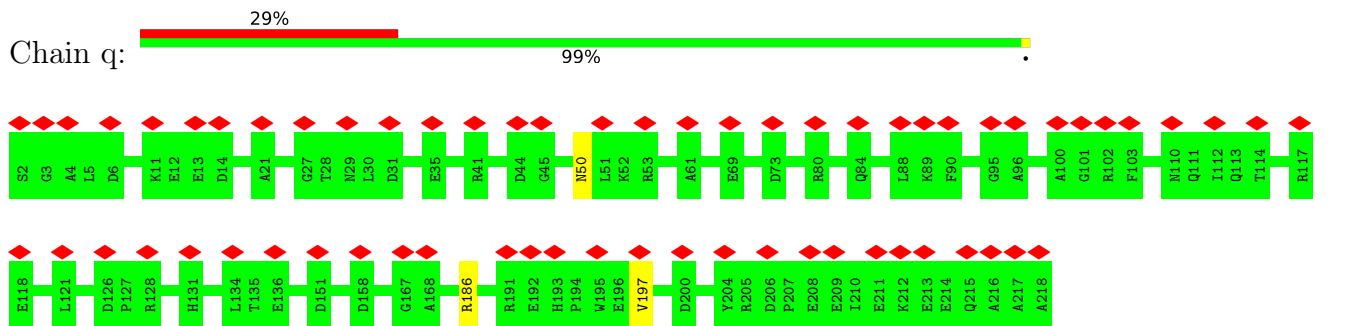

• Molecule 77: eL28

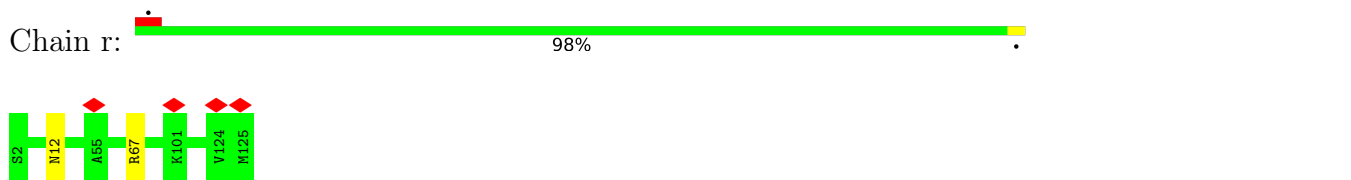

• Molecule 78: 60S acidic ribosomal protein P0

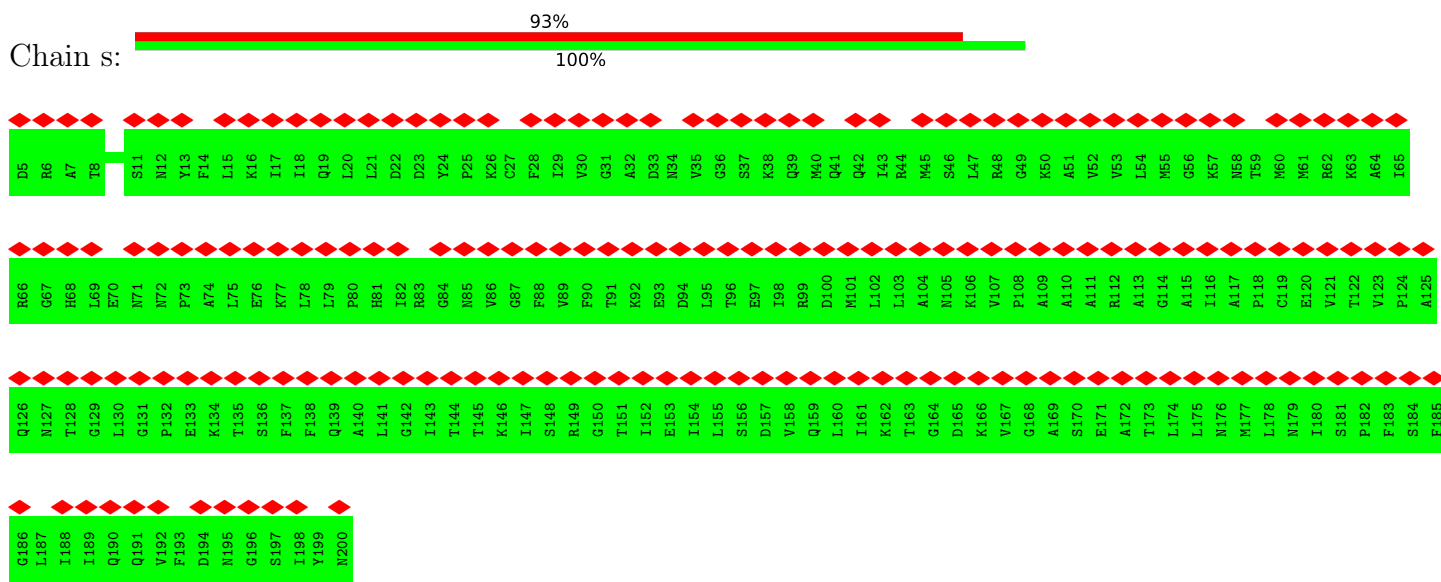

• Molecule 79: uL11





- Molecule 80: 40S ribosomal protein S3a

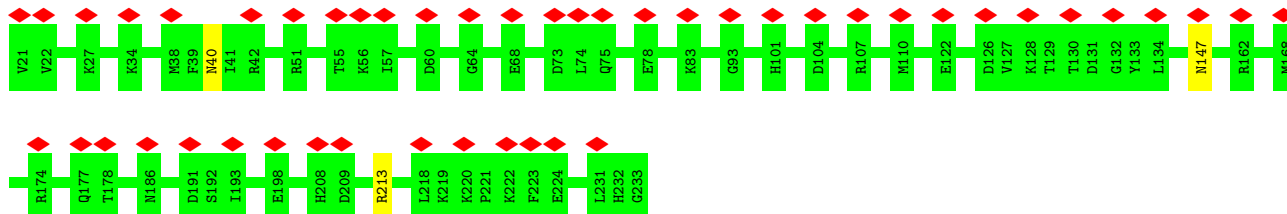

- Molecule 81: uS5

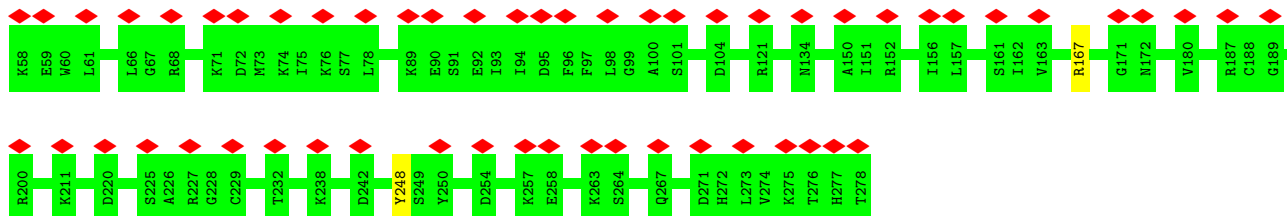

- Molecule 82: Ribosomal protein S3

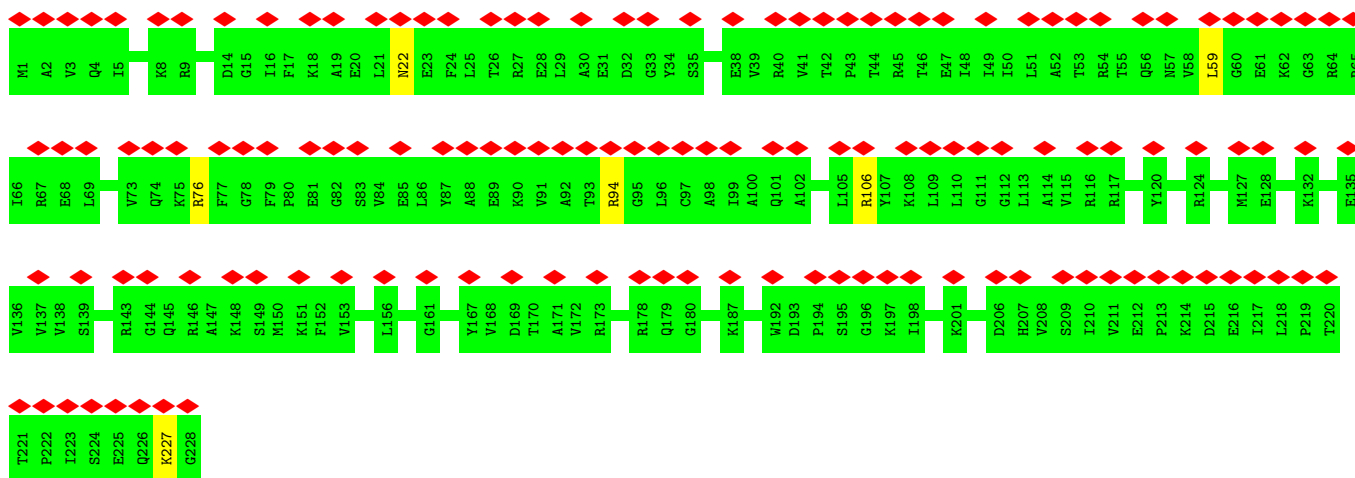

- Molecule 83: 40S ribosomal protein S4



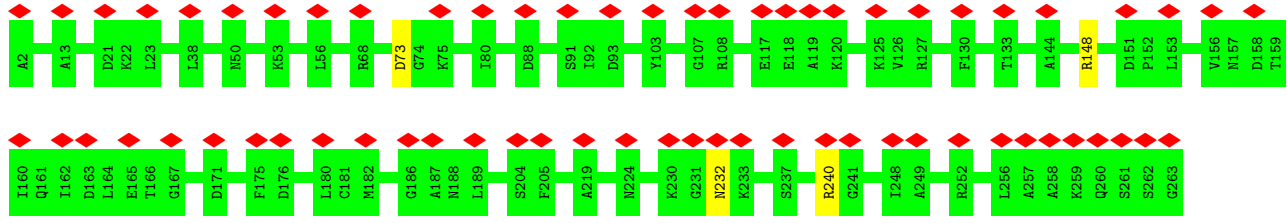

• Molecule 84: Ribosomal protein S5

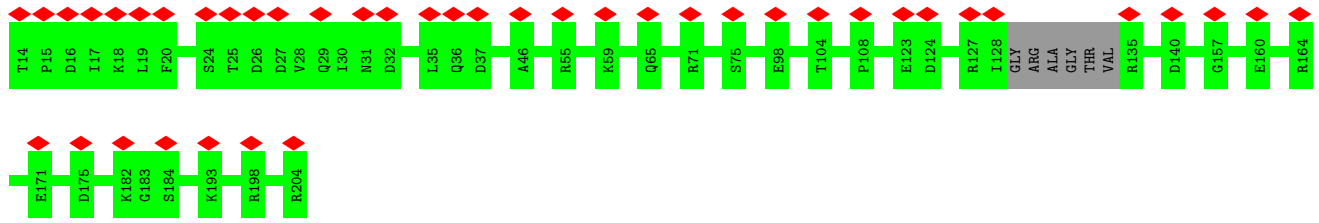

• Molecule 85: 40S ribosomal protein S6

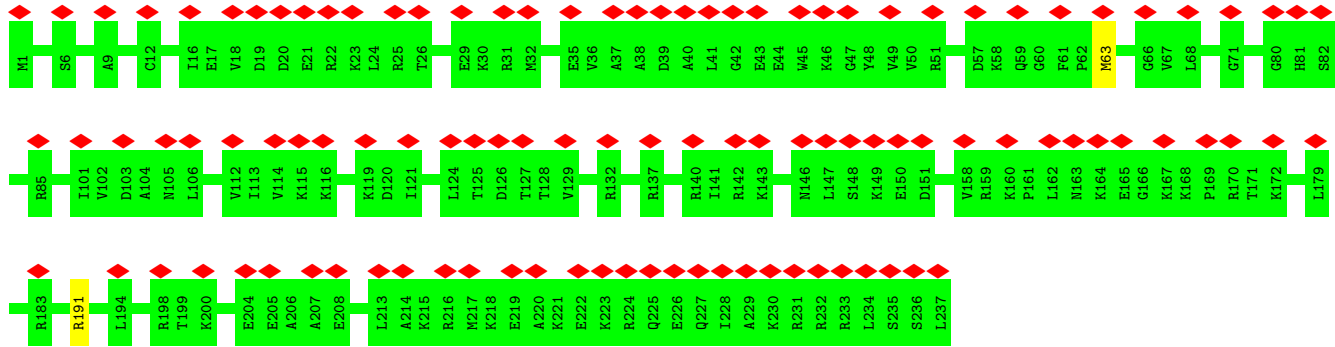
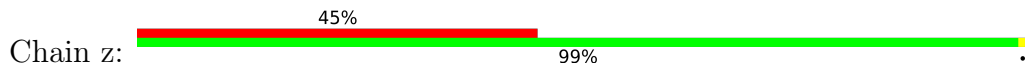

• Molecule 86: Signal recognition particle 54 kDa protein



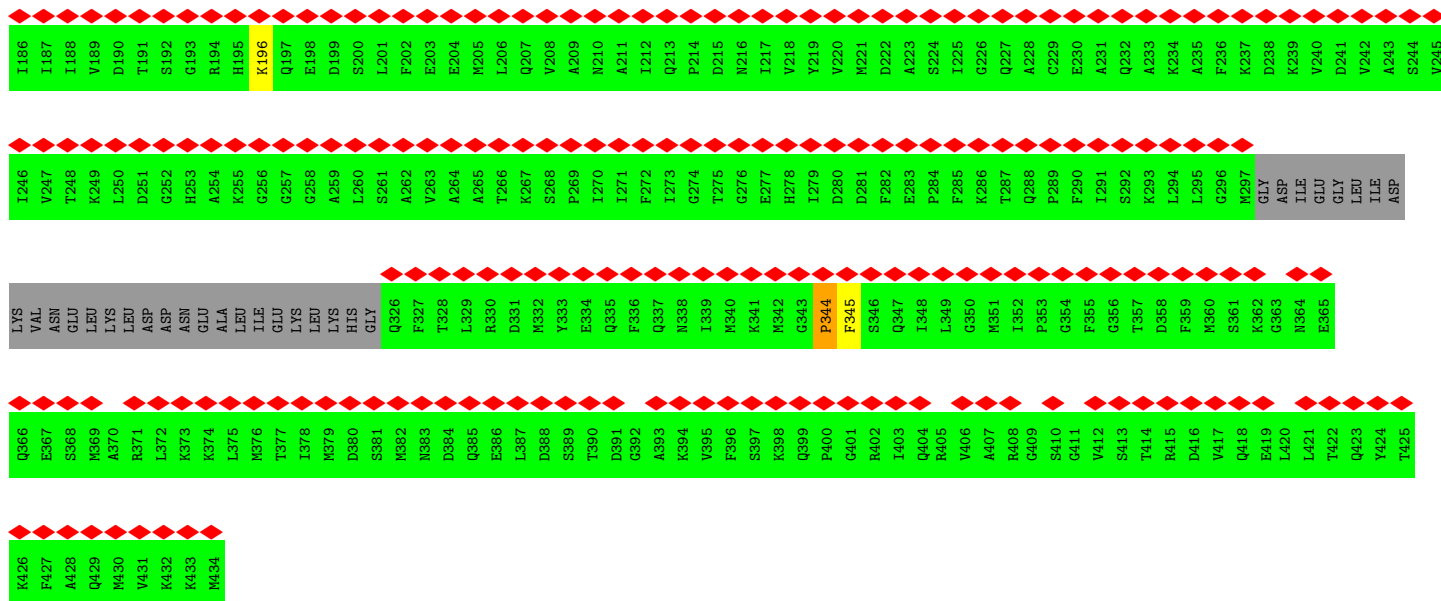

• Molecule 87: 7S RNA

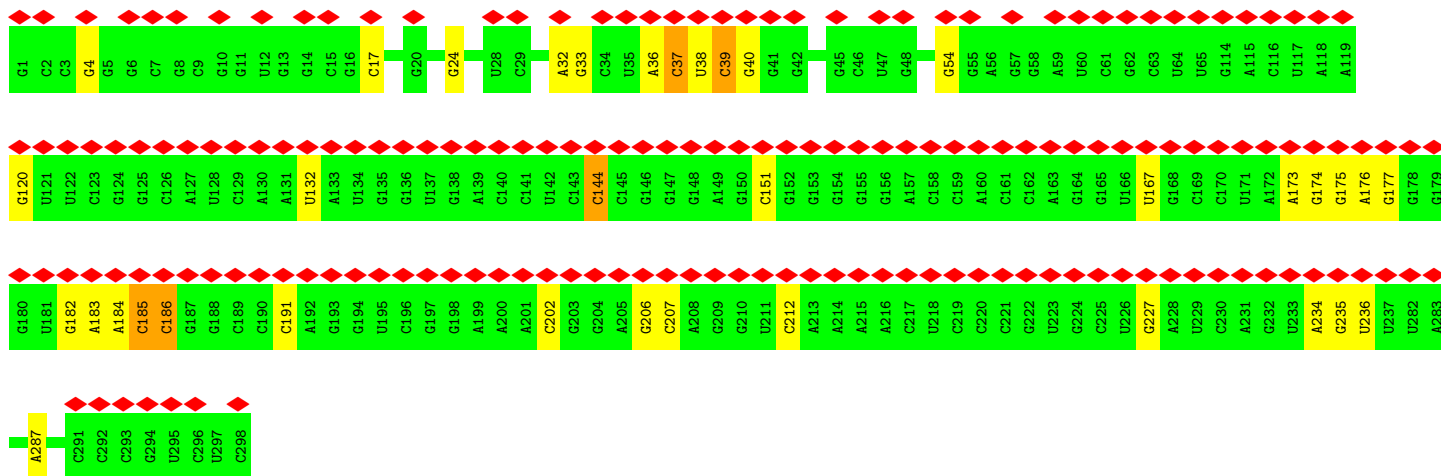
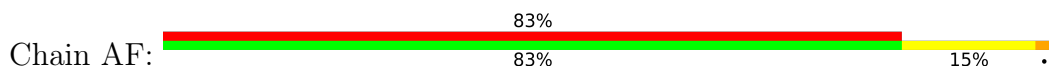

• Molecule 88: Signal recognition particle subunit SRP19



• Molecule 89: Signal recognition particle subunit SRP68

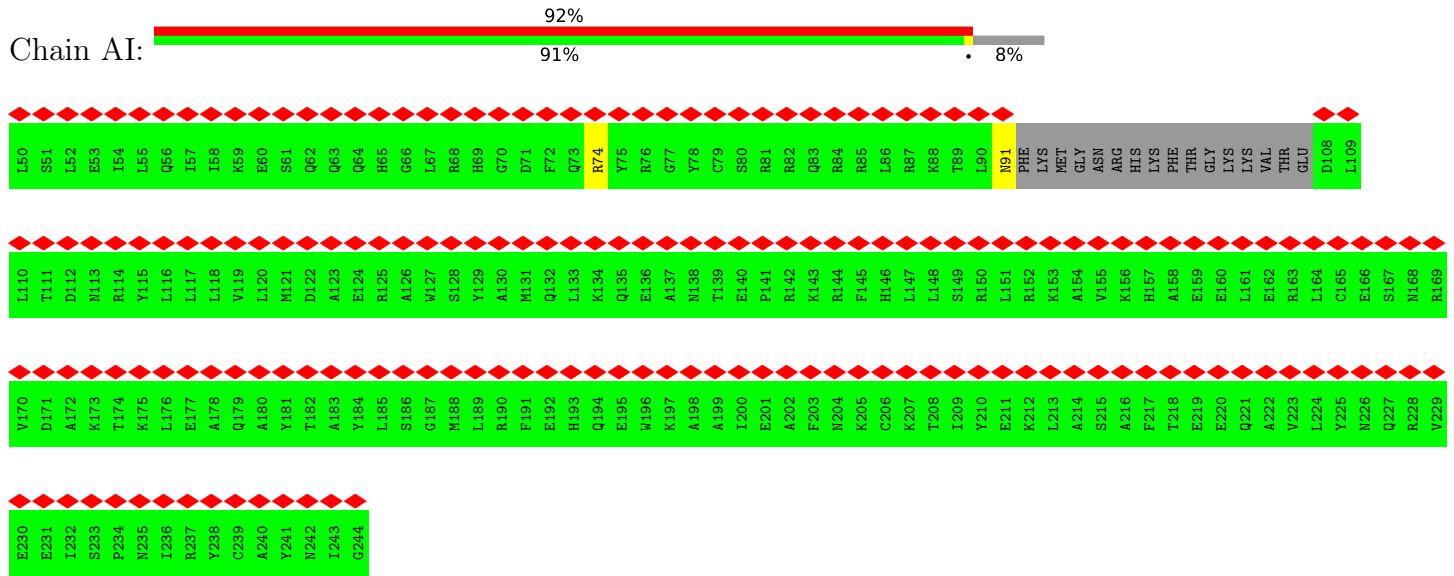

• Molecule 90: Signal recognition particle 9 kDa protein

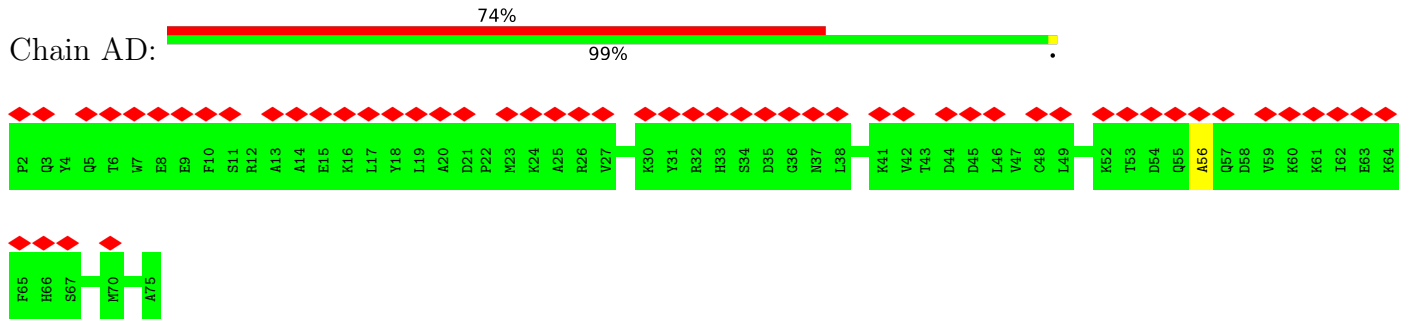

• Molecule 91: Signal recognition particle 14 kDa protein

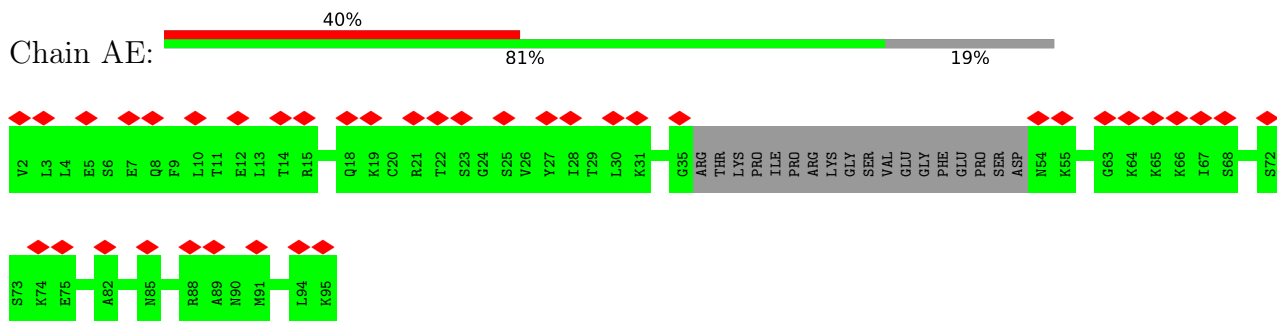

• Molecule 92: Signal sequence (HR2)

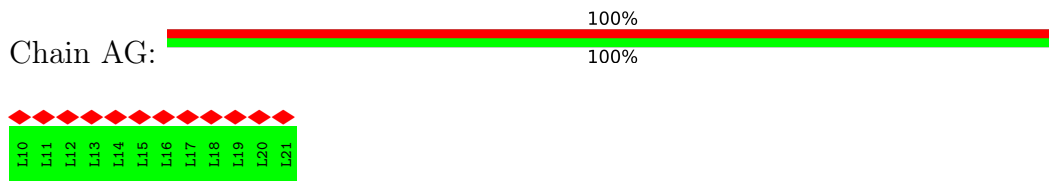

4 Experimental information

Property	Value	Source
EM reconstruction method	SINGLE PARTICLE	Depositor
Imposed symmetry	POINT, C1	Depositor
Number of particles used	24875	Depositor
Resolution determination method	FSC 0.143 CUT-OFF	Depositor
CTF correction method	NONE	Depositor
Microscope	FEI TITAN KRIOS	Depositor
Voltage (kV)	300	Depositor
Electron dose ($e^-/\text{\AA}^2$)	28	Depositor
Minimum defocus (nm)	Not provided	
Maximum defocus (nm)	Not provided	
Magnification	Not provided	
Image detector	FEI FALCON II (4k x 4k)	Depositor
Maximum map value	0.613	Depositor
Minimum map value	-0.452	Depositor
Average map value	0.002	Depositor
Map value standard deviation	0.026	Depositor
Recommended contour level	0.08	Depositor
Map size (\AA)	429.264, 429.264, 429.264	wwPDB
Map dimensions	396, 396, 396	wwPDB
Map angles ($^\circ$)	90.0, 90.0, 90.0	wwPDB
Pixel spacing (\AA)	1.084, 1.084, 1.084	Depositor

5 Model quality [i](#)

5.1 Standard geometry [i](#)

Bond lengths and bond angles in the following residue types are not validated in this section: ZN, MG

The Z score for a bond length (or angle) is the number of standard deviations the observed value is removed from the expected value. A bond length (or angle) with $|Z| > 5$ is considered an outlier worth inspection. RMSZ is the root-mean-square of all Z scores of the bond lengths (or angles).

Mol	Chain	Bond lengths		Bond angles	
		RMSZ	# Z >5	RMSZ	# Z >5
1	0	0.26	0/567	0.49	0/753
2	1	0.92	2/216 (0.9%)	1.26	4/298 (1.3%)
3	2	0.46	3/1780 (0.2%)	1.08	9/2770 (0.3%)
4	3	0.30	0/1783	1.04	7/2773 (0.3%)
5	4	0.20	0/141	0.99	1/217 (0.5%)
6	5	0.31	6/84978 (0.0%)	1.05	358/132528 (0.3%)
7	6	0.26	0/2493	0.54	0/3394
8	7	0.27	0/2858	1.00	10/4455 (0.2%)
9	8	0.30	0/3581	1.06	15/5577 (0.3%)
10	9	0.26	0/470	0.44	0/623
11	A	0.27	0/1936	0.52	0/2596
12	AA	0.27	0/447	0.45	0/587
13	B	0.26	0/3240	0.52	2/4339 (0.0%)
14	BB	0.26	0/1510	0.52	1/2022 (0.0%)
15	C	0.26	0/2937	0.49	0/3946
16	CC	0.25	0/1715	0.49	0/2287
17	DD	0.26	0/1550	0.51	0/2069
18	D	0.27	0/2437	0.46	0/3264
19	EE	0.26	0/1195	0.49	0/1597
20	E	0.26	0/1762	0.51	0/2362
21	FF	0.26	0/490	0.50	0/656
22	F	0.27	0/1911	0.49	0/2549
23	GG	0.26	0/805	0.50	0/1081
24	G	0.27	0/1910	0.51	0/2569
25	H	0.26	0/1535	0.51	0/2063
26	HH	0.27	0/643	0.54	0/860
27	I	0.26	0/1702	0.48	0/2272
28	II	0.27	0/1208	0.54	0/1618
29	JJ	0.24	0/665	0.48	0/891
30	J	0.27	0/1385	0.51	0/1852
31	K	0.31	0/40531	1.07	214/63162 (0.3%)
32	KK	0.25	0/1082	0.44	0/1452

Mol	Chain	Bond lengths		Bond angles	
		RMSZ	# Z >5	RMSZ	# Z >5
33	L	0.26	0/1733	0.48	0/2316
34	LL	0.25	0/828	0.48	0/1109
35	M	0.27	0/1158	0.49	0/1547
36	MM	0.33	0/1029	0.54	0/1380
37	N	0.27	0/1746	0.48	0/2338
38	NN	0.26	0/1028	0.47	0/1366
39	O	0.27	0/1662	0.49	0/2222
40	OO	0.25	0/604	0.51	0/810
41	P	0.32	0/1268	0.51	0/1700
42	PP	0.27	0/1115	0.51	1/1493 (0.1%)
43	Q	0.25	0/1539	0.51	0/2054
44	QQ	0.26	0/1226	0.48	0/1649
45	R	0.25	0/1524	0.47	0/2013
46	RR	0.27	0/918	0.56	0/1233
47	S	0.27	0/1501	0.51	0/2012
48	SS	0.27	0/834	0.55	0/1125
49	T	0.27	0/1326	0.46	0/1770
50	TT	0.27	0/1051	0.52	0/1406
51	UU	0.27	0/1146	0.52	0/1534
52	U	0.27	0/823	0.52	0/1104
53	VV	0.26	0/1116	0.51	0/1490
54	V	0.26	0/993	0.51	0/1332
55	W	0.28	0/873	0.44	0/1158
56	WW	0.27	0/1017	0.53	0/1358
57	X	0.24	0/984	0.48	0/1323
58	Y	0.25	0/1132	0.46	0/1504
59	Z	0.27	0/1130	0.48	0/1507
60	a	0.24	0/1191	0.45	0/1590
61	b	0.24	0/861	0.43	0/1138
62	c	0.26	0/771	0.46	0/1034
63	d	0.29	0/903	0.53	0/1216
64	e	0.27	0/1071	0.50	1/1429 (0.1%)
65	f	0.26	0/895	0.51	0/1198
66	g	0.25	0/916	0.50	0/1220
67	h	0.26	0/1021	0.44	0/1348
68	i	0.26	0/841	0.46	0/1112
69	j	0.25	0/720	0.46	0/952
70	k	0.25	0/575	0.50	0/761
71	l	0.25	0/459	0.49	1/608 (0.2%)
72	m	0.23	0/435	0.45	0/575
73	n	0.22	0/240	0.42	0/305
74	o	0.25	0/864	0.48	0/1140
75	p	0.26	0/718	0.47	0/953

Mol	Chain	Bond lengths		Bond angles	
		RMSZ	# Z >5	RMSZ	# Z >5
76	q	0.27	0/1747	0.52	1/2374 (0.0%)
77	r	0.27	0/1010	0.53	0/1354
78	s	0.26	0/1530	0.49	0/2064
79	t	0.25	0/1174	0.53	0/1582
80	u	0.26	0/1756	0.54	0/2350
81	v	0.27	0/1753	0.51	0/2369
82	w	0.28	0/1796	0.55	1/2417 (0.0%)
83	x	0.26	0/2118	0.51	1/2849 (0.0%)
84	y	0.26	0/1492	0.50	0/2005
85	z	0.26	0/1946	0.49	0/2590
86	AB	0.29	0/3170	0.54	0/4254
87	AF	0.26	0/5090	0.97	19/7936 (0.2%)
88	AC	0.26	0/858	0.51	1/1156 (0.1%)
89	AI	0.25	0/1521	0.44	0/2039
90	AD	0.27	0/619	0.51	0/832
91	AE	0.25	0/608	0.49	0/809
92	AG	0.21	0/95	0.42	0/129
All	All	0.29	11/243531 (0.0%)	0.88	647/357023 (0.2%)

Chiral center outliers are detected by calculating the chiral volume of a chiral center and verifying if the center is modelled as a planar moiety or with the opposite hand. A planarity outlier is detected by checking planarity of atoms in a peptide group, atoms in a mainchain group or atoms of a sidechain that are expected to be planar.

Mol	Chain	#Chirality outliers	#Planarity outliers
2	1	0	1
53	VV	0	1
56	WW	0	2
86	AB	0	4
All	All	0	8

All (11) bond length outliers are listed below:

Mol	Chain	Res	Type	Atoms	Z	Observed(Å)	Ideal(Å)
3	2	7	G	C1'-N9	-6.99	1.37	1.46
2	1	260	MET	CA-C	6.24	1.69	1.52
6	5	3087	A	O3'-P	-6.22	1.53	1.61
6	5	2961	G	O3'-P	-6.05	1.53	1.61
3	2	66	C	C1'-N1	5.60	1.57	1.48
6	5	3126	U	O3'-P	-5.59	1.54	1.61
6	5	1159	G	O3'-P	-5.58	1.54	1.61
3	2	60	A	C1'-N9	-5.56	1.39	1.46

Continued on next page...

Continued from previous page...

Mol	Chain	Res	Type	Atoms	Z	Observed(Å)	Ideal(Å)
6	5	3017	C	O3'-P	-5.37	1.54	1.61
6	5	2608	C	O3'-P	-5.21	1.54	1.61
2	1	258	PRO	C-N	5.12	1.45	1.34

All (647) bond angle outliers are listed below:

Mol	Chain	Res	Type	Atoms	Z	Observed(°)	Ideal(°)
6	5	2181	U	C5-C4-O4	21.61	138.87	125.90
6	5	2181	U	N3-C4-O4	-20.11	105.32	119.40
6	5	2612	U	N3-C4-O4	-18.39	106.53	119.40
6	5	2612	U	C5-C4-O4	18.27	136.86	125.90
6	5	1760	A	N1-C6-N6	-12.77	110.94	118.60
6	5	1898	C	C6-N1-C2	-11.14	115.84	120.30
87	AF	37	C	N1-C2-O2	11.14	125.58	118.90
6	5	1898	C	N1-C2-O2	10.87	125.42	118.90
87	AF	37	C	C2-N1-C1'	10.82	130.70	118.80
6	5	1898	C	N3-C2-O2	-9.78	115.06	121.90
2	1	243	PRO	C-N-CD	-9.69	99.27	120.60
31	K	1139	C	N1-C2-O2	9.61	124.67	118.90
6	5	2948	A	N1-C6-N6	-9.61	112.83	118.60
31	K	853	C	C2-N1-C1'	9.46	129.21	118.80
6	5	100	C	C2-N1-C1'	9.37	129.10	118.80
31	K	1520	G	N3-C4-C5	-9.32	123.94	128.60
87	AF	37	C	N3-C2-O2	-9.14	115.50	121.90
6	5	100	C	N1-C2-O2	9.11	124.36	118.90
2	1	258	PRO	CA-C-N	-9.05	97.30	117.20
31	K	1303	C	N1-C2-O2	9.04	124.32	118.90
31	K	1303	C	C2-N1-C1'	8.90	128.59	118.80
6	5	2884	C	N1-C2-O2	8.84	124.20	118.90
31	K	293	C	N1-C2-O2	8.80	124.18	118.90
31	K	853	C	N1-C2-O2	8.72	124.14	118.90
6	5	2213	C	N1-C2-O2	8.69	124.11	118.90
6	5	1231	U	N3-C2-O2	-8.66	116.14	122.20
6	5	1559	C	N3-C2-O2	-8.65	115.84	121.90
6	5	2696	C	N1-C2-O2	8.60	124.06	118.90
6	5	2696	C	C2-N1-C1'	8.59	128.25	118.80
31	K	1453	C	N1-C2-O2	8.59	124.05	118.90
31	K	1123	C	N1-C2-O2	8.51	124.00	118.90
31	K	174	C	N3-C2-O2	-8.50	115.95	121.90
6	5	3322	C	N1-C2-O2	8.46	123.98	118.90
6	5	1559	C	N1-C2-O2	8.44	123.97	118.90
6	5	1898	C	C2-N1-C1'	8.40	128.04	118.80

Continued on next page...

Continued from previous page...

Mol	Chain	Res	Type	Atoms	Z	Observed(°)	Ideal(°)
6	5	2884	C	N3-C2-O2	-8.39	116.03	121.90
2	1	258	PRO	C-N-CA	-8.28	101.01	121.70
9	8	128	C	N1-C2-O2	8.28	123.87	118.90
31	K	570	C	N1-C2-O2	8.27	123.86	118.90
6	5	1760	A	C5-C6-N6	8.27	130.31	123.70
6	5	3017	C	C4'-C3'-O3'	8.25	129.51	113.00
31	K	1453	C	C2-N1-C1'	8.17	127.78	118.80
6	5	1898	C	C5-C6-N1	8.14	125.07	121.00
31	K	1520	G	C2-N3-C4	8.13	115.96	111.90
31	K	1551	U	C2-N1-C1'	8.11	127.43	117.70
6	5	1760	A	N1-C2-N3	-7.99	125.31	129.30
6	5	3322	C	C2-N1-C1'	7.96	127.55	118.80
31	K	1139	C	N3-C2-O2	-7.96	116.33	121.90
31	K	823	U	N1-C2-O2	7.96	128.37	122.80
6	5	1231	U	N1-C2-O2	7.95	128.37	122.80
31	K	1364	U	N1-C2-O2	7.87	128.31	122.80
31	K	823	U	N3-C2-O2	-7.86	116.70	122.20
76	q	197	VAL	C-N-CA	7.85	141.31	121.70
6	5	3017	C	C2'-C3'-O3'	-7.84	92.25	109.50
31	K	293	C	C2-N1-C1'	7.83	127.41	118.80
31	K	1139	C	C2-N1-C1'	7.81	127.39	118.80
6	5	2993	U	C2-N1-C1'	7.81	127.08	117.70
31	K	823	U	C2-N1-C1'	7.79	127.05	117.70
31	K	1520	G	C8-N9-C4	-7.79	103.29	106.40
31	K	1551	U	N1-C2-O2	7.78	128.24	122.80
6	5	2334	C	N3-C2-O2	-7.65	116.54	121.90
31	K	914	U	C2-N1-C1'	7.65	126.89	117.70
6	5	749	C	N1-C2-O2	7.64	123.48	118.90
31	K	1364	U	C2-N1-C1'	7.63	126.85	117.70
31	K	1520	G	C4-N9-C1'	7.59	136.37	126.50
87	AF	37	C	C6-N1-C1'	-7.55	111.74	120.80
3	2	5	C	N1-C2-O2	7.49	123.39	118.90
6	5	466	C	N1-C2-O2	7.48	123.39	118.90
6	5	2813	C	N1-C2-O2	7.43	123.36	118.90
6	5	1044	G	C4-N9-C1'	7.43	136.16	126.50
6	5	1199	U	C2-N1-C1'	7.42	126.60	117.70
87	AF	144	C	N1-C2-O2	7.35	123.31	118.90
6	5	1961	C	N1-C2-O2	7.34	123.30	118.90
31	K	1624	U	C2-N1-C1'	7.30	126.46	117.70
6	5	214	C	C2-N1-C1'	7.29	126.81	118.80
31	K	1591	C	N1-C2-O2	7.29	123.27	118.90
6	5	2875	G	C4-N9-C1'	7.28	135.96	126.50

Continued on next page...

Continued from previous page...

Mol	Chain	Res	Type	Atoms	Z	Observed(°)	Ideal(°)
31	K	1751	C	N1-C2-O2	7.28	123.27	118.90
6	5	775	U	C2-N1-C1'	7.27	126.42	117.70
31	K	340	C	N1-C2-O2	7.22	123.23	118.90
31	K	1303	C	N3-C2-O2	-7.20	116.86	121.90
6	5	1044	G	N3-C4-C5	-7.20	125.00	128.60
31	K	1123	C	N3-C2-O2	-7.20	116.86	121.90
31	K	1551	U	N3-C2-O2	-7.18	117.17	122.20
6	5	3279	U	N1-C2-O2	7.17	127.82	122.80
2	1	258	PRO	O-C-N	7.16	134.15	122.70
31	K	1123	C	C6-N1-C2	-7.16	117.44	120.30
31	K	1364	U	N3-C2-O2	-7.15	117.19	122.20
31	K	1261	C	N1-C2-O2	7.14	123.19	118.90
31	K	174	C	N1-C2-O2	7.10	123.16	118.90
6	5	2213	C	N3-C2-O2	-7.09	116.94	121.90
87	AF	207	C	N1-C2-O2	7.08	123.14	118.90
31	K	130	G	N3-C4-C5	-7.05	125.08	128.60
6	5	1172	G	N3-C4-N9	7.04	130.23	126.00
6	5	100	C	N3-C2-O2	-7.03	116.98	121.90
6	5	2875	G	N3-C4-N9	7.02	130.21	126.00
31	K	530	U	C2-N1-C1'	7.01	126.11	117.70
6	5	2181	U	C2-N3-C4	7.00	131.20	127.00
8	7	29	C	N1-C2-O2	7.00	123.10	118.90
6	5	990	C	N1-C2-O2	6.98	123.09	118.90
8	7	94	C	N1-C2-O2	6.98	123.09	118.90
31	K	1118	C	C2-N1-C1'	6.97	126.47	118.80
31	K	853	C	N3-C2-O2	-6.97	117.02	121.90
6	5	30	C	C2-N1-C1'	6.95	126.44	118.80
6	5	3303	C	N1-C2-O2	6.95	123.07	118.90
31	K	130	G	C4-N9-C1'	6.94	135.53	126.50
6	5	2508	C	C2-N1-C1'	6.93	126.42	118.80
88	AC	18	ILE	C-N-CA	6.93	139.03	121.70
31	K	183	G	N3-C4-C5	-6.92	125.14	128.60
6	5	466	C	C2-N1-C1'	6.92	126.41	118.80
6	5	2993	U	N1-C2-O2	6.91	127.63	122.80
31	K	1664	A	P-O3'-C3'	6.91	127.99	119.70
31	K	130	G	N3-C4-N9	6.90	130.14	126.00
31	K	1139	C	C6-N1-C2	-6.90	117.54	120.30
6	5	2920	C	N1-C2-O2	6.90	123.04	118.90
6	5	1172	G	C4-N9-C1'	6.90	135.47	126.50
6	5	3017	C	C4'-C3'-C2'	-6.89	95.70	102.60
6	5	1044	G	N3-C4-N9	6.89	130.13	126.00
6	5	775	U	N1-C2-O2	6.88	127.61	122.80

Continued on next page...

Continued from previous page...

Mol	Chain	Res	Type	Atoms	Z	Observed(°)	Ideal(°)
87	AF	37	C	C6-N1-C2	-6.87	117.55	120.30
6	5	152	U	N3-C2-O2	-6.87	117.39	122.20
31	K	578	C	N1-C2-O2	6.86	123.01	118.90
31	K	1624	U	N1-C2-O2	6.84	127.59	122.80
6	5	1041	C	N1-C2-O2	6.80	122.98	118.90
6	5	2875	G	N3-C4-C5	-6.79	125.20	128.60
31	K	570	C	C2-N1-C1'	6.78	126.26	118.80
31	K	1683	C	N1-C2-O2	6.78	122.97	118.90
31	K	1624	U	N3-C2-O2	-6.78	117.46	122.20
31	K	570	C	N3-C2-O2	-6.77	117.16	121.90
6	5	1095	C	N1-C2-O2	6.76	122.96	118.90
31	K	293	C	N3-C2-O2	-6.76	117.17	121.90
6	5	3279	U	N3-C2-O2	-6.76	117.47	122.20
9	8	128	C	N3-C2-O2	-6.75	117.18	121.90
6	5	1272	U	N1-C2-O2	6.75	127.52	122.80
6	5	3322	C	N3-C2-O2	-6.75	117.18	121.90
6	5	2508	C	N1-C2-O2	6.74	122.94	118.90
6	5	2785	C	N1-C2-O2	6.73	122.94	118.90
31	K	1453	C	N3-C2-O2	-6.71	117.20	121.90
6	5	2920	C	N3-C2-O2	-6.70	117.21	121.90
31	K	1123	C	C2-N1-C1'	6.69	126.16	118.80
31	K	183	G	C4-N9-C1'	6.67	135.18	126.50
31	K	1274	G	C4-N9-C1'	6.67	135.17	126.50
6	5	2993	U	N3-C2-O2	-6.67	117.53	122.20
31	K	1120	U	C2-N1-C1'	6.66	125.69	117.70
6	5	2334	C	N1-C2-O2	6.64	122.89	118.90
31	K	151	C	C2-N1-C1'	6.64	126.11	118.80
6	5	112	C	C2-N1-C1'	6.63	126.09	118.80
6	5	1006	C	N1-C2-O2	6.61	122.87	118.90
31	K	688	U	P-O3'-C3'	6.61	127.63	119.70
6	5	2813	C	N3-C2-O2	-6.59	117.29	121.90
31	K	1520	G	N3-C4-N9	6.59	129.95	126.00
31	K	1057	C	C2-N1-C1'	6.58	126.04	118.80
6	5	3197	U	N1-C2-O2	6.58	127.41	122.80
31	K	973	C	N1-C2-O2	6.58	122.85	118.90
6	5	100	C	C6-N1-C1'	-6.58	112.90	120.80
31	K	752	G	P-O3'-C3'	6.58	127.60	119.70
3	2	5	C	N3-C2-O2	-6.57	117.30	121.90
6	5	1550	A	C6-N1-C2	-6.57	114.66	118.60
31	K	853	C	C6-N1-C1'	-6.55	112.94	120.80
31	K	1274	G	N3-C4-N9	6.55	129.93	126.00
31	K	1274	G	N3-C4-C5	-6.55	125.33	128.60

Continued on next page...

Continued from previous page...

Mol	Chain	Res	Type	Atoms	Z	Observed(°)	Ideal(°)
6	5	1803	C	C2-N1-C1'	6.53	125.99	118.80
31	K	824	C	N1-C2-O2	6.53	122.82	118.90
6	5	1037	C	C2-N1-C1'	6.53	125.98	118.80
6	5	1199	U	N1-C2-O2	6.53	127.37	122.80
13	B	309	LEU	CA-CB-CG	6.53	130.31	115.30
31	K	1298	G	C4-N9-C1'	6.53	134.99	126.50
6	5	737	C	P-O3'-C3'	6.52	127.53	119.70
6	5	2696	C	N3-C2-O2	-6.52	117.33	121.90
9	8	2	G	C4-N9-C1'	6.52	134.97	126.50
31	K	494	C	N1-C2-O2	6.51	122.80	118.90
6	5	1515	C	N1-C2-O2	6.50	122.80	118.90
31	K	930	C	N1-C2-O2	6.50	122.80	118.90
31	K	1518	C	C2-N1-C1'	6.50	125.95	118.80
6	5	534	C	N1-C2-O2	6.48	122.79	118.90
6	5	1545	U	C2-N1-C1'	6.48	125.47	117.70
6	5	1867	G	P-O3'-C3'	6.47	127.47	119.70
6	5	3362	C	C2-N1-C1'	6.47	125.92	118.80
6	5	77	U	N3-C2-O2	-6.46	117.67	122.20
31	K	943	U	C2-N1-C1'	6.46	125.45	117.70
6	5	2054	U	P-O3'-C3'	6.46	127.45	119.70
6	5	1349	C	N1-C2-O2	6.45	122.77	118.90
31	K	1298	G	N3-C4-N9	6.44	129.87	126.00
6	5	1344	C	C2-N1-C1'	6.43	125.88	118.80
31	K	183	G	N3-C4-N9	6.43	129.86	126.00
31	K	1689	C	C2-N1-C1'	6.43	125.87	118.80
3	2	5	C	C2-N1-C1'	6.42	125.86	118.80
6	5	1272	U	N3-C2-O2	-6.42	117.71	122.20
6	5	2465	C	C2-N1-C1'	6.42	125.86	118.80
6	5	3018	G	P-O3'-C3'	6.41	127.40	119.70
6	5	49	U	N1-C2-O2	6.41	127.28	122.80
31	K	814	U	N1-C2-O2	6.41	127.28	122.80
71	1	49	LEU	CA-CB-CG	6.40	130.02	115.30
6	5	1172	G	N3-C4-C5	-6.40	125.40	128.60
6	5	490	C	N1-C2-O2	6.39	122.73	118.90
6	5	1961	C	C2-N1-C1'	6.39	125.82	118.80
6	5	1583	G	P-O3'-C3'	6.37	127.34	119.70
6	5	2612	U	N1-C2-O2	6.37	127.25	122.80
9	8	128	C	C2-N1-C1'	6.35	125.79	118.80
6	5	1038	C	C2-N1-C1'	6.35	125.78	118.80
6	5	2983	C	C2-N1-C1'	6.34	125.77	118.80
6	5	775	U	N3-C2-O2	-6.33	117.77	122.20
31	K	356	C	C2-N1-C1'	6.29	125.72	118.80

Continued on next page...

Continued from previous page...

Mol	Chain	Res	Type	Atoms	Z	Observed(°)	Ideal(°)
6	5	2088	A	P-O3'-C3'	6.29	127.25	119.70
6	5	3017	C	C5'-C4'-C3'	6.28	126.05	116.00
6	5	890	G	C2'-C3'-O3'	6.28	123.75	113.70
6	5	1384	C	C2-N1-C1'	6.28	125.71	118.80
6	5	1029	C	N3-C2-O2	-6.27	117.51	121.90
31	K	1664	A	OP1-P-O3'	6.27	118.99	105.20
6	5	3408	C	N1-C2-O2	6.25	122.65	118.90
6	5	2813	C	C6-N1-C2	-6.25	117.80	120.30
31	K	1315	U	N3-C2-O2	-6.25	117.83	122.20
31	K	914	U	C6-N1-C1'	-6.24	112.46	121.20
6	5	3408	C	C2-N1-C1'	6.22	125.64	118.80
6	5	975	C	C2-N1-C1'	6.21	125.64	118.80
6	5	2260	C	C2-N1-C1'	6.21	125.63	118.80
6	5	2873	C	C2-N1-C1'	6.21	125.63	118.80
8	7	94	C	N3-C2-O2	-6.21	117.56	121.90
4	3	63	C	N1-C2-O2	6.20	122.62	118.90
6	5	1349	C	C2-N1-C1'	6.20	125.62	118.80
6	5	1044	G	C8-N9-C1'	-6.18	118.96	127.00
6	5	806	C	N1-C2-O2	6.18	122.61	118.90
6	5	2875	G	C8-N9-C1'	-6.17	118.98	127.00
31	K	1303	C	C6-N1-C1'	-6.17	113.40	120.80
14	BB	36	LEU	CA-CB-CG	6.17	129.48	115.30
9	8	128	C	C6-N1-C2	-6.15	117.84	120.30
6	5	2249	C	N1-C2-O2	6.14	122.59	118.90
6	5	2769	C	N1-C2-O2	6.14	122.59	118.90
6	5	1396	C	N1-C2-O2	6.14	122.58	118.90
31	K	118	C	N1-C2-O2	6.13	122.58	118.90
6	5	975	C	N1-C2-O2	6.13	122.58	118.90
31	K	1073	U	N3-C2-O2	-6.13	117.91	122.20
31	K	1315	U	N1-C2-O2	6.13	127.09	122.80
6	5	2181	U	N1-C2-N3	-6.13	111.22	114.90
31	K	853	C	C6-N1-C2	-6.13	117.85	120.30
6	5	1314	C	N1-C2-O2	6.12	122.57	118.90
6	5	1545	U	N1-C2-O2	6.12	127.09	122.80
31	K	1298	G	N3-C4-C5	-6.12	125.54	128.60
31	K	407	G	C4-N9-C1'	6.12	134.46	126.50
31	K	1590	C	N1-C2-O2	6.12	122.57	118.90
31	K	1423	C	N1-C2-O2	6.11	122.57	118.90
6	5	989	U	N1-C2-O2	6.11	127.07	122.80
8	7	102	U	N1-C2-O2	6.10	127.07	122.80
6	5	806	C	C2-N1-C1'	6.08	125.48	118.80
31	K	407	G	N3-C4-C5	-6.07	125.56	128.60

Continued on next page...

Continued from previous page...

Mol	Chain	Res	Type	Atoms	Z	Observed(°)	Ideal(°)
6	5	1199	U	N3-C2-O2	-6.07	117.95	122.20
6	5	2334	C	C6-N1-C2	-6.07	117.87	120.30
31	K	151	C	C6-N1-C2	-6.07	117.87	120.30
31	K	1078	C	C2-N1-C1'	6.06	125.46	118.80
6	5	2213	C	C2-N1-C1'	6.05	125.46	118.80
6	5	1329	U	N1-C2-O2	6.05	127.03	122.80
6	5	3279	U	C2-N1-C1'	6.05	124.95	117.70
4	3	40	C	C2-N1-C1'	6.04	125.44	118.80
31	K	1518	C	N1-C2-O2	6.04	122.52	118.90
6	5	3017	C	O4'-C4'-C3'	-6.04	97.96	104.00
31	K	814	U	N3-C2-O2	-6.04	117.97	122.20
6	5	2696	C	C6-N1-C1'	-6.03	113.56	120.80
6	5	580	C	C2-N1-C1'	6.02	125.43	118.80
31	K	183	G	C2-N3-C4	6.02	114.91	111.90
6	5	2181	U	C4-C5-C6	-6.02	116.09	119.70
6	5	3510	U	N3-C2-O2	-6.02	117.99	122.20
31	K	579	C	N1-C2-O2	6.02	122.51	118.90
6	5	1961	C	N3-C2-O2	-6.01	117.69	121.90
6	5	2213	C	C6-N1-C2	-6.01	117.89	120.30
6	5	155	C	N1-C2-O2	6.01	122.51	118.90
6	5	1028	C	N1-C2-O2	6.01	122.50	118.90
31	K	407	G	N3-C4-N9	6.01	129.60	126.00
31	K	1261	C	C2-N1-C1'	6.01	125.41	118.80
6	5	155	C	N3-C2-O2	-6.00	117.70	121.90
6	5	1172	G	C8-N9-C1'	-6.00	119.19	127.00
6	5	990	C	C2-N1-C1'	6.00	125.40	118.80
6	5	1231	U	C2-N1-C1'	5.99	124.89	117.70
6	5	749	C	N3-C2-O2	-5.99	117.71	121.90
31	K	930	C	C2-N1-C1'	5.98	125.38	118.80
6	5	2165	C	C6-N1-C2	-5.97	117.91	120.30
6	5	2741	C	N1-C2-O2	5.97	122.48	118.90
6	5	1074	U	N3-C2-O2	-5.97	118.02	122.20
8	7	29	C	N3-C2-O2	-5.97	117.72	121.90
87	AF	186	C	C2-N1-C1'	5.96	125.36	118.80
6	5	749	C	C2-N1-C1'	5.96	125.36	118.80
87	AF	207	C	C6-N1-C2	-5.96	117.92	120.30
31	K	537	C	C2-N1-C1'	5.95	125.34	118.80
6	5	3197	U	N3-C2-O2	-5.95	118.04	122.20
31	K	1261	C	N3-C2-O2	-5.95	117.74	121.90
31	K	119	U	N1-C2-O2	5.94	126.96	122.80
9	8	101	C	C2-N1-C1'	5.94	125.33	118.80
6	5	77	U	N1-C2-O2	5.94	126.95	122.80

Continued on next page...

Continued from previous page...

Mol	Chain	Res	Type	Atoms	Z	Observed(°)	Ideal(°)
6	5	572	C	P-O3'-C3'	5.93	126.82	119.70
6	5	2580	C	N1-C2-O2	5.93	122.46	118.90
6	5	1921	G	C4-N9-C1'	5.93	134.21	126.50
8	7	29	C	C2-N1-C1'	5.93	125.32	118.80
6	5	3252	U	N3-C2-O2	-5.92	118.05	122.20
6	5	3428	C	C2-N1-C1'	5.92	125.32	118.80
6	5	2465	C	C5-C6-N1	5.92	123.96	121.00
31	K	1591	C	N3-C2-O2	-5.92	117.75	121.90
31	K	1281	G	C4-N9-C1'	5.92	134.19	126.50
31	K	1660	C	C2-N1-C1'	5.91	125.30	118.80
6	5	537	C	C2-N1-C1'	5.91	125.30	118.80
6	5	48	G	P-O3'-C3'	5.90	126.78	119.70
6	5	466	C	N3-C2-O2	-5.90	117.77	121.90
31	K	119	U	N3-C2-O2	-5.90	118.07	122.20
6	5	1193	G	P-O3'-C3'	5.90	126.78	119.70
31	K	1314	U	C2-N1-C1'	5.90	124.78	117.70
31	K	1261	C	C6-N1-C2	-5.89	117.94	120.30
31	K	1298	G	C8-N9-C1'	-5.89	119.35	127.00
31	K	537	C	N1-C2-O2	5.88	122.43	118.90
6	5	3046	C	C2-N1-C1'	5.88	125.26	118.80
87	AF	207	C	N3-C2-O2	-5.87	117.79	121.90
87	AF	144	C	N3-C2-O2	-5.87	117.79	121.90
6	5	1503	C	N1-C2-O2	5.86	122.42	118.90
87	AF	37	C	C5-C6-N1	5.86	123.93	121.00
31	K	1057	C	C6-N1-C2	-5.86	117.95	120.30
9	8	2	G	N3-C4-N9	5.86	129.51	126.00
6	5	2799	U	N3-C2-O2	-5.86	118.10	122.20
6	5	2054	U	OP1-P-O3'	5.85	118.07	105.20
6	5	2465	C	C6-N1-C2	-5.85	117.96	120.30
6	5	2824	G	N3-C4-C5	-5.85	125.68	128.60
31	K	1271	C	N1-C2-O2	5.85	122.41	118.90
6	5	3405	U	P-O3'-C3'	5.83	126.70	119.70
6	5	1018	C	N1-C2-O2	5.83	122.40	118.90
6	5	2802	U	P-O3'-C3'	5.83	126.69	119.70
6	5	2983	C	N1-C2-O2	5.83	122.39	118.90
6	5	1515	C	C2-N1-C1'	5.82	125.20	118.80
31	K	531	A	P-O3'-C3'	5.81	126.68	119.70
6	5	1216	U	N1-C2-O2	5.81	126.86	122.80
31	K	1303	C	C6-N1-C2	-5.80	117.98	120.30
31	K	570	C	C6-N1-C2	-5.80	117.98	120.30
6	5	3406	C	C2-N1-C1'	5.79	125.17	118.80
6	5	50	C	N1-C2-O2	5.79	122.38	118.90

Continued on next page...

Continued from previous page...

Mol	Chain	Res	Type	Atoms	Z	Observed(°)	Ideal(°)
87	AF	39	C	P-O3'-C3'	5.79	126.65	119.70
6	5	2735	C	C2-N1-C1'	5.79	125.17	118.80
31	K	340	C	N3-C2-O2	-5.79	117.85	121.90
6	5	2612	U	C4-C5-C6	-5.77	116.24	119.70
31	K	632	C	C2-N1-C1'	5.77	125.15	118.80
6	5	30	C	C6-N1-C2	-5.77	117.99	120.30
6	5	115	C	C2-N1-C1'	5.77	125.15	118.80
6	5	100	C	C6-N1-C2	-5.77	117.99	120.30
31	K	130	G	C8-N9-C1'	-5.76	119.51	127.00
6	5	1359	U	N1-C2-O2	5.75	126.82	122.80
8	7	102	U	N3-C2-O2	-5.75	118.18	122.20
31	K	659	G	C4-N9-C1'	5.74	133.97	126.50
6	5	2165	C	C2-N1-C1'	5.74	125.11	118.80
9	8	99	U	C2-N1-C1'	5.73	124.58	117.70
31	K	1022	U	C2-N1-C1'	5.72	124.56	117.70
31	K	356	C	N1-C2-O2	5.71	122.33	118.90
31	K	1185	C	N1-C2-O2	5.70	122.32	118.90
6	5	2824	G	C4-N9-C1'	5.69	133.90	126.50
6	5	1041	C	C2-N1-C1'	5.69	125.06	118.80
31	K	1057	C	N1-C2-O2	5.69	122.31	118.90
31	K	1564	C	C2-N1-C1'	5.69	125.06	118.80
6	5	712	C	N1-C2-O2	5.69	122.31	118.90
6	5	2180	A	C2-N3-C4	5.69	113.44	110.60
6	5	1553	C	C6-N1-C2	-5.68	118.03	120.30
9	8	64	U	N3-C2-O2	-5.68	118.22	122.20
6	5	3130	C	N1-C2-O2	5.67	122.30	118.90
31	K	1453	C	C6-N1-C1'	-5.67	114.00	120.80
6	5	807	G	P-O3'-C3'	5.66	126.49	119.70
31	K	1742	C	C2-N1-C1'	5.66	125.02	118.80
6	5	214	C	C6-N1-C2	-5.65	118.04	120.30
6	5	2960	A	C1'-C2'-O2'	-5.65	93.64	110.60
9	8	2	G	N3-C4-C5	-5.65	125.78	128.60
6	5	658	C	P-O3'-C3'	5.64	126.47	119.70
6	5	1329	U	N3-C2-O2	-5.64	118.25	122.20
6	5	1074	U	N1-C2-O2	5.64	126.75	122.80
31	K	578	C	N3-C2-O2	-5.64	117.95	121.90
31	K	1274	G	C8-N9-C1'	-5.64	119.67	127.00
6	5	1674	U	N1-C2-O2	5.63	126.74	122.80
6	5	3303	C	N3-C2-O2	-5.63	117.96	121.90
6	5	2585	C	N1-C2-O2	5.63	122.28	118.90
6	5	562	A	C2-N3-C4	5.63	113.41	110.60
9	8	54	C	N1-C2-O2	5.63	122.28	118.90

Continued on next page...

Continued from previous page...

Mol	Chain	Res	Type	Atoms	Z	Observed(°)	Ideal(°)
6	5	1803	C	C6-N1-C2	-5.63	118.05	120.30
6	5	1466	A	C4-N9-C1'	5.62	136.41	126.30
31	K	1118	C	N1-C2-O2	5.62	122.27	118.90
6	5	749	C	C6-N1-C2	-5.62	118.05	120.30
6	5	1550	A	C5-C6-N1	5.62	120.51	117.70
6	5	2230	U	N1-C2-O2	5.62	126.73	122.80
6	5	1095	C	N3-C2-O2	-5.61	117.97	121.90
6	5	989	U	N3-C2-O2	-5.61	118.28	122.20
87	AF	144	C	C2-N1-C1'	5.61	124.97	118.80
31	K	1395	C	P-O3'-C3'	5.60	126.42	119.70
6	5	2651	U	N1-C2-O2	5.60	126.72	122.80
6	5	1803	C	C5-C6-N1	5.60	123.80	121.00
6	5	2824	G	N3-C4-N9	5.60	129.36	126.00
6	5	1867	G	OP1-P-O3'	5.59	117.50	105.20
31	K	1123	C	C5-C6-N1	5.58	123.79	121.00
6	5	1158	C	N1-C2-O2	5.57	122.24	118.90
6	5	276	C	N1-C2-O2	5.57	122.24	118.90
6	5	1074	U	C2-N1-C1'	5.57	124.38	117.70
6	5	3510	U	N1-C2-O2	5.57	126.70	122.80
6	5	466	C	C6-N1-C2	-5.57	118.07	120.30
6	5	1254	C	C2-N1-C1'	5.57	124.92	118.80
6	5	1961	C	C6-N1-C2	-5.57	118.07	120.30
31	K	1618	C	N1-C2-O2	5.57	122.24	118.90
6	5	2097	C	N1-C2-O2	5.56	122.23	118.90
6	5	1847	U	N3-C2-O2	-5.56	118.31	122.20
31	K	1649	U	N1-C2-O2	5.55	126.69	122.80
31	K	532	C	P-O3'-C3'	5.55	126.36	119.70
6	5	1384	C	N1-C2-O2	5.55	122.23	118.90
6	5	2231	G	C4-N9-C1'	5.55	133.71	126.50
9	8	2	G	C8-N9-C1'	-5.55	119.79	127.00
6	5	2674	G	C4-N9-C1'	5.55	133.71	126.50
31	K	1520	G	N7-C8-N9	5.55	115.87	113.10
6	5	1466	A	C2-N3-C4	5.54	113.37	110.60
6	5	559	C	N1-C2-O2	5.53	122.22	118.90
6	5	664	C	N1-C2-O2	5.53	122.22	118.90
83	x	73	ASP	CB-CG-OD1	5.53	123.28	118.30
6	5	2459	C	N1-C2-O2	5.53	122.22	118.90
6	5	990	C	N3-C2-O2	-5.53	118.03	121.90
6	5	2025	U	N1-C2-O2	5.52	126.67	122.80
31	K	1185	C	N3-C2-O2	-5.52	118.03	121.90
6	5	2025	U	N3-C2-O2	-5.51	118.35	122.20
31	K	1518	C	N3-C2-O2	-5.50	118.05	121.90

Continued on next page...

Continued from previous page...

Mol	Chain	Res	Type	Atoms	Z	Observed(°)	Ideal(°)
31	K	1591	C	C6-N1-C2	-5.50	118.10	120.30
6	5	400	C	P-O3'-C3'	5.50	126.30	119.70
31	K	124	U	N1-C2-O2	5.50	126.65	122.80
31	K	1118	C	C6-N1-C2	-5.50	118.10	120.30
6	5	49	U	N3-C2-O2	-5.49	118.36	122.20
6	5	1192	A	C2-N3-C4	5.49	113.34	110.60
6	5	2930	U	N3-C2-O2	-5.49	118.36	122.20
6	5	3321	U	C2-N1-C1'	5.49	124.28	117.70
6	5	1466	A	N3-C4-N9	5.49	131.79	127.40
6	5	1359	U	N3-C2-O2	-5.48	118.36	122.20
13	B	214	ASP	CB-CG-OD1	5.48	123.23	118.30
6	5	559	C	C2-N1-C1'	5.48	124.83	118.80
6	5	1006	C	N3-C2-O2	-5.48	118.06	121.90
6	5	2508	C	N3-C2-O2	-5.47	118.07	121.90
31	K	1315	U	C2-N1-C1'	5.47	124.27	117.70
31	K	494	C	C2-N1-C1'	5.47	124.82	118.80
6	5	1863	C	N1-C2-O2	5.47	122.18	118.90
31	K	872	A	N9-C4-C5	-5.46	103.61	105.80
6	5	2651	U	N3-C2-O2	-5.46	118.38	122.20
31	K	293	C	C6-N1-C2	-5.46	118.12	120.30
6	5	1216	U	N3-C2-O2	-5.45	118.39	122.20
6	5	1925	C	C2-N1-C1'	5.45	124.79	118.80
6	5	1660	U	C2-N1-C1'	5.45	124.23	117.70
6	5	3322	C	C6-N1-C1'	-5.45	114.27	120.80
31	K	1111	U	N1-C2-O2	5.45	126.61	122.80
6	5	2394	C	C2-N1-C1'	5.44	124.78	118.80
31	K	1111	U	N3-C2-O2	-5.44	118.39	122.20
6	5	1314	C	C2-N1-C1'	5.44	124.78	118.80
31	K	630	U	C2-N1-C1'	5.43	124.22	117.70
6	5	1545	U	N3-C2-O2	-5.43	118.40	122.20
6	5	534	C	N3-C2-O2	-5.43	118.10	121.90
6	5	1523	U	C2-N3-C4	-5.42	123.75	127.00
6	5	1921	G	N3-C4-N9	5.42	129.25	126.00
6	5	1503	C	N3-C2-O2	-5.42	118.11	121.90
6	5	2391	U	N1-C2-O2	5.42	126.59	122.80
6	5	580	C	N1-C2-O2	5.41	122.15	118.90
6	5	2260	C	N1-C2-O2	5.41	122.15	118.90
6	5	819	C	C6-N1-C2	-5.41	118.14	120.30
31	K	183	G	C8-N9-C1'	-5.41	119.97	127.00
6	5	490	C	N3-C2-O2	-5.41	118.11	121.90
6	5	2813	C	C2-N1-C1'	5.41	124.75	118.80
31	K	980	A	C6-N1-C2	-5.40	115.36	118.60

Continued on next page...

Continued from previous page...

Mol	Chain	Res	Type	Atoms	Z	Observed(°)	Ideal(°)
31	K	973	C	N3-C2-O2	-5.40	118.12	121.90
31	K	427	U	C2-N1-C1'	5.40	124.18	117.70
87	AF	132	U	N1-C2-O2	5.39	126.58	122.80
6	5	1344	C	N1-C2-O2	5.39	122.14	118.90
6	5	2254	C	N1-C2-O2	5.39	122.14	118.90
6	5	1626	G	P-O3'-C3'	5.39	126.17	119.70
6	5	3197	U	C2-N1-C1'	5.38	124.16	117.70
31	K	1865	C	C6-N1-C2	-5.38	118.15	120.30
6	5	2391	U	N3-C2-O2	-5.38	118.44	122.20
6	5	2651	U	C2-N1-C1'	5.38	124.15	117.70
6	5	820	C	N1-C2-O2	5.37	122.12	118.90
6	5	1895	A	OP1-P-O3'	5.37	117.02	105.20
6	5	3252	U	C2-N1-C1'	5.37	124.14	117.70
87	AF	185	C	N1-C2-O2	5.36	122.12	118.90
6	5	2785	C	N3-C2-O2	-5.36	118.15	121.90
6	5	811	C	N1-C2-O2	5.35	122.11	118.90
6	5	572	C	OP2-P-O3'	5.35	116.97	105.20
31	K	530	U	N1-C2-O2	5.35	126.55	122.80
6	5	777	U	C2-N1-C1'	5.35	124.12	117.70
4	3	67	U	N3-C2-O2	-5.34	118.46	122.20
6	5	670	C	N1-C2-O2	5.34	122.11	118.90
31	K	973	C	C6-N1-C2	-5.34	118.17	120.30
31	K	1304	U	N3-C2-O2	-5.34	118.46	122.20
64	e	89	LEU	CA-CB-CG	5.33	127.57	115.30
6	5	3362	C	N1-C2-O2	5.33	122.10	118.90
31	K	1751	C	N3-C2-O2	-5.33	118.17	121.90
3	2	13	C	N1-C2-O2	5.33	122.10	118.90
3	2	31	G	C4-N9-C1'	5.33	133.43	126.50
31	K	87	U	N3-C2-O2	-5.33	118.47	122.20
6	5	100	C	C5-C6-N1	5.32	123.66	121.00
31	K	151	C	C5-C6-N1	5.32	123.66	121.00
4	3	67	U	N1-C2-O2	5.31	126.52	122.80
6	5	1095	C	C6-N1-C2	-5.31	118.17	120.30
31	K	124	U	N3-C2-O2	-5.31	118.48	122.20
6	5	778	C	N1-C2-O2	5.31	122.08	118.90
6	5	2230	U	N3-C2-O2	-5.31	118.48	122.20
6	5	2407	U	C2-N1-C1'	5.31	124.07	117.70
6	5	2476	U	N1-C2-O2	5.31	126.52	122.80
6	5	3322	C	C6-N1-C2	-5.31	118.18	120.30
31	K	790	C	N1-C2-O2	5.31	122.08	118.90
6	5	2097	C	C2-N1-C1'	5.30	124.64	118.80
6	5	1953	C	N1-C2-O2	5.30	122.08	118.90

Continued on next page...

Continued from previous page...

Mol	Chain	Res	Type	Atoms	Z	Observed(°)	Ideal(°)
82	w	59	LEU	CA-CB-CG	5.30	127.49	115.30
6	5	211	C	C2-N1-C1'	5.30	124.63	118.80
6	5	1553	C	C2-N1-C1'	5.30	124.63	118.80
31	K	1683	C	N3-C2-O2	-5.30	118.19	121.90
6	5	269	C	P-O3'-C3'	5.29	126.05	119.70
31	K	151	C	N1-C2-O2	5.29	122.07	118.90
31	K	1751	C	C2-N1-C1'	5.29	124.61	118.80
6	5	2165	C	C5-C6-N1	5.28	123.64	121.00
6	5	2696	C	C6-N1-C2	-5.28	118.19	120.30
31	K	1281	G	N3-C4-C5	-5.28	125.96	128.60
6	5	3252	U	N1-C2-O2	5.28	126.49	122.80
6	5	2371	C	N1-C2-O2	5.27	122.06	118.90
31	K	293	C	C6-N1-C1'	-5.27	114.47	120.80
4	3	67	U	C2-N1-C1'	5.27	124.02	117.70
6	5	1674	U	N3-C2-O2	-5.26	118.52	122.20
9	8	99	U	N1-C2-O2	5.26	126.48	122.80
6	5	658	C	OP1-P-O3'	5.26	116.78	105.20
31	K	872	A	C5-C6-N6	-5.26	119.49	123.70
31	K	853	C	C5-C6-N1	5.25	123.63	121.00
6	5	379	A	P-O3'-C3'	5.25	126.00	119.70
31	K	531	A	OP1-P-O3'	5.25	116.75	105.20
6	5	1847	U	N1-C2-O2	5.25	126.47	122.80
31	K	130	G	C2-N3-C4	5.25	114.53	111.90
31	K	453	C	C2-N1-C1'	5.25	124.58	118.80
31	K	1551	U	C6-N1-C1'	-5.25	113.85	121.20
6	5	3351	U	C2-N1-C1'	5.25	124.00	117.70
6	5	2930	U	N1-C2-O2	5.25	126.47	122.80
6	5	1760	A	C6-N1-C2	5.25	121.75	118.60
31	K	1358	U	N3-C2-O2	-5.24	118.53	122.20
6	5	2304	U	C2-N1-C1'	5.24	123.99	117.70
31	K	1139	C	C5-C6-N1	5.23	123.61	121.00
6	5	1396	C	N3-C2-O2	-5.23	118.24	121.90
31	K	1453	C	C6-N1-C2	-5.22	118.21	120.30
6	5	2094	U	N1-C2-O2	5.21	126.45	122.80
31	K	1067	C	C2-N1-C1'	5.21	124.53	118.80
6	5	2948	A	C5-C6-N1	5.21	120.31	117.70
31	K	1304	U	N1-C2-O2	5.20	126.44	122.80
31	K	1161	U	N3-C2-O2	-5.20	118.56	122.20
31	K	1637	A	P-O3'-C3'	5.20	125.94	119.70
6	5	112	C	C6-N1-C2	-5.20	118.22	120.30
6	5	1272	U	C2-N1-C1'	5.19	123.92	117.70
6	5	1280	A	C2-N3-C4	5.19	113.19	110.60

Continued on next page...

Continued from previous page...

Mol	Chain	Res	Type	Atoms	Z	Observed(°)	Ideal(°)
31	K	1624	U	O4'-C1'-N1	5.18	112.35	108.20
31	K	1660	C	N1-C2-O2	5.18	122.01	118.90
31	K	876	C	C2-N1-C1'	5.18	124.50	118.80
6	5	463	C	N1-C2-O2	5.17	122.00	118.90
3	2	5	C	C6-N1-C2	-5.17	118.23	120.30
3	2	20	C	N1-C2-O2	5.17	122.00	118.90
31	K	1281	G	N3-C4-N9	5.16	129.10	126.00
6	5	1921	G	N3-C4-C5	-5.16	126.02	128.60
87	AF	132	U	N3-C2-O2	-5.15	118.59	122.20
6	5	3303	C	C2-N1-C1'	5.14	124.46	118.80
6	5	1893	U	N1-C2-O2	5.14	126.40	122.80
6	5	2674	G	N3-C4-N9	5.14	129.09	126.00
31	K	1591	C	C2-N1-C1'	5.14	124.46	118.80
6	5	530	C	N1-C2-O2	5.14	121.98	118.90
6	5	1329	U	C2-N1-C1'	5.14	123.87	117.70
6	5	196	C	C2-N1-C1'	5.14	124.45	118.80
6	5	1530	C	C2-N1-C1'	5.14	124.45	118.80
31	K	1137	U	P-O3'-C3'	5.13	125.86	119.70
87	AF	186	C	N1-C2-O2	5.13	121.98	118.90
31	K	1520	G	C8-N9-C1'	-5.13	120.33	127.00
6	5	115	C	N1-C2-O2	5.13	121.98	118.90
6	5	3198	U	N1-C2-O2	5.12	126.39	122.80
31	K	1057	C	N3-C2-O2	-5.12	118.31	121.90
5	4	44	U	C2-N1-C1'	5.12	123.84	117.70
31	K	14	C	C2-N1-C1'	5.12	124.43	118.80
31	K	494	C	N3-C2-O2	-5.12	118.32	121.90
31	K	790	C	N3-C2-O2	-5.12	118.32	121.90
6	5	820	C	C2-N1-C1'	5.11	124.43	118.80
6	5	1038	C	C5-C6-N1	5.11	123.56	121.00
6	5	2799	U	N1-C2-O2	5.11	126.38	122.80
31	K	824	C	N3-C2-O2	-5.11	118.33	121.90
6	5	1921	G	C8-N9-C1'	-5.11	120.36	127.00
6	5	3408	C	N3-C2-O2	-5.11	118.33	121.90
31	K	659	G	C8-N9-C1'	-5.10	120.36	127.00
31	K	1535	U	C2-N1-C1'	5.10	123.82	117.70
31	K	407	G	C8-N9-C1'	-5.10	120.37	127.00
31	K	824	C	C2-N1-C1'	5.10	124.41	118.80
6	5	2696	C	P-O3'-C3'	5.10	125.82	119.70
6	5	777	U	N1-C2-O2	5.09	126.37	122.80
6	5	2437	C	N1-C2-O2	5.09	121.96	118.90
31	K	118	C	N3-C2-O2	-5.09	118.33	121.90
6	5	3017	C	C1'-O4'-C4'	-5.09	105.83	109.90

Continued on next page...

Continued from previous page...

Mol	Chain	Res	Type	Atoms	Z	Observed(°)	Ideal(°)
6	5	3366	G	P-O3'-C3'	5.09	125.81	119.70
31	K	1590	C	N3-C2-O2	-5.09	118.34	121.90
6	5	2732	C	N1-C2-O2	5.09	121.95	118.90
87	AF	132	U	C2-N1-C1'	5.09	123.80	117.70
6	5	2231	G	N3-C4-N9	5.08	129.05	126.00
6	5	1041	C	N3-C2-O2	-5.08	118.34	121.90
6	5	2231	G	C8-N9-C1'	-5.08	120.39	127.00
6	5	2529	U	N1-C2-O2	5.08	126.36	122.80
6	5	2769	C	N3-C2-O2	-5.08	118.34	121.90
6	5	496	G	P-O3'-C3'	5.08	125.80	119.70
31	K	1118	C	N3-C2-O2	-5.08	118.34	121.90
4	3	74	C	C2-N1-C1'	5.08	124.39	118.80
6	5	1349	C	N3-C2-O2	-5.08	118.35	121.90
4	3	8	U	C2-N1-C1'	5.08	123.79	117.70
6	5	1430	C	C2-N1-C1'	5.08	124.38	118.80
3	2	56	C	N1-C2-O2	5.07	121.94	118.90
6	5	1029	C	C6-N1-C2	-5.07	118.27	120.30
31	K	4	C	N1-C2-O2	5.07	121.94	118.90
6	5	239	C	P-O3'-C3'	5.07	125.78	119.70
31	K	501	C	C6-N1-C2	-5.06	118.28	120.30
6	5	1895	A	P-O3'-C3'	5.06	125.77	119.70
6	5	3405	U	OP2-P-O3'	5.06	116.33	105.20
31	K	1595	U	N1-C2-O2	5.06	126.34	122.80
6	5	3362	C	N3-C2-O2	-5.06	118.36	121.90
6	5	3412	U	N1-C2-O2	5.06	126.34	122.80
9	8	4	C	C5-C6-N1	5.05	123.53	121.00
3	2	31	G	N3-C4-N9	5.05	129.03	126.00
6	5	1515	C	N3-C2-O2	-5.05	118.36	121.90
8	7	28	C	N1-C2-O2	5.05	121.93	118.90
31	K	93	U	N1-C2-O2	5.05	126.33	122.80
6	5	244	C	C2-N1-C1'	5.05	124.35	118.80
6	5	2180	A	C4-N9-C1'	5.05	135.39	126.30
31	K	55	U	C2-N1-C1'	5.05	123.76	117.70
6	5	2580	C	C2-N1-C1'	5.05	124.35	118.80
6	5	2486	C	N1-C2-O2	5.04	121.93	118.90
31	K	1689	C	C6-N1-C2	-5.04	118.28	120.30
6	5	1006	C	C6-N1-C2	-5.04	118.28	120.30
42	PP	110	LEU	CA-CB-CG	5.04	126.88	115.30
6	5	3182	C	N1-C2-O2	5.04	121.92	118.90
31	K	340	C	C2-N1-C1'	5.04	124.34	118.80
31	K	1261	C	C5-C6-N1	5.04	123.52	121.00
31	K	1358	U	N1-C2-O2	5.03	126.32	122.80

Continued on next page...

Continued from previous page...

Mol	Chain	Res	Type	Atoms	Z	Observed(°)	Ideal(°)
6	5	2920	C	C6-N1-C2	-5.03	118.29	120.30
31	K	1303	C	O4'-C1'-N1	5.03	112.22	108.20
9	8	135	C	C2-N1-C1'	5.03	124.33	118.80
8	7	28	C	N3-C2-O2	-5.02	118.38	121.90
31	K	1161	U	N1-C2-O2	5.02	126.32	122.80
31	K	1590	C	C6-N1-C2	-5.02	118.29	120.30
6	5	2674	G	N3-C4-C5	-5.02	126.09	128.60
6	5	2993	U	C6-N1-C1'	-5.02	114.17	121.20
6	5	1559	C	C6-N1-C2	-5.02	118.29	120.30
31	K	1834	A	C4-N9-C1'	5.02	135.34	126.30
6	5	1452	C	N1-C2-O2	5.02	121.91	118.90
6	5	214	C	C5-C6-N1	5.01	123.51	121.00
6	5	379	A	OP1-P-O3'	5.01	116.23	105.20
31	K	140	U	C2-N1-C1'	5.01	123.72	117.70
6	5	1527	A	OP1-P-O3'	5.01	116.23	105.20
31	K	1259	A	C2-N3-C4	5.01	113.11	110.60
6	5	1038	C	C6-N1-C2	-5.01	118.30	120.30
6	5	1095	C	C2-N1-C1'	5.01	124.31	118.80
31	K	553	U	P-O3'-C3'	5.01	125.71	119.70
6	5	74	G	C4-N9-C1'	5.00	133.01	126.50
6	5	1359	U	C2-N1-C1'	5.00	123.71	117.70
6	5	548	C	N1-C2-O2	5.00	121.90	118.90
6	5	2230	U	C2-N1-C1'	5.00	123.70	117.70
8	7	29	C	C6-N1-C2	-5.00	118.30	120.30

There are no chirality outliers.

All (8) planarity outliers are listed below:

Mol	Chain	Res	Type	Group
2	1	258	PRO	Mainchain
86	AB	196	LYS	Peptide
86	AB	22	ILE	Peptide
86	AB	344	PRO	Peptide
86	AB	43	ASP	Peptide
53	VV	61	GLN	Peptide
56	WW	17	TYR	Peptide
56	WW	37	TYR	Peptide

5.2 Too-close contacts

Due to software issues we are unable to calculate clashes - this section is therefore empty.

5.3 Torsion angles

5.3.1 Protein backbone

In the following table, the Percentiles column shows the percent Ramachandran outliers of the chain as a percentile score with respect to all PDB entries followed by that with respect to all EM entries.

The Analysed column shows the number of residues for which the backbone conformation was analysed, and the total number of residues.

Mol	Chain	Analysed	Favoured	Allowed	Outliers	Percentiles	
1	0	66/68 (97%)	61 (92%)	5 (8%)	0	100	100
2	1	22/24 (92%)	13 (59%)	5 (23%)	4 (18%)	0	1
7	6	311/313 (99%)	292 (94%)	19 (6%)	0	100	100
10	9	53/55 (96%)	52 (98%)	1 (2%)	0	100	100
11	A	246/248 (99%)	231 (94%)	15 (6%)	0	100	100
12	AA	53/55 (96%)	53 (100%)	0	0	100	100
13	B	392/394 (100%)	374 (95%)	18 (5%)	0	100	100
14	BB	181/189 (96%)	174 (96%)	7 (4%)	0	100	100
15	C	360/362 (99%)	347 (96%)	11 (3%)	2 (1%)	25	62
16	CC	204/206 (99%)	193 (95%)	11 (5%)	0	100	100
17	DD	183/185 (99%)	180 (98%)	3 (2%)	0	100	100
18	D	291/293 (99%)	281 (97%)	10 (3%)	0	100	100
19	EE	139/151 (92%)	134 (96%)	5 (4%)	0	100	100
20	E	208/251 (83%)	201 (97%)	7 (3%)	0	100	100
21	FF	60/62 (97%)	59 (98%)	1 (2%)	0	100	100
22	F	223/225 (99%)	214 (96%)	9 (4%)	0	100	100
23	GG	98/100 (98%)	94 (96%)	4 (4%)	0	100	100
24	G	229/240 (95%)	218 (95%)	11 (5%)	0	100	100
25	H	188/190 (99%)	182 (97%)	6 (3%)	0	100	100
26	HH	81/83 (98%)	78 (96%)	3 (4%)	0	100	100
27	I	201/213 (94%)	193 (96%)	8 (4%)	0	100	100
28	II	142/144 (99%)	134 (94%)	8 (6%)	0	100	100
29	JJ	81/83 (98%)	80 (99%)	1 (1%)	0	100	100
30	J	168/170 (99%)	163 (97%)	5 (3%)	0	100	100
32	KK	130/132 (98%)	127 (98%)	3 (2%)	0	100	100

Continued on next page...

Continued from previous page...

Mol	Chain	Analysed	Favoured	Allowed	Outliers	Percentiles	
33	L	208/210 (99%)	200 (96%)	7 (3%)	1 (0%)	29	66
34	LL	99/101 (98%)	94 (95%)	5 (5%)	0	100	100
35	M	136/138 (99%)	128 (94%)	8 (6%)	0	100	100
36	MM	134/136 (98%)	127 (95%)	7 (5%)	0	100	100
37	N	201/203 (99%)	190 (94%)	11 (6%)	0	100	100
38	NN	122/124 (98%)	120 (98%)	2 (2%)	0	100	100
39	O	197/199 (99%)	193 (98%)	4 (2%)	0	100	100
40	OO	73/75 (97%)	72 (99%)	1 (1%)	0	100	100
41	P	151/153 (99%)	144 (95%)	7 (5%)	0	100	100
42	PP	139/141 (99%)	133 (96%)	6 (4%)	0	100	100
43	Q	185/187 (99%)	177 (96%)	8 (4%)	0	100	100
44	QQ	147/149 (99%)	146 (99%)	1 (1%)	0	100	100
45	R	178/180 (99%)	175 (98%)	3 (2%)	0	100	100
46	RR	115/117 (98%)	105 (91%)	10 (9%)	0	100	100
47	S	174/176 (99%)	166 (95%)	8 (5%)	0	100	100
48	SS	94/96 (98%)	89 (95%)	5 (5%)	0	100	100
49	T	157/159 (99%)	150 (96%)	7 (4%)	0	100	100
50	TT	127/129 (98%)	123 (97%)	4 (3%)	0	100	100
51	UU	140/142 (99%)	136 (97%)	4 (3%)	0	100	100
52	U	97/99 (98%)	94 (97%)	3 (3%)	0	100	100
53	VV	139/141 (99%)	134 (96%)	4 (3%)	1 (1%)	22	59
54	V	129/131 (98%)	127 (98%)	2 (2%)	0	100	100
55	W	102/121 (84%)	100 (98%)	2 (2%)	0	100	100
56	WW	118/120 (98%)	109 (92%)	9 (8%)	0	100	100
57	X	116/118 (98%)	114 (98%)	2 (2%)	0	100	100
58	Y	132/134 (98%)	129 (98%)	3 (2%)	0	100	100
59	Z	133/135 (98%)	128 (96%)	5 (4%)	0	100	100
60	a	145/147 (99%)	141 (97%)	4 (3%)	0	100	100
61	b	100/116 (86%)	97 (97%)	3 (3%)	0	100	100
62	c	96/98 (98%)	93 (97%)	3 (3%)	0	100	100
63	d	105/107 (98%)	101 (96%)	4 (4%)	0	100	100

Continued on next page...

Continued from previous page...

Mol	Chain	Analysed	Favoured	Allowed	Outliers	Percentiles	
64	e	126/128 (98%)	123 (98%)	3 (2%)	0	100	100
65	f	107/109 (98%)	103 (96%)	4 (4%)	0	100	100
66	g	112/114 (98%)	111 (99%)	1 (1%)	0	100	100
67	h	120/122 (98%)	118 (98%)	2 (2%)	0	100	100
68	i	100/102 (98%)	97 (97%)	3 (3%)	0	100	100
69	j	84/86 (98%)	81 (96%)	3 (4%)	0	100	100
70	k	67/69 (97%)	67 (100%)	0	0	100	100
71	l	48/50 (96%)	48 (100%)	0	0	100	100
72	m	50/52 (96%)	49 (98%)	1 (2%)	0	100	100
73	n	23/25 (92%)	23 (100%)	0	0	100	100
74	o	102/104 (98%)	98 (96%)	4 (4%)	0	100	100
75	p	89/91 (98%)	86 (97%)	3 (3%)	0	100	100
76	q	215/217 (99%)	208 (97%)	7 (3%)	0	100	100
77	r	122/124 (98%)	114 (93%)	8 (7%)	0	100	100
78	s	194/196 (99%)	184 (95%)	10 (5%)	0	100	100
79	t	151/153 (99%)	135 (89%)	16 (11%)	0	100	100
80	u	211/213 (99%)	205 (97%)	6 (3%)	0	100	100
81	v	219/221 (99%)	213 (97%)	6 (3%)	0	100	100
82	w	226/228 (99%)	220 (97%)	6 (3%)	0	100	100
83	x	260/262 (99%)	250 (96%)	10 (4%)	0	100	100
84	y	181/191 (95%)	170 (94%)	11 (6%)	0	100	100
85	z	235/237 (99%)	233 (99%)	2 (1%)	0	100	100
86	AB	397/431 (92%)	358 (90%)	36 (9%)	3 (1%)	19	56
88	AC	103/105 (98%)	99 (96%)	4 (4%)	0	100	100
89	AI	175/195 (90%)	172 (98%)	3 (2%)	0	100	100
90	AD	72/74 (97%)	65 (90%)	6 (8%)	1 (1%)	11	45
91	AE	72/94 (77%)	71 (99%)	1 (1%)	0	100	100
92	AG	10/12 (83%)	10 (100%)	0	0	100	100
All	All	12370/12723 (97%)	11874 (96%)	484 (4%)	12 (0%)	54	83

All (12) Ramachandran outliers are listed below:

Mol	Chain	Res	Type
86	AB	345	PHE
2	1	247	CYS
15	C	85	HIS
2	1	258	PRO
90	AD	56	ALA
86	AB	344	PRO
2	1	249	TRP
15	C	72	ALA
33	L	64	VAL
2	1	254	PRO
53	VV	62	PRO
86	AB	23	ILE

5.3.2 Protein sidechains [i](#)

In the following table, the Percentiles column shows the percent sidechain outliers of the chain as a percentile score with respect to all PDB entries followed by that with respect to all EM entries.

The Analysed column shows the number of residues for which the sidechain conformation was analysed, and the total number of residues.

Mol	Chain	Analysed	Rotameric	Outliers	Percentiles	
1	0	61/61 (100%)	60 (98%)	1 (2%)	62	80
2	1	22/22 (100%)	17 (77%)	5 (23%)	1	6
7	6	272/272 (100%)	270 (99%)	2 (1%)	84	91
10	9	48/48 (100%)	48 (100%)	0	100	100
11	A	190/190 (100%)	184 (97%)	6 (3%)	39	65
12	AA	46/46 (100%)	44 (96%)	2 (4%)	29	58
13	B	342/342 (100%)	340 (99%)	2 (1%)	86	93
14	BB	165/169 (98%)	165 (100%)	0	100	100
15	C	302/302 (100%)	294 (97%)	8 (3%)	46	69
16	CC	178/178 (100%)	175 (98%)	3 (2%)	60	79
17	DD	161/161 (100%)	157 (98%)	4 (2%)	47	70
18	D	247/247 (100%)	244 (99%)	3 (1%)	71	84
19	EE	130/136 (96%)	127 (98%)	3 (2%)	50	71
20	E	190/223 (85%)	187 (98%)	3 (2%)	62	80
21	FF	55/55 (100%)	54 (98%)	1 (2%)	59	77

Continued on next page...

Continued from previous page...

Mol	Chain	Analysed	Rotameric	Outliers	Percentiles	
22	F	196/196 (100%)	195 (100%)	1 (0%)	88	94
23	GG	92/92 (100%)	91 (99%)	1 (1%)	73	85
24	G	200/205 (98%)	196 (98%)	4 (2%)	55	74
25	H	169/169 (100%)	165 (98%)	4 (2%)	49	71
26	HH	67/67 (100%)	66 (98%)	1 (2%)	65	81
27	I	175/180 (97%)	170 (97%)	5 (3%)	42	66
28	II	125/125 (100%)	124 (99%)	1 (1%)	81	89
29	JJ	75/75 (100%)	74 (99%)	1 (1%)	69	83
30	J	143/143 (100%)	143 (100%)	0	100	100
32	KK	119/119 (100%)	119 (100%)	0	100	100
33	L	175/175 (100%)	175 (100%)	0	100	100
34	LL	88/88 (100%)	87 (99%)	1 (1%)	73	85
35	M	117/117 (100%)	116 (99%)	1 (1%)	78	88
36	MM	106/106 (100%)	104 (98%)	2 (2%)	57	76
37	N	171/171 (100%)	170 (99%)	1 (1%)	86	93
38	NN	107/107 (100%)	106 (99%)	1 (1%)	78	88
39	O	171/171 (100%)	169 (99%)	2 (1%)	71	84
40	OO	66/66 (100%)	66 (100%)	0	100	100
41	P	134/134 (100%)	132 (98%)	2 (2%)	65	81
42	PP	111/111 (100%)	110 (99%)	1 (1%)	78	88
43	Q	164/164 (100%)	163 (99%)	1 (1%)	86	93
44	QQ	130/130 (100%)	129 (99%)	1 (1%)	81	89
45	R	159/159 (100%)	156 (98%)	3 (2%)	57	76
46	RR	99/99 (100%)	98 (99%)	1 (1%)	76	86
47	S	157/157 (100%)	157 (100%)	0	100	100
48	SS	87/87 (100%)	85 (98%)	2 (2%)	50	71
49	T	139/139 (100%)	137 (99%)	2 (1%)	67	82
50	TT	112/112 (100%)	112 (100%)	0	100	100
51	UU	117/117 (100%)	116 (99%)	1 (1%)	78	88
52	U	89/89 (100%)	88 (99%)	1 (1%)	73	85
53	VV	113/113 (100%)	113 (100%)	0	100	100

Continued on next page...

Continued from previous page...

Mol	Chain	Analysed	Rotameric	Outliers	Percentiles	
54	V	101/101 (100%)	99 (98%)	2 (2%)	55	74
55	W	86/100 (86%)	86 (100%)	0	100	100
56	WW	109/109 (100%)	108 (99%)	1 (1%)	78	88
57	X	106/106 (100%)	105 (99%)	1 (1%)	78	88
58	Y	124/124 (100%)	123 (99%)	1 (1%)	81	89
59	Z	117/117 (100%)	117 (100%)	0	100	100
60	a	119/119 (100%)	118 (99%)	1 (1%)	81	89
61	b	84/95 (88%)	82 (98%)	2 (2%)	49	71
62	c	84/84 (100%)	83 (99%)	1 (1%)	71	84
63	d	98/98 (100%)	96 (98%)	2 (2%)	55	74
64	e	114/114 (100%)	114 (100%)	0	100	100
65	f	88/88 (100%)	87 (99%)	1 (1%)	73	85
66	g	98/98 (100%)	96 (98%)	2 (2%)	55	74
67	h	109/109 (100%)	109 (100%)	0	100	100
68	i	86/86 (100%)	85 (99%)	1 (1%)	71	84
69	j	73/73 (100%)	72 (99%)	1 (1%)	67	82
70	k	64/64 (100%)	64 (100%)	0	100	100
71	l	47/47 (100%)	47 (100%)	0	100	100
72	m	48/48 (100%)	48 (100%)	0	100	100
73	n	24/24 (100%)	24 (100%)	0	100	100
74	o	92/92 (100%)	91 (99%)	1 (1%)	73	85
75	p	74/74 (100%)	73 (99%)	1 (1%)	67	82
76	q	180/181 (99%)	178 (99%)	2 (1%)	73	85
77	r	108/108 (100%)	106 (98%)	2 (2%)	57	76
78	s	164/164 (100%)	164 (100%)	0	100	100
79	t	126/126 (100%)	126 (100%)	0	100	100
80	u	194/194 (100%)	191 (98%)	3 (2%)	65	81
81	v	187/187 (100%)	185 (99%)	2 (1%)	73	85
82	w	190/190 (100%)	185 (97%)	5 (3%)	46	69
83	x	224/224 (100%)	221 (99%)	3 (1%)	69	83
84	y	158/161 (98%)	158 (100%)	0	100	100

Continued on next page...

Continued from previous page...

Mol	Chain	Analysed	Rotameric	Outliers	Percentiles	
85	z	207/207 (100%)	205 (99%)	2 (1%)	76	86
86	AB	340/364 (93%)	337 (99%)	3 (1%)	78	88
88	AC	92/94 (98%)	92 (100%)	0	100	100
89	AI	157/171 (92%)	155 (99%)	2 (1%)	69	83
90	AD	67/67 (100%)	67 (100%)	0	100	100
91	AE	69/85 (81%)	69 (100%)	0	100	100
92	AG	12/12 (100%)	12 (100%)	0	100	100
All	All	10802/10940 (99%)	10676 (99%)	126 (1%)	72	84

All (126) residues with a non-rotameric sidechain are listed below:

Mol	Chain	Res	Type
1	0	138	ARG
2	1	237	ASP
2	1	246	LEU
2	1	247	CYS
2	1	259	LEU
2	1	260	MET
7	6	159	ASN
7	6	178	ASN
11	A	128	ARG
11	A	163	ARG
11	A	193	ARG
11	A	194	ASN
11	A	200	ARG
11	A	242	ARG
12	AA	99	LYS
12	AA	104	ARG
13	B	24	ARG
13	B	261	ARG
15	C	38	ASN
15	C	71	ARG
15	C	95	MET
15	C	100	ARG
15	C	188	ARG
15	C	223	ASN
15	C	312	ARG
15	C	321	ASN
16	CC	84	ASN
16	CC	87	ASN

Continued on next page...

Continued from previous page...

Mol	Chain	Res	Type
16	CC	99	ASN
17	DD	29	LEU
17	DD	69	ARG
17	DD	70	ARG
17	DD	79	ARG
18	D	111	ASN
18	D	157	ASN
18	D	268	ARG
19	EE	20	LYS
19	EE	69	ARG
19	EE	97	ARG
20	E	58	ARG
20	E	164	ARG
20	E	289	LEU
21	FF	40	ARG
22	F	205	ASN
23	GG	47	ASN
24	G	134	ASN
24	G	242	ARG
24	G	249	ARG
24	G	293	ASN
25	H	1	MET
25	H	15	ASN
25	H	102	ASN
25	H	128	MET
26	HH	82	ASN
27	I	3	ARG
27	I	24	ARG
27	I	73	ASN
27	I	100	ASN
27	I	116	ARG
28	II	8	LYS
29	JJ	81	ARG
34	LL	5	ARG
35	M	119	ARG
36	MM	146	ARG
36	MM	150	ARG
37	N	50	ARG
38	NN	101	LYS
39	O	117	ARG
39	O	140	ARG
41	P	127	ARG

Continued on next page...

Continued from previous page...

Mol	Chain	Res	Type
41	P	128	ARG
42	PP	62	ARG
43	Q	97	LYS
44	QQ	27	LYS
45	R	36	ASN
45	R	130	ASN
45	R	133	LYS
46	RR	33	ARG
48	SS	2	LEU
48	SS	96	ARG
49	T	136	ARG
49	T	146	LYS
51	UU	41	MET
52	U	81	ARG
54	V	15	ARG
54	V	48	ARG
56	WW	13	ARG
57	X	53	ARG
58	Y	2	LYS
60	a	4	ARG
61	b	60	ASN
61	b	72	ILE
62	c	90	ARG
63	d	18	ASN
63	d	31	LYS
65	f	16	ARG
66	g	14	ASN
66	g	18	ASN
68	i	29	ARG
69	j	20	ARG
74	o	82	MET
75	p	84	ARG
76	q	50	ASN
76	q	186	ARG
77	r	12	ASN
77	r	67	ARG
80	u	40	ASN
80	u	147	ASN
80	u	213	ARG
81	v	167	ARG
81	v	248	TYR
82	w	22	ASN

Continued on next page...

Continued from previous page...

Mol	Chain	Res	Type
82	w	76	ARG
82	w	94	ARG
82	w	106	ARG
82	w	227	LYS
83	x	148	ARG
83	x	232	ASN
83	x	240	ARG
85	z	63	MET
85	z	191	ARG
86	AB	19	ASN
86	AB	70	ASN
86	AB	100	LYS
89	AI	74	ARG
89	AI	91	ASN

Sometimes sidechains can be flipped to improve hydrogen bonding and reduce clashes. All (104) such sidechains are listed below:

Mol	Chain	Res	Type
7	6	104	HIS
7	6	133	ASN
7	6	159	ASN
7	6	178	ASN
11	A	194	ASN
12	AA	88	GLN
12	AA	117	ASN
14	BB	186	ASN
15	C	38	ASN
15	C	321	ASN
16	CC	84	ASN
16	CC	87	ASN
16	CC	99	ASN
16	CC	165	GLN
18	D	157	ASN
18	D	202	GLN
20	E	45	HIS
20	E	193	HIS
20	E	214	HIS
21	FF	29	GLN
22	F	38	GLN
22	F	79	ASN
22	F	109	GLN
22	F	118	ASN

Continued on next page...

Continued from previous page...

Mol	Chain	Res	Type
22	F	130	ASN
22	F	205	ASN
23	GG	47	ASN
24	G	99	GLN
24	G	134	ASN
24	G	293	ASN
25	H	15	ASN
25	H	102	ASN
26	HH	47	ASN
26	HH	82	ASN
27	I	73	ASN
27	I	95	HIS
27	I	100	ASN
27	I	144	ASN
29	JJ	26	GLN
30	J	98	ASN
30	J	104	ASN
32	KK	62	GLN
34	LL	17	HIS
35	M	20	HIS
35	M	83	ASN
37	N	32	GLN
37	N	196	ASN
37	N	201	HIS
38	NN	63	HIS
41	P	25	HIS
41	P	64	ASN
41	P	75	GLN
41	P	80	GLN
41	P	120	ASN
45	R	36	ASN
45	R	178	GLN
46	RR	82	ASN
47	S	50	GLN
48	SS	7	ASN
48	SS	44	HIS
49	T	127	GLN
50	TT	56	HIS
50	TT	113	HIS
51	UU	80	GLN
51	UU	97	GLN
54	V	77	HIS

Continued on next page...

Continued from previous page...

Mol	Chain	Res	Type
55	W	17	HIS
57	X	93	ASN
57	X	107	HIS
57	X	111	GLN
58	Y	14	ASN
60	a	34	ASN
60	a	120	GLN
61	b	12	GLN
61	b	101	HIS
63	d	18	ASN
65	f	99	HIS
66	g	14	ASN
66	g	18	ASN
66	g	114	GLN
67	h	63	GLN
70	k	28	ASN
77	r	12	ASN
78	s	68	HIS
79	t	100	HIS
80	u	40	ASN
80	u	124	HIS
80	u	147	ASN
80	u	157	GLN
81	v	113	GLN
81	v	272	HIS
82	w	22	ASN
83	x	67	GLN
83	x	142	HIS
83	x	232	ASN
84	y	31	ASN
84	y	65	GLN
84	y	114	ASN
85	z	59	GLN
85	z	81	HIS
86	AB	70	ASN
86	AB	195	HIS
89	AI	91	ASN
89	AI	157	HIS

5.3.3 RNA

Mol	Chain	Analysed	Backbone Outliers	Pucker Outliers
3	2	73/75 (97%)	20 (27%)	1 (1%)
31	K	1686/1698 (99%)	345 (20%)	21 (1%)
4	3	72/75 (96%)	15 (20%)	0
5	4	5/6 (83%)	3 (60%)	0
6	5	3519/3544 (99%)	780 (22%)	67 (1%)
8	7	119/120 (99%)	14 (11%)	0
87	AF	197/206 (95%)	32 (16%)	4 (2%)
9	8	149/151 (98%)	34 (22%)	1 (0%)
All	All	5820/5875 (99%)	1243 (21%)	94 (1%)

All (1243) RNA backbone outliers are listed below:

Mol	Chain	Res	Type
3	2	5	C
3	2	7	G
3	2	8	U
3	2	9	A
3	2	13	C
3	2	16	C
3	2	19	G
3	2	20	C
3	2	21	A
3	2	35	A
3	2	42	A
3	2	47	U
3	2	52	G
3	2	58	A
3	2	63	A
3	2	64	U
3	2	72	C
3	2	74	C
3	2	75	C
3	2	76	A
4	3	7	A
4	3	13	C
4	3	16	C
4	3	21	A
4	3	34	U
4	3	35	A
4	3	47	U
4	3	49	C
4	3	58	A
4	3	61	C

Continued on next page...

Continued from previous page...

Mol	Chain	Res	Type
4	3	63	C
4	3	65	G
4	3	69	G
4	3	70	G
4	3	76	A
5	4	44	U
5	4	45	A
5	4	46	A
6	5	12	A
6	5	13	U
6	5	17	A
6	5	25	A
6	5	30	C
6	5	35	U
6	5	39	A
6	5	42	A
6	5	43	U
6	5	47	A
6	5	48	G
6	5	49	U
6	5	56	A
6	5	59	A
6	5	64	A
6	5	65	A
6	5	66	A
6	5	71	C
6	5	73	A
6	5	91	G
6	5	93	G
6	5	104	G
6	5	109	G
6	5	110	C
6	5	116	G
6	5	117	C
6	5	118	C
6	5	119	G
6	5	126	C
6	5	134	G
6	5	135	G
6	5	136	C
6	5	137	G
6	5	151	G

Continued on next page...

Continued from previous page...

Mol	Chain	Res	Type
6	5	157	U
6	5	159	C
6	5	171	U
6	5	172	C
6	5	173	C
6	5	191	A
6	5	194	U
6	5	195	C
6	5	196	C
6	5	199	C
6	5	203	U
6	5	210	C
6	5	211	C
6	5	212	A
6	5	214	C
6	5	215	C
6	5	218	U
6	5	220	G
6	5	221	A
6	5	227	U
6	5	228	G
6	5	240	G
6	5	256	G
6	5	259	C
6	5	260	C
6	5	270	C
6	5	274	G
6	5	275	U
6	5	291	U
6	5	300	A
6	5	303	C
6	5	309	G
6	5	310	U
6	5	316	C
6	5	320	C
6	5	328	A
6	5	334	C
6	5	339	C
6	5	344	C
6	5	357	A
6	5	380	A
6	5	381	G

Continued on next page...

Continued from previous page...

Mol	Chain	Res	Type
6	5	393	G
6	5	401	A
6	5	404	A
6	5	406	G
6	5	407	G
6	5	425	G
6	5	426	U
6	5	434	U
6	5	440	C
6	5	443	C
6	5	444	G
6	5	446	A
6	5	447	G
6	5	448	U
6	5	458	G
6	5	461	U
6	5	462	U
6	5	475	G
6	5	476	C
6	5	477	G
6	5	478	G
6	5	480	C
6	5	481	C
6	5	487	U
6	5	488	G
6	5	490	C
6	5	492	G
6	5	493	C
6	5	494	G
6	5	497	G
6	5	502	U
6	5	517	G
6	5	525	A
6	5	534	C
6	5	542	G
6	5	543	A
6	5	545	C
6	5	546	G
6	5	559	C
6	5	561	C
6	5	563	U
6	5	572	C

Continued on next page...

Continued from previous page...

Mol	Chain	Res	Type
6	5	573	G
6	5	580	C
6	5	581	G
6	5	584	G
6	5	595	C
6	5	606	G
6	5	607	G
6	5	614	C
6	5	615	C
6	5	616	G
6	5	619	G
6	5	624	A
6	5	625	G
6	5	626	G
6	5	628	G
6	5	635	G
6	5	647	U
6	5	648	U
6	5	651	A
6	5	652	G
6	5	659	C
6	5	661	C
6	5	662	G
6	5	664	C
6	5	665	A
6	5	667	C
6	5	668	A
6	5	669	G
6	5	670	C
6	5	671	A
6	5	672	G
6	5	673	C
6	5	676	G
6	5	678	C
6	5	680	A
6	5	681	A
6	5	682	U
6	5	696	G
6	5	697	A
6	5	698	G
6	5	699	C
6	5	701	A

Continued on next page...

Continued from previous page...

Mol	Chain	Res	Type
6	5	702	G
6	5	703	A
6	5	704	C
6	5	705	C
6	5	706	C
6	5	710	C
6	5	717	C
6	5	721	C
6	5	728	C
6	5	737	C
6	5	738	G
6	5	741	C
6	5	744	C
6	5	747	C
6	5	754	G
6	5	773	A
6	5	777	U
6	5	778	C
6	5	780	A
6	5	783	G
6	5	791	G
6	5	807	G
6	5	808	G
6	5	810	C
6	5	811	C
6	5	817	G
6	5	818	G
6	5	819	C
6	5	820	C
6	5	821	A
6	5	822	C
6	5	833	C
6	5	834	G
6	5	837	C
6	5	838	G
6	5	845	G
6	5	848	G
6	5	853	C
6	5	854	G
6	5	855	A
6	5	856	U
6	5	857	G

Continued on next page...

Continued from previous page...

Mol	Chain	Res	Type
6	5	862	C
6	5	864	A
6	5	865	C
6	5	875	C
6	5	879	C
6	5	880	U
6	5	887	A
6	5	890	G
6	5	891	A
6	5	915	A
6	5	919	G
6	5	920	G
6	5	929	A
6	5	935	G
6	5	937	C
6	5	938	G
6	5	939	U
6	5	945	A
6	5	952	G
6	5	955	A
6	5	956	A
6	5	976	G
6	5	977	G
6	5	980	G
6	5	981	A
6	5	982	G
6	5	990	C
6	5	998	C
6	5	999	U
6	5	1001	C
6	5	1005	U
6	5	1006	C
6	5	1008	G
6	5	1013	G
6	5	1016	C
6	5	1017	G
6	5	1018	C
6	5	1025	G
6	5	1035	G
6	5	1038	C
6	5	1042	G
6	5	1043	C

Continued on next page...

Continued from previous page...

Mol	Chain	Res	Type
6	5	1044	G
6	5	1049	G
6	5	1057	A
6	5	1058	G
6	5	1061	C
6	5	1062	G
6	5	1074	U
6	5	1076	G
6	5	1078	A
6	5	1083	A
6	5	1085	A
6	5	1094	A
6	5	1103	G
6	5	1107	A
6	5	1123	A
6	5	1124	A
6	5	1126	C
6	5	1134	G
6	5	1138	U
6	5	1151	U
6	5	1156	U
6	5	1157	G
6	5	1162	U
6	5	1172	G
6	5	1173	A
6	5	1174	C
6	5	1184	G
6	5	1185	G
6	5	1191	A
6	5	1193	G
6	5	1194	A
6	5	1198	A
6	5	1201	G
6	5	1210	A
6	5	1214	G
6	5	1220	U
6	5	1221	C
6	5	1236	C
6	5	1237	U
6	5	1239	A
6	5	1251	G
6	5	1270	G

Continued on next page...

Continued from previous page...

Mol	Chain	Res	Type
6	5	1271	G
6	5	1277	C
6	5	1278	G
6	5	1279	A
6	5	1283	A
6	5	1287	G
6	5	1292	C
6	5	1293	U
6	5	1298	G
6	5	1301	G
6	5	1305	C
6	5	1309	C
6	5	1310	U
6	5	1313	A
6	5	1314	C
6	5	1318	U
6	5	1324	A
6	5	1336	G
6	5	1340	G
6	5	1341	A
6	5	1342	A
6	5	1349	C
6	5	1352	G
6	5	1356	G
6	5	1358	G
6	5	1359	U
6	5	1365	C
6	5	1367	G
6	5	1371	U
6	5	1372	G
6	5	1373	G
6	5	1374	A
6	5	1379	G
6	5	1392	G
6	5	1406	G
6	5	1418	C
6	5	1430	C
6	5	1434	A
6	5	1443	U
6	5	1447	G
6	5	1455	U
6	5	1457	C

Continued on next page...

Continued from previous page...

Mol	Chain	Res	Type
6	5	1458	C
6	5	1459	G
6	5	1460	A
6	5	1462	G
6	5	1467	U
6	5	1468	C
6	5	1469	A
6	5	1485	G
6	5	1494	U
6	5	1495	A
6	5	1496	U
6	5	1497	A
6	5	1498	G
6	5	1499	A
6	5	1501	A
6	5	1504	A
6	5	1508	U
6	5	1511	U
6	5	1512	G
6	5	1514	C
6	5	1517	U
6	5	1520	A
6	5	1521	A
6	5	1523	U
6	5	1524	C
6	5	1528	A
6	5	1534	U
6	5	1538	G
6	5	1539	A
6	5	1540	G
6	5	1541	U
6	5	1545	U
6	5	1548	C
6	5	1562	A
6	5	1563	A
6	5	1584	A
6	5	1585	U
6	5	1589	G
6	5	1592	G
6	5	1593	G
6	5	1599	C
6	5	1601	G

Continued on next page...

Continued from previous page...

Mol	Chain	Res	Type
6	5	1606	A
6	5	1607	U
6	5	1621	U
6	5	1622	G
6	5	1626	G
6	5	1627	U
6	5	1629	G
6	5	1630	G
6	5	1631	C
6	5	1632	A
6	5	1634	A
6	5	1635	G
6	5	1637	G
6	5	1639	G
6	5	1641	A
6	5	1642	A
6	5	1644	A
6	5	1645	G
6	5	1647	G
6	5	1652	G
6	5	1653	C
6	5	1655	G
6	5	1659	C
6	5	1660	U
6	5	1661	A
6	5	1662	C
6	5	1663	G
6	5	1668	G
6	5	1682	C
6	5	1693	A
6	5	1694	G
6	5	1699	G
6	5	1706	A
6	5	1707	G
6	5	1709	G
6	5	1724	G
6	5	1726	G
6	5	1741	G
6	5	1744	C
6	5	1753	A
6	5	1763	A
6	5	1775	A

Continued on next page...

Continued from previous page...

Mol	Chain	Res	Type
6	5	1777	U
6	5	1788	A
6	5	1789	A
6	5	1809	G
6	5	1815	C
6	5	1817	G
6	5	1818	U
6	5	1826	G
6	5	1834	C
6	5	1843	G
6	5	1864	G
6	5	1868	G
6	5	1878	U
6	5	1881	C
6	5	1882	C
6	5	1883	U
6	5	1884	C
6	5	1886	G
6	5	1896	G
6	5	1897	C
6	5	1898	C
6	5	1899	G
6	5	1906	A
6	5	1922	A
6	5	1923	U
6	5	1930	A
6	5	1939	G
6	5	1940	G
6	5	1942	G
6	5	1946	A
6	5	1947	U
6	5	1959	G
6	5	1963	U
6	5	1965	C
6	5	1968	U
6	5	1974	A
6	5	1976	C
6	5	1979	G
6	5	1980	A
6	5	1982	C
6	5	1994	A
6	5	2013	G

Continued on next page...

Continued from previous page...

Mol	Chain	Res	Type
6	5	2031	G
6	5	2051	G
6	5	2054	U
6	5	2055	G
6	5	2062	C
6	5	2063	C
6	5	2066	G
6	5	2069	A
6	5	2074	G
6	5	2079	G
6	5	2080	U
6	5	2082	C
6	5	2088	A
6	5	2089	A
6	5	2097	C
6	5	2100	U
6	5	2101	U
6	5	2104	G
6	5	2105	G
6	5	2109	C
6	5	2112	C
6	5	2114	G
6	5	2118	A
6	5	2119	G
6	5	2128	G
6	5	2133	U
6	5	2137	A
6	5	2147	G
6	5	2153	G
6	5	2154	U
6	5	2156	U
6	5	2157	A
6	5	2165	C
6	5	2180	A
6	5	2181	U
6	5	2182	A
6	5	2183	U
6	5	2199	A
6	5	2200	A
6	5	2204	G
6	5	2207	C
6	5	2219	U

Continued on next page...

Continued from previous page...

Mol	Chain	Res	Type
6	5	2220	G
6	5	2221	U
6	5	2231	G
6	5	2235	G
6	5	2248	G
6	5	2268	C
6	5	2291	G
6	5	2296	C
6	5	2302	A
6	5	2303	C
6	5	2304	U
6	5	2313	G
6	5	2323	G
6	5	2324	G
6	5	2328	A
6	5	2333	A
6	5	2355	U
6	5	2360	A
6	5	2371	C
6	5	2378	U
6	5	2386	U
6	5	2390	A
6	5	2396	G
6	5	2400	A
6	5	2409	A
6	5	2427	U
6	5	2446	A
6	5	2451	G
6	5	2457	A
6	5	2458	A
6	5	2461	A
6	5	2463	G
6	5	2470	U
6	5	2471	U
6	5	2472	A
6	5	2473	A
6	5	2474	G
6	5	2475	G
6	5	2476	U
6	5	2481	A
6	5	2482	A
6	5	2484	U

Continued on next page...

Continued from previous page...

Mol	Chain	Res	Type
6	5	2497	A
6	5	2508	C
6	5	2510	C
6	5	2512	U
6	5	2515	A
6	5	2517	G
6	5	2536	U
6	5	2537	G
6	5	2538	U
6	5	2541	C
6	5	2574	A
6	5	2575	A
6	5	2576	C
6	5	2577	G
6	5	2587	G
6	5	2590	U
6	5	2595	G
6	5	2596	G
6	5	2599	A
6	5	2603	A
6	5	2604	A
6	5	2605	G
6	5	2606	A
6	5	2607	C
6	5	2608	C
6	5	2613	U
6	5	2614	G
6	5	2615	A
6	5	2625	U
6	5	2636	G
6	5	2637	G
6	5	2639	G
6	5	2644	G
6	5	2651	U
6	5	2655	A
6	5	2658	G
6	5	2667	A
6	5	2668	G
6	5	2670	C
6	5	2693	C
6	5	2696	C
6	5	2697	U

Continued on next page...

Continued from previous page...

Mol	Chain	Res	Type
6	5	2699	G
6	5	2704	A
6	5	2728	C
6	5	2732	C
6	5	2733	U
6	5	2736	G
6	5	2740	A
6	5	2741	C
6	5	2743	G
6	5	2753	G
6	5	2754	G
6	5	2761	G
6	5	2773	A
6	5	2782	A
6	5	2795	G
6	5	2799	U
6	5	2802	U
6	5	2803	A
6	5	2813	C
6	5	2819	G
6	5	2821	A
6	5	2824	G
6	5	2835	U
6	5	2836	G
6	5	2838	A
6	5	2841	A
6	5	2843	A
6	5	2851	A
6	5	2852	A
6	5	2861	G
6	5	2866	U
6	5	2867	G
6	5	2874	A
6	5	2875	G
6	5	2876	U
6	5	2883	A
6	5	2884	C
6	5	2889	C
6	5	2896	G
6	5	2900	G
6	5	2902	C
6	5	2918	A

Continued on next page...

Continued from previous page...

Mol	Chain	Res	Type
6	5	2919	C
6	5	2920	C
6	5	2924	U
6	5	2925	G
6	5	2943	G
6	5	2947	G
6	5	2948	A
6	5	2949	A
6	5	2955	A
6	5	2957	C
6	5	2963	G
6	5	2964	A
6	5	2965	U
6	5	2966	A
6	5	2968	C
6	5	2969	U
6	5	2971	G
6	5	2989	U
6	5	2991	C
6	5	2992	A
6	5	3006	U
6	5	3007	U
6	5	3010	G
6	5	3014	C
6	5	3016	U
6	5	3017	C
6	5	3018	G
6	5	3019	A
6	5	3021	G
6	5	3023	C
6	5	3034	A
6	5	3041	U
6	5	3045	G
6	5	3058	A
6	5	3065	G
6	5	3070	U
6	5	3081	A
6	5	3082	U
6	5	3083	A
6	5	3085	G
6	5	3088	A
6	5	3089	C

Continued on next page...

Continued from previous page...

Mol	Chain	Res	Type
6	5	3090	G
6	5	3094	G
6	5	3101	U
6	5	3118	A
6	5	3130	C
6	5	3137	G
6	5	3143	G
6	5	3144	U
6	5	3145	G
6	5	3147	U
6	5	3154	A
6	5	3156	G
6	5	3157	G
6	5	3160	A
6	5	3169	A
6	5	3194	A
6	5	3205	A
6	5	3206	U
6	5	3207	G
6	5	3209	G
6	5	3222	G
6	5	3226	A
6	5	3227	U
6	5	3231	G
6	5	3237	C
6	5	3240	C
6	5	3242	A
6	5	3247	U
6	5	3248	G
6	5	3270	A
6	5	3279	U
6	5	3288	G
6	5	3289	G
6	5	3290	C
6	5	3301	C
6	5	3303	C
6	5	3308	G
6	5	3313	G
6	5	3314	G
6	5	3317	G
6	5	3319	C
6	5	3320	C

Continued on next page...

Continued from previous page...

Mol	Chain	Res	Type
6	5	3322	C
6	5	3327	A
6	5	3328	G
6	5	3333	U
6	5	3334	C
6	5	3335	C
6	5	3338	C
6	5	3349	G
6	5	3352	G
6	5	3353	C
6	5	3354	G
6	5	3355	G
6	5	3357	G
6	5	3358	A
6	5	3359	G
6	5	3363	U
6	5	3364	U
6	5	3365	C
6	5	3367	U
6	5	3377	C
6	5	3390	A
6	5	3393	G
6	5	3394	G
6	5	3395	G
6	5	3398	C
6	5	3399	G
6	5	3401	C
6	5	3402	C
6	5	3405	U
6	5	3406	C
6	5	3407	G
6	5	3408	C
6	5	3411	G
6	5	3414	A
6	5	3417	C
6	5	3418	A
6	5	3420	C
6	5	3423	A
6	5	3424	C
6	5	3427	U
6	5	3428	C
6	5	3429	G

Continued on next page...

Continued from previous page...

Mol	Chain	Res	Type
6	5	3430	U
6	5	3431	G
6	5	3435	A
6	5	3436	A
6	5	3437	C
6	5	3438	C
6	5	3440	G
6	5	3444	C
6	5	3445	U
6	5	3446	A
6	5	3447	A
6	5	3456	U
6	5	3459	A
6	5	3468	U
6	5	3469	U
6	5	3470	C
6	5	3473	G
6	5	3479	G
6	5	3486	U
6	5	3487	A
6	5	3494	A
6	5	3497	G
6	5	3515	U
6	5	3516	G
6	5	3522	C
6	5	3525	C
6	5	3527	C
6	5	3528	U
6	5	3529	C
6	5	3531	A
6	5	3536	A
6	5	3537	G
8	7	7	G
8	7	22	A
8	7	25	G
8	7	33	U
8	7	53	U
8	7	54	A
8	7	63	C
8	7	64	G
8	7	97	G
8	7	100	A

Continued on next page...

Continued from previous page...

Mol	Chain	Res	Type
8	7	106	G
8	7	110	G
8	7	111	C
8	7	120	U
9	8	2	G
9	8	3	A
9	8	16	G
9	8	23	C
9	8	34	U
9	8	35	C
9	8	39	G
9	8	49	G
9	8	51	U
9	8	59	A
9	8	62	A
9	8	63	U
9	8	70	G
9	8	71	A
9	8	75	G
9	8	79	G
9	8	87	G
9	8	94	G
9	8	95	A
9	8	99	U
9	8	103	A
9	8	105	C
9	8	107	C
9	8	109	C
9	8	110	U
9	8	111	U
9	8	114	G
9	8	123	U
9	8	125	C
9	8	126	C
9	8	127	U
9	8	128	C
9	8	147	G
9	8	150	C
31	K	2	A
31	K	3	C
31	K	20	G
31	K	25	A

Continued on next page...

Continued from previous page...

Mol	Chain	Res	Type
31	K	26	U
31	K	33	G
31	K	41	G
31	K	42	A
31	K	44	U
31	K	46	A
31	K	56	G
31	K	58	C
31	K	62	G
31	K	65	C
31	K	67	C
31	K	68	A
31	K	71	G
31	K	73	C
31	K	74	G
31	K	75	G
31	K	77	A
31	K	79	A
31	K	99	A
31	K	103	A
31	K	111	A
31	K	113	G
31	K	115	U
31	K	124	U
31	K	126	G
31	K	129	C
31	K	130	G
31	K	141	A
31	K	143	U
31	K	147	A
31	K	154	U
31	K	155	G
31	K	158	A
31	K	162	C
31	K	163	U
31	K	168	C
31	K	180	G
31	K	182	C
31	K	183	G
31	K	184	G
31	K	188	C
31	K	190	G

Continued on next page...

Continued from previous page...

Mol	Chain	Res	Type
31	K	191	A
31	K	192	C
31	K	202	G
31	K	215	G
31	K	294	U
31	K	302	A
31	K	304	C
31	K	305	U
31	K	307	G
31	K	308	G
31	K	309	G
31	K	311	C
31	K	312	G
31	K	314	U
31	K	318	A
31	K	319	C
31	K	323	C
31	K	332	G
31	K	335	G
31	K	339	A
31	K	347	G
31	K	350	C
31	K	351	G
31	K	360	A
31	K	364	A
31	K	368	U
31	K	370	G
31	K	381	C
31	K	385	G
31	K	386	C
31	K	398	A
31	K	400	C
31	K	407	G
31	K	408	A
31	K	409	C
31	K	417	C
31	K	418	A
31	K	426	A
31	K	435	A
31	K	438	G
31	K	448	A
31	K	450	C

Continued on next page...

Continued from previous page...

Mol	Chain	Res	Type
31	K	460	A
31	K	464	A
31	K	465	A
31	K	466	G
31	K	471	G
31	K	472	C
31	K	473	A
31	K	474	G
31	K	476	A
31	K	482	G
31	K	487	U
31	K	492	C
31	K	496	C
31	K	525	A
31	K	532	C
31	K	533	A
31	K	542	U
31	K	544	G
31	K	547	G
31	K	548	C
31	K	549	C
31	K	550	C
31	K	551	U
31	K	554	A
31	K	555	A
31	K	556	U
31	K	559	G
31	K	560	A
31	K	563	G
31	K	564	A
31	K	568	C
31	K	570	C
31	K	576	A
31	K	583	A
31	K	587	A
31	K	588	G
31	K	590	A
31	K	591	U
31	K	606	G
31	K	608	C
31	K	614	C
31	K	617	G

Continued on next page...

Continued from previous page...

Mol	Chain	Res	Type
31	K	621	C
31	K	643	A
31	K	644	G
31	K	660	C
31	K	664	A
31	K	668	A
31	K	669	A
31	K	670	A
31	K	671	A
31	K	672	A
31	K	673	G
31	K	683	G
31	K	688	U
31	K	689	U
31	K	690	G
31	K	752	G
31	K	753	C
31	K	754	G
31	K	798	G
31	K	799	U
31	K	811	A
31	K	821	G
31	K	822	U
31	K	830	A
31	K	833	C
31	K	834	C
31	K	844	U
31	K	847	A
31	K	867	G
31	K	870	A
31	K	871	U
31	K	872	A
31	K	873	G
31	K	874	G
31	K	875	A
31	K	878	G
31	K	887	U
31	K	890	U
31	K	892	U
31	K	907	G
31	K	913	A
31	K	914	U

Continued on next page...

Continued from previous page...

Mol	Chain	Res	Type
31	K	920	A
31	K	933	G
31	K	934	G
31	K	943	U
31	K	955	A
31	K	971	G
31	K	990	A
31	K	992	A
31	K	999	G
31	K	1017	U
31	K	1023	A
31	K	1041	G
31	K	1045	U
31	K	1060	A
31	K	1062	A
31	K	1067	C
31	K	1083	A
31	K	1085	C
31	K	1100	A
31	K	1111	U
31	K	1115	U
31	K	1116	C
31	K	1117	C
31	K	1118	C
31	K	1123	C
31	K	1126	G
31	K	1131	G
31	K	1133	A
31	K	1138	C
31	K	1139	C
31	K	1149	A
31	K	1153	C
31	K	1154	U
31	K	1155	U
31	K	1170	A
31	K	1195	A
31	K	1207	G
31	K	1208	A
31	K	1215	C
31	K	1221	G
31	K	1224	G
31	K	1242	U

Continued on next page...

Continued from previous page...

Mol	Chain	Res	Type
31	K	1243	U
31	K	1251	A
31	K	1253	A
31	K	1254	C
31	K	1255	G
31	K	1256	G
31	K	1257	G
31	K	1259	A
31	K	1264	C
31	K	1271	C
31	K	1274	G
31	K	1275	G
31	K	1280	G
31	K	1281	G
31	K	1282	A
31	K	1284	A
31	K	1285	G
31	K	1286	G
31	K	1294	G
31	K	1298	G
31	K	1299	A
31	K	1301	A
31	K	1302	G
31	K	1303	C
31	K	1304	U
31	K	1307	U
31	K	1308	U
31	K	1313	A
31	K	1314	U
31	K	1315	U
31	K	1316	C
31	K	1322	G
31	K	1333	U
31	K	1341	C
31	K	1342	U
31	K	1348	G
31	K	1371	U
31	K	1372	U
31	K	1376	A
31	K	1378	A
31	K	1382	A
31	K	1395	C

Continued on next page...

Continued from previous page...

Mol	Chain	Res	Type
31	K	1396	A
31	K	1397	U
31	K	1401	A
31	K	1402	A
31	K	1404	U
31	K	1410	C
31	K	1412	C
31	K	1428	G
31	K	1439	A
31	K	1442	U
31	K	1449	G
31	K	1454	A
31	K	1462	U
31	K	1463	U
31	K	1466	G
31	K	1473	G
31	K	1476	A
31	K	1477	U
31	K	1487	A
31	K	1489	A
31	K	1490	G
31	K	1494	U
31	K	1498	A
31	K	1507	G
31	K	1509	U
31	K	1510	G
31	K	1521	C
31	K	1522	A
31	K	1523	C
31	K	1531	A
31	K	1533	A
31	K	1536	G
31	K	1544	C
31	K	1545	A
31	K	1548	G
31	K	1552	G
31	K	1553	C
31	K	1556	A
31	K	1557	C
31	K	1560	U
31	K	1570	G
31	K	1574	C

Continued on next page...

Continued from previous page...

Mol	Chain	Res	Type
31	K	1575	G
31	K	1580	A
31	K	1585	U
31	K	1586	U
31	K	1587	G
31	K	1588	A
31	K	1601	A
31	K	1604	G
31	K	1621	U
31	K	1623	A
31	K	1637	A
31	K	1638	G
31	K	1646	C
31	K	1648	G
31	K	1649	U
31	K	1654	G
31	K	1665	G
31	K	1680	G
31	K	1683	C
31	K	1686	G
31	K	1695	A
31	K	1698	C
31	K	1699	A
31	K	1721	U
31	K	1722	G
31	K	1726	G
31	K	1729	U
31	K	1732	G
31	K	1744	G
31	K	1753	C
31	K	1783	C
31	K	1785	C
31	K	1823	A
31	K	1825	A
31	K	1826	G
31	K	1829	G
31	K	1831	A
31	K	1836	G
31	K	1838	U
31	K	1849	G
31	K	1851	A
31	K	1852	C

Continued on next page...

Continued from previous page...

Mol	Chain	Res	Type
31	K	1861	G
31	K	1862	G
31	K	1863	A
31	K	1865	C
31	K	1866	A
87	AF	4	G
87	AF	17	C
87	AF	24	G
87	AF	32	A
87	AF	33	G
87	AF	36	A
87	AF	38	U
87	AF	39	C
87	AF	40	G
87	AF	54	G
87	AF	120	G
87	AF	144	C
87	AF	151	C
87	AF	167	U
87	AF	173	A
87	AF	174	G
87	AF	175	G
87	AF	176	A
87	AF	177	G
87	AF	182	G
87	AF	183	A
87	AF	184	A
87	AF	185	C
87	AF	186	C
87	AF	191	C
87	AF	202	C
87	AF	206	G
87	AF	212	C
87	AF	227	G
87	AF	235	G
87	AF	236	U
87	AF	287	A

All (94) RNA pucker outliers are listed below:

Mol	Chain	Res	Type
3	2	20	C

Continued on next page...

Continued from previous page...

Mol	Chain	Res	Type
6	5	47	A
6	5	48	G
6	5	125	C
6	5	134	G
6	5	211	C
6	5	220	G
6	5	239	C
6	5	259	C
6	5	269	C
6	5	379	A
6	5	400	C
6	5	443	C
6	5	474	C
6	5	480	C
6	5	496	G
6	5	572	C
6	5	666	G
6	5	696	G
6	5	703	A
6	5	709	G
6	5	737	C
6	5	772	G
6	5	807	G
6	5	819	C
6	5	821	A
6	5	852	G
6	5	890	G
6	5	928	G
6	5	1000	U
6	5	1005	U
6	5	1015	G
6	5	1193	G
6	5	1341	A
6	5	1355	G
6	5	1371	U
6	5	1372	G
6	5	1458	C
6	5	1516	A
6	5	1520	A
6	5	1583	G
6	5	1605	C
6	5	1626	G

Continued on next page...

Continued from previous page...

Mol	Chain	Res	Type
6	5	1659	C
6	5	1867	G
6	5	1895	A
6	5	1939	G
6	5	2054	U
6	5	2088	A
6	5	2187	C
6	5	2323	G
6	5	2395	U
6	5	2574	A
6	5	2586	G
6	5	2606	A
6	5	2696	C
6	5	2740	A
6	5	2802	U
6	5	2963	G
6	5	3018	G
6	5	3019	A
6	5	3101	U
6	5	3269	U
6	5	3289	G
6	5	3366	G
6	5	3405	U
6	5	3416	G
6	5	3427	U
9	8	124	U
31	K	110	U
31	K	182	C
31	K	434	G
31	K	465	A
31	K	532	C
31	K	553	U
31	K	642	U
31	K	688	U
31	K	752	G
31	K	870	A
31	K	1137	U
31	K	1253	A
31	K	1394	G
31	K	1395	C
31	K	1396	A
31	K	1489	A

Continued on next page...

Continued from previous page...

Mol	Chain	Res	Type
31	K	1520	G
31	K	1637	A
31	K	1664	A
31	K	1679	A
31	K	1824	A
87	AF	37	C
87	AF	38	U
87	AF	39	C
87	AF	234	A

5.4 Non-standard residues in protein, DNA, RNA chains [i](#)

There are no non-standard protein/DNA/RNA residues in this entry.

5.5 Carbohydrates [i](#)

There are no monosaccharides in this entry.

5.6 Ligand geometry [i](#)

Of 304 ligands modelled in this entry, 304 are monoatomic - leaving 0 for Mogul analysis.

There are no bond length outliers.

There are no bond angle outliers.

There are no chirality outliers.

There are no torsion outliers.

There are no ring outliers.

No monomer is involved in short contacts.

5.7 Other polymers [i](#)

There are no such residues in this entry.

5.8 Polymer linkage issues [i](#)

The following chains have linkage breaks:

Mol	Chain	Number of breaks
6	5	25
31	K	11
87	AF	2
4	3	2
9	8	1
3	2	1
86	AB	1

All chain breaks are listed below:

Model	Chain	Residue-1	Atom-1	Residue-2	Atom-2	Distance (Å)
1	AF	237:U	O3'	282:U	P	93.22
1	AF	65:U	O3'	114:G	P	86.59
1	5	1650:G	O3'	1651:C	P	41.09
1	5	831:C	O3'	832:G	P	36.72
1	5	815:G	O3'	816:G	P	22.49
1	5	2646:C	O3'	2647:G	P	19.48
1	5	968:G	O3'	969:C	P	18.41
1	K	697:G	O3'	729:C	P	18.40
1	5	728:C	O3'	729:G	P	18.12
1	K	1761:U	O3'	1771:G	P	17.91
1	5	513:C	O3'	514:G	P	17.83
1	K	756:C	O3'	788:G	P	17.68
1	5	2683:C	O3'	2684:G	P	17.61
1	5	2715:C	O3'	2716:G	P	17.40
1	K	834:C	O3'	841:G	P	17.12
1	K	323:C	O3'	329:G	P	16.83
1	5	3340:C	O3'	3341:C	P	16.53
1	K	130:G	O3'	140:U	P	15.98
1	K	1417:C	O3'	1423:C	P	15.83
1	5	637:G	O3'	638:C	P	15.07
1	5	1256:C	O3'	1257:C	P	15.04
1	5	3502:U	O3'	3503:G	P	14.51
1	5	182:G	O3'	183:G	P	13.41
1	5	2294:G	O3'	2295:G	P	13.31
1	5	925:U	O3'	926:A	P	12.92
1	8	79:G	O3'	85:U	P	12.74
1	5	3299:A	O3'	3300:G	P	9.51
1	5	778:C	O3'	779:C	P	9.49
1	5	504:U	O3'	505:C	P	8.80
1	K	225:G	O3'	287:U	P	8.21
1	K	745:C	O3'	749:U	P	7.79
1	K	736:C	O3'	743:U	P	6.78
1	3	19:G	O3'	20:U	P	6.01

Continued on next page...

Continued from previous page...

Model	Chain	Residue-1	Atom-1	Residue-2	Atom-2	Distance (Å)
1	5	822:C	O3'	823:G	P	5.85
1	5	495:G	O3'	496:G	P	5.68
1	2	16:C	O3'	18:G	P	5.39
1	5	765:U	O3'	766:G	P	5.23
1	3	16:C	O3'	18:U	P	4.84
1	5	3305:G	O3'	3306:G	P	4.59
1	K	1432:U	O3'	1438:A	P	4.12
1	5	3381:G	O3'	3382:C	P	3.53
1	5	999:U	O3'	1000:U	P	3.35
1	AB	86:LEU	C	87:VAL	N	3.26

6 Map visualisation [i](#)

This section contains visualisations of the EMDB entry EMD-4735. These allow visual inspection of the internal detail of the map and identification of artifacts.

No raw map or half-maps were deposited for this entry and therefore no images, graphs, etc. pertaining to the raw map can be shown.

6.1 Orthogonal projections [i](#)

6.1.1 Primary map

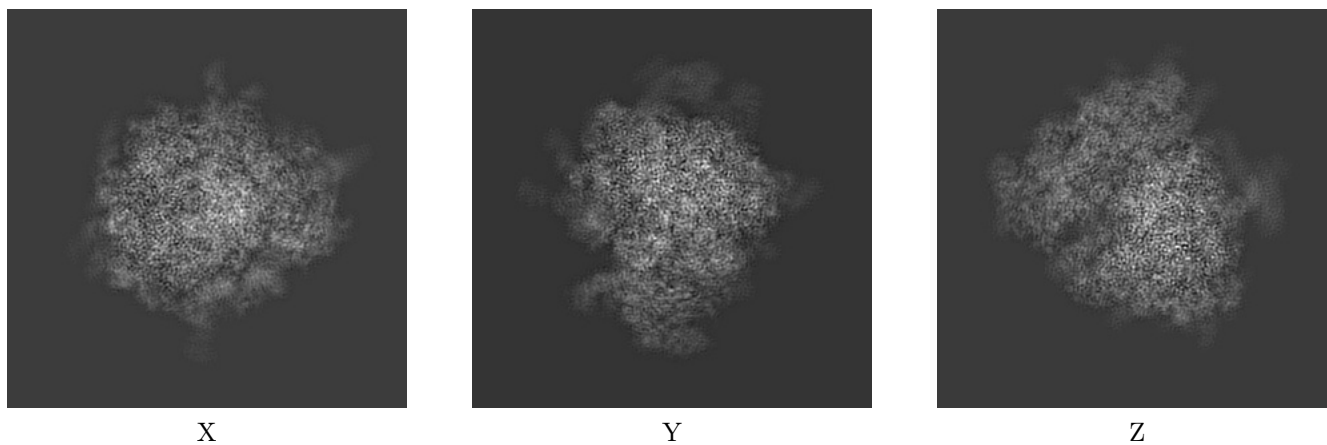

The images above show the map projected in three orthogonal directions.

6.2 Central slices [i](#)

6.2.1 Primary map

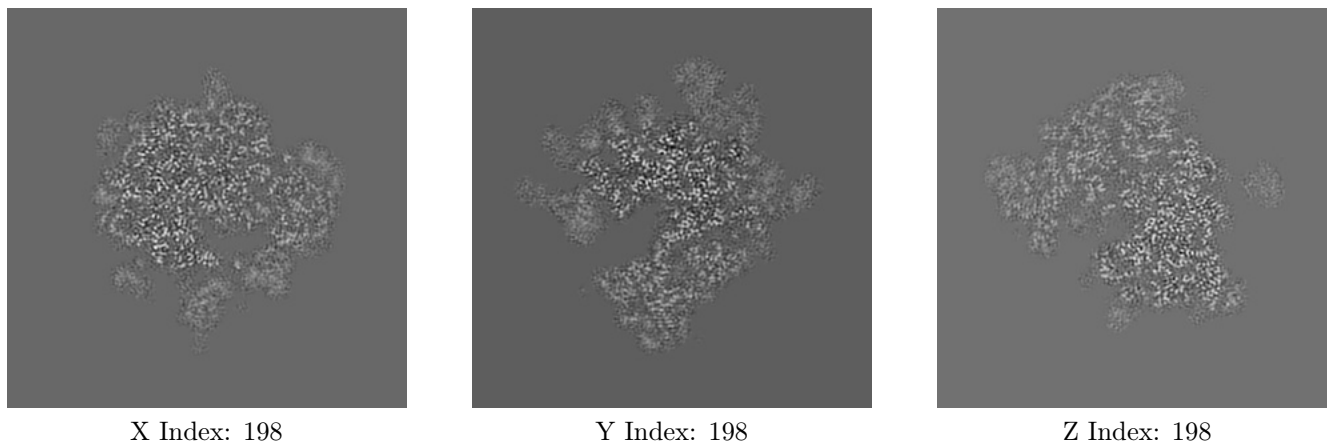

The images above show central slices of the map in three orthogonal directions.

6.3 Largest variance slices [i](#)

6.3.1 Primary map

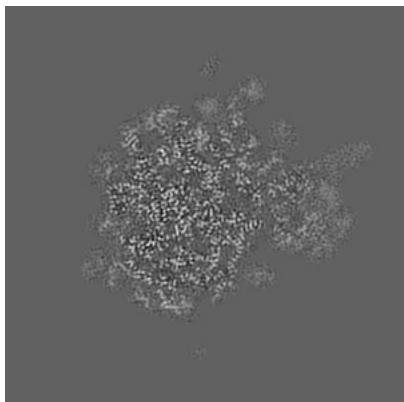

X Index: 229

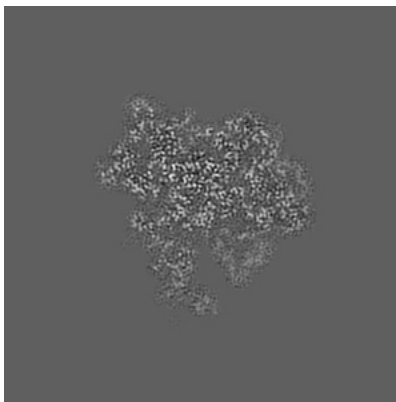

Y Index: 160

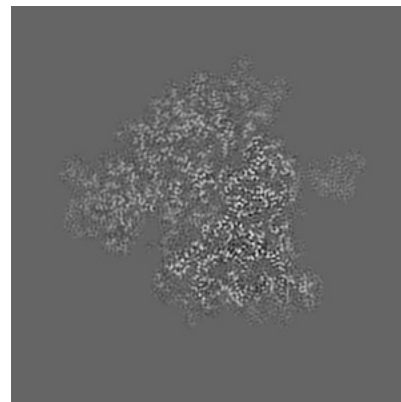

Z Index: 191

The images above show the largest variance slices of the map in three orthogonal directions.

6.4 Orthogonal surface views [i](#)

6.4.1 Primary map

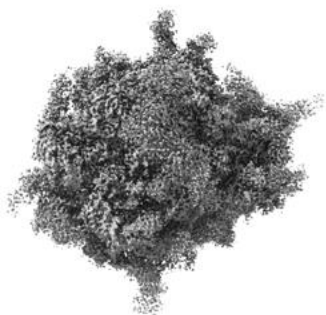

X

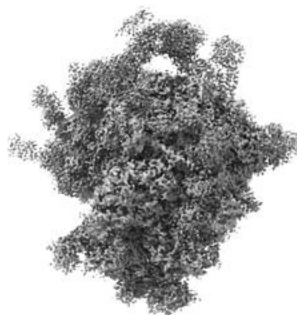

Y

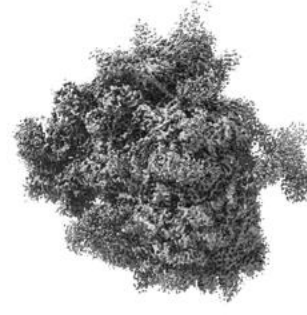

Z

The images above show the 3D surface view of the map at the recommended contour level 0.08. These images, in conjunction with the slice images, may facilitate assessment of whether an appropriate contour level has been provided.

6.5 Mask visualisation

This section was not generated. No masks/segmentation were deposited.

7 Map analysis [i](#)

This section contains the results of statistical analysis of the map.

7.1 Map-value distribution [i](#)

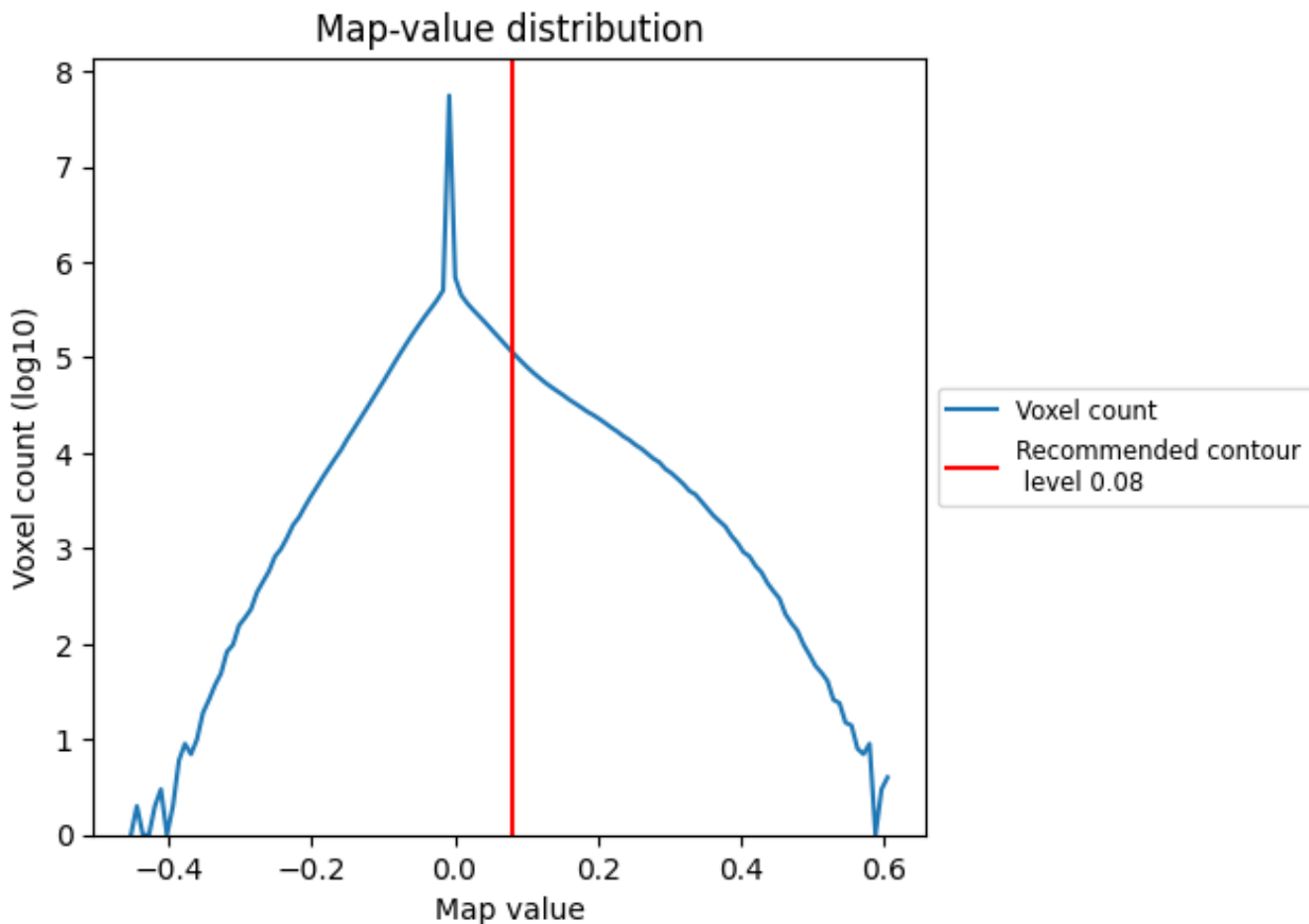

The map-value distribution is plotted in 128 intervals along the x-axis. The y-axis is logarithmic. A spike in this graph at zero usually indicates that the volume has been masked.

7.2 Volume estimate [i](#)

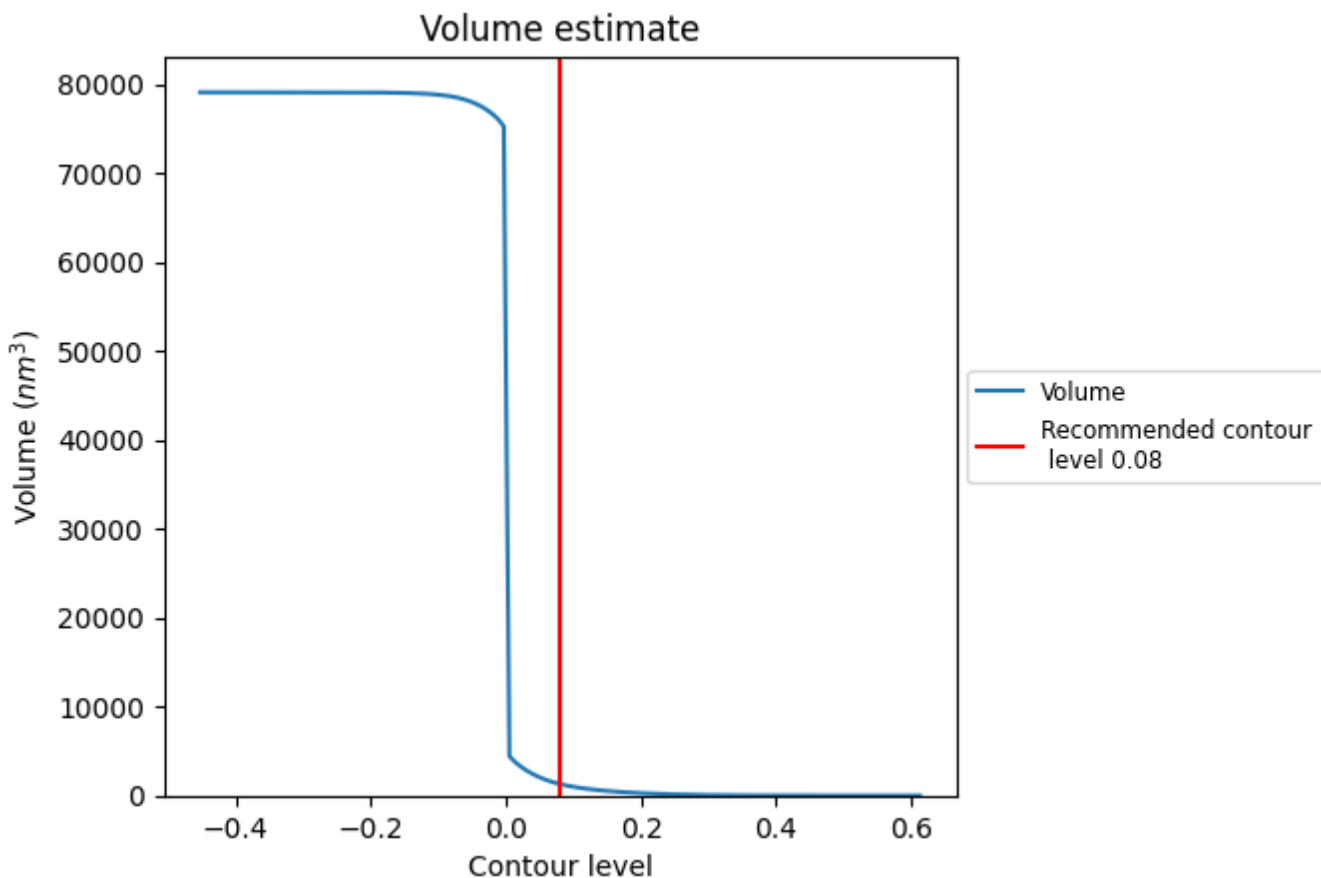

The volume at the recommended contour level is 1300 nm³; this corresponds to an approximate mass of 1174 kDa.

The volume estimate graph shows how the enclosed volume varies with the contour level. The recommended contour level is shown as a vertical line and the intersection between the line and the curve gives the volume of the enclosed surface at the given level.

7.3 Rotationally averaged power spectrum [i](#)

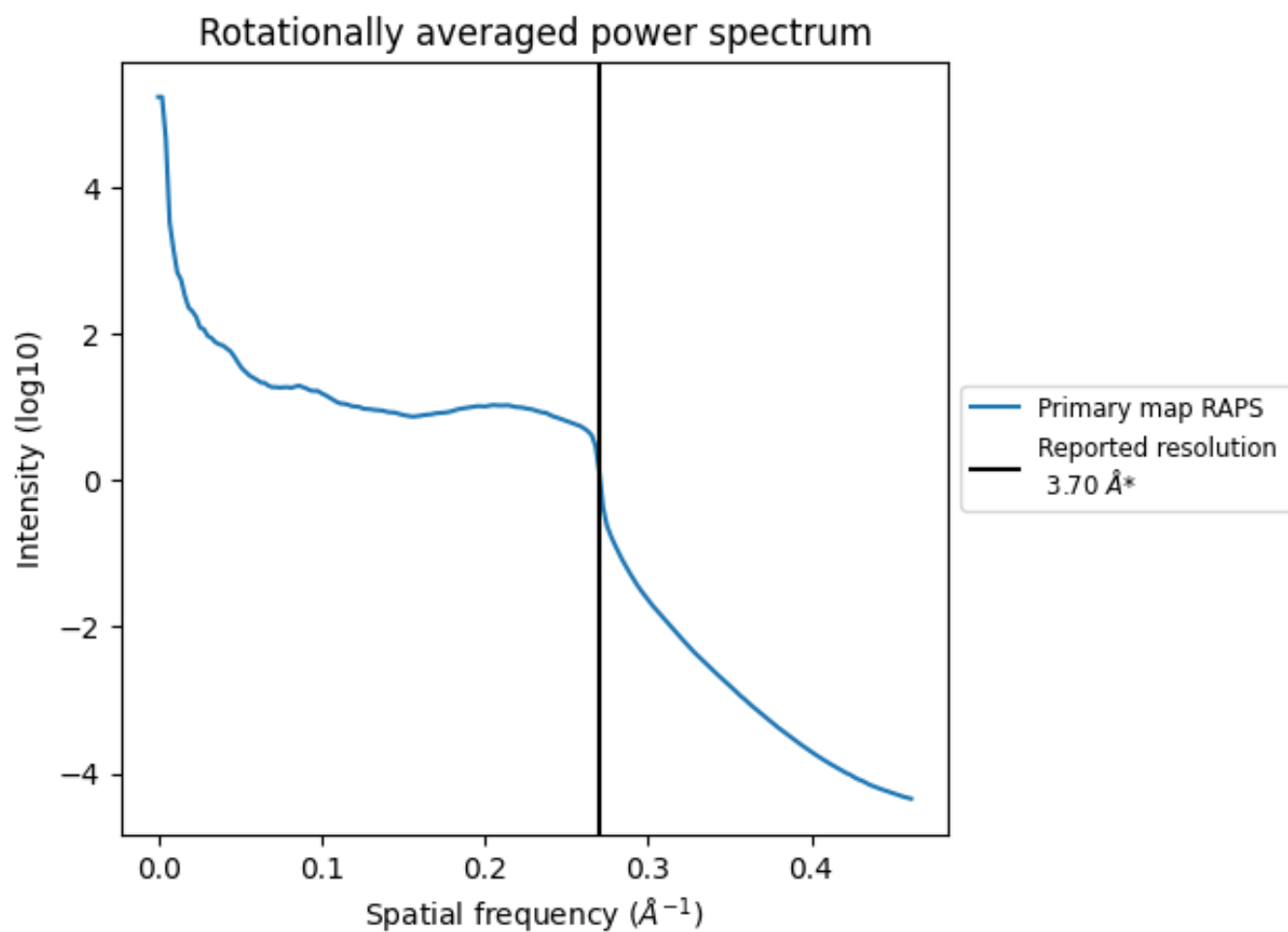

*Reported resolution corresponds to spatial frequency of 0.270\AA^{-1}

8 Fourier-Shell correlation [i](#)

Fourier-Shell Correlation (FSC) is the most commonly used method to estimate the resolution of single-particle and subtomogram-averaged maps. The shape of the curve depends on the imposed symmetry, mask and whether or not the two 3D reconstructions used were processed from a common reference. The reported resolution is shown as a black line. A curve is displayed for the half-bit criterion in addition to lines showing the 0.143 gold standard cut-off and 0.5 cut-off.

8.1 FSC [i](#)

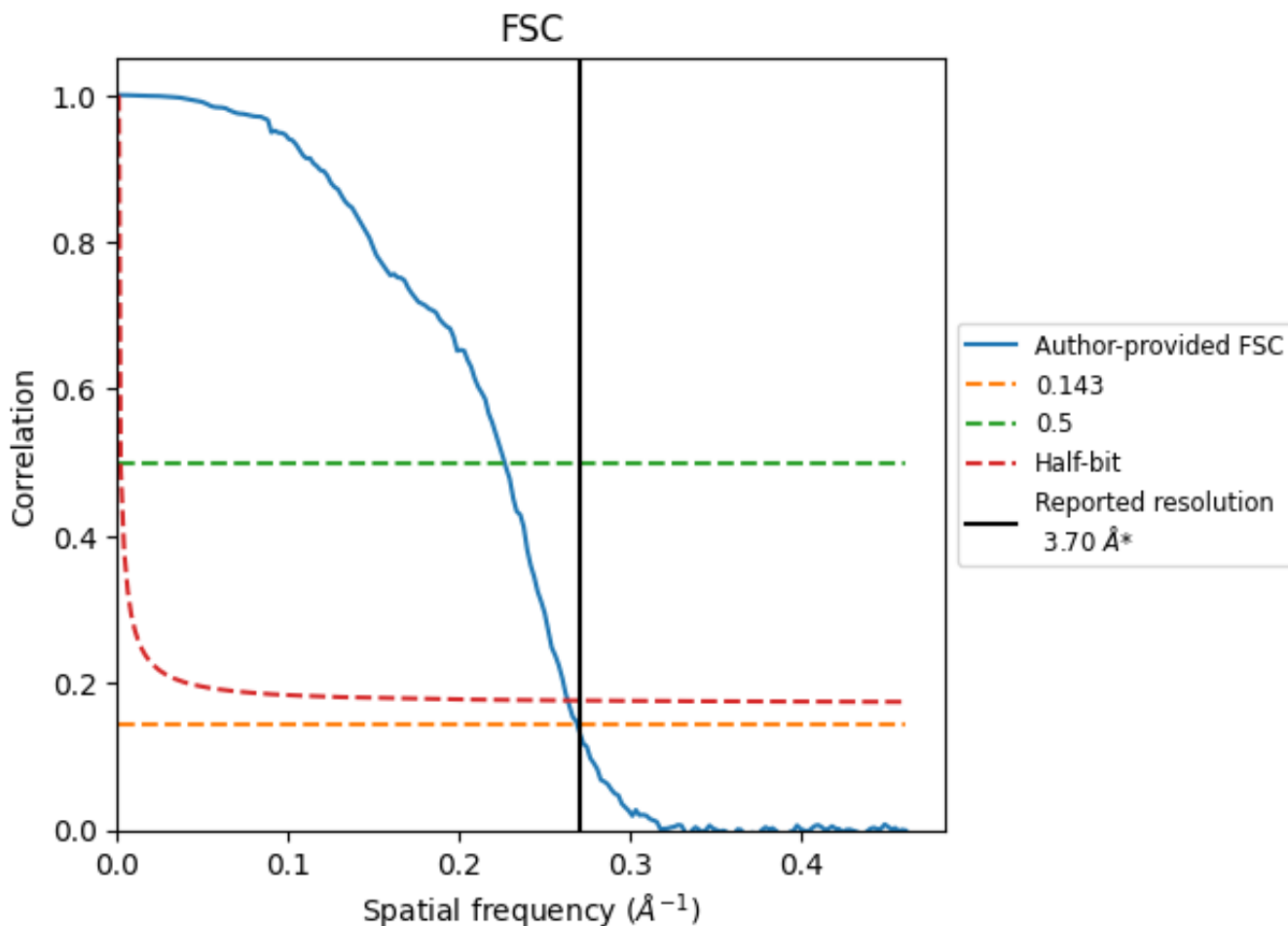

*Reported resolution corresponds to spatial frequency of 0.270 Å⁻¹

8.2 Resolution estimates [i](#)

Resolution estimate (Å)	Estimation criterion (FSC cut-off)		
	0.143	0.5	Half-bit
Reported by author	3.70	-	-
Author-provided FSC curve	3.71	4.41	3.79
Unmasked-calculated*	-	-	-

*Resolution estimate based on FSC curve calculated by comparison of deposited half-maps.

9 Map-model fit [i](#)

This section contains information regarding the fit between EMDB map EMD-4735 and PDB model 6R6G. Per-residue inclusion information can be found in section 3 on page 23.

9.1 Map-model overlay [i](#)

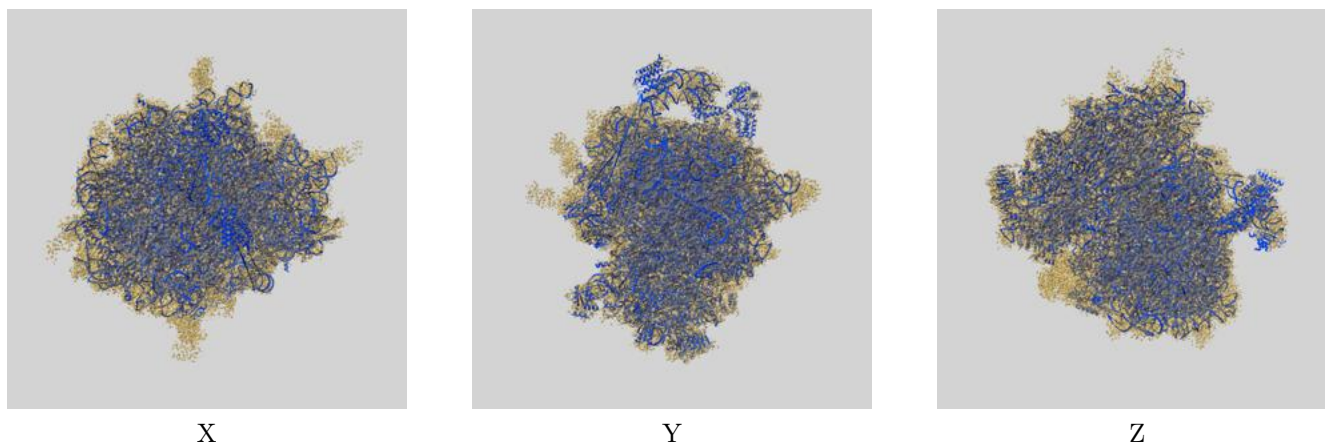

The images above show the 3D surface view of the map at the recommended contour level 0.08 at 50% transparency in yellow overlaid with a ribbon representation of the model coloured in blue. These images allow for the visual assessment of the quality of fit between the atomic model and the map.

9.2 Q-score mapped to coordinate model [i](#)

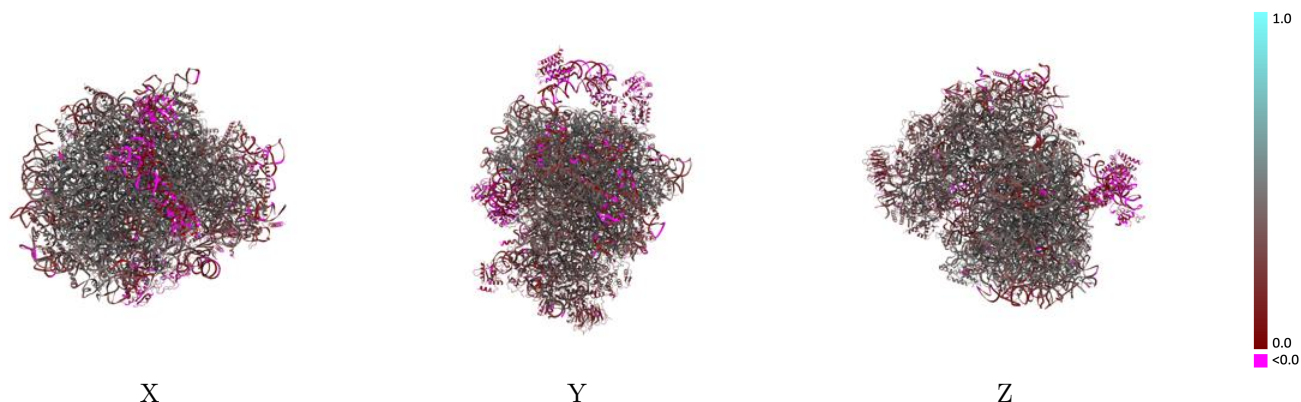

The images above show the model with each residue coloured according to its Q-score. This shows their resolvability in the map with higher Q-score values reflecting better resolvability. Please note: Q-score is calculating the resolvability of atoms, and thus high values are only expected at resolutions at which atoms can be resolved. Low Q-score values may therefore be expected for many entries.

9.3 Atom inclusion mapped to coordinate model [i](#)

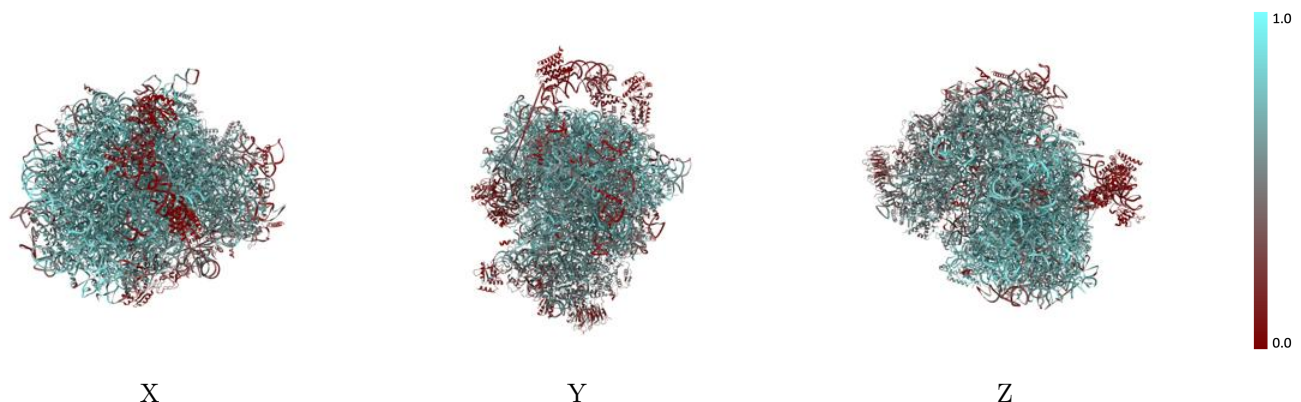

The images above show the model with each residue coloured according to its atom inclusion. This shows to what extent they are inside the map at the recommended contour level (0.08).



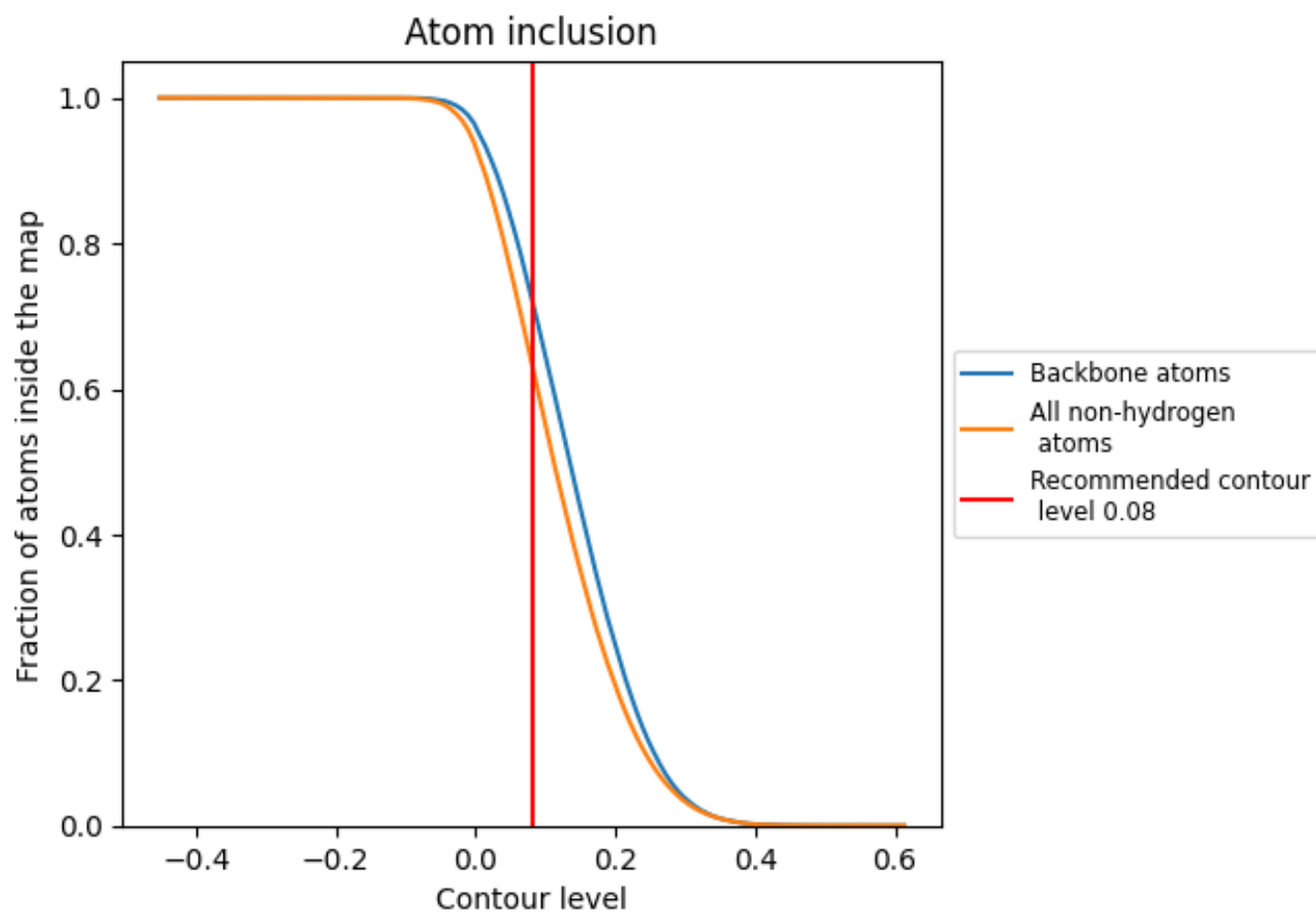



































































9.4 Atom inclusion [i](#)



At the recommended contour level, 73% of all backbone atoms, 64% of all non-hydrogen atoms, are inside the map.

9.5 Map-model fit summary

The table lists the average atom inclusion at the recommended contour level (0.08) and Q-score for the entire model and for each chain.

Chain	Atom inclusion	Q-score
All	 0.6357	 0.3580
0	 0.2556	 0.1590
1	 0.7387	 0.5170
2	 0.6324	 0.3240
3	 0.3688	 0.1950
4	 0.6850	 0.4110
5	 0.7498	 0.3910
6	 0.3107	 0.2240
7	 0.8319	 0.4360
8	 0.7681	 0.3970
9	 0.5125	 0.3550
A	 0.6759	 0.4390
AA	 0.4343	 0.3090
AB	 0.0819	 0.0730
AC	 0.0488	 0.0180
AD	 0.2958	 0.1800
AE	 0.3963	 0.2490
AF	 0.2151	 0.0710
AG	 0.0938	 0.0090
AI	 0.0359	 0.0370
B	 0.6965	 0.4450
BB	 0.4702	 0.3030
C	 0.7166	 0.4470
CC	 0.5716	 0.3700
D	 0.6865	 0.4180
DD	 0.5024	 0.3290
E	 0.6766	 0.4130
EE	 0.5693	 0.3960
F	 0.7056	 0.4310
FF	 0.4723	 0.3570
G	 0.6055	 0.3720
GG	 0.3695	 0.2890
H	 0.6583	 0.4190
HH	 0.4984	 0.3330
I	 0.7096	 0.4350



































Continued on next page...

Continued from previous page...

Chain	Atom inclusion	Q-score
II	0.5328	0.3150
J	0.6609	0.3860
JJ	0.4820	0.3250
K	0.6734	0.3500
KK	0.4451	0.2880
L	0.6457	0.3920
LL	0.5775	0.3870
M	0.7216	0.4330
MM	0.5583	0.3790
N	0.7358	0.4440
NN	0.5005	0.3120
O	0.7108	0.4400
OO	0.4717	0.2890
P	0.7020	0.4460
PP	0.5108	0.2980
Q	0.7103	0.4400
QQ	0.5840	0.3930
R	0.6280	0.3840
RR	0.2136	0.1310
S	0.7223	0.4440
SS	0.3886	0.2530
T	0.6841	0.4240
TT	0.5594	0.4000
U	0.5803	0.3410
UU	0.4661	0.3170
V	0.6806	0.4540
VV	0.5696	0.3910
W	0.5126	0.3170
WW	0.4974	0.2870
X	0.6266	0.4170
Y	0.6744	0.4170
Z	0.6263	0.3970
a	0.7307	0.4460
b	0.5718	0.3600
c	0.6263	0.4050
d	0.6663	0.4200
e	0.7404	0.4560
f	0.7340	0.4530
g	0.6471	0.4190
h	0.6517	0.3900
i	0.6394	0.3760
j	0.7240	0.4510

Continued on next page...

Continued from previous page...

Chain	Atom inclusion	Q-score
k	 0.5781	 0.3740
l	 0.6604	 0.4420
m	 0.6803	 0.4340
n	 0.6376	 0.3950
o	 0.6646	 0.4030
p	 0.6386	 0.4230
q	 0.5075	 0.3440
r	 0.7315	 0.4530
s	 0.1030	 0.0510
t	 0.0387	 0.0160
u	 0.5409	 0.3540
v	 0.5327	 0.3540
w	 0.3745	 0.2890
x	 0.5200	 0.3470
y	 0.5328	 0.3370
z	 0.4259	 0.2550