



wwPDB EM Validation Summary Report ⓘ

Dec 10, 2022 – 02:41 pm GMT

PDB ID : 6RDP
EMDB ID : EMD-4826
Title : Cryo-EM structure of Polytomella F-ATP synthase, Rotary substate 1C, focused refinement of F1 head and rotor
Authors : Murphy, B.J.; Klusch, N.; Yildiz, O.; Kuhlbrandt, W.
Deposited on : 2019-04-12
Resolution : 2.80 Å(reported)

This is a wwPDB EM Validation Summary Report for a publicly released PDB entry.

We welcome your comments at validation@mail.wwpdb.org

A user guide is available at

<https://www.wwpdb.org/validation/2017/EMValidationReportHelp>

with specific help available everywhere you see the ⓘ symbol.

The types of validation reports are described at

<http://www.wwpdb.org/validation/2017/FAQs#types>.

The following versions of software and data (see [references ⓘ](#)) were used in the production of this report:

EMDB validation analysis : 0.0.1.dev43
Mogul : 1.8.4, CSD as541be (2020)
MolProbity : 4.02b-467
buster-report : 1.1.7 (2018)
Percentile statistics : 20191225.v01 (using entries in the PDB archive December 25th 2019)
MapQ : 1.9.9
Ideal geometry (proteins) : Engh & Huber (2001)
Ideal geometry (DNA, RNA) : Parkinson et al. (1996)
Validation Pipeline (wwPDB-VP) : 2.31.3

1 Overall quality at a glance i

The following experimental techniques were used to determine the structure:

ELECTRON MICROSCOPY

The reported resolution of this entry is 2.80 Å.

Percentile scores (ranging between 0-100) for global validation metrics of the entry are shown in the following graphic. The table shows the number of entries on which the scores are based.

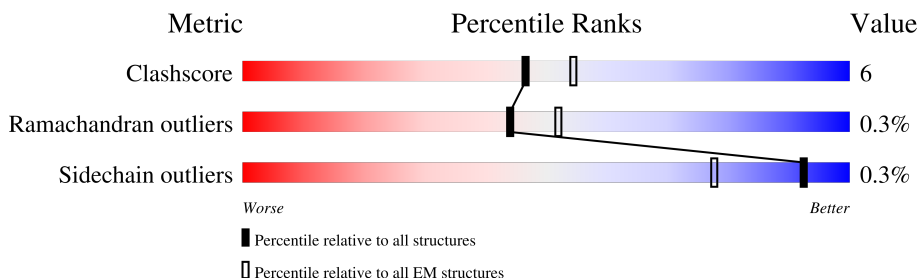

Metric	Whole archive (#Entries)	EM structures (#Entries)
Clashscore	158937	4297
Ramachandran outliers	154571	4023
Sidechain outliers	154315	3826

The table below summarises the geometric issues observed across the polymeric chains and their fit to the map. The red, orange, yellow and green segments of the bar indicate the fraction of residues that contain outliers for ≥ 3 , 2, 1 and 0 types of geometric quality criteria respectively. A grey segment represents the fraction of residues that are not modelled. The numeric value for each fraction is indicated below the corresponding segment, with a dot representing fractions $\leq 5\%$. The upper red bar (where present) indicates the fraction of residues that have poor fit to the EM map (all-atom inclusion $< 40\%$). The numeric value is given above the bar.

Mol	Chain	Length	Quality of chain
1	A	127	<div style="display: flex; justify-content: space-between; align-items: center;"> <div style="text-align: center;">52%</div> <div style="width: 100%; height: 15px; background: linear-gradient(to right, red, orange, yellow, green, grey);"></div> <div style="text-align: center;">42%</div> </div> <div style="display: flex; justify-content: space-between; align-items: center; margin-top: 5px;"> <div style="text-align: center;">43%</div> <div style="width: 100%; height: 15px; background: linear-gradient(to right, red, orange, yellow, green, grey);"></div> <div style="text-align: center;">42%</div> </div>
1	B	127	<div style="display: flex; justify-content: space-between; align-items: center;"> <div style="text-align: center;">54%</div> <div style="width: 100%; height: 15px; background: linear-gradient(to right, red, orange, yellow, green, grey);"></div> <div style="text-align: center;">42%</div> </div> <div style="display: flex; justify-content: space-between; align-items: center; margin-top: 5px;"> <div style="text-align: center;">39%</div> <div style="width: 100%; height: 15px; background: linear-gradient(to right, red, orange, yellow, green, grey);"></div> <div style="text-align: center;">42%</div> </div>
1	C	127	<div style="display: flex; justify-content: space-between; align-items: center;"> <div style="text-align: center;">54%</div> <div style="width: 100%; height: 15px; background: linear-gradient(to right, red, orange, yellow, green, grey);"></div> <div style="text-align: center;">42%</div> </div> <div style="display: flex; justify-content: space-between; align-items: center; margin-top: 5px;"> <div style="text-align: center;">46%</div> <div style="width: 100%; height: 15px; background: linear-gradient(to right, red, orange, yellow, green, grey);"></div> <div style="text-align: center;">42%</div> </div>
1	D	127	<div style="display: flex; justify-content: space-between; align-items: center;"> <div style="text-align: center;">54%</div> <div style="width: 100%; height: 15px; background: linear-gradient(to right, red, orange, yellow, green, grey);"></div> <div style="text-align: center;">42%</div> </div> <div style="display: flex; justify-content: space-between; align-items: center; margin-top: 5px;"> <div style="text-align: center;">51%</div> <div style="width: 100%; height: 15px; background: linear-gradient(to right, red, orange, yellow, green, grey);"></div> <div style="text-align: center;">42%</div> </div>
1	E	127	<div style="display: flex; justify-content: space-between; align-items: center;"> <div style="text-align: center;">48%</div> <div style="width: 100%; height: 15px; background: linear-gradient(to right, red, orange, yellow, green, grey);"></div> <div style="text-align: center;">42%</div> </div> <div style="display: flex; justify-content: space-between; align-items: center; margin-top: 5px;"> <div style="text-align: center;">49%</div> <div style="width: 100%; height: 15px; background: linear-gradient(to right, red, orange, yellow, green, grey);"></div> <div style="text-align: center;">42%</div> </div>
1	F	127	<div style="display: flex; justify-content: space-between; align-items: center;"> <div style="text-align: center;">46%</div> <div style="width: 100%; height: 15px; background: linear-gradient(to right, red, orange, yellow, green, grey);"></div> <div style="text-align: center;">42%</div> </div> <div style="display: flex; justify-content: space-between; align-items: center; margin-top: 5px;"> <div style="text-align: center;">47%</div> <div style="width: 100%; height: 15px; background: linear-gradient(to right, red, orange, yellow, green, grey);"></div> <div style="text-align: center;">42%</div> </div>
1	G	127	<div style="display: flex; justify-content: space-between; align-items: center;"> <div style="text-align: center;">47%</div> <div style="width: 100%; height: 15px; background: linear-gradient(to right, red, orange, yellow, green, grey);"></div> <div style="text-align: center;">42%</div> </div> <div style="display: flex; justify-content: space-between; align-items: center; margin-top: 5px;"> <div style="text-align: center;">46%</div> <div style="width: 100%; height: 15px; background: linear-gradient(to right, red, orange, yellow, green, grey);"></div> <div style="text-align: center;">42%</div> </div>
1	H	127	<div style="display: flex; justify-content: space-between; align-items: center;"> <div style="text-align: center;">54%</div> <div style="width: 100%; height: 15px; background: linear-gradient(to right, red, orange, yellow, green, grey);"></div> <div style="text-align: center;">42%</div> </div> <div style="display: flex; justify-content: space-between; align-items: center; margin-top: 5px;"> <div style="text-align: center;">41%</div> <div style="width: 100%; height: 15px; background: linear-gradient(to right, red, orange, yellow, green, grey);"></div> <div style="text-align: center;">42%</div> </div>

Continued on next page...

Continued from previous page...

Mol	Chain	Length	Quality of chain
1	I	127	
1	J	127	
2	P	229	
3	Q	74	
4	R	199	
5	S	317	
6	T	562	
6	U	562	
6	V	562	
7	X	574	
7	Y	574	
7	Z	574	

2 Entry composition [i](#)

There are 10 unique types of molecules in this entry. The entry contains 33891 atoms, of which 0 are hydrogens and 0 are deuteriums.

In the tables below, the AltConf column contains the number of residues with at least one atom in alternate conformation and the Trace column contains the number of residues modelled with at most 2 atoms.

- Molecule 1 is a protein called Mitochondrial ATP synthase subunit c.

Mol	Chain	Residues	Atoms					AltConf	Trace
			Total	C	N	O	S		
1	A	74	514	340	83	88	3	0	0
1	B	74	514	340	83	88	3	0	0
1	C	74	514	340	83	88	3	0	0
1	D	74	514	340	83	88	3	0	0
1	E	74	514	340	83	88	3	0	0
1	F	74	514	340	83	88	3	0	0
1	G	74	514	340	83	88	3	0	0
1	H	74	514	340	83	88	3	0	0
1	I	74	514	340	83	88	3	0	0
1	J	74	514	340	83	88	3	0	0

- Molecule 2 is a protein called Mitochondrial ATP synthase subunit OSCP.

Mol	Chain	Residues	Atoms					AltConf	Trace
			Total	C	N	O	S		
2	P	114	895	576	147	171	1	0	0

- Molecule 3 is a protein called epsilon: Polytomella F-ATP synthase epsilon subunit.

Mol	Chain	Residues	Atoms					AltConf	Trace
			Total	C	N	O	S		
3	Q	72	561	358	102	99	2	0	0

- Molecule 4 is a protein called Mitochondrial ATP synthase subunit delta.

Mol	Chain	Residues	Atoms					AltConf	Trace
			Total	C	N	O	S		
4	R	177	1303	833	213	256	1	0	0

- Molecule 5 is a protein called ATP synthase gamma chain, mitochondrial.

Mol	Chain	Residues	Atoms					AltConf	Trace
			Total	C	N	O	S		
5	S	277	2130	1327	377	416	10	0	0

- Molecule 6 is a protein called ATP synthase subunit alpha.

Mol	Chain	Residues	Atoms					AltConf	Trace
			Total	C	N	O	S		
6	T	478	3609	2294	640	664	11	0	0
6	U	523	3980	2537	703	729	11	0	0
6	V	520	3962	2527	700	724	11	0	0

There are 3 discrepancies between the modelled and reference sequences:

Chain	Residue	Modelled	Actual	Comment	Reference
T	266	ARG	LYS	conflict	UNP A0ZW40
U	266	ARG	LYS	conflict	UNP A0ZW40
V	266	ARG	LYS	conflict	UNP A0ZW40

- Molecule 7 is a protein called ATP synthase subunit beta.

Mol	Chain	Residues	Atoms					AltConf	Trace
			Total	C	N	O	S		
7	X	542	4115	2586	696	820	13	0	0
7	Y	521	3957	2485	670	789	13	0	0
7	Z	538	4087	2568	692	814	13	0	0

There are 6 discrepancies between the modelled and reference sequences:

Chain	Residue	Modelled	Actual	Comment	Reference
X	350	ALA	GLY	conflict	UNP A0ZW41
X	387	LEU	ARG	conflict	UNP A0ZW41
Y	350	ALA	GLY	conflict	UNP A0ZW41

Continued on next page...

Continued from previous page...

Chain	Residue	Modelled	Actual	Comment	Reference
Y	387	LEU	ARG	conflict	UNP A0ZW41
Z	350	ALA	GLY	conflict	UNP A0ZW41
Z	387	LEU	ARG	conflict	UNP A0ZW41

- Molecule 8 is ADENOSINE-5'-TRIPHOSPHATE (three-letter code: ATP) (formula: $C_{10}H_{16}N_5O_{13}P_3$).

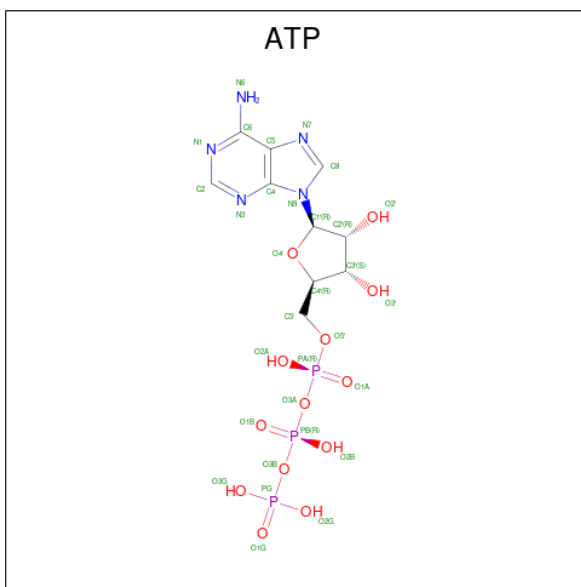

Mol	Chain	Residues	Atoms				AltConf	
			Total	C	N	O		P
8	T	1	Total	C	N	O	P	0
			31	10	5	13	3	
8	U	1	Total	C	N	O	P	0
			31	10	5	13	3	
8	V	1	Total	C	N	O	P	0
			31	10	5	13	3	

- Molecule 9 is MAGNESIUM ION (three-letter code: MG) (formula: Mg).

Mol	Chain	Residues	Atoms		AltConf
			Total	Mg	
9	T	1	Total	Mg	0
			1	1	
9	U	1	Total	Mg	0
			1	1	
9	V	1	Total	Mg	0
			1	1	
9	X	1	Total	Mg	0
			1	1	

Continued on next page...

Continued from previous page...

Mol	Chain	Residues	Atoms		AltConf
			Total	Mg	
9	Y	1	1	1	0

- Molecule 10 is ADENOSINE-5'-DIPHOSPHATE (three-letter code: ADP) (formula: $C_{10}H_{15}N_5O_{10}P_2$).

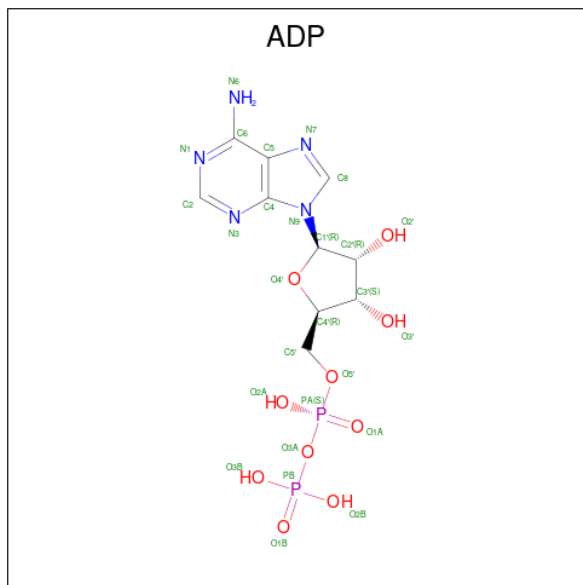

Mol	Chain	Residues	Atoms					AltConf
			Total	C	N	O	P	
10	X	1	27	10	5	10	2	0
10	Y	1	27	10	5	10	2	0

3 Residue-property plots [i](#)

These plots are drawn for all protein, RNA, DNA and oligosaccharide chains in the entry. The first graphic for a chain summarises the proportions of the various outlier classes displayed in the second graphic. The second graphic shows the sequence view annotated by issues in geometry and atom inclusion in map density. Residues are color-coded according to the number of geometric quality criteria for which they contain at least one outlier: green = 0, yellow = 1, orange = 2 and red = 3 or more. A red diamond above a residue indicates a poor fit to the EM map for this residue (all-atom inclusion < 40%). Stretches of 2 or more consecutive residues without any outlier are shown as a green connector. Residues present in the sample, but not in the model, are shown in grey.

- Molecule 1: Mitochondrial ATP synthase subunit c

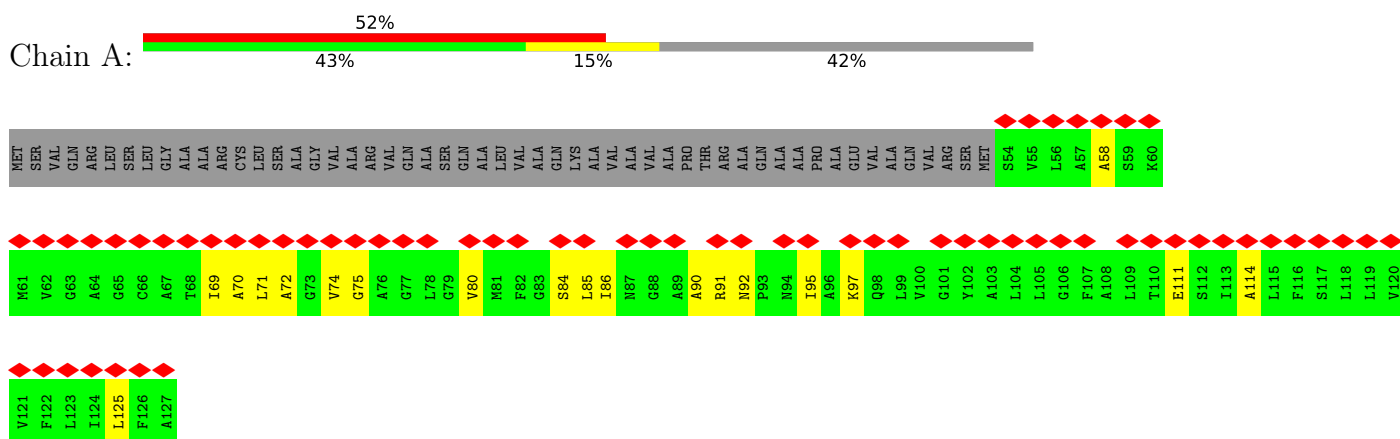

- Molecule 1: Mitochondrial ATP synthase subunit c

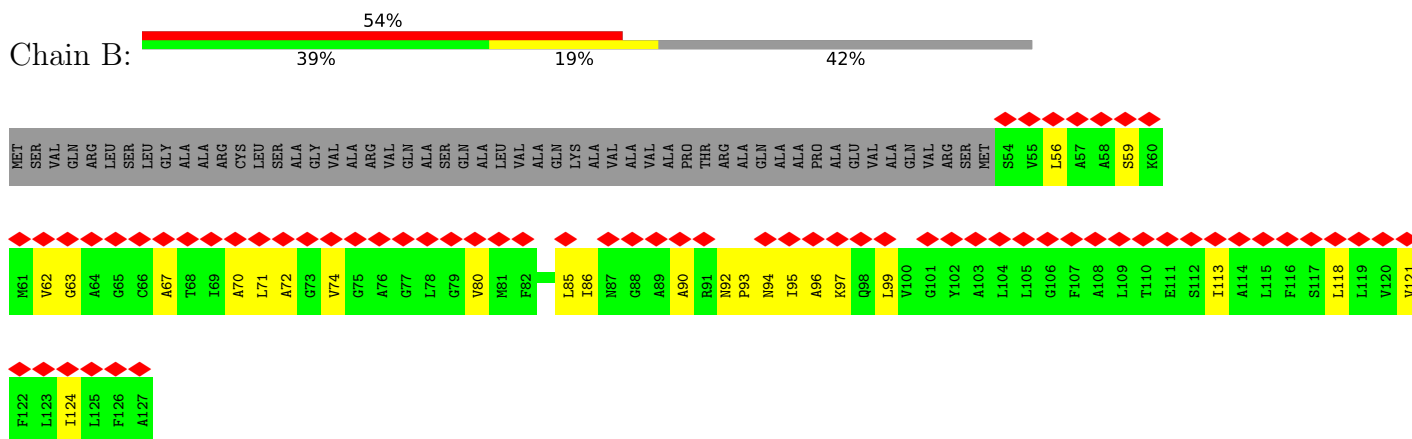

- Molecule 1: Mitochondrial ATP synthase subunit c

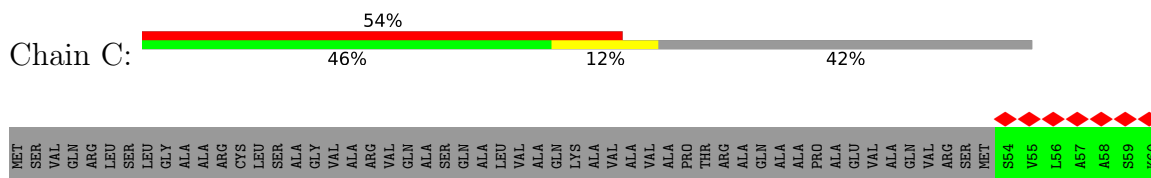

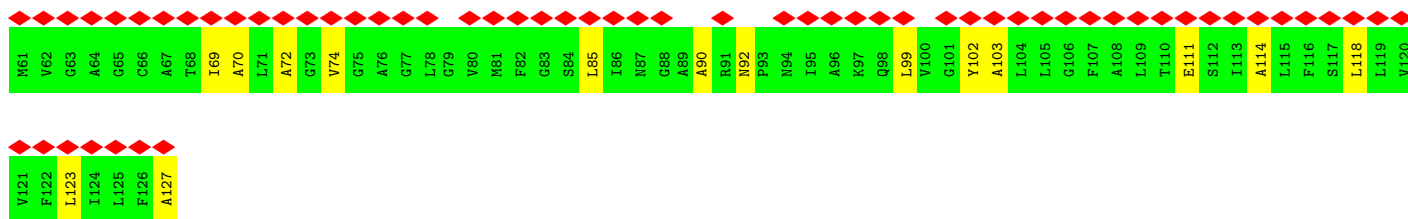

• Molecule 1: Mitochondrial ATP synthase subunit c

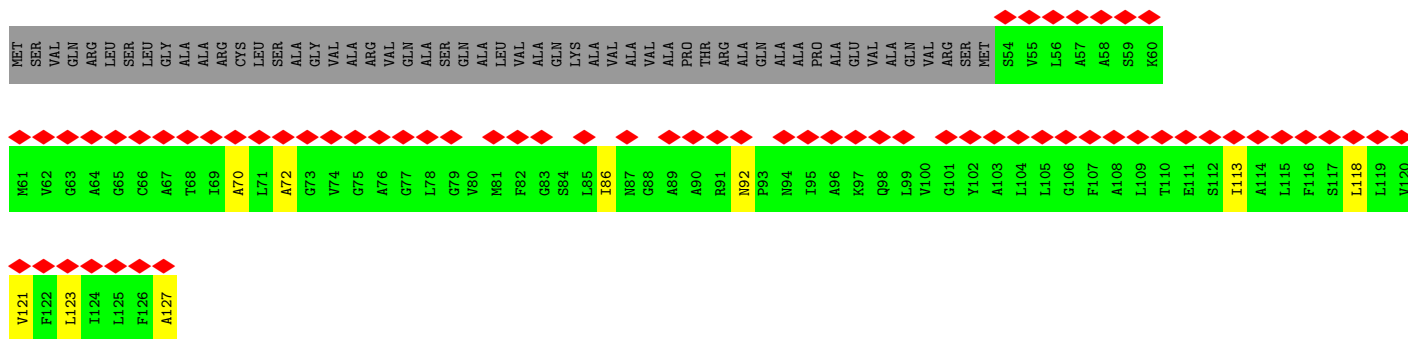

• Molecule 1: Mitochondrial ATP synthase subunit c

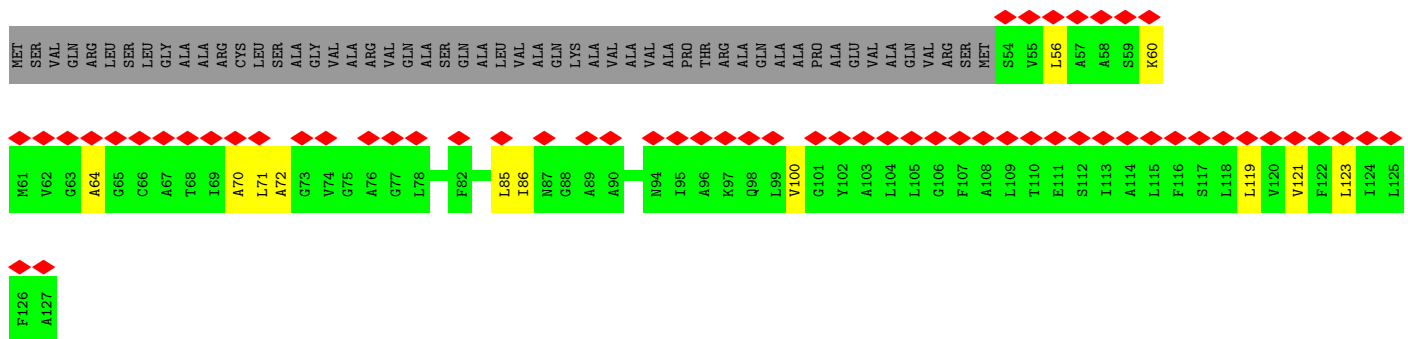

• Molecule 1: Mitochondrial ATP synthase subunit c

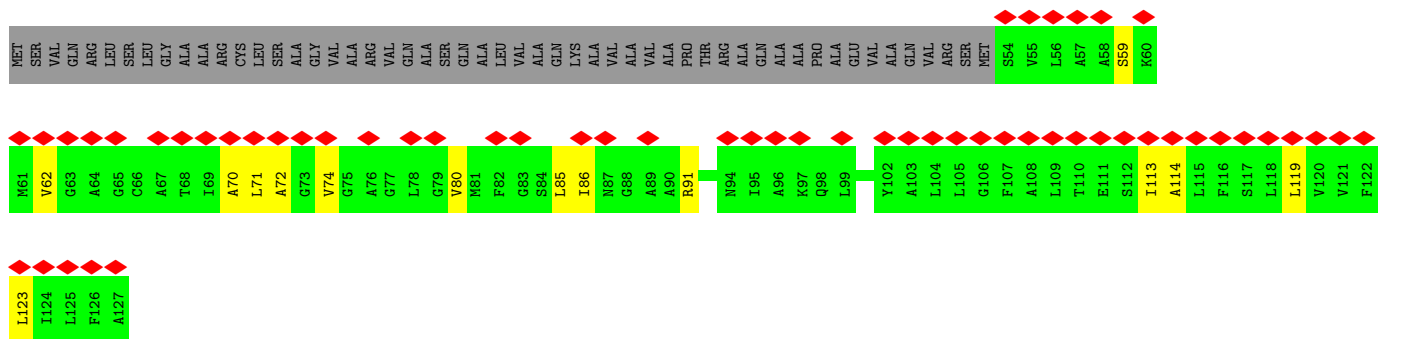

• Molecule 1: Mitochondrial ATP synthase subunit c

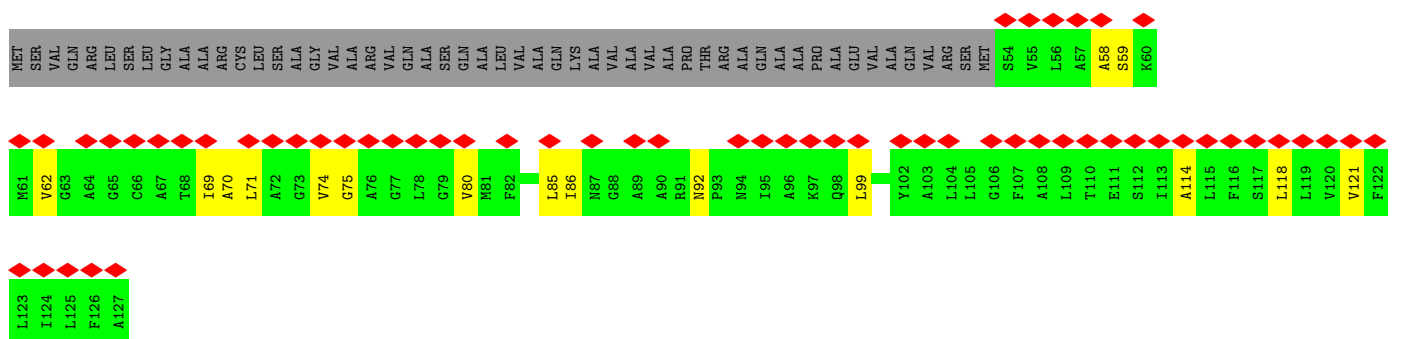
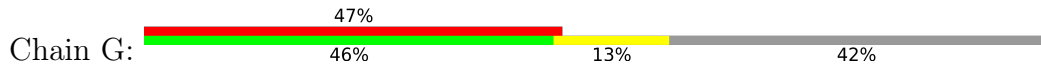

• Molecule 1: Mitochondrial ATP synthase subunit c

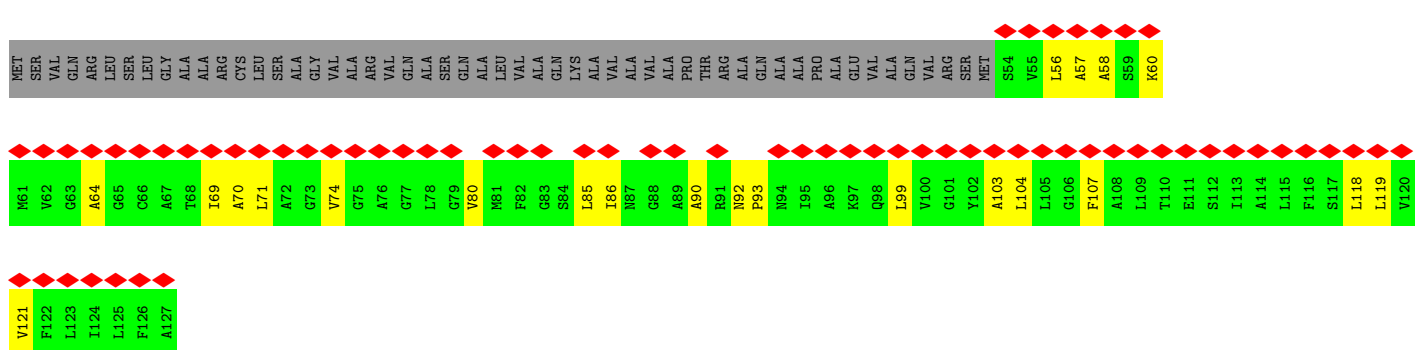
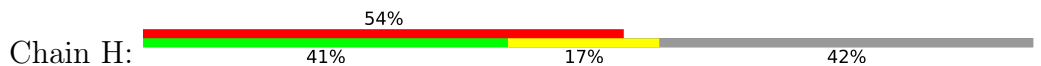

• Molecule 1: Mitochondrial ATP synthase subunit c

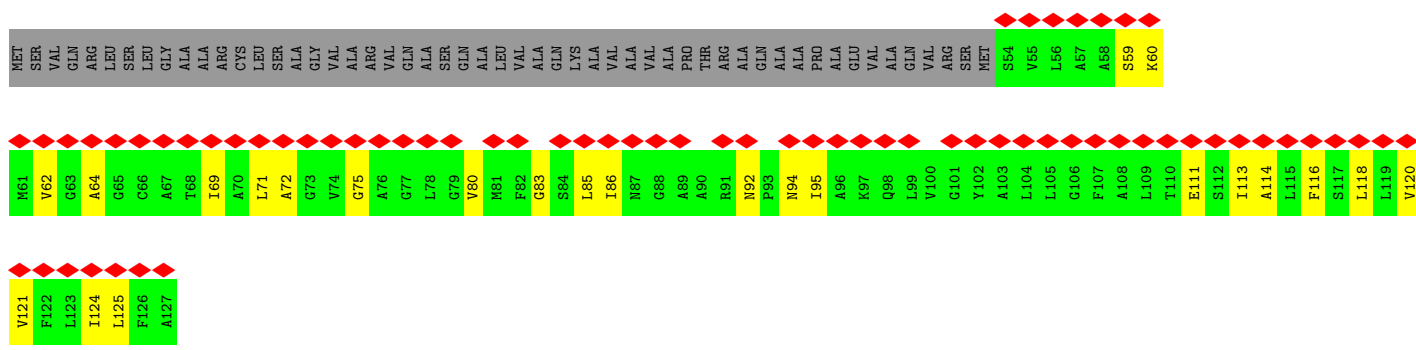

• Molecule 1: Mitochondrial ATP synthase subunit c

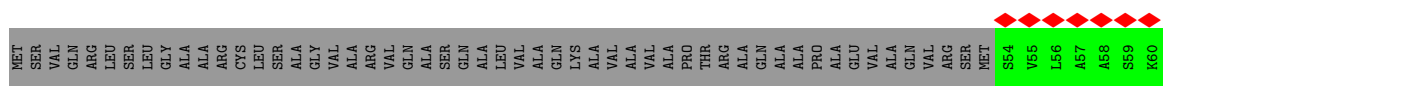

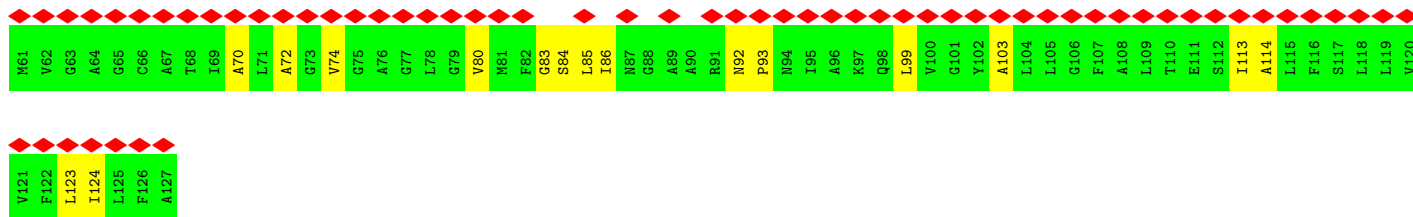

• Molecule 2: Mitochondrial ATP synthase subunit OSCP

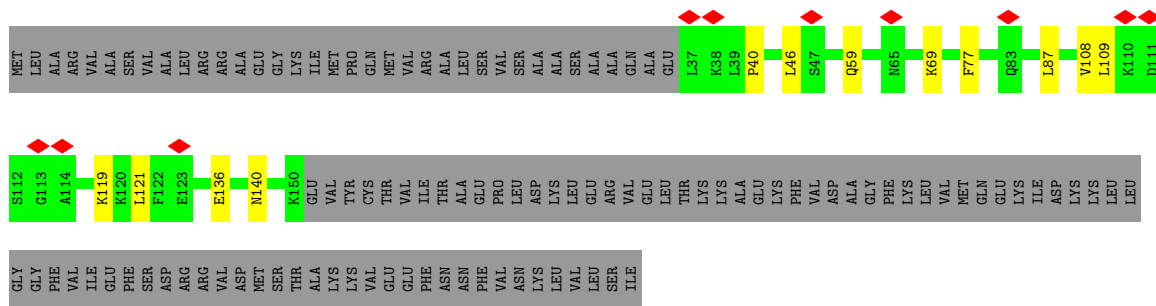

• Molecule 3: epsilon: Polytomella F-ATP synthase epsilon subunit

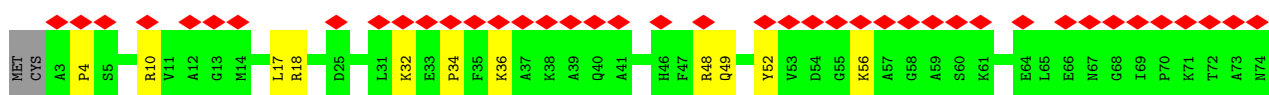
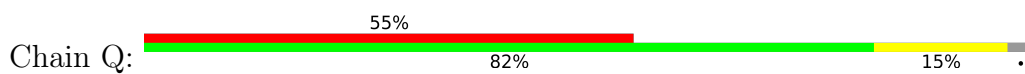

• Molecule 4: Mitochondrial ATP synthase subunit delta

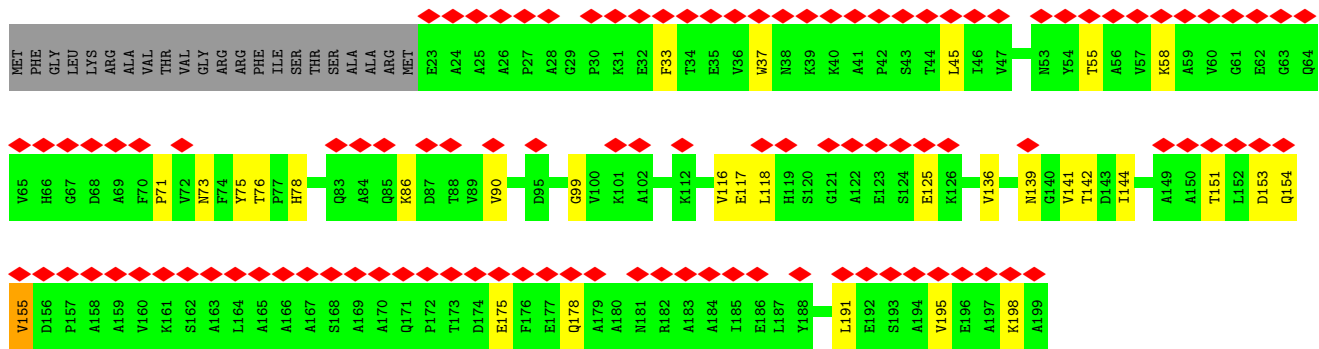
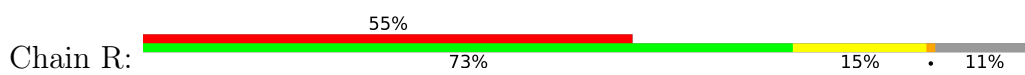

• Molecule 5: ATP synthase gamma chain, mitochondrial

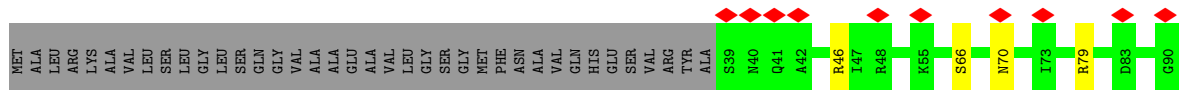

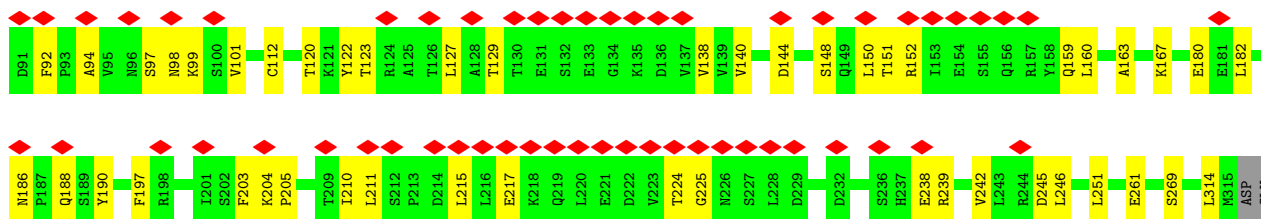

• Molecule 6: ATP synthase subunit alpha

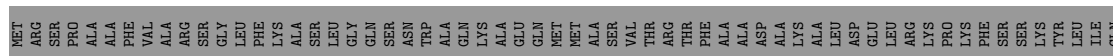
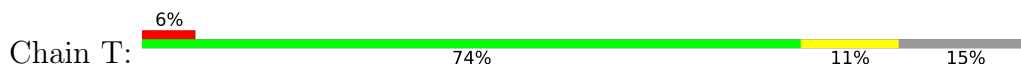

• Molecule 6: ATP synthase subunit alpha

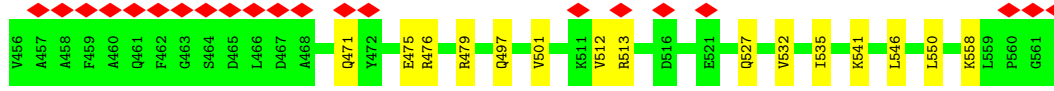
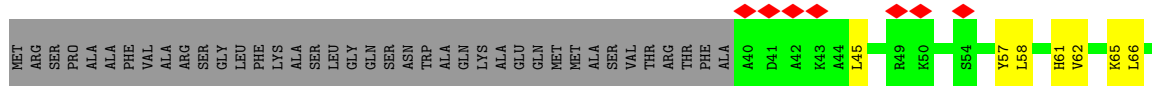
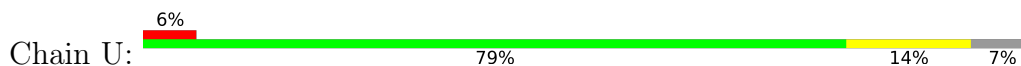

• Molecule 6: ATP synthase subunit alpha

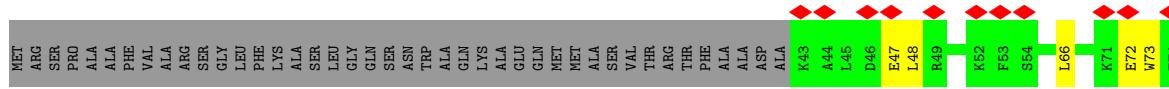
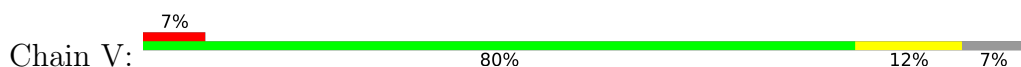

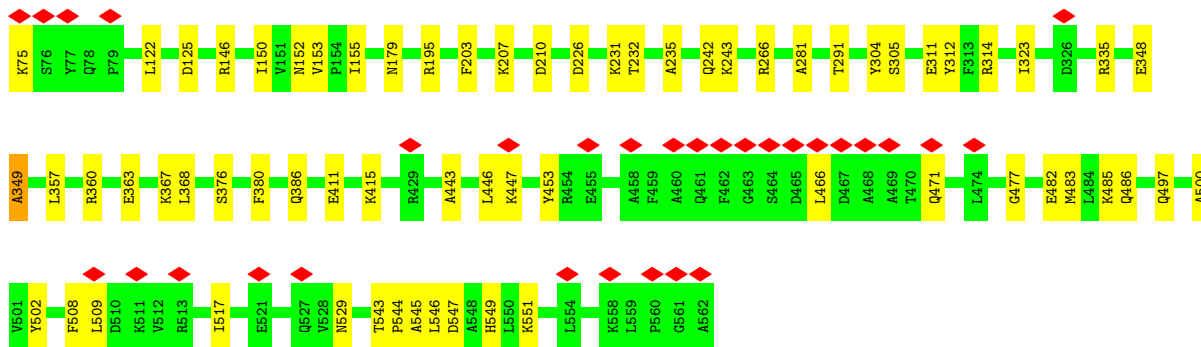

• Molecule 7: ATP synthase subunit beta

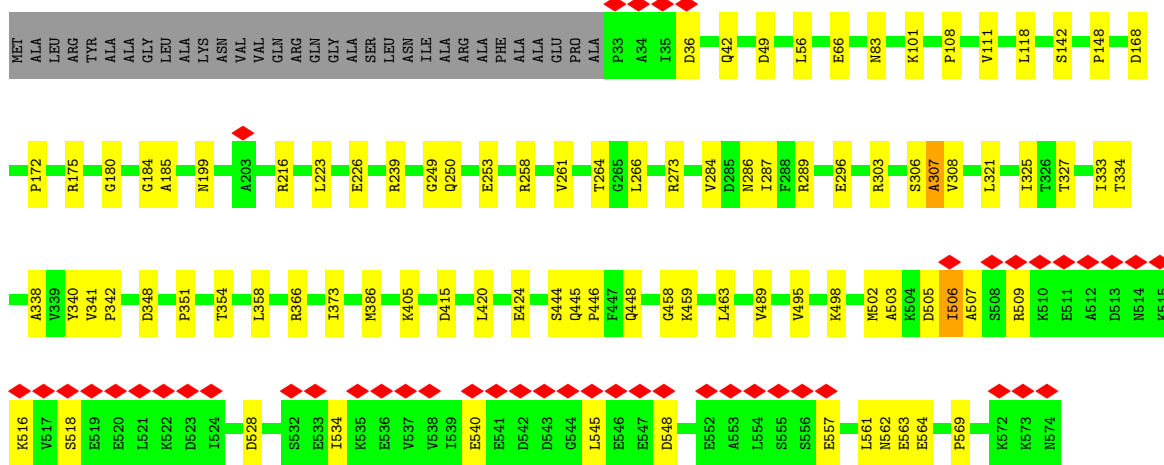
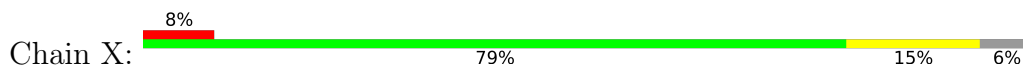

• Molecule 7: ATP synthase subunit beta

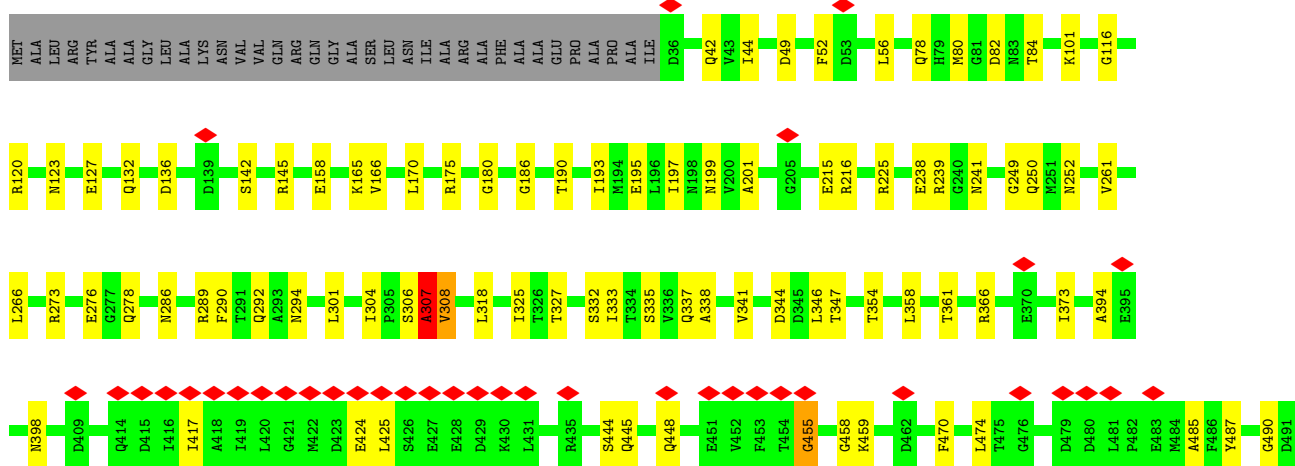
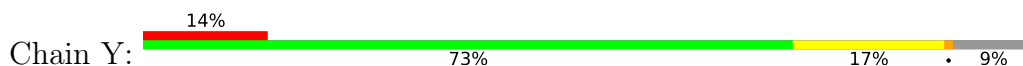

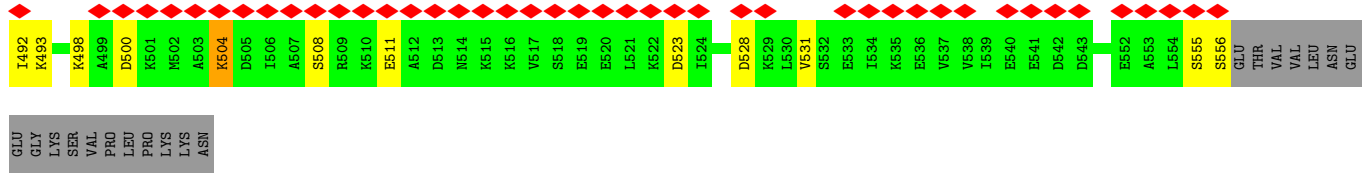

• Molecule 7: ATP synthase subunit beta

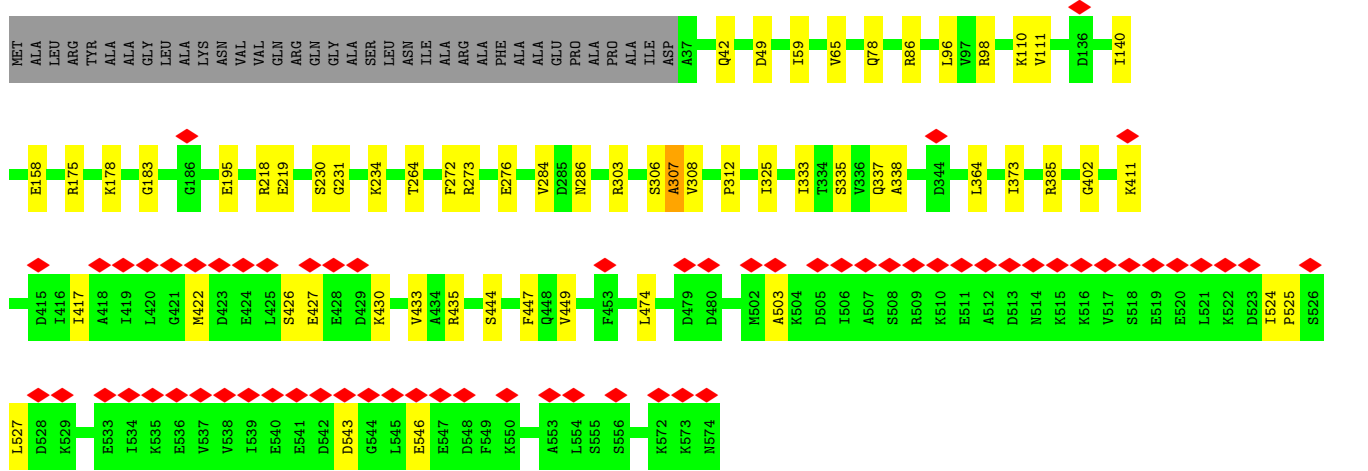
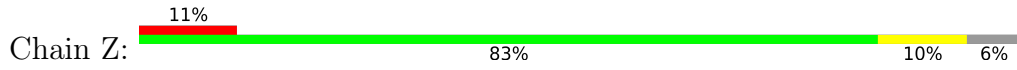

4 Experimental information

Property	Value	Source
EM reconstruction method	SINGLE PARTICLE	Depositor
Imposed symmetry	POINT, Not provided	
Number of particles used	112810	Depositor
Resolution determination method	FSC 0.143 CUT-OFF	Depositor
CTF correction method	PHASE FLIPPING AND AMPLITUDE CORRECTION	Depositor
Microscope	FEI TITAN KRIOS	Depositor
Voltage (kV)	300	Depositor
Electron dose ($e^-/\text{\AA}^2$)	35	Depositor
Minimum defocus (nm)	-400	Depositor
Maximum defocus (nm)	-5000	Depositor
Magnification	75000	Depositor
Image detector	FEI FALCON III (4k x 4k)	Depositor
Maximum map value	0.247	Depositor
Minimum map value	-0.120	Depositor
Average map value	-0.000	Depositor
Map value standard deviation	0.006	Depositor
Recommended contour level	0.04	Depositor
Map size (\AA)	505.44, 505.44, 505.44	wwPDB
Map dimensions	480, 480, 480	wwPDB
Map angles ($^\circ$)	90.0, 90.0, 90.0	wwPDB
Pixel spacing (\AA)	1.053, 1.053, 1.053	Depositor

5 Model quality i

5.1 Standard geometry i

Bond lengths and bond angles in the following residue types are not validated in this section: ATP, ADP, MG

The Z score for a bond length (or angle) is the number of standard deviations the observed value is removed from the expected value. A bond length (or angle) with $|Z| > 5$ is considered an outlier worth inspection. RMSZ is the root-mean-square of all Z scores of the bond lengths (or angles).

Mol	Chain	Bond lengths		Bond angles	
		RMSZ	# Z >5	RMSZ	# Z >5
1	A	0.38	0/520	0.56	0/704
1	B	0.39	0/520	0.63	2/704 (0.3%)
1	C	0.35	0/519	0.61	0/701
1	D	0.32	0/520	0.58	0/704
1	E	0.32	0/520	0.63	0/704
1	F	0.34	0/520	0.56	0/704
1	G	0.35	0/520	0.56	0/704
1	H	0.36	0/520	0.66	0/704
1	I	0.33	0/520	0.60	0/704
1	J	0.35	0/520	0.56	1/704 (0.1%)
2	P	0.42	0/908	0.57	0/1229
3	Q	0.36	0/574	0.58	0/774
4	R	0.42	0/1336	0.57	1/1827 (0.1%)
5	S	0.43	0/2153	0.59	0/2901
6	T	0.57	0/3667	0.61	0/4965
6	U	0.59	0/4049	0.63	2/5481 (0.0%)
6	V	0.53	0/4031	0.61	0/5456
7	X	0.57	0/4176	0.61	1/5659 (0.0%)
7	Y	0.49	0/4015	0.58	0/5440
7	Z	0.53	0/4147	0.59	0/5619
All	All	0.50	0/34255	0.60	7/46388 (0.0%)

Chiral center outliers are detected by calculating the chiral volume of a chiral center and verifying if the center is modelled as a planar moiety or with the opposite hand. A planarity outlier is detected by checking planarity of atoms in a peptide group, atoms in a mainchain group or atoms of a sidechain that are expected to be planar.

Mol	Chain	#Chirality outliers	#Planarity outliers
6	T	0	1
6	U	0	1
6	V	0	2

Continued on next page...

Continued from previous page...

Mol	Chain	#Chirality outliers	#Planarity outliers
7	X	0	1
7	Y	0	4
7	Z	0	2
All	All	0	11

There are no bond length outliers.

The worst 5 of 7 bond angle outliers are listed below:

Mol	Chain	Res	Type	Atoms	Z	Observed(°)	Ideal(°)
7	X	36	ASP	CB-CG-OD1	6.60	124.24	118.30
1	B	95	ILE	CG1-CB-CG2	-6.05	98.09	111.40
1	J	123	LEU	CA-CB-CG	5.34	127.57	115.30
4	R	155	VAL	C-N-CA	-5.28	108.50	121.70
1	B	56	LEU	CA-CB-CG	5.09	127.01	115.30

There are no chirality outliers.

5 of 11 planarity outliers are listed below:

Mol	Chain	Res	Type	Group
6	T	348	GLU	Peptide
6	U	348	GLU	Peptide
6	V	348	GLU	Peptide
6	V	75	LYS	Peptide
7	X	307	ALA	Peptide

5.2 Too-close contacts [i](#)

In the following table, the Non-H and H(model) columns list the number of non-hydrogen atoms and hydrogen atoms in the chain respectively. The H(added) column lists the number of hydrogen atoms added and optimized by MolProbity. The Clashes column lists the number of clashes within the asymmetric unit, whereas Symm-Clashes lists symmetry-related clashes.

Mol	Chain	Non-H	H(model)	H(added)	Clashes	Symm-Clashes
1	A	514	0	554	20	0
1	B	514	0	554	21	0
1	C	514	0	553	16	0
1	D	514	0	554	12	0
1	E	514	0	554	9	0
1	F	514	0	554	12	0
1	G	514	0	554	15	0

Continued on next page...

Continued from previous page...

Mol	Chain	Non-H	H(model)	H(added)	Clashes	Symm-Clashes
1	H	514	0	554	20	0
1	I	514	0	554	24	0
1	J	514	0	554	19	0
2	P	895	0	934	9	0
3	Q	561	0	565	13	0
4	R	1303	0	1266	21	0
5	S	2130	0	2180	39	0
6	T	3609	0	3731	47	0
6	U	3980	0	4119	53	0
6	V	3962	0	4105	44	0
7	X	4115	0	4137	57	0
7	Y	3957	0	3966	62	0
7	Z	4087	0	4110	35	0
8	T	31	0	12	0	0
8	U	31	0	12	1	0
8	V	31	0	12	1	0
9	T	1	0	0	0	0
9	U	1	0	0	0	0
9	V	1	0	0	0	0
9	X	1	0	0	0	0
9	Y	1	0	0	0	0
10	X	27	0	12	0	0
10	Y	27	0	12	2	0
All	All	33891	0	34712	445	0

The all-atom clashscore is defined as the number of clashes found per 1000 atoms (including hydrogen atoms). The all-atom clashscore for this structure is 6.

The worst 5 of 445 close contacts within the same asymmetric unit are listed below, sorted by their clash magnitude.

Atom-1	Atom-2	Interatomic distance (Å)	Clash overlap (Å)
6:T:453:TYR:CE1	6:T:474:LEU:HD12	1.63	1.32
7:X:498:LYS:O	7:X:502:MET:HG3	1.51	1.08
6:T:453:TYR:CE1	6:T:474:LEU:CD1	2.50	0.93
6:T:453:TYR:HE1	6:T:474:LEU:HD12	1.28	0.88
7:Y:500:ASP:O	7:Y:504:LYS:HG2	1.75	0.86

There are no symmetry-related clashes.

5.3 Torsion angles [i](#)

5.3.1 Protein backbone [i](#)

In the following table, the Percentiles column shows the percent Ramachandran outliers of the chain as a percentile score with respect to all PDB entries followed by that with respect to all EM entries.

The Analysed column shows the number of residues for which the backbone conformation was analysed, and the total number of residues.

Mol	Chain	Analysed	Favoured	Allowed	Outliers	Percentiles	
1	A	72/127 (57%)	70 (97%)	2 (3%)	0	100	100
1	B	72/127 (57%)	69 (96%)	3 (4%)	0	100	100
1	C	71/127 (56%)	68 (96%)	3 (4%)	0	100	100
1	D	72/127 (57%)	70 (97%)	2 (3%)	0	100	100
1	E	72/127 (57%)	70 (97%)	2 (3%)	0	100	100
1	F	72/127 (57%)	70 (97%)	2 (3%)	0	100	100
1	G	72/127 (57%)	70 (97%)	2 (3%)	0	100	100
1	H	72/127 (57%)	72 (100%)	0	0	100	100
1	I	72/127 (57%)	66 (92%)	6 (8%)	0	100	100
1	J	72/127 (57%)	71 (99%)	1 (1%)	0	100	100
2	P	112/229 (49%)	101 (90%)	11 (10%)	0	100	100
3	Q	70/74 (95%)	68 (97%)	2 (3%)	0	100	100
4	R	175/199 (88%)	160 (91%)	15 (9%)	0	100	100
5	S	275/317 (87%)	262 (95%)	13 (5%)	0	100	100
6	T	476/562 (85%)	452 (95%)	21 (4%)	3 (1%)	25	56
6	U	521/562 (93%)	489 (94%)	31 (6%)	1 (0%)	47	78
6	V	518/562 (92%)	496 (96%)	21 (4%)	1 (0%)	47	78
7	X	540/574 (94%)	503 (93%)	35 (6%)	2 (0%)	34	66
7	Y	519/574 (90%)	478 (92%)	38 (7%)	3 (1%)	25	56
7	Z	536/574 (93%)	503 (94%)	31 (6%)	2 (0%)	34	66
All	All	4461/5497 (81%)	4208 (94%)	241 (5%)	12 (0%)	44	72

5 of 12 Ramachandran outliers are listed below:

Mol	Chain	Res	Type
7	X	308	VAL

Continued on next page...

Continued from previous page...

Mol	Chain	Res	Type
7	Z	308	VAL
6	T	493	PRO
6	U	349	ALA
6	V	349	ALA

5.3.2 Protein sidechains [i](#)

In the following table, the Percentiles column shows the percent sidechain outliers of the chain as a percentile score with respect to all PDB entries followed by that with respect to all EM entries.

The Analysed column shows the number of residues for which the sidechain conformation was analysed, and the total number of residues.

Mol	Chain	Analysed	Rotameric	Outliers	Percentiles	
1	A	50/86 (58%)	50 (100%)	0	100	100
1	B	50/86 (58%)	49 (98%)	1 (2%)	55	84
1	C	50/86 (58%)	50 (100%)	0	100	100
1	D	50/86 (58%)	50 (100%)	0	100	100
1	E	50/86 (58%)	50 (100%)	0	100	100
1	F	50/86 (58%)	50 (100%)	0	100	100
1	G	50/86 (58%)	50 (100%)	0	100	100
1	H	50/86 (58%)	49 (98%)	1 (2%)	55	84
1	I	50/86 (58%)	50 (100%)	0	100	100
1	J	50/86 (58%)	50 (100%)	0	100	100
2	P	99/196 (50%)	99 (100%)	0	100	100
3	Q	56/58 (97%)	56 (100%)	0	100	100
4	R	134/151 (89%)	134 (100%)	0	100	100
5	S	235/265 (89%)	234 (100%)	1 (0%)	91	97
6	T	378/448 (84%)	376 (100%)	2 (0%)	88	96
6	U	419/448 (94%)	417 (100%)	2 (0%)	88	96
6	V	418/448 (93%)	417 (100%)	1 (0%)	93	98
7	X	449/469 (96%)	449 (100%)	0	100	100
7	Y	430/469 (92%)	427 (99%)	3 (1%)	84	95
7	Z	446/469 (95%)	445 (100%)	1 (0%)	93	98

Continued on next page...

Continued from previous page...

Mol	Chain	Analysed	Rotameric	Outliers	Percentiles
All	All	3564/4281 (83%)	3552 (100%)	12 (0%)	92 98

5 of 12 residues with a non-rotameric sidechain are listed below:

Mol	Chain	Res	Type
6	V	146	ARG
7	Y	82	ASP
7	Z	411	LYS
7	Y	417	ILE
6	T	180	VAL

Sometimes sidechains can be flipped to improve hydrogen bonding and reduce clashes. 5 of 51 such sidechains are listed below:

Mol	Chain	Res	Type
6	V	60	GLN
6	V	278	GLN
7	Z	398	ASN
6	V	121	ASN
6	V	152	ASN

5.3.3 RNA [i](#)

There are no RNA molecules in this entry.

5.4 Non-standard residues in protein, DNA, RNA chains [i](#)

There are no non-standard protein/DNA/RNA residues in this entry.

5.5 Carbohydrates [i](#)

There are no monosaccharides in this entry.

5.6 Ligand geometry [i](#)

Of 10 ligands modelled in this entry, 5 are monoatomic - leaving 5 for Mogul analysis.

In the following table, the Counts columns list the number of bonds (or angles) for which Mogul statistics could be retrieved, the number of bonds (or angles) that are observed in the model and the number of bonds (or angles) that are defined in the Chemical Component Dictionary. The

Link column lists molecule types, if any, to which the group is linked. The Z score for a bond length (or angle) is the number of standard deviations the observed value is removed from the expected value. A bond length (or angle) with $|Z| > 2$ is considered an outlier worth inspection. RMSZ is the root-mean-square of all Z scores of the bond lengths (or angles).

Mol	Type	Chain	Res	Link	Bond lengths			Bond angles		
					Counts	RMSZ	# Z > 2	Counts	RMSZ	# Z > 2
8	ATP	U	1001	9	26,33,33	0.97	0	31,52,52	1.47	5 (16%)
8	ATP	T	1001	9	26,33,33	0.99	1 (3%)	31,52,52	1.60	6 (19%)
10	ADP	X	601	9	24,29,29	0.99	0	29,45,45	1.36	4 (13%)
10	ADP	Y	601	9	24,29,29	0.97	1 (4%)	29,45,45	1.39	4 (13%)
8	ATP	V	1001	9	26,33,33	0.97	1 (3%)	31,52,52	1.43	4 (12%)

In the following table, the Chirals column lists the number of chiral outliers, the number of chiral centers analysed, the number of these observed in the model and the number defined in the Chemical Component Dictionary. Similar counts are reported in the Torsion and Rings columns. '-' means no outliers of that kind were identified.

Mol	Type	Chain	Res	Link	Chirals	Torsions	Rings
8	ATP	U	1001	9	-	2/18/38/38	0/3/3/3
8	ATP	T	1001	9	-	4/18/38/38	0/3/3/3
10	ADP	X	601	9	-	0/12/32/32	0/3/3/3
10	ADP	Y	601	9	-	5/12/32/32	0/3/3/3
8	ATP	V	1001	9	-	2/18/38/38	0/3/3/3

All (3) bond length outliers are listed below:

Mol	Chain	Res	Type	Atoms	Z	Observed(Å)	Ideal(Å)
10	Y	601	ADP	C5-C4	2.26	1.46	1.40
8	T	1001	ATP	C2'-C1'	-2.12	1.50	1.53
8	V	1001	ATP	C5-C4	2.00	1.46	1.40

The worst 5 of 23 bond angle outliers are listed below:

Mol	Chain	Res	Type	Atoms	Z	Observed(°)	Ideal(°)
8	U	1001	ATP	PB-O3B-PG	-3.51	120.79	132.83
8	V	1001	ATP	PB-O3B-PG	-3.48	120.87	132.83
8	T	1001	ATP	N3-C2-N1	-3.44	123.30	128.68
10	X	601	ADP	N3-C2-N1	-3.32	123.49	128.68
8	T	1001	ATP	C3'-C2'-C1'	3.31	105.96	100.98

There are no chirality outliers.

5 of 13 torsion outliers are listed below:

Mol	Chain	Res	Type	Atoms
10	Y	601	ADP	C5'-O5'-PA-O1A
10	Y	601	ADP	C5'-O5'-PA-O2A
8	U	1001	ATP	PA-O3A-PB-O1B
8	T	1001	ATP	C5'-O5'-PA-O3A
10	Y	601	ADP	C5'-O5'-PA-O3A

There are no ring outliers.

3 monomers are involved in 4 short contacts:

Mol	Chain	Res	Type	Clashes	Symm-Clashes
8	U	1001	ATP	1	0
10	Y	601	ADP	2	0
8	V	1001	ATP	1	0

The following is a two-dimensional graphical depiction of Mogul quality analysis of bond lengths, bond angles, torsion angles, and ring geometry for all instances of the Ligand of Interest. In addition, ligands with molecular weight > 250 and outliers as shown on the validation Tables will also be included. For torsion angles, if less than 5% of the Mogul distribution of torsion angles is within 10 degrees of the torsion angle in question, then that torsion angle is considered an outlier. Any bond that is central to one or more torsion angles identified as an outlier by Mogul will be highlighted in the graph. For rings, the root-mean-square deviation (RMSD) between the ring in question and similar rings identified by Mogul is calculated over all ring torsion angles. If the average RMSD is greater than 60 degrees and the minimal RMSD between the ring in question and any Mogul-identified rings is also greater than 60 degrees, then that ring is considered an outlier. The outliers are highlighted in purple. The color gray indicates Mogul did not find sufficient equivalents in the CSD to analyse the geometry.

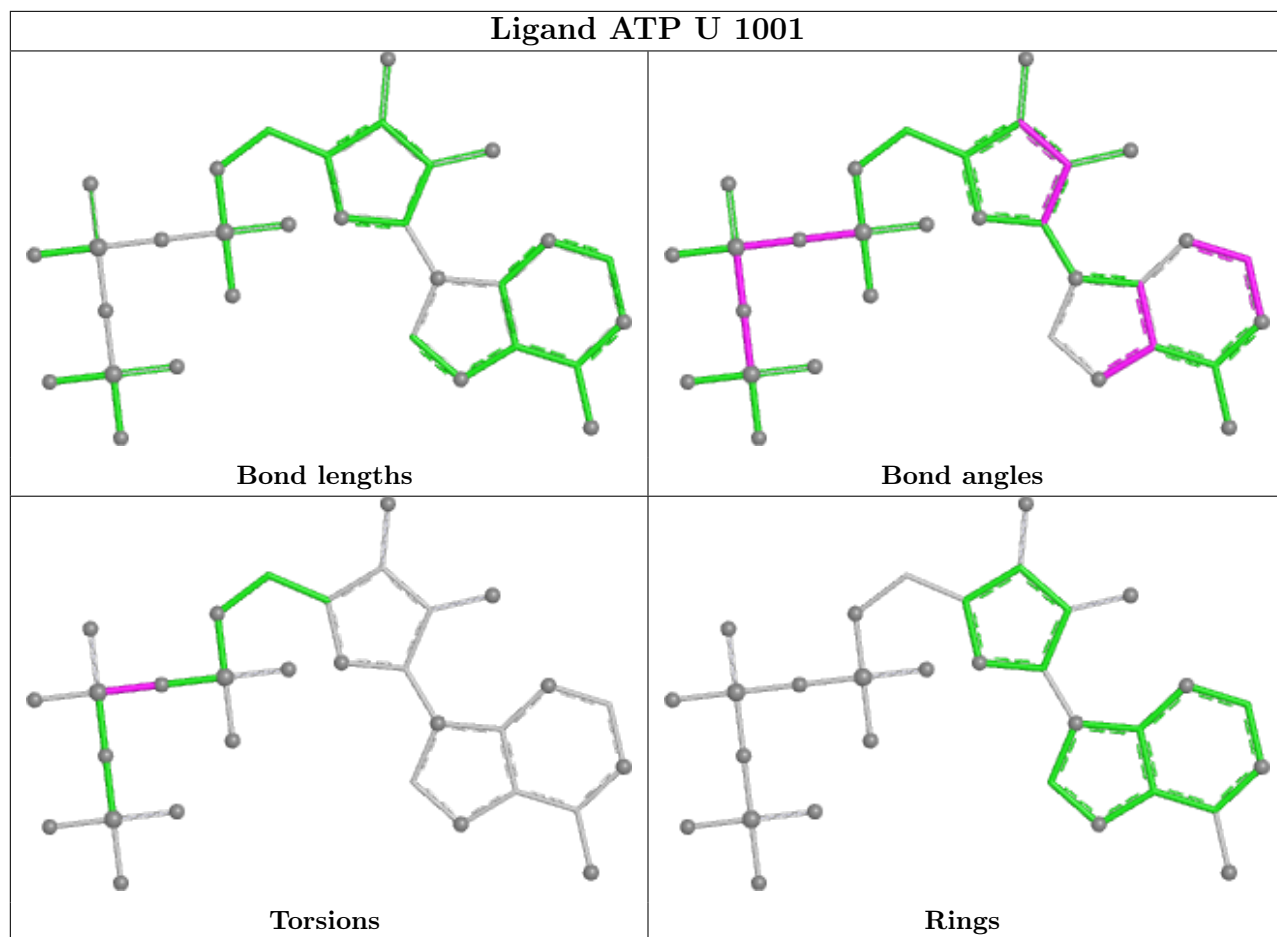

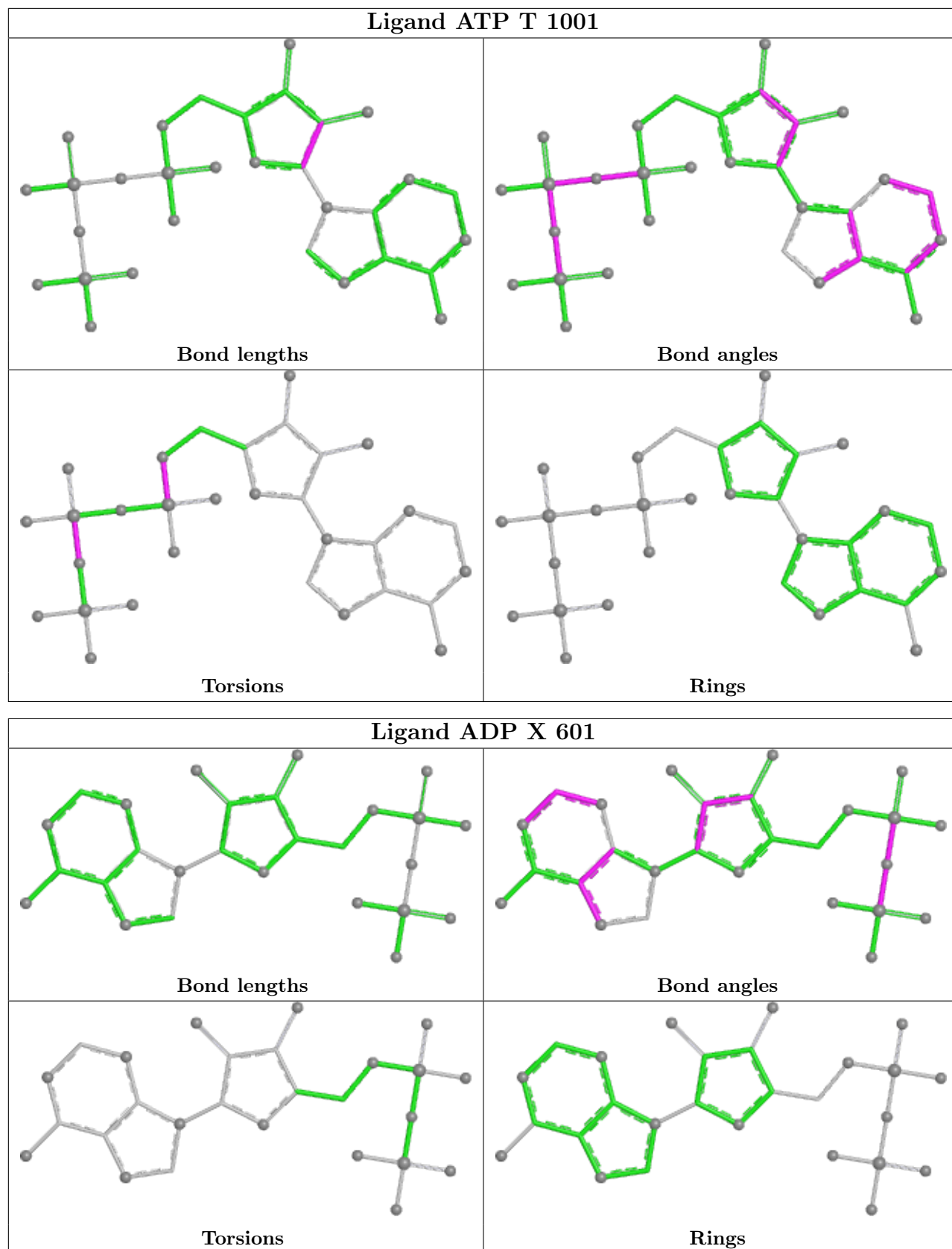

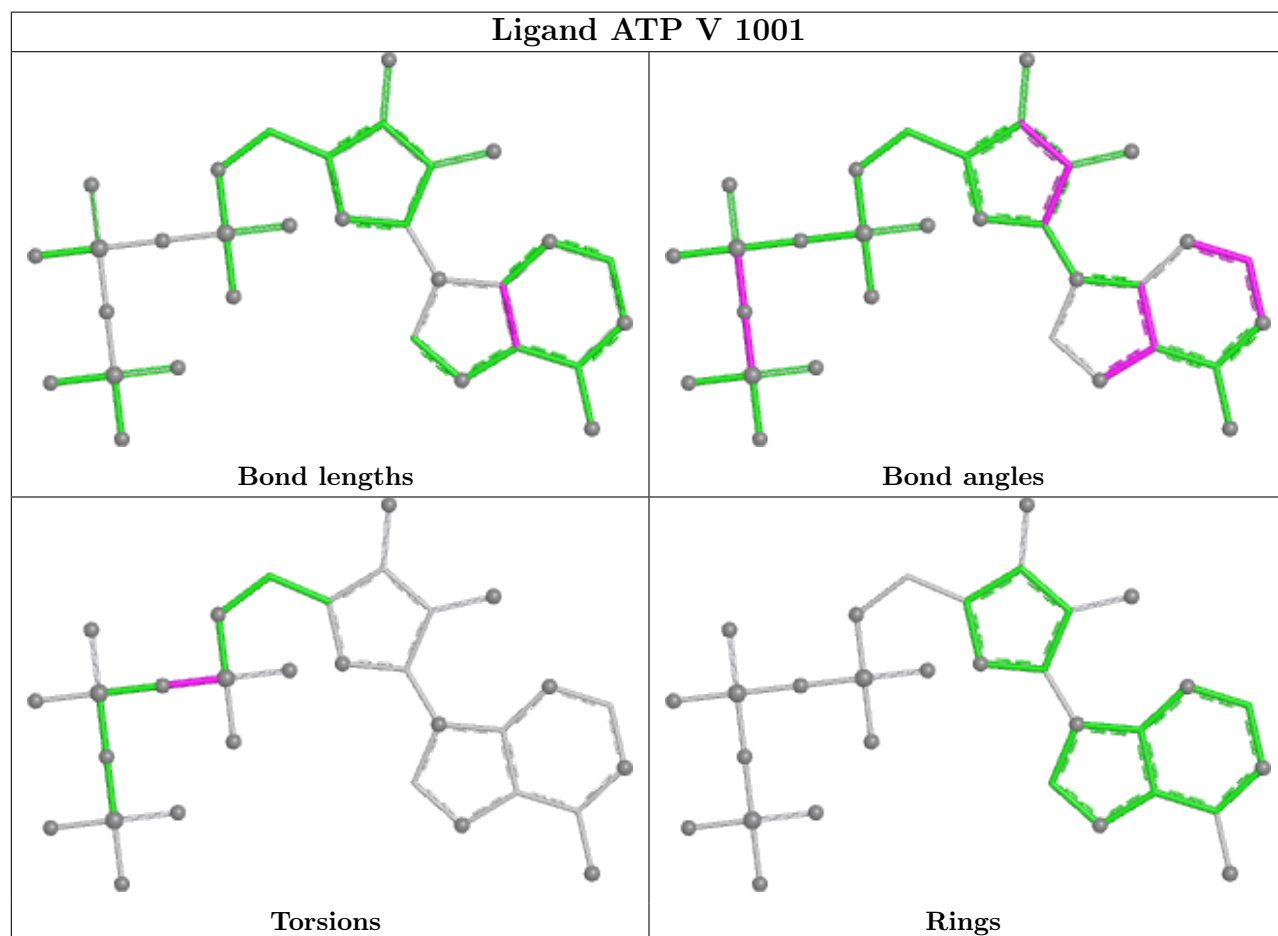
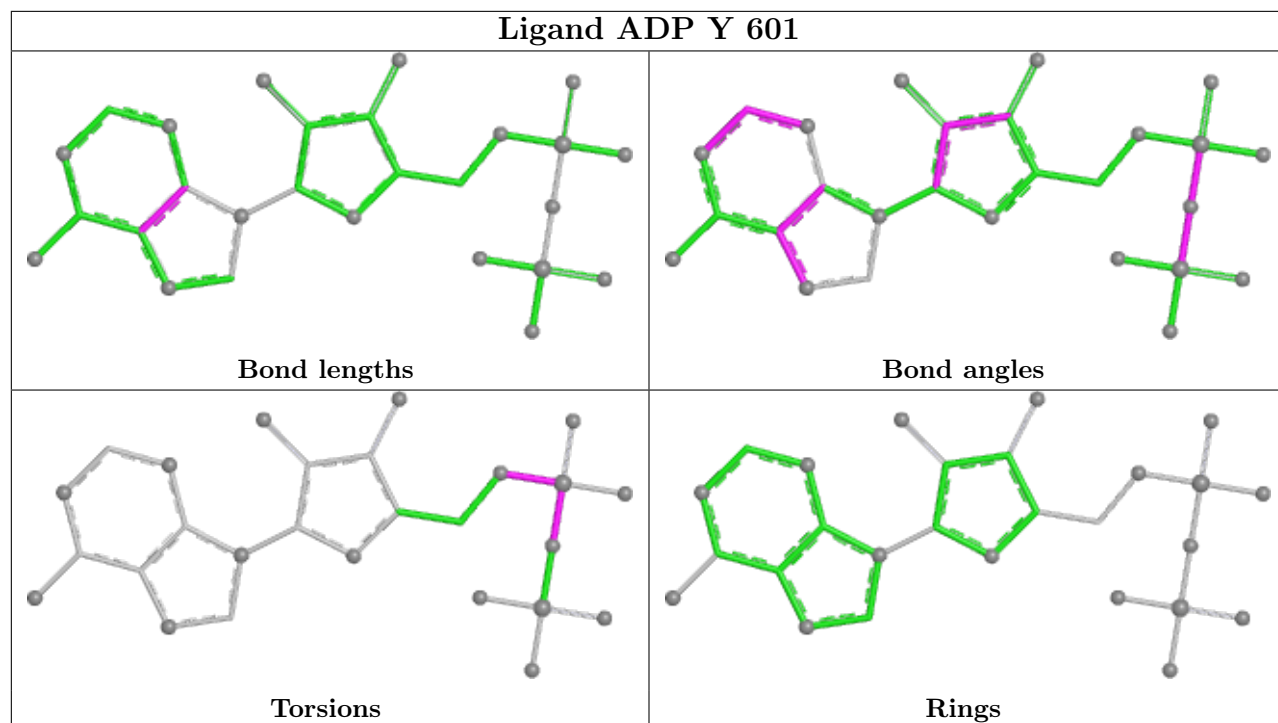

5.7 Other polymers [i](#)

There are no such residues in this entry.

5.8 Polymer linkage issues [i](#)

The following chains have linkage breaks:

Mol	Chain	Number of breaks
1	C	1

All chain breaks are listed below:

Model	Chain	Residue-1	Atom-1	Residue-2	Atom-2	Distance (Å)
1	C	126:PHE	C	127:ALA	N	3.51

6 Map visualisation [i](#)

This section contains visualisations of the EMDB entry EMD-4826. These allow visual inspection of the internal detail of the map and identification of artifacts.

Images derived from a raw map, generated by summing the deposited half-maps, are presented below the corresponding image components of the primary map to allow further visual inspection and comparison with those of the primary map.

6.1 Orthogonal projections [i](#)

6.1.1 Primary map

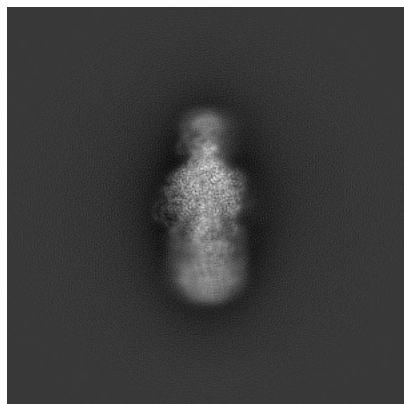

X

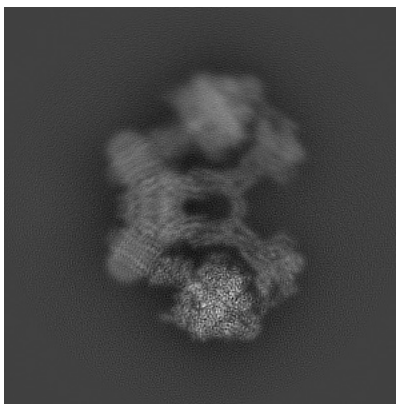

Y

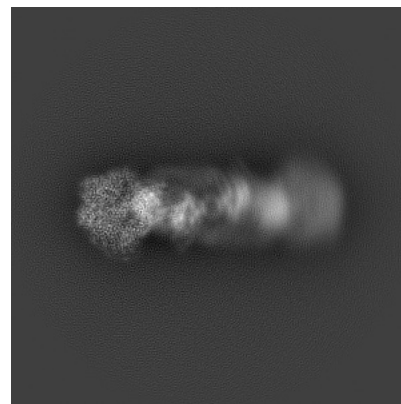

Z

6.1.2 Raw map

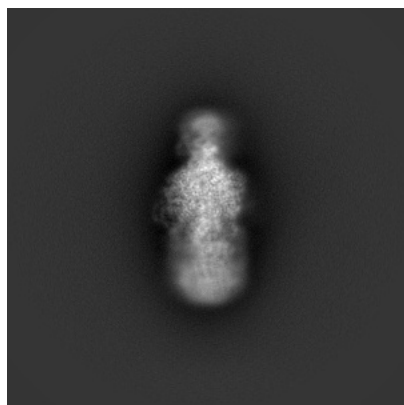

X

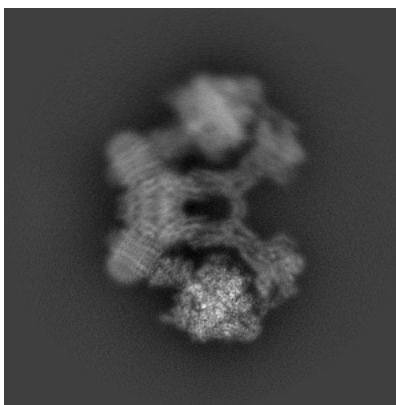

Y

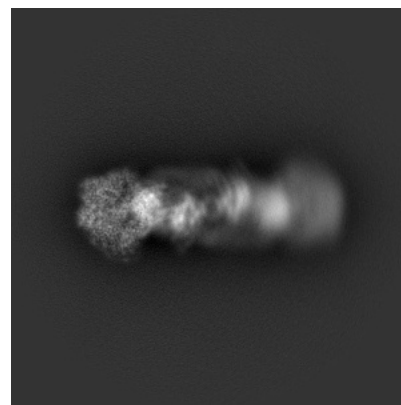

Z

The images above show the map projected in three orthogonal directions.

6.2 Central slices [i](#)

6.2.1 Primary map

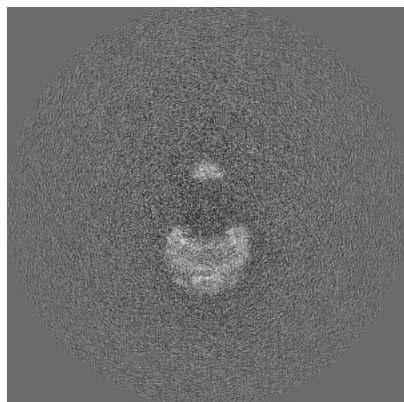

X Index: 240

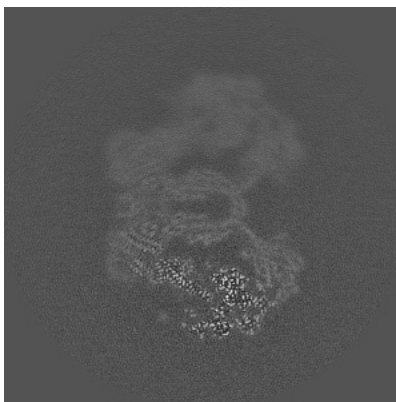

Y Index: 240

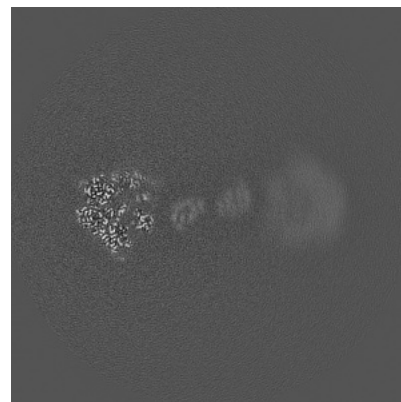

Z Index: 240

6.2.2 Raw map

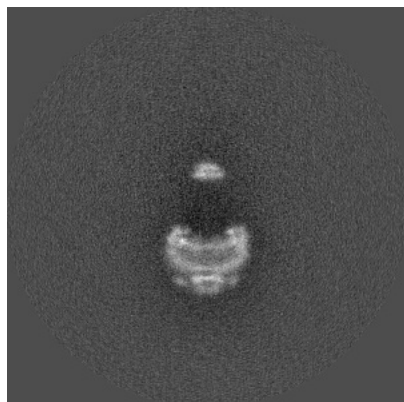

X Index: 240

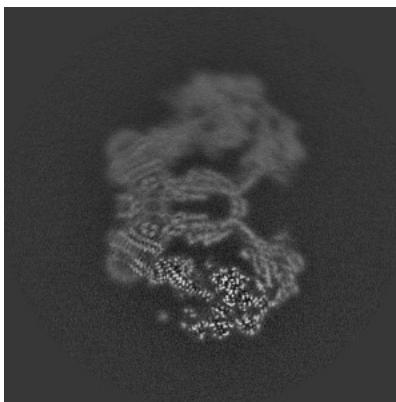

Y Index: 240

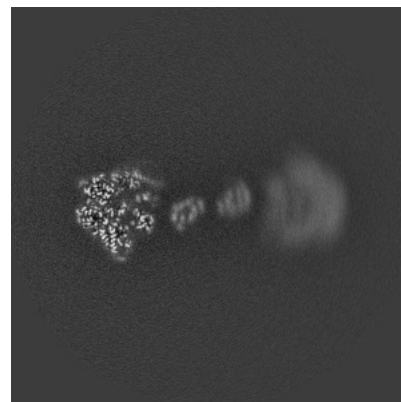

Z Index: 240

The images above show central slices of the map in three orthogonal directions.

6.3 Largest variance slices [i](#)

6.3.1 Primary map

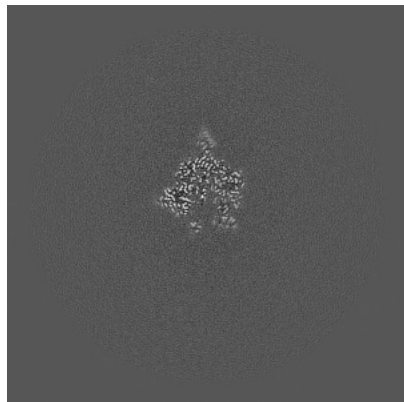

X Index: 124

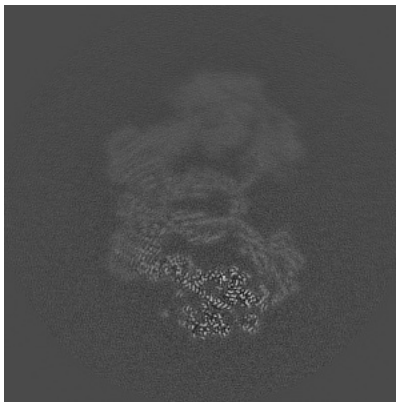

Y Index: 236

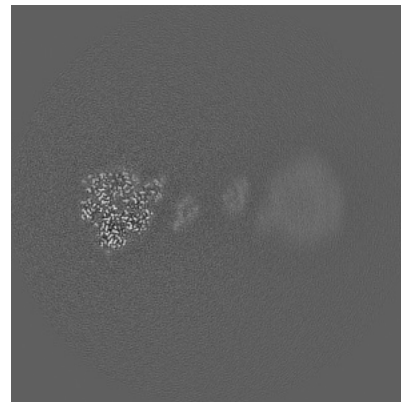

Z Index: 257

6.3.2 Raw map

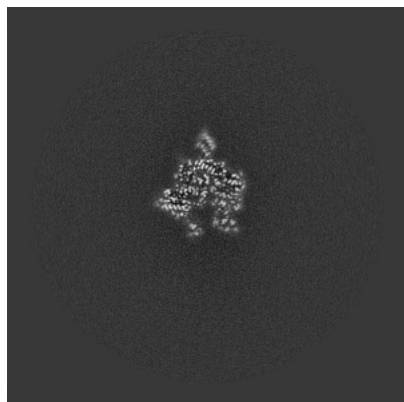

X Index: 123

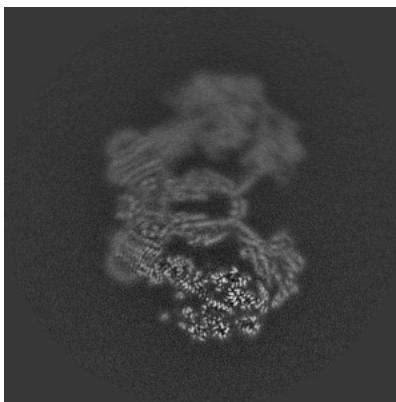

Y Index: 237

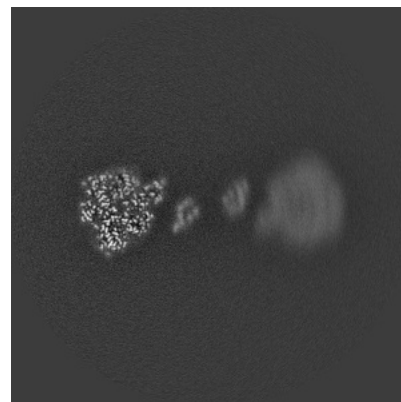

Z Index: 257

The images above show the largest variance slices of the map in three orthogonal directions.

6.4 Orthogonal surface views [i](#)

6.4.1 Primary map



The images above show the 3D surface view of the map at the recommended contour level 0.04. These images, in conjunction with the slice images, may facilitate assessment of whether an appropriate contour level has been provided.

6.4.2 Raw map



These images show the 3D surface of the raw map. The raw map's contour level was selected so that its surface encloses the same volume as the primary map does at its recommended contour level.

6.5 Mask visualisation [i](#)

This section was not generated. No masks/segmentation were deposited.

7 Map analysis [i](#)

This section contains the results of statistical analysis of the map.

7.1 Map-value distribution [i](#)

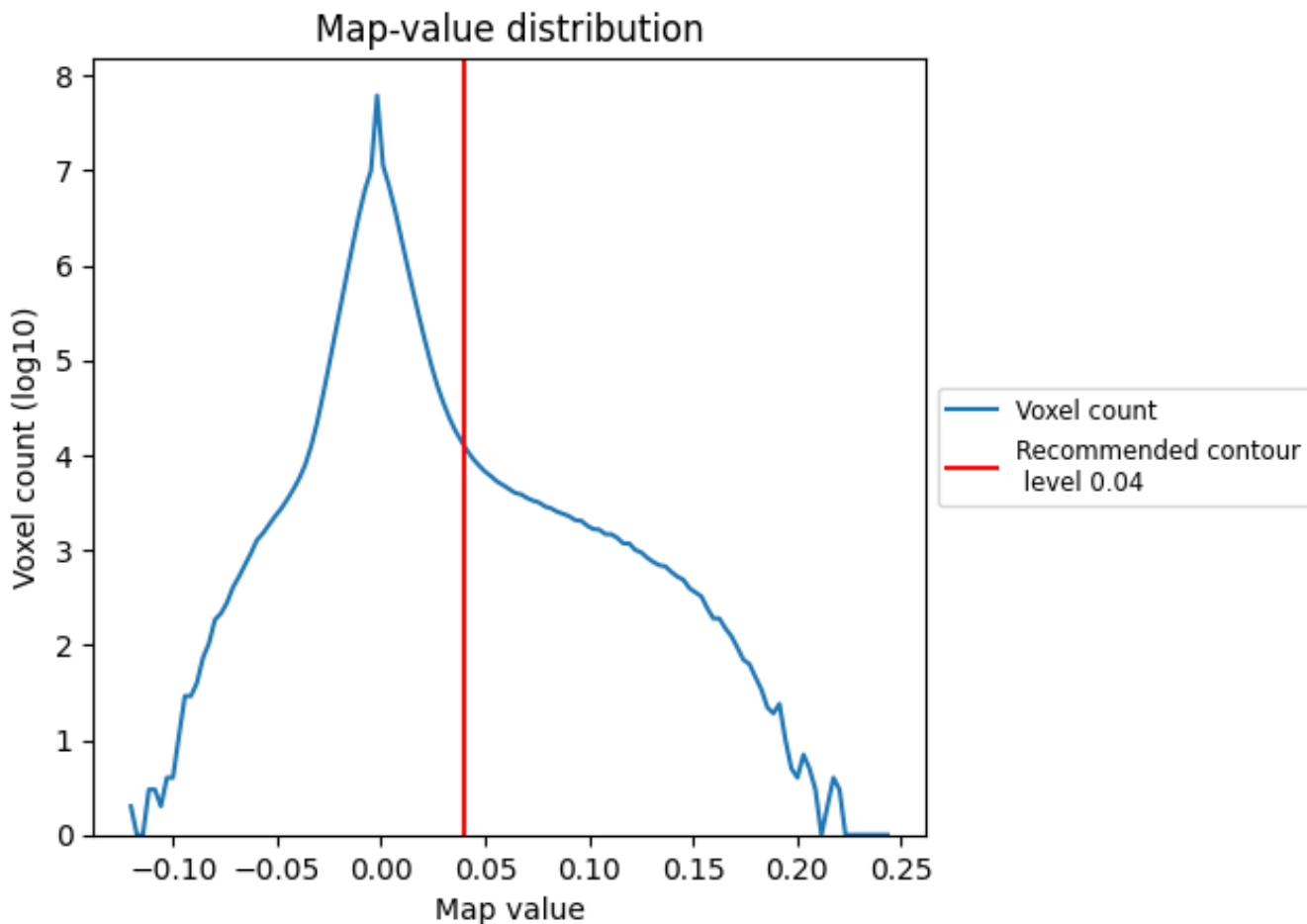

The map-value distribution is plotted in 128 intervals along the x-axis. The y-axis is logarithmic. A spike in this graph at zero usually indicates that the volume has been masked.

7.2 Volume estimate [\(i\)](#)

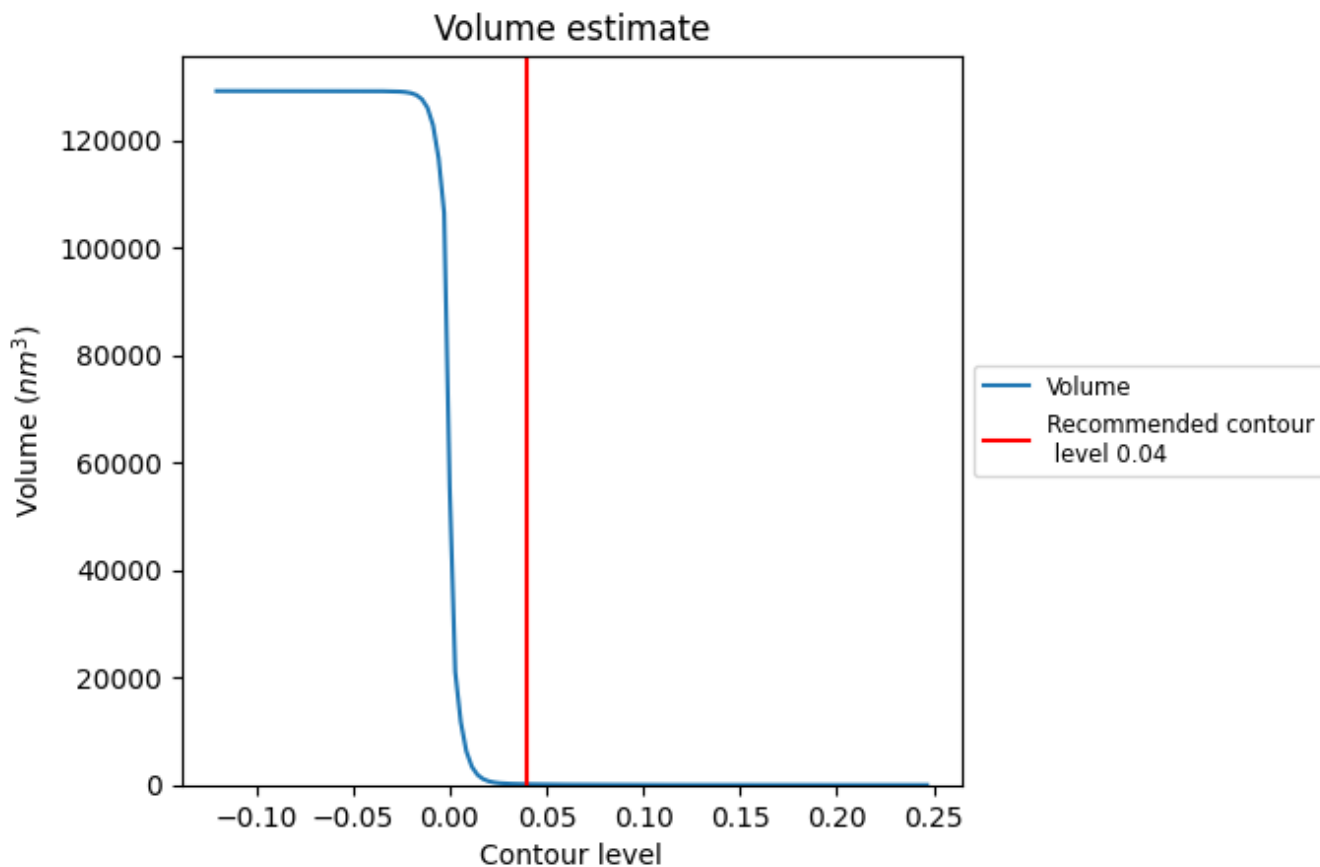

The volume at the recommended contour level is 137 nm^3 ; this corresponds to an approximate mass of 124 kDa.

The volume estimate graph shows how the enclosed volume varies with the contour level. The recommended contour level is shown as a vertical line and the intersection between the line and the curve gives the volume of the enclosed surface at the given level.

7.3 Rotationally averaged power spectrum i

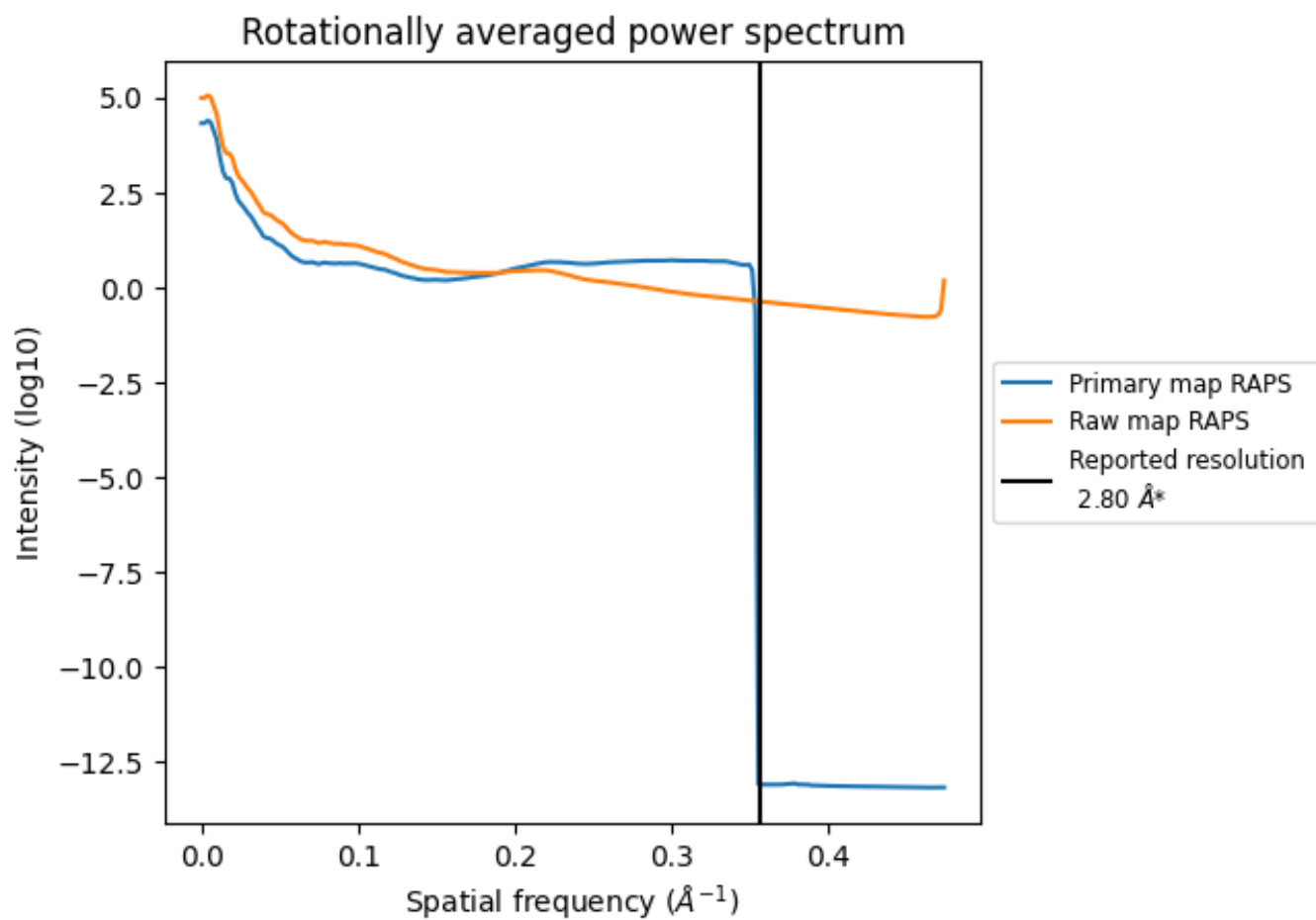

*Reported resolution corresponds to spatial frequency of 0.357 Å⁻¹

8 Fourier-Shell correlation [i](#)

Fourier-Shell Correlation (FSC) is the most commonly used method to estimate the resolution of single-particle and subtomogram-averaged maps. The shape of the curve depends on the imposed symmetry, mask and whether or not the two 3D reconstructions used were processed from a common reference. The reported resolution is shown as a black line. A curve is displayed for the half-bit criterion in addition to lines showing the 0.143 gold standard cut-off and 0.5 cut-off.

8.1 FSC [i](#)

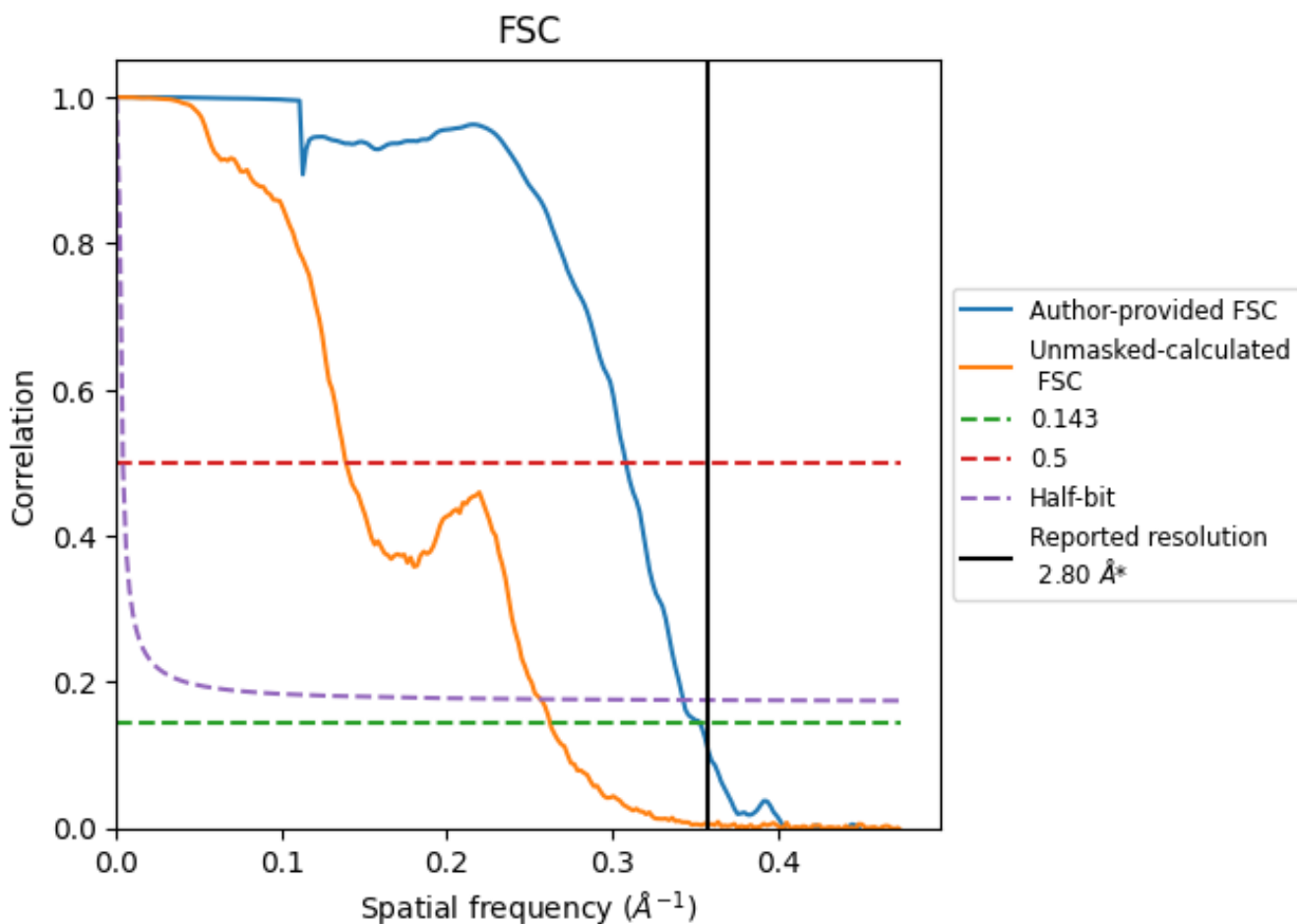

*Reported resolution corresponds to spatial frequency of 0.357\AA^{-1}

8.2 Resolution estimates [i](#)

Resolution estimate (Å)	Estimation criterion (FSC cut-off)		
	0.143	0.5	Half-bit
Reported by author	2.80	-	-
Author-provided FSC curve	2.83	3.24	2.92
Unmasked-calculated*	3.81	7.20	3.90

*Resolution estimate based on FSC curve calculated by comparison of deposited half-maps. The value from deposited half-maps intersecting FSC 0.143 CUT-OFF 3.81 differs from the reported value 2.8 by more than 10 %

9 Map-model fit [i](#)

This section contains information regarding the fit between EMDB map EMD-4826 and PDB model 6RDP. Per-residue inclusion information can be found in section 3 on page 8.

9.1 Map-model overlay [i](#)

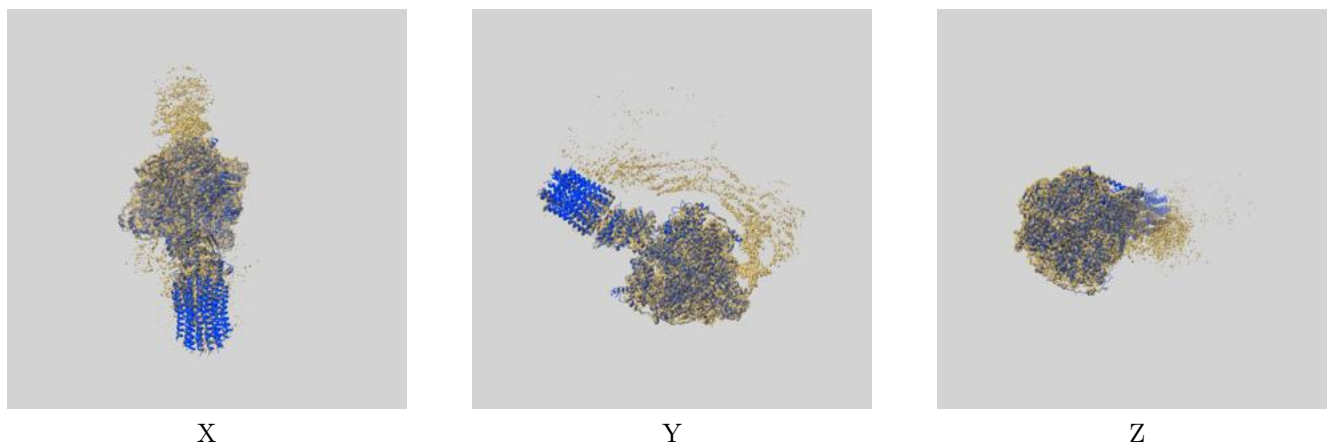

The images above show the 3D surface view of the map at the recommended contour level 0.04 at 50% transparency in yellow overlaid with a ribbon representation of the model coloured in blue. These images allow for the visual assessment of the quality of fit between the atomic model and the map.

9.2 Q-score mapped to coordinate model [i](#)

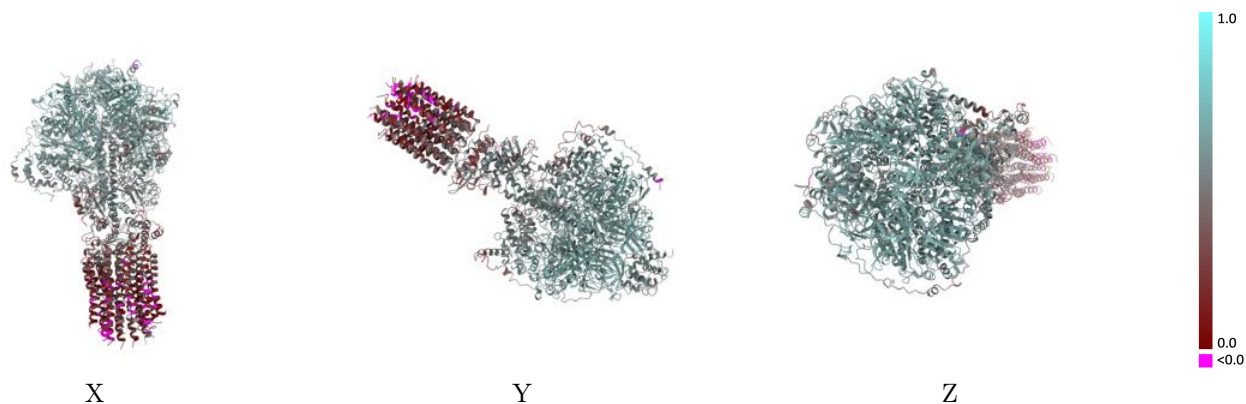

The images above show the model with each residue coloured according to its Q-score. This shows their resolvability in the map with higher Q-score values reflecting better resolvability. Please note: Q-score is calculating the resolvability of atoms, and thus high values are only expected at resolutions at which atoms can be resolved. Low Q-score values may therefore be expected for many entries.

9.3 Atom inclusion mapped to coordinate model [i](#)

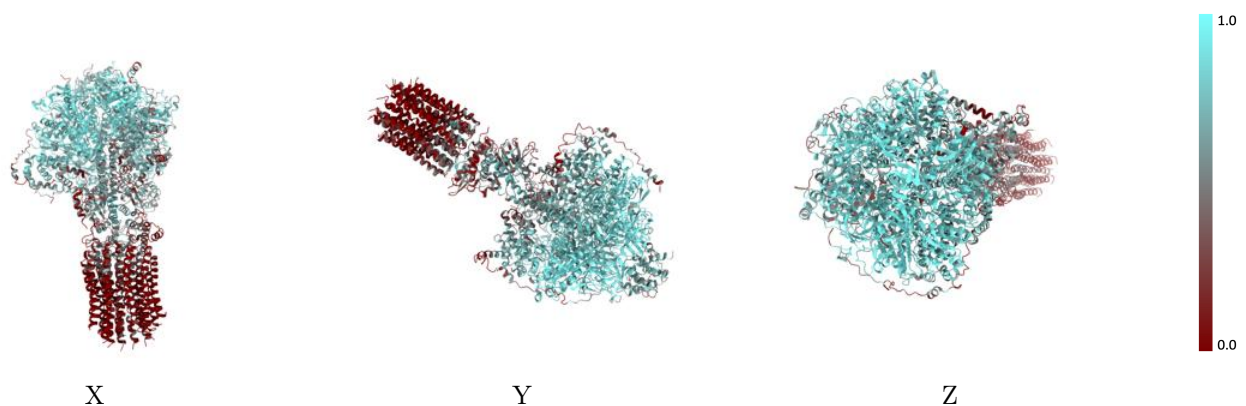

The images above show the model with each residue coloured according to its atom inclusion. This shows to what extent they are inside the map at the recommended contour level (0.04).



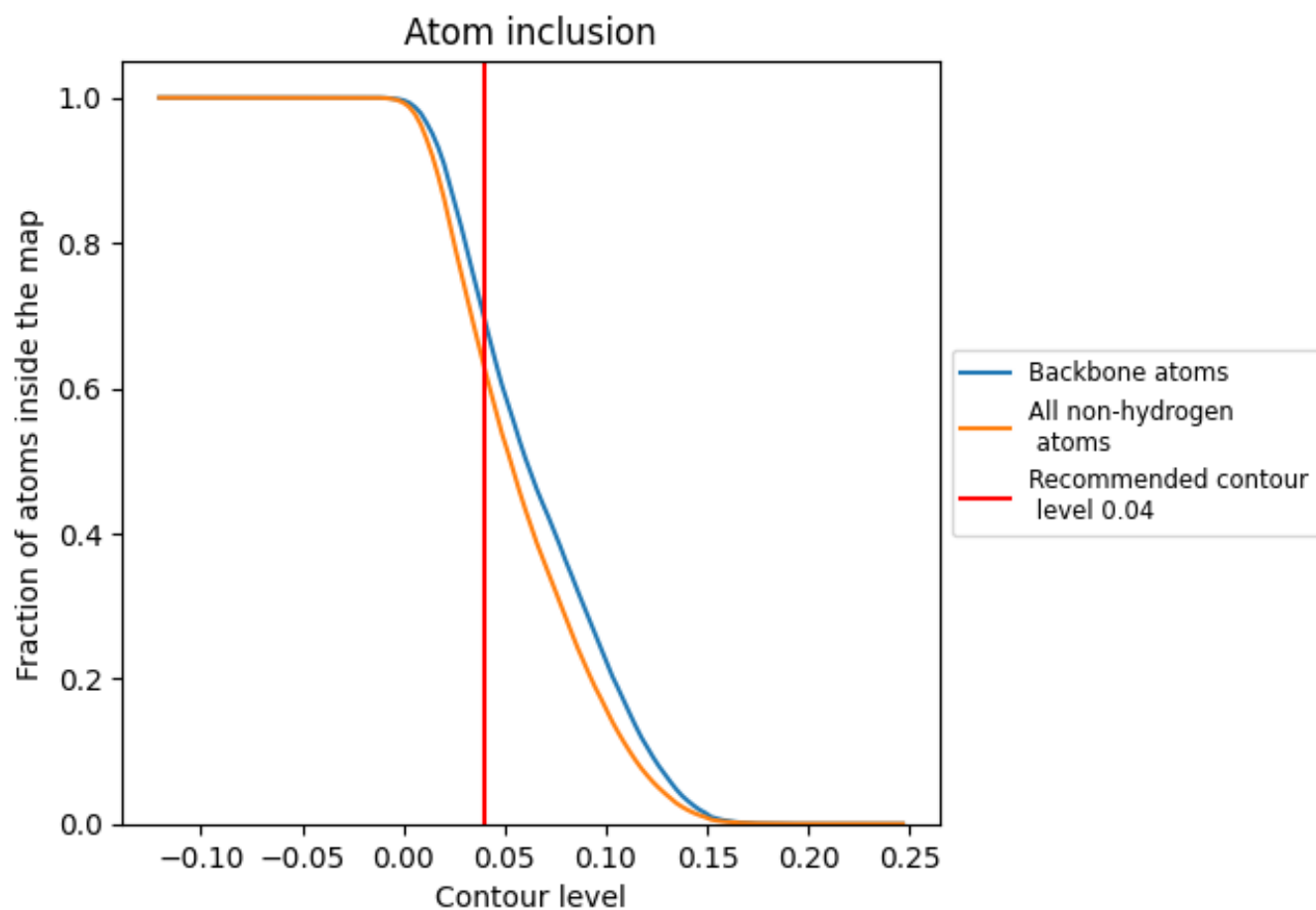







































9.4 Atom inclusion [i](#)



At the recommended contour level, 70% of all backbone atoms, 63% of all non-hydrogen atoms, are inside the map.

9.5 Map-model fit summary

The table lists the average atom inclusion at the recommended contour level (0.04) and Q-score for the entire model and for each chain.

Chain	Atom inclusion	Q-score
All	 0.6280	 0.5190
A	 0.1429	 0.2510
B	 0.0998	 0.2410
C	 0.1057	 0.1970
D	 0.1076	 0.2370
E	 0.2016	 0.3280
F	 0.2603	 0.3150
G	 0.2114	 0.3130
H	 0.0959	 0.2070
I	 0.0802	 0.2000
J	 0.1057	 0.2340
P	 0.6546	 0.5440
Q	 0.3883	 0.4440
R	 0.3488	 0.4150
S	 0.5733	 0.5140
T	 0.7880	 0.5900
U	 0.7909	 0.5930
V	 0.7739	 0.5830
X	 0.7769	 0.5940
Y	 0.6868	 0.5690
Z	 0.7395	 0.5740

