



## wwPDB EM Validation Summary Report ⓘ

Feb 13, 2023 – 03:35 PM EST

PDB ID : 7SD3  
EMDB ID : EMD-25045  
Title : Cytoplasmic tail deleted HIV-1 Env bound with three 4E10 Fabs  
Authors : Yang, S.; Walz, T.  
Deposited on : 2021-09-29  
Resolution : 3.67 Å(reported)

This is a wwPDB EM Validation Summary Report for a publicly released PDB entry.

We welcome your comments at [validation@mail.wwpdb.org](mailto:validation@mail.wwpdb.org)

A user guide is available at

<https://www.wwpdb.org/validation/2017/EMValidationReportHelp>

with specific help available everywhere you see the ⓘ symbol.

The types of validation reports are described at

<http://www.wwpdb.org/validation/2017/FAQs#types>.

---

The following versions of software and data (see [references ⓘ](#)) were used in the production of this report:

EMDB validation analysis : 0.0.1.dev43  
Mogul : 1.8.5 (274361), CSD as541be (2020)  
MolProbity : 4.02b-467  
Percentile statistics : 20191225.v01 (using entries in the PDB archive December 25th 2019)  
MapQ : 1.9.9  
Ideal geometry (proteins) : Engh & Huber (2001)  
Ideal geometry (DNA, RNA) : Parkinson et al. (1996)  
Validation Pipeline (wwPDB-VP) : 2.32.1

# 1 Overall quality at a glance i

The following experimental techniques were used to determine the structure:

*ELECTRON MICROSCOPY*

The reported resolution of this entry is 3.67 Å.

Percentile scores (ranging between 0-100) for global validation metrics of the entry are shown in the following graphic. The table shows the number of entries on which the scores are based.

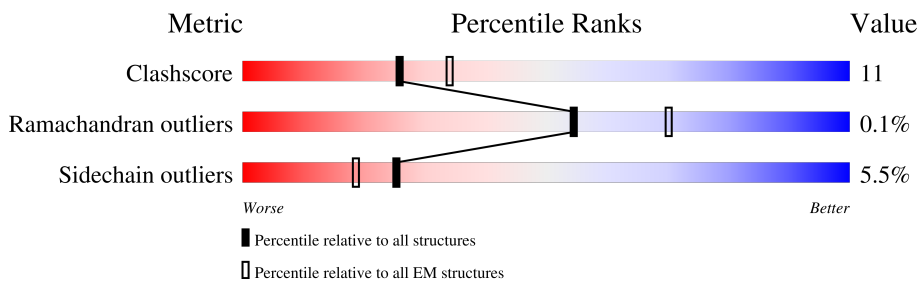

Metric	Whole archive (#Entries)	EM structures (#Entries)
Clashscore	158937	4297
Ramachandran outliers	154571	4023
Sidechain outliers	154315	3826

The table below summarises the geometric issues observed across the polymeric chains and their fit to the map. The red, orange, yellow and green segments of the bar indicate the fraction of residues that contain outliers for  $\geq 3$ , 2, 1 and 0 types of geometric quality criteria respectively. A grey segment represents the fraction of residues that are not modelled. The numeric value for each fraction is indicated below the corresponding segment, with a dot representing fractions  $\leq 5\%$ . The upper red bar (where present) indicates the fraction of residues that have poor fit to the EM map (all-atom inclusion  $< 40\%$ ). The numeric value is given above the bar.

Mol	Chain	Length	Quality of chain
1	H	214	
1	M	214	
1	N	214	
2	G	230	
2	I	230	
2	K	230	
3	A	481	
3	C	481	

Continued on next page...

Continued from previous page...

Mol	Chain	Length	Quality of chain
3	E	481	68% 22% 9%
4	B	173	12% 66% 25% 6%
4	D	173	12% 60% 31% 6%
4	F	173	14% 66% 25% 6%
5	J	3	100%
5	O	3	33% 67%
5	P	3	100%
5	R	3	33% 67%
5	S	3	100%
5	U	3	33% 67%
6	L	2	50% 50%
6	Q	2	50% 50%
6	T	2	50% 50%

## 2 Entry composition [i](#)

There are 7 unique types of molecules in this entry. The entry contains 25256 atoms, of which 0 are hydrogens and 0 are deuteriums.

In the tables below, the AltConf column contains the number of residues with at least one atom in alternate conformation and the Trace column contains the number of residues modelled with at most 2 atoms.

- Molecule 1 is a protein called 4E10 Fab light chain.

Mol	Chain	Residues	Atoms					AltConf	Trace
			Total	C	N	O	S		
1	H	214	1733	1080	302	345	6	18	0
1	N	214	1746	1089	302	349	6	21	0
1	M	214	1746	1089	302	349	6	21	0

- Molecule 2 is a protein called 4E10 Fab heavy chain.

Mol	Chain	Residues	Atoms					AltConf	Trace
			Total	C	N	O	S		
2	G	220	1702	1080	287	328	7	15	0
2	K	220	1725	1091	296	330	8	20	0
2	I	220	1725	1091	296	330	8	20	0

- Molecule 3 is a protein called Envelope glycoprotein gp120.

Mol	Chain	Residues	Atoms					AltConf	Trace
			Total	C	N	O	S		
3	A	440	3448	2172	603	646	27	0	0
3	C	440	3452	2174	608	643	27	0	0
3	E	440	3458	2176	609	646	27	0	0

There are 21 discrepancies between the modelled and reference sequences:

Chain	Residue	Modelled	Actual	Comment	Reference
A	374	SER	TYR	conflict	UNP A0A6H1VID3
A	499	CYS	ALA	conflict	UNP A0A6H1VID3
A	507	ARG	-	expression tag	UNP A0A6H1VID3

*Continued on next page...*

Continued from previous page...

Chain	Residue	Modelled	Actual	Comment	Reference
A	508	ARG	-	expression tag	UNP A0A6H1VID3
A	509	ARG	-	expression tag	UNP A0A6H1VID3
A	510	ARG	-	expression tag	UNP A0A6H1VID3
A	511	ARG	-	expression tag	UNP A0A6H1VID3
C	374	SER	TYR	conflict	UNP A0A6H1VID3
C	499	CYS	ALA	conflict	UNP A0A6H1VID3
C	507	ARG	-	expression tag	UNP A0A6H1VID3
C	508	ARG	-	expression tag	UNP A0A6H1VID3
C	509	ARG	-	expression tag	UNP A0A6H1VID3
C	510	ARG	-	expression tag	UNP A0A6H1VID3
C	511	ARG	-	expression tag	UNP A0A6H1VID3
E	374	SER	TYR	conflict	UNP A0A6H1VID3
E	499	CYS	ALA	conflict	UNP A0A6H1VID3
E	507	ARG	-	expression tag	UNP A0A6H1VID3
E	508	ARG	-	expression tag	UNP A0A6H1VID3
E	509	ARG	-	expression tag	UNP A0A6H1VID3
E	510	ARG	-	expression tag	UNP A0A6H1VID3
E	511	ARG	-	expression tag	UNP A0A6H1VID3

- Molecule 4 is a protein called Transmembrane protein gp41.

Mol	Chain	Residues	Atoms					AltConf	Trace
			Total	C	N	O	S		
4	B	163	1236	775	222	233	6	0	0
4	D	163	1236	770	222	238	6	0	0
4	F	163	1227	767	221	233	6	0	0

There are 9 discrepancies between the modelled and reference sequences:

Chain	Residue	Modelled	Actual	Comment	Reference
B	559	PRO	ILE	conflict	UNP A0A173DX29
B	605	CYS	THR	conflict	UNP A0A173DX29
B	684	LEU	ILE	conflict	UNP A0A173DX29
D	559	PRO	ILE	conflict	UNP A0A173DX29
D	605	CYS	THR	conflict	UNP A0A173DX29
D	684	LEU	ILE	conflict	UNP A0A173DX29
F	559	PRO	ILE	conflict	UNP A0A173DX29
F	605	CYS	THR	conflict	UNP A0A173DX29
F	684	LEU	ILE	conflict	UNP A0A173DX29

- Molecule 5 is an oligosaccharide called beta-D-mannopyranose-(1-4)-2-acetamido-2-deoxy-beta-D-glucopyranose-(1-4)-2-acetamido-2-deoxy-beta-D-glucopyranose.

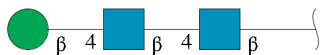

Mol	Chain	Residues	Atoms				AltConf	Trace
			Total	C	N	O		
5	J	3	39	22	2	15	0	0
5	O	3	39	22	2	15	0	0
5	P	3	39	22	2	15	0	0
5	R	3	39	22	2	15	0	0
5	S	3	39	22	2	15	0	0
5	U	3	39	22	2	15	0	0

- Molecule 6 is an oligosaccharide called 2-acetamido-2-deoxy-beta-D-glucopyranose-(1-4)-2-acetamido-2-deoxy-beta-D-glucopyranose.



Mol	Chain	Residues	Atoms				AltConf	Trace
			Total	C	N	O		
6	L	2	28	16	2	10	0	0
6	Q	2	28	16	2	10	0	0
6	T	2	28	16	2	10	0	0

- Molecule 7 is 2-acetamido-2-deoxy-beta-D-glucopyranose (three-letter code: NAG) (formula: C<sub>8</sub>H<sub>15</sub>NO<sub>6</sub>).



Mol	Chain	Residues	Atoms				AltConf
			Total	C	N	O	
7	A	1	Total 14	8	1	5	0
7	A	1	Total 14	8	1	5	0
7	A	1	Total 14	8	1	5	0
7	A	1	Total 14	8	1	5	0
7	A	1	Total 14	8	1	5	0
7	A	1	Total 14	8	1	5	0
7	A	1	Total 14	8	1	5	0
7	A	1	Total 14	8	1	5	0
7	A	1	Total 14	8	1	5	0
7	B	1	Total 14	8	1	5	0
7	B	1	Total 14	8	1	5	0
7	B	1	Total 14	8	1	5	0
7	C	1	Total 14	8	1	5	0
7	C	1	Total 14	8	1	5	0

*Continued on next page...*

*Continued from previous page...*

Mol	Chain	Residues	Atoms				AltConf
			Total	C	N	O	
7	C	1	Total 14	C 8	N 1	O 5	0
7	C	1	Total 14	C 8	N 1	O 5	0
7	C	1	Total 14	C 8	N 1	O 5	0
7	C	1	Total 14	C 8	N 1	O 5	0
7	C	1	Total 14	C 8	N 1	O 5	0
7	C	1	Total 14	C 8	N 1	O 5	0
7	C	1	Total 14	C 8	N 1	O 5	0
7	D	1	Total 14	C 8	N 1	O 5	0
7	D	1	Total 14	C 8	N 1	O 5	0
7	D	1	Total 14	C 8	N 1	O 5	0
7	E	1	Total 14	C 8	N 1	O 5	0
7	E	1	Total 14	C 8	N 1	O 5	0
7	E	1	Total 14	C 8	N 1	O 5	0
7	E	1	Total 14	C 8	N 1	O 5	0
7	E	1	Total 14	C 8	N 1	O 5	0
7	E	1	Total 14	C 8	N 1	O 5	0
7	E	1	Total 14	C 8	N 1	O 5	0
7	E	1	Total 14	C 8	N 1	O 5	0
7	E	1	Total 14	C 8	N 1	O 5	0
7	F	1	Total 14	C 8	N 1	O 5	0
7	F	1	Total 14	C 8	N 1	O 5	0

*Continued on next page...*



*Continued from previous page...*

Mol	Chain	Residues	Atoms				AltConf
			Total	C	N	O	
7	F	1	14	8	1	5	0

### 3 Residue-property plots

These plots are drawn for all protein, RNA, DNA and oligosaccharide chains in the entry. The first graphic for a chain summarises the proportions of the various outlier classes displayed in the second graphic. The second graphic shows the sequence view annotated by issues in geometry and atom inclusion in map density. Residues are color-coded according to the number of geometric quality criteria for which they contain at least one outlier: green = 0, yellow = 1, orange = 2 and red = 3 or more. A red diamond above a residue indicates a poor fit to the EM map for this residue (all-atom inclusion < 40%). Stretches of 2 or more consecutive residues without any outlier are shown as a green connector. Residues present in the sample, but not in the model, are shown in grey.

- Molecule 1: 4E10 Fab light chain

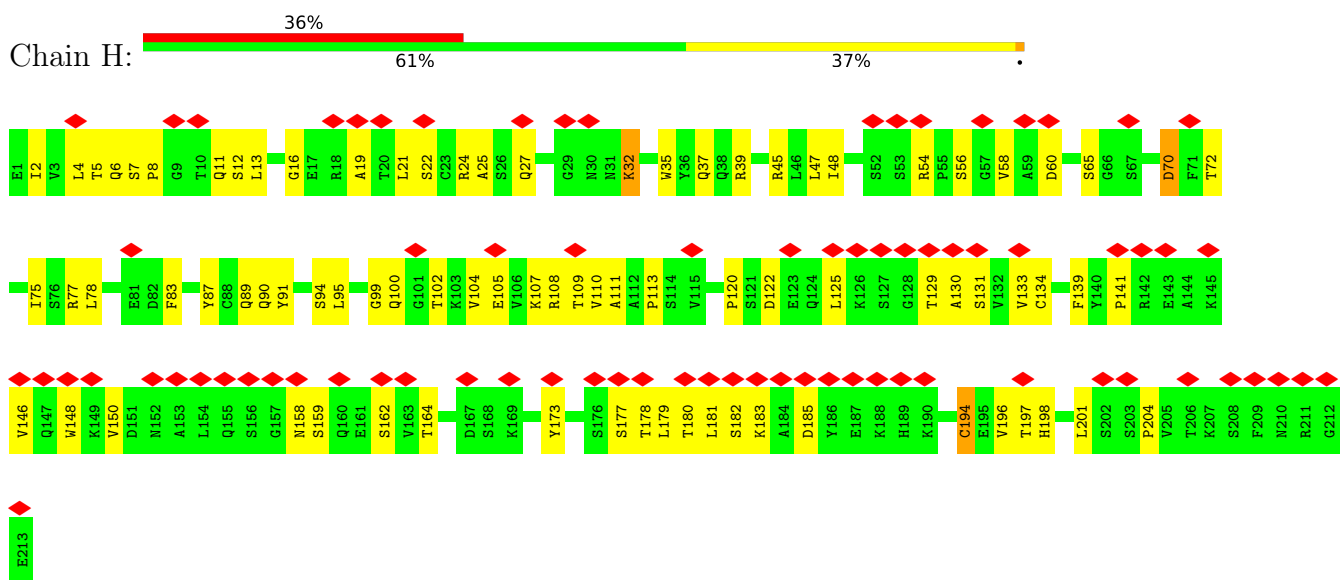

- Molecule 1: 4E10 Fab light chain

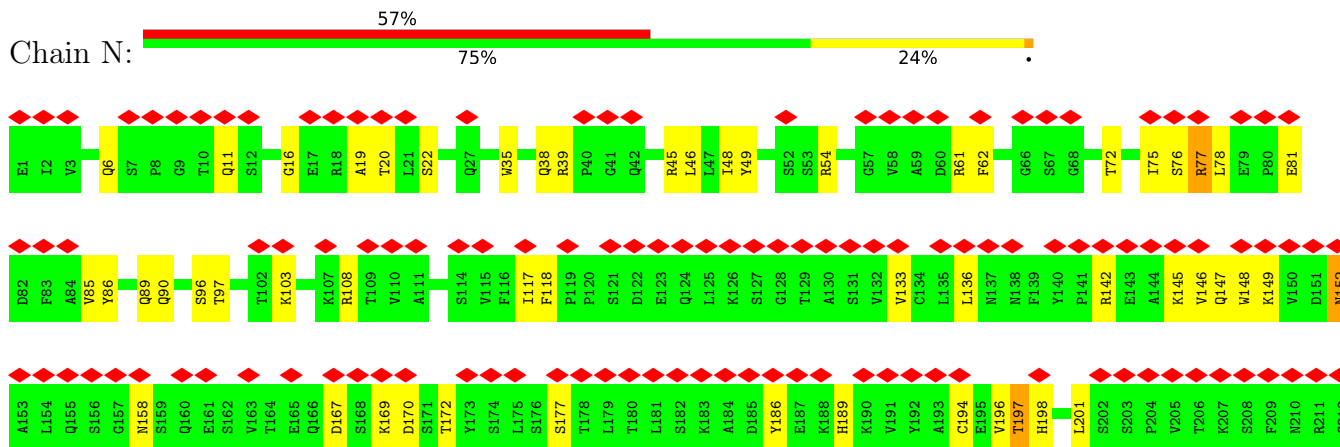

- Molecule 1: 4E10 Fab light chain

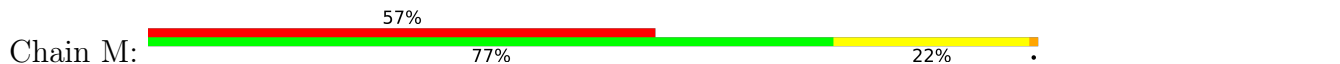

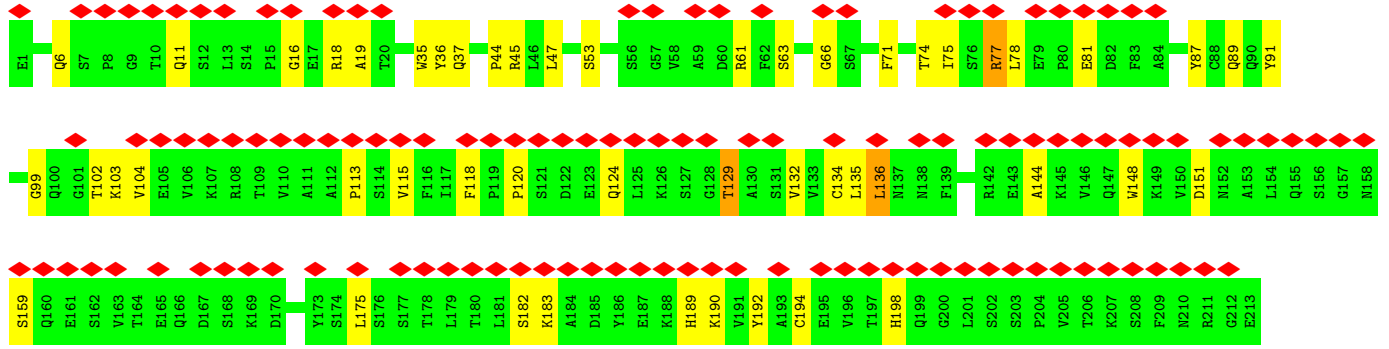

• Molecule 2: 4E10 Fab heavy chain

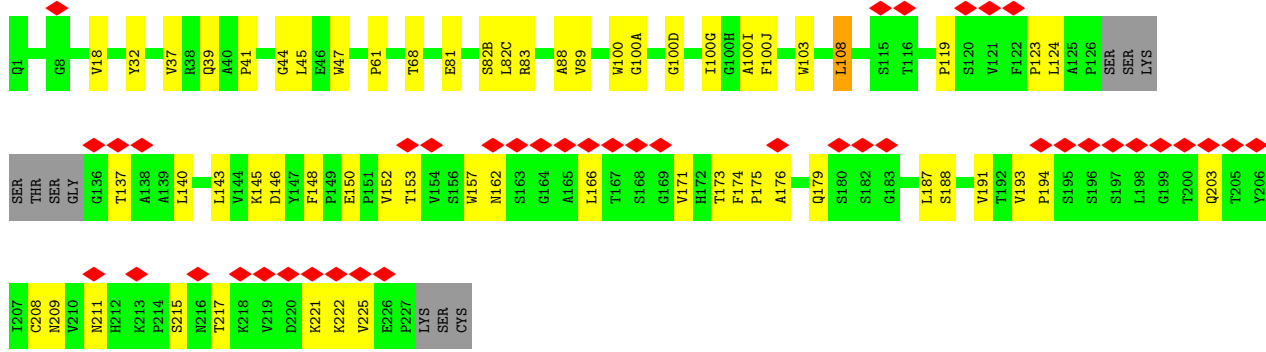

• Molecule 2: 4E10 Fab heavy chain

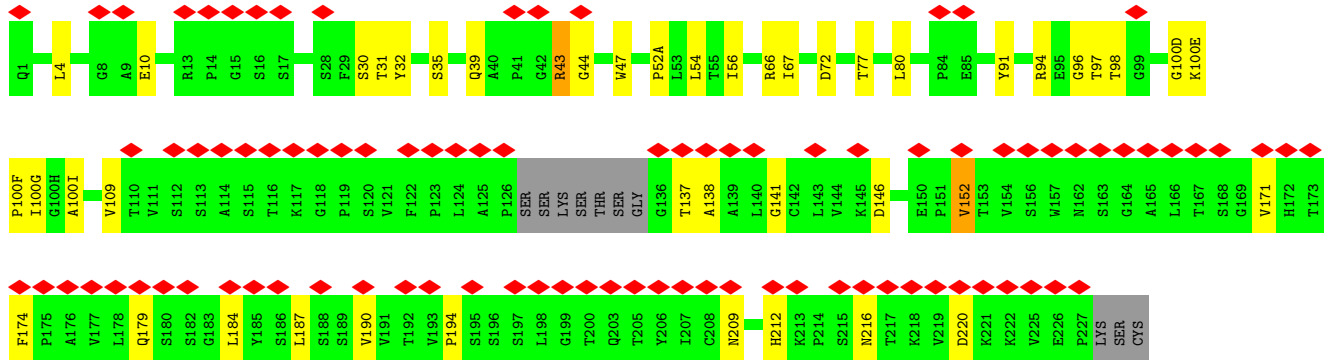
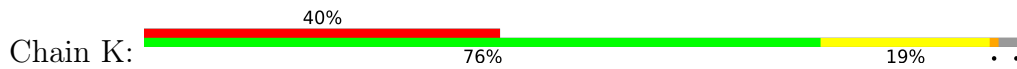

• Molecule 2: 4E10 Fab heavy chain



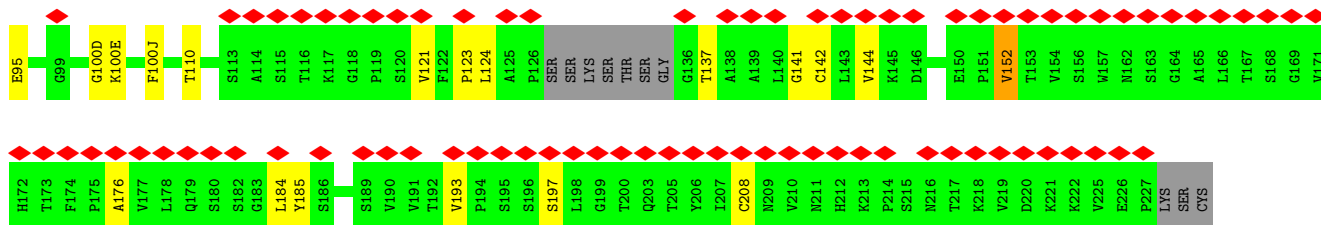

• Molecule 3: Envelope glycoprotein gp120

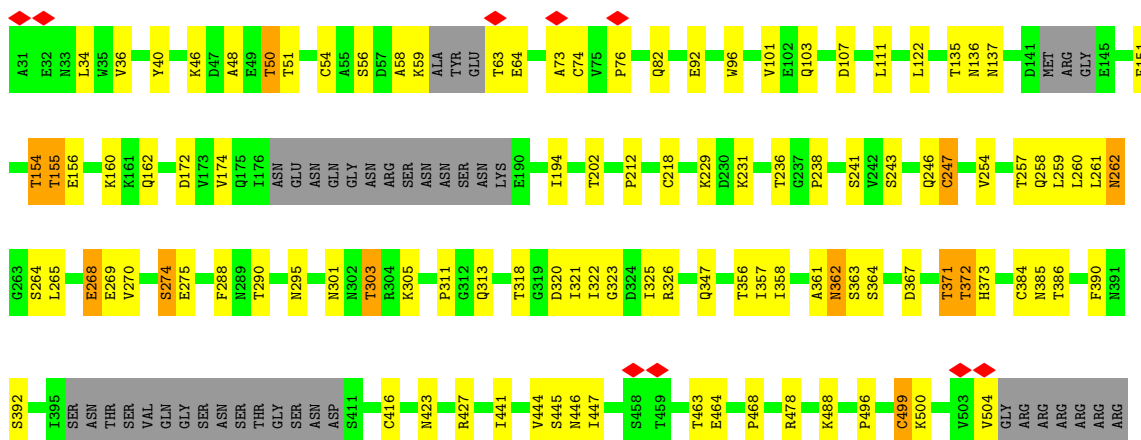

• Molecule 3: Envelope glycoprotein gp120

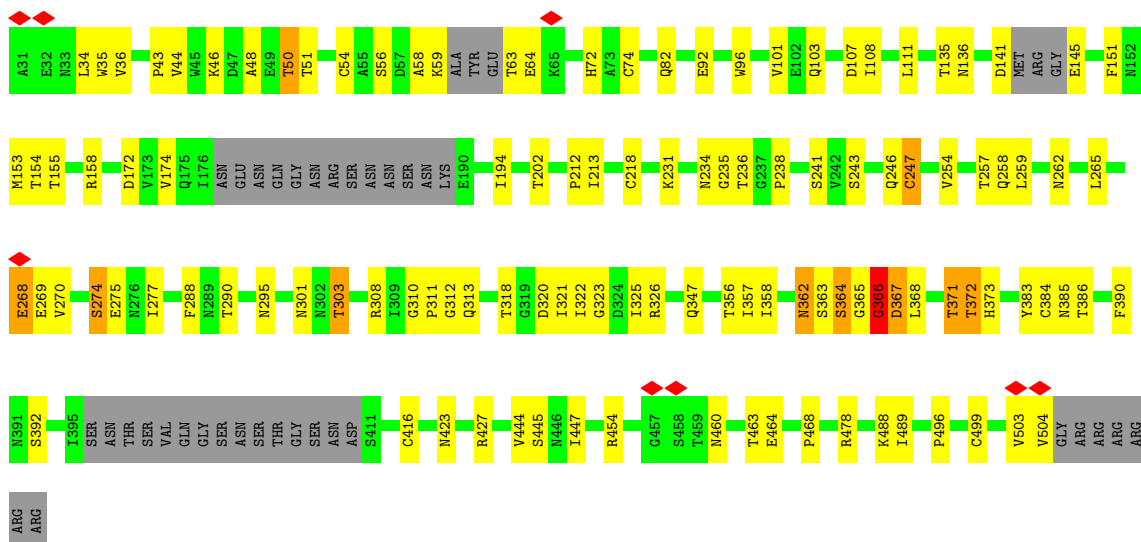

• Molecule 3: Envelope glycoprotein gp120



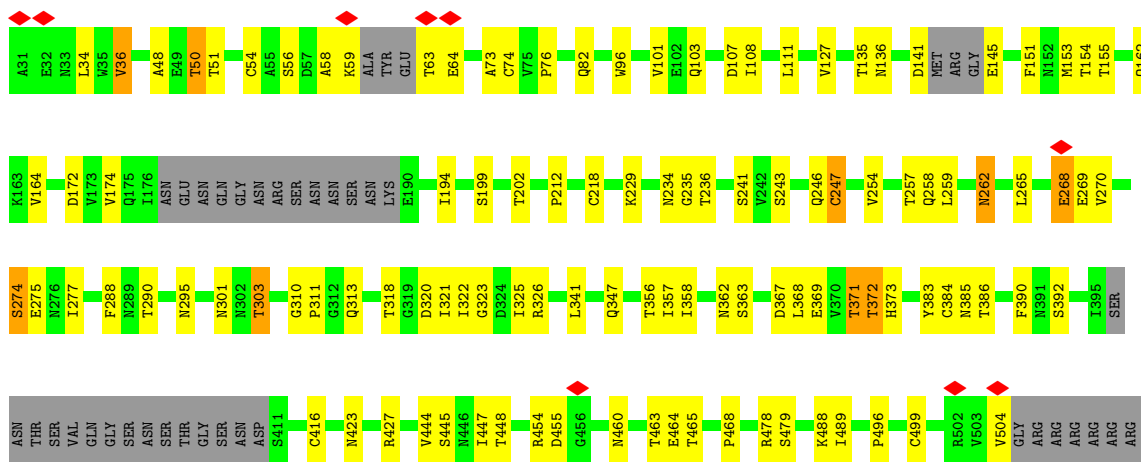

• Molecule 4: Transmembrane protein gp41

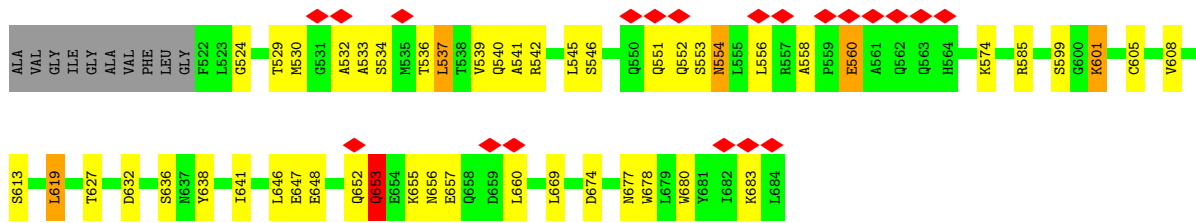

• Molecule 4: Transmembrane protein gp41

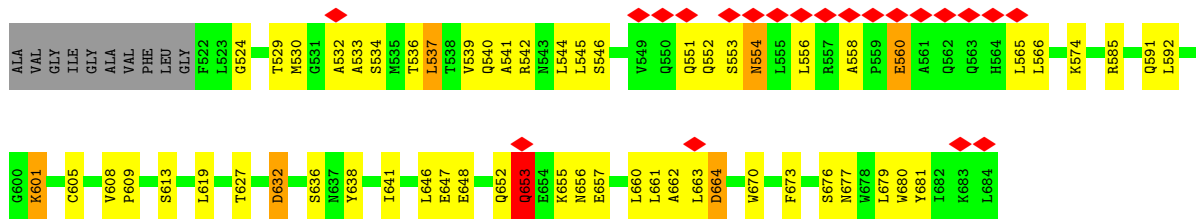

• Molecule 4: Transmembrane protein gp41

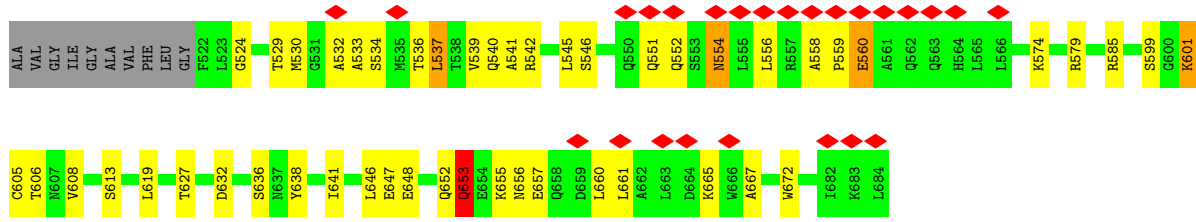

• Molecule 5: beta-D-mannopyranose-(1-4)-2-acetamido-2-deoxy-beta-D-glucopyranose-(1-4)-2-acetamido-2-deoxy-beta-D-glucopyranose

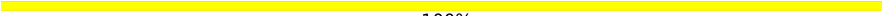
Chain J:  100%

MAG1  
MAG2  
BMA3

- Molecule 5: beta-D-mannopyranose-(1-4)-2-acetamido-2-deoxy-beta-D-glucopyranose-(1-4)-2-acetamido-2-deoxy-beta-D-glucopyranose

Chain O:  33% 67% 67%

MAG1  
MAG2  
BMA3

- Molecule 5: beta-D-mannopyranose-(1-4)-2-acetamido-2-deoxy-beta-D-glucopyranose-(1-4)-2-acetamido-2-deoxy-beta-D-glucopyranose

Chain P:  100%

MAG1  
MAG2  
BMA3

- Molecule 5: beta-D-mannopyranose-(1-4)-2-acetamido-2-deoxy-beta-D-glucopyranose-(1-4)-2-acetamido-2-deoxy-beta-D-glucopyranose

Chain R:  33% 67% 67%

MAG1  
MAG2  
BMA3

- Molecule 5: beta-D-mannopyranose-(1-4)-2-acetamido-2-deoxy-beta-D-glucopyranose-(1-4)-2-acetamido-2-deoxy-beta-D-glucopyranose

Chain S:  100%

MAG1  
MAG2  
BMA3

- Molecule 5: beta-D-mannopyranose-(1-4)-2-acetamido-2-deoxy-beta-D-glucopyranose-(1-4)-2-acetamido-2-deoxy-beta-D-glucopyranose

Chain U:  33% 67% 67%

MAG1  
MAG2  
BMA3

- Molecule 6: 2-acetamido-2-deoxy-beta-D-glucopyranose-(1-4)-2-acetamido-2-deoxy-beta-D-glucopyranose

Chain L:  50% 50% 50%



- Molecule 6: 2-acetamido-2-deoxy-beta-D-glucopyranose-(1-4)-2-acetamido-2-deoxy-beta-D-glucopyranose

Chain Q:  50% 50%

A horizontal progress bar for Chain Q. The left half is green and labeled '50%', and the right half is yellow and labeled '50%'.



- Molecule 6: 2-acetamido-2-deoxy-beta-D-glucopyranose-(1-4)-2-acetamido-2-deoxy-beta-D-glucopyranose

Chain T:  50% 50%

A horizontal progress bar for Chain T. The left half is green and labeled '50%', and the right half is yellow and labeled '50%'.



## 4 Experimental information

Property	Value	Source
EM reconstruction method	SINGLE PARTICLE	Depositor
Imposed symmetry	POINT, Not provided	
Number of particles used	362646	Depositor
Resolution determination method	FSC 0.143 CUT-OFF	Depositor
CTF correction method	NONE	Depositor
Microscope	FEI TITAN KRIOS	Depositor
Voltage (kV)	300	Depositor
Electron dose ( $e^-/\text{\AA}^2$ )	80	Depositor
Minimum defocus (nm)	1500	Depositor
Maximum defocus (nm)	2500	Depositor
Magnification	Not provided	
Image detector	GATAN K2 SUMMIT (4k x 4k)	Depositor
Maximum map value	2.181	Depositor
Minimum map value	-1.062	Depositor
Average map value	0.001	Depositor
Map value standard deviation	0.040	Depositor
Recommended contour level	0.296	Depositor
Map size ( $\text{\AA}$ )	395.52, 395.52, 395.52	wwPDB
Map dimensions	384, 384, 384	wwPDB
Map angles ( $^\circ$ )	90.0, 90.0, 90.0	wwPDB
Pixel spacing ( $\text{\AA}$ )	1.03, 1.03, 1.03	Depositor



## 5 Model quality [i](#)

### 5.1 Standard geometry [i](#)

Bond lengths and bond angles in the following residue types are not validated in this section: NAG, BMA

The Z score for a bond length (or angle) is the number of standard deviations the observed value is removed from the expected value. A bond length (or angle) with  $|Z| > 5$  is considered an outlier worth inspection. RMSZ is the root-mean-square of all Z scores of the bond lengths (or angles).

Mol	Chain	Bond lengths		Bond angles	
		RMSZ	# Z  >5	RMSZ	# Z  >5
1	H	0.27	0/1814	0.56	2/2456 (0.1%)
1	M	0.27	0/1836	0.54	1/2486 (0.0%)
1	N	0.28	0/1836	0.55	0/2486
2	G	0.28	0/1775	0.63	1/2423 (0.0%)
2	I	0.27	0/1808	0.59	1/2464 (0.0%)
2	K	0.28	0/1808	0.59	0/2464
3	A	0.70	1/3519 (0.0%)	0.74	5/4780 (0.1%)
3	C	0.70	1/3523 (0.0%)	0.73	2/4784 (0.0%)
3	E	0.70	1/3529 (0.0%)	0.73	3/4792 (0.1%)
4	B	0.57	0/1257	0.82	5/1711 (0.3%)
4	D	0.57	0/1255	0.85	5/1707 (0.3%)
4	F	0.56	0/1246	0.80	5/1695 (0.3%)
All	All	0.54	3/25206 (0.0%)	0.69	30/34248 (0.1%)

Chiral center outliers are detected by calculating the chiral volume of a chiral center and verifying if the center is modelled as a planar moiety or with the opposite hand. A planarity outlier is detected by checking planarity of atoms in a peptide group, atoms in a mainchain group or atoms of a sidechain that are expected to be planar.

Mol	Chain	#Chirality outliers	#Planarity outliers
1	H	0	1
3	A	0	1
3	C	0	2
4	B	0	1
4	D	0	2
4	F	0	1
All	All	0	8

All (3) bond length outliers are listed below:

Mol	Chain	Res	Type	Atoms	Z	Observed(Å)	Ideal(Å)
3	E	54	CYS	CB-SG	-5.80	1.72	1.81
3	A	54	CYS	CB-SG	-5.79	1.72	1.81
3	C	54	CYS	CB-SG	-5.78	1.72	1.81

The worst 5 of 30 bond angle outliers are listed below:

Mol	Chain	Res	Type	Atoms	Z	Observed(°)	Ideal(°)
4	D	653	GLN	CA-CB-CG	7.51	129.92	113.40
4	F	653	GLN	CA-CB-CG	7.51	129.91	113.40
4	B	653	GLN	CA-CB-CG	7.50	129.90	113.40
3	E	262	ASN	CB-CA-C	6.77	123.94	110.40
1	H	111	ALA	C-N-CA	6.02	136.74	121.70

There are no chirality outliers.

5 of 8 planarity outliers are listed below:

Mol	Chain	Res	Type	Group
3	A	260	LEU	Mainchain
4	B	558	ALA	Peptide
3	C	362	ASN	Mainchain
3	C	366	GLY	Mainchain
1	H	7	SER	Peptide

## 5.2 Too-close contacts [i](#)

In the following table, the Non-H and H(model) columns list the number of non-hydrogen atoms and hydrogen atoms in the chain respectively. The H(added) column lists the number of hydrogen atoms added and optimized by MolProbity. The Clashes column lists the number of clashes within the asymmetric unit, whereas Symm-Clashes lists symmetry-related clashes.

Mol	Chain	Non-H	H(model)	H(added)	Clashes	Symm-Clashes
1	H	1733	0	1736	59	0
1	M	1746	0	1752	34	0
1	N	1746	0	1752	38	0
2	G	1702	0	1709	47	0
2	I	1725	0	1746	47	0
2	K	1725	0	1746	40	0
3	A	3448	0	3382	67	0
3	C	3452	0	3396	82	0
3	E	3458	0	3399	86	0
4	B	1236	0	1159	42	0
4	D	1236	0	1159	58	0

*Continued on next page...*

Continued from previous page...

Mol	Chain	Non-H	H(model)	H(added)	Clashes	Symm-Clashes
4	F	1227	0	1151	30	0
5	J	39	0	34	4	0
5	O	39	0	34	1	0
5	P	39	0	34	1	0
5	R	39	0	34	1	0
5	S	39	0	34	6	0
5	U	39	0	34	1	0
6	L	28	0	25	0	0
6	Q	28	0	25	0	0
6	T	28	0	25	0	0
7	A	126	0	117	2	0
7	B	42	0	39	0	0
7	C	126	0	117	2	0
7	D	42	0	39	0	0
7	E	126	0	117	2	0
7	F	42	0	39	0	0
All	All	25256	0	24834	564	0

The all-atom clashscore is defined as the number of clashes found per 1000 atoms (including hydrogen atoms). The all-atom clashscore for this structure is 11.

The worst 5 of 564 close contacts within the same asymmetric unit are listed below, sorted by their clash magnitude.

Atom-1	Atom-2	Interatomic distance (Å)	Clash overlap (Å)
3:E:362:ASN:ND2	3:E:371:THR:O	1.59	1.36
2:G:100(A):GLY:HA3	4:B:669:LEU:CB	1.53	1.35
3:E:262:ASN:HD21	3:E:445:SER:CB	1.44	1.30
1:H:56:SER:CB	2:G:100:TRP:HE1	1.55	1.19
2:I:100(E):LYS:NZ	4:D:660:LEU:CD1	2.05	1.17

There are no symmetry-related clashes.

## 5.3 Torsion angles [i](#)

### 5.3.1 Protein backbone [i](#)

In the following table, the Percentiles column shows the percent Ramachandran outliers of the chain as a percentile score with respect to all PDB entries followed by that with respect to all EM entries.

The Analysed column shows the number of residues for which the backbone conformation was analysed, and the total number of residues.

Mol	Chain	Analysed	Favoured	Allowed	Outliers	Percentiles	
1	H	230/214 (108%)	219 (95%)	11 (5%)	0	100	100
1	M	233/214 (109%)	224 (96%)	9 (4%)	0	100	100
1	N	233/214 (109%)	215 (92%)	18 (8%)	0	100	100
2	G	231/230 (100%)	212 (92%)	19 (8%)	0	100	100
2	I	236/230 (103%)	226 (96%)	10 (4%)	0	100	100
2	K	236/230 (103%)	226 (96%)	10 (4%)	0	100	100
3	A	430/481 (89%)	374 (87%)	56 (13%)	0	100	100
3	C	430/481 (89%)	374 (87%)	55 (13%)	1 (0%)	47	78
3	E	430/481 (89%)	372 (86%)	58 (14%)	0	100	100
4	B	161/173 (93%)	142 (88%)	19 (12%)	0	100	100
4	D	161/173 (93%)	142 (88%)	18 (11%)	1 (1%)	25	62
4	F	161/173 (93%)	140 (87%)	21 (13%)	0	100	100
All	All	3172/3294 (96%)	2866 (90%)	304 (10%)	2 (0%)	54	83

All (2) Ramachandran outliers are listed below:

Mol	Chain	Res	Type
4	D	670	TRP
3	C	366	GLY

### 5.3.2 Protein sidechains [i](#)

In the following table, the Percentiles column shows the percent sidechain outliers of the chain as a percentile score with respect to all PDB entries followed by that with respect to all EM entries.

The Analysed column shows the number of residues for which the sidechain conformation was analysed, and the total number of residues.

Mol	Chain	Analysed	Rotameric	Outliers	Percentiles	
1	H	202/184 (110%)	192 (95%)	10 (5%)	24	55
1	M	205/184 (111%)	198 (97%)	7 (3%)	37	64
1	N	205/184 (111%)	198 (97%)	7 (3%)	37	64
2	G	193/189 (102%)	188 (97%)	5 (3%)	46	69

*Continued on next page...*

Continued from previous page...

Mol	Chain	Analysed	Rotameric	Outliers	Percentiles	
2	I	197/189 (104%)	187 (95%)	10 (5%)	24	55
2	K	197/189 (104%)	193 (98%)	4 (2%)	55	74
3	A	390/428 (91%)	362 (93%)	28 (7%)	14	45
3	C	390/428 (91%)	366 (94%)	24 (6%)	18	49
3	E	391/428 (91%)	369 (94%)	22 (6%)	21	53
4	B	122/148 (82%)	107 (88%)	15 (12%)	4	24
4	D	124/148 (84%)	108 (87%)	16 (13%)	4	22
4	F	121/148 (82%)	106 (88%)	15 (12%)	4	23
All	All	2737/2847 (96%)	2574 (94%)	163 (6%)	25	50

5 of 163 residues with a non-rotameric sidechain are listed below:

Mol	Chain	Res	Type
4	D	574	LYS
3	E	371	THR
4	D	613	SER
3	E	107	ASP
4	F	551	GLN

Sometimes sidechains can be flipped to improve hydrogen bonding and reduce clashes. 5 of 50 such sidechains are listed below:

Mol	Chain	Res	Type
3	C	258	GLN
3	C	373	HIS
4	F	540	GLN
3	C	262	ASN
3	C	295	ASN

### 5.3.3 RNA [i](#)

There are no RNA molecules in this entry.

## 5.4 Non-standard residues in protein, DNA, RNA chains [i](#)

There are no non-standard protein/DNA/RNA residues in this entry.

## 5.5 Carbohydrates i

24 monosaccharides are modelled in this entry.

In the following table, the Counts columns list the number of bonds (or angles) for which Mogul statistics could be retrieved, the number of bonds (or angles) that are observed in the model and the number of bonds (or angles) that are defined in the Chemical Component Dictionary. The Link column lists molecule types, if any, to which the group is linked. The Z score for a bond length (or angle) is the number of standard deviations the observed value is removed from the expected value. A bond length (or angle) with  $|Z| > 2$  is considered an outlier worth inspection. RMSZ is the root-mean-square of all Z scores of the bond lengths (or angles).

Mol	Type	Chain	Res	Link	Bond lengths			Bond angles		
					Counts	RMSZ	# Z  > 2	Counts	RMSZ	# Z  > 2
5	NAG	J	1	5,3	14,14,15	0.45	0	17,19,21	0.65	0
5	NAG	J	2	5	14,14,15	0.38	0	17,19,21	1.26	2 (11%)
5	BMA	J	3	5	11,11,12	1.40	1 (9%)	15,15,17	1.08	1 (6%)
6	NAG	L	1	6,3	14,14,15	0.68	1 (7%)	17,19,21	1.14	1 (5%)
6	NAG	L	2	6	14,14,15	0.42	0	17,19,21	0.40	0
5	NAG	O	1	5,3	14,14,15	0.23	0	17,19,21	0.75	1 (5%)
5	NAG	O	2	5	14,14,15	0.81	1 (7%)	17,19,21	0.87	1 (5%)
5	BMA	O	3	5	11,11,12	0.77	0	15,15,17	0.79	0
5	NAG	P	1	5,3	14,14,15	0.44	0	17,19,21	0.65	0
5	NAG	P	2	5	14,14,15	0.39	0	17,19,21	1.25	2 (11%)
5	BMA	P	3	5	11,11,12	1.40	1 (9%)	15,15,17	1.09	1 (6%)
6	NAG	Q	1	6,3	14,14,15	0.68	1 (7%)	17,19,21	1.14	1 (5%)
6	NAG	Q	2	6	14,14,15	0.44	0	17,19,21	0.40	0
5	NAG	R	1	5,3	14,14,15	0.22	0	17,19,21	0.75	1 (5%)
5	NAG	R	2	5	14,14,15	0.82	1 (7%)	17,19,21	0.87	1 (5%)
5	BMA	R	3	5	11,11,12	0.76	0	15,15,17	0.79	0
5	NAG	S	1	5	14,14,15	0.44	0	17,19,21	0.64	0
5	NAG	S	2	5	14,14,15	0.38	0	17,19,21	1.25	2 (11%)
5	BMA	S	3	5	11,11,12	1.40	1 (9%)	15,15,17	1.09	1 (6%)
6	NAG	T	1	6,3	14,14,15	0.67	1 (7%)	17,19,21	1.15	1 (5%)
6	NAG	T	2	6	14,14,15	0.43	0	17,19,21	0.39	0
5	NAG	U	1	5,3	14,14,15	0.23	0	17,19,21	0.75	1 (5%)
5	NAG	U	2	5	14,14,15	0.81	1 (7%)	17,19,21	0.87	1 (5%)
5	BMA	U	3	5	11,11,12	0.76	0	15,15,17	0.79	0

In the following table, the Chirals column lists the number of chiral outliers, the number of chiral centers analysed, the number of these observed in the model and the number defined in the Chemical Component Dictionary. Similar counts are reported in the Torsion and Rings columns.

'-' means no outliers of that kind were identified.

Mol	Type	Chain	Res	Link	Chirals	Torsions	Rings
5	NAG	J	1	5,3	-	2/6/23/26	0/1/1/1
5	NAG	J	2	5	-	1/6/23/26	0/1/1/1
5	BMA	J	3	5	-	1/2/19/22	0/1/1/1
6	NAG	L	1	6,3	-	2/6/23/26	0/1/1/1
6	NAG	L	2	6	-	2/6/23/26	0/1/1/1
5	NAG	O	1	5,3	-	1/6/23/26	0/1/1/1
5	NAG	O	2	5	-	2/6/23/26	0/1/1/1
5	BMA	O	3	5	-	0/2/19/22	0/1/1/1
5	NAG	P	1	5,3	-	2/6/23/26	0/1/1/1
5	NAG	P	2	5	-	1/6/23/26	0/1/1/1
5	BMA	P	3	5	-	1/2/19/22	0/1/1/1
6	NAG	Q	1	6,3	-	2/6/23/26	0/1/1/1
6	NAG	Q	2	6	-	2/6/23/26	0/1/1/1
5	NAG	R	1	5,3	-	1/6/23/26	0/1/1/1
5	NAG	R	2	5	-	2/6/23/26	0/1/1/1
5	BMA	R	3	5	-	0/2/19/22	0/1/1/1
5	NAG	S	1	5	-	2/6/23/26	0/1/1/1
5	NAG	S	2	5	-	1/6/23/26	0/1/1/1
5	BMA	S	3	5	-	1/2/19/22	0/1/1/1
6	NAG	T	1	6,3	-	2/6/23/26	0/1/1/1
6	NAG	T	2	6	-	2/6/23/26	0/1/1/1
5	NAG	U	1	5,3	-	1/6/23/26	0/1/1/1
5	NAG	U	2	5	-	2/6/23/26	0/1/1/1
5	BMA	U	3	5	-	0/2/19/22	0/1/1/1

The worst 5 of 9 bond length outliers are listed below:

Mol	Chain	Res	Type	Atoms	Z	Observed(Å)	Ideal(Å)
5	P	3	BMA	C1-C2	3.84	1.61	1.52
5	J	3	BMA	C1-C2	3.83	1.60	1.52
5	S	3	BMA	C1-C2	3.81	1.60	1.52
5	R	2	NAG	C1-C2	2.69	1.56	1.52
5	O	2	NAG	C1-C2	2.65	1.56	1.52

The worst 5 of 18 bond angle outliers are listed below:

Mol	Chain	Res	Type	Atoms	Z	Observed(°)	Ideal(°)
6	T	1	NAG	C2-N2-C7	3.22	127.49	122.90
6	Q	1	NAG	C2-N2-C7	3.21	127.47	122.90

*Continued on next page...*

*Continued from previous page...*

Mol	Chain	Res	Type	Atoms	Z	Observed(°)	Ideal(°)
6	L	1	NAG	C2-N2-C7	3.18	127.43	122.90
5	S	2	NAG	C2-N2-C7	3.03	127.22	122.90
5	J	2	NAG	C2-N2-C7	3.03	127.21	122.90

There are no chirality outliers.

5 of 33 torsion outliers are listed below:

Mol	Chain	Res	Type	Atoms
5	J	1	NAG	O5-C5-C6-O6
5	P	1	NAG	O5-C5-C6-O6
5	S	1	NAG	O5-C5-C6-O6
5	O	2	NAG	C8-C7-N2-C2
5	O	2	NAG	O7-C7-N2-C2

There are no ring outliers.

9 monomers are involved in 14 short contacts:

Mol	Chain	Res	Type	Clashes	Symm-Clashes
5	P	1	NAG	1	0
5	O	1	NAG	1	0
5	O	2	NAG	1	0
5	R	1	NAG	1	0
5	U	1	NAG	1	0
5	U	2	NAG	1	0
5	R	2	NAG	1	0
5	J	1	NAG	4	0
5	S	1	NAG	6	0

The following is a two-dimensional graphical depiction of Mogul quality analysis of bond lengths, bond angles, torsion angles, and ring geometry for oligosaccharide.



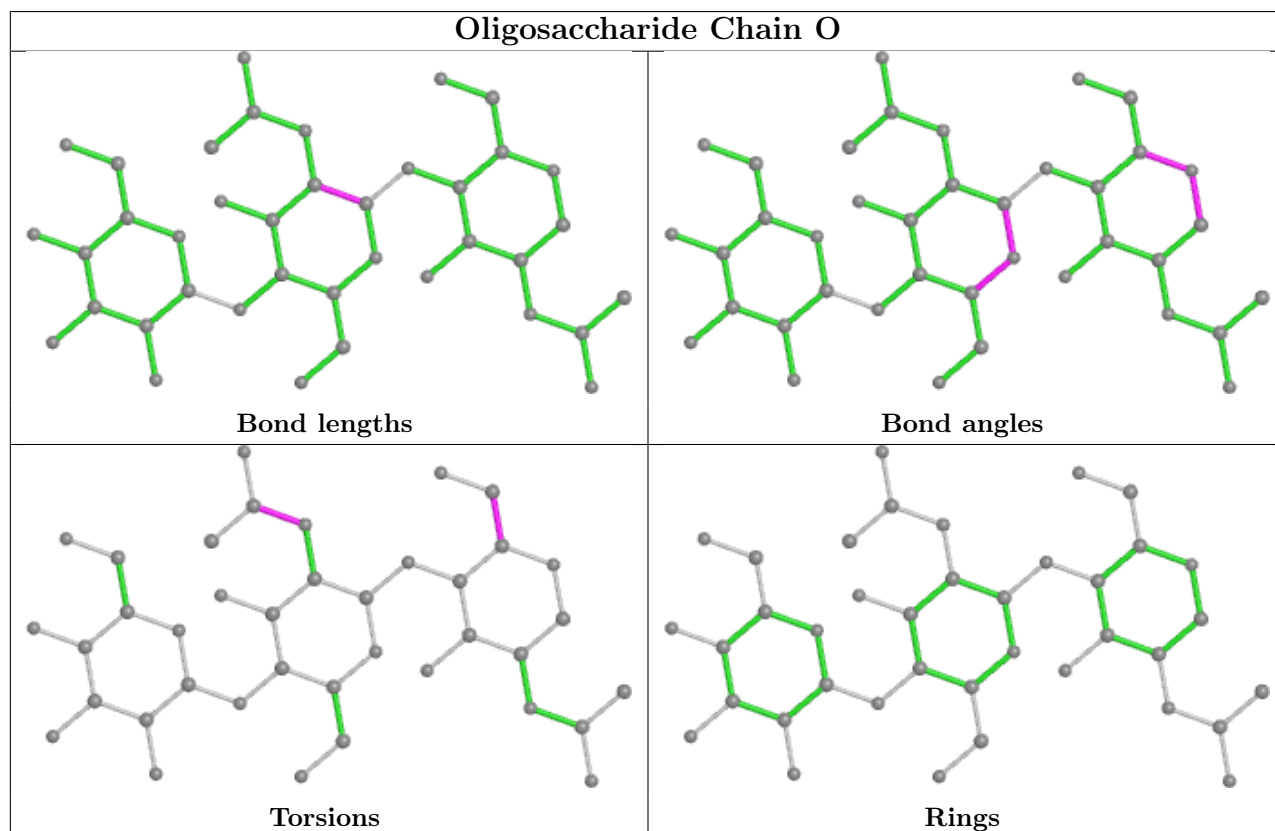
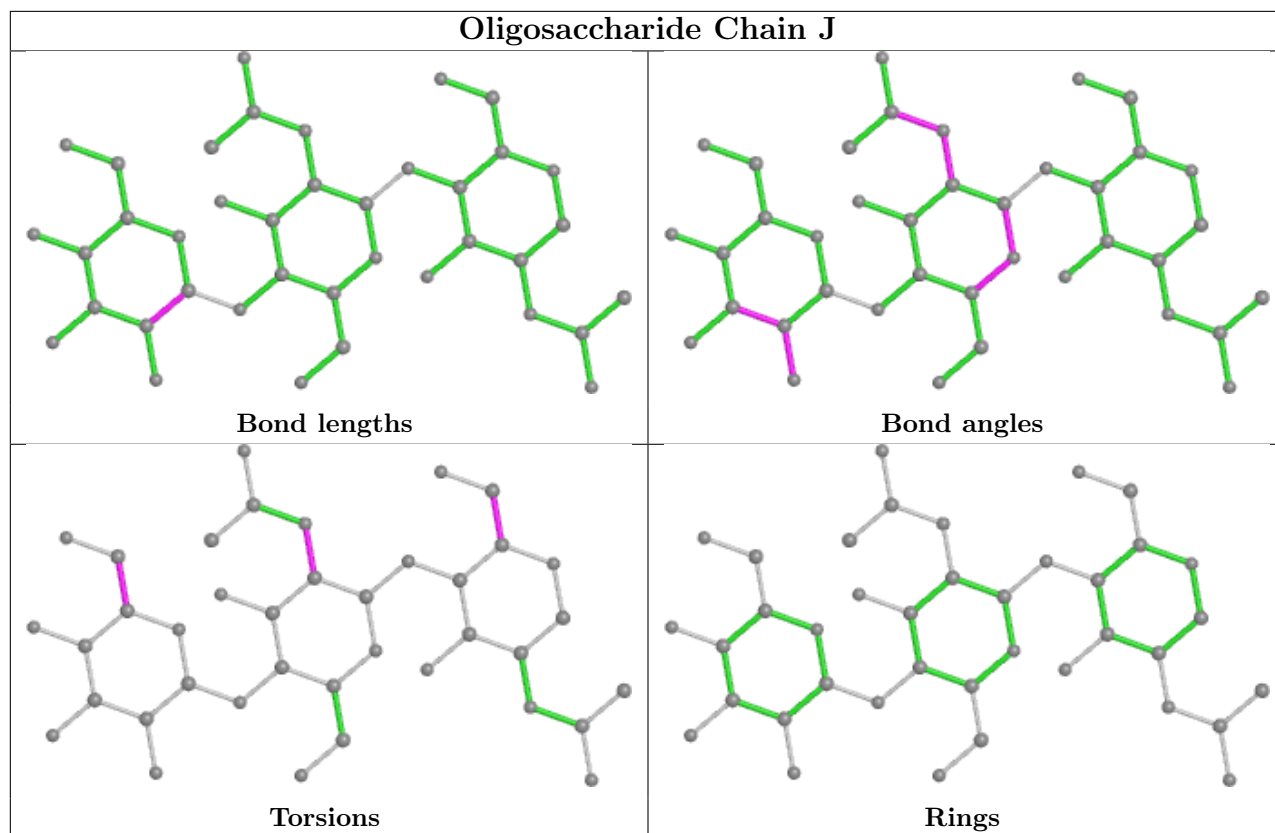

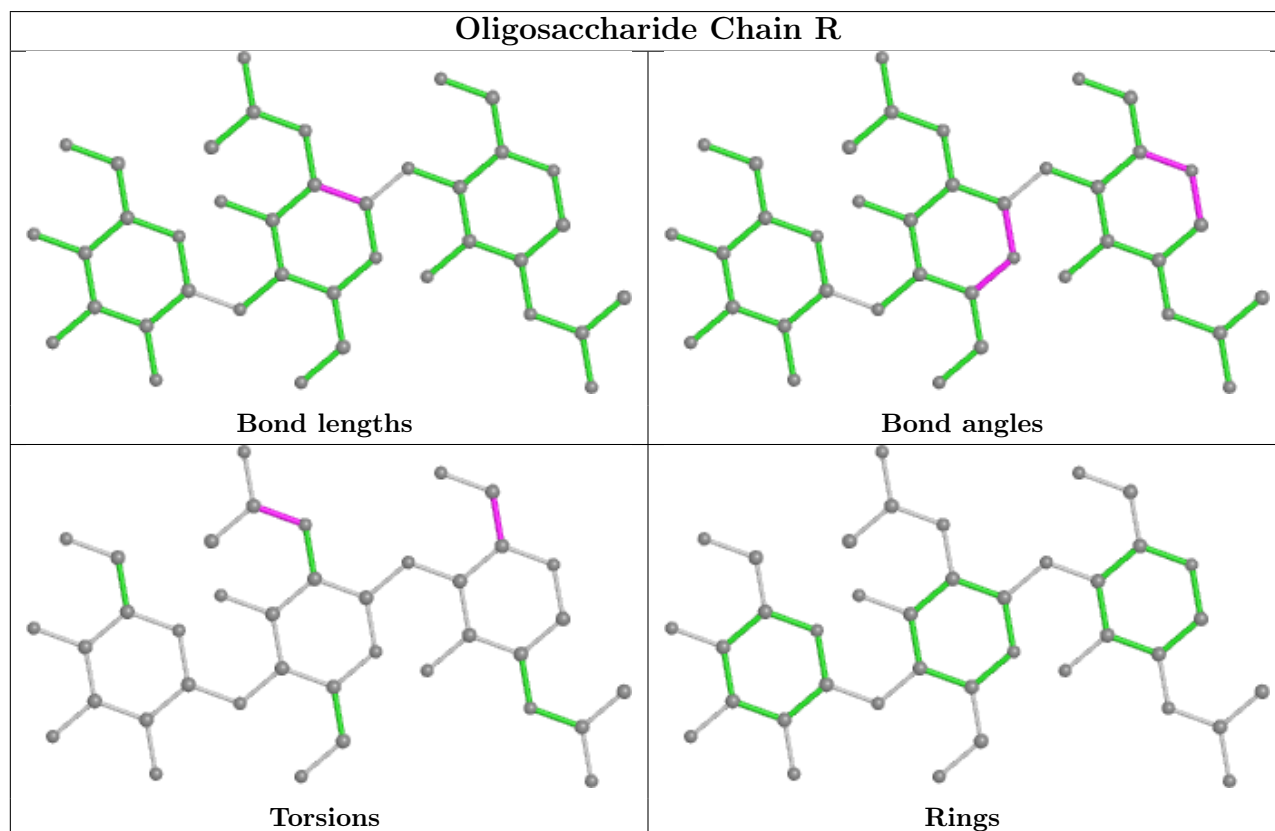
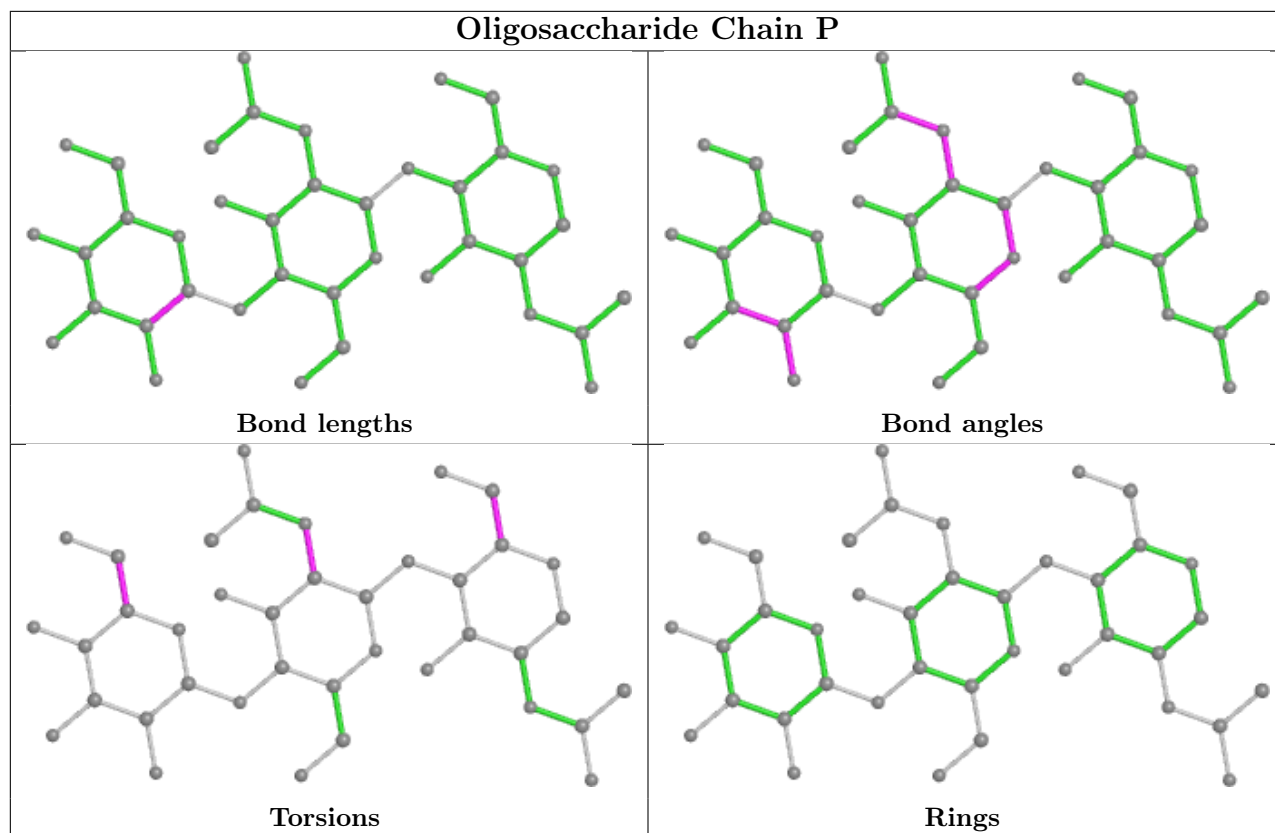

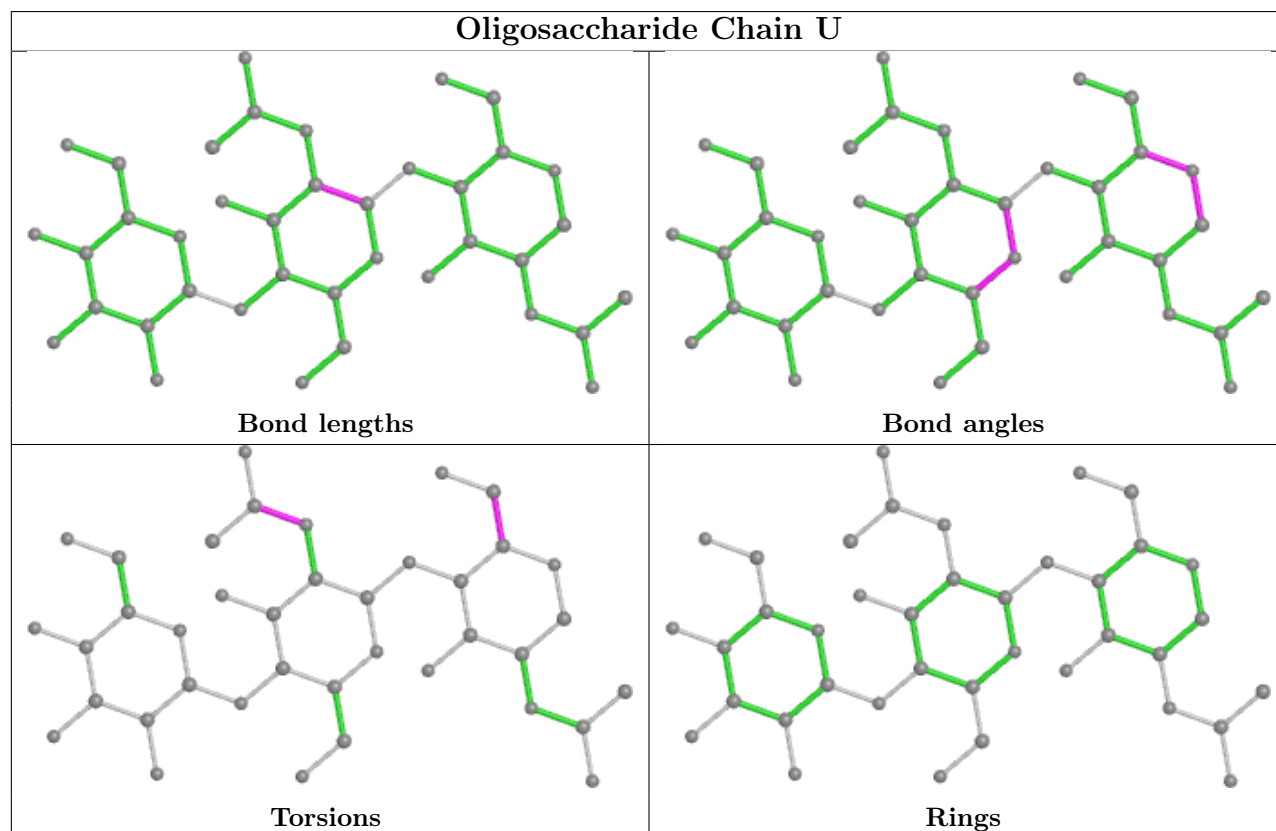
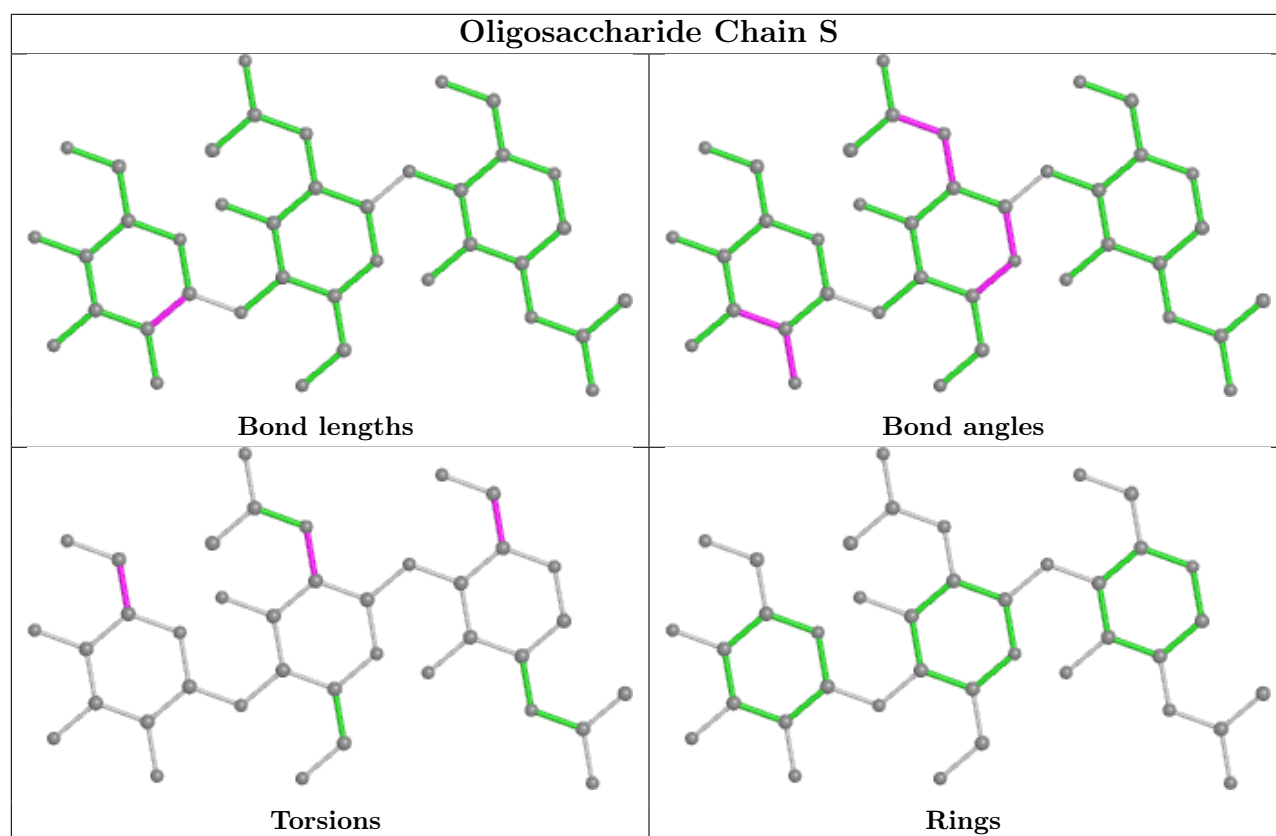

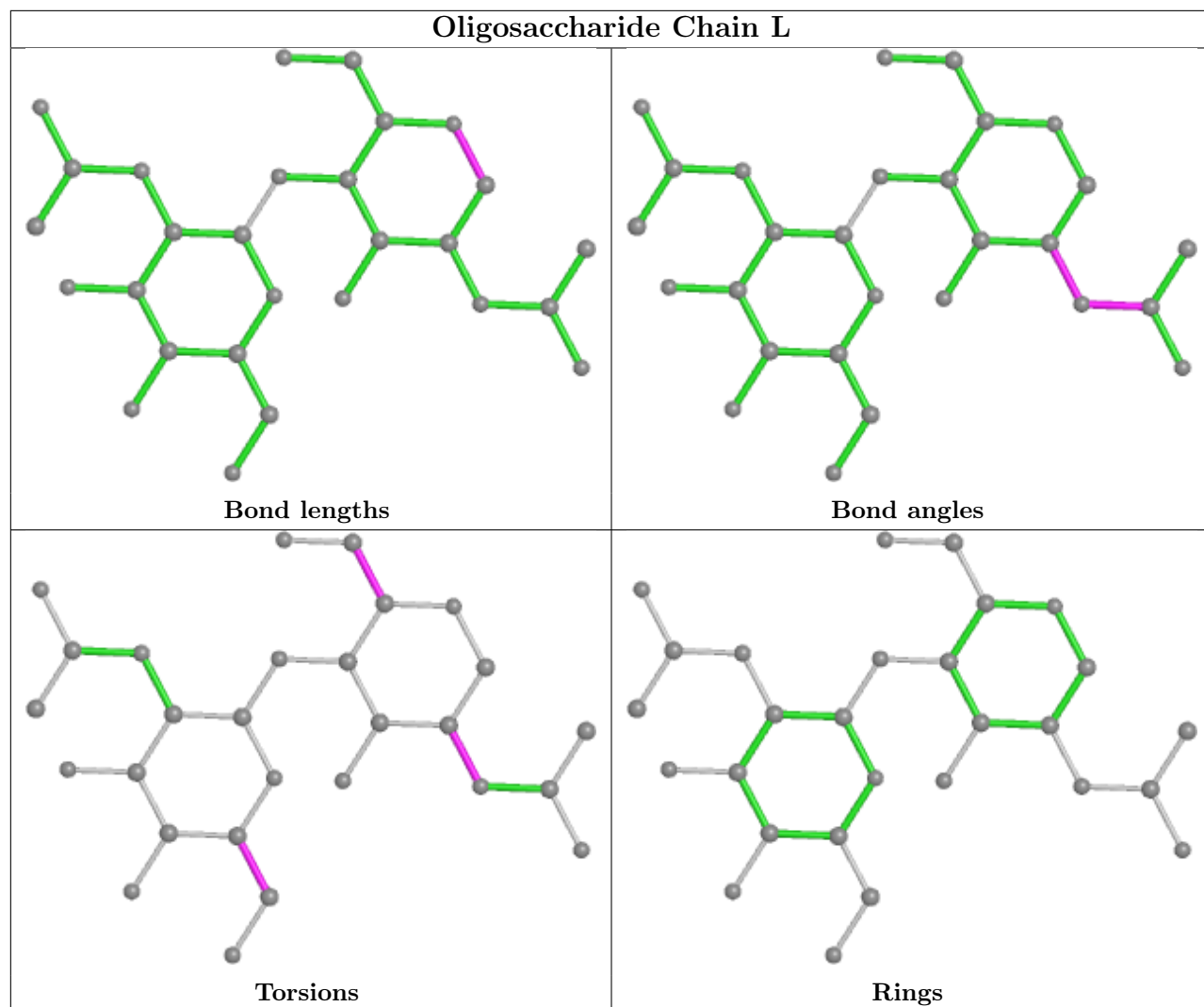

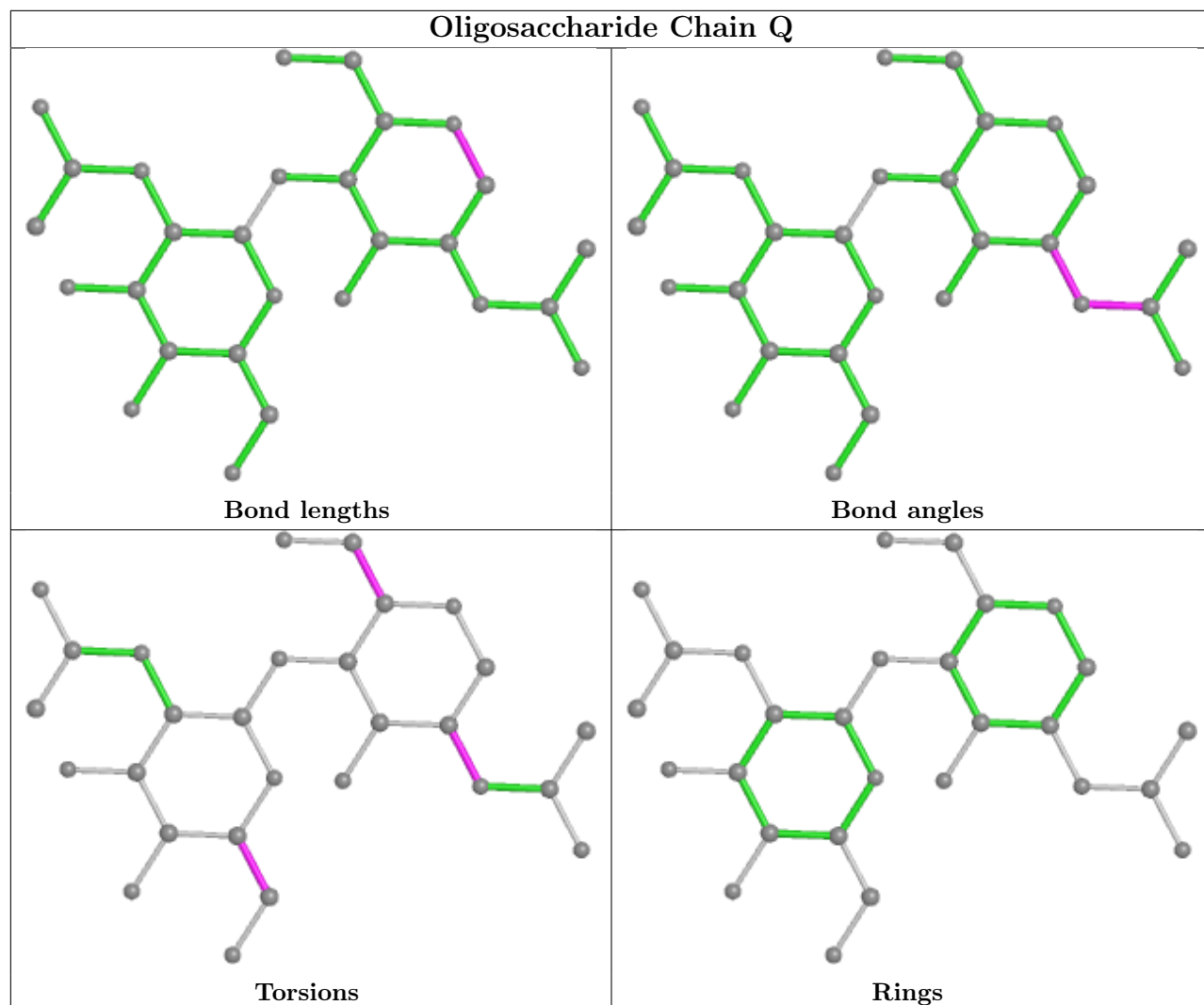

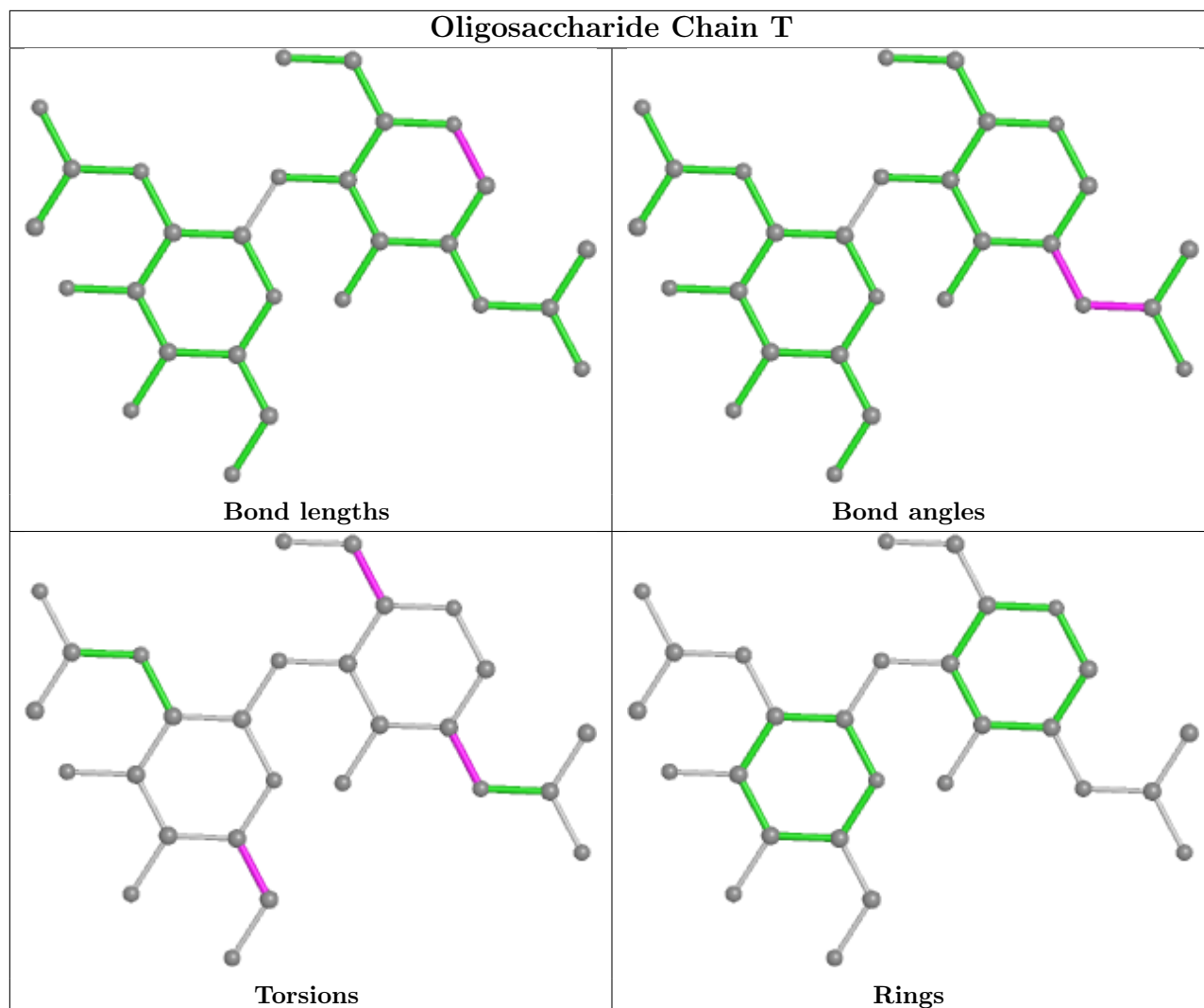

## 5.6 Ligand geometry [i](#)

36 ligands are modelled in this entry.

In the following table, the Counts columns list the number of bonds (or angles) for which Mogul statistics could be retrieved, the number of bonds (or angles) that are observed in the model and the number of bonds (or angles) that are defined in the Chemical Component Dictionary. The Link column lists molecule types, if any, to which the group is linked. The Z score for a bond length (or angle) is the number of standard deviations the observed value is removed from the expected value. A bond length (or angle) with  $|Z| > 2$  is considered an outlier worth inspection. RMSZ is the root-mean-square of all Z scores of the bond lengths (or angles).

Mol	Type	Chain	Res	Link	Bond lengths			Bond angles		
					Counts	RMSZ	$\# Z  > 2$	Counts	RMSZ	$\# Z  > 2$
7	NAG	E	603	3	14,14,15	0.68	0	17,19,21	2.24	4 (23%)
7	NAG	A	607	3	14,14,15	0.78	1 (7%)	17,19,21	0.71	0
7	NAG	E	601	3	14,14,15	0.40	0	17,19,21	0.62	0

Mol	Type	Chain	Res	Link	Bond lengths			Bond angles		
					Counts	RMSZ	# Z  > 2	Counts	RMSZ	# Z  > 2
7	NAG	A	606	3	14,14,15	0.84	1 (7%)	17,19,21	0.59	0
7	NAG	C	605	3	14,14,15	0.70	0	17,19,21	2.29	4 (23%)
7	NAG	A	608	3	14,14,15	0.27	0	17,19,21	0.61	1 (5%)
7	NAG	A	609	3	14,14,15	0.25	0	17,19,21	0.62	0
7	NAG	E	607	3	14,14,15	0.78	1 (7%)	17,19,21	0.70	0
7	NAG	B	703	4	14,14,15	0.69	0	17,19,21	2.22	3 (17%)
7	NAG	A	602	3	14,14,15	0.17	0	17,19,21	0.61	0
7	NAG	D	701	4	14,14,15	0.35	0	17,19,21	0.57	0
7	NAG	C	606	3	14,14,15	0.84	1 (7%)	17,19,21	0.59	0
7	NAG	B	701	4	14,14,15	0.35	0	17,19,21	0.57	0
7	NAG	F	703	4	14,14,15	0.70	0	17,19,21	2.21	3 (17%)
7	NAG	C	608	3	14,14,15	0.29	0	17,19,21	0.60	1 (5%)
7	NAG	E	604	3	14,14,15	0.26	0	17,19,21	0.61	1 (5%)
7	NAG	F	701	4	14,14,15	0.35	0	17,19,21	0.56	0
7	NAG	A	603	3	14,14,15	0.68	0	17,19,21	2.24	4 (23%)
7	NAG	E	606	3	14,14,15	0.84	1 (7%)	17,19,21	0.59	0
7	NAG	C	603	3	14,14,15	0.69	0	17,19,21	2.24	4 (23%)
7	NAG	B	702	4	14,14,15	0.35	0	17,19,21	0.85	1 (5%)
7	NAG	C	607	3	14,14,15	0.78	1 (7%)	17,19,21	0.70	0
7	NAG	E	609	3	14,14,15	0.25	0	17,19,21	0.62	0
7	NAG	F	702	4	14,14,15	0.36	0	17,19,21	0.87	1 (5%)
7	NAG	C	601	3	14,14,15	0.40	0	17,19,21	0.61	0
7	NAG	E	605	3	14,14,15	0.70	0	17,19,21	2.29	4 (23%)
7	NAG	A	605	3	14,14,15	0.71	0	17,19,21	2.28	4 (23%)
7	NAG	C	609	3	14,14,15	0.25	0	17,19,21	0.63	0
7	NAG	D	703	4	14,14,15	0.69	0	17,19,21	2.21	3 (17%)
7	NAG	E	602	3	14,14,15	0.18	0	17,19,21	0.61	0
7	NAG	C	602	3	14,14,15	0.16	0	17,19,21	0.60	0
7	NAG	E	608	3	14,14,15	0.28	0	17,19,21	0.60	1 (5%)
7	NAG	A	604	3	14,14,15	0.27	0	17,19,21	0.60	1 (5%)
7	NAG	C	604	3	14,14,15	0.27	0	17,19,21	0.60	1 (5%)
7	NAG	A	601	3	14,14,15	0.41	0	17,19,21	0.61	0
7	NAG	D	702	4	14,14,15	0.35	0	17,19,21	0.86	1 (5%)

In the following table, the Chirals column lists the number of chiral outliers, the number of chiral centers analysed, the number of these observed in the model and the number defined in the Chemical Component Dictionary. Similar counts are reported in the Torsion and Rings columns. '-' means no outliers of that kind were identified.

Mol	Type	Chain	Res	Link	Chirals	Torsions	Rings
7	NAG	E	603	3	-	5/6/23/26	0/1/1/1
7	NAG	A	607	3	-	2/6/23/26	0/1/1/1
7	NAG	E	601	3	-	2/6/23/26	0/1/1/1
7	NAG	A	606	3	-	1/6/23/26	0/1/1/1
7	NAG	C	605	3	-	3/6/23/26	0/1/1/1
7	NAG	A	608	3	-	2/6/23/26	0/1/1/1
7	NAG	A	609	3	-	2/6/23/26	0/1/1/1
7	NAG	E	607	3	-	2/6/23/26	0/1/1/1
7	NAG	B	703	4	-	5/6/23/26	0/1/1/1
7	NAG	A	602	3	-	2/6/23/26	0/1/1/1
7	NAG	D	701	4	-	2/6/23/26	0/1/1/1
7	NAG	C	606	3	-	1/6/23/26	0/1/1/1
7	NAG	B	701	4	-	2/6/23/26	0/1/1/1
7	NAG	F	703	4	-	5/6/23/26	0/1/1/1
7	NAG	C	608	3	-	2/6/23/26	0/1/1/1
7	NAG	E	604	3	-	2/6/23/26	0/1/1/1
7	NAG	F	701	4	-	2/6/23/26	0/1/1/1
7	NAG	A	603	3	-	5/6/23/26	0/1/1/1
7	NAG	E	606	3	-	1/6/23/26	0/1/1/1
7	NAG	C	603	3	-	5/6/23/26	0/1/1/1
7	NAG	B	702	4	-	0/6/23/26	0/1/1/1
7	NAG	C	607	3	-	2/6/23/26	0/1/1/1
7	NAG	E	609	3	-	2/6/23/26	0/1/1/1
7	NAG	F	702	4	-	0/6/23/26	0/1/1/1
7	NAG	C	601	3	-	2/6/23/26	0/1/1/1
7	NAG	E	605	3	-	3/6/23/26	0/1/1/1
7	NAG	A	605	3	-	3/6/23/26	0/1/1/1
7	NAG	C	609	3	-	2/6/23/26	0/1/1/1
7	NAG	D	703	4	-	5/6/23/26	0/1/1/1
7	NAG	E	602	3	-	2/6/23/26	0/1/1/1
7	NAG	C	602	3	-	2/6/23/26	0/1/1/1
7	NAG	E	608	3	-	2/6/23/26	0/1/1/1
7	NAG	A	604	3	-	2/6/23/26	0/1/1/1
7	NAG	C	604	3	-	2/6/23/26	0/1/1/1
7	NAG	A	601	3	-	2/6/23/26	0/1/1/1
7	NAG	D	702	4	-	0/6/23/26	0/1/1/1



The worst 5 of 6 bond length outliers are listed below:

Mol	Chain	Res	Type	Atoms	Z	Observed(Å)	Ideal(Å)
7	E	607	NAG	C1-C2	2.69	1.56	1.52
7	A	607	NAG	C1-C2	2.68	1.56	1.52
7	C	607	NAG	C1-C2	2.68	1.56	1.52
7	E	606	NAG	O5-C1	2.53	1.47	1.43
7	A	606	NAG	O5-C1	2.52	1.47	1.43

The worst 5 of 42 bond angle outliers are listed below:

Mol	Chain	Res	Type	Atoms	Z	Observed(°)	Ideal(°)
7	B	703	NAG	C2-N2-C7	7.93	134.20	122.90
7	D	703	NAG	C2-N2-C7	7.87	134.11	122.90
7	F	703	NAG	C2-N2-C7	7.87	134.11	122.90
7	E	603	NAG	C2-N2-C7	7.79	134.00	122.90
7	A	603	NAG	C2-N2-C7	7.79	133.99	122.90

There are no chirality outliers.

5 of 84 torsion outliers are listed below:

Mol	Chain	Res	Type	Atoms
7	A	604	NAG	C4-C5-C6-O6
7	C	604	NAG	C4-C5-C6-O6
7	E	604	NAG	C4-C5-C6-O6
7	A	603	NAG	C4-C5-C6-O6
7	C	603	NAG	C4-C5-C6-O6

There are no ring outliers.

6 monomers are involved in 6 short contacts:

Mol	Chain	Res	Type	Clashes	Symm-Clashes
7	A	607	NAG	1	0
7	E	601	NAG	1	0
7	E	607	NAG	1	0
7	C	607	NAG	1	0
7	C	601	NAG	1	0
7	A	601	NAG	1	0

## 5.7 Other polymers [i](#)

There are no such residues in this entry.

## 5.8 Polymer linkage issues

There are no chain breaks in this entry.

## 6 Map visualisation [i](#)

This section contains visualisations of the EMDB entry EMD-25045. These allow visual inspection of the internal detail of the map and identification of artifacts.

No raw map or half-maps were deposited for this entry and therefore no images, graphs, etc. pertaining to the raw map can be shown.

### 6.1 Orthogonal projections [i](#)

#### 6.1.1 Primary map

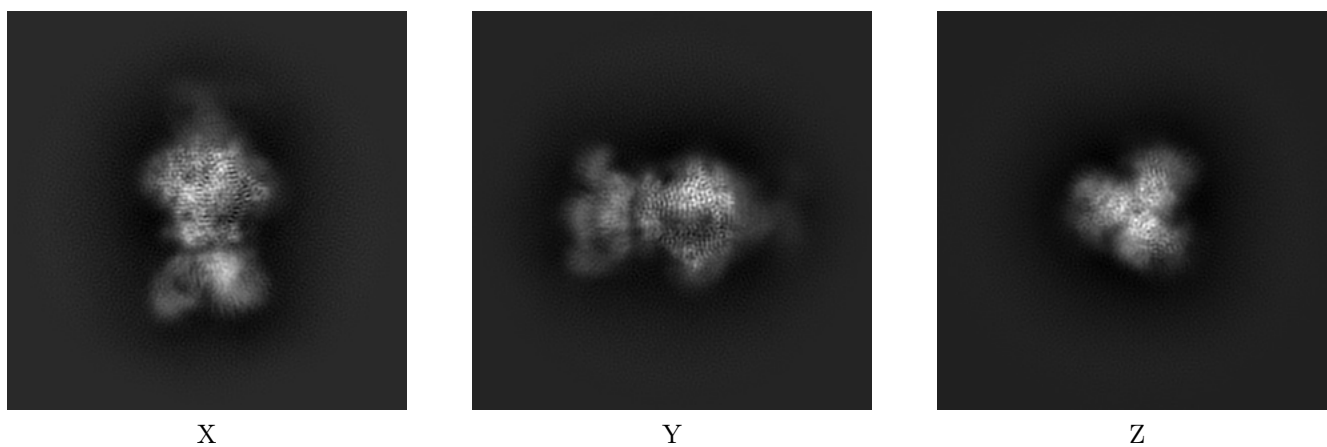

The images above show the map projected in three orthogonal directions.

### 6.2 Central slices [i](#)

#### 6.2.1 Primary map

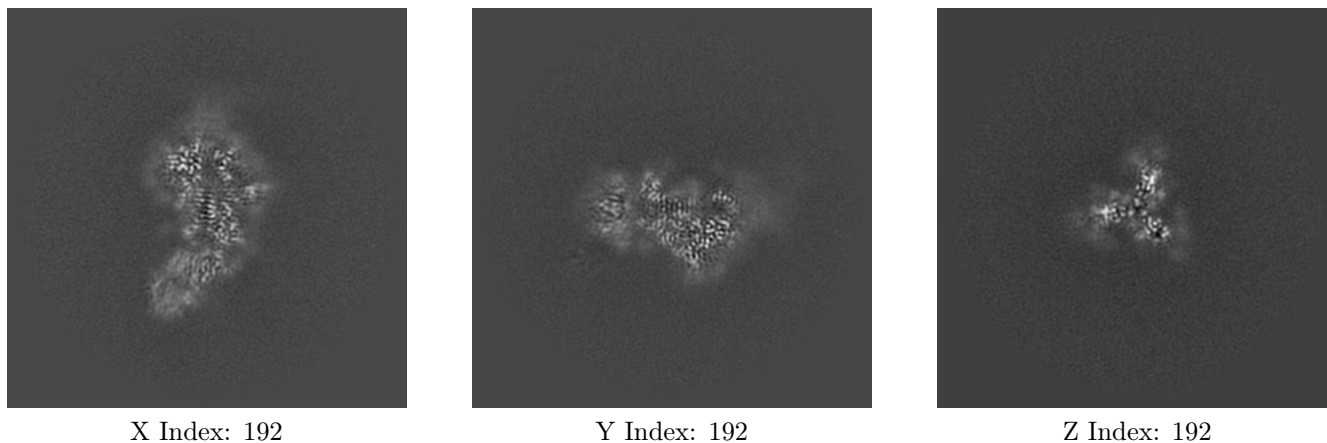

The images above show central slices of the map in three orthogonal directions.

## 6.3 Largest variance slices [i](#)

### 6.3.1 Primary map

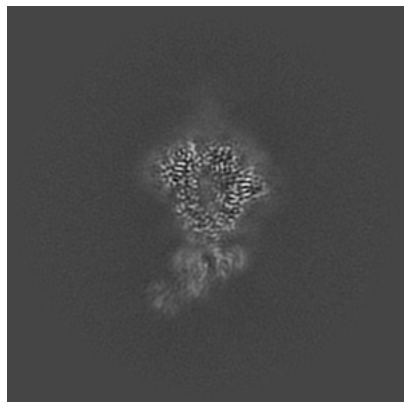

X Index: 203

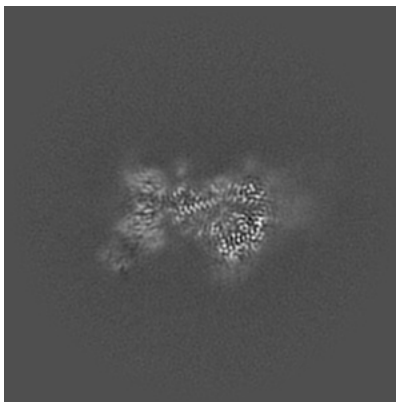

Y Index: 198

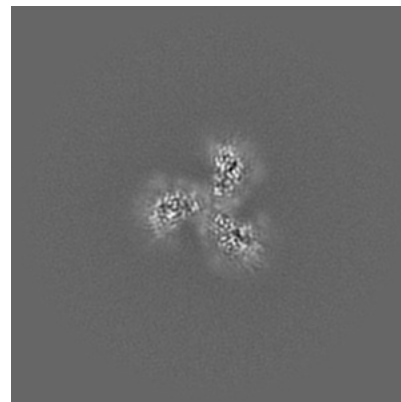

Z Index: 213

The images above show the largest variance slices of the map in three orthogonal directions.

## 6.4 Orthogonal surface views [i](#)

### 6.4.1 Primary map



X

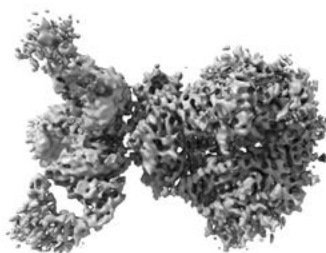

Y



Z

The images above show the 3D surface view of the map at the recommended contour level 0.296. These images, in conjunction with the slice images, may facilitate assessment of whether an appropriate contour level has been provided.

## 6.5 Mask visualisation

This section was not generated. No masks/segmentation were deposited.

## 7 Map analysis [i](#)

This section contains the results of statistical analysis of the map.

### 7.1 Map-value distribution [i](#)

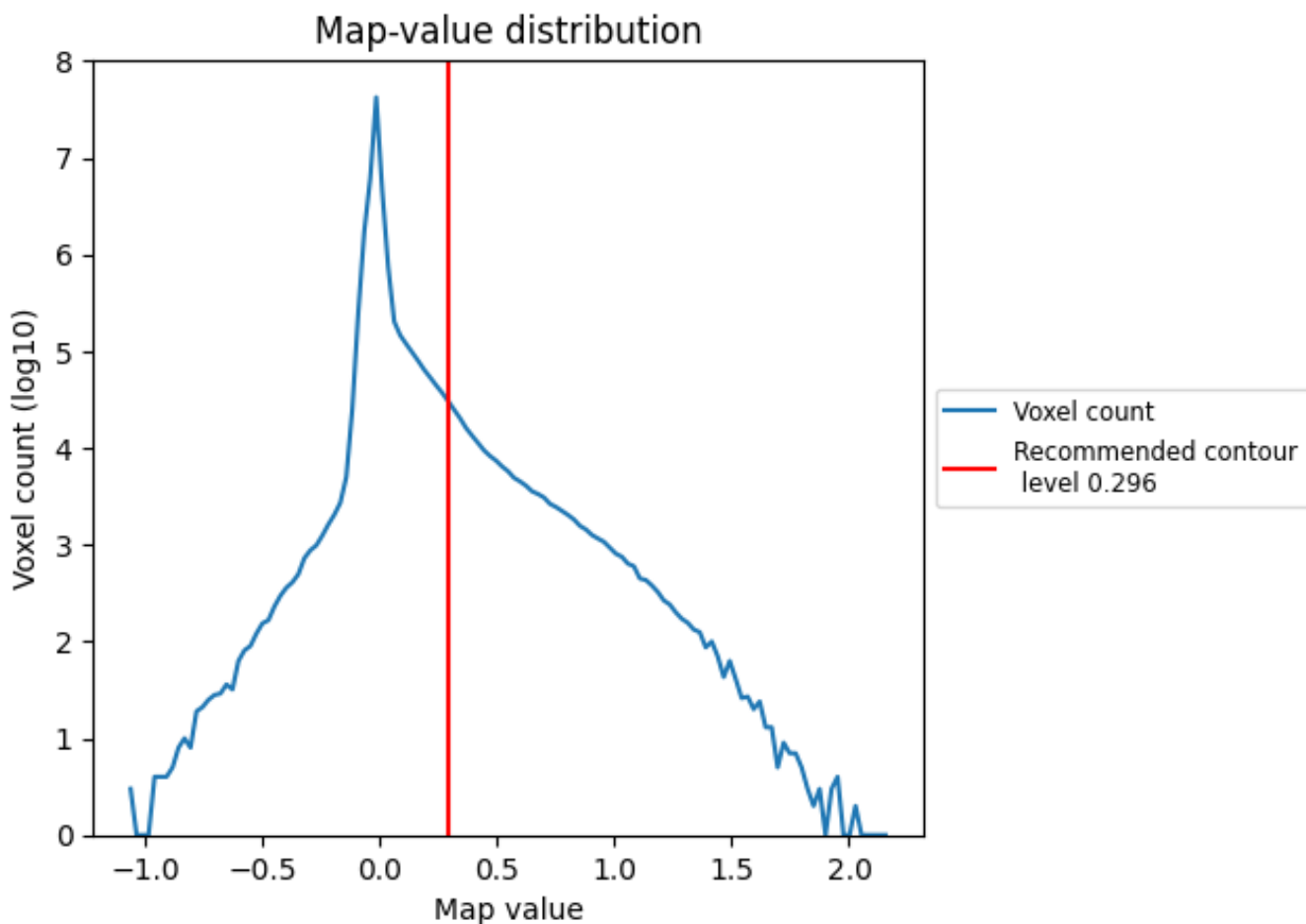

The map-value distribution is plotted in 128 intervals along the x-axis. The y-axis is logarithmic. A spike in this graph at zero usually indicates that the volume has been masked.

## 7.2 Volume estimate [\(i\)](#)

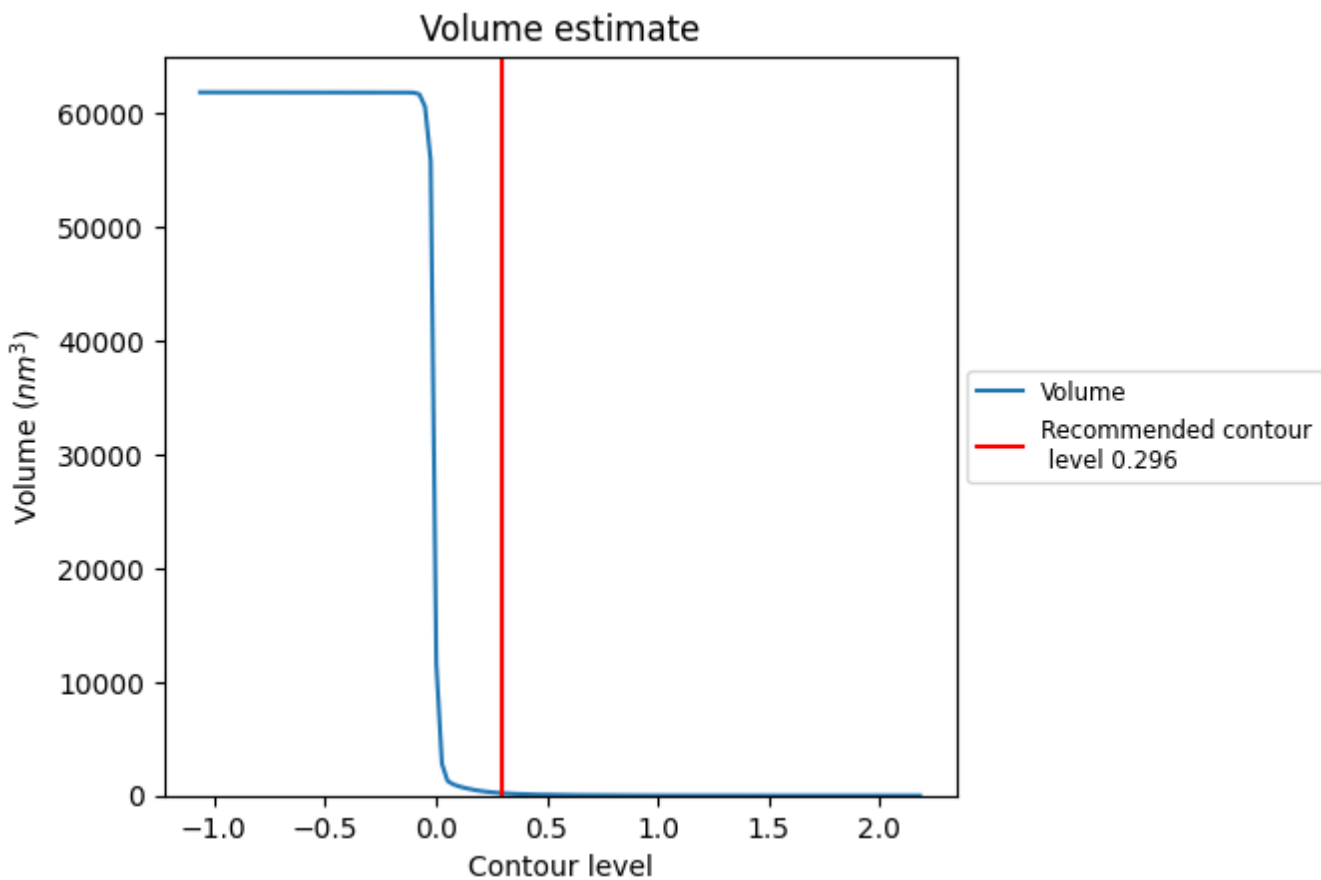

The volume at the recommended contour level is 215 nm<sup>3</sup>; this corresponds to an approximate mass of 194 kDa.

The volume estimate graph shows how the enclosed volume varies with the contour level. The recommended contour level is shown as a vertical line and the intersection between the line and the curve gives the volume of the enclosed surface at the given level.

### 7.3 Rotationally averaged power spectrum [i](#)

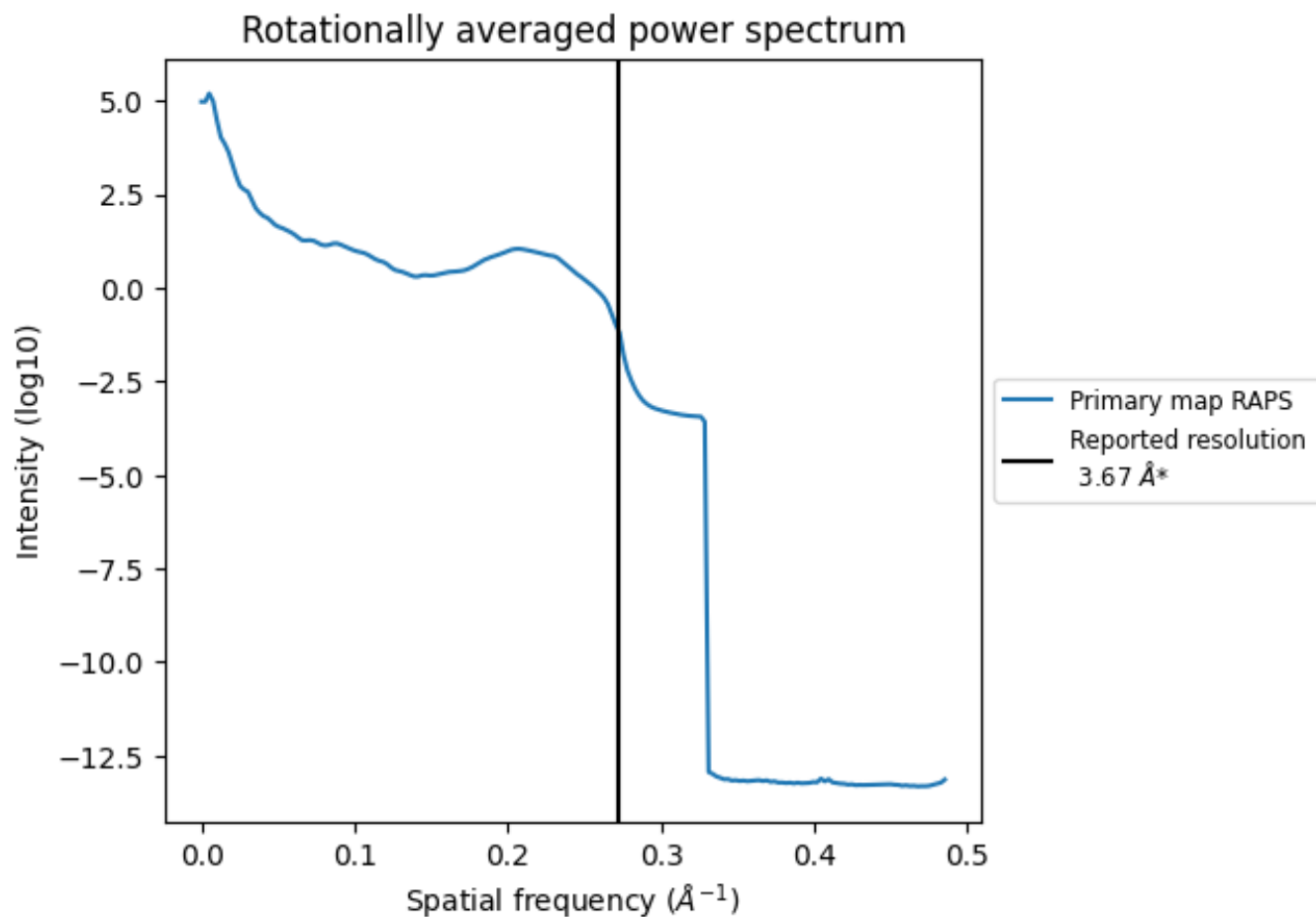

\*Reported resolution corresponds to spatial frequency of 0.272 Å<sup>-1</sup>



## 8 Fourier-Shell correlation

This section was not generated. No FSC curve or half-maps provided.

## 9 Map-model fit [i](#)

This section contains information regarding the fit between EMDB map EMD-25045 and PDB model 7SD3. Per-residue inclusion information can be found in section 3 on page 10.

### 9.1 Map-model overlay [i](#)

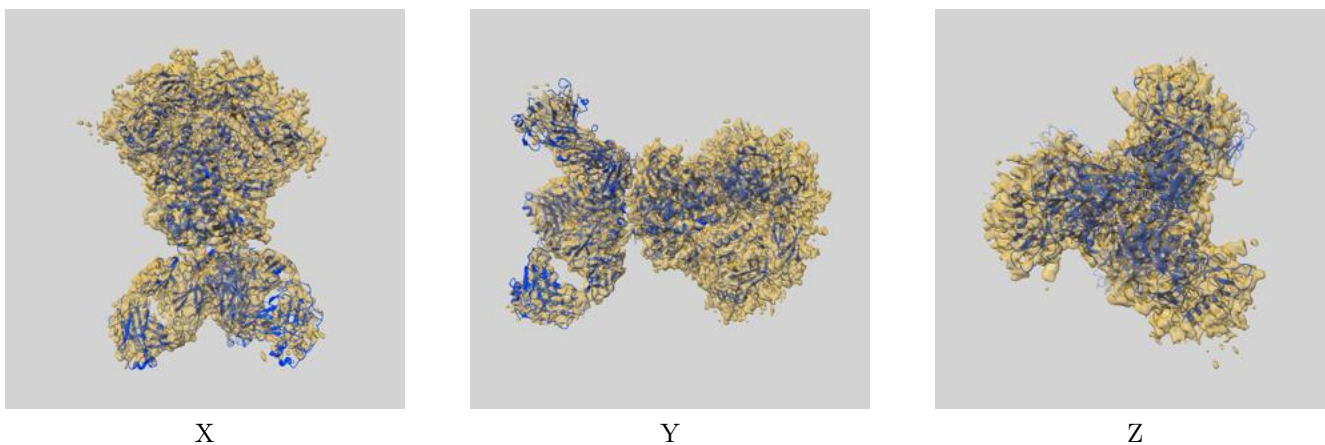

The images above show the 3D surface view of the map at the recommended contour level 0.296 at 50% transparency in yellow overlaid with a ribbon representation of the model coloured in blue. These images allow for the visual assessment of the quality of fit between the atomic model and the map.

## 9.2 Q-score mapped to coordinate model [\(i\)](#)

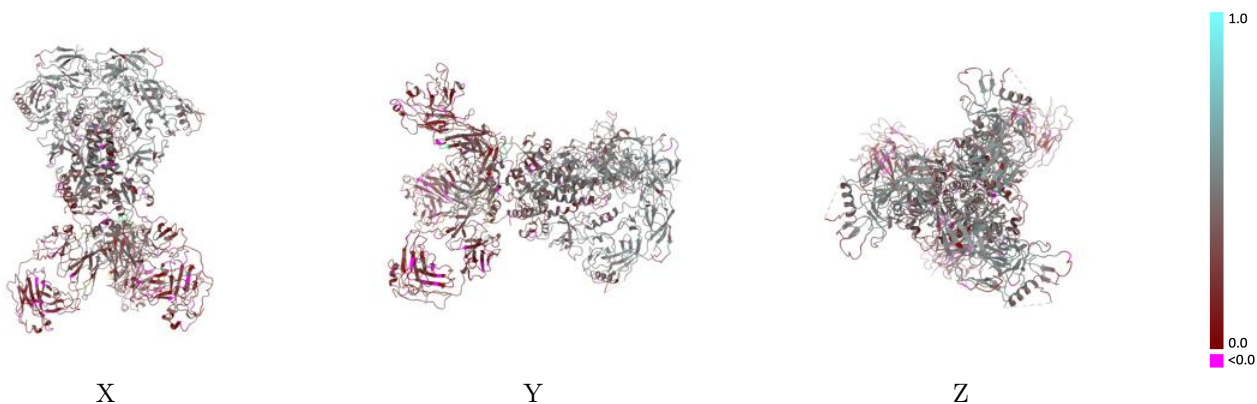

The images above show the model with each residue coloured according to its Q-score. This shows their resolvability in the map with higher Q-score values reflecting better resolvability. Please note: Q-score is calculating the resolvability of atoms, and thus high values are only expected at resolutions at which atoms can be resolved. Low Q-score values may therefore be expected for many entries.

## 9.3 Atom inclusion mapped to coordinate model [\(i\)](#)

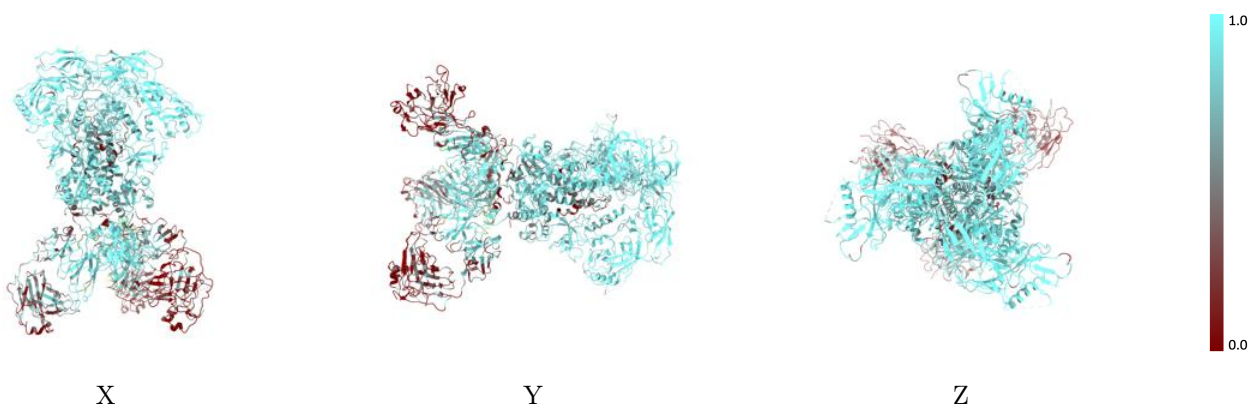

The images above show the model with each residue coloured according to its atom inclusion. This shows to what extent they are inside the map at the recommended contour level (0.296).



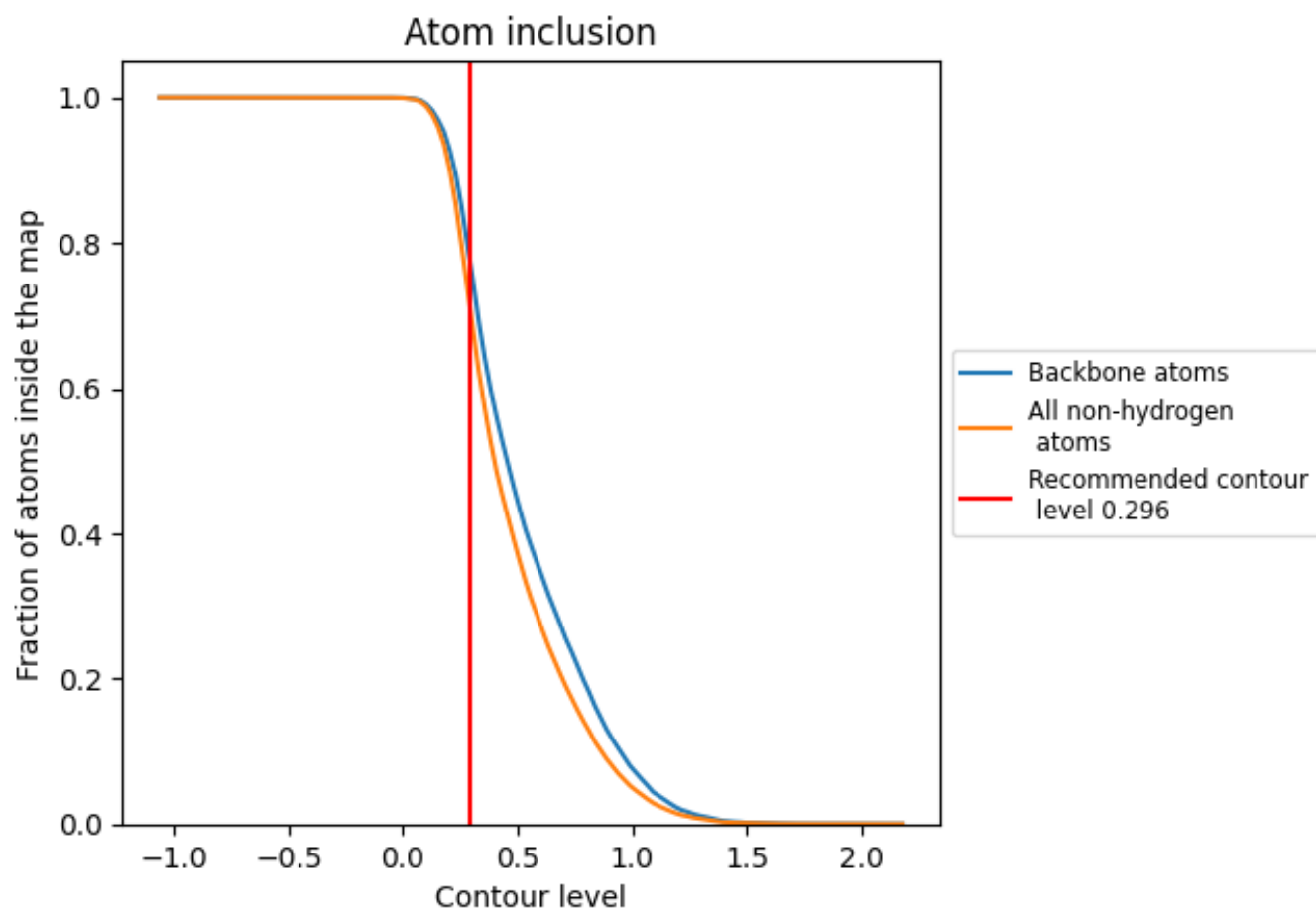









































## 9.4 Atom inclusion [i](#)



At the recommended contour level, 77% of all backbone atoms, 70% of all non-hydrogen atoms, are inside the map.

## 9.5 Map-model fit summary

The table lists the average atom inclusion at the recommended contour level (0.296) and Q-score for the entire model and for each chain.

Chain	Atom inclusion	Q-score
All	 0.7023	 0.3490
A	 0.8800	 0.4410
B	 0.7174	 0.3300
C	 0.8911	 0.4390
D	 0.7216	 0.3280
E	 0.8800	 0.4350
F	 0.6915	 0.3170
G	 0.6798	 0.2960
H	 0.5259	 0.2350
I	 0.5234	 0.2890
J	 0.8462	 0.3930
K	 0.5126	 0.2780
L	 0.5714	 0.2100
M	 0.3766	 0.2580
N	 0.4085	 0.2350
O	 0.2564	 0.1790
P	 0.7949	 0.3520
Q	 0.6786	 0.2610
R	 0.2308	 0.0340
S	 0.8718	 0.3550
T	 0.4643	 0.2420
U	 0.1795	 -0.0100

