



# wwPDB EM Validation Summary Report ⓘ

Sep 29, 2024 – 02:40 PM EDT

PDB ID : 8SF7  
EMDB ID : EMD-40436  
Title : 48-nm doublet microtubule from Tetrahymena thermophila strain MEC17  
Authors : Black, C.S.; Kubo, S.; Yang, S.K.; Bui, K.H.  
Deposited on : 2023-04-10  
Resolution : 4.10 Å (reported)

This is a wwPDB EM Validation Summary Report for a publicly released PDB entry.

We welcome your comments at [validation@mail.wwpdb.org](mailto:validation@mail.wwpdb.org)

A user guide is available at

<https://www.wwpdb.org/validation/2017/EMValidationReportHelp>

with specific help available everywhere you see the ⓘ symbol.

The types of validation reports are described at

<http://www.wwpdb.org/validation/2017/FAQs#types>.

---

The following versions of software and data (see [references ⓘ](#)) were used in the production of this report:

EMDB validation analysis : 0.0.1.dev113  
Mogul : 2022.3.0, CSD as543be (2022)  
MolProbity : 4.02b-467  
buster-report : 1.1.7 (2018)  
Percentile statistics : 20231227.v01 (using entries in the PDB archive December 27th 2023)  
MapQ : 1.9.13  
Ideal geometry (proteins) : Engh & Huber (2001)  
Ideal geometry (DNA, RNA) : Parkinson et al. (1996)  
Validation Pipeline (wwPDB-VP) : 2.39

# 1 Overall quality at a glance i

The following experimental techniques were used to determine the structure:

*ELECTRON MICROSCOPY*

The reported resolution of this entry is 4.10 Å.

Percentile scores (ranging between 0-100) for global validation metrics of the entry are shown in the following graphic. The table shows the number of entries on which the scores are based.

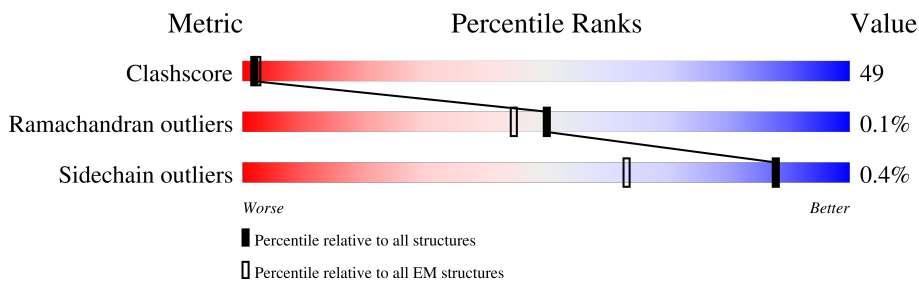

Metric	Whole archive (#Entries)	EM structures (#Entries)
Clashscore	210492	15764
Ramachandran outliers	207382	16835
Sidechain outliers	206894	16415

The table below summarises the geometric issues observed across the polymeric chains and their fit to the map. The red, orange, yellow and green segments of the bar indicate the fraction of residues that contain outliers for  $\geq 3$ , 2, 1 and 0 types of geometric quality criteria respectively. A grey segment represents the fraction of residues that are not modelled. The numeric value for each fraction is indicated below the corresponding segment, with a dot representing fractions  $\leq 5\%$ . The upper red bar (where present) indicates the fraction of residues that have poor fit to the EM map (all-atom inclusion  $< 40\%$ ). The numeric value is given above the bar.

Mol	Chain	Length	Quality of chain
1	6H	518	
2	0A	236	
2	1A	236	
2	2A	236	
2	3A	236	
3	0B	329	
4	0C	156	
4	1C	156	

Continued on next page...

Continued from previous page...

Mol	Chain	Length	Quality of chain
5	0D	225	48% 68% 20% 10%
5	1D	225	31% 72% 17% 10%
5	2D	225	36% 69% 20% 10%
6	0E	191	68% 95%
6	1E	191	51% 97%
6	2E	191	44% 92% 7%
6	3E	191	72% 93% 6%
7	0F	219	39% 74% 20% 6%
8	0G	183	48% 67% 24% 8%
8	1G	183	40% 57% 15% 27%
9	0H	447	14% 23% 75%
9	1H	447	56% 85% 8% 6%
10	0N	492	21% 53% 43%
10	1N	492	33% 89% 5% 6%
10	2N	492	28% 54% 43%
11	0Q	195	20% 91% 5%
11	1Q	195	12% 90% 5% 5%
11	2Q	195	14% 90% 6% 5%
11	3Q	195	13% 86% 9% 5%
11	4Q	195	11% 92% 5%
11	5Q	195	11% 33% 62% 5%
11	6Q	195	21% 30% 64% 5%
12	0S	319	48% 82% 5% 12%
12	1S	319	24% 84% 7% 10%
12	2S	319	19% 83% 8% 10%











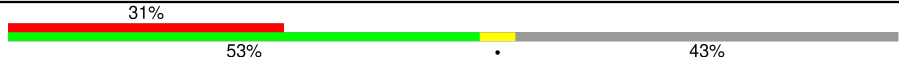

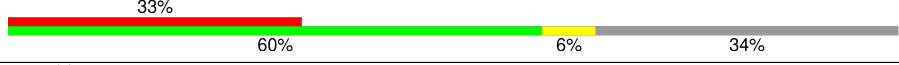

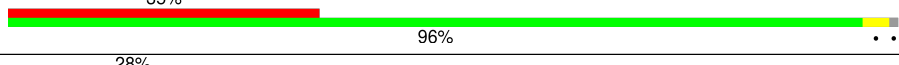
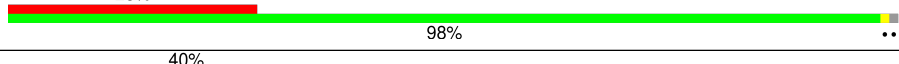

Continued on next page...

Continued from previous page...

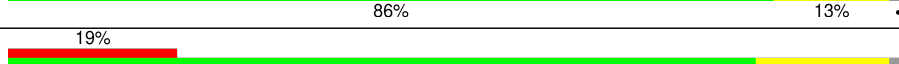
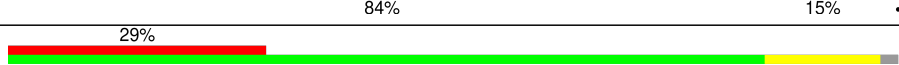
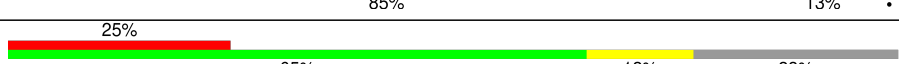
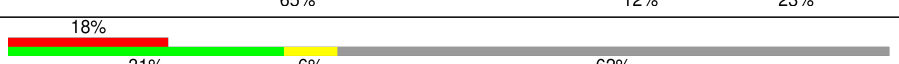
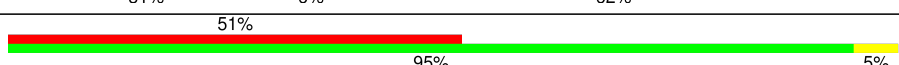
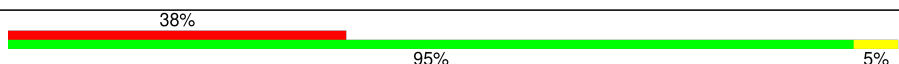
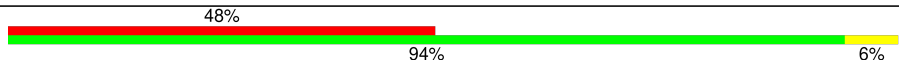
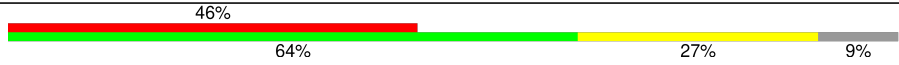
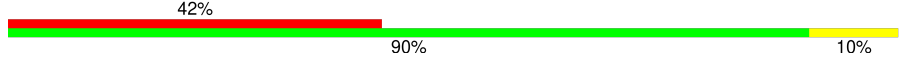
Mol	Chain	Length	Quality of chain
12	3S	319	26% 83% 7% 10%
13	0T	298	54% 73% 24%
13	1T	298	32% 88% 8%
13	2T	298	27% 90% 6%
13	3T	298	30% 90% 5%
14	0U	656	50% 92% 7%
14	1U	656	25% 91% 7%
14	2U	656	23% 90% 7%
14	3U	656	43% 90% 7%
15	0V	269	50% 71% 7% 21%
15	1V	269	49% 80% 17%
15	2V	269	49% 80% 17%
15	3V	269	54% 82% 15%
16	0X	142	22% 63% 12% 25%
16	1X	142	24% 82% 18%
16	2X	142	18% 85% 15%
16	3X	142	25% 82% 18%
16	4X	142	25% 82% 17%
17	1B	498	43% 98%
17	2B	498	58% 56% 41%
17	3B	498	45% 59% 40%
18	1F	173	31% 61% 17% 21%
19	1I	263	32% 59% 13% 29%
20	1J	422	40% 69% 18% 12%
21	1K	489	29% 49% 6% 45%

Continued on next page...

Continued from previous page...

Mol	Chain	Length	Quality of chain
21	2K	489	
22	1L	940	
22	2L	940	
22	3L	940	
23	1M	372	
23	2M	372	
24	1O	494	
24	2O	494	
24	3O	494	
25	1P	507	
25	2P	507	
26	1R	516	
26	2R	516	
26	3R	516	
27	1W	280	
27	2W	280	
28	2C	300	
28	3C	300	
28	4C	300	
29	2F	96	
30	2G	99	
31	2H	229	
31	3H	229	
31	4H	229	
32	2I	293	

Continued on next page...

Continued from previous page...

Mol	Chain	Length	Quality of chain
32	3I	293	13% 18% 11% 70%
33	3D	237	66% 98%
34	4F	276	49% 56% 17% 28%
35	4R	613	20% 89% 10%
35	5R	613	23% 38% 62%
35	6R	613	54% 54% 42%
35	7R	613	45% 35% 64%
36	4S	249	15% 72% 24%
36	5S	249	14% 34% 41% 24%
37	5A	175	61% 75% 15% 10%
37	5B	175	51% 72% 17% 10%
37	5C	175	49% 75% 14% 10%
37	5D	175	51% 26% 31% 39%
38	5E	247	60% 57% 16% 27%
38	5F	247	55% 53% 31% 15%
38	5G	247	49% 34% 50% 15%
38	5H	247	40% 18% 34% 47%
39	5I	168	38% 32% 23% 45%
39	5J	168	40% 34% 30% 35%
39	5K	168	31% 11% 29% 58%
40	6F	145	52% 37% 52% 9%
41	6G	364	37% 22% 37% 41%
42	8L	385	44% 63% 37%
42	8N	385	50% 67% 26% 7%
43	8P	363	55% 69% 31%

Continued on next page...

Continued from previous page...

Mol	Chain	Length	Quality of chain
43	8R	363	58% 77% 22%
44	AA	449	13% 37% 61%
44	AC	449	7% 39% 58%
44	AE	449	7% 41% 57%
44	AG	449	7% 38% 59%
44	AI	449	8% 42% 56%
44	AK	449	5% 40% 57%
44	AM	449	13% 37% 61%
44	BA	449	32% 32% 64%
44	BC	449	8% 39% 57%
44	BE	449	10% 38% 58%
44	BG	449	9% 36% 59%
44	BI	449	9% 45% 51%
44	BK	449	8% 39% 57%
44	BM	449	14% 31% 65%
44	CA	449	52% 29% 67%
44	CC	449	27% 35% 62%
44	CE	449	20% 37% 59%
44	CG	449	20% 41% 56%
44	CI	449	14% 42% 55%
44	CK	449	17% 39% 58%
44	CM	449	36% 32% 65%
44	DA	449	63% 26% 70%
44	DC	449	36% 31% 66%
44	DE	449	24% 31% 65%

Continued on next page...

Continued from previous page...

Mol	Chain	Length	Quality of chain
44	DG	449	
44	DI	449	
44	DK	449	
44	DM	449	
44	EA	449	
44	EC	449	
44	EE	449	
44	EG	449	
44	EI	449	
44	EK	449	
44	EM	449	
44	FA	449	
44	FC	449	
44	FE	449	
44	FG	449	
44	FI	449	
44	FK	449	
44	FM	449	
44	GA	449	
44	GC	449	
44	GE	449	
44	GG	449	
44	GI	449	
44	GK	449	
44	GM	449	

Continued on next page...











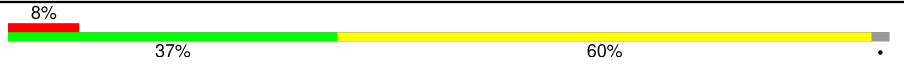
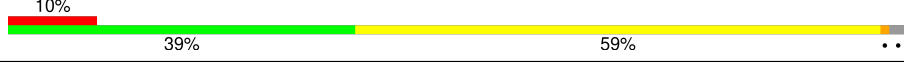
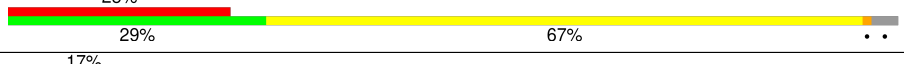
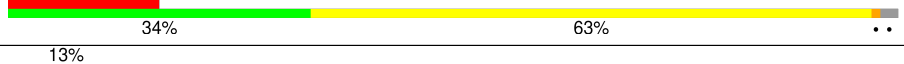
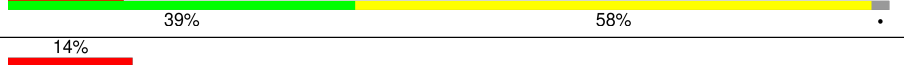
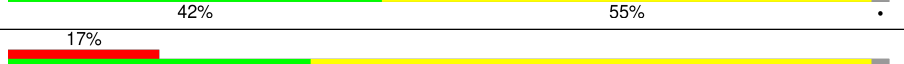
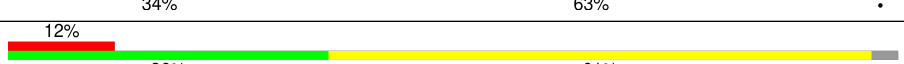
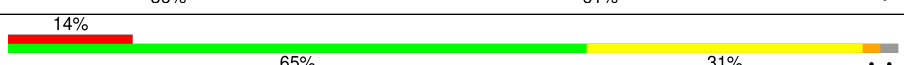
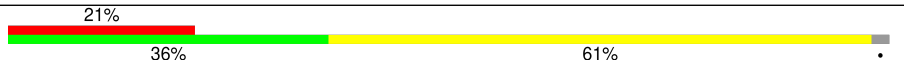

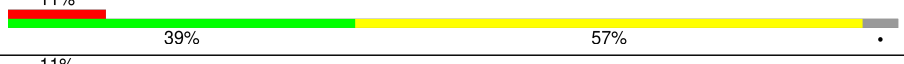
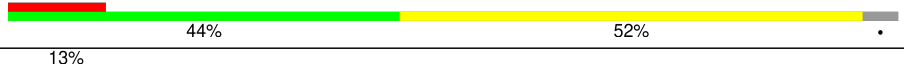
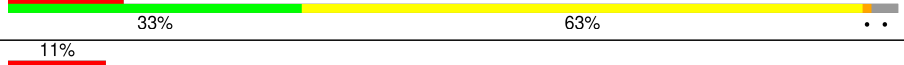
Continued from previous page...

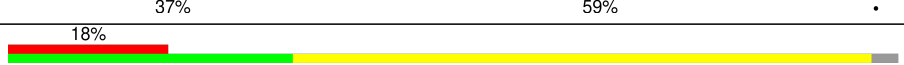
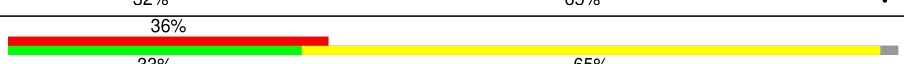
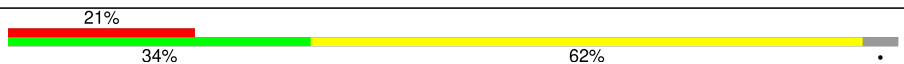
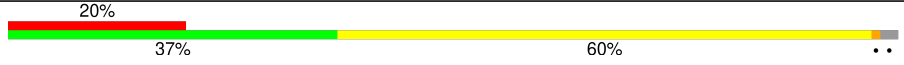
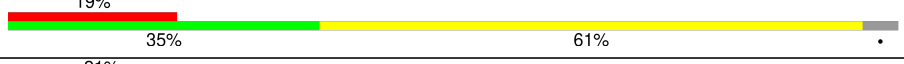
Mol	Chain	Length	Quality of chain
44	HA	449	
44	HC	449	
44	HE	449	
44	HG	449	
44	HI	449	
44	HK	449	
44	HM	449	
44	IA	449	
44	IC	449	
44	IE	449	
44	IG	449	
44	II	449	
44	IK	449	
44	IM	449	
44	JA	449	
44	JC	449	
44	JE	449	
44	JG	449	
44	JI	449	
44	JK	449	
44	JM	449	
44	KA	449	
44	KC	449	
44	KE	449	
44	KG	449	

Continued on next page...

Continued from previous page...

Mol	Chain	Length	Quality of chain
44	KI	449	
44	KK	449	
44	KM	449	
44	LA	449	
44	LC	449	
44	LE	449	
44	LG	449	
44	LI	449	
44	LK	449	
44	LM	449	
44	MA	449	
44	MC	449	
44	ME	449	
44	MG	449	
44	MI	449	
44	MK	449	
44	MM	449	
44	NA	449	
44	NC	449	
44	NE	449	
44	NG	449	
44	NI	449	
44	NK	449	
44	NM	449	
44	OA	449	

Continued on next page...

Continued from previous page...

Mol	Chain	Length	Quality of chain
44	OC	449	26% 34% 63%
44	OE	449	20% 36% 60%
44	OG	449	22% 33% 63%
44	OI	449	22% 37% 60%
44	OK	449	31% 35% 61%
44	OM	449	55% 34% 63%
44	PA	449	51% 29% 67%
44	PC	449	32% 33% 63%
44	PE	449	26% 35% 60%
44	PG	449	24% 38% 57%
44	PI	449	26% 37% 57%
44	PK	449	27% 38% 57%
44	PM	449	55% 33% 62%
44	QA	449	66% 33% 62%
44	QC	449	36% 26% 70%
44	QE	449	32% 33% 63%
44	QG	449	27% 35% 61%
44	QI	449	29% 39% 56%
44	QK	449	30% 36% 60%
44	QM	449	53% 29% 66%
44	RA	449	70% 39% 57%
44	RC	449	39% 33% 62%
44	RE	449	32% 31% 64%
44	RG	449	27% 33% 62%
44	RI	449	28% 37% 59%

Continued on next page...

Continued from previous page...

Mol	Chain	Length	Quality of chain
44	RK	449	28% 35% 61%
44	RM	449	50% 29% 67%
44	SA	449	63% 32% 63%
44	SC	449	40% 30% 65%
44	SE	449	32% 31% 64%
44	SG	449	27% 33% 63%
44	SI	449	25% 32% 63%
44	SK	449	31% 33% 62%
44	SM	449	51% 26% 69%
44	TA	449	72% 30% 65%
44	TC	449	52% 32% 64%
44	TE	449	37% 25% 70%
44	TG	449	34% 34% 62%
44	TI	449	31% 30% 65%
44	TK	449	38% 34% 62%
44	TM	449	52% 29% 67%
44	UA	449	76% 35% 61%
44	UC	449	44% 27% 69%
44	UE	449	35% 29% 66%
44	UG	449	38% 33% 63%
44	UI	449	33% 33% 63%
44	UK	449	34% 32% 64%
44	UM	449	47% 29% 66%
44	VA	449	41% 32% 65%
44	VC	449	29% 38% 59%

Continued on next page...

Continued from previous page...

Mol	Chain	Length	Quality of chain
44	VE	449	24% 35% 61%
44	VG	449	26% 32% 66%
44	VI	449	26% 31% 65%
44	VK	449	32% 32% 65%
44	VM	449	61% 31% 65%
44	WA	449	31% 31% 64%
44	WC	449	25% 34% 64%
44	WE	449	21% 36% 60%
44	WG	449	21% 39% 57%
44	WI	449	19% 37% 59%
44	WK	449	24% 34% 63%
44	WM	449	52% 27% 68%
45	AB	443	37% 29% 66%
45	AD	443	7% 36% 61%
45	AF	443	8% 38% 59%
45	AH	443	8% 38% 59%
45	AJ	443	8% 39% 58%
45	AL	443	5% 38% 58%
45	AN	443	11% 36% 61%
45	BB	443	63% 74% 23%
45	BD	443	15% 32% 65%
45	BF	443	9% 44% 52%
45	BH	443	10% 37% 59%
45	BJ	443	8% 39% 58%
45	BL	443	6% 36% 60%

Continued on next page...

Continued from previous page...

Mol	Chain	Length	Quality of chain
45	BN	443	9% 30% 67%
45	CB	443	35% 26% 70%
45	CD	443	22% 36% 61%
45	CF	443	23% 37% 59%
45	CH	443	20% 41% 56%
45	CJ	443	16% 38% 59%
45	CL	443	23% 27% 70%
45	CN	443	51% 28% 69%
45	DB	443	44% 32% 65%
45	DD	443	29% 36% 60%
45	DF	443	24% 36% 61%
45	DH	443	22% 36% 61%
45	DJ	443	22% 31% 66%
45	DL	443	30% 32% 64%
45	DN	443	59% 31% 65%
45	EB	443	40% 26% 71%
45	ED	443	28% 29% 68%
45	EF	443	23% 28% 69%
45	EH	443	22% 33% 65%
45	EJ	443	20% 27% 70%
45	EL	443	31% 33% 64%
45	EN	443	61% 31% 65%
45	FB	443	43% 28% 69%
45	FD	443	25% 33% 65%
45	FF	443	17% 37% 60%

Continued on next page...

Continued from previous page...

Mol	Chain	Length	Quality of chain
45	FH	443	17% 34% 62%
45	FJ	443	14% 35% 62%
45	FL	443	20% 33% 64%
45	FN	443	48% 24% 73%
45	GB	443	48% 33% 64%
45	GD	443	23% 31% 66%
45	GF	443	14% 35% 62%
45	GH	443	15% 35% 61%
45	GJ	443	13% 35% 62%
45	GL	443	20% 28% 69%
45	GN	443	49% 28% 70%
45	HB	443	56% 30% 67%
45	HD	443	25% 37% 60%
45	HF	443	12% 38% 58%
45	HH	443	16% 35% 62%
45	HJ	443	15% 36% 61%
45	HL	443	16% 36% 61%
45	HN	443	36% 33% 63%
45	IB	443	55% 29% 68%
45	ID	443	18% 37% 59%
45	IF	443	12% 37% 60%
45	IH	443	16% 34% 63%
45	IJ	443	14% 37% 60%
45	IL	443	13% 39% 57%
45	IN	443	26% 33% 64%

Continued on next page...

Continued from previous page...

Mol	Chain	Length	Quality of chain
45	JB	443	24% 33% 64%
45	JD	443	13% 40% 57%
45	JF	443	6% 40% 57%
45	JH	443	10% 32% 65%
45	JJ	443	11% 36% 60%
45	JL	443	11% 40% 57%
45	JN	443	27% 29% 67%
45	KB	443	23% 34% 63%
45	KD	443	10% 39% 58%
45	KF	443	7% 35% 61%
45	KH	443	5% 38% 58%
45	KJ	443	11% 32% 65%
45	KL	443	5% 43% 53%
45	KN	443	16% 28% 68%
45	LB	443	25% 31% 65%
45	LD	443	13% 35% 62%
45	LF	443	13% 40% 57%
45	LH	443	11% 42% 55%
45	LJ	443	12% 35% 62%
45	LL	443	9% 35% 63%
45	LN	443	15% 33% 63%
45	MB	443	20% 32% 65%
45	MD	443	7% 37% 60%
45	MF	443	14% 32% 65%
45	MH	443	9% 40% 57%

Continued on next page...



Continued from previous page...

Mol	Chain	Length	Quality of chain
45	MJ	443	
45	ML	443	
45	MN	443	
45	NB	443	
45	ND	443	
45	NF	443	
45	NH	443	
45	NJ	443	
45	NL	443	
45	NN	443	
45	OB	443	
45	OD	443	
45	OF	443	
45	OH	443	
45	OJ	443	
45	OL	443	
45	ON	443	
45	PB	443	
45	PD	443	
45	PF	443	
45	PH	443	
45	PJ	443	
45	PL	443	
45	PN	443	
45	QB	443	









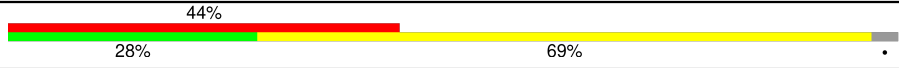

Continued on next page...

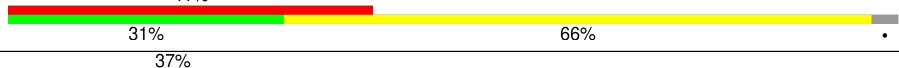
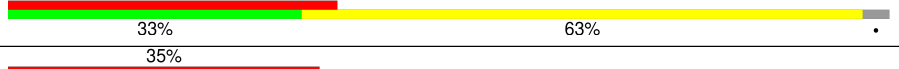
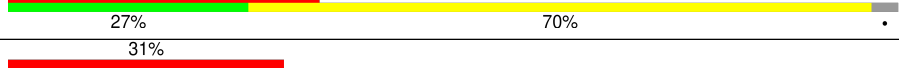
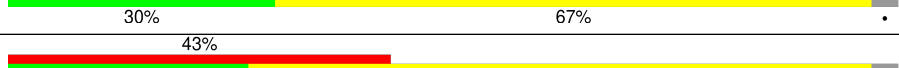
Continued from previous page...

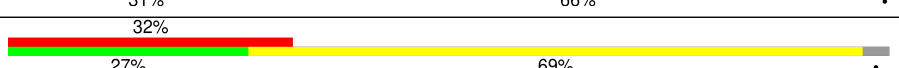
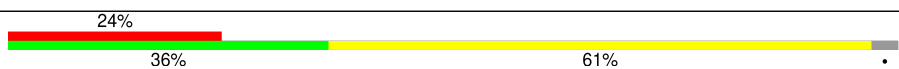
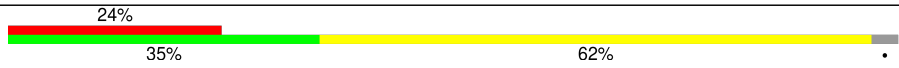
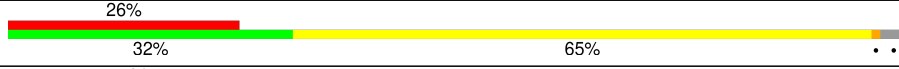
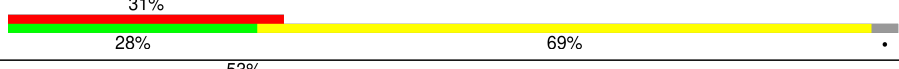
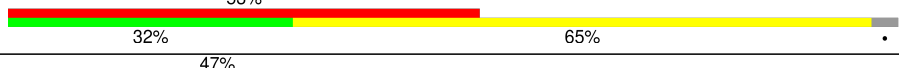
Mol	Chain	Length	Quality of chain
45	QD	443	41% 32% 65%
45	QF	443	31% 37% 60%
45	QH	443	29% 31% 65%
45	QJ	443	35% 30% 67%
45	QL	443	46% 30% 67%
45	QN	443	69% 39% 56% 5%
45	RB	443	56% 30% 67%
45	RD	443	35% 29% 68%
45	RF	443	31% 34% 63%
45	RH	443	28% 32% 65%
45	RJ	443	30% 30% 67%
45	RL	443	47% 29% 68%
45	RN	443	73% 38% 59%
45	SB	443	51% 25% 72%
45	SD	443	36% 33% 64%
45	SF	443	30% 33% 64%
45	SH	443	29% 35% 62%
45	SJ	443	29% 32% 65%
45	SL	443	39% 27% 70%
45	SN	443	64% 35% 63%
45	TB	443	72% 33% 64%
45	TD	443	40% 28% 69%
45	TF	443	39% 26% 71%
45	TH	443	32% 30% 67%
45	TJ	443	33% 30% 67%

Continued on next page...

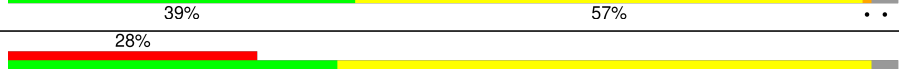
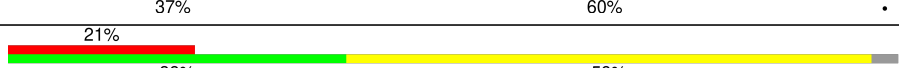
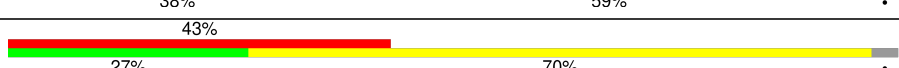
Continued from previous page...

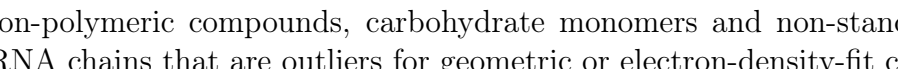
Mol	Chain	Length	Quality of chain
45	TL	443	
45	TN	443	
45	UB	443	
45	UD	443	
45	UF	443	
45	UH	443	
45	UJ	443	
45	UL	443	
45	UN	443	
45	VB	443	
45	VD	443	
45	VF	443	
45	VH	443	
45	VJ	443	
45	VL	443	
45	VN	443	
45	WB	443	
45	WD	443	
45	WF	443	
45	WH	443	
45	WJ	443	
45	WL	443	
45	WN	443	

The following table lists non-polymeric compounds, carbohydrate monomers and non-standard residues in protein, DNA, RNA chains that are outliers for geometric or electron-density-fit criteria:

Mol	Type	Chain	Res	Chirality	Geometry	Clashes	Electron density
46	GTP	CM	501	-	-	X	-
46	GTP	DA	501	-	-	X	-
46	GTP	DM	501	-	-	X	-
46	GTP	EC	501	-	-	X	-
46	GTP	EI	501	-	-	X	-
46	GTP	EM	501	-	-	X	-
46	GTP	HA	501	-	-	X	-
46	GTP	HI	501	-	-	X	-
46	GTP	IG	501	-	-	X	-
46	GTP	JM	501	-	-	X	-
46	GTP	PK	501	-	-	X	-
46	GTP	QA	501	-	-	X	-
46	GTP	QC	501	-	-	X	-
46	GTP	QG	501	-	-	X	-
46	GTP	QM	501	-	-	X	-
46	GTP	RI	501	-	-	X	-
46	GTP	RM	501	-	-	X	-
46	GTP	SA	501	-	-	X	-
46	GTP	TA	501	-	-	X	-
46	GTP	TC	501	-	-	X	-
46	GTP	TG	501	-	-	X	-
46	GTP	TM	501	-	-	X	-
46	GTP	UA	501	-	-	X	-
46	GTP	UG	501	-	-	X	-
46	GTP	UI	501	-	-	X	-
46	GTP	UK	501	-	-	X	-
46	GTP	VA	501	-	-	X	-
46	GTP	VM	501	-	-	X	-
46	GTP	WC	501	-	-	X	-
48	GDP	BF	502	-	-	X	-
48	GDP	CB	501	-	-	X	-
48	GDP	IF	501	-	-	X	-
48	GDP	QH	501	-	-	X	-
48	GDP	RJ	501	-	-	X	-
48	GDP	TD	501	-	-	X	-
48	GDP	TL	501	-	-	X	-
48	GDP	UJ	501	-	-	X	-

## 2 Entry composition

There are 48 unique types of molecules in this entry. The entry contains 1334198 atoms, of which 10347 are hydrogens and 0 are deuteriums.

In the tables below, the AltConf column contains the number of residues with at least one atom in alternate conformation and the Trace column contains the number of residues modelled with at most 2 atoms.

- Molecule 1 is a protein called Nebulin.

Mol	Chain	Residues	Atoms					AltConf	Trace
			Total	C	N	O	S		
1	6H	166	1370	861	234	269	6	0	0

- Molecule 2 is a protein called RIB27A.

Mol	Chain	Residues	Atoms					AltConf	Trace
			Total	C	N	O	S		
2	0A	152	1229	776	224	228	1	0	0
2	1A	152	1229	776	224	228	1	0	0
2	2A	152	1229	776	224	228	1	0	0
2	3A	152	1229	776	224	228	1	0	0

- Molecule 3 is a protein called RIB38.

Mol	Chain	Residues	Atoms					AltConf	Trace
			Total	C	N	O	S		
3	0B	321	2614	1633	472	503	6	0	0

- Molecule 4 is a protein called CFAM166B.

Mol	Chain	Residues	Atoms					AltConf	Trace
			Total	C	N	O	S		
4	0C	95	747	471	131	143	2	0	0
4	1C	95	747	471	131	143	2	0	0

- Molecule 5 is a protein called CFAM166A.

Mol	Chain	Residues	Atoms					AltConf	Trace
5	0D	202	Total	C	N	O	S	1	0
			1621	1019	293	307	2		
5	1D	202	Total	C	N	O	S	1	0
			1621	1019	293	307	2		
5	2D	202	Total	C	N	O	S	1	0
			1621	1019	293	307	2		

- Molecule 6 is a protein called RIB22.

Mol	Chain	Residues	Atoms					AltConf	Trace
6	0E	189	Total	C	N	O	S	0	0
			1557	978	280	294	5		
6	1E	189	Total	C	N	O	S	0	0
			1557	978	280	294	5		
6	2E	189	Total	C	N	O	S	0	0
			1557	978	280	294	5		
6	3E	189	Total	C	N	O	S	0	0
			1557	978	280	294	5		

- Molecule 7 is a protein called CFAM166C.

Mol	Chain	Residues	Atoms					AltConf	Trace
7	0F	206	Total	C	N	O	S	0	0
			1665	1048	300	314	3		

- Molecule 8 is a protein called CFAP107.

Mol	Chain	Residues	Atoms					AltConf	Trace
8	0G	168	Total	C	N	O	S	0	0
			1378	872	237	265	4		
8	1G	133	Total	C	N	O	S	0	0
			1089	692	185	210	2		

- Molecule 9 is a protein called CFAP127.

Mol	Chain	Residues	Atoms					AltConf	Trace
9	0H	111	Total	C	N	O	S	0	2
			949	591	172	183	3		
9	1H	418	Total	C	N	O	S	0	0
			3654	2250	680	710	14		

- Molecule 10 is a protein called CFAP161A.

Mol	Chain	Residues	Atoms					AltConf	Trace
10	0N	280	Total	C	N	O	S	0	0
			2305	1455	396	441	13		
10	1N	463	Total	C	N	O	S	0	0
			3805	2414	653	723	15		
10	2N	280	Total	C	N	O	S	0	0
			2305	1455	396	441	13		

- Molecule 11 is a protein called CFAP20.

Mol	Chain	Residues	Atoms					AltConf	Trace
11	0Q	186	Total	C	N	O	S	0	0
			1548	997	268	276	7		
11	1Q	186	Total	C	N	O	S	0	0
			1548	997	268	276	7		
11	2Q	186	Total	C	N	O	S	0	0
			1548	997	268	276	7		
11	3Q	186	Total	C	N	O	S	0	0
			1548	997	268	276	7		
11	4Q	186	Total	C	N	O	S	0	0
			1548	997	268	276	7		
11	5Q	186	Total	C	N	O	S	0	0
			1548	997	268	276	7		
11	6Q	186	Total	C	N	O	S	0	0
			1548	997	268	276	7		

- Molecule 12 is a protein called Parkin co-regulated protein PACRGA.

Mol	Chain	Residues	Atoms					AltConf	Trace
12	0S	281	Total	C	N	O	S	0	1
			2227	1430	383	408	6		
12	1S	288	Total	C	N	O	S	0	0
			2310	1485	397	422	6		
12	2S	288	Total	C	N	O	S	0	0
			2310	1485	397	422	6		
12	3S	288	Total	C	N	O	S	0	0
			2310	1485	397	422	6		

- Molecule 13 is a protein called IJ34.

Mol	Chain	Residues	Atoms					AltConf	Trace
13	0T	226	Total	C	N	O	S	0	4
			1774	1138	305	322	9		

*Continued on next page...*

*Continued from previous page...*

Mol	Chain	Residues	Atoms					AltConf	Trace
13	1T	285	Total	C	N	O	S	0	0
			2321	1471	411	430	9		
13	2T	285	Total	C	N	O	S	0	0
			2321	1471	411	430	9		
13	3T	285	Total	C	N	O	S	0	0
			2321	1471	411	430	9		

- Molecule 14 is a protein called Cilia- and flagella-associated protein 52.

Mol	Chain	Residues	Atoms					AltConf	Trace
14	0U	607	Total	C	N	O	S	0	0
			4774	3025	819	906	24		
14	1U	607	Total	C	N	O	S	0	0
			4774	3025	819	906	24		
14	2U	607	Total	C	N	O	S	0	0
			4774	3025	819	906	24		
14	3U	607	Total	C	N	O	S	0	0
			4774	3025	819	906	24		

- Molecule 15 is a protein called DNA polymerase delta C4-type zinc-finger protein.

Mol	Chain	Residues	Atoms					AltConf	Trace	
15	0V	212	Total	C	N	O	S	0	0	
			1750	1095	317	332	6			
15	1V	263	Total	C	H	N	O	S	0	0
			3379	1359	1211	388	412	9		
15	2V	263	Total	C	H	N	O	S	0	0
			3379	1359	1211	388	412	9		
15	3V	263	Total	C	H	N	O	S	0	0
			3379	1359	1211	388	412	9		

- Molecule 16 is a protein called RIB43A protein.

Mol	Chain	Residues	Atoms					AltConf	Trace
16	0X	106	Total	C	N	O	S	0	0
			903	553	170	175	5		
16	1X	141	Total	C	N	O	S	0	0
			1205	736	229	234	6		
16	2X	141	Total	C	N	O	S	0	0
			1205	736	229	234	6		
16	3X	141	Total	C	N	O	S	0	0
			1205	736	229	234	6		

*Continued on next page...*



*Continued from previous page...*

Mol	Chain	Residues	Atoms					AltConf	Trace
			Total	C	N	O	S		
16	4X	141	1205	736	229	234	6	0	0

- Molecule 17 is a protein called RIB57.

Mol	Chain	Residues	Atoms					AltConf	Trace
			Total	C	N	O	S		
17	1B	498	4066	2598	692	768	8	0	0
17	2B	295	2439	1553	416	464	6	0	0
17	3B	297	2449	1558	418	467	6	0	0

- Molecule 18 is a protein called CFAP182A.

Mol	Chain	Residues	Atoms					AltConf	Trace
			Total	C	N	O	S		
18	1F	136	1093	696	184	208	5	0	0

- Molecule 19 is a protein called CFAP143.

Mol	Chain	Residues	Atoms					AltConf	Trace
			Total	C	N	O	S		
19	1I	188	1546	951	285	306	4	0	0

- Molecule 20 is a protein called CFAP21A.

Mol	Chain	Residues	Atoms					AltConf	Trace
			Total	C	N	O	S		
20	1J	370	3025	1901	534	579	11	0	0

- Molecule 21 is a protein called Cilia- and flagella-associated protein 53.

Mol	Chain	Residues	Atoms					AltConf	Trace
			Total	C	N	O	S		
21	1K	269	2335	1441	440	447	7	0	1
21	2K	278	2396	1473	443	473	7	0	2

- Molecule 22 is a protein called CFAP115.

Mol	Chain	Residues	Atoms					AltConf	Trace
22	1L	820	Total	C	N	O	S	0	0
			6841	4357	1186	1280	18		
22	2L	620	Total	C	N	O	S	0	0
			5181	3304	902	963	12		
22	3L	200	Total	C	N	O	S	0	0
			1660	1053	284	317	6		

- Molecule 23 is a protein called Nucleoside diphosphate kinase.

Mol	Chain	Residues	Atoms					AltConf	Trace	
23	1M	369	Total	C	H	N	O	S	0	0
			5154	1910	2176	501	552	15		
23	2M	369	Total	C	H	N	O	S	0	0
			5169	1910	2191	501	552	15		

- Molecule 24 is a protein called Cilia- and flagella-associated protein 45.

Mol	Chain	Residues	Atoms					AltConf	Trace	
24	1O	235	Total	C	N	O	S	0	0	
			1983	1235	350	386	12			
24	2O	370	Total	C	N	O	S	0	0	
			3173	1948	595	617	13			
24	3O	269	Total	C	H	N	O	S	0	1
			4637	1404	2347	438	444	4		

- Molecule 25 is a protein called CFAP210.

Mol	Chain	Residues	Atoms					AltConf	Trace
25	1P	344	Total	C	N	O	S	0	0
			2958	1831	552	567	8		
25	2P	179	Total	C	N	O	S	0	2
			1507	928	282	293	4		

- Molecule 26 is a protein called RIB72B.

Mol	Chain	Residues	Atoms					AltConf	Trace
26	1R	508	Total	C	N	O	S	0	0
			4244	2744	711	777	12		
26	2R	508	Total	C	N	O	S	0	0
			4244	2744	711	777	12		
26	3R	508	Total	C	N	O	S	0	0
			4244	2744	711	777	12		

- Molecule 27 is a protein called Protofilament ribbon protein.

Mol	Chain	Residues	Atoms					AltConf	Trace
			Total	C	N	O	S		
27	1W	216	Total	C	N	O	S	0	1
			1840	1113	365	353	9		
27	2W	105	Total	C	N	O	S	0	0
			890	550	171	164	5		

- Molecule 28 is a protein called RIB35.

Mol	Chain	Residues	Atoms					AltConf	Trace
			Total	C	N	O	S		
28	2C	300	Total	C	N	O	S	0	0
			2467	1581	417	464	5		
28	3C	300	Total	C	N	O	S	0	0
			2467	1581	417	464	5		
28	4C	300	Total	C	N	O	S	0	0
			2467	1581	417	464	5		

- Molecule 29 is a protein called CFAP182B.

Mol	Chain	Residues	Atoms					AltConf	Trace
			Total	C	N	O	S		
29	2F	87	Total	C	N	O	S	0	0
			746	469	136	137	4		

- Molecule 30 is a protein called Flagellar FliJ protein.

Mol	Chain	Residues	Atoms					AltConf	Trace
			Total	C	N	O	S		
30	2G	99	Total	C	N	O	S	0	0
			848	536	153	155	4		

- Molecule 31 is a protein called RIB27B.

Mol	Chain	Residues	Atoms					AltConf	Trace
			Total	C	N	O	S		
31	2H	61	Total	C	N	O	S	0	0
			501	313	92	94	2		
31	3H	61	Total	C	N	O	S	0	0
			501	313	92	94	2		
31	4H	61	Total	C	N	O	S	0	0
			501	313	92	94	2		

- Molecule 32 is a protein called STPG2.

Mol	Chain	Residues	Atoms					AltConf	Trace
32	2I	136	Total	C	N	O	S	0	1
			1086	699	190	196	1		
32	3I	87	Total	C	N	O	S	0	0
			712	451	130	127	4		

- Molecule 33 is a protein called RIB26.

Mol	Chain	Residues	Atoms					AltConf	Trace
33	3D	237	Total	C	N	O	S	0	0
			1835	1174	310	340	11		

- Molecule 34 is a protein called CFAP129.

Mol	Chain	Residues	Atoms					AltConf	Trace
34	4F	200	Total	C	N	O	S	0	0
			1622	1022	286	312	2		

- Molecule 35 is a protein called Flagellar microtugule protofilament ribbon protein.

Mol	Chain	Residues	Atoms					AltConf	Trace
35	4R	609	Total	C	N	O	S	0	0
			5070	3267	847	932	24		
35	5R	609	Total	C	N	O	S	0	0
			5070	3267	847	932	24		
35	6R	609	Total	C	N	O	S	0	0
			5070	3267	847	932	24		
35	7R	609	Total	C	N	O	S	0	0
			5070	3267	847	932	24		

- Molecule 36 is a protein called Parkin co-regulated protein PACRGB.

Mol	Chain	Residues	Atoms					AltConf	Trace
36	4S	188	Total	C	N	O	S	0	0
			1537	999	251	279	8		
36	5S	188	Total	C	N	O	S	0	0
			1537	999	251	279	8		

- Molecule 37 is a protein called OJ2.

Mol	Chain	Residues	Atoms					AltConf	Trace
37	5A	157	Total	C	N	O	S	0	0
			1261	795	234	229	3		

*Continued on next page...*

*Continued from previous page...*

Mol	Chain	Residues	Atoms					AltConf	Trace
37	5B	157	Total	C	N	O	S	0	0
			1261	795	234	229	3		
37	5C	157	Total	C	N	O	S	0	0
			1261	795	234	229	3		
37	5D	107	Total	C	N	O	S	0	1
			846	535	154	154	3		

- Molecule 38 is a protein called CFAP77A.

Mol	Chain	Residues	Atoms					AltConf	Trace
38	5E	181	Total	C	N	O	S	0	1
			1500	949	272	274	5		
38	5F	210	Total	C	N	O	S	0	0
			1750	1107	316	322	5		
38	5G	210	Total	C	N	O	S	0	0
			1750	1107	316	322	5		
38	5H	132	Total	C	N	O	S	0	1
			1077	683	194	197	3		

- Molecule 39 is a protein called OJ3.

Mol	Chain	Residues	Atoms					AltConf	Trace
39	5I	93	Total	C	N	O	S	0	1
			732	465	122	143	2		
39	5J	109	Total	C	N	O	S	0	0
			878	559	147	169	3		
39	5K	70	Total	C	N	O	S	0	0
			553	358	92	102	1		

- Molecule 40 is a protein called SB1.

Mol	Chain	Residues	Atoms					AltConf	Trace
40	6F	132	Total	C	N	O	S	0	0
			1140	718	197	221	4		

- Molecule 41 is a protein called STPG1A.

Mol	Chain	Residues	Atoms					AltConf	Trace
41	6G	216	Total	C	N	O	S	0	0
			1769	1128	303	333	5		

- Molecule 42 is a protein called CFAP112B.

Mol	Chain	Residues	Atoms				AltConf	Trace
42	8L	385	Total	C	N	O	0	0
			1925	1155	385	385		
42	8N	358	Total	C	N	O	0	0
			1790	1074	358	358		

- Molecule 43 is a protein called CFAP112A.

Mol	Chain	Residues	Atoms				AltConf	Trace
43	8P	363	Total	C	N	O	0	0
			1815	1089	363	363		
43	8R	361	Total	C	N	O	0	0
			2020	1269	361	390		

- Molecule 44 is a protein called Tubulin alpha chain.

Mol	Chain	Residues	Atoms					AltConf	Trace
44	AA	439	Total	C	N	O	S	0	0
			3408	2155	579	652	22		
44	AC	439	Total	C	N	O	S	0	0
			3408	2155	579	652	22		
44	AE	439	Total	C	N	O	S	0	0
			3408	2155	579	652	22		
44	AG	439	Total	C	N	O	S	0	0
			3408	2155	579	652	22		
44	AI	439	Total	C	N	O	S	0	0
			3408	2155	579	652	22		
44	AK	439	Total	C	N	O	S	0	0
			3408	2155	579	652	22		
44	AM	439	Total	C	N	O	S	0	0
			3408	2155	579	652	22		
44	BA	432	Total	C	N	O	S	0	0
			3364	2129	571	642	22		
44	BC	432	Total	C	N	O	S	0	0
			3364	2129	571	642	22		
44	BE	432	Total	C	N	O	S	0	0
			3364	2129	571	642	22		
44	BG	432	Total	C	N	O	S	0	0
			3364	2129	571	642	22		
44	BI	432	Total	C	N	O	S	0	0
			3364	2129	571	642	22		
44	BK	432	Total	C	N	O	S	0	0
			3364	2129	571	642	22		
44	BM	432	Total	C	N	O	S	0	0
			3364	2129	571	642	22		

*Continued on next page...*

*Continued from previous page...*

Mol	Chain	Residues	Atoms					AltConf	Trace
			Total	C	N	O	S		
44	CA	439	3408	2155	579	652	22	0	0
44	CC	439	3408	2155	579	652	22	0	0
44	CE	439	3408	2155	579	652	22	0	0
44	CG	439	3408	2155	579	652	22	0	0
44	CI	439	3408	2155	579	652	22	0	0
44	CK	439	3408	2155	579	652	22	0	0
44	CM	439	3408	2155	579	652	22	0	0
44	DA	433	3372	2133	572	645	22	0	0
44	DC	433	3368	2131	572	643	22	0	0
44	DE	433	3372	2133	572	645	22	0	0
44	DG	436	3389	2143	576	648	22	0	0
44	DI	433	3372	2133	572	645	22	0	0
44	DK	436	3389	2143	576	648	22	0	0
44	DM	433	3372	2133	572	645	22	0	0
44	EA	439	3397	2147	576	652	22	0	0
44	EC	439	3408	2155	579	652	22	0	0
44	EE	439	3408	2155	579	652	22	0	0
44	EG	439	3408	2155	579	652	22	0	0
44	EI	439	3408	2155	579	652	22	0	0
44	EK	439	3408	2155	579	652	22	0	0
44	EM	439	3408	2155	579	652	22	0	0

*Continued on next page...*

*Continued from previous page...*

Mol	Chain	Residues	Atoms					AltConf	Trace
			Total	C	N	O	S		
44	FA	429	Total 3342	C 2118	N 568	O 634	S 22	0	0
44	FC	432	Total 3364	C 2129	N 571	O 642	S 22	0	0
44	FE	434	Total 3376	C 2135	N 573	O 646	S 22	0	0
44	FG	439	Total 3408	C 2155	N 579	O 652	S 22	0	0
44	FI	433	Total 3372	C 2133	N 572	O 645	S 22	0	0
44	FK	432	Total 3364	C 2129	N 571	O 642	S 22	0	0
44	FM	420	Total 3239	C 2055	N 549	O 613	S 22	0	4
44	GA	429	Total 3342	C 2118	N 568	O 634	S 22	0	0
44	GC	431	Total 3358	C 2126	N 570	O 640	S 22	0	0
44	GE	431	Total 3358	C 2126	N 570	O 640	S 22	0	0
44	GG	431	Total 3358	C 2126	N 570	O 640	S 22	0	0
44	GI	431	Total 3358	C 2126	N 570	O 640	S 22	0	0
44	GK	439	Total 3408	C 2155	N 579	O 652	S 22	0	0
44	GM	429	Total 3342	C 2118	N 568	O 634	S 22	0	0
44	HA	431	Total 3356	C 2125	N 570	O 639	S 22	0	0
44	HC	431	Total 3356	C 2125	N 570	O 639	S 22	0	0
44	HE	431	Total 3356	C 2125	N 570	O 639	S 22	0	0
44	HG	431	Total 3356	C 2125	N 570	O 639	S 22	0	0
44	HI	431	Total 3356	C 2125	N 570	O 639	S 22	0	0
44	HK	431	Total 3356	C 2125	N 570	O 639	S 22	0	0
44	HM	431	Total 3356	C 2125	N 570	O 639	S 22	0	0

*Continued on next page...*



*Continued from previous page...*

Mol	Chain	Residues	Atoms					AltConf	Trace
			Total	C	N	O	S		
44	IA	432	Total 3364	C 2129	N 571	O 642	S 22	0	0
44	IC	439	Total 3408	C 2155	N 579	O 652	S 22	0	0
44	IE	432	Total 3364	C 2129	N 571	O 642	S 22	0	0
44	IG	439	Total 3408	C 2155	N 579	O 652	S 22	0	0
44	II	439	Total 3408	C 2155	N 579	O 652	S 22	0	0
44	IK	432	Total 3364	C 2129	N 571	O 642	S 22	0	0
44	IM	432	Total 3364	C 2129	N 571	O 642	S 22	0	0
44	JA	432	Total 3364	C 2129	N 571	O 642	S 22	0	0
44	JC	434	Total 3376	C 2135	N 573	O 646	S 22	0	0
44	JE	439	Total 3408	C 2155	N 579	O 652	S 22	0	0
44	JG	439	Total 3408	C 2155	N 579	O 652	S 22	0	0
44	JI	439	Total 3404	C 2151	N 579	O 652	S 22	0	0
44	JK	439	Total 3408	C 2155	N 579	O 652	S 22	0	0
44	JM	434	Total 3376	C 2135	N 573	O 646	S 22	0	0
44	KA	434	Total 3376	C 2135	N 573	O 646	S 22	0	0
44	KC	433	Total 3372	C 2133	N 572	O 645	S 22	0	0
44	KE	435	Total 3385	C 2141	N 575	O 647	S 22	0	0
44	KG	439	Total 3408	C 2155	N 579	O 652	S 22	0	0
44	KI	439	Total 3408	C 2155	N 579	O 652	S 22	0	0
44	KK	439	Total 3408	C 2155	N 579	O 652	S 22	0	0
44	KM	434	Total 3376	C 2135	N 573	O 646	S 22	0	0

*Continued on next page...*

*Continued from previous page...*

Mol	Chain	Residues	Atoms					AltConf	Trace
			Total	C	N	O	S		
44	LA	439	Total 3408	C 2155	N 579	O 652	S 22	0	0
44	LC	439	Total 3408	C 2155	N 579	O 652	S 22	0	0
44	LE	438	Total 3400	C 2149	N 578	O 651	S 22	0	0
44	LG	439	Total 3408	C 2155	N 579	O 652	S 22	0	0
44	LI	434	Total 3381	C 2139	N 574	O 646	S 22	0	0
44	LK	439	Total 3408	C 2155	N 579	O 652	S 22	0	0
44	LM	439	Total 3408	C 2155	N 579	O 652	S 22	0	0
44	MA	436	Total 3392	C 2145	N 576	O 649	S 22	0	0
44	MC	433	Total 3368	C 2131	N 572	O 643	S 22	0	0
44	ME	433	Total 3372	C 2133	N 572	O 645	S 22	0	0
44	MG	437	Total 3400	C 2151	N 577	O 650	S 22	0	0
44	MI	439	Total 3408	C 2155	N 579	O 652	S 22	0	0
44	MK	436	Total 3384	C 2139	N 575	O 648	S 22	0	0
44	MM	436	Total 3392	C 2145	N 576	O 649	S 22	0	0
44	NA	439	Total 3408	C 2155	N 579	O 652	S 22	0	0
44	NC	432	Total 3364	C 2129	N 571	O 642	S 22	0	0
44	NE	439	Total 3408	C 2155	N 579	O 652	S 22	0	0
44	NG	432	Total 3364	C 2129	N 571	O 642	S 22	0	0
44	NI	439	Total 3408	C 2155	N 579	O 652	S 22	0	0
44	NK	432	Total 3364	C 2129	N 571	O 642	S 22	0	0
44	NM	439	Total 3408	C 2155	N 579	O 652	S 22	0	0

*Continued on next page...*

*Continued from previous page...*

Mol	Chain	Residues	Atoms					AltConf	Trace
			Total	C	N	O	S		
44	OA	433	3368	2131	572	643	22	0	0
44	OC	433	3368	2131	572	643	22	0	0
44	OE	433	3368	2131	572	643	22	0	0
44	OG	433	3368	2131	572	643	22	0	0
44	OI	433	3368	2131	572	643	22	0	0
44	OK	433	3368	2131	572	643	22	0	0
44	OM	433	3368	2131	572	643	22	0	0
44	PA	429	3342	2118	568	634	22	0	0
44	PC	429	3342	2118	568	634	22	0	0
44	PE	429	3342	2118	568	634	22	0	0
44	PG	429	3342	2118	568	634	22	0	0
44	PI	429	3342	2118	568	634	22	0	0
44	PK	429	3342	2118	568	634	22	0	0
44	PM	429	3342	2118	568	634	22	0	0
44	QA	431	3356	2125	570	639	22	0	0
44	QC	431	3356	2125	570	639	22	0	0
44	QE	431	3356	2125	570	639	22	0	0
44	QG	431	3356	2125	570	639	22	0	0
44	QI	431	3356	2125	570	639	22	0	0
44	QK	431	3356	2125	570	639	22	0	0
44	QM	431	3356	2125	570	639	22	0	0

*Continued on next page...*

*Continued from previous page...*

Mol	Chain	Residues	Atoms					AltConf	Trace
			Total	C	N	O	S		
44	RA	431	Total 3356	C 2125	N 570	O 639	S 22	0	0
44	RC	431	Total 3356	C 2125	N 570	O 639	S 22	0	0
44	RE	431	Total 3356	C 2125	N 570	O 639	S 22	0	0
44	RG	431	Total 3356	C 2125	N 570	O 639	S 22	0	0
44	RI	431	Total 3356	C 2125	N 570	O 639	S 22	0	0
44	RK	431	Total 3356	C 2125	N 570	O 639	S 22	0	0
44	RM	431	Total 3356	C 2125	N 570	O 639	S 22	0	0
44	SA	430	Total 3350	C 2122	N 569	O 637	S 22	0	0
44	SC	430	Total 3350	C 2122	N 569	O 637	S 22	0	0
44	SE	430	Total 3350	C 2122	N 569	O 637	S 22	0	0
44	SG	430	Total 3350	C 2122	N 569	O 637	S 22	0	0
44	SI	430	Total 3350	C 2122	N 569	O 637	S 22	0	0
44	SK	430	Total 3350	C 2122	N 569	O 637	S 22	0	0
44	SM	430	Total 3350	C 2122	N 569	O 637	S 22	0	0
44	TA	430	Total 3350	C 2122	N 569	O 637	S 22	0	0
44	TC	430	Total 3350	C 2122	N 569	O 637	S 22	0	0
44	TE	430	Total 3350	C 2122	N 569	O 637	S 22	0	0
44	TG	430	Total 3350	C 2122	N 569	O 637	S 22	0	0
44	TI	430	Total 3350	C 2122	N 569	O 637	S 22	0	0
44	TK	430	Total 3350	C 2122	N 569	O 637	S 22	0	0
44	TM	430	Total 3350	C 2122	N 569	O 637	S 22	0	0

*Continued on next page...*

*Continued from previous page...*

Mol	Chain	Residues	Atoms					AltConf	Trace
			Total	C	N	O	S		
44	UA	430	Total 3350	C 2122	N 569	O 637	S 22	0	0
44	UC	431	Total 3356	C 2125	N 570	O 639	S 22	0	0
44	UE	431	Total 3356	C 2125	N 570	O 639	S 22	0	0
44	UG	431	Total 3356	C 2125	N 570	O 639	S 22	0	0
44	UI	431	Total 3356	C 2125	N 570	O 639	S 22	0	0
44	UK	431	Total 3356	C 2125	N 570	O 639	S 22	0	0
44	UM	431	Total 3356	C 2125	N 570	O 639	S 22	0	0
44	VA	433	Total 3372	C 2133	N 572	O 645	S 22	0	0
44	VC	439	Total 3408	C 2155	N 579	O 652	S 22	0	0
44	VE	433	Total 3372	C 2133	N 572	O 645	S 22	0	0
44	VG	439	Total 3408	C 2155	N 579	O 652	S 22	0	0
44	VI	433	Total 3372	C 2133	N 572	O 645	S 22	0	0
44	VK	439	Total 3408	C 2155	N 579	O 652	S 22	0	0
44	VM	433	Total 3365	C 2128	N 570	O 645	S 22	0	0
44	WA	431	Total 3356	C 2125	N 570	O 639	S 22	0	0
44	WC	439	Total 3408	C 2155	N 579	O 652	S 22	0	0
44	WE	431	Total 3356	C 2125	N 570	O 639	S 22	0	0
44	WG	439	Total 3408	C 2155	N 579	O 652	S 22	0	0
44	WI	431	Total 3356	C 2125	N 570	O 639	S 22	0	0
44	WK	439	Total 3408	C 2155	N 579	O 652	S 22	0	0
44	WM	431	Total 3356	C 2125	N 570	O 639	S 22	0	0

- Molecule 45 is a protein called Tubulin beta chain.

Mol	Chain	Residues	Atoms					AltConf	Trace
			Total	C	N	O	S		
45	AB	425	Total 3291	C 2066	N 563	O 634	S 28	0	1
45	AD	430	Total 3366	C 2115	N 577	O 646	S 28	0	0
45	AF	430	Total 3366	C 2115	N 577	O 646	S 28	0	0
45	AH	430	Total 3366	C 2115	N 577	O 646	S 28	0	0
45	AJ	430	Total 3366	C 2115	N 577	O 646	S 28	0	0
45	AL	430	Total 3366	C 2115	N 577	O 646	S 28	0	0
45	AN	430	Total 3366	C 2115	N 577	O 646	S 28	0	0
45	BB	430	Total 3366	C 2115	N 577	O 646	S 28	0	0
45	BD	430	Total 3366	C 2115	N 577	O 646	S 28	0	0
45	BF	430	Total 3366	C 2115	N 577	O 646	S 28	0	0
45	BH	430	Total 3366	C 2115	N 577	O 646	S 28	0	0
45	BJ	430	Total 3366	C 2115	N 577	O 646	S 28	0	0
45	BL	430	Total 3366	C 2115	N 577	O 646	S 28	0	0
45	BN	430	Total 3366	C 2115	N 577	O 646	S 28	0	0
45	CB	430	Total 3366	C 2115	N 577	O 646	S 28	0	0
45	CD	430	Total 3366	C 2115	N 577	O 646	S 28	0	0
45	CF	430	Total 3366	C 2115	N 577	O 646	S 28	0	0
45	CH	430	Total 3366	C 2115	N 577	O 646	S 28	0	0
45	CJ	430	Total 3366	C 2115	N 577	O 646	S 28	0	0
45	CL	430	Total 3366	C 2115	N 577	O 646	S 28	0	0
45	CN	430	Total 3366	C 2115	N 577	O 646	S 28	0	0

*Continued on next page...*

*Continued from previous page...*

Mol	Chain	Residues	Atoms					AltConf	Trace
			Total	C	N	O	S		
45	DB	430	3366	2115	577	646	28	0	0
45	DD	430	3366	2115	577	646	28	0	0
45	DF	430	3366	2115	577	646	28	0	0
45	DH	430	3366	2115	577	646	28	0	0
45	DJ	430	3366	2115	577	646	28	0	0
45	DL	430	3366	2115	577	646	28	0	0
45	DN	430	3366	2115	577	646	28	0	0
45	EB	430	3366	2115	577	646	28	0	0
45	ED	430	3366	2115	577	646	28	0	0
45	EF	430	3366	2115	577	646	28	0	0
45	EH	430	3366	2115	577	646	28	0	0
45	EJ	430	3366	2115	577	646	28	0	0
45	EL	430	3366	2115	577	646	28	0	0
45	EN	430	3366	2115	577	646	28	0	0
45	FB	430	3366	2115	577	646	28	0	0
45	FD	430	3366	2115	577	646	28	0	0
45	FF	430	3366	2115	577	646	28	0	0
45	FH	430	3366	2115	577	646	28	0	0
45	FJ	430	3366	2115	577	646	28	0	0
45	FL	430	3366	2115	577	646	28	0	0
45	FN	430	3366	2115	577	646	28	0	0

*Continued on next page...*

*Continued from previous page...*

Mol	Chain	Residues	Atoms					AltConf	Trace
			Total	C	N	O	S		
45	GB	430	3366	2115	577	646	28	0	0
45	GD	430	3366	2115	577	646	28	0	0
45	GF	430	3366	2115	577	646	28	0	0
45	GH	430	3366	2115	577	646	28	0	0
45	GJ	430	3366	2115	577	646	28	0	0
45	GL	430	3366	2115	577	646	28	0	0
45	GN	430	3366	2115	577	646	28	0	0
45	HB	430	3366	2115	577	646	28	0	0
45	HD	430	3366	2115	577	646	28	0	0
45	HF	430	3366	2115	577	646	28	0	0
45	HH	430	3366	2115	577	646	28	0	0
45	HJ	430	3366	2115	577	646	28	0	0
45	HL	430	3366	2115	577	646	28	0	0
45	HN	430	3366	2115	577	646	28	0	0
45	IB	430	3366	2115	577	646	28	0	0
45	ID	430	3366	2115	577	646	28	0	0
45	IF	430	3366	2115	577	646	28	0	0
45	IH	430	3366	2115	577	646	28	0	0
45	IJ	430	3366	2115	577	646	28	0	0
45	IL	430	3366	2115	577	646	28	0	0
45	IN	430	3366	2115	577	646	28	0	0

*Continued on next page...*



*Continued from previous page...*

Mol	Chain	Residues	Atoms					AltConf	Trace
			Total	C	N	O	S		
45	JB	430	3366	2115	577	646	28	0	0
45	JD	430	3366	2115	577	646	28	0	0
45	JF	430	3366	2115	577	646	28	0	0
45	JH	430	3366	2115	577	646	28	0	0
45	JJ	430	3366	2115	577	646	28	0	0
45	JL	430	3366	2115	577	646	28	0	0
45	JN	430	3366	2115	577	646	28	0	0
45	KB	430	3366	2115	577	646	28	0	0
45	KD	430	3366	2115	577	646	28	0	0
45	KF	430	3366	2115	577	646	28	0	0
45	KH	430	3366	2115	577	646	28	0	0
45	KJ	430	3366	2115	577	646	28	0	0
45	KL	430	3366	2115	577	646	28	0	0
45	KN	430	3366	2115	577	646	28	0	0
45	LB	430	3366	2115	577	646	28	0	0
45	LD	430	3366	2115	577	646	28	0	0
45	LF	430	3366	2115	577	646	28	0	0
45	LH	430	3366	2115	577	646	28	0	0
45	LJ	430	3366	2115	577	646	28	0	0
45	LL	430	3366	2115	577	646	28	0	0
45	LN	430	3366	2115	577	646	28	0	0

*Continued on next page...*

*Continued from previous page...*

Mol	Chain	Residues	Atoms					AltConf	Trace
			Total	C	N	O	S		
45	MB	430	3366	2115	577	646	28	0	0
45	MD	430	3366	2115	577	646	28	0	0
45	MF	430	3366	2115	577	646	28	0	0
45	MH	430	3366	2115	577	646	28	0	0
45	MJ	430	3366	2115	577	646	28	0	0
45	ML	430	3366	2115	577	646	28	0	0
45	MN	430	3366	2115	577	646	28	0	0
45	NB	423	3304	2079	562	635	28	0	0
45	ND	430	3366	2115	577	646	28	0	0
45	NF	423	3304	2079	562	635	28	0	0
45	NH	430	3366	2115	577	646	28	0	0
45	NJ	423	3304	2079	562	635	28	0	0
45	NL	430	3366	2115	577	646	28	0	0
45	NN	423	3304	2079	562	635	28	0	0
45	OB	430	3366	2115	577	646	28	0	0
45	OD	430	3366	2115	577	646	28	0	0
45	OF	430	3366	2115	577	646	28	0	0
45	OH	430	3366	2115	577	646	28	0	0
45	OJ	430	3366	2115	577	646	28	0	0
45	OL	430	3366	2115	577	646	28	0	0
45	ON	430	3366	2115	577	646	28	0	0

*Continued on next page...*

*Continued from previous page...*

Mol	Chain	Residues	Atoms					AltConf	Trace
			Total	C	N	O	S		
45	PB	430	3351	2106	571	646	28	0	0
45	PD	430	3366	2115	577	646	28	0	0
45	PF	430	3366	2115	577	646	28	0	0
45	PH	430	3366	2115	577	646	28	0	0
45	PJ	430	3366	2115	577	646	28	0	0
45	PL	430	3366	2115	577	646	28	0	0
45	PN	430	3366	2115	577	646	28	0	0
45	QB	430	3366	2115	577	646	28	0	0
45	QD	430	3366	2115	577	646	28	0	0
45	QF	430	3366	2115	577	646	28	0	0
45	QH	430	3366	2115	577	646	28	0	0
45	QJ	430	3366	2115	577	646	28	0	0
45	QL	430	3366	2115	577	646	28	0	0
45	QN	420	3244	2045	551	620	28	0	3
45	RB	430	3366	2115	577	646	28	0	0
45	RD	430	3366	2115	577	646	28	0	0
45	RF	430	3366	2115	577	646	28	0	0
45	RH	430	3366	2115	577	646	28	0	0
45	RJ	430	3366	2115	577	646	28	0	0
45	RL	430	3366	2115	577	646	28	0	0
45	RN	430	3366	2115	577	646	28	0	0

*Continued on next page...*

*Continued from previous page...*

Mol	Chain	Residues	Atoms					AltConf	Trace
			Total	C	N	O	S		
45	SB	430	3366	2115	577	646	28	0	0
45	SD	430	3366	2115	577	646	28	0	0
45	SF	430	3366	2115	577	646	28	0	0
45	SH	430	3366	2115	577	646	28	0	0
45	SJ	430	3366	2115	577	646	28	0	0
45	SL	430	3366	2115	577	646	28	0	0
45	SN	430	3366	2115	577	646	28	0	0
45	TB	430	3366	2115	577	646	28	0	0
45	TD	430	3366	2115	577	646	28	0	0
45	TF	430	3366	2115	577	646	28	0	0
45	TH	430	3366	2115	577	646	28	0	0
45	TJ	430	3366	2115	577	646	28	0	0
45	TL	430	3366	2115	577	646	28	0	0
45	TN	430	3366	2115	577	646	28	0	0
45	UB	430	3366	2115	577	646	28	0	0
45	UD	430	3366	2115	577	646	28	0	0
45	UF	430	3366	2115	577	646	28	0	0
45	UH	430	3366	2115	577	646	28	0	0
45	UJ	430	3366	2115	577	646	28	0	0
45	UL	430	3366	2115	577	646	28	0	0
45	UN	430	3366	2115	577	646	28	0	0

*Continued on next page...*

*Continued from previous page...*

Mol	Chain	Residues	Atoms					AltConf	Trace
			Total	C	N	O	S		
45	VB	430	3366	2115	577	646	28	0	0
45	VD	430	3366	2115	577	646	28	0	0
45	VF	430	3366	2115	577	646	28	0	0
45	VH	430	3366	2115	577	646	28	0	0
45	VJ	430	3366	2115	577	646	28	0	0
45	VL	430	3366	2115	577	646	28	0	0
45	VN	430	3366	2115	577	646	28	0	0
45	WB	430	3366	2115	577	646	28	0	0
45	WD	430	3366	2115	577	646	28	0	0
45	WF	430	3366	2115	577	646	28	0	0
45	WH	430	3366	2115	577	646	28	0	0
45	WJ	430	3366	2115	577	646	28	0	0
45	WL	430	3366	2115	577	646	28	0	0
45	WN	430	3366	2115	577	646	28	0	0

- Molecule 46 is GUANOSINE-5'-TRIPHOSPHATE (three-letter code: GTP) (formula:  $C_{10}H_{16}N_5O_{14}P_3$ ) (labeled as "Ligand of Interest" by depositor).



Mol	Chain	Residues	Atoms					AltConf
			Total	C	N	O	P	
46	AA	1	Total 32	C 10	N 5	O 14	P 3	0
46	AC	1	Total 32	C 10	N 5	O 14	P 3	0
46	AE	1	Total 32	C 10	N 5	O 14	P 3	0
46	AG	1	Total 32	C 10	N 5	O 14	P 3	0
46	AI	1	Total 32	C 10	N 5	O 14	P 3	0
46	AK	1	Total 32	C 10	N 5	O 14	P 3	0
46	AM	1	Total 32	C 10	N 5	O 14	P 3	0
46	BA	1	Total 32	C 10	N 5	O 14	P 3	0
46	BC	1	Total 32	C 10	N 5	O 14	P 3	0
46	BE	1	Total 32	C 10	N 5	O 14	P 3	0
46	BG	1	Total 32	C 10	N 5	O 14	P 3	0
46	BI	1	Total 32	C 10	N 5	O 14	P 3	0
46	BK	1	Total 32	C 10	N 5	O 14	P 3	0
46	BM	1	Total 32	C 10	N 5	O 14	P 3	0

*Continued on next page...*

*Continued from previous page...*

Mol	Chain	Residues	Atoms					AltConf
			Total	C	N	O	P	
46	CA	1	Total 32	C 10	N 5	O 14	P 3	0
46	CC	1	Total 32	C 10	N 5	O 14	P 3	0
46	CE	1	Total 32	C 10	N 5	O 14	P 3	0
46	CG	1	Total 32	C 10	N 5	O 14	P 3	0
46	CI	1	Total 32	C 10	N 5	O 14	P 3	0
46	CK	1	Total 32	C 10	N 5	O 14	P 3	0
46	CM	1	Total 32	C 10	N 5	O 14	P 3	0
46	DA	1	Total 32	C 10	N 5	O 14	P 3	0
46	DB	1	Total 32	C 10	N 5	O 14	P 3	0
46	DE	1	Total 32	C 10	N 5	O 14	P 3	0
46	DG	1	Total 32	C 10	N 5	O 14	P 3	0
46	DI	1	Total 32	C 10	N 5	O 14	P 3	0
46	DK	1	Total 32	C 10	N 5	O 14	P 3	0
46	DM	1	Total 32	C 10	N 5	O 14	P 3	0
46	EA	1	Total 32	C 10	N 5	O 14	P 3	0
46	EC	1	Total 32	C 10	N 5	O 14	P 3	0
46	EE	1	Total 32	C 10	N 5	O 14	P 3	0
46	EG	1	Total 32	C 10	N 5	O 14	P 3	0
46	EI	1	Total 32	C 10	N 5	O 14	P 3	0
46	EK	1	Total 32	C 10	N 5	O 14	P 3	0
46	EM	1	Total 32	C 10	N 5	O 14	P 3	0

*Continued on next page...*

*Continued from previous page...*

Mol	Chain	Residues	Atoms					AltConf
			Total	C	N	O	P	
46	FA	1	Total 32	C 10	N 5	O 14	P 3	0
46	FC	1	Total 32	C 10	N 5	O 14	P 3	0
46	FE	1	Total 32	C 10	N 5	O 14	P 3	0
46	FG	1	Total 32	C 10	N 5	O 14	P 3	0
46	FI	1	Total 32	C 10	N 5	O 14	P 3	0
46	FK	1	Total 32	C 10	N 5	O 14	P 3	0
46	FM	1	Total 32	C 10	N 5	O 14	P 3	0
46	GB	1	Total 32	C 10	N 5	O 14	P 3	0
46	GD	1	Total 32	C 10	N 5	O 14	P 3	0
46	GE	1	Total 32	C 10	N 5	O 14	P 3	0
46	GG	1	Total 32	C 10	N 5	O 14	P 3	0
46	GI	1	Total 32	C 10	N 5	O 14	P 3	0
46	GL	1	Total 32	C 10	N 5	O 14	P 3	0
46	GM	1	Total 32	C 10	N 5	O 14	P 3	0
46	HA	1	Total 32	C 10	N 5	O 14	P 3	0
46	HC	1	Total 32	C 10	N 5	O 14	P 3	0
46	HE	1	Total 32	C 10	N 5	O 14	P 3	0
46	HG	1	Total 32	C 10	N 5	O 14	P 3	0
46	HI	1	Total 32	C 10	N 5	O 14	P 3	0
46	HK	1	Total 32	C 10	N 5	O 14	P 3	0
46	HM	1	Total 32	C 10	N 5	O 14	P 3	0

*Continued on next page...*



*Continued from previous page...*

Mol	Chain	Residues	Atoms					AltConf
			Total	C	N	O	P	
46	IA	1	Total 32	C 10	N 5	O 14	P 3	0
46	ID	1	Total 32	C 10	N 5	O 14	P 3	0
46	IE	1	Total 32	C 10	N 5	O 14	P 3	0
46	IG	1	Total 32	C 10	N 5	O 14	P 3	0
46	II	1	Total 32	C 10	N 5	O 14	P 3	0
46	IK	1	Total 32	C 10	N 5	O 14	P 3	0
46	IM	1	Total 32	C 10	N 5	O 14	P 3	0
46	JA	1	Total 32	C 10	N 5	O 14	P 3	0
46	JC	1	Total 32	C 10	N 5	O 14	P 3	0
46	JE	1	Total 32	C 10	N 5	O 14	P 3	0
46	JG	1	Total 32	C 10	N 5	O 14	P 3	0
46	JI	1	Total 32	C 10	N 5	O 14	P 3	0
46	JK	1	Total 32	C 10	N 5	O 14	P 3	0
46	JM	1	Total 32	C 10	N 5	O 14	P 3	0
46	KA	1	Total 32	C 10	N 5	O 14	P 3	0
46	KC	1	Total 32	C 10	N 5	O 14	P 3	0
46	KE	1	Total 32	C 10	N 5	O 14	P 3	0
46	KG	1	Total 32	C 10	N 5	O 14	P 3	0
46	KJ	1	Total 32	C 10	N 5	O 14	P 3	0
46	KK	1	Total 32	C 10	N 5	O 14	P 3	0
46	KM	1	Total 32	C 10	N 5	O 14	P 3	0

*Continued on next page...*

*Continued from previous page...*

Mol	Chain	Residues	Atoms					AltConf
			Total	C	N	O	P	
46	LB	1	Total 32	C 10	N 5	O 14	P 3	0
46	LC	1	Total 32	C 10	N 5	O 14	P 3	0
46	LE	1	Total 32	C 10	N 5	O 14	P 3	0
46	LG	1	Total 32	C 10	N 5	O 14	P 3	0
46	LI	1	Total 32	C 10	N 5	O 14	P 3	0
46	LK	1	Total 32	C 10	N 5	O 14	P 3	0
46	LM	1	Total 32	C 10	N 5	O 14	P 3	0
46	MA	1	Total 32	C 10	N 5	O 14	P 3	0
46	MC	1	Total 32	C 10	N 5	O 14	P 3	0
46	ME	1	Total 32	C 10	N 5	O 14	P 3	0
46	MG	1	Total 32	C 10	N 5	O 14	P 3	0
46	MI	1	Total 32	C 10	N 5	O 14	P 3	0
46	MK	1	Total 32	C 10	N 5	O 14	P 3	0
46	MM	1	Total 32	C 10	N 5	O 14	P 3	0
46	NA	1	Total 32	C 10	N 5	O 14	P 3	0
46	NC	1	Total 32	C 10	N 5	O 14	P 3	0
46	NE	1	Total 32	C 10	N 5	O 14	P 3	0
46	NG	1	Total 32	C 10	N 5	O 14	P 3	0
46	NI	1	Total 32	C 10	N 5	O 14	P 3	0
46	NK	1	Total 32	C 10	N 5	O 14	P 3	0
46	NM	1	Total 32	C 10	N 5	O 14	P 3	0

*Continued on next page...*

*Continued from previous page...*

Mol	Chain	Residues	Atoms					AltConf
			Total	C	N	O	P	
46	OA	1	Total 32	C 10	N 5	O 14	P 3	0
46	OC	1	Total 32	C 10	N 5	O 14	P 3	0
46	OE	1	Total 32	C 10	N 5	O 14	P 3	0
46	OG	1	Total 32	C 10	N 5	O 14	P 3	0
46	OI	1	Total 32	C 10	N 5	O 14	P 3	0
46	OL	1	Total 32	C 10	N 5	O 14	P 3	0
46	OM	1	Total 32	C 10	N 5	O 14	P 3	0
46	PA	1	Total 32	C 10	N 5	O 14	P 3	0
46	PC	1	Total 32	C 10	N 5	O 14	P 3	0
46	PE	1	Total 32	C 10	N 5	O 14	P 3	0
46	PG	1	Total 32	C 10	N 5	O 14	P 3	0
46	PI	1	Total 32	C 10	N 5	O 14	P 3	0
46	PK	1	Total 32	C 10	N 5	O 14	P 3	0
46	PM	1	Total 32	C 10	N 5	O 14	P 3	0
46	QA	1	Total 32	C 10	N 5	O 14	P 3	0
46	QC	1	Total 32	C 10	N 5	O 14	P 3	0
46	QE	1	Total 32	C 10	N 5	O 14	P 3	0
46	QG	1	Total 32	C 10	N 5	O 14	P 3	0
46	QI	1	Total 32	C 10	N 5	O 14	P 3	0
46	QK	1	Total 32	C 10	N 5	O 14	P 3	0
46	QM	1	Total 32	C 10	N 5	O 14	P 3	0

*Continued on next page...*

*Continued from previous page...*

Mol	Chain	Residues	Atoms					AltConf
			Total	C	N	O	P	
46	RA	1	Total 32	C 10	N 5	O 14	P 3	0
46	RC	1	Total 32	C 10	N 5	O 14	P 3	0
46	RE	1	Total 32	C 10	N 5	O 14	P 3	0
46	RG	1	Total 32	C 10	N 5	O 14	P 3	0
46	RI	1	Total 32	C 10	N 5	O 14	P 3	0
46	RK	1	Total 32	C 10	N 5	O 14	P 3	0
46	RM	1	Total 32	C 10	N 5	O 14	P 3	0
46	SA	1	Total 32	C 10	N 5	O 14	P 3	0
46	SC	1	Total 32	C 10	N 5	O 14	P 3	0
46	SE	1	Total 32	C 10	N 5	O 14	P 3	0
46	SG	1	Total 32	C 10	N 5	O 14	P 3	0
46	SI	1	Total 32	C 10	N 5	O 14	P 3	0
46	SK	1	Total 32	C 10	N 5	O 14	P 3	0
46	SM	1	Total 32	C 10	N 5	O 14	P 3	0
46	TA	1	Total 32	C 10	N 5	O 14	P 3	0
46	TC	1	Total 32	C 10	N 5	O 14	P 3	0
46	TE	1	Total 32	C 10	N 5	O 14	P 3	0
46	TG	1	Total 32	C 10	N 5	O 14	P 3	0
46	TI	1	Total 32	C 10	N 5	O 14	P 3	0
46	TK	1	Total 32	C 10	N 5	O 14	P 3	0
46	TM	1	Total 32	C 10	N 5	O 14	P 3	0

*Continued on next page...*

*Continued from previous page...*

Mol	Chain	Residues	Atoms					AltConf
			Total	C	N	O	P	
46	UA	1	Total 32	C 10	N 5	O 14	P 3	0
46	UC	1	Total 32	C 10	N 5	O 14	P 3	0
46	UE	1	Total 32	C 10	N 5	O 14	P 3	0
46	UG	1	Total 32	C 10	N 5	O 14	P 3	0
46	UI	1	Total 32	C 10	N 5	O 14	P 3	0
46	UK	1	Total 32	C 10	N 5	O 14	P 3	0
46	UM	1	Total 32	C 10	N 5	O 14	P 3	0
46	VA	1	Total 32	C 10	N 5	O 14	P 3	0
46	VC	1	Total 32	C 10	N 5	O 14	P 3	0
46	VE	1	Total 32	C 10	N 5	O 14	P 3	0
46	VG	1	Total 32	C 10	N 5	O 14	P 3	0
46	VI	1	Total 32	C 10	N 5	O 14	P 3	0
46	VK	1	Total 32	C 10	N 5	O 14	P 3	0
46	VM	1	Total 32	C 10	N 5	O 14	P 3	0
46	WA	1	Total 32	C 10	N 5	O 14	P 3	0
46	WC	1	Total 32	C 10	N 5	O 14	P 3	0
46	WE	1	Total 32	C 10	N 5	O 14	P 3	0
46	WG	1	Total 32	C 10	N 5	O 14	P 3	0
46	WI	1	Total 32	C 10	N 5	O 14	P 3	0
46	WK	1	Total 32	C 10	N 5	O 14	P 3	0
46	WM	1	Total 32	C 10	N 5	O 14	P 3	0

- Molecule 47 is MAGNESIUM ION (three-letter code: MG) (formula: Mg).

Mol	Chain	Residues	Atoms		AltConf
47	AB	1	Total 1	Mg 1	0
47	AC	1	Total 1	Mg 1	0
47	AE	1	Total 1	Mg 1	0
47	AG	1	Total 1	Mg 1	0
47	AI	1	Total 1	Mg 1	0
47	AL	1	Total 1	Mg 1	0
47	AM	1	Total 1	Mg 1	0
47	BA	1	Total 1	Mg 1	0
47	BD	1	Total 1	Mg 1	0
47	BF	1	Total 1	Mg 1	0
47	BH	1	Total 1	Mg 1	0
47	BJ	1	Total 1	Mg 1	0
47	BL	1	Total 1	Mg 1	0
47	BM	1	Total 1	Mg 1	0
47	CA	1	Total 1	Mg 1	0
47	CC	1	Total 1	Mg 1	0
47	CE	1	Total 1	Mg 1	0
47	CF	1	Total 1	Mg 1	0
47	CH	1	Total 1	Mg 1	0
47	CJ	1	Total 1	Mg 1	0
47	CM	1	Total 1	Mg 1	0

*Continued on next page...*

*Continued from previous page...*

Mol	Chain	Residues	Atoms		AltConf
			Total	Mg	
47	DA	1	1	1	0
47	DB	1	1	1	0
47	DE	1	1	1	0
47	DG	1	1	1	0
47	DI	1	1	1	0
47	DK	1	1	1	0
47	DM	1	1	1	0
47	EA	1	1	1	0
47	EB	1	1	1	0
47	EE	1	1	1	0
47	EG	1	1	1	0
47	EI	1	1	1	0
47	EJ	1	1	1	0
47	EL	1	1	1	0
47	FA	1	1	1	0
47	FD	1	1	1	0
47	FF	1	1	1	0
47	FG	1	1	1	0
47	FI	1	1	1	0
47	FK	1	1	1	0
47	FM	1	1	1	0

*Continued on next page...*

*Continued from previous page...*

Mol	Chain	Residues	Atoms		AltConf
			Total	Mg	
47	GA	1	1	1	0
47	GD	1	1	1	0
47	GE	1	1	1	0
47	GH	1	1	1	0
47	GJ	1	1	1	0
47	GK	1	1	1	0
47	GM	1	1	1	0
47	HA	1	1	1	0
47	HC	1	1	1	0
47	HF	1	1	1	0
47	HG	1	1	1	0
47	HI	1	1	1	0
47	HL	1	1	1	0
47	HM	1	1	1	0
47	IA	1	1	1	0
47	IC	1	1	1	0
47	IE	1	1	1	0
47	IH	1	1	1	0
47	IJ	1	1	1	0
47	IK	1	1	1	0
47	IM	1	1	1	0

*Continued on next page...*



*Continued from previous page...*

Mol	Chain	Residues	Atoms		AltConf
			Total	Mg	
47	JA	1	1	1	0
47	JC	1	1	1	0
47	JE	1	1	1	0
47	JG	1	1	1	0
47	JI	1	1	1	0
47	JK	1	1	1	0
47	JM	1	1	1	0
47	KA	1	1	1	0
47	KC	1	1	1	0
47	KF	1	1	1	0
47	KG	1	1	1	0
47	KI	1	1	1	0
47	KK	1	1	1	0
47	KM	1	1	1	0
47	LA	1	1	1	0
47	LC	1	1	1	0
47	LE	1	1	1	0
47	LG	1	1	1	0
47	LI	1	1	1	0
47	LK	1	1	1	0
47	LN	1	1	1	0

*Continued on next page...*

*Continued from previous page...*

Mol	Chain	Residues	Atoms		AltConf
			Total	Mg	
47	MA	1	1	1	0
47	MC	1	1	1	0
47	MF	1	1	1	0
47	MG	1	1	1	0
47	MJ	1	1	1	0
47	MK	1	1	1	0
47	MN	1	1	1	0
47	NA	1	1	1	0
47	NC	1	1	1	0
47	NE	1	1	1	0
47	NG	1	1	1	0
47	NI	1	1	1	0
47	NK	1	1	1	0
47	NM	1	1	1	0
47	OA	1	1	1	0
47	OD	1	1	1	0
47	OE	1	1	1	0
47	OG	1	1	1	0
47	OI	1	1	1	0
47	OK	1	1	1	0
47	OM	1	1	1	0

*Continued on next page...*

*Continued from previous page...*

Mol	Chain	Residues	Atoms		AltConf
			Total	Mg	
47	PA	1	1	1	0
47	PD	1	1	1	0
47	PE	1	1	1	0
47	PG	1	1	1	0
47	PI	1	1	1	0
47	PK	1	1	1	0
47	PM	1	1	1	0
47	QA	1	1	1	0
47	QC	1	1	1	0
47	QD	1	1	1	0
47	QG	1	1	1	0
47	QI	1	1	1	0
47	QJ	1	1	1	0
47	QM	1	1	1	0
47	RA	1	1	1	0
47	RC	1	1	1	0
47	RE	1	1	1	0
47	RG	1	1	1	0
47	RH	1	1	1	0
47	RK	1	1	1	0
47	RM	1	1	1	0

*Continued on next page...*

*Continued from previous page...*

Mol	Chain	Residues	Atoms		AltConf
			Total	Mg	
47	SA	1	1	1	0
47	SC	1	1	1	0
47	SE	1	1	1	0
47	SG	1	1	1	0
47	SI	1	1	1	0
47	SK	1	1	1	0
47	SM	1	1	1	0
47	TA	1	1	1	0
47	TC	1	1	1	0
47	TE	1	1	1	0
47	TG	1	1	1	0
47	TI	1	1	1	0
47	TK	1	1	1	0
47	TM	1	1	1	0
47	UA	1	1	1	0
47	UC	1	1	1	0
47	UE	1	1	1	0
47	UG	1	1	1	0
47	UI	1	1	1	0
47	UK	1	1	1	0
47	UL	1	1	1	0

*Continued on next page...*

*Continued from previous page...*

Mol	Chain	Residues	Atoms		AltConf
			Total	Mg	
47	VB	1	1	1	0
47	VC	1	1	1	0
47	VE	1	1	1	0
47	VG	1	1	1	0
47	VI	1	1	1	0
47	VK	1	1	1	0
47	VM	1	1	1	0
47	WA	1	1	1	0
47	WC	1	1	1	0
47	WE	1	1	1	0
47	WG	1	1	1	0
47	WJ	1	1	1	0
47	WK	1	1	1	0
47	WM	1	1	1	0

- Molecule 48 is GUANOSINE-5'-DIPHOSPHATE (three-letter code: GDP) (formula:  $C_{10}H_{15}N_5O_{11}P_2$ ) (labeled as "Ligand of Interest" by depositor).



*Continued from previous page...*

Mol	Chain	Residues	Atoms					AltConf
			Total	C	N	O	P	
48	CB	1	Total 28	C 10	N 5	O 11	P 2	0
48	CD	1	Total 28	C 10	N 5	O 11	P 2	0
48	CF	1	Total 28	C 10	N 5	O 11	P 2	0
48	CH	1	Total 28	C 10	N 5	O 11	P 2	0
48	CJ	1	Total 28	C 10	N 5	O 11	P 2	0
48	CL	1	Total 28	C 10	N 5	O 11	P 2	0
48	CN	1	Total 28	C 10	N 5	O 11	P 2	0
48	DB	1	Total 28	C 10	N 5	O 11	P 2	0
48	DD	1	Total 28	C 10	N 5	O 11	P 2	0
48	DF	1	Total 28	C 10	N 5	O 11	P 2	0
48	DH	1	Total 28	C 10	N 5	O 11	P 2	0
48	DJ	1	Total 28	C 10	N 5	O 11	P 2	0
48	DL	1	Total 28	C 10	N 5	O 11	P 2	0
48	DN	1	Total 28	C 10	N 5	O 11	P 2	0
48	EB	1	Total 28	C 10	N 5	O 11	P 2	0
48	ED	1	Total 28	C 10	N 5	O 11	P 2	0
48	EF	1	Total 28	C 10	N 5	O 11	P 2	0
48	EH	1	Total 28	C 10	N 5	O 11	P 2	0
48	EJ	1	Total 28	C 10	N 5	O 11	P 2	0
48	EL	1	Total 28	C 10	N 5	O 11	P 2	0
48	EN	1	Total 28	C 10	N 5	O 11	P 2	0

*Continued on next page...*

*Continued from previous page...*

Mol	Chain	Residues	Atoms					AltConf
			Total	C	N	O	P	
48	FB	1	Total 28	C 10	N 5	O 11	P 2	0
48	FD	1	Total 28	C 10	N 5	O 11	P 2	0
48	FF	1	Total 28	C 10	N 5	O 11	P 2	0
48	FH	1	Total 28	C 10	N 5	O 11	P 2	0
48	FJ	1	Total 28	C 10	N 5	O 11	P 2	0
48	FL	1	Total 28	C 10	N 5	O 11	P 2	0
48	FN	1	Total 28	C 10	N 5	O 11	P 2	0
48	GB	1	Total 28	C 10	N 5	O 11	P 2	0
48	GD	1	Total 28	C 10	N 5	O 11	P 2	0
48	GF	1	Total 28	C 10	N 5	O 11	P 2	0
48	GH	1	Total 28	C 10	N 5	O 11	P 2	0
48	GJ	1	Total 28	C 10	N 5	O 11	P 2	0
48	GL	1	Total 28	C 10	N 5	O 11	P 2	0
48	GN	1	Total 28	C 10	N 5	O 11	P 2	0
48	HB	1	Total 28	C 10	N 5	O 11	P 2	0
48	HD	1	Total 28	C 10	N 5	O 11	P 2	0
48	HF	1	Total 28	C 10	N 5	O 11	P 2	0
48	HH	1	Total 28	C 10	N 5	O 11	P 2	0
48	HJ	1	Total 28	C 10	N 5	O 11	P 2	0
48	HL	1	Total 28	C 10	N 5	O 11	P 2	0
48	HN	1	Total 28	C 10	N 5	O 11	P 2	0

*Continued on next page...*



*Continued from previous page...*

Mol	Chain	Residues	Atoms					AltConf
			Total	C	N	O	P	
48	IB	1	Total 28	C 10	N 5	O 11	P 2	0
48	ID	1	Total 28	C 10	N 5	O 11	P 2	0
48	IF	1	Total 28	C 10	N 5	O 11	P 2	0
48	IH	1	Total 28	C 10	N 5	O 11	P 2	0
48	IJ	1	Total 28	C 10	N 5	O 11	P 2	0
48	IL	1	Total 28	C 10	N 5	O 11	P 2	0
48	IN	1	Total 28	C 10	N 5	O 11	P 2	0
48	JB	1	Total 28	C 10	N 5	O 11	P 2	0
48	JD	1	Total 28	C 10	N 5	O 11	P 2	0
48	JF	1	Total 28	C 10	N 5	O 11	P 2	0
48	JH	1	Total 28	C 10	N 5	O 11	P 2	0
48	JJ	1	Total 28	C 10	N 5	O 11	P 2	0
48	JL	1	Total 28	C 10	N 5	O 11	P 2	0
48	JN	1	Total 28	C 10	N 5	O 11	P 2	0
48	KB	1	Total 28	C 10	N 5	O 11	P 2	0
48	KD	1	Total 28	C 10	N 5	O 11	P 2	0
48	KF	1	Total 28	C 10	N 5	O 11	P 2	0
48	KH	1	Total 28	C 10	N 5	O 11	P 2	0
48	KJ	1	Total 28	C 10	N 5	O 11	P 2	0
48	KL	1	Total 28	C 10	N 5	O 11	P 2	0
48	KN	1	Total 28	C 10	N 5	O 11	P 2	0

*Continued on next page...*

*Continued from previous page...*

Mol	Chain	Residues	Atoms					AltConf
			Total	C	N	O	P	
48	LB	1	Total 28	C 10	N 5	O 11	P 2	0
48	LD	1	Total 28	C 10	N 5	O 11	P 2	0
48	LF	1	Total 28	C 10	N 5	O 11	P 2	0
48	LH	1	Total 28	C 10	N 5	O 11	P 2	0
48	LJ	1	Total 28	C 10	N 5	O 11	P 2	0
48	LL	1	Total 28	C 10	N 5	O 11	P 2	0
48	LN	1	Total 28	C 10	N 5	O 11	P 2	0
48	MB	1	Total 28	C 10	N 5	O 11	P 2	0
48	MD	1	Total 28	C 10	N 5	O 11	P 2	0
48	MF	1	Total 28	C 10	N 5	O 11	P 2	0
48	MH	1	Total 28	C 10	N 5	O 11	P 2	0
48	MJ	1	Total 28	C 10	N 5	O 11	P 2	0
48	ML	1	Total 28	C 10	N 5	O 11	P 2	0
48	MN	1	Total 28	C 10	N 5	O 11	P 2	0
48	NB	1	Total 28	C 10	N 5	O 11	P 2	0
48	ND	1	Total 28	C 10	N 5	O 11	P 2	0
48	NF	1	Total 28	C 10	N 5	O 11	P 2	0
48	NH	1	Total 28	C 10	N 5	O 11	P 2	0
48	NJ	1	Total 28	C 10	N 5	O 11	P 2	0
48	NL	1	Total 28	C 10	N 5	O 11	P 2	0
48	NN	1	Total 28	C 10	N 5	O 11	P 2	0

*Continued on next page...*

*Continued from previous page...*

Mol	Chain	Residues	Atoms					AltConf
			Total	C	N	O	P	
48	OB	1	Total 28	C 10	N 5	O 11	P 2	0
48	OD	1	Total 28	C 10	N 5	O 11	P 2	0
48	OF	1	Total 28	C 10	N 5	O 11	P 2	0
48	OH	1	Total 28	C 10	N 5	O 11	P 2	0
48	OJ	1	Total 28	C 10	N 5	O 11	P 2	0
48	OL	1	Total 28	C 10	N 5	O 11	P 2	0
48	ON	1	Total 28	C 10	N 5	O 11	P 2	0
48	PB	1	Total 28	C 10	N 5	O 11	P 2	0
48	PD	1	Total 28	C 10	N 5	O 11	P 2	0
48	PF	1	Total 28	C 10	N 5	O 11	P 2	0
48	PH	1	Total 28	C 10	N 5	O 11	P 2	0
48	PJ	1	Total 28	C 10	N 5	O 11	P 2	0
48	PL	1	Total 28	C 10	N 5	O 11	P 2	0
48	PN	1	Total 28	C 10	N 5	O 11	P 2	0
48	QB	1	Total 28	C 10	N 5	O 11	P 2	0
48	QD	1	Total 28	C 10	N 5	O 11	P 2	0
48	QF	1	Total 28	C 10	N 5	O 11	P 2	0
48	QH	1	Total 28	C 10	N 5	O 11	P 2	0
48	QJ	1	Total 28	C 10	N 5	O 11	P 2	0
48	QL	1	Total 28	C 10	N 5	O 11	P 2	0
48	QN	1	Total 28	C 10	N 5	O 11	P 2	0

*Continued on next page...*

*Continued from previous page...*

Mol	Chain	Residues	Atoms					AltConf
			Total	C	N	O	P	
48	RB	1	28	10	5	11	2	0
48	RD	1	28	10	5	11	2	0
48	RF	1	28	10	5	11	2	0
48	RH	1	28	10	5	11	2	0
48	RJ	1	28	10	5	11	2	0
48	RL	1	28	10	5	11	2	0
48	RN	1	28	10	5	11	2	0
48	SB	1	28	10	5	11	2	0
48	SD	1	28	10	5	11	2	0
48	SF	1	28	10	5	11	2	0
48	SH	1	28	10	5	11	2	0
48	SJ	1	28	10	5	11	2	0
48	SL	1	28	10	5	11	2	0
48	SN	1	28	10	5	11	2	0
48	TB	1	28	10	5	11	2	0
48	TD	1	28	10	5	11	2	0
48	TF	1	28	10	5	11	2	0
48	TH	1	28	10	5	11	2	0
48	TJ	1	28	10	5	11	2	0
48	TL	1	28	10	5	11	2	0
48	TN	1	28	10	5	11	2	0

*Continued on next page...*

*Continued from previous page...*

Mol	Chain	Residues	Atoms					AltConf
			Total	C	N	O	P	
48	UB	1	28	10	5	11	2	0
48	UD	1	28	10	5	11	2	0
48	UF	1	28	10	5	11	2	0
48	UH	1	28	10	5	11	2	0
48	UJ	1	28	10	5	11	2	0
48	UL	1	28	10	5	11	2	0
48	UN	1	28	10	5	11	2	0
48	VB	1	28	10	5	11	2	0
48	VD	1	28	10	5	11	2	0
48	VF	1	28	10	5	11	2	0
48	VH	1	28	10	5	11	2	0
48	VJ	1	28	10	5	11	2	0
48	VL	1	28	10	5	11	2	0
48	VN	1	28	10	5	11	2	0
48	WB	1	28	10	5	11	2	0
48	WD	1	28	10	5	11	2	0
48	WF	1	28	10	5	11	2	0
48	WH	1	28	10	5	11	2	0
48	WJ	1	28	10	5	11	2	0
48	WL	1	28	10	5	11	2	0
48	WN	1	28	10	5	11	2	0

### 3 Residue-property plots

These plots are drawn for all protein, RNA, DNA and oligosaccharide chains in the entry. The first graphic for a chain summarises the proportions of the various outlier classes displayed in the second graphic. The second graphic shows the sequence view annotated by issues in geometry and atom inclusion in map density. Residues are color-coded according to the number of geometric quality criteria for which they contain at least one outlier: green = 0, yellow = 1, orange = 2 and red = 3 or more. A red diamond above a residue indicates a poor fit to the EM map for this residue (all-atom inclusion < 40%). Stretches of 2 or more consecutive residues without any outlier are shown as a green connector. Residues present in the sample, but not in the model, are shown in grey.

#### • Molecule 1: Nebulin

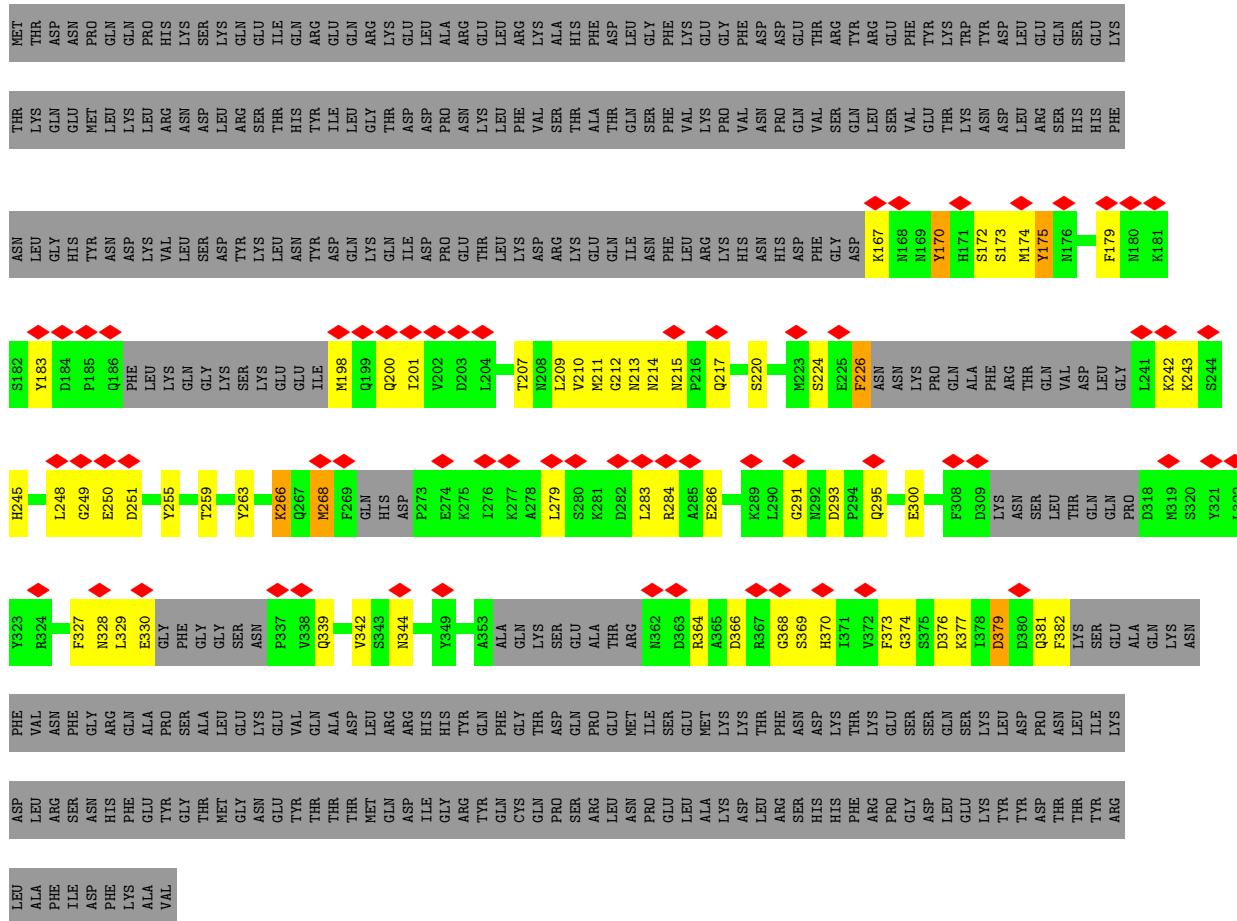

#### • Molecule 2: RIB27A

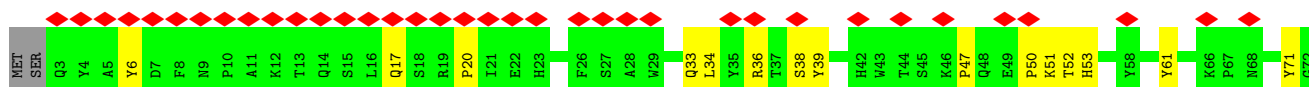



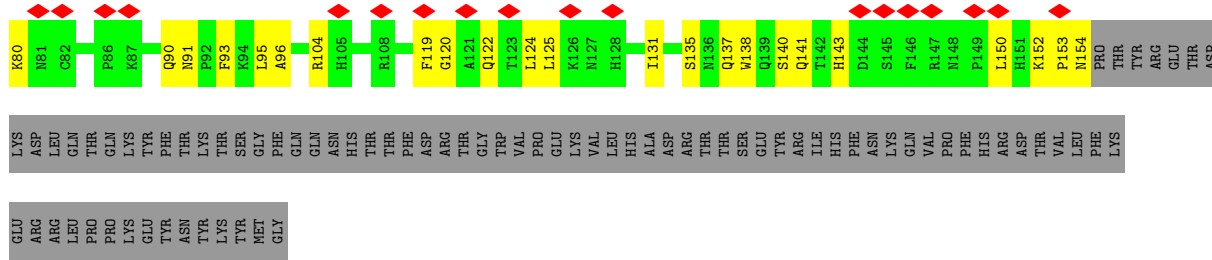

• Molecule 3: RIB38

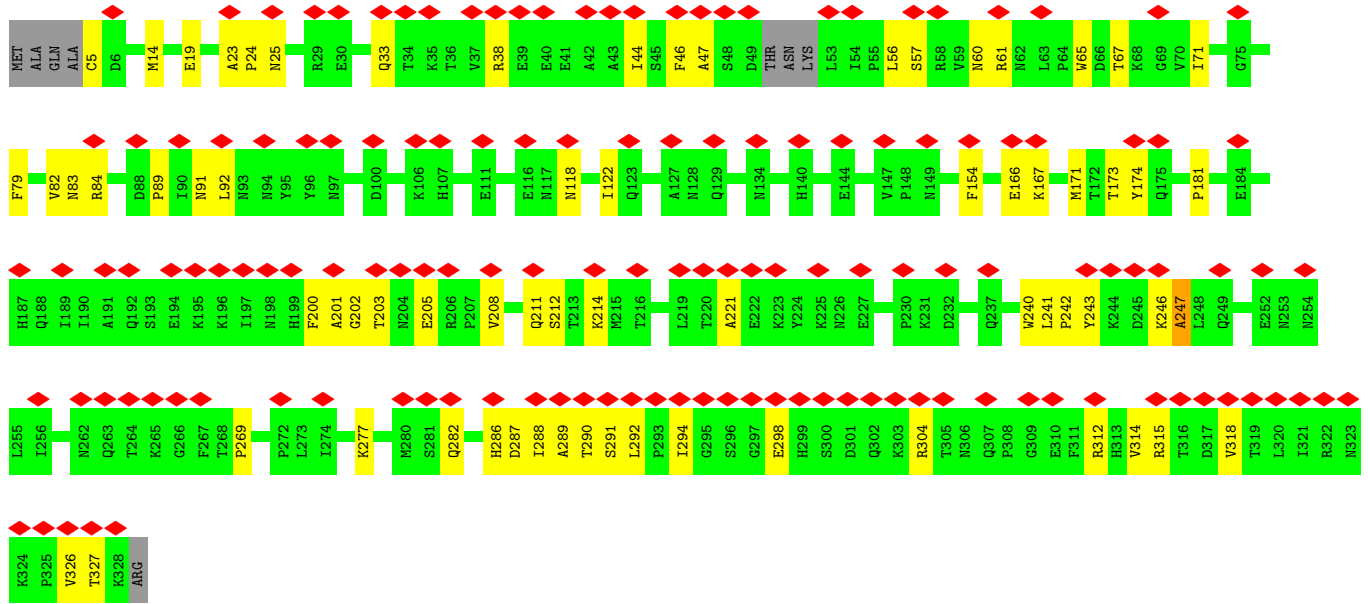
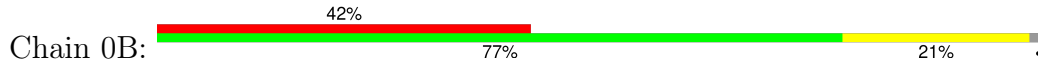

• Molecule 4: CFAM166B

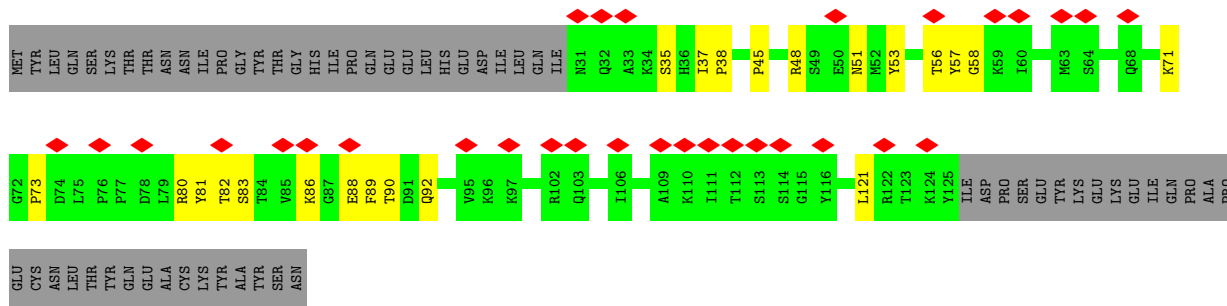

• Molecule 4: CFAM166B





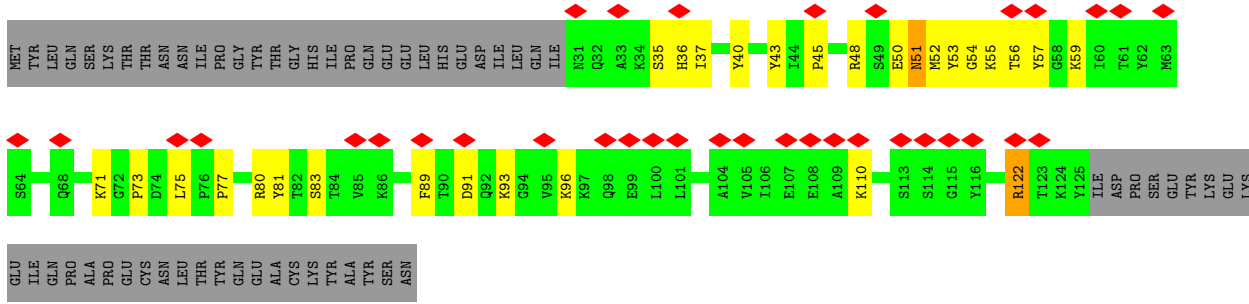

• Molecule 5: CFAM166A

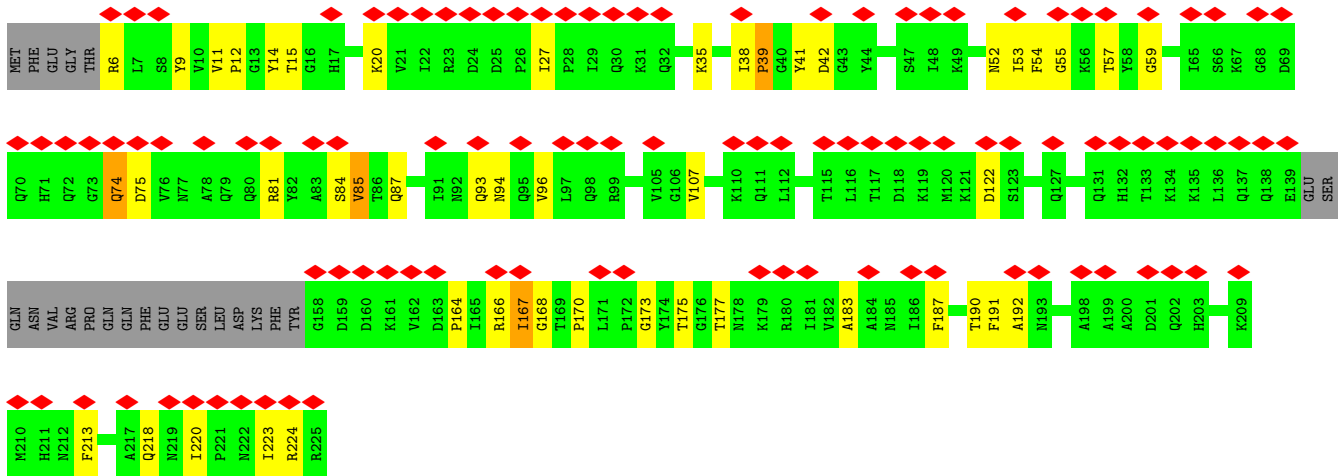

• Molecule 5: CFAM166A

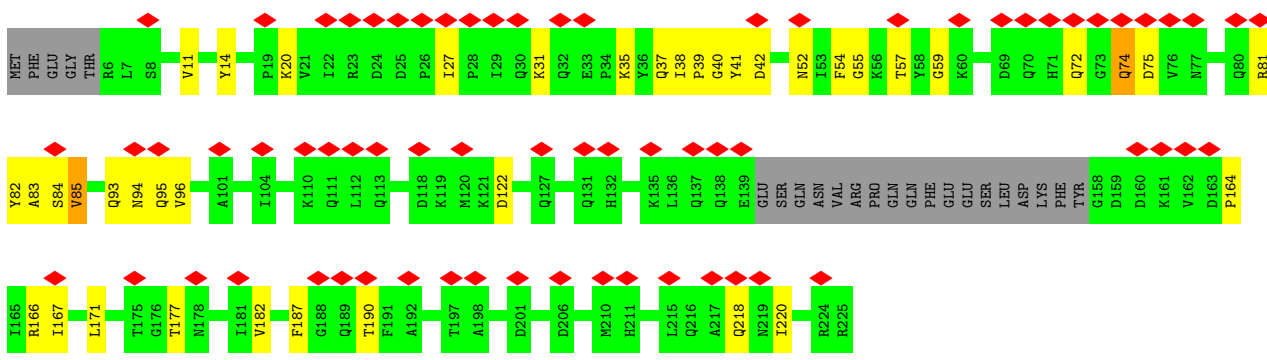

• Molecule 5: CFAM166A

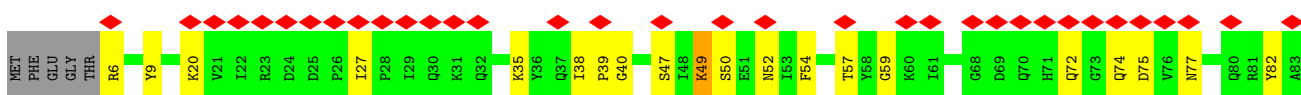

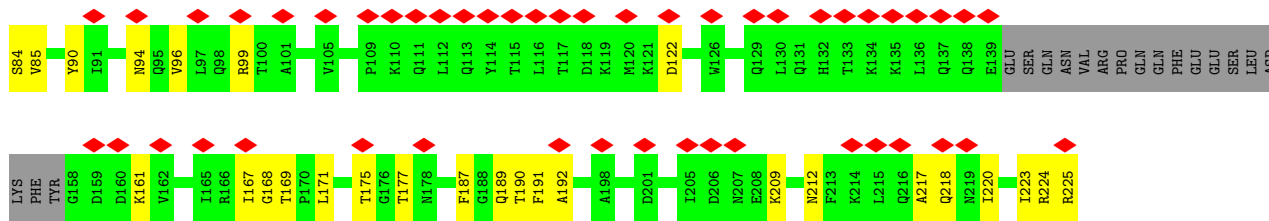

• Molecule 6: RIB22



Chain 0E:

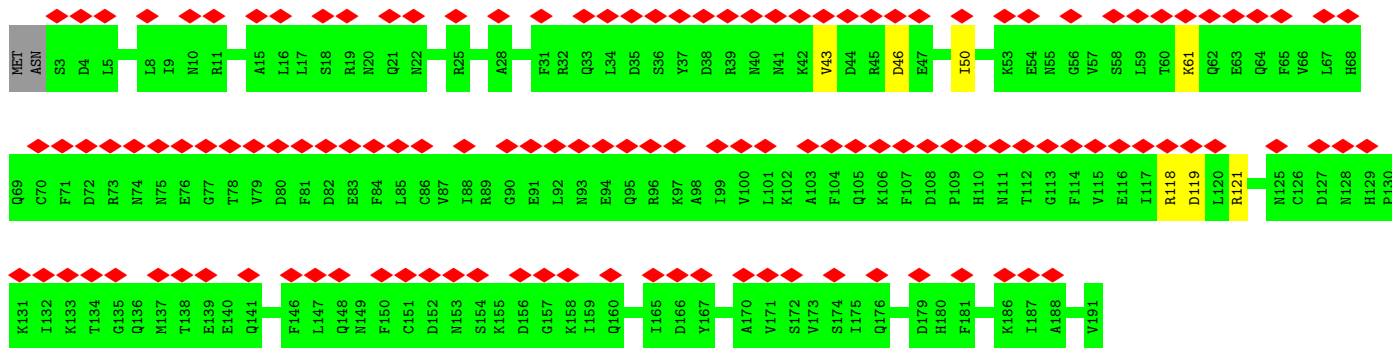

• Molecule 6: RIB22



Chain 1E:

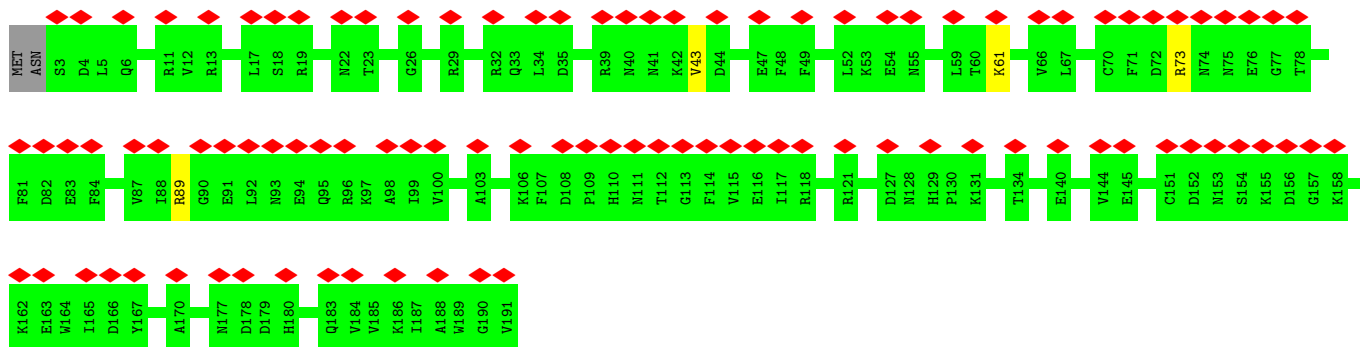

• Molecule 6: RIB22

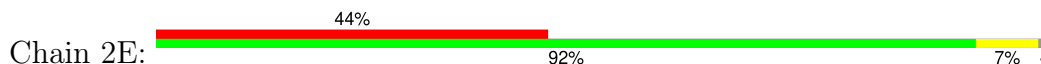

Chain 2E:

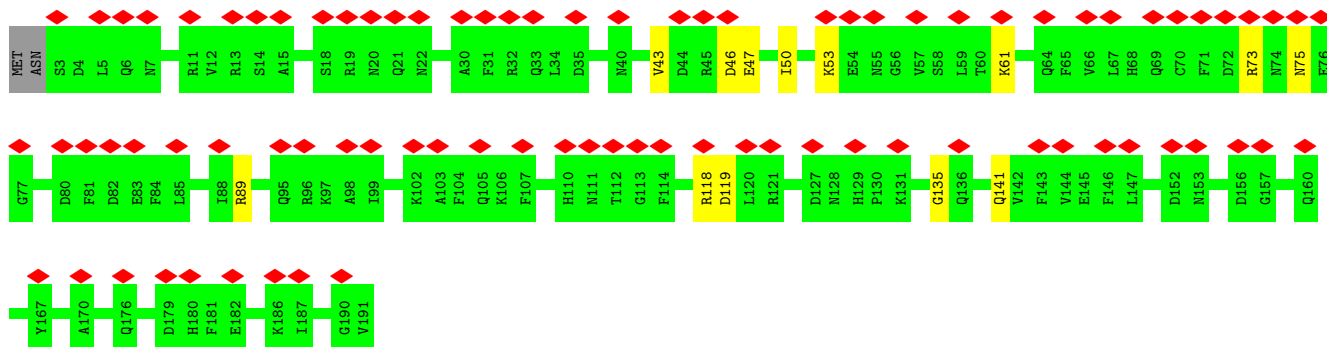

• Molecule 6: RIB22

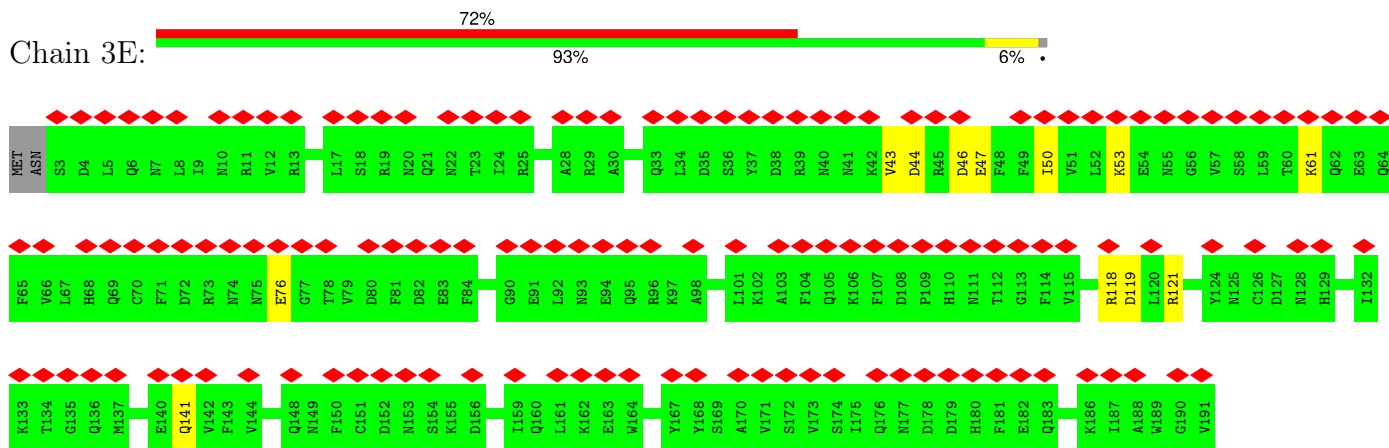

• Molecule 7: CFAM166C

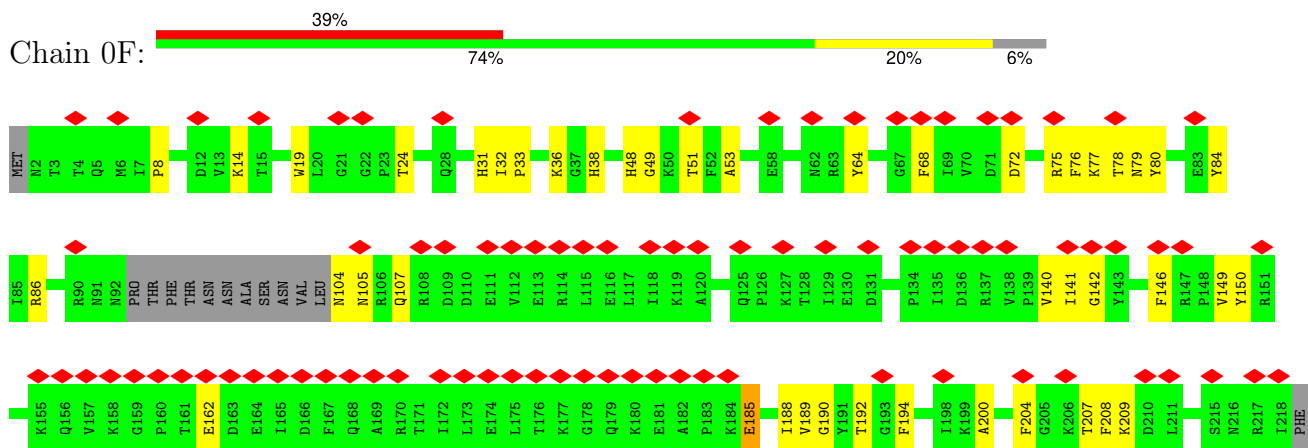

• Molecule 8: CFAP107

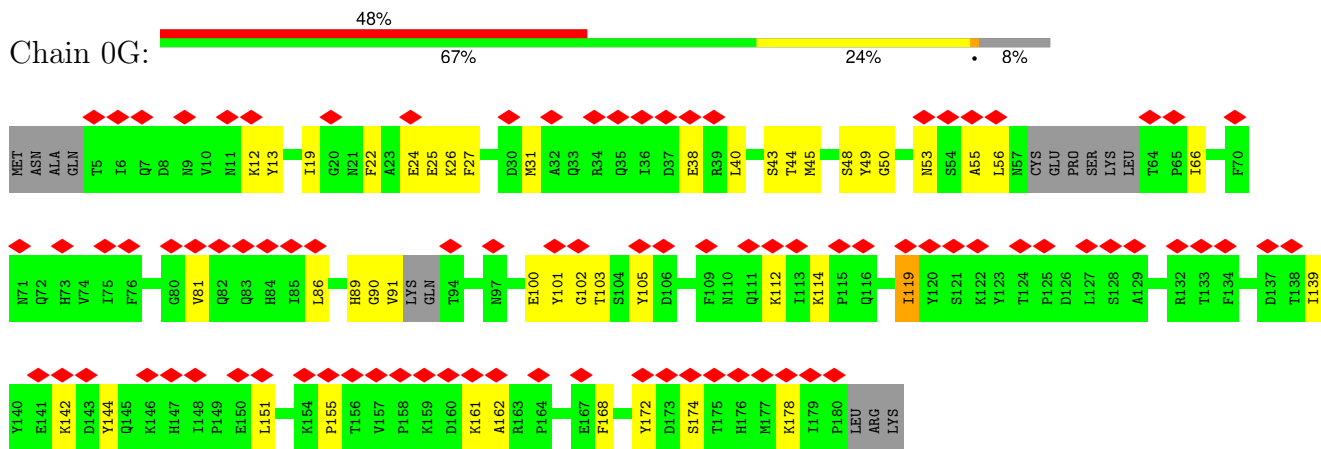

• Molecule 8: CFAP107

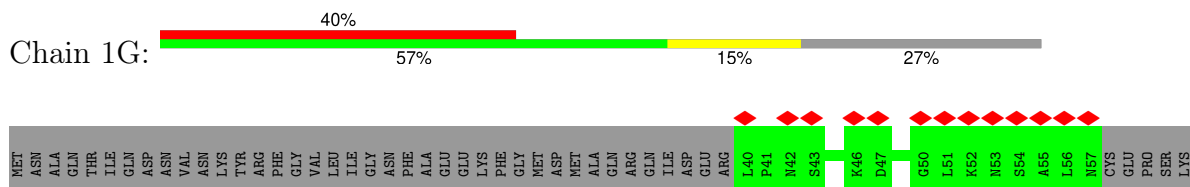

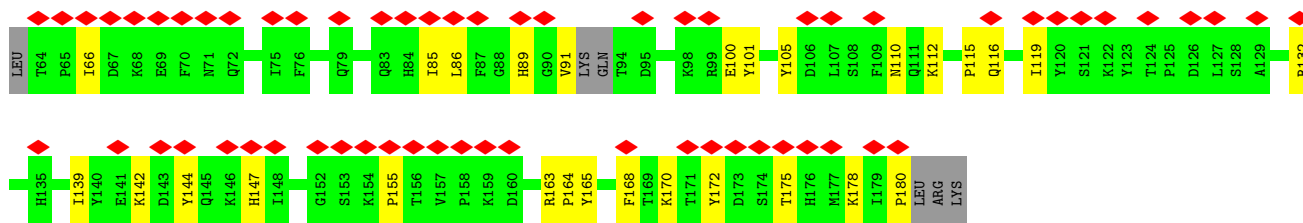

• Molecule 9: CFAP127

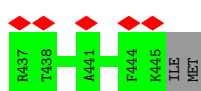
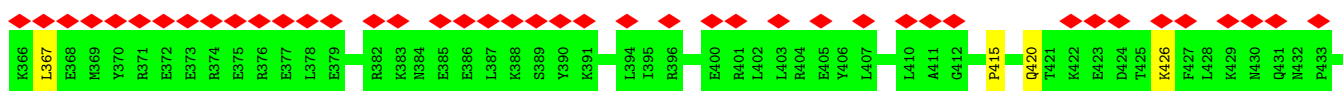
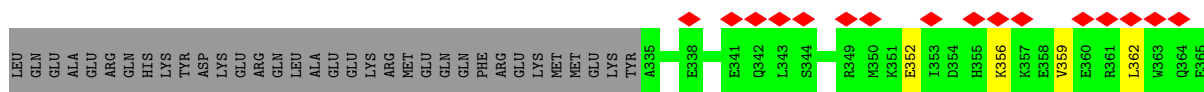
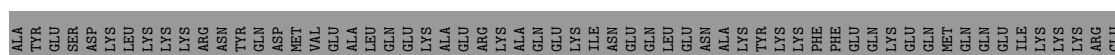
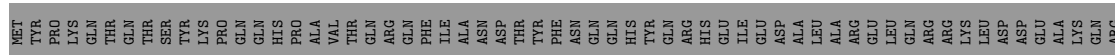

• Molecule 9: CFAP127

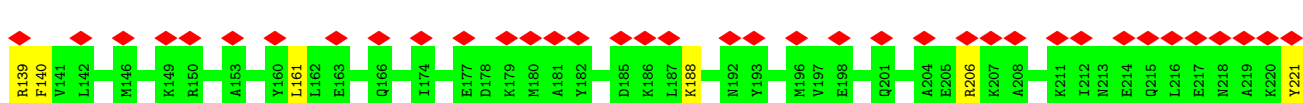
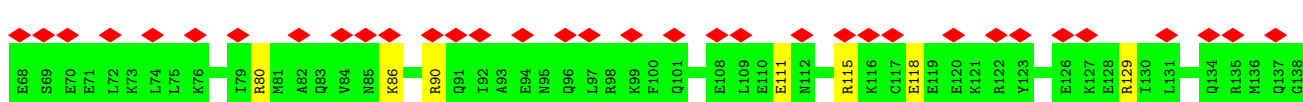
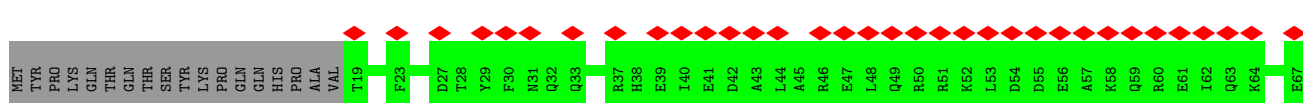



• Molecule 10: CFAP161A

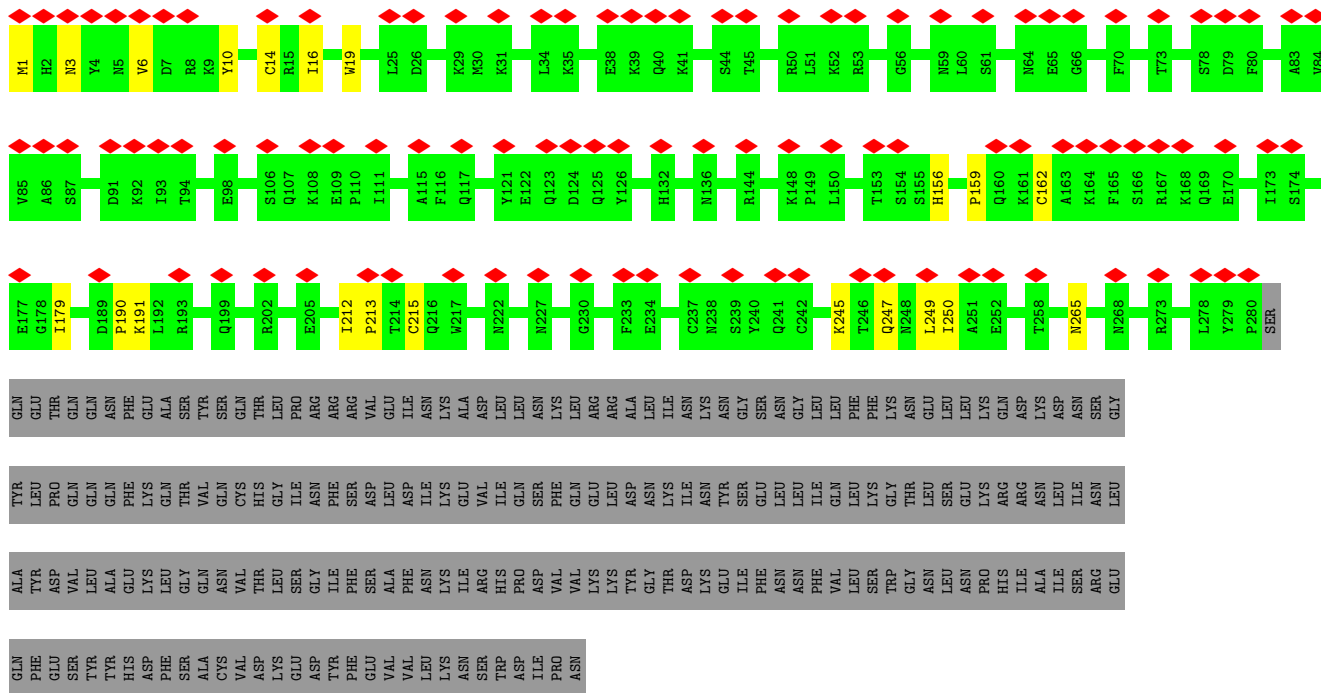

• Molecule 10: CFAP161A

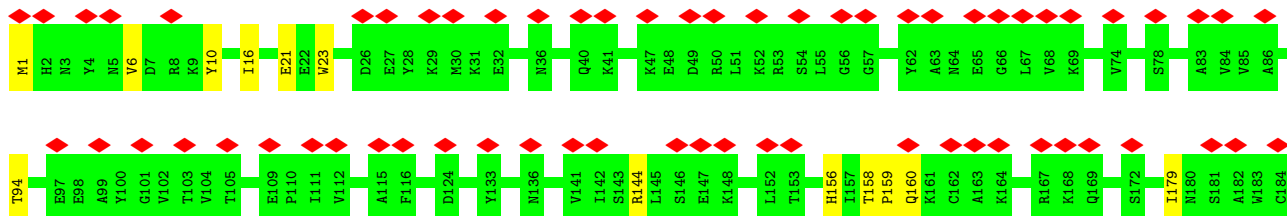
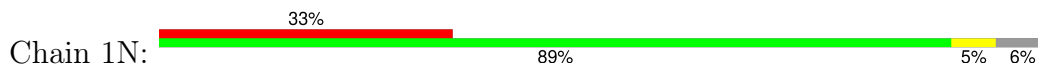

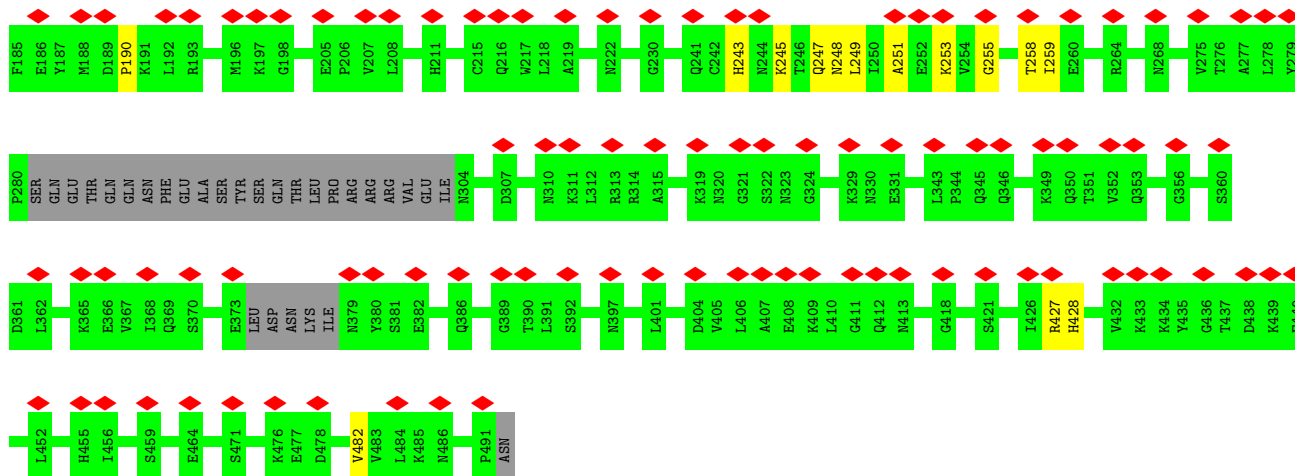

• Molecule 10: CFAP161A

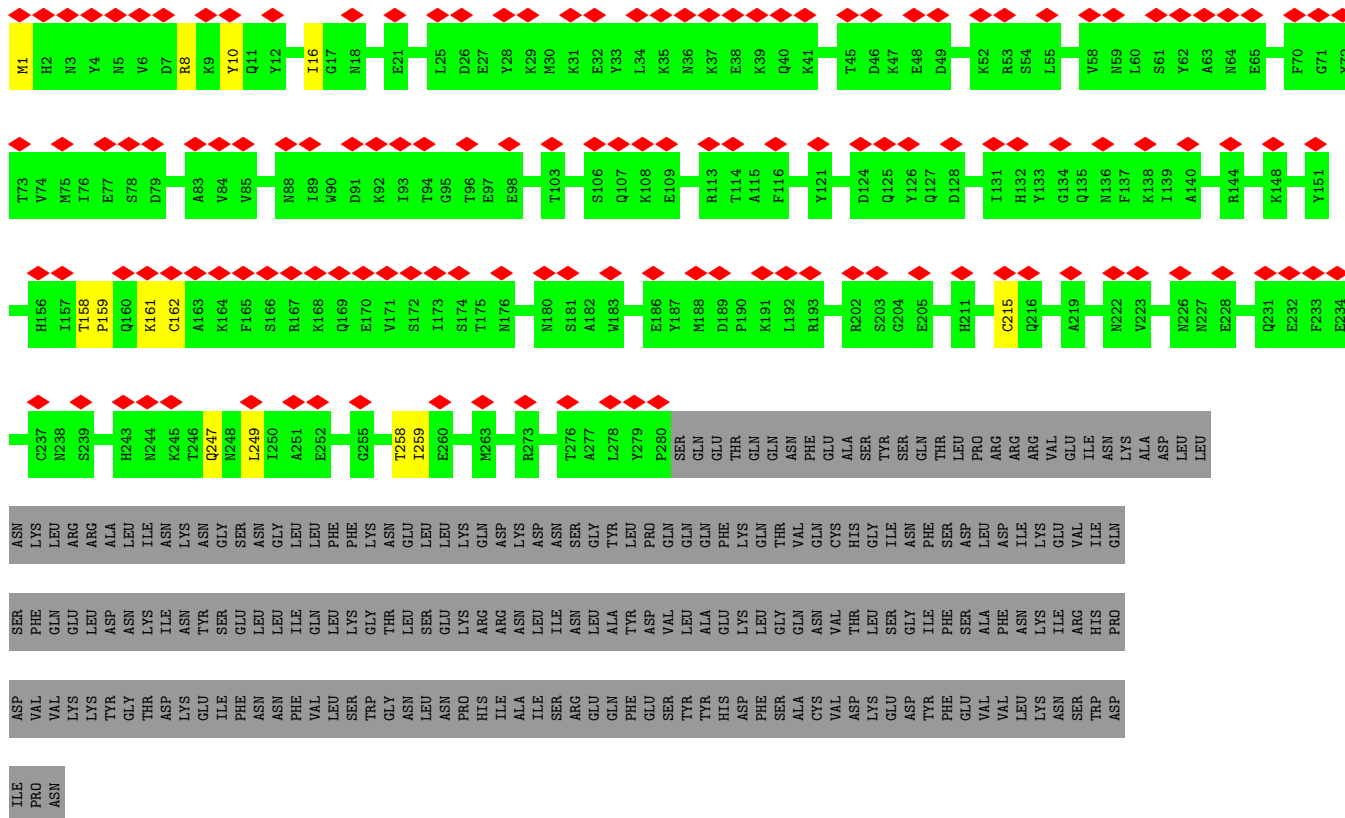

• Molecule 11: CFAP20



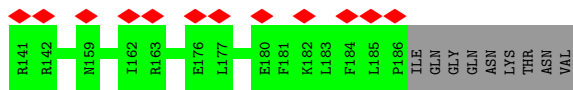

• Molecule 11: CFAP20

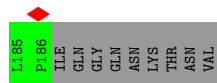
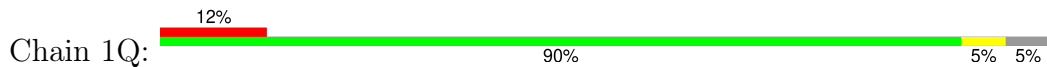

• Molecule 11: CFAP20

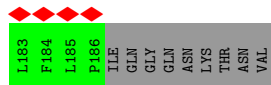
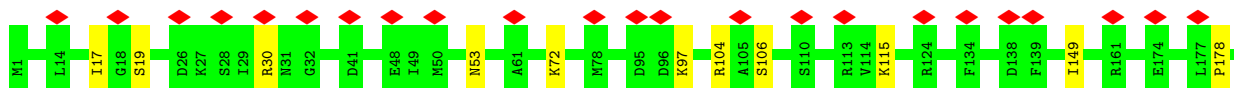
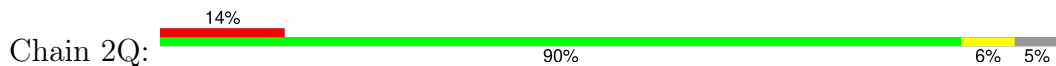

• Molecule 11: CFAP20

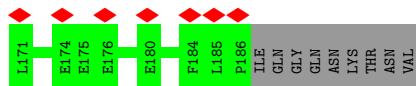
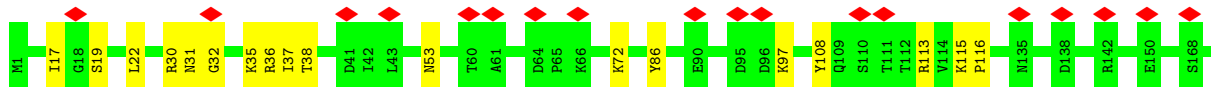
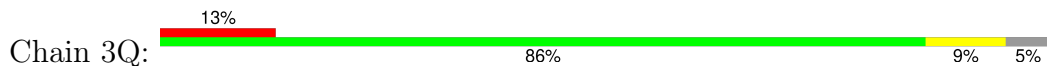

• Molecule 11: CFAP20

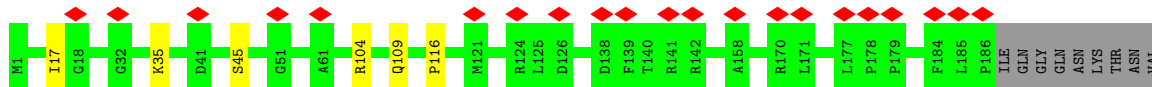

• Molecule 11: CFAP20



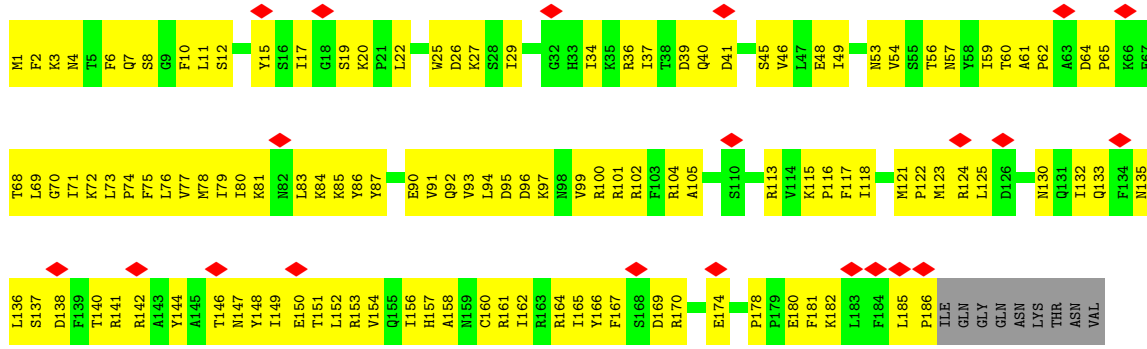

• Molecule 11: CFAP20

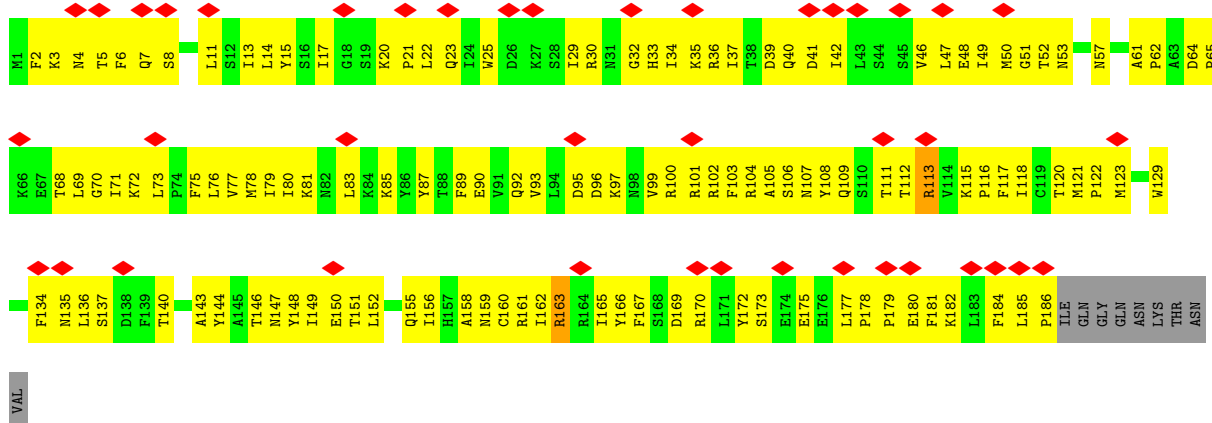

• Molecule 12: Parkin co-regulated protein PACRGA

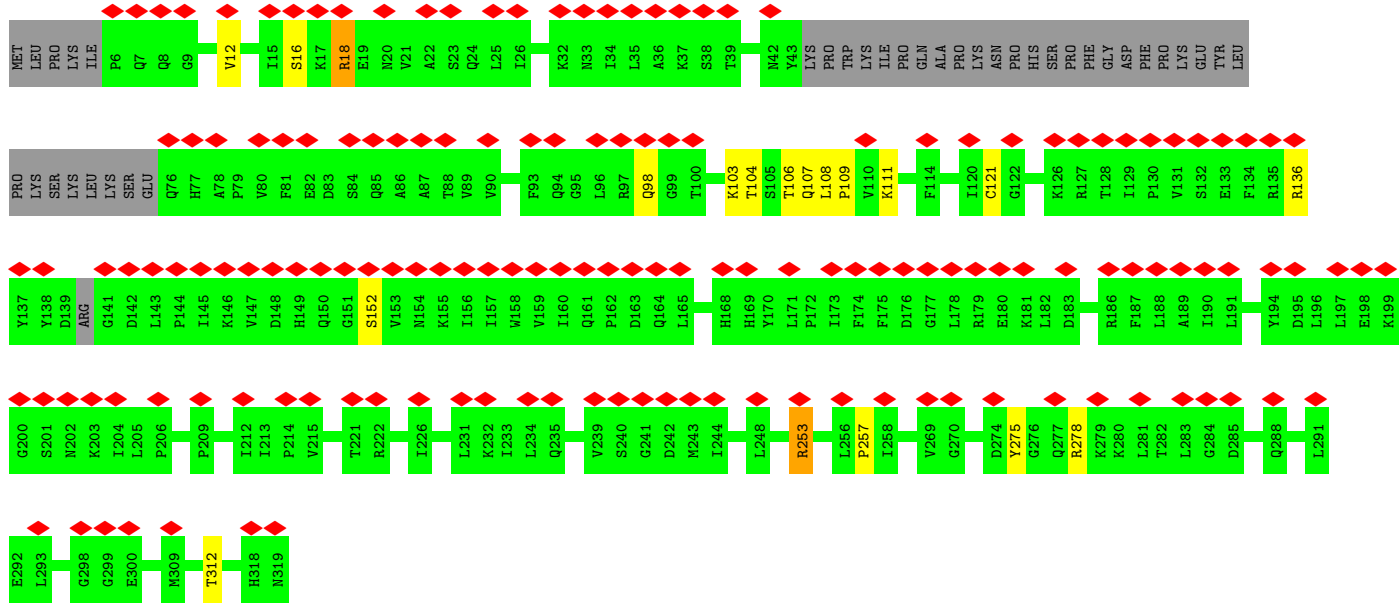
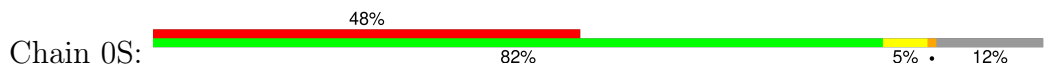



• Molecule 12: Parkin co-regulated protein PACRGA

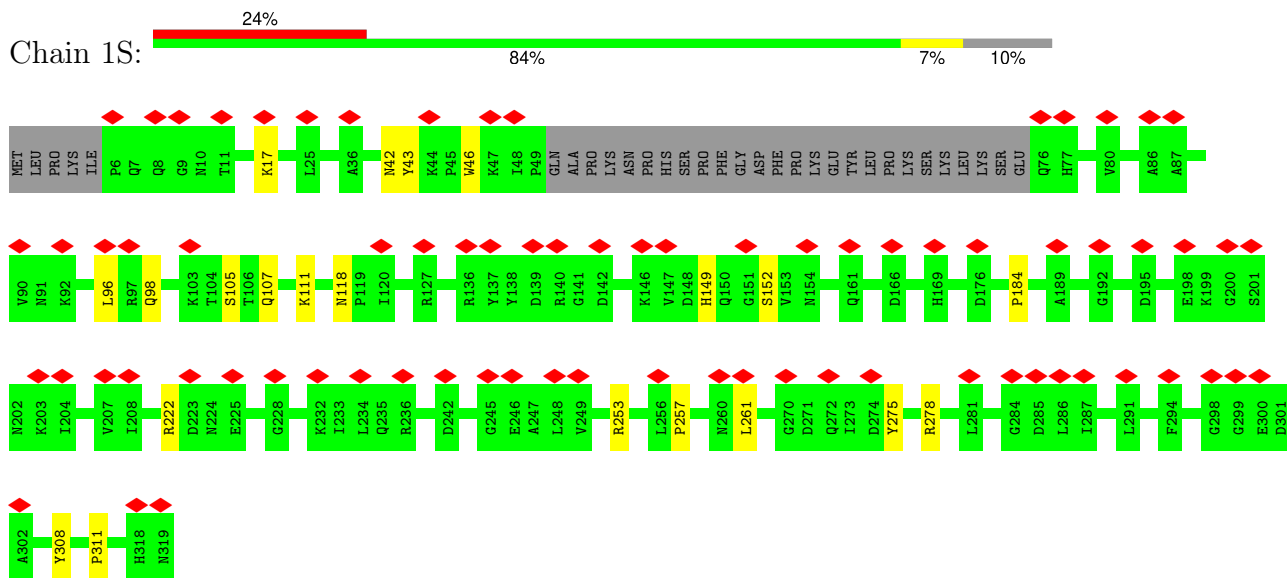

• Molecule 12: Parkin co-regulated protein PACRGA

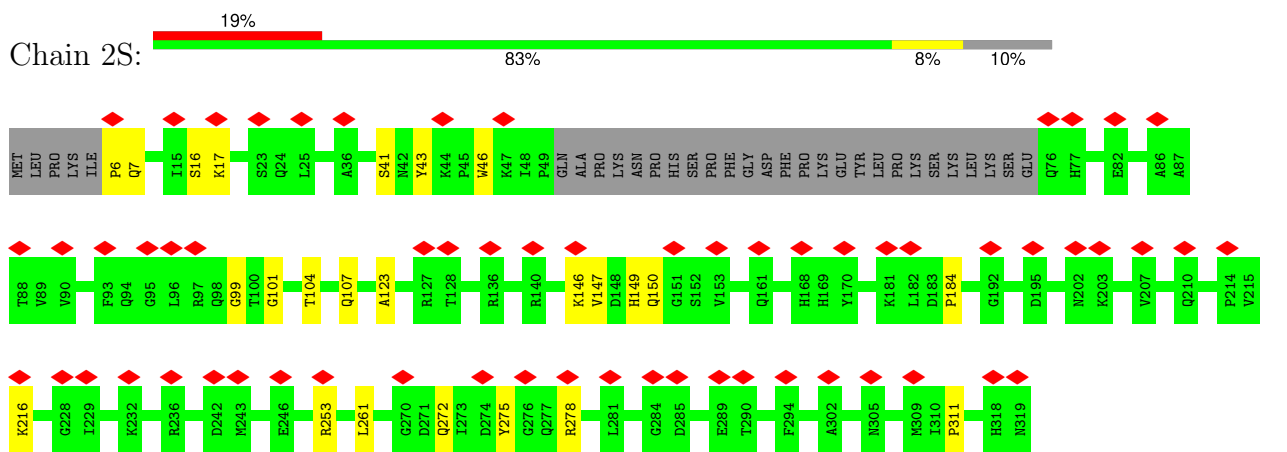

• Molecule 12: Parkin co-regulated protein PACRGA

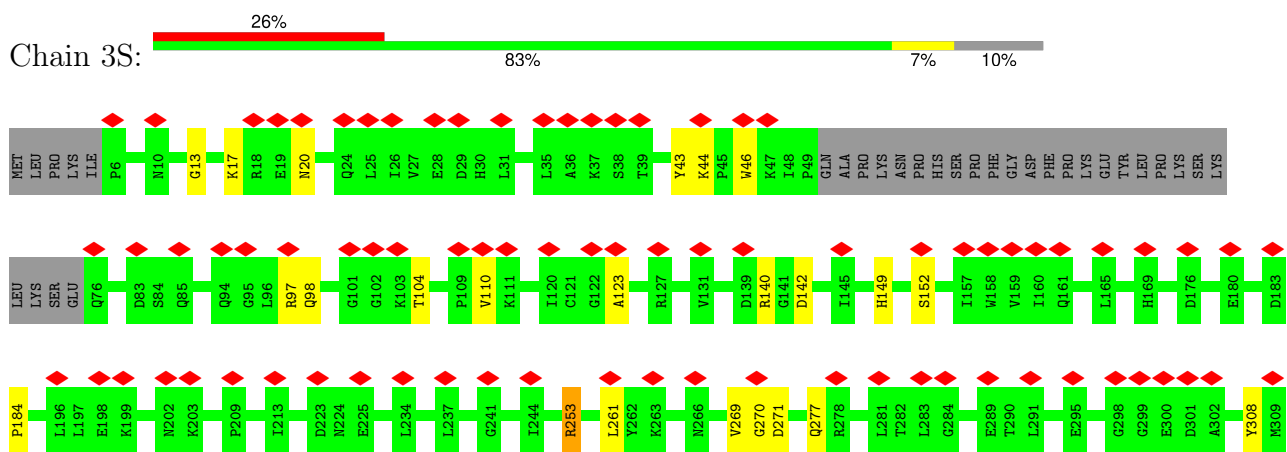

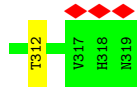

Molecule 13: IJ34

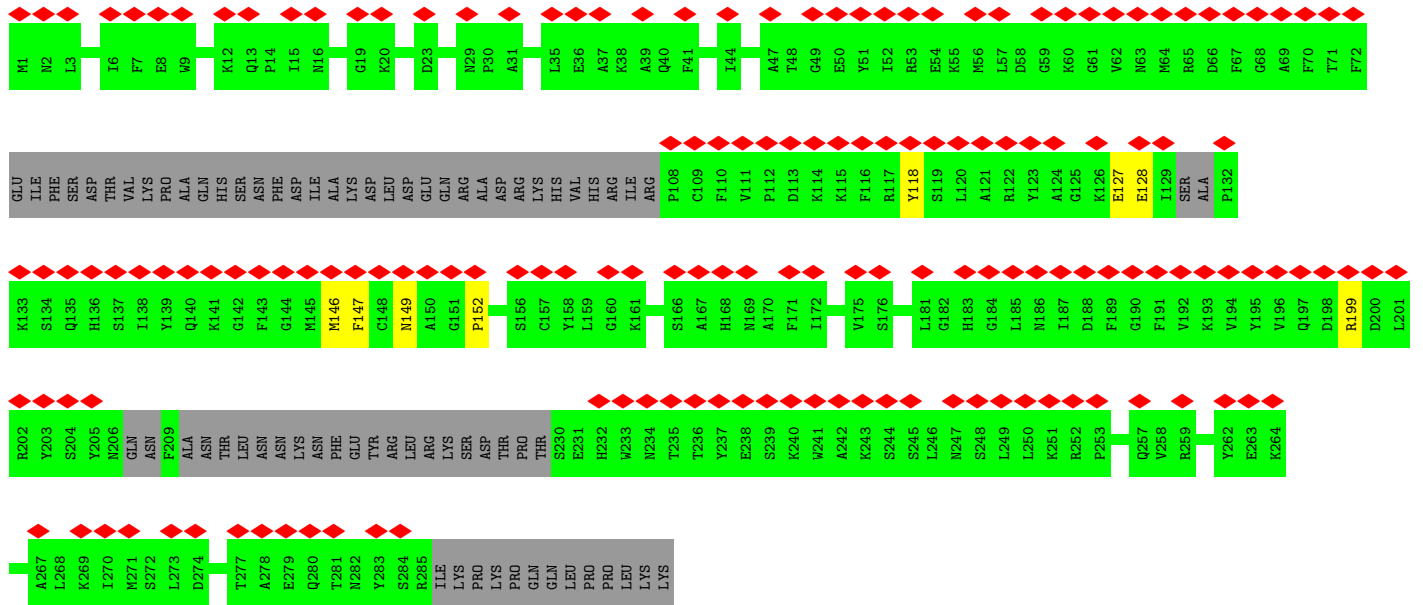
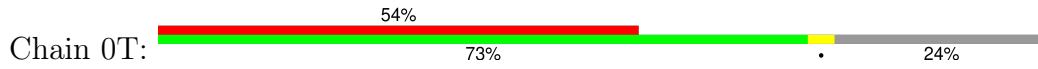

Molecule 13: IJ34

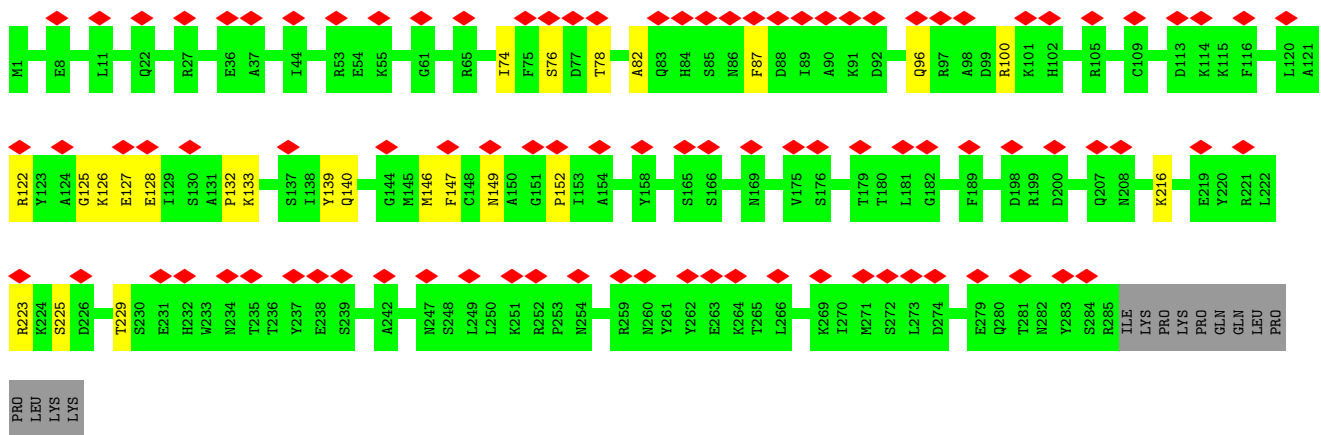
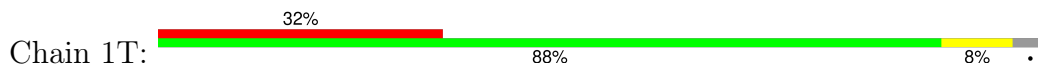

Molecule 13: IJ34

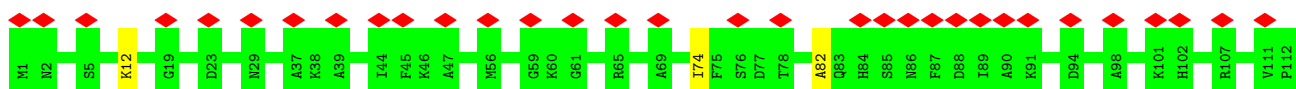
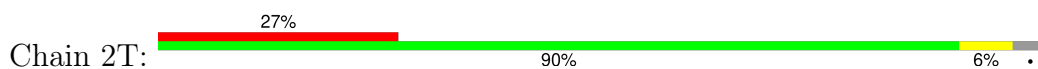

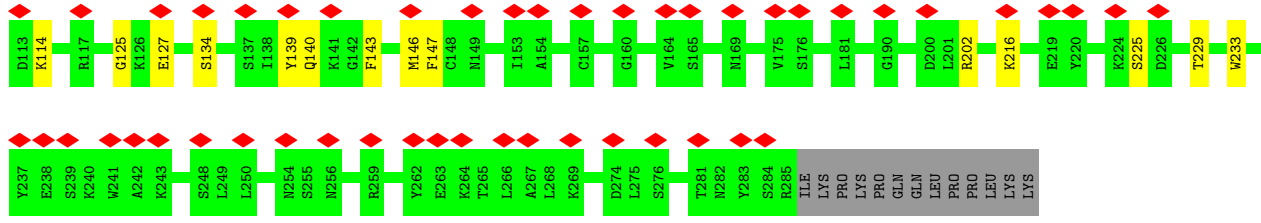

• Molecule 13: IJ34

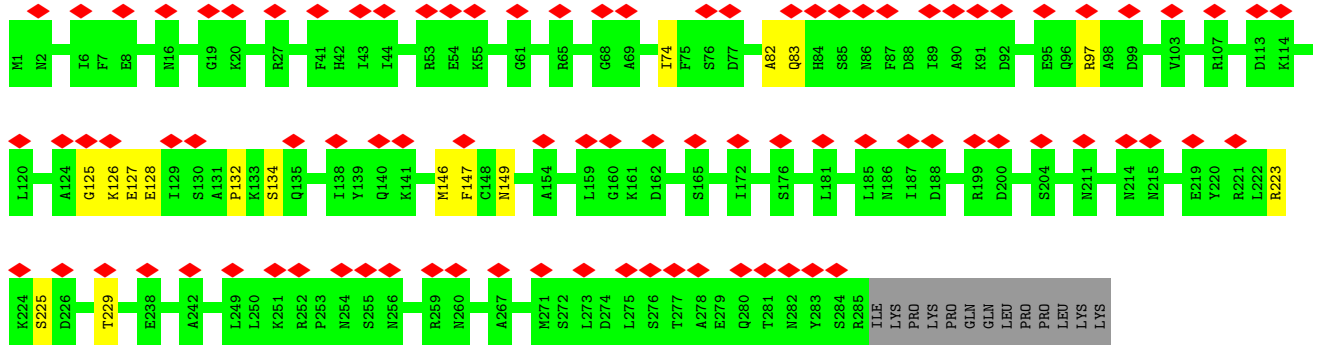
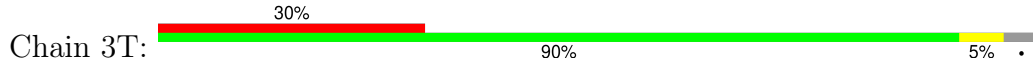

• Molecule 14: Cilia- and flagella-associated protein 52

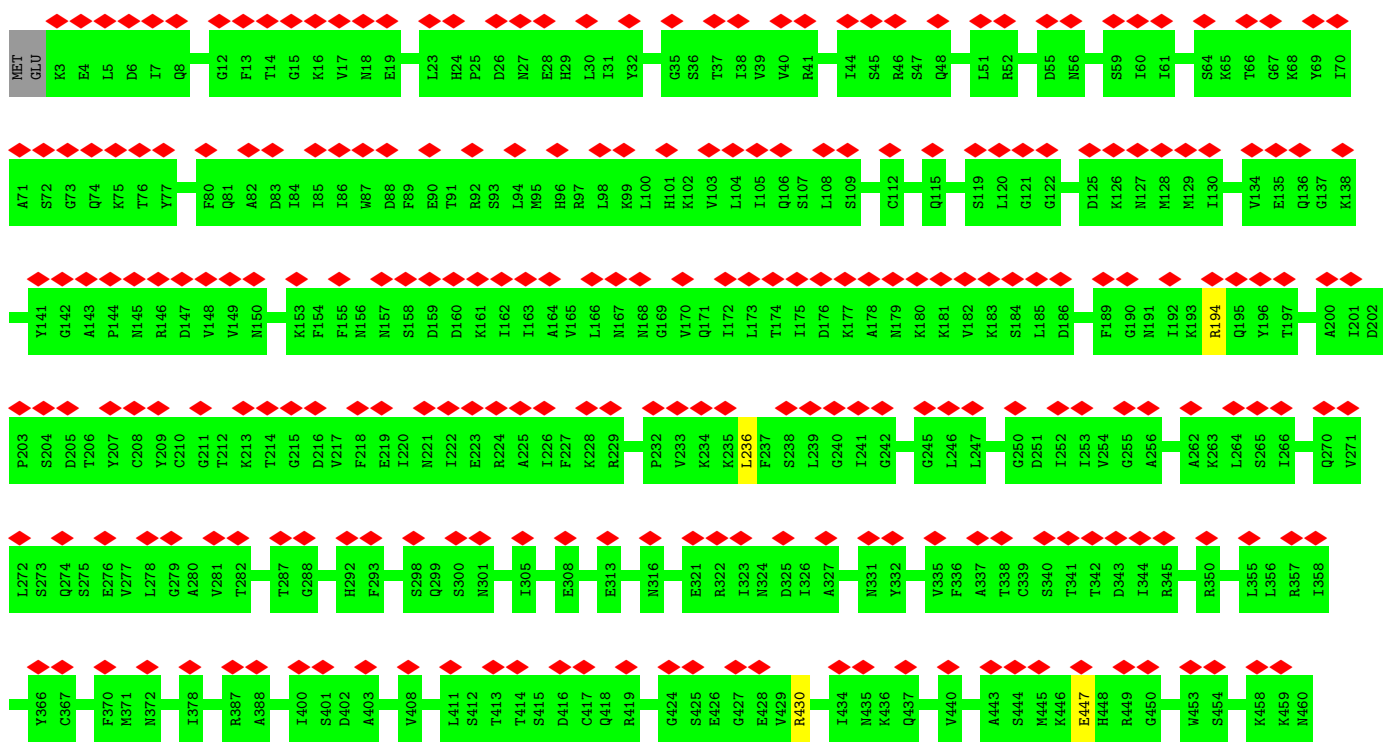

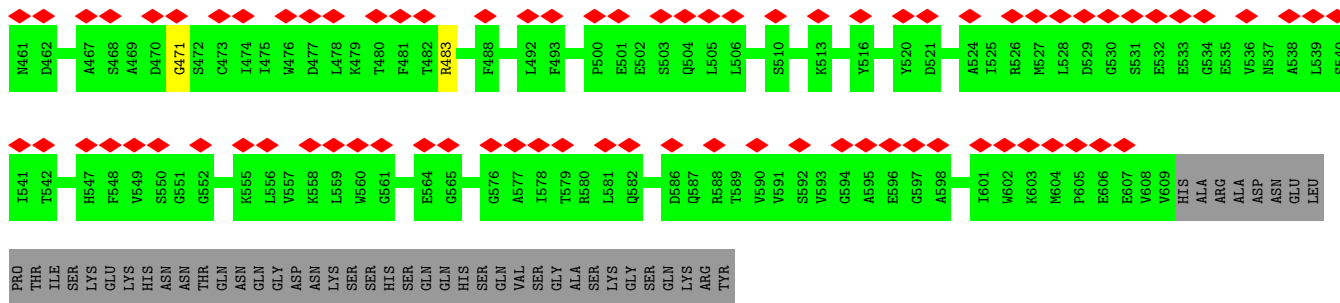

• Molecule 14: Cilia- and flagella-associated protein 52

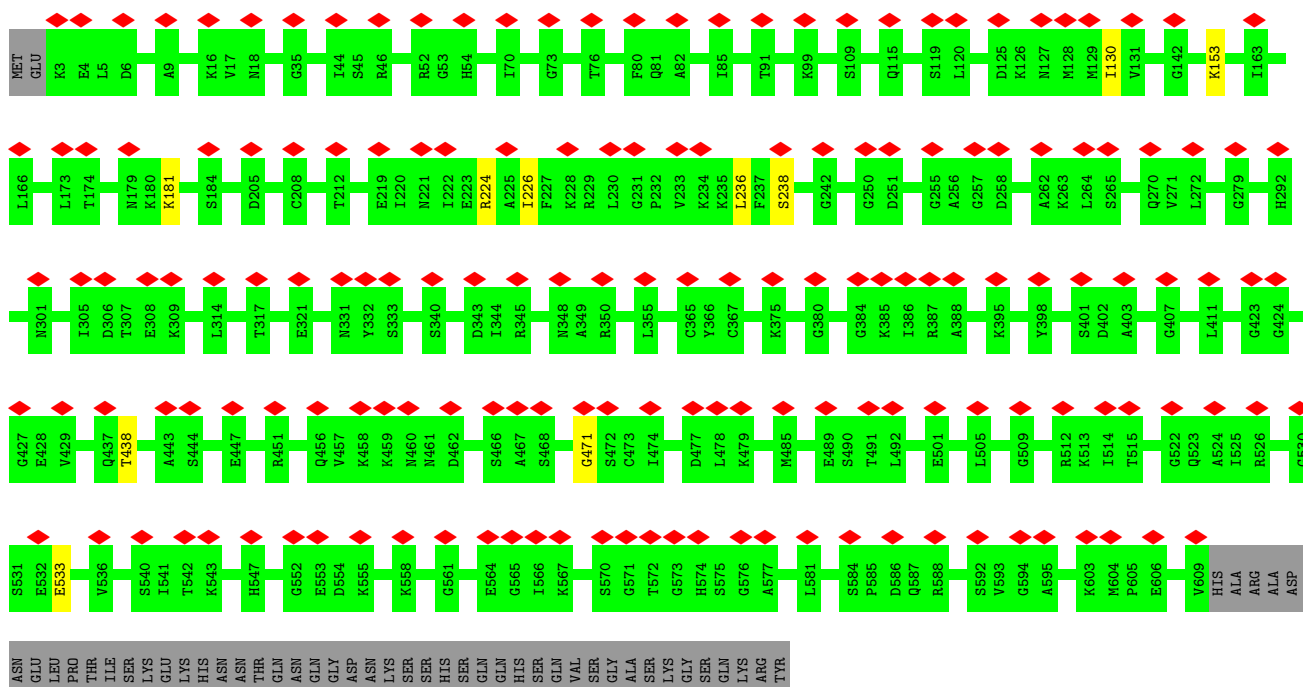
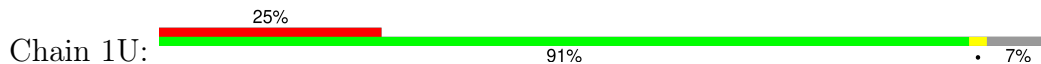

• Molecule 14: Cilia- and flagella-associated protein 52

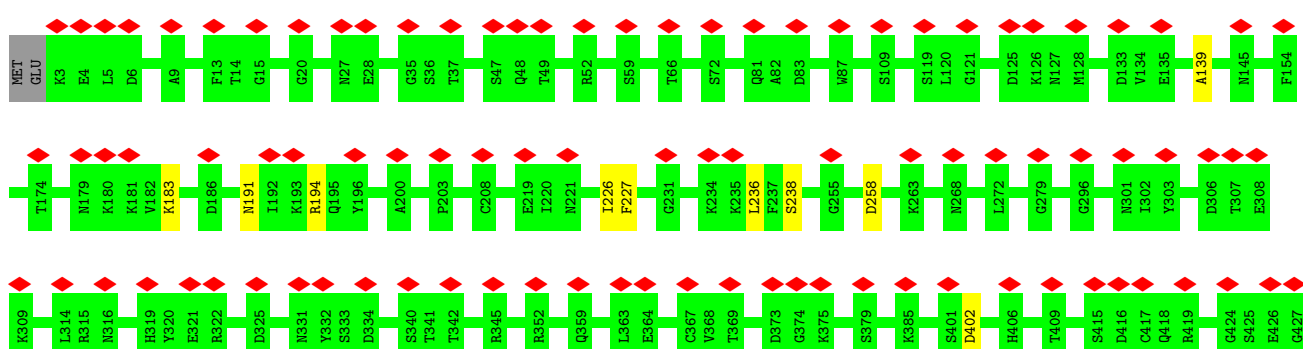

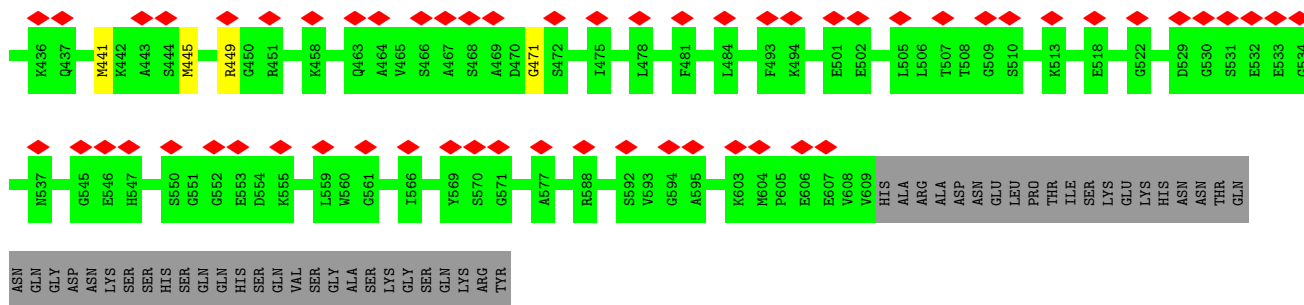

● Molecule 14: Cilia- and flagella-associated protein 52

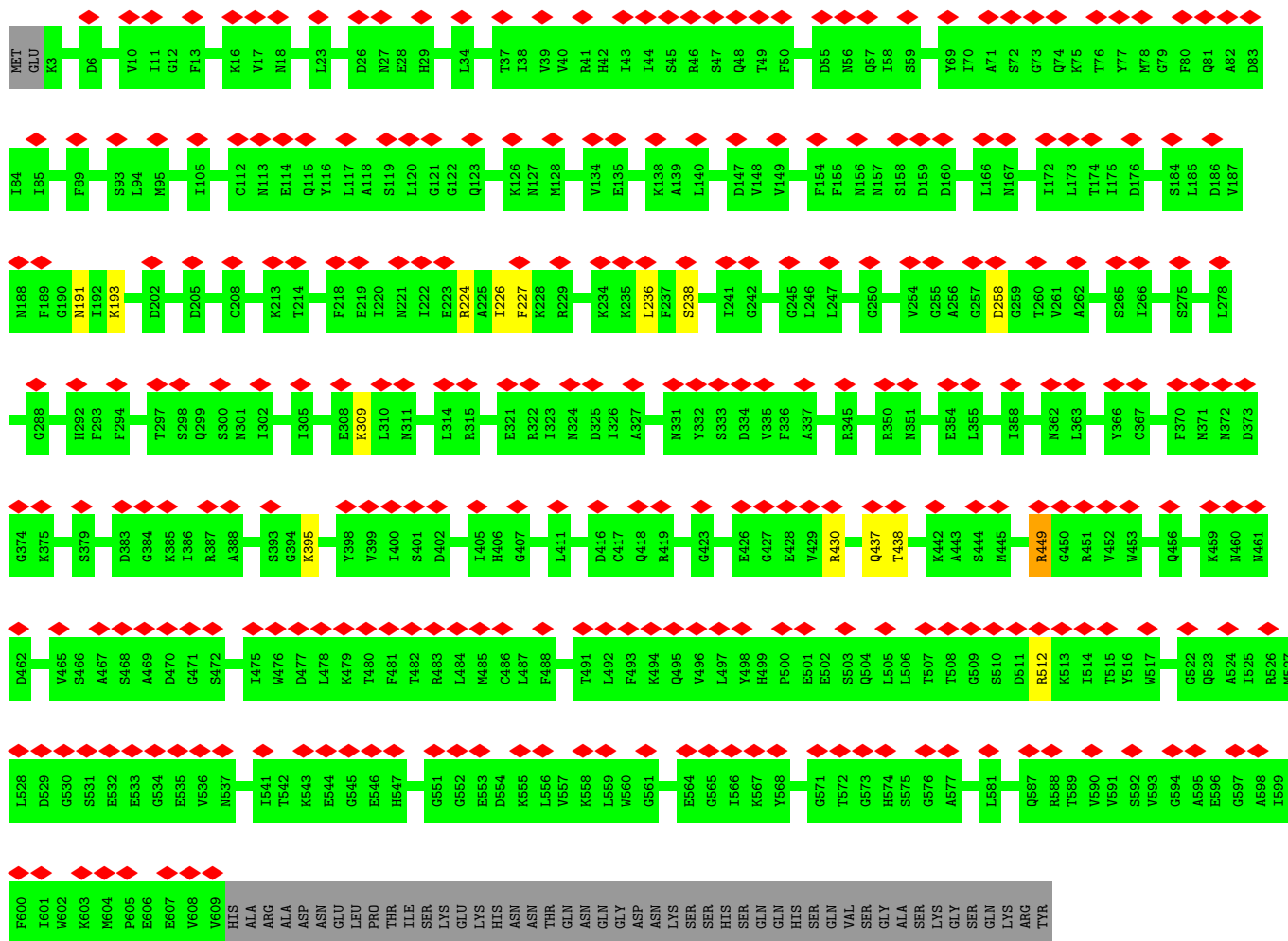
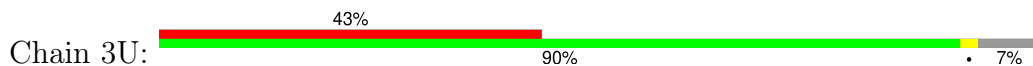

● Molecule 15: DNA polymerase delta C4-type zinc-finger protein

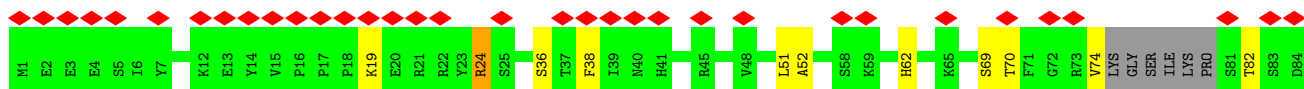
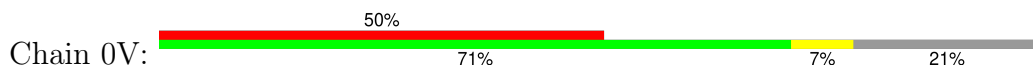

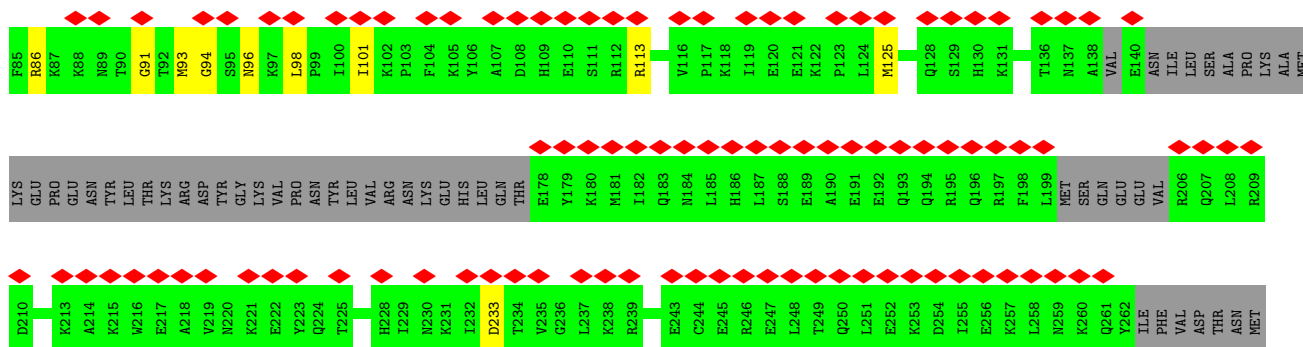

• Molecule 15: DNA polymerase delta C4-type zinc-finger protein

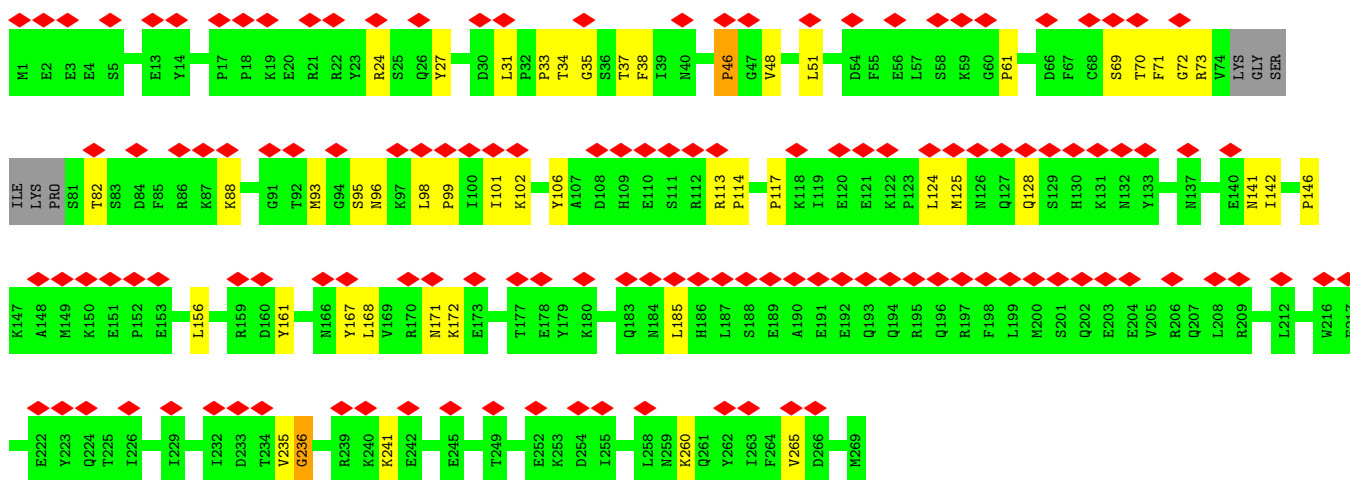
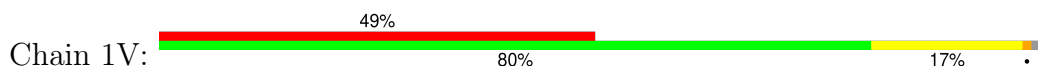

• Molecule 15: DNA polymerase delta C4-type zinc-finger protein

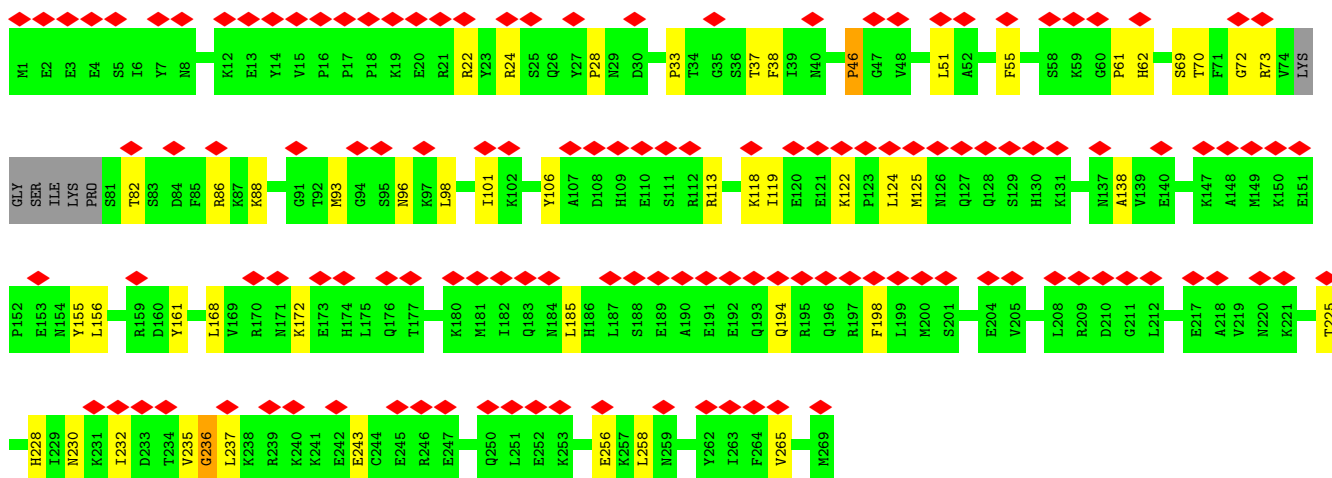
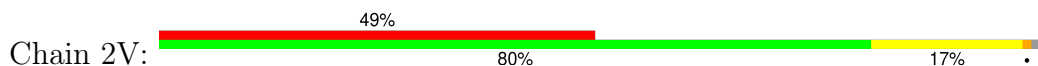

• Molecule 15: DNA polymerase delta C4-type zinc-finger protein

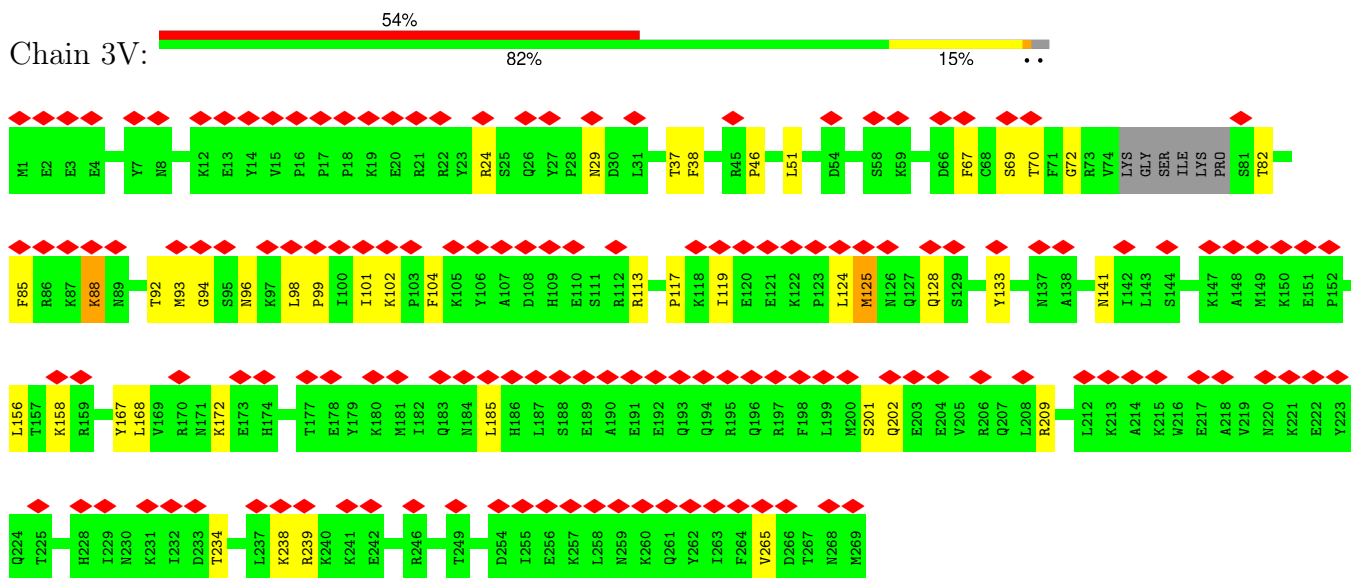

• Molecule 16: RIB43A protein

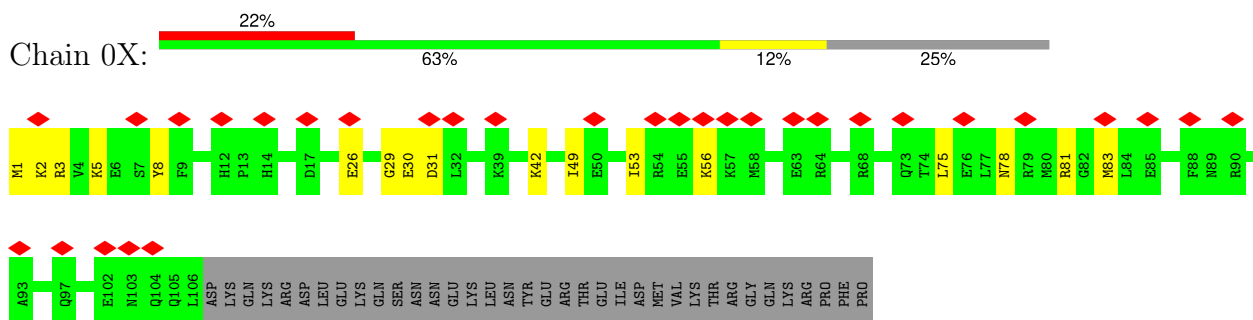

• Molecule 16: RIB43A protein

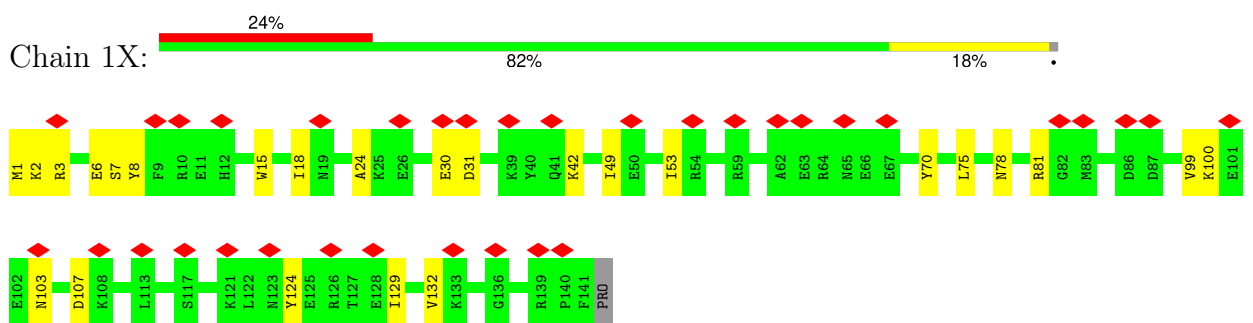

• Molecule 16: RIB43A protein

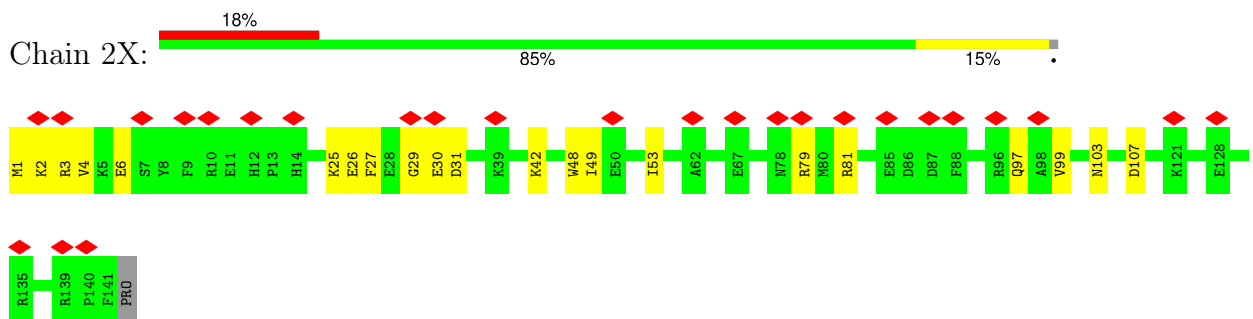

• Molecule 16: RIB43A protein

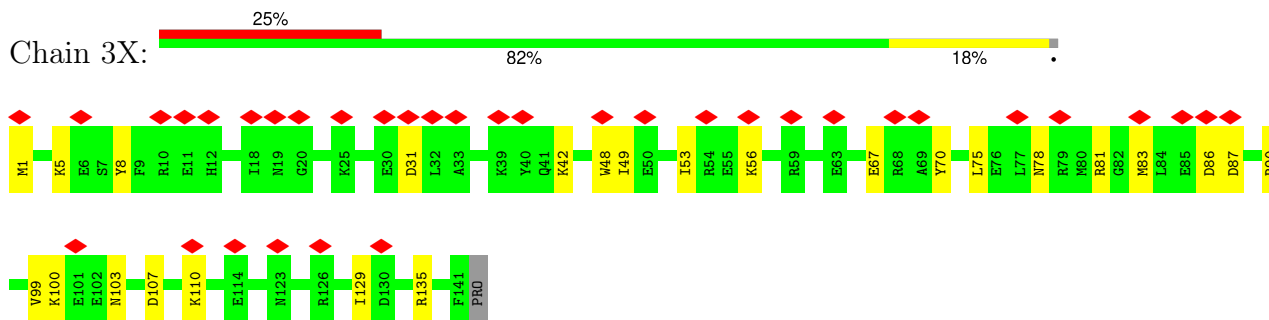

• Molecule 16: RIB43A protein

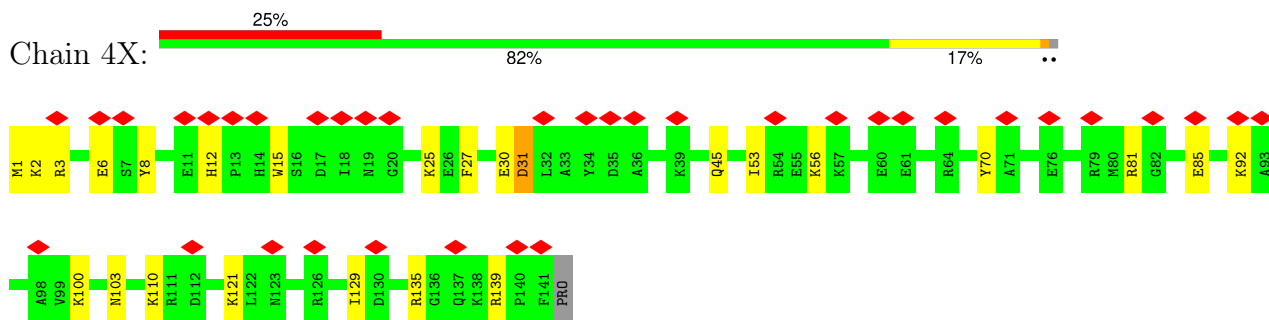

• Molecule 17: RIB57

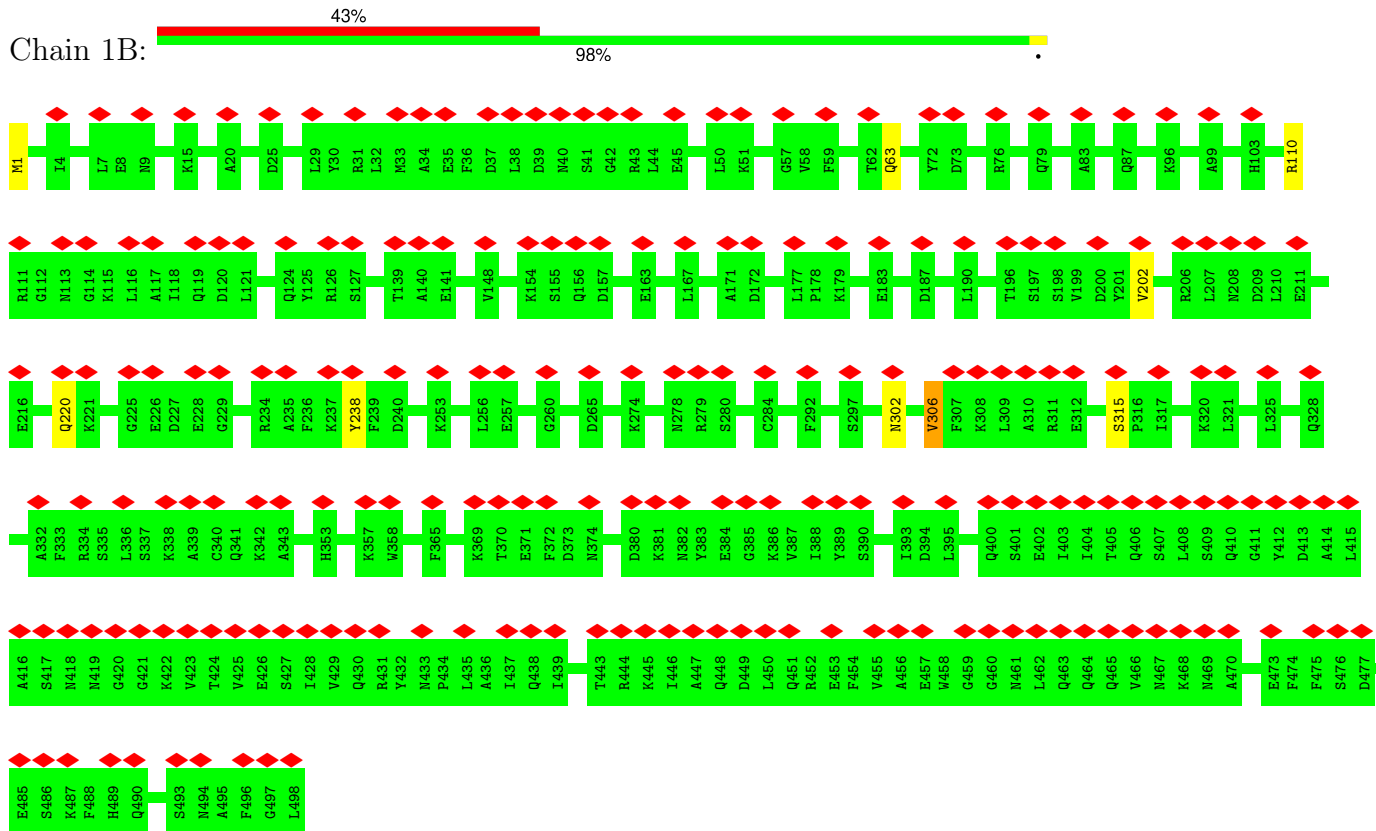

• Molecule 17: RIB57





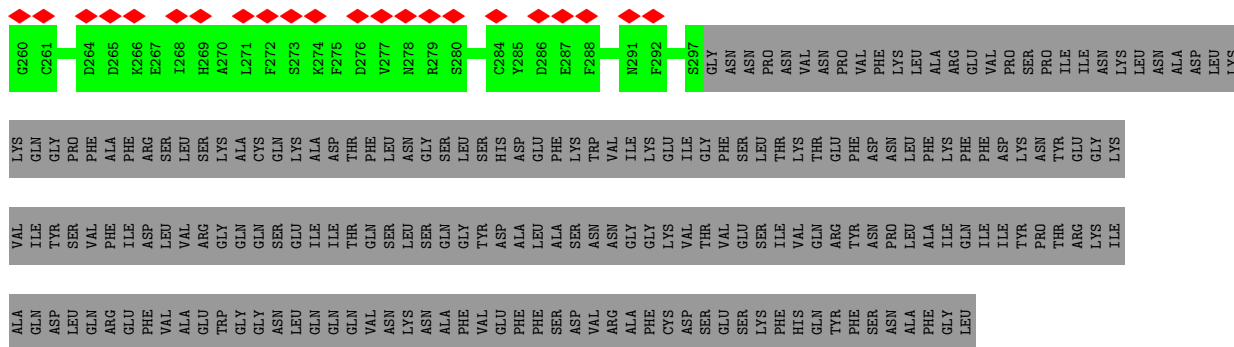

• Molecule 18: CFAP182A

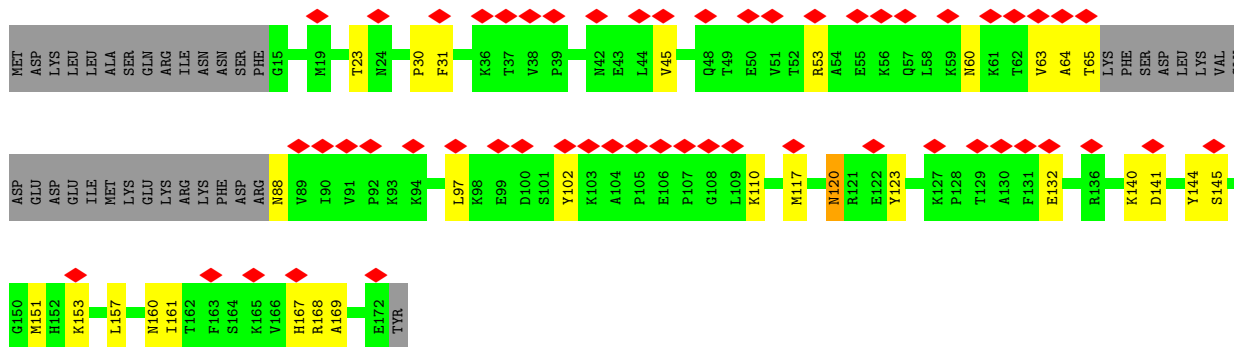

• Molecule 19: CFAP143

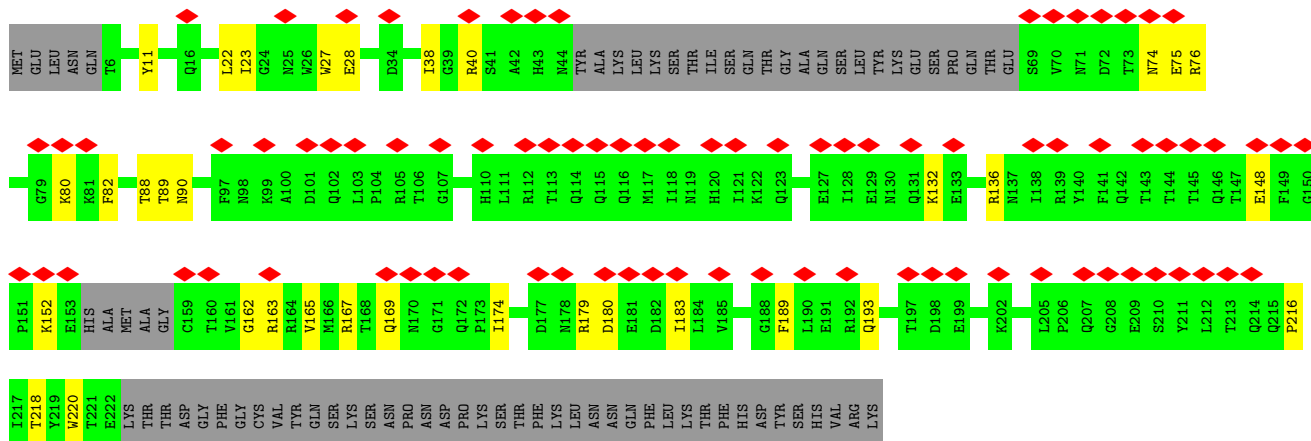

• Molecule 20: CFAP21A

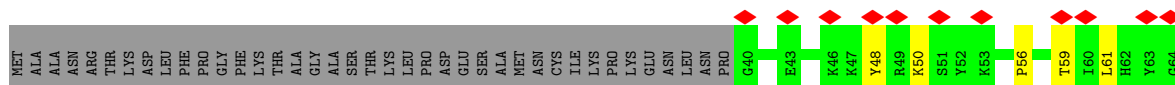
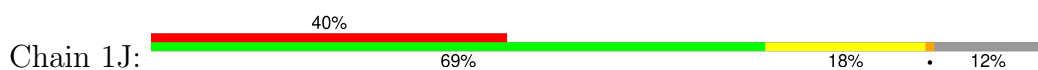

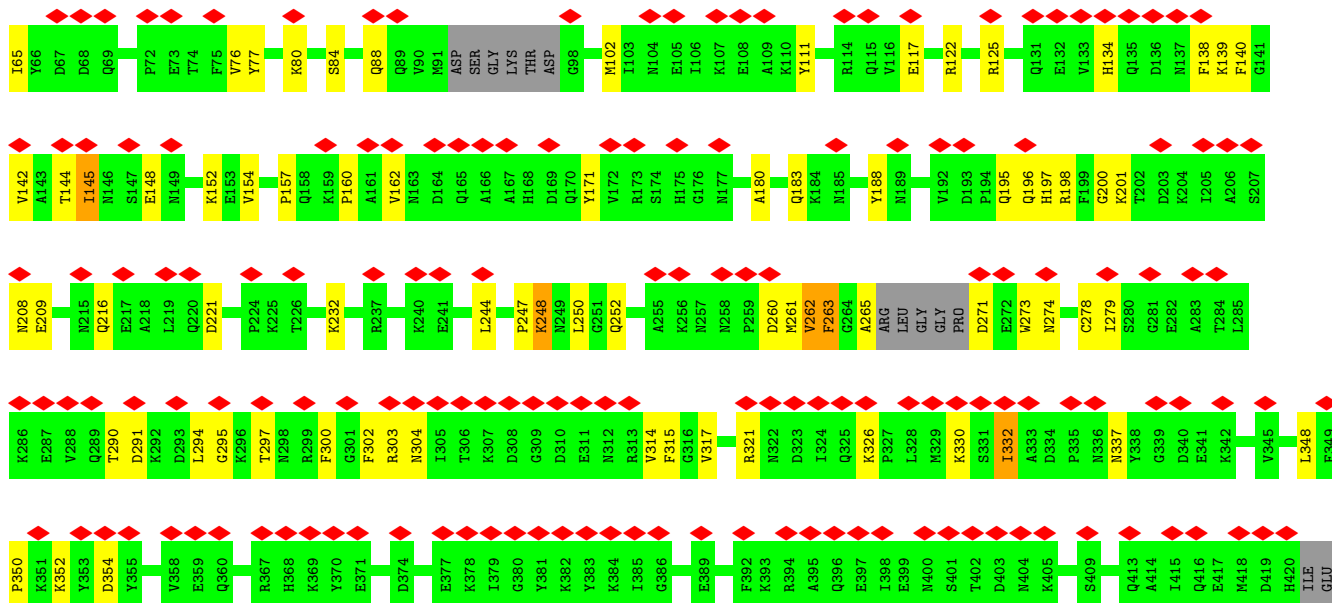

• Molecule 21: Cilia- and flagella-associated protein 53

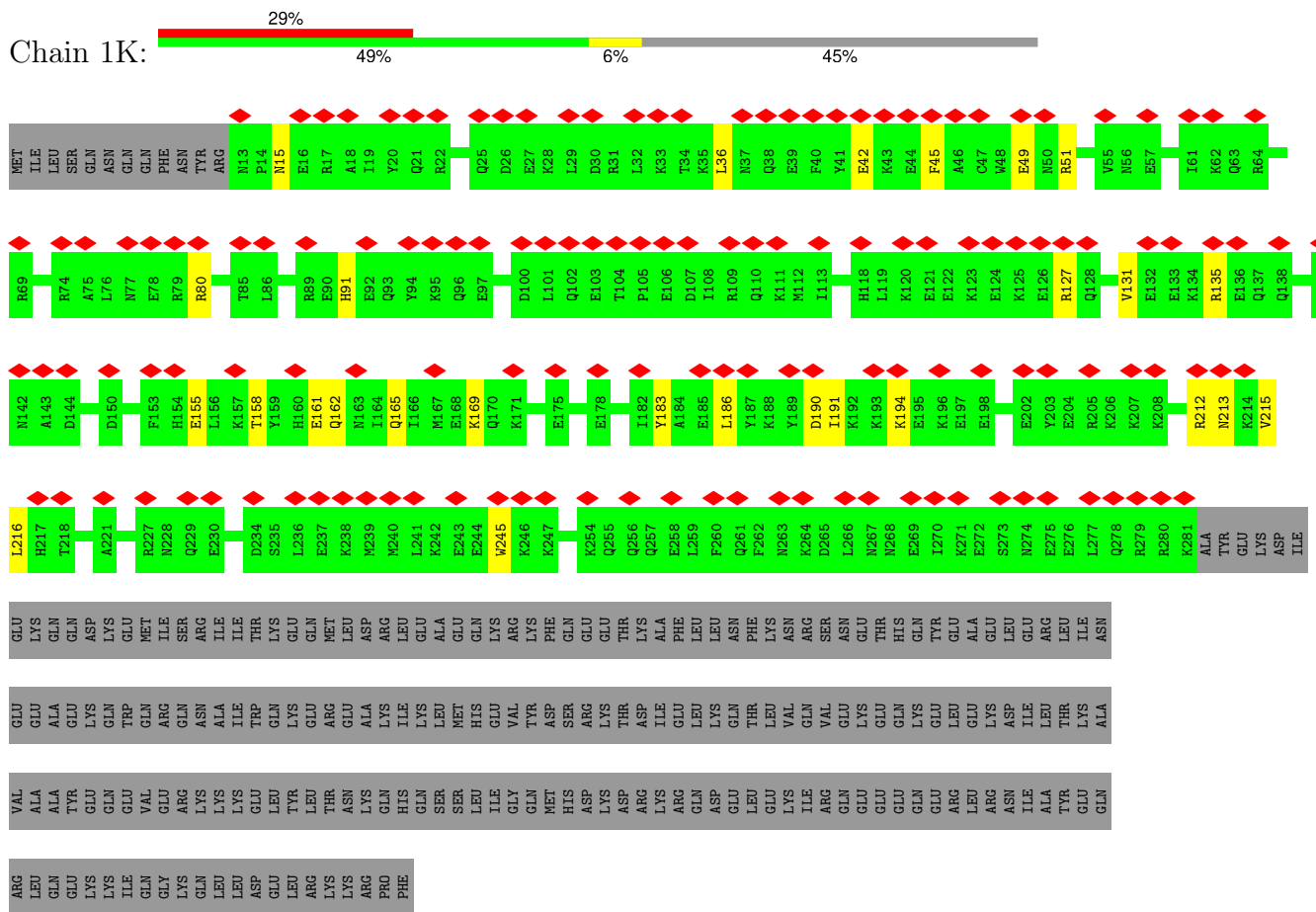

• Molecule 21: Cilia- and flagella-associated protein 53



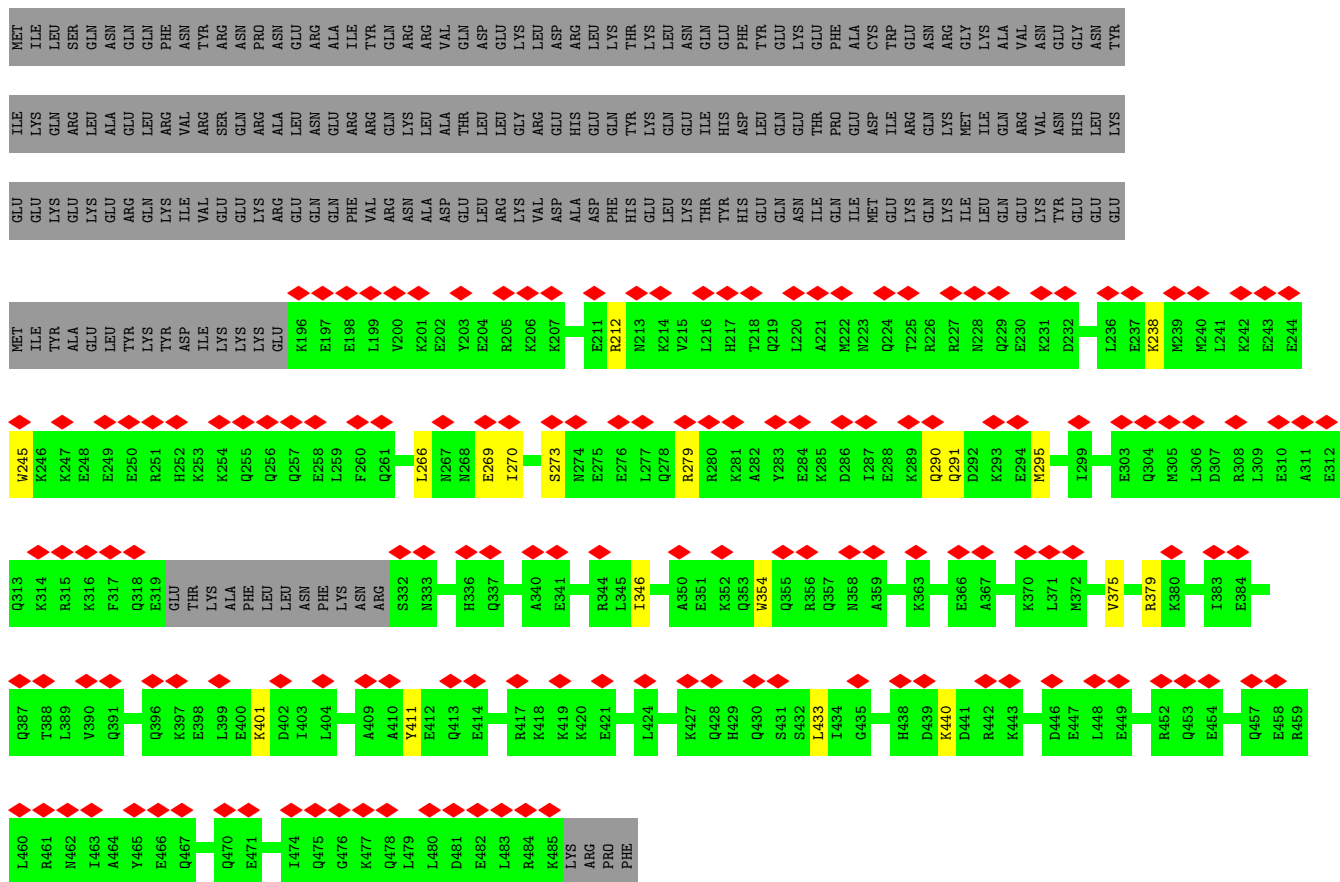

• Molecule 22: CFAP115

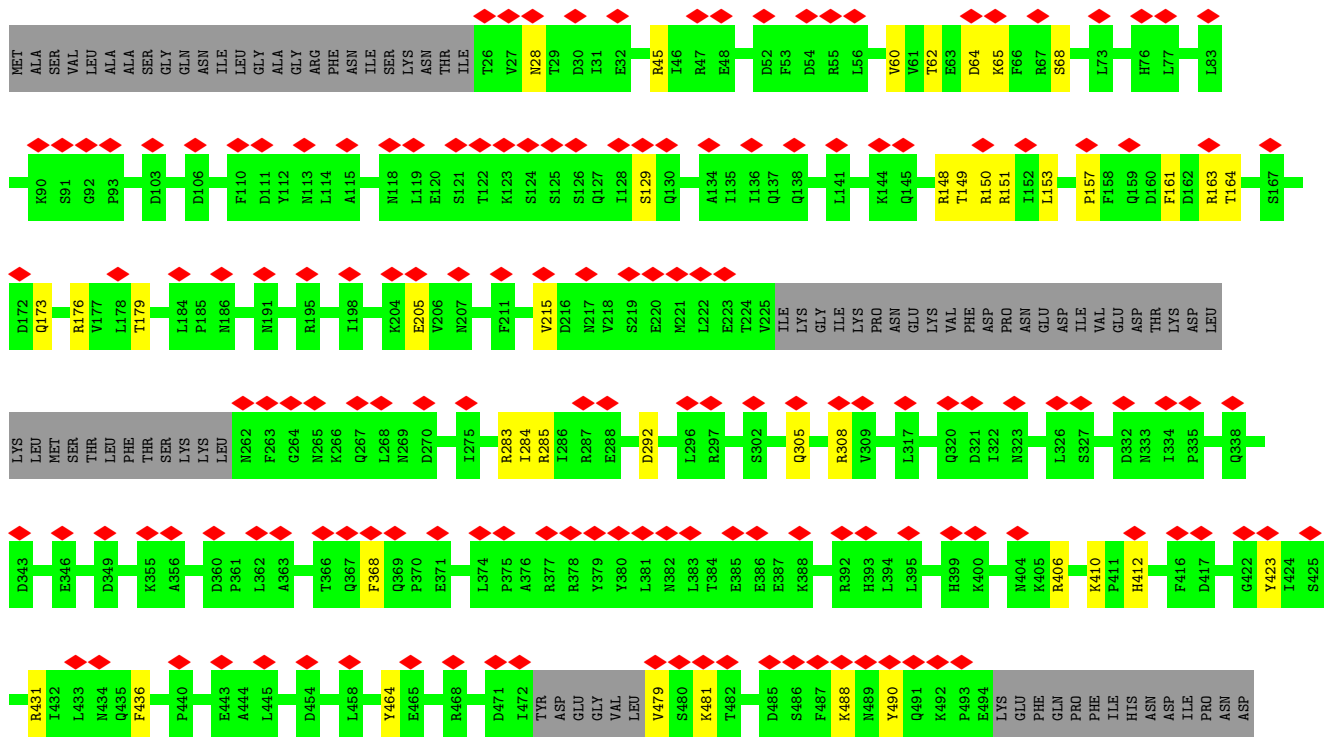
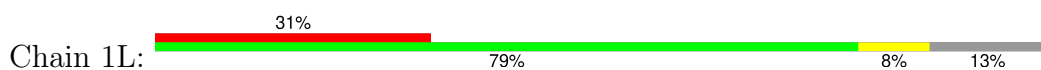

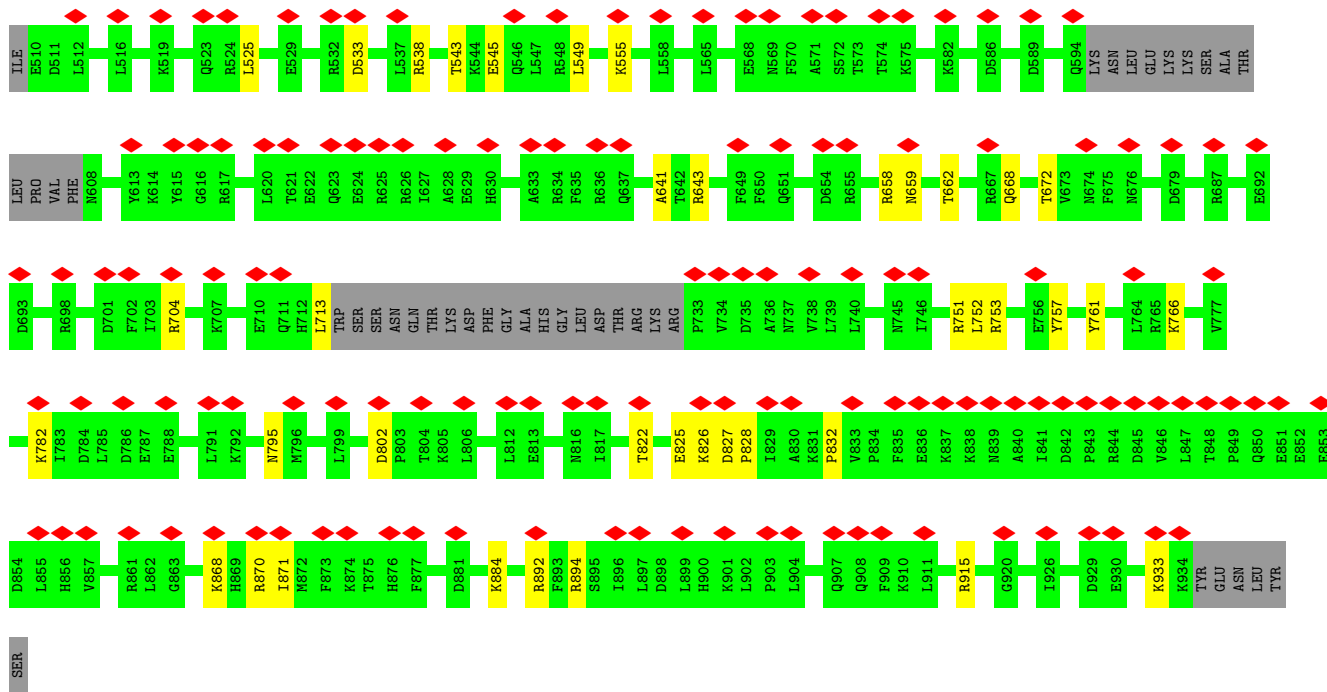

• Molecule 22: CFAP115

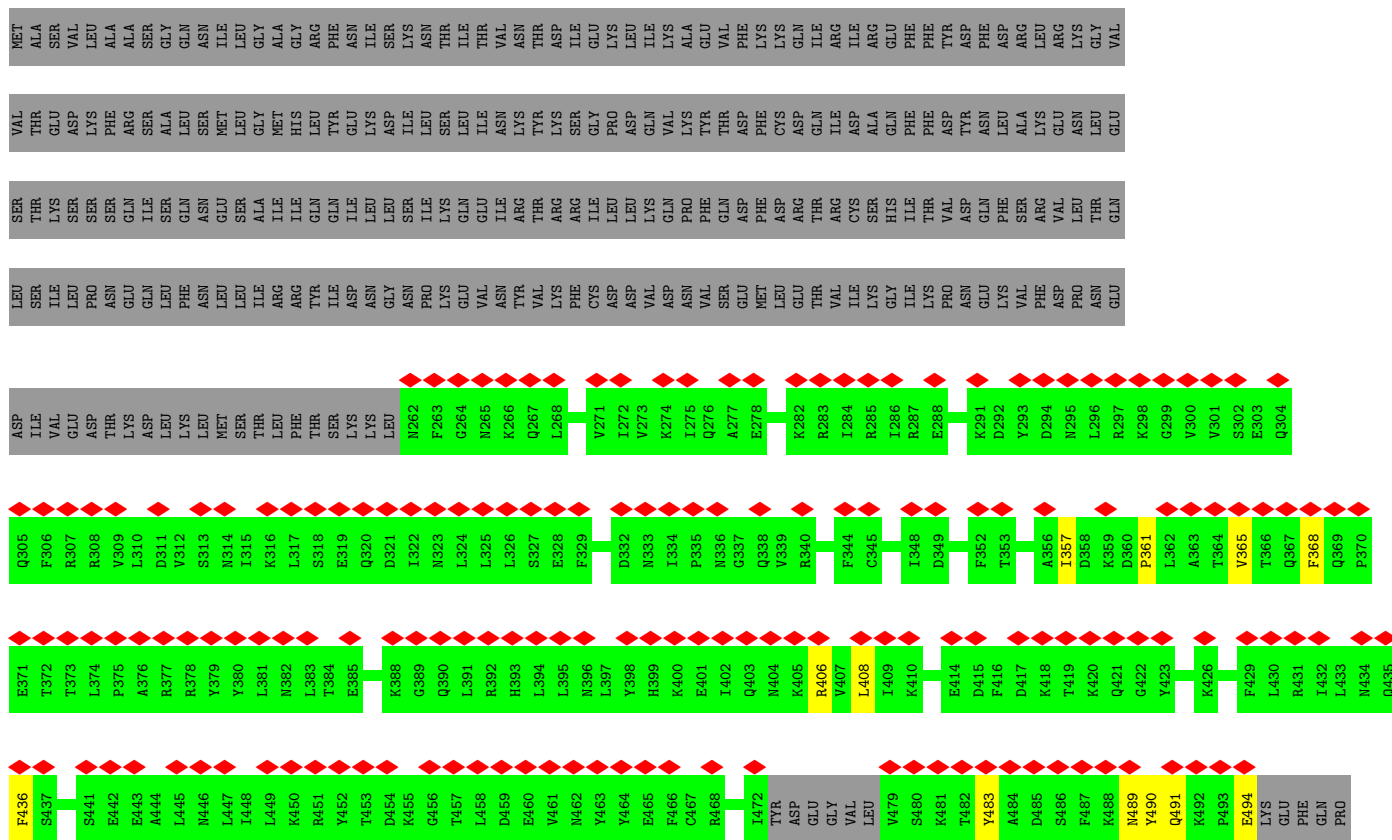

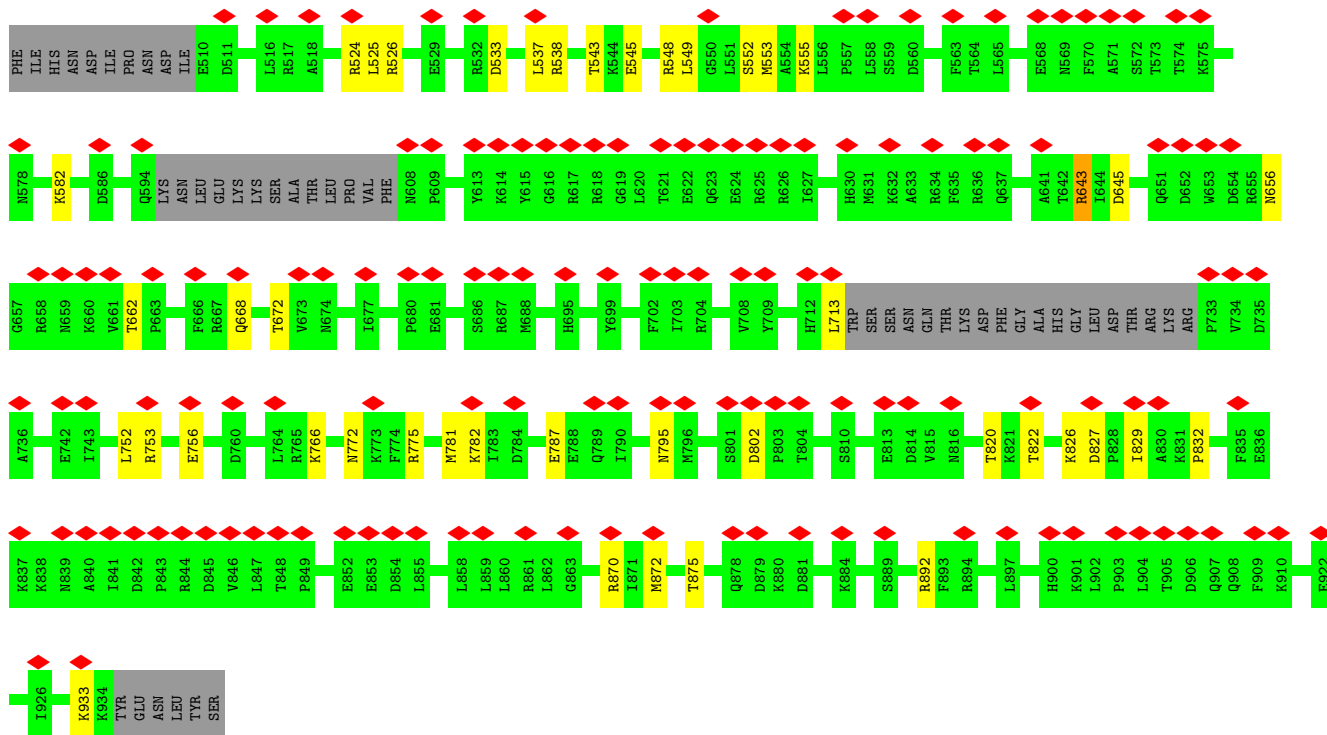

• Molecule 22: CFAP115

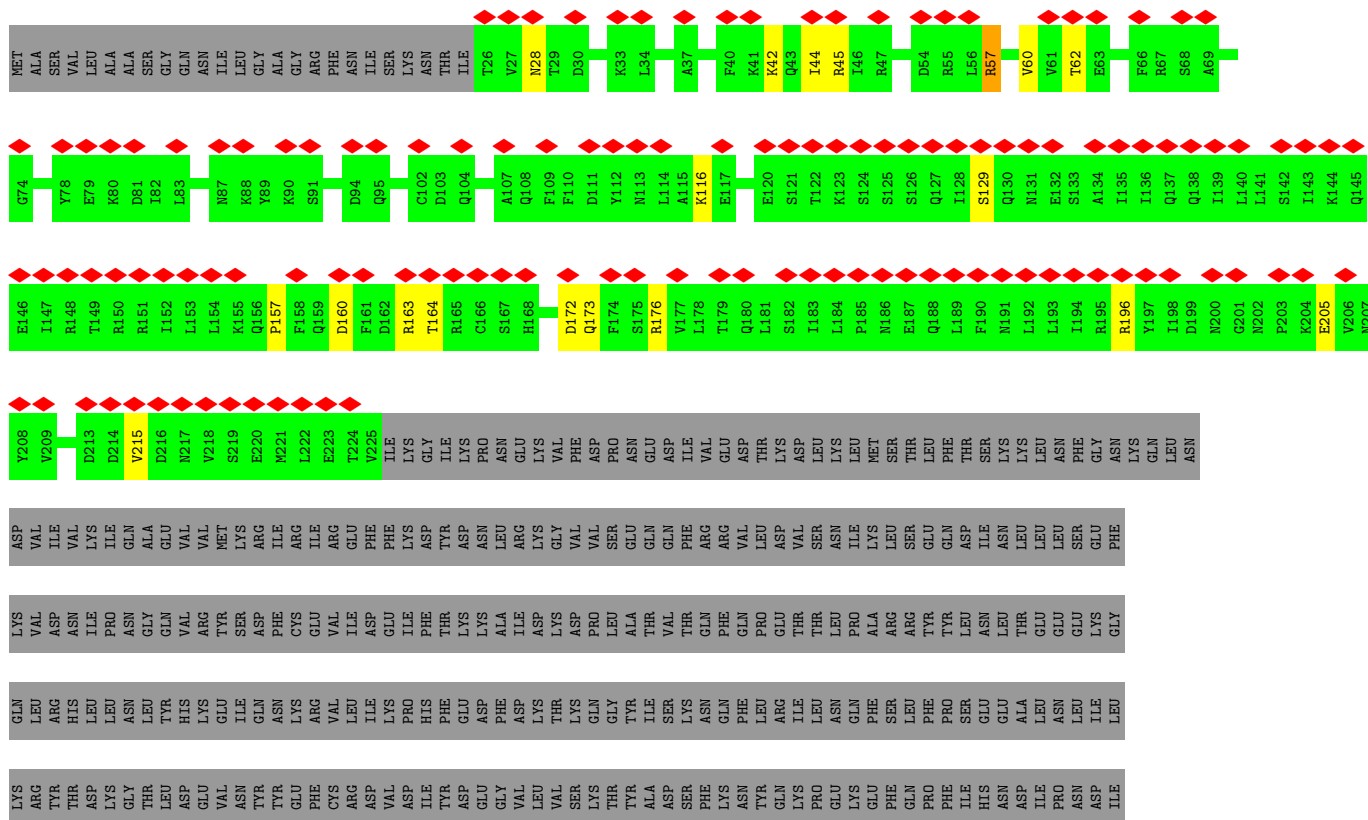



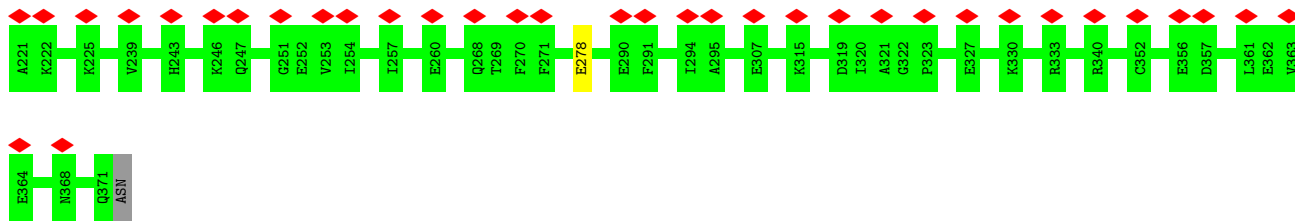

• Molecule 24: Cilia- and flagella-associated protein 45

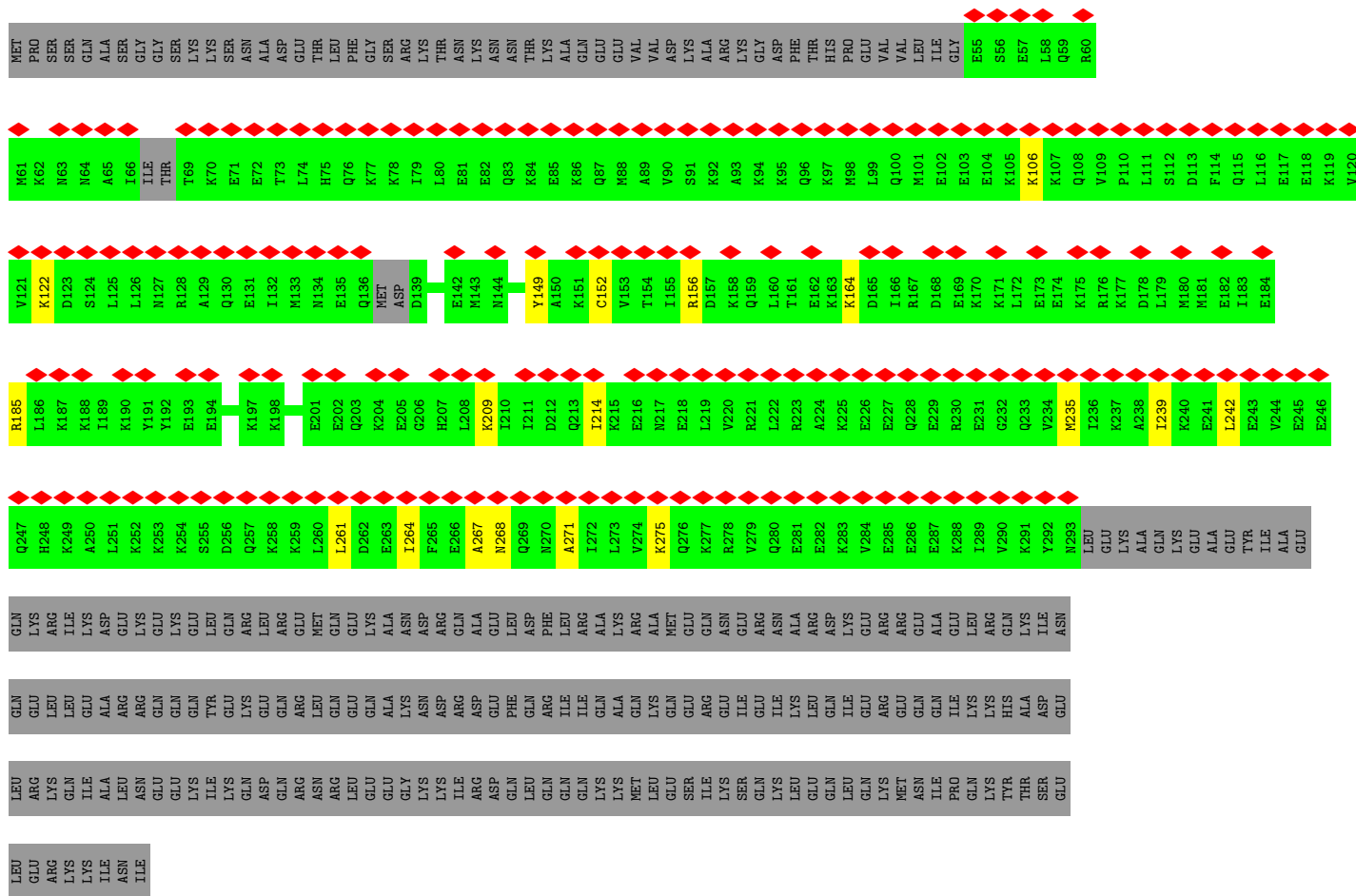
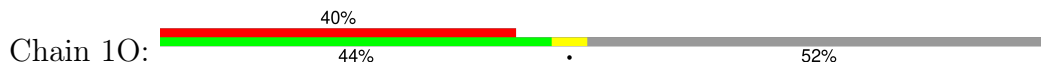

• Molecule 24: Cilia- and flagella-associated protein 45

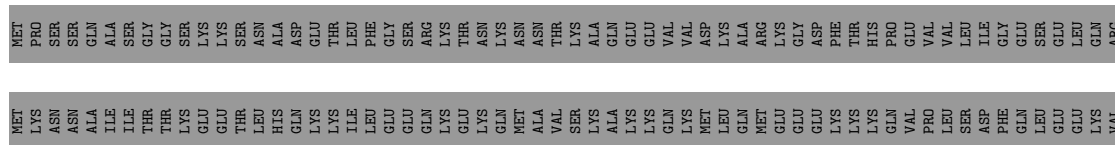



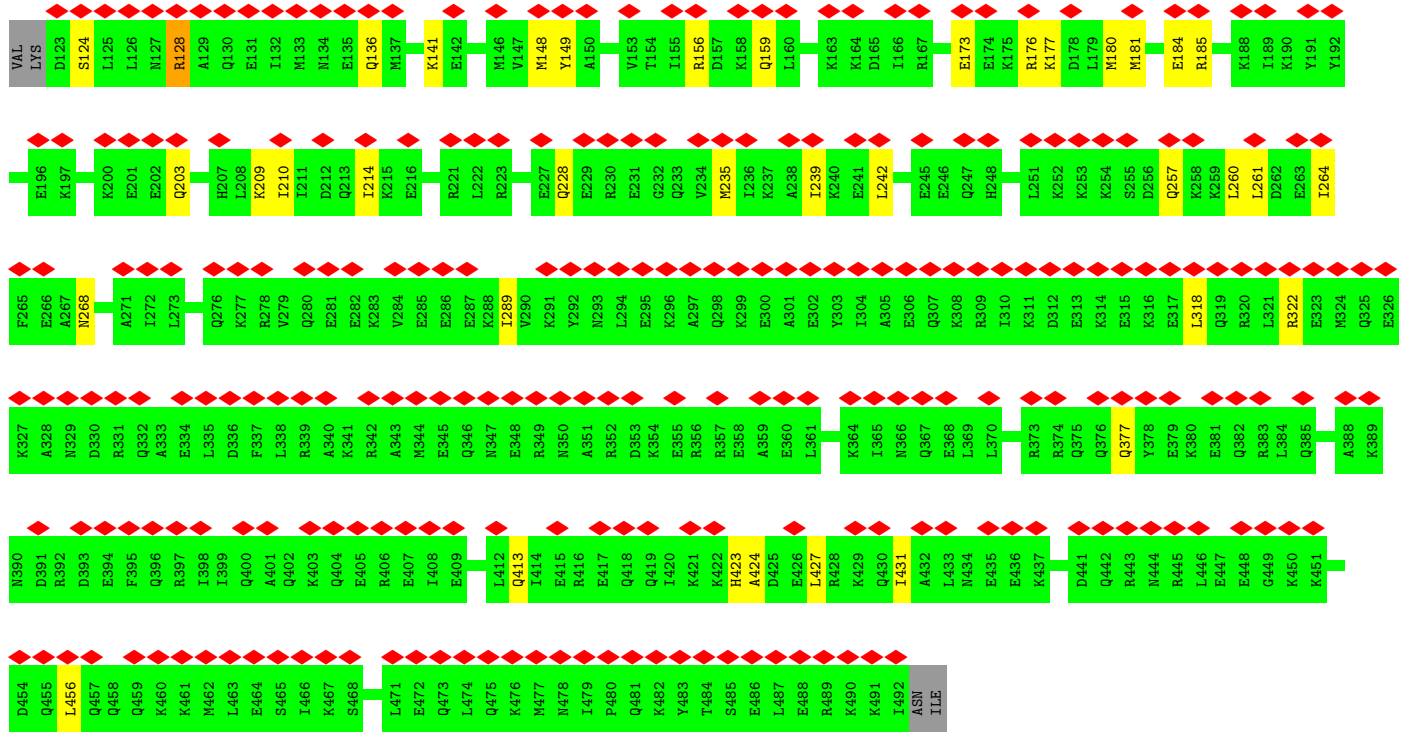

● Molecule 24: Cilia- and flagella-associated protein 45

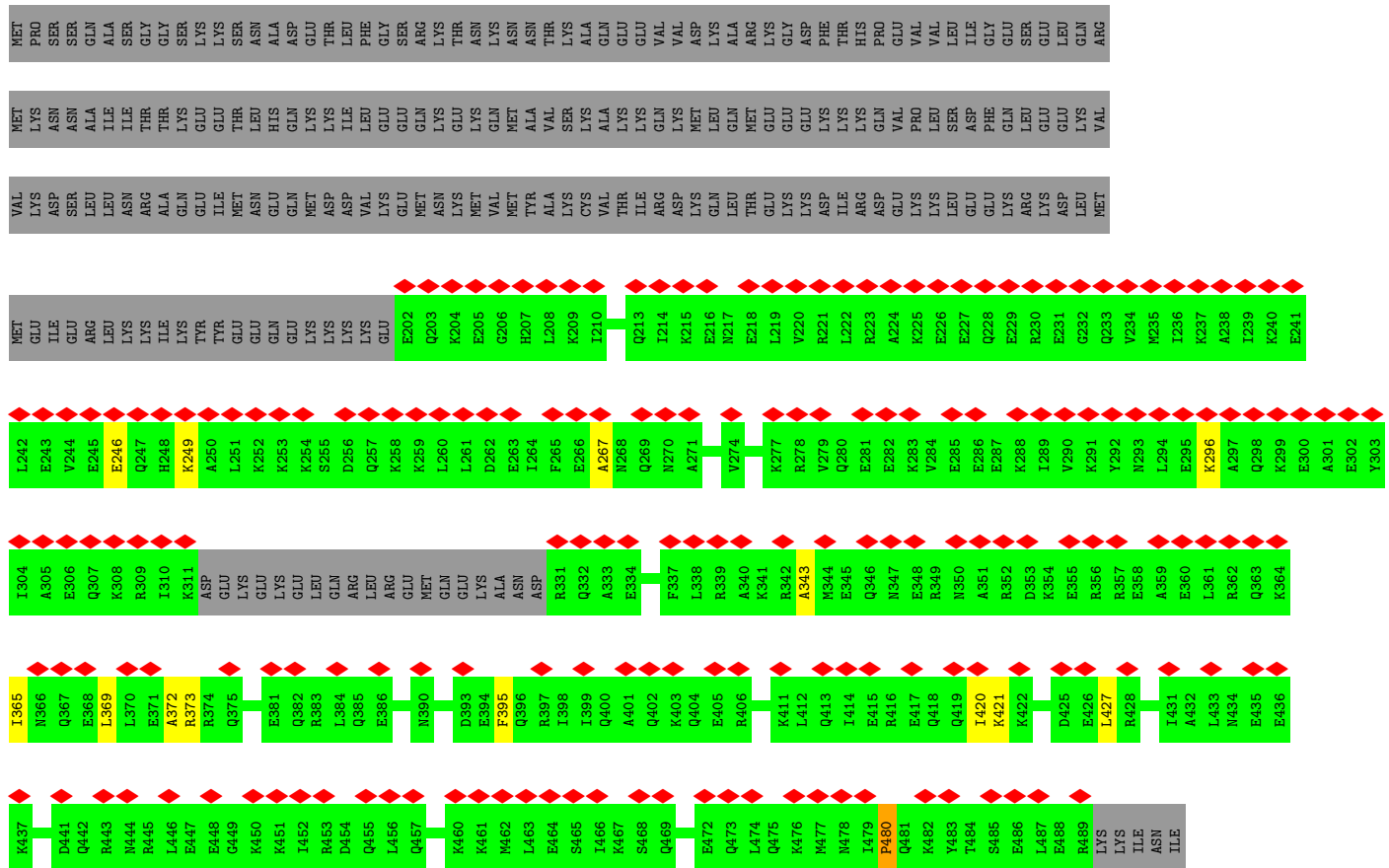
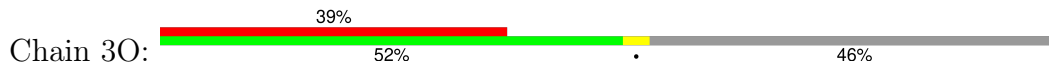



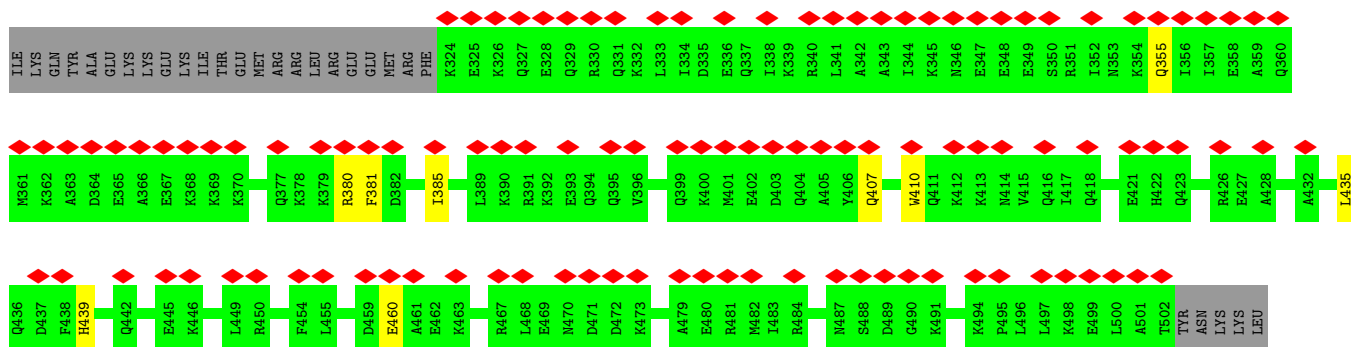

## Chain 1R:

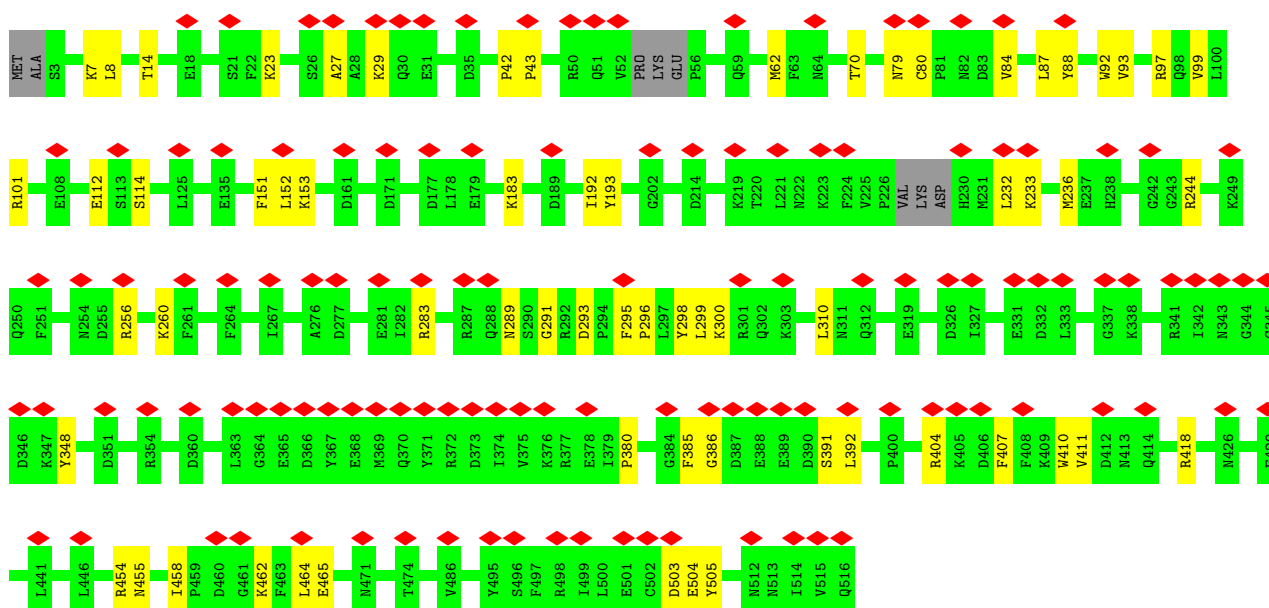
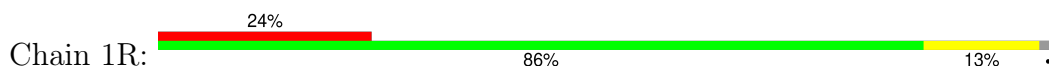

## Chain 2R:

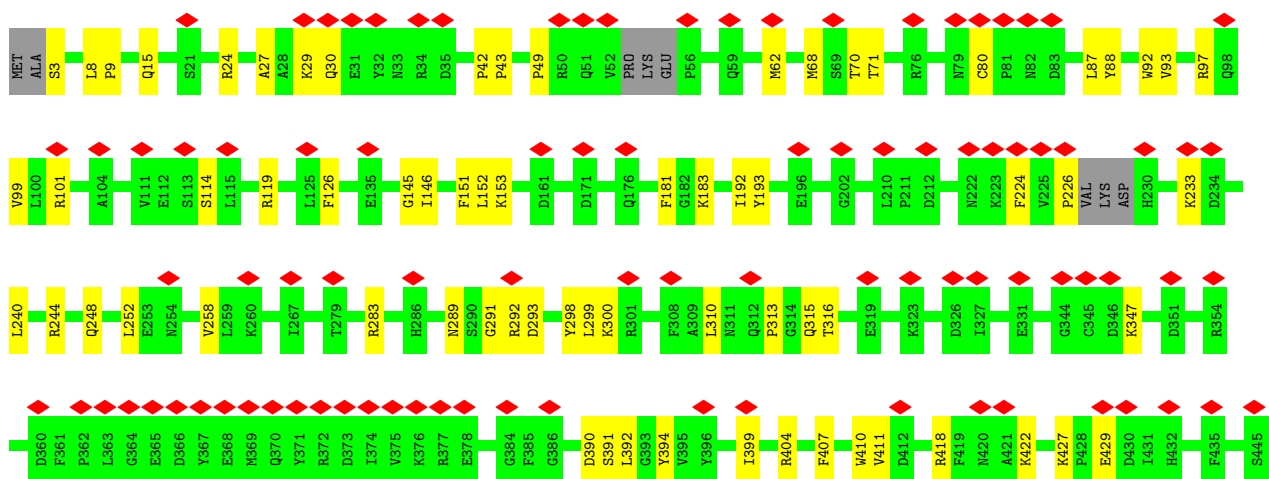
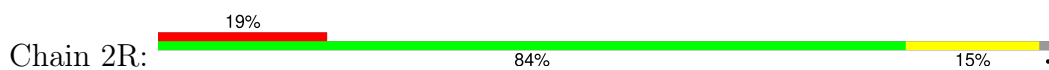



• Molecule 26: RIB72B

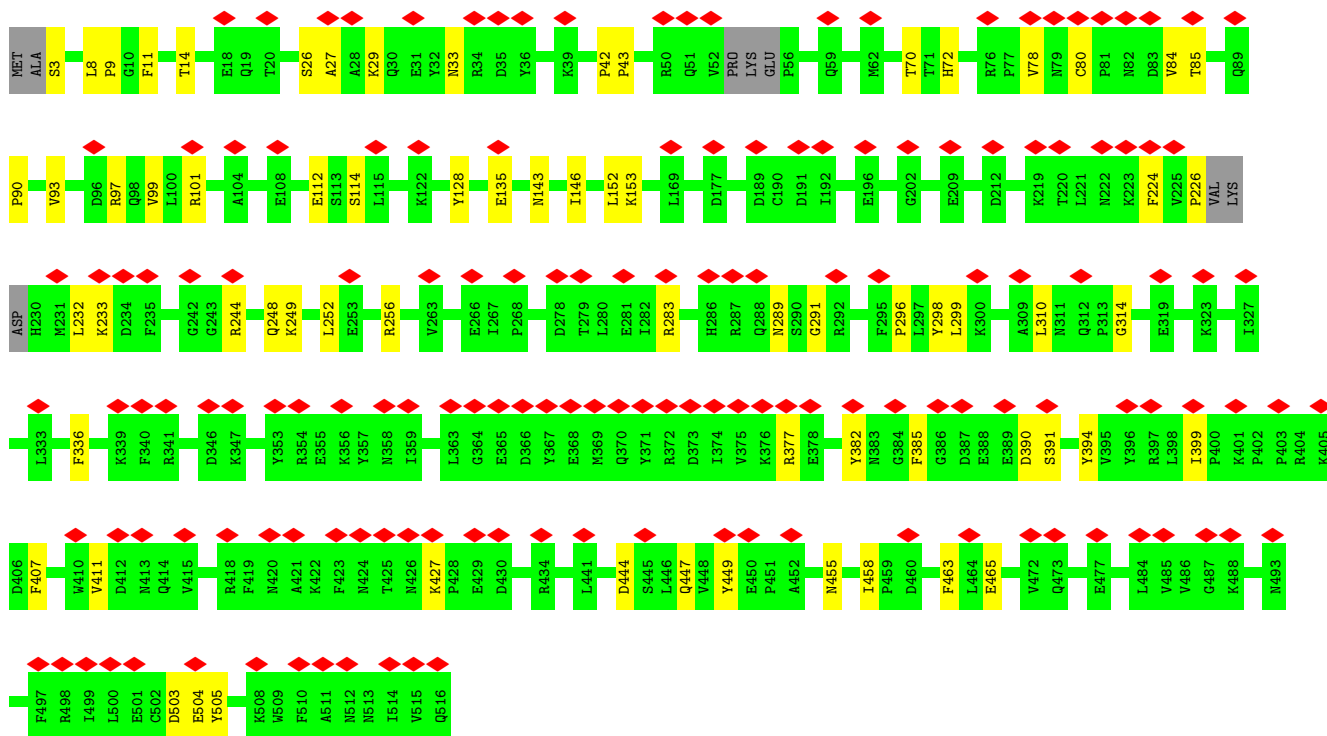
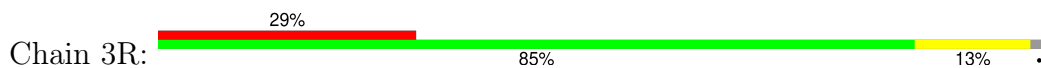

• Molecule 27: Protofilament ribbon protein

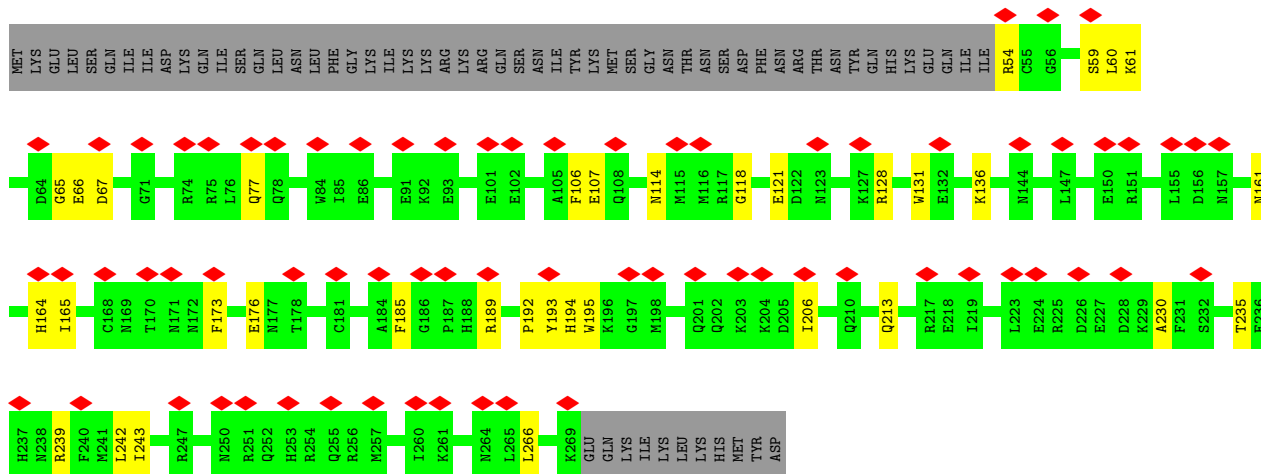

• Molecule 27: Protofilament ribbon protein



MET  
LYS  
GLU  
LEU  
SER  
GLN  
GLN  
ILE  
ASP  
GLN  
ASN  
ILE  
GLN  
GLN  
SER  
LEU  
LEU  
PHE  
GLY  
GLN  
LYS  
LYS  
LYS  
ARG  
TRP  
ARG  
LYS  
ARG  
GLN  
SER  
SER  
ILE  
ASN  
TYR  
TYR  
LYS  
MET  
GLY  
LEU  
GLY  
THR  
THR  
ASN  
SER  
SER  
SER  
ILE  
TYR  
LYS  
LYS  
MET  
GLY  
LEU  
GLY  
THR  
ALA  
ASN  
TYR  
PHE  
GLU  
GLN  
GLN  
HIS  
HIS  
LYS  
LYS  
GLU  
GLN  
ILE  
ILE  
ILE  
ASN  
ARG  
CYS  
GLY  
MET  
MET  
GLY  
ILE  
SER  
SER  
LEU

LYS  
CYS  
LEU  
ASP  
GLY  
GLU  
GLN  
ASP  
ASN  
ASN  
GLN  
TRP  
GLU  
ASN  
ARG  
ARG  
ARG  
ARG  
LEU  
ASN  
GLN  
GLN  
GLN  
PHE  
GLN  
ASN  
ILE  
ILE  
GLN  
GLN  
ASP  
ASP  
TRP  
ASP  
GLY  
GLU  
GLU  
GLU  
LYS  
LYS  
LYS  
ALA  
PHE  
GLU  
GLN  
GLN  
CYS  
THR  
THR  
ASN  
ASN  
ASN  
PHE  
GLN  
THR  
THR  
THR

GLU  
ASP  
ASN  
LEU  
ASN  
GLN  
LYS  
ARG  
ARG  
TRP  
GLU  
ASN  
LYS  
ASN  
THR  
PHE  
GLU  
LYS  
ASN  
ILE  
ILE  
GLN  
GLN  
ASP  
ASP  
SER  
SER  
HIS  
LEU  
LEU  
ASN  
ASN  
ASN  
GLN  
GLN  
GLN  
THR  
E176  
M177  
T178  
G179  
T180

C181  
T182  
S183  
A184  
F185  
G186  
P187  
H188  
R189  
V190  
I191  
P192  
Y193  
H194  
W195  
K196  
G197  
M198  
N199  
P200  
Q201  
Q202  
K203  
K204  
D205  
L206  
I207  
L208  
R214  
H215  
E216  
N222  
R225  
D228  
F231  
S232  
M235  
Q234  
T235  
E236  
R239  
F240  
R240  
T243  
M244  
L245  
E246  
R247  
Q248  
K249  
N250  
R251  
R254

Q255  
R256  
M257  
T260  
K261  
L265  
L266  
E270  
Q271  
H277  
D280

• Molecule 28: RIB35



M1  
S2  
L3  
Y4  
M9  
V12  
D13  
R14  
E18  
S24  
K25  
Q26  
K27  
G28  
G29  
L30  
N31  
R33  
N34  
L35  
R36  
R37  
E40  
Q41  
L42  
D43  
Y44  
Q49  
L50  
N51  
L52  
D53  
D54  
F55  
K56  
A57  
G58  
L59  
M60  
G63  
F64  
F65  
L66  
K67  
M68  
V69  
D70  
C73  
D79  
V80

E81  
Q82  
N83  
G84  
L89  
A90  
S93  
C94  
I95  
S96  
Q97  
T98  
L99  
N100  
Q101  
R102  
M105  
F106  
V107  
L108  
K109  
V110  
F111  
D112  
S113  
I114  
D115  
S116  
E117  
Q118  
K119  
G120  
A121  
V122  
H123  
P124  
F125  
S126  
L127  
A128  
E129  
L130  
L131  
E132  
V133  
V134  
K135  
M136  
K137  
D138  
Y139  
Q140  
I141  
G142  
S143  
K144  
T145

R146  
E147  
Q148  
L149  
G151  
E152  
A155  
Q156  
F157  
H158  
K159  
M160  
Q161  
D162  
G163  
L164  
I165  
T166  
R167  
F170  
V171  
S172  
Y173  
D176  
L179  
G180  
I181  
Q182  
S182  
S183  
E189  
Q192  
T193  
Q194  
W195  
G196  
I197  
K198  
E199  
D200  
D201  
D202  
L203  
A204  
T205  
T206  
K207  
E208  
E209  
G212  
R218  
Q219

Q223  
K226  
G227  
A228  
M229  
D230  
E231  
F232  
L233  
L234  
R235  
K239  
I243  
S244  
T250  
M254  
M255  
A256  
I263  
K267  
M271  
F274  
S275  
Q276  
L277  
D278  
H281  
E286  
F287  
E288  
E289  
F290  
P298  
Y299  
P300

• Molecule 28: RIB35

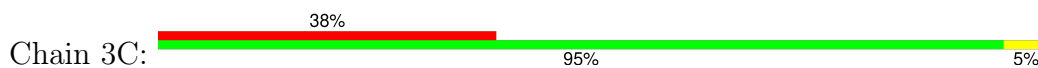

M1  
S2  
L3  
Y4  
G5  
L8  
N9  
D13  
R14  
T17  
E18  
L21  
R33  
N34  
L35  
R36  
R37  
L38  
F39  
E40  
D43  
Y44  
Q45  
Q46  
D54  
F55  
D56  
K56  
A57  
M60  
F65  
L66  
K67  
M68  
Q72  
G73  
D79  
W80  
E81  
Q82  
G84  
N85  
L89  
S93  
T98

R103  
K109  
D112  
S113  
I114  
D115  
S116  
E117  
Q118  
K119  
G120  
A121  
F125  
S126  
L127  
A128  
E129  
K135  
M136  
K137  
D138  
I141  
G142  
S143  
K144  
T145  
R146  
E147  
Q148  
L149  
V150  
Y153  
V154  
A155  
H158  
K159  
M160  
Q161  
D162  
G163  
L164  
R167  
D168  
E169  
Y174  
L177  
G178  
L179  
G180

E189  
Q192  
T193  
Q194  
W195  
G196  
I197  
K198  
E199  
D200  
D201  
D202  
L203  
K245  
Q219  
I222  
Q223  
G227  
A228  
M229  
D230  
E231  
F232  
L233  
L234  
K239  
D242  
I243  
S244  
M245  
S246  
D252  
A256  
M257  
L258  
I259  
K260  
L261  
E262  
I263  
K267  
M271  
F274  
S275  
Q276  
R279



• Molecule 28: RIB35

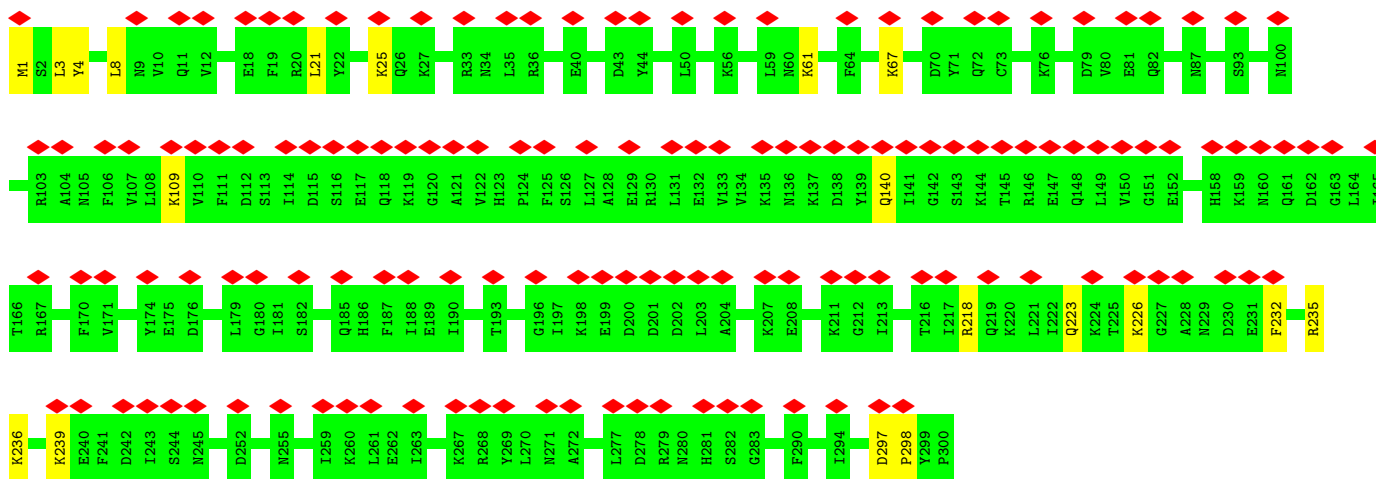

• Molecule 29: CFAP182B

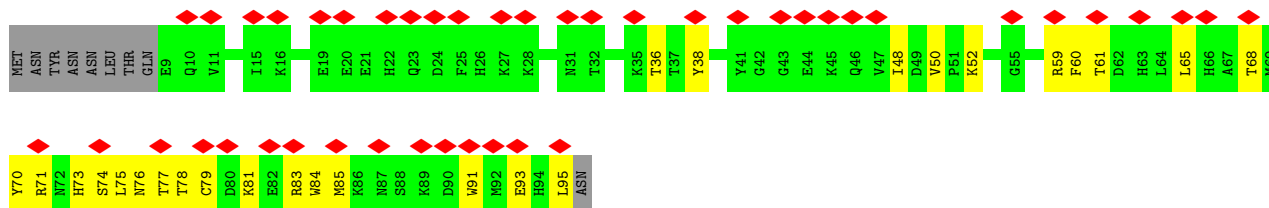

• Molecule 30: Flagellar FliJ protein

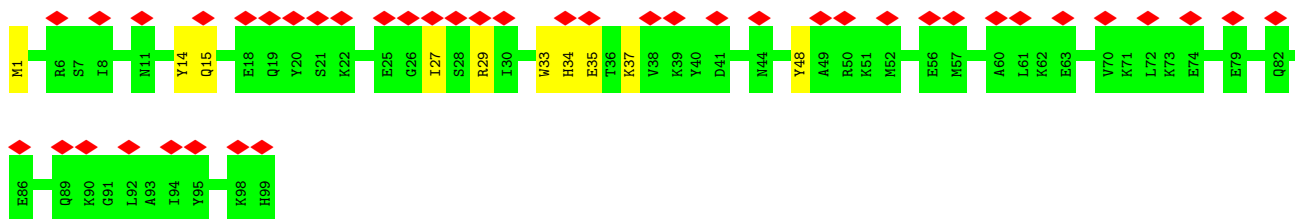
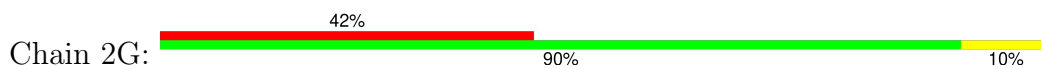

• Molecule 31: RIB27B



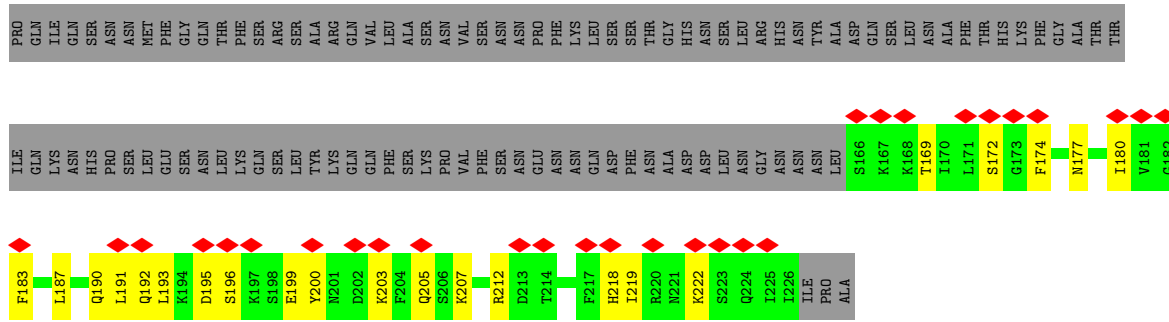

• Molecule 31: RIB27B

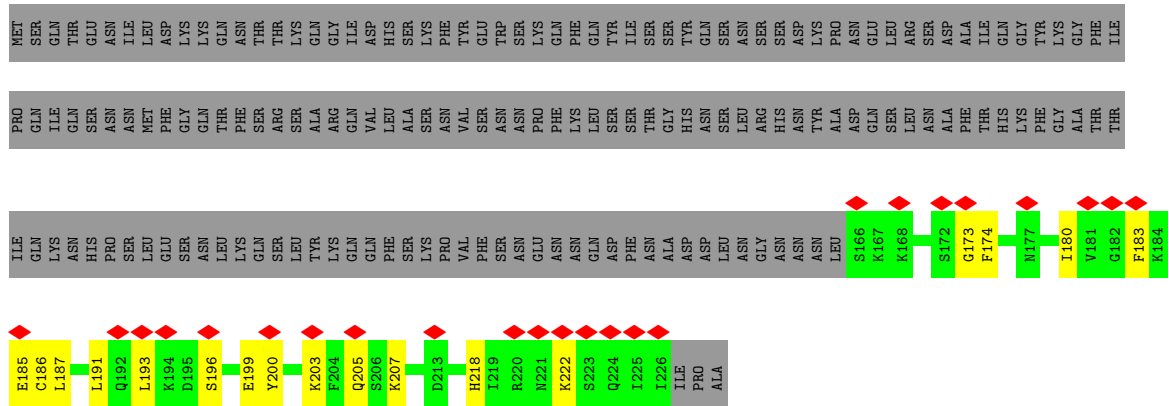

• Molecule 31: RIB27B

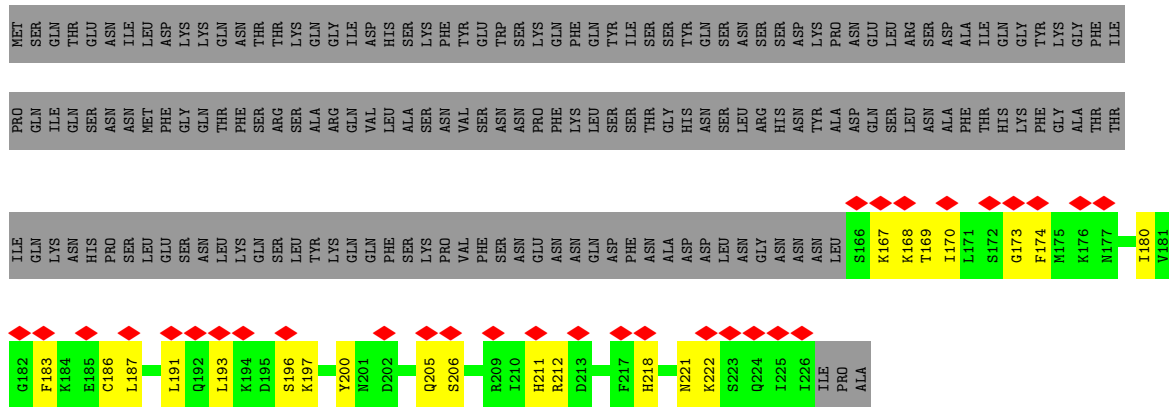

• Molecule 32: STPG2

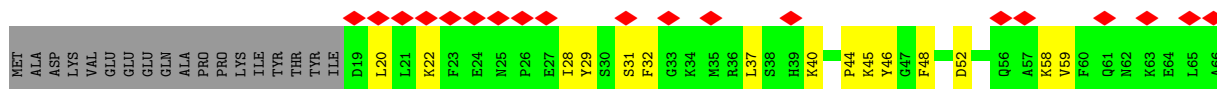
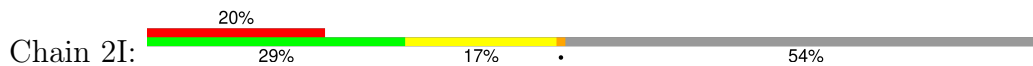





## • Molecule 34: CFAP129

Chain 4F:

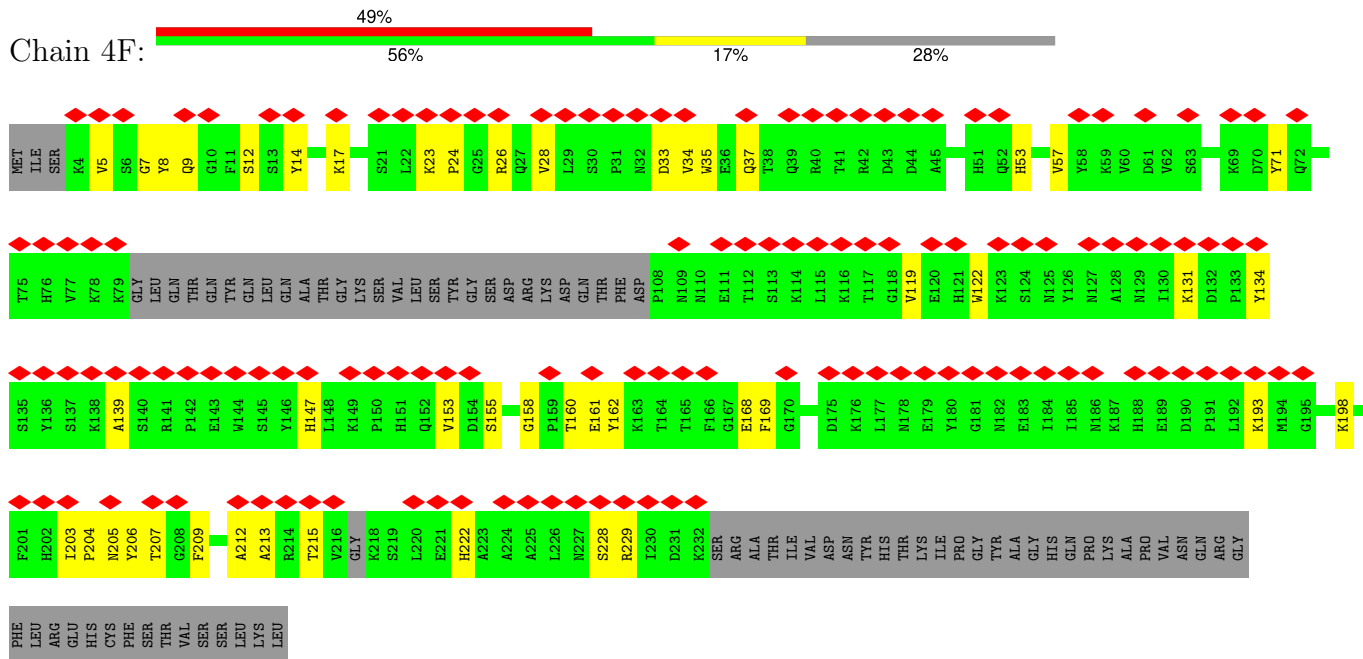

## • Molecule 35: Flagellar microtugule protofilament ribbon protein

Chain 4R:



## • Molecule 35: Flagellar microtugule protofilament ribbon protein

Chain 5R:

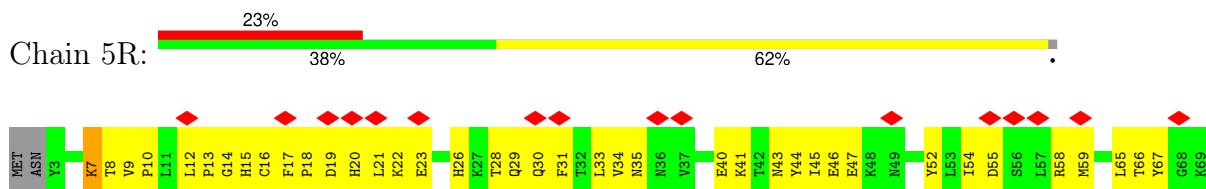

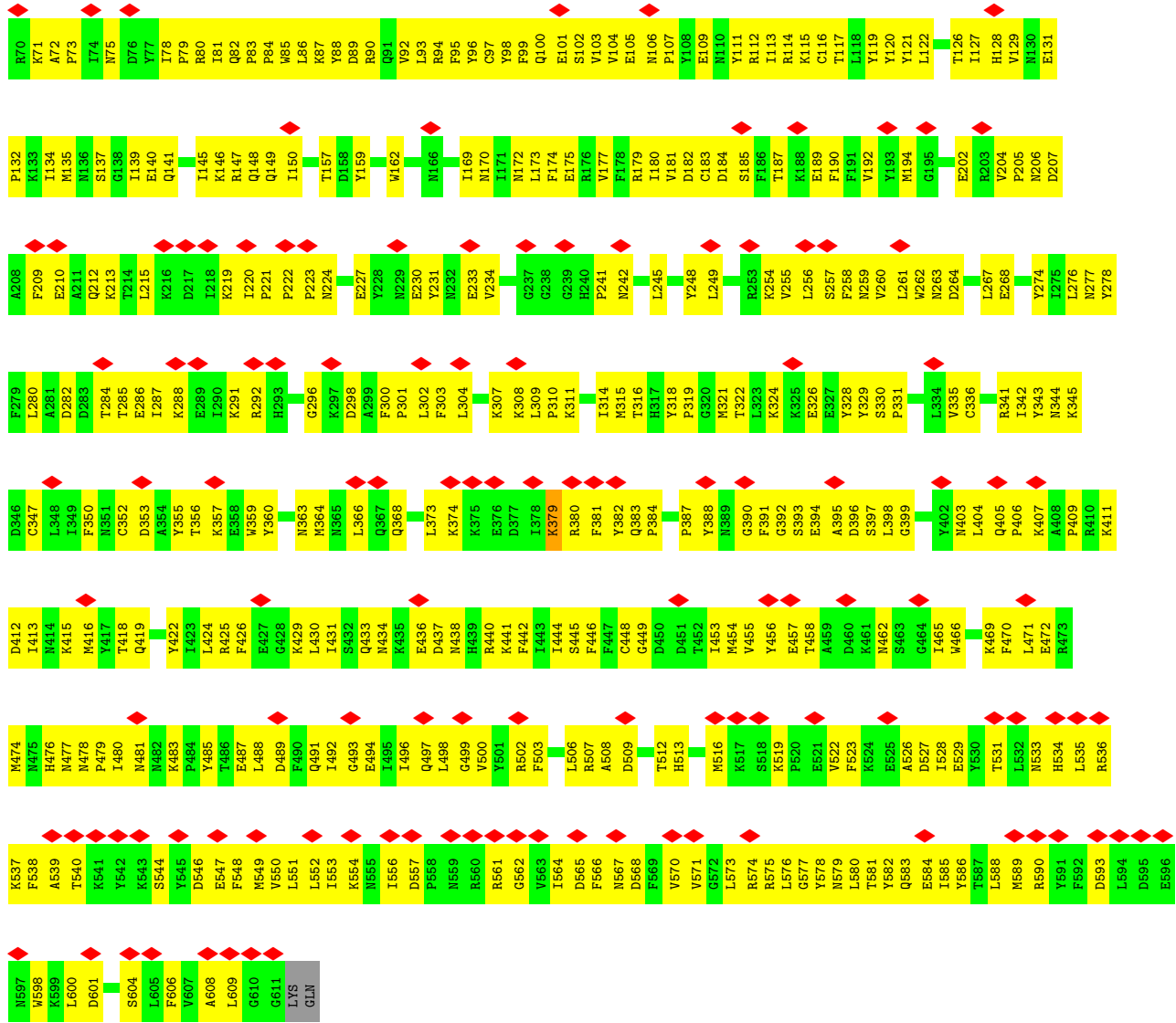

• Molecule 35: Flagellar microtubule protofilament ribbon protein



Chain 6R:

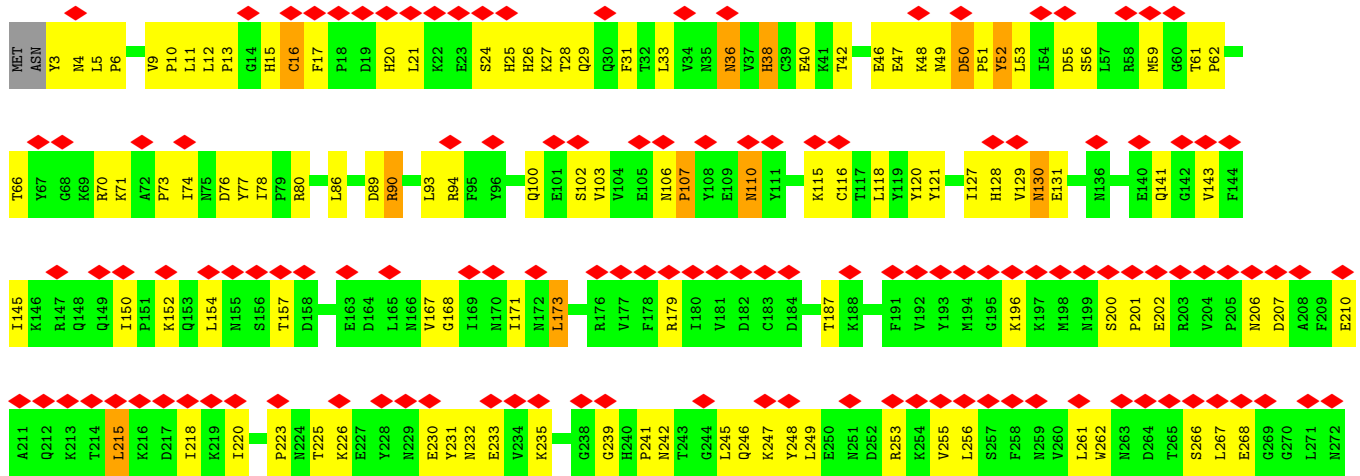

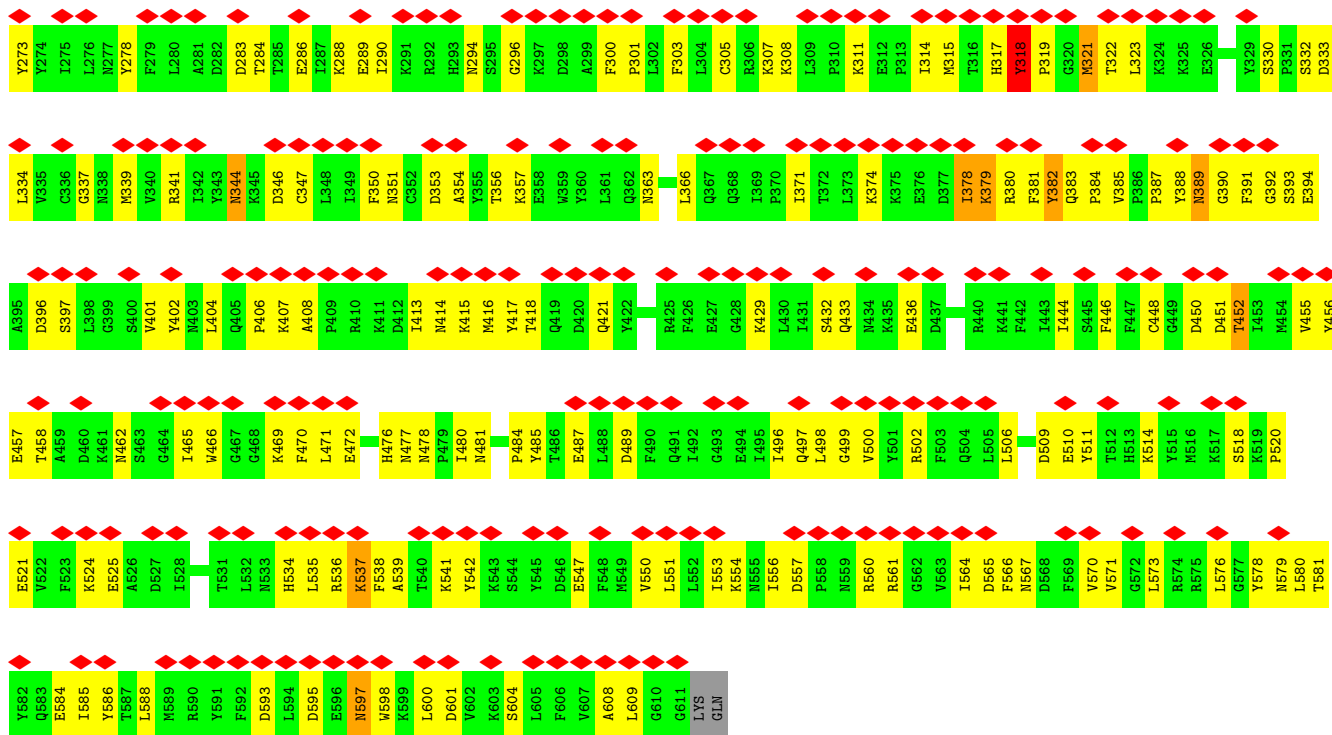

• Molecule 35: Flagellar microtubule protofilament ribbon protein

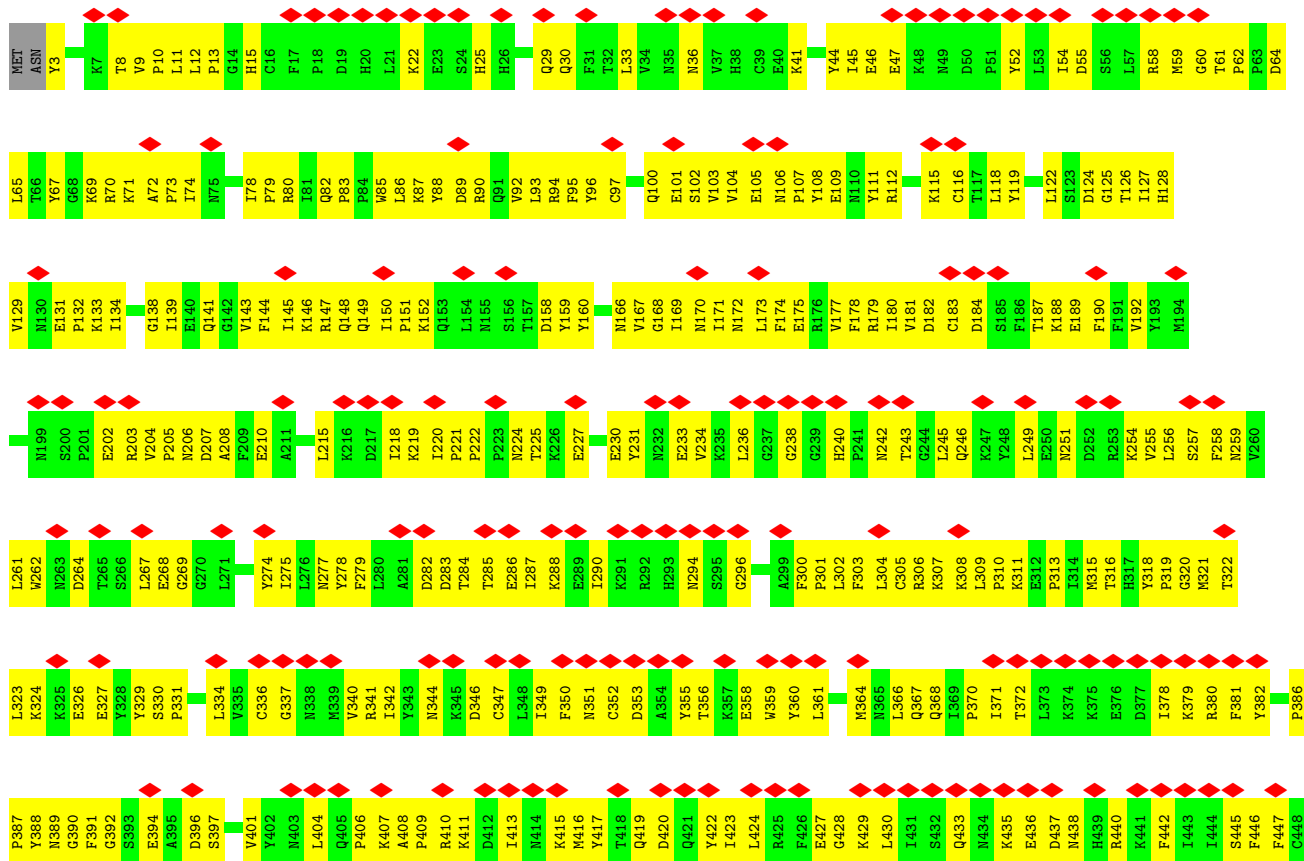

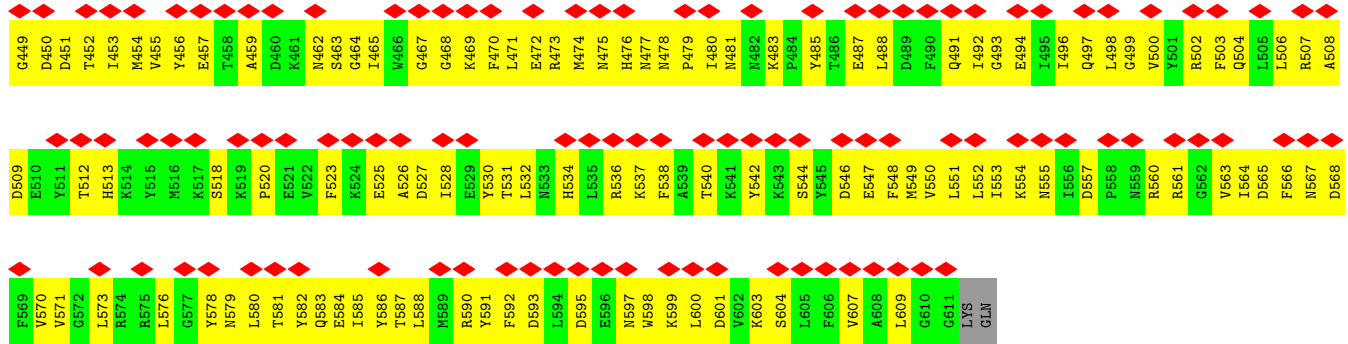

• Molecule 36: Parkin co-regulated protein PACRGB

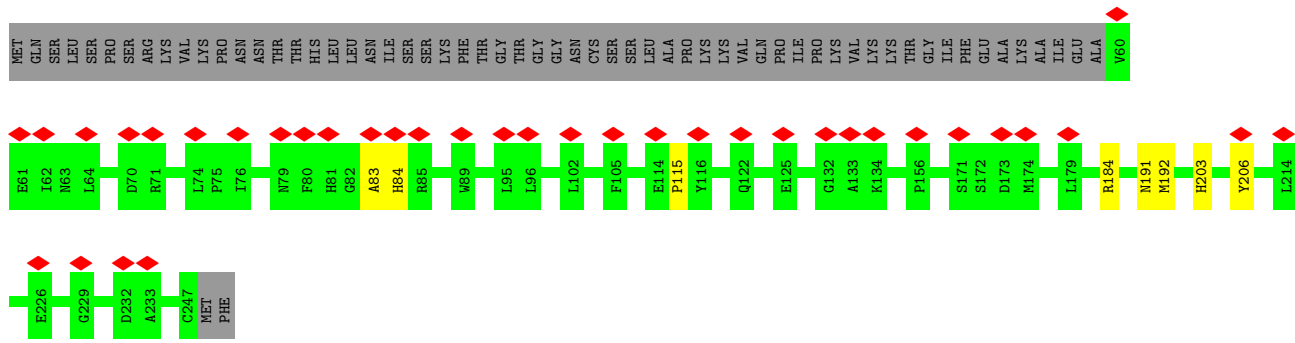
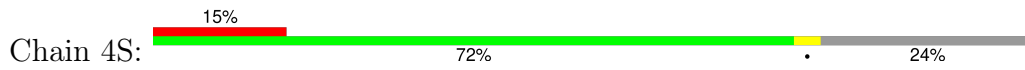

• Molecule 36: Parkin co-regulated protein PACRGB

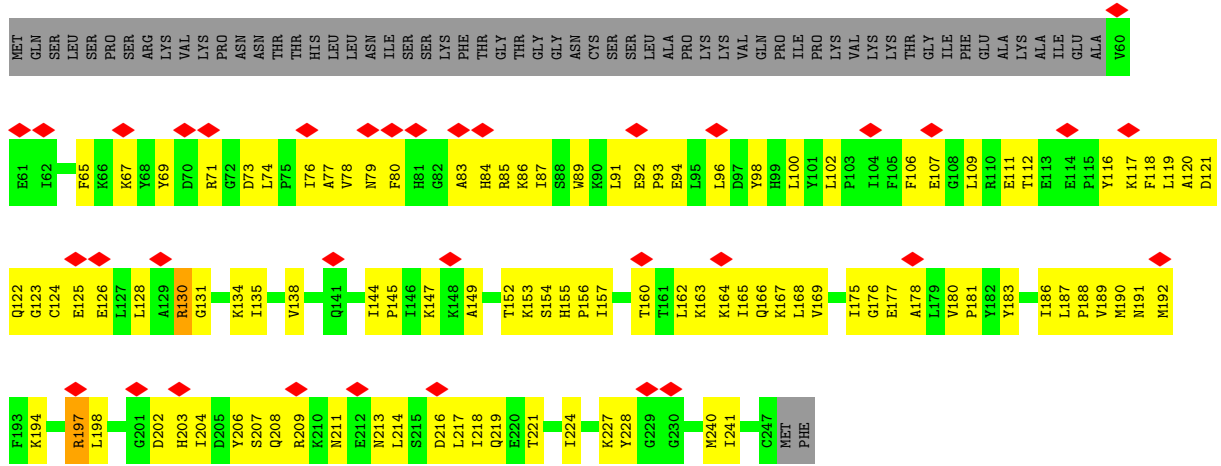

• Molecule 37: OJ2

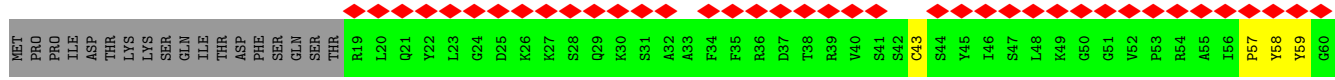
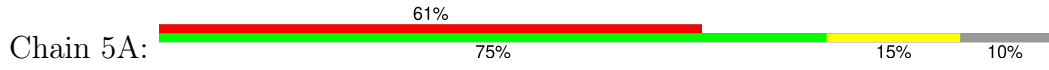

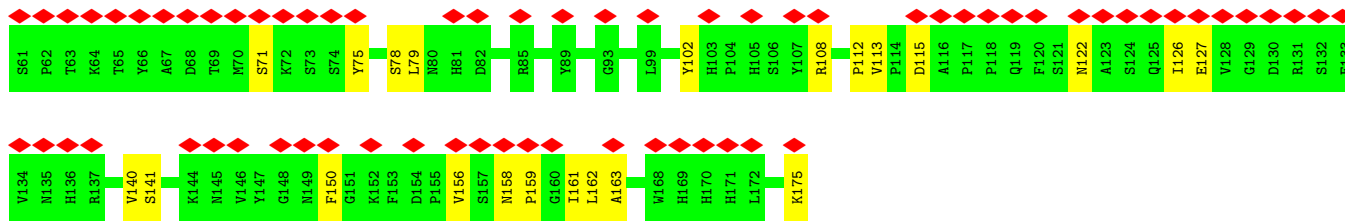

• Molecule 37: OJ2

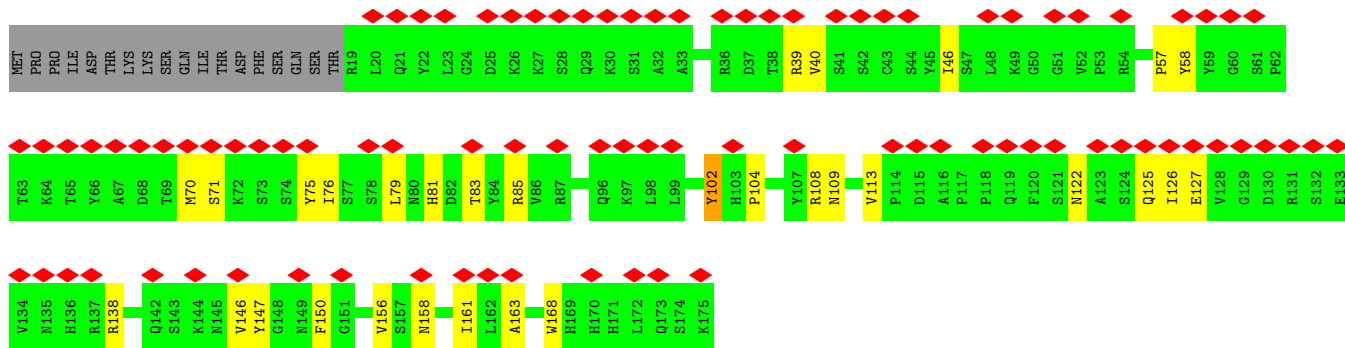
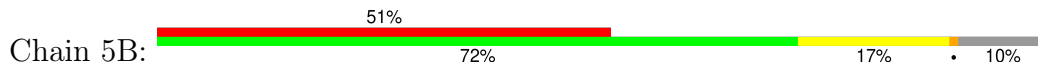

• Molecule 37: OJ2

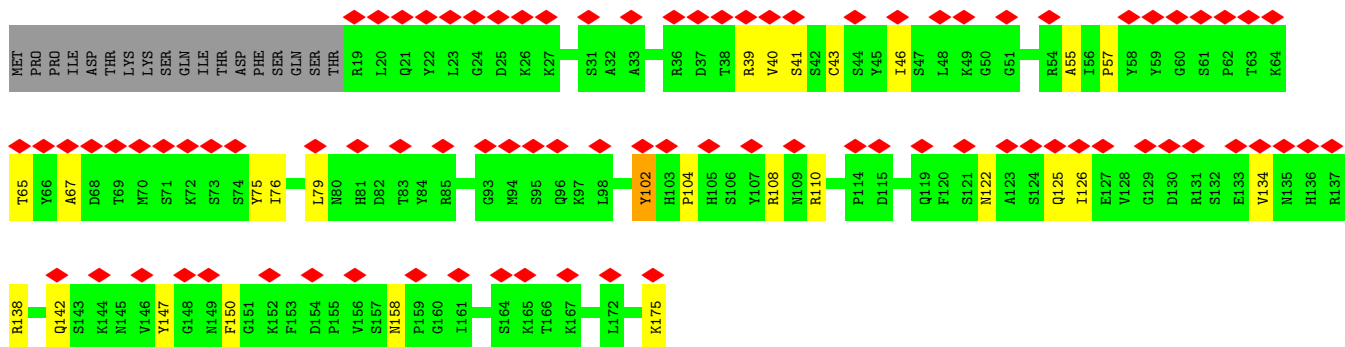
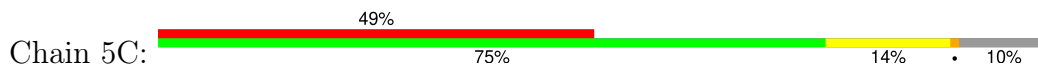

• Molecule 37: OJ2

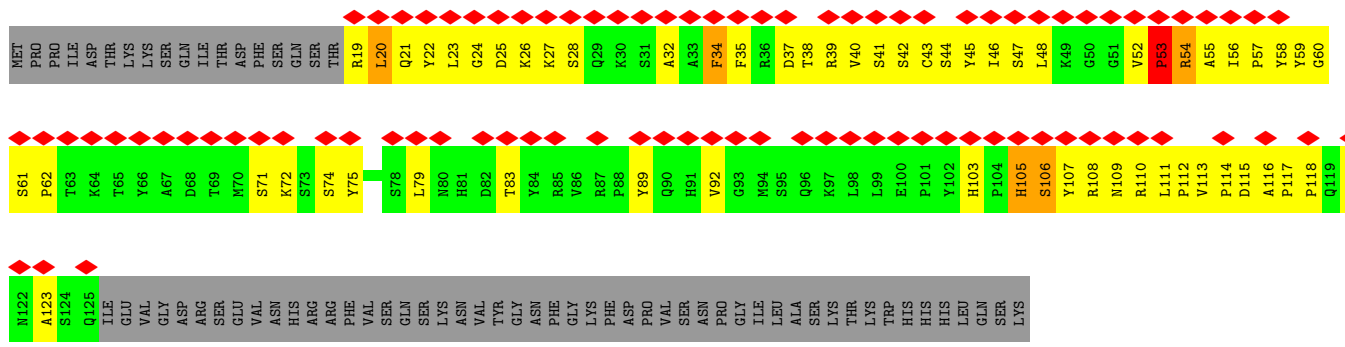
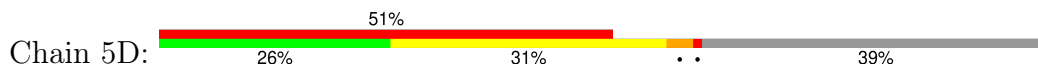



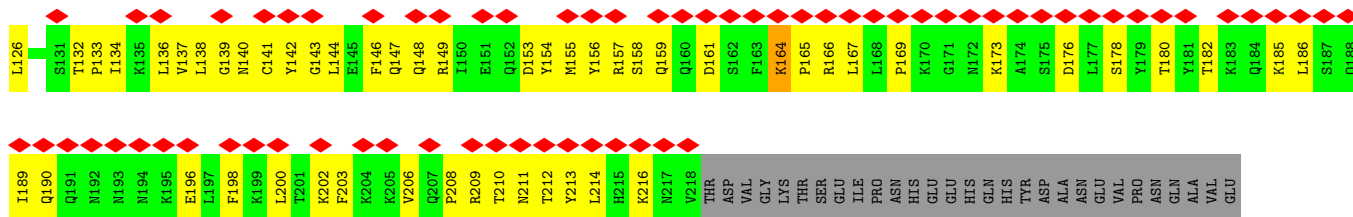

• Molecule 38: CFAP77A

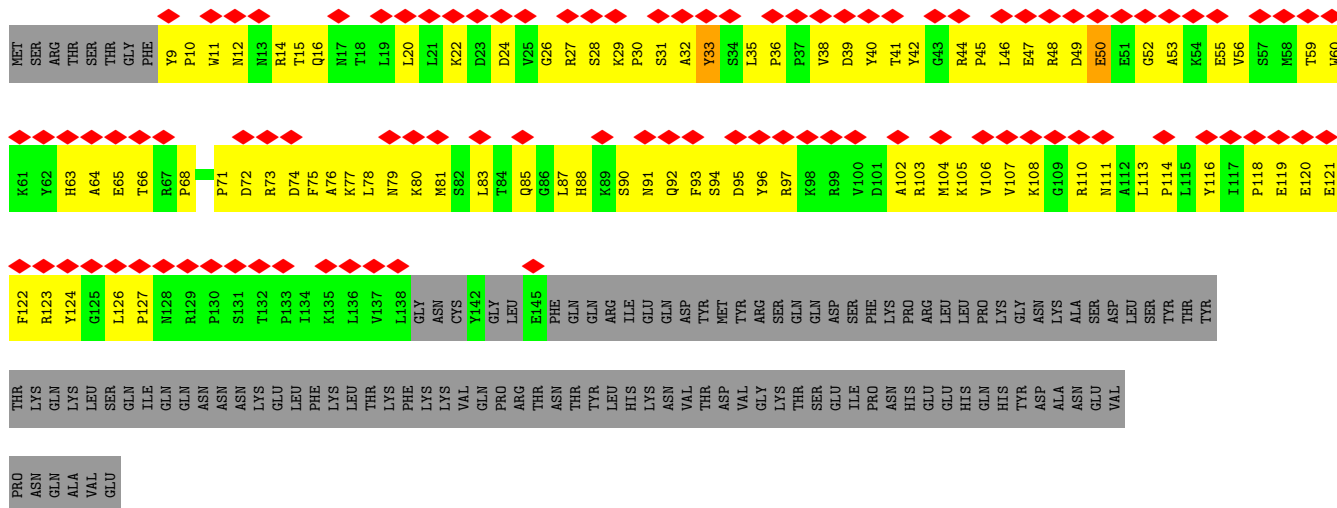
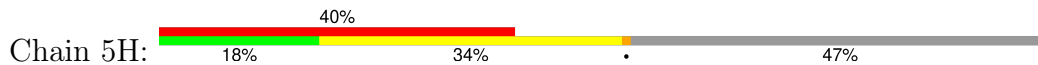

• Molecule 39: OJ3

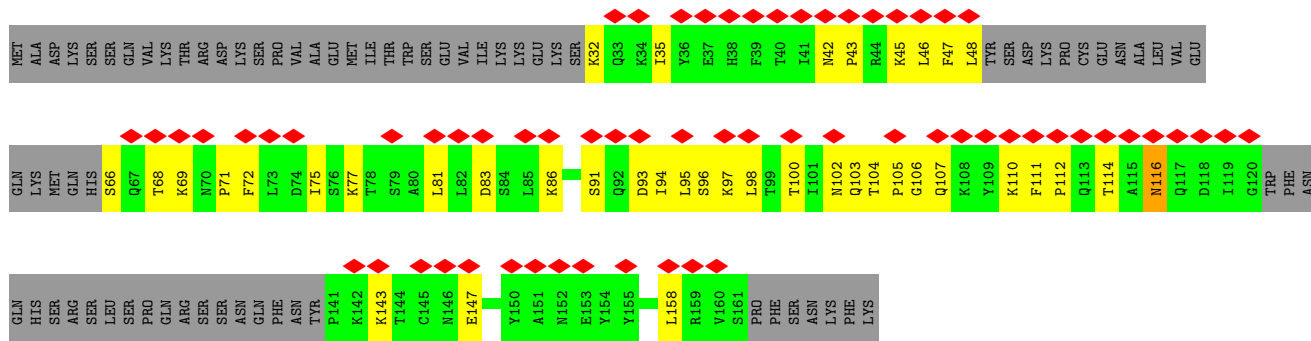
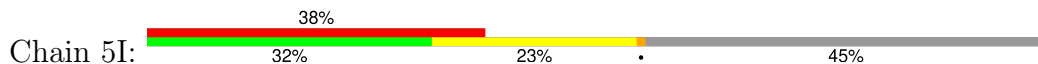

• Molecule 39: OJ3

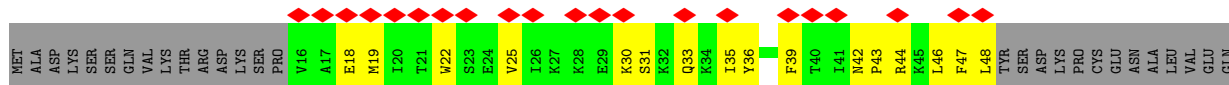

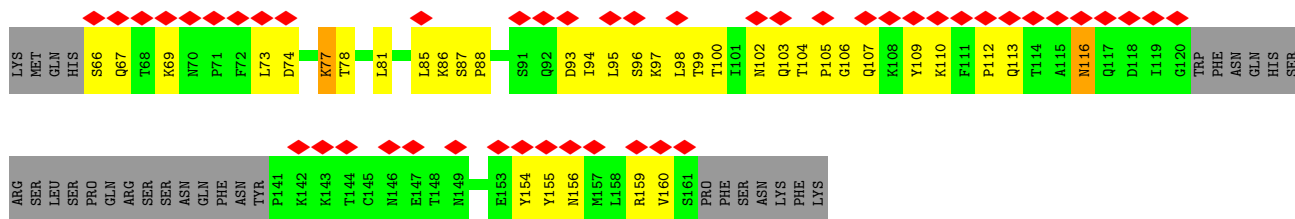

• Molecule 39: OJ3

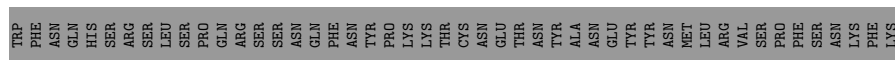
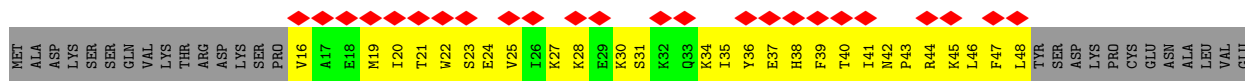

• Molecule 40: SB1

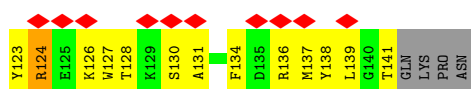
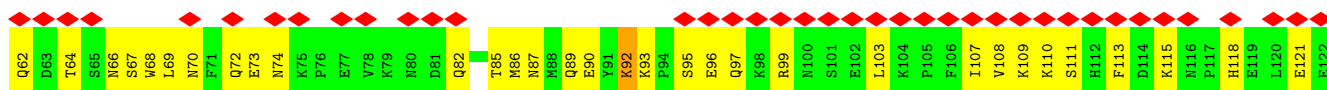
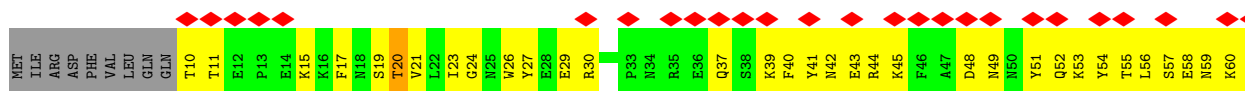
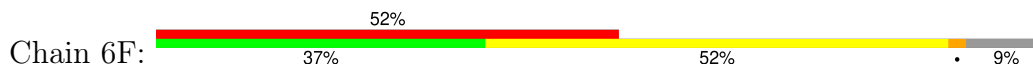

• Molecule 41: STPG1A

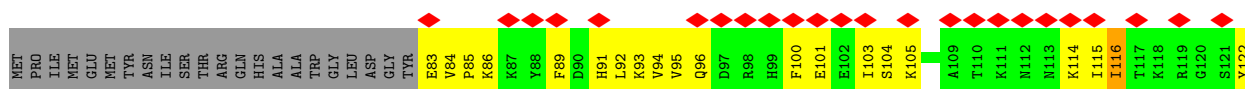
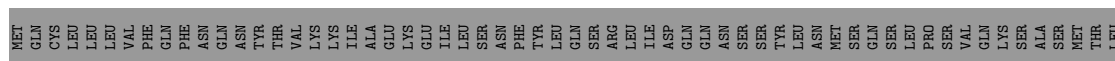
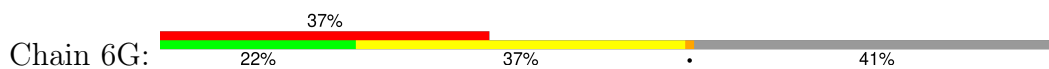



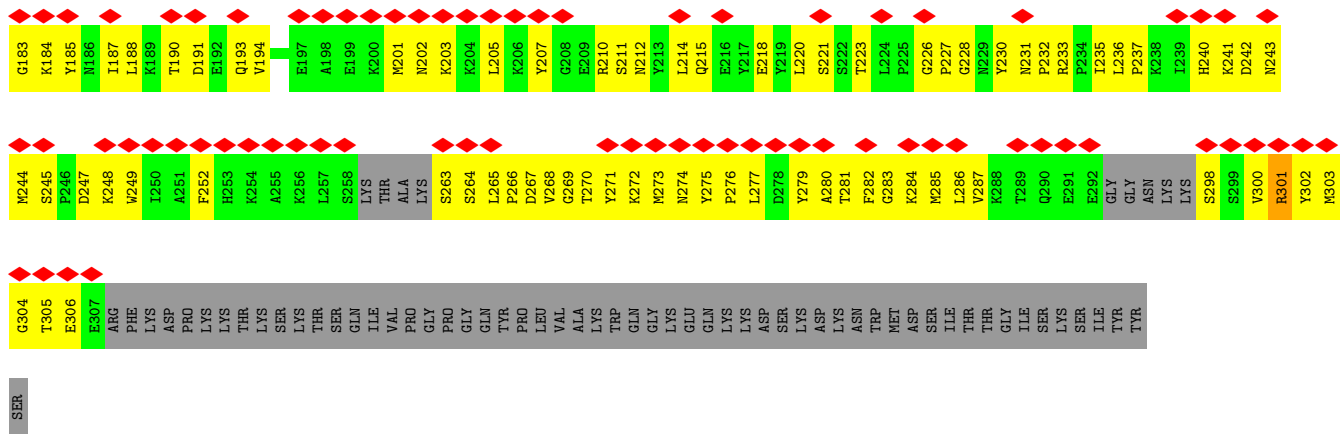

• Molecule 42: CFAP112B

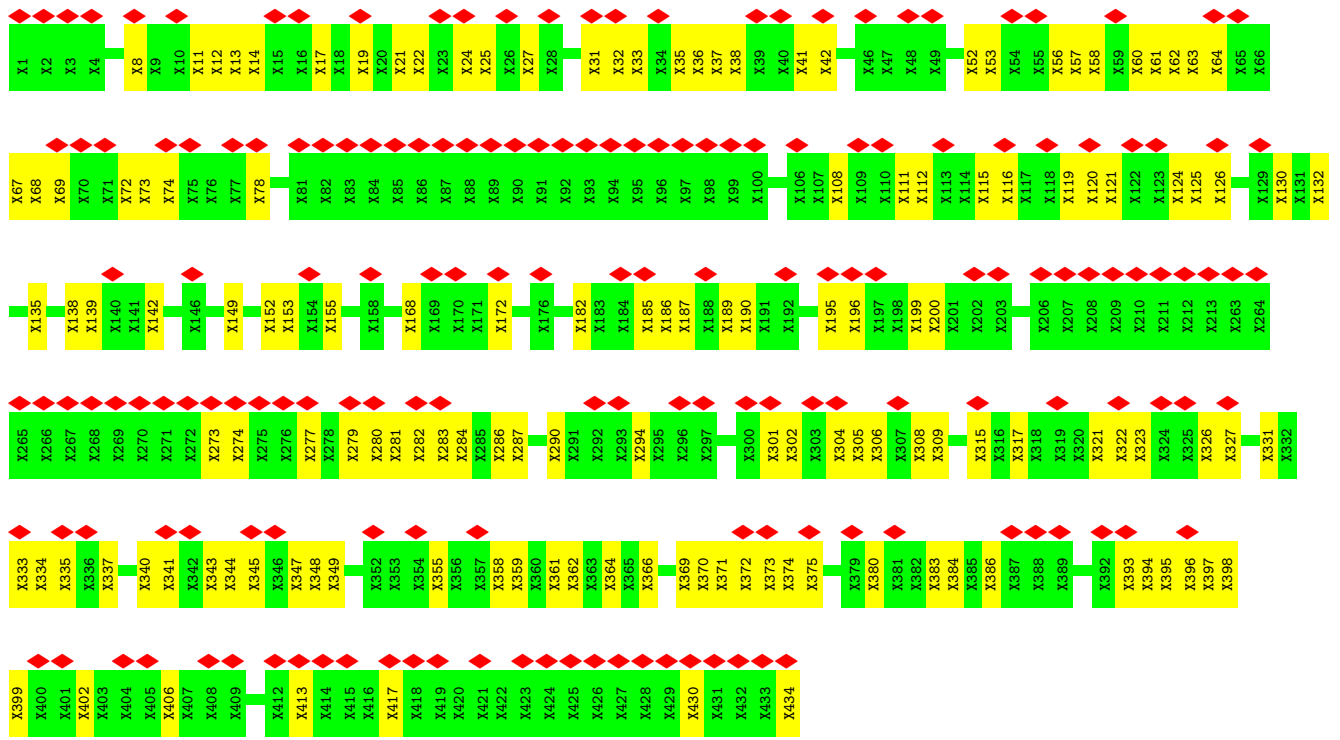
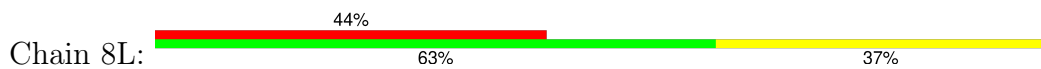

• Molecule 42: CFAP112B

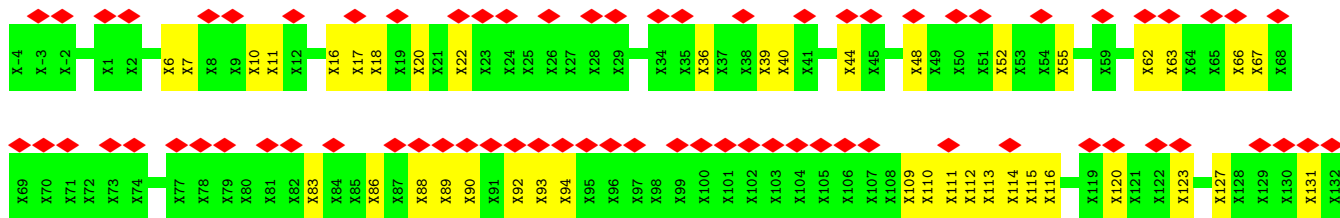

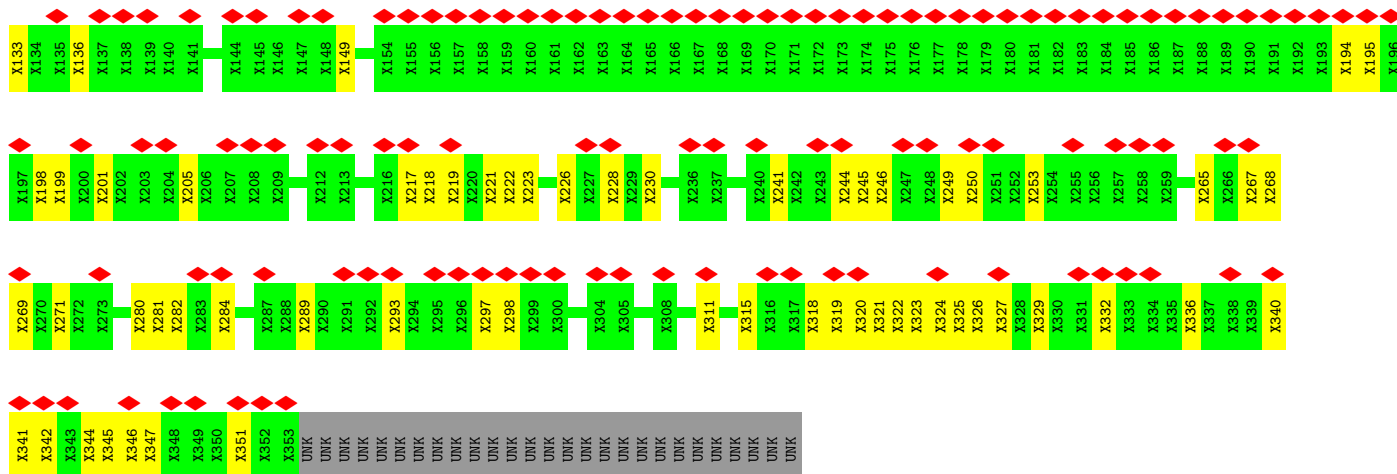

• Molecule 43: CFAP112A

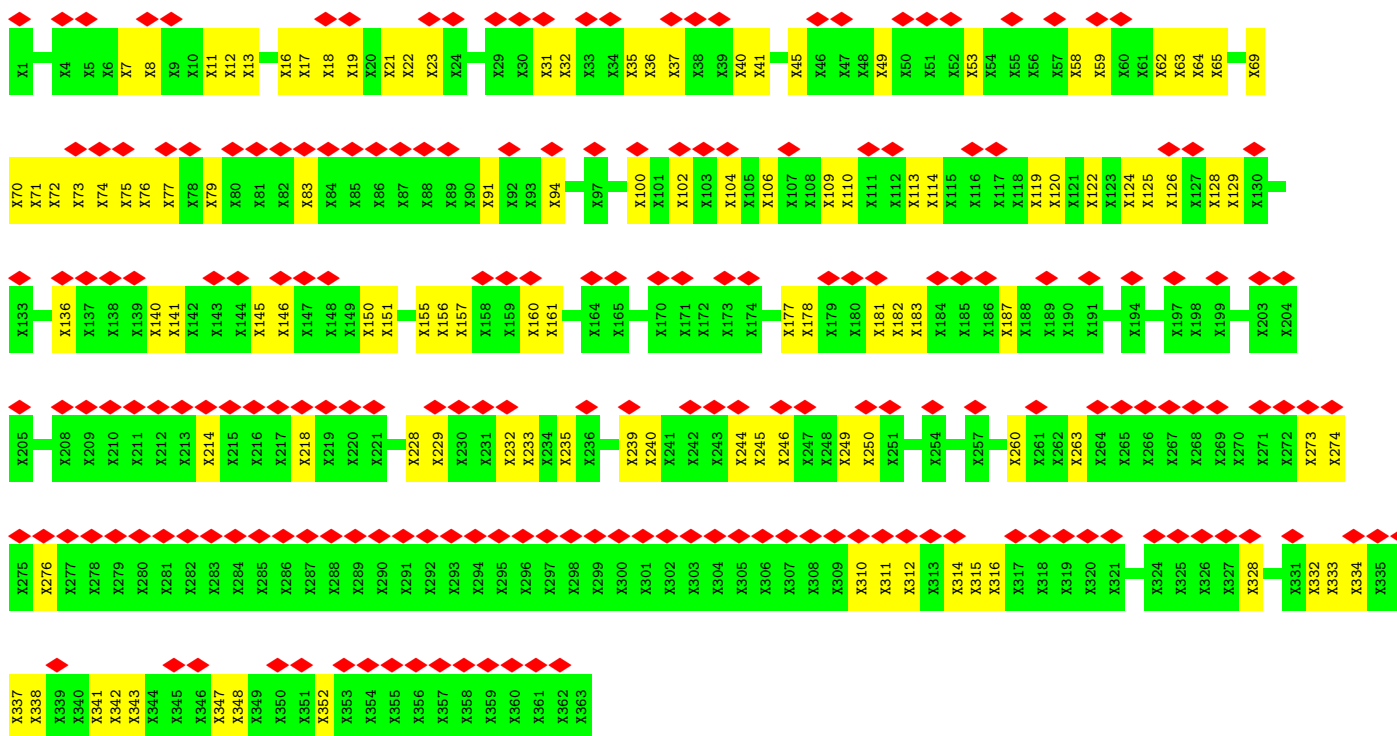

• Molecule 43: CFAP112A

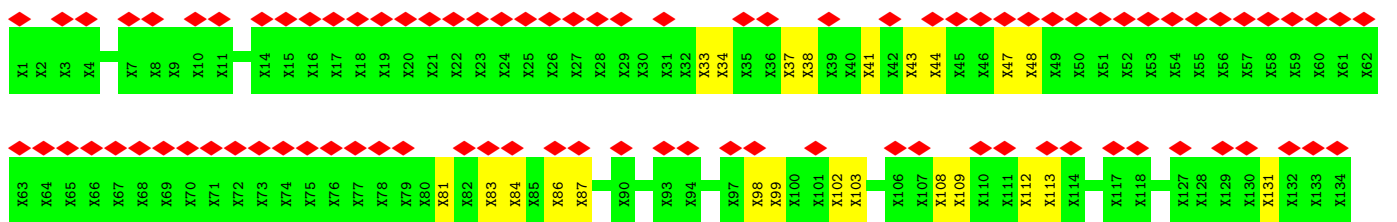
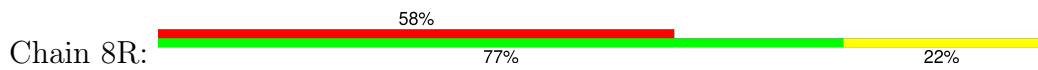

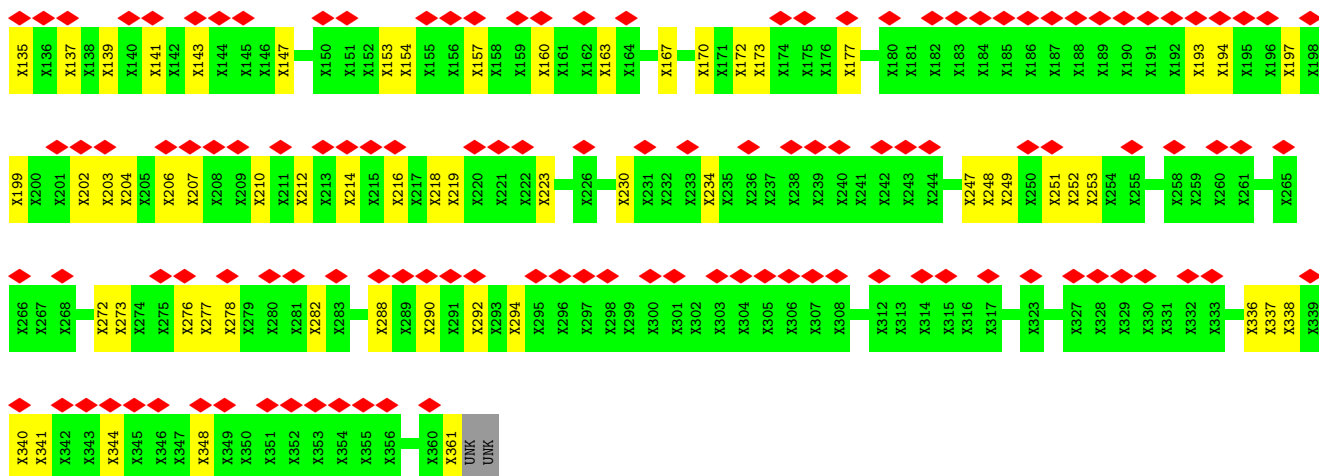

• Molecule 44: Tubulin alpha chain

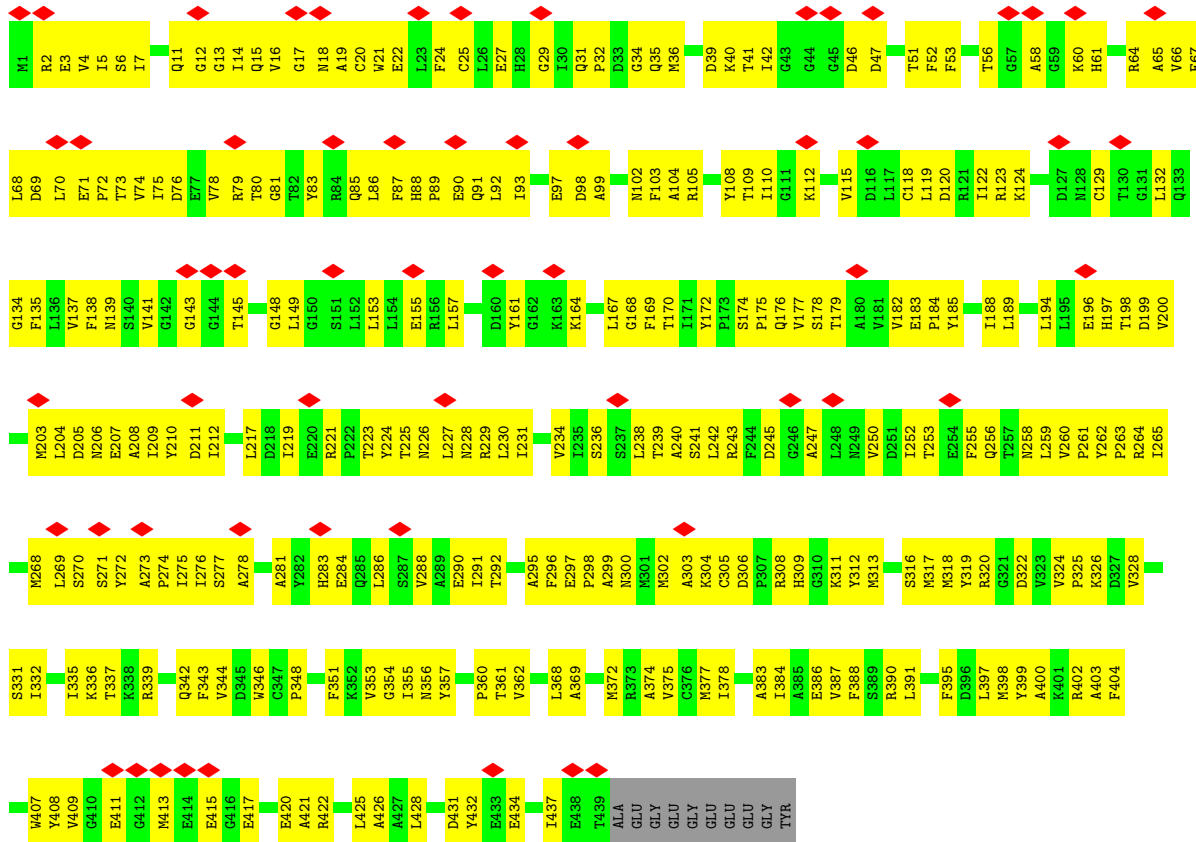

• Molecule 44: Tubulin alpha chain

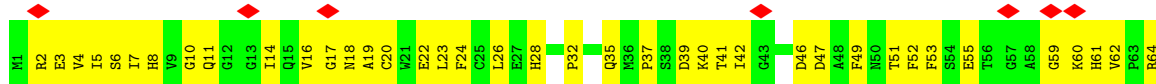

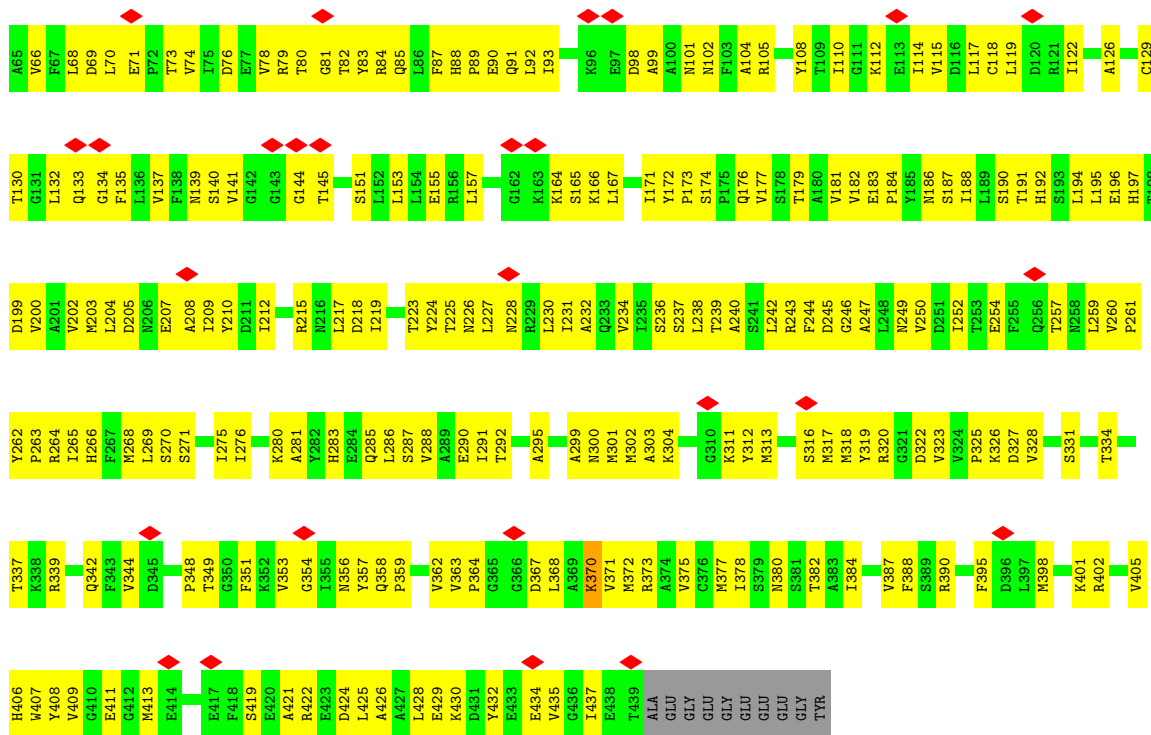

● Molecule 44: Tubulin alpha chain

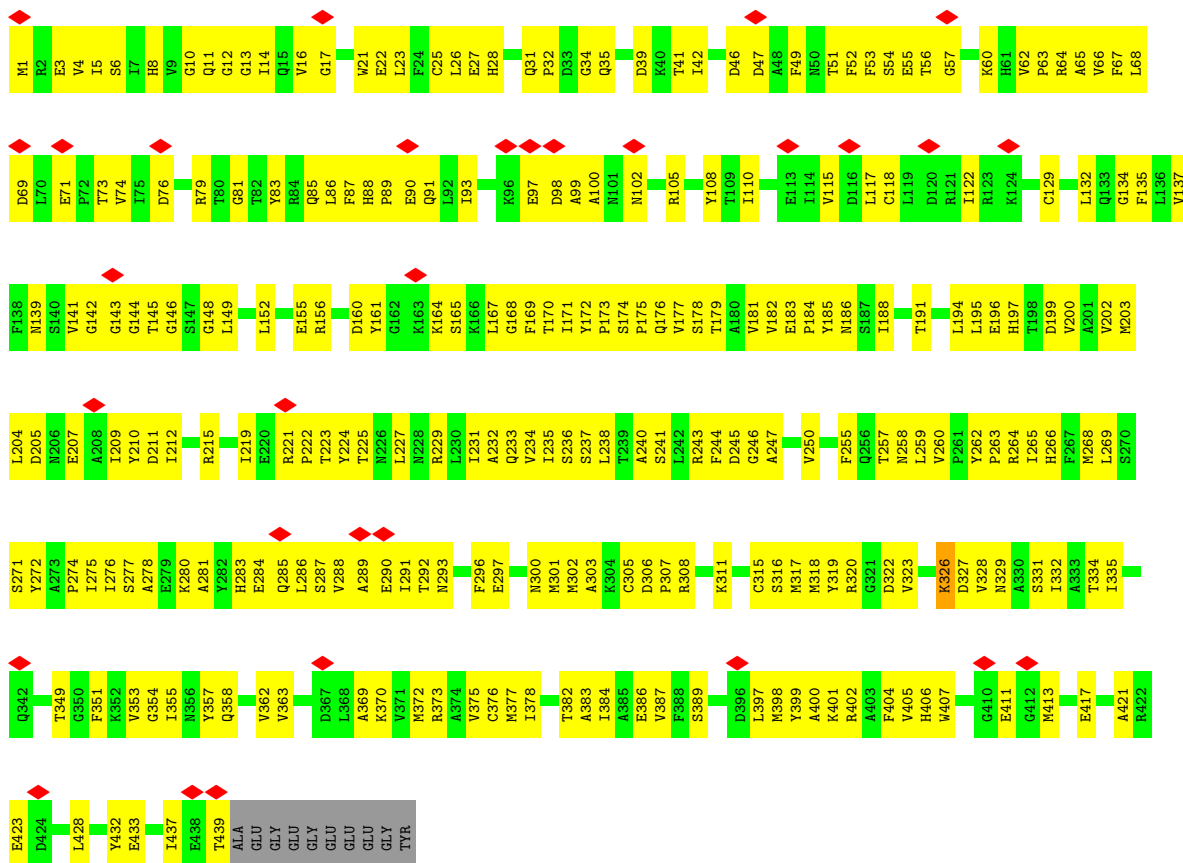

• Molecule 44: Tubulin alpha chain

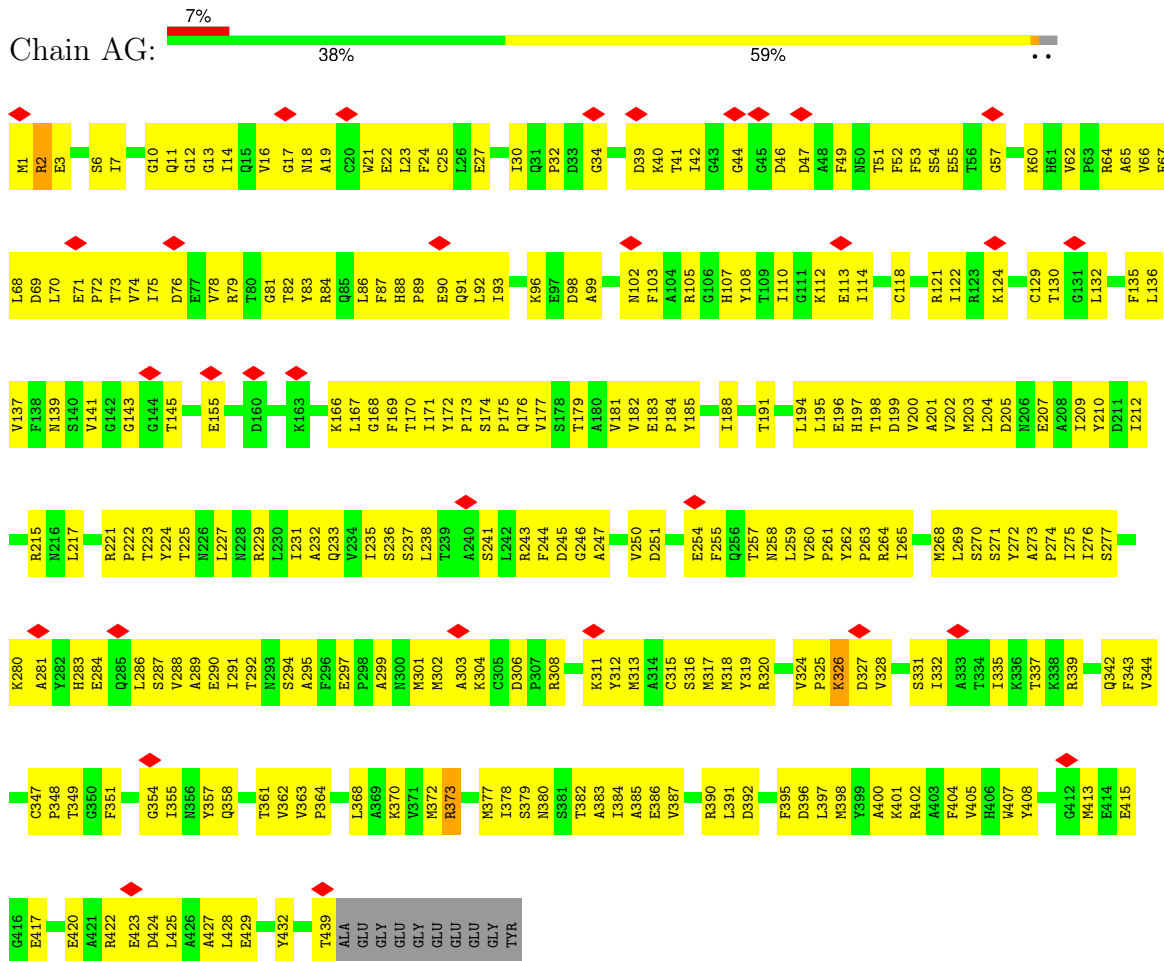

• Molecule 44: Tubulin alpha chain

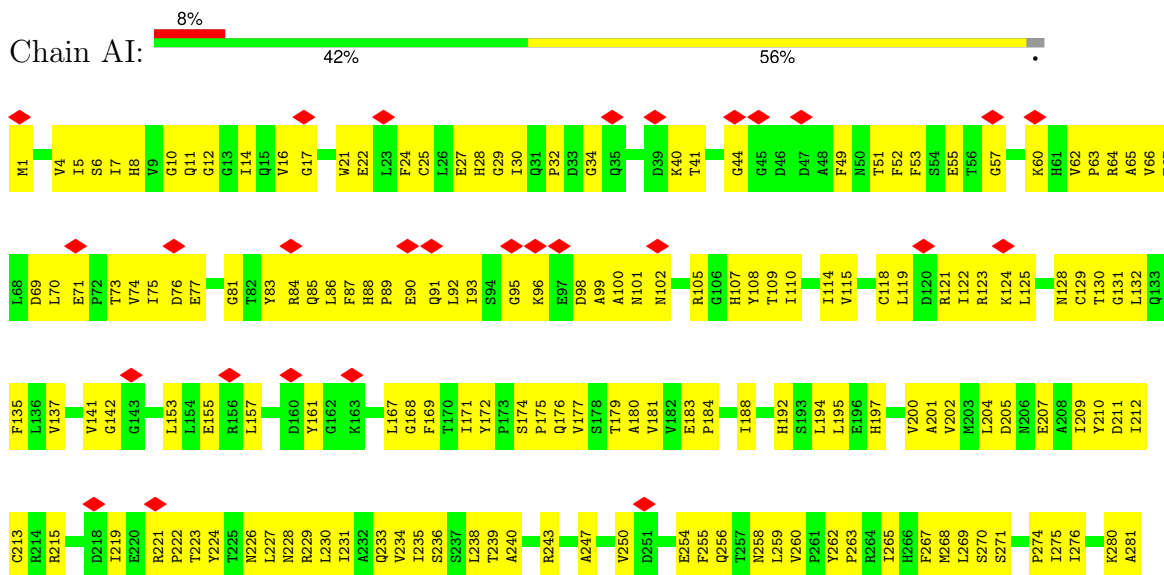

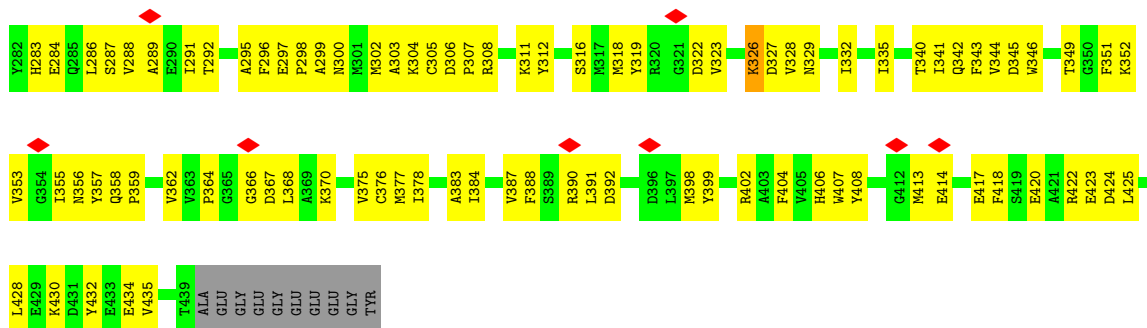

• Molecule 44: Tubulin alpha chain

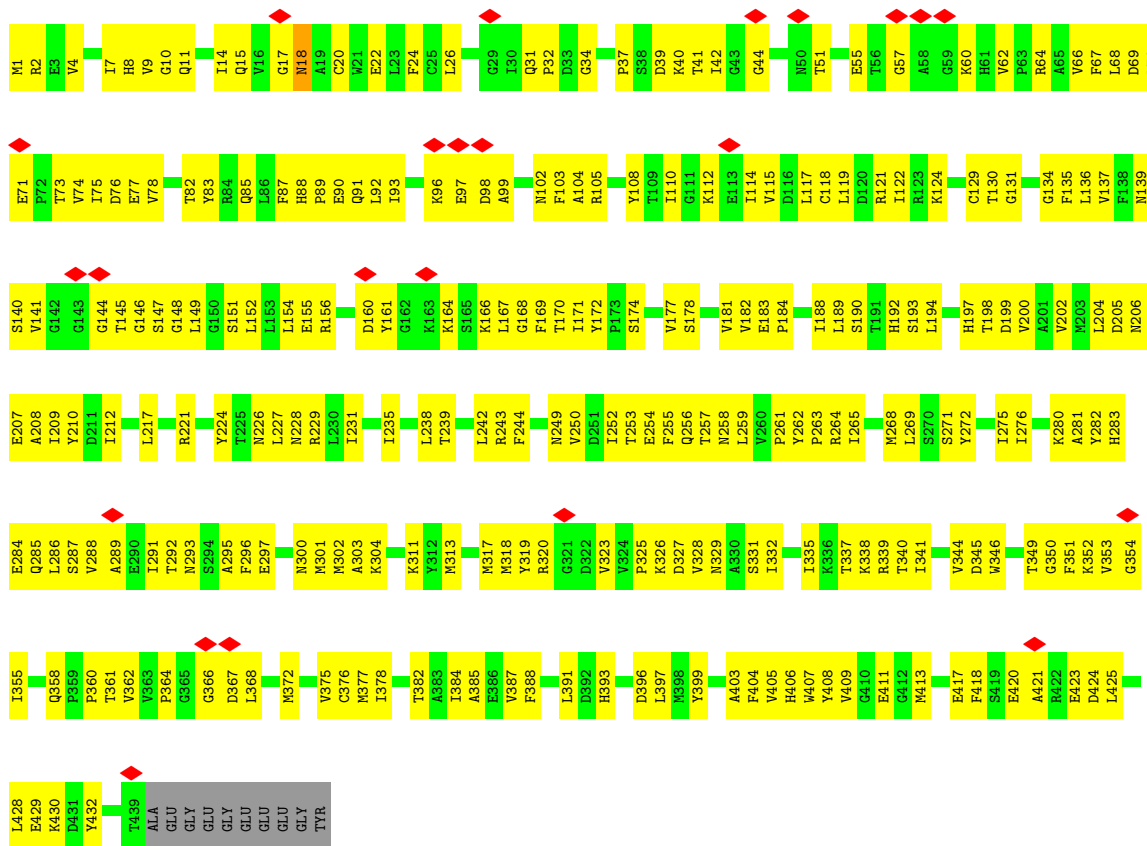

• Molecule 44: Tubulin alpha chain

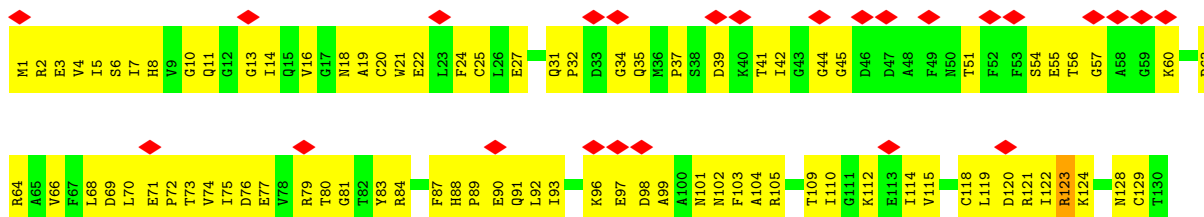

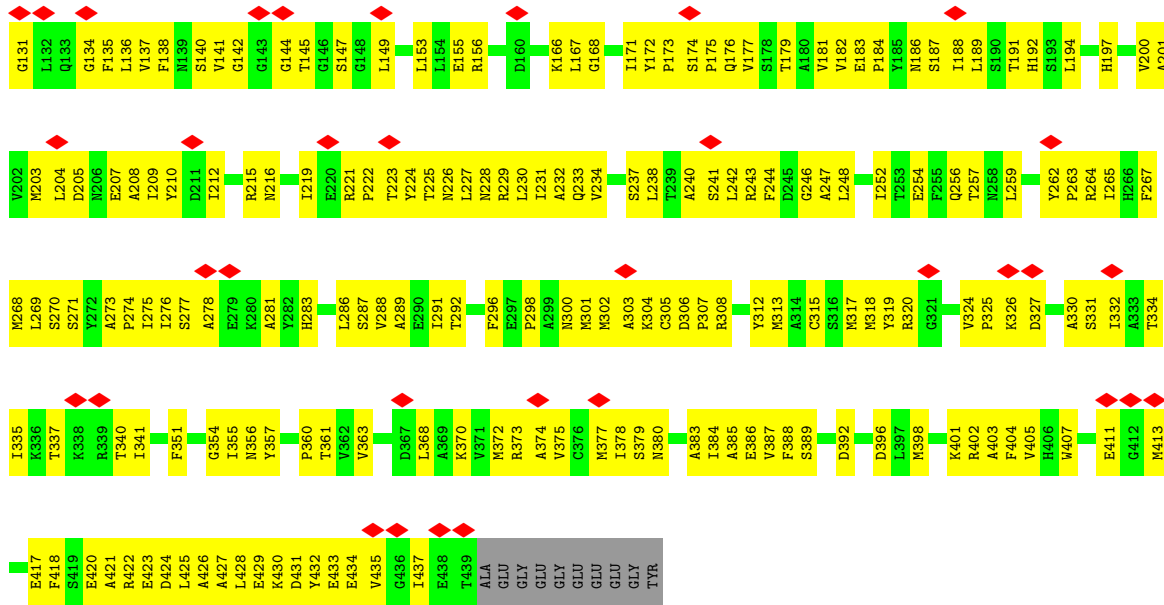

• Molecule 44: Tubulin alpha chain

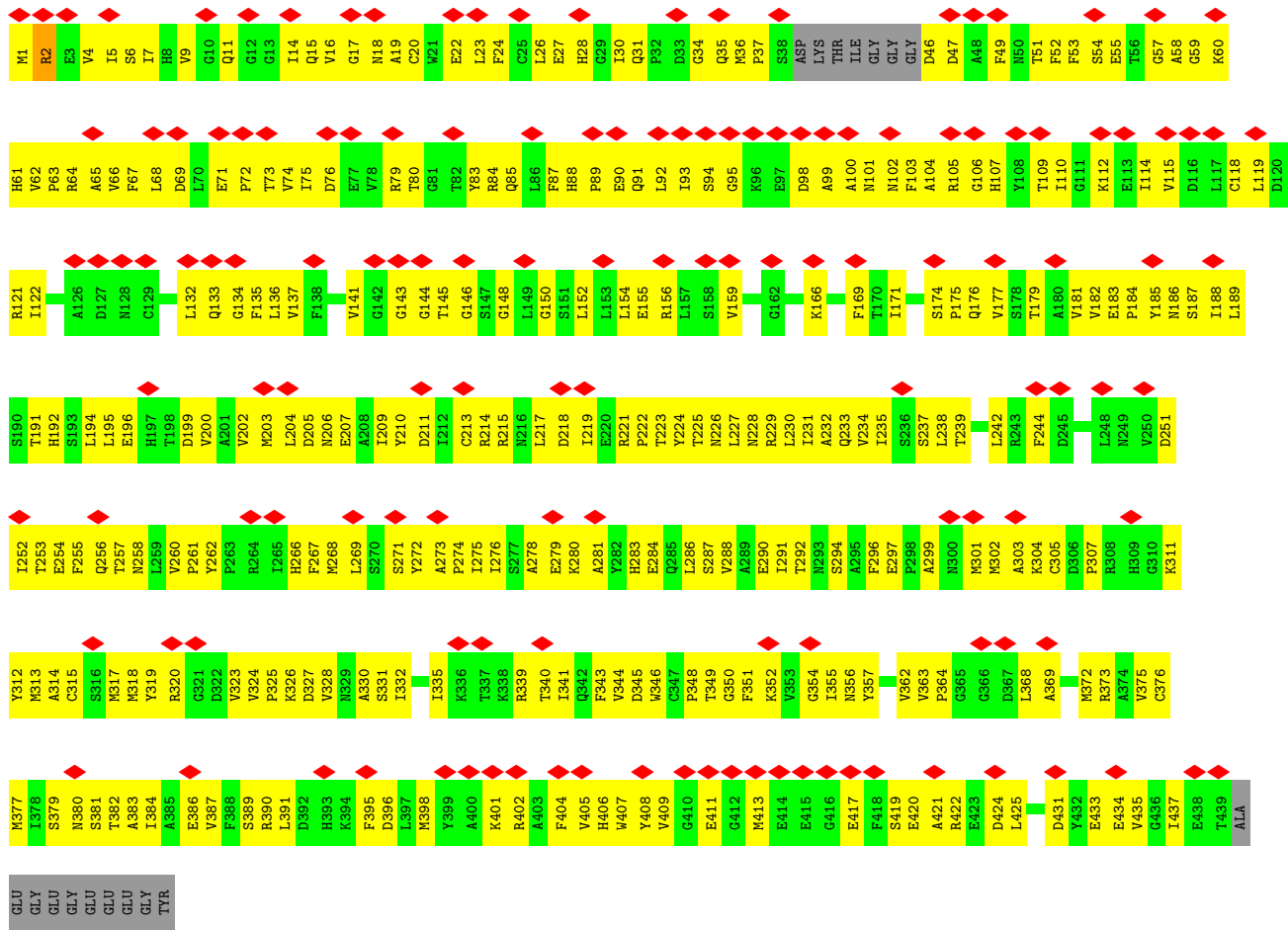

● Molecule 44: Tubulin alpha chain

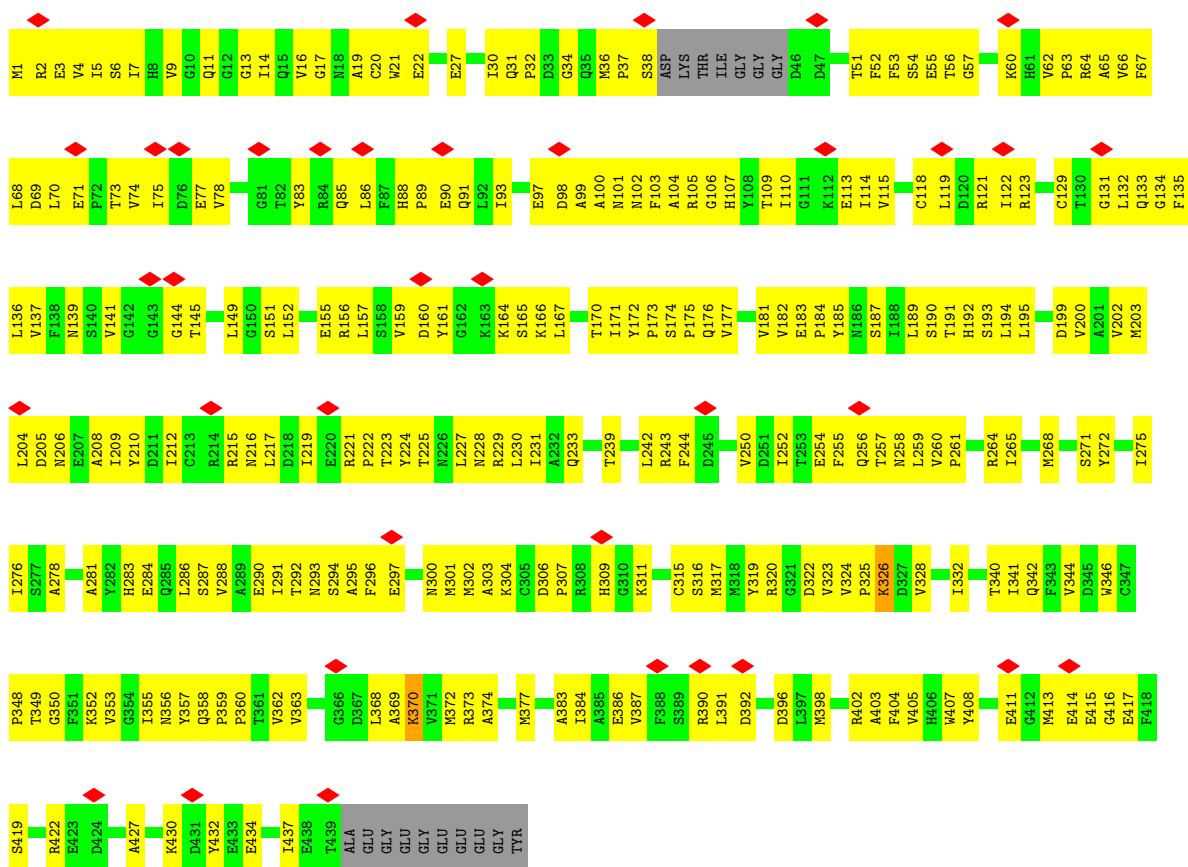

● Molecule 44: Tubulin alpha chain

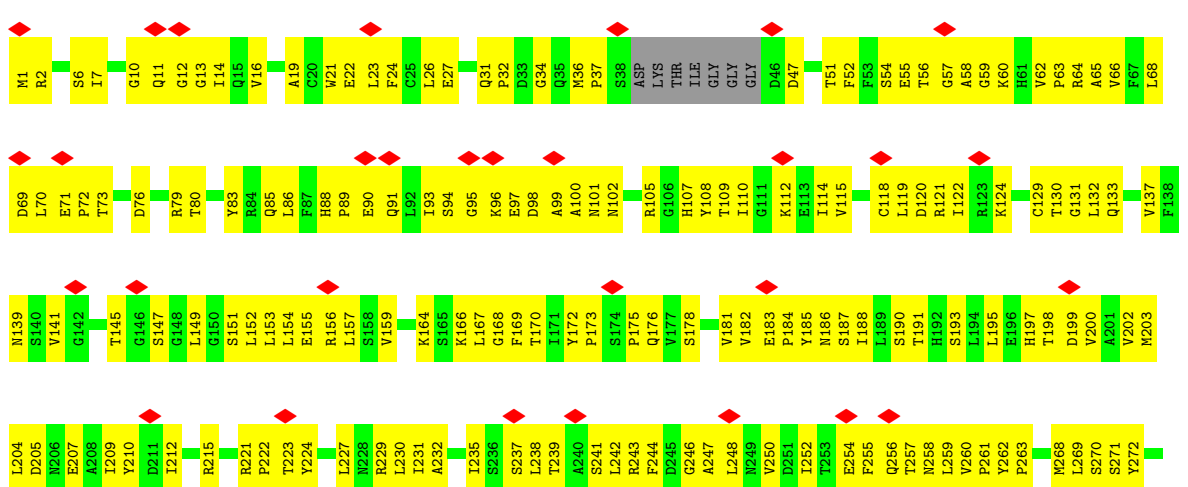



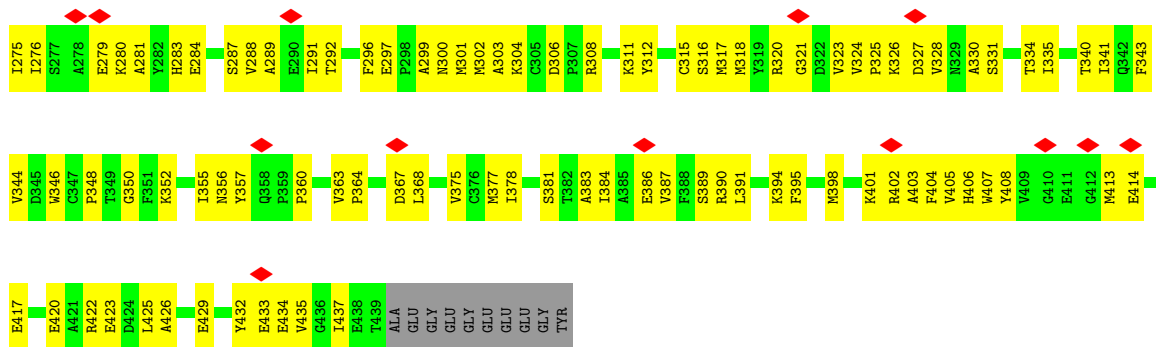

• Molecule 44: Tubulin alpha chain

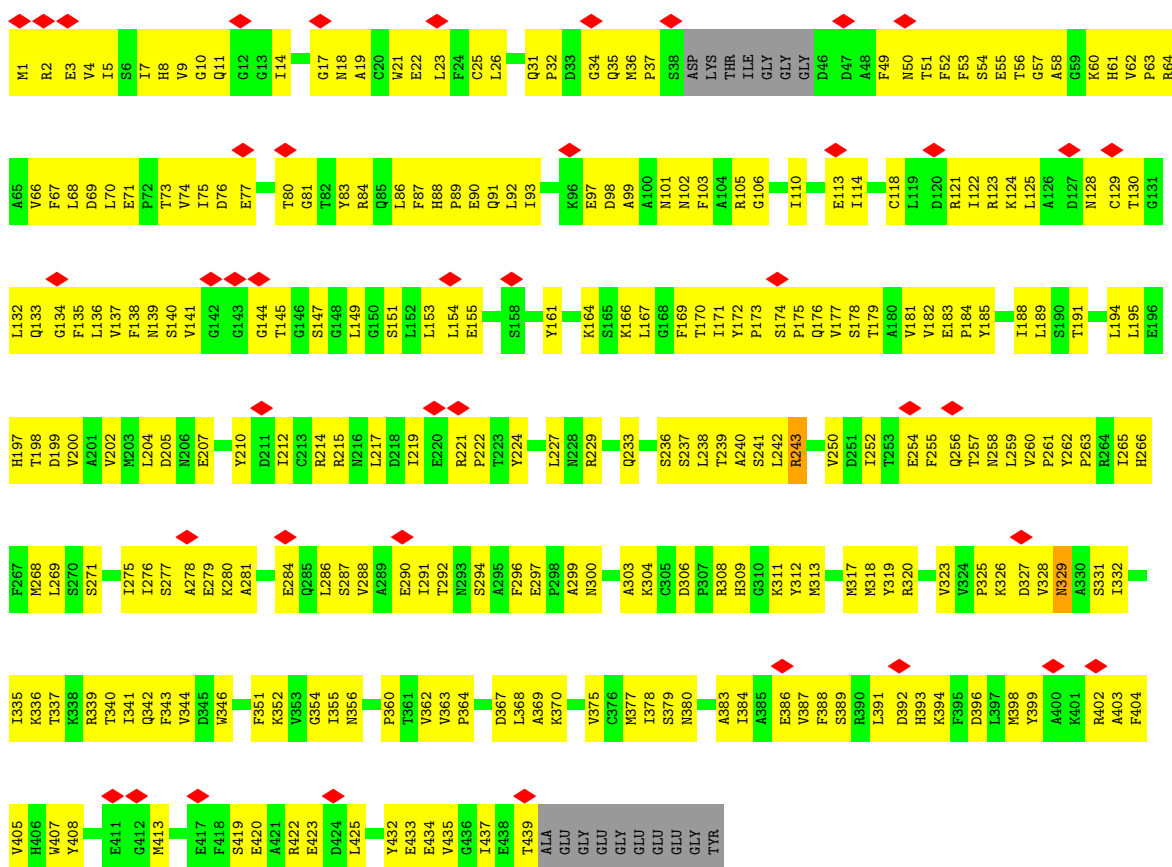

• Molecule 44: Tubulin alpha chain

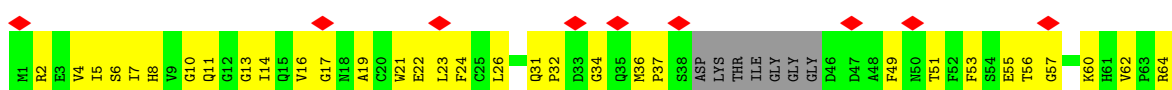

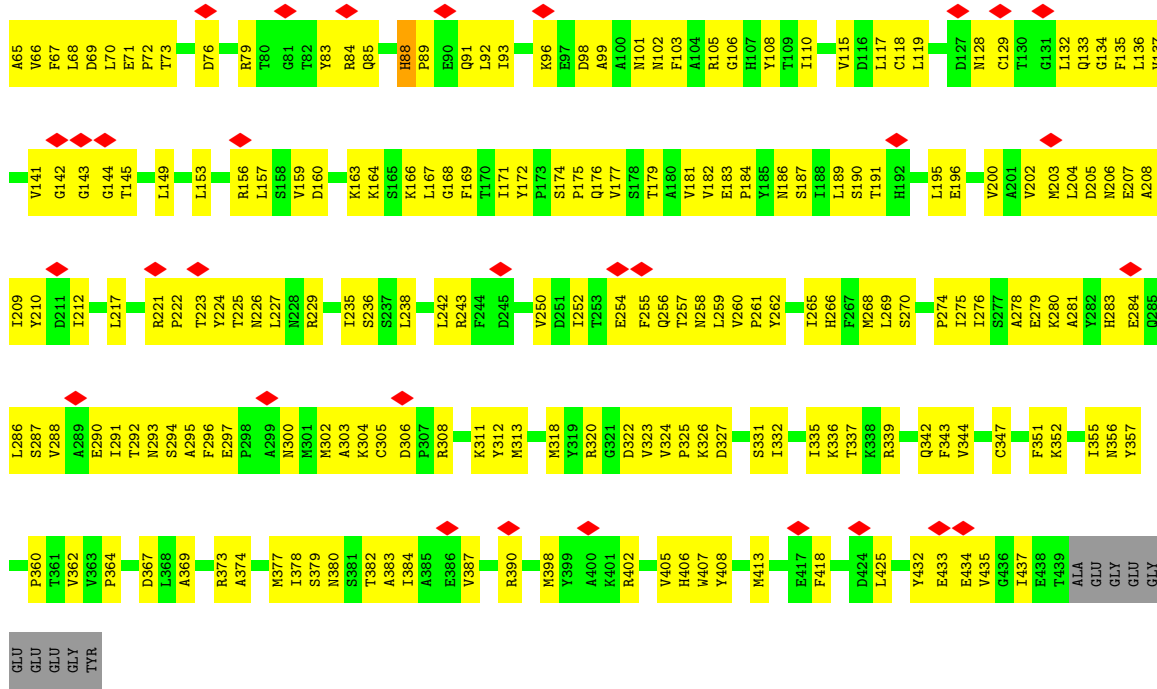

• Molecule 44: Tubulin alpha chain

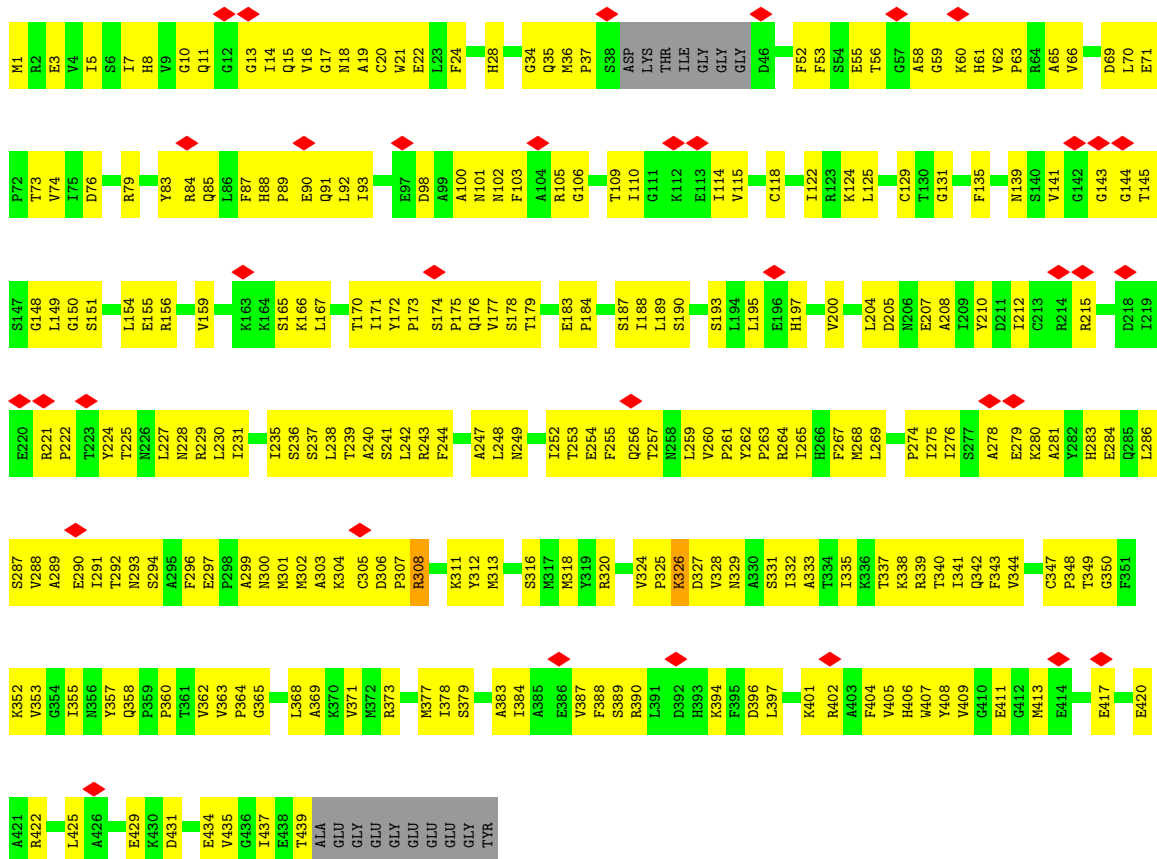

• Molecule 44: Tubulin alpha chain

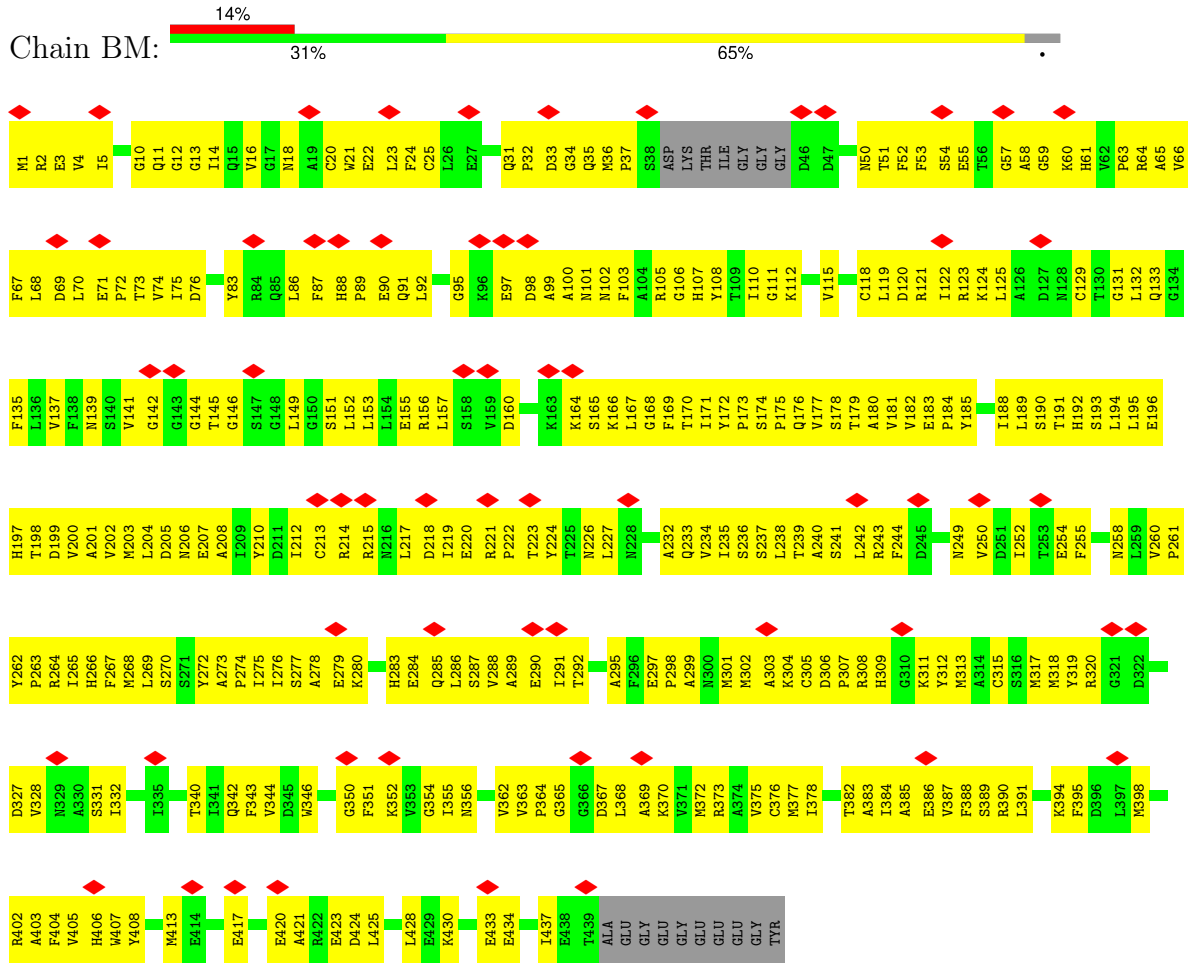

• Molecule 44: Tubulin alpha chain

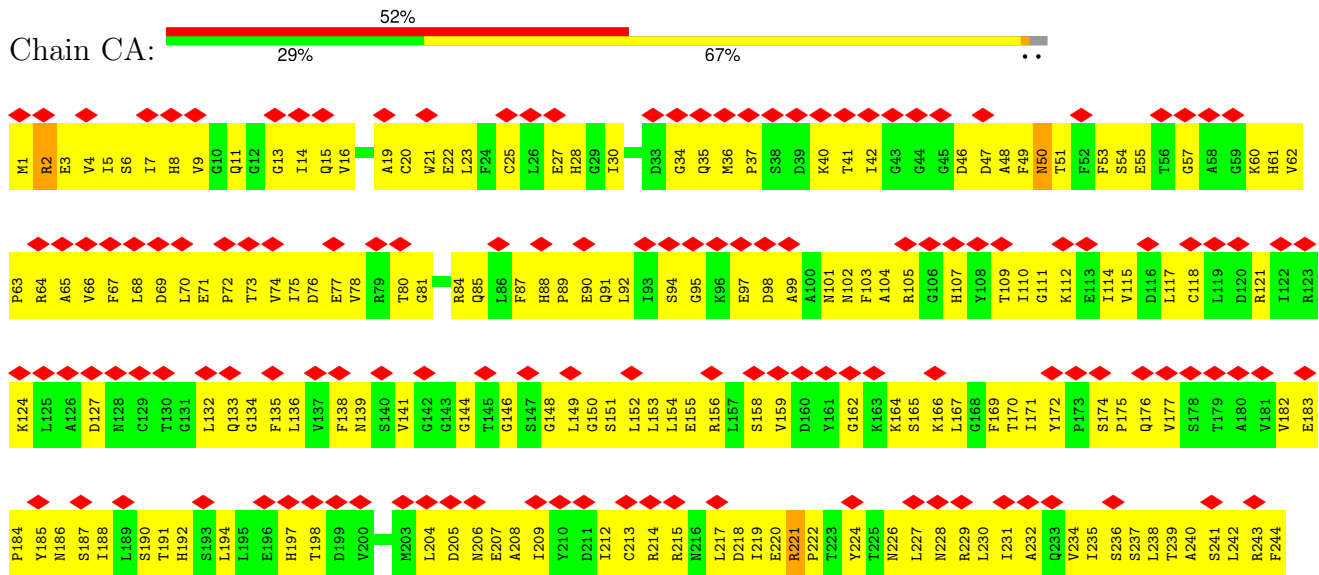

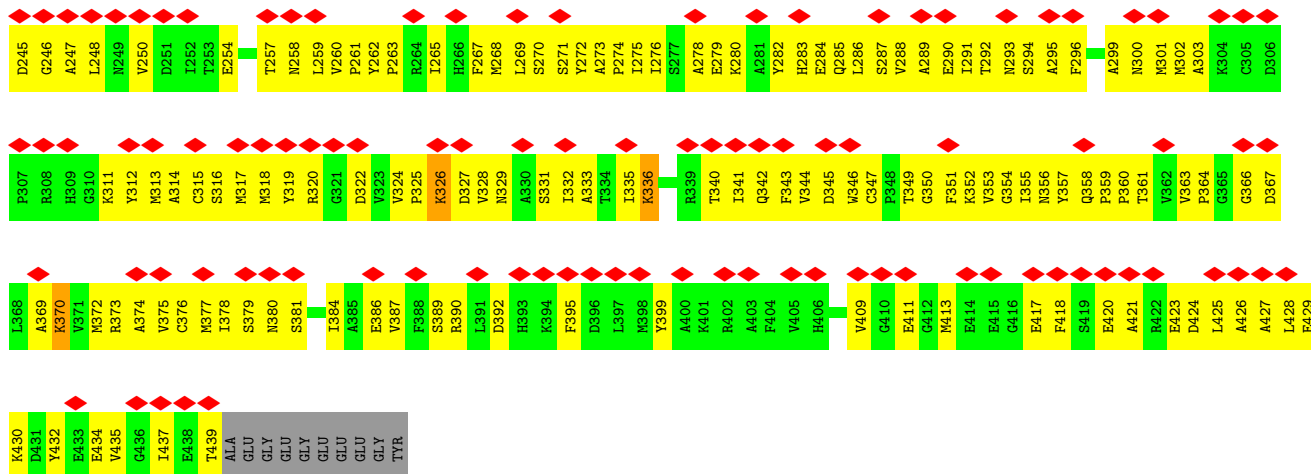

• Molecule 44: Tubulin alpha chain

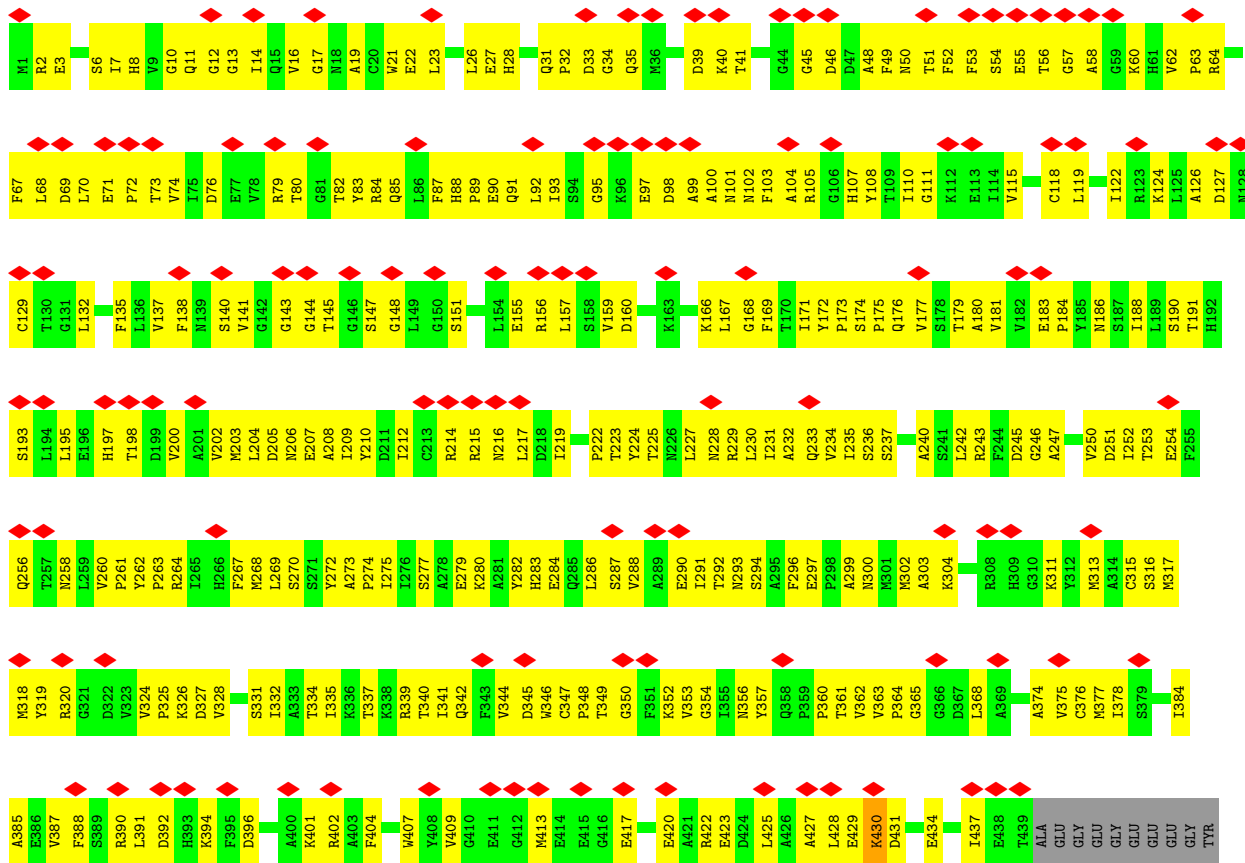

• Molecule 44: Tubulin alpha chain



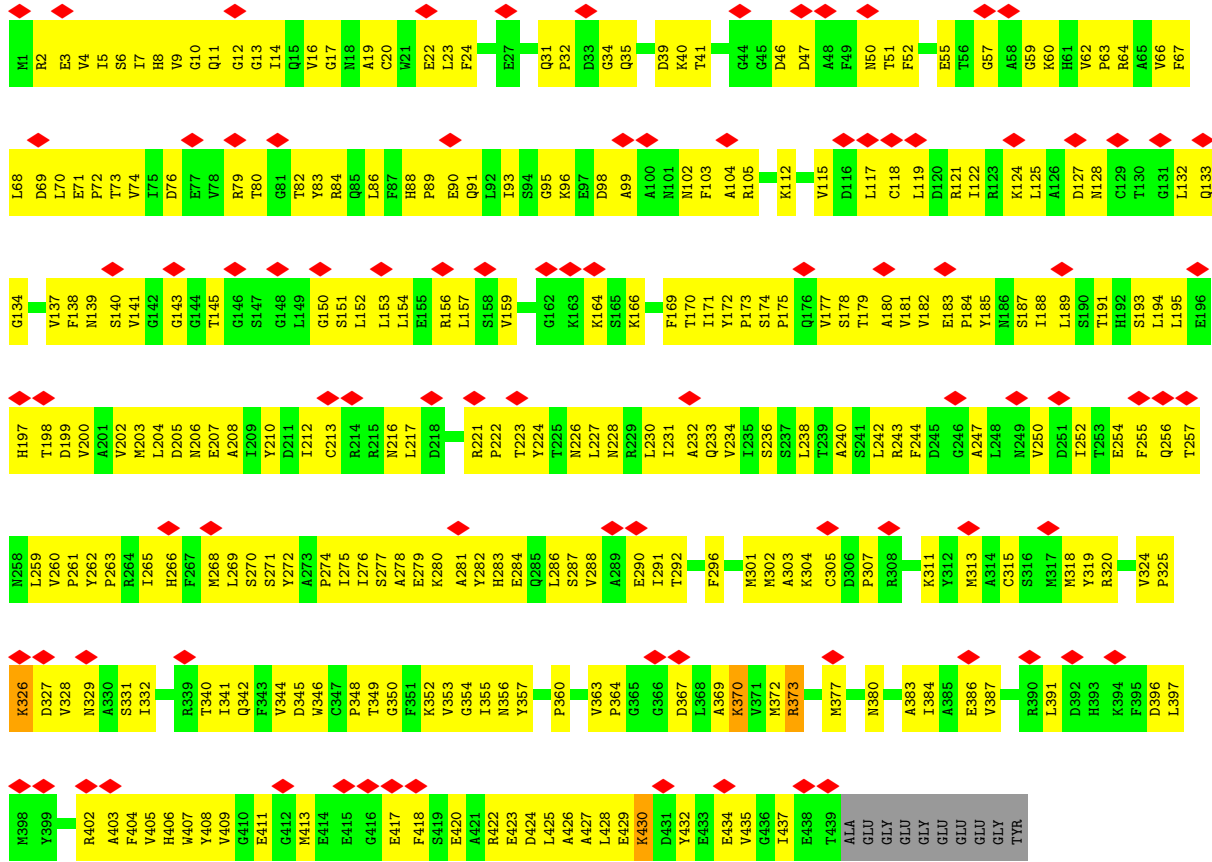

• Molecule 44: Tubulin alpha chain

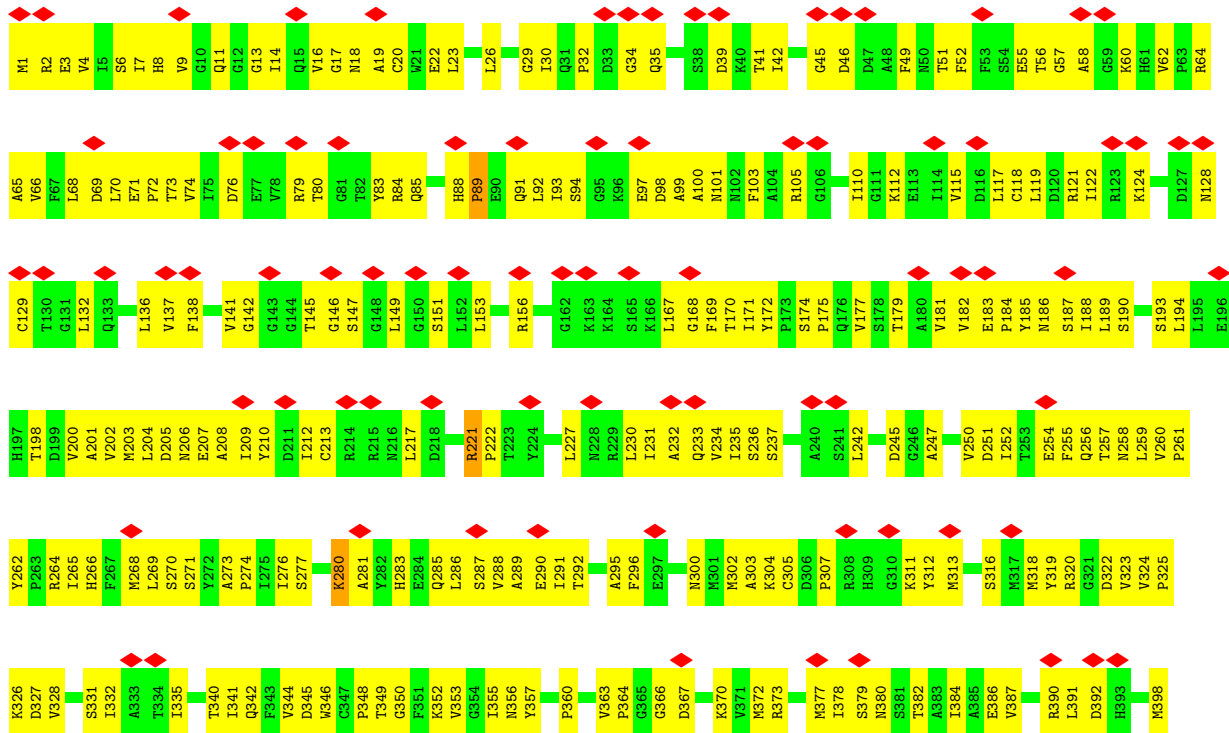

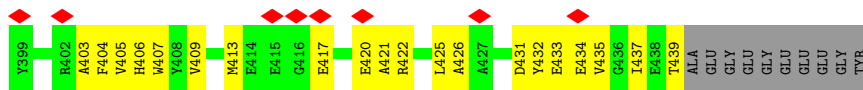

• Molecule 44: Tubulin alpha chain

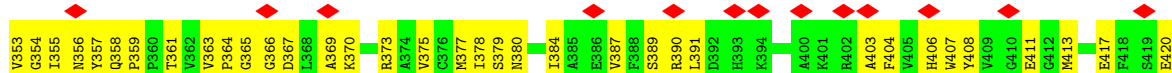

• Molecule 44: Tubulin alpha chain

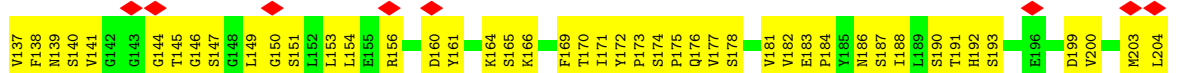
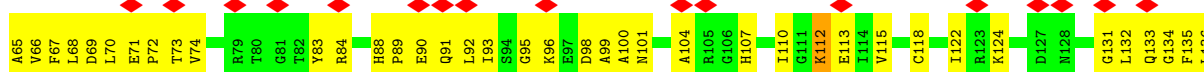
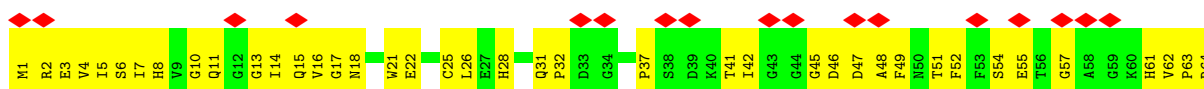

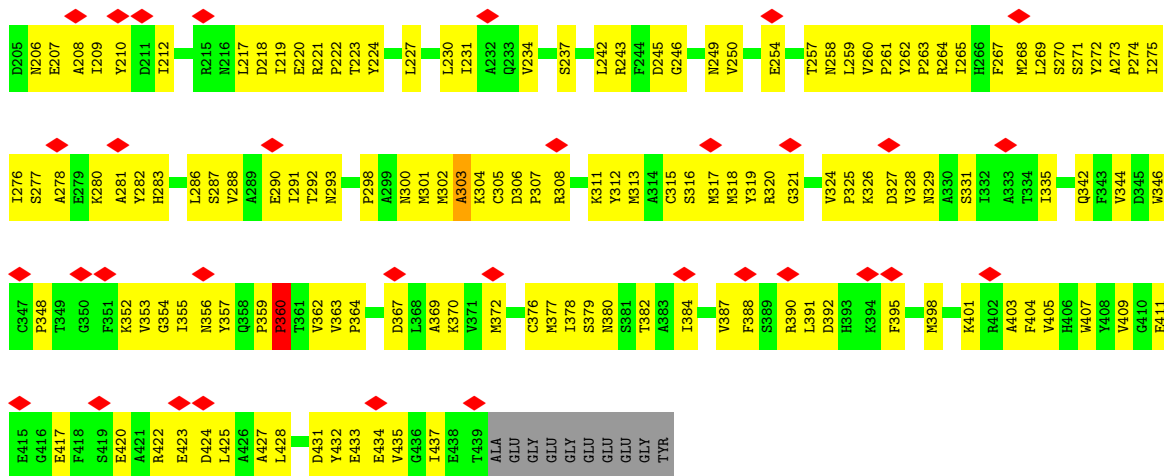

• Molecule 44: Tubulin alpha chain

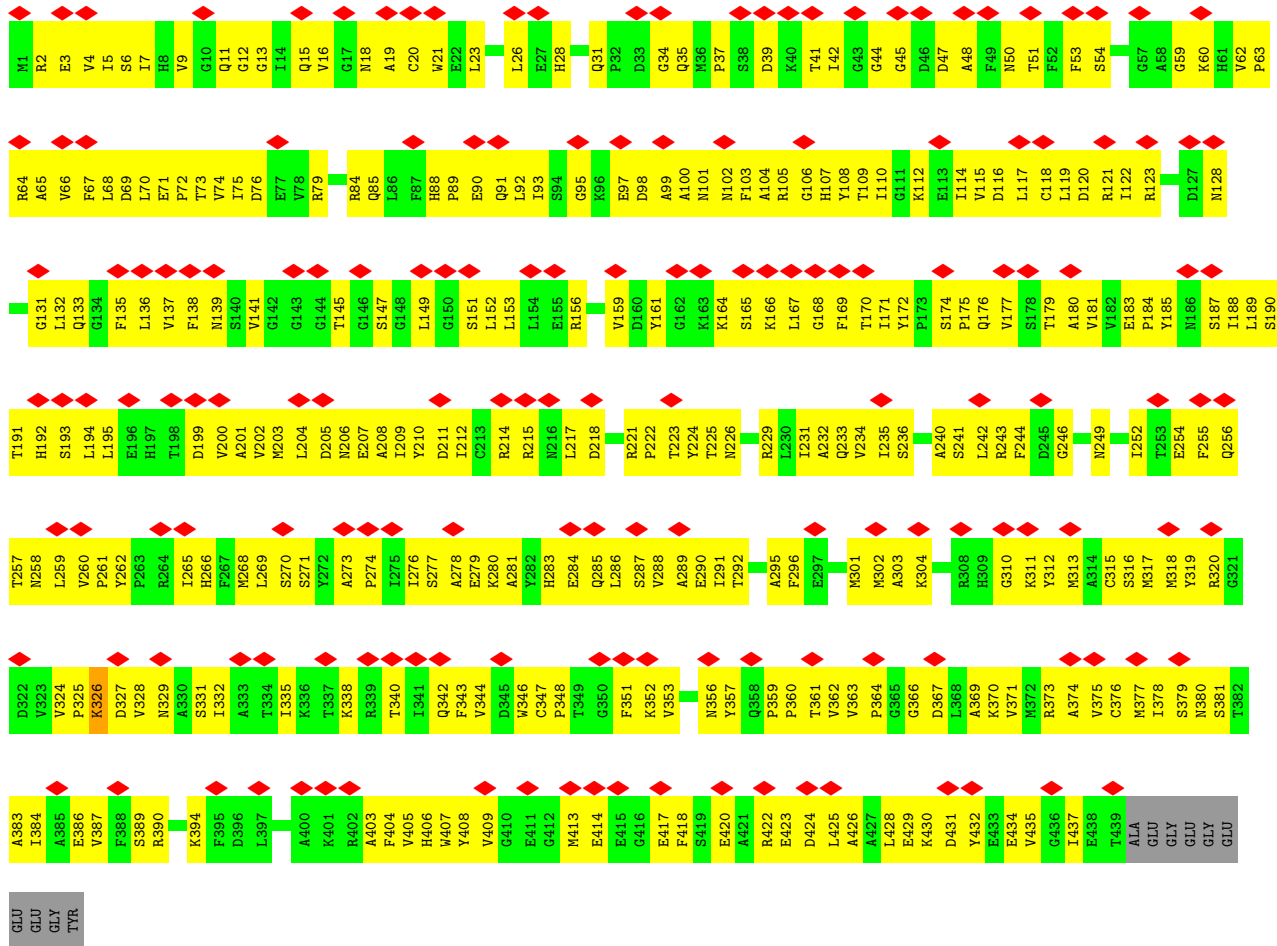

• Molecule 44: Tubulin alpha chain



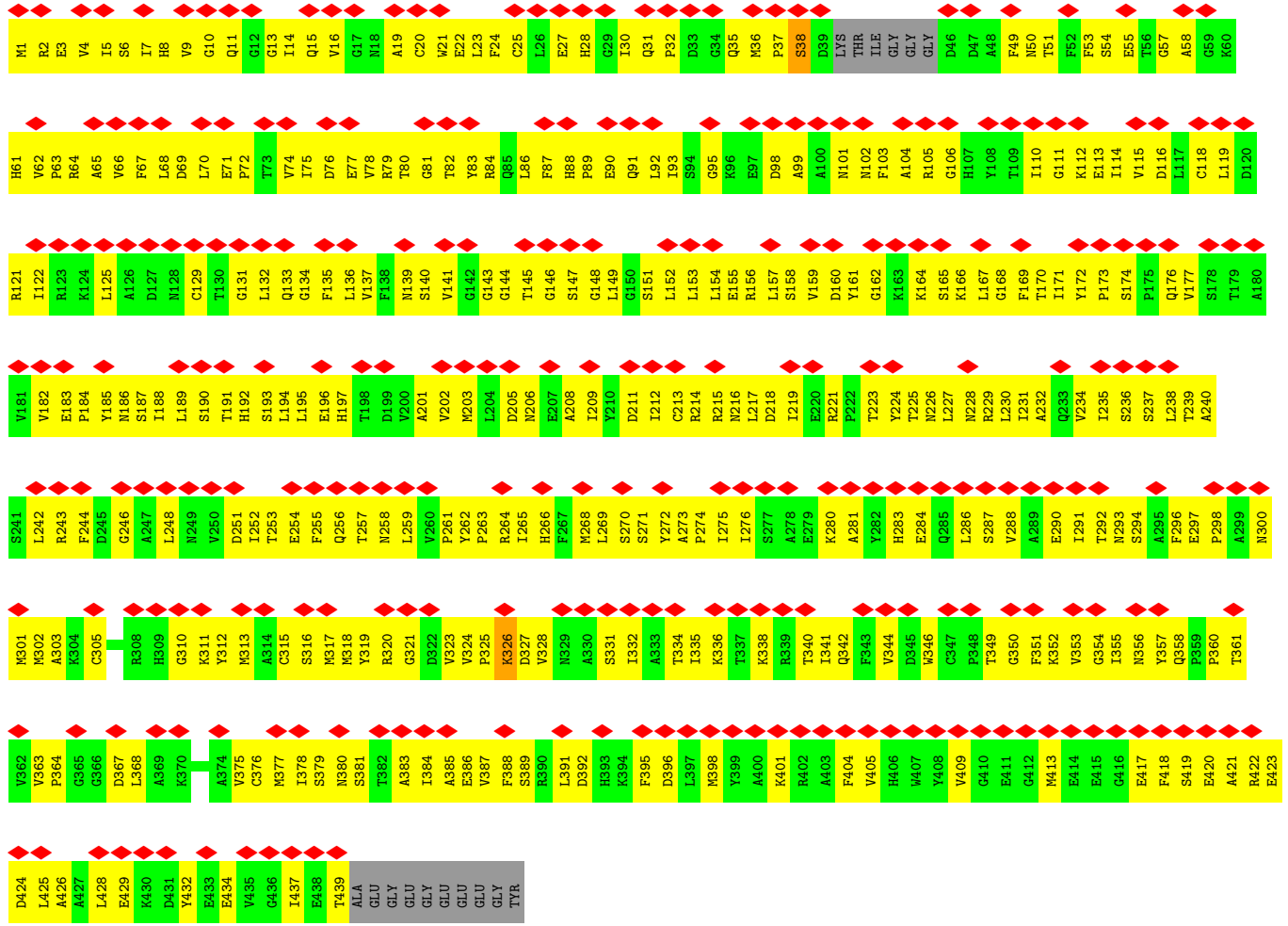

● Molecule 44: Tubulin alpha chain

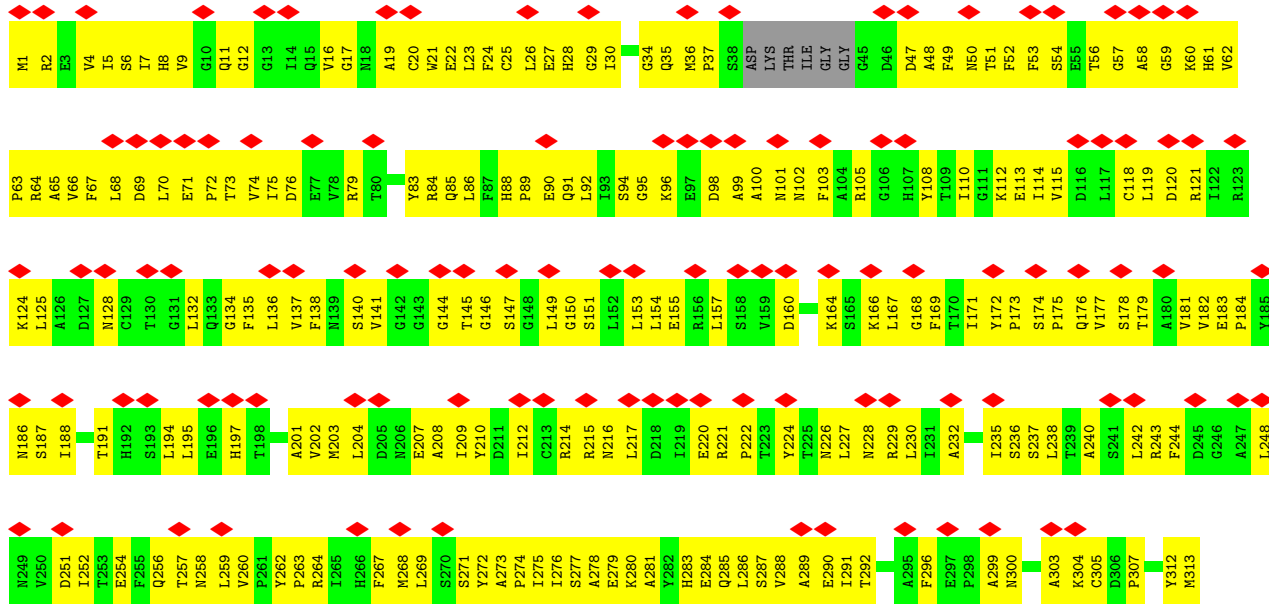



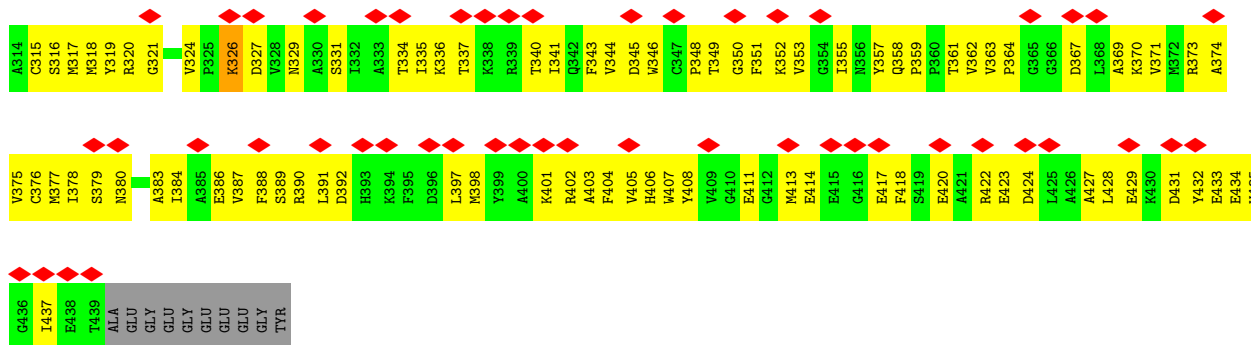

• Molecule 44: Tubulin alpha chain

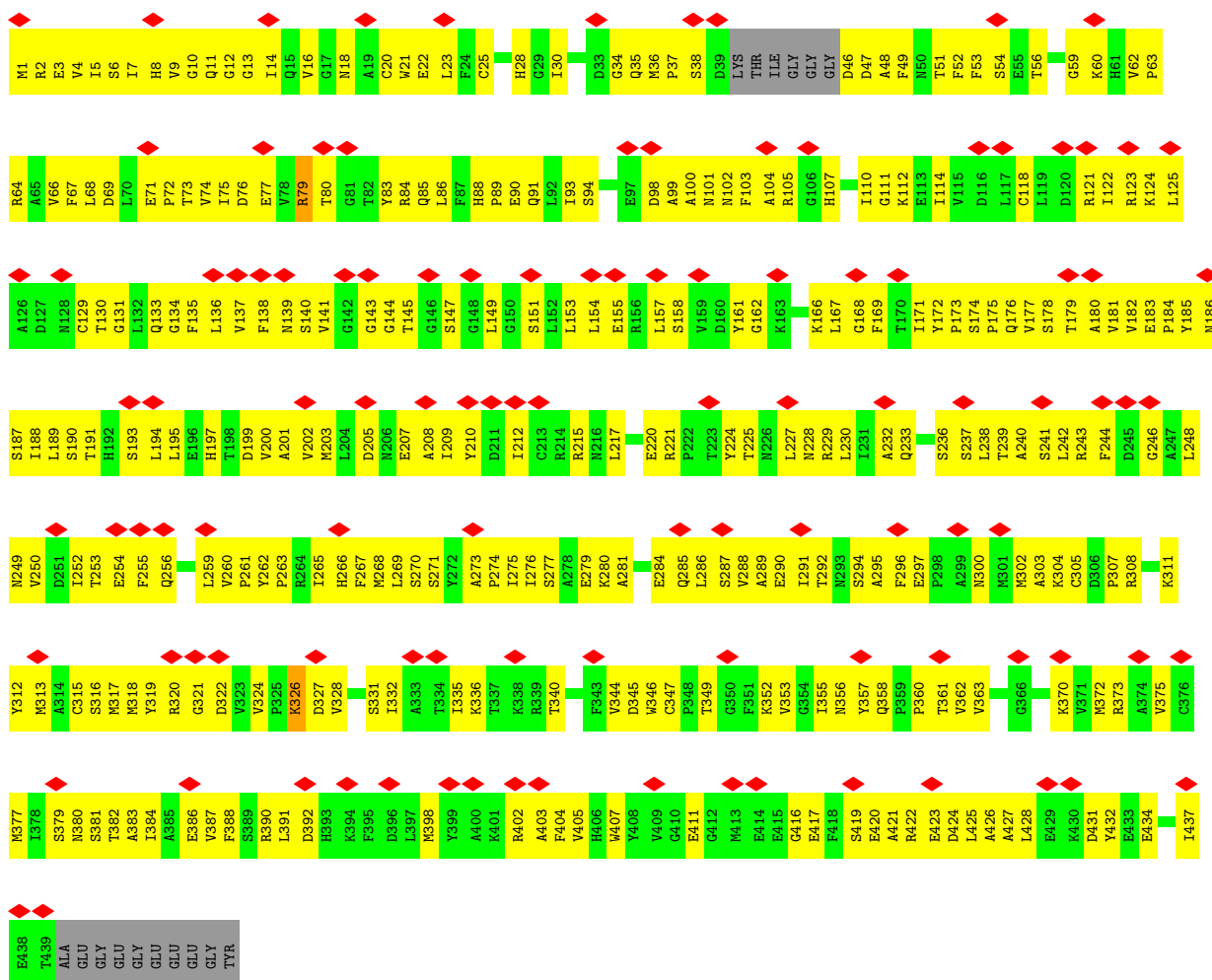

• Molecule 44: Tubulin alpha chain



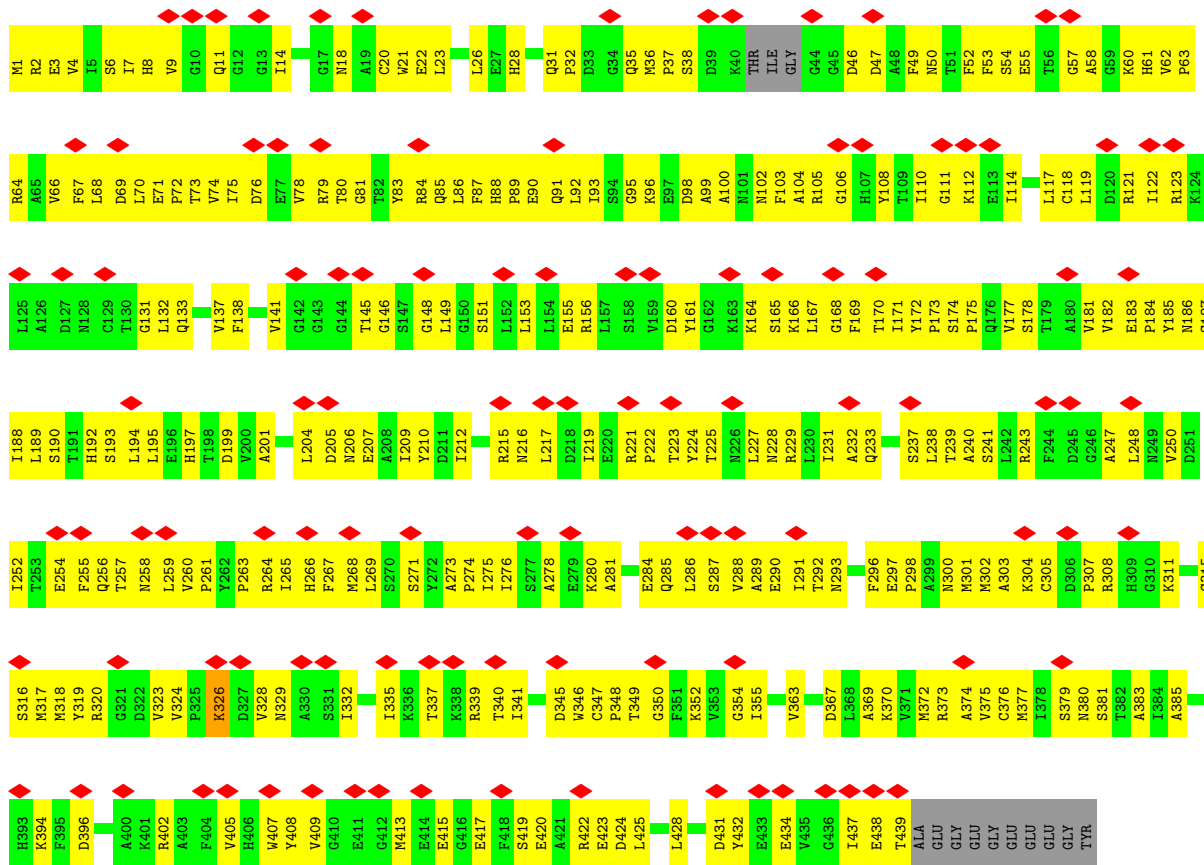

• Molecule 44: Tubulin alpha chain

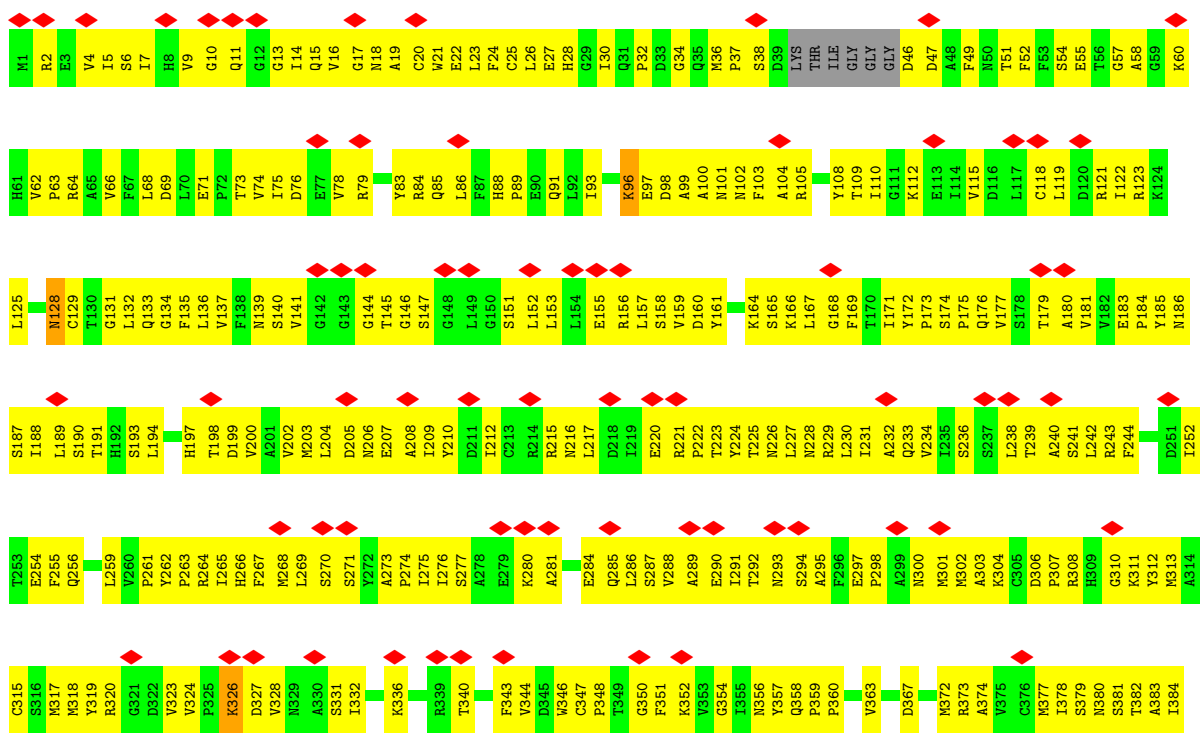

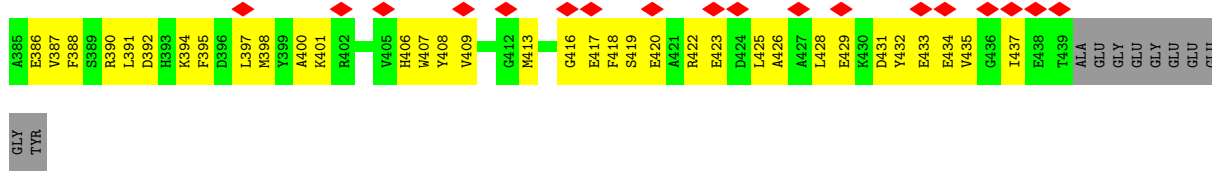

• Molecule 44: Tubulin alpha chain

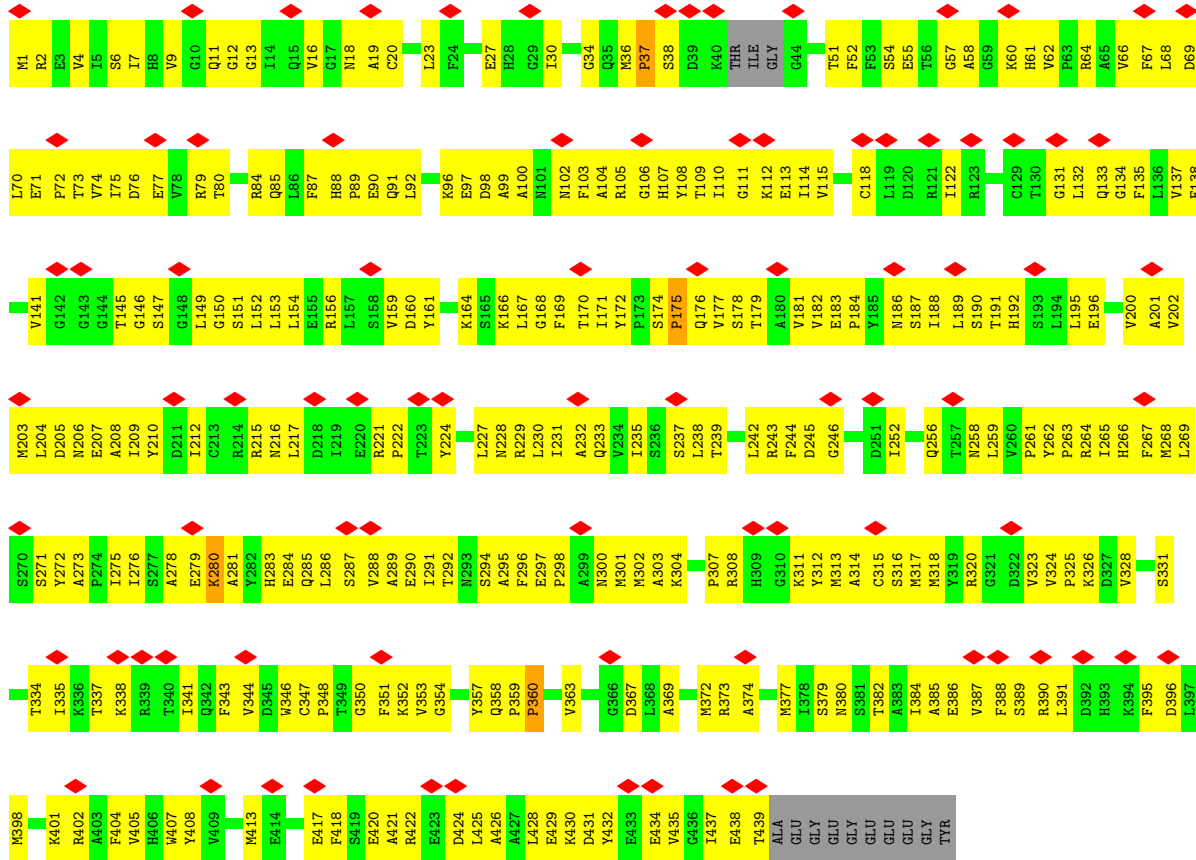

• Molecule 44: Tubulin alpha chain

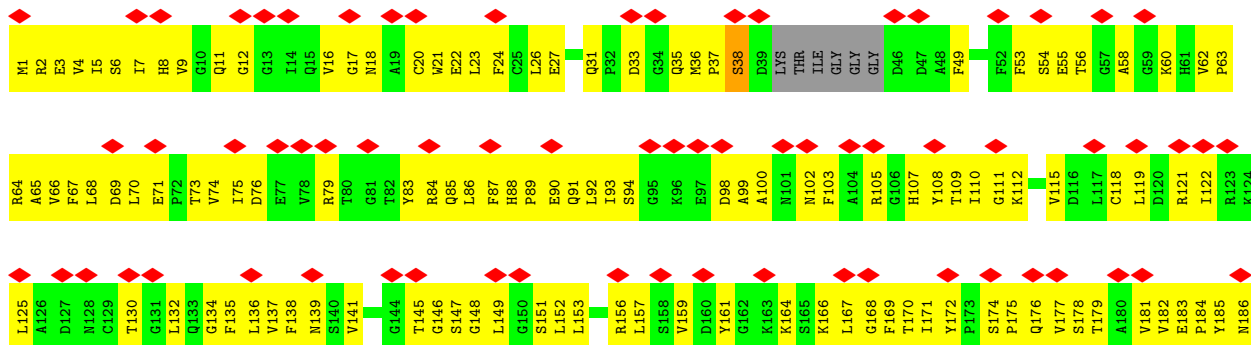

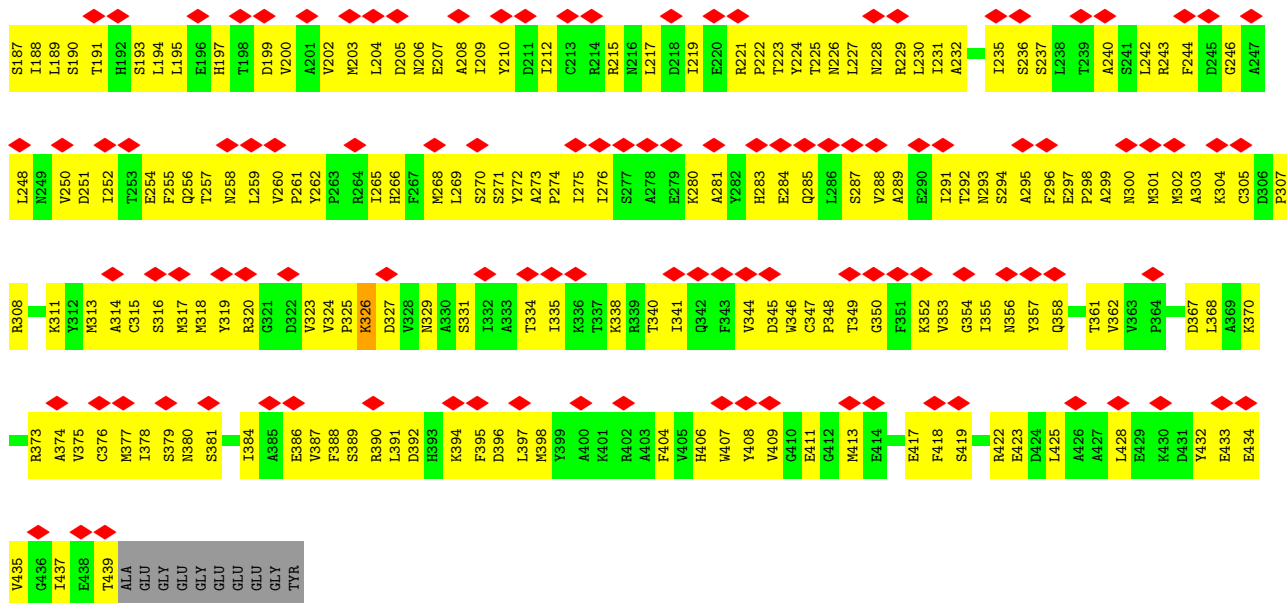

- Molecule 44: Tubulin alpha chain

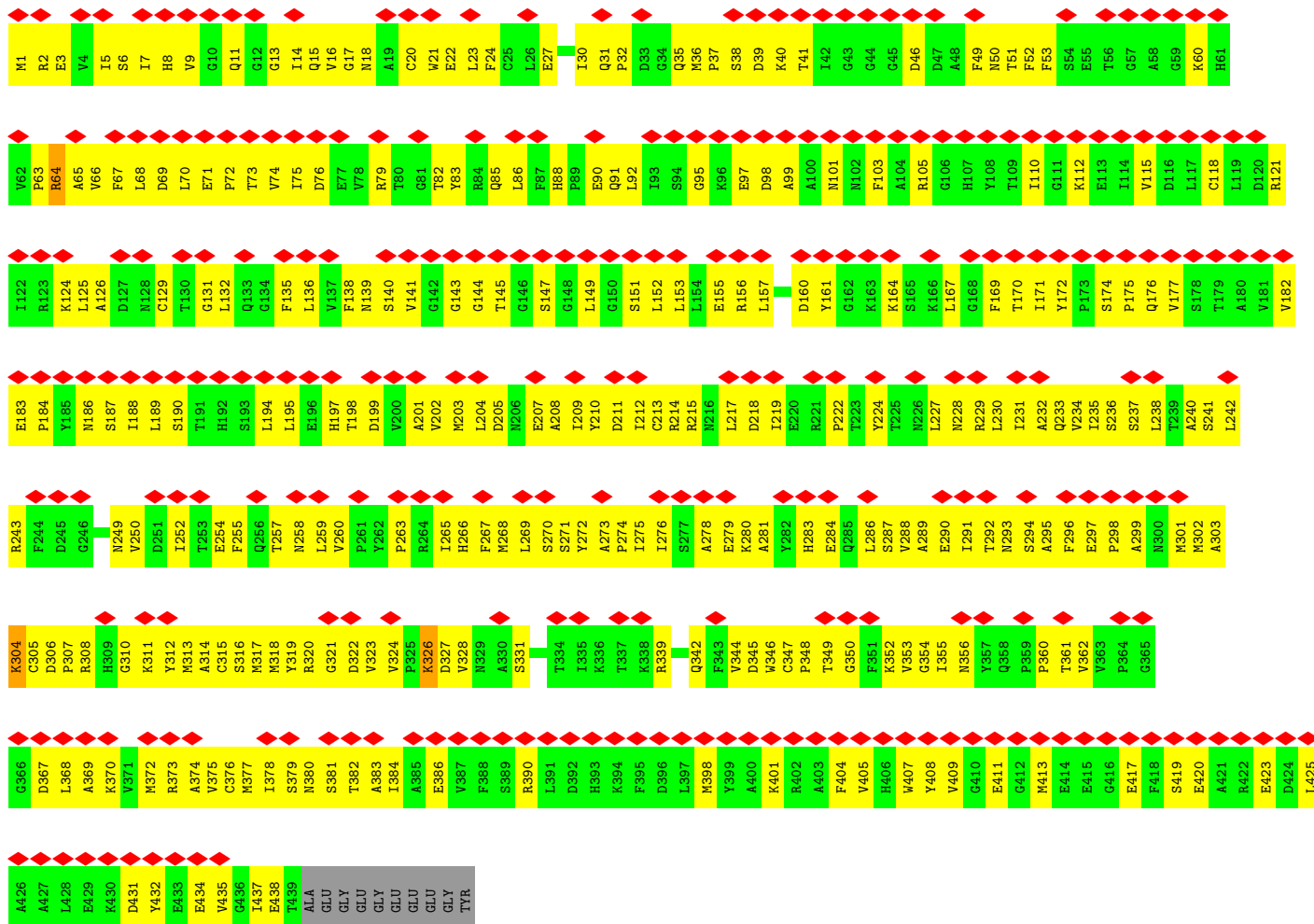

• Molecule 44: Tubulin alpha chain

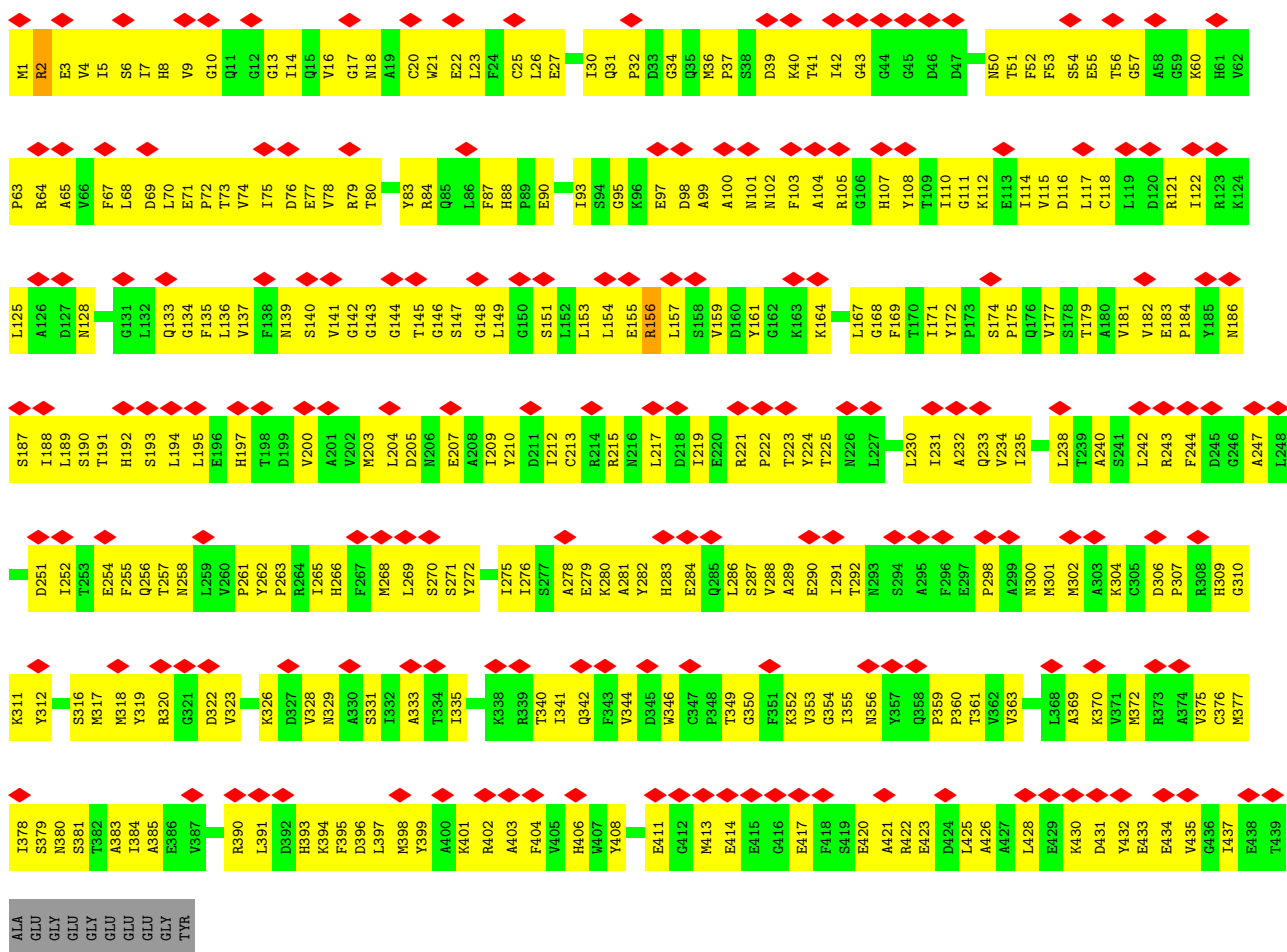

• Molecule 44: Tubulin alpha chain

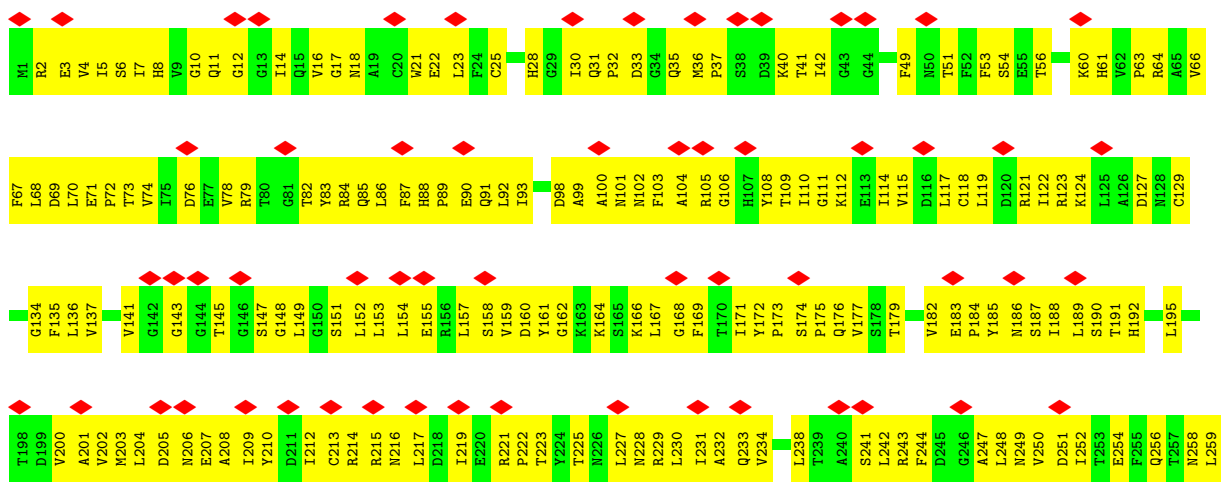
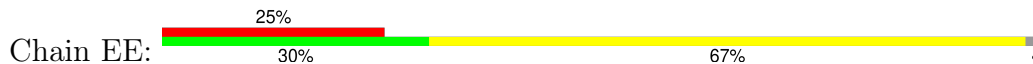

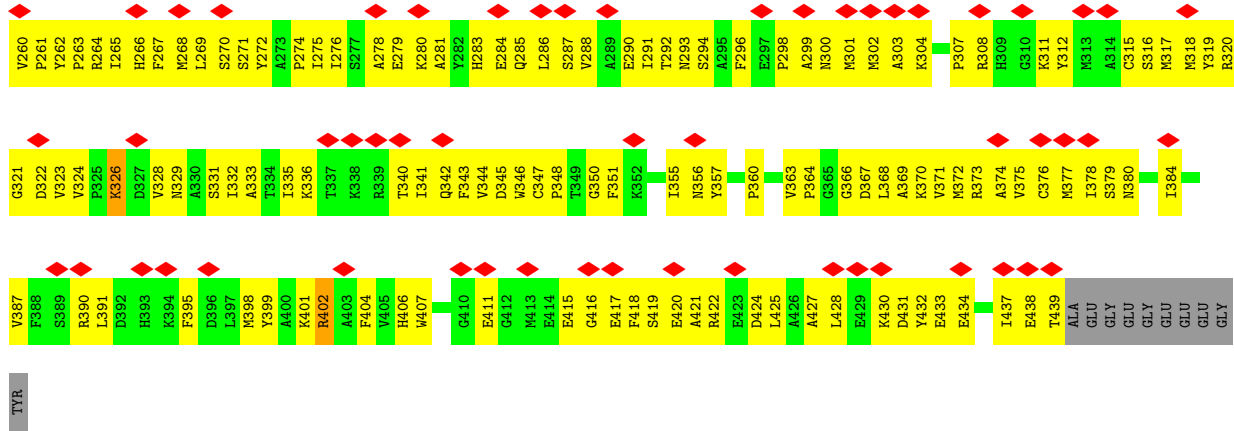

• Molecule 44: Tubulin alpha chain

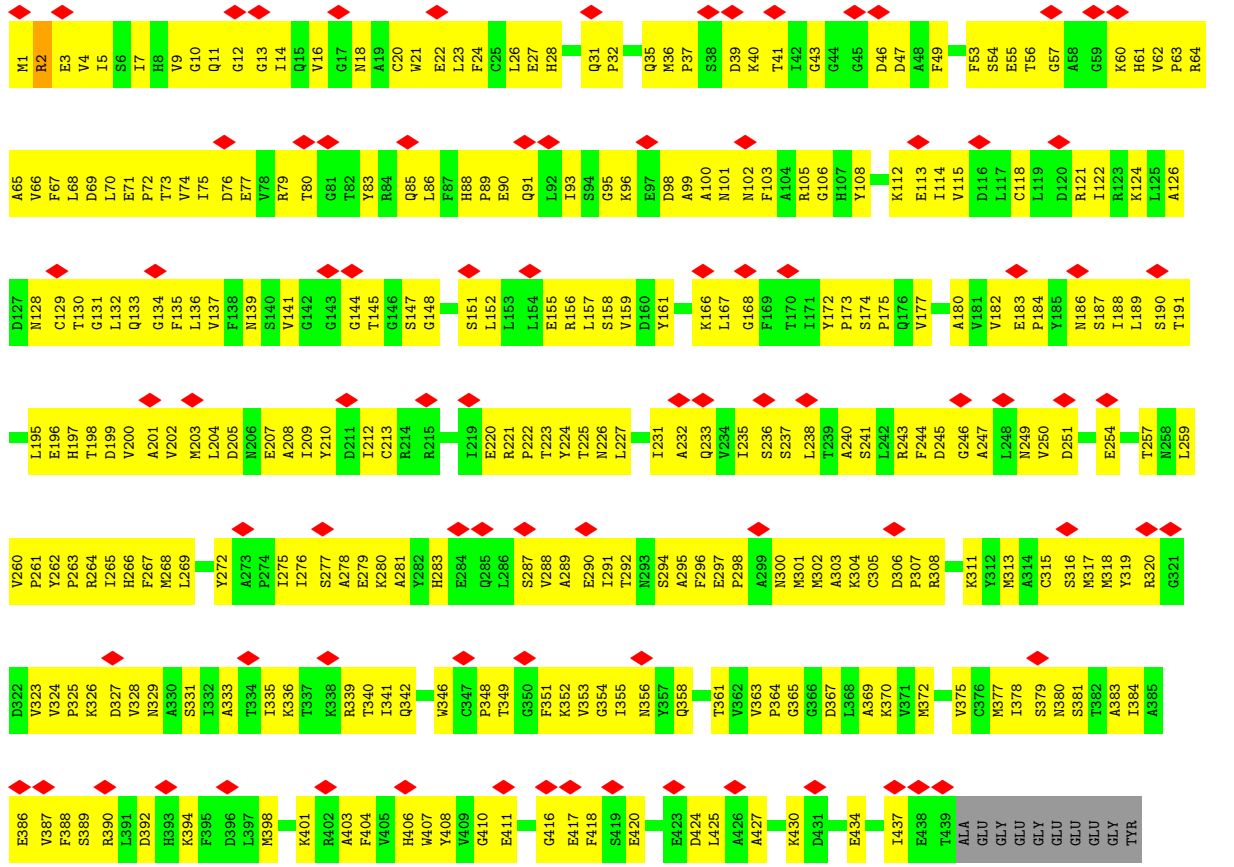

• Molecule 44: Tubulin alpha chain

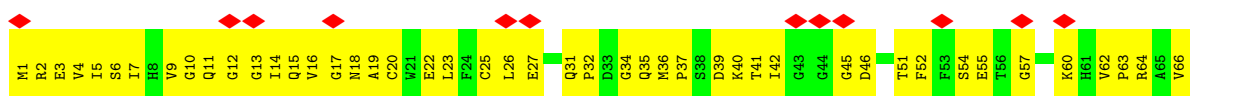

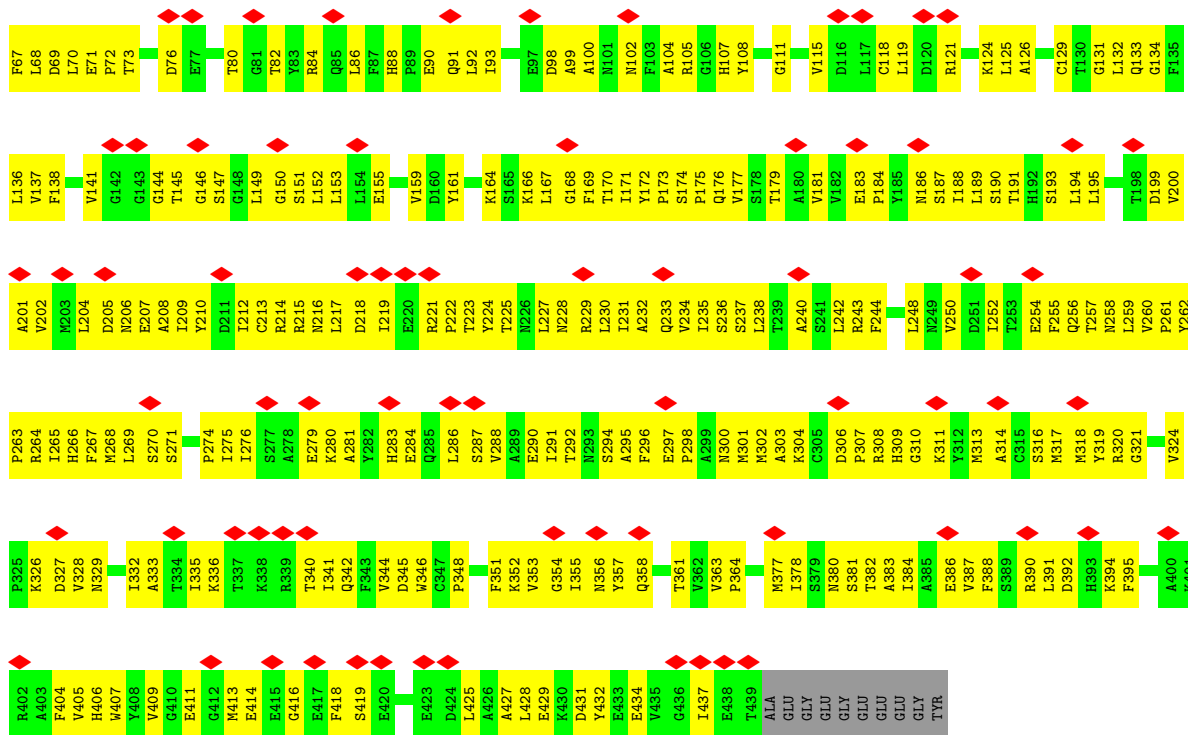

• Molecule 44: Tubulin alpha chain

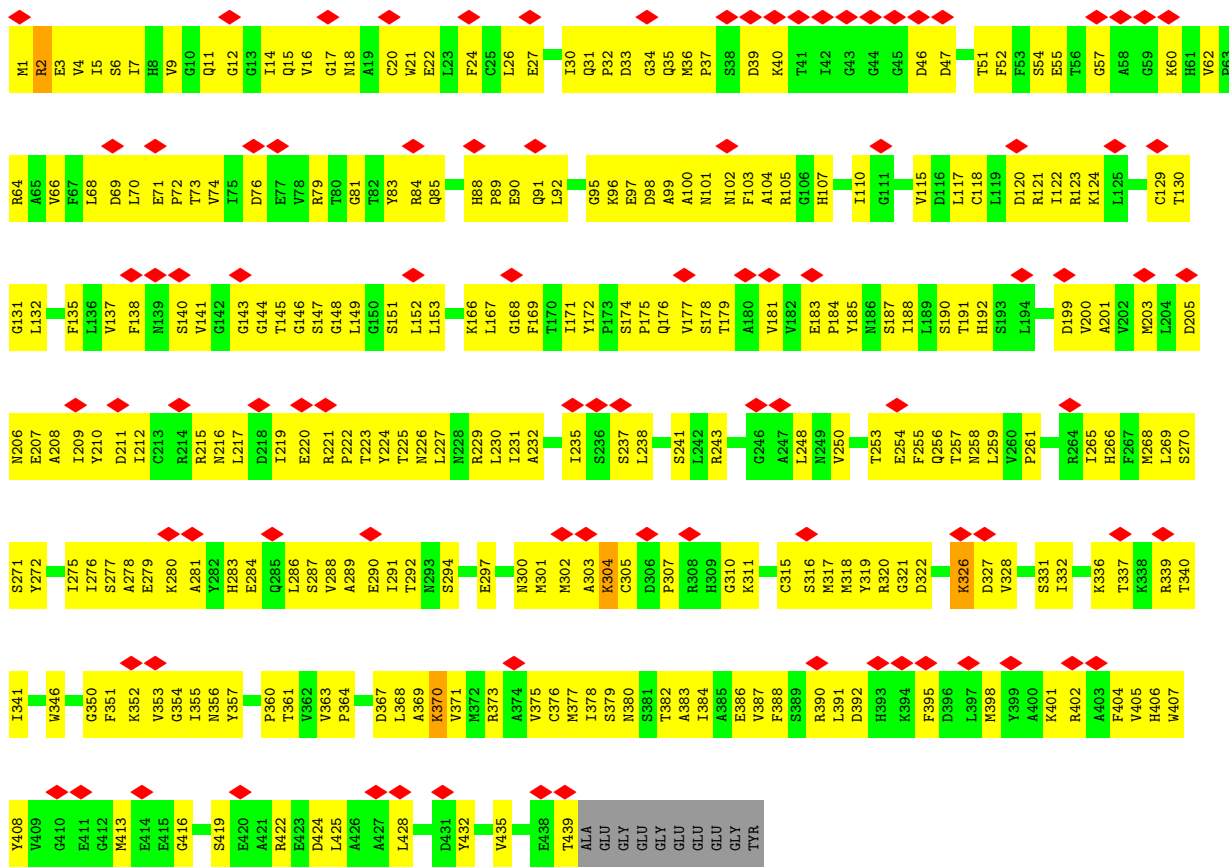

• Molecule 44: Tubulin alpha chain

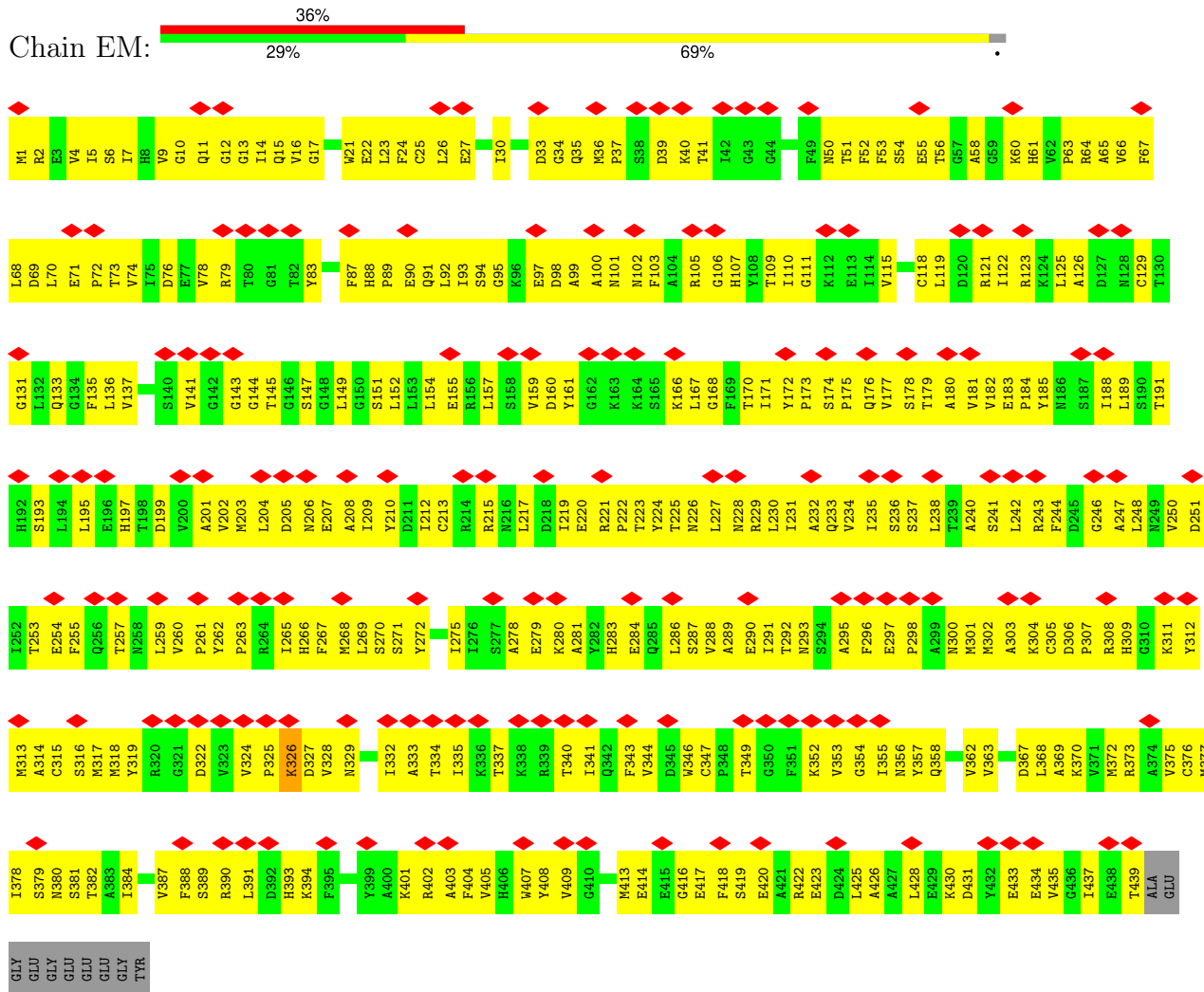

• Molecule 44: Tubulin alpha chain

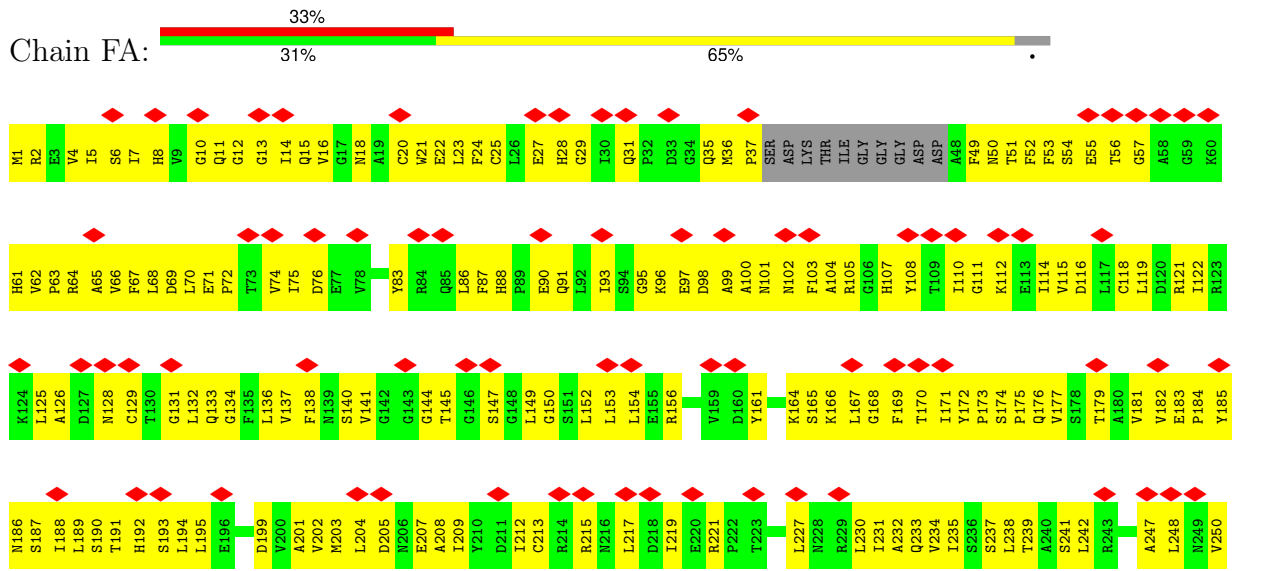





• Molecule 44: Tubulin alpha chain

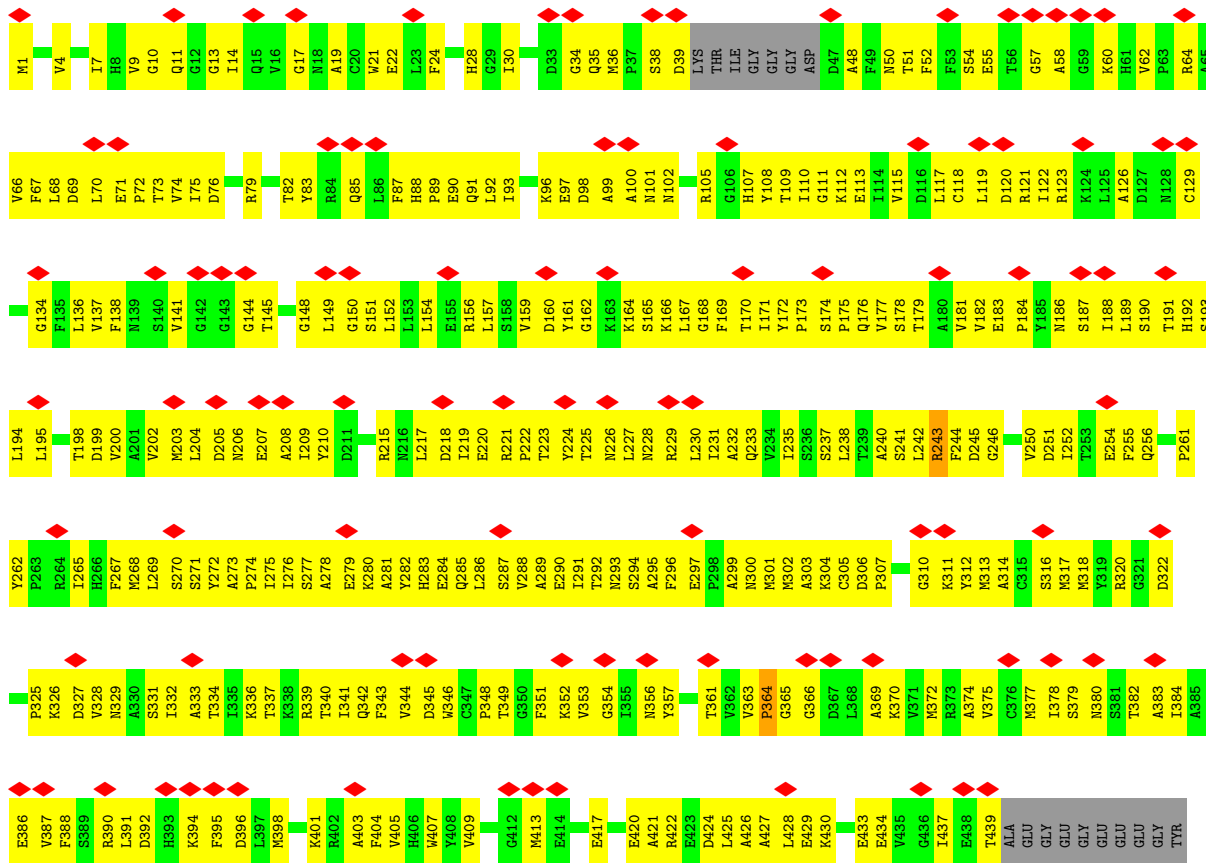

• Molecule 44: Tubulin alpha chain



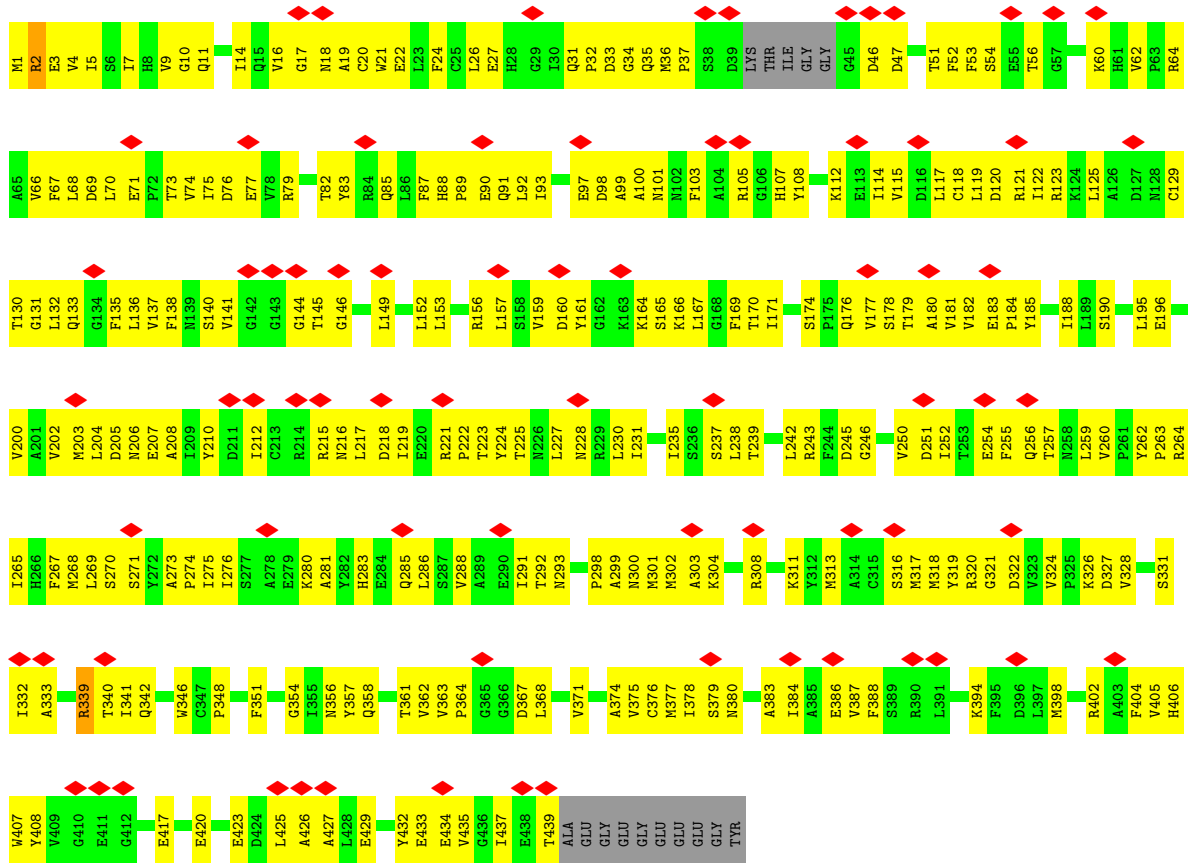

• Molecule 44: Tubulin alpha chain

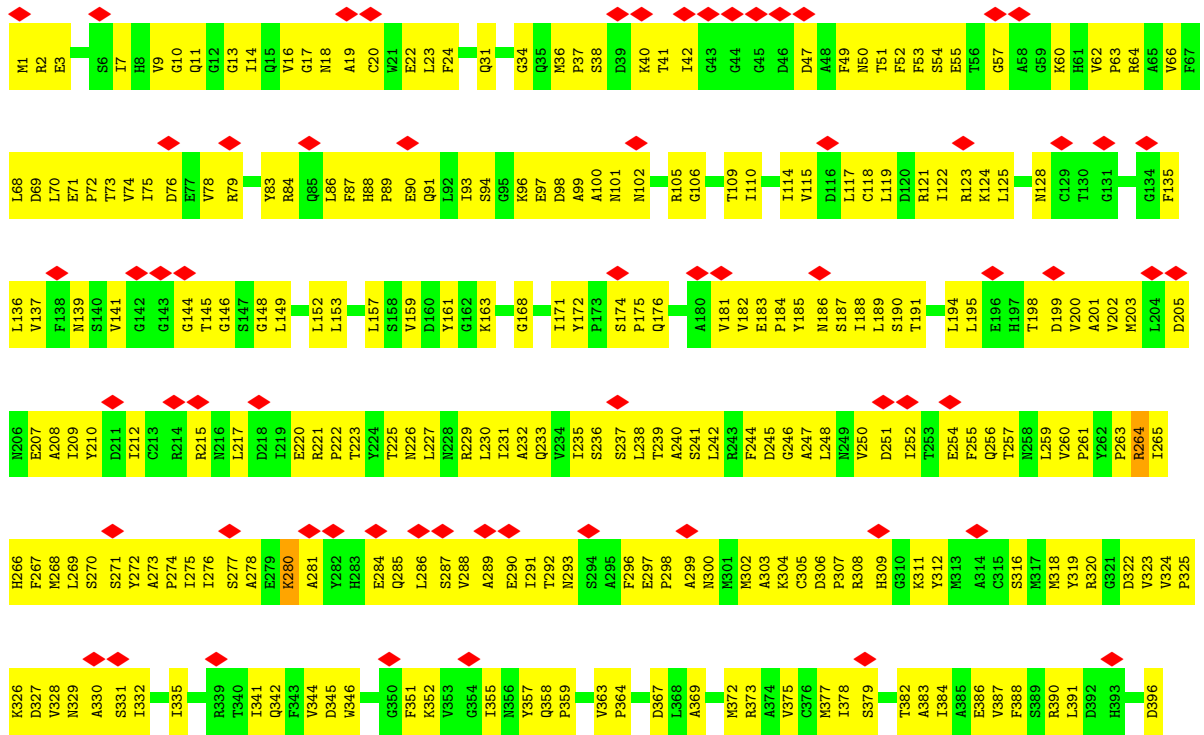



• Molecule 44: Tubulin alpha chain

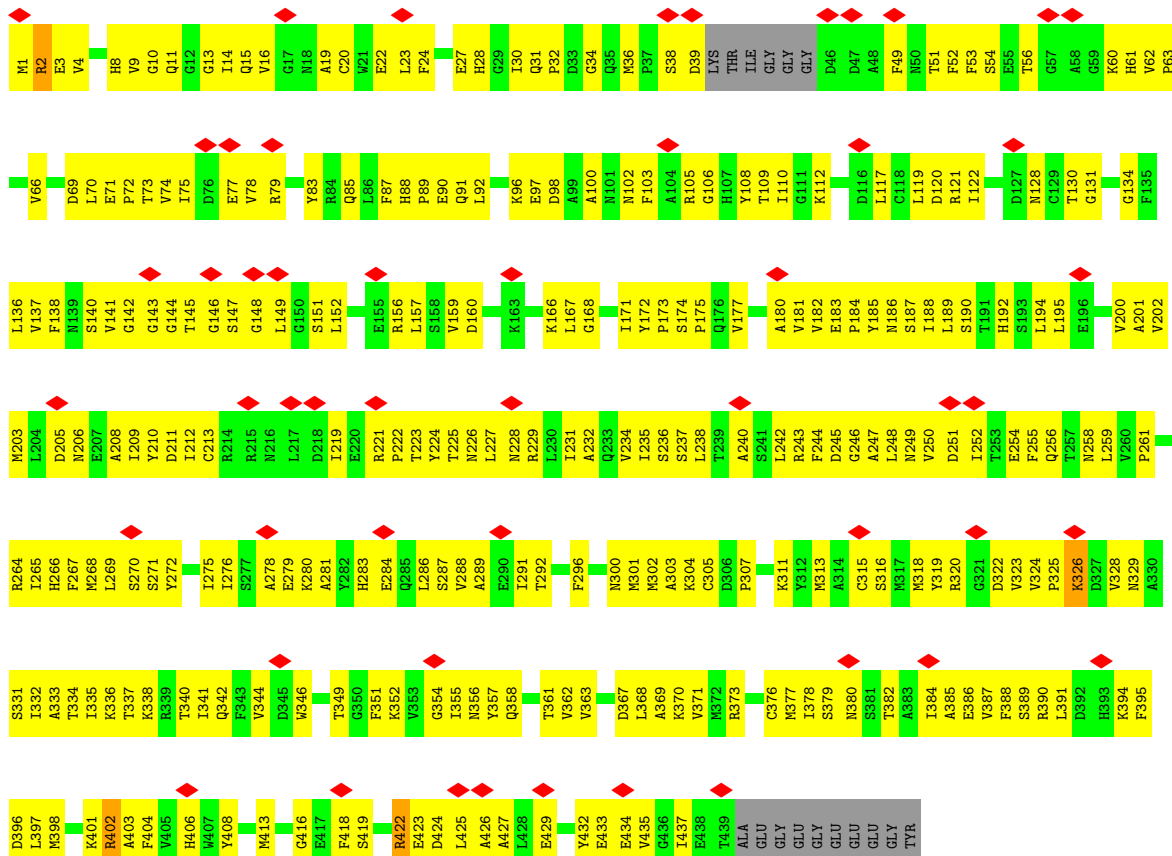

• Molecule 44: Tubulin alpha chain

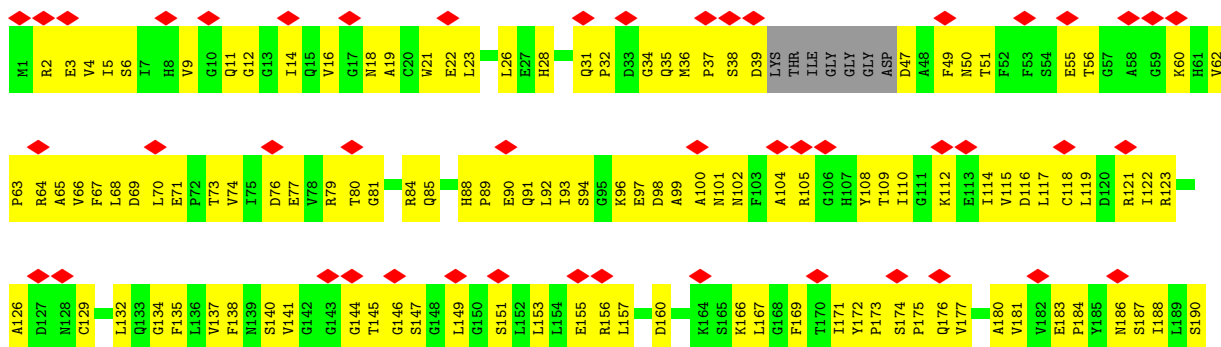

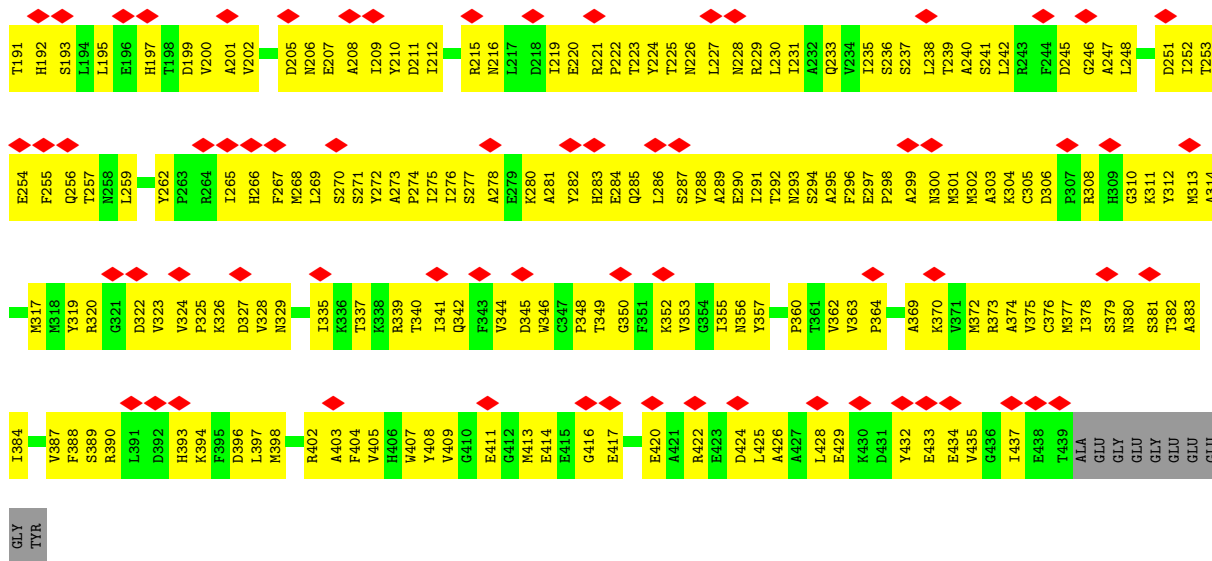

• Molecule 44: Tubulin alpha chain

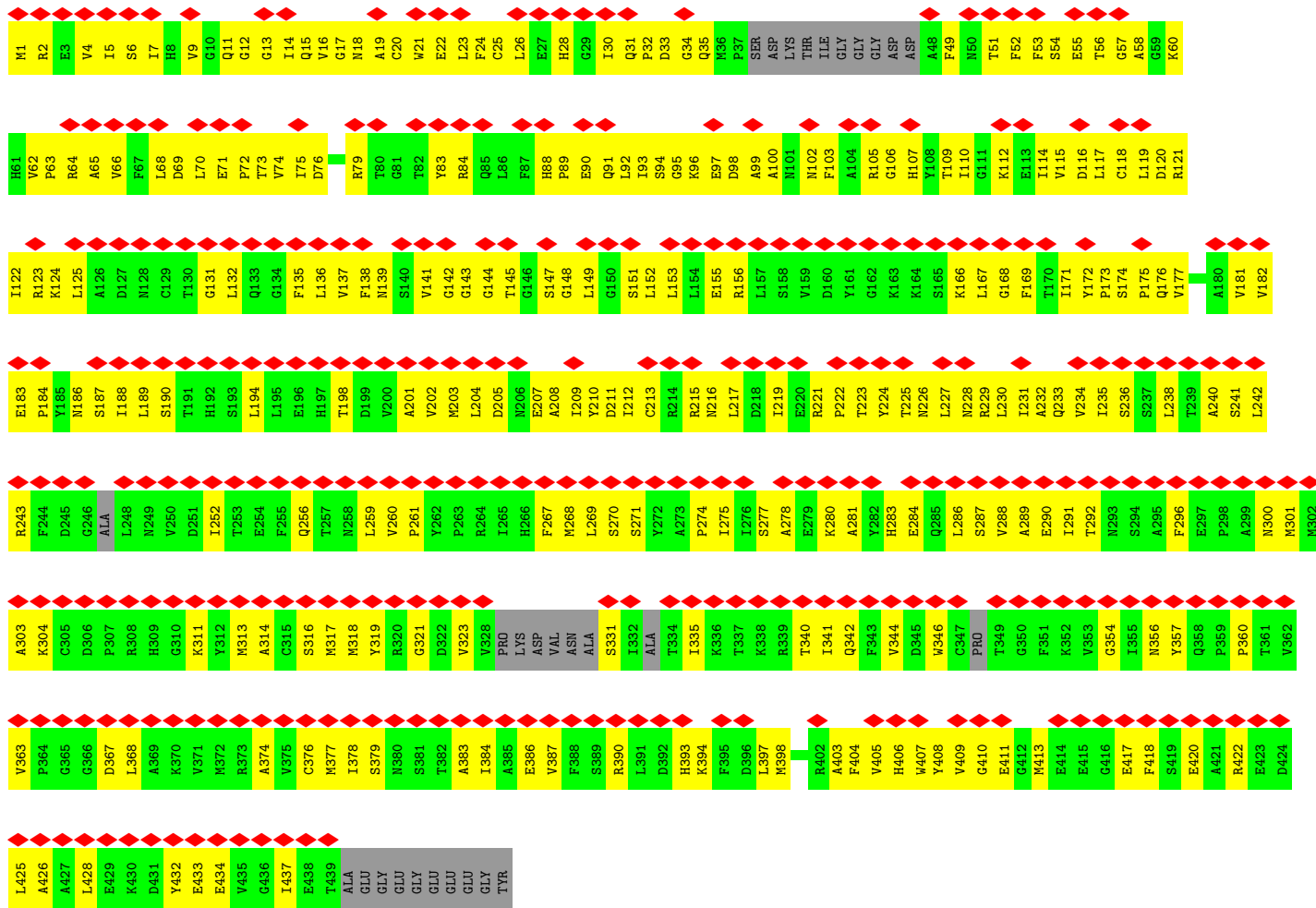
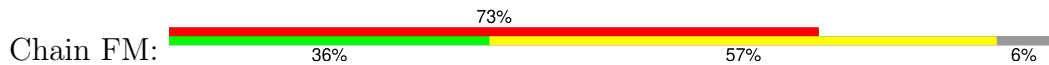

• Molecule 44: Tubulin alpha chain

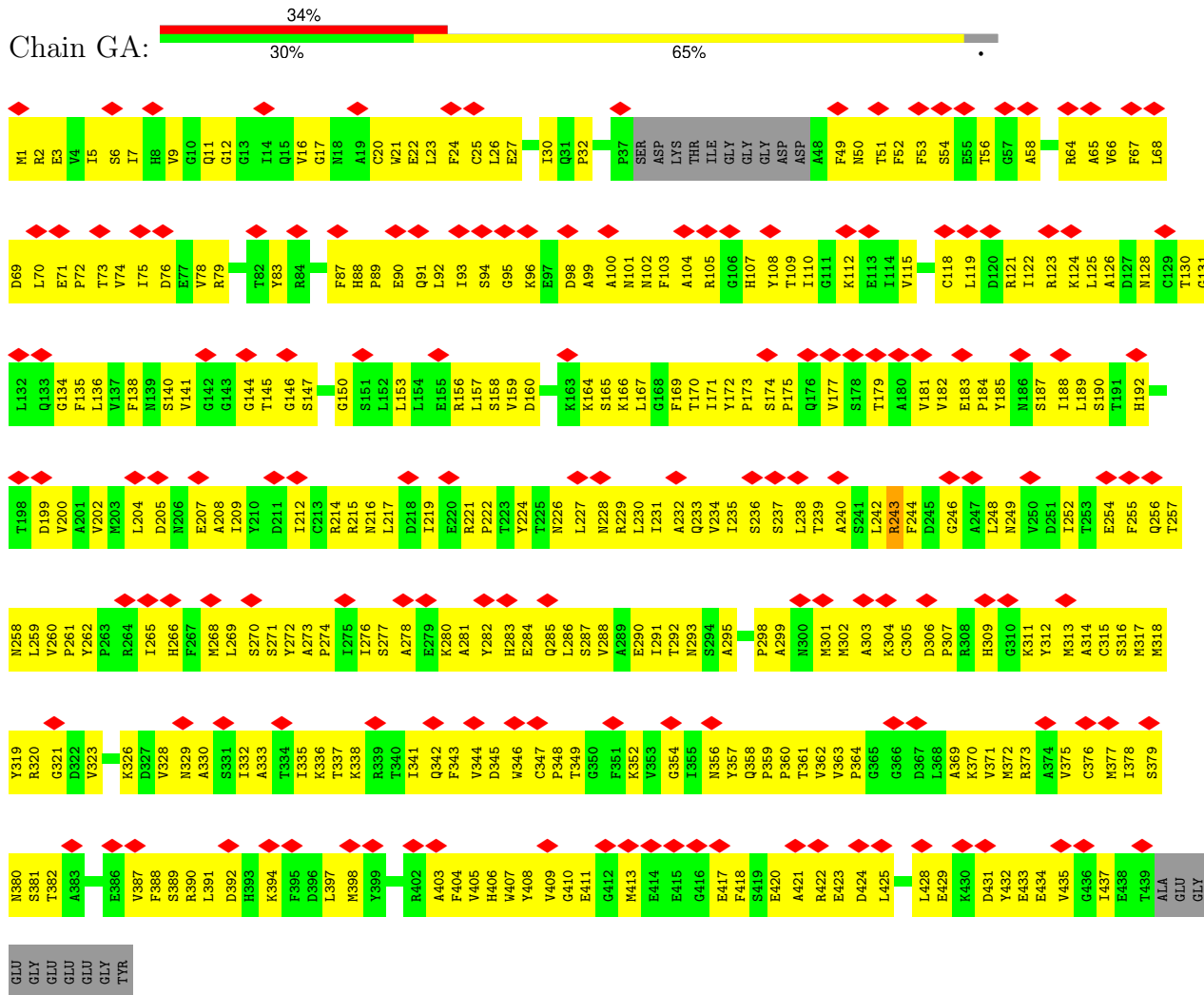

• Molecule 44: Tubulin alpha chain

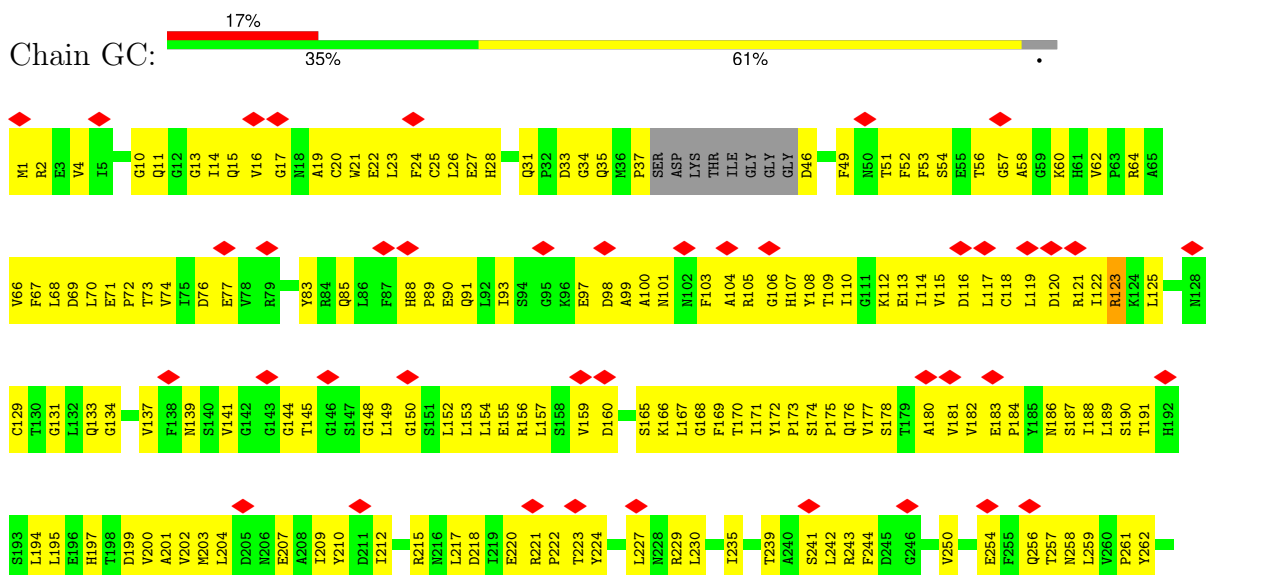

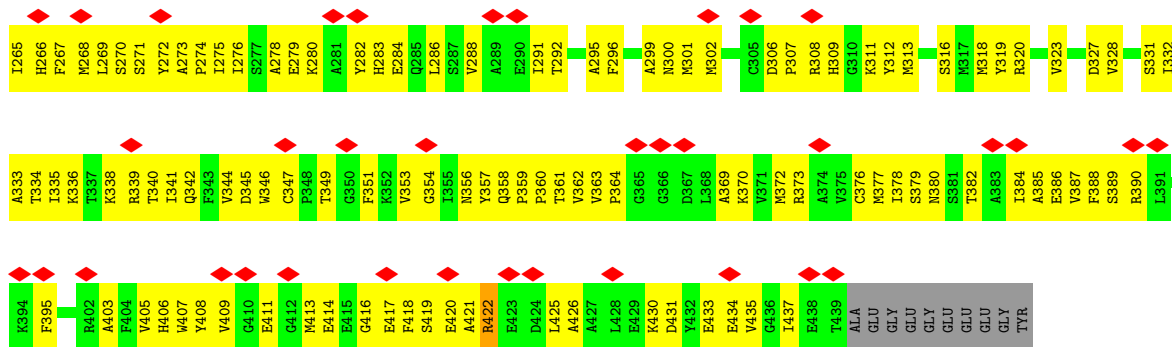

• Molecule 44: Tubulin alpha chain

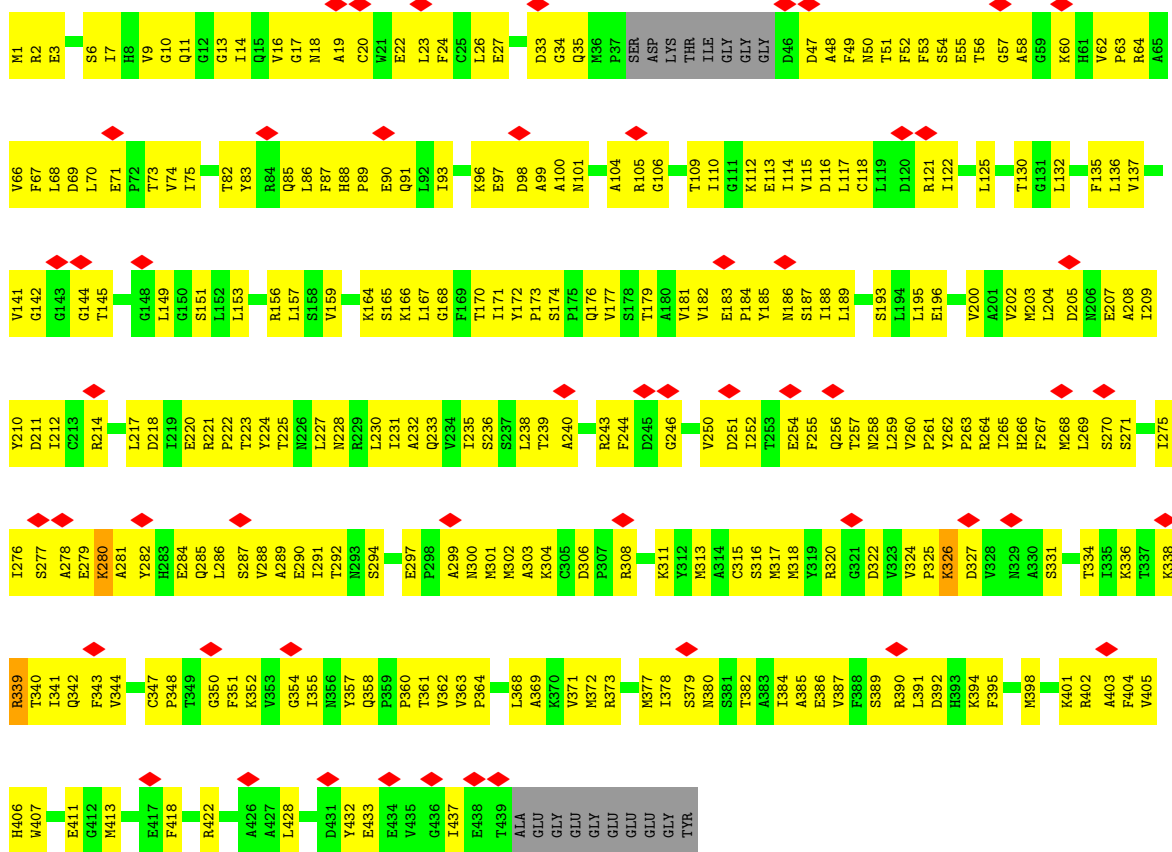

• Molecule 44: Tubulin alpha chain

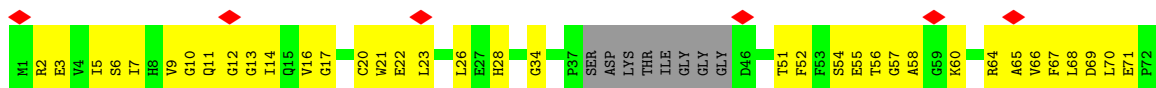



• Molecule 44: Tubulin alpha chain



• Molecule 44: Tubulin alpha chain

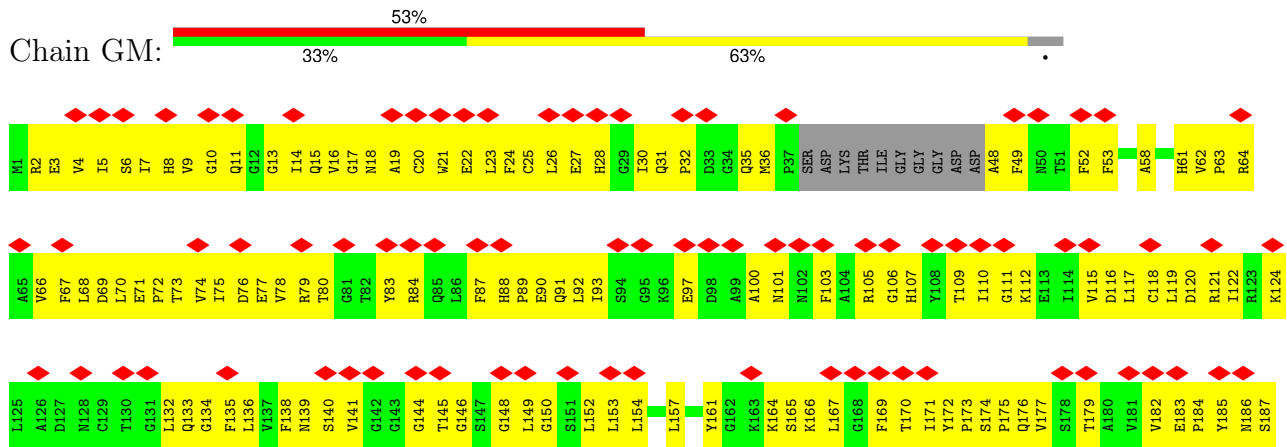



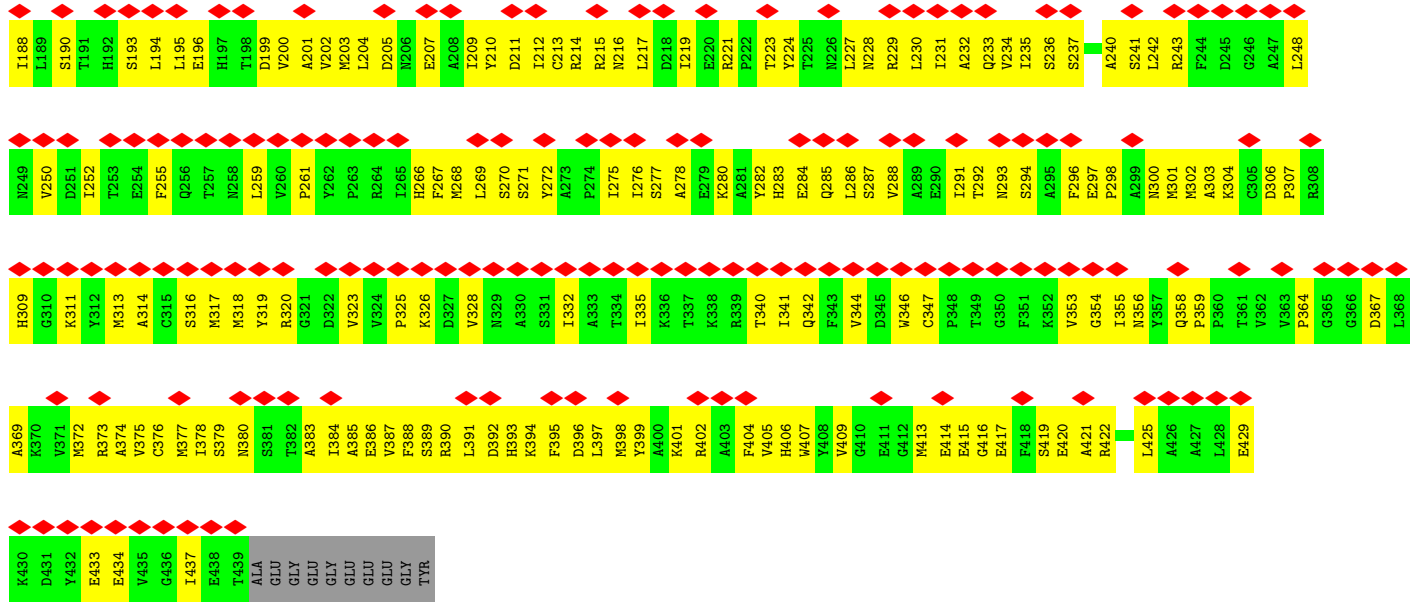

• Molecule 44: Tubulin alpha chain

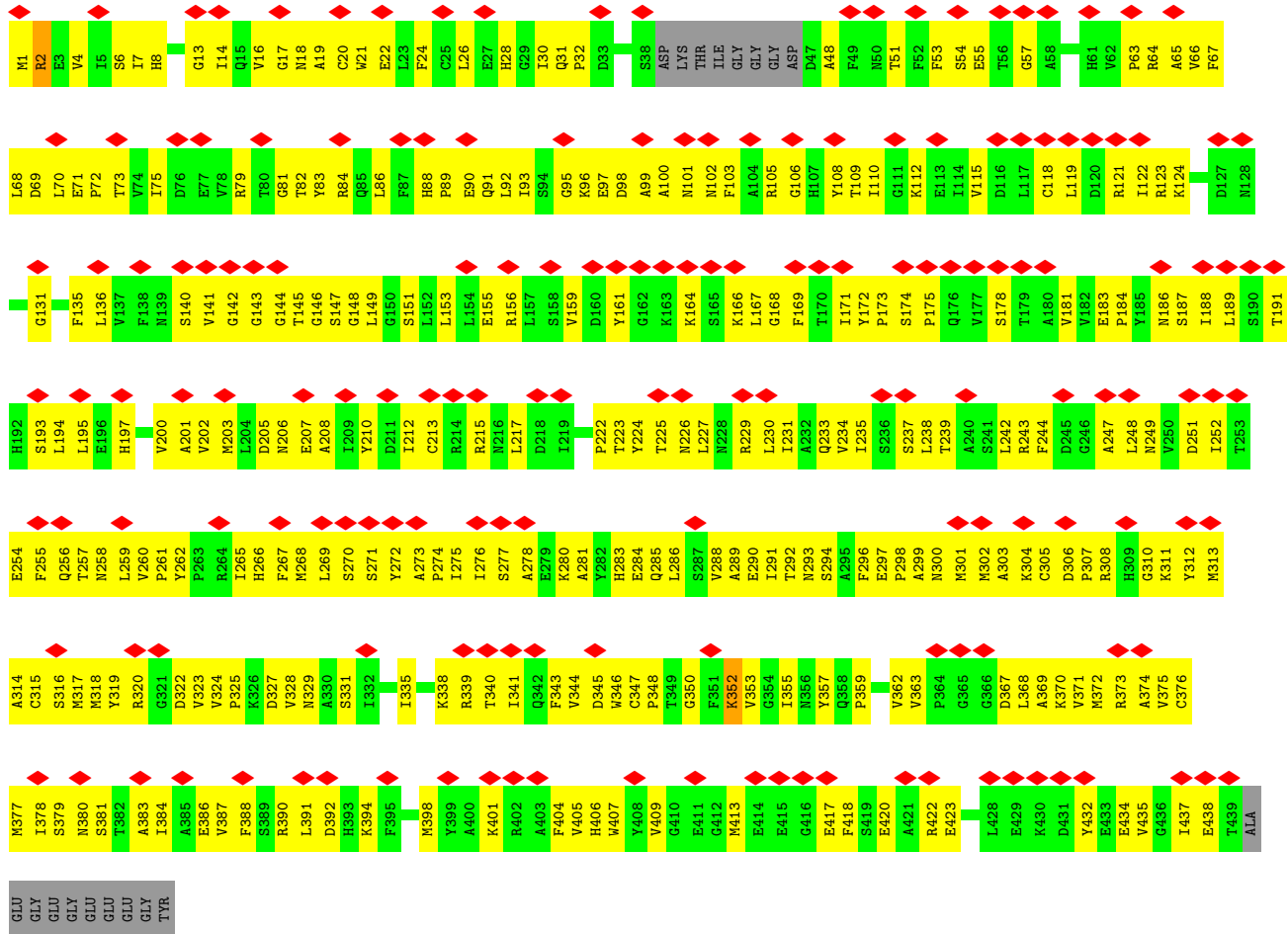

• Molecule 44: Tubulin alpha chain

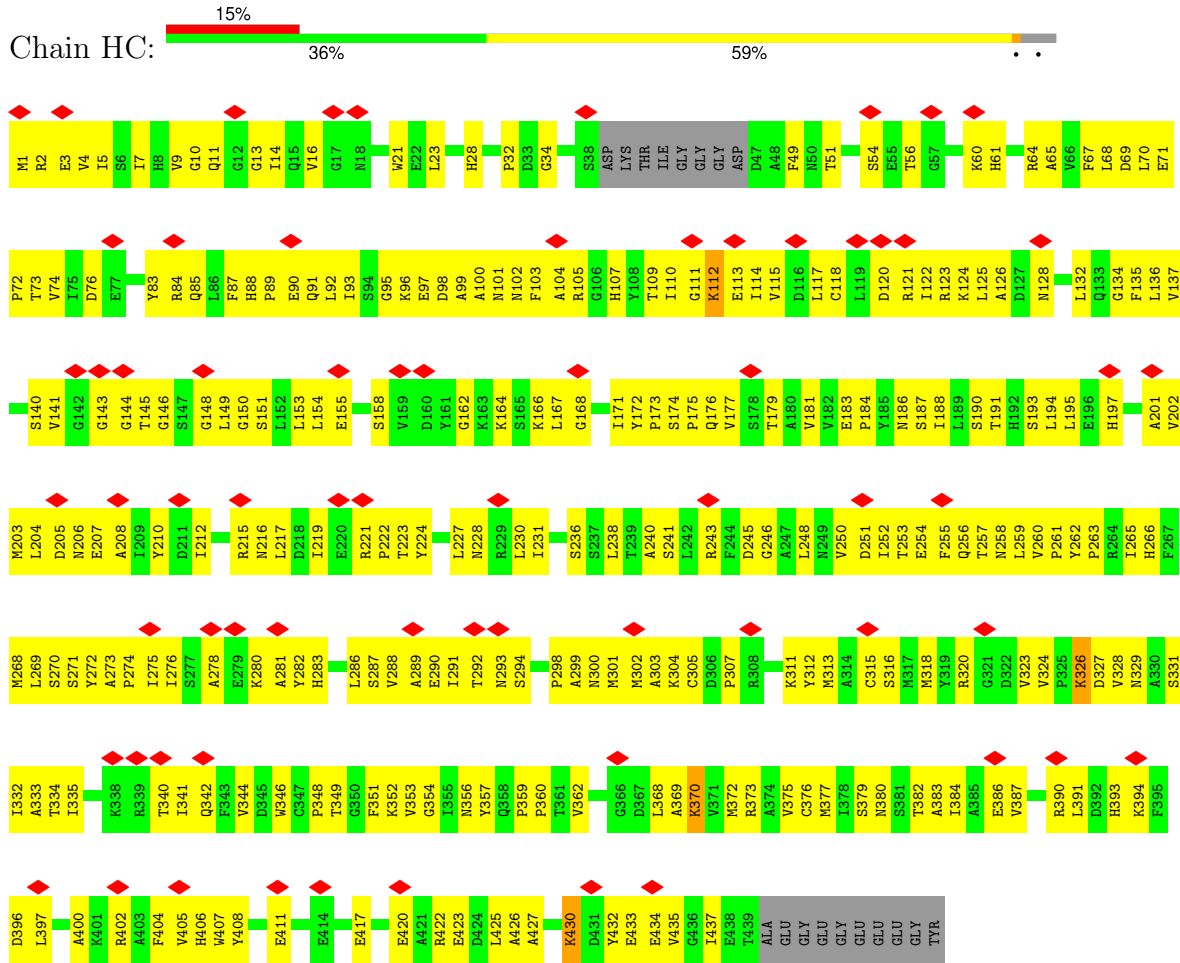

• Molecule 44: Tubulin alpha chain

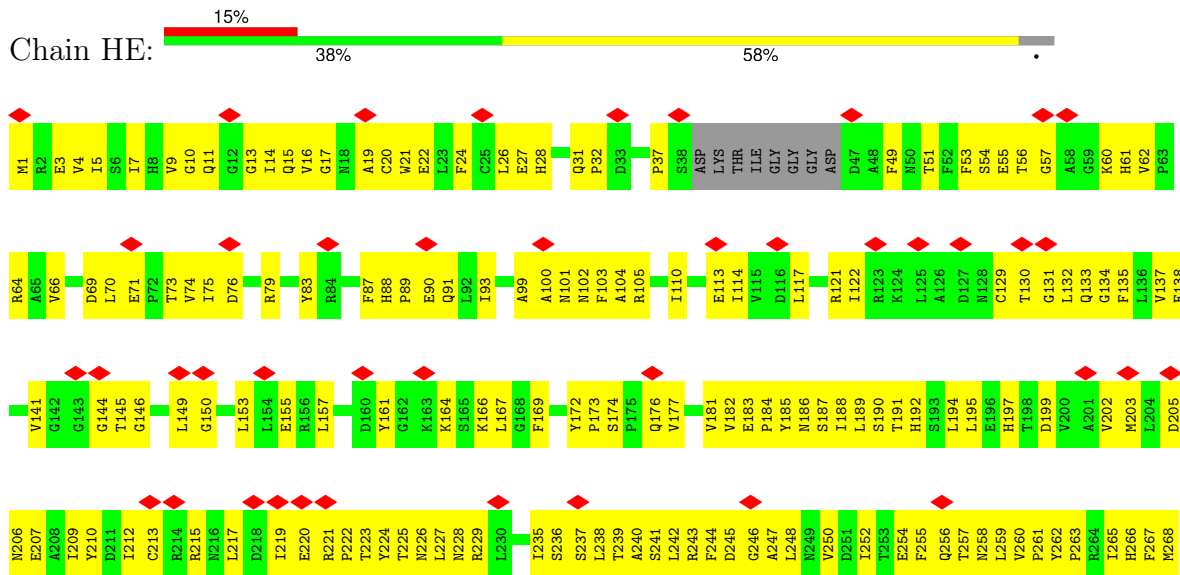

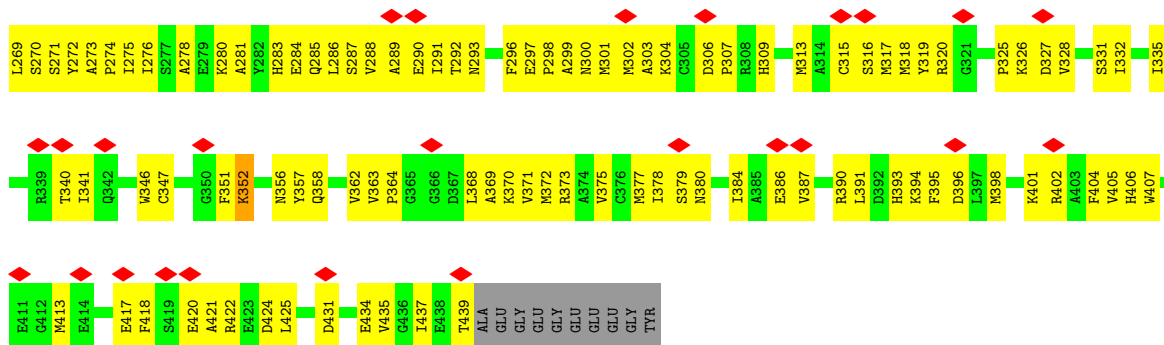

• Molecule 44: Tubulin alpha chain

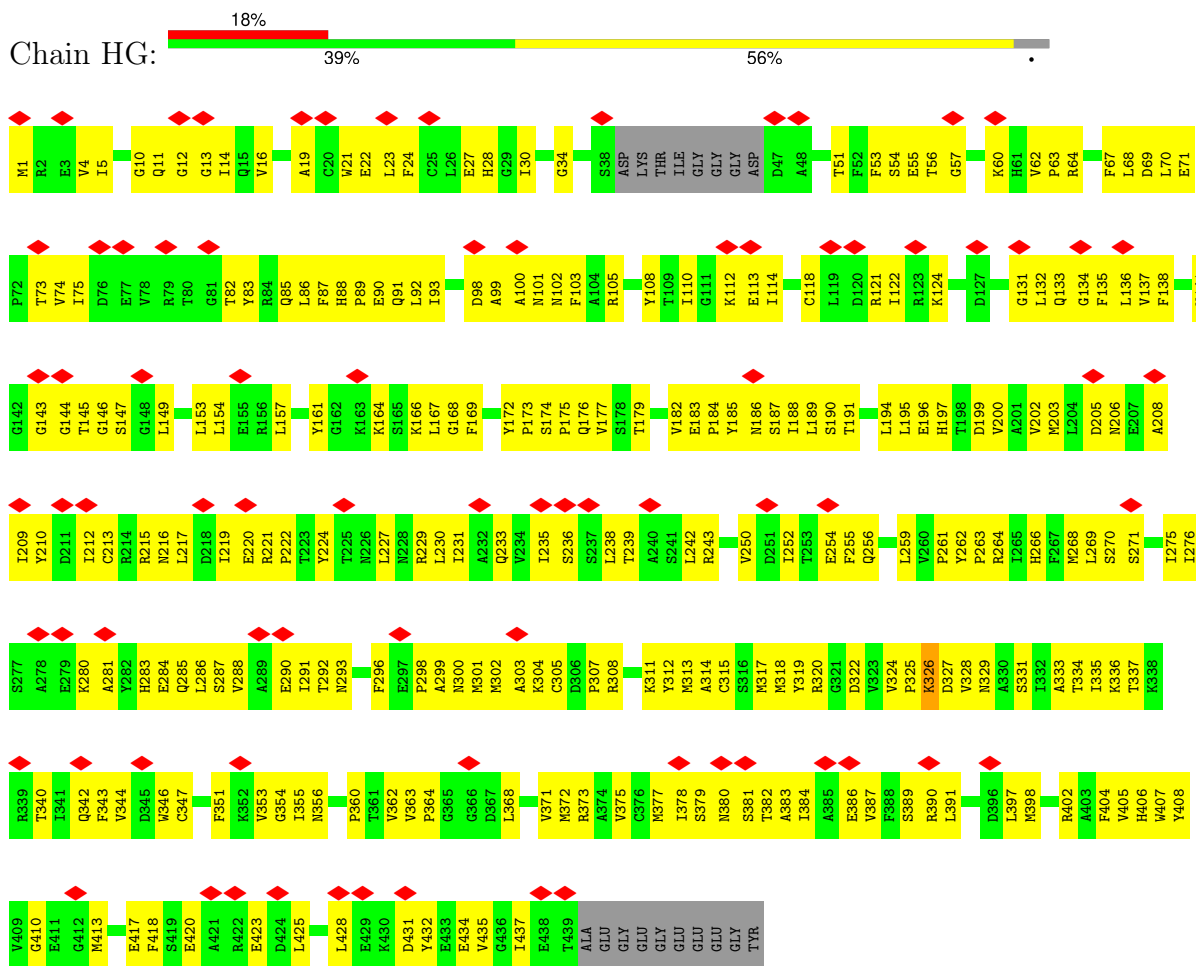

• Molecule 44: Tubulin alpha chain

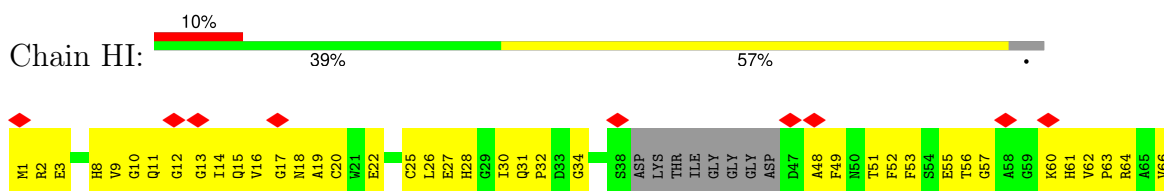

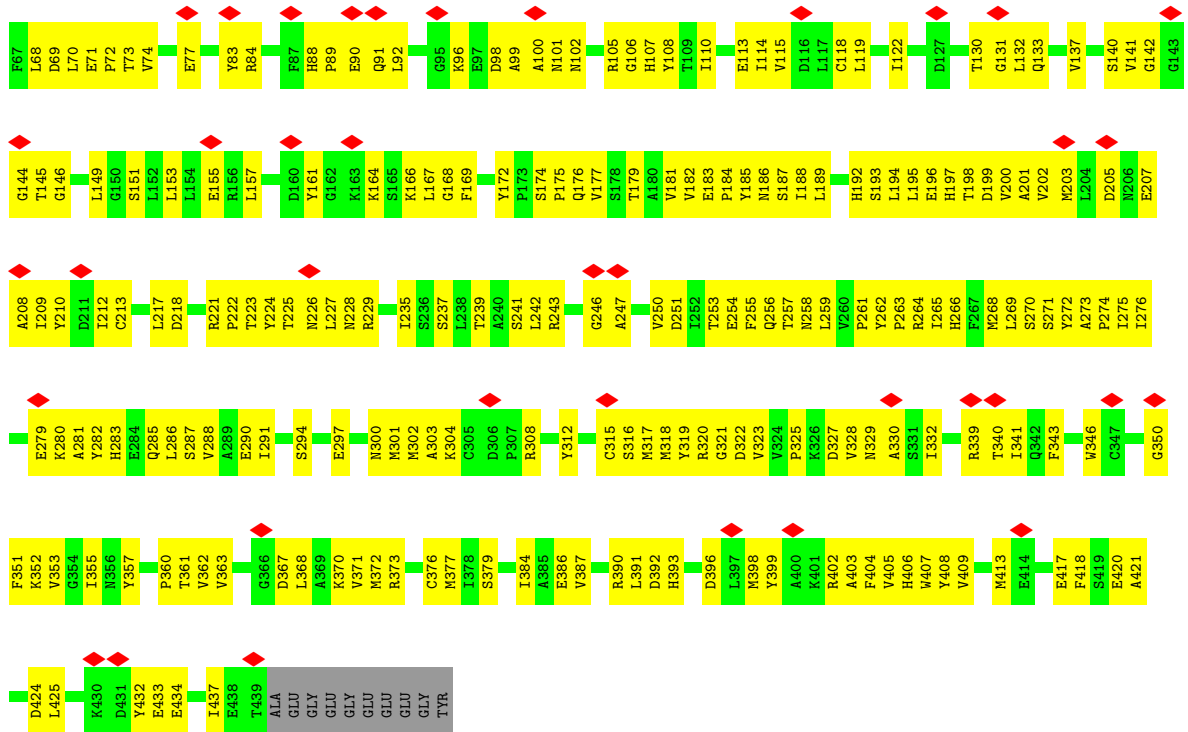

• Molecule 44: Tubulin alpha chain

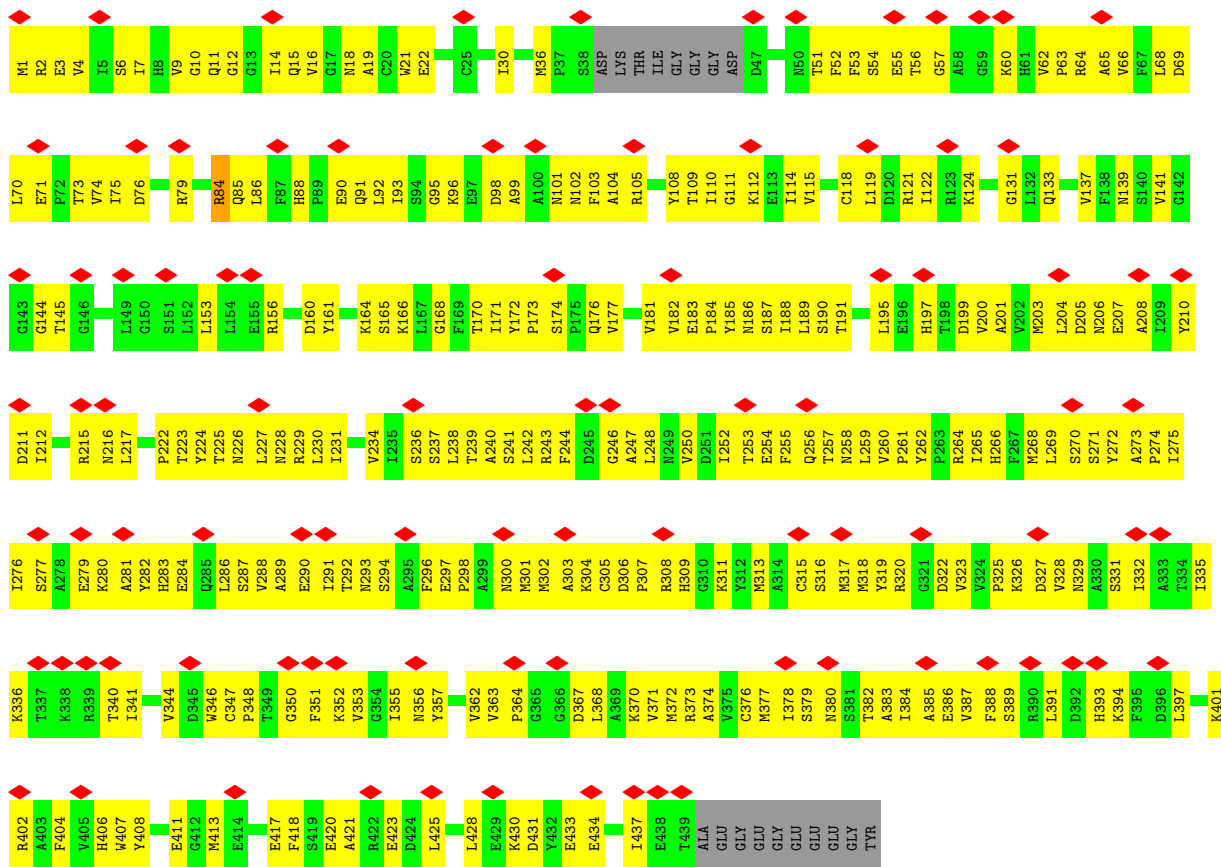



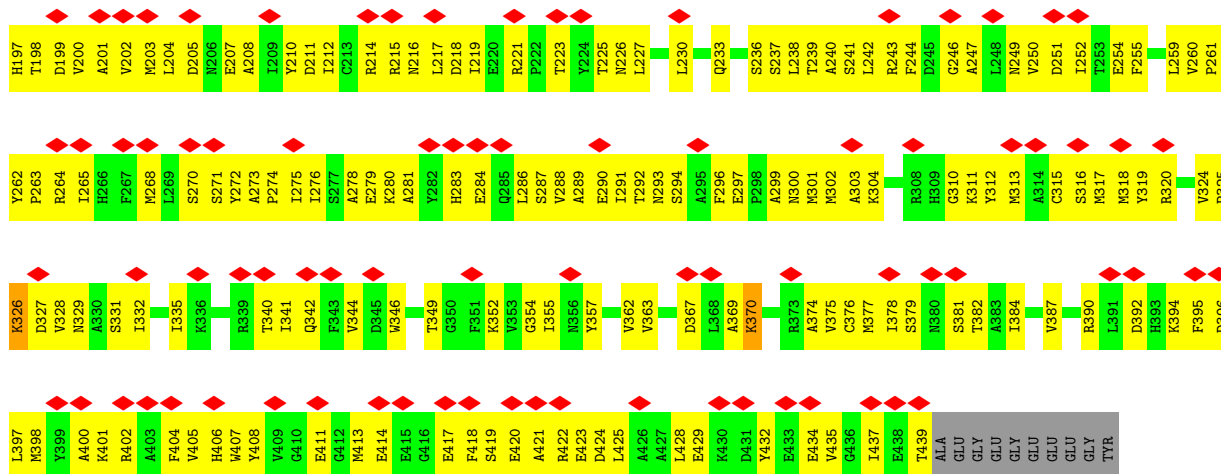

• Molecule 44: Tubulin alpha chain

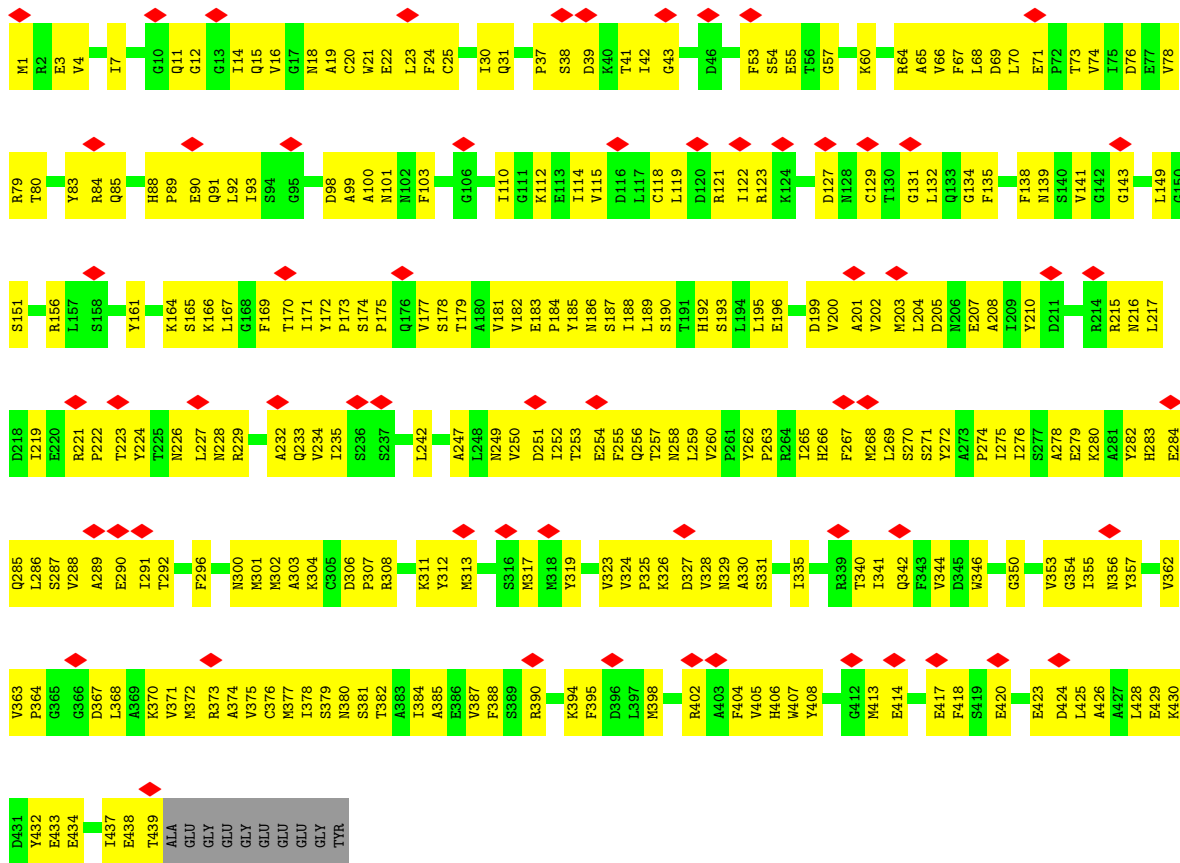

• Molecule 44: Tubulin alpha chain





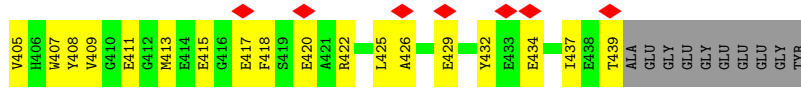

• Molecule 44: Tubulin alpha chain

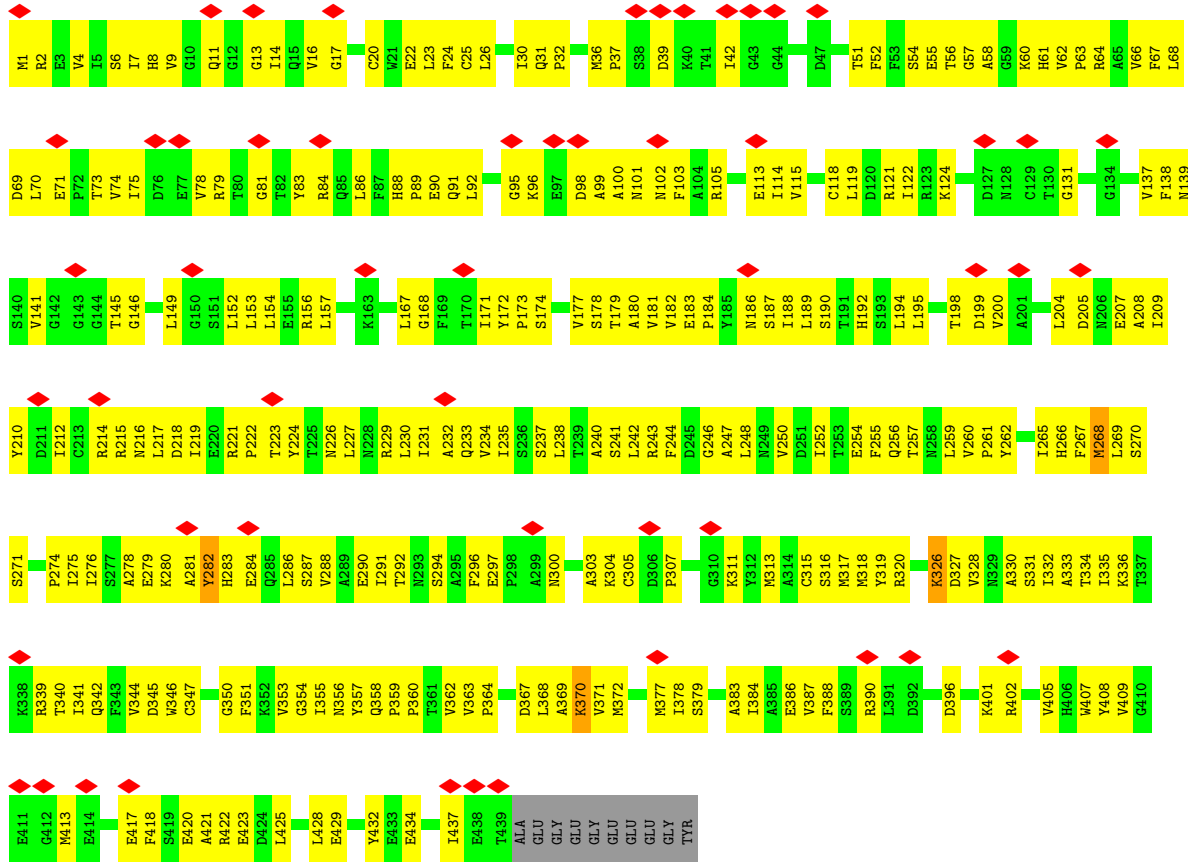

• Molecule 44: Tubulin alpha chain

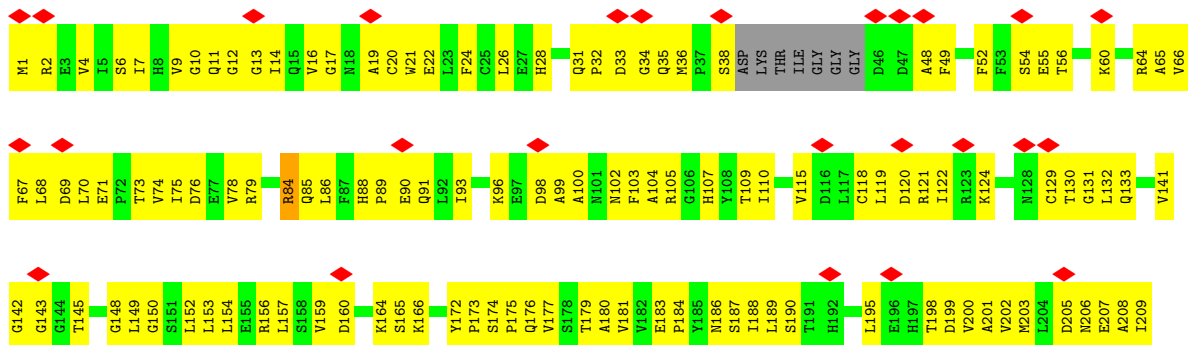



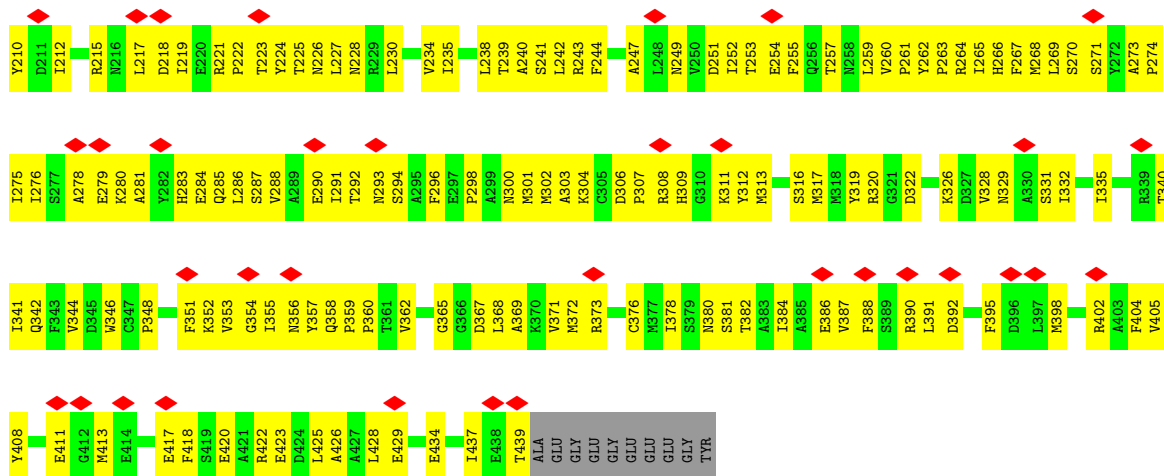

• Molecule 44: Tubulin alpha chain

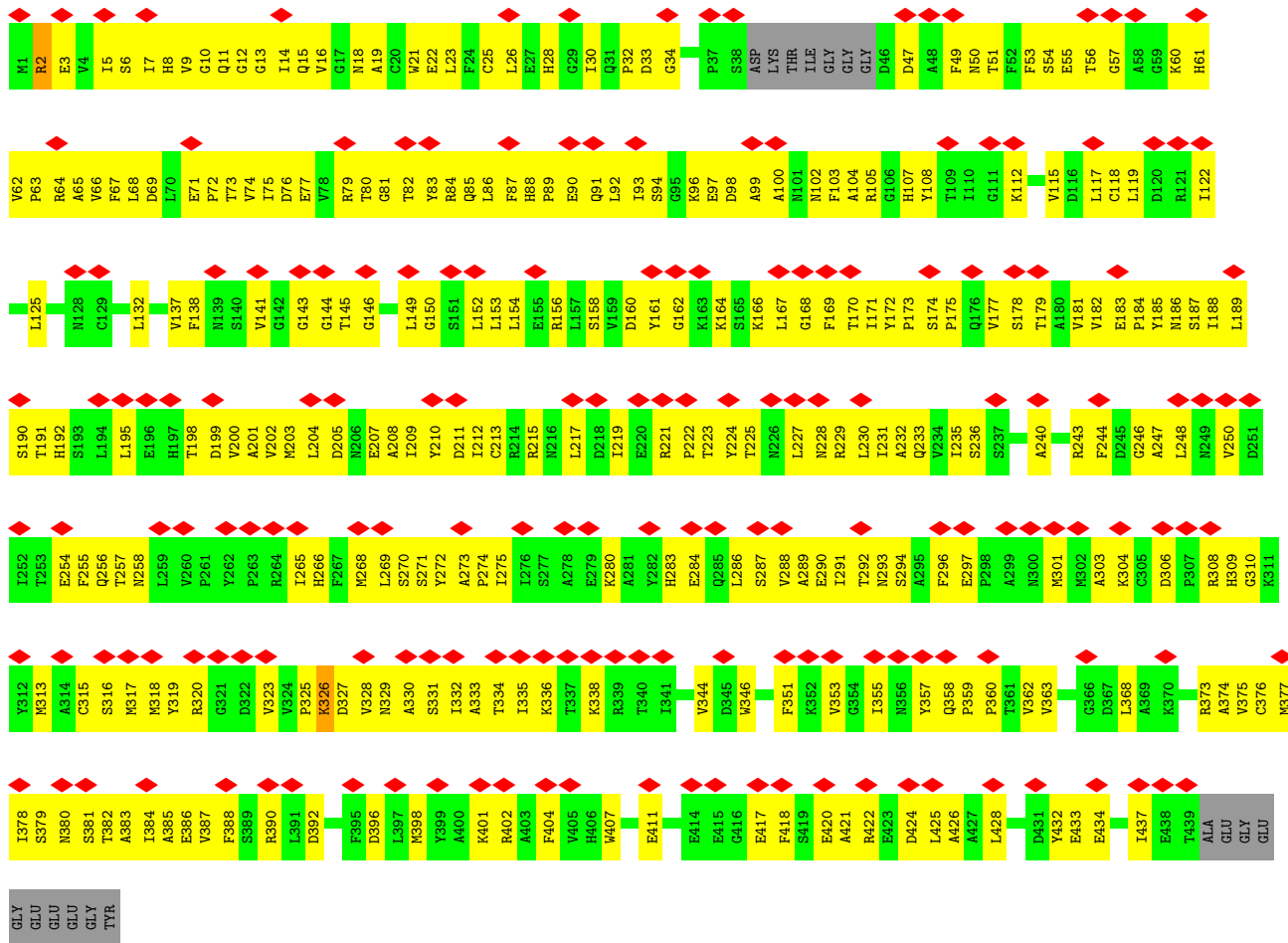
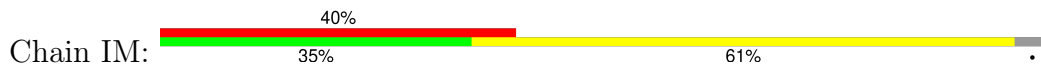

• Molecule 44: Tubulin alpha chain



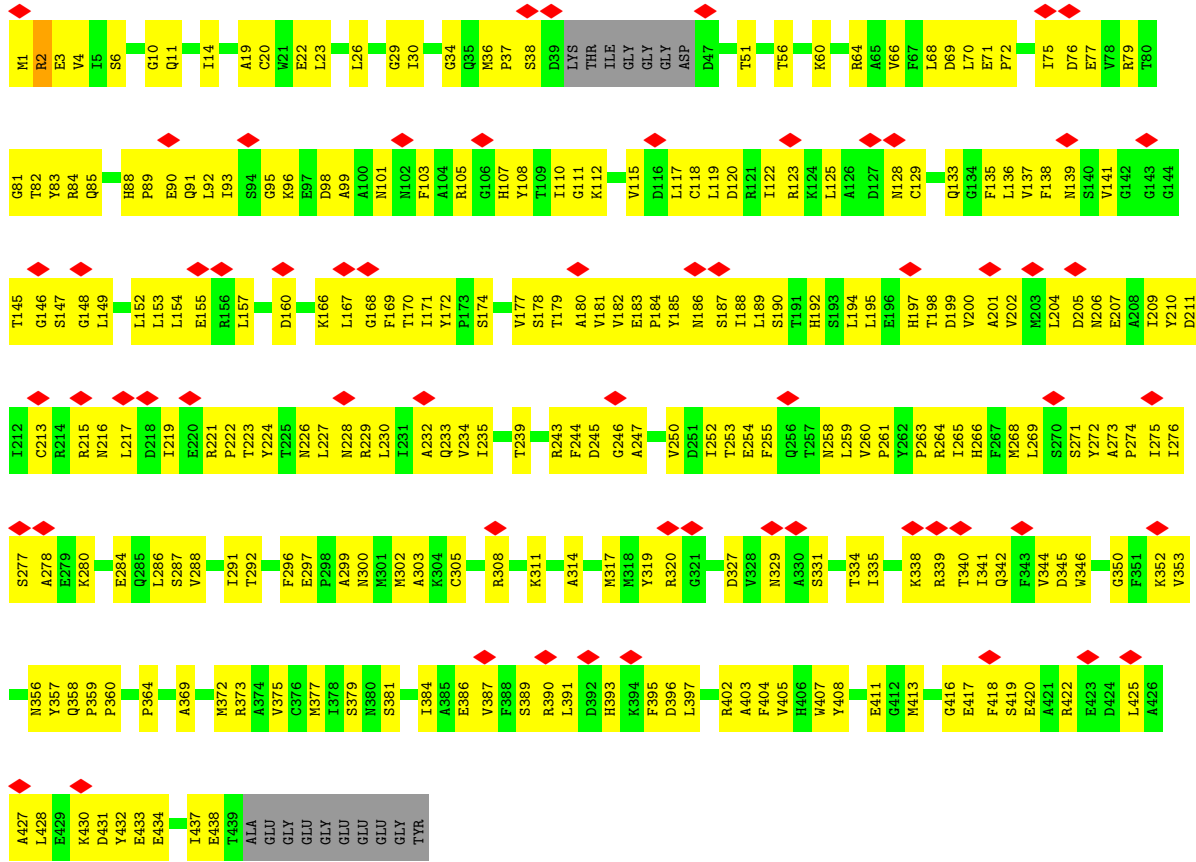

• Molecule 44: Tubulin alpha chain

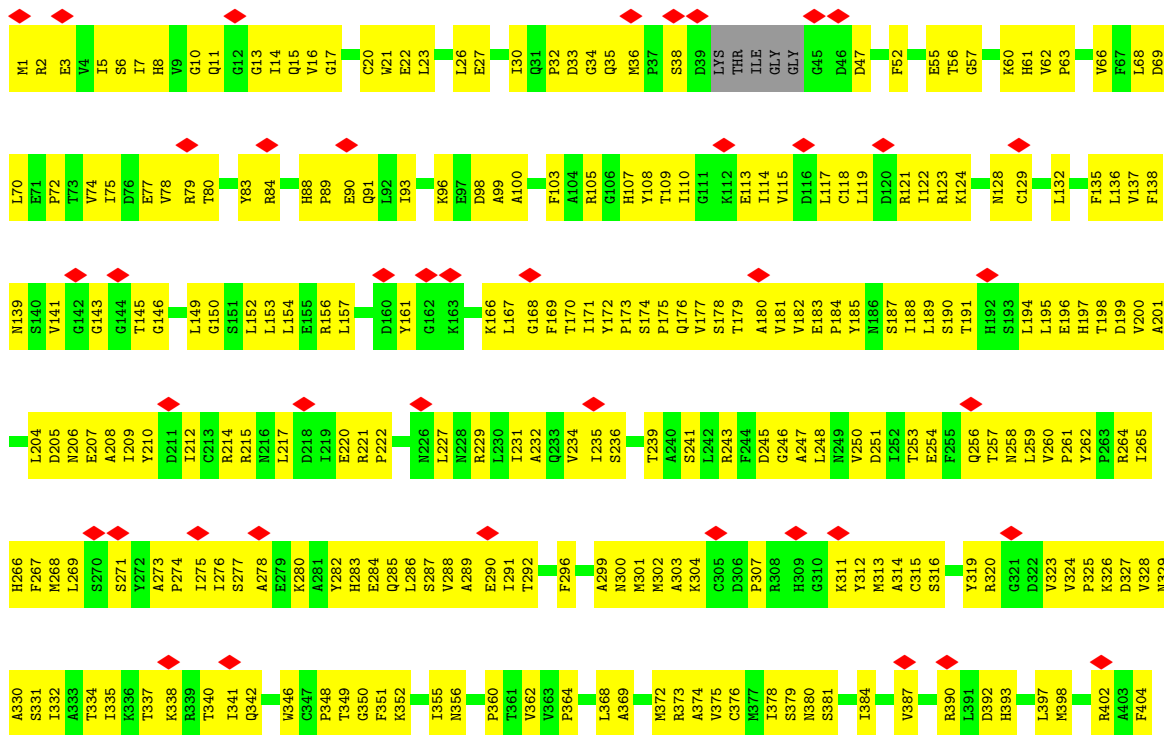



• Molecule 44: Tubulin alpha chain

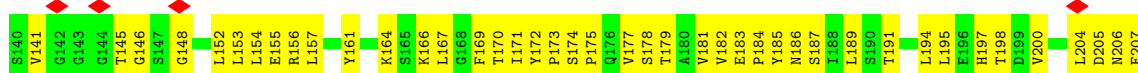
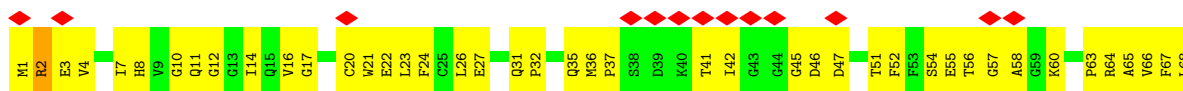

• Molecule 44: Tubulin alpha chain

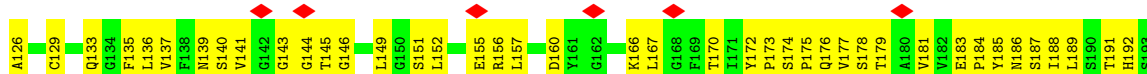

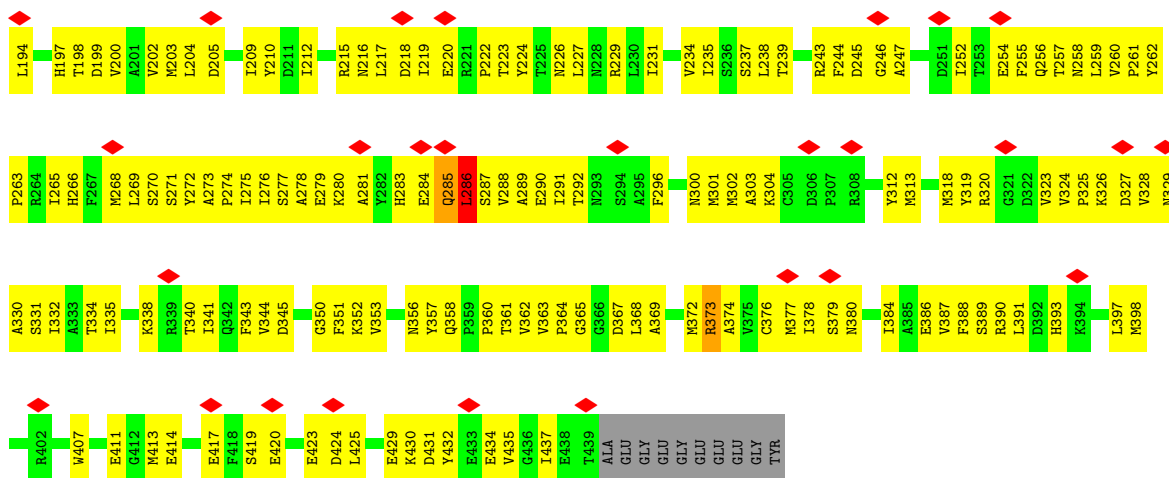

• Molecule 44: Tubulin alpha chain

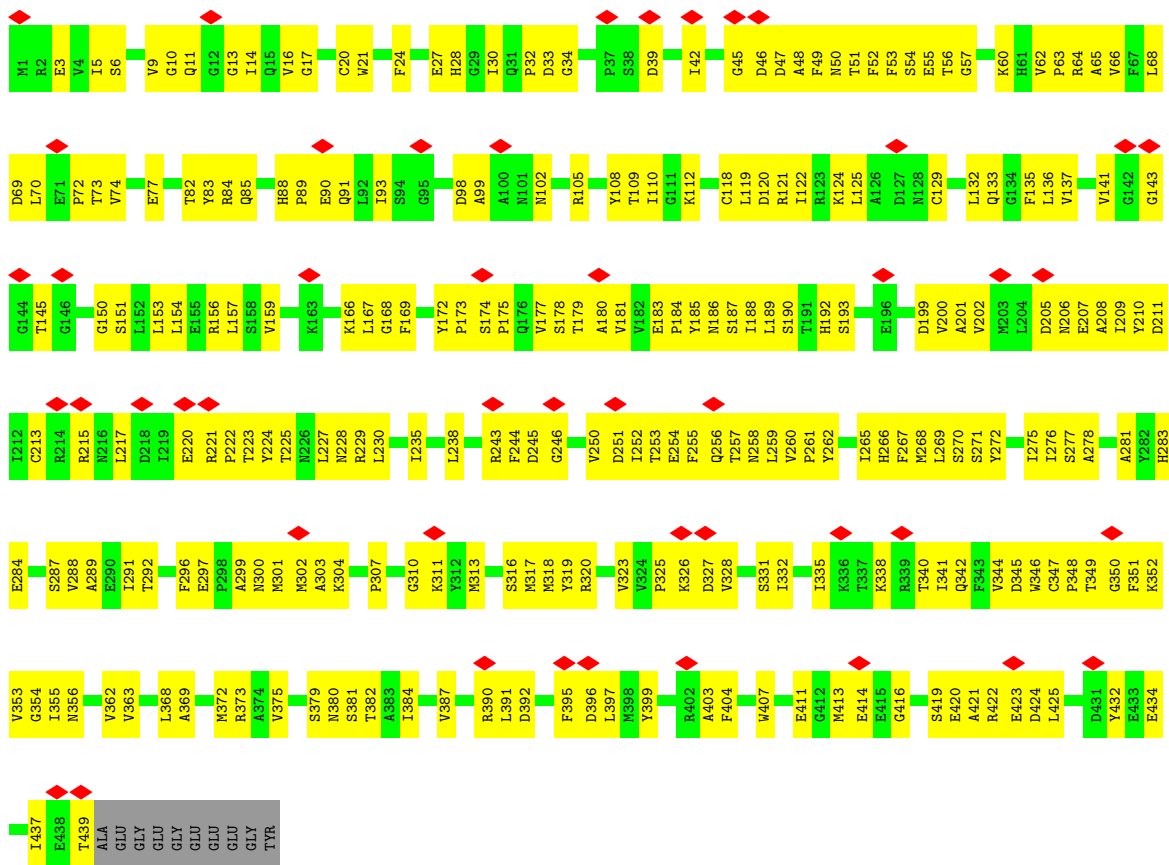

• Molecule 44: Tubulin alpha chain



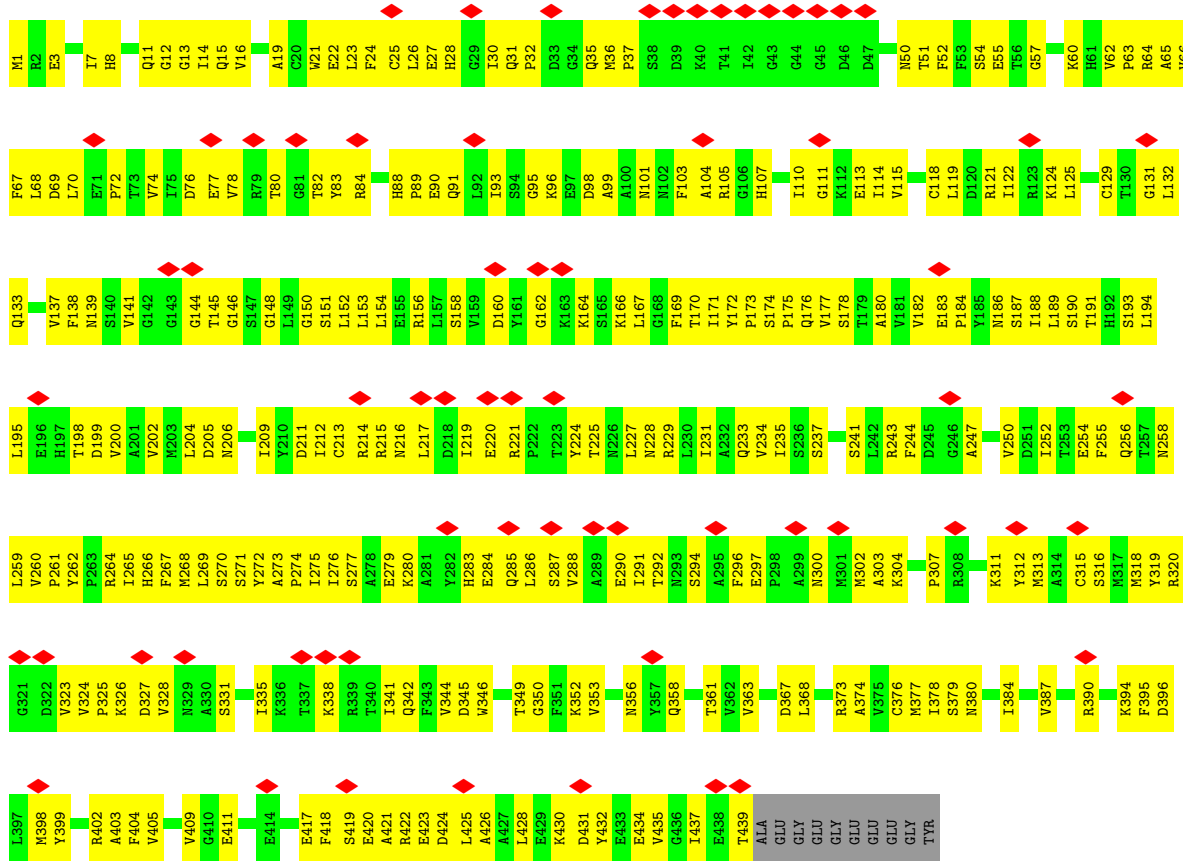

• Molecule 44: Tubulin alpha chain

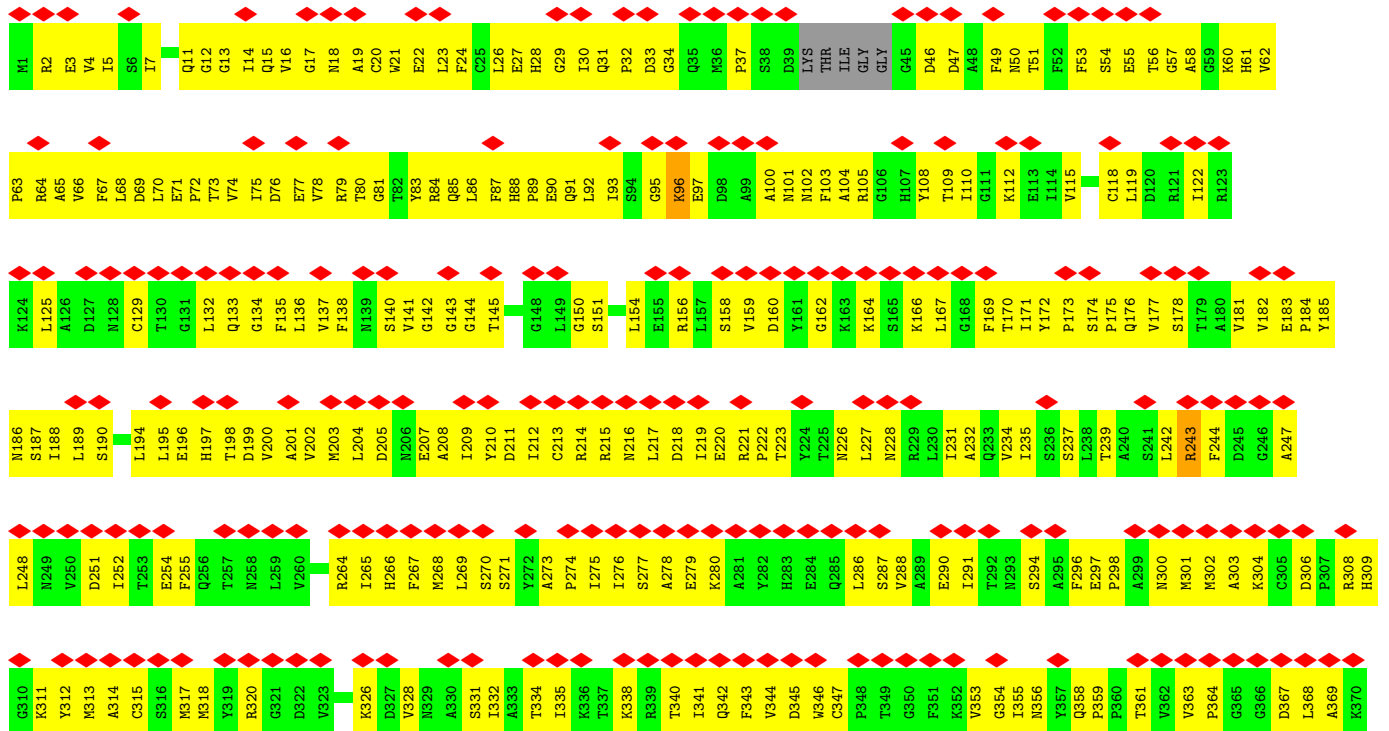

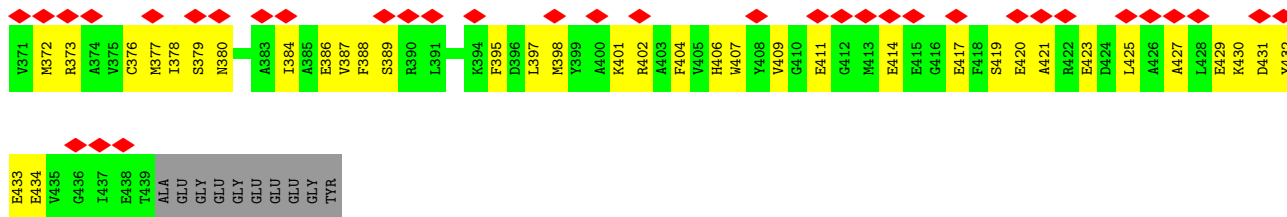

• Molecule 44: Tubulin alpha chain

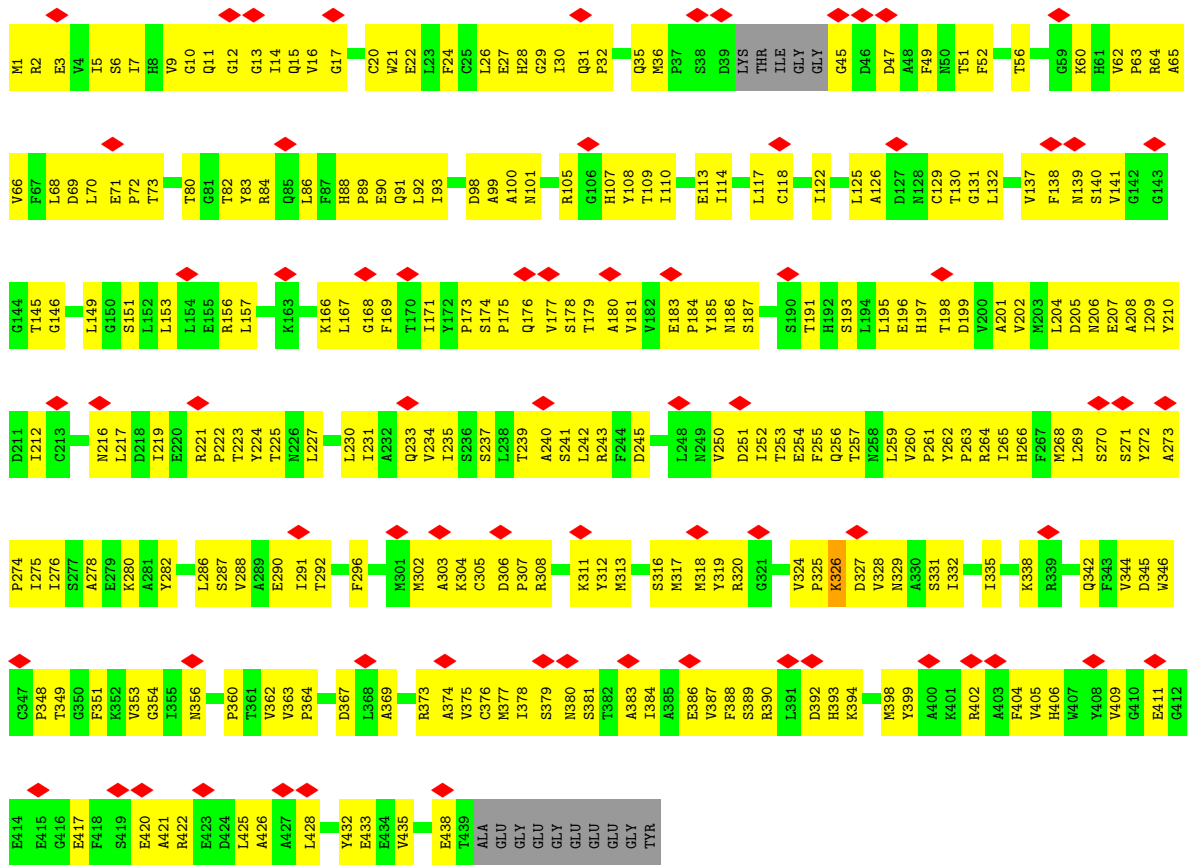

• Molecule 44: Tubulin alpha chain

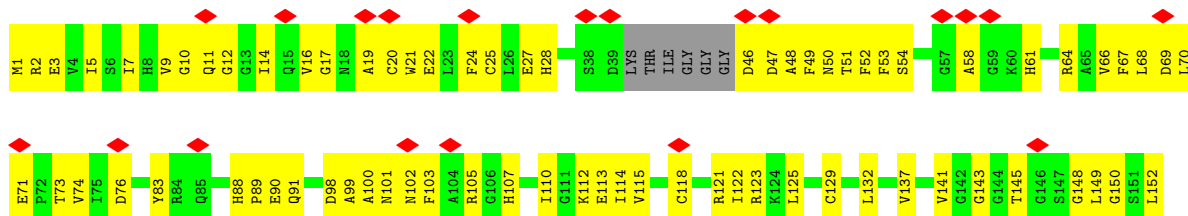

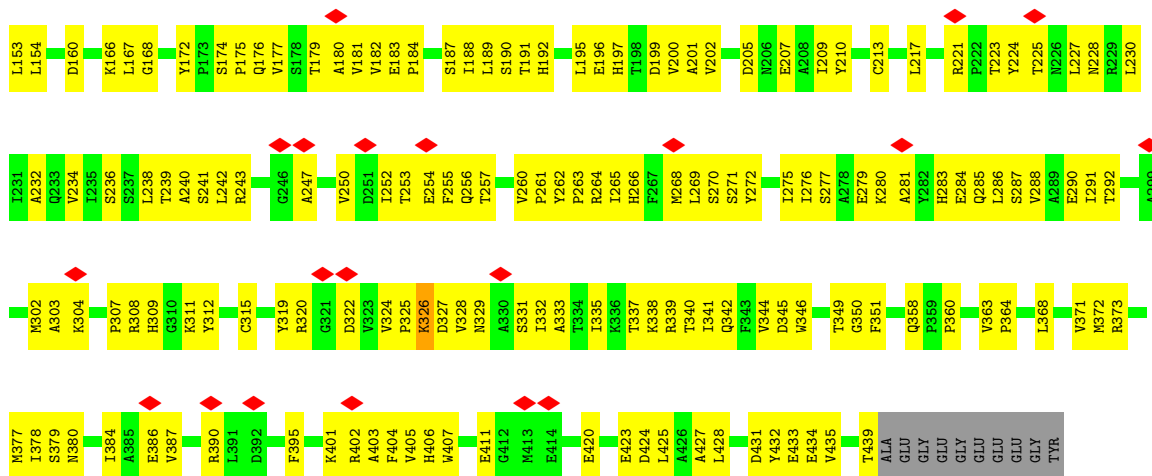

• Molecule 44: Tubulin alpha chain

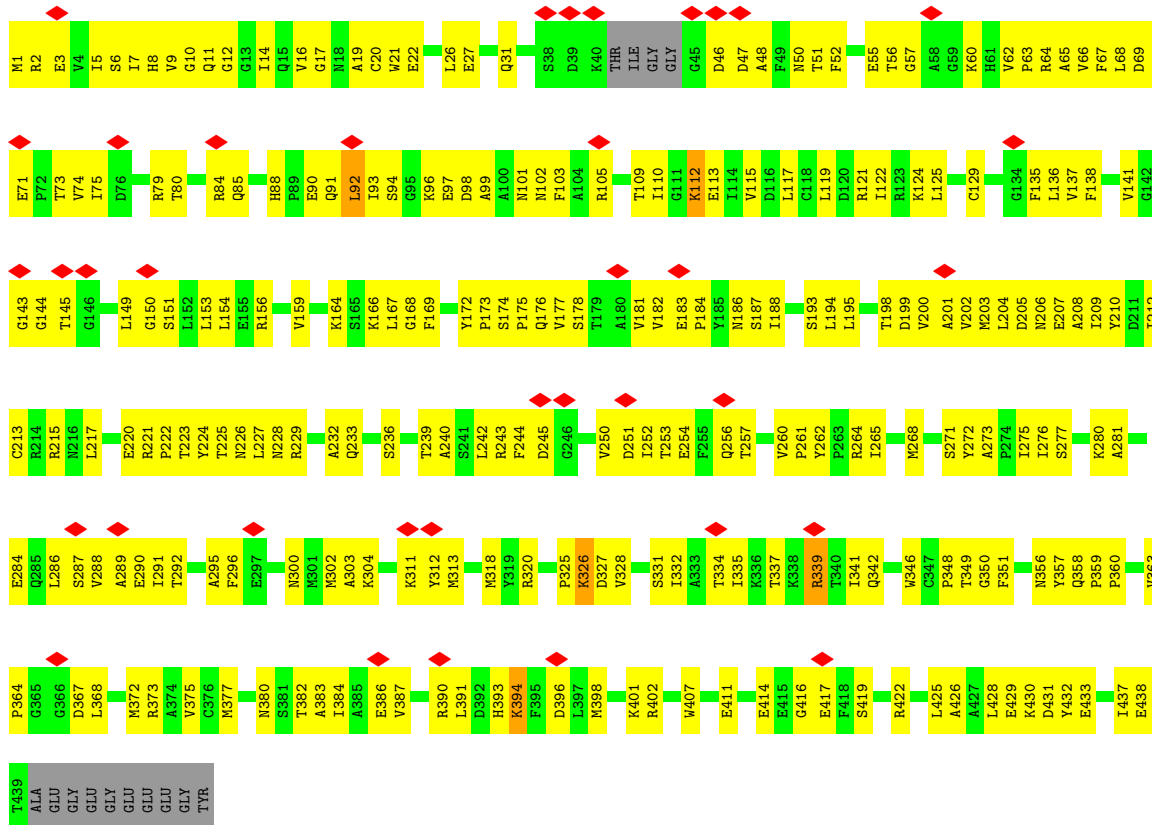

• Molecule 44: Tubulin alpha chain

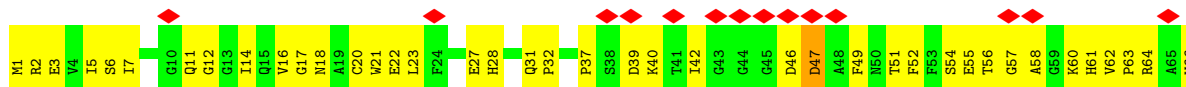

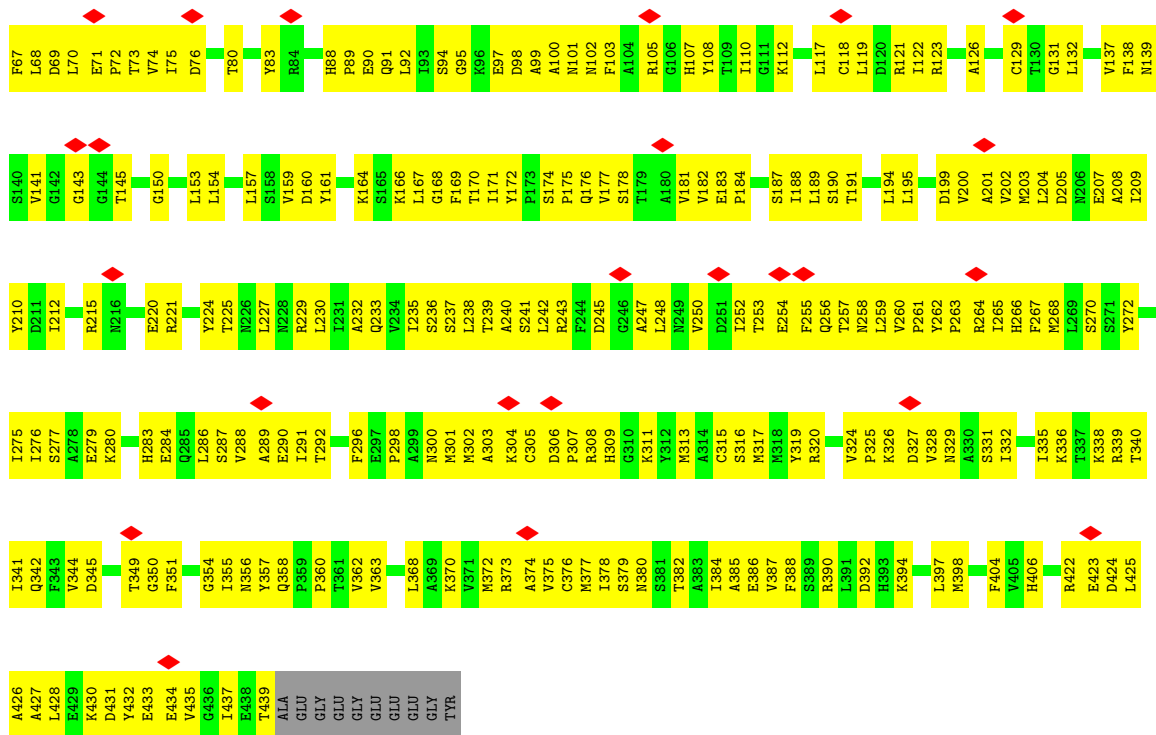

• Molecule 44: Tubulin alpha chain

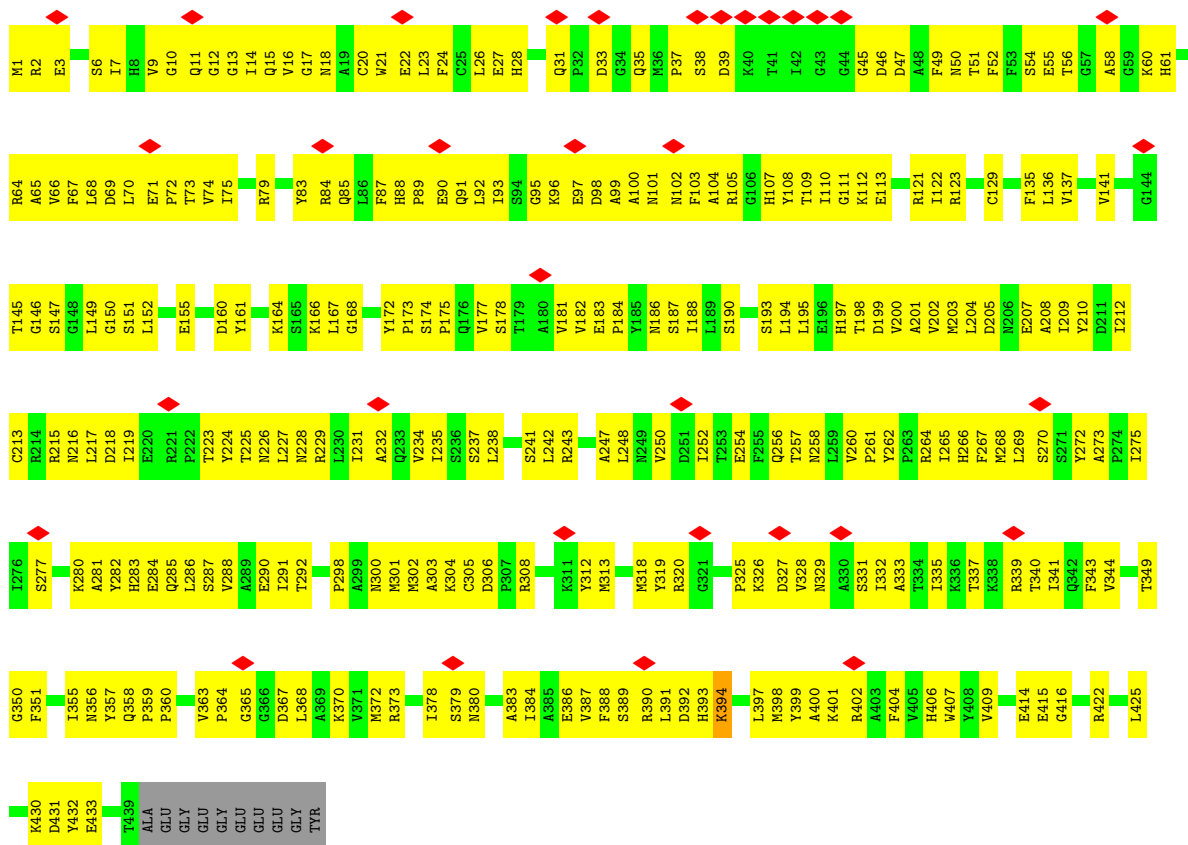





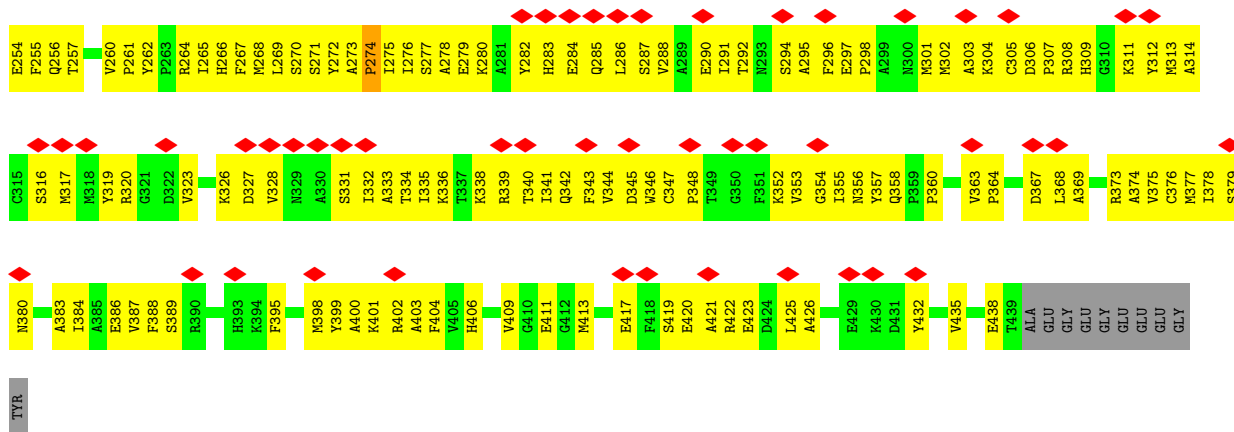

• Molecule 44: Tubulin alpha chain

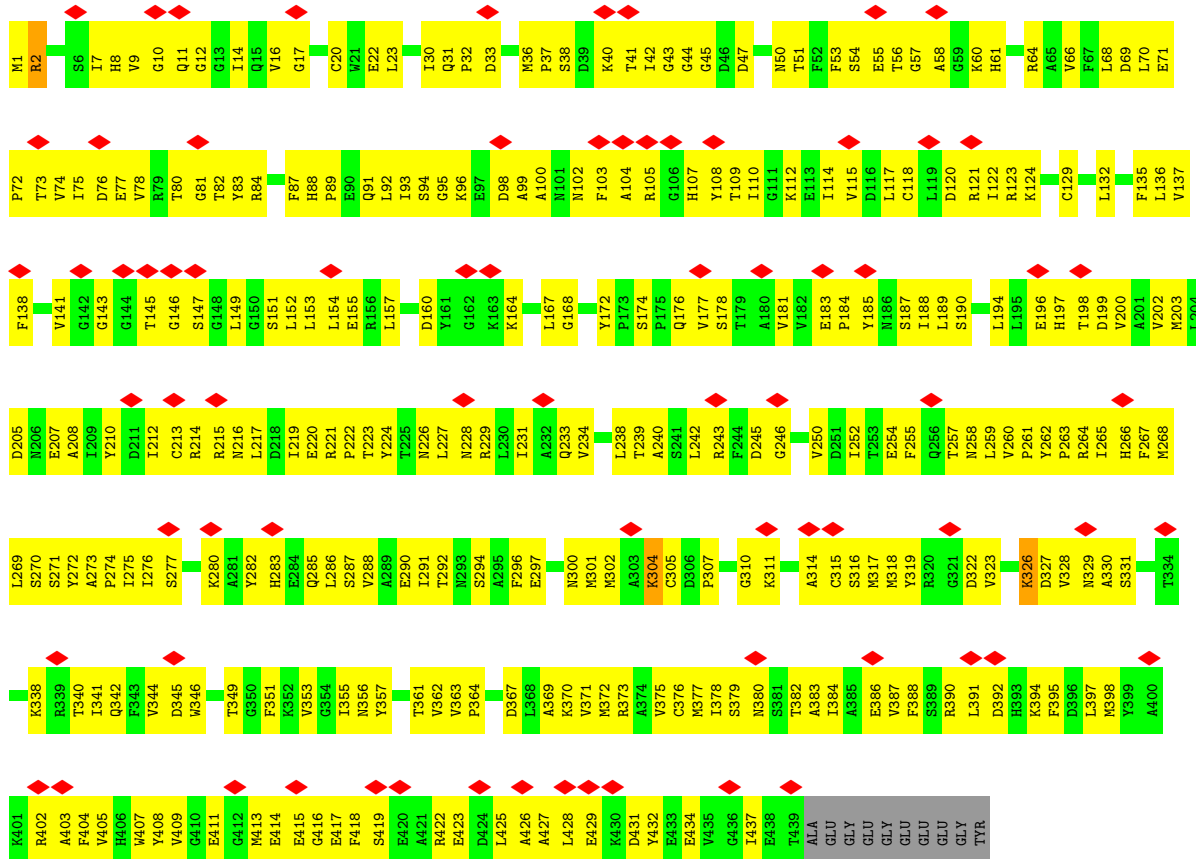

• Molecule 44: Tubulin alpha chain

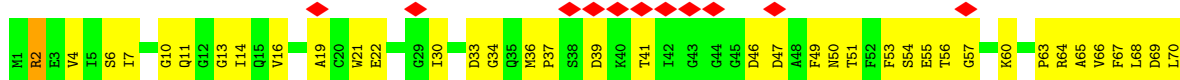
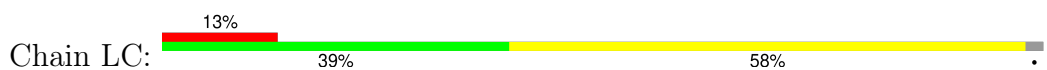

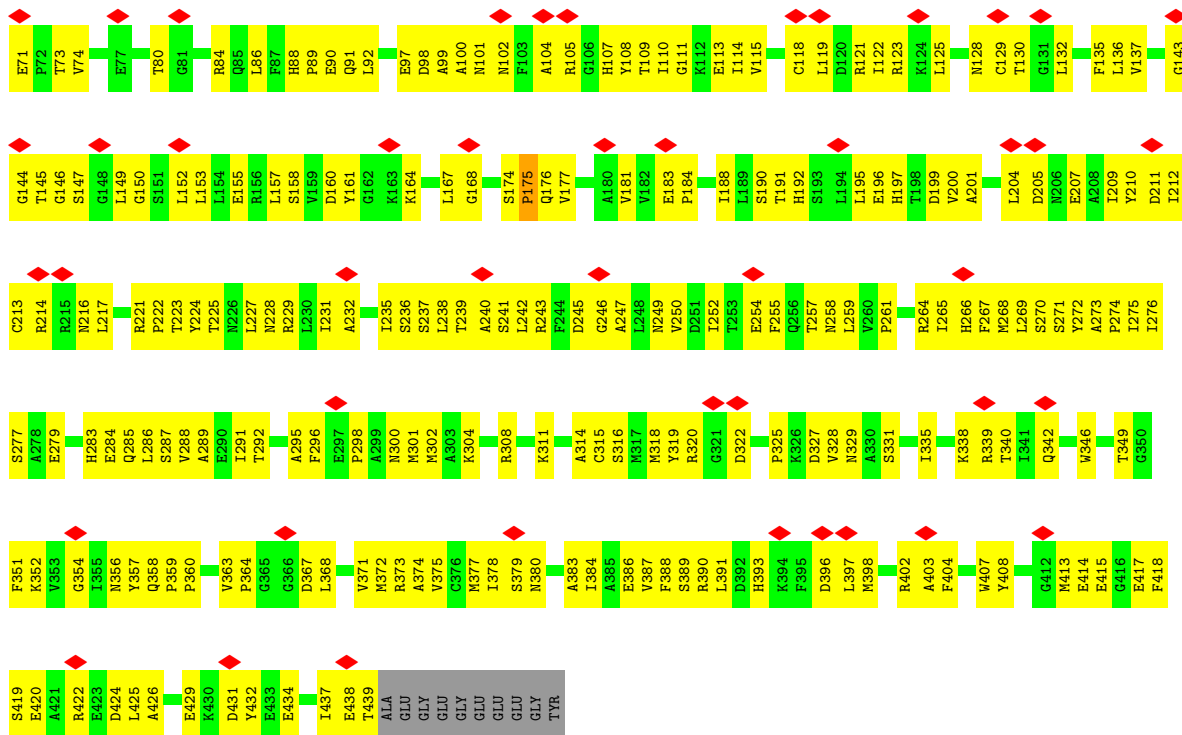

• Molecule 44: Tubulin alpha chain

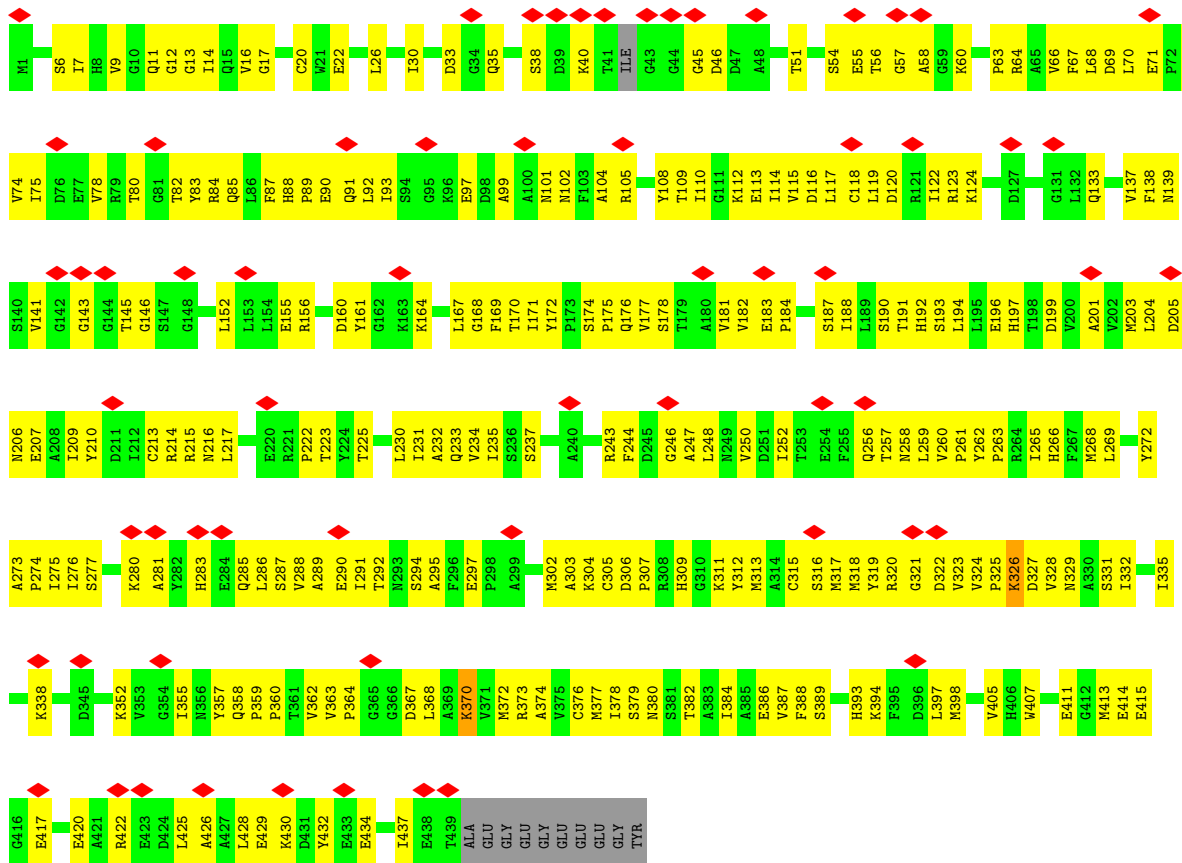

• Molecule 44: Tubulin alpha chain

Chain LG:

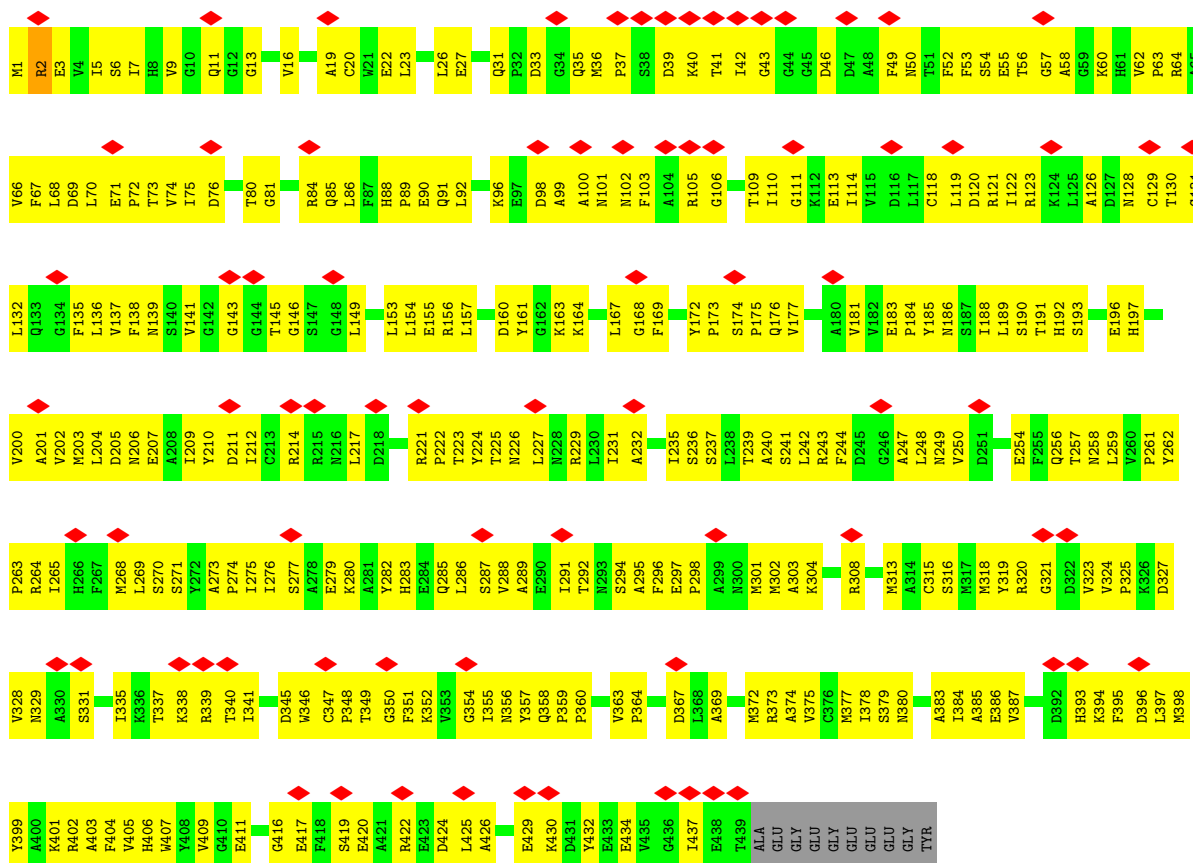

• Molecule 44: Tubulin alpha chain

Chain LI:

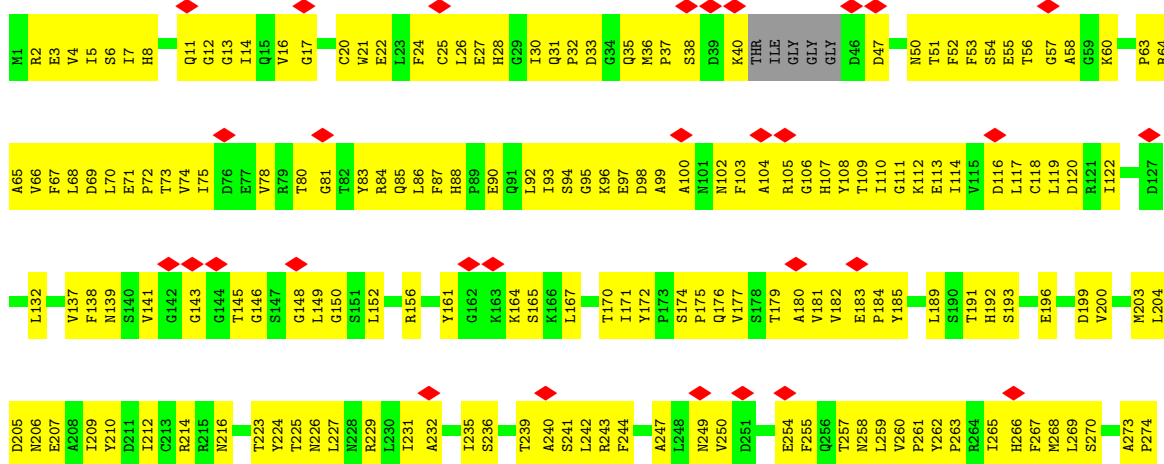

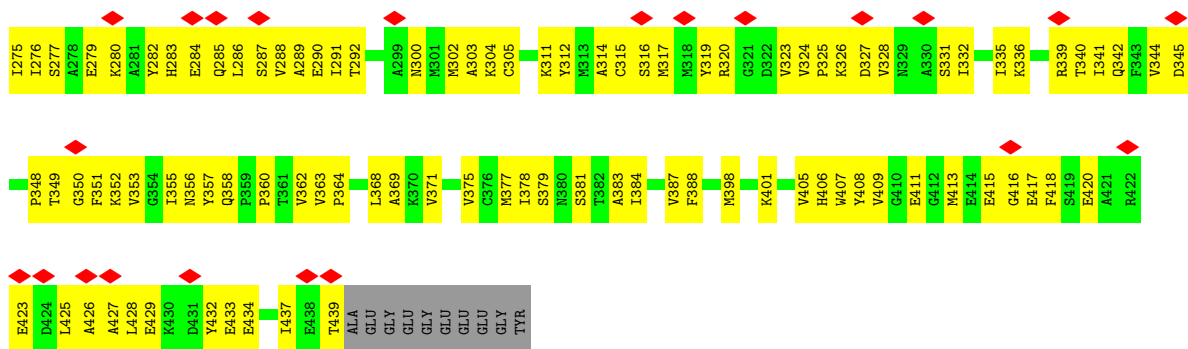

• Molecule 44: Tubulin alpha chain

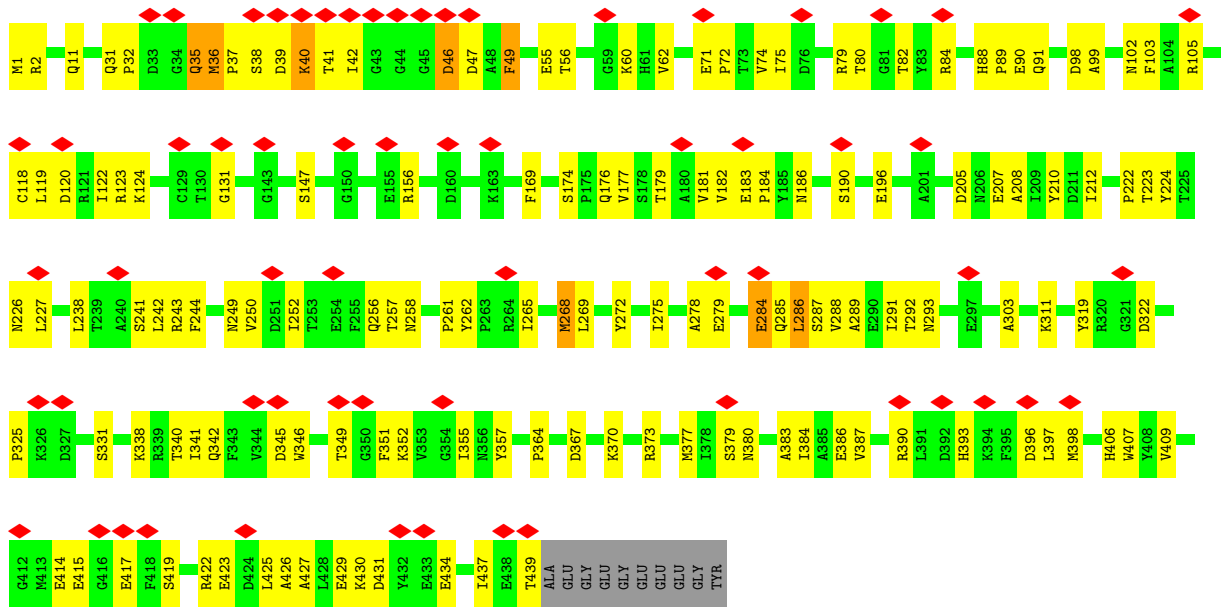

• Molecule 44: Tubulin alpha chain

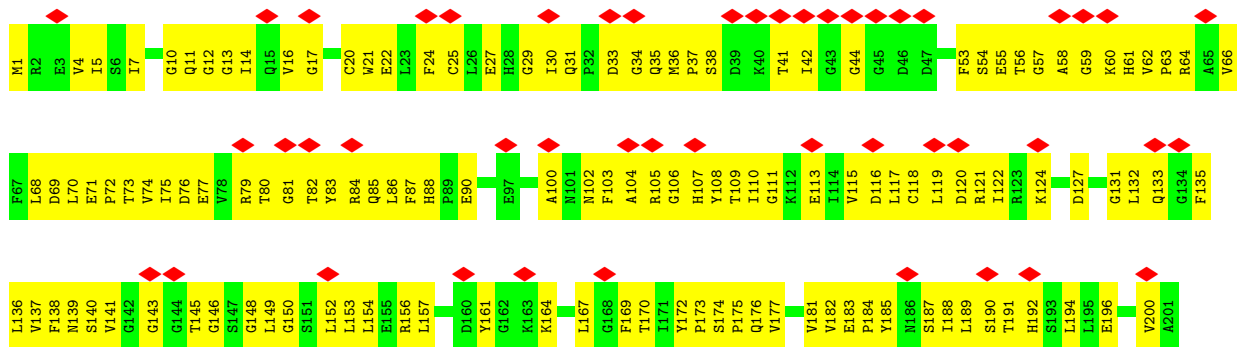

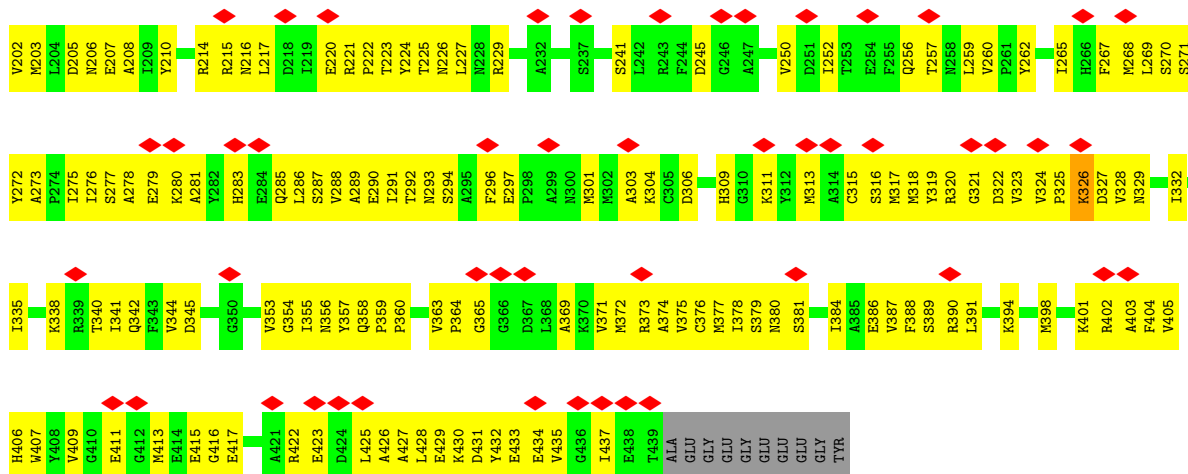

• Molecule 44: Tubulin alpha chain

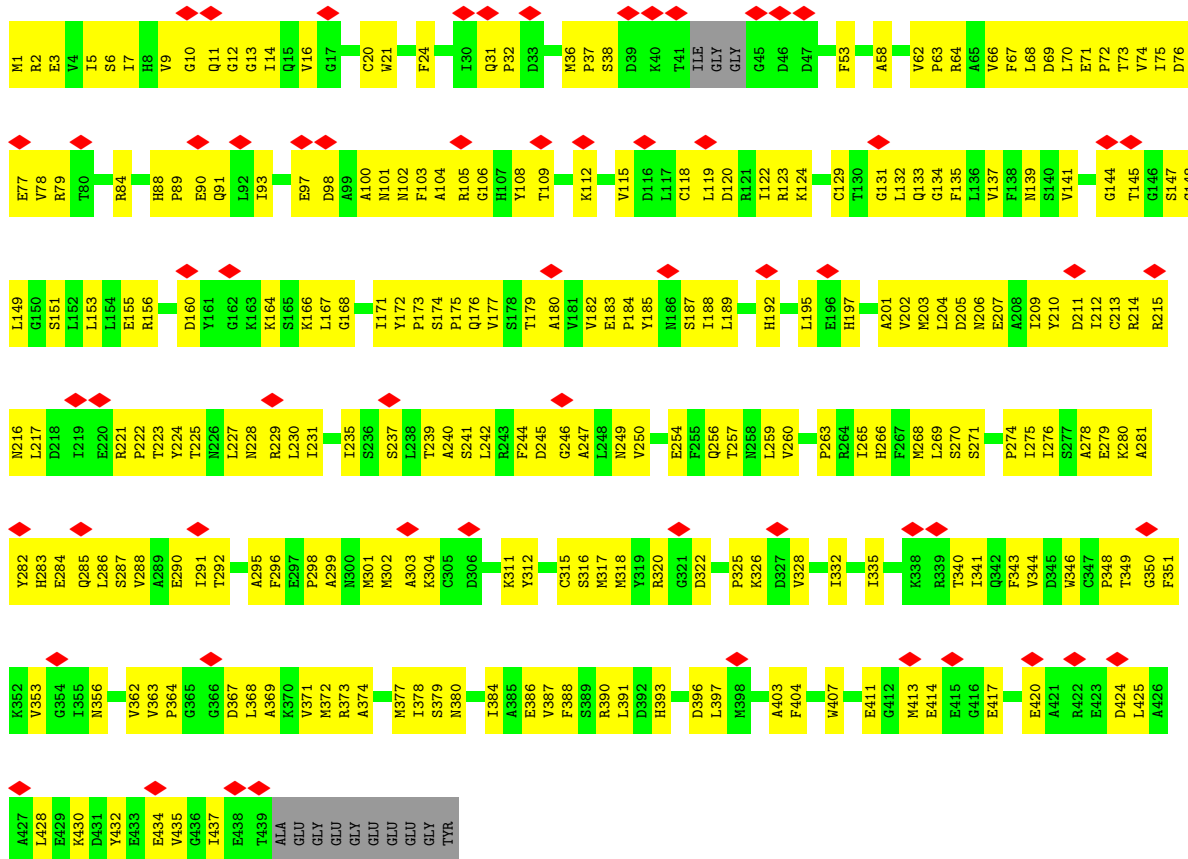
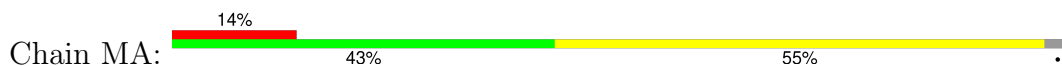

• Molecule 44: Tubulin alpha chain



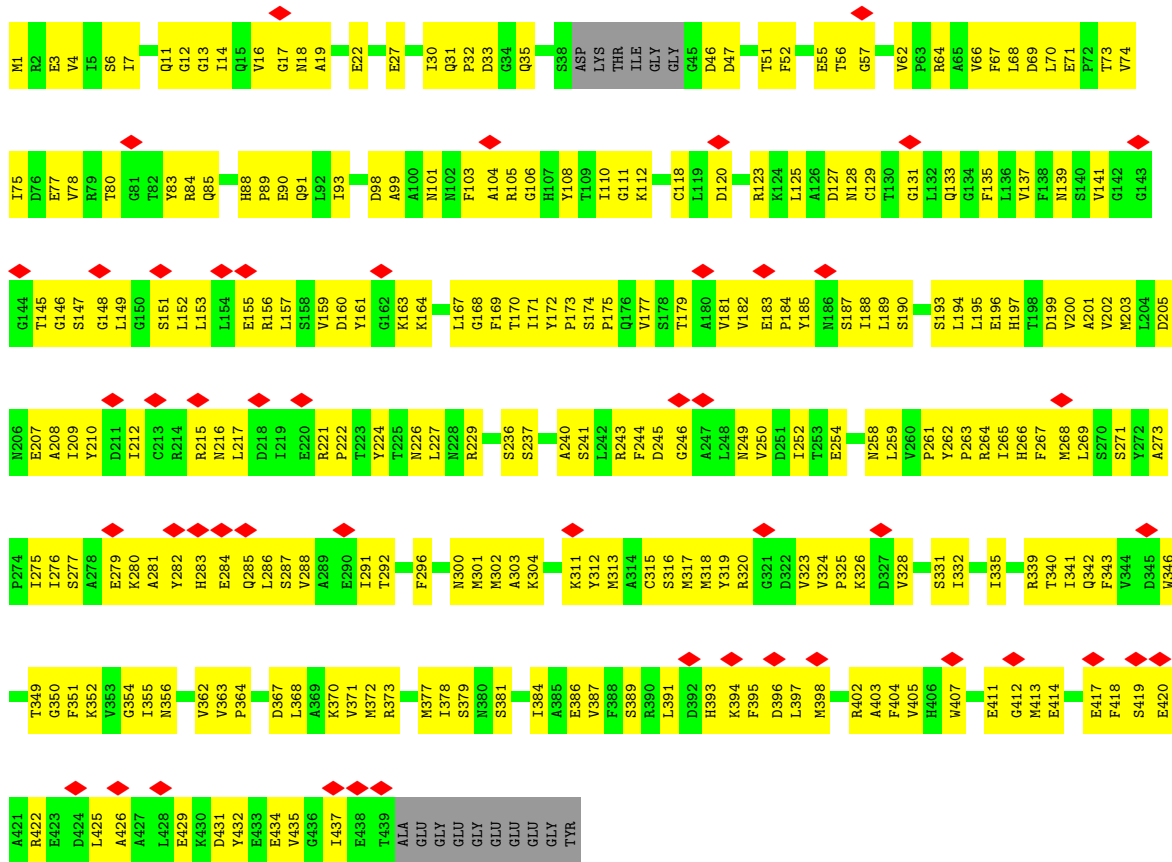

• Molecule 44: Tubulin alpha chain

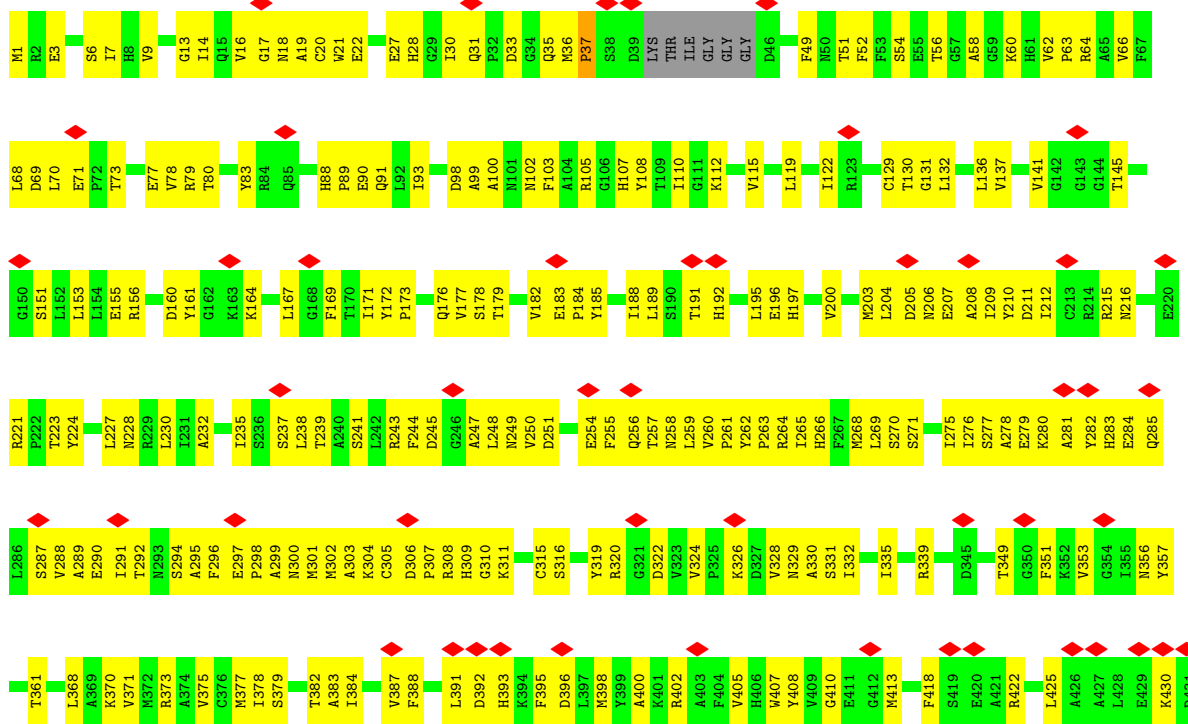
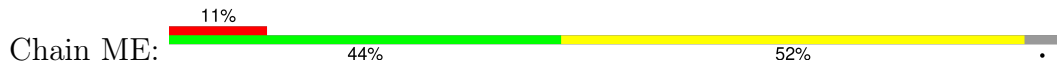

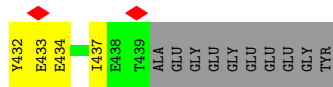

• Molecule 44: Tubulin alpha chain

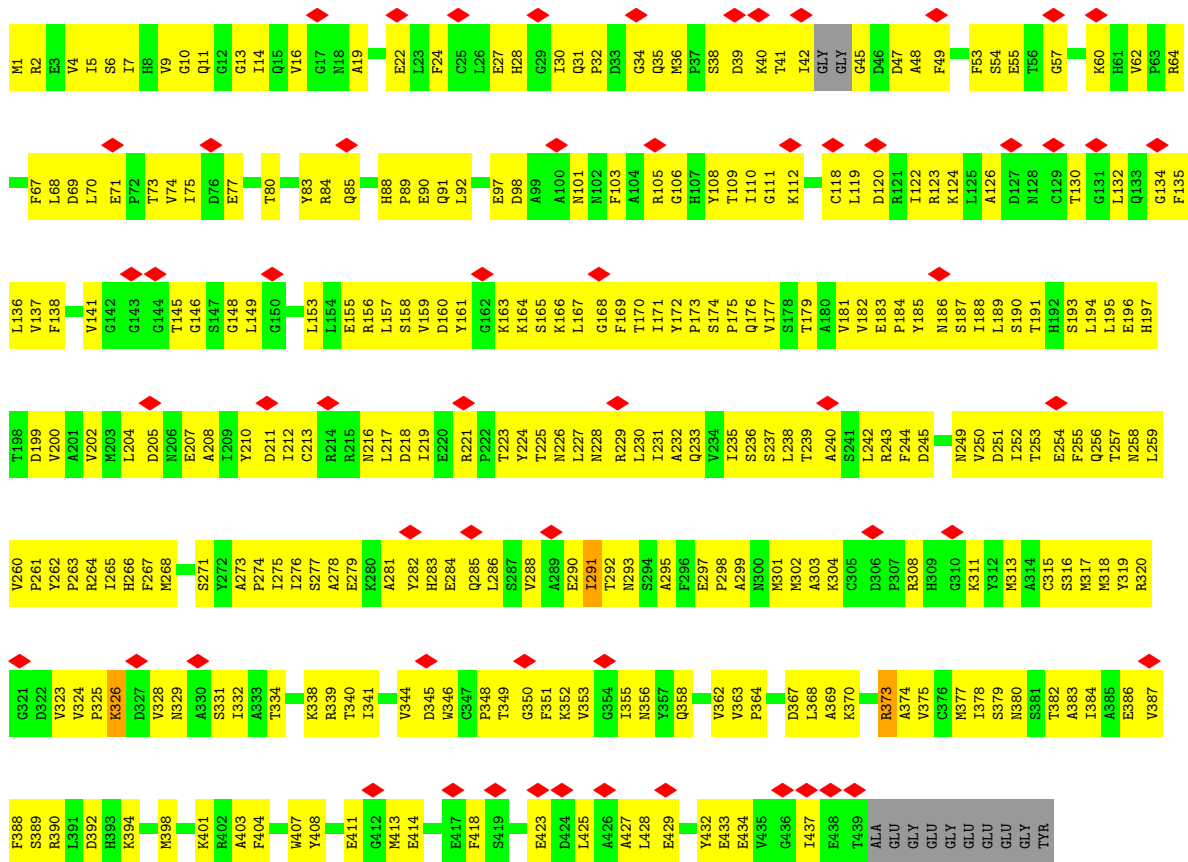

• Molecule 44: Tubulin alpha chain

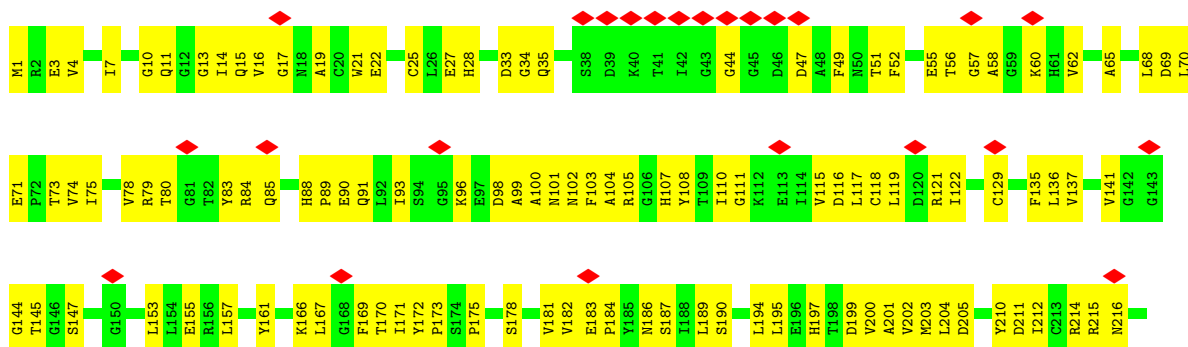





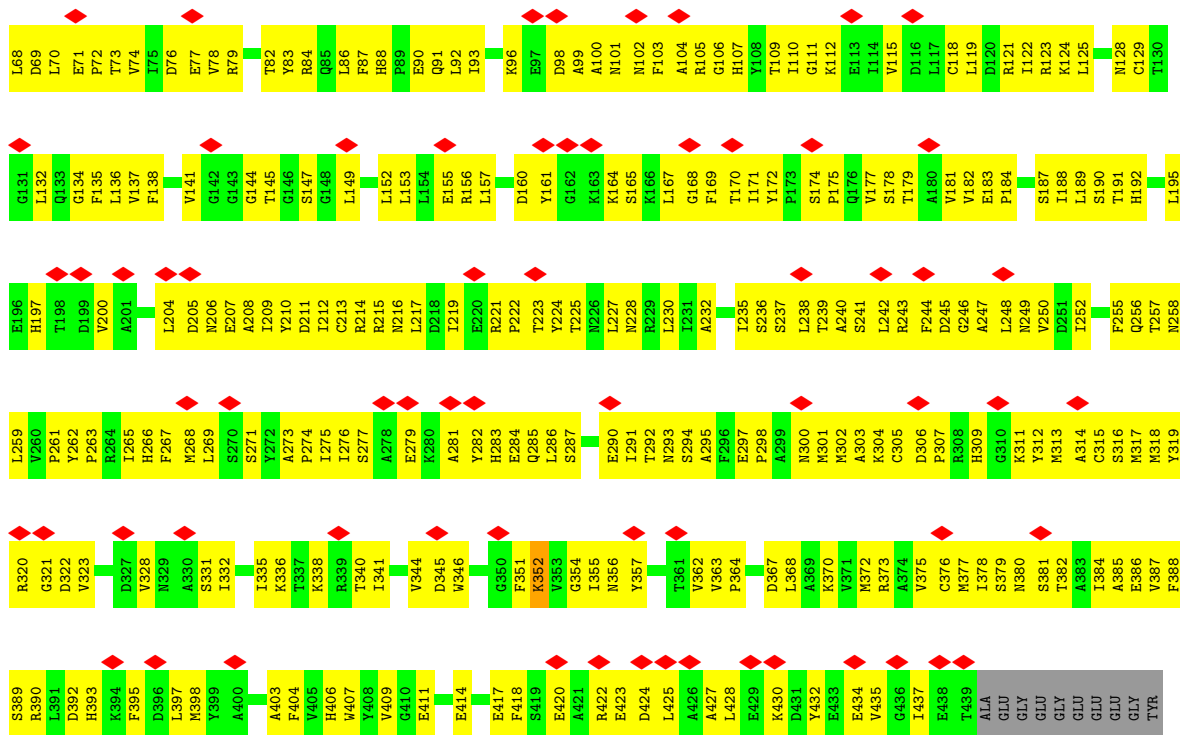

• Molecule 44: Tubulin alpha chain

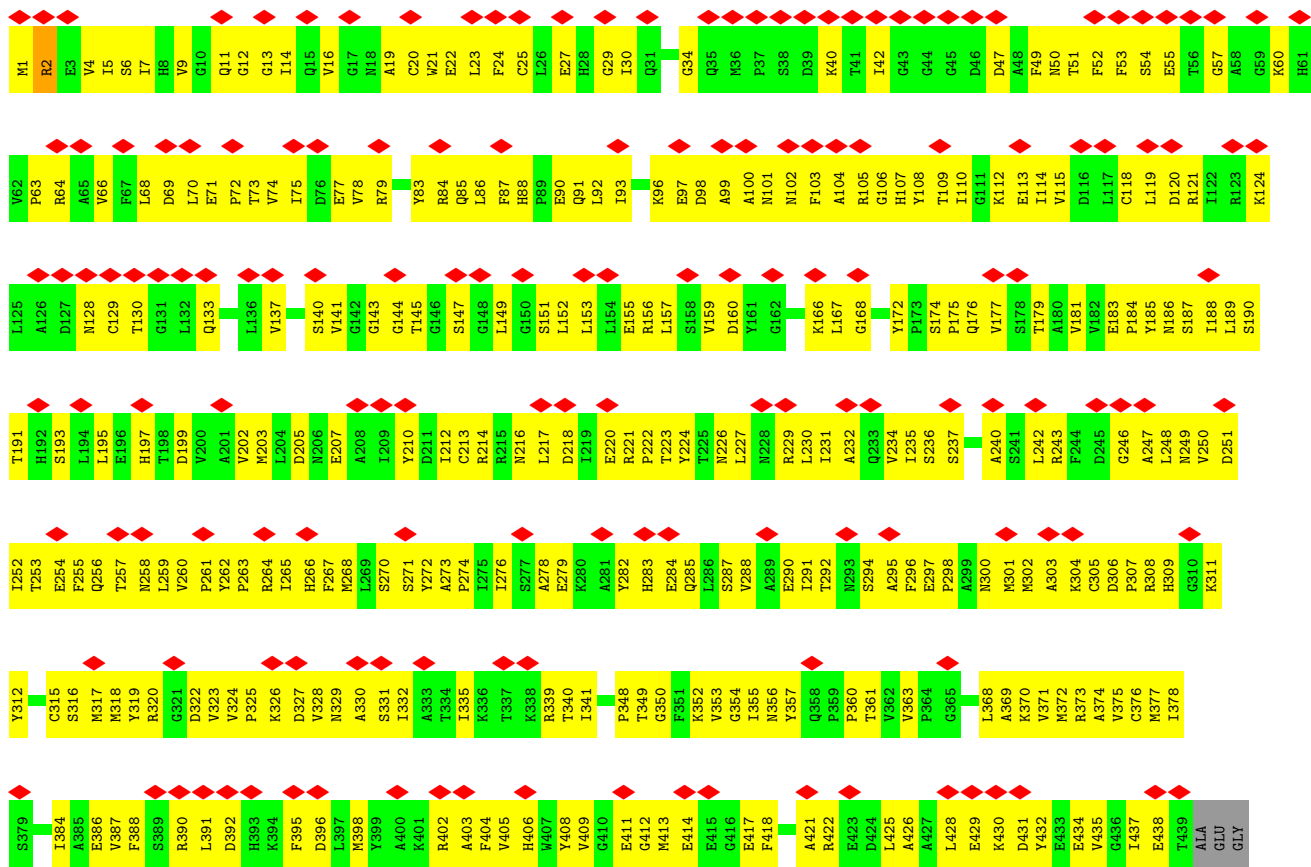

GLU  
GLY  
GLU  
GLU  
GLY  
GLY  
TYR

• Molecule 44: Tubulin alpha chain

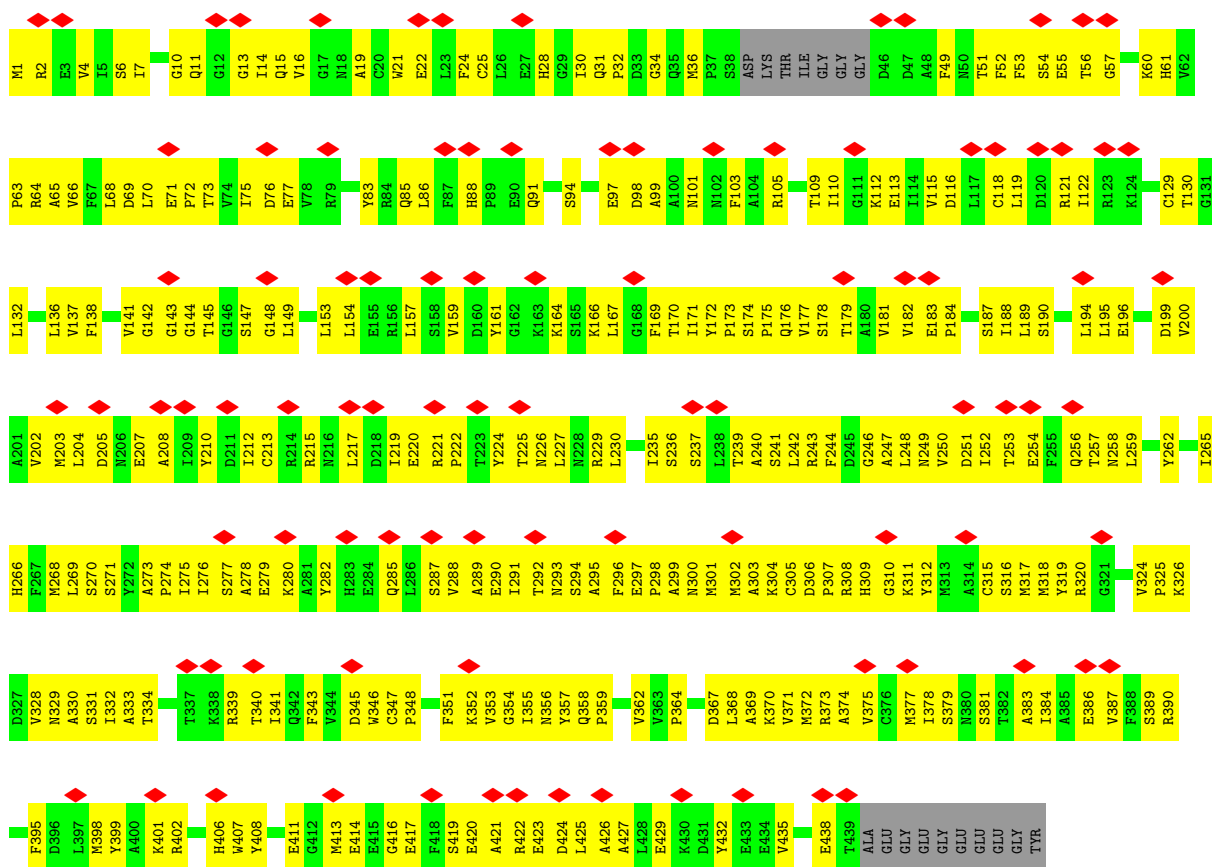

• Molecule 44: Tubulin alpha chain

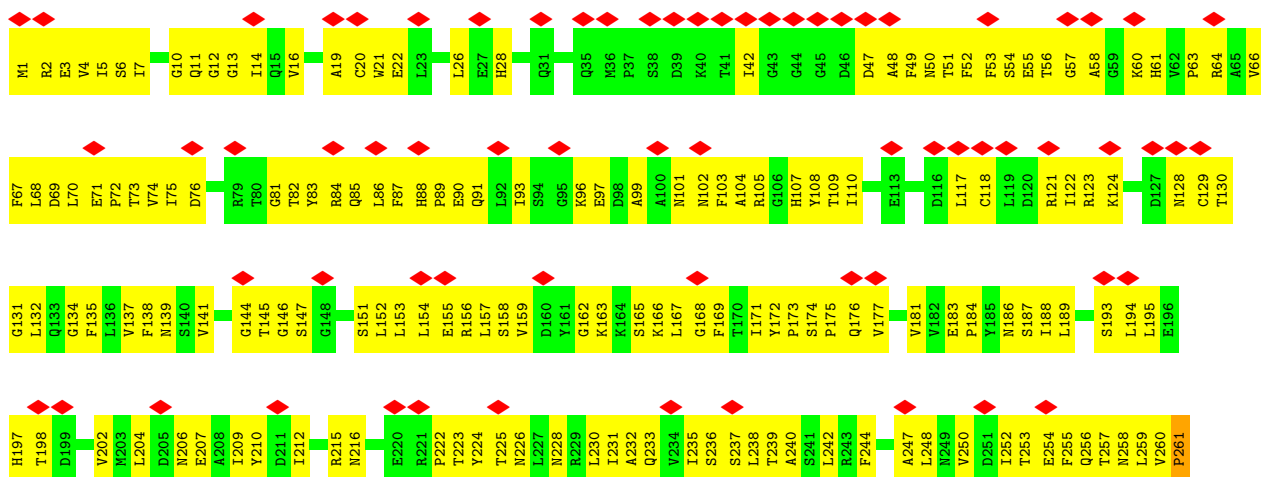

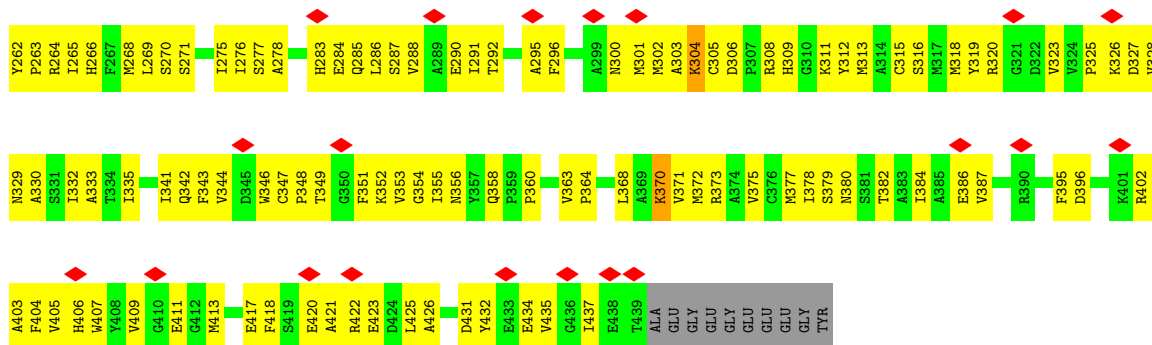

• Molecule 44: Tubulin alpha chain

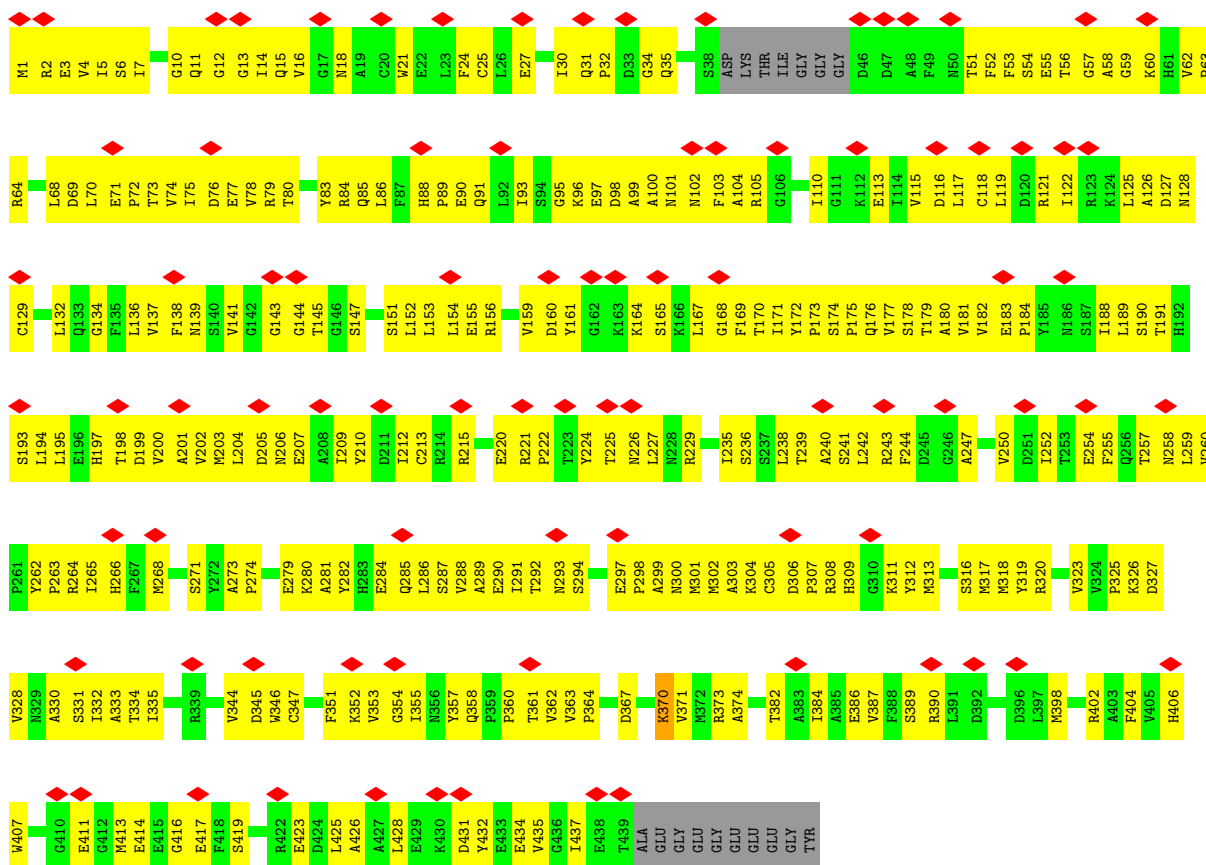

• Molecule 44: Tubulin alpha chain

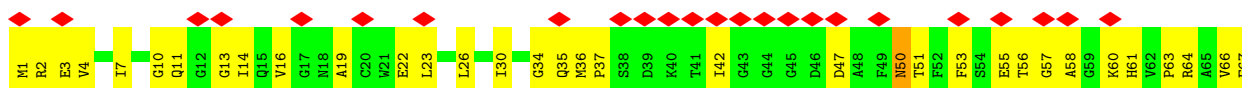

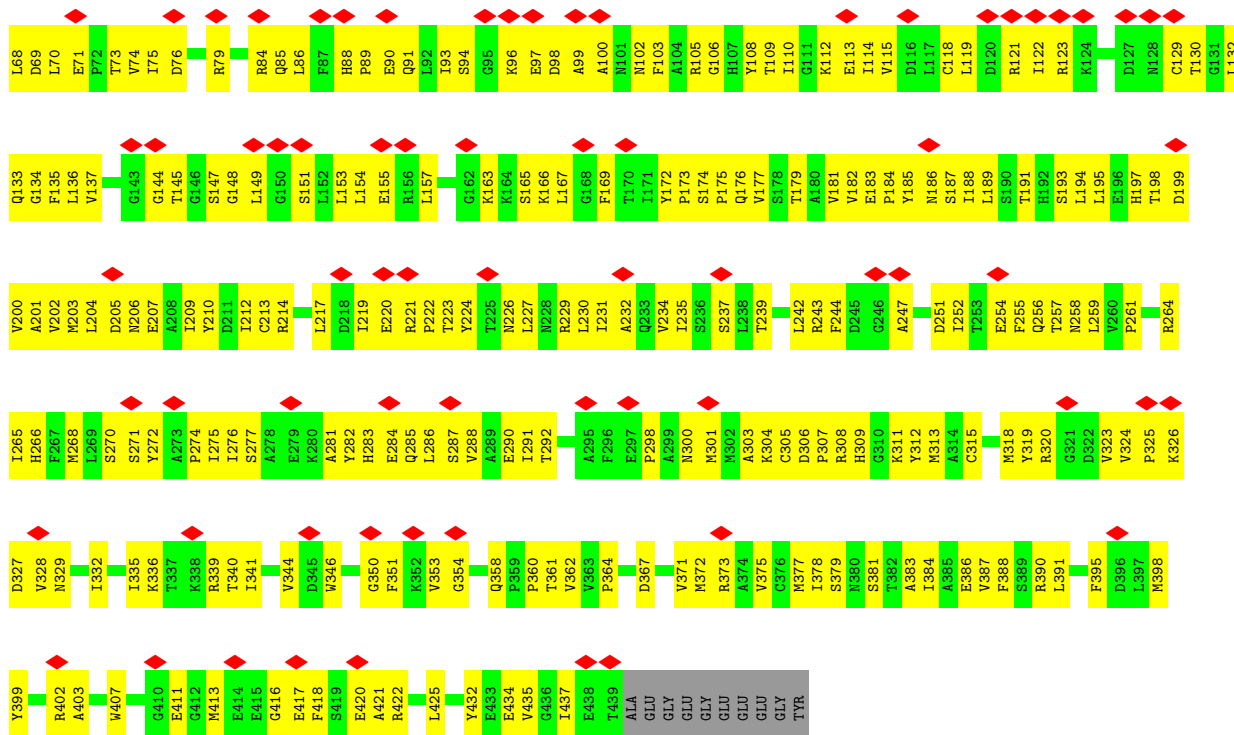

• Molecule 44: Tubulin alpha chain

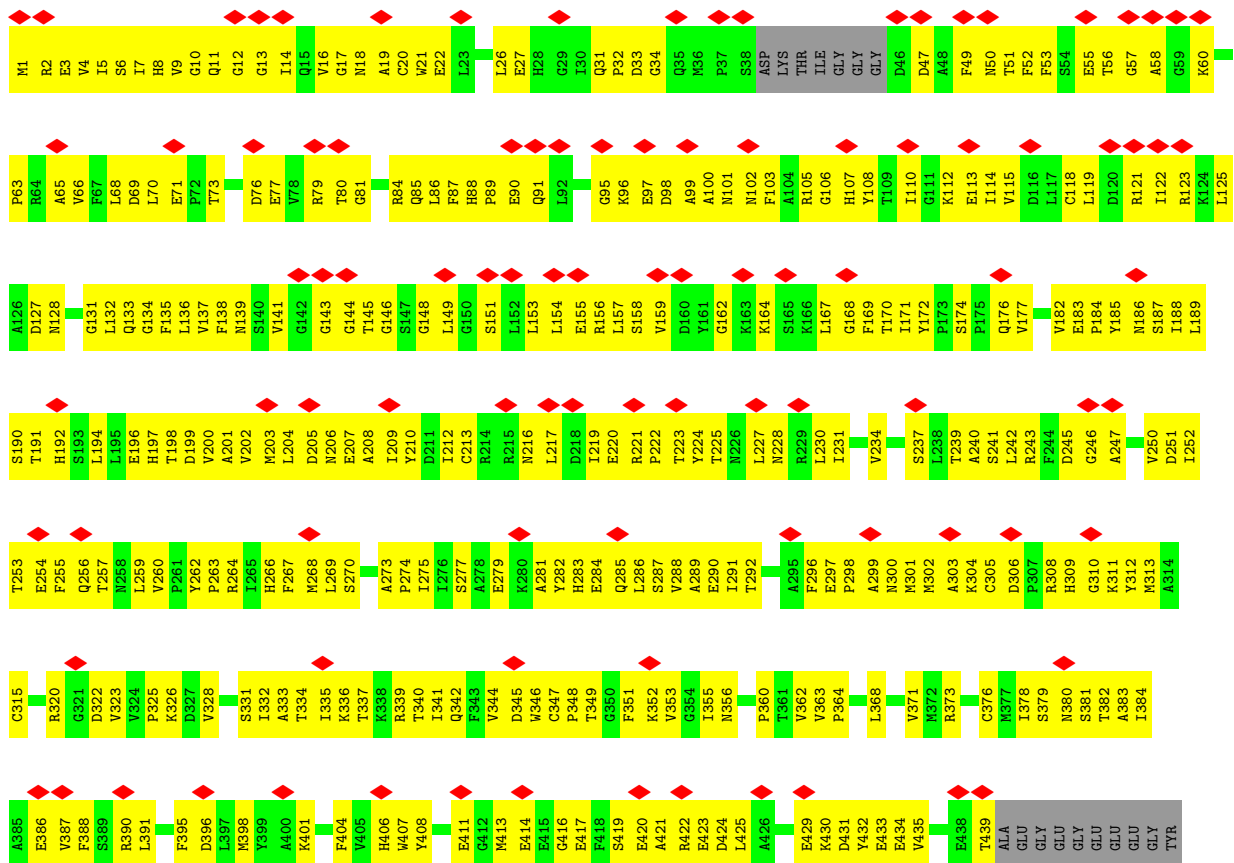

• Molecule 44: Tubulin alpha chain

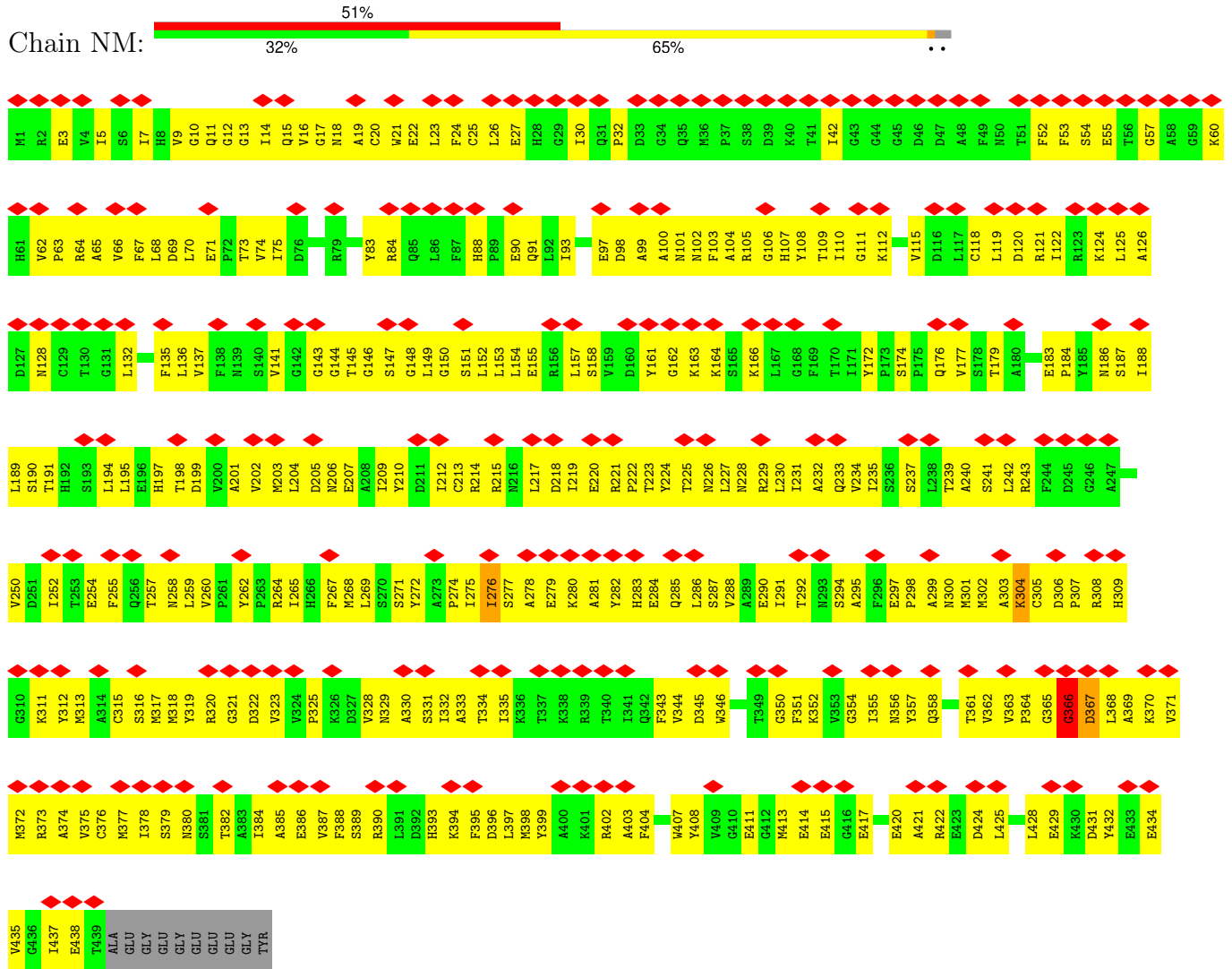

• Molecule 44: Tubulin alpha chain

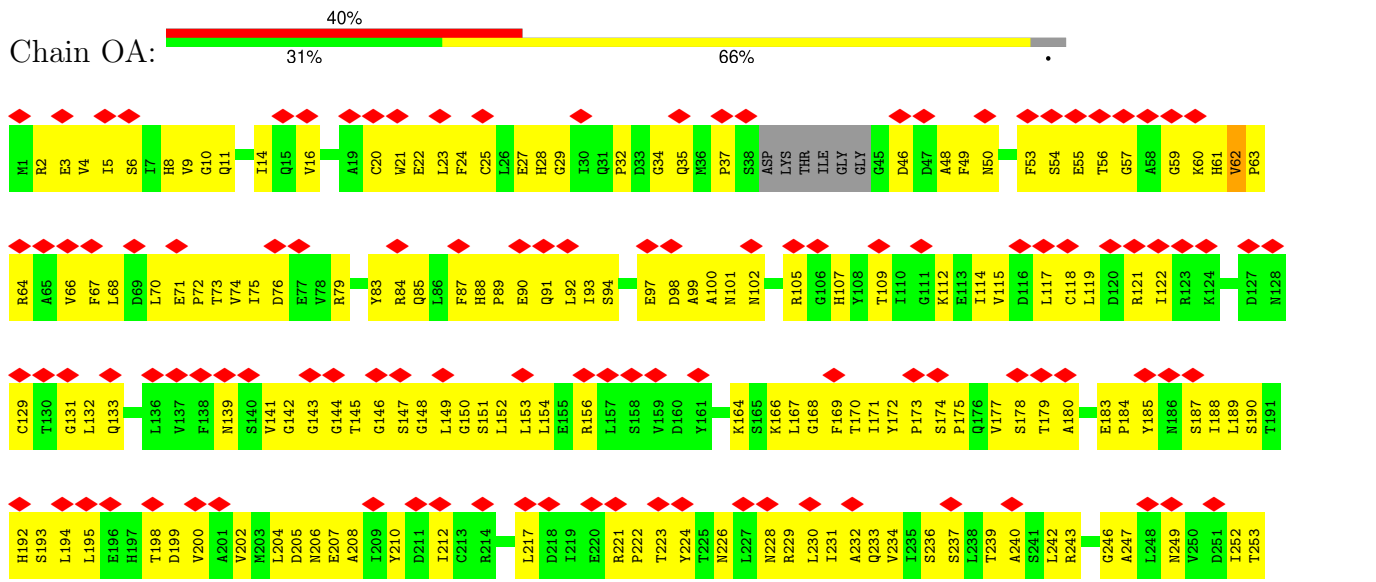

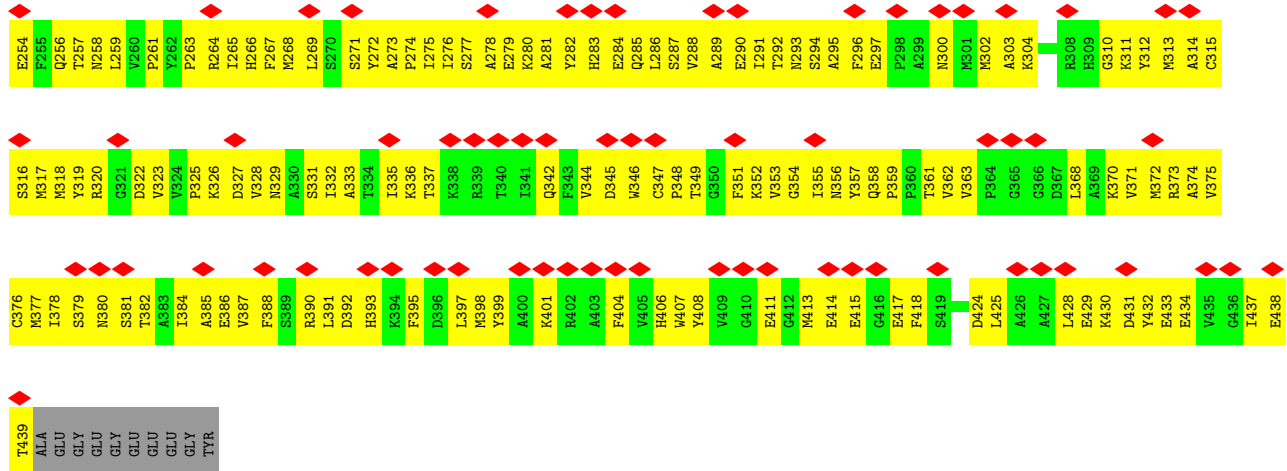

• Molecule 44: Tubulin alpha chain

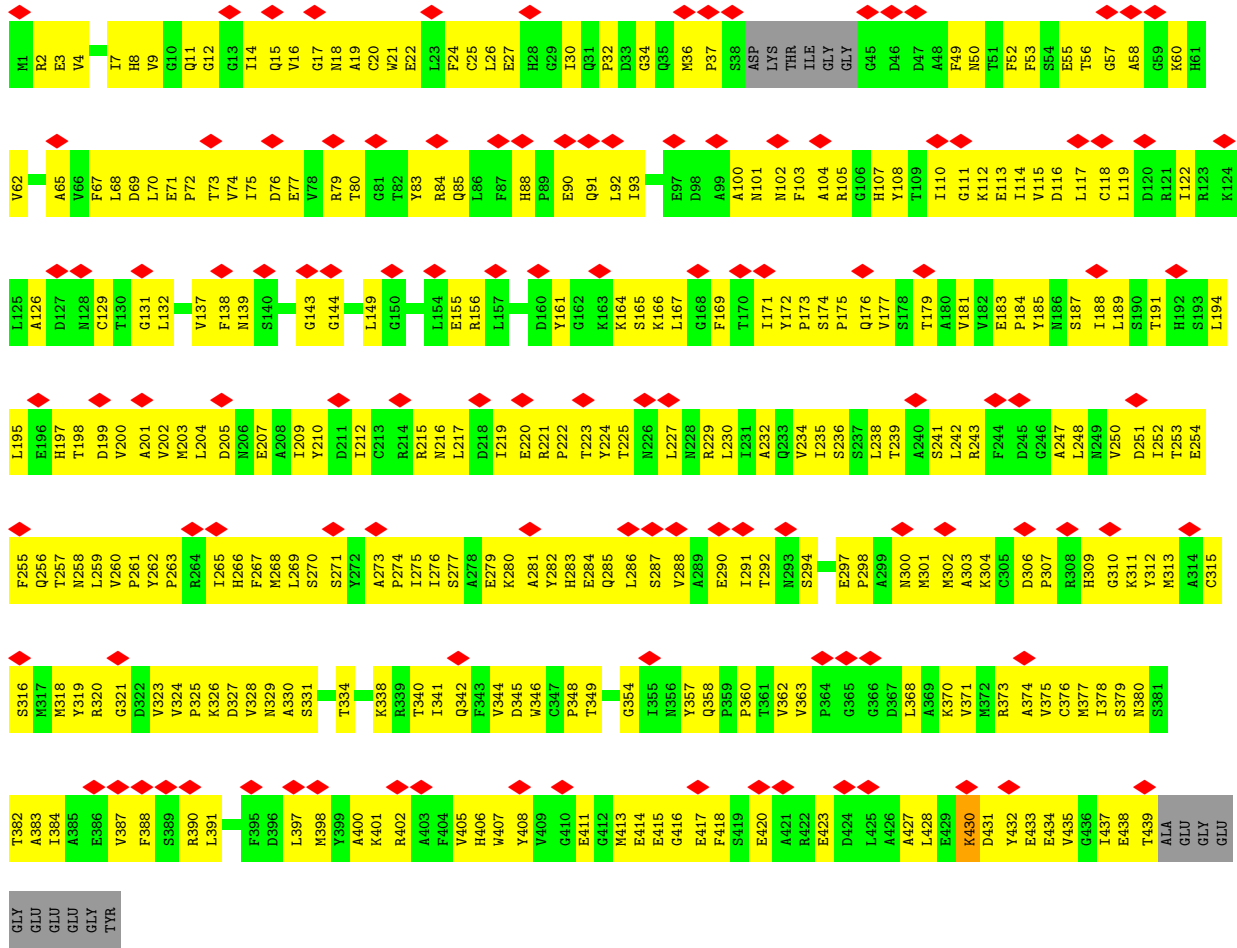

• Molecule 44: Tubulin alpha chain



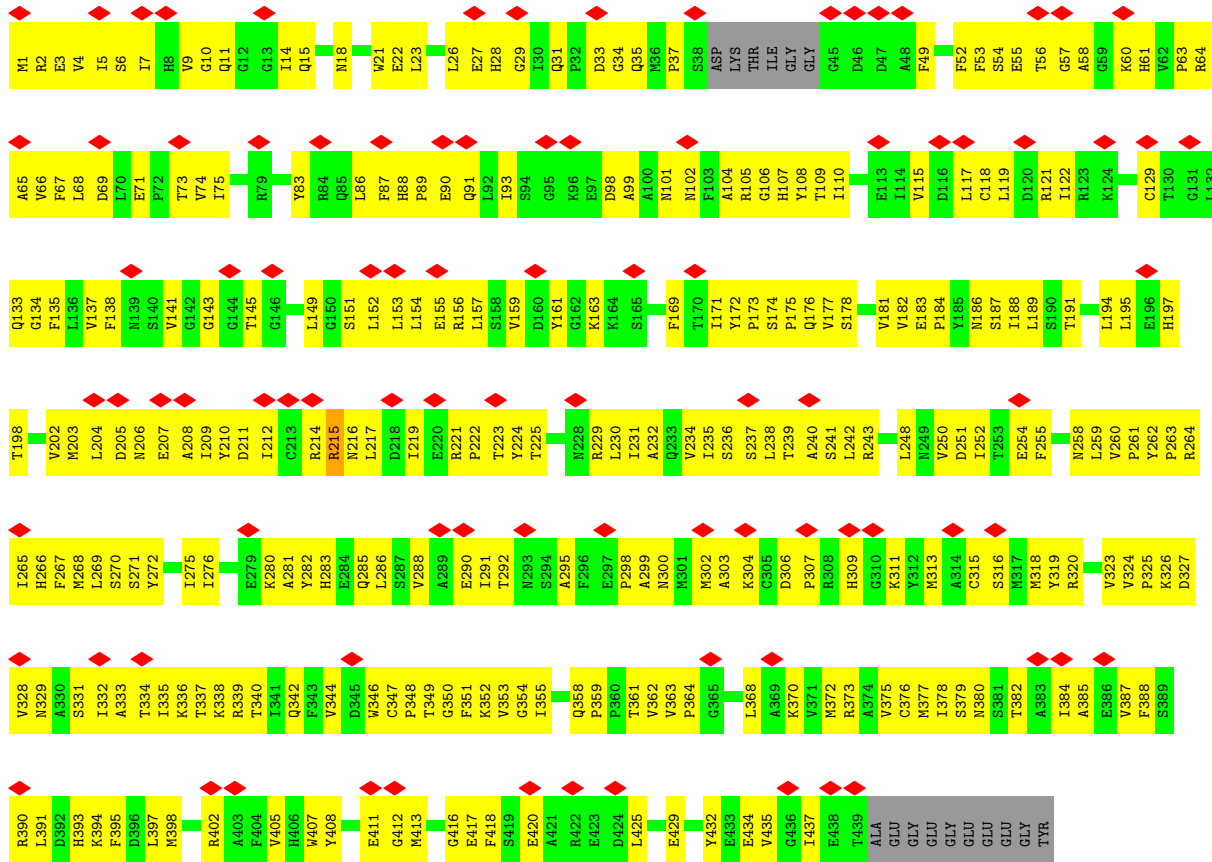

• Molecule 44: Tubulin alpha chain

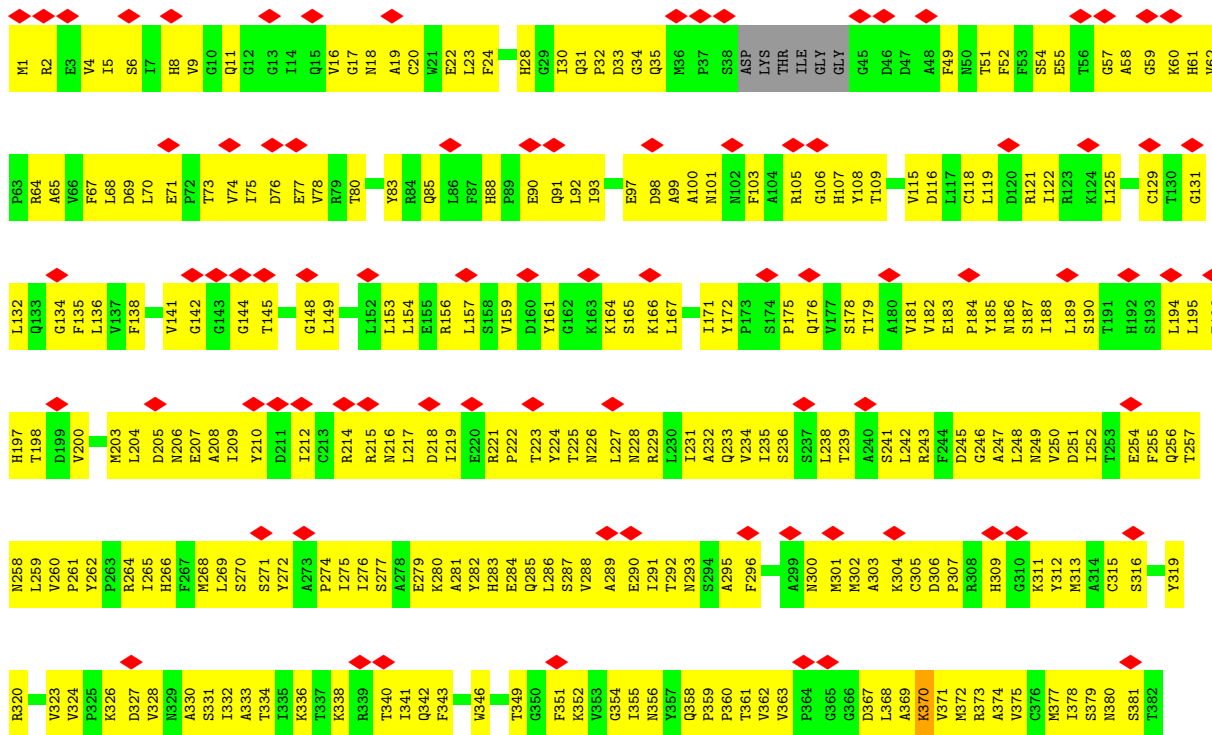



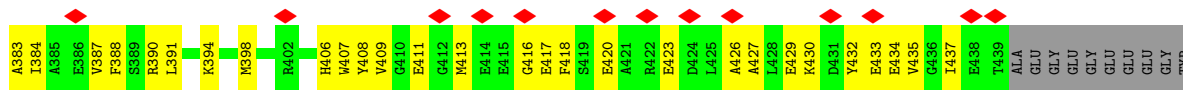

• Molecule 44: Tubulin alpha chain

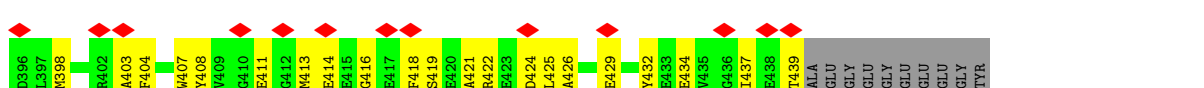
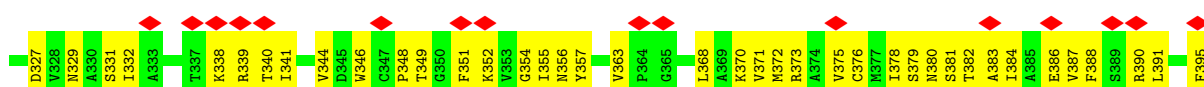
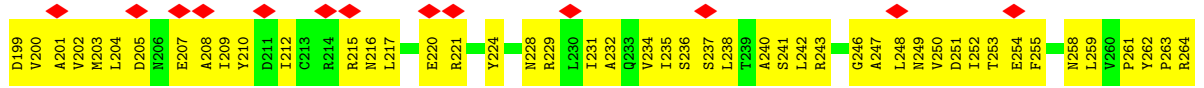
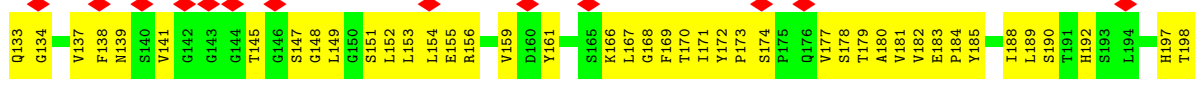
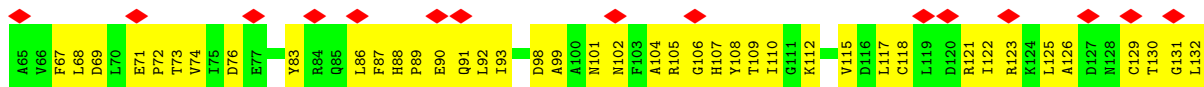
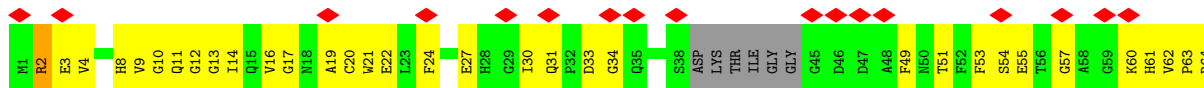
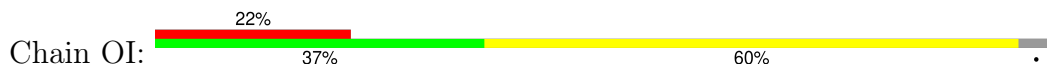

• Molecule 44: Tubulin alpha chain

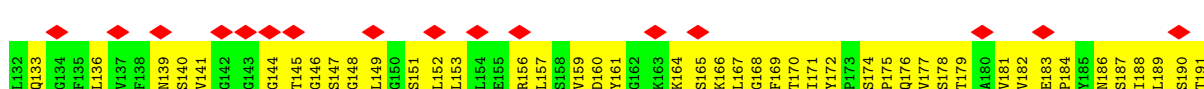
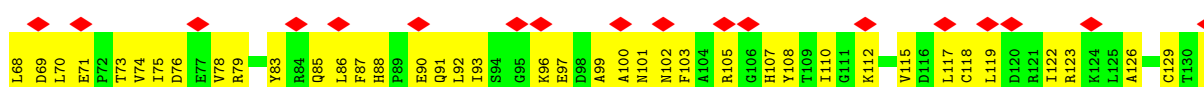
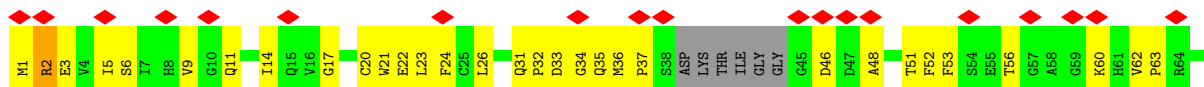

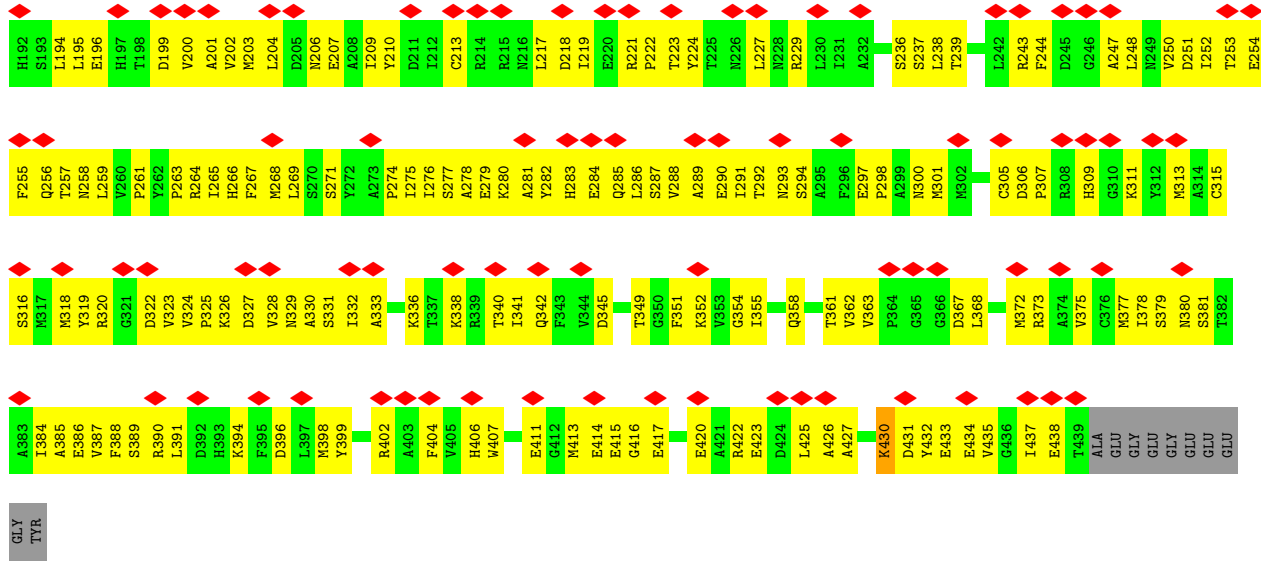

• Molecule 44: Tubulin alpha chain

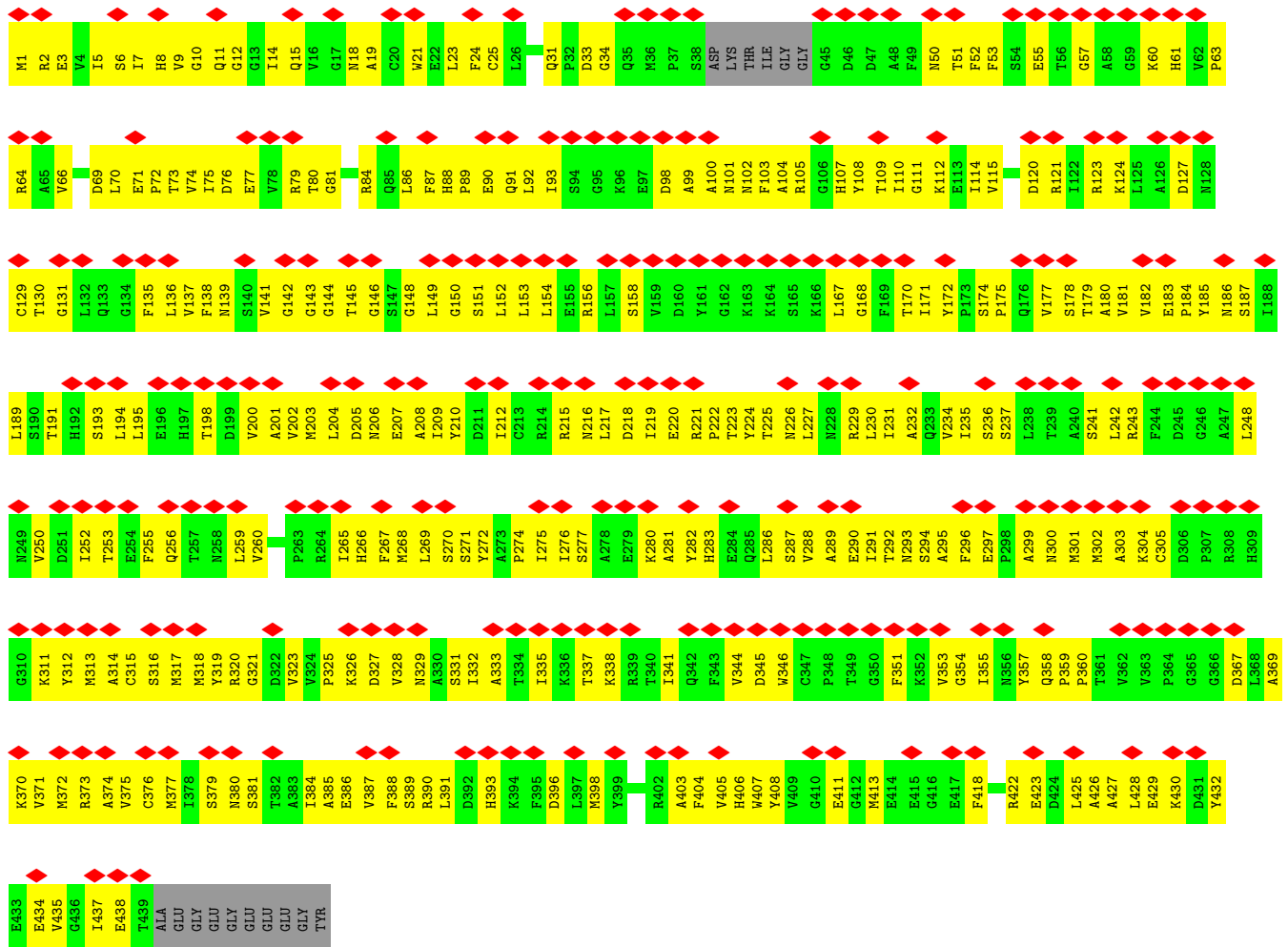

• Molecule 44: Tubulin alpha chain

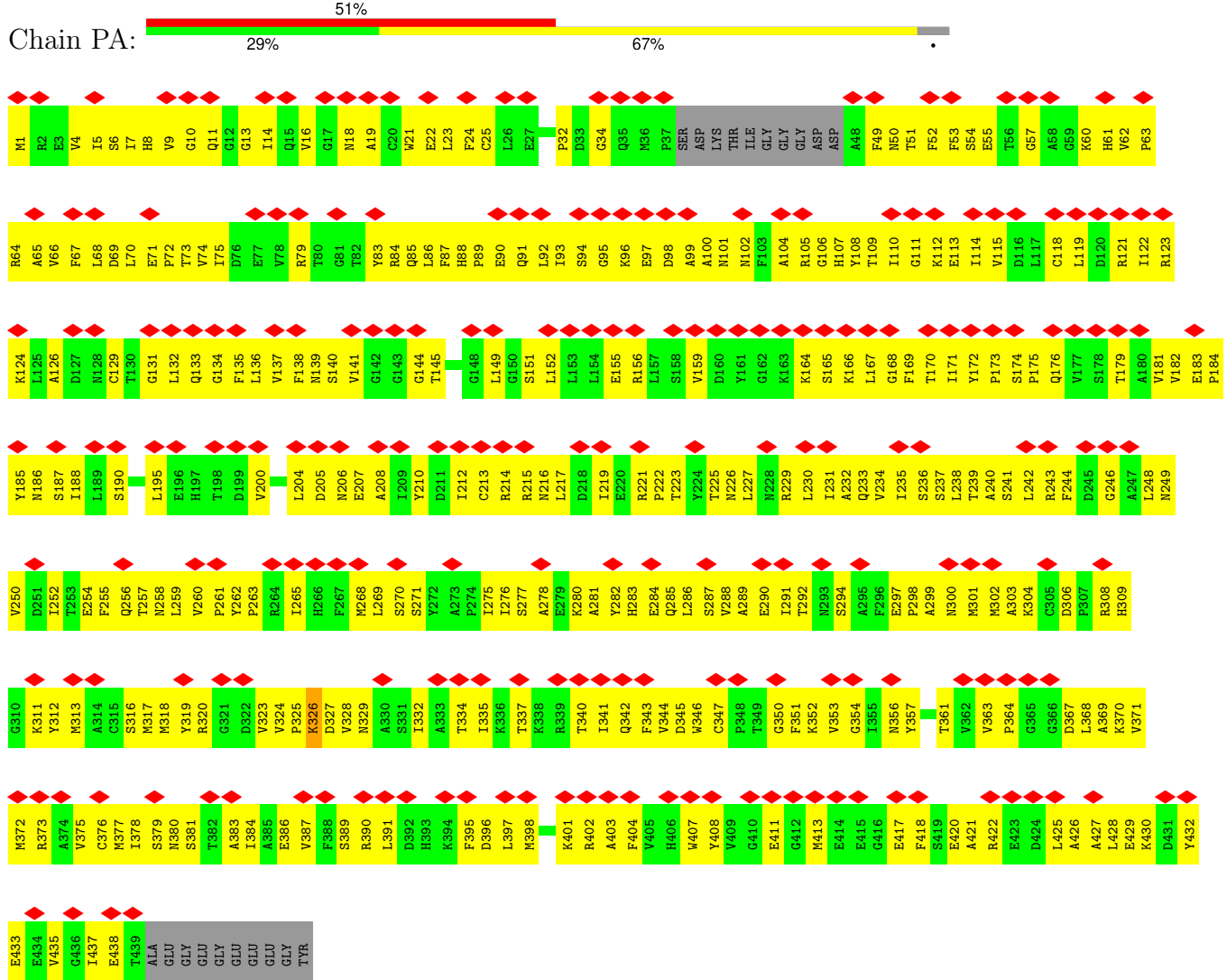

• Molecule 44: Tubulin alpha chain

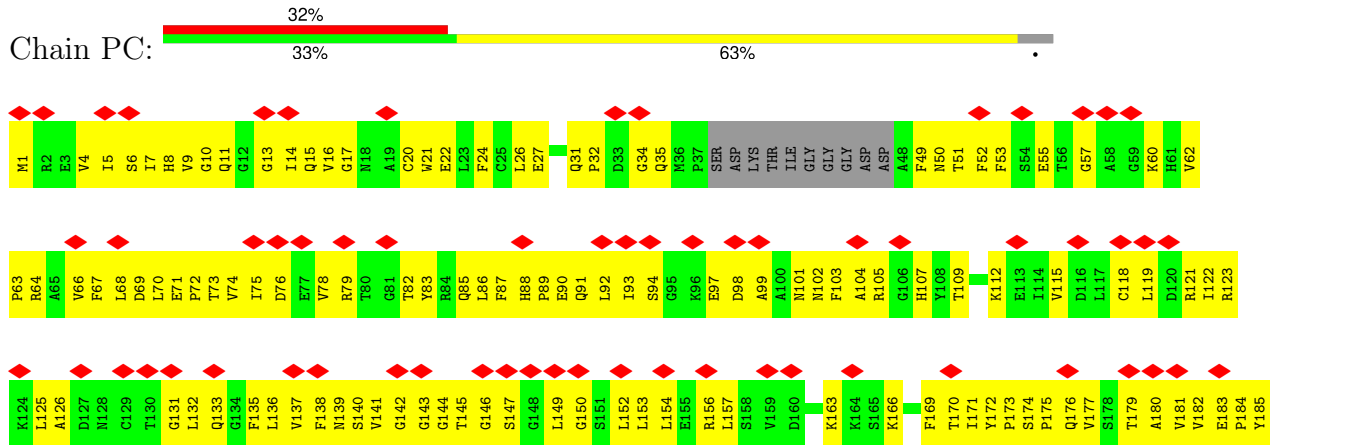

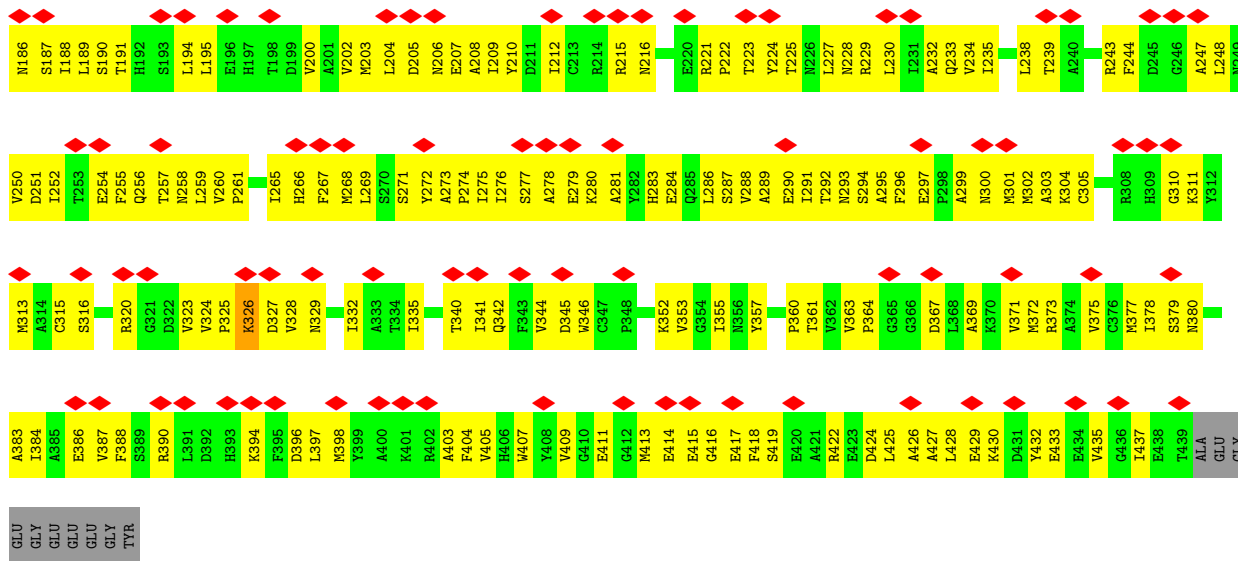

• Molecule 44: Tubulin alpha chain

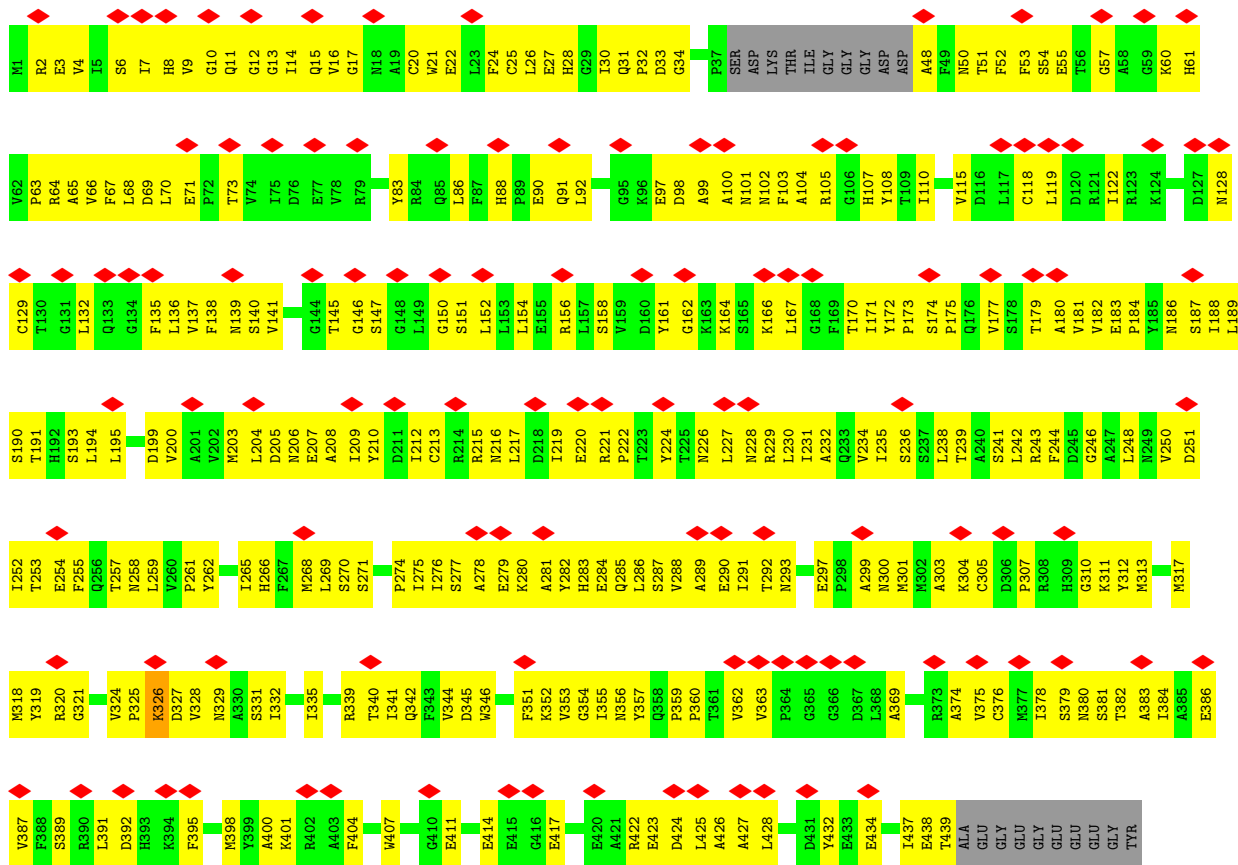

• Molecule 44: Tubulin alpha chain



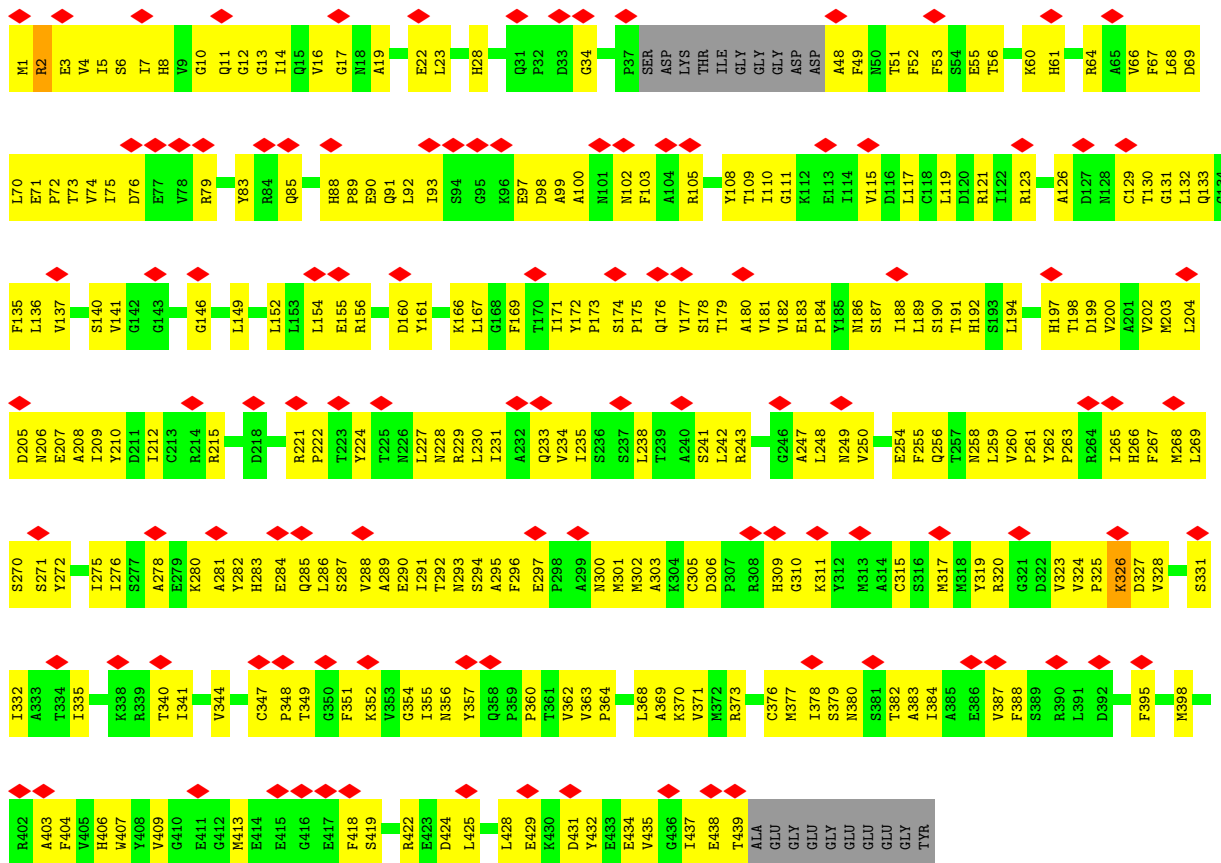

• Molecule 44: Tubulin alpha chain

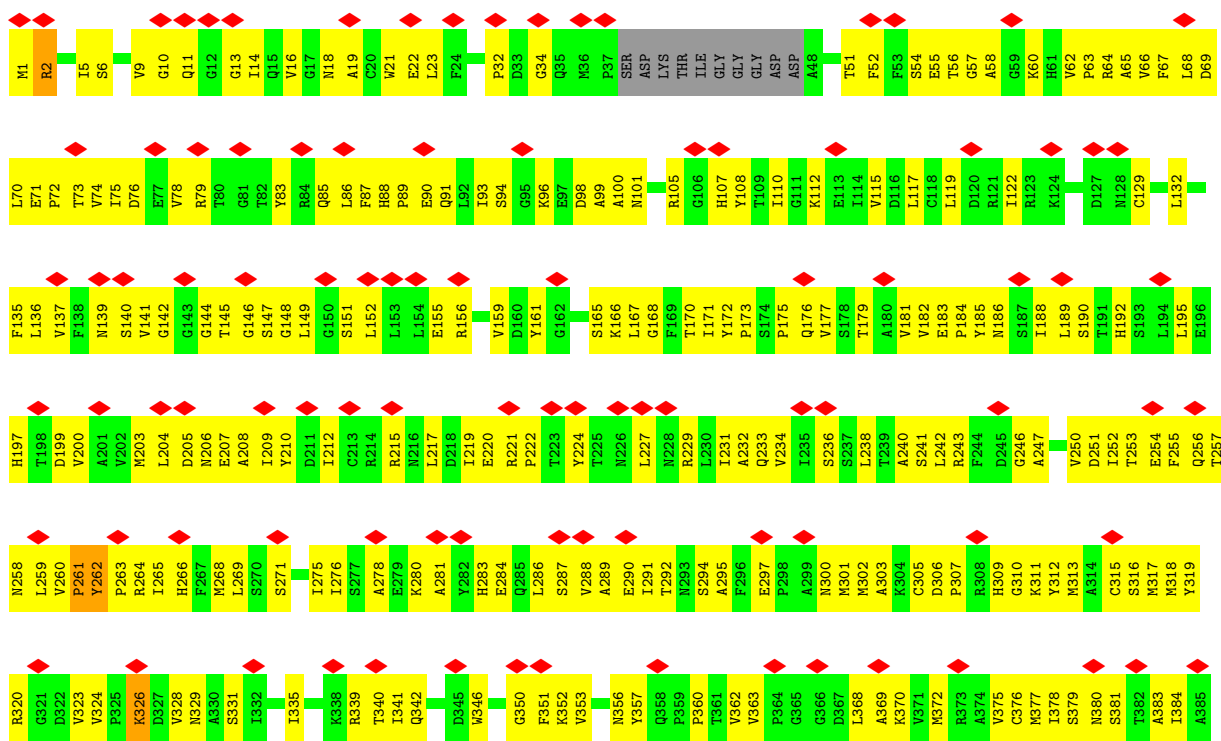



• Molecule 44: Tubulin alpha chain

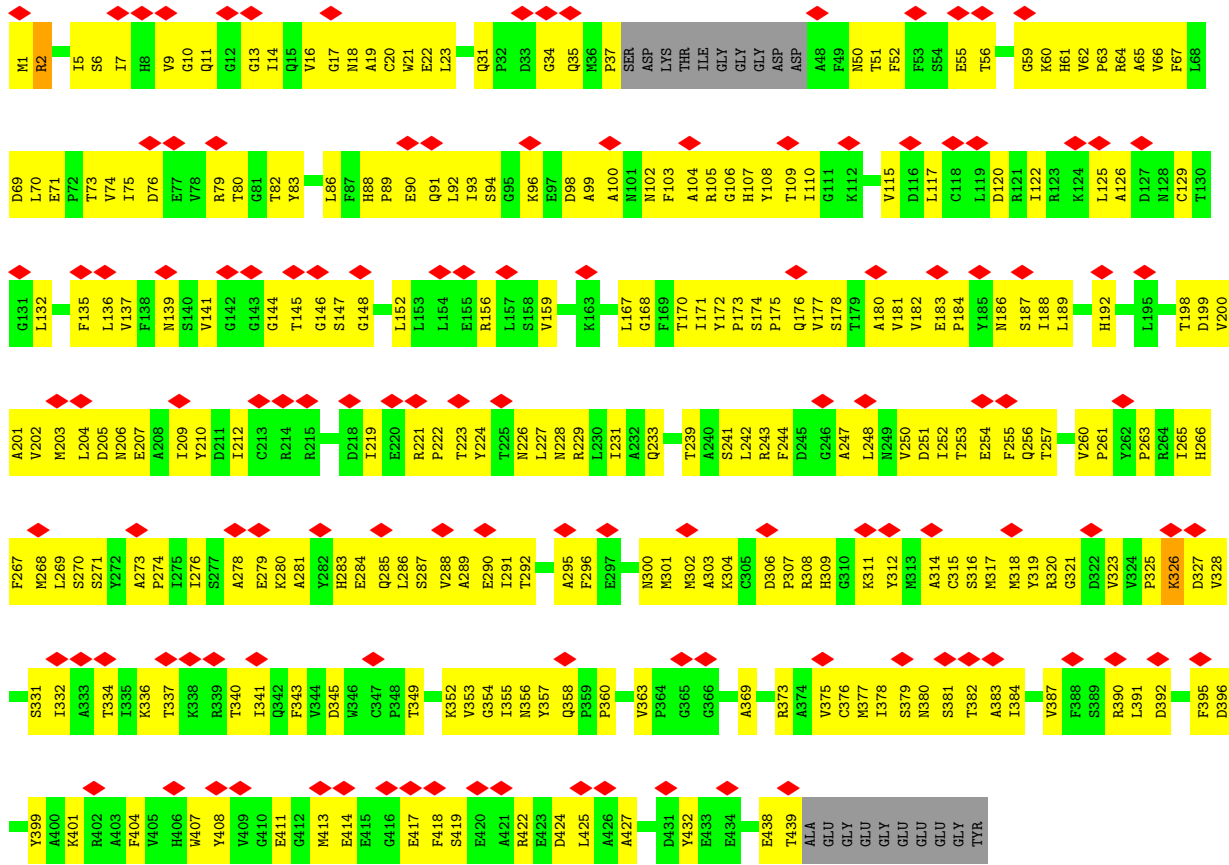

• Molecule 44: Tubulin alpha chain

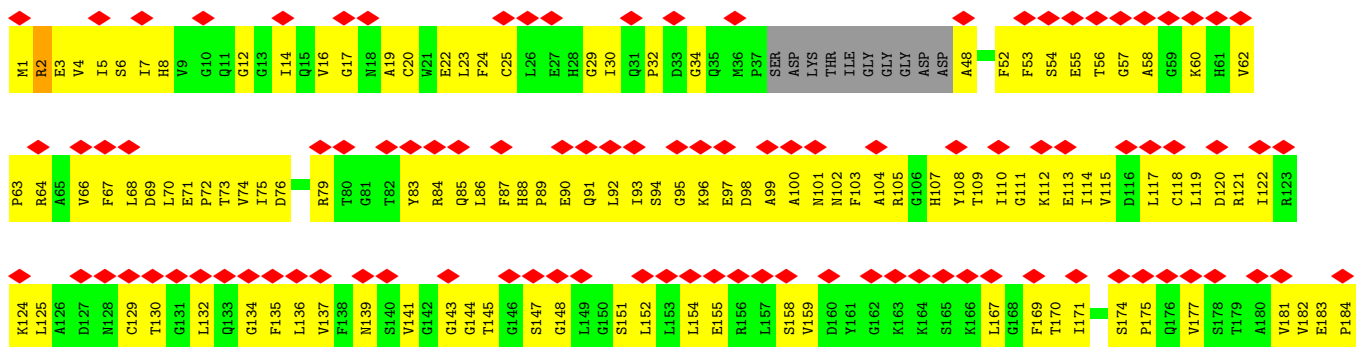

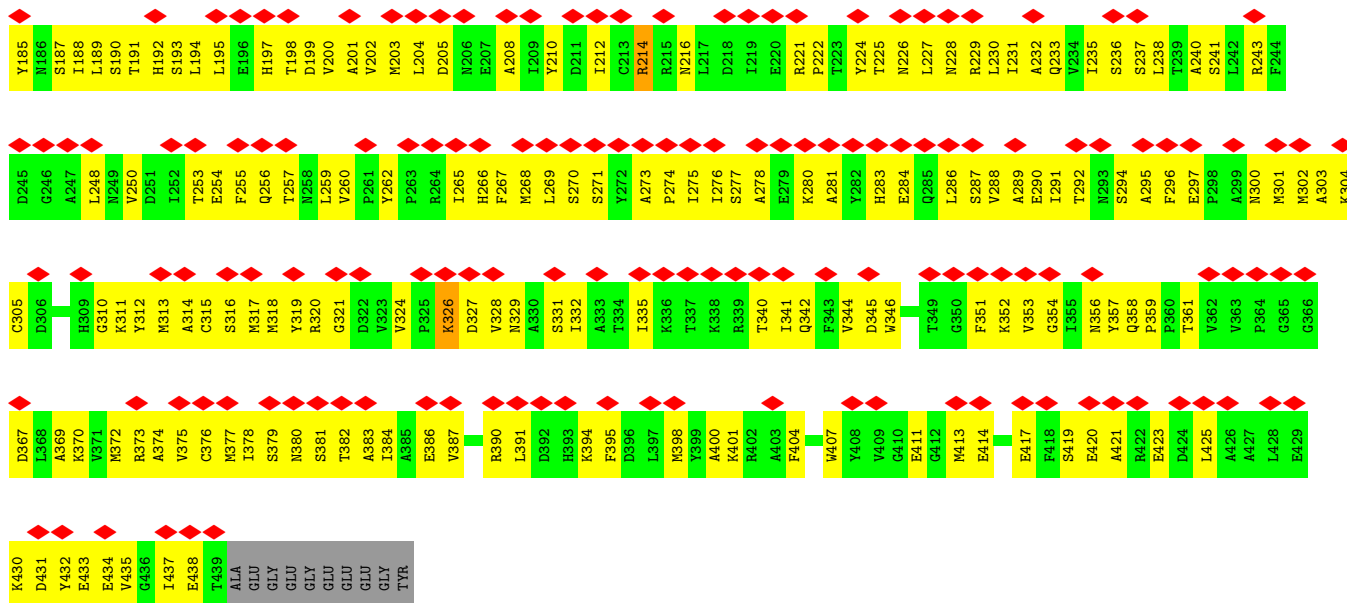

• Molecule 44: Tubulin alpha chain

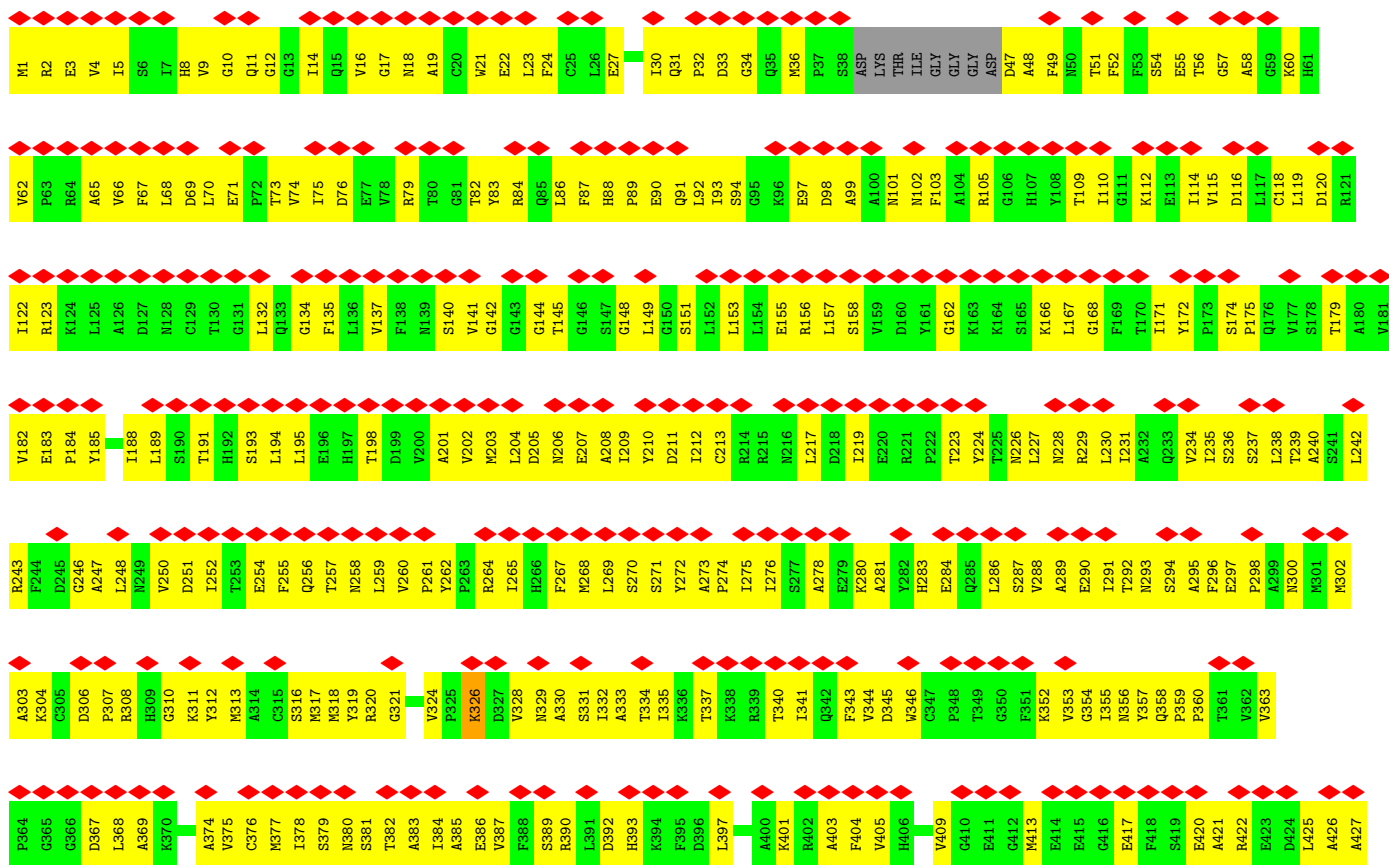

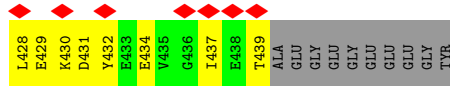

• Molecule 44: Tubulin alpha chain

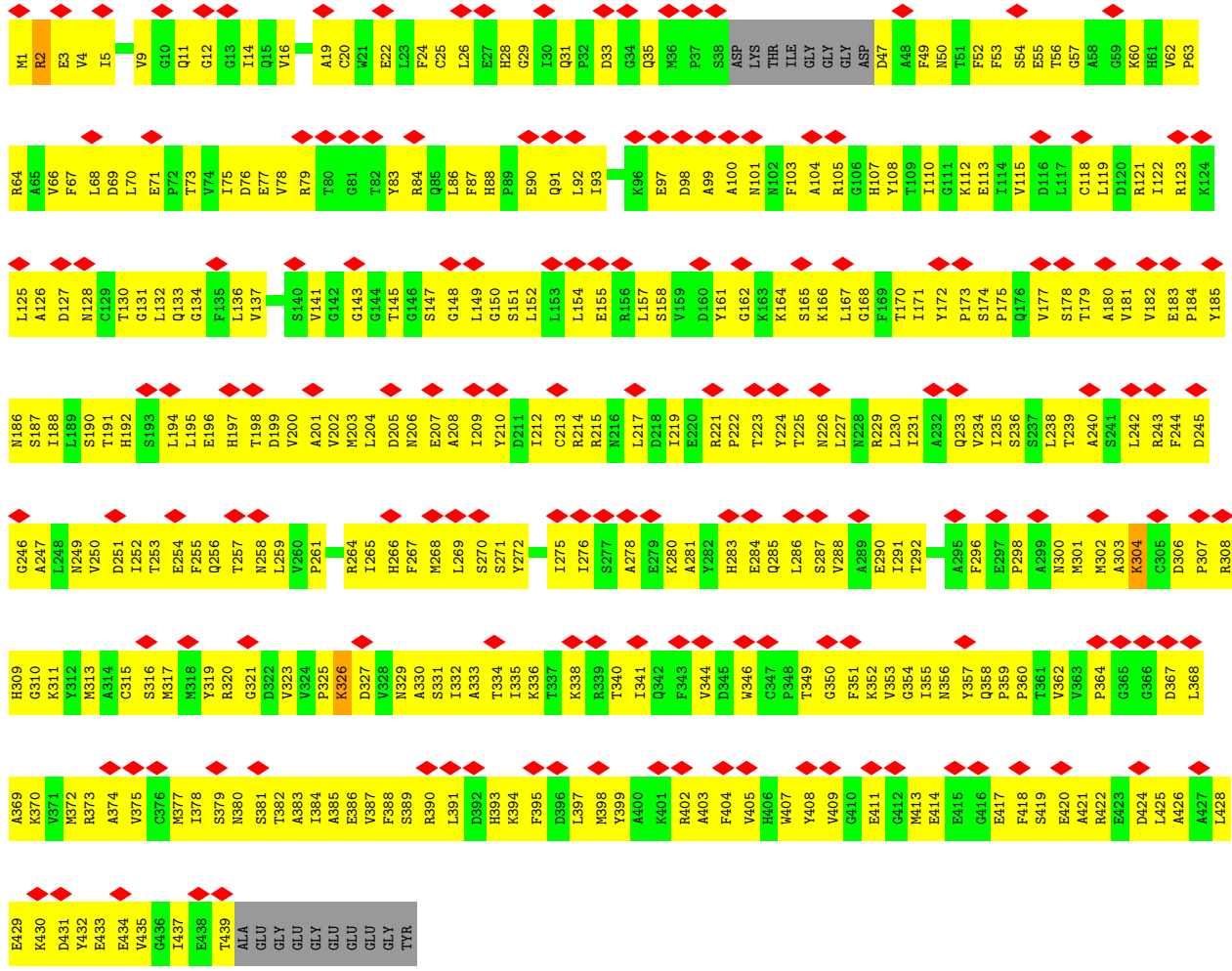

• Molecule 44: Tubulin alpha chain

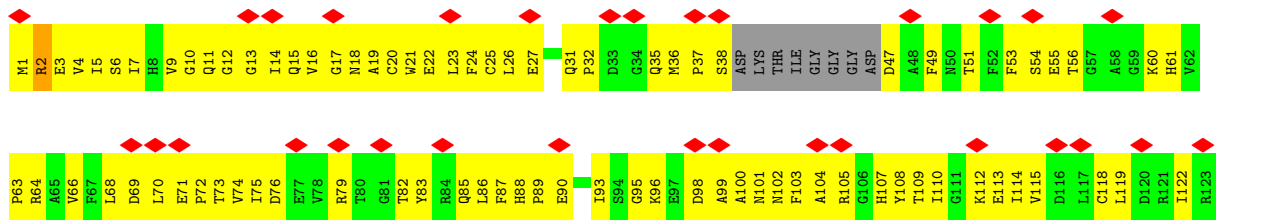



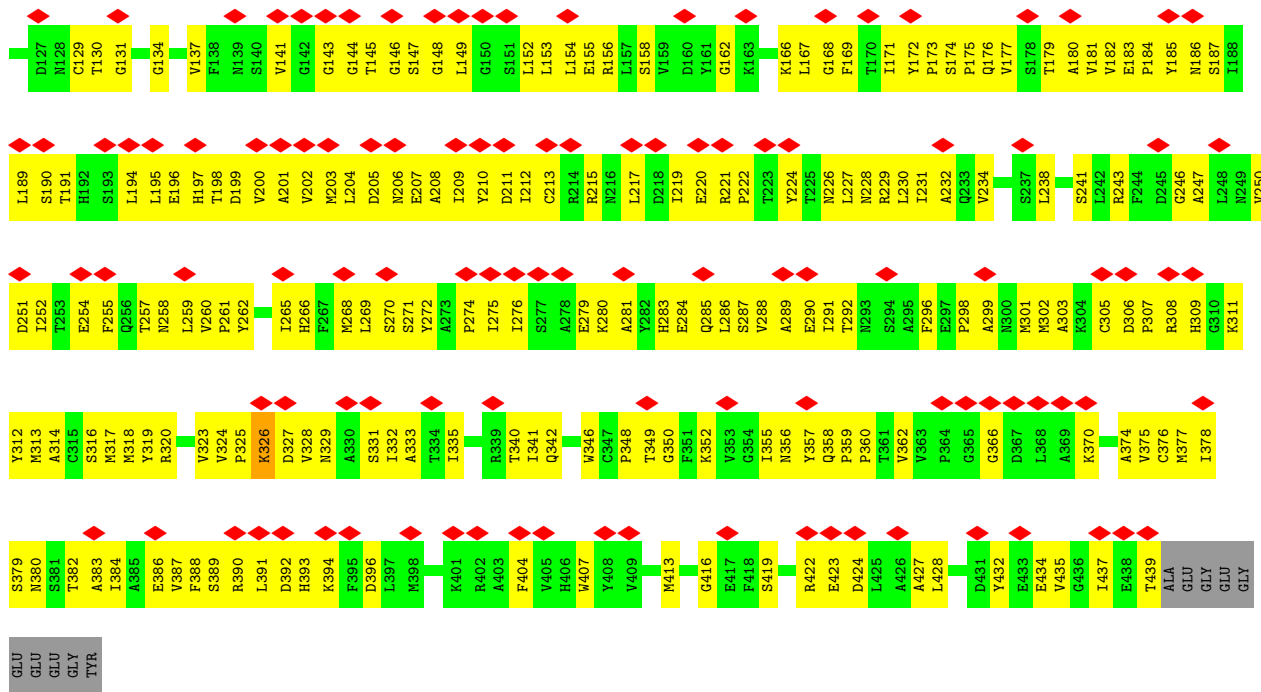

• Molecule 44: Tubulin alpha chain

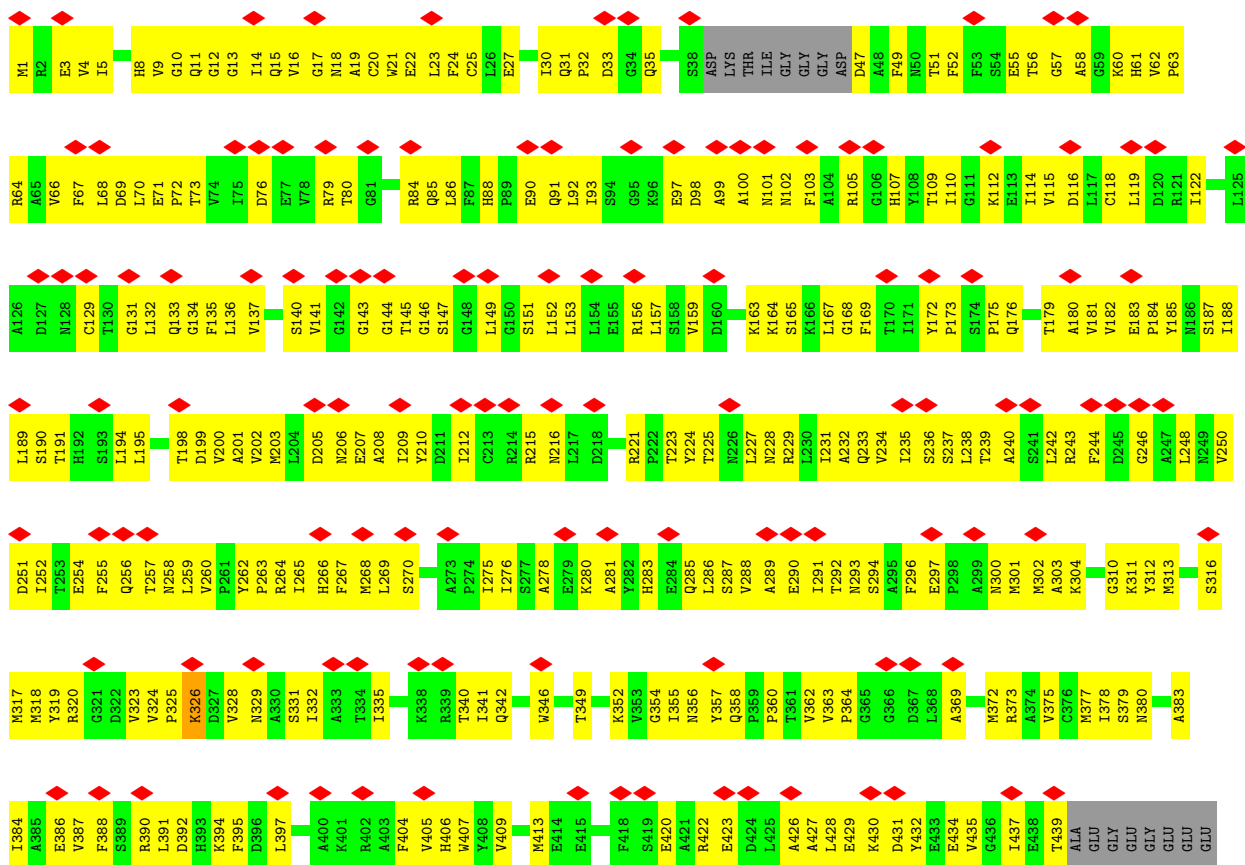

GLY  
TYR

• Molecule 44: Tubulin alpha chain

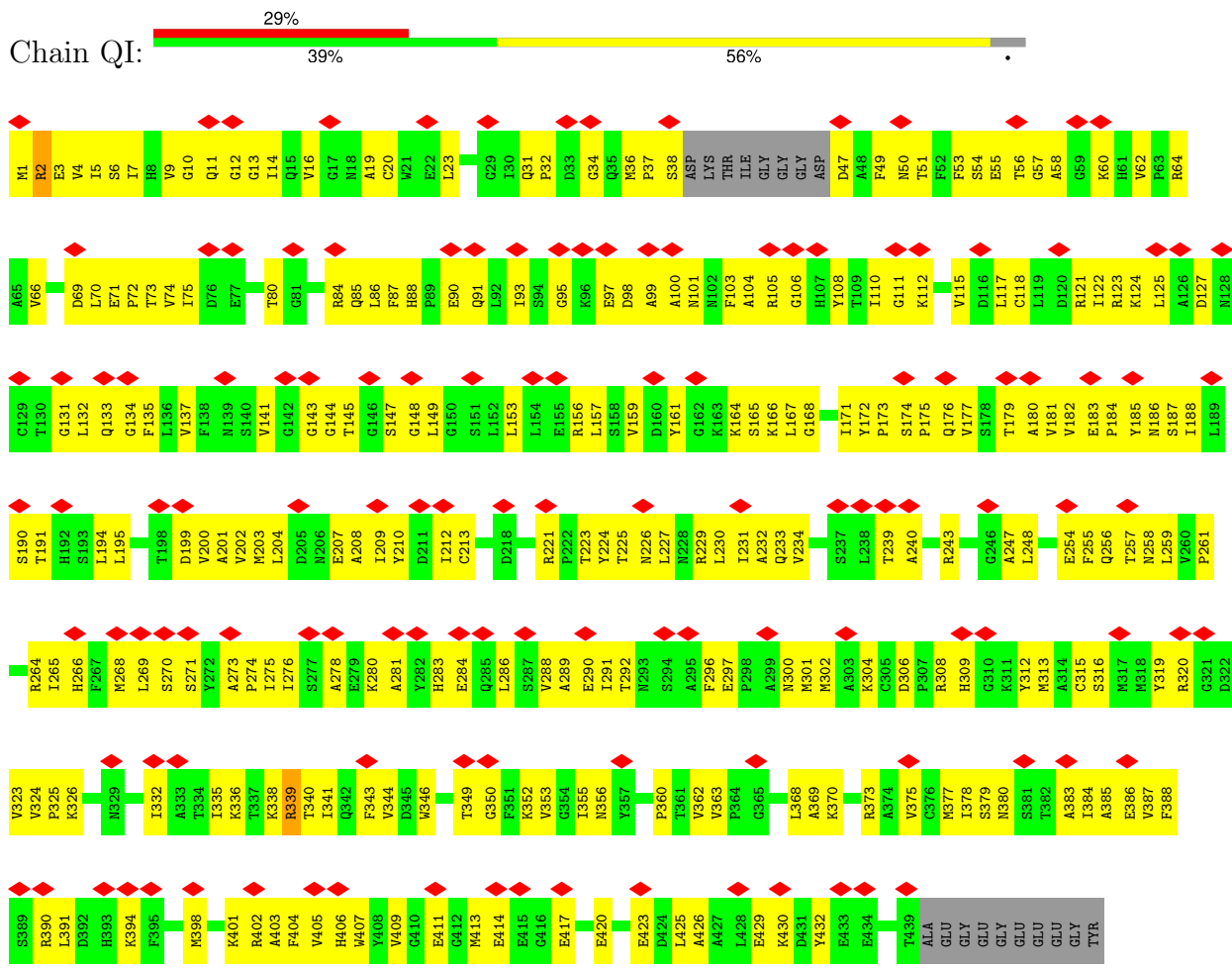

• Molecule 44: Tubulin alpha chain

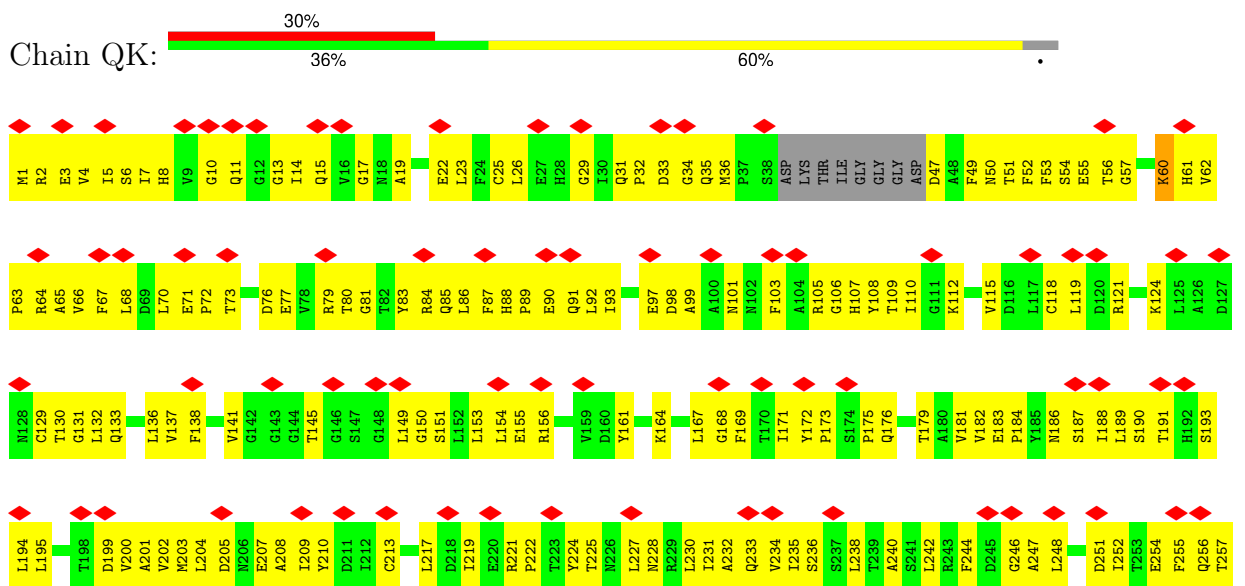



• Molecule 44: Tubulin alpha chain

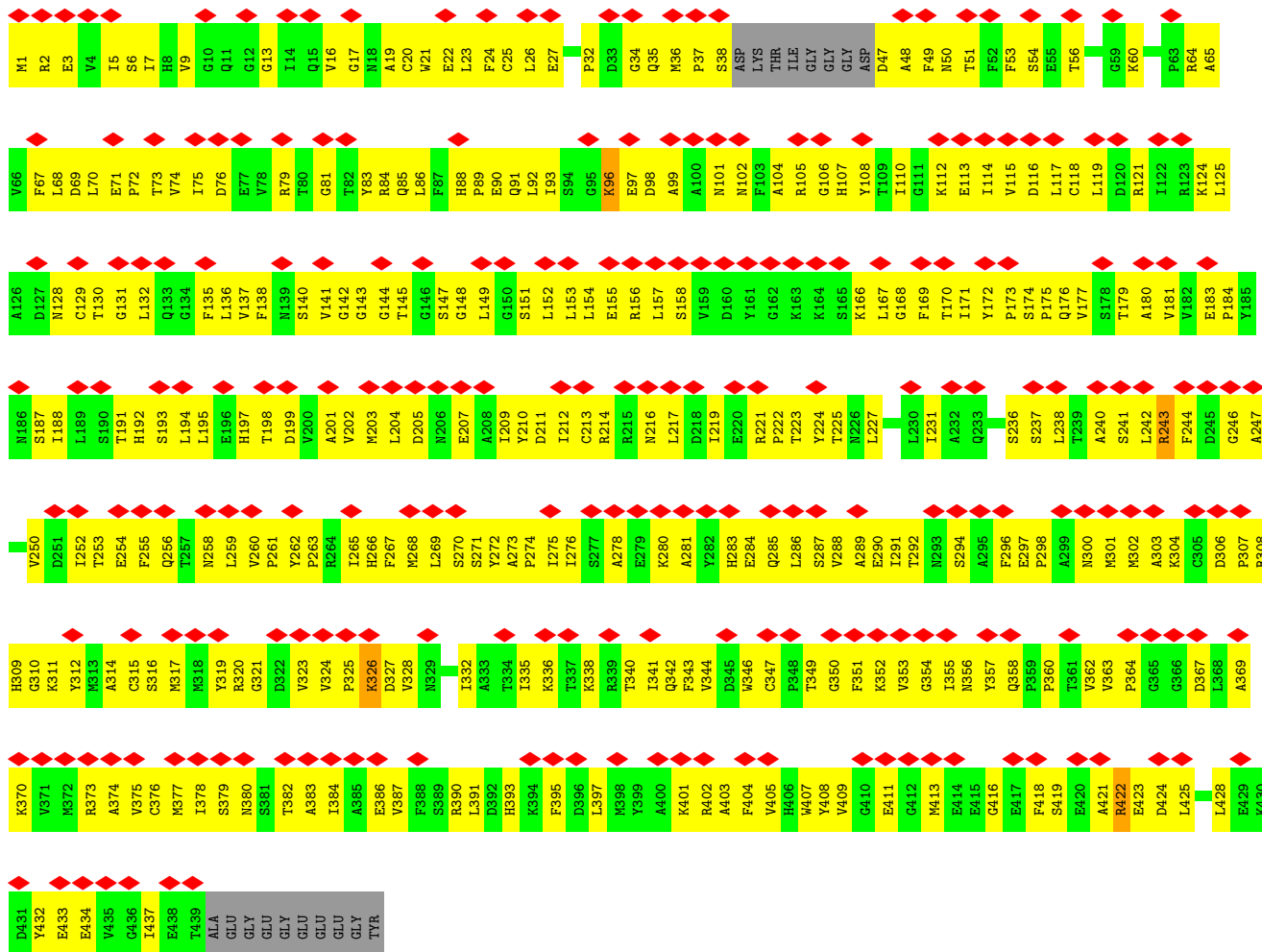

• Molecule 44: Tubulin alpha chain



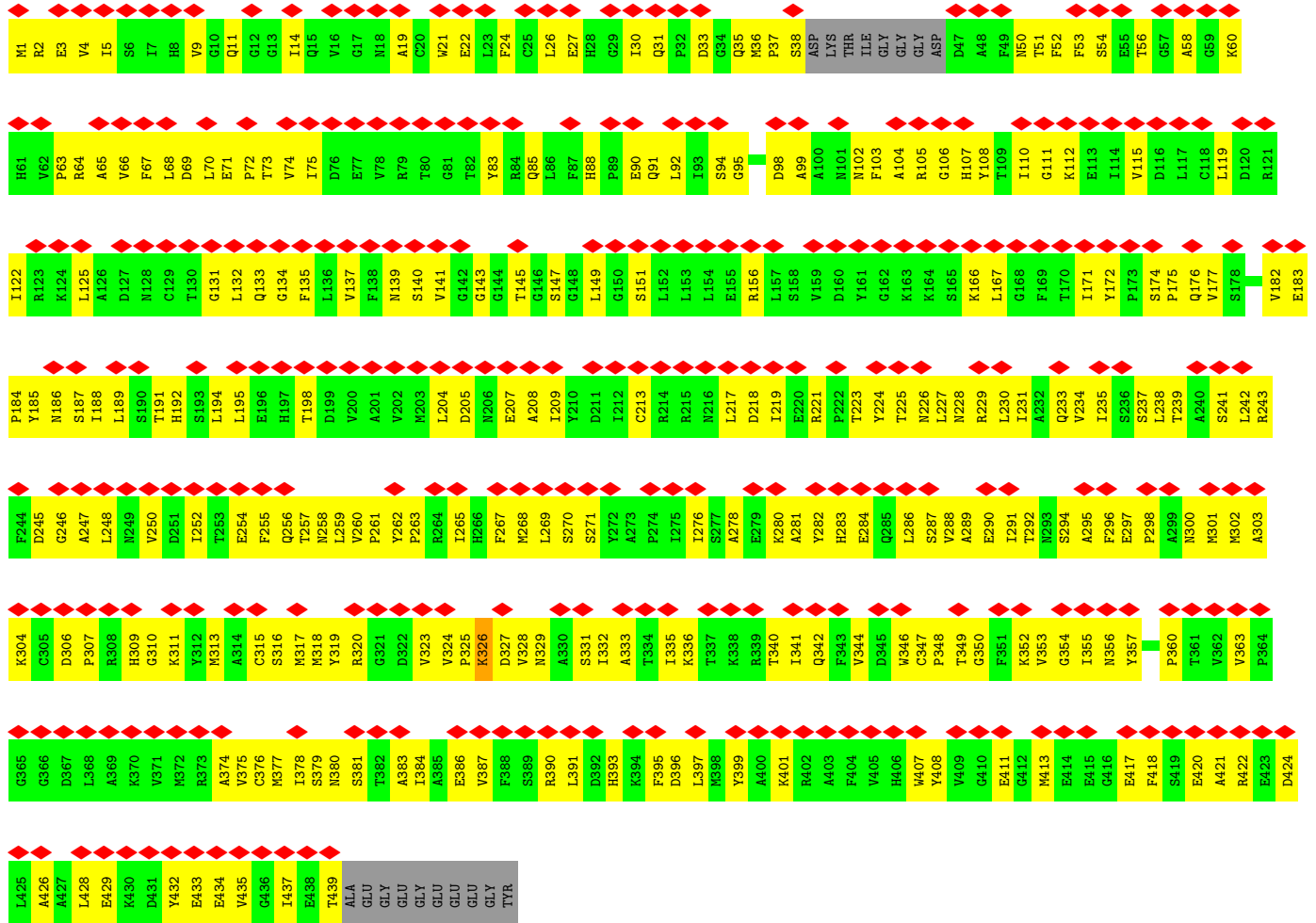

● Molecule 44: Tubulin alpha chain

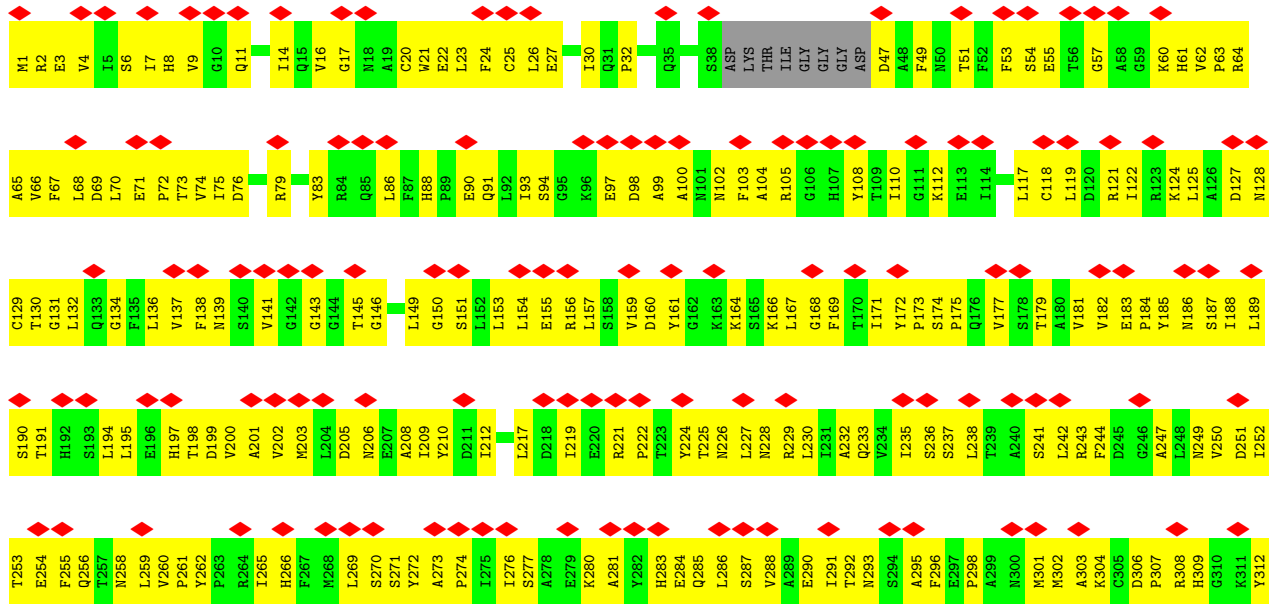

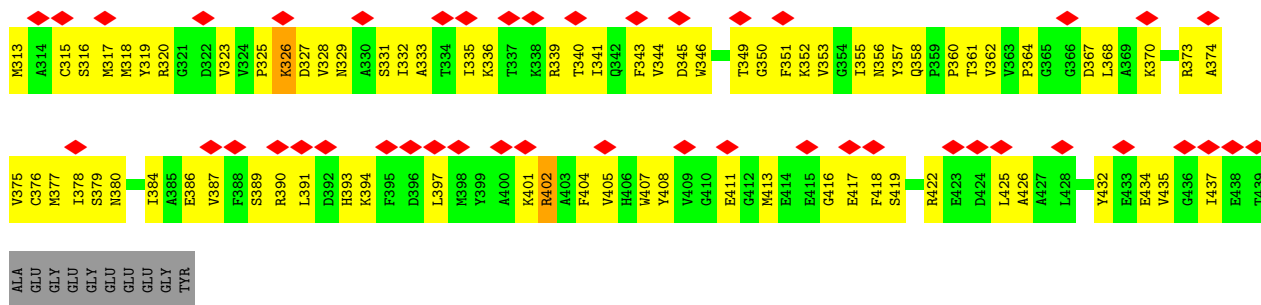

• Molecule 44: Tubulin alpha chain

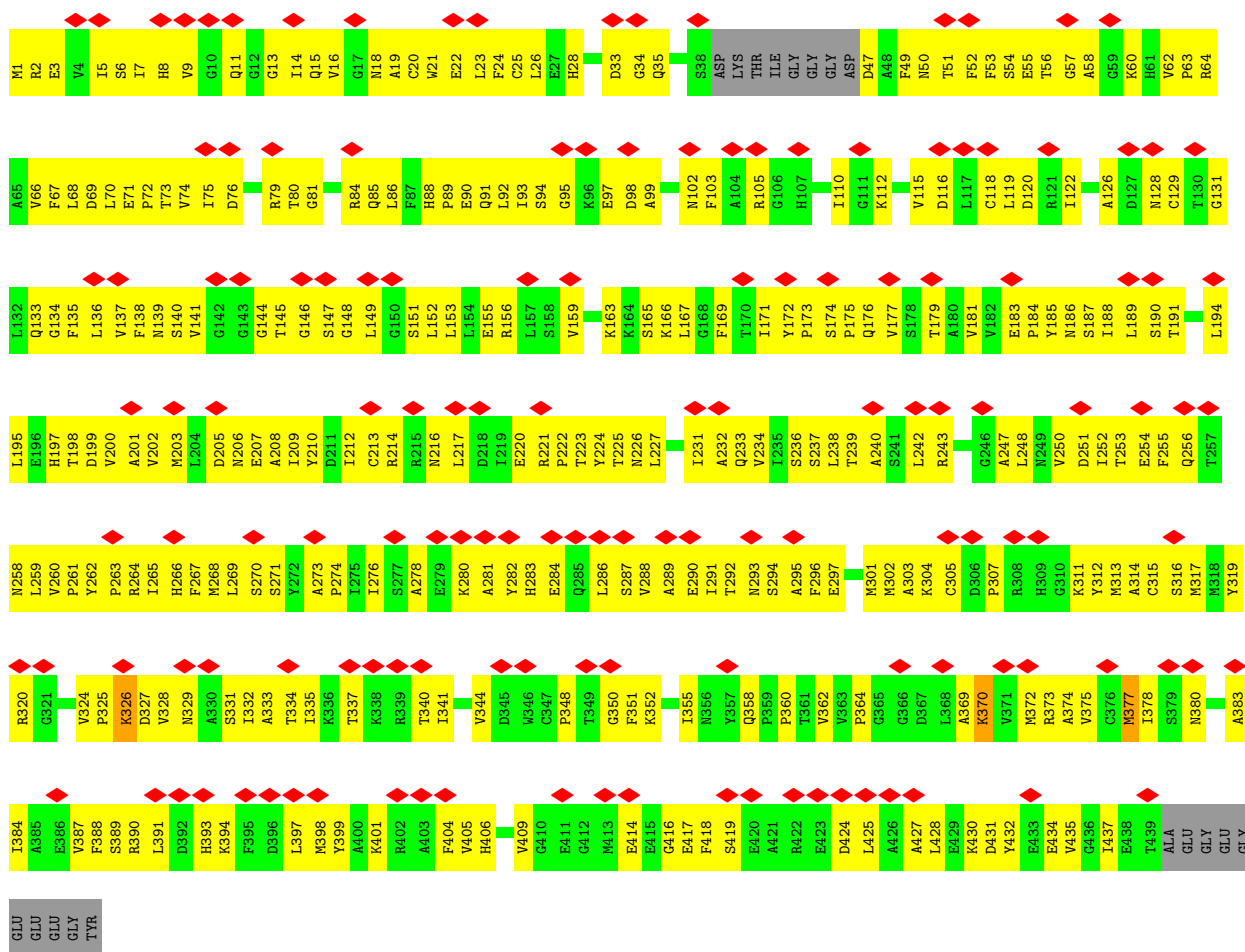

• Molecule 44: Tubulin alpha chain

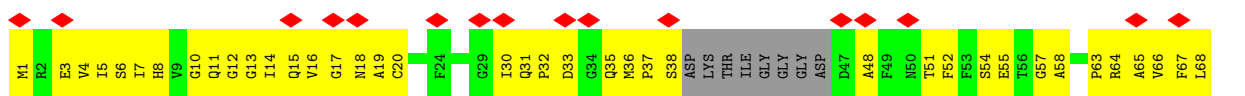

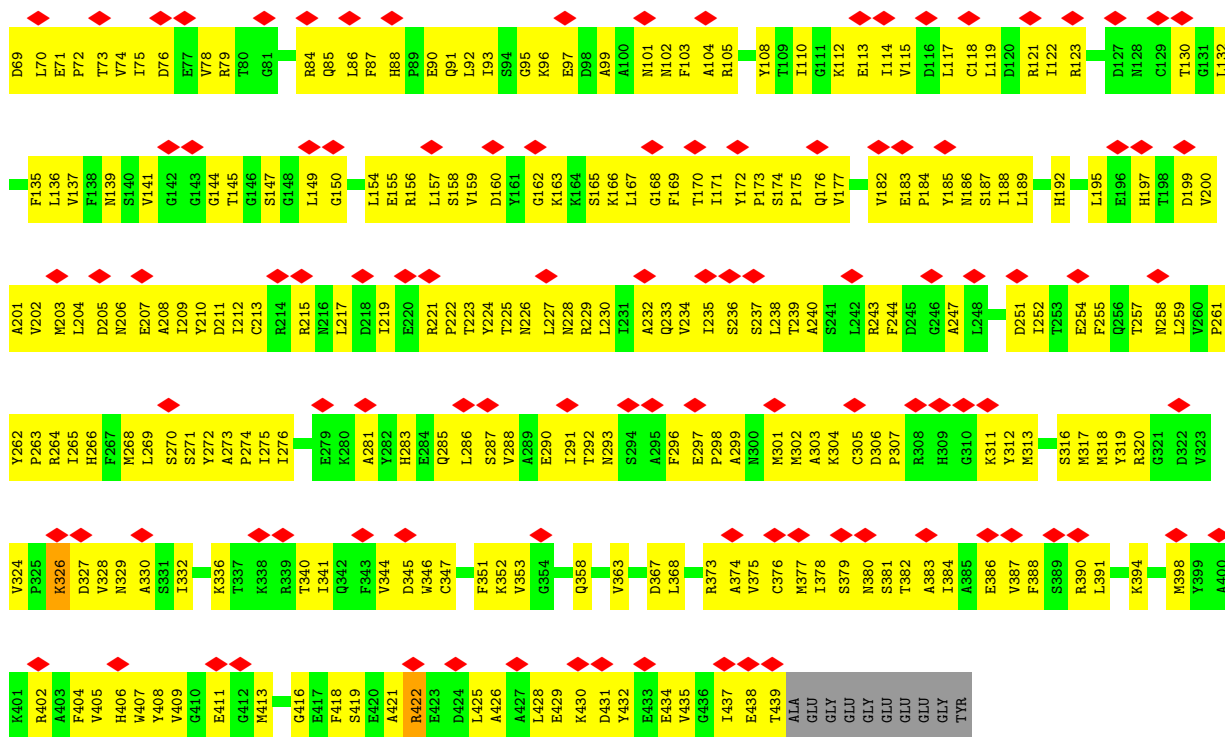

• Molecule 44: Tubulin alpha chain

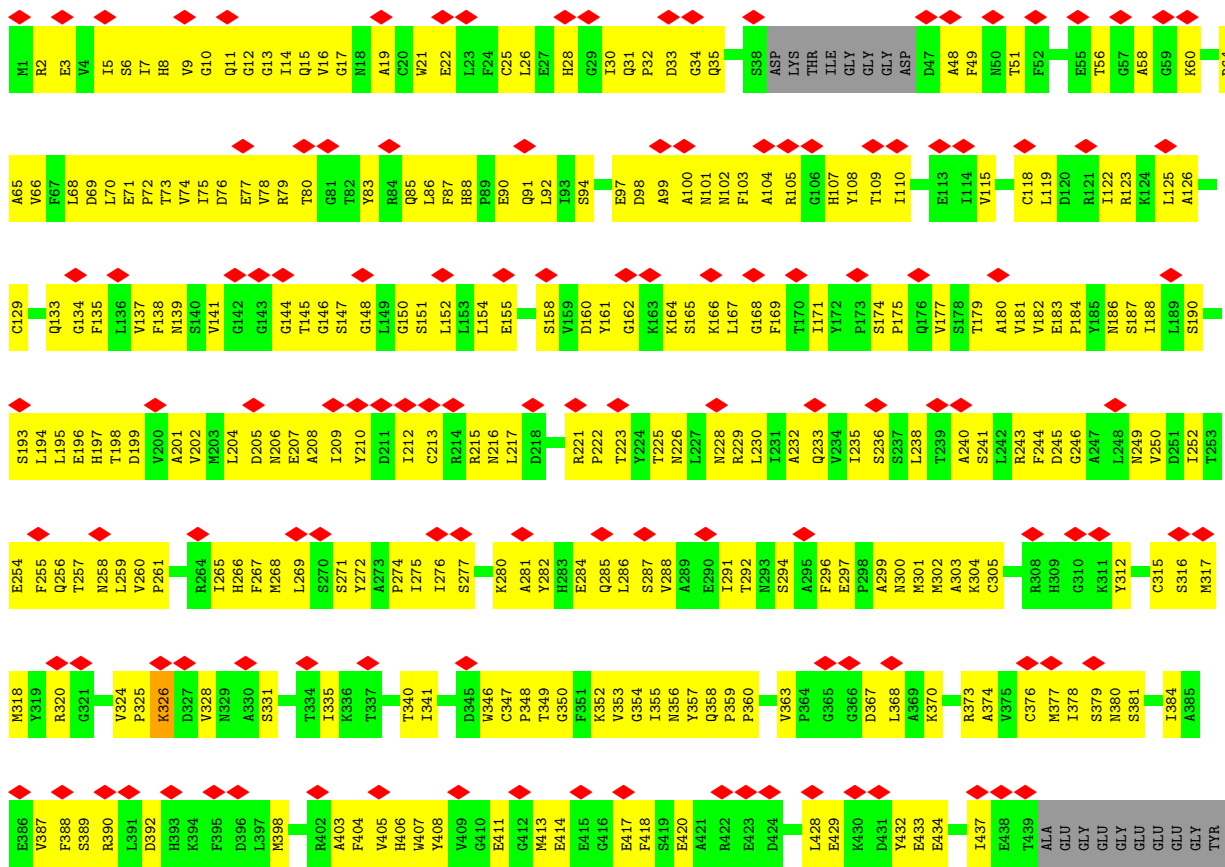

## ● Molecule 44: Tubulin alpha chain

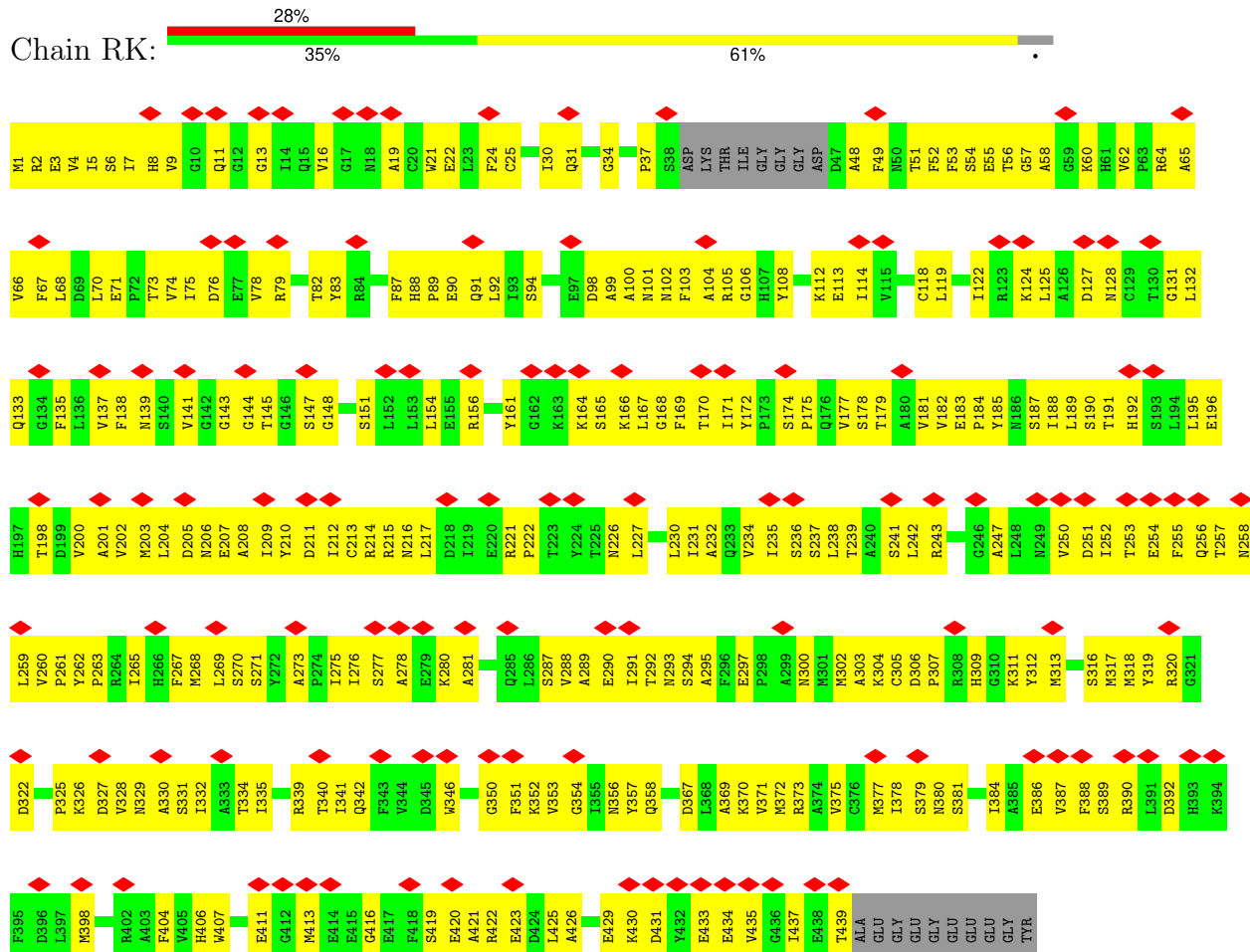

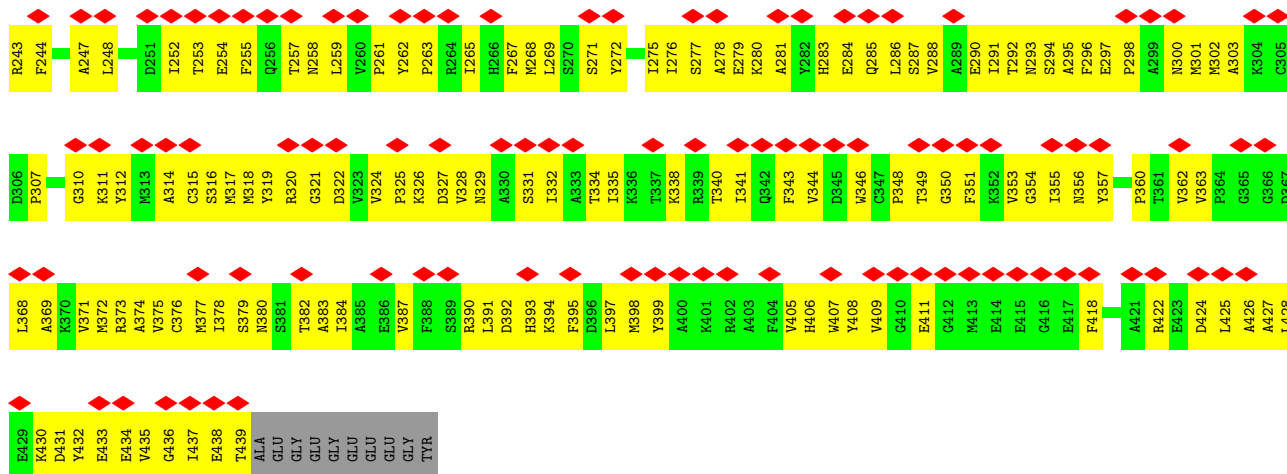

• Molecule 44: Tubulin alpha chain

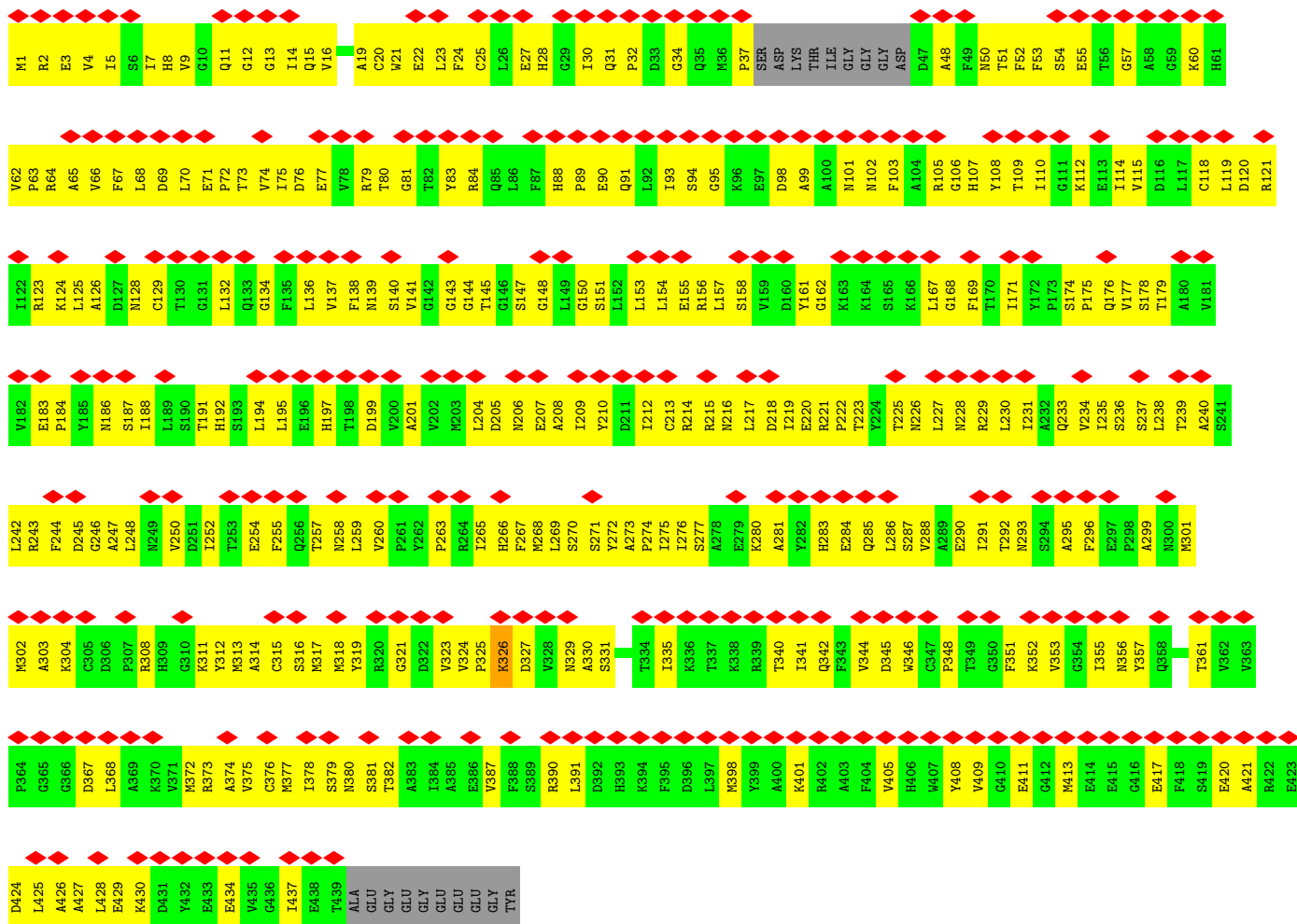

• Molecule 44: Tubulin alpha chain



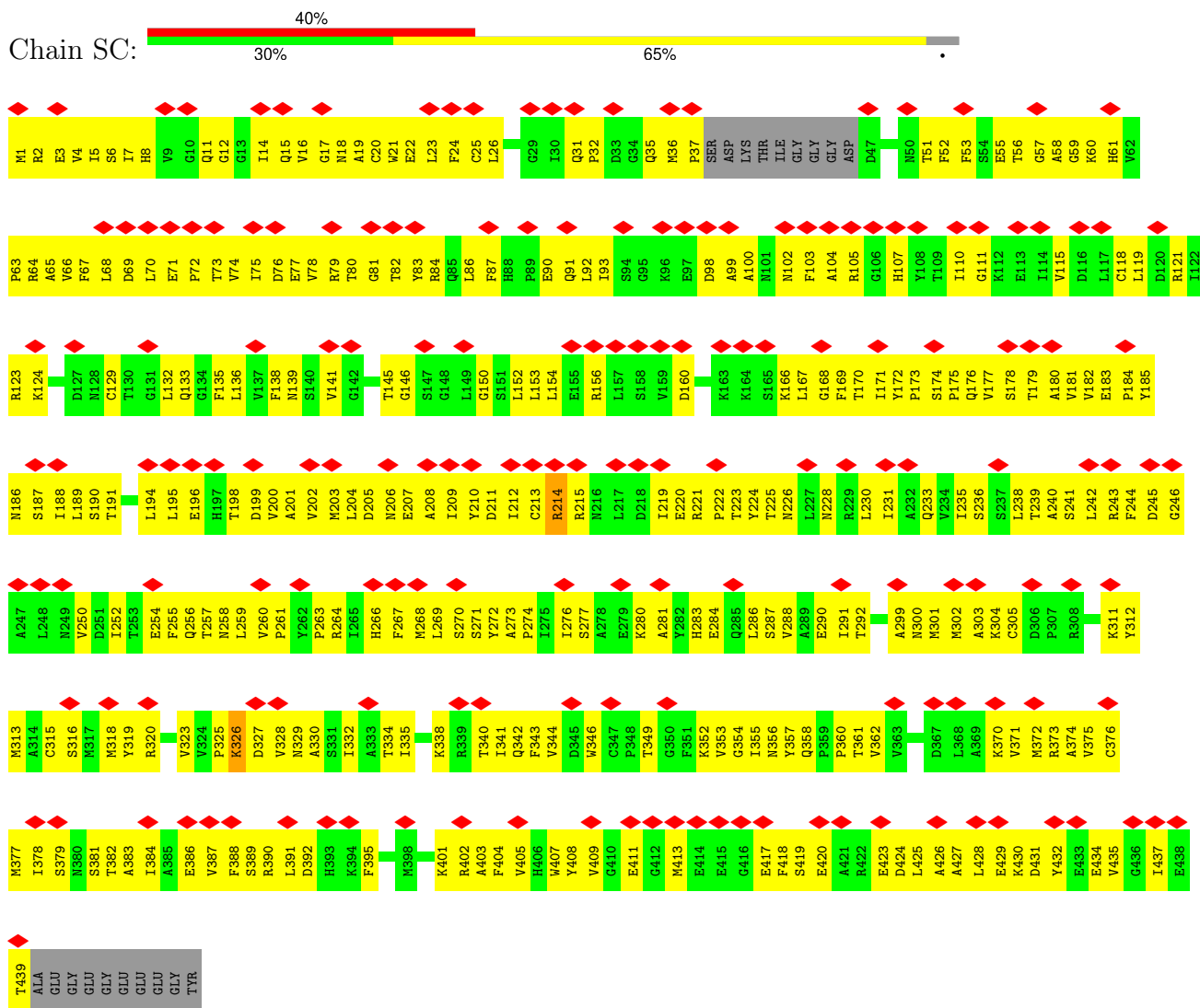

● Molecule 44: Tubulin alpha chain

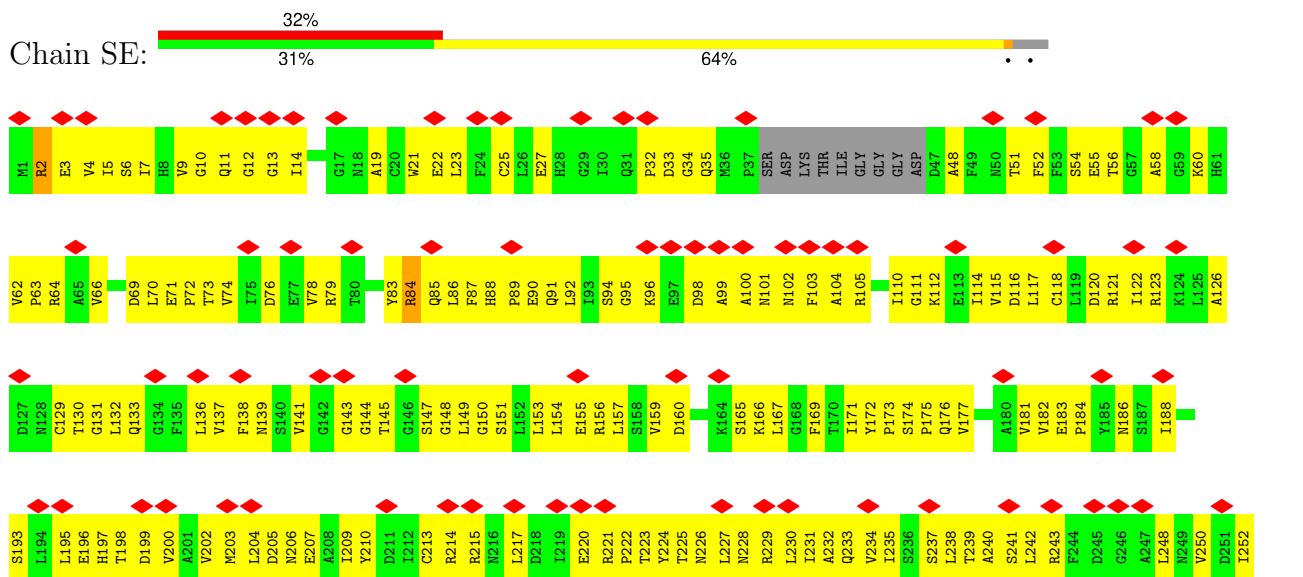

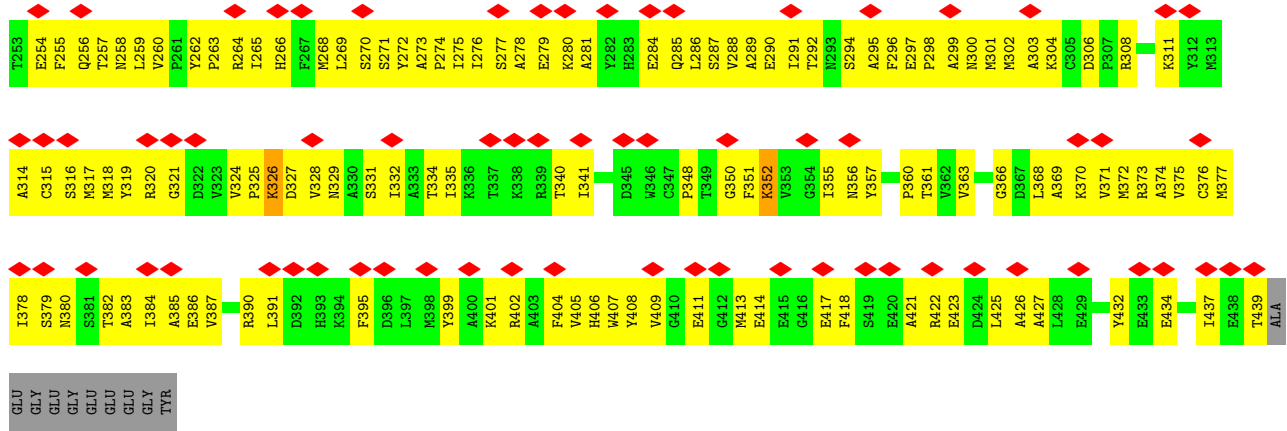

• Molecule 44: Tubulin alpha chain

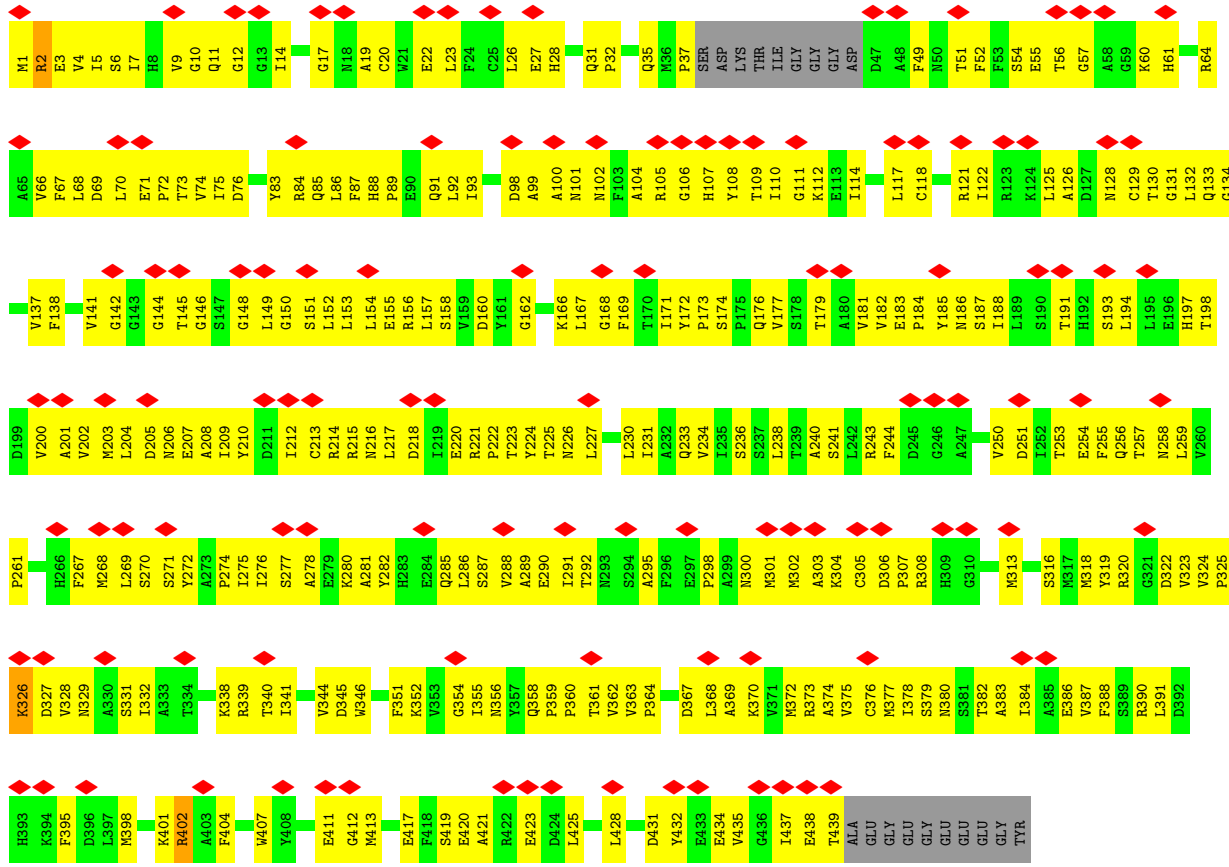

• Molecule 44: Tubulin alpha chain

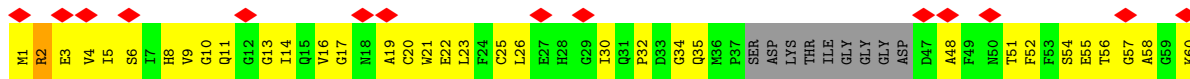

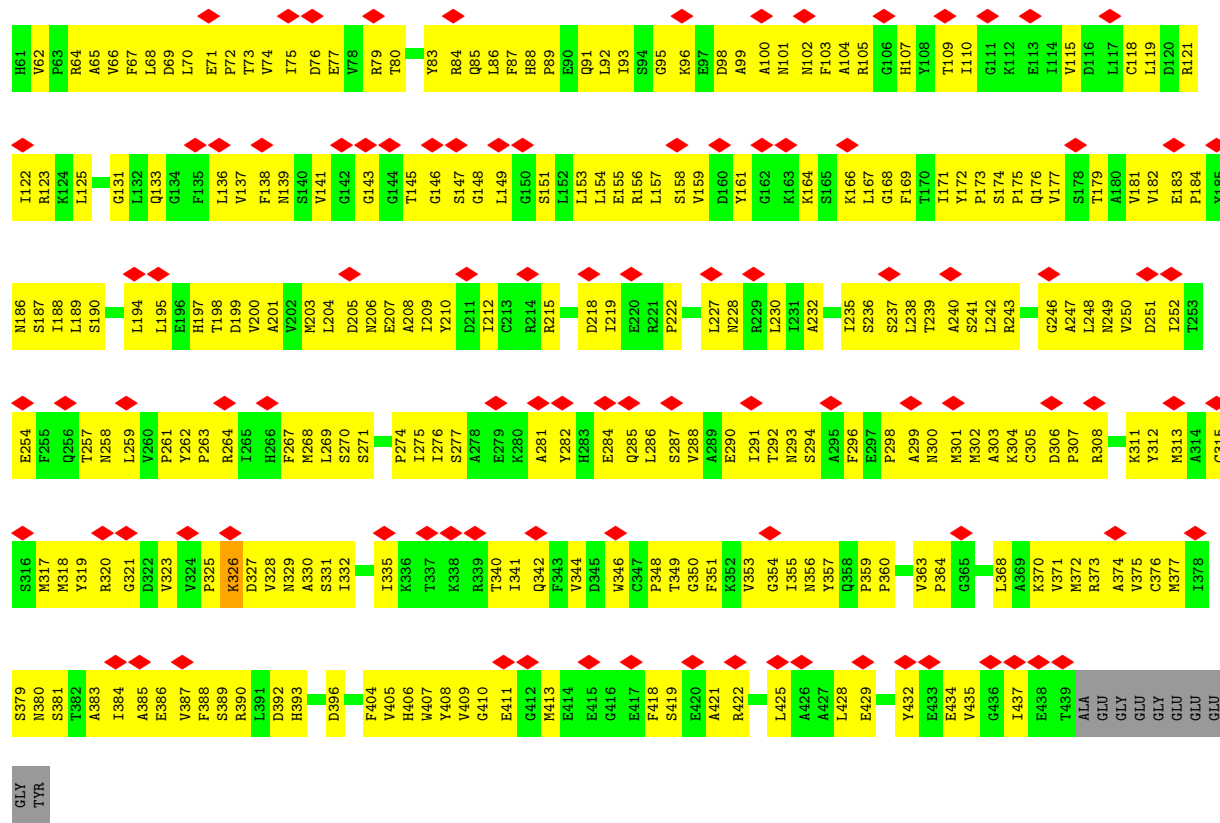

• Molecule 44: Tubulin alpha chain

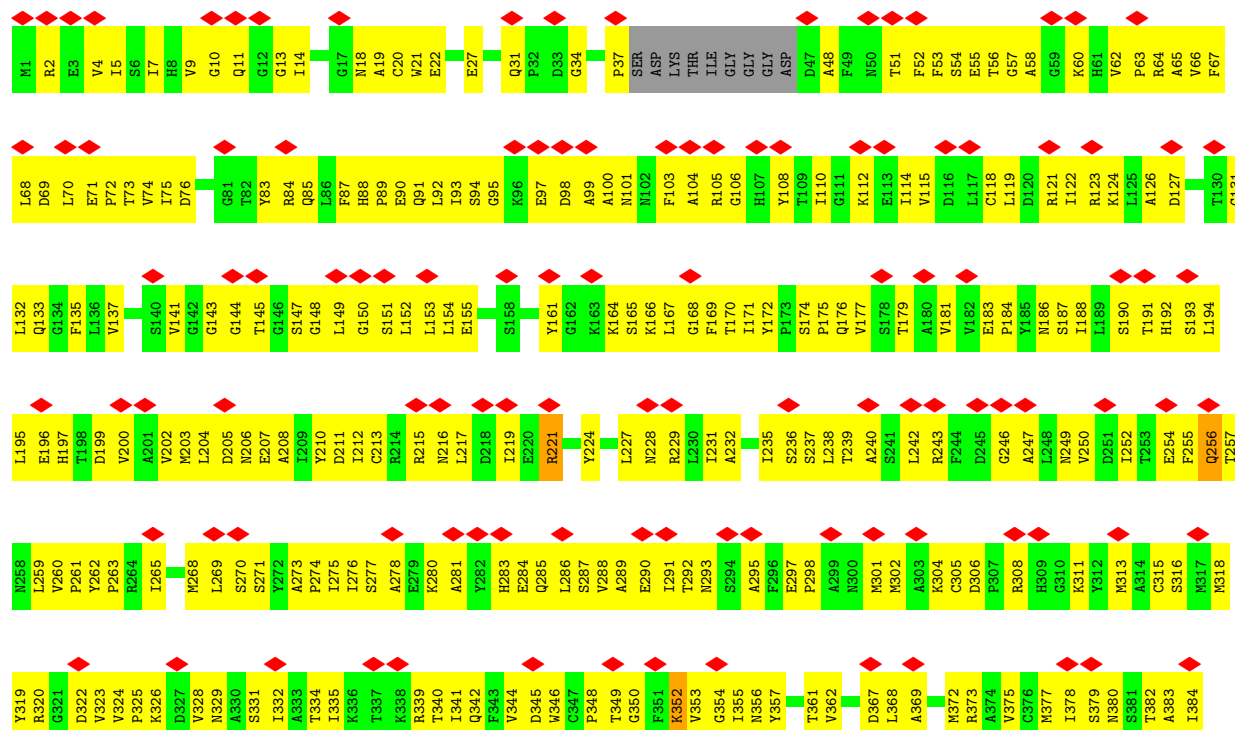

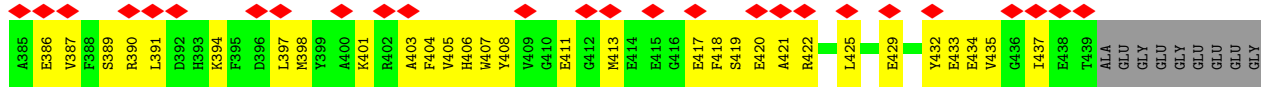

TYR

• Molecule 44: Tubulin alpha chain

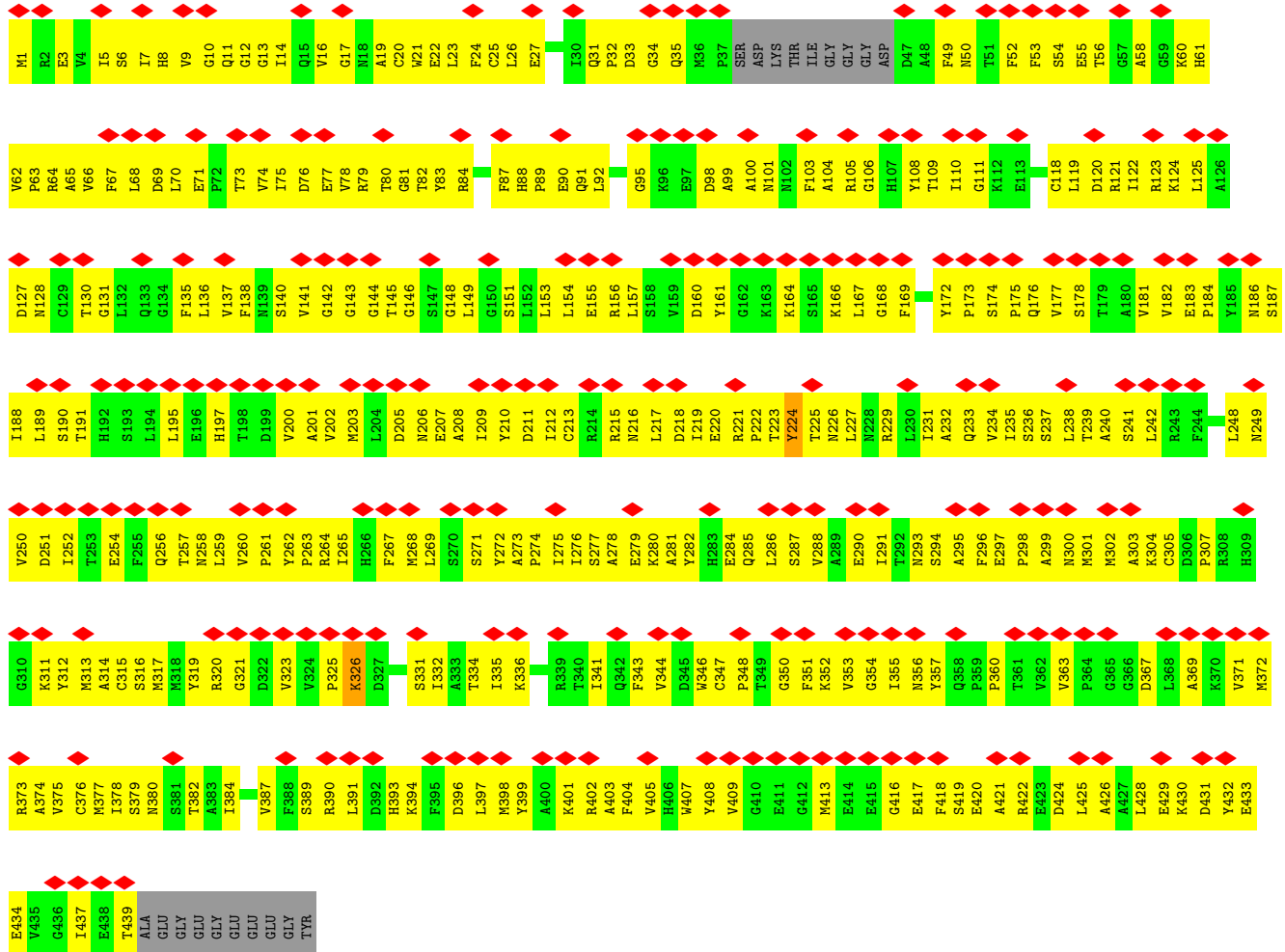

• Molecule 44: Tubulin alpha chain

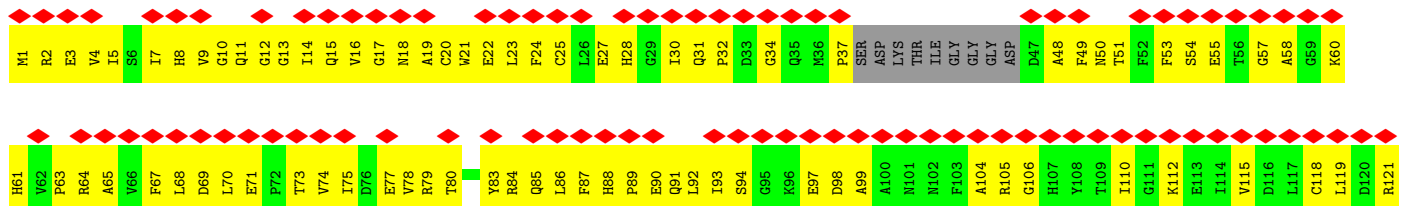
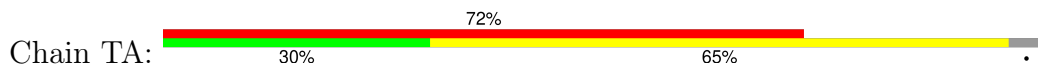

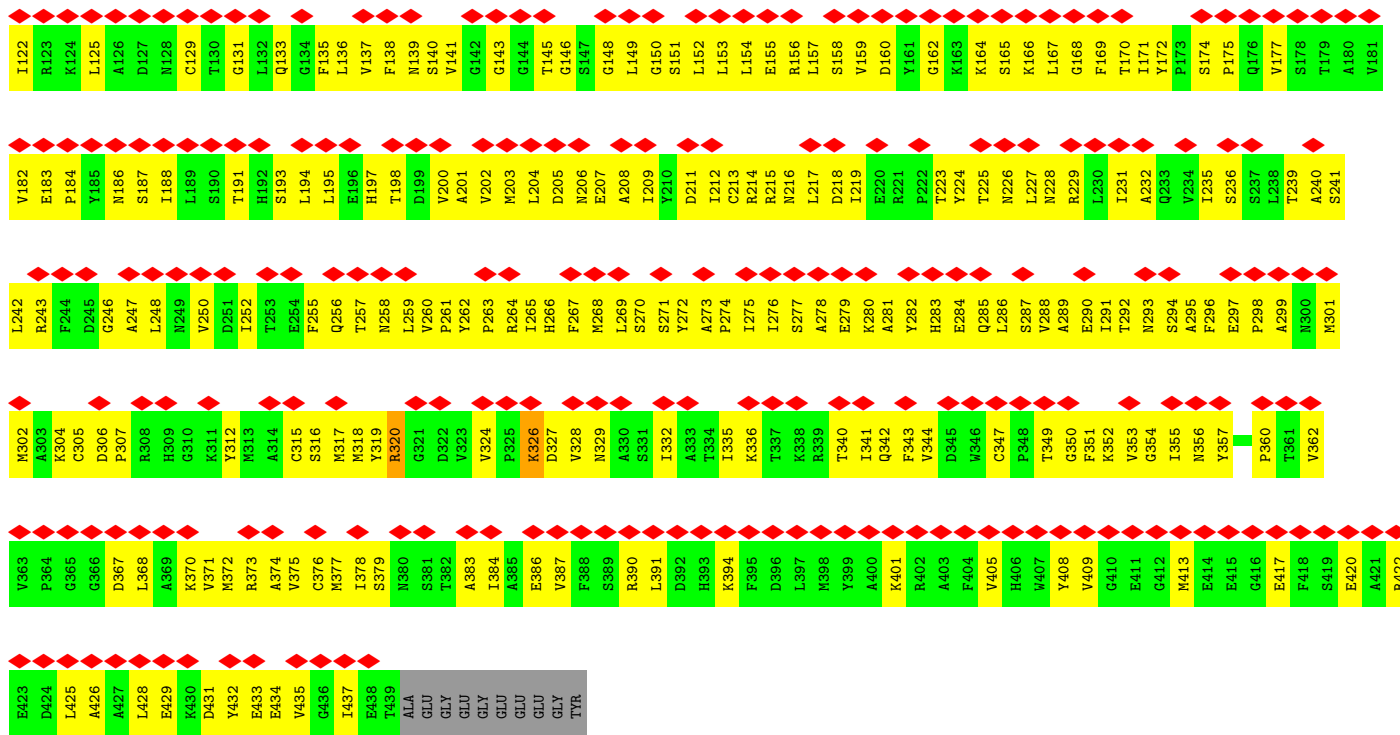

● Molecule 44: Tubulin alpha chain

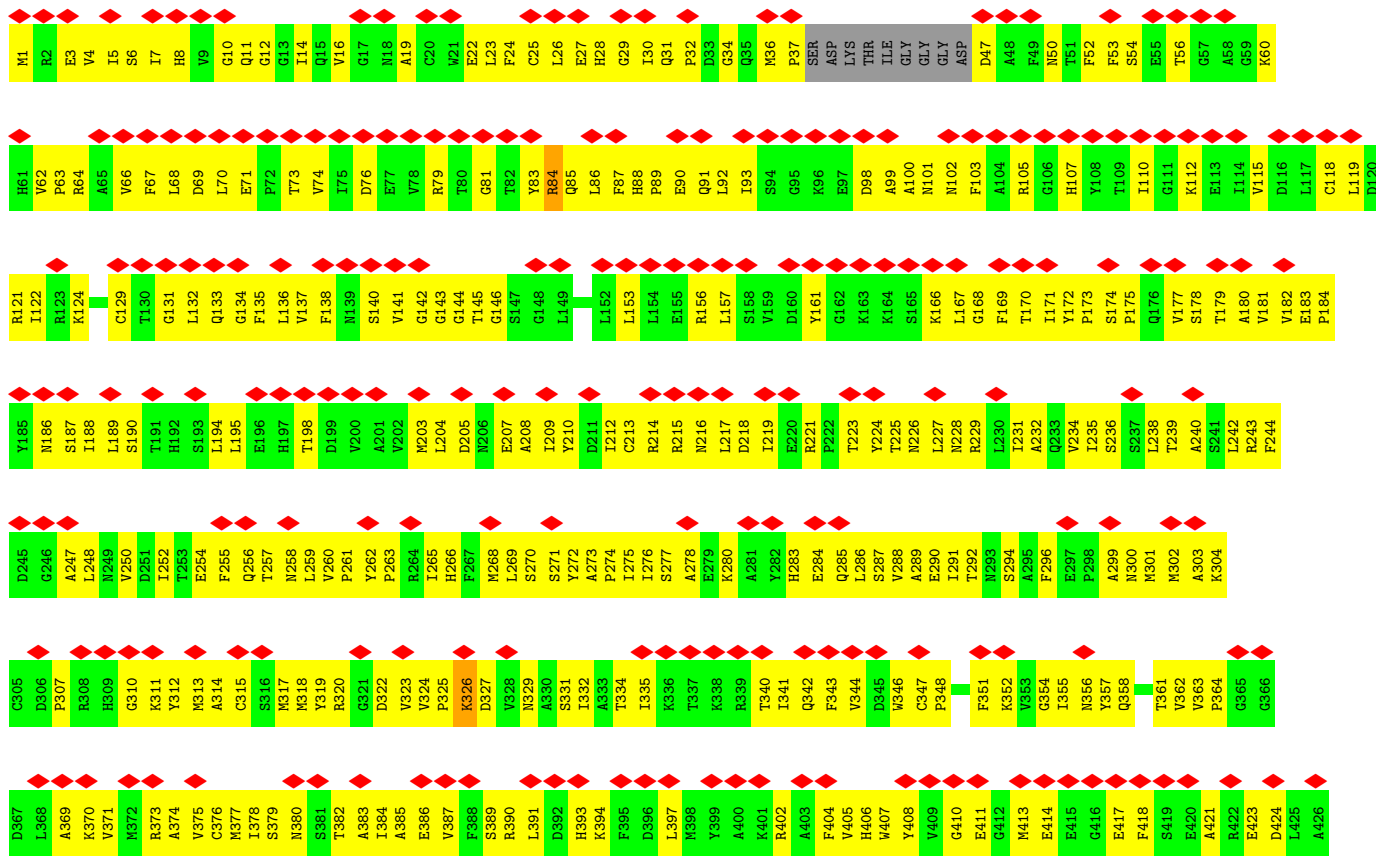



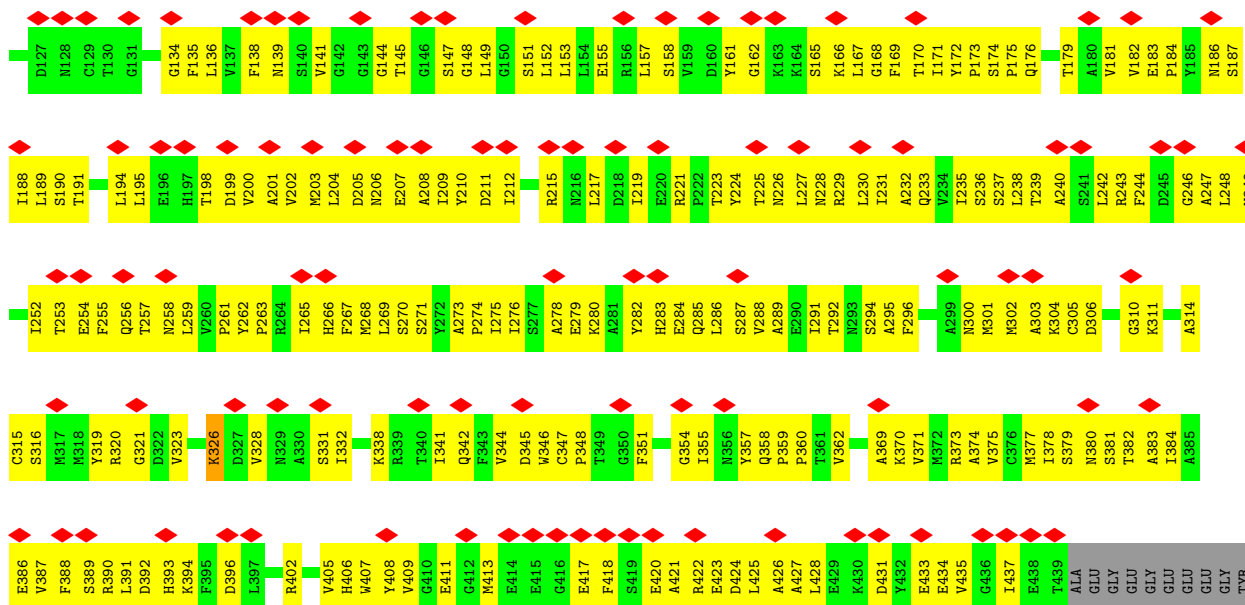

• Molecule 44: Tubulin alpha chain

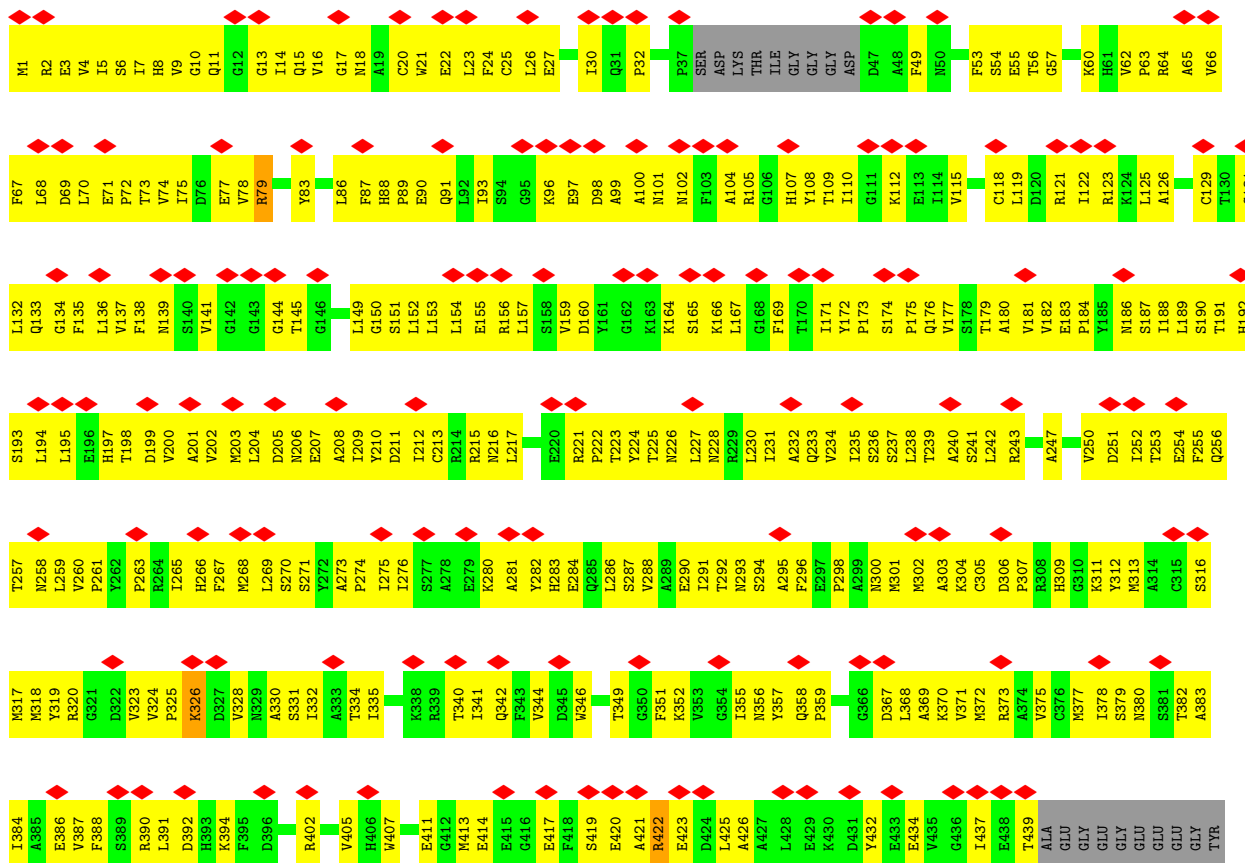

• Molecule 44: Tubulin alpha chain

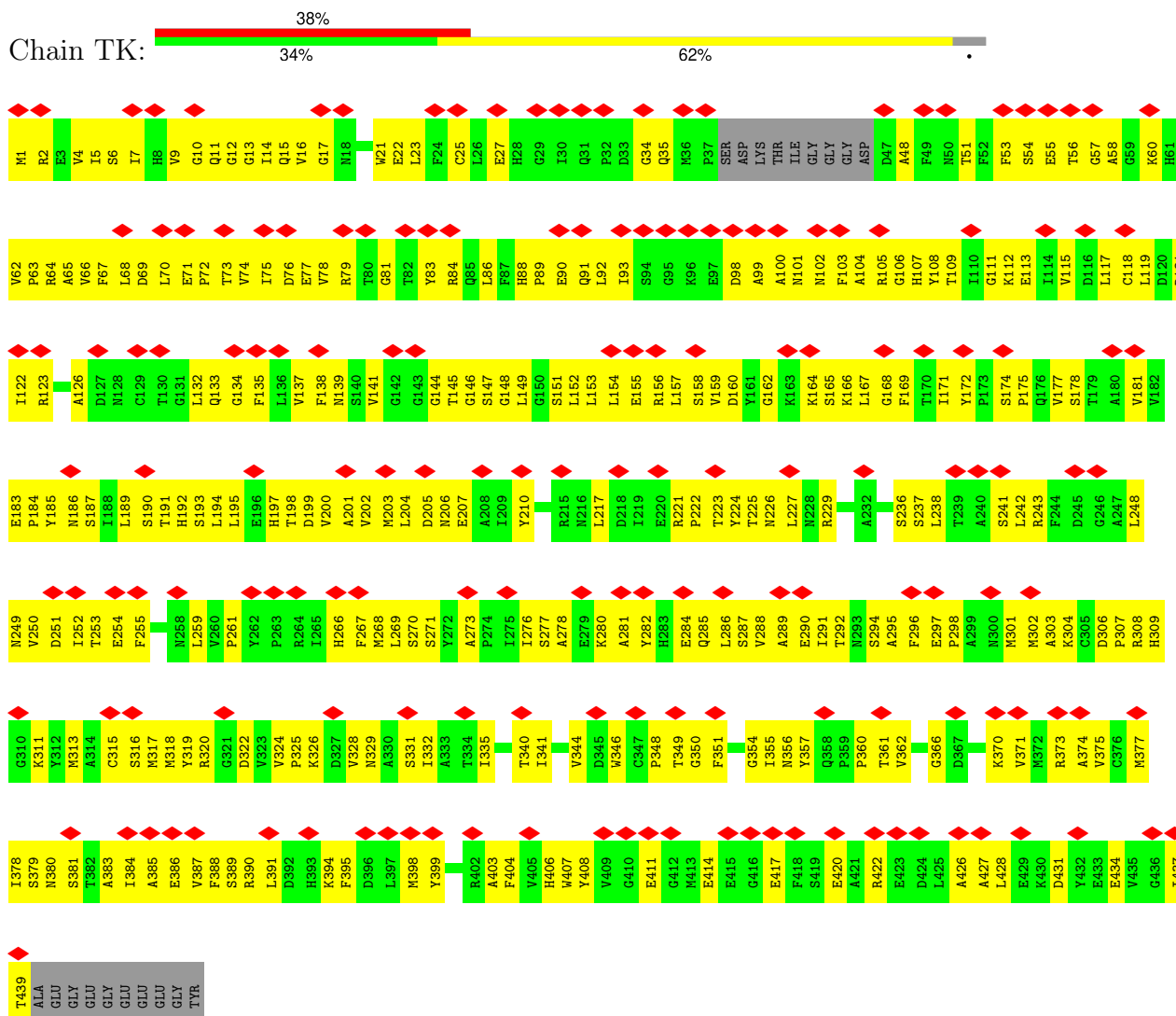

• Molecule 44: Tubulin alpha chain

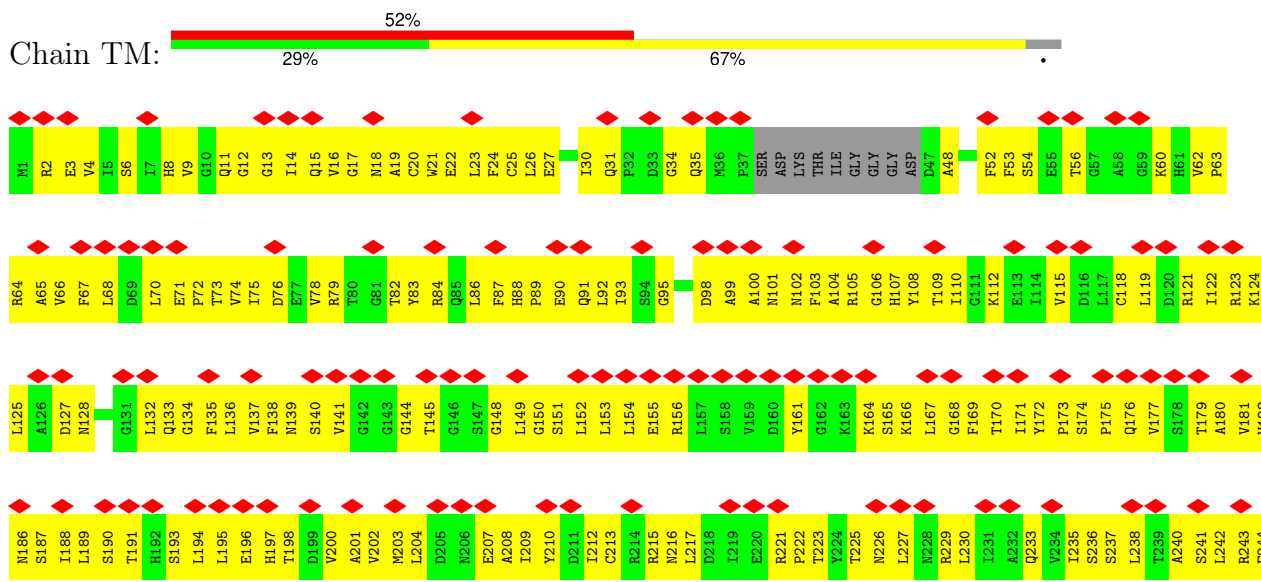



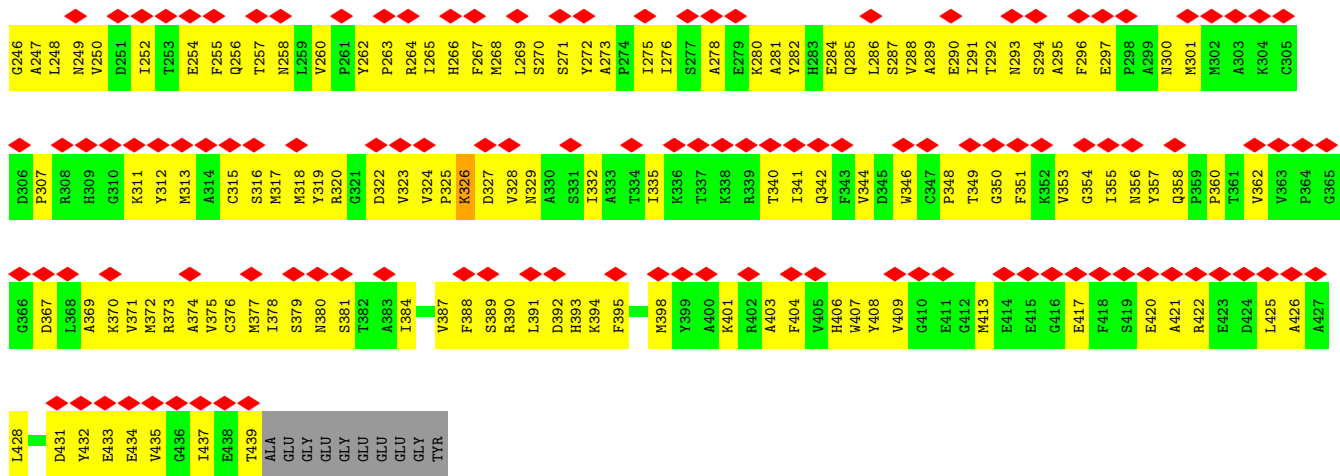

• Molecule 44: Tubulin alpha chain

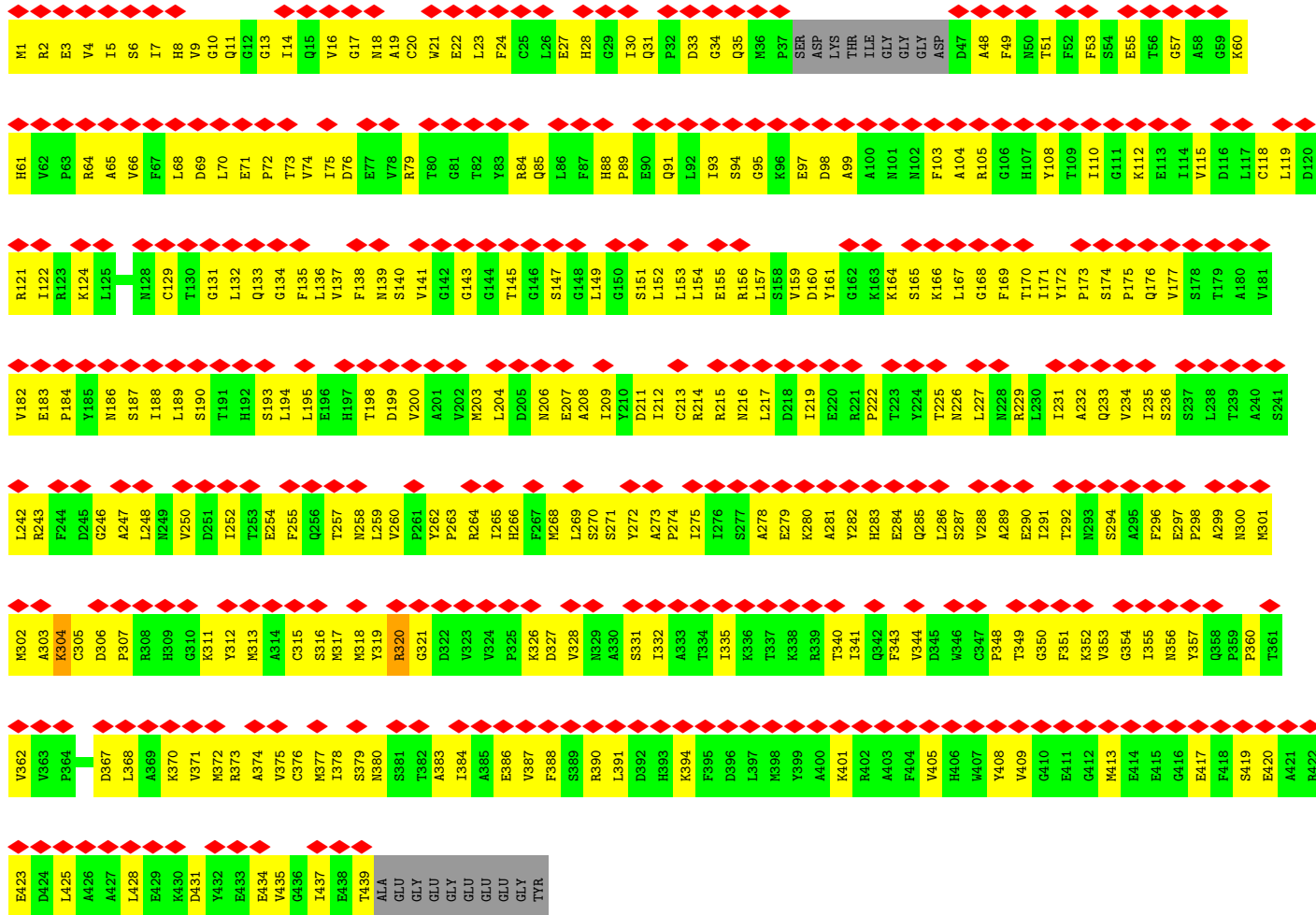
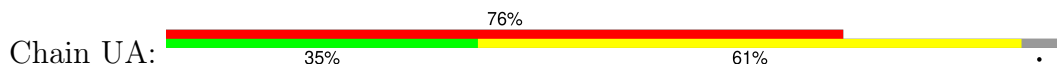

• Molecule 44: Tubulin alpha chain



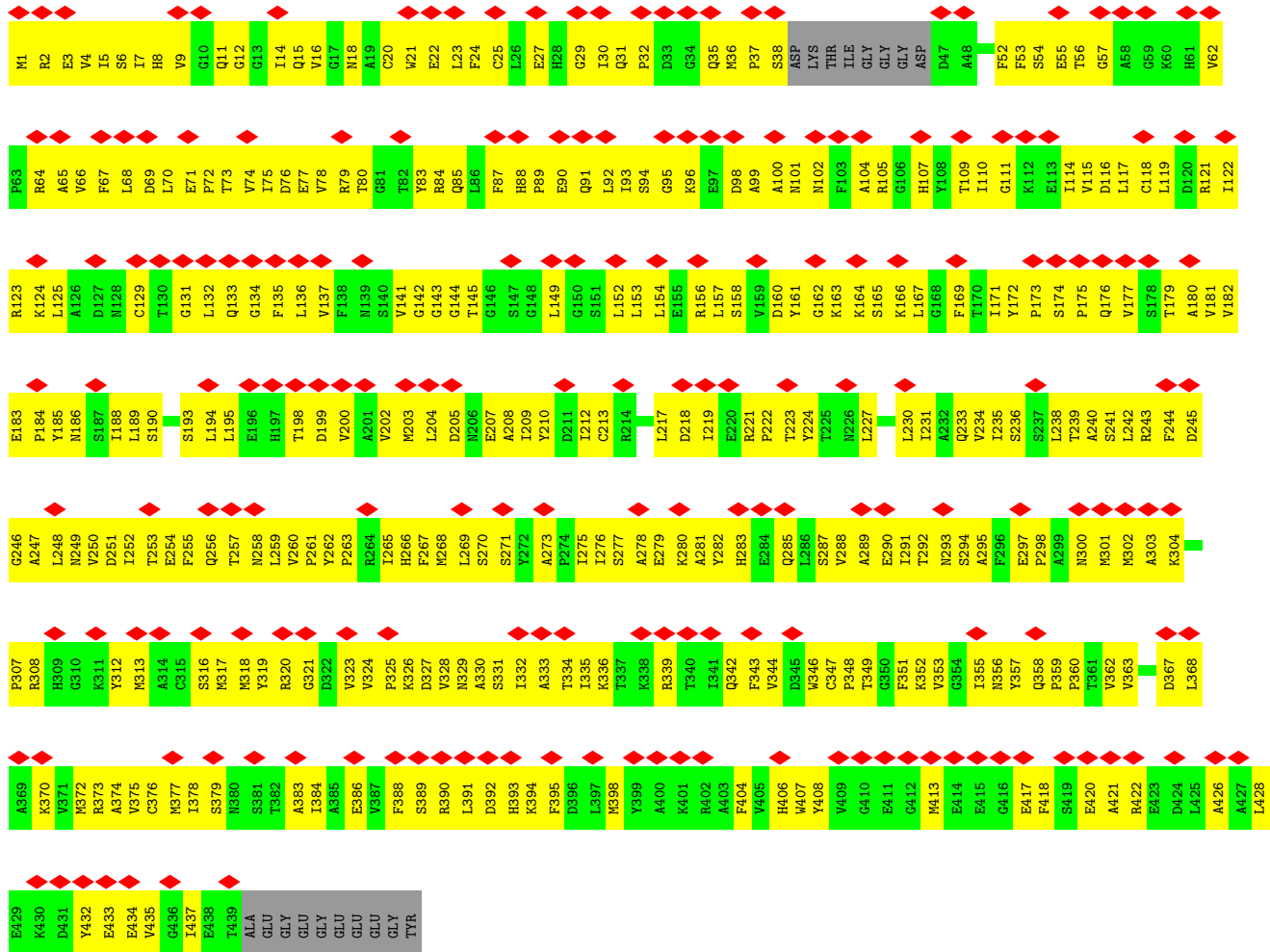

• Molecule 44: Tubulin alpha chain

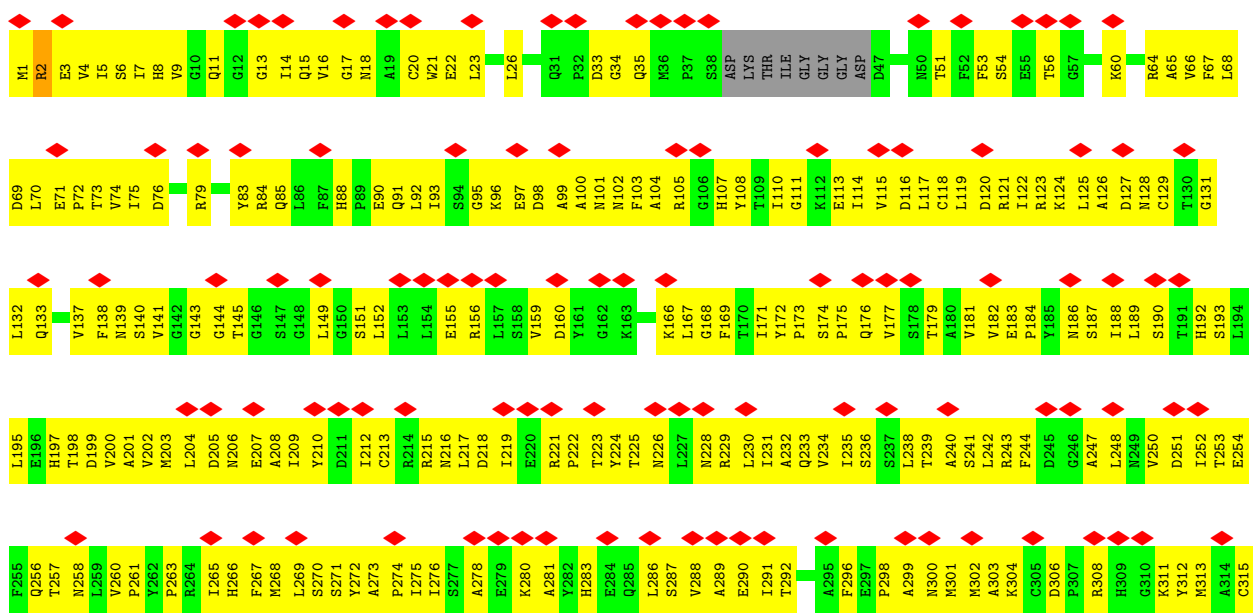

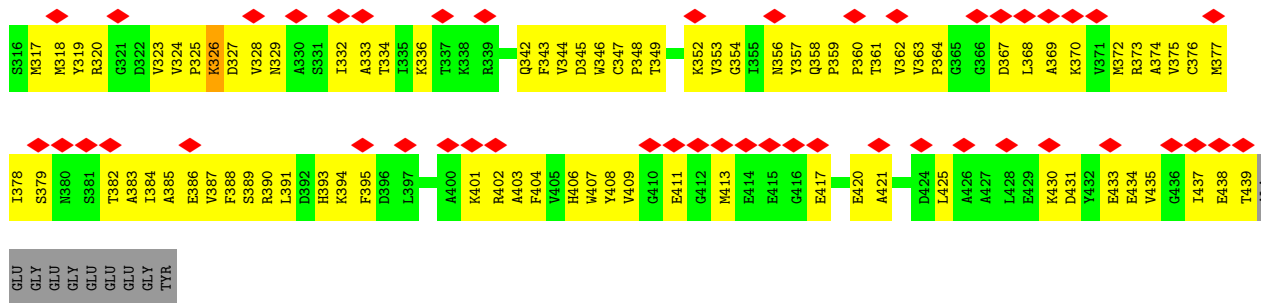

• Molecule 44: Tubulin alpha chain

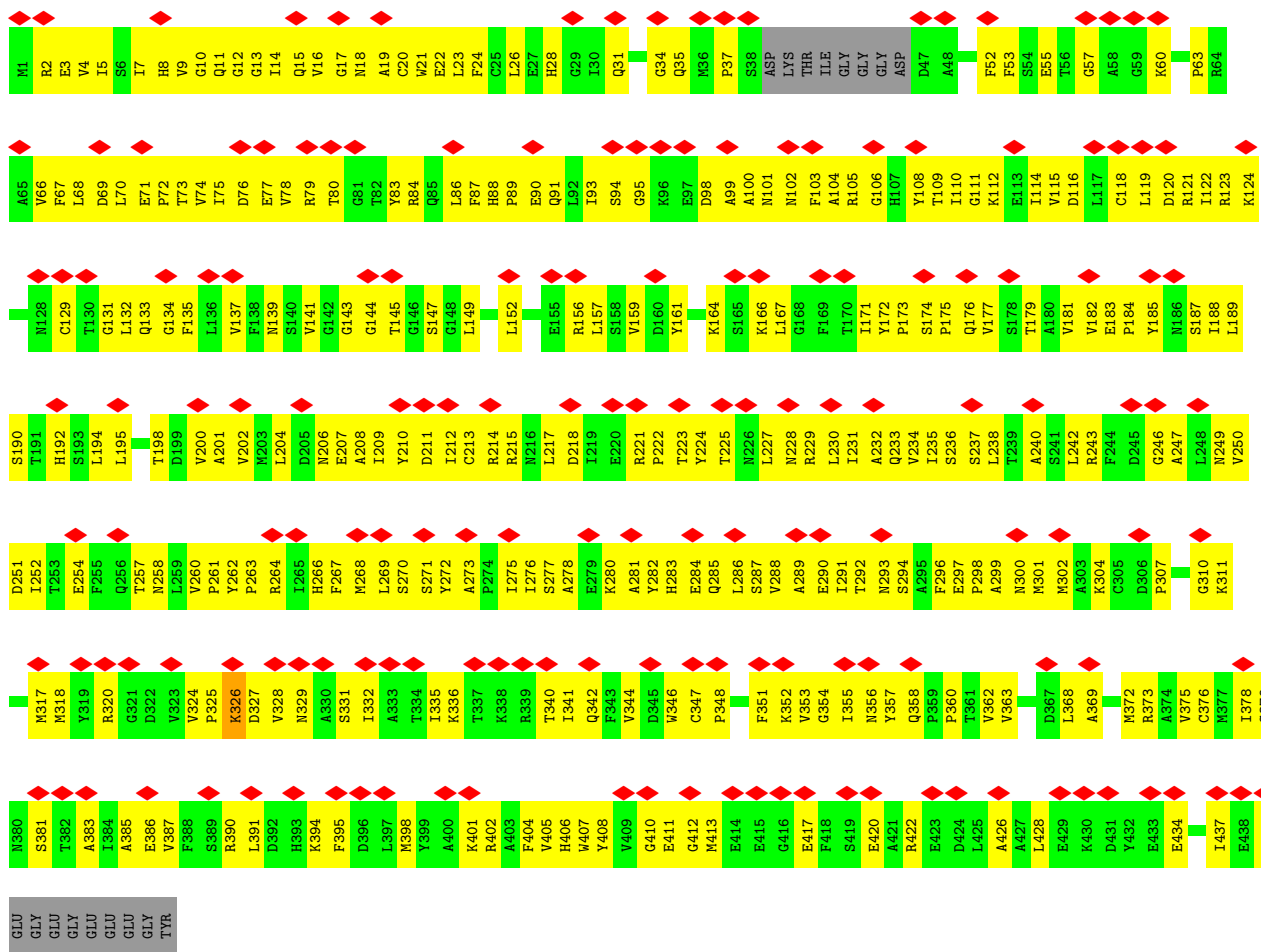

• Molecule 44: Tubulin alpha chain



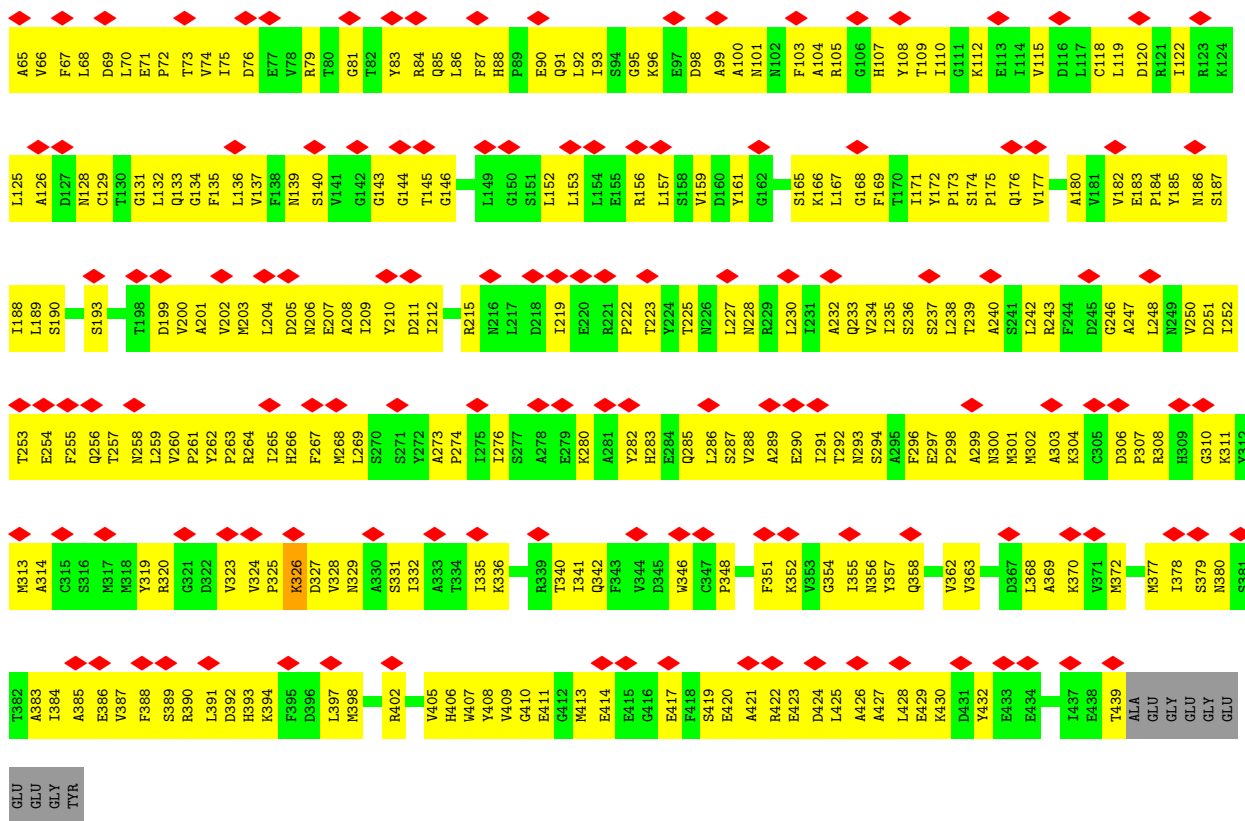

• Molecule 44: Tubulin alpha chain

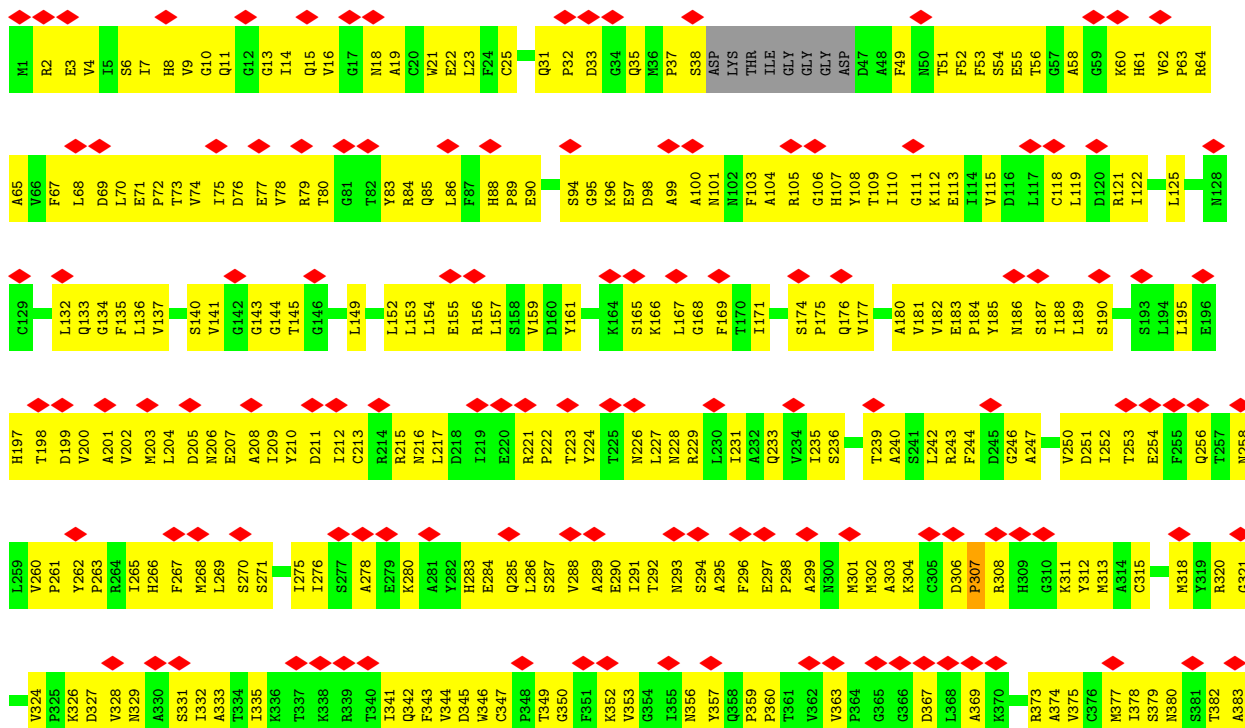
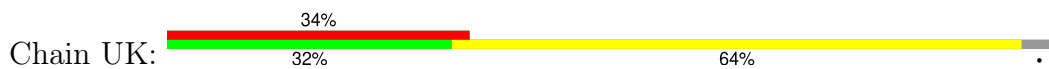

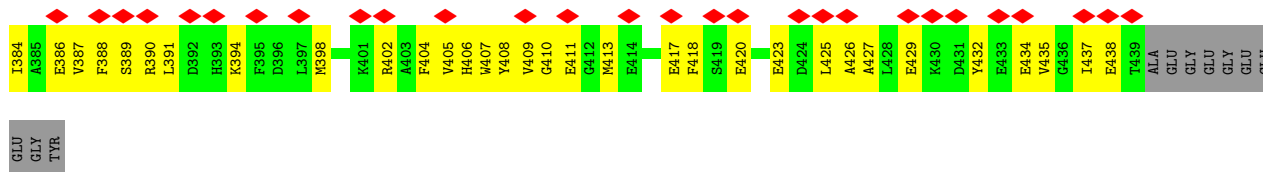

• Molecule 44: Tubulin alpha chain

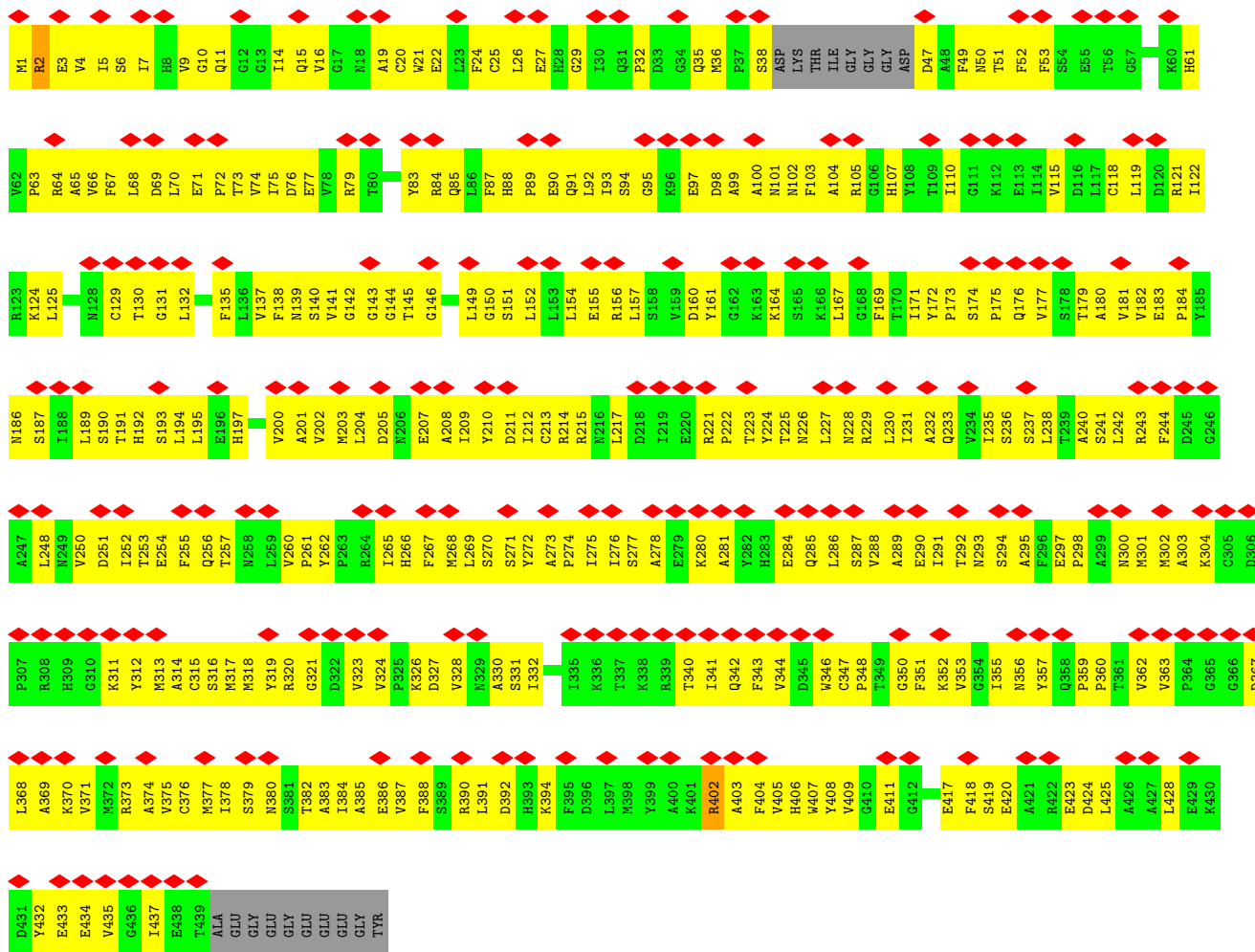

• Molecule 44: Tubulin alpha chain

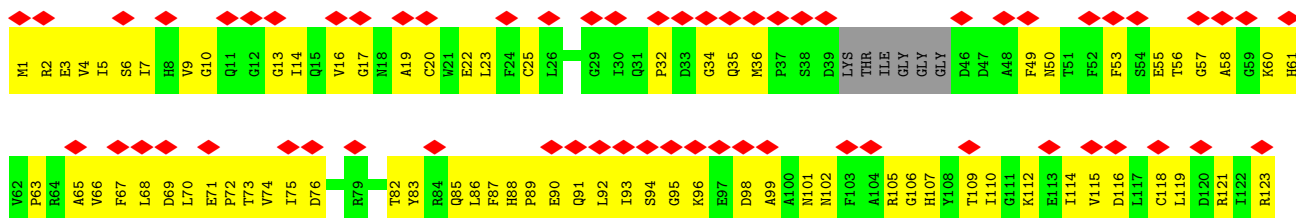



• Molecule 44: Tubulin alpha chain

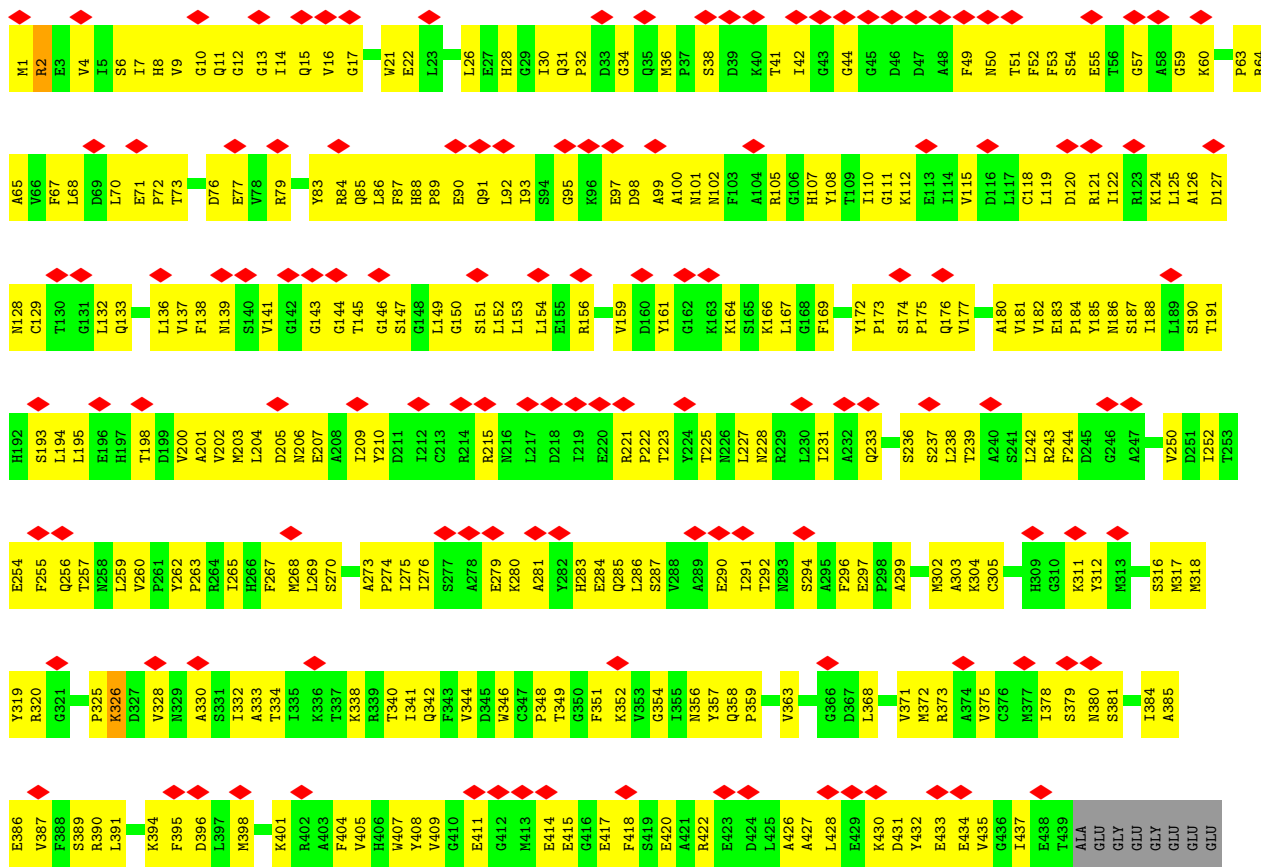

GLY  
TYR

• Molecule 44: Tubulin alpha chain

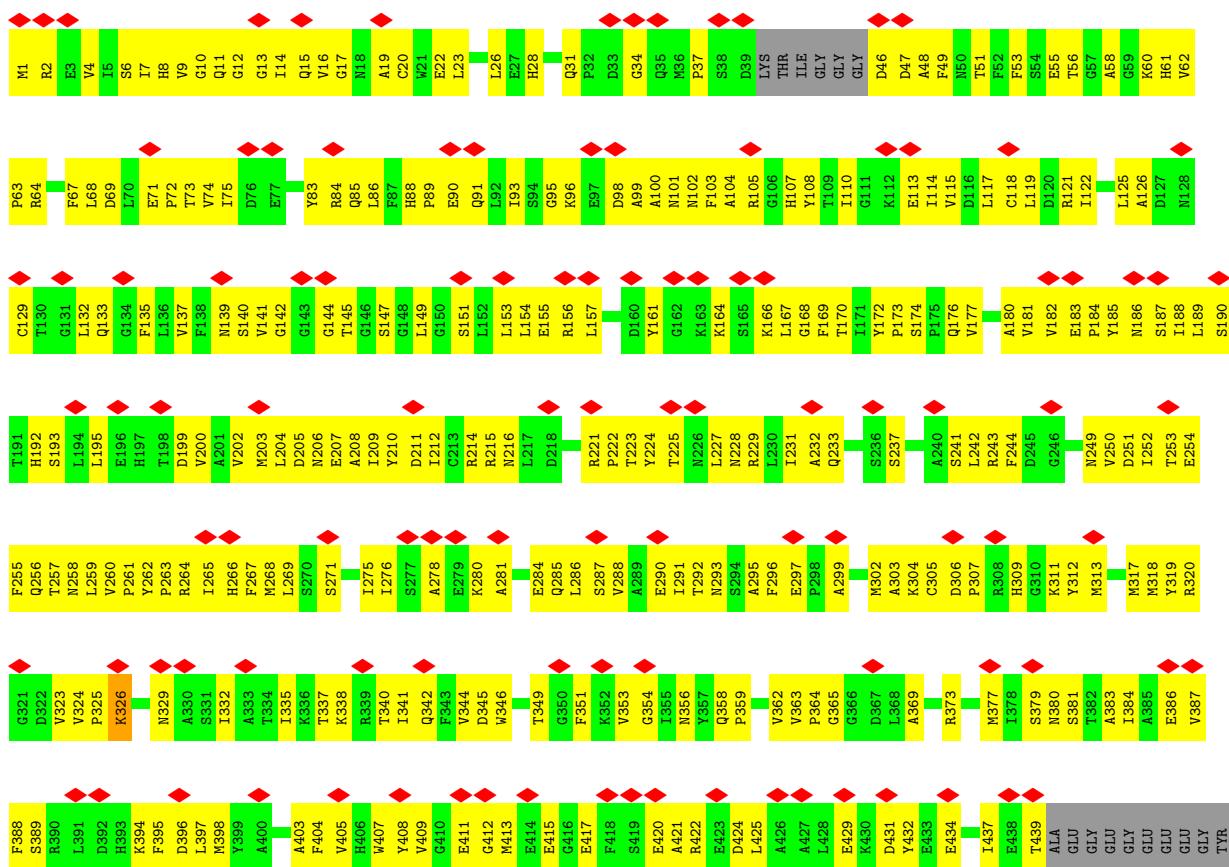

• Molecule 44: Tubulin alpha chain

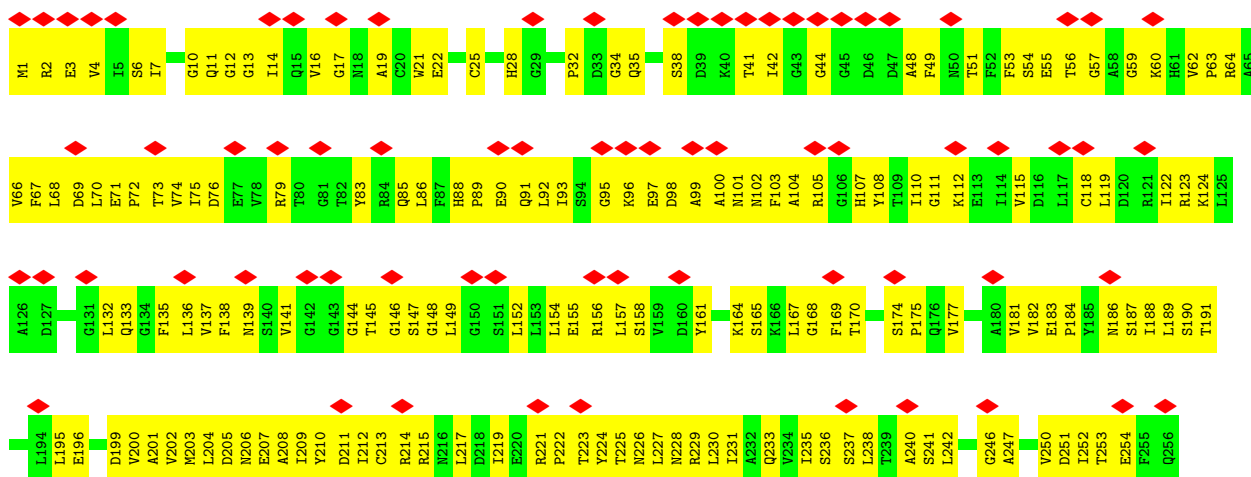

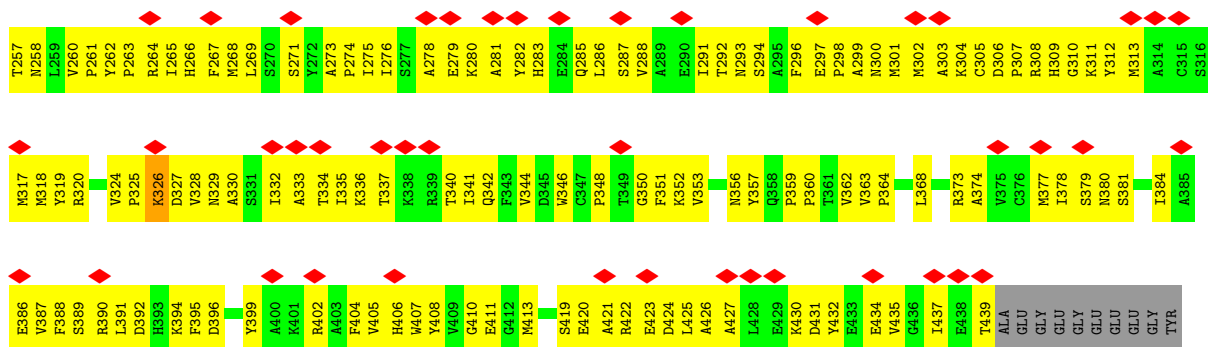

• Molecule 44: Tubulin alpha chain

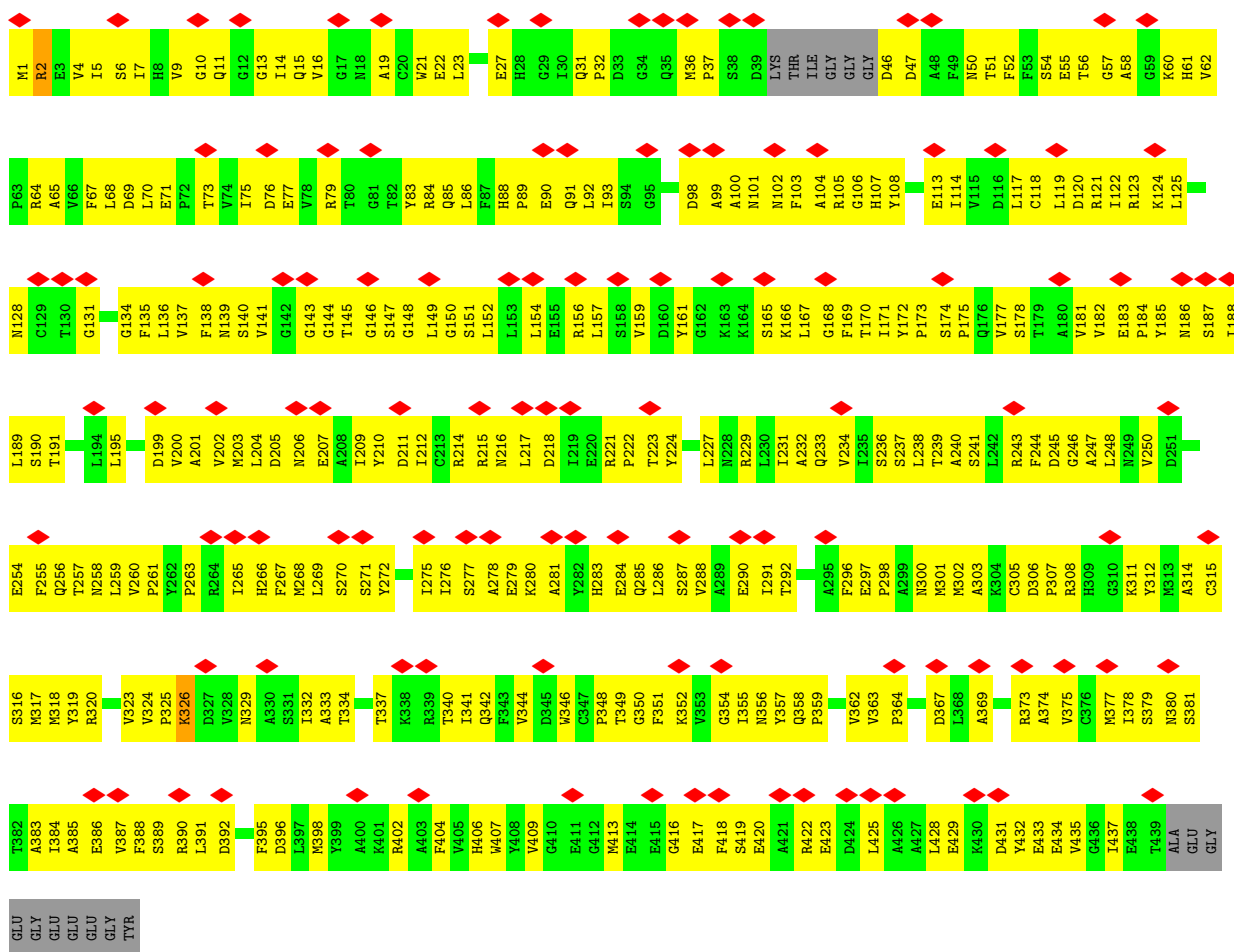

• Molecule 44: Tubulin alpha chain





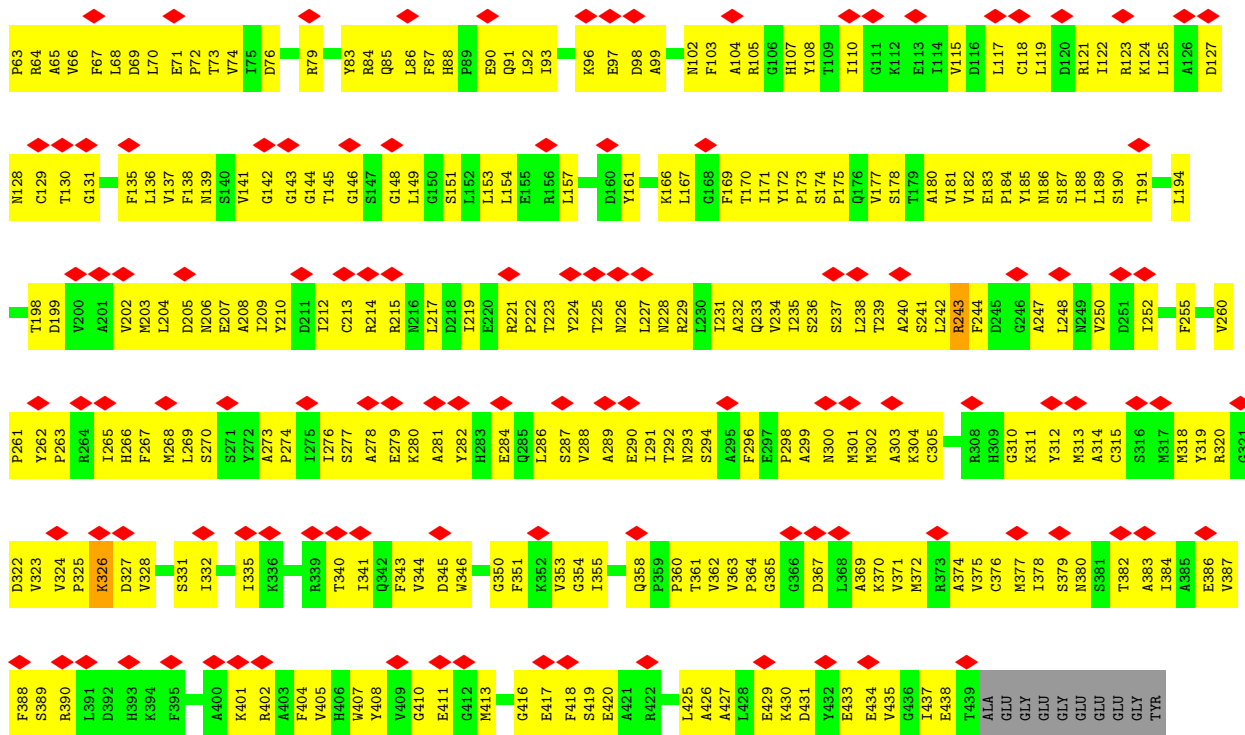

• Molecule 44: Tubulin alpha chain

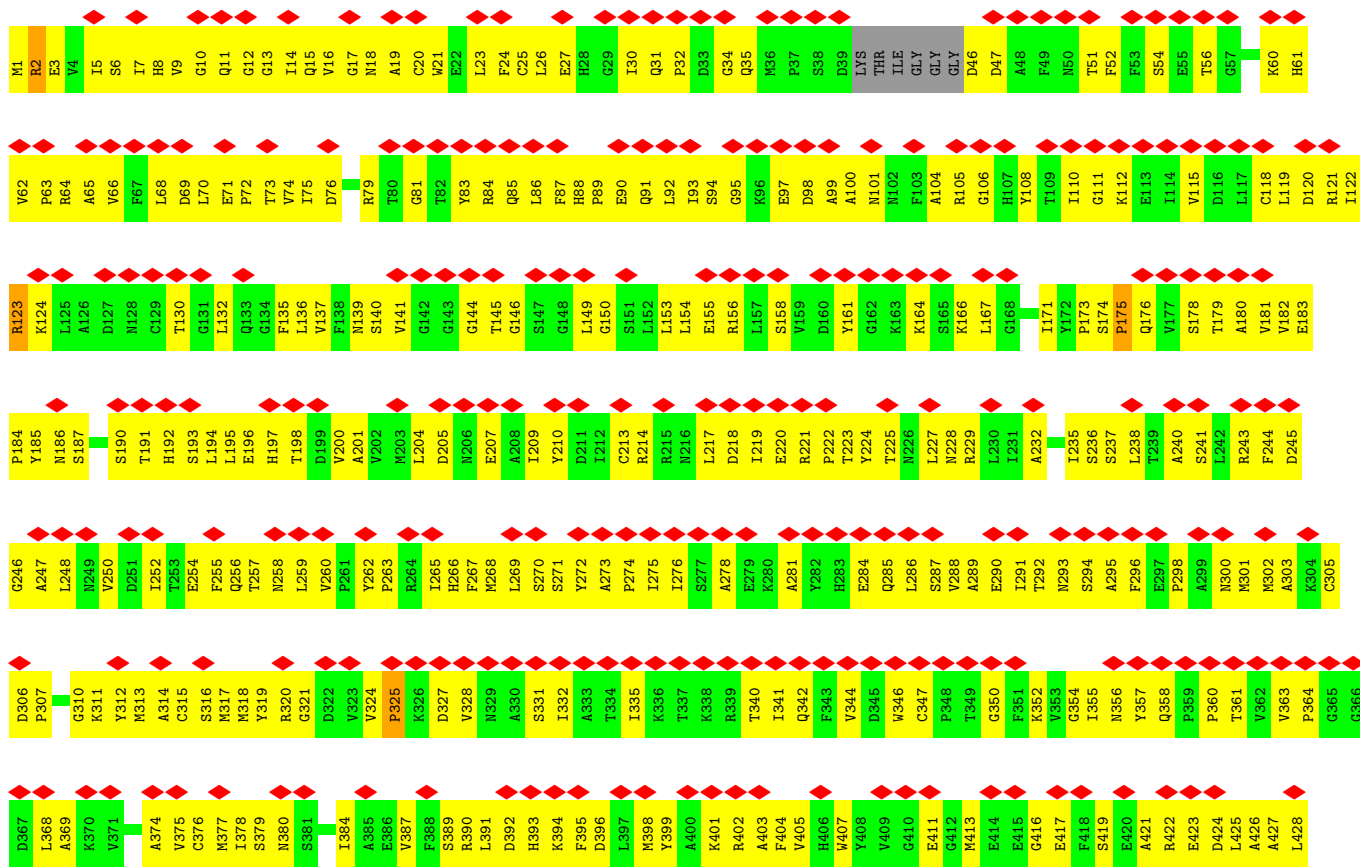

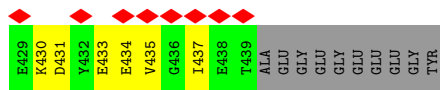

• Molecule 44: Tubulin alpha chain

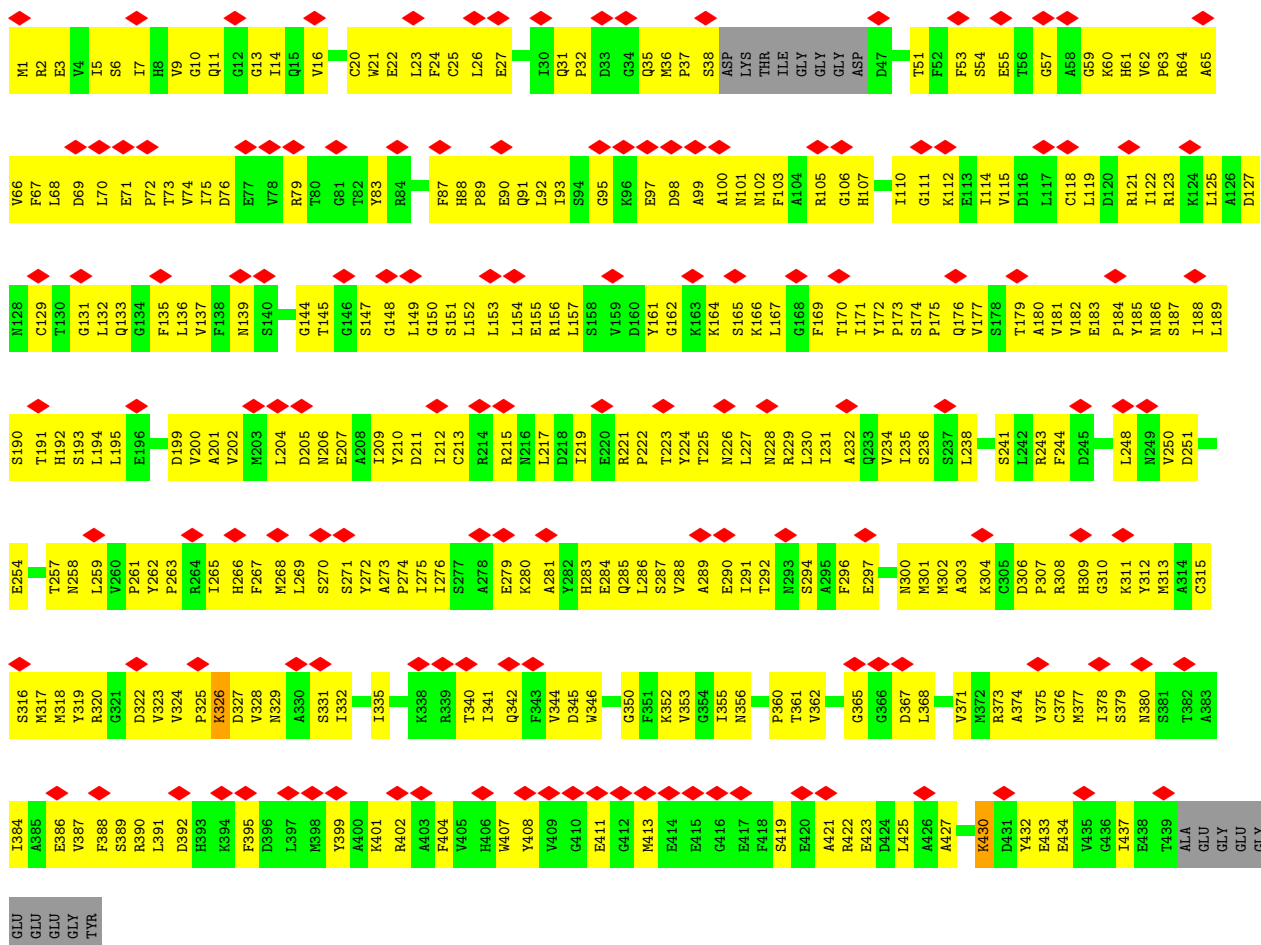
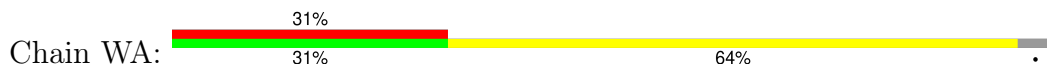

• Molecule 44: Tubulin alpha chain

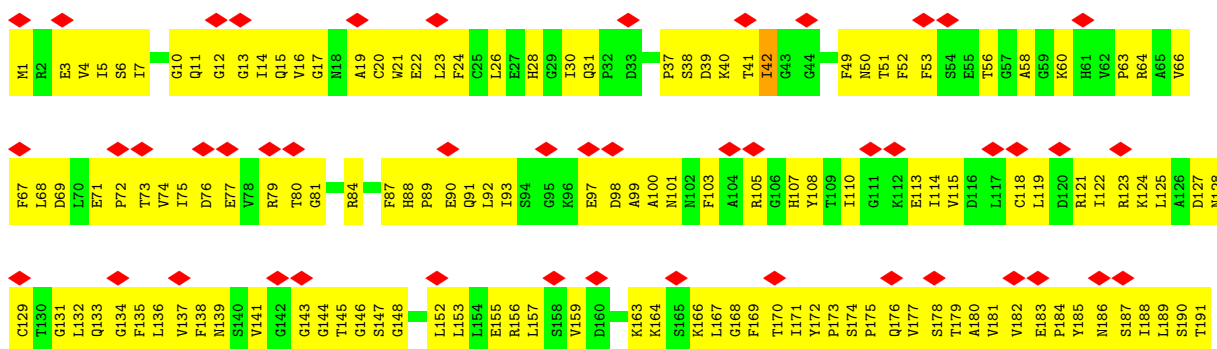

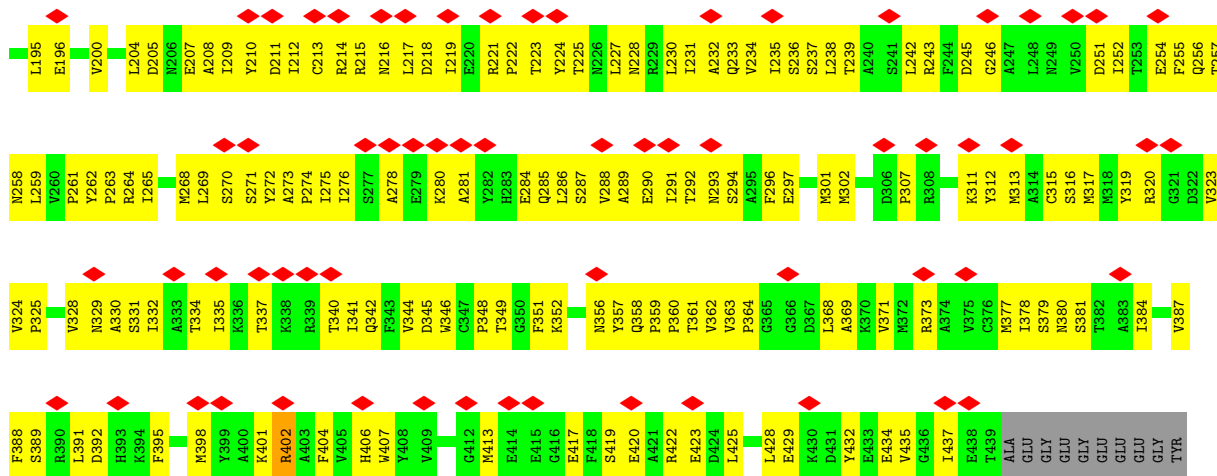

• Molecule 44: Tubulin alpha chain

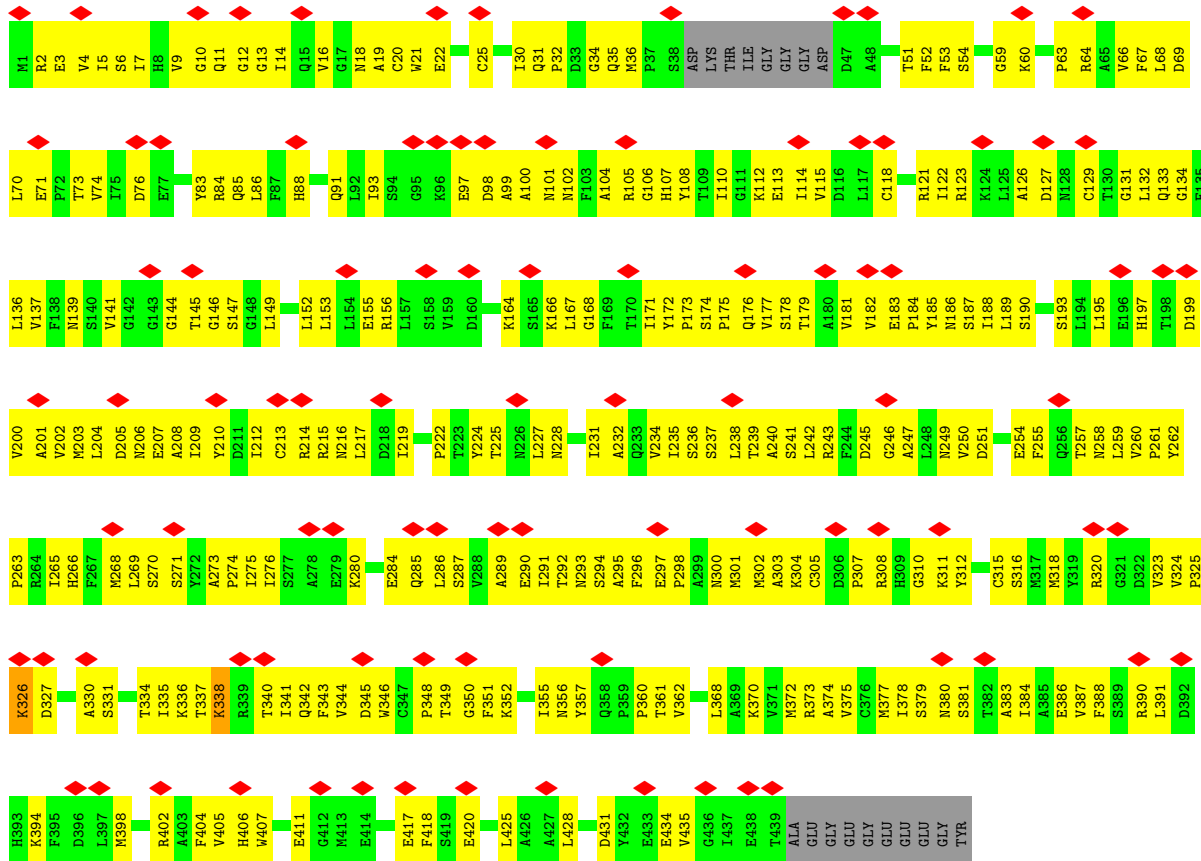

• Molecule 44: Tubulin alpha chain



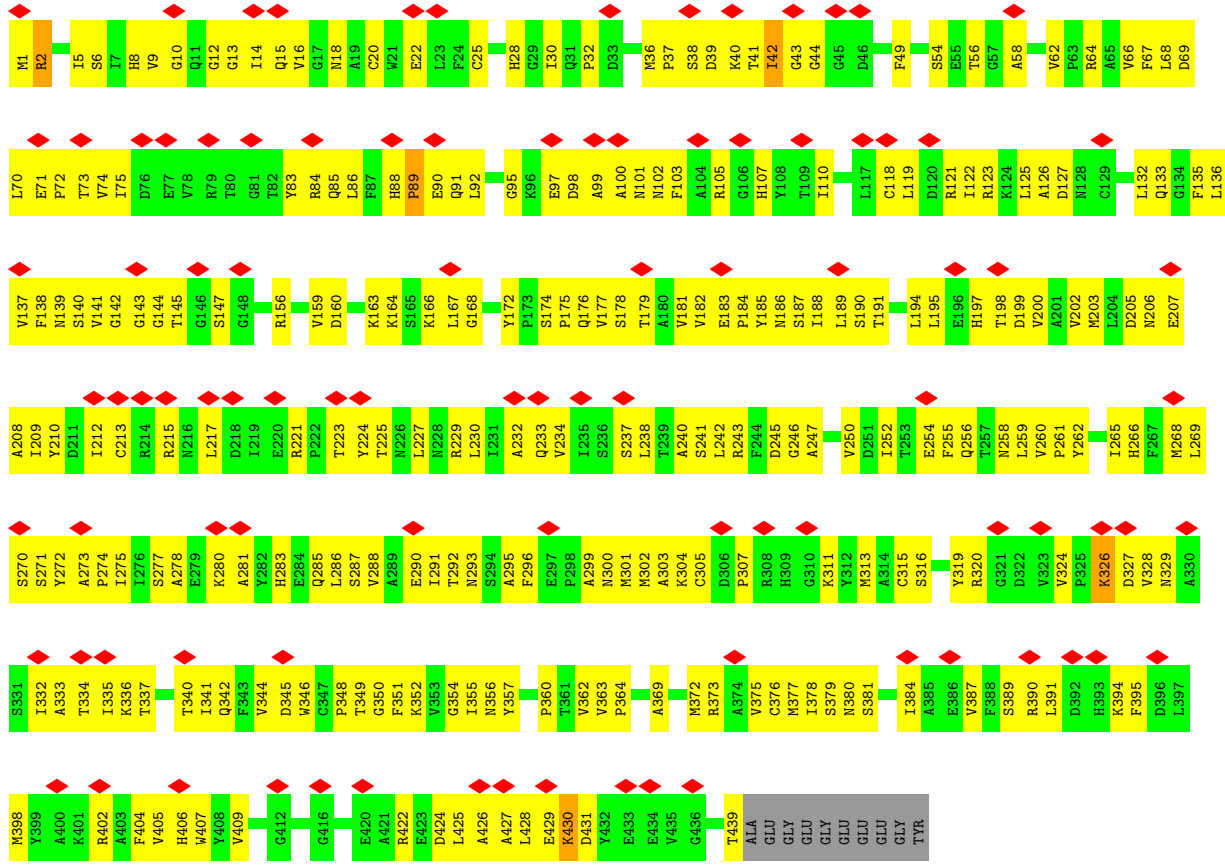

• Molecule 44: Tubulin alpha chain

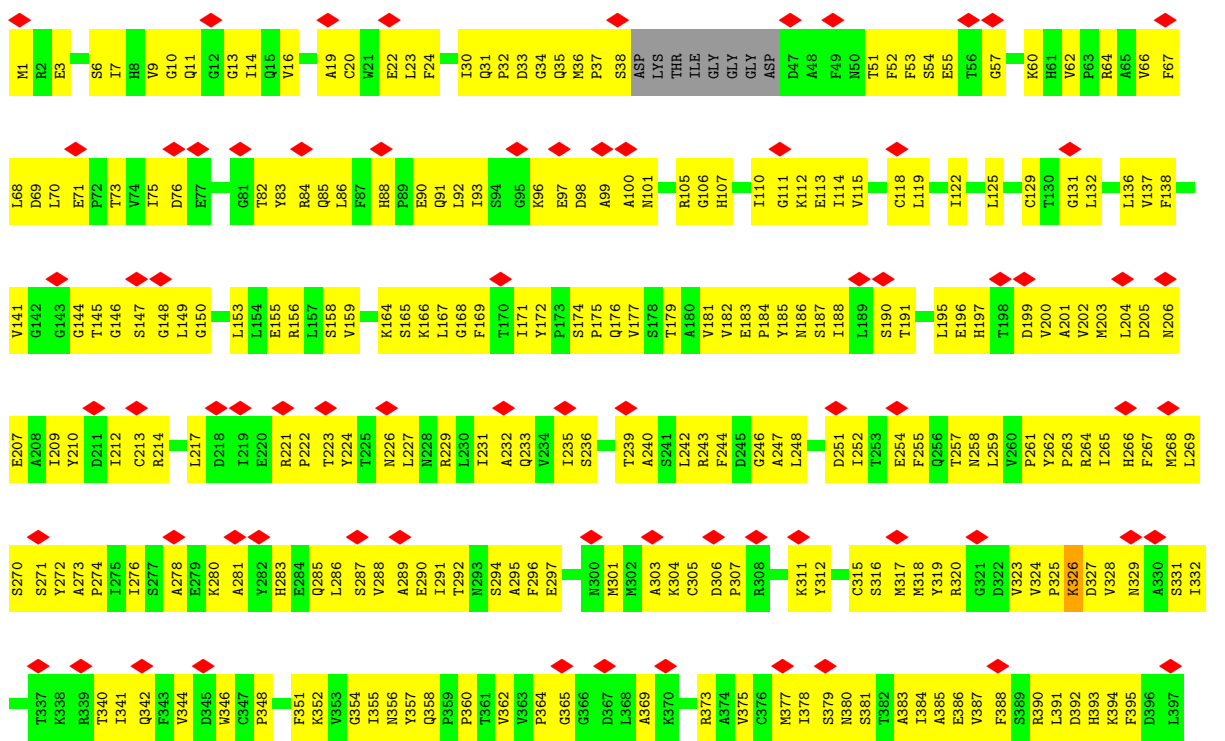

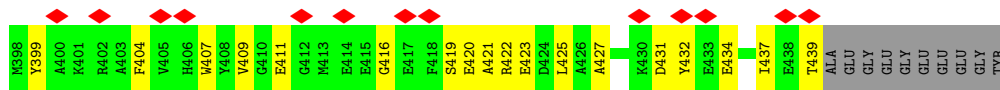

• Molecule 44: Tubulin alpha chain

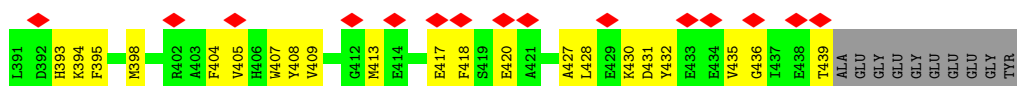
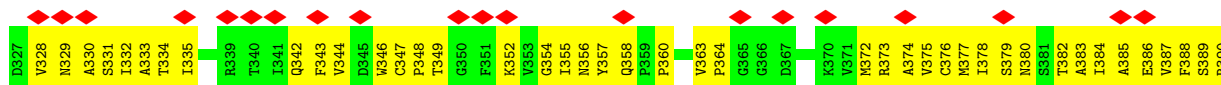
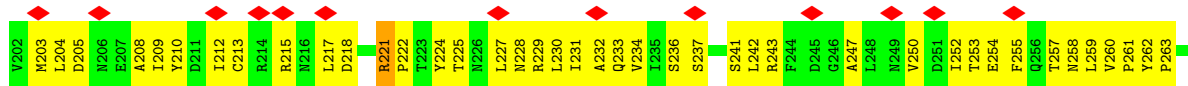
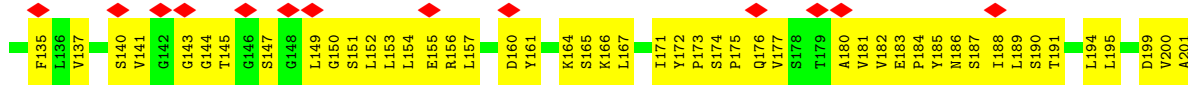
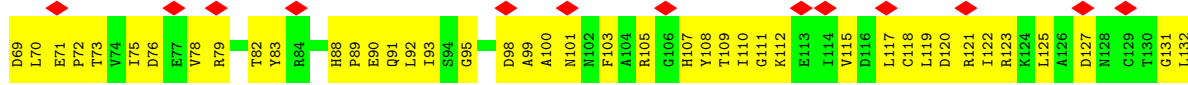
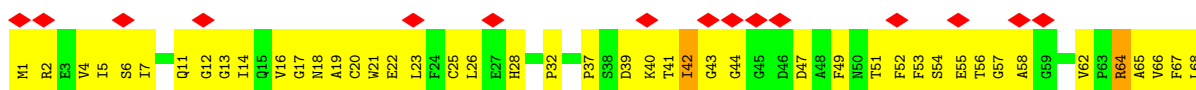
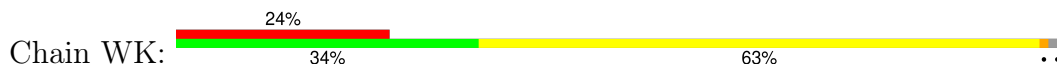

• Molecule 44: Tubulin alpha chain

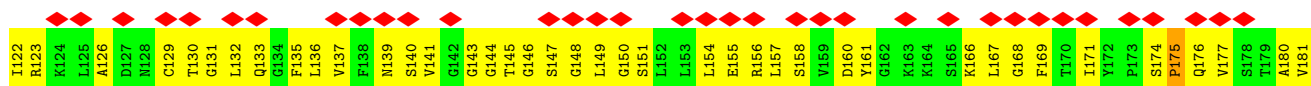
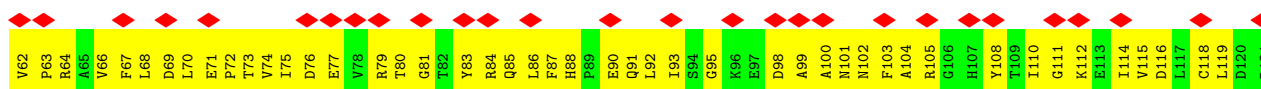
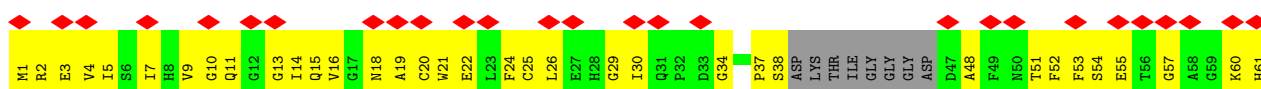

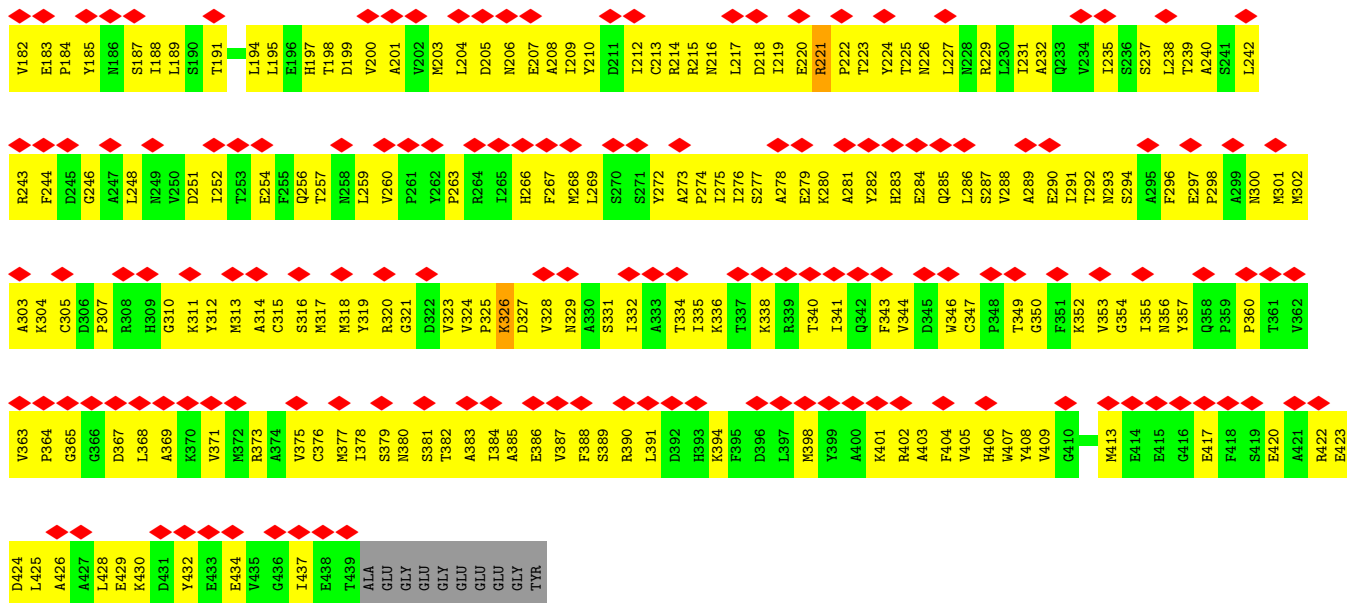

• Molecule 45: Tubulin beta chain

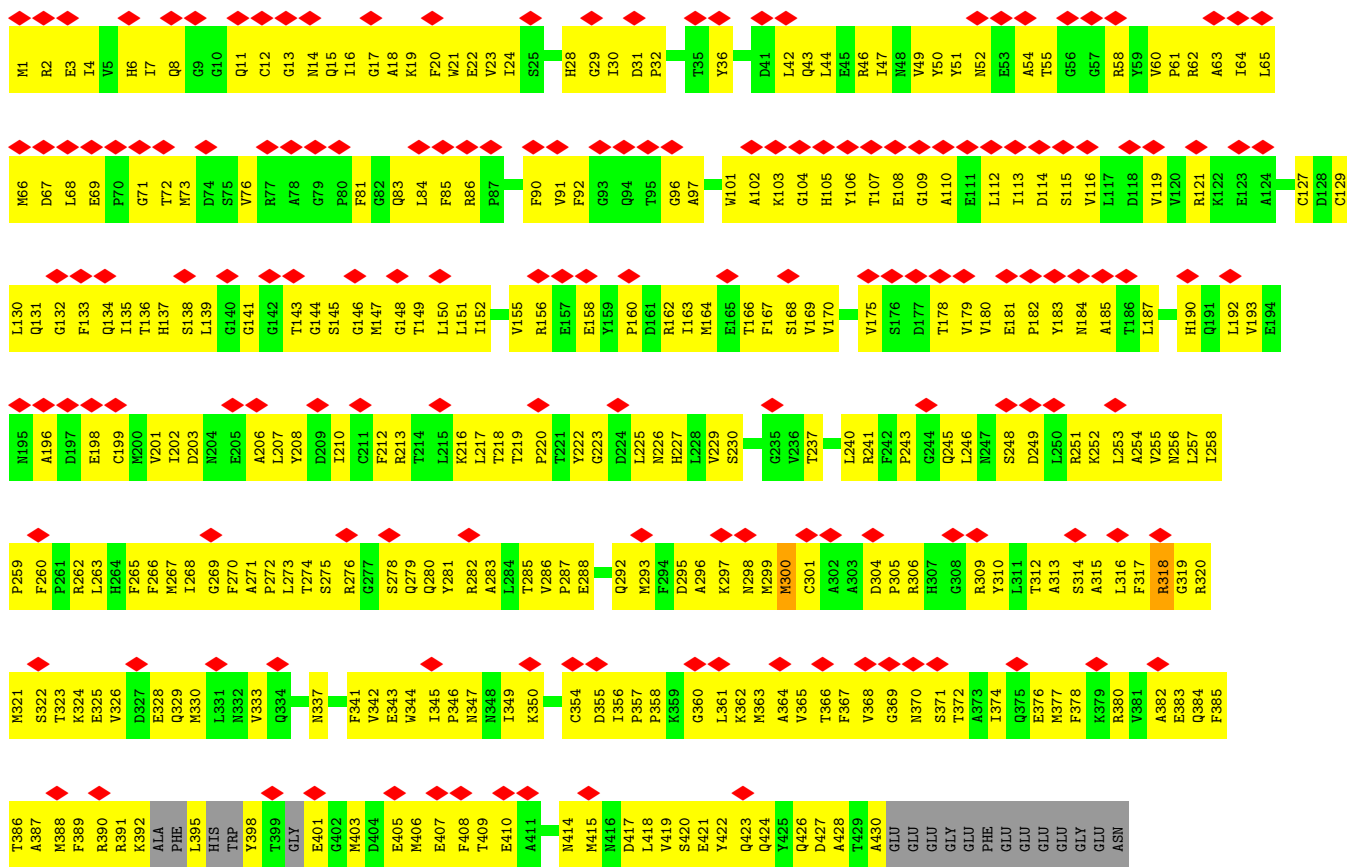

• Molecule 45: Tubulin beta chain



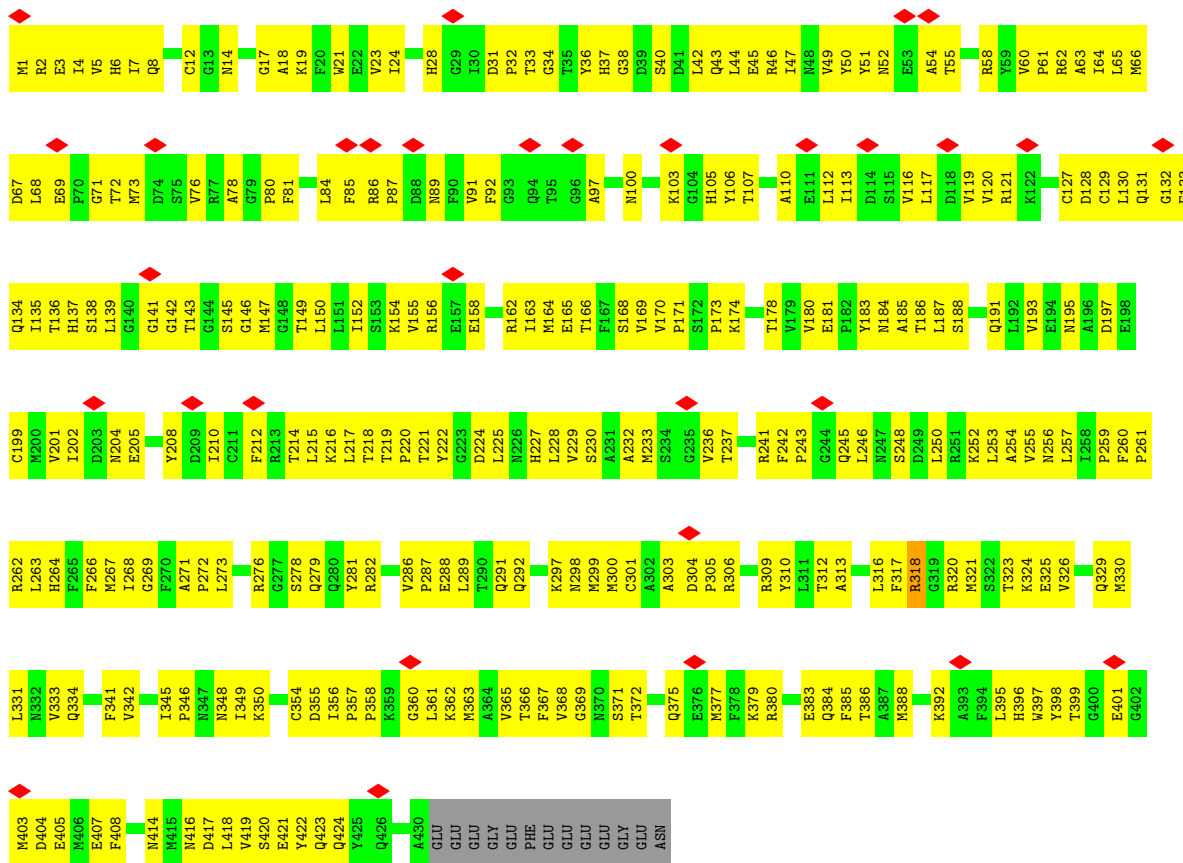

• Molecule 45: Tubulin beta chain

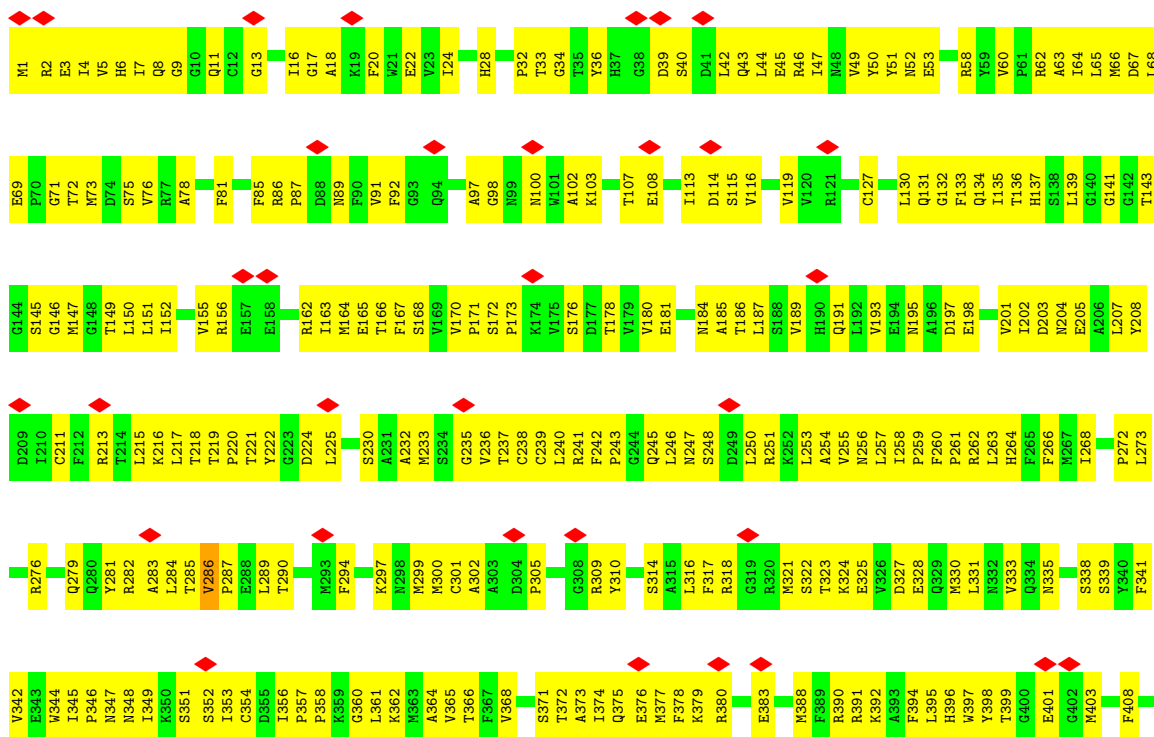





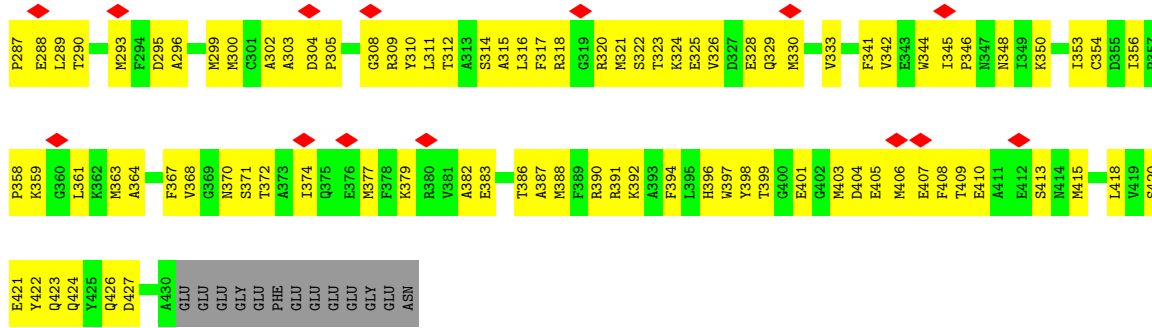

• Molecule 45: Tubulin beta chain

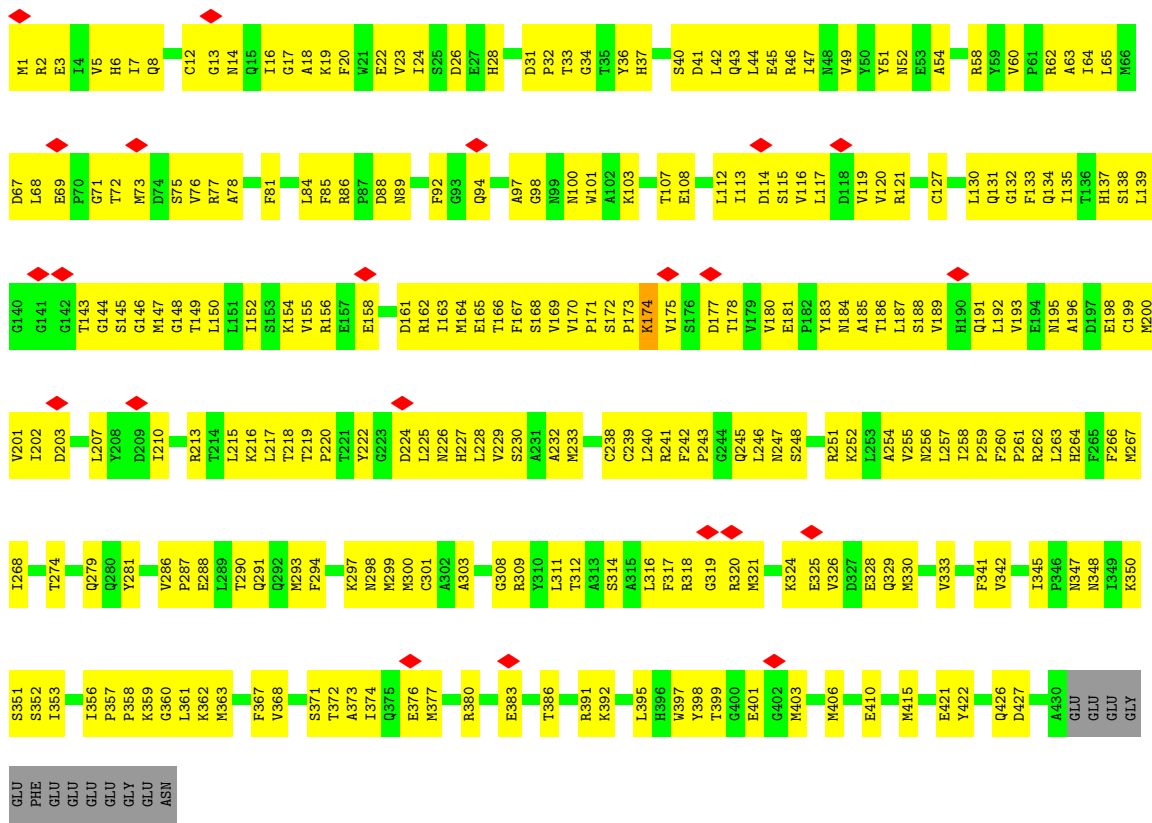

• Molecule 45: Tubulin beta chain

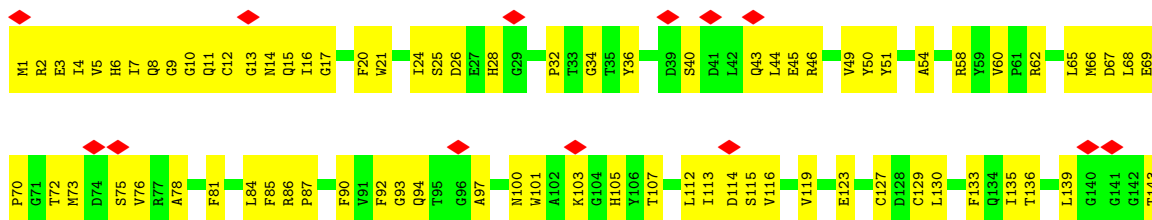

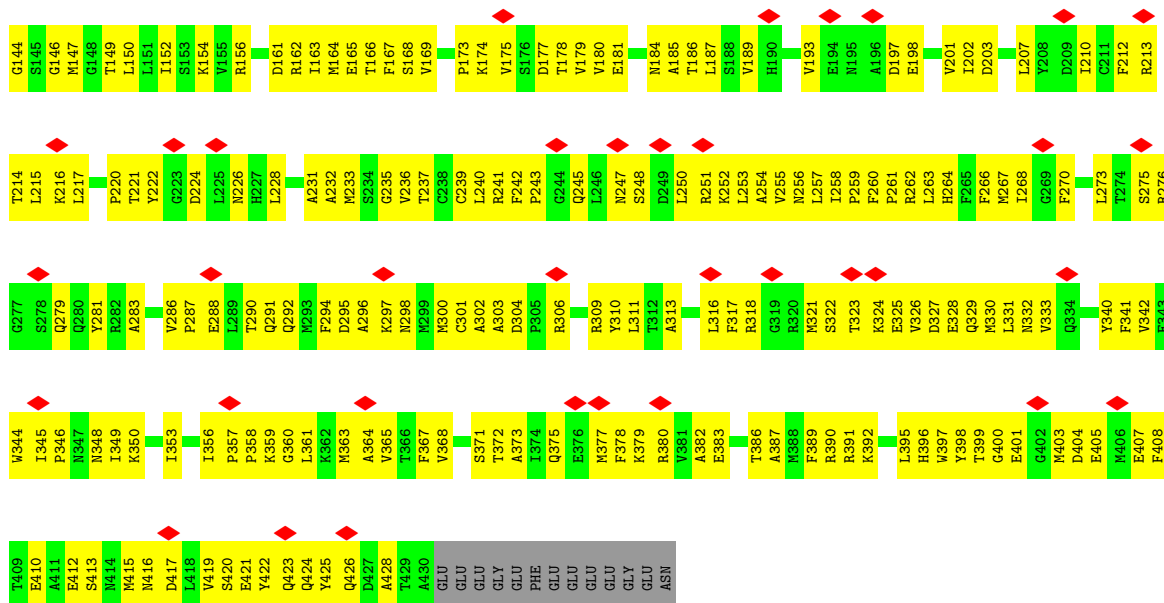

• Molecule 45: Tubulin beta chain

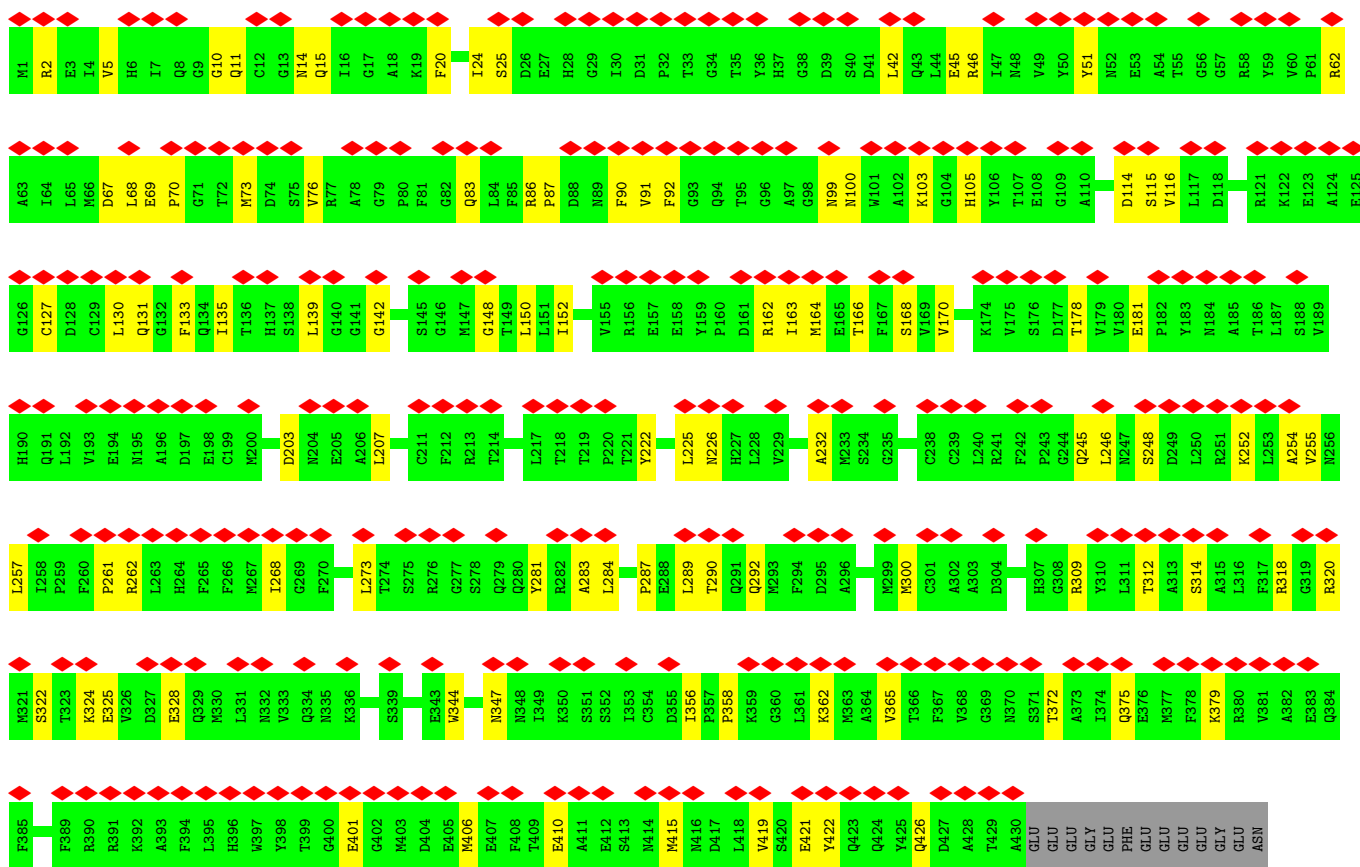
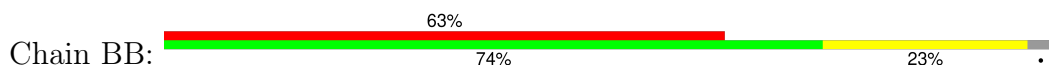

• Molecule 45: Tubulin beta chain



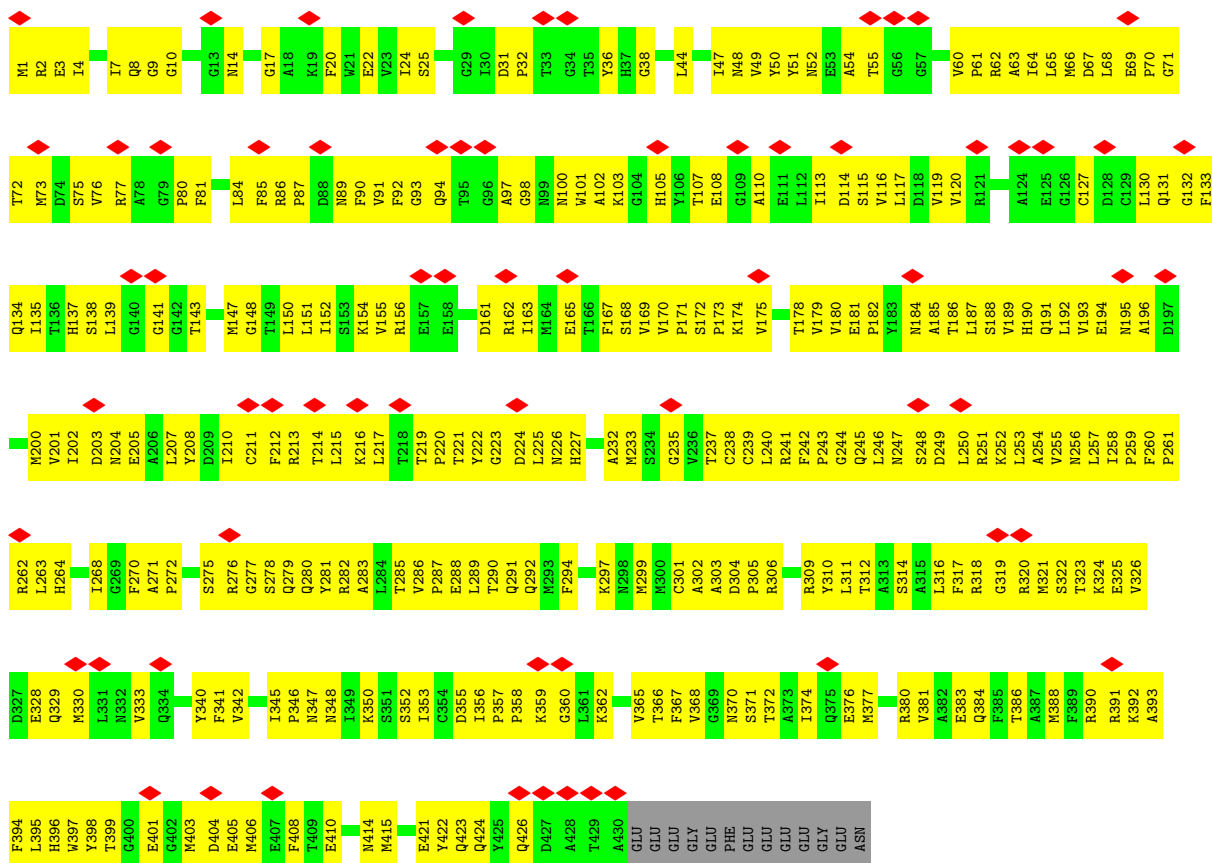

• Molecule 45: Tubulin beta chain

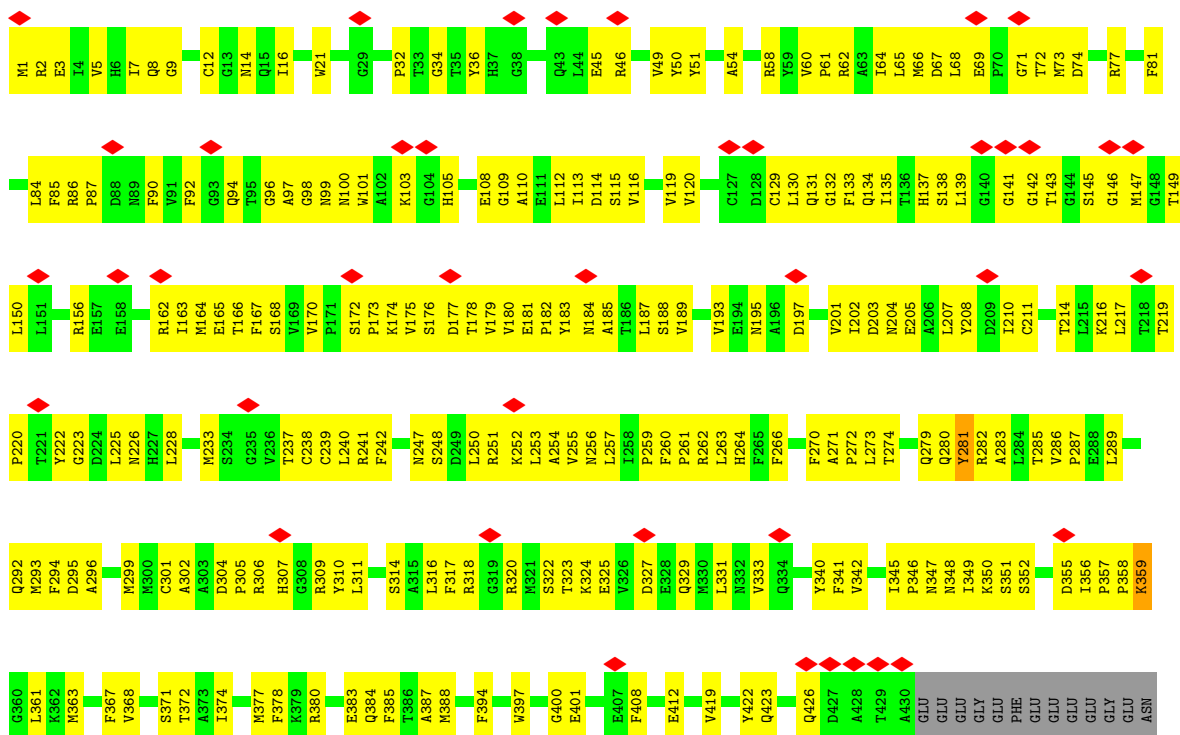

• Molecule 45: Tubulin beta chain

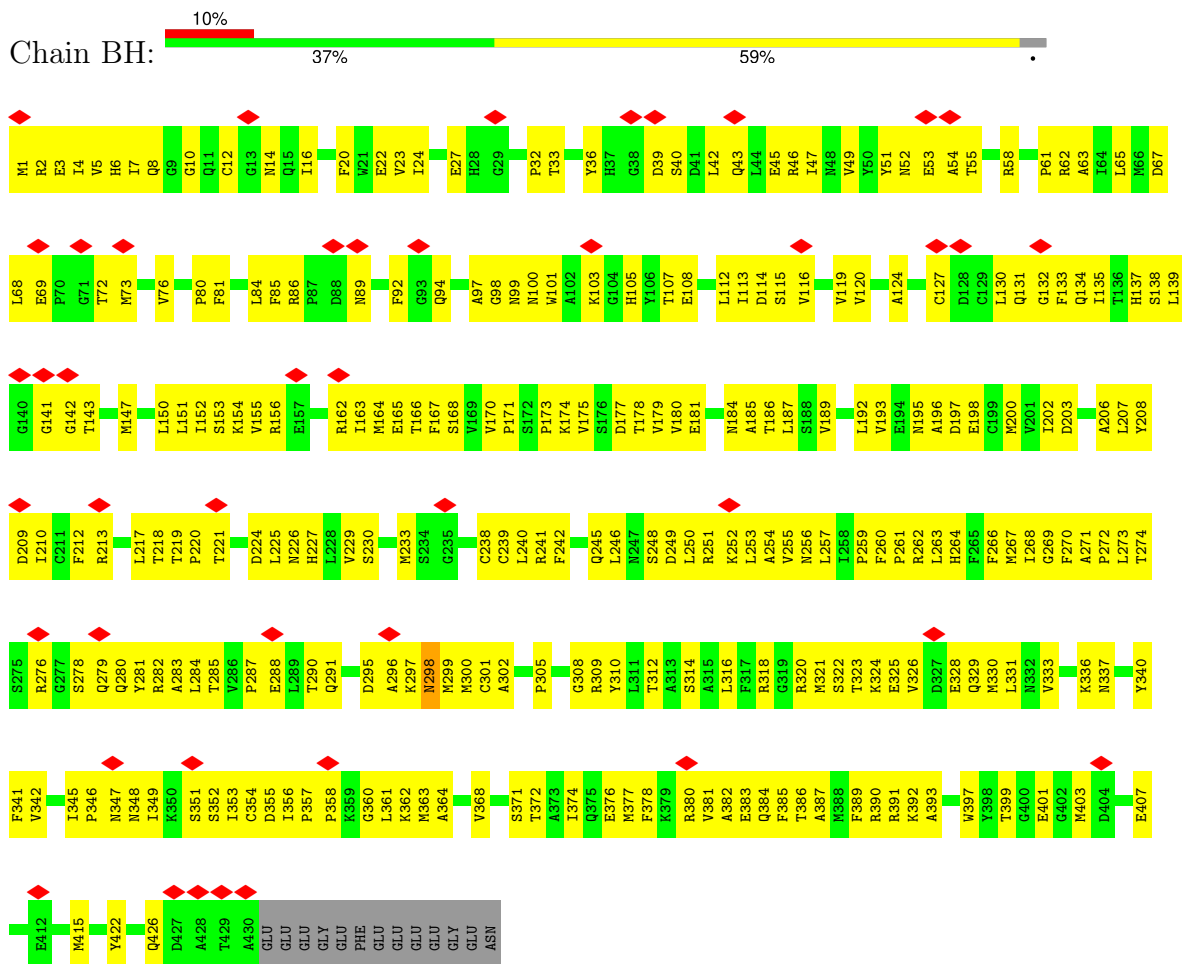

• Molecule 45: Tubulin beta chain

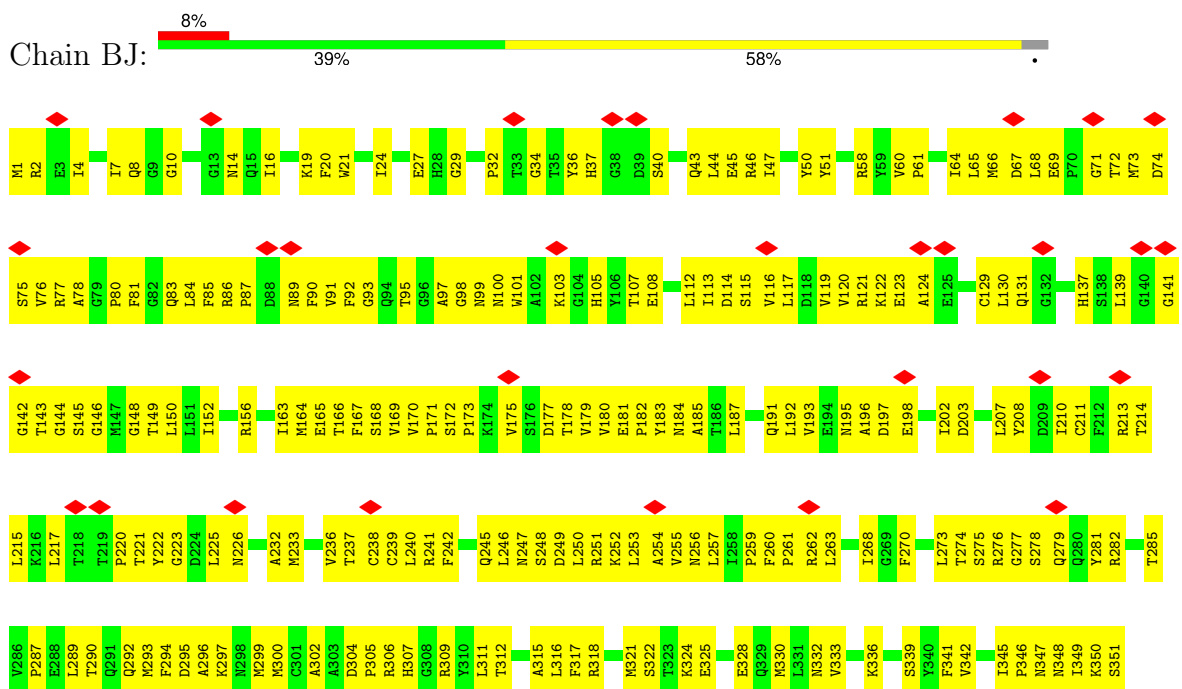

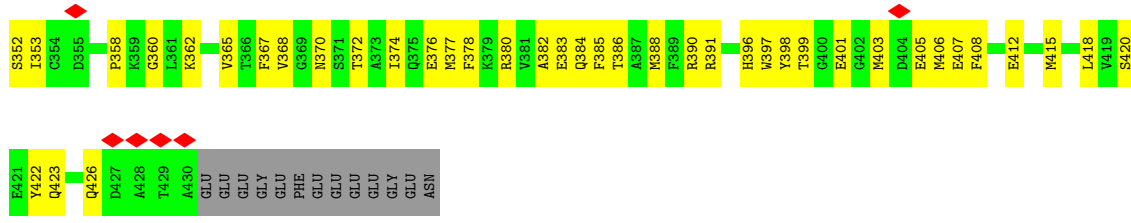

• Molecule 45: Tubulin beta chain

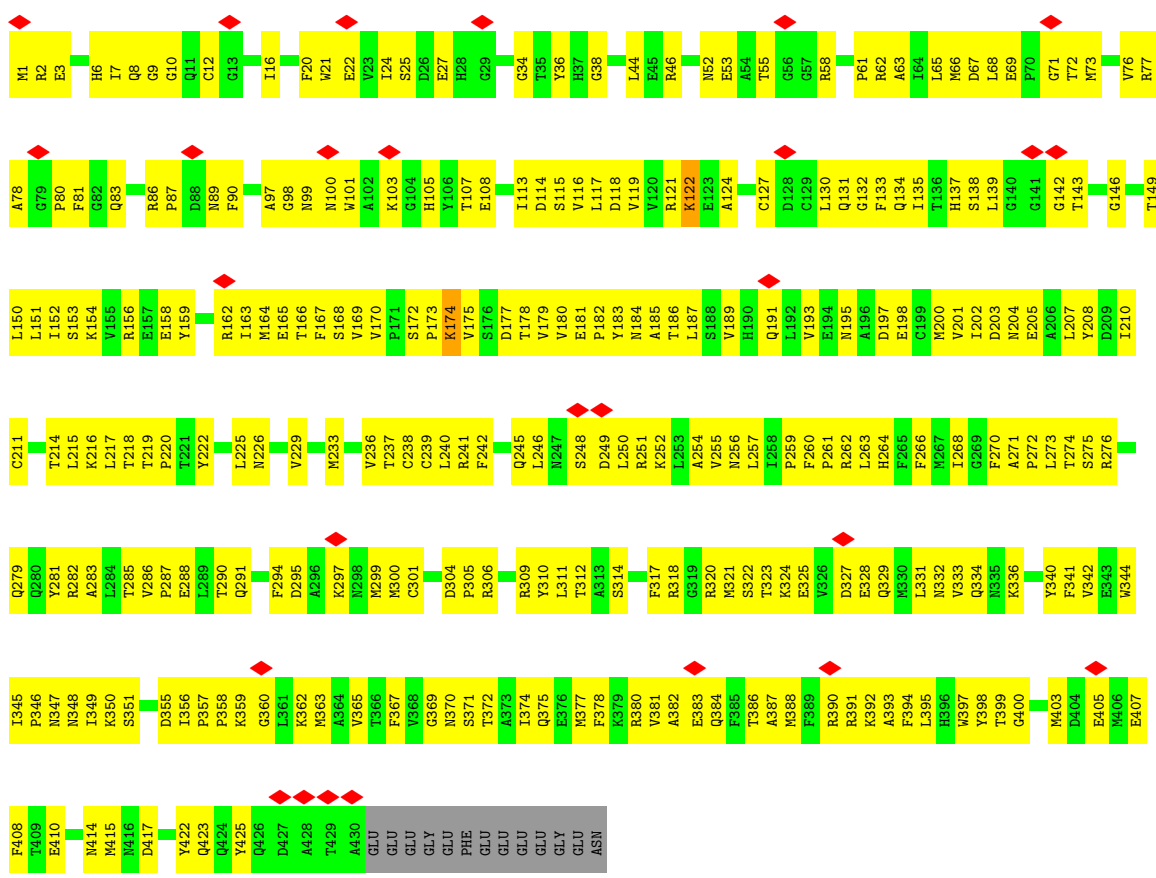

• Molecule 45: Tubulin beta chain

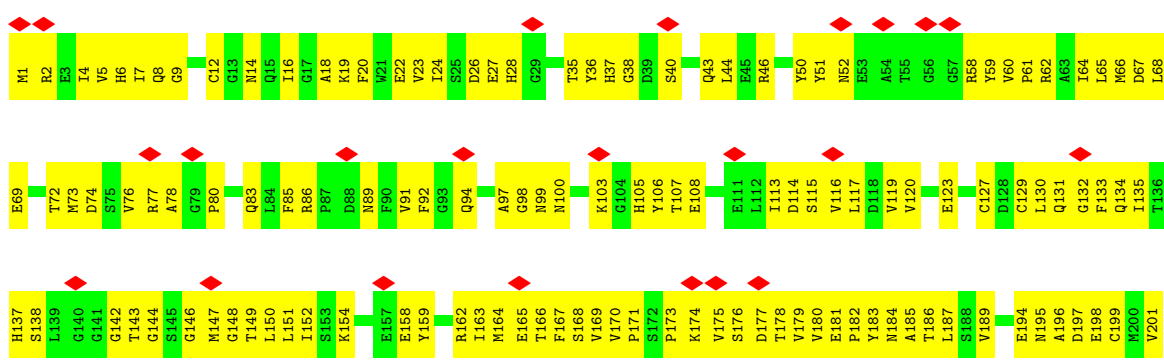

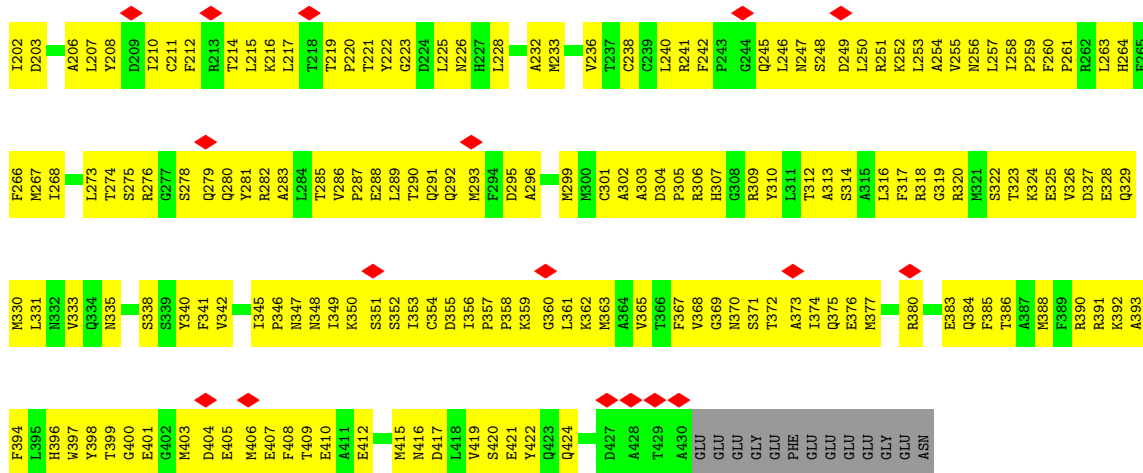

• Molecule 45: Tubulin beta chain

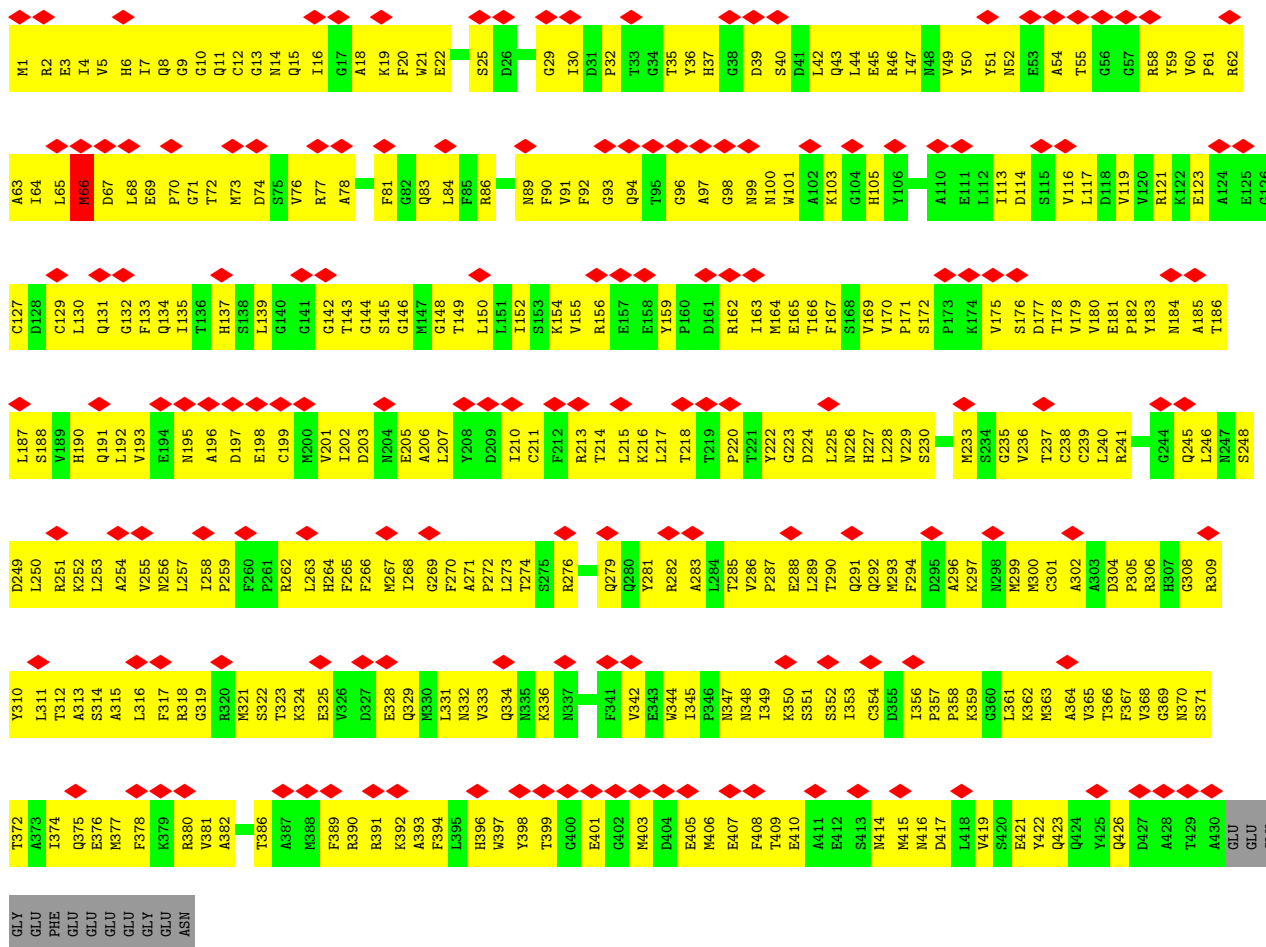

• Molecule 45: Tubulin beta chain



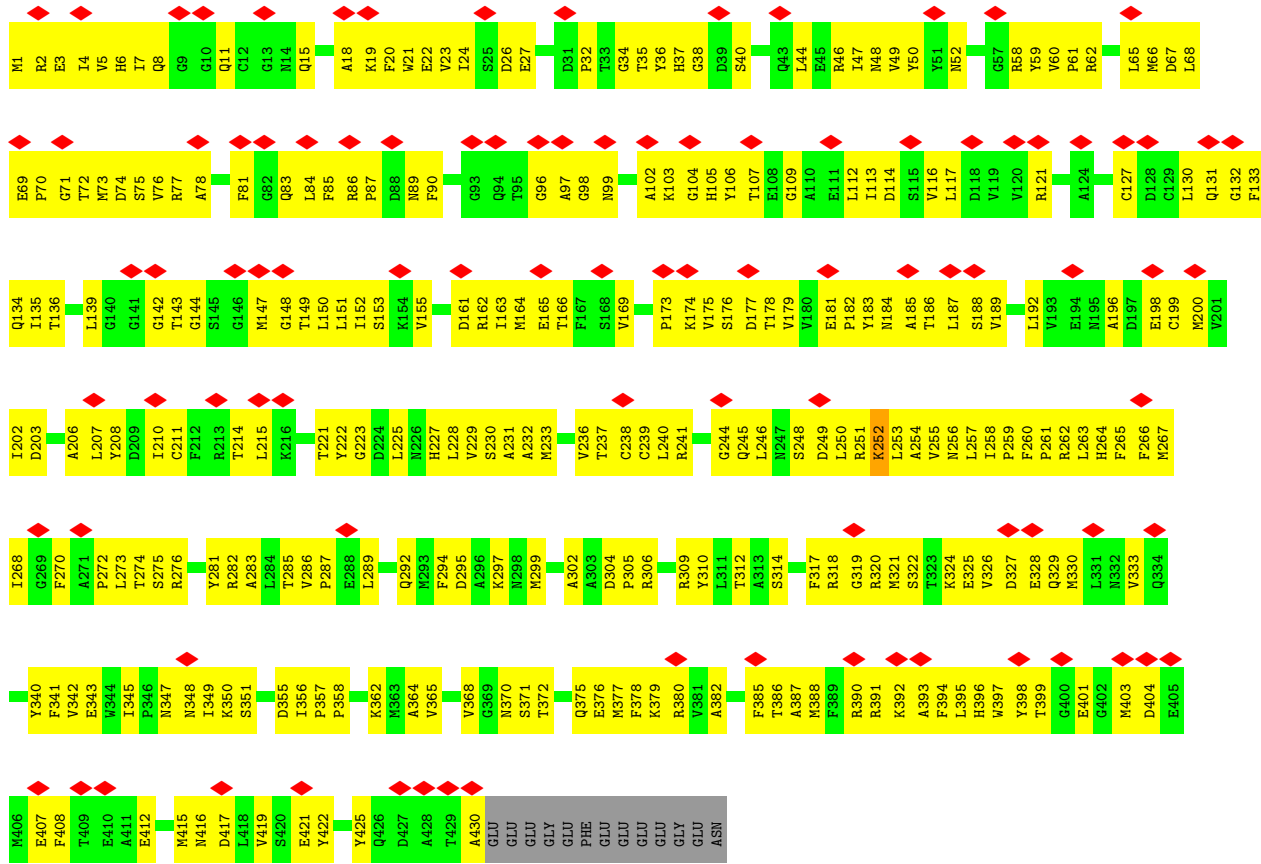

- Molecule 45: Tubulin beta chain

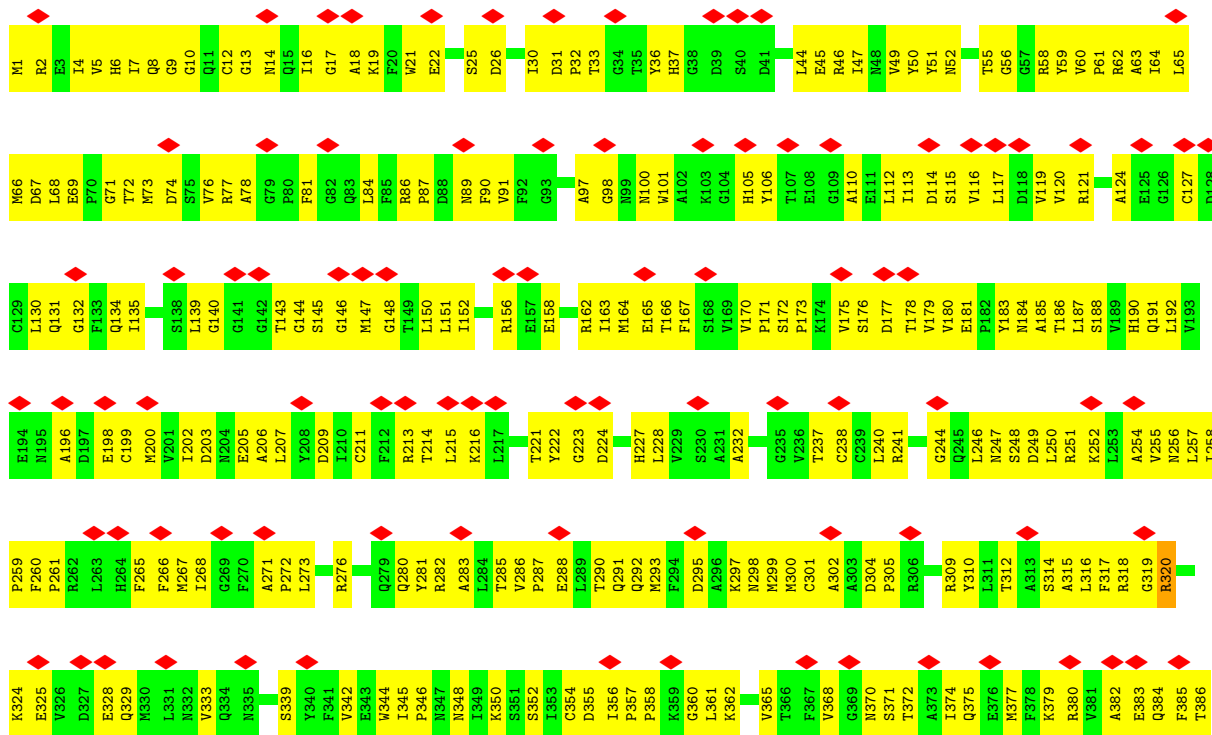



• Molecule 45: Tubulin beta chain

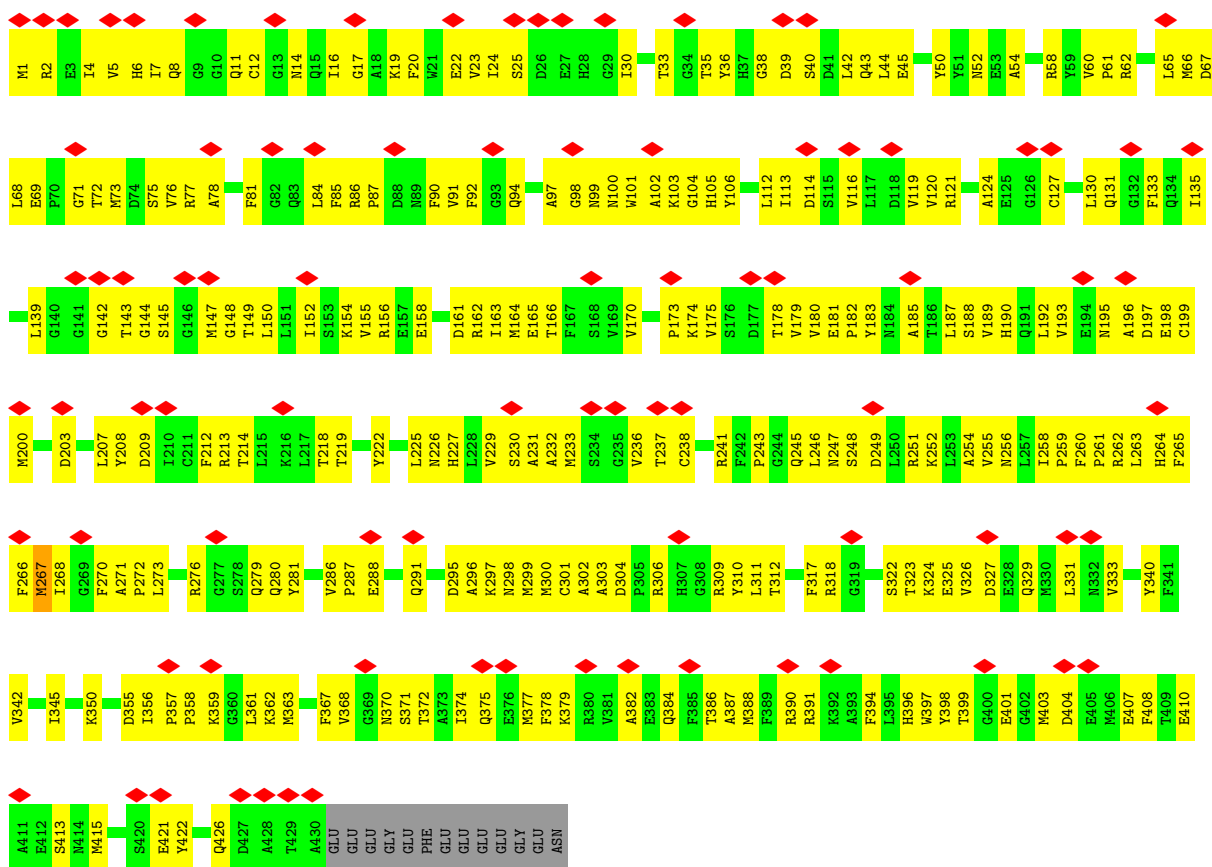
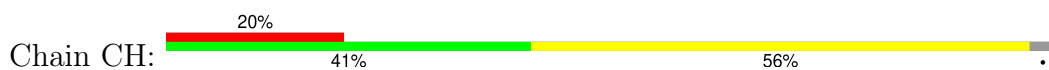

• Molecule 45: Tubulin beta chain

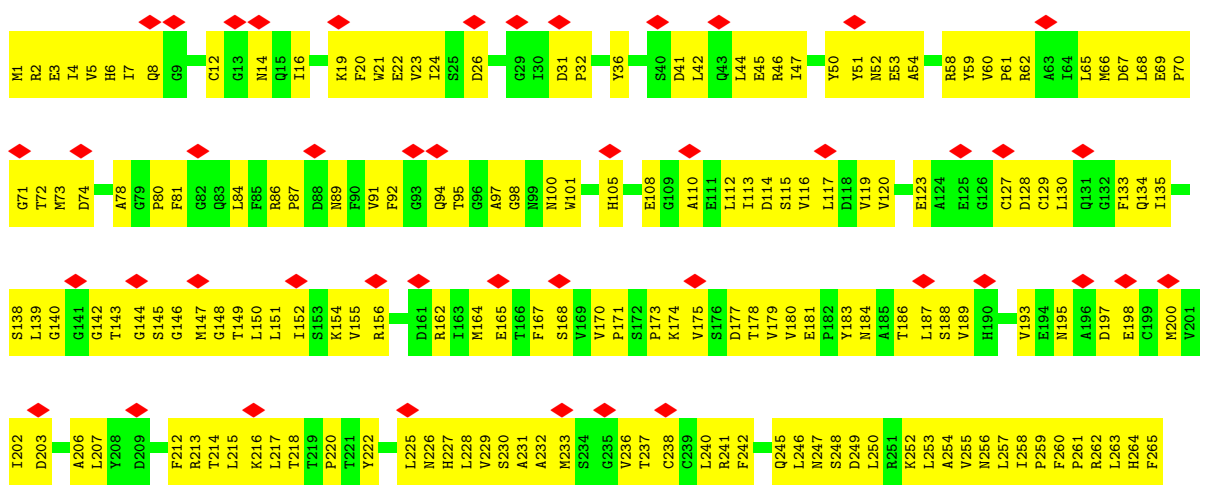



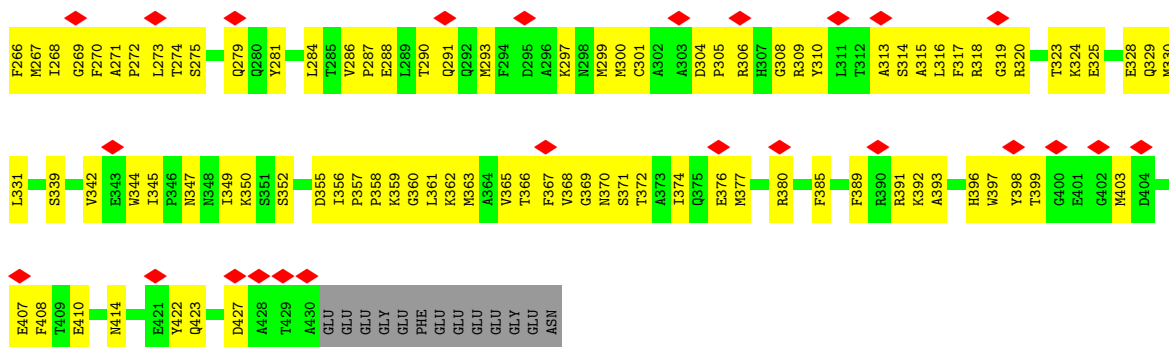

• Molecule 45: Tubulin beta chain

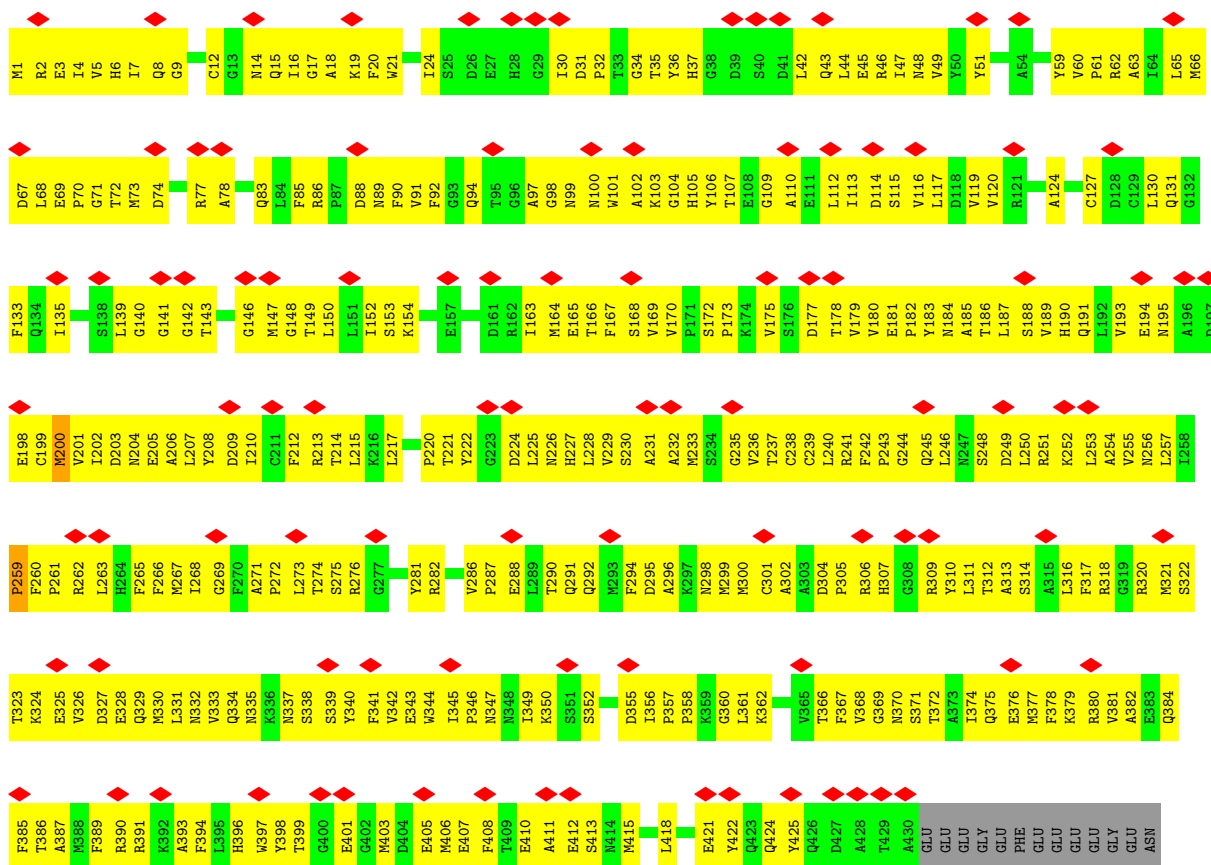

• Molecule 45: Tubulin beta chain

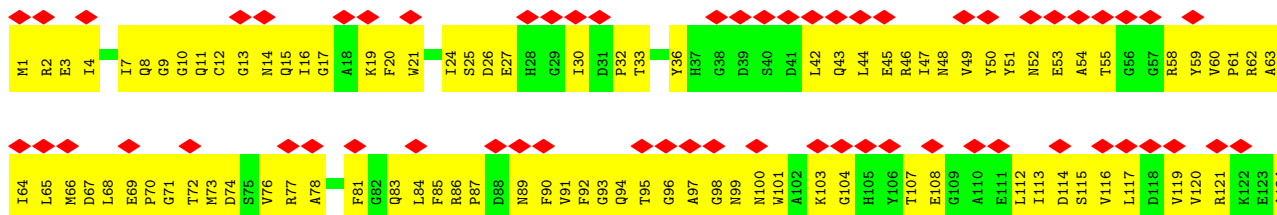



• Molecule 45: Tubulin beta chain

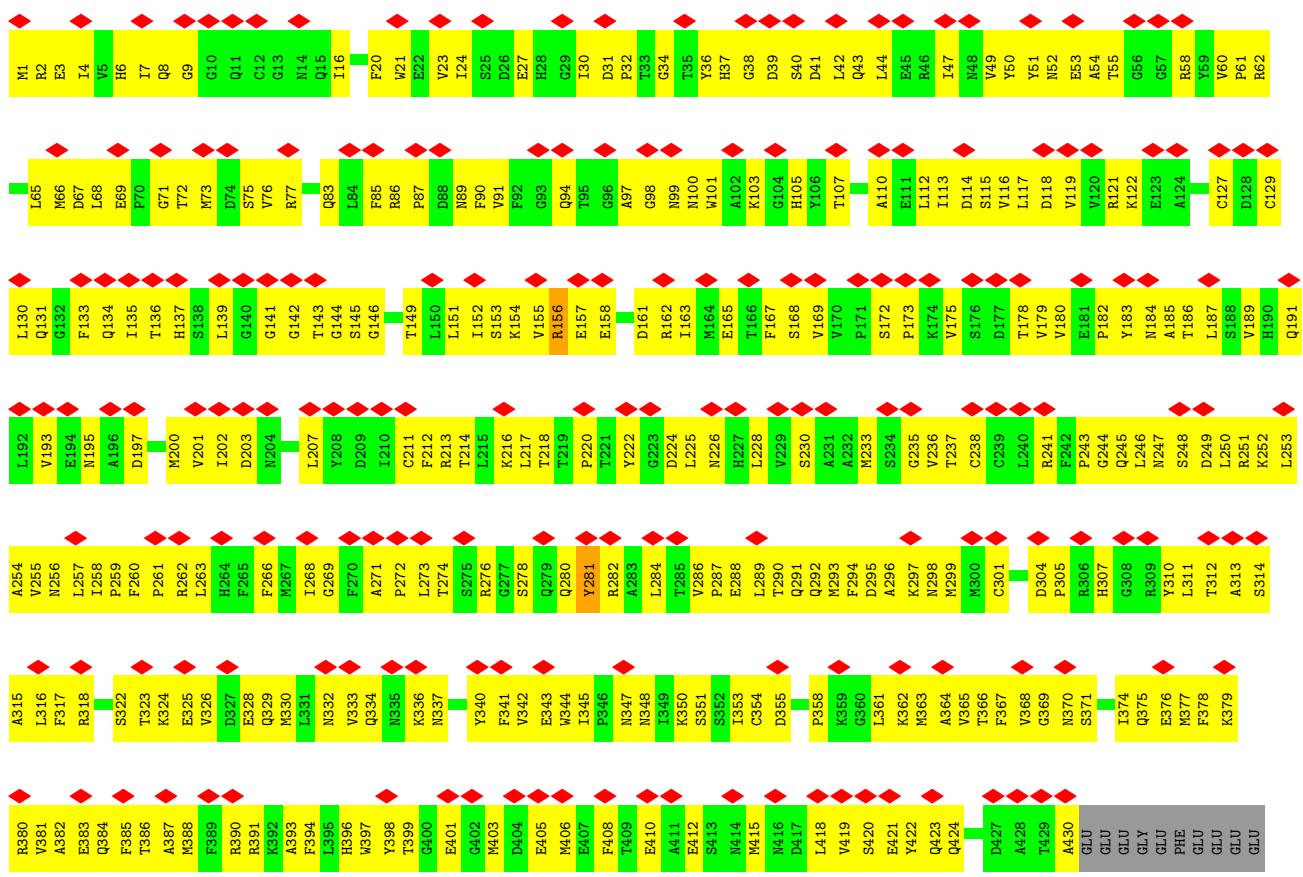

GLY  
GLU  
ASN

● Molecule 45: Tubulin beta chain

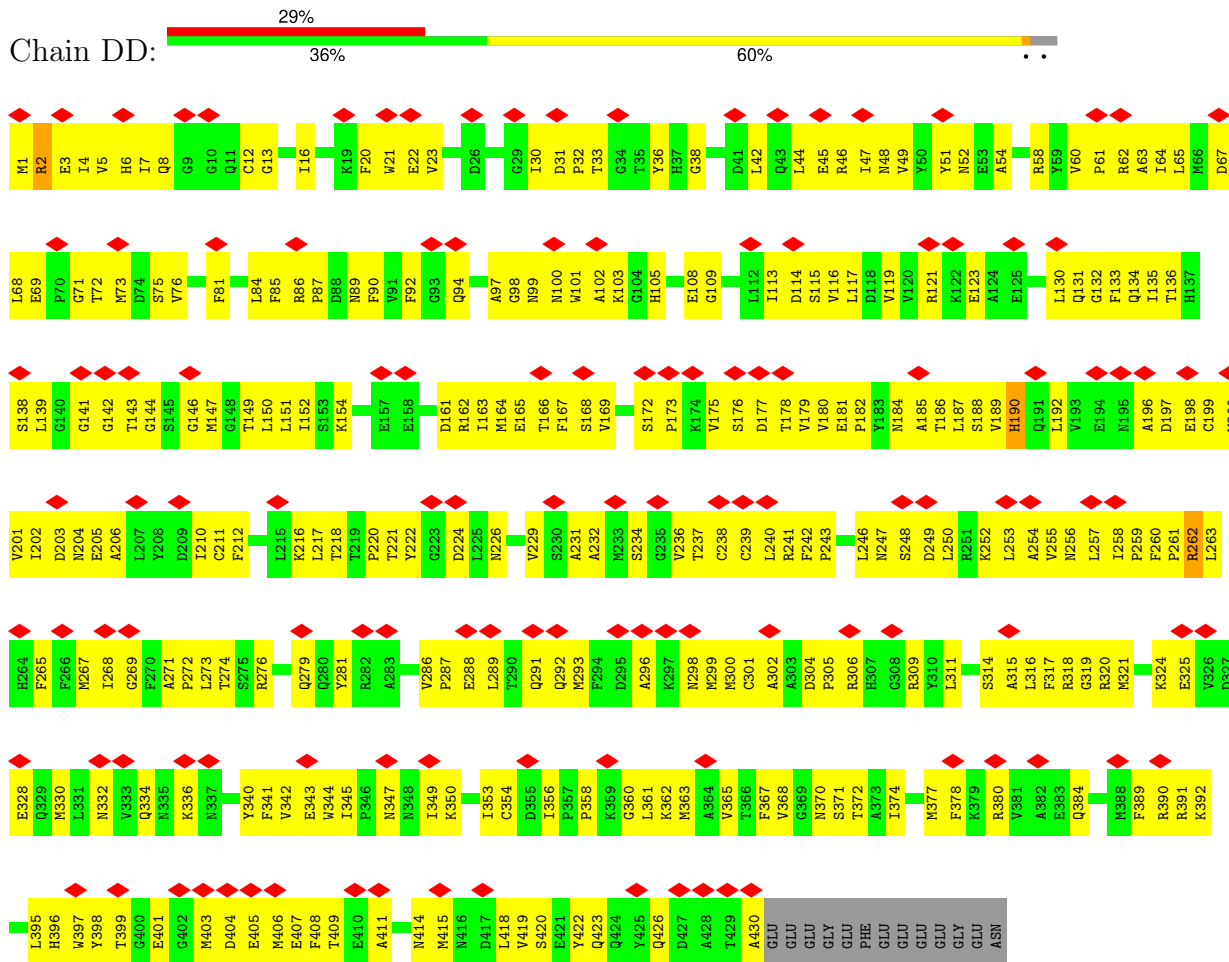

● Molecule 45: Tubulin beta chain

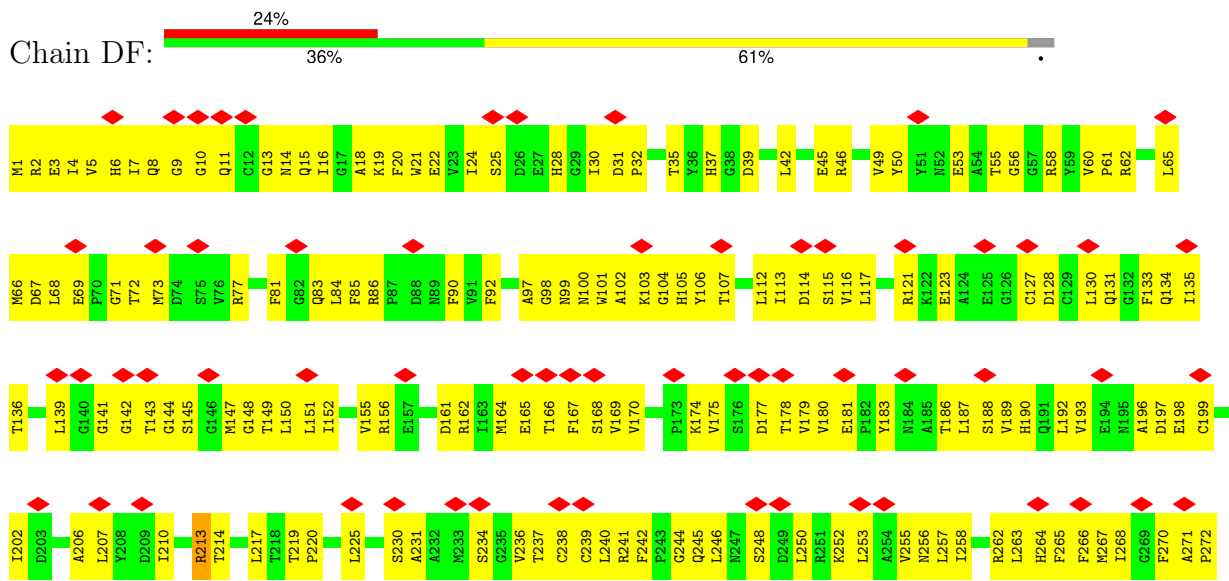

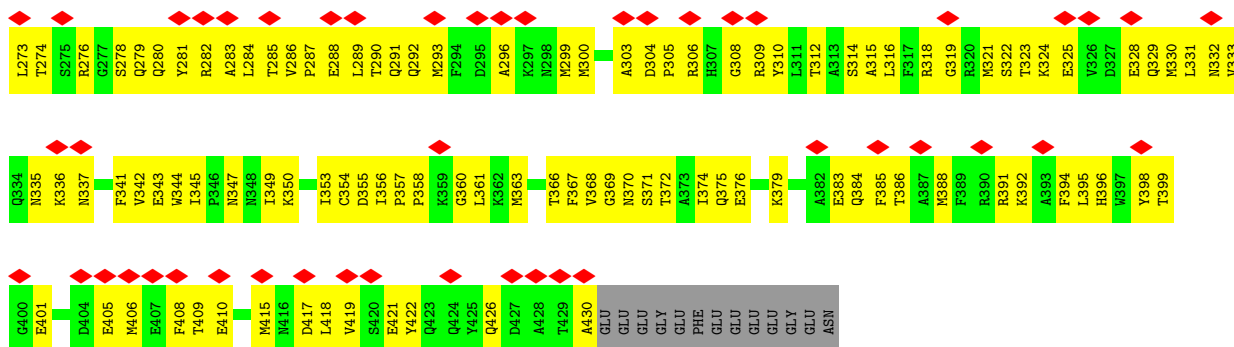

• Molecule 45: Tubulin beta chain

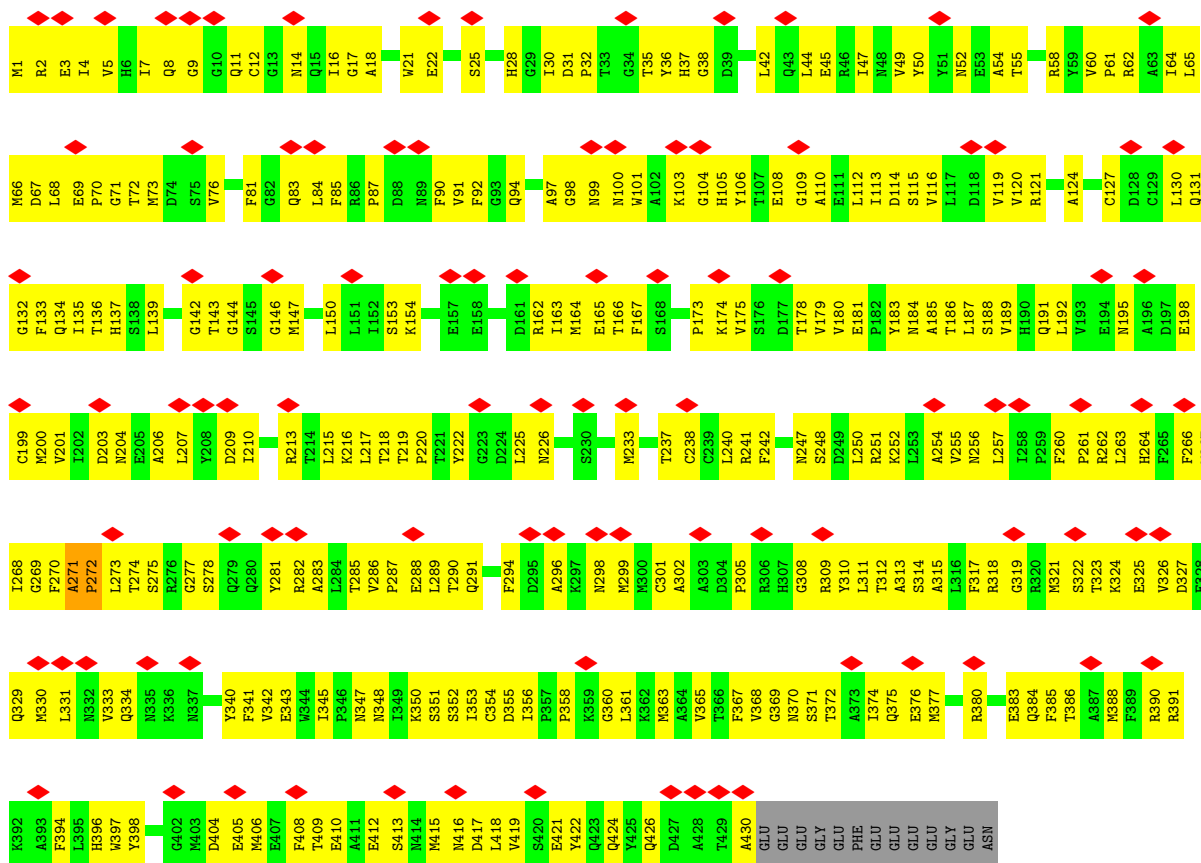

• Molecule 45: Tubulin beta chain

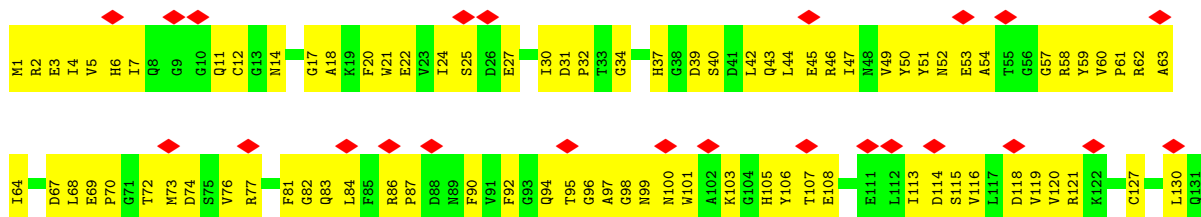

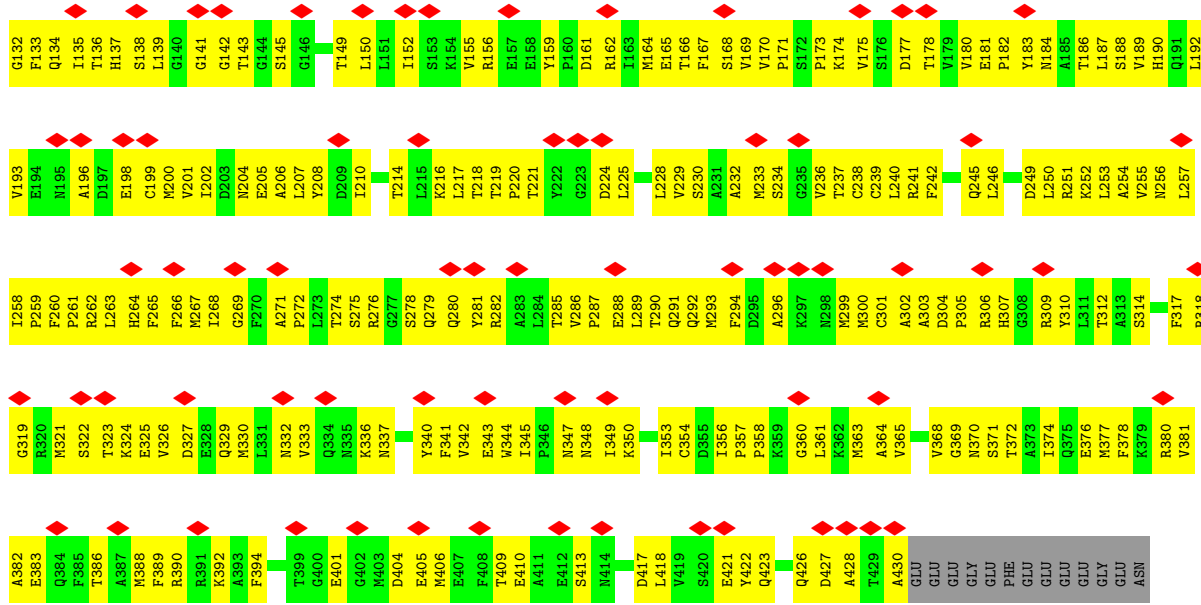

Molecule 45: Tubulin beta chain

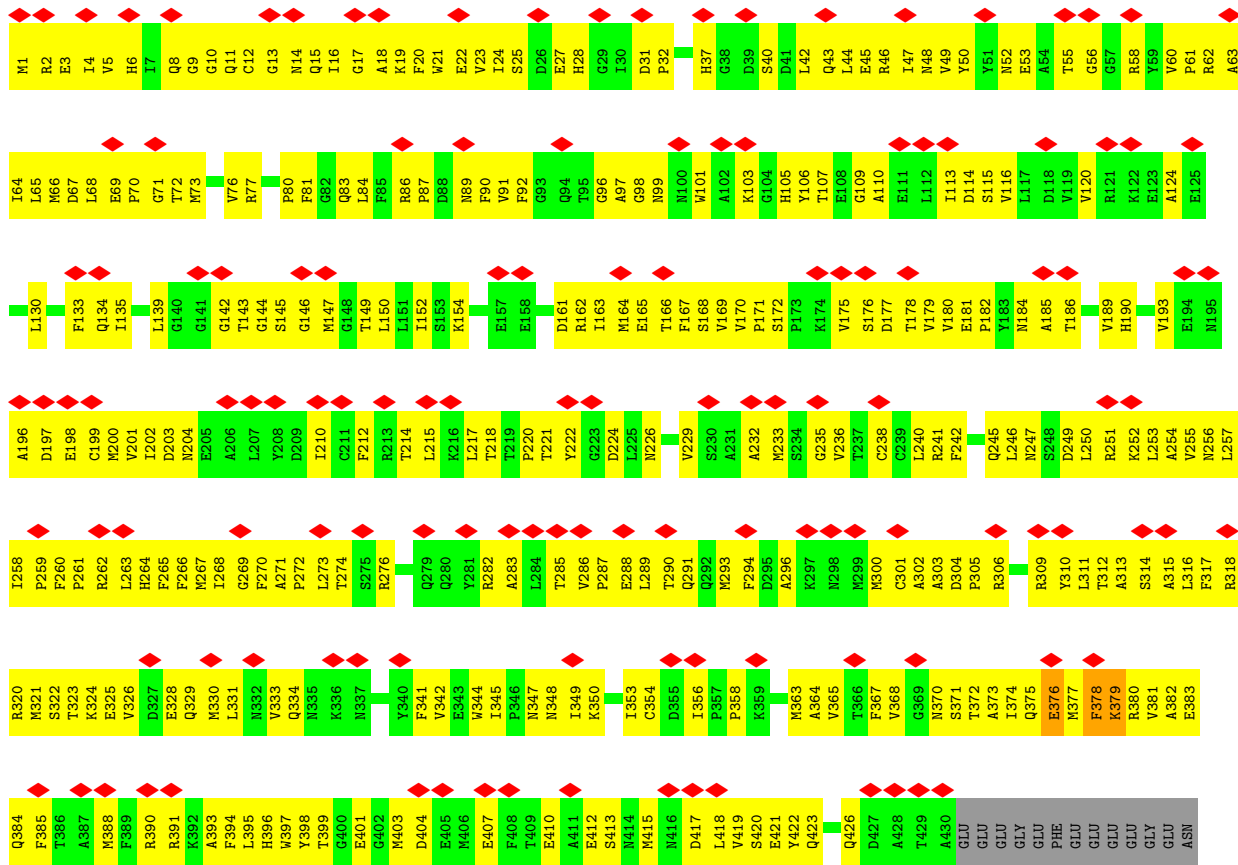

Molecule 45: Tubulin beta chain



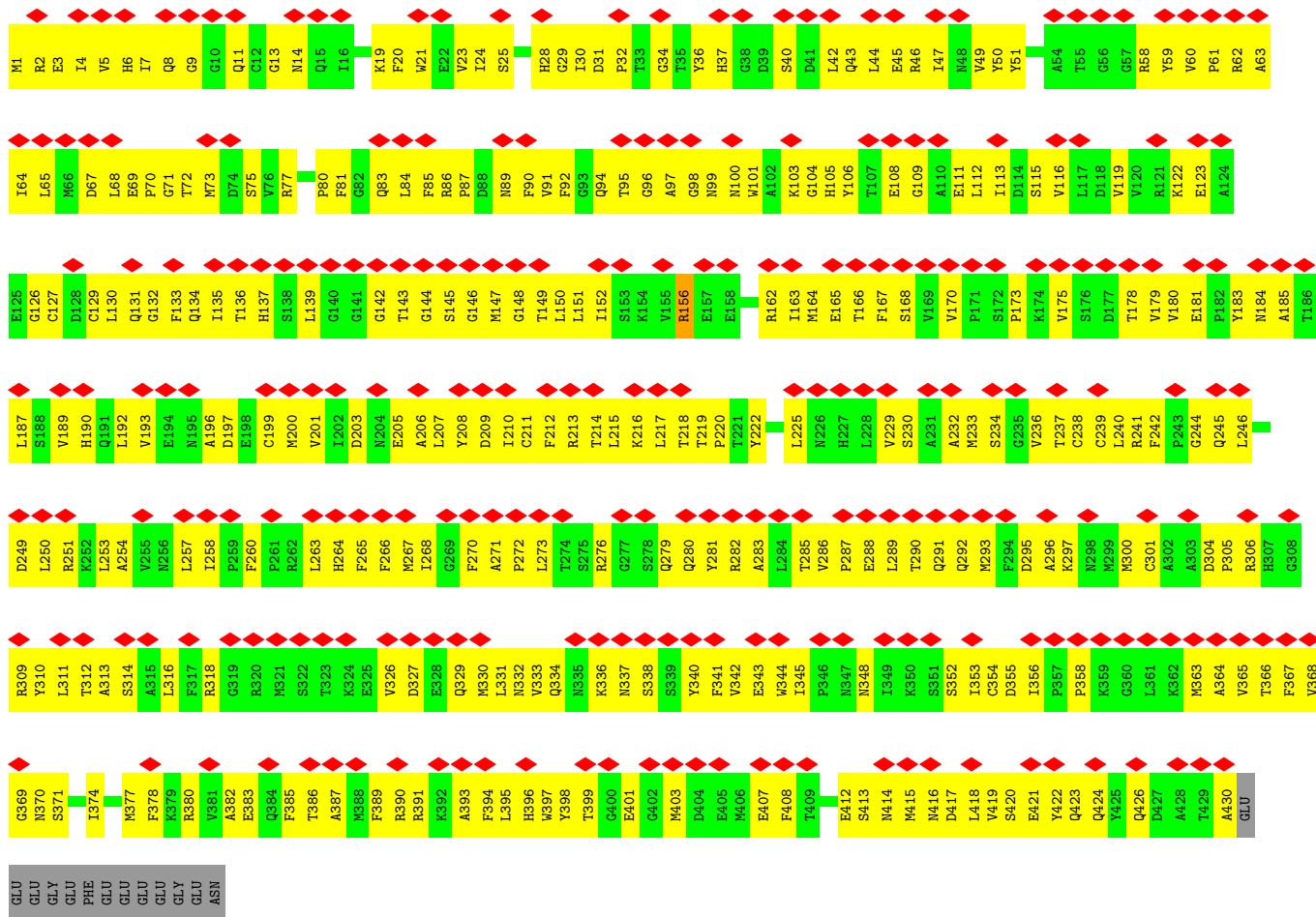

• Molecule 45: Tubulin beta chain

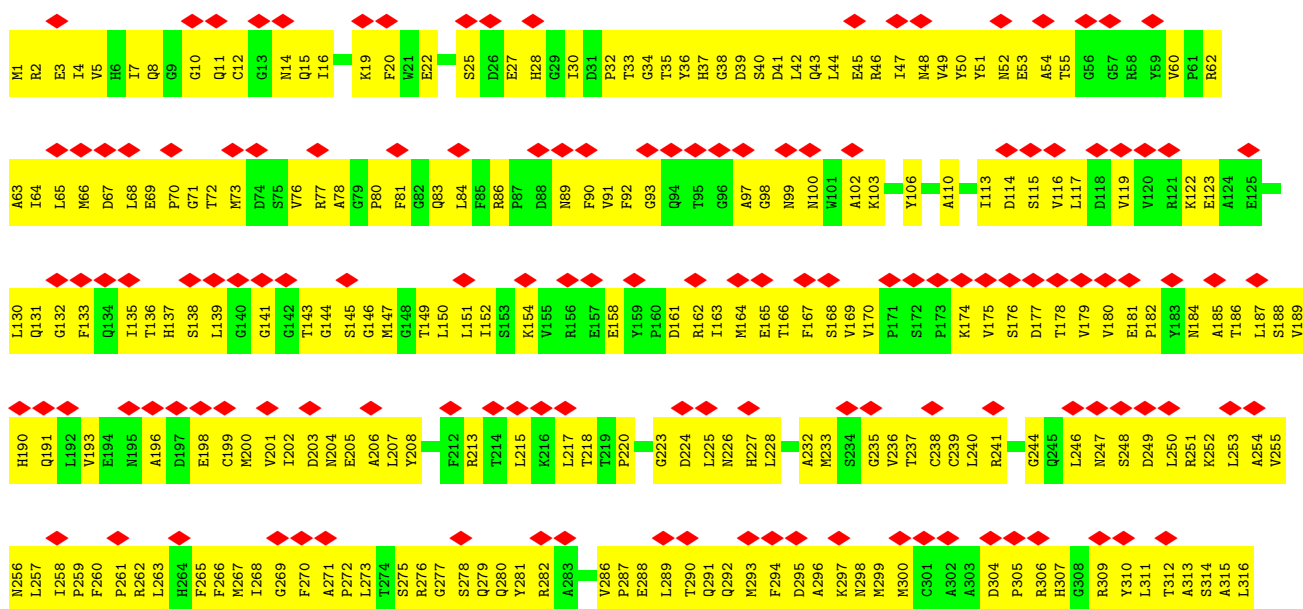

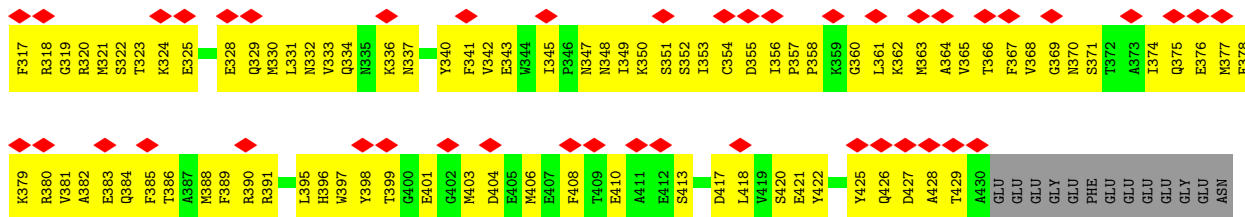

• Molecule 45: Tubulin beta chain

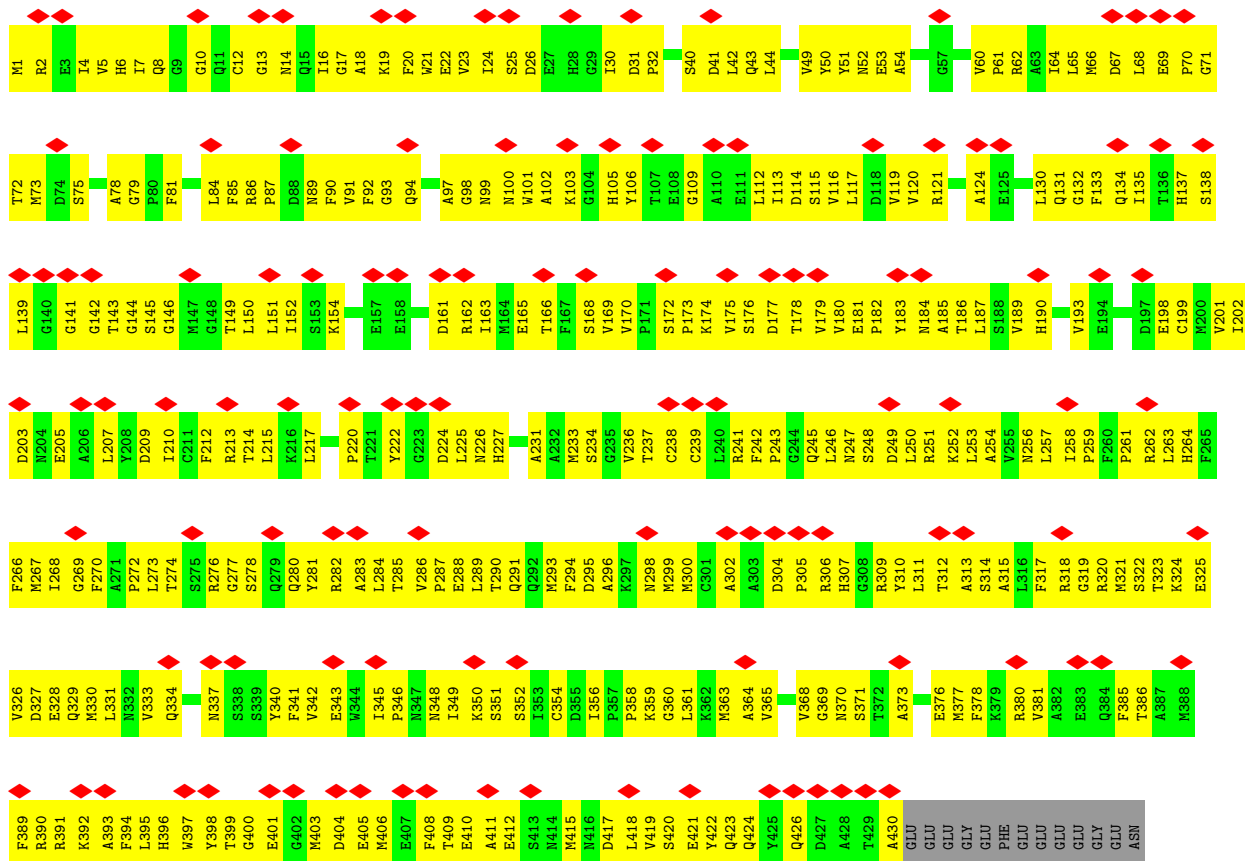

• Molecule 45: Tubulin beta chain

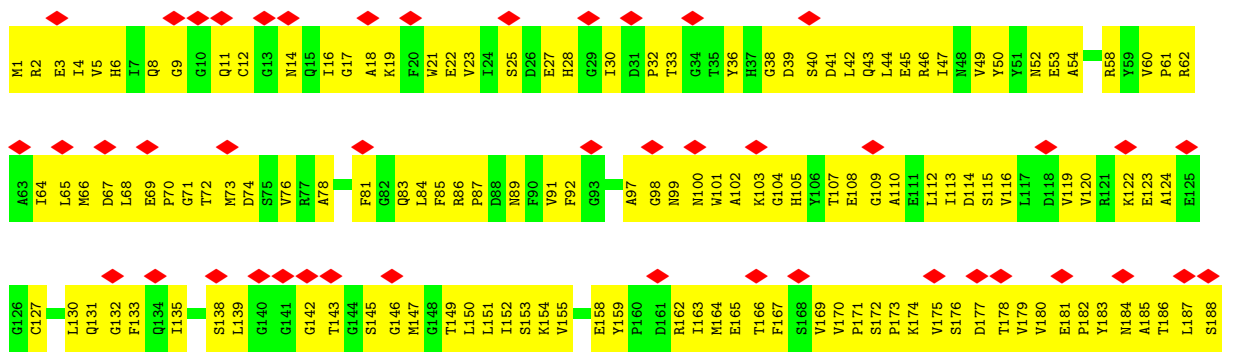

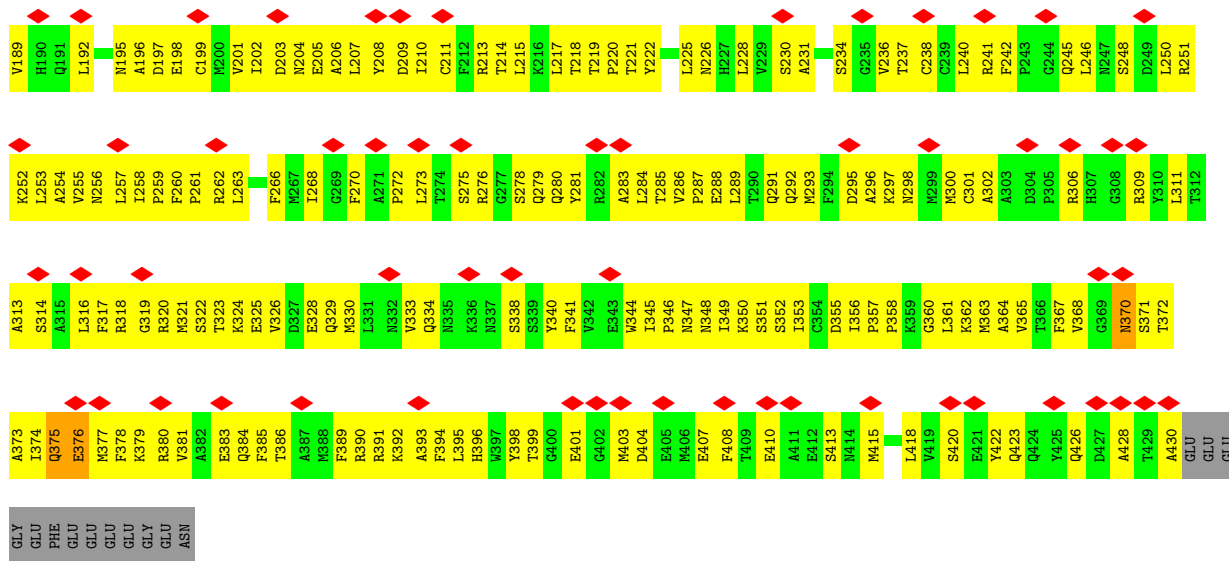

• Molecule 45: Tubulin beta chain

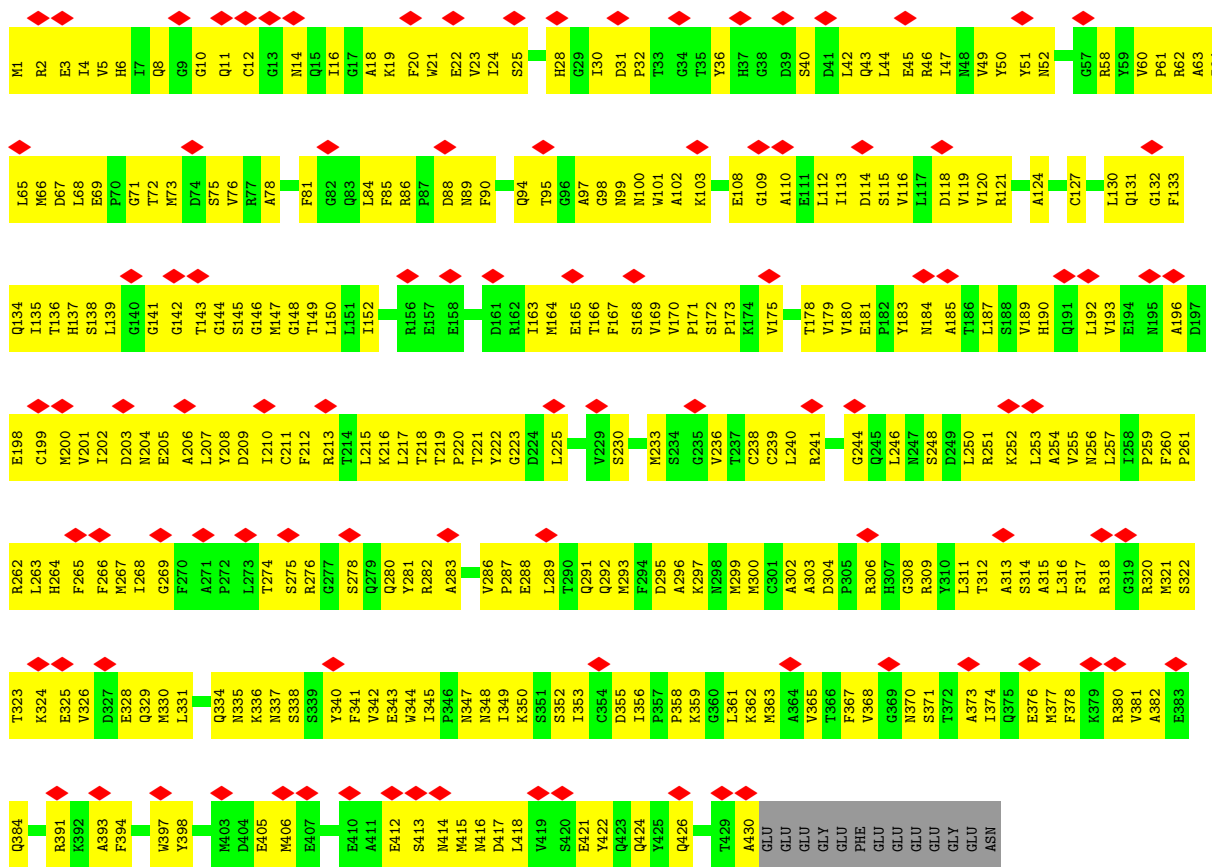

• Molecule 45: Tubulin beta chain





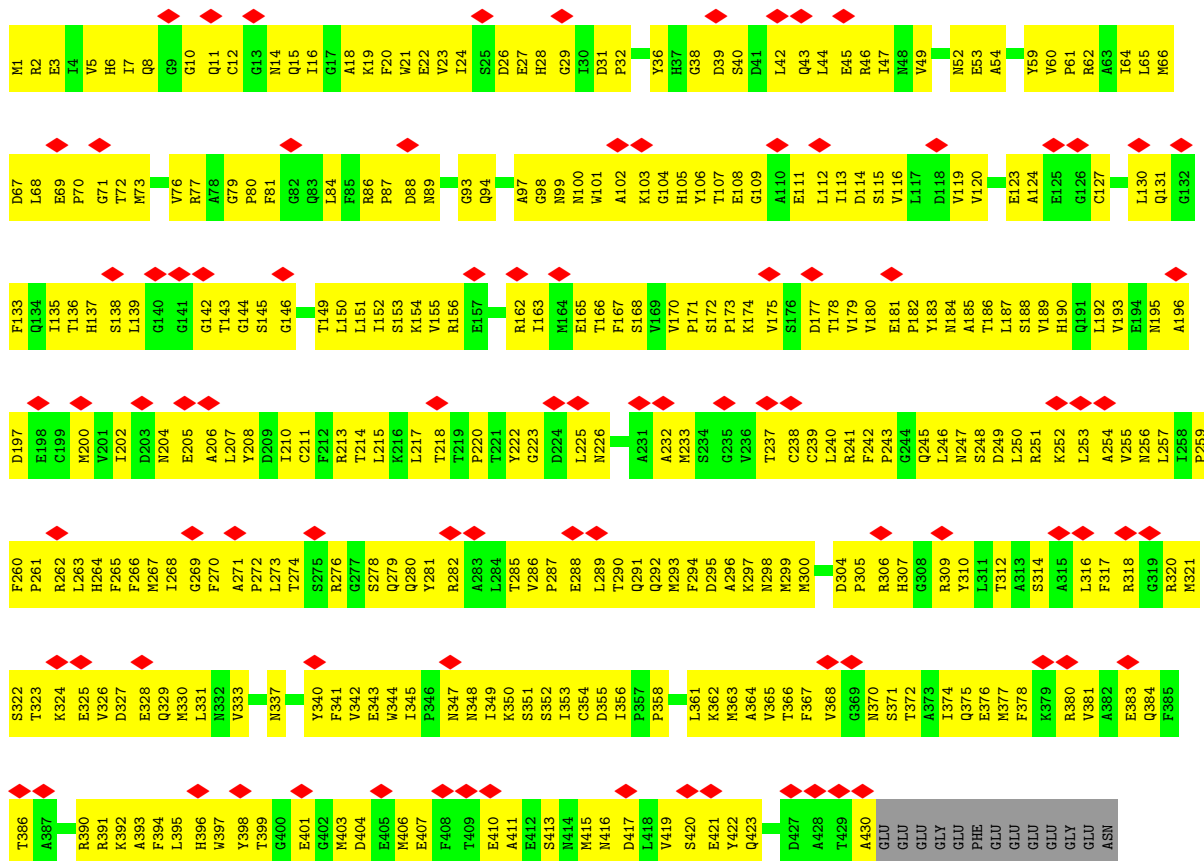

• Molecule 45: Tubulin beta chain

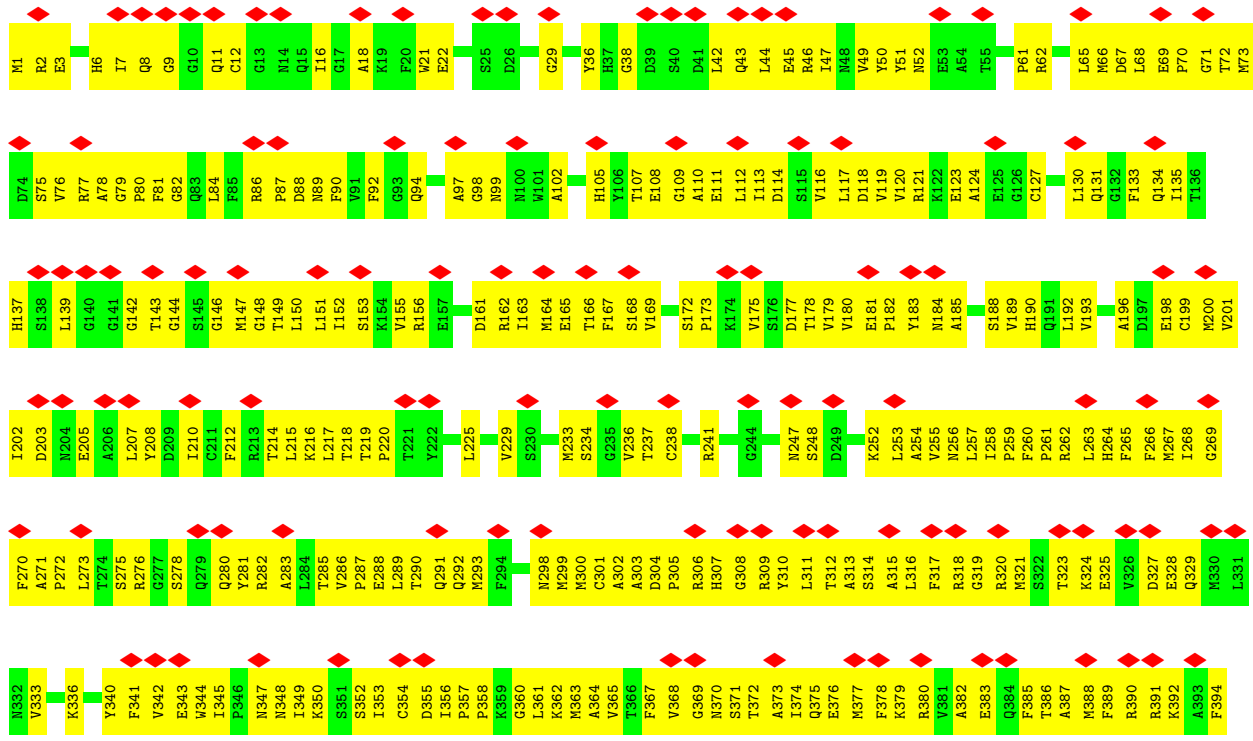

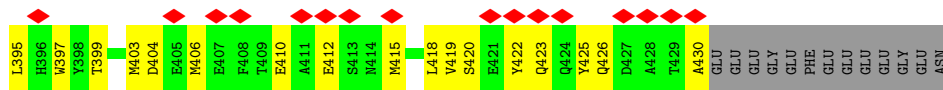

• Molecule 45: Tubulin beta chain

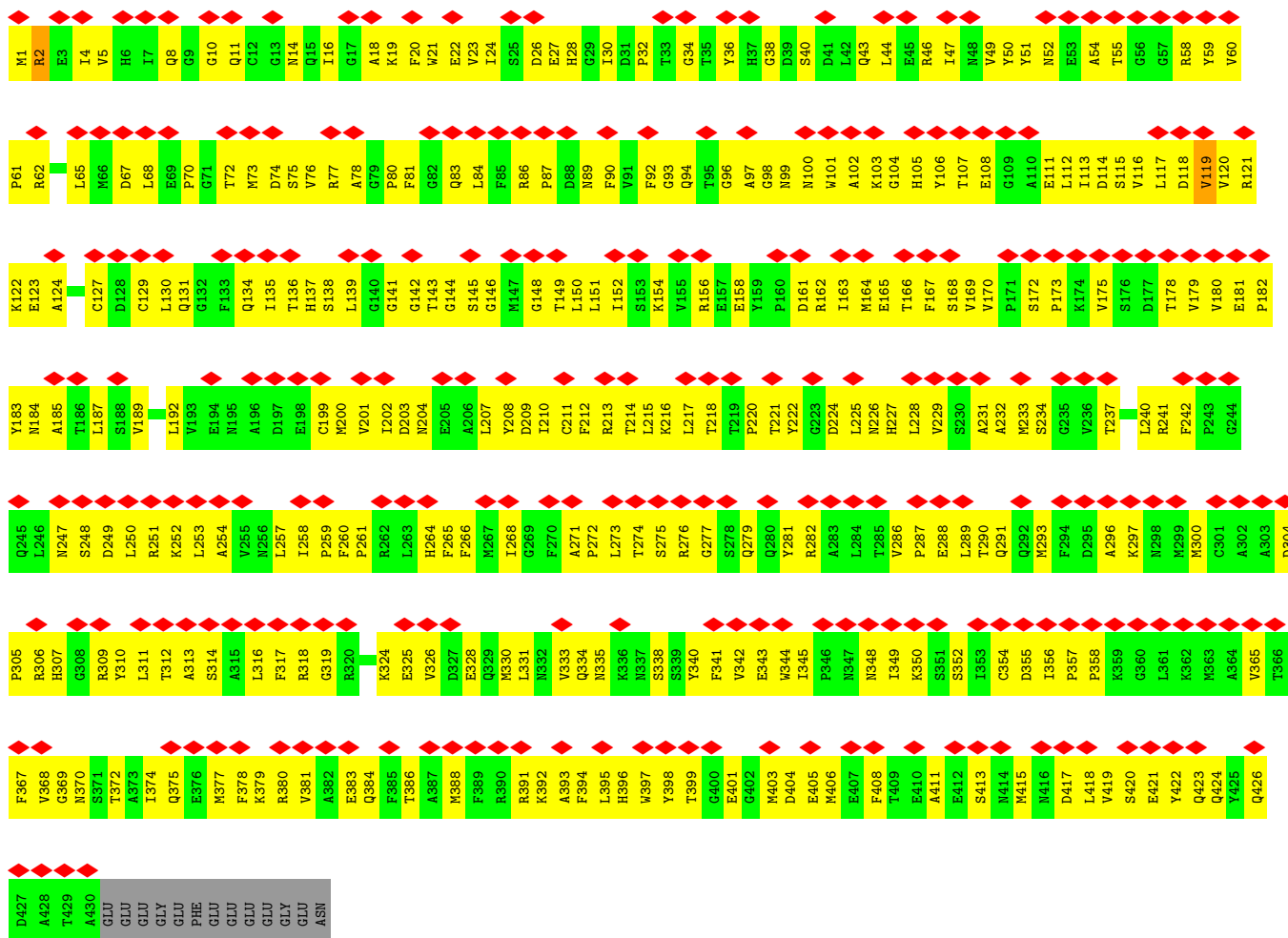

• Molecule 45: Tubulin beta chain

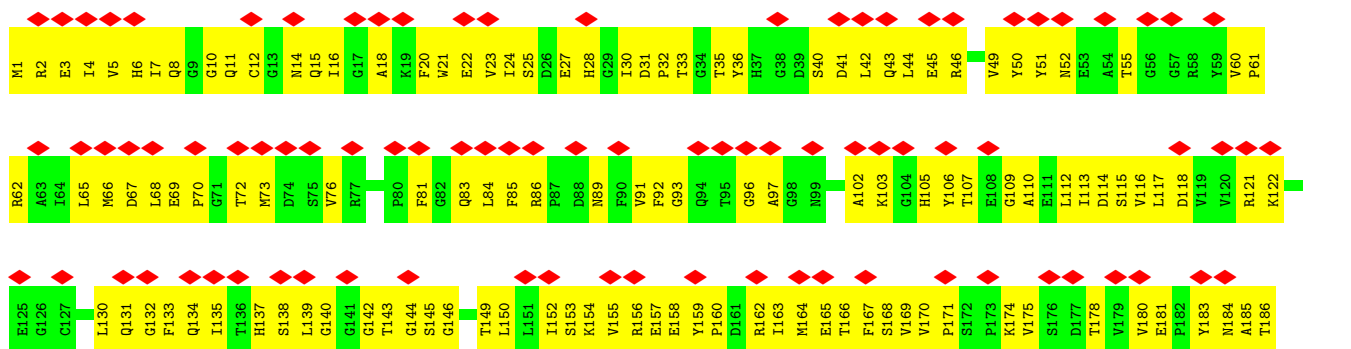

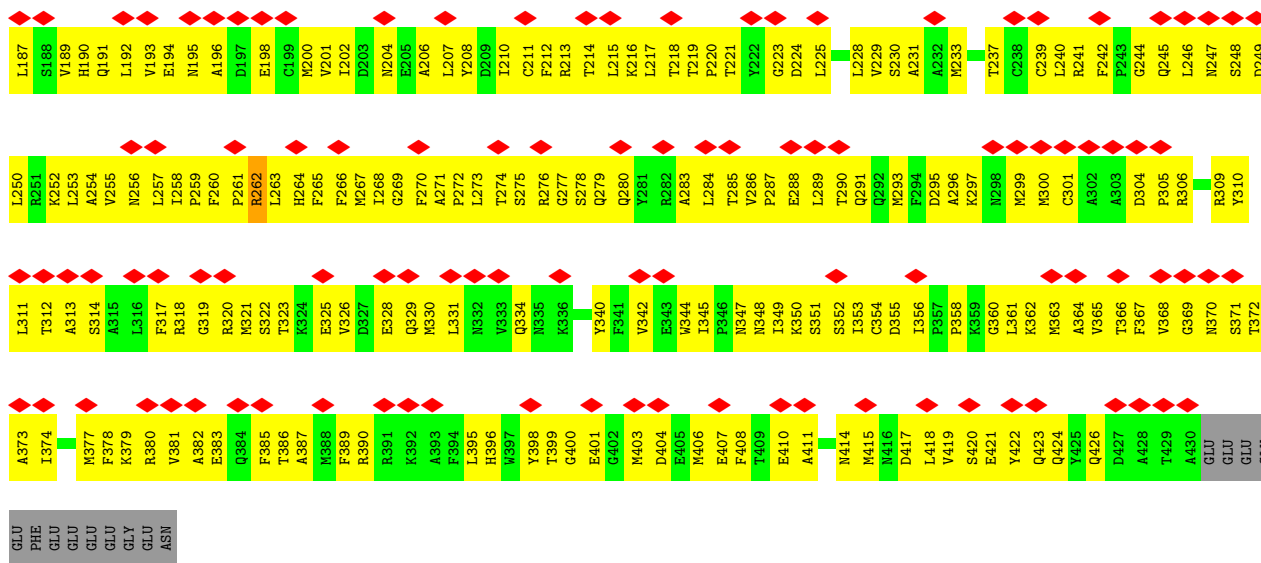

• Molecule 45: Tubulin beta chain

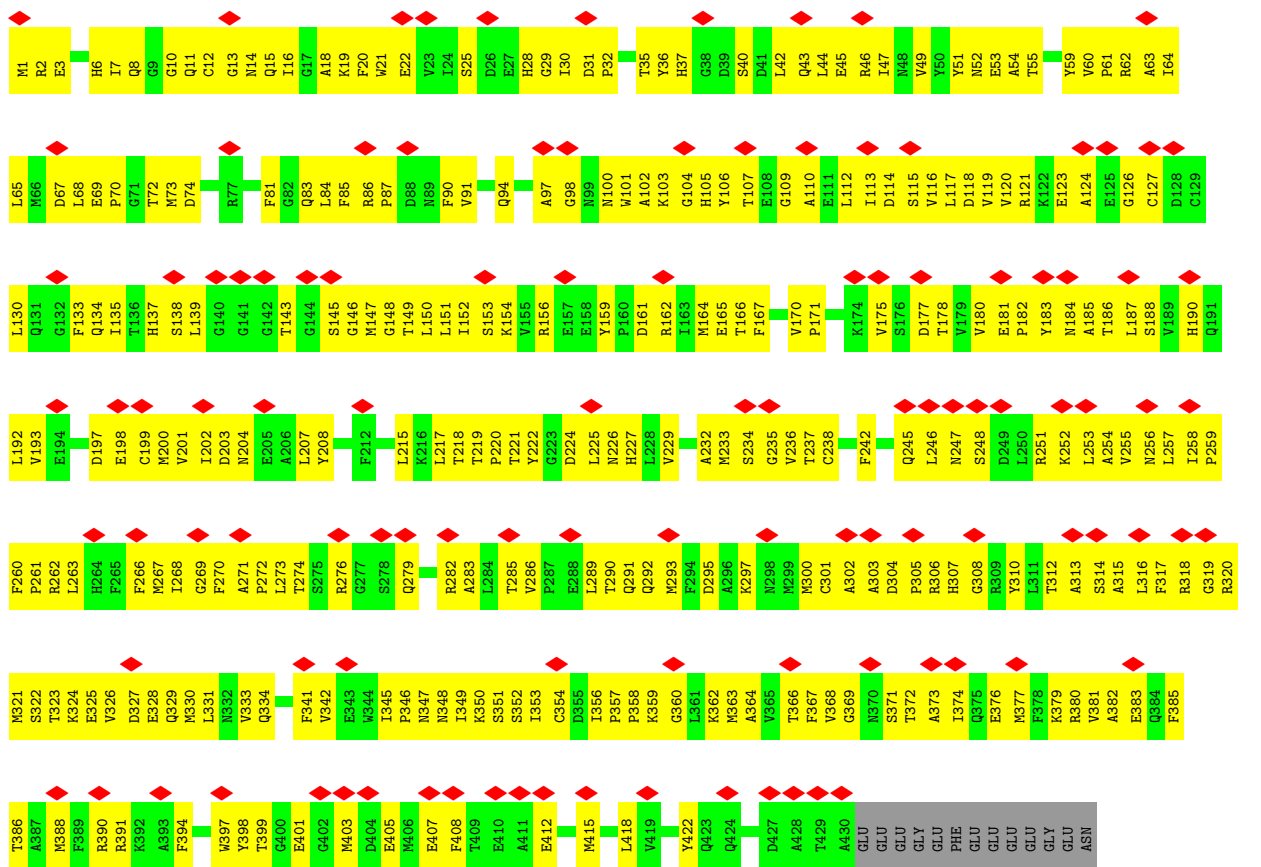

• Molecule 45: Tubulin beta chain



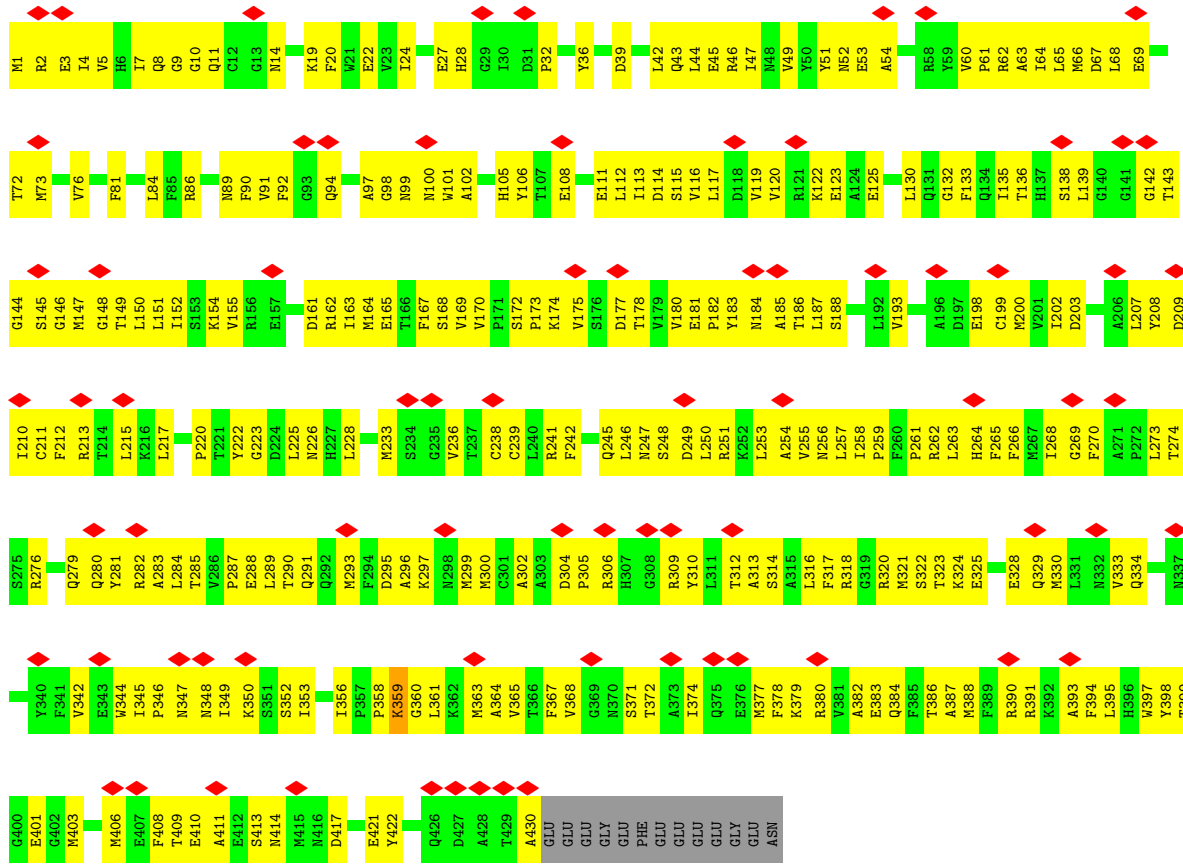

• Molecule 45: Tubulin beta chain

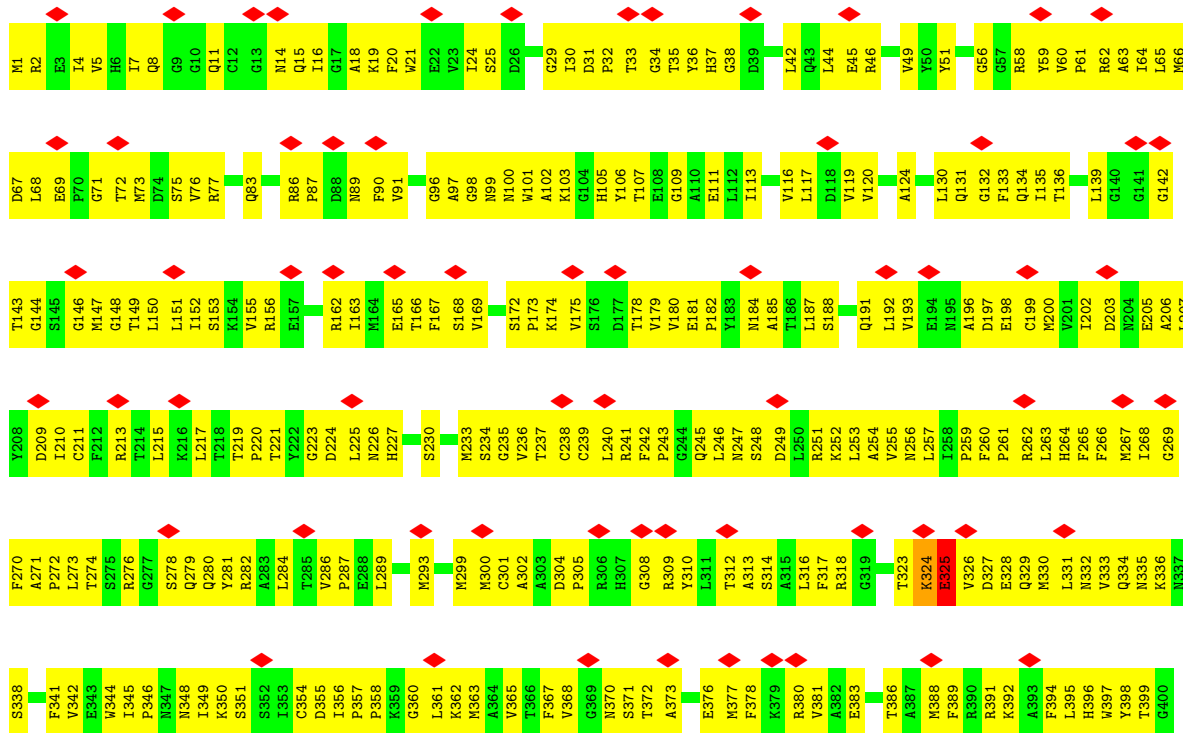

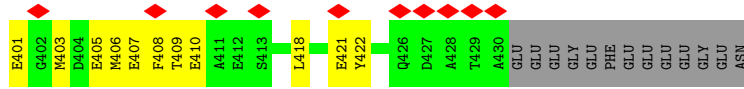

• Molecule 45: Tubulin beta chain

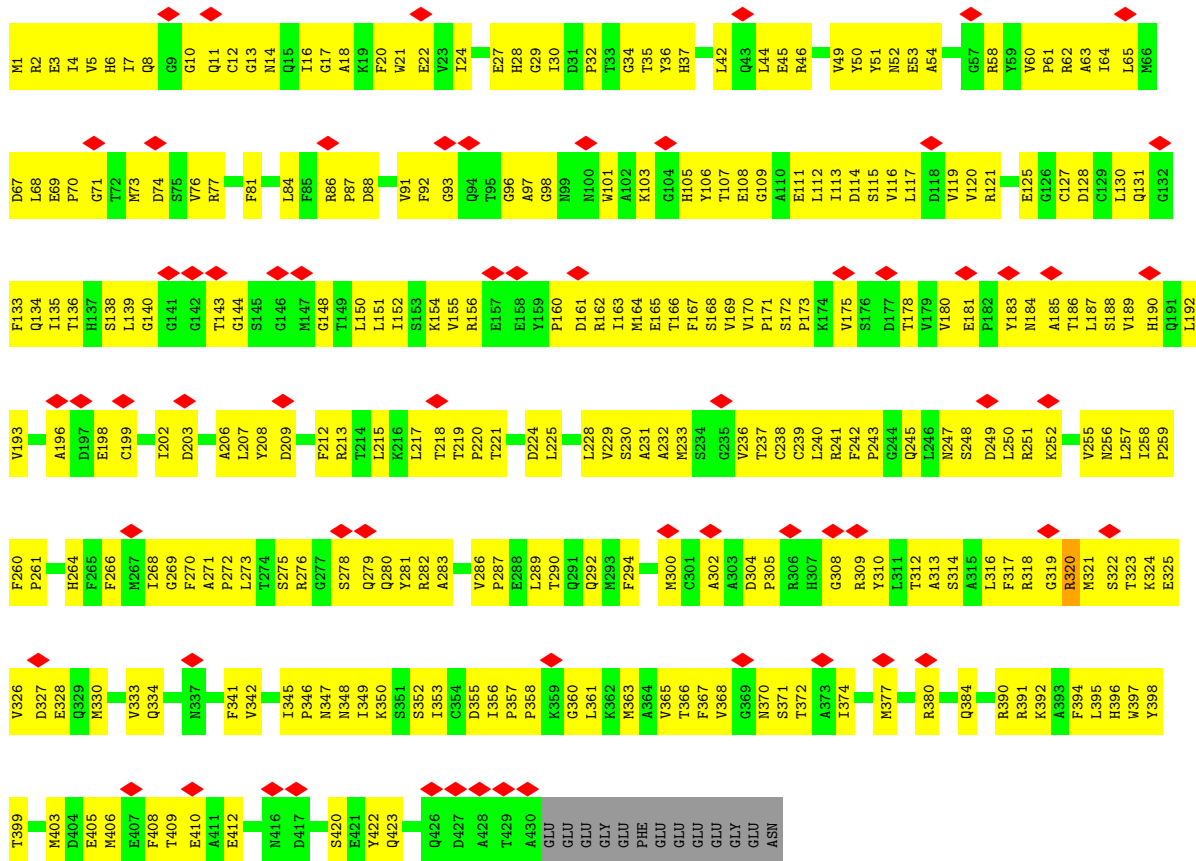

• Molecule 45: Tubulin beta chain

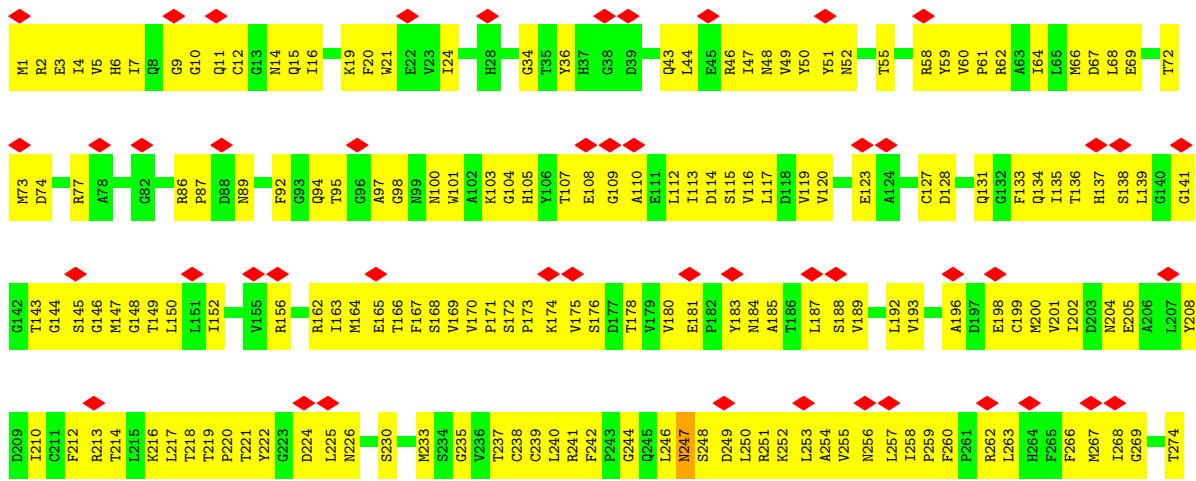

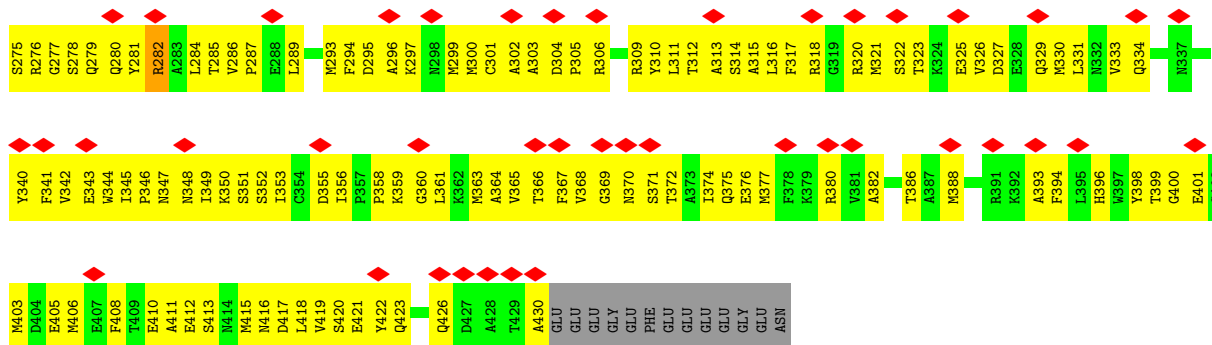

• Molecule 45: Tubulin beta chain

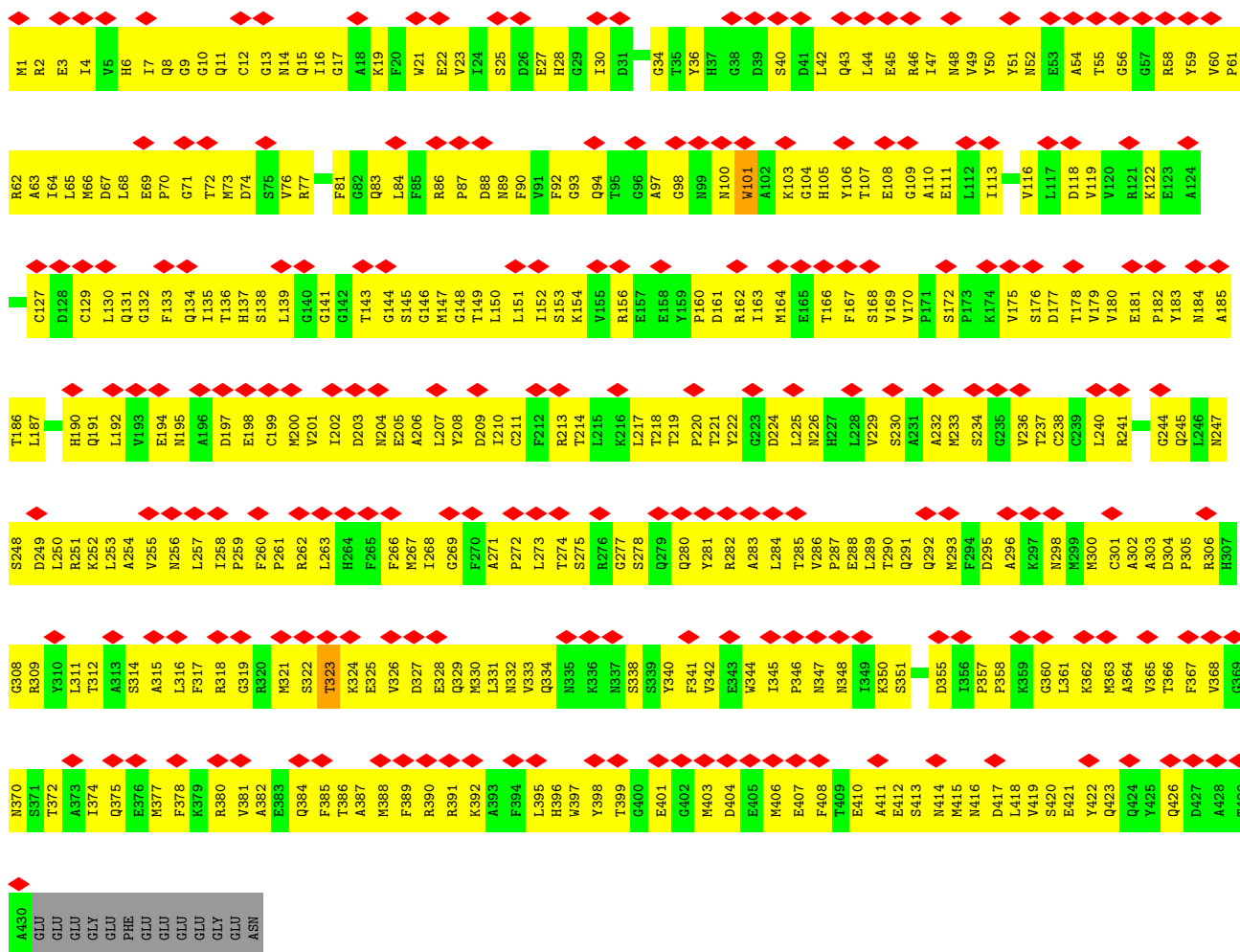

• Molecule 45: Tubulin beta chain

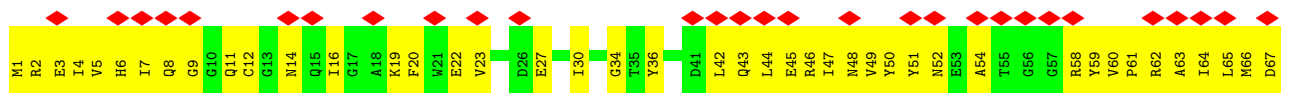

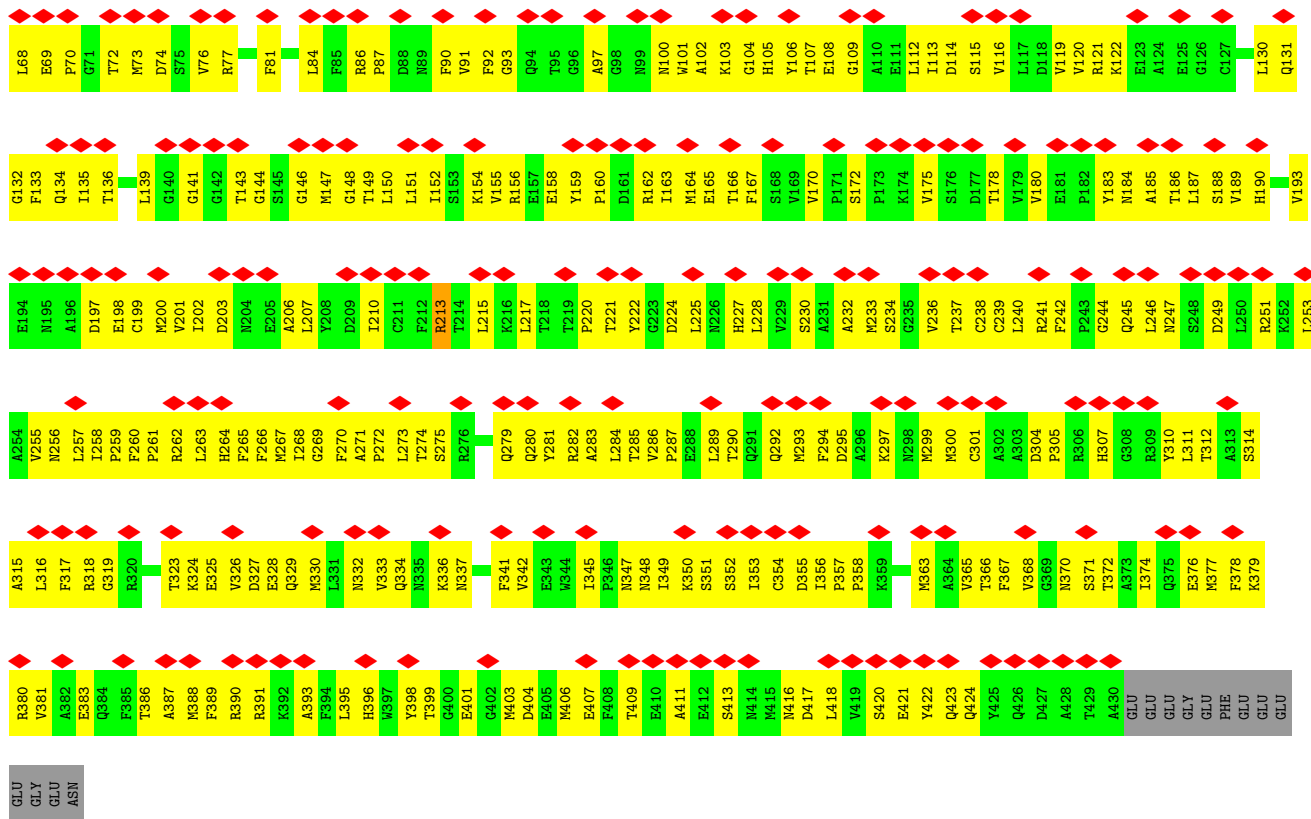

• Molecule 45: Tubulin beta chain

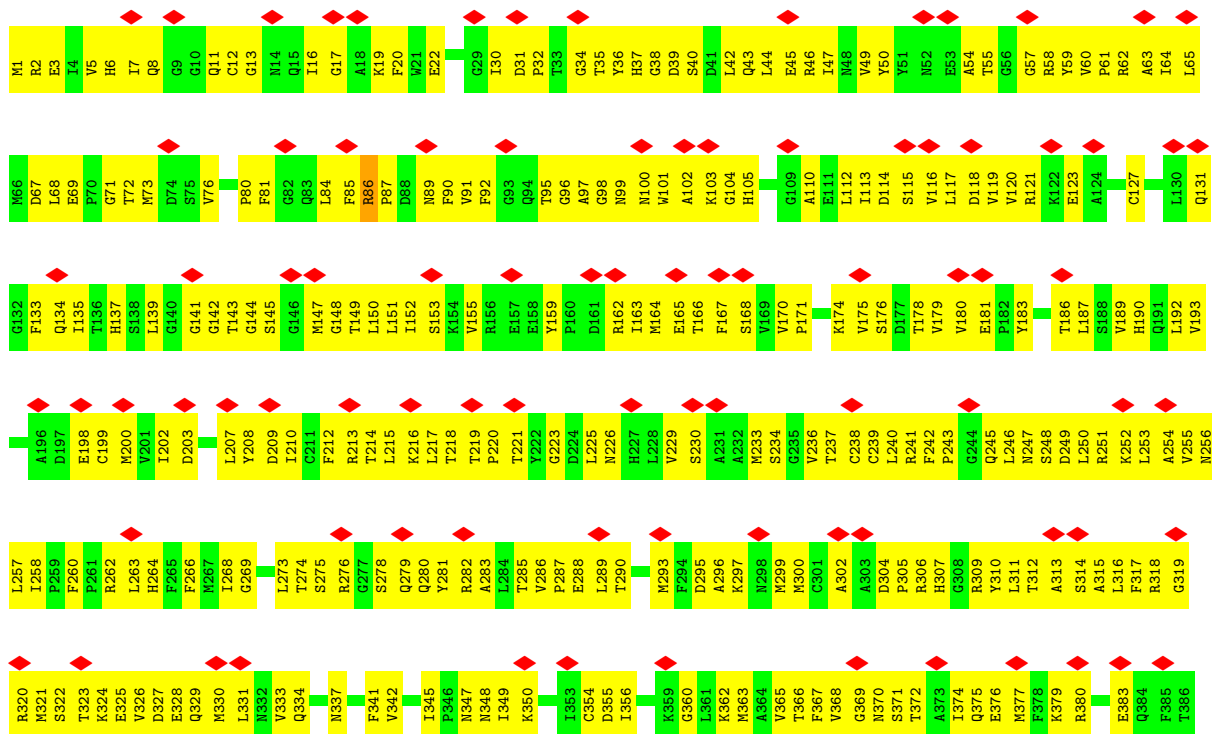
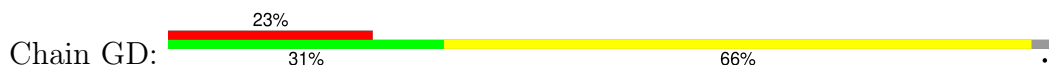

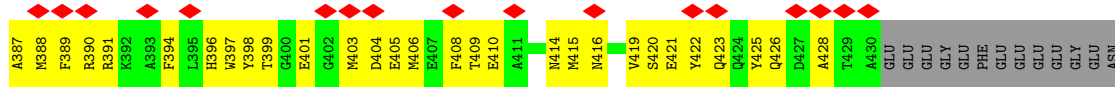

• Molecule 45: Tubulin beta chain

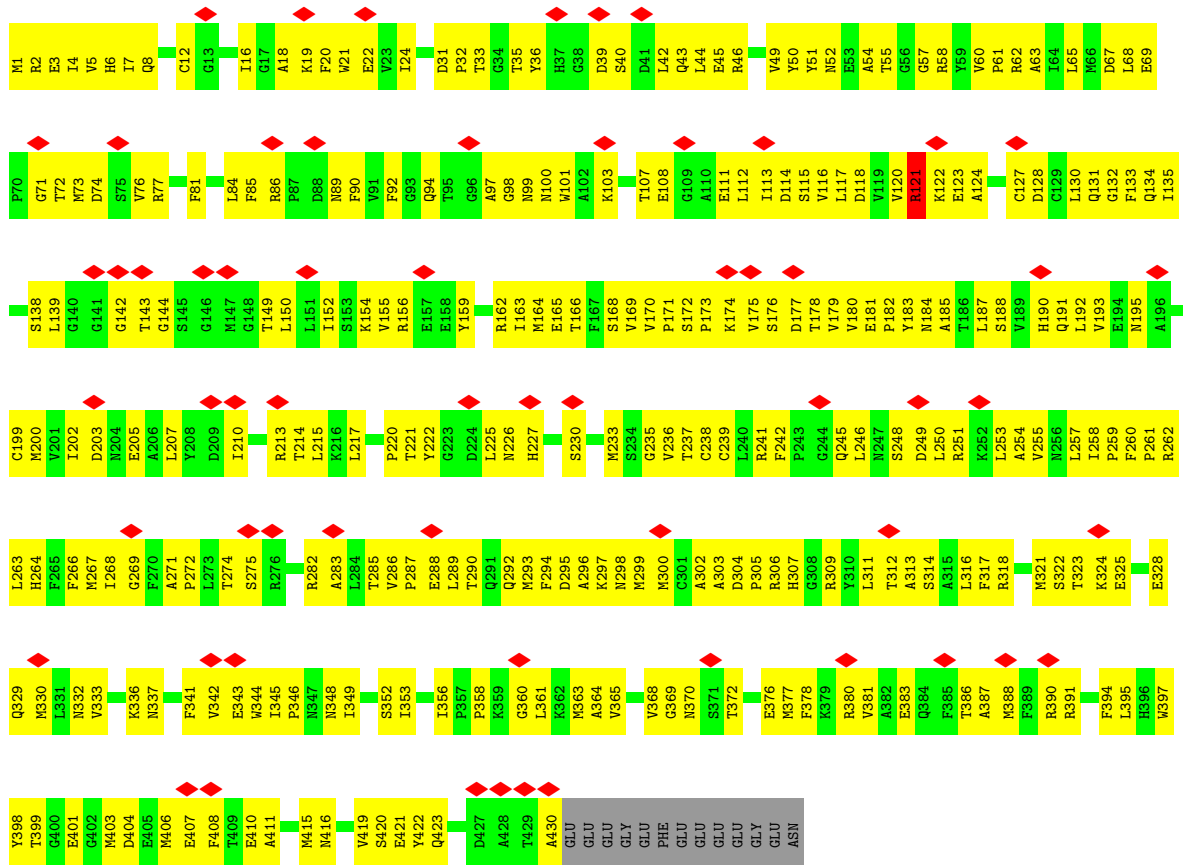

• Molecule 45: Tubulin beta chain

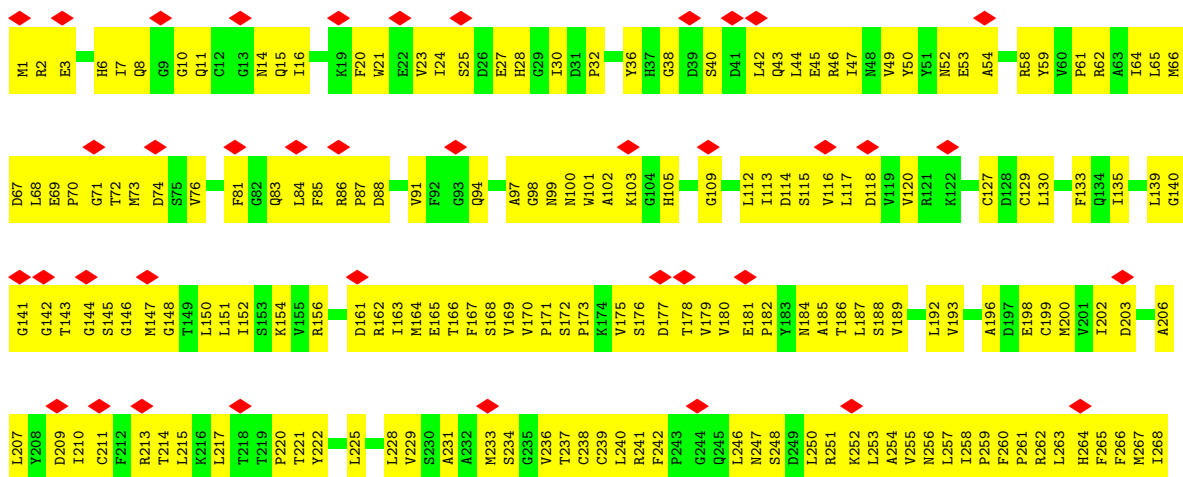



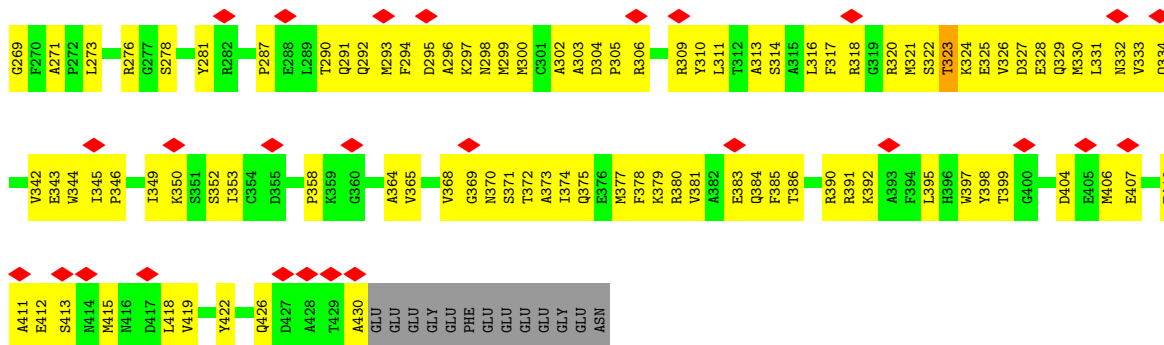

• Molecule 45: Tubulin beta chain

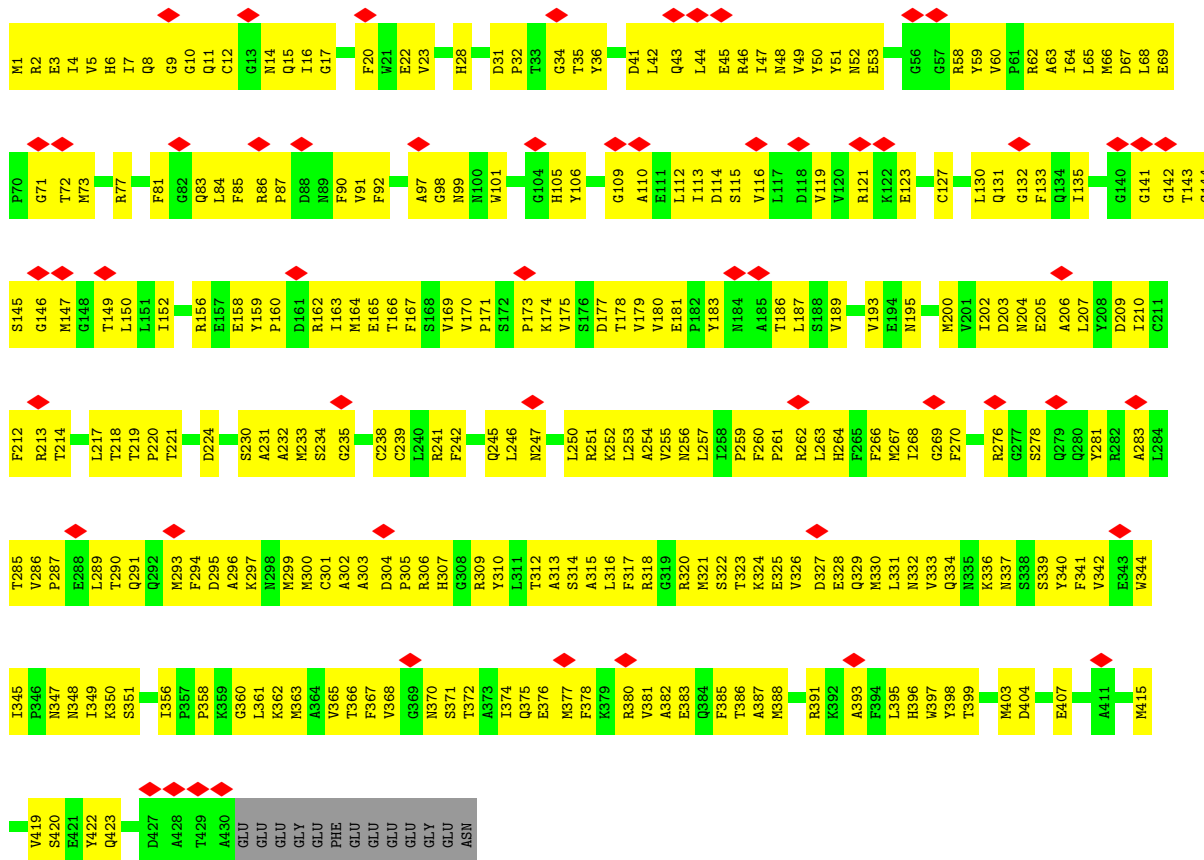

• Molecule 45: Tubulin beta chain

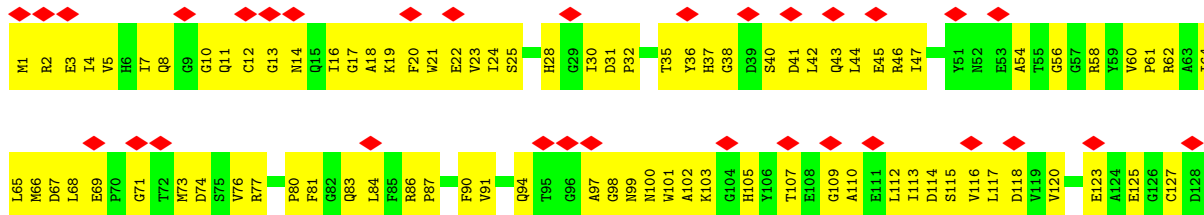

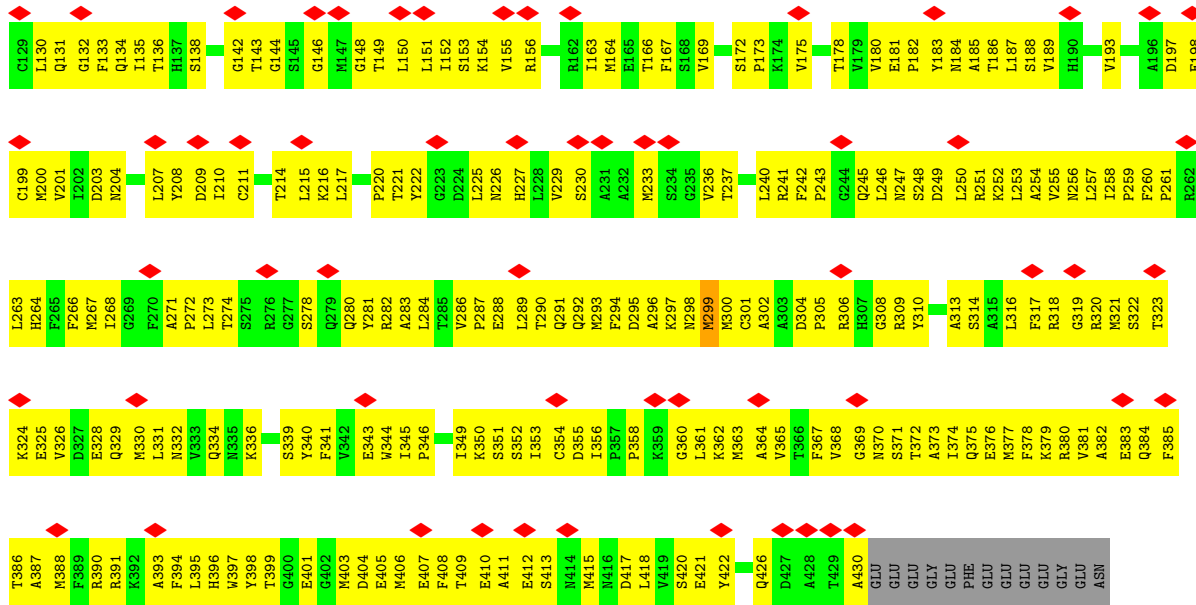

• Molecule 45: Tubulin beta chain

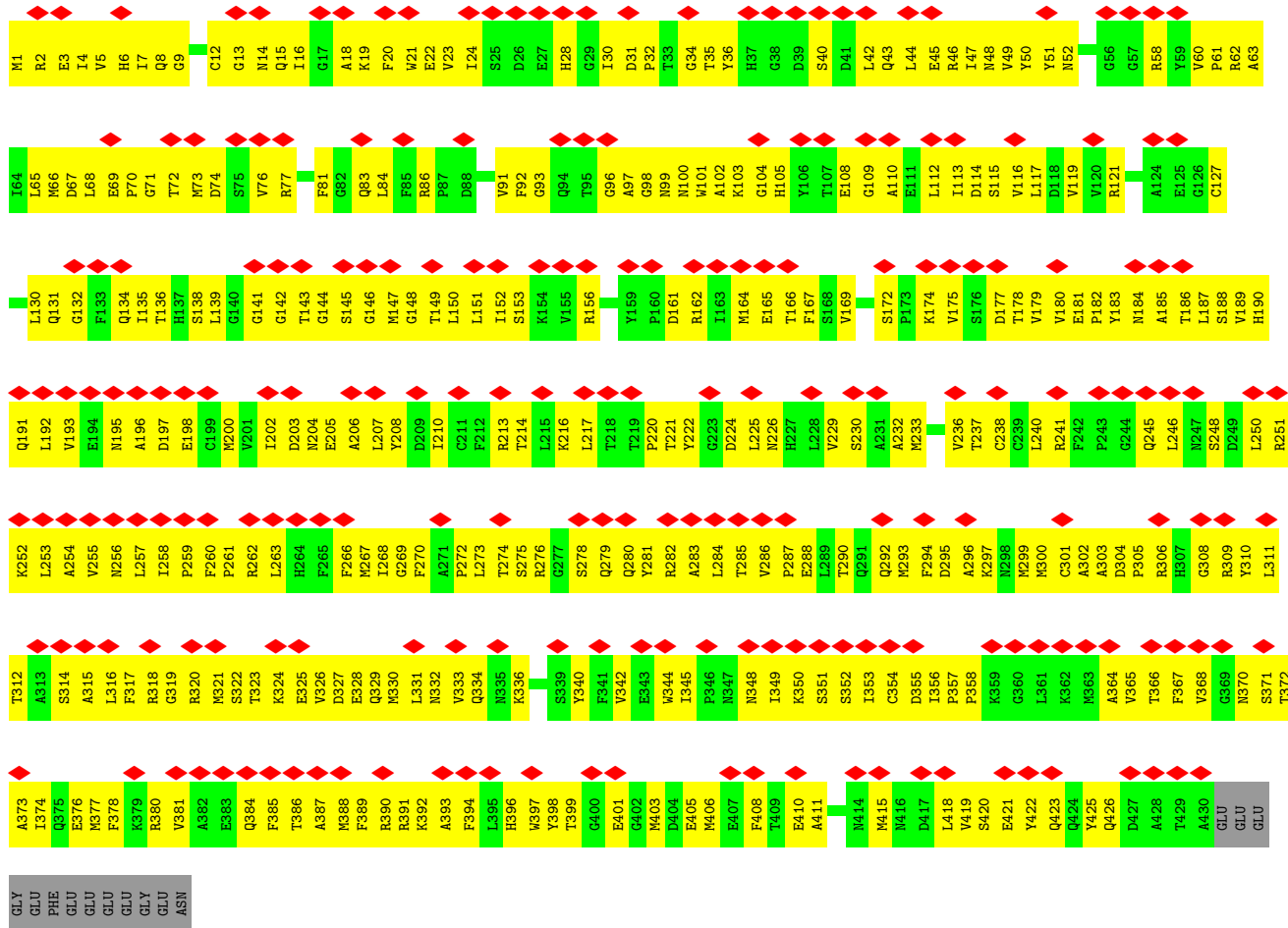

● Molecule 45: Tubulin beta chain

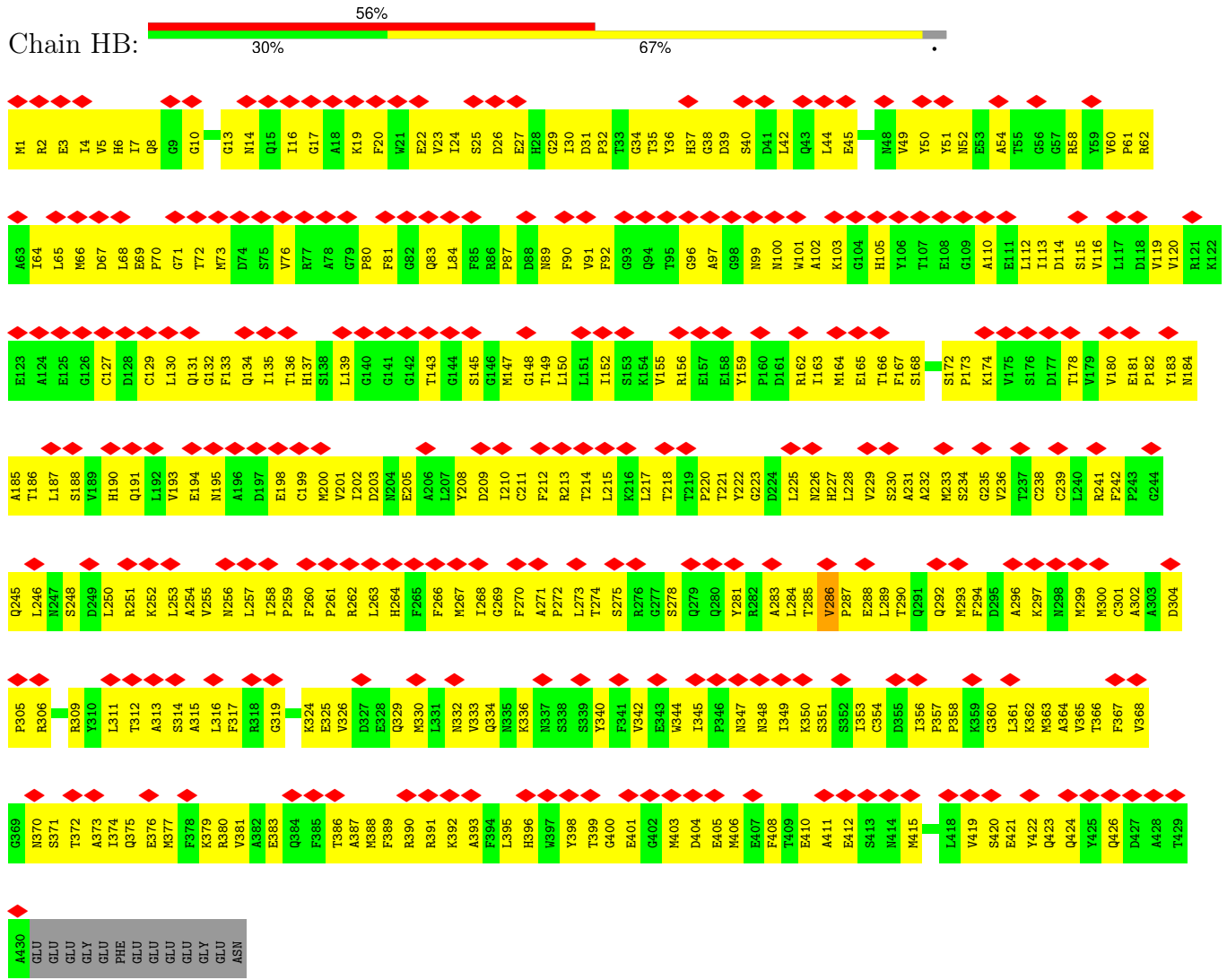

● Molecule 45: Tubulin beta chain

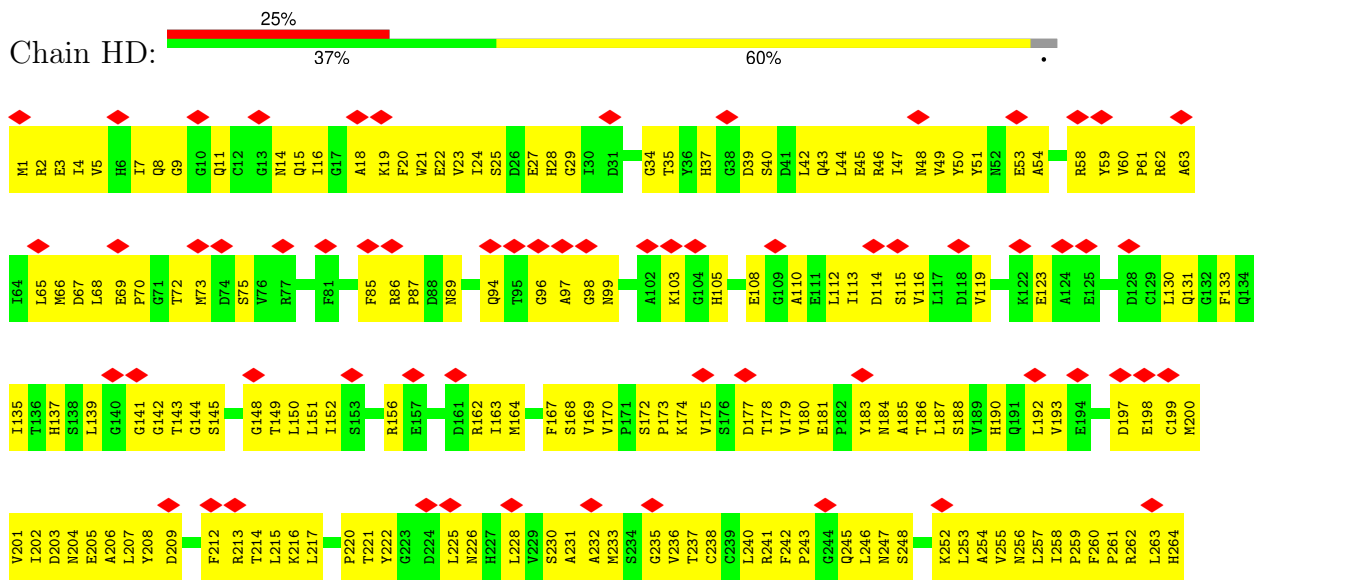

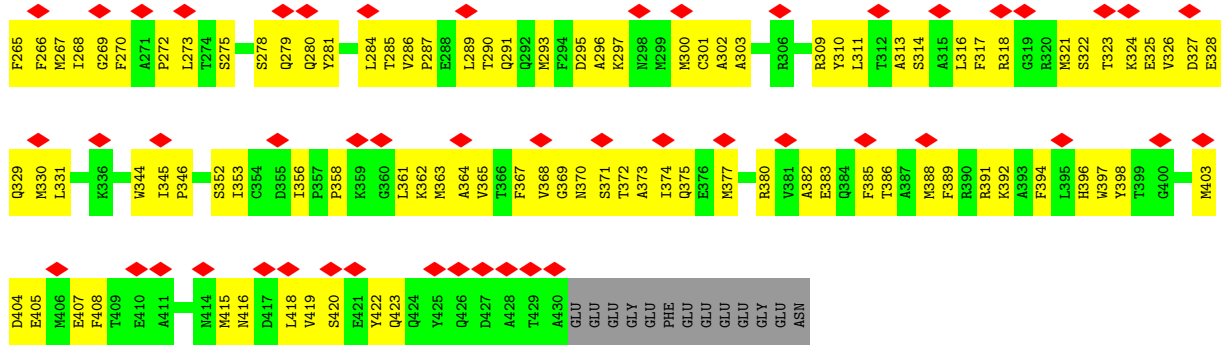

• Molecule 45: Tubulin beta chain

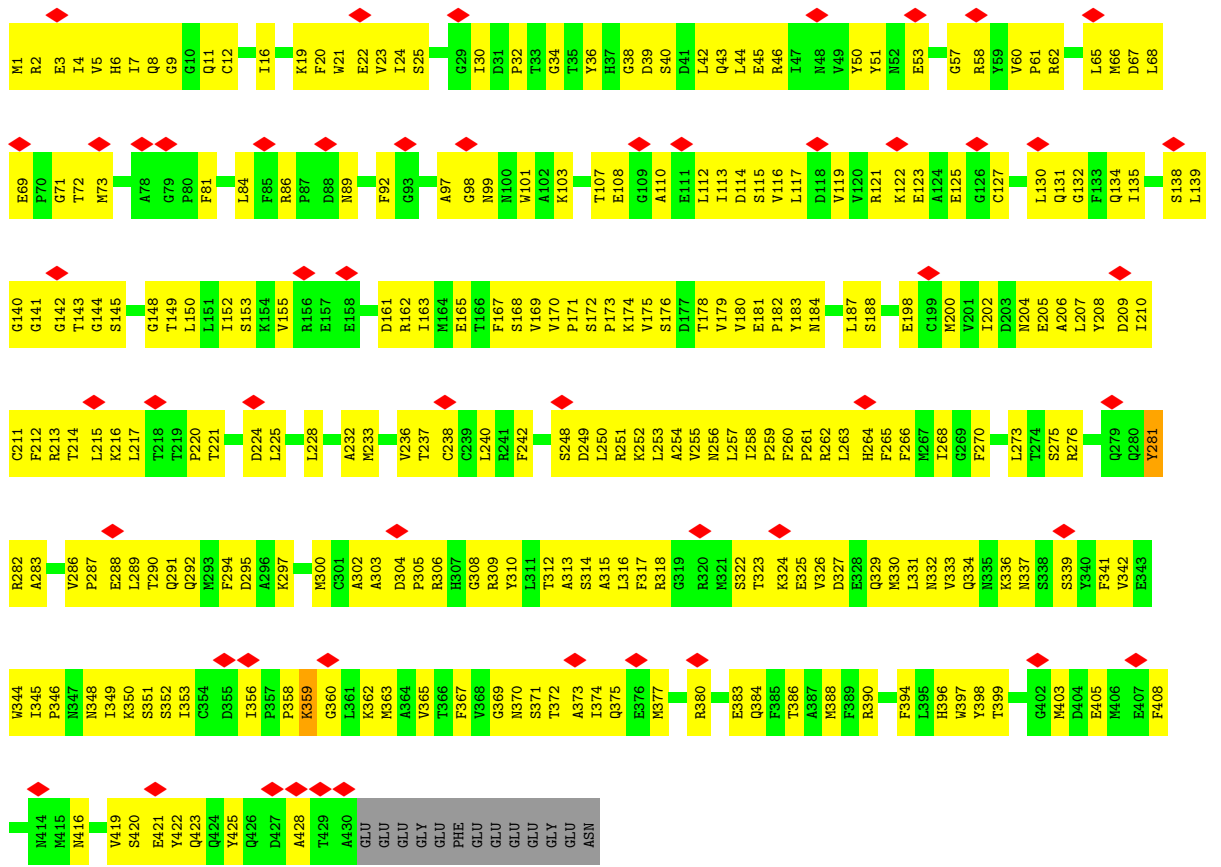

• Molecule 45: Tubulin beta chain

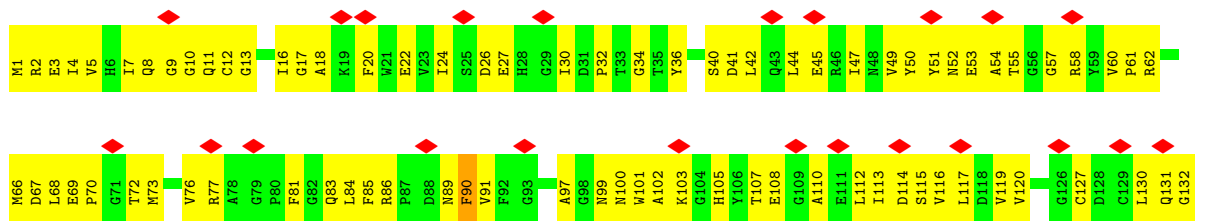



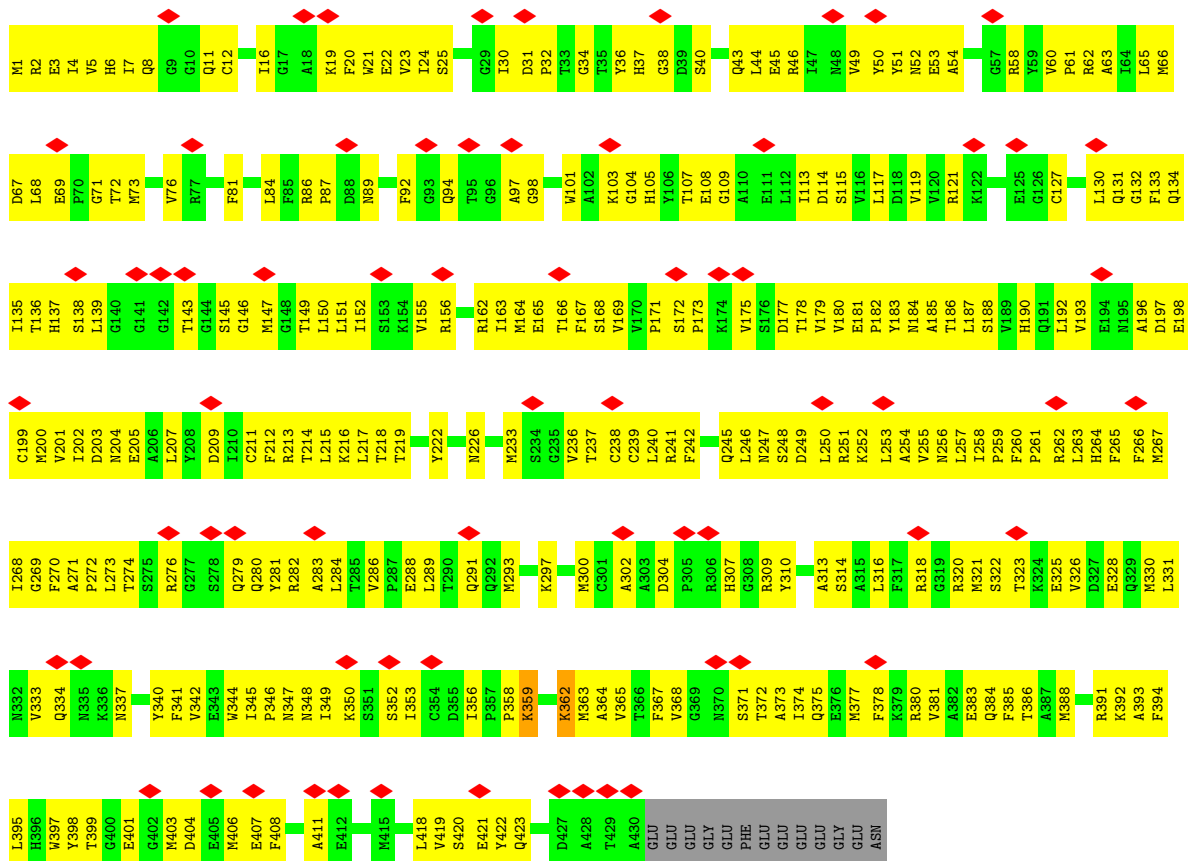

• Molecule 45: Tubulin beta chain

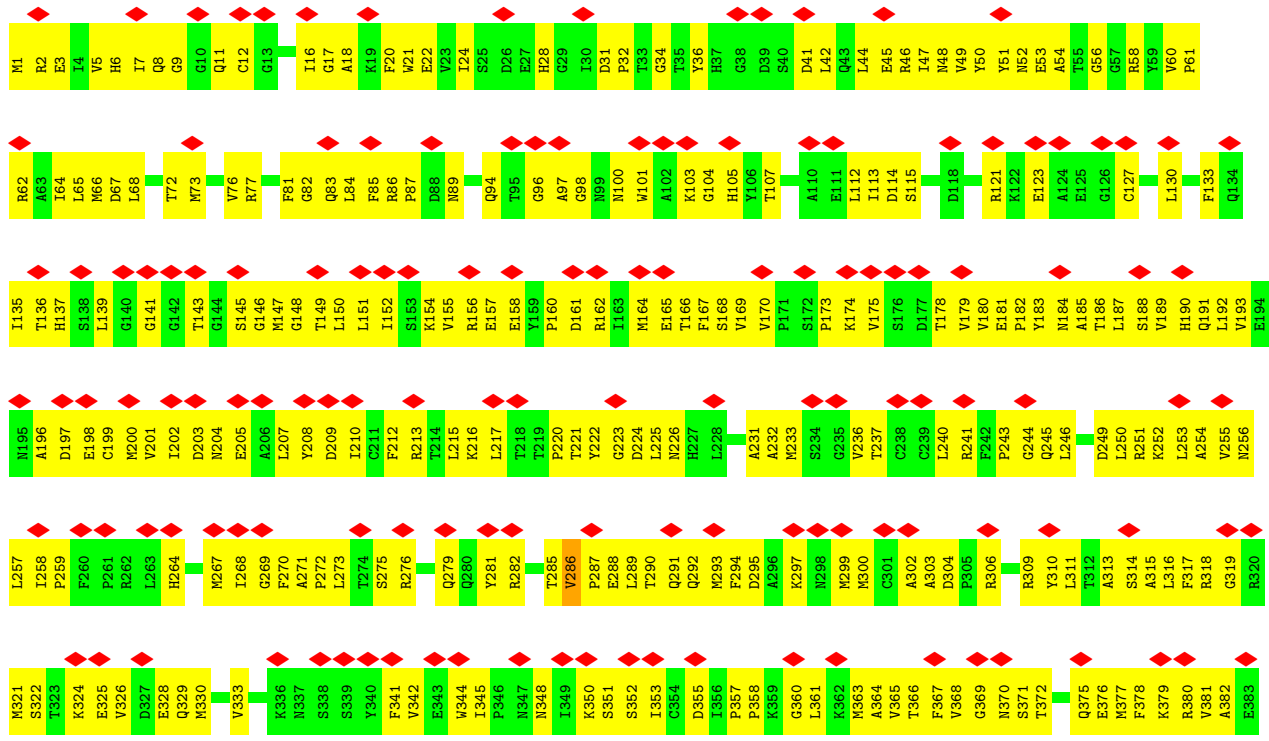

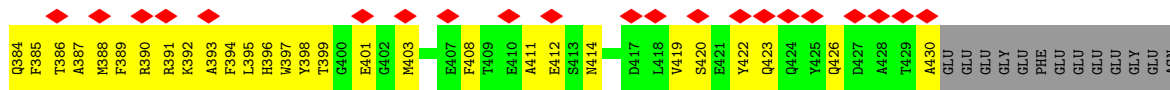

• Molecule 45: Tubulin beta chain

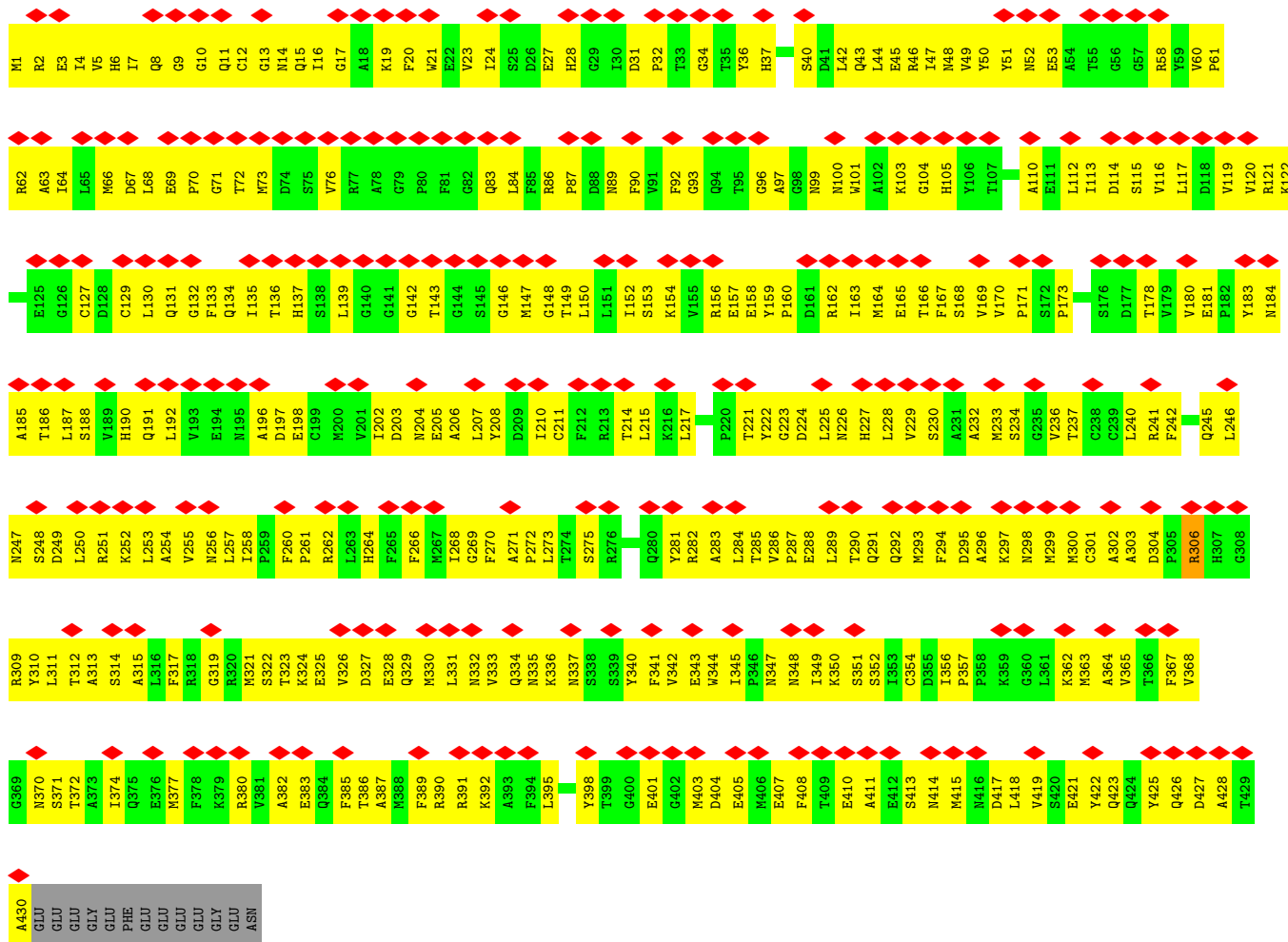

• Molecule 45: Tubulin beta chain

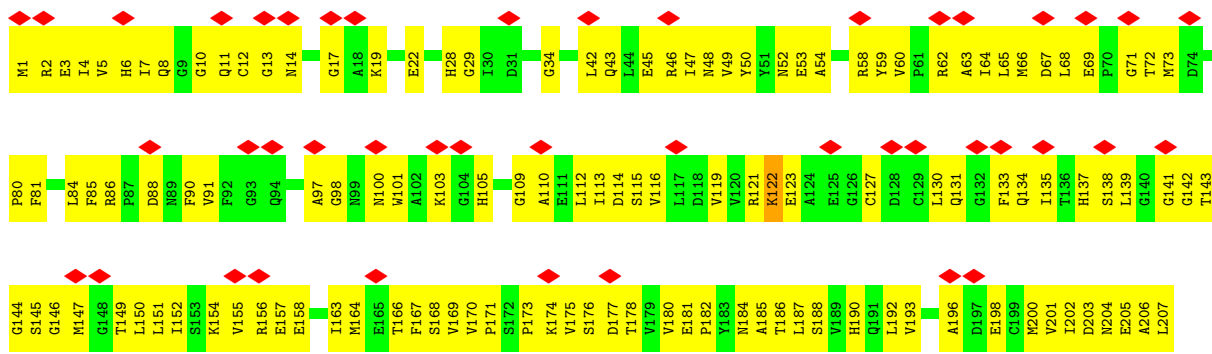

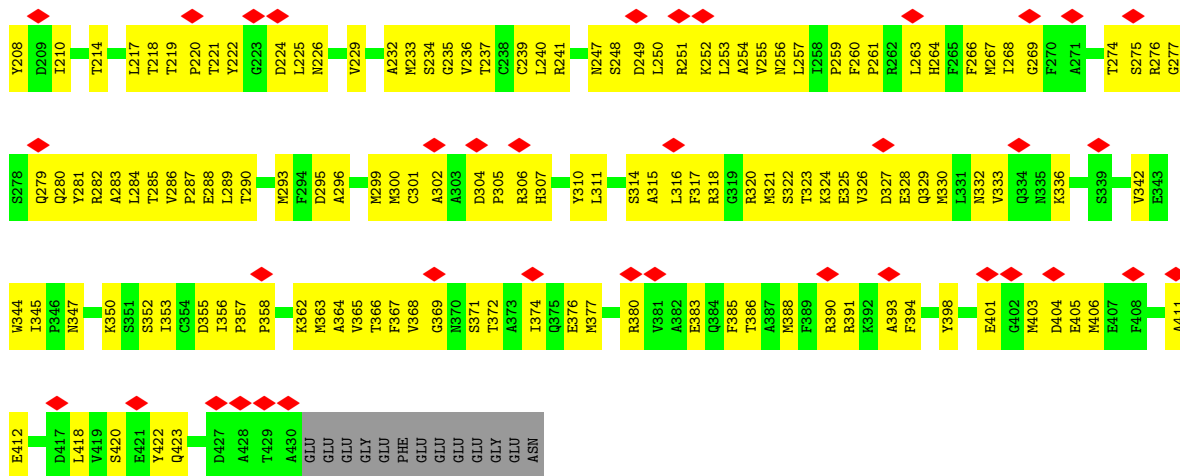

• Molecule 45: Tubulin beta chain

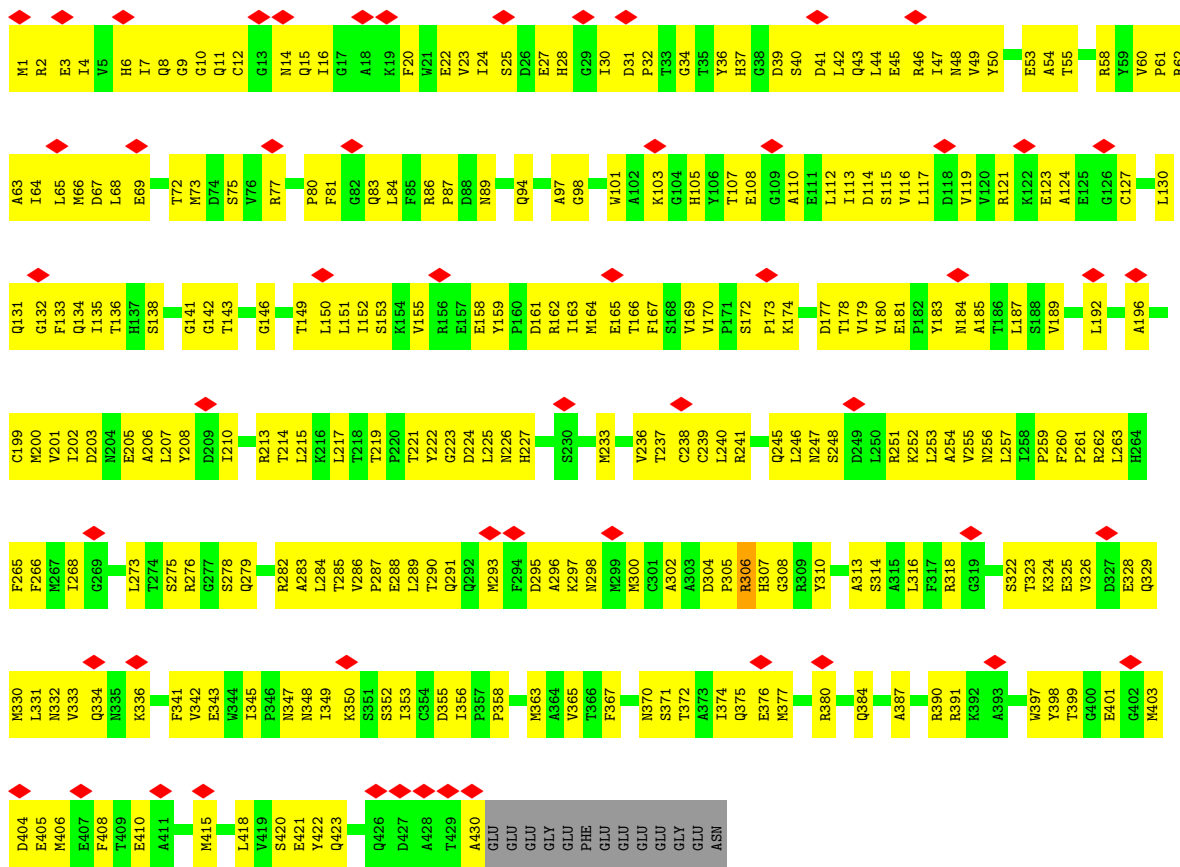

• Molecule 45: Tubulin beta chain

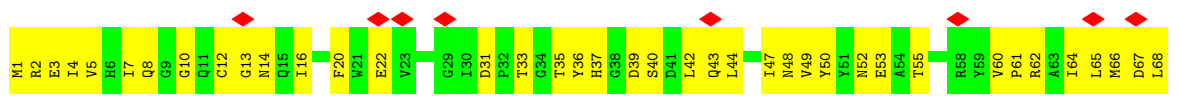



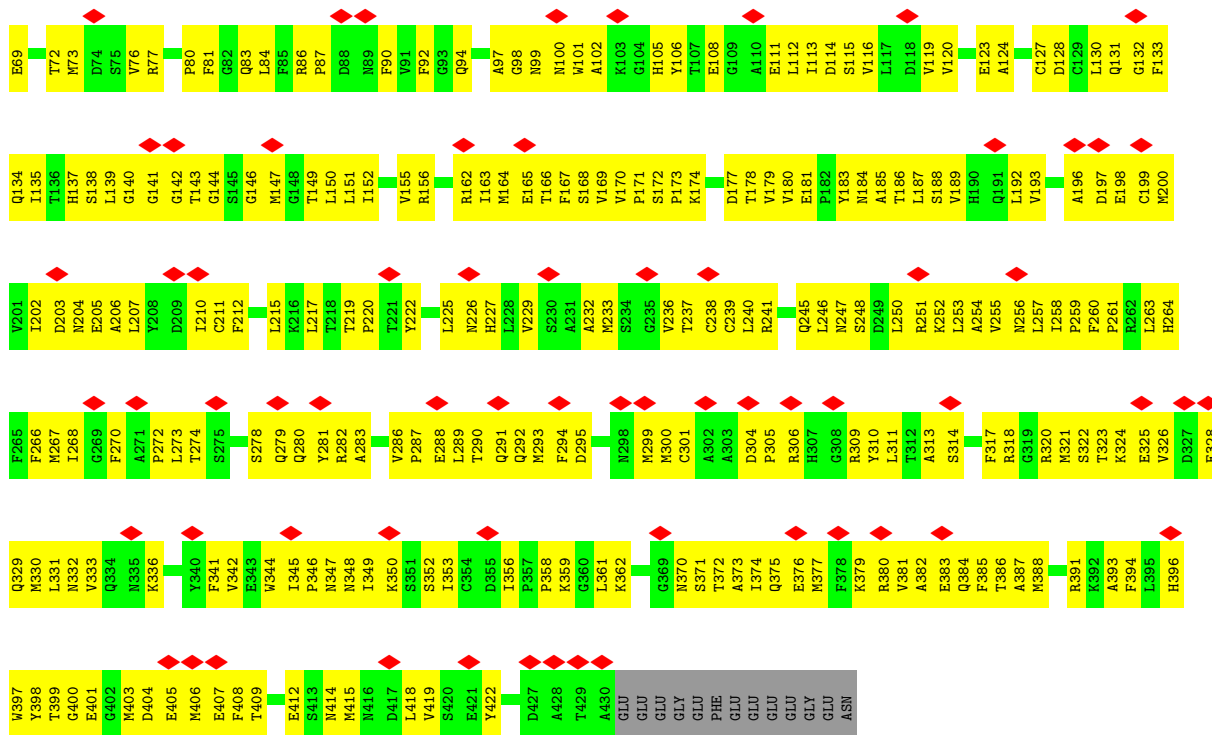

• Molecule 45: Tubulin beta chain

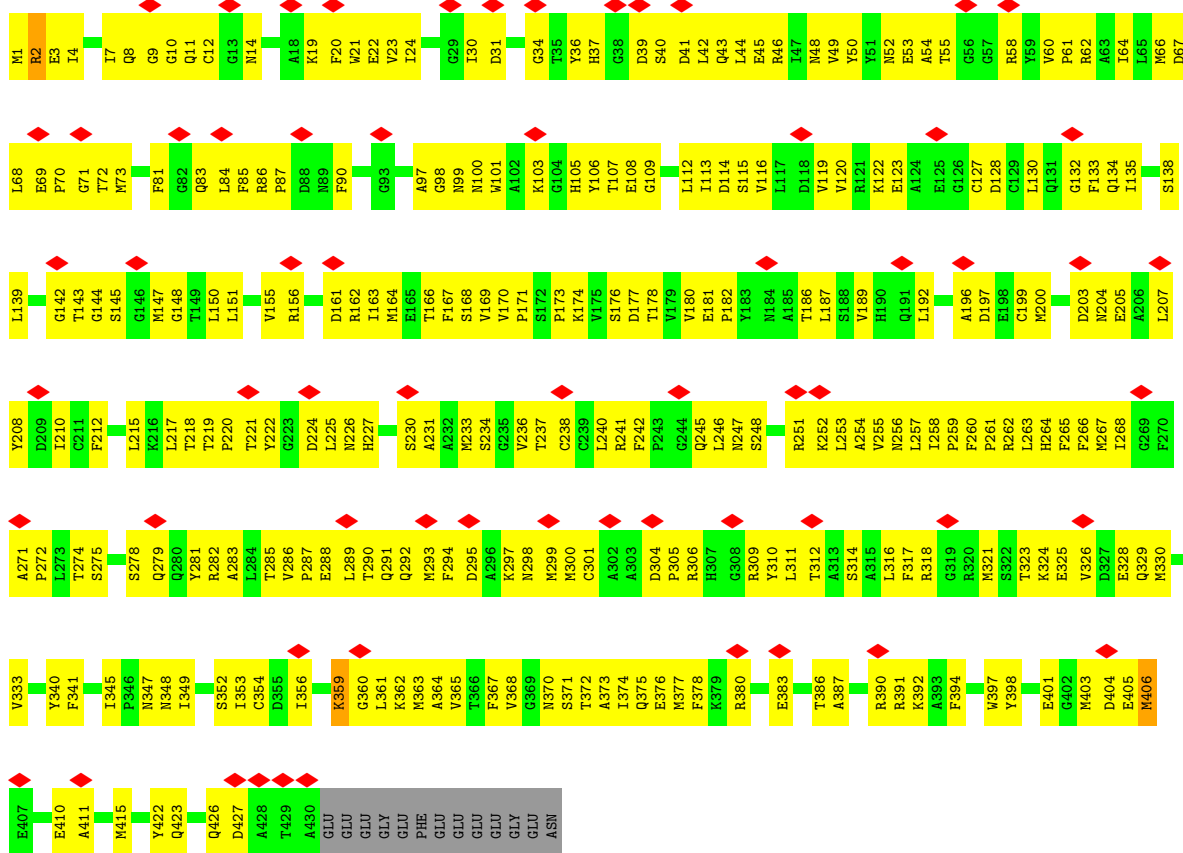

● Molecule 45: Tubulin beta chain

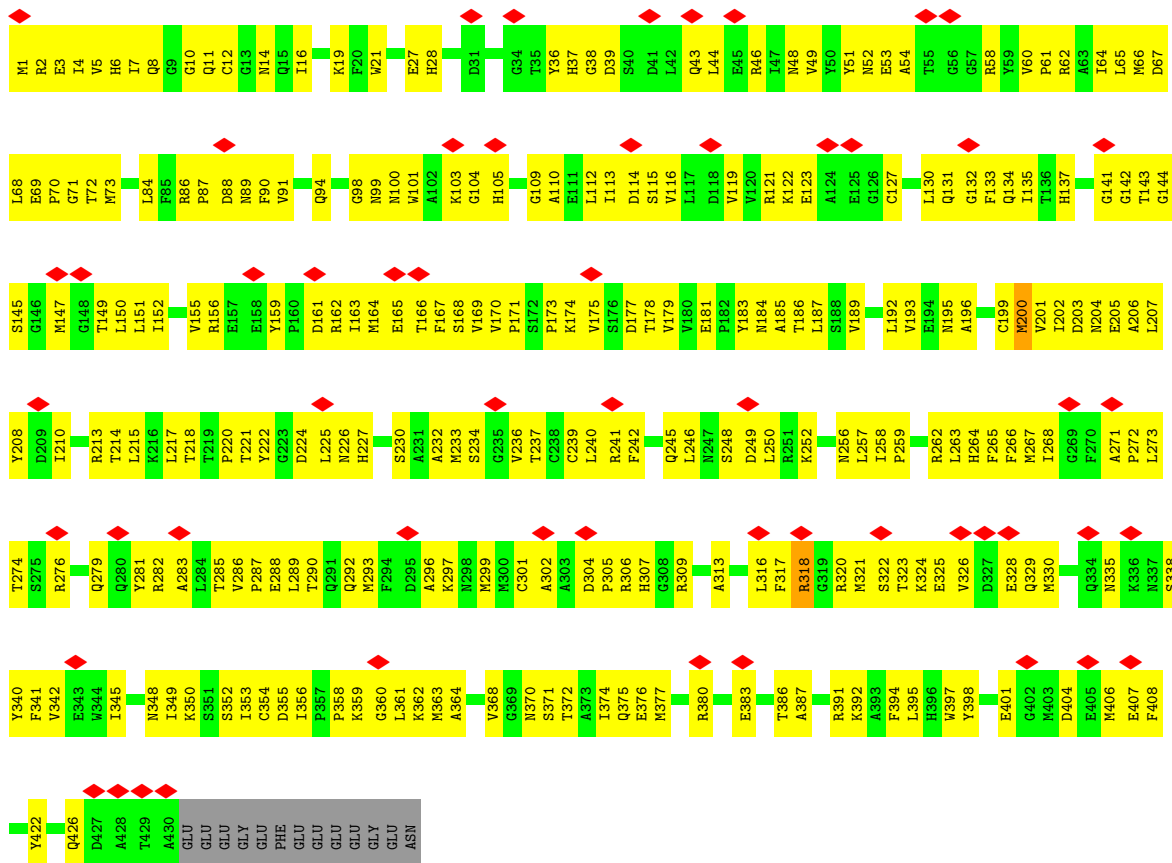

● Molecule 45: Tubulin beta chain

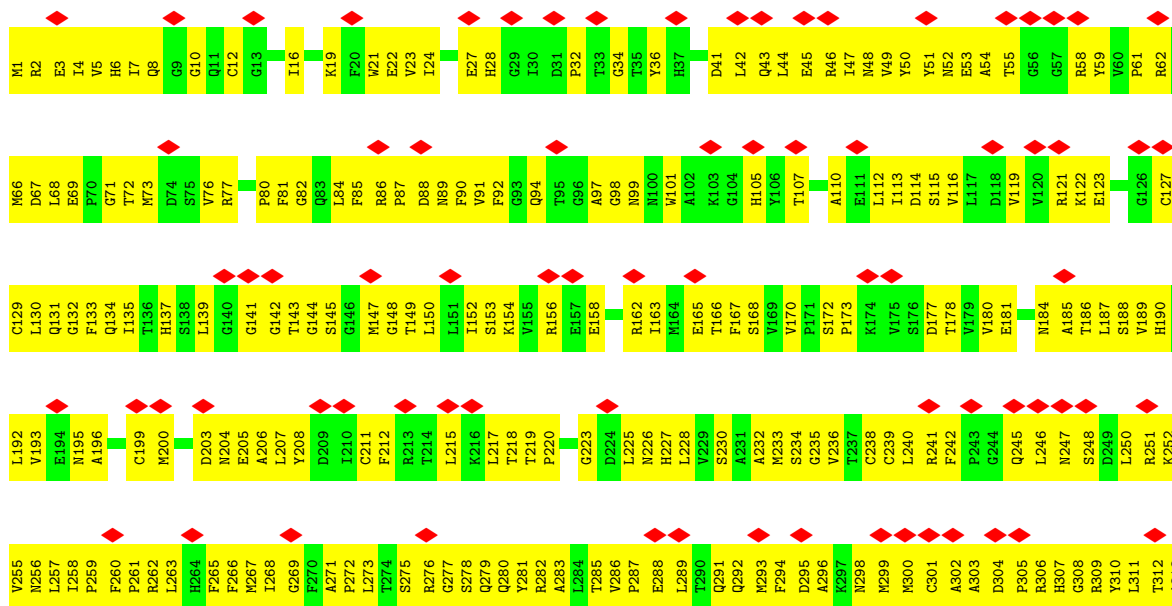

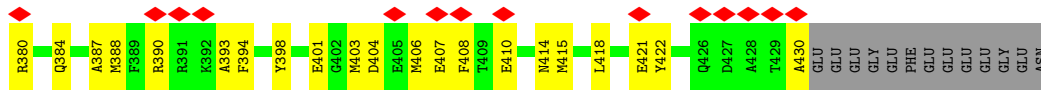
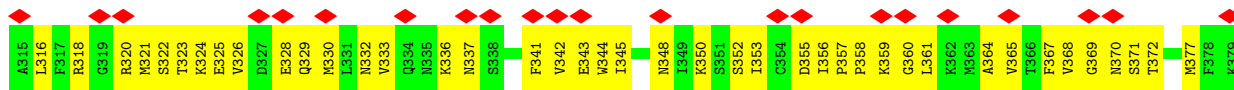

• Molecule 45: Tubulin beta chain

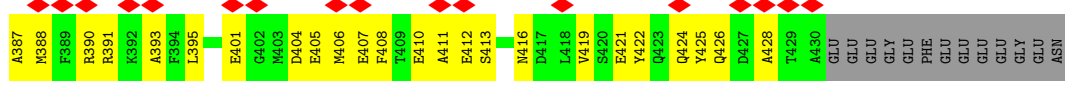
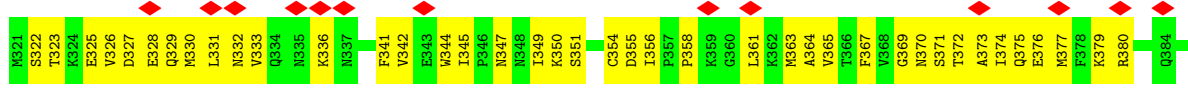
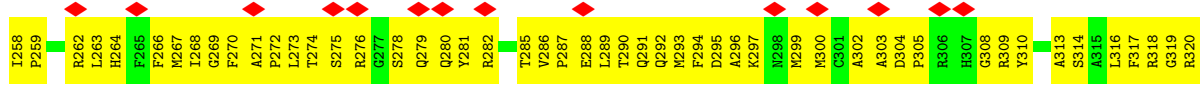
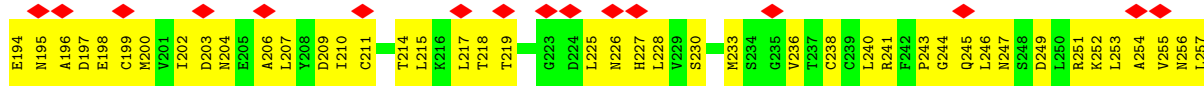
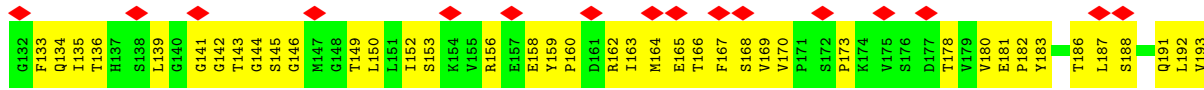
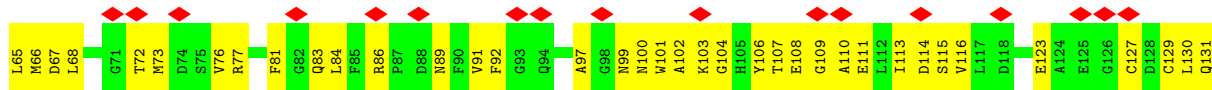
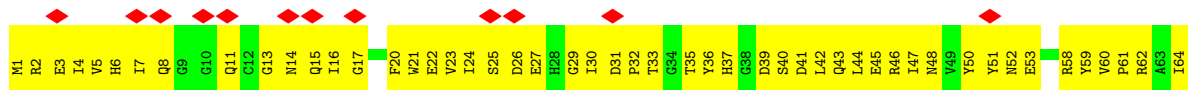
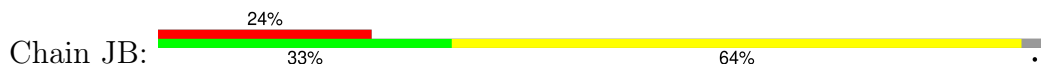

• Molecule 45: Tubulin beta chain

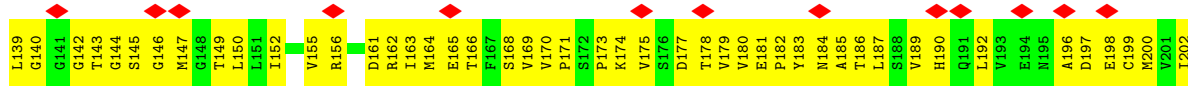
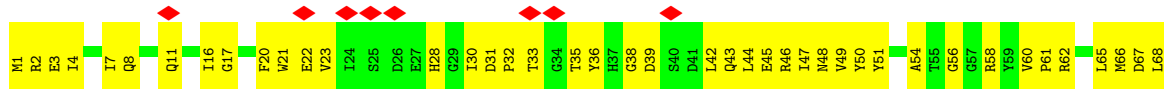
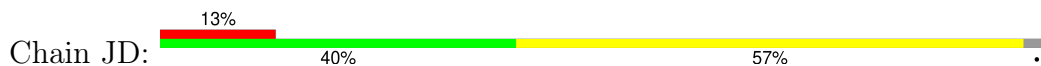

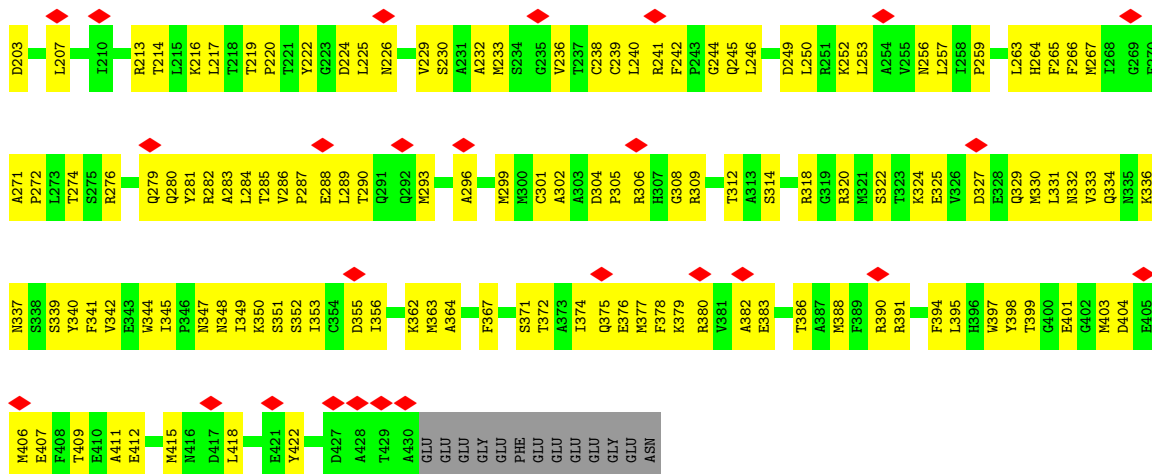

• Molecule 45: Tubulin beta chain

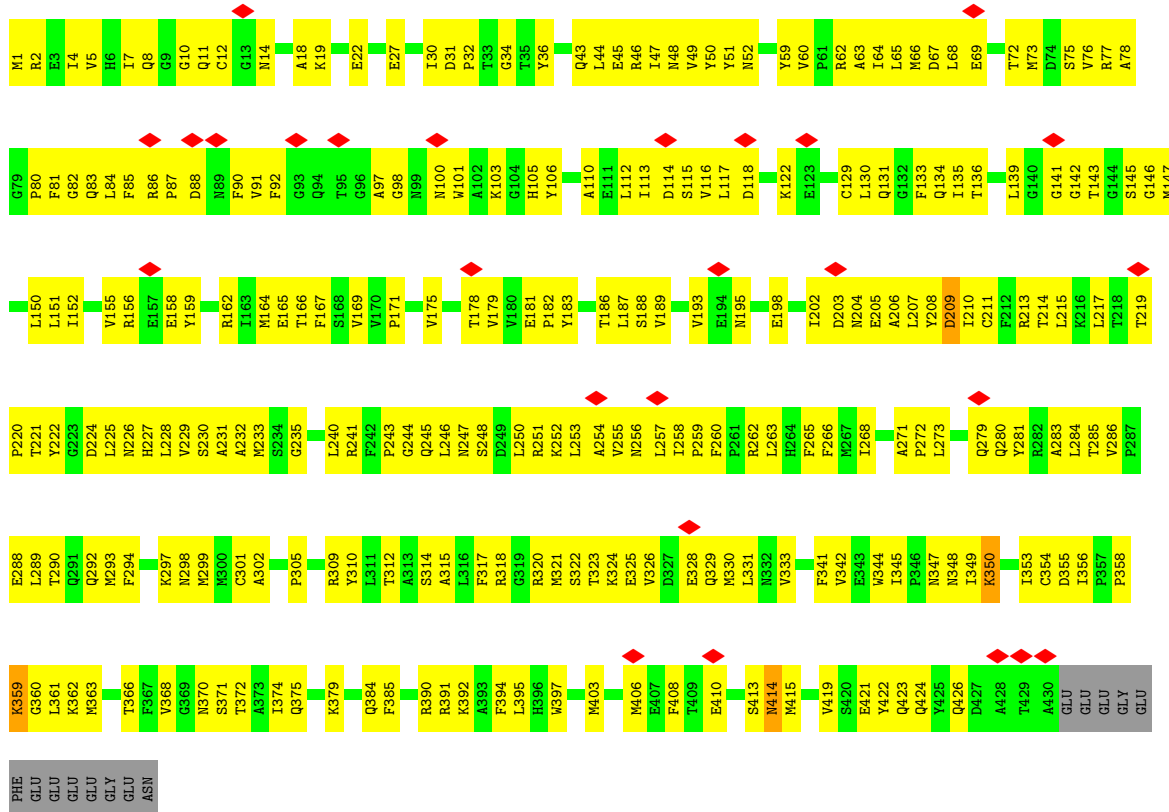

• Molecule 45: Tubulin beta chain

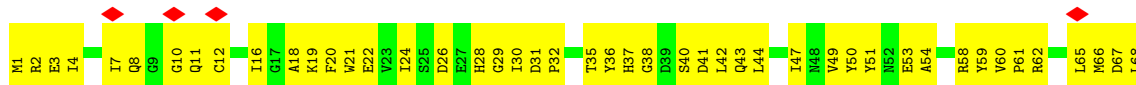
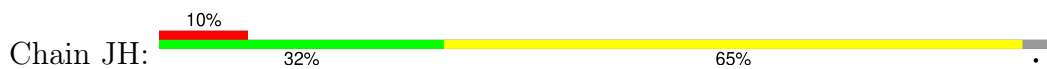

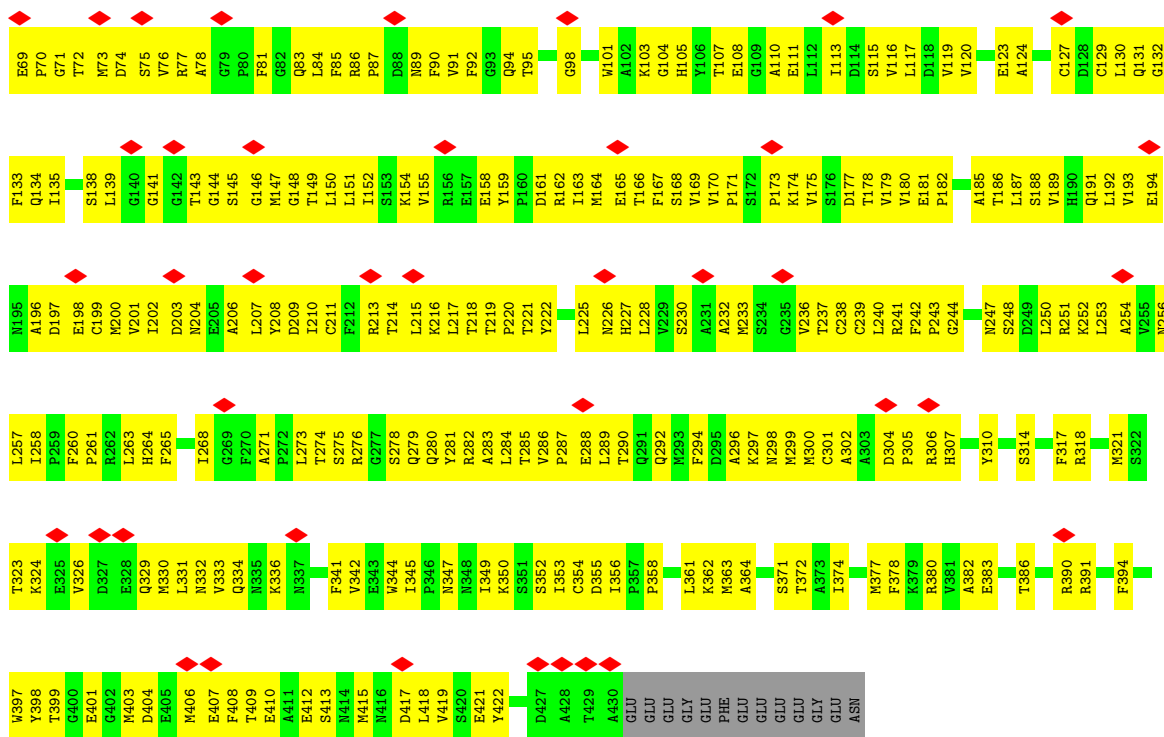

• Molecule 45: Tubulin beta chain

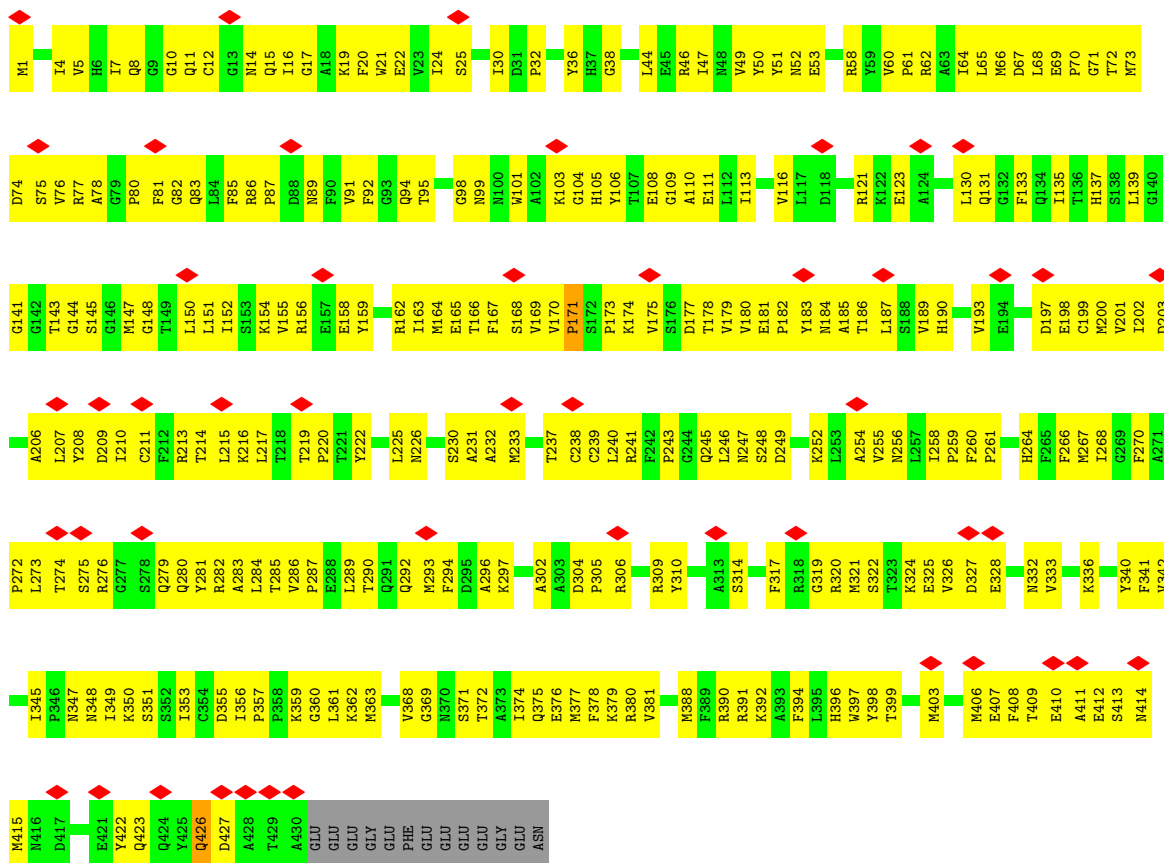

• Molecule 45: Tubulin beta chain

Chain JL:

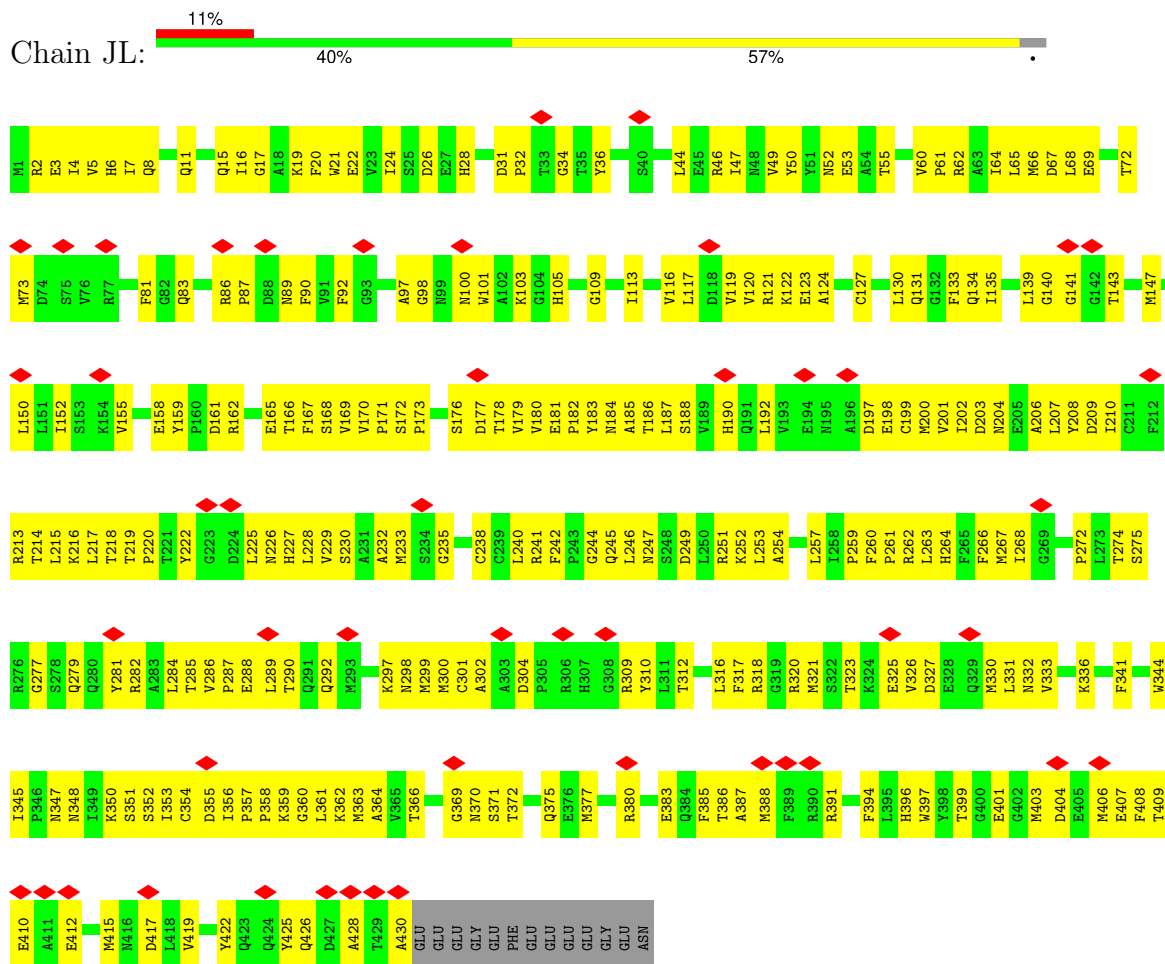

• Molecule 45: Tubulin beta chain

Chain JN:

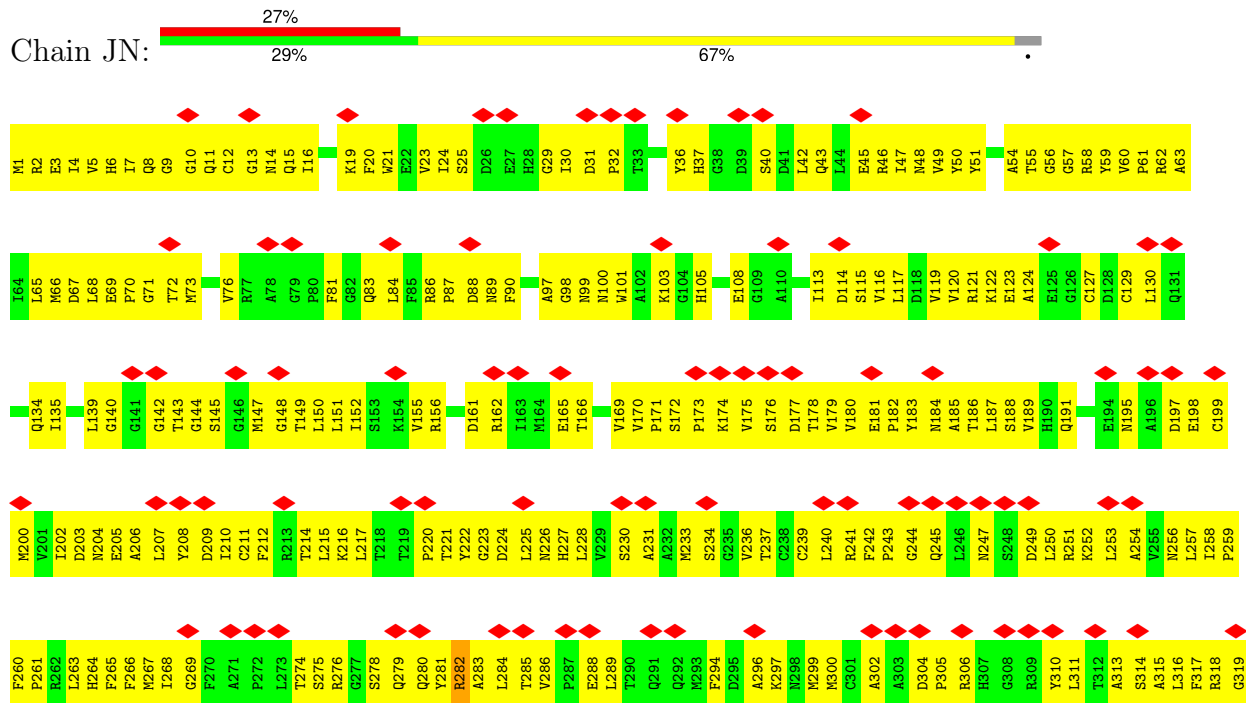

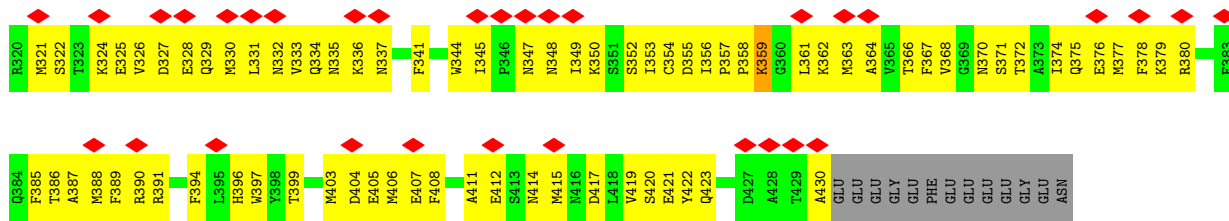

• Molecule 45: Tubulin beta chain

Chain KB:

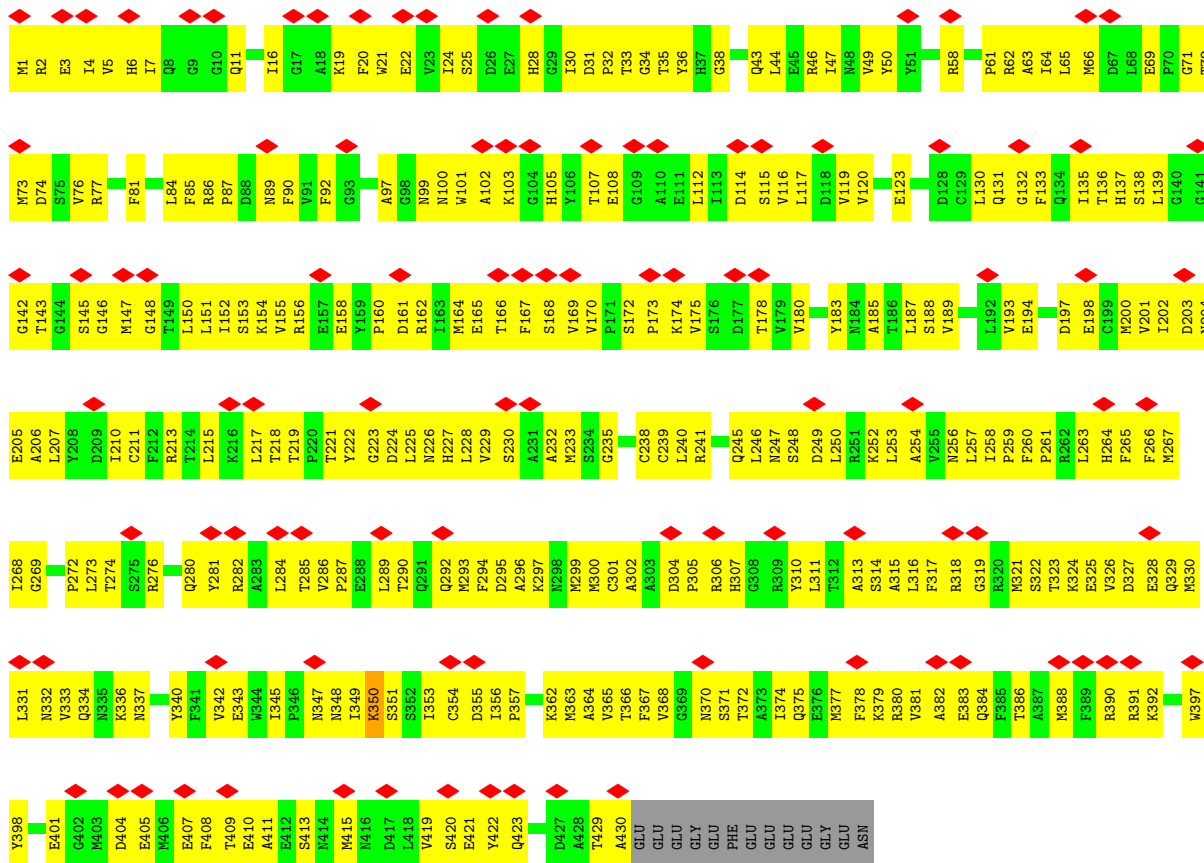

• Molecule 45: Tubulin beta chain

Chain KD:

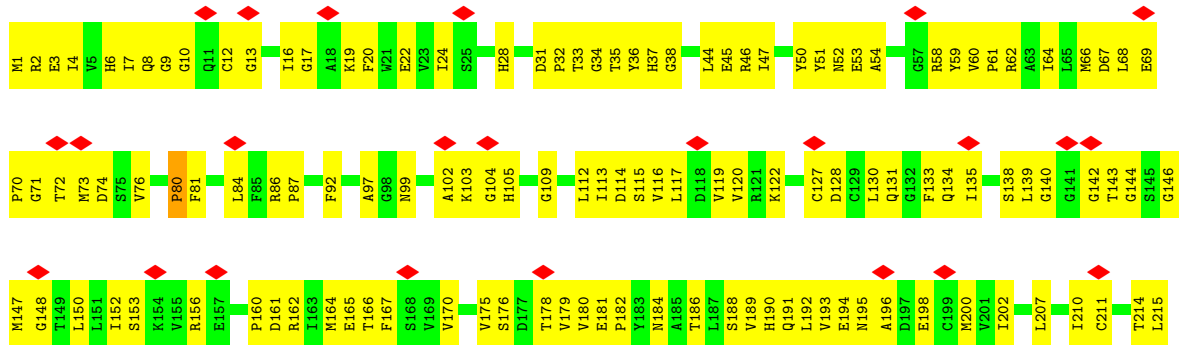

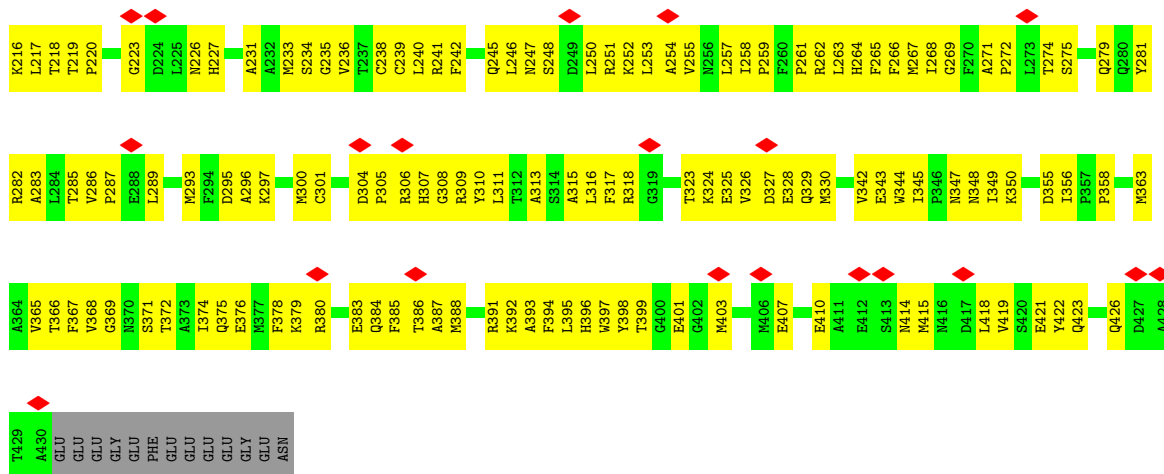

• Molecule 45: Tubulin beta chain

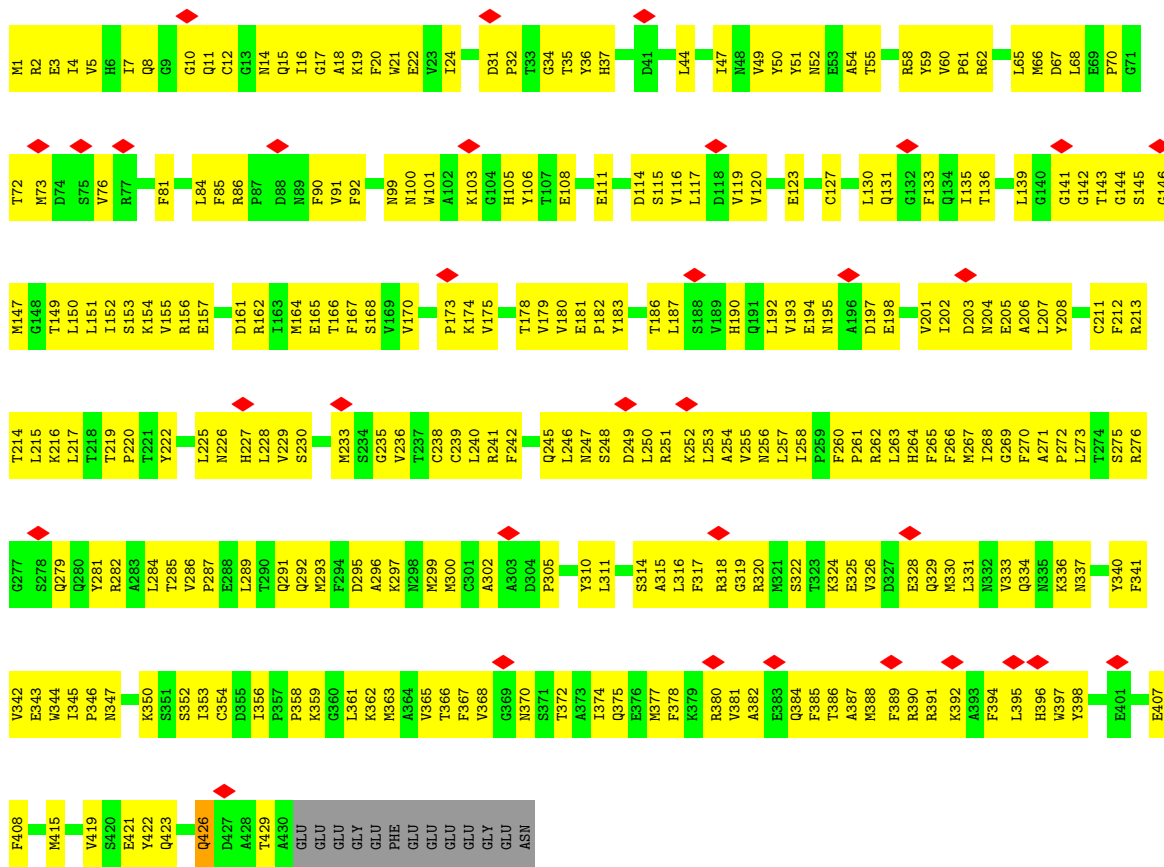

• Molecule 45: Tubulin beta chain

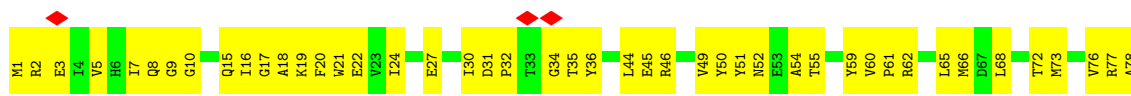



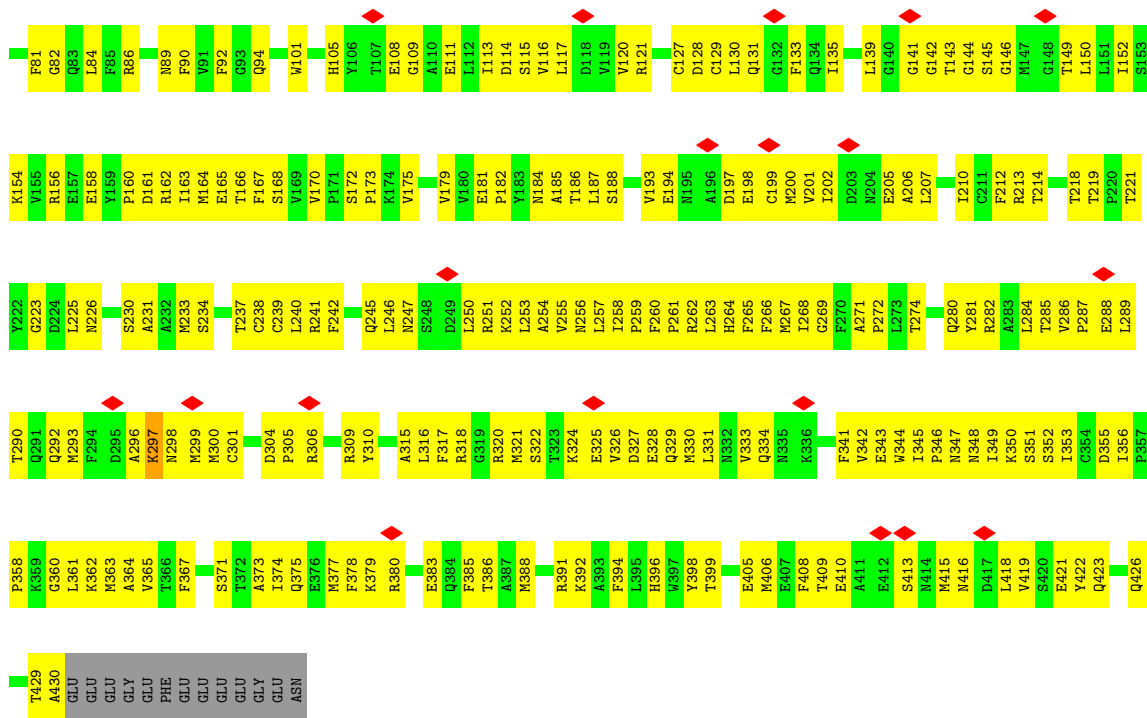

• Molecule 45: Tubulin beta chain

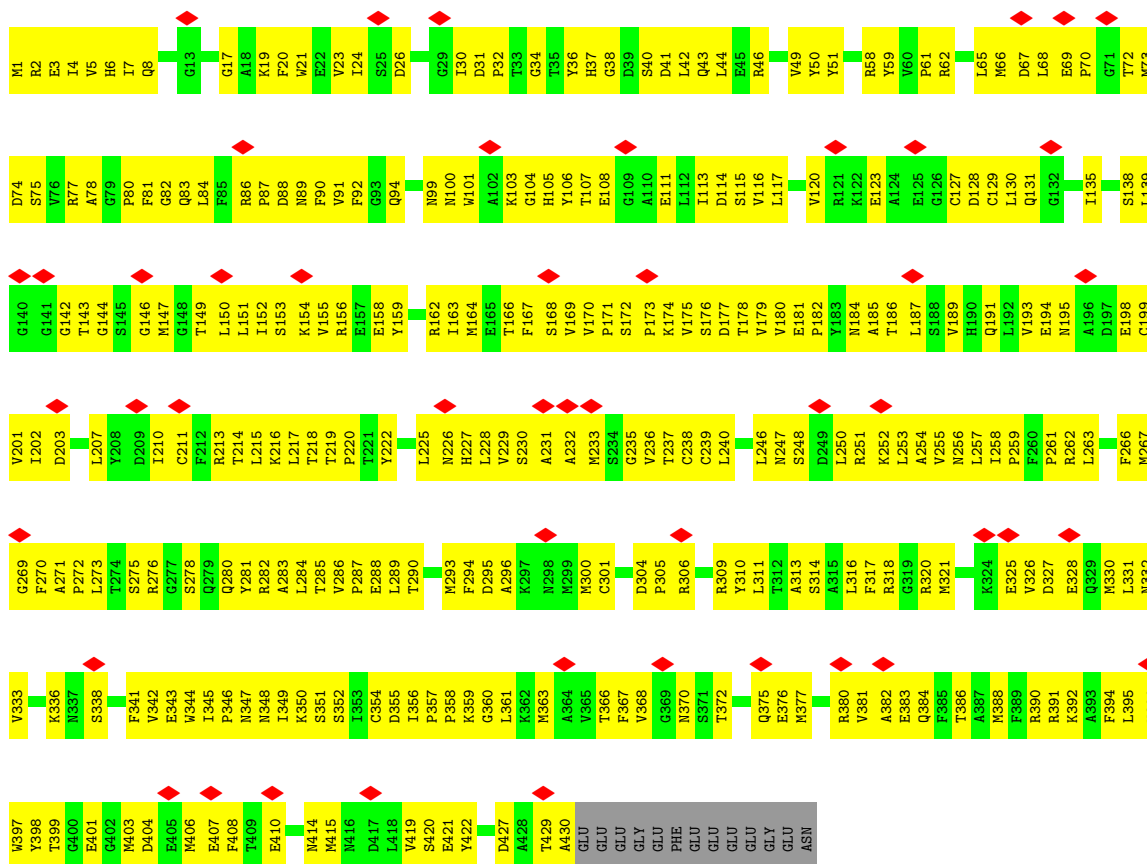

• Molecule 45: Tubulin beta chain

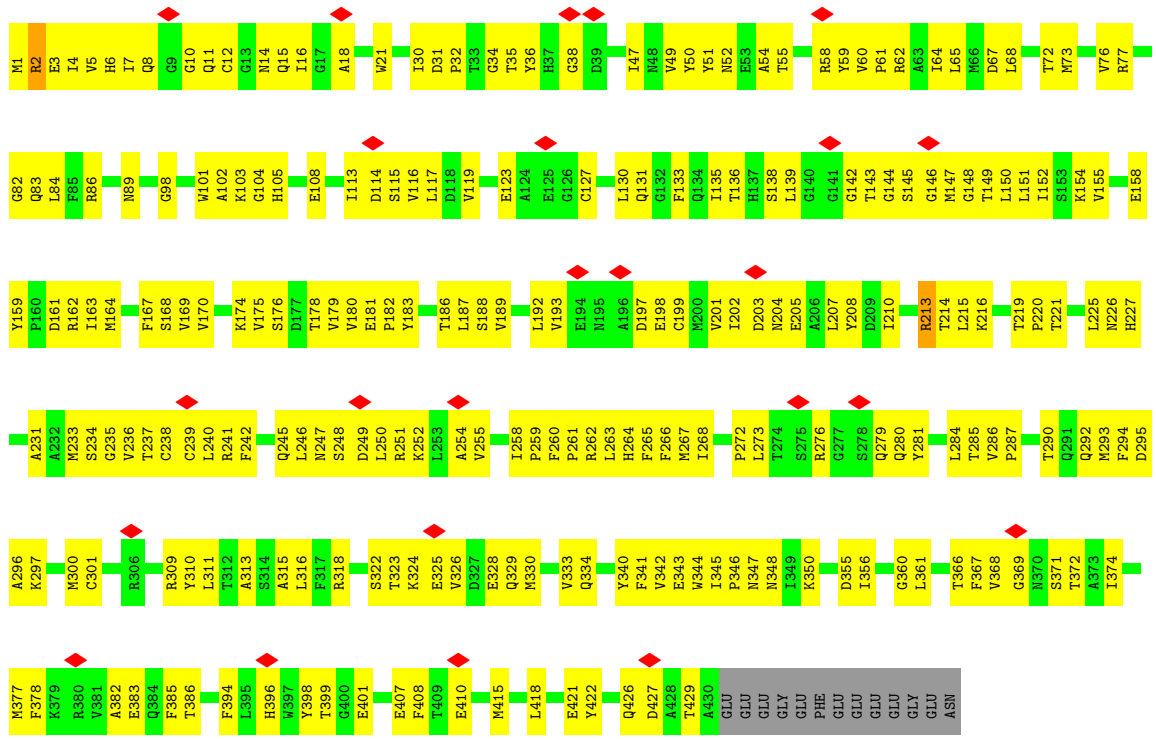
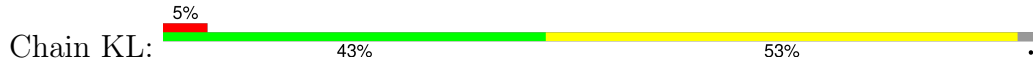

• Molecule 45: Tubulin beta chain

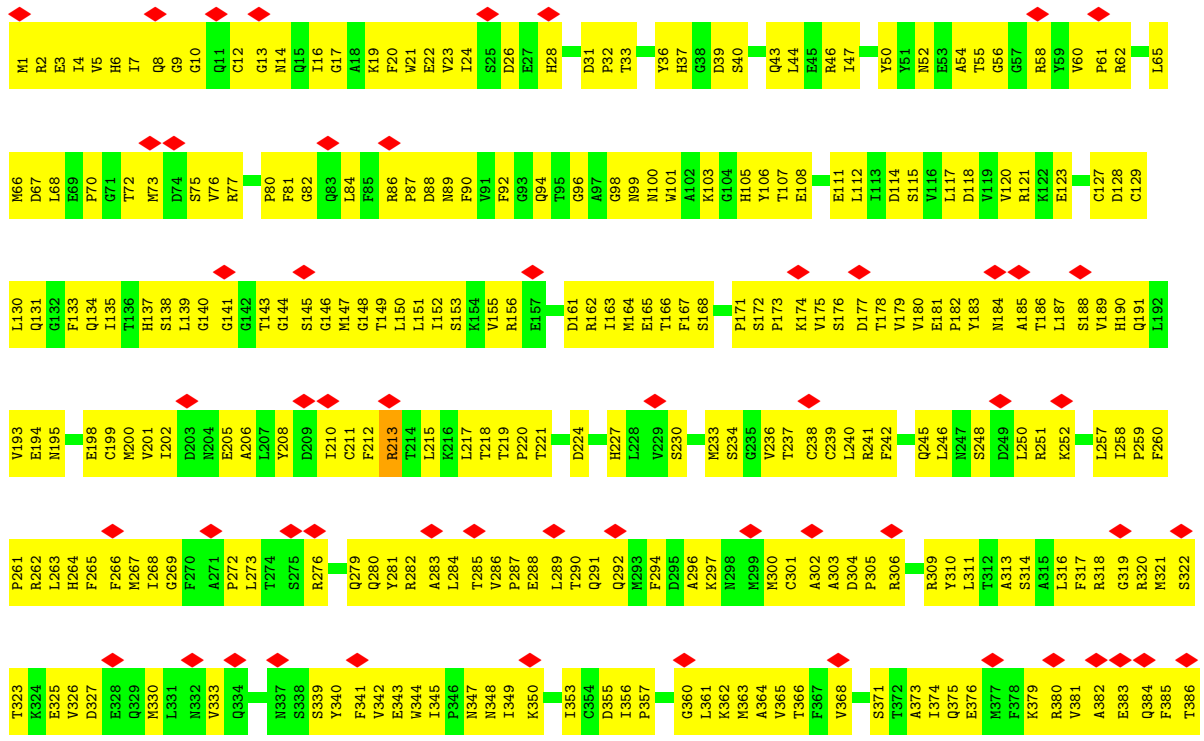



• Molecule 45: Tubulin beta chain

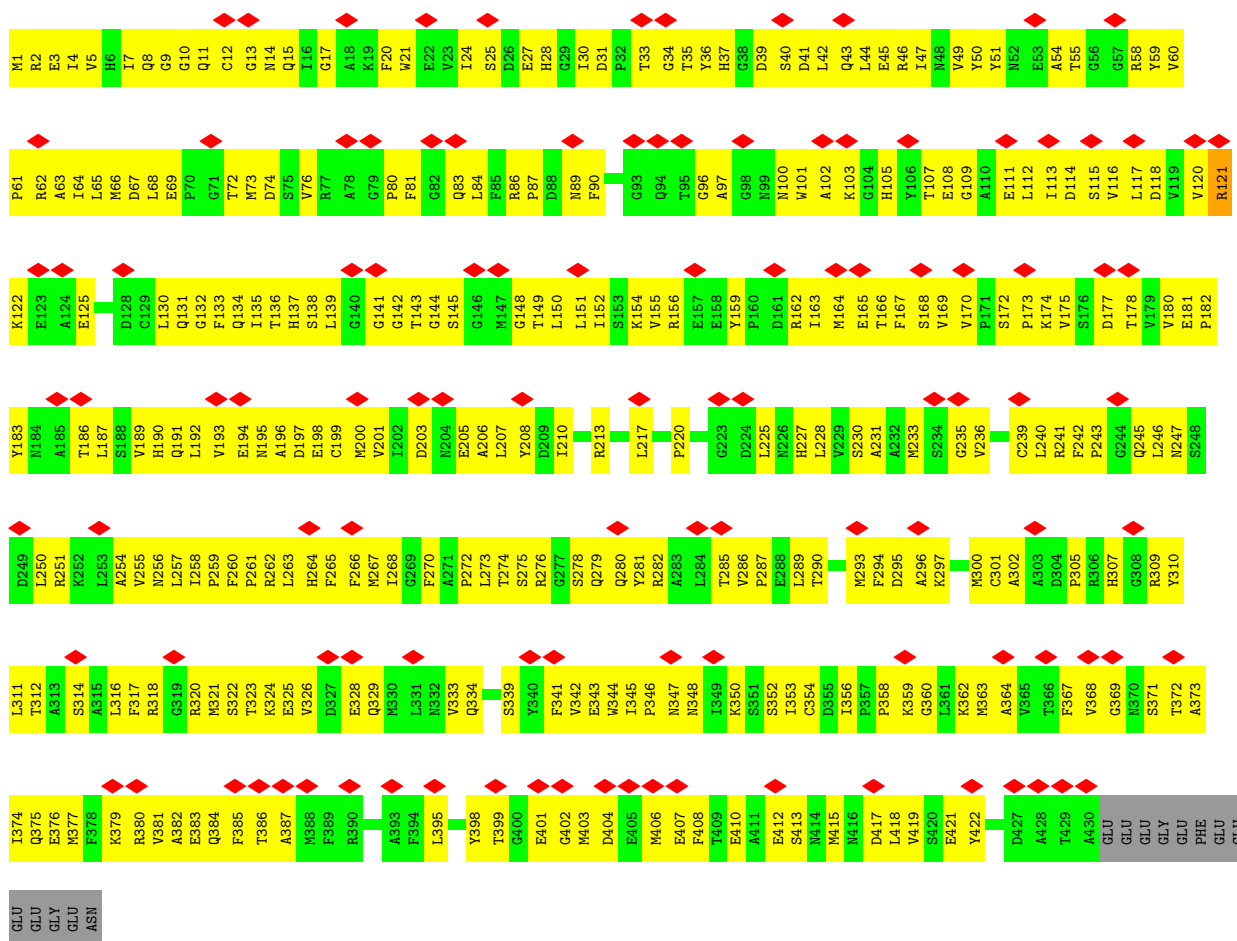

• Molecule 45: Tubulin beta chain

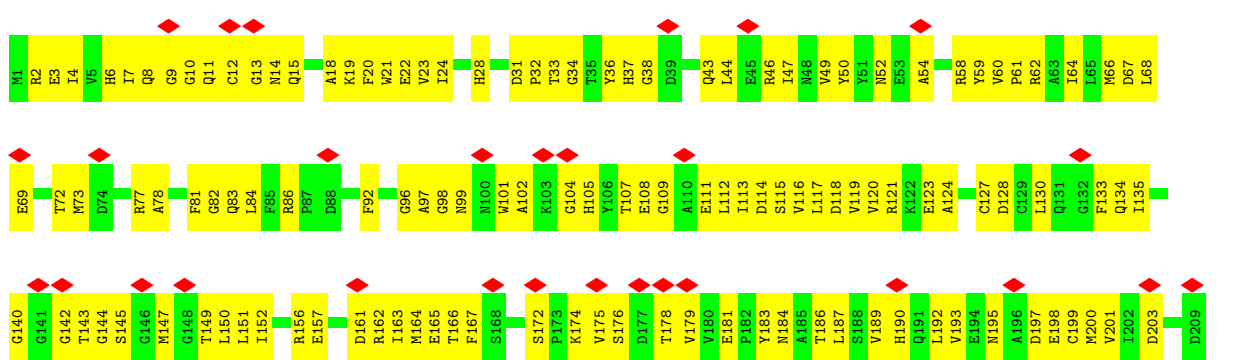

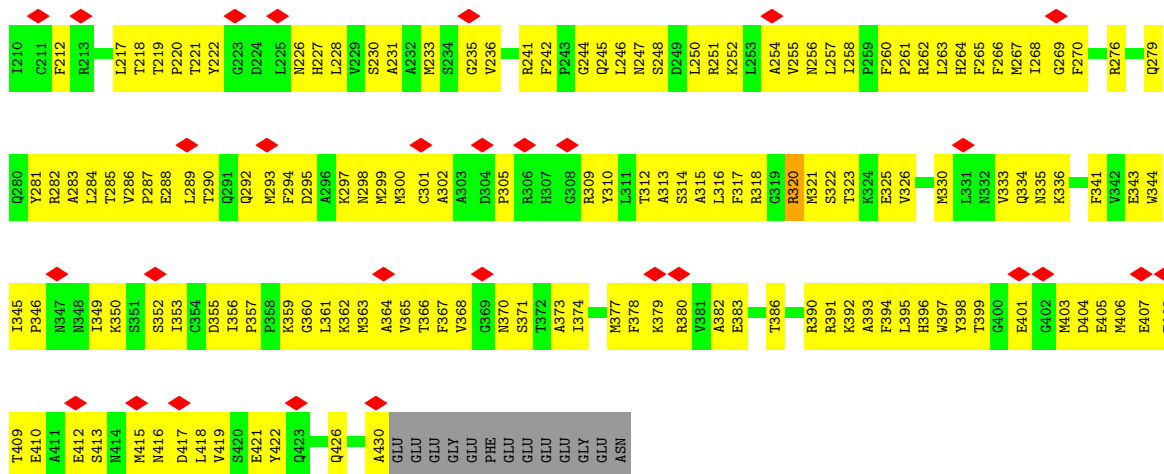

• Molecule 45: Tubulin beta chain

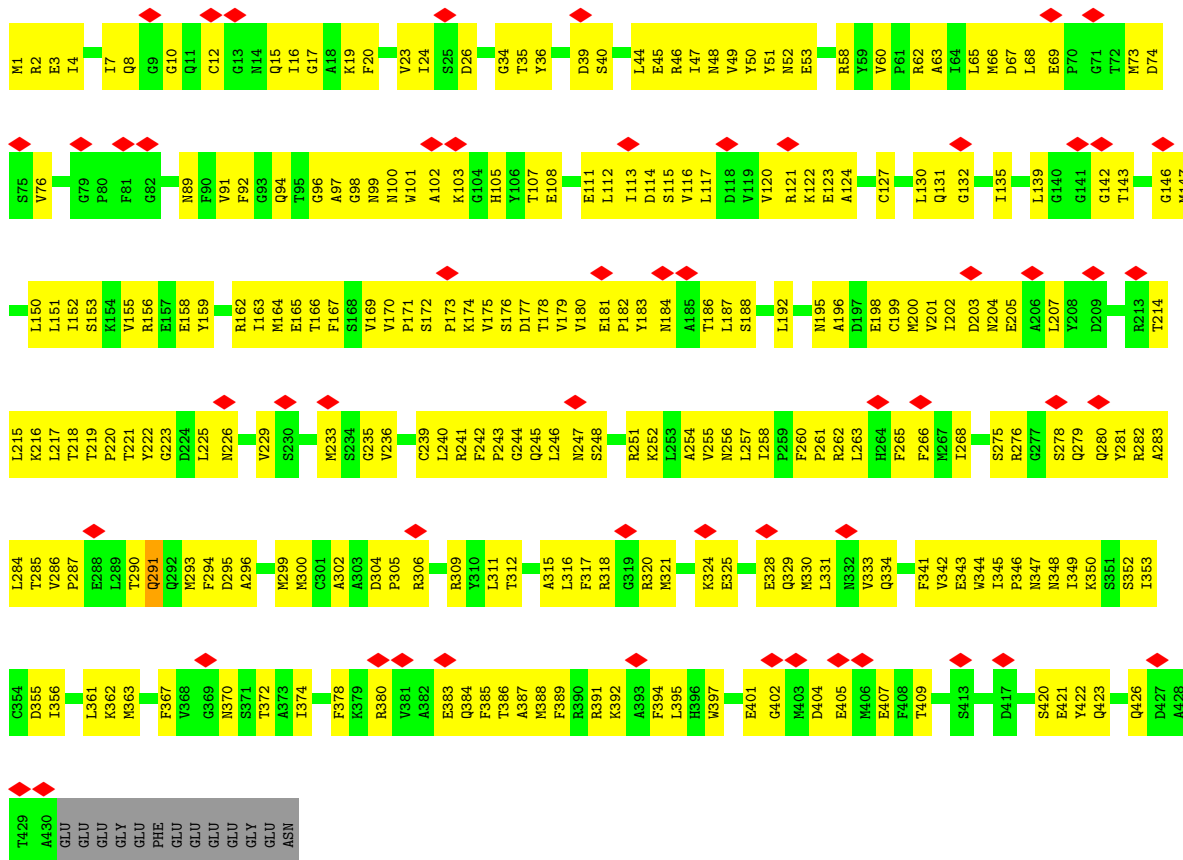

• Molecule 45: Tubulin beta chain



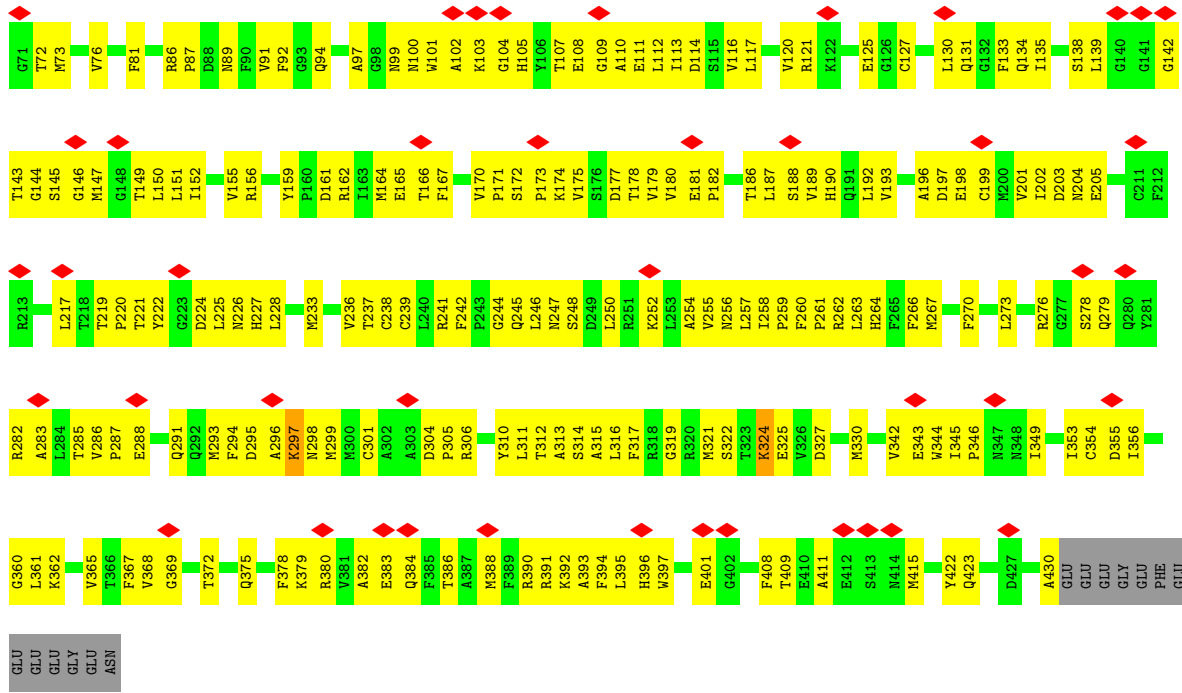

• Molecule 45: Tubulin beta chain

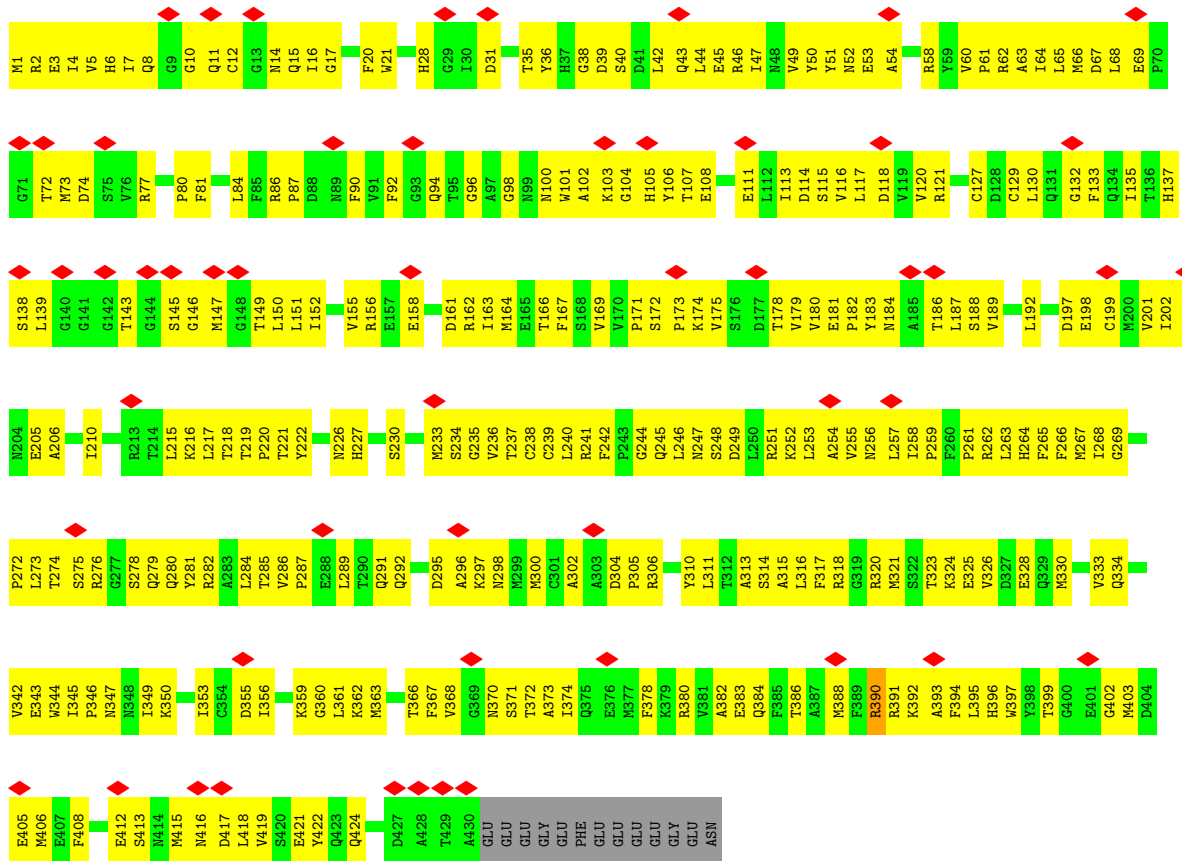

• Molecule 45: Tubulin beta chain

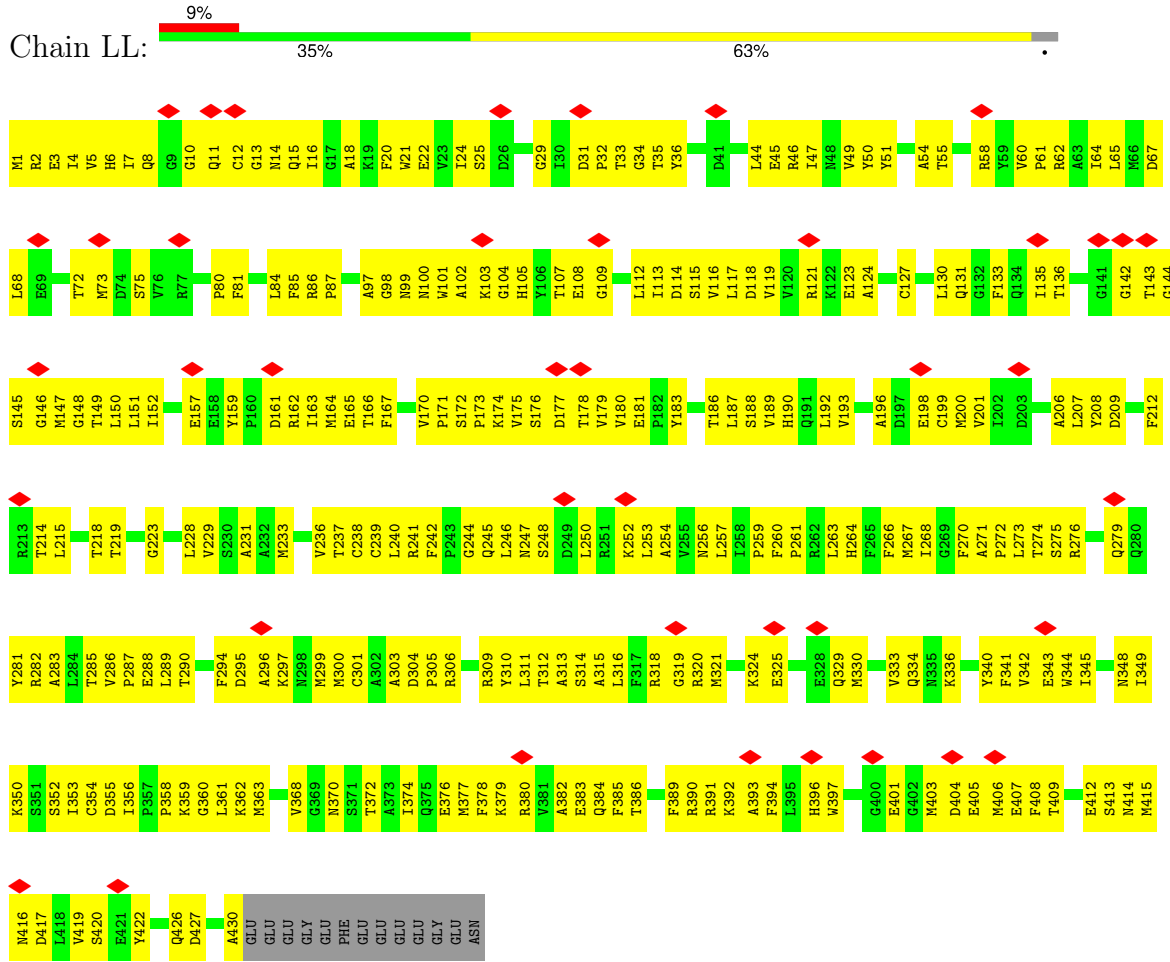

• Molecule 45: Tubulin beta chain

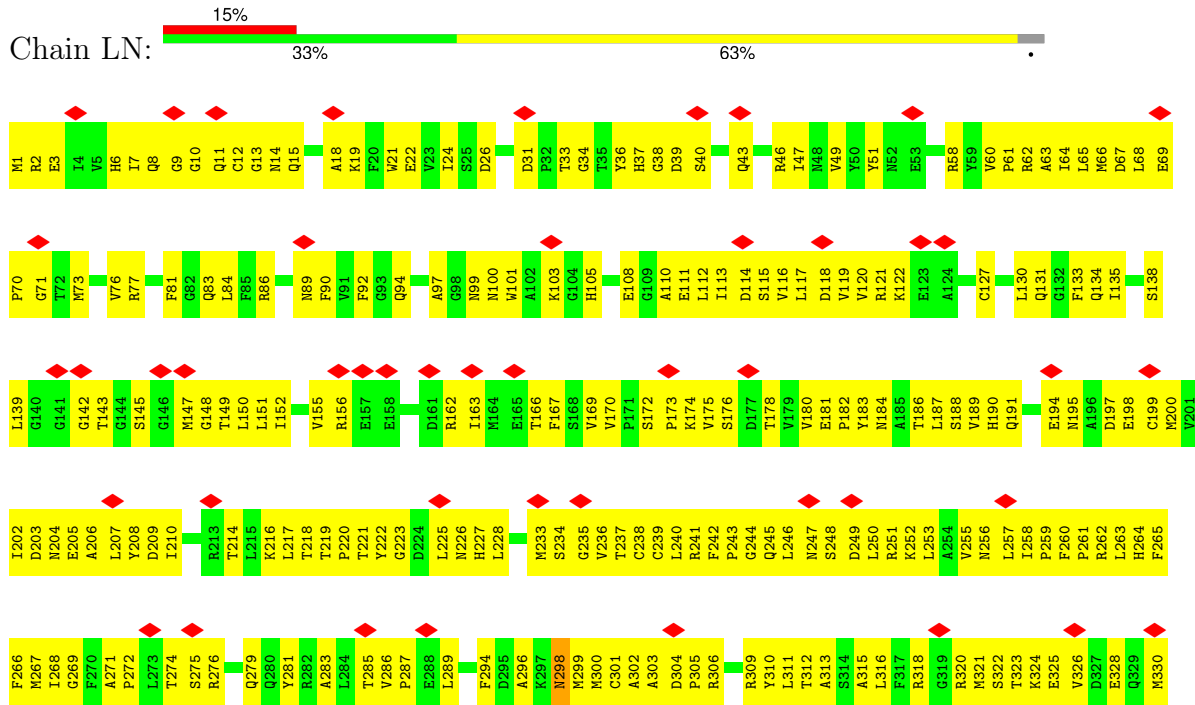

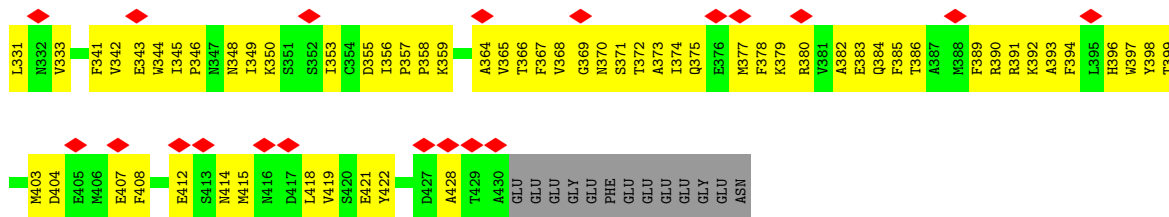

• Molecule 45: Tubulin beta chain

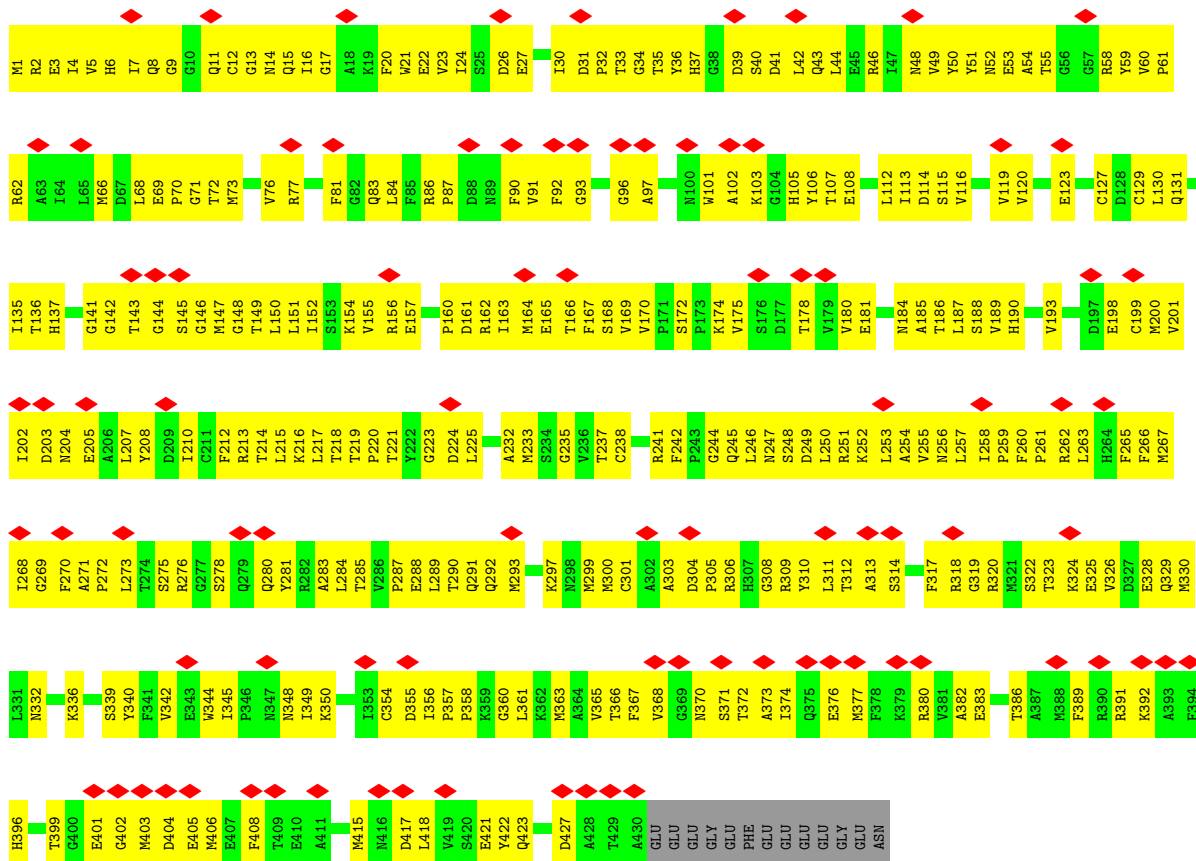

• Molecule 45: Tubulin beta chain

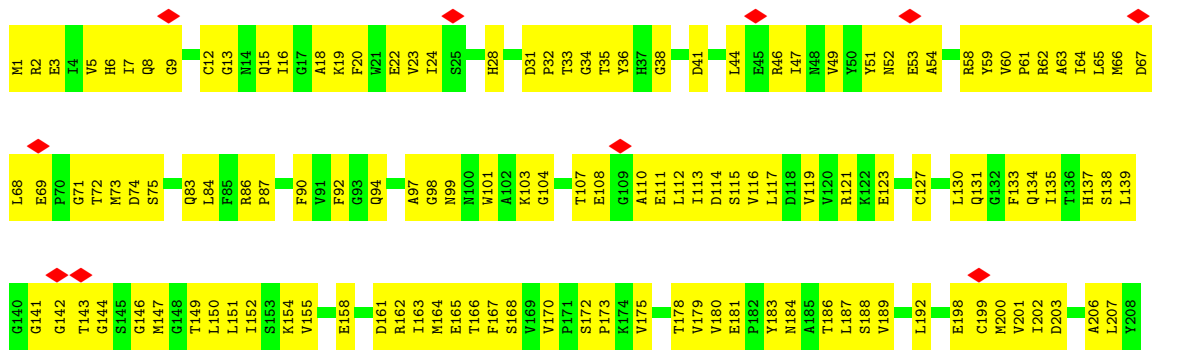

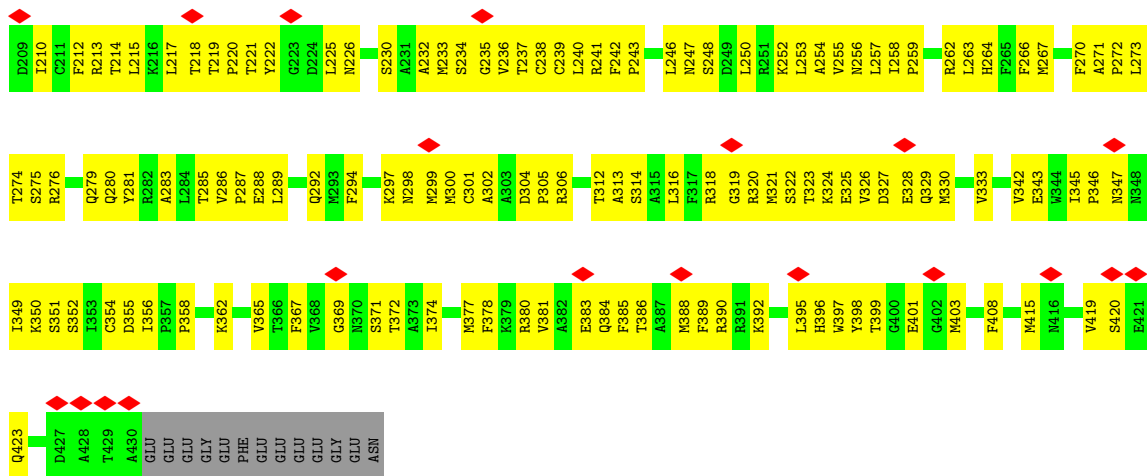

• Molecule 45: Tubulin beta chain

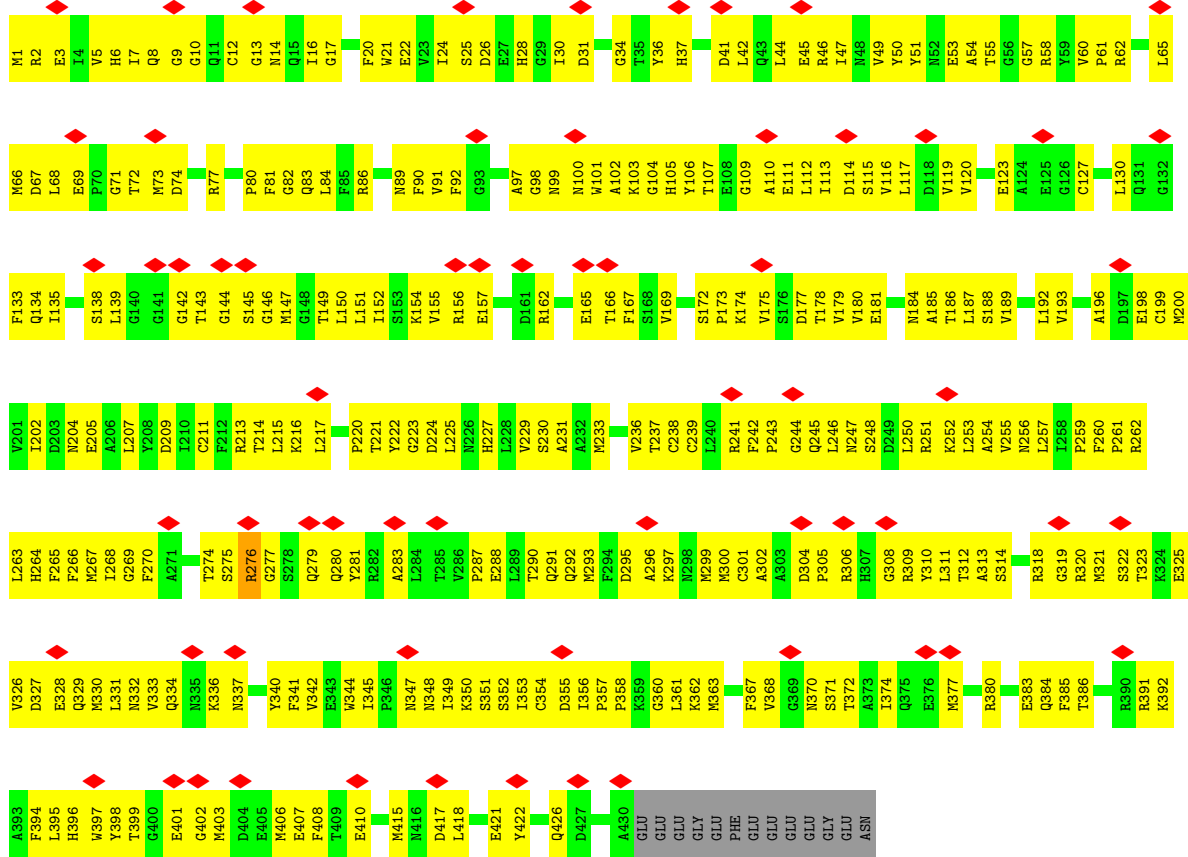

• Molecule 45: Tubulin beta chain

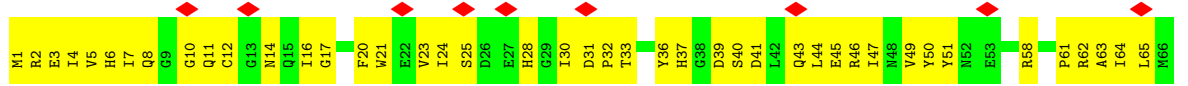



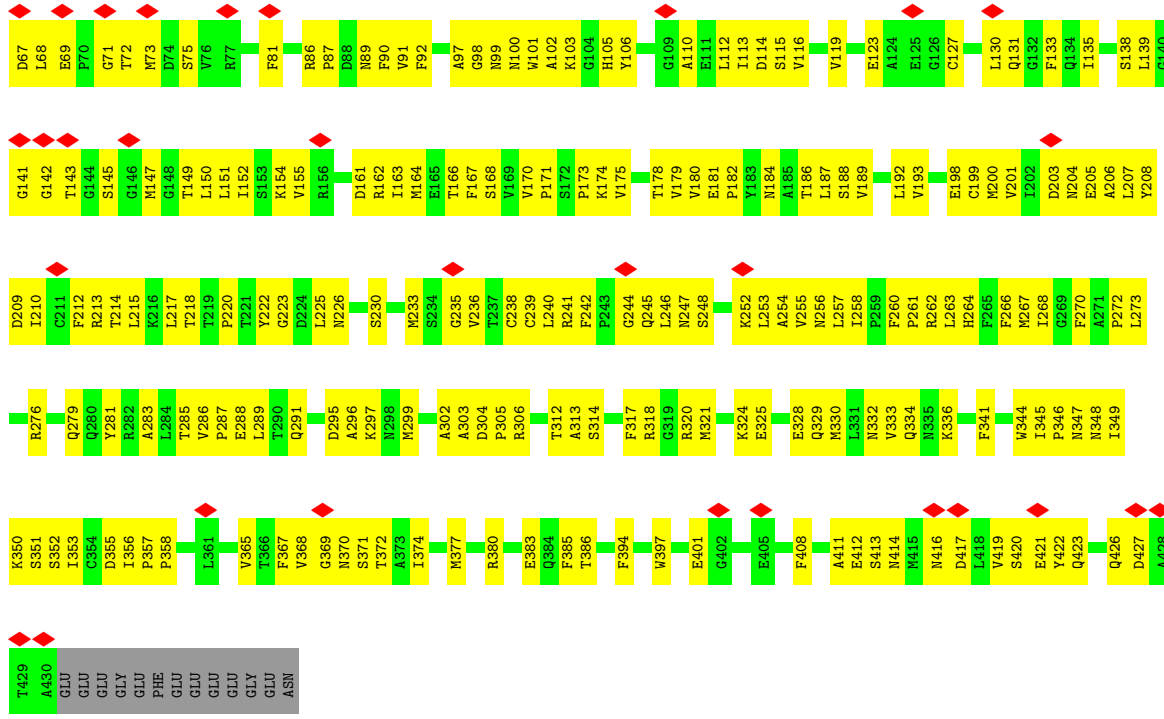

• Molecule 45: Tubulin beta chain

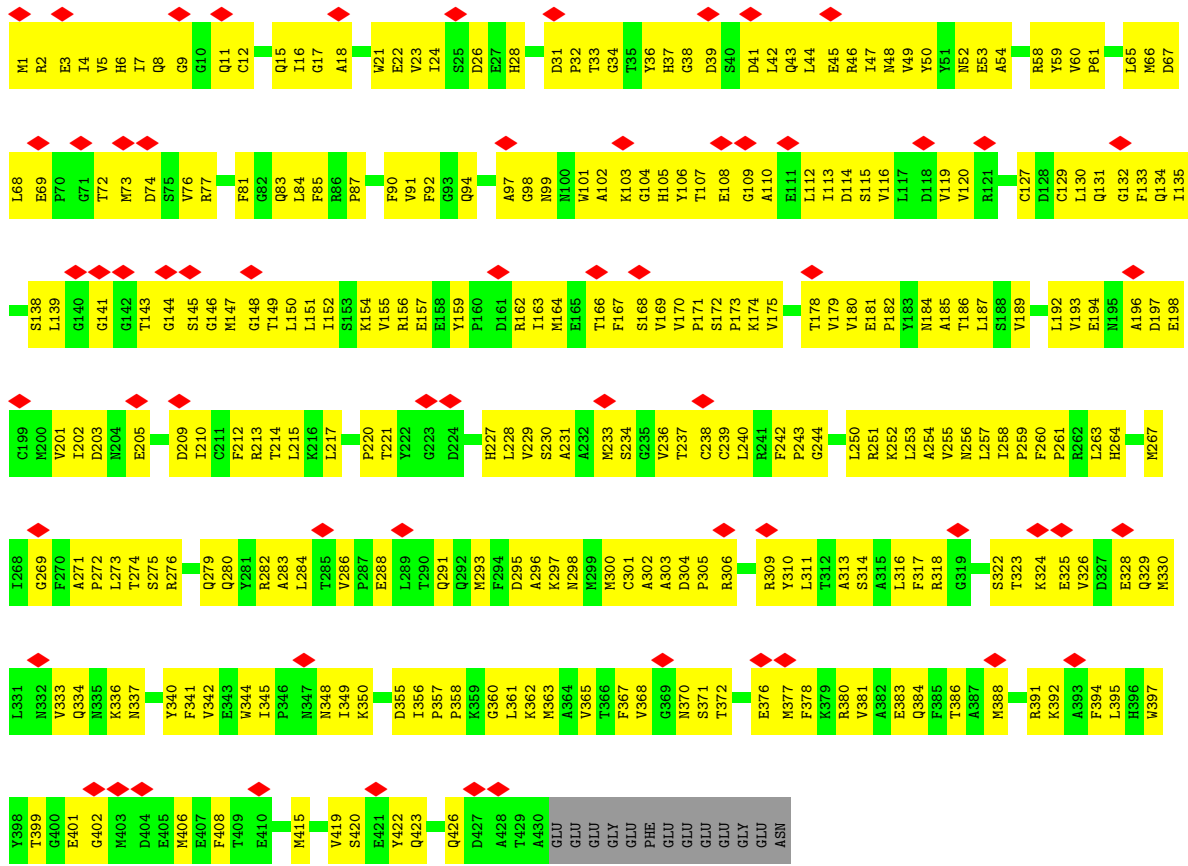

• Molecule 45: Tubulin beta chain

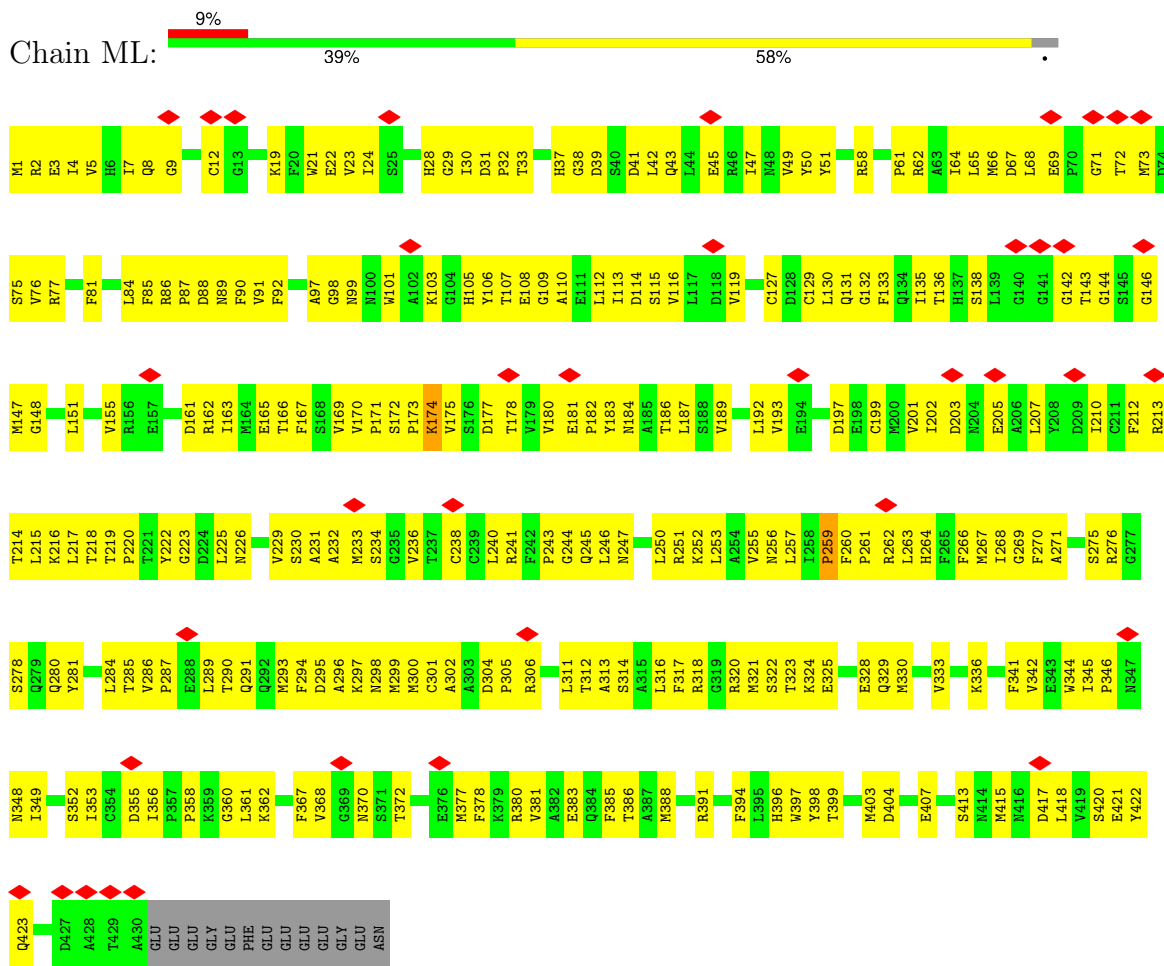

• Molecule 45: Tubulin beta chain

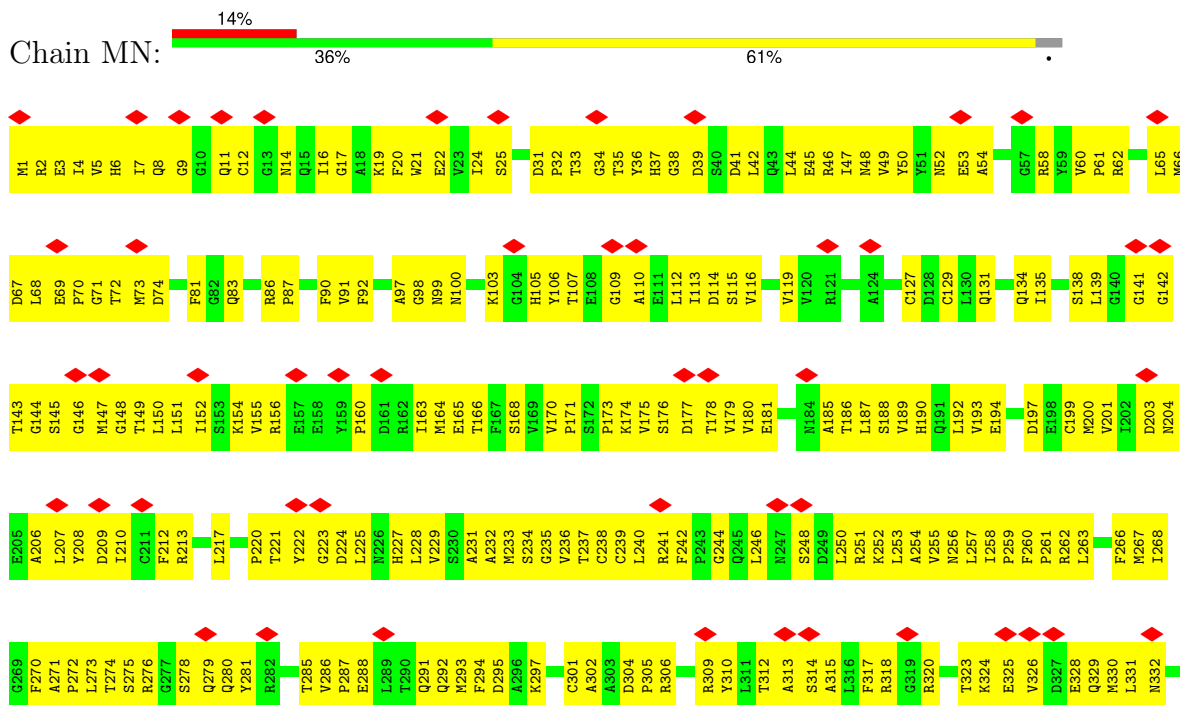

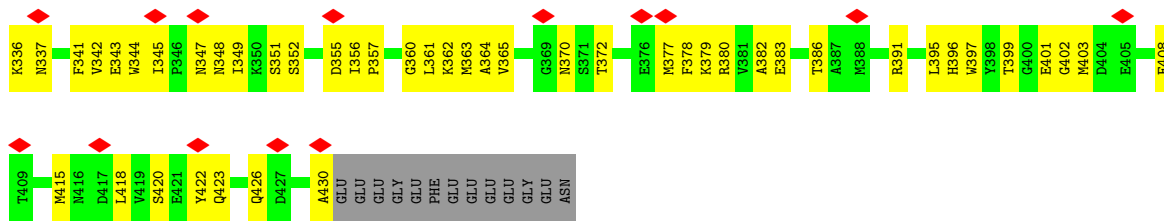

• Molecule 45: Tubulin beta chain



• Molecule 45: Tubulin beta chain

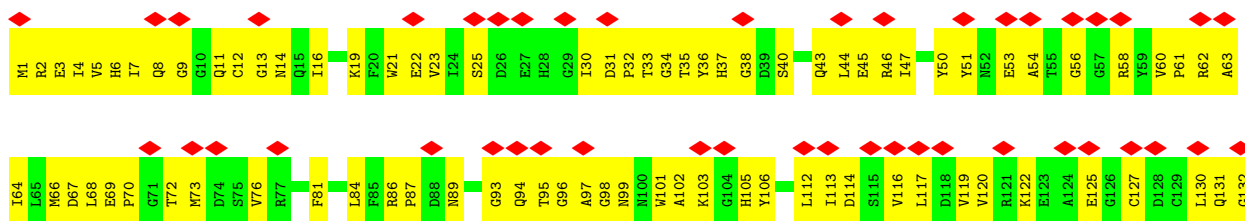
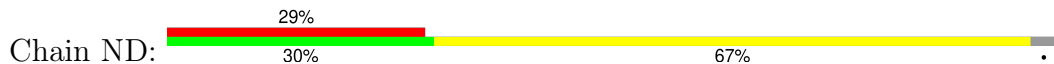

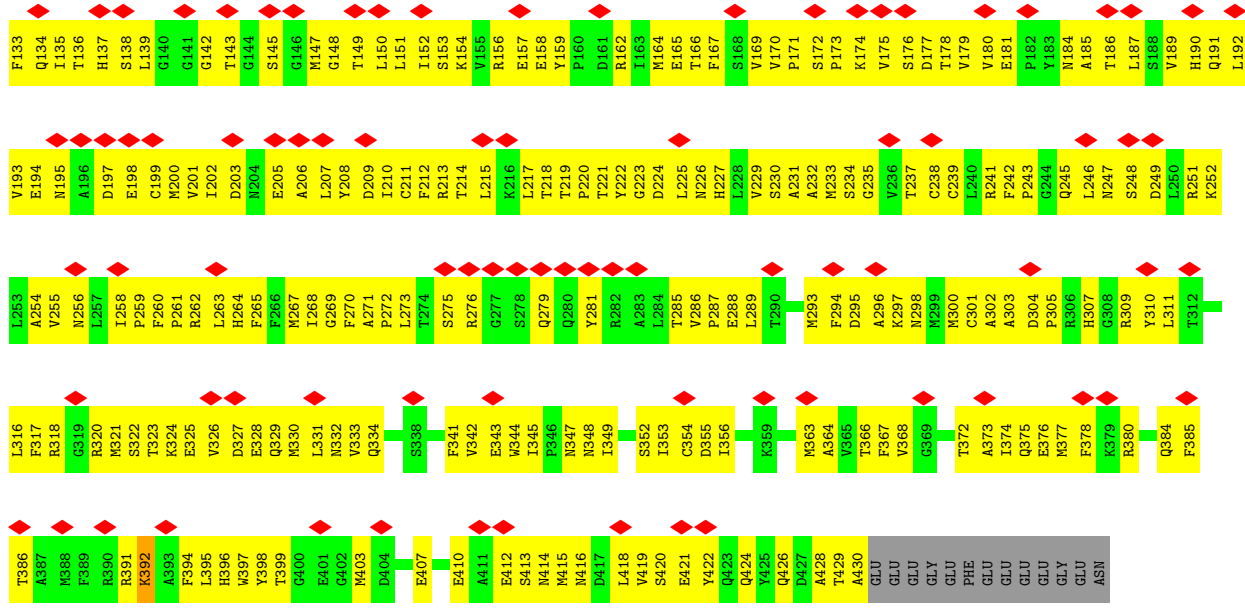

• Molecule 45: Tubulin beta chain

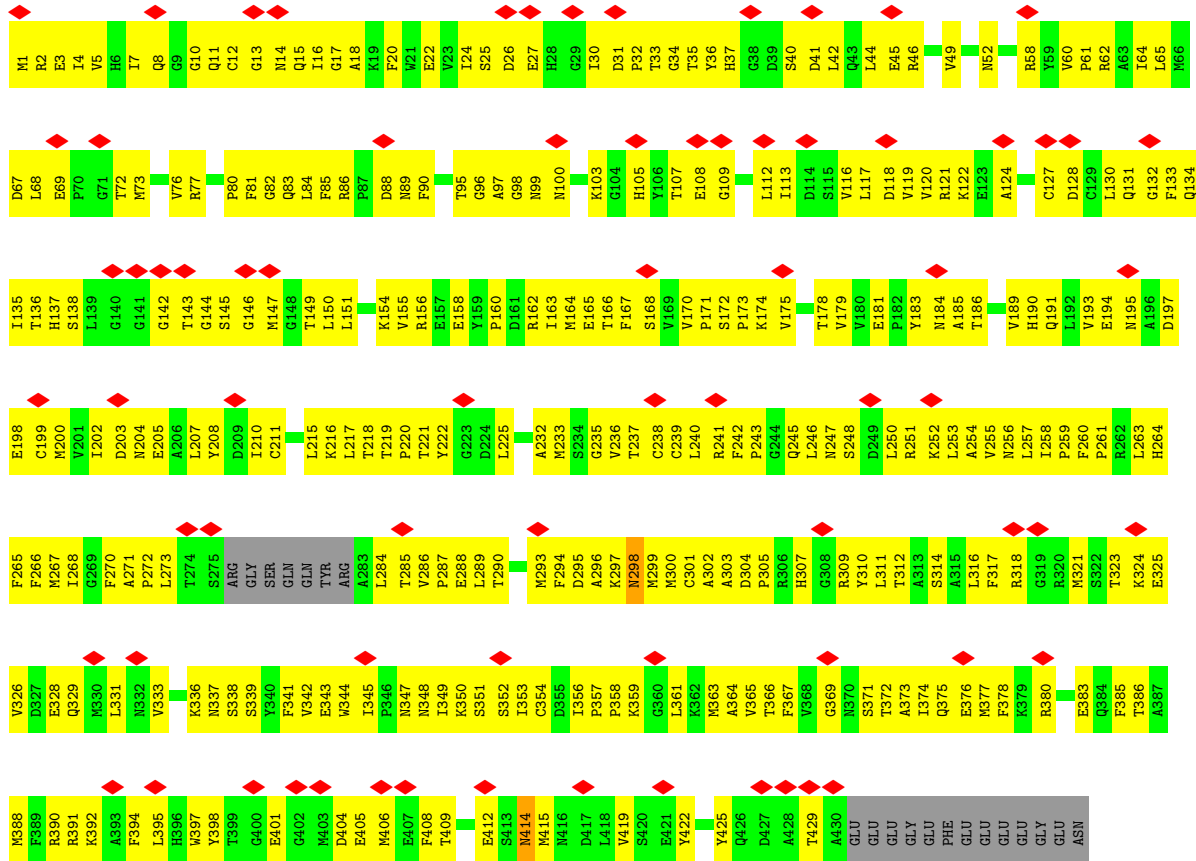

• Molecule 45: Tubulin beta chain

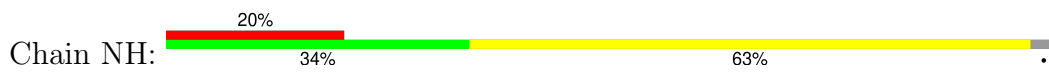

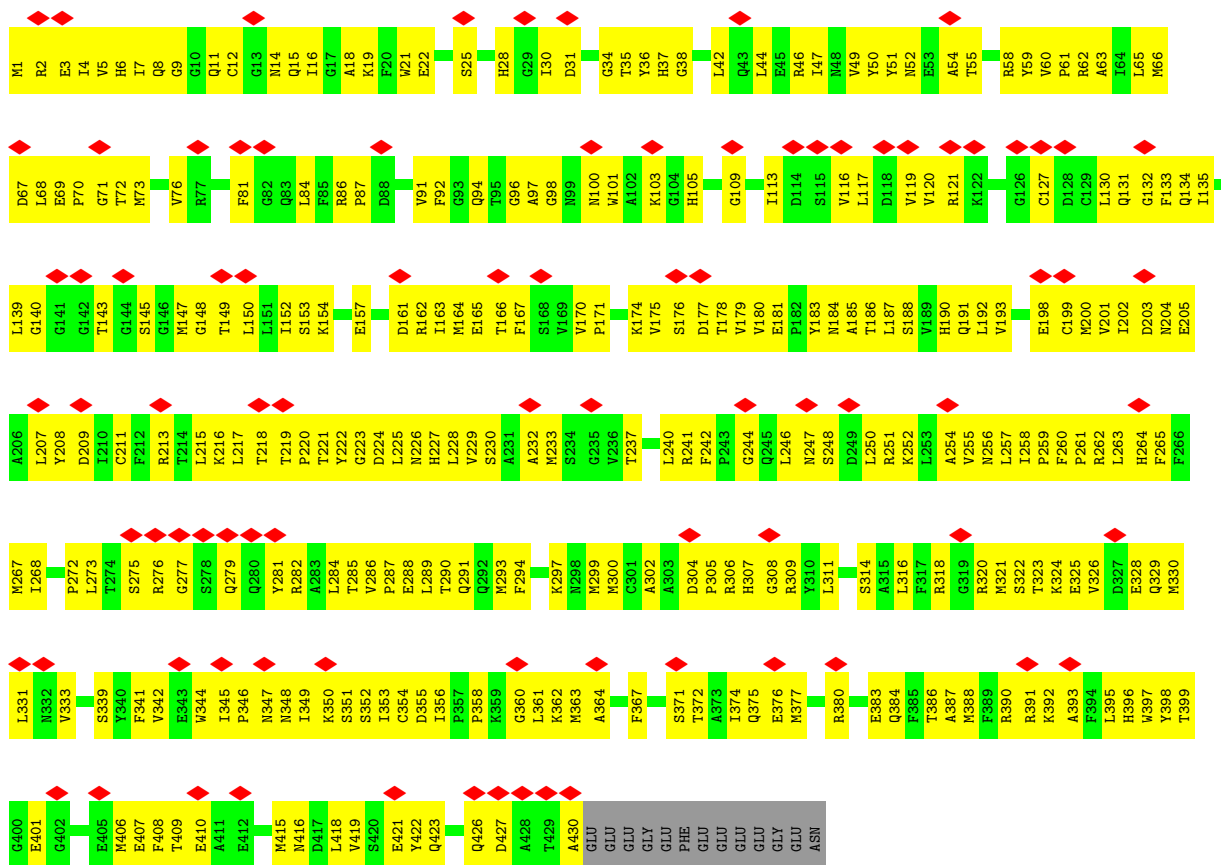

• Molecule 45: Tubulin beta chain

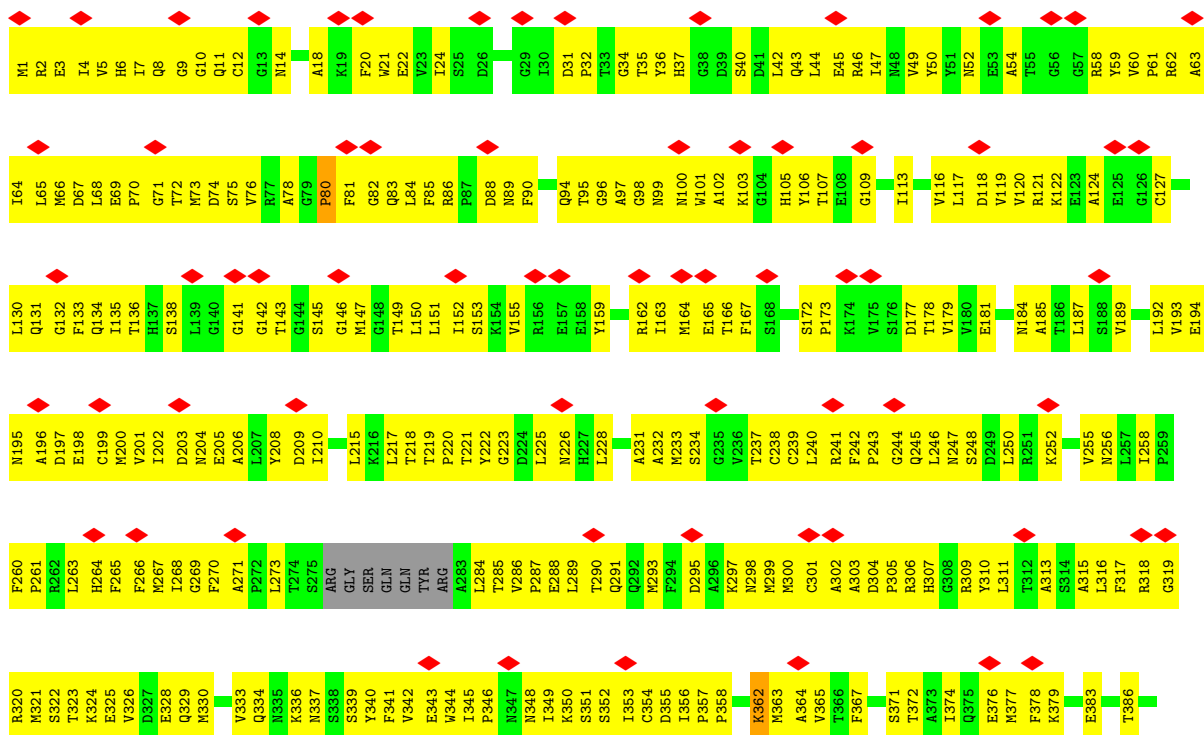

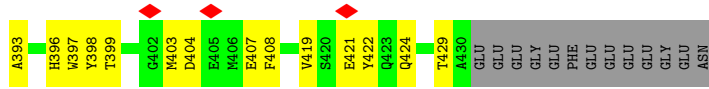

• Molecule 45: Tubulin beta chain

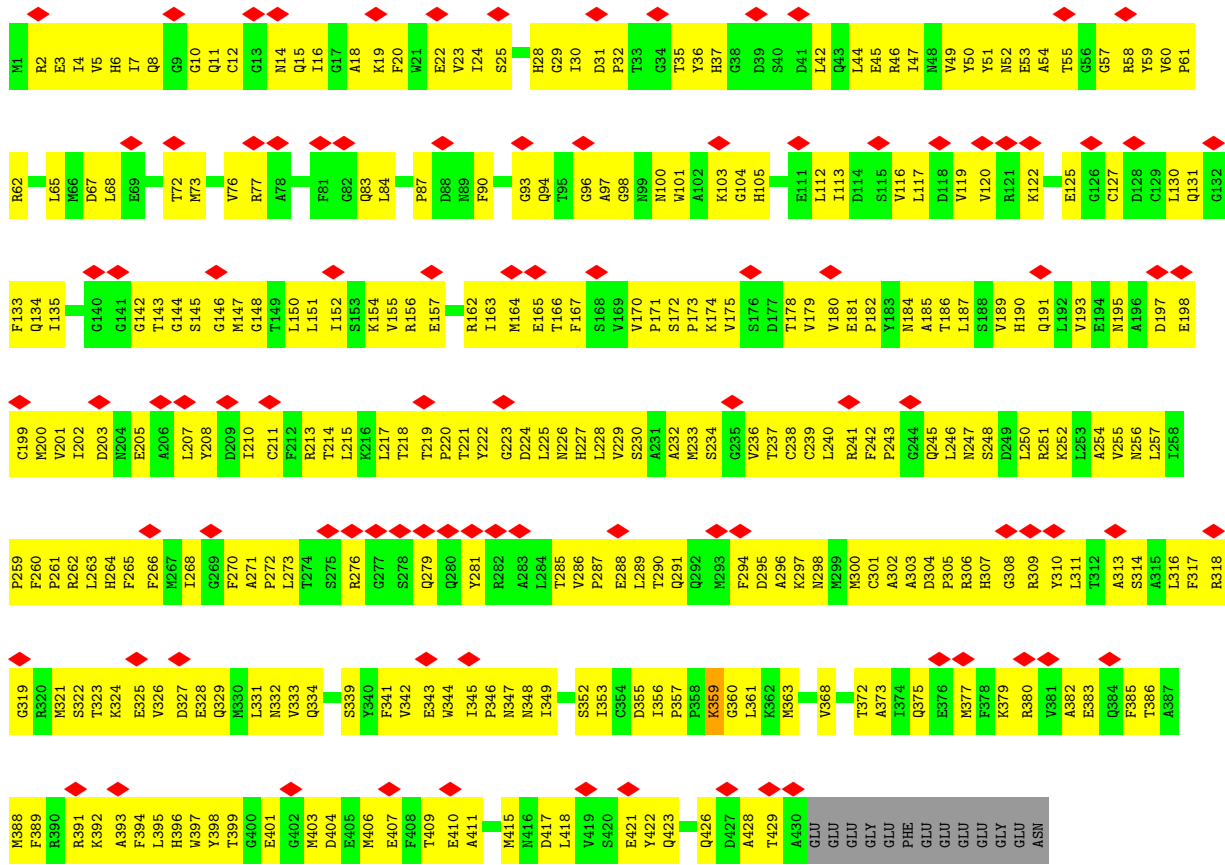

• Molecule 45: Tubulin beta chain

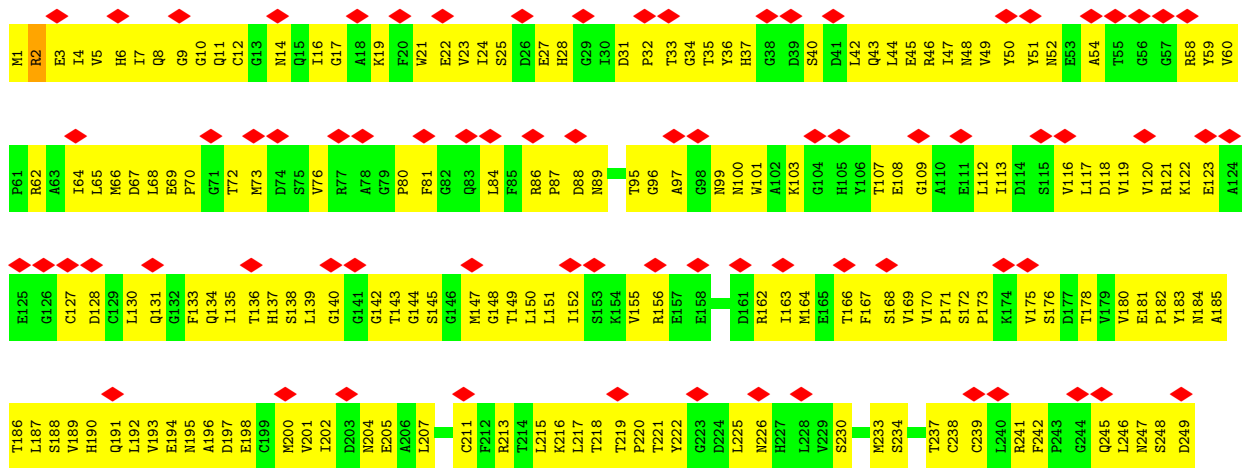

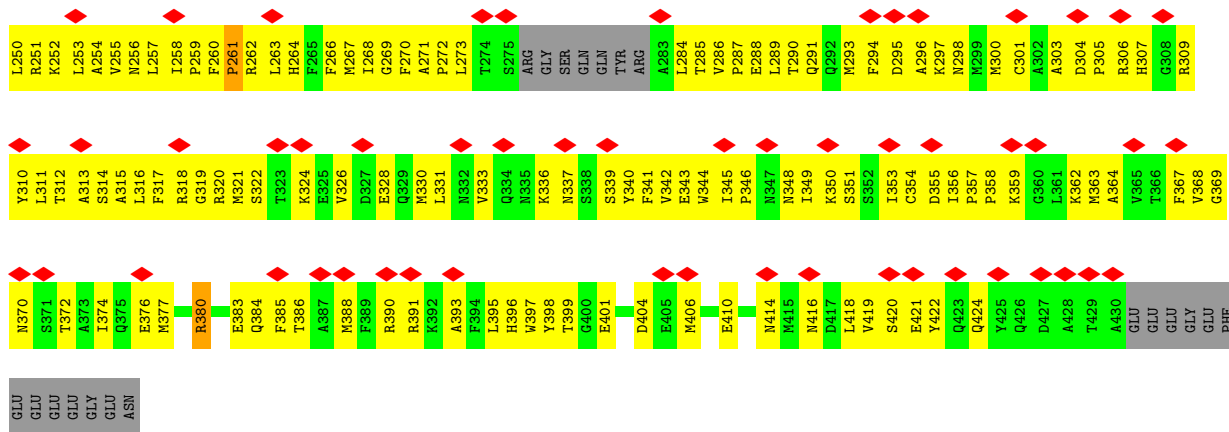

• Molecule 45: Tubulin beta chain

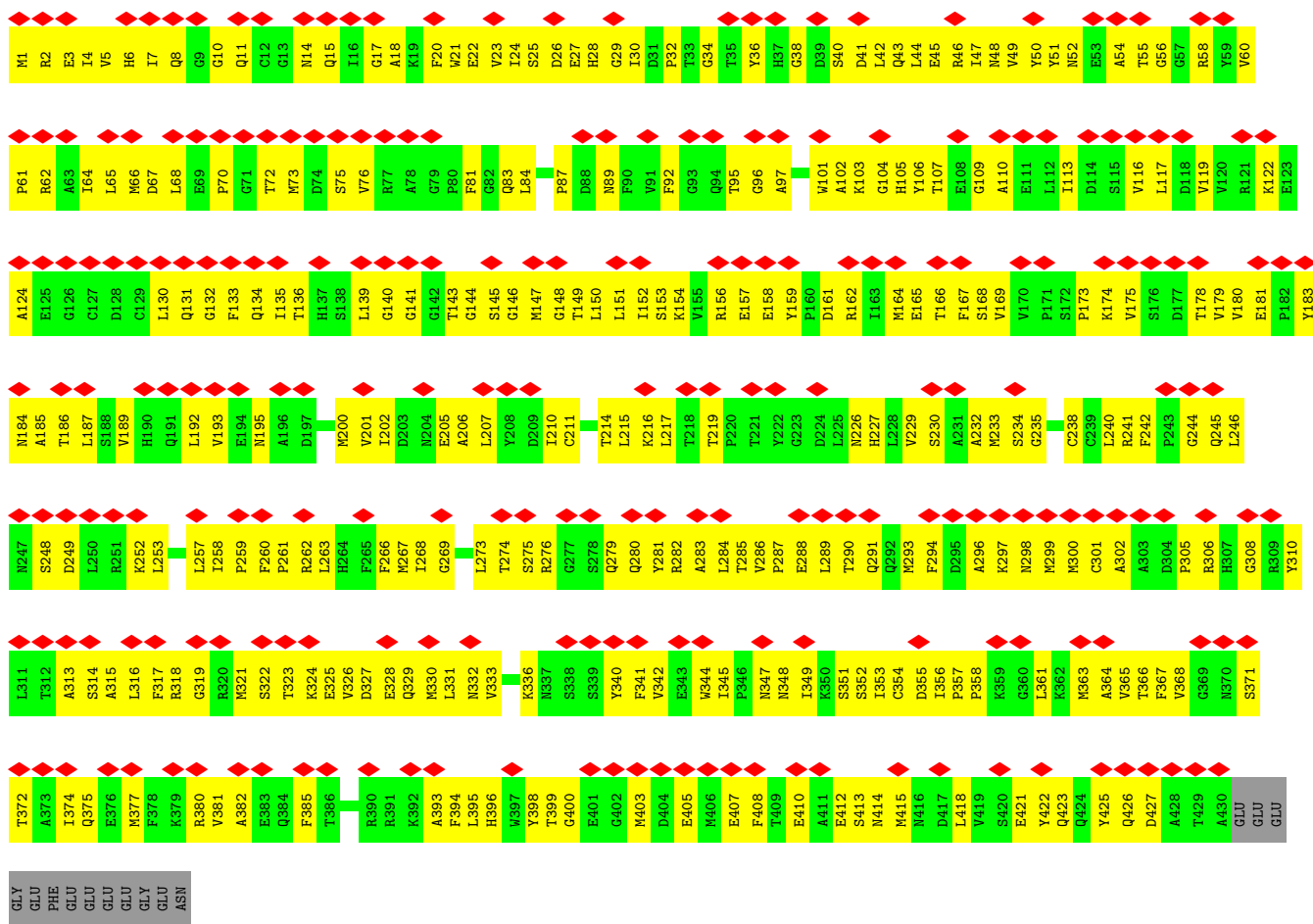

• Molecule 45: Tubulin beta chain



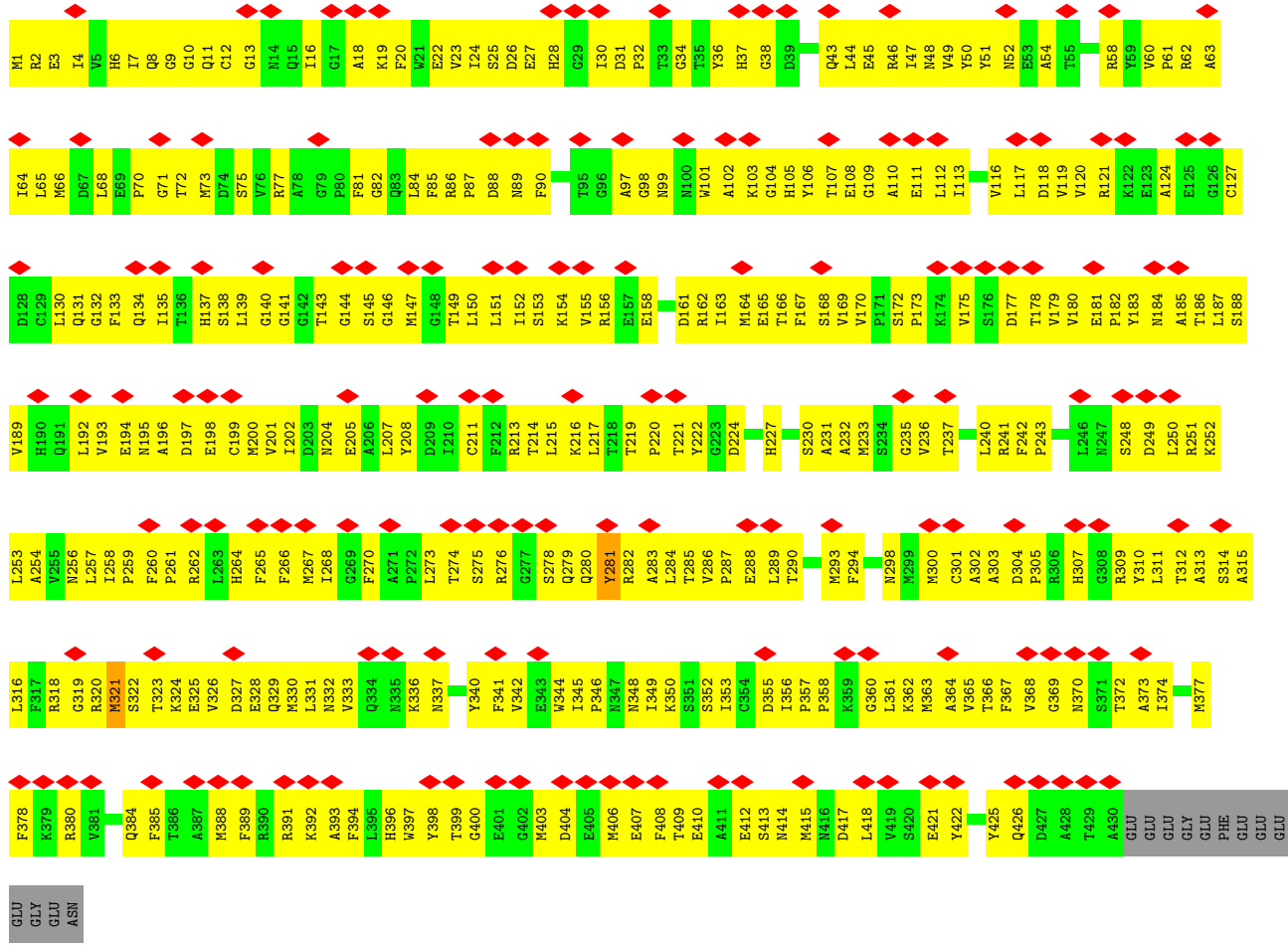

• Molecule 45: Tubulin beta chain

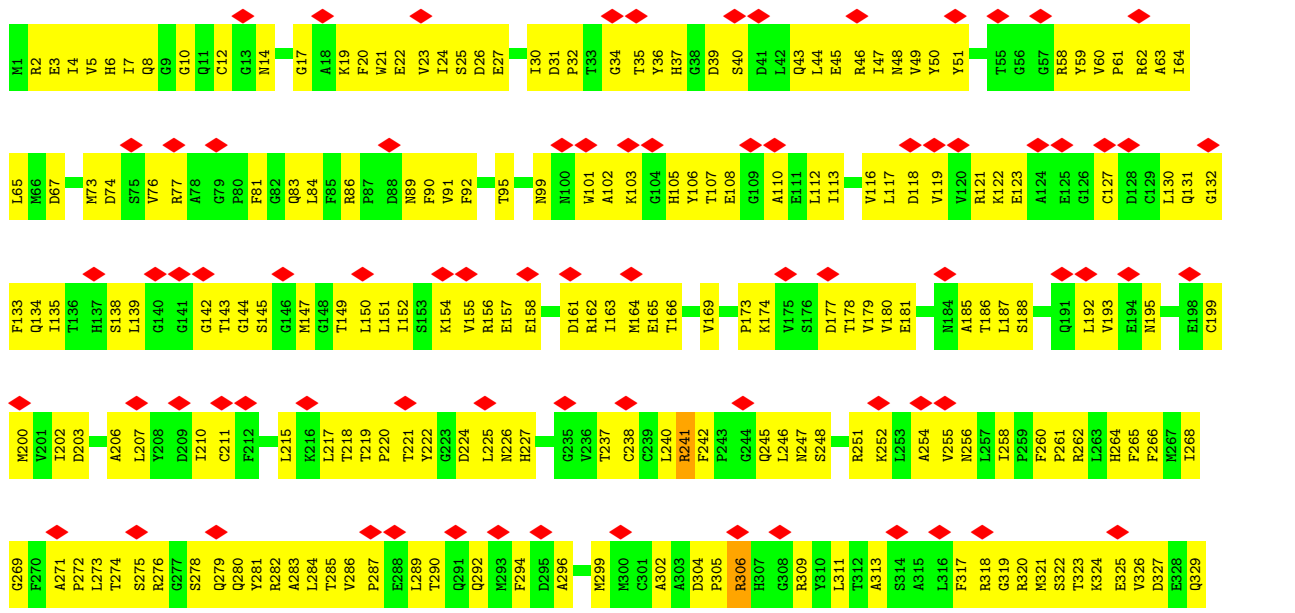



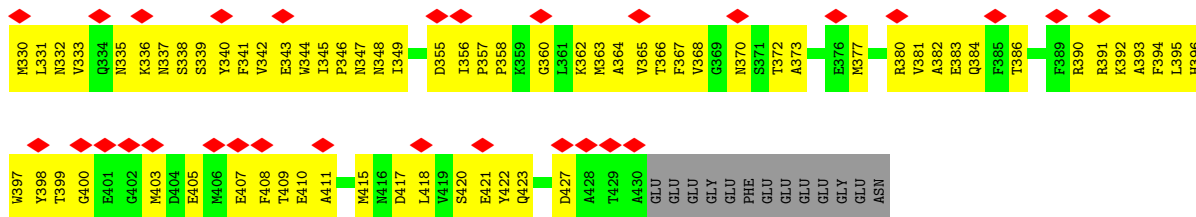

• Molecule 45: Tubulin beta chain

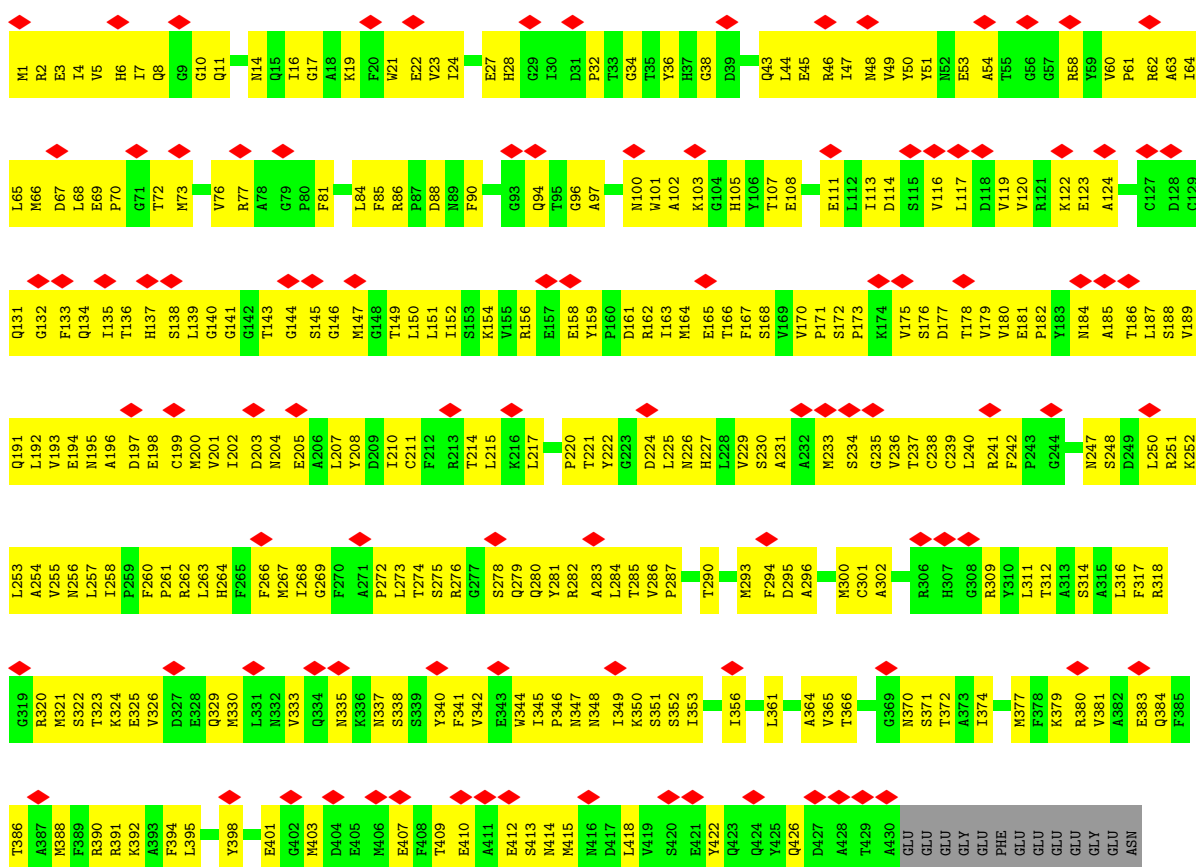

• Molecule 45: Tubulin beta chain

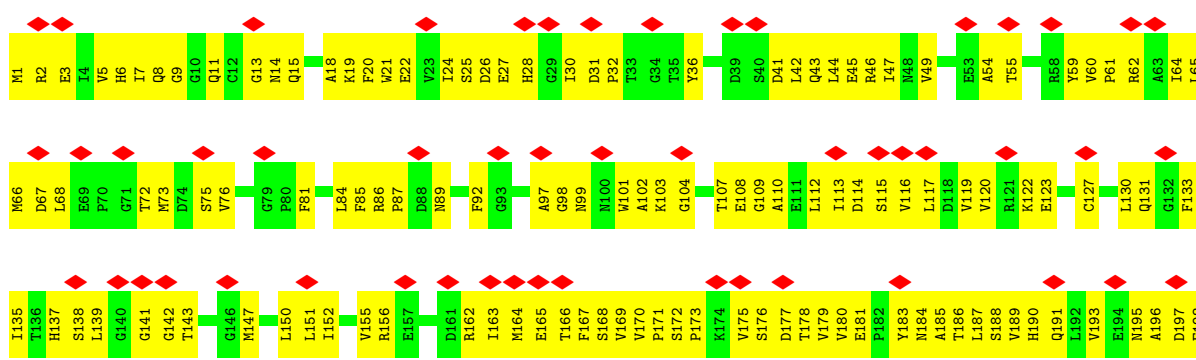

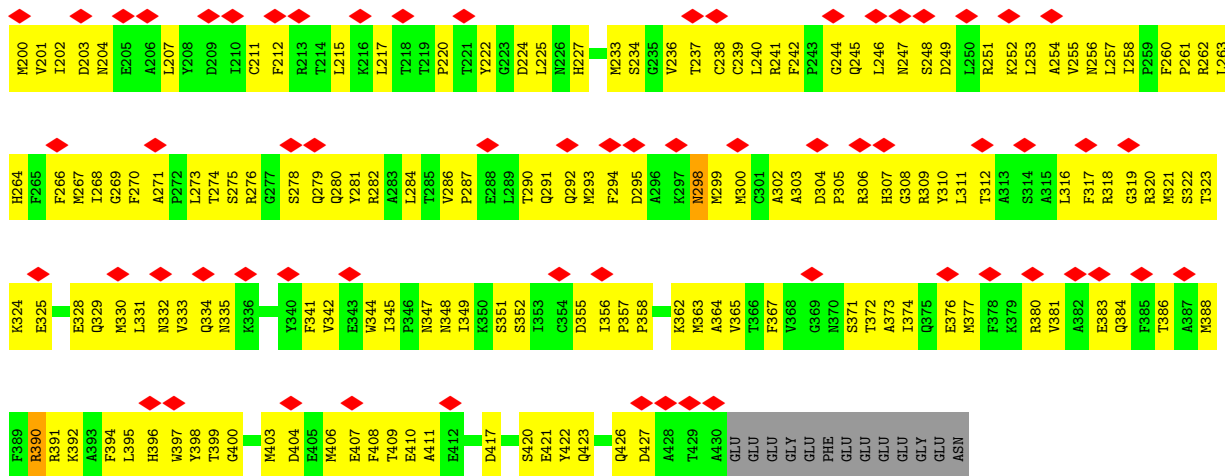

• Molecule 45: Tubulin beta chain

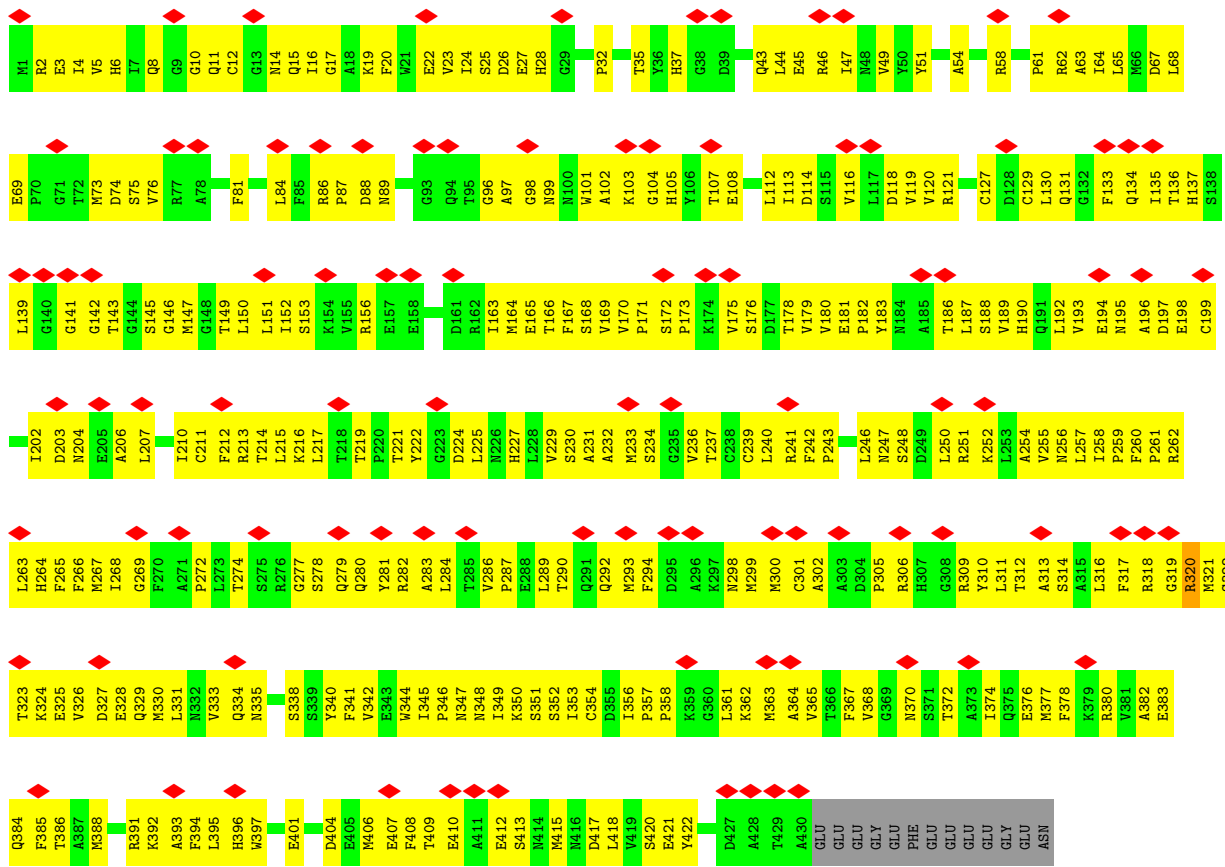

• Molecule 45: Tubulin beta chain

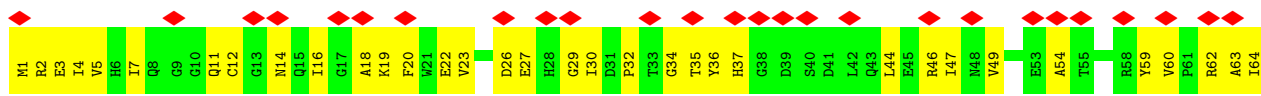

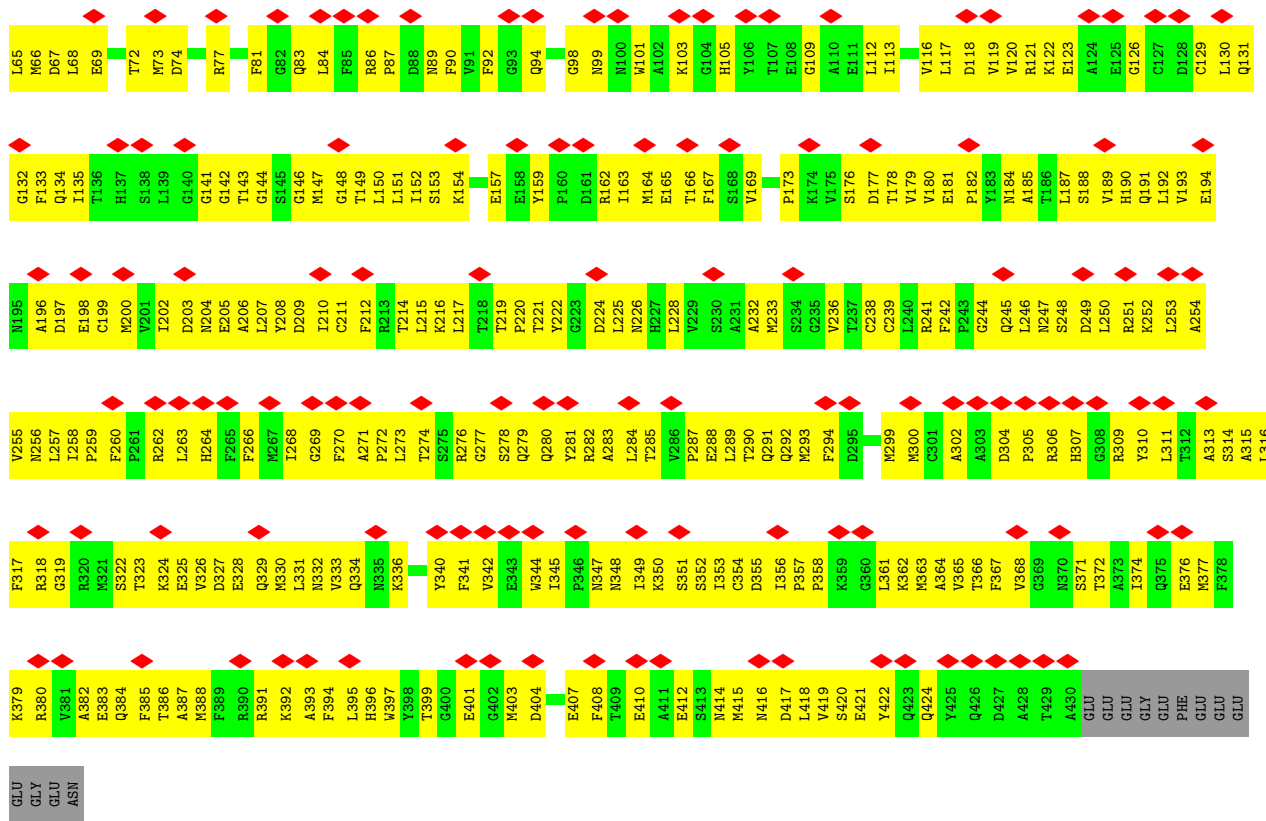

• Molecule 45: Tubulin beta chain

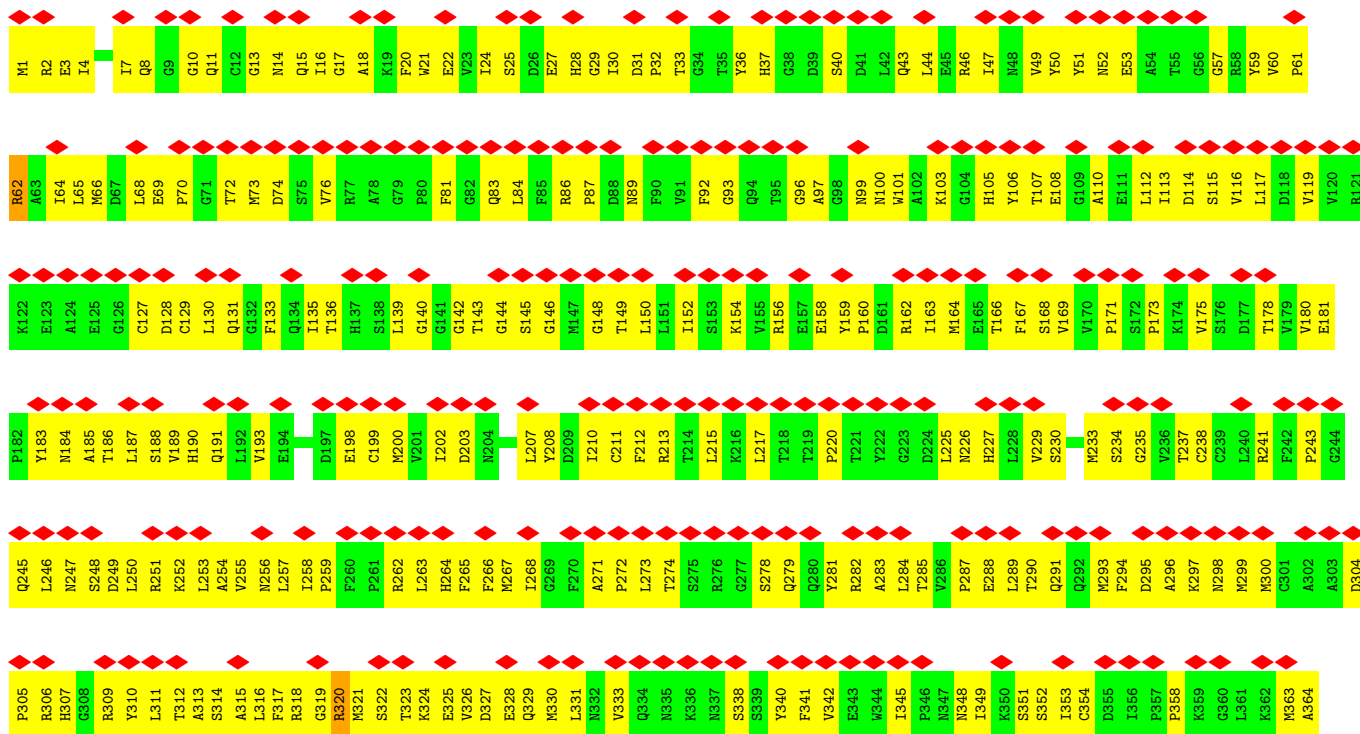



• Molecule 45: Tubulin beta chain

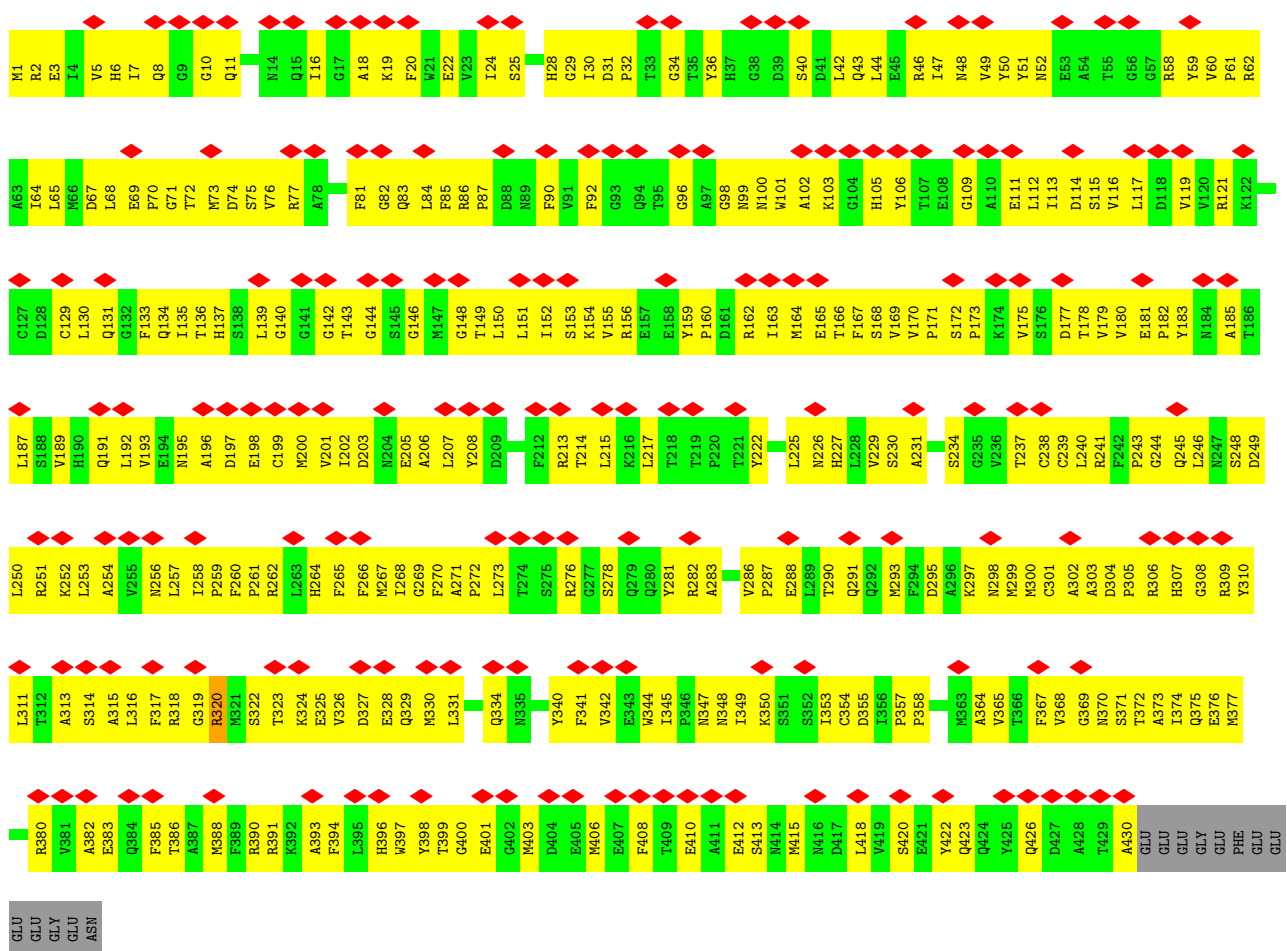

• Molecule 45: Tubulin beta chain

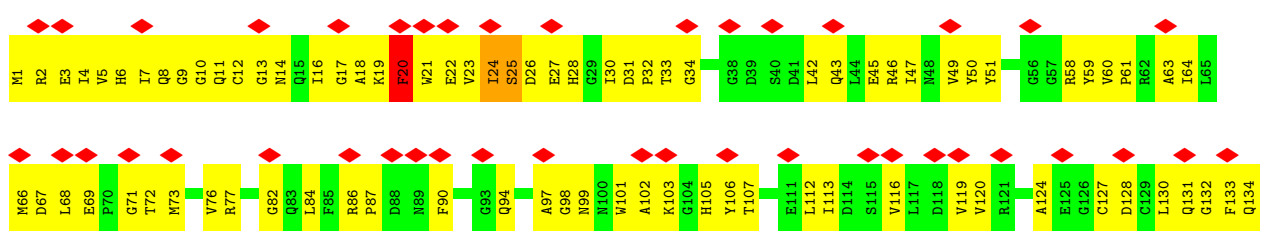

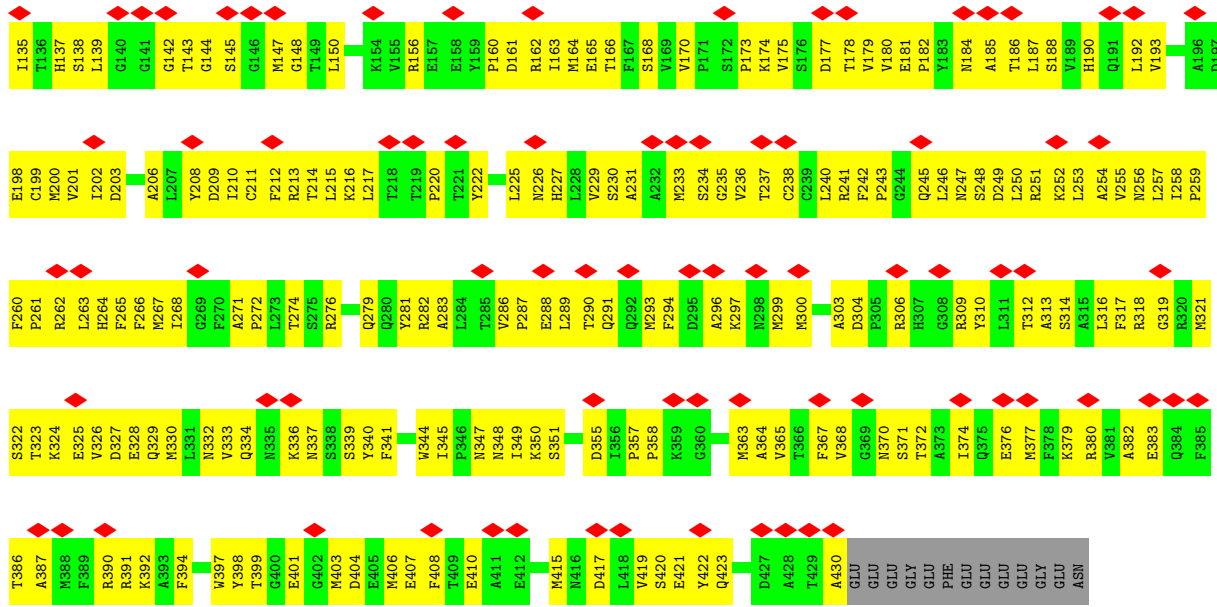

• Molecule 45: Tubulin beta chain

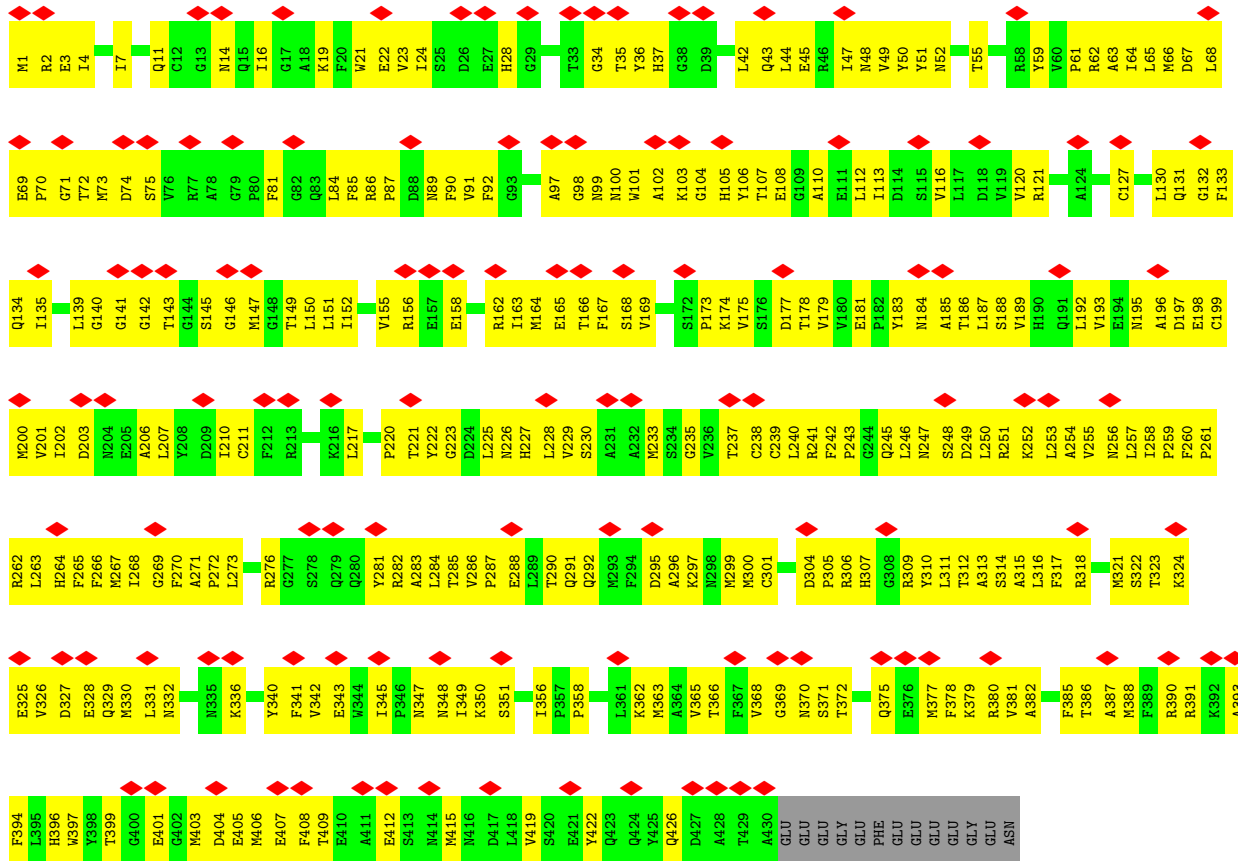

• Molecule 45: Tubulin beta chain



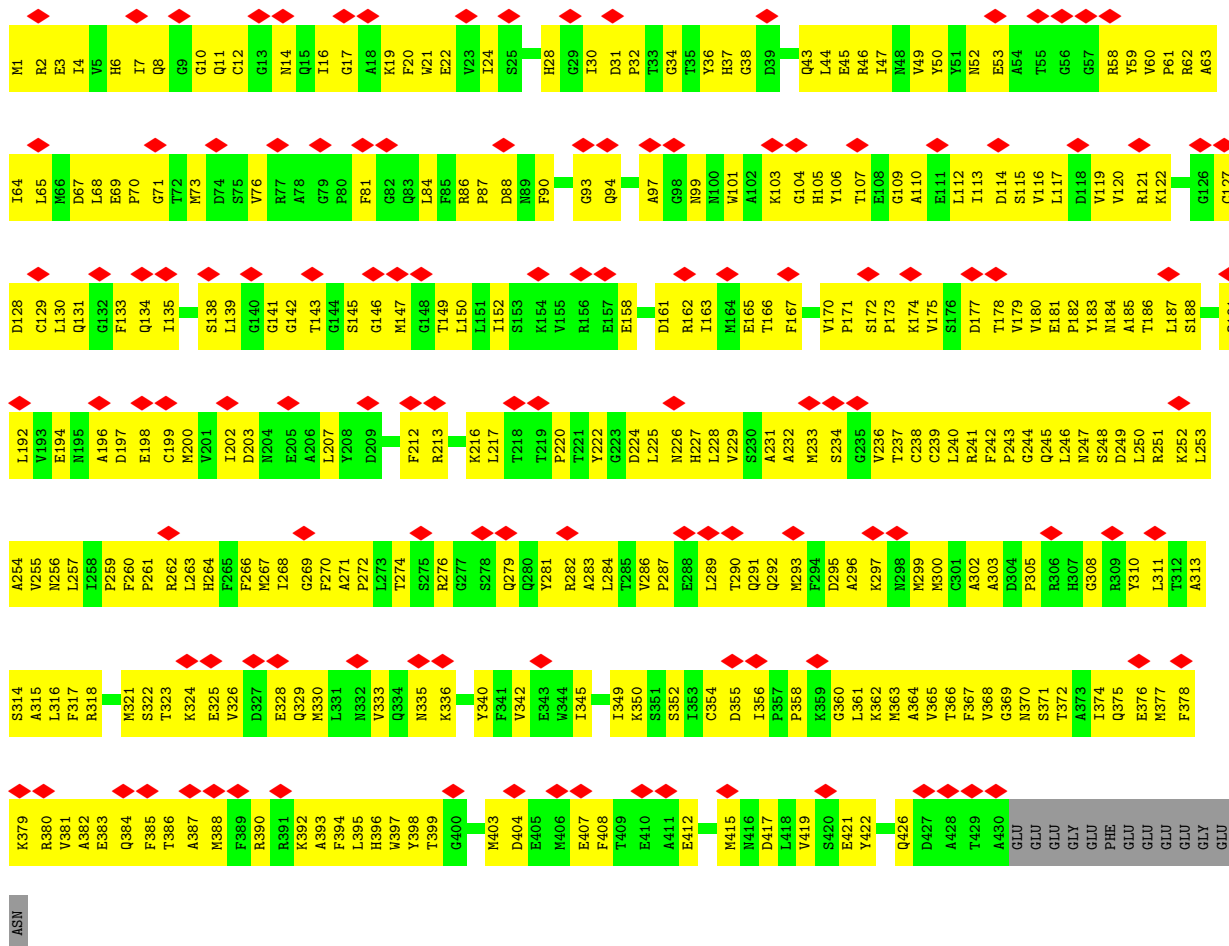

• Molecule 45: Tubulin beta chain

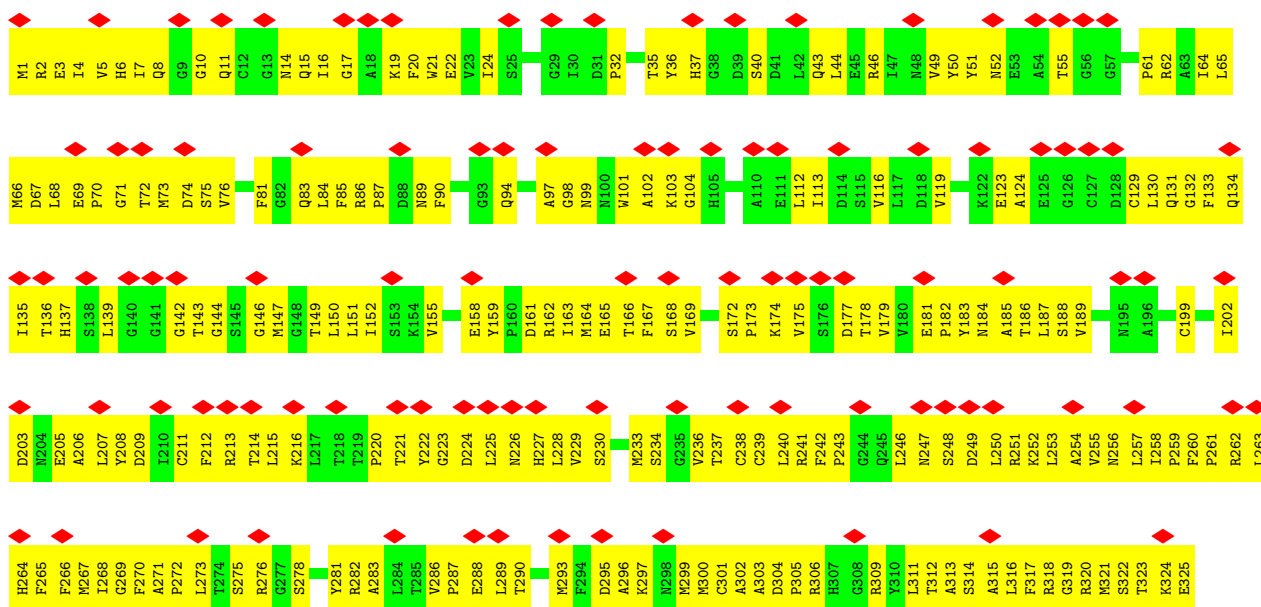

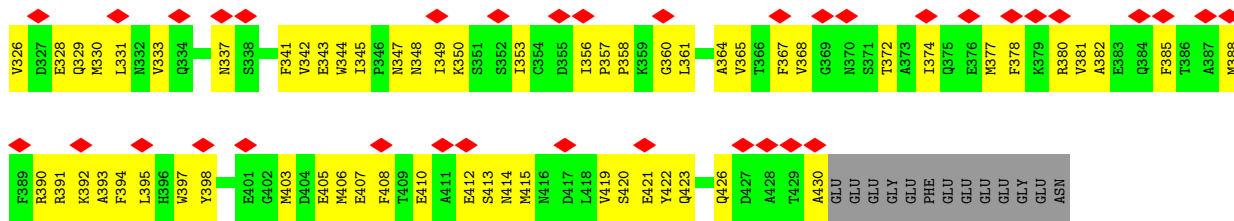

• Molecule 45: Tubulin beta chain

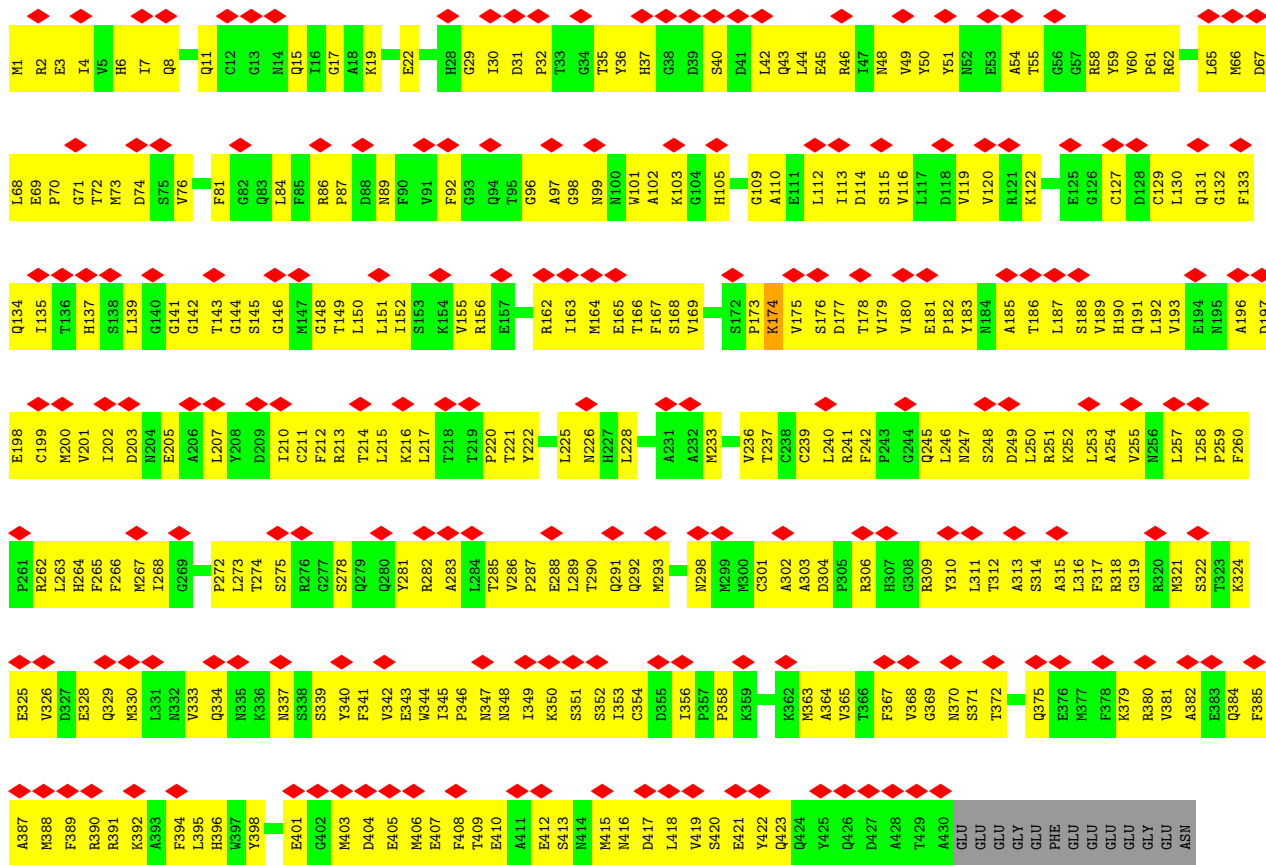

• Molecule 45: Tubulin beta chain

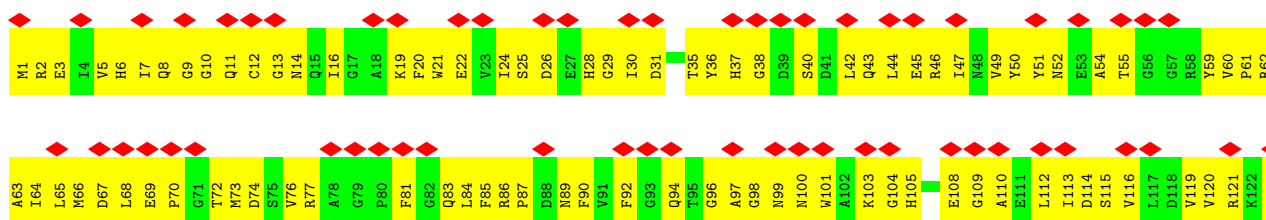

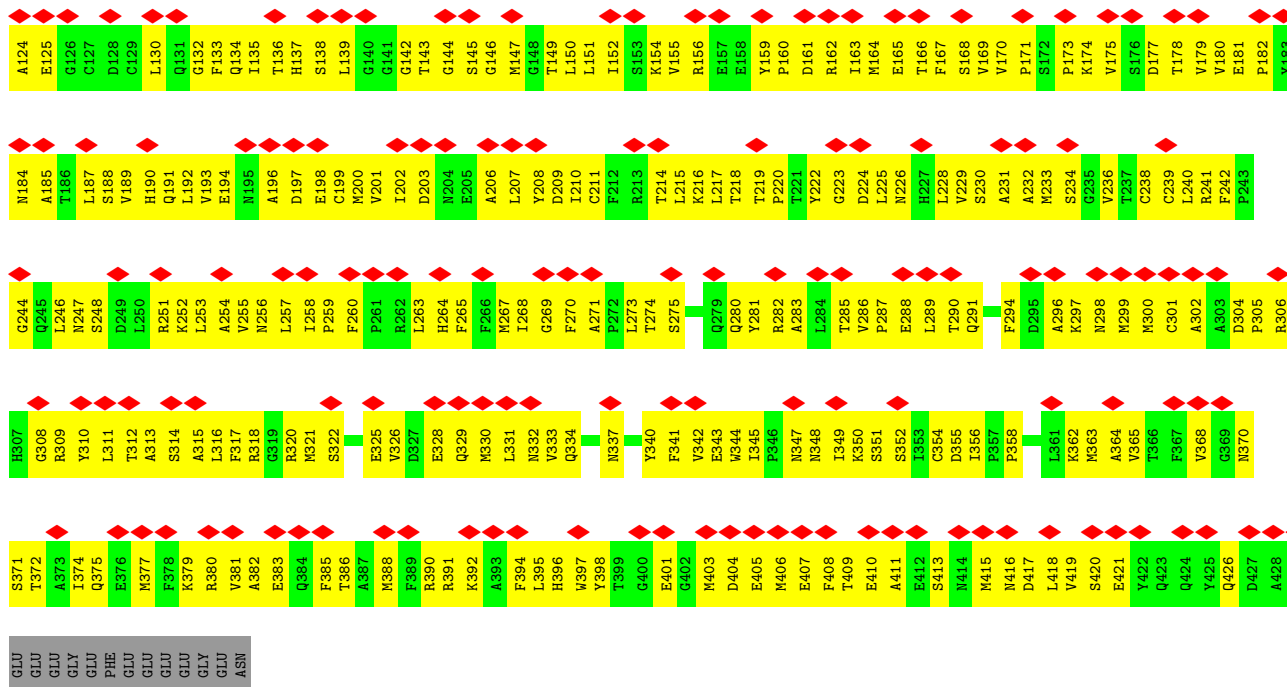

• Molecule 45: Tubulin beta chain

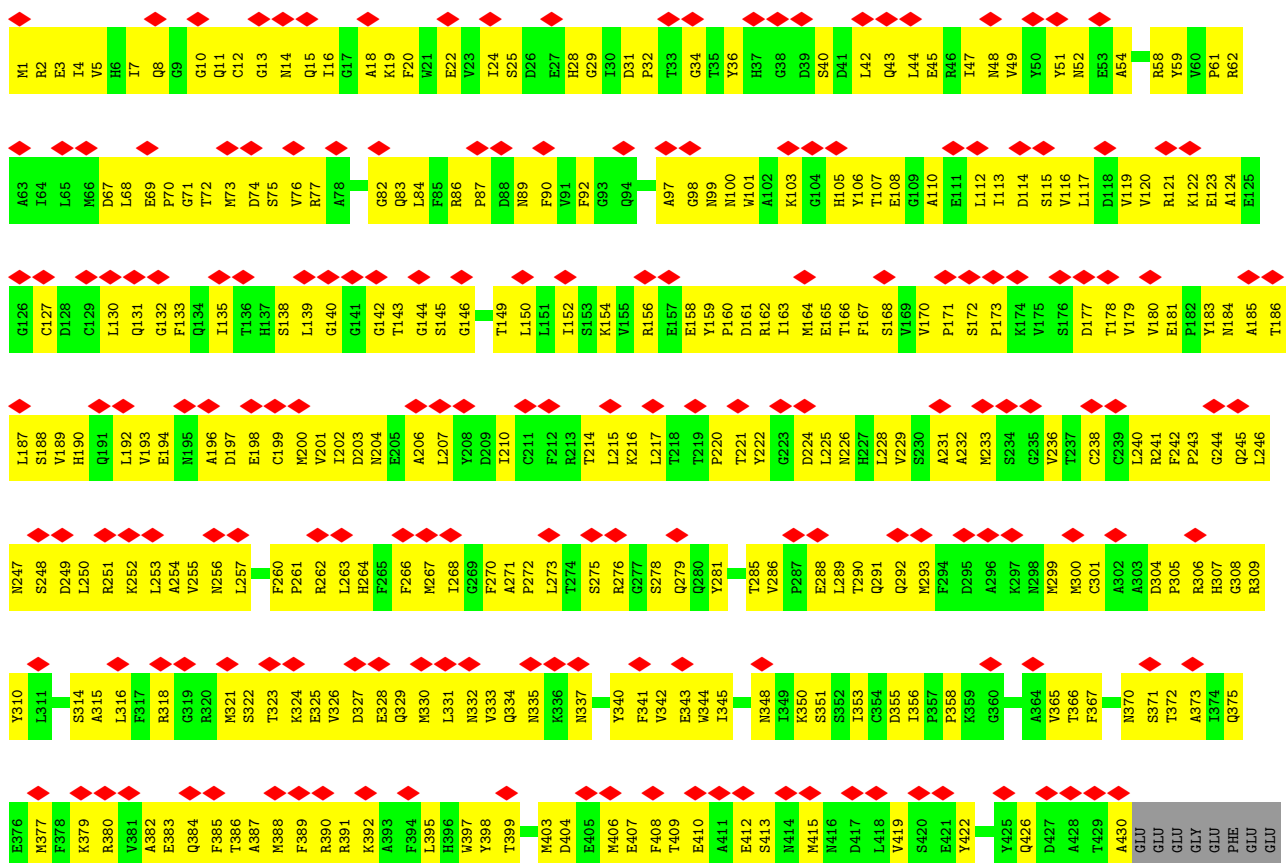



GLU  
GLU  
GLY  
GLY  
ASN

• Molecule 45: Tubulin beta chain

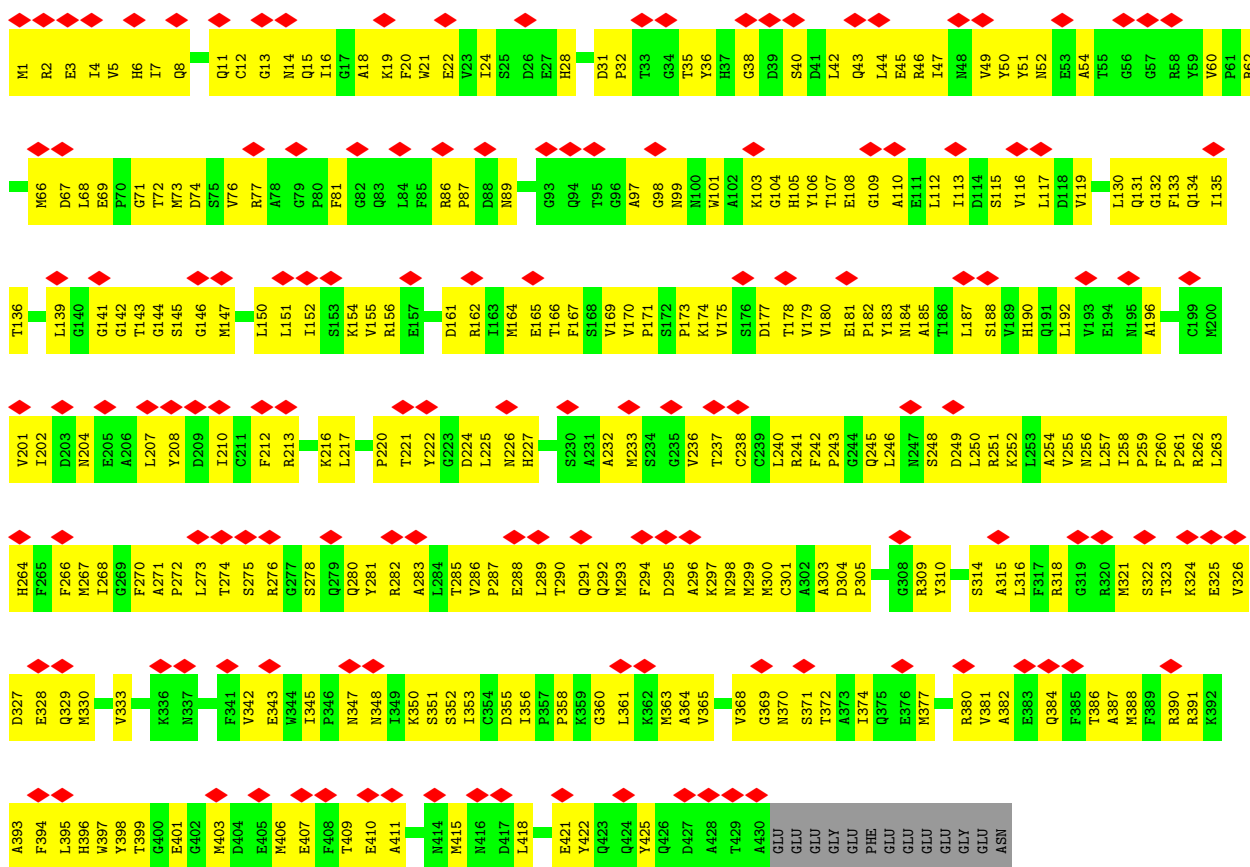

• Molecule 45: Tubulin beta chain

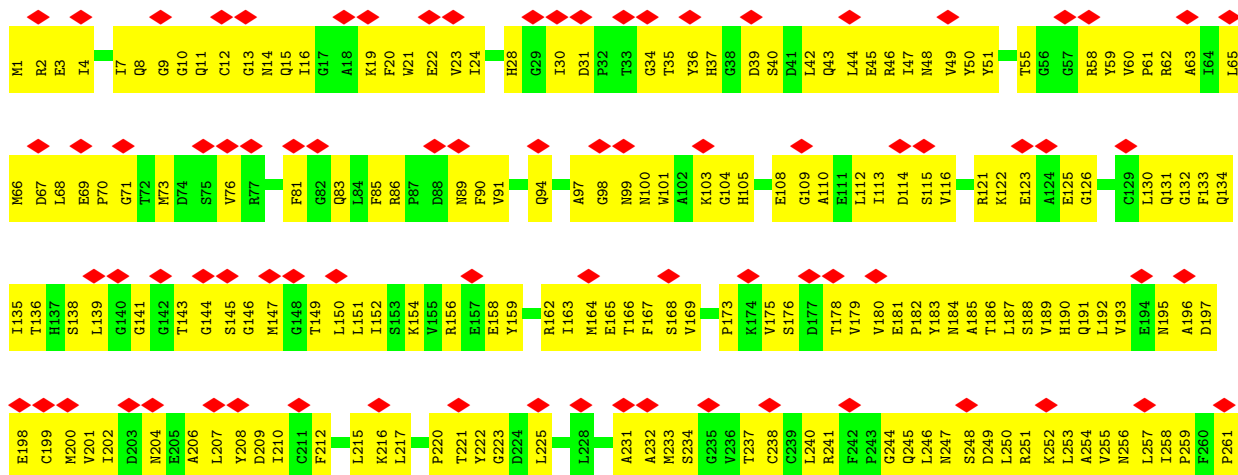

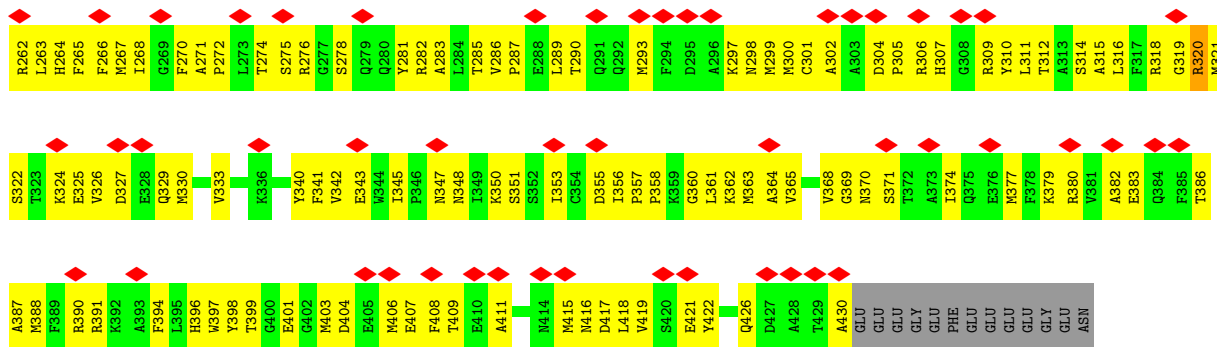

• Molecule 45: Tubulin beta chain

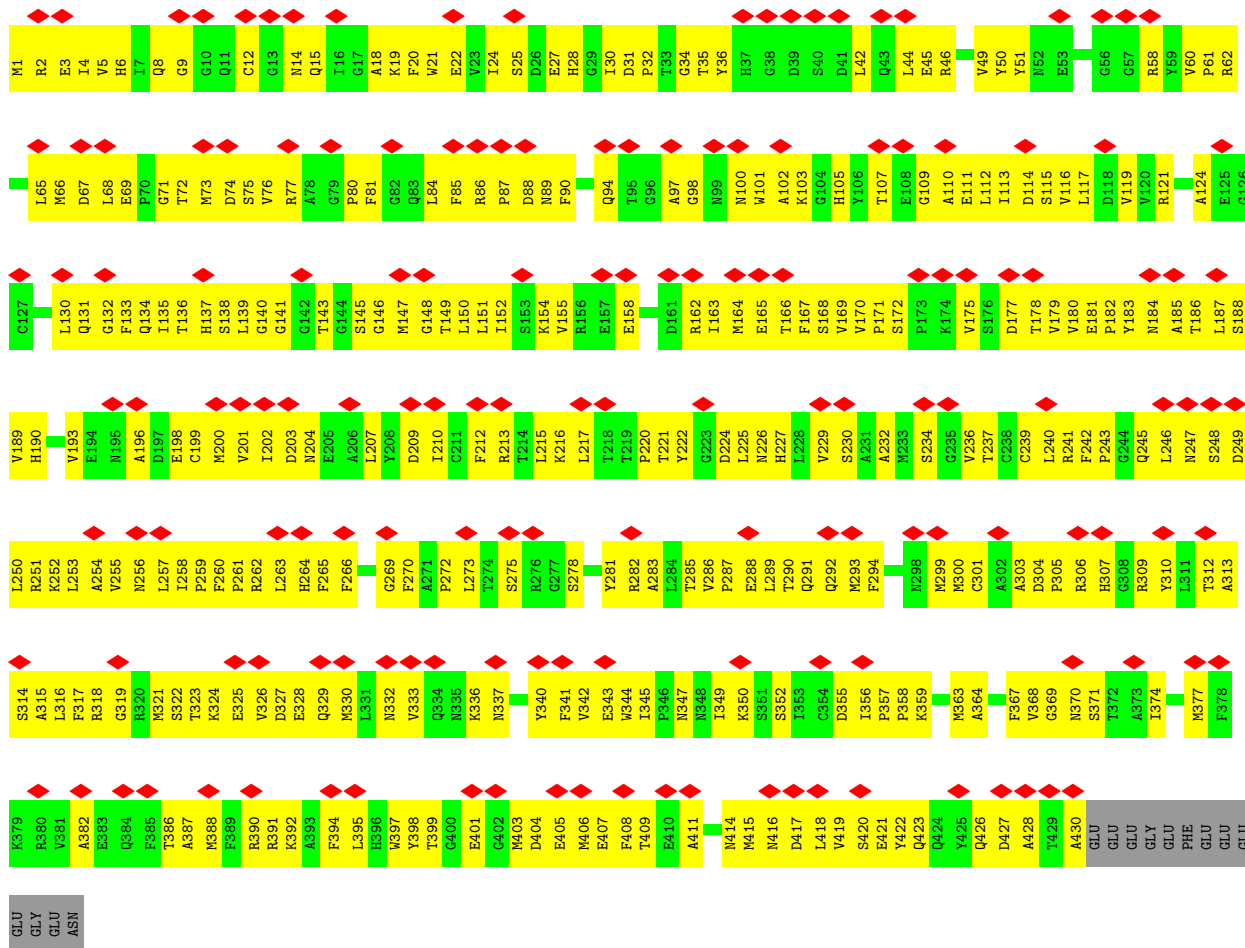

• Molecule 45: Tubulin beta chain



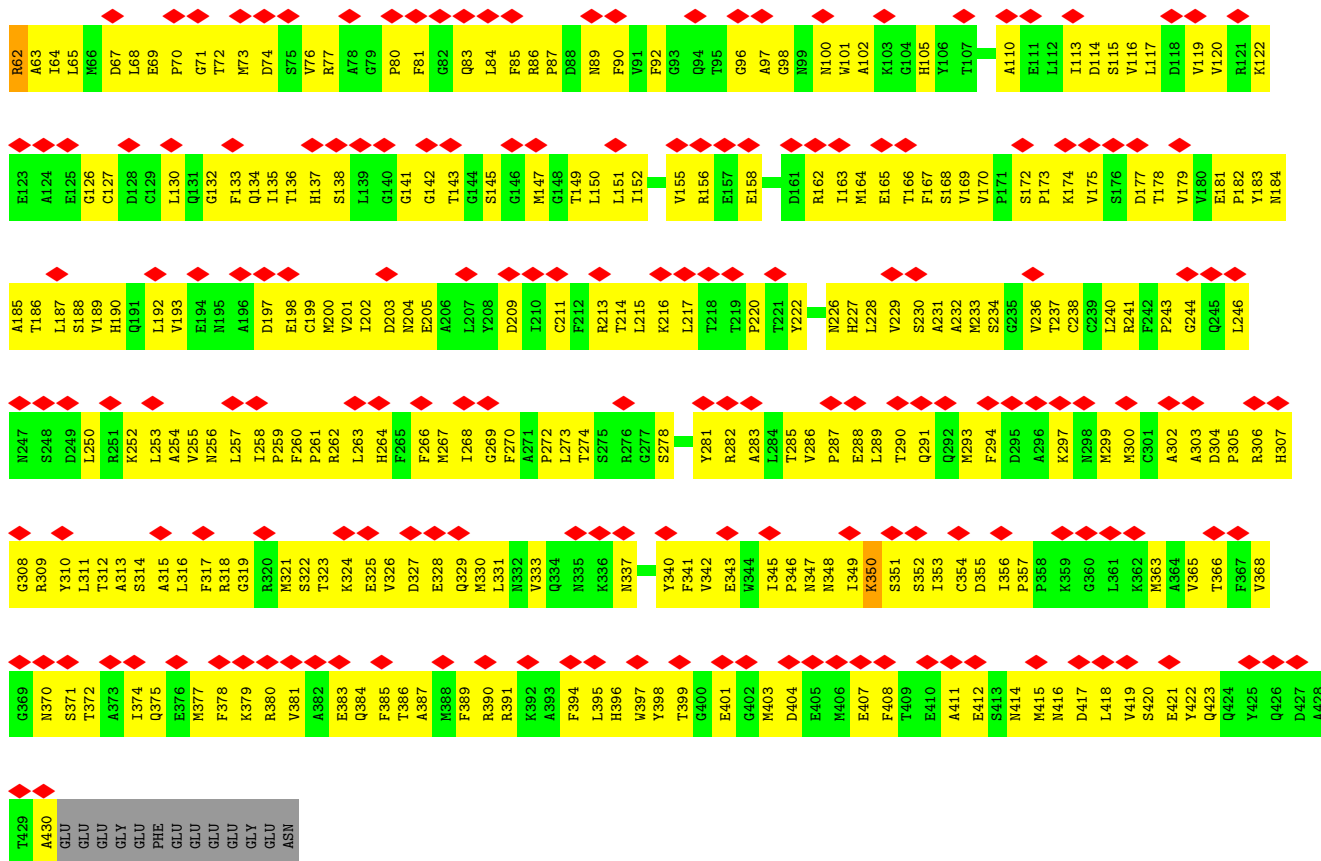

• Molecule 45: Tubulin beta chain

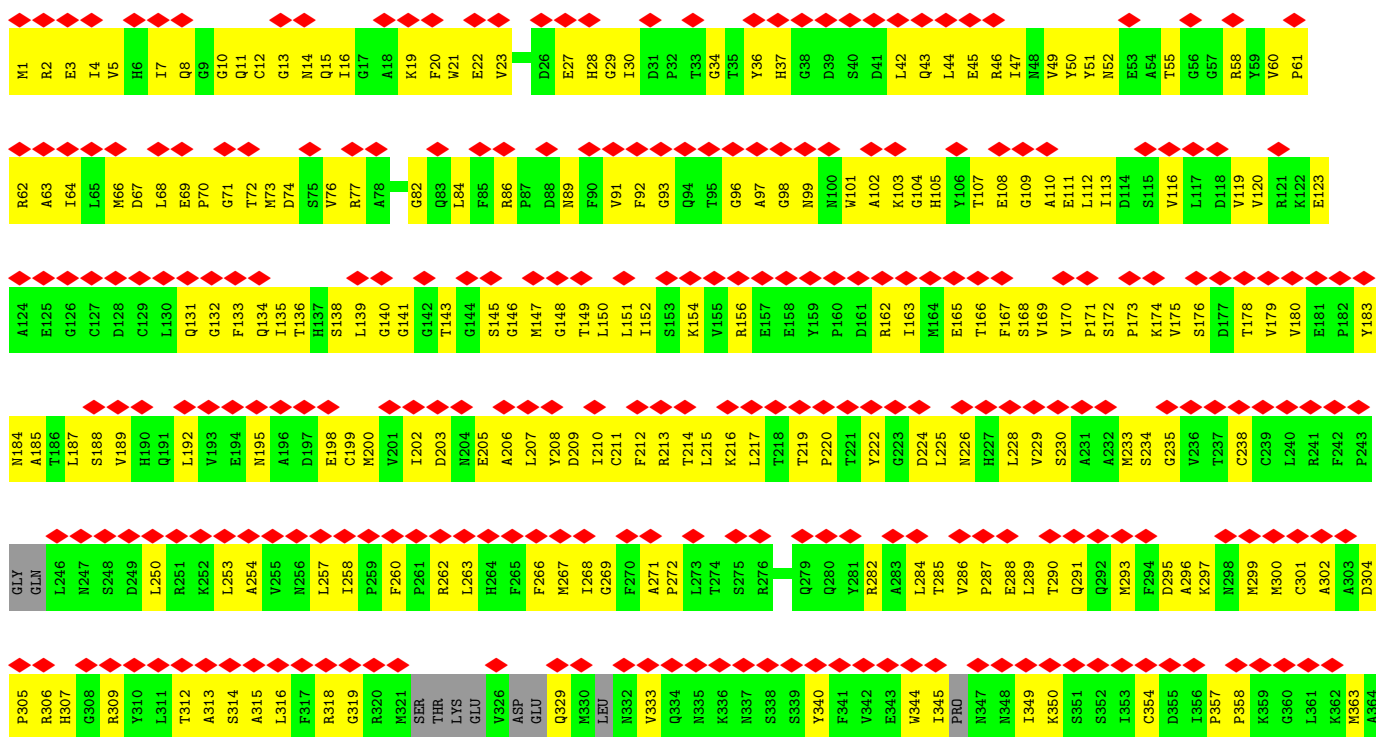

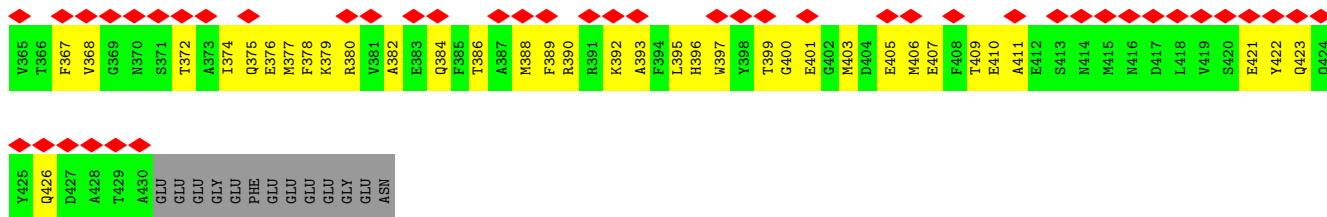

• Molecule 45: Tubulin beta chain

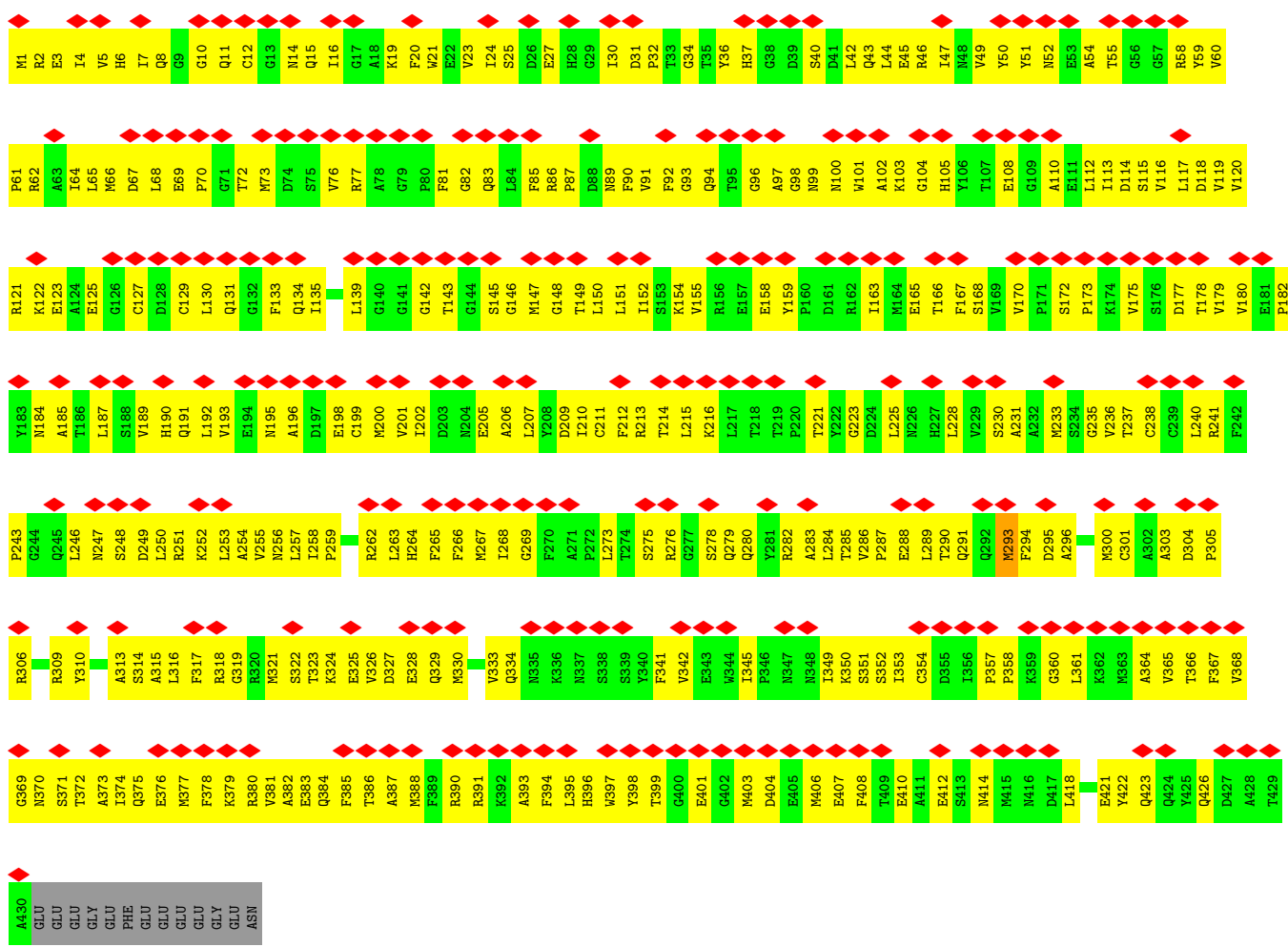

• Molecule 45: Tubulin beta chain

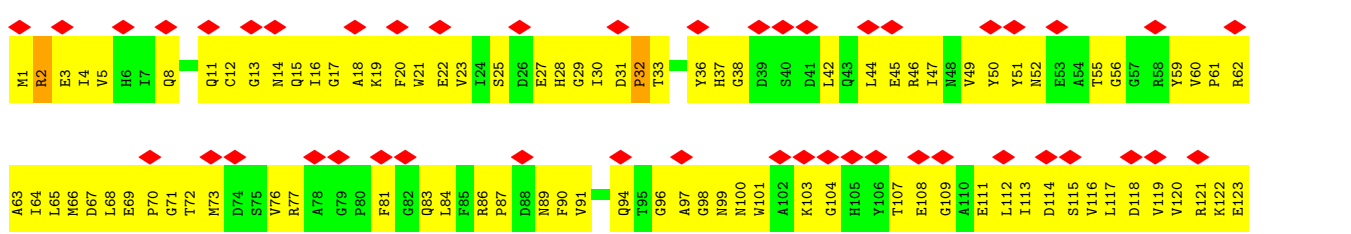

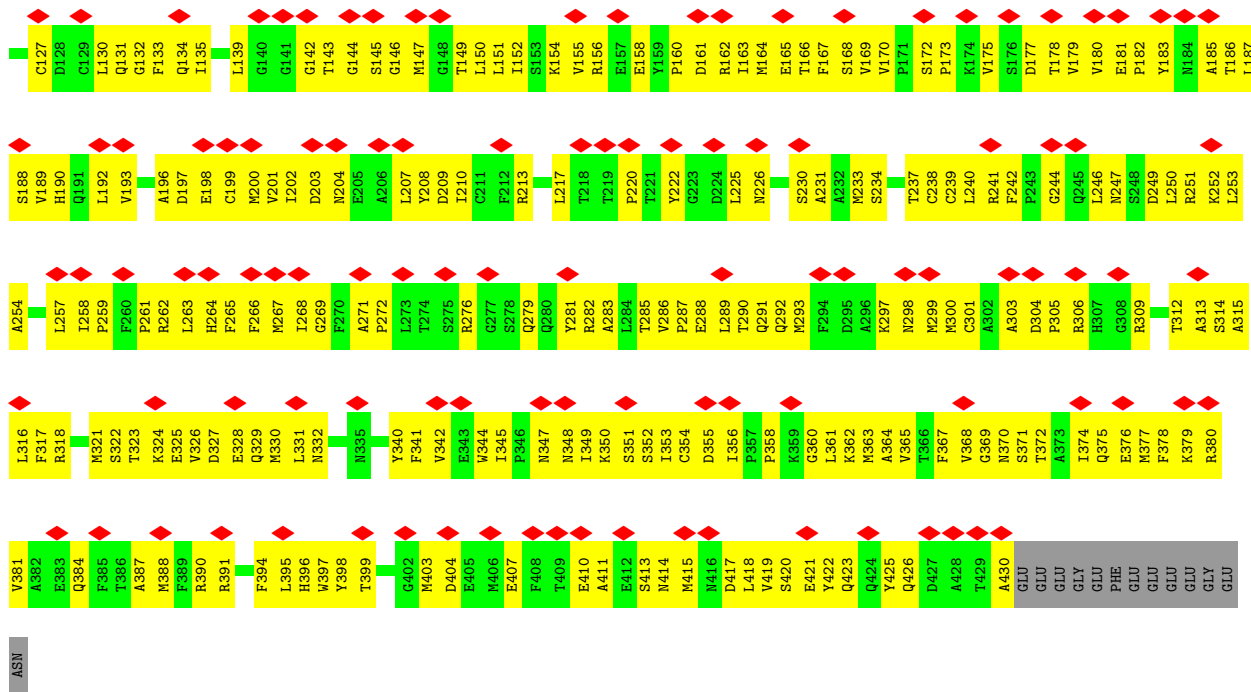

• Molecule 45: Tubulin beta chain

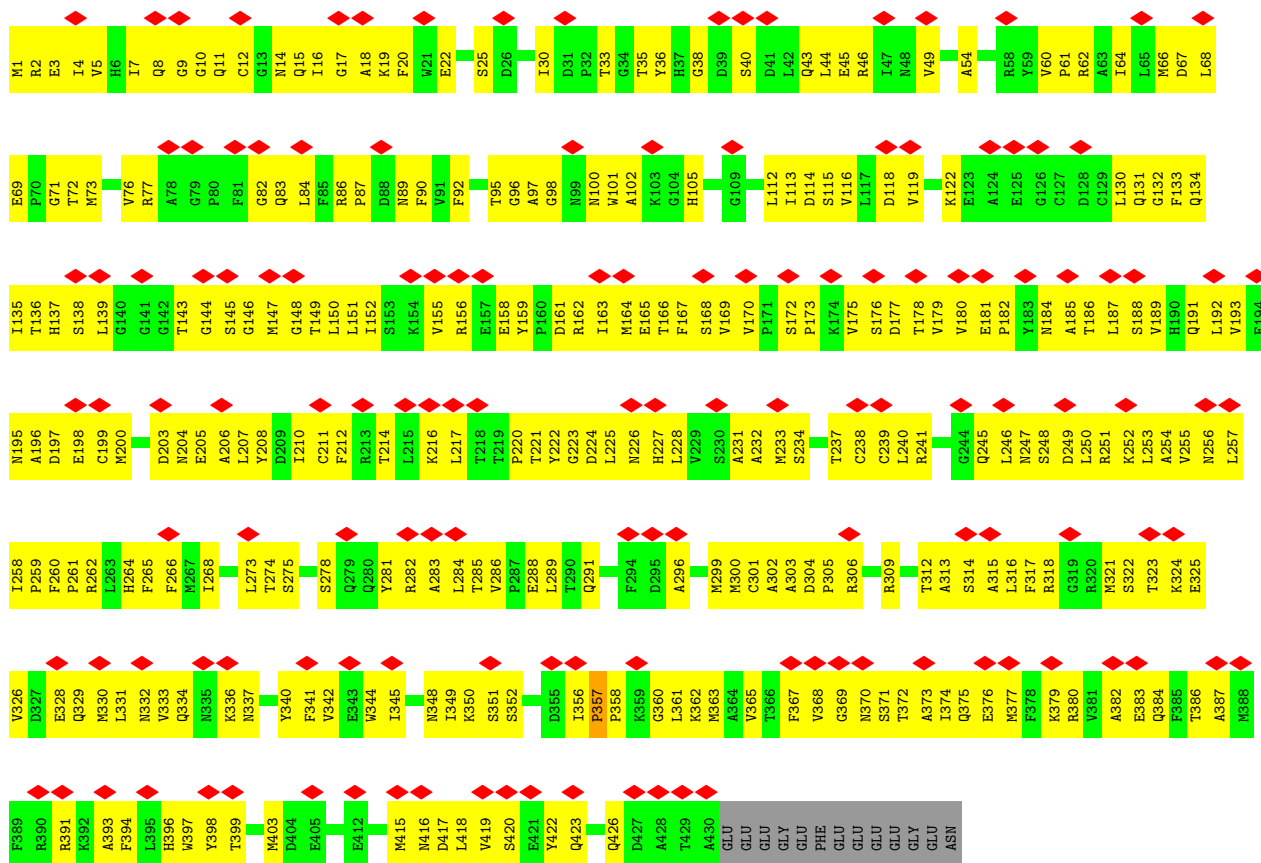

• Molecule 45: Tubulin beta chain

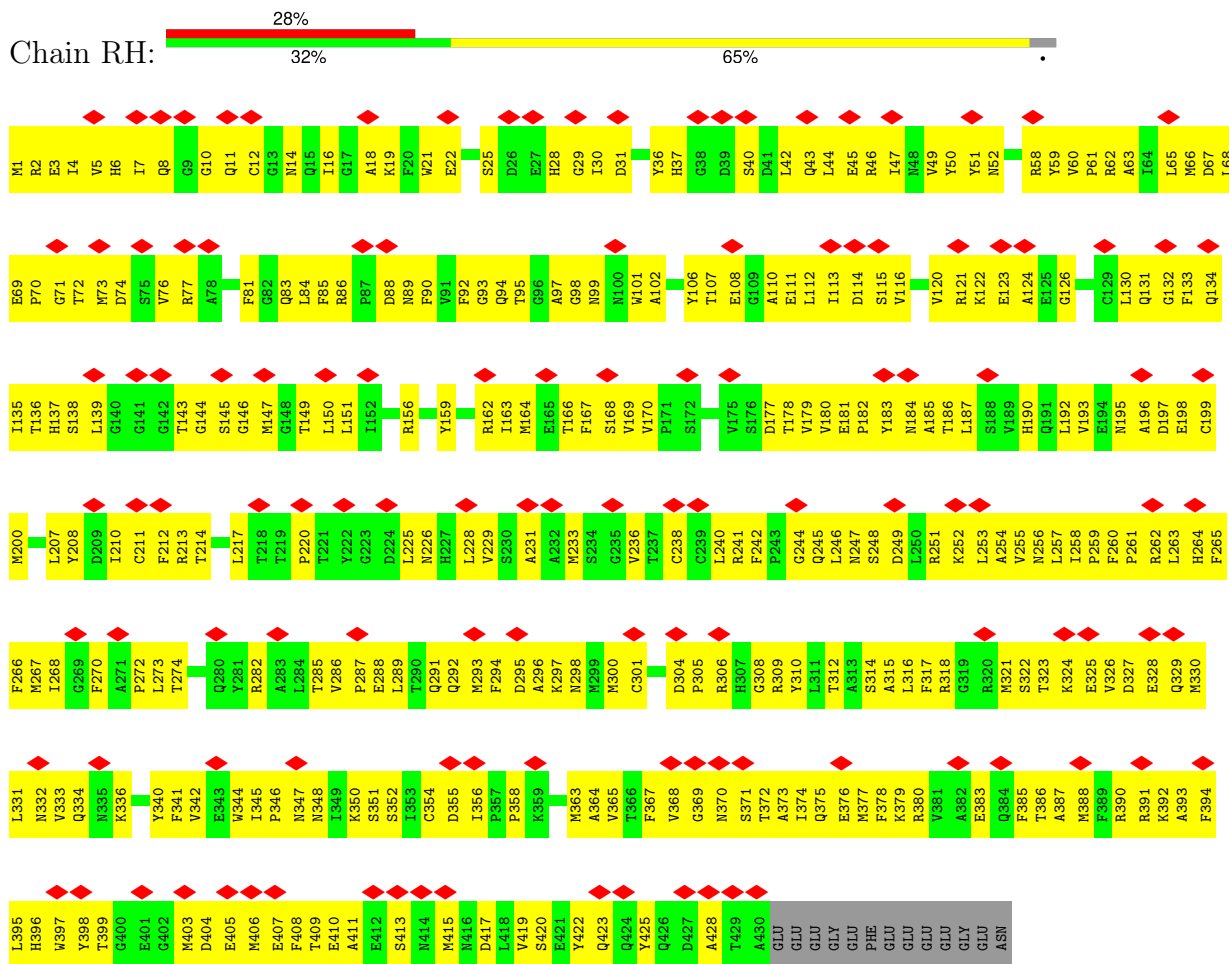

• Molecule 45: Tubulin beta chain

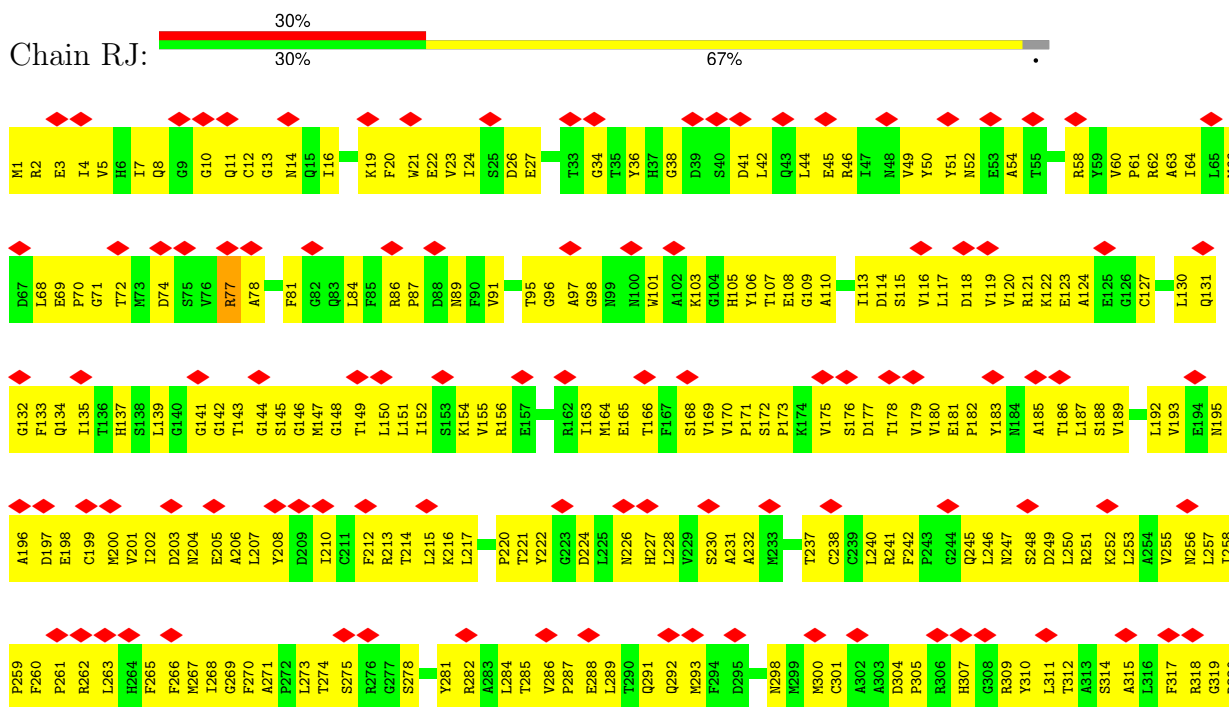

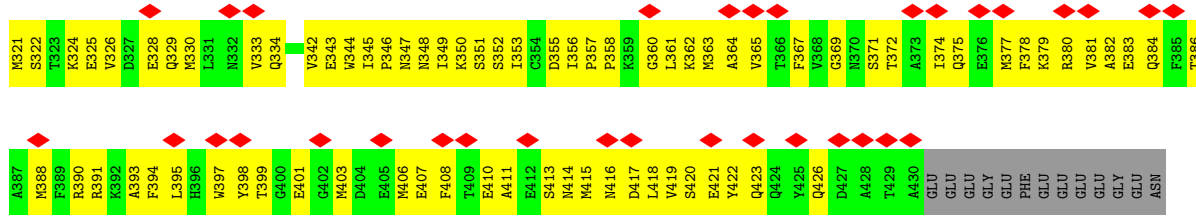

• Molecule 45: Tubulin beta chain

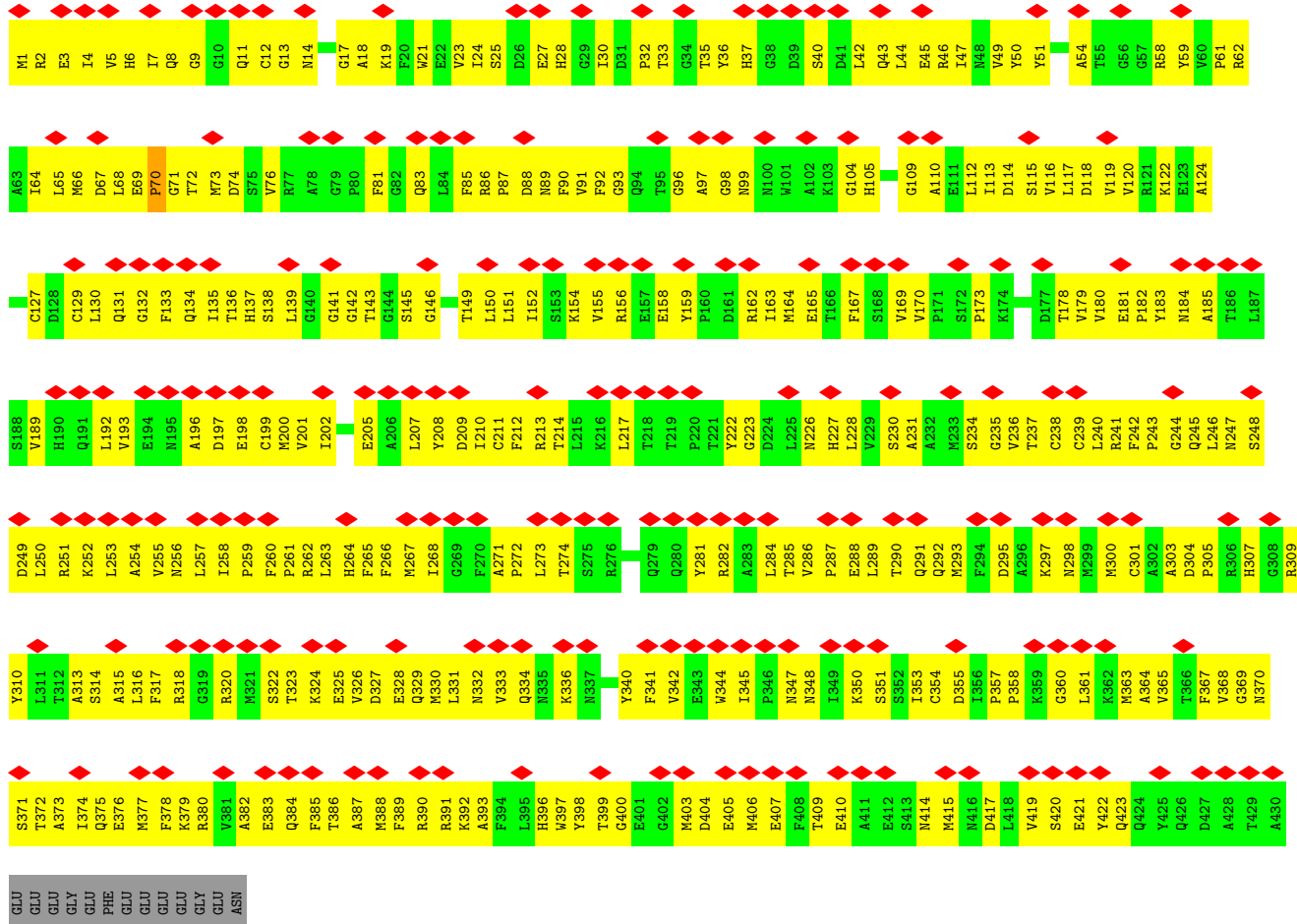

• Molecule 45: Tubulin beta chain

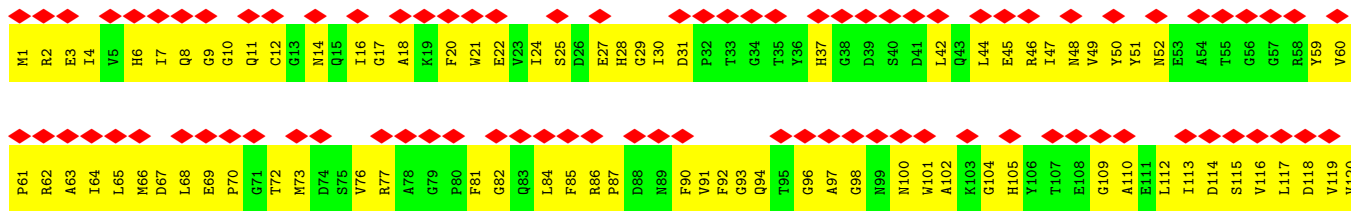
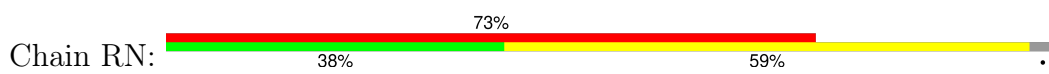

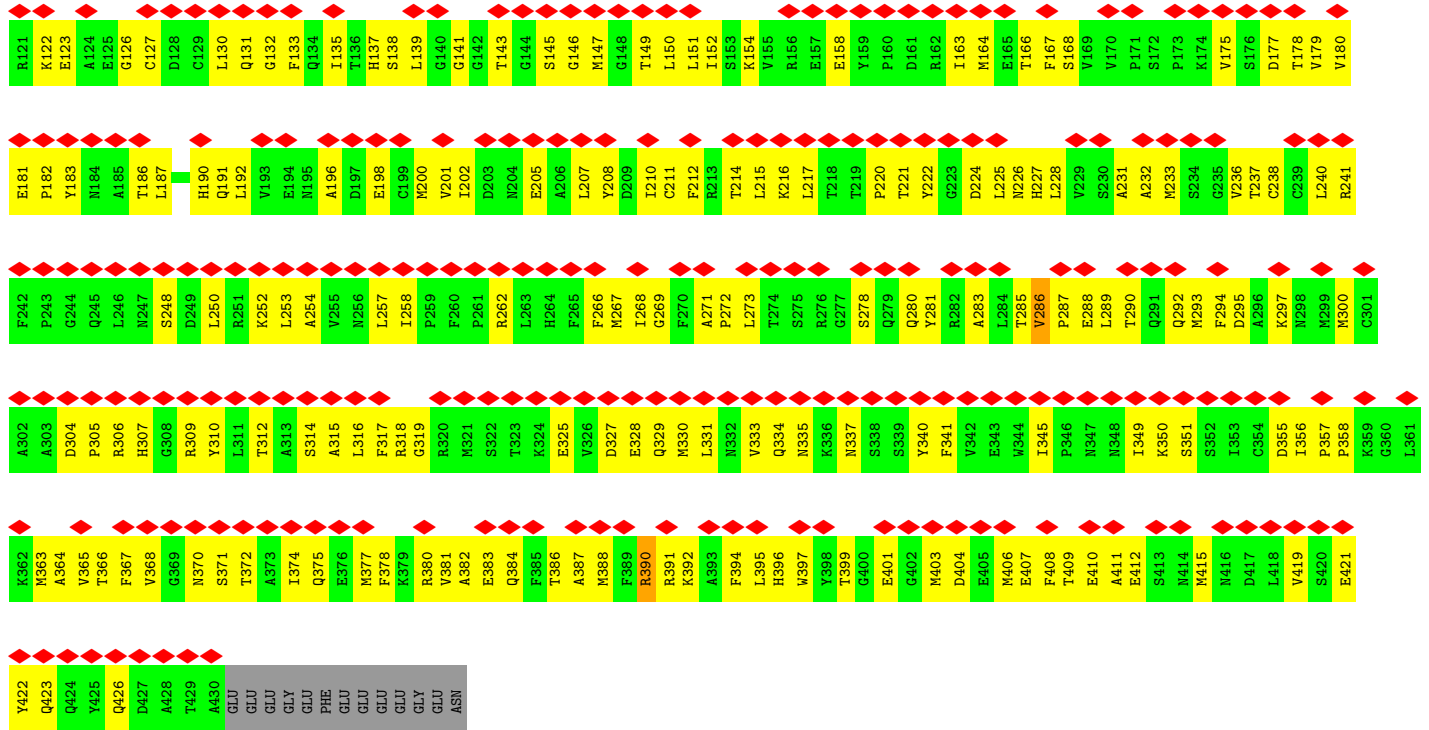

● Molecule 45: Tubulin beta chain

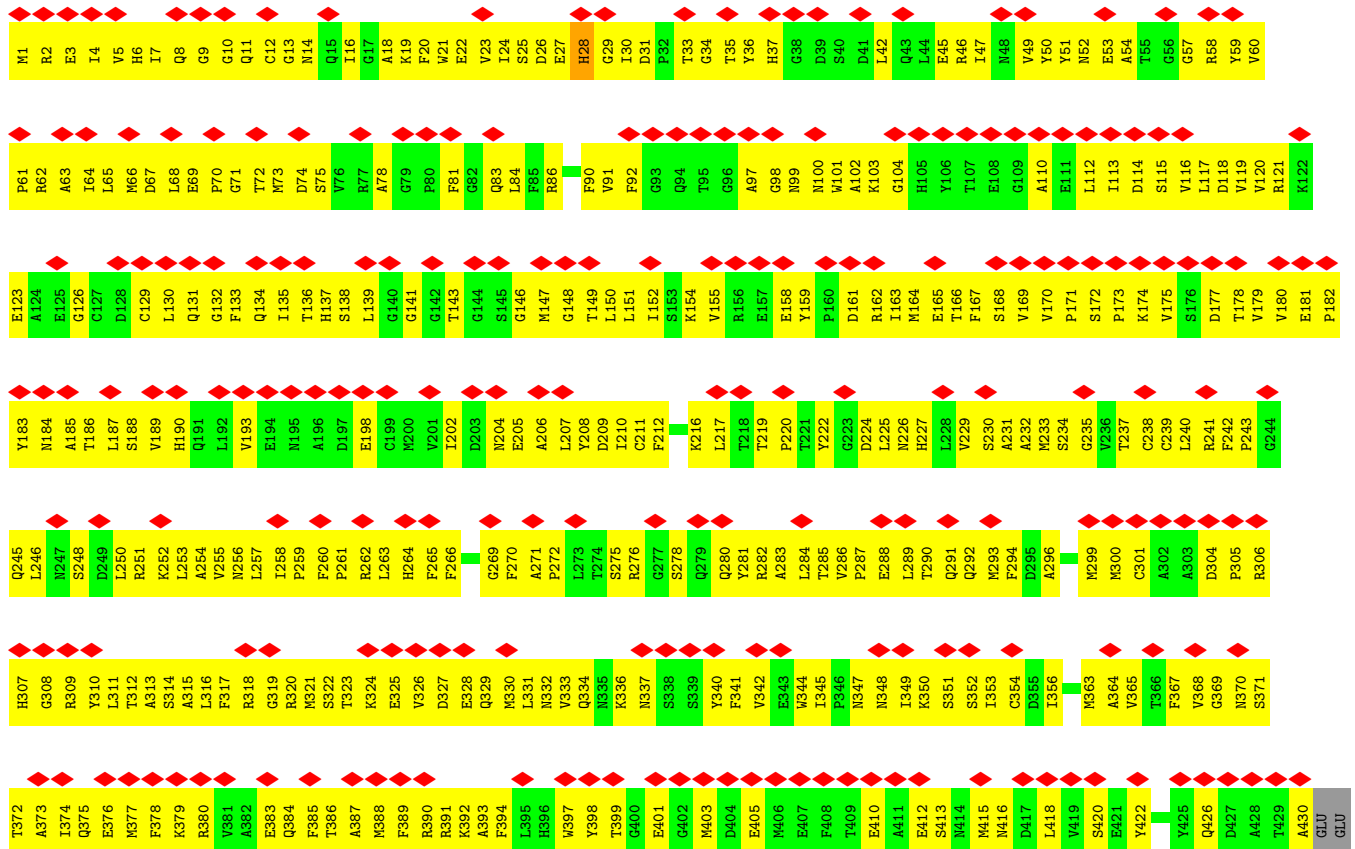



GLU  
GLY  
GLU  
PHE  
GLU  
GLU  
GLU  
GLU  
GLY  
GLY  
ASN

• Molecule 45: Tubulin beta chain

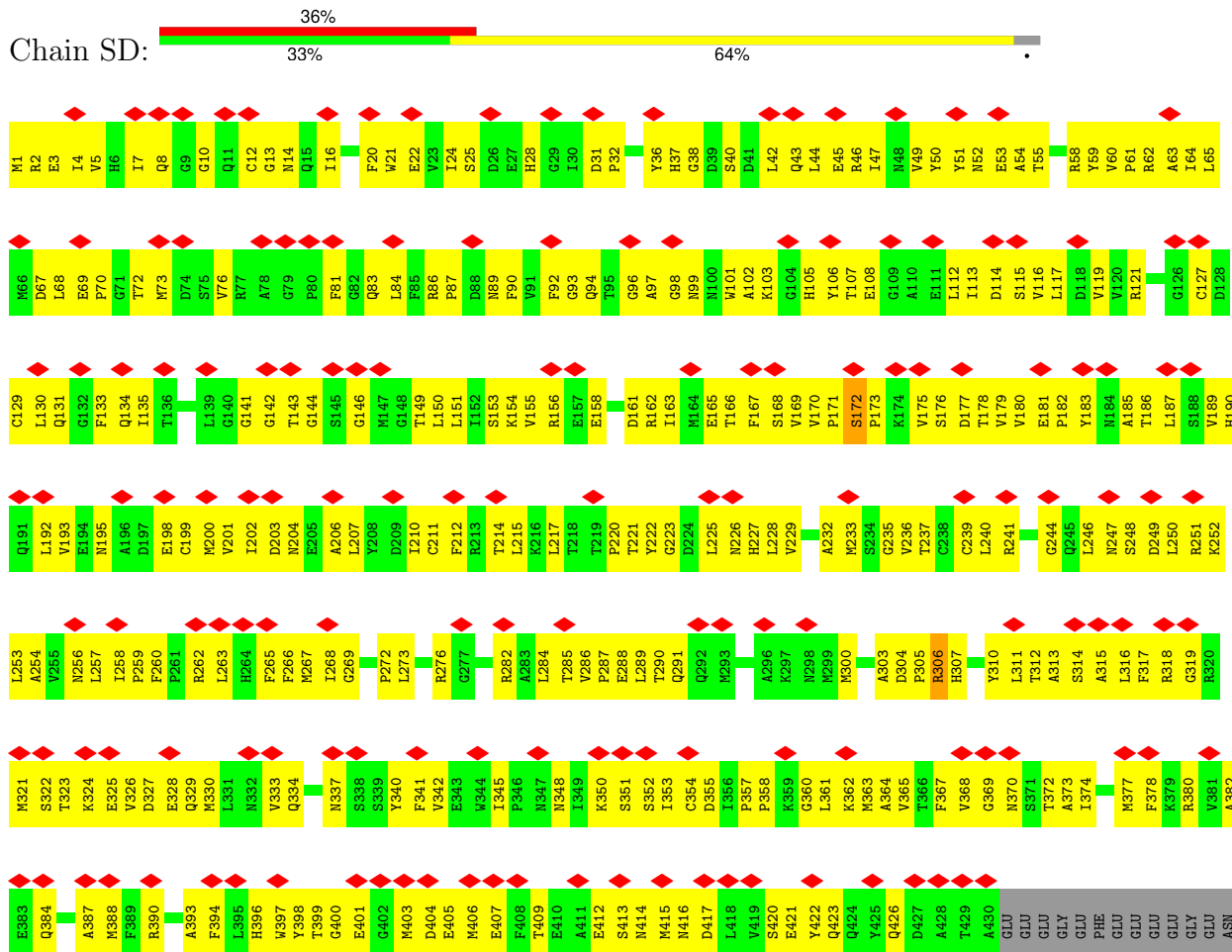

• Molecule 45: Tubulin beta chain

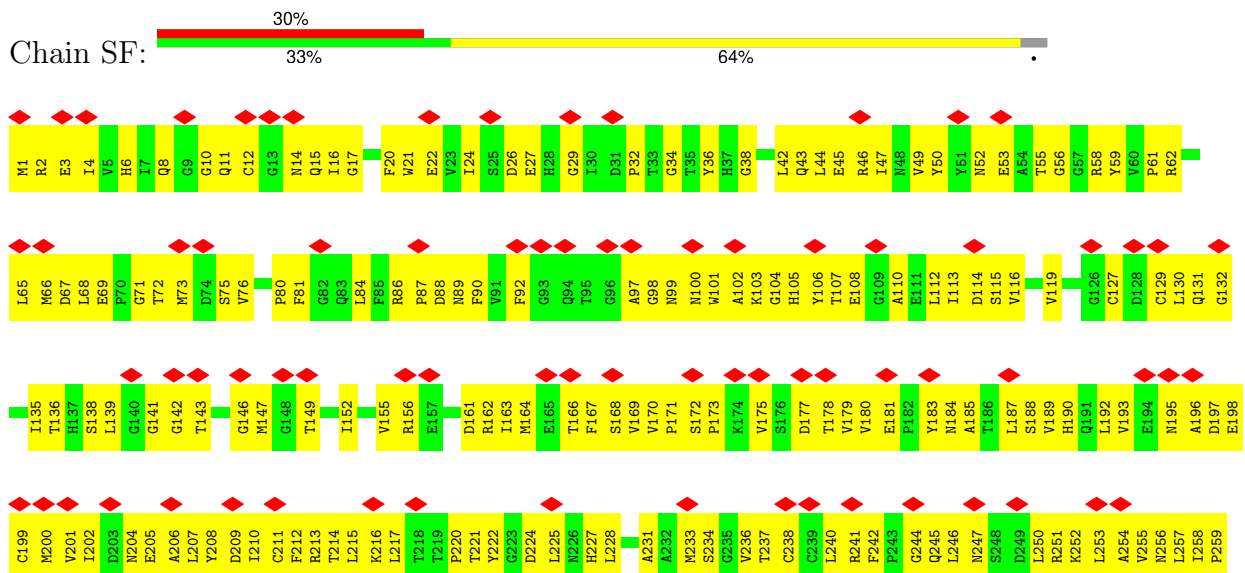

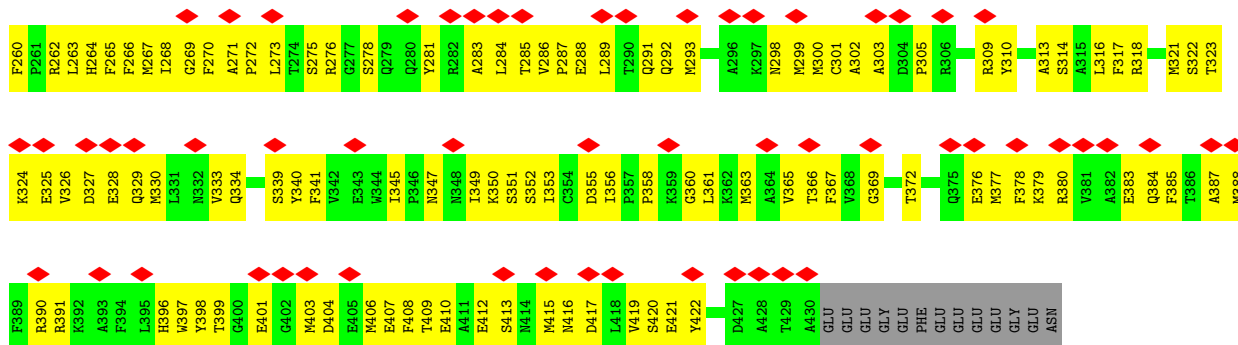

• Molecule 45: Tubulin beta chain

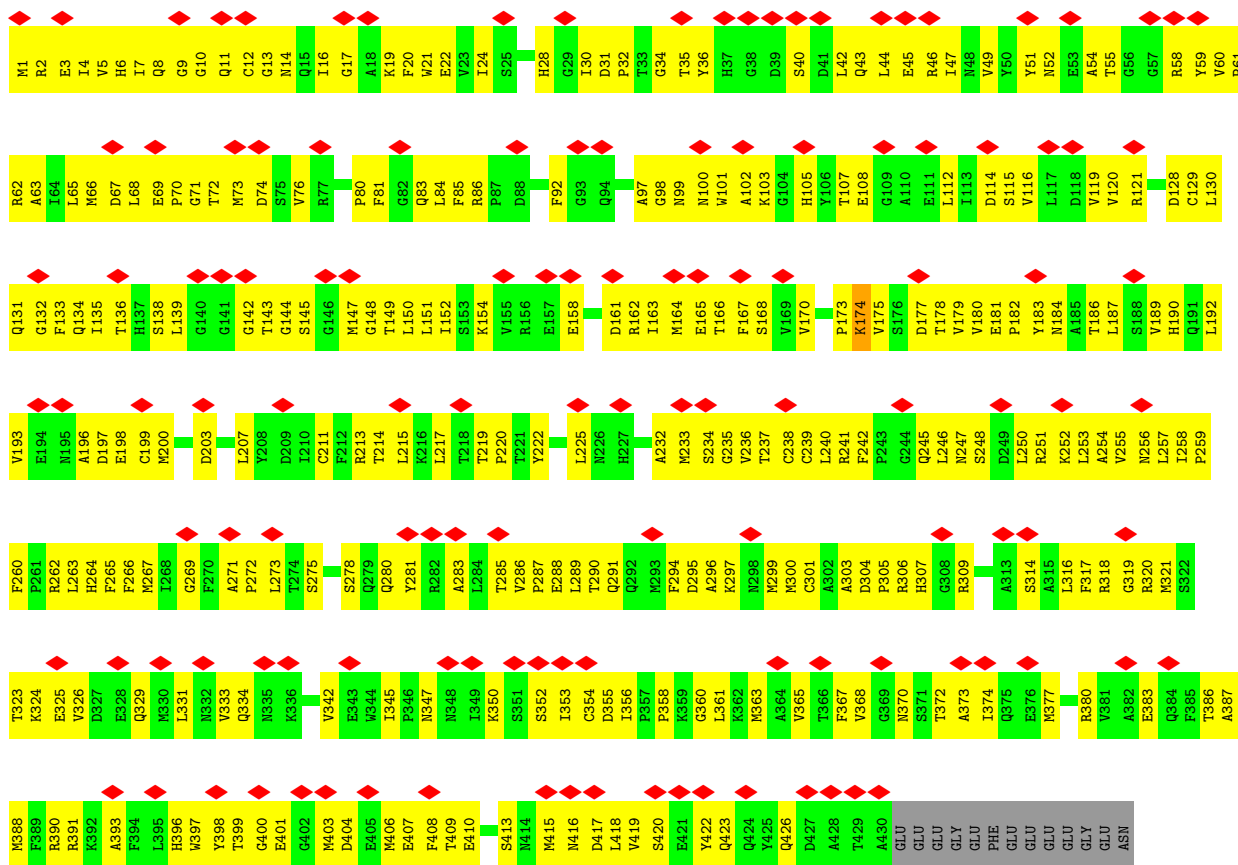

• Molecule 45: Tubulin beta chain

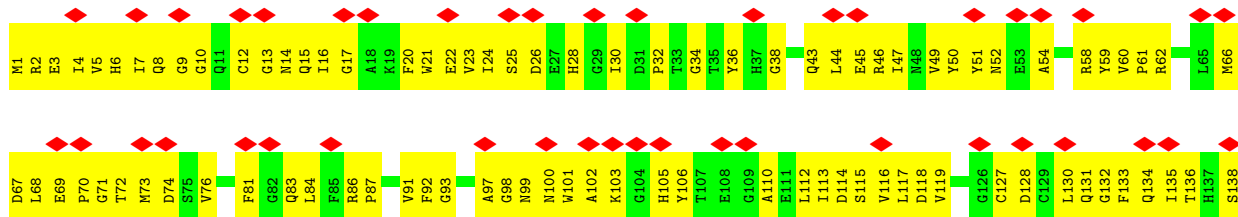

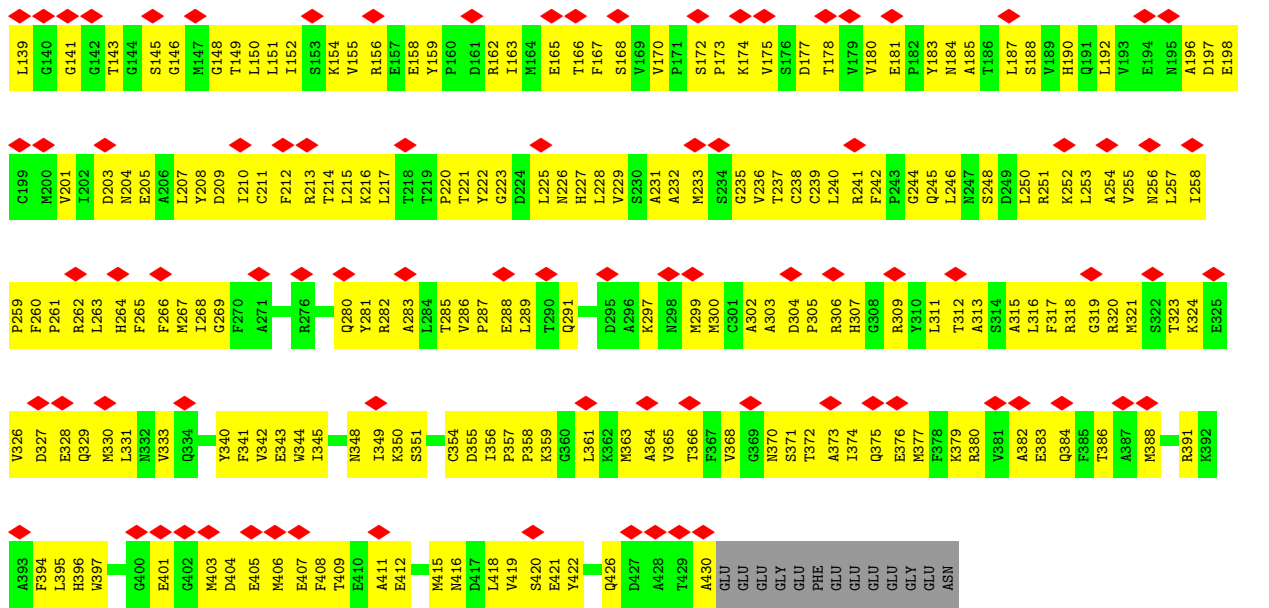

• Molecule 45: Tubulin beta chain

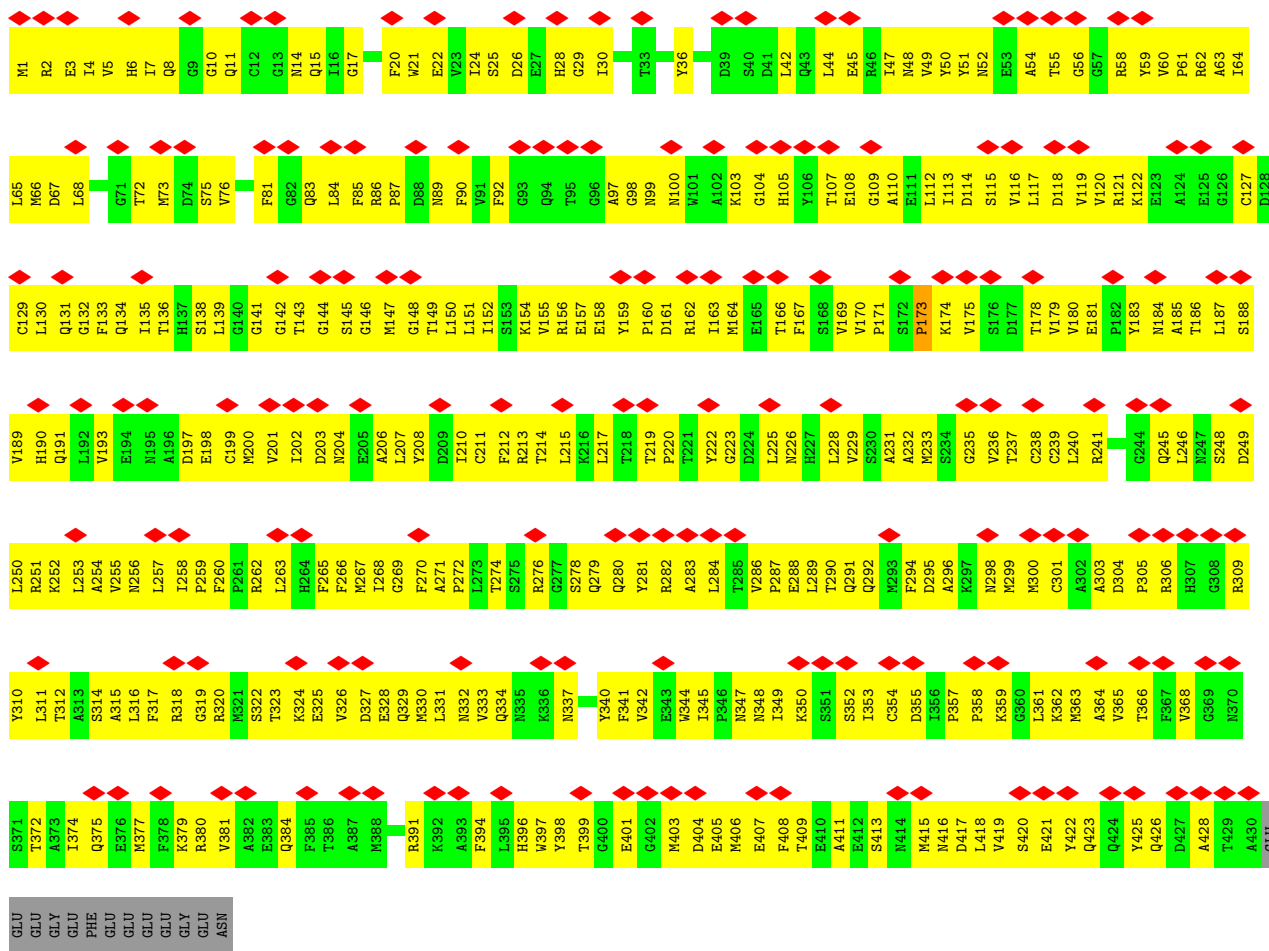





• Molecule 45: Tubulin beta chain

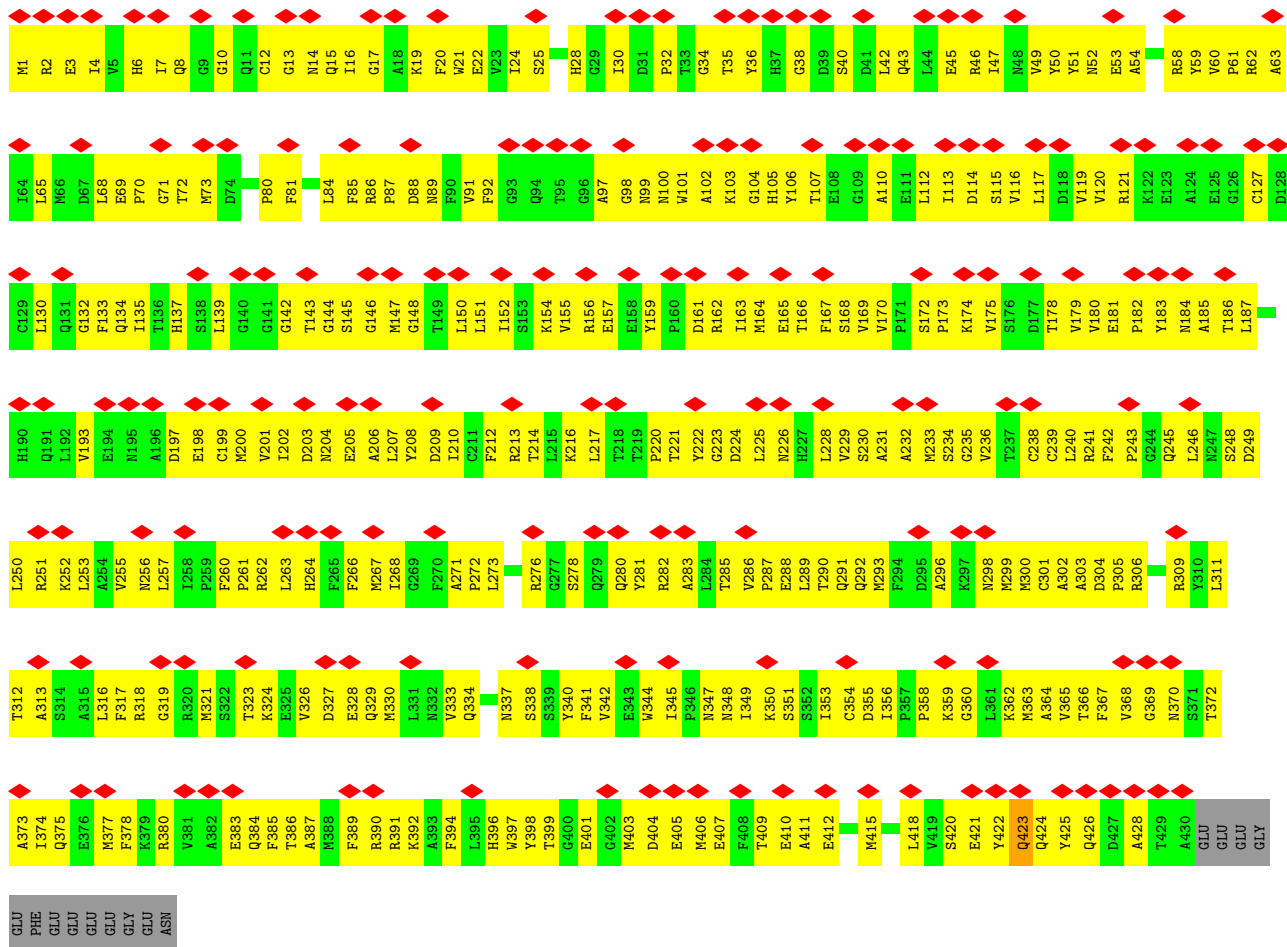

• Molecule 45: Tubulin beta chain



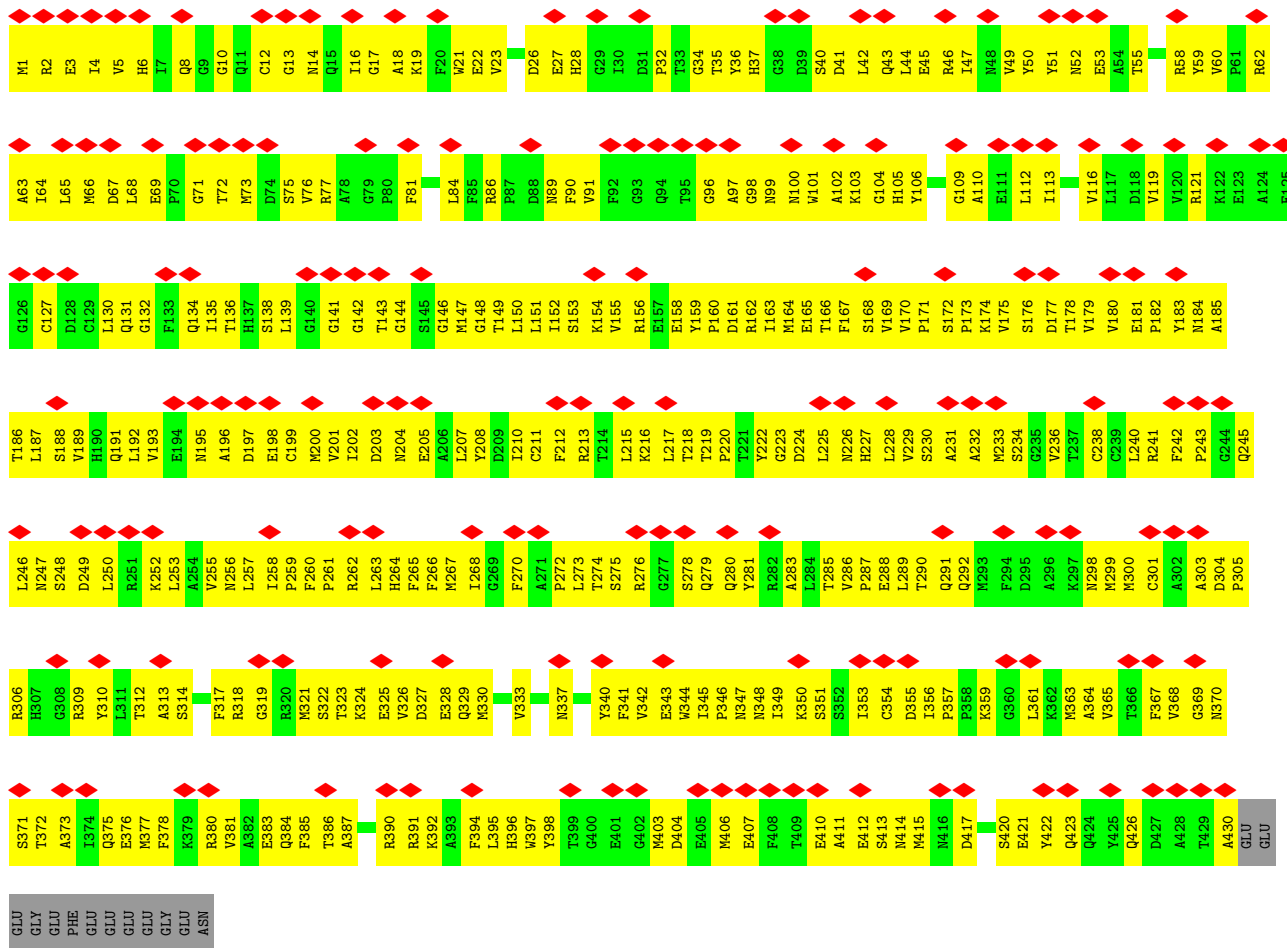

• Molecule 45: Tubulin beta chain

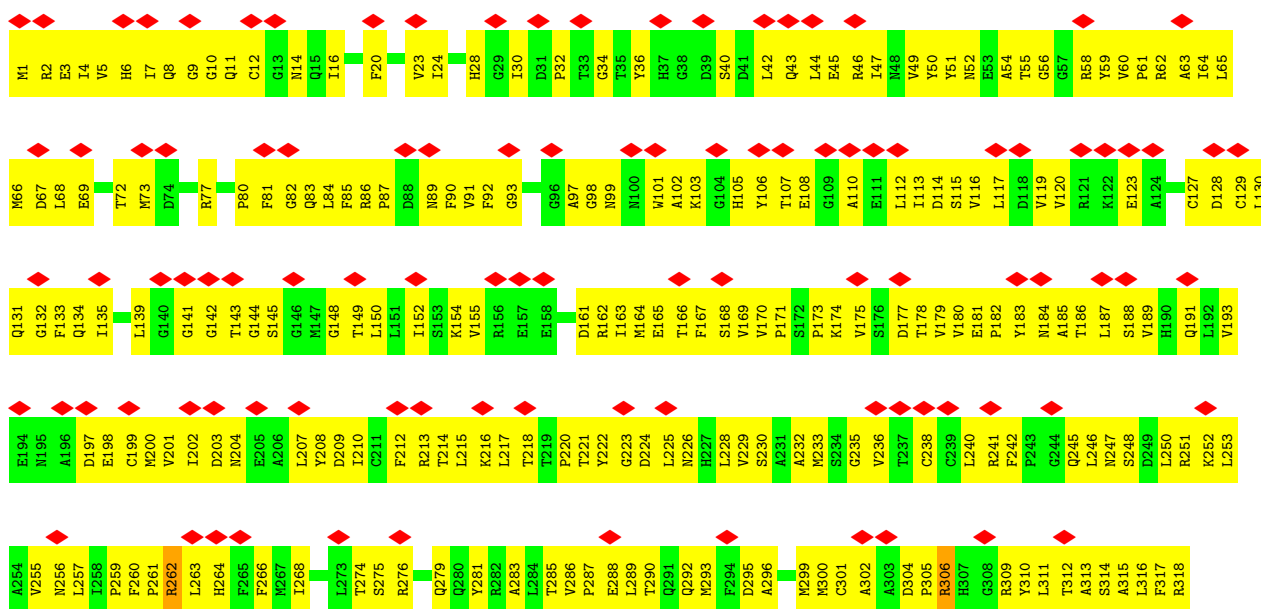

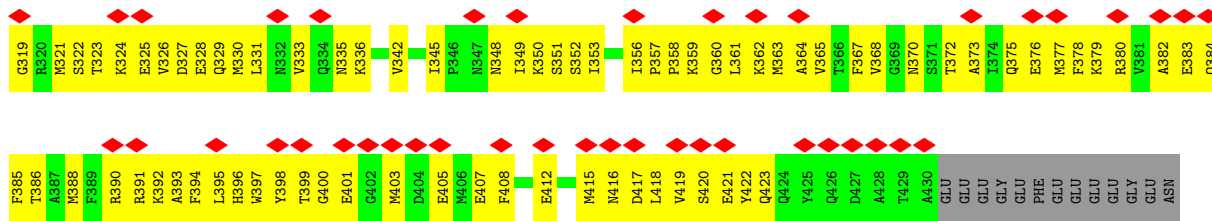

• Molecule 45: Tubulin beta chain

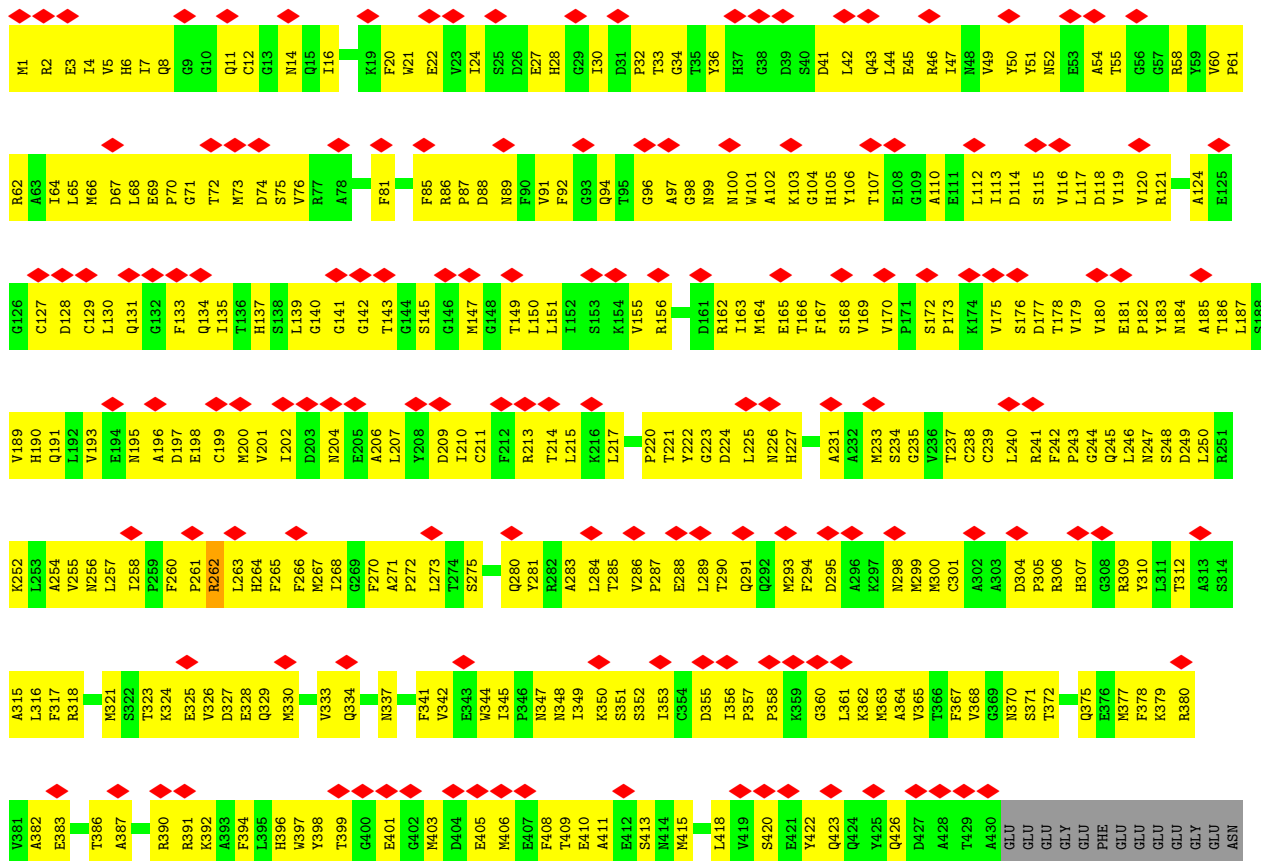

• Molecule 45: Tubulin beta chain

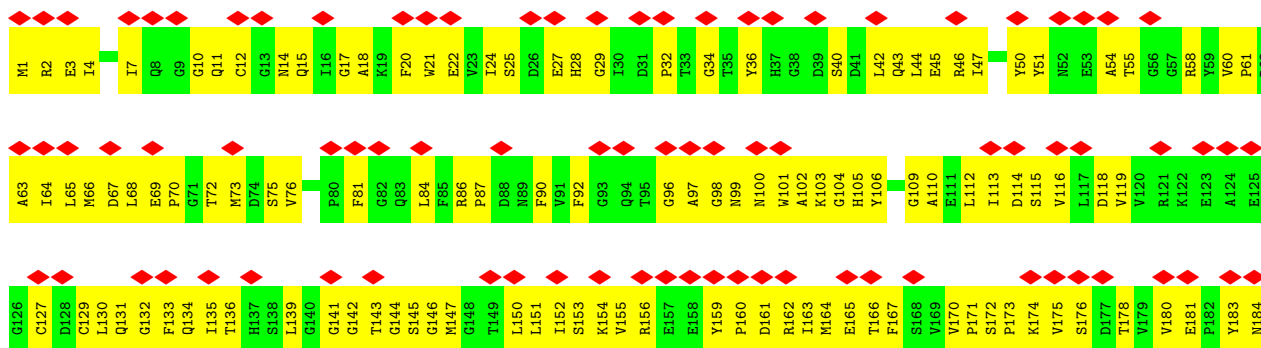

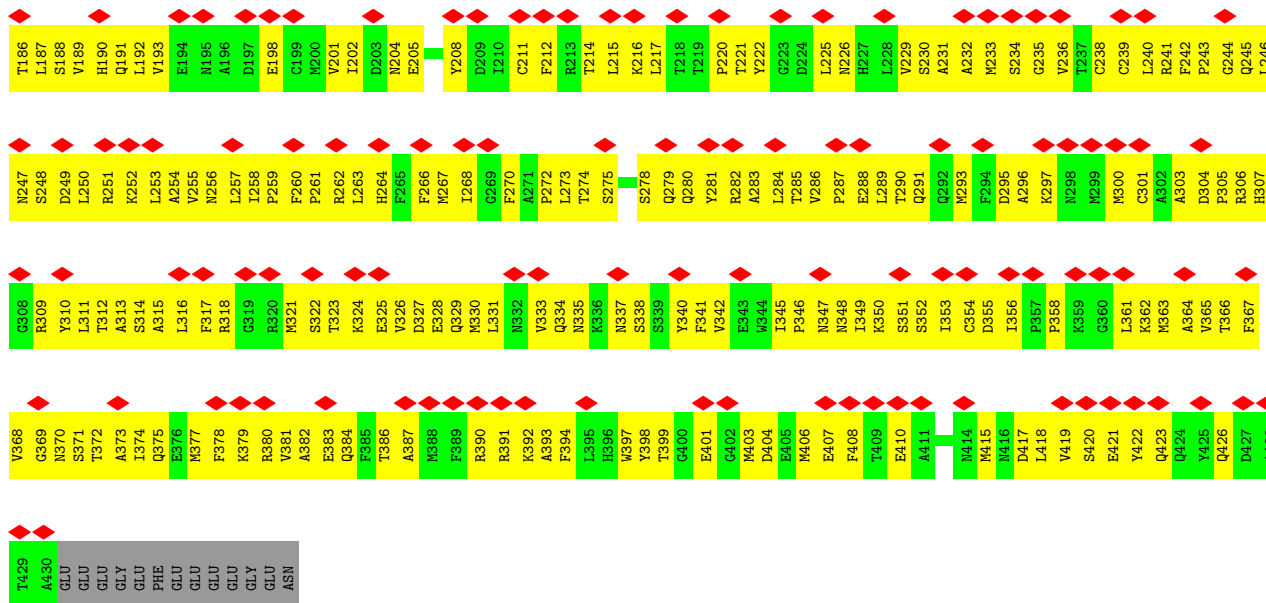

• Molecule 45: Tubulin beta chain

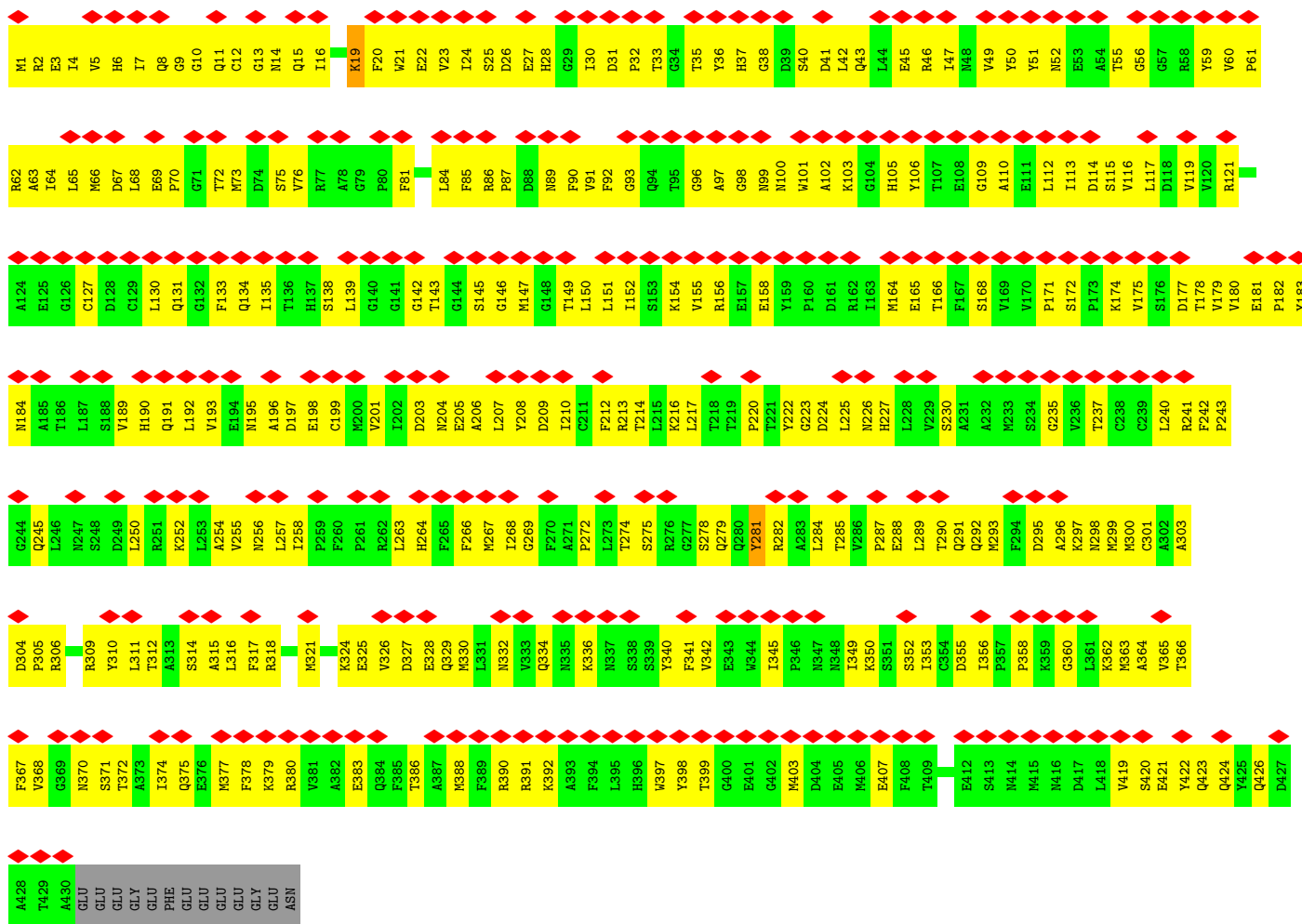



- Molecule 45: Tubulin beta chain

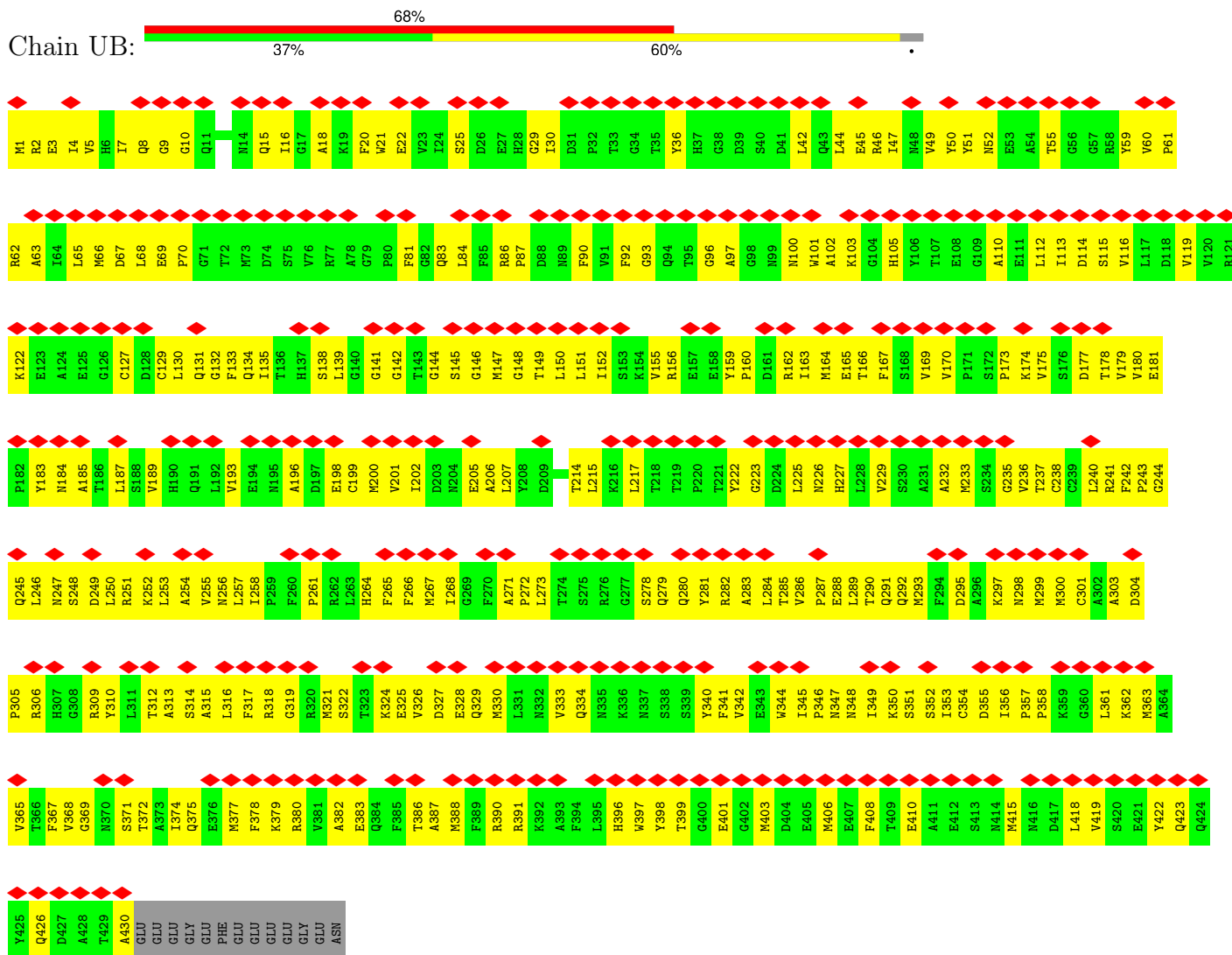

- Molecule 45: Tubulin beta chain

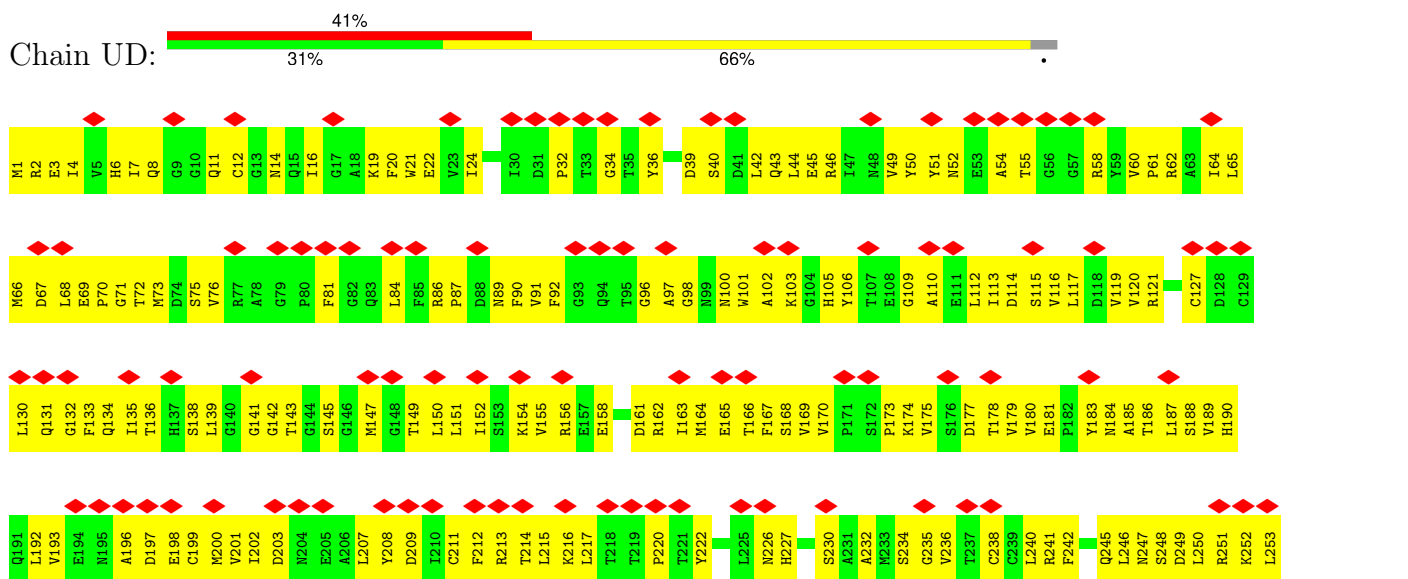

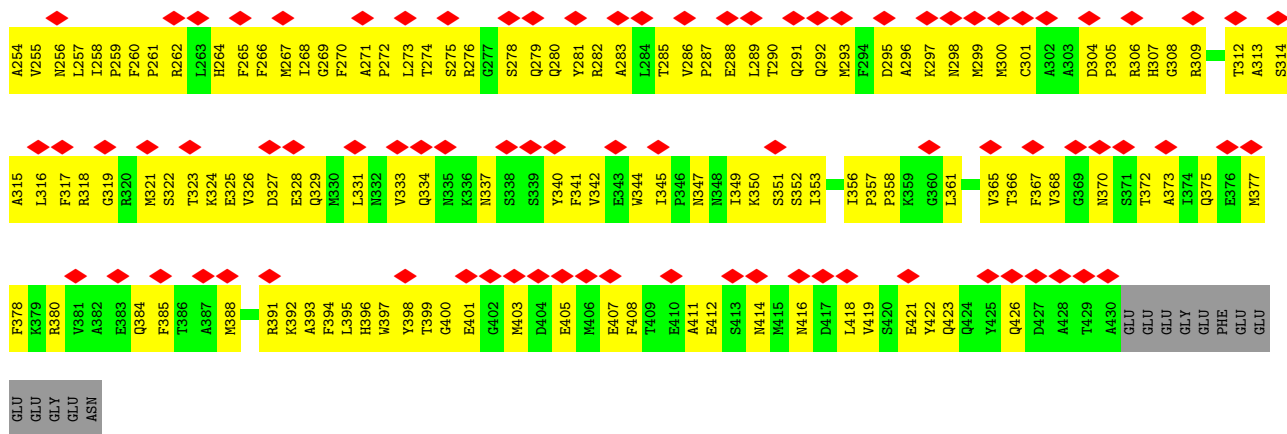

• Molecule 45: Tubulin beta chain

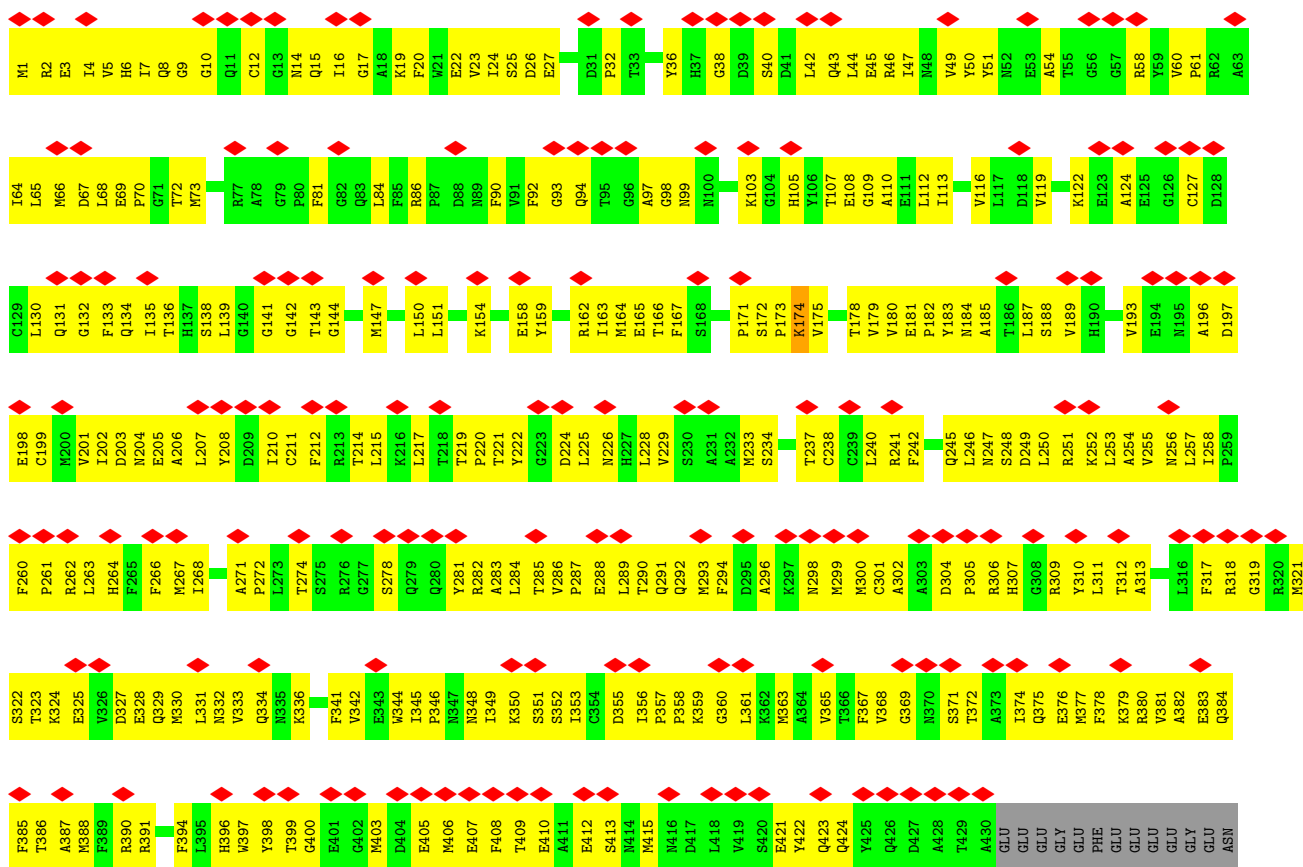

• Molecule 45: Tubulin beta chain

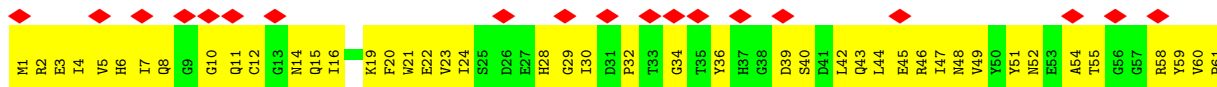

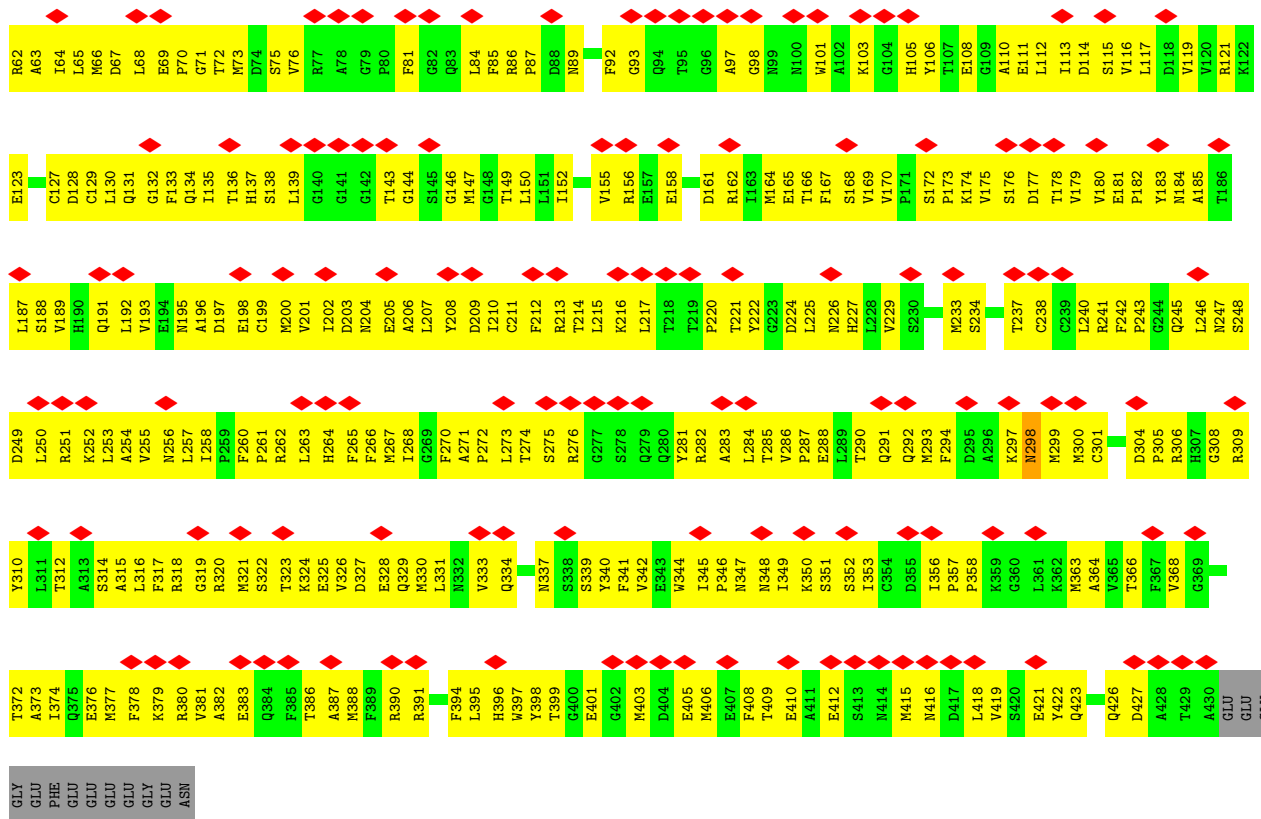

• Molecule 45: Tubulin beta chain

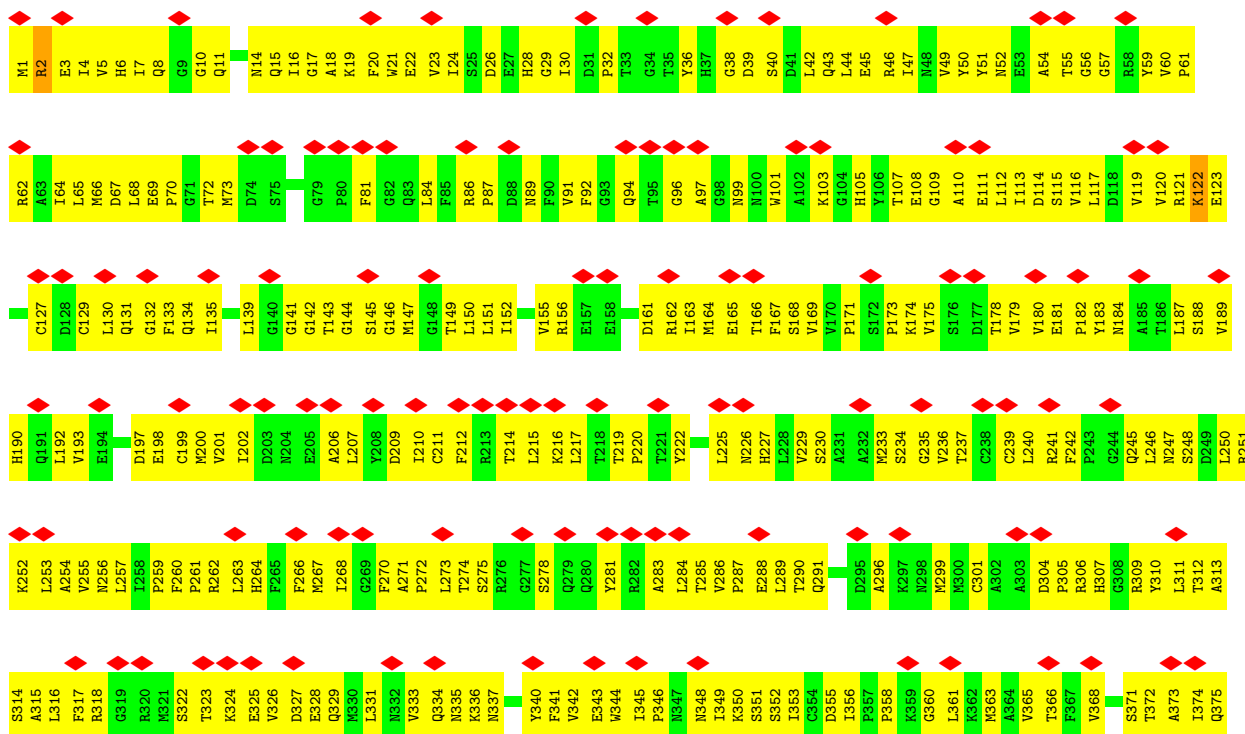

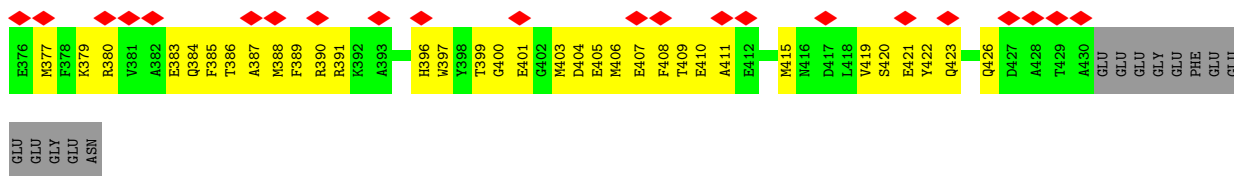

• Molecule 45: Tubulin beta chain

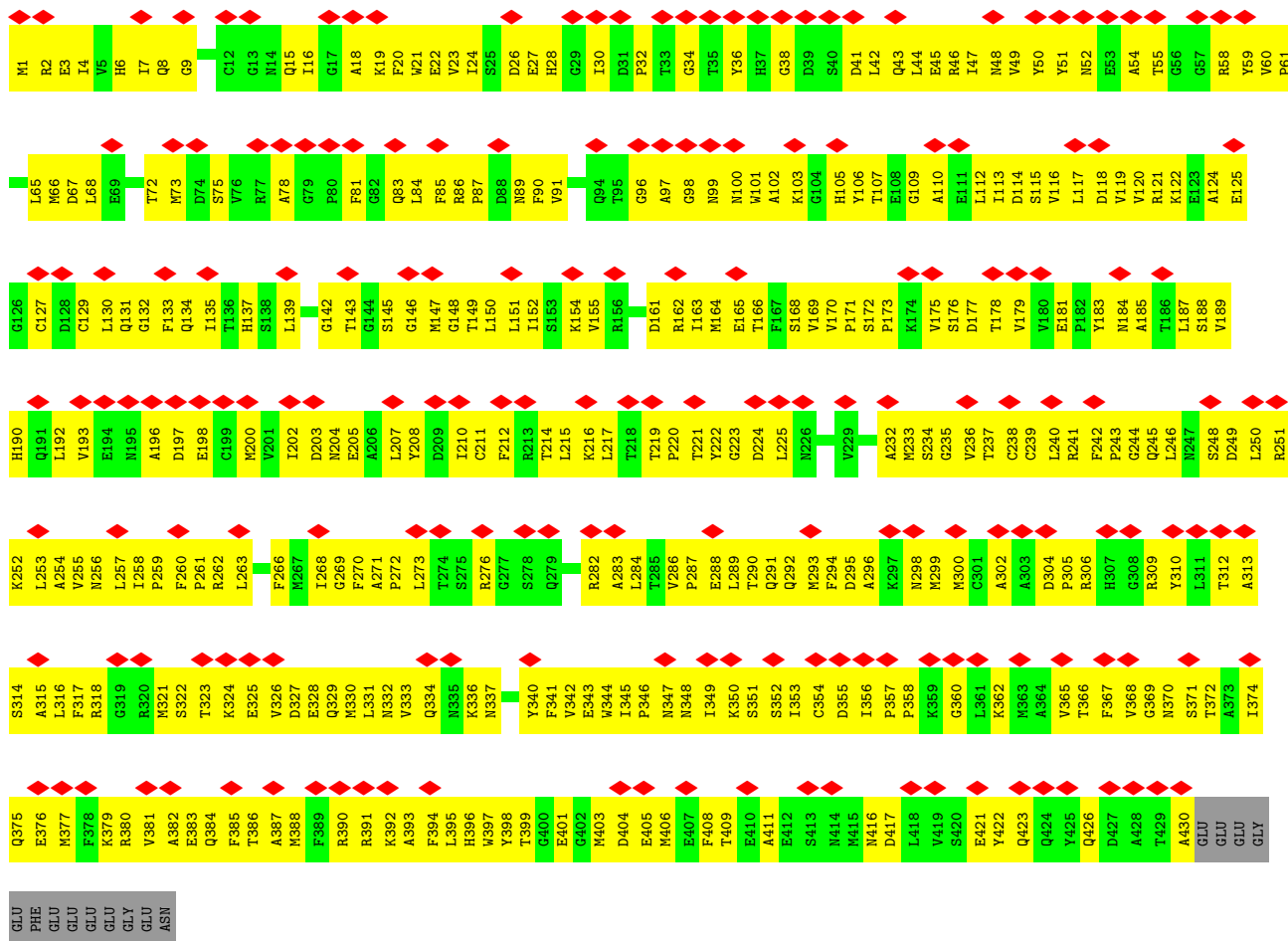

• Molecule 45: Tubulin beta chain

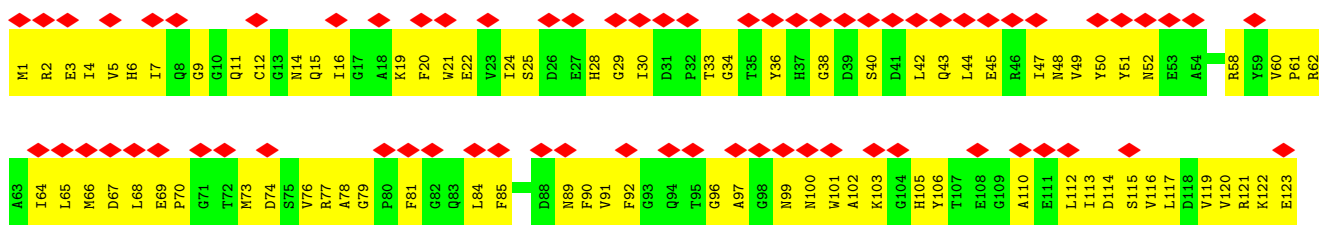

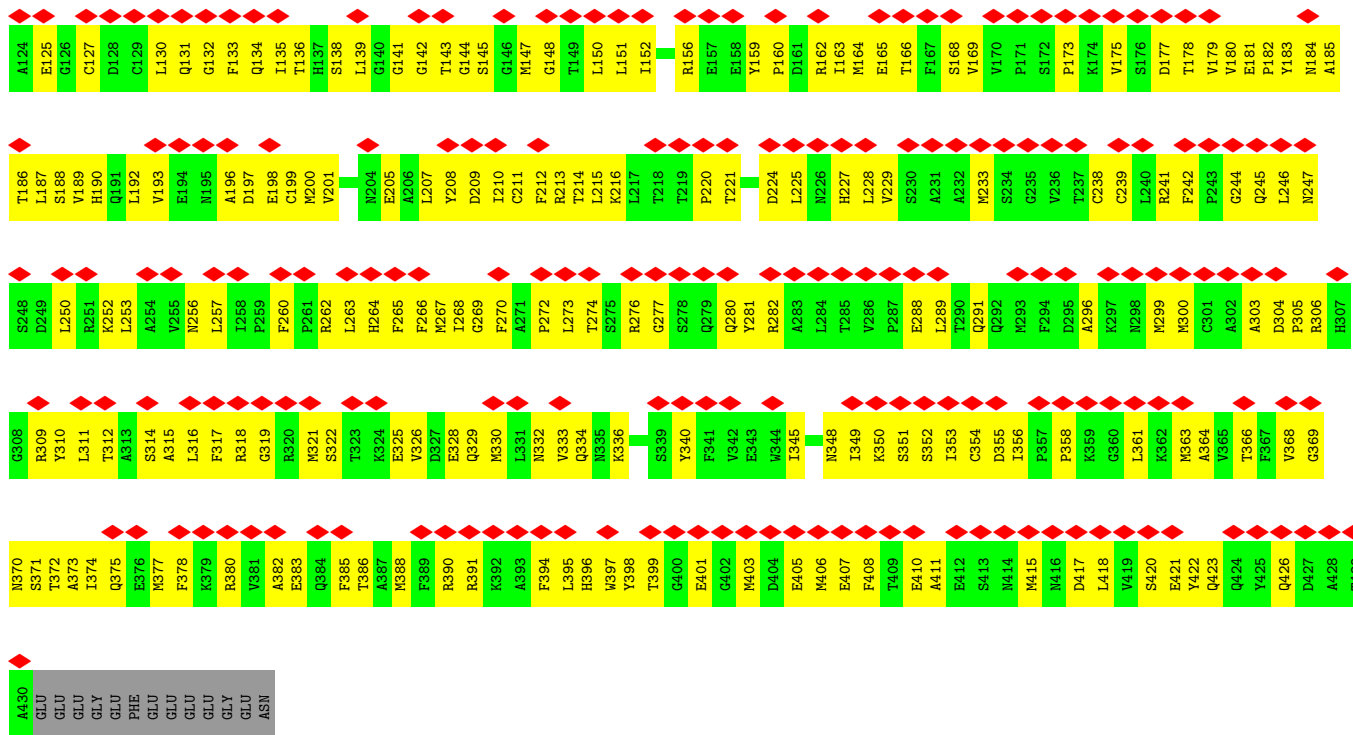

● Molecule 45: Tubulin beta chain

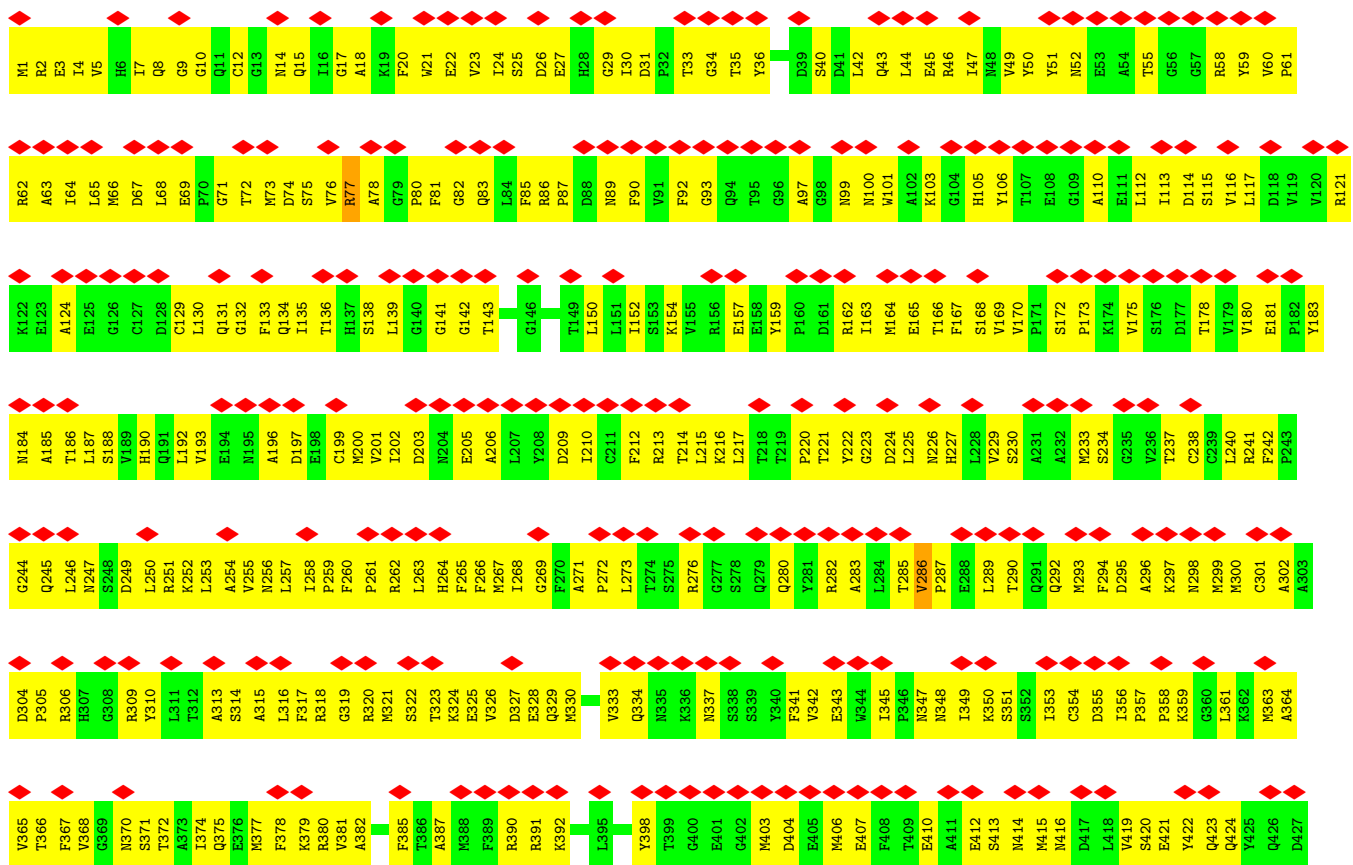

A428
T429
A430
GLU
GLU
GLY
GLU
PHE
GLU
GLU
GLY
GLU
ASN

• Molecule 45: Tubulin beta chain

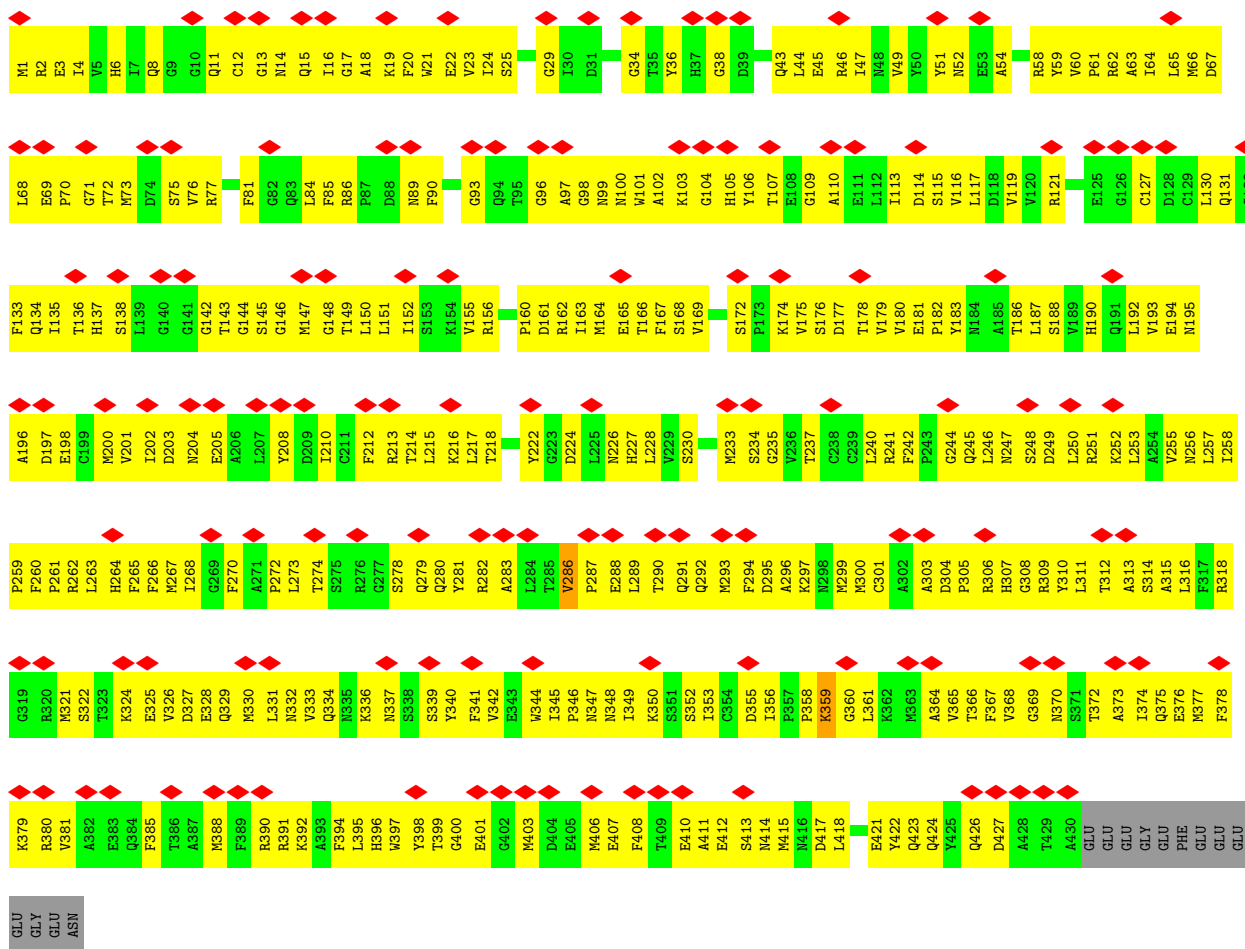

• Molecule 45: Tubulin beta chain

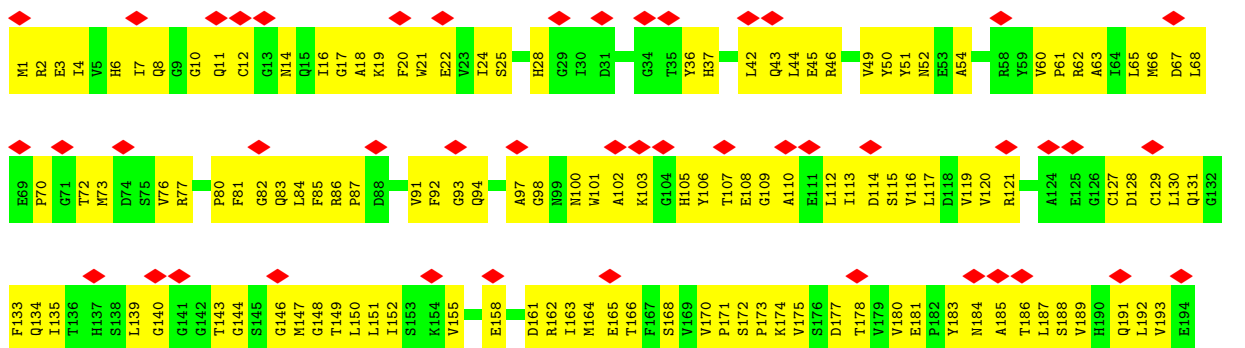
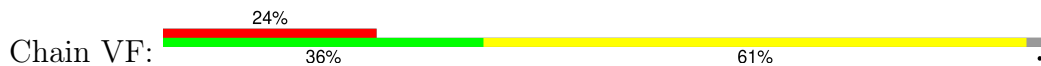

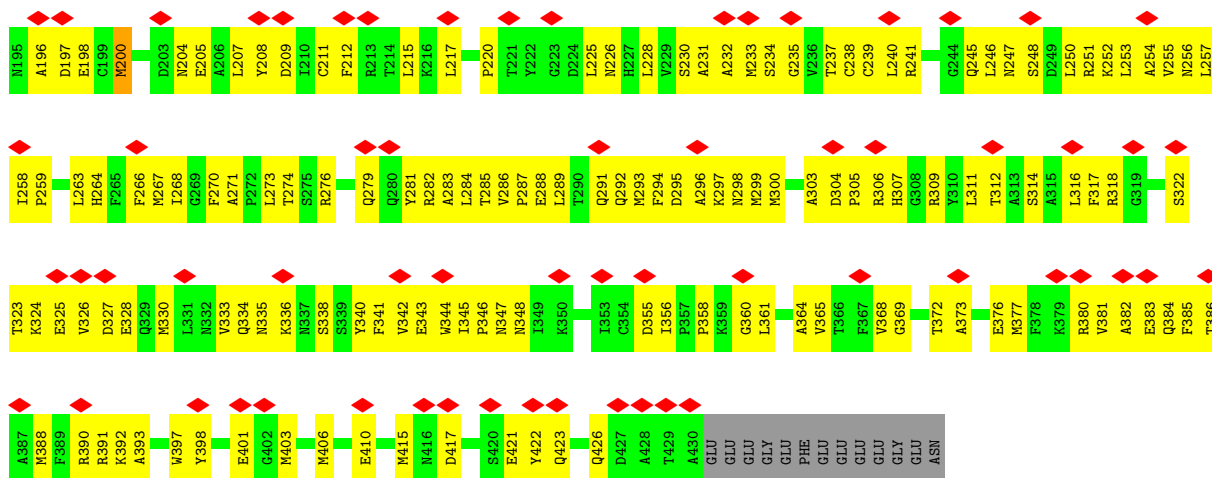

• Molecule 45: Tubulin beta chain

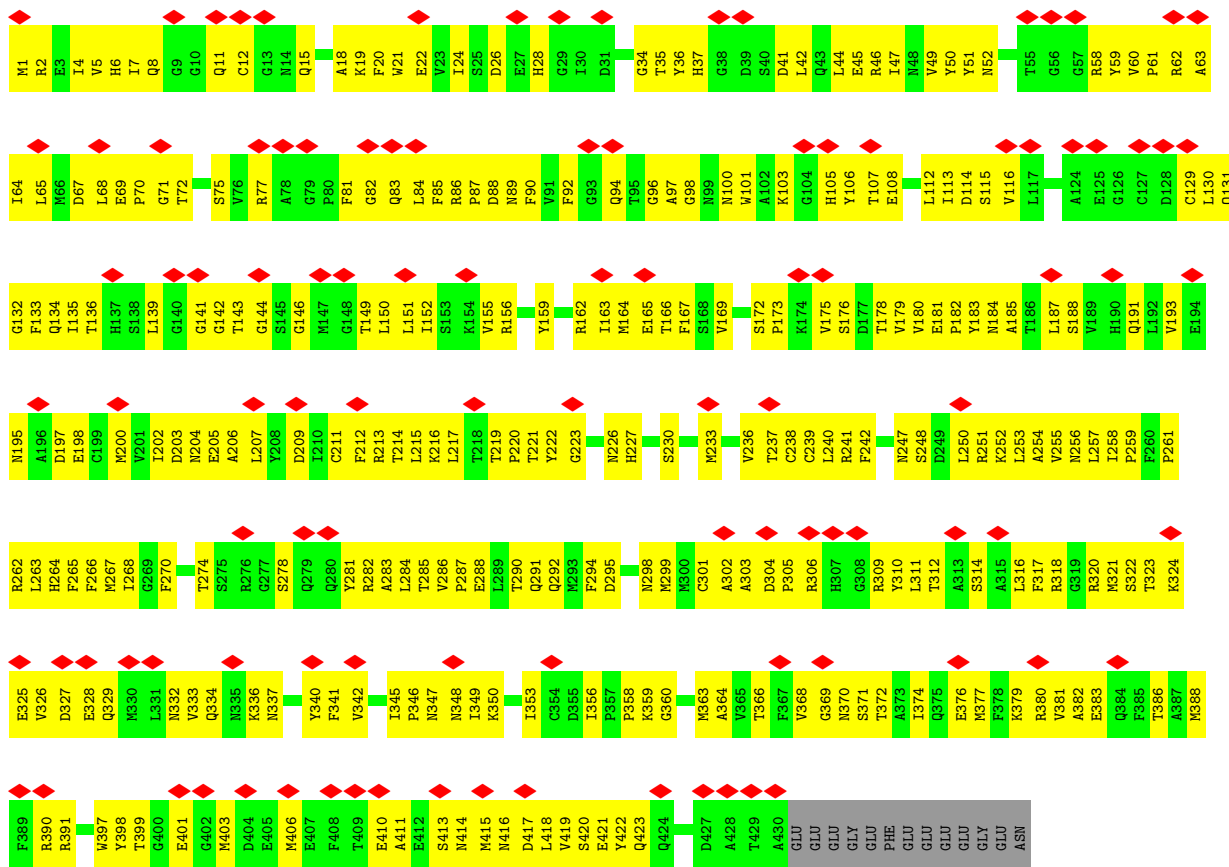

• Molecule 45: Tubulin beta chain

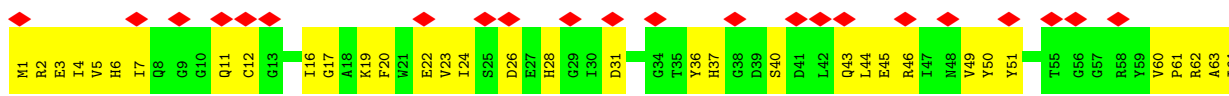

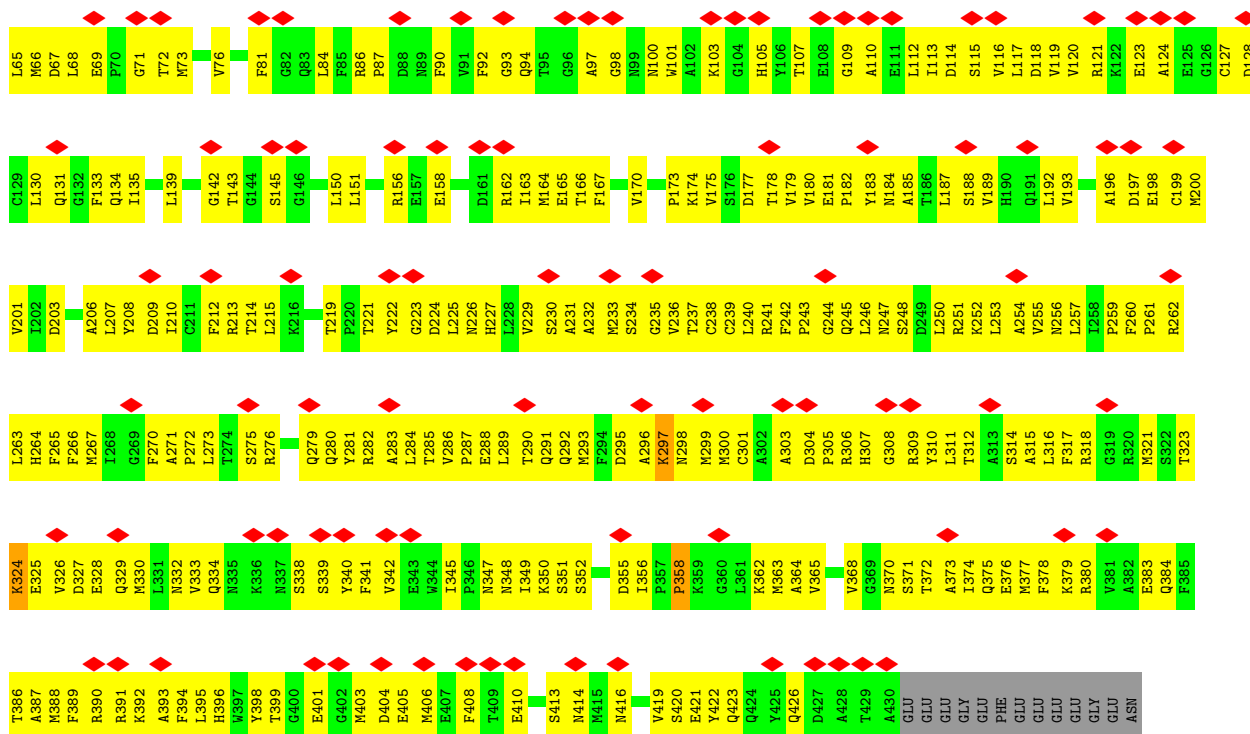

● Molecule 45: Tubulin beta chain

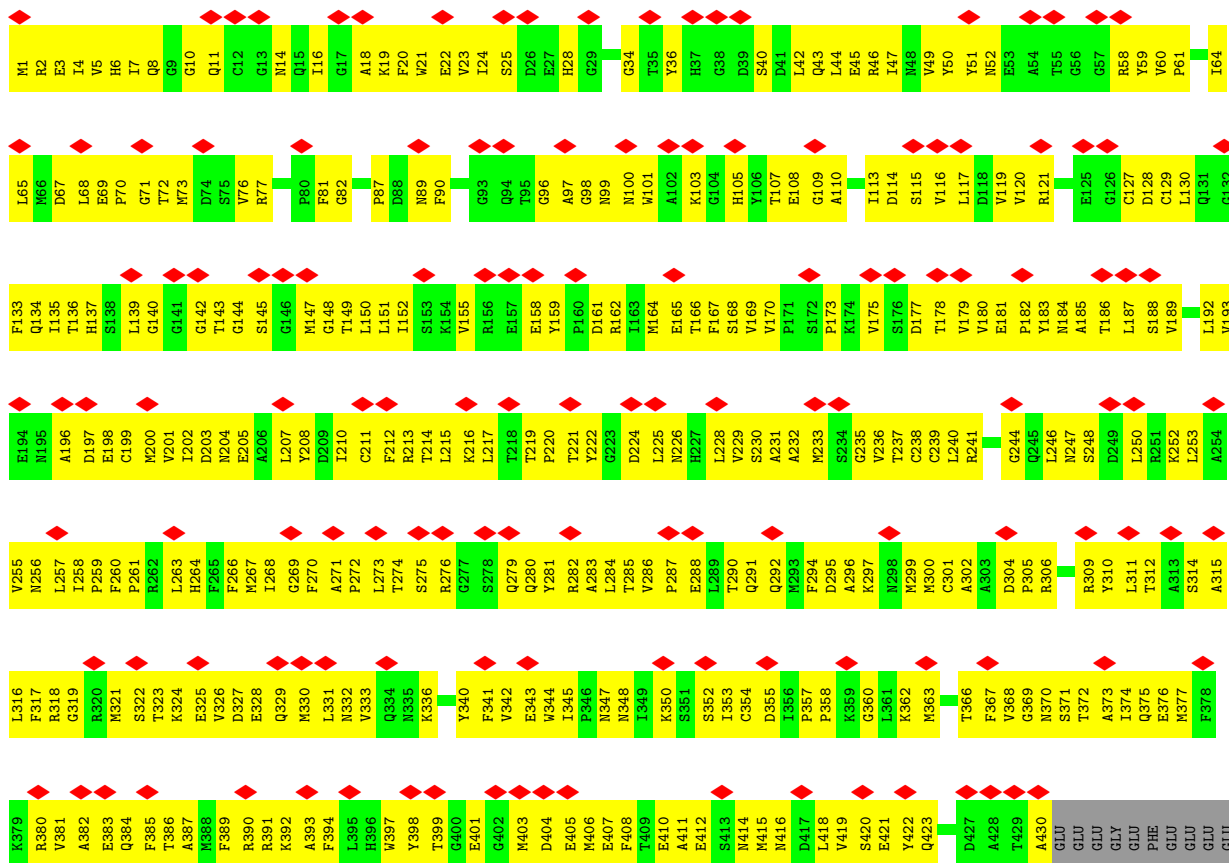



GLY  
GLU  
ASN

• Molecule 45: Tubulin beta chain

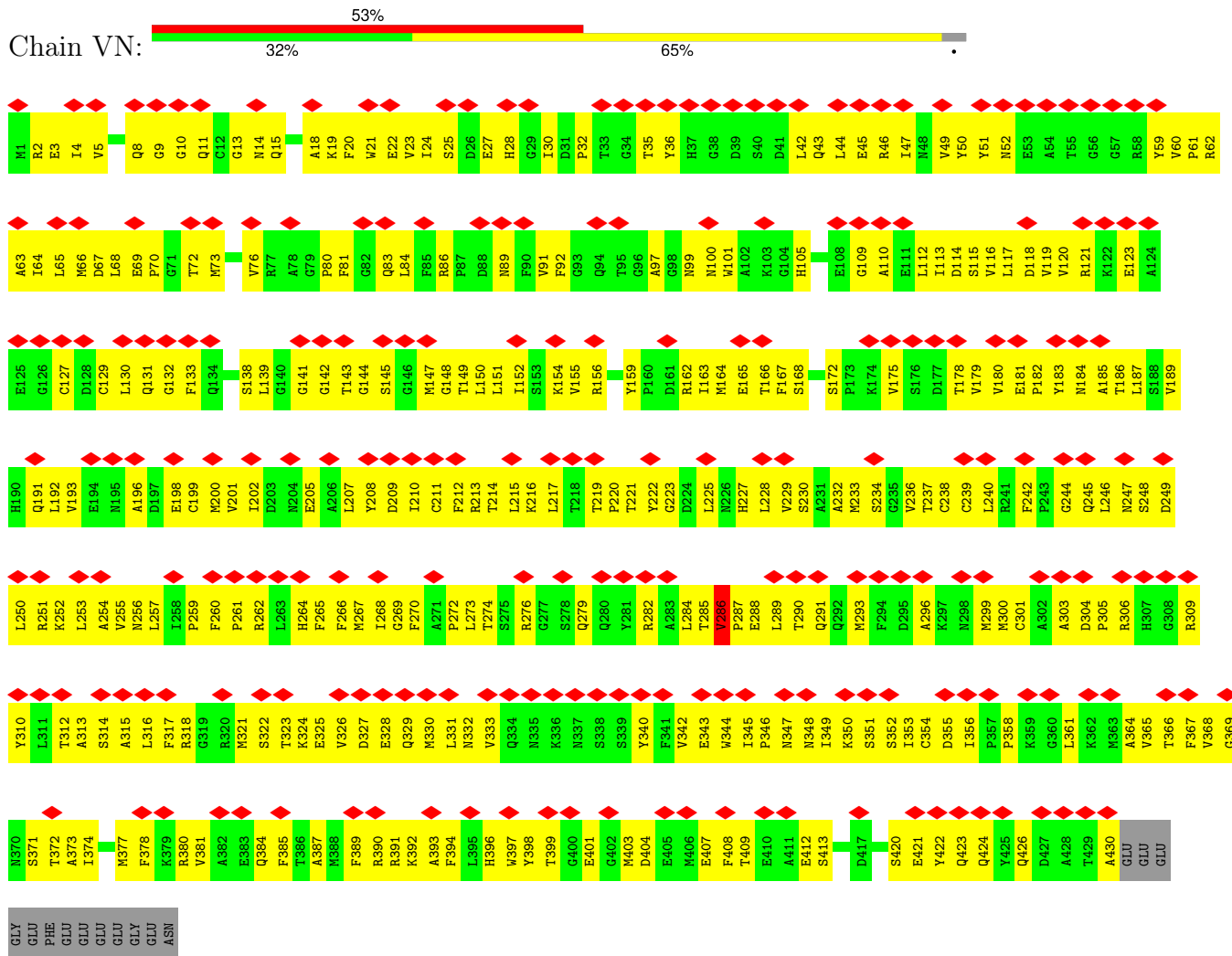

• Molecule 45: Tubulin beta chain

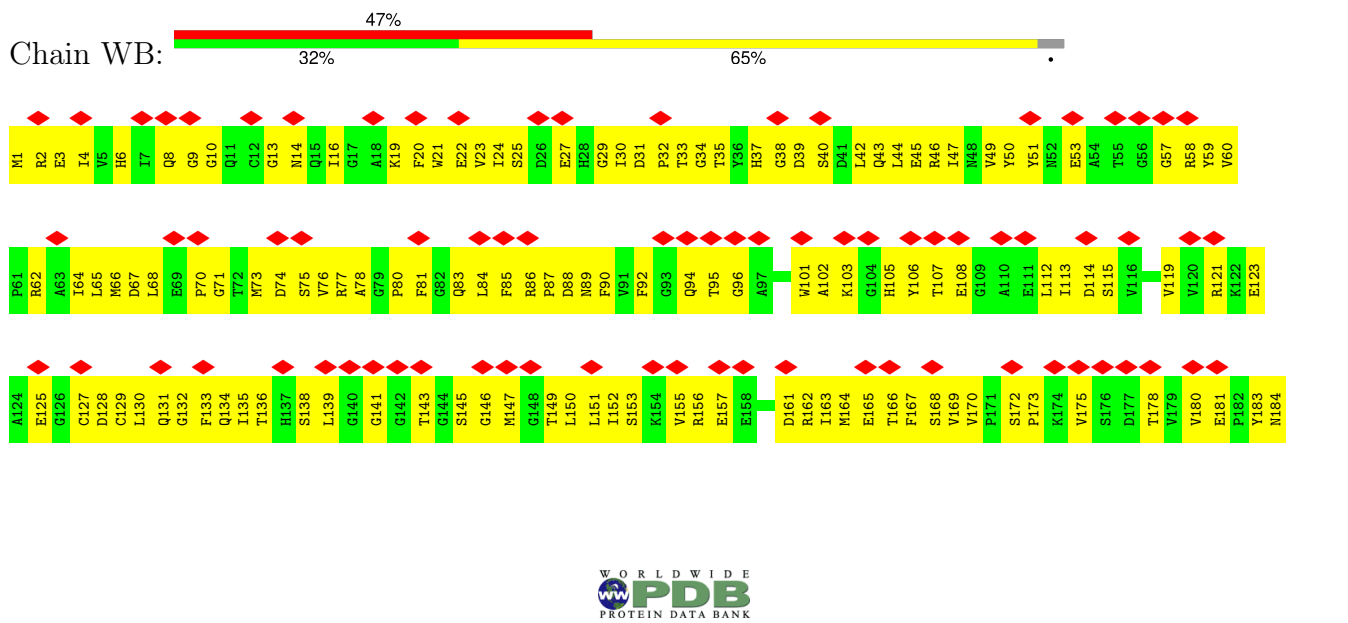

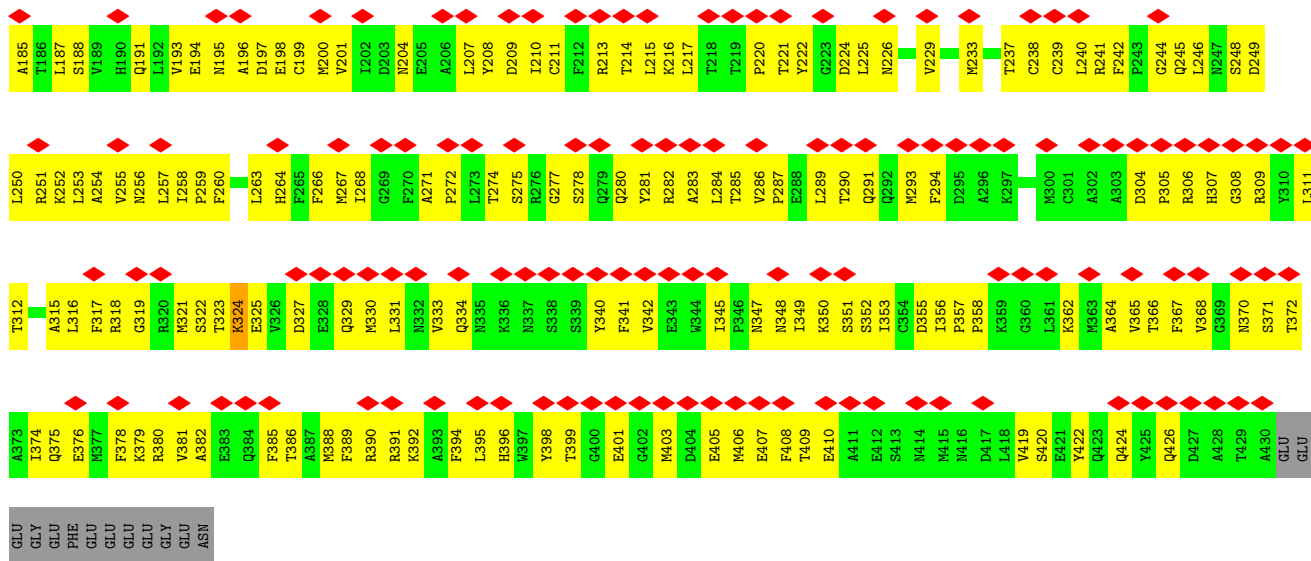

• Molecule 45: Tubulin beta chain

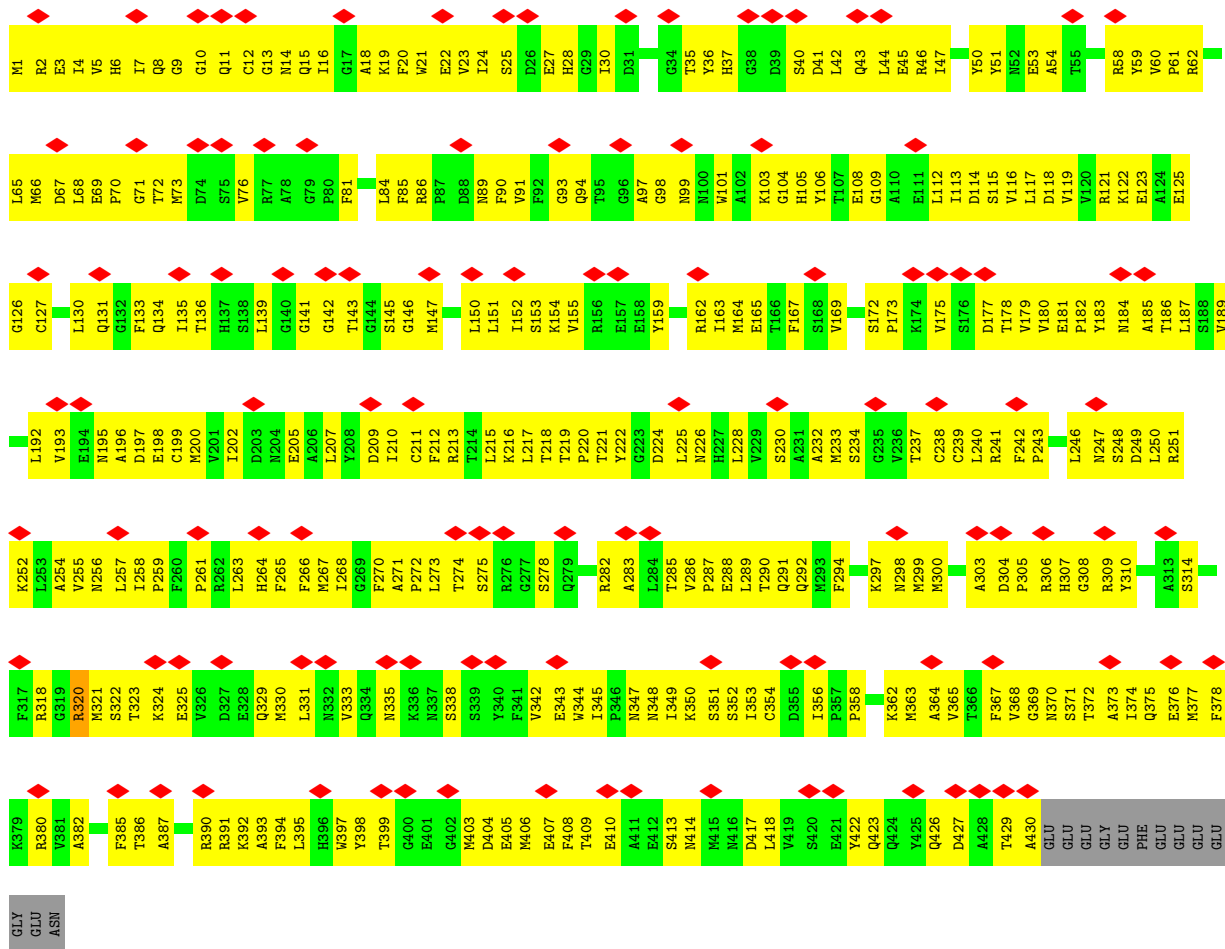

• Molecule 45: Tubulin beta chain

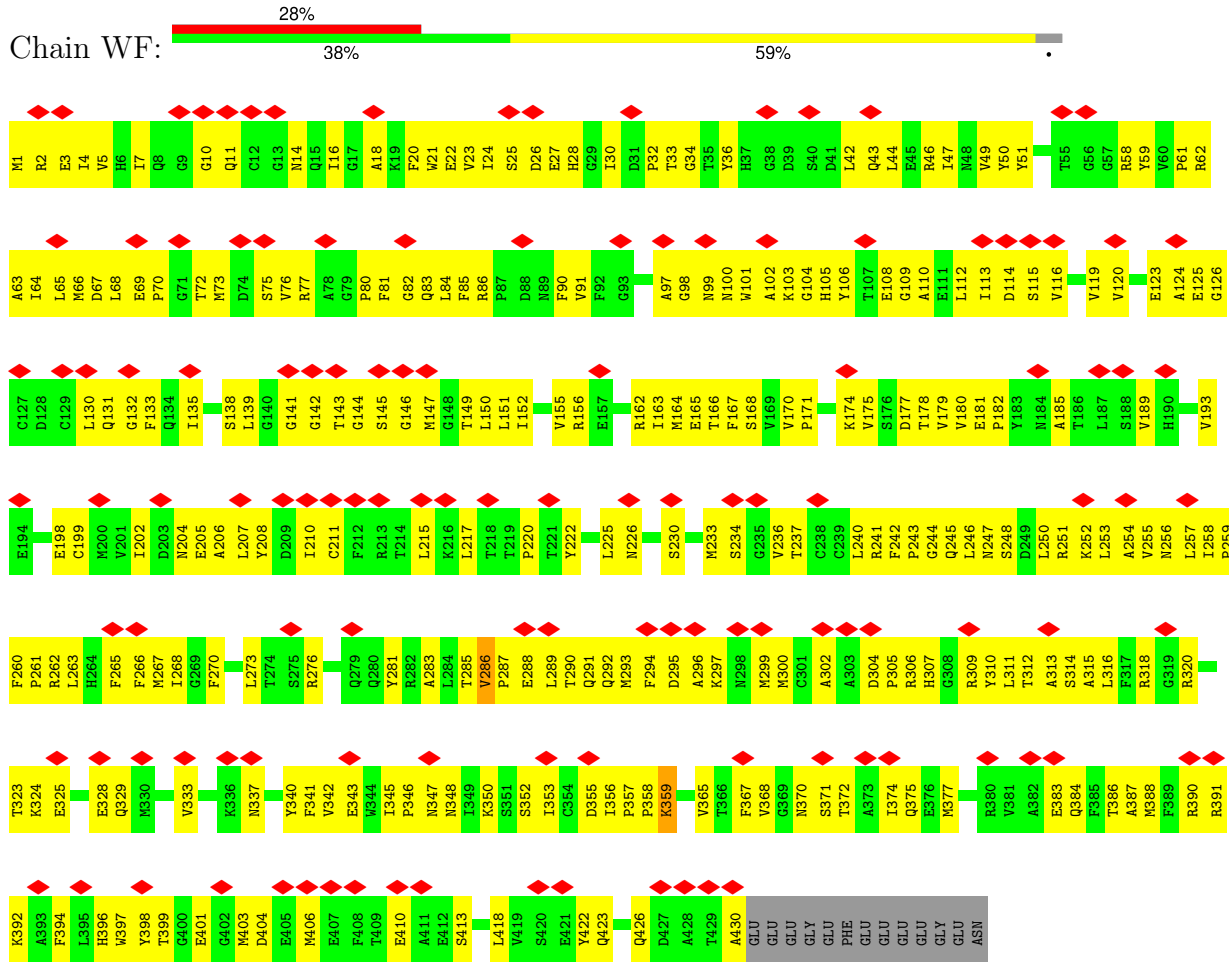

• Molecule 45: Tubulin beta chain

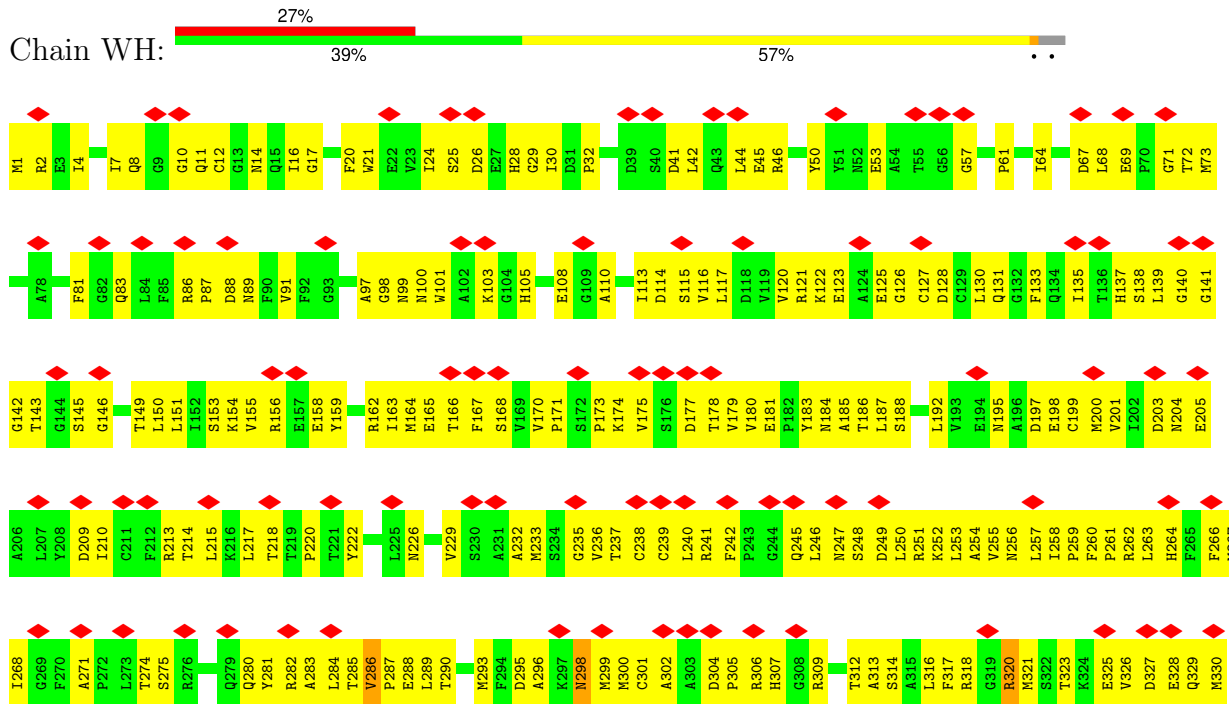

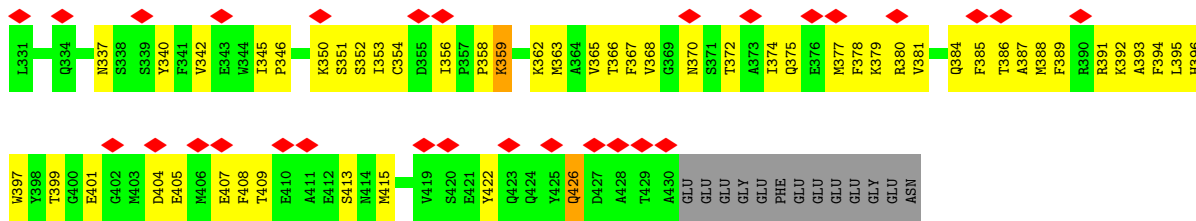

• Molecule 45: Tubulin beta chain

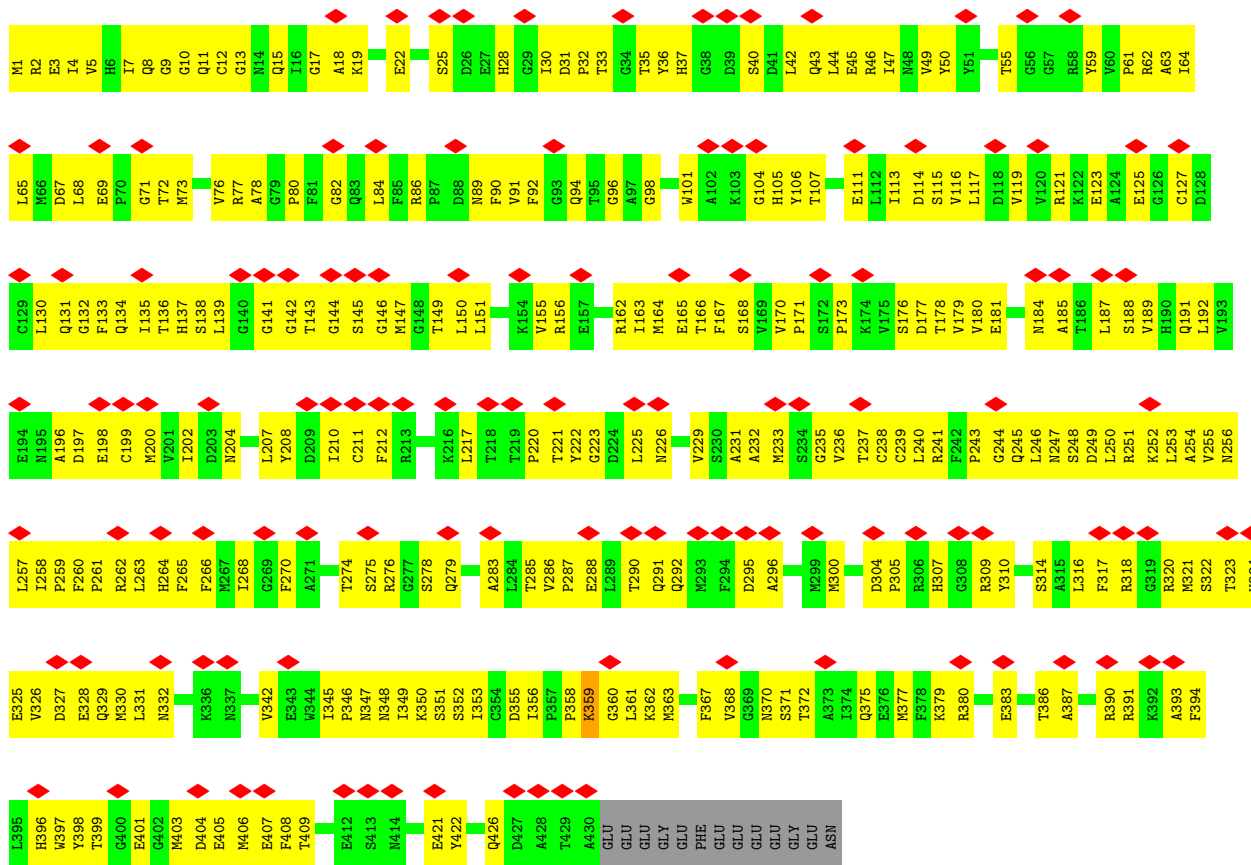

• Molecule 45: Tubulin beta chain

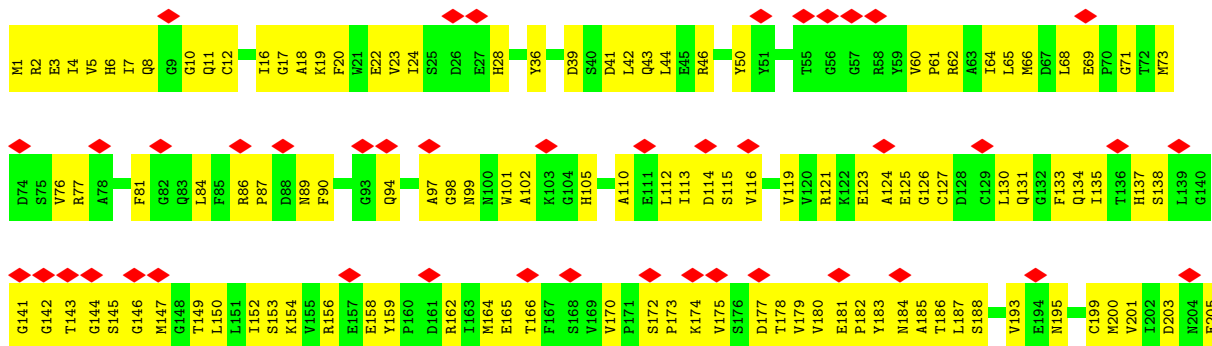

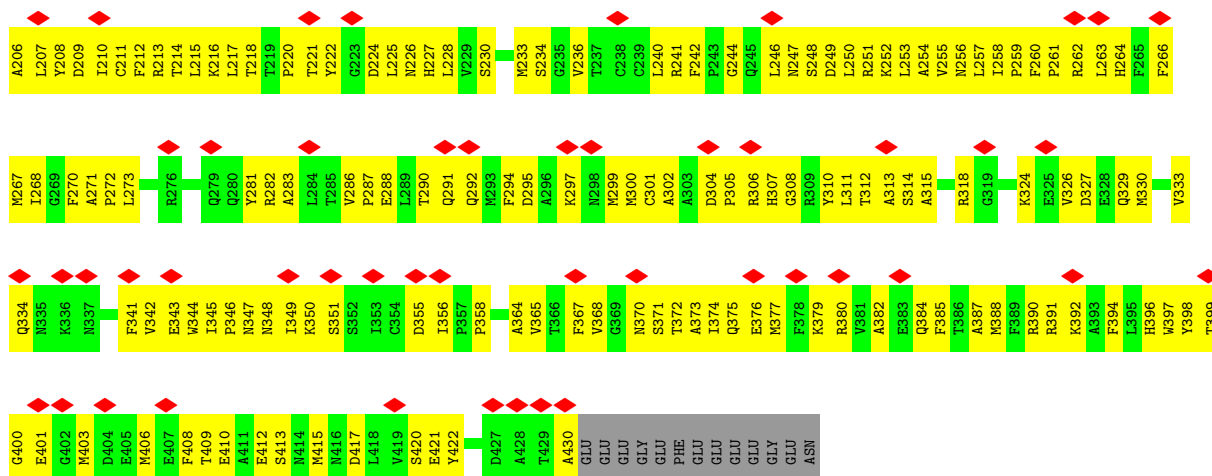

● Molecule 45: Tubulin beta chain

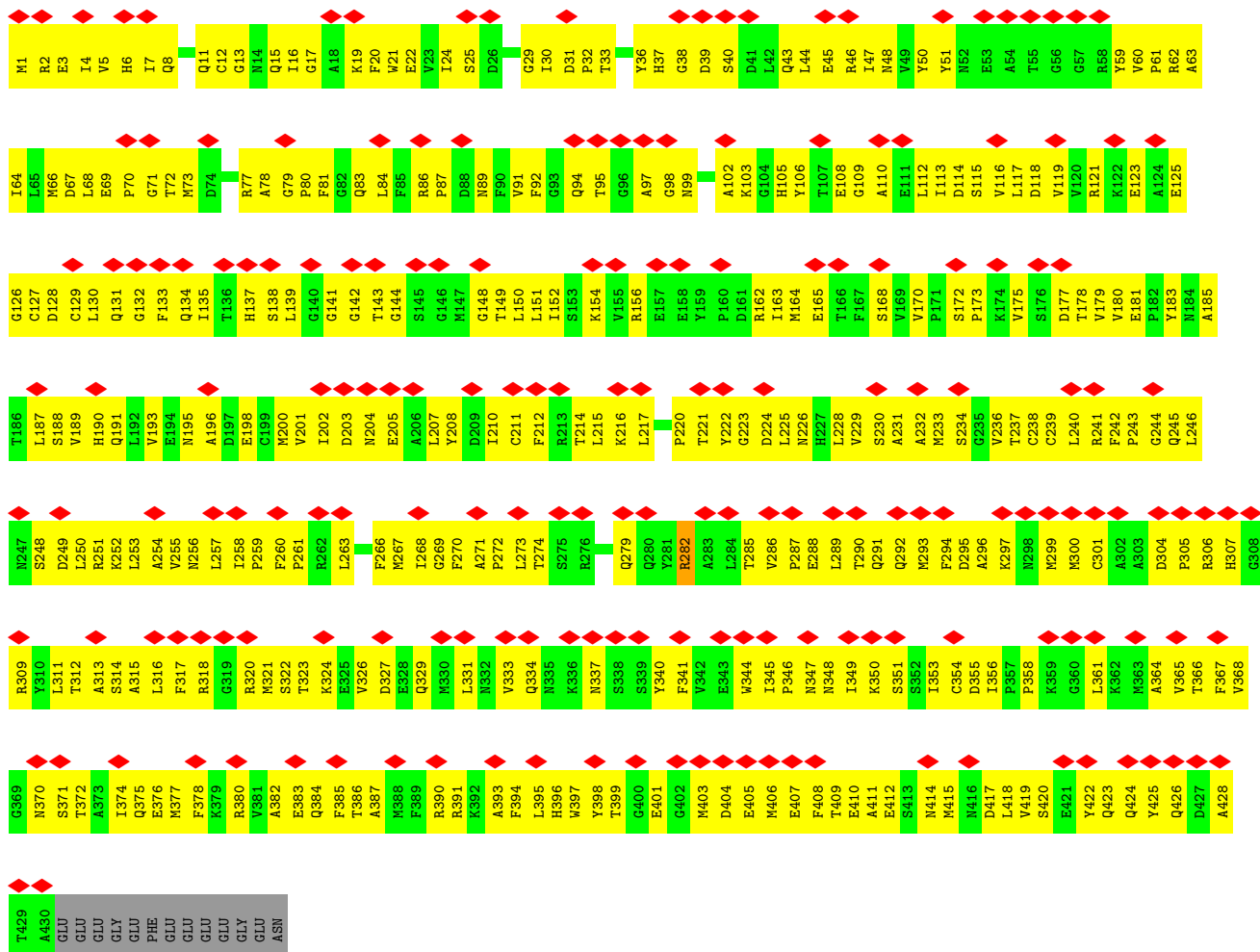

## 4 Experimental information

Property	Value	Source
EM reconstruction method	SINGLE PARTICLE	Depositor
Imposed symmetry	POINT, Not provided	
Number of particles used	39417	Depositor
Resolution determination method	FSC 0.143 CUT-OFF	Depositor
CTF correction method	NONE	Depositor
Microscope	TFS KRIOS	Depositor
Voltage (kV)	300	Depositor
Electron dose ( $e^-/\text{\AA}^2$ )	45	Depositor
Minimum defocus (nm)	1000	Depositor
Maximum defocus (nm)	3000	Depositor
Magnification	Not provided	
Image detector	GATAN K3 (6k x 4k)	Depositor
Maximum map value	2.579	Depositor
Minimum map value	-0.003	Depositor
Average map value	0.010	Depositor
Map value standard deviation	0.078	Depositor
Recommended contour level	0.15	Depositor
Map size ( $\text{\AA}$ )	701.44, 701.44, 701.44	wwPDB
Map dimensions	512, 512, 512	wwPDB
Map angles ( $^\circ$ )	90.0, 90.0, 90.0	wwPDB
Pixel spacing ( $\text{\AA}$ )	1.37, 1.37, 1.37	Depositor

## 5 Model quality [i](#)

### 5.1 Standard geometry [i](#)

Bond lengths and bond angles in the following residue types are not validated in this section: MG, GTP, GDP

The Z score for a bond length (or angle) is the number of standard deviations the observed value is removed from the expected value. A bond length (or angle) with  $|Z| > 5$  is considered an outlier worth inspection. RMSZ is the root-mean-square of all Z scores of the bond lengths (or angles).

Mol	Chain	Bond lengths		Bond angles	
		RMSZ	# Z  >5	RMSZ	# Z  >5
1	6H	0.26	0/1398	0.55	0/1867
2	0A	0.26	0/1273	0.49	0/1733
2	1A	0.26	0/1273	0.51	0/1733
2	2A	0.27	0/1273	0.51	0/1733
2	3A	0.26	0/1273	0.49	0/1733
3	0B	0.26	0/2673	0.48	0/3619
4	0C	0.28	0/762	0.50	0/1023
4	1C	0.37	0/762	0.69	2/1023 (0.2%)
5	0D	0.27	0/1655	0.49	0/2241
5	1D	0.27	0/1655	0.49	0/2241
5	2D	0.27	0/1655	0.48	0/2241
6	0E	0.25	0/1584	0.47	0/2133
6	1E	0.25	0/1584	0.46	0/2133
6	2E	0.26	0/1583	0.47	0/2130
6	3E	0.25	0/1584	0.47	0/2133
7	0F	0.27	0/1699	0.53	0/2294
8	0G	0.27	0/1410	0.46	0/1899
8	1G	0.27	0/1117	0.47	0/1508
9	0H	0.25	0/960	0.49	0/1273
9	1H	0.24	0/3687	0.49	0/4881
10	0N	0.26	0/2355	0.46	0/3181
10	1N	0.26	0/3884	0.44	0/5240
10	2N	0.26	0/2355	0.47	0/3181
11	0Q	0.27	0/1583	0.55	1/2138 (0.0%)
11	1Q	0.28	0/1583	0.52	0/2138
11	2Q	0.28	0/1583	0.54	1/2138 (0.0%)
11	3Q	0.27	0/1583	0.53	0/2138
11	4Q	0.28	0/1583	0.52	0/2138
11	5Q	0.28	0/1583	0.53	0/2138
11	6Q	0.27	0/1583	0.52	0/2138
12	0S	0.26	0/2271	0.45	0/3074
12	1S	0.27	0/2361	0.46	0/3199

Mol	Chain	Bond lengths		Bond angles	
		RMSZ	# Z  >5	RMSZ	# Z  >5
12	2S	0.28	0/2360	0.47	0/3195
12	3S	0.26	0/2361	0.45	0/3199
13	0T	0.24	0/1804	0.43	0/2414
13	1T	0.27	0/2376	0.47	0/3199
13	2T	0.28	0/2378	0.48	0/3205
13	3T	0.27	0/2379	0.48	0/3209
14	0U	0.26	0/4861	0.50	0/6567
14	1U	0.27	0/4861	0.51	0/6567
14	2U	0.26	0/4866	0.52	0/6583
14	3U	0.26	0/4866	0.50	0/6583
15	0V	0.24	0/1784	0.46	0/2393
15	1V	0.27	0/2199	0.61	1/2935 (0.0%)
15	2V	0.28	0/2200	0.69	7/2938 (0.2%)
15	3V	0.26	0/2202	0.58	2/2945 (0.1%)
16	0X	0.26	0/916	0.50	0/1218
16	1X	0.26	0/1221	0.48	0/1622
16	2X	0.26	0/1221	0.48	0/1622
16	3X	0.25	0/1221	0.48	0/1622
16	4X	0.25	0/1221	0.48	0/1622
17	1B	0.27	0/4148	0.45	0/5587
17	2B	0.24	0/2483	0.45	0/3339
17	3B	0.24	0/2493	0.44	0/3352
18	1F	0.27	0/1118	0.46	0/1510
19	1I	0.25	0/1574	0.50	0/2125
20	1J	1.39	6/3090 (0.2%)	0.49	0/4148
21	1K	0.24	0/2359	0.44	0/3133
21	2K	0.23	0/2414	0.42	0/3201
22	1L	0.26	0/6960	0.48	0/9358
22	2L	0.25	0/5275	0.47	0/7092
22	3L	0.25	0/1685	0.48	0/2266
23	1M	1.26	6/3039 (0.2%)	1.10	9/4093 (0.2%)
23	2M	0.27	0/3041	0.51	1/4100 (0.0%)
24	1O	0.25	0/1990	0.44	0/2623
24	2O	0.23	0/3186	0.44	0/4207
24	3O	0.24	0/2295	0.49	1/3029 (0.0%)
25	1P	0.23	0/2977	0.45	0/3933
25	2P	0.24	0/1521	0.42	0/2020
26	1R	0.28	0/4362	0.48	0/5890
26	2R	0.32	1/4364 (0.0%)	0.52	2/5896 (0.0%)
26	3R	0.28	0/4364	0.47	0/5896
27	1W	1.48	2/1865 (0.1%)	0.57	2/2490 (0.1%)
27	2W	0.24	0/902	0.49	0/1200
28	2C	0.26	0/2511	0.46	0/3378



Mol	Chain	Bond lengths		Bond angles	
		RMSZ	# Z  >5	RMSZ	# Z  >5
28	3C	0.27	0/2511	0.46	0/3378
28	4C	0.26	0/2511	0.44	0/3378
29	2F	0.25	0/767	0.45	0/1028
30	2G	0.25	0/859	0.40	0/1140
31	2H	0.25	0/507	0.48	0/672
31	3H	0.25	0/507	0.47	0/672
31	4H	0.26	0/507	0.47	0/672
32	2I	0.27	0/1112	0.49	0/1492
32	3I	0.26	0/729	0.53	0/975
33	3D	0.25	0/1878	0.41	0/2538
34	4F	0.26	0/1668	0.49	0/2256
35	4R	0.95	6/5201 (0.1%)	0.47	0/7028
35	5R	0.28	0/5200	0.46	0/7024
35	6R	0.51	0/5205	0.58	6/7042 (0.1%)
35	7R	0.26	0/5200	0.46	0/7024
36	4S	0.27	0/1572	0.46	0/2122
36	5S	0.26	0/1572	0.45	0/2122
37	5A	0.25	0/1299	0.52	0/1757
37	5B	1.81	6/1299 (0.5%)	0.52	0/1757
37	5C	1.80	6/1299 (0.5%)	0.52	0/1757
37	5D	2.73	6/865 (0.7%)	0.81	1/1161 (0.1%)
38	5E	0.24	0/1531	0.46	0/2055
38	5F	0.25	0/1791	0.49	0/2411
38	5G	0.25	0/1789	0.51	1/2405 (0.0%)
38	5H	0.25	0/1101	0.52	0/1481
39	5I	0.24	0/744	0.40	0/1003
39	5J	0.24	0/893	0.39	0/1201
39	5K	0.23	0/559	0.38	0/750
40	6F	0.25	0/1168	0.46	0/1566
41	6G	0.26	0/1809	0.47	0/2426
44	AA	0.28	0/3478	0.47	0/4710
44	AC	0.29	0/3478	0.48	0/4710
44	AE	0.28	0/3480	0.48	0/4716
44	AG	0.28	0/3480	0.47	0/4716
44	AI	0.28	0/3480	0.47	0/4716
44	AK	0.29	0/3480	0.48	0/4716
44	AM	0.27	0/3479	0.47	0/4713
44	BA	0.27	0/3435	0.47	0/4655
44	BC	0.27	0/3435	0.47	0/4655
44	BE	0.28	0/3435	0.47	0/4655
44	BG	0.27	0/3434	0.48	0/4651
44	BI	0.27	0/3435	0.47	0/4655
44	BK	0.28	0/3434	0.48	0/4651

Mol	Chain	Bond lengths		Bond angles	
		RMSZ	# Z  >5	RMSZ	# Z  >5
44	BM	0.27	0/3435	0.46	0/4655
44	CA	0.26	0/3480	0.47	0/4716
44	CC	0.26	0/3480	0.47	0/4716
44	CE	0.27	0/3480	0.47	0/4716
44	CG	0.28	0/3479	0.50	1/4712 (0.0%)
44	CI	0.27	0/3480	0.46	0/4716
44	CK	0.27	0/3478	0.71	3/4709 (0.1%)
44	CM	0.27	0/3480	0.47	0/4716
44	DA	0.25	0/3443	0.46	0/4666
44	DC	0.26	0/3439	0.46	0/4660
44	DE	0.27	0/3443	0.46	0/4666
44	DG	0.27	0/3457	0.47	0/4678
44	DI	0.28	0/3443	0.48	0/4666
44	DK	0.28	0/3460	0.51	3/4687 (0.1%)
44	DM	0.26	0/3443	0.48	0/4666
44	EA	0.25	0/3466	0.46	0/4694
44	EC	0.26	0/3480	0.48	0/4716
44	EE	0.27	0/3479	0.47	0/4713
44	EG	0.27	0/3480	0.47	0/4716
44	EI	0.28	0/3480	0.47	0/4716
44	EK	0.28	0/3478	0.47	0/4709
44	EM	0.26	0/3476	0.46	0/4703
44	FA	0.26	0/3413	0.46	0/4625
44	FC	0.28	0/3435	0.49	0/4655
44	FE	0.27	0/3447	0.48	0/4671
44	FG	0.27	0/3479	0.48	0/4713
44	FI	0.27	0/3443	0.47	0/4666
44	FK	0.26	0/3435	0.46	0/4655
44	FM	0.25	0/3299	0.45	0/4458
44	GA	0.27	0/3413	0.48	0/4625
44	GC	0.27	0/3428	0.47	0/4643
44	GE	0.28	0/3429	0.48	0/4647
44	GG	0.28	0/3429	0.47	0/4647
44	GI	0.28	0/3429	0.49	0/4647
44	GK	0.26	0/3478	0.47	0/4710
44	GM	0.25	0/3412	0.46	0/4621
44	HA	0.26	0/3425	0.46	0/4638
44	HC	0.27	0/3427	0.47	0/4644
44	HE	0.28	0/3427	0.47	0/4644
44	HG	0.27	0/3427	0.47	0/4644
44	HI	0.28	0/3425	0.48	0/4638
44	HK	0.26	0/3427	0.46	0/4644
44	HM	0.26	0/3427	0.48	0/4644

Mol	Chain	Bond lengths		Bond angles	
		RMSZ	# Z  >5	RMSZ	# Z  >5
44	IA	0.26	0/3435	0.47	0/4655
44	IC	0.27	0/3480	0.46	0/4716
44	IE	0.28	0/3435	0.48	0/4655
44	IG	0.27	0/3480	0.47	0/4716
44	II	0.88	3/3480 (0.1%)	0.56	3/4716 (0.1%)
44	IK	0.27	0/3435	0.46	0/4655
44	IM	0.26	0/3435	0.46	0/4655
44	JA	0.27	0/3435	0.47	0/4655
44	JC	0.28	0/3447	0.48	0/4671
44	JE	0.28	0/3480	0.47	0/4716
44	JG	0.28	0/3480	0.48	0/4716
44	JI	0.27	0/3476	0.47	0/4710
44	JK	0.27	0/3480	0.48	0/4716
44	JM	0.25	0/3447	0.47	0/4671
44	KA	0.27	0/3447	0.48	0/4671
44	KC	0.27	0/3443	0.46	0/4666
44	KE	0.81	1/3456 (0.0%)	0.50	2/4682 (0.0%)
44	KG	0.28	0/3480	0.48	0/4716
44	KI	0.81	1/3480 (0.0%)	0.50	1/4716 (0.0%)
44	KK	0.36	2/3478 (0.1%)	0.52	2/4710 (0.0%)
44	KM	0.26	0/3447	0.47	1/4671 (0.0%)
44	LA	0.27	0/3480	0.47	0/4716
44	LC	0.29	0/3480	0.49	2/4716 (0.0%)
44	LE	0.28	0/3469	0.47	0/4696
44	LG	0.28	0/3480	0.47	0/4716
44	LI	0.28	0/3452	0.48	0/4677
44	LK	0.33	0/3480	0.54	0/4716
44	LM	0.26	0/3480	0.47	0/4716
44	MA	0.28	0/3463	0.47	0/4692
44	MC	0.28	0/3439	0.47	0/4660
44	ME	0.28	0/3440	0.48	0/4657
44	MG	0.27	0/3469	0.47	0/4697
44	MI	0.28	0/3479	0.47	0/4713
44	MK	0.28	0/3455	0.47	0/4681
44	MM	0.27	0/3463	0.47	0/4692
44	NA	0.27	0/3480	0.46	0/4716
44	NC	0.28	0/3435	0.47	0/4655
44	NE	0.28	0/3480	0.49	1/4716 (0.0%)
44	NG	0.27	0/3435	0.48	0/4655
44	NI	0.27	0/3480	0.47	0/4716
44	NK	0.27	0/3435	0.48	0/4655
44	NM	0.26	0/3476	0.48	0/4704
44	OA	0.26	0/3438	0.48	1/4657 (0.0%)

Mol	Chain	Bond lengths		Bond angles	
		RMSZ	# Z  >5	RMSZ	# Z  >5
44	OC	0.27	0/3439	0.47	0/4660
44	OE	0.27	0/3439	0.47	0/4660
44	OG	0.27	0/3439	0.48	0/4660
44	OI	0.27	0/3439	0.46	0/4660
44	OK	0.26	0/3439	0.47	0/4660
44	OM	0.25	0/3439	0.46	0/4660
44	PA	0.25	0/3413	0.46	0/4625
44	PC	0.27	0/3413	0.48	0/4625
44	PE	0.27	0/3413	0.47	0/4625
44	PG	0.27	0/3413	0.46	0/4625
44	PI	0.27	0/3412	0.46	0/4622
44	PK	0.26	0/3413	0.46	0/4625
44	PM	0.25	0/3413	0.45	0/4625
44	QA	0.24	0/3427	0.46	0/4644
44	QC	0.26	0/3427	0.47	0/4644
44	QE	0.26	0/3427	0.46	0/4644
44	QG	0.27	0/3427	0.48	0/4644
44	QI	0.26	0/3427	0.47	0/4644
44	QK	0.26	0/3427	0.47	0/4644
44	QM	0.25	0/3426	0.47	0/4640
44	RA	0.24	0/3427	0.45	0/4644
44	RC	0.26	0/3427	0.46	0/4644
44	RE	0.27	0/3427	0.46	0/4644
44	RG	0.26	0/3426	0.47	0/4641
44	RI	0.27	0/3427	0.47	0/4644
44	RK	0.26	0/3427	0.47	0/4644
44	RM	0.26	0/3425	0.47	0/4638
44	SA	0.25	0/3421	0.45	0/4636
44	SC	0.26	0/3418	0.47	0/4627
44	SE	0.26	0/3419	0.47	0/4630
44	SG	0.27	0/3420	0.47	0/4633
44	SI	0.26	0/3421	0.46	0/4636
44	SK	0.27	0/3421	0.46	0/4636
44	SM	0.26	0/3417	0.47	0/4624
44	TA	0.25	0/3421	0.46	0/4636
44	TC	0.26	0/3421	0.47	0/4636
44	TE	0.26	0/3421	0.47	0/4636
44	TG	0.27	0/3419	0.47	0/4630
44	TI	0.27	0/3421	0.47	0/4636
44	TK	0.26	0/3421	0.46	0/4636
44	TM	0.25	0/3419	0.46	0/4630
44	UA	0.25	0/3421	0.46	0/4636
44	UC	0.26	0/3426	0.46	0/4641

Mol	Chain	Bond lengths		Bond angles	
		RMSZ	# Z  >5	RMSZ	# Z  >5
44	UE	0.26	0/3427	0.47	0/4644
44	UG	0.27	0/3427	0.46	0/4644
44	UI	0.27	0/3427	0.47	0/4644
44	UK	0.28	0/3426	0.50	1/4640 (0.0%)
44	UM	0.25	0/3427	0.46	0/4644
44	VA	0.26	0/3443	0.46	0/4666
44	VC	0.26	0/3478	0.46	0/4710
44	VE	0.27	0/3443	0.47	0/4666
44	VG	0.27	0/3480	0.47	0/4716
44	VI	0.27	0/3443	0.48	0/4666
44	VK	0.26	0/3480	0.47	0/4716
44	VM	0.26	0/3435	0.49	2/4654 (0.0%)
44	WA	0.26	0/3425	0.46	0/4638
44	WC	0.27	0/3479	0.47	0/4713
44	WE	0.26	0/3427	0.46	0/4644
44	WG	0.27	0/3479	0.49	1/4713 (0.0%)
44	WI	0.27	0/3427	0.47	0/4644
44	WK	0.27	0/3479	0.47	0/4713
44	WM	0.25	0/3427	0.46	0/4644
45	AB	0.26	0/3355	0.48	0/4534
45	AD	0.28	0/3439	0.49	0/4655
45	AF	0.28	0/3439	0.48	0/4655
45	AH	0.28	0/3439	0.48	0/4655
45	AJ	0.28	0/3437	0.47	0/4649
45	AL	0.29	0/3439	0.48	0/4655
45	AN	0.28	0/3436	0.47	0/4644
45	BB	0.26	0/3439	0.52	0/4655
45	BD	0.27	0/3439	0.47	0/4655
45	BF	1.32	6/3439 (0.2%)	1.22	10/4655 (0.2%)
45	BH	0.28	0/3435	0.48	0/4642
45	BJ	0.28	0/3438	0.48	0/4652
45	BL	0.28	0/3439	0.47	0/4655
45	BN	0.28	0/3439	0.48	0/4655
45	CB	0.27	0/3439	0.51	1/4655 (0.0%)
45	CD	0.26	0/3439	0.48	0/4655
45	CF	0.28	0/3439	0.49	0/4655
45	CH	0.27	0/3438	0.50	0/4651
45	CJ	0.27	0/3439	0.48	0/4655
45	CL	0.27	0/3437	0.50	1/4649 (0.0%)
45	CN	0.25	0/3439	0.47	0/4655
45	DB	1.37	7/3437 (0.2%)	1.43	7/4649 (0.2%)
45	DD	0.27	0/3439	0.47	0/4655
45	DF	0.27	0/3437	0.47	0/4649

Mol	Chain	Bond lengths		Bond angles	
		RMSZ	# Z  >5	RMSZ	# Z  >5
45	DH	0.27	0/3439	0.55	1/4655 (0.0%)
45	DJ	0.27	0/3436	0.48	0/4646
45	DL	0.26	0/3438	0.47	0/4652
45	DN	0.25	0/3439	0.47	0/4655
45	EB	0.26	0/3439	0.47	0/4655
45	ED	0.26	0/3439	0.47	0/4655
45	EF	0.27	0/3439	0.48	0/4655
45	EH	0.27	0/3439	0.48	0/4655
45	EJ	0.26	0/3439	0.48	0/4655
45	EL	0.26	0/3439	0.49	0/4655
45	EN	0.25	0/3439	0.48	0/4655
45	FB	0.26	0/3439	0.47	0/4655
45	FD	0.27	0/3439	0.48	0/4655
45	FF	0.28	0/3439	0.48	0/4655
45	FH	0.27	0/3437	0.48	0/4649
45	FJ	1.10	6/3439 (0.2%)	1.08	7/4655 (0.2%)
45	FL	0.27	0/3439	0.48	0/4655
45	FN	0.26	0/3439	0.48	0/4655
45	GB	0.26	0/3439	0.47	0/4655
45	GD	0.27	0/3439	0.48	0/4655
45	GF	0.29	0/3437	0.53	2/4649 (0.0%)
45	GH	0.27	0/3438	0.49	0/4652
45	GJ	0.28	0/3439	0.47	0/4655
45	GL	0.27	0/3439	0.48	0/4655
45	GN	0.26	0/3438	0.47	0/4652
45	HB	0.25	0/3437	0.46	0/4648
45	HD	0.26	0/3439	0.47	0/4655
45	HF	1.37	7/3439 (0.2%)	1.42	7/4655 (0.2%)
45	HH	1.07	6/3439 (0.2%)	1.01	8/4655 (0.2%)
45	HJ	0.27	0/3439	0.47	0/4655
45	HL	0.27	0/3439	0.48	0/4655
45	HN	1.37	7/3439 (0.2%)	1.43	7/4655 (0.2%)
45	IB	0.25	0/3439	0.47	0/4655
45	ID	0.27	0/3439	0.48	0/4655
45	IF	0.27	0/3439	0.47	0/4655
45	IH	0.28	0/3439	0.50	0/4655
45	IJ	0.27	0/3439	0.48	0/4655
45	IL	0.27	0/3437	0.48	0/4649
45	IN	0.27	0/3439	0.48	0/4655
45	JB	0.26	0/3439	0.47	0/4655
45	JD	0.28	0/3439	0.49	0/4655
45	JF	0.27	0/3438	0.47	0/4652
45	JH	0.28	0/3439	0.49	0/4655

Mol	Chain	Bond lengths		Bond angles	
		RMSZ	# Z  >5	RMSZ	# Z  >5
45	JJ	0.29	0/3438	0.49	1/4651 (0.0%)
45	JL	0.28	0/3438	0.48	0/4652
45	JN	0.26	0/3439	0.47	0/4655
45	KB	0.27	0/3439	0.49	0/4655
45	KD	0.29	0/3439	0.50	2/4655 (0.0%)
45	KF	0.28	0/3439	0.49	0/4655
45	KH	0.27	0/3439	0.47	0/4655
45	KJ	0.29	0/3439	0.49	0/4655
45	KL	0.28	0/3439	0.48	0/4655
45	KN	0.29	0/3436	0.51	0/4646
45	LB	0.27	0/3439	0.48	0/4655
45	LD	0.27	0/3439	0.49	0/4655
45	LF	0.29	0/3439	0.49	0/4655
45	LH	0.28	0/3439	0.47	0/4655
45	LJ	0.28	0/3439	0.49	0/4655
45	LL	0.27	0/3439	0.47	0/4655
45	LN	0.28	0/3439	0.48	0/4655
45	MB	0.26	0/3438	0.47	0/4652
45	MD	0.28	0/3439	0.48	0/4655
45	MF	0.28	0/3437	0.49	0/4649
45	MH	0.28	0/3439	0.48	0/4655
45	MJ	0.28	0/3439	0.49	0/4655
45	ML	0.28	0/3438	0.49	1/4651 (0.0%)
45	MN	0.27	0/3439	0.48	0/4655
45	NB	0.25	0/3375	0.46	0/4569
45	ND	0.27	0/3439	0.48	0/4655
45	NF	0.28	0/3375	0.47	0/4569
45	NH	0.27	0/3439	0.48	0/4655
45	NJ	0.28	0/3375	0.49	1/4569 (0.0%)
45	NL	0.27	0/3439	0.48	0/4655
45	NN	0.26	0/3373	0.47	1/4563 (0.0%)
45	OB	0.25	0/3439	0.46	0/4655
45	OD	0.26	0/3439	0.48	0/4655
45	OF	0.27	0/3439	0.48	0/4655
45	OH	0.27	0/3439	0.48	0/4655
45	OJ	0.27	0/3439	0.48	0/4655
45	OL	0.27	0/3439	0.48	0/4655
45	ON	0.26	0/3439	0.47	0/4655
45	PB	0.25	0/3421	0.47	0/4628
45	PD	0.26	0/3436	0.47	0/4646
45	PF	1.42	8/3439 (0.2%)	0.54	3/4655 (0.1%)
45	PH	0.27	0/3439	0.46	0/4655
45	PJ	0.27	0/3439	0.47	0/4655

Mol	Chain	Bond lengths		Bond angles	
		RMSZ	# Z  >5	RMSZ	# Z  >5
45	PL	0.26	0/3439	0.47	0/4655
45	PN	0.26	0/3439	0.46	0/4655
45	QB	0.27	0/3439	0.47	0/4655
45	QD	0.26	0/3439	0.48	0/4655
45	QF	0.26	0/3438	0.47	0/4652
45	QH	0.26	0/3439	0.47	0/4655
45	QJ	0.26	0/3436	0.47	0/4646
45	QL	0.26	0/3439	0.47	0/4655
45	QN	0.25	0/3306	0.45	0/4463
45	RB	0.25	0/3439	0.46	0/4655
45	RD	0.26	0/3439	0.49	1/4655 (0.0%)
45	RF	0.27	0/3439	0.49	1/4655 (0.0%)
45	RH	0.26	0/3439	0.48	0/4655
45	RJ	0.26	0/3439	0.48	0/4655
45	RL	0.26	0/3439	0.48	1/4655 (0.0%)
45	RN	0.25	0/3439	0.46	0/4655
45	SB	0.26	0/3437	0.46	0/4649
45	SD	0.26	0/3439	0.48	0/4655
45	SF	0.27	0/3439	0.48	0/4655
45	SH	0.27	0/3439	0.48	0/4655
45	SJ	0.26	0/3439	0.48	0/4655
45	SL	0.28	0/3439	0.49	2/4655 (0.0%)
45	SN	0.25	0/3439	0.46	0/4655
45	TB	0.25	0/3439	0.46	0/4655
45	TD	0.26	0/3439	0.47	0/4655
45	TF	0.26	0/3439	0.48	0/4655
45	TH	0.26	0/3437	0.47	0/4649
45	TJ	0.28	0/3439	0.47	0/4655
45	TL	0.25	0/3439	0.46	0/4655
45	TN	1.37	7/3436 (0.2%)	1.42	7/4646 (0.2%)
45	UB	0.25	0/3436	0.46	0/4645
45	UD	0.26	0/3438	0.48	0/4652
45	UF	0.26	0/3439	0.47	0/4655
45	UH	0.27	0/3439	0.47	0/4655
45	UJ	0.27	0/3439	0.48	0/4655
45	UL	0.25	0/3439	0.46	0/4655
45	UN	0.25	0/3439	0.46	0/4655
45	VB	0.25	0/3439	0.47	0/4655
45	VD	0.27	0/3438	0.47	0/4652
45	VF	0.27	0/3437	0.47	0/4649
45	VH	0.27	0/3439	0.48	0/4655
45	VJ	0.27	0/3439	0.48	1/4655 (0.0%)
45	VL	0.26	0/3438	0.47	0/4652



Mol	Chain	Bond lengths		Bond angles	
		RMSZ	# Z  >5	RMSZ	# Z  >5
45	VN	0.25	0/3437	0.47	1/4649 (0.0%)
45	WB	0.26	0/3439	0.47	0/4655
45	WD	0.27	0/3439	0.48	0/4655
45	WF	0.27	0/3439	0.48	0/4655
45	WH	0.27	0/3438	0.48	0/4652
45	WJ	0.27	0/3438	0.46	0/4652
45	WL	0.27	0/3439	0.47	0/4655
45	WN	0.26	0/3439	0.47	0/4655
All	All	0.37	100/1333976 (0.0%)	0.51	135/1804342 (0.0%)

Chiral center outliers are detected by calculating the chiral volume of a chiral center and verifying if the center is modelled as a planar moiety or with the opposite hand. A planarity outlier is detected by checking planarity of atoms in a peptide group, atoms in a mainchain group or atoms of a sidechain that are expected to be planar.

Mol	Chain	#Chirality outliers	#Planarity outliers
2	0A	0	1
2	1A	0	1
2	2A	0	1
2	3A	0	1
12	0S	0	1
14	0U	0	1
14	1U	0	1
14	2U	0	1
15	1V	0	2
15	2V	0	3
26	1R	0	1
26	2R	0	1
26	3R	0	1
37	5D	0	2
38	5F	0	1
44	BI	0	1
44	CK	0	2
44	FC	0	1
44	JG	0	1
44	NM	0	3
44	QM	0	1
44	SK	0	1
45	CB	0	1
45	DL	0	1
45	EF	0	1
45	FH	0	2

*Continued on next page...*

Continued from previous page...

Mol	Chain	#Chirality outliers	#Planarity outliers
45	FN	0	1
45	GL	0	1
45	KL	0	1
45	KN	0	2
45	OD	0	1
45	PF	0	1
45	SB	0	1
45	SD	0	1
All	All	0	43

The worst 5 of 100 bond length outliers are listed below:

Mol	Chain	Res	Type	Atoms	Z	Observed(Å)	Ideal(Å)
27	1W	121	GLU	CG-CD	62.58	2.45	1.51
45	DB	281	TYR	CE2-CZ	48.74	2.02	1.38
45	HN	281	TYR	CE2-CZ	48.70	2.01	1.38
45	TN	281	TYR	CE2-CZ	48.49	2.01	1.38
44	II	282	TYR	CB-CG	48.48	2.24	1.51

The worst 5 of 135 bond angle outliers are listed below:

Mol	Chain	Res	Type	Atoms	Z	Observed(°)	Ideal(°)
45	HF	281	TYR	CD1-CE1-CZ	-64.39	61.85	119.80
45	DB	281	TYR	CD1-CE1-CZ	-64.33	61.90	119.80
45	HN	281	TYR	CD1-CE1-CZ	-64.31	61.92	119.80
45	TN	281	TYR	CD1-CE1-CZ	-64.10	62.11	119.80
45	DB	281	TYR	CG-CD2-CE2	-53.20	78.74	121.30

There are no chirality outliers.

5 of 43 planarity outliers are listed below:

Mol	Chain	Res	Type	Group
2	0A	38	SER	Peptide
12	0S	18	ARG	Sidechain
14	0U	471	GLY	Peptide
2	1A	38	SER	Peptide
26	1R	42	PRO	Peptide

## 5.2 Too-close contacts [i](#)

In the following table, the Non-H and H(model) columns list the number of non-hydrogen atoms and hydrogen atoms in the chain respectively. The H(added) column lists the number of hydrogen atoms added and optimized by MolProbity. The Clashes column lists the number of clashes within the asymmetric unit, whereas Symm-Clashes lists symmetry-related clashes.

Mol	Chain	Non-H	H(model)	H(added)	Clashes	Symm-Clashes
1	6H	1370	0	1276	200	0
2	0A	1229	0	1157	80	0
2	1A	1229	0	1157	59	0
2	2A	1229	0	1157	83	0
2	3A	1229	0	1156	91	0
3	0B	2614	0	2537	119	0
4	0C	747	0	744	32	0
4	1C	747	0	744	48	0
5	0D	1621	0	1610	96	0
5	1D	1621	0	1610	68	0
5	2D	1621	0	1610	68	0
6	0E	1557	0	1513	17	0
6	1E	1557	0	1513	1	0
6	2E	1557	0	1512	20	0
6	3E	1557	0	1513	30	0
7	0F	1665	0	1658	81	0
8	0G	1378	0	1335	82	0
8	1G	1089	0	1056	52	0
9	0H	949	0	952	15	0
9	1H	3654	0	3670	65	0
10	0N	2305	0	2251	50	0
10	1N	3805	0	3734	59	0
10	2N	2305	0	2251	31	0
11	0Q	1548	0	1575	11	0
11	1Q	1548	0	1575	14	0
11	2Q	1548	0	1575	19	0
11	3Q	1548	0	1575	25	0
11	4Q	1548	0	1575	6	0
11	5Q	1548	0	1575	164	0
11	6Q	1548	0	1575	191	0
12	0S	2227	0	2261	24	0
12	1S	2310	0	2349	35	0
12	2S	2310	0	2349	32	0
12	3S	2310	0	2349	52	0
13	0T	1774	0	1722	9	0
13	1T	2321	0	2265	43	0
13	2T	2321	0	2267	27	0

*Continued on next page...*

*Continued from previous page...*

Mol	Chain	Non-H	H(model)	H(added)	Clashes	Symm-Clashes
13	3T	2321	0	2267	33	0
14	0U	4774	0	4746	9	0
14	1U	4774	0	4746	17	0
14	2U	4774	0	4750	21	0
14	3U	4774	0	4750	25	0
15	0V	1750	0	1740	46	0
15	1V	2168	1211	2151	86	0
15	2V	2168	1211	2152	64	0
15	3V	2168	1211	2153	71	0
16	0X	903	0	878	39	0
16	1X	1205	0	1184	42	0
16	2X	1205	0	1184	53	0
16	3X	1205	0	1184	51	0
16	4X	1205	0	1184	42	0
17	1B	4066	0	4014	19	0
17	2B	2439	0	2418	32	0
17	3B	2449	0	2426	3	0
18	1F	1093	0	1079	49	0
19	1I	1546	0	1485	64	0
20	1J	3025	0	2938	221	0
21	1K	2335	0	2336	56	0
21	2K	2396	0	2419	43	0
22	1L	6841	0	6886	155	0
22	2L	5181	0	5214	109	0
22	3L	1660	0	1671	47	0
23	1M	2978	2176	2956	16	0
23	2M	2978	2191	2957	6	0
24	1O	1983	0	2096	26	0
24	2O	3173	0	3303	79	0
24	3O	2290	2347	2371	20	0
25	1P	2958	0	3087	101	0
25	2P	1507	0	1507	24	0
26	1R	4244	0	4117	119	0
26	2R	4244	0	4119	140	0
26	3R	4244	0	4119	116	0
27	1W	1840	0	1771	77	0
27	2W	890	0	869	66	0
28	2C	2467	0	2457	26	0
28	3C	2467	0	2457	29	0
28	4C	2467	0	2457	38	0
29	2F	746	0	703	41	0
30	2G	848	0	869	23	0

*Continued on next page...*

*Continued from previous page...*

Mol	Chain	Non-H	H(model)	H(added)	Clashes	Symm-Clashes
31	2H	501	0	513	46	0
31	3H	501	0	513	37	0
31	4H	501	0	513	52	0
32	2I	1086	0	1081	118	0
32	3I	712	0	722	92	0
33	3D	1835	0	1817	4	0
34	4F	1622	0	1559	94	0
35	4R	5070	0	4974	127	0
35	5R	5070	0	4974	599	0
35	6R	5070	0	4975	661	0
35	7R	5070	0	4974	668	0
36	4S	1537	0	1565	9	0
36	5S	1537	0	1565	161	0
37	5A	1261	0	1230	44	0
37	5B	1261	0	1230	73	0
37	5C	1261	0	1230	87	0
37	5D	846	0	821	452	0
38	5E	1500	0	1504	76	0
38	5F	1750	0	1753	146	0
38	5G	1750	0	1751	227	0
38	5H	1077	0	1073	170	0
39	5I	732	0	722	64	0
39	5J	878	0	889	74	0
39	5K	553	0	580	86	0
40	6F	1140	0	1075	141	0
41	6G	1769	0	1772	289	0
42	8L	1925	0	391	97	0
42	8N	1790	0	363	65	0
43	8P	1815	0	370	67	0
43	8R	2020	0	427	64	0
44	AA	3408	0	3345	398	0
44	AC	3408	0	3345	377	0
44	AE	3408	0	3347	331	0
44	AG	3408	0	3347	366	0
44	AI	3408	0	3347	318	0
44	AK	3408	0	3347	354	0
44	AM	3408	0	3346	395	0
44	BA	3364	0	3300	470	0
44	BC	3364	0	3302	331	0
44	BE	3364	0	3302	358	0
44	BG	3364	0	3302	380	0
44	BI	3364	0	3302	330	0

*Continued on next page...*

*Continued from previous page...*

Mol	Chain	Non-H	H(model)	H(added)	Clashes	Symm-Clashes
44	BK	3364	0	3302	341	0
44	BM	3364	0	3302	405	0
44	CA	3408	0	3347	464	0
44	CC	3408	0	3347	408	0
44	CE	3408	0	3347	363	0
44	CG	3408	0	3347	366	0
44	CI	3408	0	3347	339	0
44	CK	3408	0	3346	366	0
44	CM	3408	0	3347	527	0
44	DA	3372	0	3306	501	0
44	DC	3368	0	3305	415	0
44	DE	3372	0	3306	418	0
44	DG	3389	0	3321	397	0
44	DI	3372	0	3306	406	0
44	DK	3389	0	3325	419	0
44	DM	3372	0	3305	473	0
44	EA	3397	0	3336	404	0
44	EC	3408	0	3347	500	0
44	EE	3408	0	3346	478	0
44	EG	3408	0	3347	433	0
44	EI	3408	0	3347	386	0
44	EK	3408	0	3346	444	0
44	EM	3408	0	3343	488	0
44	FA	3342	0	3288	443	0
44	FC	3364	0	3302	485	0
44	FE	3376	0	3309	399	0
44	FG	3408	0	3346	375	0
44	FI	3372	0	3306	385	0
44	FK	3364	0	3301	447	0
44	FM	3239	0	3156	338	0
44	GA	3342	0	3289	465	0
44	GC	3358	0	3297	404	0
44	GE	3358	0	3297	383	0
44	GG	3358	0	3297	364	0
44	GI	3358	0	3297	390	0
44	GK	3408	0	3345	524	0
44	GM	3342	0	3288	459	0
44	HA	3356	0	3296	421	0
44	HC	3356	0	3298	382	0
44	HE	3356	0	3298	378	0
44	HG	3356	0	3298	346	0
44	HI	3356	0	3296	350	0

*Continued on next page...*

*Continued from previous page...*

Mol	Chain	Non-H	H(model)	H(added)	Clashes	Symm-Clashes
44	HK	3356	0	3297	383	0
44	HM	3356	0	3297	416	0
44	IA	3364	0	3302	421	0
44	IC	3408	0	3347	364	0
44	IE	3364	0	3302	389	0
44	IG	3408	0	3347	387	0
44	II	3408	0	3347	411	0
44	IK	3364	0	3302	367	0
44	IM	3364	0	3301	420	0
44	JA	3364	0	3302	334	0
44	JC	3376	0	3309	350	0
44	JE	3408	0	3347	348	0
44	JG	3408	0	3346	401	0
44	JI	3404	0	3336	327	0
44	JK	3408	0	3347	404	0
44	JM	3376	0	3308	433	0
44	KA	3376	0	3309	391	0
44	KC	3372	0	3306	316	0
44	KE	3385	0	3321	365	0
44	KG	3408	0	3347	408	0
44	KI	3408	0	3347	383	0
44	KK	3408	0	3345	512	0
44	KM	3376	0	3308	446	0
44	LA	3408	0	3347	411	0
44	LC	3408	0	3347	348	0
44	LE	3400	0	3333	319	0
44	LG	3408	0	3347	385	0
44	LI	3381	0	3319	398	0
44	LK	3408	0	3333	218	0
44	LM	3408	0	3347	401	0
44	MA	3392	0	3329	329	0
44	MC	3368	0	3305	357	0
44	ME	3372	0	3303	373	0
44	MG	3400	0	3336	412	0
44	MI	3408	0	3346	344	0
44	MK	3384	0	3315	391	0
44	MM	3392	0	3329	453	0
44	NA	3408	0	3347	432	0
44	NC	3364	0	3302	392	0
44	NE	3408	0	3347	394	0
44	NG	3364	0	3302	405	0
44	NI	3408	0	3347	383	0

*Continued on next page...*

*Continued from previous page...*

Mol	Chain	Non-H	H(model)	H(added)	Clashes	Symm-Clashes
44	NK	3364	0	3302	424	0
44	NM	3408	0	3343	602	0
44	OA	3368	0	3304	446	0
44	OC	3368	0	3305	408	0
44	OE	3368	0	3305	409	0
44	OG	3368	0	3305	414	0
44	OI	3368	0	3305	393	0
44	OK	3368	0	3304	394	0
44	OM	3368	0	3303	397	0
44	PA	3342	0	3288	452	0
44	PC	3342	0	3289	439	0
44	PE	3342	0	3289	407	0
44	PG	3342	0	3289	368	0
44	PI	3342	0	3288	360	0
44	PK	3342	0	3289	390	0
44	PM	3342	0	3289	374	0
44	QA	3356	0	3298	393	0
44	QC	3356	0	3297	489	0
44	QE	3356	0	3298	394	0
44	QG	3356	0	3298	402	0
44	QI	3356	0	3298	363	0
44	QK	3356	0	3298	363	0
44	QM	3356	0	3298	468	0
44	RA	3356	0	3297	358	0
44	RC	3356	0	3297	434	0
44	RE	3356	0	3298	485	0
44	RG	3356	0	3295	431	0
44	RI	3356	0	3297	410	0
44	RK	3356	0	3298	408	0
44	RM	3356	0	3294	474	0
44	SA	3350	0	3293	459	0
44	SC	3350	0	3290	431	0
44	SE	3350	0	3291	442	0
44	SG	3350	0	3290	431	0
44	SI	3350	0	3293	385	0
44	SK	3350	0	3292	421	0
44	SM	3350	0	3288	501	0
44	TA	3350	0	3293	432	0
44	TC	3350	0	3290	439	0
44	TE	3350	0	3293	521	0
44	TG	3350	0	3291	404	0
44	TI	3350	0	3293	464	0

*Continued on next page...*



*Continued from previous page...*

Mol	Chain	Non-H	H(model)	H(added)	Clashes	Symm-Clashes
44	TK	3350	0	3293	401	0
44	TM	3350	0	3289	497	0
44	UA	3350	0	3293	425	0
44	UC	3356	0	3297	497	0
44	UE	3356	0	3298	510	0
44	UG	3356	0	3298	472	0
44	UI	3356	0	3298	442	0
44	UK	3356	0	3296	472	0
44	UM	3356	0	3297	465	0
44	VA	3372	0	3305	497	0
44	VC	3408	0	3345	413	0
44	VE	3372	0	3306	398	0
44	VG	3408	0	3346	446	0
44	VI	3372	0	3306	441	0
44	VK	3408	0	3347	393	0
44	VM	3365	0	3291	410	0
44	WA	3356	0	3295	447	0
44	WC	3408	0	3345	427	0
44	WE	3356	0	3297	342	0
44	WG	3408	0	3346	371	0
44	WI	3356	0	3297	370	0
44	WK	3408	0	3346	416	0
44	WM	3356	0	3298	495	0
45	AB	3291	0	3167	424	0
45	AD	3366	0	3257	401	0
45	AF	3366	0	3257	379	0
45	AH	3366	0	3257	362	0
45	AJ	3366	0	3255	368	0
45	AL	3366	0	3257	383	0
45	AN	3366	0	3256	399	0
45	BB	3366	0	3255	163	0
45	BD	3366	0	3256	450	0
45	BF	3366	0	3256	365	0
45	BH	3366	0	3253	387	0
45	BJ	3366	0	3256	377	0
45	BL	3366	0	3257	385	0
45	BN	3366	0	3257	453	0
45	CB	3366	0	3257	533	0
45	CD	3366	0	3257	381	0
45	CF	3366	0	3257	383	0
45	CH	3366	0	3257	385	0
45	CJ	3366	0	3257	377	0

*Continued on next page...*

*Continued from previous page...*

Mol	Chain	Non-H	H(model)	H(added)	Clashes	Symm-Clashes
45	CL	3366	0	3255	494	0
45	CN	3366	0	3257	529	0
45	DB	3366	0	3253	459	0
45	DD	3366	0	3256	350	0
45	DF	3366	0	3255	397	0
45	DH	3366	0	3257	387	0
45	DJ	3366	0	3254	434	0
45	DL	3366	0	3256	428	0
45	DN	3366	0	3257	456	0
45	EB	3366	0	3257	538	0
45	ED	3366	0	3257	492	0
45	EF	3366	0	3257	534	0
45	EH	3366	0	3257	421	0
45	EJ	3366	0	3257	487	0
45	EL	3366	0	3257	427	0
45	EN	3366	0	3256	477	0
45	FB	3366	0	3257	523	0
45	FD	3366	0	3257	481	0
45	FF	3366	0	3257	373	0
45	FH	3366	0	3255	452	0
45	FJ	3366	0	3257	392	0
45	FL	3366	0	3257	432	0
45	FN	3366	0	3257	571	0
45	GB	3366	0	3255	433	0
45	GD	3366	0	3255	476	0
45	GF	3366	0	3255	441	0
45	GH	3366	0	3256	418	0
45	GJ	3366	0	3256	391	0
45	GL	3366	0	3255	472	0
45	GN	3366	0	3255	481	0
45	HB	3366	0	3256	451	0
45	HD	3366	0	3257	402	0
45	HF	3366	0	3257	349	0
45	HH	3366	0	3257	402	0
45	HJ	3366	0	3256	358	0
45	HL	3366	0	3257	420	0
45	HN	3366	0	3257	456	0
45	IB	3366	0	3257	514	0
45	ID	3366	0	3255	396	0
45	IF	3366	0	3257	372	0
45	IH	3366	0	3257	411	0
45	IJ	3366	0	3257	410	0

*Continued on next page...*

*Continued from previous page...*

Mol	Chain	Non-H	H(model)	H(added)	Clashes	Symm-Clashes
45	IL	3366	0	3255	370	0
45	IN	3366	0	3257	437	0
45	JB	3366	0	3256	423	0
45	JD	3366	0	3257	340	0
45	JF	3366	0	3254	385	0
45	JH	3366	0	3256	435	0
45	JJ	3366	0	3256	409	0
45	JL	3366	0	3255	332	0
45	JN	3366	0	3257	460	0
45	KB	3366	0	3257	418	0
45	KD	3366	0	3257	366	0
45	KF	3366	0	3257	394	0
45	KH	3366	0	3257	325	0
45	KJ	3366	0	3255	424	0
45	KL	3366	0	3257	342	0
45	KN	3366	0	3254	613	0
45	LB	3366	0	3255	426	0
45	LD	3366	0	3255	366	0
45	LF	3366	0	3257	351	0
45	LH	3366	0	3257	310	0
45	LJ	3366	0	3257	417	0
45	LL	3366	0	3255	396	0
45	LN	3366	0	3255	438	0
45	MB	3366	0	3256	428	0
45	MD	3366	0	3257	363	0
45	MF	3366	0	3255	446	0
45	MH	3366	0	3257	323	0
45	MJ	3366	0	3257	458	0
45	ML	3366	0	3257	397	0
45	MN	3366	0	3257	412	0
45	NB	3304	0	3196	462	0
45	ND	3366	0	3257	470	0
45	NF	3304	0	3197	455	0
45	NH	3366	0	3257	440	0
45	NJ	3304	0	3194	419	0
45	NL	3366	0	3257	465	0
45	NN	3304	0	3194	431	0
45	OB	3366	0	3257	433	0
45	OD	3366	0	3257	480	0
45	OF	3366	0	3257	392	0
45	OH	3366	0	3255	459	0
45	OJ	3366	0	3255	396	0

*Continued on next page...*

*Continued from previous page...*

Mol	Chain	Non-H	H(model)	H(added)	Clashes	Symm-Clashes
45	OL	3366	0	3254	430	0
45	ON	3366	0	3256	446	0
45	PB	3351	0	3239	368	0
45	PD	3366	0	3254	465	0
45	PF	3366	0	3257	469	0
45	PH	3366	0	3256	399	0
45	PJ	3366	0	3257	430	0
45	PL	3366	0	3257	428	0
45	PN	3366	0	3255	444	0
45	QB	3366	0	3257	494	0
45	QD	3366	0	3257	411	0
45	QF	3366	0	3256	416	0
45	QH	3366	0	3256	401	0
45	QJ	3366	0	3254	428	0
45	QL	3366	0	3257	493	0
45	QN	3244	0	3107	343	0
45	RB	3366	0	3257	468	0
45	RD	3366	0	3257	464	0
45	RF	3366	0	3257	429	0
45	RH	3366	0	3257	435	0
45	RJ	3366	0	3257	480	0
45	RL	3366	0	3257	470	0
45	RN	3366	0	3257	409	0
45	SB	3366	0	3254	548	0
45	SD	3366	0	3257	410	0
45	SF	3366	0	3257	396	0
45	SH	3366	0	3257	392	0
45	SJ	3366	0	3257	455	0
45	SL	3366	0	3257	465	0
45	SN	3366	0	3257	386	0
45	TB	3366	0	3257	384	0
45	TD	3366	0	3257	513	0
45	TF	3366	0	3257	518	0
45	TH	3366	0	3255	458	0
45	TJ	3366	0	3257	480	0
45	TL	3366	0	3257	503	0
45	TN	3366	0	3254	411	0
45	UB	3366	0	3255	438	0
45	UD	3366	0	3256	526	0
45	UF	3366	0	3257	500	0
45	UH	3366	0	3257	510	0
45	UJ	3366	0	3255	525	0

*Continued on next page...*

*Continued from previous page...*

Mol	Chain	Non-H	H(model)	H(added)	Clashes	Symm-Clashes
45	UL	3366	0	3257	492	0
45	UN	3366	0	3255	383	0
45	VB	3366	0	3256	427	0
45	VD	3366	0	3256	504	0
45	VF	3366	0	3255	407	0
45	VH	3366	0	3257	403	0
45	VJ	3366	0	3257	423	0
45	VL	3366	0	3256	454	0
45	VN	3366	0	3255	474	0
45	WB	3366	0	3256	414	0
45	WD	3366	0	3256	447	0
45	WF	3366	0	3257	383	0
45	WH	3366	0	3254	349	0
45	WJ	3366	0	3256	371	0
45	WL	3366	0	3257	325	0
45	WN	3366	0	3257	459	0
46	AA	32	0	12	6	0
46	AC	32	0	12	4	0
46	AE	32	0	12	4	0
46	AG	32	0	12	4	0
46	AI	32	0	12	6	0
46	AK	32	0	12	3	0
46	AM	32	0	12	4	0
46	BA	32	0	12	8	0
46	BC	32	0	12	7	0
46	BE	32	0	12	7	0
46	BG	32	0	12	7	0
46	BI	32	0	12	5	0
46	BK	32	0	12	8	0
46	BM	32	0	12	1	0
46	CA	32	0	12	5	0
46	CC	32	0	12	8	0
46	CE	32	0	12	8	0
46	CG	32	0	12	6	0
46	CI	32	0	12	6	0
46	CK	32	0	12	6	0
46	CM	32	0	12	10	0
46	DA	32	0	12	10	0
46	DB	32	0	11	6	0
46	DE	32	0	12	8	0
46	DG	32	0	12	6	0
46	DI	32	0	12	2	0

*Continued on next page...*

*Continued from previous page...*

Mol	Chain	Non-H	H(model)	H(added)	Clashes	Symm-Clashes
46	DK	32	0	12	6	0
46	DM	32	0	12	12	0
46	EA	32	0	11	6	0
46	EC	32	0	12	12	0
46	EE	32	0	12	5	0
46	EG	32	0	12	2	0
46	EI	32	0	12	9	0
46	EK	32	0	12	7	0
46	EM	32	0	12	10	0
46	FA	32	0	12	5	0
46	FC	32	0	12	2	0
46	FE	32	0	12	8	0
46	FG	32	0	12	2	0
46	FI	32	0	12	6	0
46	FK	32	0	12	8	0
46	FM	32	0	12	3	0
46	GB	32	0	12	4	0
46	GD	32	0	12	3	0
46	GE	32	0	12	4	0
46	GG	32	0	12	3	0
46	GI	32	0	12	7	0
46	GL	32	0	12	2	0
46	GM	32	0	12	4	0
46	HA	32	0	12	10	0
46	HC	32	0	12	6	0
46	HE	32	0	12	3	0
46	HG	32	0	12	5	0
46	HI	32	0	12	17	0
46	HK	32	0	12	5	0
46	HM	32	0	12	4	0
46	IA	32	0	12	4	0
46	ID	32	0	12	5	0
46	IE	32	0	12	6	0
46	IG	32	0	12	10	0
46	II	32	0	12	7	0
46	IK	32	0	12	5	0
46	IM	32	0	12	6	0
46	JA	32	0	11	4	0
46	JC	32	0	12	4	0
46	JE	32	0	12	5	0
46	JG	32	0	12	4	0
46	JI	32	0	12	3	0

*Continued on next page...*

*Continued from previous page...*

Mol	Chain	Non-H	H(model)	H(added)	Clashes	Symm-Clashes
46	JK	32	0	12	7	0
46	JM	32	0	11	9	0
46	KA	32	0	12	6	0
46	KC	32	0	12	4	0
46	KE	32	0	12	7	0
46	KG	32	0	12	2	0
46	KJ	32	0	12	3	0
46	KK	32	0	12	3	0
46	KM	32	0	11	3	0
46	LB	32	0	12	6	0
46	LC	32	0	12	3	0
46	LE	32	0	12	2	0
46	LG	32	0	11	2	0
46	LI	32	0	12	7	0
46	LK	32	0	12	0	0
46	LM	32	0	12	5	0
46	MA	32	0	12	8	0
46	MC	32	0	12	5	0
46	ME	32	0	12	3	0
46	MG	32	0	10	6	0
46	MI	32	0	12	1	0
46	MK	32	0	12	2	0
46	MM	32	0	12	4	0
46	NA	32	0	12	4	0
46	NC	32	0	12	6	0
46	NE	32	0	12	7	0
46	NG	32	0	12	6	0
46	NI	32	0	12	2	0
46	NK	32	0	12	4	0
46	NM	32	0	12	4	0
46	OA	32	0	12	2	0
46	OC	32	0	12	4	0
46	OE	32	0	12	3	0
46	OG	32	0	12	2	0
46	OI	32	0	12	0	0
46	OL	32	0	12	3	0
46	OM	32	0	12	5	0
46	PA	32	0	12	5	0
46	PC	32	0	12	7	0
46	PE	32	0	12	6	0
46	PG	32	0	12	4	0
46	PI	32	0	12	4	0

*Continued on next page...*

*Continued from previous page...*

Mol	Chain	Non-H	H(model)	H(added)	Clashes	Symm-Clashes
46	PK	32	0	12	10	0
46	PM	32	0	12	5	0
46	QA	32	0	12	13	0
46	QC	32	0	12	15	0
46	QE	32	0	12	7	0
46	QG	32	0	12	10	0
46	QI	32	0	12	7	0
46	QK	32	0	12	8	0
46	QM	32	0	12	10	0
46	RA	32	0	12	5	0
46	RC	32	0	12	5	0
46	RE	32	0	12	4	0
46	RG	32	0	12	8	0
46	RI	32	0	12	10	0
46	RK	32	0	12	7	0
46	RM	32	0	12	10	0
46	SA	32	0	12	16	0
46	SC	32	0	12	8	0
46	SE	32	0	12	5	0
46	SG	32	0	12	8	0
46	SI	32	0	12	6	0
46	SK	32	0	12	8	0
46	SM	32	0	12	8	0
46	TA	32	0	12	16	0
46	TC	32	0	12	17	0
46	TE	32	0	11	7	0
46	TG	32	0	12	9	0
46	TI	32	0	12	6	0
46	TK	32	0	12	6	0
46	TM	32	0	12	11	0
46	UA	32	0	12	10	0
46	UC	32	0	12	3	0
46	UE	32	0	12	6	0
46	UG	32	0	12	9	0
46	UI	32	0	12	13	0
46	UK	32	0	12	9	0
46	UM	32	0	12	5	0
46	VA	32	0	12	9	0
46	VC	32	0	12	3	0
46	VE	32	0	12	7	0
46	VG	32	0	12	6	0
46	VI	32	0	12	7	0

*Continued on next page...*



*Continued from previous page...*

Mol	Chain	Non-H	H(model)	H(added)	Clashes	Symm-Clashes
46	VK	32	0	12	7	0
46	VM	32	0	12	9	0
46	WA	32	0	12	8	0
46	WC	32	0	12	11	0
46	WE	32	0	12	6	0
46	WG	32	0	12	6	0
46	WI	32	0	12	5	0
46	WK	32	0	12	7	0
46	WM	32	0	12	7	0
47	AB	1	0	0	0	0
47	AC	1	0	0	0	0
47	AE	1	0	0	0	0
47	AG	1	0	0	0	0
47	AI	1	0	0	0	0
47	AL	1	0	0	0	0
47	AM	1	0	0	0	0
47	BA	1	0	0	0	0
47	BD	1	0	0	0	0
47	BF	1	0	0	0	0
47	BH	1	0	0	0	0
47	BJ	1	0	0	0	0
47	BL	1	0	0	0	0
47	BM	1	0	0	0	0
47	CA	1	0	0	0	0
47	CC	1	0	0	0	0
47	CE	1	0	0	0	0
47	CF	1	0	0	0	0
47	CH	1	0	0	0	0
47	CJ	1	0	0	0	0
47	CM	1	0	0	0	0
47	DA	1	0	0	0	0
47	DB	1	0	0	0	0
47	DE	1	0	0	0	0
47	DG	1	0	0	0	0
47	DI	1	0	0	0	0
47	DK	1	0	0	0	0
47	DM	1	0	0	0	0
47	EA	1	0	0	0	0
47	EB	1	0	0	0	0
47	EE	1	0	0	0	0
47	EG	1	0	0	0	0
47	EI	1	0	0	0	0

*Continued on next page...*

*Continued from previous page...*

Mol	Chain	Non-H	H(model)	H(added)	Clashes	Symm-Clashes
47	EJ	1	0	0	0	0
47	EL	1	0	0	0	0
47	FA	1	0	0	0	0
47	FD	1	0	0	0	0
47	FF	1	0	0	0	0
47	FG	1	0	0	0	0
47	FI	1	0	0	0	0
47	FK	1	0	0	0	0
47	FM	1	0	0	0	0
47	GA	1	0	0	0	0
47	GD	1	0	0	0	0
47	GE	1	0	0	0	0
47	GH	1	0	0	0	0
47	GJ	1	0	0	0	0
47	GK	1	0	0	0	0
47	GM	1	0	0	0	0
47	HA	1	0	0	0	0
47	HC	1	0	0	0	0
47	HF	1	0	0	0	0
47	HG	1	0	0	0	0
47	HI	1	0	0	0	0
47	HL	1	0	0	0	0
47	HM	1	0	0	0	0
47	IA	1	0	0	0	0
47	IC	1	0	0	0	0
47	IE	1	0	0	0	0
47	IH	1	0	0	0	0
47	IJ	1	0	0	0	0
47	IK	1	0	0	0	0
47	IM	1	0	0	0	0
47	JA	1	0	0	0	0
47	JC	1	0	0	0	0
47	JE	1	0	0	0	0
47	JG	1	0	0	0	0
47	JI	1	0	0	0	0
47	JK	1	0	0	0	0
47	JM	1	0	0	0	0
47	KA	1	0	0	0	0
47	KC	1	0	0	0	0
47	KF	1	0	0	0	0
47	KG	1	0	0	0	0
47	KI	1	0	0	0	0

*Continued on next page...*

*Continued from previous page...*

Mol	Chain	Non-H	H(model)	H(added)	Clashes	Symm-Clashes
47	KK	1	0	0	0	0
47	KM	1	0	0	0	0
47	LA	1	0	0	0	0
47	LC	1	0	0	0	0
47	LE	1	0	0	0	0
47	LG	1	0	0	0	0
47	LI	1	0	0	0	0
47	LK	1	0	0	0	0
47	LN	1	0	0	0	0
47	MA	1	0	0	0	0
47	MC	1	0	0	0	0
47	MF	1	0	0	0	0
47	MG	1	0	0	0	0
47	MJ	1	0	0	0	0
47	MK	1	0	0	0	0
47	MN	1	0	0	0	0
47	NA	1	0	0	0	0
47	NC	1	0	0	0	0
47	NE	1	0	0	0	0
47	NG	1	0	0	0	0
47	NI	1	0	0	0	0
47	NK	1	0	0	0	0
47	NM	1	0	0	0	0
47	OA	1	0	0	0	0
47	OD	1	0	0	0	0
47	OE	1	0	0	0	0
47	OG	1	0	0	0	0
47	OI	1	0	0	0	0
47	OK	1	0	0	0	0
47	OM	1	0	0	0	0
47	PA	1	0	0	0	0
47	PD	1	0	0	0	0
47	PE	1	0	0	0	0
47	PG	1	0	0	0	0
47	PI	1	0	0	0	0
47	PK	1	0	0	0	0
47	PM	1	0	0	0	0
47	QA	1	0	0	0	0
47	QC	1	0	0	0	0
47	QD	1	0	0	0	0
47	QG	1	0	0	0	0
47	QI	1	0	0	0	0

*Continued on next page...*

*Continued from previous page...*

Mol	Chain	Non-H	H(model)	H(added)	Clashes	Symm-Clashes
47	QJ	1	0	0	0	0
47	QM	1	0	0	0	0
47	RA	1	0	0	0	0
47	RC	1	0	0	0	0
47	RE	1	0	0	0	0
47	RG	1	0	0	0	0
47	RH	1	0	0	0	0
47	RK	1	0	0	0	0
47	RM	1	0	0	0	0
47	SA	1	0	0	0	0
47	SC	1	0	0	0	0
47	SE	1	0	0	0	0
47	SG	1	0	0	0	0
47	SI	1	0	0	0	0
47	SK	1	0	0	0	0
47	SM	1	0	0	0	0
47	TA	1	0	0	0	0
47	TC	1	0	0	0	0
47	TE	1	0	0	0	0
47	TG	1	0	0	0	0
47	TI	1	0	0	0	0
47	TK	1	0	0	0	0
47	TM	1	0	0	0	0
47	UA	1	0	0	0	0
47	UC	1	0	0	0	0
47	UE	1	0	0	0	0
47	UG	1	0	0	0	0
47	UI	1	0	0	0	0
47	UK	1	0	0	0	0
47	UL	1	0	0	0	0
47	VB	1	0	0	0	0
47	VC	1	0	0	0	0
47	VE	1	0	0	0	0
47	VG	1	0	0	0	0
47	VI	1	0	0	0	0
47	VK	1	0	0	0	0
47	VM	1	0	0	0	0
47	WA	1	0	0	0	0
47	WC	1	0	0	0	0
47	WE	1	0	0	0	0
47	WG	1	0	0	0	0
47	WJ	1	0	0	0	0

*Continued on next page...*

*Continued from previous page...*

Mol	Chain	Non-H	H(model)	H(added)	Clashes	Symm-Clashes
47	WK	1	0	0	0	0
47	WM	1	0	0	0	0
48	AB	28	0	12	3	0
48	AD	28	0	12	3	0
48	AF	28	0	12	2	0
48	AH	28	0	12	3	0
48	AJ	28	0	12	1	0
48	AL	28	0	12	2	0
48	AN	28	0	12	2	0
48	BB	28	0	12	2	0
48	BD	28	0	12	6	0
48	BF	28	0	12	11	0
48	BH	28	0	12	7	0
48	BJ	28	0	12	8	0
48	BL	28	0	12	3	0
48	BN	28	0	12	2	0
48	CB	28	0	10	16	0
48	CD	28	0	12	4	0
48	CF	28	0	12	2	0
48	CH	28	0	12	1	0
48	CJ	28	0	12	2	0
48	CL	28	0	12	8	0
48	CN	28	0	12	1	0
48	DB	28	0	12	3	0
48	DD	28	0	12	3	0
48	DF	28	0	12	4	0
48	DH	28	0	12	4	0
48	DJ	28	0	12	7	0
48	DL	28	0	12	2	0
48	DN	28	0	12	0	0
48	EB	28	0	12	7	0
48	ED	28	0	12	4	0
48	EF	28	0	12	1	0
48	EH	28	0	12	5	0
48	EJ	28	0	12	5	0
48	EL	28	0	12	4	0
48	EN	28	0	12	2	0
48	FB	28	0	12	1	0
48	FD	28	0	12	5	0
48	FF	28	0	12	0	0
48	FH	28	0	12	3	0
48	FJ	28	0	12	3	0

*Continued on next page...*

*Continued from previous page...*

Mol	Chain	Non-H	H(model)	H(added)	Clashes	Symm-Clashes
48	FL	28	0	12	1	0
48	FN	28	0	12	7	0
48	GB	28	0	12	3	0
48	GD	28	0	12	6	0
48	GF	28	0	12	6	0
48	GH	28	0	12	4	0
48	GJ	28	0	12	7	0
48	GL	28	0	12	2	0
48	GN	28	0	12	2	0
48	HB	28	0	12	0	0
48	HD	28	0	12	2	0
48	HF	28	0	12	7	0
48	HH	28	0	12	2	0
48	HJ	28	0	12	5	0
48	HL	28	0	12	2	0
48	HN	28	0	12	5	0
48	IB	28	0	12	4	0
48	ID	28	0	12	6	0
48	IF	28	0	12	9	0
48	IH	28	0	12	4	0
48	IJ	28	0	12	1	0
48	IL	28	0	12	7	0
48	IN	28	0	12	2	0
48	JB	28	0	11	6	0
48	JD	28	0	12	6	0
48	JF	28	0	11	3	0
48	JH	28	0	10	7	0
48	JJ	28	0	12	8	0
48	JL	28	0	12	3	0
48	JN	28	0	12	4	0
48	KB	28	0	12	4	0
48	KD	28	0	12	4	0
48	KF	28	0	12	6	0
48	KH	28	0	12	7	0
48	KJ	28	0	12	2	0
48	KL	28	0	12	6	0
48	KN	28	0	12	3	0
48	LB	28	0	12	4	0
48	LD	28	0	12	1	0
48	LF	28	0	12	4	0
48	LH	28	0	12	4	0
48	LJ	28	0	12	2	0

*Continued on next page...*

*Continued from previous page...*

Mol	Chain	Non-H	H(model)	H(added)	Clashes	Symm-Clashes
48	LL	28	0	12	3	0
48	LN	28	0	12	5	0
48	MB	28	0	12	3	0
48	MD	28	0	12	3	0
48	MF	28	0	12	2	0
48	MH	28	0	12	7	0
48	MJ	28	0	12	4	0
48	ML	28	0	12	3	0
48	MN	28	0	12	4	0
48	NB	28	0	12	3	0
48	ND	28	0	12	2	0
48	NF	28	0	12	3	0
48	NH	28	0	12	2	0
48	NJ	28	0	12	2	0
48	NL	28	0	12	1	0
48	NN	28	0	12	3	0
48	OB	28	0	12	5	0
48	OD	28	0	12	6	0
48	OF	28	0	12	2	0
48	OH	28	0	12	4	0
48	OJ	28	0	12	7	0
48	OL	28	0	12	5	0
48	ON	28	0	12	5	0
48	PB	28	0	12	0	0
48	PD	28	0	12	3	0
48	PF	28	0	12	2	0
48	PH	28	0	12	4	0
48	PJ	28	0	12	4	0
48	PL	28	0	12	3	0
48	PN	28	0	12	5	0
48	QB	28	0	12	3	0
48	QD	28	0	12	4	0
48	QF	28	0	12	3	0
48	QH	28	0	12	9	0
48	QJ	28	0	12	2	0
48	QL	28	0	12	6	0
48	QN	28	0	12	2	0
48	RB	28	0	12	0	0
48	RD	28	0	12	1	0
48	RF	28	0	12	3	0
48	RH	28	0	12	4	0
48	RJ	28	0	12	10	0

*Continued on next page...*

*Continued from previous page...*

Mol	Chain	Non-H	H(model)	H(added)	Clashes	Symm-Clashes
48	RL	28	0	12	3	0
48	RN	28	0	12	6	0
48	SB	28	0	12	6	0
48	SD	28	0	12	6	0
48	SF	28	0	12	3	0
48	SH	28	0	12	6	0
48	SJ	28	0	12	2	0
48	SL	28	0	12	4	0
48	SN	28	0	12	4	0
48	TB	28	0	12	2	0
48	TD	28	0	12	9	0
48	TF	28	0	12	1	0
48	TH	28	0	12	6	0
48	TJ	28	0	12	6	0
48	TL	28	0	12	10	0
48	TN	28	0	12	3	0
48	UB	28	0	12	2	0
48	UD	28	0	12	5	0
48	UF	28	0	12	4	0
48	UH	28	0	12	4	0
48	UJ	28	0	12	10	0
48	UL	28	0	12	1	0
48	UN	28	0	12	4	0
48	VB	28	0	11	6	0
48	VD	28	0	12	4	0
48	VF	28	0	12	2	0
48	VH	28	0	12	8	0
48	VJ	28	0	12	2	0
48	VL	28	0	12	3	0
48	VN	28	0	12	4	0
48	WB	28	0	12	2	0
48	WD	28	0	12	3	0
48	WF	28	0	12	2	0
48	WH	28	0	12	5	0
48	WJ	28	0	12	8	0
48	WL	28	0	12	3	0
48	WN	28	0	12	4	0
All	All	1323851	10347	1282441	127387	0

The all-atom clashscore is defined as the number of clashes found per 1000 atoms (including hydrogen atoms). The all-atom clashscore for this structure is 49.

The worst 5 of 127387 close contacts within the same asymmetric unit are listed below, sorted by their clash magnitude.



Atom-1	Atom-2	Interatomic distance (Å)	Clash overlap (Å)
44:BA:407:TRP:CZ3	45:BB:255:VAL:HA	1.25	1.71
35:6R:268:GLU:CB	45:DN:280:GLN:HG2	1.16	1.62
27:2W:239:ARG:CZ	35:6R:5:LEU:HD13	1.21	1.60
20:1J:263:PHE:CE1	44:II:282:TYR:HB3	1.30	1.58
35:6R:118:LEU:HD13	35:6R:129:VAL:CG2	1.23	1.57

There are no symmetry-related clashes.

## 5.3 Torsion angles [i](#)

### 5.3.1 Protein backbone [i](#)

In the following table, the Percentiles column shows the percent Ramachandran outliers of the chain as a percentile score with respect to all PDB entries followed by that with respect to all EM entries.

The Analysed column shows the number of residues for which the backbone conformation was analysed, and the total number of residues.

Mol	Chain	Analysed	Favoured	Allowed	Outliers	Percentiles	
1	6H	152/518 (29%)	123 (81%)	26 (17%)	3 (2%)	6	34
2	0A	150/236 (64%)	111 (74%)	34 (23%)	5 (3%)	3	25
2	1A	150/236 (64%)	109 (73%)	33 (22%)	8 (5%)	1	18
2	2A	150/236 (64%)	105 (70%)	40 (27%)	5 (3%)	3	25
2	3A	150/236 (64%)	114 (76%)	30 (20%)	6 (4%)	2	21
3	0B	317/329 (96%)	246 (78%)	64 (20%)	7 (2%)	5	32
4	0C	90/156 (58%)	70 (78%)	14 (16%)	6 (7%)	1	15
4	1C	90/156 (58%)	68 (76%)	17 (19%)	5 (6%)	1	17
5	0D	198/225 (88%)	151 (76%)	38 (19%)	9 (4%)	2	20
5	1D	198/225 (88%)	143 (72%)	46 (23%)	9 (4%)	2	20
5	2D	198/225 (88%)	149 (75%)	40 (20%)	9 (4%)	2	20
6	0E	187/191 (98%)	174 (93%)	12 (6%)	1 (0%)	25	62
6	1E	187/191 (98%)	173 (92%)	13 (7%)	1 (0%)	25	62
6	2E	185/191 (97%)	173 (94%)	11 (6%)	1 (0%)	25	62
6	3E	187/191 (98%)	174 (93%)	11 (6%)	2 (1%)	12	46
7	0F	202/219 (92%)	145 (72%)	50 (25%)	7 (4%)	3	24

Continued on next page...

*Continued from previous page...*

Mol	Chain	Analysed	Favoured	Allowed	Outliers	Percentiles	
8	0G	162/183 (88%)	121 (75%)	37 (23%)	4 (2%)	4	30
8	1G	127/183 (69%)	93 (73%)	31 (24%)	3 (2%)	5	30
9	0H	108/447 (24%)	96 (89%)	10 (9%)	2 (2%)	6	35
9	1H	414/447 (93%)	386 (93%)	26 (6%)	2 (0%)	25	62
10	0N	278/492 (56%)	261 (94%)	17 (6%)	0	100	100
10	1N	457/492 (93%)	433 (95%)	23 (5%)	1 (0%)	44	77
10	2N	278/492 (56%)	260 (94%)	18 (6%)	0	100	100
11	0Q	184/195 (94%)	160 (87%)	24 (13%)	0	100	100
11	1Q	184/195 (94%)	158 (86%)	26 (14%)	0	100	100
11	2Q	184/195 (94%)	168 (91%)	16 (9%)	0	100	100
11	3Q	184/195 (94%)	163 (89%)	20 (11%)	1 (0%)	25	62
11	4Q	184/195 (94%)	168 (91%)	16 (9%)	0	100	100
11	5Q	184/195 (94%)	168 (91%)	16 (9%)	0	100	100
11	6Q	184/195 (94%)	170 (92%)	14 (8%)	0	100	100
12	0S	275/319 (86%)	257 (94%)	17 (6%)	1 (0%)	30	67
12	1S	284/319 (89%)	255 (90%)	28 (10%)	1 (0%)	30	67
12	2S	282/319 (88%)	249 (88%)	32 (11%)	1 (0%)	30	67
12	3S	284/319 (89%)	258 (91%)	26 (9%)	0	100	100
13	0T	208/298 (70%)	189 (91%)	18 (9%)	1 (0%)	25	62
13	1T	279/298 (94%)	245 (88%)	34 (12%)	0	100	100
13	2T	281/298 (94%)	245 (87%)	36 (13%)	0	100	100
13	3T	283/298 (95%)	249 (88%)	34 (12%)	0	100	100
14	0U	595/656 (91%)	531 (89%)	64 (11%)	0	100	100
14	1U	596/656 (91%)	511 (86%)	85 (14%)	0	100	100
14	2U	605/656 (92%)	528 (87%)	77 (13%)	0	100	100
14	3U	605/656 (92%)	535 (88%)	70 (12%)	0	100	100
15	0V	203/269 (76%)	170 (84%)	32 (16%)	1 (0%)	25	62
15	1V	239/269 (89%)	193 (81%)	40 (17%)	6 (2%)	4	30
15	2V	239/269 (89%)	191 (80%)	40 (17%)	8 (3%)	3	25
15	3V	243/269 (90%)	196 (81%)	42 (17%)	5 (2%)	5	33
16	0X	104/142 (73%)	95 (91%)	9 (9%)	0	100	100

*Continued on next page...*

*Continued from previous page...*

Mol	Chain	Analysed	Favoured	Allowed	Outliers	Percentiles	
16	1X	139/142 (98%)	134 (96%)	5 (4%)	0	100	100
16	2X	139/142 (98%)	129 (93%)	10 (7%)	0	100	100
16	3X	139/142 (98%)	129 (93%)	9 (6%)	1 (1%)	19	56
16	4X	139/142 (98%)	132 (95%)	6 (4%)	1 (1%)	19	56
17	1B	496/498 (100%)	459 (92%)	34 (7%)	3 (1%)	22	59
17	2B	293/498 (59%)	276 (94%)	16 (6%)	1 (0%)	37	71
17	3B	295/498 (59%)	270 (92%)	25 (8%)	0	100	100
18	1F	130/173 (75%)	112 (86%)	15 (12%)	3 (2%)	5	31
19	1I	182/263 (69%)	151 (83%)	29 (16%)	2 (1%)	12	46
20	1J	364/422 (86%)	308 (85%)	48 (13%)	8 (2%)	5	32
21	1K	264/489 (54%)	260 (98%)	4 (2%)	0	100	100
21	2K	273/489 (56%)	271 (99%)	2 (1%)	0	100	100
22	1L	808/940 (86%)	706 (87%)	95 (12%)	7 (1%)	14	50
22	2L	610/940 (65%)	547 (90%)	60 (10%)	3 (0%)	25	62
22	3L	198/940 (21%)	174 (88%)	19 (10%)	5 (2%)	4	30
23	1M	364/372 (98%)	326 (90%)	38 (10%)	0	100	100
23	2M	367/372 (99%)	336 (92%)	31 (8%)	0	100	100
24	1O	229/494 (46%)	225 (98%)	4 (2%)	0	100	100
24	2O	368/494 (74%)	364 (99%)	4 (1%)	0	100	100
24	3O	262/494 (53%)	256 (98%)	5 (2%)	1 (0%)	30	67
25	1P	342/507 (68%)	333 (97%)	9 (3%)	0	100	100
25	2P	176/507 (35%)	173 (98%)	3 (2%)	0	100	100
26	1R	496/516 (96%)	450 (91%)	45 (9%)	1 (0%)	44	77
26	2R	499/516 (97%)	451 (90%)	47 (9%)	1 (0%)	44	77
26	3R	499/516 (97%)	449 (90%)	47 (9%)	3 (1%)	22	59
27	1W	212/280 (76%)	199 (94%)	12 (6%)	1 (0%)	25	62
27	2W	102/280 (36%)	96 (94%)	6 (6%)	0	100	100
28	2C	298/300 (99%)	273 (92%)	24 (8%)	1 (0%)	37	71
28	3C	298/300 (99%)	267 (90%)	31 (10%)	0	100	100
28	4C	298/300 (99%)	272 (91%)	25 (8%)	1 (0%)	37	71
29	2F	85/96 (88%)	75 (88%)	10 (12%)	0	100	100

*Continued on next page...*

Continued from previous page...

Mol	Chain	Analysed	Favoured	Allowed	Outliers	Percentiles	
30	2G	94/99 (95%)	87 (93%)	7 (7%)	0	100	100
31	2H	59/229 (26%)	49 (83%)	9 (15%)	1 (2%)	7	37
31	3H	59/229 (26%)	50 (85%)	8 (14%)	1 (2%)	7	37
31	4H	59/229 (26%)	50 (85%)	8 (14%)	1 (2%)	7	37
32	2I	129/293 (44%)	105 (81%)	22 (17%)	2 (2%)	8	39
32	3I	83/293 (28%)	68 (82%)	14 (17%)	1 (1%)	11	44
33	3D	235/237 (99%)	224 (95%)	11 (5%)	0	100	100
34	4F	194/276 (70%)	170 (88%)	22 (11%)	2 (1%)	13	48
35	4R	601/613 (98%)	551 (92%)	50 (8%)	0	100	100
35	5R	600/613 (98%)	560 (93%)	40 (7%)	0	100	100
35	6R	607/613 (99%)	546 (90%)	58 (10%)	3 (0%)	25	62
35	7R	600/613 (98%)	558 (93%)	42 (7%)	0	100	100
36	4S	186/249 (75%)	181 (97%)	5 (3%)	0	100	100
36	5S	186/249 (75%)	174 (94%)	12 (6%)	0	100	100
37	5A	155/175 (89%)	127 (82%)	28 (18%)	0	100	100
37	5B	155/175 (89%)	123 (79%)	32 (21%)	0	100	100
37	5C	155/175 (89%)	126 (81%)	29 (19%)	0	100	100
37	5D	94/175 (54%)	58 (62%)	31 (33%)	5 (5%)	1	18
38	5E	178/247 (72%)	158 (89%)	18 (10%)	2 (1%)	12	46
38	5F	206/247 (83%)	166 (81%)	38 (18%)	2 (1%)	13	48
38	5G	202/247 (82%)	172 (85%)	28 (14%)	2 (1%)	13	48
38	5H	125/247 (51%)	96 (77%)	27 (22%)	2 (2%)	8	39
39	5I	86/168 (51%)	81 (94%)	5 (6%)	0	100	100
39	5J	103/168 (61%)	97 (94%)	6 (6%)	0	100	100
39	5K	66/168 (39%)	58 (88%)	7 (11%)	1 (2%)	8	40
40	6F	127/145 (88%)	106 (84%)	19 (15%)	2 (2%)	8	39
41	6G	210/364 (58%)	187 (89%)	22 (10%)	1 (0%)	25	62
44	AA	434/449 (97%)	409 (94%)	25 (6%)	0	100	100
44	AC	434/449 (97%)	409 (94%)	25 (6%)	0	100	100
44	AE	437/449 (97%)	414 (95%)	23 (5%)	0	100	100
44	AG	437/449 (97%)	414 (95%)	23 (5%)	0	100	100

Continued on next page...

*Continued from previous page...*

Mol	Chain	Analysed	Favoured	Allowed	Outliers	Percentiles	
44	AI	437/449 (97%)	410 (94%)	27 (6%)	0	100	100
44	AK	437/449 (97%)	409 (94%)	28 (6%)	0	100	100
44	AM	435/449 (97%)	414 (95%)	21 (5%)	0	100	100
44	BA	428/449 (95%)	417 (97%)	11 (3%)	0	100	100
44	BC	428/449 (95%)	406 (95%)	22 (5%)	0	100	100
44	BE	428/449 (95%)	402 (94%)	26 (6%)	0	100	100
44	BG	426/449 (95%)	403 (95%)	23 (5%)	0	100	100
44	BI	428/449 (95%)	409 (96%)	19 (4%)	0	100	100
44	BK	426/449 (95%)	405 (95%)	21 (5%)	0	100	100
44	BM	428/449 (95%)	409 (96%)	19 (4%)	0	100	100
44	CA	437/449 (97%)	415 (95%)	22 (5%)	0	100	100
44	CC	437/449 (97%)	407 (93%)	30 (7%)	0	100	100
44	CE	437/449 (97%)	414 (95%)	23 (5%)	0	100	100
44	CG	435/449 (97%)	415 (95%)	20 (5%)	0	100	100
44	CI	437/449 (97%)	415 (95%)	22 (5%)	0	100	100
44	CK	433/449 (96%)	407 (94%)	26 (6%)	0	100	100
44	CM	437/449 (97%)	413 (94%)	24 (6%)	0	100	100
44	DA	429/449 (96%)	409 (95%)	19 (4%)	1 (0%)	44	77
44	DC	429/449 (96%)	401 (94%)	28 (6%)	0	100	100
44	DE	429/449 (96%)	400 (93%)	29 (7%)	0	100	100
44	DG	427/449 (95%)	402 (94%)	25 (6%)	0	100	100
44	DI	429/449 (96%)	396 (92%)	33 (8%)	0	100	100
44	DK	432/449 (96%)	407 (94%)	25 (6%)	0	100	100
44	DM	429/449 (96%)	398 (93%)	30 (7%)	1 (0%)	44	77
44	EA	437/449 (97%)	411 (94%)	26 (6%)	0	100	100
44	EC	437/449 (97%)	400 (92%)	37 (8%)	0	100	100
44	EE	435/449 (97%)	397 (91%)	38 (9%)	0	100	100
44	EG	437/449 (97%)	406 (93%)	31 (7%)	0	100	100
44	EI	437/449 (97%)	407 (93%)	30 (7%)	0	100	100
44	EK	434/449 (97%)	407 (94%)	27 (6%)	0	100	100
44	EM	431/449 (96%)	396 (92%)	35 (8%)	0	100	100

*Continued on next page...*

*Continued from previous page...*

Mol	Chain	Analysed	Favoured	Allowed	Outliers	Percentiles	
44	FA	425/449 (95%)	399 (94%)	26 (6%)	0	100	100
44	FC	428/449 (95%)	395 (92%)	32 (8%)	1 (0%)	44	77
44	FE	430/449 (96%)	400 (93%)	30 (7%)	0	100	100
44	FG	435/449 (97%)	415 (95%)	20 (5%)	0	100	100
44	FI	429/449 (96%)	396 (92%)	33 (8%)	0	100	100
44	FK	428/449 (95%)	395 (92%)	33 (8%)	0	100	100
44	FM	406/449 (90%)	391 (96%)	15 (4%)	0	100	100
44	GA	425/449 (95%)	407 (96%)	18 (4%)	0	100	100
44	GC	425/449 (95%)	399 (94%)	26 (6%)	0	100	100
44	GE	427/449 (95%)	403 (94%)	24 (6%)	0	100	100
44	GG	427/449 (95%)	393 (92%)	34 (8%)	0	100	100
44	GI	427/449 (95%)	404 (95%)	23 (5%)	0	100	100
44	GK	434/449 (97%)	400 (92%)	34 (8%)	0	100	100
44	GM	423/449 (94%)	402 (95%)	21 (5%)	0	100	100
44	HA	424/449 (94%)	402 (95%)	22 (5%)	0	100	100
44	HC	427/449 (95%)	404 (95%)	23 (5%)	0	100	100
44	HE	427/449 (95%)	402 (94%)	25 (6%)	0	100	100
44	HG	427/449 (95%)	398 (93%)	29 (7%)	0	100	100
44	HI	424/449 (94%)	400 (94%)	24 (6%)	0	100	100
44	HK	427/449 (95%)	405 (95%)	22 (5%)	0	100	100
44	HM	427/449 (95%)	401 (94%)	25 (6%)	1 (0%)	44	77
44	IA	428/449 (95%)	410 (96%)	18 (4%)	0	100	100
44	IC	437/449 (97%)	411 (94%)	26 (6%)	0	100	100
44	IE	428/449 (95%)	409 (96%)	19 (4%)	0	100	100
44	IG	437/449 (97%)	416 (95%)	21 (5%)	0	100	100
44	II	437/449 (97%)	412 (94%)	25 (6%)	0	100	100
44	IK	428/449 (95%)	406 (95%)	22 (5%)	0	100	100
44	IM	428/449 (95%)	405 (95%)	23 (5%)	0	100	100
44	JA	428/449 (95%)	407 (95%)	21 (5%)	0	100	100
44	JC	430/449 (96%)	402 (94%)	28 (6%)	0	100	100
44	JE	437/449 (97%)	407 (93%)	30 (7%)	0	100	100

*Continued on next page...*

*Continued from previous page...*

Mol	Chain	Analysed	Favoured	Allowed	Outliers	Percentiles	
44	JG	437/449 (97%)	404 (92%)	31 (7%)	2 (0%)	25	62
44	JI	437/449 (97%)	403 (92%)	33 (8%)	1 (0%)	44	77
44	JK	437/449 (97%)	424 (97%)	13 (3%)	0	100	100
44	JM	430/449 (96%)	409 (95%)	21 (5%)	0	100	100
44	KA	430/449 (96%)	403 (94%)	27 (6%)	0	100	100
44	KC	429/449 (96%)	405 (94%)	24 (6%)	0	100	100
44	KE	431/449 (96%)	402 (93%)	29 (7%)	0	100	100
44	KG	437/449 (97%)	408 (93%)	28 (6%)	1 (0%)	44	77
44	KI	437/449 (97%)	413 (94%)	24 (6%)	0	100	100
44	KK	433/449 (96%)	402 (93%)	30 (7%)	1 (0%)	44	77
44	KM	430/449 (96%)	409 (95%)	21 (5%)	0	100	100
44	LA	437/449 (97%)	408 (93%)	29 (7%)	0	100	100
44	LC	437/449 (97%)	415 (95%)	22 (5%)	0	100	100
44	LE	430/449 (96%)	408 (95%)	22 (5%)	0	100	100
44	LG	437/449 (97%)	408 (93%)	29 (7%)	0	100	100
44	LI	430/449 (96%)	404 (94%)	26 (6%)	0	100	100
44	LK	437/449 (97%)	420 (96%)	15 (3%)	2 (0%)	25	62
44	LM	437/449 (97%)	414 (95%)	23 (5%)	0	100	100
44	MA	432/449 (96%)	410 (95%)	22 (5%)	0	100	100
44	MC	429/449 (96%)	402 (94%)	27 (6%)	0	100	100
44	ME	424/449 (94%)	396 (93%)	27 (6%)	1 (0%)	44	77
44	MG	430/449 (96%)	398 (93%)	31 (7%)	1 (0%)	44	77
44	MI	435/449 (97%)	408 (94%)	27 (6%)	0	100	100
44	MK	432/449 (96%)	415 (96%)	17 (4%)	0	100	100
44	MM	432/449 (96%)	408 (94%)	24 (6%)	0	100	100
44	NA	437/449 (97%)	413 (94%)	23 (5%)	1 (0%)	44	77
44	NC	428/449 (95%)	405 (95%)	23 (5%)	0	100	100
44	NE	437/449 (97%)	413 (94%)	23 (5%)	1 (0%)	44	77
44	NG	428/449 (95%)	403 (94%)	25 (6%)	0	100	100
44	NI	437/449 (97%)	407 (93%)	29 (7%)	1 (0%)	44	77
44	NK	428/449 (95%)	409 (96%)	19 (4%)	0	100	100

*Continued on next page...*

*Continued from previous page...*

Mol	Chain	Analysed	Favoured	Allowed	Outliers	Percentiles	
44	NM	431/449 (96%)	399 (93%)	30 (7%)	2 (0%)	25	62
44	OA	427/449 (95%)	402 (94%)	25 (6%)	0	100	100
44	OC	429/449 (96%)	399 (93%)	30 (7%)	0	100	100
44	OE	429/449 (96%)	406 (95%)	23 (5%)	0	100	100
44	OG	429/449 (96%)	408 (95%)	21 (5%)	0	100	100
44	OI	429/449 (96%)	410 (96%)	19 (4%)	0	100	100
44	OK	429/449 (96%)	403 (94%)	26 (6%)	0	100	100
44	OM	429/449 (96%)	416 (97%)	13 (3%)	0	100	100
44	PA	425/449 (95%)	404 (95%)	21 (5%)	0	100	100
44	PC	425/449 (95%)	406 (96%)	19 (4%)	0	100	100
44	PE	425/449 (95%)	401 (94%)	24 (6%)	0	100	100
44	PG	425/449 (95%)	402 (95%)	23 (5%)	0	100	100
44	PI	423/449 (94%)	389 (92%)	32 (8%)	2 (0%)	25	62
44	PK	425/449 (95%)	401 (94%)	24 (6%)	0	100	100
44	PM	425/449 (95%)	405 (95%)	20 (5%)	0	100	100
44	QA	427/449 (95%)	408 (96%)	19 (4%)	0	100	100
44	QC	427/449 (95%)	398 (93%)	29 (7%)	0	100	100
44	QE	427/449 (95%)	404 (95%)	23 (5%)	0	100	100
44	QG	427/449 (95%)	397 (93%)	30 (7%)	0	100	100
44	QI	427/449 (95%)	406 (95%)	21 (5%)	0	100	100
44	QK	427/449 (95%)	400 (94%)	27 (6%)	0	100	100
44	QM	425/449 (95%)	404 (95%)	21 (5%)	0	100	100
44	RA	427/449 (95%)	416 (97%)	11 (3%)	0	100	100
44	RC	427/449 (95%)	409 (96%)	18 (4%)	0	100	100
44	RE	427/449 (95%)	400 (94%)	27 (6%)	0	100	100
44	RG	425/449 (95%)	387 (91%)	38 (9%)	0	100	100
44	RI	427/449 (95%)	397 (93%)	30 (7%)	0	100	100
44	RK	427/449 (95%)	398 (93%)	29 (7%)	0	100	100
44	RM	424/449 (94%)	396 (93%)	28 (7%)	0	100	100
44	SA	426/449 (95%)	410 (96%)	16 (4%)	0	100	100
44	SC	421/449 (94%)	395 (94%)	26 (6%)	0	100	100

*Continued on next page...*



Continued from previous page...

Mol	Chain	Analysed	Favoured	Allowed	Outliers	Percentiles	
44	SE	423/449 (94%)	398 (94%)	25 (6%)	0	100	100
44	SG	424/449 (94%)	382 (90%)	42 (10%)	0	100	100
44	SI	426/449 (95%)	398 (93%)	28 (7%)	0	100	100
44	SK	426/449 (95%)	401 (94%)	25 (6%)	0	100	100
44	SM	420/449 (94%)	398 (95%)	21 (5%)	1 (0%)	44	77
44	TA	426/449 (95%)	411 (96%)	15 (4%)	0	100	100
44	TC	426/449 (95%)	403 (95%)	23 (5%)	0	100	100
44	TE	426/449 (95%)	392 (92%)	34 (8%)	0	100	100
44	TG	423/449 (94%)	395 (93%)	28 (7%)	0	100	100
44	TI	426/449 (95%)	400 (94%)	26 (6%)	0	100	100
44	TK	426/449 (95%)	399 (94%)	27 (6%)	0	100	100
44	TM	423/449 (94%)	405 (96%)	18 (4%)	0	100	100
44	UA	426/449 (95%)	412 (97%)	14 (3%)	0	100	100
44	UC	425/449 (95%)	395 (93%)	30 (7%)	0	100	100
44	UE	427/449 (95%)	401 (94%)	26 (6%)	0	100	100
44	UG	427/449 (95%)	394 (92%)	33 (8%)	0	100	100
44	UI	427/449 (95%)	402 (94%)	25 (6%)	0	100	100
44	UK	425/449 (95%)	393 (92%)	32 (8%)	0	100	100
44	UM	427/449 (95%)	399 (93%)	28 (7%)	0	100	100
44	VA	429/449 (96%)	405 (94%)	24 (6%)	0	100	100
44	VC	434/449 (97%)	401 (92%)	33 (8%)	0	100	100
44	VE	429/449 (96%)	409 (95%)	20 (5%)	0	100	100
44	VG	437/449 (97%)	405 (93%)	32 (7%)	0	100	100
44	VI	429/449 (96%)	401 (94%)	28 (6%)	0	100	100
44	VK	437/449 (97%)	406 (93%)	31 (7%)	0	100	100
44	VM	428/449 (95%)	400 (94%)	27 (6%)	1 (0%)	44	77
44	WA	424/449 (94%)	401 (95%)	23 (5%)	0	100	100
44	WC	435/449 (97%)	404 (93%)	30 (7%)	1 (0%)	44	77
44	WE	427/449 (95%)	402 (94%)	25 (6%)	0	100	100
44	WG	435/449 (97%)	399 (92%)	35 (8%)	1 (0%)	44	77
44	WI	427/449 (95%)	401 (94%)	26 (6%)	0	100	100

Continued on next page...

Continued from previous page...

Mol	Chain	Analysed	Favoured	Allowed	Outliers	Percentiles	
44	WK	435/449 (97%)	403 (93%)	31 (7%)	1 (0%)	44	77
44	WM	427/449 (95%)	407 (95%)	19 (4%)	1 (0%)	44	77
45	AB	417/443 (94%)	400 (96%)	17 (4%)	0	100	100
45	AD	428/443 (97%)	409 (96%)	19 (4%)	0	100	100
45	AF	428/443 (97%)	410 (96%)	17 (4%)	1 (0%)	44	77
45	AH	428/443 (97%)	408 (95%)	20 (5%)	0	100	100
45	AJ	425/443 (96%)	409 (96%)	16 (4%)	0	100	100
45	AL	428/443 (97%)	410 (96%)	18 (4%)	0	100	100
45	AN	424/443 (96%)	403 (95%)	21 (5%)	0	100	100
45	BB	428/443 (97%)	423 (99%)	5 (1%)	0	100	100
45	BD	428/443 (97%)	416 (97%)	12 (3%)	0	100	100
45	BF	428/443 (97%)	412 (96%)	16 (4%)	0	100	100
45	BH	422/443 (95%)	406 (96%)	16 (4%)	0	100	100
45	BJ	426/443 (96%)	409 (96%)	17 (4%)	0	100	100
45	BL	428/443 (97%)	412 (96%)	16 (4%)	0	100	100
45	BN	428/443 (97%)	408 (95%)	20 (5%)	0	100	100
45	CB	428/443 (97%)	412 (96%)	16 (4%)	0	100	100
45	CD	428/443 (97%)	413 (96%)	15 (4%)	0	100	100
45	CF	428/443 (97%)	409 (96%)	19 (4%)	0	100	100
45	CH	426/443 (96%)	400 (94%)	26 (6%)	0	100	100
45	CJ	428/443 (97%)	414 (97%)	14 (3%)	0	100	100
45	CL	425/443 (96%)	399 (94%)	26 (6%)	0	100	100
45	CN	428/443 (97%)	401 (94%)	27 (6%)	0	100	100
45	DB	424/443 (96%)	405 (96%)	19 (4%)	0	100	100
45	DD	428/443 (97%)	409 (96%)	19 (4%)	0	100	100
45	DF	425/443 (96%)	405 (95%)	20 (5%)	0	100	100
45	DH	428/443 (97%)	407 (95%)	20 (5%)	1 (0%)	44	77
45	DJ	424/443 (96%)	403 (95%)	21 (5%)	0	100	100
45	DL	426/443 (96%)	403 (95%)	21 (5%)	2 (0%)	25	62
45	DN	428/443 (97%)	419 (98%)	9 (2%)	0	100	100
45	EB	428/443 (97%)	401 (94%)	27 (6%)	0	100	100

Continued on next page...

*Continued from previous page...*

Mol	Chain	Analysed	Favoured	Allowed	Outliers	Percentiles	
45	ED	428/443 (97%)	409 (96%)	19 (4%)	0	100	100
45	EF	428/443 (97%)	399 (93%)	28 (6%)	1 (0%)	44	77
45	EH	428/443 (97%)	401 (94%)	27 (6%)	0	100	100
45	EJ	428/443 (97%)	411 (96%)	17 (4%)	0	100	100
45	EL	428/443 (97%)	399 (93%)	29 (7%)	0	100	100
45	EN	428/443 (97%)	400 (94%)	27 (6%)	1 (0%)	44	77
45	FB	428/443 (97%)	408 (95%)	20 (5%)	0	100	100
45	FD	428/443 (97%)	405 (95%)	23 (5%)	0	100	100
45	FF	428/443 (97%)	411 (96%)	17 (4%)	0	100	100
45	FH	424/443 (96%)	395 (93%)	28 (7%)	1 (0%)	44	77
45	FJ	428/443 (97%)	416 (97%)	12 (3%)	0	100	100
45	FL	428/443 (97%)	404 (94%)	24 (6%)	0	100	100
45	FN	428/443 (97%)	397 (93%)	30 (7%)	1 (0%)	44	77
45	GB	428/443 (97%)	405 (95%)	23 (5%)	0	100	100
45	GD	428/443 (97%)	404 (94%)	24 (6%)	0	100	100
45	GF	425/443 (96%)	402 (95%)	23 (5%)	0	100	100
45	GH	426/443 (96%)	408 (96%)	17 (4%)	1 (0%)	44	77
45	GJ	428/443 (97%)	411 (96%)	17 (4%)	0	100	100
45	GL	428/443 (97%)	407 (95%)	21 (5%)	0	100	100
45	GN	426/443 (96%)	397 (93%)	29 (7%)	0	100	100
45	HB	424/443 (96%)	409 (96%)	14 (3%)	1 (0%)	44	77
45	HD	428/443 (97%)	408 (95%)	20 (5%)	0	100	100
45	HF	428/443 (97%)	410 (96%)	18 (4%)	0	100	100
45	HH	428/443 (97%)	405 (95%)	23 (5%)	0	100	100
45	HJ	428/443 (97%)	411 (96%)	17 (4%)	0	100	100
45	HL	428/443 (97%)	412 (96%)	16 (4%)	0	100	100
45	HN	428/443 (97%)	403 (94%)	24 (6%)	1 (0%)	44	77
45	IB	428/443 (97%)	413 (96%)	15 (4%)	0	100	100
45	ID	428/443 (97%)	405 (95%)	23 (5%)	0	100	100
45	IF	428/443 (97%)	412 (96%)	16 (4%)	0	100	100
45	IH	428/443 (97%)	410 (96%)	18 (4%)	0	100	100

*Continued on next page...*

*Continued from previous page...*

Mol	Chain	Analysed	Favoured	Allowed	Outliers	Percentiles	
45	IJ	428/443 (97%)	410 (96%)	18 (4%)	0	100	100
45	IL	425/443 (96%)	407 (96%)	18 (4%)	0	100	100
45	IN	428/443 (97%)	408 (95%)	20 (5%)	0	100	100
45	JB	428/443 (97%)	407 (95%)	21 (5%)	0	100	100
45	JD	428/443 (97%)	401 (94%)	27 (6%)	0	100	100
45	JF	426/443 (96%)	408 (96%)	17 (4%)	1 (0%)	44	77
45	JH	428/443 (97%)	408 (95%)	20 (5%)	0	100	100
45	JJ	426/443 (96%)	408 (96%)	18 (4%)	0	100	100
45	JL	426/443 (96%)	400 (94%)	26 (6%)	0	100	100
45	JN	428/443 (97%)	400 (94%)	28 (6%)	0	100	100
45	KB	428/443 (97%)	407 (95%)	21 (5%)	0	100	100
45	KD	428/443 (97%)	412 (96%)	16 (4%)	0	100	100
45	KF	428/443 (97%)	403 (94%)	25 (6%)	0	100	100
45	KH	428/443 (97%)	408 (95%)	20 (5%)	0	100	100
45	KJ	428/443 (97%)	404 (94%)	24 (6%)	0	100	100
45	KL	428/443 (97%)	404 (94%)	24 (6%)	0	100	100
45	KN	423/443 (96%)	394 (93%)	29 (7%)	0	100	100
45	LB	428/443 (97%)	410 (96%)	18 (4%)	0	100	100
45	LD	428/443 (97%)	408 (95%)	20 (5%)	0	100	100
45	LF	428/443 (97%)	406 (95%)	22 (5%)	0	100	100
45	LH	428/443 (97%)	405 (95%)	23 (5%)	0	100	100
45	LJ	428/443 (97%)	410 (96%)	18 (4%)	0	100	100
45	LL	428/443 (97%)	409 (96%)	19 (4%)	0	100	100
45	LN	428/443 (97%)	412 (96%)	16 (4%)	0	100	100
45	MB	426/443 (96%)	399 (94%)	27 (6%)	0	100	100
45	MD	428/443 (97%)	411 (96%)	17 (4%)	0	100	100
45	MF	425/443 (96%)	401 (94%)	23 (5%)	1 (0%)	44	77
45	MH	428/443 (97%)	414 (97%)	14 (3%)	0	100	100
45	MJ	428/443 (97%)	414 (97%)	14 (3%)	0	100	100
45	ML	426/443 (96%)	406 (95%)	20 (5%)	0	100	100
45	MN	428/443 (97%)	405 (95%)	23 (5%)	0	100	100

*Continued on next page...*

*Continued from previous page...*

Mol	Chain	Analysed	Favoured	Allowed	Outliers	Percentiles	
45	NB	419/443 (95%)	403 (96%)	16 (4%)	0	100	100
45	ND	428/443 (97%)	407 (95%)	21 (5%)	0	100	100
45	NF	419/443 (95%)	397 (95%)	22 (5%)	0	100	100
45	NH	428/443 (97%)	406 (95%)	22 (5%)	0	100	100
45	NJ	419/443 (95%)	398 (95%)	21 (5%)	0	100	100
45	NL	428/443 (97%)	399 (93%)	29 (7%)	0	100	100
45	NN	416/443 (94%)	395 (95%)	21 (5%)	0	100	100
45	OB	428/443 (97%)	406 (95%)	22 (5%)	0	100	100
45	OD	428/443 (97%)	404 (94%)	24 (6%)	0	100	100
45	OF	428/443 (97%)	400 (94%)	28 (6%)	0	100	100
45	OH	428/443 (97%)	412 (96%)	16 (4%)	0	100	100
45	OJ	428/443 (97%)	395 (92%)	33 (8%)	0	100	100
45	OL	428/443 (97%)	404 (94%)	24 (6%)	0	100	100
45	ON	428/443 (97%)	416 (97%)	12 (3%)	0	100	100
45	PB	428/443 (97%)	414 (97%)	14 (3%)	0	100	100
45	PD	423/443 (96%)	399 (94%)	24 (6%)	0	100	100
45	PF	428/443 (97%)	395 (92%)	33 (8%)	0	100	100
45	PH	428/443 (97%)	408 (95%)	20 (5%)	0	100	100
45	PJ	428/443 (97%)	408 (95%)	20 (5%)	0	100	100
45	PL	428/443 (97%)	398 (93%)	30 (7%)	0	100	100
45	PN	428/443 (97%)	412 (96%)	16 (4%)	0	100	100
45	QB	428/443 (97%)	411 (96%)	17 (4%)	0	100	100
45	QD	428/443 (97%)	411 (96%)	17 (4%)	0	100	100
45	QF	426/443 (96%)	408 (96%)	18 (4%)	0	100	100
45	QH	428/443 (97%)	415 (97%)	13 (3%)	0	100	100
45	QJ	424/443 (96%)	406 (96%)	18 (4%)	0	100	100
45	QL	428/443 (97%)	412 (96%)	16 (4%)	0	100	100
45	QN	407/443 (92%)	397 (98%)	10 (2%)	0	100	100
45	RB	428/443 (97%)	414 (97%)	14 (3%)	0	100	100
45	RD	428/443 (97%)	405 (95%)	23 (5%)	0	100	100
45	RF	428/443 (97%)	404 (94%)	24 (6%)	0	100	100

*Continued on next page...*

*Continued from previous page...*

Mol	Chain	Analysed	Favoured	Allowed	Outliers	Percentiles	
45	RH	428/443 (97%)	402 (94%)	26 (6%)	0	100	100
45	RJ	428/443 (97%)	402 (94%)	26 (6%)	0	100	100
45	RL	428/443 (97%)	411 (96%)	17 (4%)	0	100	100
45	RN	428/443 (97%)	415 (97%)	12 (3%)	1 (0%)	44	77
45	SB	425/443 (96%)	404 (95%)	21 (5%)	0	100	100
45	SD	428/443 (97%)	406 (95%)	22 (5%)	0	100	100
45	SF	428/443 (97%)	409 (96%)	19 (4%)	0	100	100
45	SH	428/443 (97%)	407 (95%)	21 (5%)	0	100	100
45	SJ	428/443 (97%)	401 (94%)	27 (6%)	0	100	100
45	SL	428/443 (97%)	406 (95%)	22 (5%)	0	100	100
45	SN	428/443 (97%)	415 (97%)	13 (3%)	0	100	100
45	TB	428/443 (97%)	419 (98%)	9 (2%)	0	100	100
45	TD	428/443 (97%)	405 (95%)	23 (5%)	0	100	100
45	TF	428/443 (97%)	404 (94%)	24 (6%)	0	100	100
45	TH	426/443 (96%)	396 (93%)	30 (7%)	0	100	100
45	TJ	428/443 (97%)	401 (94%)	27 (6%)	0	100	100
45	TL	428/443 (97%)	411 (96%)	17 (4%)	0	100	100
45	TN	424/443 (96%)	412 (97%)	12 (3%)	0	100	100
45	UB	423/443 (96%)	415 (98%)	8 (2%)	0	100	100
45	UD	426/443 (96%)	406 (95%)	20 (5%)	0	100	100
45	UF	428/443 (97%)	414 (97%)	14 (3%)	0	100	100
45	UH	428/443 (97%)	403 (94%)	25 (6%)	0	100	100
45	UJ	428/443 (97%)	401 (94%)	27 (6%)	0	100	100
45	UL	428/443 (97%)	411 (96%)	17 (4%)	0	100	100
45	UN	428/443 (97%)	410 (96%)	18 (4%)	0	100	100
45	VB	428/443 (97%)	408 (95%)	19 (4%)	1 (0%)	44	77
45	VD	426/443 (96%)	400 (94%)	25 (6%)	1 (0%)	44	77
45	VF	425/443 (96%)	403 (95%)	22 (5%)	0	100	100
45	VH	428/443 (97%)	410 (96%)	18 (4%)	0	100	100
45	VJ	428/443 (97%)	402 (94%)	26 (6%)	0	100	100
45	VL	426/443 (96%)	406 (95%)	20 (5%)	0	100	100

*Continued on next page...*

Continued from previous page...

Mol	Chain	Analysed	Favoured	Allowed	Outliers	Percentiles	
45	VN	425/443 (96%)	411 (97%)	13 (3%)	1 (0%)	44	77
45	WB	428/443 (97%)	417 (97%)	11 (3%)	0	100	100
45	WD	428/443 (97%)	406 (95%)	22 (5%)	0	100	100
45	WF	428/443 (97%)	401 (94%)	26 (6%)	1 (0%)	44	77
45	WH	426/443 (96%)	402 (94%)	23 (5%)	1 (0%)	44	77
45	WJ	426/443 (96%)	403 (95%)	23 (5%)	0	100	100
45	WL	428/443 (97%)	412 (96%)	16 (4%)	0	100	100
45	WN	428/443 (97%)	411 (96%)	17 (4%)	0	100	100
All	All	164328/178382 (92%)	154012 (94%)	10079 (6%)	237 (0%)	50	82

5 of 237 Ramachandran outliers are listed below:

Mol	Chain	Res	Type
1	6H	243	LYS
2	0A	20	PRO
3	0B	33	GLN
3	0B	44	ILE
3	0B	67	THR

### 5.3.2 Protein sidechains [i](#)

In the following table, the Percentiles column shows the percent sidechain outliers of the chain as a percentile score with respect to all PDB entries followed by that with respect to all EM entries.

The Analysed column shows the number of residues for which the sidechain conformation was analysed, and the total number of residues.

Mol	Chain	Analysed	Rotameric	Outliers	Percentiles	
1	6H	151/474 (32%)	141 (93%)	10 (7%)	14	36
2	0A	133/213 (62%)	133 (100%)	0	100	100
2	1A	133/213 (62%)	133 (100%)	0	100	100
2	2A	133/213 (62%)	132 (99%)	1 (1%)	79	84
2	3A	133/213 (62%)	132 (99%)	1 (1%)	79	84
3	0B	291/301 (97%)	291 (100%)	0	100	100
4	0C	81/137 (59%)	81 (100%)	0	100	100
4	1C	81/137 (59%)	79 (98%)	2 (2%)	42	62

Continued on next page...

Continued from previous page...

Mol	Chain	Analysed	Rotameric	Outliers	Percentiles	
5	0D	176/198 (89%)	176 (100%)	0	100	100
5	1D	176/198 (89%)	176 (100%)	0	100	100
5	2D	176/198 (89%)	173 (98%)	3 (2%)	56	72
6	0E	172/175 (98%)	172 (100%)	0	100	100
6	1E	172/175 (98%)	170 (99%)	2 (1%)	67	79
6	2E	172/175 (98%)	170 (99%)	2 (1%)	67	79
6	3E	172/175 (98%)	172 (100%)	0	100	100
7	0F	182/194 (94%)	180 (99%)	2 (1%)	70	80
8	0G	153/167 (92%)	152 (99%)	1 (1%)	81	86
8	1G	123/167 (74%)	122 (99%)	1 (1%)	79	84
9	0H	101/413 (24%)	100 (99%)	1 (1%)	73	81
9	1H	387/413 (94%)	380 (98%)	7 (2%)	54	71
10	0N	256/451 (57%)	256 (100%)	0	100	100
10	1N	423/451 (94%)	422 (100%)	1 (0%)	92	94
10	2N	256/451 (57%)	256 (100%)	0	100	100
11	0Q	174/182 (96%)	172 (99%)	2 (1%)	70	80
11	1Q	174/182 (96%)	173 (99%)	1 (1%)	84	88
11	2Q	174/182 (96%)	174 (100%)	0	100	100
11	3Q	174/182 (96%)	172 (99%)	2 (1%)	70	80
11	4Q	174/182 (96%)	173 (99%)	1 (1%)	84	88
11	5Q	174/182 (96%)	174 (100%)	0	100	100
11	6Q	174/182 (96%)	172 (99%)	2 (1%)	70	80
12	0S	247/286 (86%)	243 (98%)	4 (2%)	58	74
12	1S	257/286 (90%)	256 (100%)	1 (0%)	89	91
12	2S	257/286 (90%)	256 (100%)	1 (0%)	89	91
12	3S	257/286 (90%)	256 (100%)	1 (0%)	89	91
13	0T	184/264 (70%)	183 (100%)	1 (0%)	86	90
13	1T	251/264 (95%)	250 (100%)	1 (0%)	89	91
13	2T	251/264 (95%)	247 (98%)	4 (2%)	58	74
13	3T	251/264 (95%)	250 (100%)	1 (0%)	89	91
14	0U	528/571 (92%)	527 (100%)	1 (0%)	92	94

Continued on next page...



Continued from previous page...

Mol	Chain	Analysed	Rotameric	Outliers	Percentiles	
14	1U	528/571 (92%)	527 (100%)	1 (0%)	92	94
14	2U	528/571 (92%)	527 (100%)	1 (0%)	92	94
14	3U	528/571 (92%)	523 (99%)	5 (1%)	75	83
15	0V	196/249 (79%)	194 (99%)	2 (1%)	73	81
15	1V	244/249 (98%)	244 (100%)	0	100	100
15	2V	244/249 (98%)	244 (100%)	0	100	100
15	3V	244/249 (98%)	241 (99%)	3 (1%)	67	79
16	0X	94/129 (73%)	94 (100%)	0	100	100
16	1X	128/129 (99%)	128 (100%)	0	100	100
16	2X	128/129 (99%)	128 (100%)	0	100	100
16	3X	128/129 (99%)	128 (100%)	0	100	100
16	4X	128/129 (99%)	125 (98%)	3 (2%)	45	64
17	1B	441/441 (100%)	440 (100%)	1 (0%)	92	94
17	2B	264/441 (60%)	263 (100%)	1 (0%)	89	91
17	3B	265/441 (60%)	264 (100%)	1 (0%)	89	91
18	1F	121/157 (77%)	120 (99%)	1 (1%)	79	84
19	1I	172/239 (72%)	169 (98%)	3 (2%)	56	72
20	1J	328/370 (89%)	328 (100%)	0	100	100
21	1K	253/463 (55%)	252 (100%)	1 (0%)	89	91
21	2K	262/463 (57%)	262 (100%)	0	100	100
22	1L	771/878 (88%)	769 (100%)	2 (0%)	91	92
22	2L	580/878 (66%)	577 (100%)	3 (0%)	86	90
22	3L	191/878 (22%)	189 (99%)	2 (1%)	73	81
23	1M	323/325 (99%)	322 (100%)	1 (0%)	91	92
23	2M	323/325 (99%)	322 (100%)	1 (0%)	91	92
24	1O	223/458 (49%)	220 (99%)	3 (1%)	65	77
24	2O	346/458 (76%)	344 (99%)	2 (1%)	84	88
24	3O	245/458 (54%)	245 (100%)	0	100	100
25	1P	318/471 (68%)	318 (100%)	0	100	100
25	2P	158/471 (34%)	158 (100%)	0	100	100
26	1R	466/475 (98%)	464 (100%)	2 (0%)	89	91

Continued on next page...

Continued from previous page...

Mol	Chain	Analysed	Rotameric	Outliers	Percentiles	
26	2R	466/475 (98%)	465 (100%)	1 (0%)	92	94
26	3R	466/475 (98%)	466 (100%)	0	100	100
27	1W	202/265 (76%)	201 (100%)	1 (0%)	86	90
27	2W	96/265 (36%)	95 (99%)	1 (1%)	73	81
28	2C	271/271 (100%)	270 (100%)	1 (0%)	89	91
28	3C	271/271 (100%)	270 (100%)	1 (0%)	89	91
28	4C	271/271 (100%)	268 (99%)	3 (1%)	70	80
29	2F	81/90 (90%)	81 (100%)	0	100	100
30	2G	91/91 (100%)	91 (100%)	0	100	100
31	2H	59/212 (28%)	59 (100%)	0	100	100
31	3H	59/212 (28%)	59 (100%)	0	100	100
31	4H	59/212 (28%)	59 (100%)	0	100	100
32	2I	115/259 (44%)	114 (99%)	1 (1%)	75	83
32	3I	80/259 (31%)	80 (100%)	0	100	100
33	3D	195/195 (100%)	193 (99%)	2 (1%)	73	81
34	4F	180/245 (74%)	180 (100%)	0	100	100
35	4R	561/568 (99%)	558 (100%)	3 (0%)	86	90
35	5R	561/568 (99%)	558 (100%)	3 (0%)	86	90
35	6R	561/568 (99%)	528 (94%)	33 (6%)	16	40
35	7R	561/568 (99%)	561 (100%)	0	100	100
36	4S	169/222 (76%)	168 (99%)	1 (1%)	84	88
36	5S	169/222 (76%)	167 (99%)	2 (1%)	67	79
37	5A	140/159 (88%)	140 (100%)	0	100	100
37	5B	140/159 (88%)	140 (100%)	0	100	100
37	5C	140/159 (88%)	140 (100%)	0	100	100
37	5D	93/159 (58%)	92 (99%)	1 (1%)	70	80
38	5E	165/227 (73%)	164 (99%)	1 (1%)	84	88
38	5F	194/227 (86%)	193 (100%)	1 (0%)	86	90
38	5G	194/227 (86%)	194 (100%)	0	100	100
38	5H	117/227 (52%)	117 (100%)	0	100	100
39	5I	83/160 (52%)	82 (99%)	1 (1%)	67	79

Continued on next page...

Continued from previous page...

Mol	Chain	Analysed	Rotameric	Outliers	Percentiles	
39	5J	101/160 (63%)	99 (98%)	2 (2%)	50	68
39	5K	65/160 (41%)	64 (98%)	1 (2%)	60	75
40	6F	128/141 (91%)	127 (99%)	1 (1%)	79	84
41	6G	194/329 (59%)	193 (100%)	1 (0%)	86	90
44	AA	370/376 (98%)	370 (100%)	0	100	100
44	AC	370/376 (98%)	368 (100%)	2 (0%)	86	90
44	AE	370/376 (98%)	369 (100%)	1 (0%)	91	92
44	AG	370/376 (98%)	367 (99%)	3 (1%)	79	84
44	AI	370/376 (98%)	369 (100%)	1 (0%)	91	92
44	AK	370/376 (98%)	369 (100%)	1 (0%)	91	92
44	AM	370/376 (98%)	368 (100%)	2 (0%)	86	90
44	BA	366/376 (97%)	365 (100%)	1 (0%)	91	92
44	BC	366/376 (97%)	364 (100%)	2 (0%)	86	90
44	BE	366/376 (97%)	366 (100%)	0	100	100
44	BG	366/376 (97%)	364 (100%)	2 (0%)	86	90
44	BI	366/376 (97%)	365 (100%)	1 (0%)	91	92
44	BK	366/376 (97%)	364 (100%)	2 (0%)	86	90
44	BM	366/376 (97%)	365 (100%)	1 (0%)	91	92
44	CA	370/376 (98%)	364 (98%)	6 (2%)	58	74
44	CC	370/376 (98%)	368 (100%)	2 (0%)	86	90
44	CE	370/376 (98%)	366 (99%)	4 (1%)	70	80
44	CG	370/376 (98%)	368 (100%)	2 (0%)	86	90
44	CI	370/376 (98%)	367 (99%)	3 (1%)	79	84
44	CK	370/376 (98%)	369 (100%)	1 (0%)	91	92
44	CM	370/376 (98%)	369 (100%)	1 (0%)	91	92
44	DA	367/376 (98%)	366 (100%)	1 (0%)	91	92
44	DC	366/376 (97%)	365 (100%)	1 (0%)	91	92
44	DE	367/376 (98%)	365 (100%)	2 (0%)	86	90
44	DG	368/376 (98%)	367 (100%)	1 (0%)	91	92
44	DI	367/376 (98%)	364 (99%)	3 (1%)	79	84
44	DK	368/376 (98%)	367 (100%)	1 (0%)	91	92

Continued on next page...

*Continued from previous page...*

Mol	Chain	Analysed	Rotameric	Outliers	Percentiles	
44	DM	367/376 (98%)	365 (100%)	2 (0%)	86	90
44	EA	368/376 (98%)	365 (99%)	3 (1%)	79	84
44	EC	370/376 (98%)	368 (100%)	2 (0%)	86	90
44	EE	370/376 (98%)	368 (100%)	2 (0%)	86	90
44	EG	370/376 (98%)	369 (100%)	1 (0%)	91	92
44	EI	370/376 (98%)	370 (100%)	0	100	100
44	EK	370/376 (98%)	365 (99%)	5 (1%)	62	76
44	EM	370/376 (98%)	369 (100%)	1 (0%)	91	92
44	FA	363/376 (96%)	363 (100%)	0	100	100
44	FC	366/376 (97%)	366 (100%)	0	100	100
44	FE	367/376 (98%)	365 (100%)	2 (0%)	86	90
44	FG	370/376 (98%)	368 (100%)	2 (0%)	86	90
44	FI	367/376 (98%)	362 (99%)	5 (1%)	62	76
44	FK	366/376 (97%)	366 (100%)	0	100	100
44	FM	344/376 (92%)	344 (100%)	0	100	100
44	GA	363/376 (96%)	362 (100%)	1 (0%)	91	92
44	GC	365/376 (97%)	363 (100%)	2 (0%)	86	90
44	GE	365/376 (97%)	362 (99%)	3 (1%)	79	84
44	GG	365/376 (97%)	364 (100%)	1 (0%)	91	92
44	GI	365/376 (97%)	363 (100%)	2 (0%)	86	90
44	GK	370/376 (98%)	370 (100%)	0	100	100
44	GM	363/376 (96%)	362 (100%)	1 (0%)	91	92
44	HA	365/376 (97%)	363 (100%)	2 (0%)	86	90
44	HC	365/376 (97%)	361 (99%)	4 (1%)	70	80
44	HE	365/376 (97%)	364 (100%)	1 (0%)	91	92
44	HG	365/376 (97%)	364 (100%)	1 (0%)	91	92
44	HI	365/376 (97%)	365 (100%)	0	100	100
44	HK	365/376 (97%)	364 (100%)	1 (0%)	91	92
44	HM	365/376 (97%)	364 (100%)	1 (0%)	91	92
44	IA	366/376 (97%)	364 (100%)	2 (0%)	86	90
44	IC	370/376 (98%)	370 (100%)	0	100	100

*Continued on next page...*

Continued from previous page...

Mol	Chain	Analysed	Rotameric	Outliers	Percentiles	
44	IE	366/376 (97%)	366 (100%)	0	100	100
44	IG	370/376 (98%)	367 (99%)	3 (1%)	79	84
44	II	370/376 (98%)	367 (99%)	3 (1%)	79	84
44	IK	366/376 (97%)	365 (100%)	1 (0%)	91	92
44	IM	366/376 (97%)	364 (100%)	2 (0%)	86	90
44	JA	366/376 (97%)	365 (100%)	1 (0%)	91	92
44	JC	367/376 (98%)	366 (100%)	1 (0%)	91	92
44	JE	370/376 (98%)	369 (100%)	1 (0%)	91	92
44	JG	370/376 (98%)	369 (100%)	1 (0%)	91	92
44	JI	369/376 (98%)	369 (100%)	0	100	100
44	JK	370/376 (98%)	370 (100%)	0	100	100
44	JM	367/376 (98%)	364 (99%)	3 (1%)	79	84
44	KA	367/376 (98%)	366 (100%)	1 (0%)	91	92
44	KC	367/376 (98%)	366 (100%)	1 (0%)	91	92
44	KE	368/376 (98%)	365 (99%)	3 (1%)	79	84
44	KG	370/376 (98%)	369 (100%)	1 (0%)	91	92
44	KI	370/376 (98%)	368 (100%)	2 (0%)	86	90
44	KK	370/376 (98%)	369 (100%)	1 (0%)	91	92
44	KM	367/376 (98%)	363 (99%)	4 (1%)	70	80
44	LA	370/376 (98%)	367 (99%)	3 (1%)	79	84
44	LC	370/376 (98%)	368 (100%)	2 (0%)	86	90
44	LE	369/376 (98%)	366 (99%)	3 (1%)	79	84
44	LG	370/376 (98%)	369 (100%)	1 (0%)	91	92
44	LI	368/376 (98%)	368 (100%)	0	100	100
44	LK	370/376 (98%)	361 (98%)	9 (2%)	44	63
44	LM	370/376 (98%)	369 (100%)	1 (0%)	91	92
44	MA	369/376 (98%)	369 (100%)	0	100	100
44	MC	366/376 (97%)	365 (100%)	1 (0%)	91	92
44	ME	367/376 (98%)	367 (100%)	0	100	100
44	MG	370/376 (98%)	367 (99%)	3 (1%)	79	84
44	MI	370/376 (98%)	369 (100%)	1 (0%)	91	92

Continued on next page...

Continued from previous page...

Mol	Chain	Analysed	Rotameric	Outliers	Percentiles	
44	MK	367/376 (98%)	365 (100%)	2 (0%)	86	90
44	MM	369/376 (98%)	368 (100%)	1 (0%)	91	92
44	NA	370/376 (98%)	368 (100%)	2 (0%)	86	90
44	NC	366/376 (97%)	366 (100%)	0	100	100
44	NE	370/376 (98%)	368 (100%)	2 (0%)	86	90
44	NG	366/376 (97%)	365 (100%)	1 (0%)	91	92
44	NI	370/376 (98%)	368 (100%)	2 (0%)	86	90
44	NK	366/376 (97%)	366 (100%)	0	100	100
44	NM	370/376 (98%)	368 (100%)	2 (0%)	86	90
44	OA	366/376 (97%)	366 (100%)	0	100	100
44	OC	366/376 (97%)	365 (100%)	1 (0%)	91	92
44	OE	366/376 (97%)	364 (100%)	2 (0%)	86	90
44	OG	366/376 (97%)	365 (100%)	1 (0%)	91	92
44	OI	366/376 (97%)	365 (100%)	1 (0%)	91	92
44	OK	366/376 (97%)	364 (100%)	2 (0%)	86	90
44	OM	366/376 (97%)	366 (100%)	0	100	100
44	PA	363/376 (96%)	362 (100%)	1 (0%)	91	92
44	PC	363/376 (96%)	362 (100%)	1 (0%)	91	92
44	PE	363/376 (96%)	362 (100%)	1 (0%)	91	92
44	PG	363/376 (96%)	361 (99%)	2 (1%)	84	88
44	PI	363/376 (96%)	360 (99%)	3 (1%)	79	84
44	PK	363/376 (96%)	361 (99%)	2 (1%)	84	88
44	PM	363/376 (96%)	360 (99%)	3 (1%)	79	84
44	QA	365/376 (97%)	364 (100%)	1 (0%)	91	92
44	QC	365/376 (97%)	362 (99%)	3 (1%)	79	84
44	QE	365/376 (97%)	363 (100%)	2 (0%)	86	90
44	QG	365/376 (97%)	364 (100%)	1 (0%)	91	92
44	QI	365/376 (97%)	363 (100%)	2 (0%)	86	90
44	QK	365/376 (97%)	363 (100%)	2 (0%)	86	90
44	QM	365/376 (97%)	362 (99%)	3 (1%)	79	84
44	RA	365/376 (97%)	364 (100%)	1 (0%)	91	92

Continued on next page...

Continued from previous page...

Mol	Chain	Analysed	Rotameric	Outliers	Percentiles	
44	RC	365/376 (97%)	363 (100%)	2 (0%)	86	90
44	RE	365/376 (97%)	362 (99%)	3 (1%)	79	84
44	RG	365/376 (97%)	363 (100%)	2 (0%)	86	90
44	RI	365/376 (97%)	364 (100%)	1 (0%)	91	92
44	RK	365/376 (97%)	365 (100%)	0	100	100
44	RM	365/376 (97%)	365 (100%)	0	100	100
44	SA	364/376 (97%)	363 (100%)	1 (0%)	91	92
44	SC	364/376 (97%)	362 (100%)	2 (0%)	86	90
44	SE	364/376 (97%)	360 (99%)	4 (1%)	70	80
44	SG	364/376 (97%)	361 (99%)	3 (1%)	79	84
44	SI	364/376 (97%)	362 (100%)	2 (0%)	86	90
44	SK	364/376 (97%)	362 (100%)	2 (0%)	86	90
44	SM	364/376 (97%)	363 (100%)	1 (0%)	91	92
44	TA	364/376 (97%)	362 (100%)	2 (0%)	86	90
44	TC	364/376 (97%)	362 (100%)	2 (0%)	86	90
44	TE	364/376 (97%)	361 (99%)	3 (1%)	79	84
44	TG	364/376 (97%)	362 (100%)	2 (0%)	86	90
44	TI	364/376 (97%)	361 (99%)	3 (1%)	79	84
44	TK	364/376 (97%)	364 (100%)	0	100	100
44	TM	364/376 (97%)	363 (100%)	1 (0%)	91	92
44	UA	364/376 (97%)	361 (99%)	3 (1%)	79	84
44	UC	365/376 (97%)	365 (100%)	0	100	100
44	UE	365/376 (97%)	363 (100%)	2 (0%)	86	90
44	UG	365/376 (97%)	364 (100%)	1 (0%)	91	92
44	UI	365/376 (97%)	364 (100%)	1 (0%)	91	92
44	UK	365/376 (97%)	365 (100%)	0	100	100
44	UM	365/376 (97%)	363 (100%)	2 (0%)	86	90
44	VA	367/376 (98%)	366 (100%)	1 (0%)	91	92
44	VC	370/376 (98%)	368 (100%)	2 (0%)	86	90
44	VE	367/376 (98%)	366 (100%)	1 (0%)	91	92
44	VG	370/376 (98%)	369 (100%)	1 (0%)	91	92

Continued on next page...

*Continued from previous page...*

Mol	Chain	Analysed	Rotameric	Outliers	Percentiles	
44	VI	367/376 (98%)	365 (100%)	2 (0%)	86	90
44	VK	370/376 (98%)	367 (99%)	3 (1%)	79	84
44	VM	366/376 (97%)	364 (100%)	2 (0%)	86	90
44	WA	365/376 (97%)	363 (100%)	2 (0%)	86	90
44	WC	370/376 (98%)	369 (100%)	1 (0%)	91	92
44	WE	365/376 (97%)	363 (100%)	2 (0%)	86	90
44	WG	370/376 (98%)	367 (99%)	3 (1%)	79	84
44	WI	365/376 (97%)	363 (100%)	2 (0%)	86	90
44	WK	370/376 (98%)	366 (99%)	4 (1%)	70	80
44	WM	365/376 (97%)	363 (100%)	2 (0%)	86	90
45	AB	356/376 (95%)	354 (99%)	2 (1%)	84	88
45	AD	365/376 (97%)	363 (100%)	2 (0%)	86	90
45	AF	365/376 (97%)	365 (100%)	0	100	100
45	AH	365/376 (97%)	364 (100%)	1 (0%)	91	92
45	AJ	365/376 (97%)	365 (100%)	0	100	100
45	AL	365/376 (97%)	364 (100%)	1 (0%)	91	92
45	AN	365/376 (97%)	365 (100%)	0	100	100
45	BB	365/376 (97%)	365 (100%)	0	100	100
45	BD	365/376 (97%)	365 (100%)	0	100	100
45	BF	365/376 (97%)	363 (100%)	2 (0%)	86	90
45	BH	365/376 (97%)	364 (100%)	1 (0%)	91	92
45	BJ	365/376 (97%)	364 (100%)	1 (0%)	91	92
45	BL	365/376 (97%)	363 (100%)	2 (0%)	86	90
45	BN	365/376 (97%)	365 (100%)	0	100	100
45	CB	365/376 (97%)	365 (100%)	0	100	100
45	CD	365/376 (97%)	364 (100%)	1 (0%)	91	92
45	CF	365/376 (97%)	364 (100%)	1 (0%)	91	92
45	CH	365/376 (97%)	364 (100%)	1 (0%)	91	92
45	CJ	365/376 (97%)	364 (100%)	1 (0%)	91	92
45	CL	365/376 (97%)	364 (100%)	1 (0%)	91	92
45	CN	365/376 (97%)	365 (100%)	0	100	100

*Continued on next page...*



*Continued from previous page...*

Mol	Chain	Analysed	Rotameric	Outliers	Percentiles	
45	DB	365/376 (97%)	364 (100%)	1 (0%)	91	92
45	DD	365/376 (97%)	362 (99%)	3 (1%)	79	84
45	DF	365/376 (97%)	364 (100%)	1 (0%)	91	92
45	DH	365/376 (97%)	365 (100%)	0	100	100
45	DJ	365/376 (97%)	365 (100%)	0	100	100
45	DL	365/376 (97%)	365 (100%)	0	100	100
45	DN	365/376 (97%)	364 (100%)	1 (0%)	91	92
45	EB	365/376 (97%)	365 (100%)	0	100	100
45	ED	365/376 (97%)	365 (100%)	0	100	100
45	EF	365/376 (97%)	364 (100%)	1 (0%)	91	92
45	EH	365/376 (97%)	365 (100%)	0	100	100
45	EJ	365/376 (97%)	365 (100%)	0	100	100
45	EL	365/376 (97%)	365 (100%)	0	100	100
45	EN	365/376 (97%)	364 (100%)	1 (0%)	91	92
45	FB	365/376 (97%)	364 (100%)	1 (0%)	91	92
45	FD	365/376 (97%)	365 (100%)	0	100	100
45	FF	365/376 (97%)	364 (100%)	1 (0%)	91	92
45	FH	365/376 (97%)	365 (100%)	0	100	100
45	FJ	365/376 (97%)	364 (100%)	1 (0%)	91	92
45	FL	365/376 (97%)	363 (100%)	2 (0%)	86	90
45	FN	365/376 (97%)	365 (100%)	0	100	100
45	GB	365/376 (97%)	364 (100%)	1 (0%)	91	92
45	GD	365/376 (97%)	363 (100%)	2 (0%)	86	90
45	GF	365/376 (97%)	364 (100%)	1 (0%)	91	92
45	GH	365/376 (97%)	365 (100%)	0	100	100
45	GJ	365/376 (97%)	365 (100%)	0	100	100
45	GL	365/376 (97%)	365 (100%)	0	100	100
45	GN	365/376 (97%)	365 (100%)	0	100	100
45	HB	365/376 (97%)	365 (100%)	0	100	100
45	HD	365/376 (97%)	364 (100%)	1 (0%)	91	92
45	HF	365/376 (97%)	364 (100%)	1 (0%)	91	92

*Continued on next page...*

*Continued from previous page...*

Mol	Chain	Analysed	Rotameric	Outliers	Percentiles	
45	HH	365/376 (97%)	365 (100%)	0	100	100
45	HJ	365/376 (97%)	363 (100%)	2 (0%)	86	90
45	HL	365/376 (97%)	363 (100%)	2 (0%)	86	90
45	HN	365/376 (97%)	365 (100%)	0	100	100
45	IB	365/376 (97%)	364 (100%)	1 (0%)	91	92
45	ID	365/376 (97%)	364 (100%)	1 (0%)	91	92
45	IF	365/376 (97%)	364 (100%)	1 (0%)	91	92
45	IH	365/376 (97%)	364 (100%)	1 (0%)	91	92
45	IJ	365/376 (97%)	362 (99%)	3 (1%)	79	84
45	IL	365/376 (97%)	362 (99%)	3 (1%)	79	84
45	IN	365/376 (97%)	364 (100%)	1 (0%)	91	92
45	JB	365/376 (97%)	365 (100%)	0	100	100
45	JD	365/376 (97%)	365 (100%)	0	100	100
45	JF	365/376 (97%)	362 (99%)	3 (1%)	79	84
45	JH	365/376 (97%)	365 (100%)	0	100	100
45	JJ	365/376 (97%)	364 (100%)	1 (0%)	91	92
45	JL	365/376 (97%)	364 (100%)	1 (0%)	91	92
45	JN	365/376 (97%)	363 (100%)	2 (0%)	86	90
45	KB	365/376 (97%)	364 (100%)	1 (0%)	91	92
45	KD	365/376 (97%)	365 (100%)	0	100	100
45	KF	365/376 (97%)	364 (100%)	1 (0%)	91	92
45	KH	365/376 (97%)	364 (100%)	1 (0%)	91	92
45	KJ	365/376 (97%)	365 (100%)	0	100	100
45	KL	365/376 (97%)	364 (100%)	1 (0%)	91	92
45	KN	365/376 (97%)	364 (100%)	1 (0%)	91	92
45	LB	365/376 (97%)	364 (100%)	1 (0%)	91	92
45	LD	365/376 (97%)	364 (100%)	1 (0%)	91	92
45	LF	365/376 (97%)	364 (100%)	1 (0%)	91	92
45	LH	365/376 (97%)	363 (100%)	2 (0%)	86	90
45	LJ	365/376 (97%)	364 (100%)	1 (0%)	91	92
45	LL	365/376 (97%)	365 (100%)	0	100	100

*Continued on next page...*

*Continued from previous page...*

Mol	Chain	Analysed	Rotameric	Outliers	Percentiles	
45	LN	365/376 (97%)	364 (100%)	1 (0%)	91	92
45	MB	365/376 (97%)	365 (100%)	0	100	100
45	MD	365/376 (97%)	365 (100%)	0	100	100
45	MF	365/376 (97%)	365 (100%)	0	100	100
45	MH	365/376 (97%)	364 (100%)	1 (0%)	91	92
45	MJ	365/376 (97%)	365 (100%)	0	100	100
45	ML	365/376 (97%)	364 (100%)	1 (0%)	91	92
45	MN	365/376 (97%)	365 (100%)	0	100	100
45	NB	359/376 (96%)	359 (100%)	0	100	100
45	ND	365/376 (97%)	364 (100%)	1 (0%)	91	92
45	NF	359/376 (96%)	357 (99%)	2 (1%)	84	88
45	NH	365/376 (97%)	365 (100%)	0	100	100
45	NJ	359/376 (96%)	358 (100%)	1 (0%)	91	92
45	NL	365/376 (97%)	364 (100%)	1 (0%)	91	92
45	NN	359/376 (96%)	357 (99%)	2 (1%)	84	88
45	OB	365/376 (97%)	364 (100%)	1 (0%)	91	92
45	OD	365/376 (97%)	364 (100%)	1 (0%)	91	92
45	OF	365/376 (97%)	363 (100%)	2 (0%)	86	90
45	OH	365/376 (97%)	365 (100%)	0	100	100
45	OJ	365/376 (97%)	362 (99%)	3 (1%)	79	84
45	OL	365/376 (97%)	364 (100%)	1 (0%)	91	92
45	ON	365/376 (97%)	364 (100%)	1 (0%)	91	92
45	PB	362/376 (96%)	360 (99%)	2 (1%)	84	88
45	PD	365/376 (97%)	364 (100%)	1 (0%)	91	92
45	PF	365/376 (97%)	365 (100%)	0	100	100
45	PH	365/376 (97%)	365 (100%)	0	100	100
45	PJ	365/376 (97%)	365 (100%)	0	100	100
45	PL	365/376 (97%)	365 (100%)	0	100	100
45	PN	365/376 (97%)	364 (100%)	1 (0%)	91	92
45	QB	365/376 (97%)	365 (100%)	0	100	100
45	QD	365/376 (97%)	365 (100%)	0	100	100

*Continued on next page...*

Continued from previous page...

Mol	Chain	Analysed	Rotameric	Outliers	Percentiles	
45	QF	365/376 (97%)	365 (100%)	0	100	100
45	QH	365/376 (97%)	364 (100%)	1 (0%)	91	92
45	QJ	365/376 (97%)	364 (100%)	1 (0%)	91	92
45	QL	365/376 (97%)	363 (100%)	2 (0%)	86	90
45	QN	342/376 (91%)	342 (100%)	0	100	100
45	RB	365/376 (97%)	363 (100%)	2 (0%)	86	90
45	RD	365/376 (97%)	364 (100%)	1 (0%)	91	92
45	RF	365/376 (97%)	365 (100%)	0	100	100
45	RH	365/376 (97%)	365 (100%)	0	100	100
45	RJ	365/376 (97%)	364 (100%)	1 (0%)	91	92
45	RL	365/376 (97%)	365 (100%)	0	100	100
45	RN	365/376 (97%)	364 (100%)	1 (0%)	91	92
45	SB	365/376 (97%)	365 (100%)	0	100	100
45	SD	365/376 (97%)	363 (100%)	2 (0%)	86	90
45	SF	365/376 (97%)	365 (100%)	0	100	100
45	SH	365/376 (97%)	364 (100%)	1 (0%)	91	92
45	SJ	365/376 (97%)	365 (100%)	0	100	100
45	SL	365/376 (97%)	365 (100%)	0	100	100
45	SN	365/376 (97%)	365 (100%)	0	100	100
45	TB	365/376 (97%)	364 (100%)	1 (0%)	91	92
45	TD	365/376 (97%)	364 (100%)	1 (0%)	91	92
45	TF	365/376 (97%)	365 (100%)	0	100	100
45	TH	365/376 (97%)	362 (99%)	3 (1%)	79	84
45	TJ	365/376 (97%)	364 (100%)	1 (0%)	91	92
45	TL	365/376 (97%)	365 (100%)	0	100	100
45	TN	365/376 (97%)	364 (100%)	1 (0%)	91	92
45	UB	365/376 (97%)	365 (100%)	0	100	100
45	UD	365/376 (97%)	365 (100%)	0	100	100
45	UF	365/376 (97%)	364 (100%)	1 (0%)	91	92
45	UH	365/376 (97%)	364 (100%)	1 (0%)	91	92
45	UJ	365/376 (97%)	363 (100%)	2 (0%)	86	90

Continued on next page...

Continued from previous page...

Mol	Chain	Analysed	Rotameric	Outliers	Percentiles	
45	UL	365/376 (97%)	365 (100%)	0	100	100
45	UN	365/376 (97%)	365 (100%)	0	100	100
45	VB	365/376 (97%)	363 (100%)	2 (0%)	86	90
45	VD	365/376 (97%)	364 (100%)	1 (0%)	91	92
45	VF	365/376 (97%)	364 (100%)	1 (0%)	91	92
45	VH	365/376 (97%)	365 (100%)	0	100	100
45	VJ	365/376 (97%)	363 (100%)	2 (0%)	86	90
45	VL	365/376 (97%)	365 (100%)	0	100	100
45	VN	365/376 (97%)	365 (100%)	0	100	100
45	WB	365/376 (97%)	364 (100%)	1 (0%)	91	92
45	WD	365/376 (97%)	364 (100%)	1 (0%)	91	92
45	WF	365/376 (97%)	364 (100%)	1 (0%)	91	92
45	WH	365/376 (97%)	361 (99%)	4 (1%)	70	80
45	WJ	365/376 (97%)	364 (100%)	1 (0%)	91	92
45	WL	365/376 (97%)	365 (100%)	0	100	100
45	WN	365/376 (97%)	364 (100%)	1 (0%)	91	92
All	All	142145/152741 (93%)	141590 (100%)	555 (0%)	88	91

5 of 555 residues with a non-rotameric sidechain are listed below:

Mol	Chain	Res	Type
44	SC	326	LYS
44	SK	221	ARG
44	SC	214	ARG
44	VG	326	LYS
44	CA	370	LYS

Sometimes sidechains can be flipped to improve hydrogen bonding and reduce clashes. 5 of 1425 such sidechains are listed below:

Mol	Chain	Res	Type
45	NB	245	GLN
45	RH	256	ASN
44	NI	85	GLN
45	NB	226	ASN
45	PB	100	ASN

### 5.3.3 RNA [i](#)

There are no RNA molecules in this entry.

### 5.4 Non-standard residues in protein, DNA, RNA chains [i](#)

There are no non-standard protein/DNA/RNA residues in this entry.

### 5.5 Carbohydrates [i](#)

There are no oligosaccharides in this entry.

### 5.6 Ligand geometry [i](#)

Of 483 ligands modelled in this entry, 161 are monoatomic - leaving 322 for Mogul analysis.

In the following table, the Counts columns list the number of bonds (or angles) for which Mogul statistics could be retrieved, the number of bonds (or angles) that are observed in the model and the number of bonds (or angles) that are defined in the Chemical Component Dictionary. The Link column lists molecule types, if any, to which the group is linked. The Z score for a bond length (or angle) is the number of standard deviations the observed value is removed from the expected value. A bond length (or angle) with  $|Z| > 2$  is considered an outlier worth inspection. RMSZ is the root-mean-square of all Z scores of the bond lengths (or angles).

Mol	Type	Chain	Res	Link	Bond lengths			Bond angles		
					Counts	RMSZ	# Z  > 2	Counts	RMSZ	# Z  > 2
46	GTP	NI	501	47	29,34,34	1.28	1 (3%)	35,54,54	1.30	4 (11%)
48	GDP	CF	501	-	25,30,30	0.97	1 (4%)	30,47,47	1.07	2 (6%)
48	GDP	ON	501	-	25,30,30	0.99	1 (4%)	30,47,47	1.07	2 (6%)
48	GDP	DD	501	-	25,30,30	0.99	1 (4%)	30,47,47	1.09	2 (6%)
46	GTP	TC	501	47	29,34,34	1.35	3 (10%)	35,54,54	1.29	4 (11%)
46	GTP	RM	501	47	29,34,34	1.25	3 (10%)	35,54,54	1.51	6 (17%)
48	GDP	ED	501	-	25,30,30	0.95	1 (4%)	30,47,47	1.05	2 (6%)
46	GTP	JE	501	47	29,34,34	1.22	2 (6%)	35,54,54	1.35	5 (14%)
48	GDP	PF	501	-	25,30,30	0.94	1 (4%)	30,47,47	1.05	1 (3%)
48	GDP	IB	501	-	25,30,30	0.97	1 (4%)	30,47,47	1.00	1 (3%)
46	GTP	IG	501	47	29,34,34	1.22	1 (3%)	35,54,54	1.25	4 (11%)
46	GTP	PE	501	47	29,34,34	1.28	3 (10%)	35,54,54	1.29	4 (11%)
48	GDP	CD	501	-	25,30,30	0.97	1 (4%)	30,47,47	1.03	2 (6%)
48	GDP	KJ	502	-	25,30,30	0.98	1 (4%)	30,47,47	1.06	2 (6%)

Mol	Type	Chain	Res	Link	Bond lengths			Bond angles		
					Counts	RMSZ	# Z  > 2	Counts	RMSZ	# Z  > 2
46	GTP	EG	501	47	29,34,34	1.18	2 (6%)	35,54,54	1.27	4 (11%)
46	GTP	FE	501	47	29,34,34	1.30	1 (3%)	35,54,54	1.28	4 (11%)
46	GTP	RI	501	47	29,34,34	1.25	2 (6%)	35,54,54	1.36	5 (14%)
48	GDP	HF	502	-	25,30,30	0.96	1 (4%)	30,47,47	1.08	2 (6%)
46	GTP	AG	501	47	29,34,34	1.22	2 (6%)	35,54,54	1.28	4 (11%)
46	GTP	LB	501	47	29,34,34	1.25	2 (6%)	35,54,54	1.26	4 (11%)
48	GDP	WL	501	-	25,30,30	0.98	1 (4%)	30,47,47	1.01	2 (6%)
46	GTP	UI	501	47	29,34,34	1.31	3 (10%)	35,54,54	1.22	3 (8%)
46	GTP	FI	501	47	29,34,34	1.26	1 (3%)	35,54,54	1.26	4 (11%)
46	GTP	SA	501	47	29,34,34	1.31	5 (17%)	35,54,54	1.26	4 (11%)
46	GTP	LI	501	47	29,34,34	1.21	1 (3%)	35,54,54	1.26	4 (11%)
46	GTP	KM	501	47	29,34,34	1.24	2 (6%)	35,54,54	1.29	3 (8%)
46	GTP	QK	501	47	29,34,34	1.19	2 (6%)	35,54,54	1.28	4 (11%)
46	GTP	NC	501	47	29,34,34	1.25	2 (6%)	35,54,54	1.34	5 (14%)
46	GTP	DM	501	47	29,34,34	1.23	1 (3%)	35,54,54	1.27	4 (11%)
48	GDP	MF	502	-	25,30,30	0.95	1 (4%)	30,47,47	1.06	2 (6%)
48	GDP	NN	501	-	25,30,30	0.95	1 (4%)	30,47,47	1.11	2 (6%)
46	GTP	ME	501	47	29,34,34	1.21	2 (6%)	35,54,54	1.35	4 (11%)
46	GTP	GE	501	47	29,34,34	1.21	2 (6%)	35,54,54	1.29	3 (8%)
48	GDP	BB	501	-	25,30,30	0.98	1 (4%)	30,47,47	1.05	2 (6%)
48	GDP	MH	501	-	25,30,30	0.96	1 (4%)	30,47,47	1.04	1 (3%)
46	GTP	EI	501	47	29,34,34	1.25	2 (6%)	35,54,54	1.28	4 (11%)
46	GTP	NA	501	47	29,34,34	1.30	1 (3%)	35,54,54	1.25	4 (11%)
48	GDP	RL	501	-	25,30,30	0.92	1 (4%)	30,47,47	1.04	1 (3%)
46	GTP	UM	501	47	29,34,34	1.20	2 (6%)	35,54,54	1.39	5 (14%)
48	GDP	AJ	501	-	25,30,30	0.94	1 (4%)	30,47,47	1.05	2 (6%)
48	GDP	AH	501	-	25,30,30	0.96	1 (4%)	30,47,47	1.05	2 (6%)
48	GDP	BN	501	-	25,30,30	0.93	1 (4%)	30,47,47	1.06	2 (6%)
46	GTP	HG	501	47	29,34,34	1.26	2 (6%)	35,54,54	1.25	4 (11%)
48	GDP	LB	502	-	25,30,30	0.96	1 (4%)	30,47,47	1.06	1 (3%)
46	GTP	RA	501	47	29,34,34	1.26	2 (6%)	35,54,54	1.30	5 (14%)
46	GTP	VK	501	47	29,34,34	1.25	2 (6%)	35,54,54	1.26	4 (11%)
46	GTP	KJ	501	47	29,34,34	1.24	1 (3%)	35,54,54	1.28	4 (11%)
46	GTP	CG	501	47	29,34,34	1.25	2 (6%)	35,54,54	1.24	4 (11%)
46	GTP	OG	501	47	29,34,34	1.22	1 (3%)	35,54,54	1.40	5 (14%)

Mol	Type	Chain	Res	Link	Bond lengths			Bond angles		
					Counts	RMSZ	# Z  > 2	Counts	RMSZ	# Z  > 2
48	GDP	QF	501	-	25,30,30	0.96	1 (4%)	30,47,47	1.02	2 (6%)
46	GTP	MG	501	47	29,34,34	1.25	2 (6%)	35,54,54	1.32	5 (14%)
48	GDP	UH	501	-	25,30,30	1.00	1 (4%)	30,47,47	0.98	1 (3%)
46	GTP	FM	501	47	29,34,34	1.27	2 (6%)	35,54,54	1.30	4 (11%)
46	GTP	KA	501	47	29,34,34	1.25	1 (3%)	35,54,54	1.28	4 (11%)
48	GDP	JN	501	-	25,30,30	0.94	1 (4%)	30,47,47	1.06	2 (6%)
46	GTP	JM	501	47	29,34,34	1.17	2 (6%)	35,54,54	1.23	4 (11%)
48	GDP	LJ	501	-	25,30,30	0.94	1 (4%)	30,47,47	1.10	2 (6%)
48	GDP	CJ	501	-	25,30,30	0.97	1 (4%)	30,47,47	1.05	2 (6%)
48	GDP	VL	501	-	25,30,30	0.97	1 (4%)	30,47,47	1.06	2 (6%)
48	GDP	PJ	501	-	25,30,30	0.97	1 (4%)	30,47,47	1.08	2 (6%)
48	GDP	FH	501	-	25,30,30	0.94	1 (4%)	30,47,47	1.08	2 (6%)
46	GTP	WA	501	47	29,34,34	1.27	2 (6%)	35,54,54	1.30	4 (11%)
48	GDP	PH	501	-	25,30,30	1.04	1 (4%)	30,47,47	1.07	2 (6%)
46	GTP	HI	501	47	29,34,34	1.26	2 (6%)	35,54,54	1.23	3 (8%)
46	GTP	SC	501	47	29,34,34	1.25	1 (3%)	35,54,54	1.29	4 (11%)
46	GTP	WC	501	47	29,34,34	1.27	3 (10%)	35,54,54	1.32	5 (14%)
46	GTP	BI	501	47	29,34,34	1.27	2 (6%)	35,54,54	1.28	4 (11%)
46	GTP	IA	501	47	29,34,34	1.25	1 (3%)	35,54,54	1.31	5 (14%)
46	GTP	RE	501	47	29,34,34	1.25	2 (6%)	35,54,54	1.30	4 (11%)
46	GTP	QI	501	47	29,34,34	1.24	2 (6%)	35,54,54	1.28	4 (11%)
48	GDP	NH	501	-	25,30,30	0.94	1 (4%)	30,47,47	1.09	2 (6%)
46	GTP	OA	501	47	29,34,34	1.25	2 (6%)	35,54,54	1.27	4 (11%)
48	GDP	RF	501	-	25,30,30	0.98	1 (4%)	30,47,47	1.09	2 (6%)
46	GTP	VC	501	47	29,34,34	1.29	1 (3%)	35,54,54	1.31	4 (11%)
48	GDP	QJ	501	-	25,30,30	0.99	1 (4%)	30,47,47	1.25	4 (13%)
48	GDP	UB	501	-	25,30,30	0.99	1 (4%)	30,47,47	1.12	2 (6%)
46	GTP	UK	501	47	29,34,34	1.25	2 (6%)	35,54,54	1.29	4 (11%)
46	GTP	BE	501	47	29,34,34	1.22	2 (6%)	35,54,54	1.27	3 (8%)
46	GTP	KG	501	47	29,34,34	1.25	1 (3%)	35,54,54	1.32	4 (11%)
46	GTP	DI	501	47	29,34,34	1.22	2 (6%)	35,54,54	1.29	4 (11%)
48	GDP	EL	501	-	25,30,30	0.95	1 (4%)	30,47,47	1.06	2 (6%)
48	GDP	BF	502	-	25,30,30	0.99	1 (4%)	30,47,47	1.05	2 (6%)
46	GTP	BM	501	47	29,34,34	1.26	2 (6%)	35,54,54	1.24	4 (11%)
46	GTP	PG	501	47	29,34,34	1.23	2 (6%)	35,54,54	1.28	4 (11%)



Mol	Type	Chain	Res	Link	Bond lengths			Bond angles		
					Counts	RMSZ	# Z  > 2	Counts	RMSZ	# Z  > 2
48	GDP	BL	502	-	25,30,30	0.96	1 (4%)	30,47,47	1.11	2 (6%)
48	GDP	JD	501	-	25,30,30	0.96	1 (4%)	30,47,47	1.10	2 (6%)
46	GTP	QE	501	47	29,34,34	1.25	2 (6%)	35,54,54	1.28	4 (11%)
48	GDP	GF	501	-	25,30,30	0.94	1 (4%)	30,47,47	1.05	2 (6%)
46	GTP	FK	501	47	29,34,34	1.24	2 (6%)	35,54,54	1.32	4 (11%)
46	GTP	FG	501	47	29,34,34	1.27	2 (6%)	35,54,54	1.30	4 (11%)
48	GDP	RD	501	-	25,30,30	0.96	1 (4%)	30,47,47	1.03	2 (6%)
46	GTP	BA	501	-	29,34,34	1.27	2 (6%)	35,54,54	1.27	4 (11%)
48	GDP	CN	501	-	25,30,30	0.95	1 (4%)	30,47,47	1.05	2 (6%)
46	GTP	OM	501	47	29,34,34	1.26	2 (6%)	35,54,54	1.27	4 (11%)
48	GDP	WF	501	-	25,30,30	0.96	1 (4%)	30,47,47	1.00	2 (6%)
48	GDP	ID	502	-	25,30,30	0.93	1 (4%)	30,47,47	1.05	2 (6%)
48	GDP	AD	501	-	25,30,30	0.93	1 (4%)	30,47,47	1.05	2 (6%)
48	GDP	KH	501	-	25,30,30	0.95	1 (4%)	30,47,47	1.05	2 (6%)
48	GDP	DL	501	-	25,30,30	0.95	1 (4%)	30,47,47	1.06	2 (6%)
48	GDP	MN	502	-	25,30,30	0.96	1 (4%)	30,47,47	1.07	2 (6%)
48	GDP	DH	501	-	25,30,30	0.96	1 (4%)	30,47,47	1.01	2 (6%)
46	GTP	UG	501	47	29,34,34	1.27	3 (10%)	35,54,54	1.31	3 (8%)
46	GTP	CC	501	47	29,34,34	1.32	2 (6%)	35,54,54	1.28	4 (11%)
46	GTP	EK	501	47	29,34,34	1.20	2 (6%)	35,54,54	1.25	4 (11%)
48	GDP	VN	501	-	25,30,30	1.02	1 (4%)	30,47,47	1.02	2 (6%)
48	GDP	FN	501	-	25,30,30	0.96	1 (4%)	30,47,47	1.14	2 (6%)
46	GTP	NE	501	47	29,34,34	1.24	2 (6%)	35,54,54	1.27	4 (11%)
46	GTP	TE	501	47	29,34,34	1.30	4 (13%)	35,54,54	1.39	5 (14%)
46	GTP	EA	501	47	29,34,34	1.27	4 (13%)	35,54,54	1.25	4 (11%)
46	GTP	QG	501	47	29,34,34	1.33	4 (13%)	35,54,54	1.30	4 (11%)
48	GDP	GH	502	-	25,30,30	0.98	1 (4%)	30,47,47	1.11	3 (10%)
46	GTP	TA	501	47	29,34,34	1.28	2 (6%)	35,54,54	1.29	5 (14%)
48	GDP	WH	501	-	25,30,30	1.00	1 (4%)	30,47,47	1.04	2 (6%)
46	GTP	CA	501	47	29,34,34	1.22	2 (6%)	35,54,54	1.27	4 (11%)
46	GTP	HK	501	47	29,34,34	1.20	2 (6%)	35,54,54	1.32	5 (14%)
46	GTP	CI	501	47	29,34,34	1.26	2 (6%)	35,54,54	1.28	4 (11%)
46	GTP	MM	501	47	29,34,34	1.26	2 (6%)	35,54,54	1.32	4 (11%)
48	GDP	LL	501	-	25,30,30	0.92	1 (4%)	30,47,47	1.05	2 (6%)
48	GDP	WJ	502	-	25,30,30	1.00	1 (4%)	30,47,47	1.10	2 (6%)

Mol	Type	Chain	Res	Link	Bond lengths			Bond angles		
					Counts	RMSZ	# Z  > 2	Counts	RMSZ	# Z  > 2
46	GTP	VM	501	47	29,34,34	1.28	3 (10%)	35,54,54	1.26	4 (11%)
48	GDP	UD	501	-	25,30,30	0.99	1 (4%)	30,47,47	1.05	2 (6%)
48	GDP	TD	501	-	25,30,30	1.05	3 (12%)	30,47,47	1.09	3 (10%)
48	GDP	JL	501	-	25,30,30	0.98	1 (4%)	30,47,47	1.05	2 (6%)
48	GDP	FL	501	-	25,30,30	0.98	1 (4%)	30,47,47	1.14	2 (6%)
48	GDP	HH	501	-	25,30,30	0.92	1 (4%)	30,47,47	1.04	2 (6%)
46	GTP	EE	501	47	29,34,34	1.23	2 (6%)	35,54,54	1.28	4 (11%)
46	GTP	GD	501	47	29,34,34	1.24	2 (6%)	35,54,54	1.27	4 (11%)
48	GDP	EN	501	-	25,30,30	0.95	1 (4%)	30,47,47	1.06	2 (6%)
48	GDP	IH	502	-	25,30,30	0.93	1 (4%)	30,47,47	1.05	2 (6%)
48	GDP	CB	501	-	25,30,30	1.19	3 (12%)	30,47,47	1.56	6 (20%)
48	GDP	HL	502	-	25,30,30	0.96	1 (4%)	30,47,47	1.06	2 (6%)
46	GTP	FA	501	47	29,34,34	1.23	2 (6%)	35,54,54	1.33	5 (14%)
48	GDP	IL	501	-	25,30,30	0.94	1 (4%)	30,47,47	1.05	2 (6%)
48	GDP	JH	501	-	25,30,30	0.96	1 (4%)	30,47,47	1.06	2 (6%)
46	GTP	SE	501	47	29,34,34	1.21	2 (6%)	35,54,54	1.36	5 (14%)
46	GTP	SK	501	47	29,34,34	1.22	2 (6%)	35,54,54	1.26	4 (11%)
48	GDP	VH	501	-	25,30,30	0.93	1 (4%)	30,47,47	1.06	1 (3%)
48	GDP	QB	501	-	25,30,30	0.95	1 (4%)	30,47,47	1.03	2 (6%)
46	GTP	AM	501	47	29,34,34	1.21	2 (6%)	35,54,54	1.27	4 (11%)
46	GTP	DE	501	47	29,34,34	1.30	1 (3%)	35,54,54	1.24	4 (11%)
46	GTP	LC	501	47	29,34,34	1.22	2 (6%)	35,54,54	1.28	4 (11%)
46	GTP	IK	501	47	29,34,34	1.23	2 (6%)	35,54,54	1.26	4 (11%)
46	GTP	IM	501	-	29,34,34	1.30	3 (10%)	35,54,54	1.27	4 (11%)
48	GDP	PN	501	-	25,30,30	0.96	1 (4%)	30,47,47	1.02	1 (3%)
48	GDP	KL	501	-	25,30,30	0.93	1 (4%)	30,47,47	1.06	2 (6%)
48	GDP	BH	502	-	25,30,30	0.97	1 (4%)	30,47,47	1.08	2 (6%)
48	GDP	RH	501	-	25,30,30	0.96	1 (4%)	30,47,47	1.04	2 (6%)
48	GDP	OL	502	-	25,30,30	0.99	1 (4%)	30,47,47	1.05	2 (6%)
46	GTP	AA	501	47	29,34,34	1.23	2 (6%)	35,54,54	1.27	4 (11%)
48	GDP	TB	501	-	25,30,30	1.00	1 (4%)	30,47,47	1.05	2 (6%)
48	GDP	OD	502	-	25,30,30	1.01	2 (8%)	30,47,47	1.09	2 (6%)
46	GTP	NG	501	47	29,34,34	1.26	2 (6%)	35,54,54	1.34	5 (14%)
48	GDP	FJ	501	-	25,30,30	0.95	1 (4%)	30,47,47	1.08	2 (6%)
48	GDP	PL	501	-	25,30,30	0.97	1 (4%)	30,47,47	1.07	2 (6%)

Mol	Type	Chain	Res	Link	Bond lengths			Bond angles		
					Counts	RMSZ	# Z  > 2	Counts	RMSZ	# Z  > 2
48	GDP	SD	501	-	25,30,30	0.92	1 (4%)	30,47,47	1.01	2 (6%)
48	GDP	VD	501	-	25,30,30	0.97	1 (4%)	30,47,47	1.05	2 (6%)
48	GDP	HJ	501	-	25,30,30	1.09	2 (8%)	30,47,47	1.05	2 (6%)
48	GDP	AL	502	-	25,30,30	0.94	1 (4%)	30,47,47	1.03	2 (6%)
46	GTP	TI	501	47	29,34,34	1.27	2 (6%)	35,54,54	1.27	4 (11%)
48	GDP	EB	501	-	25,30,30	0.93	1 (4%)	30,47,47	1.03	2 (6%)
46	GTP	KC	501	47	29,34,34	1.20	1 (3%)	35,54,54	1.28	4 (11%)
48	GDP	OJ	501	-	25,30,30	0.99	1 (4%)	30,47,47	1.06	2 (6%)
46	GTP	TK	501	47	29,34,34	1.24	1 (3%)	35,54,54	1.24	4 (11%)
48	GDP	UL	501	-	25,30,30	0.98	1 (4%)	30,47,47	1.03	1 (3%)
48	GDP	GB	502	-	25,30,30	0.98	2 (8%)	30,47,47	1.06	2 (6%)
46	GTP	AI	501	47	29,34,34	1.20	2 (6%)	35,54,54	1.31	4 (11%)
48	GDP	TL	501	-	25,30,30	0.98	1 (4%)	30,47,47	1.06	2 (6%)
48	GDP	QN	501	-	25,30,30	0.98	1 (4%)	30,47,47	1.04	2 (6%)
48	GDP	SL	501	-	25,30,30	1.00	1 (4%)	30,47,47	1.08	2 (6%)
46	GTP	QM	501	47	29,34,34	1.31	4 (13%)	35,54,54	1.31	5 (14%)
48	GDP	PB	501	-	25,30,30	0.99	1 (4%)	30,47,47	1.04	1 (3%)
48	GDP	EF	501	-	25,30,30	0.96	1 (4%)	30,47,47	1.03	1 (3%)
48	GDP	UJ	501	-	25,30,30	1.03	1 (4%)	30,47,47	1.07	2 (6%)
48	GDP	NF	501	-	25,30,30	0.96	1 (4%)	30,47,47	1.08	1 (3%)
48	GDP	ND	501	-	25,30,30	0.97	1 (4%)	30,47,47	1.09	2 (6%)
48	GDP	BD	502	-	25,30,30	0.97	1 (4%)	30,47,47	1.03	1 (3%)
48	GDP	DJ	501	-	25,30,30	0.97	1 (4%)	30,47,47	1.05	2 (6%)
46	GTP	EC	501	47	29,34,34	1.20	2 (6%)	35,54,54	1.24	4 (11%)
48	GDP	EH	501	-	25,30,30	0.95	1 (4%)	30,47,47	1.08	2 (6%)
46	GTP	SG	501	47	29,34,34	1.25	1 (3%)	35,54,54	1.34	5 (14%)
48	GDP	KB	501	-	25,30,30	0.96	1 (4%)	30,47,47	1.01	1 (3%)
46	GTP	MC	501	47	29,34,34	1.23	1 (3%)	35,54,54	1.33	4 (11%)
48	GDP	AF	501	-	25,30,30	0.94	1 (4%)	30,47,47	1.06	2 (6%)
48	GDP	LH	501	-	25,30,30	0.93	1 (4%)	30,47,47	1.05	2 (6%)
48	GDP	FB	501	-	25,30,30	0.96	1 (4%)	30,47,47	1.04	2 (6%)
46	GTP	WM	501	47	29,34,34	1.28	3 (10%)	35,54,54	1.32	5 (14%)
48	GDP	DF	501	-	25,30,30	0.95	1 (4%)	30,47,47	1.04	2 (6%)
48	GDP	CL	501	-	25,30,30	0.94	1 (4%)	30,47,47	1.02	2 (6%)
46	GTP	UA	501	47	29,34,34	1.25	2 (6%)	35,54,54	1.24	4 (11%)

Mol	Type	Chain	Res	Link	Bond lengths			Bond angles		
					Counts	RMSZ	# Z  > 2	Counts	RMSZ	# Z  > 2
46	GTP	DB	502	47	29,34,34	1.26	2 (6%)	35,54,54	1.24	4 (11%)
48	GDP	IF	501	-	25,30,30	0.95	1 (4%)	30,47,47	1.13	2 (6%)
46	GTP	EM	501	47	29,34,34	1.23	2 (6%)	35,54,54	1.28	4 (11%)
48	GDP	QL	501	-	25,30,30	0.93	1 (4%)	30,47,47	1.05	2 (6%)
46	GTP	WK	501	47	29,34,34	1.30	1 (3%)	35,54,54	1.31	5 (14%)
48	GDP	ML	501	-	25,30,30	0.94	1 (4%)	30,47,47	1.10	2 (6%)
48	GDP	SF	501	-	25,30,30	0.96	1 (4%)	30,47,47	1.10	2 (6%)
48	GDP	MJ	502	-	25,30,30	0.94	1 (4%)	30,47,47	1.07	2 (6%)
46	GTP	II	501	47	29,34,34	1.22	1 (3%)	35,54,54	1.29	4 (11%)
46	GTP	QC	501	-	29,34,34	1.27	3 (10%)	35,54,54	1.35	5 (14%)
46	GTP	RG	501	47	29,34,34	1.25	2 (6%)	35,54,54	1.30	4 (11%)
48	GDP	GD	503	-	25,30,30	0.95	1 (4%)	30,47,47	1.04	2 (6%)
48	GDP	LF	501	-	25,30,30	0.92	1 (4%)	30,47,47	1.06	2 (6%)
48	GDP	HN	501	-	25,30,30	0.99	1 (4%)	30,47,47	1.11	2 (6%)
46	GTP	GM	501	47	29,34,34	1.31	2 (6%)	35,54,54	1.32	5 (14%)
46	GTP	BK	501	47	29,34,34	1.21	2 (6%)	35,54,54	1.31	3 (8%)
46	GTP	HM	501	47	29,34,34	1.20	2 (6%)	35,54,54	1.29	5 (14%)
46	GTP	DK	501	47	29,34,34	1.23	2 (6%)	35,54,54	1.27	4 (11%)
48	GDP	AN	501	-	25,30,30	0.95	1 (4%)	30,47,47	1.03	2 (6%)
46	GTP	OL	501	47	29,34,34	1.26	2 (6%)	35,54,54	1.47	7 (20%)
46	GTP	UC	501	47	29,34,34	1.27	2 (6%)	35,54,54	1.26	4 (11%)
46	GTP	JK	501	47	29,34,34	1.28	2 (6%)	35,54,54	1.23	4 (11%)
48	GDP	MD	501	-	25,30,30	0.94	1 (4%)	30,47,47	1.07	2 (6%)
48	GDP	RJ	501	-	25,30,30	0.95	1 (4%)	30,47,47	1.09	1 (3%)
46	GTP	TM	501	47	29,34,34	1.23	2 (6%)	35,54,54	1.35	5 (14%)
48	GDP	IJ	502	-	25,30,30	0.91	1 (4%)	30,47,47	1.02	2 (6%)
46	GTP	AC	501	47	29,34,34	1.24	2 (6%)	35,54,54	1.36	5 (14%)
46	GTP	GB	501	47	29,34,34	1.29	1 (3%)	35,54,54	1.26	4 (11%)
48	GDP	QD	501	-	25,30,30	0.95	1 (4%)	30,47,47	1.06	1 (3%)
46	GTP	BC	501	47	29,34,34	1.21	2 (6%)	35,54,54	1.33	4 (11%)
48	GDP	TF	501	-	25,30,30	0.97	1 (4%)	30,47,47	1.09	2 (6%)
48	GDP	QH	501	-	25,30,30	0.97	1 (4%)	30,47,47	1.01	2 (6%)
48	GDP	KN	501	-	25,30,30	0.92	1 (4%)	30,47,47	1.03	2 (6%)
46	GTP	GG	501	47	29,34,34	1.25	2 (6%)	35,54,54	1.31	4 (11%)
46	GTP	FC	501	47	29,34,34	1.26	2 (6%)	35,54,54	1.36	5 (14%)

Mol	Type	Chain	Res	Link	Bond lengths			Bond angles		
					Counts	RMSZ	# Z  > 2	Counts	RMSZ	# Z  > 2
46	GTP	PK	501	47	29,34,34	1.28	3 (10%)	35,54,54	1.30	4 (11%)
48	GDP	GL	502	-	25,30,30	0.95	1 (4%)	30,47,47	1.04	2 (6%)
48	GDP	LN	502	-	25,30,30	0.95	1 (4%)	30,47,47	1.07	2 (6%)
46	GTP	CM	501	47	29,34,34	1.26	2 (6%)	35,54,54	1.26	4 (11%)
46	GTP	KK	501	47	29,34,34	1.21	2 (6%)	35,54,54	1.32	4 (11%)
46	GTP	KE	501	47	29,34,34	1.23	1 (3%)	35,54,54	1.28	4 (11%)
46	GTP	JI	501	47	29,34,34	1.20	2 (6%)	35,54,54	1.27	4 (11%)
48	GDP	IN	501	-	25,30,30	0.97	1 (4%)	30,47,47	1.06	2 (6%)
46	GTP	VI	501	47	29,34,34	1.27	2 (6%)	35,54,54	1.36	5 (14%)
46	GTP	CE	501	47	29,34,34	1.31	3 (10%)	35,54,54	1.29	4 (11%)
48	GDP	WN	501	-	25,30,30	0.98	1 (4%)	30,47,47	1.07	2 (6%)
46	GTP	PC	501	47	29,34,34	1.24	1 (3%)	35,54,54	1.29	4 (11%)
48	GDP	LD	501	-	25,30,30	0.93	1 (4%)	30,47,47	1.03	2 (6%)
48	GDP	OB	501	-	25,30,30	0.99	1 (4%)	30,47,47	1.10	2 (6%)
46	GTP	LG	501	47	29,34,34	1.25	2 (6%)	35,54,54	1.26	4 (11%)
48	GDP	PD	502	-	25,30,30	0.95	1 (4%)	30,47,47	1.01	2 (6%)
48	GDP	KF	502	-	25,30,30	0.93	1 (4%)	30,47,47	1.05	2 (6%)
46	GTP	PM	501	47	29,34,34	1.26	2 (6%)	35,54,54	1.29	4 (11%)
46	GTP	UE	501	47	29,34,34	1.30	3 (10%)	35,54,54	1.27	4 (11%)
46	GTP	JG	501	47	29,34,34	1.23	1 (3%)	35,54,54	1.27	5 (14%)
46	GTP	HA	501	-	29,34,34	1.31	3 (10%)	35,54,54	1.29	4 (11%)
46	GTP	LE	501	47	29,34,34	1.26	2 (6%)	35,54,54	1.26	4 (11%)
46	GTP	HE	501	47	29,34,34	1.24	2 (6%)	35,54,54	1.39	5 (14%)
48	GDP	SB	501	-	25,30,30	0.98	1 (4%)	30,47,47	1.10	2 (6%)
48	GDP	GJ	502	-	25,30,30	0.98	1 (4%)	30,47,47	1.07	2 (6%)
48	GDP	NJ	501	-	25,30,30	1.00	1 (4%)	30,47,47	1.03	2 (6%)
46	GTP	TG	501	47	29,34,34	1.27	2 (6%)	35,54,54	1.33	4 (11%)
48	GDP	RB	501	-	25,30,30	0.99	1 (4%)	30,47,47	1.04	2 (6%)
48	GDP	HB	501	-	25,30,30	0.95	1 (4%)	30,47,47	1.04	2 (6%)
46	GTP	IE	501	47	29,34,34	1.25	2 (6%)	35,54,54	1.29	4 (11%)
48	GDP	HD	501	-	25,30,30	1.03	2 (8%)	30,47,47	1.15	3 (10%)
48	GDP	TJ	501	-	25,30,30	0.97	1 (4%)	30,47,47	1.09	2 (6%)
46	GTP	WE	501	47	29,34,34	1.25	2 (6%)	35,54,54	1.33	5 (14%)
46	GTP	NK	501	47	29,34,34	1.27	1 (3%)	35,54,54	1.31	4 (11%)
46	GTP	LK	501	-	29,34,34	1.21	2 (6%)	35,54,54	1.28	4 (11%)

Mol	Type	Chain	Res	Link	Bond lengths			Bond angles		
					Counts	RMSZ	# Z  > 2	Counts	RMSZ	# Z  > 2
46	GTP	WI	501	47	29,34,34	1.27	2 (6%)	35,54,54	1.30	4 (11%)
46	GTP	AE	501	47	29,34,34	1.25	2 (6%)	35,54,54	1.28	4 (11%)
46	GTP	WG	501	47	29,34,34	1.33	4 (13%)	35,54,54	1.36	4 (11%)
46	GTP	VA	501	47	29,34,34	1.30	4 (13%)	35,54,54	1.29	4 (11%)
48	GDP	NB	501	-	25,30,30	0.95	1 (4%)	30,47,47	1.08	2 (6%)
48	GDP	WD	501	-	25,30,30	0.97	1 (4%)	30,47,47	1.06	2 (6%)
46	GTP	MA	501	47	29,34,34	1.22	2 (6%)	35,54,54	1.29	4 (11%)
46	GTP	JA	501	47	29,34,34	1.17	2 (6%)	35,54,54	1.33	5 (14%)
48	GDP	EJ	501	-	25,30,30	0.96	1 (4%)	30,47,47	1.07	2 (6%)
48	GDP	UF	501	-	25,30,30	0.97	1 (4%)	30,47,47	1.03	1 (3%)
46	GTP	QA	501	47	29,34,34	1.26	4 (13%)	35,54,54	1.33	5 (14%)
48	GDP	AB	502	-	25,30,30	0.97	1 (4%)	30,47,47	1.04	1 (3%)
46	GTP	DG	501	47	29,34,34	1.25	2 (6%)	35,54,54	1.34	5 (14%)
46	GTP	NM	501	47	29,34,34	1.28	2 (6%)	35,54,54	1.25	4 (11%)
46	GTP	SM	501	47	29,34,34	1.25	2 (6%)	35,54,54	1.25	4 (11%)
46	GTP	MI	501	47	29,34,34	1.21	2 (6%)	35,54,54	1.27	4 (11%)
48	GDP	GN	501	-	25,30,30	1.01	2 (8%)	30,47,47	1.05	2 (6%)
46	GTP	GL	501	47	29,34,34	1.20	2 (6%)	35,54,54	1.26	3 (8%)
48	GDP	JB	501	-	25,30,30	0.97	1 (4%)	30,47,47	1.08	2 (6%)
48	GDP	FD	502	-	25,30,30	0.94	1 (4%)	30,47,47	1.04	2 (6%)
48	GDP	DB	501	-	25,30,30	0.97	1 (4%)	30,47,47	1.04	2 (6%)
48	GDP	VB	502	-	25,30,30	1.08	2 (8%)	30,47,47	1.09	2 (6%)
46	GTP	RC	501	47	29,34,34	1.25	2 (6%)	35,54,54	1.31	4 (11%)
46	GTP	HC	501	47	29,34,34	1.24	2 (6%)	35,54,54	1.30	4 (11%)
48	GDP	MB	501	-	25,30,30	1.00	2 (8%)	30,47,47	1.09	1 (3%)
46	GTP	PI	501	47	29,34,34	1.22	2 (6%)	35,54,54	1.25	4 (11%)
46	GTP	PA	501	47	29,34,34	1.17	2 (6%)	35,54,54	1.30	5 (14%)
48	GDP	NL	501	-	25,30,30	0.93	1 (4%)	30,47,47	1.05	2 (6%)
46	GTP	ID	501	47	29,34,34	1.25	2 (6%)	35,54,54	1.27	4 (11%)
48	GDP	WB	501	-	25,30,30	1.00	1 (4%)	30,47,47	1.07	2 (6%)
48	GDP	KD	501	-	25,30,30	0.95	1 (4%)	30,47,47	1.04	2 (6%)
48	GDP	VJ	501	-	25,30,30	0.93	1 (4%)	30,47,47	1.05	2 (6%)
46	GTP	OC	501	47	29,34,34	1.26	2 (6%)	35,54,54	1.33	4 (11%)
46	GTP	OE	501	47	29,34,34	1.24	2 (6%)	35,54,54	1.25	4 (11%)
48	GDP	TH	501	-	25,30,30	0.99	1 (4%)	30,47,47	1.03	2 (6%)

Mol	Type	Chain	Res	Link	Bond lengths			Bond angles		
					Counts	RMSZ	# Z  > 2	Counts	RMSZ	# Z  > 2
48	GDP	VF	501	-	25,30,30	0.95	1 (4%)	30,47,47	1.03	2 (6%)
46	GTP	AK	501	47	29,34,34	1.26	2 (6%)	35,54,54	1.29	4 (11%)
48	GDP	FF	502	-	25,30,30	0.92	1 (4%)	30,47,47	1.02	2 (6%)
48	GDP	SN	501	-	25,30,30	0.96	1 (4%)	30,47,47	1.03	2 (6%)
48	GDP	JF	501	-	25,30,30	0.96	1 (4%)	30,47,47	1.05	2 (6%)
46	GTP	OI	501	47	29,34,34	1.23	2 (6%)	35,54,54	1.31	4 (11%)
46	GTP	MK	501	47	29,34,34	1.22	2 (6%)	35,54,54	1.33	4 (11%)
48	GDP	OH	501	-	25,30,30	0.96	1 (4%)	30,47,47	1.07	2 (6%)
48	GDP	SJ	501	-	25,30,30	0.97	1 (4%)	30,47,47	1.01	1 (3%)
48	GDP	UN	501	-	25,30,30	1.00	1 (4%)	30,47,47	1.06	2 (6%)
48	GDP	JJ	501	-	25,30,30	0.94	1 (4%)	30,47,47	1.08	1 (3%)
48	GDP	BJ	502	-	25,30,30	0.98	1 (4%)	30,47,47	1.06	2 (6%)
46	GTP	GI	501	47	29,34,34	1.24	2 (6%)	35,54,54	1.32	5 (14%)
48	GDP	OF	501	-	25,30,30	0.97	1 (4%)	30,47,47	1.14	3 (10%)
46	GTP	LM	501	47	29,34,34	1.27	2 (6%)	35,54,54	1.24	4 (11%)
46	GTP	SI	501	47	29,34,34	1.28	2 (6%)	35,54,54	1.27	4 (11%)
48	GDP	SH	501	-	25,30,30	0.89	1 (4%)	30,47,47	1.07	1 (3%)
46	GTP	DA	501	47	29,34,34	1.23	2 (6%)	35,54,54	1.28	4 (11%)
46	GTP	JC	501	-	29,34,34	1.21	2 (6%)	35,54,54	1.26	3 (8%)
46	GTP	VE	501	47	29,34,34	1.28	2 (6%)	35,54,54	1.31	4 (11%)
46	GTP	BG	501	47	29,34,34	1.20	2 (6%)	35,54,54	1.33	4 (11%)
46	GTP	VG	501	47	29,34,34	1.32	4 (13%)	35,54,54	1.29	4 (11%)
48	GDP	DN	501	-	25,30,30	0.95	1 (4%)	30,47,47	1.07	2 (6%)
46	GTP	CK	501	47	29,34,34	1.23	2 (6%)	35,54,54	1.28	4 (11%)
48	GDP	CH	501	-	25,30,30	0.94	1 (4%)	30,47,47	1.04	2 (6%)
48	GDP	TN	501	-	25,30,30	0.98	1 (4%)	30,47,47	1.05	2 (6%)
48	GDP	RN	501	-	25,30,30	1.00	1 (4%)	30,47,47	1.06	2 (6%)
46	GTP	RK	501	47	29,34,34	1.24	1 (3%)	35,54,54	1.29	4 (11%)

In the following table, the Chirals column lists the number of chiral outliers, the number of chiral centers analysed, the number of these observed in the model and the number defined in the Chemical Component Dictionary. Similar counts are reported in the Torsion and Rings columns. '-' means no outliers of that kind were identified.

Mol	Type	Chain	Res	Link	Chirals	Torsions	Rings
46	GTP	NI	501	47	-	4/18/38/38	0/3/3/3

Continued on next page...

*Continued from previous page...*

Mol	Type	Chain	Res	Link	Chirals	Torsions	Rings
48	GDP	CF	501	-	-	1/12/32/32	0/3/3/3
48	GDP	ON	501	-	-	1/12/32/32	0/3/3/3
48	GDP	DD	501	-	-	3/12/32/32	0/3/3/3
46	GTP	TC	501	47	-	4/18/38/38	0/3/3/3
46	GTP	RM	501	47	-	5/18/38/38	0/3/3/3
48	GDP	ED	501	-	-	2/12/32/32	0/3/3/3
46	GTP	JE	501	47	-	1/18/38/38	0/3/3/3
48	GDP	PF	501	-	-	1/12/32/32	0/3/3/3
48	GDP	IB	501	-	-	0/12/32/32	0/3/3/3
46	GTP	IG	501	47	-	5/18/38/38	0/3/3/3
46	GTP	PE	501	47	-	6/18/38/38	0/3/3/3
48	GDP	CD	501	-	-	0/12/32/32	0/3/3/3
48	GDP	KJ	502	-	-	0/12/32/32	0/3/3/3
46	GTP	EG	501	47	-	8/18/38/38	0/3/3/3
46	GTP	FE	501	47	-	4/18/38/38	0/3/3/3
46	GTP	RI	501	47	-	2/18/38/38	0/3/3/3
48	GDP	HF	502	-	-	1/12/32/32	0/3/3/3
46	GTP	AG	501	47	-	4/18/38/38	0/3/3/3
46	GTP	LB	501	47	-	6/18/38/38	0/3/3/3
48	GDP	WL	501	-	-	0/12/32/32	0/3/3/3
46	GTP	UI	501	47	-	6/18/38/38	0/3/3/3
46	GTP	FI	501	47	-	4/18/38/38	0/3/3/3
46	GTP	SA	501	47	-	8/18/38/38	0/3/3/3
46	GTP	LI	501	47	-	2/18/38/38	0/3/3/3
46	GTP	KM	501	47	-	6/18/38/38	0/3/3/3
46	GTP	QK	501	47	-	6/18/38/38	0/3/3/3
46	GTP	NC	501	47	-	3/18/38/38	0/3/3/3
46	GTP	DM	501	47	-	4/18/38/38	0/3/3/3
48	GDP	MF	502	-	-	3/12/32/32	0/3/3/3
48	GDP	NN	501	-	-	3/12/32/32	0/3/3/3
46	GTP	ME	501	47	-	5/18/38/38	0/3/3/3
46	GTP	GE	501	47	-	4/18/38/38	0/3/3/3
48	GDP	BB	501	-	-	1/12/32/32	0/3/3/3
48	GDP	MH	501	-	-	1/12/32/32	0/3/3/3
46	GTP	EI	501	47	-	7/18/38/38	0/3/3/3
46	GTP	NA	501	47	-	9/18/38/38	0/3/3/3

*Continued on next page...*



*Continued from previous page...*

Mol	Type	Chain	Res	Link	Chirals	Torsions	Rings
48	GDP	RL	501	-	-	1/12/32/32	0/3/3/3
46	GTP	UM	501	47	-	5/18/38/38	0/3/3/3
48	GDP	AJ	501	-	-	0/12/32/32	0/3/3/3
48	GDP	AH	501	-	-	0/12/32/32	0/3/3/3
48	GDP	BN	501	-	-	1/12/32/32	0/3/3/3
46	GTP	HG	501	47	-	7/18/38/38	0/3/3/3
48	GDP	LB	502	-	-	1/12/32/32	0/3/3/3
46	GTP	RA	501	47	-	4/18/38/38	0/3/3/3
46	GTP	VK	501	47	-	7/18/38/38	0/3/3/3
46	GTP	KJ	501	47	-	7/18/38/38	0/3/3/3
46	GTP	CG	501	47	-	6/18/38/38	0/3/3/3
46	GTP	OG	501	47	-	2/18/38/38	0/3/3/3
48	GDP	QF	501	-	-	0/12/32/32	0/3/3/3
46	GTP	MG	501	47	-	5/18/38/38	0/3/3/3
48	GDP	UH	501	-	-	0/12/32/32	0/3/3/3
46	GTP	FM	501	47	-	3/18/38/38	0/3/3/3
46	GTP	KA	501	47	-	7/18/38/38	0/3/3/3
48	GDP	JN	501	-	-	3/12/32/32	0/3/3/3
46	GTP	JM	501	47	-	2/18/38/38	0/3/3/3
48	GDP	LJ	501	-	-	2/12/32/32	0/3/3/3
48	GDP	CJ	501	-	-	2/12/32/32	0/3/3/3
48	GDP	VL	501	-	-	2/12/32/32	0/3/3/3
48	GDP	PJ	501	-	-	1/12/32/32	0/3/3/3
48	GDP	FH	501	-	-	2/12/32/32	0/3/3/3
46	GTP	WA	501	47	-	3/18/38/38	0/3/3/3
48	GDP	PH	501	-	-	0/12/32/32	0/3/3/3
46	GTP	HI	501	47	-	7/18/38/38	0/3/3/3
46	GTP	SC	501	47	-	4/18/38/38	0/3/3/3
46	GTP	WC	501	47	-	5/18/38/38	0/3/3/3
46	GTP	BI	501	47	-	4/18/38/38	0/3/3/3
46	GTP	IA	501	47	-	5/18/38/38	0/3/3/3
46	GTP	RE	501	47	-	6/18/38/38	0/3/3/3
46	GTP	QI	501	47	-	6/18/38/38	0/3/3/3
48	GDP	NH	501	-	-	3/12/32/32	0/3/3/3
46	GTP	OA	501	47	-	4/18/38/38	0/3/3/3
48	GDP	RF	501	-	-	3/12/32/32	0/3/3/3

*Continued on next page...*

*Continued from previous page...*

Mol	Type	Chain	Res	Link	Chirals	Torsions	Rings
46	GTP	VC	501	47	-	4/18/38/38	0/3/3/3
48	GDP	QJ	501	-	-	1/12/32/32	0/3/3/3
48	GDP	UB	501	-	-	3/12/32/32	0/3/3/3
46	GTP	UK	501	47	-	6/18/38/38	0/3/3/3
46	GTP	BE	501	47	-	8/18/38/38	0/3/3/3
46	GTP	KG	501	47	-	3/18/38/38	0/3/3/3
46	GTP	DI	501	47	-	7/18/38/38	0/3/3/3
48	GDP	EL	501	-	-	0/12/32/32	0/3/3/3
48	GDP	BF	502	-	-	1/12/32/32	0/3/3/3
46	GTP	BM	501	47	-	5/18/38/38	0/3/3/3
46	GTP	PG	501	47	-	6/18/38/38	0/3/3/3
48	GDP	BL	502	-	-	3/12/32/32	0/3/3/3
48	GDP	JD	501	-	-	4/12/32/32	0/3/3/3
46	GTP	QE	501	47	-	7/18/38/38	0/3/3/3
48	GDP	GF	501	-	-	1/12/32/32	0/3/3/3
46	GTP	FK	501	47	-	5/18/38/38	0/3/3/3
46	GTP	FG	501	47	-	8/18/38/38	0/3/3/3
48	GDP	RD	501	-	-	0/12/32/32	0/3/3/3
46	GTP	BA	501	-	-	6/18/38/38	0/3/3/3
48	GDP	CN	501	-	-	1/12/32/32	0/3/3/3
46	GTP	OM	501	47	-	3/18/38/38	0/3/3/3
48	GDP	WF	501	-	-	0/12/32/32	0/3/3/3
48	GDP	ID	502	-	-	1/12/32/32	0/3/3/3
48	GDP	AD	501	-	-	0/12/32/32	0/3/3/3
48	GDP	KH	501	-	-	0/12/32/32	0/3/3/3
48	GDP	DL	501	-	-	3/12/32/32	0/3/3/3
48	GDP	MN	502	-	-	1/12/32/32	0/3/3/3
48	GDP	DH	501	-	-	1/12/32/32	0/3/3/3
46	GTP	UG	501	47	-	7/18/38/38	0/3/3/3
46	GTP	CC	501	47	-	4/18/38/38	0/3/3/3
46	GTP	EK	501	47	-	2/18/38/38	0/3/3/3
48	GDP	VN	501	-	-	1/12/32/32	0/3/3/3
48	GDP	FN	501	-	-	2/12/32/32	0/3/3/3
46	GTP	NE	501	47	-	6/18/38/38	0/3/3/3
46	GTP	TE	501	47	-	5/18/38/38	0/3/3/3
46	GTP	EA	501	47	-	4/18/38/38	0/3/3/3
46	GTP	QG	501	47	-	6/18/38/38	0/3/3/3

*Continued on next page...*

*Continued from previous page...*

Mol	Type	Chain	Res	Link	Chirals	Torsions	Rings
48	GDP	GH	502	-	-	2/12/32/32	0/3/3/3
46	GTP	TA	501	47	-	8/18/38/38	0/3/3/3
48	GDP	WH	501	-	-	0/12/32/32	0/3/3/3
46	GTP	CA	501	47	-	2/18/38/38	0/3/3/3
46	GTP	HK	501	47	-	1/18/38/38	0/3/3/3
46	GTP	CI	501	47	-	7/18/38/38	0/3/3/3
46	GTP	MM	501	47	-	8/18/38/38	0/3/3/3
48	GDP	LL	501	-	-	0/12/32/32	0/3/3/3
48	GDP	WJ	502	-	-	0/12/32/32	0/3/3/3
46	GTP	VM	501	47	-	8/18/38/38	0/3/3/3
48	GDP	UD	501	-	-	0/12/32/32	0/3/3/3
48	GDP	TD	501	-	-	0/12/32/32	0/3/3/3
48	GDP	JL	501	-	-	2/12/32/32	0/3/3/3
48	GDP	FL	501	-	-	2/12/32/32	0/3/3/3
48	GDP	HH	501	-	-	1/12/32/32	0/3/3/3
46	GTP	EE	501	47	-	5/18/38/38	0/3/3/3
46	GTP	GD	501	47	-	3/18/38/38	0/3/3/3
48	GDP	EN	501	-	-	4/12/32/32	0/3/3/3
48	GDP	IH	502	-	-	0/12/32/32	0/3/3/3
48	GDP	CB	501	-	-	6/12/32/32	0/3/3/3
48	GDP	HL	502	-	-	1/12/32/32	0/3/3/3
46	GTP	FA	501	47	-	1/18/38/38	0/3/3/3
48	GDP	IL	501	-	-	1/12/32/32	0/3/3/3
48	GDP	JH	501	-	-	2/12/32/32	0/3/3/3
46	GTP	SE	501	47	-	6/18/38/38	0/3/3/3
46	GTP	SK	501	47	-	4/18/38/38	0/3/3/3
48	GDP	VH	501	-	-	1/12/32/32	0/3/3/3
48	GDP	QB	501	-	-	0/12/32/32	0/3/3/3
46	GTP	AM	501	47	-	7/18/38/38	0/3/3/3
46	GTP	DE	501	47	-	7/18/38/38	0/3/3/3
46	GTP	LC	501	47	-	2/18/38/38	0/3/3/3
46	GTP	IK	501	47	-	8/18/38/38	0/3/3/3
46	GTP	IM	501	-	-	5/18/38/38	0/3/3/3
48	GDP	PN	501	-	-	0/12/32/32	0/3/3/3
48	GDP	KL	501	-	-	1/12/32/32	0/3/3/3
48	GDP	BH	502	-	-	1/12/32/32	0/3/3/3
48	GDP	RH	501	-	-	1/12/32/32	0/3/3/3
48	GDP	OL	502	-	-	1/12/32/32	0/3/3/3

*Continued on next page...*

*Continued from previous page...*

Mol	Type	Chain	Res	Link	Chirals	Torsions	Rings
46	GTP	AA	501	47	-	7/18/38/38	0/3/3/3
48	GDP	TB	501	-	-	0/12/32/32	0/3/3/3
48	GDP	OD	502	-	-	3/12/32/32	0/3/3/3
46	GTP	NG	501	47	-	5/18/38/38	0/3/3/3
48	GDP	FJ	501	-	-	0/12/32/32	0/3/3/3
48	GDP	PL	501	-	-	2/12/32/32	0/3/3/3
48	GDP	SD	501	-	-	1/12/32/32	0/3/3/3
48	GDP	VD	501	-	-	0/12/32/32	0/3/3/3
48	GDP	HJ	501	-	-	1/12/32/32	0/3/3/3
48	GDP	AL	502	-	-	0/12/32/32	0/3/3/3
46	GTP	TI	501	47	-	6/18/38/38	0/3/3/3
48	GDP	EB	501	-	-	0/12/32/32	0/3/3/3
46	GTP	KC	501	47	-	4/18/38/38	0/3/3/3
48	GDP	OJ	501	-	-	2/12/32/32	0/3/3/3
46	GTP	TK	501	47	-	8/18/38/38	0/3/3/3
48	GDP	UL	501	-	-	1/12/32/32	0/3/3/3
48	GDP	GB	502	-	-	0/12/32/32	0/3/3/3
46	GTP	AI	501	47	-	5/18/38/38	0/3/3/3
48	GDP	TL	501	-	-	0/12/32/32	0/3/3/3
48	GDP	QN	501	-	-	1/12/32/32	0/3/3/3
48	GDP	SL	501	-	-	1/12/32/32	0/3/3/3
46	GTP	QM	501	47	-	5/18/38/38	0/3/3/3
48	GDP	PB	501	-	-	1/12/32/32	0/3/3/3
48	GDP	EF	501	-	-	0/12/32/32	0/3/3/3
48	GDP	UJ	501	-	-	3/12/32/32	0/3/3/3
48	GDP	NF	501	-	-	1/12/32/32	0/3/3/3
48	GDP	ND	501	-	-	0/12/32/32	0/3/3/3
48	GDP	BD	502	-	-	0/12/32/32	0/3/3/3
48	GDP	DJ	501	-	-	1/12/32/32	0/3/3/3
46	GTP	EC	501	47	-	4/18/38/38	0/3/3/3
48	GDP	EH	501	-	-	2/12/32/32	0/3/3/3
46	GTP	SG	501	47	-	6/18/38/38	0/3/3/3
48	GDP	KB	501	-	-	0/12/32/32	0/3/3/3
46	GTP	MC	501	47	-	5/18/38/38	0/3/3/3
48	GDP	AF	501	-	-	1/12/32/32	0/3/3/3
48	GDP	LH	501	-	-	0/12/32/32	0/3/3/3
48	GDP	FB	501	-	-	1/12/32/32	0/3/3/3
46	GTP	WM	501	47	-	4/18/38/38	0/3/3/3

*Continued on next page...*

*Continued from previous page...*

Mol	Type	Chain	Res	Link	Chirals	Torsions	Rings
48	GDP	DF	501	-	-	3/12/32/32	0/3/3/3
48	GDP	CL	501	-	-	0/12/32/32	0/3/3/3
46	GTP	UA	501	47	-	4/18/38/38	0/3/3/3
46	GTP	DB	502	47	-	5/18/38/38	0/3/3/3
48	GDP	IF	501	-	-	1/12/32/32	0/3/3/3
46	GTP	EM	501	47	-	6/18/38/38	0/3/3/3
48	GDP	QL	501	-	-	0/12/32/32	0/3/3/3
46	GTP	WK	501	47	-	5/18/38/38	0/3/3/3
48	GDP	ML	501	-	-	2/12/32/32	0/3/3/3
48	GDP	SF	501	-	-	3/12/32/32	0/3/3/3
48	GDP	MJ	502	-	-	2/12/32/32	0/3/3/3
46	GTP	II	501	47	-	7/18/38/38	0/3/3/3
46	GTP	QC	501	-	-	6/18/38/38	0/3/3/3
46	GTP	RG	501	47	-	6/18/38/38	0/3/3/3
48	GDP	GD	503	-	-	1/12/32/32	0/3/3/3
48	GDP	LF	501	-	-	3/12/32/32	0/3/3/3
48	GDP	HN	501	-	-	1/12/32/32	0/3/3/3
46	GTP	GM	501	47	-	7/18/38/38	0/3/3/3
46	GTP	BK	501	47	-	5/18/38/38	0/3/3/3
46	GTP	HM	501	47	-	4/18/38/38	0/3/3/3
46	GTP	DK	501	47	-	2/18/38/38	0/3/3/3
48	GDP	AN	501	-	-	2/12/32/32	0/3/3/3
46	GTP	OL	501	47	-	3/18/38/38	0/3/3/3
46	GTP	UC	501	47	-	8/18/38/38	0/3/3/3
46	GTP	JK	501	47	-	5/18/38/38	0/3/3/3
48	GDP	MD	501	-	-	1/12/32/32	0/3/3/3
48	GDP	RJ	501	-	-	1/12/32/32	0/3/3/3
46	GTP	TM	501	47	-	7/18/38/38	0/3/3/3
48	GDP	IJ	502	-	-	3/12/32/32	0/3/3/3
46	GTP	AC	501	47	-	1/18/38/38	0/3/3/3
46	GTP	GB	501	47	-	4/18/38/38	0/3/3/3
48	GDP	QD	501	-	-	1/12/32/32	0/3/3/3
46	GTP	BC	501	47	-	4/18/38/38	0/3/3/3
48	GDP	TF	501	-	-	2/12/32/32	0/3/3/3
48	GDP	QH	501	-	-	1/12/32/32	0/3/3/3
48	GDP	KN	501	-	-	1/12/32/32	0/3/3/3

*Continued on next page...*

*Continued from previous page...*

Mol	Type	Chain	Res	Link	Chirals	Torsions	Rings
46	GTP	GG	501	47	-	1/18/38/38	0/3/3/3
46	GTP	FC	501	47	-	5/18/38/38	0/3/3/3
46	GTP	PK	501	47	-	4/18/38/38	0/3/3/3
48	GDP	GL	502	-	-	4/12/32/32	0/3/3/3
48	GDP	LN	502	-	-	2/12/32/32	0/3/3/3
46	GTP	CM	501	47	-	6/18/38/38	0/3/3/3
46	GTP	KK	501	47	-	3/18/38/38	0/3/3/3
46	GTP	KE	501	47	-	2/18/38/38	0/3/3/3
46	GTP	JI	501	47	-	8/18/38/38	0/3/3/3
48	GDP	IN	501	-	-	3/12/32/32	0/3/3/3
46	GTP	VI	501	47	-	9/18/38/38	0/3/3/3
46	GTP	CE	501	47	-	4/18/38/38	0/3/3/3
48	GDP	WN	501	-	-	1/12/32/32	0/3/3/3
46	GTP	PC	501	47	-	4/18/38/38	0/3/3/3
48	GDP	LD	501	-	-	3/12/32/32	0/3/3/3
48	GDP	OB	501	-	-	2/12/32/32	0/3/3/3
46	GTP	LG	501	47	-	4/18/38/38	0/3/3/3
48	GDP	PD	502	-	-	1/12/32/32	0/3/3/3
48	GDP	KF	502	-	-	1/12/32/32	0/3/3/3
46	GTP	PM	501	47	-	7/18/38/38	0/3/3/3
46	GTP	UE	501	47	-	6/18/38/38	0/3/3/3
46	GTP	JG	501	47	-	8/18/38/38	0/3/3/3
46	GTP	HA	501	-	-	9/18/38/38	0/3/3/3
46	GTP	LE	501	47	-	7/18/38/38	0/3/3/3
46	GTP	HE	501	47	-	5/18/38/38	0/3/3/3
48	GDP	SB	501	-	-	1/12/32/32	0/3/3/3
48	GDP	GJ	502	-	-	3/12/32/32	0/3/3/3
48	GDP	NJ	501	-	-	0/12/32/32	0/3/3/3
46	GTP	TG	501	47	-	6/18/38/38	0/3/3/3
48	GDP	RB	501	-	-	0/12/32/32	0/3/3/3
48	GDP	HB	501	-	-	1/12/32/32	0/3/3/3
46	GTP	IE	501	47	-	8/18/38/38	0/3/3/3
48	GDP	HD	501	-	-	0/12/32/32	0/3/3/3
48	GDP	TJ	501	-	-	2/12/32/32	0/3/3/3
46	GTP	WE	501	47	-	6/18/38/38	0/3/3/3
46	GTP	NK	501	47	-	5/18/38/38	0/3/3/3

*Continued on next page...*

*Continued from previous page...*

Mol	Type	Chain	Res	Link	Chirals	Torsions	Rings
46	GTP	LK	501	-	-	6/18/38/38	0/3/3/3
46	GTP	WI	501	47	-	10/18/38/38	0/3/3/3
46	GTP	AE	501	47	-	7/18/38/38	0/3/3/3
46	GTP	WG	501	47	-	7/18/38/38	0/3/3/3
46	GTP	VA	501	47	-	6/18/38/38	0/3/3/3
48	GDP	NB	501	-	-	2/12/32/32	0/3/3/3
48	GDP	WD	501	-	-	1/12/32/32	0/3/3/3
46	GTP	MA	501	47	-	6/18/38/38	0/3/3/3
46	GTP	JA	501	47	-	1/18/38/38	0/3/3/3
48	GDP	EJ	501	-	-	2/12/32/32	0/3/3/3
48	GDP	UF	501	-	-	1/12/32/32	0/3/3/3
46	GTP	QA	501	47	-	9/18/38/38	0/3/3/3
48	GDP	AB	502	-	-	1/12/32/32	0/3/3/3
46	GTP	DG	501	47	-	2/18/38/38	0/3/3/3
46	GTP	NM	501	47	-	3/18/38/38	0/3/3/3
46	GTP	SM	501	47	-	9/18/38/38	0/3/3/3
46	GTP	MI	501	47	-	6/18/38/38	0/3/3/3
48	GDP	GN	501	-	-	0/12/32/32	0/3/3/3
46	GTP	GL	501	47	-	5/18/38/38	0/3/3/3
48	GDP	JB	501	-	-	1/12/32/32	0/3/3/3
48	GDP	FD	502	-	-	0/12/32/32	0/3/3/3
48	GDP	DB	501	-	-	1/12/32/32	0/3/3/3
48	GDP	VB	502	-	-	1/12/32/32	0/3/3/3
46	GTP	RC	501	47	-	4/18/38/38	0/3/3/3
46	GTP	HC	501	47	-	6/18/38/38	0/3/3/3
48	GDP	MB	501	-	-	6/12/32/32	0/3/3/3
46	GTP	PI	501	47	-	7/18/38/38	0/3/3/3
46	GTP	PA	501	47	-	4/18/38/38	0/3/3/3
48	GDP	NL	501	-	-	3/12/32/32	0/3/3/3
46	GTP	ID	501	47	-	8/18/38/38	0/3/3/3
48	GDP	WB	501	-	-	1/12/32/32	0/3/3/3
48	GDP	KD	501	-	-	0/12/32/32	0/3/3/3
48	GDP	VJ	501	-	-	1/12/32/32	0/3/3/3
46	GTP	OC	501	47	-	5/18/38/38	0/3/3/3
46	GTP	OE	501	47	-	3/18/38/38	0/3/3/3
48	GDP	TH	501	-	-	0/12/32/32	0/3/3/3
48	GDP	VF	501	-	-	2/12/32/32	0/3/3/3

*Continued on next page...*

Continued from previous page...

Mol	Type	Chain	Res	Link	Chirals	Torsions	Rings
46	GTP	AK	501	47	-	6/18/38/38	0/3/3/3
48	GDP	FF	502	-	-	2/12/32/32	0/3/3/3
48	GDP	SN	501	-	-	1/12/32/32	0/3/3/3
48	GDP	JF	501	-	-	0/12/32/32	0/3/3/3
46	GTP	OI	501	47	-	4/18/38/38	0/3/3/3
46	GTP	MK	501	47	-	3/18/38/38	0/3/3/3
48	GDP	OH	501	-	-	1/12/32/32	0/3/3/3
48	GDP	SJ	501	-	-	2/12/32/32	0/3/3/3
48	GDP	UN	501	-	-	0/12/32/32	0/3/3/3
48	GDP	JJ	501	-	-	0/12/32/32	0/3/3/3
48	GDP	BJ	502	-	-	1/12/32/32	0/3/3/3
46	GTP	GI	501	47	-	8/18/38/38	0/3/3/3
48	GDP	OF	501	-	-	1/12/32/32	0/3/3/3
46	GTP	LM	501	47	-	6/18/38/38	0/3/3/3
46	GTP	SI	501	47	-	7/18/38/38	0/3/3/3
48	GDP	SH	501	-	-	0/12/32/32	0/3/3/3
46	GTP	DA	501	47	-	5/18/38/38	0/3/3/3
46	GTP	JC	501	-	-	6/18/38/38	0/3/3/3
46	GTP	VE	501	47	-	6/18/38/38	0/3/3/3
46	GTP	BG	501	47	-	2/18/38/38	0/3/3/3
46	GTP	VG	501	47	-	4/18/38/38	0/3/3/3
48	GDP	DN	501	-	-	0/12/32/32	0/3/3/3
46	GTP	CK	501	47	-	6/18/38/38	0/3/3/3
48	GDP	CH	501	-	-	1/12/32/32	0/3/3/3
48	GDP	TN	501	-	-	1/12/32/32	0/3/3/3
48	GDP	RN	501	-	-	0/12/32/32	0/3/3/3
46	GTP	RK	501	47	-	7/18/38/38	0/3/3/3

The worst 5 of 500 bond length outliers are listed below:

Mol	Chain	Res	Type	Atoms	Z	Observed(Å)	Ideal(Å)
46	SG	501	GTP	C5-C6	-4.80	1.38	1.47
46	FC	501	GTP	C5-C6	-4.78	1.38	1.47
46	FI	501	GTP	C5-C6	-4.75	1.38	1.47
46	EI	501	GTP	C5-C6	-4.71	1.38	1.47
46	FE	501	GTP	C5-C6	-4.70	1.38	1.47

The worst 5 of 984 bond angle outliers are listed below:



Mol	Chain	Res	Type	Atoms	Z	Observed(°)	Ideal(°)
46	RM	501	GTP	C4'-O4'-C1'	3.74	113.35	109.92
46	OG	501	GTP	C8-N7-C5	3.73	108.91	102.55
46	WG	501	GTP	C8-N7-C5	3.73	108.90	102.55
46	NE	501	GTP	C8-N7-C5	3.72	108.89	102.55
46	OL	501	GTP	C8-N7-C5	3.72	108.88	102.55

There are no chirality outliers.

5 of 1039 torsion outliers are listed below:

Mol	Chain	Res	Type	Atoms
46	AA	501	GTP	PB-O3B-PG-O3G
46	AA	501	GTP	C5'-O5'-PA-O3A
46	AC	501	GTP	C4'-C5'-O5'-PA
46	AE	501	GTP	PB-O3A-PA-O5'
46	AG	501	GTP	C5'-O5'-PA-O3A

There are no ring outliers.

315 monomers are involved in 1637 short contacts:

Mol	Chain	Res	Type	Clashes	Symm-Clashes
46	NI	501	GTP	2	0
48	CF	501	GDP	2	0
48	ON	501	GDP	5	0
48	DD	501	GDP	3	0
46	TC	501	GTP	17	0
46	RM	501	GTP	10	0
48	ED	501	GDP	4	0
46	JE	501	GTP	5	0
48	PF	501	GDP	2	0
48	IB	501	GDP	4	0
46	IG	501	GTP	10	0
46	PE	501	GTP	6	0
48	CD	501	GDP	4	0
48	KJ	502	GDP	2	0
46	EG	501	GTP	2	0
46	FE	501	GTP	8	0
46	RI	501	GTP	10	0
48	HF	502	GDP	7	0
46	AG	501	GTP	4	0
46	LB	501	GTP	6	0
48	WL	501	GDP	3	0
46	UI	501	GTP	13	0

*Continued on next page...*

*Continued from previous page...*

Mol	Chain	Res	Type	Clashes	Symm-Clashes
46	FI	501	GTP	6	0
46	SA	501	GTP	16	0
46	LI	501	GTP	7	0
46	KM	501	GTP	3	0
46	QK	501	GTP	8	0
46	NC	501	GTP	6	0
46	DM	501	GTP	12	0
48	MF	502	GDP	2	0
48	NN	501	GDP	3	0
46	ME	501	GTP	3	0
46	GE	501	GTP	4	0
48	BB	501	GDP	2	0
48	MH	501	GDP	7	0
46	EI	501	GTP	9	0
46	NA	501	GTP	4	0
48	RL	501	GDP	3	0
46	UM	501	GTP	5	0
48	AJ	501	GDP	1	0
48	AH	501	GDP	3	0
48	BN	501	GDP	2	0
46	HG	501	GTP	5	0
48	LB	502	GDP	4	0
46	RA	501	GTP	5	0
46	VK	501	GTP	7	0
46	KJ	501	GTP	3	0
46	CG	501	GTP	6	0
46	OG	501	GTP	2	0
48	QF	501	GDP	3	0
46	MG	501	GTP	6	0
48	UH	501	GDP	4	0
46	FM	501	GTP	3	0
46	KA	501	GTP	6	0
48	JN	501	GDP	4	0
46	JM	501	GTP	9	0
48	LJ	501	GDP	2	0
48	CJ	501	GDP	2	0
48	VL	501	GDP	3	0
48	PJ	501	GDP	4	0
48	FH	501	GDP	3	0
46	WA	501	GTP	8	0
48	PH	501	GDP	4	0
46	HI	501	GTP	17	0

*Continued on next page...*

*Continued from previous page...*

Mol	Chain	Res	Type	Clashes	Symm-Clashes
46	SC	501	GTP	8	0
46	WC	501	GTP	11	0
46	BI	501	GTP	5	0
46	IA	501	GTP	4	0
46	RE	501	GTP	4	0
46	QI	501	GTP	7	0
48	NH	501	GDP	2	0
46	OA	501	GTP	2	0
48	RF	501	GDP	3	0
46	VC	501	GTP	3	0
48	QJ	501	GDP	2	0
48	UB	501	GDP	2	0
46	UK	501	GTP	9	0
46	BE	501	GTP	7	0
46	KG	501	GTP	2	0
46	DI	501	GTP	2	0
48	EL	501	GDP	4	0
48	BF	502	GDP	11	0
46	BM	501	GTP	1	0
46	PG	501	GTP	4	0
48	BL	502	GDP	3	0
48	JD	501	GDP	6	0
46	QE	501	GTP	7	0
48	GF	501	GDP	6	0
46	FK	501	GTP	8	0
46	FG	501	GTP	2	0
48	RD	501	GDP	1	0
46	BA	501	GTP	8	0
48	CN	501	GDP	1	0
46	OM	501	GTP	5	0
48	WF	501	GDP	2	0
48	ID	502	GDP	6	0
48	AD	501	GDP	3	0
48	KH	501	GDP	7	0
48	DL	501	GDP	2	0
48	MN	502	GDP	4	0
48	DH	501	GDP	4	0
46	UG	501	GTP	9	0
46	CC	501	GTP	8	0
46	EK	501	GTP	7	0
48	VN	501	GDP	4	0
48	FN	501	GDP	7	0

*Continued on next page...*

*Continued from previous page...*

Mol	Chain	Res	Type	Clashes	Symm-Clashes
46	NE	501	GTP	7	0
46	TE	501	GTP	7	0
46	EA	501	GTP	6	0
46	QG	501	GTP	10	0
48	GH	502	GDP	4	0
46	TA	501	GTP	16	0
48	WH	501	GDP	5	0
46	CA	501	GTP	5	0
46	HK	501	GTP	5	0
46	CI	501	GTP	6	0
46	MM	501	GTP	4	0
48	LL	501	GDP	3	0
48	WJ	502	GDP	8	0
46	VM	501	GTP	9	0
48	UD	501	GDP	5	0
48	TD	501	GDP	9	0
48	JL	501	GDP	3	0
48	FL	501	GDP	1	0
48	HH	501	GDP	2	0
46	EE	501	GTP	5	0
46	GD	501	GTP	3	0
48	EN	501	GDP	2	0
48	IH	502	GDP	4	0
48	CB	501	GDP	16	0
48	HL	502	GDP	2	0
46	FA	501	GTP	5	0
48	IL	501	GDP	7	0
48	JH	501	GDP	7	0
46	SE	501	GTP	5	0
46	SK	501	GTP	8	0
48	VH	501	GDP	8	0
48	QB	501	GDP	3	0
46	AM	501	GTP	4	0
46	DE	501	GTP	8	0
46	LC	501	GTP	3	0
46	IK	501	GTP	5	0
46	IM	501	GTP	6	0
48	PN	501	GDP	5	0
48	KL	501	GDP	6	0
48	BH	502	GDP	7	0
48	RH	501	GDP	4	0
48	OL	502	GDP	5	0

*Continued on next page...*

*Continued from previous page...*

<b>Mol</b>	<b>Chain</b>	<b>Res</b>	<b>Type</b>	<b>Clashes</b>	<b>Symm-Clashes</b>
46	AA	501	GTP	6	0
48	TB	501	GDP	2	0
48	OD	502	GDP	6	0
46	NG	501	GTP	6	0
48	FJ	501	GDP	3	0
48	PL	501	GDP	3	0
48	SD	501	GDP	6	0
48	VD	501	GDP	4	0
48	HJ	501	GDP	5	0
48	AL	502	GDP	2	0
46	TI	501	GTP	6	0
48	EB	501	GDP	7	0
46	KC	501	GTP	4	0
48	OJ	501	GDP	7	0
46	TK	501	GTP	6	0
48	UL	501	GDP	1	0
48	GB	502	GDP	3	0
46	AI	501	GTP	6	0
48	TL	501	GDP	10	0
48	QN	501	GDP	2	0
48	SL	501	GDP	4	0
46	QM	501	GTP	10	0
48	EF	501	GDP	1	0
48	UJ	501	GDP	10	0
48	NF	501	GDP	3	0
48	ND	501	GDP	2	0
48	BD	502	GDP	6	0
48	DJ	501	GDP	7	0
46	EC	501	GTP	12	0
48	EH	501	GDP	5	0
46	SG	501	GTP	8	0
48	KB	501	GDP	4	0
46	MC	501	GTP	5	0
48	AF	501	GDP	2	0
48	LH	501	GDP	4	0
48	FB	501	GDP	1	0
46	WM	501	GTP	7	0
48	DF	501	GDP	4	0
48	CL	501	GDP	8	0
46	UA	501	GTP	10	0
46	DB	502	GTP	6	0
48	IF	501	GDP	9	0

*Continued on next page...*

*Continued from previous page...*

Mol	Chain	Res	Type	Clashes	Symm-Clashes
46	EM	501	GTP	10	0
48	QL	501	GDP	6	0
46	WK	501	GTP	7	0
48	ML	501	GDP	3	0
48	SF	501	GDP	3	0
48	MJ	502	GDP	4	0
46	II	501	GTP	7	0
46	QC	501	GTP	15	0
46	RG	501	GTP	8	0
48	GD	503	GDP	6	0
48	LF	501	GDP	4	0
48	HN	501	GDP	5	0
46	GM	501	GTP	4	0
46	BK	501	GTP	8	0
46	HM	501	GTP	4	0
46	DK	501	GTP	6	0
48	AN	501	GDP	2	0
46	OL	501	GTP	3	0
46	UC	501	GTP	3	0
46	JK	501	GTP	7	0
48	MD	501	GDP	3	0
48	RJ	501	GDP	10	0
46	TM	501	GTP	11	0
48	IJ	502	GDP	1	0
46	AC	501	GTP	4	0
46	GB	501	GTP	4	0
48	QD	501	GDP	4	0
46	BC	501	GTP	7	0
48	TF	501	GDP	1	0
48	QH	501	GDP	9	0
48	KN	501	GDP	3	0
46	GG	501	GTP	3	0
46	FC	501	GTP	2	0
46	PK	501	GTP	10	0
48	GL	502	GDP	2	0
48	LN	502	GDP	5	0
46	CM	501	GTP	10	0
46	KK	501	GTP	3	0
46	KE	501	GTP	7	0
46	JI	501	GTP	3	0
48	IN	501	GDP	2	0
46	VI	501	GTP	7	0

*Continued on next page...*

*Continued from previous page...*

Mol	Chain	Res	Type	Clashes	Symm-Clashes
46	CE	501	GTP	8	0
48	WN	501	GDP	4	0
46	PC	501	GTP	7	0
48	LD	501	GDP	1	0
48	OB	501	GDP	5	0
46	LG	501	GTP	2	0
48	PD	502	GDP	3	0
48	KF	502	GDP	6	0
46	PM	501	GTP	5	0
46	UE	501	GTP	6	0
46	JG	501	GTP	4	0
46	HA	501	GTP	10	0
46	LE	501	GTP	2	0
46	HE	501	GTP	3	0
48	SB	501	GDP	6	0
48	GJ	502	GDP	7	0
48	NJ	501	GDP	2	0
46	TG	501	GTP	9	0
46	IE	501	GTP	6	0
48	HD	501	GDP	2	0
48	TJ	501	GDP	6	0
46	WE	501	GTP	6	0
46	NK	501	GTP	4	0
46	WI	501	GTP	5	0
46	AE	501	GTP	4	0
46	WG	501	GTP	6	0
46	VA	501	GTP	9	0
48	NB	501	GDP	3	0
48	WD	501	GDP	3	0
46	MA	501	GTP	8	0
46	JA	501	GTP	4	0
48	EJ	501	GDP	5	0
48	UF	501	GDP	4	0
46	QA	501	GTP	13	0
48	AB	502	GDP	3	0
46	DG	501	GTP	6	0
46	NM	501	GTP	4	0
46	SM	501	GTP	8	0
46	MI	501	GTP	1	0
48	GN	501	GDP	2	0
46	GL	501	GTP	2	0
48	JB	501	GDP	6	0

*Continued on next page...*

*Continued from previous page...*

Mol	Chain	Res	Type	Clashes	Symm-Clashes
48	FD	502	GDP	5	0
48	DB	501	GDP	3	0
48	VB	502	GDP	6	0
46	RC	501	GTP	5	0
46	HC	501	GTP	6	0
48	MB	501	GDP	3	0
46	PI	501	GTP	4	0
46	PA	501	GTP	5	0
48	NL	501	GDP	1	0
46	ID	501	GTP	5	0
48	WB	501	GDP	2	0
48	KD	501	GDP	4	0
48	VJ	501	GDP	2	0
46	OC	501	GTP	4	0
46	OE	501	GTP	3	0
48	TH	501	GDP	6	0
48	VF	501	GDP	2	0
46	AK	501	GTP	3	0
48	SN	501	GDP	4	0
48	JF	501	GDP	3	0
46	MK	501	GTP	2	0
48	OH	501	GDP	4	0
48	SJ	501	GDP	2	0
48	UN	501	GDP	4	0
48	JJ	501	GDP	8	0
48	BJ	502	GDP	8	0
46	GI	501	GTP	7	0
48	OF	501	GDP	2	0
46	LM	501	GTP	5	0
46	SI	501	GTP	6	0
48	SH	501	GDP	6	0
46	DA	501	GTP	10	0
46	JC	501	GTP	4	0
46	VE	501	GTP	7	0
46	BG	501	GTP	7	0
46	VG	501	GTP	6	0
46	CK	501	GTP	6	0
48	CH	501	GDP	1	0
48	TN	501	GDP	3	0
48	RN	501	GDP	6	0
46	RK	501	GTP	7	0

The following is a two-dimensional graphical depiction of Mogul quality analysis of bond lengths,



bond angles, torsion angles, and ring geometry for all instances of the Ligand of Interest. In addition, ligands with molecular weight > 250 and outliers as shown on the validation Tables will also be included. For torsion angles, if less than 5% of the Mogul distribution of torsion angles is within 10 degrees of the torsion angle in question, then that torsion angle is considered an outlier. Any bond that is central to one or more torsion angles identified as an outlier by Mogul will be highlighted in the graph. For rings, the root-mean-square deviation (RMSD) between the ring in question and similar rings identified by Mogul is calculated over all ring torsion angles. If the average RMSD is greater than 60 degrees and the minimal RMSD between the ring in question and any Mogul-identified rings is also greater than 60 degrees, then that ring is considered an outlier. The outliers are highlighted in purple. The color gray indicates Mogul did not find sufficient equivalents in the CSD to analyse the geometry.

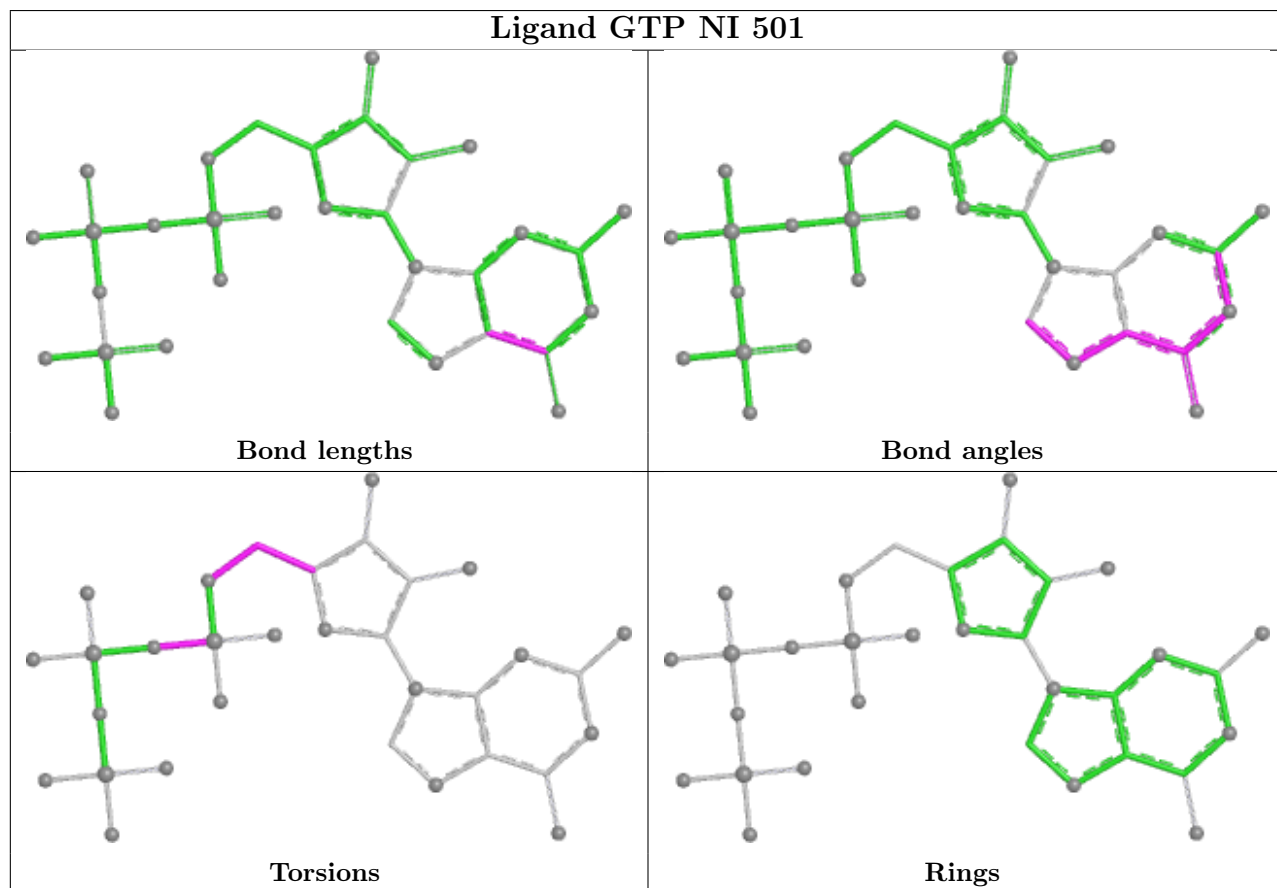

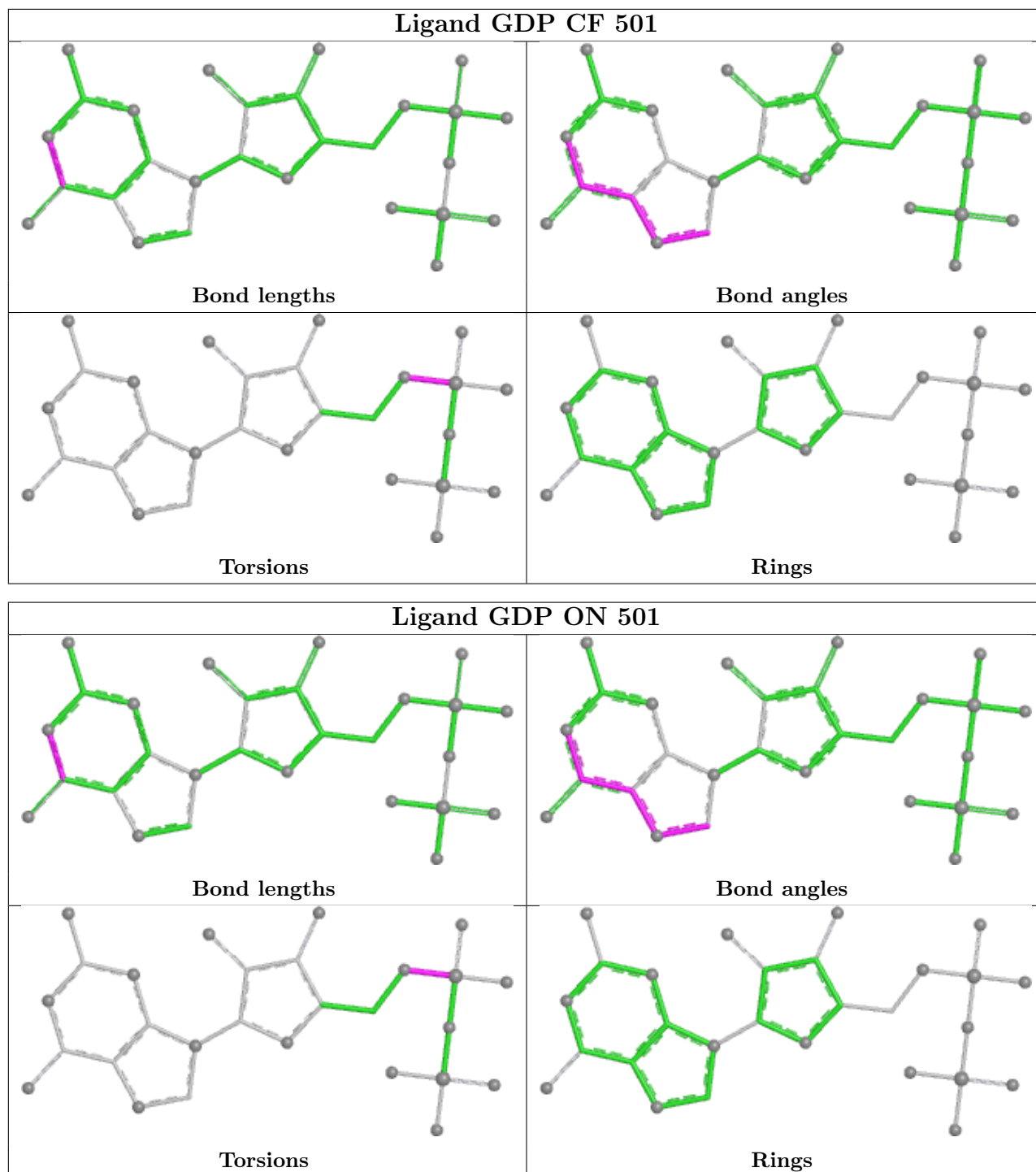

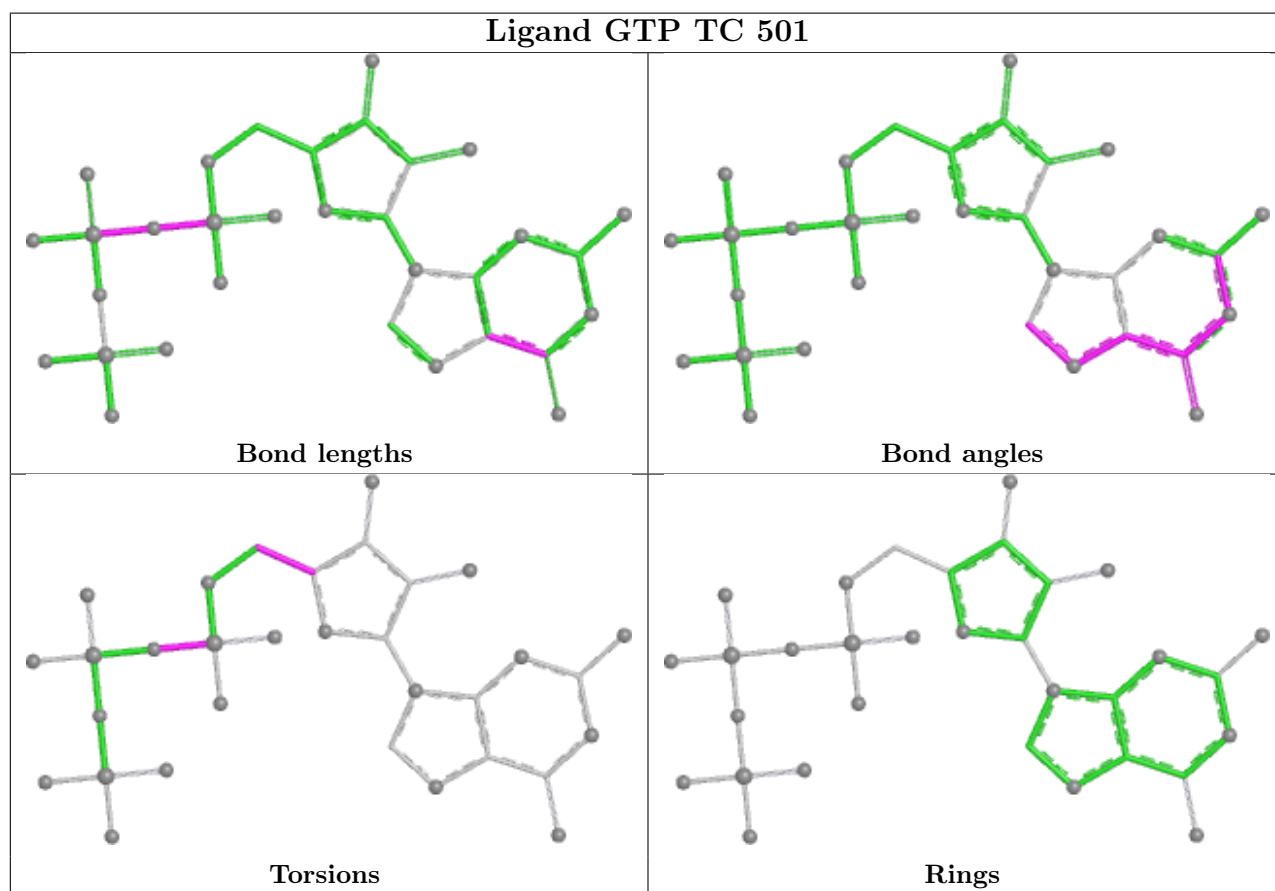
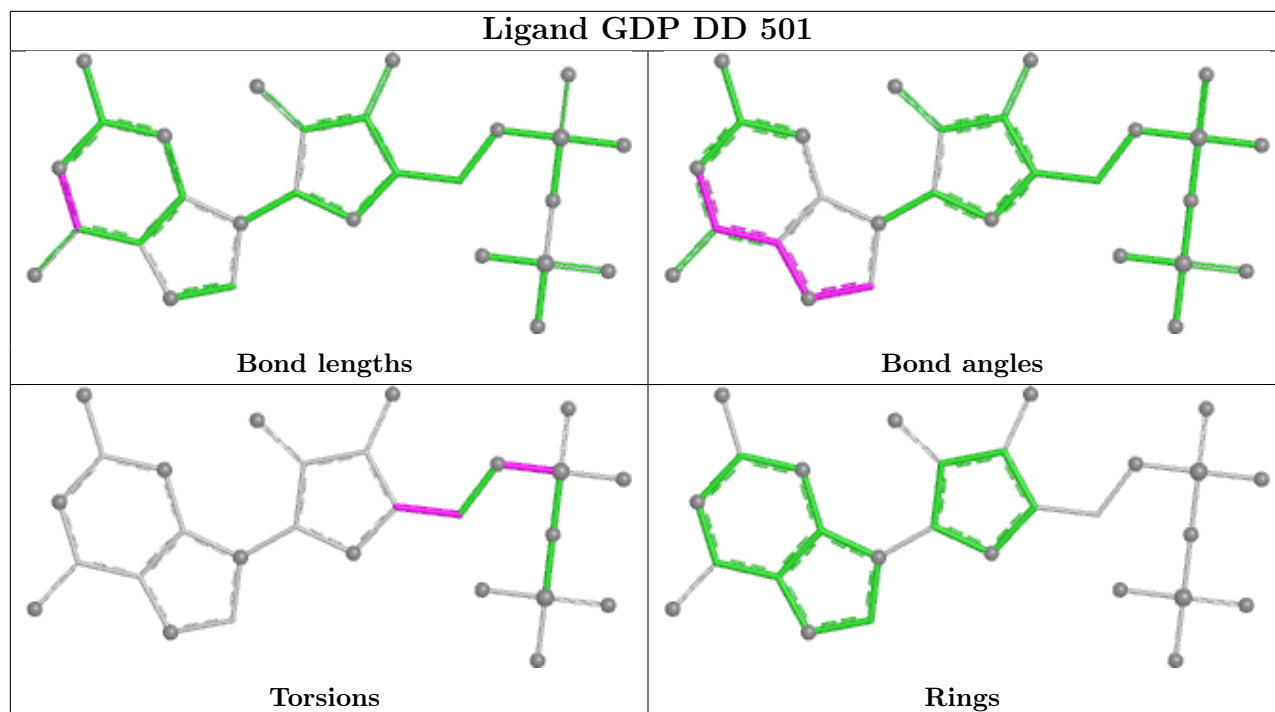

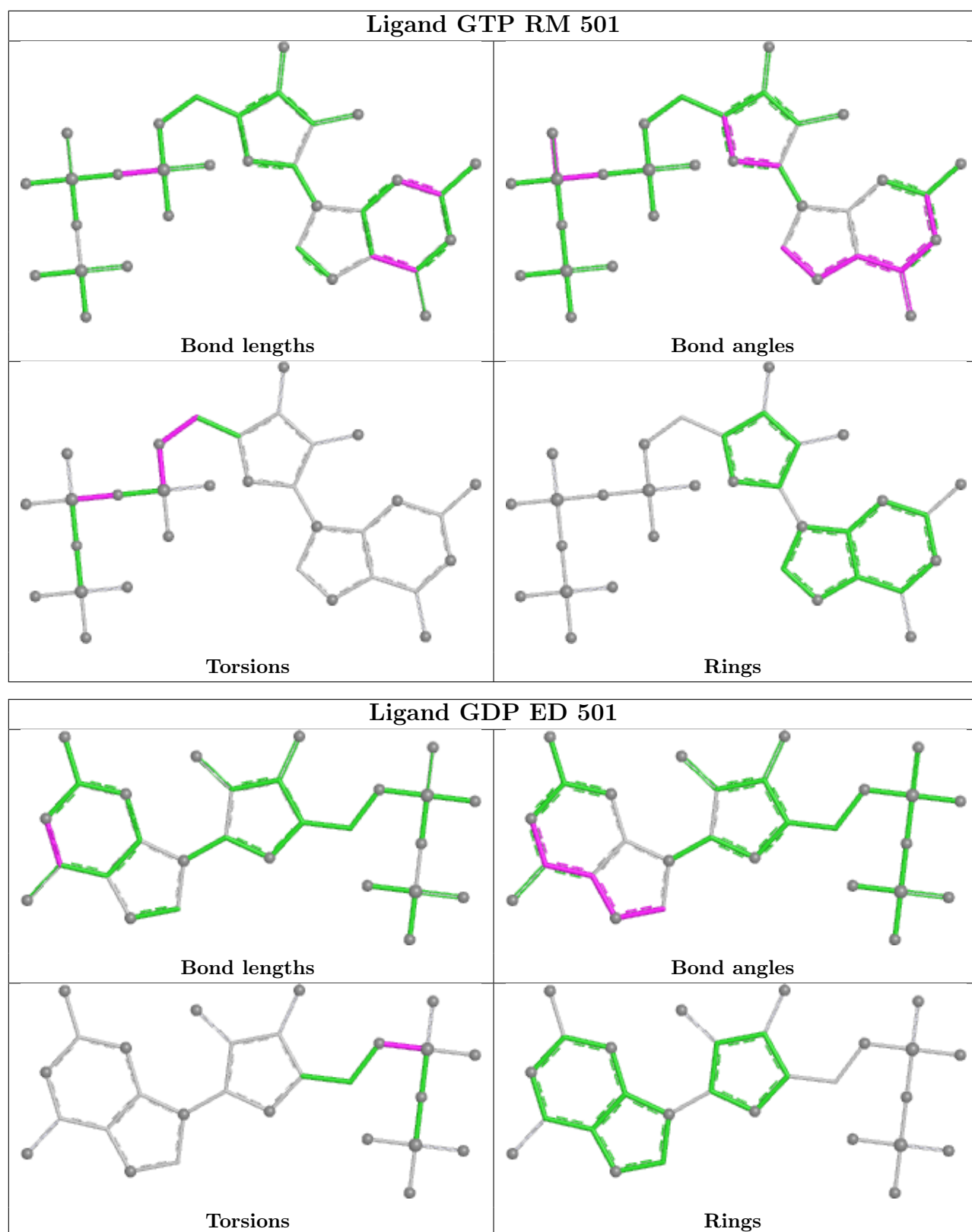

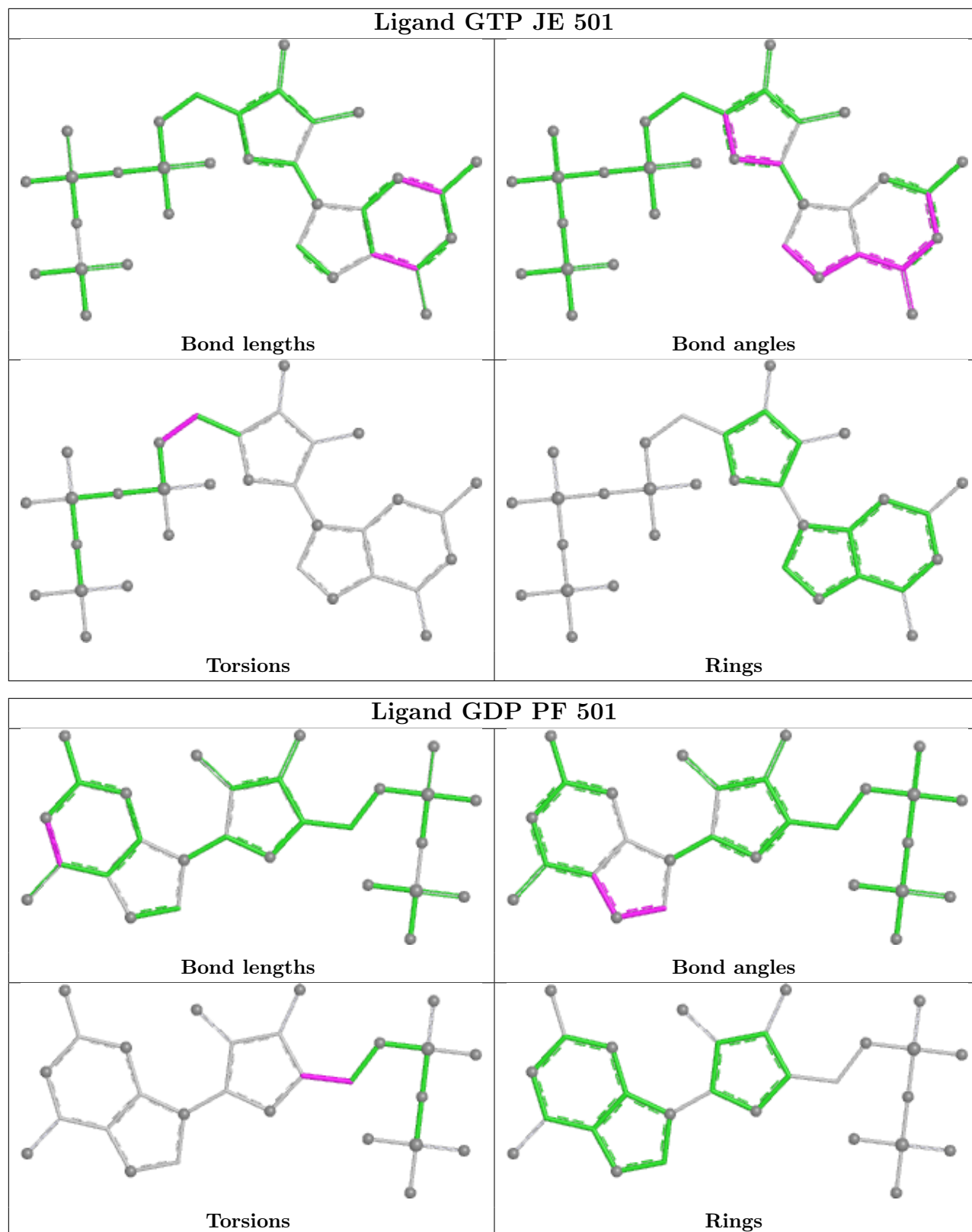

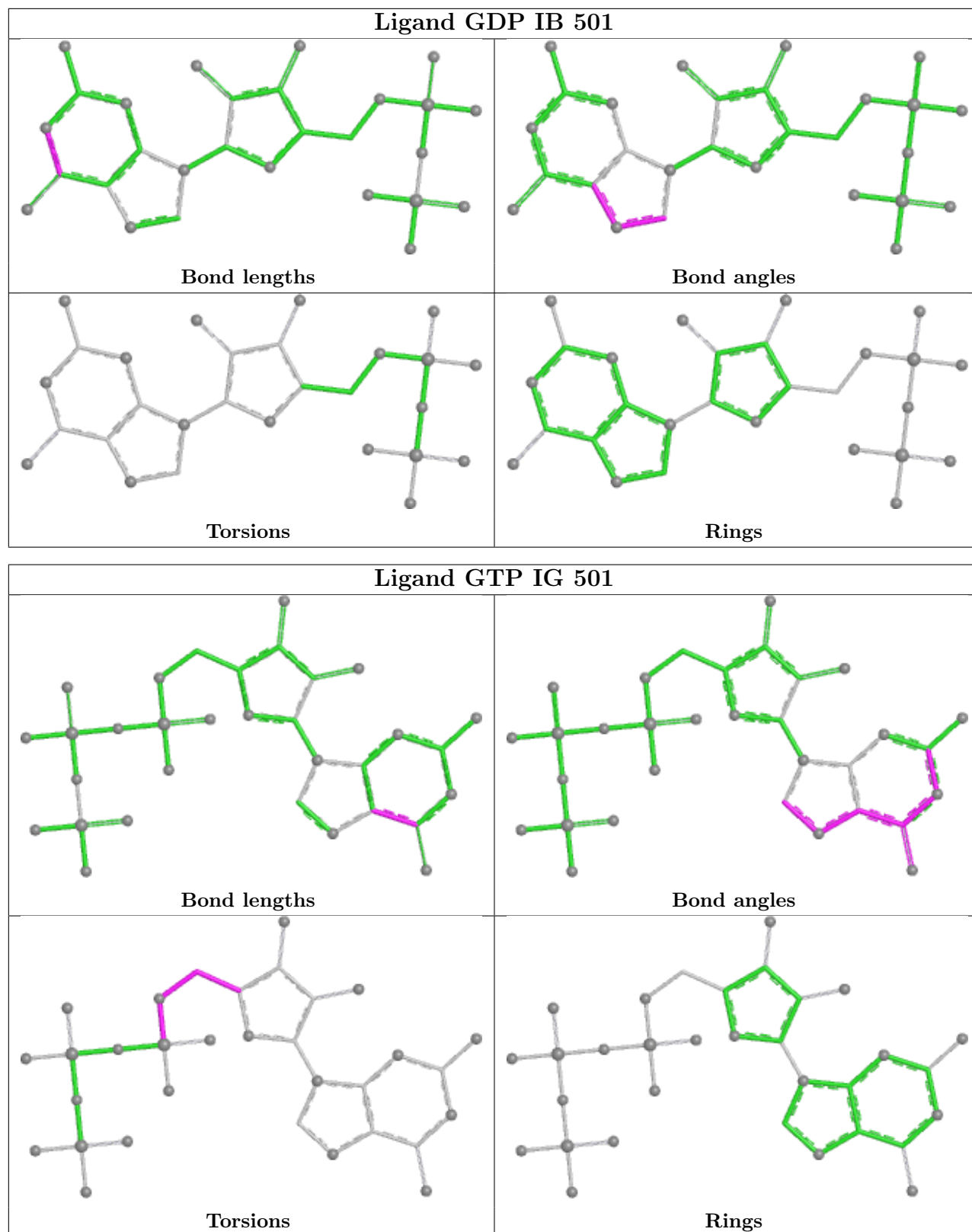

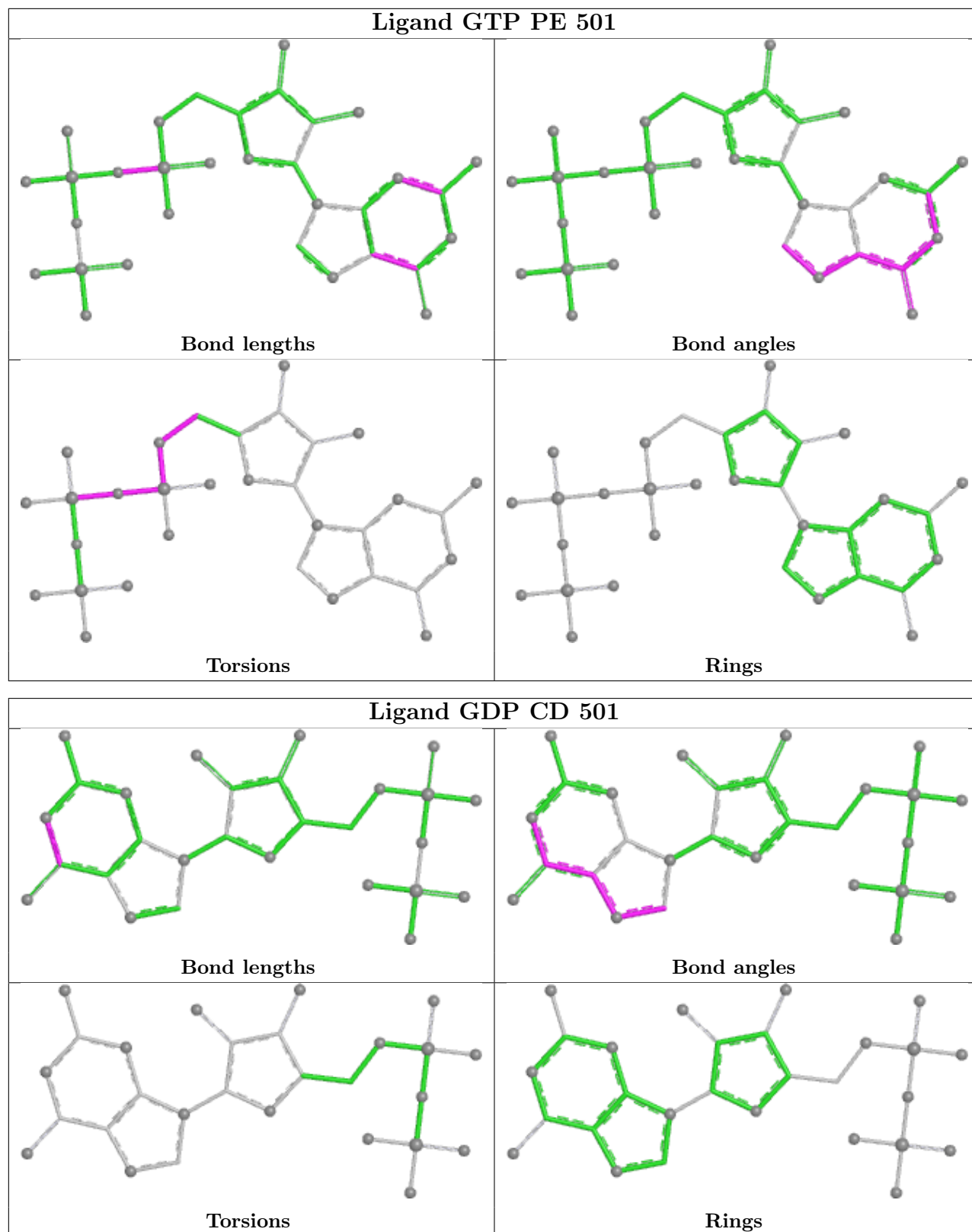

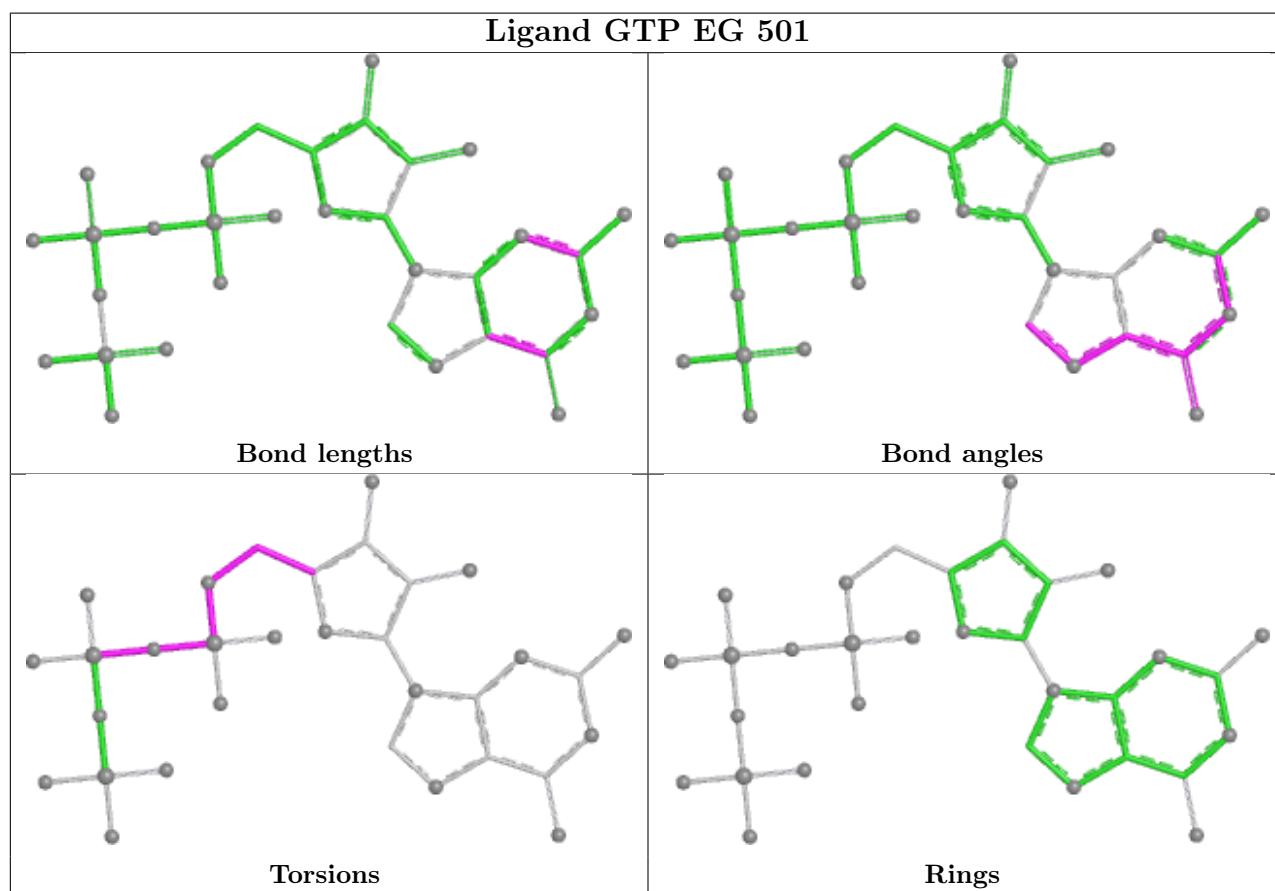
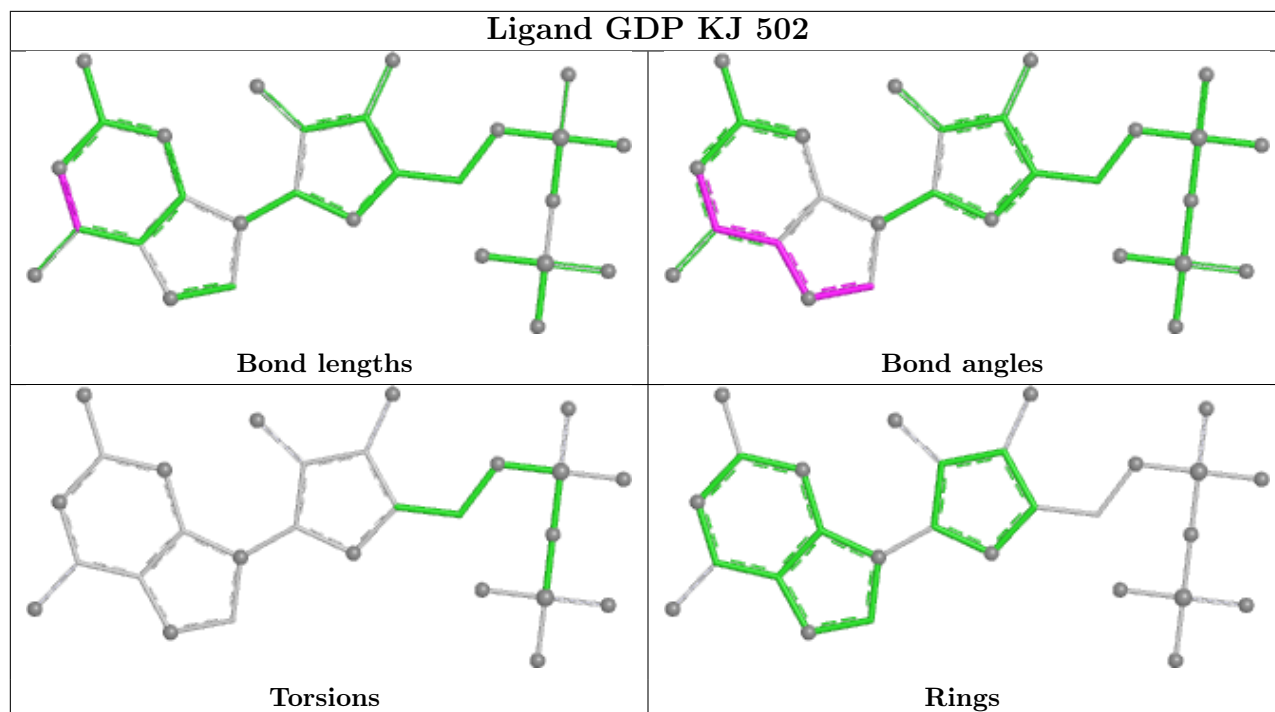



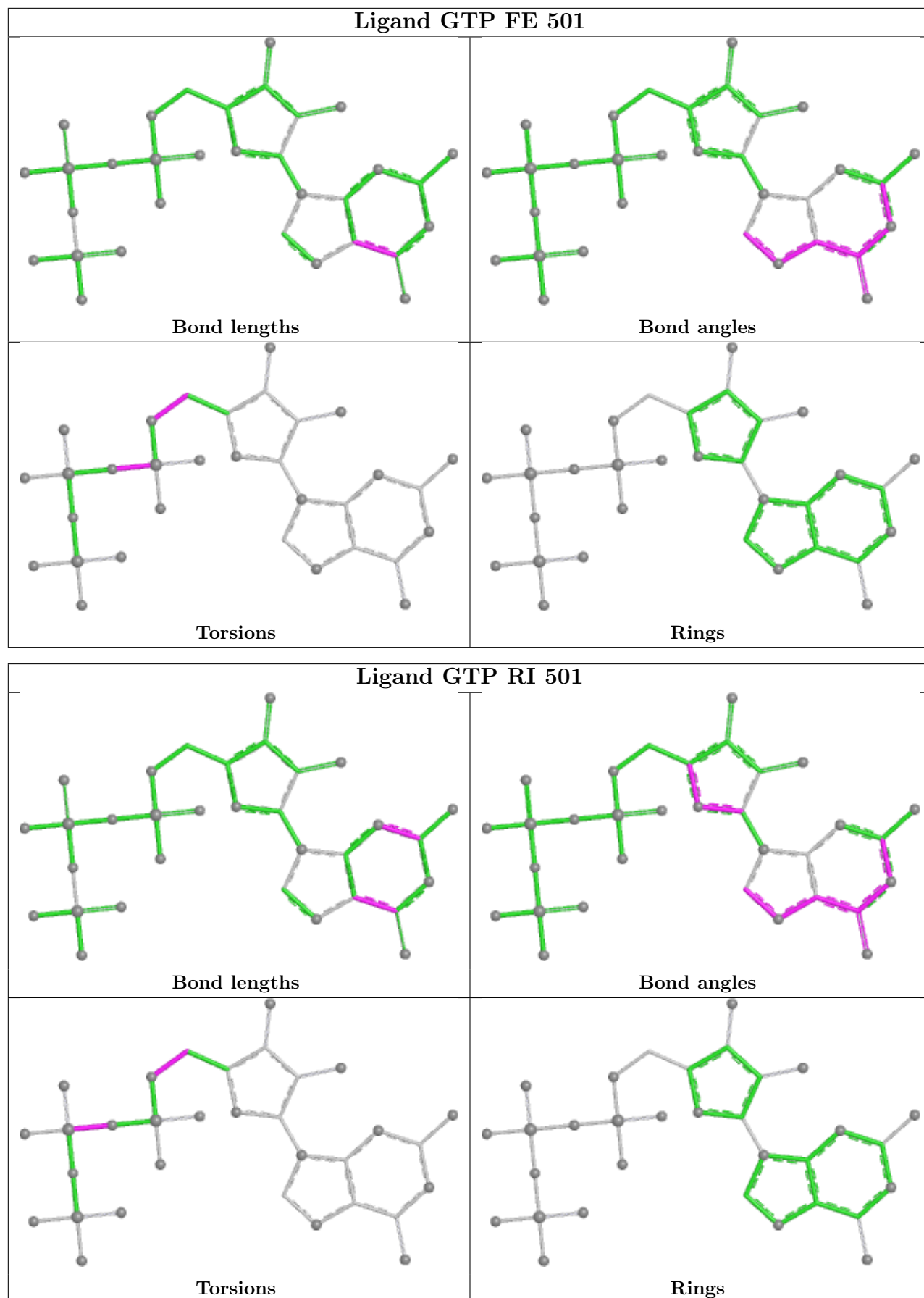

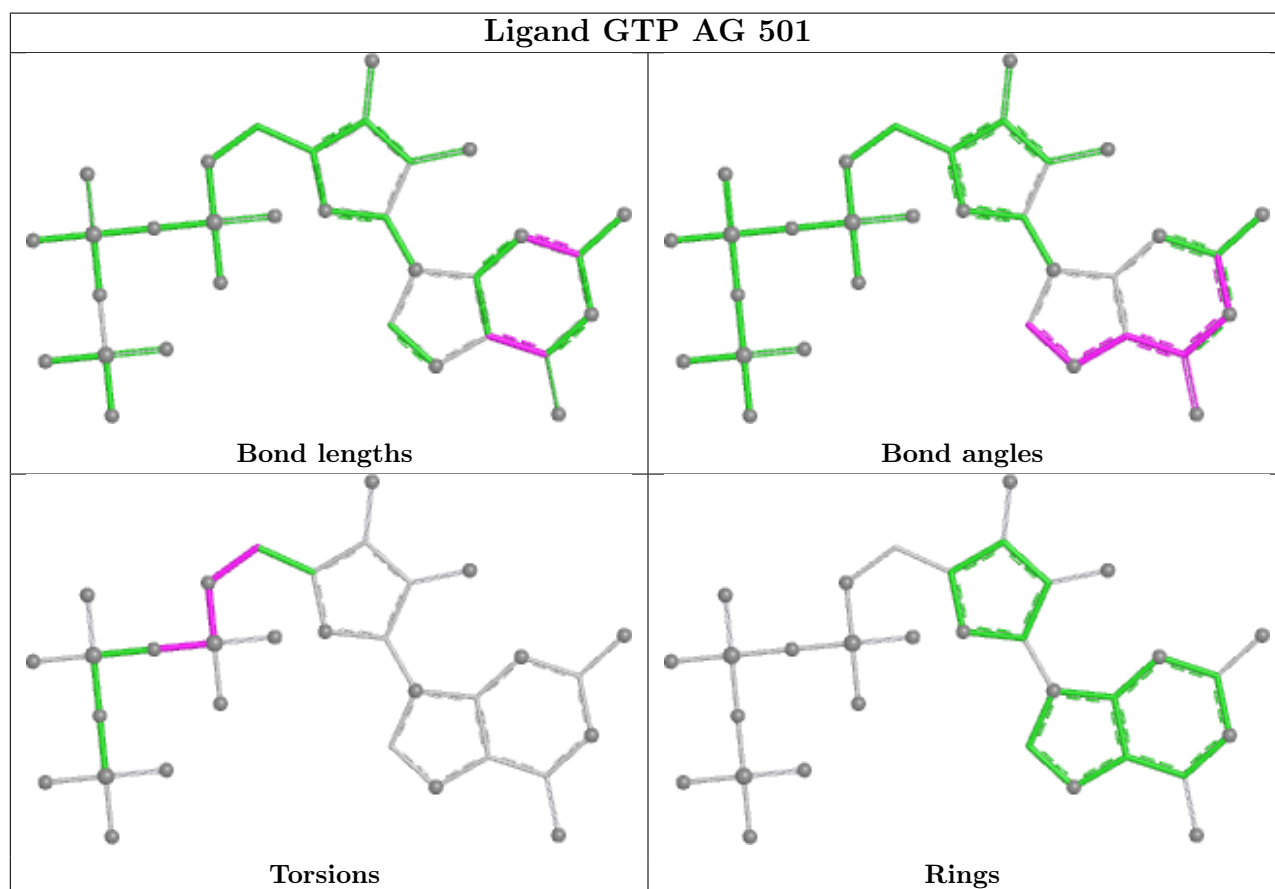
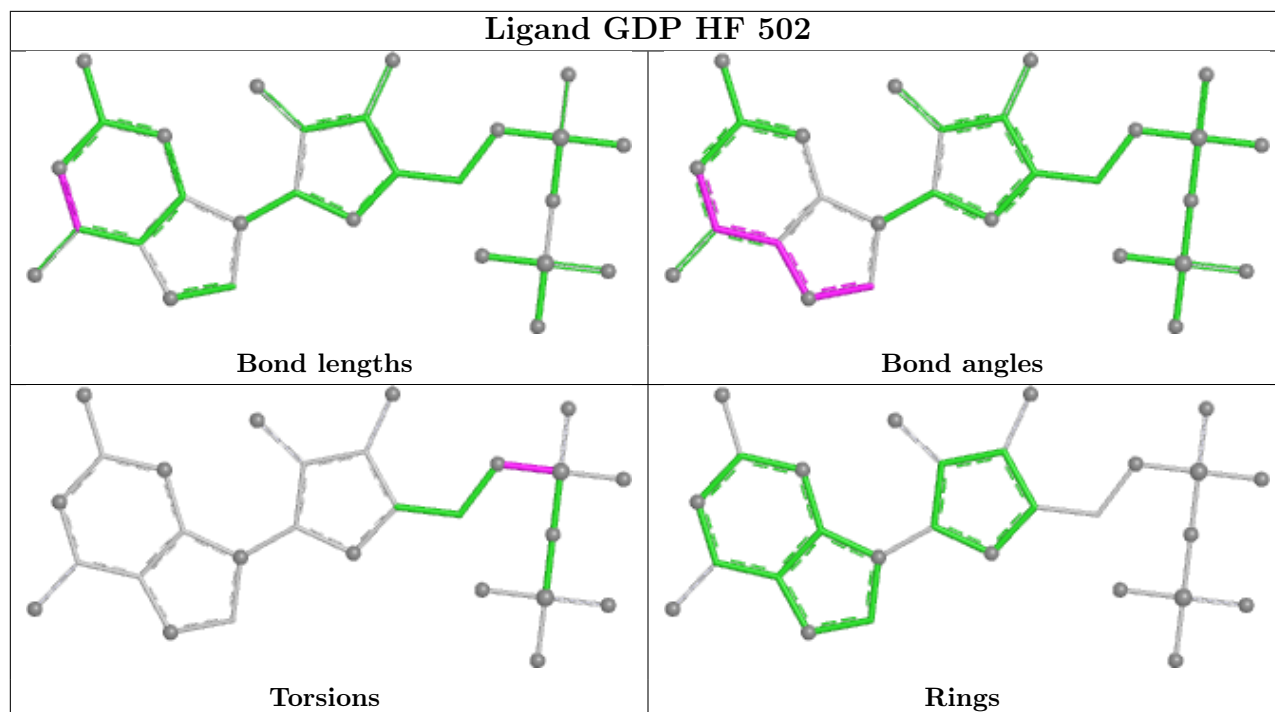

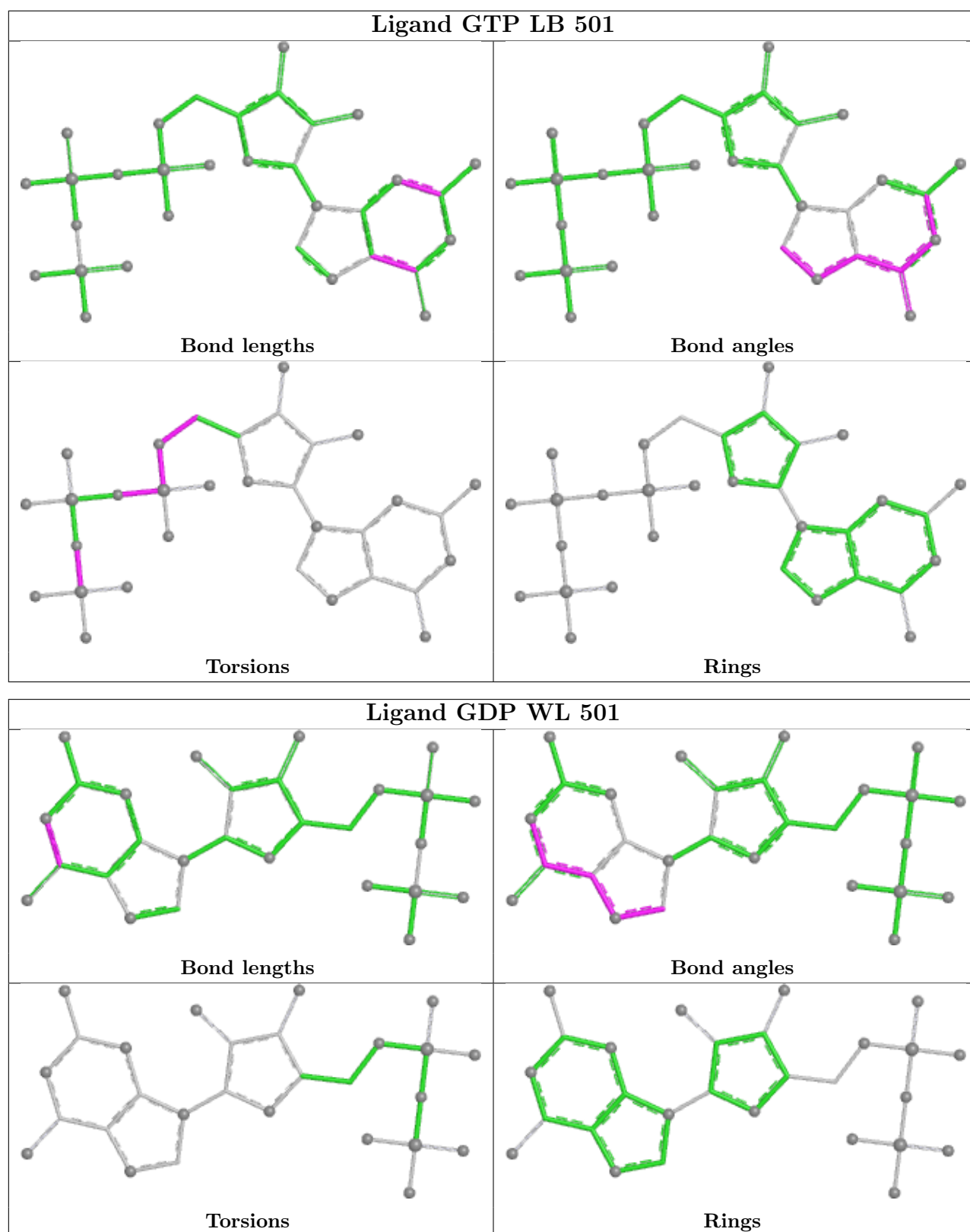

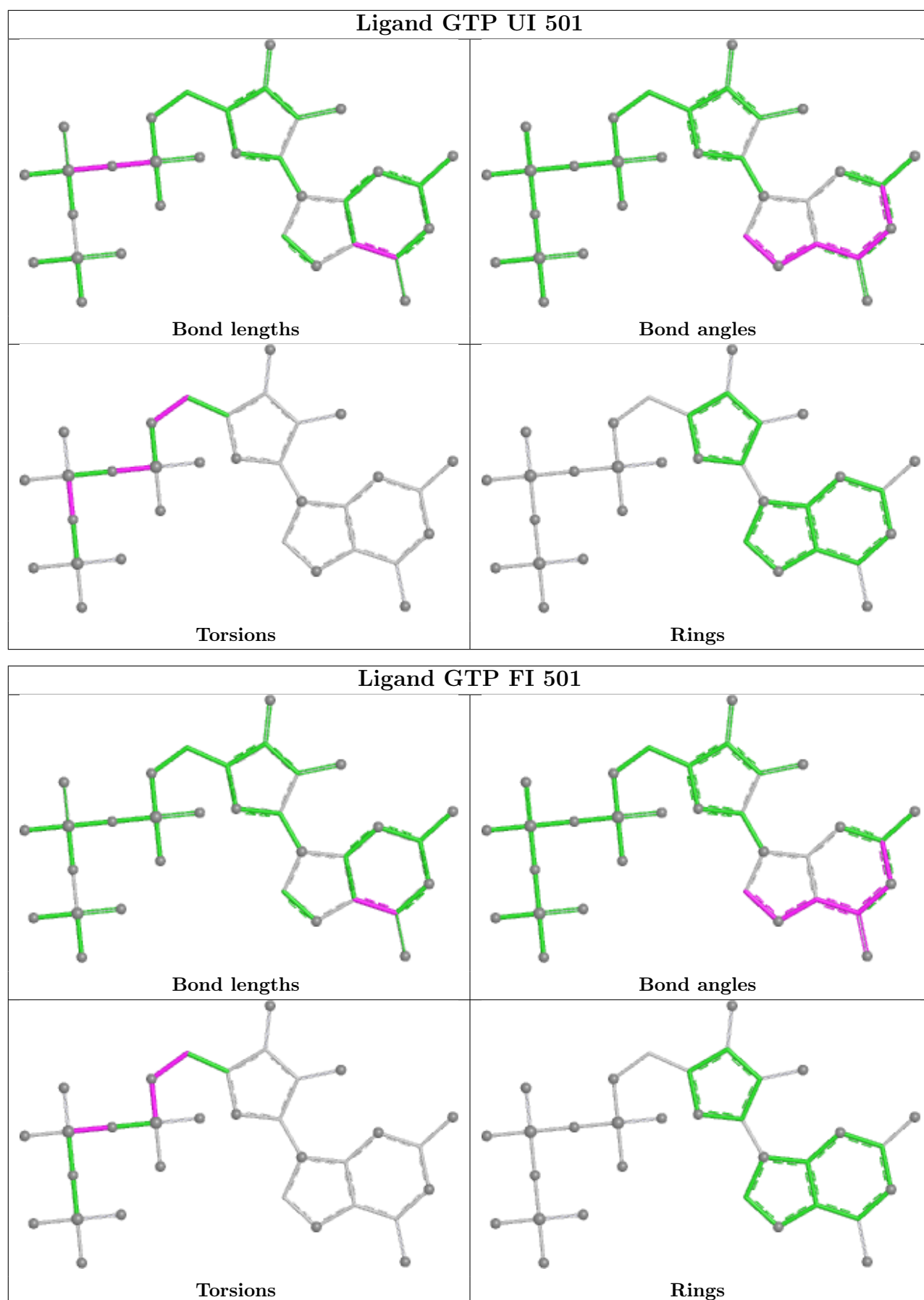

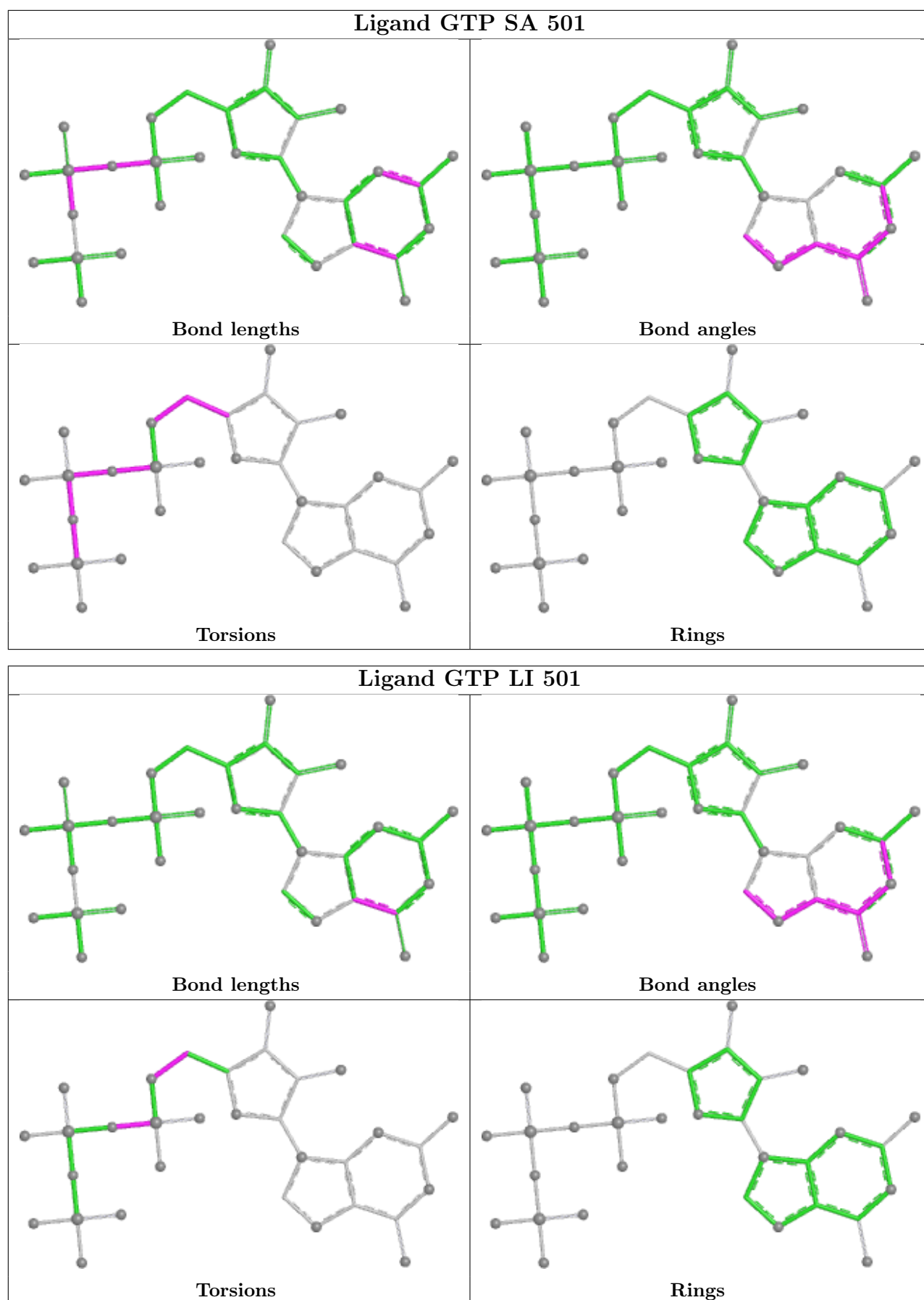

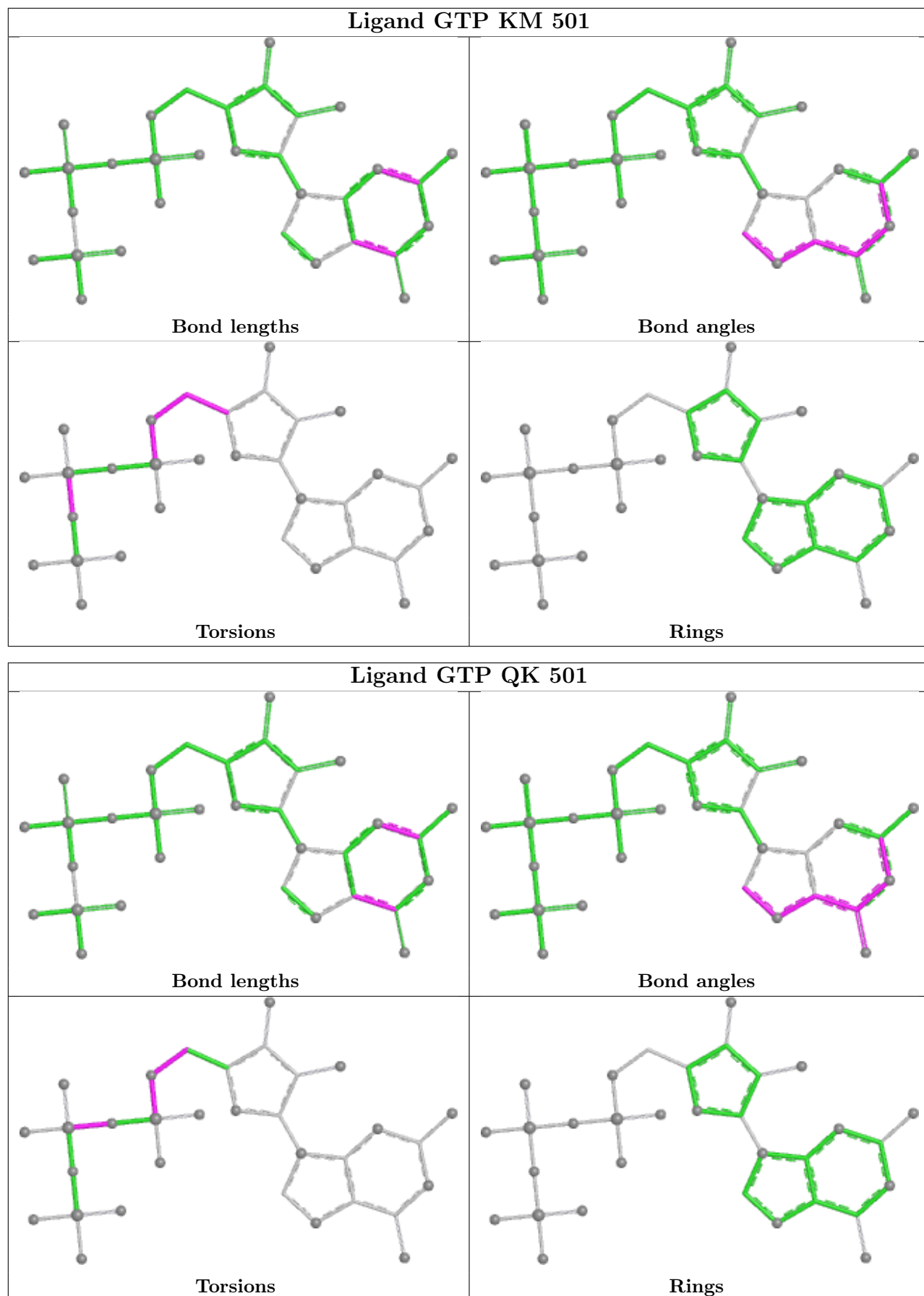

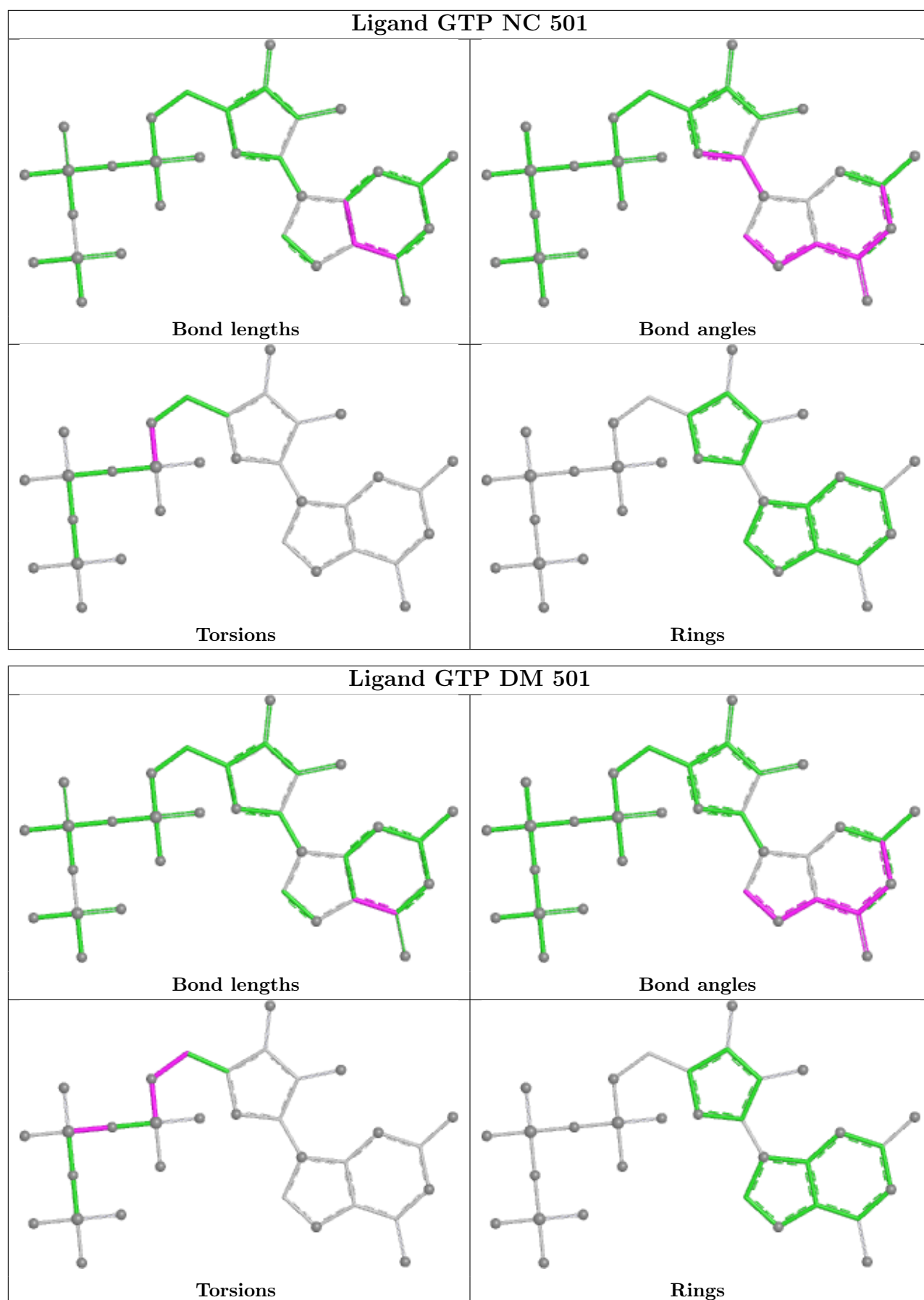

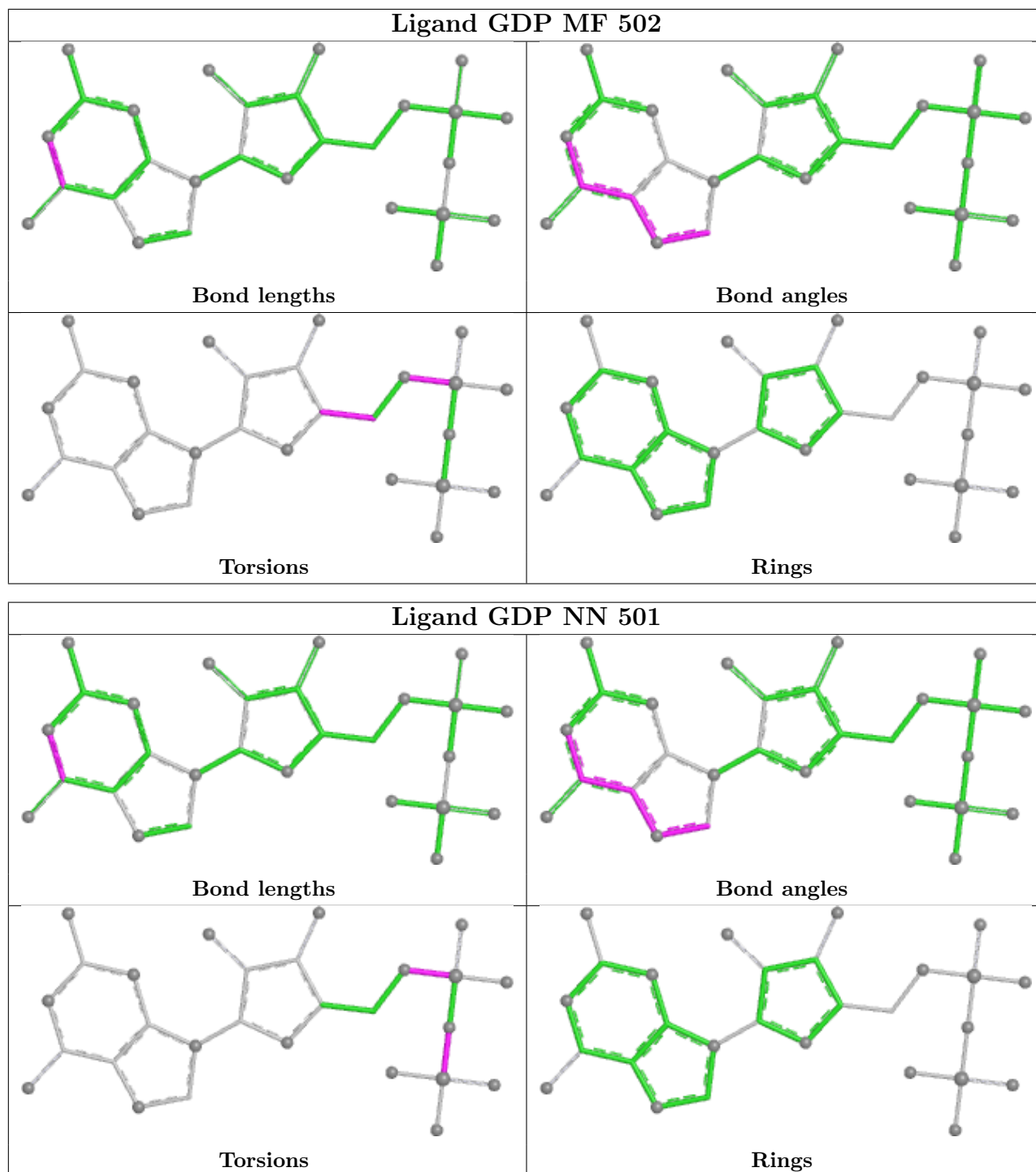



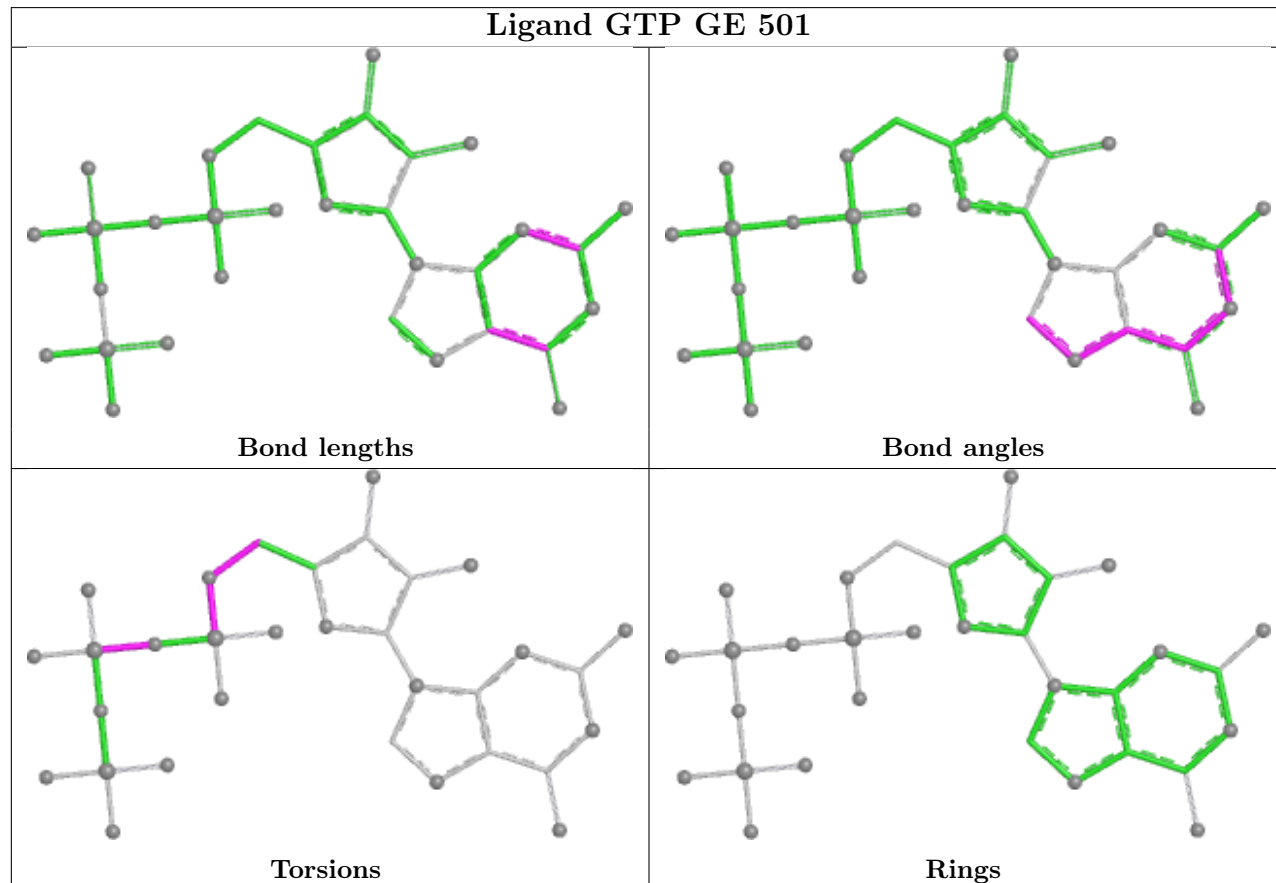
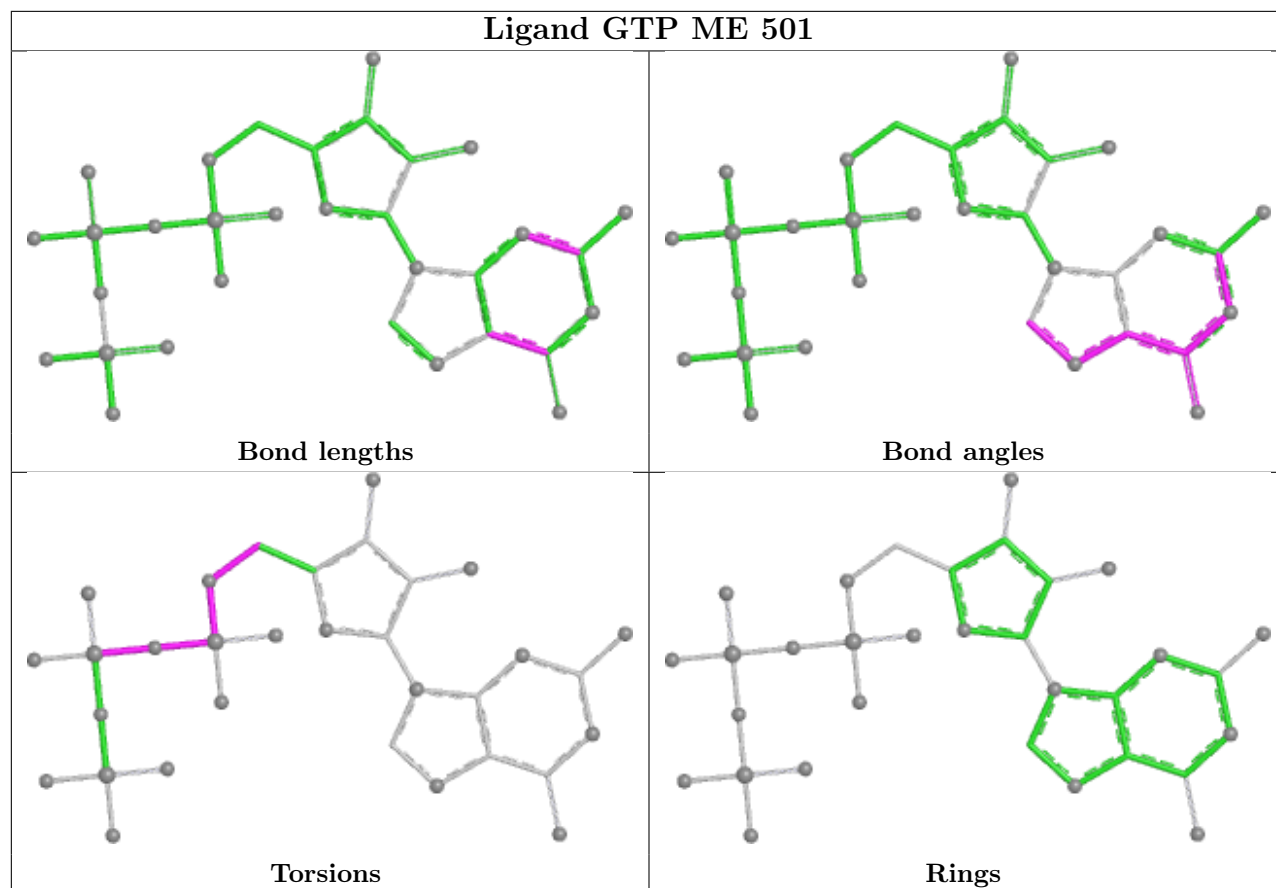

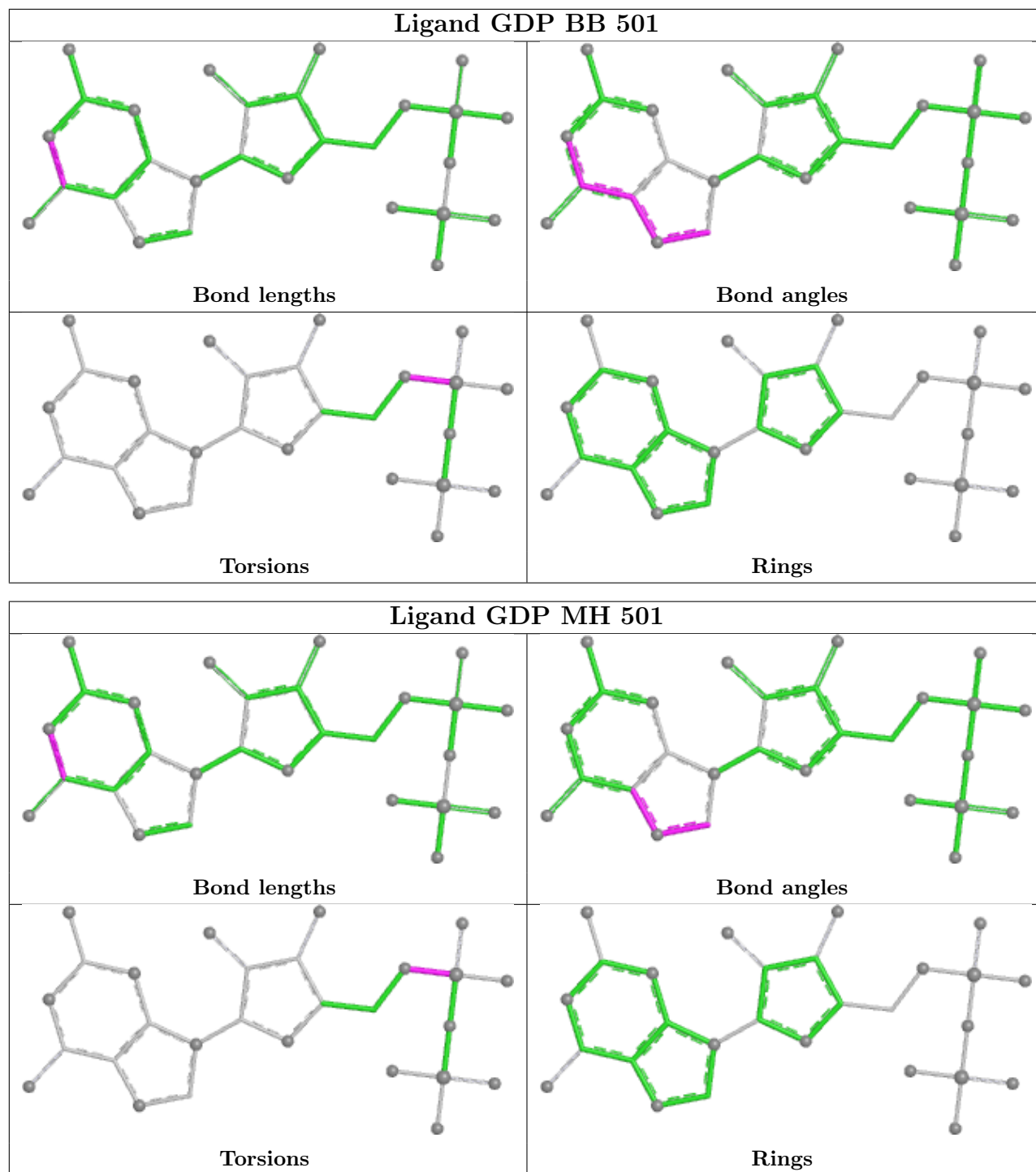

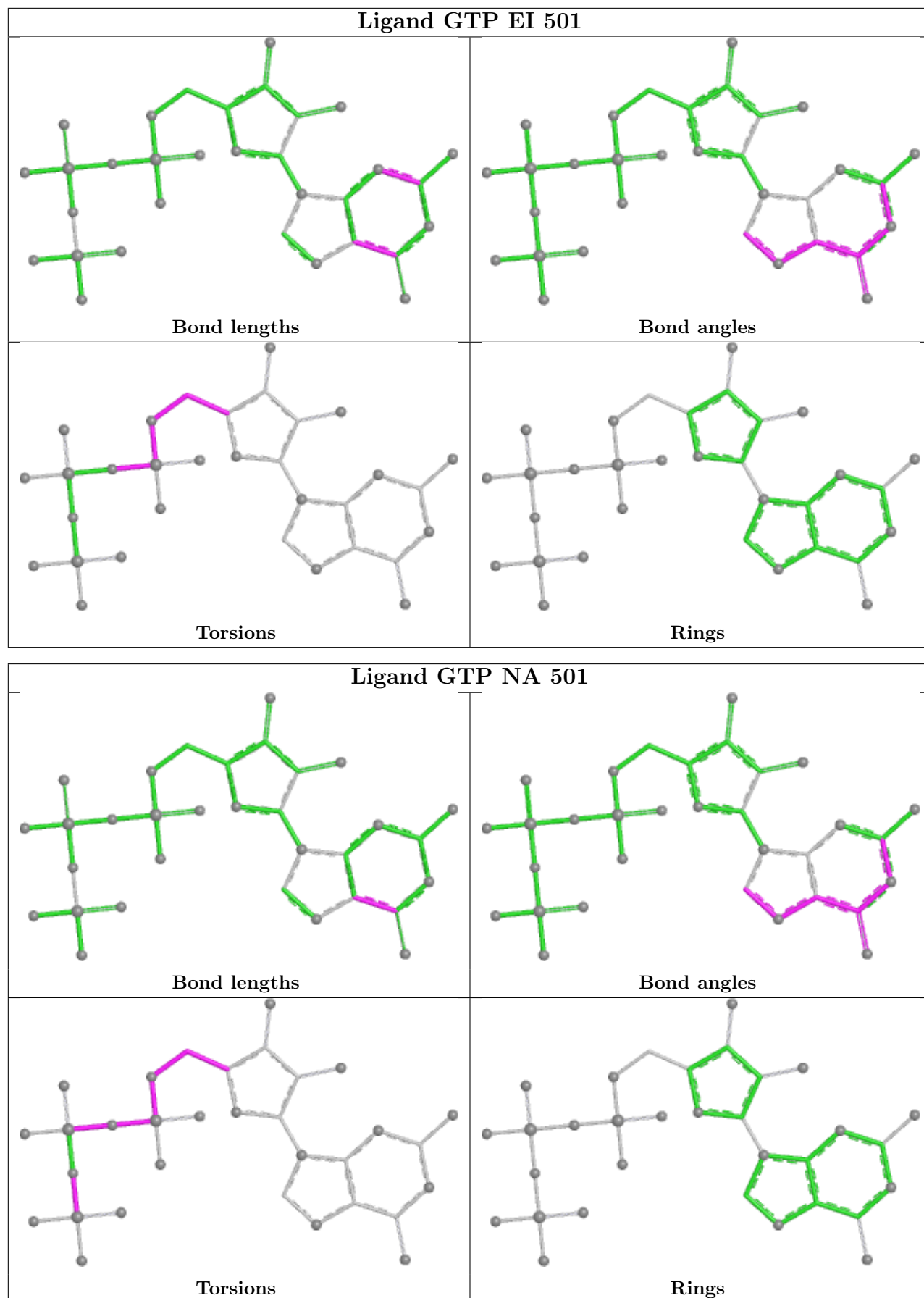

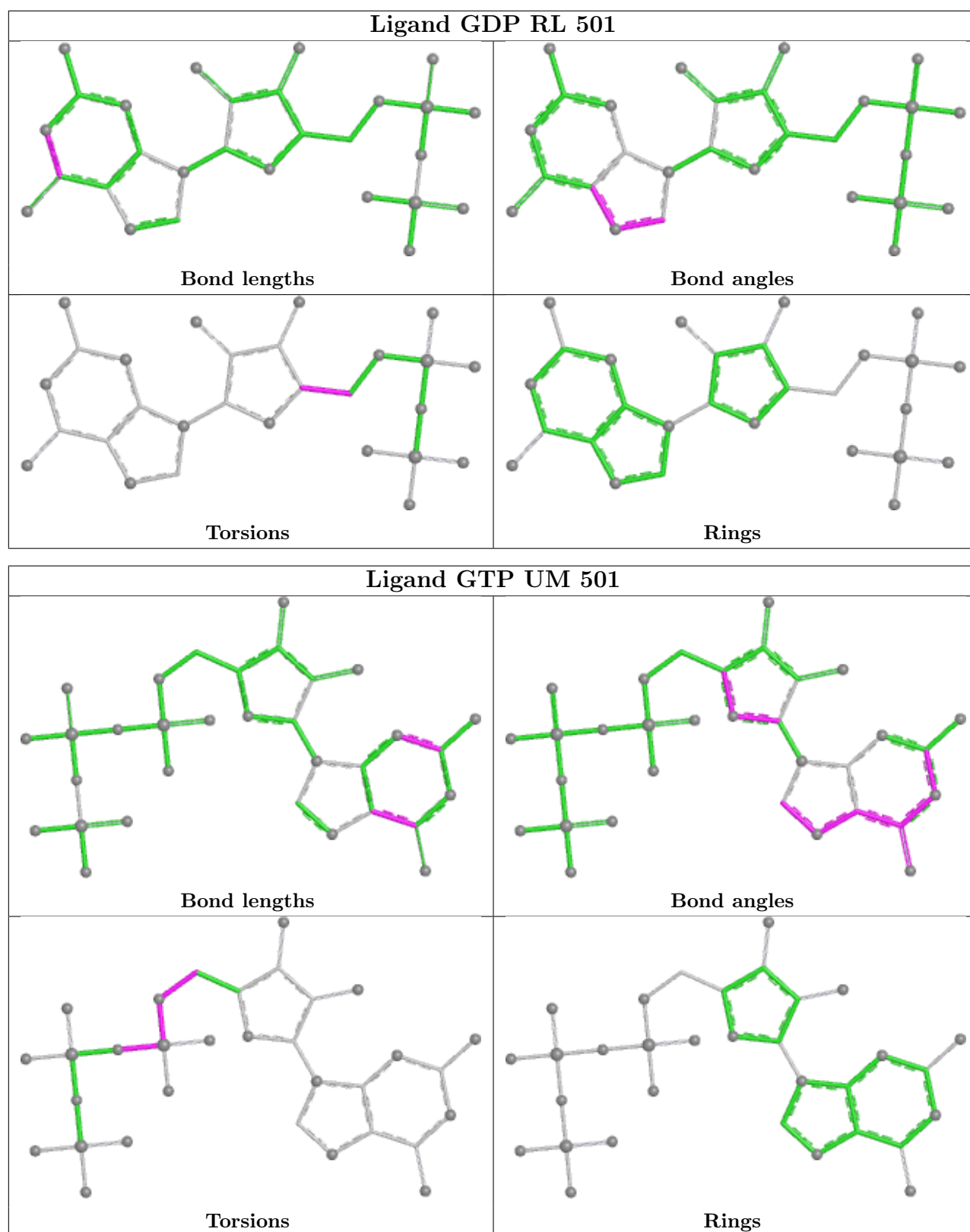

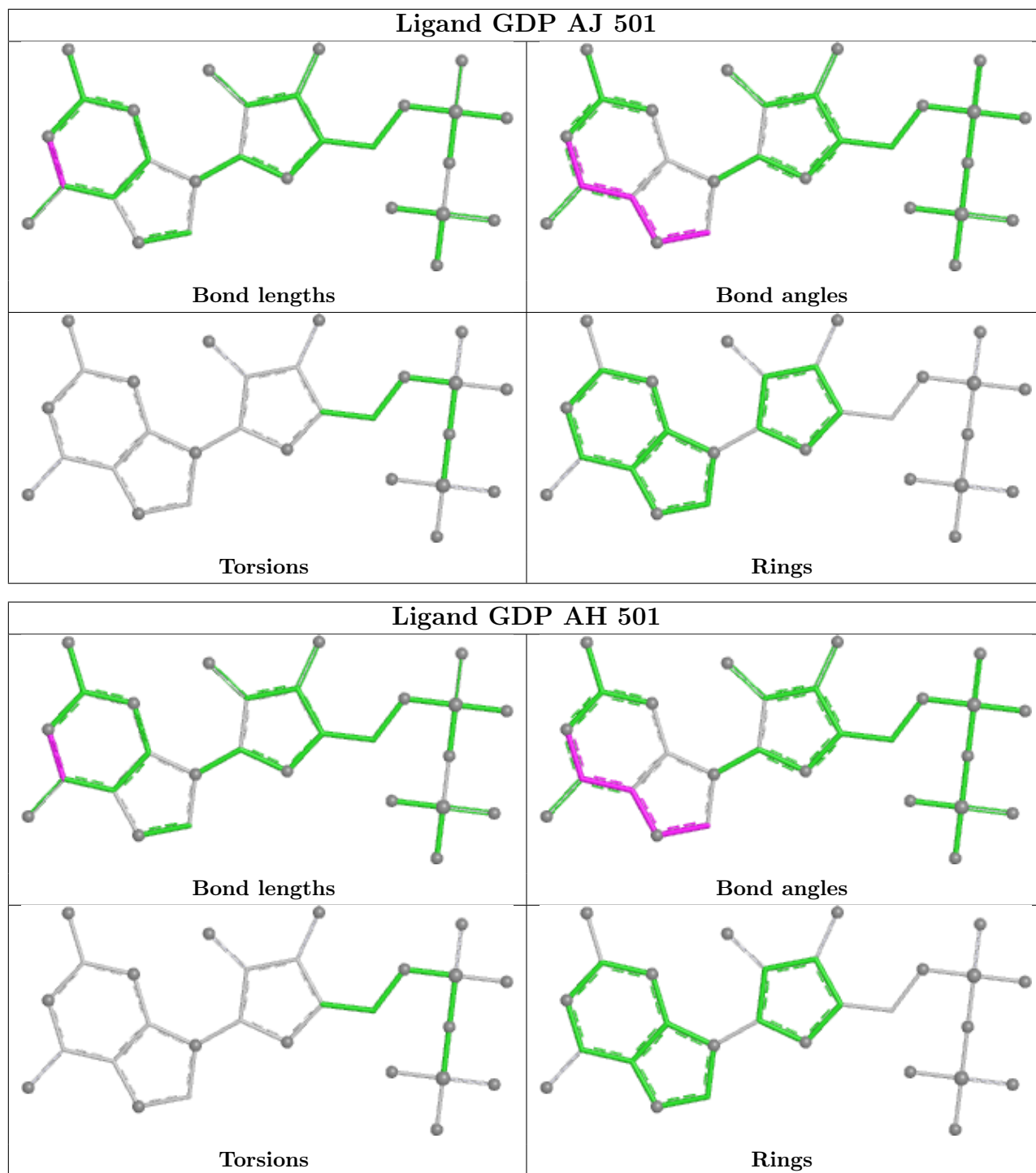

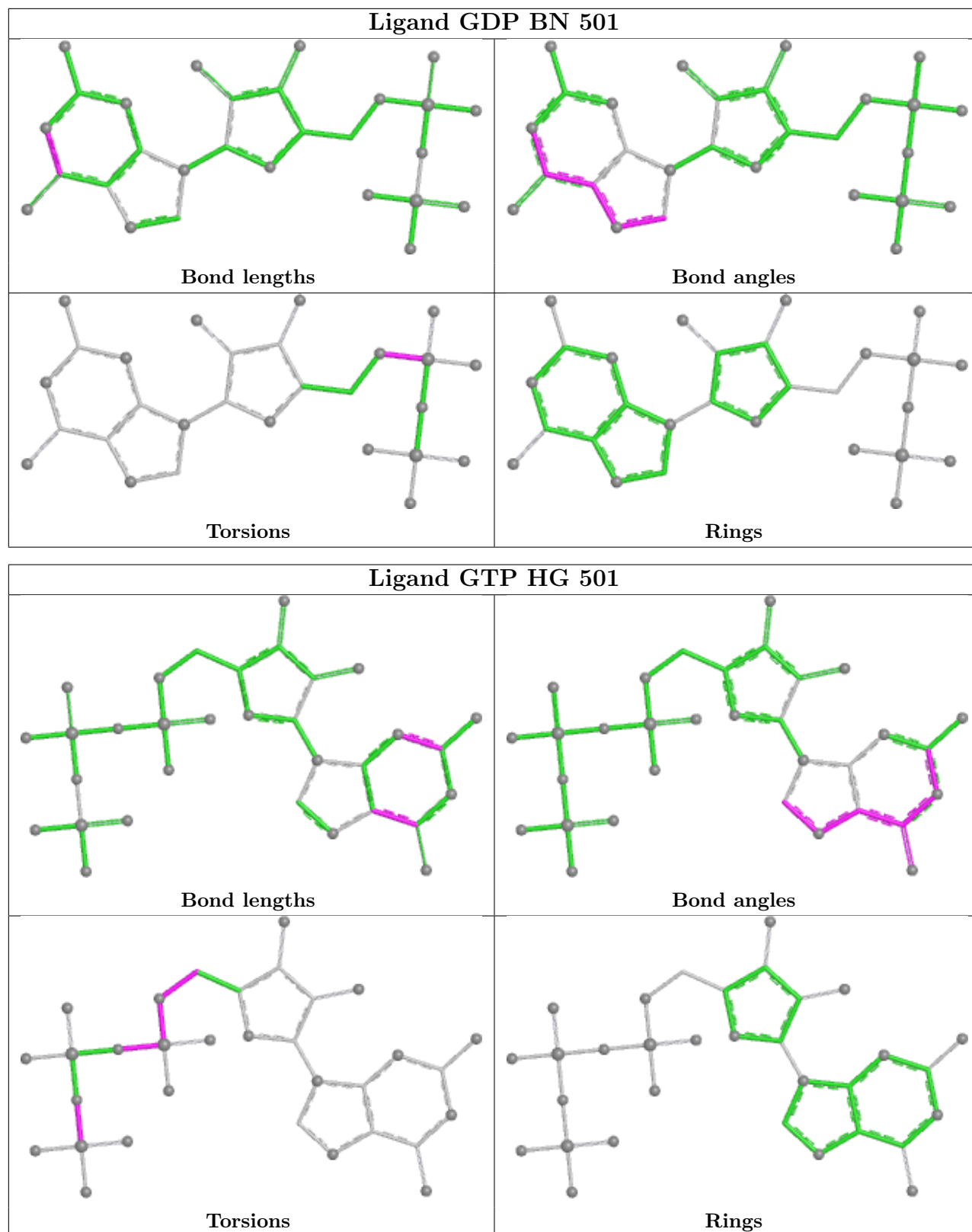

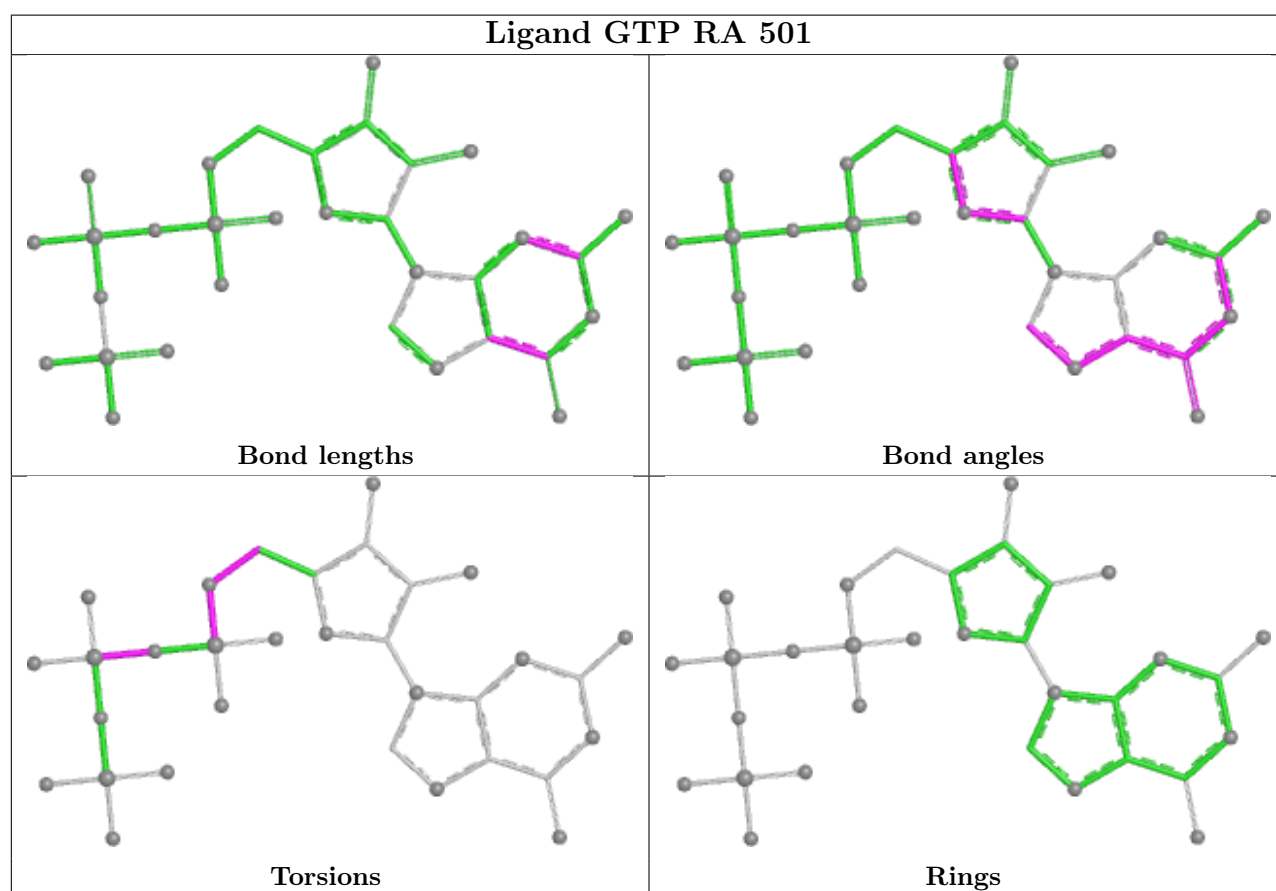
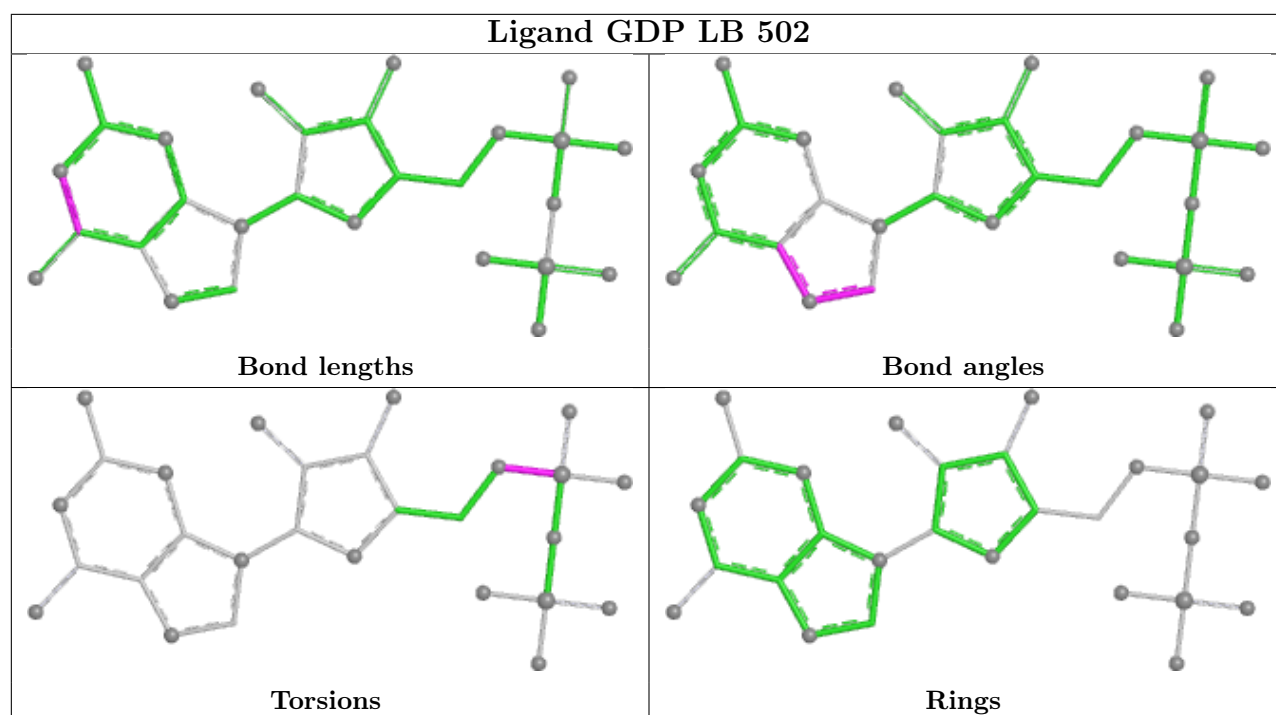

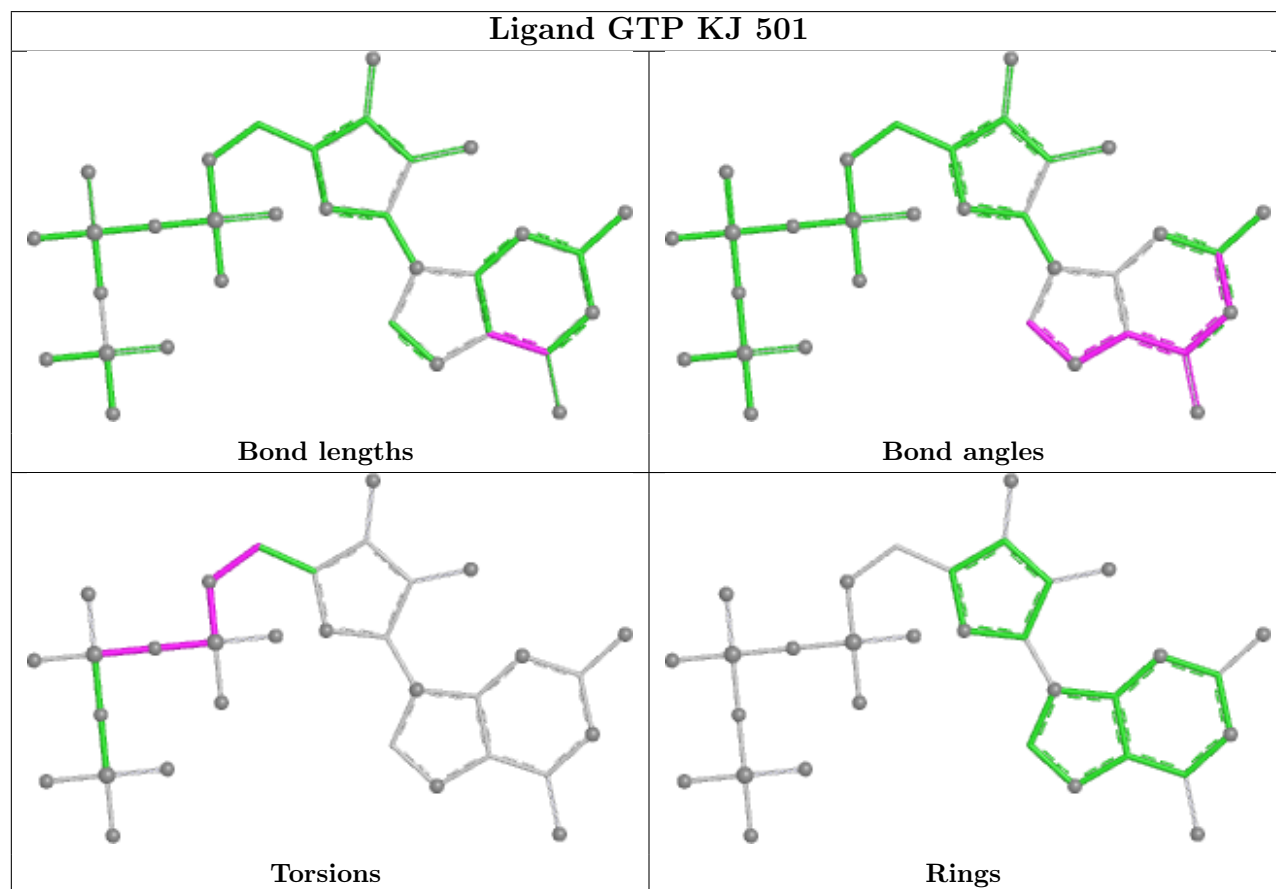
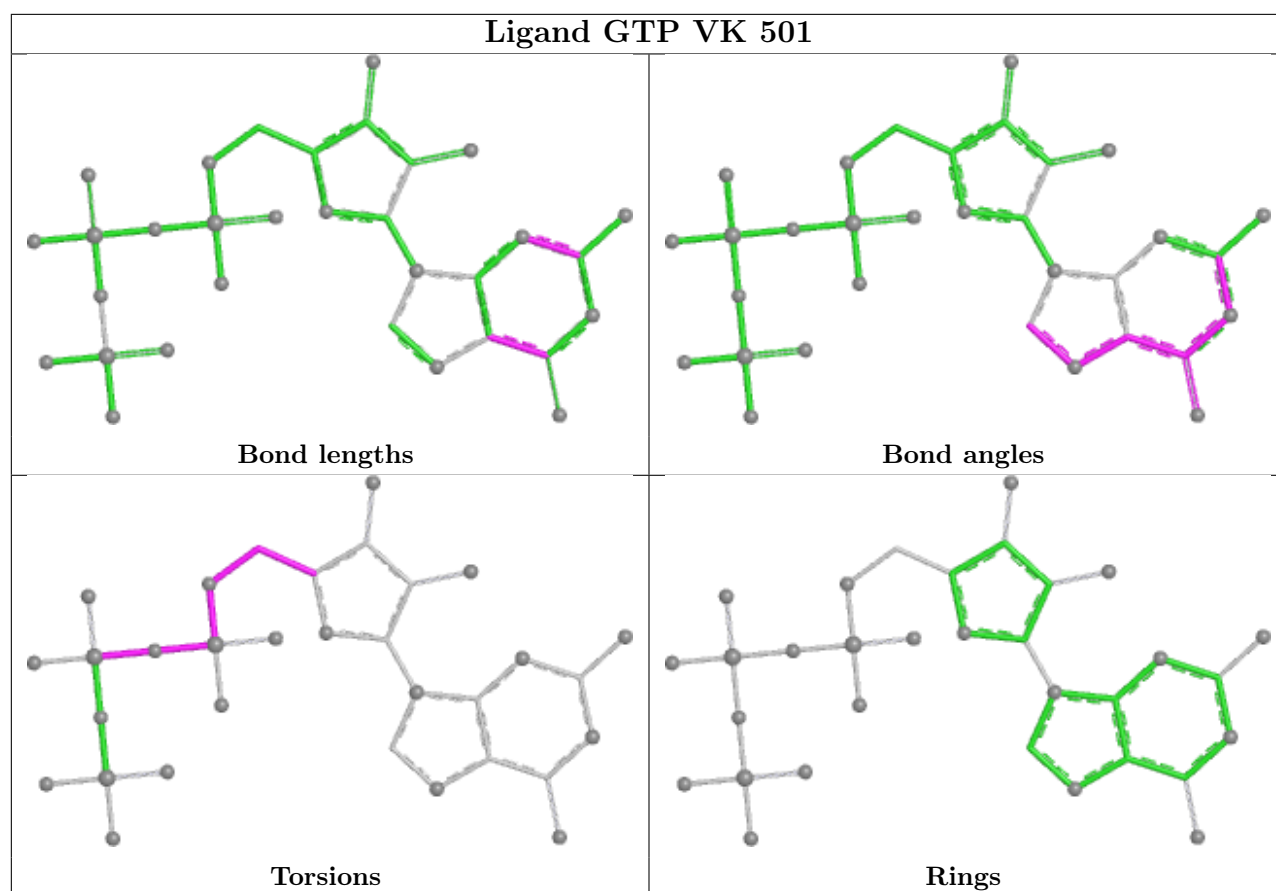



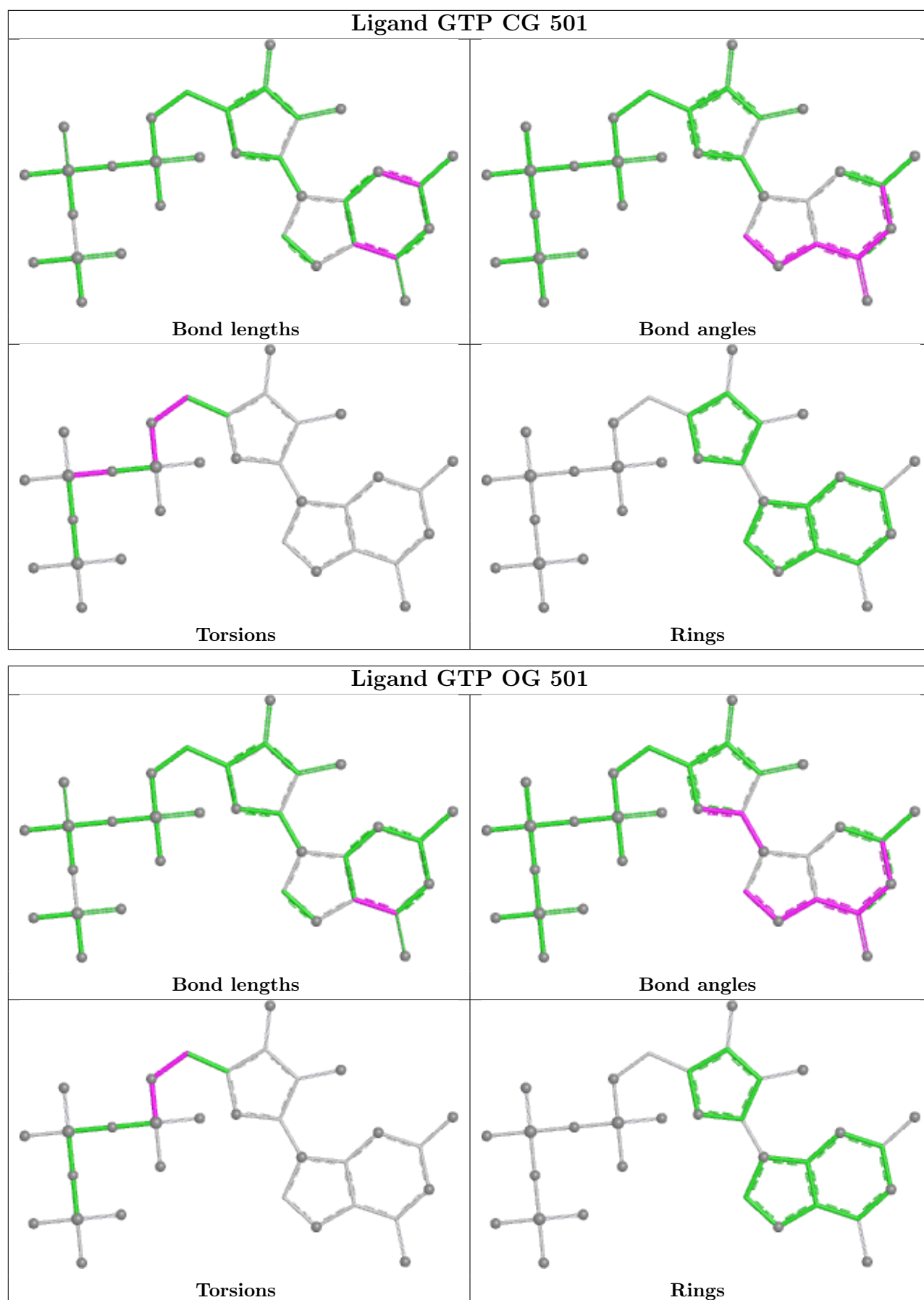

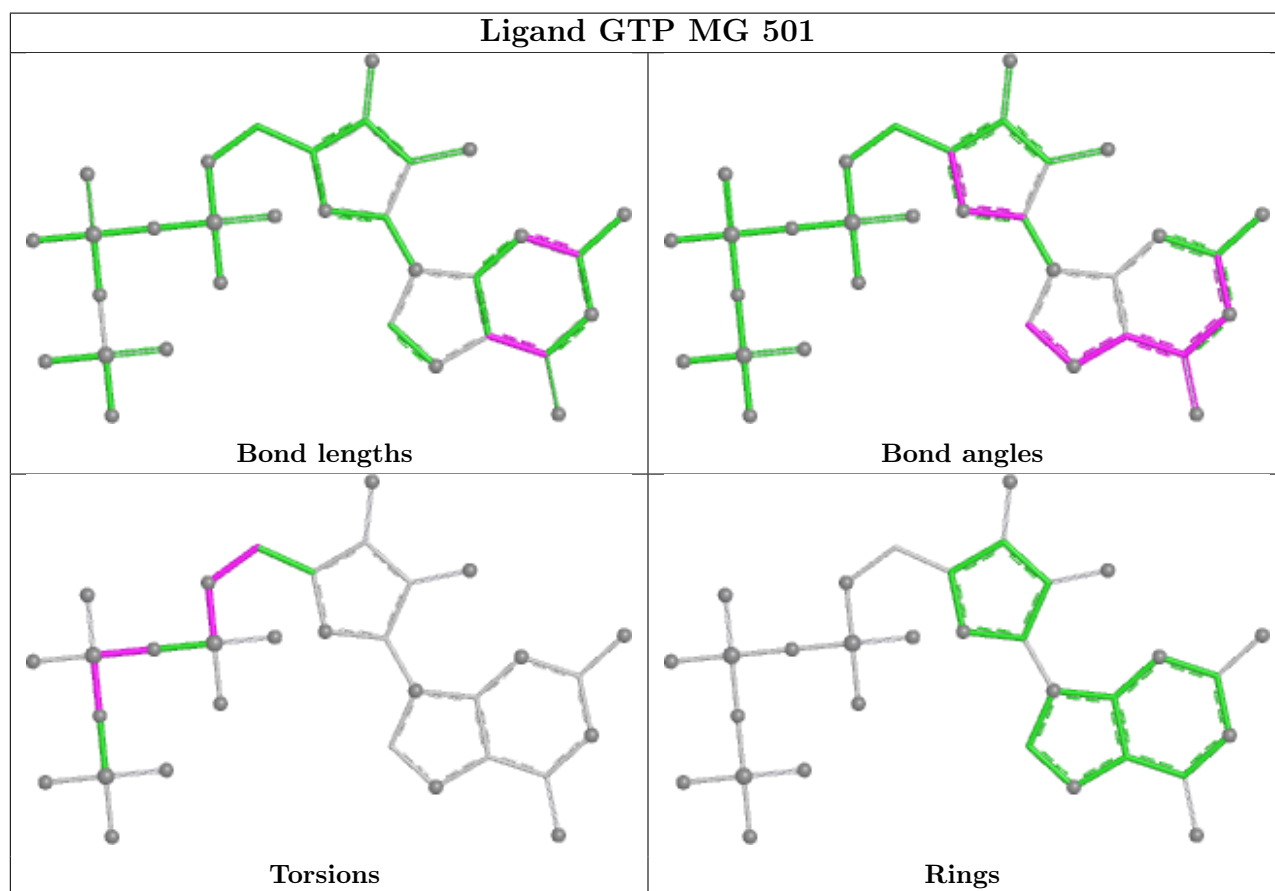
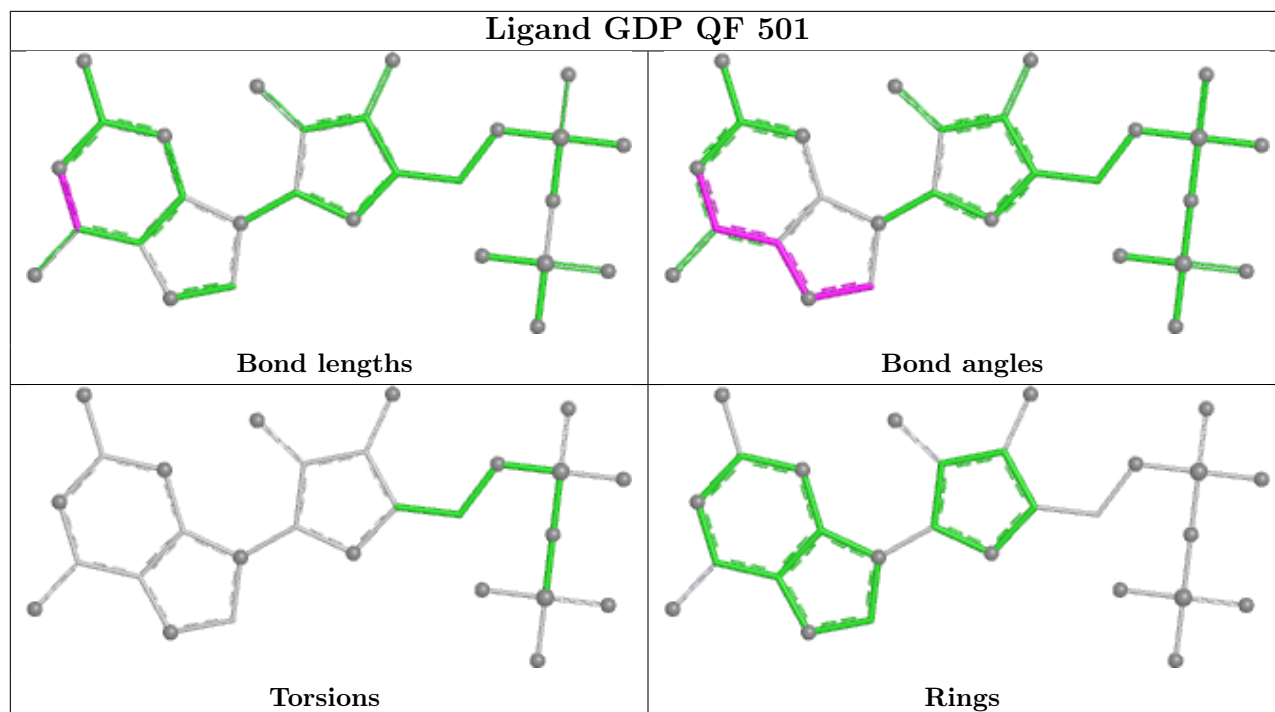

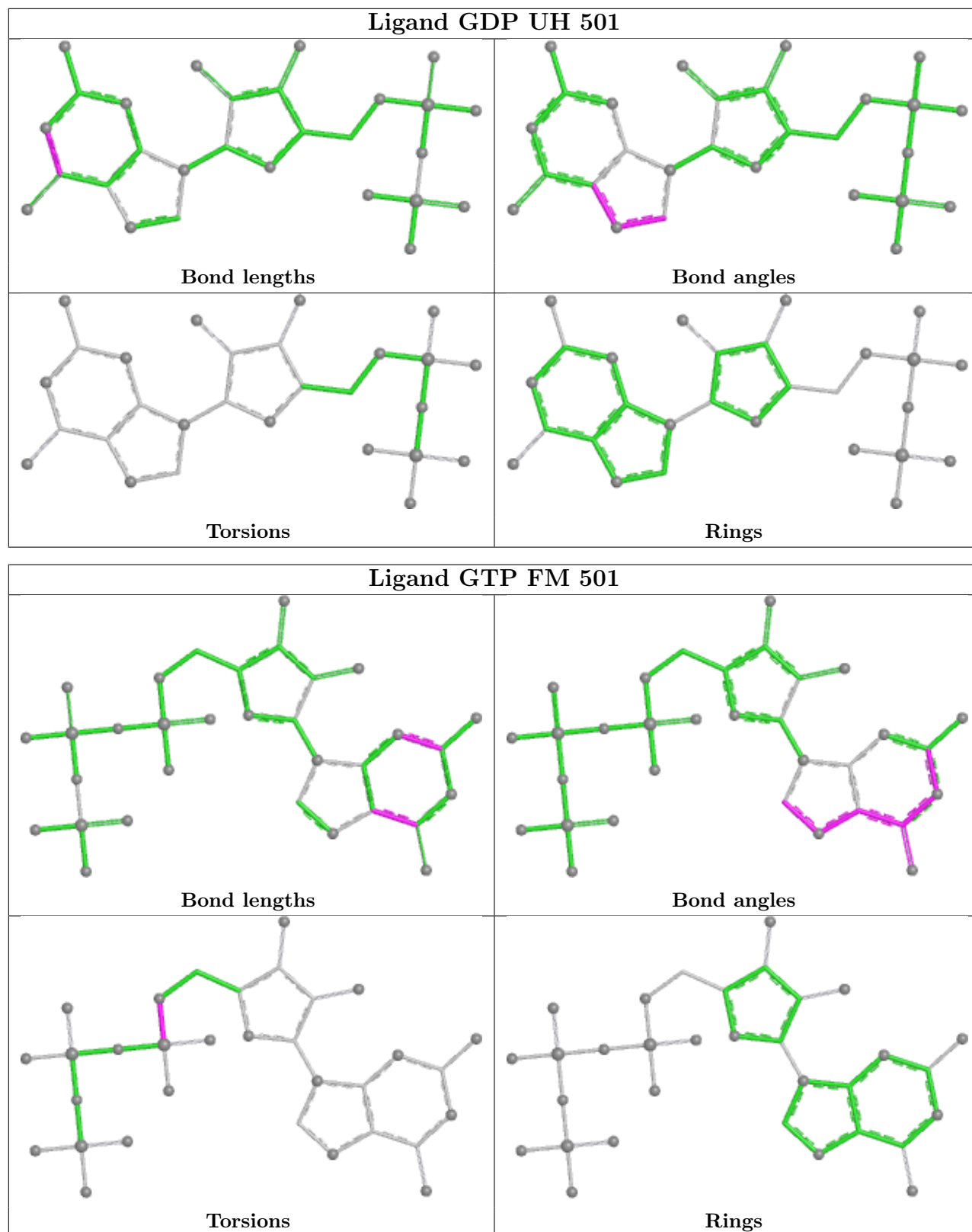

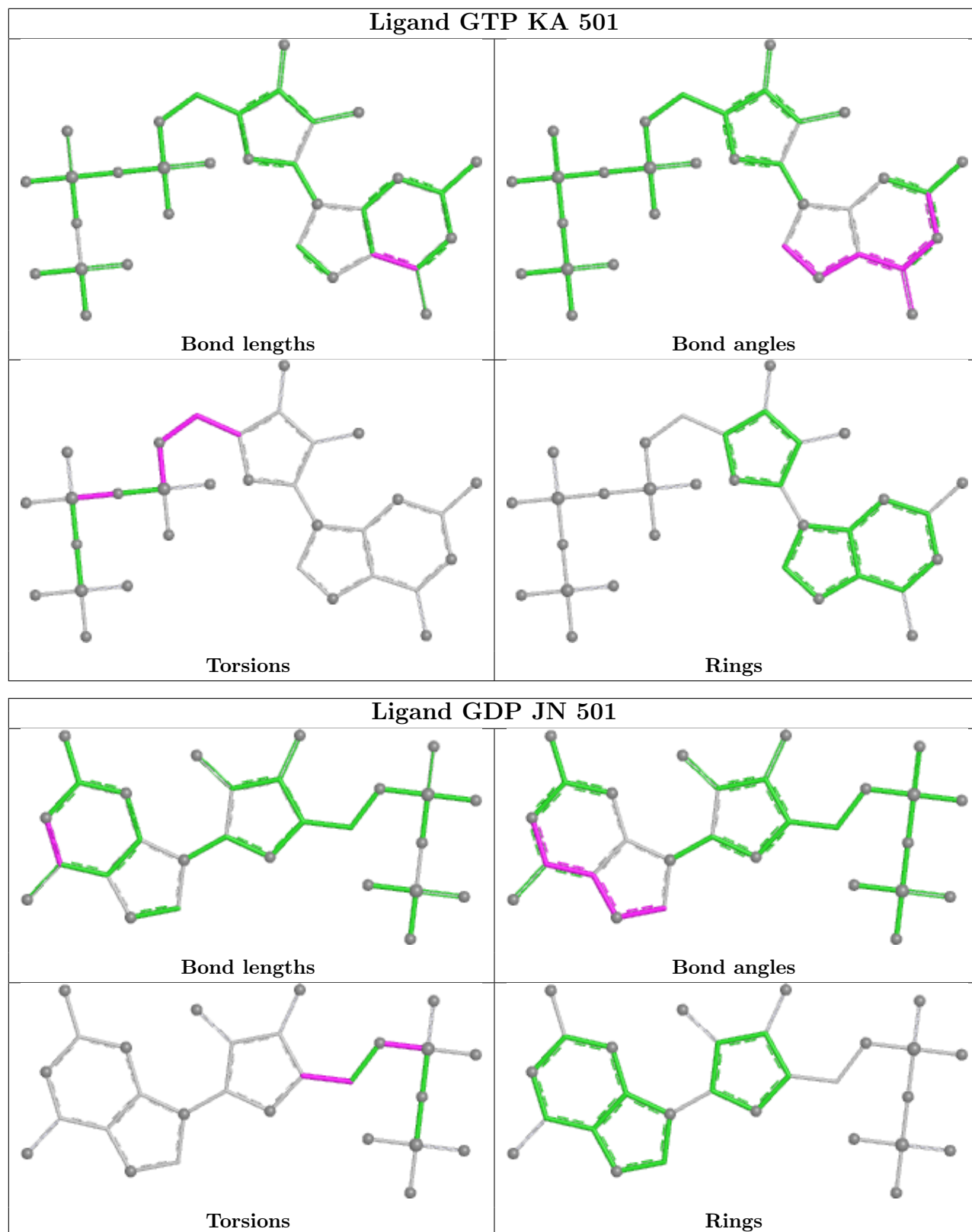

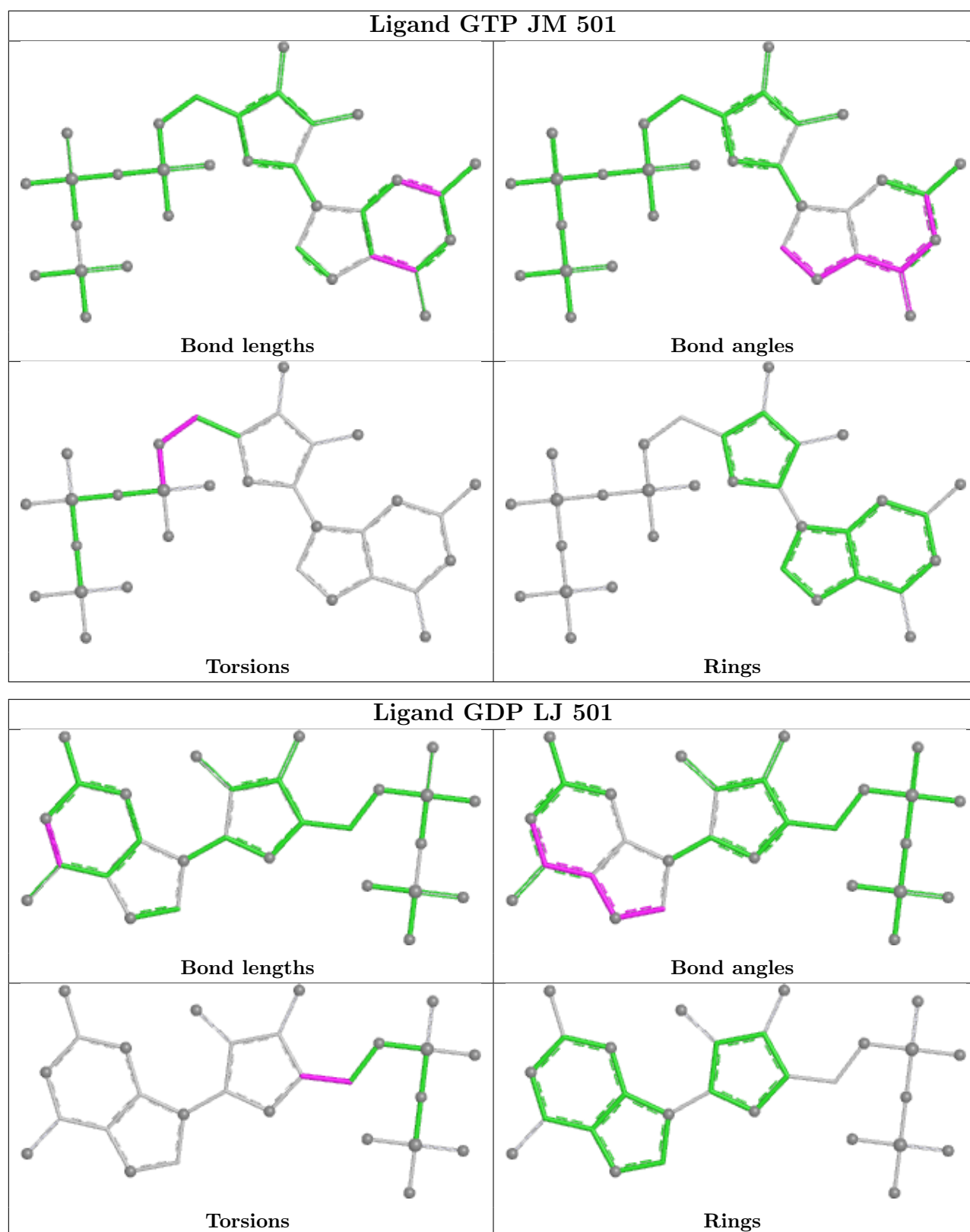

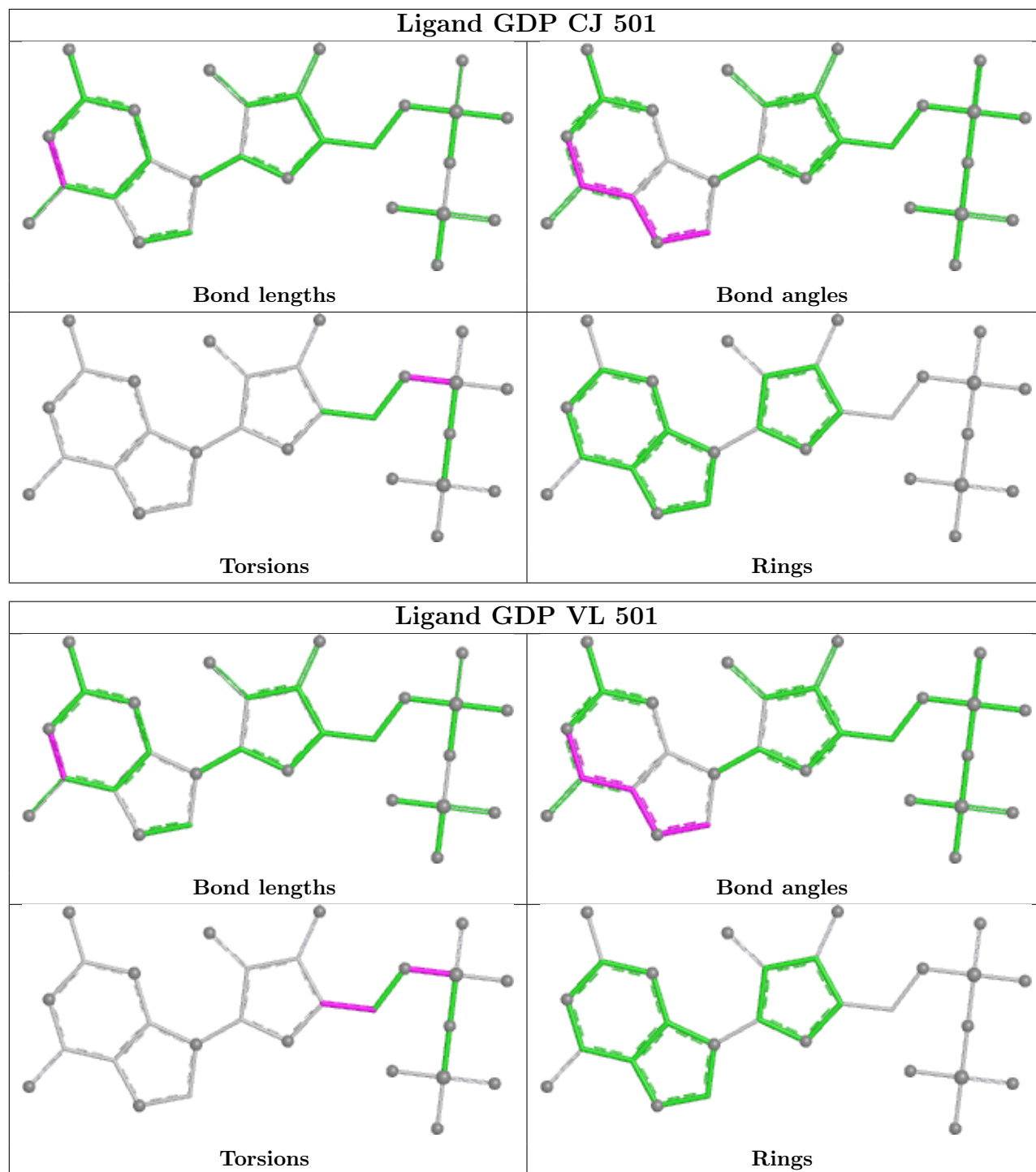

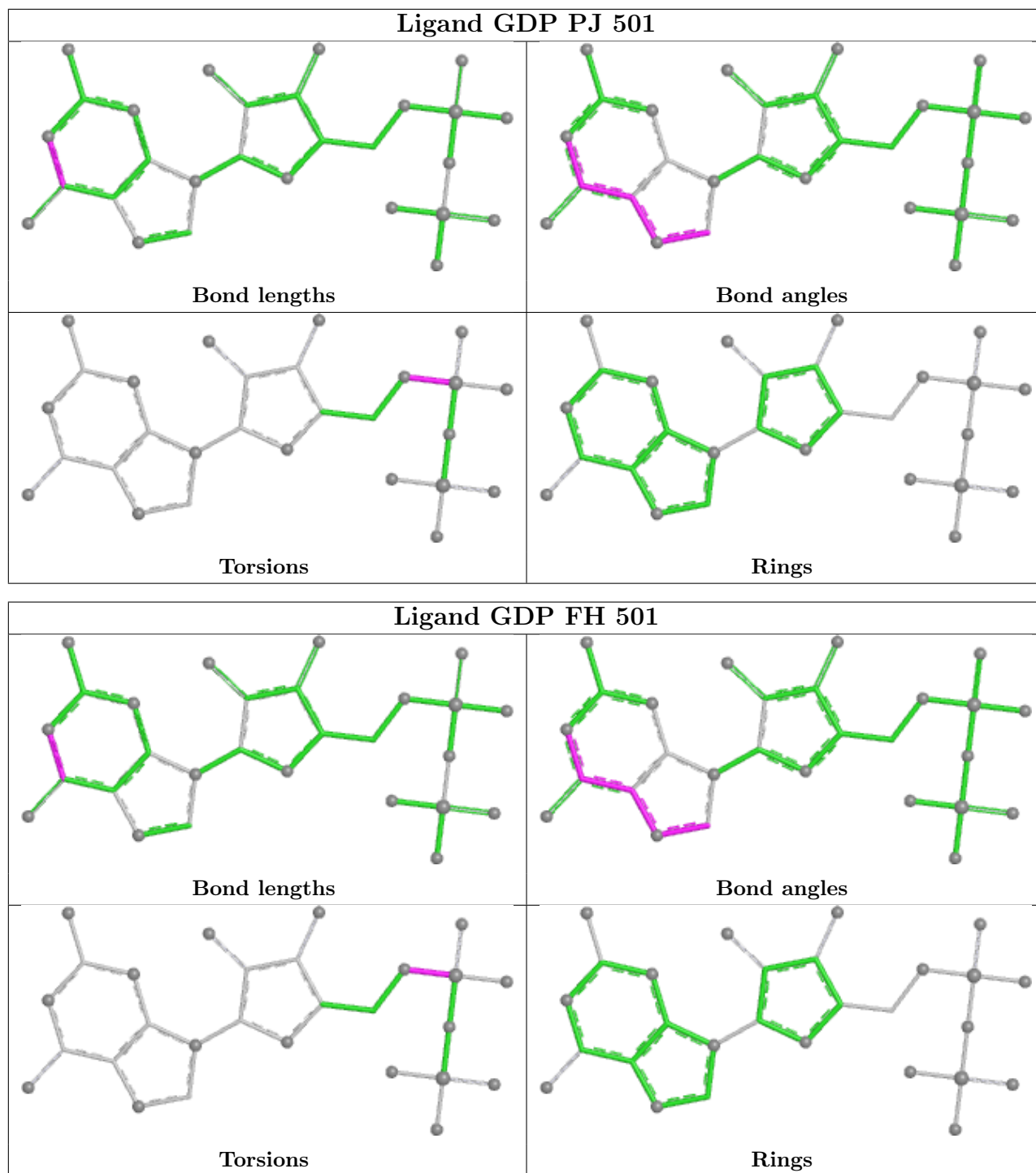

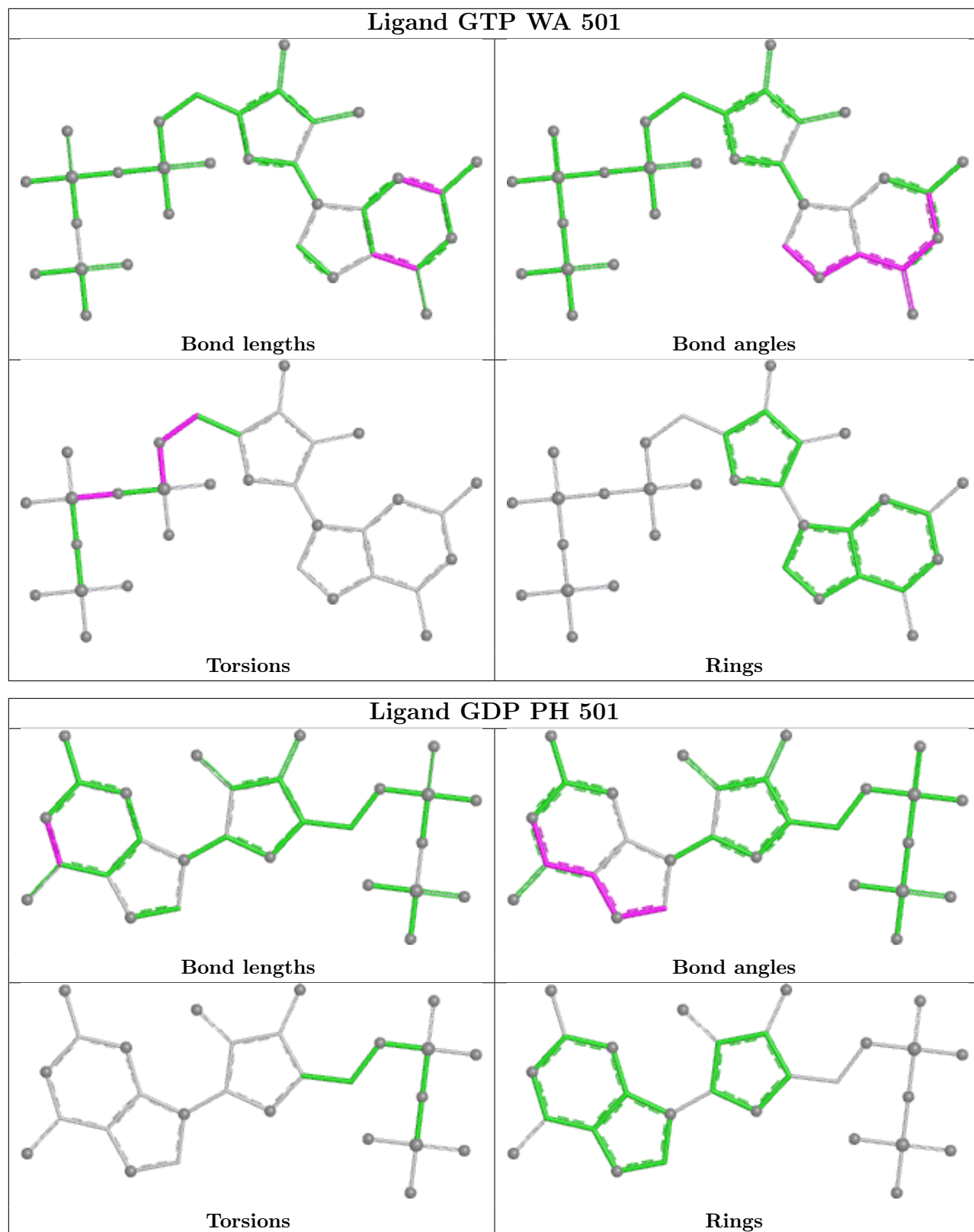



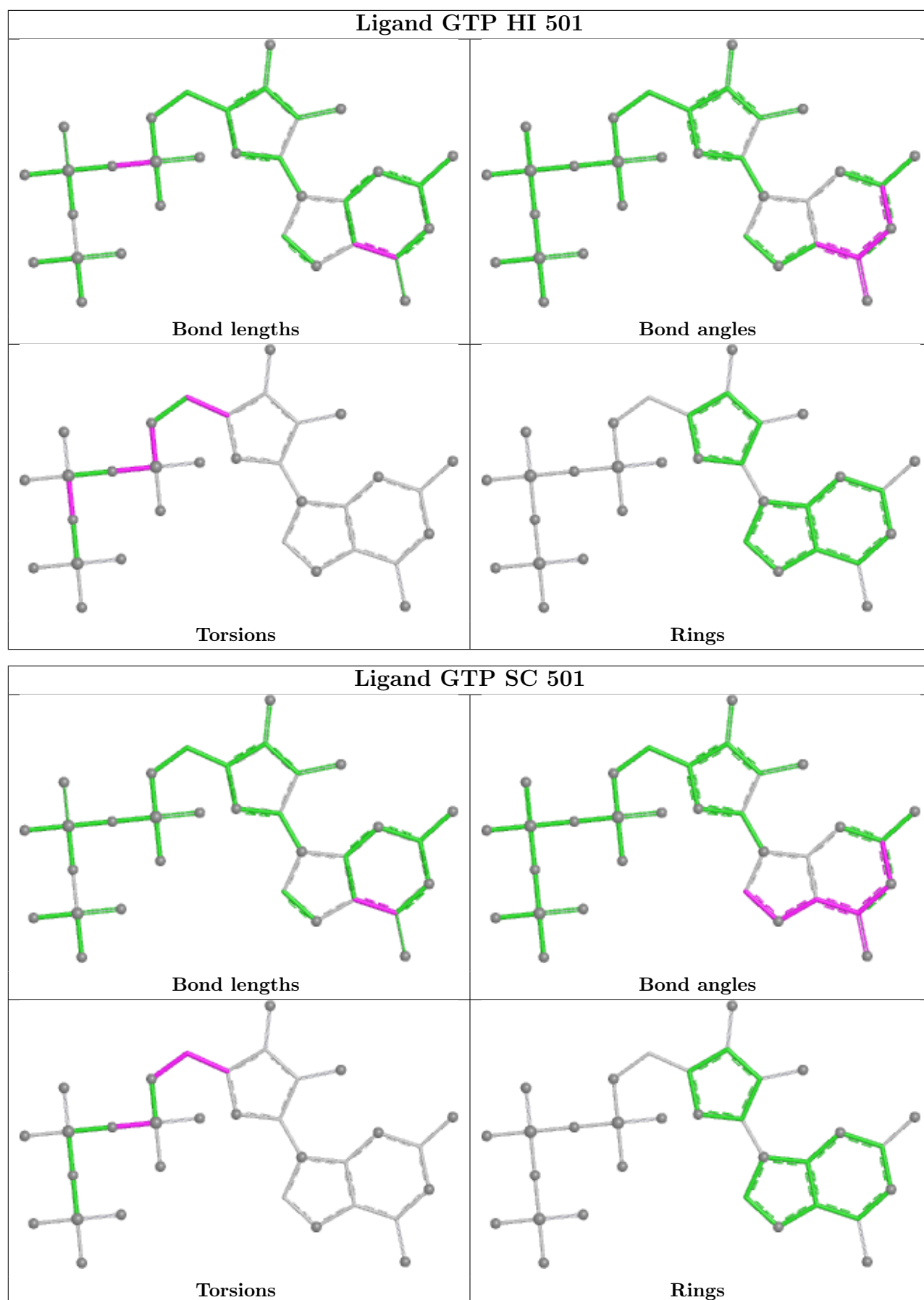

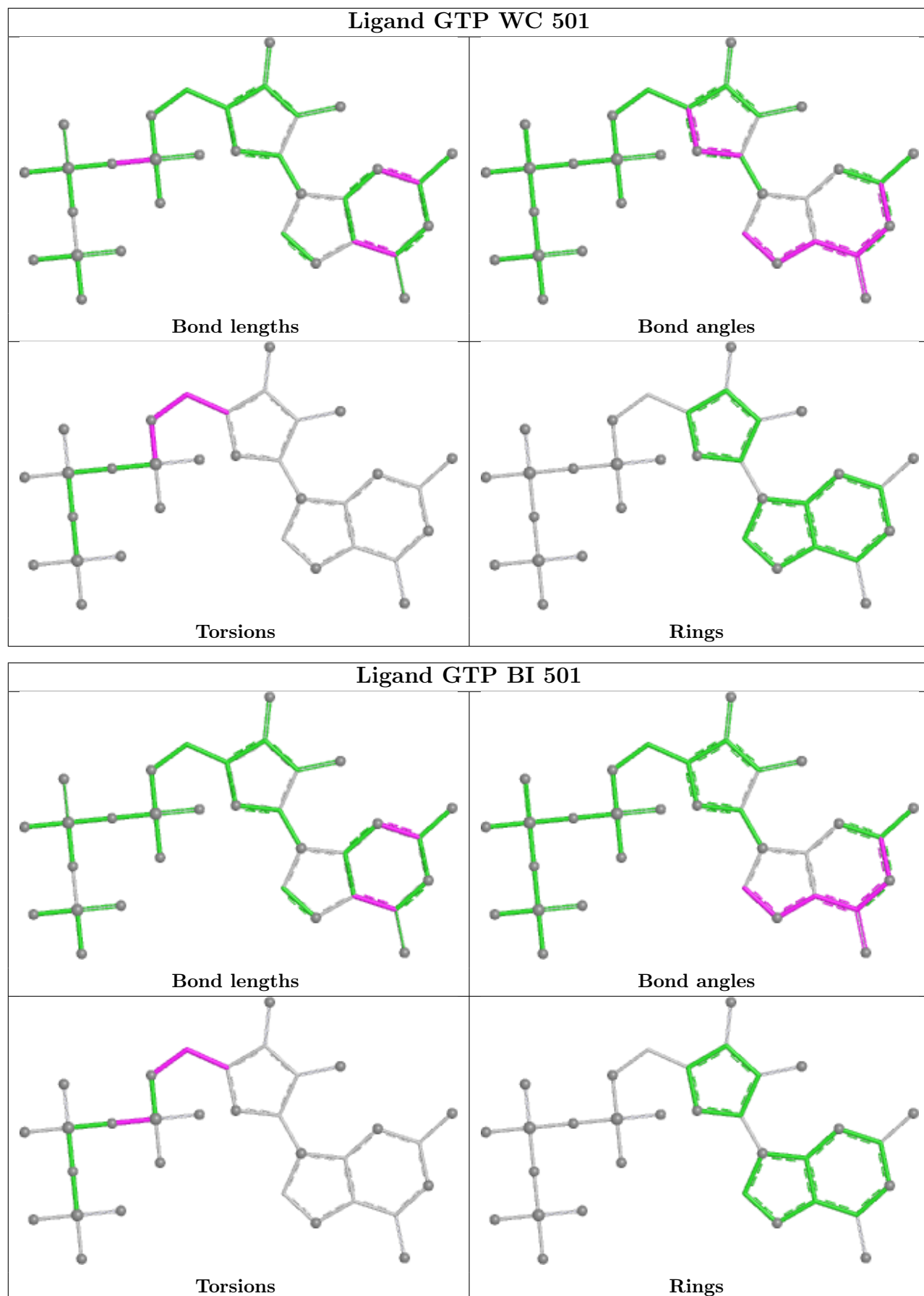

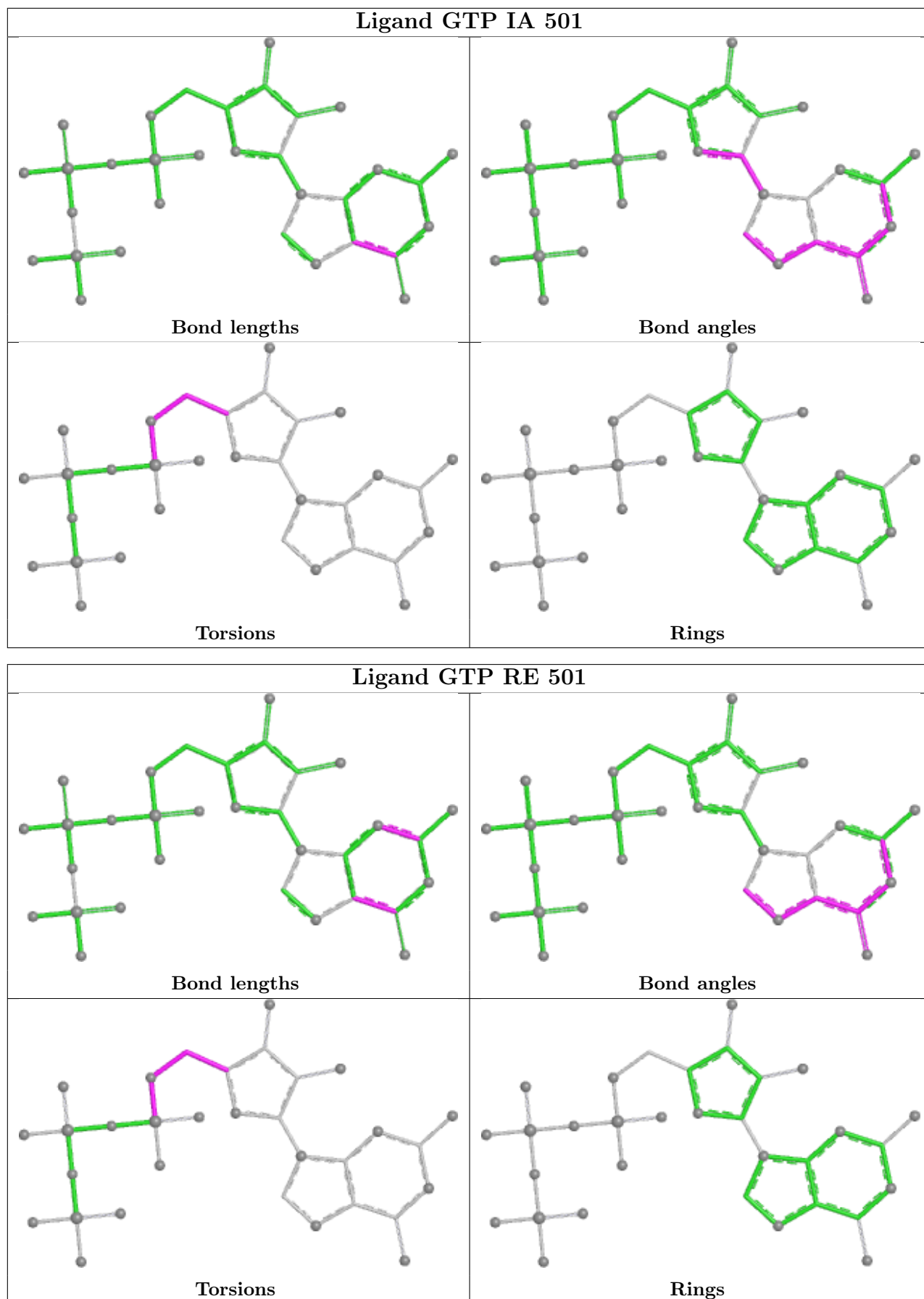

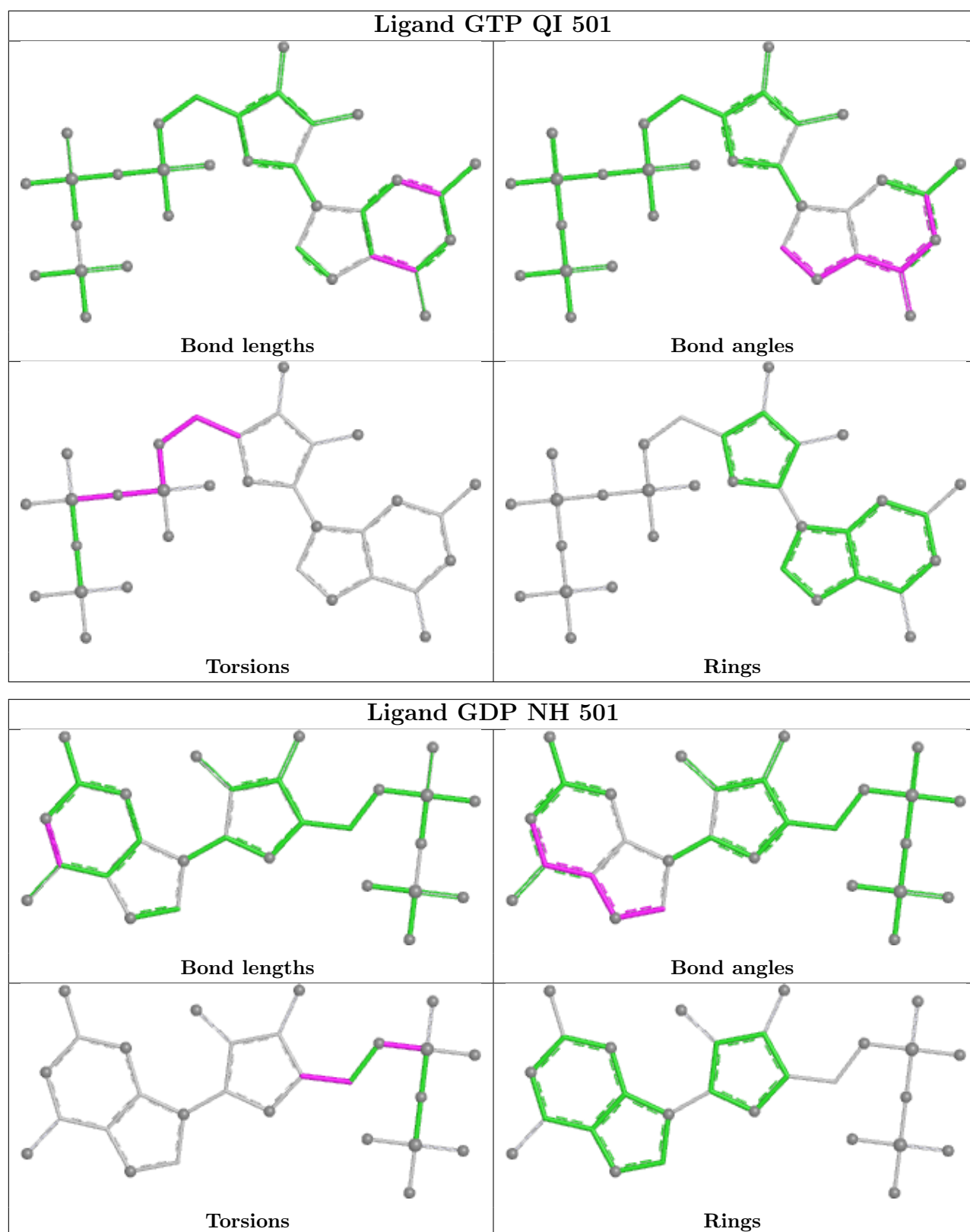

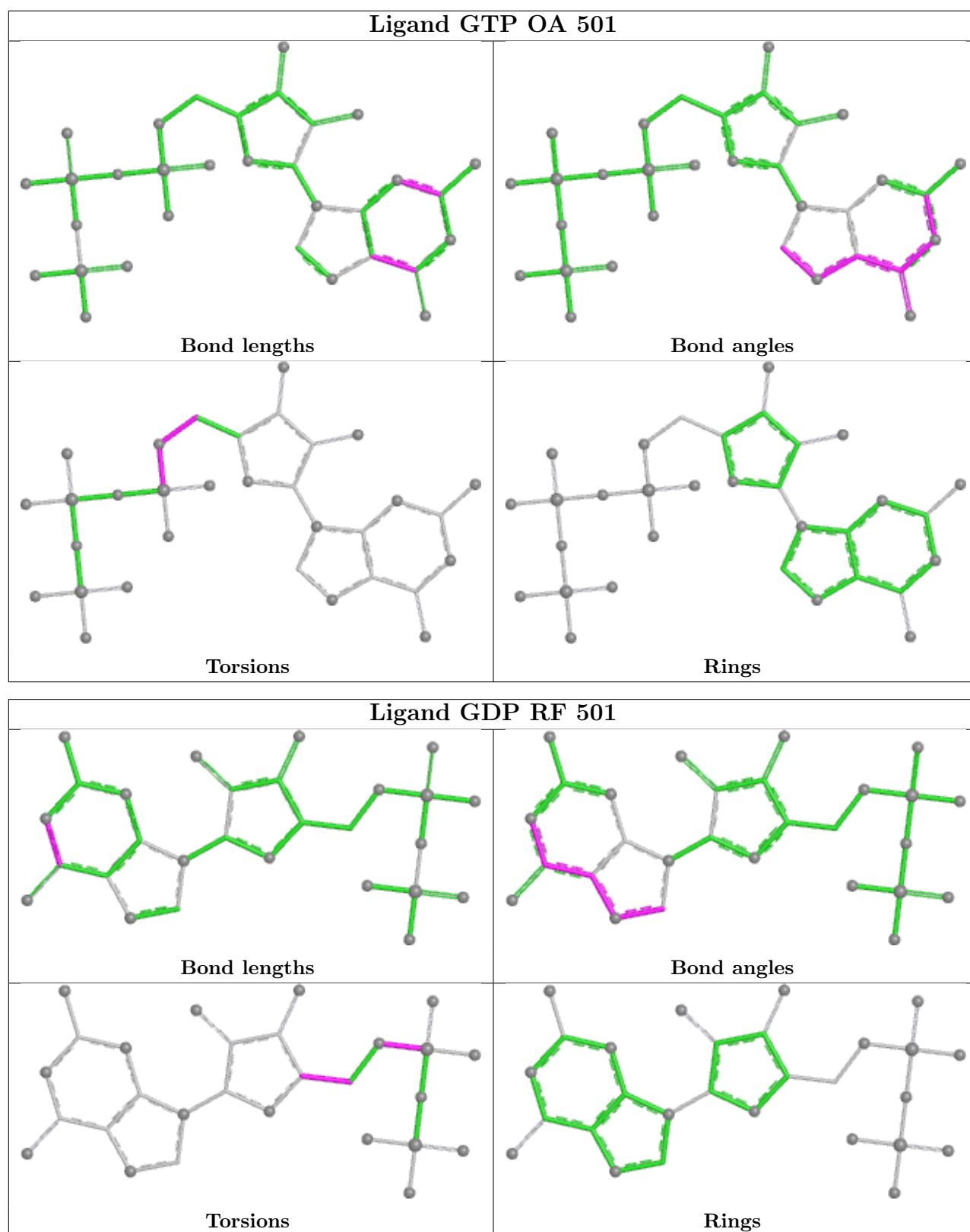

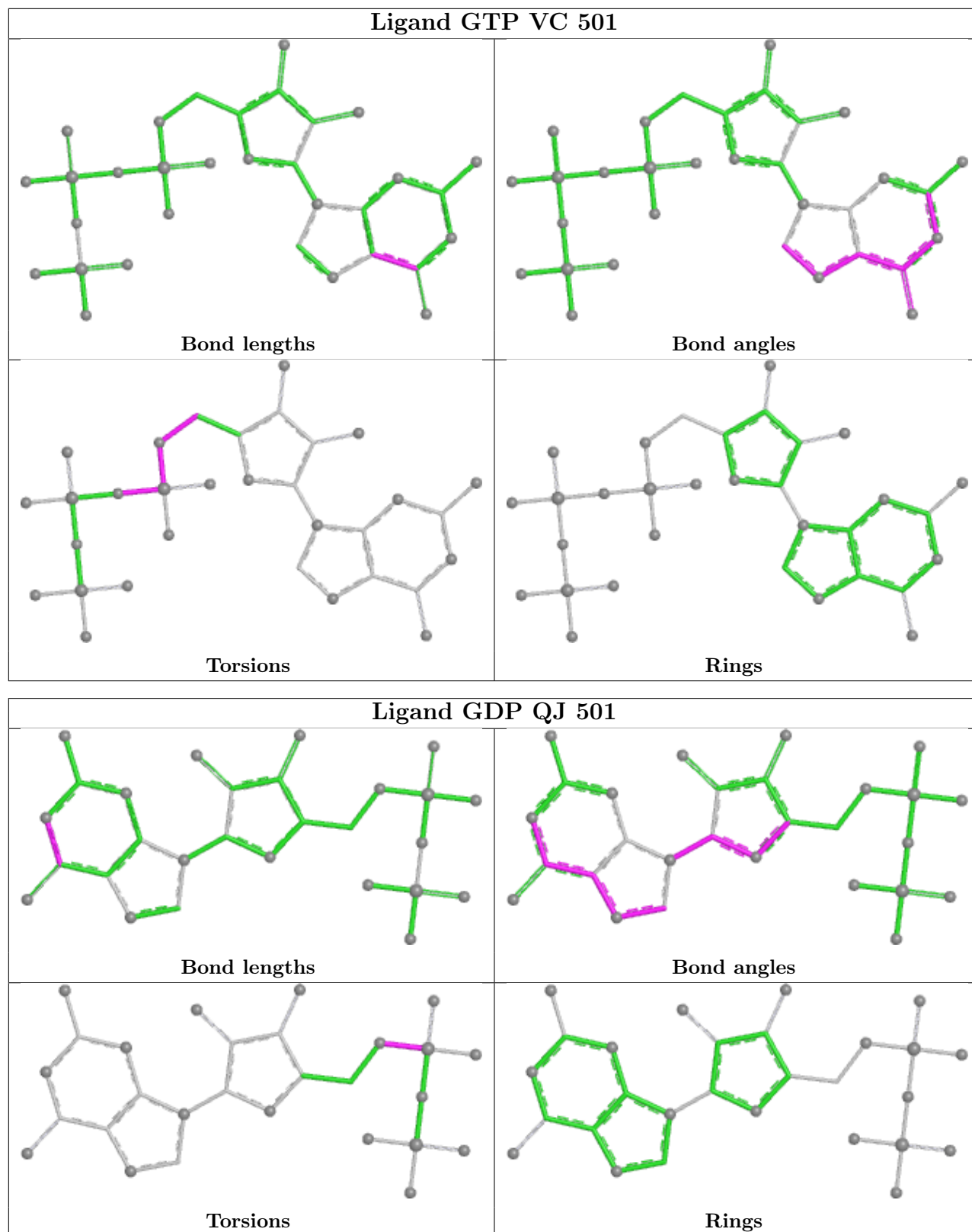

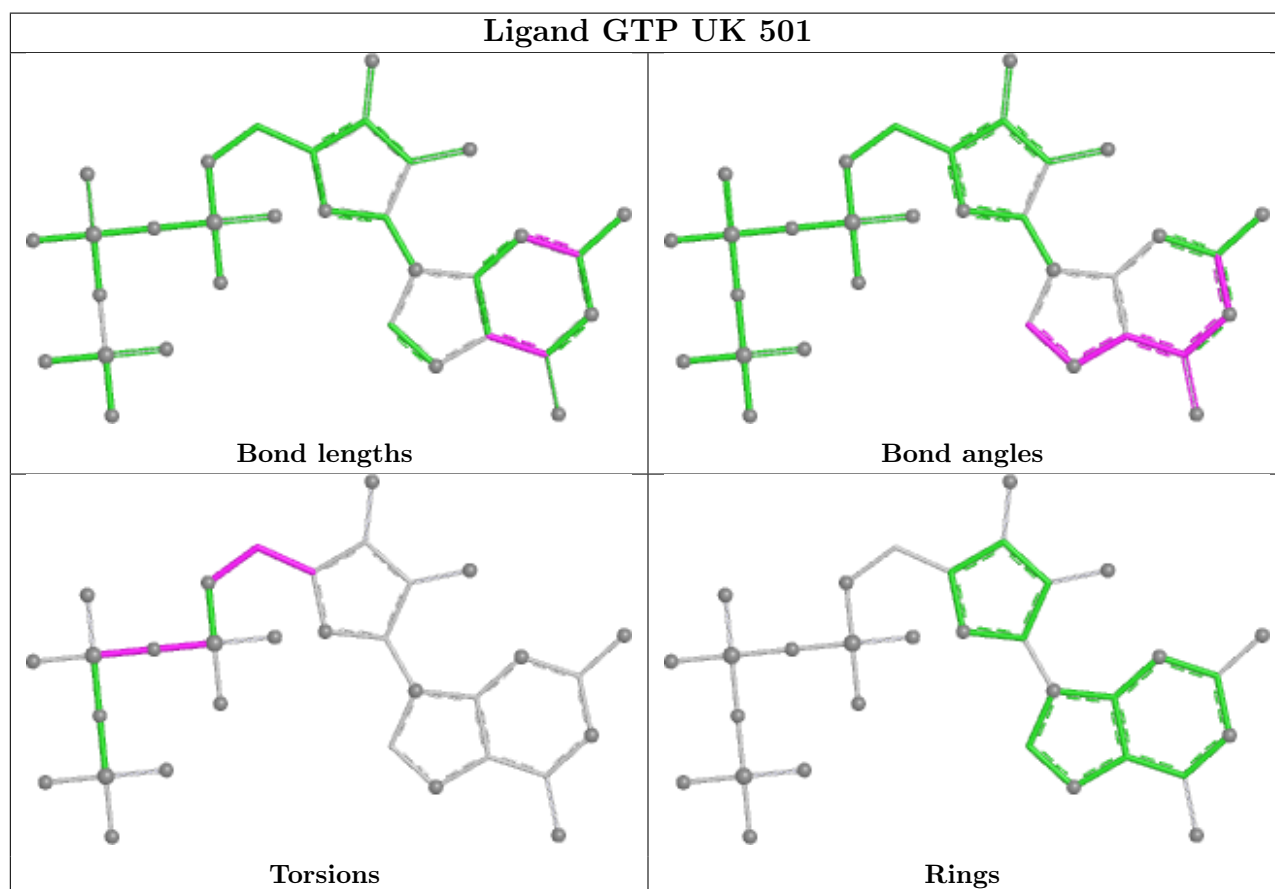
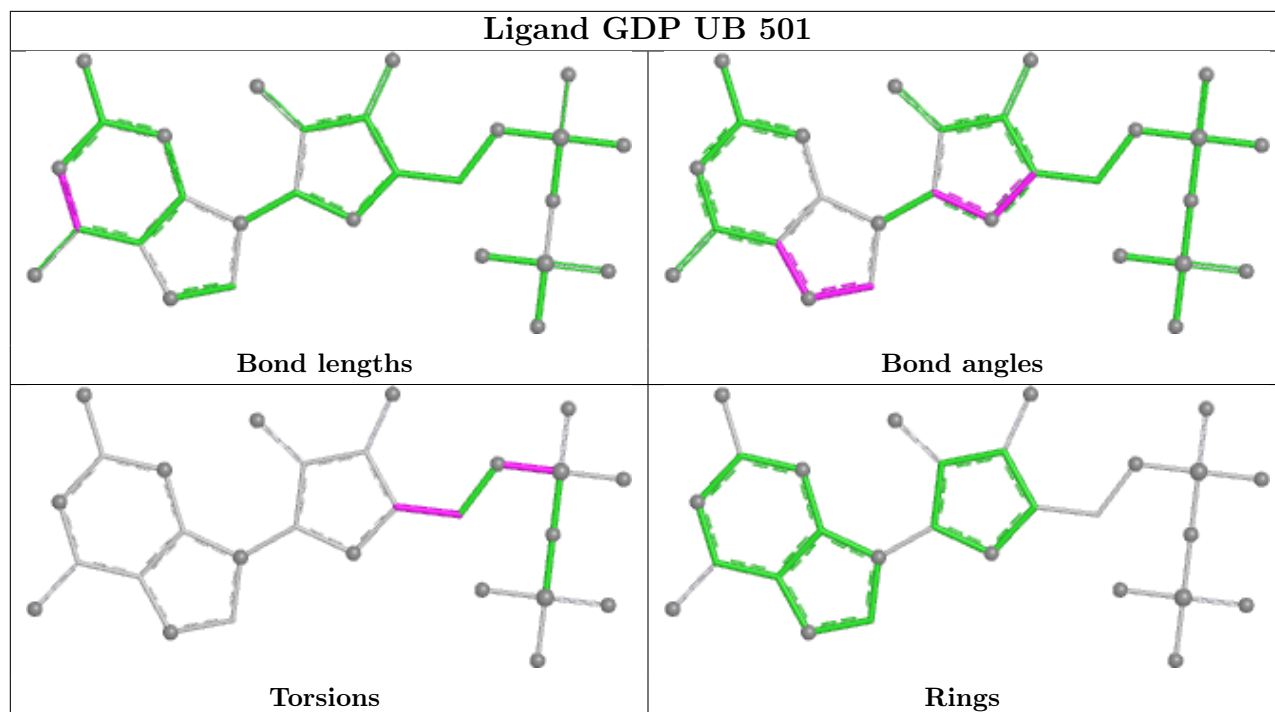

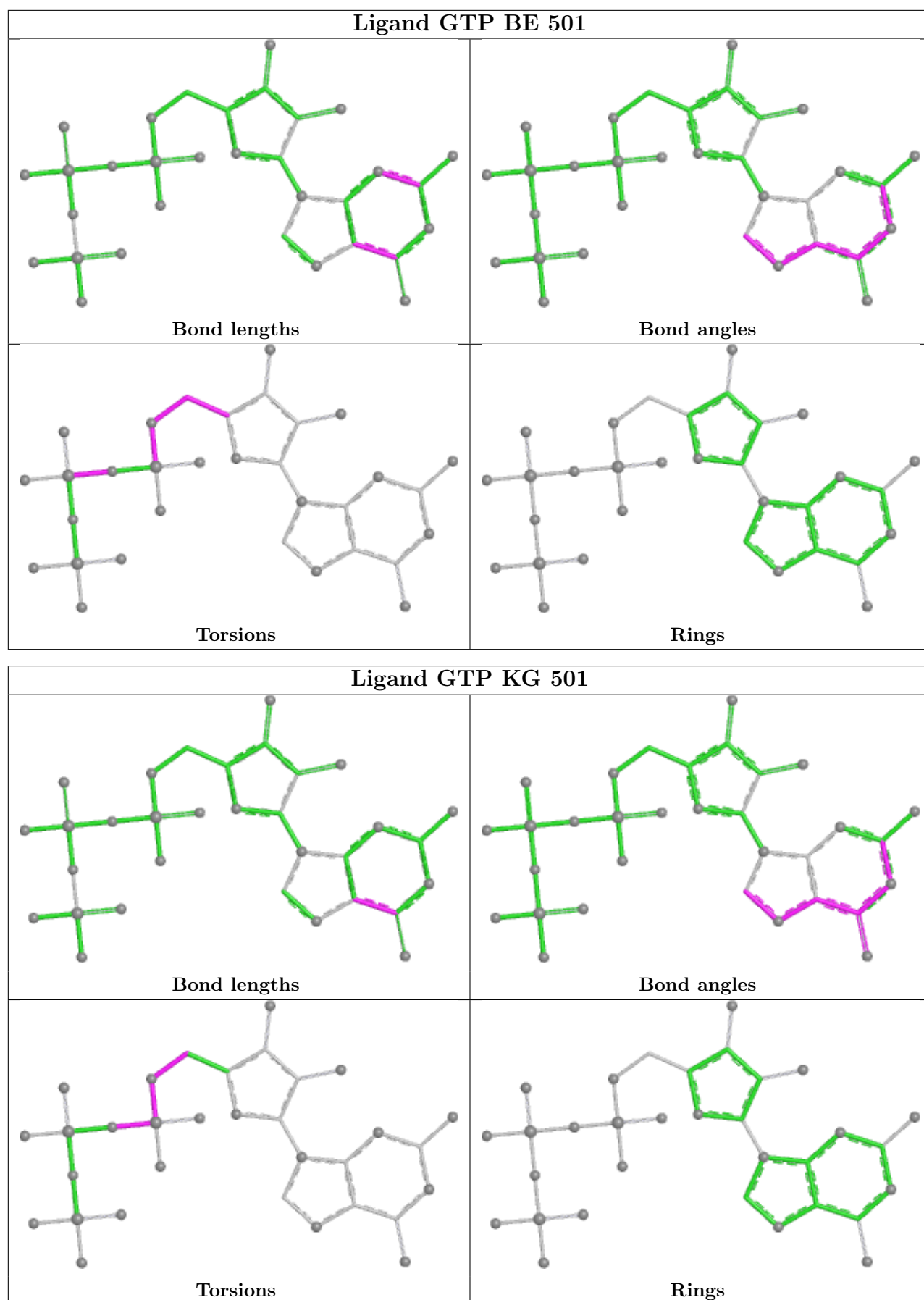



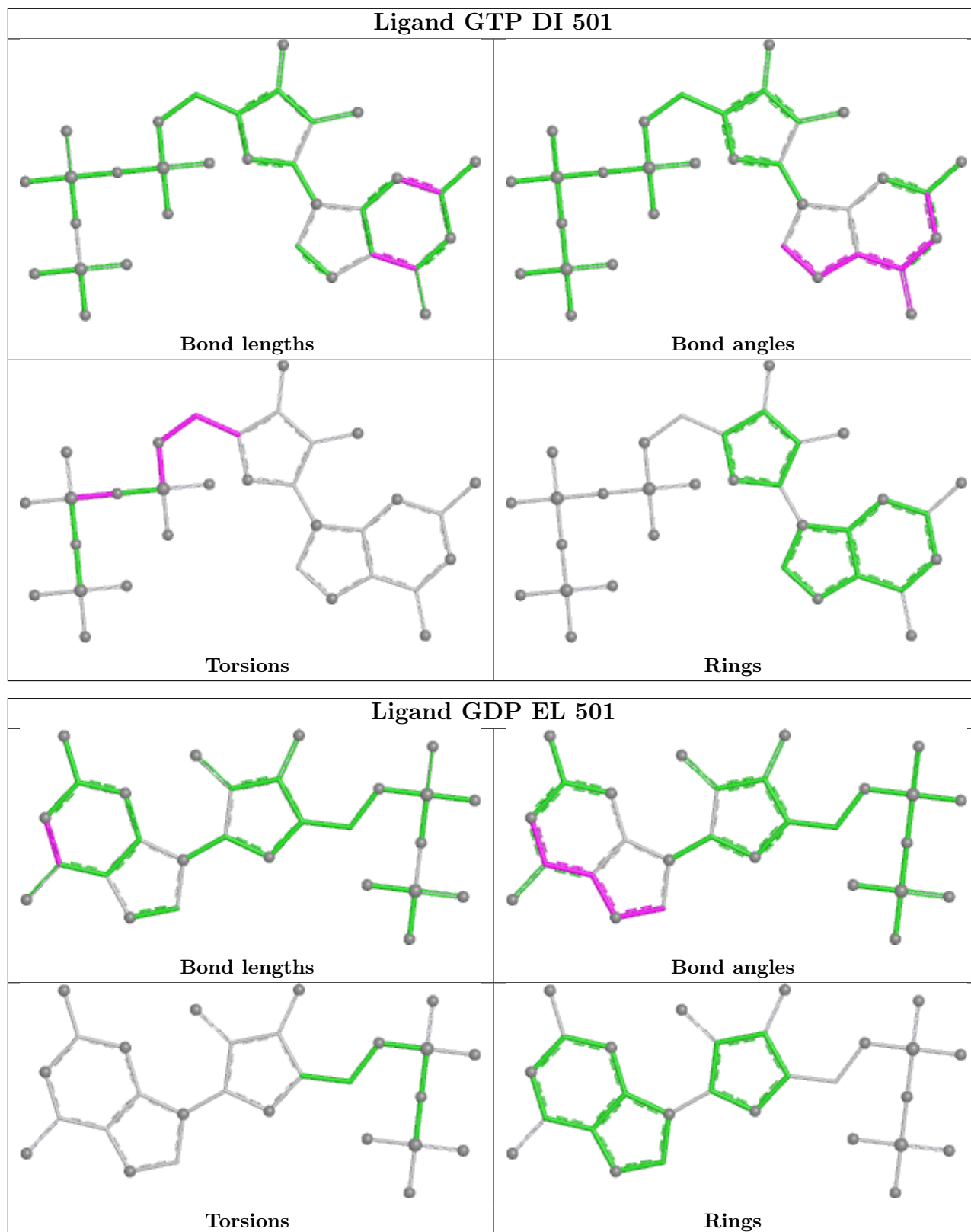

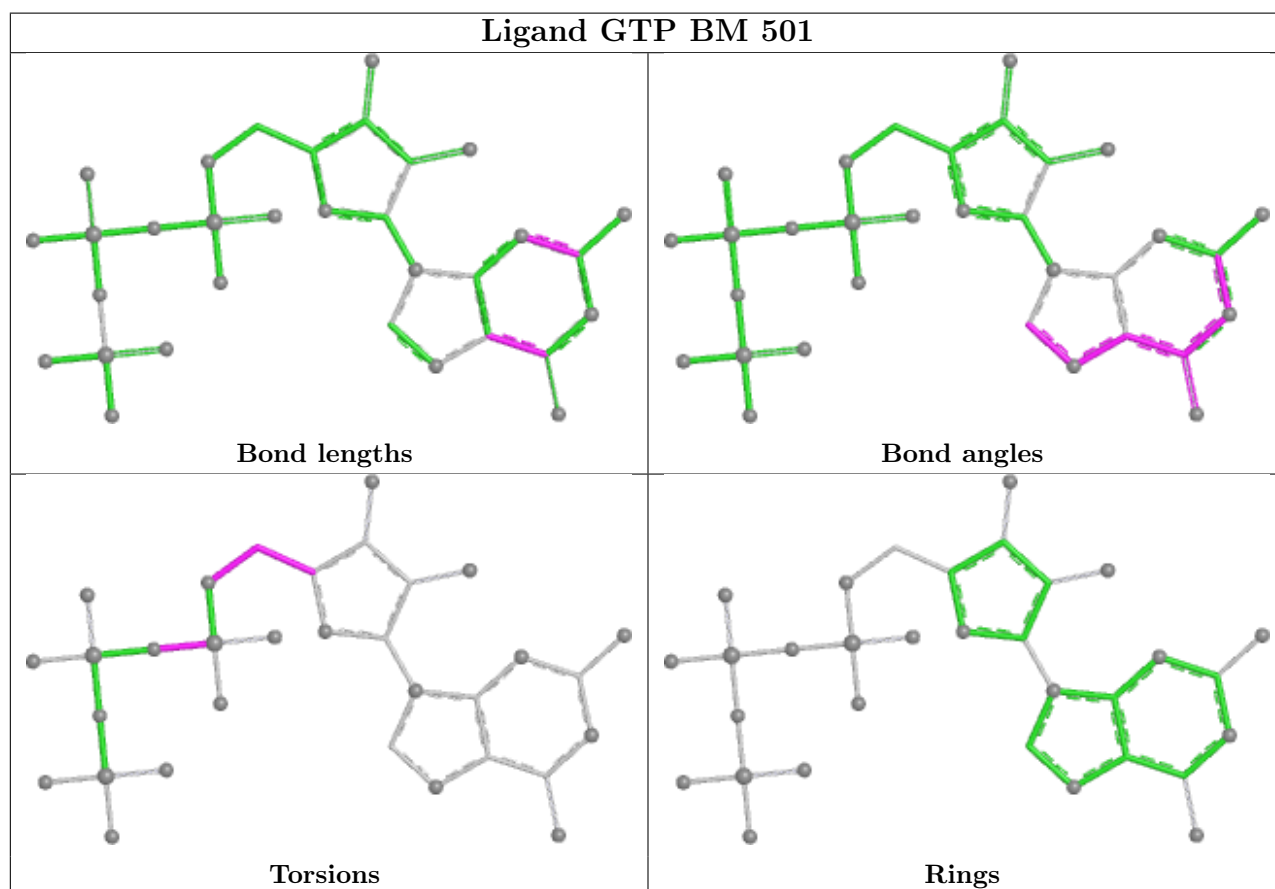
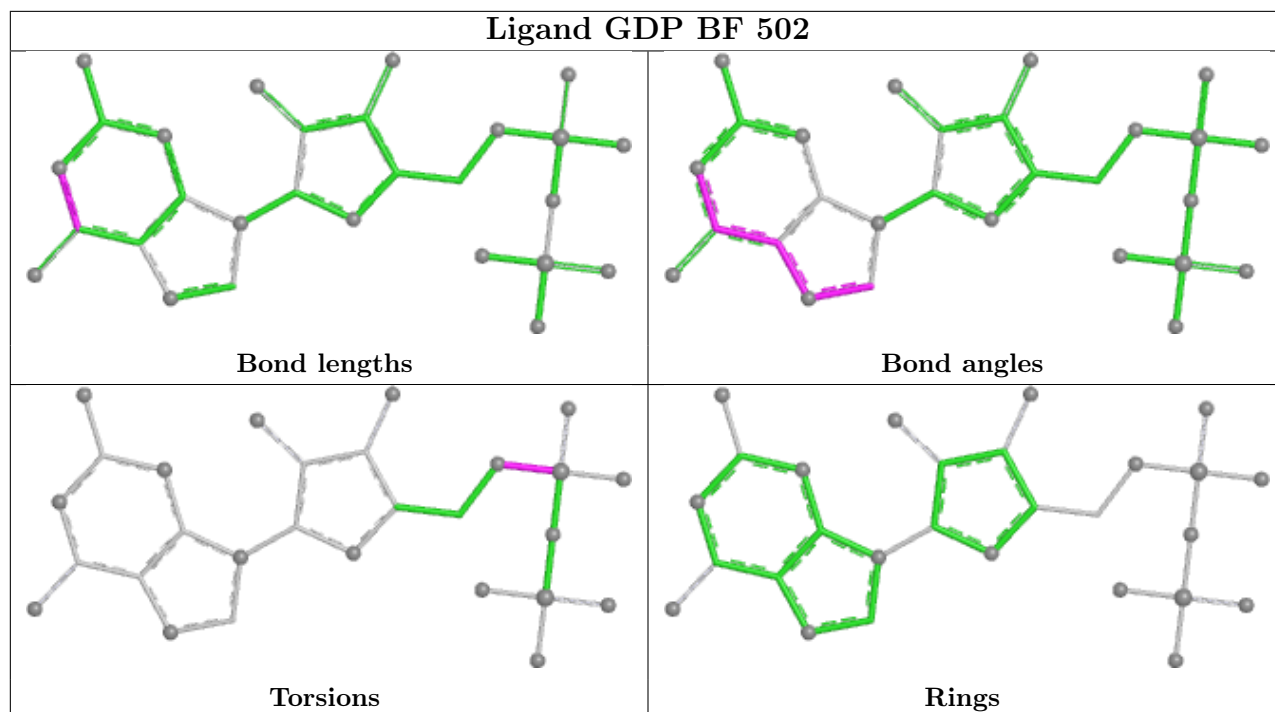

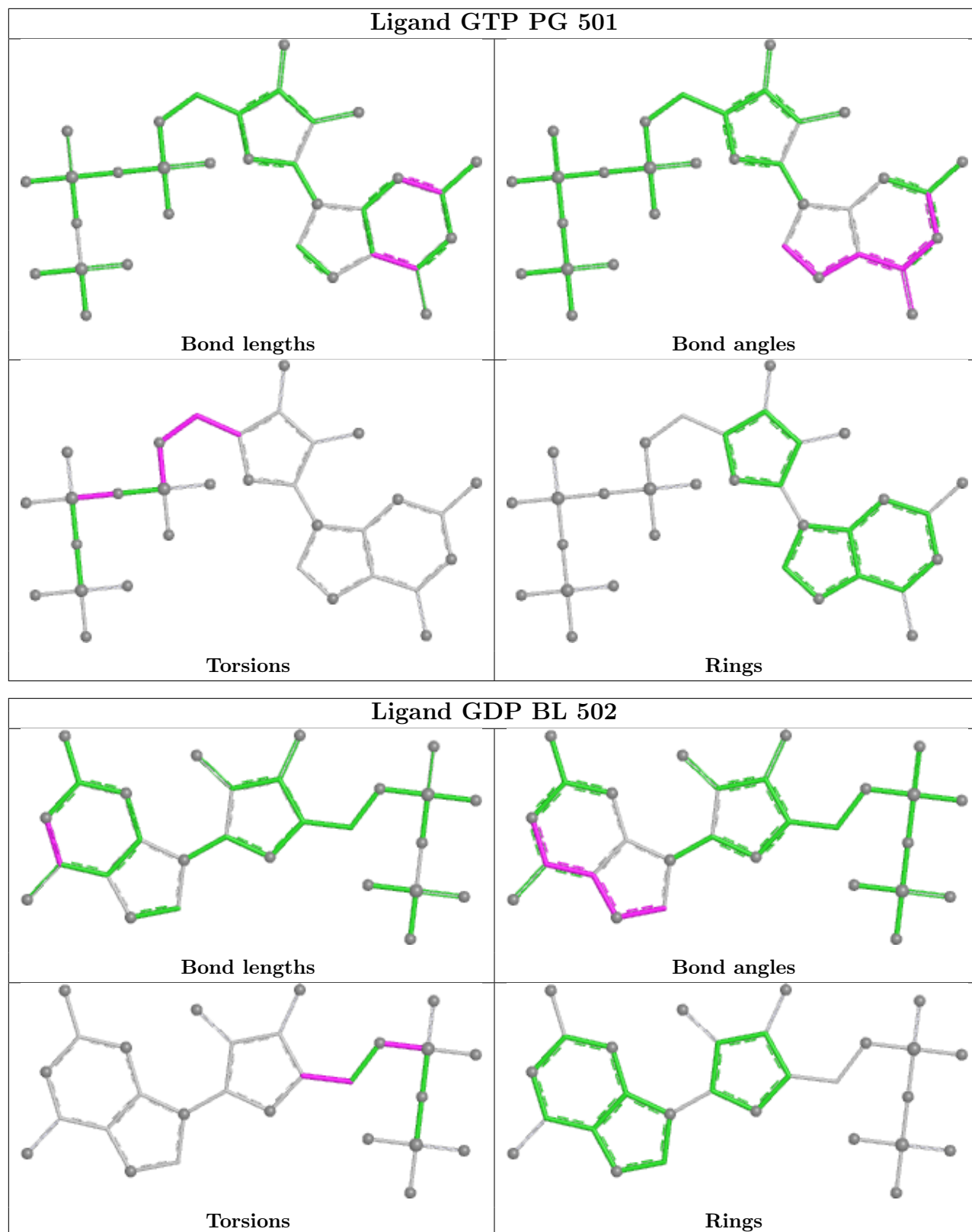

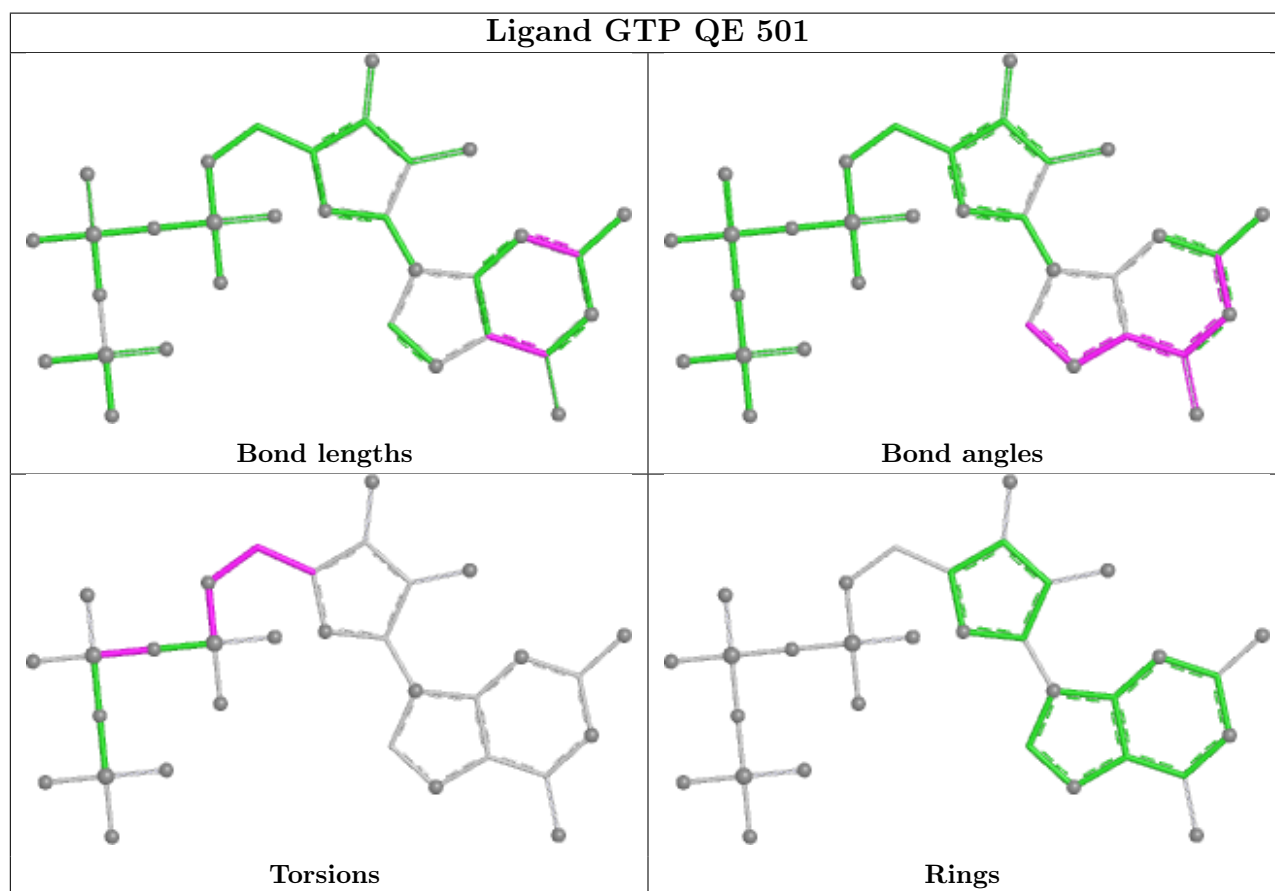
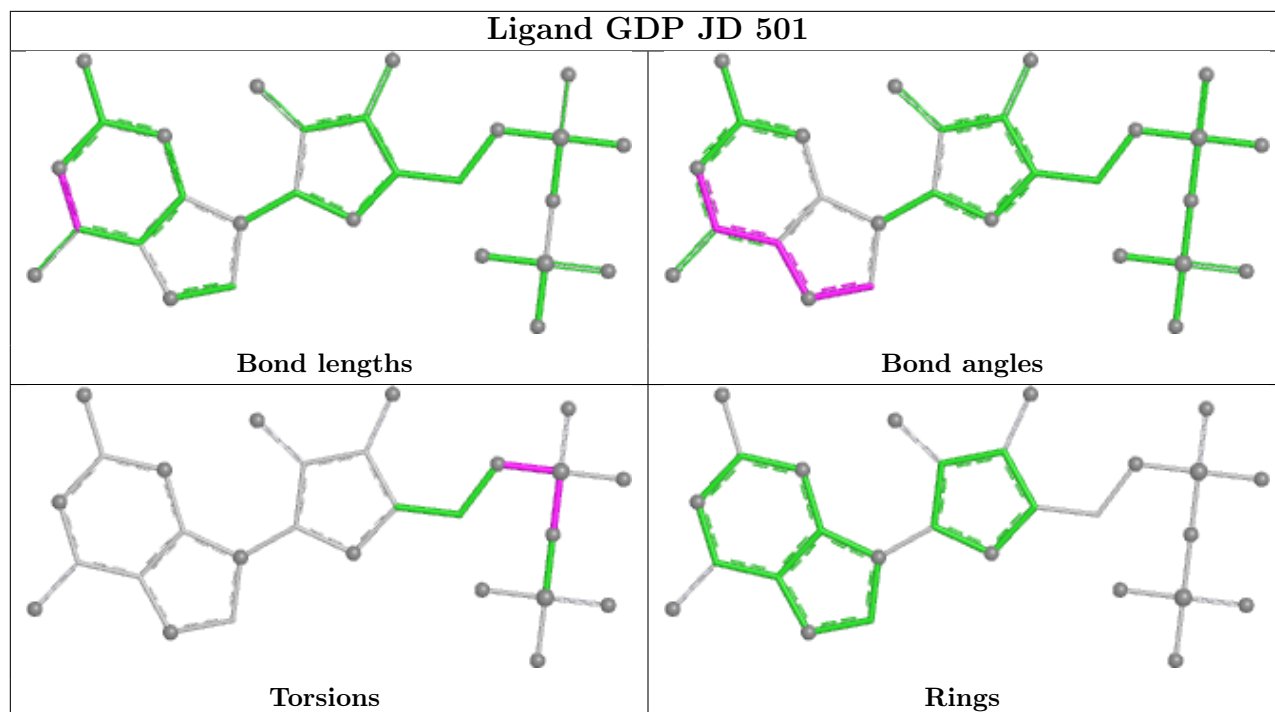

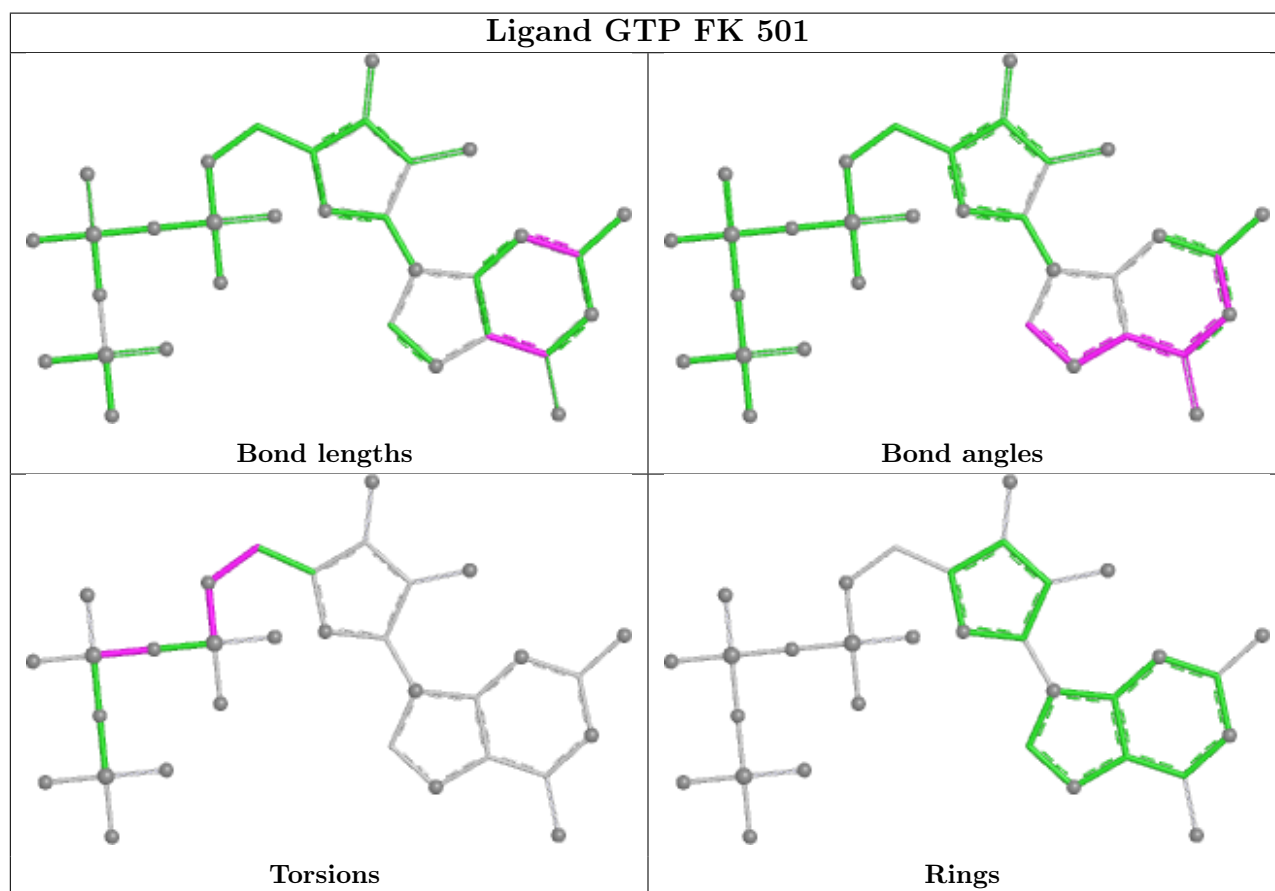
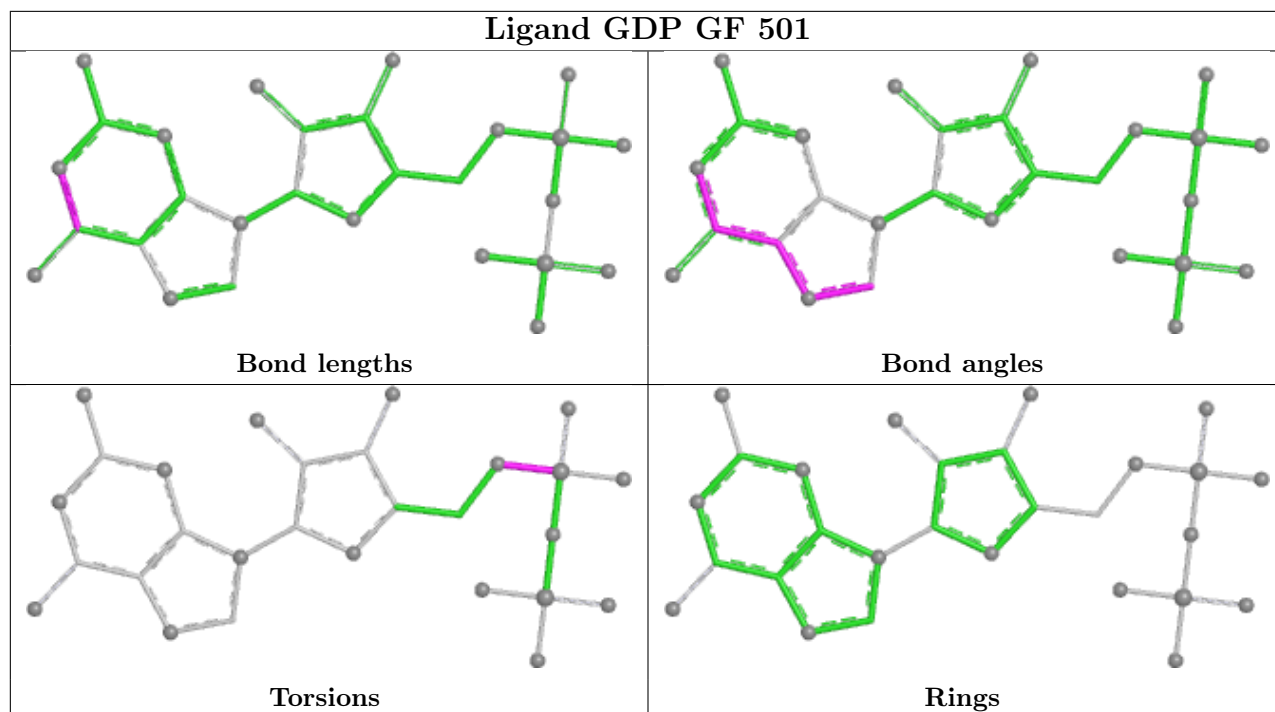

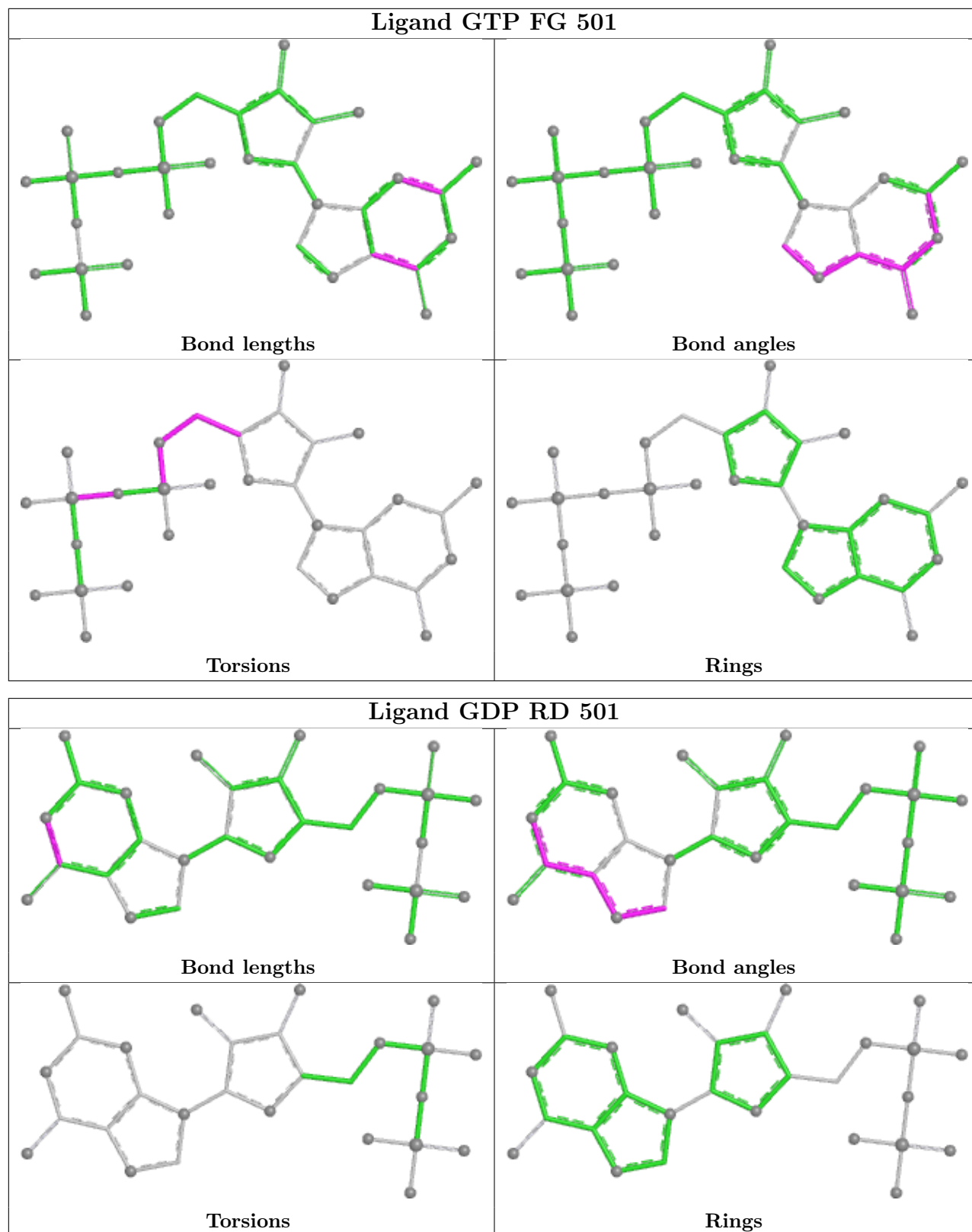

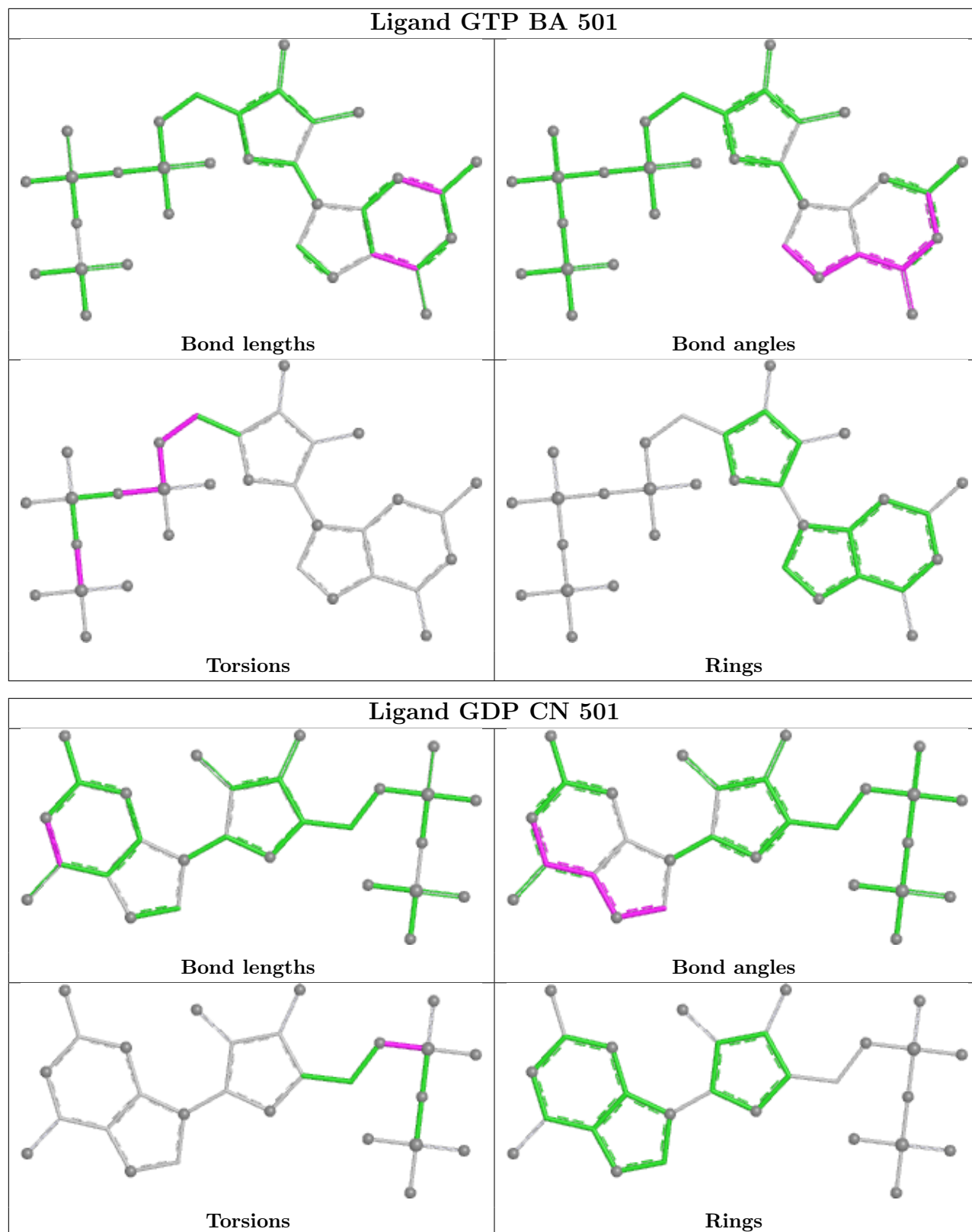

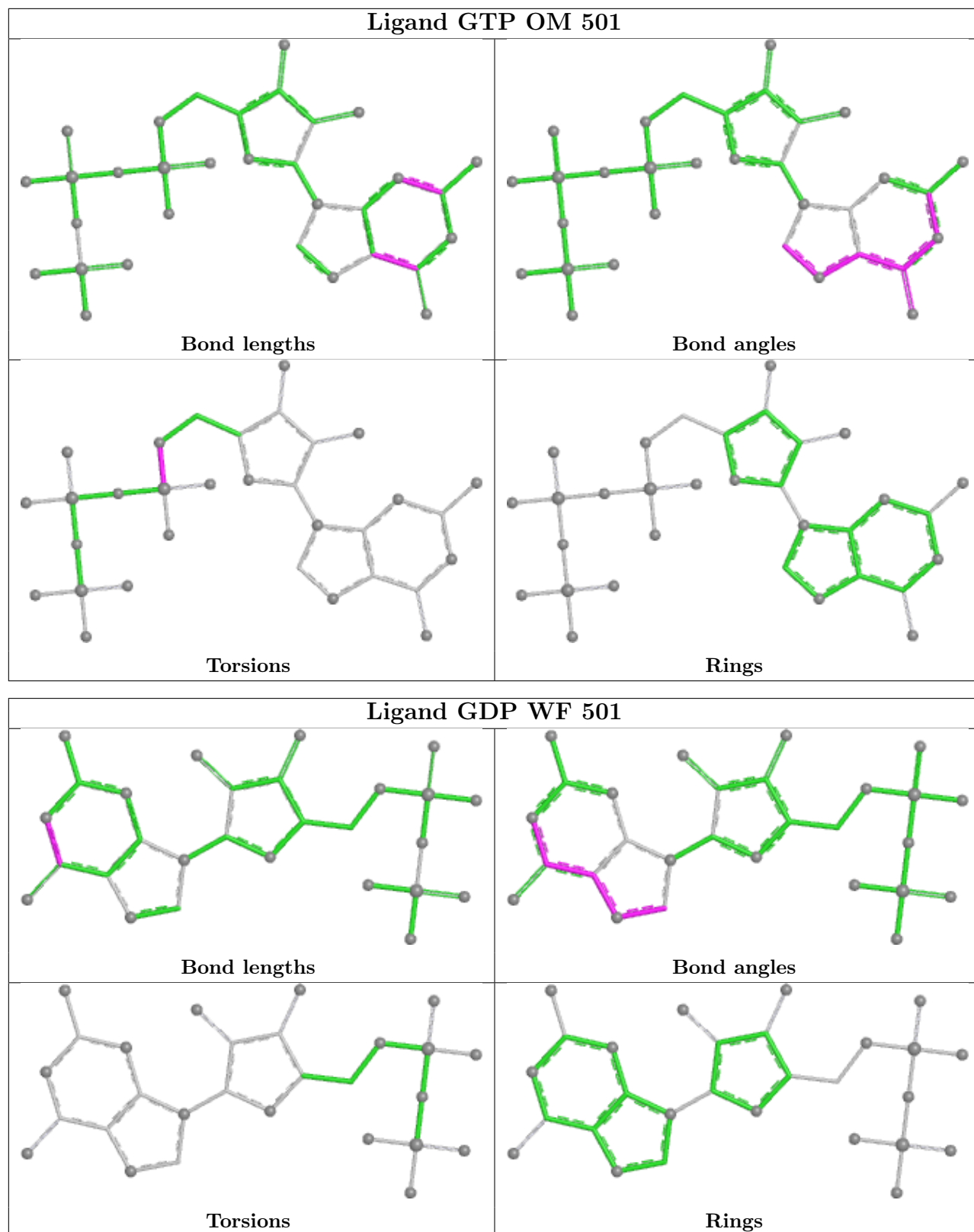



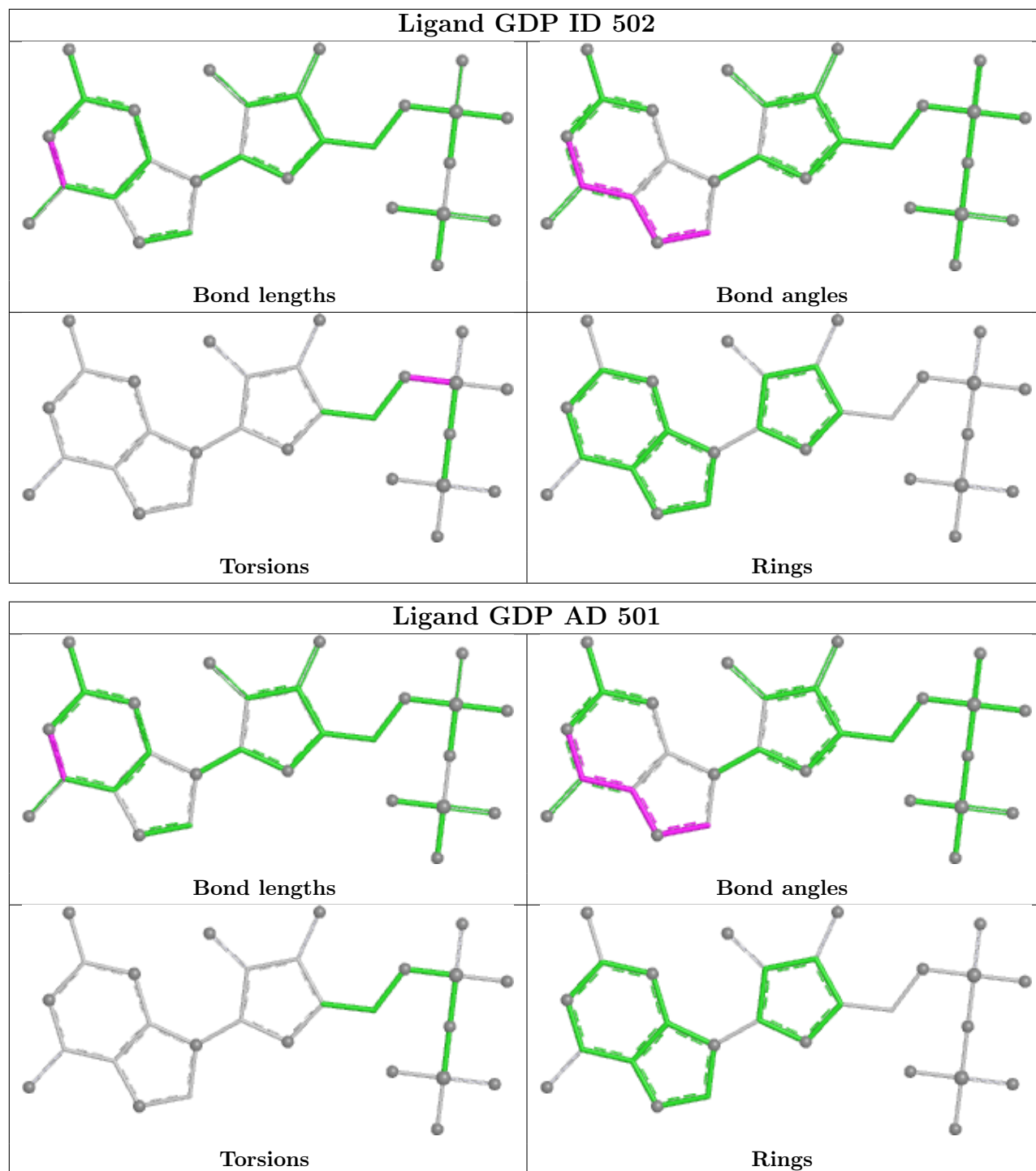

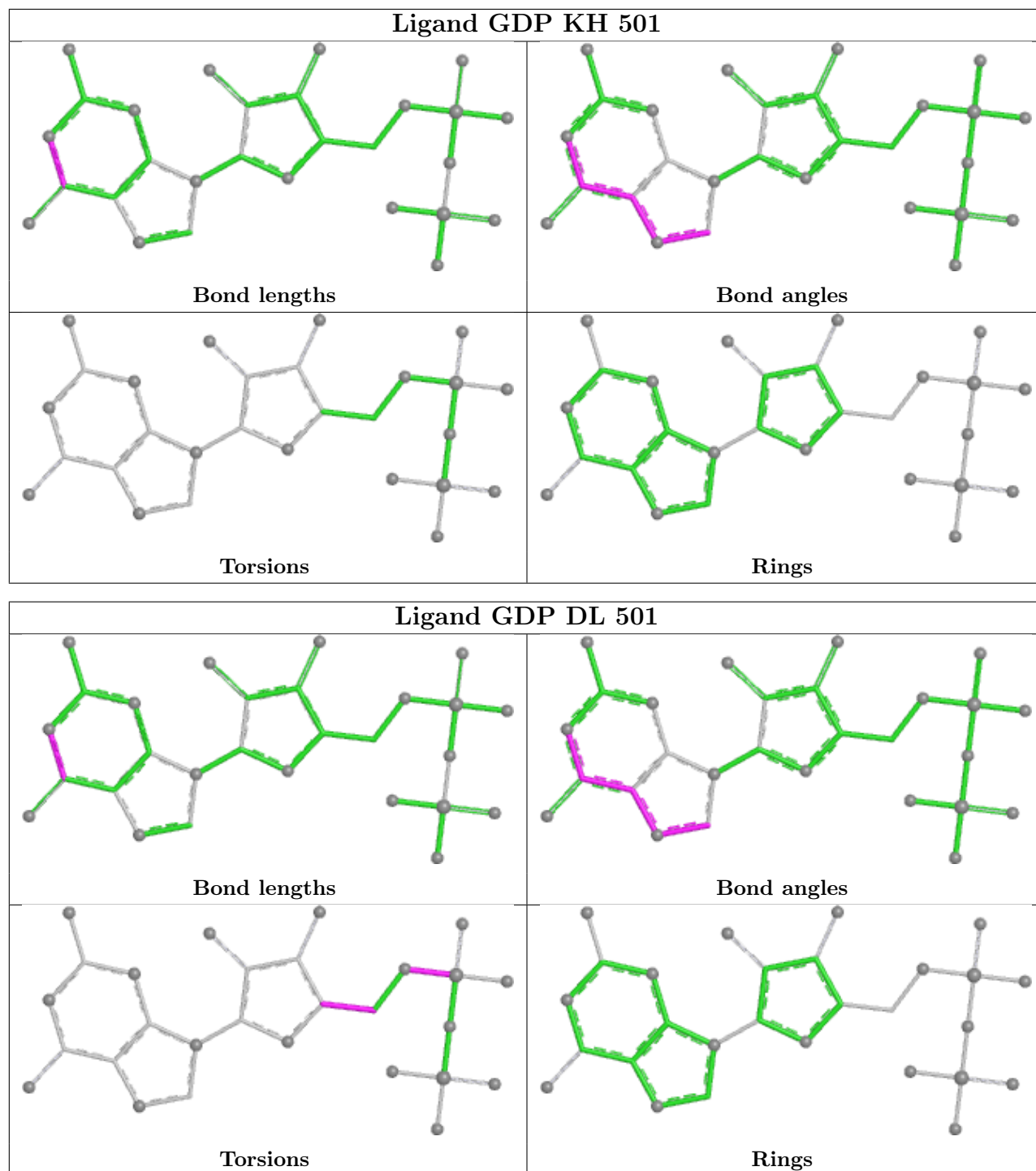

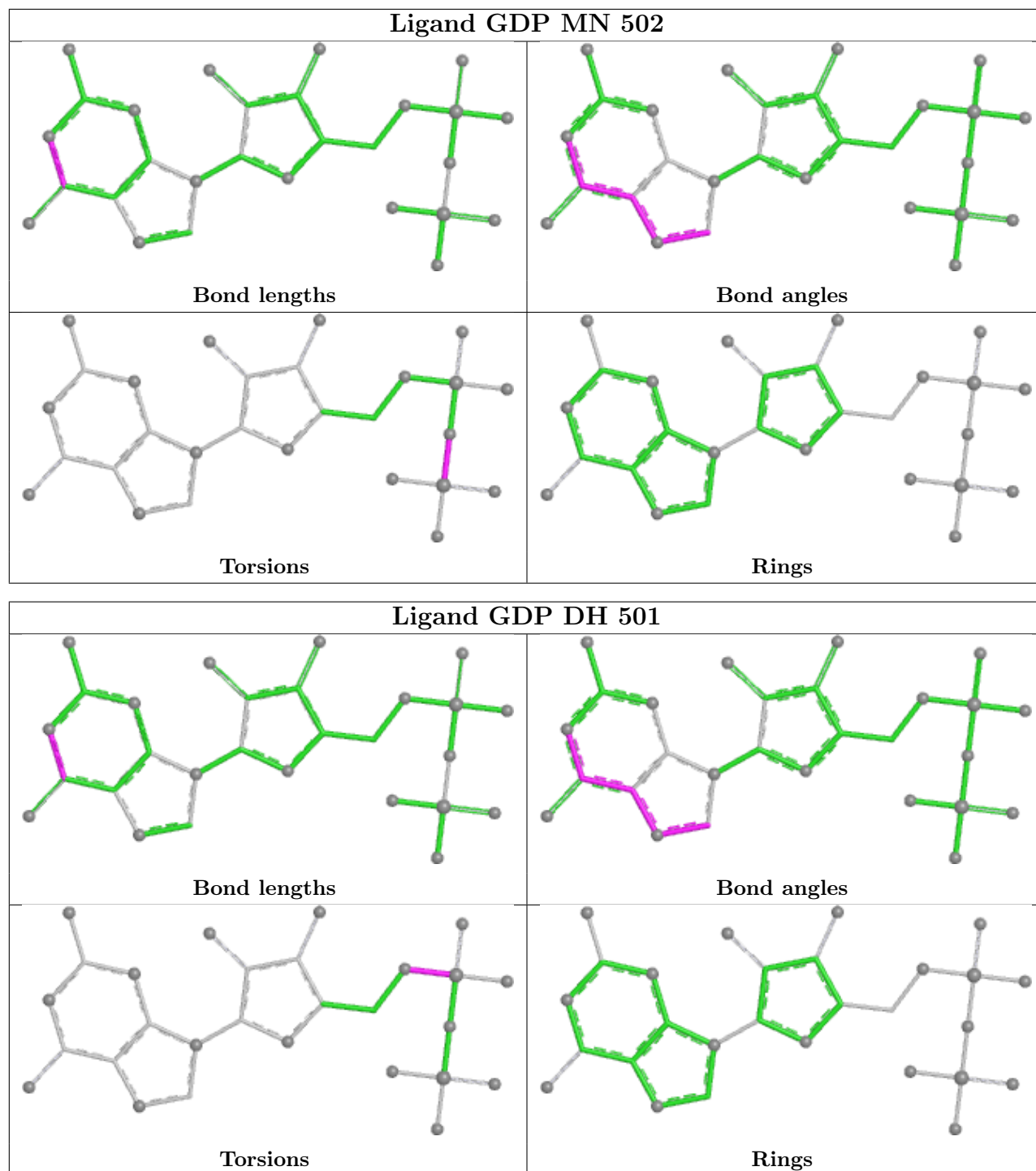

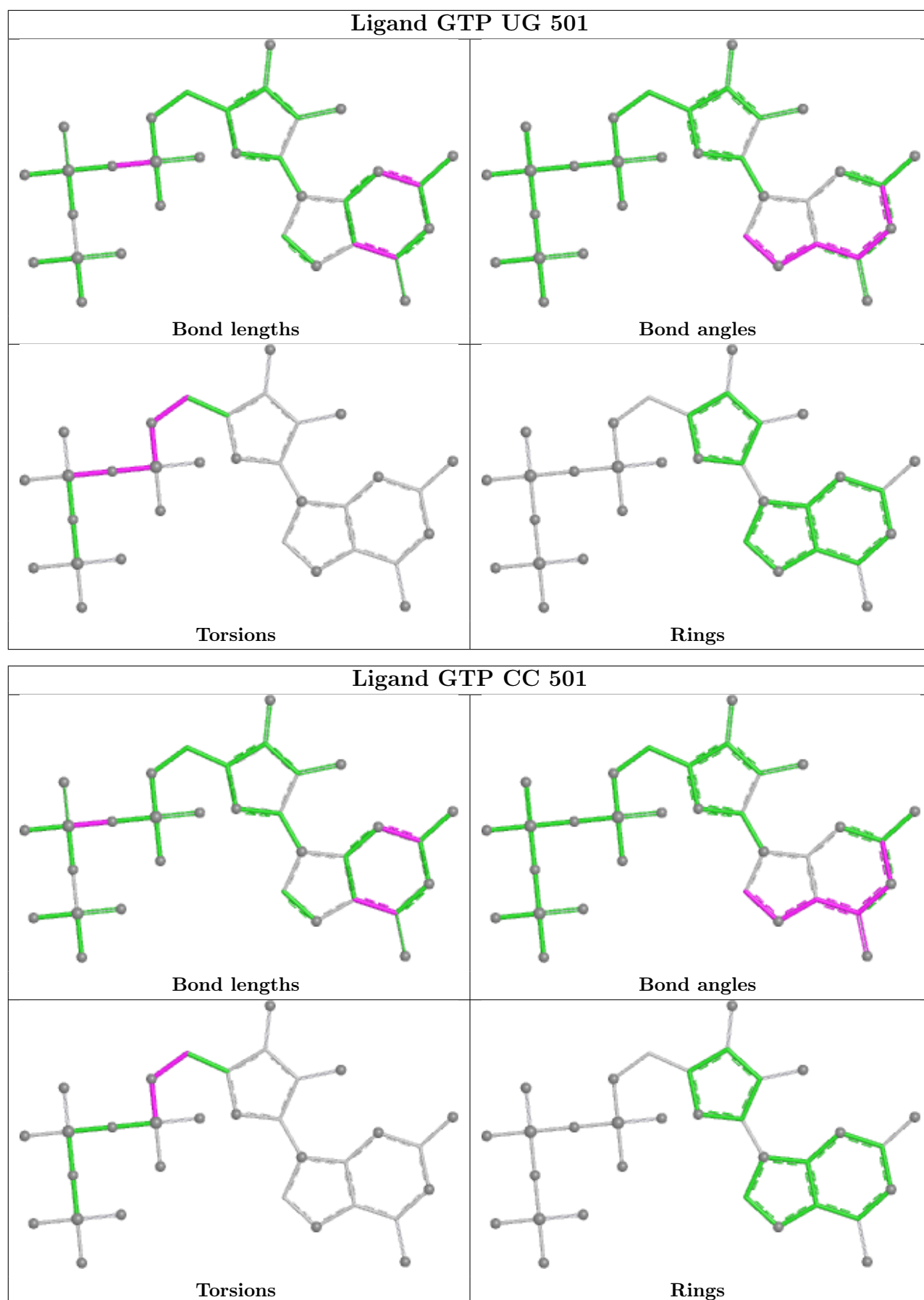

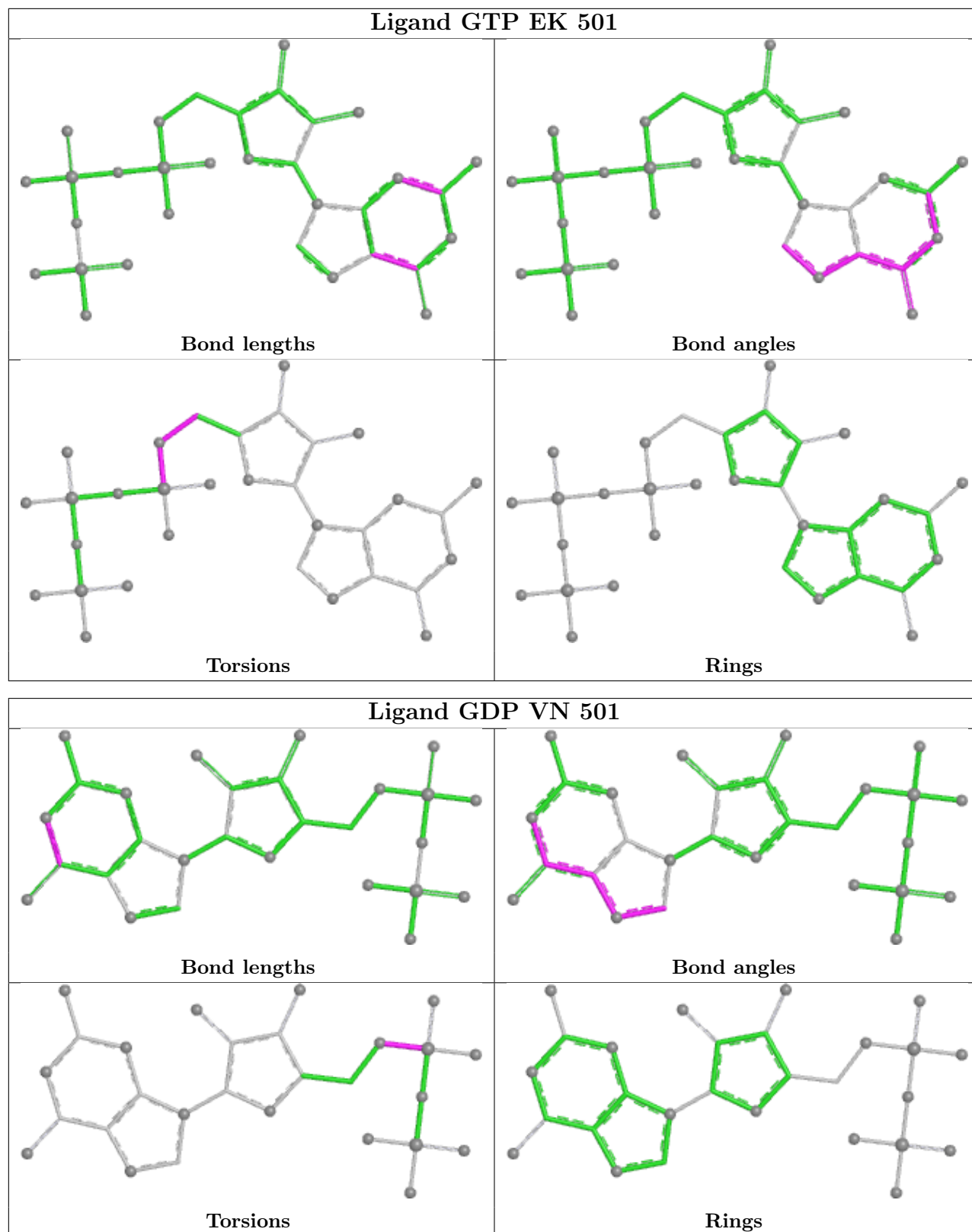

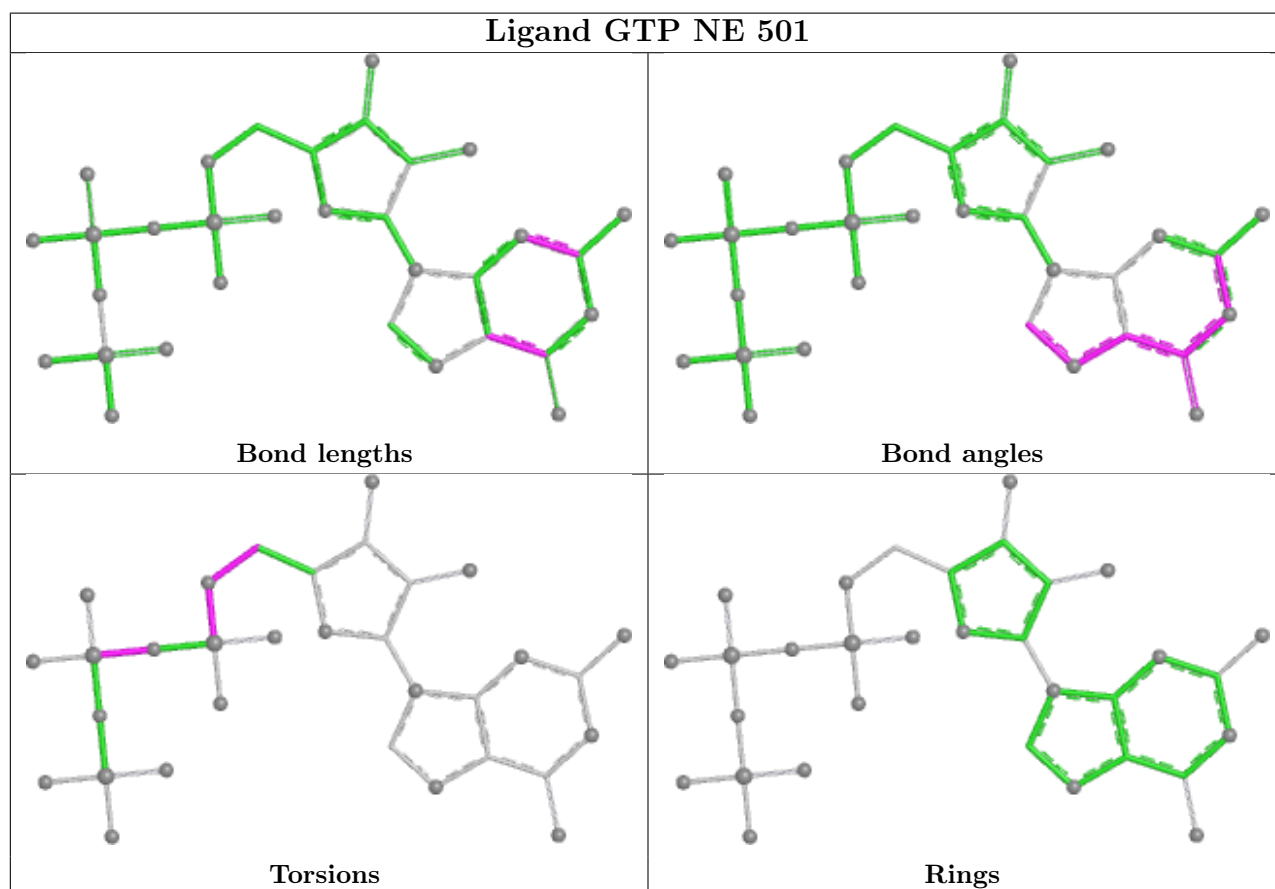
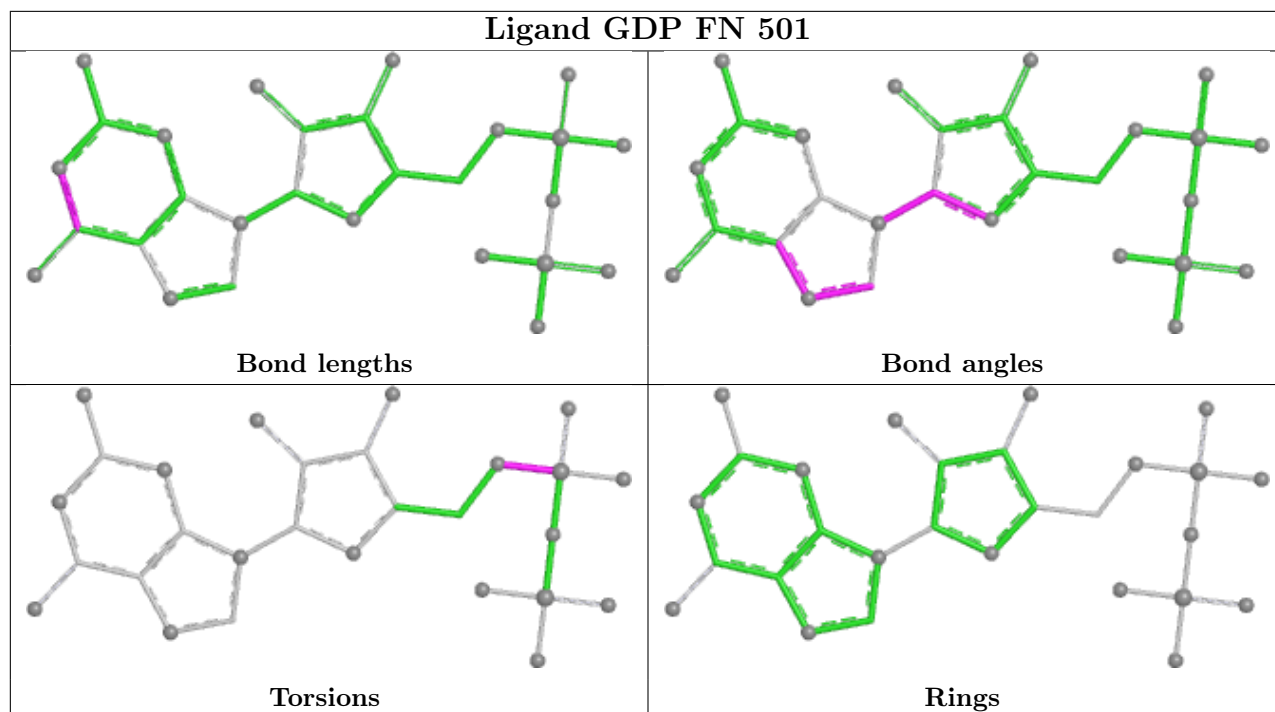

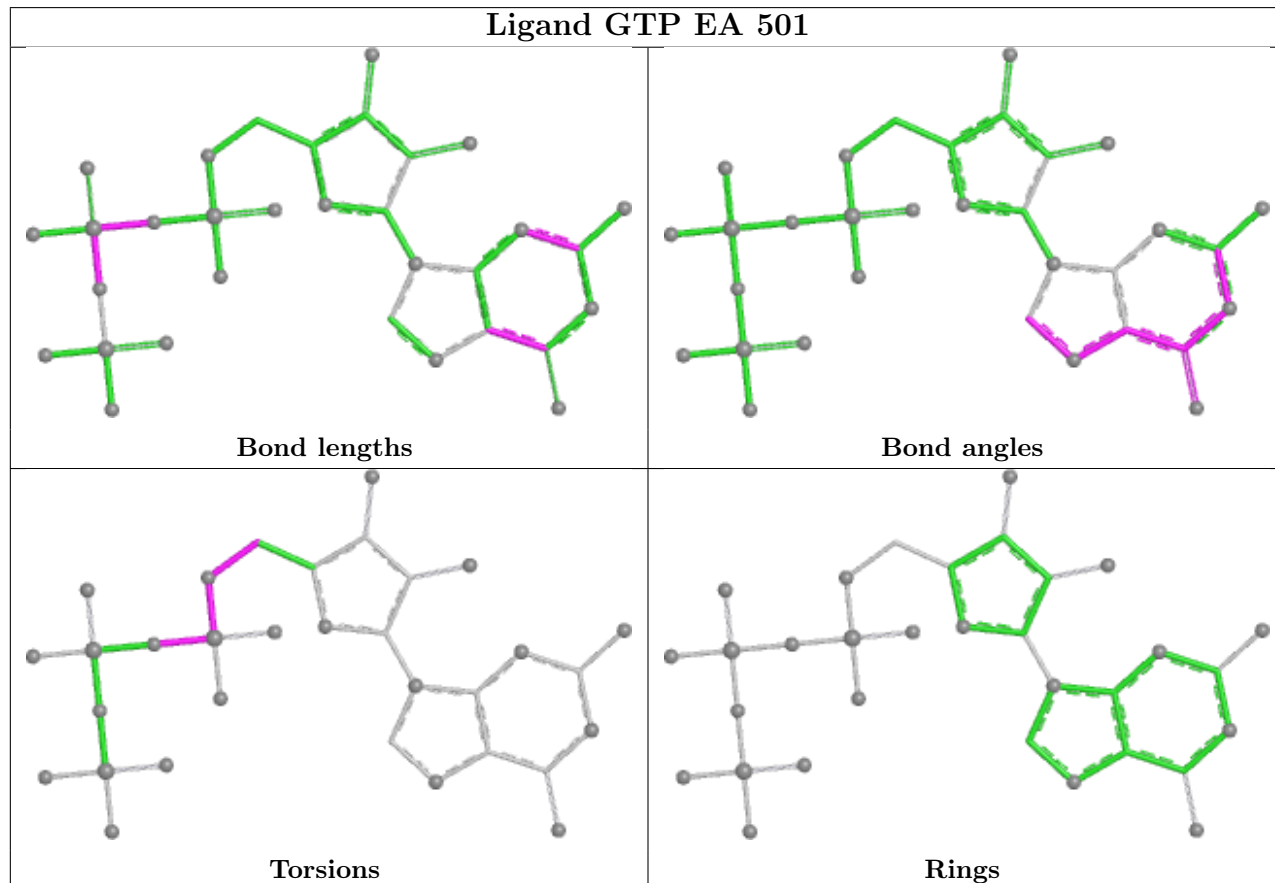
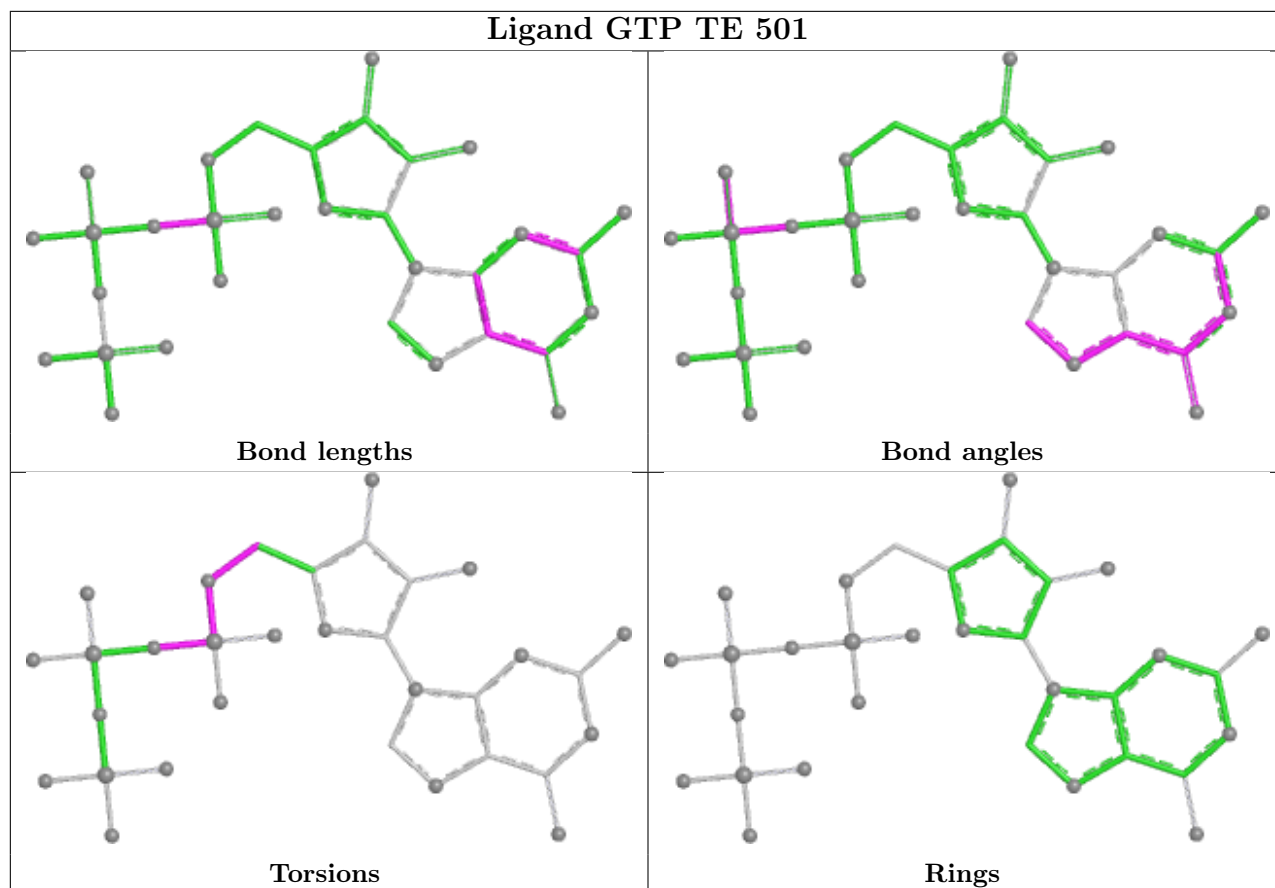

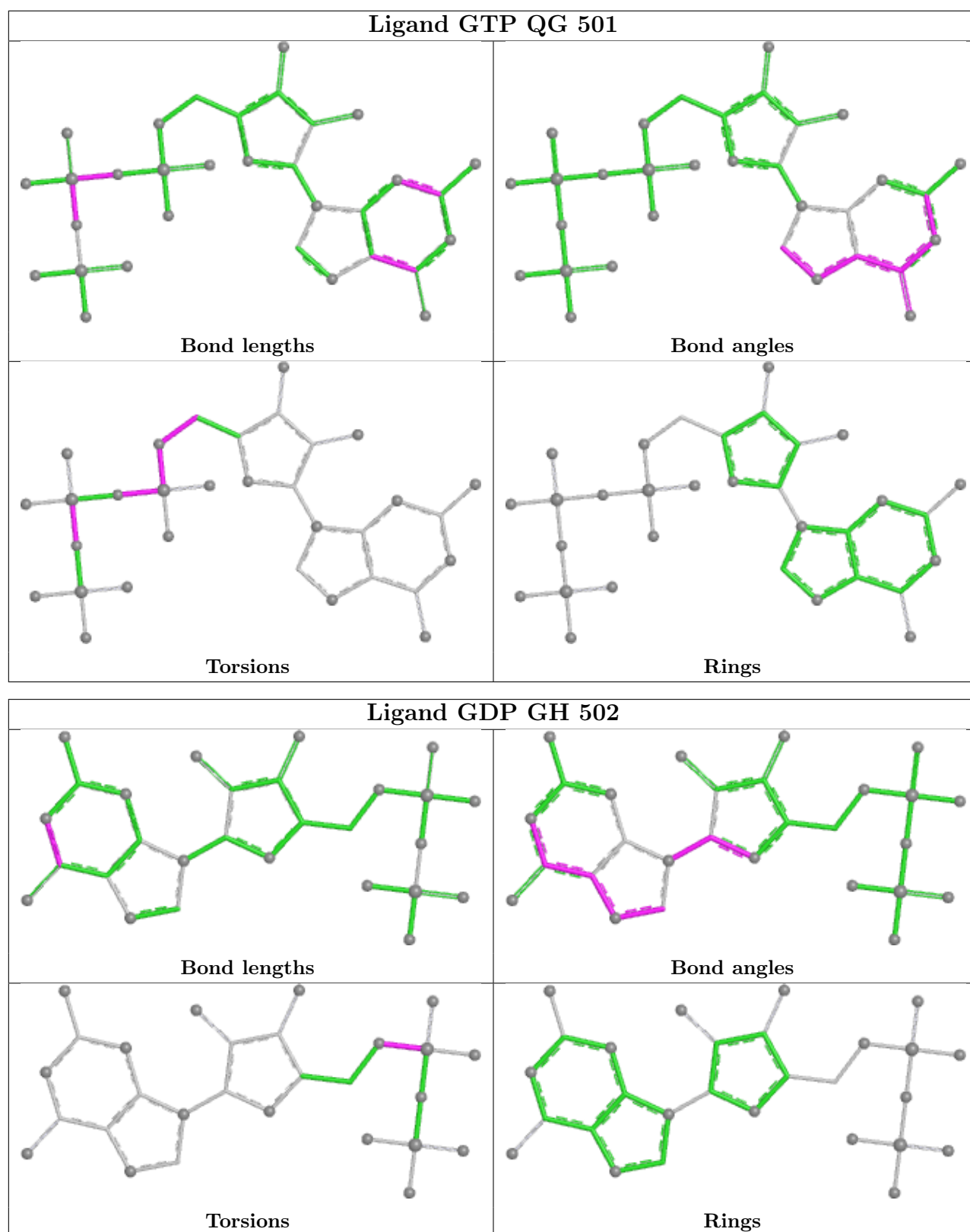



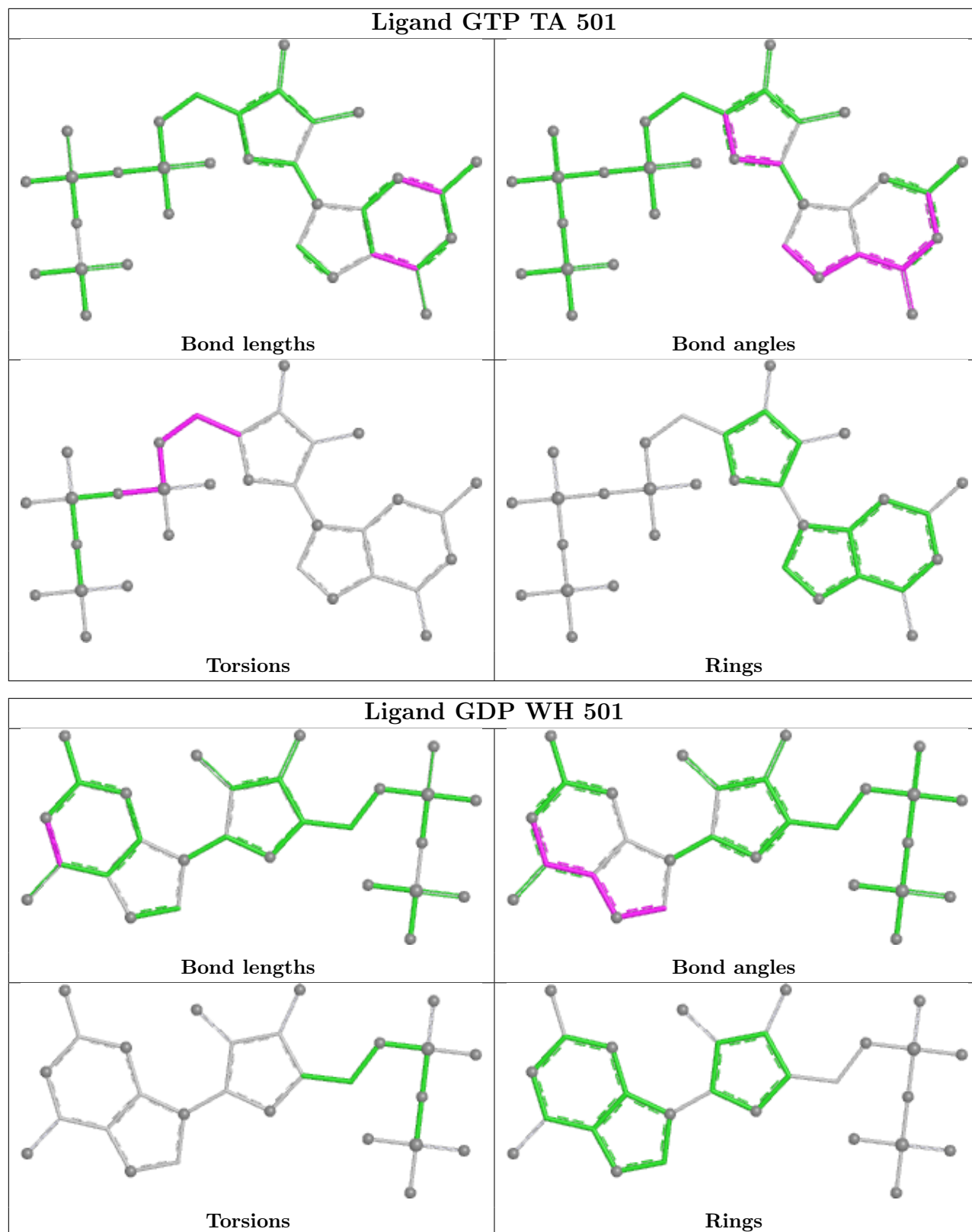

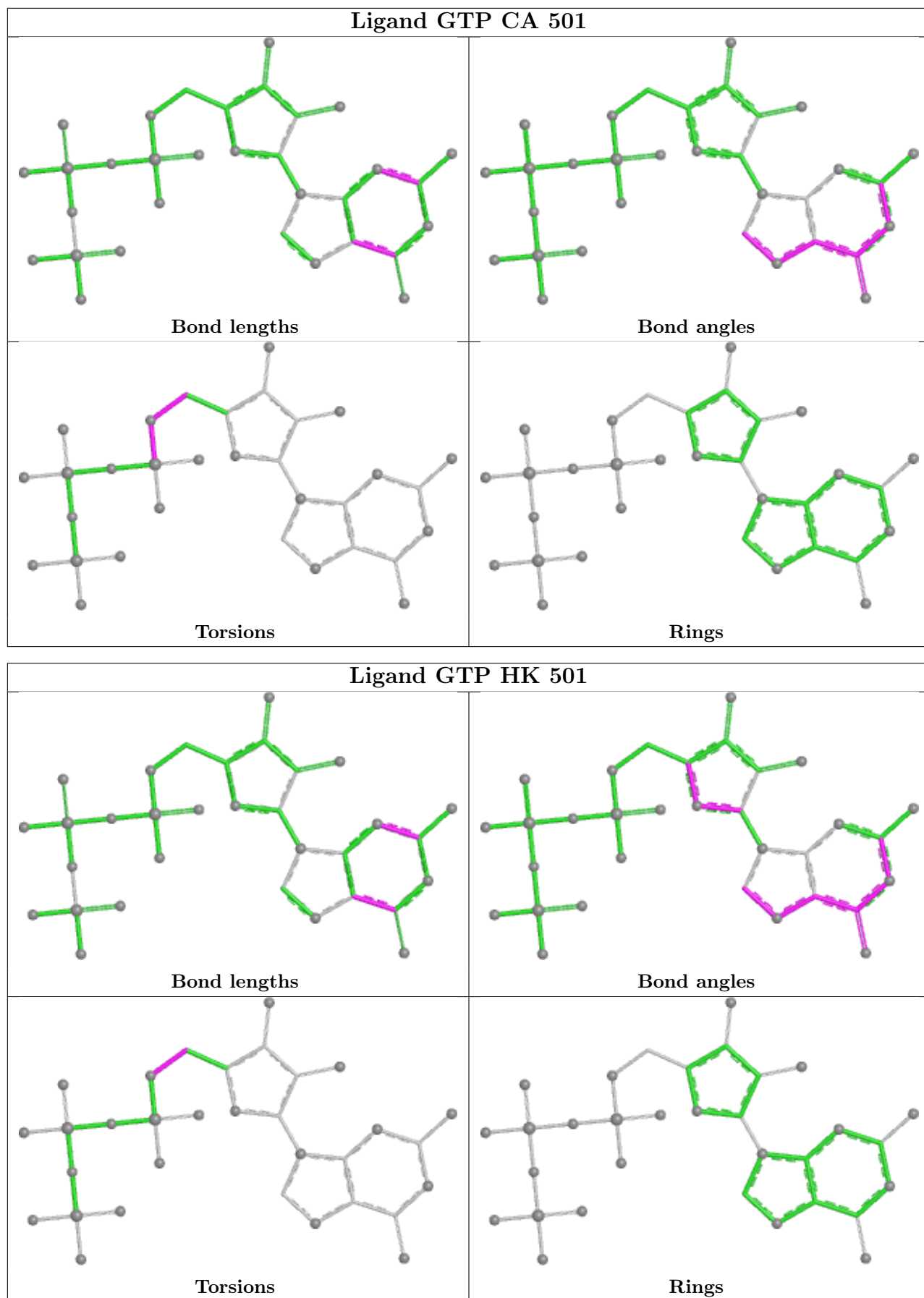

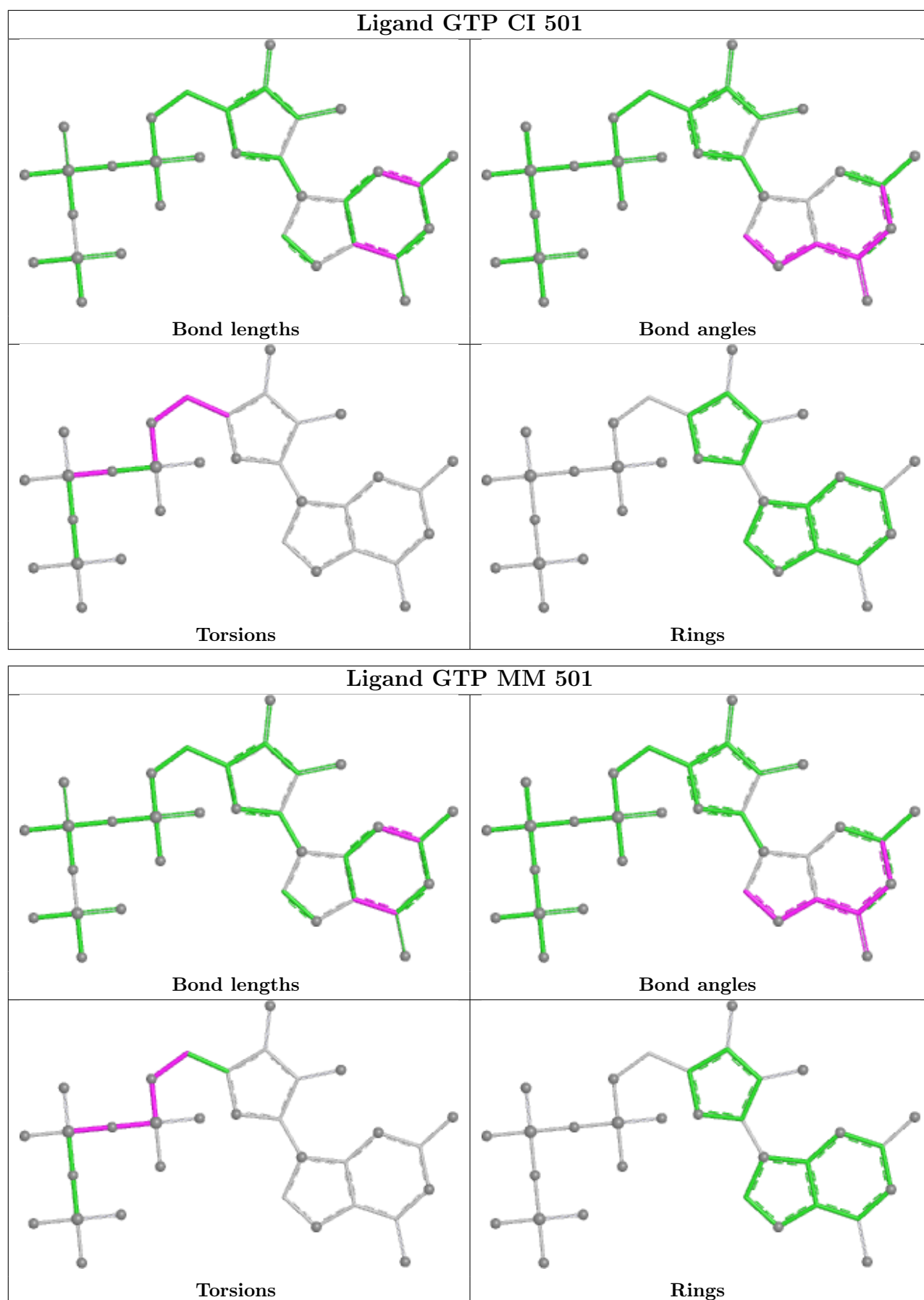

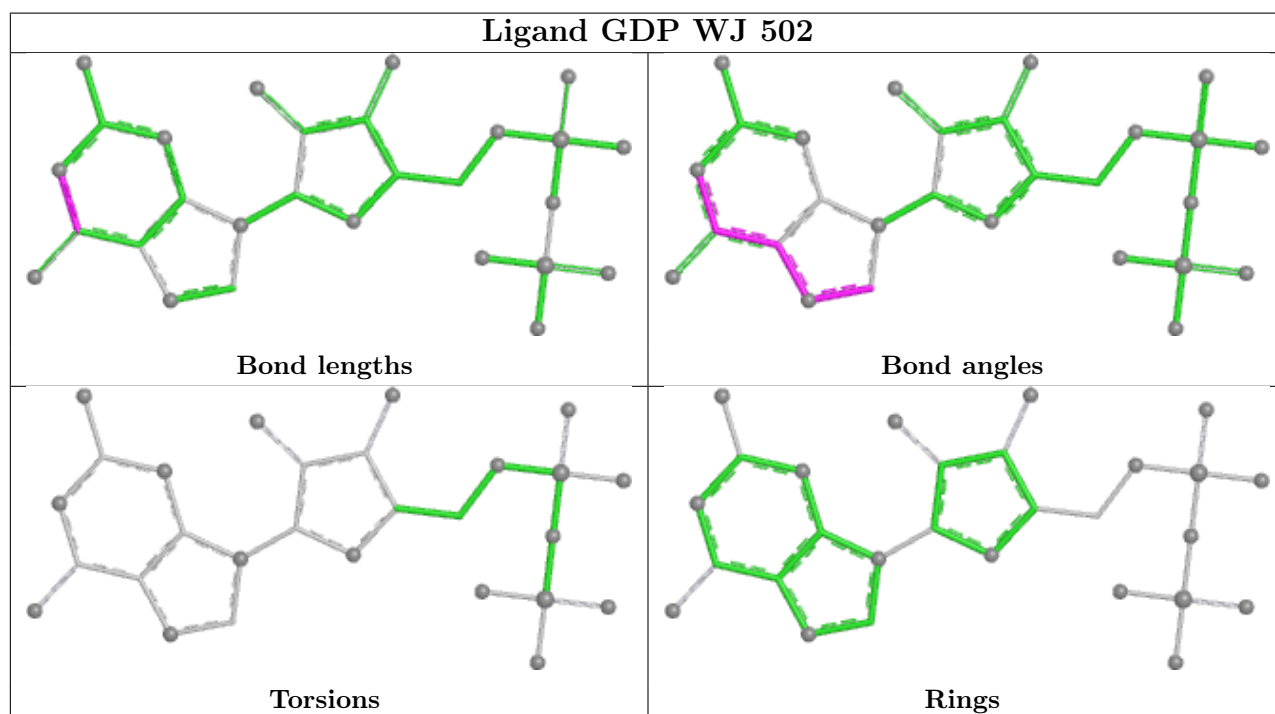
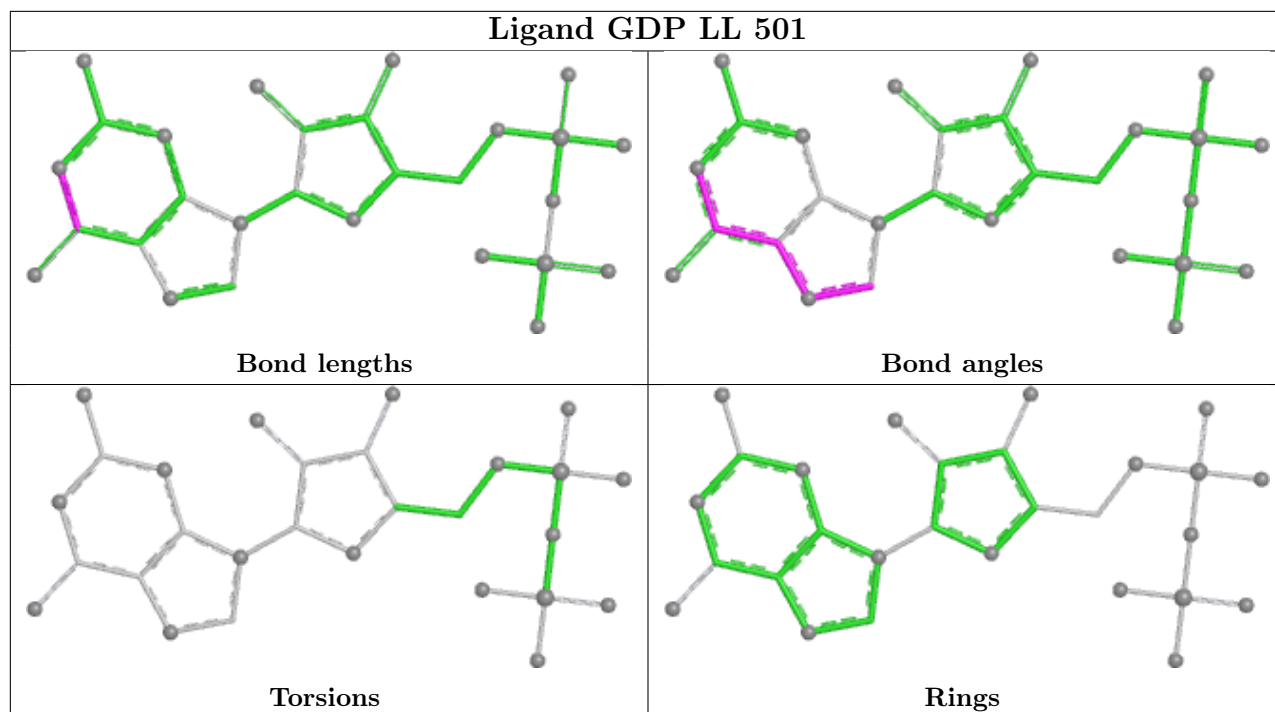

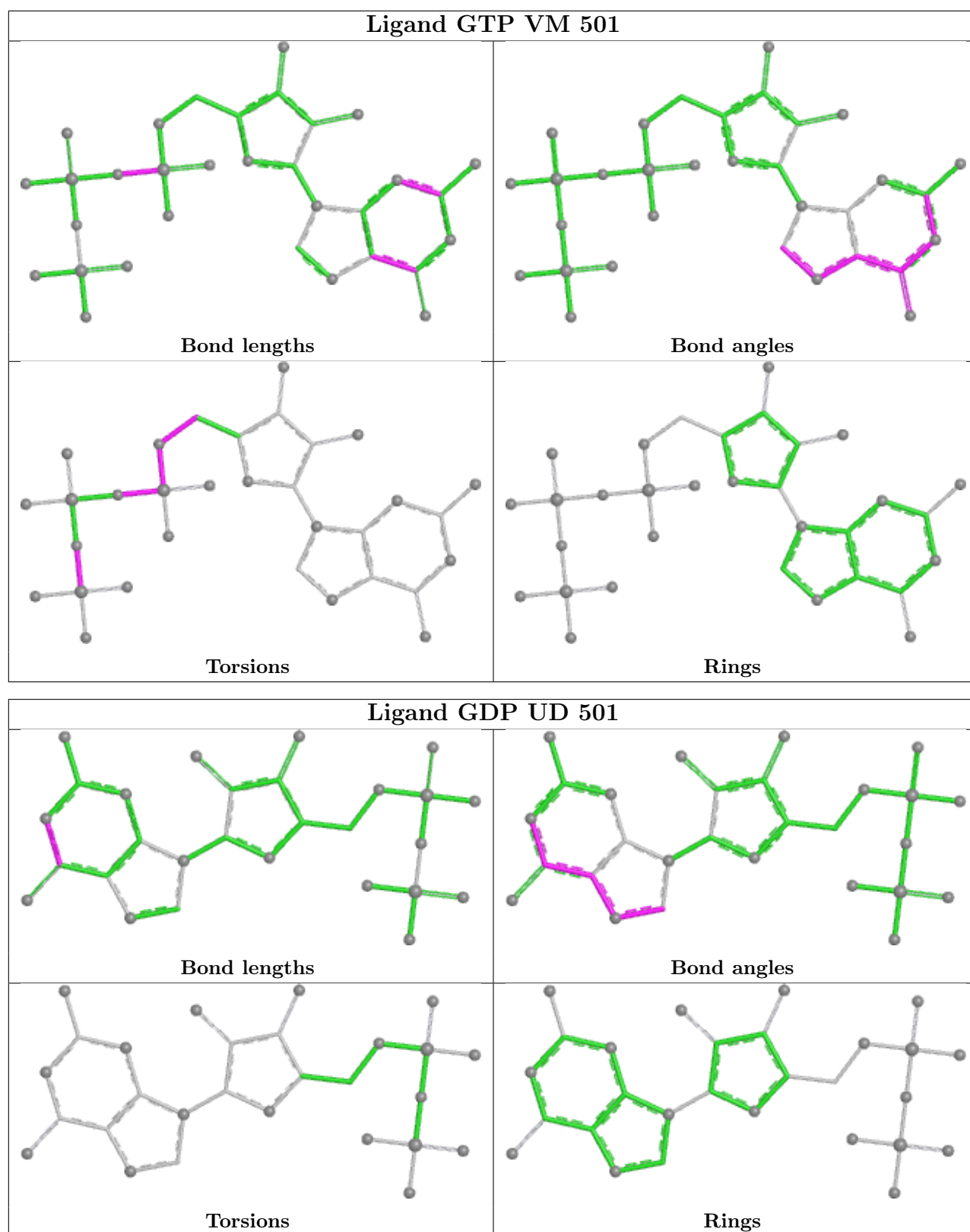

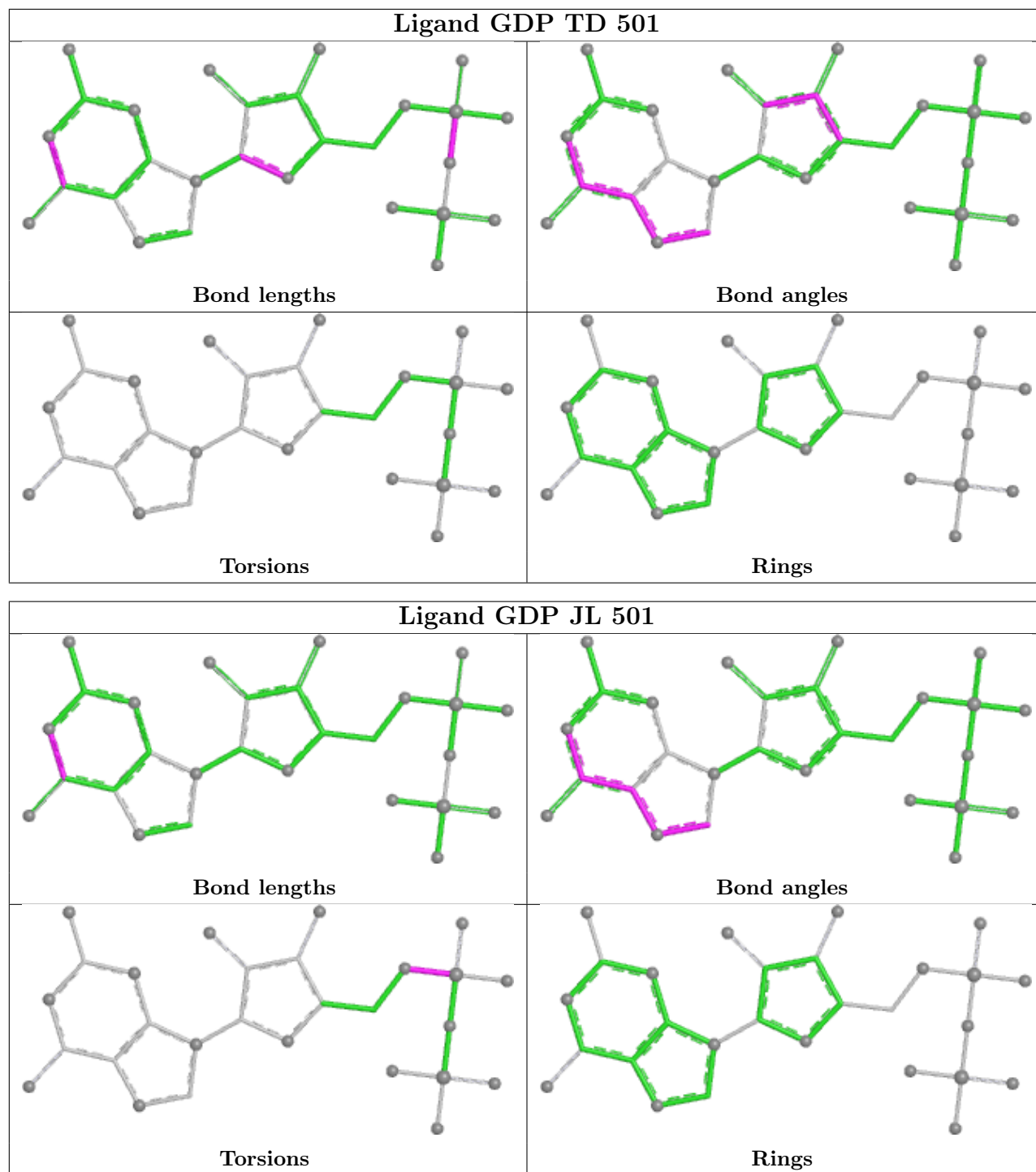

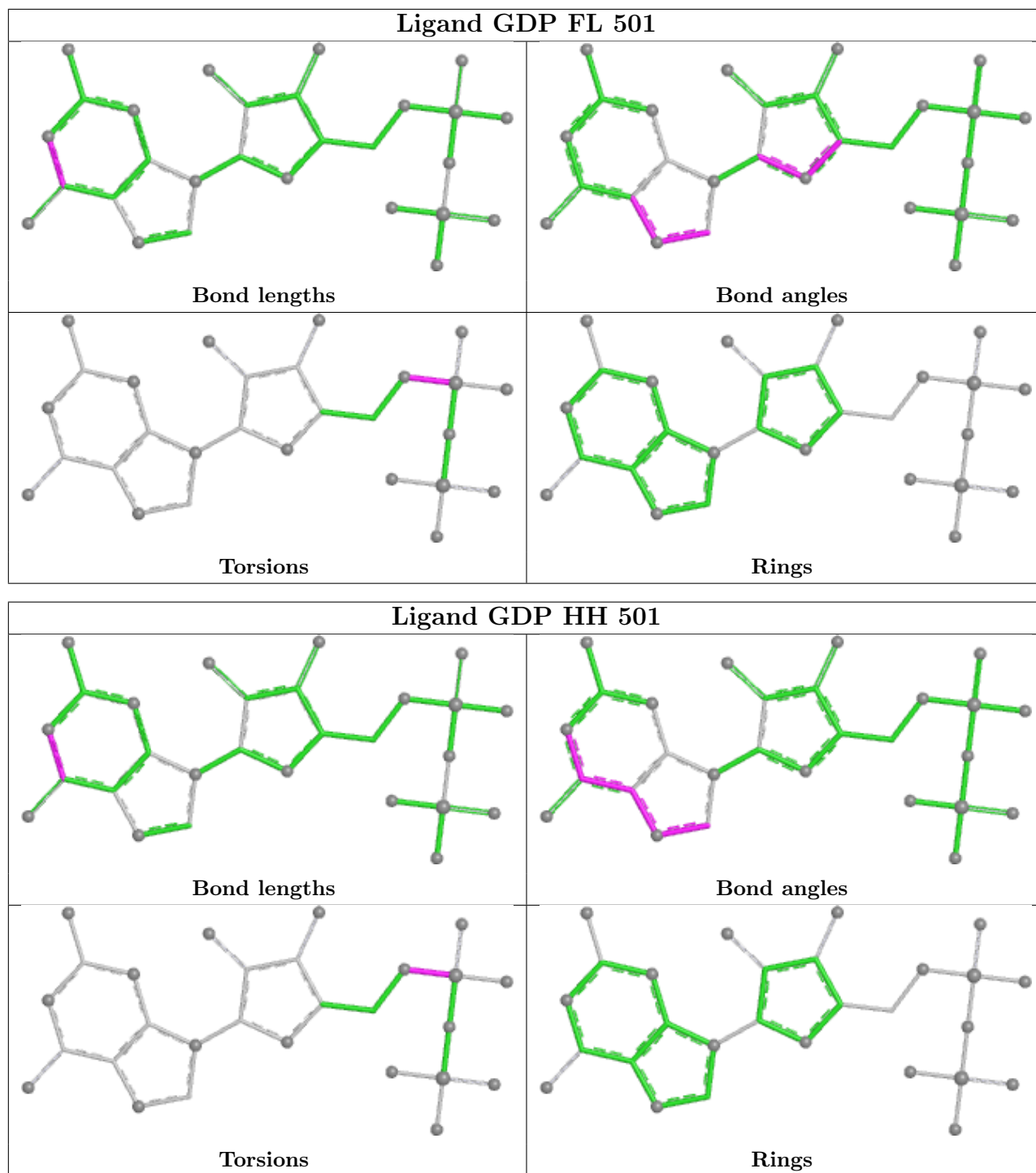

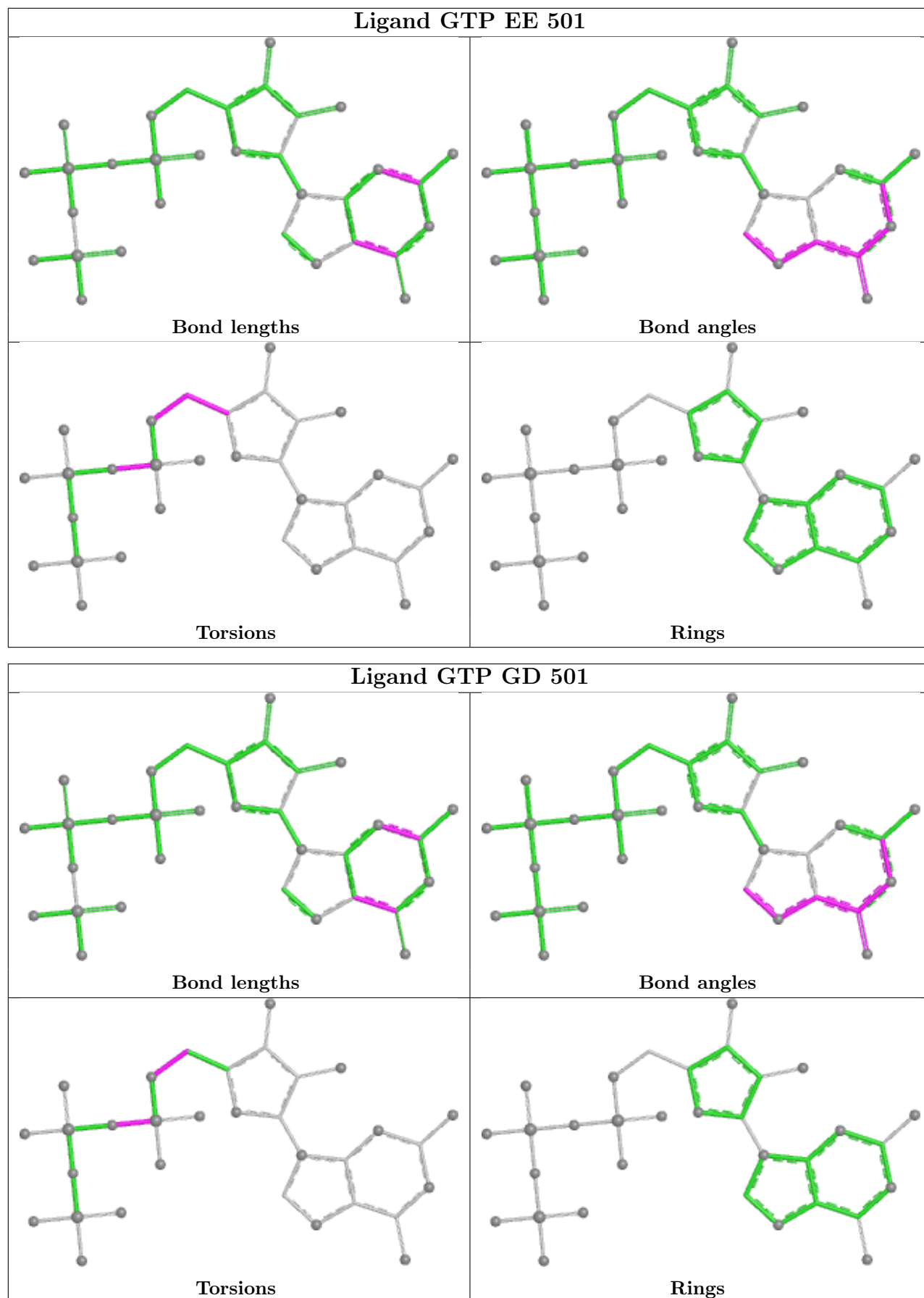



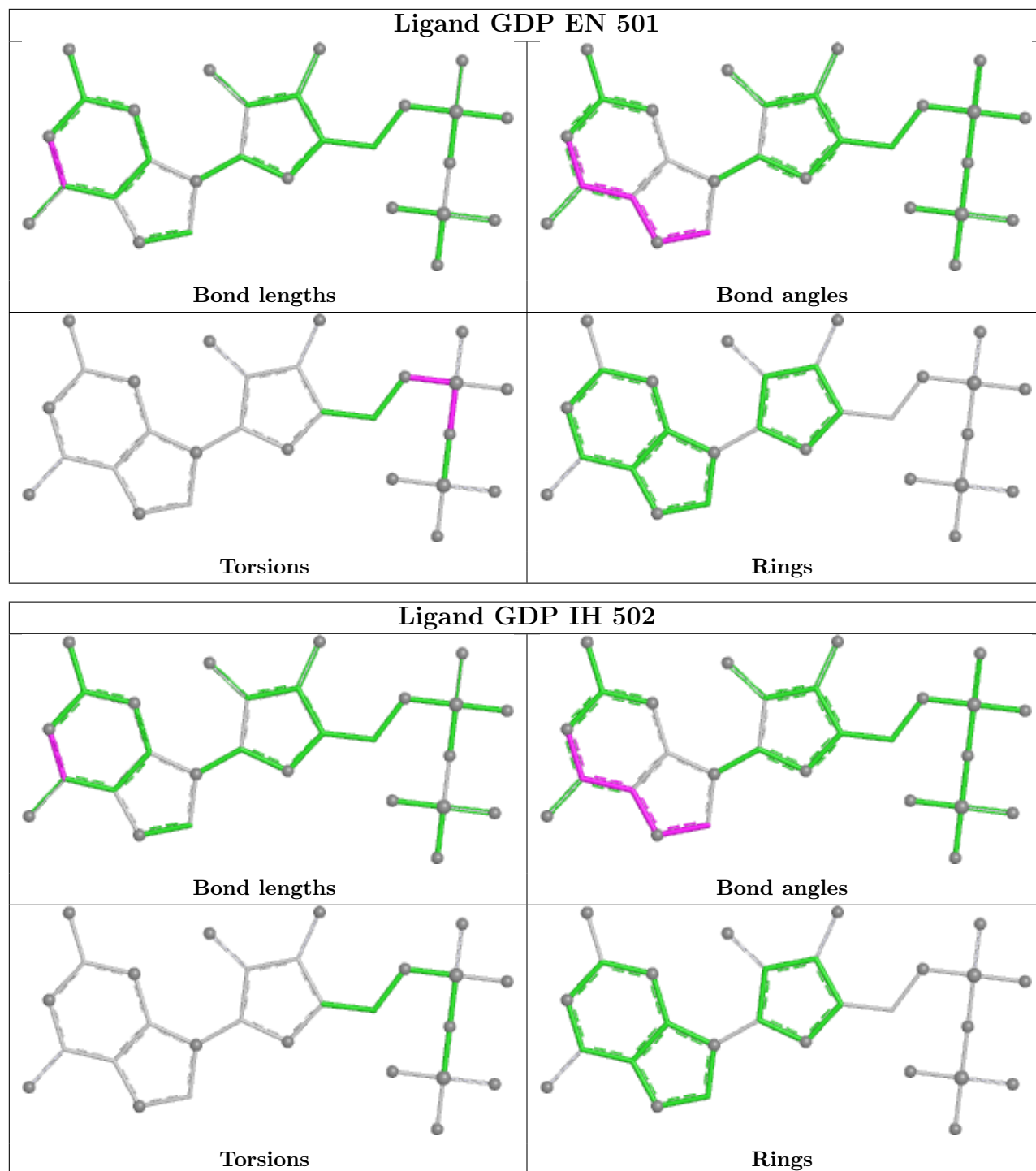

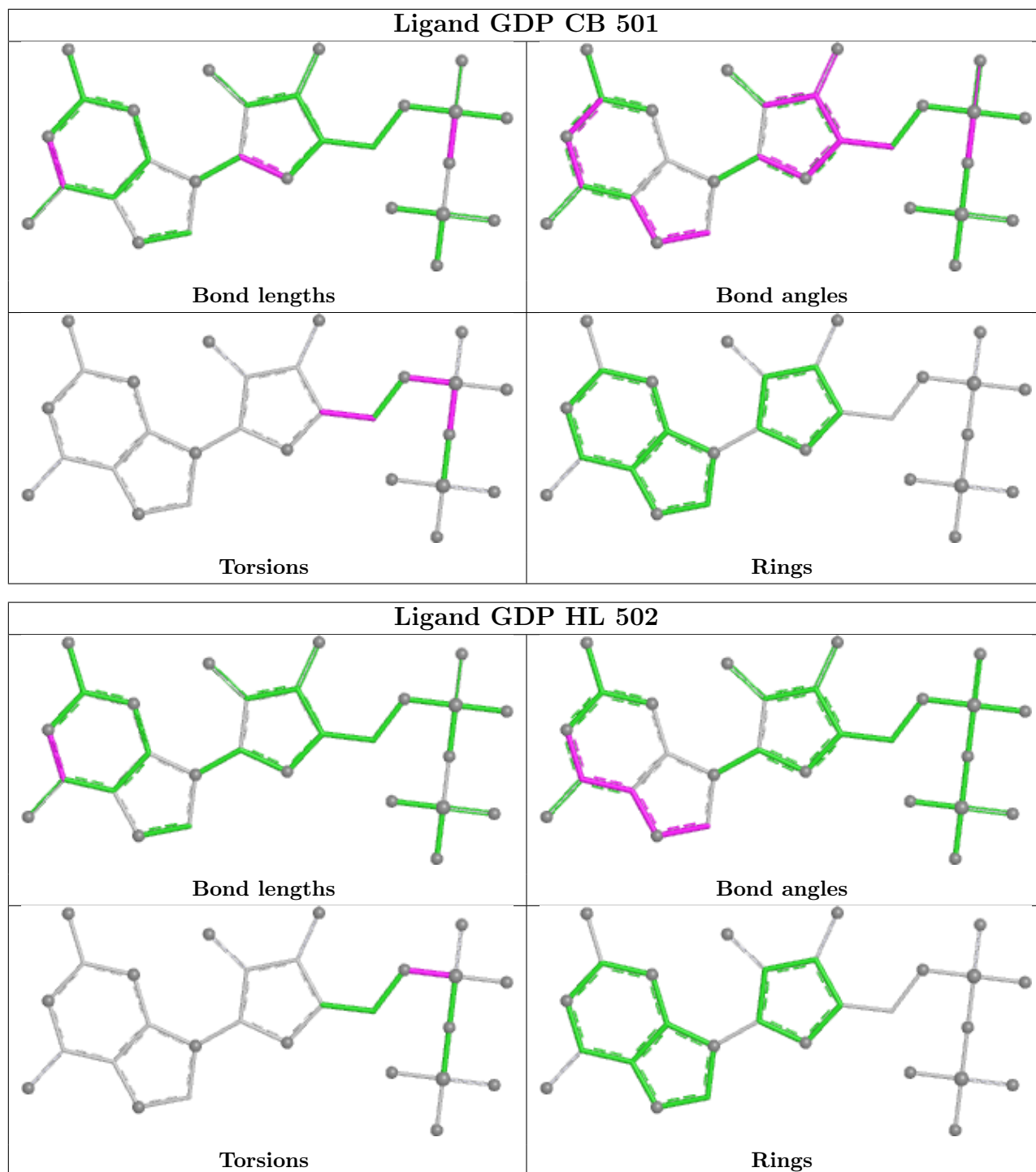

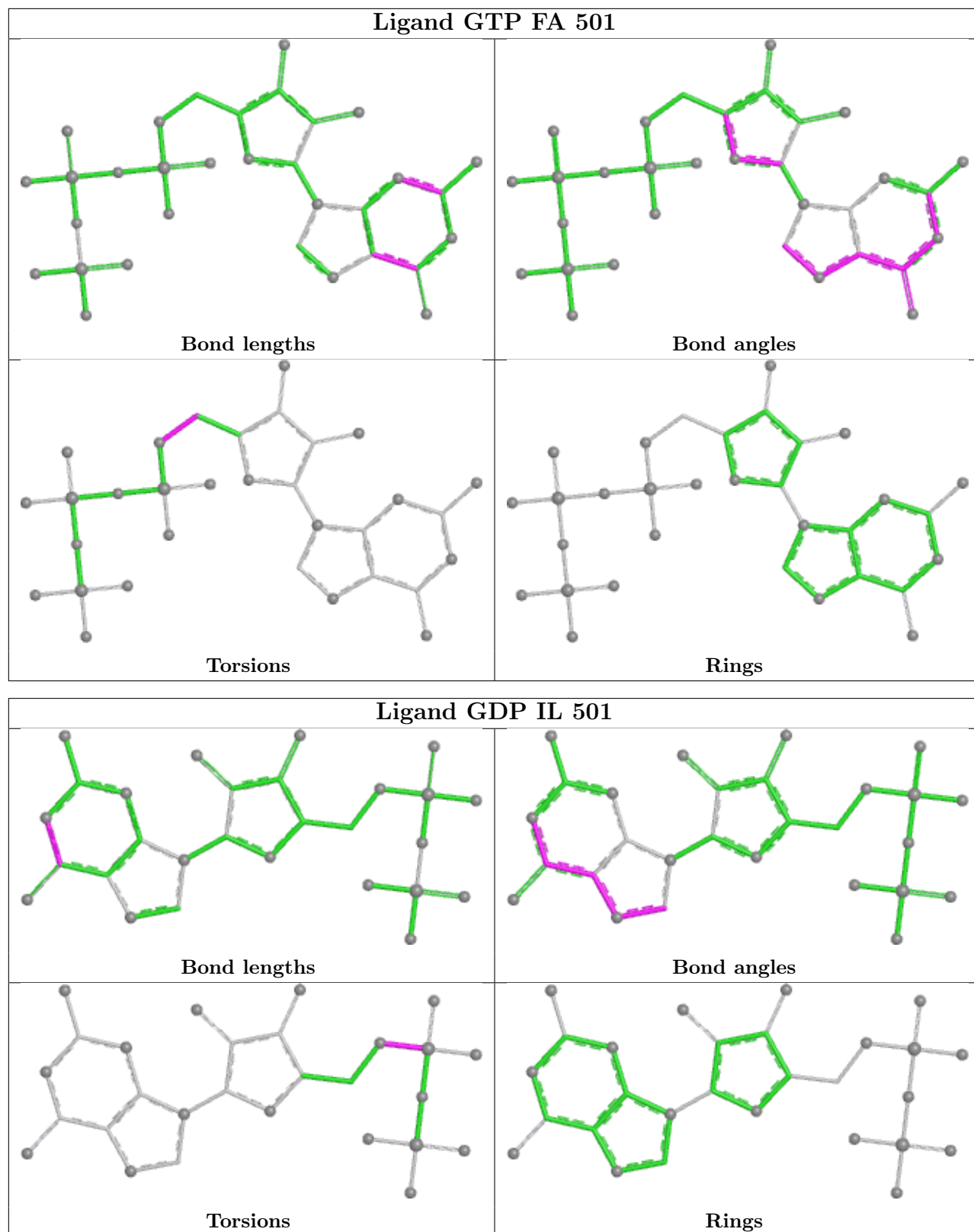

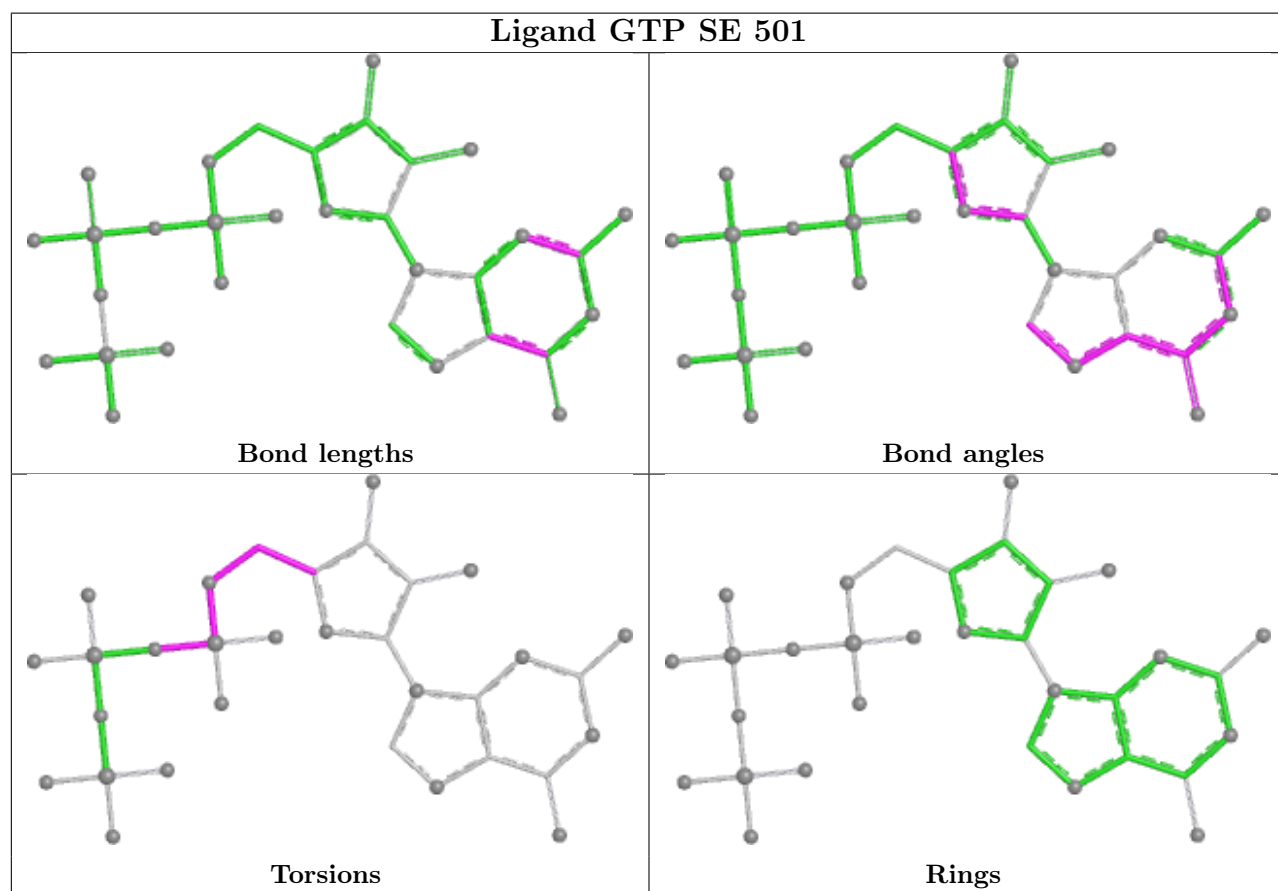
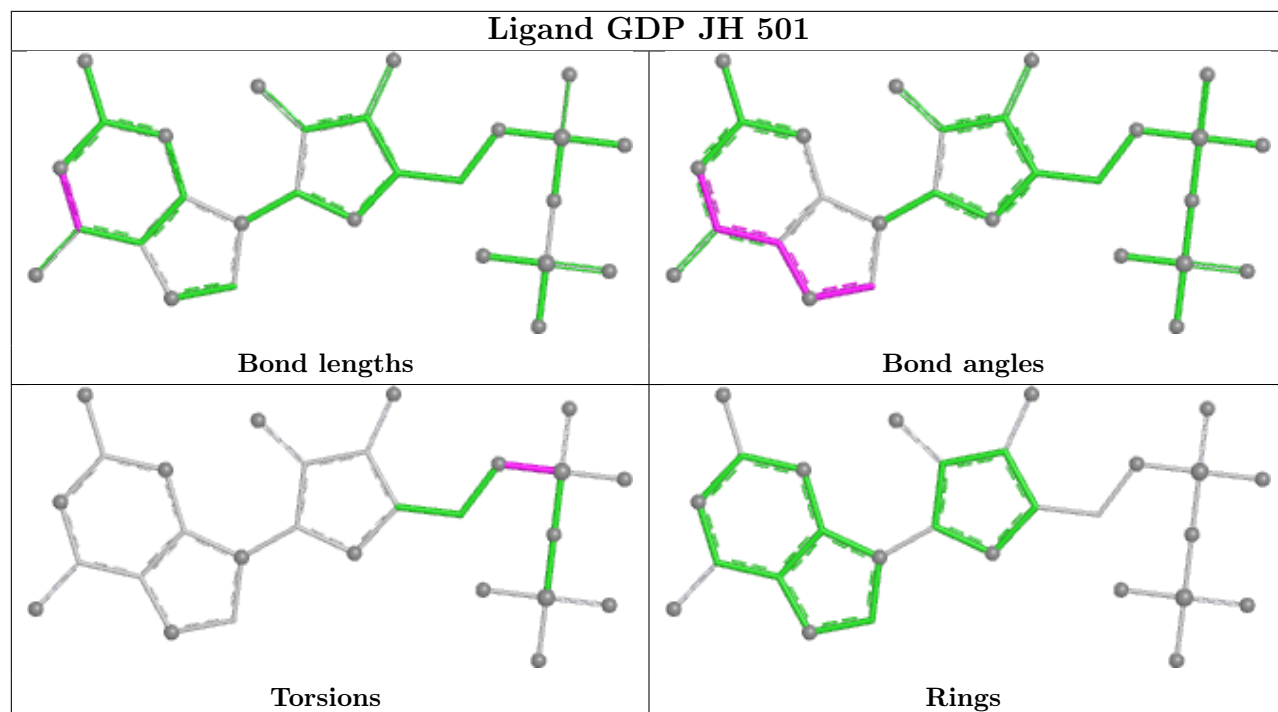

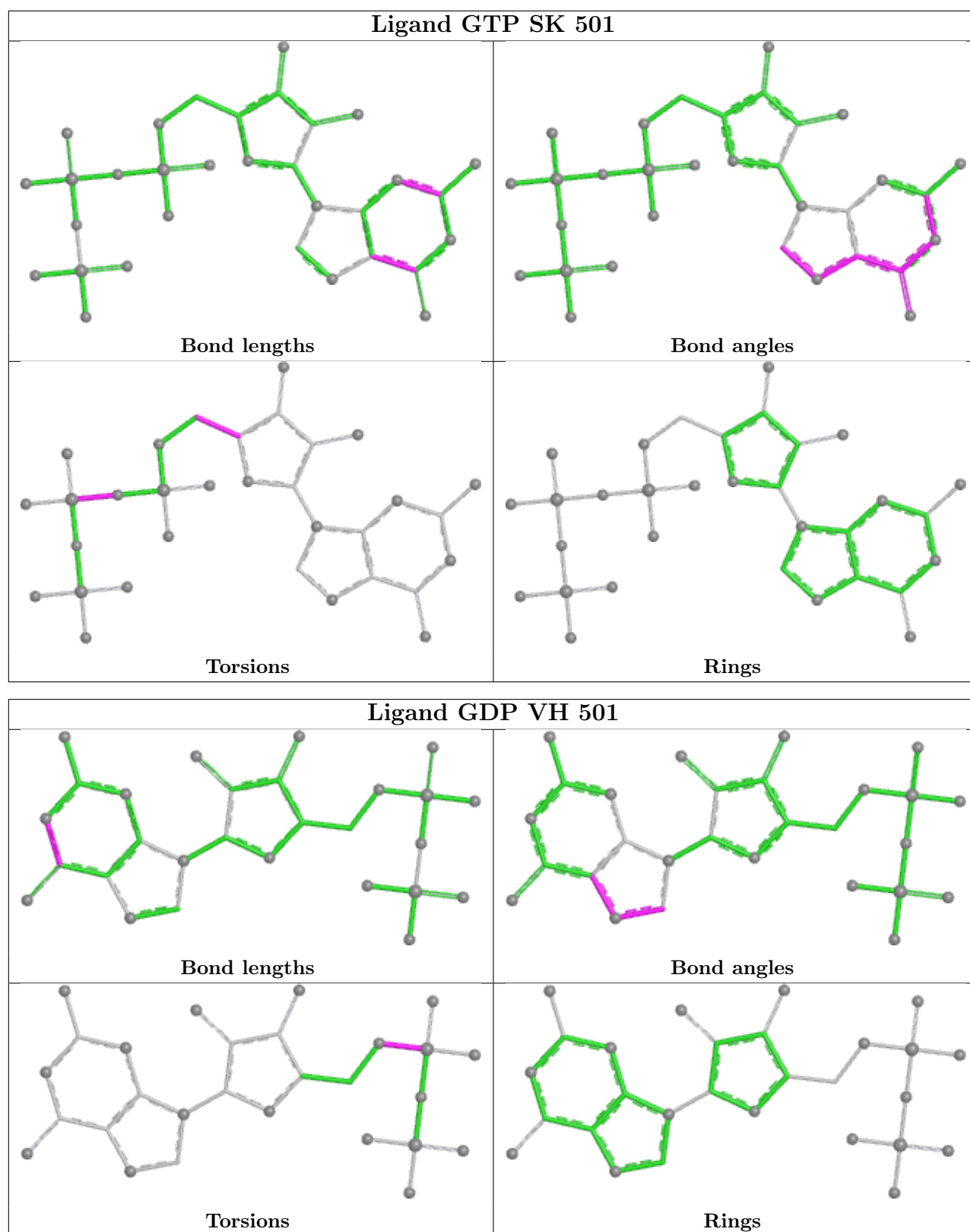

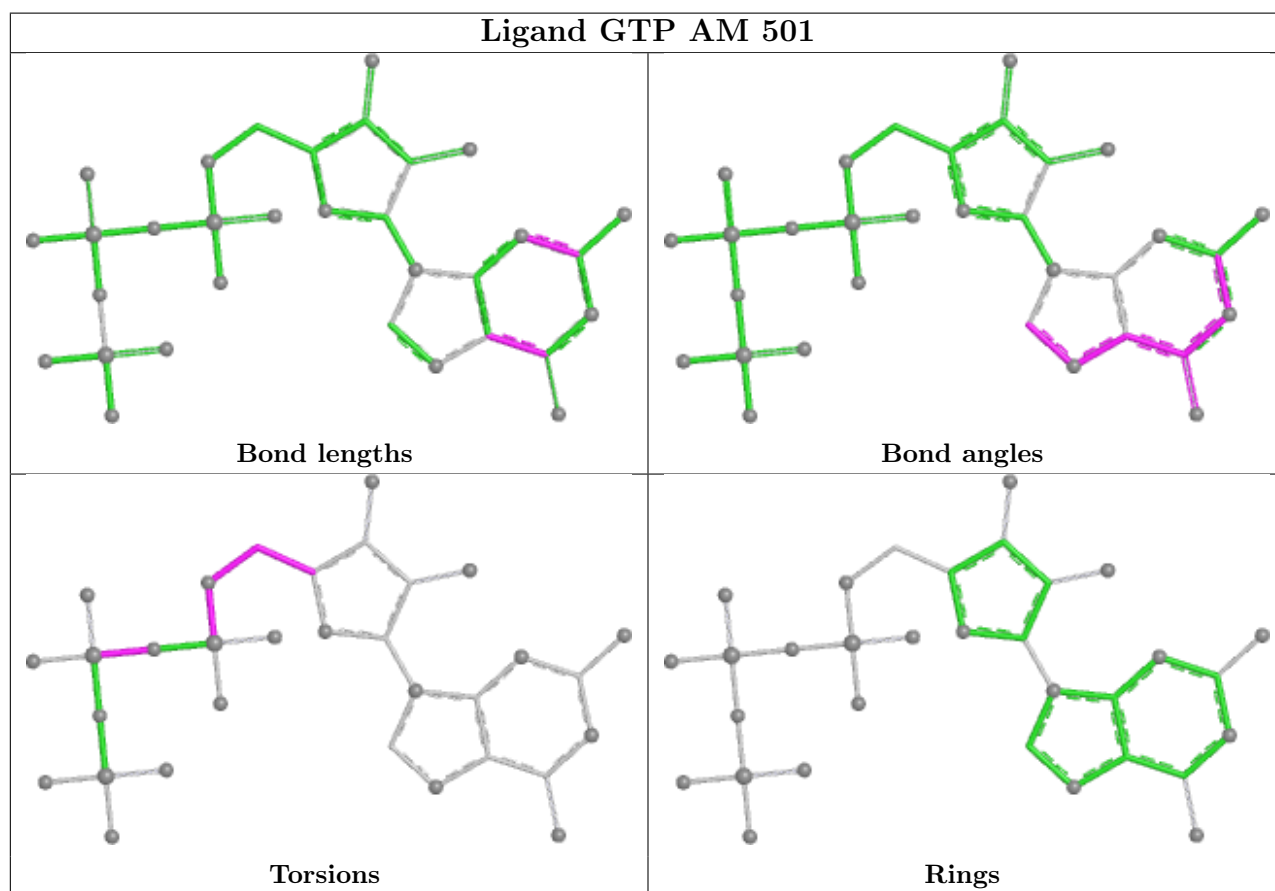
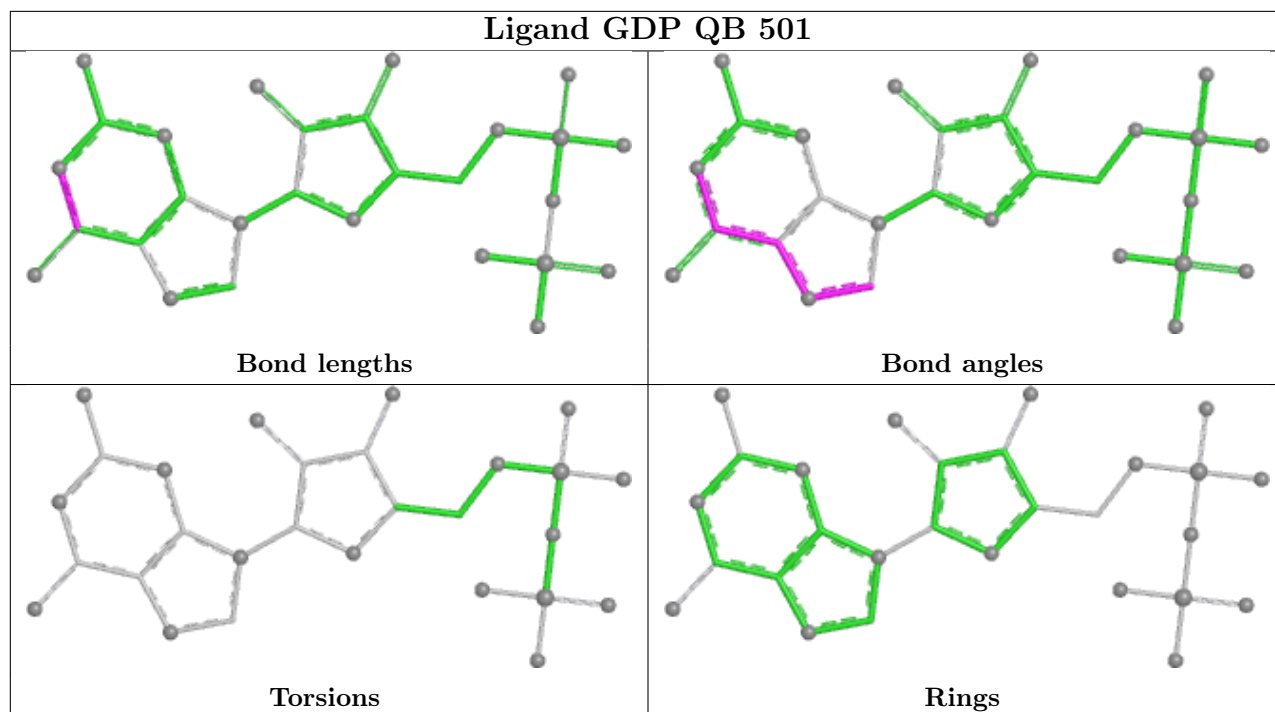

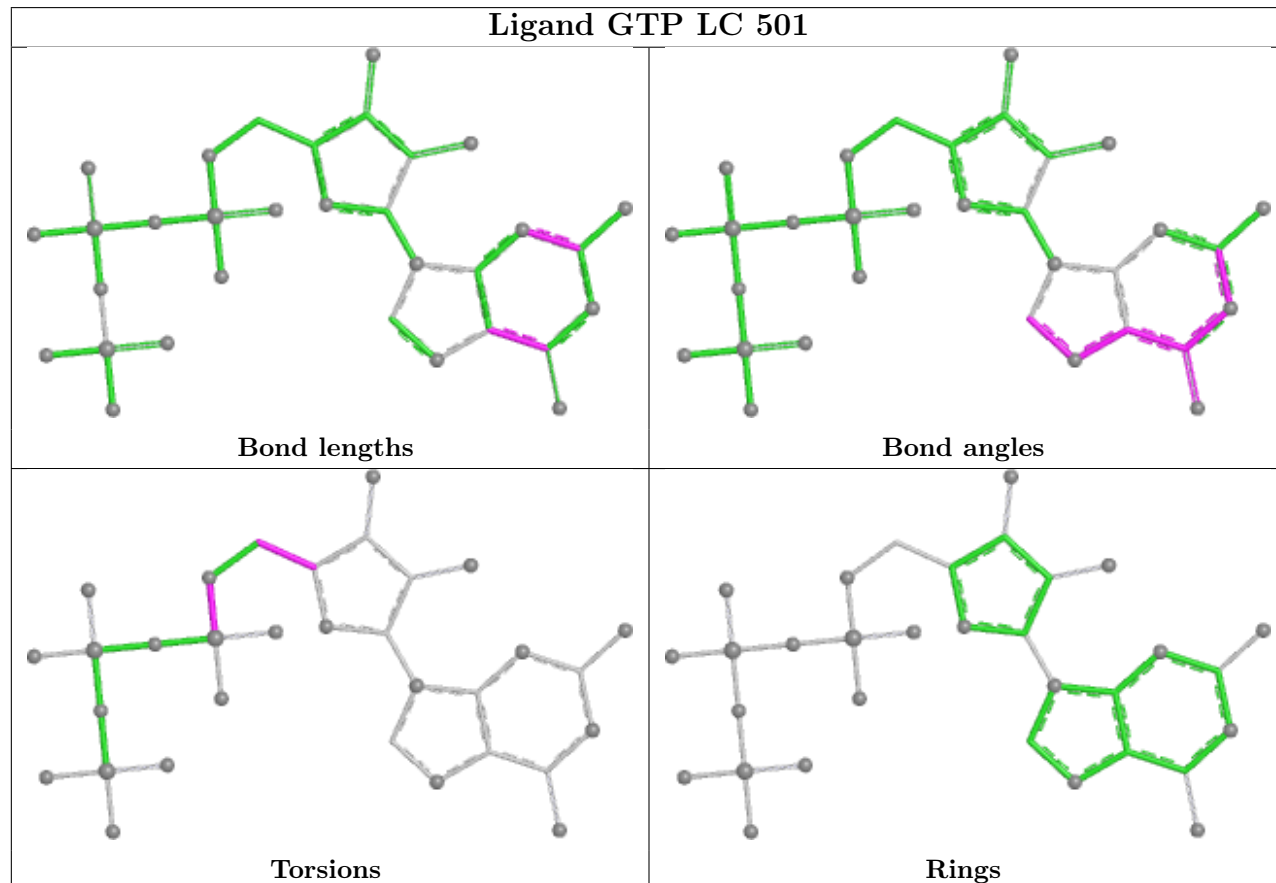
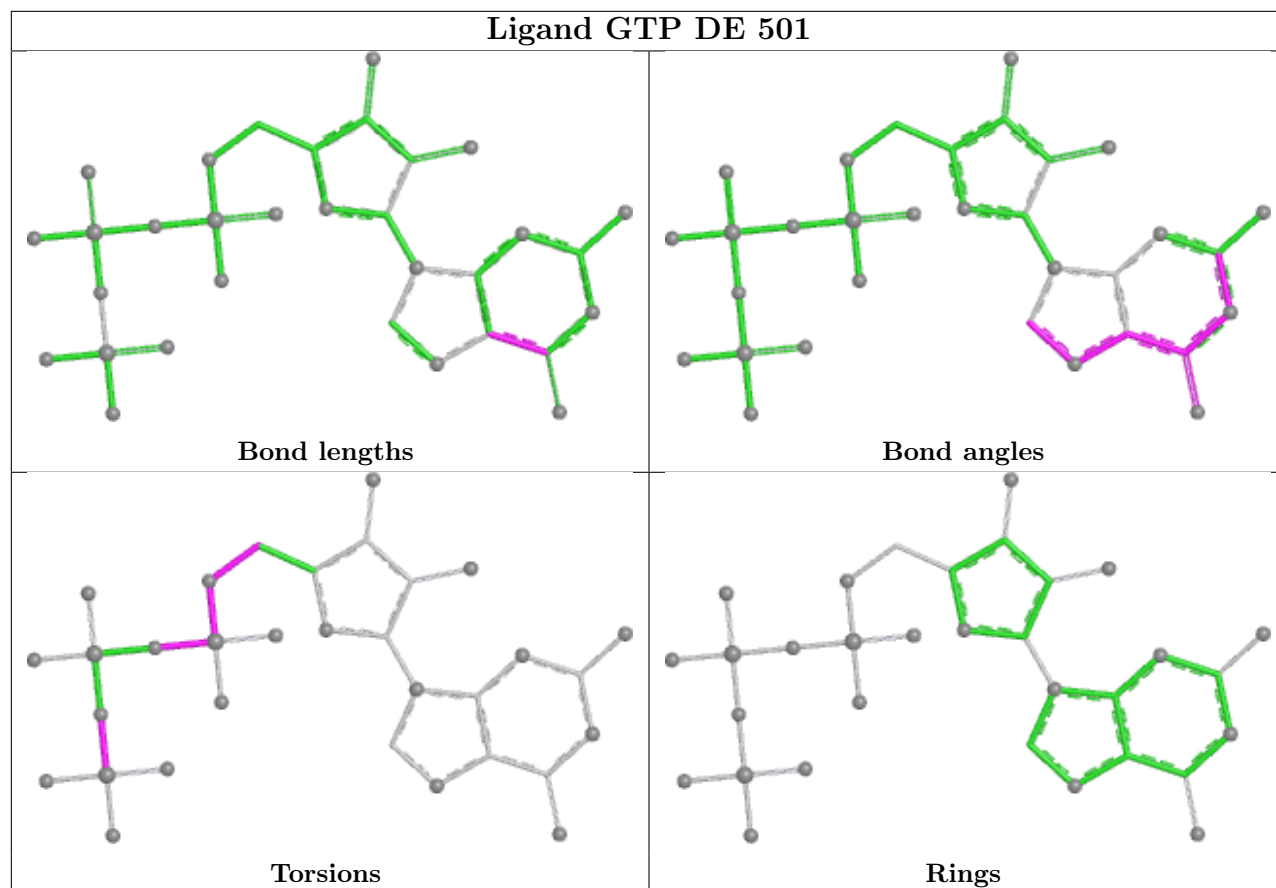

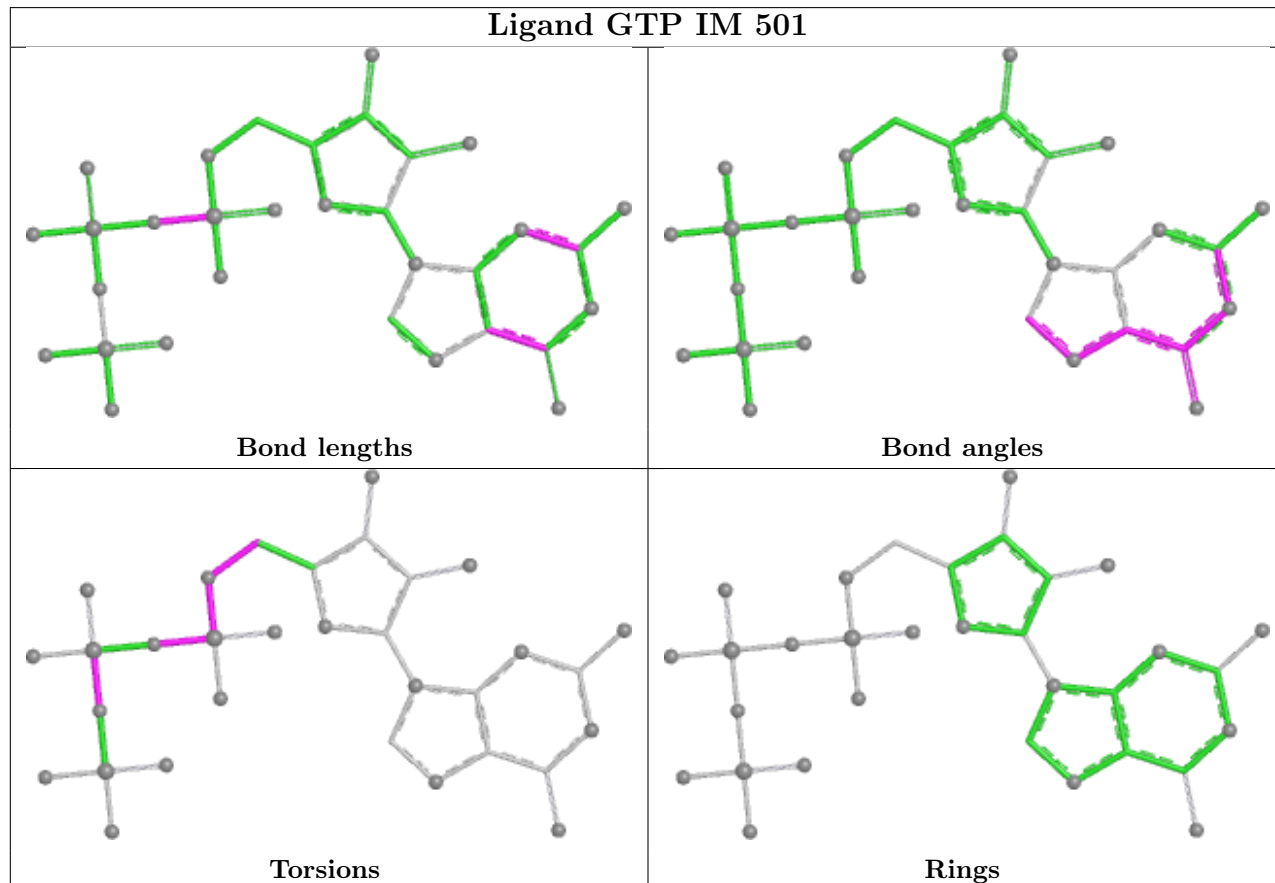
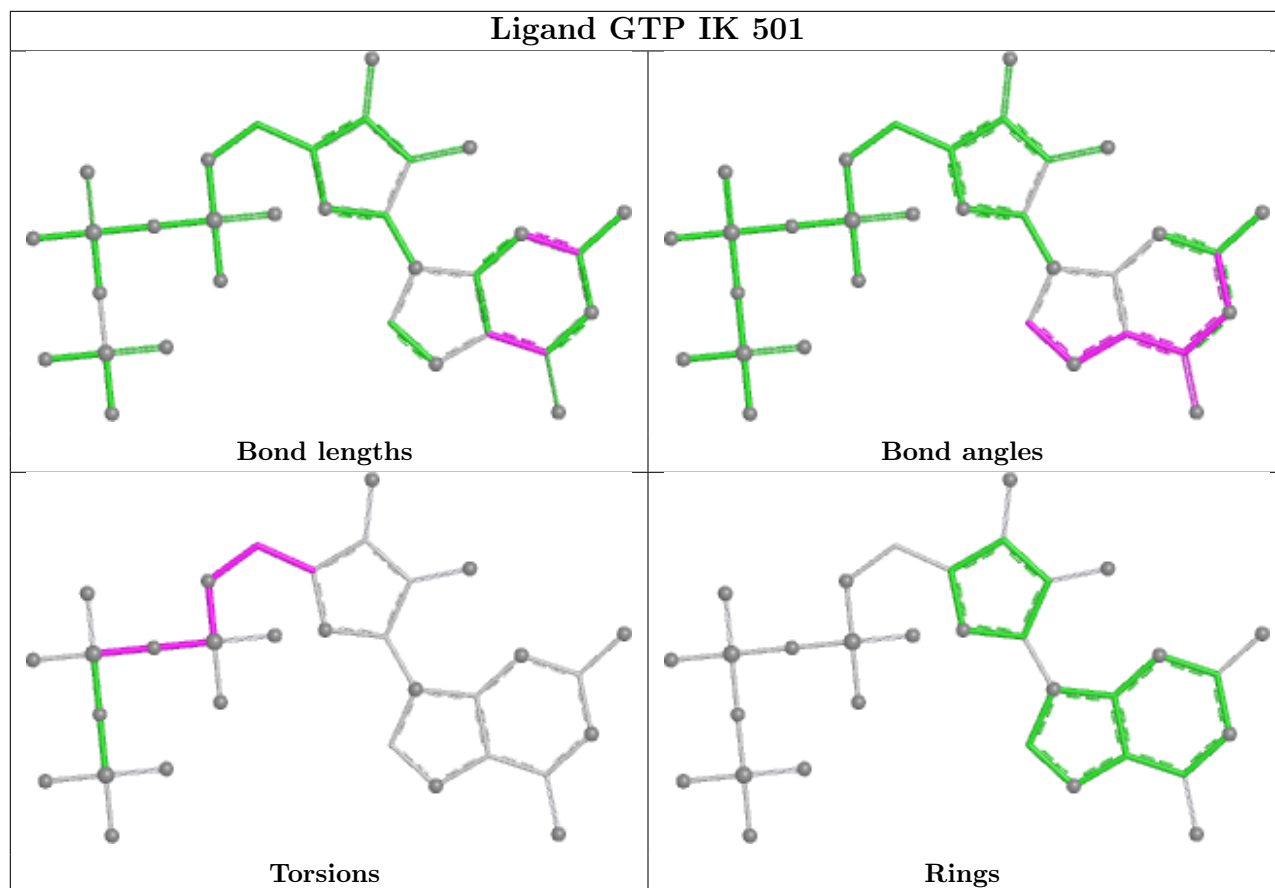



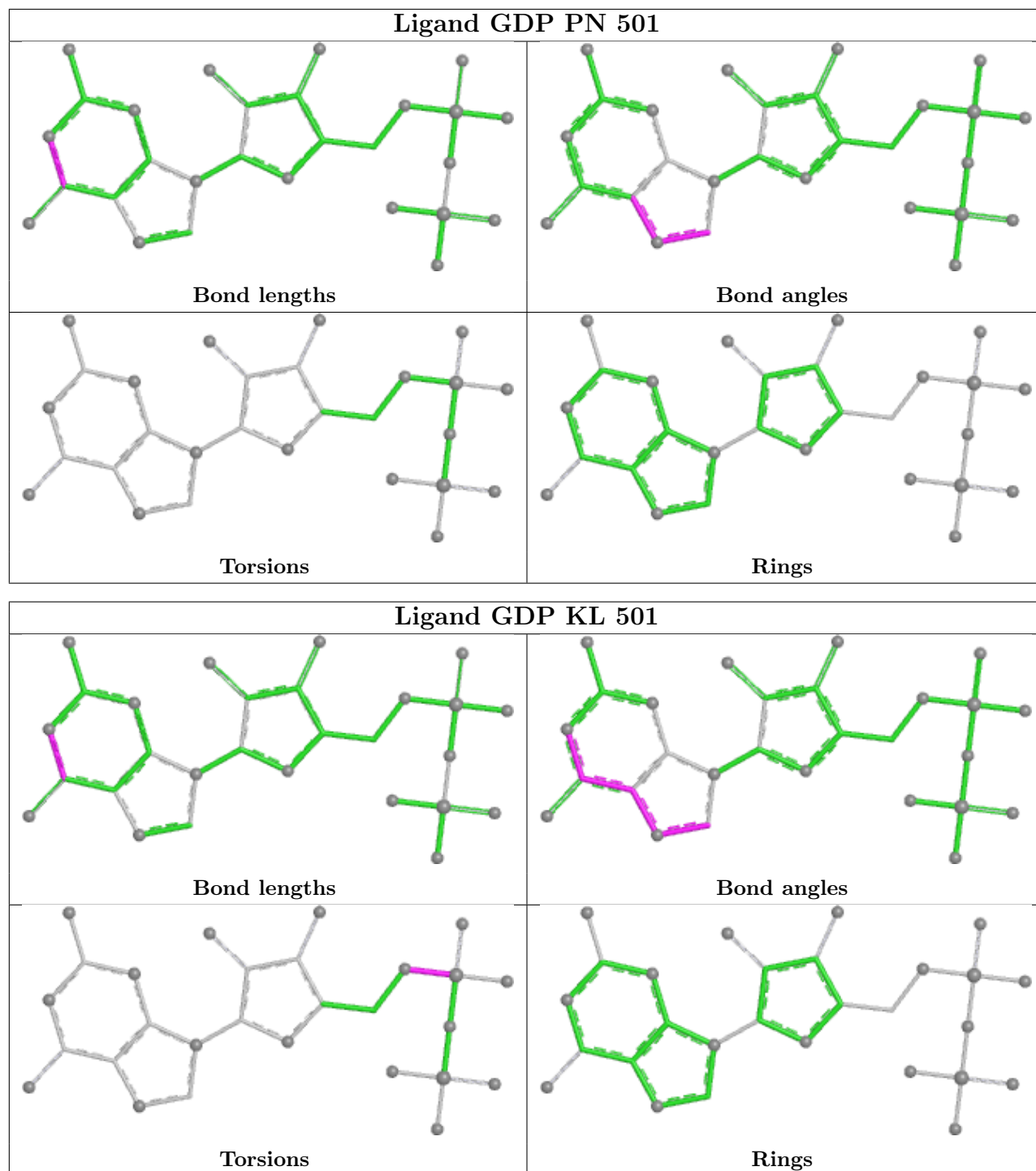

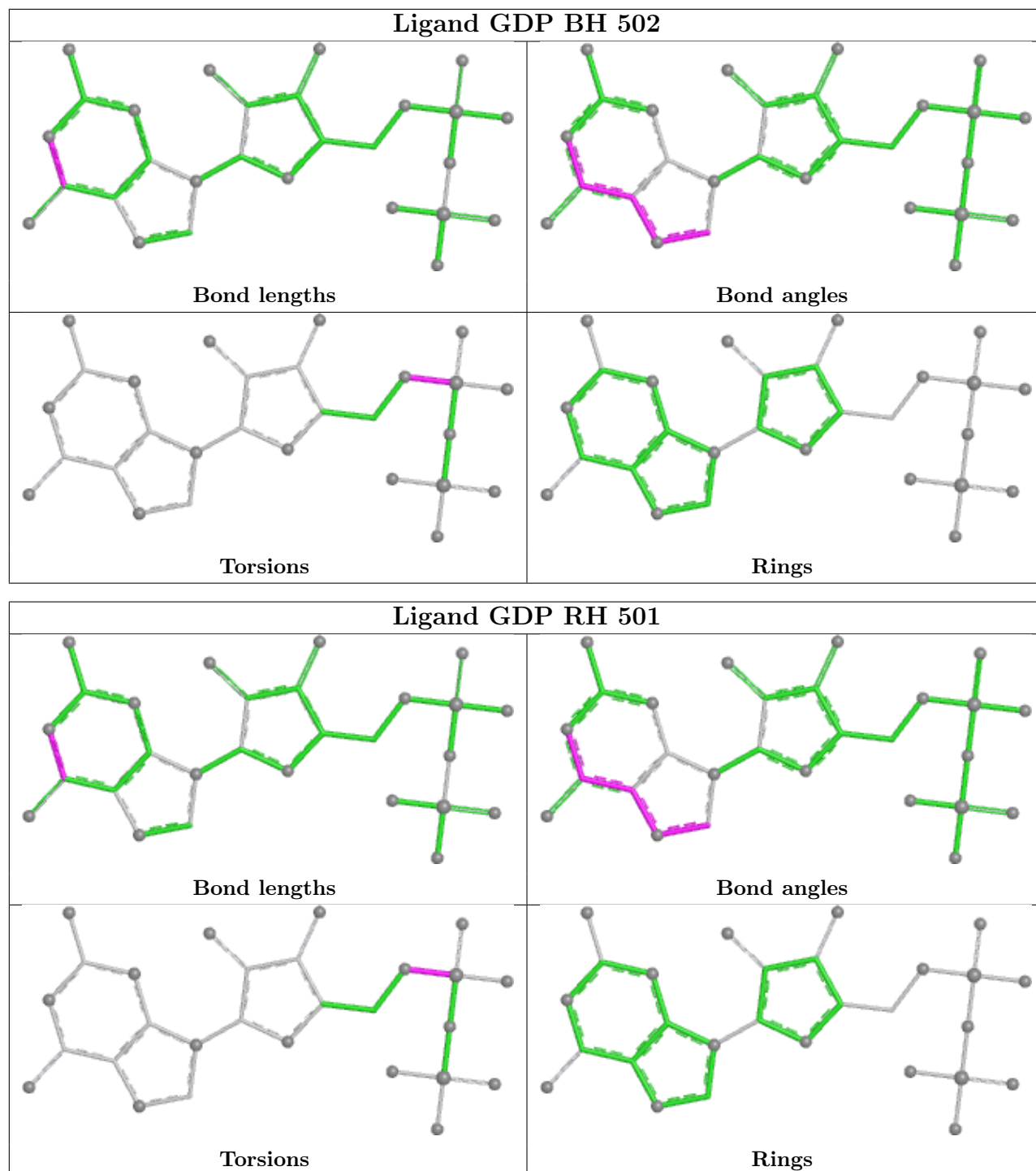

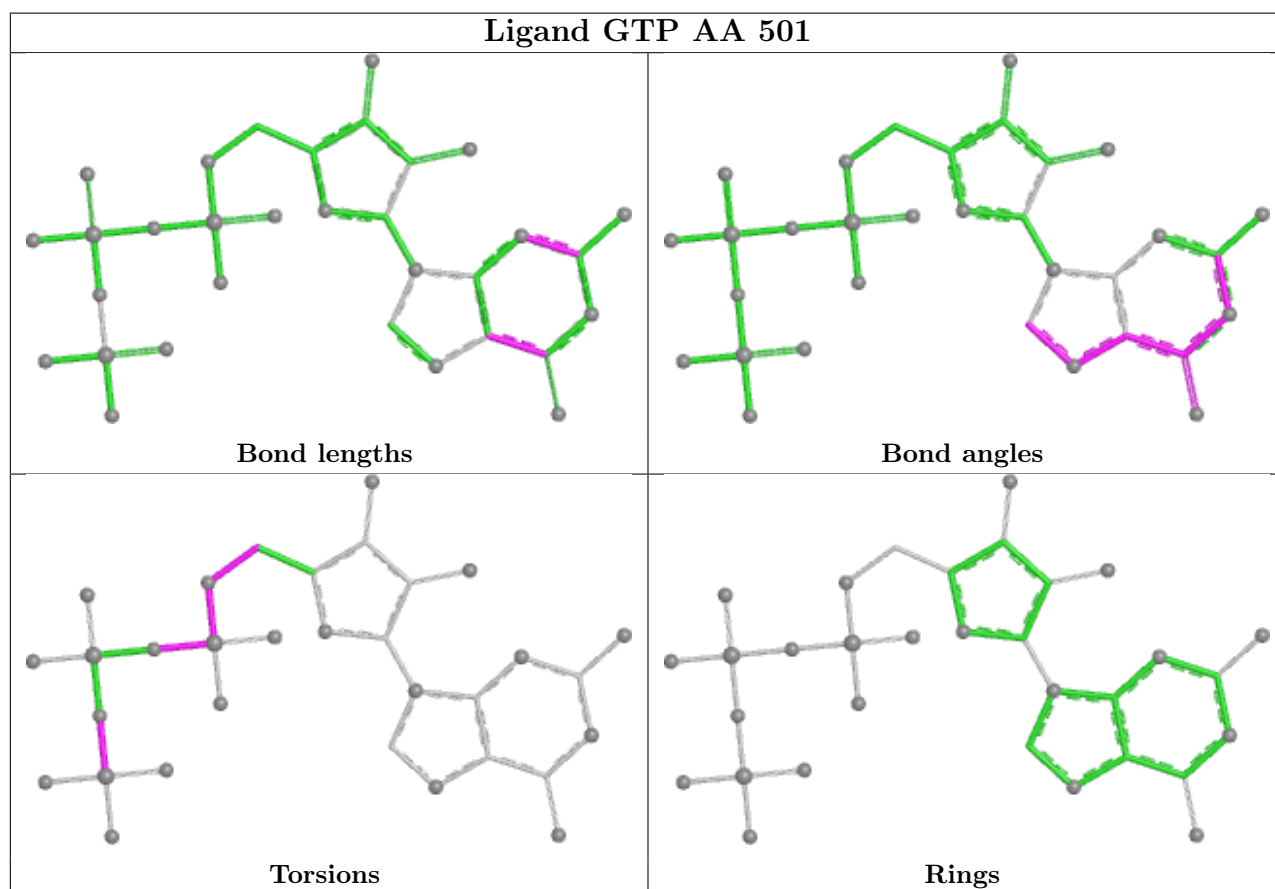
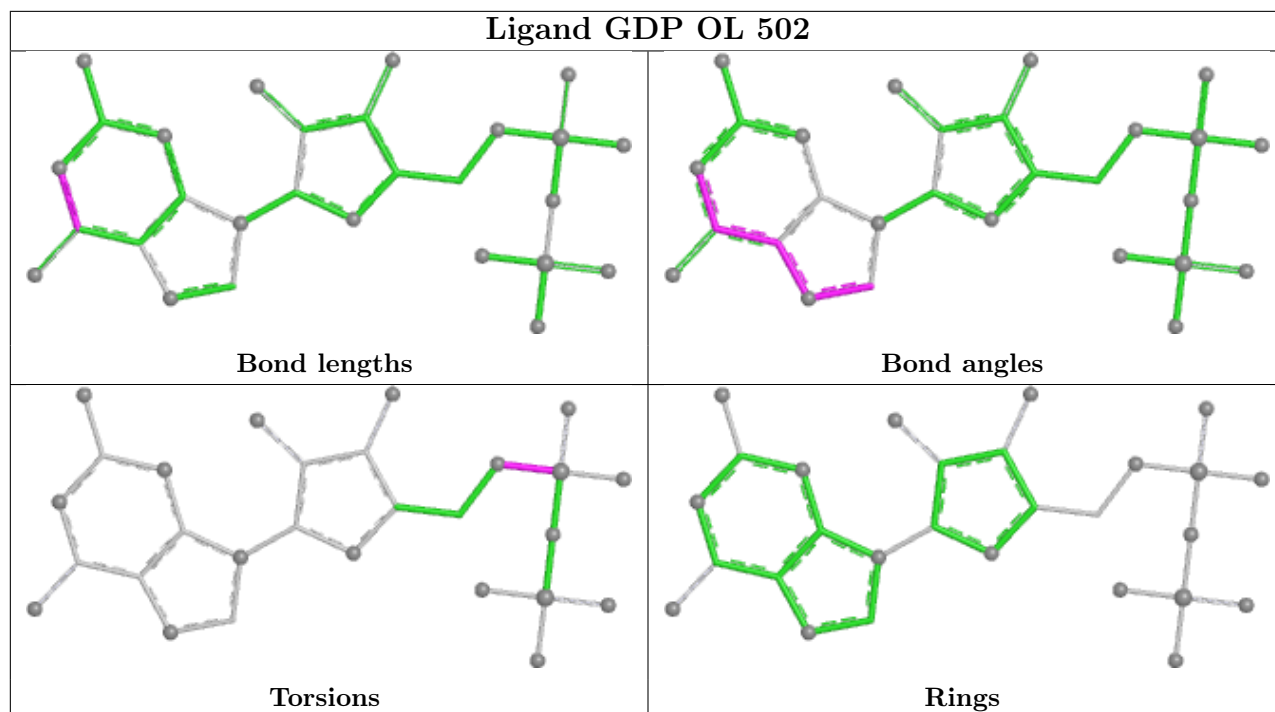

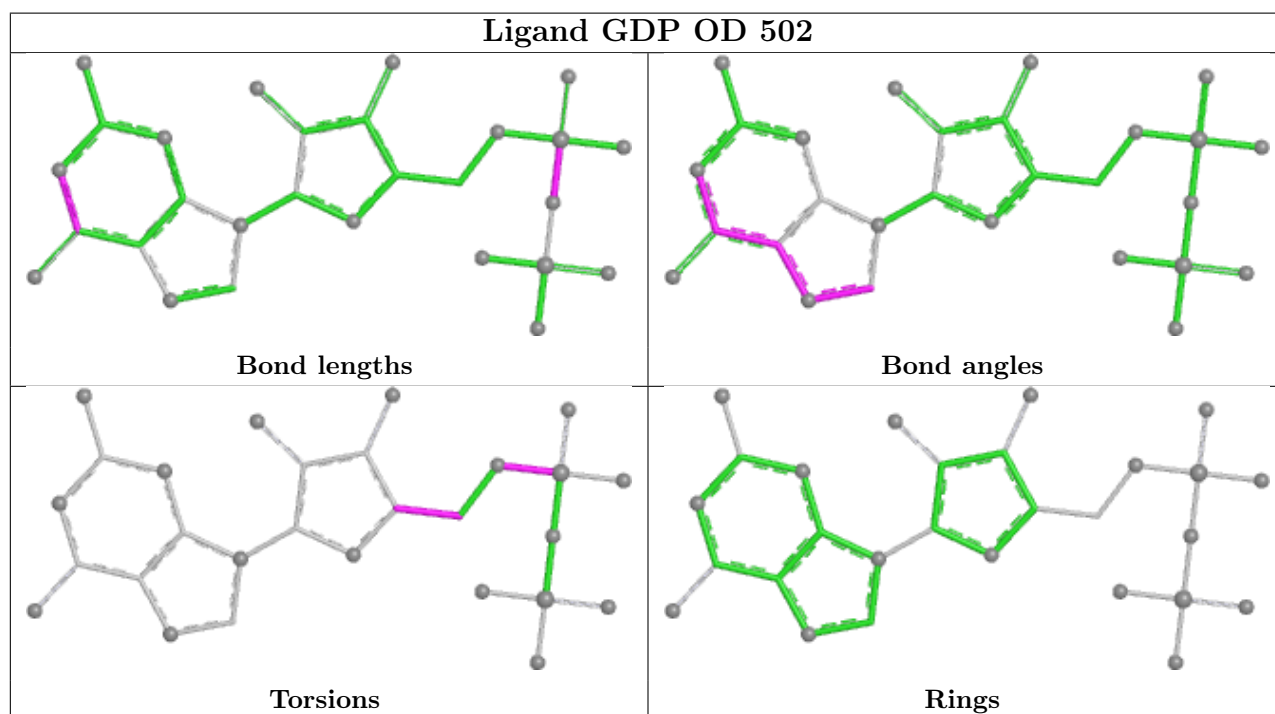
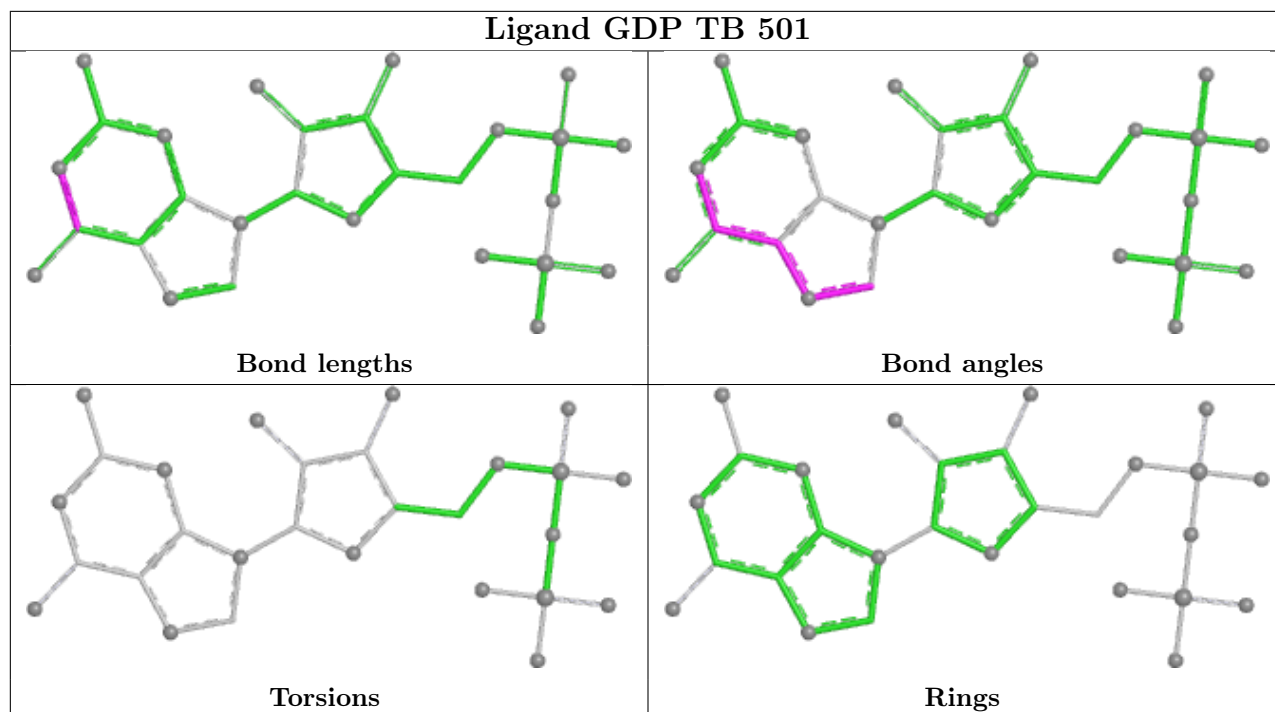

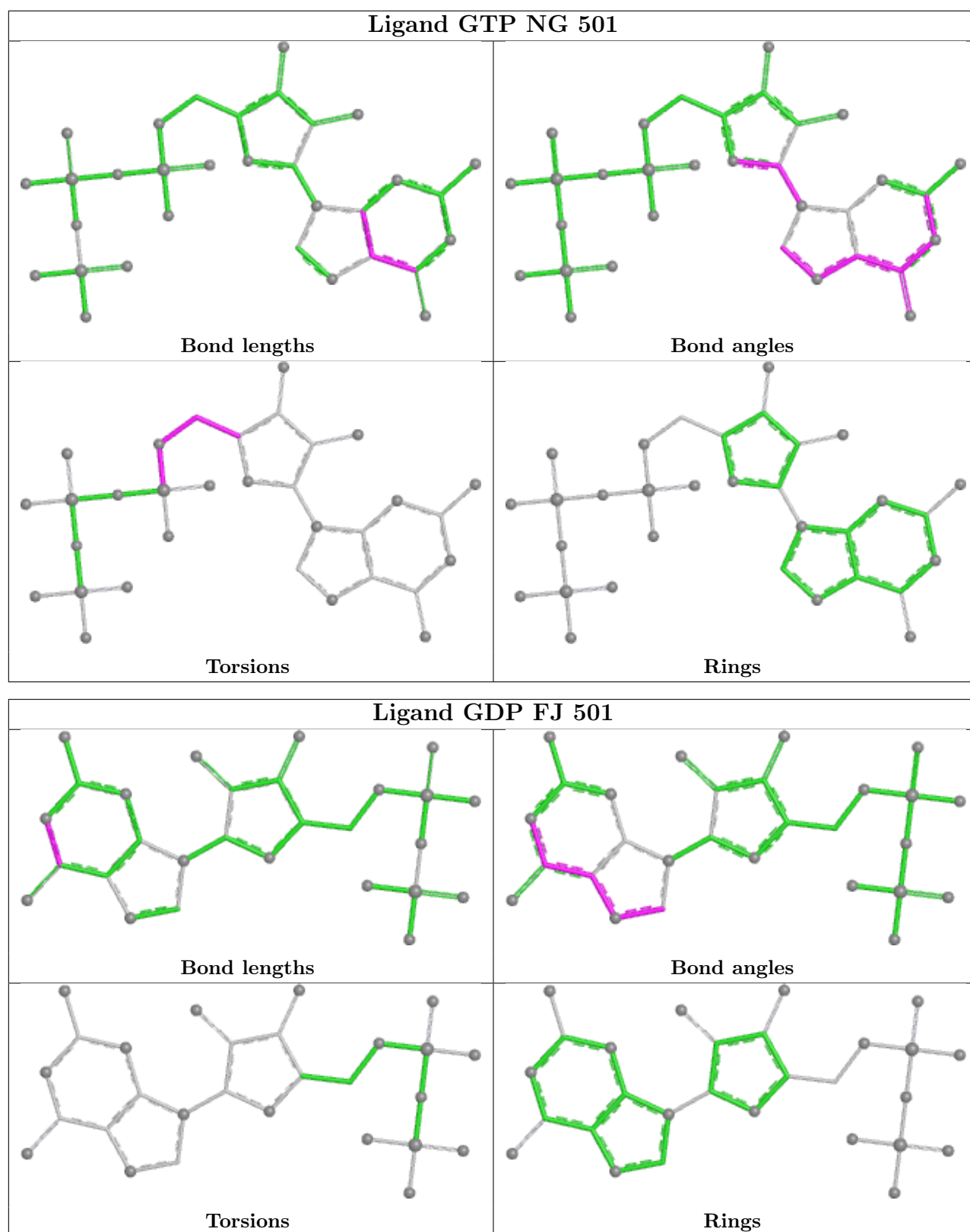

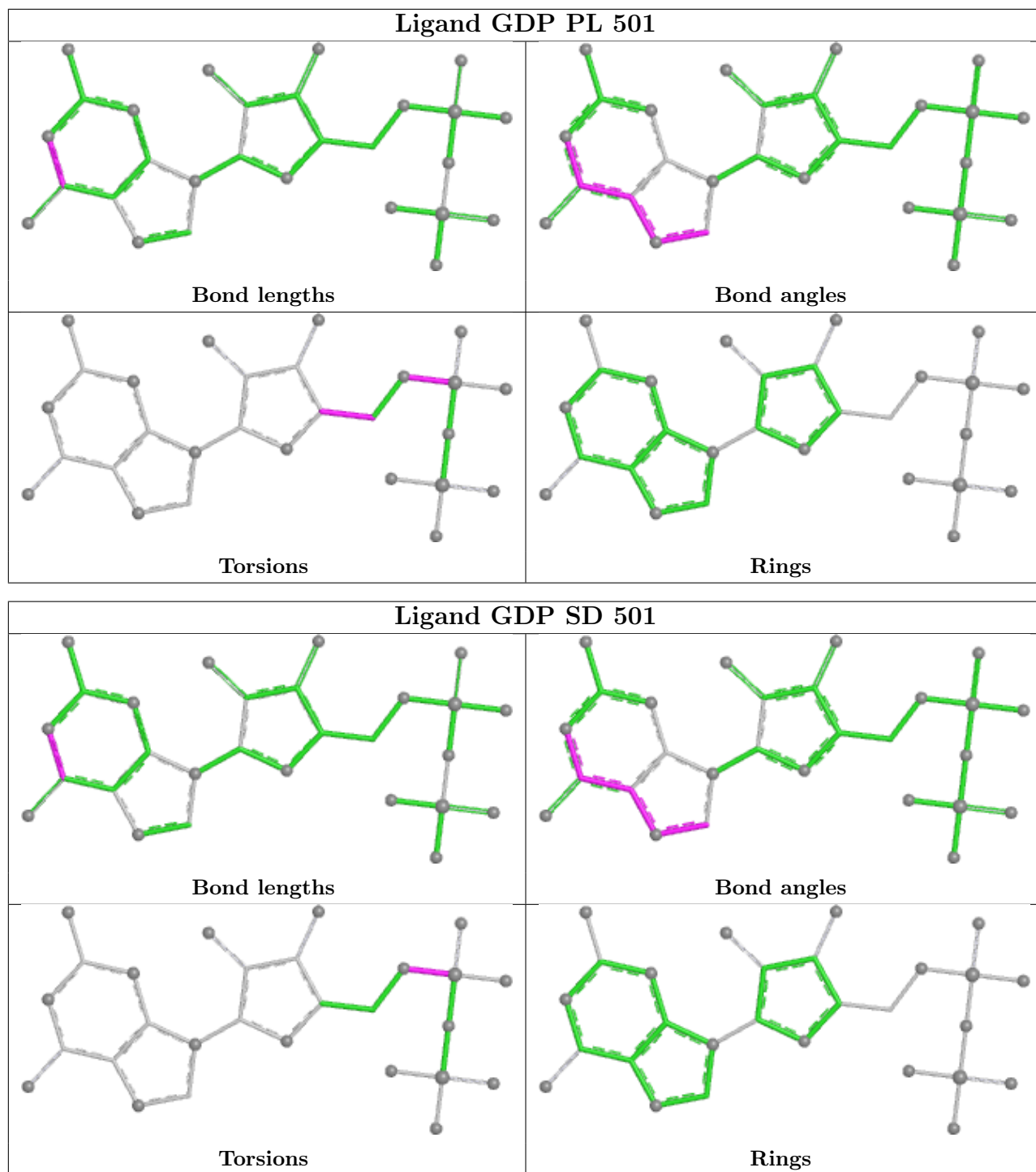

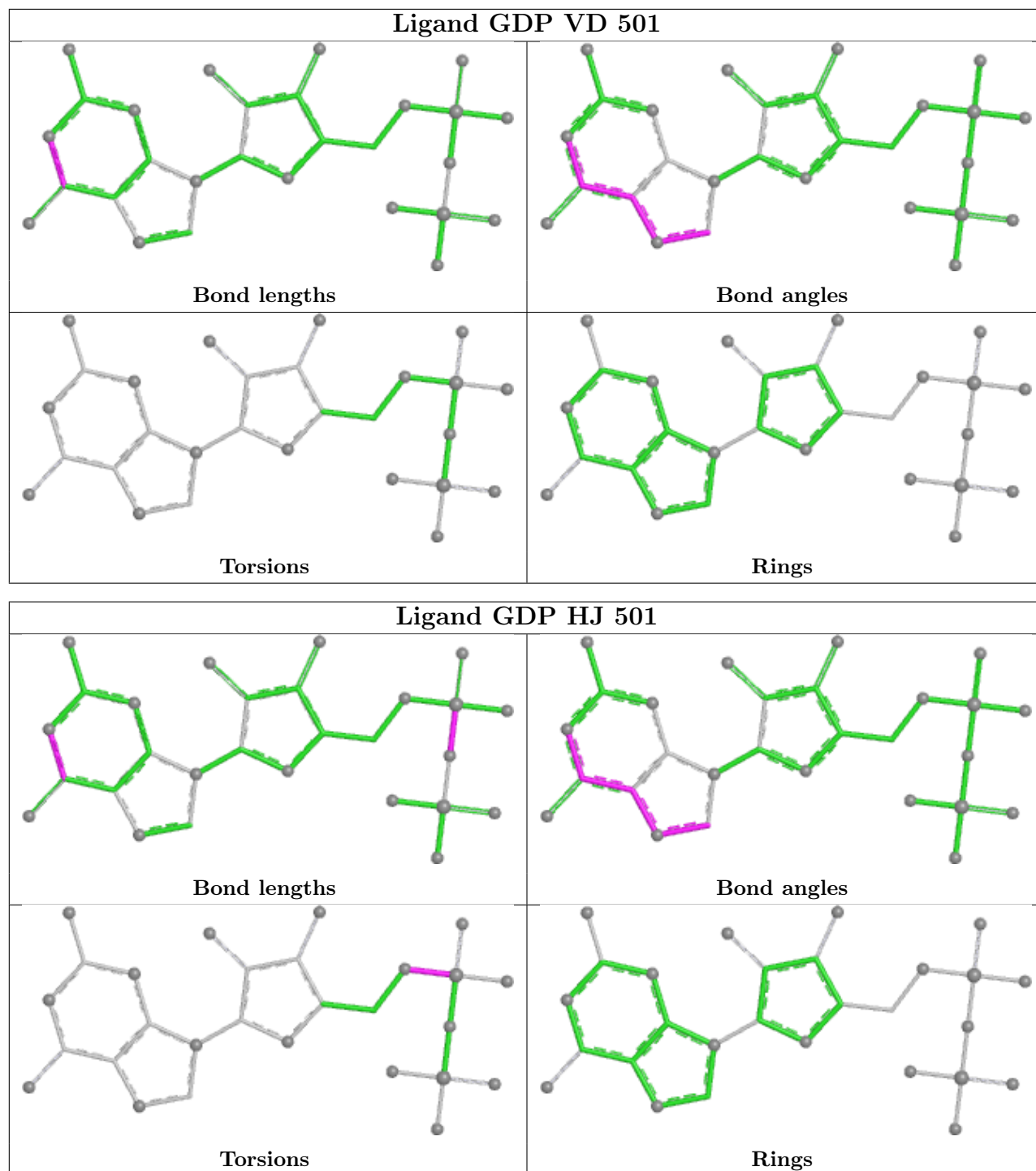

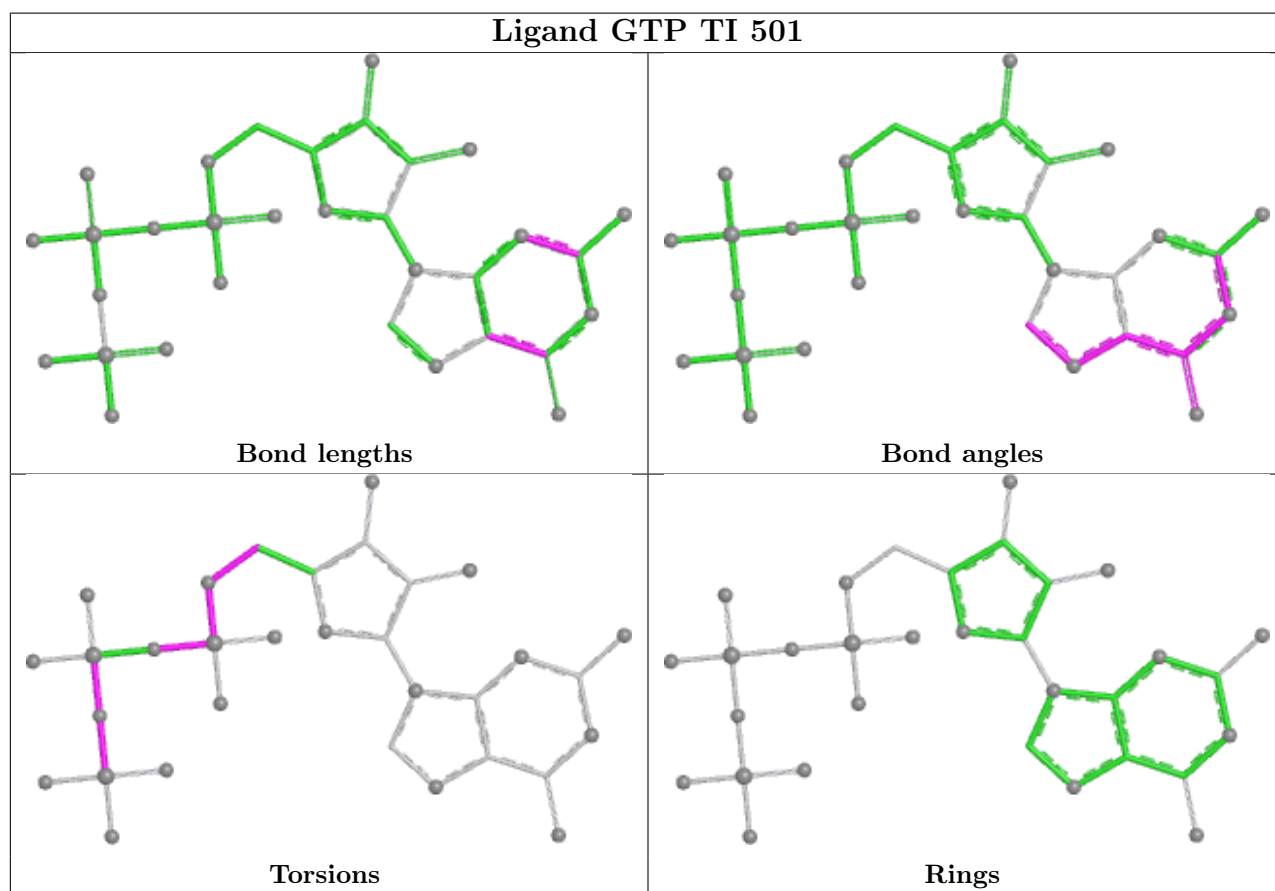
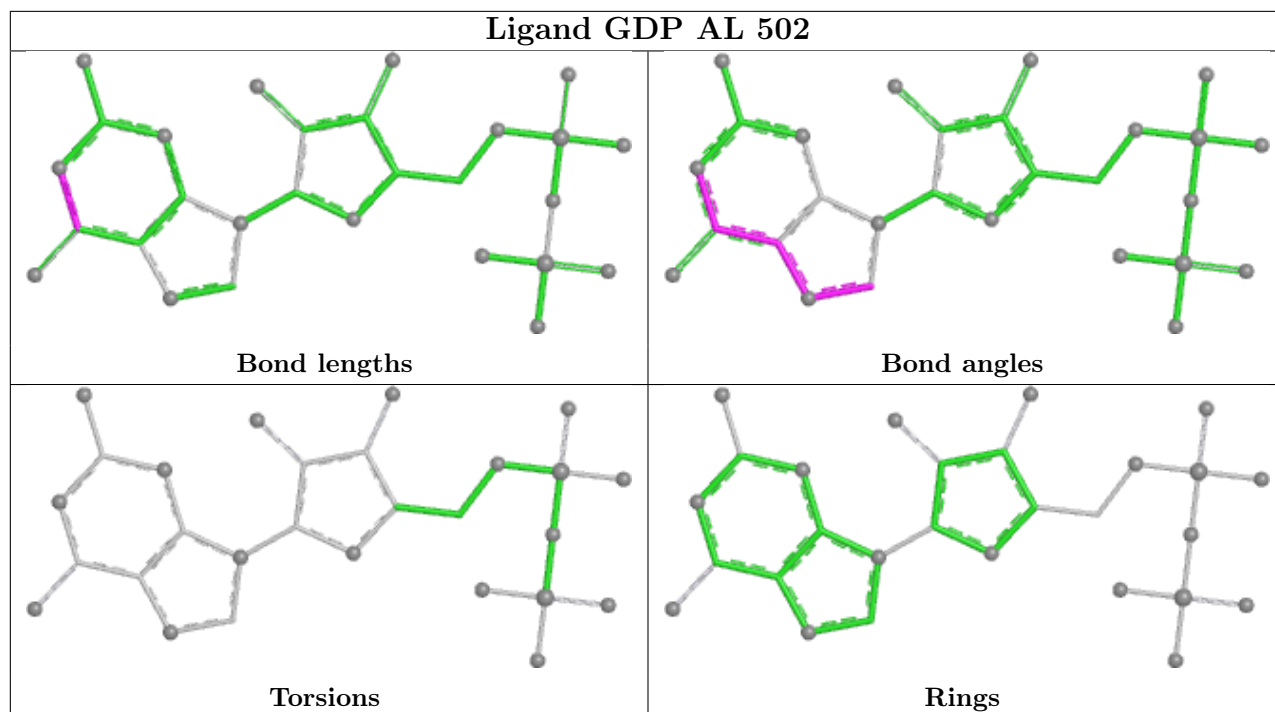



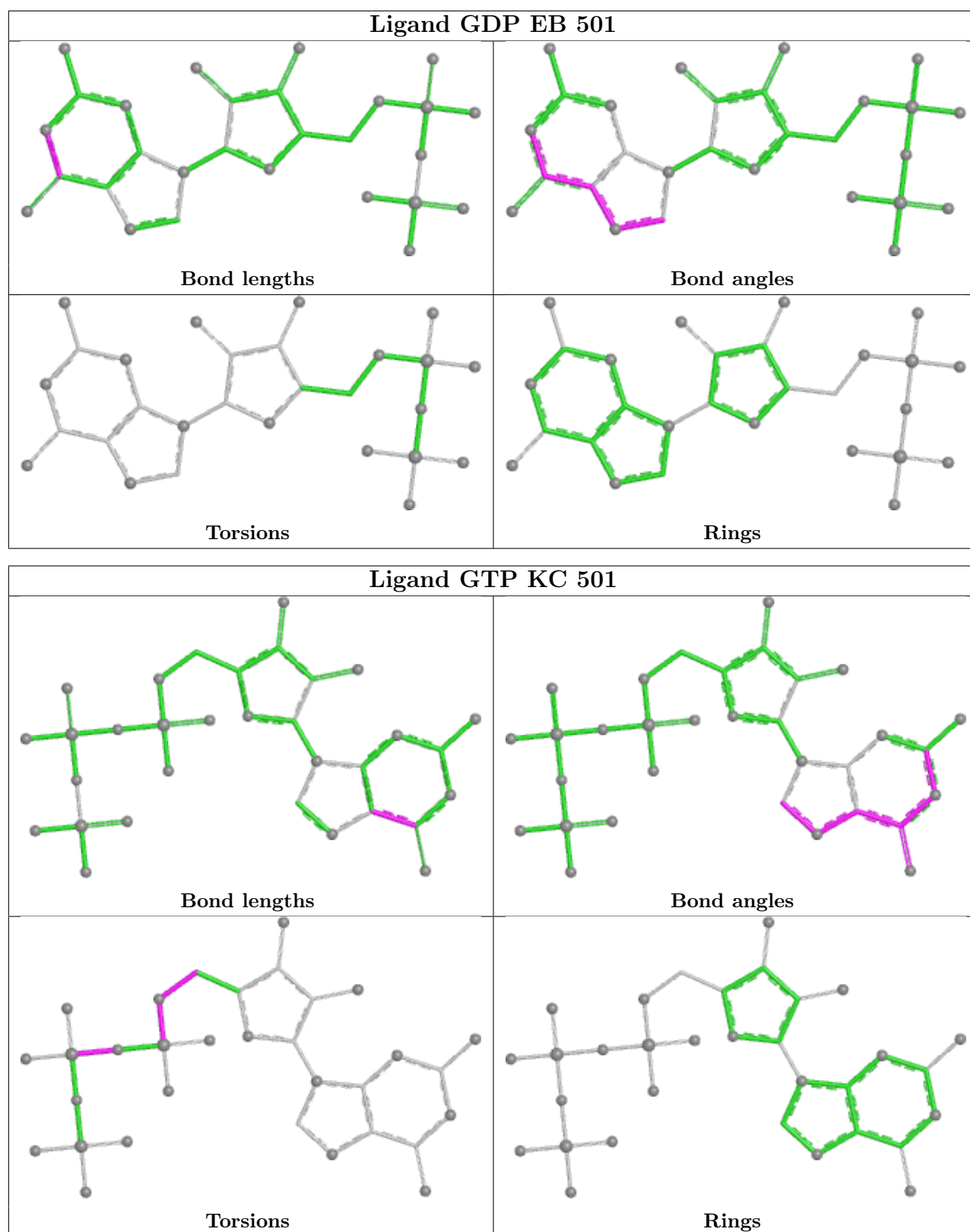

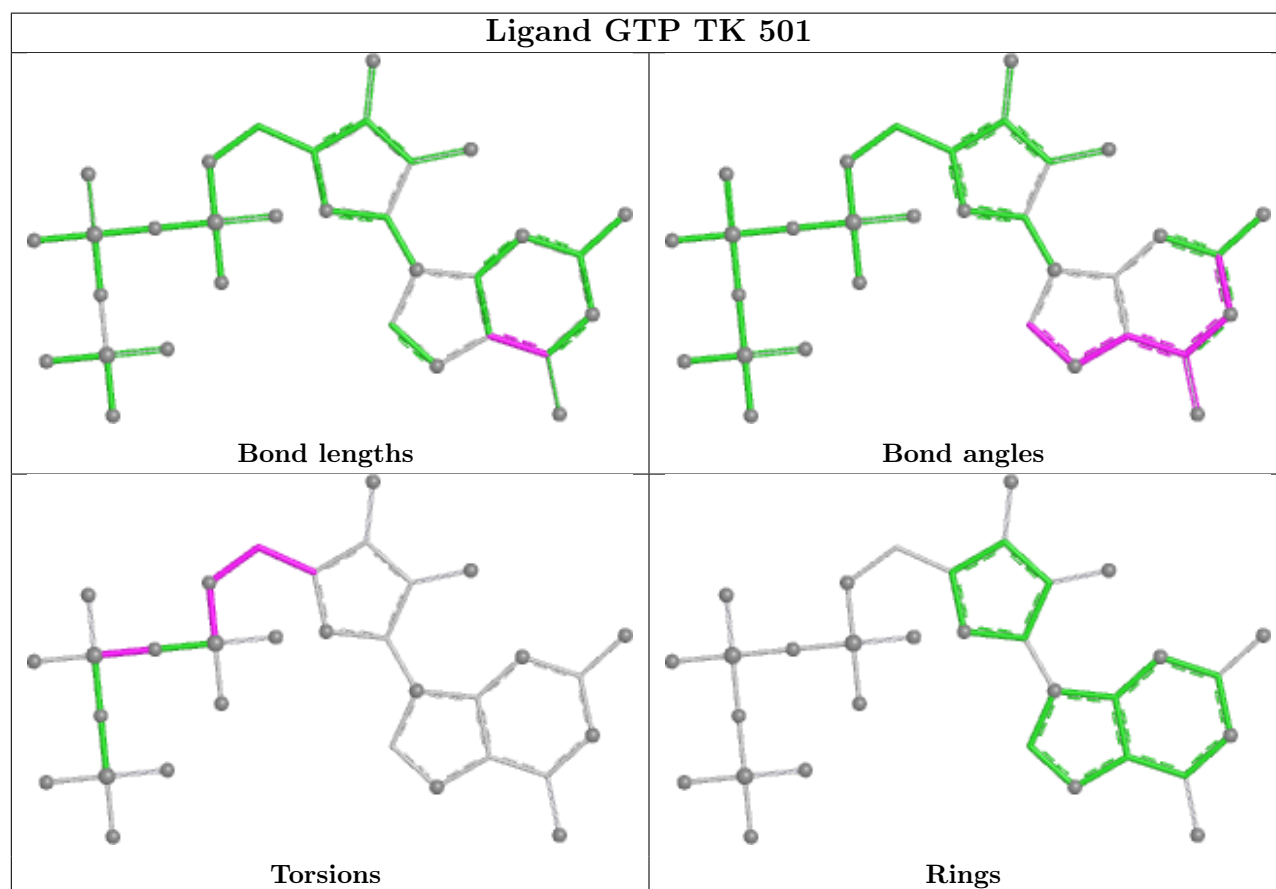
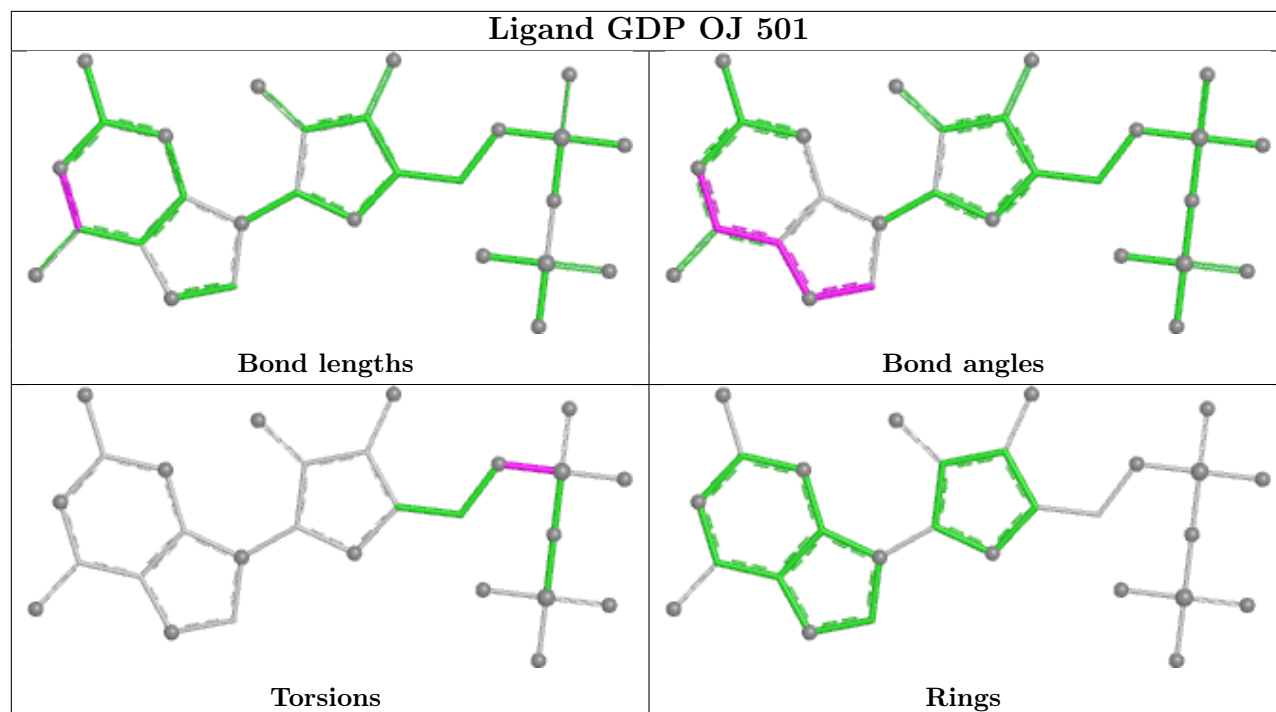

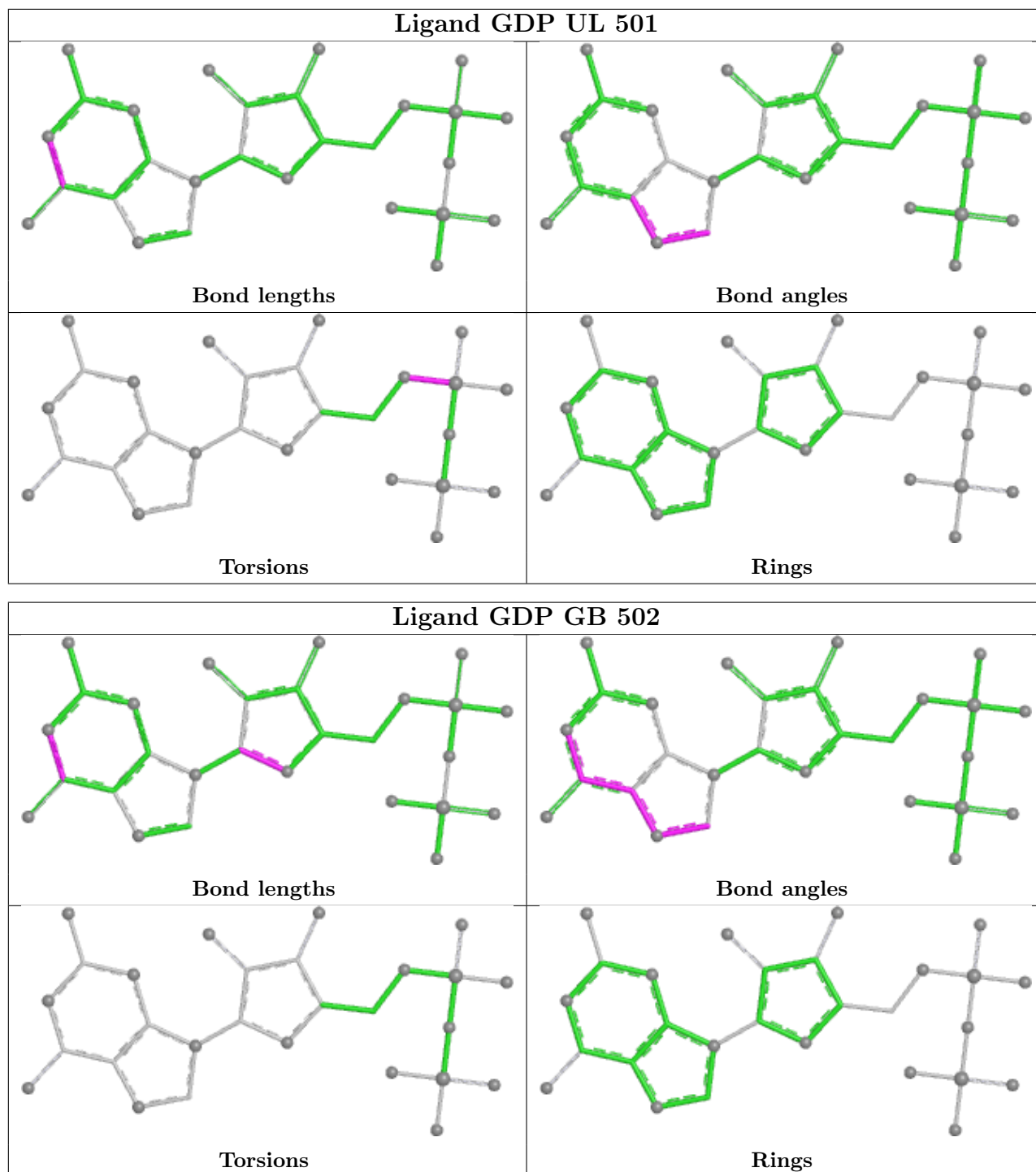

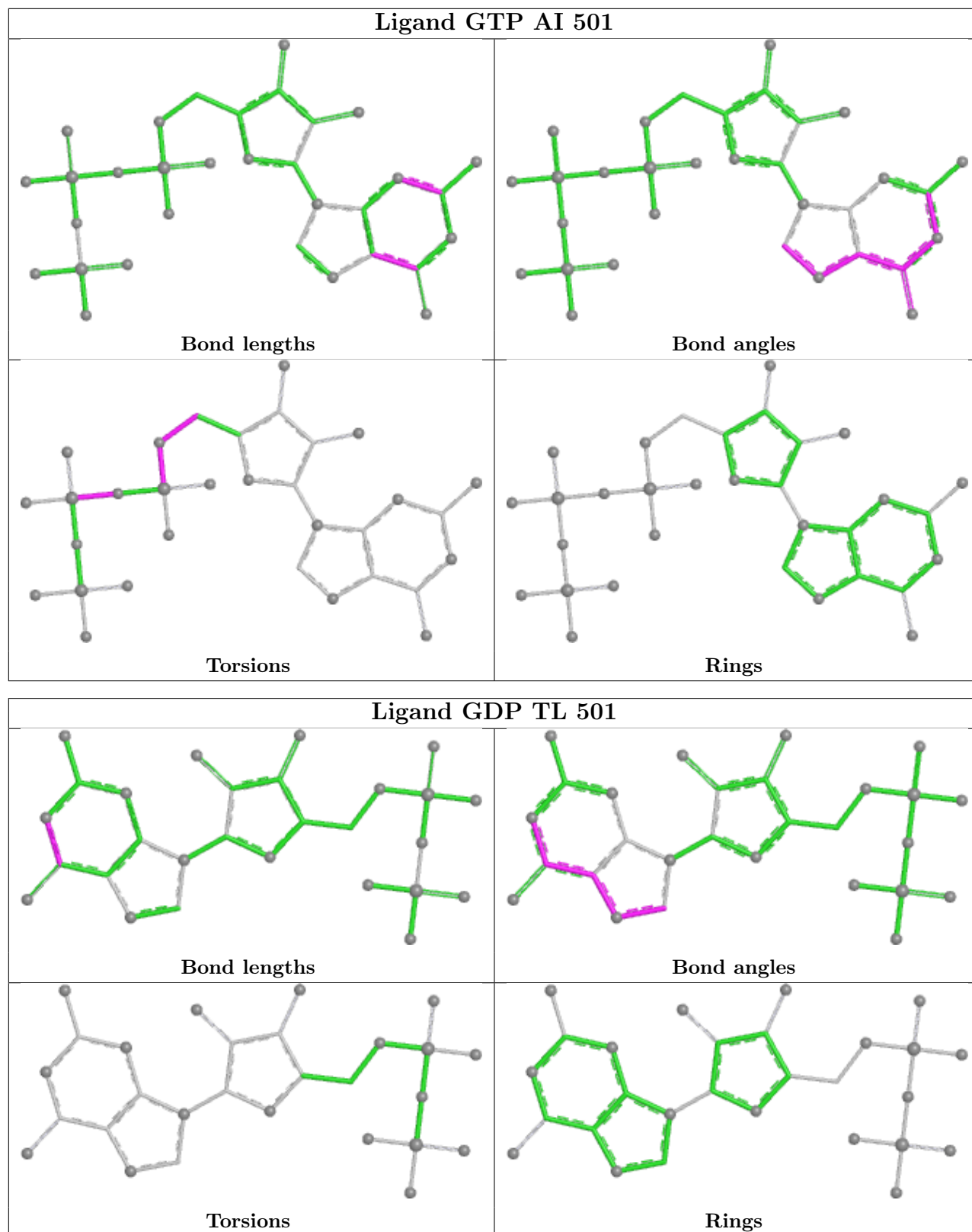

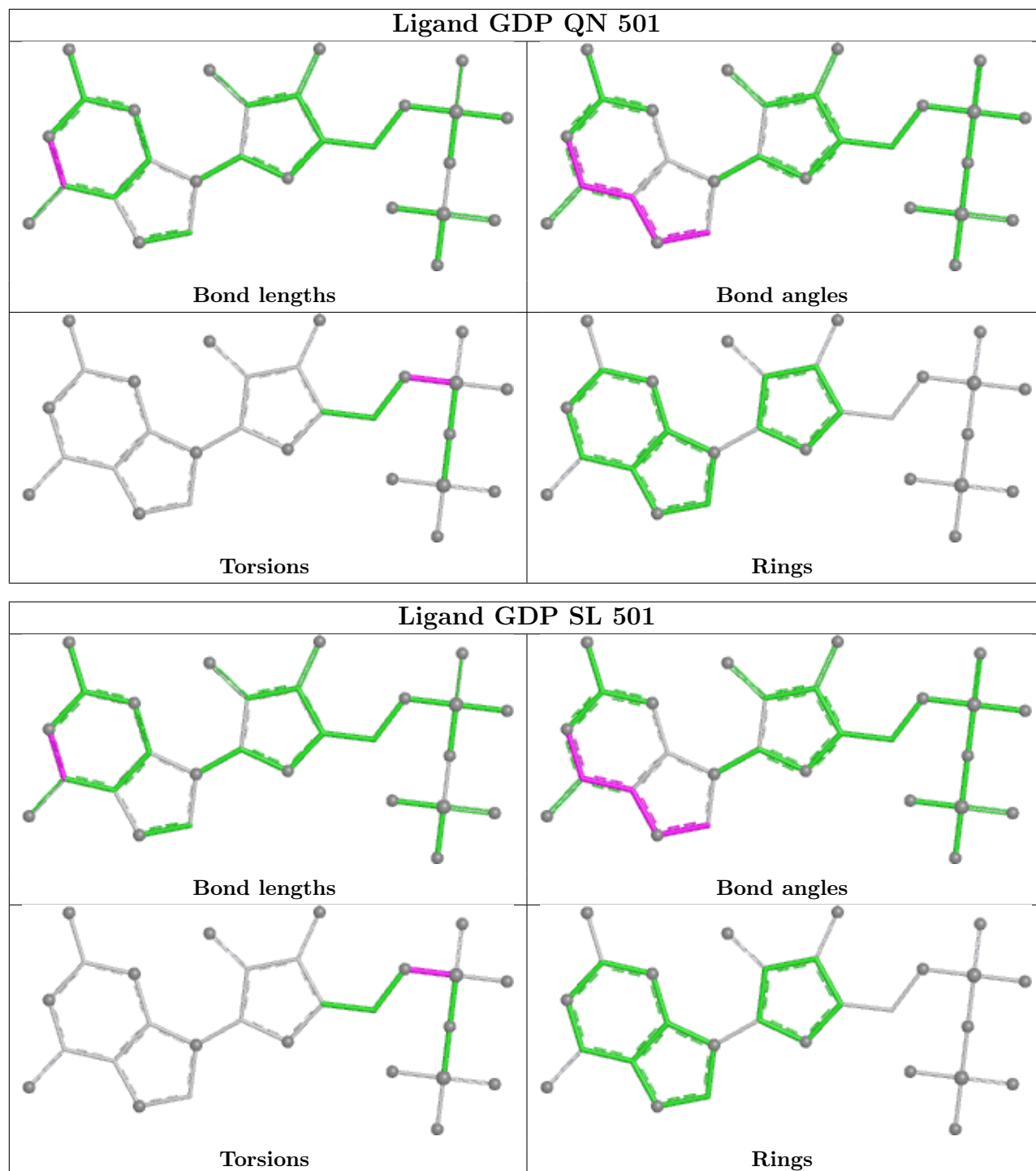

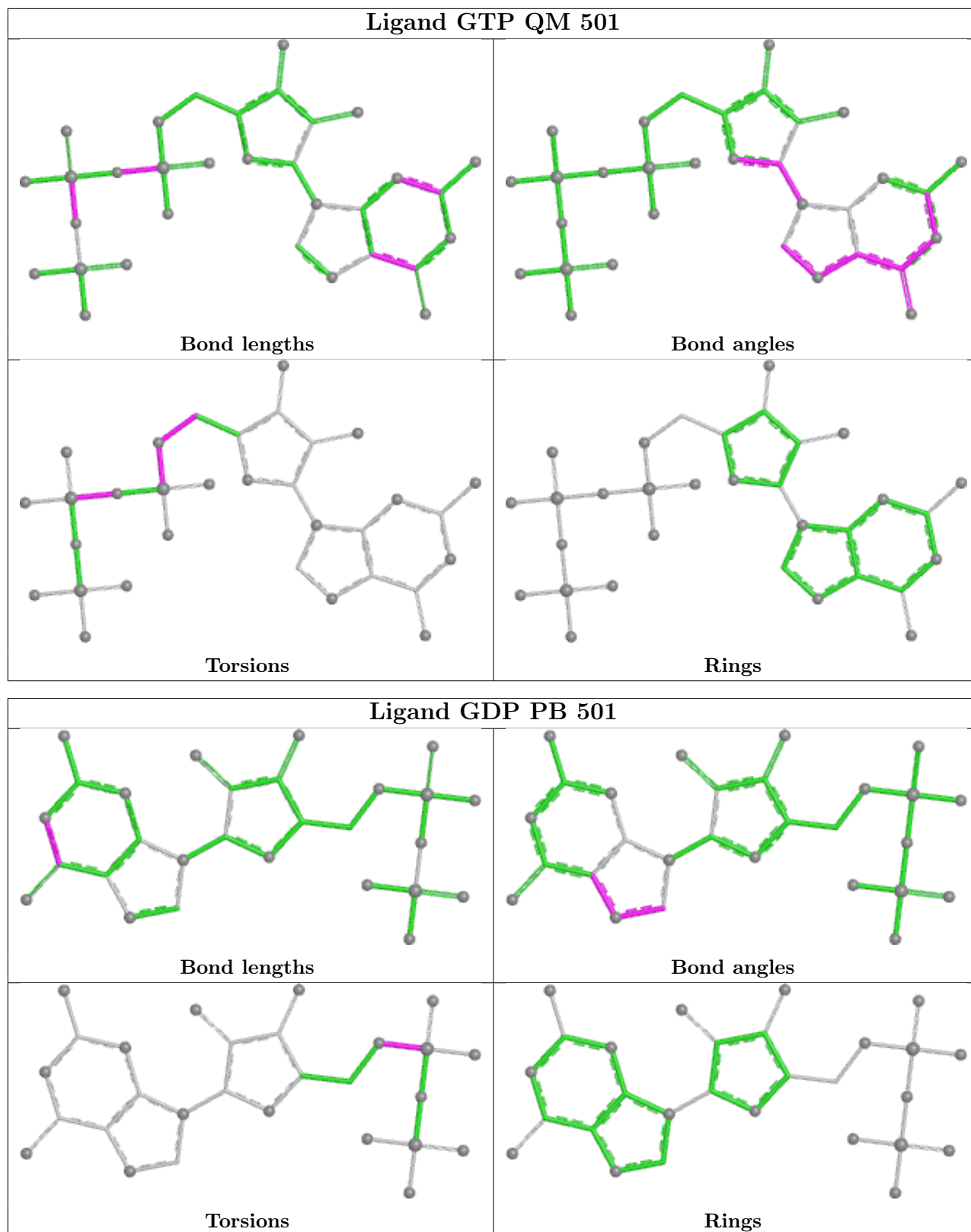

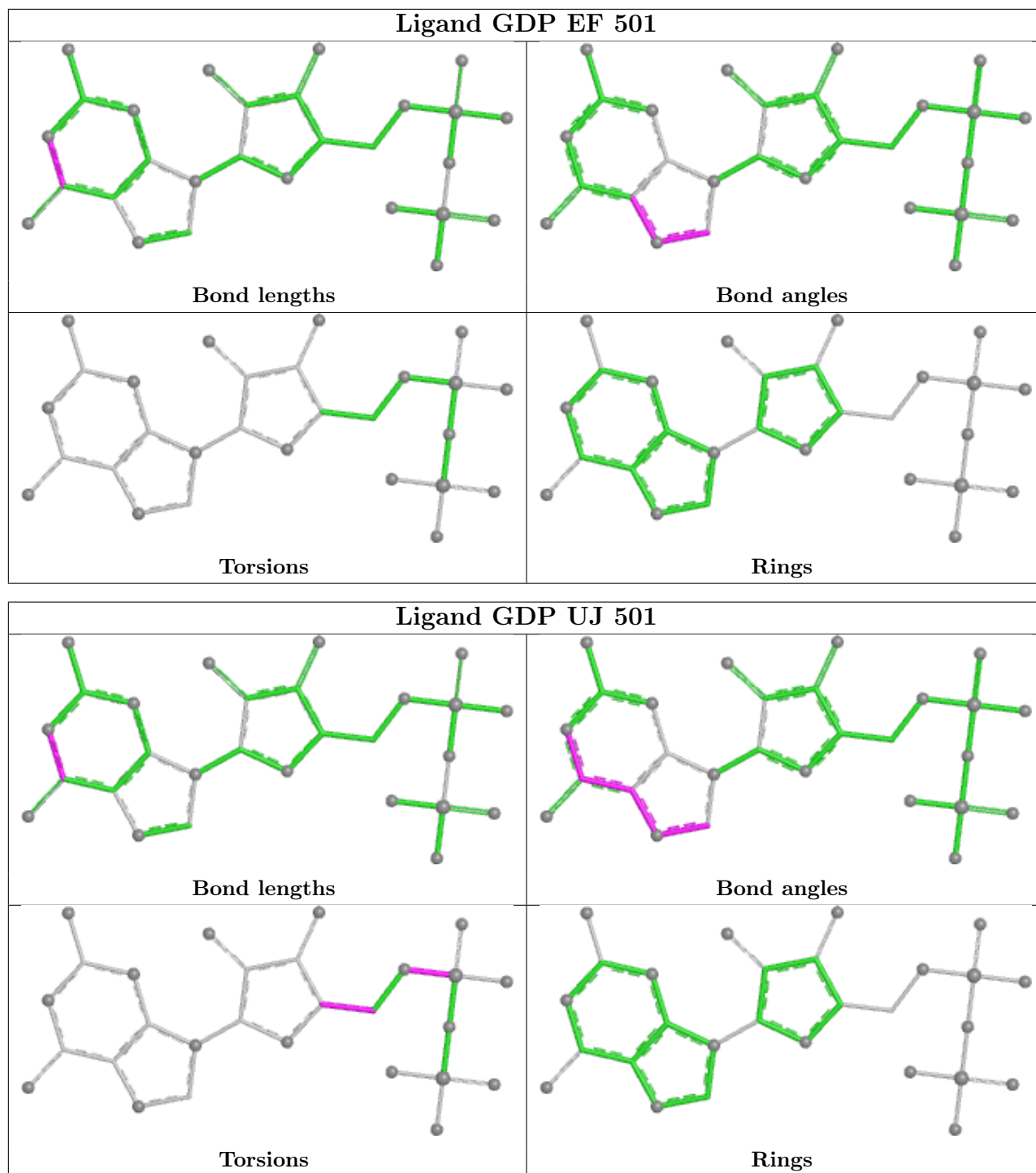

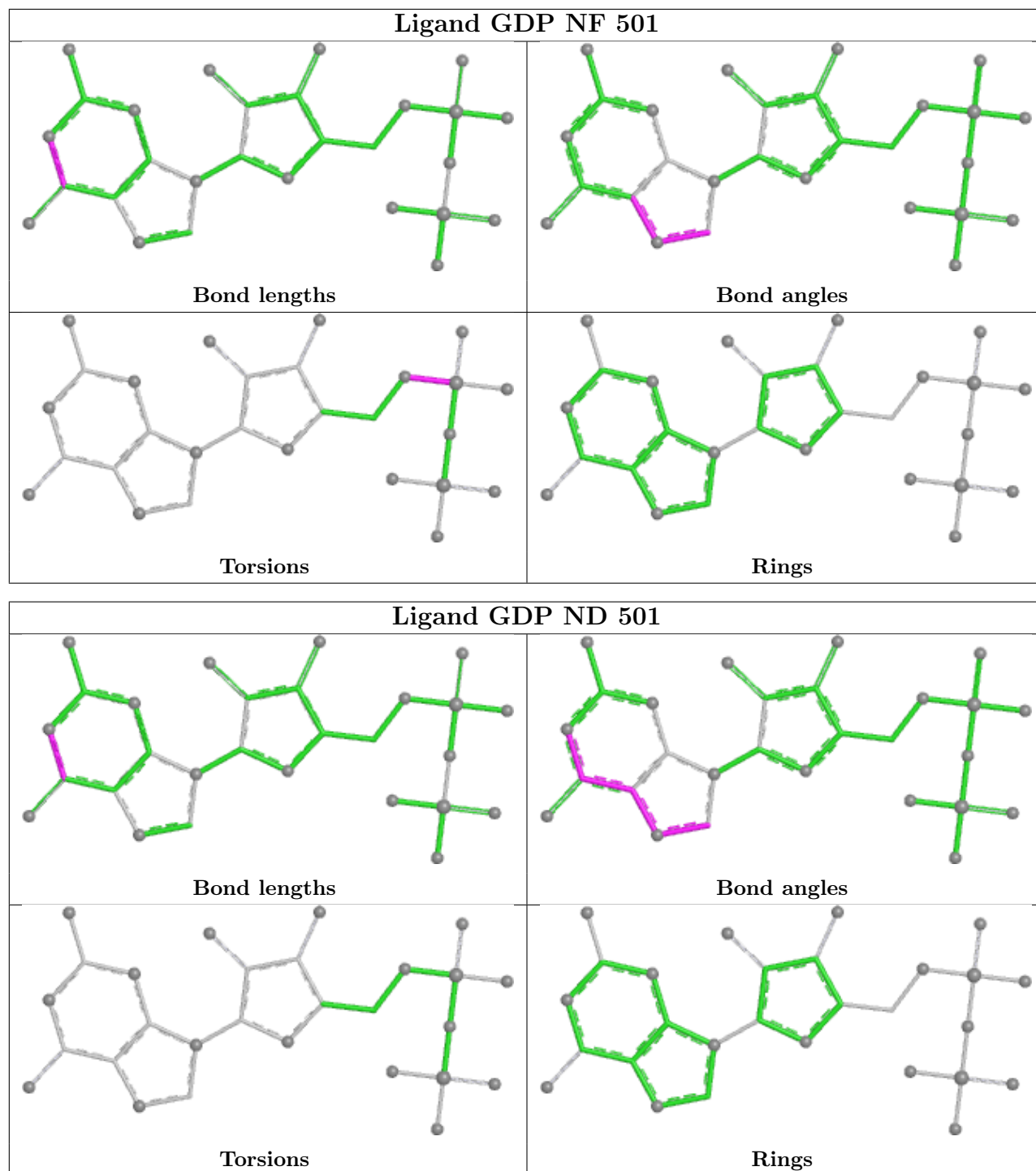



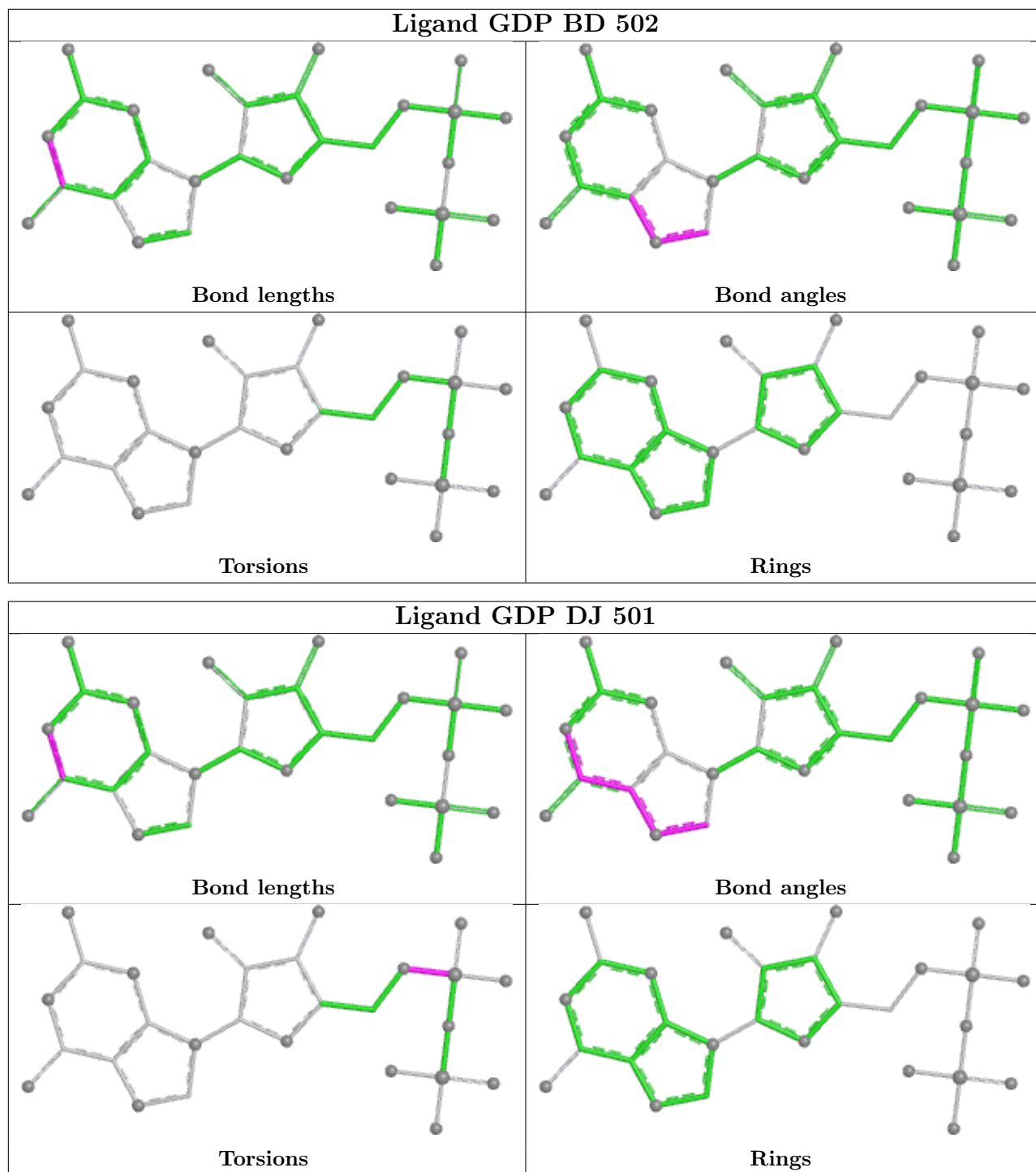

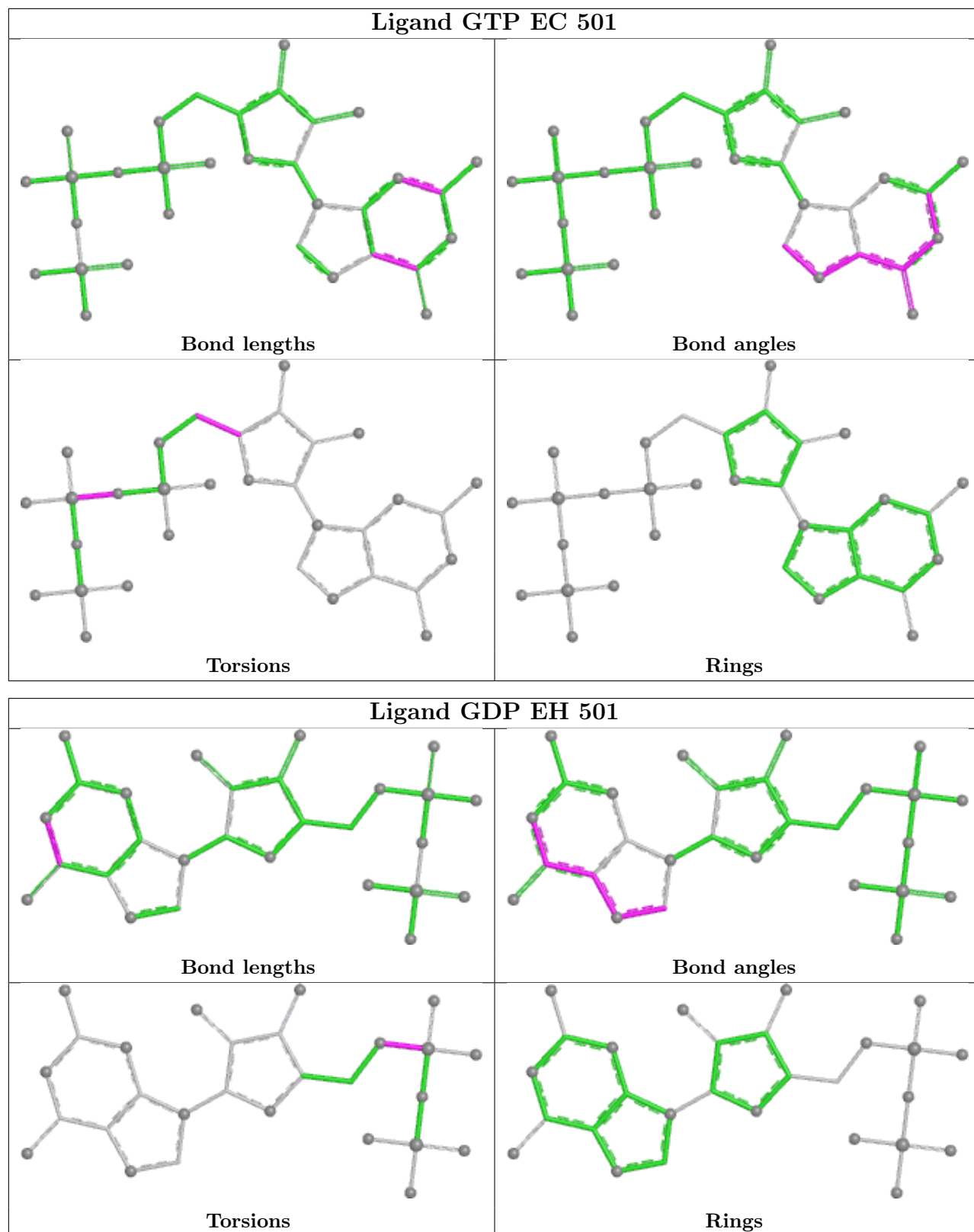

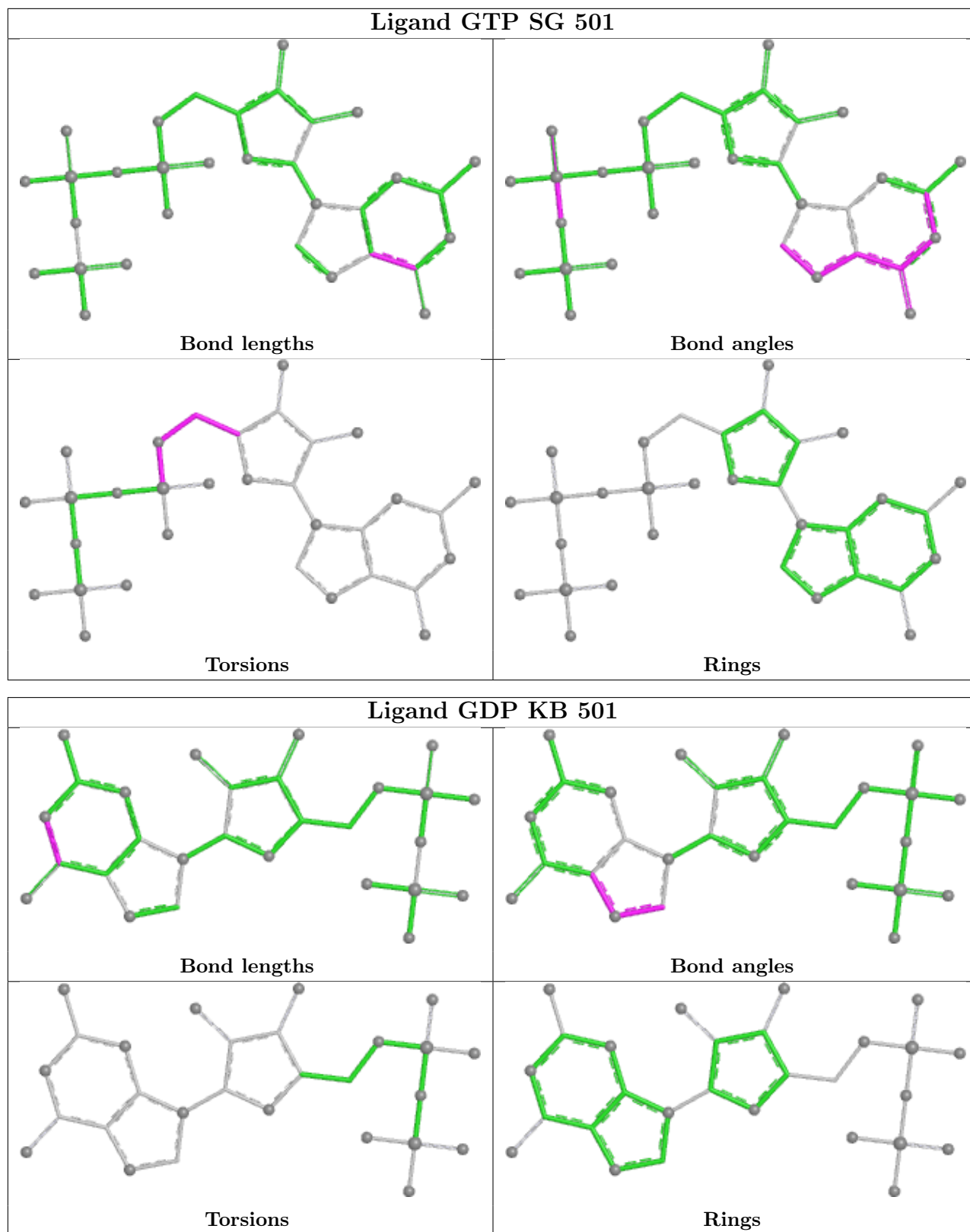

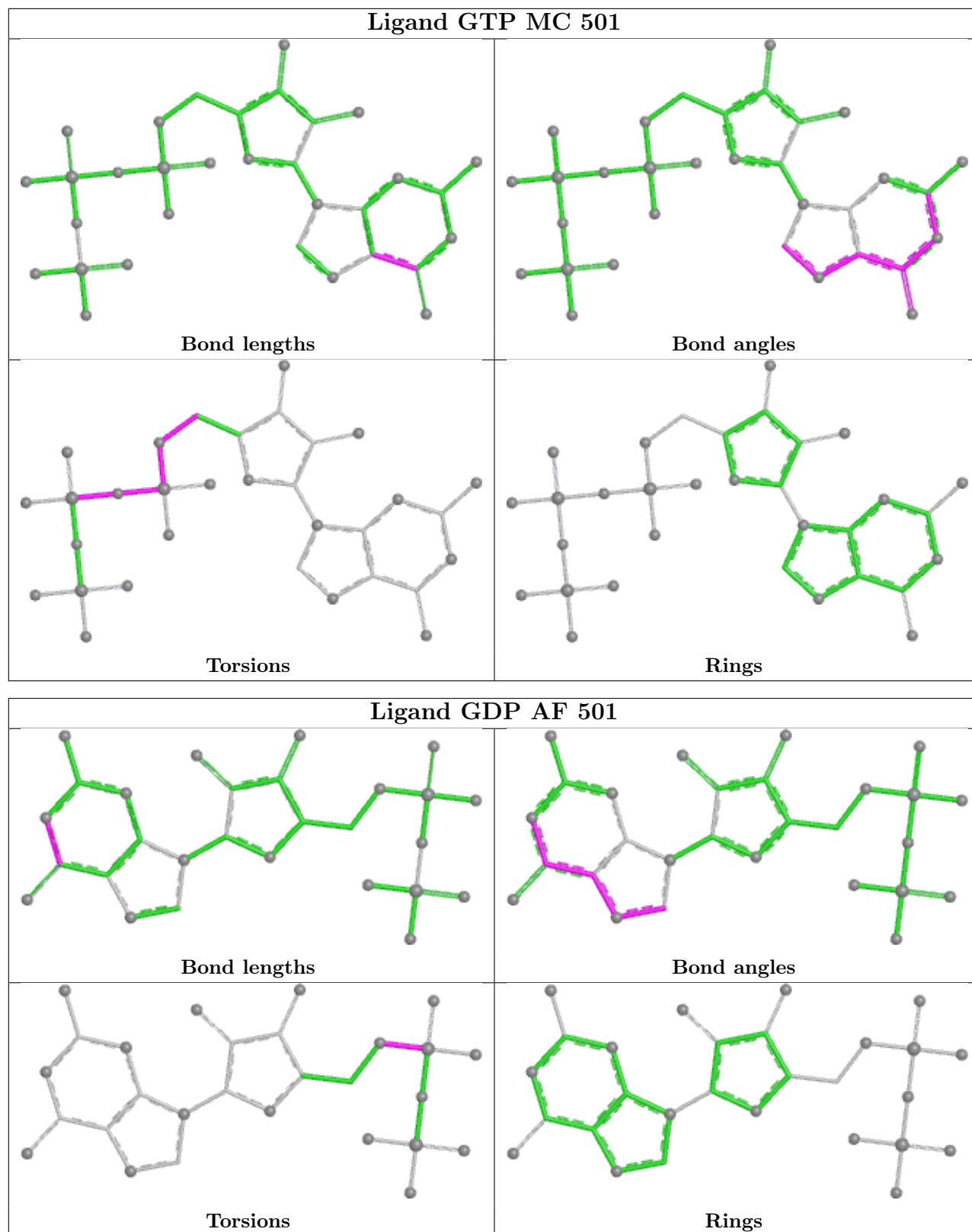

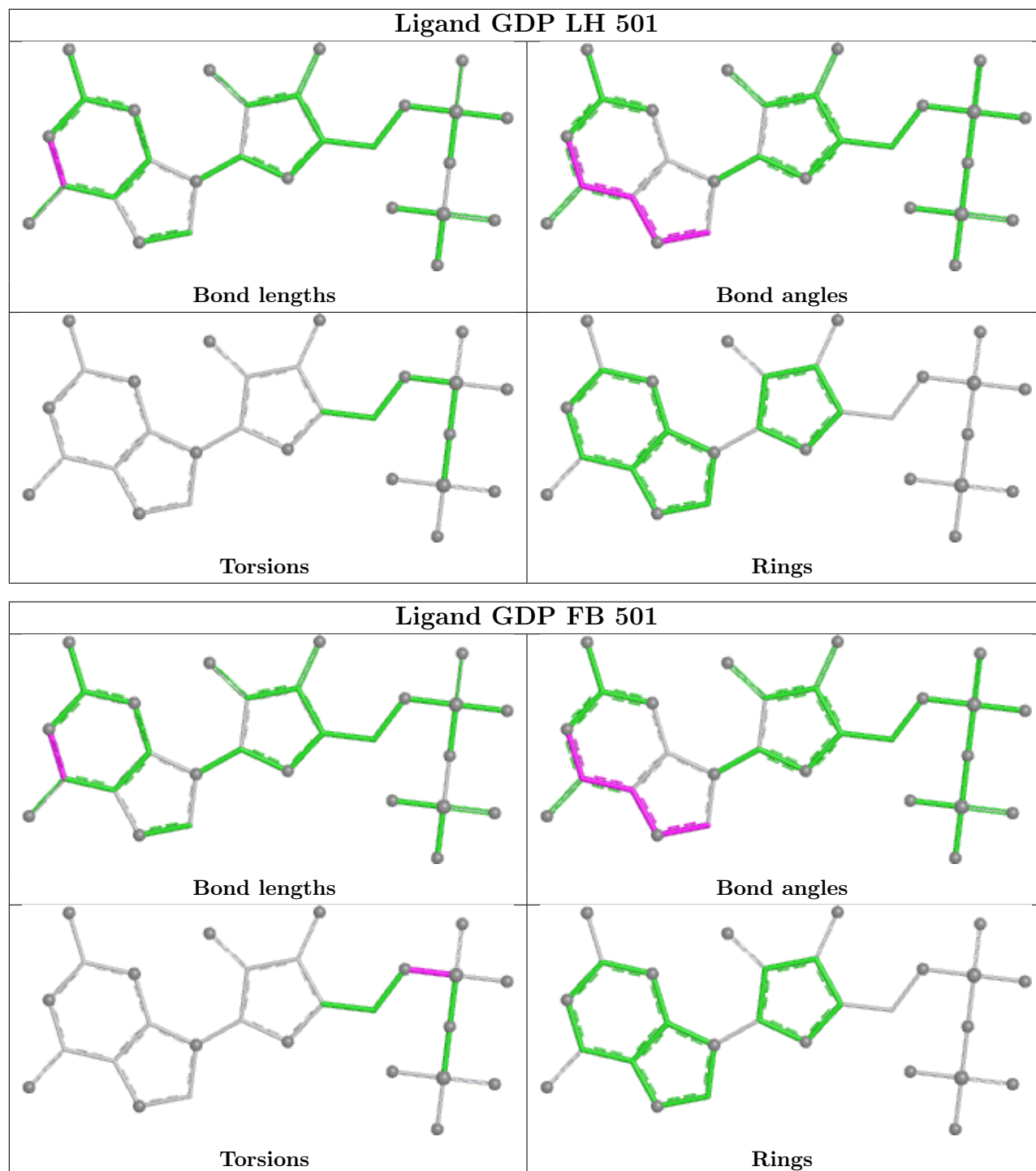

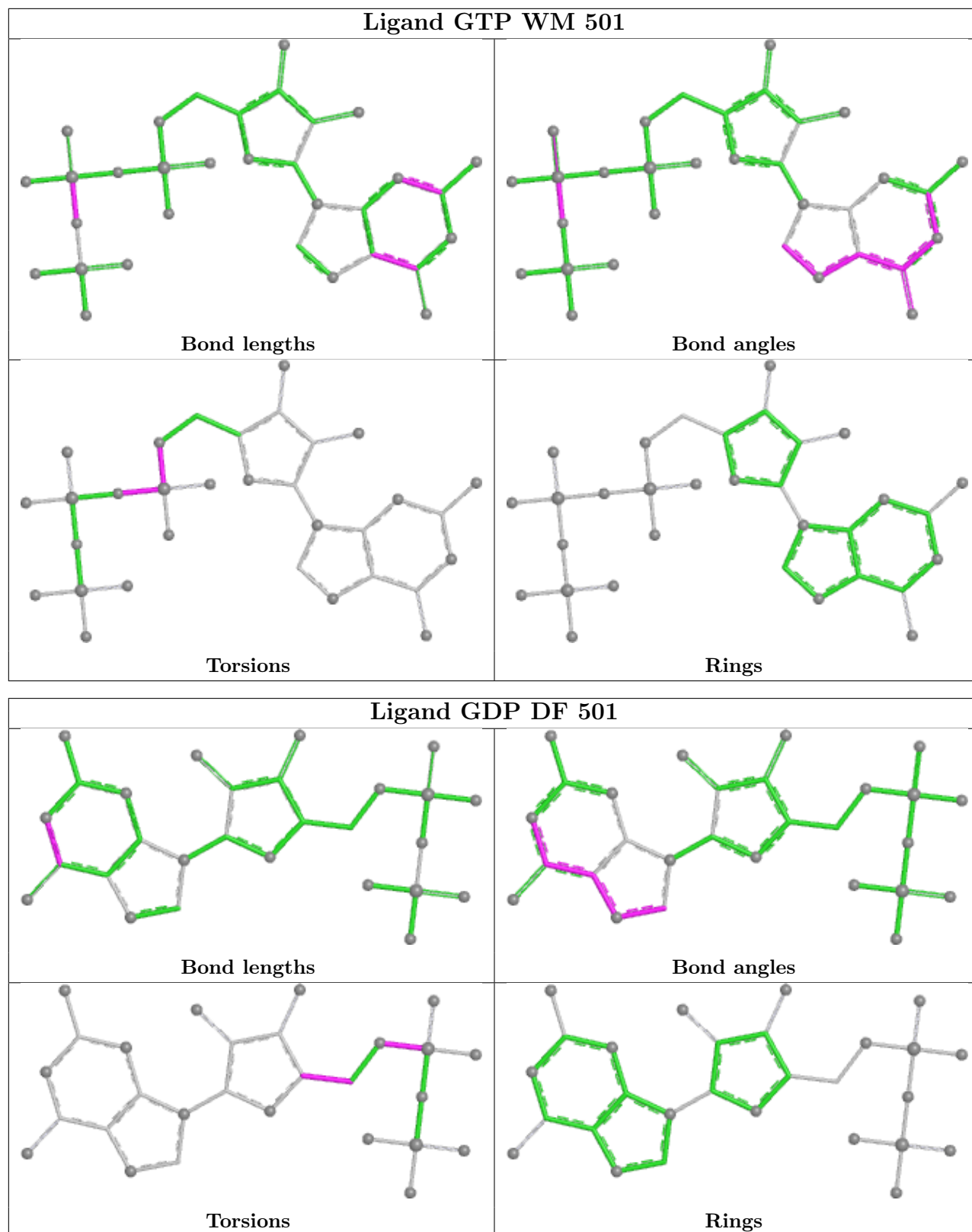

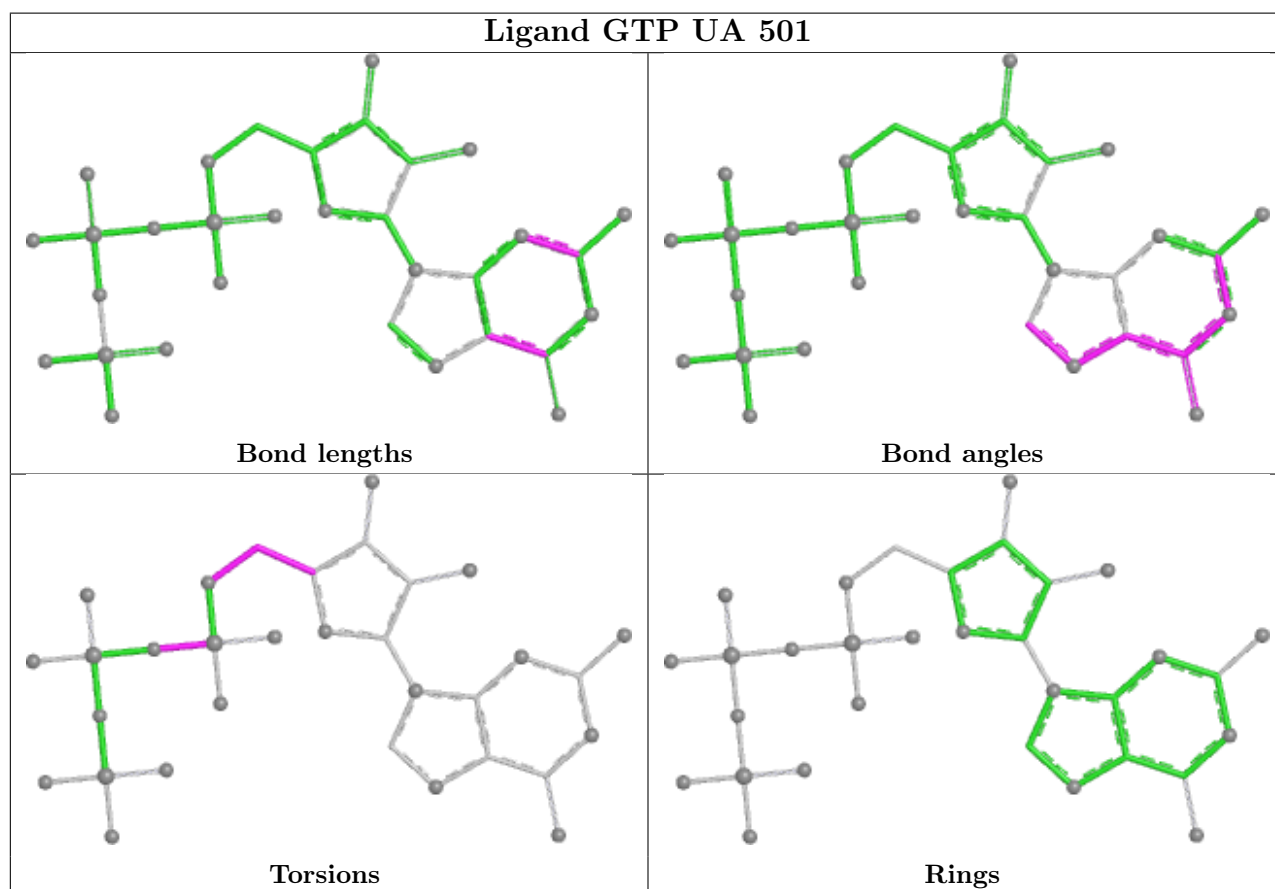
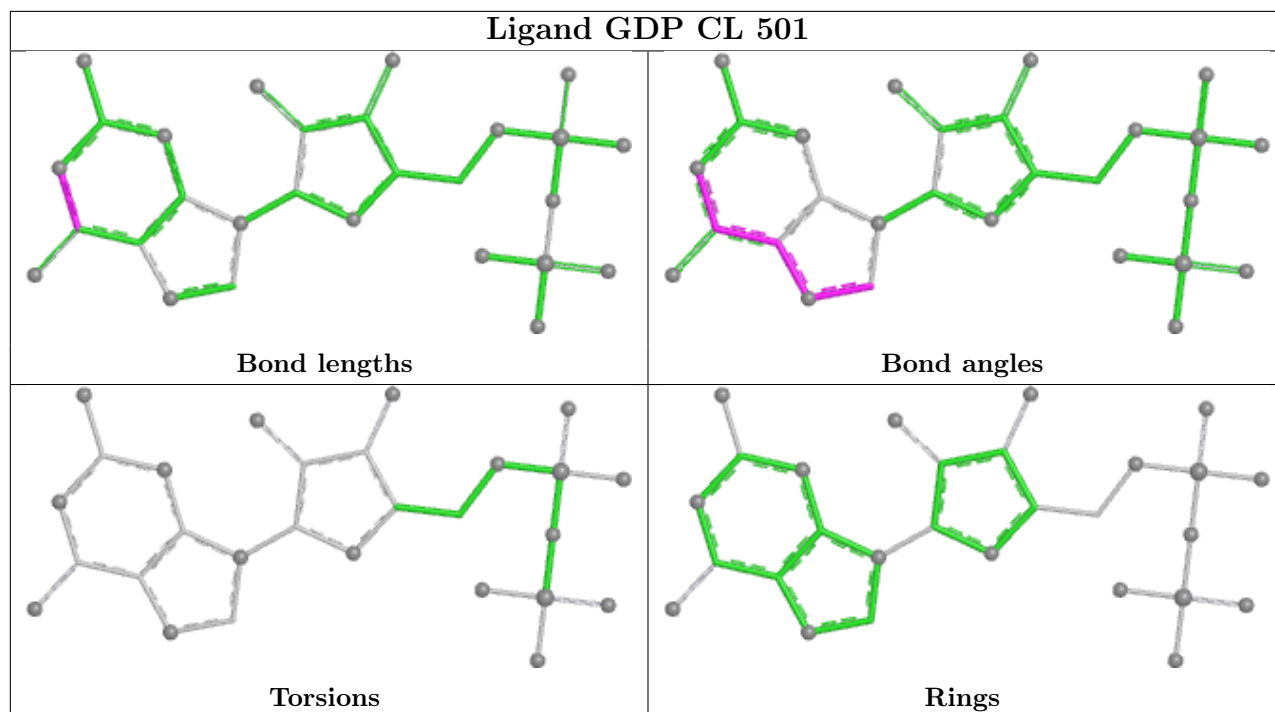

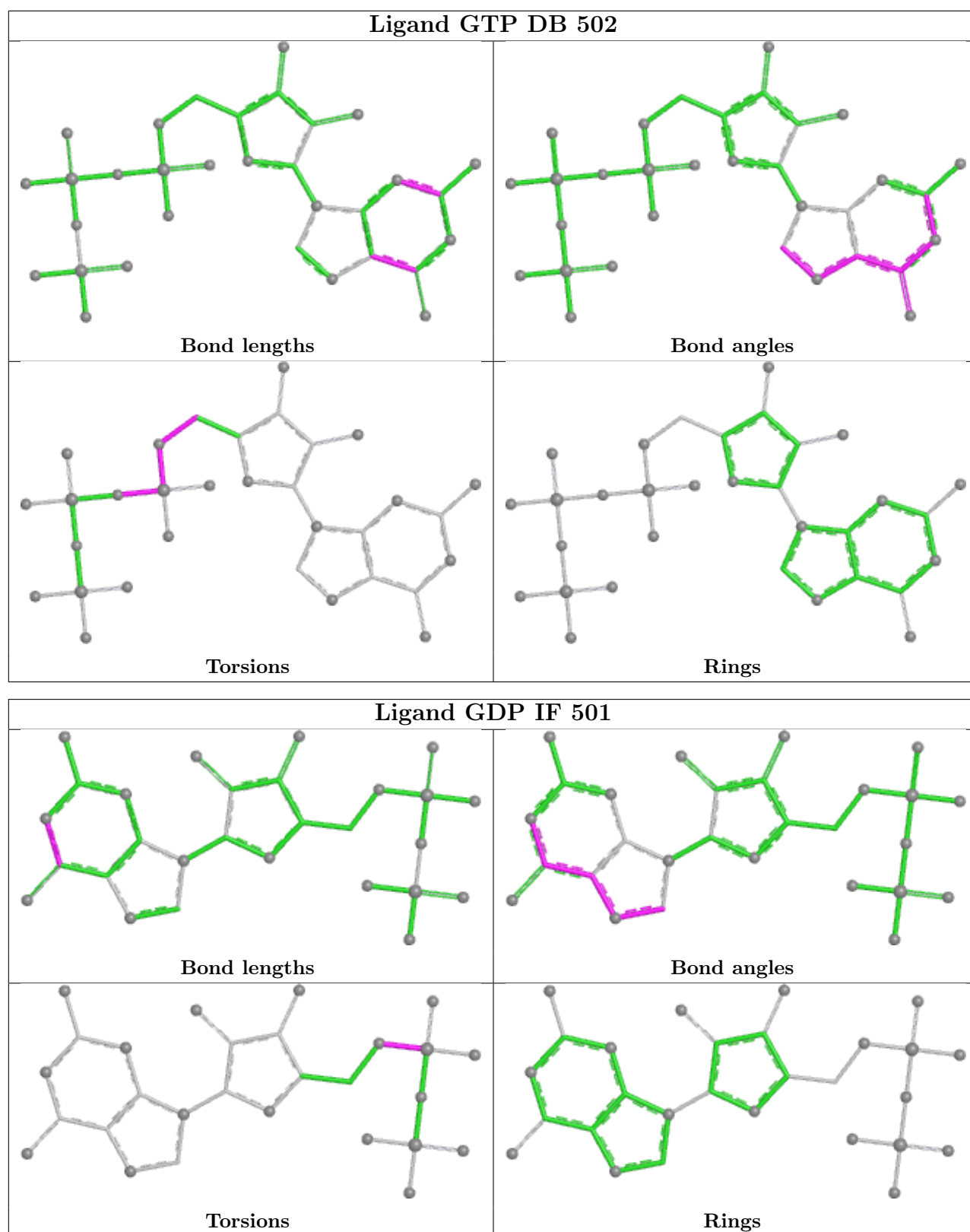



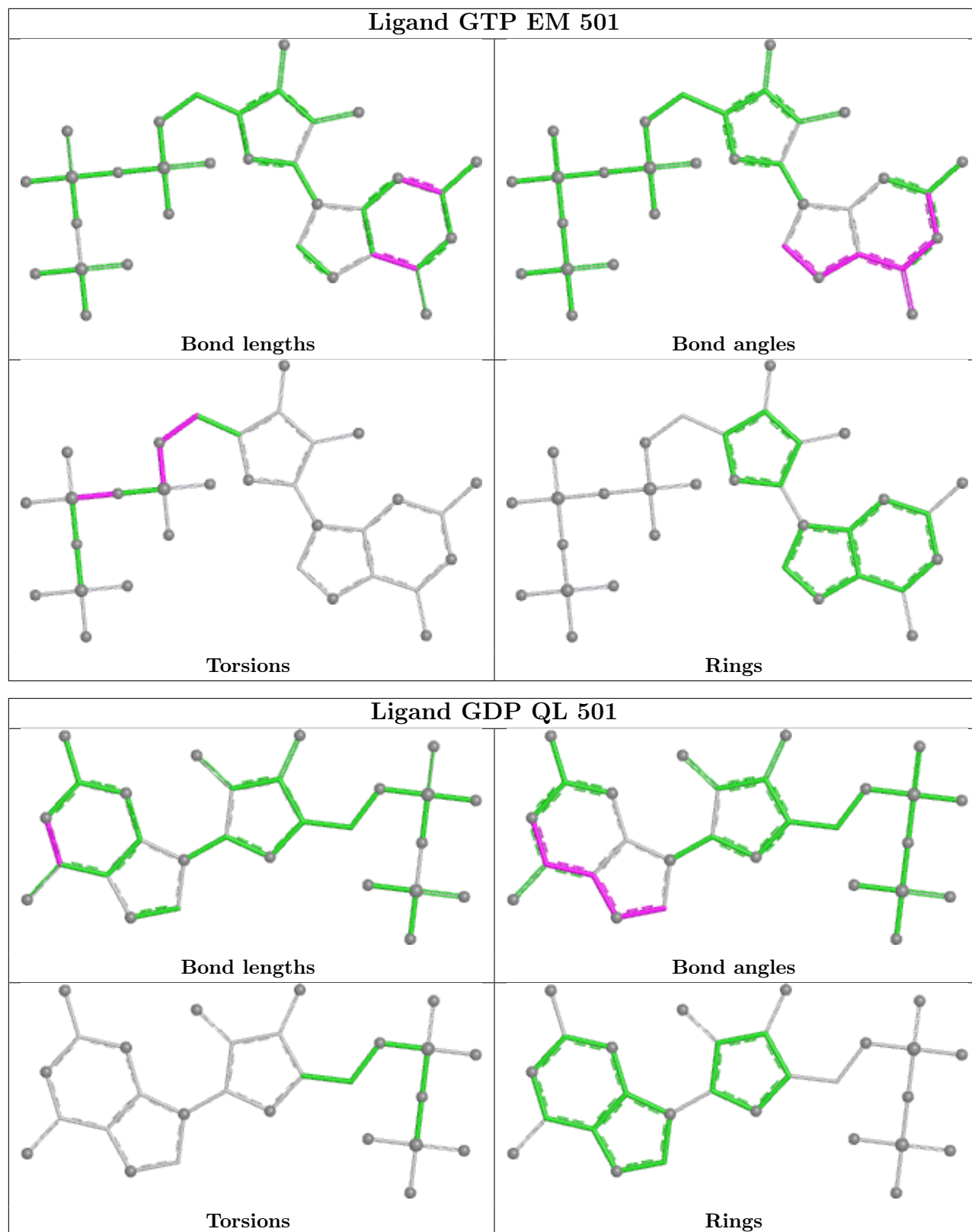

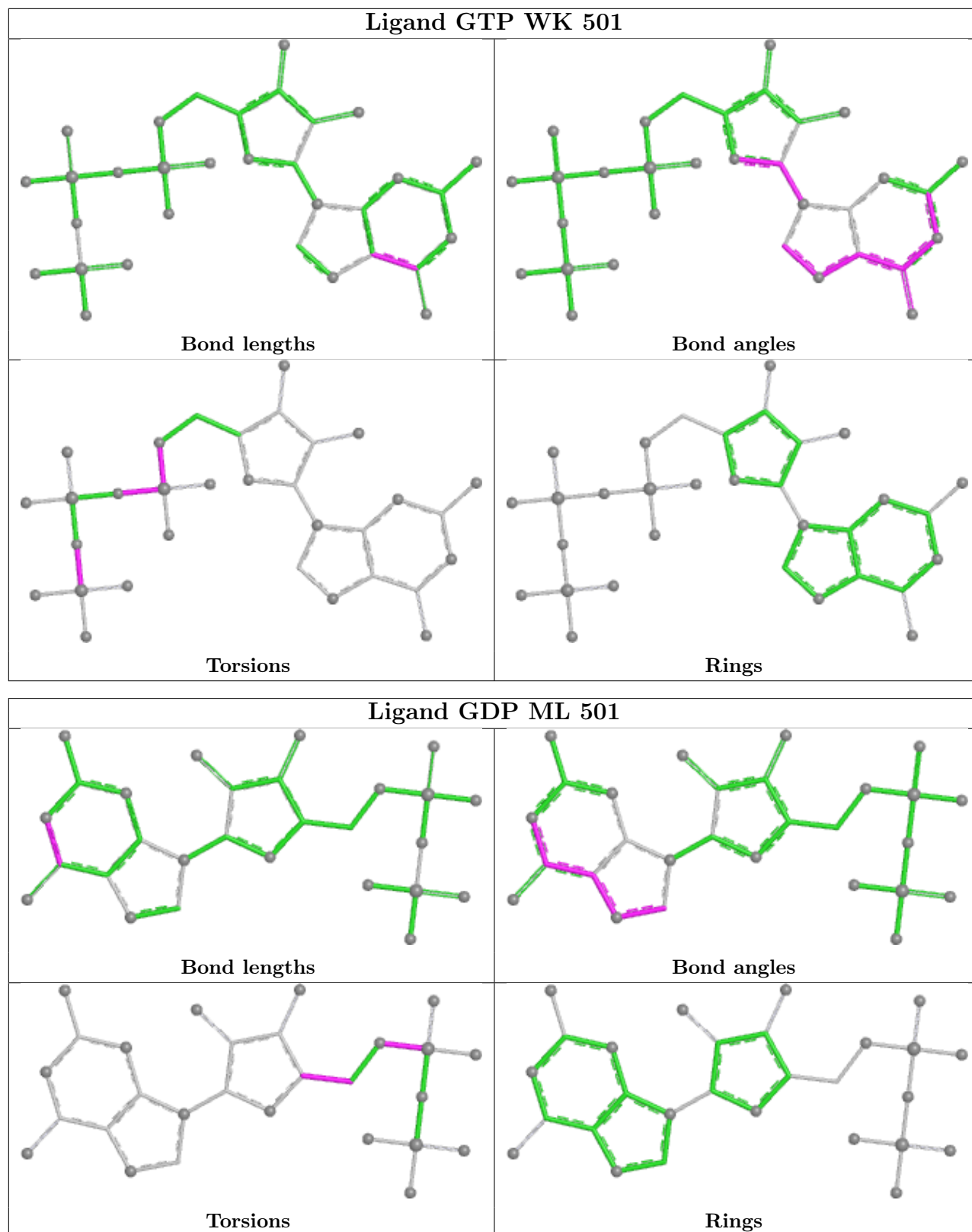

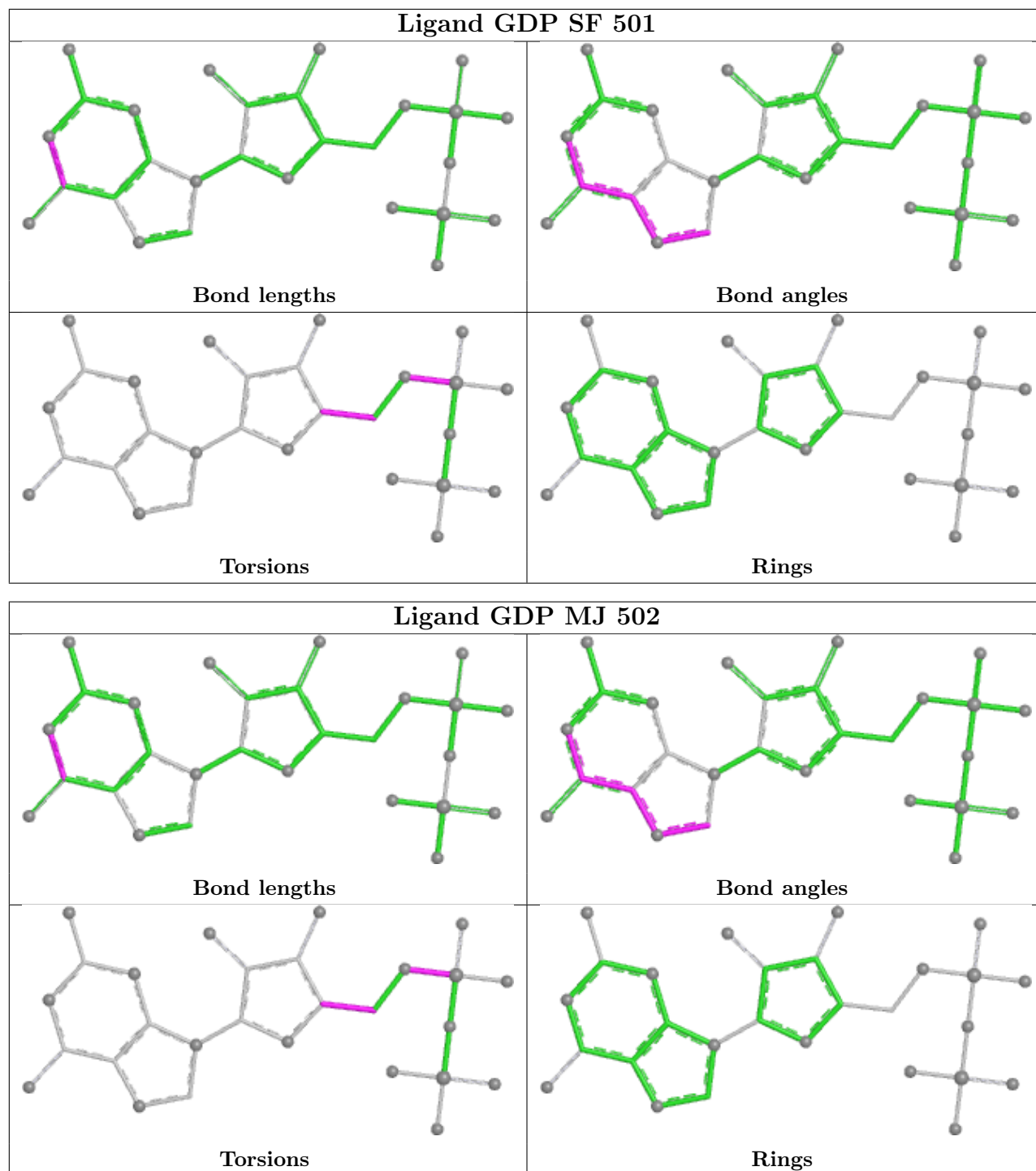

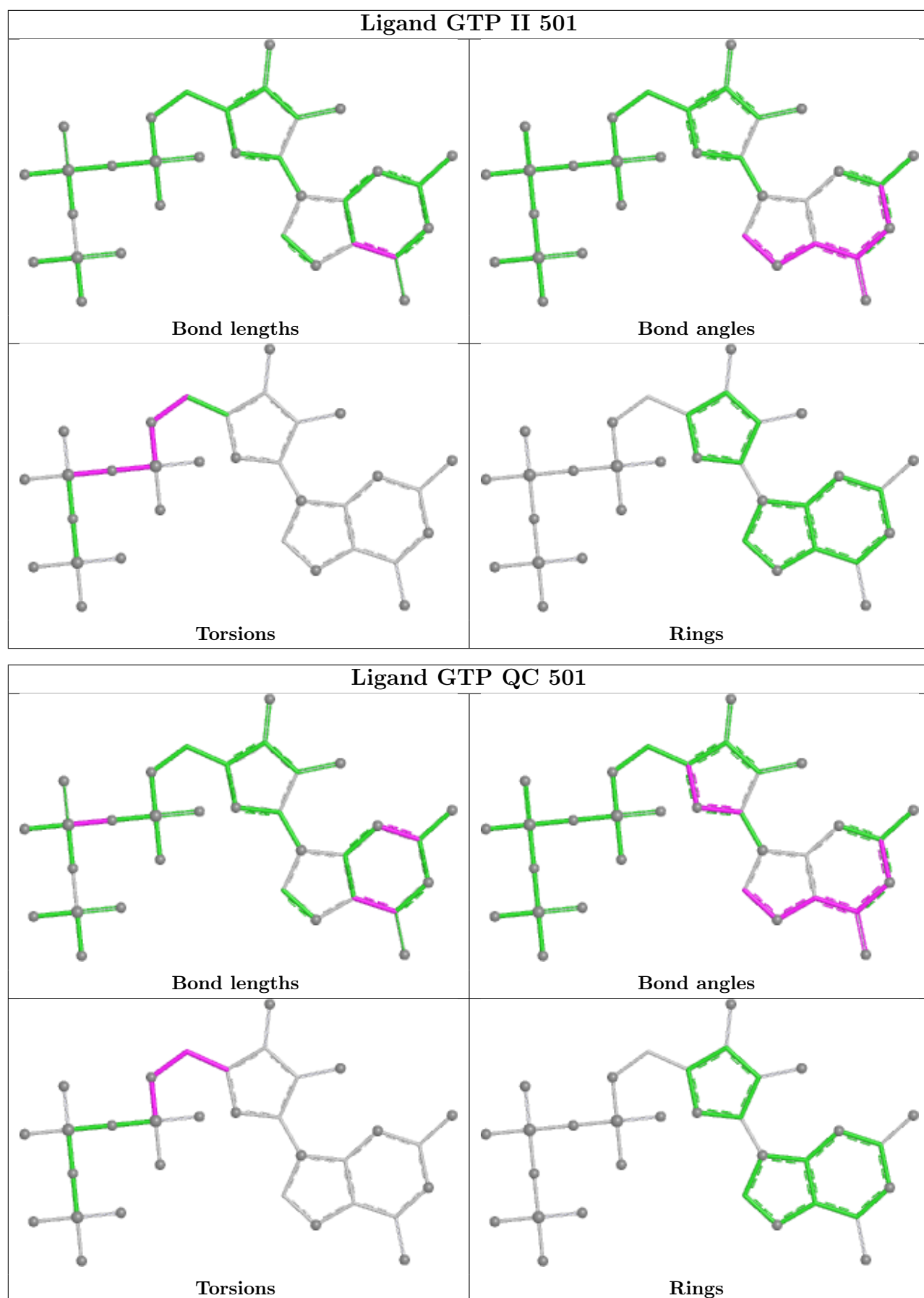

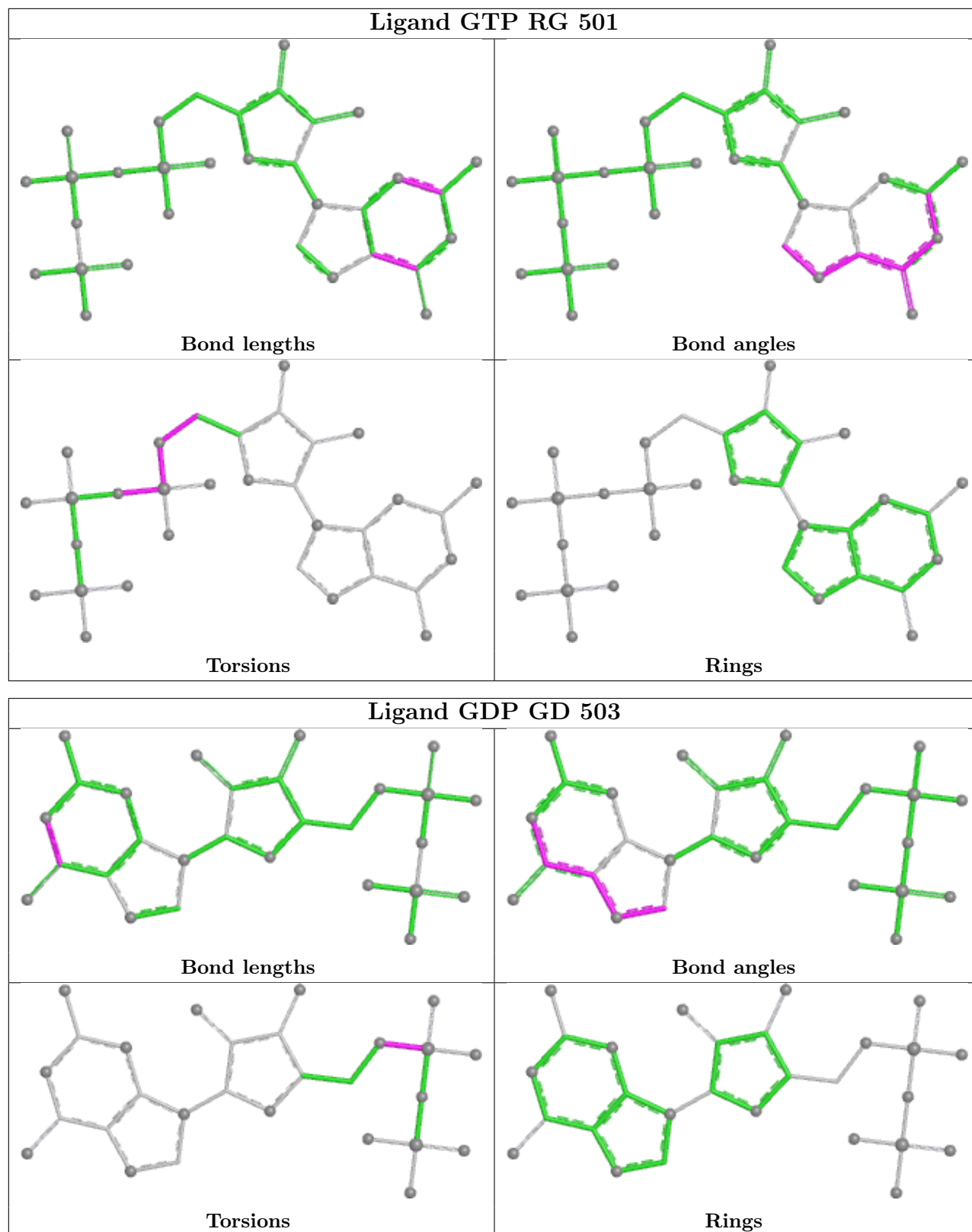

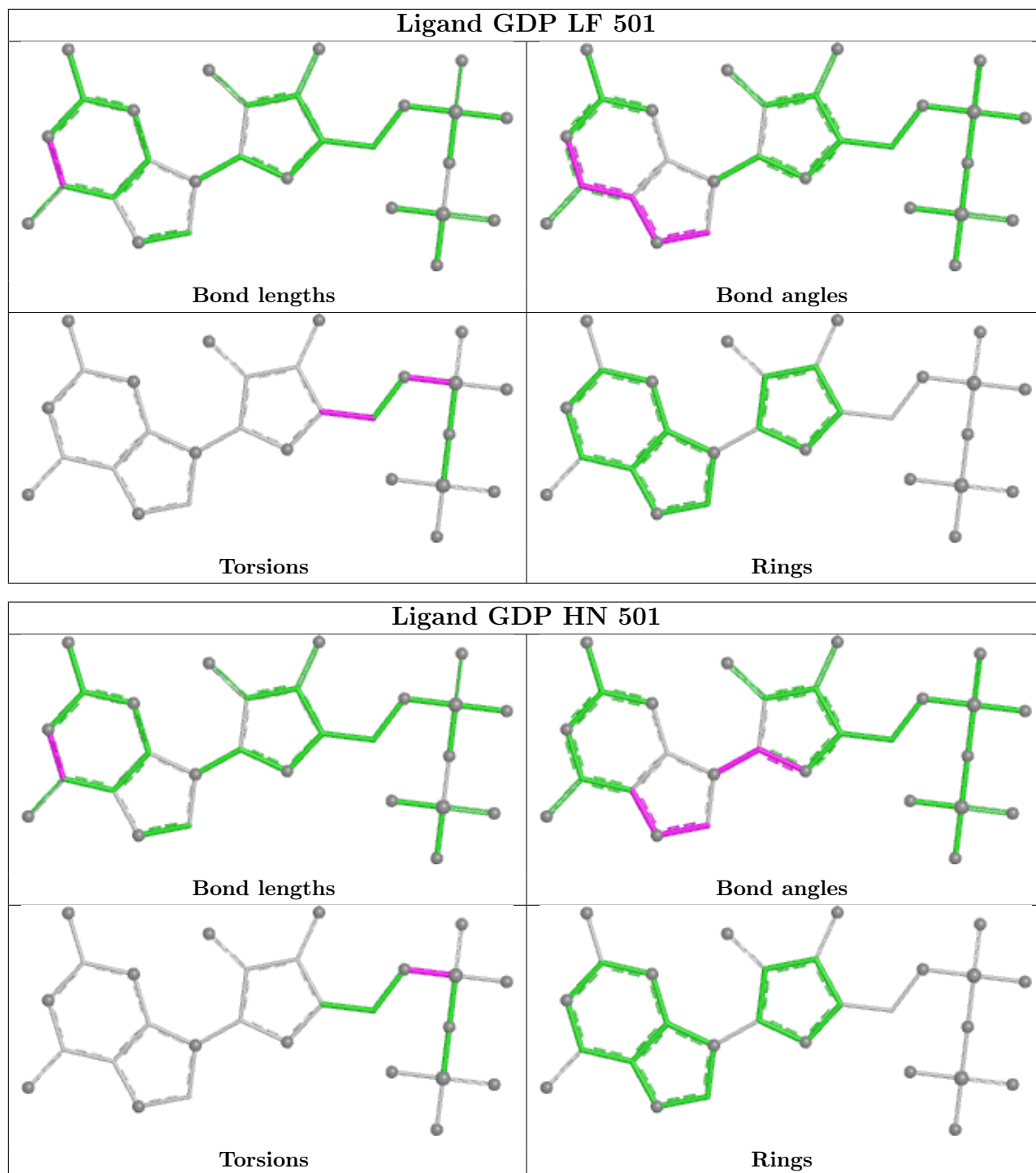

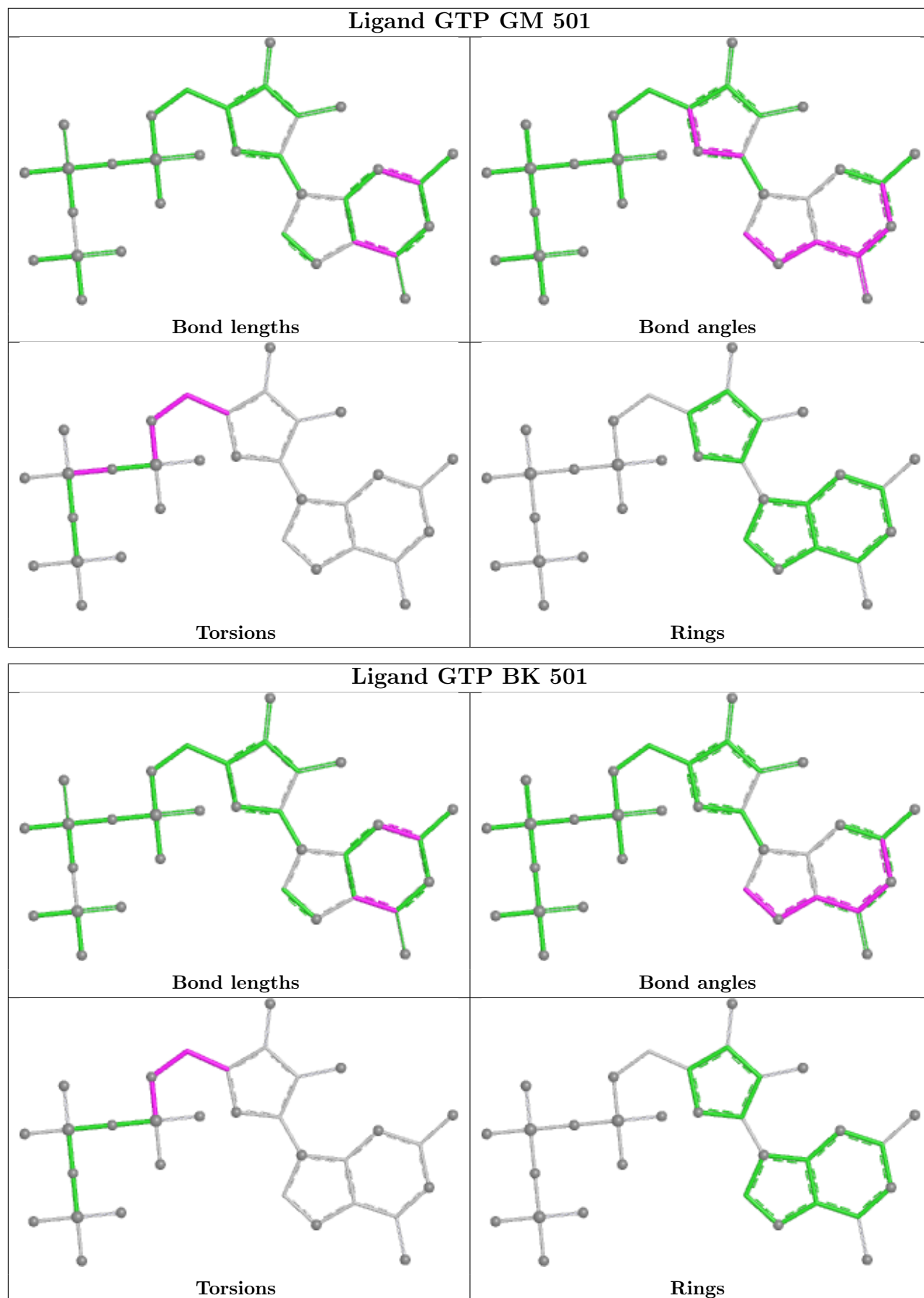

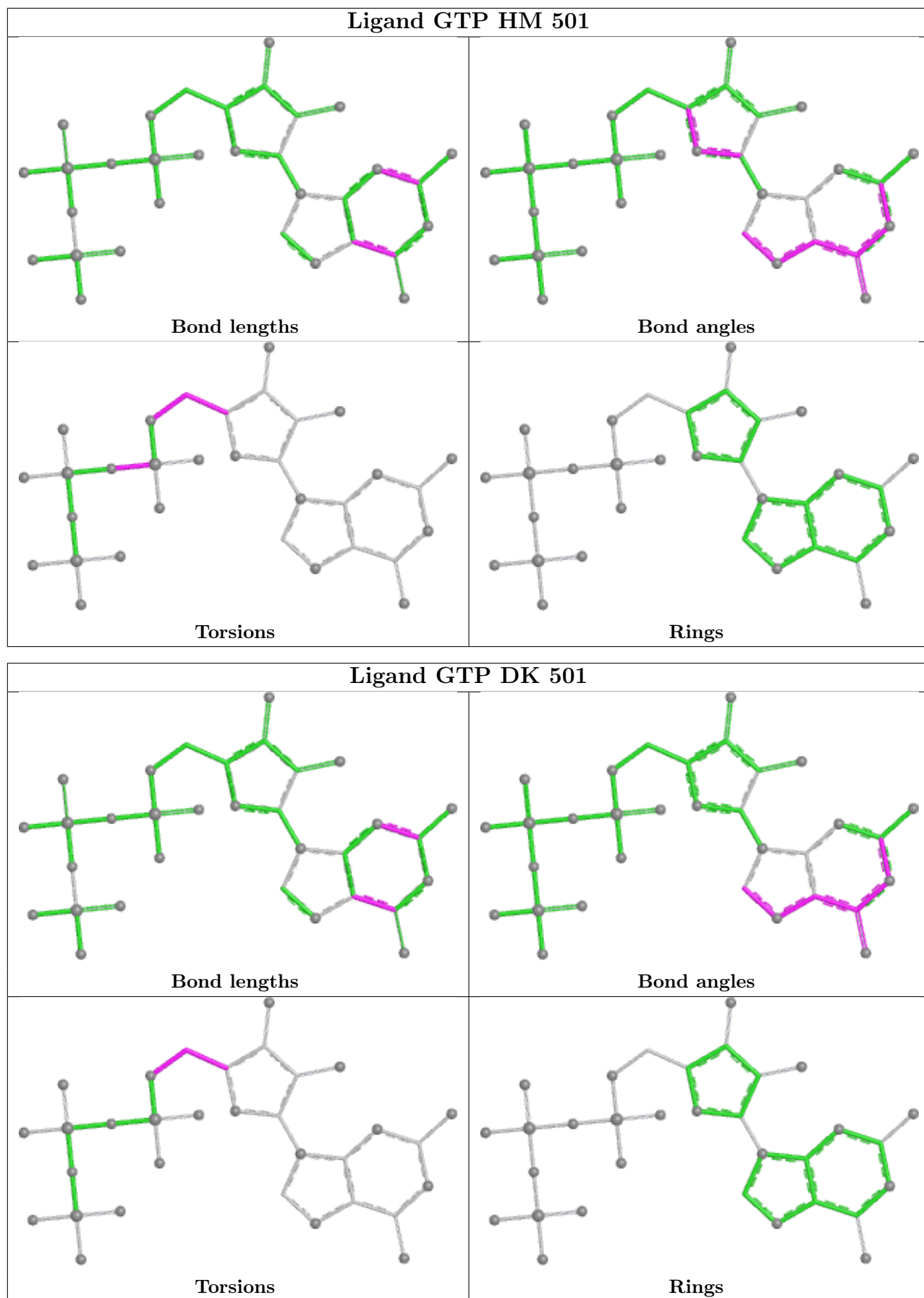



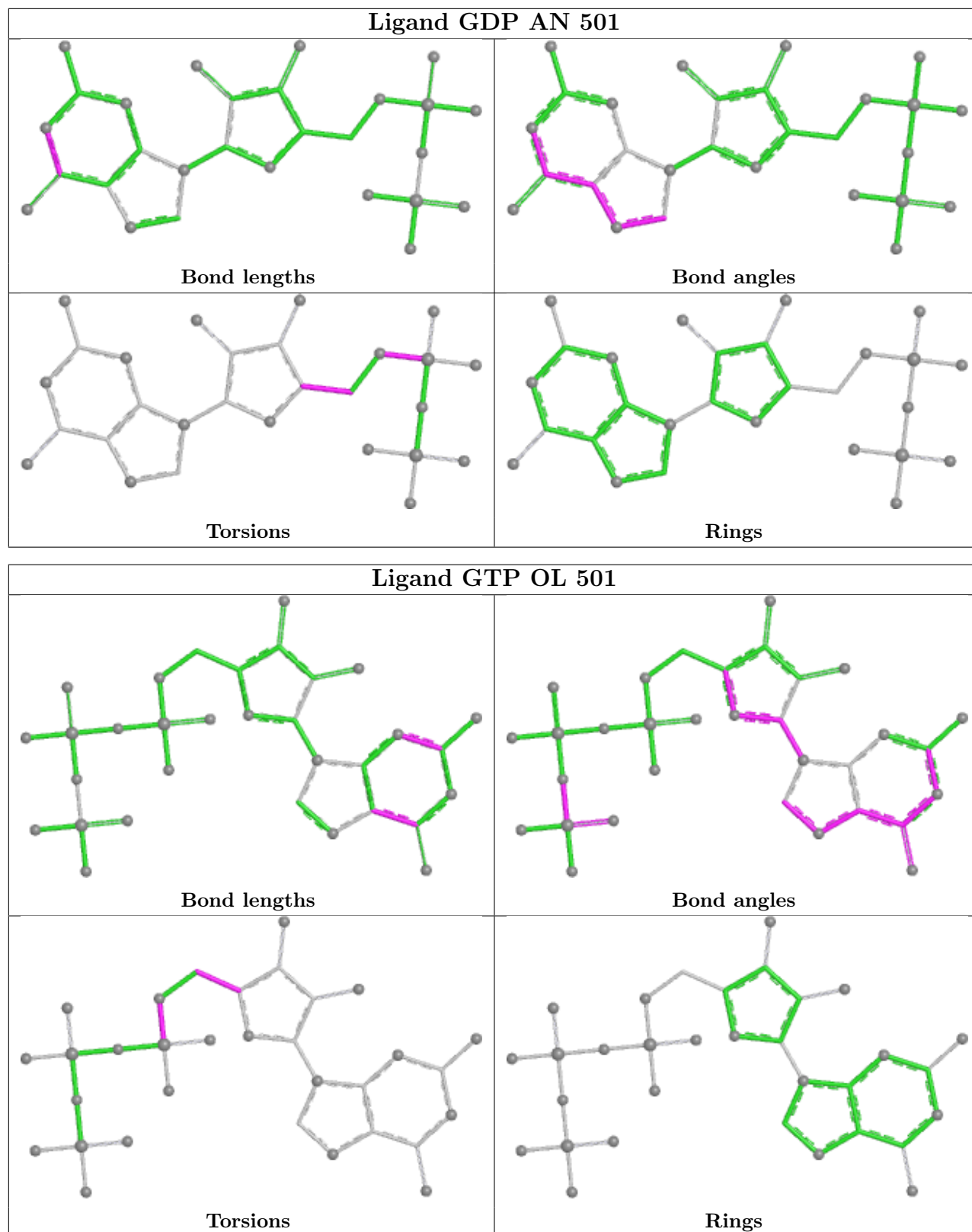

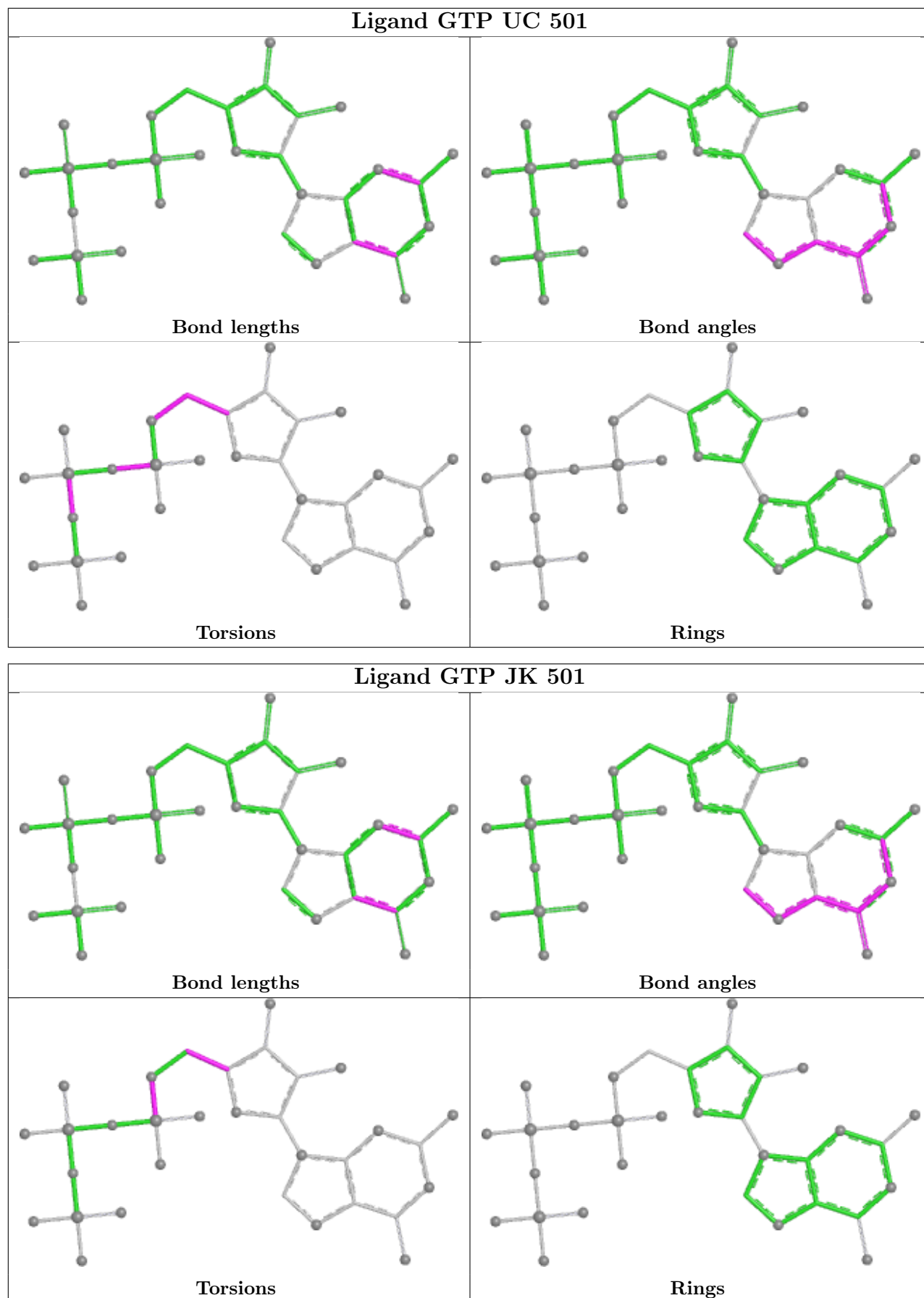

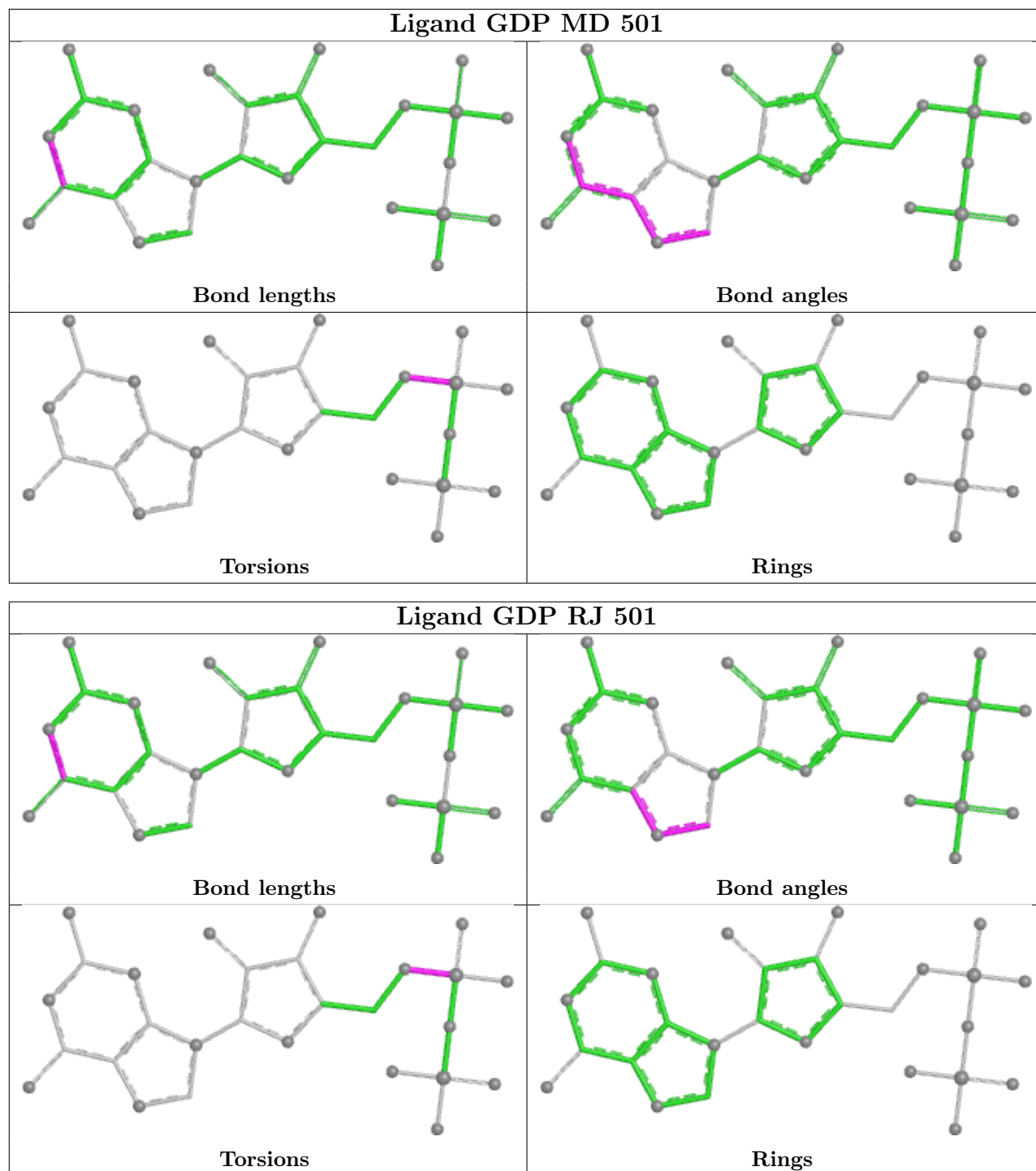

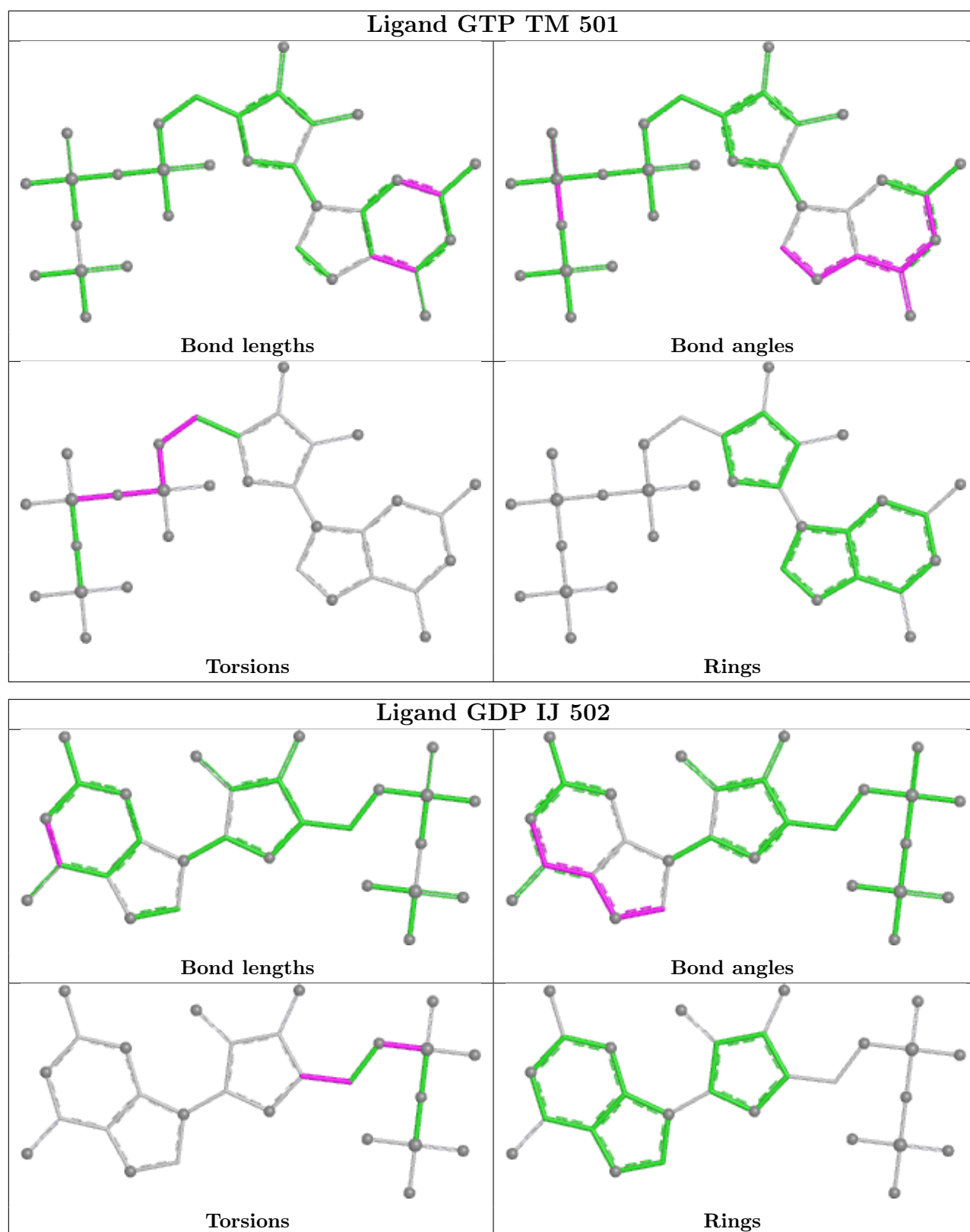

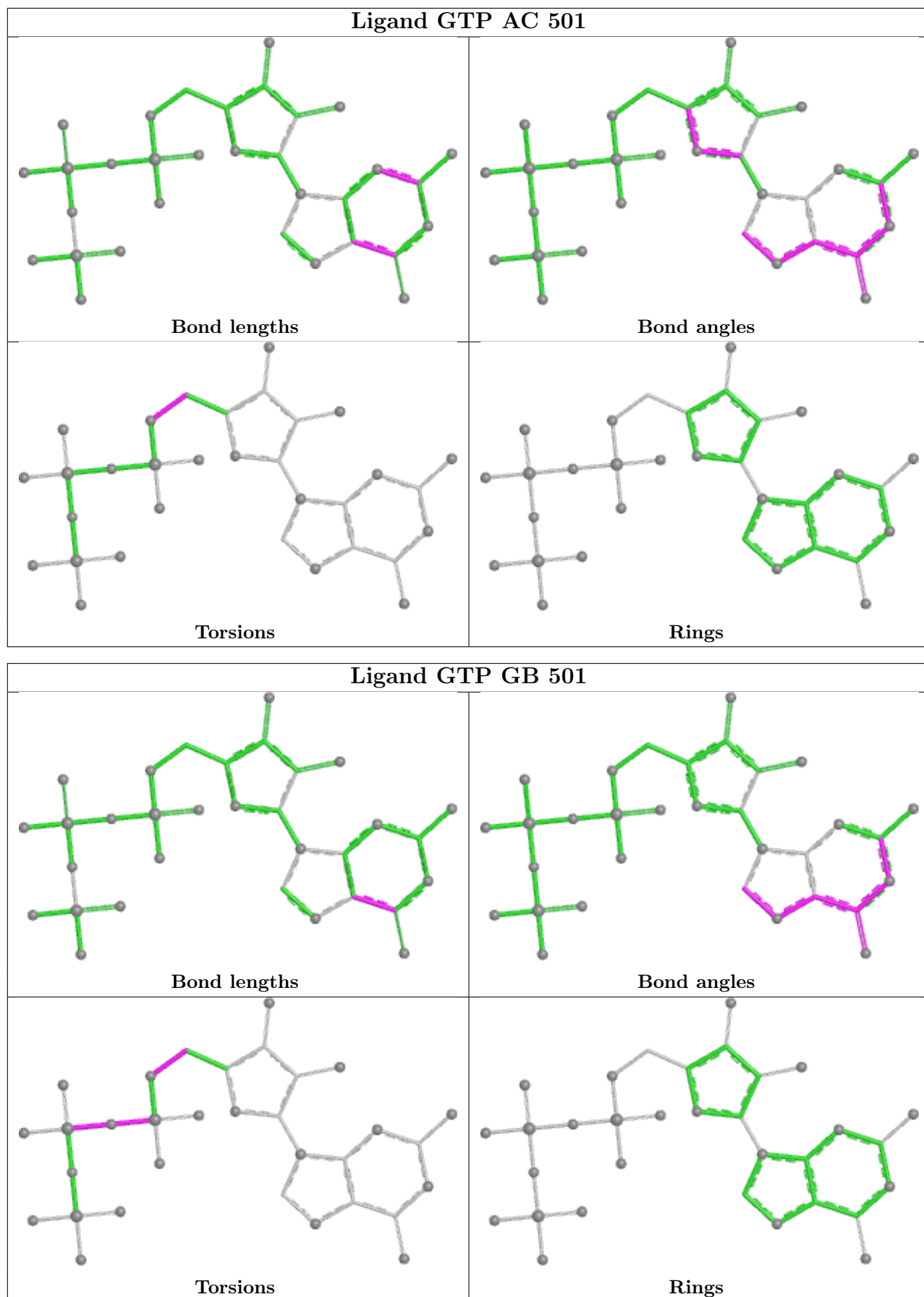

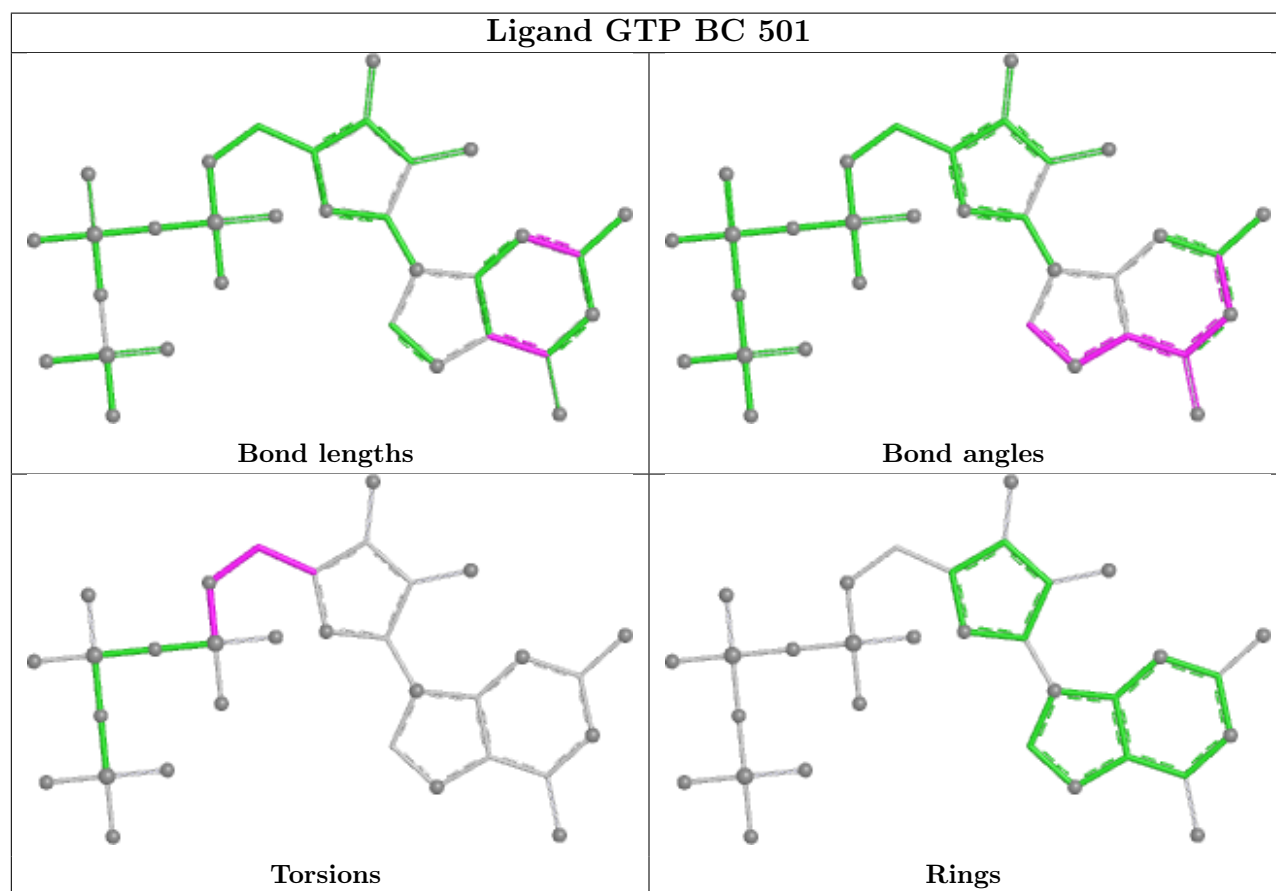
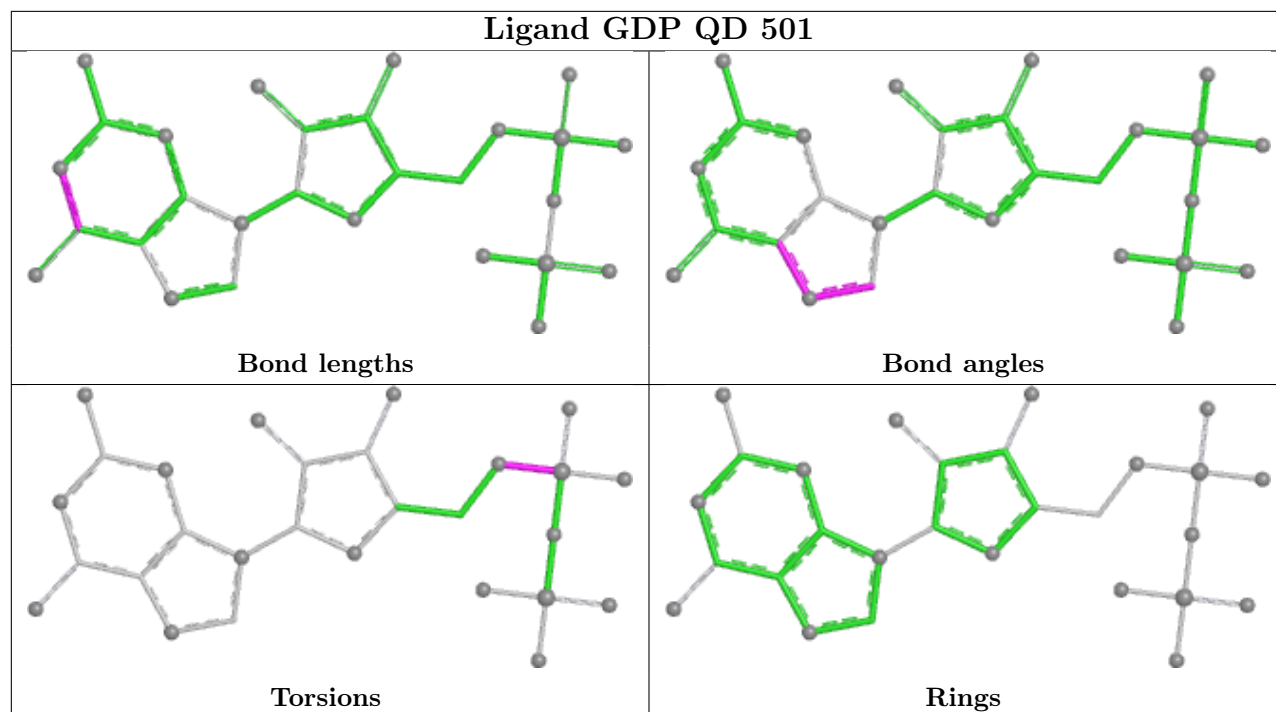

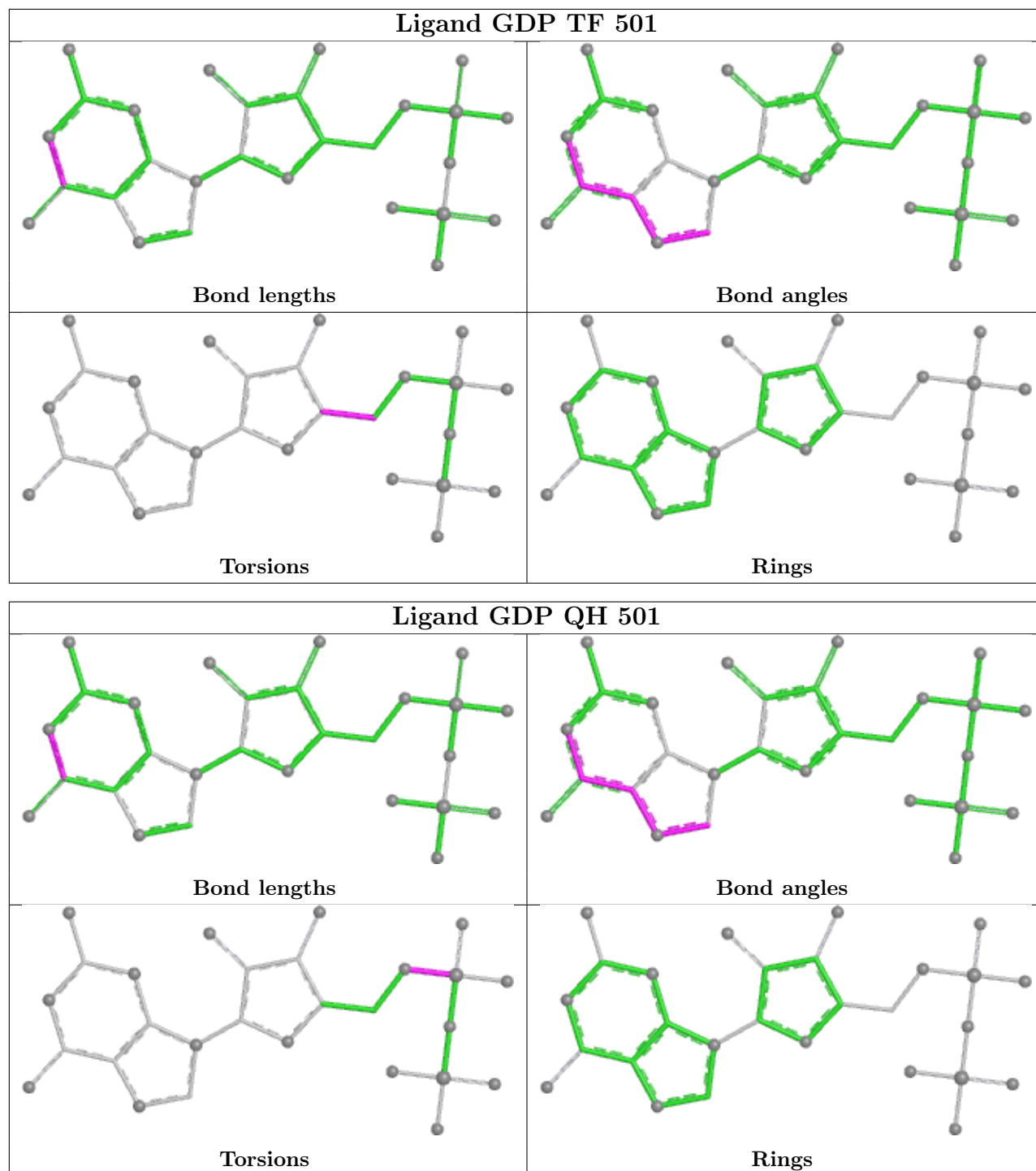

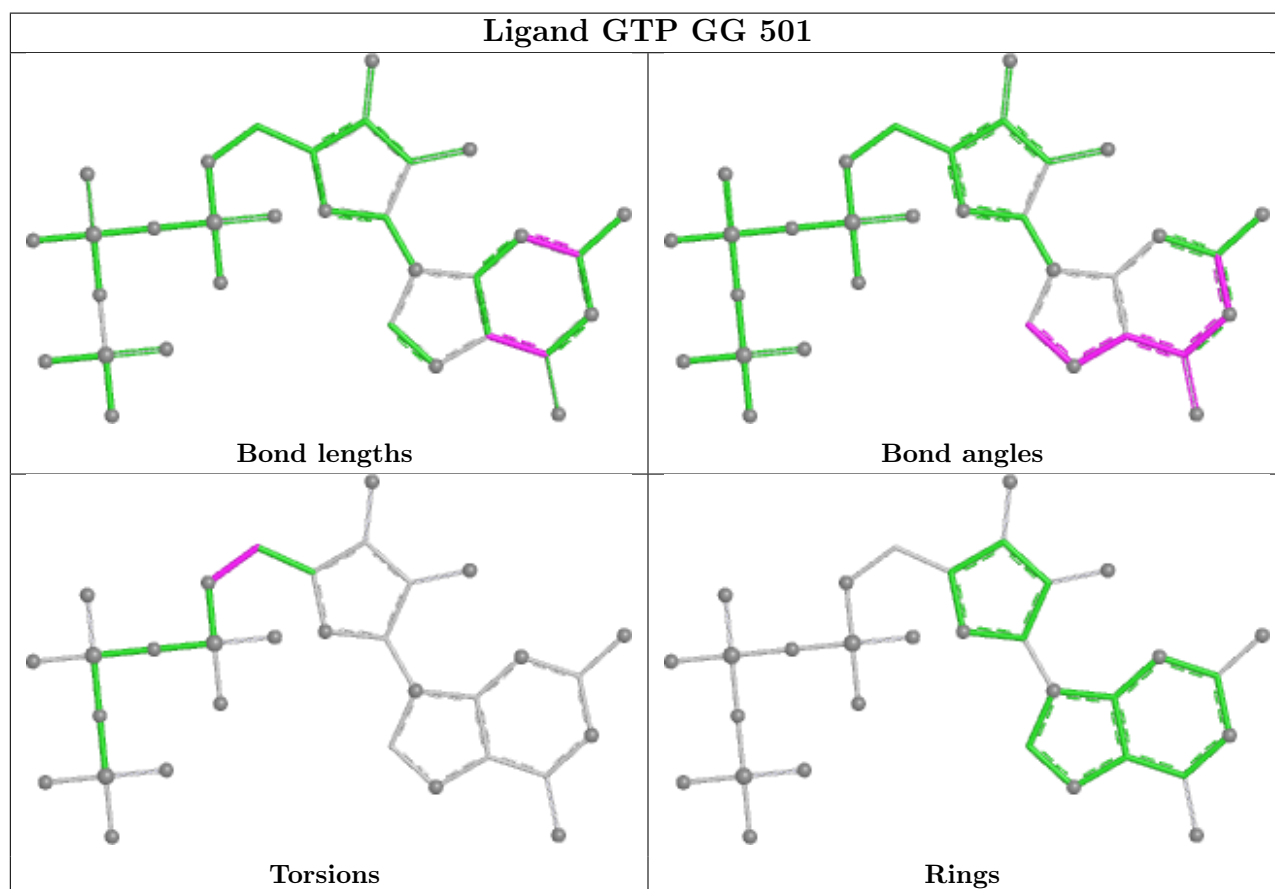
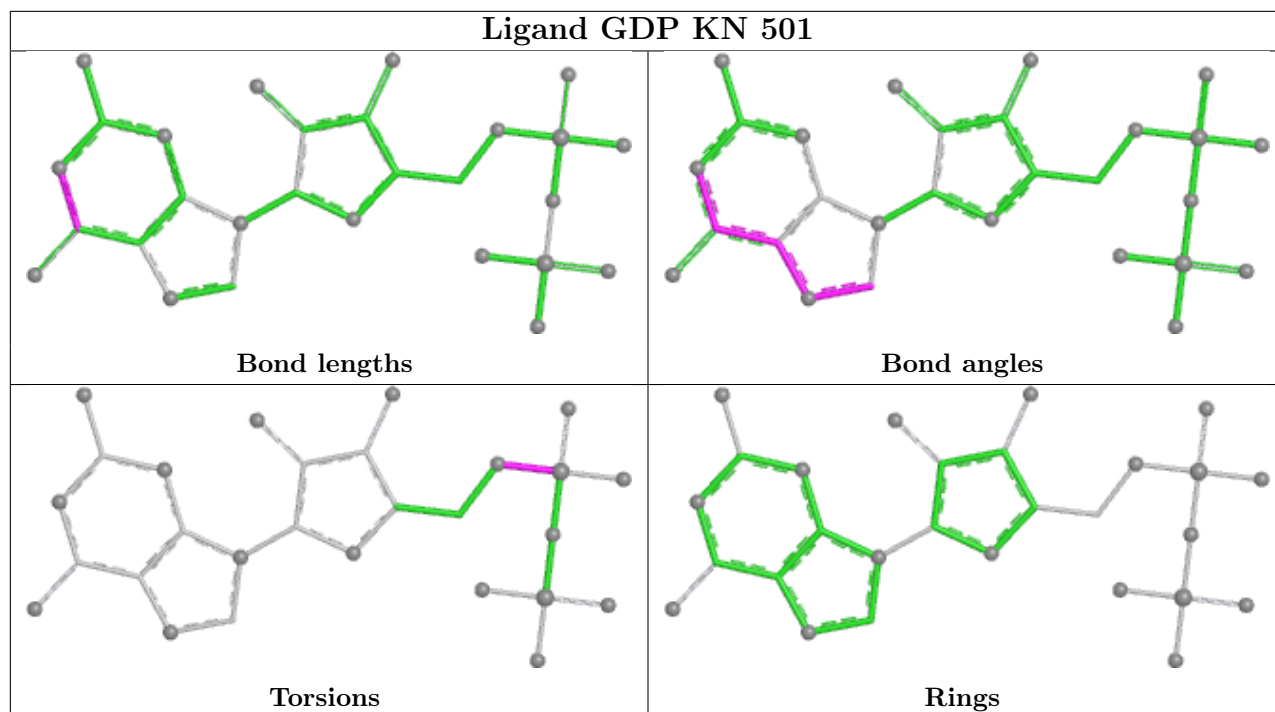



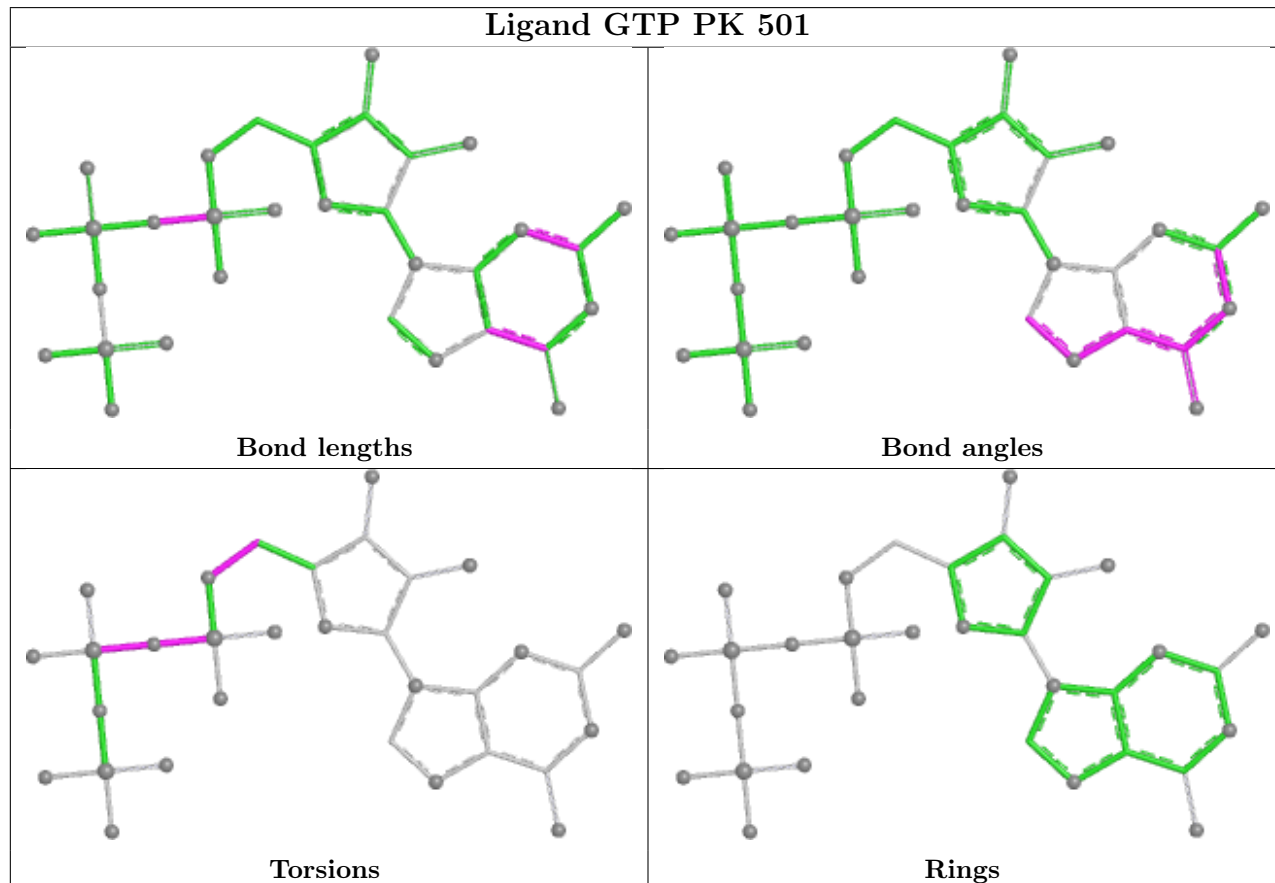
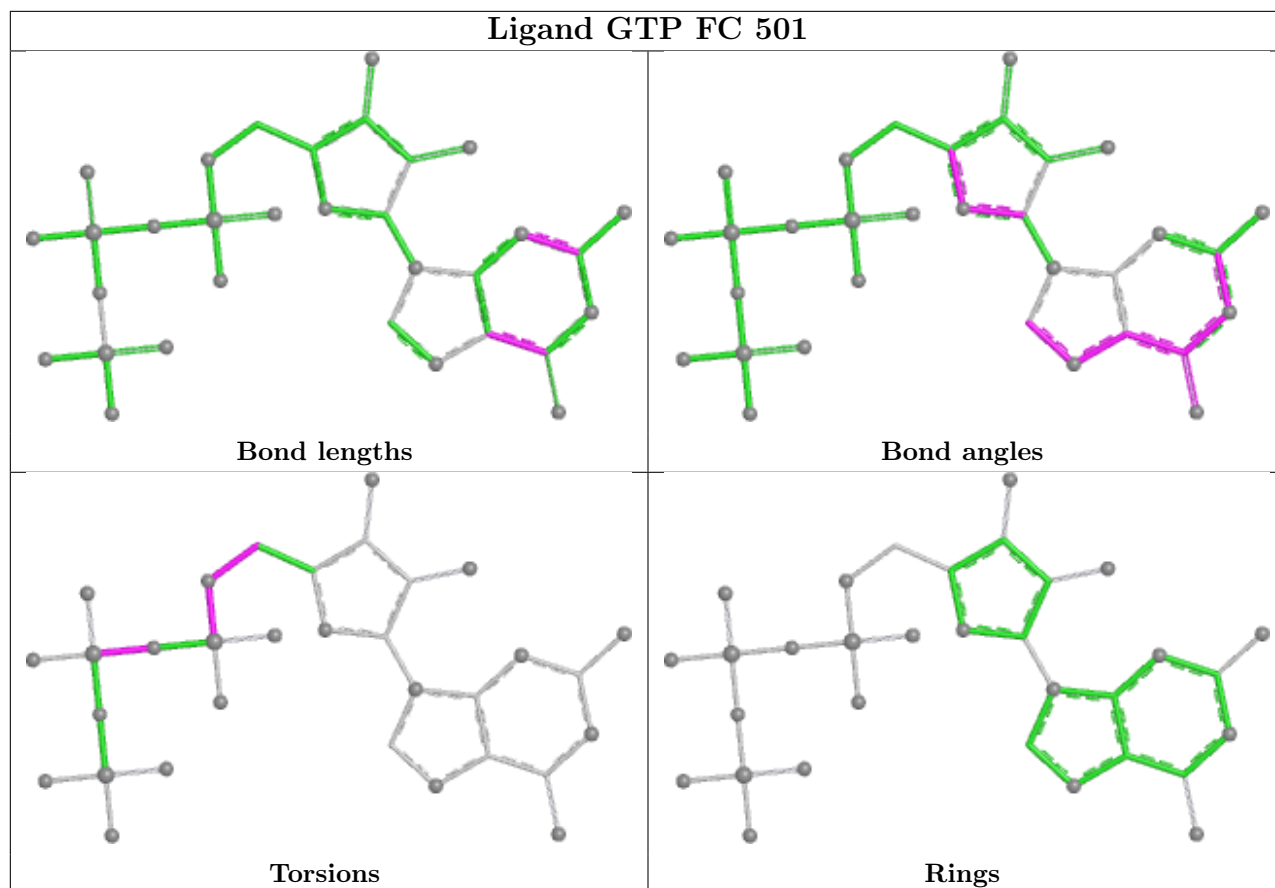

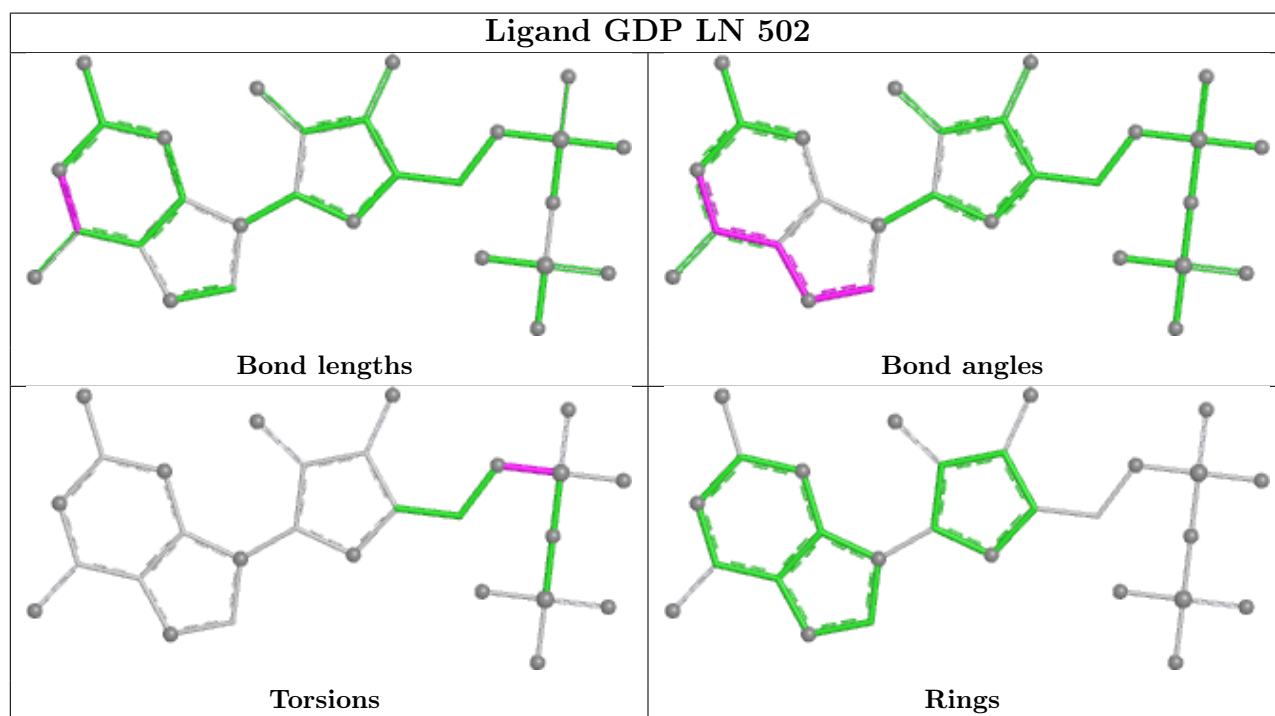
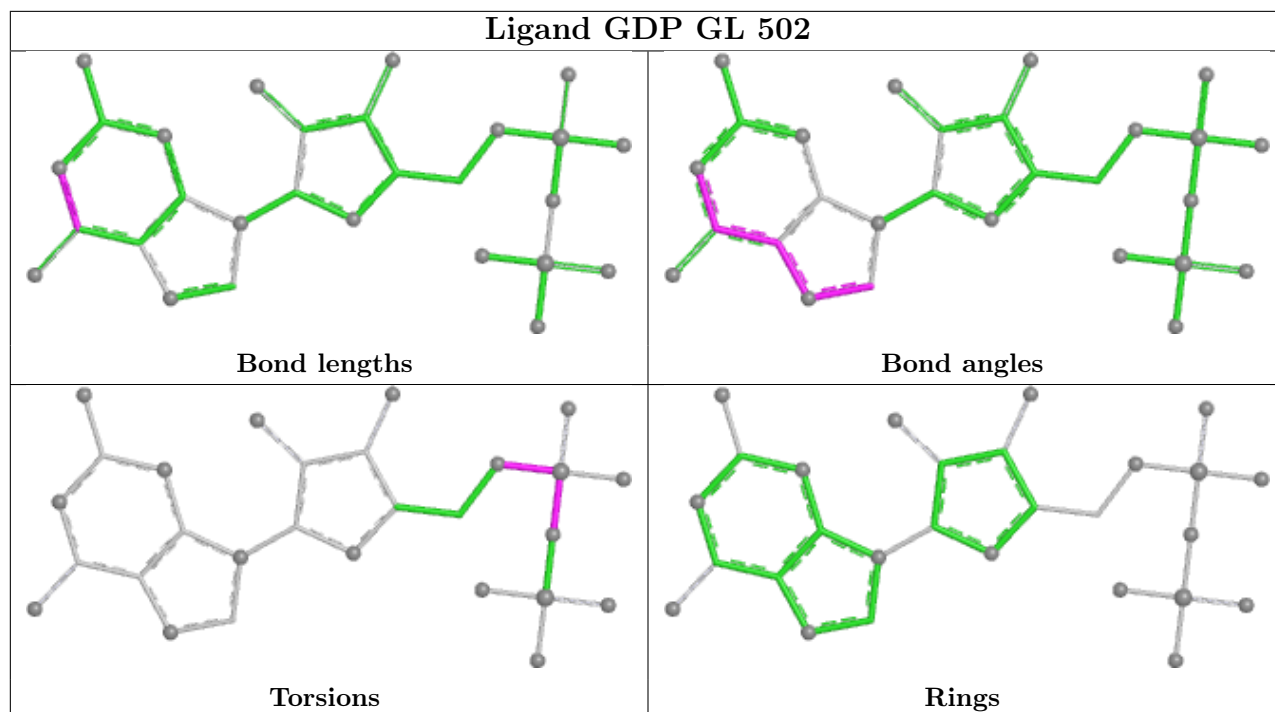

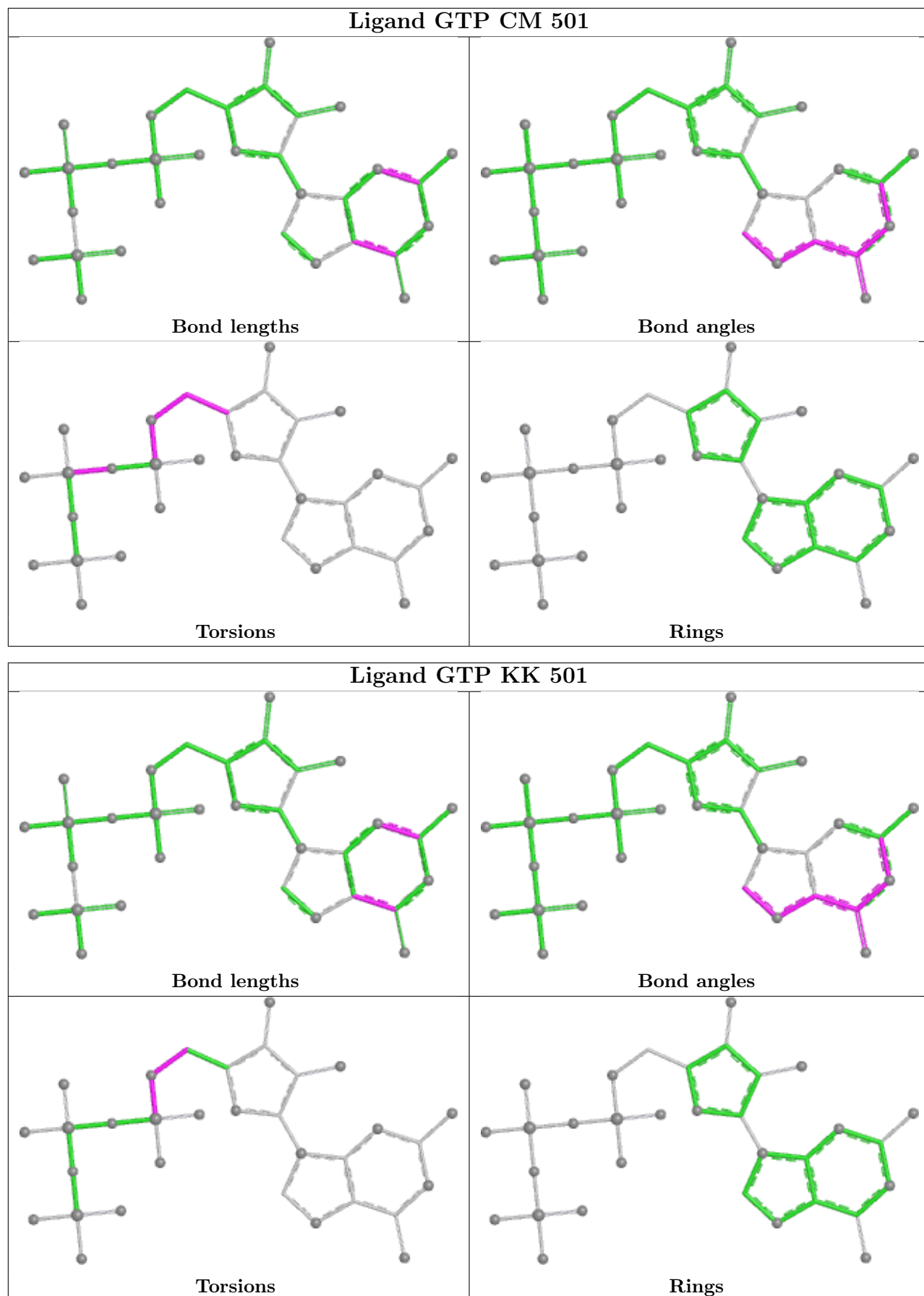

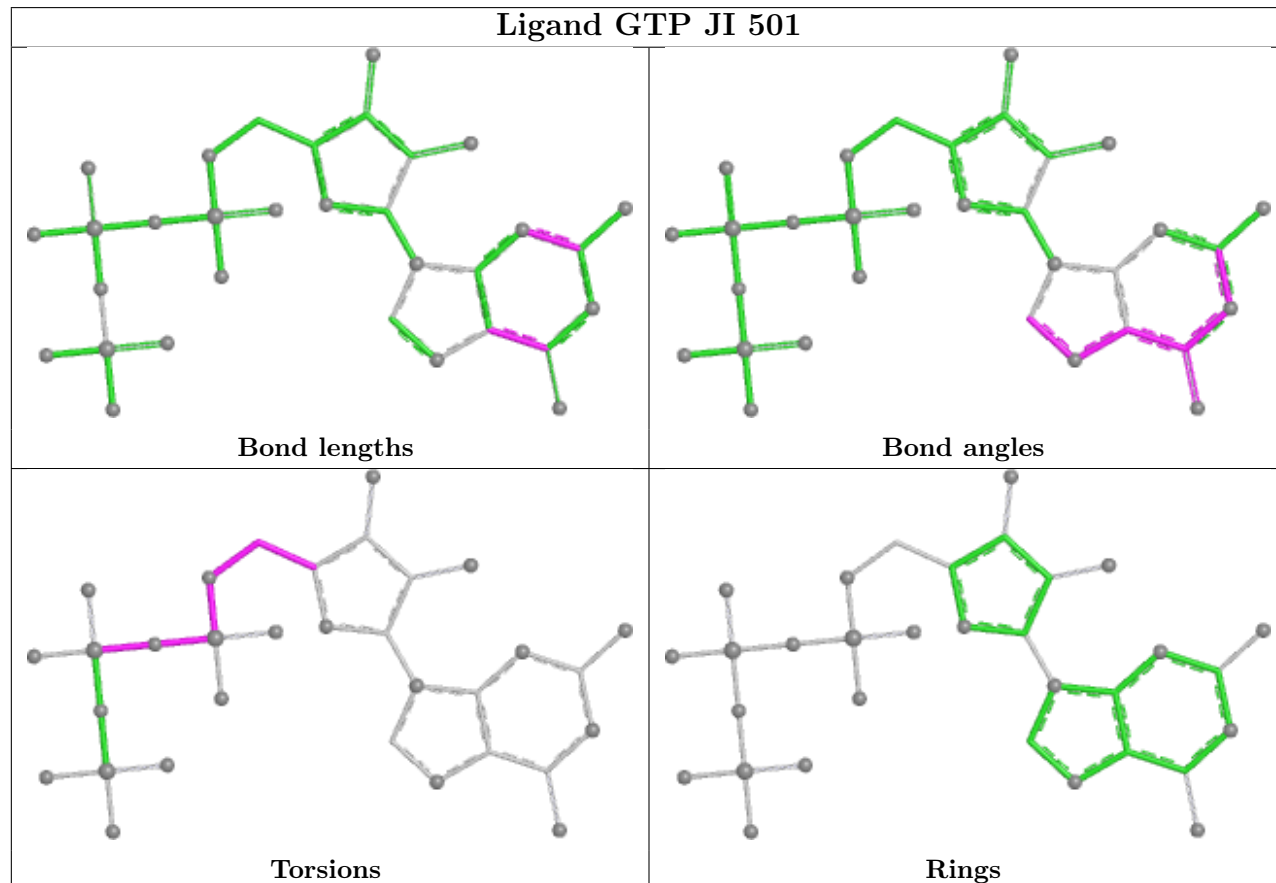
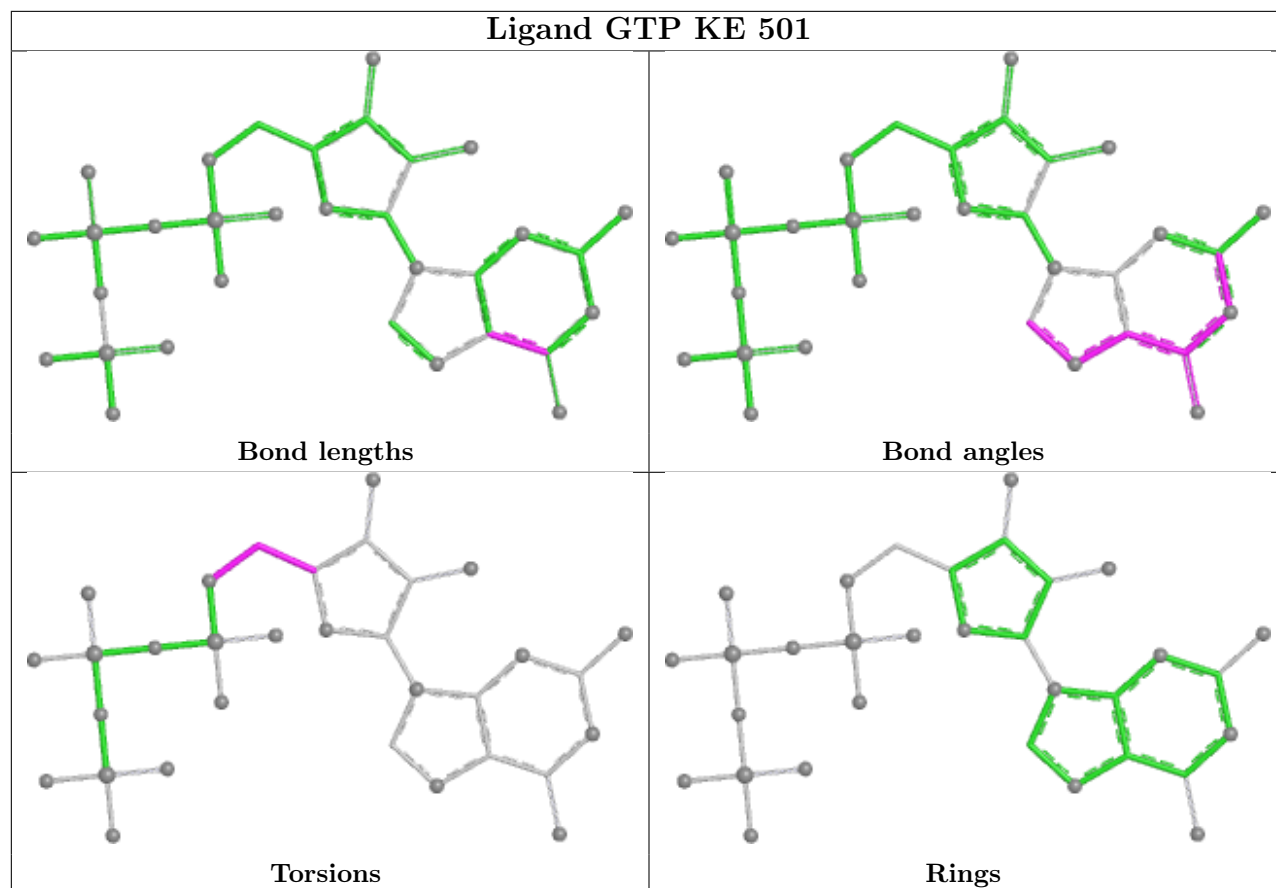

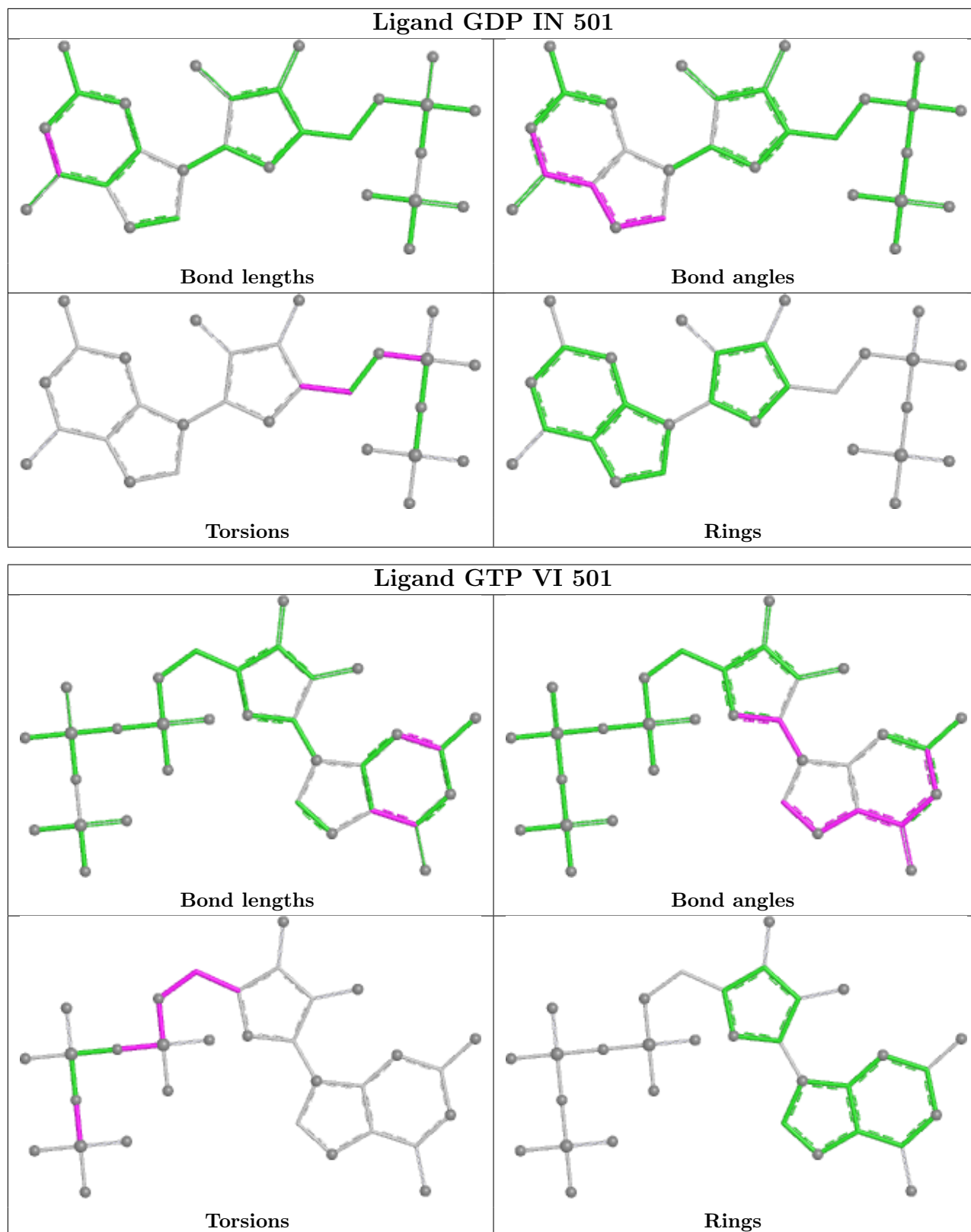

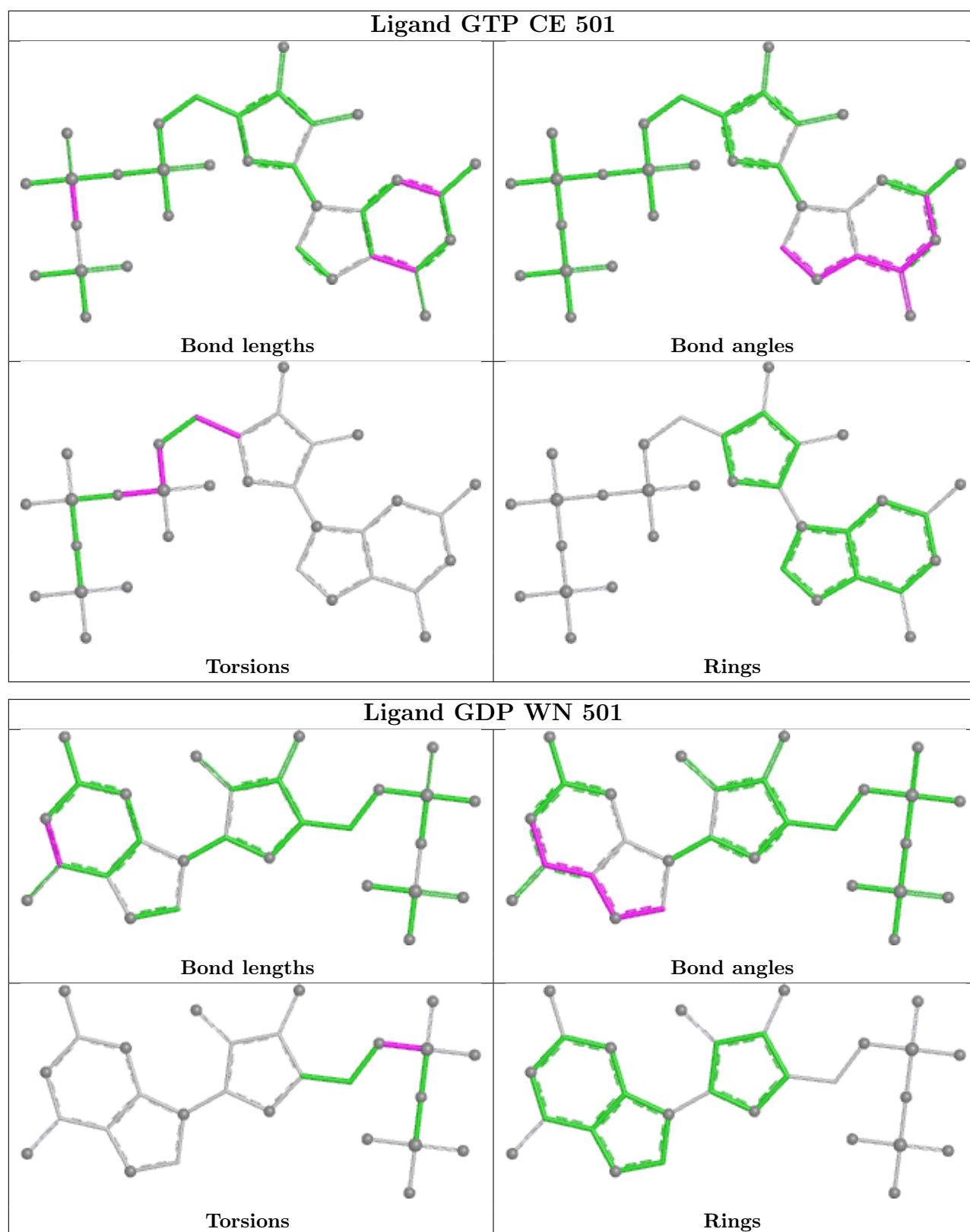

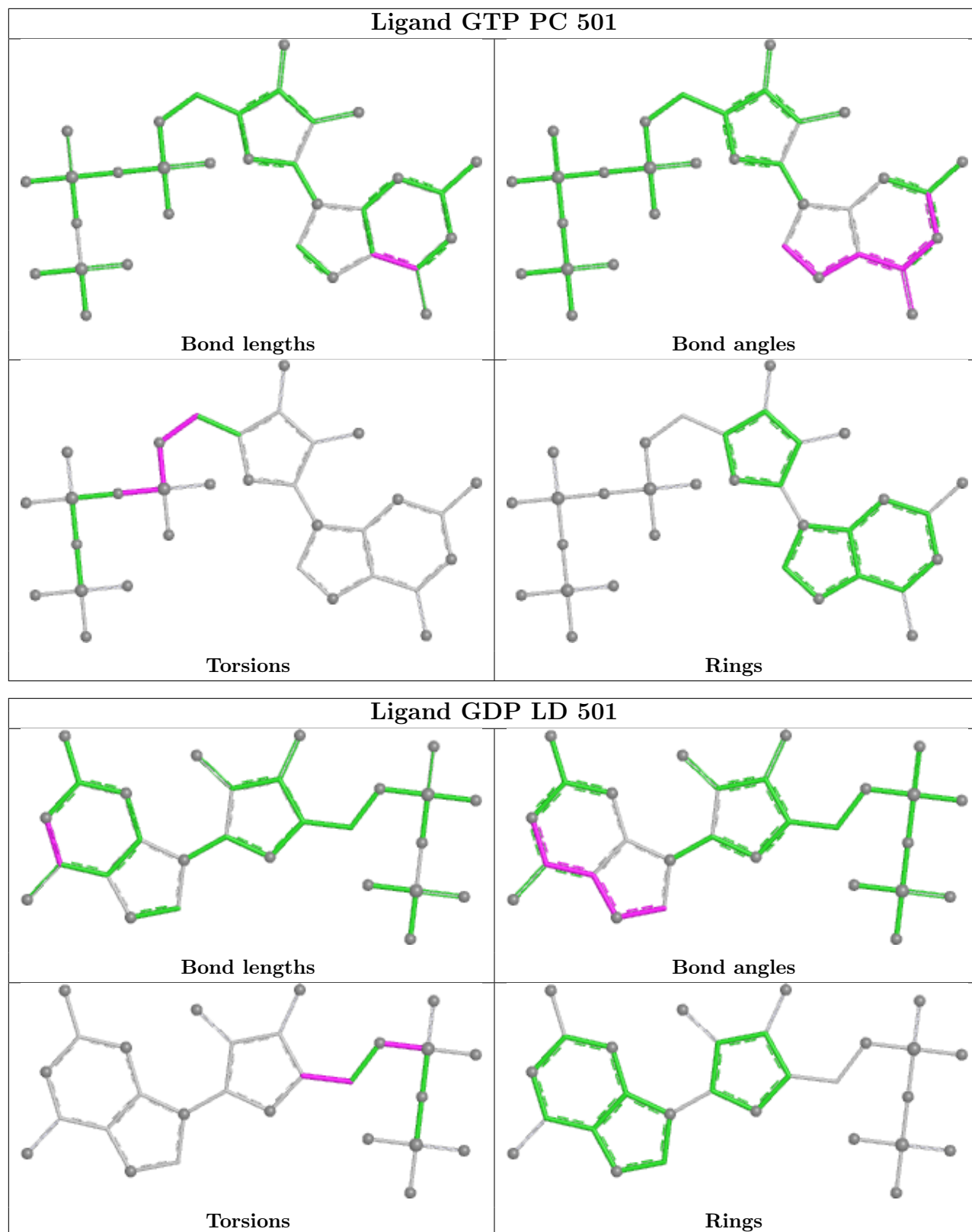

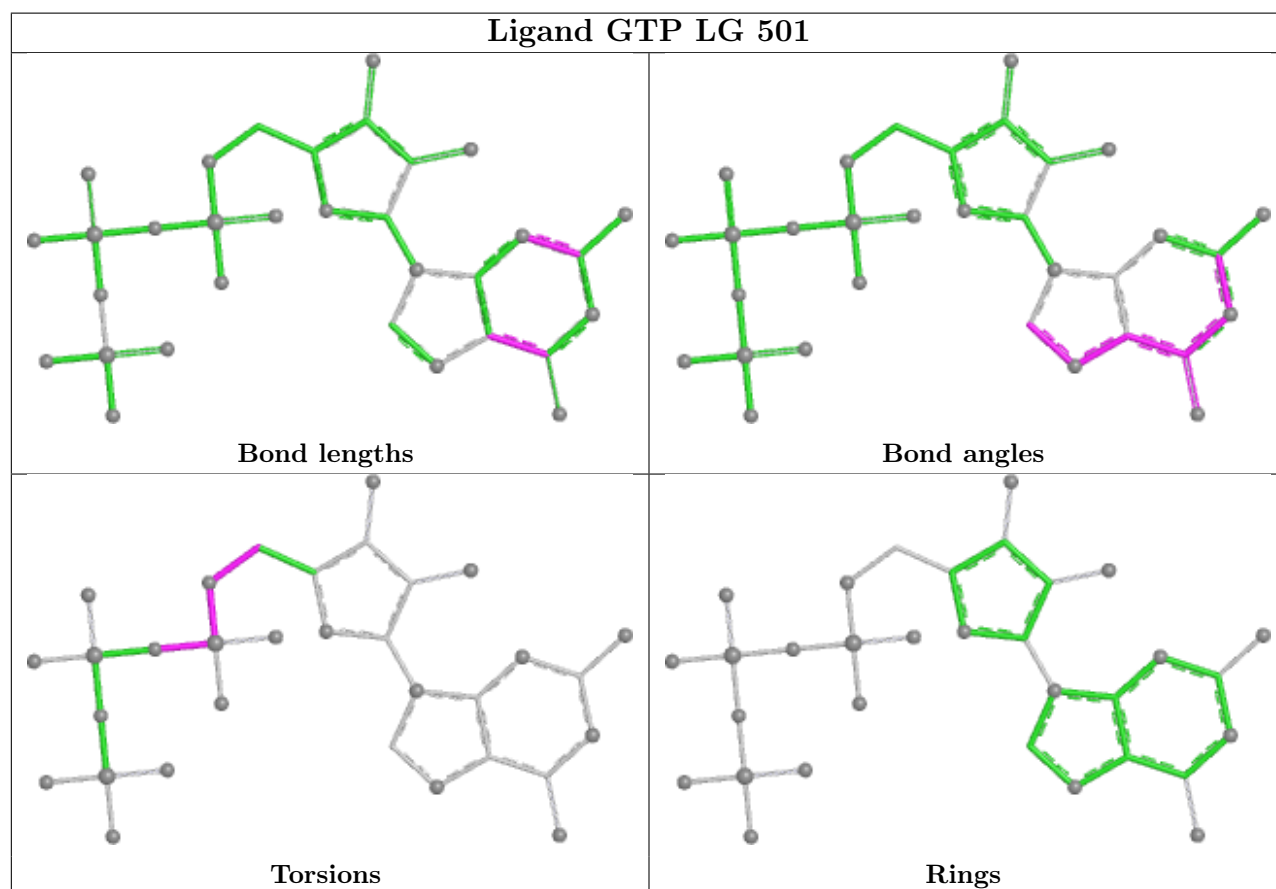
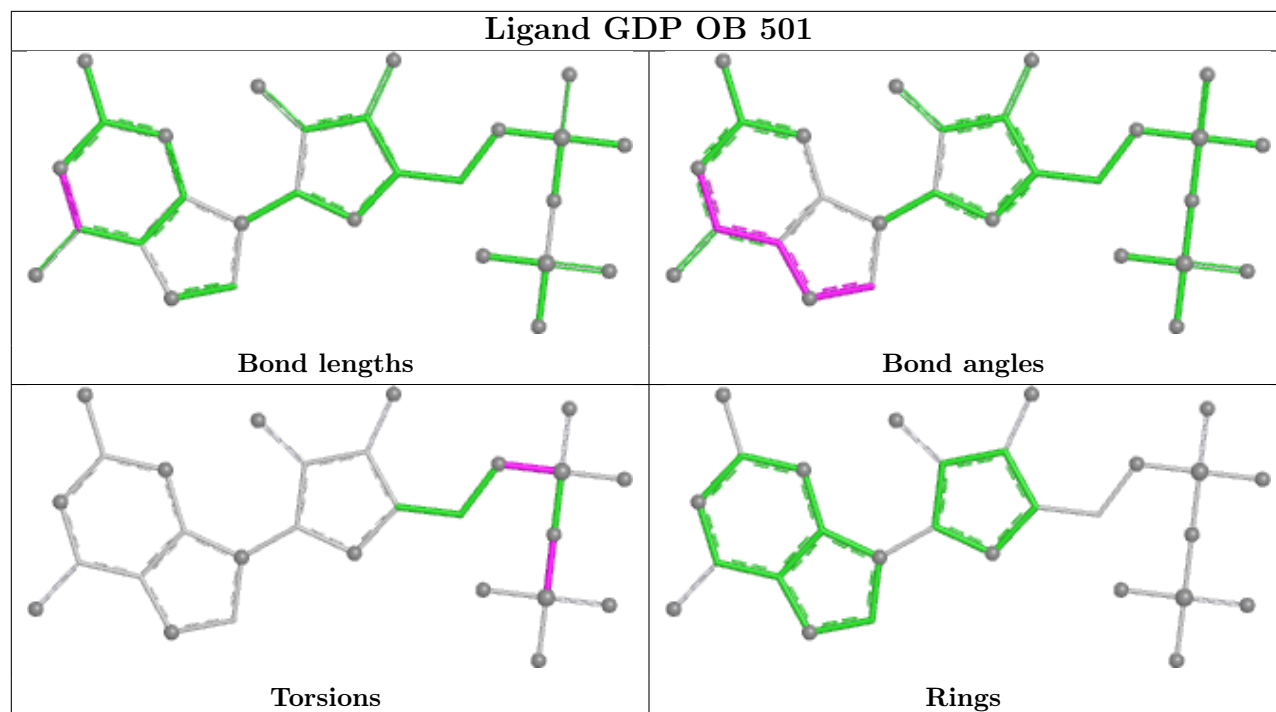



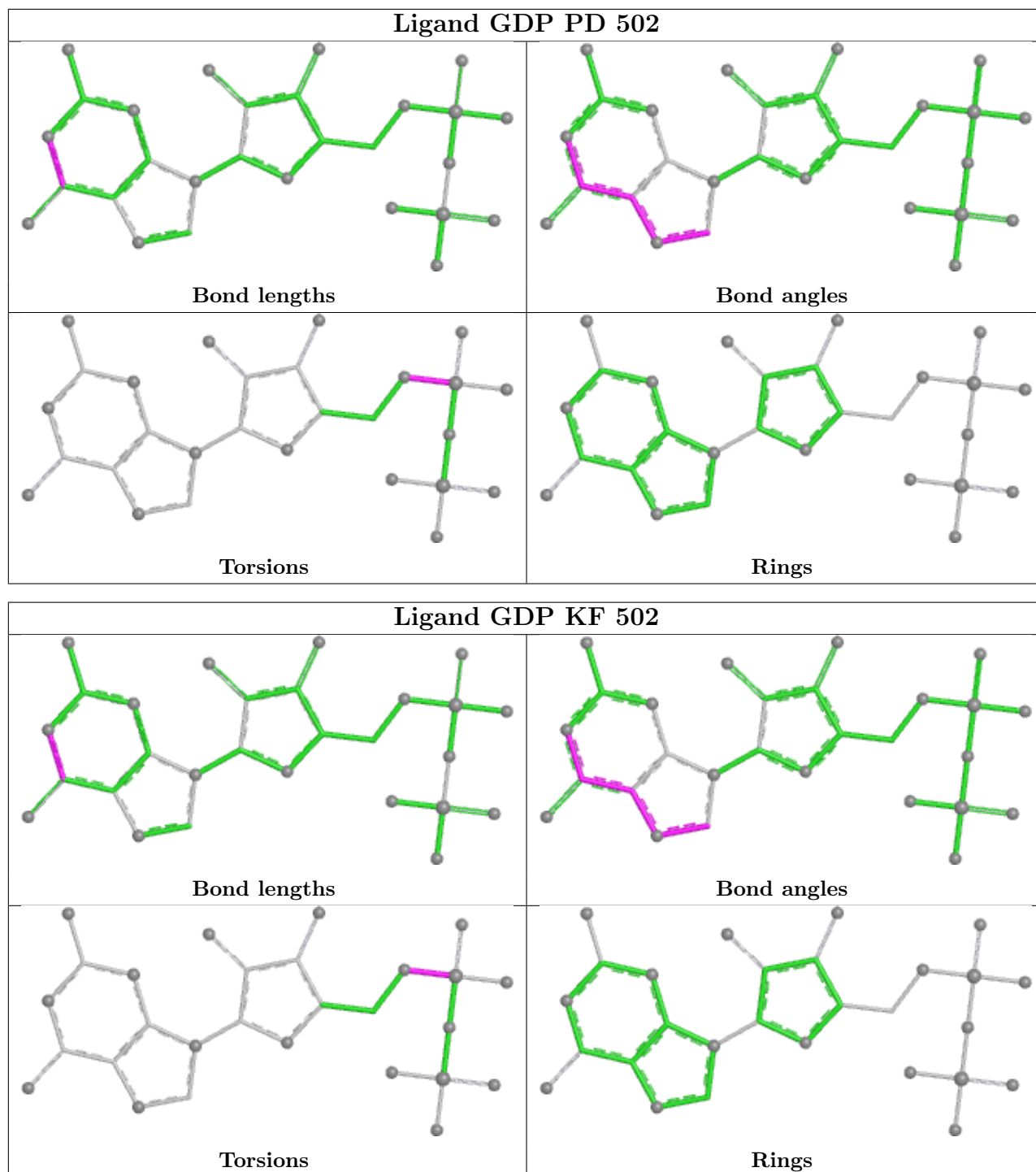

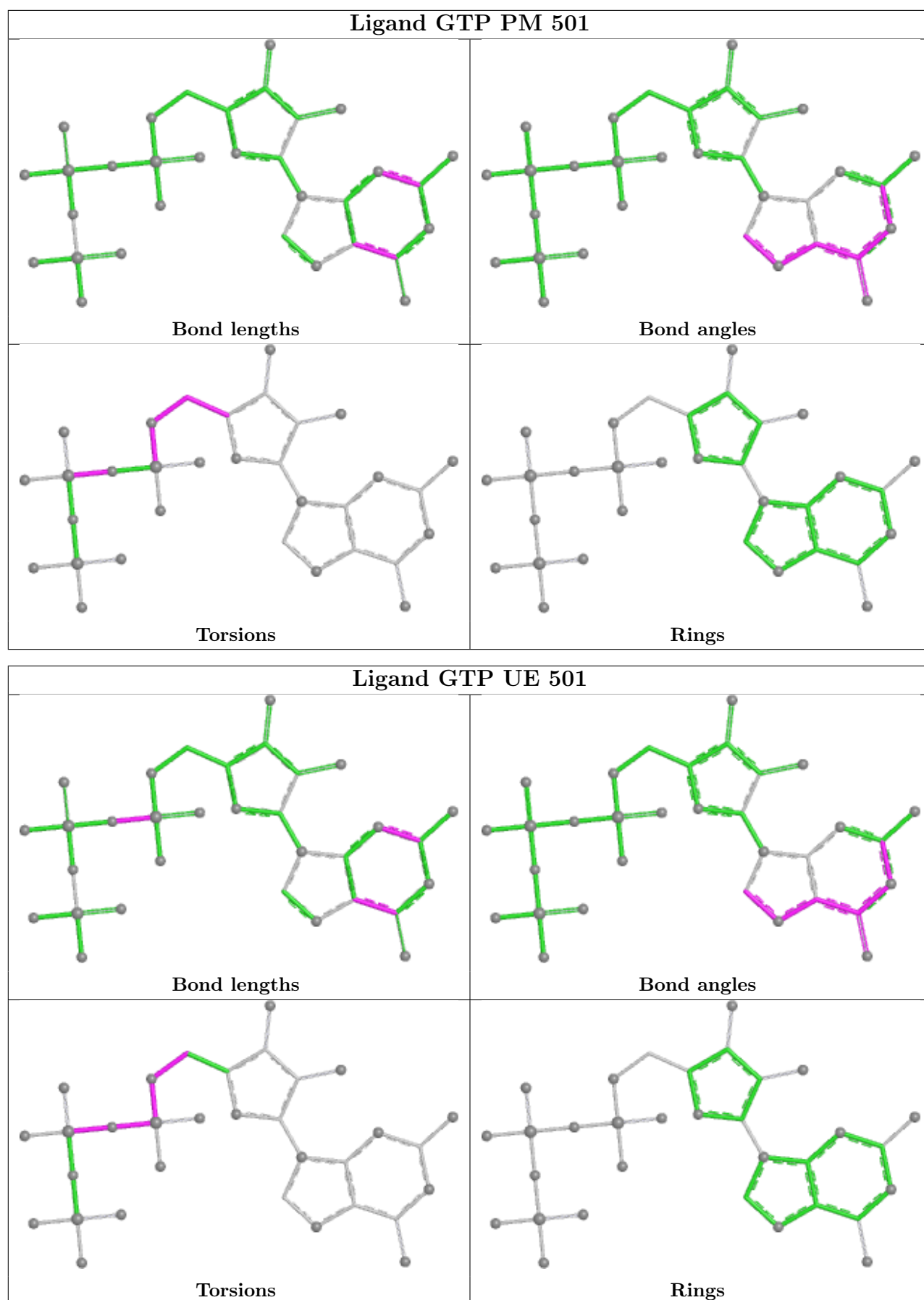

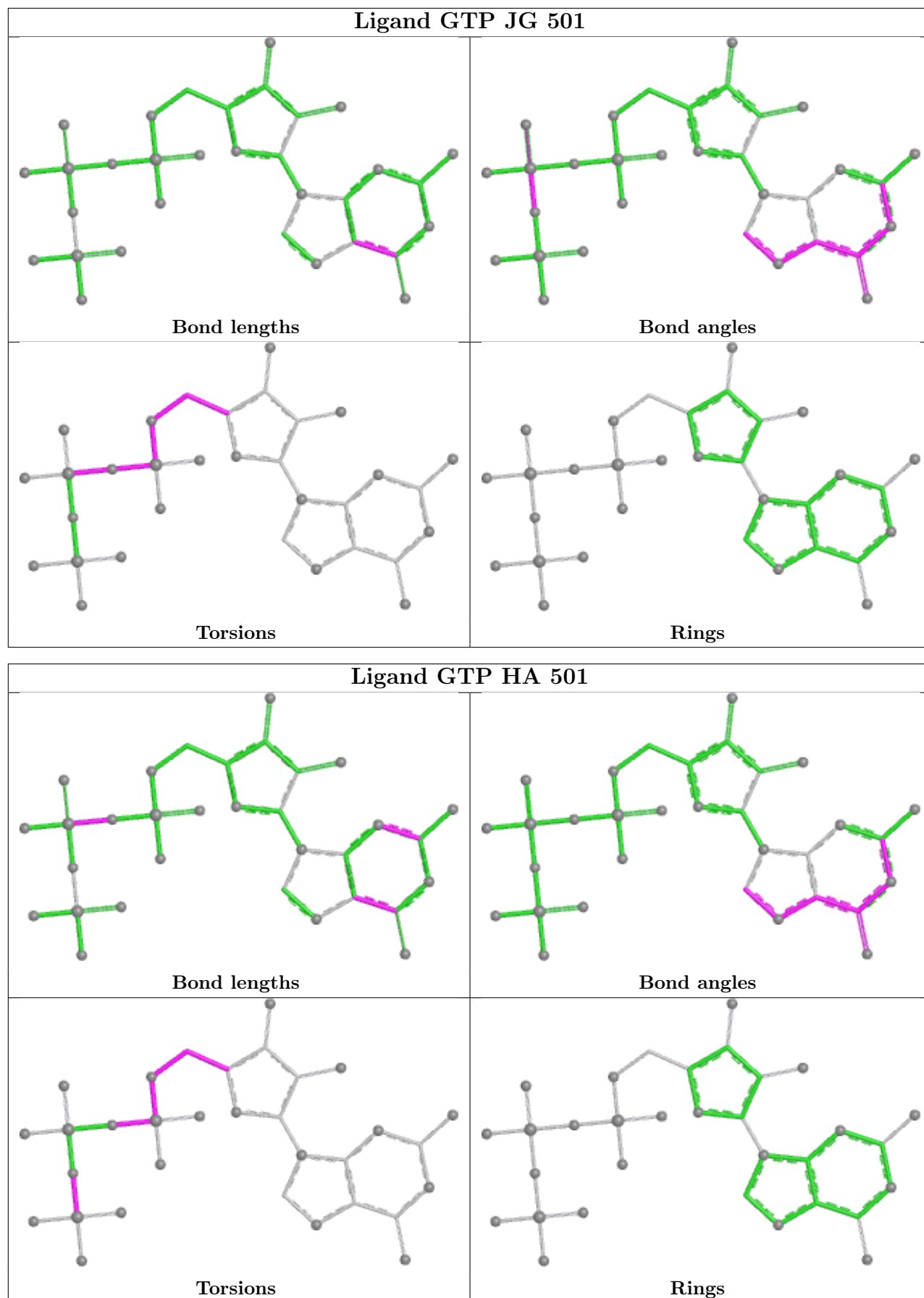

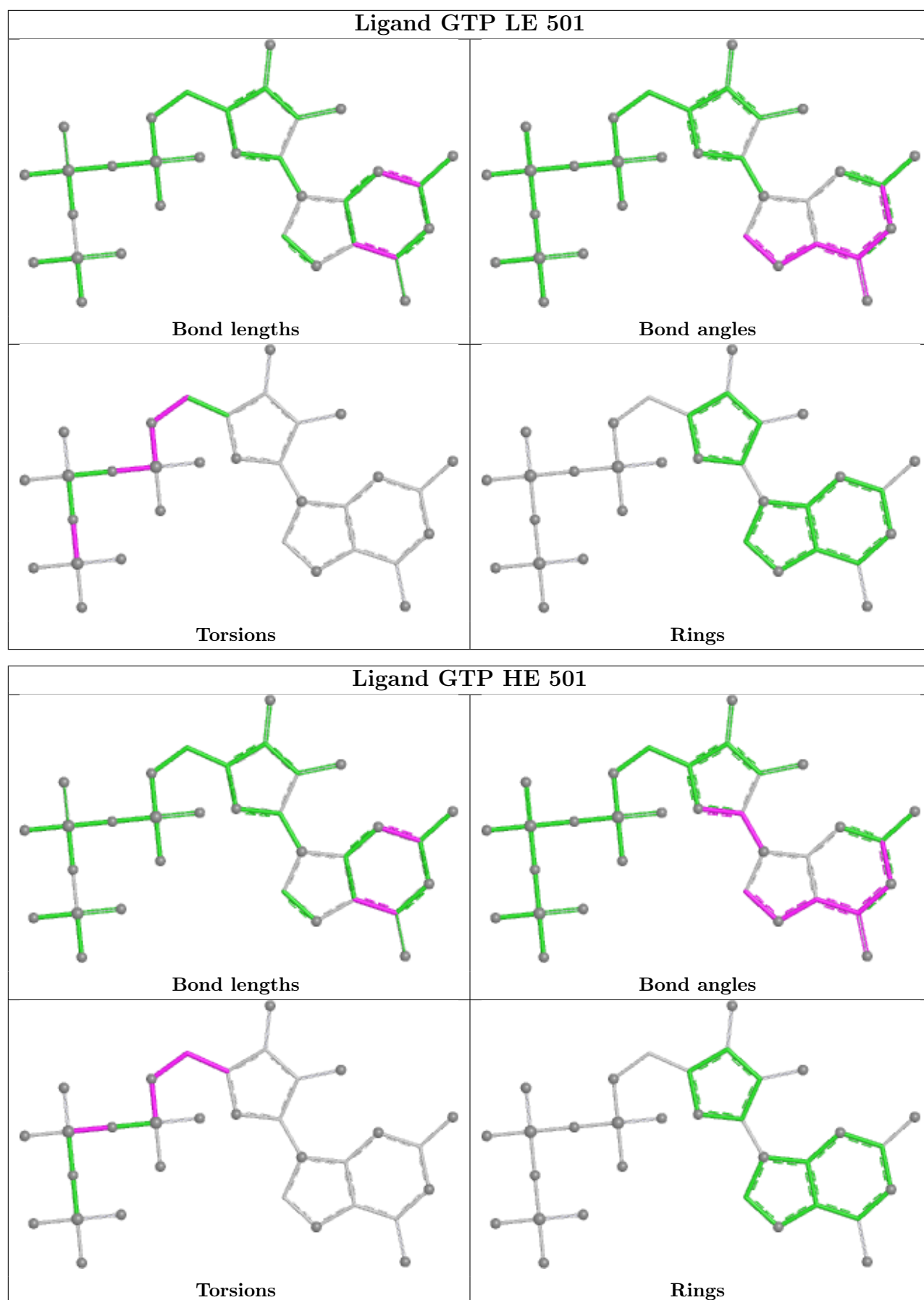

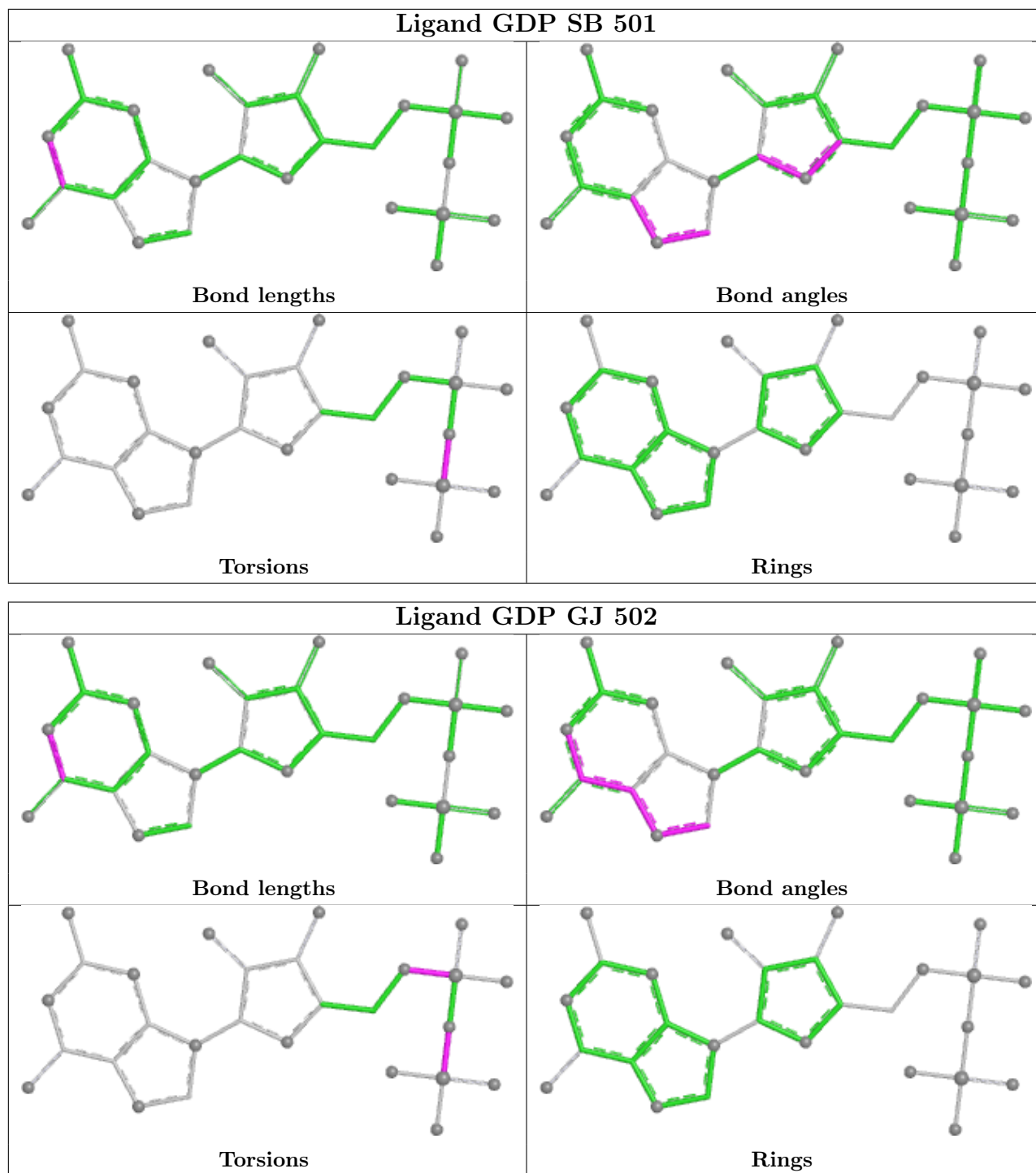

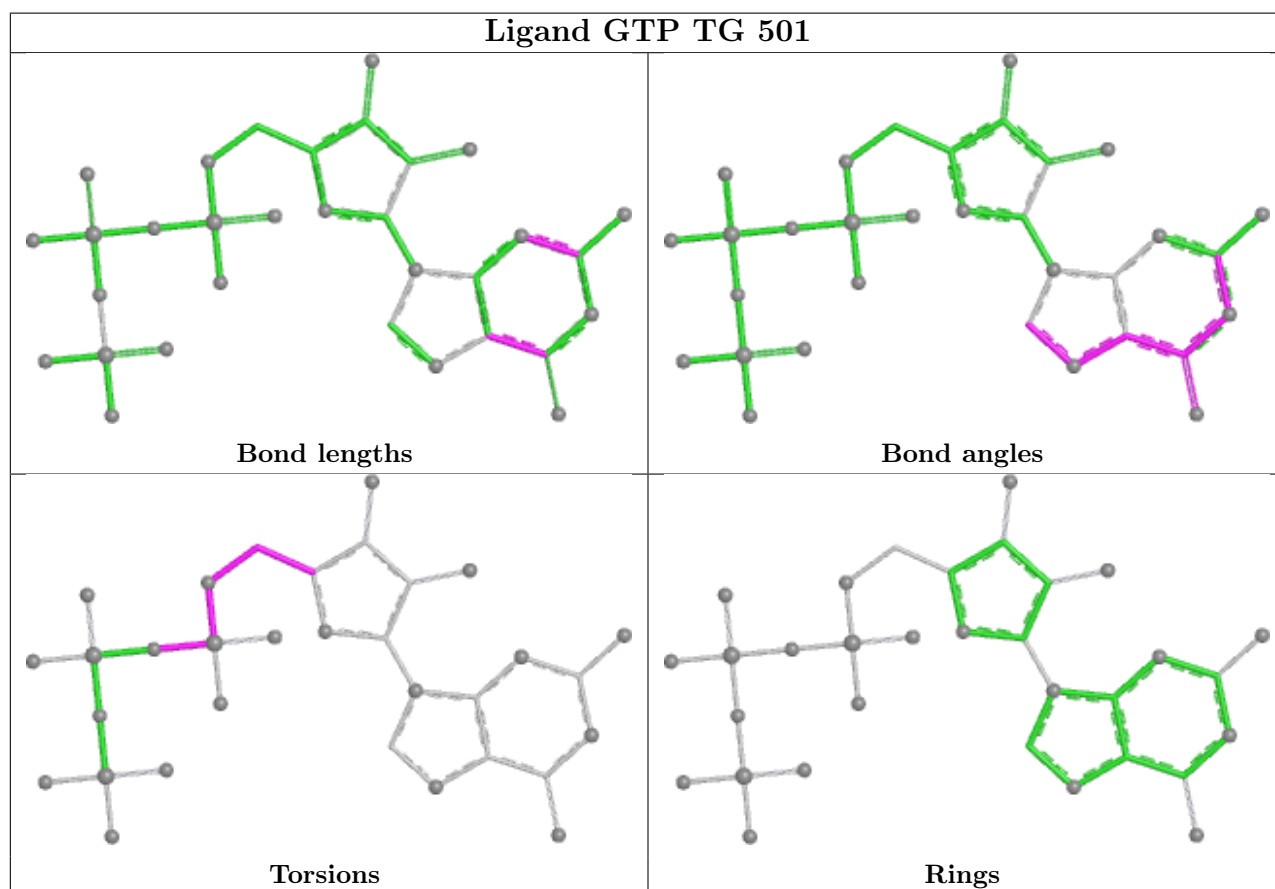
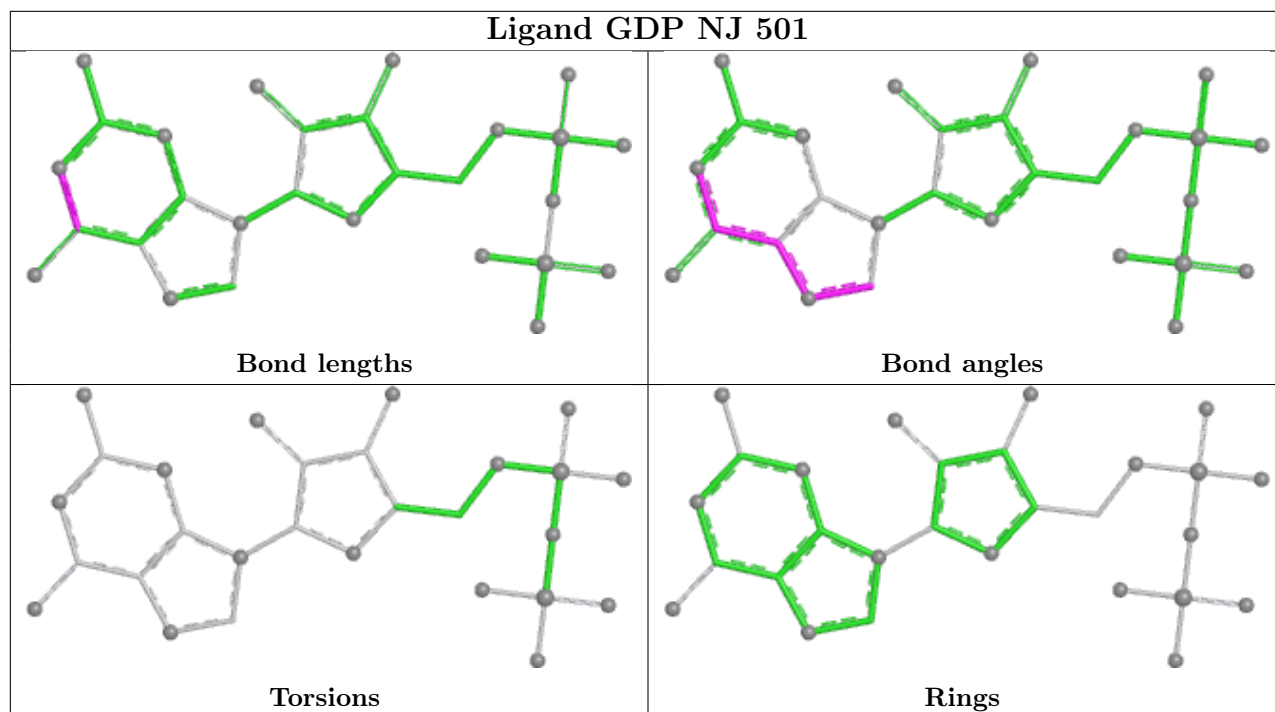

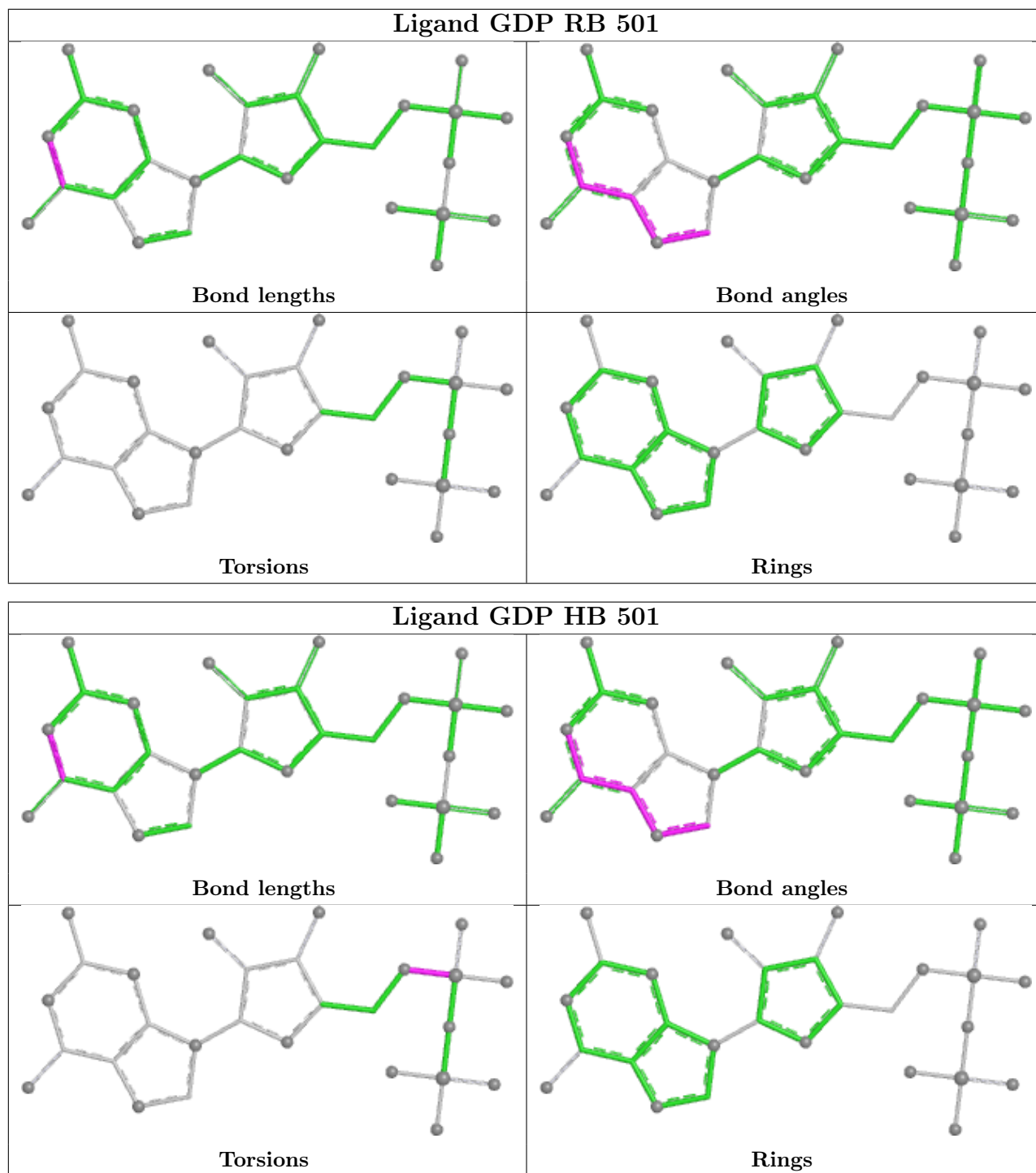

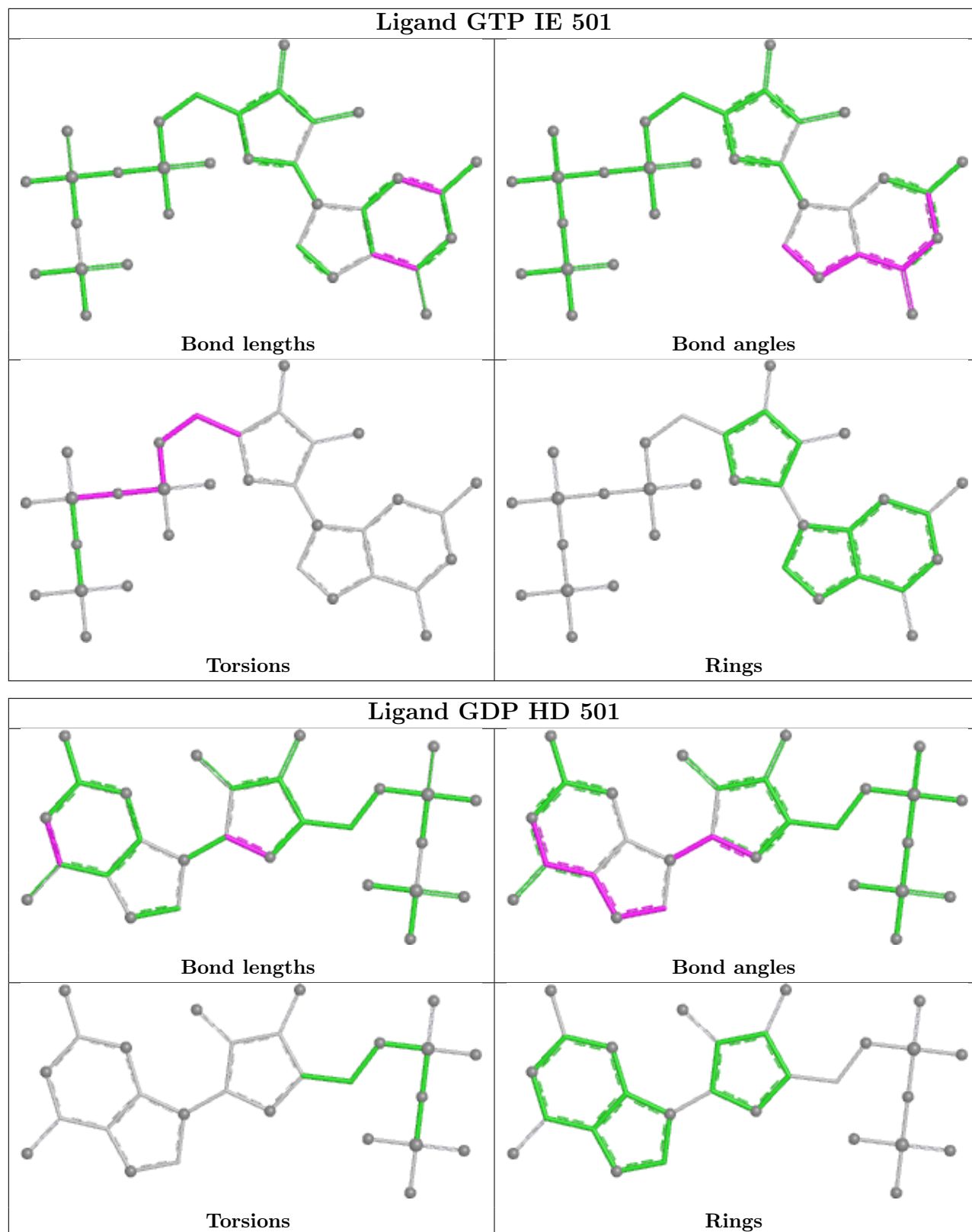



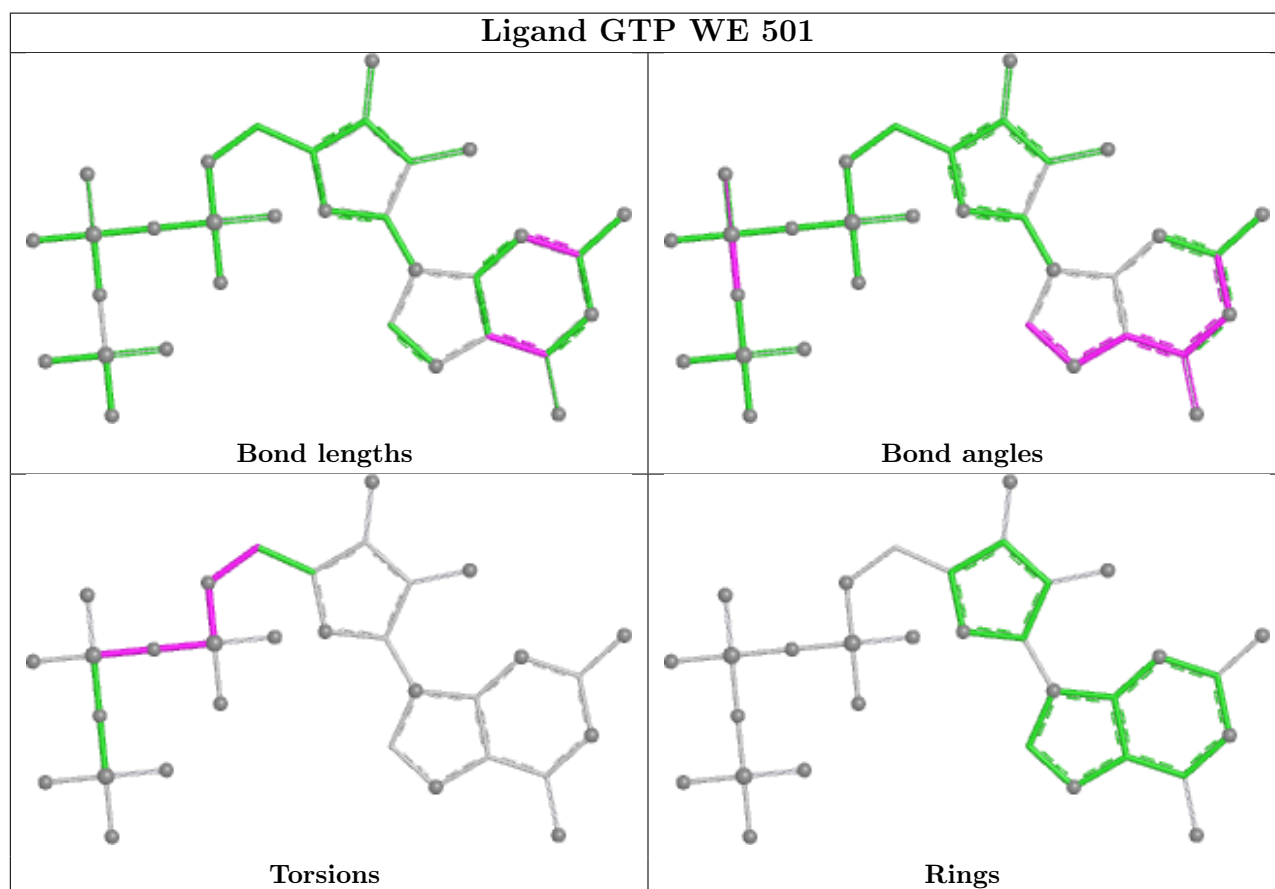
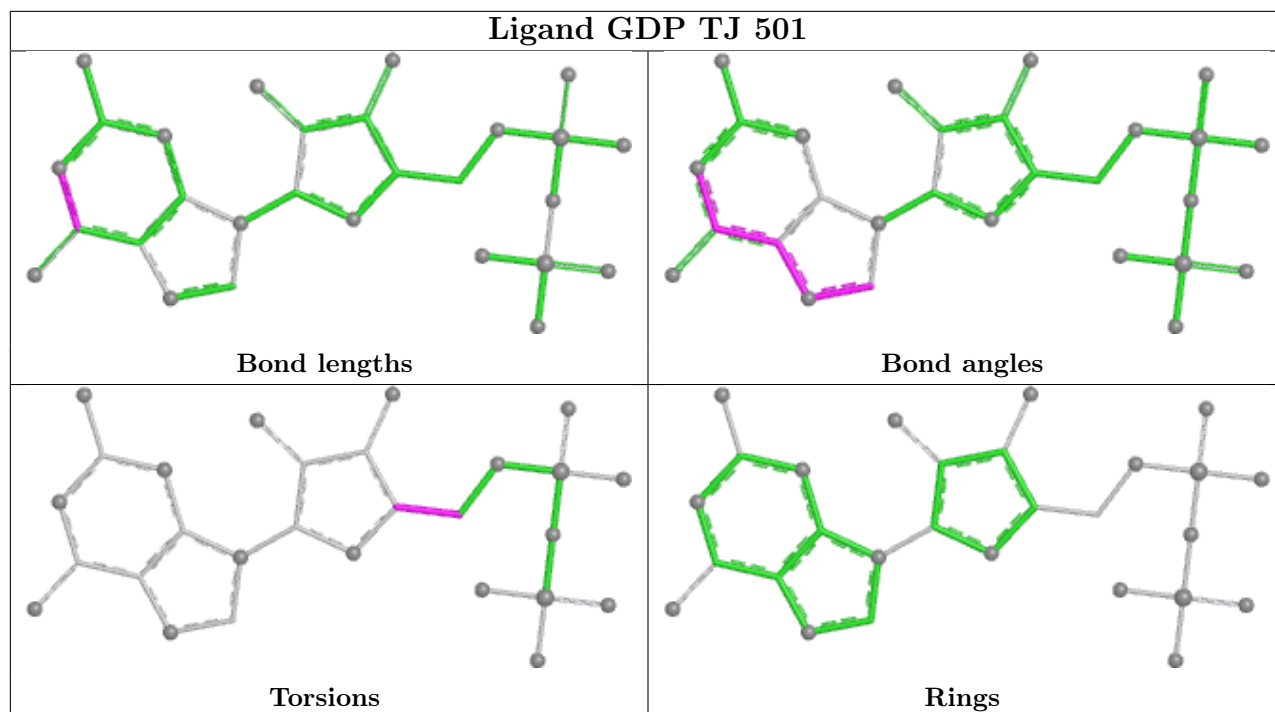

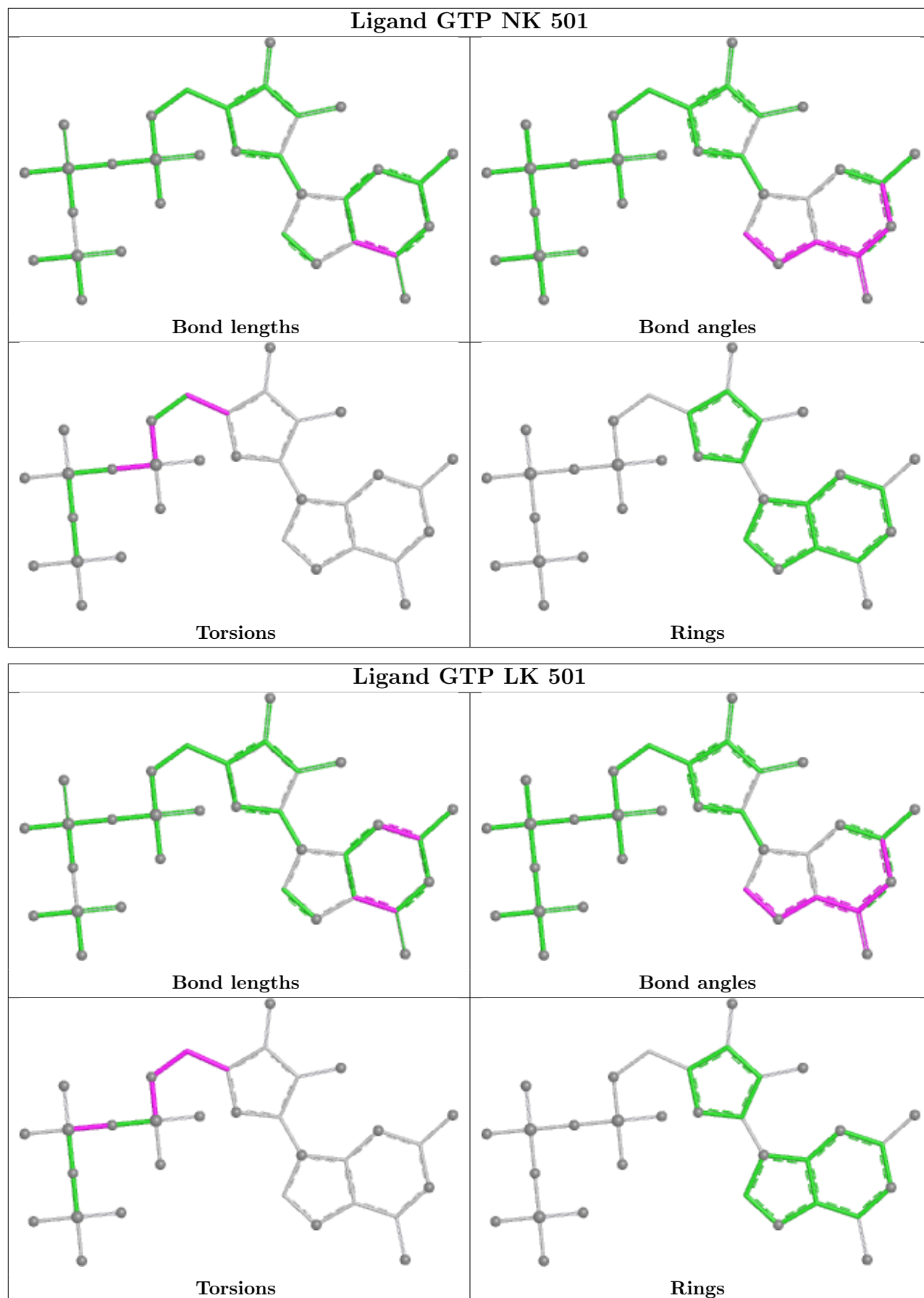

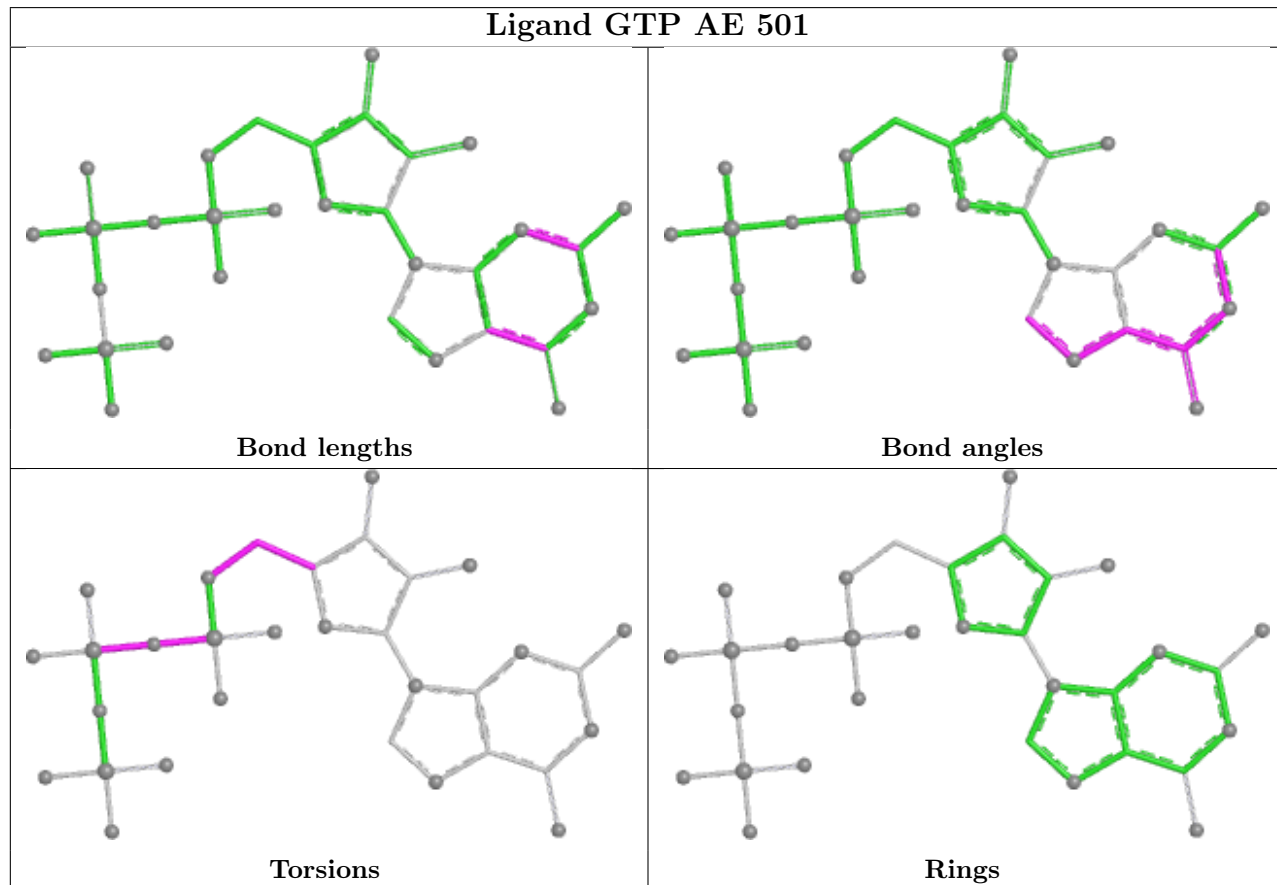
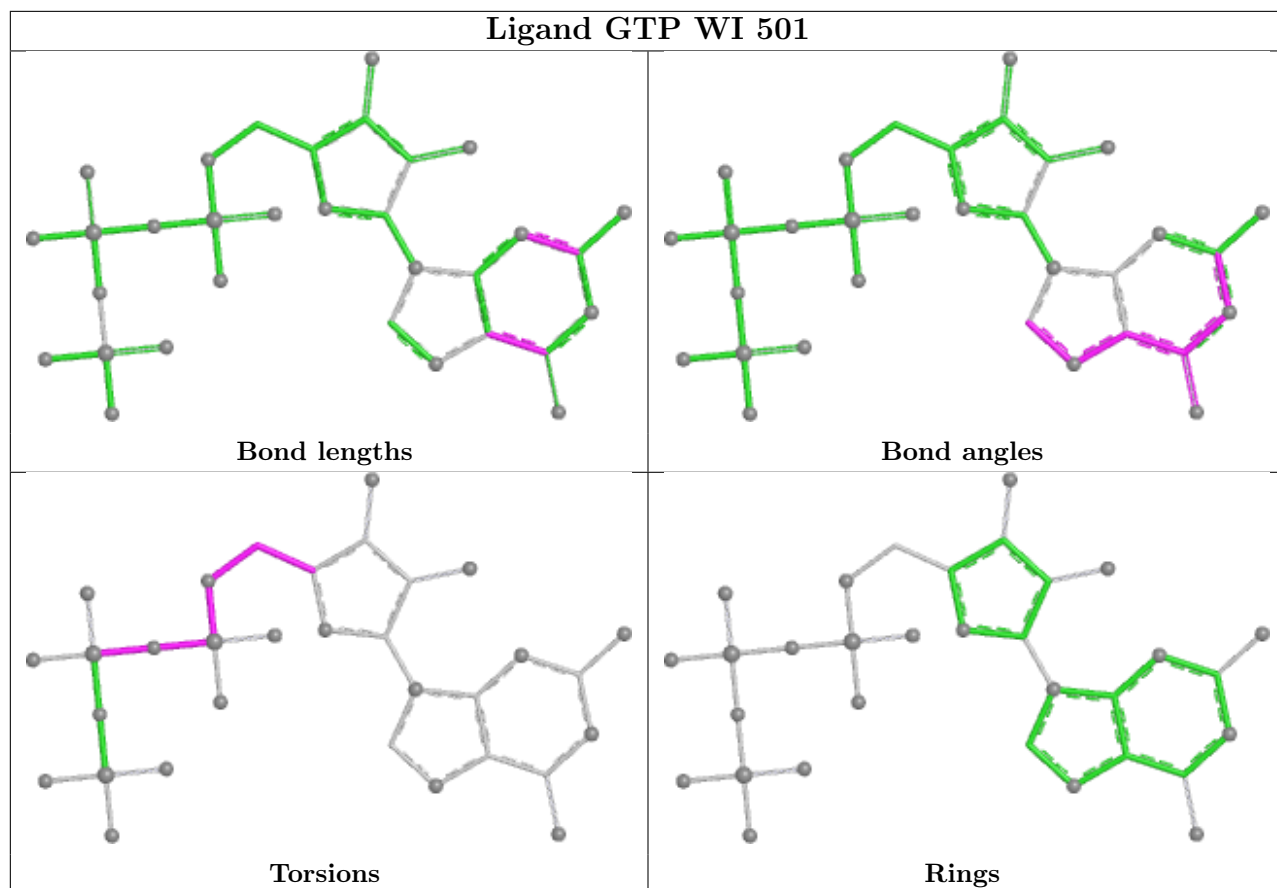

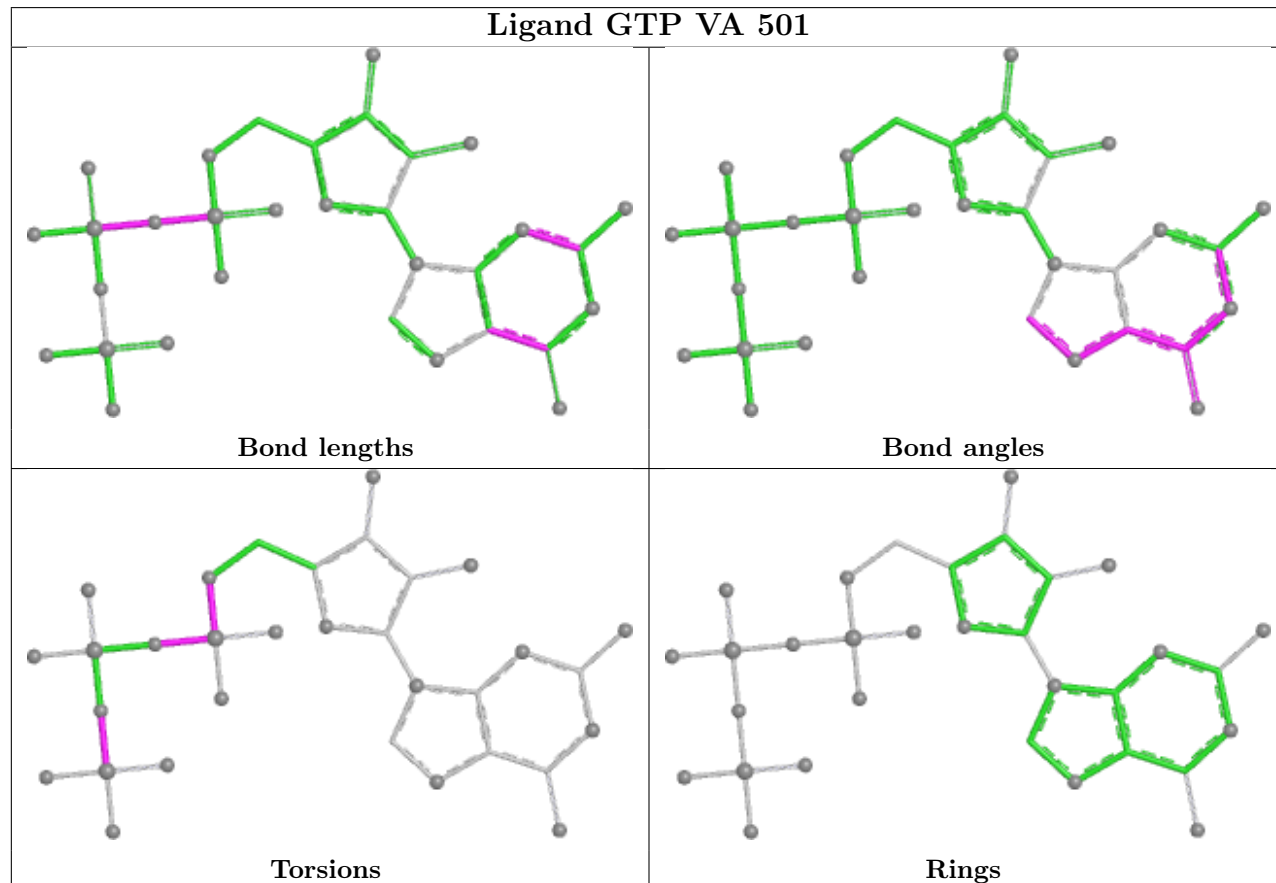
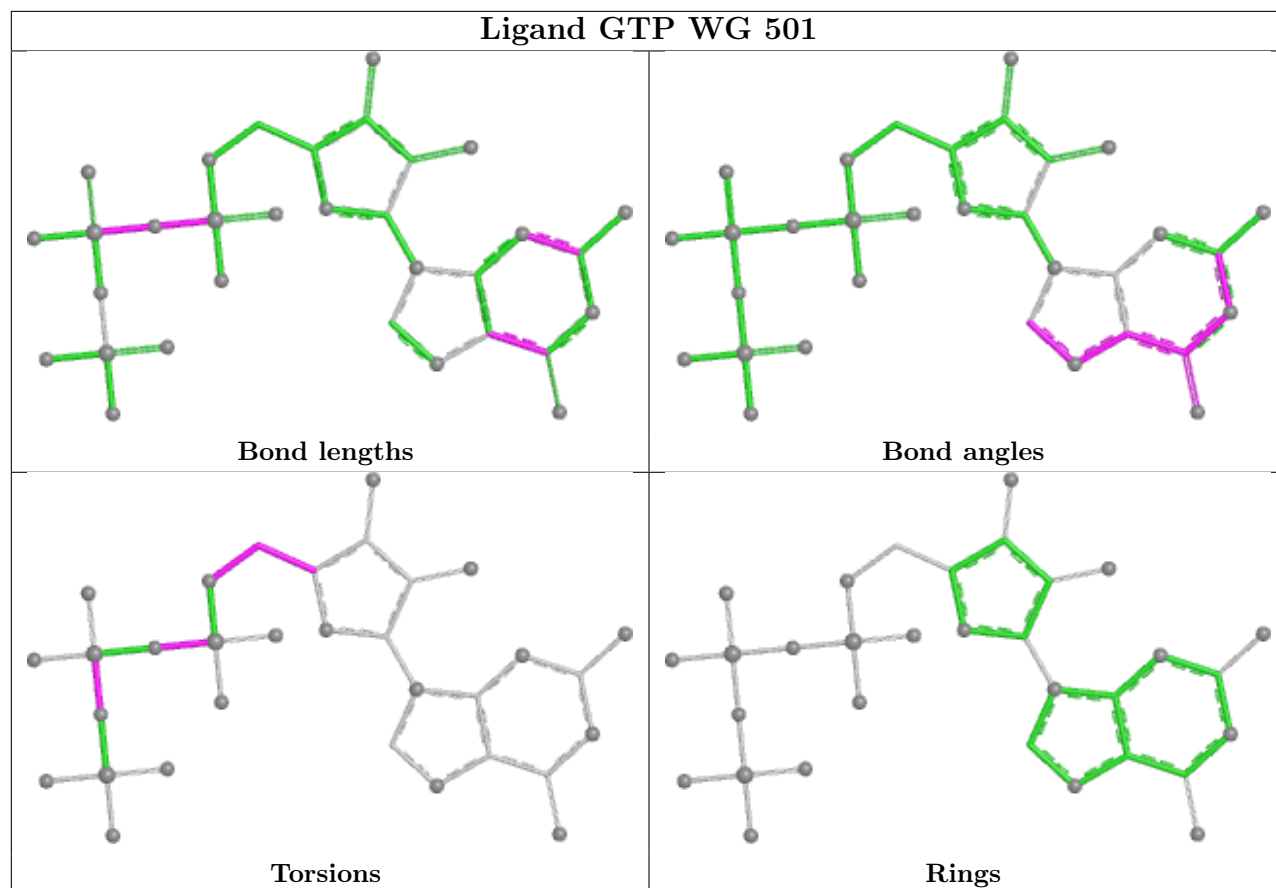

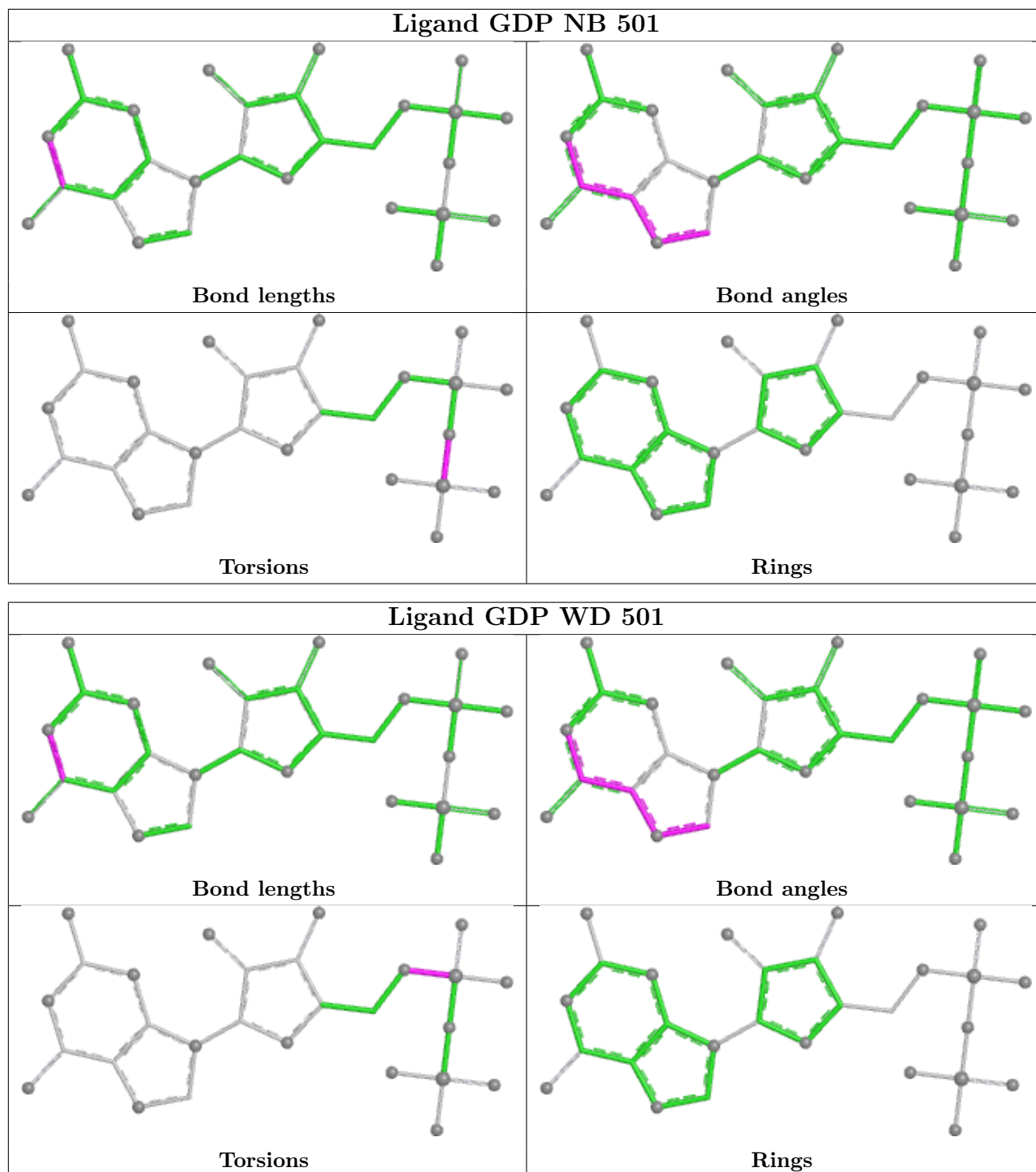

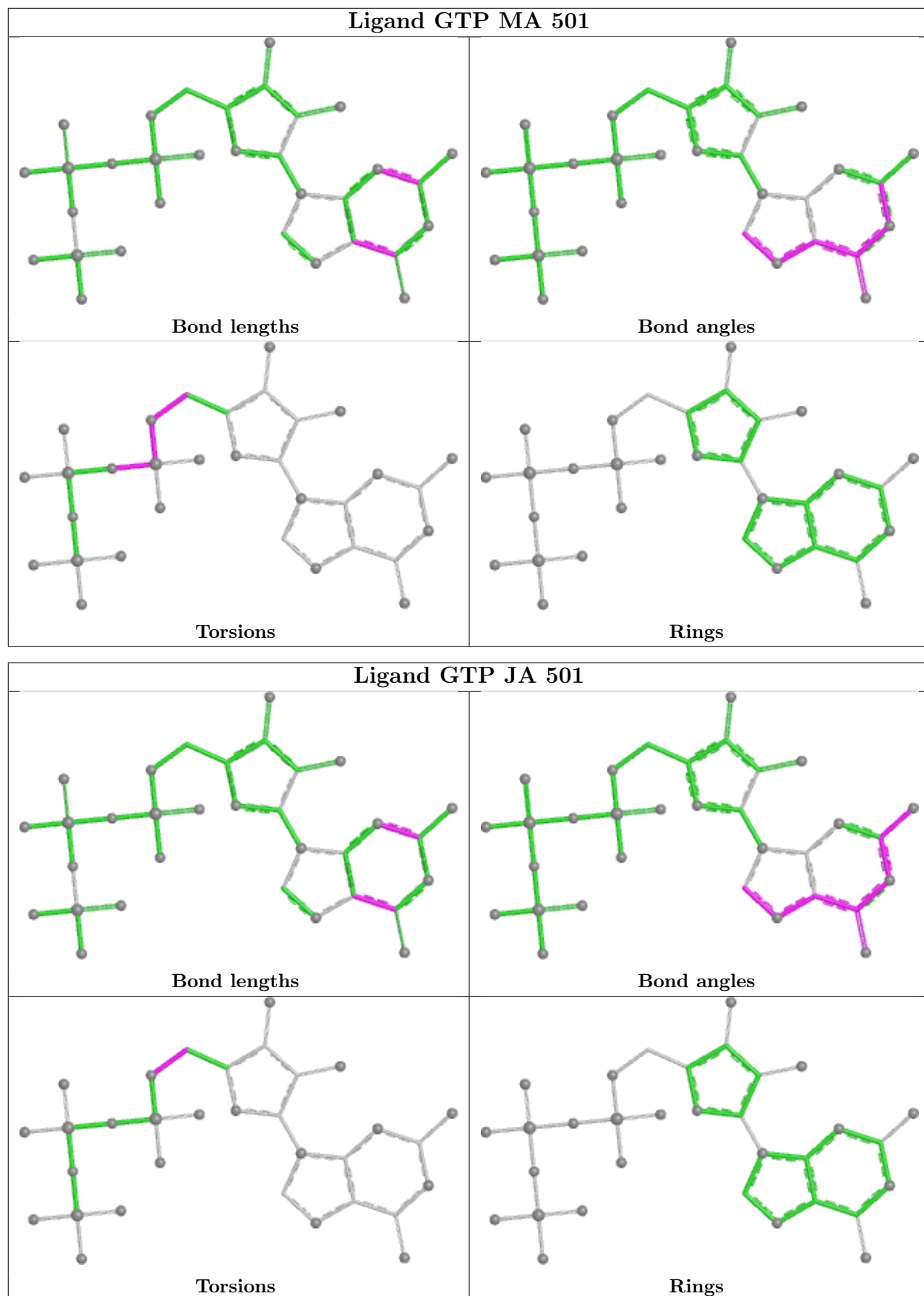

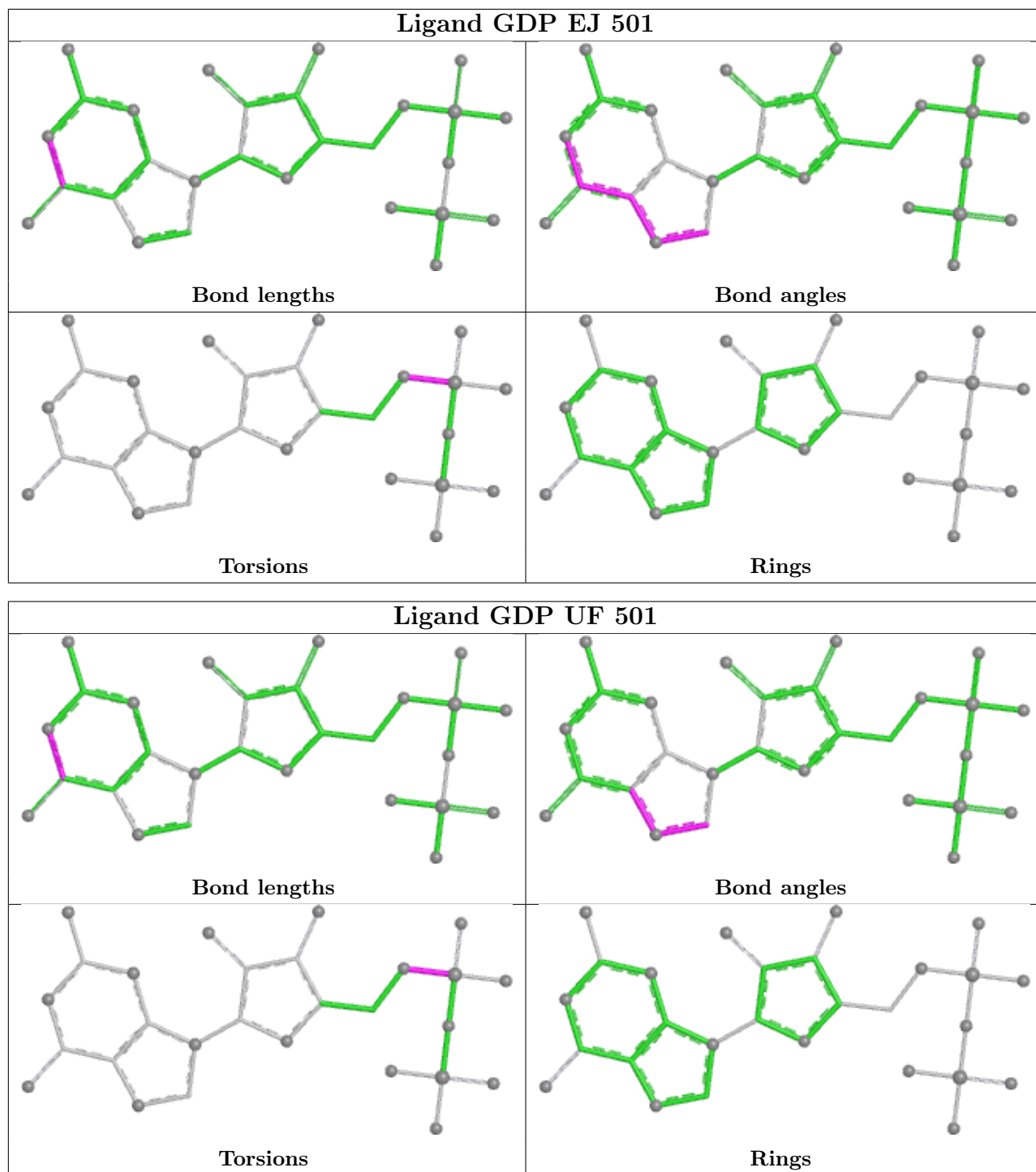

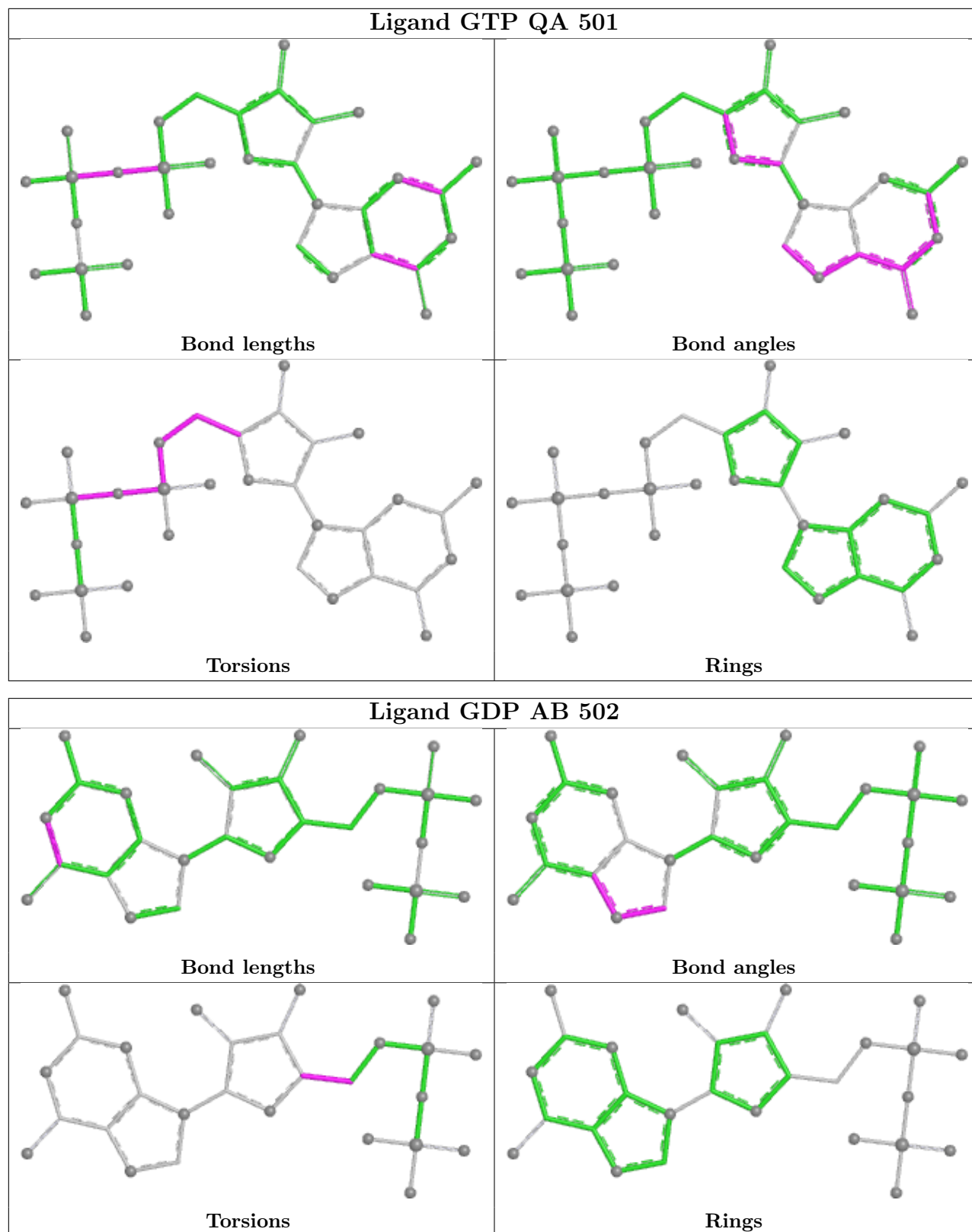



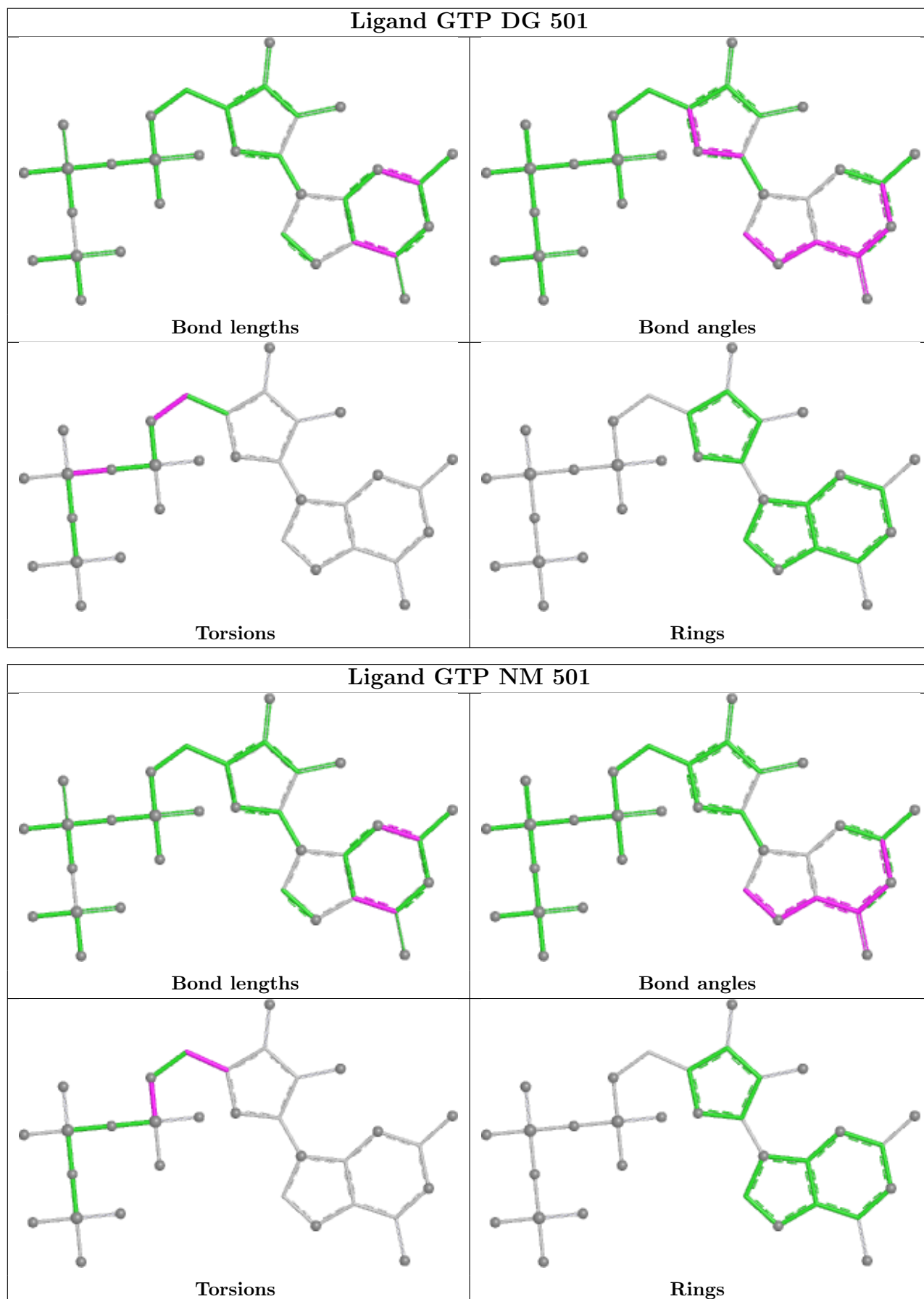

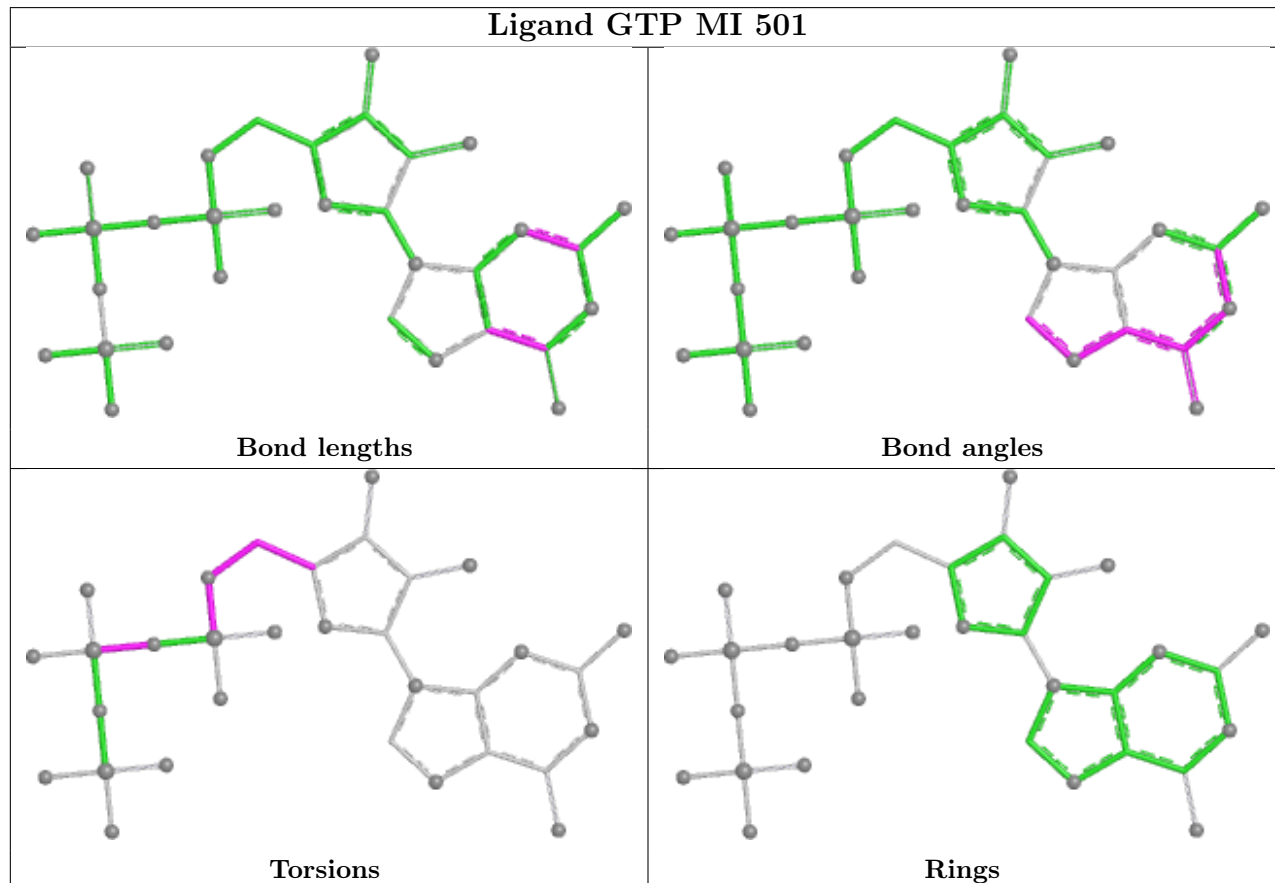
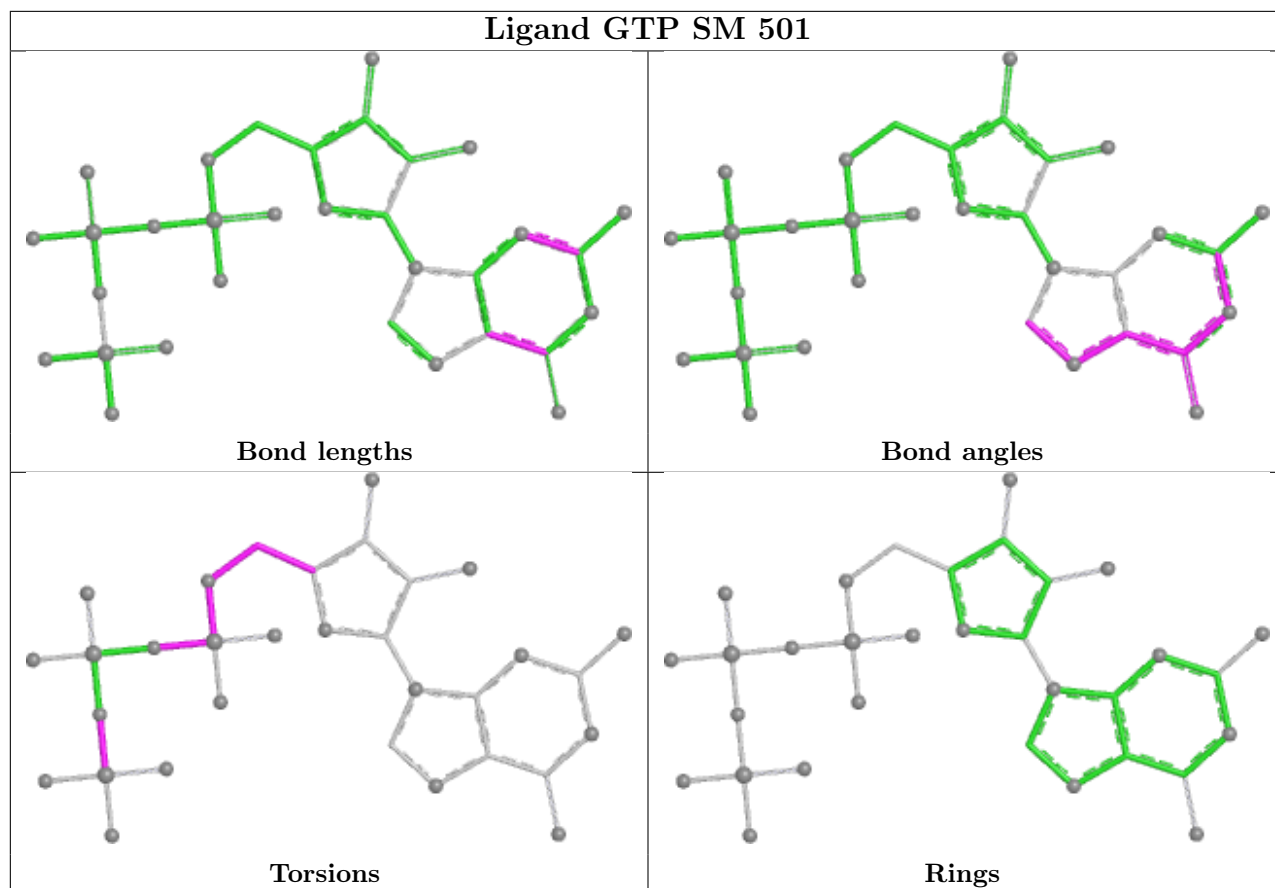

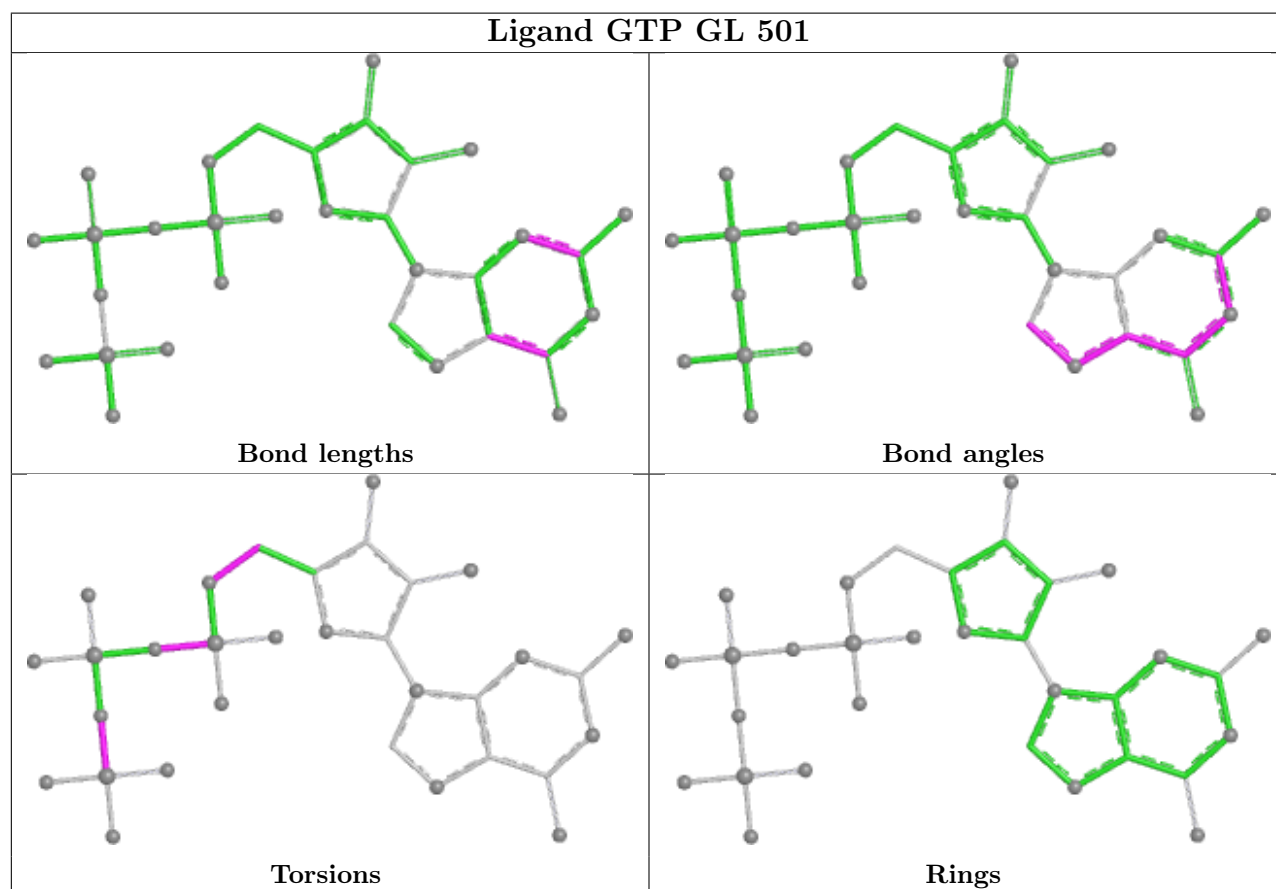
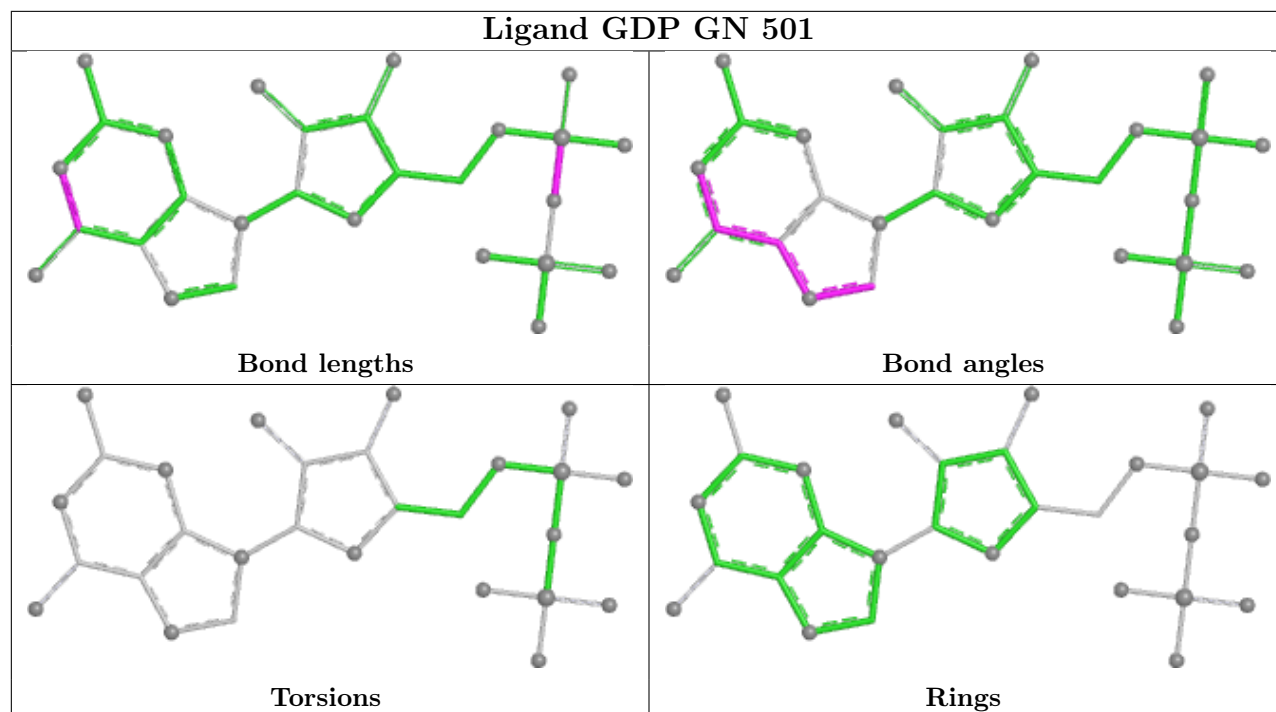

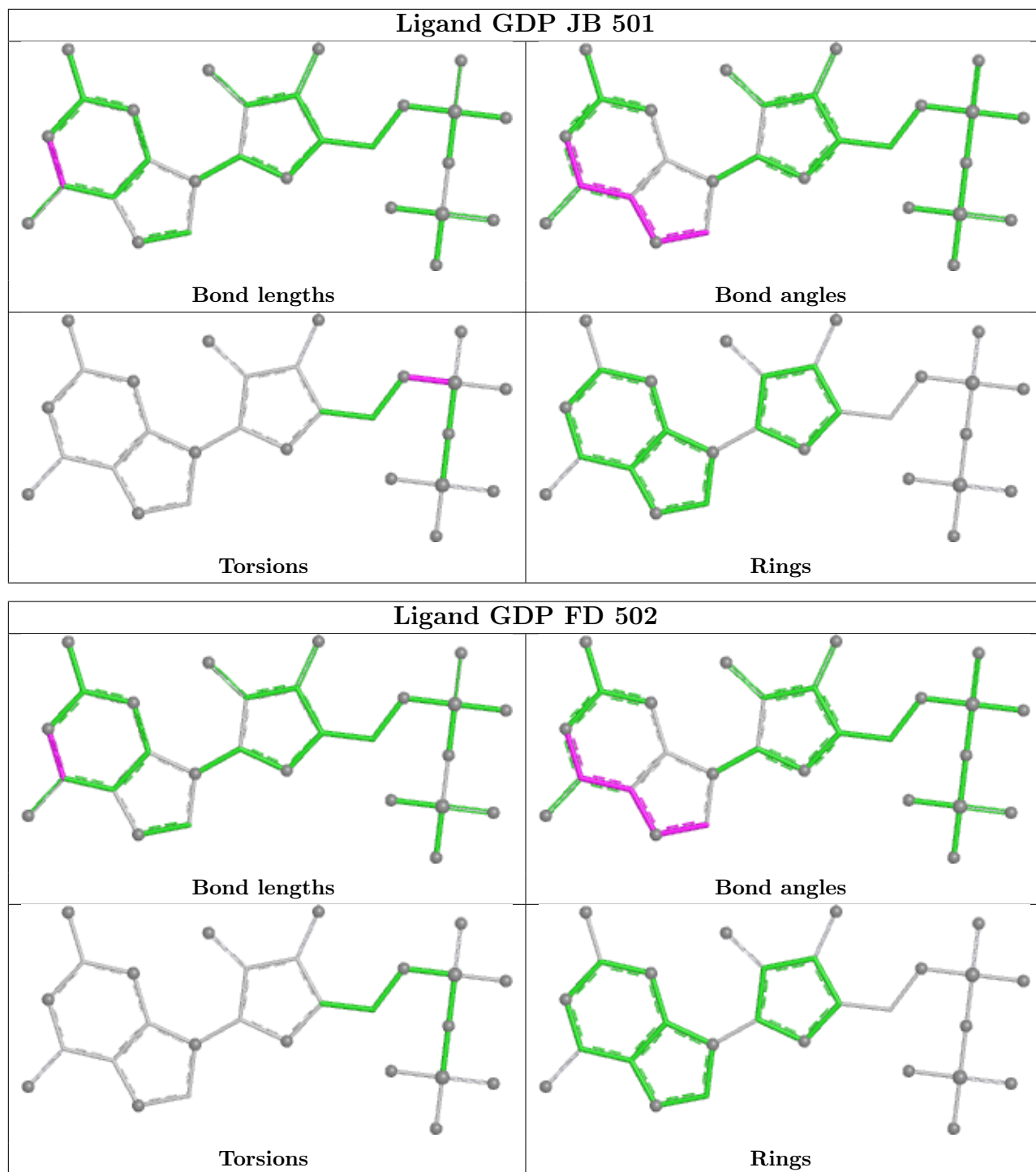

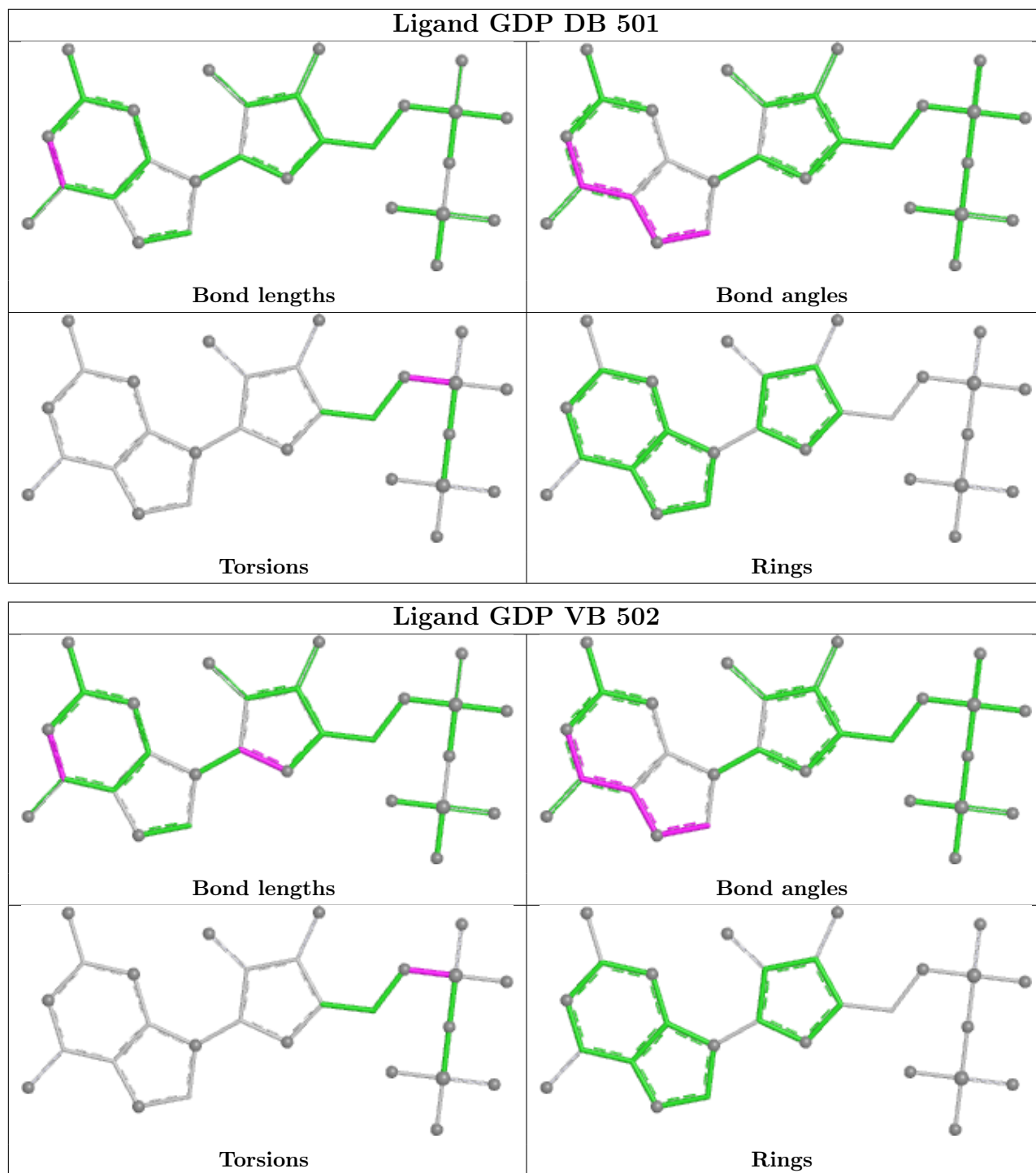

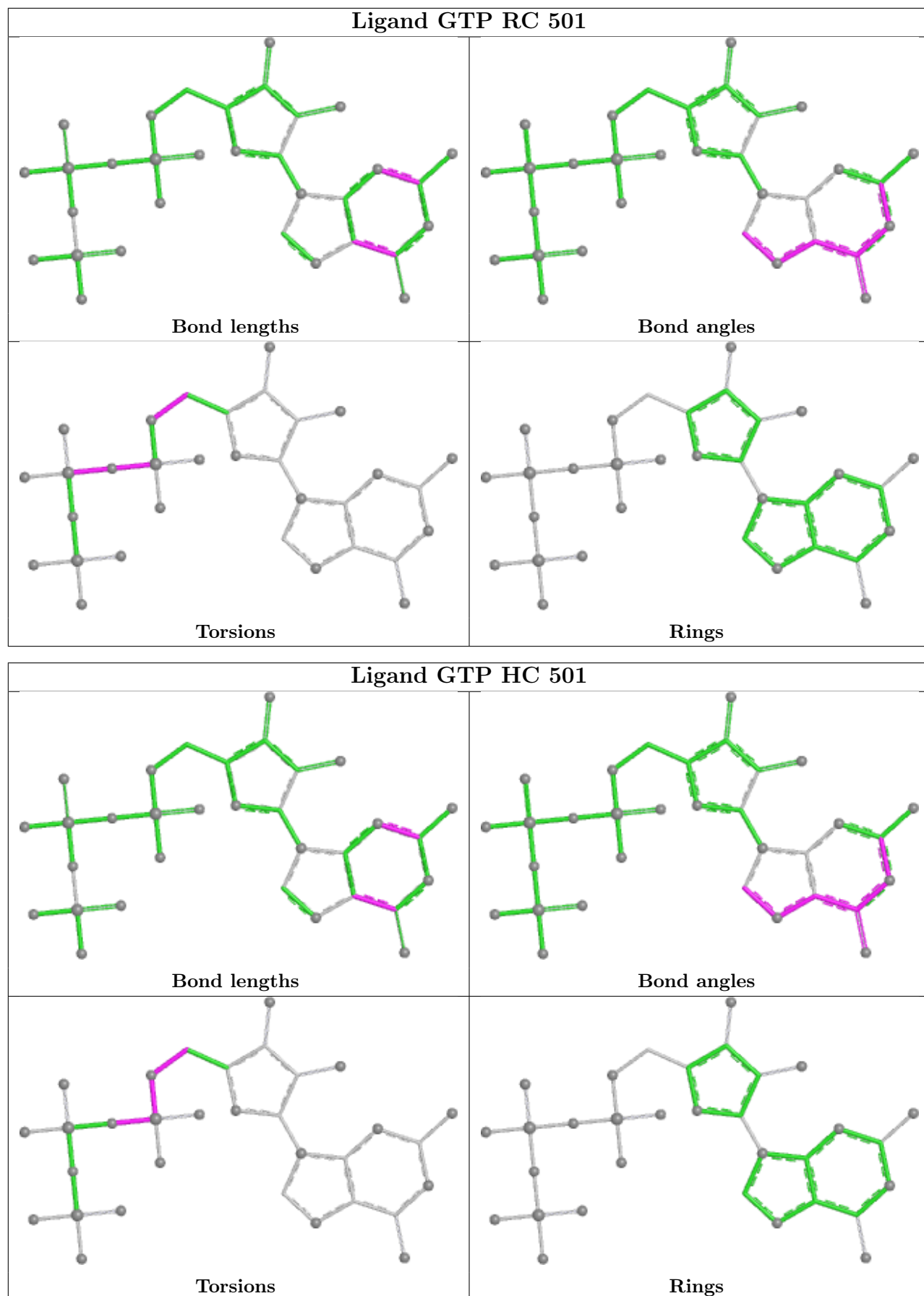

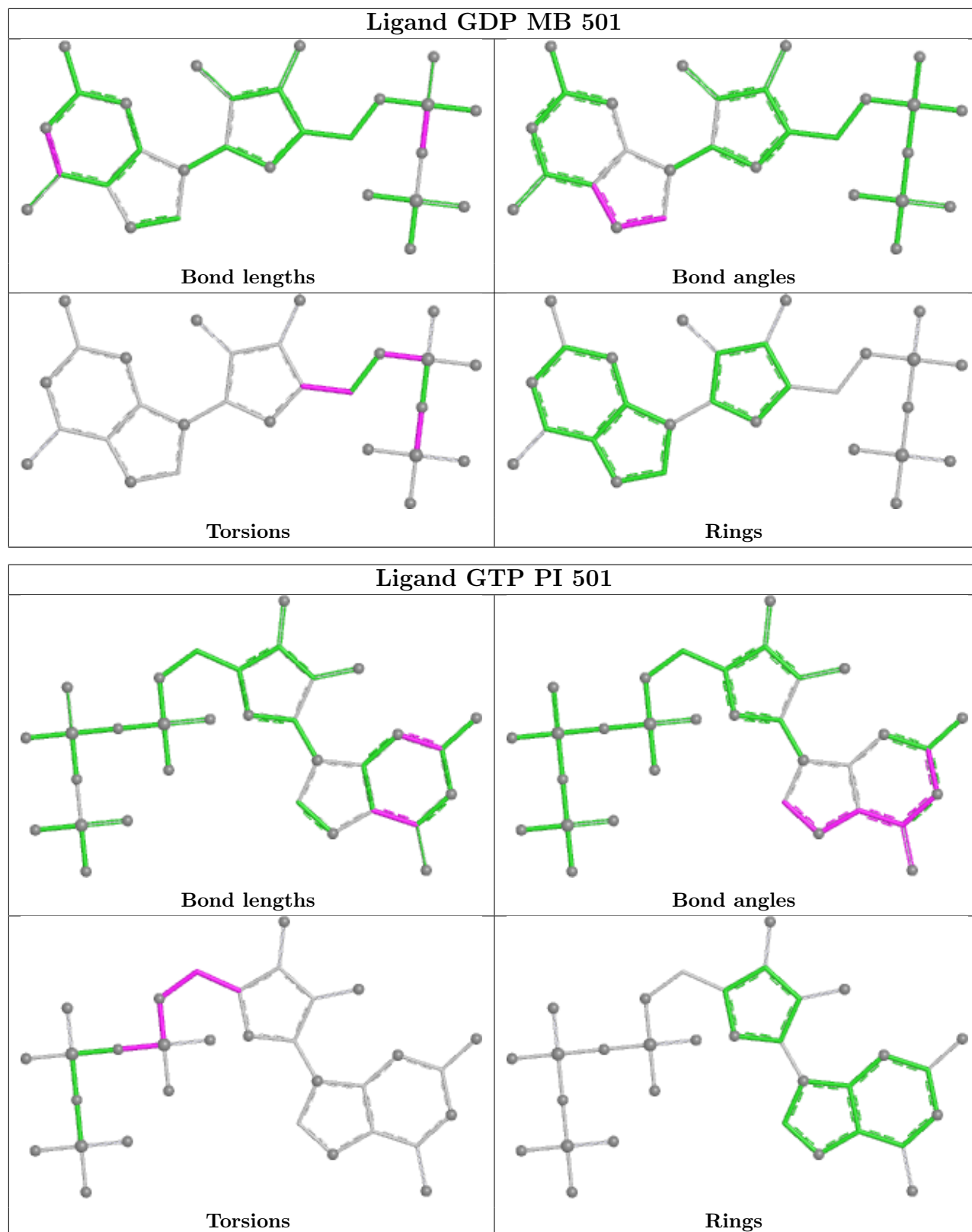

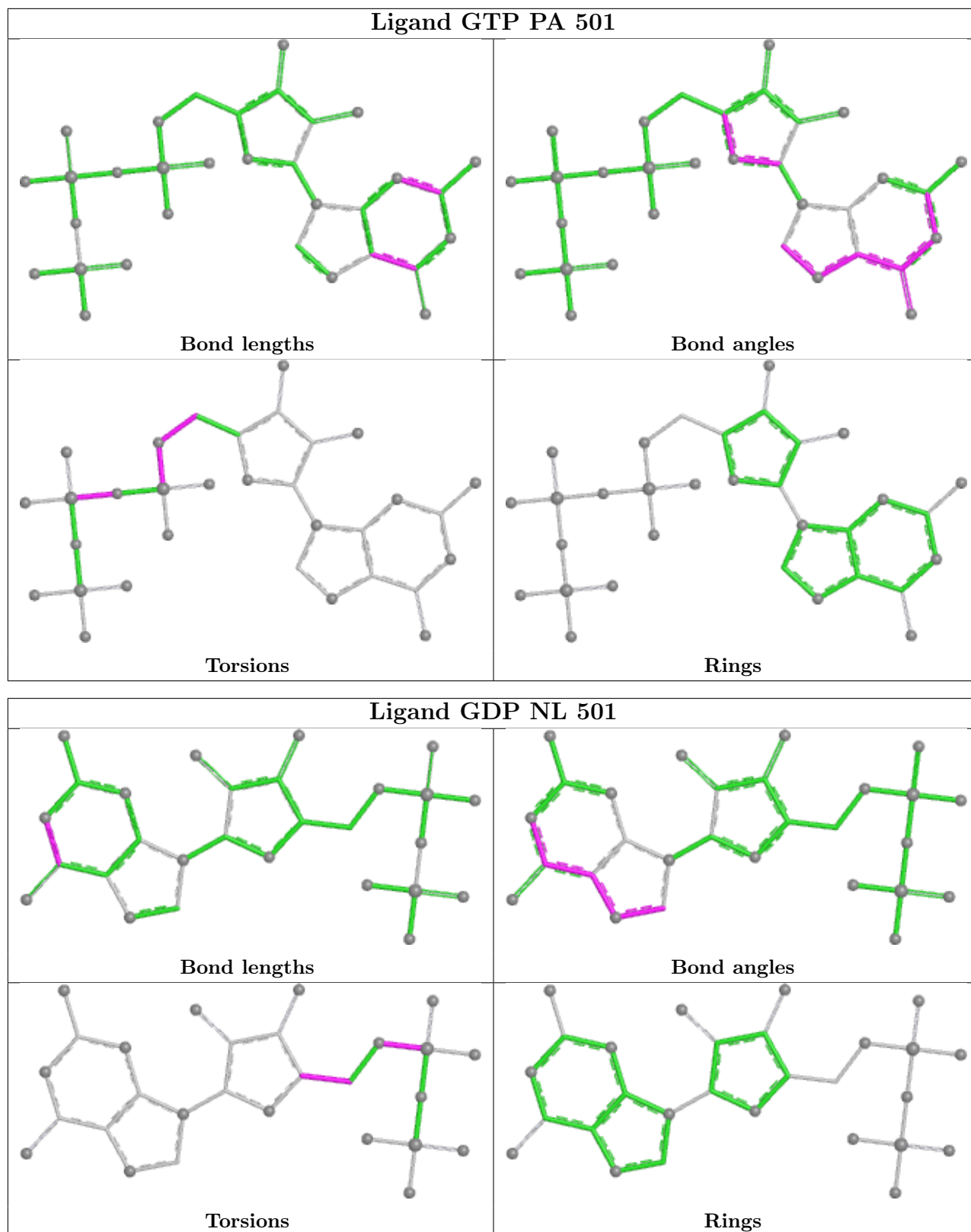



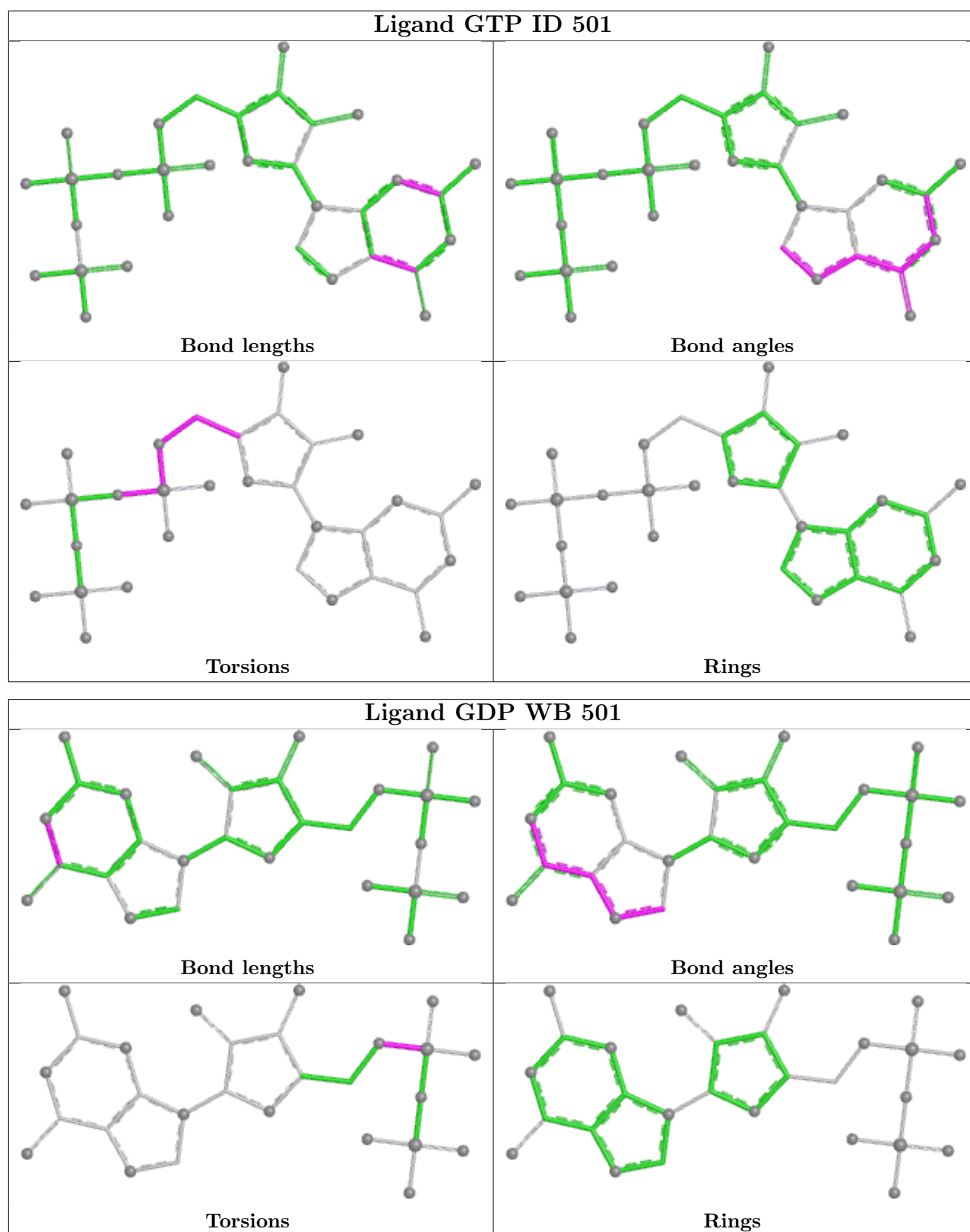

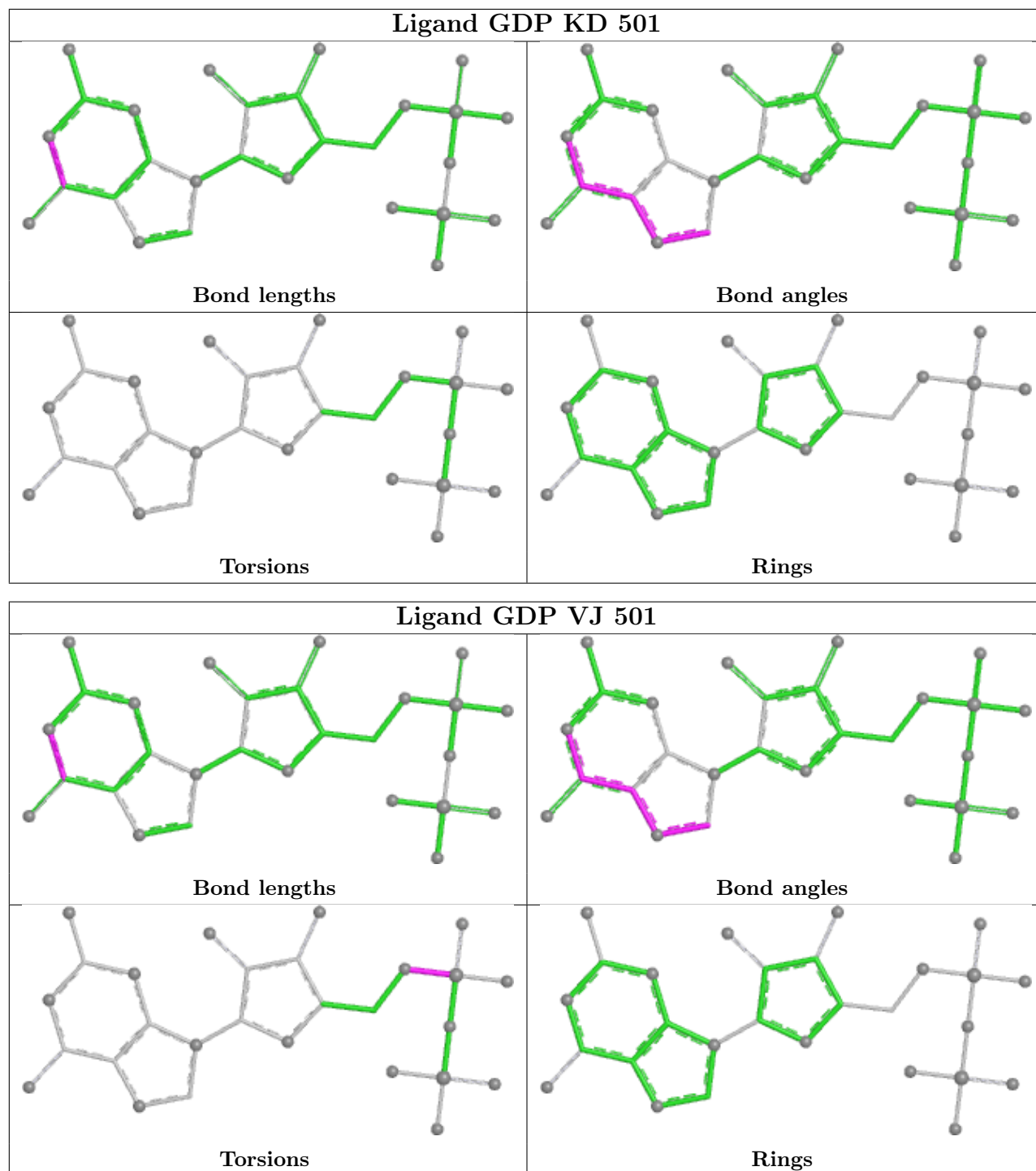

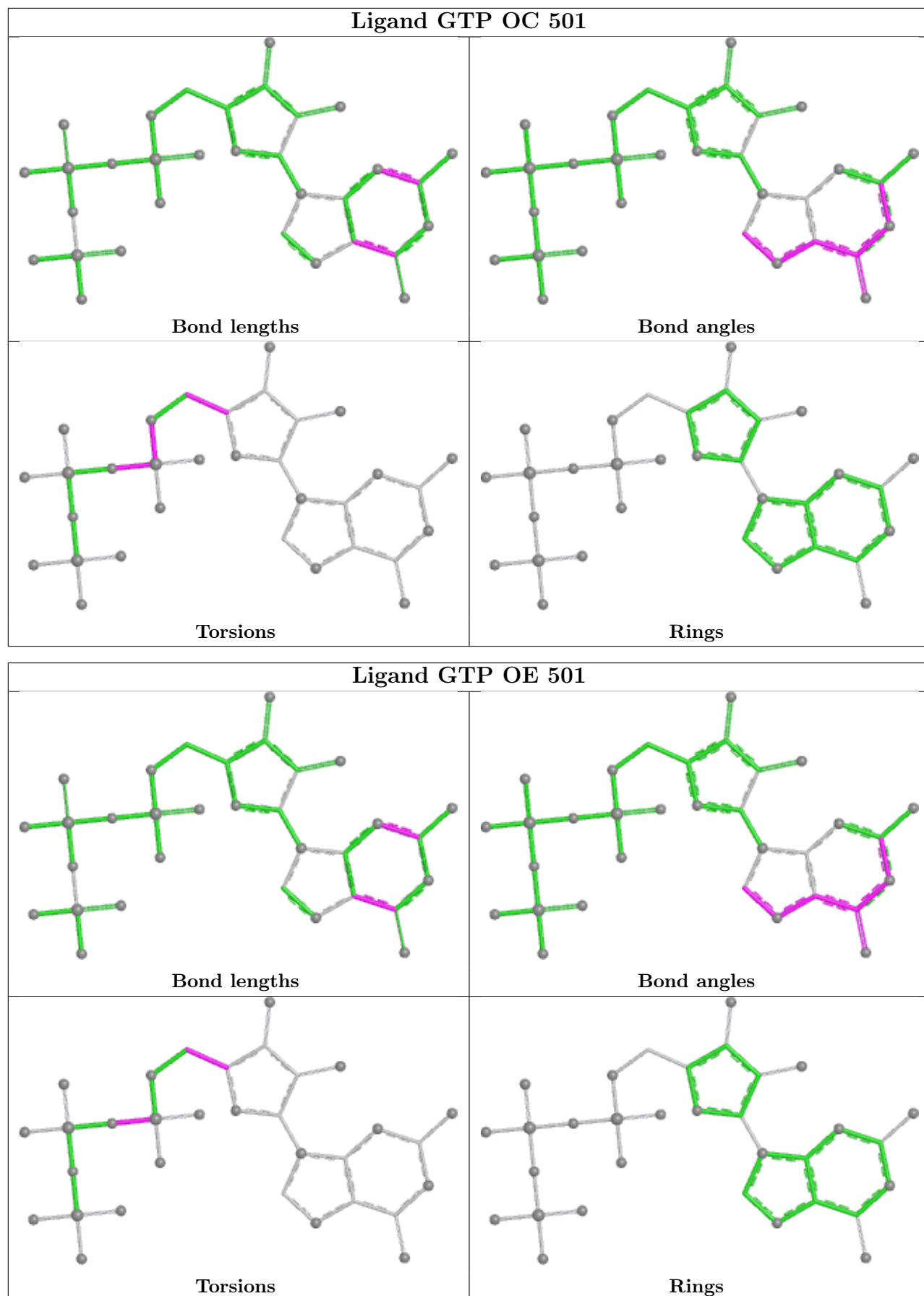

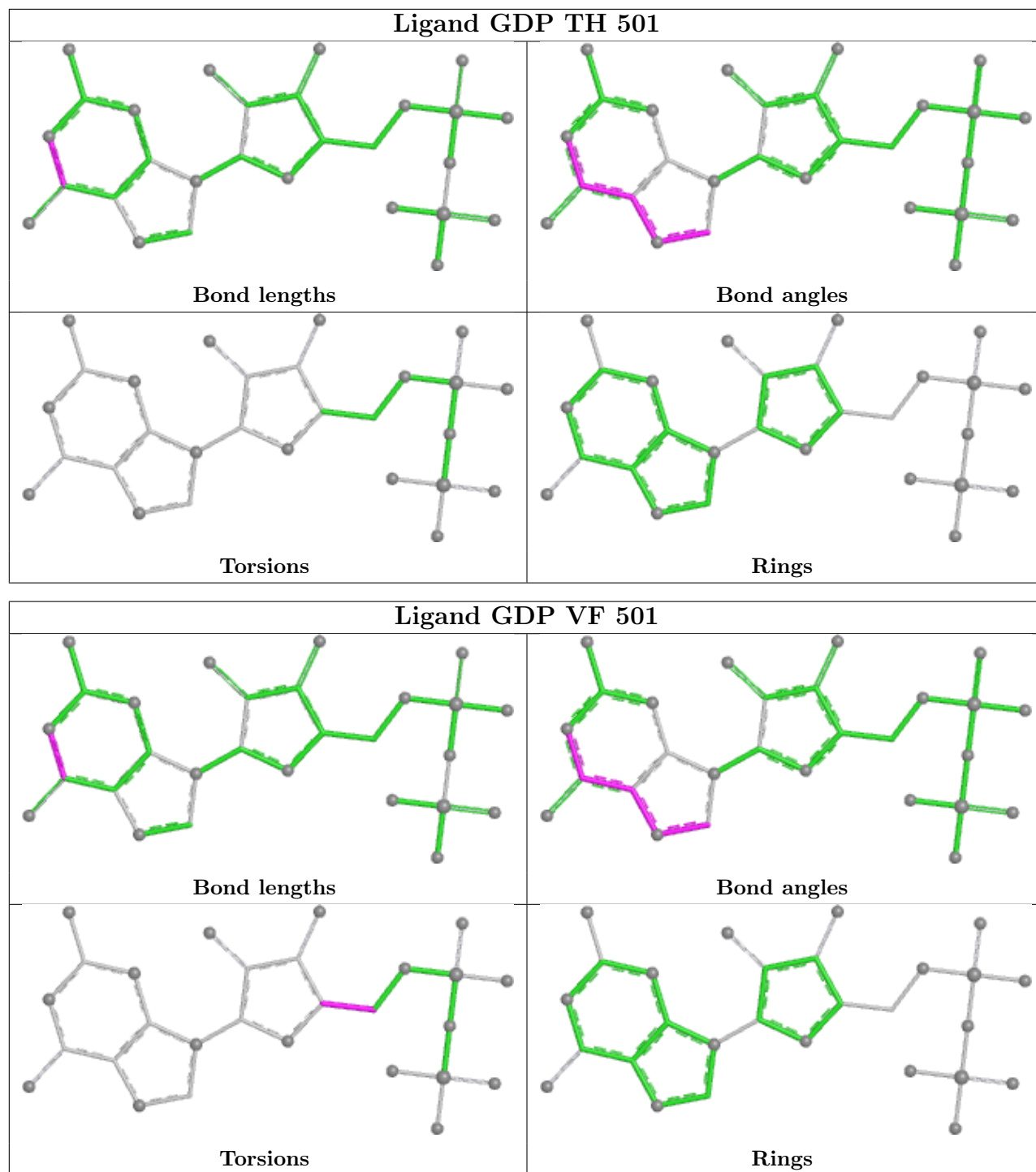

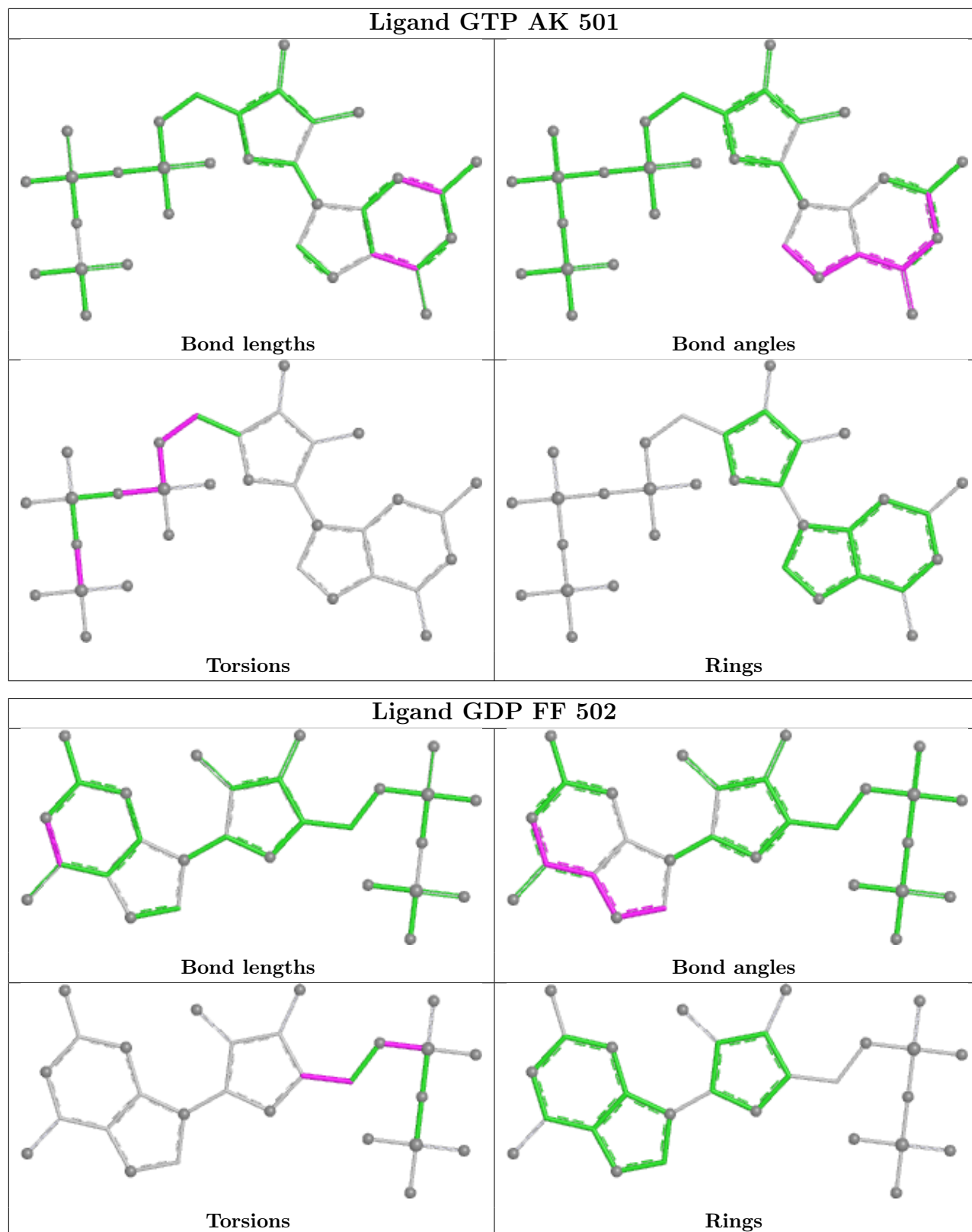

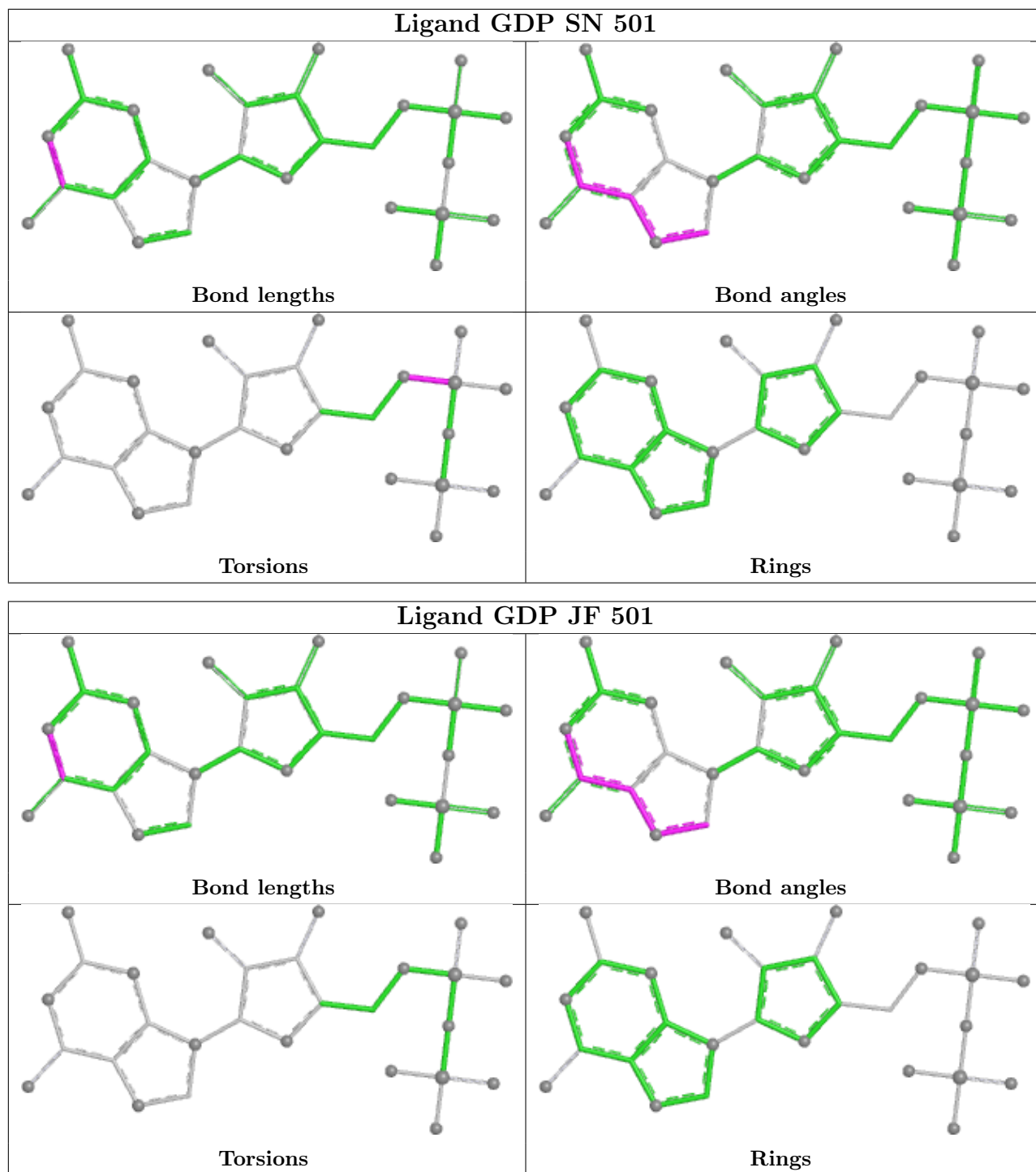

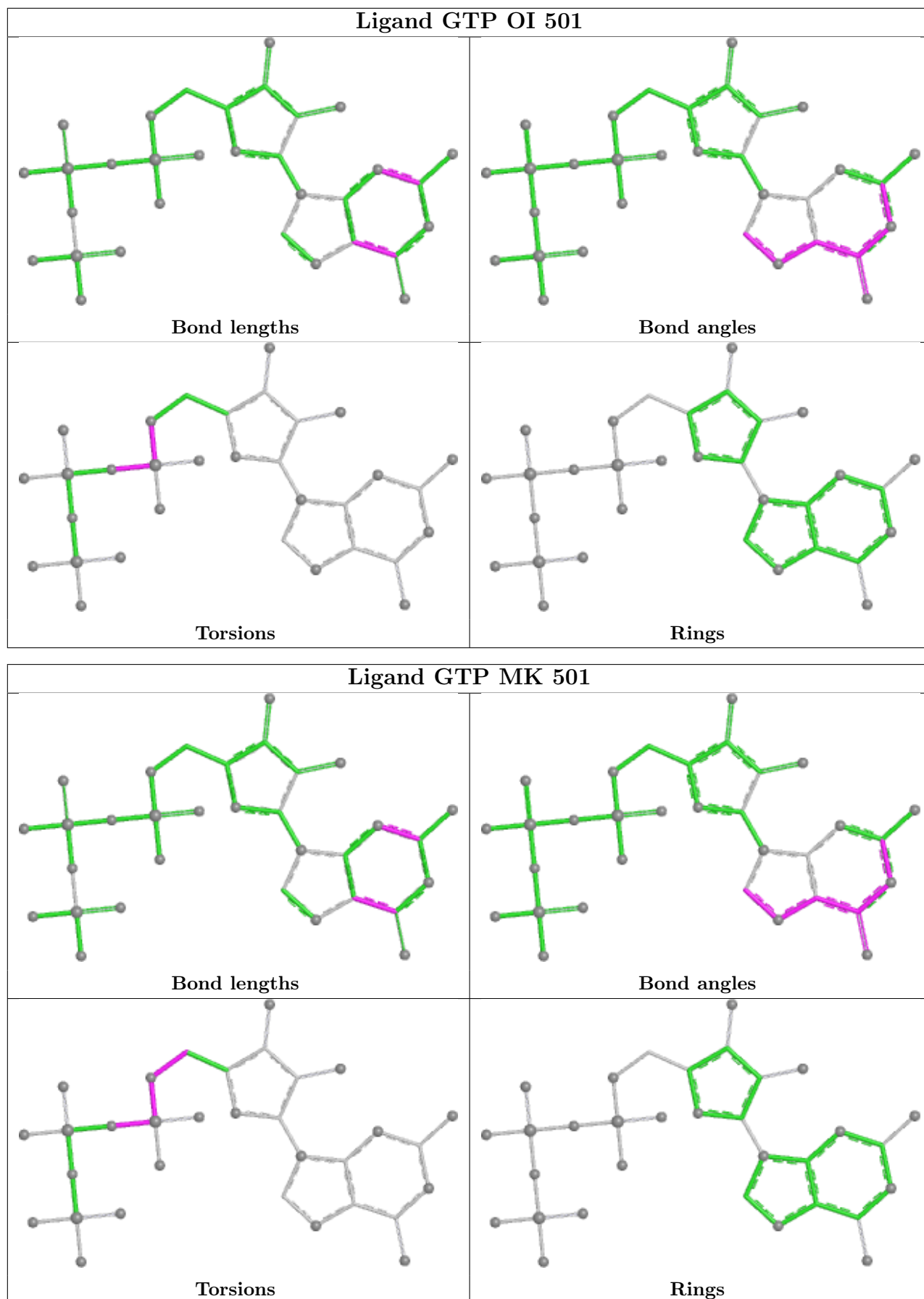

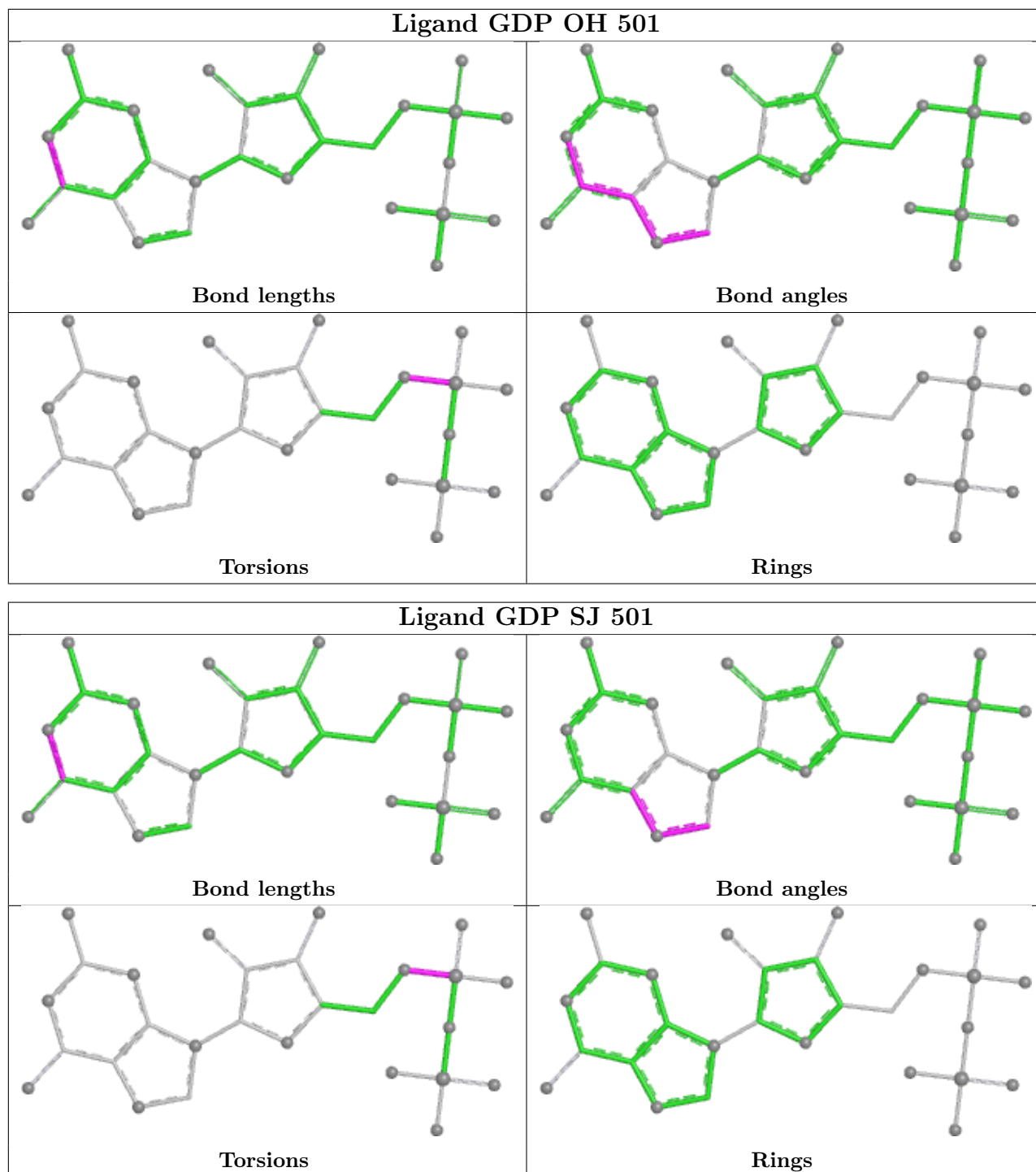



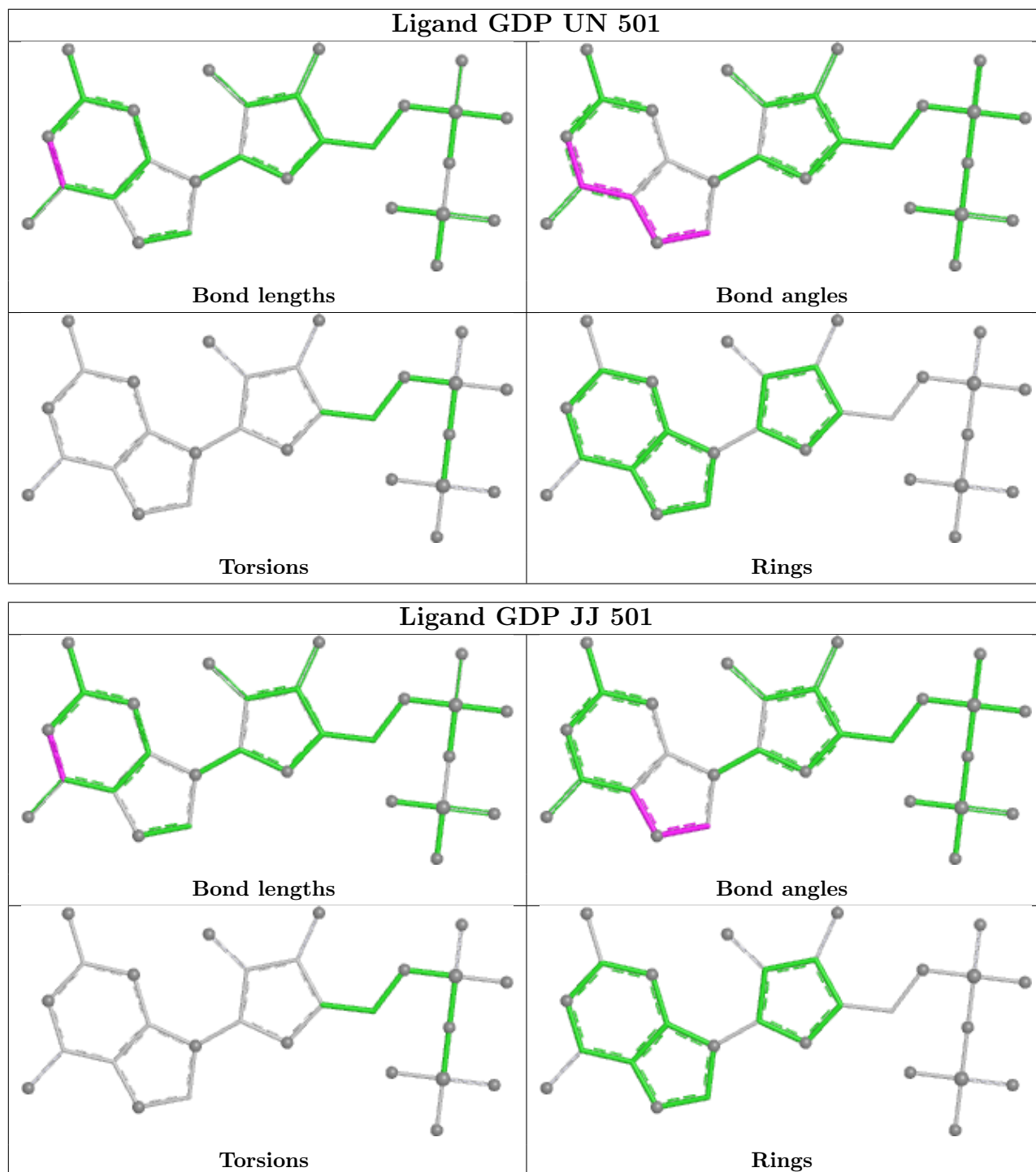

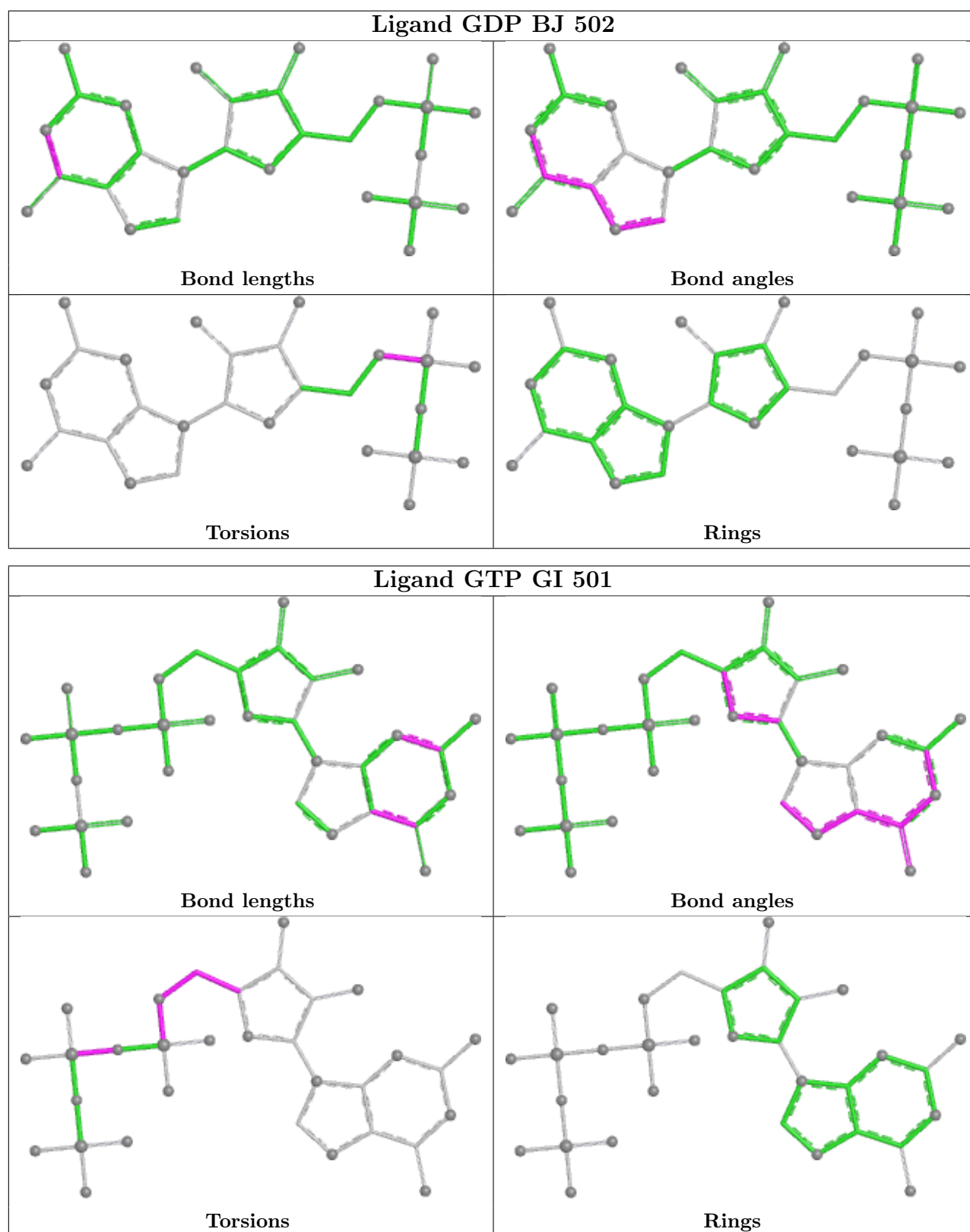

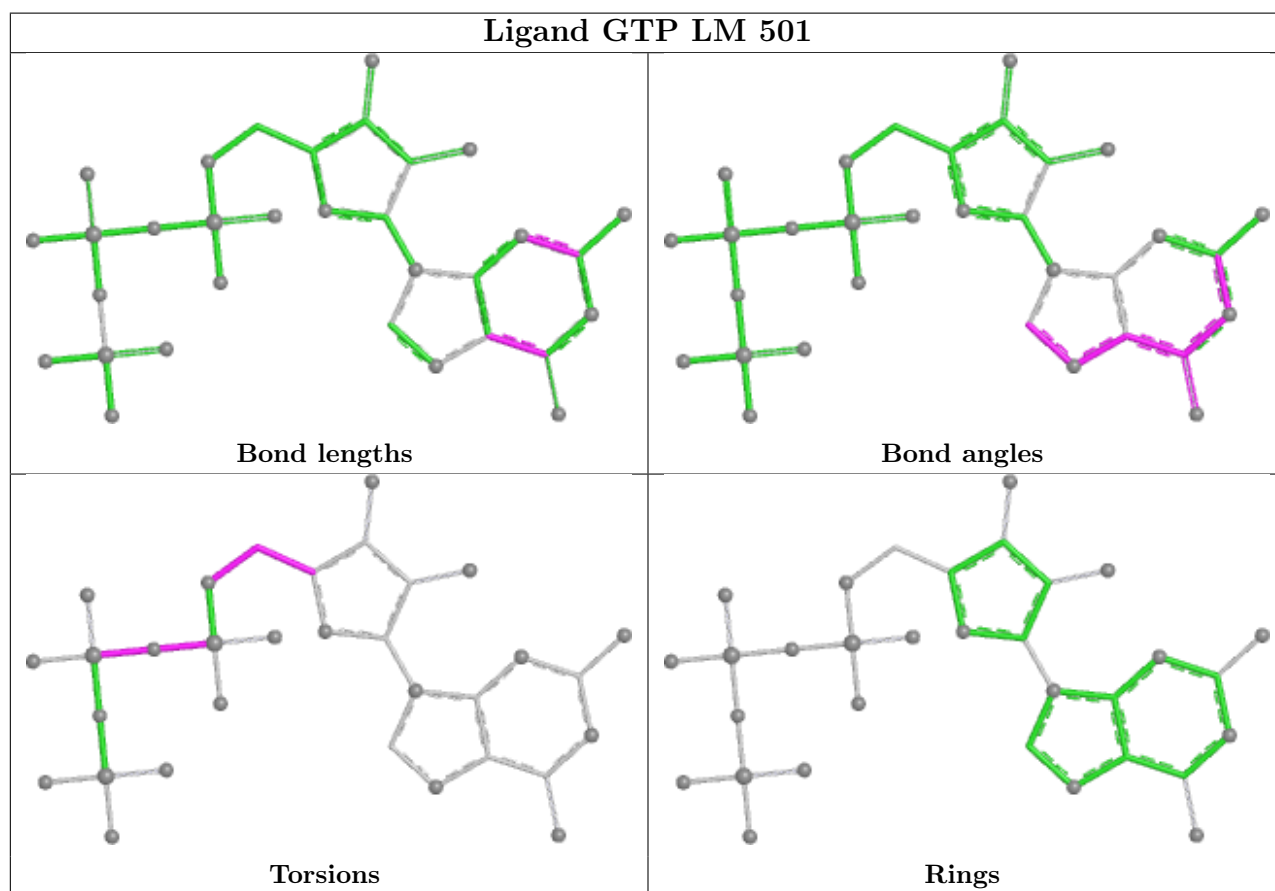
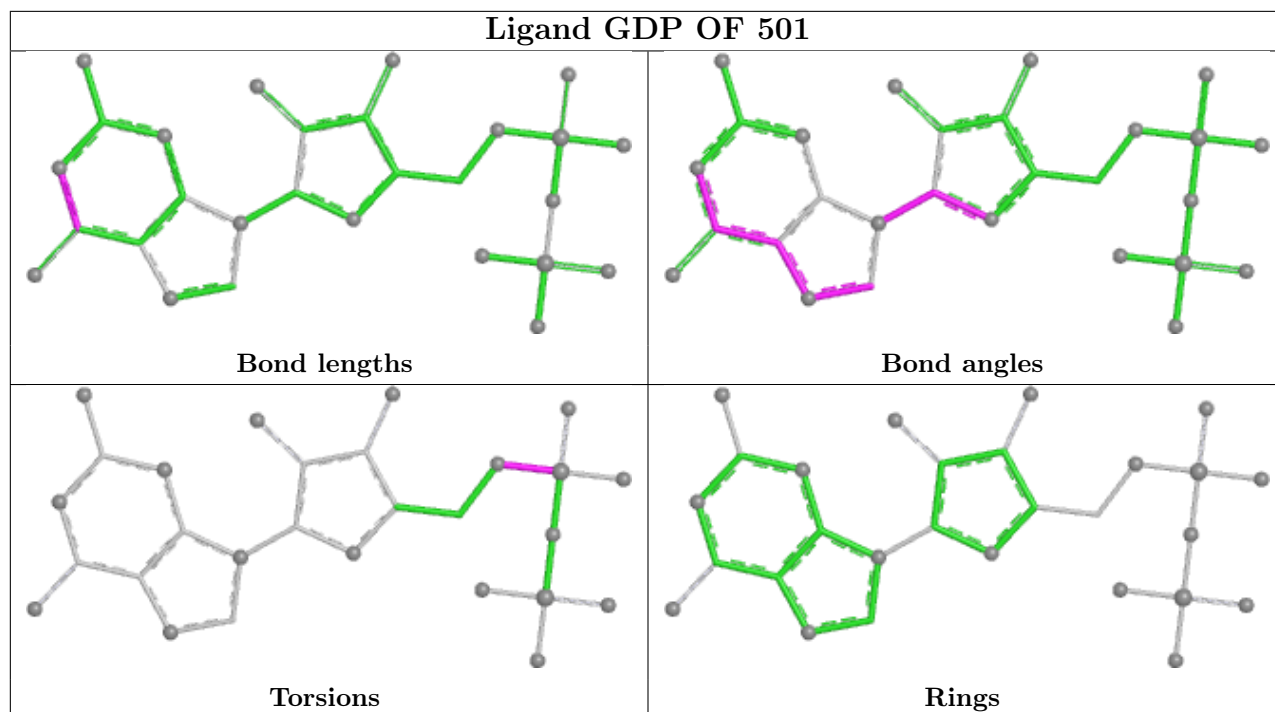

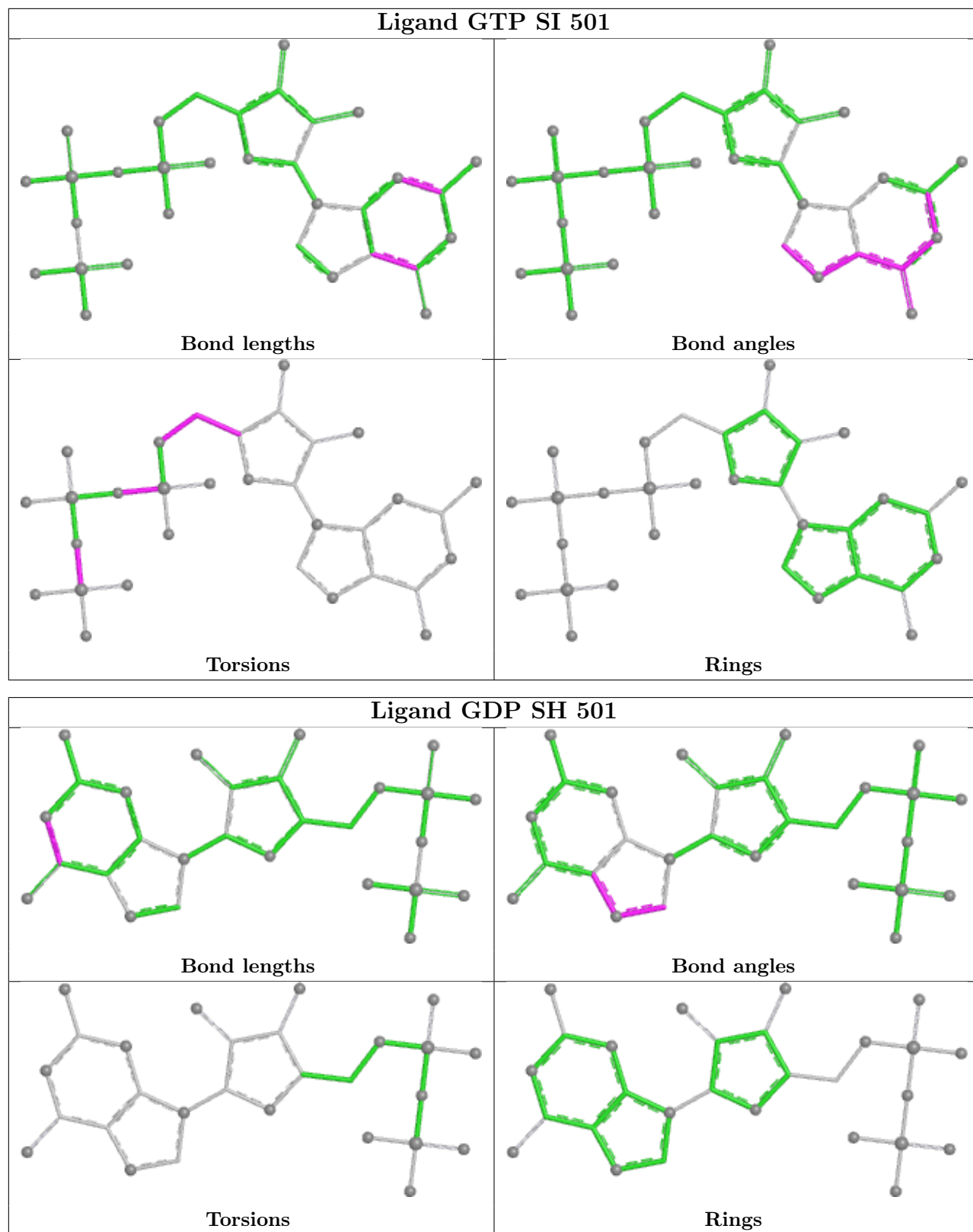

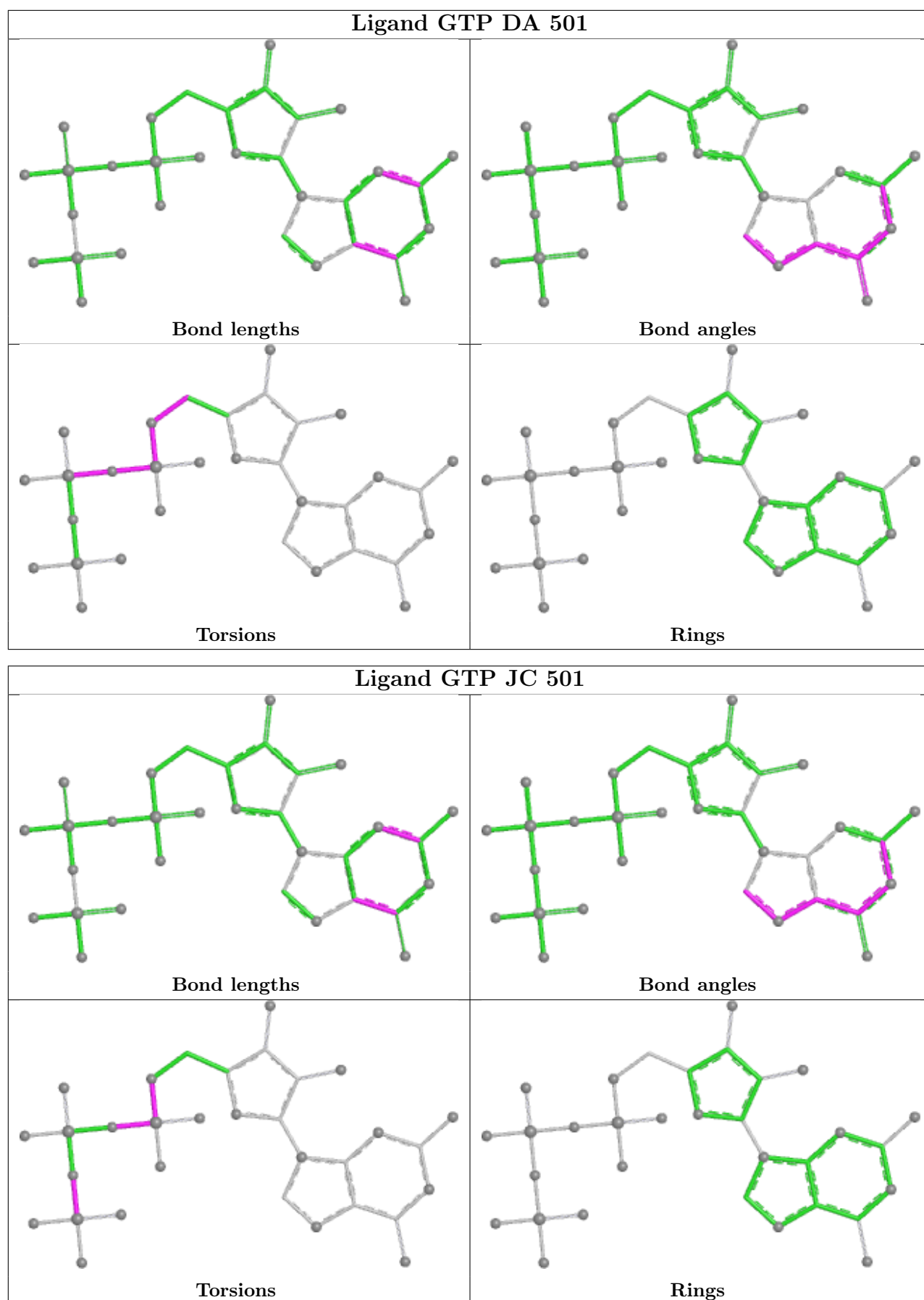

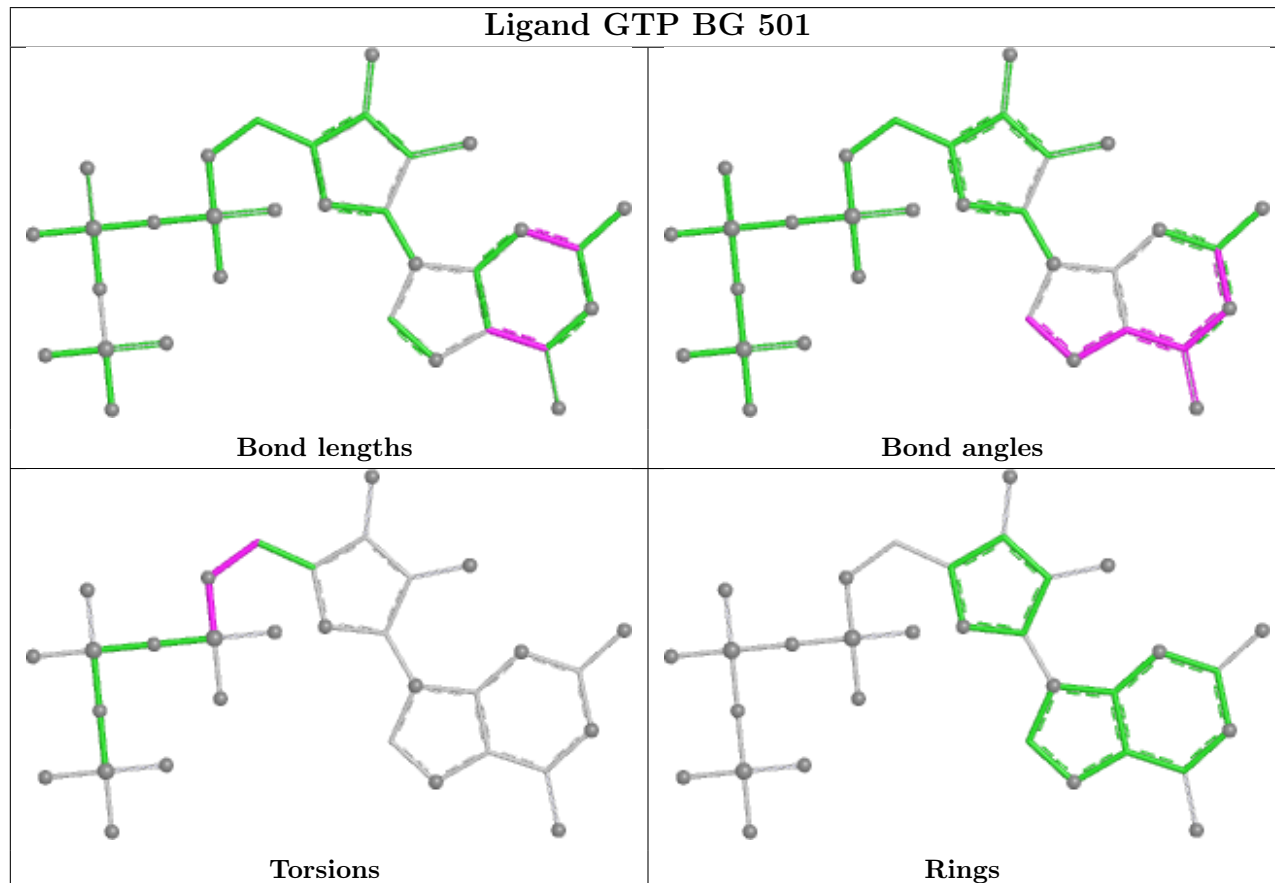
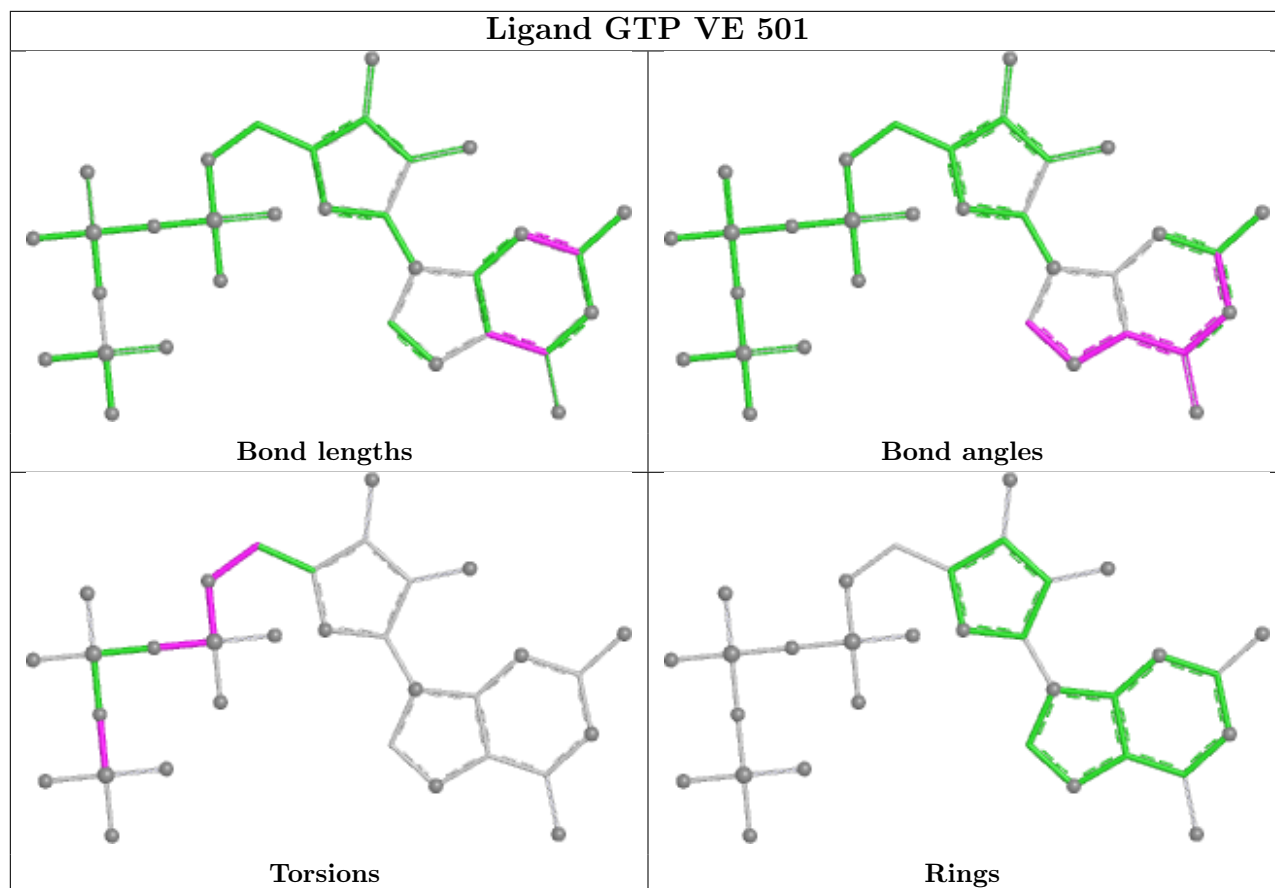

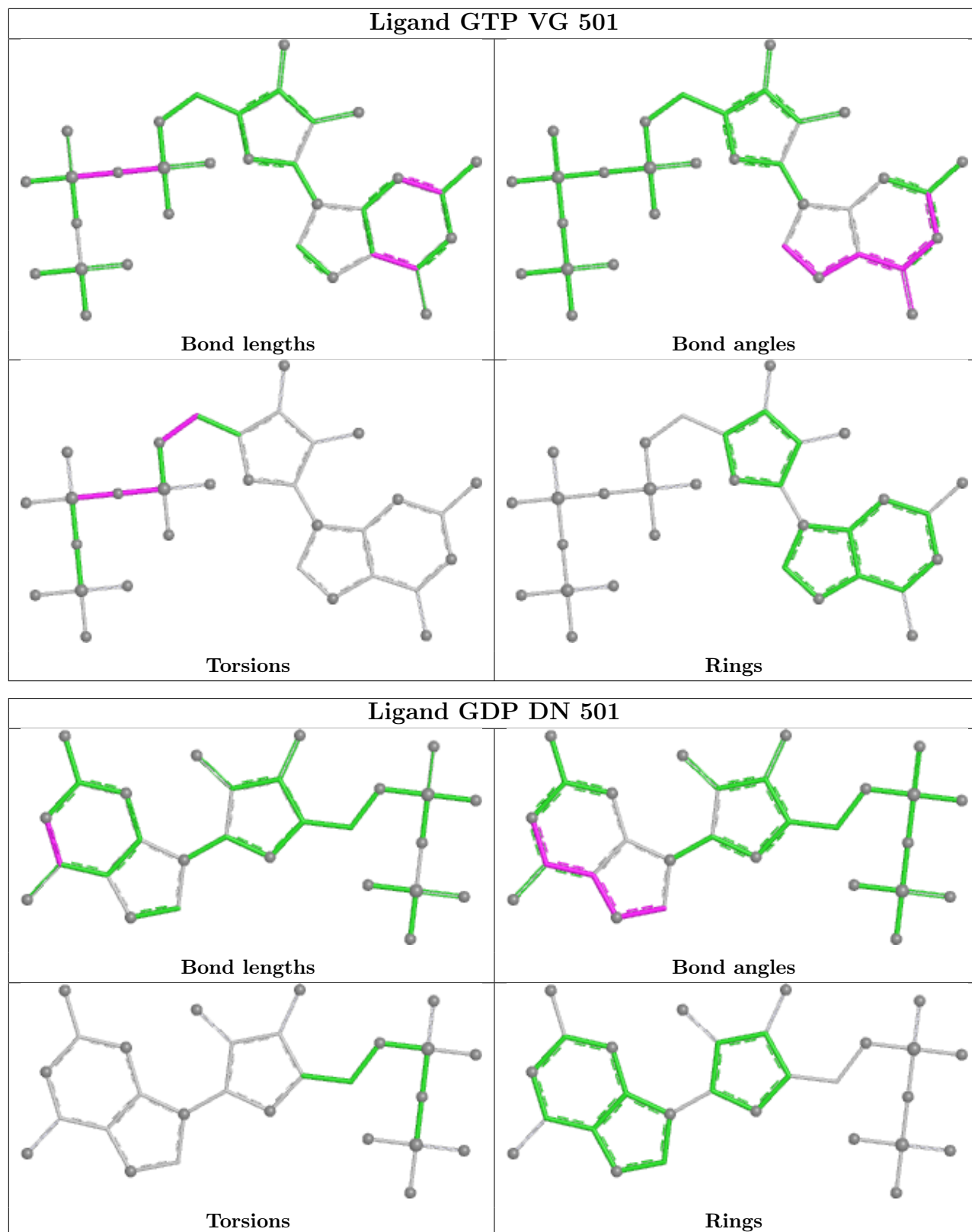

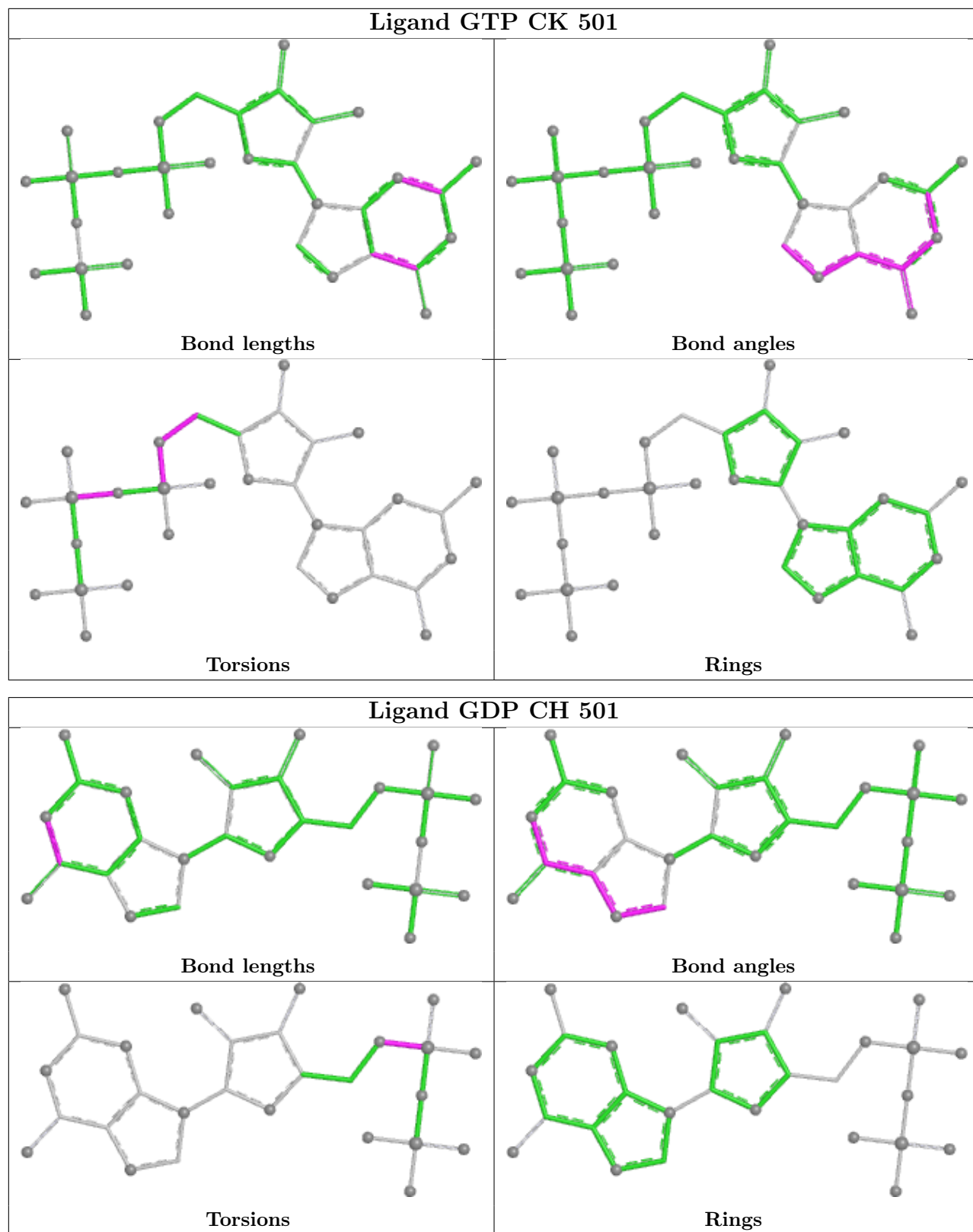



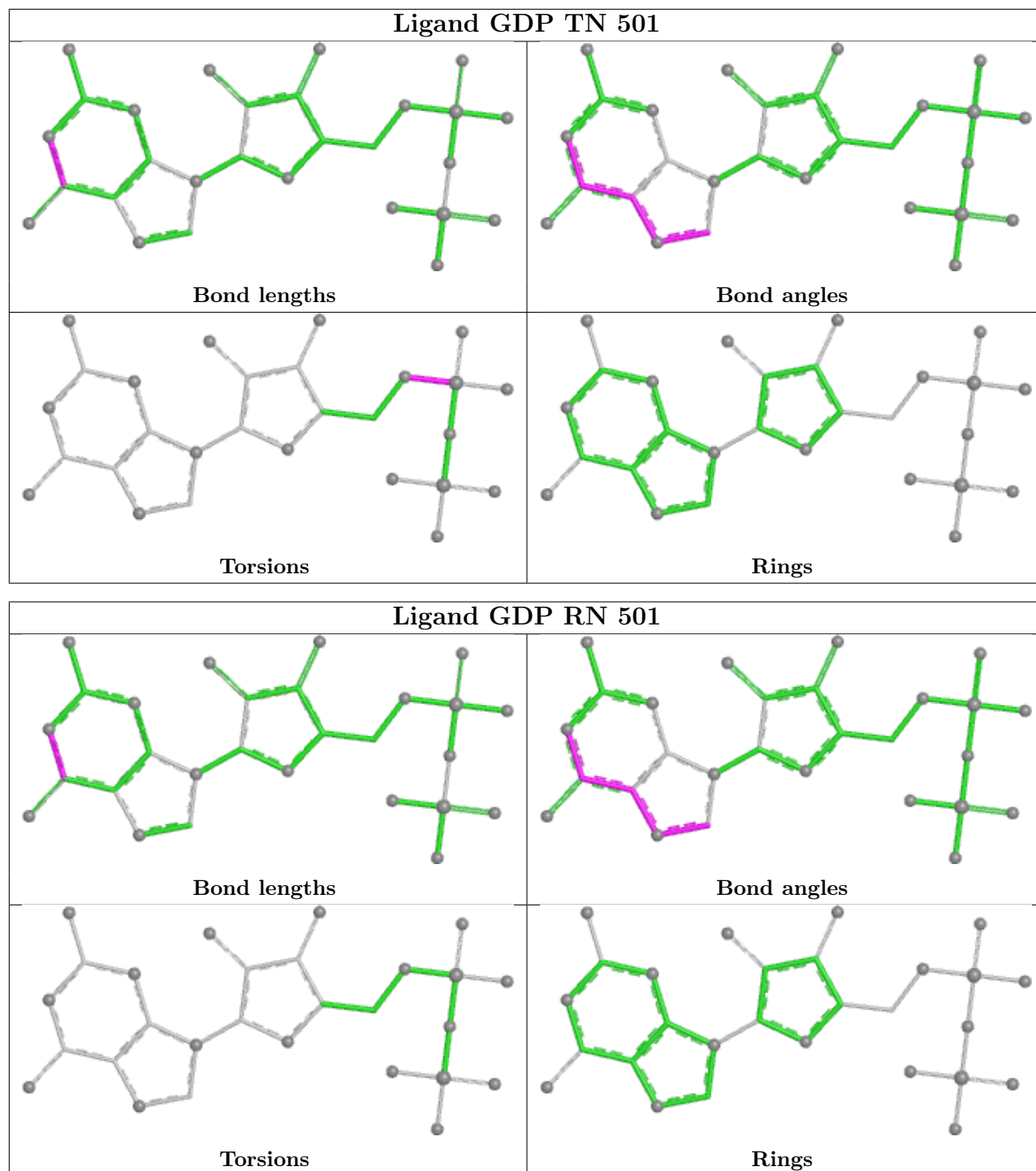

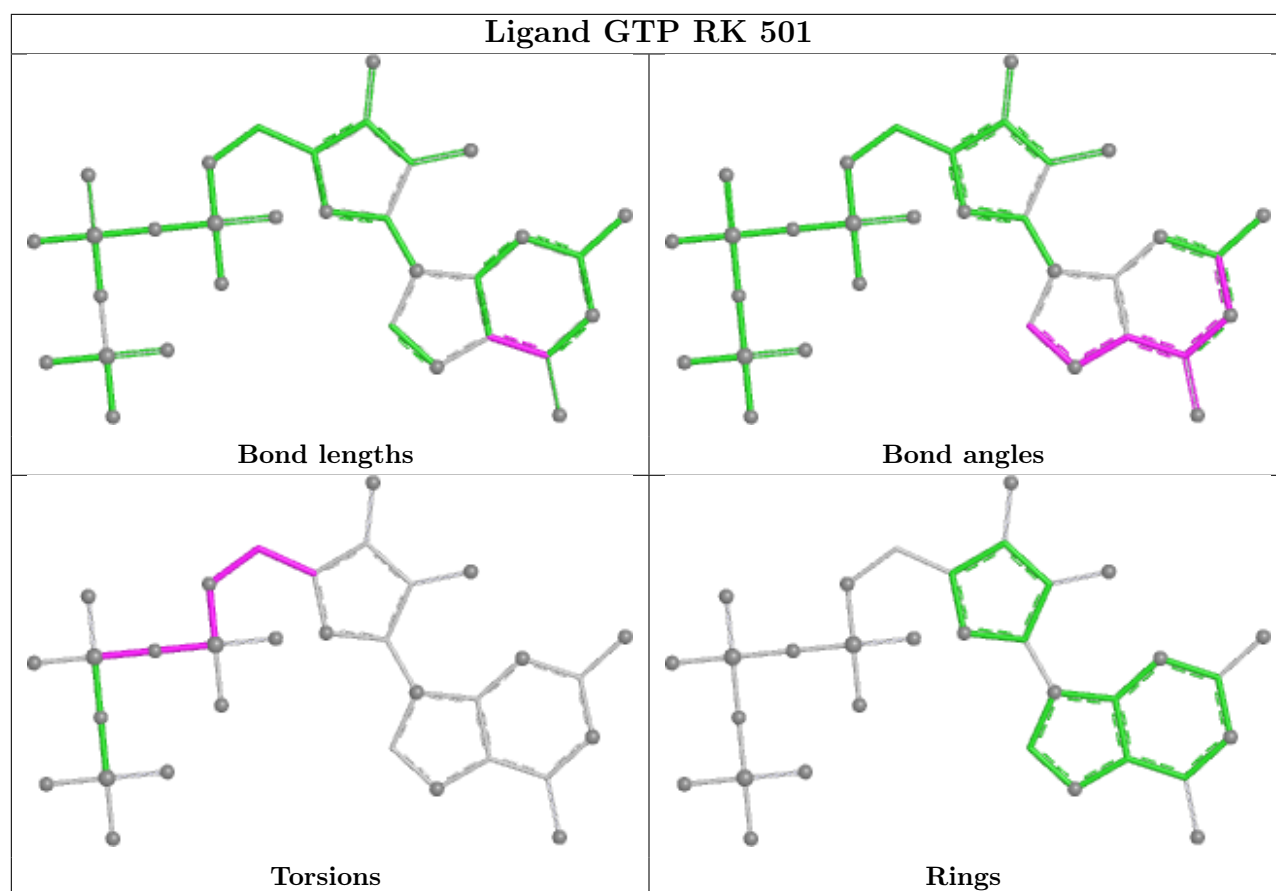

## 5.7 Other polymers [\(i\)](#)

There are no such residues in this entry.

## 5.8 Polymer linkage issues [\(i\)](#)

The following chains have linkage breaks:

Mol	Chain	Number of breaks
15	1V	14
15	2V	13
15	3V	11
37	5D	6
35	7R	5
14	1U	5
14	0U	5
35	5R	5
35	4R	4
45	BH	4
44	EM	4

*Continued on next page...*

*Continued from previous page...*

<b>Mol</b>	<b>Chain</b>	<b>Number of breaks</b>
44	SM	4
26	1R	4
44	NM	4
44	ME	3
45	DJ	3
45	TN	3
45	QJ	3
45	KN	3
45	PD	3
45	UB	3
13	1T	3
44	DG	3
45	AN	3
44	SC	3
38	5G	3
45	IL	2
44	GK	2
44	MG	2
45	VN	2
45	VF	2
45	SB	2
45	GF	2
45	CL	2
45	NN	2
38	5H	2
44	TG	2
4	1C	2
44	RM	2
44	HI	2
44	VC	2
45	TH	2
45	DF	2
44	WA	2
30	2G	2
44	KK	2
44	SE	2
44	HA	2
23	1M	2
44	TM	2
40	6F	2
45	FH	2
45	AJ	2

*Continued on next page...*

*Continued from previous page...*

<b>Mol</b>	<b>Chain</b>	<b>Number of breaks</b>
13	0T	2
44	AA	2
4	0C	2
26	2R	2
45	DB	2
26	3R	2
45	MF	2
44	LE	2
44	EK	2
45	HB	2
44	CK	2
44	AC	2
42	8L	1
44	FG	1
45	CH	1
9	1H	1
45	MB	1
44	PI	1
45	VL	1
6	2E	1
44	EE	1
44	RG	1
45	BJ	1
45	VD	1
45	GH	1
45	JF	1
45	WH	1
45	GN	1
45	JL	1
44	UC	1
38	5F	1
44	AM	1
45	UD	1
44	WC	1
44	OA	1
45	WJ	1
44	WK	1
44	QM	1
44	BG	1
44	GC	1
44	GM	1
13	2T	1

*Continued on next page...*

*Continued from previous page...*

Mol	Chain	Number of breaks
45	JJ	1
45	QF	1
12	2S	1
45	DL	1
44	WG	1
24	3O	1
44	MI	1
44	SG	1
18	1F	1
44	BK	1
44	UK	1
45	ML	1
44	CG	1

The worst 5 of 245 chain breaks are listed below:

Model	Chain	Residue-1	Atom-1	Residue-2	Atom-2	Distance (Å)
1	8L	213:UNK	C	263:UNK	N	38.22
1	3V	1:MET	C	2:GLU	N	15.78
1	ME	433:GLU	C	434:GLU	N	14.54
1	IL	87:PRO	C	88:ASP	N	14.40
1	DJ	279:GLN	C	280:GLN	N	12.77

## 6 Map visualisation [i](#)

This section contains visualisations of the EMDB entry EMD-40436. These allow visual inspection of the internal detail of the map and identification of artifacts.

Images derived from a raw map, generated by summing the deposited half-maps, are presented below the corresponding image components of the primary map to allow further visual inspection and comparison with those of the primary map.

### 6.1 Orthogonal projections [i](#)

#### 6.1.1 Primary map

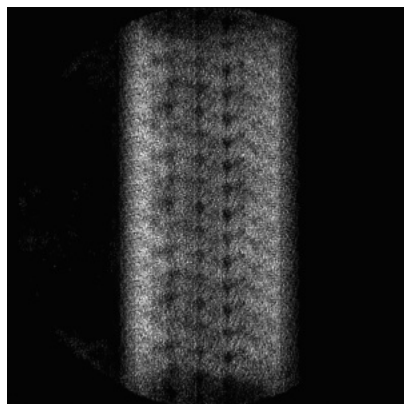

X

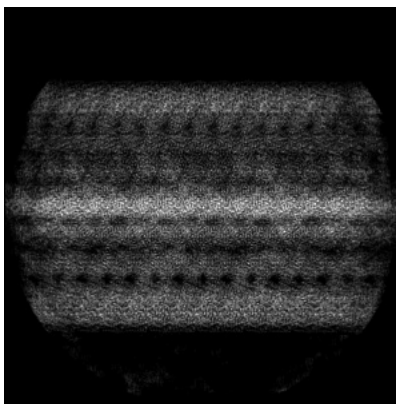

Y

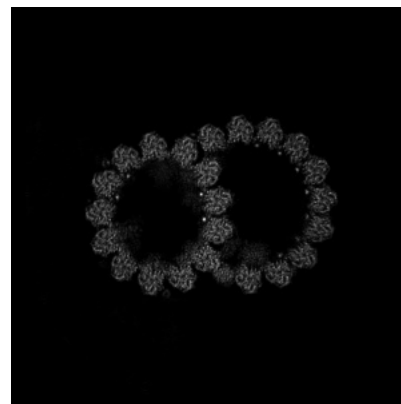

Z

#### 6.1.2 Raw map

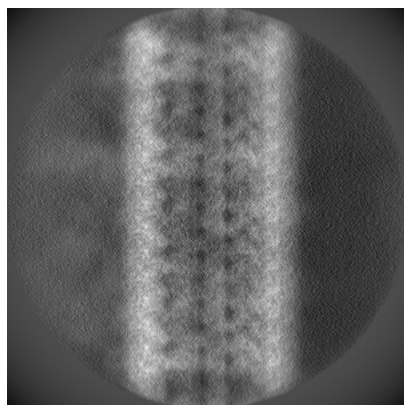

X

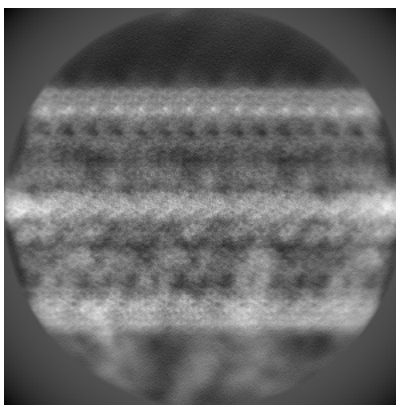

Y

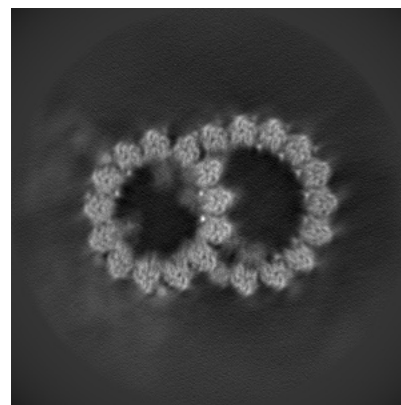

Z

The images above show the map projected in three orthogonal directions.

## 6.2 Central slices [i](#)

### 6.2.1 Primary map

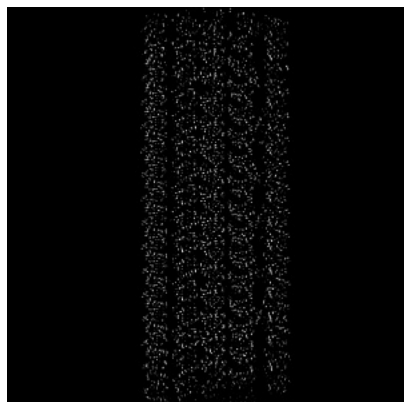

X Index: 256

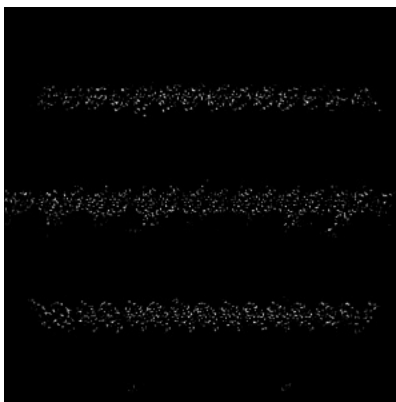

Y Index: 256

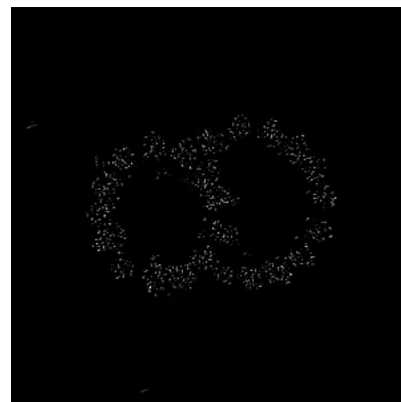

Z Index: 256

### 6.2.2 Raw map

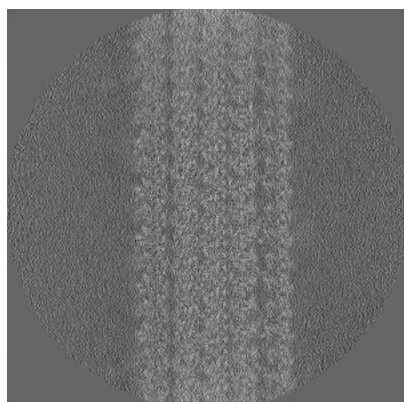

X Index: 256

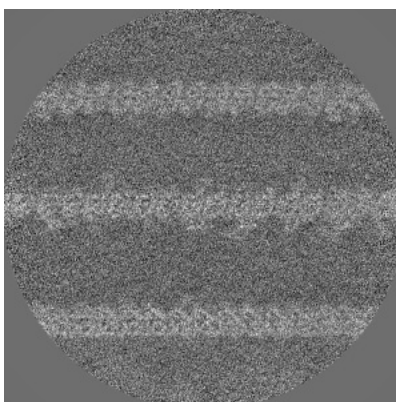

Y Index: 256

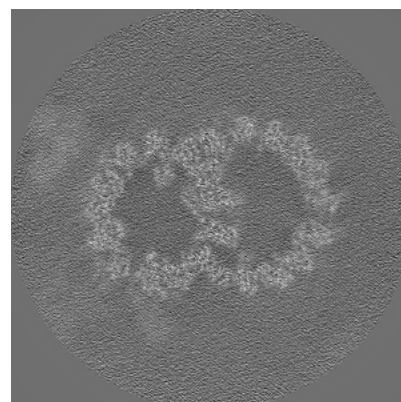

Z Index: 256

The images above show central slices of the map in three orthogonal directions.

## 6.3 Largest variance slices [i](#)

### 6.3.1 Primary map

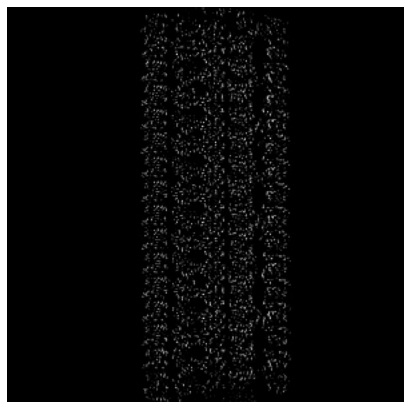

X Index: 255

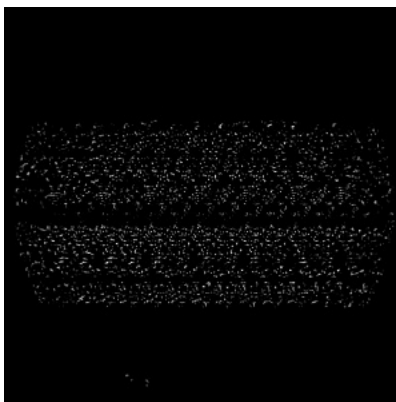

Y Index: 173



Z Index: 200

### 6.3.2 Raw map

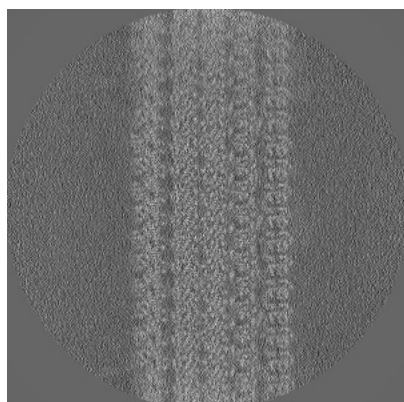

X Index: 258

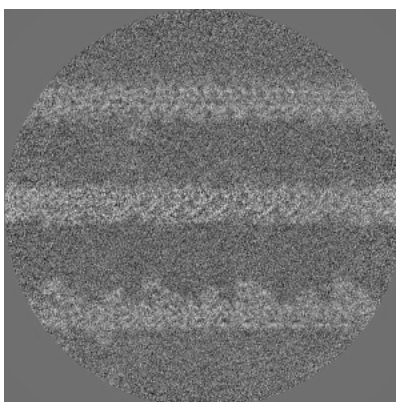

Y Index: 225

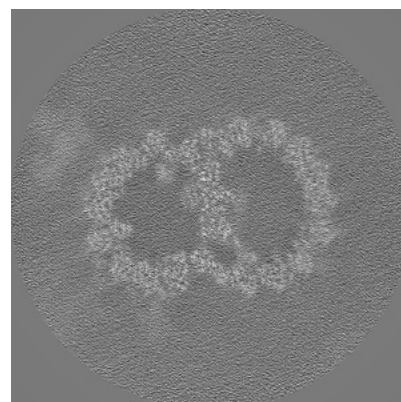

Z Index: 262

The images above show the largest variance slices of the map in three orthogonal directions.



## 6.4 Orthogonal standard-deviation projections (False-color) [i](#)

### 6.4.1 Primary map

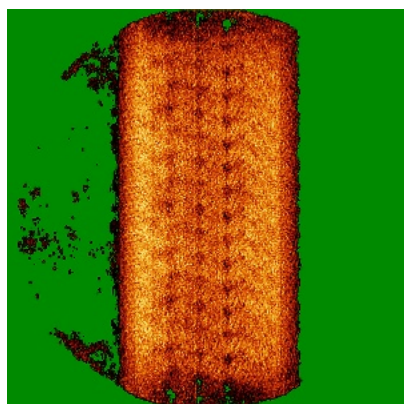

X

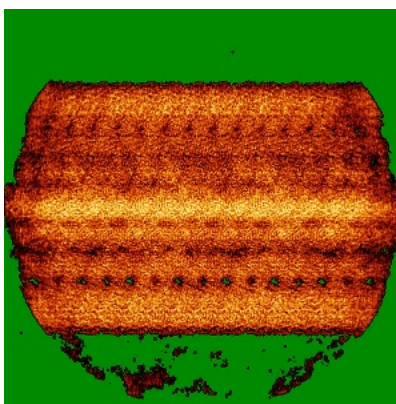

Y



Z

### 6.4.2 Raw map

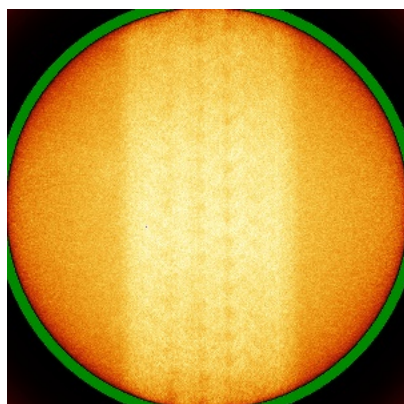

X

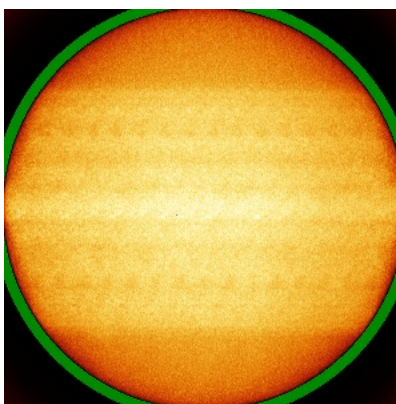

Y

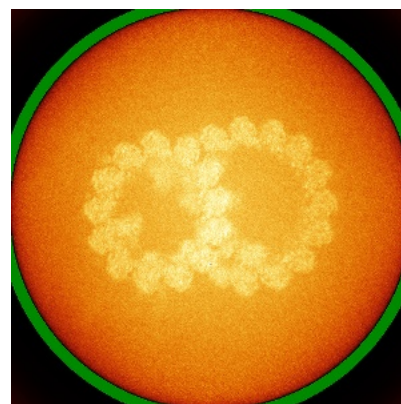

Z

The images above show the map standard deviation projections with false color in three orthogonal directions. Minimum values are shown in green, max in blue, and dark to light orange shades represent small to large values respectively.

## 6.5 Orthogonal surface views [i](#)

### 6.5.1 Primary map

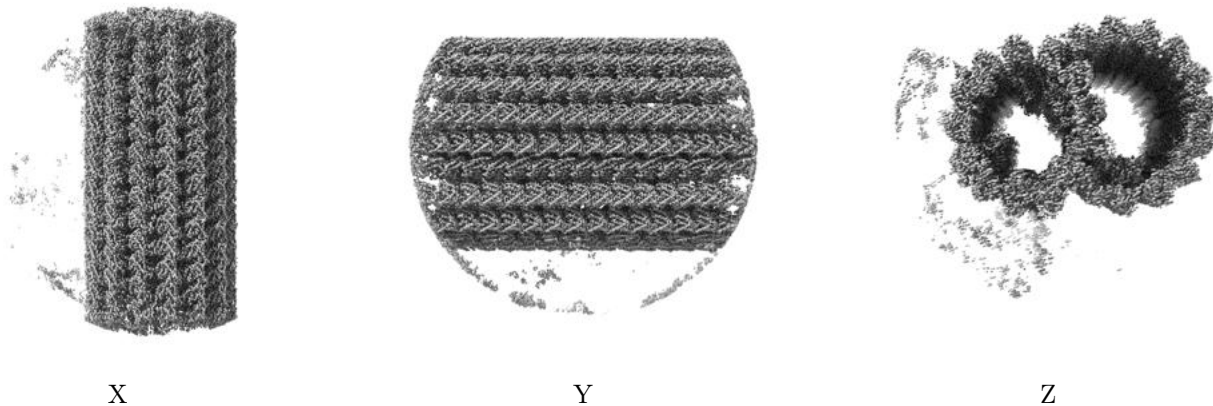

The images above show the 3D surface view of the map at the recommended contour level 0.15. These images, in conjunction with the slice images, may facilitate assessment of whether an appropriate contour level has been provided.

### 6.5.2 Raw map

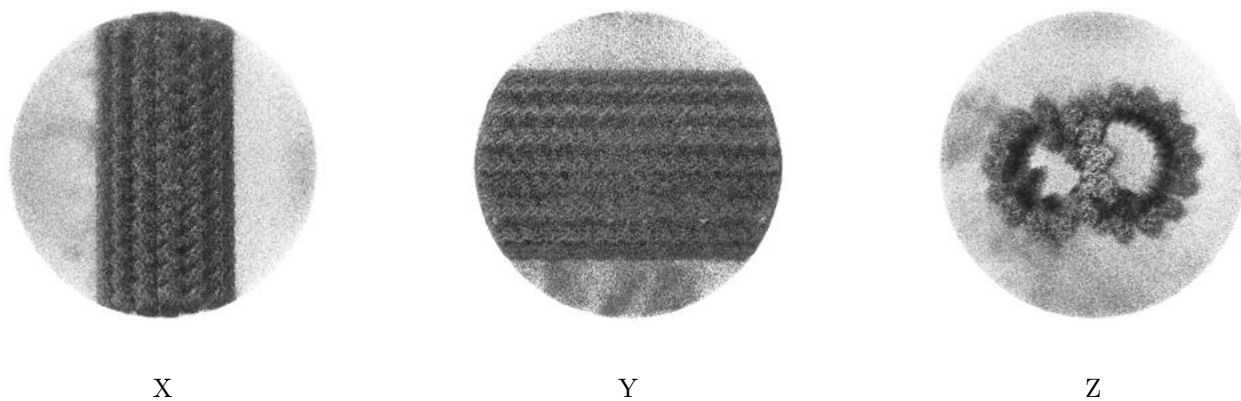

These images show the 3D surface of the raw map. The raw map's contour level was selected so that its surface encloses the same volume as the primary map does at its recommended contour level.

## 6.6 Mask visualisation [i](#)

This section shows the 3D surface view of the primary map at 50% transparency overlaid with the specified mask at 0% transparency

A mask typically either:

- Encompasses the whole structure
- Separates out a domain, a functional unit, a monomer or an area of interest from a larger structure

### 6.6.1 emd\_40436\_msk\_1.map [i](#)

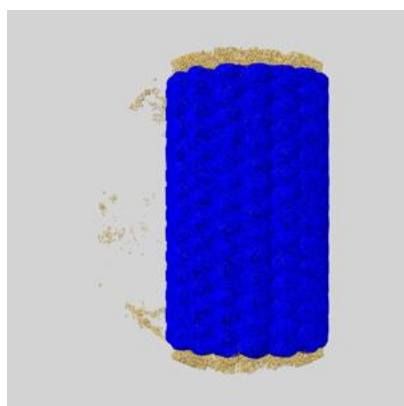

X

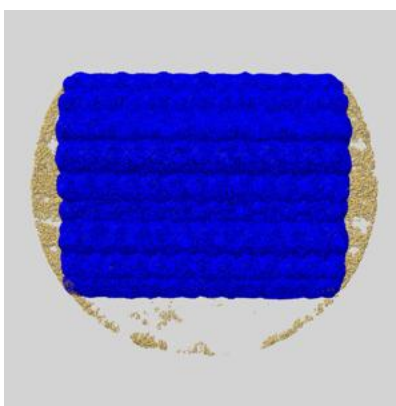

Y

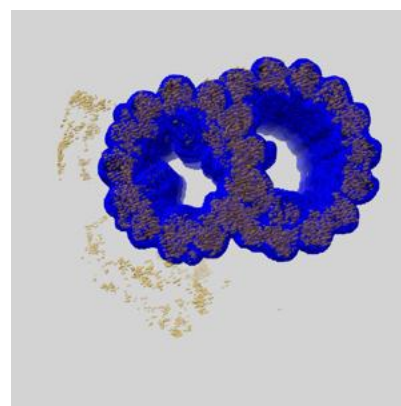

Z

## 7 Map analysis [i](#)

This section contains the results of statistical analysis of the map.

### 7.1 Map-value distribution [i](#)

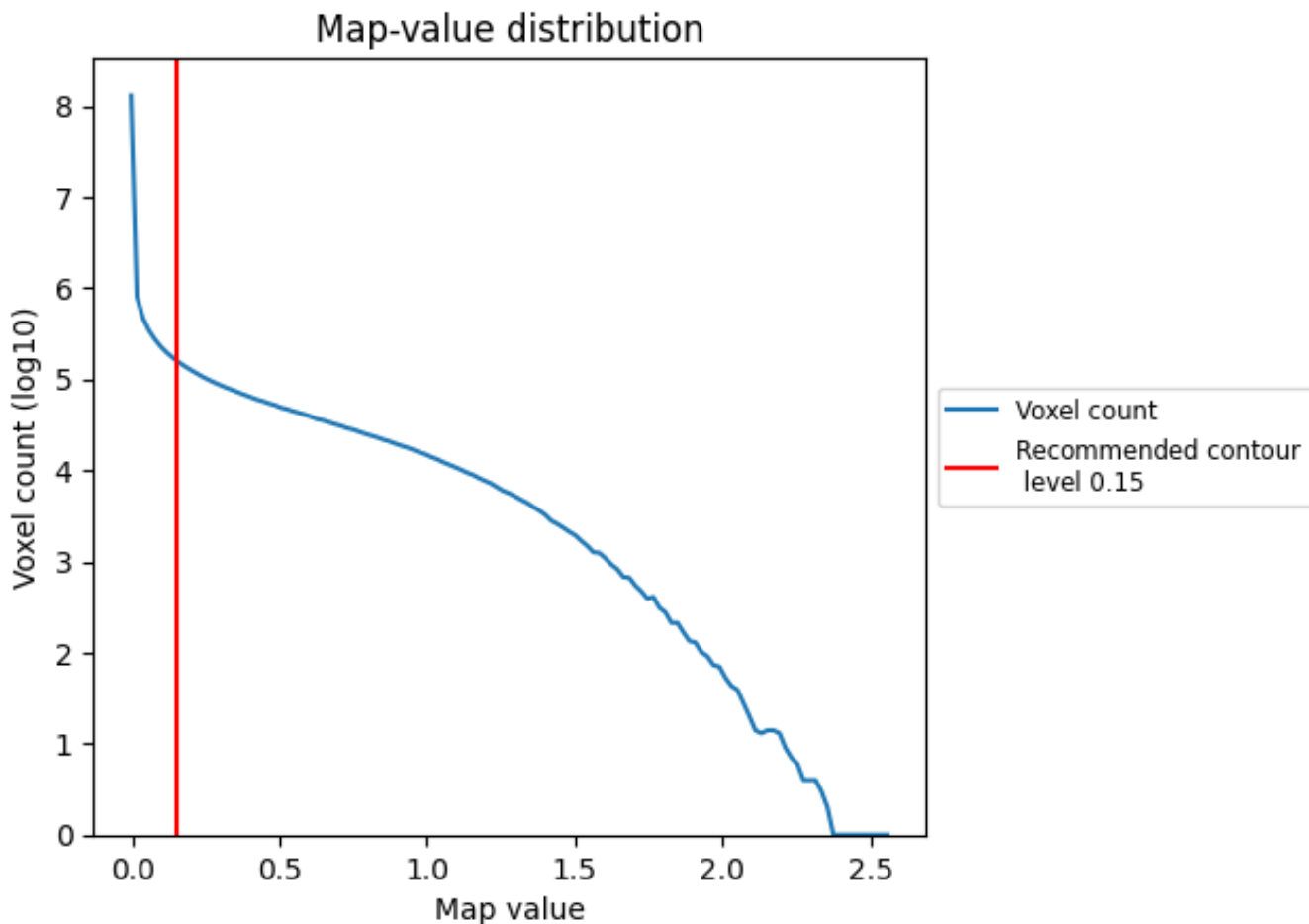

The map-value distribution is plotted in 128 intervals along the x-axis. The y-axis is logarithmic. A spike in this graph at zero usually indicates that the volume has been masked.

## 7.2 Volume estimate [\(i\)](#)

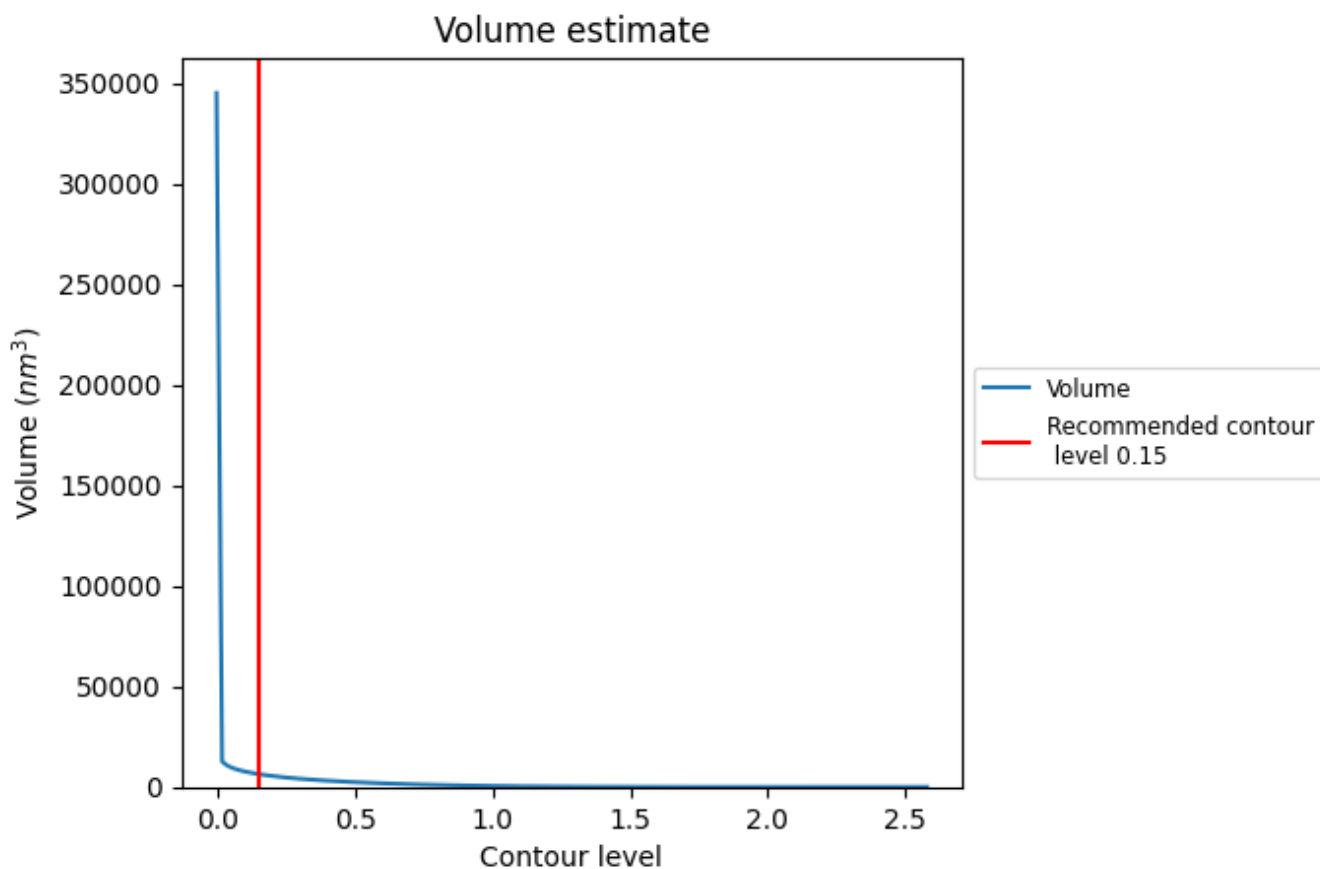

The volume at the recommended contour level is 6396 nm<sup>3</sup>; this corresponds to an approximate mass of 5778 kDa.

The volume estimate graph shows how the enclosed volume varies with the contour level. The recommended contour level is shown as a vertical line and the intersection between the line and the curve gives the volume of the enclosed surface at the given level.

### 7.3 Rotationally averaged power spectrum i

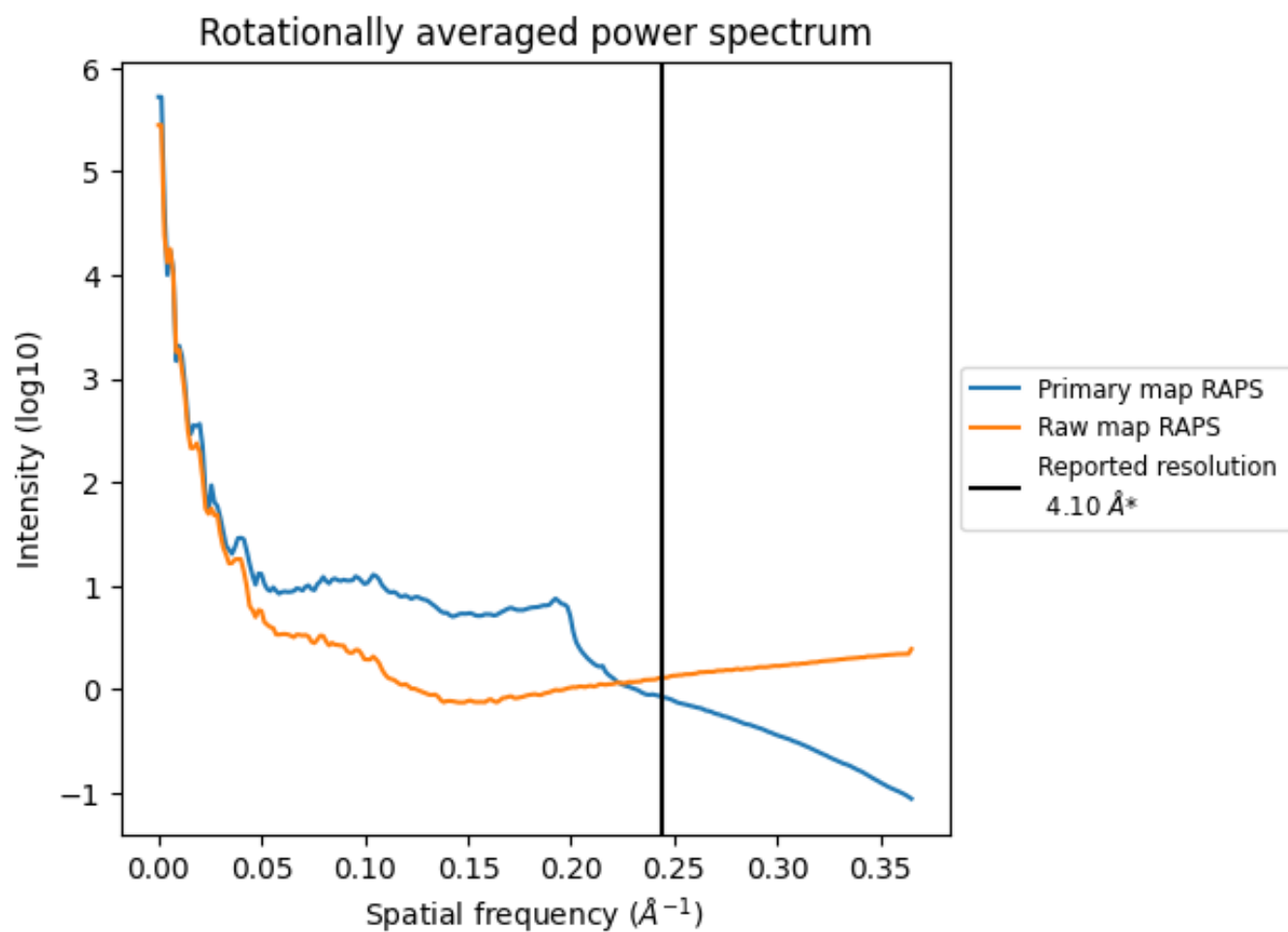

\*Reported resolution corresponds to spatial frequency of  $0.244 \text{ \AA}^{-1}$

## 8 Fourier-Shell correlation [i](#)

Fourier-Shell Correlation (FSC) is the most commonly used method to estimate the resolution of single-particle and subtomogram-averaged maps. The shape of the curve depends on the imposed symmetry, mask and whether or not the two 3D reconstructions used were processed from a common reference. The reported resolution is shown as a black line. A curve is displayed for the half-bit criterion in addition to lines showing the 0.143 gold standard cut-off and 0.5 cut-off.

### 8.1 FSC [i](#)

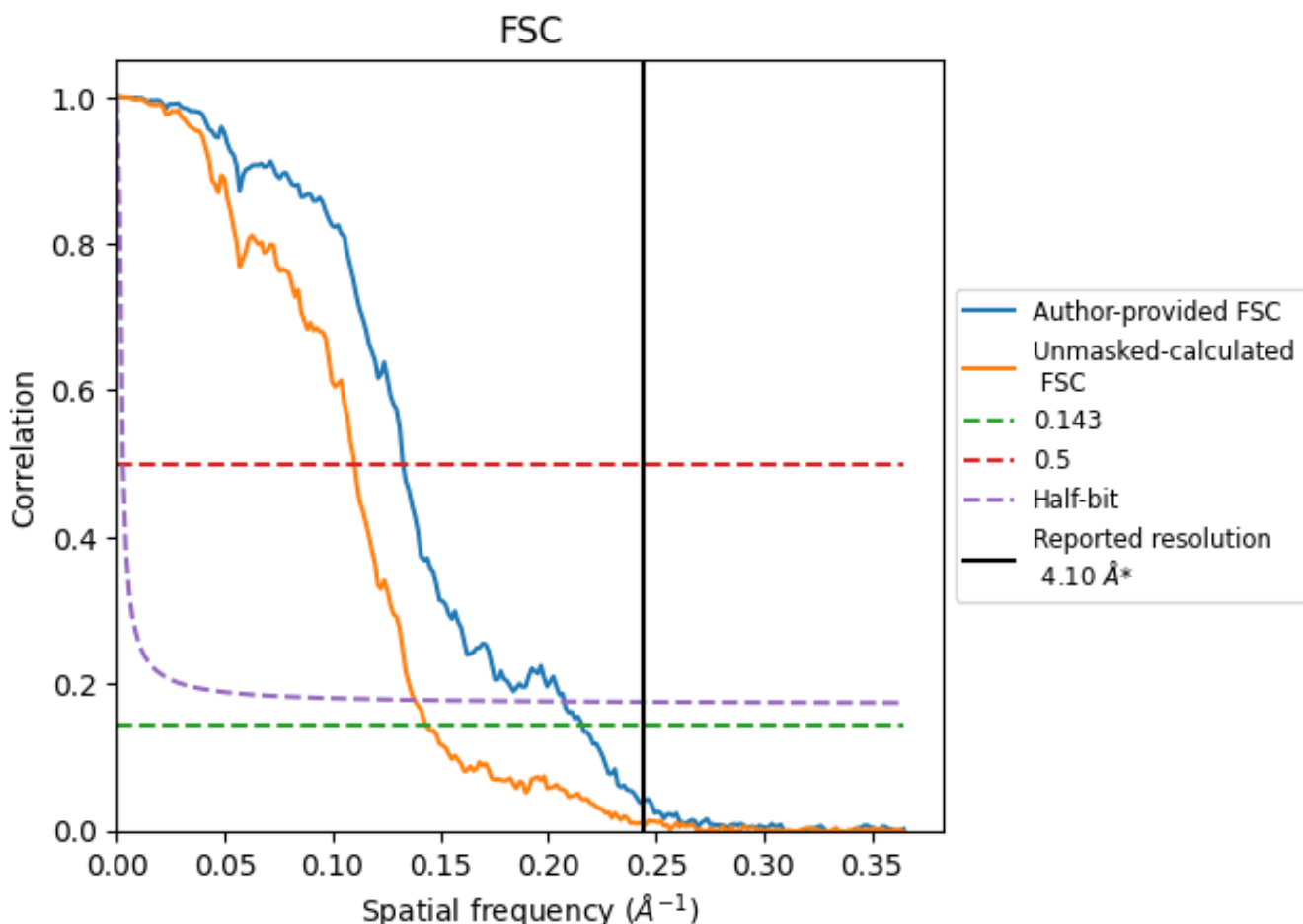

\*Reported resolution corresponds to spatial frequency of 0.244 Å<sup>-1</sup>

## 8.2 Resolution estimates [i](#)

Resolution estimate (Å)	Estimation criterion (FSC cut-off)		
	0.143	0.5	Half-bit
Reported by author	4.10	-	-
Author-provided FSC curve	4.64	7.54	4.82
Unmasked-calculated*	6.97	9.08	7.24

\*Resolution estimate based on FSC curve calculated by comparison of deposited half-maps. The value from author-provided FSC intersecting FSC 0.143 CUT-OFF 4.64 differs from the reported value 4.1 by more than 10 %

The value from deposited half-maps intersecting FSC 0.143 CUT-OFF 6.97 differs from the reported value 4.1 by more than 10 %



## 9 Map-model fit [i](#)

This section contains information regarding the fit between EMDB map EMD-40436 and PDB model 8SF7. Per-residue inclusion information can be found in section 3 on page 70.

### 9.1 Map-model overlay [i](#)

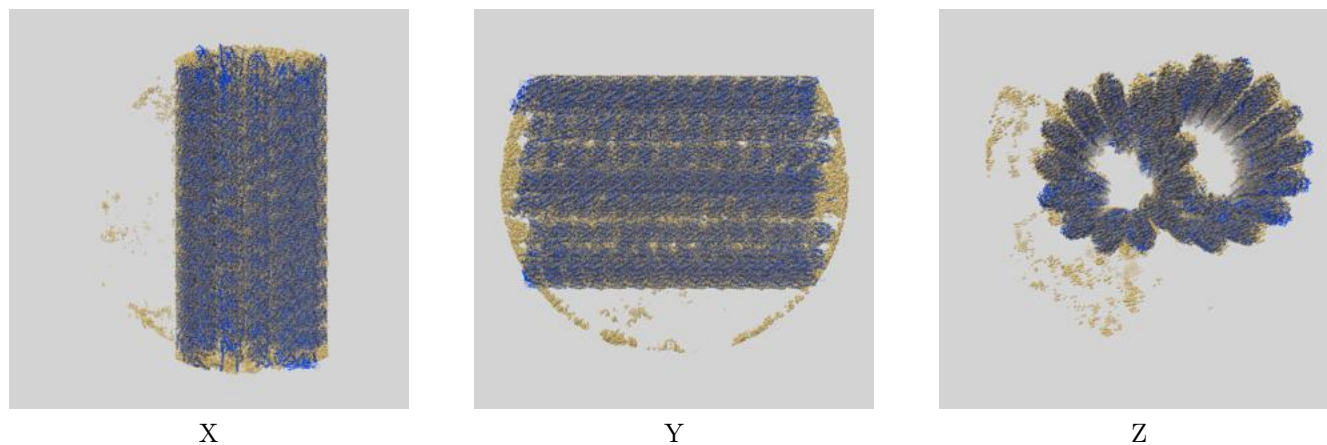

The images above show the 3D surface view of the map at the recommended contour level 0.15 at 50% transparency in yellow overlaid with a ribbon representation of the model coloured in blue. These images allow for the visual assessment of the quality of fit between the atomic model and the map.

## 9.2 Q-score mapped to coordinate model [i](#)

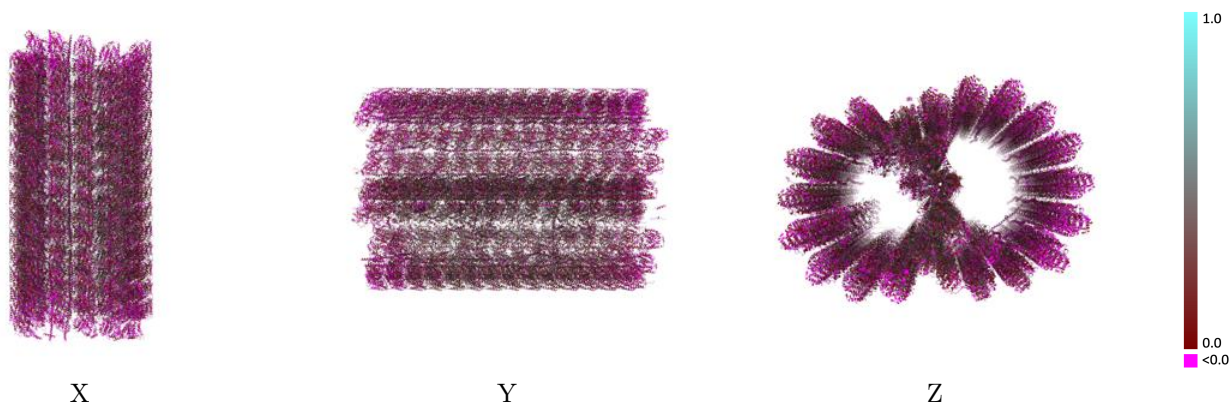

The images above show the model with each residue coloured according to its Q-score. This shows their resolvability in the map with higher Q-score values reflecting better resolvability. Please note: Q-score is calculating the resolvability of atoms, and thus high values are only expected at resolutions at which atoms can be resolved. Low Q-score values may therefore be expected for many entries.

## 9.3 Atom inclusion mapped to coordinate model [i](#)

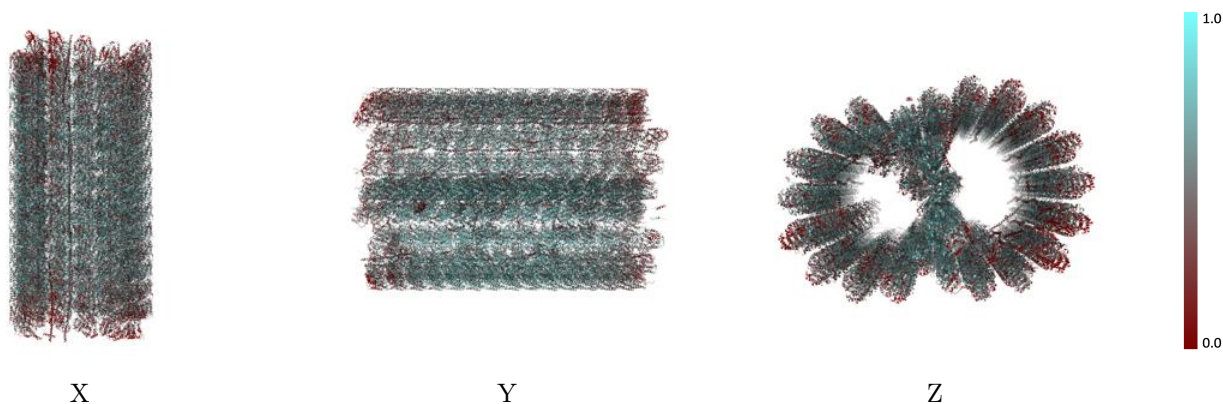

The images above show the model with each residue coloured according to its atom inclusion. This shows to what extent they are inside the map at the recommended contour level (0.15).



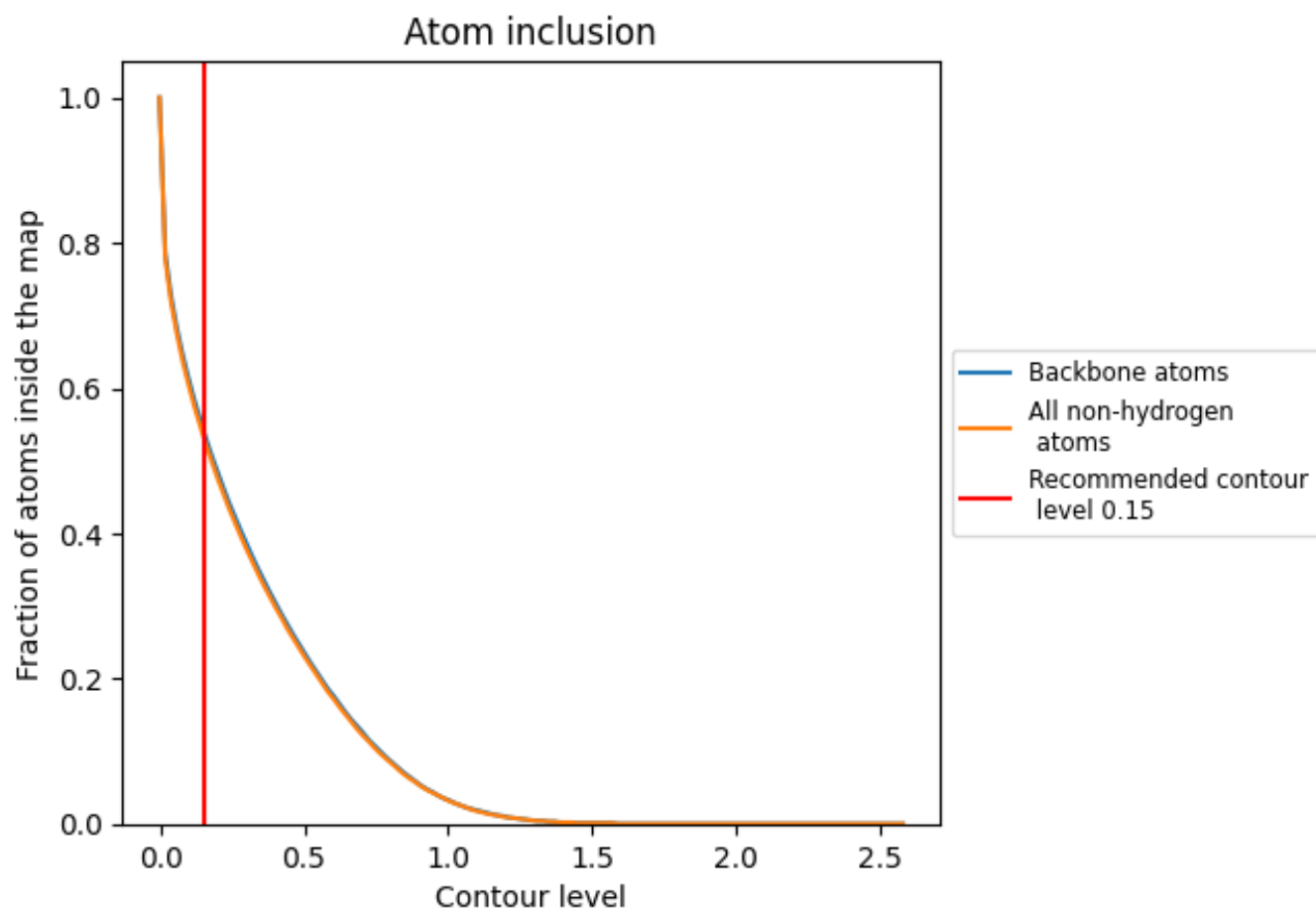



































































## 9.4 Atom inclusion [i](#)



At the recommended contour level, 54% of all backbone atoms, 53% of all non-hydrogen atoms, are inside the map.

## 9.5 Map-model fit summary

The table lists the average atom inclusion at the recommended contour level (0.15) and Q-score for the entire model and for each chain.

Chain	Atom inclusion	Q-score
All	 0.5330	 0.2060
0A	 0.4040	 0.1360
0B	 0.4670	 0.1850
0C	 0.5620	 0.2160
0D	 0.3880	 0.0990
0E	 0.2890	 0.0540
0F	 0.4690	 0.1740
0G	 0.3760	 0.1210
0H	 0.3630	 0.0820
0N	 0.4800	 0.1610
0Q	 0.5790	 0.2580
0S	 0.3570	 0.1000
0T	 0.2560	 0.0500
0U	 0.3920	 0.1050
0V	 0.2830	 0.0920
0X	 0.5220	 0.1570
1A	 0.5330	 0.2140
1B	 0.4630	 0.1570
1C	 0.4970	 0.1550
1D	 0.5210	 0.1870
1E	 0.3880	 0.1330
1F	 0.4910	 0.2020
1G	 0.3840	 0.1280
1H	 0.3380	 0.0600
1I	 0.4430	 0.1830
1J	 0.4270	 0.1400
1K	 0.3820	 0.0860
1L	 0.4960	 0.1960
1M	 0.4990	 0.1940
1N	 0.5240	 0.2060
1O	 0.1270	 -0.0060
1P	 0.2600	 0.0410
1Q	 0.6680	 0.3120
1R	 0.5800	 0.2470
1S	 0.5740	 0.2280























































































*Continued on next page...*

*Continued from previous page...*

Chain	Atom inclusion	Q-score
1T	0.5490	0.2140
1U	0.5680	0.2310
1V	0.3950	0.1400
1W	0.5250	0.1760
1X	0.5950	0.2260
2A	0.5970	0.2370
2B	0.0540	-0.0040
2C	0.4140	0.1080
2D	0.4710	0.1660
2E	0.4540	0.1430
2F	0.4180	0.1480
2G	0.4700	0.1630
2H	0.4430	0.1830
2I	0.4490	0.1750
2K	0.3830	0.0780
2L	0.3940	0.1240
2M	0.5530	0.2100
2N	0.4100	0.1350
2O	0.2770	0.0200
2P	0.3180	0.0700
2Q	0.6590	0.3080
2R	0.5980	0.2630
2S	0.6060	0.2490
2T	0.5600	0.2150
2U	0.5740	0.2320
2V	0.3920	0.1370
2W	0.3830	0.0920
2X	0.6020	0.2240
3A	0.4980	0.1750
3B	0.2170	0.0330
3C	0.4980	0.1590
3D	0.2900	0.0970
3E	0.2580	0.0450
3H	0.4640	0.2140
3I	0.4680	0.2030
3L	0.3240	0.0810
3O	0.2550	0.0260
3Q	0.6510	0.3090
3R	0.5420	0.2200
3S	0.5410	0.2090
3T	0.5300	0.1920
3U	0.4310	0.1270





















































































*Continued on next page...*

*Continued from previous page...*

Chain	Atom inclusion	Q-score
3V	 0.3650	 0.1140
3X	 0.5330	 0.1680
4C	 0.4030	 0.1090
4F	 0.2910	 0.0920
4H	 0.4190	 0.1910
4Q	 0.6670	 0.3180
4R	 0.6080	 0.2570
4S	 0.5930	 0.2610
4X	 0.5620	 0.2200
5A	 0.2820	 0.0960
5B	 0.3830	 0.1500
5C	 0.3810	 0.1500
5D	 0.1660	 -0.0560
5E	 0.1630	 0.0310
5F	 0.3030	 0.1110
5G	 0.3500	 0.1190
5H	 0.2570	 0.0890
5I	 0.2530	 0.0730
5J	 0.3180	 0.1090
5K	 0.2300	 0.0160
5Q	 0.6790	 0.3320
5R	 0.5950	 0.2450
5S	 0.6140	 0.2800
6F	 0.3770	 0.1480
6G	 0.3200	 0.0760
6H	 0.4660	 0.1320
6Q	 0.5710	 0.2630
6R	 0.3680	 0.0620
7R	 0.4340	 0.1410
8L	 0.5290	 0.1590
8N	 0.4450	 0.1210
8P	 0.4320	 0.1340
8R	 0.3940	 0.1160
AA	 0.6480	 0.2940
AB	 0.4940	 0.1750
AC	 0.7150	 0.3500
AD	 0.7060	 0.3450
AE	 0.7320	 0.3690
AF	 0.6960	 0.3410
AG	 0.7220	 0.3650
AH	 0.7140	 0.3570
AI	 0.7250	 0.3750





















































































*Continued on next page...*

*Continued from previous page...*

Chain	Atom inclusion	Q-score
AJ	 0.7020	 0.3500
AK	 0.7360	 0.3730
AL	 0.7360	 0.3700
AM	 0.6540	 0.3030
AN	 0.6890	 0.3210
BA	 0.5230	 0.1950
BB	 0.3140	 0.0080
BC	 0.6890	 0.3360
BD	 0.6440	 0.2890
BE	 0.7000	 0.3410
BF	 0.6810	 0.3360
BG	 0.7010	 0.3410
BH	 0.6810	 0.3290
BI	 0.7010	 0.3470
BJ	 0.7000	 0.3450
BK	 0.7000	 0.3430
BL	 0.7070	 0.3490
BM	 0.6380	 0.2740
BN	 0.6830	 0.3160
CA	 0.3950	 0.0940
CB	 0.5070	 0.1690
CC	 0.5650	 0.2230
CD	 0.6100	 0.2610
CE	 0.6240	 0.2780
CF	 0.6040	 0.2480
CG	 0.6060	 0.2620
CH	 0.6300	 0.2660
CI	 0.6490	 0.3020
CJ	 0.6290	 0.2740
CK	 0.6300	 0.2790
CL	 0.5880	 0.2260
CM	 0.4980	 0.1710
CN	 0.4090	 0.0960
DA	 0.3310	 0.0530
DB	 0.4620	 0.1290
DC	 0.4980	 0.1620
DD	 0.5580	 0.2070
DE	 0.5840	 0.2450
DF	 0.5880	 0.2440
DG	 0.5800	 0.2250
DH	 0.5930	 0.2420
DI	 0.6200	 0.2620

*Continued on next page...*





















































































*Continued from previous page...*

Chain	Atom inclusion	Q-score
DJ	 0.6070	 0.2390
DK	 0.6060	 0.2590
DL	 0.5370	 0.1930
DM	 0.4710	 0.1260
DN	 0.3500	 0.0640
EA	 0.2840	 0.0600
EB	 0.4650	 0.1090
EC	 0.4860	 0.1430
ED	 0.5570	 0.2020
EE	 0.5760	 0.2160
EF	 0.6030	 0.2300
EG	 0.6230	 0.2560
EH	 0.6090	 0.2380
EI	 0.6200	 0.2520
EJ	 0.5940	 0.2290
EK	 0.5970	 0.2300
EL	 0.5210	 0.1680
EM	 0.4790	 0.1420
EN	 0.3530	 0.0610
FA	 0.5100	 0.1650
FB	 0.4400	 0.1110
FC	 0.6050	 0.2400
FD	 0.5790	 0.2120
FE	 0.6370	 0.2680
FF	 0.6230	 0.2500
FG	 0.6370	 0.2650
FH	 0.6250	 0.2560
FI	 0.6520	 0.2800
FJ	 0.6450	 0.2820
FK	 0.5500	 0.1850
FL	 0.6010	 0.2330
FM	 0.2090	 0.0340
FN	 0.4240	 0.0950
GA	 0.4970	 0.1550
GB	 0.4210	 0.0980
GC	 0.6260	 0.2500
GD	 0.5950	 0.2190
GE	 0.6580	 0.2880
GF	 0.6500	 0.2750
GG	 0.6600	 0.2880
GH	 0.6520	 0.2800
GI	 0.6660	 0.2950

*Continued on next page...*























































































*Continued from previous page...*

Chain	Atom inclusion	Q-score
GJ	 0.6640	 0.2920
GK	 0.5580	 0.2030
GL	 0.5980	 0.2390
GM	 0.3580	 0.0720
GN	 0.4070	 0.0890
HA	 0.4840	 0.1540
HB	 0.3760	 0.0830
HC	 0.6240	 0.2680
HD	 0.5690	 0.2220
HE	 0.6600	 0.3000
HF	 0.6490	 0.2950
HG	 0.6470	 0.2830
HH	 0.6440	 0.2750
HI	 0.6640	 0.3010
HJ	 0.6410	 0.2880
HK	 0.5910	 0.2310
HL	 0.6280	 0.2730
HM	 0.3940	 0.0860
HN	 0.4980	 0.1520
IA	 0.5150	 0.1830
IB	 0.3950	 0.0910
IC	 0.6350	 0.2770
ID	 0.6130	 0.2650
IE	 0.6700	 0.3110
IF	 0.6490	 0.2920
IG	 0.6500	 0.3010
IH	 0.6450	 0.2810
II	 0.6770	 0.3180
IJ	 0.6460	 0.2980
IK	 0.6500	 0.2970
IL	 0.6620	 0.3110
IM	 0.4520	 0.1320
IN	 0.5620	 0.2140
JA	 0.6370	 0.2780
JB	 0.5760	 0.2190
JC	 0.6730	 0.3060
JD	 0.6580	 0.2880
JE	 0.6990	 0.3300
JF	 0.7070	 0.3460
JG	 0.6760	 0.3120
JH	 0.6920	 0.3250
JI	 0.6920	 0.3260





















































































*Continued on next page...*

*Continued from previous page...*

Chain	Atom inclusion	Q-score
JJ	 0.6780	 0.3090
JK	 0.6510	 0.2960
JL	 0.6780	 0.3140
JM	 0.3660	 0.0890
JN	 0.5450	 0.1970
KA	 0.6360	 0.2650
KB	 0.5890	 0.2270
KC	 0.6940	 0.3410
KD	 0.6780	 0.3170
KE	 0.7120	 0.3430
KF	 0.7000	 0.3360
KG	 0.6950	 0.3270
KH	 0.7010	 0.3370
KI	 0.7050	 0.3350
KJ	 0.6950	 0.3200
KK	 0.6750	 0.3140
KL	 0.7180	 0.3450
KM	 0.5530	 0.2140
KN	 0.6260	 0.2490
LA	 0.6330	 0.2710
LB	 0.5800	 0.2180
LC	 0.6600	 0.3120
LD	 0.6630	 0.3050
LE	 0.6830	 0.3220
LF	 0.6750	 0.3060
LG	 0.6590	 0.3000
LH	 0.6820	 0.3230
LI	 0.6760	 0.3140
LJ	 0.6760	 0.3040
LK	 0.6370	 0.2480
LL	 0.6890	 0.3260
LM	 0.5970	 0.2400
LN	 0.6450	 0.2850
MA	 0.6550	 0.2930
MB	 0.5840	 0.2330
MC	 0.6770	 0.3240
MD	 0.7130	 0.3550
ME	 0.6810	 0.3250
MF	 0.6720	 0.3120
MG	 0.6750	 0.3150
MH	 0.6950	 0.3530
MI	 0.6860	 0.3350





















































































*Continued on next page...*

*Continued from previous page...*

Chain	Atom inclusion	Q-score
MJ	 0.6720	 0.2980
MK	 0.6880	 0.3260
ML	 0.7020	 0.3530
MM	 0.6150	 0.2620
MN	 0.6370	 0.2690
NA	 0.5040	 0.1820
NB	 0.4420	 0.1320
NC	 0.6010	 0.2440
ND	 0.5530	 0.2160
NE	 0.6210	 0.2700
NF	 0.6240	 0.2690
NG	 0.6130	 0.2630
NH	 0.6020	 0.2410
NI	 0.6150	 0.2620
NJ	 0.6180	 0.2590
NK	 0.5990	 0.2470
NL	 0.5910	 0.2470
NM	 0.4080	 0.1130
NN	 0.5310	 0.2000
OA	 0.4540	 0.1380
OB	 0.3730	 0.0980
OC	 0.5480	 0.2100
OD	 0.5110	 0.1750
OE	 0.5880	 0.2340
OF	 0.5730	 0.2210
OG	 0.5940	 0.2420
OH	 0.5880	 0.2300
OI	 0.5880	 0.2410
OJ	 0.5610	 0.2220
OK	 0.5280	 0.2030
OL	 0.5820	 0.2200
OM	 0.3810	 0.1030
ON	 0.4900	 0.1600
PA	 0.4020	 0.1010
PB	 0.2990	 0.0500
PC	 0.5250	 0.1810
PD	 0.4620	 0.1320
PE	 0.5700	 0.2190
PF	 0.5450	 0.2000
PG	 0.5810	 0.2270
PH	 0.5610	 0.2200
PI	 0.5710	 0.2230

*Continued on next page...*

*Continued from previous page...*

Chain	Atom inclusion	Q-score
PJ	 0.5550	 0.2070
PK	 0.5470	 0.2010
PL	 0.5370	 0.1960
PM	 0.3630	 0.0910
PN	 0.4640	 0.1350
QA	 0.2900	 0.0500
QB	 0.4390	 0.1170
QC	 0.4850	 0.1390
QD	 0.4870	 0.1590
QE	 0.5240	 0.1880
QF	 0.5470	 0.1990
QG	 0.5670	 0.2170
QH	 0.5520	 0.2000
QI	 0.5500	 0.2020
QJ	 0.5030	 0.1660
QK	 0.5280	 0.1780
QL	 0.4470	 0.1280
QM	 0.3790	 0.0880
QN	 0.2280	 0.0360
RA	 0.2520	 0.0270
RB	 0.3800	 0.0910
RC	 0.4690	 0.1350
RD	 0.5110	 0.1580
RE	 0.5260	 0.1770
RF	 0.5330	 0.1940
RG	 0.5510	 0.1910
RH	 0.5630	 0.2080
RI	 0.5530	 0.2040
RJ	 0.5290	 0.1710
RK	 0.5440	 0.1840
RL	 0.4300	 0.1270
RM	 0.4000	 0.0950
RN	 0.2240	 0.0240
SA	 0.3110	 0.0500
SB	 0.4020	 0.0910
SC	 0.4770	 0.1420
SD	 0.5050	 0.1620
SE	 0.5260	 0.1820
SF	 0.5360	 0.1950
SG	 0.5750	 0.2130
SH	 0.5460	 0.1950
SI	 0.5760	 0.2150







































*Continued on next page...*

*Continued from previous page...*

Chain	Atom inclusion	Q-score
SJ	█ 0.5410	█ 0.1900
SK	█ 0.5410	█ 0.1890
SL	█ 0.4890	█ 0.1480
SM	█ 0.3890	█ 0.0930
SN	█ 0.3100	█ 0.0500
TA	█ 0.2420	█ 0.0260
TB	█ 0.2480	█ 0.0350
TC	█ 0.3930	█ 0.1030
TD	█ 0.4750	█ 0.1410
TE	█ 0.4970	█ 0.1570
TF	█ 0.4820	█ 0.1500
TG	█ 0.5390	█ 0.1870
TH	█ 0.5200	█ 0.1700
TI	█ 0.5330	█ 0.1900
TJ	█ 0.5120	█ 0.1640
TK	█ 0.4830	█ 0.1530
TL	█ 0.4400	█ 0.1250
TM	█ 0.3830	█ 0.0880
TN	█ 0.2970	█ 0.0480
UA	█ 0.2100	█ -0.0040
UB	█ 0.2710	█ 0.0520
UC	█ 0.4320	█ 0.1230
UD	█ 0.4770	█ 0.1490
UE	█ 0.5080	█ 0.1710
UF	█ 0.5010	█ 0.1540
UG	█ 0.5040	█ 0.1720
UH	█ 0.4990	█ 0.1630
UI	█ 0.5220	█ 0.1740
UJ	█ 0.5190	█ 0.1700
UK	█ 0.5140	█ 0.1630
UL	█ 0.4550	█ 0.1250
UM	█ 0.4260	█ 0.1170
UN	█ 0.3080	█ 0.0430
VA	█ 0.4720	█ 0.1590
VB	█ 0.3730	█ 0.0890
VC	█ 0.5560	█ 0.2050
VD	█ 0.5360	█ 0.1910
VE	█ 0.5800	█ 0.2250
VF	█ 0.5740	█ 0.2240
VG	█ 0.5810	█ 0.2290
VH	█ 0.5700	█ 0.2210
VI	█ 0.5690	█ 0.2180

*Continued on next page...*

*Continued from previous page...*

Chain	Atom inclusion	Q-score
VJ	 0.5560	 0.2210
VK	 0.5160	 0.1720
VL	 0.5410	 0.1960
VM	 0.3240	 0.0640
VN	 0.4000	 0.1130
WA	 0.5190	 0.1770
WB	 0.4230	 0.1160
WC	 0.5820	 0.2320
WD	 0.5730	 0.2240
WE	 0.5930	 0.2400
WF	 0.5690	 0.2190
WG	 0.5960	 0.2460
WH	 0.5920	 0.2360
WI	 0.6030	 0.2510
WJ	 0.5710	 0.2300
WK	 0.5830	 0.2170
WL	 0.5890	 0.2370
WM	 0.3880	 0.0850
WN	 0.4660	 0.1430