



wwPDB X-ray Structure Validation Summary Report ⓘ

Jun 16, 2024 – 07:22 PM EDT

PDB ID : 3TCF
Title : Crystal structure of E. coli OppA complexed with endogenous ligands
Authors : Klepsch, M.M.; Kovermann, M.; Low, C.; Balbach, J.; de Gier, J.W.; Slotboom, D.J.; Berntsson, R.P.-A.
Deposited on : 2011-08-09
Resolution : 2.00 Å(reported)

This is a wwPDB X-ray Structure Validation Summary Report for a publicly released PDB entry.

We welcome your comments at validation@mail.wwpdb.org

A user guide is available at

<https://www.wwpdb.org/validation/2017/XrayValidationReportHelp>

with specific help available everywhere you see the ⓘ symbol.

The types of validation reports are described at

<http://www.wwpdb.org/validation/2017/FAQs#types>.

The following versions of software and data (see [references ⓘ](#)) were used in the production of this report:

MolProbity : 4.02b-467
Xtriage (Phenix) : 1.20.1
EDS : 2.37.1
Percentile statistics : 20191225.v01 (using entries in the PDB archive December 25th 2019)
Refmac : 5.8.0158
CCP4 : 7.0.044 (Gargrove)
Ideal geometry (proteins) : Engh & Huber (2001)
Ideal geometry (DNA, RNA) : Parkinson et al. (1996)
Validation Pipeline (wwPDB-VP) : 2.37.1

1 Overall quality at a glance

The following experimental techniques were used to determine the structure:

X-RAY DIFFRACTION

The reported resolution of this entry is 2.00 Å.

Percentile scores (ranging between 0-100) for global validation metrics of the entry are shown in the following graphic. The table shows the number of entries on which the scores are based.

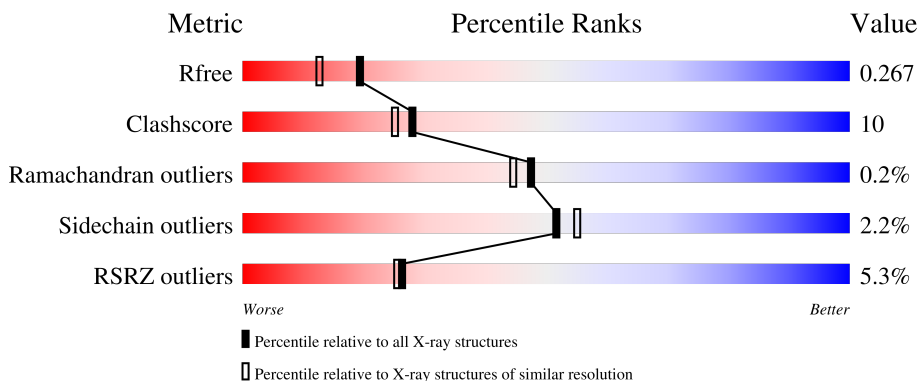

Metric	Whole archive (#Entries)	Similar resolution (#Entries, resolution range(Å))
R_{free}	130704	8085 (2.00-2.00)
Clashscore	141614	9178 (2.00-2.00)
Ramachandran outliers	138981	9054 (2.00-2.00)
Sidechain outliers	138945	9053 (2.00-2.00)
RSRZ outliers	127900	7900 (2.00-2.00)

The table below summarises the geometric issues observed across the polymeric chains and their fit to the electron density. The red, orange, yellow and green segments of the lower bar indicate the fraction of residues that contain outliers for ≥ 3 , 2, 1 and 0 types of geometric quality criteria respectively. A grey segment represents the fraction of residues that are not modelled. The numeric value for each fraction is indicated below the corresponding segment, with a dot representing fractions $\leq 5\%$. The upper red bar (where present) indicates the fraction of residues that have poor fit to the electron density. The numeric value is given above the bar.

Mol	Chain	Length	Quality of chain
1	A	524	 79% 18% ..
1	B	524	 6% 85% 13% .
1	C	524	 3% 85% 13% .
1	D	524	 2% 85% 12% ..
1	E	524	 % 84% 14% ..

Continued on next page...

Continued from previous page...

Mol	Chain	Length	Quality of chain
1	F	524	 5% 81% 16% ..
1	G	524	 9% 78% 20% ..
1	H	524	 15% 79% 19% ..
2	I	3	 67% 33%
2	J	3	 67% 33%
2	K	3	 67% 33%
2	L	3	 67% 33%
2	M	3	 33% 67%
2	N	3	 67% 33%
2	O	3	 100%
2	P	3	 67% 33%

2 Entry composition [i](#)

There are 3 unique types of molecules in this entry. The entry contains 35615 atoms, of which 0 are hydrogens and 0 are deuteriums.

In the tables below, the ZeroOcc column contains the number of atoms modelled with zero occupancy, the AltConf column contains the number of residues with at least one atom in alternate conformation and the Trace column contains the number of residues modelled with at most 2 atoms.

- Molecule 1 is a protein called Periplasmic oligopeptide-binding protein.

Mol	Chain	Residues	Atoms					ZeroOcc	AltConf	Trace
			Total	C	N	O	S			
1	A	517	4137	2636	695	796	10	0	2	0
1	B	517	4136	2636	694	796	10	0	2	0
1	C	517	4129	2632	693	794	10	0	1	0
1	D	517	4129	2632	693	794	10	0	1	0
1	E	517	4137	2636	694	797	10	0	2	0
1	F	517	4155	2649	696	800	10	0	4	0
1	G	517	4135	2635	694	796	10	0	2	0
1	H	517	4129	2632	693	794	10	0	1	0

There are 56 discrepancies between the modelled and reference sequences:

Chain	Residue	Modelled	Actual	Comment	Reference
A	26	MET	-	EXPRESSION TAG	UNP P23843
A	544	HIS	-	EXPRESSION TAG	UNP P23843
A	545	HIS	-	EXPRESSION TAG	UNP P23843
A	546	HIS	-	EXPRESSION TAG	UNP P23843
A	547	HIS	-	EXPRESSION TAG	UNP P23843
A	548	HIS	-	EXPRESSION TAG	UNP P23843
A	549	HIS	-	EXPRESSION TAG	UNP P23843
B	26	MET	-	EXPRESSION TAG	UNP P23843
B	544	HIS	-	EXPRESSION TAG	UNP P23843
B	545	HIS	-	EXPRESSION TAG	UNP P23843
B	546	HIS	-	EXPRESSION TAG	UNP P23843
B	547	HIS	-	EXPRESSION TAG	UNP P23843
B	548	HIS	-	EXPRESSION TAG	UNP P23843

Continued on next page...

Continued from previous page...

Chain	Residue	Modelled	Actual	Comment	Reference
B	549	HIS	-	EXPRESSION TAG	UNP P23843
C	26	MET	-	EXPRESSION TAG	UNP P23843
C	544	HIS	-	EXPRESSION TAG	UNP P23843
C	545	HIS	-	EXPRESSION TAG	UNP P23843
C	546	HIS	-	EXPRESSION TAG	UNP P23843
C	547	HIS	-	EXPRESSION TAG	UNP P23843
C	548	HIS	-	EXPRESSION TAG	UNP P23843
C	549	HIS	-	EXPRESSION TAG	UNP P23843
D	26	MET	-	EXPRESSION TAG	UNP P23843
D	544	HIS	-	EXPRESSION TAG	UNP P23843
D	545	HIS	-	EXPRESSION TAG	UNP P23843
D	546	HIS	-	EXPRESSION TAG	UNP P23843
D	547	HIS	-	EXPRESSION TAG	UNP P23843
D	548	HIS	-	EXPRESSION TAG	UNP P23843
D	549	HIS	-	EXPRESSION TAG	UNP P23843
E	26	MET	-	EXPRESSION TAG	UNP P23843
E	544	HIS	-	EXPRESSION TAG	UNP P23843
E	545	HIS	-	EXPRESSION TAG	UNP P23843
E	546	HIS	-	EXPRESSION TAG	UNP P23843
E	547	HIS	-	EXPRESSION TAG	UNP P23843
E	548	HIS	-	EXPRESSION TAG	UNP P23843
E	549	HIS	-	EXPRESSION TAG	UNP P23843
F	26	MET	-	EXPRESSION TAG	UNP P23843
F	544	HIS	-	EXPRESSION TAG	UNP P23843
F	545	HIS	-	EXPRESSION TAG	UNP P23843
F	546	HIS	-	EXPRESSION TAG	UNP P23843
F	547	HIS	-	EXPRESSION TAG	UNP P23843
F	548	HIS	-	EXPRESSION TAG	UNP P23843
F	549	HIS	-	EXPRESSION TAG	UNP P23843
G	26	MET	-	EXPRESSION TAG	UNP P23843
G	544	HIS	-	EXPRESSION TAG	UNP P23843
G	545	HIS	-	EXPRESSION TAG	UNP P23843
G	546	HIS	-	EXPRESSION TAG	UNP P23843
G	547	HIS	-	EXPRESSION TAG	UNP P23843
G	548	HIS	-	EXPRESSION TAG	UNP P23843
G	549	HIS	-	EXPRESSION TAG	UNP P23843
H	26	MET	-	EXPRESSION TAG	UNP P23843
H	544	HIS	-	EXPRESSION TAG	UNP P23843
H	545	HIS	-	EXPRESSION TAG	UNP P23843
H	546	HIS	-	EXPRESSION TAG	UNP P23843
H	547	HIS	-	EXPRESSION TAG	UNP P23843
H	548	HIS	-	EXPRESSION TAG	UNP P23843

Continued on next page...

Continued from previous page...

Chain	Residue	Modelled	Actual	Comment	Reference
H	549	HIS	-	EXPRESSION TAG	UNP P23843

- Molecule 2 is a protein called Endogenous peptide.

Mol	Chain	Residues	Atoms				ZeroOcc	AltConf	Trace
2	I	3	Total	C	N	O	0	0	0
			15	9	3	3			
2	J	3	Total	C	N	O	0	0	0
			15	9	3	3			
2	K	3	Total	C	N	O	0	0	0
			15	9	3	3			
2	L	3	Total	C	N	O	0	0	0
			15	9	3	3			
2	M	3	Total	C	N	O	0	0	0
			15	9	3	3			
2	N	3	Total	C	N	O	0	0	0
			15	9	3	3			
2	O	3	Total	C	N	O	0	0	0
			15	9	3	3			
2	P	3	Total	C	N	O	0	0	0
			15	9	3	3			

- Molecule 3 is water.

Mol	Chain	Residues	Atoms		ZeroOcc	AltConf
3	A	360	Total	O	0	0
			360	360		
3	B	268	Total	O	0	0
			268	268		
3	C	285	Total	O	0	0
			285	285		
3	D	265	Total	O	0	0
			265	265		
3	E	351	Total	O	0	0
			351	351		
3	F	344	Total	O	0	0
			344	344		
3	G	305	Total	O	0	0
			305	305		
3	H	221	Total	O	0	0
			221	221		
3	I	2	Total	O	0	0
			2	2		

Continued on next page...

Continued from previous page...

Mol	Chain	Residues	Atoms	ZeroOcc	AltConf
3	J	2	Total O 2 2	0	0
3	K	1	Total O 1 1	0	0
3	M	2	Total O 2 2	0	0
3	P	2	Total O 2 2	0	0

3 Residue-property plots

These plots are drawn for all protein, RNA, DNA and oligosaccharide chains in the entry. The first graphic for a chain summarises the proportions of the various outlier classes displayed in the second graphic. The second graphic shows the sequence view annotated by issues in geometry and electron density. Residues are color-coded according to the number of geometric quality criteria for which they contain at least one outlier: green = 0, yellow = 1, orange = 2 and red = 3 or more. A red dot above a residue indicates a poor fit to the electron density ($RSRZ > 2$). Stretches of 2 or more consecutive residues without any outlier are shown as a green connector. Residues present in the sample, but not in the model, are shown in grey.

• Molecule 1: Periplasmic oligopeptide-binding protein

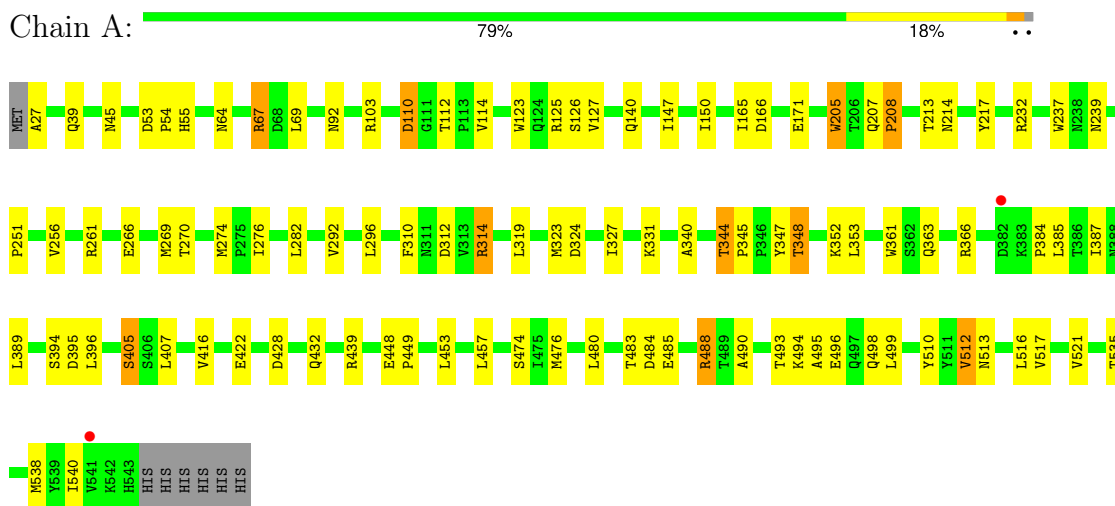

• Molecule 1: Periplasmic oligopeptide-binding protein

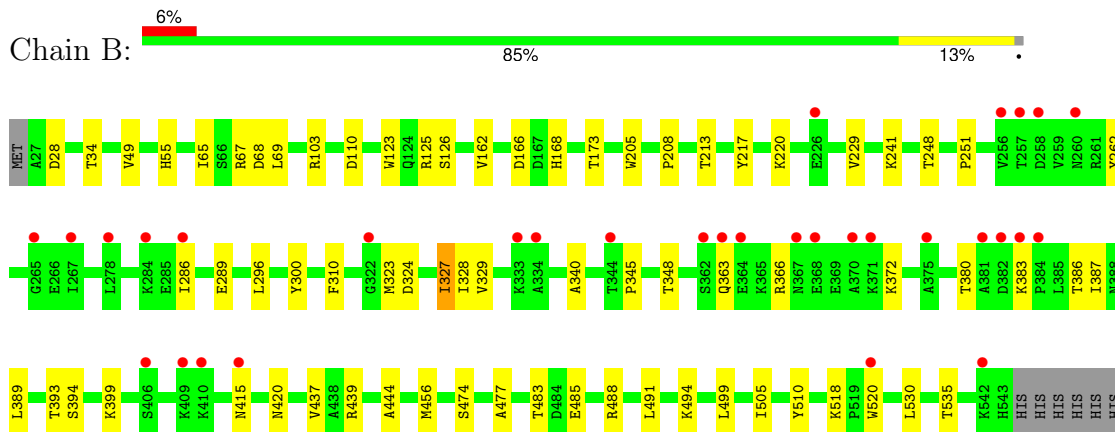

• Molecule 1: Periplasmic oligopeptide-binding protein

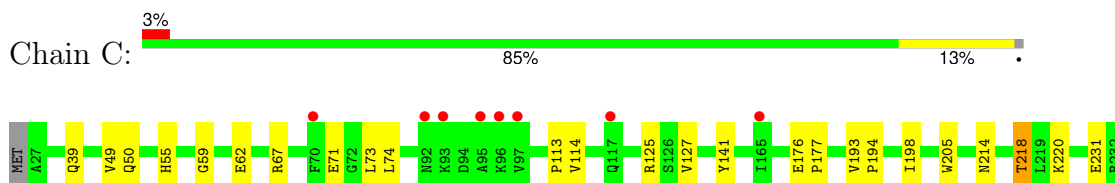

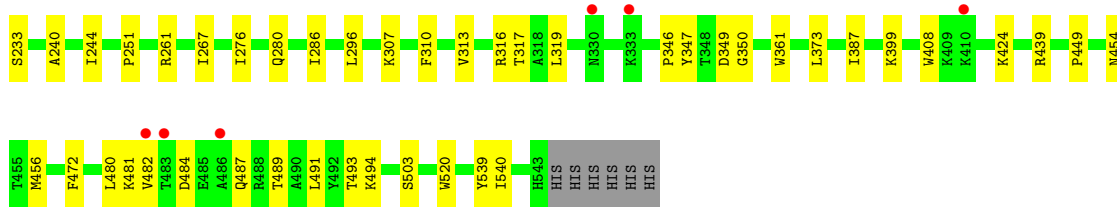

● Molecule 1: Periplasmic oligopeptide-binding protein

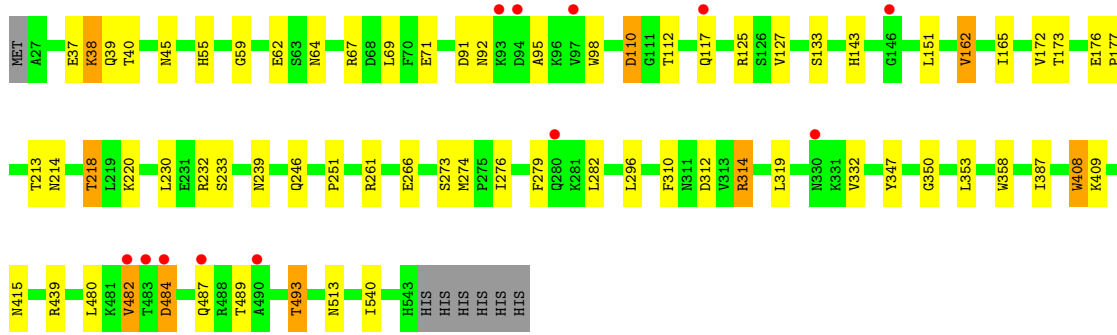
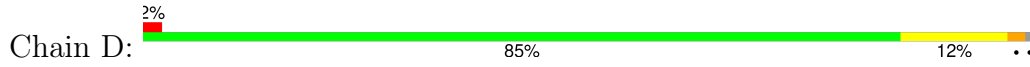

● Molecule 1: Periplasmic oligopeptide-binding protein

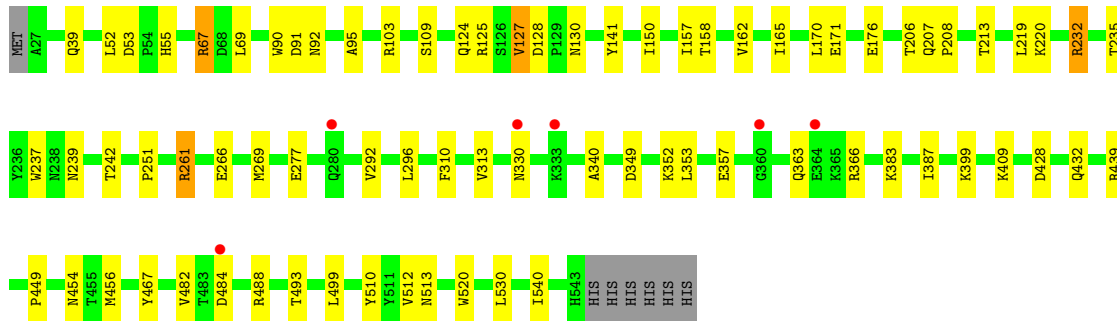
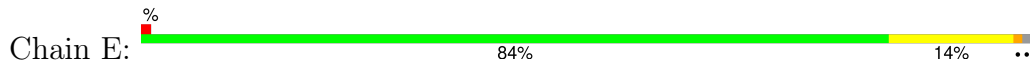

● Molecule 1: Periplasmic oligopeptide-binding protein

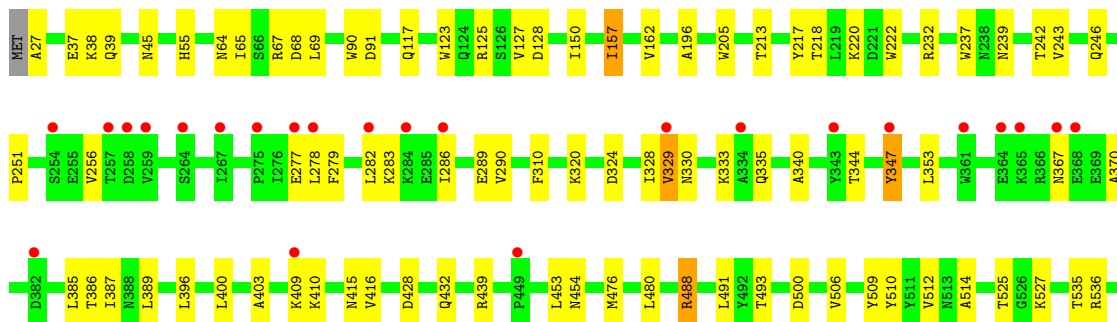
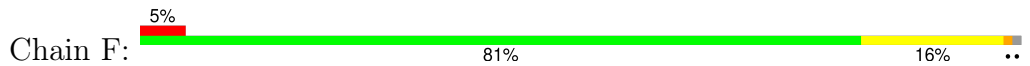

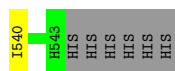

• Molecule 1: Periplasmic oligopeptide-binding protein

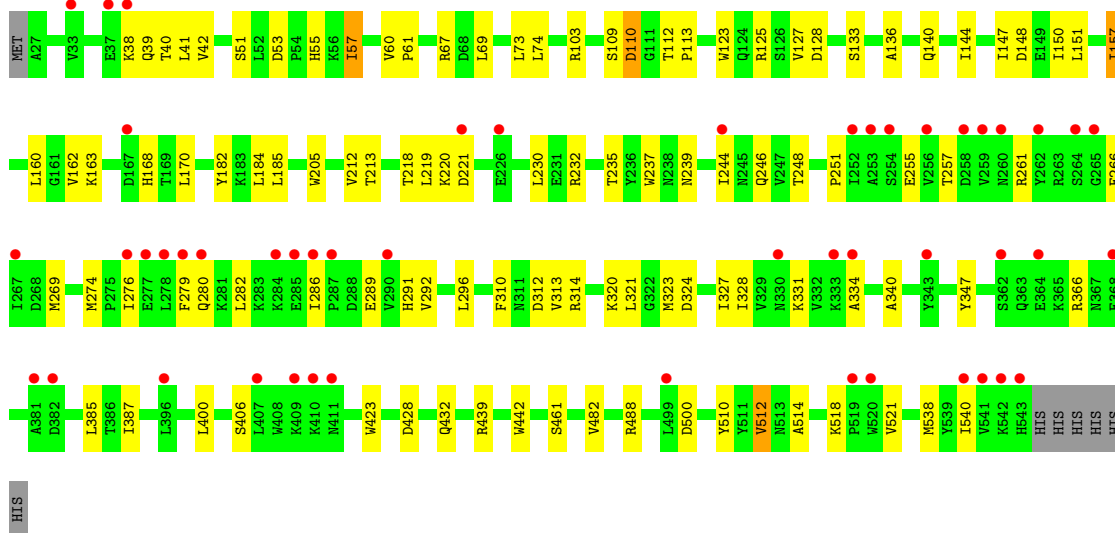
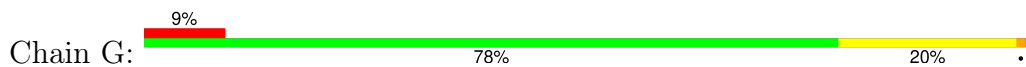

• Molecule 1: Periplasmic oligopeptide-binding protein

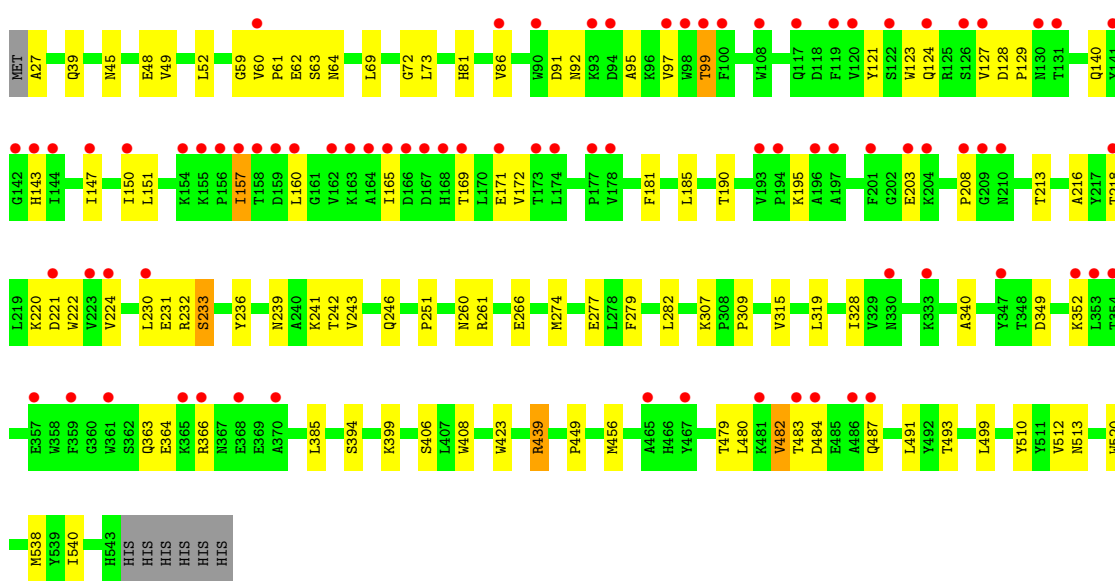
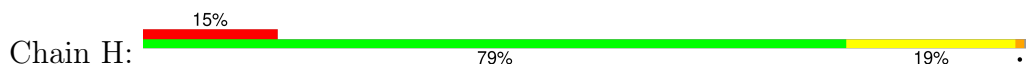

• Molecule 2: Endogenous peptide



- Molecule 2: Endogenous peptide

Chain J:  67% 33%



- Molecule 2: Endogenous peptide

Chain K:  67% 33%



- Molecule 2: Endogenous peptide

Chain L:  67% 33%



- Molecule 2: Endogenous peptide

Chain M:  33% 67%



- Molecule 2: Endogenous peptide

Chain N:  67% 33%



- Molecule 2: Endogenous peptide

Chain O:  100%

There are no outlier residues recorded for this chain.

- Molecule 2: Endogenous peptide

Chain P:  67% 33%



4 Data and refinement statistics

Property	Value	Source
Space group	P 1 21 1	Depositor
Cell constants a, b, c, α , β , γ	62.62Å 202.60Å 208.95Å 90.00° 95.71° 90.00°	Depositor
Resolution (Å)	48.37 – 2.00 48.37 – 2.00	Depositor EDS
% Data completeness (in resolution range)	98.9 (48.37-2.00) 98.9 (48.37-2.00)	Depositor EDS
R_{merge}	0.08	Depositor
R_{sym}	(Not available)	Depositor
$\langle I/\sigma(I) \rangle$ ¹	1.98 (at 2.00Å)	Xtrriage
Refinement program	REFMAC	Depositor
R, R_{free}	0.229 , 0.267 0.230 , 0.267	Depositor DCC
R_{free} test set	17271 reflections (5.00%)	wwPDB-VP
Wilson B-factor (Å ²)	25.7	Xtrriage
Anisotropy	0.225	Xtrriage
Bulk solvent k_{sol} (e/Å ³), B_{sol} (Å ²)	0.39 , 50.5	EDS
L-test for twinning ²	$\langle L \rangle = 0.45$, $\langle L^2 \rangle = 0.28$	Xtrriage
Estimated twinning fraction	0.033 for h,-k,-h-l	Xtrriage
F_o, F_c correlation	0.93	EDS
Total number of atoms	35615	wwPDB-VP
Average B, all atoms (Å ²)	29.0	wwPDB-VP

Xtrriage's analysis on translational NCS is as follows: *The analyses of the Patterson function reveals a significant off-origin peak that is 33.69 % of the origin peak, indicating pseudo-translational symmetry. The chance of finding a peak of this or larger height randomly in a structure without pseudo-translational symmetry is equal to 7.6804e-04. The detected translational NCS is most likely also responsible for the elevated intensity ratio.*

¹Intensities estimated from amplitudes.

²Theoretical values of $\langle |L| \rangle$, $\langle L^2 \rangle$ for acentric reflections are 0.5, 0.333 respectively for untwinned datasets, and 0.375, 0.2 for perfectly twinned datasets.

5 Model quality i

5.1 Standard geometry i

The Z score for a bond length (or angle) is the number of standard deviations the observed value is removed from the expected value. A bond length (or angle) with $|Z| > 5$ is considered an outlier worth inspection. RMSZ is the root-mean-square of all Z scores of the bond lengths (or angles).

Mol	Chain	Bond lengths		Bond angles	
		RMSZ	# Z >5	RMSZ	# Z >5
1	A	0.77	2/4245 (0.0%)	0.80	6/5790 (0.1%)
1	B	0.68	2/4244 (0.0%)	0.71	4/5789 (0.1%)
1	C	0.68	4/4237 (0.1%)	0.68	2/5779 (0.0%)
1	D	0.66	3/4237 (0.1%)	0.69	2/5779 (0.0%)
1	E	0.71	2/4245 (0.0%)	0.74	5/5790 (0.1%)
1	F	0.72	4/4264 (0.1%)	0.71	3/5817 (0.1%)
1	G	0.69	5/4243 (0.1%)	0.70	3/5788 (0.1%)
1	H	0.66	2/4237 (0.0%)	0.64	1/5779 (0.0%)
All	All	0.70	24/33952 (0.1%)	0.71	26/46311 (0.1%)

Chiral center outliers are detected by calculating the chiral volume of a chiral center and verifying if the center is modelled as a planar moiety or with the opposite hand. A planarity outlier is detected by checking planarity of atoms in a peptide group, atoms in a mainchain group or atoms of a sidechain that are expected to be planar.

Mol	Chain	#Chirality outliers	#Planarity outliers
1	B	0	1

The worst 5 of 24 bond length outliers are listed below:

Mol	Chain	Res	Type	Atoms	Z	Observed(Å)	Ideal(Å)
1	B	205	TRP	CD2-CE2	5.75	1.48	1.41
1	A	205	TRP	CD2-CE2	5.72	1.48	1.41
1	F	237	TRP	CD2-CE2	5.70	1.48	1.41
1	G	205	TRP	CD2-CE2	5.63	1.48	1.41
1	D	98	TRP	CD2-CE2	5.58	1.48	1.41

The worst 5 of 26 bond angle outliers are listed below:

Mol	Chain	Res	Type	Atoms	Z	Observed(°)	Ideal(°)
1	E	67	ARG	NE-CZ-NH2	-12.89	113.86	120.30
1	A	67	ARG	NE-CZ-NH2	-10.32	115.14	120.30
1	B	103	ARG	NE-CZ-NH2	-9.74	115.43	120.30

Continued on next page...

Continued from previous page...

Mol	Chain	Res	Type	Atoms	Z	Observed(°)	Ideal(°)
1	A	67	ARG	NE-CZ-NH1	9.53	125.06	120.30
1	B	103	ARG	NE-CZ-NH1	9.42	125.01	120.30

There are no chirality outliers.

All (1) planarity outliers are listed below:

Mol	Chain	Res	Type	Group
1	B	483	THR	Peptide

5.2 Too-close contacts [i](#)

In the following table, the Non-H and H(model) columns list the number of non-hydrogen atoms and hydrogen atoms in the chain respectively. The H(added) column lists the number of hydrogen atoms added and optimized by MolProbity. The Clashes column lists the number of clashes within the asymmetric unit, whereas Symm-Clashes lists symmetry-related clashes.

Mol	Chain	Non-H	H(model)	H(added)	Clashes	Symm-Clashes
1	A	4137	0	4046	92	0
1	B	4136	0	4047	59	0
1	C	4129	0	4041	73	0
1	D	4129	0	4041	55	0
1	E	4137	0	4044	69	0
1	F	4155	0	4061	89	0
1	G	4135	0	4046	107	0
1	H	4129	0	4041	99	0
2	I	15	0	5	2	0
2	J	15	0	5	1	0
2	K	15	0	5	1	0
2	L	15	0	5	1	0
2	M	15	0	5	2	0
2	N	15	0	5	1	0
2	O	15	0	5	0	0
2	P	15	0	5	1	0
3	A	360	0	0	35	0
3	B	268	0	0	12	0
3	C	285	0	0	25	0
3	D	265	0	0	9	0
3	E	351	0	0	20	0
3	F	344	0	0	38	0
3	G	305	0	0	33	0
3	H	221	0	0	41	0

Continued on next page...

Continued from previous page...

Mol	Chain	Non-H	H(model)	H(added)	Clashes	Symm-Clashes
3	I	2	0	0	1	0
3	J	2	0	0	0	0
3	K	1	0	0	0	0
3	M	2	0	0	0	0
3	P	2	0	0	1	0
All	All	35615	0	32407	650	0

The all-atom clashscore is defined as the number of clashes found per 1000 atoms (including hydrogen atoms). The all-atom clashscore for this structure is 10.

The worst 5 of 650 close contacts within the same asymmetric unit are listed below, sorted by their clash magnitude.

Atom-1	Atom-2	Interatomic distance (Å)	Clash overlap (Å)
1:H:147:ILE:HG21	3:H:3221:HOH:O	1.16	1.33
1:E:158:THR:HG23	3:E:3234:HOH:O	1.21	1.30
1:G:184:LEU:HD22	3:G:3263:HOH:O	1.27	1.29
1:A:457:LEU:HD13	3:A:3253:HOH:O	1.11	1.27
1:F:65:ILE:HG22	3:F:3274:HOH:O	1.26	1.26

There are no symmetry-related clashes.

5.3 Torsion angles [i](#)

5.3.1 Protein backbone [i](#)

In the following table, the Percentiles column shows the percent Ramachandran outliers of the chain as a percentile score with respect to all X-ray entries followed by that with respect to entries of similar resolution.

The Analysed column shows the number of residues for which the backbone conformation was analysed, and the total number of residues.

Mol	Chain	Analysed	Favoured	Allowed	Outliers	Percentiles
1	A	517/524 (99%)	500 (97%)	15 (3%)	2 (0%)	34 30
1	B	517/524 (99%)	504 (98%)	12 (2%)	1 (0%)	47 44
1	C	516/524 (98%)	497 (96%)	18 (4%)	1 (0%)	47 44
1	D	516/524 (98%)	501 (97%)	14 (3%)	1 (0%)	47 44
1	E	517/524 (99%)	500 (97%)	16 (3%)	1 (0%)	47 44

Continued on next page...

Continued from previous page...

Mol	Chain	Analysed	Favoured	Allowed	Outliers	Percentiles	
1	F	519/524 (99%)	503 (97%)	15 (3%)	1 (0%)	47	44
1	G	517/524 (99%)	503 (97%)	13 (2%)	1 (0%)	47	44
1	H	516/524 (98%)	498 (96%)	16 (3%)	2 (0%)	34	30
All	All	4135/4192 (99%)	4006 (97%)	119 (3%)	10 (0%)	47	44

5 of 10 Ramachandran outliers are listed below:

Mol	Chain	Res	Type
1	B	251	PRO
1	F	251	PRO
1	G	251	PRO
1	A	251	PRO
1	A	394	SER

5.3.2 Protein sidechains [i](#)

In the following table, the Percentiles column shows the percent sidechain outliers of the chain as a percentile score with respect to all X-ray entries followed by that with respect to entries of similar resolution.

The Analysed column shows the number of residues for which the sidechain conformation was analysed, and the total number of residues.

Mol	Chain	Analysed	Rotameric	Outliers	Percentiles	
1	A	453/458 (99%)	442 (98%)	11 (2%)	49	51
1	B	453/458 (99%)	444 (98%)	9 (2%)	55	58
1	C	452/458 (99%)	447 (99%)	5 (1%)	73	78
1	D	452/458 (99%)	437 (97%)	15 (3%)	38	37
1	E	453/458 (99%)	446 (98%)	7 (2%)	65	69
1	F	455/458 (99%)	447 (98%)	8 (2%)	59	63
1	G	453/458 (99%)	441 (97%)	12 (3%)	46	48
1	H	452/458 (99%)	437 (97%)	15 (3%)	38	37
All	All	3623/3664 (99%)	3541 (98%)	82 (2%)	52	53

5 of 82 residues with a non-rotameric sidechain are listed below:

Mol	Chain	Res	Type
1	G	110	ASP

Continued on next page...

Continued from previous page...

Mol	Chain	Res	Type
1	H	203	GLU
1	G	133[B]	SER
1	G	482	VAL
1	H	307	LYS

Sometimes sidechains can be flipped to improve hydrogen bonding and reduce clashes. 5 of 68 such sidechains are listed below:

Mol	Chain	Res	Type
1	G	432	GLN
1	H	39	GLN
1	H	363	GLN
1	D	246	GLN
1	D	239	ASN

5.3.3 RNA [i](#)

There are no RNA molecules in this entry.

5.4 Non-standard residues in protein, DNA, RNA chains [i](#)

There are no non-standard protein/DNA/RNA residues in this entry.

5.5 Carbohydrates [i](#)

There are no monosaccharides in this entry.

5.6 Ligand geometry [i](#)

There are no ligands in this entry.

5.7 Other polymers [i](#)

There are no such residues in this entry.

5.8 Polymer linkage issues [i](#)

There are no chain breaks in this entry.

6 Fit of model and data [i](#)

6.1 Protein, DNA and RNA chains [i](#)

In the following table, the column labelled '#RSRZ > 2' contains the number (and percentage) of RSRZ outliers, followed by percent RSRZ outliers for the chain as percentile scores relative to all X-ray entries and entries of similar resolution. The OWAB column contains the minimum, median, 95th percentile and maximum values of the occupancy-weighted average B-factor per residue. The column labelled 'Q < 0.9' lists the number of (and percentage) of residues with an average occupancy less than 0.9.

Mol	Chain	Analysed	<RSRZ>	#RSRZ>2	OWAB(Å ²)	Q<0.9
1	A	517/524 (98%)	0.02	2 (0%) 92 92	14, 22, 36, 51	0
1	B	517/524 (98%)	0.25	32 (6%) 20 19	16, 28, 47, 61	0
1	C	517/524 (98%)	0.23	14 (2%) 54 53	19, 29, 42, 53	0
1	D	517/524 (98%)	0.21	12 (2%) 60 59	21, 30, 42, 53	0
1	E	517/524 (98%)	0.06	6 (1%) 79 78	17, 25, 36, 44	0
1	F	517/524 (98%)	0.28	24 (4%) 32 31	16, 25, 41, 57	0
1	G	517/524 (98%)	0.55	49 (9%) 8 7	17, 30, 51, 64	0
1	H	517/524 (98%)	0.84	80 (15%) 2 1	22, 38, 67, 79	0
2	I	0/3	-	-	-	-
2	J	0/3	-	-	-	-
2	K	0/3	-	-	-	-
2	L	0/3	-	-	-	-
2	M	0/3	-	-	-	-
2	N	0/3	-	-	-	-
2	O	0/3	-	-	-	-
2	P	0/3	-	-	-	-
All	All	4136/4216 (98%)	0.30	219 (5%) 26 25	14, 28, 48, 79	0

The worst 5 of 219 RSRZ outliers are listed below:

Mol	Chain	Res	Type	RSRZ
1	H	484	ASP	5.3
1	H	117	GLN	5.3
1	H	155	LYS	5.2
1	H	97	VAL	5.2
1	H	147	ILE	4.7

6.2 Non-standard residues in protein, DNA, RNA chains [i](#)

There are no non-standard protein/DNA/RNA residues in this entry.

6.3 Carbohydrates [i](#)

There are no monosaccharides in this entry.

6.4 Ligands [i](#)

There are no ligands in this entry.

6.5 Other polymers [i](#)

There are no such residues in this entry.