



# wwPDB EM Validation Summary Report

Sep 29, 2024 – 03:38 AM EDT

PDB ID : 7TRA  
EMDB ID : EMD-26084  
Title : Cascade complex from type I-A CRISPR-Cas system  
Authors : Hu, C.; Ni, D.; Nam, K.H.; Majumdar, S.; McLean, J.; Stahlberg, H.; Terns, M.; Ke, A.  
Deposited on : 2022-01-28  
Resolution : 3.30 Å(reported)

This is a wwPDB EM Validation Summary Report for a publicly released PDB entry.

We welcome your comments at [validation@mail.wwpdb.org](mailto:validation@mail.wwpdb.org)

A user guide is available at

<https://www.wwpdb.org/validation/2017/EMValidationReportHelp>

with specific help available everywhere you see the  symbol.

The types of validation reports are described at

<http://www.wwpdb.org/validation/2017/FAQs#types>.

---

The following versions of software and data (see [references](#) ) were used in the production of this report:

EMDB validation analysis : 0.0.1.dev113  
MolProbity : 4.02b-467  
Percentile statistics : 20231227.v01 (using entries in the PDB archive December 27th 2023)  
MapQ : 1.9.13  
Ideal geometry (proteins) : Engh & Huber (2001)  
Ideal geometry (DNA, RNA) : Parkinson et al. (1996)  
Validation Pipeline (wwPDB-VP) : 2.39

# 1 Overall quality at a glance i

The following experimental techniques were used to determine the structure:  
*ELECTRON MICROSCOPY*

The reported resolution of this entry is 3.30 Å.

Percentile scores (ranging between 0-100) for global validation metrics of the entry are shown in the following graphic. The table shows the number of entries on which the scores are based.

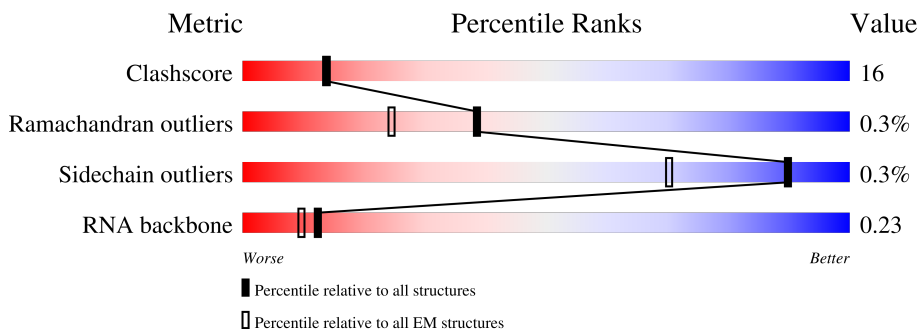











Metric	Whole archive (#Entries)	EM structures (#Entries)
Clashscore	210492	15764
Ramachandran outliers	207382	16835
Sidechain outliers	206894	16415
RNA backbone	6643	2191

The table below summarises the geometric issues observed across the polymeric chains and their fit to the map. The red, orange, yellow and green segments of the bar indicate the fraction of residues that contain outliers for  $\geq 3$ , 2, 1 and 0 types of geometric quality criteria respectively. A grey segment represents the fraction of residues that are not modelled. The numeric value for each fraction is indicated below the corresponding segment, with a dot representing fractions  $\leq 5\%$ . The upper red bar (where present) indicates the fraction of residues that have poor fit to the EM map (all-atom inclusion  $< 40\%$ ). The numeric value is given above the bar.

Mol	Chain	Length	Quality of chain
1	A	572	
2	B	341	
3	C	108	
3	D	108	
3	E	108	
3	F	108	
3	G	108	

Continued on next page...

Continued from previous page...

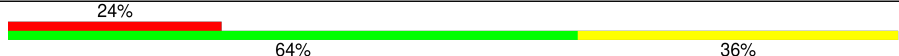
Mol	Chain	Length	Quality of chain
4	H	336	 59% 40%
4	I	336	 63% 37%
4	J	336	 60% 40%
4	K	336	 58% 42%
4	L	336	 61% 39%
4	M	336	 62% 34% 5%
4	N	336	 55% 26% 18%
5	O	256	 57% 36% 6%
6	Q	219	 63% 37% 5%
7	R	44	 20% 70% 9%
8	S	44	 52% 48%
9	T	25	 64% 36% 24%

## 2 Entry composition

There are 10 unique types of molecules in this entry. The entry contains 34872 atoms, of which 0 are hydrogens and 0 are deuteriums.

In the tables below, the AltConf column contains the number of residues with at least one atom in alternate conformation and the Trace column contains the number of residues modelled with at most 2 atoms.

- Molecule 1 is a protein called CRISPR-associated helicase Cas3.

Mol	Chain	Residues	Atoms					AltConf	Trace
			Total	C	N	O	S		
1	A	572	4315	2756	746	805	8	0	0

There are 97 discrepancies between the modelled and reference sequences:

Chain	Residue	Modelled	Actual	Comment	Reference
A	228	LYS	ARG	conflict	UNP A0A5C0XNV5
A	?	-	VAL	deletion	UNP A0A5C0XNV5
A	364	ALA	GLU	conflict	UNP A0A5C0XNV5
A	365	ALA	ASN	conflict	UNP A0A5C0XNV5
A	366	ALA	CYS	conflict	UNP A0A5C0XNV5
A	367	ALA	ILE	conflict	UNP A0A5C0XNV5
A	368	ALA	GLU	conflict	UNP A0A5C0XNV5
A	369	ALA	HIS	conflict	UNP A0A5C0XNV5
A	370	ALA	GLU	conflict	UNP A0A5C0XNV5
A	371	ALA	LYS	conflict	UNP A0A5C0XNV5
A	372	ALA	ILE	conflict	UNP A0A5C0XNV5
A	373	ALA	VAL	conflict	UNP A0A5C0XNV5
A	374	ALA	ARG	conflict	UNP A0A5C0XNV5
A	375	ALA	GLY	conflict	UNP A0A5C0XNV5
A	376	ALA	LEU	conflict	UNP A0A5C0XNV5
A	377	ALA	SER	conflict	UNP A0A5C0XNV5
A	378	ALA	GLU	conflict	UNP A0A5C0XNV5
A	379	ALA	LEU	conflict	UNP A0A5C0XNV5
A	380	ALA	MET	conflict	UNP A0A5C0XNV5
A	381	ALA	GLU	conflict	UNP A0A5C0XNV5
A	382	ALA	LYS	conflict	UNP A0A5C0XNV5
A	383	ALA	ILE	conflict	UNP A0A5C0XNV5
A	384	ALA	GLY	conflict	UNP A0A5C0XNV5
A	385	ALA	GLU	conflict	UNP A0A5C0XNV5
A	386	ALA	ASP	conflict	UNP A0A5C0XNV5
A	387	ALA	THR	conflict	UNP A0A5C0XNV5
A	388	ALA	VAL	conflict	UNP A0A5C0XNV5
A	389	ALA	VAL	conflict	UNP A0A5C0XNV5

*Continued on next page...*

*Continued from previous page...*

Chain	Residue	Modelled	Actual	Comment	Reference
A	390	ALA	PHE	conflict	UNP A0A5C0XNV5
A	392	VAL	THR	conflict	UNP A0A5C0XNV5
A	451	PRO	-	insertion	UNP A0A5C0XNV5
A	?	-	ALA	deletion	UNP A0A5C0XNV5
A	517	LYS	-	expression tag	UNP A0A5C0XNV5
A	518	ALA	-	expression tag	UNP A0A5C0XNV5
A	519	ALA	-	expression tag	UNP A0A5C0XNV5
A	520	ALA	-	expression tag	UNP A0A5C0XNV5
A	521	ALA	-	expression tag	UNP A0A5C0XNV5
A	522	ALA	-	expression tag	UNP A0A5C0XNV5
A	523	ALA	-	expression tag	UNP A0A5C0XNV5
A	524	ALA	-	expression tag	UNP A0A5C0XNV5
A	525	ALA	-	expression tag	UNP A0A5C0XNV5
A	526	ALA	-	expression tag	UNP A0A5C0XNV5
A	527	ALA	-	expression tag	UNP A0A5C0XNV5
A	528	ALA	-	expression tag	UNP A0A5C0XNV5
A	529	ALA	-	expression tag	UNP A0A5C0XNV5
A	530	ALA	-	expression tag	UNP A0A5C0XNV5
A	531	ALA	-	expression tag	UNP A0A5C0XNV5
A	580	ALA	-	expression tag	UNP A0A5C0XNV5
A	581	ALA	-	expression tag	UNP A0A5C0XNV5
A	582	ALA	-	expression tag	UNP A0A5C0XNV5
A	583	ALA	-	expression tag	UNP A0A5C0XNV5
A	584	ALA	-	expression tag	UNP A0A5C0XNV5
A	585	ALA	-	expression tag	UNP A0A5C0XNV5
A	586	ALA	-	expression tag	UNP A0A5C0XNV5
A	587	ALA	-	expression tag	UNP A0A5C0XNV5
A	588	ALA	-	expression tag	UNP A0A5C0XNV5
A	589	ALA	-	expression tag	UNP A0A5C0XNV5
A	590	ALA	-	expression tag	UNP A0A5C0XNV5
A	591	ALA	-	expression tag	UNP A0A5C0XNV5
A	592	ALA	-	expression tag	UNP A0A5C0XNV5
A	593	ALA	-	expression tag	UNP A0A5C0XNV5
A	594	ALA	-	expression tag	UNP A0A5C0XNV5
A	595	ALA	-	expression tag	UNP A0A5C0XNV5
A	596	ALA	-	expression tag	UNP A0A5C0XNV5
A	597	ALA	-	expression tag	UNP A0A5C0XNV5
A	598	ALA	-	expression tag	UNP A0A5C0XNV5
A	599	ALA	-	expression tag	UNP A0A5C0XNV5
A	600	ALA	-	expression tag	UNP A0A5C0XNV5
A	601	ILE	-	expression tag	UNP A0A5C0XNV5
A	602	ASP	-	expression tag	UNP A0A5C0XNV5

*Continued on next page...*

*Continued from previous page...*

Chain	Residue	Modelled	Actual	Comment	Reference
A	603	ALA	-	expression tag	UNP A0A5C0XNV5
A	604	LYS	-	expression tag	UNP A0A5C0XNV5
A	605	TYR	-	expression tag	UNP A0A5C0XNV5
A	606	TYR	-	expression tag	UNP A0A5C0XNV5
A	607	ASN	-	expression tag	UNP A0A5C0XNV5
A	608	SER	-	expression tag	UNP A0A5C0XNV5
A	609	GLU	-	expression tag	UNP A0A5C0XNV5
A	610	LEU	-	expression tag	UNP A0A5C0XNV5
A	611	ALA	-	expression tag	UNP A0A5C0XNV5
A	612	ALA	-	expression tag	UNP A0A5C0XNV5
A	613	ALA	-	expression tag	UNP A0A5C0XNV5
A	614	ALA	-	expression tag	UNP A0A5C0XNV5
A	615	ALA	-	expression tag	UNP A0A5C0XNV5
A	616	ALA	-	expression tag	UNP A0A5C0XNV5
A	617	ALA	-	expression tag	UNP A0A5C0XNV5
A	618	ALA	-	expression tag	UNP A0A5C0XNV5
A	619	ALA	-	expression tag	UNP A0A5C0XNV5
A	620	ALA	-	expression tag	UNP A0A5C0XNV5
A	621	ALA	-	expression tag	UNP A0A5C0XNV5
A	622	ALA	-	expression tag	UNP A0A5C0XNV5
A	623	ALA	-	expression tag	UNP A0A5C0XNV5
A	624	ALA	-	expression tag	UNP A0A5C0XNV5
A	625	ALA	-	expression tag	UNP A0A5C0XNV5
A	626	ALA	-	expression tag	UNP A0A5C0XNV5
A	627	ALA	-	expression tag	UNP A0A5C0XNV5
A	628	ALA	-	expression tag	UNP A0A5C0XNV5
A	629	ALA	-	expression tag	UNP A0A5C0XNV5

- Molecule 2 is a protein called Cas8a.

Mol	Chain	Residues	Atoms					AltConf	Trace
			Total	C	N	O	S		
2	B	333	2662	1730	439	484	9	0	0

There are 6 discrepancies between the modelled and reference sequences:

Chain	Residue	Modelled	Actual	Comment	Reference
B	24	VAL	GLU	conflict	UNP Q8U338
B	64	SER	GLU	conflict	UNP Q8U338
B	110	LEU	VAL	conflict	UNP Q8U338
B	?	-	SER	deletion	UNP Q8U338
B	?	-	LEU	deletion	UNP Q8U338

*Continued on next page...*

*Continued from previous page...*

Chain	Residue	Modelled	Actual	Comment	Reference
B	?	-	GLY	deletion	UNP Q8U338

- Molecule 3 is a protein called Cas11a.

Mol	Chain	Residues	Atoms					AltConf	Trace
3	C	107	Total	C	N	O	S	0	0
			856	550	144	160	2		
3	D	108	Total	C	N	O	S	0	0
			860	552	145	161	2		
3	E	107	Total	C	N	O	S	0	0
			856	550	144	160	2		
3	F	107	Total	C	N	O	S	0	0
			856	550	144	160	2		
3	G	107	Total	C	N	O	S	0	0
			856	550	144	160	2		

- Molecule 4 is a protein called Cas7a.

Mol	Chain	Residues	Atoms					AltConf	Trace
4	H	335	Total	C	N	O	S	0	0
			2597	1655	450	487	5		
4	I	336	Total	C	N	O	S	0	0
			2603	1659	451	488	5		
4	J	336	Total	C	N	O	S	0	0
			2596	1656	448	487	5		
4	K	336	Total	C	N	O	S	0	0
			2597	1656	448	488	5		
4	L	336	Total	C	N	O	S	0	0
			2597	1656	448	488	5		
4	M	321	Total	C	N	O	S	0	0
			2494	1595	431	463	5		
4	N	274	Total	C	N	O	S	0	0
			2134	1370	364	396	4		

- Molecule 5 is a protein called Cas5a.

Mol	Chain	Residues	Atoms					AltConf	Trace
5	O	240	Total	C	N	O	S	0	0
			1936	1266	315	349	6		

There is a discrepancy between the modelled and reference sequences:

Chain	Residue	Modelled	Actual	Comment	Reference
O	?	-	THR	deletion	UNP A0A5C0XNV9

- Molecule 6 is a protein called CRISPR-associated endonuclease Cas3-HD.

Mol	Chain	Residues	Atoms					AltConf	Trace
			Total	C	N	O	S		
6	Q	219	1733	1113	296	311	13	0	0

There are 5 discrepancies between the modelled and reference sequences:

Chain	Residue	Modelled	Actual	Comment	Reference
Q	?	-	LEU	deletion	UNP Q8U336
Q	217	ALA	-	expression tag	UNP Q8U336
Q	218	ALA	-	expression tag	UNP Q8U336
Q	219	ALA	-	expression tag	UNP Q8U336
Q	220	ALA	-	expression tag	UNP Q8U336

- Molecule 7 is a RNA chain called crRNA (44-MER).

Mol	Chain	Residues	Atoms					AltConf	Trace
			Total	C	N	O	P		
7	R	44	890	417	161	269	43	0	0

- Molecule 8 is a DNA chain called Target strand DNA (44-MER).

Mol	Chain	Residues	Atoms					AltConf	Trace
			Total	C	N	O	P		
8	S	44	913	433	173	263	44	0	0

- Molecule 9 is a DNA chain called Non-Target strand DNA (25-MER).

Mol	Chain	Residues	Atoms					AltConf	Trace
			Total	C	N	O	P		
9	T	25	519	247	113	134	25	0	0

- Molecule 10 is NICKEL (II) ION (three-letter code: NI) (formula: Ni) (labeled as "Ligand of Interest" by depositor).

Mol	Chain	Residues	Atoms		AltConf
10	Q	2	Total	Ni	0
			2	2	



### 3 Residue-property plots [i](#)

These plots are drawn for all protein, RNA, DNA and oligosaccharide chains in the entry. The first graphic for a chain summarises the proportions of the various outlier classes displayed in the second graphic. The second graphic shows the sequence view annotated by issues in geometry and atom inclusion in map density. Residues are color-coded according to the number of geometric quality criteria for which they contain at least one outlier: green = 0, yellow = 1, orange = 2 and red = 3 or more. A red diamond above a residue indicates a poor fit to the EM map for this residue (all-atom inclusion < 40%). Stretches of 2 or more consecutive residues without any outlier are shown as a green connector. Residues present in the sample, but not in the model, are shown in grey.

- Molecule 1: CRISPR-associated helicase Cas3

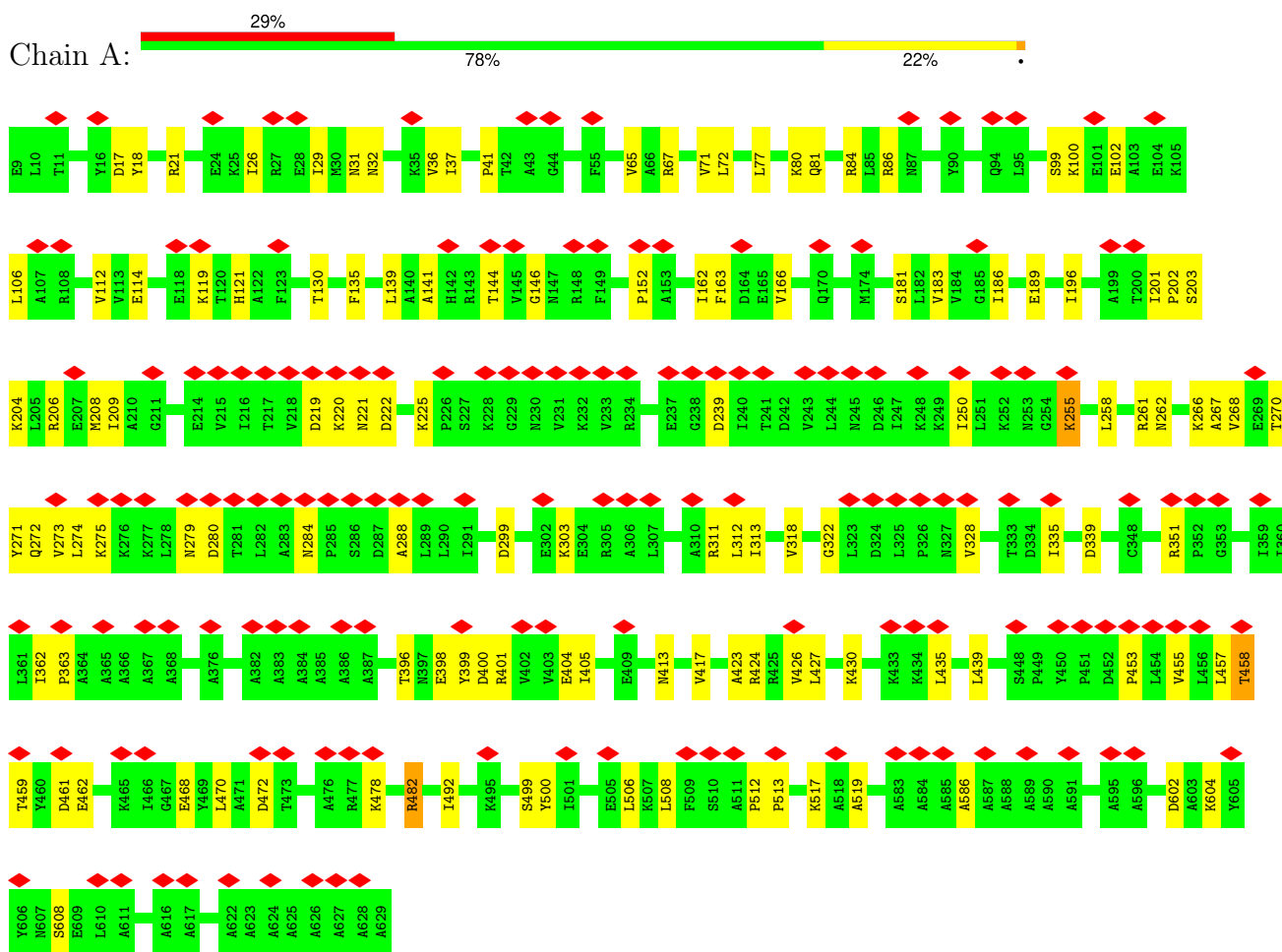

- Molecule 2: Cas8a

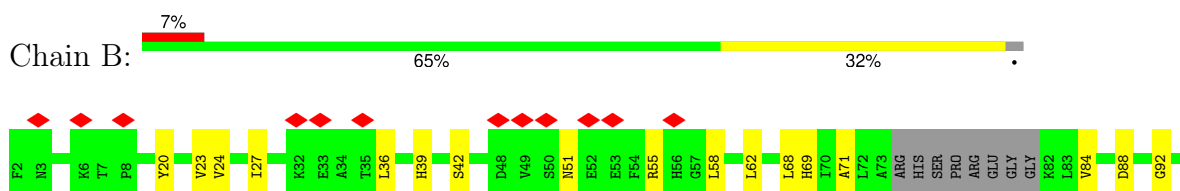



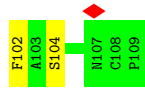

• Molecule 3: Cas11a

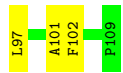

• Molecule 4: Cas7a

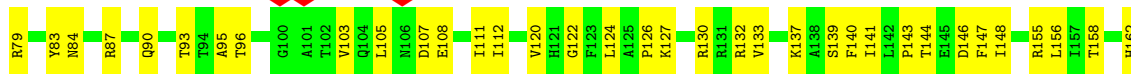
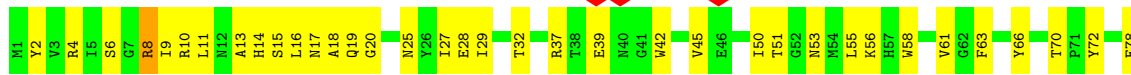

• Molecule 4: Cas7a

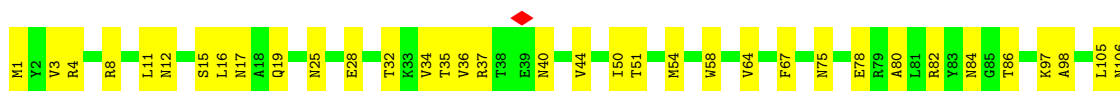

## ● Molecule 4: Cas7a

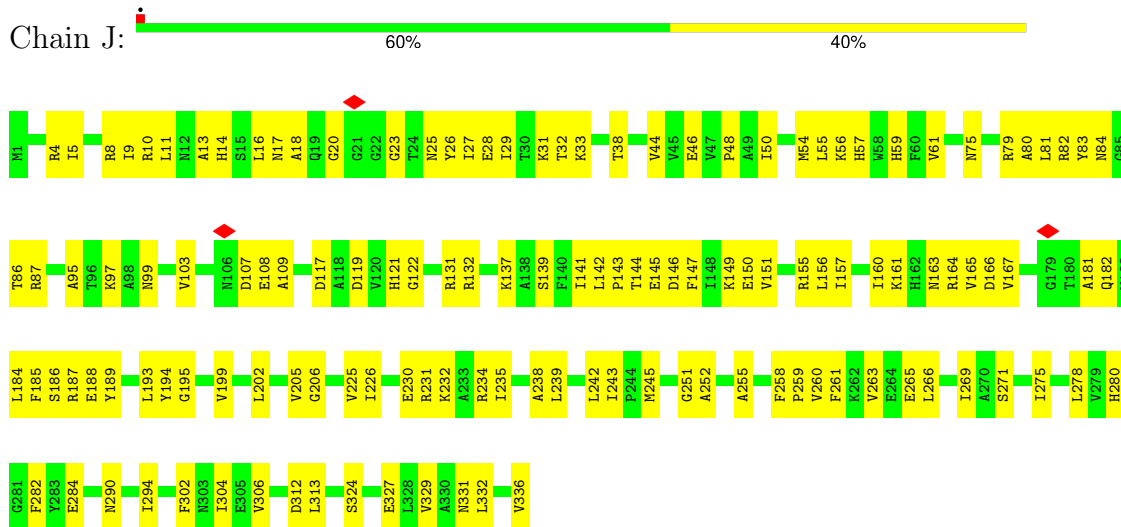

## ● Molecule 4: Cas7a

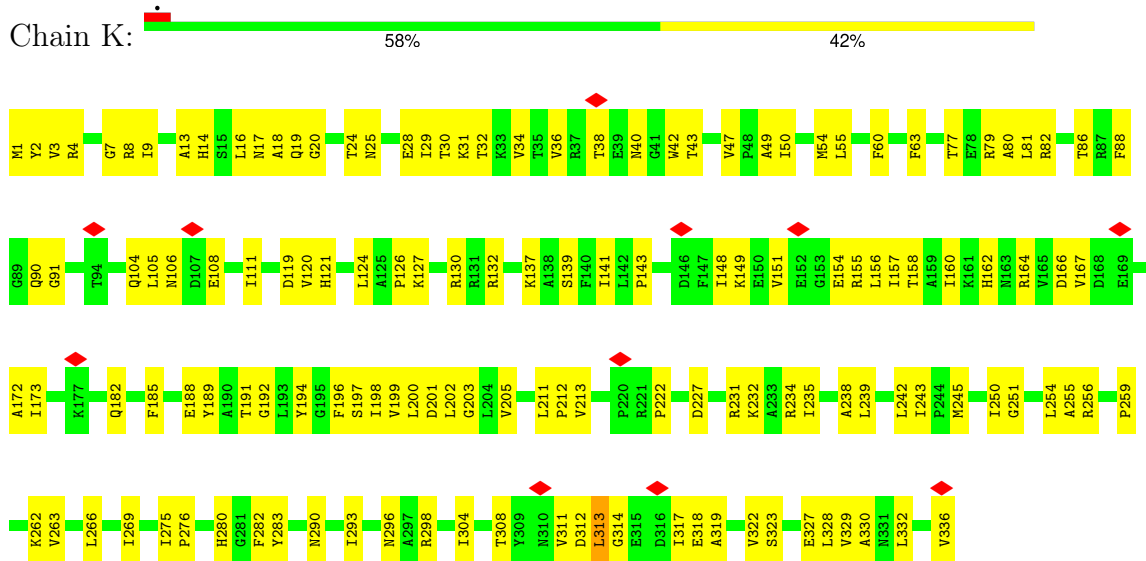

## ● Molecule 4: Cas7a

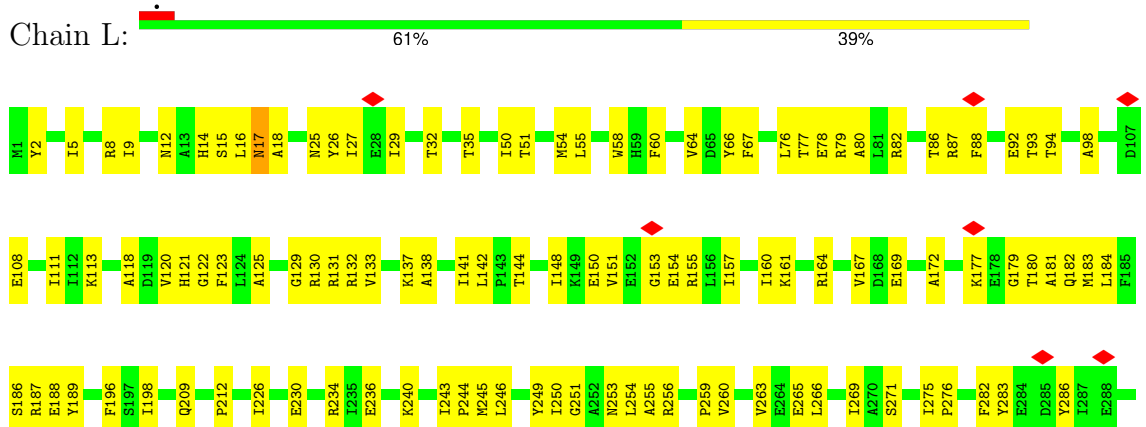

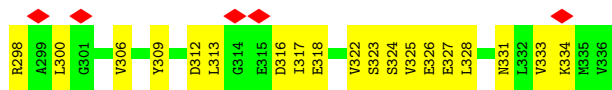

• Molecule 4: Cas7a

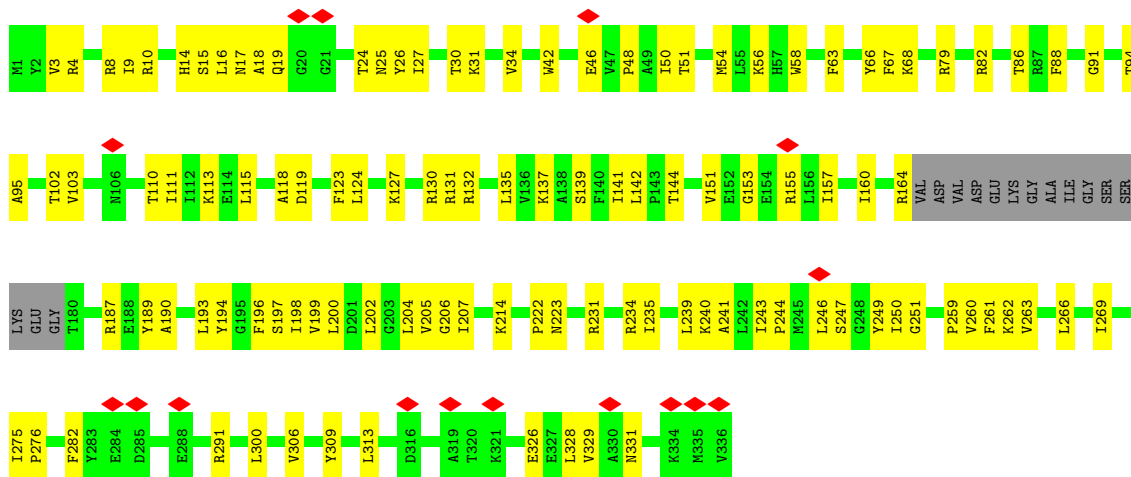

• Molecule 4: Cas7a

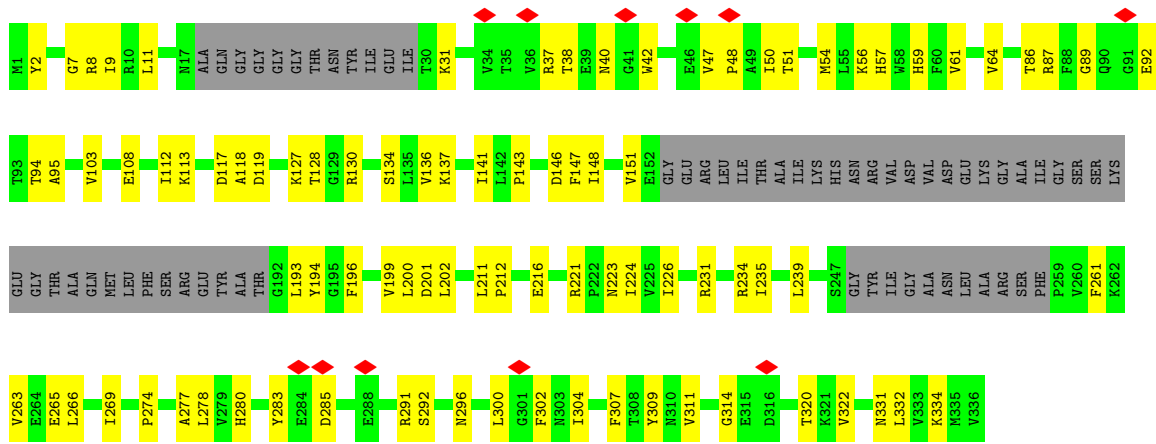

• Molecule 5: Cas5a

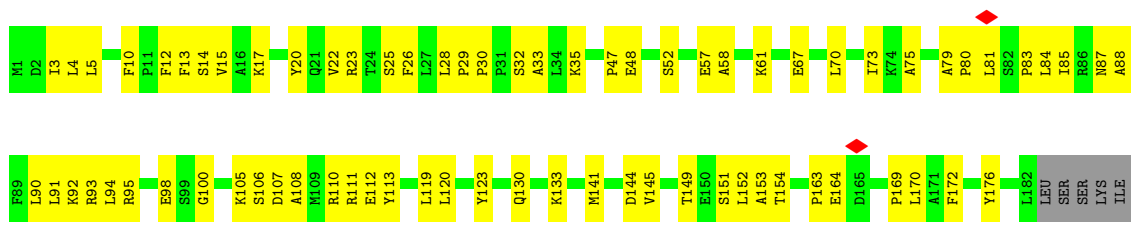



● Molecule 6: CRISPR-associated endonuclease Cas3-HD

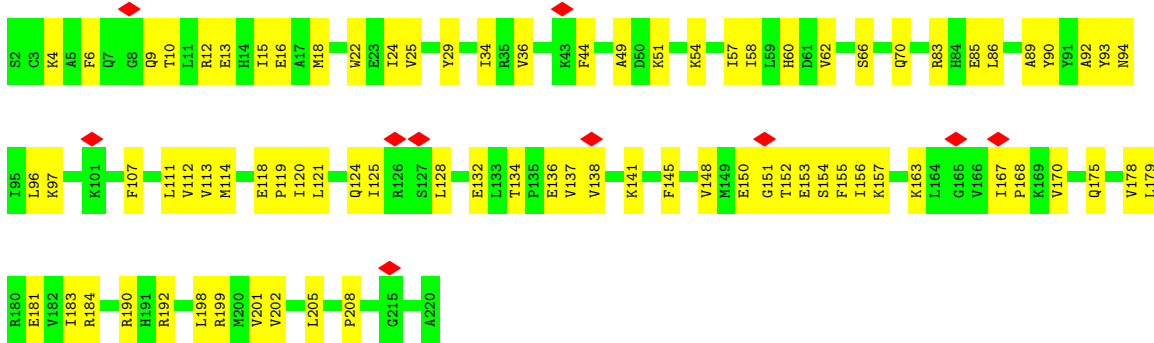

● Molecule 7: crRNA (44-MER)

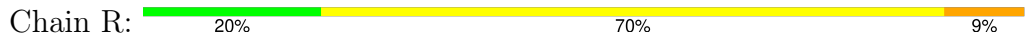

● Molecule 8: Target strand DNA (44-MER)

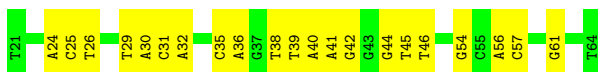
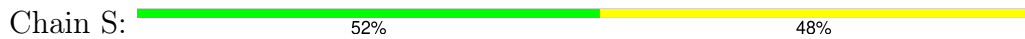

● Molecule 9: Non-Target strand DNA (25-MER)

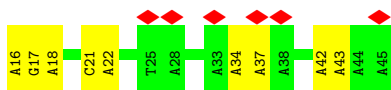

## 4 Experimental information

Property	Value	Source
EM reconstruction method	SINGLE PARTICLE	Depositor
Imposed symmetry	POINT, Not provided	
Number of particles used	44773	Depositor
Resolution determination method	FSC 0.143 CUT-OFF	Depositor
CTF correction method	PHASE FLIPPING AND AMPLITUDE CORRECTION	Depositor
Microscope	TFS TALOS	Depositor
Voltage (kV)	200	Depositor
Electron dose ( $e^-/\text{\AA}^2$ )	50	Depositor
Minimum defocus (nm)	1000	Depositor
Maximum defocus (nm)	2500	Depositor
Magnification	Not provided	
Image detector	GATAN K3 BIOQUANTUM (6k x 4k)	Depositor
Maximum map value	1.033	Depositor
Minimum map value	-0.425	Depositor
Average map value	-0.002	Depositor
Map value standard deviation	0.038	Depositor
Recommended contour level	0.145	Depositor
Map size ( $\text{\AA}$ )	372.0, 372.0, 372.0	wwPDB
Map dimensions	300, 300, 300	wwPDB
Map angles ( $^\circ$ )	90.0, 90.0, 90.0	wwPDB
Pixel spacing ( $\text{\AA}$ )	1.24, 1.24, 1.24	Depositor

## 5 Model quality [i](#)

### 5.1 Standard geometry [i](#)

Bond lengths and bond angles in the following residue types are not validated in this section:  
NI

The Z score for a bond length (or angle) is the number of standard deviations the observed value is removed from the expected value. A bond length (or angle) with  $|Z| > 5$  is considered an outlier worth inspection. RMSZ is the root-mean-square of all Z scores of the bond lengths (or angles).

Mol	Chain	Bond lengths		Bond angles	
		RMSZ	# Z  >5	RMSZ	# Z  >5
1	A	0.25	0/4387	0.51	0/5960
2	B	0.25	0/2723	0.49	0/3684
3	C	0.24	0/876	0.48	0/1188
3	D	0.25	0/880	0.47	0/1193
3	E	0.26	0/876	0.52	0/1188
3	F	0.26	0/876	0.53	0/1188
3	G	0.27	0/876	0.57	0/1188
4	H	0.25	0/2645	0.51	0/3583
4	I	0.25	0/2651	0.53	0/3592
4	J	0.25	0/2644	0.50	0/3584
4	K	0.26	0/2645	0.52	0/3585
4	L	0.25	0/2645	0.52	0/3585
4	M	0.25	0/2541	0.51	0/3445
4	N	0.24	0/2173	0.49	0/2946
5	O	0.25	0/1977	0.53	0/2673
6	Q	0.26	0/1764	0.53	0/2376
7	R	0.34	0/998	0.81	2/1536 (0.1%)
8	S	0.50	0/1026	0.88	0/1584
9	T	0.44	0/584	0.72	0/888
All	All	0.27	0/35787	0.54	2/48966 (0.0%)

Chiral center outliers are detected by calculating the chiral volume of a chiral center and verifying if the center is modelled as a planar moiety or with the opposite hand. A planarity outlier is detected by checking planarity of atoms in a peptide group, atoms in a mainchain group or atoms of a sidechain that are expected to be planar.

Mol	Chain	#Chirality outliers	#Planarity outliers
6	Q	0	1

There are no bond length outliers.



All (2) bond angle outliers are listed below:

Mol	Chain	Res	Type	Atoms	Z	Observed(°)	Ideal(°)
7	R	26	U	O4'-C1'-N1	5.62	112.70	108.20
7	R	14	U	O4'-C1'-N1	5.15	112.32	108.20

There are no chirality outliers.

All (1) planarity outliers are listed below:

Mol	Chain	Res	Type	Group
6	Q	134	THR	Peptide

## 5.2 Too-close contacts [i](#)

In the following table, the Non-H and H(model) columns list the number of non-hydrogen atoms and hydrogen atoms in the chain respectively. The H(added) column lists the number of hydrogen atoms added and optimized by MolProbity. The Clashes column lists the number of clashes within the asymmetric unit, whereas Symm-Clashes lists symmetry-related clashes.

Mol	Chain	Non-H	H(model)	H(added)	Clashes	Symm-Clashes
1	A	4315	0	4428	88	0
2	B	2662	0	2668	91	0
3	C	856	0	860	29	0
3	D	860	0	863	30	0
3	E	856	0	860	26	0
3	F	856	0	860	23	0
3	G	856	0	860	30	0
4	H	2597	0	2628	119	0
4	I	2603	0	2635	102	0
4	J	2596	0	2621	114	0
4	K	2597	0	2624	122	0
4	L	2597	0	2624	110	0
4	M	2494	0	2524	109	0
4	N	2134	0	2168	66	0
5	O	1936	0	2018	77	0
6	Q	1733	0	1801	57	0
7	R	890	0	470	63	0
8	S	913	0	496	27	0
9	T	519	0	282	8	0
10	Q	2	0	0	0	0
All	All	34872	0	34290	1074	0

The all-atom clashscore is defined as the number of clashes found per 1000 atoms (including

hydrogen atoms). The all-atom clashscore for this structure is 16.

The worst 5 of 1074 close contacts within the same asymmetric unit are listed below, sorted by their clash magnitude.

Atom-1	Atom-2	Interatomic distance (Å)	Clash overlap (Å)
4:K:36:VAL:O	4:K:42:TRP:HA	1.68	0.93
4:H:164:ARG:O	4:H:182:GLN:HA	1.68	0.92
3:D:77:LEU:HA	3:D:80:LYS:HE2	1.54	0.88
2:B:219:ILE:HG13	2:B:220:ASN:H	1.38	0.88
4:H:165:VAL:HA	4:H:182:GLN:HG2	1.61	0.82

There are no symmetry-related clashes.

## 5.3 Torsion angles [i](#)

### 5.3.1 Protein backbone [i](#)

In the following table, the Percentiles column shows the percent Ramachandran outliers of the chain as a percentile score with respect to all PDB entries followed by that with respect to all EM entries.

The Analysed column shows the number of residues for which the backbone conformation was analysed, and the total number of residues.

Mol	Chain	Analysed	Favoured	Allowed	Outliers	Percentiles	
1	A	568/572 (99%)	488 (86%)	73 (13%)	7 (1%)	11	38
2	B	329/341 (96%)	301 (92%)	26 (8%)	2 (1%)	22	53
3	C	105/108 (97%)	99 (94%)	6 (6%)	0	100	100
3	D	106/108 (98%)	99 (93%)	7 (7%)	0	100	100
3	E	105/108 (97%)	98 (93%)	7 (7%)	0	100	100
3	F	105/108 (97%)	92 (88%)	13 (12%)	0	100	100
3	G	105/108 (97%)	97 (92%)	8 (8%)	0	100	100
4	H	333/336 (99%)	315 (95%)	18 (5%)	0	100	100
4	I	334/336 (99%)	314 (94%)	19 (6%)	1 (0%)	37	66
4	J	334/336 (99%)	319 (96%)	15 (4%)	0	100	100
4	K	334/336 (99%)	306 (92%)	27 (8%)	1 (0%)	37	66
4	L	334/336 (99%)	310 (93%)	24 (7%)	0	100	100
4	M	317/336 (94%)	292 (92%)	25 (8%)	0	100	100

*Continued on next page...*

Continued from previous page...

Mol	Chain	Analysed	Favoured	Allowed	Outliers	Percentiles	
4	N	266/336 (79%)	254 (96%)	12 (4%)	0	100	100
5	O	234/256 (91%)	214 (92%)	20 (8%)	0	100	100
6	Q	217/219 (99%)	202 (93%)	15 (7%)	0	100	100
All	All	4126/4280 (96%)	3800 (92%)	315 (8%)	11 (0%)	38	66

5 of 11 Ramachandran outliers are listed below:

Mol	Chain	Res	Type
2	B	219	ILE
1	A	492	ILE
4	K	313	LEU
1	A	284	ASN
1	A	458	THR

### 5.3.2 Protein sidechains [i](#)

In the following table, the Percentiles column shows the percent sidechain outliers of the chain as a percentile score with respect to all PDB entries followed by that with respect to all EM entries.

The Analysed column shows the number of residues for which the sidechain conformation was analysed, and the total number of residues.

Mol	Chain	Analysed	Rotameric	Outliers	Percentiles	
1	A	424/427 (99%)	421 (99%)	3 (1%)	81	88
2	B	282/292 (97%)	282 (100%)	0	100	100
3	C	91/91 (100%)	91 (100%)	0	100	100
3	D	91/91 (100%)	91 (100%)	0	100	100
3	E	91/91 (100%)	91 (100%)	0	100	100
3	F	91/91 (100%)	91 (100%)	0	100	100
3	G	91/91 (100%)	90 (99%)	1 (1%)	70	82
4	H	275/277 (99%)	273 (99%)	2 (1%)	81	88
4	I	276/277 (100%)	275 (100%)	1 (0%)	89	93
4	J	274/277 (99%)	274 (100%)	0	100	100
4	K	275/277 (99%)	274 (100%)	1 (0%)	89	93
4	L	275/277 (99%)	273 (99%)	2 (1%)	81	88
4	M	264/277 (95%)	264 (100%)	0	100	100

Continued on next page...

Continued from previous page...

Mol	Chain	Analysed	Rotameric	Outliers	Percentiles	
4	N	230/277 (83%)	230 (100%)	0	100	100
5	O	211/224 (94%)	211 (100%)	0	100	100
6	Q	191/191 (100%)	191 (100%)	0	100	100
All	All	3432/3528 (97%)	3422 (100%)	10 (0%)	90	94

5 of 10 residues with a non-rotameric sidechain are listed below:

Mol	Chain	Res	Type
3	G	67	ARG
4	L	17	ASN
4	L	177	LYS
4	H	8	ARG
4	H	84	ASN

Sometimes sidechains can be flipped to improve hydrogen bonding and reduce clashes. 5 of 13 such sidechains are listed below:

Mol	Chain	Res	Type
4	L	331	ASN
4	M	17	ASN
4	N	331	ASN
4	N	59	HIS
4	N	223	ASN

### 5.3.3 RNA [i](#)

Mol	Chain	Analysed	Backbone Outliers	Pucker Outliers
7	R	7/44 (15%)	2 (28%)	0

All (2) RNA backbone outliers are listed below:

Mol	Chain	Res	Type
7	R	2	U
7	R	4	G

There are no RNA pucker outliers to report.

## 5.4 Non-standard residues in protein, DNA, RNA chains [i](#)

There are no non-standard protein/DNA/RNA residues in this entry.

## 5.5 Carbohydrates [i](#)

There are no oligosaccharides in this entry.

## 5.6 Ligand geometry [i](#)

Of 2 ligands modelled in this entry, 2 are monoatomic - leaving 0 for Mogul analysis.

There are no bond length outliers.

There are no bond angle outliers.

There are no chirality outliers.

There are no torsion outliers.

There are no ring outliers.

No monomer is involved in short contacts.

## 5.7 Other polymers [i](#)

There are no such residues in this entry.

## 5.8 Polymer linkage issues [i](#)

The following chains have linkage breaks:

Mol	Chain	Number of breaks
9	T	4
1	A	1

All chain breaks are listed below:

Model	Chain	Residue-1	Atom-1	Residue-2	Atom-2	Distance (Å)
1	A	531:ALA	C	580:ALA	N	39.61
1	T	34:DA	O3'	37:DA	P	10.51
1	T	25:DT	O3'	28:DA	P	8.77
1	T	40:DA	O3'	42:DA	P	7.92
1	T	44:DA	O3'	45:DA	P	3.28

## 6 Map visualisation [i](#)

This section contains visualisations of the EMDB entry EMD-26084. These allow visual inspection of the internal detail of the map and identification of artifacts.

No raw map or half-maps were deposited for this entry and therefore no images, graphs, etc. pertaining to the raw map can be shown.

### 6.1 Orthogonal projections [i](#)

#### 6.1.1 Primary map

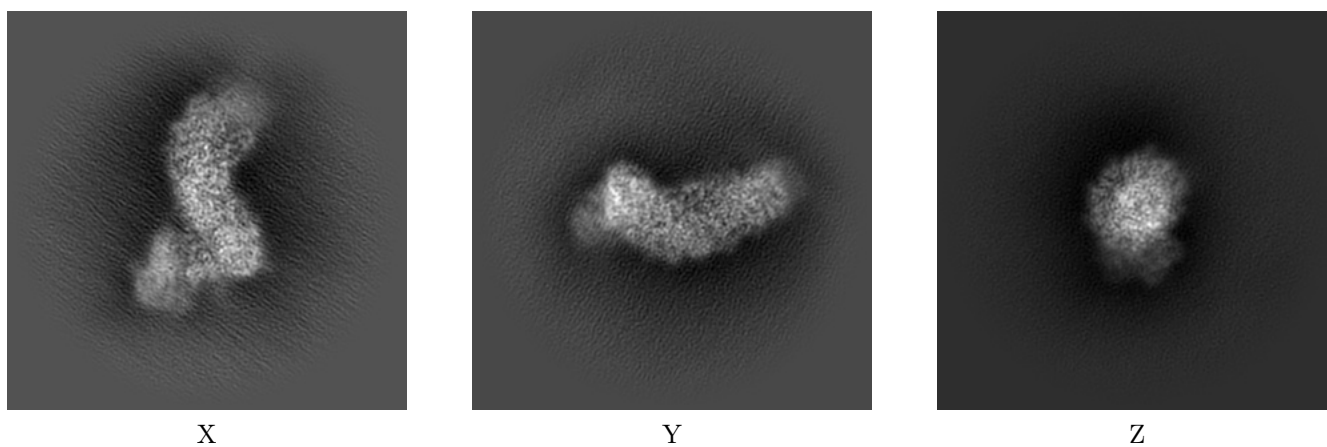

The images above show the map projected in three orthogonal directions.

### 6.2 Central slices [i](#)

#### 6.2.1 Primary map

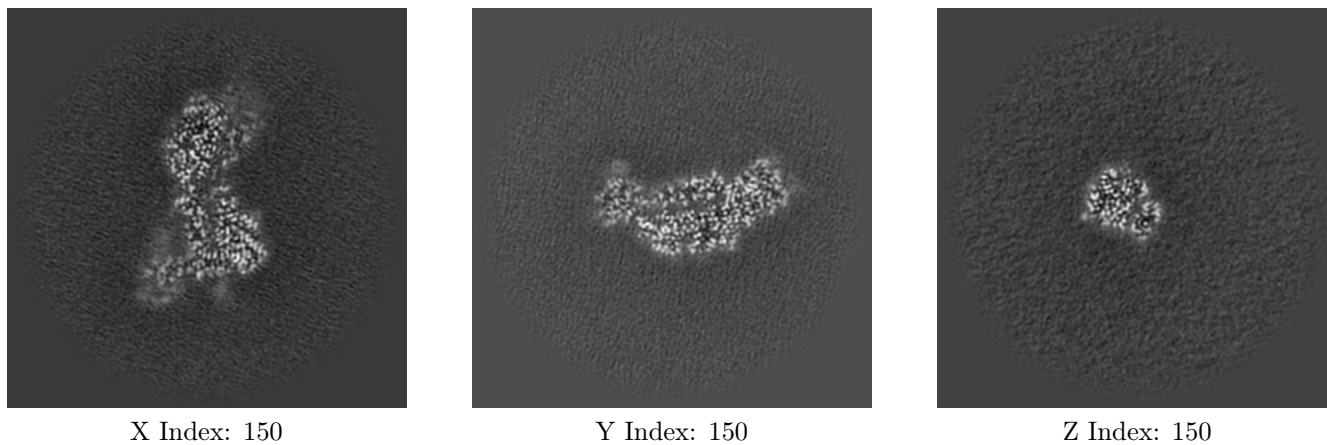

The images above show central slices of the map in three orthogonal directions.

## 6.3 Largest variance slices [i](#)

### 6.3.1 Primary map

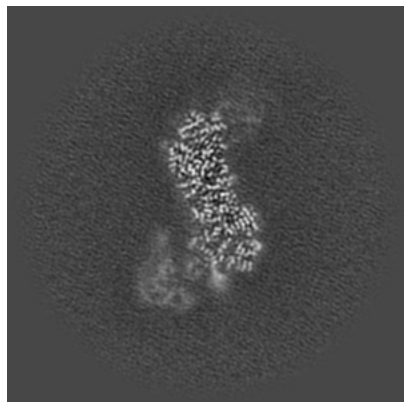

X Index: 142

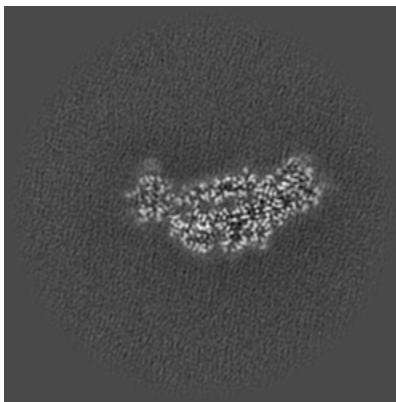

Y Index: 149

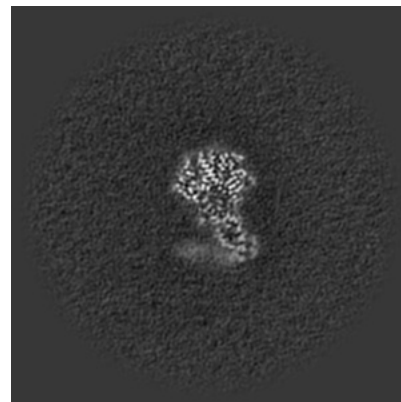

Z Index: 121

The images above show the largest variance slices of the map in three orthogonal directions.

## 6.4 Orthogonal standard-deviation projections (False-color) [i](#)

### 6.4.1 Primary map

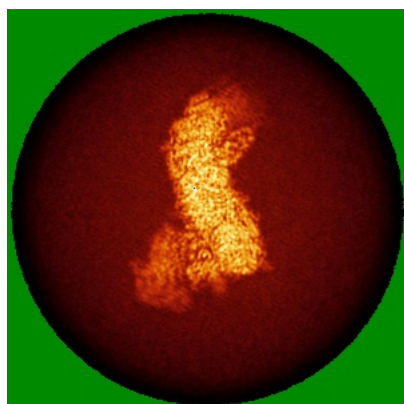

X

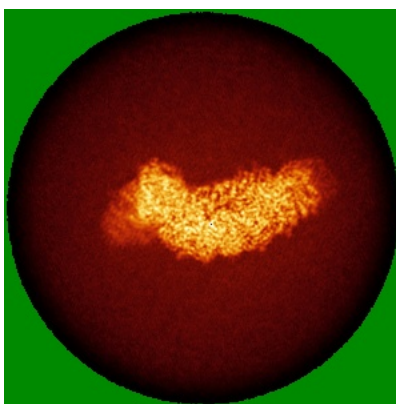

Y

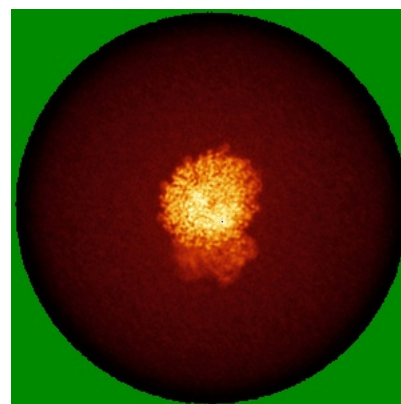

Z

The images above show the map standard deviation projections with false color in three orthogonal directions. Minimum values are shown in green, max in blue, and dark to light orange shades represent small to large values respectively.

## 6.5 Orthogonal surface views [i](#)

### 6.5.1 Primary map

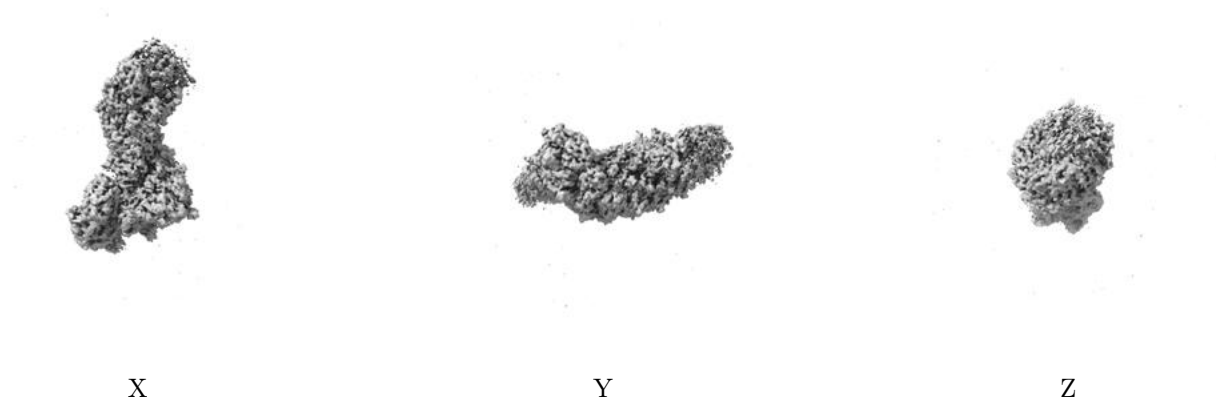

The images above show the 3D surface view of the map at the recommended contour level 0.145. These images, in conjunction with the slice images, may facilitate assessment of whether an appropriate contour level has been provided.

## 6.6 Mask visualisation [i](#)

This section was not generated. No masks/segmentation were deposited.



## 7 Map analysis [i](#)

This section contains the results of statistical analysis of the map.

### 7.1 Map-value distribution [i](#)

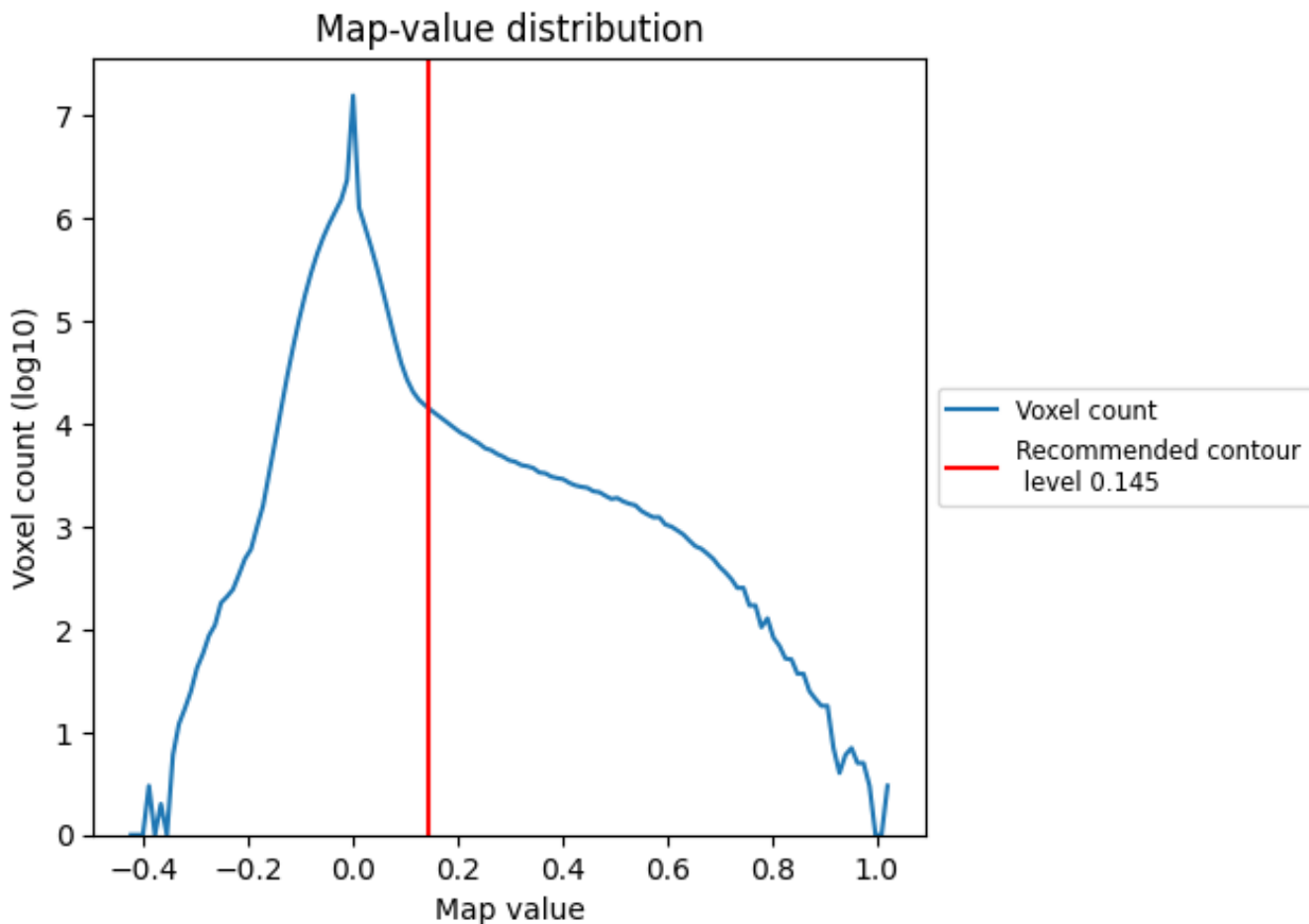

The map-value distribution is plotted in 128 intervals along the x-axis. The y-axis is logarithmic. A spike in this graph at zero usually indicates that the volume has been masked.

## 7.2 Volume estimate [i](#)

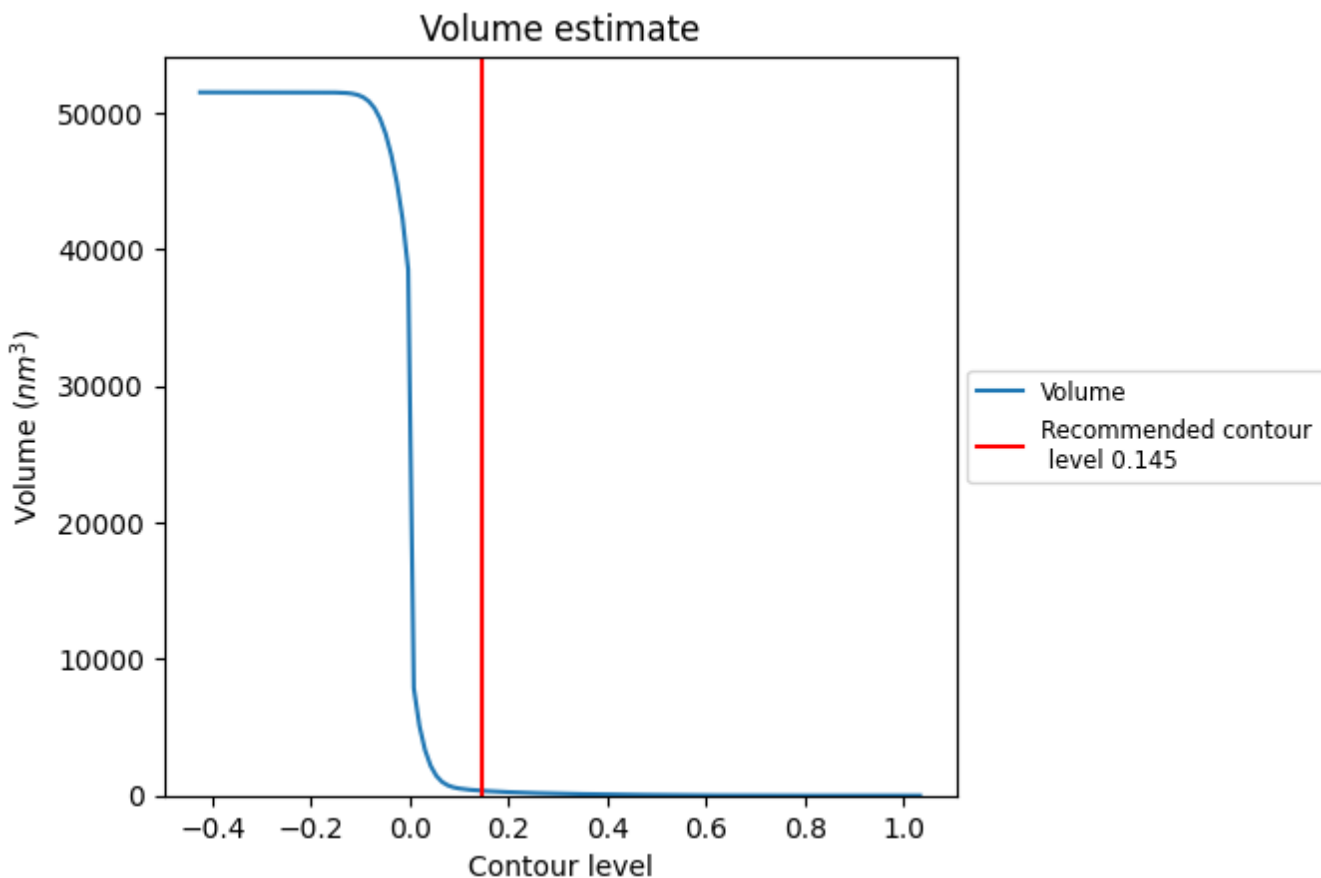

The volume at the recommended contour level is 356 nm<sup>3</sup>; this corresponds to an approximate mass of 322 kDa.

The volume estimate graph shows how the enclosed volume varies with the contour level. The recommended contour level is shown as a vertical line and the intersection between the line and the curve gives the volume of the enclosed surface at the given level.

### 7.3 Rotationally averaged power spectrum i

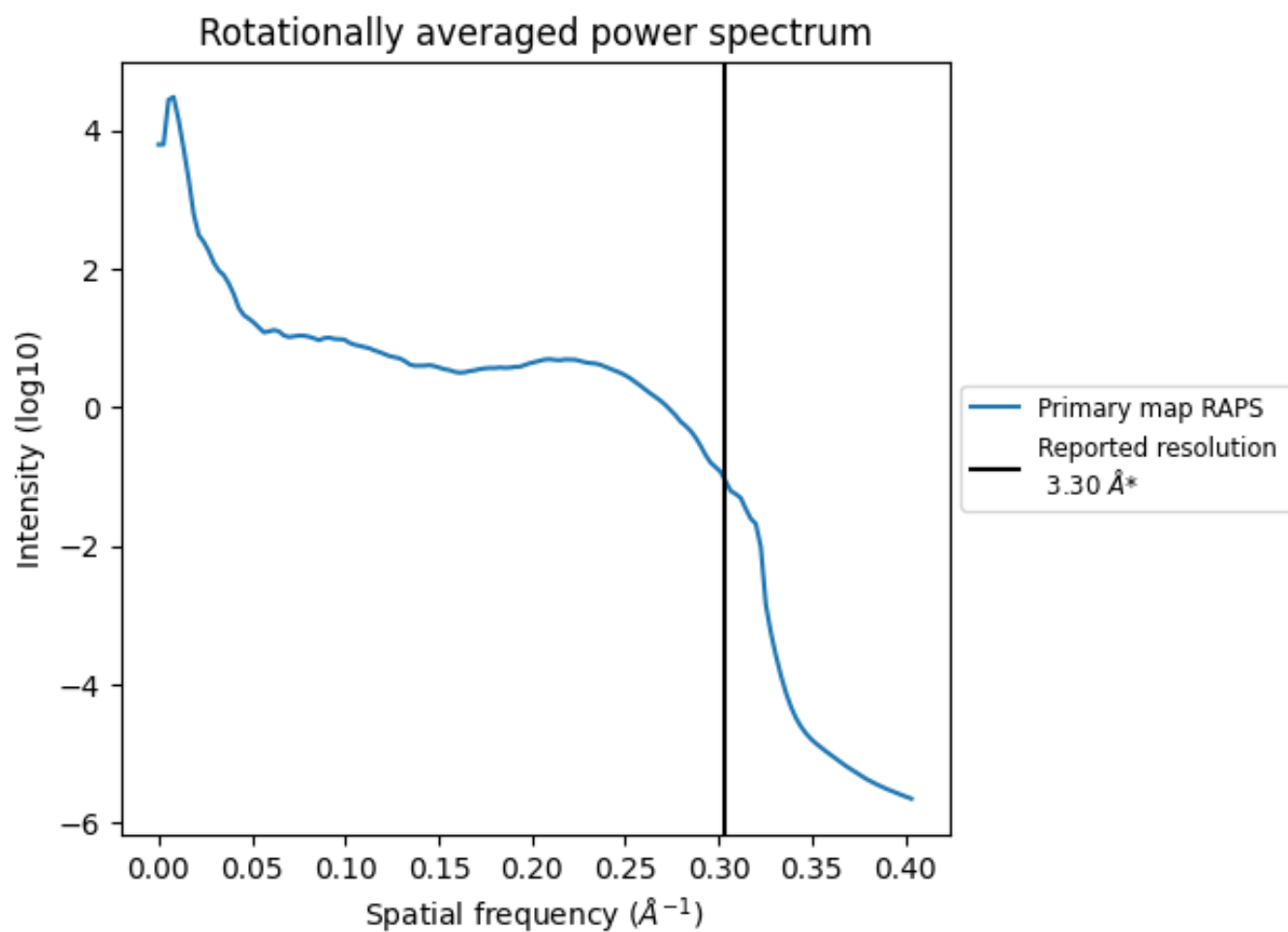

\*Reported resolution corresponds to spatial frequency of 0.303 Å<sup>-1</sup>

## 8 Fourier-Shell correlation

This section was not generated. No FSC curve or half-maps provided.

## 9 Map-model fit [i](#)

This section contains information regarding the fit between EMDB map EMD-26084 and PDB model 7TRA. Per-residue inclusion information can be found in section [3](#) on page [9](#).

### 9.1 Map-model overlay [i](#)

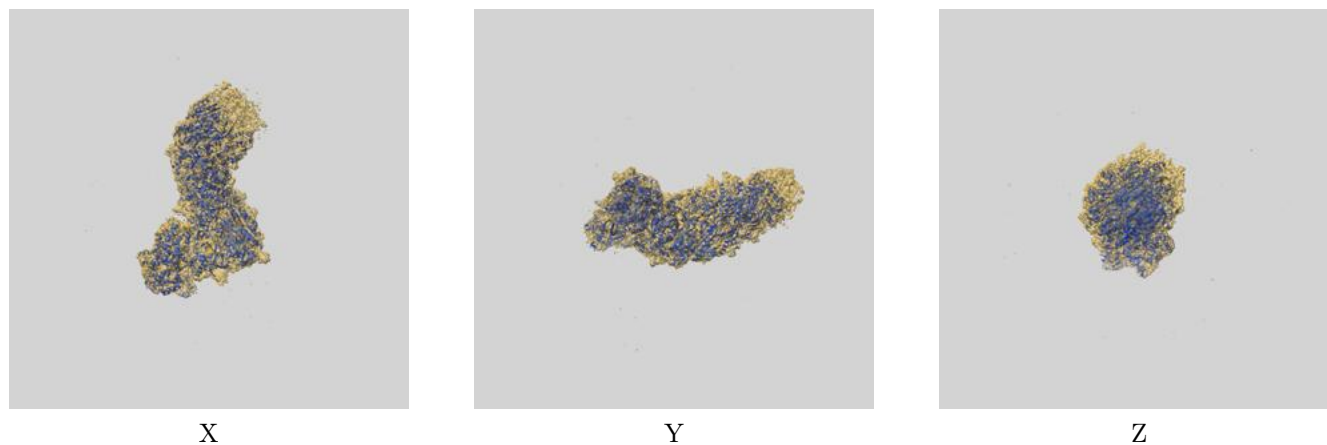

The images above show the 3D surface view of the map at the recommended contour level 0.145 at 50% transparency in yellow overlaid with a ribbon representation of the model coloured in blue. These images allow for the visual assessment of the quality of fit between the atomic model and the map.

## 9.2 Q-score mapped to coordinate model [i](#)

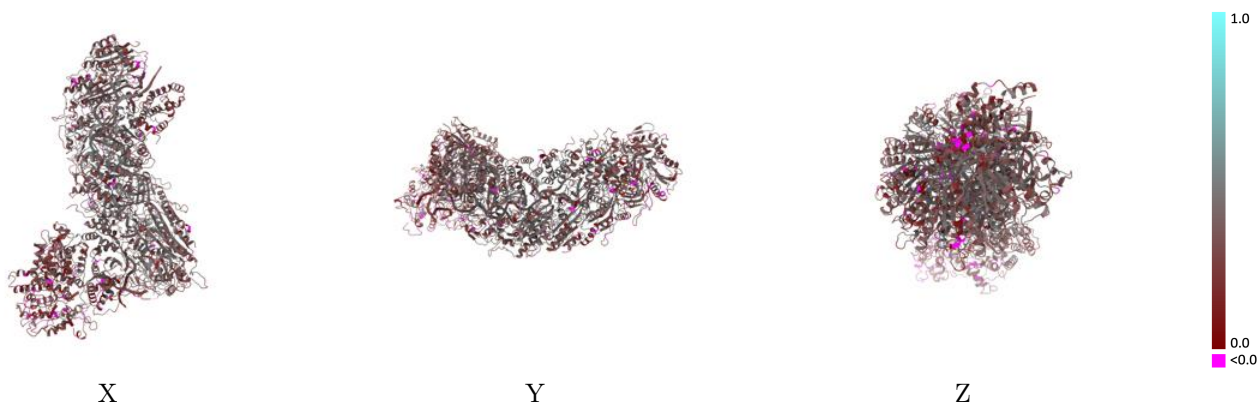

The images above show the model with each residue coloured according to its Q-score. This shows their resolvability in the map with higher Q-score values reflecting better resolvability. Please note: Q-score is calculating the resolvability of atoms, and thus high values are only expected at resolutions at which atoms can be resolved. Low Q-score values may therefore be expected for many entries.

## 9.3 Atom inclusion mapped to coordinate model [i](#)

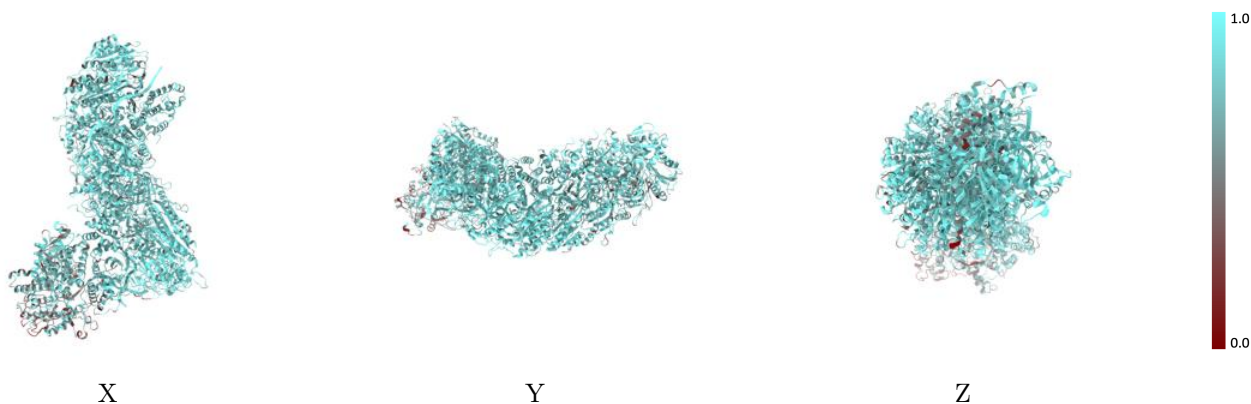

The images above show the model with each residue coloured according to its atom inclusion. This shows to what extent they are inside the map at the recommended contour level (0.145).



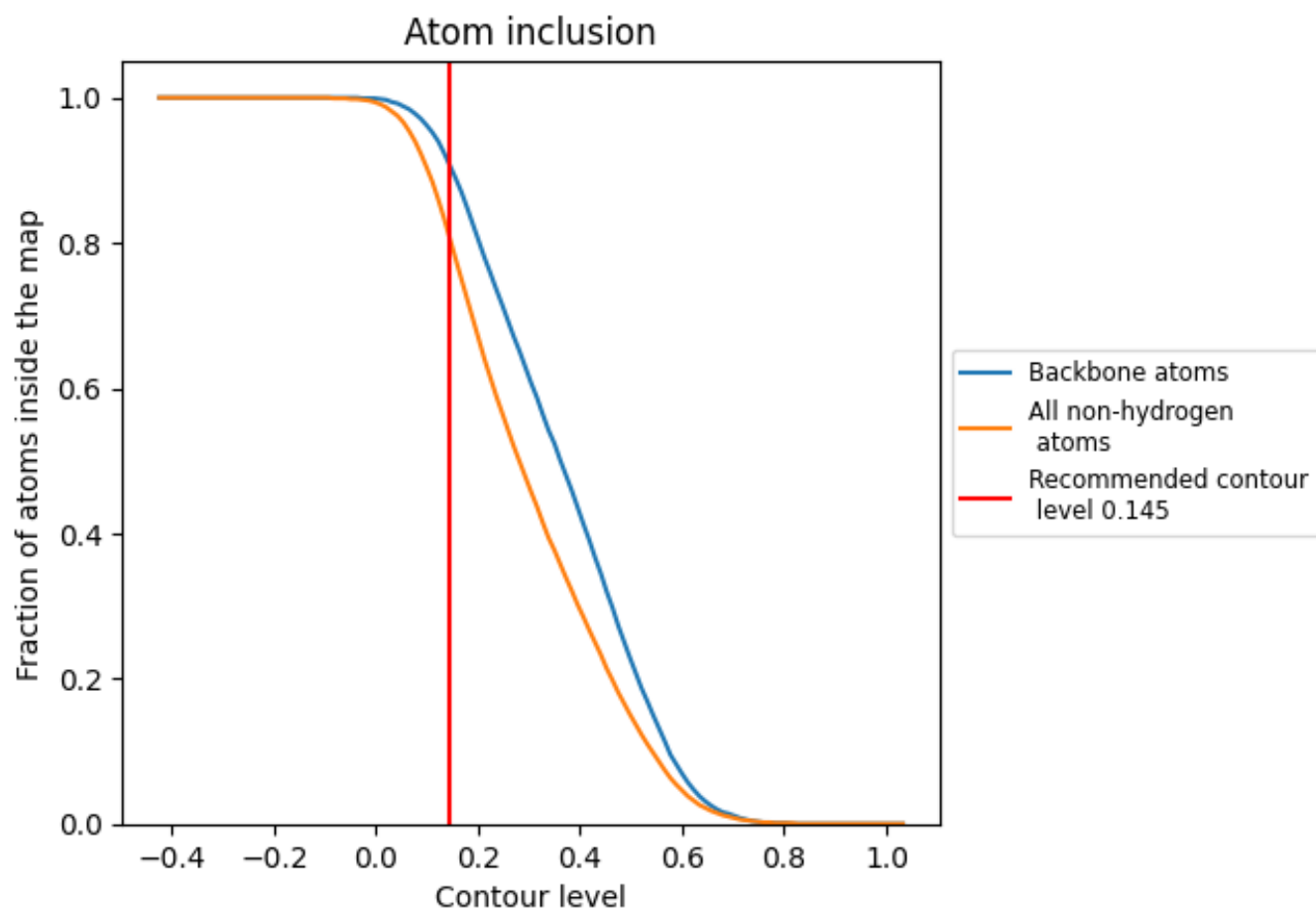





































## 9.4 Atom inclusion [i](#)



At the recommended contour level, 91% of all backbone atoms, 80% of all non-hydrogen atoms, are inside the map.

## 9.5 Map-model fit summary

The table lists the average atom inclusion at the recommended contour level (0.145) and Q-score for the entire model and for each chain.

Chain	Atom inclusion	Q-score
All	 0.8050	 0.3240
A	 0.5930	 0.1970
B	 0.7850	 0.3150
C	 0.8740	 0.3600
D	 0.8740	 0.3510
E	 0.8600	 0.3680
F	 0.8150	 0.3270
G	 0.7300	 0.2690
H	 0.8470	 0.3420
I	 0.8720	 0.3560
J	 0.8880	 0.3870
K	 0.8510	 0.3510
L	 0.8260	 0.3480
M	 0.8040	 0.3310
N	 0.8050	 0.3240
O	 0.8440	 0.3480
Q	 0.7680	 0.2980
R	 0.9610	 0.4340
S	 0.9470	 0.3850
T	 0.6220	 0.1960

