



Full wwPDB X-ray Structure Validation Report ⓘ

Sep 24, 2023 – 08:54 AM EDT

PDB ID : 5TXV
Title : HslU P21 cell with 4 hexamers
Authors : Grant, R.A.; Chen, J.; Glynn, S.E.; Sauer, R.T.
Deposited on : 2016-11-17
Resolution : 7.09 Å(reported)

This is a Full wwPDB X-ray Structure Validation Report for a publicly released PDB entry.

We welcome your comments at validation@mail.wwpdb.org

A user guide is available at

<https://www.wwpdb.org/validation/2017/XrayValidationReportHelp>

with specific help available everywhere you see the ⓘ symbol.

The types of validation reports are described at

<http://www.wwpdb.org/validation/2017/FAQs#types>.

The following versions of software and data (see [references ⓘ](#)) were used in the production of this report:

MolProbity : 4.02b-467
Mogul : 1.8.5 (274361), CSD as541be (2020)
Xtriage (Phenix) : 1.13
EDS : 2.35.1
buster-report : 1.1.7 (2018)
Percentile statistics : 20191225.v01 (using entries in the PDB archive December 25th 2019)
Refmac : 5.8.0158
CCP4 : 7.0.044 (Gargrove)
Ideal geometry (proteins) : Engh & Huber (2001)
Ideal geometry (DNA, RNA) : Parkinson et al. (1996)
Validation Pipeline (wwPDB-VP) : 2.35.1

1 Overall quality at a glance

The following experimental techniques were used to determine the structure:

X-RAY DIFFRACTION

The reported resolution of this entry is 7.09 Å.

Percentile scores (ranging between 0-100) for global validation metrics of the entry are shown in the following graphic. The table shows the number of entries on which the scores are based.

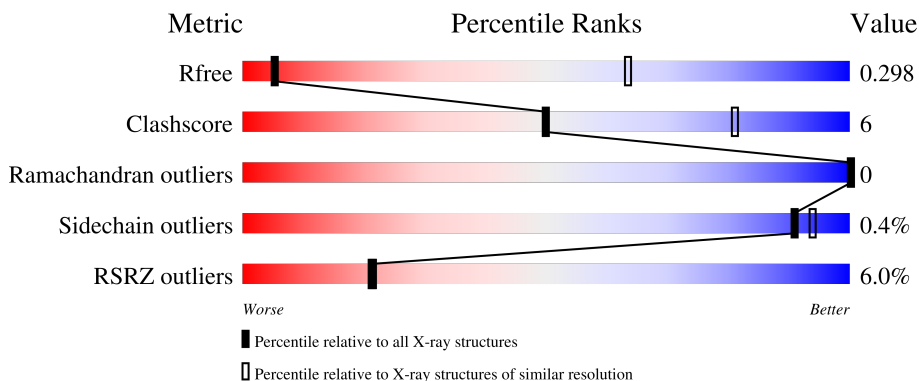











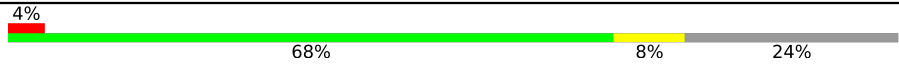

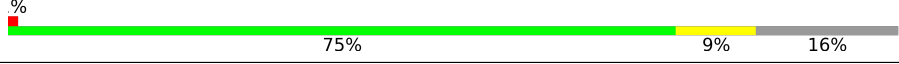
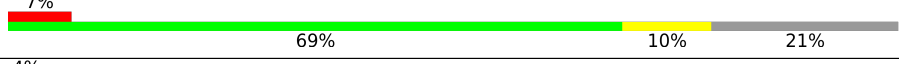
Metric	Whole archive (#Entries)	Similar resolution (#Entries, resolution range(Å))
R_{free}	130704	1004 (10.00-3.90)
Clashscore	141614	1069 (10.00-3.90)
Ramachandran outliers	138981	1002 (10.00-3.90)
Sidechain outliers	138945	1002 (10.00-3.86)
RSRZ outliers	127900	1004 (9.50-3.80)

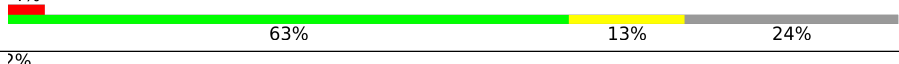
The table below summarises the geometric issues observed across the polymeric chains and their fit to the electron density. The red, orange, yellow and green segments of the lower bar indicate the fraction of residues that contain outliers for ≥ 3 , 2, 1 and 0 types of geometric quality criteria respectively. A grey segment represents the fraction of residues that are not modelled. The numeric value for each fraction is indicated below the corresponding segment, with a dot representing fractions $\leq 5\%$. The upper red bar (where present) indicates the fraction of residues that have poor fit to the electron density. The numeric value is given above the bar.

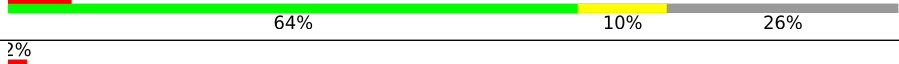
Mol	Chain	Length	Quality of chain
1	A	442	 5% 68% 7% 25%
1	B	442	 5% 65% 11% 24%
1	C	442	 3% 71% 12% 17%
1	D	442	 6% 65% 11% 25%
1	E	442	 3% 69% 12% 19%

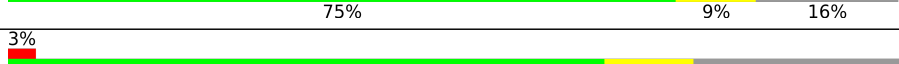
Continued on next page...

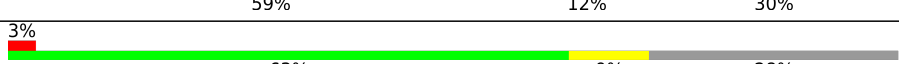
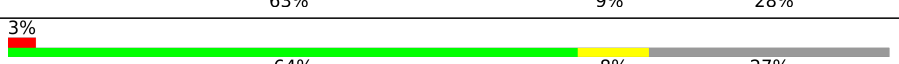
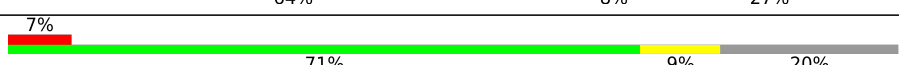
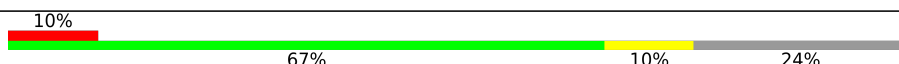
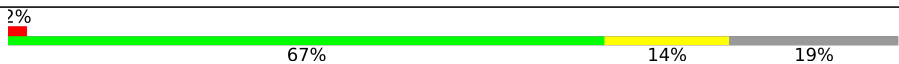
Continued from previous page...

Mol	Chain	Length	Quality of chain
1	F	442	
1	G	442	
1	H	442	
1	I	442	
1	J	442	
1	K	442	
1	L	442	
1	M	442	
1	N	442	
1	O	442	
1	P	442	
1	Q	442	
1	R	442	
1	S	442	
1	T	442	
1	U	442	
1	V	442	
1	W	442	
1	X	442	

The following table lists non-polymeric compounds, carbohydrate monomers and non-standard residues in protein, DNA, RNA chains that are outliers for geometric or electron-density-fit criteria:

Mol	Type	Chain	Res	Chirality	Geometry	Clashes	Electron density
2	ADP	B	501	-	-	-	X
2	ADP	C	501	-	-	-	X
2	ADP	D	501	-	-	-	X
2	ADP	H	501	-	-	-	X
2	ADP	I	501	-	-	-	X

Continued on next page...

Continued from previous page...

Mol	Type	Chain	Res	Chirality	Geometry	Clashes	Electron density
2	ADP	J	501	-	-	-	X
2	ADP	K	501	-	-	-	X
2	ADP	L	501	-	-	-	X
2	ADP	O	501	-	-	-	X
2	ADP	R	501	-	-	-	X
2	ADP	T	501	-	-	-	X

2 Entry composition

There are 2 unique types of molecules in this entry. The entry contains 64889 atoms, of which 0 are hydrogens and 0 are deuteriums.

In the tables below, the ZeroOcc column contains the number of atoms modelled with zero occupancy, the AltConf column contains the number of residues with at least one atom in alternate conformation and the Trace column contains the number of residues modelled with at most 2 atoms.

- Molecule 1 is a protein called ATP-dependent protease ATPase subunit HslU.

Mol	Chain	Residues	Atoms					ZeroOcc	AltConf	Trace
1	A	330	Total	C	N	O	S	0	0	0
			2586	1615	456	506	9			
1	B	337	Total	C	N	O	S	0	0	0
			2638	1650	466	513	9			
1	C	366	Total	C	N	O	S	0	0	0
			2867	1792	509	556	10			
1	D	333	Total	C	N	O	S	0	0	0
			2609	1629	460	511	9			
1	E	359	Total	C	N	O	S	0	0	0
			2817	1764	501	542	10			
1	F	338	Total	C	N	O	S	0	0	0
			2654	1657	467	520	10			
1	G	327	Total	C	N	O	S	0	0	0
			2568	1606	454	498	10			
1	H	371	Total	C	N	O	S	0	0	0
			2915	1825	517	563	10			
1	I	348	Total	C	N	O	S	0	0	0
			2743	1712	490	531	10			
1	J	332	Total	C	N	O	S	0	0	0
			2608	1633	458	507	10			
1	K	337	Total	C	N	O	S	0	0	0
			2646	1651	467	519	9			
1	L	371	Total	C	N	O	S	0	0	0
			2915	1822	517	566	10			
1	M	342	Total	C	N	O	S	0	0	0
			2695	1687	481	519	8			
1	N	328	Total	C	N	O	S	0	0	0
			2581	1614	456	502	9			
1	O	348	Total	C	N	O	S	0	0	0
			2742	1715	489	529	9			
1	P	305	Total	C	N	O	S	0	0	0
			2387	1491	422	465	9			

Continued on next page...

Continued from previous page...

Mol	Chain	Residues	Atoms					ZeroOcc	AltConf	Trace
1	Q	370	Total	C	N	O	S	0	0	0
			2906	1819	516	561	10			
1	R	338	Total	C	N	O	S	0	0	0
			2667	1664	479	515	9			
1	S	310	Total	C	N	O	S	0	0	0
			2436	1522	434	471	9			
1	T	318	Total	C	N	O	S	0	0	0
			2503	1564	444	487	8			
1	U	321	Total	C	N	O	S	0	0	0
			2511	1568	447	487	9			
1	V	352	Total	C	N	O	S	0	0	0
			2768	1730	493	535	10			
1	W	336	Total	C	N	O	S	0	0	0
			2637	1649	465	514	9			
1	X	360	Total	C	N	O	S	0	0	0
			2842	1779	504	549	10			

- Molecule 2 is ADENOSINE-5'-DIPHOSPHATE (three-letter code: ADP) (formula: $C_{10}H_{15}N_5O_{10}P_2$).

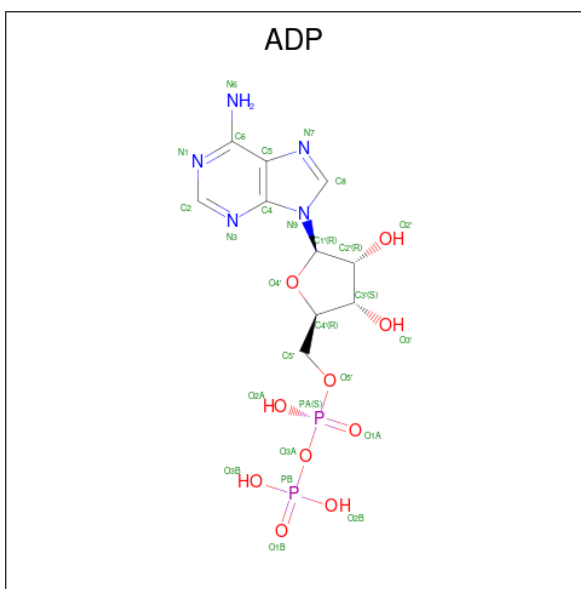

Mol	Chain	Residues	Atoms					ZeroOcc	AltConf
2	A	1	Total	C	N	O	P	0	0
			27	10	5	10	2		
2	B	1	Total	C	N	O	P	0	0
			27	10	5	10	2		
2	C	1	Total	C	N	O	P	0	0
			27	10	5	10	2		

Continued on next page...

Continued from previous page...

Mol	Chain	Residues	Atoms					ZeroOcc	AltConf
2	D	1	Total	C	N	O	P	0	0
			27	10	5	10	2		
2	E	1	Total	C	N	O	P	0	0
			27	10	5	10	2		
2	F	1	Total	C	N	O	P	0	0
			27	10	5	10	2		
2	G	1	Total	C	N	O	P	0	0
			27	10	5	10	2		
2	H	1	Total	C	N	O	P	0	0
			27	10	5	10	2		
2	I	1	Total	C	N	O	P	0	0
			27	10	5	10	2		
2	J	1	Total	C	N	O	P	0	0
			27	10	5	10	2		
2	K	1	Total	C	N	O	P	0	0
			27	10	5	10	2		
2	L	1	Total	C	N	O	P	0	0
			27	10	5	10	2		
2	M	1	Total	C	N	O	P	0	0
			27	10	5	10	2		
2	N	1	Total	C	N	O	P	0	0
			27	10	5	10	2		
2	O	1	Total	C	N	O	P	0	0
			27	10	5	10	2		
2	P	1	Total	C	N	O	P	0	0
			27	10	5	10	2		
2	Q	1	Total	C	N	O	P	0	0
			27	10	5	10	2		
2	R	1	Total	C	N	O	P	0	0
			27	10	5	10	2		
2	S	1	Total	C	N	O	P	0	0
			27	10	5	10	2		
2	T	1	Total	C	N	O	P	0	0
			27	10	5	10	2		
2	U	1	Total	C	N	O	P	0	0
			27	10	5	10	2		
2	V	1	Total	C	N	O	P	0	0
			27	10	5	10	2		
2	W	1	Total	C	N	O	P	0	0
			27	10	5	10	2		
2	X	1	Total	C	N	O	P	0	0
			27	10	5	10	2		

3 Residue-property plots [i](#)

These plots are drawn for all protein, RNA, DNA and oligosaccharide chains in the entry. The first graphic for a chain summarises the proportions of the various outlier classes displayed in the second graphic. The second graphic shows the sequence view annotated by issues in geometry and electron density. Residues are color-coded according to the number of geometric quality criteria for which they contain at least one outlier: green = 0, yellow = 1, orange = 2 and red = 3 or more. A red dot above a residue indicates a poor fit to the electron density ($RSRZ > 2$). Stretches of 2 or more consecutive residues without any outlier are shown as a green connector. Residues present in the sample, but not in the model, are shown in grey.

- Molecule 1: ATP-dependent protease ATPase subunit HslU

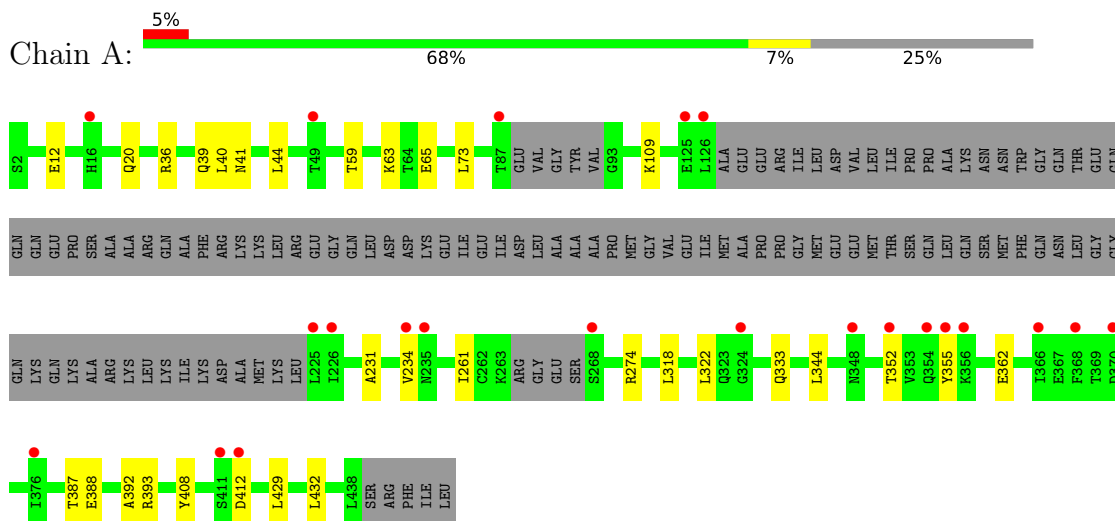

- Molecule 1: ATP-dependent protease ATPase subunit HslU

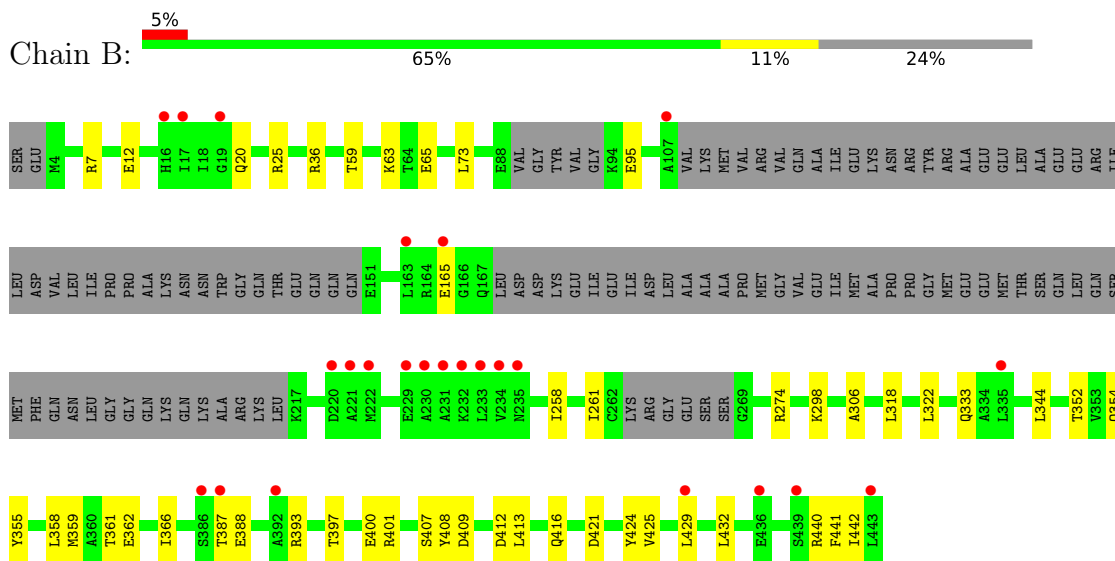

- Molecule 1: ATP-dependent protease ATPase subunit HslU



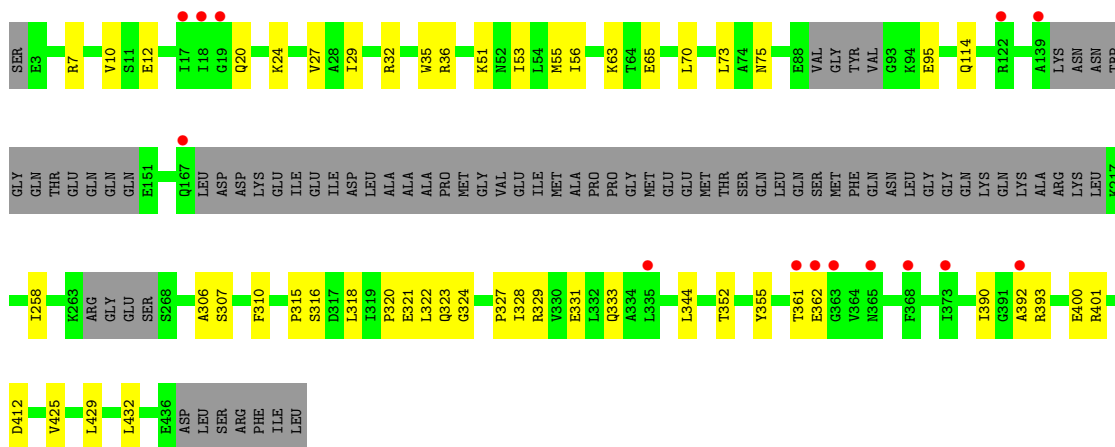

- Molecule 1: ATP-dependent protease ATPase subunit HslU

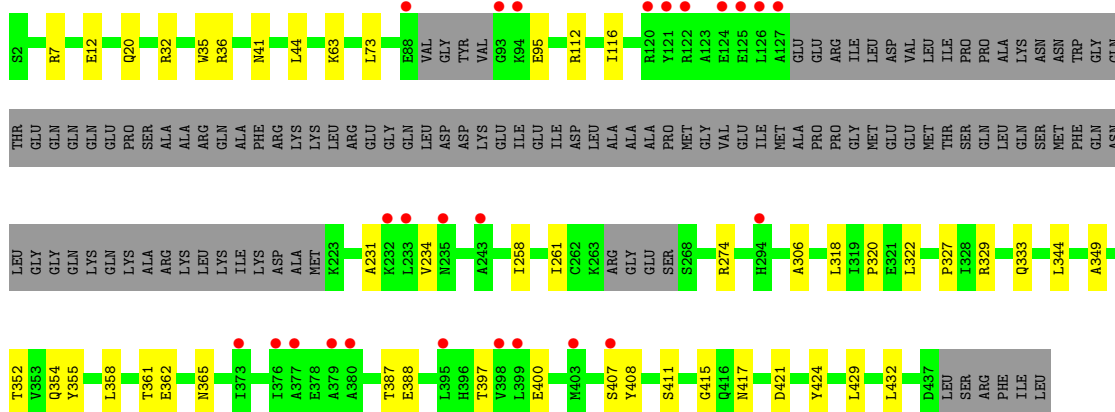

- Molecule 1: ATP-dependent protease ATPase subunit HslU

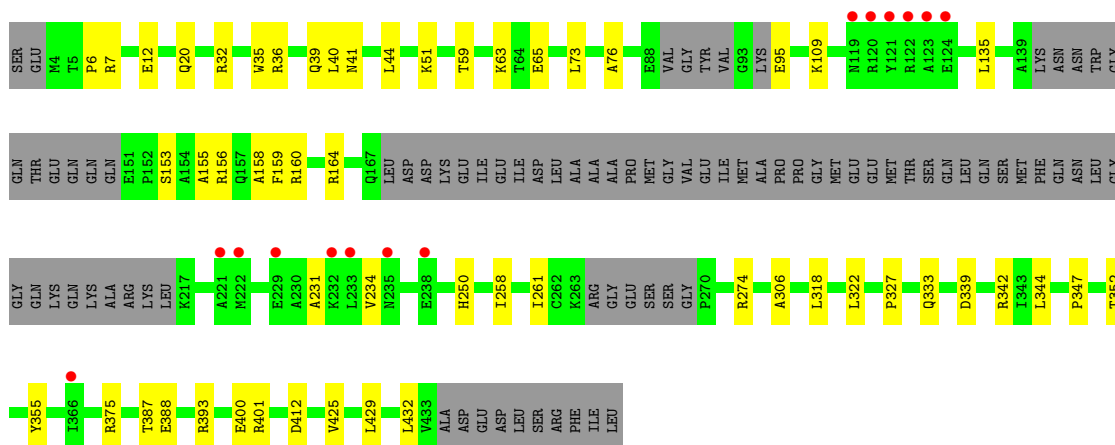

- Molecule 1: ATP-dependent protease ATPase subunit HslU

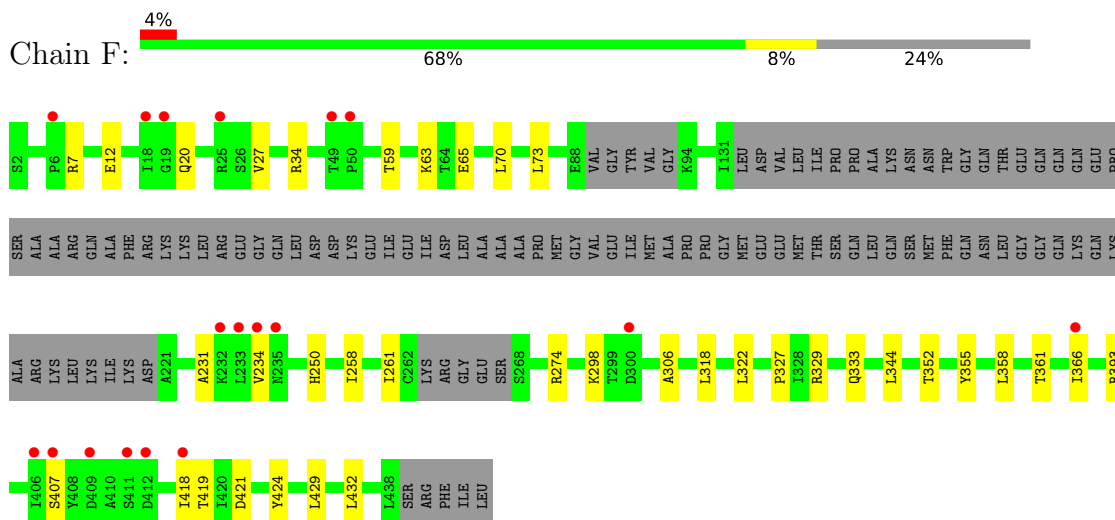

- Molecule 1: ATP-dependent protease ATPase subunit HslU

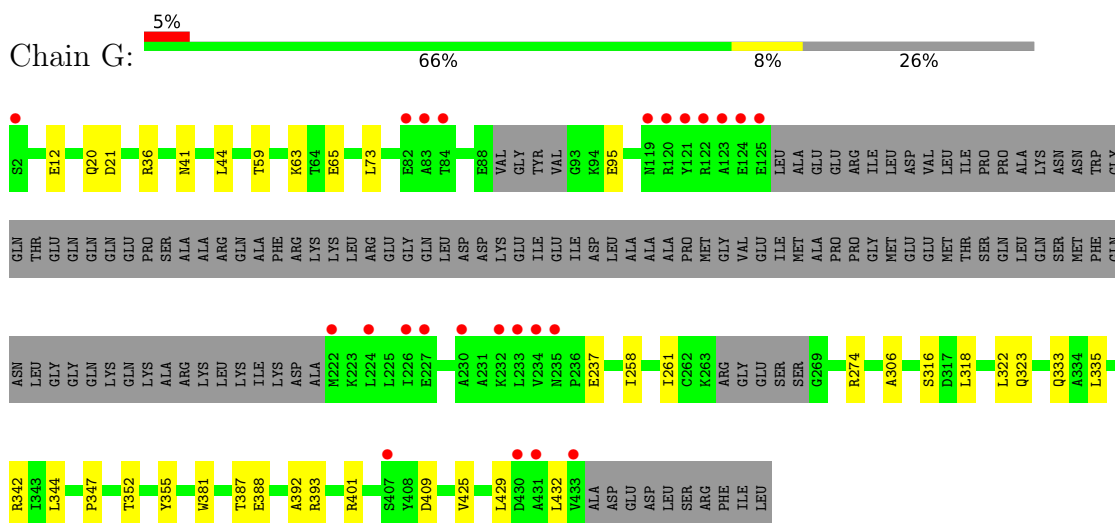

- Molecule 1: ATP-dependent protease ATPase subunit HslU

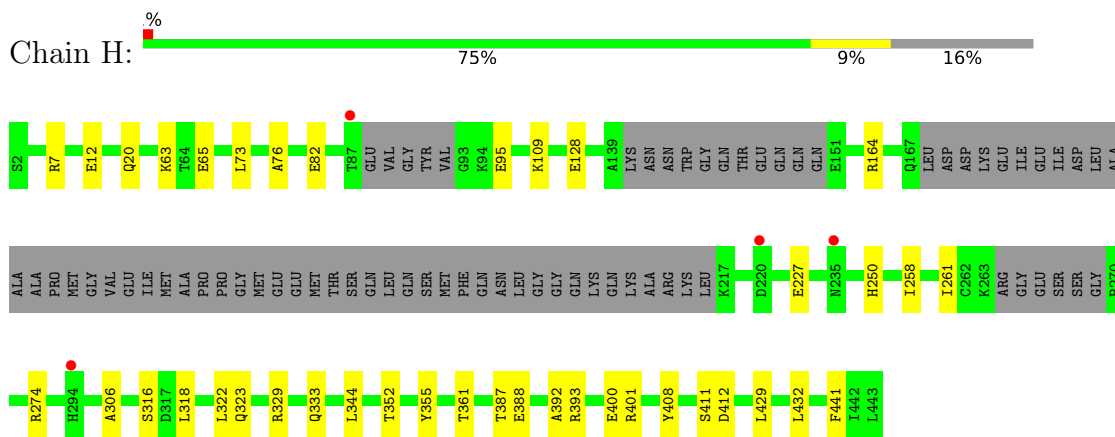

- Molecule 1: ATP-dependent protease ATPase subunit HslU



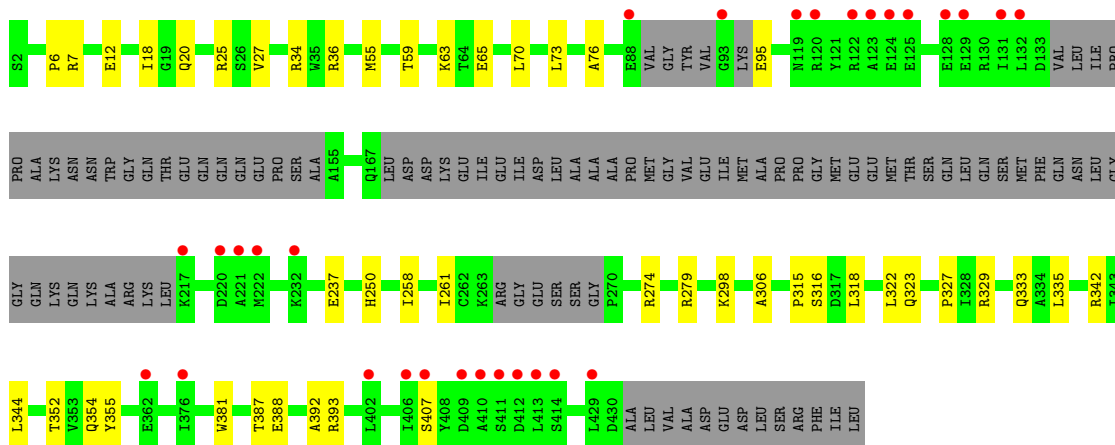

• Molecule 1: ATP-dependent protease ATPase subunit HslU

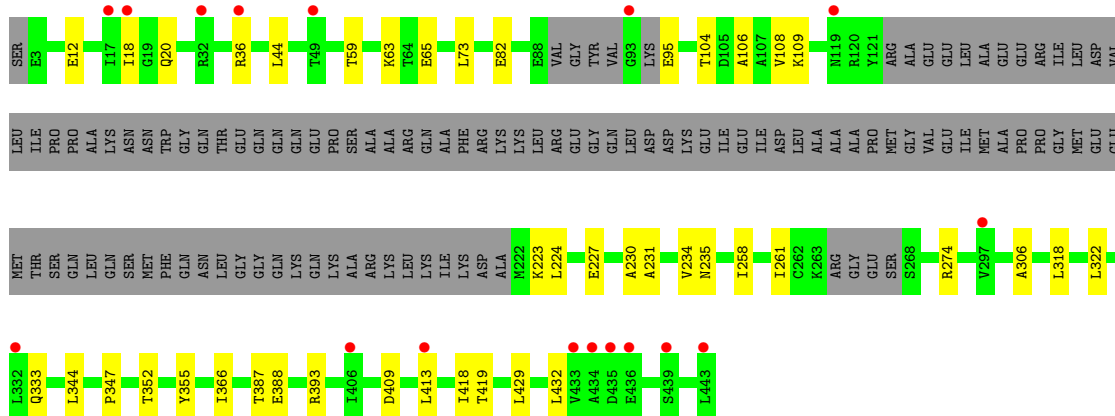

• Molecule 1: ATP-dependent protease ATPase subunit HslU

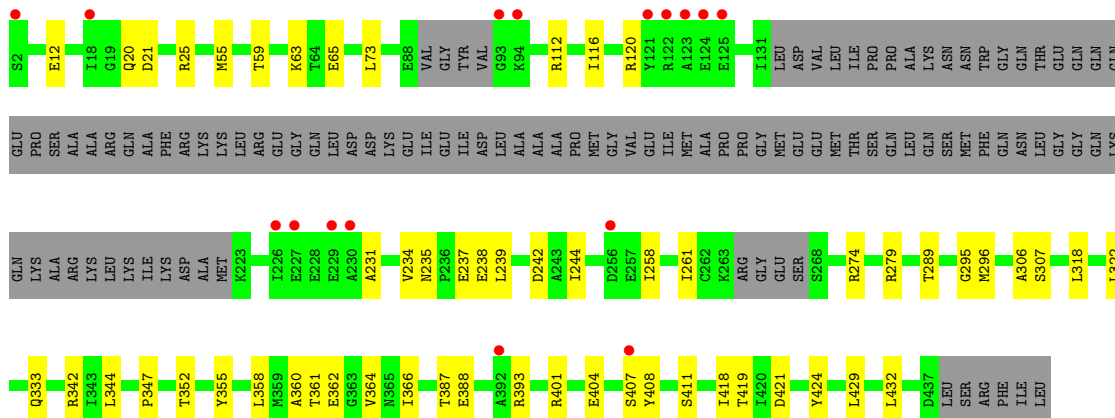

• Molecule 1: ATP-dependent protease ATPase subunit HslU

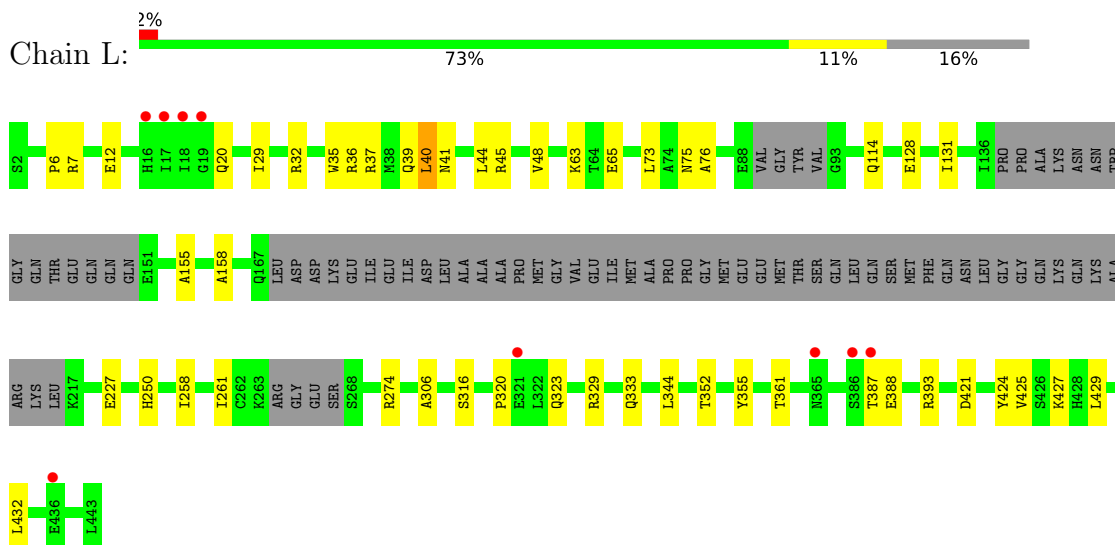

• Molecule 1: ATP-dependent protease ATPase subunit HslU

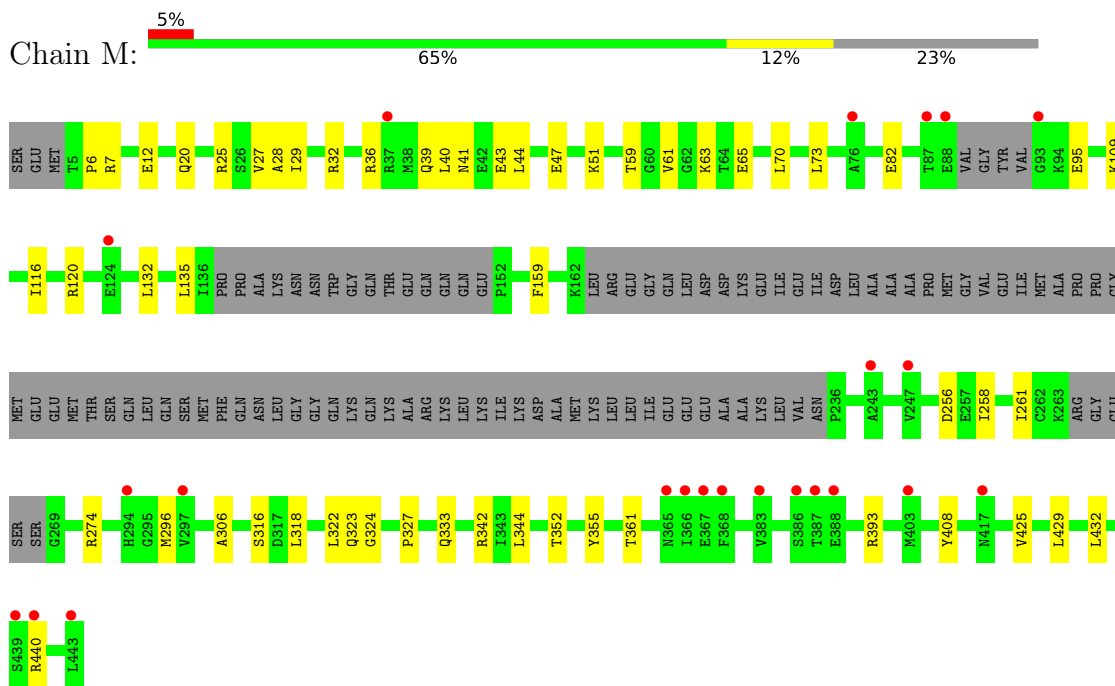

• Molecule 1: ATP-dependent protease ATPase subunit HslU

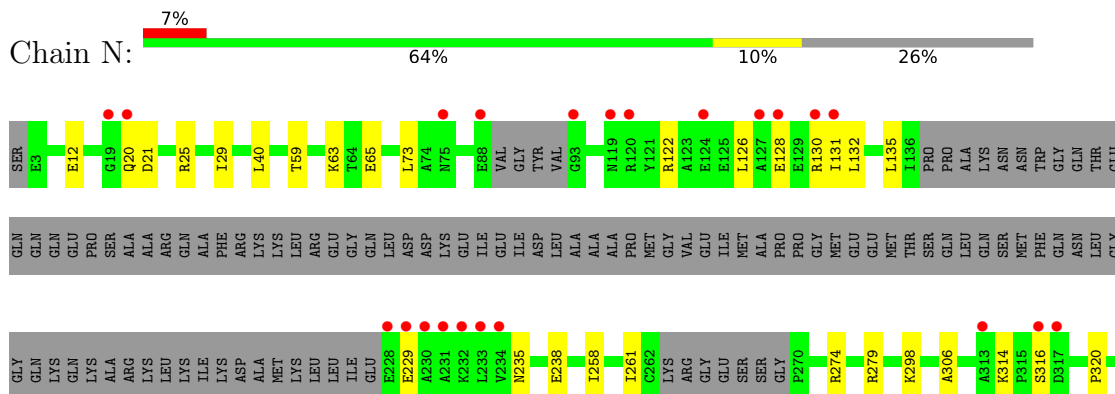

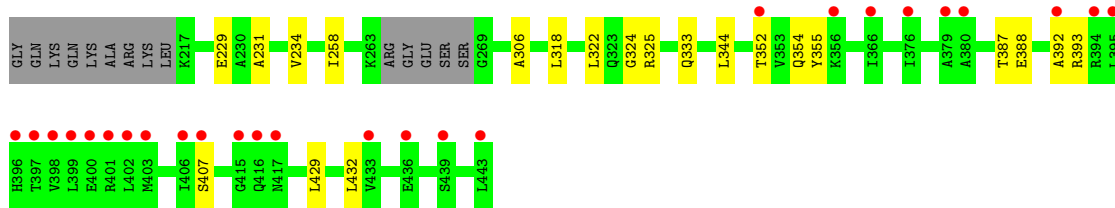

• Molecule 1: ATP-dependent protease ATPase subunit HslU

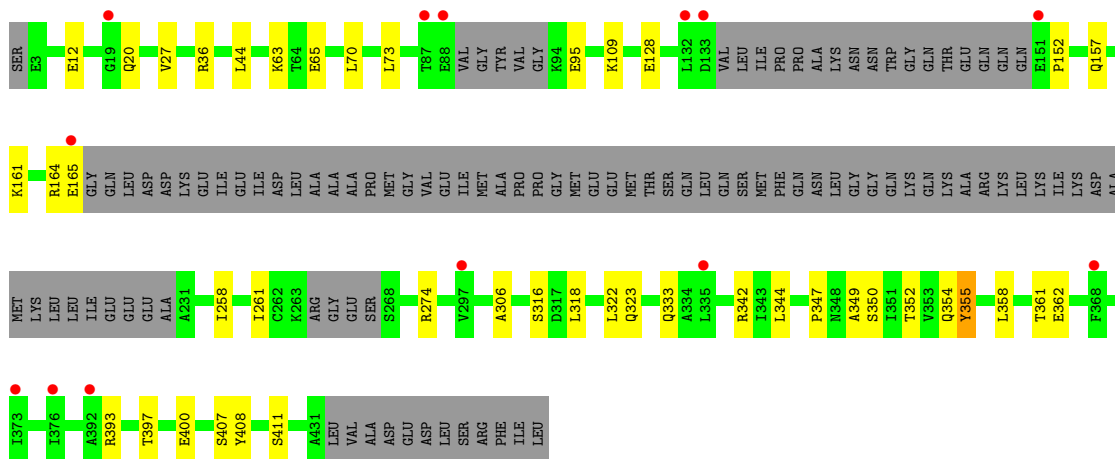

• Molecule 1: ATP-dependent protease ATPase subunit HslU

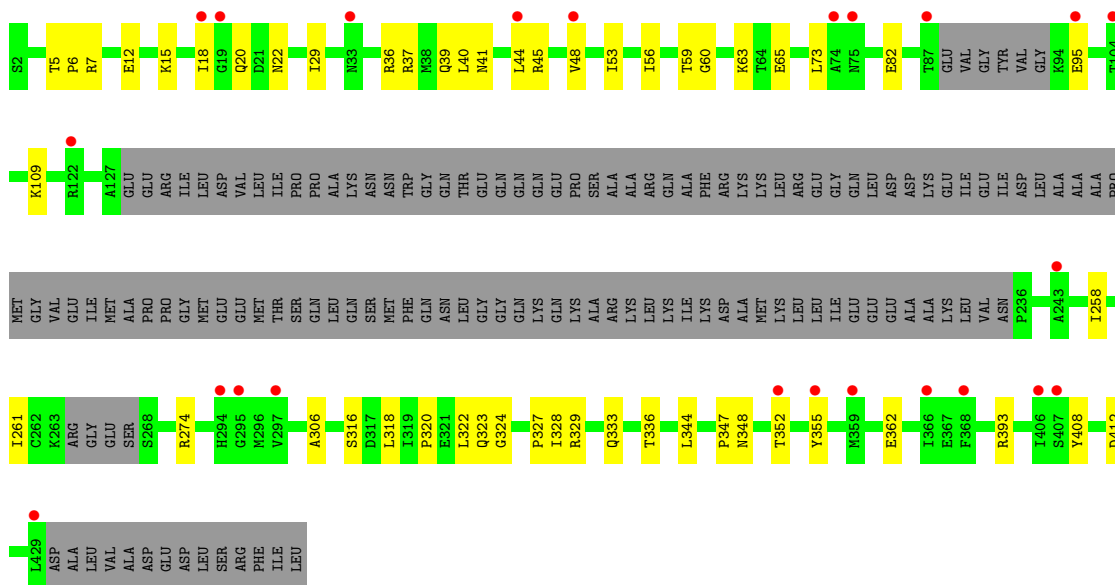

• Molecule 1: ATP-dependent protease ATPase subunit HslU



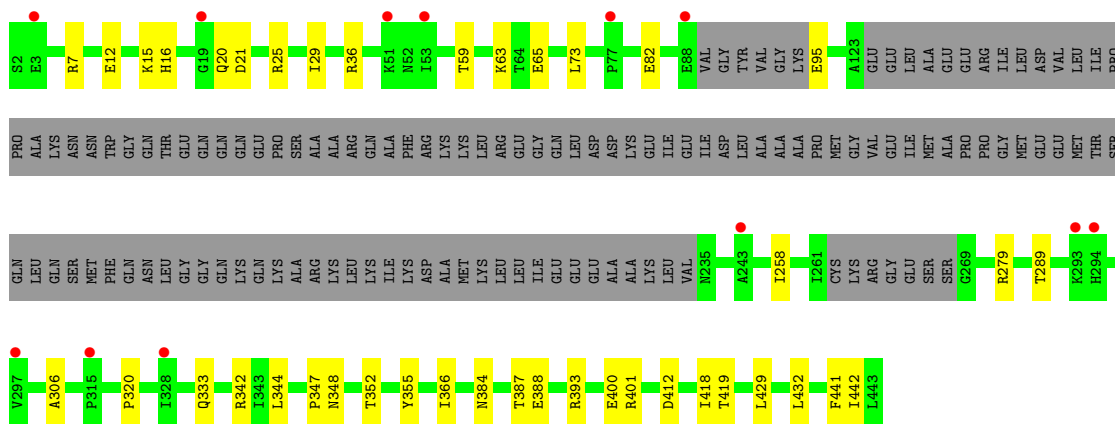

• Molecule 1: ATP-dependent protease ATPase subunit HslU

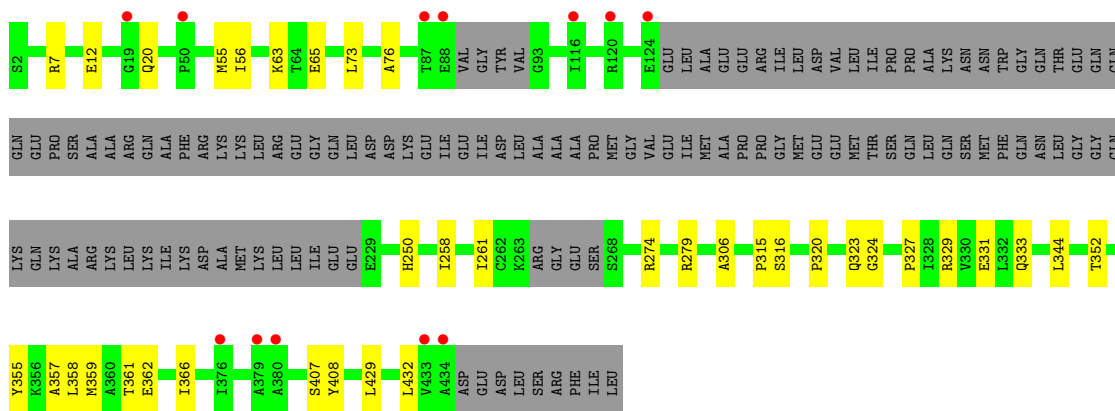

• Molecule 1: ATP-dependent protease ATPase subunit HslU

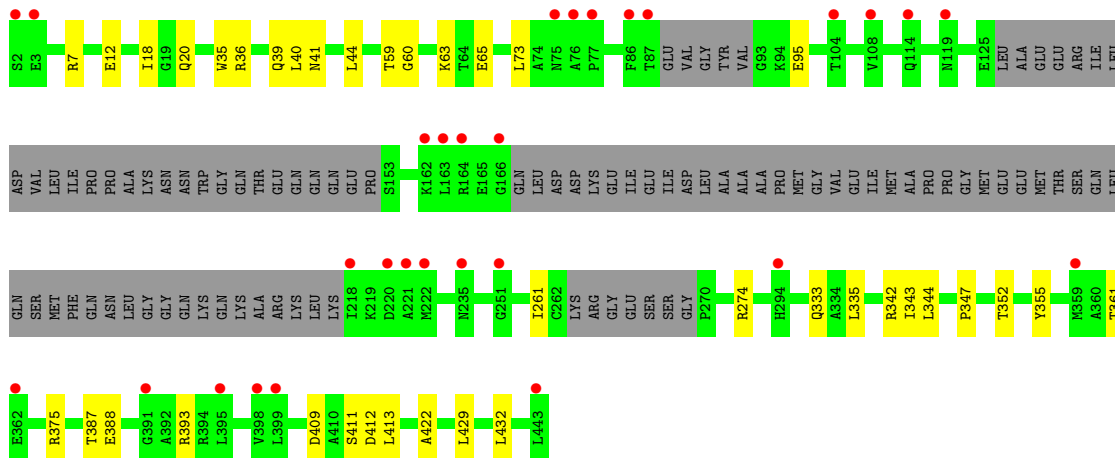

• Molecule 1: ATP-dependent protease ATPase subunit HslU

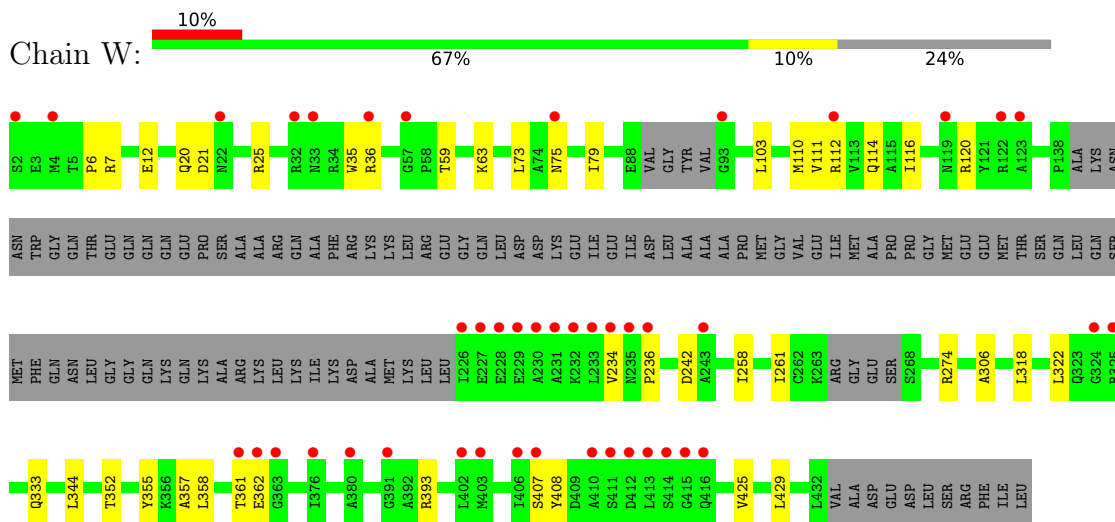

• Molecule 1: ATP-dependent protease ATPase subunit HslU

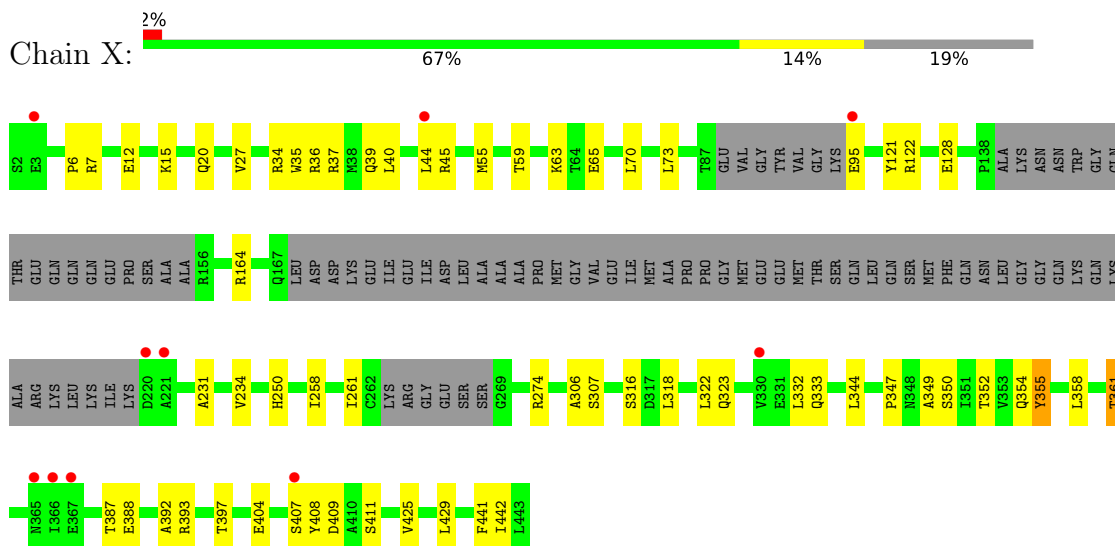

4 Data and refinement statistics

Property	Value	Source
Space group	P 1 21 1	Depositor
Cell constants a, b, c, α , β , γ	86.50Å 420.86Å 176.42Å 90.00° 98.56° 90.00°	Depositor
Resolution (Å)	49.19 – 7.09 49.19 – 7.09	Depositor EDS
% Data completeness (in resolution range)	98.6 (49.19-7.09) 98.8 (49.19-7.09)	Depositor EDS
R_{merge}	0.10	Depositor
R_{sym}	(Not available)	Depositor
$\langle I/\sigma(I) \rangle$ ¹	2.43 (at 7.37Å)	Xtrriage
Refinement program	PHENIX	Depositor
R, R_{free}	0.274 , 0.298 0.274 , 0.298	Depositor DCC
R_{free} test set	1889 reflections (10.14%)	wwPDB-VP
Wilson B-factor (Å ²)	397.2	Xtrriage
Anisotropy	0.626	Xtrriage
Bulk solvent k_{sol} (e/Å ³), B_{sol} (Å ²)	0.27 , 356.6	EDS
L-test for twinning ²	$\langle L \rangle = 0.45$, $\langle L^2 \rangle = 0.27$	Xtrriage
Estimated twinning fraction	No twinning to report.	Xtrriage
F_o, F_c correlation	0.82	EDS
Total number of atoms	64889	wwPDB-VP
Average B, all atoms (Å ²)	414.0	wwPDB-VP

Xtrriage's analysis on translational NCS is as follows: *The largest off-origin peak in the Patterson function is 5.99% of the height of the origin peak. No significant pseudotranslation is detected.*

¹Intensities estimated from amplitudes.

²Theoretical values of $\langle |L| \rangle$, $\langle L^2 \rangle$ for acentric reflections are 0.5, 0.333 respectively for untwinned datasets, and 0.375, 0.2 for perfectly twinned datasets.

5 Model quality [i](#)

5.1 Standard geometry [i](#)

Bond lengths and bond angles in the following residue types are not validated in this section: ADP

The Z score for a bond length (or angle) is the number of standard deviations the observed value is removed from the expected value. A bond length (or angle) with $|Z| > 5$ is considered an outlier worth inspection. RMSZ is the root-mean-square of all Z scores of the bond lengths (or angles).

Mol	Chain	Bond lengths		Bond angles	
		RMSZ	# Z >5	RMSZ	# Z >5
1	A	0.26	0/2615	0.42	0/3529
1	B	0.26	0/2668	0.42	0/3597
1	C	0.26	0/2899	0.43	0/3909
1	D	0.26	0/2638	0.43	0/3559
1	E	0.26	0/2848	0.44	0/3839
1	F	0.26	0/2683	0.42	0/3620
1	G	0.25	0/2597	0.42	0/3502
1	H	0.25	0/2948	0.42	0/3973
1	I	0.26	0/2771	0.42	0/3729
1	J	0.27	0/2637	0.42	0/3555
1	K	0.27	0/2675	0.44	0/3608
1	L	0.26	0/2946	0.45	1/3968 (0.0%)
1	M	0.27	0/2726	0.45	0/3672
1	N	0.25	0/2610	0.43	0/3522
1	O	0.26	0/2773	0.43	0/3735
1	P	0.26	0/2415	0.43	0/3260
1	Q	0.26	0/2938	0.43	0/3959
1	R	0.30	0/2697	0.44	0/3633
1	S	0.26	0/2465	0.44	0/3324
1	T	0.25	0/2533	0.42	0/3419
1	U	0.26	0/2540	0.42	0/3427
1	V	0.25	0/2798	0.43	0/3767
1	W	0.26	0/2668	0.43	0/3602
1	X	0.27	0/2874	0.44	0/3874
All	All	0.26	0/64962	0.43	1/87582 (0.0%)

There are no bond length outliers.

All (1) bond angle outliers are listed below:

Continued on next page...

Continued from previous page...

Mol	Chain	Res	Type	Atoms	Z	Observed(^o)	Ideal(^o)
1	L	40	LEU	CA-CB-CG	5.62	128.24	115.30

There are no chirality outliers.

There are no planarity outliers.

5.2 Too-close contacts [\(i\)](#)

In the following table, the Non-H and H(model) columns list the number of non-hydrogen atoms and hydrogen atoms in the chain respectively. The H(added) column lists the number of hydrogen atoms added and optimized by MolProbity. The Clashes column lists the number of clashes within the asymmetric unit, whereas Symm-Clashes lists symmetry-related clashes.

Mol	Chain	Non-H	H(model)	H(added)	Clashes	Symm-Clashes
1	A	2586	0	2628	26	0
1	B	2638	0	2676	48	1
1	C	2867	0	2919	50	0
1	D	2609	0	2652	61	0
1	E	2817	0	2877	63	0
1	F	2654	0	2697	26	1
1	G	2568	0	2621	25	0
1	H	2915	0	2975	30	0
1	I	2743	0	2790	33	0
1	J	2608	0	2656	36	1
1	K	2646	0	2688	66	3
1	L	2915	0	2969	57	0
1	M	2695	0	2753	63	1
1	N	2581	0	2629	42	0
1	O	2742	0	2800	32	1
1	P	2387	0	2427	40	1
1	Q	2906	0	2965	39	1
1	R	2667	0	2718	47	0
1	S	2436	0	2483	57	0
1	T	2503	0	2538	36	1
1	U	2511	0	2558	37	0
1	V	2768	0	2822	38	0
1	W	2637	0	2685	39	0
1	X	2842	0	2900	65	3
2	A	27	0	12	4	0
2	B	27	0	12	2	0

Continued on next page...

Continued from previous page...

Mol	Chain	Non-H	H(model)	H(added)	Clashes	Symm-Clashes
2	C	27	0	12	4	0
2	D	27	0	12	1	0
2	E	27	0	12	4	0
2	F	27	0	12	2	0
2	G	27	0	12	5	0
2	H	27	0	12	5	0
2	I	27	0	12	4	0
2	J	27	0	12	3	0
2	K	27	0	12	4	0
2	L	27	0	12	3	0
2	M	27	0	12	5	0
2	N	27	0	12	2	0
2	O	27	0	12	3	0
2	P	27	0	12	5	0
2	Q	27	0	12	4	0
2	R	27	0	12	3	0
2	S	27	0	12	4	0
2	T	27	0	12	4	0
2	U	27	0	12	2	0
2	V	27	0	12	3	0
2	W	27	0	12	1	0
2	X	27	0	12	4	0
All	All	64889	0	65714	755	7

The all-atom clashscore is defined as the number of clashes found per 1000 atoms (including hydrogen atoms). The all-atom clashscore for this structure is 6.

All (755) close contacts within the same asymmetric unit are listed below, sorted by their clash magnitude.

Atom-1	Atom-2	Interatomic distance (Å)	Clash overlap (Å)
1:D:407:SER:O	1:E:36:ARG:NH2	1.65	1.30
1:P:407:SER:O	1:Q:36:ARG:NH2	1.79	1.14
1:D:407:SER:OG	1:E:36:ARG:NH1	1.80	1.14
1:K:407:SER:O	1:L:36:ARG:NH1	1.80	1.12
1:B:401:ARG:NH2	1:C:329:ARG:O	1.88	1.06
1:P:407:SER:OG	1:Q:36:ARG:NH1	1.88	1.06
1:M:39:GLN:HB3	1:R:361:THR:HG21	1.35	1.02
1:S:82:GLU:HG3	1:T:279:ARG:HD2	1.46	0.97
1:U:407:SER:O	1:V:36:ARG:NH2	1.98	0.96
1:D:415:GLY:O	1:S:333:GLN:NE2	1.99	0.95
1:W:407:SER:O	1:X:36:ARG:NH2	2.00	0.95

Continued on next page...

Continued from previous page...

Atom-1	Atom-2	Interatomic distance (Å)	Clash overlap (Å)
1:C:412:ASP:OD2	1:D:7:ARG:NE	2.02	0.92
1:W:358:LEU:CD2	1:X:40:LEU:HD11	2.02	0.90
1:M:327:PRO:HA	1:R:397:THR:HG22	1.51	0.90
1:A:412:ASP:OD2	1:B:7:ARG:NH2	2.07	0.87
1:W:358:LEU:HA	1:X:40:LEU:HD21	1.57	0.87
1:M:82:GLU:HG3	1:N:279:ARG:HB3	1.56	0.86
1:D:354:GLN:HG2	1:E:44:LEU:HD22	1.58	0.86
1:F:59:THR:OG1	1:F:393:ARG:NH2	2.08	0.86
1:M:36:ARG:NH2	1:R:407:SER:O	2.09	0.86
1:O:441:PHE:O	1:P:329:ARG:NH1	2.10	0.84
1:H:412:ASP:OD2	1:I:7:ARG:NE	2.10	0.84
1:O:59:THR:OG1	1:O:393:ARG:NH2	2.11	0.83
1:M:393:ARG:NH1	2:M:501:ADP:O5'	2.11	0.83
1:D:415:GLY:HA3	1:S:22:ASN:ND2	1.94	0.82
1:T:401:ARG:NH2	1:U:329:ARG:O	2.14	0.81
1:B:441:PHE:HA	1:C:315:PRO:HG2	1.63	0.81
1:P:408:TYR:CD1	1:Q:6:PRO:HB2	2.16	0.81
1:D:415:GLY:HA3	1:S:22:ASN:HD22	1.44	0.80
1:W:358:LEU:HD21	1:X:40:LEU:HD11	1.62	0.80
1:T:59:THR:OG1	1:T:393:ARG:NH2	2.15	0.79
1:J:109:LYS:HB2	1:K:296:MET:HG2	1.62	0.79
1:W:59:THR:OG1	1:W:393:ARG:NH2	2.16	0.79
1:R:152:PRO:HB2	1:R:157:GLN:HE21	1.47	0.79
1:D:417:ASN:ND2	1:S:333:GLN:OE1	2.16	0.78
1:K:407:SER:O	1:L:36:ARG:CZ	2.31	0.78
1:V:59:THR:OG1	1:V:393:ARG:NH2	2.16	0.77
1:B:442:ILE:HD11	1:C:331:GLU:HG3	1.66	0.77
1:S:29:ILE:HD13	1:X:404:GLU:HB2	1.66	0.77
1:T:400:GLU:HG3	1:U:327:PRO:HB2	1.67	0.77
1:S:59:THR:OG1	1:S:393:ARG:NH2	2.17	0.76
1:K:116:ILE:O	1:K:120:ARG:N	2.18	0.76
1:J:224:LEU:HD21	1:K:235:ASN:HB3	1.66	0.76
1:K:407:SER:C	1:L:36:ARG:HH12	1.90	0.76
1:B:441:PHE:HD2	1:C:56:ILE:HG21	1.51	0.75
1:P:361:THR:HG21	1:Q:39:GLN:HG3	1.67	0.75
1:P:407:SER:HG	1:Q:36:ARG:HH12	1.31	0.75
1:H:82:GLU:HG3	1:I:279:ARG:HB3	1.68	0.75
1:K:59:THR:OG1	1:K:393:ARG:NH2	2.20	0.75
1:K:404:GLU:HB2	1:L:29:ILE:HD13	1.69	0.75
1:P:354:GLN:HG2	1:Q:44:LEU:HD22	1.69	0.74
1:M:39:GLN:HB3	1:R:361:THR:CG2	2.14	0.74

Continued on next page...

Continued from previous page...

Atom-1	Atom-2	Interatomic distance (Å)	Clash overlap (Å)
1:S:7:ARG:HG2	1:X:408:TYR:HE2	1.52	0.74
1:B:393:ARG:HB3	1:C:324:GLY:HA3	1.69	0.73
1:R:393:ARG:NH1	2:R:501:ADP:O5'	2.20	0.73
1:B:412:ASP:OD2	1:C:7:ARG:NE	2.21	0.72
1:M:132:LEU:HD22	1:M:159:PHE:CG	2.25	0.72
1:W:110:MET:HG2	1:W:114:GLN:HE22	1.54	0.72
1:J:109:LYS:NZ	1:K:296:MET:O	2.18	0.72
1:E:59:THR:OG1	1:E:393:ARG:NH2	2.23	0.72
1:E:412:ASP:OD2	1:F:7:ARG:NE	2.23	0.71
1:M:44:LEU:HD22	1:R:354:GLN:HG2	1.71	0.71
1:M:32:ARG:NH2	1:R:411:SER:OG	2.24	0.71
1:J:231:ALA:HA	1:J:234:VAL:HG12	1.72	0.71
1:C:362:GLU:OE2	1:D:32:ARG:NE	2.22	0.71
1:M:393:ARG:HE	1:N:320:PRO:HB2	1.56	0.71
1:K:407:SER:O	1:L:36:ARG:NH2	2.23	0.71
1:N:401:ARG:NH2	1:O:329:ARG:O	2.23	0.71
1:M:51:LYS:HE2	1:R:400:GLU:OE2	1.91	0.71
1:M:324:GLY:HA3	1:R:393:ARG:HD2	1.72	0.70
1:N:126:LEU:HB2	1:N:229:GLU:HG2	1.72	0.70
1:V:412:ASP:OD2	1:W:7:ARG:NE	2.24	0.70
1:F:63:LYS:N	2:F:501:ADP:O1B	2.25	0.70
1:S:327:PRO:HA	1:X:397:THR:HG22	1.71	0.70
1:M:7:ARG:HG3	1:R:408:TYR:CZ	2.27	0.70
1:S:7:ARG:NH2	1:X:409:ASP:OD1	2.25	0.70
1:P:358:LEU:HD21	1:Q:40:LEU:HD11	1.74	0.70
1:S:362:GLU:OE2	1:T:36:ARG:NE	2.24	0.70
1:B:59:THR:OG1	1:B:393:ARG:NH2	2.26	0.69
1:A:63:LYS:N	2:A:501:ADP:O1B	2.26	0.69
1:Q:407:SER:O	1:R:36:ARG:NH2	2.26	0.69
1:C:361:THR:HG21	1:D:36:ARG:HA	1.75	0.69
1:K:408:TYR:CZ	1:L:6:PRO:HB2	2.28	0.69
1:K:362:GLU:OE2	1:L:35:TRP:HZ3	1.75	0.69
1:W:408:TYR:CE1	1:X:6:PRO:HB2	2.28	0.68
1:J:227:GLU:HB2	1:K:237:GLU:HG2	1.75	0.68
1:A:408:TYR:CE2	1:B:25:ARG:NH2	2.62	0.68
1:X:63:LYS:N	2:X:501:ADP:O1B	2.26	0.68
1:D:362:GLU:OE2	1:E:35:TRP:CZ3	2.47	0.67
1:U:361:THR:HG23	1:V:39:GLN:HB2	1.77	0.67
1:H:401:ARG:NH2	1:I:329:ARG:O	2.28	0.67
1:I:63:LYS:N	2:I:501:ADP:O1B	2.27	0.67
1:I:344:LEU:O	1:I:352:THR:OG1	2.11	0.67

Continued on next page...

Continued from previous page...

Atom-1	Atom-2	Interatomic distance (Å)	Clash overlap (Å)
1:D:417:ASN:HD21	1:S:333:GLN:HA	1.59	0.67
1:H:63:LYS:N	2:H:501:ADP:O1B	2.28	0.67
1:S:63:LYS:N	2:S:501:ADP:O3B	2.27	0.67
1:B:441:PHE:CD2	1:C:56:ILE:HG21	2.29	0.66
1:J:223:LYS:HD2	1:K:238:GLU:CD	2.16	0.66
1:H:393:ARG:NH1	2:H:501:ADP:O5'	2.29	0.66
1:U:63:LYS:N	2:U:501:ADP:O3B	2.27	0.66
1:C:361:THR:HG22	1:D:35:TRP:CZ3	2.31	0.66
1:L:393:ARG:NH1	2:L:501:ADP:O5'	2.28	0.66
1:K:408:TYR:OH	1:L:7:ARG:HA	1.96	0.65
1:Q:63:LYS:N	2:Q:501:ADP:O3B	2.29	0.65
1:K:63:LYS:N	2:K:501:ADP:O3B	2.28	0.65
1:N:63:LYS:N	2:N:501:ADP:O3B	2.29	0.65
1:H:400:GLU:HG3	1:I:327:PRO:HB2	1.78	0.65
1:U:20:GLN:NE2	1:U:333:GLN:O	2.29	0.65
1:U:361:THR:CG2	1:V:39:GLN:HB2	2.27	0.65
1:T:63:LYS:N	2:T:501:ADP:O3B	2.29	0.65
1:J:223:LYS:NZ	1:K:238:GLU:OE2	2.22	0.65
1:J:230:ALA:O	1:J:234:VAL:HG12	1.97	0.65
1:T:366:ILE:HD13	1:T:418:ILE:HB	1.78	0.65
1:R:355:TYR:HA	1:R:358:LEU:HD12	1.79	0.65
1:B:440:ARG:O	1:C:315:PRO:HB2	1.97	0.64
1:K:358:LEU:HD23	1:L:40:LEU:HD11	1.78	0.64
1:F:20:GLN:NE2	1:F:333:GLN:O	2.30	0.64
1:D:415:GLY:CA	1:S:22:ASN:ND2	2.59	0.64
1:S:329:ARG:HB2	1:X:442:ILE:HA	1.79	0.64
1:I:392:ALA:HB3	2:I:501:ADP:C8	2.33	0.64
1:D:63:LYS:N	2:D:501:ADP:O3B	2.31	0.64
1:A:109:LYS:HE2	1:B:298:LYS:HB2	1.80	0.64
1:S:324:GLY:HA3	1:X:393:ARG:HB3	1.79	0.64
1:N:59:THR:OG1	1:N:393:ARG:NH2	2.31	0.64
1:D:361:THR:CG2	1:E:39:GLN:HG3	2.28	0.63
1:M:59:THR:OG1	1:M:393:ARG:NH2	2.31	0.63
1:W:407:SER:O	1:X:36:ARG:CZ	2.46	0.63
1:E:63:LYS:N	2:E:501:ADP:O1B	2.30	0.63
1:J:63:LYS:N	2:J:501:ADP:O1B	2.31	0.63
1:O:63:LYS:N	2:O:501:ADP:O3B	2.31	0.63
1:W:362:GLU:OE2	1:X:35:TRP:HZ3	1.82	0.63
1:S:393:ARG:NE	1:T:320:PRO:HB2	2.14	0.63
1:B:362:GLU:OE2	1:C:32:ARG:NE	2.27	0.62
1:C:63:LYS:N	2:C:501:ADP:O3B	2.33	0.62

Continued on next page...

Continued from previous page...

Atom-1	Atom-2	Interatomic distance (Å)	Clash overlap (Å)
1:N:407:SER:O	1:O:36:ARG:NH2	2.29	0.62
1:P:20:GLN:NE2	1:P:333:GLN:O	2.30	0.62
1:H:20:GLN:NE2	1:H:333:GLN:O	2.30	0.62
1:P:400:GLU:OE2	1:Q:51:LYS:HE2	1.99	0.62
1:L:63:LYS:N	2:L:501:ADP:O3B	2.33	0.62
1:W:361:THR:HG21	1:X:39:GLN:HB2	1.80	0.62
1:M:109:LYS:HE2	1:N:298:LYS:HB2	1.81	0.62
1:P:358:LEU:CD2	1:Q:40:LEU:HD11	2.30	0.62
1:F:366:ILE:HD13	1:F:418:ILE:HB	1.82	0.62
1:M:63:LYS:N	2:M:501:ADP:O1B	2.31	0.62
1:O:440:ARG:HB3	1:P:316:SER:HB3	1.82	0.61
1:K:408:TYR:CE1	1:L:6:PRO:HB2	2.35	0.61
1:V:63:LYS:N	2:V:501:ADP:O3B	2.33	0.61
1:H:227:GLU:CD	1:I:237:GLU:HG2	2.20	0.61
1:H:109:LYS:HE2	1:I:298:LYS:HB2	1.82	0.61
1:P:63:LYS:N	2:P:501:ADP:O3B	2.34	0.61
1:D:361:THR:HG21	1:E:39:GLN:HG3	1.83	0.61
1:M:361:THR:OG1	1:N:40:LEU:HD21	1.99	0.61
1:P:409:ASP:OD1	1:Q:7:ARG:NH2	2.34	0.61
1:K:344:LEU:O	1:K:352:THR:OG1	2.13	0.61
1:P:393:ARG:NH1	2:P:501:ADP:O5'	2.33	0.61
1:L:20:GLN:NE2	1:L:333:GLN:O	2.33	0.60
1:P:408:TYR:CE2	1:Q:7:ARG:HG2	2.36	0.60
1:G:63:LYS:N	2:G:501:ADP:O3B	2.34	0.60
1:J:223:LYS:HD2	1:K:238:GLU:OE2	2.00	0.60
1:J:393:ARG:NH1	2:J:501:ADP:O5'	2.35	0.60
1:W:63:LYS:N	2:W:501:ADP:O1B	2.33	0.60
1:C:344:LEU:O	1:C:352:THR:OG1	2.12	0.60
1:K:408:TYR:HE2	1:L:7:ARG:CG	2.14	0.60
1:C:400:GLU:HG3	1:D:327:PRO:HB2	1.83	0.60
1:W:408:TYR:CZ	1:X:6:PRO:HB2	2.36	0.60
1:A:36:ARG:NH1	1:F:407:SER:O	2.34	0.60
1:W:20:GLN:NE2	1:W:333:GLN:O	2.32	0.60
1:W:75:ASN:HD21	1:W:114:GLN:CD	2.04	0.60
1:V:18:ILE:CG1	1:V:347:PRO:HG3	2.32	0.60
1:A:362:GLU:OE2	1:B:36:ARG:NE	2.33	0.59
1:J:409:ASP:O	1:J:413:LEU:HG	2.02	0.59
1:M:393:ARG:HH12	2:M:501:ADP:PA	2.25	0.59
1:O:344:LEU:O	1:O:352:THR:OG1	2.14	0.59
1:B:400:GLU:HG3	1:C:327:PRO:HB2	1.83	0.59
1:S:7:ARG:CG	1:X:408:TYR:HE2	2.15	0.59

Continued on next page...

Continued from previous page...

Atom-1	Atom-2	Interatomic distance (Å)	Clash overlap (Å)
1:C:401:ARG:NH2	1:D:329:ARG:O	2.35	0.59
1:S:53:ILE:HA	1:S:328:ILE:O	2.02	0.59
1:S:408:TYR:HD1	1:T:29:ILE:HD11	1.67	0.59
1:U:361:THR:HG23	1:V:39:GLN:CB	2.32	0.59
1:A:20:GLN:NE2	1:A:333:GLN:O	2.31	0.59
1:K:393:ARG:NH1	2:K:501:ADP:O5'	2.35	0.59
1:J:109:LYS:HB2	1:K:296:MET:CG	2.30	0.58
1:N:361:THR:HG21	1:O:36:ARG:HA	1.84	0.58
1:D:407:SER:HG	1:E:36:ARG:NH1	2.00	0.58
1:W:358:LEU:HD23	1:X:40:LEU:HD11	1.84	0.58
1:C:20:GLN:NE2	1:C:333:GLN:O	2.34	0.58
1:D:365:ASN:OD1	1:S:336:THR:HG21	2.03	0.58
1:H:441:PHE:HA	1:I:315:PRO:HD2	1.84	0.58
1:D:400:GLU:OE2	1:E:51:LYS:HE2	2.03	0.58
1:R:63:LYS:N	2:R:501:ADP:O1B	2.37	0.58
1:K:358:LEU:CD2	1:L:40:LEU:HD11	2.33	0.58
1:S:36:ARG:NH1	1:X:407:SER:OG	2.37	0.58
1:T:344:LEU:O	1:T:352:THR:OG1	2.14	0.58
1:E:155:ALA:HA	1:E:158:ALA:HB3	1.85	0.58
1:N:408:TYR:HE2	1:O:7:ARG:HG2	1.67	0.58
1:B:20:GLN:NE2	1:B:333:GLN:O	2.34	0.57
1:D:408:TYR:CE2	1:E:7:ARG:HG2	2.38	0.57
1:Q:344:LEU:O	1:Q:352:THR:OG1	2.14	0.57
1:S:82:GLU:CG	1:T:279:ARG:HD2	2.29	0.57
1:B:63:LYS:N	2:B:501:ADP:O3B	2.37	0.57
1:A:36:ARG:NH2	1:F:407:SER:O	2.37	0.57
1:L:12:GLU:HG2	1:L:73:LEU:HD13	1.86	0.57
1:B:441:PHE:HD2	1:C:56:ILE:HD13	1.69	0.57
1:H:344:LEU:O	1:H:352:THR:OG1	2.18	0.57
1:O:116:ILE:O	1:O:120:ARG:N	2.35	0.57
1:R:20:GLN:NE2	1:R:333:GLN:O	2.36	0.57
1:M:7:ARG:H	1:R:408:TYR:HE1	1.51	0.57
1:F:344:LEU:O	1:F:352:THR:OG1	2.15	0.57
1:M:135:LEU:HB2	1:M:159:PHE:CE1	2.40	0.57
1:P:344:LEU:O	1:P:352:THR:OG1	2.18	0.57
1:V:344:LEU:O	1:V:352:THR:OG1	2.12	0.56
1:I:59:THR:OG1	1:I:393:ARG:NH2	2.37	0.56
1:L:344:LEU:O	1:L:352:THR:OG1	2.14	0.56
1:D:408:TYR:CE1	1:E:6:PRO:HB2	2.40	0.56
1:K:20:GLN:NE2	1:K:333:GLN:O	2.38	0.56
1:U:407:SER:OG	1:V:36:ARG:NH1	2.37	0.56

Continued on next page...

Continued from previous page...

Atom-1	Atom-2	Interatomic distance (Å)	Clash overlap (Å)
1:G:20:GLN:NE2	1:G:333:GLN:O	2.34	0.56
1:C:393:ARG:NH1	2:C:501:ADP:O5'	2.38	0.56
1:D:362:GLU:OE2	1:E:32:ARG:NH2	2.39	0.56
1:G:393:ARG:NH1	2:G:501:ADP:O5'	2.39	0.56
1:M:256:ASP:OD2	1:N:279:ARG:NH1	2.39	0.56
1:G:344:LEU:O	1:G:352:THR:OG1	2.17	0.55
1:S:344:LEU:O	1:S:352:THR:OG1	2.13	0.55
1:D:358:LEU:HD22	1:E:36:ARG:HB3	1.88	0.55
1:M:135:LEU:HB2	1:M:159:PHE:HE1	1.71	0.55
1:J:366:ILE:HD13	1:J:418:ILE:HB	1.87	0.55
1:W:358:LEU:HD23	1:X:40:LEU:HD21	1.89	0.55
1:D:344:LEU:O	1:D:352:THR:OG1	2.15	0.55
1:H:109:LYS:CE	1:I:298:LYS:HB2	2.36	0.55
1:M:63:LYS:NZ	2:M:501:ADP:O3B	2.32	0.55
1:J:429:LEU:O	1:J:432:LEU:N	2.38	0.55
1:M:36:ARG:CZ	1:R:407:SER:HB3	2.36	0.55
1:J:344:LEU:O	1:J:352:THR:OG1	2.16	0.55
1:M:82:GLU:CG	1:N:279:ARG:HB3	2.33	0.55
1:D:361:THR:OG1	1:E:39:GLN:HB2	2.07	0.55
1:S:36:ARG:HA	1:X:361:THR:HG21	1.88	0.55
1:B:441:PHE:HE2	1:C:310:PHE:HB2	1.72	0.54
1:M:59:THR:HG21	1:N:320:PRO:HG3	1.88	0.54
1:U:407:SER:O	1:V:36:ARG:CZ	2.54	0.54
1:C:392:ALA:HB3	2:C:501:ADP:C8	2.42	0.54
1:S:29:ILE:CD1	1:X:404:GLU:HB2	2.37	0.54
1:J:234:VAL:HG22	1:J:235:ASN:N	2.23	0.54
1:B:359:MET:HG3	1:B:366:ILE:HG13	1.89	0.54
1:Q:407:SER:OG	1:R:36:ARG:NH1	2.41	0.54
1:E:344:LEU:O	1:E:352:THR:OG1	2.15	0.54
1:E:375:ARG:HH21	1:G:21:ASP:HB2	1.73	0.54
1:V:41:ASN:HD21	1:V:44:LEU:HD12	1.73	0.54
1:D:20:GLN:NE2	1:D:333:GLN:O	2.36	0.54
1:Q:20:GLN:NE2	1:Q:333:GLN:O	2.37	0.54
1:S:412:ASP:OD2	1:T:7:ARG:NH2	2.33	0.54
1:D:358:LEU:HA	1:E:40:LEU:HD21	1.90	0.53
1:B:400:GLU:OE2	1:C:51:LYS:HE2	2.08	0.53
1:P:354:GLN:HG2	1:Q:44:LEU:CD2	2.36	0.53
1:S:56:ILE:HG21	1:X:441:PHE:CE2	2.44	0.53
1:T:412:ASP:OD2	1:U:7:ARG:NE	2.39	0.53
1:B:441:PHE:CD2	1:C:56:ILE:HD13	2.43	0.53
1:E:401:ARG:NH2	1:F:329:ARG:O	2.41	0.53

Continued on next page...

Continued from previous page...

Atom-1	Atom-2	Interatomic distance (Å)	Clash overlap (Å)
1:J:65:GLU:HG3	2:J:501:ADP:H2'	1.90	0.53
1:P:358:LEU:HD22	1:Q:36:ARG:HB3	1.90	0.53
1:M:6:PRO:HB3	1:M:28:ALA:HB1	1.90	0.53
1:U:429:LEU:O	1:U:432:LEU:N	2.41	0.53
1:V:411:SER:OG	1:W:6:PRO:HD2	2.08	0.53
1:J:82:GLU:HG3	1:K:279:ARG:HB3	1.89	0.53
1:Q:59:THR:OG1	1:Q:393:ARG:NH2	2.42	0.53
1:T:442:ILE:HD11	1:U:331:GLU:HG3	1.90	0.53
1:K:408:TYR:CE2	1:L:6:PRO:HB2	2.44	0.53
1:K:408:TYR:HE2	1:L:7:ARG:HG2	1.74	0.53
1:T:429:LEU:O	1:T:432:LEU:N	2.41	0.53
1:J:231:ALA:HA	1:J:234:VAL:CG1	2.39	0.53
1:B:397:THR:HG22	1:C:327:PRO:HA	1.92	0.53
1:X:344:LEU:O	1:X:352:THR:OG1	2.15	0.53
1:O:20:GLN:NE2	1:O:333:GLN:O	2.39	0.52
1:S:56:ILE:HD13	1:X:441:PHE:CD2	2.44	0.52
1:E:109:LYS:HE2	1:F:298:LYS:HB2	1.91	0.52
1:U:344:LEU:O	1:U:352:THR:OG1	2.16	0.52
1:A:344:LEU:O	1:A:352:THR:OG1	2.16	0.52
1:T:393:ARG:NH1	2:T:501:ADP:O5'	2.43	0.52
1:M:116:ILE:O	1:M:120:ARG:N	2.41	0.52
1:S:20:GLN:NE2	1:S:333:GLN:O	2.38	0.52
1:S:44:LEU:HD23	1:X:349:ALA:HB1	1.90	0.52
1:K:388:GLU:HB2	1:L:316:SER:HB2	1.91	0.52
1:M:20:GLN:NE2	1:M:333:GLN:O	2.42	0.52
1:W:75:ASN:OD1	1:W:114:GLN:NE2	2.43	0.52
1:X:318:LEU:HD22	1:X:322:LEU:HD23	1.92	0.52
1:I:393:ARG:NH1	2:I:501:ADP:O5'	2.43	0.51
1:M:344:LEU:O	1:M:352:THR:OG1	2.14	0.51
1:C:53:ILE:HA	1:C:328:ILE:O	2.09	0.51
1:D:408:TYR:CE2	1:E:7:ARG:CG	2.94	0.51
1:F:429:LEU:O	1:F:432:LEU:N	2.42	0.51
1:P:362:GLU:OE2	1:Q:32:ARG:NH2	2.40	0.51
1:K:366:ILE:HD13	1:K:418:ILE:HB	1.92	0.51
1:N:20:GLN:NE2	1:N:333:GLN:O	2.40	0.51
1:W:12:GLU:HG2	1:W:73:LEU:HD13	1.90	0.51
1:P:361:THR:HG21	1:Q:39:GLN:CG	2.39	0.51
1:W:116:ILE:O	1:W:120:ARG:N	2.38	0.51
1:D:408:TYR:CD1	1:E:6:PRO:HB2	2.45	0.51
1:K:65:GLU:HG3	2:K:501:ADP:H2'	1.93	0.51
1:Q:354:GLN:HG2	1:R:44:LEU:HD22	1.92	0.51

Continued on next page...

Continued from previous page...

Atom-1	Atom-2	Interatomic distance (Å)	Clash overlap (Å)
1:T:20:GLN:NE2	1:T:333:GLN:O	2.39	0.51
1:C:390:ILE:HG22	1:D:320:PRO:HB3	1.92	0.51
1:L:261:ILE:O	1:L:274:ARG:HB3	2.11	0.51
1:O:41:ASN:HD21	1:O:44:LEU:HD12	1.76	0.51
1:D:417:ASN:OD1	1:S:333:GLN:HB3	2.10	0.51
1:J:59:THR:OG1	1:J:393:ARG:NH2	2.44	0.51
1:K:361:THR:CG2	1:L:39:GLN:HB2	2.41	0.51
1:E:12:GLU:HG2	1:E:73:LEU:HD13	1.93	0.51
1:K:408:TYR:HE2	1:L:7:ARG:HG3	1.76	0.51
1:N:407:SER:O	1:O:36:ARG:NH1	2.41	0.51
1:A:393:ARG:NH1	2:A:501:ADP:O5'	2.44	0.51
1:Q:392:ALA:HB3	2:Q:501:ADP:C8	2.46	0.51
1:T:21:ASP:O	1:T:25:ARG:HG3	2.11	0.50
1:W:407:SER:OG	1:X:36:ARG:NH1	2.44	0.50
1:R:355:TYR:HE1	1:R:407:SER:OG	1.94	0.50
1:I:407:SER:O	1:J:36:ARG:NH2	2.40	0.50
1:U:358:LEU:HA	1:V:40:LEU:HD21	1.93	0.50
1:E:20:GLN:NE2	1:E:333:GLN:O	2.42	0.50
1:F:65:GLU:HG3	2:F:501:ADP:H2'	1.93	0.50
1:N:131:ILE:O	1:N:135:LEU:HG	2.12	0.50
1:U:407:SER:O	1:V:36:ARG:NH1	2.45	0.50
1:H:12:GLU:HG2	1:H:73:LEU:HD13	1.93	0.50
1:M:40:LEU:HD21	1:R:358:LEU:HA	1.94	0.50
1:R:95:GLU:OE1	1:R:95:GLU:N	2.45	0.50
1:S:56:ILE:HG21	1:X:441:PHE:CD2	2.47	0.50
1:A:392:ALA:HB3	2:A:501:ADP:C8	2.46	0.50
1:F:318:LEU:HD22	1:F:322:LEU:HD23	1.92	0.50
1:O:429:LEU:O	1:O:432:LEU:N	2.44	0.50
1:P:408:TYR:CE1	1:Q:6:PRO:HB2	2.46	0.50
1:B:407:SER:OG	1:C:36:ARG:NH1	2.35	0.50
1:D:12:GLU:HG2	1:D:73:LEU:HD13	1.94	0.50
1:D:408:TYR:OH	1:E:7:ARG:HG2	2.11	0.50
1:E:342:ARG:HH11	1:L:427:LYS:HG3	1.75	0.50
1:M:6:PRO:HB2	1:R:408:TYR:CD1	2.47	0.50
1:K:358:LEU:HD21	1:L:48:VAL:HG21	1.94	0.49
1:M:393:ARG:NE	1:N:320:PRO:HB2	2.25	0.49
1:P:392:ALA:HB3	2:P:501:ADP:C8	2.47	0.49
1:X:392:ALA:HB3	2:X:501:ADP:C8	2.47	0.49
1:D:408:TYR:HE2	1:E:7:ARG:CG	2.25	0.49
1:M:40:LEU:HD21	1:R:358:LEU:CA	2.41	0.49
1:E:393:ARG:NH1	2:E:501:ADP:O5'	2.45	0.49

Continued on next page...

Continued from previous page...

Atom-1	Atom-2	Interatomic distance (Å)	Clash overlap (Å)
1:H:65:GLU:HG3	2:H:501:ADP:H2'	1.94	0.49
1:J:224:LEU:HD21	1:K:235:ASN:CB	2.37	0.49
1:U:12:GLU:HG2	1:U:73:LEU:HD13	1.94	0.49
1:V:12:GLU:HG2	1:V:73:LEU:HD13	1.94	0.49
1:H:361:THR:HG21	1:I:36:ARG:HA	1.94	0.49
1:A:65:GLU:HG3	2:A:501:ADP:H2'	1.93	0.49
1:E:63:LYS:NZ	2:E:501:ADP:O3B	2.33	0.49
1:W:408:TYR:OH	1:X:7:ARG:HG2	2.12	0.49
1:O:318:LEU:HD22	1:O:322:LEU:HD23	1.93	0.49
1:S:48:VAL:HG22	1:X:354:GLN:HB3	1.95	0.49
1:B:441:PHE:CE2	1:C:310:PHE:HB2	2.48	0.49
1:G:12:GLU:HG2	1:G:73:LEU:HD13	1.94	0.49
1:L:41:ASN:HD21	1:L:44:LEU:HD12	1.77	0.49
1:V:375:ARG:HD2	1:V:422:ALA:HB1	1.95	0.49
1:D:354:GLN:HG2	1:E:44:LEU:CD2	2.37	0.49
1:M:82:GLU:OE1	1:N:279:ARG:HD2	2.13	0.49
1:P:258:ILE:HG21	1:P:306:ALA:HB1	1.95	0.49
1:T:441:PHE:HA	1:U:315:PRO:HG2	1.94	0.49
1:I:354:GLN:HG2	1:J:44:LEU:HD22	1.95	0.48
1:D:41:ASN:HD21	1:D:44:LEU:HD12	1.79	0.48
1:V:429:LEU:O	1:V:432:LEU:N	2.45	0.48
1:J:20:GLN:NE2	1:J:333:GLN:O	2.41	0.48
1:K:112:ARG:HA	1:K:239:LEU:HD11	1.95	0.48
1:T:65:GLU:HG3	2:T:501:ADP:H2'	1.94	0.48
1:C:55:MET:O	1:C:307:SER:HA	2.13	0.48
1:G:59:THR:OG1	1:G:393:ARG:NH2	2.47	0.48
1:G:387:THR:OG1	1:G:388:GLU:N	2.47	0.48
1:N:235:ASN:HB2	1:N:238:GLU:HB3	1.96	0.48
1:W:21:ASP:O	1:W:25:ARG:HG3	2.12	0.48
1:K:429:LEU:O	1:K:432:LEU:N	2.45	0.48
1:P:261:ILE:O	1:P:274:ARG:HB3	2.13	0.48
1:I:65:GLU:HG3	2:I:501:ADP:H2'	1.96	0.48
1:K:318:LEU:HD22	1:K:322:LEU:HD23	1.96	0.48
1:S:316:SER:HB2	1:X:388:GLU:OE1	2.14	0.48
1:B:429:LEU:O	1:B:432:LEU:N	2.45	0.48
1:H:392:ALA:HB3	2:H:501:ADP:C8	2.49	0.48
1:P:393:ARG:HD2	1:Q:324:GLY:HA3	1.96	0.48
1:W:75:ASN:ND2	1:W:114:GLN:OE1	2.44	0.48
1:G:36:ARG:HA	1:L:361:THR:HG21	1.95	0.48
1:H:318:LEU:HD22	1:H:322:LEU:HD23	1.96	0.48
1:P:12:GLU:HG2	1:P:73:LEU:HD13	1.95	0.48

Continued on next page...

Continued from previous page...

Atom-1	Atom-2	Interatomic distance (Å)	Clash overlap (Å)
1:W:261:ILE:O	1:W:274:ARG:HB3	2.14	0.48
1:E:261:ILE:O	1:E:274:ARG:HB3	2.14	0.47
1:K:408:TYR:O	1:L:6:PRO:HG2	2.14	0.47
1:M:316:SER:O	1:M:323:GLN:NE2	2.47	0.47
1:S:7:ARG:HG2	1:X:408:TYR:CE2	2.42	0.47
1:D:400:GLU:CD	1:E:51:LYS:HE2	2.33	0.47
1:E:400:GLU:HG3	1:F:327:PRO:HB2	1.95	0.47
1:G:258:ILE:HG21	1:G:306:ALA:HB1	1.96	0.47
1:K:361:THR:OG1	1:L:40:LEU:HD23	2.14	0.47
1:S:37:ARG:O	1:S:45:ARG:HG2	2.13	0.47
1:W:318:LEU:HD22	1:W:322:LEU:HD23	1.96	0.47
1:D:358:LEU:CA	1:E:40:LEU:HD21	2.44	0.47
1:S:12:GLU:HG2	1:S:73:LEU:HD13	1.96	0.47
1:A:40:LEU:HD11	1:F:358:LEU:HD23	1.95	0.47
1:B:393:ARG:NH2	1:C:321:GLU:HG3	2.29	0.47
1:C:318:LEU:HD22	1:C:322:LEU:HD23	1.96	0.47
1:D:361:THR:OG1	1:E:39:GLN:CB	2.63	0.47
1:R:12:GLU:HG2	1:R:73:LEU:HD13	1.96	0.47
1:O:387:THR:OG1	1:O:388:GLU:N	2.48	0.47
1:N:344:LEU:O	1:N:352:THR:OG1	2.16	0.47
1:A:40:LEU:CD2	1:F:361:THR:OG1	2.62	0.47
1:R:344:LEU:O	1:R:352:THR:OG1	2.17	0.47
1:U:357:ALA:HB3	1:V:44:LEU:HD13	1.95	0.47
1:E:65:GLU:HG3	2:E:501:ADP:H2'	1.96	0.47
1:K:408:TYR:CE2	1:L:7:ARG:HG2	2.50	0.47
1:O:390:ILE:HG22	1:P:320:PRO:HB3	1.95	0.47
1:J:104:THR:O	1:J:108:VAL:HG23	2.15	0.47
1:J:106:ALA:HA	1:K:289:THR:HB	1.96	0.47
1:N:316:SER:O	1:N:323:GLN:NE2	2.47	0.47
1:A:39:GLN:HB2	1:F:361:THR:CG2	2.45	0.46
1:M:261:ILE:O	1:M:274:ARG:HB3	2.15	0.46
1:J:12:GLU:HG2	1:J:73:LEU:HD13	1.97	0.46
1:N:128:GLU:O	1:N:131:ILE:HG22	2.15	0.46
1:Q:429:LEU:O	1:Q:432:LEU:N	2.48	0.46
1:D:318:LEU:HD22	1:D:322:LEU:HD23	1.98	0.46
1:G:261:ILE:O	1:G:274:ARG:HB3	2.15	0.46
1:M:6:PRO:N	1:R:408:TYR:HE1	2.13	0.46
1:N:126:LEU:O	1:N:130:ARG:HG2	2.15	0.46
1:Q:318:LEU:HD22	1:Q:322:LEU:HD23	1.98	0.46
1:S:318:LEU:HD22	1:S:322:LEU:HD23	1.97	0.46
1:B:258:ILE:HG21	1:B:306:ALA:HB1	1.96	0.46

Continued on next page...

Continued from previous page...

Atom-1	Atom-2	Interatomic distance (Å)	Clash overlap (Å)
1:G:425:VAL:HG13	1:G:429:LEU:HD12	1.98	0.46
1:R:161:LYS:HE3	1:R:165:GLU:OE2	2.16	0.46
1:W:344:LEU:O	1:W:352:THR:OG1	2.19	0.46
1:C:12:GLU:HG2	1:C:73:LEU:HD13	1.97	0.46
1:E:41:ASN:HD21	1:E:44:LEU:HD12	1.81	0.46
1:K:408:TYR:CE1	1:L:6:PRO:CB	2.99	0.46
1:S:56:ILE:HD13	1:X:441:PHE:HD2	1.81	0.46
1:A:429:LEU:O	1:A:432:LEU:N	2.44	0.46
1:E:425:VAL:HG13	1:E:429:LEU:HD12	1.97	0.46
1:H:258:ILE:HG21	1:H:306:ALA:HB1	1.97	0.46
1:M:408:TYR:HB2	1:N:29:ILE:HD11	1.98	0.46
1:Q:63:LYS:NZ	2:Q:501:ADP:O1B	2.33	0.46
1:R:65:GLU:HG3	2:R:501:ADP:H2'	1.98	0.46
1:X:65:GLU:HG3	2:X:501:ADP:H2'	1.98	0.46
1:E:95:GLU:N	1:E:95:GLU:OE1	2.48	0.46
1:K:21:ASP:O	1:K:25:ARG:HG3	2.16	0.46
1:X:55:MET:N	1:X:306:ALA:O	2.46	0.46
1:J:231:ALA:CA	1:J:234:VAL:HG12	2.44	0.46
1:P:408:TYR:OH	1:Q:7:ARG:HA	2.16	0.46
1:N:126:LEU:CB	1:N:229:GLU:HG2	2.44	0.46
1:S:63:LYS:NZ	2:S:501:ADP:O2B	2.32	0.46
1:A:261:ILE:O	1:A:274:ARG:HB3	2.15	0.45
1:D:349:ALA:HB1	1:E:44:LEU:HD23	1.98	0.45
1:D:361:THR:HG23	1:E:39:GLN:HG3	1.97	0.45
1:E:231:ALA:HA	1:E:234:VAL:HG12	1.98	0.45
1:M:40:LEU:HD21	1:R:358:LEU:N	2.31	0.45
1:W:425:VAL:HG13	1:W:429:LEU:HD12	1.99	0.45
1:C:27:VAL:HB	1:C:70:LEU:HD22	1.98	0.45
1:C:258:ILE:HG21	1:C:306:ALA:HB1	1.97	0.45
1:G:318:LEU:HD22	1:G:322:LEU:HD23	1.97	0.45
1:K:63:LYS:NZ	2:K:501:ADP:O2B	2.38	0.45
1:O:37:ARG:O	1:O:45:ARG:HG2	2.15	0.45
1:S:65:GLU:HG3	2:S:501:ADP:H2'	1.97	0.45
1:U:362:GLU:OE2	1:V:35:TRP:HZ3	1.98	0.45
1:W:234:VAL:HG13	1:W:236:PRO:HD3	1.98	0.45
1:B:12:GLU:HG2	1:B:73:LEU:HD13	1.98	0.45
1:B:261:ILE:O	1:B:274:ARG:HB3	2.16	0.45
1:D:258:ILE:HG21	1:D:306:ALA:HB1	1.99	0.45
1:K:401:ARG:NH2	1:L:329:ARG:O	2.49	0.45
1:K:411:SER:OG	1:L:32:ARG:NH2	2.36	0.45
1:O:358:LEU:CD2	1:P:40:LEU:HD11	2.47	0.45

Continued on next page...

Continued from previous page...

Atom-1	Atom-2	Interatomic distance (Å)	Clash overlap (Å)
1:S:36:ARG:NH2	1:X:407:SER:O	2.41	0.45
1:T:258:ILE:HG21	1:T:306:ALA:HB1	1.97	0.45
1:V:261:ILE:O	1:V:274:ARG:HB3	2.16	0.45
1:V:335:LEU:HD13	1:V:343:ILE:CD1	2.47	0.45
1:T:12:GLU:HG2	1:T:73:LEU:HD13	1.97	0.45
1:W:258:ILE:HG21	1:W:306:ALA:HB1	1.99	0.45
1:G:95:GLU:N	1:G:95:GLU:OE1	2.49	0.45
1:O:65:GLU:HG3	2:O:501:ADP:H2'	1.98	0.45
1:K:387:THR:OG1	1:K:388:GLU:N	2.50	0.45
1:A:12:GLU:HG2	1:A:73:LEU:HD13	1.99	0.45
1:D:362:GLU:OE2	1:E:35:TRP:HZ3	1.98	0.45
1:D:429:LEU:O	1:D:432:LEU:N	2.48	0.45
1:F:12:GLU:HG2	1:F:73:LEU:HD13	1.99	0.45
1:G:65:GLU:HG3	2:G:501:ADP:H2'	1.97	0.45
1:L:421:ASP:OD1	1:L:424:TYR:N	2.43	0.45
1:S:109:LYS:HD3	1:T:289:THR:OG1	2.16	0.45
1:A:59:THR:OG1	1:A:393:ARG:NH2	2.49	0.45
1:M:39:GLN:HB3	1:R:361:THR:CB	2.46	0.45
1:N:12:GLU:HG2	1:N:73:LEU:HD13	1.99	0.45
1:V:65:GLU:HG3	2:V:501:ADP:H2'	1.98	0.45
1:K:361:THR:HG21	1:L:39:GLN:HB2	1.99	0.45
1:N:261:ILE:O	1:N:274:ARG:HB3	2.16	0.45
1:T:95:GLU:N	1:T:95:GLU:OE1	2.50	0.45
1:N:59:THR:HG21	1:O:320:PRO:CG	2.46	0.45
1:N:429:LEU:O	1:N:432:LEU:N	2.44	0.45
1:O:63:LYS:NZ	2:O:501:ADP:O2B	2.37	0.45
1:D:354:GLN:CG	1:E:44:LEU:HD22	2.38	0.44
1:G:401:ARG:NH2	1:H:329:ARG:O	2.50	0.44
1:M:44:LEU:HD22	1:R:354:GLN:CG	2.44	0.44
1:S:18:ILE:HG12	1:S:347:PRO:HG3	1.99	0.44
1:X:55:MET:O	1:X:307:SER:HA	2.17	0.44
1:B:318:LEU:HD22	1:B:322:LEU:HD23	1.98	0.44
1:J:387:THR:OG1	1:J:388:GLU:N	2.51	0.44
1:K:360:ALA:HA	1:K:364:VAL:O	2.17	0.44
1:K:408:TYR:OH	1:L:7:ARG:CA	2.66	0.44
1:M:27:VAL:HB	1:M:70:LEU:HD22	1.99	0.44
1:B:413:LEU:HA	1:B:416:GLN:NE2	2.32	0.44
1:B:441:PHE:CE2	1:C:310:PHE:CB	3.01	0.44
1:I:316:SER:O	1:I:323:GLN:NE2	2.51	0.44
1:M:12:GLU:HG2	1:M:73:LEU:HD13	1.99	0.44
1:T:387:THR:OG1	1:T:388:GLU:N	2.50	0.44

Continued on next page...

Continued from previous page...

Atom-1	Atom-2	Interatomic distance (Å)	Clash overlap (Å)
1:U:258:ILE:HG21	1:U:306:ALA:HB1	1.99	0.44
1:V:361:THR:HG21	1:W:36:ARG:HA	1.98	0.44
1:I:95:GLU:OE1	1:I:95:GLU:N	2.51	0.44
1:K:408:TYR:OH	1:L:6:PRO:C	2.56	0.44
1:M:32:ARG:NH2	1:R:362:GLU:OE2	2.50	0.44
1:U:261:ILE:O	1:U:274:ARG:HB3	2.18	0.44
1:X:95:GLU:OE1	1:X:95:GLU:N	2.51	0.44
1:I:387:THR:OG1	1:I:388:GLU:N	2.50	0.44
1:M:425:VAL:HG13	1:M:429:LEU:HD12	2.00	0.44
1:X:261:ILE:O	1:X:274:ARG:HB3	2.18	0.44
1:L:75:ASN:OD1	1:L:114:GLN:NE2	2.49	0.44
1:L:258:ILE:HG21	1:L:306:ALA:HB1	2.00	0.44
1:P:342:ARG:O	1:P:347:PRO:HD3	2.18	0.44
1:J:261:ILE:O	1:J:274:ARG:HB3	2.17	0.44
1:O:258:ILE:HG21	1:O:306:ALA:HB1	2.00	0.44
1:P:34:ARG:NH1	1:P:250:HIS:HA	2.33	0.44
1:P:361:THR:CG2	1:Q:39:GLN:HG3	2.43	0.44
1:P:387:THR:OG1	1:P:388:GLU:N	2.50	0.44
1:X:20:GLN:NE2	1:X:333:GLN:O	2.42	0.44
1:B:361:THR:HG22	1:C:35:TRP:CH2	2.52	0.43
1:B:407:SER:OG	1:C:29:ILE:HG23	2.18	0.43
1:B:442:ILE:HA	1:C:329:ARG:HB2	2.00	0.43
1:G:429:LEU:O	1:G:432:LEU:N	2.50	0.43
1:L:387:THR:OG1	1:L:388:GLU:N	2.50	0.43
1:P:63:LYS:NZ	2:P:501:ADP:O2B	2.40	0.43
1:P:425:VAL:HG13	1:P:429:LEU:HD12	1.99	0.43
1:S:320:PRO:CB	1:X:59:THR:HG21	2.47	0.43
1:U:358:LEU:CD2	1:V:40:LEU:HD11	2.48	0.43
1:X:425:VAL:HG13	1:X:429:LEU:HD12	2.00	0.43
1:A:40:LEU:HD23	1:F:361:THR:OG1	2.18	0.43
1:B:65:GLU:HG3	2:B:501:ADP:H2'	2.00	0.43
1:D:407:SER:O	1:E:36:ARG:CZ	2.54	0.43
1:I:20:GLN:NE2	1:I:333:GLN:O	2.42	0.43
1:M:429:LEU:O	1:M:432:LEU:N	2.48	0.43
1:V:18:ILE:HG13	1:V:347:PRO:HG3	1.99	0.43
1:X:316:SER:O	1:X:323:GLN:NE2	2.51	0.43
1:E:339:ASP:OD1	1:L:427:LYS:NZ	2.51	0.43
1:I:12:GLU:HG2	1:I:73:LEU:HD13	2.00	0.43
1:P:65:GLU:HG3	2:P:501:ADP:H2'	2.00	0.43
1:T:393:ARG:HB3	1:U:324:GLY:HA3	1.99	0.43
1:V:342:ARG:O	1:V:347:PRO:HD3	2.18	0.43

Continued on next page...

Continued from previous page...

Atom-1	Atom-2	Interatomic distance (Å)	Clash overlap (Å)
1:M:258:ILE:HG21	1:M:306:ALA:HB1	2.00	0.43
1:S:15:LYS:HB3	1:S:348:ASN:ND2	2.33	0.43
1:X:355:TYR:HA	1:X:358:LEU:HD12	1.99	0.43
1:G:342:ARG:O	1:G:347:PRO:HD3	2.18	0.43
1:G:392:ALA:HB3	2:G:501:ADP:C8	2.53	0.43
1:H:76:ALA:HB1	1:H:250:HIS:O	2.18	0.43
1:J:95:GLU:N	1:J:95:GLU:OE1	2.52	0.43
1:M:324:GLY:HA3	1:R:393:ARG:HB3	2.00	0.43
1:O:12:GLU:HG2	1:O:73:LEU:HD13	2.01	0.43
1:D:387:THR:OG1	1:D:388:GLU:N	2.51	0.43
1:D:408:TYR:HE2	1:E:7:ARG:HG2	1.76	0.43
1:H:393:ARG:HH12	2:H:501:ADP:PA	2.42	0.43
1:N:258:ILE:HG21	1:N:306:ALA:HB1	2.01	0.43
1:O:358:LEU:HD23	1:P:40:LEU:HD11	2.00	0.43
1:I:18:ILE:HG21	1:I:342:ARG:HB2	2.00	0.43
1:G:335:LEU:O	1:G:381:TRP:HZ3	2.02	0.43
1:K:55:MET:N	1:K:306:ALA:O	2.46	0.43
1:K:261:ILE:O	1:K:274:ARG:HB3	2.19	0.43
1:N:21:ASP:O	1:N:25:ARG:HG3	2.19	0.43
1:R:316:SER:O	1:R:323:GLN:NE2	2.52	0.43
1:R:350:SER:O	1:R:354:GLN:HG3	2.19	0.43
1:J:18:ILE:HD11	1:J:347:PRO:HG3	2.00	0.43
1:K:12:GLU:HG2	1:K:73:LEU:HD13	2.01	0.43
1:M:41:ASN:HD21	1:M:44:LEU:HD12	1.83	0.43
1:N:122:ARG:O	1:N:126:LEU:HD23	2.19	0.43
1:B:95:GLU:OE1	1:B:95:GLU:N	2.51	0.43
1:E:135:LEU:HD13	1:E:159:PHE:CD1	2.54	0.43
1:E:318:LEU:HD22	1:E:322:LEU:HD23	2.00	0.43
1:E:342:ARG:NH1	1:L:427:LYS:HG3	2.34	0.43
1:L:429:LEU:O	1:L:432:LEU:N	2.52	0.43
1:H:261:ILE:O	1:H:274:ARG:HB3	2.19	0.42
1:L:41:ASN:ND2	1:L:44:LEU:HD12	2.33	0.42
1:P:362:GLU:OE2	1:Q:35:TRP:CZ3	2.72	0.42
1:V:361:THR:HG22	1:W:35:TRP:CZ3	2.54	0.42
1:X:27:VAL:HB	1:X:70:LEU:HD22	2.01	0.42
1:X:128:GLU:OE1	1:X:164:ARG:NH2	2.52	0.42
1:B:440:ARG:HG2	1:C:316:SER:HB3	2.00	0.42
1:C:429:LEU:O	1:C:432:LEU:N	2.51	0.42
1:J:258:ILE:HG21	1:J:306:ALA:HB1	2.00	0.42
1:L:37:ARG:O	1:L:45:ARG:HG2	2.19	0.42
1:T:15:LYS:HB3	1:T:348:ASN:ND2	2.34	0.42

Continued on next page...

Continued from previous page...

Atom-1	Atom-2	Interatomic distance (Å)	Clash overlap (Å)
1:E:342:ARG:O	1:E:347:PRO:HD3	2.20	0.42
1:N:128:GLU:O	1:N:132:LEU:HG	2.19	0.42
1:R:318:LEU:HD22	1:R:322:LEU:HD23	2.01	0.42
1:V:95:GLU:OE1	1:V:95:GLU:N	2.50	0.42
1:W:111:VAL:HB	1:W:242:ASP:OD2	2.20	0.42
1:E:160:ARG:O	1:E:164:ARG:HG3	2.19	0.42
1:E:429:LEU:O	1:E:432:LEU:N	2.50	0.42
1:M:43:GLU:OE2	1:R:349:ALA:HB2	2.20	0.42
1:Q:258:ILE:HG21	1:Q:306:ALA:HB1	2.00	0.42
1:A:318:LEU:HD22	1:A:322:LEU:HD23	2.00	0.42
1:B:425:VAL:HG13	1:B:429:LEU:HD12	2.01	0.42
1:D:261:ILE:O	1:D:274:ARG:HB3	2.19	0.42
1:E:258:ILE:HG21	1:E:306:ALA:HB1	2.01	0.42
1:T:342:ARG:O	1:T:347:PRO:HD3	2.19	0.42
1:X:63:LYS:NZ	2:X:501:ADP:O3B	2.35	0.42
1:X:231:ALA:HA	1:X:234:VAL:HG12	2.01	0.42
1:C:75:ASN:OD1	1:C:114:GLN:NE2	2.51	0.42
1:C:95:GLU:OE1	1:C:95:GLU:N	2.50	0.42
1:C:425:VAL:HG13	1:C:429:LEU:HD12	2.02	0.42
1:H:95:GLU:OE1	1:H:95:GLU:N	2.52	0.42
1:I:27:VAL:HB	1:I:70:LEU:HD22	2.01	0.42
1:K:231:ALA:HA	1:K:234:VAL:HG12	2.00	0.42
1:L:76:ALA:HB1	1:L:250:HIS:O	2.19	0.42
1:O:261:ILE:O	1:O:274:ARG:HB3	2.20	0.42
1:R:27:VAL:HB	1:R:70:LEU:HD22	2.01	0.42
1:S:6:PRO:HG2	1:X:408:TYR:HA	2.00	0.42
1:T:15:LYS:O	1:T:348:ASN:N	2.35	0.42
1:U:55:MET:N	1:U:306:ALA:O	2.45	0.42
1:U:357:ALA:CB	1:V:44:LEU:HD13	2.49	0.42
1:W:79:ILE:HG22	1:W:103:LEU:HD13	2.01	0.42
1:W:112:ARG:O	1:W:116:ILE:HG13	2.20	0.42
1:B:344:LEU:O	1:B:352:THR:OG1	2.20	0.42
1:D:397:THR:HG22	1:E:327:PRO:HA	2.00	0.42
1:G:316:SER:O	1:G:323:GLN:NE2	2.52	0.42
1:H:387:THR:OG1	1:H:388:GLU:N	2.52	0.42
1:K:244:ILE:HD11	1:K:295:GLY:HA3	2.02	0.42
1:M:132:LEU:HD22	1:M:159:PHE:CD1	2.54	0.42
1:V:409:ASP:O	1:V:413:LEU:HG	2.20	0.42
1:D:112:ARG:O	1:D:116:ILE:HG13	2.19	0.42
1:I:261:ILE:O	1:I:274:ARG:HB3	2.20	0.42
1:M:318:LEU:HD22	1:M:322:LEU:HD23	2.02	0.42

Continued on next page...

Continued from previous page...

Atom-1	Atom-2	Interatomic distance (Å)	Clash overlap (Å)
1:S:258:ILE:HG21	1:S:306:ALA:HB1	2.01	0.42
1:V:40:LEU:HD13	1:V:44:LEU:HB3	2.01	0.42
1:D:358:LEU:N	1:E:40:LEU:HD21	2.35	0.42
1:F:231:ALA:HA	1:F:234:VAL:HG12	2.01	0.42
1:L:316:SER:O	1:L:323:GLN:NE2	2.52	0.42
1:L:425:VAL:HG13	1:L:429:LEU:HD12	2.00	0.42
1:M:20:GLN:NE2	1:M:61:VAL:HB	2.34	0.42
1:S:60:GLY:N	2:S:501:ADP:O2B	2.49	0.42
1:U:76:ALA:HB1	1:U:250:HIS:O	2.20	0.42
1:W:357:ALA:HB3	1:X:44:LEU:CD1	2.50	0.42
1:X:63:LYS:HG2	1:X:332:LEU:HD13	2.02	0.42
1:A:387:THR:OG1	1:A:388:GLU:N	2.51	0.42
1:C:65:GLU:HG3	2:C:501:ADP:H2'	2.02	0.42
1:D:421:ASP:OD1	1:D:424:TYR:N	2.46	0.42
1:L:65:GLU:HG3	2:L:501:ADP:H2'	2.02	0.42
1:R:342:ARG:O	1:R:347:PRO:HD3	2.20	0.42
1:T:441:PHE:HD2	1:U:56:ILE:HD13	1.85	0.42
1:X:387:THR:OG1	1:X:388:GLU:N	2.53	0.42
1:A:231:ALA:HA	1:A:234:VAL:HG12	2.01	0.41
1:C:10:VAL:HG13	1:C:24:LYS:HD3	2.01	0.41
1:F:258:ILE:HG21	1:F:306:ALA:HB1	2.02	0.41
1:M:296:MET:HG2	1:R:109:LYS:HD2	2.01	0.41
1:M:393:ARG:HD2	1:N:320:PRO:O	2.20	0.41
1:T:441:PHE:HD2	1:U:56:ILE:HG21	1.84	0.41
1:X:15:LYS:O	1:X:347:PRO:HA	2.19	0.41
1:B:387:THR:OG1	1:B:388:GLU:N	2.52	0.41
1:D:95:GLU:OE1	1:D:95:GLU:N	2.52	0.41
1:J:318:LEU:HD22	1:J:322:LEU:HD23	2.01	0.41
1:L:40:LEU:HD13	1:L:44:LEU:HB3	2.01	0.41
1:P:408:TYR:CD1	1:Q:6:PRO:CB	2.98	0.41
1:U:362:GLU:OE2	1:V:35:TRP:CZ3	2.73	0.41
1:U:362:GLU:CD	1:V:35:TRP:HZ3	2.24	0.41
1:W:408:TYR:CE1	1:X:6:PRO:CB	3.01	0.41
1:X:350:SER:O	1:X:354:GLN:HG3	2.20	0.41
1:I:55:MET:N	1:I:306:ALA:O	2.45	0.41
1:K:238:GLU:O	1:K:242:ASP:HB2	2.20	0.41
1:N:387:THR:OG1	1:N:388:GLU:N	2.52	0.41
1:S:316:SER:O	1:S:323:GLN:NE2	2.54	0.41
1:A:36:ARG:CZ	1:F:407:SER:O	2.69	0.41
1:A:41:ASN:HD21	1:A:44:LEU:HD12	1.84	0.41
1:K:59:THR:HG21	1:L:320:PRO:HG3	2.01	0.41

Continued on next page...

Continued from previous page...

Atom-1	Atom-2	Interatomic distance (Å)	Clash overlap (Å)
1:T:16:HIS:O	1:T:347:PRO:HB3	2.20	0.41
1:B:421:ASP:OD1	1:B:424:TYR:N	2.49	0.41
1:D:358:LEU:O	1:D:361:THR:HB	2.19	0.41
1:E:76:ALA:HB1	1:E:250:HIS:O	2.21	0.41
1:M:6:PRO:HD2	1:R:408:TYR:CD1	2.54	0.41
1:M:440:ARG:HD3	1:N:314:LYS:HD2	2.01	0.41
1:Q:387:THR:OG1	1:Q:388:GLU:N	2.52	0.41
1:S:95:GLU:OE1	1:S:95:GLU:N	2.49	0.41
1:B:354:GLN:O	1:B:358:LEU:HG	2.20	0.41
1:B:408:TYR:CE2	1:C:7:ARG:HG2	2.56	0.41
1:F:27:VAL:HB	1:F:70:LEU:HD22	2.01	0.41
1:F:421:ASP:OD1	1:F:424:TYR:N	2.49	0.41
1:G:41:ASN:HD21	1:G:44:LEU:HD12	1.85	0.41
1:G:237:GLU:HG2	1:L:227:GLU:CD	2.41	0.41
1:L:155:ALA:HA	1:L:158:ALA:HB3	2.03	0.41
1:T:384:ASN:HA	1:T:388:GLU:O	2.20	0.41
1:X:258:ILE:HG21	1:X:306:ALA:HB1	2.01	0.41
1:C:316:SER:O	1:C:323:GLN:NE2	2.53	0.41
1:K:258:ILE:HG21	1:K:306:ALA:HB1	2.01	0.41
1:K:358:LEU:HA	1:L:40:LEU:HD21	2.02	0.41
1:Q:12:GLU:HG2	1:Q:73:LEU:HD13	2.02	0.41
1:S:41:ASN:HD21	1:S:44:LEU:HD12	1.86	0.41
1:U:316:SER:O	1:U:323:GLN:NE2	2.53	0.41
1:E:387:THR:OG1	1:E:388:GLU:N	2.54	0.41
1:I:34:ARG:NH1	1:I:250:HIS:HA	2.36	0.41
1:S:39:GLN:HB2	1:X:361:THR:OG1	2.20	0.41
1:X:34:ARG:NH1	1:X:250:HIS:HA	2.35	0.41
1:A:109:LYS:CE	1:B:298:LYS:HB2	2.50	0.41
1:F:261:ILE:O	1:F:274:ARG:HB3	2.20	0.41
1:G:63:LYS:NZ	2:G:501:ADP:O2B	2.37	0.41
1:H:316:SER:O	1:H:323:GLN:NE2	2.54	0.41
1:I:258:ILE:HG21	1:I:306:ALA:HB1	2.03	0.41
1:K:421:ASP:OD1	1:K:424:TYR:N	2.44	0.41
1:L:128:GLU:HA	1:L:131:ILE:HG22	2.02	0.41
1:M:25:ARG:O	1:M:29:ILE:HG13	2.21	0.41
1:N:384:ASN:HA	1:N:388:GLU:O	2.20	0.41
1:N:400:GLU:HG3	1:O:327:PRO:HB2	2.03	0.41
1:N:408:TYR:O	1:O:6:PRO:HG2	2.21	0.41
1:O:95:GLU:OE1	1:O:95:GLU:N	2.52	0.41
1:Q:231:ALA:HA	1:Q:234:VAL:HG12	2.03	0.41
1:R:128:GLU:OE1	1:R:164:ARG:NH2	2.53	0.41

Continued on next page...

Continued from previous page...

Atom-1	Atom-2	Interatomic distance (Å)	Clash overlap (Å)
1:R:258:ILE:HG21	1:R:306:ALA:HB1	2.01	0.41
1:S:5:THR:HG22	1:X:411:SER:CB	2.51	0.41
1:U:408:TYR:CE2	1:V:7:ARG:HG2	2.56	0.41
1:O:34:ARG:NH1	1:O:250:HIS:HA	2.36	0.41
1:Q:52:ASN:HB2	1:Q:325:ARG:O	2.21	0.41
1:Q:65:GLU:HG3	2:Q:501:ADP:H2'	2.03	0.41
1:Q:123:ALA:HA	1:Q:229:GLU:HG2	2.02	0.41
1:M:65:GLU:HG3	2:M:501:ADP:H2'	2.02	0.40
1:V:20:GLN:NE2	1:V:333:GLN:O	2.51	0.40
1:B:59:THR:HG21	1:C:320:PRO:HB2	2.04	0.40
1:D:411:SER:OG	1:E:32:ARG:NH2	2.54	0.40
1:H:408:TYR:CE2	1:I:25:ARG:CZ	3.04	0.40
1:H:411:SER:OG	1:I:6:PRO:HD2	2.21	0.40
1:J:234:VAL:CG2	1:J:235:ASN:N	2.84	0.40
1:M:51:LYS:HE2	1:R:400:GLU:CD	2.40	0.40
1:N:357:ALA:HB3	1:O:44:LEU:HD13	2.03	0.40
1:V:60:GLY:N	2:V:501:ADP:O1B	2.49	0.40
1:D:231:ALA:HA	1:D:234:VAL:HG12	2.02	0.40
1:H:128:GLU:OE1	1:H:164:ARG:NH2	2.54	0.40
1:K:55:MET:O	1:K:307:SER:HA	2.22	0.40
1:K:342:ARG:O	1:K:347:PRO:HD3	2.22	0.40
1:K:408:TYR:CD1	1:L:6:PRO:HB2	2.57	0.40
1:M:95:GLU:OE1	1:M:95:GLU:N	2.52	0.40
1:O:15:LYS:HB3	1:O:348:ASN:ND2	2.36	0.40
1:S:40:LEU:HD21	1:X:358:LEU:HA	2.03	0.40
1:S:261:ILE:O	1:S:274:ARG:HB3	2.21	0.40
1:T:82:GLU:HG3	1:U:279:ARG:O	2.21	0.40
1:V:387:THR:OG1	1:V:388:GLU:N	2.53	0.40
1:W:361:THR:OG1	1:X:40:LEU:HD23	2.22	0.40
1:B:409:ASP:O	1:B:413:LEU:HG	2.21	0.40
1:G:409:ASP:OD1	1:H:7:ARG:NH2	2.53	0.40
1:H:429:LEU:O	1:H:432:LEU:N	2.51	0.40
1:I:76:ALA:HB1	1:I:250:HIS:O	2.21	0.40
1:I:335:LEU:O	1:I:381:TRP:HZ3	2.05	0.40
1:M:47:GLU:HG3	1:R:349:ALA:CB	2.52	0.40
1:N:65:GLU:HG3	2:N:501:ADP:H2'	2.02	0.40
1:T:63:LYS:NZ	2:T:501:ADP:O2B	2.33	0.40
1:X:12:GLU:HG2	1:X:73:LEU:HD13	2.03	0.40
1:E:153:SER:HB2	1:E:156:ARG:HB2	2.04	0.40
1:E:339:ASP:OD1	1:L:427:LYS:HE3	2.21	0.40
1:F:34:ARG:NH1	1:F:250:HIS:HA	2.37	0.40

Continued on next page...

Continued from previous page...

Atom-1	Atom-2	Interatomic distance (Å)	Clash overlap (Å)
1:I:318:LEU:HD22	1:I:322:LEU:HD23	2.02	0.40
1:R:261:ILE:O	1:R:274:ARG:HB3	2.22	0.40
1:T:59:THR:HG21	1:U:320:PRO:CB	2.51	0.40
1:U:65:GLU:HG3	2:U:501:ADP:H2'	2.03	0.40
1:U:359:MET:HG3	1:U:366:ILE:HG13	2.03	0.40
1:X:37:ARG:O	1:X:45:ARG:HG2	2.21	0.40

All (7) symmetry-related close contacts are listed below. The label for Atom-2 includes the symmetry operator and encoded unit-cell translations to be applied.

Atom-1	Atom-2	Interatomic distance (Å)	Clash overlap (Å)
1:K:419:THR:OG1	1:X:122:ARG:NH1[1_455]	1.55	0.65
1:K:418:ILE:CD1	1:X:121:TYR:CE2[1_455]	1.81	0.39
1:K:418:ILE:CD1	1:X:121:TYR:CZ[1_455]	1.84	0.36
1:J:419:THR:O	1:Q:122:ARG:NH1[2_454]	1.88	0.32
1:F:419:THR:OG1	1:O:122:ARG:NH1[1_655]	1.93	0.27
1:P:417:ASN:ND2	1:T:419:THR:O[2_545]	2.09	0.11
1:B:165:GLU:OE1	1:M:342:ARG:NH1[1_656]	2.13	0.07

5.3 Torsion angles [i](#)

5.3.1 Protein backbone [i](#)

In the following table, the Percentiles column shows the percent Ramachandran outliers of the chain as a percentile score with respect to all X-ray entries followed by that with respect to entries of similar resolution.

The Analysed column shows the number of residues for which the backbone conformation was analysed, and the total number of residues.

Mol	Chain	Analysed	Favoured	Allowed	Outliers	Percentiles	
1	A	322/442 (73%)	315 (98%)	7 (2%)	0	100	100
1	B	327/442 (74%)	321 (98%)	6 (2%)	0	100	100
1	C	356/442 (80%)	350 (98%)	6 (2%)	0	100	100
1	D	325/442 (74%)	318 (98%)	7 (2%)	0	100	100
1	E	348/442 (79%)	341 (98%)	7 (2%)	0	100	100
1	F	330/442 (75%)	323 (98%)	7 (2%)	0	100	100
1	G	319/442 (72%)	312 (98%)	7 (2%)	0	100	100

Continued on next page...

Continued from previous page...

Mol	Chain	Analysed	Favoured	Allowed	Outliers	Percentiles	
1	H	361/442 (82%)	355 (98%)	6 (2%)	0	100	100
1	I	337/442 (76%)	330 (98%)	7 (2%)	0	100	100
1	J	323/442 (73%)	317 (98%)	6 (2%)	0	100	100
1	K	329/442 (74%)	322 (98%)	7 (2%)	0	100	100
1	L	361/442 (82%)	355 (98%)	6 (2%)	0	100	100
1	M	332/442 (75%)	325 (98%)	7 (2%)	0	100	100
1	N	320/442 (72%)	313 (98%)	7 (2%)	0	100	100
1	O	338/442 (76%)	331 (98%)	7 (2%)	0	100	100
1	P	297/442 (67%)	291 (98%)	6 (2%)	0	100	100
1	Q	360/442 (81%)	355 (99%)	5 (1%)	0	100	100
1	R	328/442 (74%)	321 (98%)	7 (2%)	0	100	100
1	S	302/442 (68%)	296 (98%)	6 (2%)	0	100	100
1	T	310/442 (70%)	303 (98%)	7 (2%)	0	100	100
1	U	313/442 (71%)	306 (98%)	7 (2%)	0	100	100
1	V	342/442 (77%)	335 (98%)	7 (2%)	0	100	100
1	W	328/442 (74%)	321 (98%)	7 (2%)	0	100	100
1	X	350/442 (79%)	344 (98%)	6 (2%)	0	100	100
All	All	7958/10608 (75%)	7800 (98%)	158 (2%)	0	100	100

There are no Ramachandran outliers to report.

5.3.2 Protein sidechains [i](#)

In the following table, the Percentiles column shows the percent sidechain outliers of the chain as a percentile score with respect to all X-ray entries followed by that with respect to entries of similar resolution.

The Analysed column shows the number of residues for which the sidechain conformation was analysed, and the total number of residues.

Mol	Chain	Analysed	Rotameric	Outliers	Percentiles	
1	A	283/376 (75%)	282 (100%)	1 (0%)	91	94
1	B	286/376 (76%)	285 (100%)	1 (0%)	92	95
1	C	310/376 (82%)	309 (100%)	1 (0%)	92	95
1	D	285/376 (76%)	284 (100%)	1 (0%)	91	94

Continued on next page...

Continued from previous page...

Mol	Chain	Analysed	Rotameric	Outliers	Percentiles	
1	E	305/376 (81%)	304 (100%)	1 (0%)	92	95
1	F	290/376 (77%)	289 (100%)	1 (0%)	92	95
1	G	281/376 (75%)	280 (100%)	1 (0%)	91	94
1	H	316/376 (84%)	315 (100%)	1 (0%)	92	95
1	I	297/376 (79%)	296 (100%)	1 (0%)	92	95
1	J	286/376 (76%)	285 (100%)	1 (0%)	92	95
1	K	289/376 (77%)	288 (100%)	1 (0%)	92	95
1	L	316/376 (84%)	315 (100%)	1 (0%)	92	95
1	M	293/376 (78%)	292 (100%)	1 (0%)	92	95
1	N	282/376 (75%)	280 (99%)	2 (1%)	84	90
1	O	298/376 (79%)	297 (100%)	1 (0%)	92	95
1	P	263/376 (70%)	262 (100%)	1 (0%)	91	94
1	Q	314/376 (84%)	313 (100%)	1 (0%)	92	95
1	R	290/376 (77%)	289 (100%)	1 (0%)	92	95
1	S	267/376 (71%)	266 (100%)	1 (0%)	91	94
1	T	274/376 (73%)	273 (100%)	1 (0%)	91	94
1	U	274/376 (73%)	273 (100%)	1 (0%)	91	94
1	V	300/376 (80%)	299 (100%)	1 (0%)	92	95
1	W	289/376 (77%)	288 (100%)	1 (0%)	92	95
1	X	310/376 (82%)	308 (99%)	2 (1%)	86	92
All	All	6998/9024 (78%)	6972 (100%)	26 (0%)	91	94

All (26) residues with a non-rotameric sidechain are listed below:

Mol	Chain	Res	Type
1	A	355	TYR
1	B	355	TYR
1	C	355	TYR
1	D	355	TYR
1	E	355	TYR
1	F	355	TYR
1	G	355	TYR
1	H	355	TYR
1	I	355	TYR
1	J	355	TYR

Continued on next page...

Continued from previous page...

Mol	Chain	Res	Type
1	K	355	TYR
1	L	355	TYR
1	M	355	TYR
1	N	355	TYR
1	N	361	THR
1	O	355	TYR
1	P	355	TYR
1	Q	355	TYR
1	R	355	TYR
1	S	355	TYR
1	T	355	TYR
1	U	355	TYR
1	V	355	TYR
1	W	355	TYR
1	X	355	TYR
1	X	361	THR

Sometimes sidechains can be flipped to improve hydrogen bonding and reduce clashes. All (59) such sidechains are listed below:

Mol	Chain	Res	Type
1	A	301	HIS
1	C	75	ASN
1	C	114	GLN
1	C	301	HIS
1	D	33	ASN
1	D	75	ASN
1	D	114	GLN
1	D	365	ASN
1	D	417	ASN
1	E	75	ASN
1	E	114	GLN
1	F	75	ASN
1	F	114	GLN
1	G	75	ASN
1	G	114	GLN
1	H	75	ASN
1	H	114	GLN
1	H	301	HIS
1	I	75	ASN
1	I	114	GLN
1	J	75	ASN
1	J	114	GLN

Continued on next page...

Continued from previous page...

Mol	Chain	Res	Type
1	J	301	HIS
1	K	75	ASN
1	K	114	GLN
1	K	416	GLN
1	L	41	ASN
1	L	75	ASN
1	L	114	GLN
1	L	428	HIS
1	M	75	ASN
1	M	114	GLN
1	N	75	ASN
1	N	114	GLN
1	O	75	ASN
1	O	114	GLN
1	P	75	ASN
1	P	114	GLN
1	Q	301	HIS
1	R	75	ASN
1	R	114	GLN
1	R	157	GLN
1	R	301	HIS
1	S	22	ASN
1	S	75	ASN
1	S	114	GLN
1	S	301	HIS
1	T	75	ASN
1	T	114	GLN
1	U	75	ASN
1	U	114	GLN
1	U	301	HIS
1	V	75	ASN
1	V	114	GLN
1	W	75	ASN
1	W	114	GLN
1	X	75	ASN
1	X	114	GLN
1	X	301	HIS

5.3.3 RNA [i](#)

There are no RNA molecules in this entry.

5.4 Non-standard residues in protein, DNA, RNA chains [i](#)

There are no non-standard protein/DNA/RNA residues in this entry.

5.5 Carbohydrates [i](#)

There are no monosaccharides in this entry.

5.6 Ligand geometry [i](#)

24 ligands are modelled in this entry.

In the following table, the Counts columns list the number of bonds (or angles) for which Mogul statistics could be retrieved, the number of bonds (or angles) that are observed in the model and the number of bonds (or angles) that are defined in the Chemical Component Dictionary. The Link column lists molecule types, if any, to which the group is linked. The Z score for a bond length (or angle) is the number of standard deviations the observed value is removed from the expected value. A bond length (or angle) with $|Z| > 2$ is considered an outlier worth inspection. RMSZ is the root-mean-square of all Z scores of the bond lengths (or angles).

Mol	Type	Chain	Res	Link	Bond lengths			Bond angles		
					Counts	RMSZ	# Z > 2	Counts	RMSZ	# Z > 2
2	ADP	B	501	-	24,29,29	0.97	1 (4%)	29,45,45	1.43	4 (13%)
2	ADP	X	501	-	24,29,29	0.99	1 (4%)	29,45,45	1.41	4 (13%)
2	ADP	S	501	-	24,29,29	0.96	1 (4%)	29,45,45	1.42	4 (13%)
2	ADP	I	501	-	24,29,29	0.95	1 (4%)	29,45,45	1.46	4 (13%)
2	ADP	N	501	-	24,29,29	0.99	1 (4%)	29,45,45	1.43	4 (13%)
2	ADP	M	501	-	24,29,29	0.96	1 (4%)	29,45,45	1.43	4 (13%)
2	ADP	V	501	-	24,29,29	0.98	1 (4%)	29,45,45	1.41	4 (13%)
2	ADP	A	501	-	24,29,29	0.94	1 (4%)	29,45,45	1.43	4 (13%)
2	ADP	C	501	-	24,29,29	0.98	1 (4%)	29,45,45	1.41	4 (13%)
2	ADP	W	501	-	24,29,29	0.99	1 (4%)	29,45,45	1.43	4 (13%)
2	ADP	L	501	-	24,29,29	0.97	1 (4%)	29,45,45	1.43	4 (13%)
2	ADP	E	501	-	24,29,29	0.98	1 (4%)	29,45,45	1.47	4 (13%)
2	ADP	P	501	-	24,29,29	0.98	1 (4%)	29,45,45	1.43	4 (13%)
2	ADP	J	501	-	24,29,29	0.98	1 (4%)	29,45,45	1.46	4 (13%)
2	ADP	H	501	-	24,29,29	0.94	1 (4%)	29,45,45	1.46	4 (13%)
2	ADP	U	501	-	24,29,29	0.99	1 (4%)	29,45,45	1.42	4 (13%)
2	ADP	T	501	-	24,29,29	1.00	1 (4%)	29,45,45	1.46	4 (13%)
2	ADP	F	501	-	24,29,29	0.98	1 (4%)	29,45,45	1.46	4 (13%)

Mol	Type	Chain	Res	Link	Bond lengths			Bond angles		
					Counts	RMSZ	# Z > 2	Counts	RMSZ	# Z > 2
2	ADP	K	501	-	24,29,29	0.99	1 (4%)	29,45,45	1.46	4 (13%)
2	ADP	R	501	-	24,29,29	0.98	1 (4%)	29,45,45	1.43	4 (13%)
2	ADP	Q	501	-	24,29,29	0.97	1 (4%)	29,45,45	1.43	4 (13%)
2	ADP	O	501	-	24,29,29	0.98	1 (4%)	29,45,45	1.45	4 (13%)
2	ADP	D	501	-	24,29,29	1.00	1 (4%)	29,45,45	1.43	4 (13%)
2	ADP	G	501	-	24,29,29	1.00	1 (4%)	29,45,45	1.43	4 (13%)

In the following table, the Chirals column lists the number of chiral outliers, the number of chiral centers analysed, the number of these observed in the model and the number defined in the Chemical Component Dictionary. Similar counts are reported in the Torsion and Rings columns. '-' means no outliers of that kind were identified.

Mol	Type	Chain	Res	Link	Chirals	Torsions	Rings
2	ADP	B	501	-	-	5/12/32/32	0/3/3/3
2	ADP	X	501	-	-	5/12/32/32	0/3/3/3
2	ADP	S	501	-	-	5/12/32/32	0/3/3/3
2	ADP	I	501	-	-	5/12/32/32	0/3/3/3
2	ADP	N	501	-	-	3/12/32/32	0/3/3/3
2	ADP	M	501	-	-	5/12/32/32	0/3/3/3
2	ADP	V	501	-	-	2/12/32/32	0/3/3/3
2	ADP	A	501	-	-	4/12/32/32	0/3/3/3
2	ADP	C	501	-	-	5/12/32/32	0/3/3/3
2	ADP	W	501	-	-	4/12/32/32	0/3/3/3
2	ADP	L	501	-	-	2/12/32/32	0/3/3/3
2	ADP	E	501	-	-	4/12/32/32	0/3/3/3
2	ADP	P	501	-	-	5/12/32/32	0/3/3/3
2	ADP	J	501	-	-	4/12/32/32	0/3/3/3
2	ADP	H	501	-	-	2/12/32/32	0/3/3/3
2	ADP	U	501	-	-	2/12/32/32	0/3/3/3
2	ADP	T	501	-	-	5/12/32/32	0/3/3/3
2	ADP	F	501	-	-	3/12/32/32	0/3/3/3
2	ADP	K	501	-	-	4/12/32/32	0/3/3/3
2	ADP	R	501	-	-	5/12/32/32	0/3/3/3
2	ADP	Q	501	-	-	4/12/32/32	0/3/3/3
2	ADP	O	501	-	-	4/12/32/32	0/3/3/3
2	ADP	D	501	-	-	4/12/32/32	0/3/3/3

Continued on next page...

Continued from previous page...

Mol	Type	Chain	Res	Link	Chirals	Torsions	Rings
2	ADP	G	501	-	-	4/12/32/32	0/3/3/3

All (24) bond length outliers are listed below:

Mol	Chain	Res	Type	Atoms	Z	Observed(Å)	Ideal(Å)
2	T	501	ADP	C5-C4	2.66	1.48	1.40
2	O	501	ADP	C5-C4	2.66	1.48	1.40
2	D	501	ADP	C5-C4	2.65	1.47	1.40
2	X	501	ADP	C5-C4	2.64	1.47	1.40
2	U	501	ADP	C5-C4	2.63	1.47	1.40
2	G	501	ADP	C5-C4	2.63	1.47	1.40
2	K	501	ADP	C5-C4	2.62	1.47	1.40
2	W	501	ADP	C5-C4	2.62	1.47	1.40
2	E	501	ADP	C5-C4	2.62	1.47	1.40
2	C	501	ADP	C5-C4	2.62	1.47	1.40
2	P	501	ADP	C5-C4	2.61	1.47	1.40
2	N	501	ADP	C5-C4	2.61	1.47	1.40
2	J	501	ADP	C5-C4	2.61	1.47	1.40
2	R	501	ADP	C5-C4	2.59	1.47	1.40
2	B	501	ADP	C5-C4	2.59	1.47	1.40
2	F	501	ADP	C5-C4	2.58	1.47	1.40
2	L	501	ADP	C5-C4	2.57	1.47	1.40
2	Q	501	ADP	C5-C4	2.55	1.47	1.40
2	V	501	ADP	C5-C4	2.54	1.47	1.40
2	M	501	ADP	C5-C4	2.53	1.47	1.40
2	I	501	ADP	C5-C4	2.53	1.47	1.40
2	H	501	ADP	C5-C4	2.52	1.47	1.40
2	S	501	ADP	C5-C4	2.47	1.47	1.40
2	A	501	ADP	C5-C4	2.45	1.47	1.40

All (96) bond angle outliers are listed below:

Mol	Chain	Res	Type	Atoms	Z	Observed(°)	Ideal(°)
2	C	501	ADP	C3'-C2'-C1'	3.70	106.55	100.98
2	T	501	ADP	C3'-C2'-C1'	3.70	106.55	100.98
2	F	501	ADP	C3'-C2'-C1'	3.67	106.51	100.98
2	N	501	ADP	C3'-C2'-C1'	3.65	106.47	100.98
2	K	501	ADP	C3'-C2'-C1'	3.62	106.44	100.98
2	U	501	ADP	C3'-C2'-C1'	3.62	106.43	100.98
2	E	501	ADP	C3'-C2'-C1'	3.61	106.41	100.98
2	D	501	ADP	C3'-C2'-C1'	3.61	106.41	100.98
2	H	501	ADP	C3'-C2'-C1'	3.60	106.40	100.98

Continued on next page...

Continued from previous page...

Mol	Chain	Res	Type	Atoms	Z	Observed(°)	Ideal(°)
2	I	501	ADP	C3'-C2'-C1'	3.60	106.40	100.98
2	O	501	ADP	C3'-C2'-C1'	3.57	106.36	100.98
2	P	501	ADP	C3'-C2'-C1'	3.57	106.35	100.98
2	L	501	ADP	C3'-C2'-C1'	3.55	106.33	100.98
2	J	501	ADP	C3'-C2'-C1'	3.53	106.30	100.98
2	B	501	ADP	C3'-C2'-C1'	3.53	106.29	100.98
2	G	501	ADP	C3'-C2'-C1'	3.52	106.28	100.98
2	V	501	ADP	C3'-C2'-C1'	3.51	106.26	100.98
2	W	501	ADP	C3'-C2'-C1'	3.51	106.26	100.98
2	X	501	ADP	C3'-C2'-C1'	3.50	106.25	100.98
2	R	501	ADP	C3'-C2'-C1'	3.49	106.24	100.98
2	L	501	ADP	PA-O3A-PB	-3.46	120.96	132.83
2	A	501	ADP	C3'-C2'-C1'	3.43	106.14	100.98
2	M	501	ADP	PA-O3A-PB	-3.37	121.27	132.83
2	E	501	ADP	PA-O3A-PB	-3.36	121.30	132.83
2	S	501	ADP	C3'-C2'-C1'	3.36	106.03	100.98
2	O	501	ADP	PA-O3A-PB	-3.33	121.41	132.83
2	Q	501	ADP	PA-O3A-PB	-3.32	121.45	132.83
2	Q	501	ADP	C3'-C2'-C1'	3.31	105.96	100.98
2	H	501	ADP	PA-O3A-PB	-3.28	121.56	132.83
2	J	501	ADP	PA-O3A-PB	-3.28	121.58	132.83
2	B	501	ADP	PA-O3A-PB	-3.27	121.62	132.83
2	S	501	ADP	N3-C2-N1	-3.26	123.58	128.68
2	M	501	ADP	C3'-C2'-C1'	3.26	105.89	100.98
2	S	501	ADP	PA-O3A-PB	-3.25	121.67	132.83
2	G	501	ADP	PA-O3A-PB	-3.24	121.72	132.83
2	I	501	ADP	PA-O3A-PB	-3.23	121.75	132.83
2	K	501	ADP	PA-O3A-PB	-3.22	121.76	132.83
2	T	501	ADP	PA-O3A-PB	-3.21	121.81	132.83
2	M	501	ADP	N3-C2-N1	-3.20	123.67	128.68
2	A	501	ADP	N3-C2-N1	-3.20	123.68	128.68
2	H	501	ADP	N3-C2-N1	-3.19	123.69	128.68
2	P	501	ADP	PA-O3A-PB	-3.18	121.90	132.83
2	I	501	ADP	N3-C2-N1	-3.16	123.73	128.68
2	Q	501	ADP	N3-C2-N1	-3.16	123.74	128.68
2	A	501	ADP	PA-O3A-PB	-3.12	122.13	132.83
2	R	501	ADP	PA-O3A-PB	-3.11	122.16	132.83
2	J	501	ADP	N3-C2-N1	-3.10	123.83	128.68
2	F	501	ADP	N3-C2-N1	-3.10	123.84	128.68
2	B	501	ADP	N3-C2-N1	-3.09	123.84	128.68
2	F	501	ADP	PA-O3A-PB	-3.09	122.23	132.83
2	N	501	ADP	PA-O3A-PB	-3.09	122.24	132.83

Continued on next page...

Continued from previous page...

Mol	Chain	Res	Type	Atoms	Z	Observed(°)	Ideal(°)
2	V	501	ADP	N3-C2-N1	-3.08	123.87	128.68
2	U	501	ADP	N3-C2-N1	-3.07	123.87	128.68
2	G	501	ADP	N3-C2-N1	-3.06	123.89	128.68
2	D	501	ADP	PA-O3A-PB	-3.06	122.32	132.83
2	W	501	ADP	N3-C2-N1	-3.06	123.89	128.68
2	W	501	ADP	PA-O3A-PB	-3.06	122.33	132.83
2	K	501	ADP	N3-C2-N1	-3.05	123.91	128.68
2	U	501	ADP	PA-O3A-PB	-3.05	122.36	132.83
2	R	501	ADP	N3-C2-N1	-3.05	123.91	128.68
2	O	501	ADP	N3-C2-N1	-3.04	123.93	128.68
2	V	501	ADP	PA-O3A-PB	-3.04	122.41	132.83
2	N	501	ADP	N3-C2-N1	-3.03	123.94	128.68
2	E	501	ADP	N3-C2-N1	-3.03	123.94	128.68
2	P	501	ADP	N3-C2-N1	-3.03	123.94	128.68
2	L	501	ADP	N3-C2-N1	-3.03	123.94	128.68
2	C	501	ADP	N3-C2-N1	-3.03	123.95	128.68
2	D	501	ADP	N3-C2-N1	-3.00	123.99	128.68
2	T	501	ADP	N3-C2-N1	-2.99	124.01	128.68
2	X	501	ADP	PA-O3A-PB	-2.95	122.71	132.83
2	X	501	ADP	N3-C2-N1	-2.94	124.08	128.68
2	C	501	ADP	PA-O3A-PB	-2.71	123.51	132.83
2	N	501	ADP	C4-C5-N7	-2.69	106.59	109.40
2	D	501	ADP	C4-C5-N7	-2.68	106.61	109.40
2	C	501	ADP	C4-C5-N7	-2.64	106.65	109.40
2	K	501	ADP	C4-C5-N7	-2.64	106.65	109.40
2	U	501	ADP	C4-C5-N7	-2.61	106.67	109.40
2	X	501	ADP	C4-C5-N7	-2.61	106.68	109.40
2	W	501	ADP	C4-C5-N7	-2.60	106.69	109.40
2	T	501	ADP	C4-C5-N7	-2.59	106.70	109.40
2	P	501	ADP	C4-C5-N7	-2.59	106.70	109.40
2	E	501	ADP	C4-C5-N7	-2.59	106.70	109.40
2	J	501	ADP	C4-C5-N7	-2.55	106.75	109.40
2	G	501	ADP	C4-C5-N7	-2.53	106.76	109.40
2	F	501	ADP	C4-C5-N7	-2.51	106.79	109.40
2	O	501	ADP	C4-C5-N7	-2.49	106.81	109.40
2	I	501	ADP	C4-C5-N7	-2.46	106.84	109.40
2	R	501	ADP	C4-C5-N7	-2.45	106.84	109.40
2	B	501	ADP	C4-C5-N7	-2.44	106.86	109.40
2	V	501	ADP	C4-C5-N7	-2.41	106.89	109.40
2	L	501	ADP	C4-C5-N7	-2.39	106.91	109.40
2	H	501	ADP	C4-C5-N7	-2.38	106.92	109.40
2	Q	501	ADP	C4-C5-N7	-2.32	106.98	109.40

Continued on next page...

Continued from previous page...

Mol	Chain	Res	Type	Atoms	Z	Observed(°)	Ideal(°)
2	M	501	ADP	C4-C5-N7	-2.31	106.99	109.40
2	S	501	ADP	C4-C5-N7	-2.28	107.02	109.40
2	A	501	ADP	C4-C5-N7	-2.18	107.13	109.40

There are no chirality outliers.

All (95) torsion outliers are listed below:

Mol	Chain	Res	Type	Atoms
2	A	501	ADP	C5'-O5'-PA-O1A
2	A	501	ADP	O4'-C4'-C5'-O5'
2	C	501	ADP	C5'-O5'-PA-O2A
2	C	501	ADP	O4'-C4'-C5'-O5'
2	I	501	ADP	C5'-O5'-PA-O1A
2	I	501	ADP	O4'-C4'-C5'-O5'
2	M	501	ADP	C5'-O5'-PA-O1A
2	M	501	ADP	O4'-C4'-C5'-O5'
2	P	501	ADP	C5'-O5'-PA-O2A
2	P	501	ADP	O4'-C4'-C5'-O5'
2	R	501	ADP	C5'-O5'-PA-O1A
2	S	501	ADP	C5'-O5'-PA-O1A
2	S	501	ADP	O4'-C4'-C5'-O5'
2	X	501	ADP	C5'-O5'-PA-O1A
2	A	501	ADP	C3'-C4'-C5'-O5'
2	B	501	ADP	O4'-C4'-C5'-O5'
2	D	501	ADP	O4'-C4'-C5'-O5'
2	E	501	ADP	O4'-C4'-C5'-O5'
2	G	501	ADP	O4'-C4'-C5'-O5'
2	H	501	ADP	O4'-C4'-C5'-O5'
2	J	501	ADP	O4'-C4'-C5'-O5'
2	J	501	ADP	C3'-C4'-C5'-O5'
2	K	501	ADP	O4'-C4'-C5'-O5'
2	L	501	ADP	O4'-C4'-C5'-O5'
2	M	501	ADP	C3'-C4'-C5'-O5'
2	N	501	ADP	O4'-C4'-C5'-O5'
2	O	501	ADP	O4'-C4'-C5'-O5'
2	Q	501	ADP	O4'-C4'-C5'-O5'
2	Q	501	ADP	C3'-C4'-C5'-O5'
2	R	501	ADP	O4'-C4'-C5'-O5'
2	T	501	ADP	O4'-C4'-C5'-O5'
2	W	501	ADP	O4'-C4'-C5'-O5'
2	X	501	ADP	O4'-C4'-C5'-O5'
2	X	501	ADP	C3'-C4'-C5'-O5'

Continued on next page...

Continued from previous page...

Mol	Chain	Res	Type	Atoms
2	B	501	ADP	C3'-C4'-C5'-O5'
2	C	501	ADP	C3'-C4'-C5'-O5'
2	E	501	ADP	C3'-C4'-C5'-O5'
2	G	501	ADP	C3'-C4'-C5'-O5'
2	H	501	ADP	C3'-C4'-C5'-O5'
2	I	501	ADP	C3'-C4'-C5'-O5'
2	K	501	ADP	C3'-C4'-C5'-O5'
2	N	501	ADP	C3'-C4'-C5'-O5'
2	O	501	ADP	C3'-C4'-C5'-O5'
2	P	501	ADP	C3'-C4'-C5'-O5'
2	R	501	ADP	C3'-C4'-C5'-O5'
2	S	501	ADP	C3'-C4'-C5'-O5'
2	T	501	ADP	C3'-C4'-C5'-O5'
2	W	501	ADP	C3'-C4'-C5'-O5'
2	L	501	ADP	C3'-C4'-C5'-O5'
2	D	501	ADP	C3'-C4'-C5'-O5'
2	U	501	ADP	O4'-C4'-C5'-O5'
2	U	501	ADP	C3'-C4'-C5'-O5'
2	V	501	ADP	O4'-C4'-C5'-O5'
2	V	501	ADP	C3'-C4'-C5'-O5'
2	F	501	ADP	O4'-C4'-C5'-O5'
2	F	501	ADP	C3'-C4'-C5'-O5'
2	A	501	ADP	C5'-O5'-PA-O3A
2	C	501	ADP	C5'-O5'-PA-O3A
2	I	501	ADP	C5'-O5'-PA-O3A
2	J	501	ADP	C5'-O5'-PA-O3A
2	M	501	ADP	C5'-O5'-PA-O3A
2	O	501	ADP	C5'-O5'-PA-O3A
2	P	501	ADP	C5'-O5'-PA-O3A
2	R	501	ADP	C5'-O5'-PA-O3A
2	S	501	ADP	C5'-O5'-PA-O3A
2	X	501	ADP	C5'-O5'-PA-O3A
2	E	501	ADP	C5'-O5'-PA-O1A
2	I	501	ADP	C5'-O5'-PA-O2A
2	J	501	ADP	C5'-O5'-PA-O1A
2	B	501	ADP	C5'-O5'-PA-O3A
2	D	501	ADP	C5'-O5'-PA-O3A
2	E	501	ADP	C5'-O5'-PA-O3A
2	F	501	ADP	C5'-O5'-PA-O3A
2	G	501	ADP	C5'-O5'-PA-O3A
2	K	501	ADP	C5'-O5'-PA-O3A
2	N	501	ADP	C5'-O5'-PA-O3A

Continued on next page...

Continued from previous page...

Mol	Chain	Res	Type	Atoms
2	Q	501	ADP	C5'-O5'-PA-O3A
2	T	501	ADP	C5'-O5'-PA-O3A
2	W	501	ADP	C5'-O5'-PA-O3A
2	B	501	ADP	C5'-O5'-PA-O1A
2	B	501	ADP	C5'-O5'-PA-O2A
2	C	501	ADP	C5'-O5'-PA-O1A
2	D	501	ADP	C5'-O5'-PA-O1A
2	G	501	ADP	C5'-O5'-PA-O1A
2	K	501	ADP	C5'-O5'-PA-O1A
2	M	501	ADP	C5'-O5'-PA-O2A
2	O	501	ADP	C5'-O5'-PA-O1A
2	P	501	ADP	C5'-O5'-PA-O1A
2	Q	501	ADP	C5'-O5'-PA-O1A
2	R	501	ADP	C5'-O5'-PA-O2A
2	S	501	ADP	C5'-O5'-PA-O2A
2	T	501	ADP	C5'-O5'-PA-O1A
2	T	501	ADP	C5'-O5'-PA-O2A
2	W	501	ADP	C5'-O5'-PA-O1A
2	X	501	ADP	C5'-O5'-PA-O2A

There are no ring outliers.

24 monomers are involved in 81 short contacts:

Mol	Chain	Res	Type	Clashes	Symm-Clashes
2	B	501	ADP	2	0
2	X	501	ADP	4	0
2	S	501	ADP	4	0
2	I	501	ADP	4	0
2	N	501	ADP	2	0
2	M	501	ADP	5	0
2	V	501	ADP	3	0
2	A	501	ADP	4	0
2	C	501	ADP	4	0
2	W	501	ADP	1	0
2	L	501	ADP	3	0
2	E	501	ADP	4	0
2	P	501	ADP	5	0
2	J	501	ADP	3	0
2	H	501	ADP	5	0
2	U	501	ADP	2	0
2	T	501	ADP	4	0
2	F	501	ADP	2	0

Continued on next page...

Continued from previous page...

Mol	Chain	Res	Type	Clashes	Symm-Clashes
2	K	501	ADP	4	0
2	R	501	ADP	3	0
2	Q	501	ADP	4	0
2	O	501	ADP	3	0
2	D	501	ADP	1	0
2	G	501	ADP	5	0

The following is a two-dimensional graphical depiction of Mogul quality analysis of bond lengths, bond angles, torsion angles, and ring geometry for all instances of the Ligand of Interest. In addition, ligands with molecular weight > 250 and outliers as shown on the validation Tables will also be included. For torsion angles, if less than 5% of the Mogul distribution of torsion angles is within 10 degrees of the torsion angle in question, then that torsion angle is considered an outlier. Any bond that is central to one or more torsion angles identified as an outlier by Mogul will be highlighted in the graph. For rings, the root-mean-square deviation (RMSD) between the ring in question and similar rings identified by Mogul is calculated over all ring torsion angles. If the average RMSD is greater than 60 degrees and the minimal RMSD between the ring in question and any Mogul-identified rings is also greater than 60 degrees, then that ring is considered an outlier. The outliers are highlighted in purple. The color gray indicates Mogul did not find sufficient equivalents in the CSD to analyse the geometry.

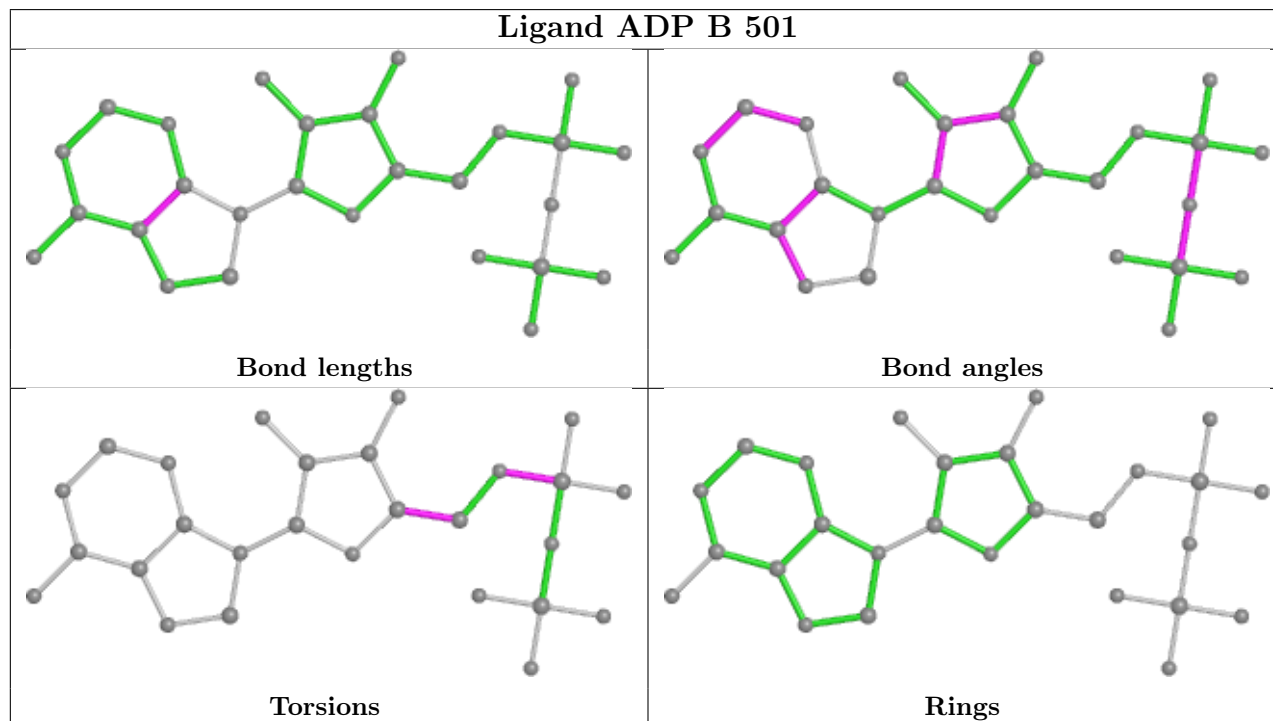

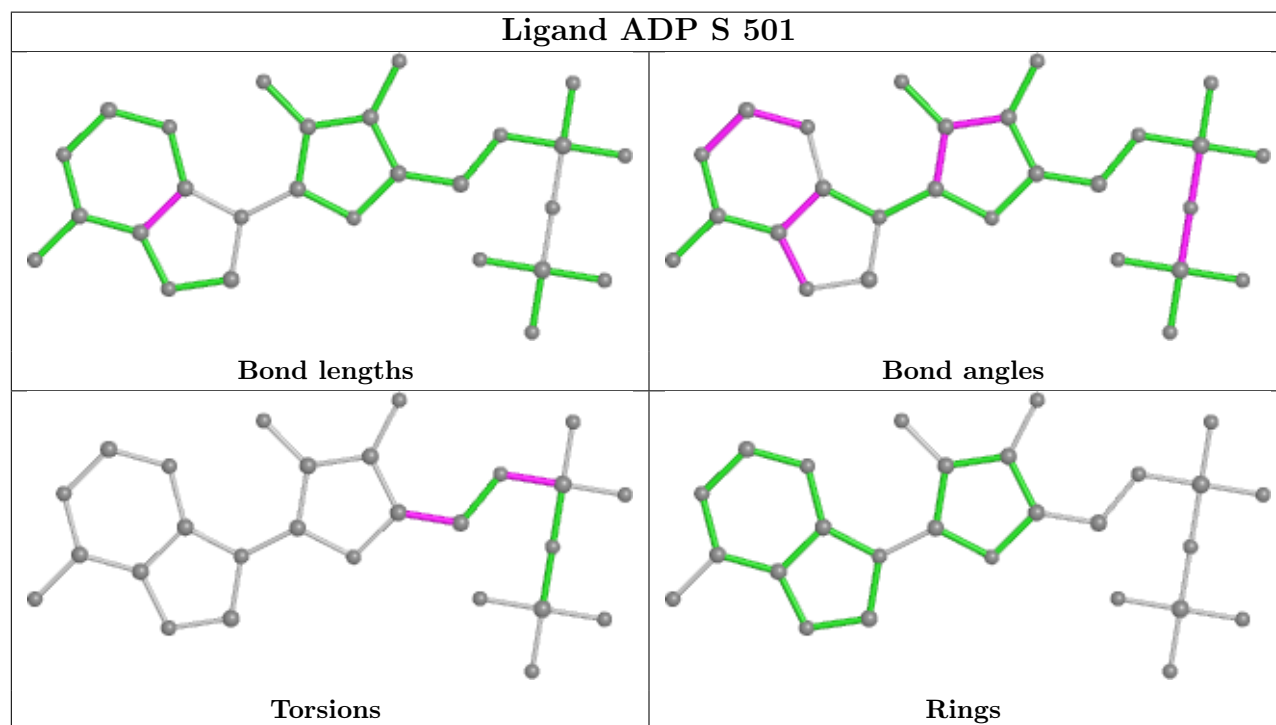
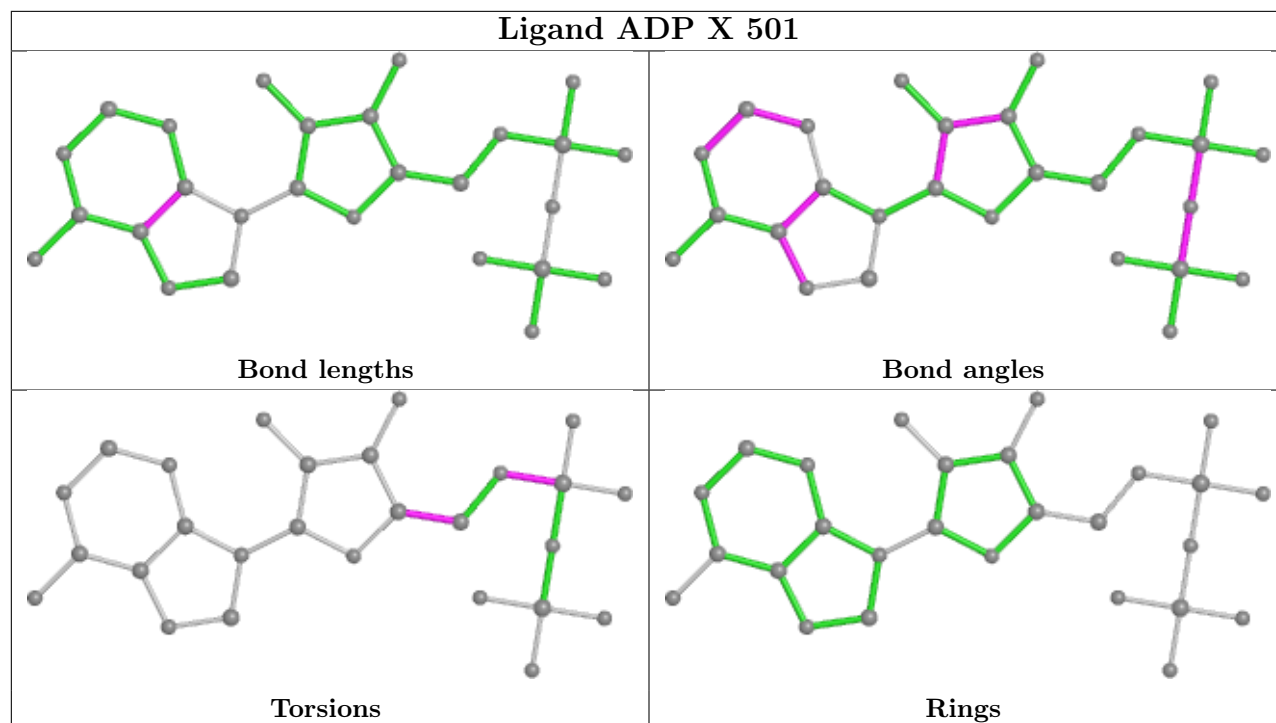

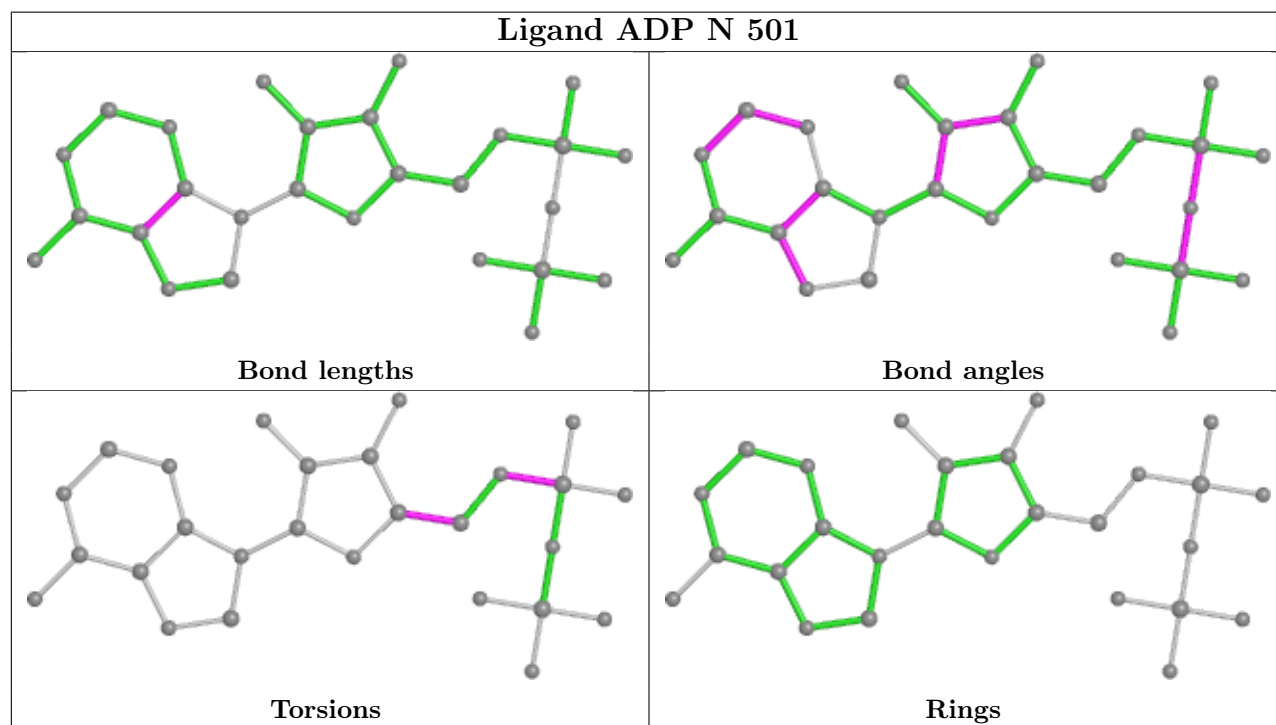
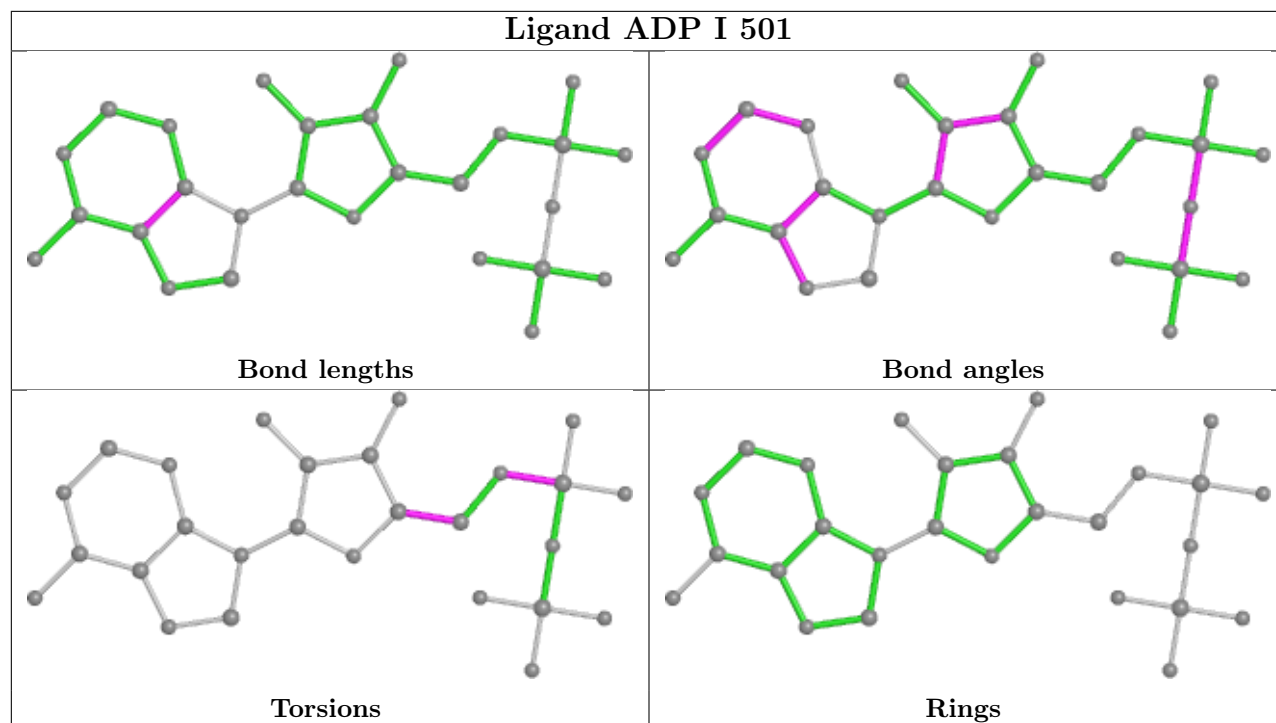

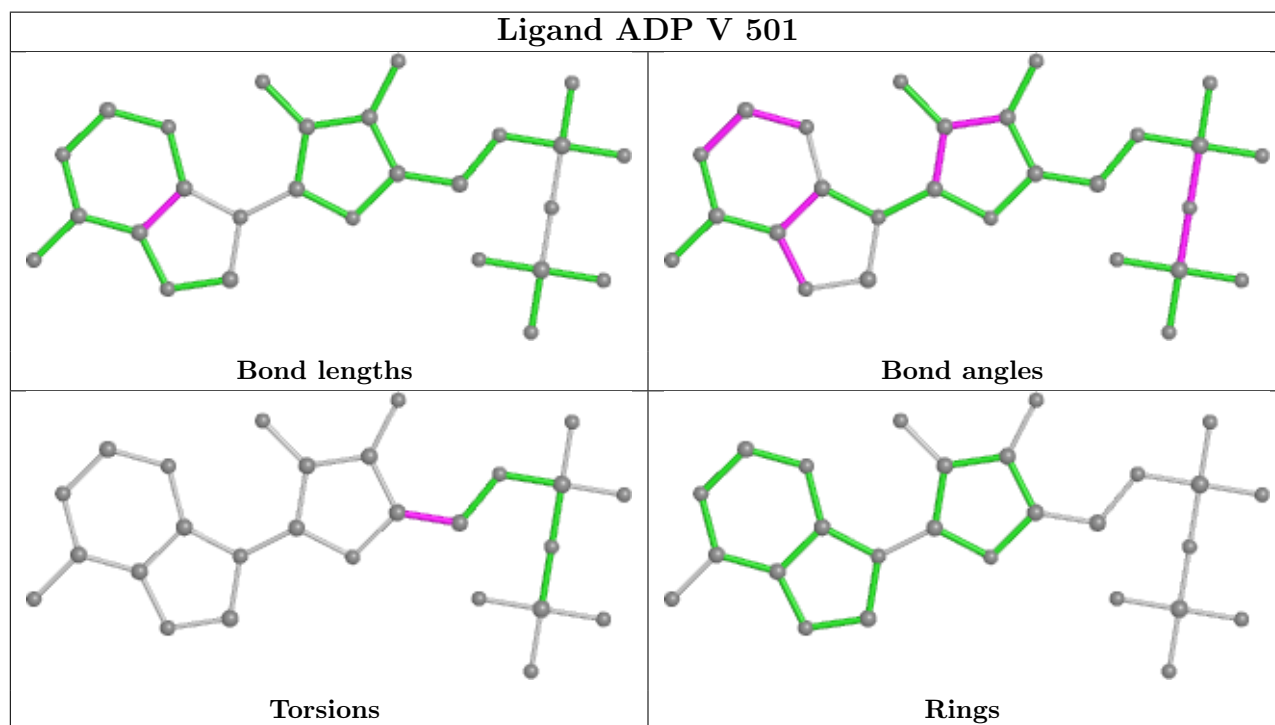
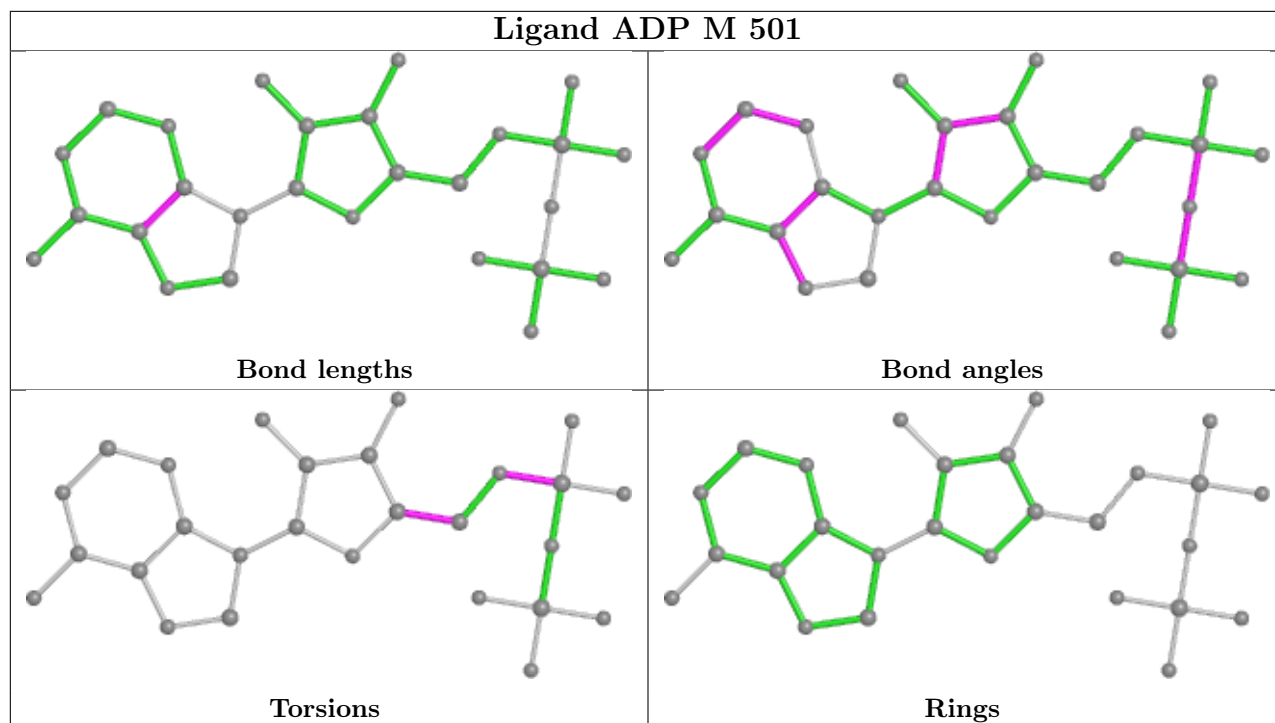

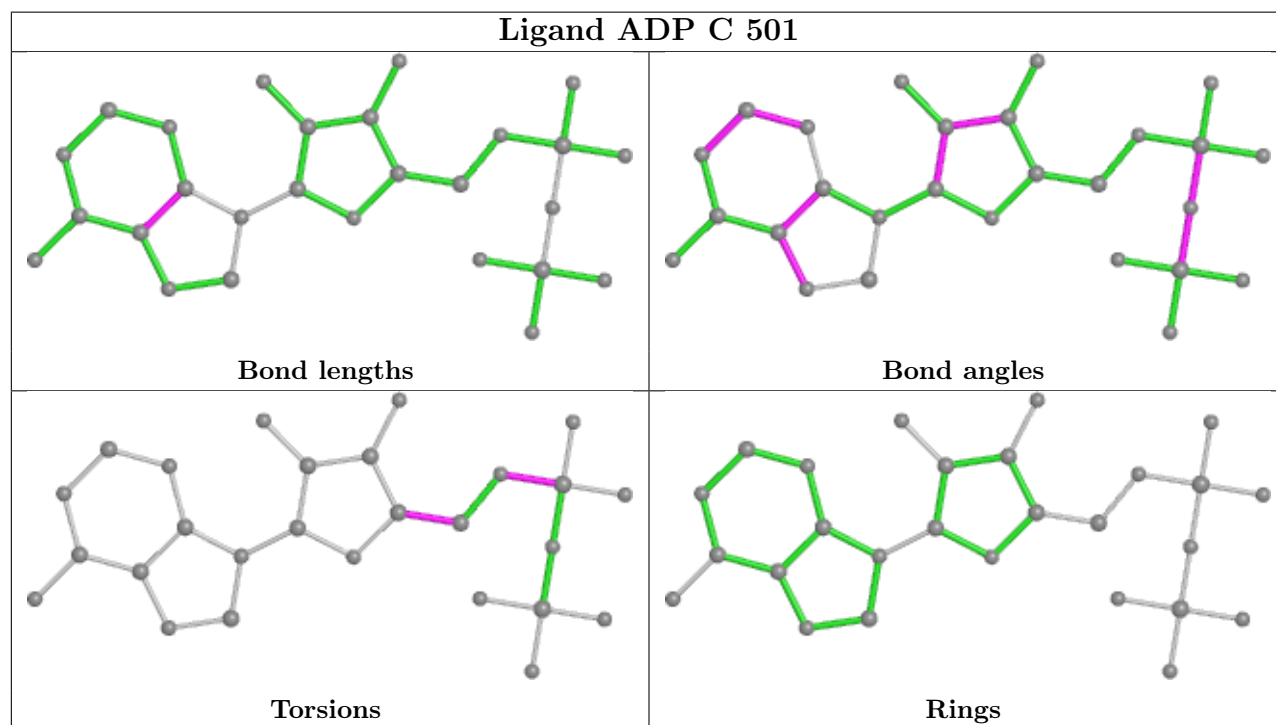
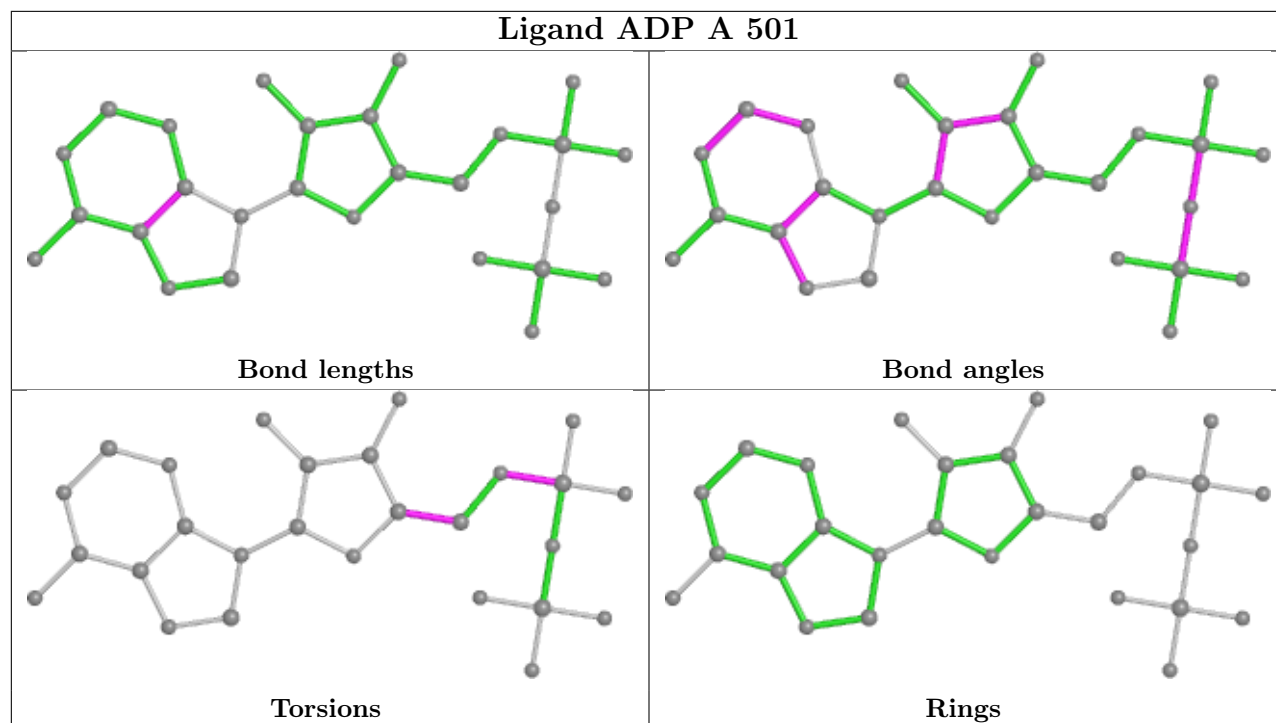

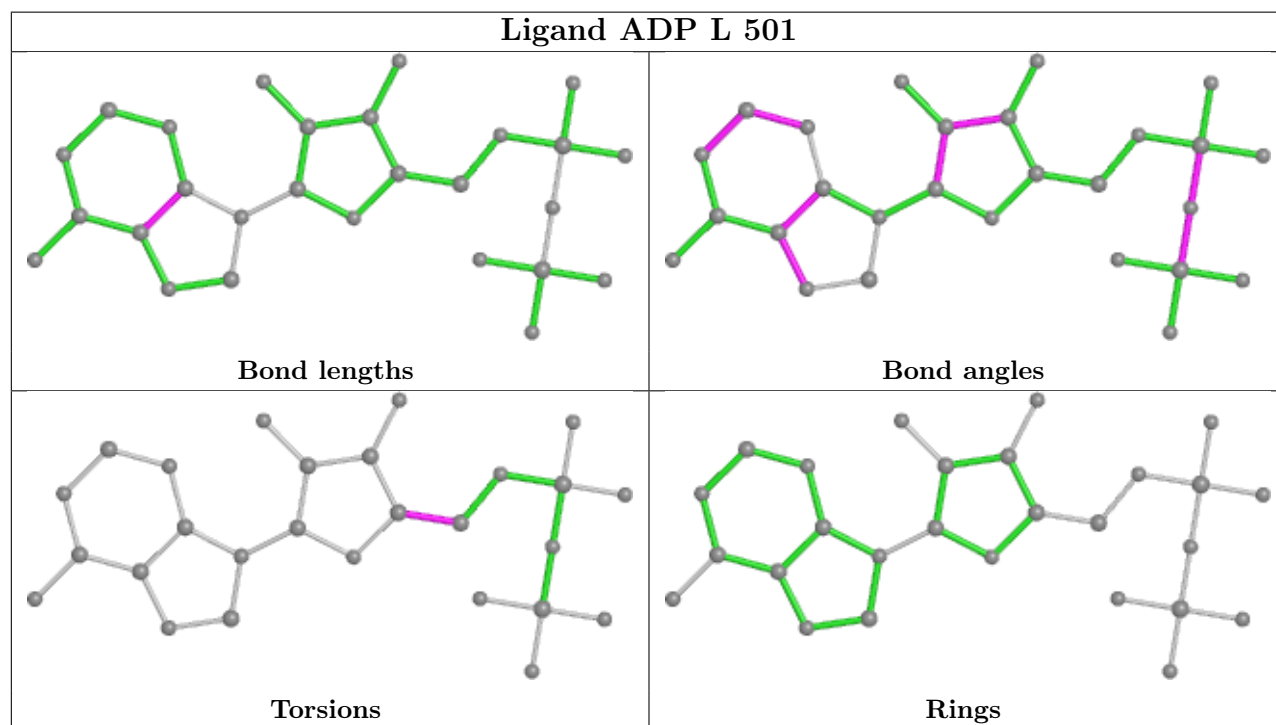
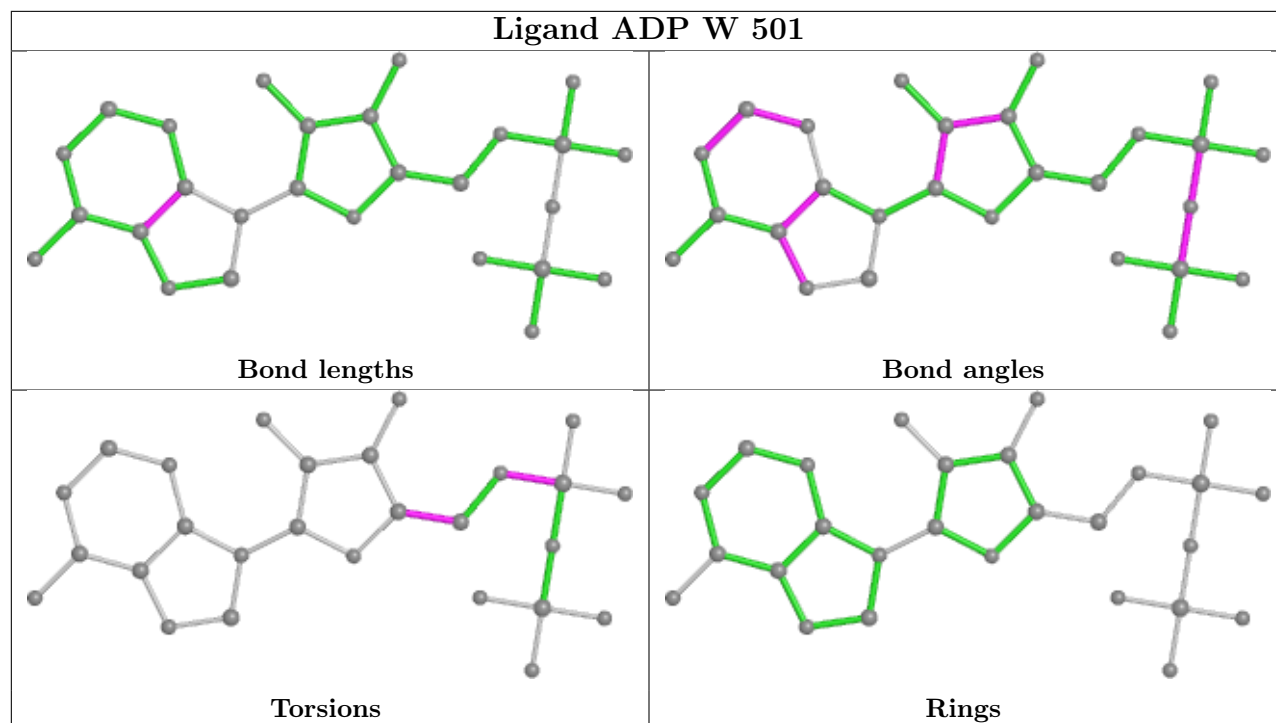

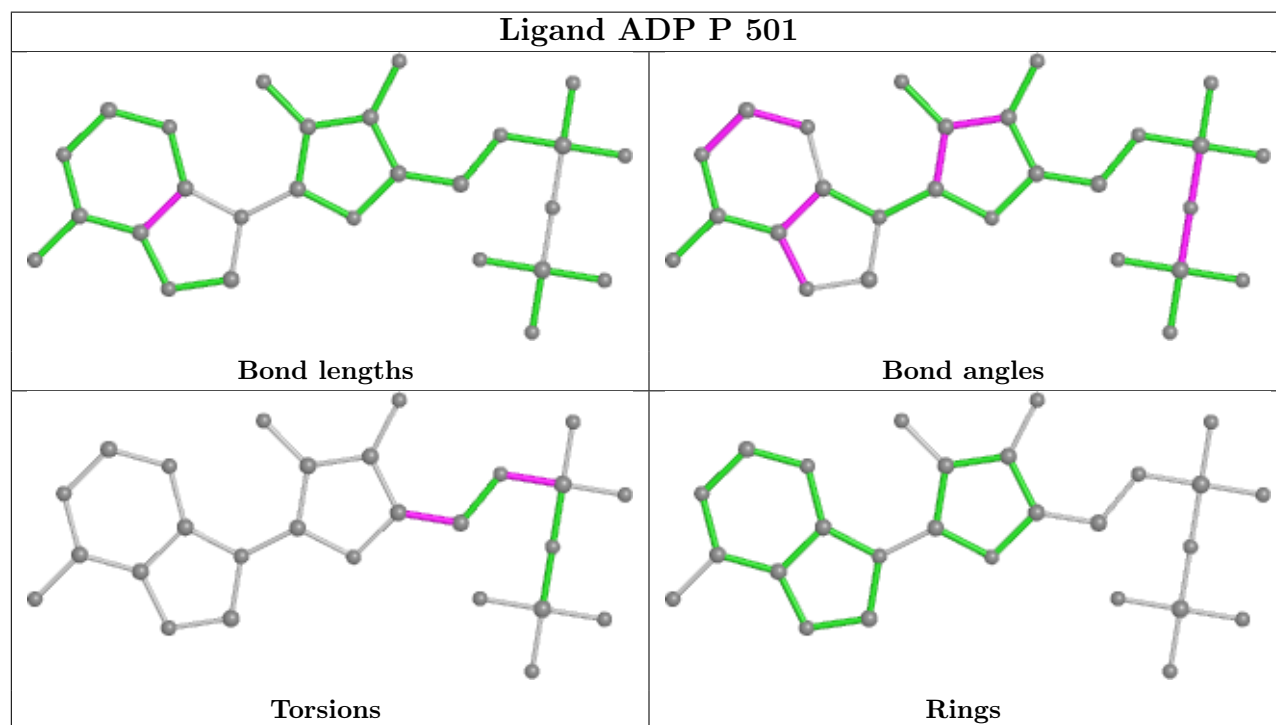
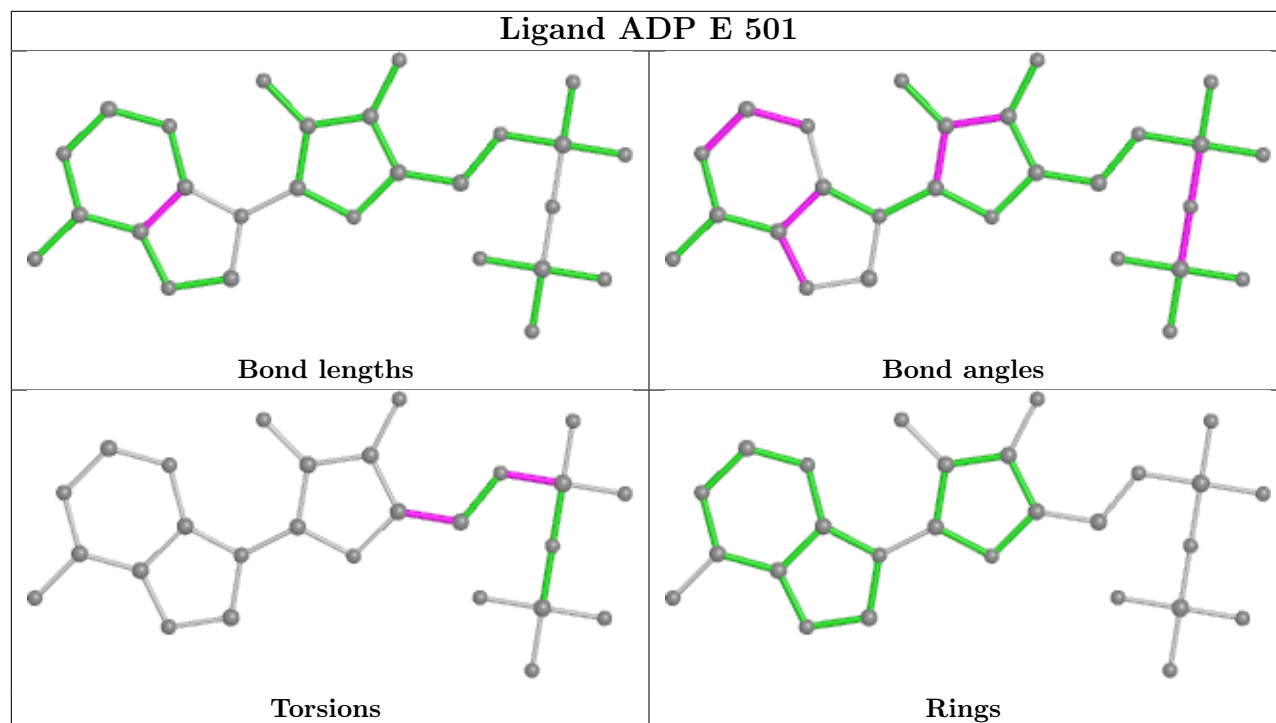

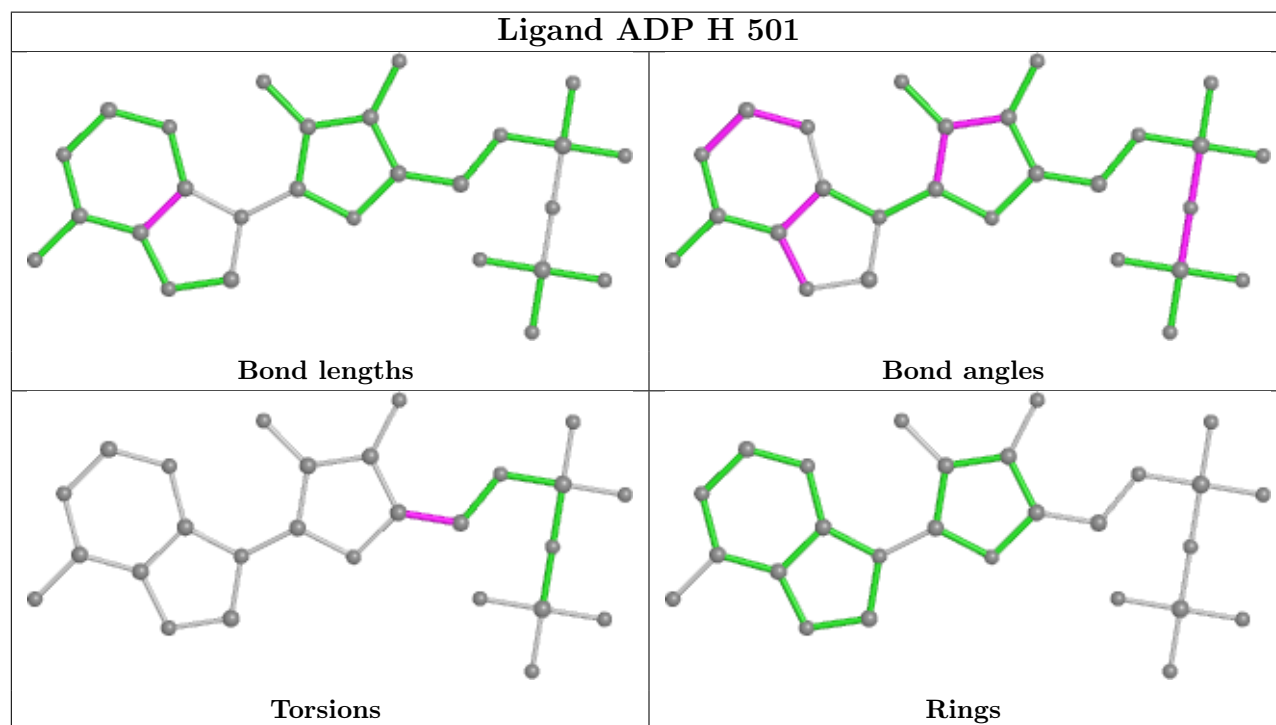
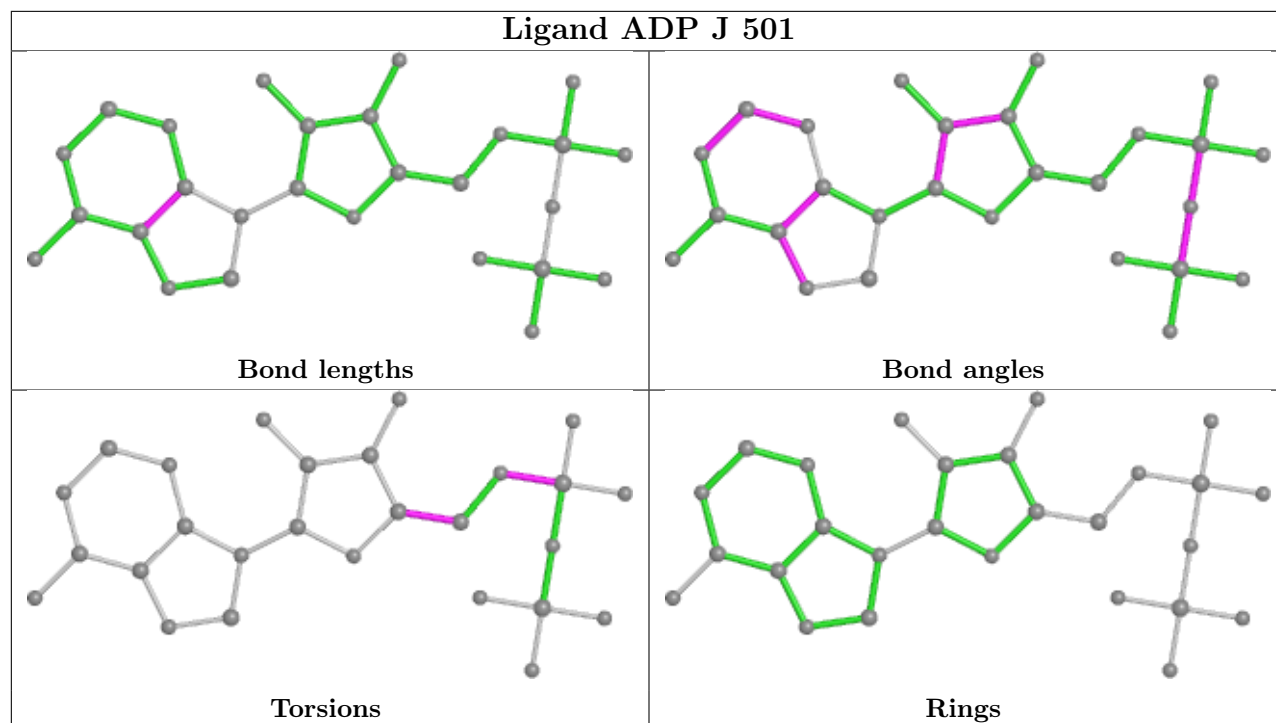

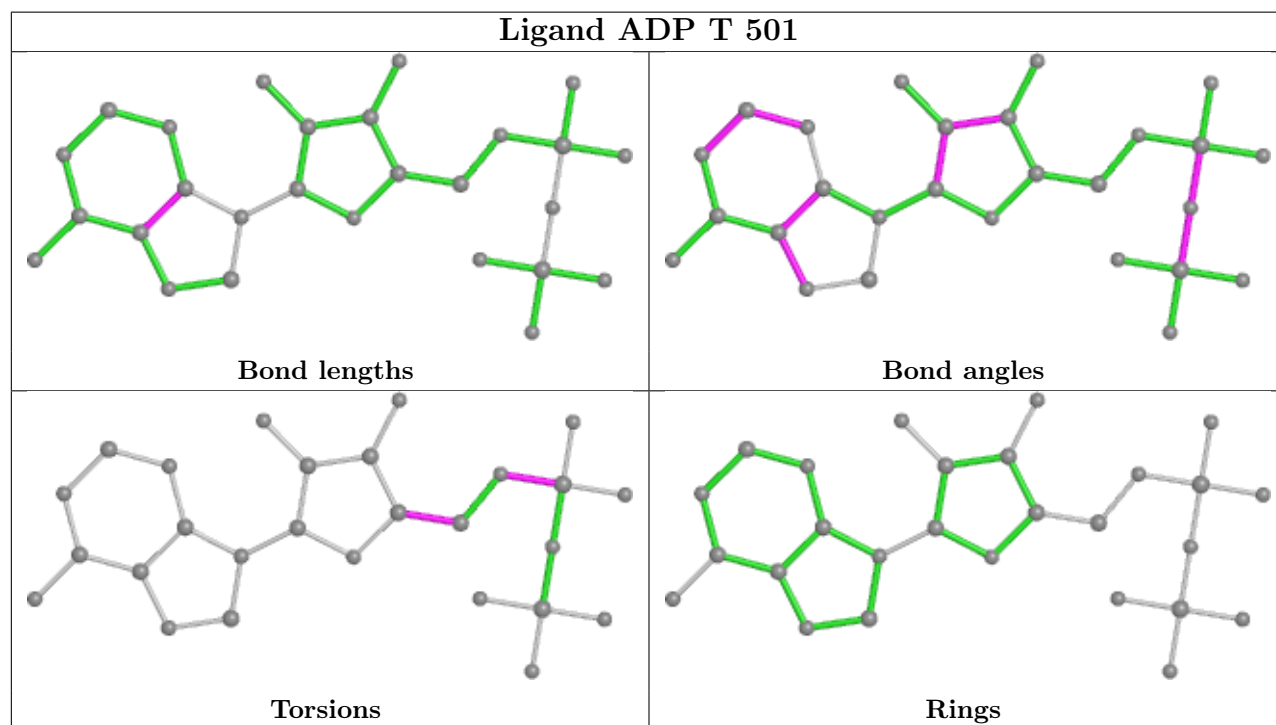
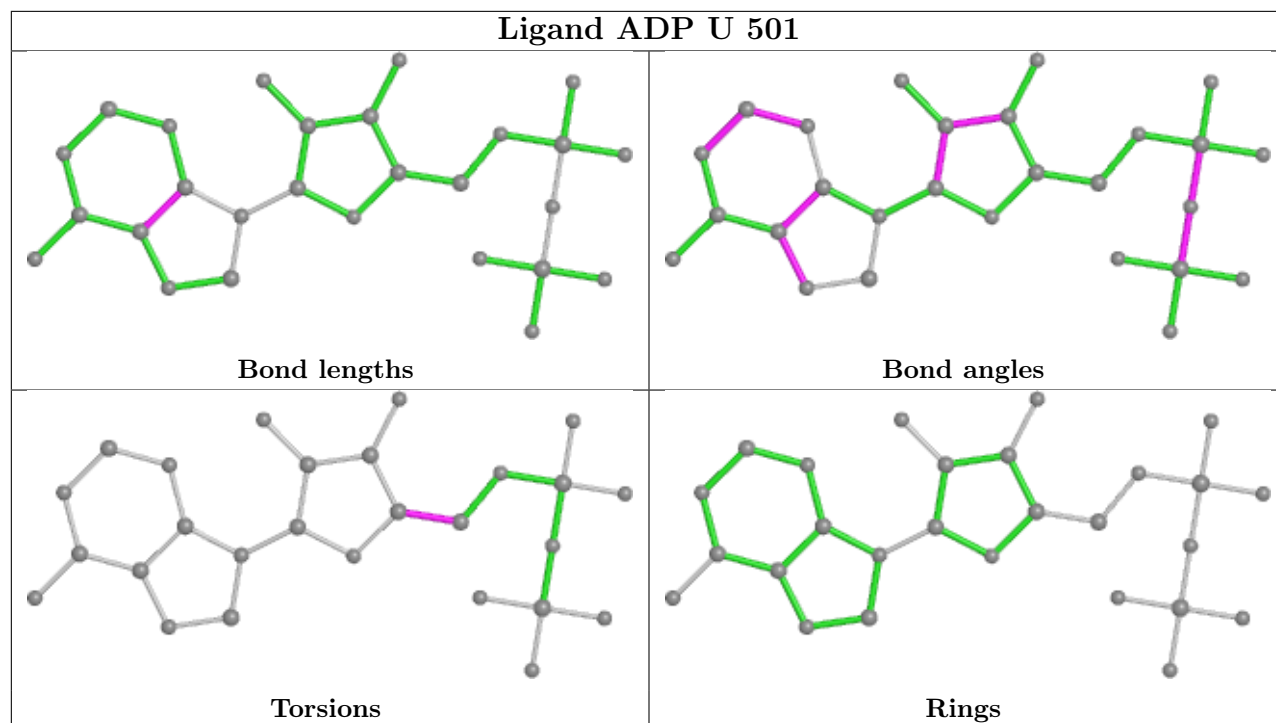

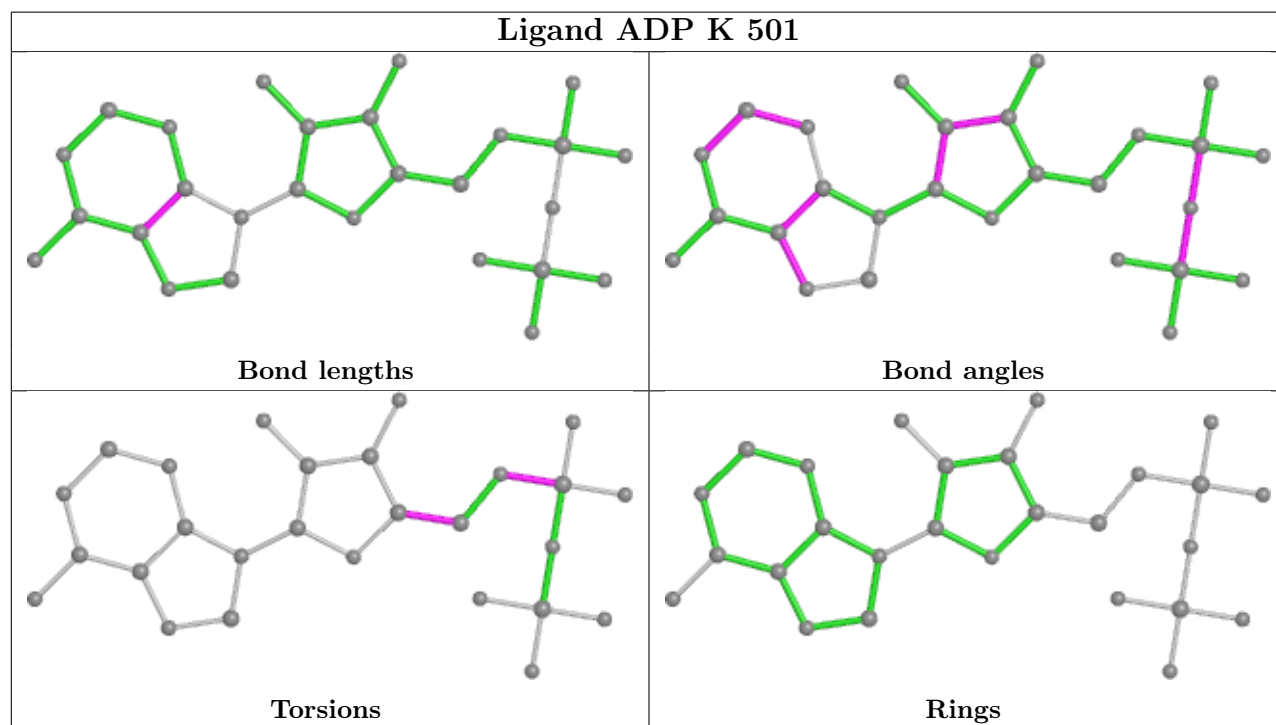
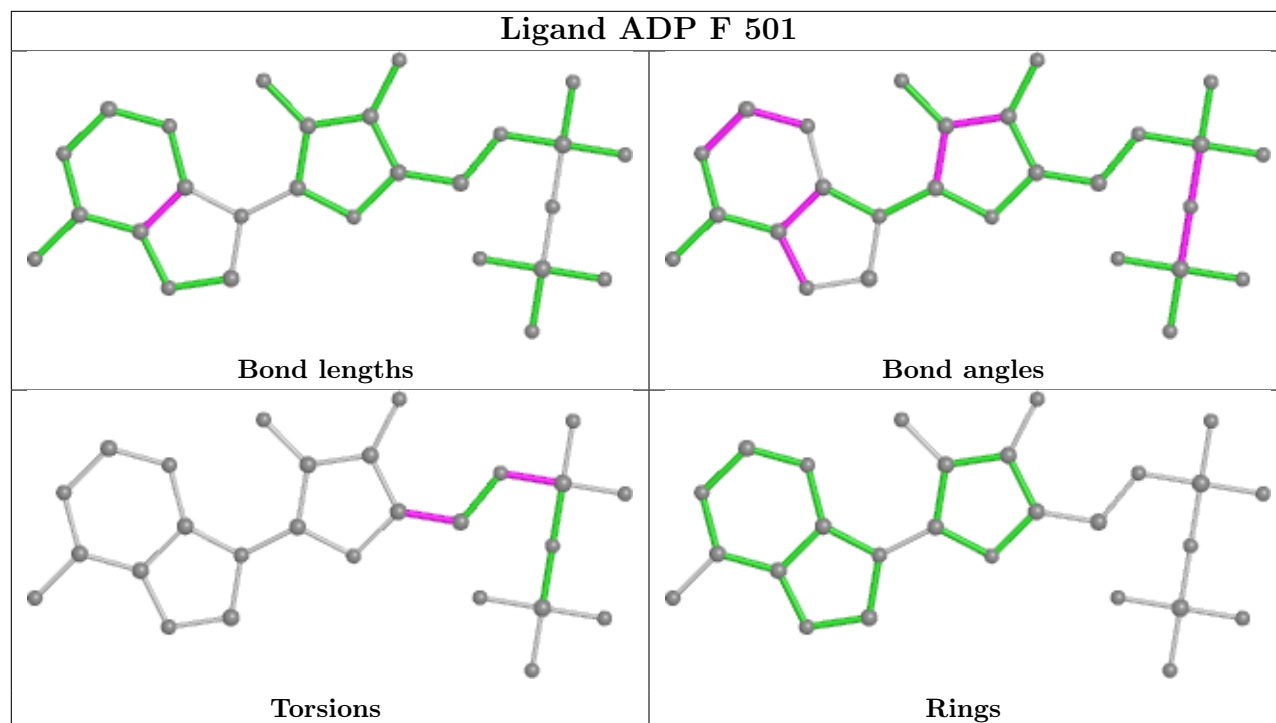

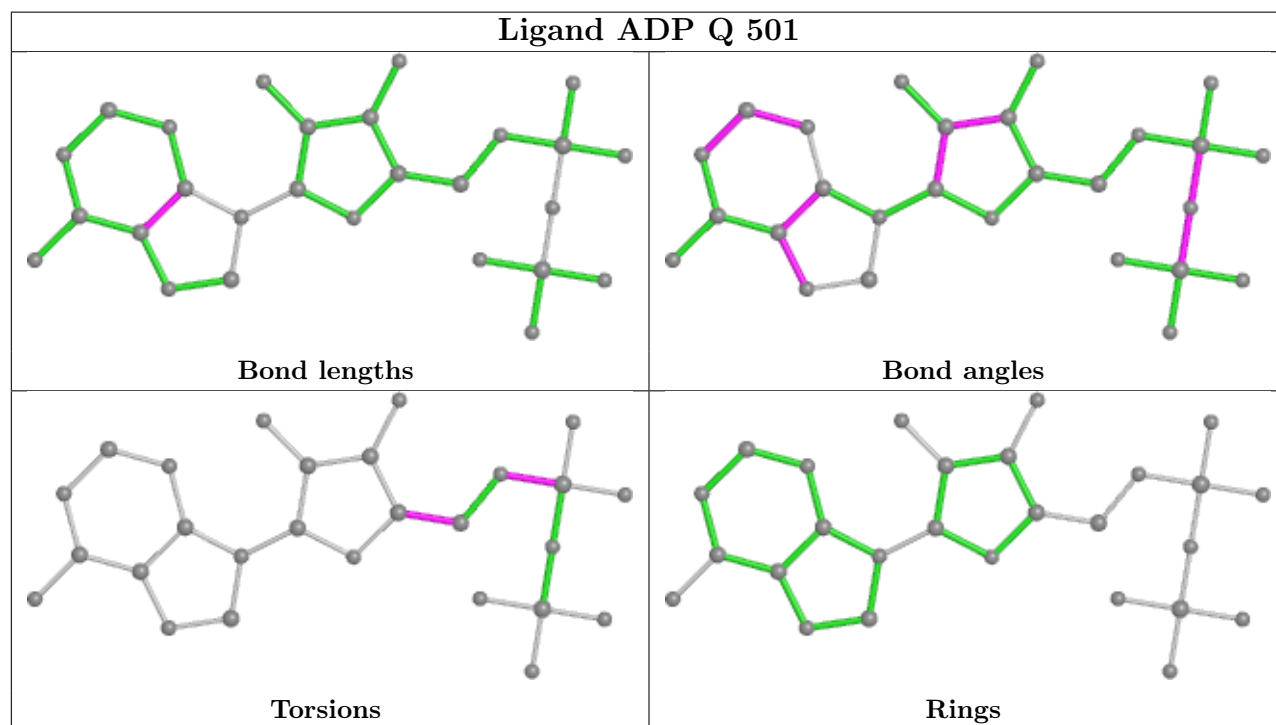
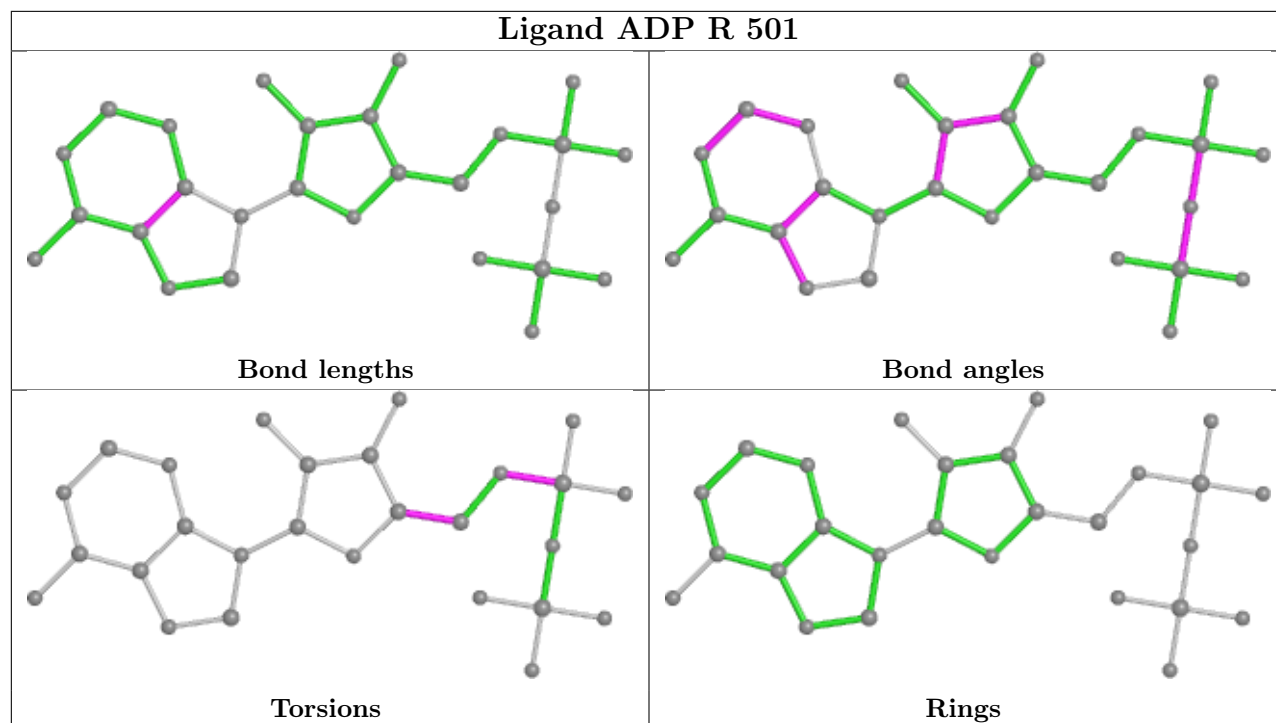

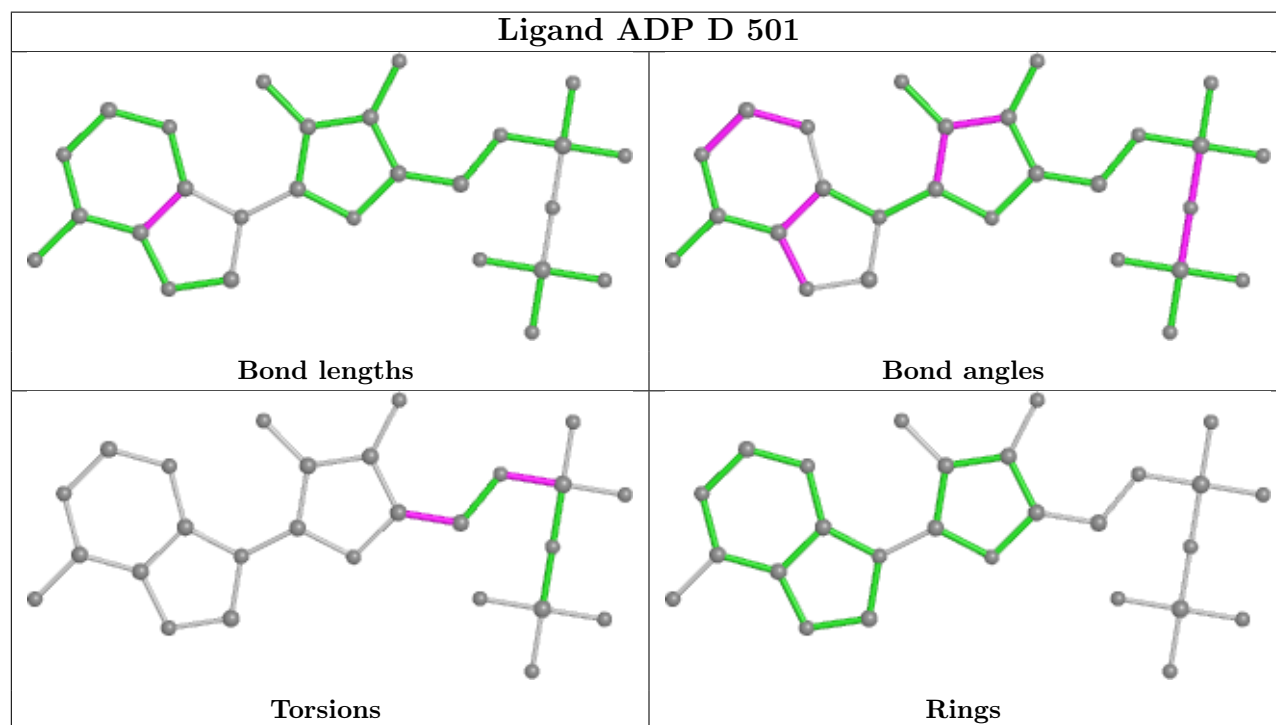
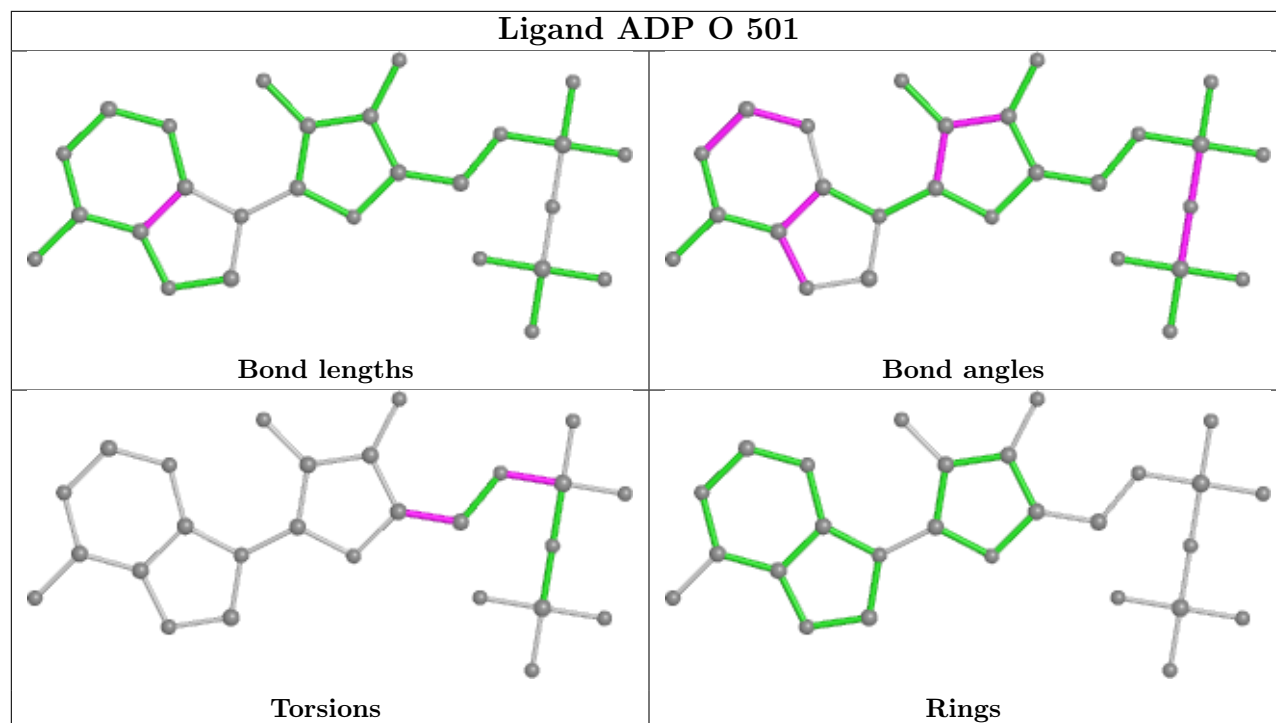

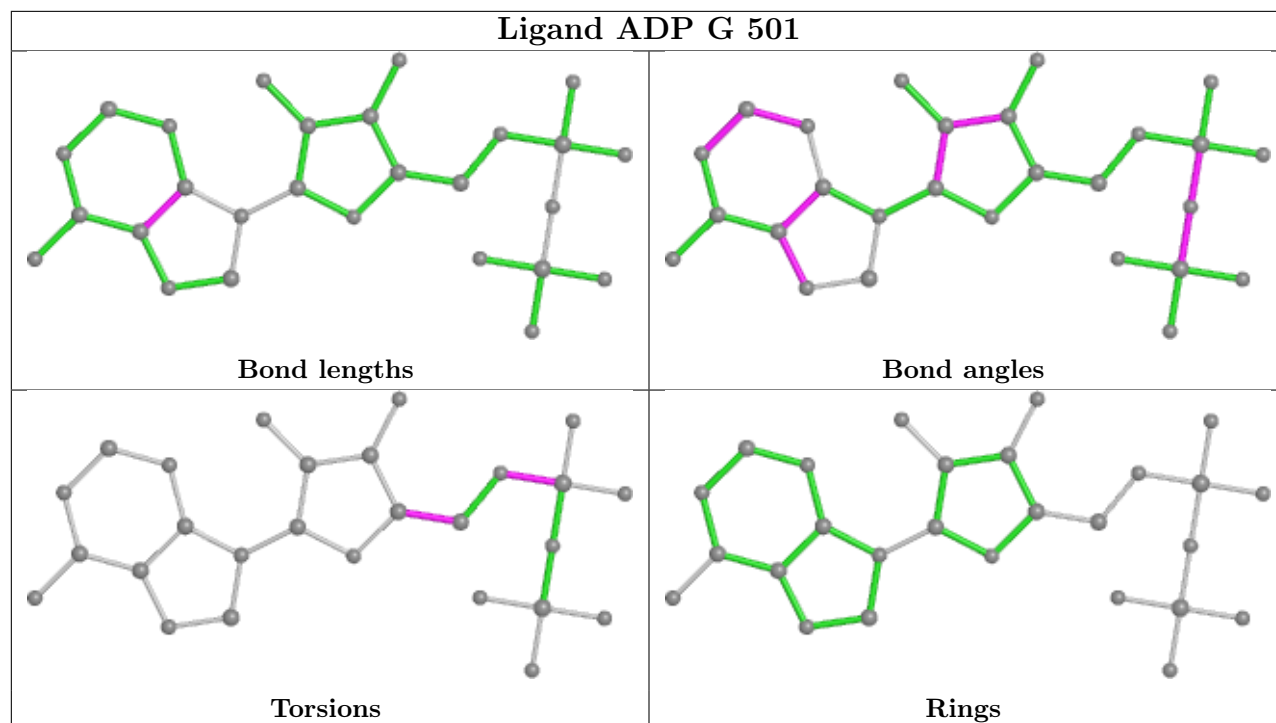

5.7 Other polymers [i](#)

There are no such residues in this entry.

5.8 Polymer linkage issues [i](#)

There are no chain breaks in this entry.

6 Fit of model and data i

6.1 Protein, DNA and RNA chains i

In the following table, the column labelled ‘#RSRZ> 2’ contains the number (and percentage) of RSRZ outliers, followed by percent RSRZ outliers for the chain as percentile scores relative to all X-ray entries and entries of similar resolution. The OWAB column contains the minimum, median, 95th percentile and maximum values of the occupancy-weighted average B-factor per residue. The column labelled ‘Q< 0.9’ lists the number of (and percentage) of residues with an average occupancy less than 0.9.

Mol	Chain	Analysed	<RSRZ>	#RSRZ>2	OWAB(Å ²)	Q<0.9
1	A	330/442 (74%)	0.44	22 (6%) 17 18	348, 386, 520, 579	0
1	B	337/442 (76%)	0.46	24 (7%) 16 16	359, 407, 523, 668	0
1	C	366/442 (82%)	0.33	14 (3%) 40 36	338, 364, 431, 475	0
1	D	333/442 (75%)	0.43	25 (7%) 14 15	324, 387, 495, 545	0
1	E	359/442 (81%)	0.31	14 (3%) 39 35	349, 404, 477, 537	0
1	F	338/442 (76%)	0.39	18 (5%) 26 26	312, 365, 465, 546	0
1	G	327/442 (73%)	0.45	24 (7%) 15 16	342, 388, 491, 572	0
1	H	371/442 (83%)	0.16	4 (1%) 80 73	329, 368, 418, 450	0
1	I	348/442 (78%)	0.48	29 (8%) 11 13	321, 398, 501, 526	0
1	J	332/442 (75%)	0.31	17 (5%) 28 27	355, 395, 477, 581	0
1	K	337/442 (76%)	0.35	16 (4%) 31 30	327, 380, 455, 532	0
1	L	371/442 (83%)	0.37	9 (2%) 59 52	335, 370, 437, 506	0
1	M	342/442 (77%)	0.45	23 (6%) 17 18	377, 426, 490, 553	0
1	N	328/442 (74%)	0.69	32 (9%) 7 10	371, 471, 572, 699	0
1	O	348/442 (78%)	0.29	11 (3%) 47 41	367, 405, 458, 526	0
1	P	305/442 (69%)	0.53	21 (6%) 16 17	342, 380, 436, 479	0
1	Q	370/442 (83%)	0.54	45 (12%) 4 8	327, 378, 565, 603	0
1	R	338/442 (76%)	0.41	13 (3%) 40 36	394, 427, 522, 610	0
1	S	310/442 (70%)	0.43	23 (7%) 14 15	415, 467, 563, 658	0
1	T	318/442 (71%)	0.47	12 (3%) 40 36	359, 429, 516, 594	0
1	U	321/442 (72%)	0.38	12 (3%) 41 37	358, 387, 446, 534	0
1	V	352/442 (79%)	0.69	29 (8%) 11 14	375, 439, 573, 616	0
1	W	336/442 (76%)	0.66	44 (13%) 3 7	406, 444, 509, 548	0
1	X	360/442 (81%)	0.22	10 (2%) 53 46	412, 448, 493, 543	0

Continued on next page...

Continued from previous page...

Mol	Chain	Analysed	<RSRZ>	#RSRZ>2	OWAB(Å ²)	Q<0.9
All	All	8177/10608 (77%)	0.43	491 (6%) 21 21	312, 406, 515, 699	0

All (491) RSRZ outliers are listed below:

Mol	Chain	Res	Type	RSRZ
1	G	124	GLU	10.0
1	I	410	ALA	7.7
1	I	362	GLU	6.7
1	G	120	ARG	6.5
1	I	411	SER	6.4
1	G	125	GLU	5.8
1	W	235	ASN	5.8
1	B	232	LYS	5.8
1	Q	398	VAL	5.7
1	Q	403	MET	5.6
1	N	228	GLU	5.6
1	W	233	LEU	5.5
1	J	93	GLY	5.4
1	V	220	ASP	5.4
1	W	234	VAL	5.4
1	W	232	LYS	5.2
1	C	18	ILE	5.1
1	I	128	GLU	5.1
1	W	93	GLY	5.1
1	W	403	MET	5.1
1	P	367	GLU	4.8
1	M	387	THR	4.8
1	W	231	ALA	4.7
1	V	77	PRO	4.7
1	M	443	LEU	4.6
1	N	232	LYS	4.6
1	I	124	GLU	4.6
1	G	119	ASN	4.6
1	M	366	ILE	4.5
1	P	366	ILE	4.5
1	Q	399	LEU	4.5
1	M	386	SER	4.5
1	D	125	GLU	4.4
1	W	227	GLU	4.4
1	W	411	SER	4.3
1	W	230	ALA	4.3
1	Q	139	ALA	4.3

Continued on next page...

Continued from previous page...

Mol	Chain	Res	Type	RSRZ
1	F	235	ASN	4.2
1	N	93	GLY	4.2
1	V	163	LEU	4.2
1	X	220	ASP	4.2
1	K	392	ALA	4.1
1	W	407	SER	4.1
1	F	49	THR	4.1
1	Q	135	LEU	4.1
1	M	440	ARG	4.0
1	Q	136	ILE	4.0
1	D	88	GLU	4.0
1	P	2	SER	4.0
1	V	166	GLY	3.9
1	X	365	ASN	3.9
1	B	233	LEU	3.9
1	T	294	HIS	3.8
1	D	376	ILE	3.8
1	Q	406	ILE	3.8
1	Q	402	LEU	3.8
1	R	165	GLU	3.8
1	V	398	VAL	3.8
1	U	87	THR	3.8
1	K	124	GLU	3.8
1	U	433	VAL	3.8
1	F	234	VAL	3.8
1	E	119	ASN	3.8
1	B	235	ASN	3.7
1	Q	131	ILE	3.7
1	O	387	THR	3.7
1	Q	397	THR	3.7
1	V	222	MET	3.7
1	R	87	THR	3.7
1	J	119	ASN	3.7
1	L	17	ILE	3.7
1	I	221	ALA	3.7
1	N	376	ILE	3.7
1	P	365	ASN	3.7
1	G	122	ARG	3.7
1	I	406	ILE	3.6
1	Q	443	LEU	3.6
1	V	76	ALA	3.6
1	C	17	ILE	3.6

Continued on next page...

Continued from previous page...

Mol	Chain	Res	Type	RSRZ
1	F	232	LYS	3.6
1	G	233	LEU	3.6
1	J	439	SER	3.6
1	S	33	ASN	3.6
1	S	294	HIS	3.6
1	G	123	ALA	3.5
1	W	414	SER	3.5
1	W	119	ASN	3.5
1	W	229	GLU	3.5
1	W	376	ILE	3.5
1	D	124	GLU	3.5
1	P	116	ILE	3.5
1	M	368	PHE	3.5
1	P	333	GLN	3.5
1	F	407	SER	3.5
1	W	2	SER	3.5
1	W	412	ASP	3.5
1	L	18	ILE	3.5
1	I	413	LEU	3.5
1	R	133	ASP	3.4
1	I	222	MET	3.4
1	V	221	ALA	3.4
1	J	433	VAL	3.4
1	V	2	SER	3.4
1	X	366	ILE	3.4
1	S	48	VAL	3.4
1	I	93	GLY	3.4
1	A	87	THR	3.4
1	E	235	ASN	3.3
1	I	120	ARG	3.3
1	E	122	ARG	3.3
1	Q	376	ILE	3.3
1	S	352	THR	3.3
1	M	93	GLY	3.3
1	S	297	VAL	3.3
1	T	243	ALA	3.3
1	T	77	PRO	3.3
1	T	53	ILE	3.3
1	N	230	ALA	3.3
1	G	121	TYR	3.3
1	F	366	ILE	3.3
1	M	294	HIS	3.3

Continued on next page...

Continued from previous page...

Mol	Chain	Res	Type	RSRZ
1	E	121	TYR	3.3
1	B	220	ASP	3.3
1	R	376	ILE	3.2
1	A	356	LYS	3.2
1	M	88	GLU	3.2
1	W	236	PRO	3.2
1	R	335	LEU	3.2
1	K	93	GLY	3.2
1	D	233	LEU	3.2
1	V	362	GLU	3.2
1	S	75	ASN	3.1
1	I	125	GLU	3.1
1	C	362	GLU	3.1
1	P	77	PRO	3.1
1	K	407	SER	3.1
1	Q	395	LEU	3.1
1	A	366	ILE	3.1
1	R	368	PHE	3.1
1	N	313	ALA	3.1
1	W	406	ILE	3.1
1	N	332	LEU	3.1
1	N	333	GLN	3.1
1	U	124	GLU	3.1
1	B	107	ALA	3.1
1	E	233	LEU	3.1
1	S	104	THR	3.1
1	A	368	PHE	3.1
1	V	294	HIS	3.1
1	M	388	GLU	3.0
1	Q	401	ARG	3.0
1	B	17	ILE	3.0
1	N	119	ASN	3.0
1	R	151	GLU	3.0
1	N	317	ASP	3.0
1	Q	132	LEU	3.0
1	W	32	ARG	3.0
1	N	395	LEU	3.0
1	W	228	GLU	3.0
1	P	75	ASN	3.0
1	J	434	ALA	3.0
1	W	112	ARG	3.0
1	N	88	GLU	3.0

Continued on next page...

Continued from previous page...

Mol	Chain	Res	Type	RSRZ
1	N	231	ALA	3.0
1	A	411	SER	3.0
1	D	379	ALA	3.0
1	I	407	SER	3.0
1	E	124	GLU	3.0
1	V	251	GLY	3.0
1	A	412	ASP	3.0
1	P	19	GLY	3.0
1	N	20	GLN	2.9
1	J	18	ILE	2.9
1	F	233	LEU	2.9
1	G	232	LYS	2.9
1	V	75	ASN	2.9
1	I	412	ASP	2.9
1	Q	133	ASP	2.9
1	W	324	GLY	2.9
1	P	3	GLU	2.9
1	A	268	SER	2.9
1	B	221	ALA	2.9
1	C	368	PHE	2.9
1	W	4	MET	2.9
1	N	127	ALA	2.8
1	B	234	VAL	2.8
1	T	88	GLU	2.8
1	S	295	GLY	2.8
1	M	297	VAL	2.8
1	R	88	GLU	2.8
1	U	434	ALA	2.8
1	D	235	ASN	2.8
1	Q	153	SER	2.8
1	A	348	ASN	2.8
1	T	315	PRO	2.8
1	J	36	ARG	2.8
1	R	373	ILE	2.8
1	V	3	GLU	2.8
1	A	235	ASN	2.8
1	N	229	GLU	2.8
1	V	395	LEU	2.8
1	U	19	GLY	2.8
1	A	352	THR	2.8
1	F	409	ASP	2.8
1	N	233	LEU	2.8

Continued on next page...

Continued from previous page...

Mol	Chain	Res	Type	RSRZ
1	B	231	ALA	2.8
1	M	383	VAL	2.8
1	B	229	GLU	2.8
1	M	439	SER	2.7
1	Q	436	GLU	2.7
1	Q	439	SER	2.7
1	B	16	HIS	2.7
1	G	430	ASP	2.7
1	W	402	LEU	2.7
1	W	415	GLY	2.7
1	Q	394	ARG	2.7
1	Q	128	GLU	2.7
1	T	19	GLY	2.7
1	V	359	MET	2.7
1	C	373	ILE	2.7
1	G	234	VAL	2.7
1	A	354	GLN	2.7
1	N	124	GLU	2.7
1	S	366	ILE	2.7
1	J	436	GLU	2.7
1	T	3	GLU	2.7
1	U	88	GLU	2.7
1	U	120	ARG	2.7
1	I	220	ASP	2.7
1	G	230	ALA	2.7
1	D	122	ARG	2.7
1	I	122	ARG	2.7
1	K	121	TYR	2.7
1	P	117	GLU	2.7
1	E	232	LYS	2.7
1	L	386	SER	2.7
1	Q	121	TYR	2.6
1	B	386	SER	2.6
1	N	128	GLU	2.6
1	C	19	GLY	2.6
1	N	120	ARG	2.6
1	E	366	ILE	2.6
1	P	376	ILE	2.6
1	K	125	GLU	2.6
1	B	230	ALA	2.6
1	I	409	ASP	2.6
1	V	104	THR	2.6

Continued on next page...

Continued from previous page...

Mol	Chain	Res	Type	RSRZ
1	A	226	ILE	2.6
1	P	406	ILE	2.6
1	M	365	ASN	2.6
1	V	87	THR	2.6
1	E	222	MET	2.6
1	Q	416	GLN	2.6
1	Q	134	VAL	2.6
1	F	19	GLY	2.6
1	S	19	GLY	2.6
1	W	57	GLY	2.6
1	J	32	ARG	2.6
1	J	443	LEU	2.6
1	J	413	LEU	2.6
1	F	300	ASP	2.6
1	C	139	ALA	2.5
1	V	399	LEU	2.5
1	F	406	ILE	2.5
1	K	123	ALA	2.5
1	O	51	LYS	2.5
1	A	234	VAL	2.5
1	B	19	GLY	2.5
1	E	221	ALA	2.5
1	Q	159	PHE	2.5
1	V	162	LYS	2.5
1	E	238	GLU	2.5
1	S	18	ILE	2.5
1	C	122	ARG	2.5
1	I	129	GLU	2.5
1	D	395	LEU	2.5
1	O	386	SER	2.5
1	L	19	GLY	2.5
1	P	360	ALA	2.5
1	P	379	ALA	2.5
1	P	403	MET	2.5
1	I	123	ALA	2.5
1	Q	129	GLU	2.5
1	W	410	ALA	2.5
1	F	411	SER	2.5
1	Q	156	ARG	2.5
1	A	16	HIS	2.5
1	D	380	ALA	2.5
1	W	362	GLU	2.5

Continued on next page...

Continued from previous page...

Mol	Chain	Res	Type	RSRZ
1	I	132	LEU	2.5
1	S	429	LEU	2.5
1	X	221	ALA	2.5
1	D	407	SER	2.5
1	R	132	LEU	2.5
1	A	126	LEU	2.5
1	A	125	GLU	2.5
1	D	93	GLY	2.5
1	B	335	LEU	2.5
1	W	33	ASN	2.5
1	S	74	ALA	2.5
1	A	49	THR	2.5
1	Q	366	ILE	2.4
1	G	235	ASN	2.4
1	N	407	SER	2.4
1	G	226	ILE	2.4
1	N	392	ALA	2.4
1	T	297	VAL	2.4
1	K	18	ILE	2.4
1	C	363	GLY	2.4
1	D	232	LYS	2.4
1	P	76	ALA	2.4
1	S	243	ALA	2.4
1	C	392	ALA	2.4
1	D	127	ALA	2.4
1	L	436	GLU	2.4
1	J	297	VAL	2.4
1	O	39	GLN	2.4
1	G	222	MET	2.4
1	K	227	GLU	2.4
1	V	108	VAL	2.4
1	V	218	ILE	2.4
1	O	75	ASN	2.4
1	U	379	ALA	2.4
1	Q	407	SER	2.4
1	U	376	ILE	2.4
1	G	433	VAL	2.4
1	C	167	GLN	2.4
1	G	224	LEU	2.4
1	G	84	THR	2.4
1	S	95	GLU	2.4
1	X	95	GLU	2.4

Continued on next page...

Continued from previous page...

Mol	Chain	Res	Type	RSRZ
1	G	431	ALA	2.3
1	J	435	ASP	2.3
1	G	227	GLU	2.3
1	V	86	PHE	2.3
1	R	392	ALA	2.3
1	L	387	THR	2.3
1	A	225	LEU	2.3
1	F	418	ILE	2.3
1	L	321	GLU	2.3
1	K	229	GLU	2.3
1	K	122	ARG	2.3
1	B	443	LEU	2.3
1	T	328	ILE	2.3
1	B	439	SER	2.3
1	I	414	SER	2.3
1	Q	352	THR	2.3
1	E	120	ARG	2.3
1	W	122	ARG	2.3
1	I	376	ILE	2.3
1	M	124	GLU	2.3
1	S	87	THR	2.3
1	W	75	ASN	2.3
1	J	17	ILE	2.3
1	N	428	HIS	2.3
1	S	359	MET	2.3
1	T	293	LYS	2.3
1	Q	163	LEU	2.3
1	I	88	GLU	2.3
1	O	33	ASN	2.3
1	V	235	ASN	2.3
1	F	50	PRO	2.3
1	M	403	MET	2.3
1	R	297	VAL	2.3
1	A	324	GLY	2.3
1	K	256	ASP	2.3
1	M	87	THR	2.3
1	M	417	ASN	2.3
1	B	165	GLU	2.2
1	G	407	SER	2.2
1	S	44	LEU	2.2
1	M	76	ALA	2.2
1	C	365	ASN	2.2

Continued on next page...

Continued from previous page...

Mol	Chain	Res	Type	RSRZ
1	U	50	PRO	2.2
1	B	436	GLU	2.2
1	Q	379	ALA	2.2
1	D	373	ILE	2.2
1	Q	433	VAL	2.2
1	E	229	GLU	2.2
1	W	22	ASN	2.2
1	K	2	SER	2.2
1	W	380	ALA	2.2
1	N	75	ASN	2.2
1	P	22	ASN	2.2
1	Q	380	ALA	2.2
1	B	163	LEU	2.2
1	I	429	LEU	2.2
1	B	387	THR	2.2
1	N	131	ILE	2.2
1	N	331	GLU	2.2
1	F	412	ASP	2.2
1	L	16	HIS	2.2
1	A	376	ILE	2.2
1	X	330	VAL	2.2
1	H	235	ASN	2.2
1	F	18	ILE	2.2
1	N	234	VAL	2.2
1	C	335	LEU	2.2
1	F	25	ARG	2.2
1	O	406	ILE	2.2
1	W	123	ALA	2.2
1	A	370	ASP	2.2
1	E	123	ALA	2.2
1	D	403	MET	2.2
1	I	217	LYS	2.2
1	B	222	MET	2.2
1	I	119	ASN	2.2
1	Q	160	ARG	2.1
1	W	363	GLY	2.1
1	A	355	TYR	2.1
1	H	87	THR	2.1
1	V	114	GLN	2.1
1	D	126	LEU	2.1
1	N	429	LEU	2.1
1	D	377	ALA	2.1

Continued on next page...

Continued from previous page...

Mol	Chain	Res	Type	RSRZ
1	N	316	SER	2.1
1	B	392	ALA	2.1
1	O	346	GLU	2.1
1	Q	3	GLU	2.1
1	D	120	ARG	2.1
1	G	2	SER	2.1
1	W	226	ILE	2.1
1	X	3	GLU	2.1
1	V	164	ARG	2.1
1	D	398	VAL	2.1
1	P	297	VAL	2.1
1	D	121	TYR	2.1
1	H	220	ASP	2.1
1	O	392	ALA	2.1
1	Q	119	ASN	2.1
1	K	94	LYS	2.1
1	K	226	ILE	2.1
1	O	335	LEU	2.1
1	S	406	ILE	2.1
1	W	325	ARG	2.1
1	K	230	ALA	2.1
1	S	368	PHE	2.1
1	I	402	LEU	2.1
1	M	367	GLU	2.1
1	W	36	ARG	2.1
1	D	94	LYS	2.1
1	N	19	GLY	2.1
1	O	36	ARG	2.1
1	F	6	PRO	2.1
1	D	243	ALA	2.1
1	Q	137	PRO	2.1
1	U	116	ILE	2.1
1	Q	415	GLY	2.1
1	Q	417	ASN	2.1
1	G	82	GLU	2.1
1	R	19	GLY	2.1
1	Q	400	GLU	2.1
1	J	406	ILE	2.1
1	V	391	GLY	2.1
1	N	130	ARG	2.1
1	Q	87	THR	2.1
1	D	399	LEU	2.0

Continued on next page...

Continued from previous page...

Mol	Chain	Res	Type	RSRZ
1	H	294	HIS	2.0
1	S	122	ARG	2.0
1	T	51	LYS	2.0
1	V	443	LEU	2.0
1	U	380	ALA	2.0
1	M	37	ARG	2.0
1	W	413	LEU	2.0
1	G	83	ALA	2.0
1	M	243	ALA	2.0
1	W	243	ALA	2.0
1	J	332	LEU	2.0
1	Q	396	HIS	2.0
1	P	407	SER	2.0
1	W	416	GLN	2.0
1	L	365	ASN	2.0
1	Q	356	LYS	2.0
1	S	355	TYR	2.0
1	M	247	VAL	2.0
1	D	294	HIS	2.0
1	V	119	ASN	2.0
1	S	407	SER	2.0
1	B	429	LEU	2.0
1	C	361	THR	2.0
1	X	407	SER	2.0
1	I	131	ILE	2.0
1	X	44	LEU	2.0
1	P	348	ASN	2.0
1	W	361	THR	2.0
1	I	232	LYS	2.0
1	Q	392	ALA	2.0
1	N	335	LEU	2.0
1	X	367	GLU	2.0
1	J	49	THR	2.0
1	W	391	GLY	2.0

6.2 Non-standard residues in protein, DNA, RNA chains

There are no non-standard protein/DNA/RNA residues in this entry.

6.3 Carbohydrates [i](#)

There are no monosaccharides in this entry.

6.4 Ligands [i](#)

In the following table, the Atoms column lists the number of modelled atoms in the group and the number defined in the chemical component dictionary. The B-factors column lists the minimum, median, 95th percentile and maximum values of B factors of atoms in the group. The column labelled 'Q< 0.9' lists the number of atoms with occupancy less than 0.9.

Mol	Type	Chain	Res	Atoms	RSCC	RSR	B-factors(Å ²)	Q<0.9
2	ADP	J	501	27/27	0.65	0.49	352,357,367,370	0
2	ADP	D	501	27/27	0.70	0.41	367,381,393,394	0
2	ADP	I	501	27/27	0.71	0.48	372,390,412,414	0
2	ADP	C	501	27/27	0.72	0.45	348,353,357,358	0
2	ADP	T	501	27/27	0.72	0.49	363,375,385,390	0
2	ADP	R	501	27/27	0.73	0.48	400,410,414,415	0
2	ADP	K	501	27/27	0.73	0.56	345,351,360,362	0
2	ADP	L	501	27/27	0.74	0.48	337,343,347,348	0
2	ADP	O	501	27/27	0.74	0.43	381,387,392,397	0
2	ADP	H	501	27/27	0.76	0.41	356,360,364,365	0
2	ADP	B	501	27/27	0.76	0.48	372,381,394,400	0
2	ADP	S	501	27/27	0.77	0.40	422,429,441,443	0
2	ADP	F	501	27/27	0.77	0.37	312,321,330,331	0
2	ADP	M	501	27/27	0.79	0.40	405,413,424,426	0
2	ADP	A	501	27/27	0.79	0.36	357,374,384,386	0
2	ADP	P	501	27/27	0.79	0.36	345,348,352,354	0
2	ADP	N	501	27/27	0.81	0.40	448,470,480,482	0
2	ADP	U	501	27/27	0.81	0.37	358,361,365,368	0
2	ADP	E	501	27/27	0.82	0.40	381,386,388,390	0
2	ADP	Q	501	27/27	0.83	0.38	355,379,383,385	0
2	ADP	W	501	27/27	0.83	0.29	434,448,455,456	0
2	ADP	X	501	27/27	0.84	0.29	423,430,439,442	0
2	ADP	G	501	27/27	0.85	0.39	348,358,372,375	0
2	ADP	V	501	27/27	0.87	0.42	381,388,395,396	0

The following is a graphical depiction of the model fit to experimental electron density of all instances of the Ligand of Interest. In addition, ligands with molecular weight > 250 and outliers as shown on the geometry validation Tables will also be included. Each fit is shown from different orientation to approximate a three-dimensional view.

Electron density around ADP J 501:

$2mF_o-DF_c$ (at 0.7 rmsd) in gray
 mF_o-DF_c (at 3 rmsd) in purple (negative)
and green (positive)

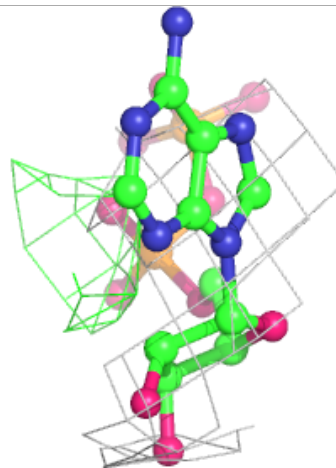
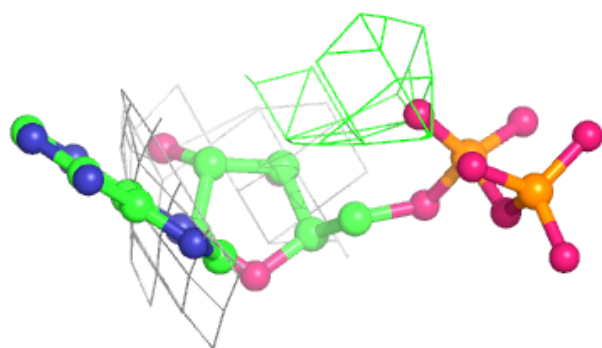
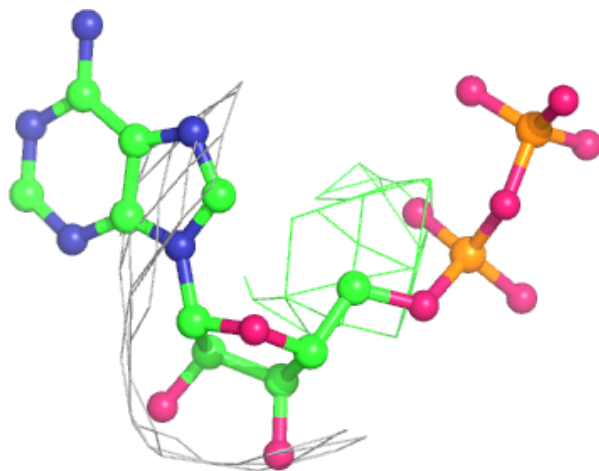

Electron density around ADP D 501:

$2mF_o-DF_c$ (at 0.7 rmsd) in gray
 mF_o-DF_c (at 3 rmsd) in purple (negative)
and green (positive)

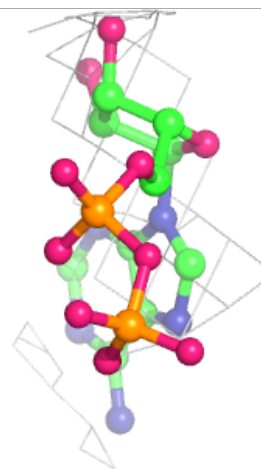
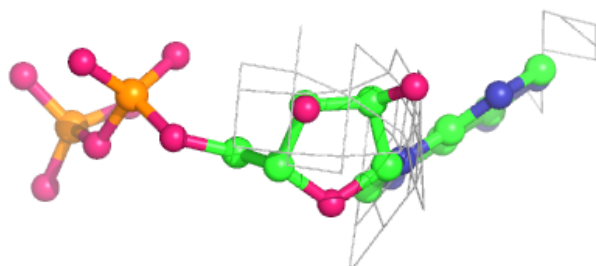
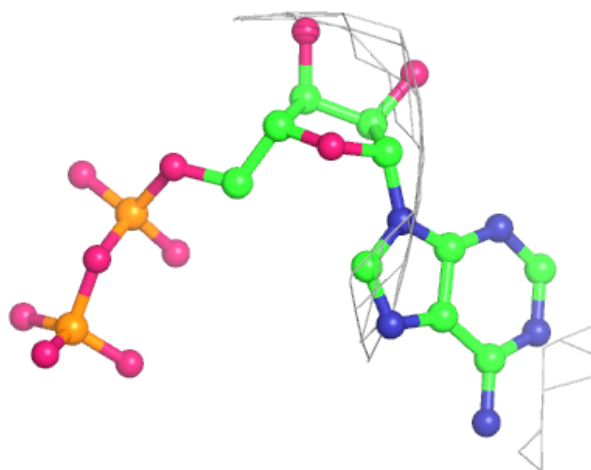

Electron density around ADP I 501:

$2mF_o-DF_c$ (at 0.7 rmsd) in gray
 mF_o-DF_c (at 3 rmsd) in purple (negative)
and green (positive)

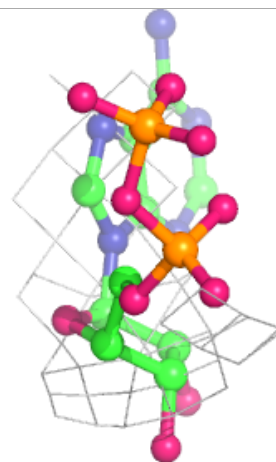
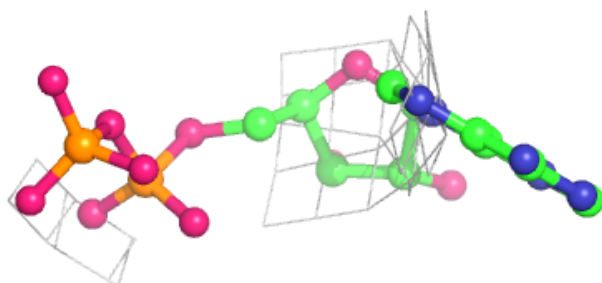
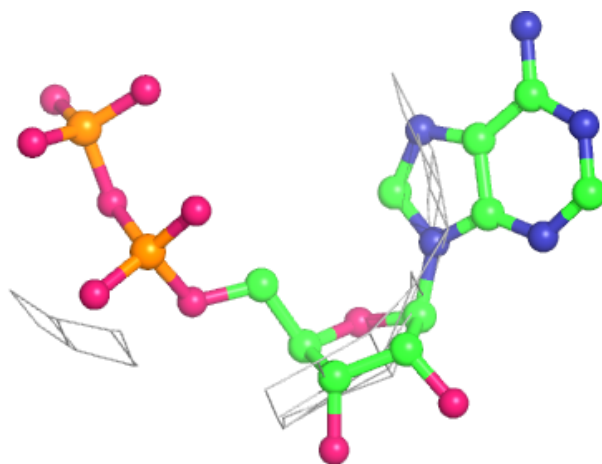

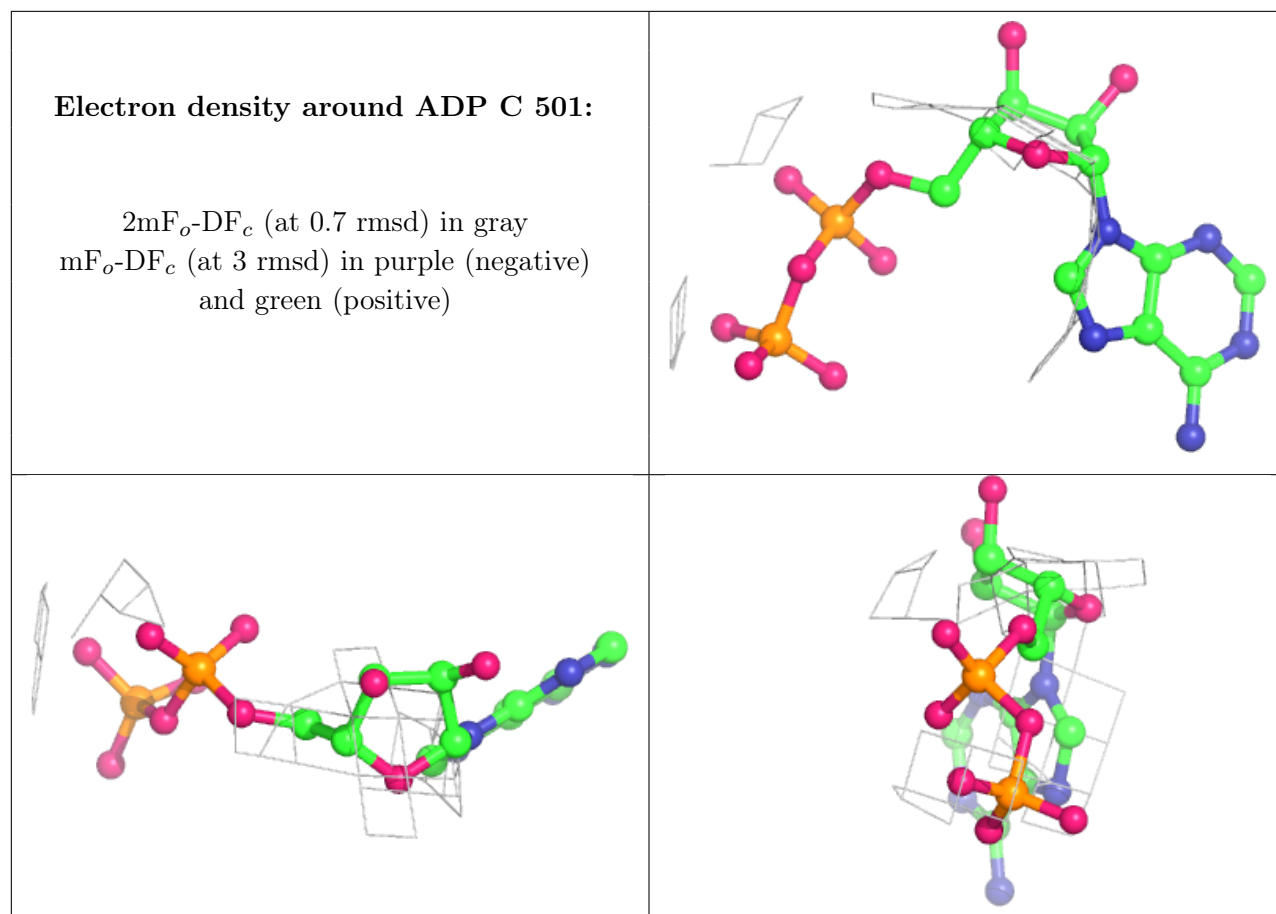

Electron density around ADP T 501:

$2mF_o-DF_c$ (at 0.7 rmsd) in gray
 mF_o-DF_c (at 3 rmsd) in purple (negative)
and green (positive)

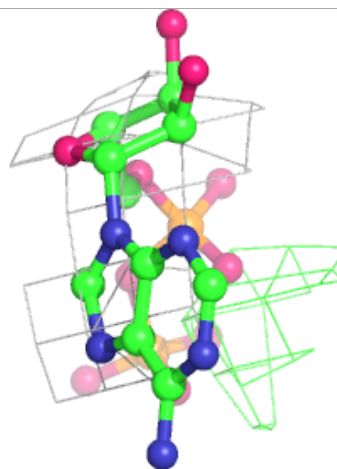
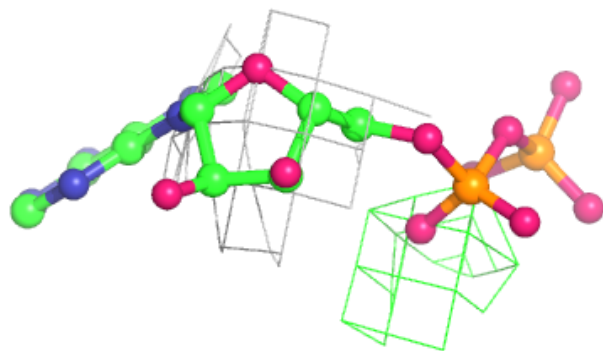
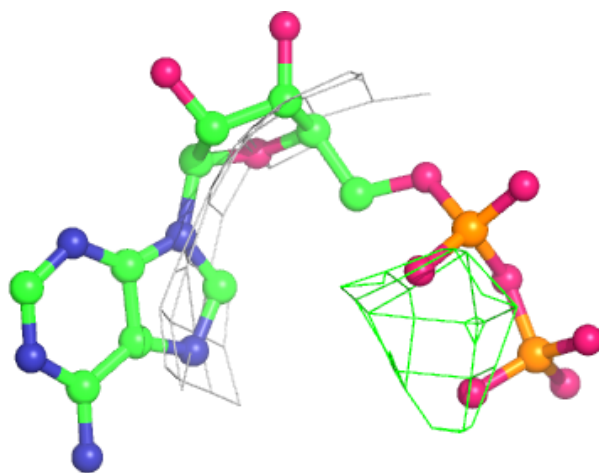

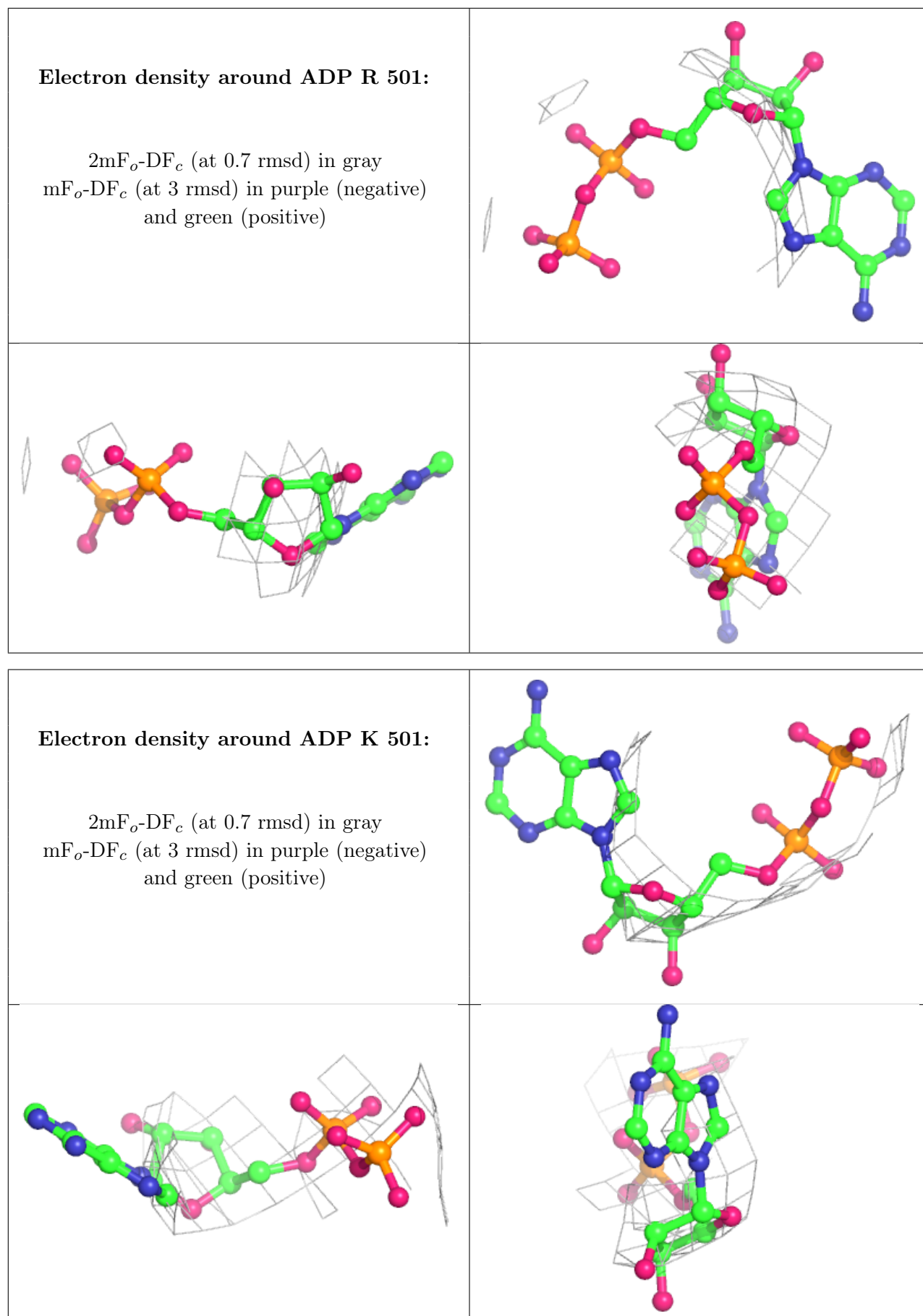

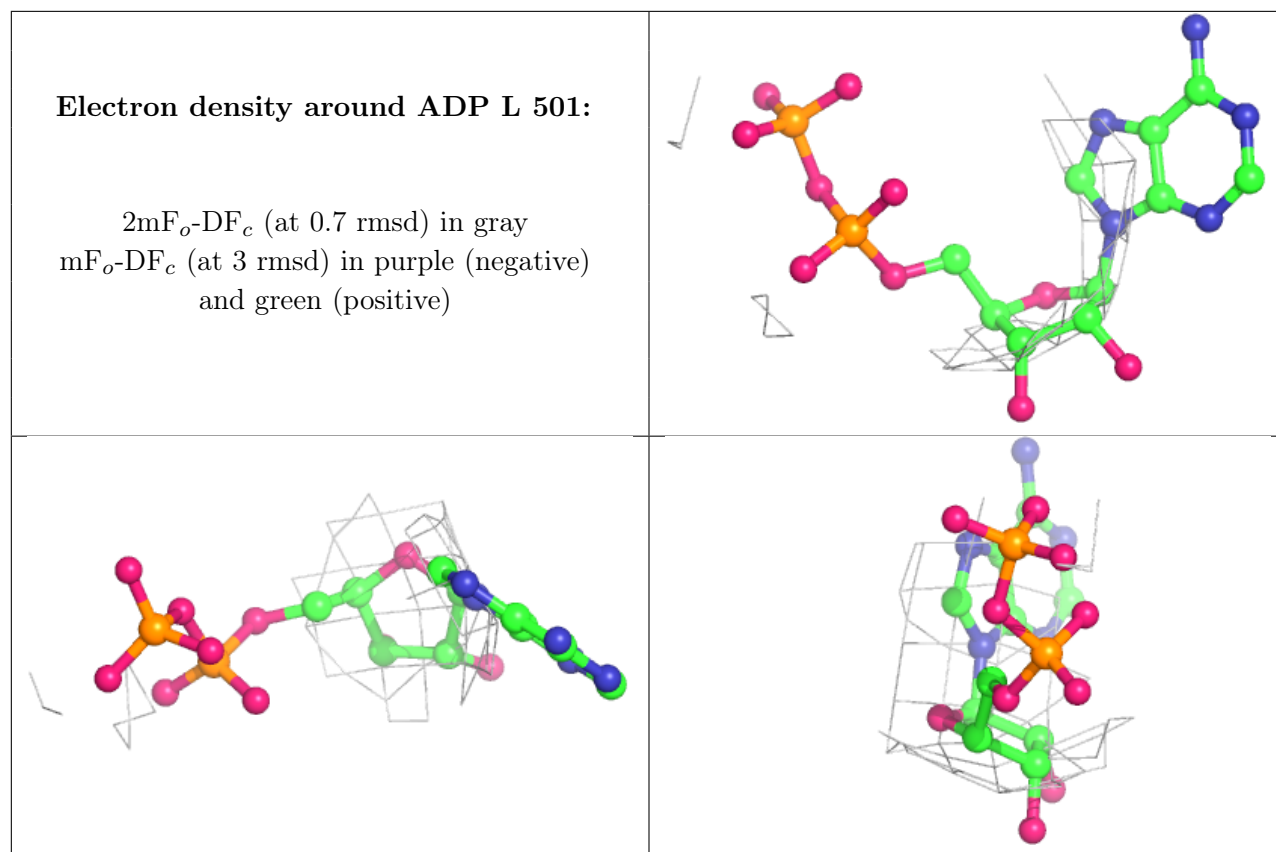

Electron density around ADP O 501:

$2mF_o-DF_c$ (at 0.7 rmsd) in gray
 mF_o-DF_c (at 3 rmsd) in purple (negative)
and green (positive)

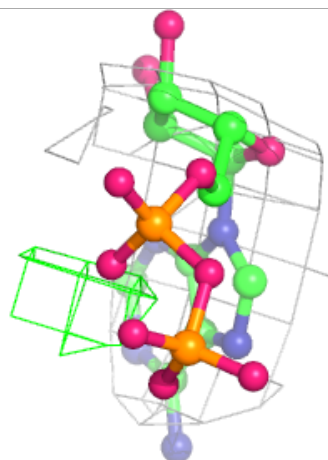
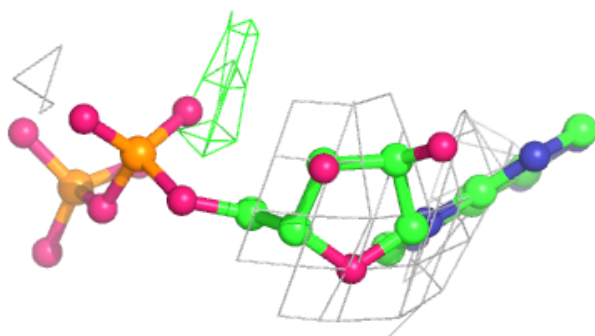
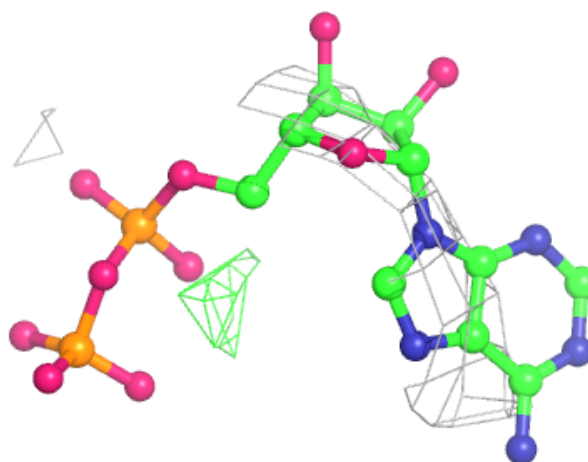

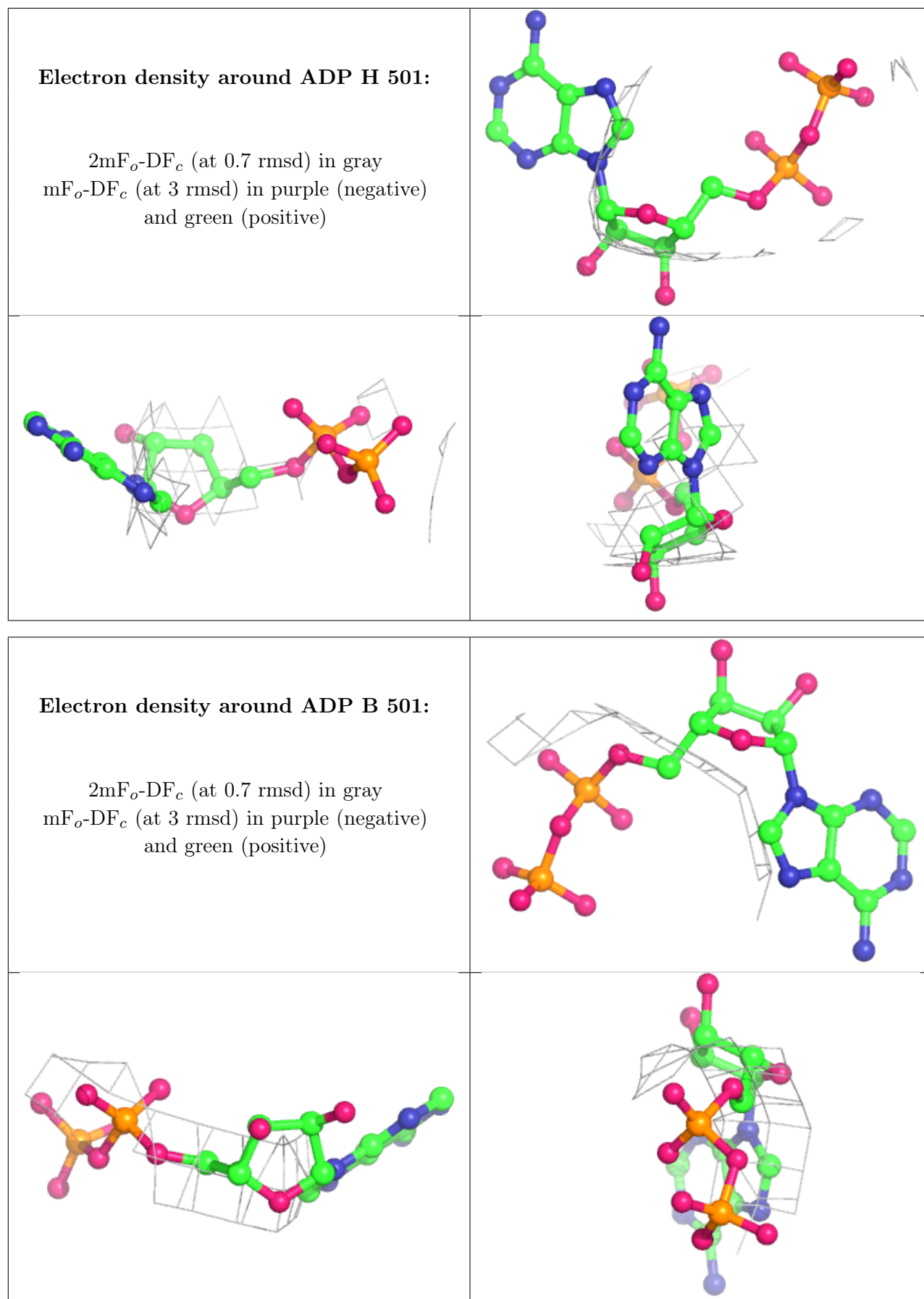

Electron density around ADP S 501:

$2mF_o-DF_c$ (at 0.7 rmsd) in gray
 mF_o-DF_c (at 3 rmsd) in purple (negative)
and green (positive)

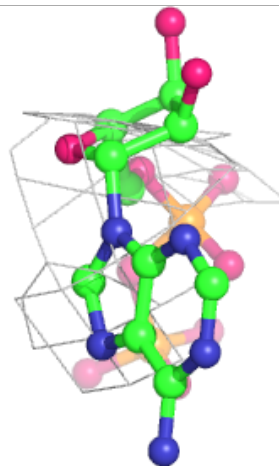
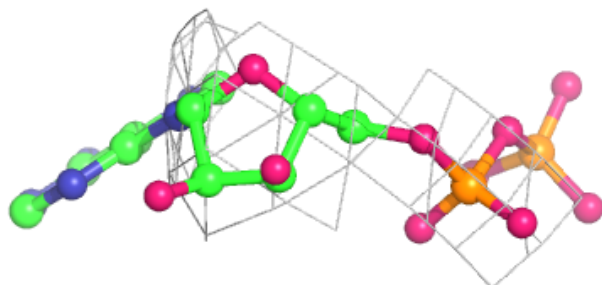
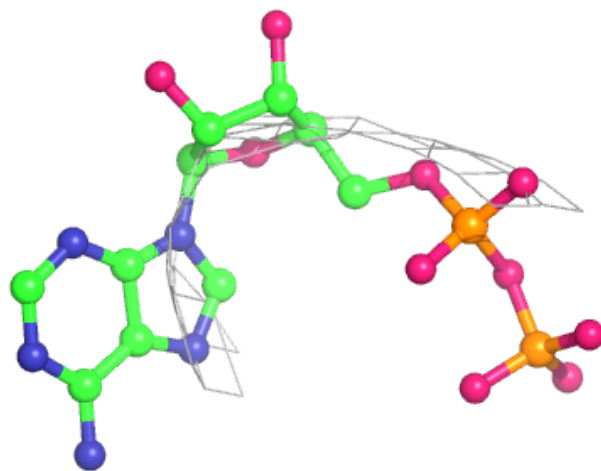

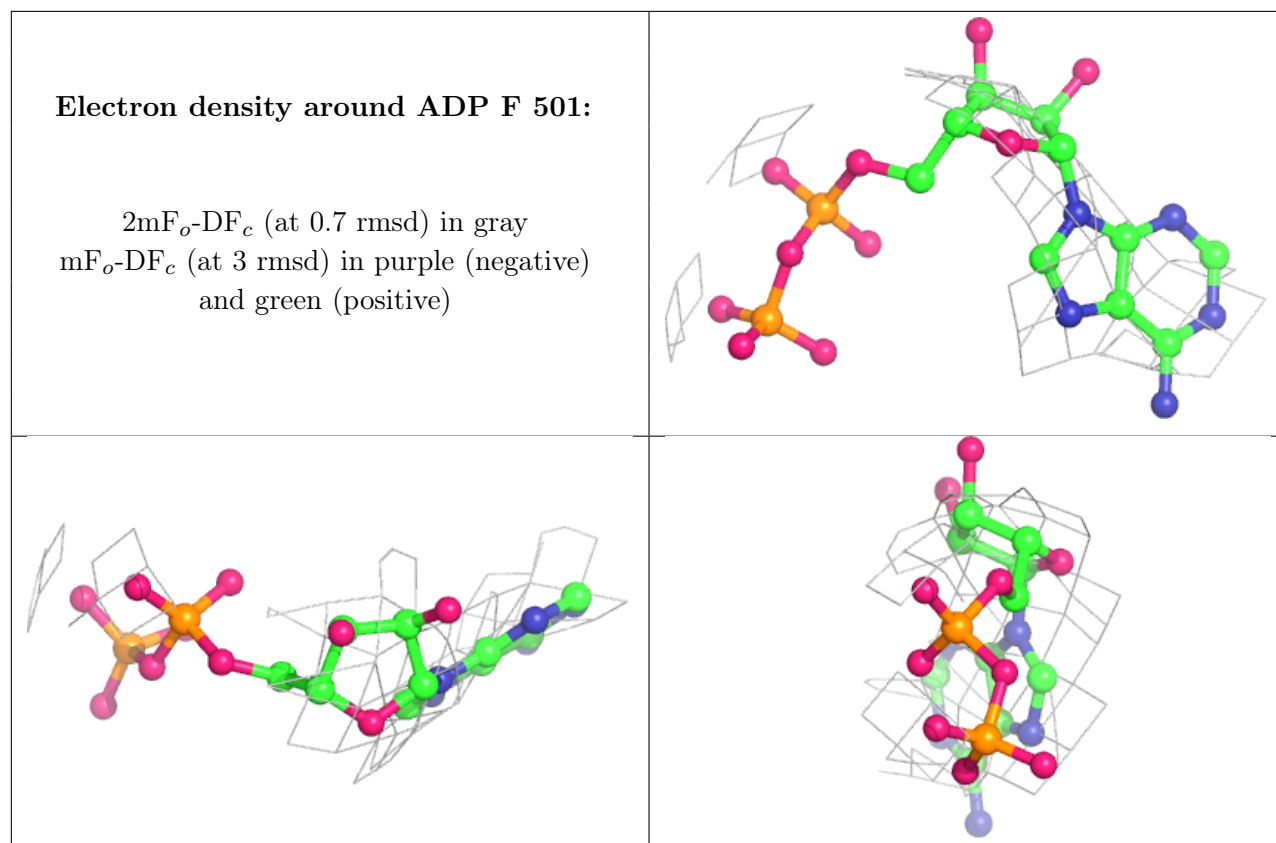

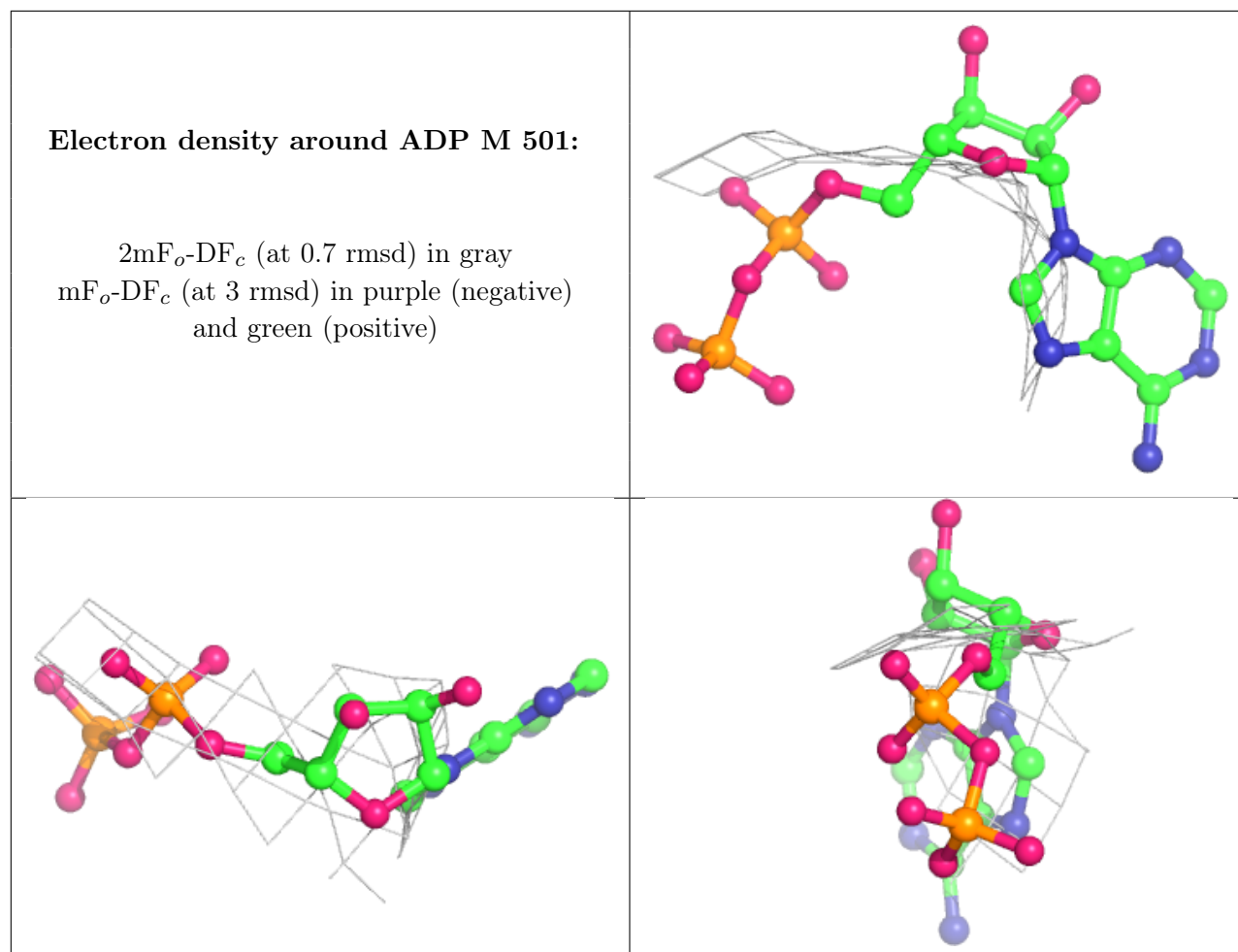

Electron density around ADP A 501:

$2mF_o-DF_c$ (at 0.7 rmsd) in gray
 mF_o-DF_c (at 3 rmsd) in purple (negative)
and green (positive)

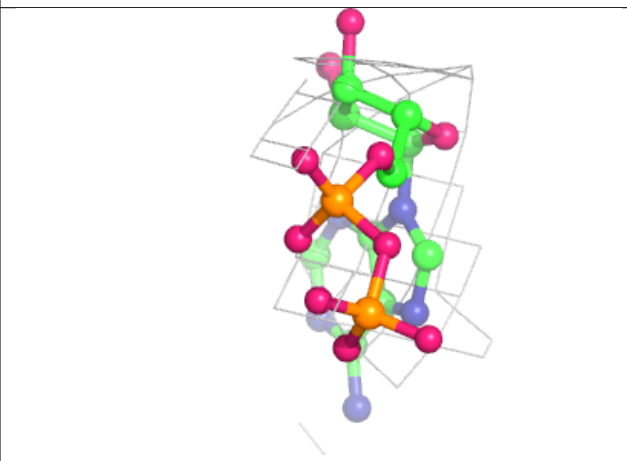
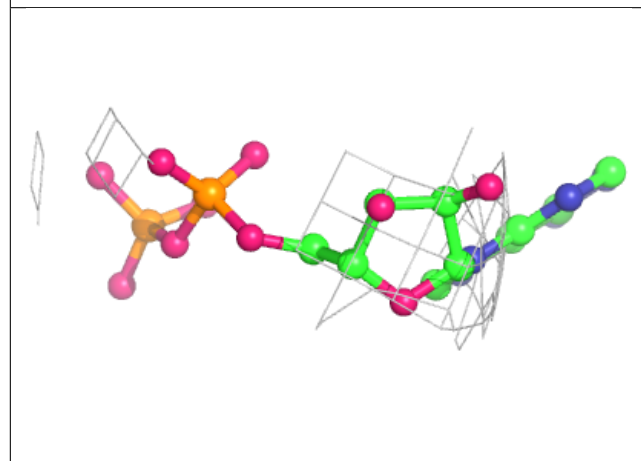
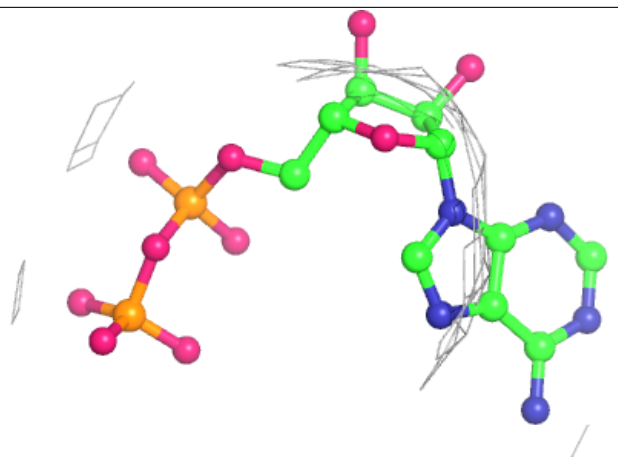
**Electron density around ADP P 501:**

$2mF_o-DF_c$ (at 0.7 rmsd) in gray
 mF_o-DF_c (at 3 rmsd) in purple (negative)
and green (positive)

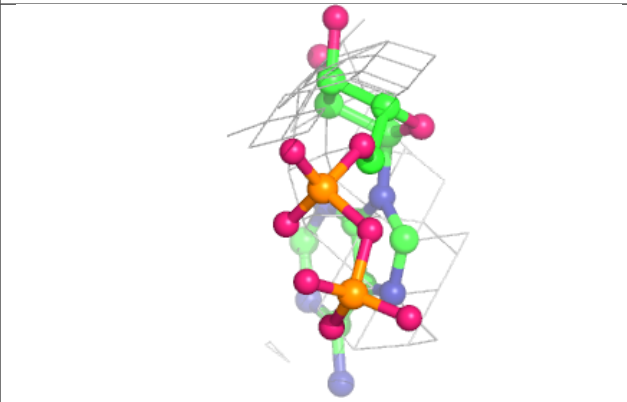
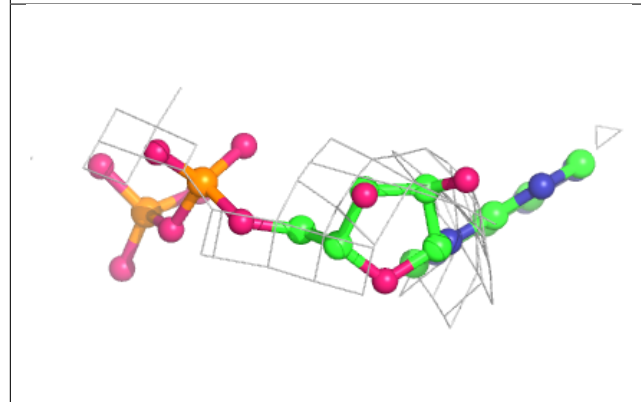
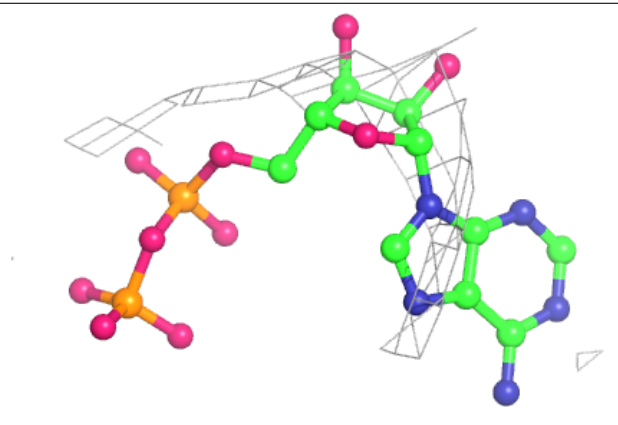

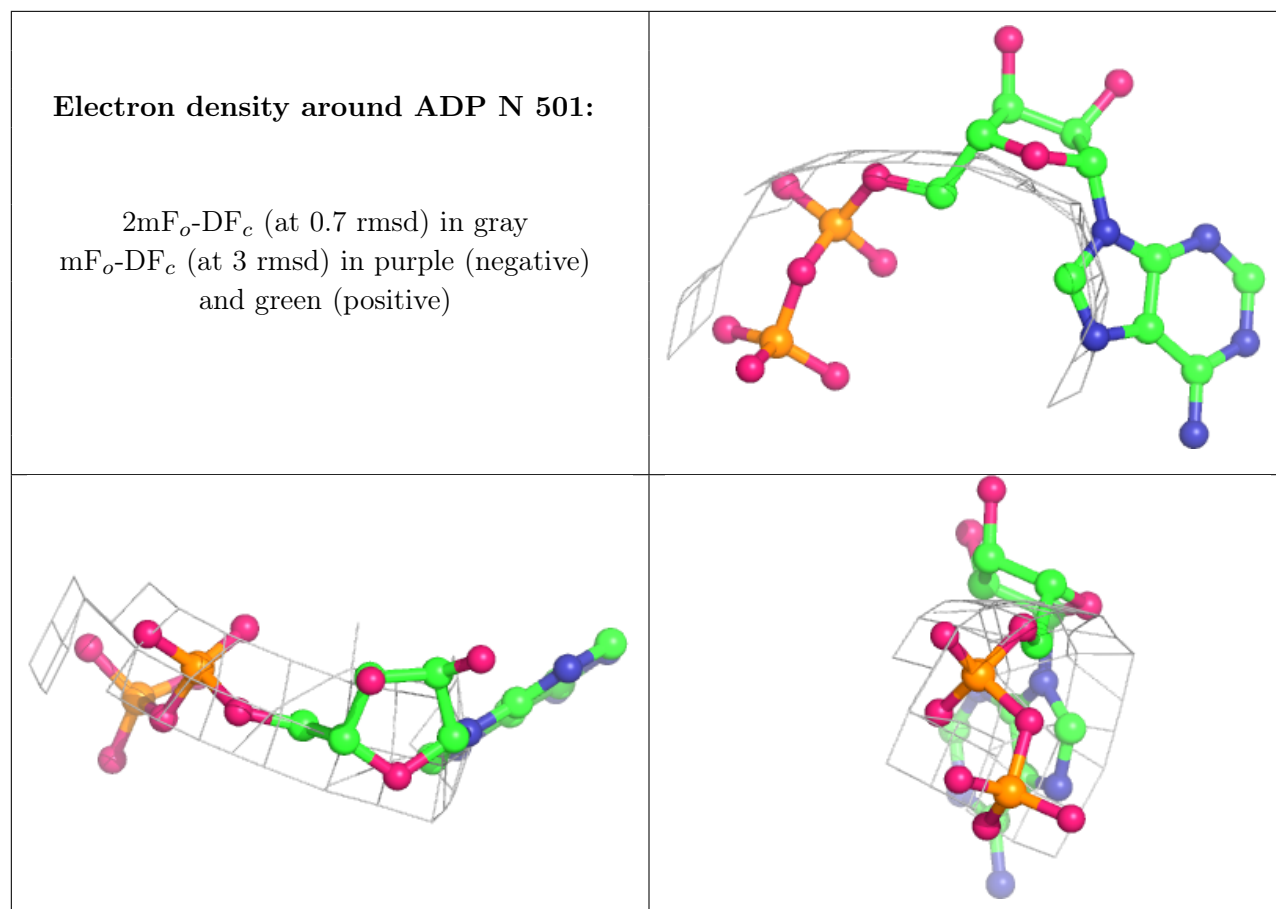

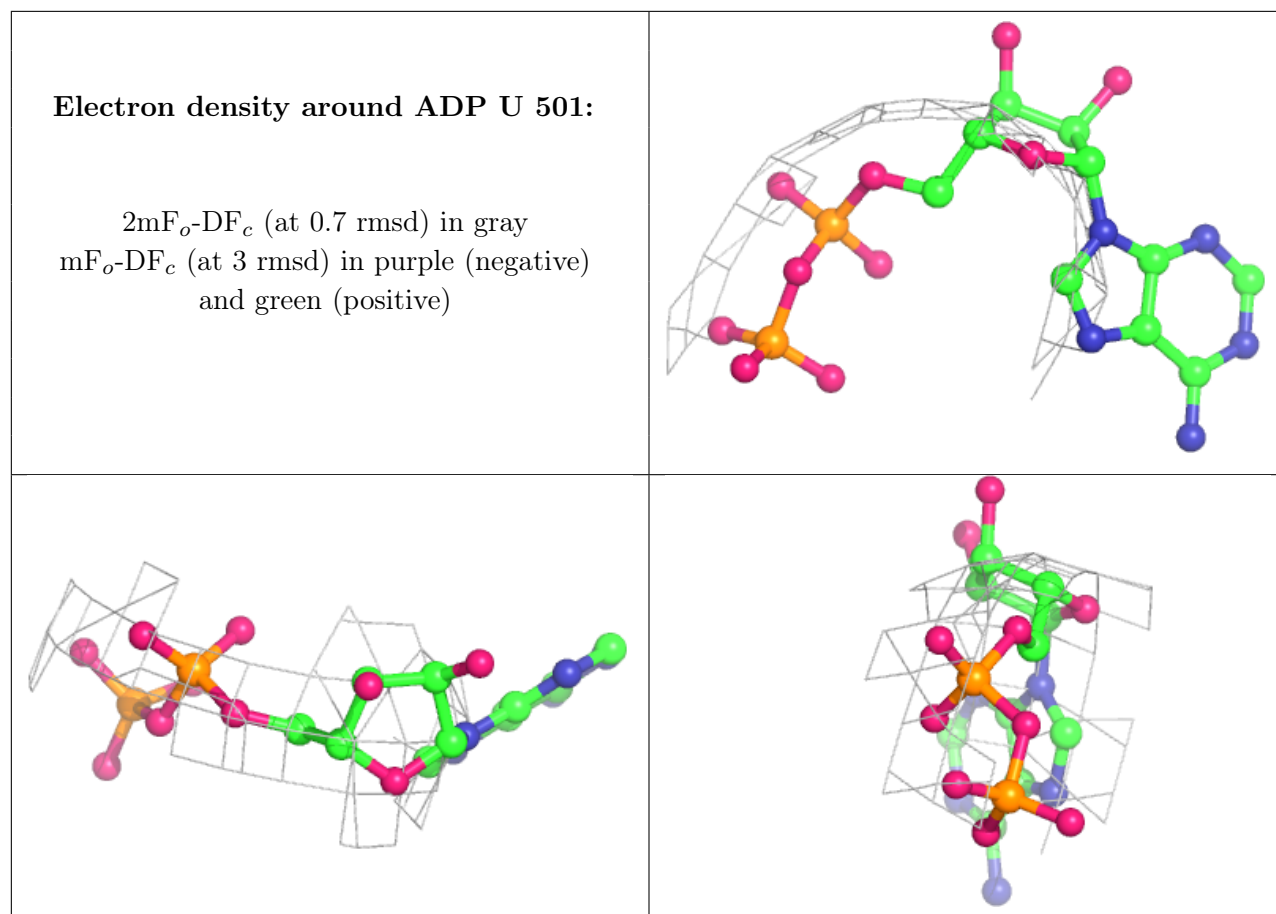

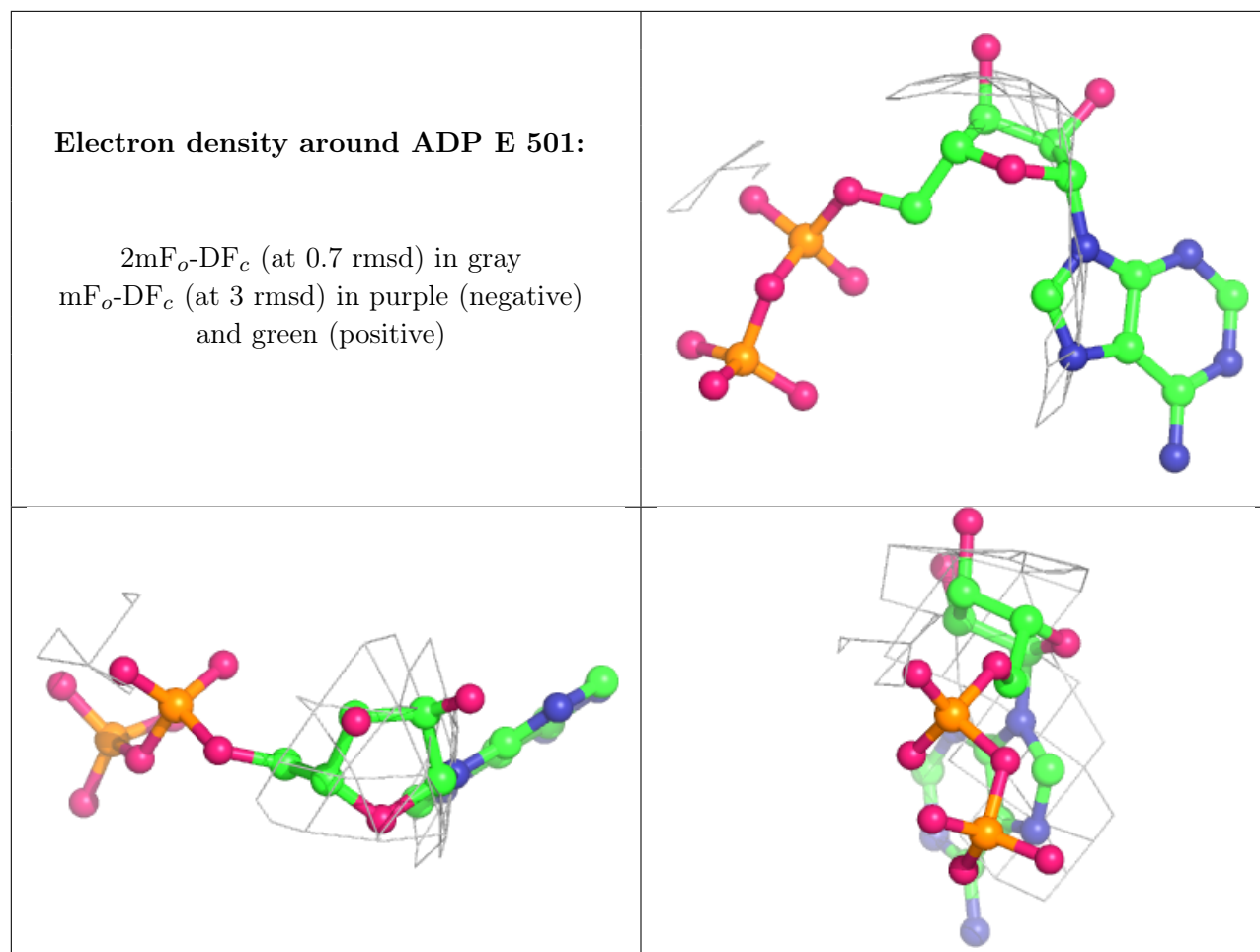

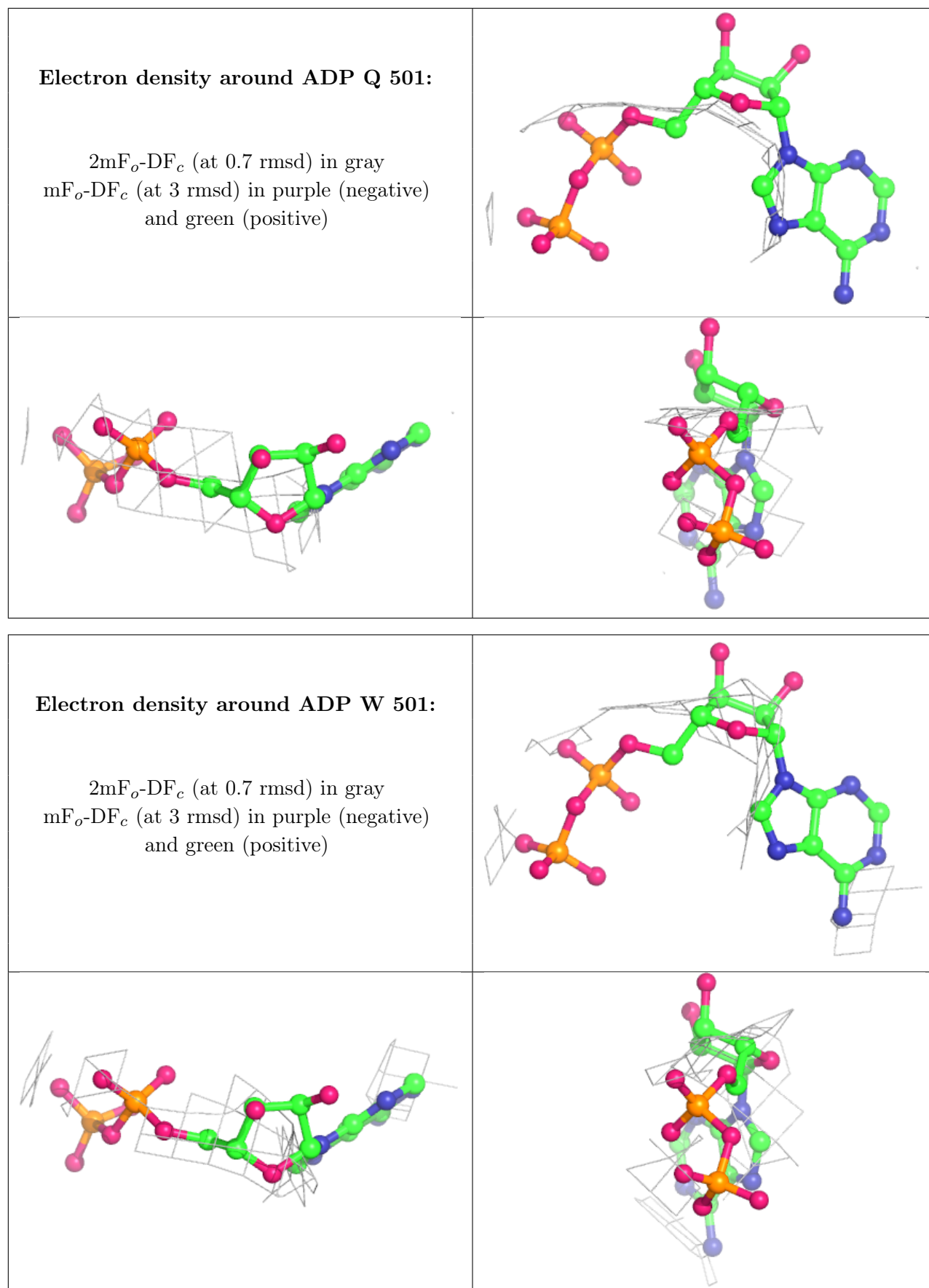

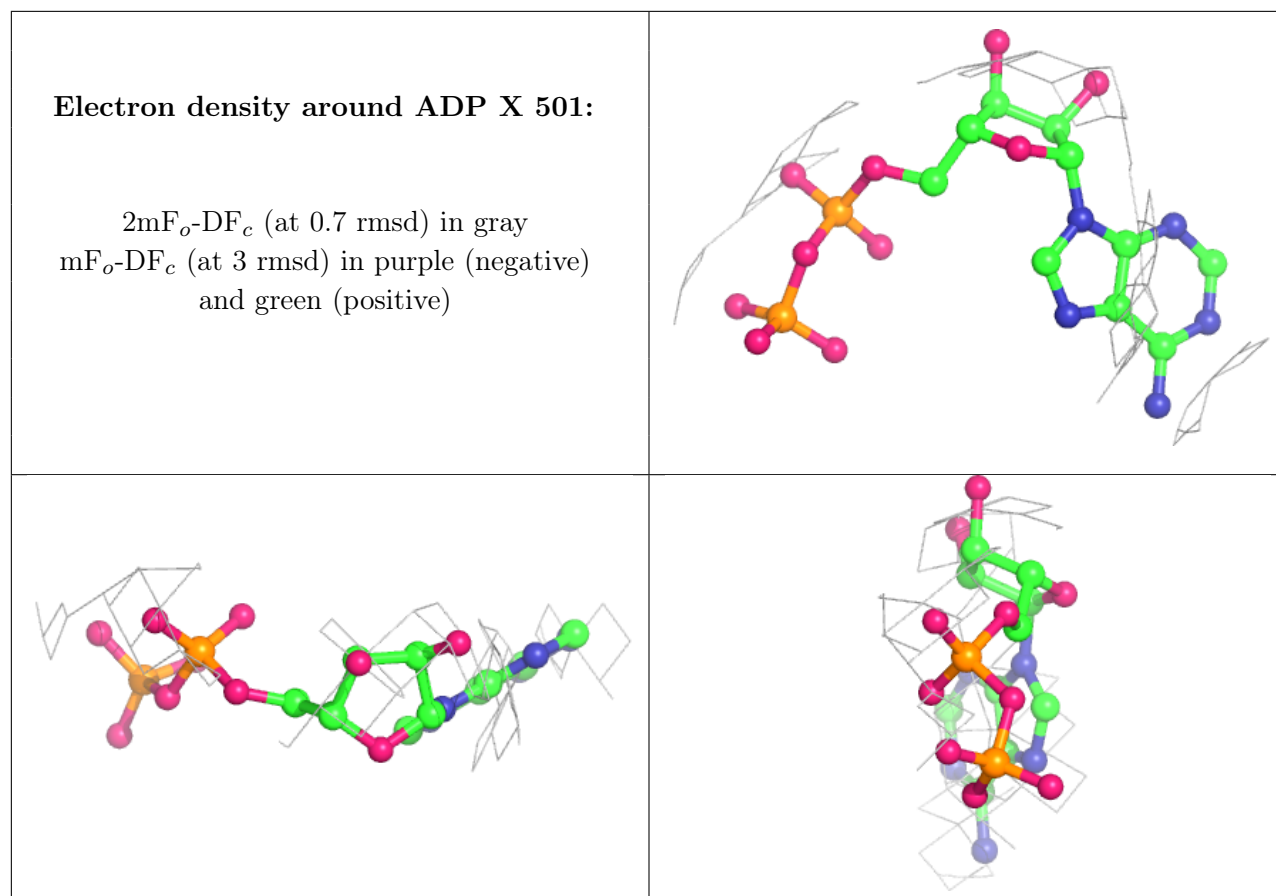

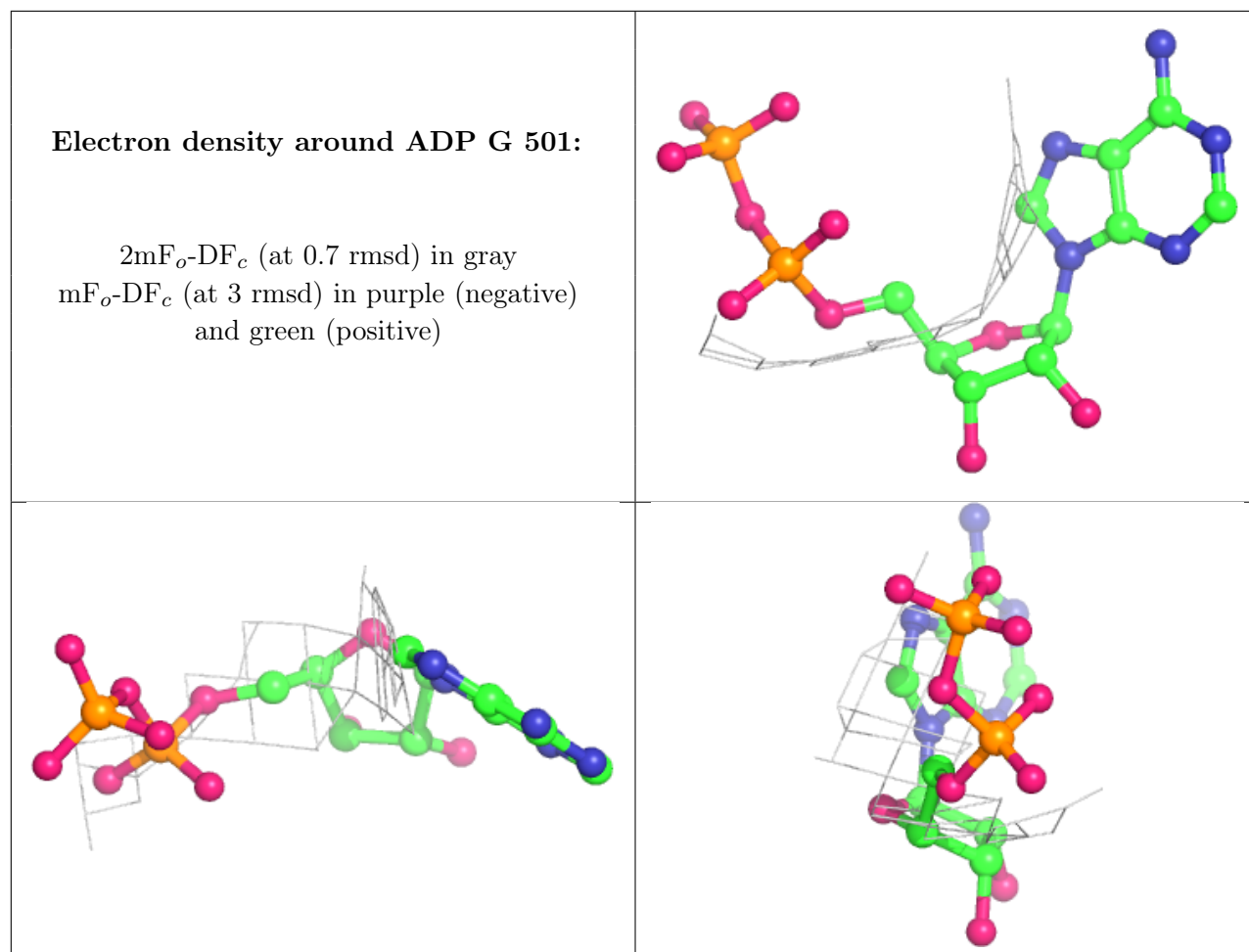

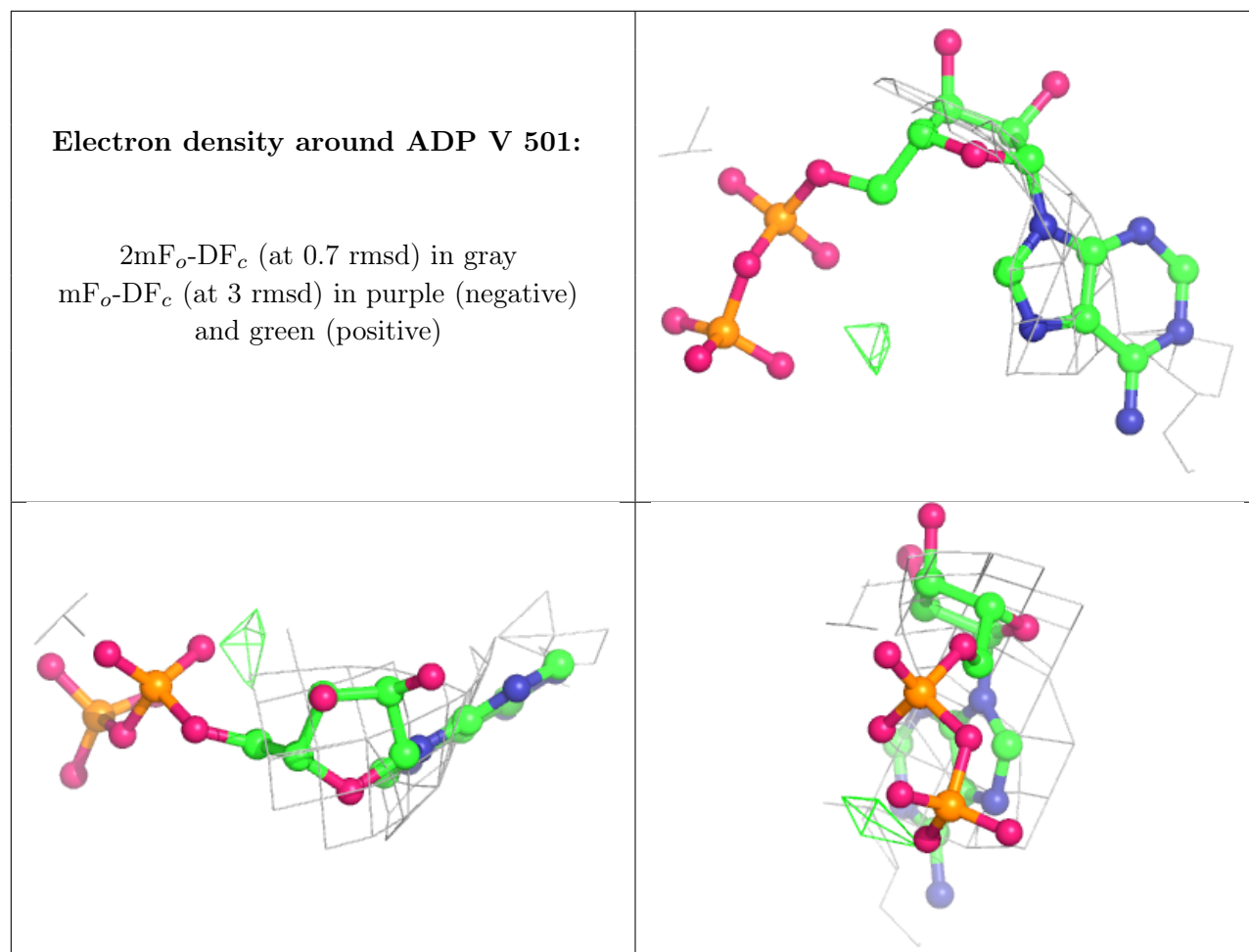

6.5 Other polymers [i](#)

There are no such residues in this entry.