



Full wwPDB EM Validation Report ⓘ

Nov 23, 2022 – 11:43 AM EST

PDB ID : 7TYT
EMDB ID : EMD-26194
Title : Cryo-EM structure of the pancreatic ATP-sensitive potassium channel bound to ATP and repaglinide with Kir6.2-CTD in the down conformation
Authors : Shyng, S.L.; Sung, M.W.; Driggers, C.M.
Deposited on : 2022-02-14
Resolution : 3.60 Å (reported)
Based on initial models : 6PZ9, 6BAA

This is a Full wwPDB EM Validation Report for a publicly released PDB entry.

We welcome your comments at validation@mail.wwpdb.org

A user guide is available at

<https://www.wwpdb.org/validation/2017/EMValidationReportHelp>

with specific help available everywhere you see the ⓘ symbol.

The types of validation reports are described at

<http://www.wwpdb.org/validation/2017/FAQs#types>.

The following versions of software and data (see [references ⓘ](#)) were used in the production of this report:

EMDB validation analysis : 0.0.1.dev43
Mogul : 1.8.5 (274361), CSD as541be (2020)
MolProbity : 4.02b-467
buster-report : 1.1.7 (2018)
Percentile statistics : 20191225.v01 (using entries in the PDB archive December 25th 2019)
MapQ : 1.9.9
Ideal geometry (proteins) : Engh & Huber (2001)
Ideal geometry (DNA, RNA) : Parkinson et al. (1996)
Validation Pipeline (wwPDB-VP) : 2.31.3

1 Overall quality at a glance i

The following experimental techniques were used to determine the structure:

ELECTRON MICROSCOPY

The reported resolution of this entry is 3.60 Å.

Percentile scores (ranging between 0-100) for global validation metrics of the entry are shown in the following graphic. The table shows the number of entries on which the scores are based.

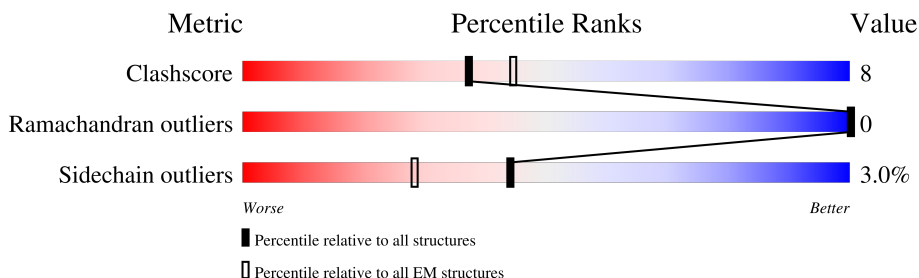

Metric	Whole archive (#Entries)	EM structures (#Entries)
Clashscore	158937	4297
Ramachandran outliers	154571	4023
Sidechain outliers	154315	3826

The table below summarises the geometric issues observed across the polymeric chains and their fit to the map. The red, orange, yellow and green segments of the bar indicate the fraction of residues that contain outliers for ≥ 3 , 2, 1 and 0 types of geometric quality criteria respectively. A grey segment represents the fraction of residues that are not modelled. The numeric value for each fraction is indicated below the corresponding segment, with a dot representing fractions $\leq 5\%$. The upper red bar (where present) indicates the fraction of residues that have poor fit to the EM map (all-atom inclusion $< 40\%$). The numeric value is given above the bar.

Mol	Chain	Length	Quality of chain
1	A	390	
1	B	390	
1	C	390	
1	D	390	
2	E	1582	
3	F	2	

2 Entry composition [i](#)

There are 9 unique types of molecules in this entry. The entry contains 20349 atoms, of which 0 are hydrogens and 0 are deuteriums.

In the tables below, the AltConf column contains the number of residues with at least one atom in alternate conformation and the Trace column contains the number of residues modelled with at most 2 atoms.

- Molecule 1 is a protein called ATP-sensitive inward rectifier potassium channel 11.

Mol	Chain	Residues	Atoms					AltConf	Trace
			Total	C	N	O	S		
1	A	356	Total 2535	C 1634	N 446	O 441	S 14	0	0
1	B	326	Total 2349	C 1529	N 407	O 400	S 13	0	0
1	C	326	Total 2370	C 1542	N 410	O 403	S 15	0	0
1	D	326	Total 2395	C 1554	N 410	O 416	S 15	0	0

- Molecule 2 is a protein called ATP-binding cassette sub-family C member 8.

Mol	Chain	Residues	Atoms					AltConf	Trace
			Total	C	N	O	S		
2	E	1425	Total 10003	C 6473	N 1737	O 1757	S 36	0	0

- Molecule 3 is an oligosaccharide called 2-acetamido-2-deoxy-beta-D-glucopyranose-(1-4)-2-acetamido-2-deoxy-beta-D-glucopyranose.



Mol	Chain	Residues	Atoms				AltConf	Trace
			Total	C	N	O		
3	F	2	Total 28	C 16	N 2	O 10	0	0

- Molecule 4 is ADENOSINE-5'-TRIPHOSPHATE (three-letter code: ATP) (formula: C₁₀H₁₆N₅O₁₃P₃) (labeled as "Ligand of Interest" by depositor).

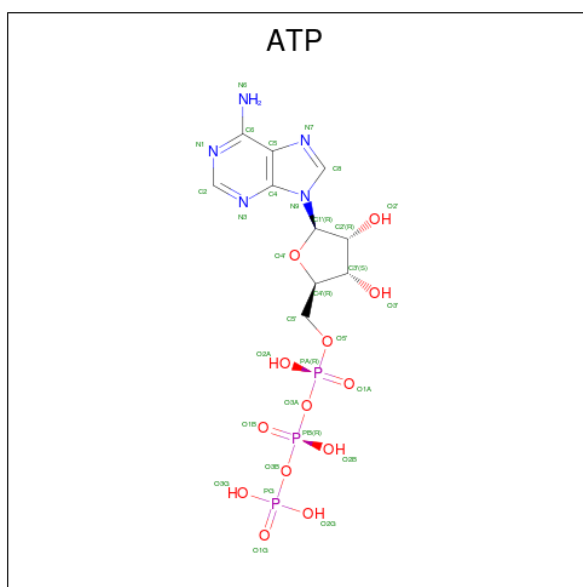

Mol	Chain	Residues	Atoms					AltConf
			Total	C	N	O	P	
4	A	1	Total	C	N	O	P	0
			31	10	5	13	3	
4	B	1	Total	C	N	O	P	0
			62	20	10	26	6	
4	B	1	Total	C	N	O	P	0
			62	20	10	26	6	
4	D	1	Total	C	N	O	P	0
			31	10	5	13	3	
4	E	1	Total	C	N	O	P	0
			31	10	5	13	3	

- Molecule 5 is POTASSIUM ION (three-letter code: K) (formula: K).

Mol	Chain	Residues	Atoms		AltConf
5	A	1	Total	K	0
			1	1	

- Molecule 6 is (2S)-3-(hexadecanoyloxy)-2-[(9Z)-octadec-9-enoyloxy]propyl 2-(trimethylammonio)ethyl phosphate (three-letter code: POV) (formula: C₄₂H₈₂NO₈P).

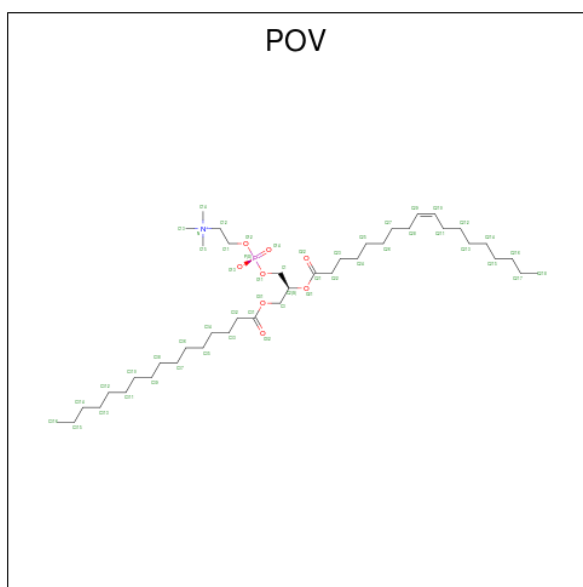

Mol	Chain	Residues	Atoms					AltConf
			Total	C	N	O	P	
6	A	1	Total 36	26	1	8	1	0
6	B	1	Total 36	26	1	8	1	0
6	C	1	Total 36	26	1	8	1	0
6	D	1	Total 36	26	1	8	1	0
6	E	1	Total 36	26	1	8	1	0

- Molecule 7 is O-[(R)-{[(2R)-2,3-bis(octadecanoyloxy)propyl]oxy}](hydroxy)phosphoryl]-L-serine (three-letter code: P5S) (formula: C₄₂H₈₂NO₁₀P).

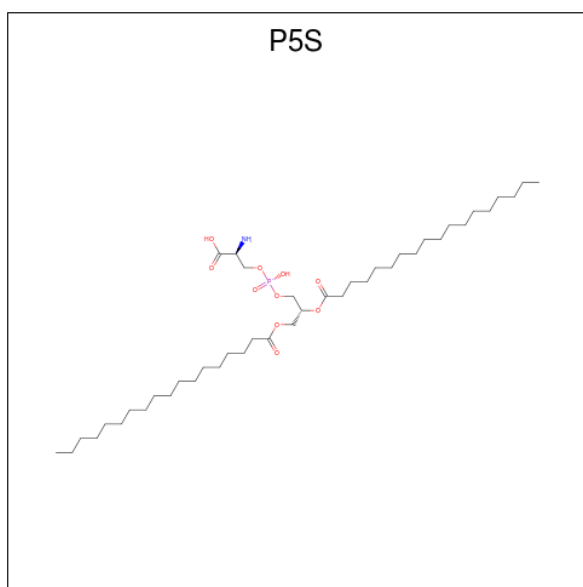

Mol	Chain	Residues	Atoms					AltConf
			Total	C	N	O	P	
7	B	1	54	42	1	10	1	0
7	E	1	54	42	1	10	1	0

- Molecule 8 is PHOSPHATIDYLETHANOLAMINE (three-letter code: PTY) (formula: $C_{40}H_{80}NO_8P$).

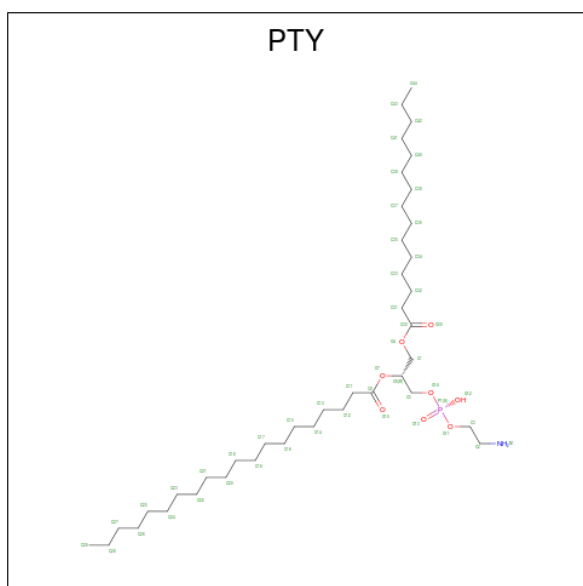

Mol	Chain	Residues	Atoms					AltConf
			Total	C	N	O	P	
8	E	1	192	132	6	48	6	0

Continued on next page...

Continued from previous page...

Mol	Chain	Residues	Atoms					AltConf
8	E	1	Total	C	N	O	P	0
			192	132	6	48	6	
8	E	1	Total	C	N	O	P	0
			192	132	6	48	6	
8	E	1	Total	C	N	O	P	0
			192	132	6	48	6	
8	E	1	Total	C	N	O	P	0
			192	132	6	48	6	
8	E	1	Total	C	N	O	P	0
			192	132	6	48	6	

- Molecule 9 is Repaglinide (three-letter code: BJX) (formula: $C_{27}H_{36}N_2O_4$) (labeled as "Ligand of Interest" by depositor).

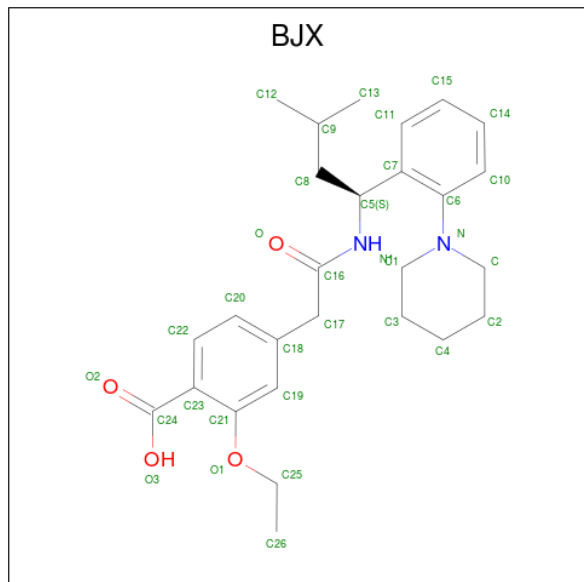

Mol	Chain	Residues	Atoms				AltConf
9	E	1	Total	C	N	O	0
			33	27	2	4	

3 Residue-property plots [i](#)

These plots are drawn for all protein, RNA, DNA and oligosaccharide chains in the entry. The first graphic for a chain summarises the proportions of the various outlier classes displayed in the second graphic. The second graphic shows the sequence view annotated by issues in geometry and atom inclusion in map density. Residues are color-coded according to the number of geometric quality criteria for which they contain at least one outlier: green = 0, yellow = 1, orange = 2 and red = 3 or more. A red diamond above a residue indicates a poor fit to the EM map for this residue (all-atom inclusion < 40%). Stretches of 2 or more consecutive residues without any outlier are shown as a green connector. Residues present in the sample, but not in the model, are shown in grey.

- Molecule 1: ATP-sensitive inward rectifier potassium channel 11

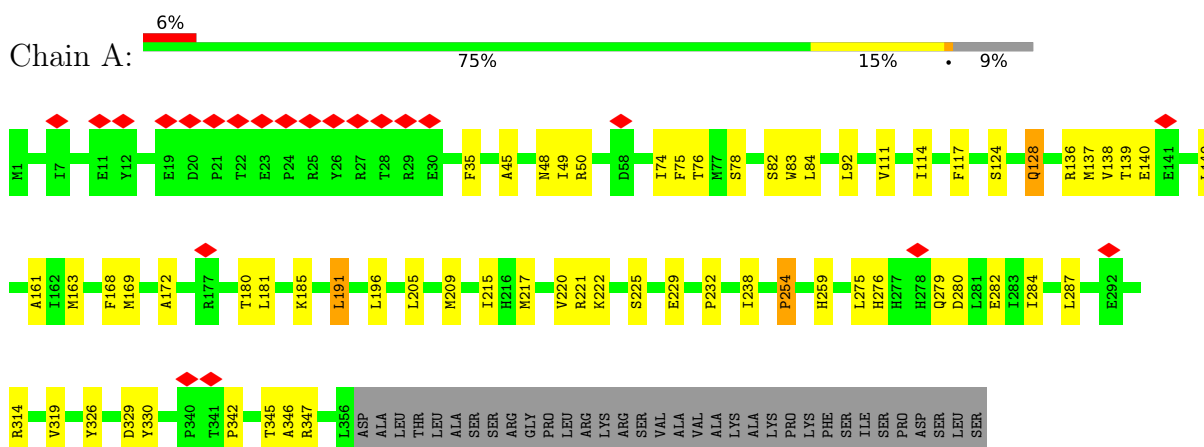

- Molecule 1: ATP-sensitive inward rectifier potassium channel 11

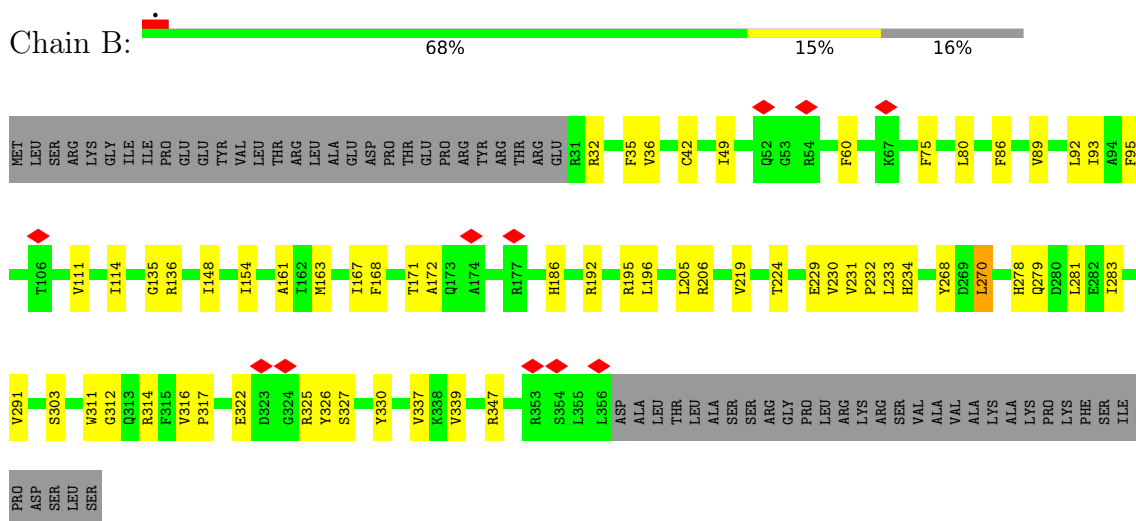

- Molecule 1: ATP-sensitive inward rectifier potassium channel 11



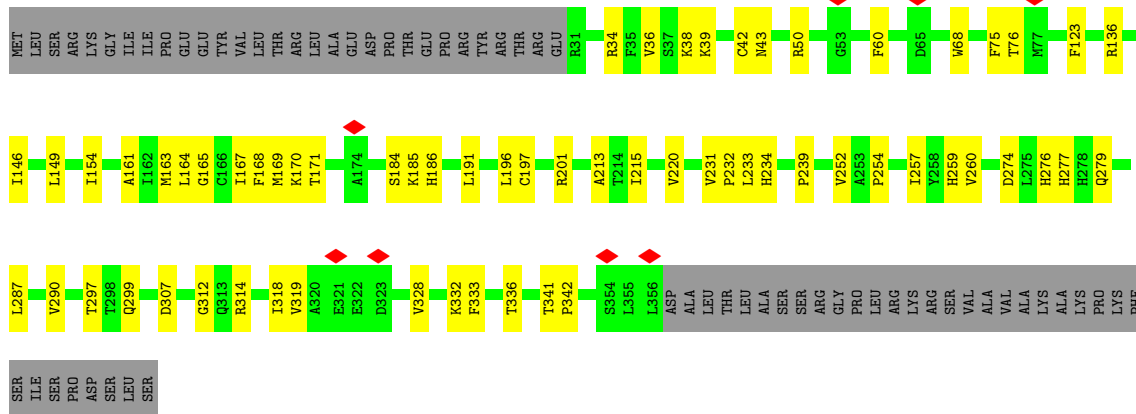

• Molecule 1: ATP-sensitive inward rectifier potassium channel 11

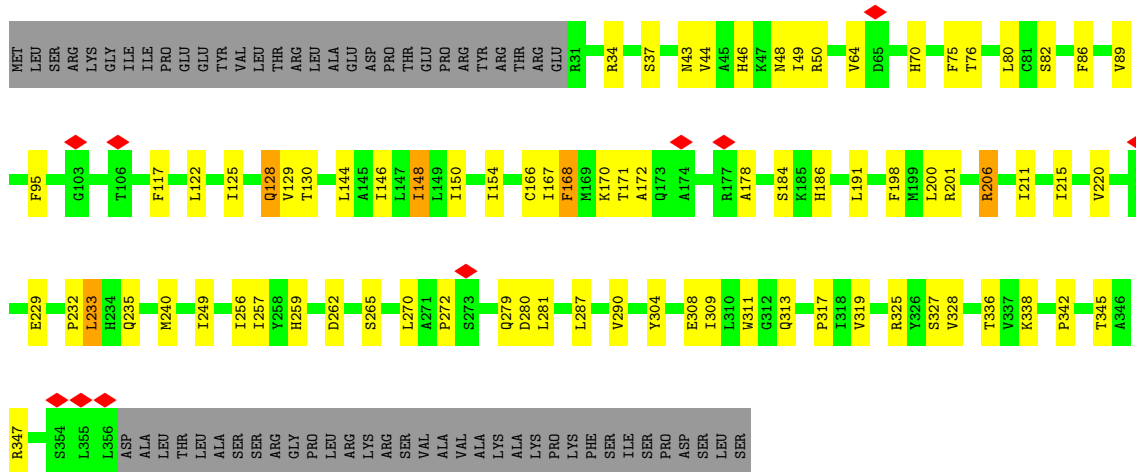

• Molecule 2: ATP-binding cassette sub-family C member 8

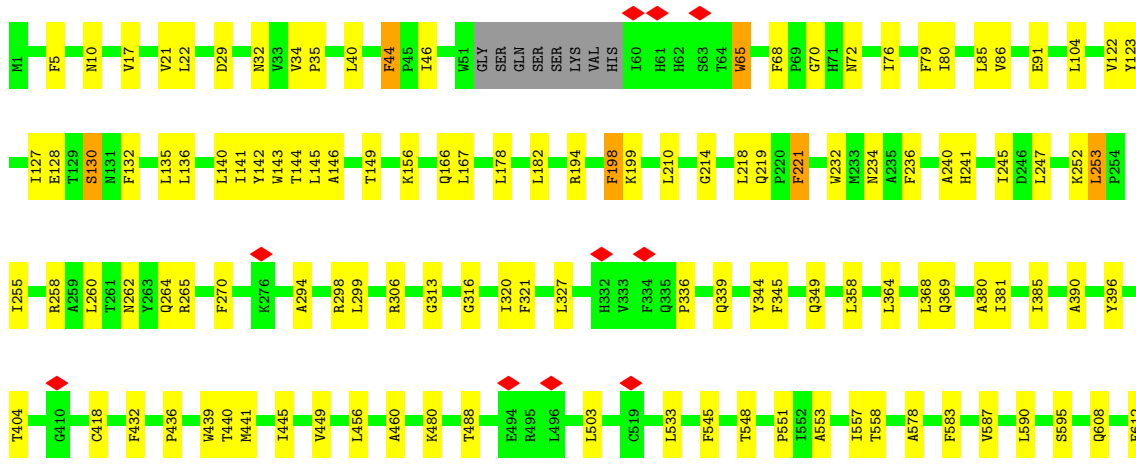

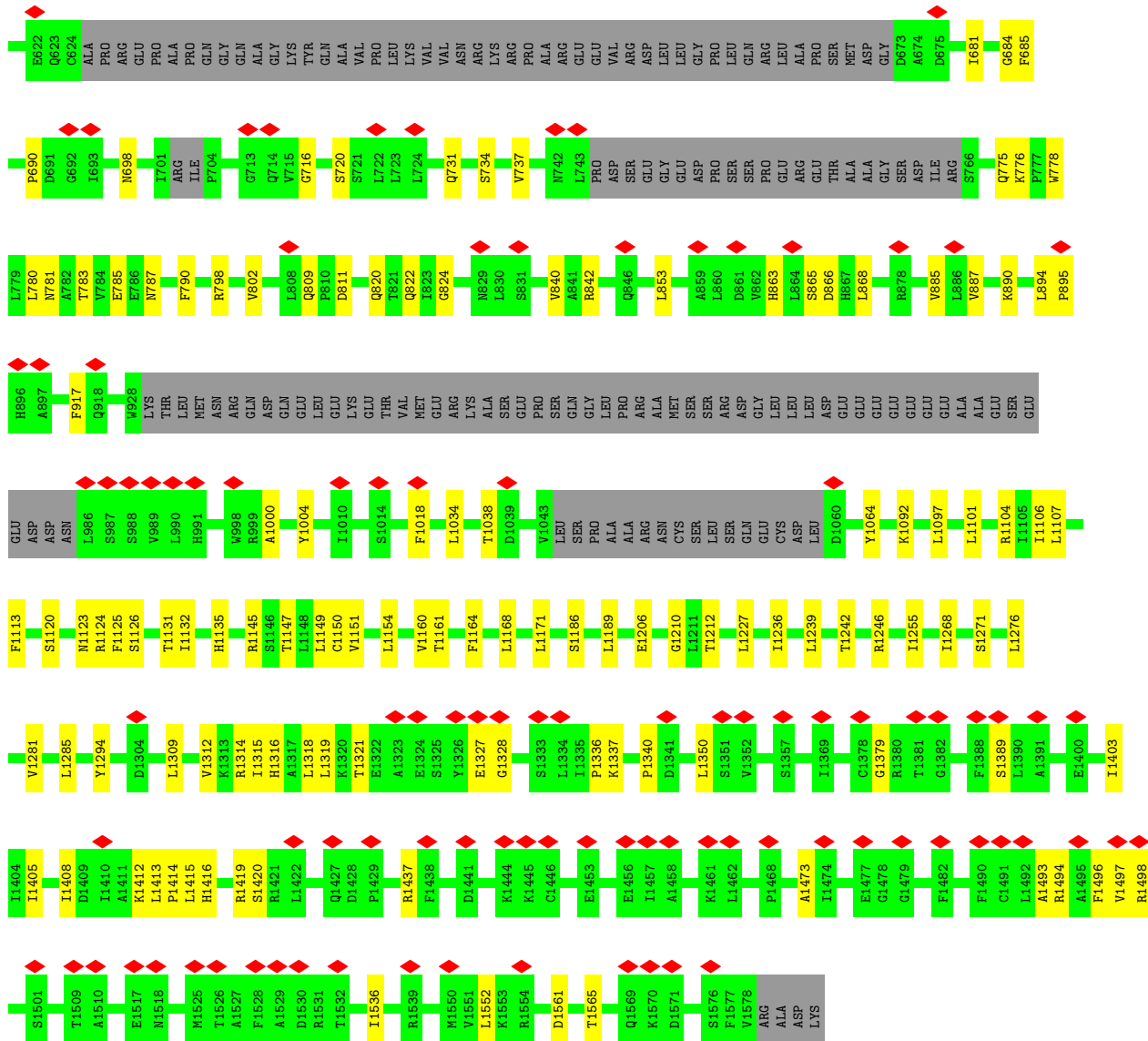

● Molecule 3: 2-acetamido-2-deoxy-beta-D-glucopyranose-(1-4)-2-acetamido-2-deoxy-beta-D-glucopyranose



4 Experimental information

Property	Value	Source
EM reconstruction method	SINGLE PARTICLE	Depositor
Imposed symmetry	POINT, Not provided	
Number of particles used	36042	Depositor
Resolution determination method	FSC 0.143 CUT-OFF	Depositor
CTF correction method	NONE	Depositor
Microscope	FEI TITAN KRIOS	Depositor
Voltage (kV)	300	Depositor
Electron dose ($e^-/\text{\AA}^2$)	40	Depositor
Minimum defocus (nm)	1000	Depositor
Maximum defocus (nm)	2600	Depositor
Magnification	Not provided	
Image detector	FEI FALCON III (4k x 4k)	Depositor
Maximum map value	14.074	Depositor
Minimum map value	-9.463	Depositor
Average map value	-0.000	Depositor
Map value standard deviation	1.000	Depositor
Recommended contour level	1.0	Depositor
Map size (\AA)	166.155, 109.725, 149.435	wwPDB
Map dimensions	143, 105, 159	wwPDB
Map angles ($^\circ$)	90.0, 90.0, 90.0	wwPDB
Pixel spacing (\AA)	1.045, 1.045, 1.045	Depositor

5 Model quality [i](#)

5.1 Standard geometry [i](#)

Bond lengths and bond angles in the following residue types are not validated in this section: PTY, K, POV, ATP, BJX, NAG, P5S

The Z score for a bond length (or angle) is the number of standard deviations the observed value is removed from the expected value. A bond length (or angle) with $|Z| > 5$ is considered an outlier worth inspection. RMSZ is the root-mean-square of all Z scores of the bond lengths (or angles).

Mol	Chain	Bond lengths		Bond angles	
		RMSZ	# Z >5	RMSZ	# Z >5
1	A	0.28	0/2592	0.47	0/3551
1	B	0.27	0/2402	0.48	0/3287
1	C	0.28	0/2424	0.48	0/3315
1	D	0.28	0/2451	0.48	0/3355
2	E	0.27	0/10215	0.44	0/13997
All	All	0.27	0/20084	0.46	0/27505

There are no bond length outliers.

There are no bond angle outliers.

There are no chirality outliers.

There are no planarity outliers.

5.2 Too-close contacts [i](#)

In the following table, the Non-H and H(model) columns list the number of non-hydrogen atoms and hydrogen atoms in the chain respectively. The H(added) column lists the number of hydrogen atoms added and optimized by MolProbity. The Clashes column lists the number of clashes within the asymmetric unit, whereas Symm-Clashes lists symmetry-related clashes.

Mol	Chain	Non-H	H(model)	H(added)	Clashes	Symm-Clashes
1	A	2535	0	2344	51	0
1	B	2349	0	2249	44	0
1	C	2370	0	2286	53	0
1	D	2395	0	2297	59	0
2	E	10003	0	9134	147	0
3	F	28	0	25	1	0
4	A	31	0	12	5	0
4	B	62	0	24	5	0

Continued on next page...

Continued from previous page...

Mol	Chain	Non-H	H(model)	H(added)	Clashes	Symm-Clashes
4	D	31	0	12	1	0
4	E	31	0	12	4	0
5	A	1	0	0	0	0
6	A	36	0	45	2	0
6	B	36	0	45	0	0
6	C	36	0	45	0	0
6	D	36	0	45	2	0
6	E	36	0	45	1	0
7	B	54	0	80	1	0
7	E	54	0	80	5	0
8	E	192	0	222	7	0
9	E	33	0	0	1	0
All	All	20349	0	19002	322	0

The all-atom clashscore is defined as the number of clashes found per 1000 atoms (including hydrogen atoms). The all-atom clashscore for this structure is 8.

All (322) close contacts within the same asymmetric unit are listed below, sorted by their clash magnitude.

Atom-1	Atom-2	Interatomic distance (Å)	Clash overlap (Å)
1:A:225:SER:HB3	1:A:229:GLU:HB2	1.67	0.75
2:E:781:ASN:ND2	2:E:1206:GLU:OE2	2.22	0.73
1:A:181:LEU:HD21	1:A:287:LEU:HD22	1.70	0.72
2:E:775:GLN:NE2	4:E:1603:ATP:O2G	2.25	0.69
2:E:690:PRO:HA	2:E:731:GLN:HG2	1.74	0.69
1:B:49:ILE:HA	4:B:404:ATP:HN62	1.58	0.68
1:B:161:ALA:HB1	1:C:167:ILE:HG21	1.75	0.67
1:C:68:TRP:HD1	1:C:170:LYS:HE3	1.59	0.67
2:E:127:ILE:HG21	2:E:136:LEU:HG	1.76	0.66
2:E:234:ASN:ND2	8:E:1606:PTY:O10	2.28	0.66
1:B:311:TRP:HD1	1:B:312:GLY:H	1.44	0.66
1:C:274:ASP:OD2	1:C:279:GLN:NE2	2.29	0.66
1:C:201:ARG:NH2	1:C:318:ILE:HG13	2.11	0.66
1:D:178:ALA:O	1:D:206:ARG:NH2	2.28	0.66
1:C:232:PRO:HG3	1:D:317:PRO:HB3	1.79	0.65
2:E:1104:ARG:NH1	2:E:1319:LEU:O	2.29	0.65
2:E:1101:LEU:HD11	2:E:1318:LEU:HD23	1.77	0.65
1:B:224:THR:HG22	1:B:230:VAL:HG22	1.78	0.65
2:E:1271:SER:HA	2:E:1276:LEU:H	1.60	0.65
1:C:184:SER:HB3	1:C:201:ARG:HB3	1.78	0.65
1:B:36:VAL:HA	1:B:42:CYS:HA	1.79	0.64

Continued on next page...

Continued from previous page...

Atom-1	Atom-2	Interatomic distance (Å)	Clash overlap (Å)
2:E:219:GLN:OE1	2:E:232:TRP:NE1	2.27	0.64
1:A:221:ARG:NH1	1:A:280:ASP:O	2.31	0.64
1:B:233:LEU:HD12	1:C:319:VAL:HG11	1.80	0.63
2:E:1104:ARG:NH2	2:E:1321:THR:O	2.25	0.63
1:A:222:LYS:HG3	1:A:232:PRO:HA	1.80	0.63
1:C:312:GLY:HA3	1:C:341:THR:HG21	1.80	0.63
2:E:866:ASP:HB3	2:E:890:LYS:HE2	1.81	0.63
1:A:326:TYR:HB2	1:D:44:VAL:HG13	1.81	0.62
1:C:36:VAL:HG12	1:C:42:CYS:HA	1.81	0.62
1:C:232:PRO:HB2	1:D:319:VAL:HB	1.80	0.62
1:A:185:LYS:NZ	4:A:401:ATP:O1G	2.28	0.61
1:A:329:ASP:OD1	1:D:48:ASN:ND2	2.34	0.61
2:E:1171:LEU:HD22	2:E:1255:ILE:HG23	1.82	0.61
1:C:146:ILE:HG12	1:D:122:LEU:HD21	1.83	0.61
2:E:1160:VAL:HG12	2:E:1161:THR:HG23	1.82	0.61
1:B:36:VAL:HG13	1:B:303:SER:HB2	1.82	0.61
2:E:80:ILE:HG22	7:E:1607:P5S:H30A	1.82	0.60
1:C:299:GLN:HB2	1:D:211:ILE:HD12	1.83	0.60
1:D:279:GLN:HG3	1:D:281:LEU:H	1.65	0.60
1:A:314:ARG:HH12	1:D:229:GLU:HA	1.67	0.59
1:A:45:ALA:N	1:B:326:TYR:O	2.33	0.59
1:D:34:ARG:NH2	1:D:308:GLU:OE1	2.36	0.59
2:E:123:TYR:OH	2:E:135:LEU:O	2.20	0.59
2:E:265:ARG:NH2	2:E:294:ALA:O	2.35	0.59
4:A:401:ATP:N6	1:D:48:ASN:O	2.35	0.59
1:B:229:GLU:OE1	1:C:314:ARG:NH1	2.37	0.58
2:E:778:TRP:CE2	2:E:1210:GLY:HA3	2.38	0.58
1:B:111:VAL:HG23	1:B:114:ILE:HG13	1.86	0.57
1:D:184:SER:HB3	1:D:201:ARG:HB3	1.86	0.57
1:A:138:VAL:HG21	1:A:149:LEU:HD22	1.86	0.57
1:A:117:PHE:N	6:A:403:POV:O14	2.37	0.56
1:C:168:PHE:O	1:C:171:THR:OG1	2.21	0.56
2:E:364:LEU:HD22	7:E:1607:P5S:H56A	1.86	0.56
1:C:34:ARG:HH12	1:C:38:LYS:HG2	1.71	0.55
1:A:45:ALA:HB3	1:B:327:SER:HA	1.88	0.55
1:C:191:LEU:HD11	1:C:342:PRO:HD2	1.87	0.55
2:E:1494:ARG:HA	2:E:1497:VAL:HB	1.88	0.55
1:A:169:MET:HE1	1:B:172:ALA:N	2.22	0.55
2:E:488:THR:HG21	2:E:533:LEU:HD13	1.88	0.55
2:E:798:ARG:O	2:E:802:VAL:HG23	2.07	0.55
4:B:404:ATP:H5'2	1:C:185:LYS:HB2	1.89	0.54

Continued on next page...

Continued from previous page...

Atom-1	Atom-2	Interatomic distance (Å)	Clash overlap (Å)
2:E:306:ARG:HG3	2:E:440:THR:HG21	1.88	0.54
1:B:316:VAL:HG22	1:B:337:VAL:HG13	1.89	0.54
2:E:1561:ASP:H	2:E:1565:THR:HA	1.72	0.54
1:D:129:VAL:O	1:D:130:THR:OG1	2.24	0.54
2:E:298:ARG:NH1	7:E:1607:P5S:O15	2.36	0.54
2:E:441:MET:O	2:E:445:ILE:HG13	2.08	0.54
1:B:32:ARG:NH1	1:B:279:GLN:O	2.41	0.54
4:A:401:ATP:HN62	1:D:49:ILE:HA	1.73	0.53
1:C:277:HIS:HB2	1:C:307:ASP:HB3	1.90	0.53
2:E:178:LEU:O	2:E:182:LEU:HG	2.09	0.53
2:E:218:LEU:H	2:E:218:LEU:HD23	1.74	0.53
1:B:168:PHE:HD2	1:C:168:PHE:HB2	1.73	0.53
1:C:146:ILE:HG21	6:D:402:POV:H27A	1.90	0.53
1:B:75:PHE:CZ	1:B:163:MET:HA	2.44	0.53
1:A:191:LEU:HD12	1:A:342:PRO:HD2	1.91	0.53
2:E:349:GLN:OE1	2:E:349:GLN:N	2.28	0.53
2:E:1034:LEU:O	2:E:1038:THR:OG1	2.24	0.53
2:E:684:GLY:O	2:E:698:ASN:N	2.42	0.52
1:B:195:ARG:NH1	1:B:196:LEU:H	2.08	0.52
1:C:215:ILE:HG21	1:C:257:ILE:HG21	1.91	0.52
2:E:456:LEU:HB2	2:E:460:ALA:HB2	1.92	0.52
1:C:213:ALA:HB1	1:C:287:LEU:HD11	1.90	0.52
1:D:272:PRO:HB3	1:D:311:TRP:CD1	2.45	0.52
1:C:201:ARG:NH1	1:C:333:PHE:O	2.43	0.52
2:E:1416:HIS:O	2:E:1420:SER:OG	2.23	0.52
1:B:167:ILE:O	1:B:171:THR:OG1	2.24	0.52
1:C:50:ARG:NH1	4:D:401:ATP:O1B	2.37	0.52
1:C:231:VAL:HG11	1:C:234:HIS:CD2	2.45	0.52
1:B:206:ARG:HH21	1:B:291:VAL:HG11	1.75	0.51
2:E:1124:ARG:HD2	2:E:1314:ARG:HB3	1.91	0.51
1:A:196:LEU:HD12	1:A:346:ALA:HB2	1.92	0.51
2:E:551:PRO:HG3	2:E:587:VAL:HG21	1.92	0.51
2:E:840:VAL:HG23	2:E:853:LEU:HD22	1.93	0.51
2:E:70:GLY:HA2	6:E:1608:POV:H2	1.91	0.51
2:E:86:VAL:HG11	2:E:364:LEU:HD11	1.91	0.51
2:E:783:THR:HB	2:E:820:GLN:HA	1.92	0.51
2:E:65:TRP:HZ3	8:E:1604:PTY:HC21	1.76	0.51
1:B:60:PHE:HB2	1:C:68:TRP:HH2	1.76	0.51
1:A:49:ILE:HD11	1:B:205:LEU:HD13	1.93	0.50
2:E:445:ILE:HD13	2:E:590:LEU:HD23	1.92	0.50
1:C:201:ARG:HH22	1:C:318:ILE:HG13	1.75	0.50

Continued on next page...

Continued from previous page...

Atom-1	Atom-2	Interatomic distance (Å)	Clash overlap (Å)
1:D:86:PHE:HA	1:D:89:VAL:HG12	1.93	0.50
2:E:40:LEU:O	2:E:44:PHE:HB2	2.11	0.50
1:A:74:ILE:O	1:A:78:SER:OG	2.21	0.50
1:C:75:PHE:CZ	1:C:163:MET:HA	2.47	0.50
1:A:83:TRP:HZ3	1:D:150:ILE:HG23	1.77	0.50
2:E:316:GLY:O	2:E:320:ILE:HG13	2.11	0.49
2:E:558:THR:HG21	2:E:583:PHE:HZ	1.75	0.49
2:E:1337:LYS:HZ2	2:E:1408:ILE:HD13	1.77	0.49
2:E:809:GLN:OE1	2:E:809:GLN:N	2.45	0.49
2:E:716:GLY:HA2	4:E:1603:ATP:H5'2	1.95	0.49
1:D:75:PHE:HZ	1:D:166:CYS:HB3	1.77	0.49
1:A:82:SER:OG	1:A:128:GLN:NE2	2.45	0.49
1:B:314:ARG:HG3	1:B:339:VAL:HG11	1.95	0.49
2:E:29:ASP:HA	2:E:32:ASN:HD22	1.77	0.49
1:C:154:ILE:HD13	1:D:76:THR:HG23	1.94	0.49
1:D:345:THR:HG22	1:D:347:ARG:H	1.78	0.49
1:A:220:VAL:HG23	1:A:282:GLU:HB3	1.95	0.49
1:B:42:CYS:SG	1:C:252:VAL:HG21	2.53	0.49
2:E:339:GLN:N	2:E:339:GLN:OE1	2.45	0.49
1:A:161:ALA:HB1	1:B:167:ILE:HG13	1.95	0.48
1:B:35:PHE:CD1	1:B:233:LEU:HD13	2.48	0.48
2:E:142:TYR:O	2:E:146:ALA:N	2.43	0.48
1:C:161:ALA:HB1	1:D:167:ILE:HG13	1.95	0.48
2:E:790:PHE:HB2	2:E:842:ARG:HD2	1.94	0.48
2:E:445:ILE:O	2:E:449:VAL:HG12	2.13	0.48
2:E:553:ALA:O	2:E:557:ILE:HG12	2.13	0.48
2:E:396:TYR:CG	2:E:1227:LEU:HD22	2.49	0.48
2:E:1389:SER:HB3	2:E:1536:ILE:HD13	1.95	0.48
1:A:140:GLU:N	1:A:140:GLU:OE1	2.47	0.48
2:E:122:VAL:HG22	8:E:1610:PTY:H112	1.96	0.48
2:E:156:LYS:HA	2:E:156:LYS:HD3	1.54	0.48
1:A:35:PHE:CZ	1:A:220:VAL:HG11	2.49	0.47
1:C:43:ASN:OD1	1:D:325:ARG:NE	2.31	0.47
1:C:319:VAL:HG22	1:C:328:VAL:HG22	1.94	0.47
1:D:211:ILE:HB	1:D:290:VAL:HG13	1.95	0.47
2:E:785:GLU:OE2	2:E:820:GLN:NE2	2.35	0.47
2:E:1415:LEU:HD22	2:E:1419:ARG:HH12	1.79	0.47
2:E:68:PHE:CE1	2:E:128:GLU:HA	2.49	0.47
1:A:92:LEU:HD11	2:E:34:VAL:HG21	1.97	0.47
1:D:215:ILE:HG23	1:D:240:MET:HG3	1.96	0.47
2:E:1101:LEU:HD22	2:E:1315:ILE:HG23	1.97	0.47

Continued on next page...

Continued from previous page...

Atom-1	Atom-2	Interatomic distance (Å)	Clash overlap (Å)
1:A:172:ALA:HB2	1:D:168:PHE:HZ	1.80	0.47
2:E:141:ILE:O	2:E:145:LEU:HB2	2.15	0.47
2:E:1350:LEU:HD13	2:E:1403:ILE:HD11	1.96	0.47
4:A:401:ATP:H2'	1:D:50:ARG:HH12	1.79	0.47
1:B:270:LEU:HD23	1:B:270:LEU:HA	1.82	0.46
1:D:313:GLN:OE1	1:D:336:THR:OG1	2.25	0.46
2:E:91:GLU:HG3	2:E:167:LEU:HD23	1.97	0.46
2:E:327:LEU:HD23	2:E:1281:VAL:HG21	1.97	0.46
2:E:439:TRP:N	2:E:439:TRP:CD1	2.84	0.46
1:A:209:MET:SD	1:A:209:MET:N	2.82	0.46
2:E:1106:ILE:HG23	2:E:1107:LEU:HD23	1.95	0.46
1:B:205:LEU:HD11	4:B:401:ATP:H2	1.80	0.46
1:A:232:PRO:HD3	1:B:317:PRO:HB3	1.98	0.46
1:A:217:MET:HA	1:A:284:ILE:O	2.16	0.46
1:A:345:THR:HG22	1:A:347:ARG:H	1.81	0.46
1:B:322:GLU:HB2	1:B:325:ARG:O	2.15	0.46
1:D:215:ILE:HB	1:D:287:LEU:HD13	1.97	0.46
2:E:368:LEU:HD21	7:E:1607:P5S:H29A	1.98	0.46
1:A:180:THR:HB	1:A:205:LEU:HB2	1.97	0.46
2:E:143:TRP:HA	2:E:143:TRP:CE3	2.51	0.46
1:C:290:VAL:HG12	1:C:297:THR:HG22	1.98	0.46
2:E:404:THR:HG21	2:E:1212:THR:HG22	1.98	0.46
2:E:608:GLN:O	2:E:612:GLU:HG3	2.16	0.46
1:A:84:LEU:HD21	6:A:403:POV:H36A	1.97	0.46
1:D:200:LEU:HD11	1:D:304:TYR:CE2	2.51	0.46
2:E:5:PHE:HA	2:E:104:LEU:HB3	1.98	0.46
1:C:220:VAL:HG13	1:C:233:LEU:HD22	1.96	0.45
2:E:385:ILE:HG21	2:E:1239:LEU:HG	1.97	0.45
2:E:1097:LEU:HD21	2:E:1315:ILE:HG21	1.98	0.45
1:B:268:TYR:CZ	1:B:347:ARG:HA	2.52	0.45
1:A:139:THR:HG22	1:A:140:GLU:H	1.81	0.45
2:E:22:LEU:HD23	2:E:22:LEU:HA	1.78	0.45
2:E:865:SER:HA	2:E:868:LEU:HD12	1.99	0.45
1:C:149:LEU:HD21	1:D:125:ILE:HG21	1.99	0.45
1:C:254:PRO:HB3	1:C:333:PHE:HE2	1.82	0.45
1:D:191:LEU:HD11	1:D:342:PRO:HD2	1.99	0.45
1:D:259:HIS:NE2	1:D:265:SER:OG	2.48	0.45
2:E:1337:LYS:HE2	2:E:1340:PRO:HA	1.98	0.45
1:A:191:LEU:HD23	1:A:196:LEU:HD23	1.98	0.45
1:A:319:VAL:HB	1:D:232:PRO:HB2	1.99	0.45
2:E:79:PHE:HB2	7:E:1607:P5S:H27	1.98	0.45

Continued on next page...

Continued from previous page...

Atom-1	Atom-2	Interatomic distance (Å)	Clash overlap (Å)
8:E:1604:PTY:H312	8:E:1604:PTY:HC12	1.78	0.45
1:C:169:MET:HE1	1:D:172:ALA:N	2.32	0.45
2:E:145:LEU:O	2:E:149:THR:HG22	2.17	0.45
1:B:80:LEU:HD12	1:B:80:LEU:HA	1.78	0.45
1:B:92:LEU:HD23	1:B:92:LEU:HA	1.74	0.45
2:E:65:TRP:NE1	2:E:221:PHE:O	2.46	0.45
1:A:75:PHE:CZ	1:A:163:MET:HA	2.52	0.44
1:D:82:SER:HB2	1:D:128:GLN:NE2	2.32	0.44
2:E:32:ASN:O	2:E:35:PRO:HD2	2.17	0.44
2:E:720:SER:OG	4:E:1603:ATP:O2B	2.35	0.44
1:A:319:VAL:O	1:D:232:PRO:HB3	2.18	0.44
1:C:197:CYS:SG	1:C:260:VAL:HG22	2.57	0.44
2:E:65:TRP:CZ3	8:E:1604:PTY:HC21	2.51	0.44
1:C:231:VAL:HG21	1:C:234:HIS:HD2	1.81	0.44
2:E:320:ILE:HG12	2:E:1285:LEU:HD23	1.98	0.44
2:E:1494:ARG:O	2:E:1498:ARG:N	2.47	0.44
2:E:240:ALA:HB2	2:E:245:ILE:HD11	1.99	0.44
2:E:720:SER:OG	4:E:1603:ATP:O1A	2.30	0.44
1:A:330:TYR:HB3	4:A:401:ATP:N6	2.32	0.44
1:D:80:LEU:HD12	1:D:80:LEU:HA	1.79	0.44
1:D:249:ILE:HD12	1:D:249:ILE:HA	1.90	0.44
2:E:380:ALA:HB2	2:E:436:PRO:HG2	1.99	0.44
2:E:681:ILE:HG23	2:E:737:VAL:HG22	1.99	0.44
1:A:215:ILE:HD11	1:A:287:LEU:HD12	2.00	0.44
1:D:233:LEU:HD13	1:D:233:LEU:HA	1.64	0.44
1:D:117:PHE:N	6:D:402:POV:O14	2.50	0.44
1:D:186:HIS:HB2	1:D:308:GLU:O	2.17	0.44
1:A:276:HIS:CD2	1:A:279:GLN:HB2	2.53	0.44
1:C:239:PRO:HG2	1:C:259:HIS:HD1	1.83	0.44
1:C:314:ARG:O	1:C:336:THR:HB	2.18	0.43
2:E:313:GLY:N	2:E:369:GLN:HG3	2.33	0.43
2:E:381:ILE:HG21	2:E:1242:THR:HG21	2.00	0.43
2:E:1123:ASN:HB3	2:E:1124:ARG:NH1	2.32	0.43
1:B:281:LEU:HD12	1:B:281:LEU:HA	1.89	0.43
1:D:220:VAL:HG22	1:D:235:GLN:HG2	1.99	0.43
2:E:247:LEU:HD12	2:E:247:LEU:HA	1.86	0.43
1:C:123:PHE:HB2	1:C:136:ARG:HD2	2.00	0.43
2:E:10:ASN:HB3	3:F:1:NAG:O5	2.18	0.43
2:E:780:LEU:O	2:E:824:GLY:HA3	2.18	0.43
1:D:313:GLN:HG2	1:D:338:LYS:HA	2.00	0.43
2:E:1000:ALA:HB1	2:E:1309:LEU:HD22	2.00	0.43

Continued on next page...

Continued from previous page...

Atom-1	Atom-2	Interatomic distance (Å)	Clash overlap (Å)
1:B:154:ILE:HD13	1:C:76:THR:HG23	1.99	0.43
2:E:358:LEU:HD12	2:E:358:LEU:HA	1.78	0.43
2:E:1164:PHE:O	2:E:1168:LEU:N	2.52	0.43
2:E:1327:GLU:HA	2:E:1414:PRO:HB3	2.00	0.43
1:B:192:ARG:HB3	1:B:192:ARG:NH1	2.34	0.43
2:E:17:VAL:HG13	2:E:21:VAL:HB	1.99	0.43
2:E:1132:ILE:HD11	2:E:1312:VAL:HG22	2.01	0.43
2:E:1493:ALA:HA	2:E:1496:PHE:HD2	1.83	0.43
2:E:1147:THR:O	2:E:1151:VAL:HG12	2.18	0.43
1:D:200:LEU:O	1:D:256:ILE:HA	2.19	0.43
1:D:220:VAL:HG13	1:D:233:LEU:HD12	2.01	0.43
1:A:76:THR:HG23	1:D:154:ILE:HD13	2.01	0.43
1:A:50:ARG:HD3	4:B:401:ATP:C5	2.54	0.42
2:E:214:GLY:O	2:E:252:LYS:HG2	2.19	0.42
1:A:217:MET:HG2	1:A:238:ILE:HG13	2.00	0.42
1:B:233:LEU:HD23	1:B:233:LEU:HA	1.92	0.42
1:B:330:TYR:O	4:B:401:ATP:N6	2.52	0.42
1:D:279:GLN:OE1	1:D:280:ASP:N	2.51	0.42
2:E:72:ASN:O	2:E:76:ILE:HG23	2.19	0.42
2:E:194:ARG:HD3	2:E:198:PHE:CE1	2.54	0.42
2:E:1145:ARG:NH1	2:E:1145:ARG:HG3	2.34	0.42
2:E:1309:LEU:HD23	2:E:1309:LEU:HA	1.84	0.42
1:A:35:PHE:HE1	1:A:220:VAL:HG21	1.84	0.42
1:A:138:VAL:O	1:B:136:ARG:NH2	2.52	0.42
2:E:327:LEU:HD11	2:E:1268:ILE:HG23	2.01	0.42
1:D:319:VAL:HG22	1:D:328:VAL:HG12	1.99	0.42
2:E:85:LEU:HD23	2:E:85:LEU:HA	1.79	0.42
2:E:143:TRP:CE2	2:E:182:LEU:HD13	2.55	0.42
1:D:64:VAL:O	1:D:170:LYS:NZ	2.52	0.42
2:E:1328:GLY:HA3	2:E:1412:LYS:O	2.19	0.42
1:A:137:MET:SD	1:B:135:GLY:HA3	2.59	0.42
1:A:225:SER:N	1:A:229:GLU:O	2.52	0.42
1:D:34:ARG:HD3	1:D:37:SER:HA	2.01	0.42
1:D:198:PHE:HE1	1:D:309:ILE:HD12	1.84	0.42
2:E:336:PRO:HG2	2:E:344:TYR:HD2	1.85	0.42
2:E:685:PHE:HB2	2:E:734:SER:O	2.20	0.42
2:E:262:ASN:HB3	2:E:390:ALA:HB2	2.02	0.42
2:E:480:LYS:HE3	2:E:480:LYS:HB3	1.91	0.42
2:E:1405:ILE:O	2:E:1408:ILE:HG12	2.19	0.42
1:B:232:PRO:HB2	1:C:319:VAL:HB	2.02	0.42
1:C:60:PHE:HE2	1:D:171:THR:HG22	1.84	0.42

Continued on next page...

Continued from previous page...

Atom-1	Atom-2	Interatomic distance (Å)	Clash overlap (Å)
2:E:720:SER:HB3	2:E:775:GLN:NE2	2.35	0.42
2:E:1124:ARG:HH11	2:E:1314:ARG:HH11	1.66	0.42
1:B:219:VAL:HG22	1:B:283:ILE:HD13	2.01	0.42
1:B:231:VAL:HG11	1:B:234:HIS:ND1	2.34	0.42
1:D:272:PRO:HB3	1:D:311:TRP:CG	2.55	0.42
1:C:34:ARG:NH1	1:C:38:LYS:HG2	2.33	0.42
2:E:236:PHE:CZ	2:E:245:ILE:HD12	2.55	0.42
2:E:1154:LEU:HD12	2:E:1164:PHE:HE2	1.85	0.42
2:E:1336:PRO:HB3	2:E:1413:LEU:HD11	2.02	0.42
8:E:1606:PTY:H151	8:E:1606:PTY:H181	1.72	0.42
2:E:130:SER:O	2:E:132:PHE:N	2.51	0.41
2:E:253:LEU:HB3	2:E:1236:ILE:HD12	2.02	0.41
1:D:44:VAL:HB	1:D:46:HIS:CE1	2.55	0.41
2:E:260:LEU:O	2:E:264:GLN:HG2	2.20	0.41
2:E:46:ILE:HD13	2:E:46:ILE:HA	1.89	0.41
1:A:92:LEU:HD23	1:A:92:LEU:HA	1.87	0.41
1:C:332:LYS:HB3	1:C:332:LYS:HE3	1.83	0.41
1:D:146:ILE:O	1:D:150:ILE:HG13	2.20	0.41
2:E:299:LEU:HD12	2:E:299:LEU:HA	1.83	0.41
2:E:1246:ARG:NH1	9:E:1602:BJX:O3	2.47	0.41
1:B:93:ILE:HD11	1:B:148:ILE:HD13	2.02	0.41
2:E:255:ILE:HA	2:E:258:ARG:HG3	2.02	0.41
2:E:822:GLN:HE21	2:E:822:GLN:HB3	1.66	0.41
2:E:1149:LEU:HD13	2:E:1294:TYR:CZ	2.56	0.41
2:E:1189:LEU:HD23	2:E:1189:LEU:HA	1.84	0.41
8:E:1604:PTY:H112	8:E:1610:PTY:H122	2.02	0.41
1:B:86:PHE:HA	1:B:89:VAL:HG12	2.03	0.41
1:D:82:SER:HB2	1:D:128:GLN:HE22	1.84	0.41
2:E:194:ARG:HB3	2:E:198:PHE:CG	2.55	0.41
2:E:885:VAL:HG12	2:E:887:VAL:HG23	2.02	0.41
7:B:403:P5S:H30A	7:B:403:P5S:H33	1.97	0.41
2:E:140:LEU:O	2:E:144:THR:HG22	2.21	0.41
1:A:254:PRO:HG3	1:A:330:TYR:CE1	2.56	0.41
1:C:164:LEU:HD23	1:C:164:LEU:HA	1.82	0.41
1:C:165:GLY:HA2	1:C:168:PHE:CE2	2.56	0.41
1:C:167:ILE:HD13	1:C:167:ILE:HA	1.94	0.41
2:E:210:LEU:O	2:E:210:LEU:HG	2.21	0.41
2:E:558:THR:HG21	2:E:583:PHE:CZ	2.54	0.41
2:E:321:PHE:HB2	2:E:578:ALA:CB	2.51	0.41
2:E:1379:GLY:HA3	2:E:1552:LEU:O	2.21	0.41
2:E:166:GLN:HB3	2:E:345:PHE:HD2	1.84	0.40

Continued on next page...

Continued from previous page...

Atom-1	Atom-2	Interatomic distance (Å)	Clash overlap (Å)
2:E:503:LEU:HD23	2:E:503:LEU:HA	1.88	0.40
2:E:894:LEU:HB3	2:E:895:PRO:HD3	2.03	0.40
1:C:254:PRO:HB3	1:C:333:PHE:CE2	2.56	0.40
2:E:503:LEU:HD22	2:E:1113:PHE:HE2	1.85	0.40
2:E:548:THR:HG22	2:E:1145:ARG:CZ	2.52	0.40
2:E:1120:SER:O	2:E:1124:ARG:HG2	2.21	0.40
1:D:144:LEU:O	1:D:148:ILE:HG22	2.22	0.40
2:E:1437:ARG:H	2:E:1473:ALA:HB3	1.86	0.40
1:A:330:TYR:HE2	1:D:46:HIS:HB3	1.85	0.40
1:C:276:HIS:O	1:C:279:GLN:HB3	2.21	0.40
1:D:215:ILE:HD13	1:D:257:ILE:HG13	2.04	0.40
1:A:83:TRP:HE1	1:A:128:GLN:HG2	1.87	0.40
1:A:111:VAL:HB	1:A:114:ILE:HG13	2.03	0.40
2:E:1131:THR:HA	2:E:1135:HIS:HD2	1.86	0.40

There are no symmetry-related clashes.

5.3 Torsion angles [i](#)

5.3.1 Protein backbone [i](#)

In the following table, the Percentiles column shows the percent Ramachandran outliers of the chain as a percentile score with respect to all PDB entries followed by that with respect to all EM entries.

The Analysed column shows the number of residues for which the backbone conformation was analysed, and the total number of residues.

Mol	Chain	Analysed	Favoured	Allowed	Outliers	Percentiles	
1	A	354/390 (91%)	341 (96%)	13 (4%)	0	100	100
1	B	324/390 (83%)	312 (96%)	12 (4%)	0	100	100
1	C	324/390 (83%)	315 (97%)	9 (3%)	0	100	100
1	D	324/390 (83%)	311 (96%)	13 (4%)	0	100	100
2	E	1411/1582 (89%)	1359 (96%)	52 (4%)	0	100	100
All	All	2737/3142 (87%)	2638 (96%)	99 (4%)	0	100	100

There are no Ramachandran outliers to report.

5.3.2 Protein sidechains [i](#)

In the following table, the Percentiles column shows the percent sidechain outliers of the chain as a percentile score with respect to all PDB entries followed by that with respect to all EM entries.

The Analysed column shows the number of residues for which the sidechain conformation was analysed, and the total number of residues.

Mol	Chain	Analysed	Rotameric	Outliers	Percentiles	
1	A	233/341 (68%)	224 (96%)	9 (4%)	32	65
1	B	224/341 (66%)	220 (98%)	4 (2%)	59	81
1	C	230/341 (67%)	227 (99%)	3 (1%)	69	86
1	D	238/341 (70%)	227 (95%)	11 (5%)	27	61
2	E	874/1373 (64%)	847 (97%)	27 (3%)	40	71
All	All	1799/2737 (66%)	1745 (97%)	54 (3%)	44	71

All (54) residues with a non-rotameric sidechain are listed below:

Mol	Chain	Res	Type
1	A	48	ASN
1	A	124	SER
1	A	128	GLN
1	A	136	ARG
1	A	168	PHE
1	A	191	LEU
1	A	254	PRO
1	A	259	HIS
1	A	275	LEU
1	B	95	PHE
1	B	186	HIS
1	B	270	LEU
1	B	278	HIS
1	C	39	LYS
1	C	186	HIS
1	C	196	LEU
1	D	43	ASN
1	D	70	HIS
1	D	95	PHE
1	D	128	GLN
1	D	148	ILE
1	D	168	PHE
1	D	206	ARG

Continued on next page...

Continued from previous page...

Mol	Chain	Res	Type
1	D	233	LEU
1	D	262	ASP
1	D	270	LEU
1	D	327	SER
2	E	44	PHE
2	E	65	TRP
2	E	130	SER
2	E	198	PHE
2	E	199	LYS
2	E	221	PHE
2	E	241	HIS
2	E	253	LEU
2	E	270	PHE
2	E	418	CYS
2	E	432	PHE
2	E	545	PHE
2	E	595	SER
2	E	776	LYS
2	E	787	ASN
2	E	811	ASP
2	E	863	HIS
2	E	917	PHE
2	E	1004	TYR
2	E	1018	PHE
2	E	1064	TYR
2	E	1092	LYS
2	E	1125	PHE
2	E	1126	SER
2	E	1150	CYS
2	E	1186	SER
2	E	1316	HIS

Sometimes sidechains can be flipped to improve hydrogen bonding and reduce clashes. All (10) such sidechains are listed below:

Mol	Chain	Res	Type
1	A	128	GLN
1	A	279	GLN
1	C	234	HIS
1	C	279	GLN
1	C	299	GLN
2	E	32	ASN
2	E	781	ASN

Continued on next page...

Continued from previous page...

Mol	Chain	Res	Type
2	E	822	GLN
2	E	836	GLN
2	E	1135	HIS

5.3.3 RNA [i](#)

There are no RNA molecules in this entry.

5.4 Non-standard residues in protein, DNA, RNA chains [i](#)

There are no non-standard protein/DNA/RNA residues in this entry.

5.5 Carbohydrates [i](#)

2 monosaccharides are modelled in this entry.

In the following table, the Counts columns list the number of bonds (or angles) for which Mogul statistics could be retrieved, the number of bonds (or angles) that are observed in the model and the number of bonds (or angles) that are defined in the Chemical Component Dictionary. The Link column lists molecule types, if any, to which the group is linked. The Z score for a bond length (or angle) is the number of standard deviations the observed value is removed from the expected value. A bond length (or angle) with $|Z| > 2$ is considered an outlier worth inspection. RMSZ is the root-mean-square of all Z scores of the bond lengths (or angles).

Mol	Type	Chain	Res	Link	Bond lengths			Bond angles		
					Counts	RMSZ	# Z > 2	Counts	RMSZ	# Z > 2
3	NAG	F	1	2,3	14,14,15	0.41	0	17,19,21	0.55	0
3	NAG	F	2	3	14,14,15	0.30	0	17,19,21	0.44	0

In the following table, the Chirals column lists the number of chiral outliers, the number of chiral centers analysed, the number of these observed in the model and the number defined in the Chemical Component Dictionary. Similar counts are reported in the Torsion and Rings columns. '2' means no outliers of that kind were identified.

Mol	Type	Chain	Res	Link	Chirals	Torsions	Rings
3	NAG	F	1	2,3	-	4/6/23/26	0/1/1/1
3	NAG	F	2	3	-	1/6/23/26	0/1/1/1

There are no bond length outliers.

There are no bond angle outliers.

There are no chirality outliers.

All (5) torsion outliers are listed below:

Mol	Chain	Res	Type	Atoms
3	F	1	NAG	O5-C5-C6-O6
3	F	1	NAG	C8-C7-N2-C2
3	F	1	NAG	O7-C7-N2-C2
3	F	1	NAG	C4-C5-C6-O6
3	F	2	NAG	O5-C5-C6-O6

There are no ring outliers.

1 monomer is involved in 1 short contact:

Mol	Chain	Res	Type	Clashes	Symm-Clashes
3	F	1	NAG	1	0

The following is a two-dimensional graphical depiction of Mogul quality analysis of bond lengths, bond angles, torsion angles, and ring geometry for oligosaccharide.

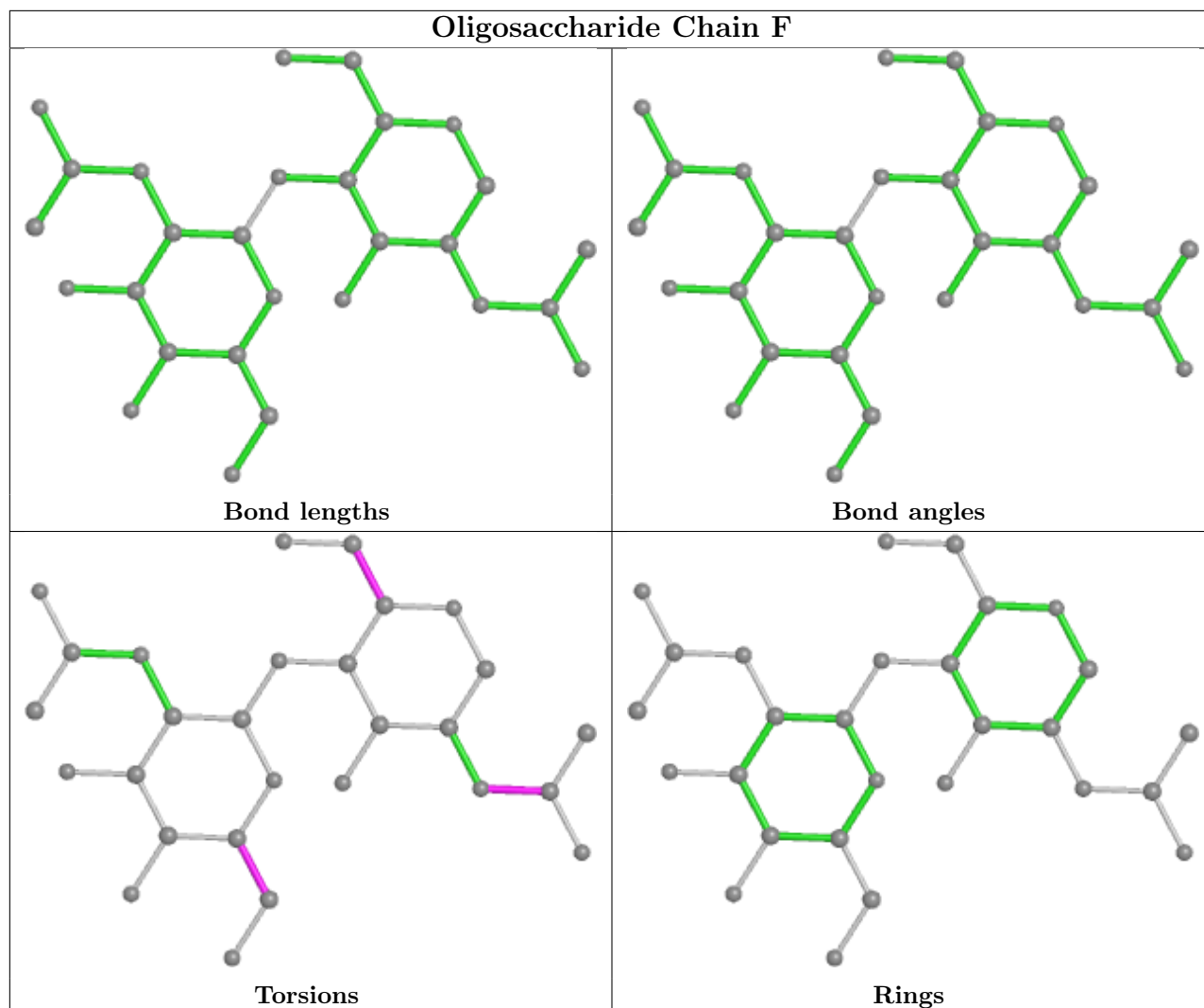

5.6 Ligand geometry [i](#)

Of 20 ligands modelled in this entry, 1 is monoatomic - leaving 19 for Mogul analysis.

In the following table, the Counts columns list the number of bonds (or angles) for which Mogul statistics could be retrieved, the number of bonds (or angles) that are observed in the model and the number of bonds (or angles) that are defined in the Chemical Component Dictionary. The Link column lists molecule types, if any, to which the group is linked. The Z score for a bond length (or angle) is the number of standard deviations the observed value is removed from the expected value. A bond length (or angle) with $|Z| > 2$ is considered an outlier worth inspection. RMSZ is the root-mean-square of all Z scores of the bond lengths (or angles).

Mol	Type	Chain	Res	Link	Bond lengths			Bond angles		
					Counts	RMSZ	$\# Z > 2$	Counts	RMSZ	$\# Z > 2$
4	ATP	B	401	-	26,33,33	0.61	0	31,52,52	0.76	2 (6%)
8	PTY	E	1605	-	31,31,49	0.55	0	34,36,54	0.45	0
8	PTY	E	1606	-	31,31,49	0.55	0	34,36,54	0.46	0

Mol	Type	Chain	Res	Link	Bond lengths			Bond angles		
					Counts	RMSZ	# Z > 2	Counts	RMSZ	# Z > 2
9	BJX	E	1602	-	35,35,35	2.62	13 (37%)	47,47,47	1.67	7 (14%)
4	ATP	B	404	-	26,33,33	0.61	0	31,52,52	0.73	2 (6%)
7	P5S	B	403	-	52,53,53	0.52	0	56,60,60	0.85	1 (1%)
4	ATP	E	1603	-	26,33,33	0.61	0	31,52,52	0.73	2 (6%)
8	PTY	E	1609	-	31,31,49	0.55	0	34,36,54	0.58	0
7	P5S	E	1607	-	52,53,53	0.52	0	56,60,60	0.82	1 (1%)
6	POV	D	402	-	35,35,51	0.61	0	41,43,59	0.51	0
8	PTY	E	1601	-	31,31,49	0.56	0	34,36,54	0.44	0
4	ATP	A	401	-	26,33,33	0.61	0	31,52,52	0.74	2 (6%)
6	POV	C	401	-	35,35,51	0.60	0	41,43,59	0.50	0
4	ATP	D	401	-	26,33,33	0.61	0	31,52,52	0.73	2 (6%)
8	PTY	E	1610	-	31,31,49	0.55	0	34,36,54	0.51	0
6	POV	E	1608	-	35,35,51	0.59	0	41,43,59	0.54	0
8	PTY	E	1604	-	31,31,49	0.55	0	34,36,54	0.54	0
6	POV	A	403	-	35,35,51	0.62	0	41,43,59	0.51	0
6	POV	B	402	-	35,35,51	0.61	0	41,43,59	0.54	1 (2%)

In the following table, the Chirals column lists the number of chiral outliers, the number of chiral centers analysed, the number of these observed in the model and the number defined in the Chemical Component Dictionary. Similar counts are reported in the Torsion and Rings columns. '-' means no outliers of that kind were identified.

Mol	Type	Chain	Res	Link	Chirals	Torsions	Rings
4	ATP	B	401	-	-	4/18/38/38	0/3/3/3
8	PTY	E	1605	-	-	5/35/35/53	-
8	PTY	E	1606	-	-	15/35/35/53	-
9	BJX	E	1602	-	-	15/27/35/35	0/3/3/3
4	ATP	B	404	-	-	3/18/38/38	0/3/3/3
7	P5S	B	403	-	-	30/59/59/59	-
4	ATP	E	1603	-	-	3/18/38/38	0/3/3/3
8	PTY	E	1609	-	-	9/35/35/53	-
7	P5S	E	1607	-	-	33/59/59/59	-
6	POV	D	402	-	-	13/39/39/55	-
8	PTY	E	1601	-	-	11/35/35/53	-
4	ATP	A	401	-	-	5/18/38/38	0/3/3/3
6	POV	C	401	-	-	12/39/39/55	-
4	ATP	D	401	-	-	7/18/38/38	0/3/3/3

Continued on next page...

Continued from previous page...

Mol	Type	Chain	Res	Link	Chirals	Torsions	Rings
8	PTY	E	1610	-	-	10/35/35/53	-
6	POV	E	1608	-	-	11/39/39/55	-
8	PTY	E	1604	-	-	13/35/35/53	-
6	POV	A	403	-	-	10/39/39/55	-
6	POV	B	402	-	-	18/39/39/55	-

All (13) bond length outliers are listed below:

Mol	Chain	Res	Type	Atoms	Z	Observed(Å)	Ideal(Å)
9	E	1602	BJX	C8-C5	7.30	1.60	1.53
9	E	1602	BJX	C6-N	5.66	1.53	1.41
9	E	1602	BJX	C16-N1	5.54	1.45	1.34
9	E	1602	BJX	C6-C7	4.91	1.45	1.40
9	E	1602	BJX	C7-C5	4.20	1.58	1.52
9	E	1602	BJX	C5-N1	4.17	1.52	1.46
9	E	1602	BJX	C-N	3.04	1.51	1.46
9	E	1602	BJX	C23-C24	2.77	1.55	1.49
9	E	1602	BJX	O1-C21	2.55	1.42	1.37
9	E	1602	BJX	C17-C18	2.38	1.55	1.51
9	E	1602	BJX	C1-N	2.27	1.50	1.46
9	E	1602	BJX	C19-C21	2.16	1.42	1.38
9	E	1602	BJX	O2-C24	2.10	1.29	1.22

All (20) bond angle outliers are listed below:

Mol	Chain	Res	Type	Atoms	Z	Observed(°)	Ideal(°)
9	E	1602	BJX	C5-N1-C16	6.83	134.20	123.33
7	B	403	P5S	OG-CB-CA	4.45	111.94	108.06
7	E	1607	P5S	OG-CB-CA	3.90	111.46	108.06
9	E	1602	BJX	C8-C5-N1	3.09	115.32	109.80
9	E	1602	BJX	C7-C6-N	2.92	123.90	119.32
9	E	1602	BJX	C17-C16-N1	2.67	120.17	115.88
9	E	1602	BJX	C10-C6-N	-2.49	118.33	122.30
4	D	401	ATP	C5-C6-N6	2.31	123.87	120.35
4	B	401	ATP	C5-C6-N6	2.31	123.86	120.35
4	E	1603	ATP	C5-C6-N6	2.30	123.84	120.35
4	A	401	ATP	C5-C6-N6	2.27	123.81	120.35
4	B	404	ATP	C5-C6-N6	2.23	123.75	120.35
9	E	1602	BJX	C-N-C1	-2.09	106.89	111.52
4	A	401	ATP	PB-O3B-PG	2.09	139.99	132.83
9	E	1602	BJX	C7-C5-N1	-2.09	107.26	111.47

Continued on next page...

Continued from previous page...

Mol	Chain	Res	Type	Atoms	Z	Observed(°)	Ideal(°)
4	D	401	ATP	PB-O3B-PG	2.04	139.84	132.83
4	B	404	ATP	PB-O3B-PG	2.04	139.84	132.83
4	B	401	ATP	PB-O3B-PG	2.04	139.83	132.83
4	E	1603	ATP	PB-O3B-PG	2.03	139.81	132.83
6	B	402	POV	O13-P-O14	2.01	122.16	112.24

There are no chirality outliers.

All (227) torsion outliers are listed below:

Mol	Chain	Res	Type	Atoms
4	A	401	ATP	O4'-C4'-C5'-O5'
4	A	401	ATP	C3'-C4'-C5'-O5'
4	B	401	ATP	O4'-C4'-C5'-O5'
4	B	401	ATP	C3'-C4'-C5'-O5'
4	D	401	ATP	C5'-O5'-PA-O1A
4	D	401	ATP	C5'-O5'-PA-O2A
4	D	401	ATP	C5'-O5'-PA-O3A
4	D	401	ATP	O4'-C4'-C5'-O5'
4	D	401	ATP	C3'-C4'-C5'-O5'
6	A	403	POV	C11-O12-P-O11
6	A	403	POV	C11-O12-P-O14
6	B	402	POV	C1-O11-P-O12
6	B	402	POV	C1-O11-P-O13
6	B	402	POV	C1-O11-P-O14
6	B	402	POV	O21-C2-C3-O31
6	B	402	POV	C12-C11-O12-P
6	C	401	POV	C1-O11-P-O13
6	C	401	POV	C11-O12-P-O11
6	C	401	POV	C11-O12-P-O13
6	C	401	POV	C12-C11-O12-P
6	D	402	POV	O12-C11-C12-N
6	E	1608	POV	C1-O11-P-O13
6	E	1608	POV	C11-O12-P-O11
6	E	1608	POV	C11-O12-P-O14
7	B	403	P5S	O19-C1-C2-O37
7	B	403	P5S	N-CA-CB-OG
7	E	1607	P5S	O-C-CA-CB
7	E	1607	P5S	OXT-C-CA-CB
7	E	1607	P5S	C-CA-CB-OG
7	E	1607	P5S	N-CA-CB-OG
7	E	1607	P5S	CB-OG-P12-O16
8	E	1601	PTY	O10-C8-O7-C6

Continued on next page...

Continued from previous page...

Mol	Chain	Res	Type	Atoms
8	E	1601	PTY	C11-C8-O7-C6
8	E	1601	PTY	C5-O14-P1-O13
8	E	1604	PTY	C5-O14-P1-O13
8	E	1606	PTY	C2-C3-O11-P1
8	E	1606	PTY	C11-C8-O7-C6
8	E	1606	PTY	C3-O11-P1-O12
8	E	1609	PTY	C11-C8-O7-C6
8	E	1610	PTY	C11-C8-O7-C6
8	E	1610	PTY	C5-O14-P1-O13
9	E	1602	BJX	N1-C5-C7-C6
9	E	1602	BJX	C8-C5-N1-C16
9	E	1602	BJX	C21-C23-C24-O2
9	E	1602	BJX	C21-C23-C24-O3
7	E	1607	P5S	O18-C17-O19-C1
7	E	1607	P5S	C20-C17-O19-C1
8	E	1604	PTY	O30-C30-O4-C1
8	E	1606	PTY	O10-C8-O7-C6
8	E	1609	PTY	O10-C8-O7-C6
8	E	1610	PTY	O10-C8-O7-C6
8	E	1604	PTY	C31-C30-O4-C1
8	E	1609	PTY	O30-C30-O4-C1
8	E	1609	PTY	C31-C30-O4-C1
7	B	403	P5S	C39-C38-O37-C2
8	E	1604	PTY	C11-C8-O7-C6
6	A	403	POV	C34-C35-C36-C37
7	B	403	P5S	C17-C20-C21-C22
8	E	1604	PTY	O10-C8-O7-C6
9	E	1602	BJX	N1-C5-C8-C9
6	D	402	POV	C23-C24-C25-C26
6	B	402	POV	C11-C12-N-C15
7	B	403	P5S	O47-C38-O37-C2
6	B	402	POV	C11-O12-P-O11
7	B	403	P5S	CB-OG-P12-O16
8	E	1606	PTY	C3-O11-P1-O14
7	E	1607	P5S	OXT-C-CA-N
8	E	1605	PTY	C31-C32-C33-C34
8	E	1609	PTY	C5-C6-O7-C8
7	E	1607	P5S	C30-C31-C32-C33
7	E	1607	P5S	C2-C3-O16-P12
7	B	403	P5S	C26-C27-C28-C29
8	E	1606	PTY	C12-C13-C14-C15
7	E	1607	P5S	C39-C40-C41-C42

Continued on next page...

Continued from previous page...

Mol	Chain	Res	Type	Atoms
6	C	401	POV	C31-C32-C33-C34
7	B	403	P5S	C30-C31-C32-C33
7	E	1607	P5S	C51-C52-C53-C54
8	E	1601	PTY	C13-C14-C15-C16
7	E	1607	P5S	C29-C30-C31-C32
7	B	403	P5S	C41-C42-C43-C44
8	E	1606	PTY	C15-C16-C17-C18
7	B	403	P5S	C-CA-CB-OG
7	B	403	P5S	C38-C39-C40-C41
7	E	1607	P5S	C39-C38-O37-C2
6	D	402	POV	O11-C1-C2-O21
7	E	1607	P5S	O47-C38-O37-C2
6	A	403	POV	O21-C2-C3-O31
7	E	1607	P5S	O19-C1-C2-O37
6	B	402	POV	C11-C12-N-C14
7	B	403	P5S	C31-C32-C33-C34
6	B	402	POV	C23-C24-C25-C26
6	D	402	POV	C22-C21-O21-C2
6	C	401	POV	C1-O11-P-O12
8	E	1610	PTY	C5-O14-P1-O11
6	E	1608	POV	O11-C1-C2-C3
7	E	1607	P5S	C1-C2-C3-O16
7	E	1607	P5S	C43-C44-C45-C46
6	B	402	POV	C22-C23-C24-C25
6	B	402	POV	C11-C12-N-C13
7	B	403	P5S	O19-C1-C2-C3
7	E	1607	P5S	O19-C1-C2-C3
6	B	402	POV	C24-C25-C26-C27
9	E	1602	BJX	C23-C21-O1-C25
6	E	1608	POV	C22-C21-O21-C2
7	B	403	P5S	C42-C43-C44-C45
7	B	403	P5S	C3-C2-O37-C38
8	E	1604	PTY	C1-C6-O7-C8
7	E	1607	P5S	C38-C39-C40-C41
8	E	1604	PTY	N1-C2-C3-O11
9	E	1602	BJX	C19-C21-O1-C25
6	D	402	POV	O22-C21-O21-C2
6	C	401	POV	C32-C31-O31-C3
6	A	403	POV	C1-C2-C3-O31
6	B	402	POV	C1-C2-C3-O31
8	E	1604	PTY	O4-C1-C6-C5
6	D	402	POV	C21-C22-C23-C24

Continued on next page...

Continued from previous page...

Mol	Chain	Res	Type	Atoms
7	B	403	P5S	C24-C25-C26-C27
4	D	401	ATP	PG-O3B-PB-O3A
8	E	1606	PTY	C17-C18-C19-C20
8	E	1609	PTY	C11-C12-C13-C14
8	E	1604	PTY	O4-C1-C6-O7
7	E	1607	P5S	O-C-CA-N
6	E	1608	POV	O22-C21-O21-C2
8	E	1606	PTY	C13-C14-C15-C16
7	E	1607	P5S	C50-C51-C52-C53
9	E	1602	BJX	C8-C5-C7-C11
6	A	403	POV	C25-C26-C27-C28
6	C	401	POV	O11-C1-C2-C3
7	B	403	P5S	C39-C40-C41-C42
9	E	1602	BJX	C22-C23-C24-O2
7	E	1607	P5S	C24-C25-C26-C27
6	D	402	POV	C35-C36-C37-C38
7	E	1607	P5S	C27-C28-C29-C30
7	E	1607	P5S	C3-C2-O37-C38
8	E	1605	PTY	O4-C1-C6-C5
6	C	401	POV	O11-C1-C2-O21
7	E	1607	P5S	O37-C2-C3-O16
8	E	1606	PTY	C14-C15-C16-C17
7	E	1607	P5S	C25-C26-C27-C28
6	C	401	POV	O32-C31-O31-C3
7	B	403	P5S	CA-CB-OG-P12
7	E	1607	P5S	CA-CB-OG-P12
4	A	401	ATP	PB-O3A-PA-O2A
4	D	401	ATP	PB-O3A-PA-O1A
4	E	1603	ATP	PA-O3A-PB-O2B
6	D	402	POV	C22-C23-C24-C25
9	E	1602	BJX	C22-C23-C24-O3
6	E	1608	POV	C1-O11-P-O12
8	E	1604	PTY	C5-O14-P1-O11
8	E	1609	PTY	C3-O11-P1-O14
8	E	1610	PTY	C3-O11-P1-O14
9	E	1602	BJX	O-C16-C17-C18
8	E	1605	PTY	C14-C15-C16-C17
6	B	402	POV	C11-O12-P-O14
6	C	401	POV	C1-O11-P-O14
6	D	402	POV	C11-O12-P-O14
7	B	403	P5S	CB-OG-P12-O13
7	E	1607	P5S	CB-OG-P12-O15

Continued on next page...

Continued from previous page...

Mol	Chain	Res	Type	Atoms
8	E	1610	PTY	C3-O11-P1-O12
9	E	1602	BJX	C7-C5-C8-C9
6	D	402	POV	O11-C1-C2-C3
8	E	1610	PTY	C2-C3-O11-P1
8	E	1604	PTY	C8-C11-C12-C13
8	E	1606	PTY	C8-C11-C12-C13
6	E	1608	POV	O11-C1-C2-O21
7	B	403	P5S	C23-C24-C25-C26
7	B	403	P5S	C43-C44-C45-C46
6	B	402	POV	C32-C33-C34-C35
6	A	403	POV	O12-C11-C12-N
6	E	1608	POV	O12-C11-C12-N
8	E	1605	PTY	C6-C5-O14-P1
7	E	1607	P5S	C53-C54-C55-C56
8	E	1610	PTY	O14-C5-C6-O7
8	E	1601	PTY	O4-C1-C6-O7
8	E	1606	PTY	C11-C12-C13-C14
6	D	402	POV	C11-O12-P-O11
7	E	1607	P5S	C3-O16-P12-OG
8	E	1601	PTY	C3-O11-P1-O14
8	E	1601	PTY	C5-O14-P1-O11
8	E	1605	PTY	C5-O14-P1-O11
8	E	1606	PTY	C5-O14-P1-O11
8	E	1609	PTY	C5-O14-P1-O11
4	B	401	ATP	PB-O3A-PA-O2A
6	B	402	POV	C21-C22-C23-C24
8	E	1610	PTY	C6-C5-O14-P1
6	A	403	POV	C21-C22-C23-C24
8	E	1601	PTY	C32-C33-C34-C35
7	E	1607	P5S	C40-C41-C42-C43
7	B	403	P5S	O18-C17-O19-C1
7	E	1607	P5S	C48-C49-C50-C51
7	B	403	P5S	C48-C49-C50-C51
7	B	403	P5S	C20-C17-O19-C1
8	E	1610	PTY	C15-C16-C17-C18
6	A	403	POV	C23-C24-C25-C26
9	E	1602	BJX	C26-C25-O1-C21
7	B	403	P5S	C2-C3-O16-P12
7	B	403	P5S	C40-C41-C42-C43
8	E	1604	PTY	O14-C5-C6-O7
8	E	1604	PTY	O14-C5-C6-C1
6	C	401	POV	C24-C25-C26-C27

Continued on next page...

Continued from previous page...

Mol	Chain	Res	Type	Atoms
4	E	1603	ATP	PB-O3B-PG-O3G
6	D	402	POV	O21-C21-C22-C23
8	E	1606	PTY	C12-C11-C8-O7
9	E	1602	BJX	N1-C16-C17-C18
4	B	401	ATP	C5'-O5'-PA-O3A
9	E	1602	BJX	C8-C5-C7-C6
4	A	401	ATP	PA-O3A-PB-O2B
4	A	401	ATP	PB-O3A-PA-O1A
4	B	404	ATP	PA-O3A-PB-O1B
4	B	404	ATP	PA-O3A-PB-O2B
4	E	1603	ATP	PA-O3A-PB-O1B
4	B	404	ATP	C5'-O5'-PA-O1A
6	A	403	POV	C1-O11-P-O14
6	E	1608	POV	C1-O11-P-O14
8	E	1601	PTY	C3-O11-P1-O13
8	E	1609	PTY	C5-O14-P1-O13
8	E	1601	PTY	C12-C11-C8-O7
8	E	1606	PTY	C12-C11-C8-O10
7	B	403	P5S	OXT-C-CA-N
6	E	1608	POV	C12-C11-O12-P
6	B	402	POV	C25-C26-C27-C28
7	B	403	P5S	O37-C38-C39-C40
7	B	403	P5S	C22-C23-C24-C25
6	D	402	POV	O22-C21-C22-C23
6	B	402	POV	O11-C1-C2-O21
7	B	403	P5S	O47-C38-C39-C40
8	E	1601	PTY	C12-C11-C8-O10

There are no ring outliers.

14 monomers are involved in 34 short contacts:

Mol	Chain	Res	Type	Clashes	Symm-Clashes
4	B	401	ATP	3	0
8	E	1606	PTY	2	0
9	E	1602	BJX	1	0
4	B	404	ATP	2	0
7	B	403	P5S	1	0
4	E	1603	ATP	4	0
7	E	1607	P5S	5	0
6	D	402	POV	2	0
4	A	401	ATP	5	0
4	D	401	ATP	1	0

Continued on next page...

Continued from previous page...

Mol	Chain	Res	Type	Clashes	Symm-Clashes
8	E	1610	PTY	2	0
6	E	1608	POV	1	0
8	E	1604	PTY	4	0
6	A	403	POV	2	0

The following is a two-dimensional graphical depiction of Mogul quality analysis of bond lengths, bond angles, torsion angles, and ring geometry for all instances of the Ligand of Interest. In addition, ligands with molecular weight > 250 and outliers as shown on the validation Tables will also be included. For torsion angles, if less than 5% of the Mogul distribution of torsion angles is within 10 degrees of the torsion angle in question, then that torsion angle is considered an outlier. Any bond that is central to one or more torsion angles identified as an outlier by Mogul will be highlighted in the graph. For rings, the root-mean-square deviation (RMSD) between the ring in question and similar rings identified by Mogul is calculated over all ring torsion angles. If the average RMSD is greater than 60 degrees and the minimal RMSD between the ring in question and any Mogul-identified rings is also greater than 60 degrees, then that ring is considered an outlier. The outliers are highlighted in purple. The color gray indicates Mogul did not find sufficient equivalents in the CSD to analyse the geometry.

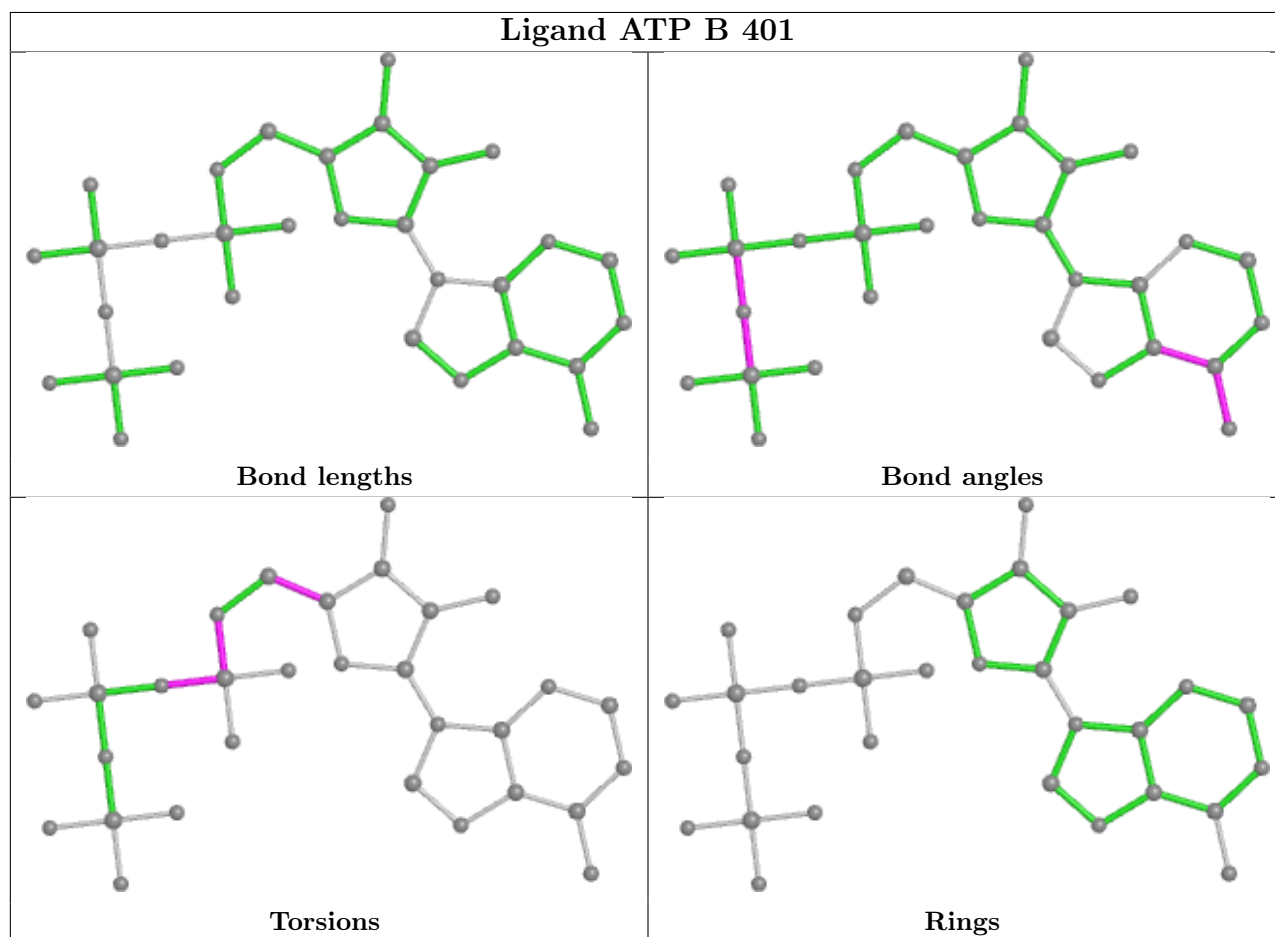

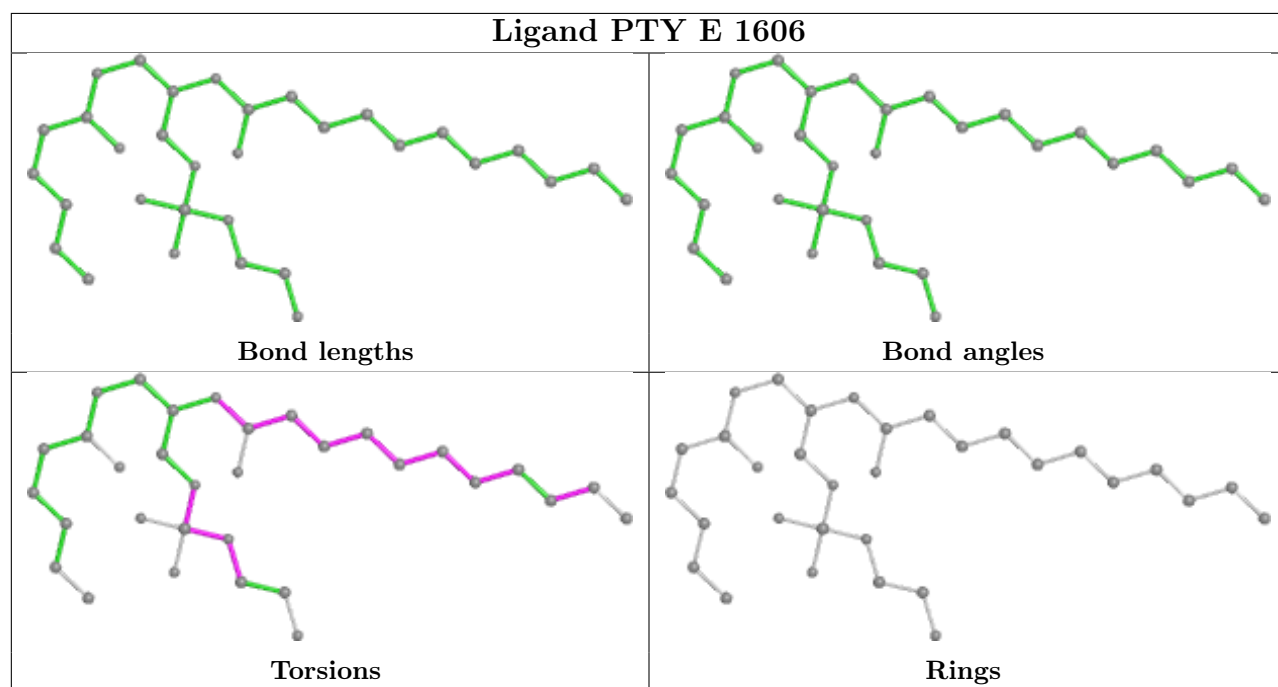
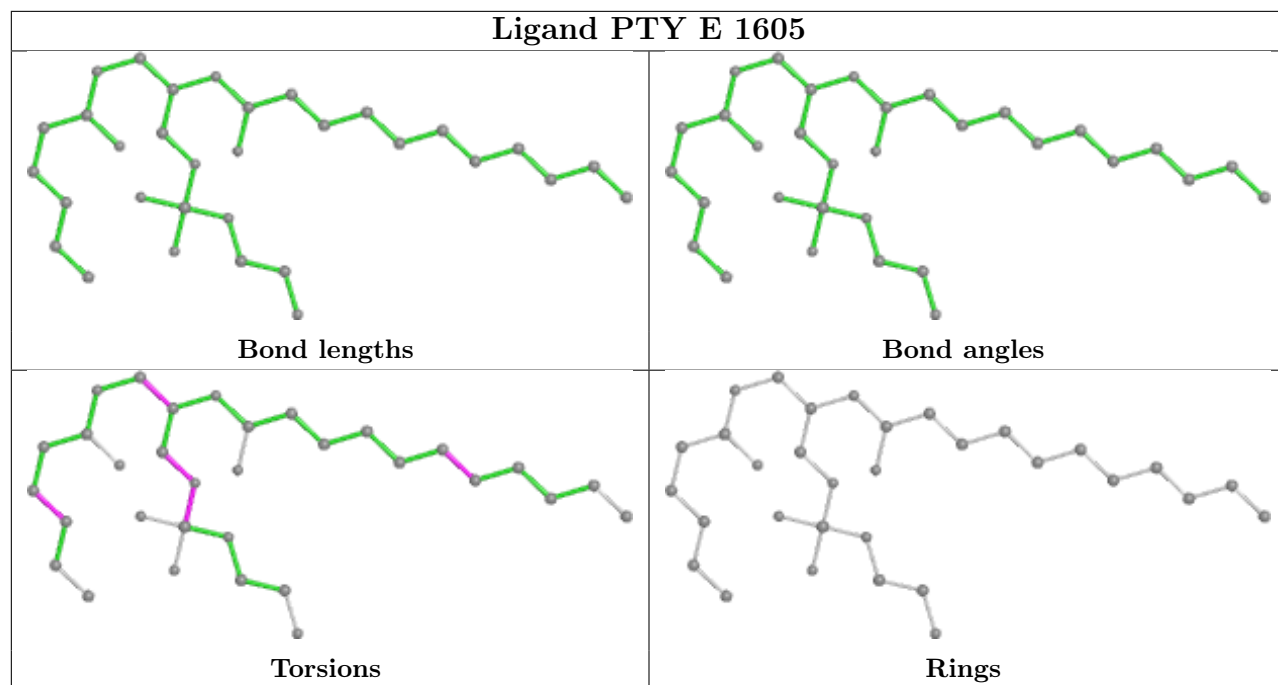

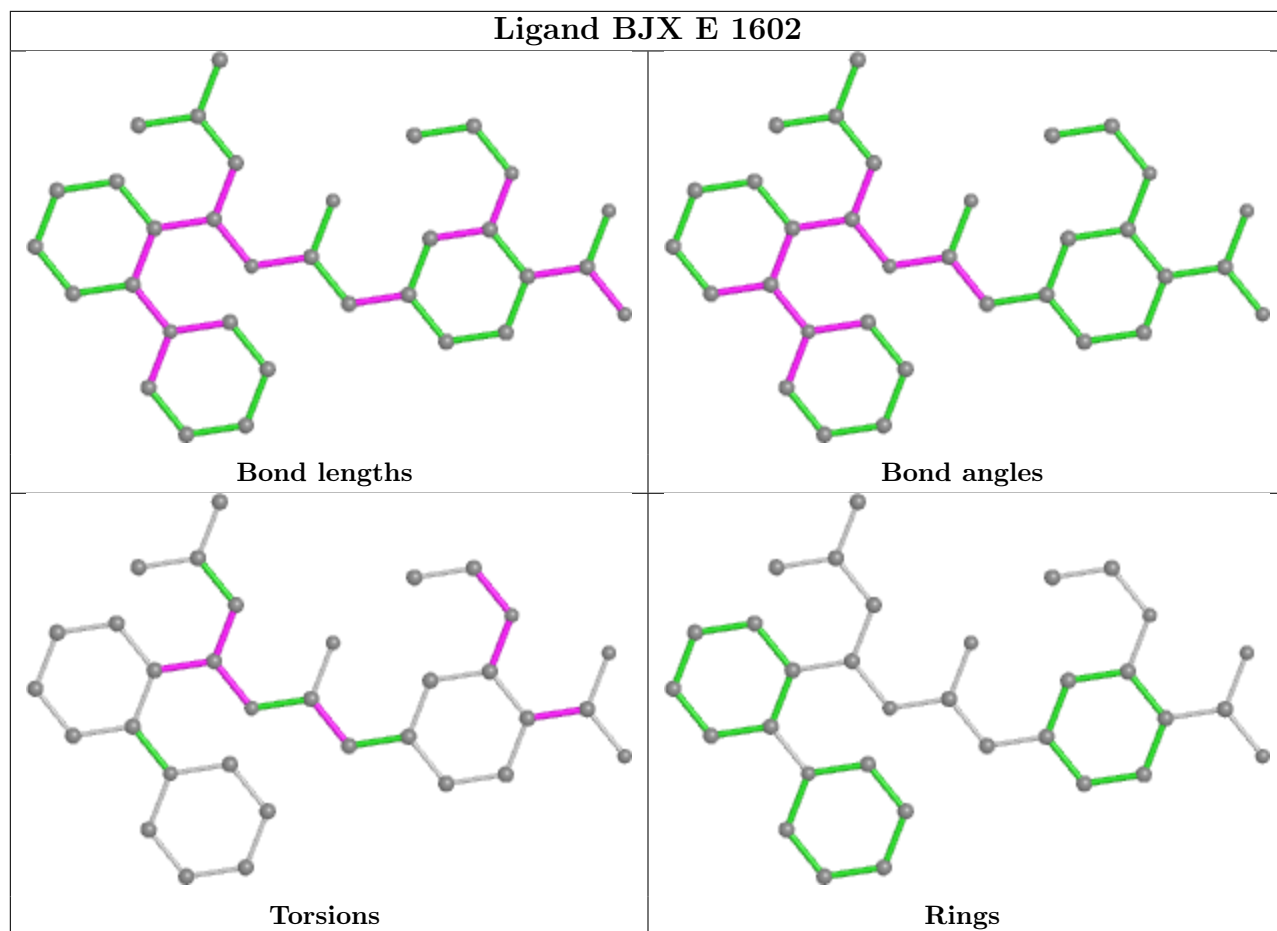

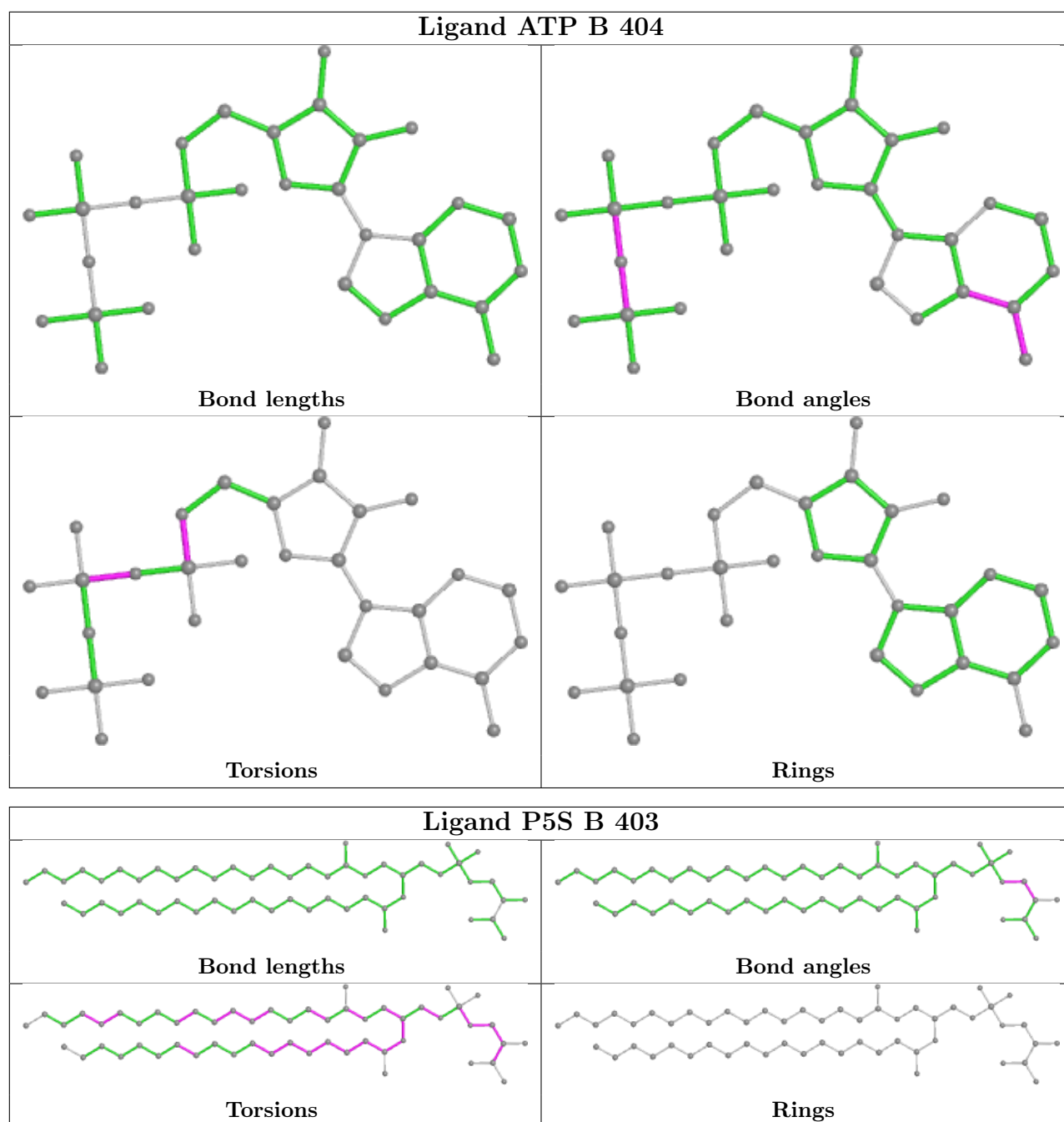

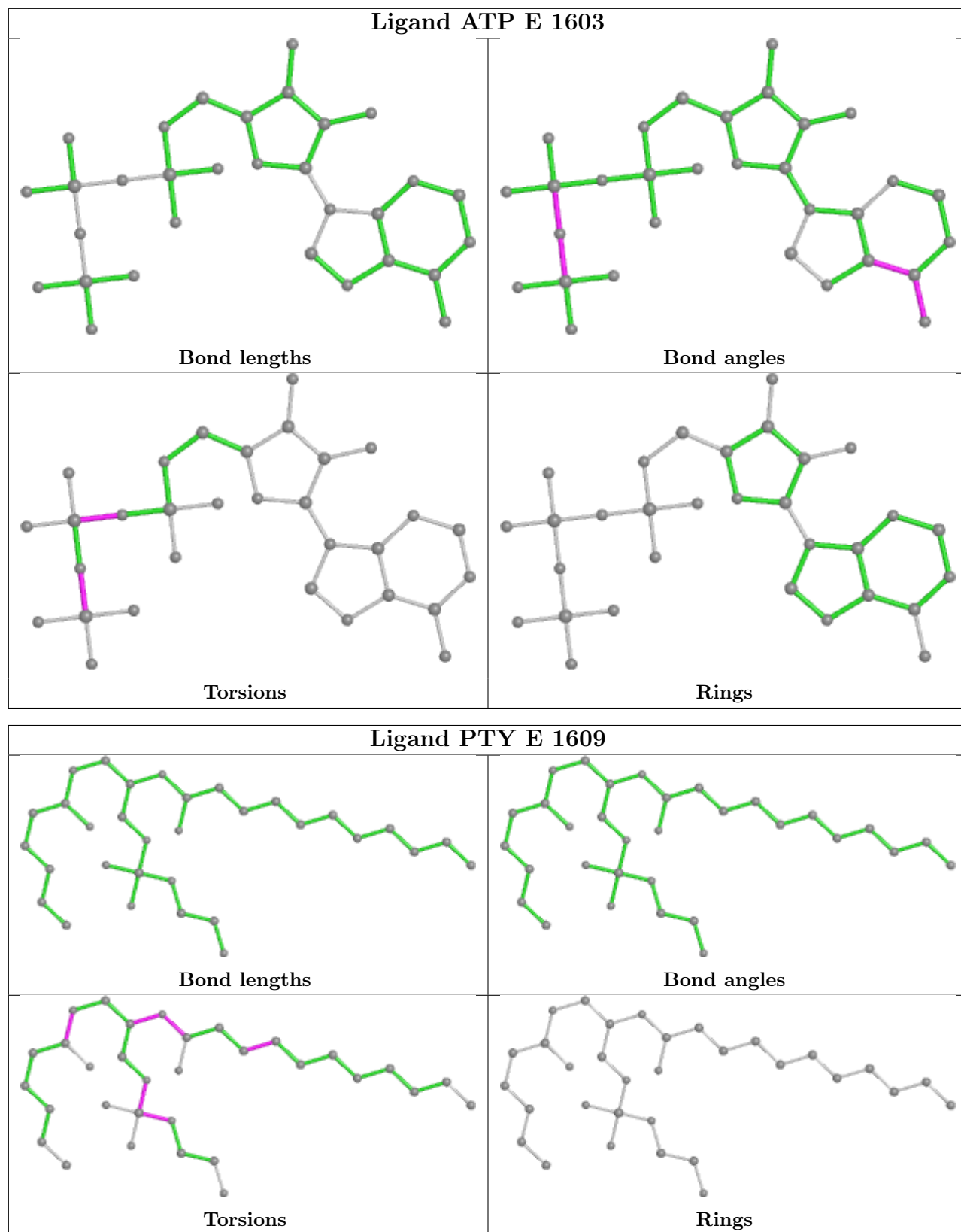

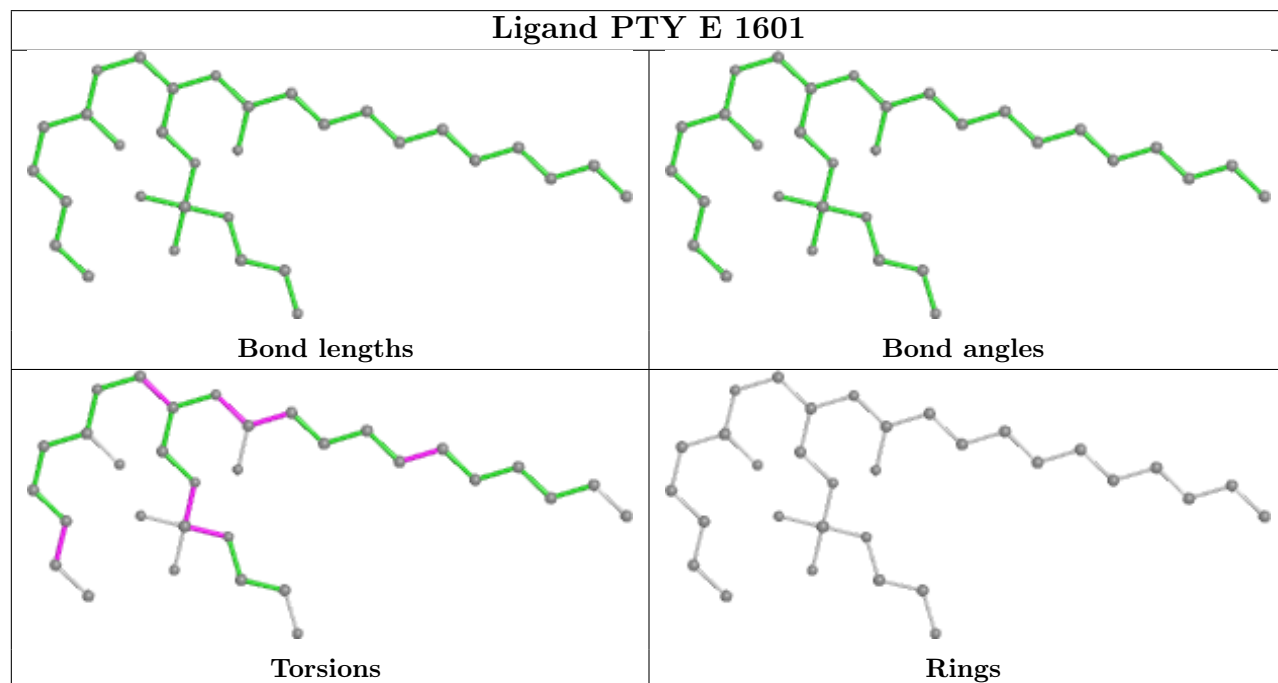
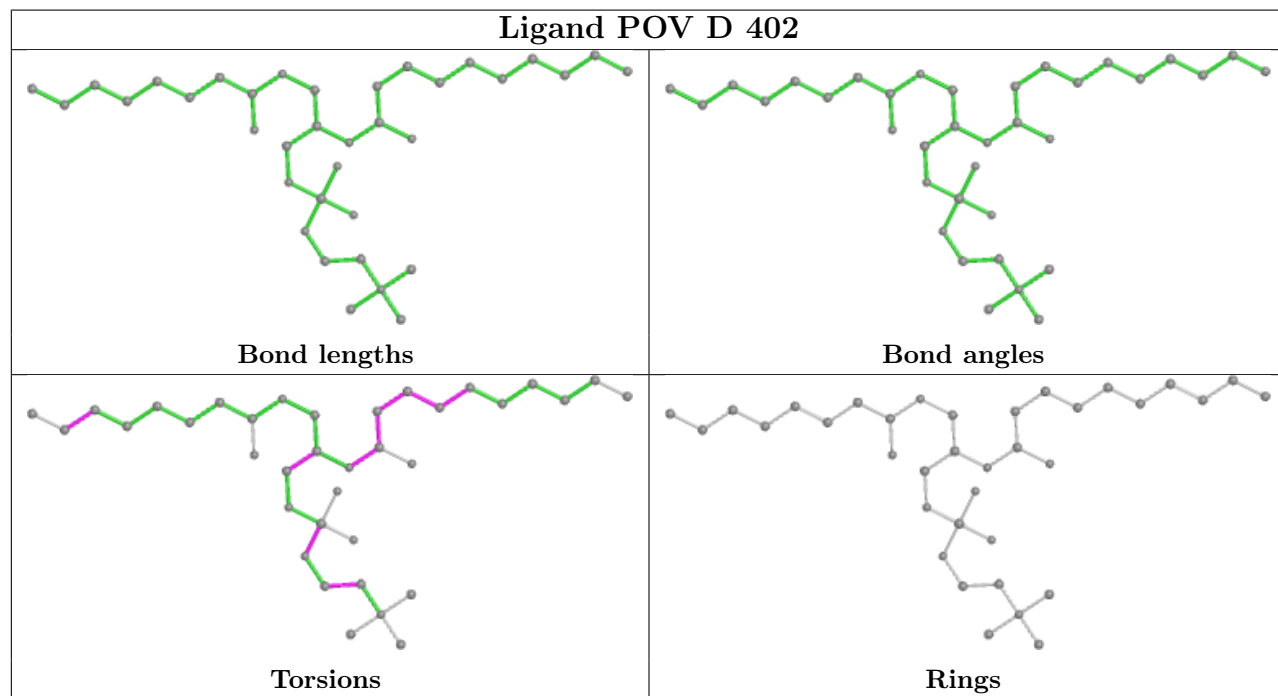
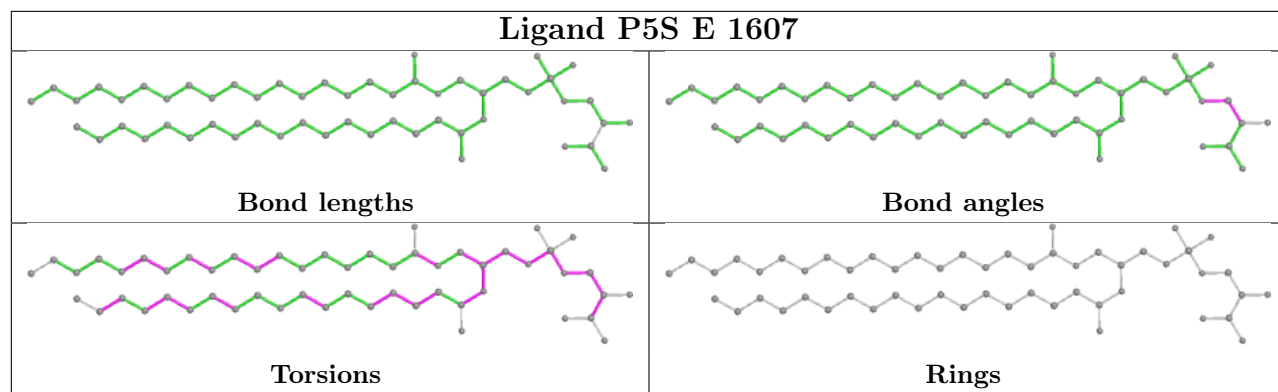

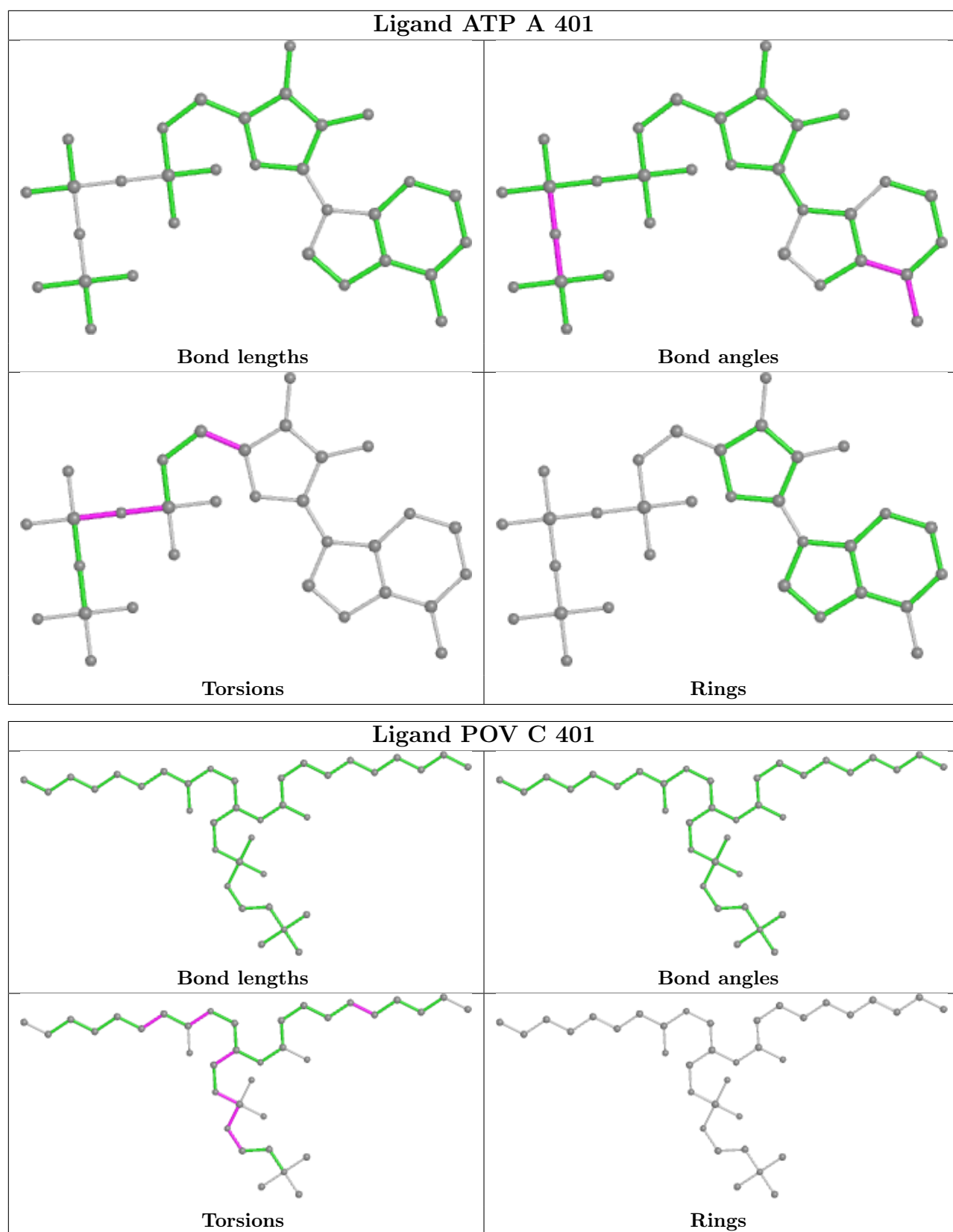

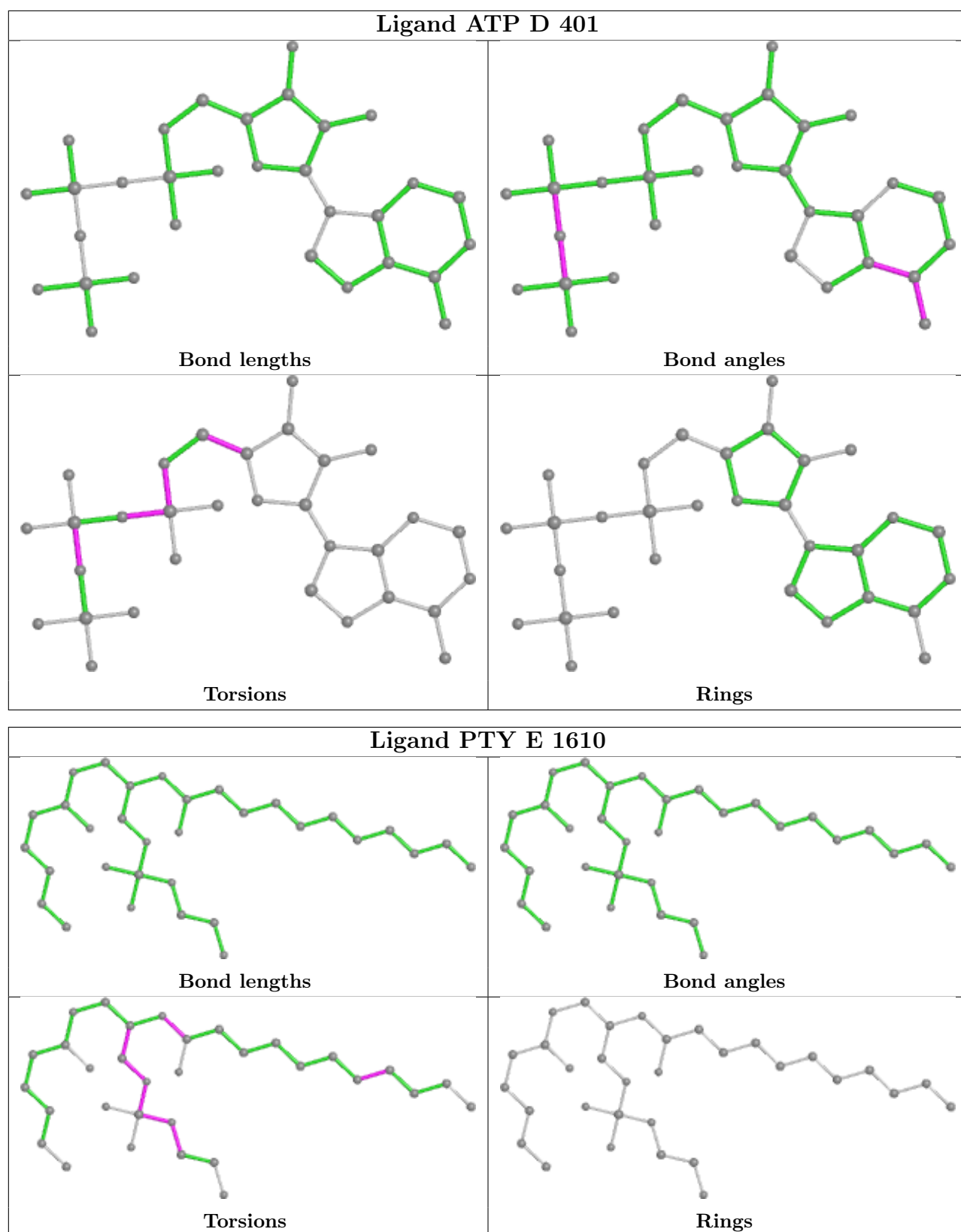

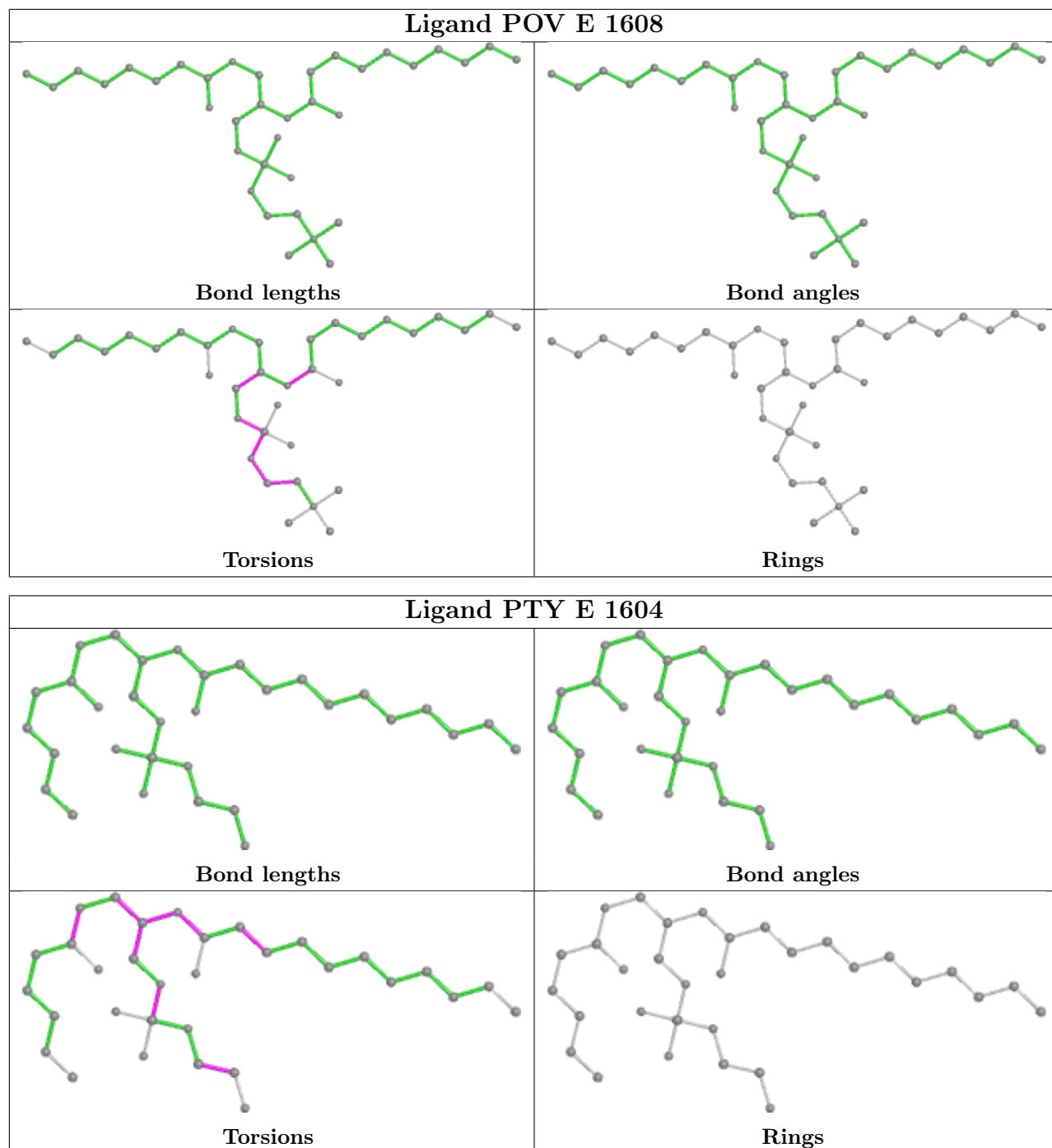

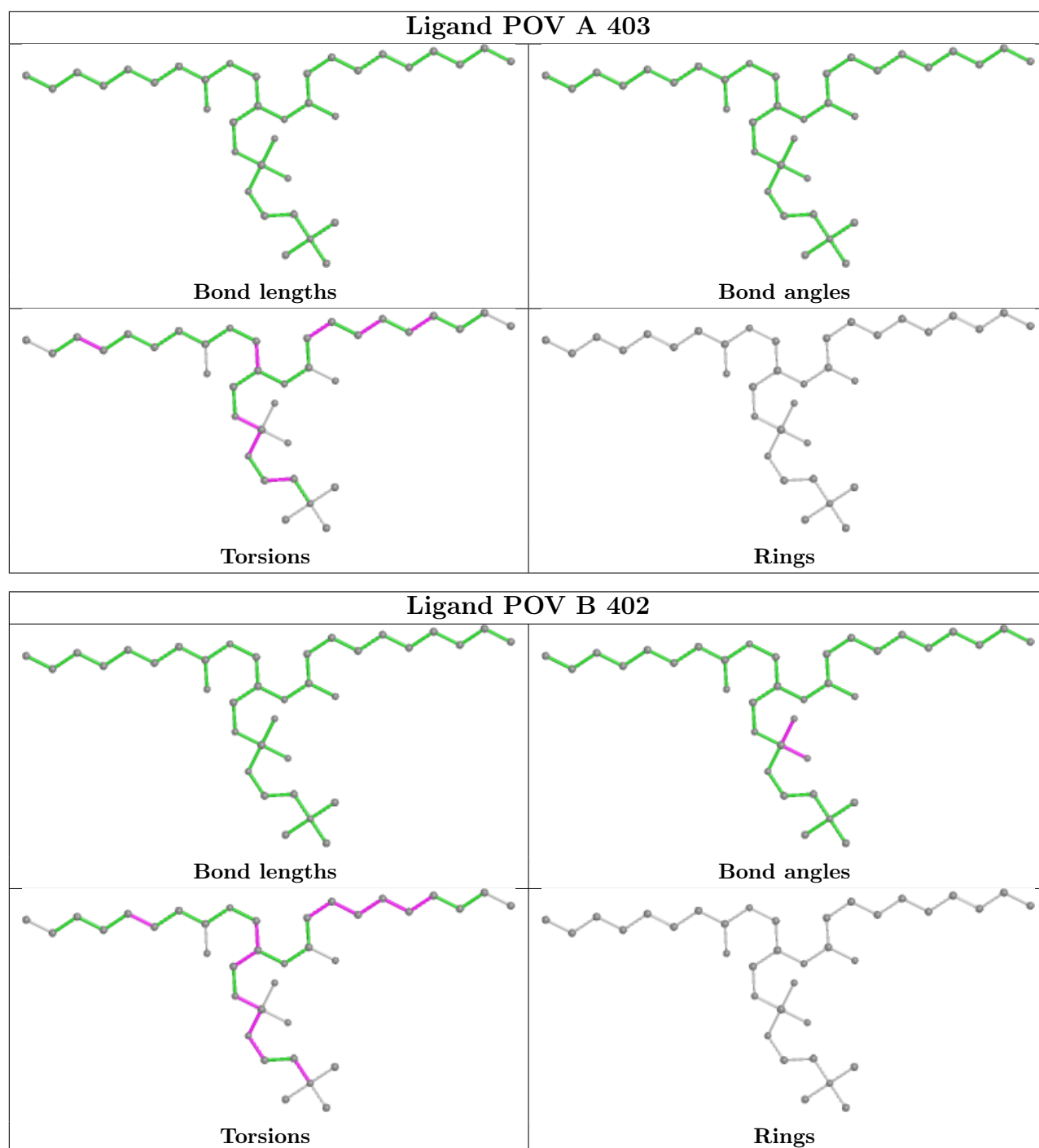

5.7 Other polymers [i](#)

There are no such residues in this entry.

5.8 Polymer linkage issues [i](#)

There are no chain breaks in this entry.

6 Map visualisation [i](#)

This section contains visualisations of the EMDB entry EMD-26194. These allow visual inspection of the internal detail of the map and identification of artifacts.

No raw map or half-maps were deposited for this entry and therefore no images, graphs, etc. pertaining to the raw map can be shown.

6.1 Orthogonal projections [i](#)

6.1.1 Primary map

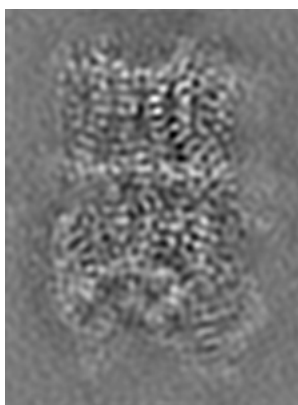

X

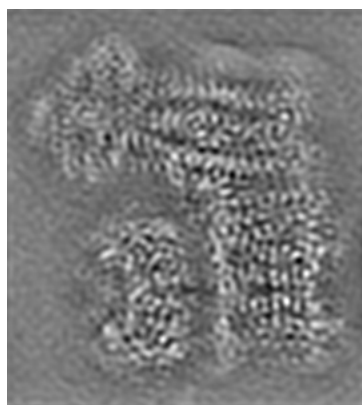

Y

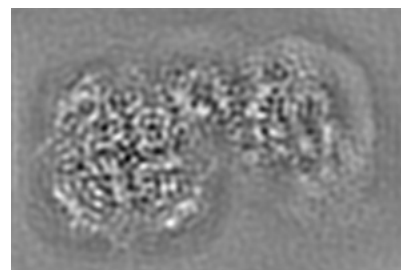

Z

The images above show the map projected in three orthogonal directions.

6.2 Central slices [i](#)

6.2.1 Primary map

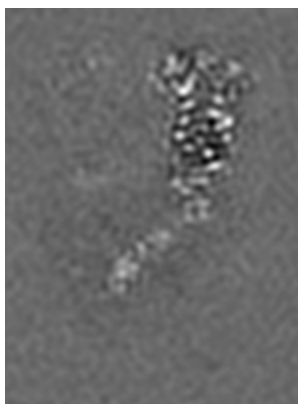

X Index: 79

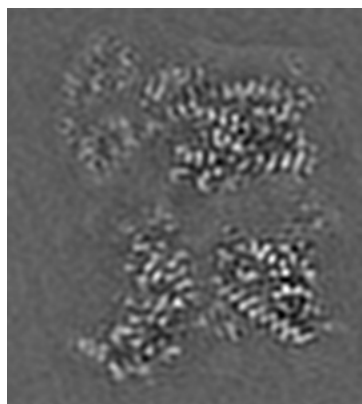

Y Index: 52

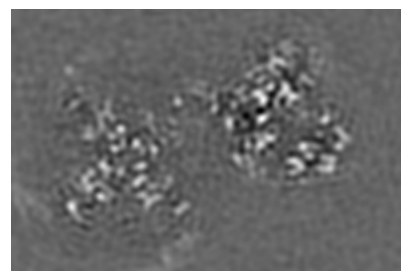

Z Index: 71

The images above show central slices of the map in three orthogonal directions.

6.3 Largest variance slices [i](#)

6.3.1 Primary map

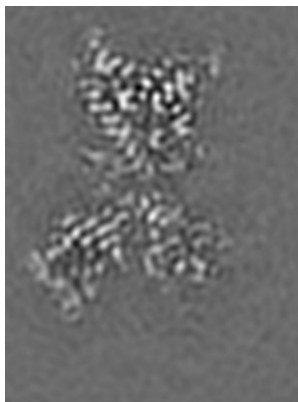

X Index: 41

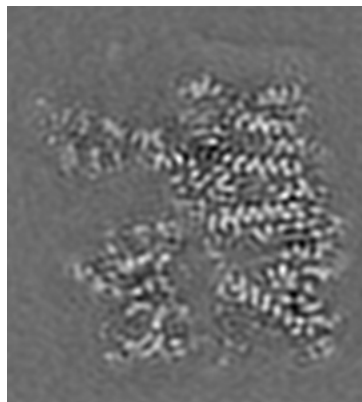

Y Index: 64

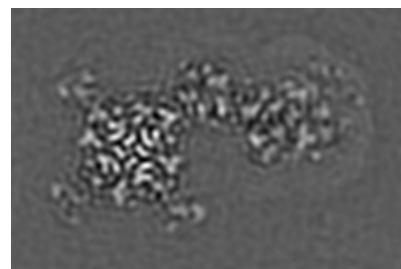

Z Index: 110

The images above show the largest variance slices of the map in three orthogonal directions.

6.4 Orthogonal surface views [i](#)

6.4.1 Primary map

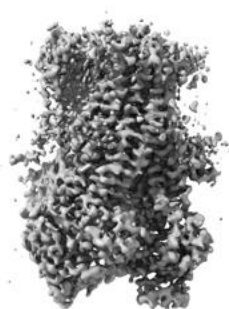

X

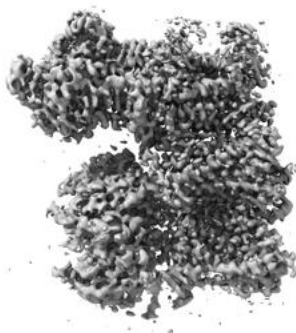

Y



Z

The images above show the 3D surface view of the map at the recommended contour level 1.0. These images, in conjunction with the slice images, may facilitate assessment of whether an appropriate contour level has been provided.

6.5 Mask visualisation

This section was not generated. No masks/segmentation were deposited.

7 Map analysis [i](#)

This section contains the results of statistical analysis of the map.

7.1 Map-value distribution [i](#)

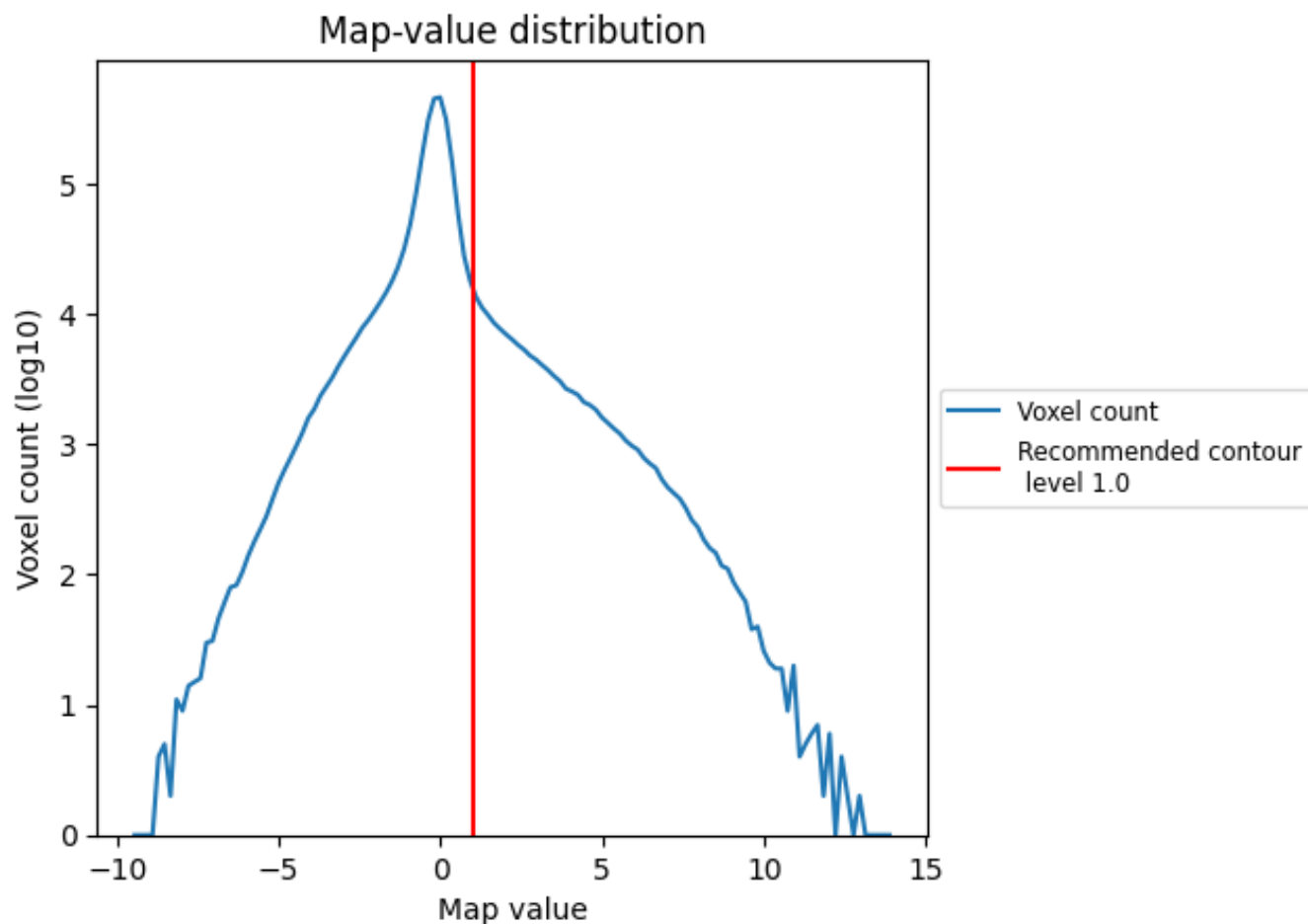

The map-value distribution is plotted in 128 intervals along the x-axis. The y-axis is logarithmic. A spike in this graph at zero usually indicates that the volume has been masked.

7.2 Volume estimate [i](#)

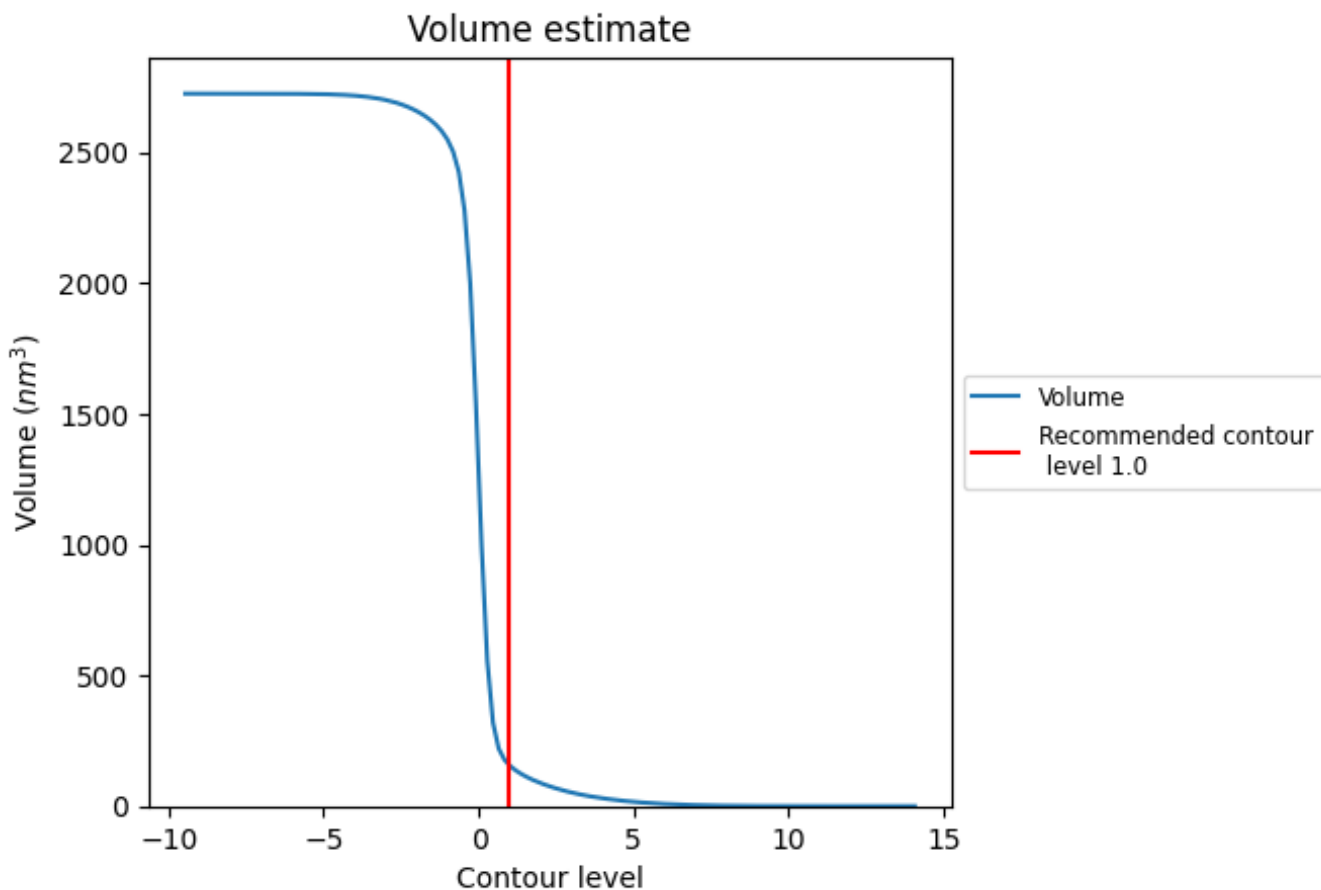

The volume at the recommended contour level is 156 nm^3 ; this corresponds to an approximate mass of 141 kDa.

The volume estimate graph shows how the enclosed volume varies with the contour level. The recommended contour level is shown as a vertical line and the intersection between the line and the curve gives the volume of the enclosed surface at the given level.

7.3 Rotationally averaged power spectrum [i](#)

This section was not generated. The rotationally averaged power spectrum is only generated for cubic maps.

8 Fourier-Shell correlation

This section was not generated. No FSC curve or half-maps provided.

9 Map-model fit [i](#)

This section contains information regarding the fit between EMDB map EMD-26194 and PDB model 7TYT. Per-residue inclusion information can be found in section 3 on page 8.

9.1 Map-model overlay [i](#)

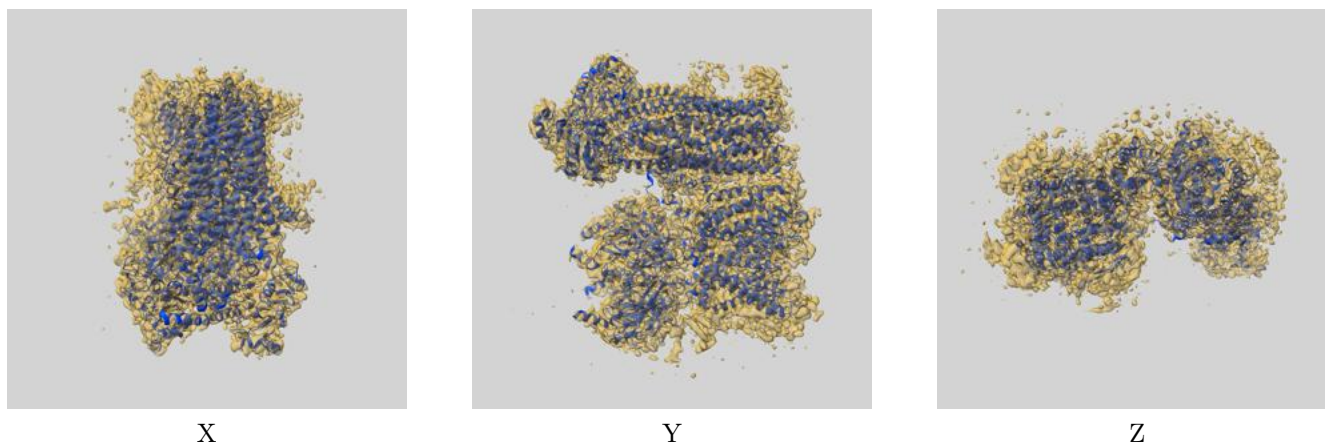

The images above show the 3D surface view of the map at the recommended contour level 1.0 at 50% transparency in yellow overlaid with a ribbon representation of the model coloured in blue. These images allow for the visual assessment of the quality of fit between the atomic model and the map.

9.2 Q-score mapped to coordinate model [i](#)

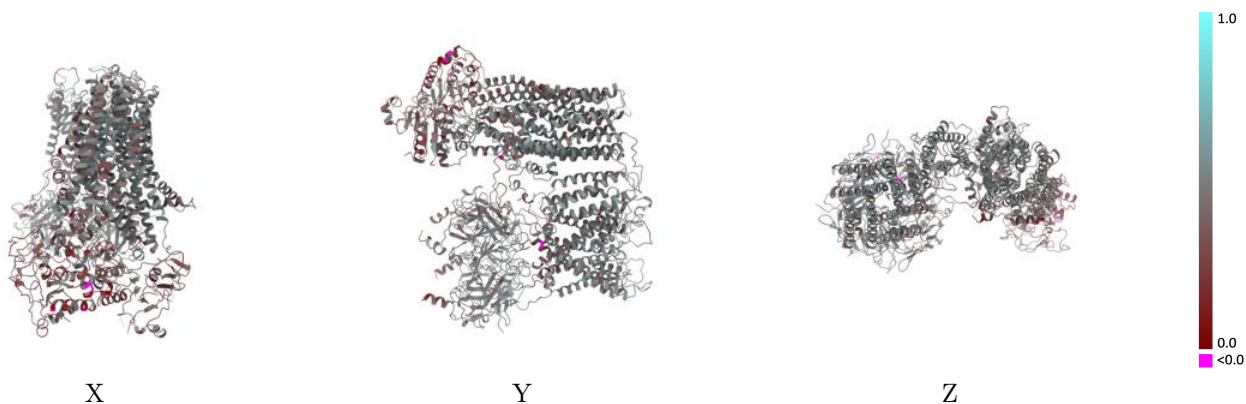

The images above show the model with each residue coloured according to its Q-score. This shows their resolvability in the map with higher Q-score values reflecting better resolvability. Please note: Q-score is calculating the resolvability of atoms, and thus high values are only expected at resolutions at which atoms can be resolved. Low Q-score values may therefore be expected for many entries.

9.3 Atom inclusion mapped to coordinate model [i](#)

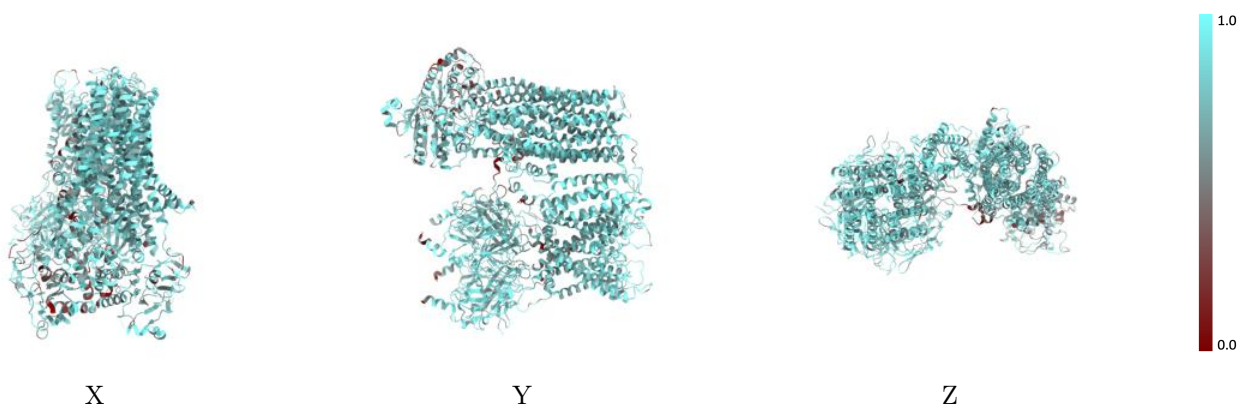

The images above show the model with each residue coloured according to its atom inclusion. This shows to what extent they are inside the map at the recommended contour level (1.0).



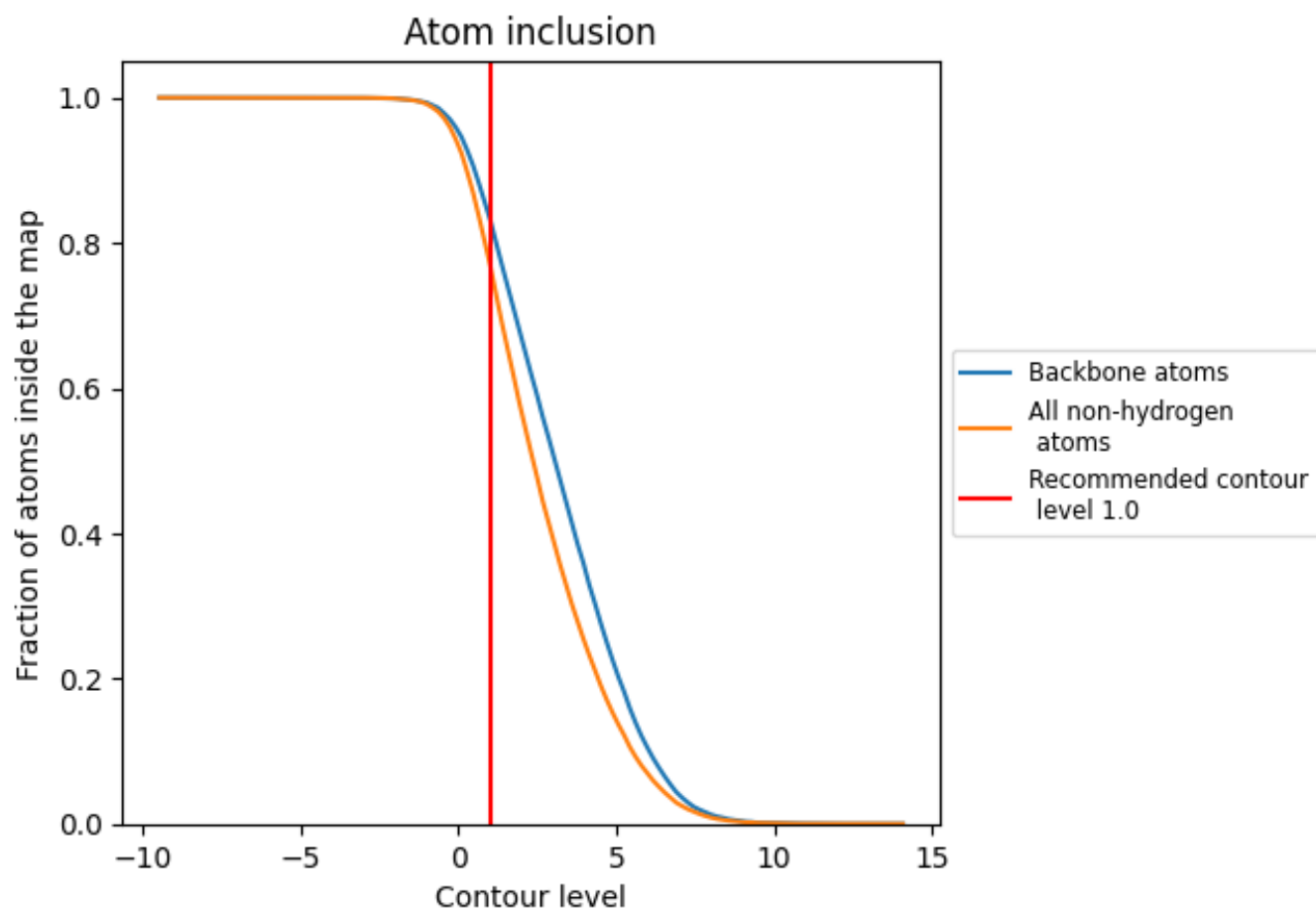











9.4 Atom inclusion [i](#)



At the recommended contour level, 83% of all backbone atoms, 77% of all non-hydrogen atoms, are inside the map.

9.5 Map-model fit summary

The table lists the average atom inclusion at the recommended contour level (1.0) and Q-score for the entire model and for each chain.

Chain	Atom inclusion	Q-score
All	 0.7705	 0.4570
A	 0.7694	 0.4590
B	 0.7904	 0.4760
C	 0.8012	 0.4740
D	 0.8045	 0.4760
E	 0.7523	 0.4430
F	 0.2500	 0.3710

