



Full wwPDB X-ray Structure Validation Report ⓘ

May 22, 2020 – 02:01 am BST

PDB ID : 6UCA
Title : Crystal structure of human ZCCHC4 in complex with SAH
Authors : Lu, J.W.; Ren, W.D.; Huang, M.J.; Gao, L.; Li, D.X.; Wang, G.G.; Song, J.
Deposited on : 2019-09-15
Resolution : 3.10 Å(reported)

This is a Full wwPDB X-ray Structure Validation Report for a publicly released PDB entry.

We welcome your comments at validation@mail.wwpdb.org

A user guide is available at

<https://www.wwpdb.org/validation/2017/XrayValidationReportHelp>

with specific help available everywhere you see the ⓘ symbol.

The following versions of software and data (see [references ⓘ](#)) were used in the production of this report:

MolProbity : 4.02b-467
Mogul : 1.8.5 (274361), CSD as541be (2020)
Xtriage (Phenix) : 1.13
EDS : 2.11
buster-report : 1.1.7 (2018)
Percentile statistics : 20191225.v01 (using entries in the PDB archive December 25th 2019)
Refmac : 5.8.0158
CCP4 : 7.0.044 (Gargrove)
Ideal geometry (proteins) : Engh & Huber (2001)
Ideal geometry (DNA, RNA) : Parkinson et al. (1996)
Validation Pipeline (wwPDB-VP) : 2.11

1 Overall quality at a glance

The following experimental techniques were used to determine the structure:

X-RAY DIFFRACTION

The reported resolution of this entry is 3.10 Å.

Percentile scores (ranging between 0-100) for global validation metrics of the entry are shown in the following graphic. The table shows the number of entries on which the scores are based.

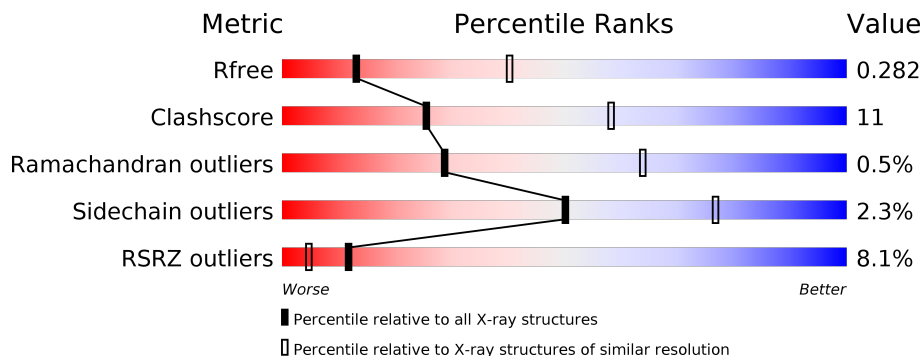

Metric	Whole archive (#Entries)	Similar resolution (#Entries, resolution range(Å))
R_{free}	130704	1094 (3.10-3.10)
Clashscore	141614	1184 (3.10-3.10)
Ramachandran outliers	138981	1141 (3.10-3.10)
Sidechain outliers	138945	1141 (3.10-3.10)
RSRZ outliers	127900	1067 (3.10-3.10)

The table below summarises the geometric issues observed across the polymeric chains and their fit to the electron density. The red, orange, yellow and green segments on the lower bar indicate the fraction of residues that contain outliers for ≥ 3 , 2, 1 and 0 types of geometric quality criteria respectively. A grey segment represents the fraction of residues that are not modelled. The numeric value for each fraction is indicated below the corresponding segment, with a dot representing fractions $\leq 5\%$. The upper red bar (where present) indicates the fraction of residues that have poor fit to the electron density. The numeric value is given above the bar.

Mol	Chain	Length	Quality of chain
1	A	442	
1	B	442	
1	C	442	
1	D	442	
1	E	442	
1	F	442	

2 Entry composition [i](#)

There are 3 unique types of molecules in this entry. The entry contains 18659 atoms, of which 0 are hydrogens and 0 are deuteriums.

In the tables below, the ZeroOcc column contains the number of atoms modelled with zero occupancy, the AltConf column contains the number of residues with at least one atom in alternate conformation and the Trace column contains the number of residues modelled with at most 2 atoms.

- Molecule 1 is a protein called rRNA N6-adenosine-methyltransferase ZCCHC4.

Mol	Chain	Residues	Atoms					ZeroOcc	AltConf	Trace
			Total	C	N	O	S			
1	A	413	Total 3239	C 2070	N 561	O 578	S 30	0	2	0
1	B	393	Total 2958	C 1891	N 509	O 530	S 28	0	2	0
1	C	387	Total 2915	C 1859	N 495	O 532	S 29	0	0	0
1	D	416	Total 3292	C 2106	N 575	O 581	S 30	0	0	0
1	E	402	Total 3075	C 1966	N 532	O 547	S 30	0	0	0
1	F	398	Total 2988	C 1912	N 509	O 537	S 30	0	0	0

There are 36 discrepancies between the modelled and reference sequences:

Chain	Residue	Modelled	Actual	Comment	Reference
A	23	SER	-	expression tag	UNP Q9H5U6
A	55	ALA	LYS	engineered mutation	UNP Q9H5U6
A	56	ALA	GLU	engineered mutation	UNP Q9H5U6
A	57	ALA	GLU	engineered mutation	UNP Q9H5U6
A	167	ALA	LYS	engineered mutation	UNP Q9H5U6
A	168	ALA	LYS	engineered mutation	UNP Q9H5U6
B	23	SER	-	expression tag	UNP Q9H5U6
B	55	ALA	LYS	engineered mutation	UNP Q9H5U6
B	56	ALA	GLU	engineered mutation	UNP Q9H5U6
B	57	ALA	GLU	engineered mutation	UNP Q9H5U6
B	167	ALA	LYS	engineered mutation	UNP Q9H5U6
B	168	ALA	LYS	engineered mutation	UNP Q9H5U6
C	23	SER	-	expression tag	UNP Q9H5U6
C	55	ALA	LYS	engineered mutation	UNP Q9H5U6
C	56	ALA	GLU	engineered mutation	UNP Q9H5U6
C	57	ALA	GLU	engineered mutation	UNP Q9H5U6
C	167	ALA	LYS	engineered mutation	UNP Q9H5U6

Continued on next page...

Continued from previous page...

Chain	Residue	Modelled	Actual	Comment	Reference
C	168	ALA	LYS	engineered mutation	UNP Q9H5U6
D	23	SER	-	expression tag	UNP Q9H5U6
D	55	ALA	LYS	engineered mutation	UNP Q9H5U6
D	56	ALA	GLU	engineered mutation	UNP Q9H5U6
D	57	ALA	GLU	engineered mutation	UNP Q9H5U6
D	167	ALA	LYS	engineered mutation	UNP Q9H5U6
D	168	ALA	LYS	engineered mutation	UNP Q9H5U6
E	23	SER	-	expression tag	UNP Q9H5U6
E	55	ALA	LYS	engineered mutation	UNP Q9H5U6
E	56	ALA	GLU	engineered mutation	UNP Q9H5U6
E	57	ALA	GLU	engineered mutation	UNP Q9H5U6
E	167	ALA	LYS	engineered mutation	UNP Q9H5U6
E	168	ALA	LYS	engineered mutation	UNP Q9H5U6
F	23	SER	-	expression tag	UNP Q9H5U6
F	55	ALA	LYS	engineered mutation	UNP Q9H5U6
F	56	ALA	GLU	engineered mutation	UNP Q9H5U6
F	57	ALA	GLU	engineered mutation	UNP Q9H5U6
F	167	ALA	LYS	engineered mutation	UNP Q9H5U6
F	168	ALA	LYS	engineered mutation	UNP Q9H5U6

- Molecule 2 is S-ADENOSYL-L-HOMOCYSTEINE (three-letter code: SAH) (formula: $C_{14}H_{20}N_6O_5S$) (labeled as "Ligand of Interest" by author).

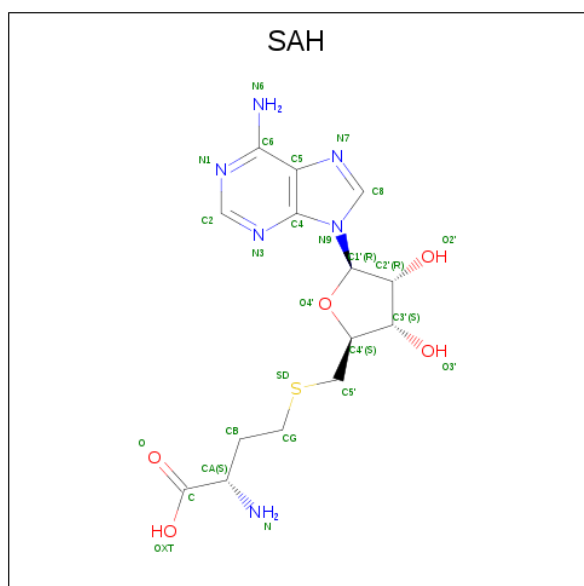

Mol	Chain	Residues	Atoms				ZeroOcc	AltConf	
			Total	C	N	O			S
2	A	1	26	14	6	5	1	0	0

Continued on next page...

Continued from previous page...

Mol	Chain	Residues	Atoms					ZeroOcc	AltConf
2	B	1	Total	C	N	O	S	0	0
			26	14	6	5	1		
2	C	1	Total	C	N	O	S	0	0
			26	14	6	5	1		
2	D	1	Total	C	N	O	S	0	0
			26	14	6	5	1		
2	E	1	Total	C	N	O	S	0	0
			26	14	6	5	1		
2	F	1	Total	C	N	O	S	0	0
			26	14	6	5	1		

- Molecule 3 is ZINC ION (three-letter code: ZN) (formula: Zn) (labeled as "Ligand of Interest" by author).

Mol	Chain	Residues	Atoms		ZeroOcc	AltConf
3	D	6	Total	Zn	0	0
			6	6		
3	E	6	Total	Zn	0	0
			6	6		
3	B	6	Total	Zn	0	0
			6	6		
3	C	6	Total	Zn	0	0
			6	6		
3	A	6	Total	Zn	0	0
			6	6		
3	F	6	Total	Zn	0	0
			6	6		

3 Residue-property plots [i](#)

These plots are drawn for all protein, RNA and DNA chains in the entry. The first graphic for a chain summarises the proportions of the various outlier classes displayed in the second graphic. The second graphic shows the sequence view annotated by issues in geometry and electron density. Residues are color-coded according to the number of geometric quality criteria for which they contain at least one outlier: green = 0, yellow = 1, orange = 2 and red = 3 or more. A red dot above a residue indicates a poor fit to the electron density ($RSRZ > 2$). Stretches of 2 or more consecutive residues without any outlier are shown as a green connector. Residues present in the sample, but not in the model, are shown in grey.

- Molecule 1: rRNA N6-adenosine-methyltransferase ZCCHC4

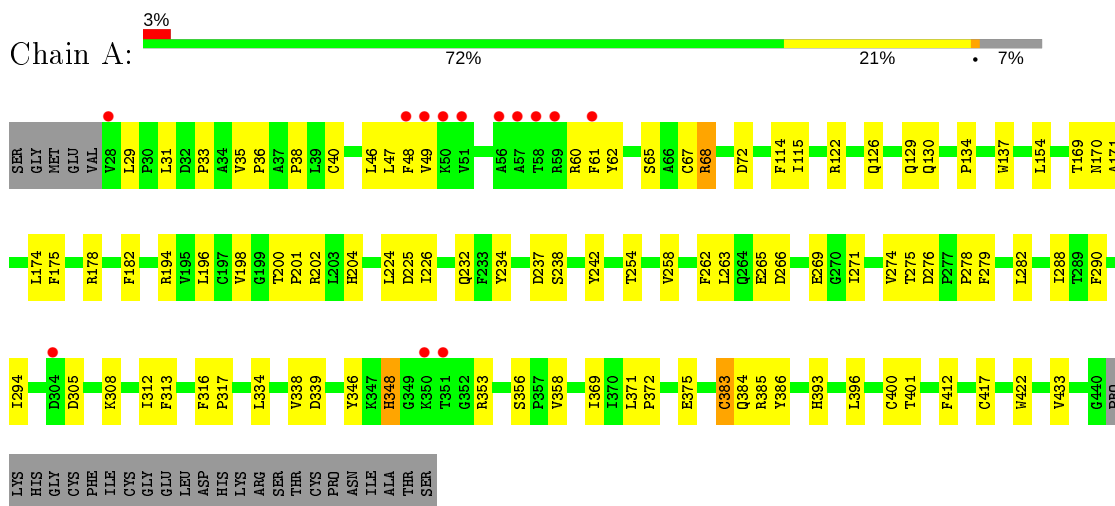

- Molecule 1: rRNA N6-adenosine-methyltransferase ZCCHC4

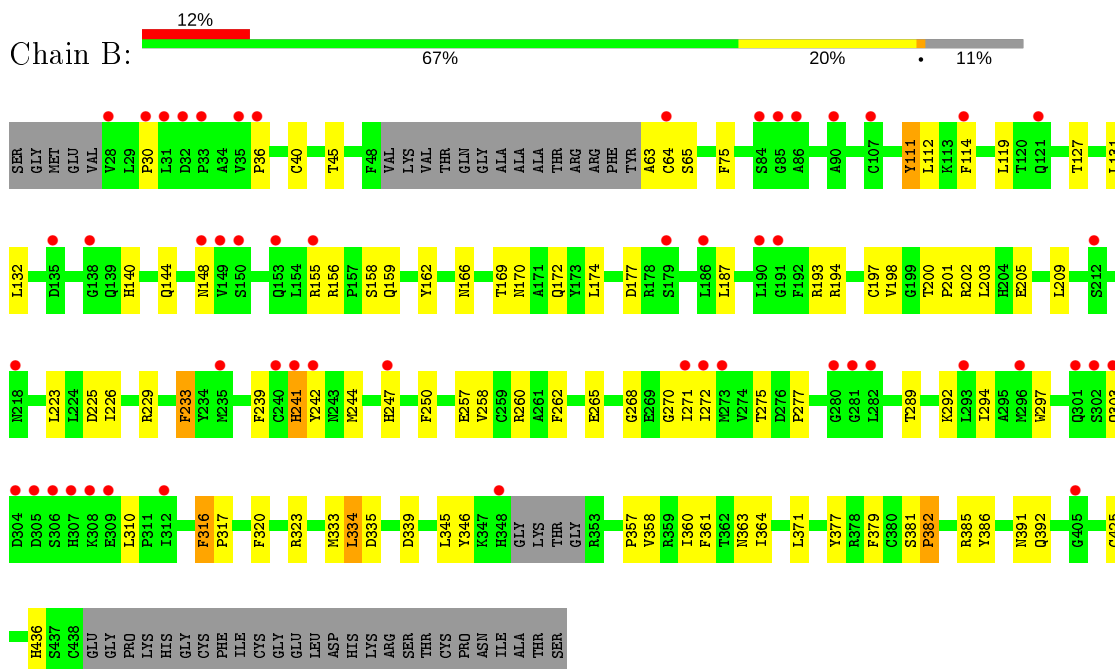

- Molecule 1: rRNA N6-adenosine-methyltransferase ZCCHC4

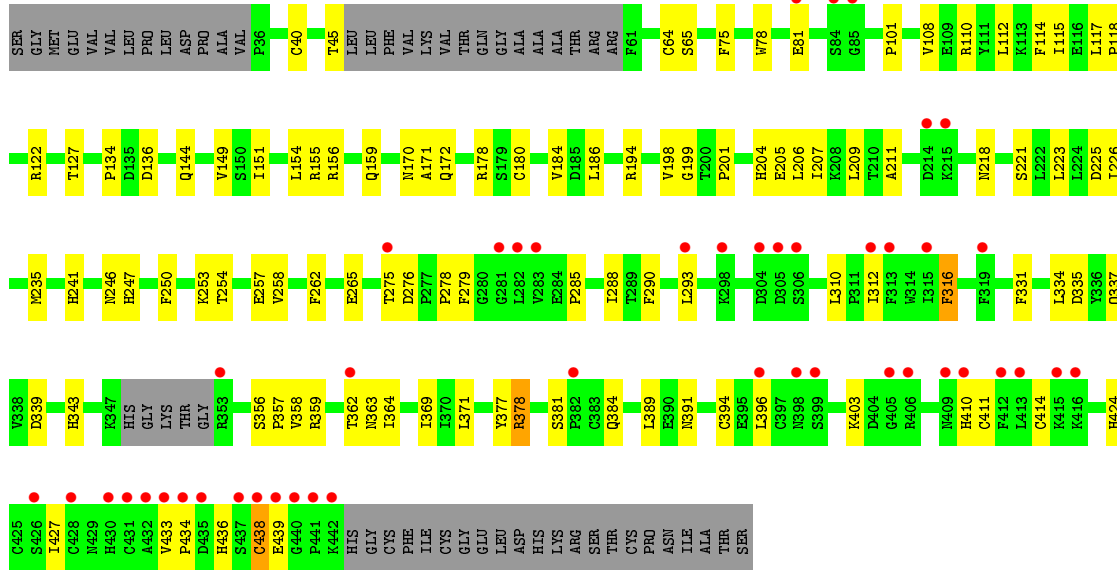

• Molecule 1: rRNA N6-adenosine-methyltransferase ZCCHC4

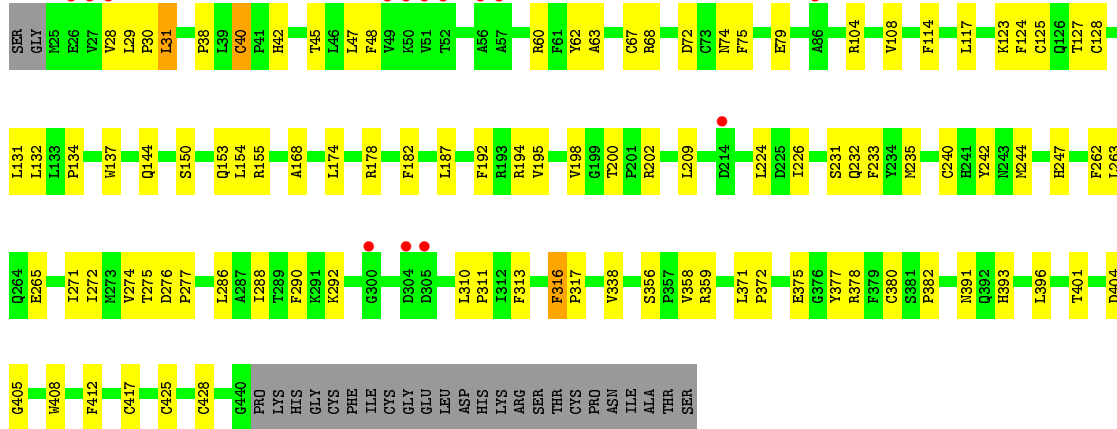

• Molecule 1: rRNA N6-adenosine-methyltransferase ZCCHC4

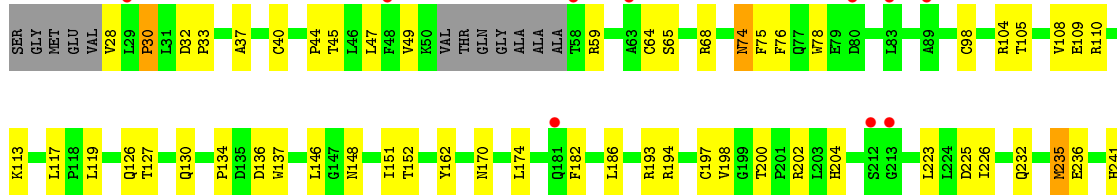

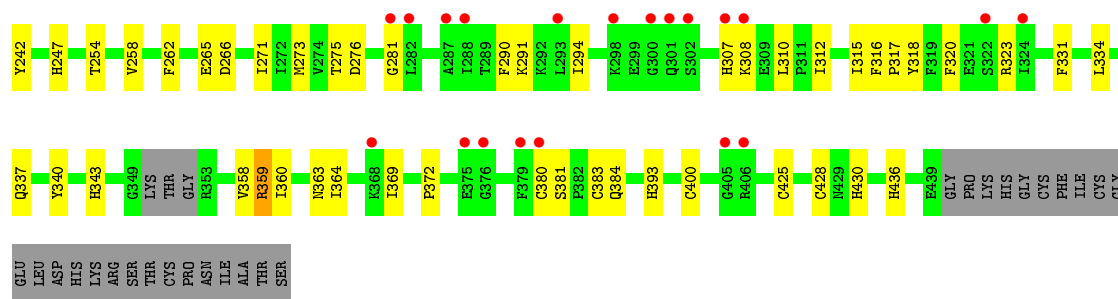

- Molecule 1: rRNA N6-adenosine-methyltransferase ZCCHC4

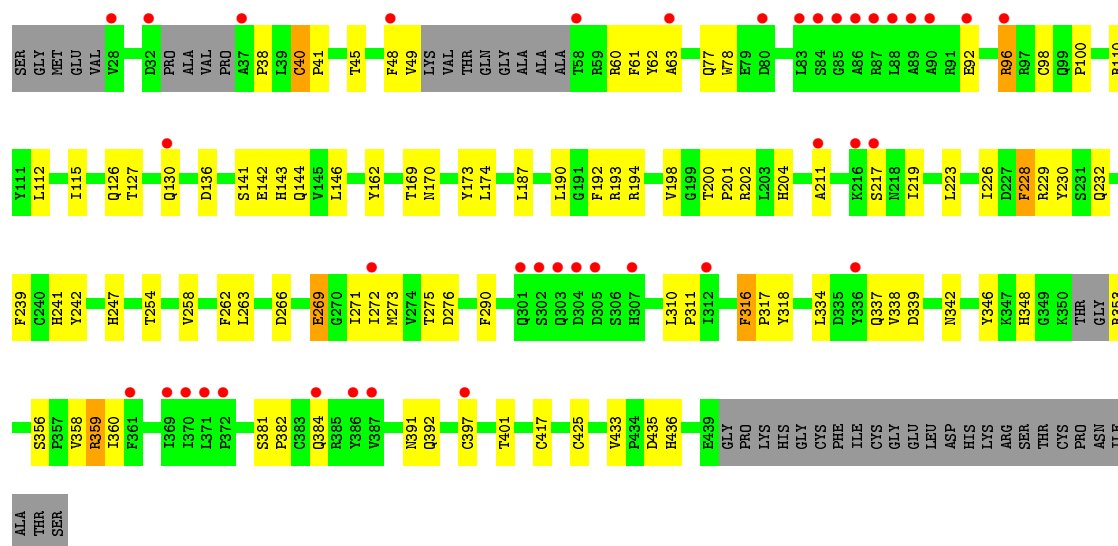

4 Data and refinement statistics

Property	Value	Source
Space group	P 21 21 2	Depositor
Cell constants a, b, c, α , β , γ	136.57Å 290.38Å 83.53Å 90.00° 90.00° 90.00°	Depositor
Resolution (Å)	47.68 – 3.10 49.68 – 3.10	Depositor EDS
% Data completeness (in resolution range)	99.0 (47.68-3.10) 90.7 (49.68-3.10)	Depositor EDS
R_{merge}	0.13	Depositor
R_{sym}	(Not available)	Depositor
$\langle I/\sigma(I) \rangle$ ¹	1.53 (at 3.12Å)	Xtrriage
Refinement program	PHENIX 1.15.2_3472	Depositor
R, R_{free}	0.249 , 0.281 0.249 , 0.282	Depositor DCC
R_{free} test set	1996 reflections (3.29%)	wwPDB-VP
Wilson B-factor (Å ²)	69.9	Xtrriage
Anisotropy	0.740	Xtrriage
Bulk solvent k_{sol} (e/Å ³), B_{sol} (Å ²)	0.26 , 51.4	EDS
L-test for twinning ²	$\langle L \rangle = 0.48$, $\langle L^2 \rangle = 0.31$	Xtrriage
Estimated twinning fraction	No twinning to report.	Xtrriage
F_o, F_c correlation	0.91	EDS
Total number of atoms	18659	wwPDB-VP
Average B, all atoms (Å ²)	105.0	wwPDB-VP

Xtrriage's analysis on translational NCS is as follows: *The analyses of the Patterson function reveals a significant off-origin peak that is 38.89 % of the origin peak, indicating pseudo-translational symmetry. The chance of finding a peak of this or larger height randomly in a structure without pseudo-translational symmetry is equal to 3.4464e-04. The detected translational NCS is most likely also responsible for the elevated intensity ratio.*

¹Intensities estimated from amplitudes.

²Theoretical values of $\langle |L| \rangle$, $\langle L^2 \rangle$ for acentric reflections are 0.5, 0.333 respectively for untwinned datasets, and 0.375, 0.2 for perfectly twinned datasets.

5 Model quality [i](#)

5.1 Standard geometry [i](#)

Bond lengths and bond angles in the following residue types are not validated in this section: ZN, SAH

The Z score for a bond length (or angle) is the number of standard deviations the observed value is removed from the expected value. A bond length (or angle) with $|Z| > 5$ is considered an outlier worth inspection. RMSZ is the root-mean-square of all Z scores of the bond lengths (or angles).

Mol	Chain	Bond lengths		Bond angles	
		RMSZ	# Z >5	RMSZ	# Z >5
1	A	0.28	0/3334	0.47	0/4534
1	B	0.28	0/3049	0.46	0/4165
1	C	0.27	0/2997	0.45	0/4091
1	D	0.28	0/3385	0.48	0/4594
1	E	0.26	0/3164	0.43	0/4311
1	F	0.26	0/3071	0.44	0/4187
All	All	0.27	0/19000	0.45	0/25882

There are no bond length outliers.

There are no bond angle outliers.

There are no chirality outliers.

There are no planarity outliers.

5.2 Too-close contacts [i](#)

In the following table, the Non-H and H(model) columns list the number of non-hydrogen atoms and hydrogen atoms in the chain respectively. The H(added) column lists the number of hydrogen atoms added and optimized by MolProbity. The Clashes column lists the number of clashes within the asymmetric unit, whereas Symm-Clashes lists symmetry related clashes.

Mol	Chain	Non-H	H(model)	H(added)	Clashes	Symm-Clashes
1	A	3239	0	3030	62	0
1	B	2958	0	2622	63	0
1	C	2915	0	2573	66	0
1	D	3292	0	3129	70	0
1	E	3075	0	2793	68	0
1	F	2988	0	2663	62	0
2	A	26	0	19	4	0

Continued on next page...

Continued from previous page...

Mol	Chain	Non-H	H(model)	H(added)	Clashes	Symm-Clashes
2	B	26	0	19	3	0
2	C	26	0	19	5	0
2	D	26	0	19	3	0
2	E	26	0	19	4	0
2	F	26	0	19	5	0
3	A	6	0	0	0	0
3	B	6	0	0	0	0
3	C	6	0	0	0	0
3	D	6	0	0	0	0
3	E	6	0	0	0	0
3	F	6	0	0	0	0
All	All	18659	0	16924	377	0

The all-atom clashscore is defined as the number of clashes found per 1000 atoms (including hydrogen atoms). The all-atom clashscore for this structure is 11.

All (377) close contacts within the same asymmetric unit are listed below, sorted by their clash magnitude.

Atom-1	Atom-2	Interatomic distance (Å)	Clash overlap (Å)
1:B:174:LEU:HA	2:B:1001:SAH:OXT	1.52	1.09
1:A:33:PRO:HA	1:D:31:LEU:HD12	1.40	1.01
1:F:242:TYR:HH	1:F:247:HIS:HD1	0.99	0.97
1:B:194:ARG:NH1	1:B:262:PHE:O	2.04	0.91
1:E:242:TYR:HH	1:E:247:HIS:HD1	1.21	0.83
1:C:211:ALA:HB1	1:C:218:ASN:HB2	1.64	0.79
1:F:49:VAL:HA	1:F:60:ARG:HB3	1.64	0.78
1:E:381:SER:O	1:E:384:GLN:NE2	2.18	0.76
1:F:41:PRO:HB3	1:F:98:CYS:SG	2.27	0.75
1:B:177:ASP:OD2	1:C:178:ARG:NH1	2.19	0.74
1:A:33:PRO:HA	1:D:31:LEU:CD1	2.17	0.73
1:E:174:LEU:HB3	1:E:202:ARG:HD2	1.71	0.73
1:C:194:ARG:NH1	1:C:262:PHE:O	2.24	0.71
1:D:356:SER:O	1:D:359:ARG:NH2	2.24	0.71
1:E:318:TYR:HB3	1:E:359:ARG:HH11	1.55	0.70
1:E:337:GLN:HG2	1:E:359:ARG:HH21	1.57	0.70
1:E:425:CYS:HB3	1:E:428:CYS:HB2	1.73	0.69
1:C:378:ARG:NH1	1:C:389:LEU:O	2.26	0.69
1:C:381:SER:O	1:C:384:GLN:NE2	2.27	0.68
1:C:378:ARG:NH2	1:C:391:ASN:O	2.27	0.68
1:E:425:CYS:SG	1:E:436:HIS:CE1	2.86	0.68
1:A:126:GLN:O	1:A:129:GLN:NE2	2.27	0.68

Continued on next page...

Continued from previous page...

Atom-1	Atom-2	Interatomic distance (Å)	Clash overlap (Å)
1:B:64:CYS:SG	1:B:65:SER:N	2.68	0.67
1:D:200:THR:HA	2:D:1001:SAH:HA	1.76	0.67
1:B:335[B]:ASP:OD1	1:B:385:ARG:NH2	2.29	0.66
1:E:276:ASP:OD2	2:E:1001:SAH:N	2.28	0.66
1:A:339:ASP:OD1	1:A:346:TYR:OH	2.12	0.66
1:E:126:GLN:HE21	1:E:146:LEU:HB2	1.59	0.66
1:B:166:ASN:ND2	1:F:141:SER:OG	2.29	0.66
1:F:318:TYR:HB3	1:F:359:ARG:HH11	1.61	0.65
1:F:194:ARG:NH2	1:F:269:GLU:O	2.30	0.65
1:F:194:ARG:NH1	1:F:262:PHE:O	2.29	0.65
1:B:198:VAL:HG13	1:B:275:THR:HG23	1.80	0.64
1:A:47:LEU:HD22	1:D:29:LEU:HD11	1.79	0.63
1:F:61:PHE:HA	1:F:78:TRP:HA	1.78	0.63
1:E:28:VAL:N	1:E:49:VAL:O	2.32	0.63
1:E:110:ARG:NH2	1:E:136:ASP:OD2	2.31	0.63
1:C:279:PHE:HA	1:C:316:PHE:CZ	2.33	0.62
1:F:110:ARG:NH2	1:F:136:ASP:OD2	2.32	0.62
1:D:124:PHE:HD2	1:D:131:LEU:HD23	1.64	0.62
1:F:276:ASP:OD2	2:F:1001:SAH:N	2.33	0.62
1:B:131:LEU:HG	1:B:233:PHE:HE2	1.64	0.62
1:D:28:VAL:HG12	1:D:30:PRO:HD3	1.81	0.62
1:C:253:LYS:O	1:C:257:GLU:HG2	1.99	0.61
1:D:274:VAL:HG22	1:D:313:PHE:HB2	1.82	0.61
1:E:37:ALA:HB3	1:E:44:PRO:HB3	1.83	0.61
1:D:178:ARG:HH21	1:D:375:GLU:HB3	1.65	0.61
1:B:200:THR:HG22	1:B:203:LEU:HB2	1.81	0.61
1:C:194:ARG:NH2	1:C:265:GLU:O	2.34	0.60
1:A:194:ARG:NH1	1:A:262:PHE:O	2.34	0.60
1:A:276:ASP:OD2	2:A:1001:SAH:N	2.34	0.60
1:B:317:PRO:HG2	1:B:320:PHE:HD2	1.67	0.60
1:C:184:VAL:HG21	1:C:206:LEU:HD22	1.83	0.60
1:E:320:PHE:HD1	1:E:323:ARG:HD2	1.67	0.60
1:B:194:ARG:NH2	1:B:265:GLU:O	2.35	0.60
1:E:320:PHE:HE1	1:E:323:ARG:HH11	1.50	0.60
1:B:197:CYS:HB3	1:B:200:THR:HB	1.84	0.60
1:B:223:LEU:O	1:B:239:PHE:HA	2.01	0.59
1:C:110:ARG:NH2	1:C:136:ASP:OD2	2.34	0.59
1:C:114:PHE:HD2	1:C:154:LEU:HD11	1.68	0.59
1:C:275:THR:HG21	1:C:290:PHE:CZ	2.37	0.59
1:E:393:HIS:HA	1:E:400:CYS:HB3	1.84	0.59
1:A:178:ARG:HH21	1:A:375:GLU:HG2	1.67	0.58

Continued on next page...

Continued from previous page...

Atom-1	Atom-2	Interatomic distance (Å)	Clash overlap (Å)
1:B:391:ASN:OD1	1:B:392:GLN:N	2.32	0.58
1:B:193:ARG:HG2	1:B:270:GLY:HA3	1.86	0.58
1:A:288:ILE:HD12	1:D:30:PRO:HG2	1.84	0.58
1:D:276:ASP:OD2	2:D:1001:SAH:N	2.37	0.58
1:D:317:PRO:HA	1:D:358:VAL:HA	1.85	0.58
1:E:225:ASP:OD1	1:E:226:ILE:N	2.37	0.58
1:F:201:PRO:HB3	1:F:230:TYR:CE2	2.39	0.57
1:A:383:CYS:O	1:A:385:ARG:N	2.37	0.57
1:F:334:LEU:HD12	1:F:360:ILE:HB	1.85	0.57
1:C:155:ARG:HB3	1:C:209:LEU:HD21	1.87	0.57
1:A:29:LEU:C	1:A:31:LEU:H	2.08	0.57
1:D:244:MET:SD	1:D:277:PRO:HB3	2.45	0.57
1:C:225:ASP:OD1	1:C:226:ILE:N	2.37	0.57
1:A:68:ARG:H	1:A:68:ARG:HD2	1.70	0.57
1:C:276:ASP:OD2	2:C:1001:SAH:N	2.38	0.57
1:E:194:ARG:NH1	1:E:262:PHE:O	2.38	0.56
1:A:401:THR:HG21	1:A:417:CYS:SG	2.45	0.56
1:F:193:ARG:NH1	1:F:266:ASP:OD2	2.38	0.56
1:C:117:LEU:HD11	1:C:134:PRO:HD3	1.88	0.56
1:B:148:ASN:O	1:B:148:ASN:ND2	2.39	0.56
1:A:182:PHE:CE1	1:A:372:PRO:HD3	2.41	0.56
1:B:194:ARG:NH1	1:B:271:ILE:HD11	2.21	0.56
1:D:382:PRO:HB2	1:D:393:HIS:CE1	2.41	0.56
1:D:125:CYS:SG	1:D:128:CYS:HB2	2.46	0.56
1:F:425:CYS:SG	1:F:436:HIS:CE1	2.99	0.56
1:B:159:GLN:OE1	1:B:202:ARG:NH2	2.39	0.55
1:E:320:PHE:HE1	1:E:323:ARG:NH1	2.04	0.55
1:C:78:TRP:HB2	1:C:81:GLU:HB3	1.87	0.55
1:D:45:THR:HG21	1:D:75:PHE:CE1	2.41	0.55
1:A:396:LEU:HD22	1:A:412:PHE:CE2	2.42	0.55
1:B:172:GLN:HA	2:B:1001:SAH:SD	2.47	0.55
1:E:45:THR:HG21	1:E:75:PHE:HD2	1.72	0.55
1:F:198:VAL:HG13	1:F:275:THR:HG23	1.88	0.55
1:B:194:ARG:NH1	1:B:265:GLU:HB3	2.23	0.54
1:D:396:LEU:HD13	1:D:412:PHE:CZ	2.42	0.54
1:D:404:ASP:OD1	1:D:405:GLY:N	2.37	0.54
1:F:391:ASN:OD1	1:F:392:GLN:N	2.41	0.54
1:A:334:LEU:HD11	1:A:369:ILE:HD13	1.90	0.54
1:A:348:HIS:HB3	1:A:353:ARG:HA	1.89	0.54
1:A:275:THR:HG21	1:A:290:PHE:CZ	2.43	0.54
1:A:178:ARG:HH21	1:A:375:GLU:CG	2.21	0.54

Continued on next page...

Continued from previous page...

Atom-1	Atom-2	Interatomic distance (Å)	Clash overlap (Å)
1:A:46:LEU:HG	1:A:65:SER:HB3	1.89	0.53
1:E:68:ARG:HG3	1:E:281:GLY:HA2	1.90	0.53
1:C:396:LEU:HD23	1:C:410:HIS:NE2	2.22	0.53
1:F:170:ASN:O	2:F:1001:SAH:H8	2.08	0.53
1:F:62:TYR:N	1:F:77:GLN:O	2.40	0.53
1:B:200:THR:HA	2:B:1001:SAH:HA	1.90	0.53
1:C:396:LEU:HD23	1:C:410:HIS:HE2	1.74	0.53
1:D:401:THR:HG21	1:D:417:CYS:SG	2.49	0.53
1:E:134:PRO:HA	1:E:137:TRP:CE2	2.43	0.52
1:B:436:HIS:HD1	1:B:436:HIS:H	1.57	0.52
1:F:211:ALA:HB1	1:F:219:ILE:H	1.74	0.52
1:A:67:CYS:SG	1:A:72:ASP:HB2	2.49	0.52
1:D:104:ARG:NH1	1:D:231:SER:OG	2.42	0.52
1:E:170:ASN:O	2:E:1001:SAH:H8	2.10	0.52
1:A:35:VAL:HG22	1:A:36:PRO:HD2	1.90	0.52
1:D:224:LEU:HD22	1:D:240:CYS:HB2	1.92	0.52
1:B:225:ASP:OD1	1:B:226:ILE:N	2.43	0.52
1:C:186:LEU:HD11	1:C:369:ILE:HG23	1.91	0.52
1:F:174:LEU:HB3	1:F:202:ARG:HD2	1.91	0.52
1:C:118:PRO:HG2	1:D:412:PHE:HE2	1.75	0.52
1:A:200:THR:HA	2:A:1001:SAH:HA	1.92	0.51
1:D:155:ARG:HB3	1:D:209:LEU:HD21	1.92	0.51
1:E:194:ARG:NH2	1:E:265:GLU:O	2.43	0.51
1:E:74:ASN:O	1:E:74:ASN:ND2	2.42	0.51
1:A:38:PRO:HD2	1:A:62:TYR:CD2	2.45	0.51
1:B:241:HIS:HB3	1:B:250:PHE:HB2	1.93	0.51
1:C:112:LEU:O	1:C:115:ILE:HG12	2.10	0.51
1:F:337:GLN:HG2	1:F:359:ARG:HH21	1.73	0.51
1:C:171:ALA:HB3	1:C:278:PRO:HB3	1.92	0.51
1:D:108:VAL:HG13	1:D:235:MET:HG2	1.92	0.51
1:D:378:ARG:NH2	1:D:391:ASN:O	2.43	0.51
1:C:198:VAL:HG13	1:C:275:THR:HG23	1.92	0.51
1:D:67:CYS:SG	1:D:72:ASP:HB2	2.51	0.51
1:F:48:PHE:HE2	1:F:63:ALA:HB3	1.76	0.51
1:E:273:MET:HB3	1:E:312:ILE:HG22	1.93	0.51
1:E:317:PRO:HA	1:E:358:VAL:HA	1.92	0.51
1:F:130:GLN:HA	1:F:232:GLN:HE22	1.75	0.51
1:A:317:PRO:HA	1:A:358:VAL:HA	1.93	0.51
1:E:198:VAL:HG13	1:E:275:THR:HG23	1.92	0.51
1:C:364:ILE:HD11	1:C:369:ILE:HD11	1.93	0.51
1:C:204:HIS:HB2	1:C:223:LEU:HD23	1.94	0.50

Continued on next page...

Continued from previous page...

Atom-1	Atom-2	Interatomic distance (Å)	Clash overlap (Å)
1:A:274:VAL:HG22	1:A:313:PHE:HB2	1.94	0.50
1:E:130:GLN:HA	1:E:232:GLN:HE22	1.77	0.50
1:E:108:VAL:HG11	1:E:236:GLU:HG3	1.93	0.50
1:B:317:PRO:HA	1:B:358:VAL:HA	1.94	0.50
1:E:312:ILE:HD11	1:E:331:PHE:HZ	1.77	0.50
1:B:244:MET:SD	1:B:277:PRO:HB3	2.52	0.50
1:C:207:ILE:HG21	1:C:221:SER:HB2	1.94	0.49
1:B:156:ARG:HG2	1:B:209:LEU:HD11	1.93	0.49
1:B:294:ILE:HG12	1:B:310:LEU:HD23	1.94	0.49
1:D:117:LEU:HD11	1:D:134:PRO:HD3	1.94	0.49
1:E:104:ARG:NH2	1:E:235:MET:O	2.45	0.49
1:B:131:LEU:HG	1:B:233:PHE:CE2	2.44	0.49
1:D:425:CYS:HB3	1:D:428:CYS:HB2	1.95	0.49
1:A:194:ARG:NH2	1:A:269:GLU:O	2.43	0.49
1:E:200:THR:HA	2:E:1001:SAH:HA	1.94	0.49
1:B:111:TYR:CD2	1:B:112:LEU:HD22	2.47	0.49
1:F:200:THR:HA	2:F:1001:SAH:HA	1.95	0.49
1:E:275:THR:HG21	1:E:290:PHE:CZ	2.48	0.49
1:F:48:PHE:N	1:F:61:PHE:O	2.39	0.49
1:D:275:THR:HG21	1:D:290:PHE:CZ	2.48	0.49
1:A:225:ASP:OD1	1:A:226:ILE:N	2.46	0.48
1:B:45:THR:HG21	1:B:75:PHE:CD2	2.48	0.48
1:D:404:ASP:HB3	1:D:408:TRP:HE1	1.78	0.48
1:D:277:PRO:HB2	1:D:286:LEU:HD21	1.95	0.48
1:E:310:LEU:O	1:E:363:ASN:ND2	2.39	0.48
1:E:425:CYS:SG	1:E:436:HIS:HE1	2.29	0.48
1:D:187:LEU:HD13	1:D:195:VAL:HG21	1.94	0.48
1:D:29:LEU:O	1:D:31:LEU:HD23	2.13	0.48
1:C:436:HIS:CD2	1:C:438:CYS:HB2	2.49	0.48
1:B:127:THR:HA	1:F:127:THR:HG22	1.95	0.48
1:B:339:ASP:OD1	1:B:346:TYR:OH	2.27	0.48
1:F:200:THR:HG23	2:F:1001:SAH:HA	1.96	0.48
1:E:64:CYS:SG	1:E:65:SER:N	2.87	0.47
1:D:182:PHE:CE1	1:D:372:PRO:HD3	2.49	0.47
1:A:114:PHE:HD2	1:A:154:LEU:HD11	1.78	0.47
1:F:187:LEU:HD22	1:F:272:ILE:HG21	1.95	0.47
1:C:343:HIS:HE1	1:C:358:VAL:HG21	1.77	0.47
1:A:114:PHE:CZ	1:A:122:ARG:HB3	2.49	0.47
1:B:158:SER:HB2	1:B:174:LEU:HD13	1.96	0.47
1:B:194:ARG:HH12	1:B:271:ILE:HD11	1.77	0.47
1:C:414:CYS:SG	1:C:424:HIS:CE1	3.07	0.47

Continued on next page...

Continued from previous page...

Atom-1	Atom-2	Interatomic distance (Å)	Clash overlap (Å)
1:E:59:ARG:HD3	1:E:78:TRP:CE3	2.50	0.47
1:F:346:TYR:CZ	1:F:356:SER:HB3	2.50	0.47
1:A:234:TYR:HB3	1:A:238:SER:HB2	1.95	0.47
1:B:316:PHE:CG	1:B:317:PRO:HD2	2.50	0.47
1:D:310:LEU:HD12	1:D:311:PRO:HD2	1.97	0.47
1:F:204:HIS:CE1	1:F:223:LEU:HB2	2.50	0.47
1:A:346:TYR:CZ	1:A:356:SER:HB3	2.50	0.47
1:B:258:VAL:O	1:B:262:PHE:HB2	2.15	0.47
1:B:289:THR:HA	1:B:292:LYS:HD3	1.95	0.47
1:B:320:PHE:HD1	1:B:323:ARG:HD3	1.80	0.47
1:C:337:GLN:HB3	1:C:356:SER:OG	2.15	0.47
1:E:307:HIS:CE1	1:E:308:LYS:HG3	2.50	0.47
1:C:438:CYS:SG	1:C:439:GLU:N	2.88	0.47
1:B:144:GLN:HB2	1:F:162:TYR:CD2	2.50	0.47
1:F:211:ALA:CB	1:F:219:ILE:H	2.28	0.47
1:F:316:PHE:CG	1:F:317:PRO:HD2	2.50	0.47
1:A:174:LEU:HB3	1:A:202:ARG:HD2	1.96	0.46
1:A:48:PHE:HB2	1:A:61:PHE:CZ	2.50	0.46
1:C:331:PHE:CE1	1:C:363:ASN:HB3	2.49	0.46
1:D:38:PRO:HD2	1:D:62:TYR:CD1	2.49	0.46
1:E:193:ARG:NH1	1:E:266:ASP:OD2	2.48	0.46
1:A:134:PRO:HA	1:A:137:TRP:CE2	2.50	0.46
1:A:198:VAL:HG22	1:A:224:LEU:HD22	1.96	0.46
1:C:45:THR:HG21	1:C:75:PHE:CE2	2.50	0.46
1:E:151:ILE:HD12	1:E:152:THR:N	2.31	0.46
1:B:257:GLU:OE2	1:B:260:ARG:NH2	2.46	0.46
1:B:333:MET:HB2	1:B:361:PHE:CE1	2.51	0.46
1:D:194:ARG:HB3	1:D:262:PHE:CZ	2.51	0.46
1:D:187:LEU:HD22	1:D:272:ILE:HG21	1.97	0.46
1:E:331:PHE:CE1	1:E:363:ASN:HB3	2.51	0.46
1:F:348:HIS:HB3	1:F:353:ARG:CB	2.46	0.46
1:B:201:PRO:O	1:B:205:GLU:HG3	2.15	0.46
1:A:393:HIS:HA	1:A:400:CYS:HA	1.97	0.46
1:B:334:LEU:HD21	1:B:360:ILE:HB	1.98	0.46
1:D:40:CYS:SG	1:D:42:HIS:HB2	2.56	0.46
1:E:428:CYS:HB3	1:E:430:HIS:CE1	2.50	0.46
1:F:126:GLN:HE21	1:F:146:LEU:HB2	1.81	0.46
1:F:162:TYR:O	1:F:229:ARG:NH1	2.49	0.46
1:F:127:THR:OG1	1:F:143:HIS:HB3	2.16	0.46
1:D:380:CYS:SG	1:D:382:PRO:HD2	2.56	0.45
1:B:242:TYR:OH	1:B:247:HIS:ND1	2.32	0.45

Continued on next page...

Continued from previous page...

Atom-1	Atom-2	Interatomic distance (Å)	Clash overlap (Å)
1:D:338:VAL:HG23	1:D:358:VAL:HB	1.98	0.45
1:E:68:ARG:CG	1:E:281:GLY:HA2	2.45	0.45
1:F:92:GLU:O	1:F:96:ARG:N	2.48	0.45
1:C:199:GLY:O	2:C:1001:SAH:HB1	2.15	0.45
1:D:68:ARG:NE	1:D:168:ALA:O	2.49	0.45
1:E:194:ARG:O	1:E:271:ILE:HA	2.16	0.45
1:E:45:THR:HG21	1:E:75:PHE:CD2	2.51	0.45
1:C:359:ARG:NH2	1:C:403:LYS:O	2.50	0.45
1:D:134:PRO:HA	1:D:137:TRP:CE2	2.52	0.45
1:C:170:ASN:O	2:C:1001:SAH:H8	2.16	0.45
1:F:381:SER:OG	1:F:382:PRO:HD3	2.16	0.45
1:B:371:LEU:HD23	1:B:377:TYR:CD2	2.52	0.45
1:C:114:PHE:CD2	1:C:154:LEU:HD11	2.49	0.45
1:E:182:PHE:CE1	1:E:372:PRO:HD3	2.51	0.45
1:F:275:THR:HG21	1:F:290:PHE:CZ	2.51	0.45
1:D:174:LEU:HD13	1:D:202:ARG:NH1	2.31	0.45
1:B:162:TYR:CD2	1:F:144:GLN:HB2	2.52	0.45
1:F:433:VAL:HG22	1:F:435:ASP:H	1.81	0.45
1:A:171:ALA:HB3	1:A:278:PRO:HB3	1.98	0.45
1:C:122:ARG:HD2	1:C:149:VAL:O	2.17	0.45
1:D:127:THR:HG23	1:D:144:GLN:HB3	1.97	0.45
1:A:114:PHE:CD2	1:A:154:LEU:HD11	2.51	0.45
1:F:254:THR:O	1:F:258:VAL:HG23	2.16	0.45
1:F:339:ASP:OD1	1:F:346:TYR:OH	2.35	0.45
1:B:320:PHE:CD1	1:B:323:ARG:HD3	2.51	0.45
1:D:123:LYS:O	1:D:132:LEU:HB2	2.16	0.45
1:D:194:ARG:NH1	1:D:265:GLU:O	2.50	0.45
1:D:74:ASN:ND2	1:D:74:ASN:O	2.50	0.45
1:E:364:ILE:HD11	1:E:369:ILE:HD11	1.99	0.44
1:C:170:ASN:HA	2:C:1001:SAH:H8	1.99	0.44
1:E:340:TYR:CD2	1:E:343:HIS:HD2	2.35	0.44
1:F:100:PRO:HB3	1:F:228:PHE:HD2	1.83	0.44
1:C:433:VAL:HG12	1:C:434:PRO:HD2	1.99	0.44
1:D:263:LEU:HD23	1:D:271:ILE:HD13	2.00	0.44
1:F:384:GLN:HA	1:F:384:GLN:OE1	2.17	0.44
1:C:285:PRO:HA	1:C:288:ILE:HB	1.99	0.44
1:D:47:LEU:HD13	1:D:62:TYR:CZ	2.53	0.44
1:A:263:LEU:HA	1:A:271:ILE:CD1	2.48	0.44
1:B:172:GLN:OE1	1:B:229:ARG:NH2	2.51	0.44
1:C:279:PHE:HE2	1:C:343:HIS:NE2	2.16	0.44
1:E:186:LEU:HD11	1:E:369:ILE:HG23	2.00	0.44

Continued on next page...

Continued from previous page...

Atom-1	Atom-2	Interatomic distance (Å)	Clash overlap (Å)
1:B:169:THR:HG23	1:B:170:ASN:H	1.83	0.44
1:C:154:LEU:HD23	1:C:154:LEU:HA	1.84	0.44
1:D:275:THR:HG21	1:D:290:PHE:HZ	1.82	0.44
1:A:263:LEU:HD23	1:A:271:ILE:CD1	2.48	0.44
1:E:30:PRO:HB3	1:E:47:LEU:O	2.17	0.44
1:F:310:LEU:HD12	1:F:311:PRO:HD2	1.99	0.44
1:A:422:TRP:NE1	1:A:433:VAL:HG22	2.33	0.44
1:B:132:LEU:HD21	1:B:140:HIS:CG	2.53	0.44
1:C:371:LEU:HD23	1:C:377:TYR:CD1	2.53	0.44
1:D:114:PHE:CE2	1:D:154:LEU:HD11	2.53	0.44
1:B:425:CYS:CB	1:B:436:HIS:NE2	2.81	0.43
1:D:371:LEU:HD23	1:D:377:TYR:CD2	2.52	0.43
1:B:156:ARG:HE	1:B:156:ARG:HB3	1.68	0.43
1:D:150:SER:OG	1:D:153:GLN:HG3	2.19	0.43
1:A:371:LEU:HD13	1:A:386:TYR:HB2	1.99	0.43
1:C:331:PHE:HE1	1:C:363:ASN:HB3	1.83	0.43
1:D:60:ARG:HD2	1:D:79:GLU:OE2	2.19	0.43
1:E:76:PHE:HE2	1:E:78:TRP:CE2	2.35	0.43
1:E:113:LYS:O	1:E:117:LEU:HG	2.19	0.43
1:F:226:ILE:HG22	2:F:1001:SAH:C4	2.48	0.43
1:C:331:PHE:HA	1:C:362:THR:O	2.19	0.43
1:F:223:LEU:HD12	1:F:239:PHE:HD2	1.83	0.43
1:C:254:THR:O	1:C:258:VAL:HG23	2.18	0.43
1:D:174:LEU:HB3	1:D:202:ARG:HD2	2.00	0.43
1:C:247:HIS:HE1	1:C:293:LEU:HD12	1.83	0.43
1:B:114:PHE:CZ	1:B:131:LEU:HD22	2.53	0.42
1:C:151:ILE:HA	1:C:154:LEU:HB2	2.01	0.42
1:D:242:TYR:OH	1:D:247:HIS:ND1	2.32	0.42
1:A:47:LEU:HB3	1:D:29:LEU:HD12	2.01	0.42
1:C:64:CYS:SG	1:C:65:SER:N	2.92	0.42
1:E:334:LEU:HD12	1:E:360:ILE:HB	2.00	0.42
1:B:119:LEU:HA	1:B:119:LEU:HD23	1.88	0.42
1:B:194:ARG:HG2	1:B:262:PHE:CZ	2.54	0.42
1:C:411:CYS:HB2	1:C:414:CYS:SG	2.59	0.42
1:D:30:PRO:O	1:D:60:ARG:NH2	2.24	0.42
1:D:131:LEU:HD21	1:D:233:PHE:CE1	2.54	0.42
1:D:192:PHE:CE1	1:D:272:ILE:HB	2.54	0.42
1:A:282:LEU:HD13	1:D:28:VAL:HG11	2.01	0.42
1:D:288:ILE:O	1:D:292:LYS:HG3	2.19	0.42
1:A:174:LEU:HA	2:A:1001:SAH:OXT	2.19	0.42
1:A:263:LEU:HD23	1:A:271:ILE:HD11	2.01	0.42

Continued on next page...

Continued from previous page...

Atom-1	Atom-2	Interatomic distance (Å)	Clash overlap (Å)
1:C:204:HIS:CE1	1:C:223:LEU:HB2	2.55	0.42
1:D:40:CYS:C	1:D:42:HIS:H	2.23	0.42
1:F:100:PRO:HB3	1:F:228:PHE:CD2	2.54	0.42
1:A:276:ASP:O	2:A:1001:SAH:H5'2	2.20	0.42
1:A:294:ILE:HD11	1:A:312:ILE:HD11	2.00	0.42
1:F:40:CYS:HB3	1:F:45:THR:HG22	2.02	0.42
1:A:254:THR:O	1:A:258:VAL:HG23	2.19	0.42
1:A:175:PHE:HE1	1:A:338:VAL:HG11	1.85	0.42
1:C:334:LEU:HD11	1:C:369:ILE:HD12	2.02	0.42
1:D:131:LEU:H	1:D:232:GLN:NE2	2.18	0.42
1:F:112:LEU:O	1:F:115:ILE:HG12	2.19	0.42
1:A:196:LEU:HD11	1:A:224:LEU:HD13	2.02	0.42
1:A:49:VAL:CG2	1:A:60:ARG:HD3	2.49	0.42
1:A:29:LEU:C	1:A:31:LEU:N	2.73	0.42
1:B:363:ASN:OD1	1:B:364:ILE:N	2.52	0.42
1:C:172:GLN:HA	2:C:1001:SAH:SD	2.60	0.42
1:C:310:LEU:HD23	1:C:312:ILE:HD11	2.02	0.42
1:E:320:PHE:CD1	1:E:323:ARG:HD2	2.50	0.42
1:F:273:MET:HB2	1:F:273:MET:HE2	1.90	0.42
1:A:263:LEU:HA	1:A:271:ILE:HD13	2.01	0.42
1:A:224:LEU:HD23	1:A:242:TYR:CD2	2.55	0.41
1:C:127:THR:HA	1:E:127:THR:HG22	2.01	0.41
1:F:142:GLU:N	1:F:142:GLU:OE1	2.53	0.41
1:B:381:SER:N	1:B:382:PRO:HD2	2.35	0.41
1:C:414:CYS:SG	1:C:424:HIS:HE1	2.43	0.41
1:D:48:PHE:CE1	1:D:63:ALA:HB3	2.55	0.41
1:E:276:ASP:O	2:E:1001:SAH:H5'2	2.20	0.41
1:E:40:CYS:HB3	1:E:45:THR:CG2	2.50	0.41
1:A:130:GLN:HA	1:A:232:GLN:HE22	1.85	0.41
1:C:335:ASP:OD2	1:C:391:ASN:ND2	2.53	0.41
1:D:226:ILE:HB	2:D:1001:SAH:C2	2.50	0.41
1:C:144:GLN:HB2	1:E:162:TYR:CD2	2.55	0.41
1:E:105:THR:O	1:E:109:GLU:HG3	2.20	0.41
1:A:194:ARG:NH1	1:A:265:GLU:HB3	2.35	0.41
1:C:108:VAL:HG12	1:C:235:MET:HA	2.02	0.41
1:E:254:THR:O	1:E:258:VAL:HG23	2.21	0.41
1:A:422:TRP:CD1	1:A:433:VAL:HG22	2.55	0.41
1:E:318:TYR:HB3	1:E:359:ARG:HD2	2.02	0.41
1:E:32:ASP:HA	1:E:33:PRO:HD3	1.96	0.41
1:F:190:LEU:HD23	1:F:192:PHE:HE2	1.85	0.41
1:F:226:ILE:O	1:F:228:PHE:N	2.54	0.41

Continued on next page...

Continued from previous page...

Atom-1	Atom-2	Interatomic distance (Å)	Clash overlap (Å)
1:F:263:LEU:HA	1:F:271:ILE:HD13	2.02	0.41
1:B:187:LEU:HD22	1:B:272:ILE:HG21	2.03	0.41
1:E:273:MET:HB2	1:E:273:MET:HE2	1.88	0.41
1:C:201:PRO:O	1:C:205:GLU:HG3	2.21	0.41
1:E:204:HIS:CG	1:E:223:LEU:HB2	2.56	0.41
1:A:169:THR:HG23	1:A:170:ASN:H	1.85	0.41
1:E:291:LYS:HA	1:E:294:ILE:HG22	2.03	0.41
1:E:315:ILE:HG12	1:E:360:ILE:HG12	2.03	0.41
1:F:401:THR:HG21	1:F:417:CYS:HB2	2.03	0.41
1:A:305:ASP:O	1:A:308:LYS:NZ	2.54	0.41
1:B:268:GLY:HA2	1:B:297:TRP:HE1	1.86	0.41
1:B:45:THR:HB	1:B:63:ALA:O	2.20	0.41
1:B:379:PHE:HB2	1:B:386:TYR:CZ	2.56	0.41
1:D:316:PHE:CG	1:D:317:PRO:HD2	2.56	0.41
1:F:204:HIS:CG	1:F:223:LEU:HB2	2.55	0.41
1:F:338:VAL:HG23	1:F:358:VAL:HB	2.02	0.41
1:C:241:HIS:HB3	1:C:250:PHE:HB2	2.03	0.40
1:D:224:LEU:CD2	1:D:240:CYS:HB2	2.51	0.40
1:C:343:HIS:CE1	1:C:358:VAL:HG21	2.54	0.40
1:F:169:THR:OG1	1:F:170:ASN:N	2.54	0.40
1:F:173:TYR:HB3	1:F:342:ASN:O	2.22	0.40
1:B:345:LEU:HD23	1:B:357:PRO:HG2	2.03	0.40
1:C:156:ARG:HD3	1:C:159:GLN:OE1	2.21	0.40
1:E:197:CYS:O	1:E:223:LEU:HA	2.21	0.40
1:A:201:PRO:O	1:A:204:HIS:HB3	2.21	0.40
1:D:198:VAL:HG22	1:D:224:LEU:HD12	2.03	0.40
1:E:119:LEU:O	1:E:148:ASN:HA	2.21	0.40

There are no symmetry-related clashes.

5.3 Torsion angles [i](#)

5.3.1 Protein backbone [i](#)

In the following table, the Percentiles column shows the percent Ramachandran outliers of the chain as a percentile score with respect to all X-ray entries followed by that with respect to entries of similar resolution.

The Analysed column shows the number of residues for which the backbone conformation was analysed, and the total number of residues.

Mol	Chain	Analysed	Favoured	Allowed	Outliers	Percentiles	
1	A	413/442 (93%)	393 (95%)	17 (4%)	3 (1%)	22	57
1	B	389/442 (88%)	370 (95%)	16 (4%)	3 (1%)	19	54
1	C	381/442 (86%)	358 (94%)	20 (5%)	3 (1%)	19	54
1	D	414/442 (94%)	391 (94%)	23 (6%)	0	100	100
1	E	396/442 (90%)	368 (93%)	27 (7%)	1 (0%)	41	73
1	F	390/442 (88%)	367 (94%)	21 (5%)	2 (0%)	29	64
All	All	2383/2652 (90%)	2247 (94%)	124 (5%)	12 (0%)	29	64

All (12) Ramachandran outliers are listed below:

Mol	Chain	Res	Type
1	A	384[A]	GLN
1	A	384[B]	GLN
1	B	30	PRO
1	F	217	SER
1	B	36	PRO
1	B	382	PRO
1	A	115	ILE
1	E	30	PRO
1	C	357	PRO
1	C	427	ILE
1	F	38	PRO
1	C	101	PRO

5.3.2 Protein sidechains [i](#)

In the following table, the Percentiles column shows the percent sidechain outliers of the chain as a percentile score with respect to all X-ray entries followed by that with respect to entries of similar resolution.

The Analysed column shows the number of residues for which the sidechain conformation was analysed, and the total number of residues.

Mol	Chain	Analysed	Rotameric	Outliers	Percentiles	
1	A	341/396 (86%)	333 (98%)	8 (2%)	50	77
1	B	291/396 (74%)	283 (97%)	8 (3%)	44	74
1	C	288/396 (73%)	280 (97%)	8 (3%)	43	73
1	D	349/396 (88%)	346 (99%)	3 (1%)	78	91
1	E	314/396 (79%)	306 (98%)	8 (2%)	47	75

Continued on next page...

Continued from previous page...

Mol	Chain	Analysed	Rotameric	Outliers	Percentiles
1	F	298/396 (75%)	290 (97%)	8 (3%)	44 74
All	All	1881/2376 (79%)	1838 (98%)	43 (2%)	50 77

All (43) residues with a non-rotameric sidechain are listed below:

Mol	Chain	Res	Type
1	A	40	CYS
1	A	68	ARG
1	A	237	ASP
1	A	266	ASP
1	A	279	PHE
1	A	316	PHE
1	A	348	HIS
1	A	383	CYS
1	B	40	CYS
1	B	111	TYR
1	B	155	ARG
1	B	233	PHE
1	B	241	HIS
1	B	303	GLN
1	B	316	PHE
1	B	334	LEU
1	C	40	CYS
1	C	180	CYS
1	C	246	ASN
1	C	316	PHE
1	C	339	ASP
1	C	378	ARG
1	C	394	CYS
1	C	438	CYS
1	D	31	LEU
1	D	40	CYS
1	D	316	PHE
1	E	74	ASN
1	E	98	CYS
1	E	235	MET
1	E	241	HIS
1	E	316	PHE
1	E	359	ARG
1	E	380	CYS
1	E	383	CYS
1	F	40	CYS

Continued on next page...

Continued from previous page...

Mol	Chain	Res	Type
1	F	96	ARG
1	F	228	PHE
1	F	241	HIS
1	F	269	GLU
1	F	316	PHE
1	F	359	ARG
1	F	397	CYS

Some sidechains can be flipped to improve hydrogen bonding and reduce clashes. All (4) such sidechains are listed below:

Mol	Chain	Res	Type
1	B	166	ASN
1	E	126	GLN
1	F	264	GLN
1	F	355	GLN

5.3.3 RNA [i](#)

There are no RNA molecules in this entry.

5.4 Non-standard residues in protein, DNA, RNA chains [i](#)

There are no non-standard protein/DNA/RNA residues in this entry.

5.5 Carbohydrates [i](#)

There are no carbohydrates in this entry.

5.6 Ligand geometry [i](#)

Of 42 ligands modelled in this entry, 36 are monoatomic - leaving 6 for Mogul analysis.

In the following table, the Counts columns list the number of bonds (or angles) for which Mogul statistics could be retrieved, the number of bonds (or angles) that are observed in the model and the number of bonds (or angles) that are defined in the Chemical Component Dictionary. The Link column lists molecule types, if any, to which the group is linked. The Z score for a bond length (or angle) is the number of standard deviations the observed value is removed from the expected value. A bond length (or angle) with $|Z| > 2$ is considered an outlier worth inspection. RMSZ is the root-mean-square of all Z scores of the bond lengths (or angles).

Mol	Type	Chain	Res	Link	Bond lengths			Bond angles		
					Counts	RMSZ	# Z > 2	Counts	RMSZ	# Z > 2
2	SAH	D	1001	-	21,28,28	1.12	2 (9%)	20,40,40	1.87	3 (15%)
2	SAH	F	1001	-	21,28,28	1.11	2 (9%)	20,40,40	1.84	3 (15%)
2	SAH	B	1001	-	21,28,28	1.17	2 (9%)	20,40,40	1.72	2 (10%)
2	SAH	E	1001	-	21,28,28	1.16	2 (9%)	20,40,40	1.71	2 (10%)
2	SAH	C	1001	-	21,28,28	1.17	2 (9%)	20,40,40	1.75	2 (10%)
2	SAH	A	1001	-	21,28,28	1.13	2 (9%)	20,40,40	1.72	2 (10%)

In the following table, the Chirals column lists the number of chiral outliers, the number of chiral centers analysed, the number of these observed in the model and the number defined in the Chemical Component Dictionary. Similar counts are reported in the Torsion and Rings columns. '-' means no outliers of that kind were identified.

Mol	Type	Chain	Res	Link	Chirals	Torsions	Rings
2	SAH	D	1001	-	-	2/7/31/31	0/3/3/3
2	SAH	F	1001	-	-	2/7/31/31	0/3/3/3
2	SAH	B	1001	-	-	4/7/31/31	0/3/3/3
2	SAH	E	1001	-	-	2/7/31/31	0/3/3/3
2	SAH	C	1001	-	-	3/7/31/31	0/3/3/3
2	SAH	A	1001	-	-	2/7/31/31	0/3/3/3

All (12) bond length outliers are listed below:

Mol	Chain	Res	Type	Atoms	Z	Observed(Å)	Ideal(Å)
2	C	1001	SAH	C2-N3	3.88	1.38	1.32
2	E	1001	SAH	C2-N3	3.79	1.38	1.32
2	B	1001	SAH	C2-N3	3.77	1.38	1.32
2	A	1001	SAH	C2-N3	3.57	1.37	1.32
2	F	1001	SAH	C2-N3	3.45	1.37	1.32
2	D	1001	SAH	C2-N3	3.43	1.37	1.32
2	C	1001	SAH	C2-N1	2.40	1.38	1.33
2	B	1001	SAH	C2-N1	2.39	1.38	1.33
2	E	1001	SAH	C2-N1	2.38	1.38	1.33
2	F	1001	SAH	C2-N1	2.37	1.38	1.33
2	A	1001	SAH	C2-N1	2.29	1.38	1.33
2	D	1001	SAH	C2-N1	2.20	1.38	1.33

All (14) bond angle outliers are listed below:

Mol	Chain	Res	Type	Atoms	Z	Observed(°)	Ideal(°)
2	D	1001	SAH	N3-C2-N1	-6.01	119.29	128.68
2	F	1001	SAH	N3-C2-N1	-5.71	119.75	128.68
2	B	1001	SAH	N3-C2-N1	-5.65	119.85	128.68
2	C	1001	SAH	N3-C2-N1	-5.60	119.92	128.68
2	E	1001	SAH	N3-C2-N1	-5.56	119.98	128.68
2	A	1001	SAH	N3-C2-N1	-5.48	120.12	128.68
2	F	1001	SAH	C5'-SD-CG	-3.81	90.84	102.27
2	C	1001	SAH	C5'-SD-CG	-3.65	91.31	102.27
2	D	1001	SAH	C5'-SD-CG	-3.63	91.38	102.27
2	A	1001	SAH	C5'-SD-CG	-3.54	91.64	102.27
2	E	1001	SAH	C5'-SD-CG	-3.49	91.78	102.27
2	B	1001	SAH	C5'-SD-CG	-3.06	93.07	102.27
2	D	1001	SAH	C1'-N9-C4	-2.20	122.77	126.64
2	F	1001	SAH	C3'-C2'-C1'	2.00	104.00	100.98

There are no chirality outliers.

All (15) torsion outliers are listed below:

Mol	Chain	Res	Type	Atoms
2	E	1001	SAH	N-CA-CB-CG
2	E	1001	SAH	C-CA-CB-CG
2	B	1001	SAH	N-CA-CB-CG
2	B	1001	SAH	C-CA-CB-CG
2	B	1001	SAH	O4'-C4'-C5'-SD
2	B	1001	SAH	C3'-C4'-C5'-SD
2	C	1001	SAH	N-CA-CB-CG
2	C	1001	SAH	C-CA-CB-CG
2	D	1001	SAH	N-CA-CB-CG
2	D	1001	SAH	C-CA-CB-CG
2	A	1001	SAH	N-CA-CB-CG
2	F	1001	SAH	N-CA-CB-CG
2	F	1001	SAH	C-CA-CB-CG
2	C	1001	SAH	CA-CB-CG-SD
2	A	1001	SAH	C-CA-CB-CG

There are no ring outliers.

6 monomers are involved in 24 short contacts:

Mol	Chain	Res	Type	Clashes	Symm-Clashes
2	D	1001	SAH	3	0
2	F	1001	SAH	5	0
2	B	1001	SAH	3	0

Continued on next page...

Continued from previous page...

Mol	Chain	Res	Type	Clashes	Symm-Clashes
2	E	1001	SAH	4	0
2	C	1001	SAH	5	0
2	A	1001	SAH	4	0

The following is a two-dimensional graphical depiction of Mogul quality analysis of bond lengths, bond angles, torsion angles, and ring geometry for all instances of the Ligand of Interest. In addition, ligands with molecular weight > 250 and outliers as shown on the validation Tables will also be included. For torsion angles, if less than 5% of the Mogul distribution of torsion angles is within 10 degrees of the torsion angle in question, then that torsion angle is considered an outlier. Any bond that is central to one or more torsion angles identified as an outlier by Mogul will be highlighted in the graph. For rings, the root-mean-square deviation (RMSD) between the ring in question and similar rings identified by Mogul is calculated over all ring torsion angles. If the average RMSD is greater than 60 degrees and the minimal RMSD between the ring in question and any Mogul-identified rings is also greater than 60 degrees, then that ring is considered an outlier. The outliers are highlighted in purple. The color gray indicates Mogul did not find sufficient equivalents in the CSD to analyse the geometry.

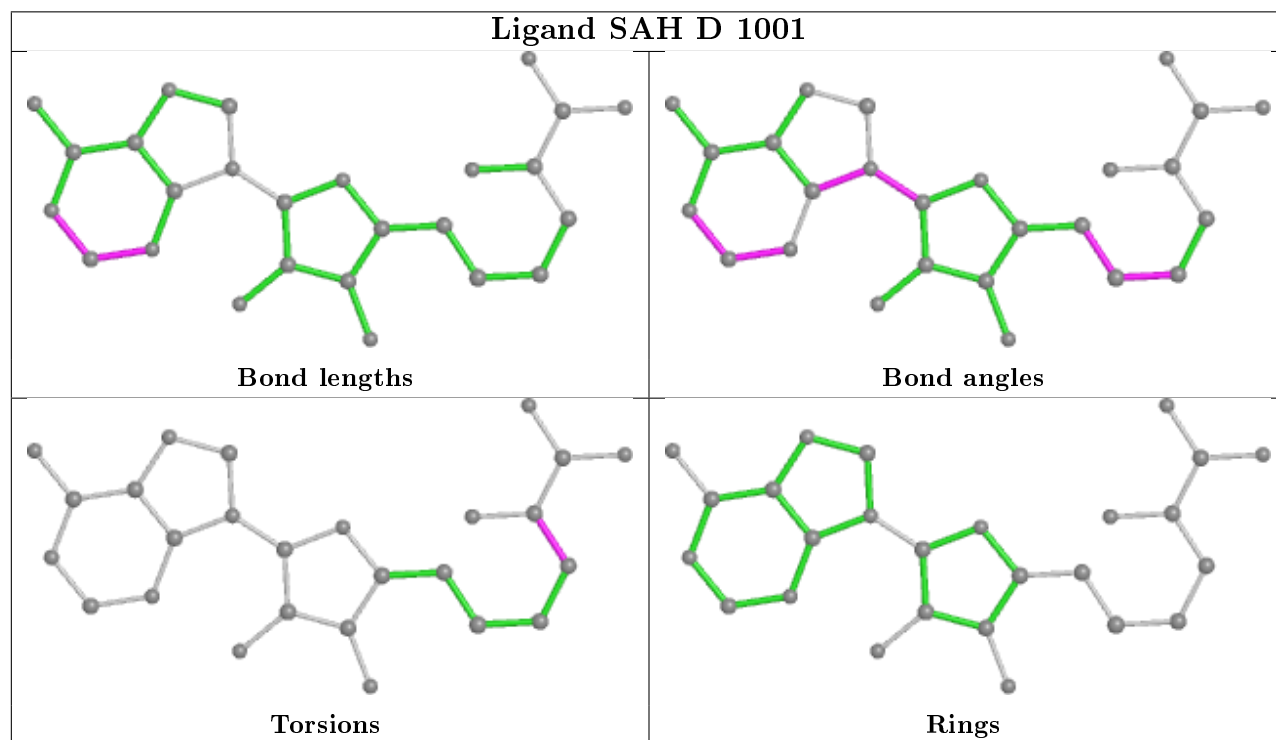

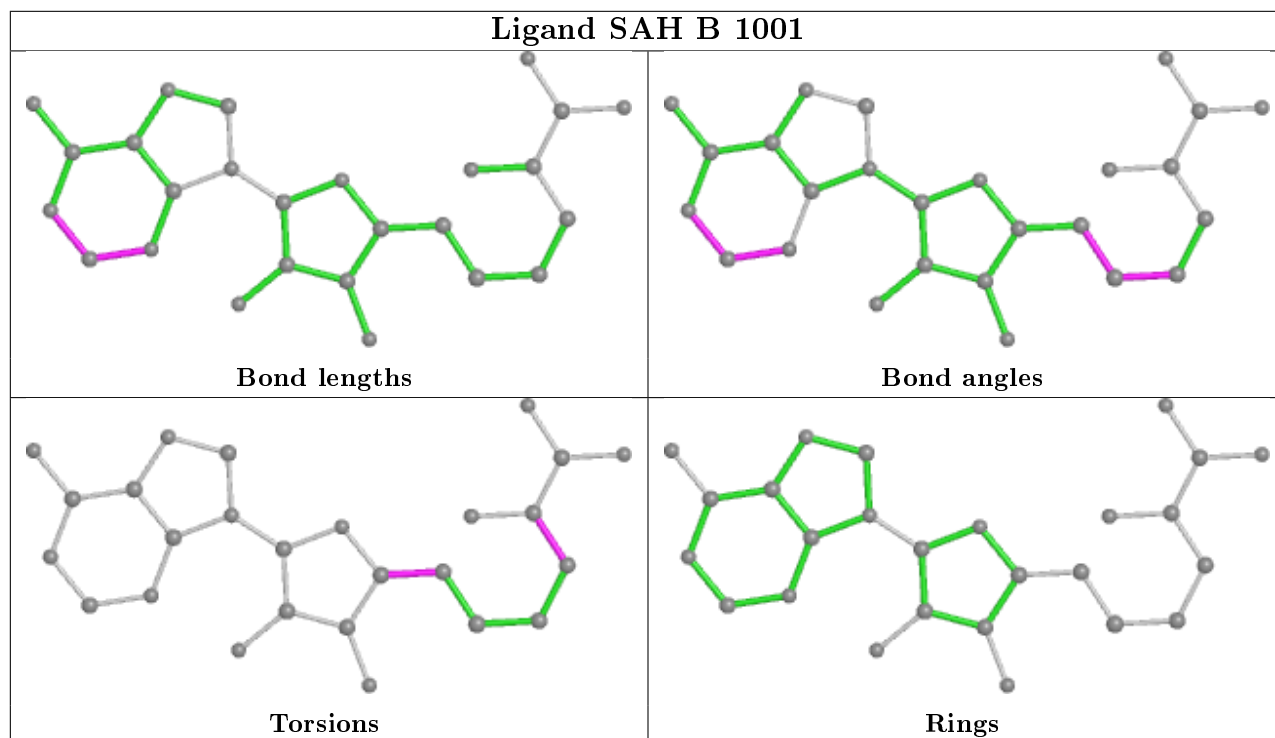
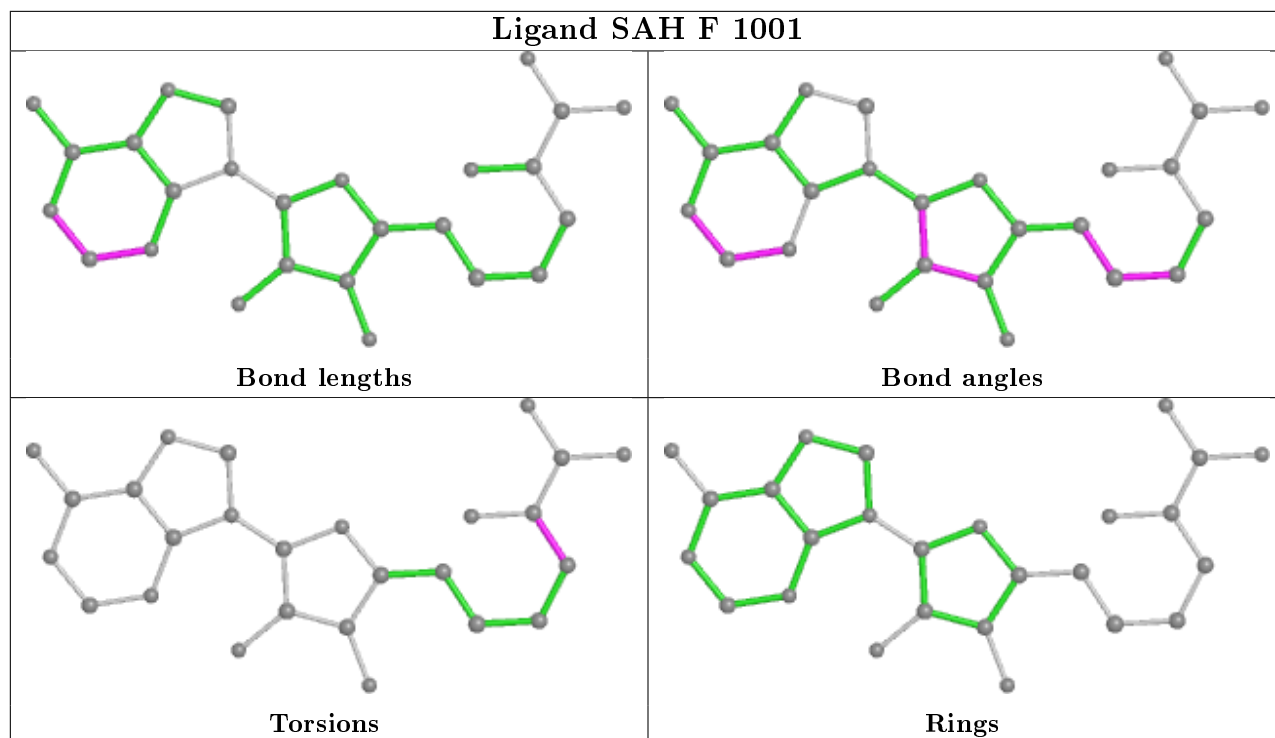

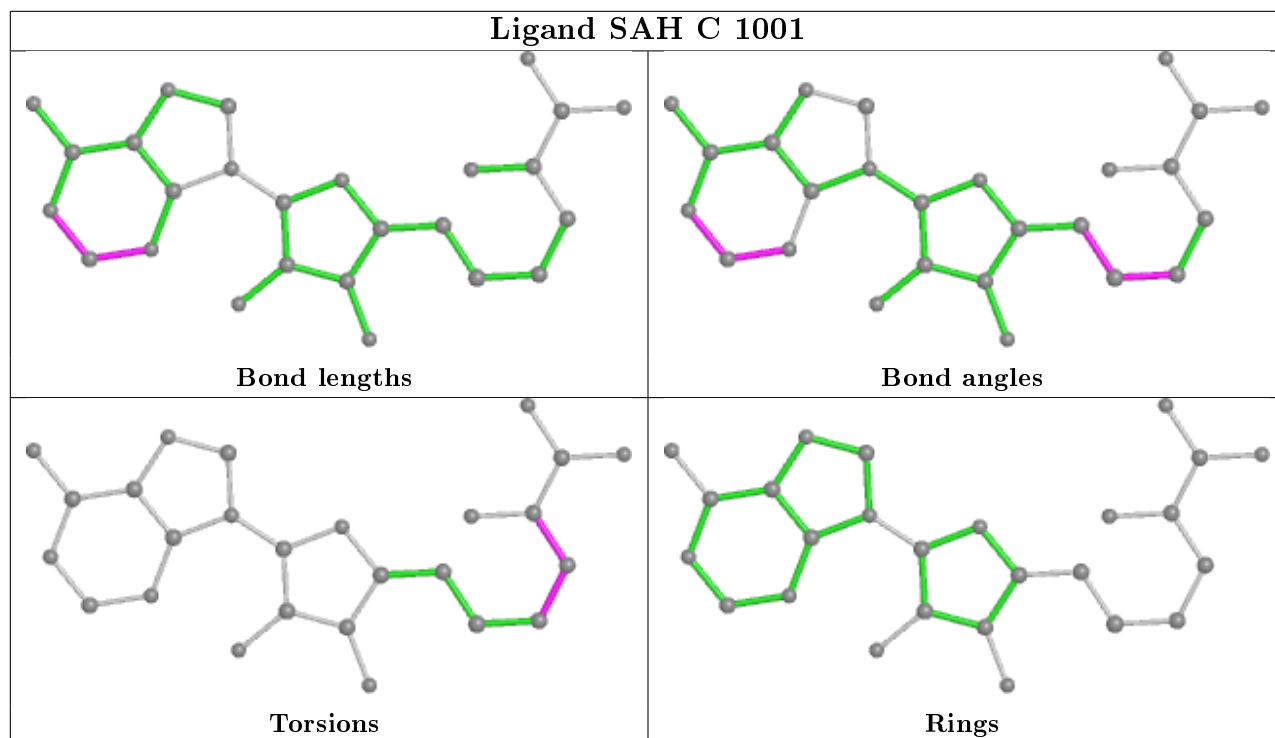
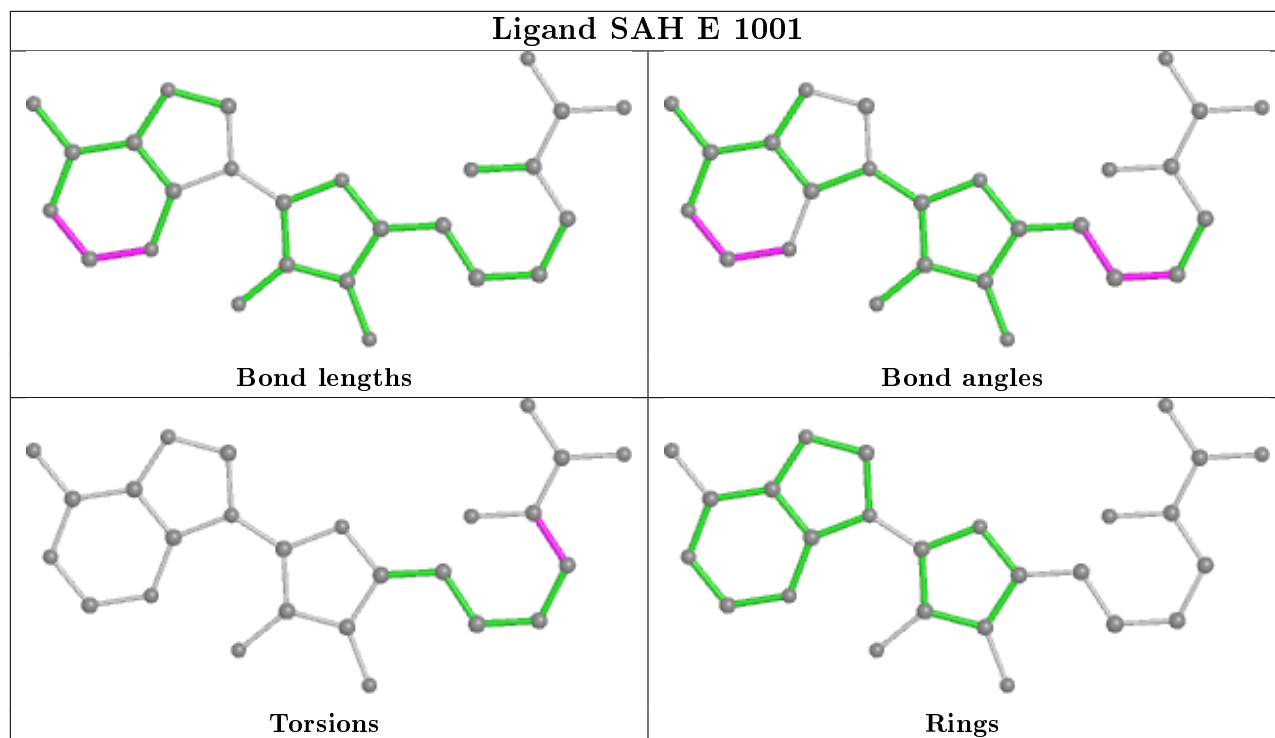

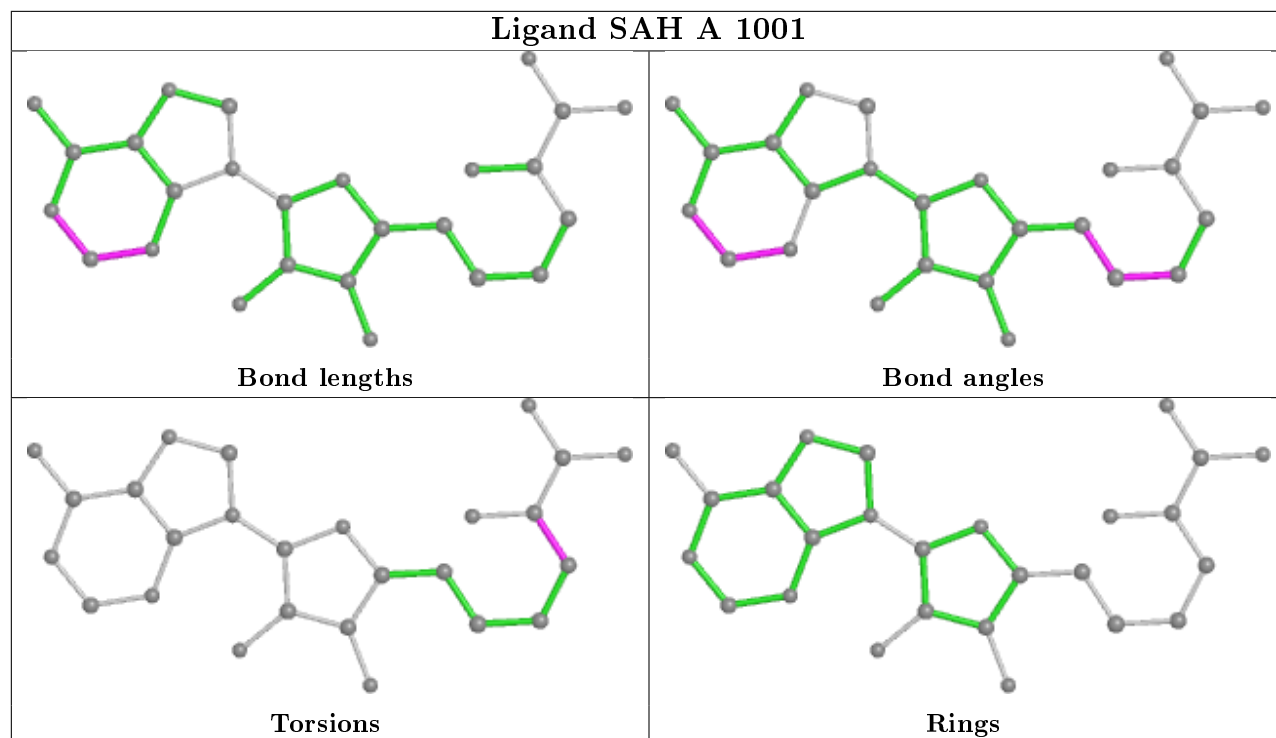

5.7 Other polymers [i](#)

There are no such residues in this entry.

5.8 Polymer linkage issues [i](#)

There are no chain breaks in this entry.

6 Fit of model and data

6.1 Protein, DNA and RNA chains

In the following table, the column labelled ‘#RSRZ> 2’ contains the number (and percentage) of RSRZ outliers, followed by percent RSRZ outliers for the chain as percentile scores relative to all X-ray entries and entries of similar resolution. The OWAB column contains the minimum, median, 95th percentile and maximum values of the occupancy-weighted average B-factor per residue. The column labelled ‘Q< 0.9’ lists the number of (and percentage) of residues with an average occupancy less than 0.9.

Mol	Chain	Analysed	<RSRZ>	#RSRZ>2	OWAB(Å ²)	Q<0.9
1	A	413/442 (93%)	-0.00	13 (3%) 49 26	40, 73, 149, 199	0
1	B	393/442 (88%)	0.70	53 (13%) 3 1	68, 127, 196, 235	0
1	C	387/442 (87%)	0.48	46 (11%) 4 2	51, 122, 206, 262	0
1	D	416/442 (94%)	-0.02	14 (3%) 45 24	40, 73, 134, 171	0
1	E	402/442 (90%)	0.31	30 (7%) 14 5	67, 118, 166, 205	0
1	F	398/442 (90%)	0.40	39 (9%) 7 2	53, 120, 189, 226	0
All	All	2409/2652 (90%)	0.31	195 (8%) 12 5	40, 105, 181, 262	0

All (195) RSRZ outliers are listed below:

Mol	Chain	Res	Type	RSRZ
1	F	58	THR	9.7
1	C	306	SER	9.3
1	E	405	GLY	8.0
1	B	281	GLY	8.0
1	B	36	PRO	7.7
1	C	415	LYS	6.9
1	D	27	VAL	6.8
1	A	57	ALA	6.7
1	B	312	ILE	6.1
1	C	438	CYS	5.9
1	D	214	ASP	5.3
1	A	50	LYS	5.2
1	C	431	CYS	5.2
1	C	293	LEU	5.1
1	E	213	GLY	5.1
1	A	351	THR	5.0
1	E	376	GLY	5.0
1	F	63	ALA	4.9
1	B	30	PRO	4.8

Continued on next page...

Continued from previous page...

Mol	Chain	Res	Type	RSRZ
1	B	304	ASP	4.8
1	D	50	LYS	4.7
1	C	362	THR	4.6
1	E	58	THR	4.6
1	E	368	LYS	4.6
1	C	298	LYS	4.5
1	C	440	GLY	4.4
1	B	293	LEU	4.4
1	C	432	ALA	4.4
1	E	302	SER	4.3
1	C	313	PHE	4.3
1	C	312	ILE	4.3
1	C	281	GLY	4.3
1	B	307	HIS	4.2
1	E	307	HIS	4.2
1	E	308	LYS	4.0
1	B	32	ASP	4.0
1	F	307	HIS	4.0
1	B	303	GLN	4.0
1	F	216	LYS	4.0
1	F	397	CYS	3.9
1	C	434	PRO	3.9
1	C	214	ASP	3.9
1	B	35	VAL	3.9
1	B	84	SER	3.9
1	C	426	SER	3.8
1	F	372	PRO	3.8
1	B	135	ASP	3.8
1	B	305	ASP	3.8
1	A	59	ARG	3.7
1	A	28	VAL	3.7
1	C	428	CYS	3.7
1	B	28	VAL	3.7
1	F	88	LEU	3.7
1	F	384	GLN	3.6
1	C	437	SER	3.6
1	F	84	SER	3.6
1	F	312	ILE	3.6
1	F	370	ILE	3.6
1	F	86	ALA	3.6
1	B	150	SER	3.6
1	F	304	ASP	3.5

Continued on next page...

Continued from previous page...

Mol	Chain	Res	Type	RSRZ
1	C	398	ASN	3.5
1	D	52	THR	3.5
1	D	51	VAL	3.4
1	E	379	PHE	3.4
1	D	28	VAL	3.4
1	B	309	GLU	3.4
1	F	28	VAL	3.3
1	C	353	ARG	3.3
1	E	300	GLY	3.3
1	A	48	PHE	3.3
1	F	96	ARG	3.2
1	F	217	SER	3.2
1	E	89	ALA	3.2
1	B	296	MET	3.2
1	B	33	PRO	3.2
1	E	48	PHE	3.2
1	B	153	GLN	3.2
1	B	191	GLY	3.2
1	A	350	LYS	3.1
1	F	386	TYR	3.1
1	F	83	LEU	3.1
1	C	406	ARG	3.1
1	F	303	GLN	3.1
1	B	302	SER	3.1
1	C	441	PRO	3.1
1	C	412	PHE	3.1
1	A	56	ALA	3.1
1	F	80	ASP	3.0
1	C	405	GLY	3.0
1	C	85	GLY	3.0
1	B	121	GLN	3.0
1	F	87	ARG	3.0
1	B	218	ASN	3.0
1	B	282	LEU	3.0
1	C	396	LEU	3.0
1	C	315	ILE	3.0
1	E	282	LEU	3.0
1	B	155	ARG	3.0
1	B	31	LEU	3.0
1	F	37	ALA	3.0
1	B	149	VAL	3.0
1	C	442	LYS	3.0

Continued on next page...

Continued from previous page...

Mol	Chain	Res	Type	RSRZ
1	B	85	GLY	3.0
1	C	84	SER	3.0
1	F	85	GLY	2.9
1	C	430	HIS	2.9
1	D	57	ALA	2.9
1	C	283	VAL	2.9
1	C	433	VAL	2.9
1	B	271	ILE	2.8
1	F	336	TYR	2.8
1	A	49	VAL	2.8
1	A	61	PHE	2.7
1	D	49	VAL	2.7
1	E	375	GLU	2.7
1	F	48	PHE	2.7
1	B	190	LEU	2.7
1	F	371	LEU	2.7
1	E	301	GLN	2.7
1	D	26	GLU	2.7
1	B	138	GLY	2.7
1	D	56	ALA	2.7
1	F	90	ALA	2.7
1	B	308	LYS	2.6
1	C	435	ASP	2.6
1	F	211	ALA	2.6
1	E	281	GLY	2.6
1	F	130	GLN	2.6
1	C	439	GLU	2.6
1	F	32	ASP	2.6
1	F	305	ASP	2.6
1	E	63	ALA	2.6
1	C	409	ASN	2.6
1	C	275	THR	2.6
1	E	212	SER	2.5
1	B	272	ILE	2.5
1	C	81	GLU	2.5
1	B	247	HIS	2.5
1	E	288	ILE	2.5
1	B	86	ALA	2.5
1	F	387	VAL	2.5
1	B	348	HIS	2.5
1	B	212	SER	2.5
1	C	416	LYS	2.4

Continued on next page...

Continued from previous page...

Mol	Chain	Res	Type	RSRZ
1	D	304	ASP	2.4
1	D	86	ALA	2.4
1	B	273	MET	2.4
1	E	324	ILE	2.4
1	C	319	PHE	2.4
1	A	58	THR	2.4
1	B	148	ASN	2.4
1	A	304	ASP	2.4
1	B	405	GLY	2.3
1	C	413	LEU	2.3
1	F	92	GLU	2.3
1	B	240	CYS	2.3
1	B	179	SER	2.3
1	B	306	SER	2.3
1	E	29	LEU	2.3
1	E	293	LEU	2.3
1	B	114	PHE	2.3
1	F	89	ALA	2.3
1	C	399	SER	2.3
1	B	64	CYS	2.2
1	C	305	ASP	2.2
1	B	186	LEU	2.2
1	F	302	SER	2.2
1	C	215	LYS	2.2
1	E	287	ALA	2.2
1	B	241	HIS	2.2
1	B	107	CYS	2.2
1	E	380	CYS	2.2
1	B	90	ALA	2.2
1	E	181	GLN	2.2
1	F	301	GLN	2.2
1	E	322	SER	2.2
1	F	361	PHE	2.2
1	E	83	LEU	2.1
1	F	369	ILE	2.1
1	B	280	GLY	2.1
1	C	410	HIS	2.1
1	E	406	ARG	2.1
1	C	382	PRO	2.1
1	A	51	VAL	2.1
1	F	272	ILE	2.1
1	E	80	ASP	2.1

Continued on next page...

Continued from previous page...

Mol	Chain	Res	Type	RSRZ
1	C	282	LEU	2.1
1	D	305	ASP	2.1
1	E	298	LYS	2.0
1	B	301	GLN	2.0
1	C	304	ASP	2.0
1	D	300	GLY	2.0
1	B	242	TYR	2.0
1	B	235	MET	2.0

6.2 Non-standard residues in protein, DNA, RNA chains [i](#)

There are no non-standard protein/DNA/RNA residues in this entry.

6.3 Carbohydrates [i](#)

There are no carbohydrates in this entry.

6.4 Ligands [i](#)

In the following table, the Atoms column lists the number of modelled atoms in the group and the number defined in the chemical component dictionary. The B-factors column lists the minimum, median, 95th percentile and maximum values of B factors of atoms in the group. The column labelled 'Q< 0.9' lists the number of atoms with occupancy less than 0.9.

Mol	Type	Chain	Res	Atoms	RSCC	RSR	B-factors(\AA^2)	Q<0.9
3	ZN	C	1006	1/1	0.51	0.09	235,235,235,235	0
3	ZN	E	1004	1/1	0.52	0.18	182,182,182,182	0
3	ZN	C	1002	1/1	0.60	0.10	176,176,176,176	0
3	ZN	A	1007	1/1	0.60	0.13	203,203,203,203	0
3	ZN	B	1002	1/1	0.60	0.30	217,217,217,217	0
3	ZN	D	1007	1/1	0.66	0.09	126,126,126,126	0
3	ZN	E	1002	1/1	0.66	0.07	134,134,134,134	0
3	ZN	F	1007	1/1	0.68	0.06	169,169,169,169	0
3	ZN	B	1007	1/1	0.68	0.14	205,205,205,205	0
3	ZN	A	1002	1/1	0.70	0.10	101,101,101,101	0
3	ZN	C	1005	1/1	0.74	0.12	206,206,206,206	0
3	ZN	E	1006	1/1	0.76	0.06	156,156,156,156	0
3	ZN	E	1005	1/1	0.77	0.12	175,175,175,175	0
3	ZN	C	1007	1/1	0.78	0.32	282,282,282,282	0
3	ZN	D	1003	1/1	0.80	0.06	97,97,97,97	0

Continued on next page...

Continued from previous page...

Mol	Type	Chain	Res	Atoms	RSCC	RSR	B-factors(Å ²)	Q<0.9
3	ZN	D	1006	1/1	0.80	0.07	103,103,103,103	0
3	ZN	D	1002	1/1	0.82	0.10	105,105,105,105	0
2	SAH	B	1001	26/26	0.83	0.29	54,93,125,136	0
3	ZN	A	1006	1/1	0.84	0.05	154,154,154,154	0
3	ZN	F	1003	1/1	0.84	0.07	110,110,110,110	0
3	ZN	F	1004	1/1	0.85	0.15	207,207,207,207	0
3	ZN	A	1005	1/1	0.85	0.15	127,127,127,127	0
3	ZN	C	1004	1/1	0.89	0.06	165,165,165,165	0
3	ZN	F	1005	1/1	0.89	0.07	182,182,182,182	0
3	ZN	B	1006	1/1	0.90	0.05	136,136,136,136	0
3	ZN	F	1006	1/1	0.90	0.05	149,149,149,149	0
3	ZN	B	1003	1/1	0.91	0.08	125,125,125,125	0
3	ZN	B	1005	1/1	0.91	0.05	99,99,99,99	0
2	SAH	F	1001	26/26	0.91	0.23	55,84,109,112	0
3	ZN	F	1002	1/1	0.91	0.09	142,142,142,142	0
2	SAH	C	1001	26/26	0.91	0.23	43,85,115,120	0
3	ZN	E	1007	1/1	0.91	0.09	185,185,185,185	0
3	ZN	D	1004	1/1	0.92	0.04	98,98,98,98	0
2	SAH	E	1001	26/26	0.92	0.22	58,80,110,127	0
2	SAH	A	1001	26/26	0.93	0.23	32,48,76,79	0
3	ZN	E	1003	1/1	0.93	0.07	111,111,111,111	0
3	ZN	B	1004	1/1	0.94	0.07	108,108,108,108	0
3	ZN	A	1004	1/1	0.95	0.05	108,108,108,108	0
2	SAH	D	1001	26/26	0.95	0.23	30,49,66,67	0
3	ZN	C	1003	1/1	0.95	0.06	92,92,92,92	0
3	ZN	D	1005	1/1	0.96	0.06	100,100,100,100	0
3	ZN	A	1003	1/1	0.98	0.04	68,68,68,68	0

The following is a graphical depiction of the model fit to experimental electron density of all instances of the Ligand of Interest. In addition, ligands with molecular weight > 250 and outliers as shown on the geometry validation Tables will also be included. Each fit is shown from different orientation to approximate a three-dimensional view.

Electron density around ZN C 1006:

$2mF_o-DF_c$ (at 0.7 rmsd) in gray
 mF_o-DF_c (at 3 rmsd) in purple (negative)
and green (positive)

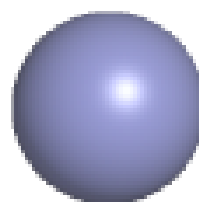
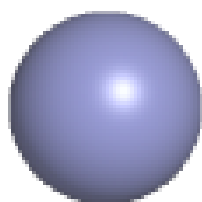
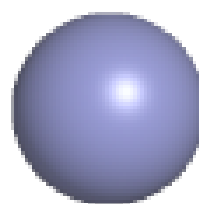

Electron density around ZN E 1004:

$2mF_o-DF_c$ (at 0.7 rmsd) in gray
 mF_o-DF_c (at 3 rmsd) in purple (negative)
and green (positive)

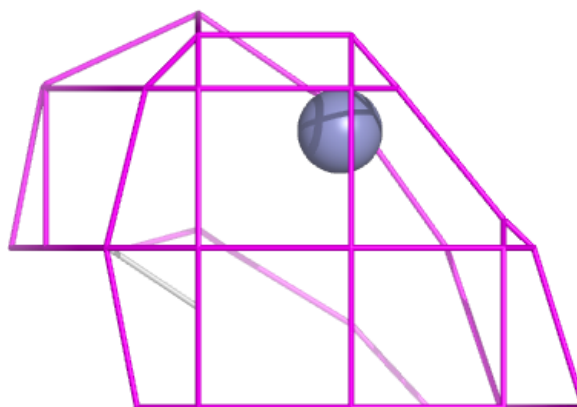
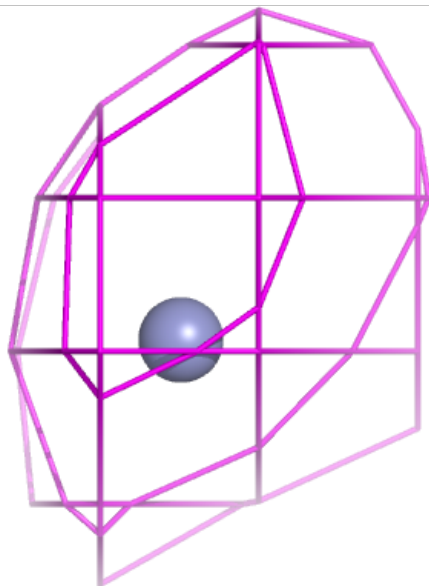
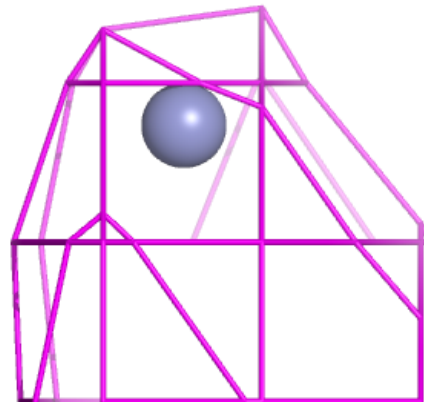

Electron density around ZN C 1002:

$2mF_o-DF_c$ (at 0.7 rmsd) in gray
 mF_o-DF_c (at 3 rmsd) in purple (negative)
and green (positive)

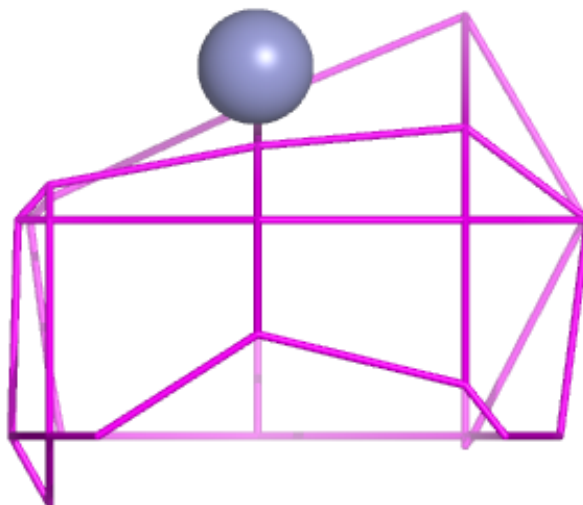
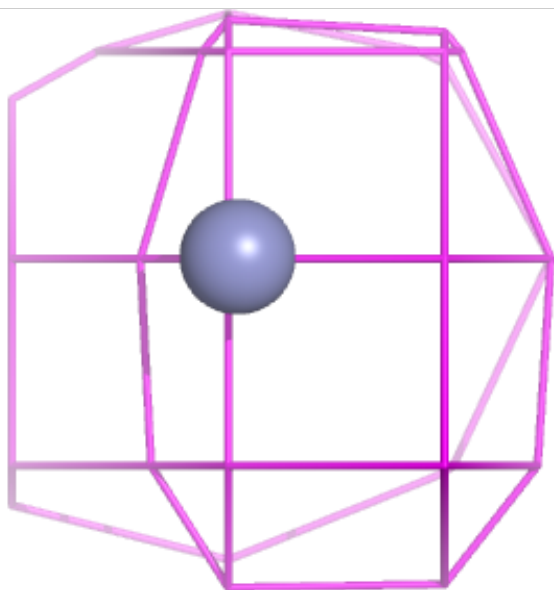
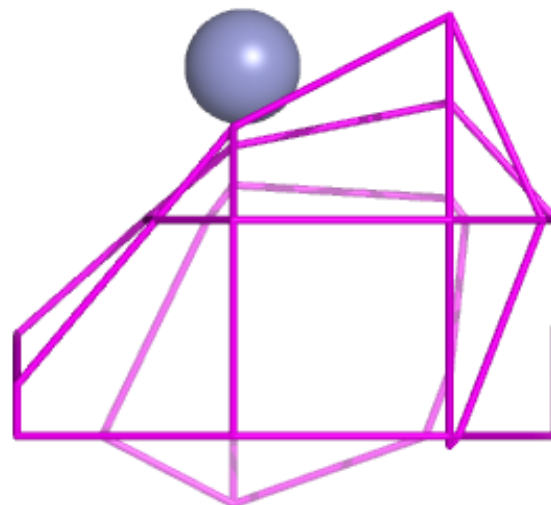

Electron density around ZN A 1007:

$2mF_o-DF_c$ (at 0.7 rmsd) in gray
 mF_o-DF_c (at 3 rmsd) in purple (negative)
and green (positive)

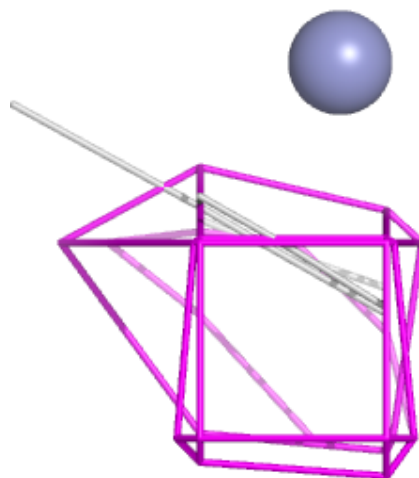
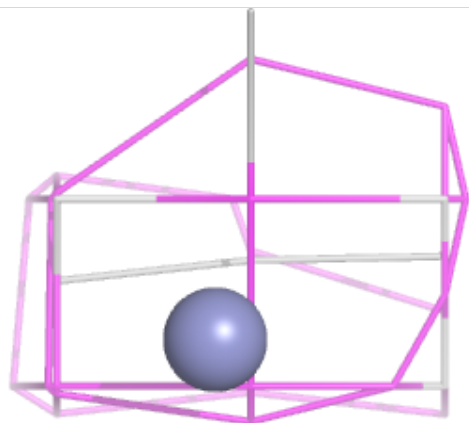
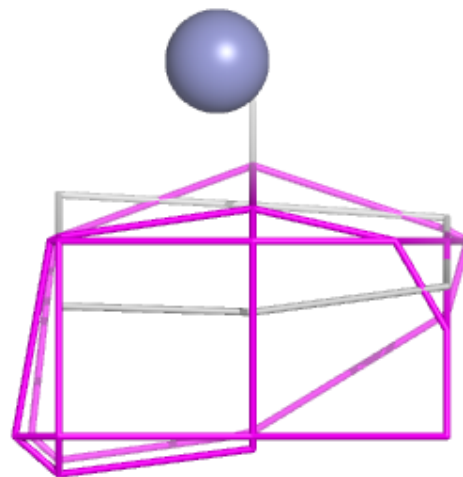

Electron density around ZN B 1002:

$2mF_o-DF_c$ (at 0.7 rmsd) in gray
 mF_o-DF_c (at 3 rmsd) in purple (negative)
and green (positive)

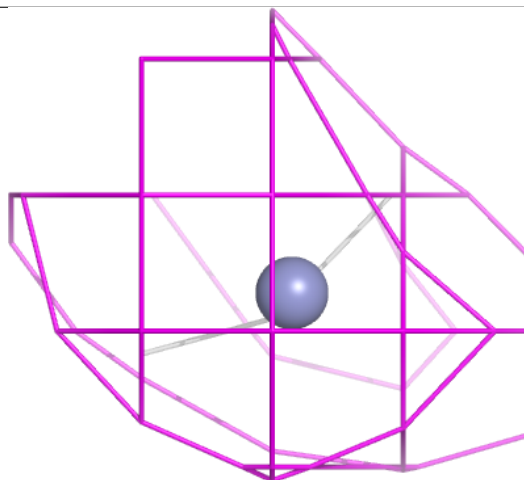
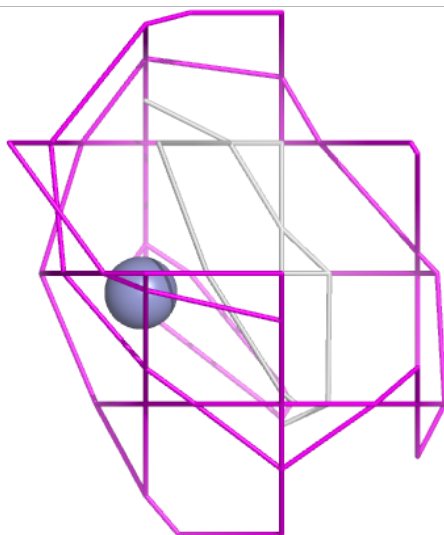
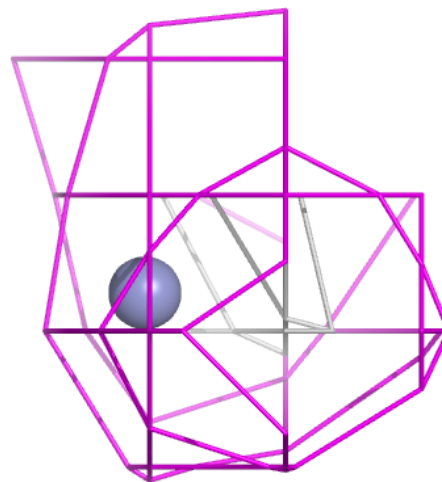

Electron density around ZN D 1007:

$2mF_o-DF_c$ (at 0.7 rmsd) in gray
 mF_o-DF_c (at 3 rmsd) in purple (negative)
and green (positive)

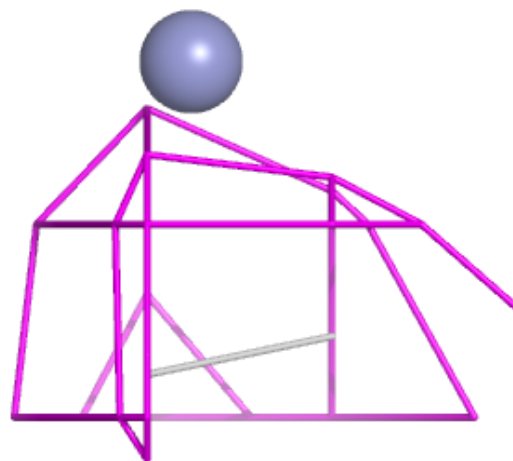
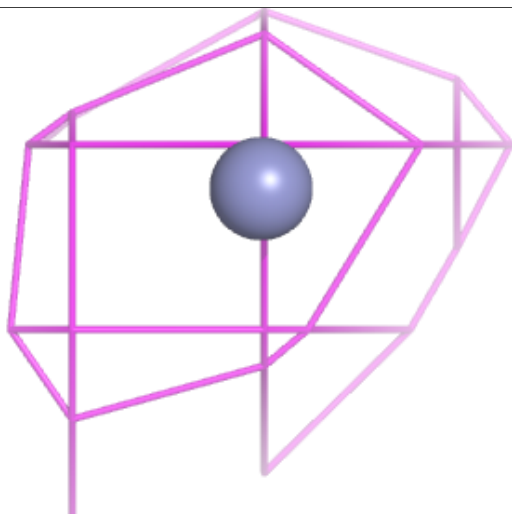
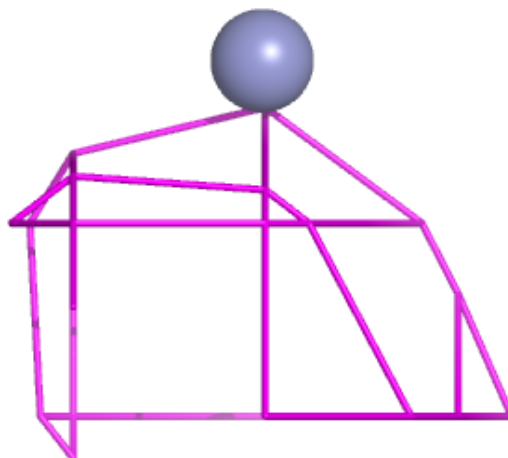

Electron density around ZN E 1002:

$2mF_o-DF_c$ (at 0.7 rmsd) in gray
 mF_o-DF_c (at 3 rmsd) in purple (negative)
and green (positive)

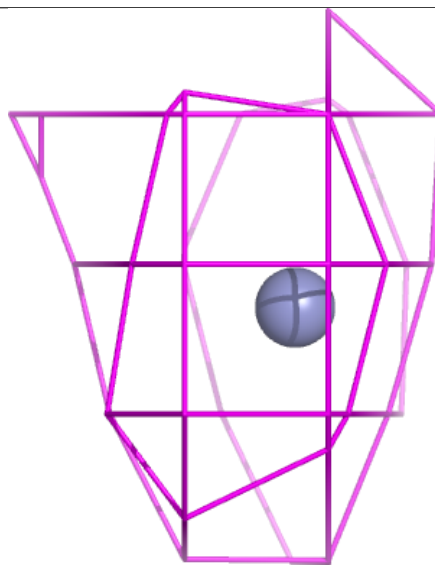
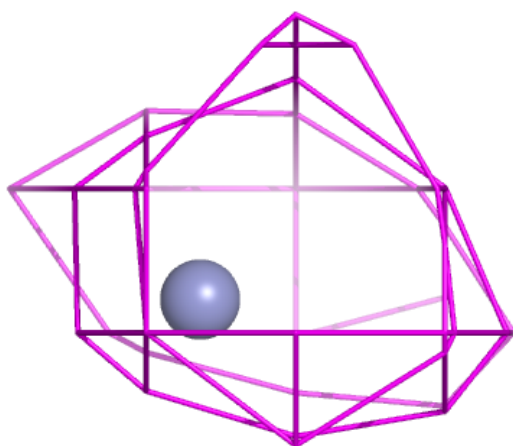
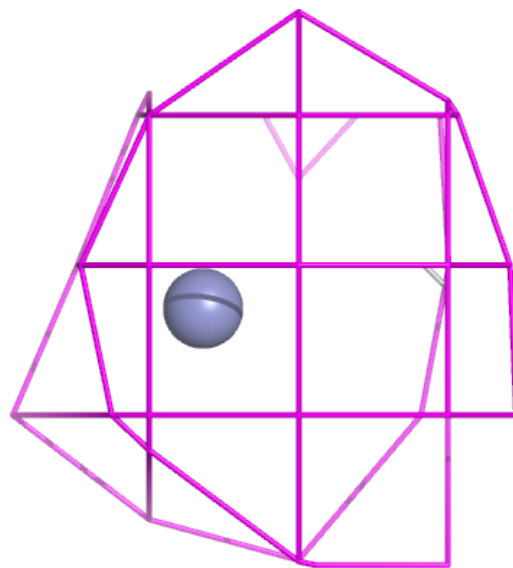

Electron density around ZN F 1007:

$2mF_o-DF_c$ (at 0.7 rmsd) in gray
 mF_o-DF_c (at 3 rmsd) in purple (negative)
and green (positive)

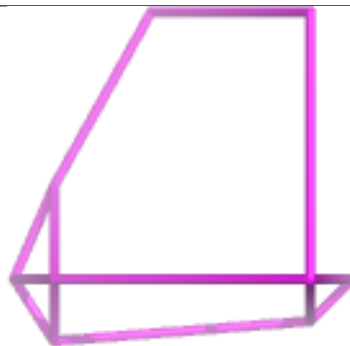
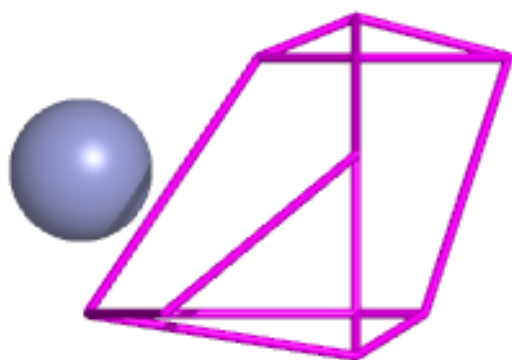

Electron density around ZN B 1007:

$2mF_o-DF_c$ (at 0.7 rmsd) in gray
 mF_o-DF_c (at 3 rmsd) in purple (negative)
and green (positive)

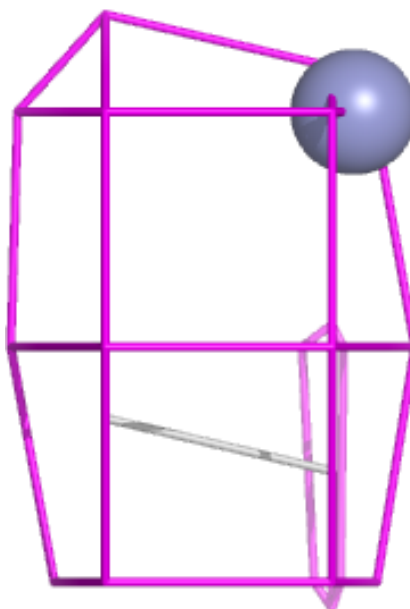
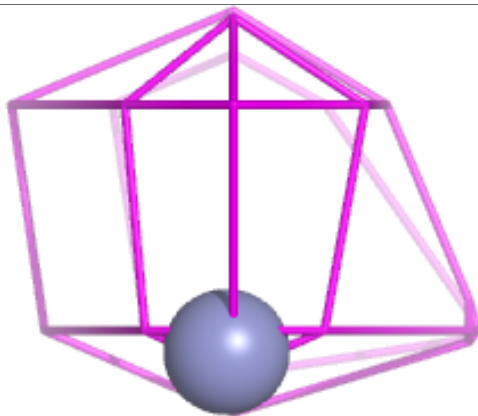
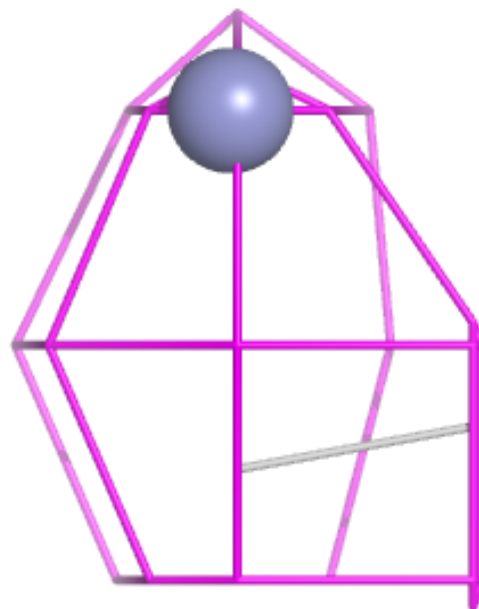

Electron density around ZN A 1002:

$2mF_o-DF_c$ (at 0.7 rmsd) in gray
 mF_o-DF_c (at 3 rmsd) in purple (negative)
and green (positive)

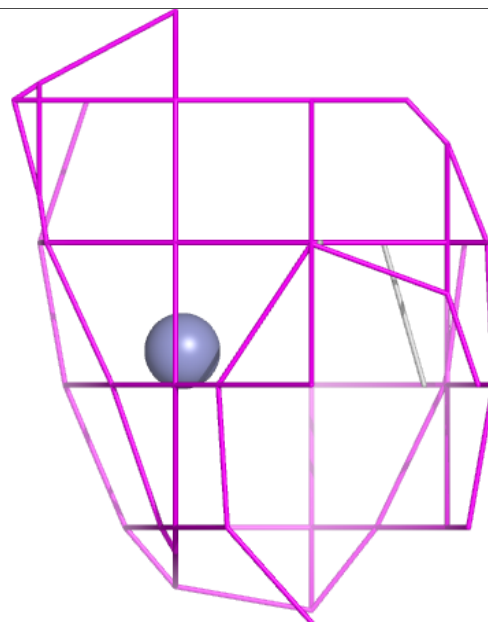
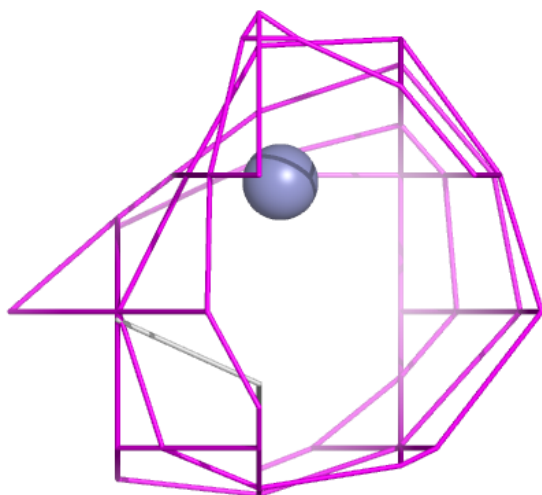
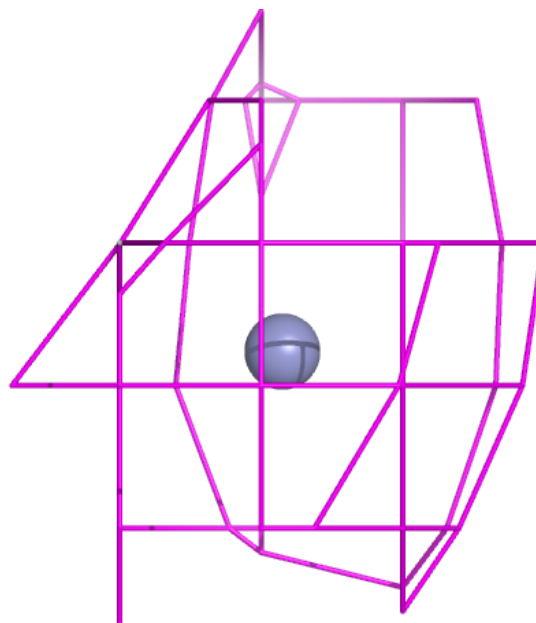

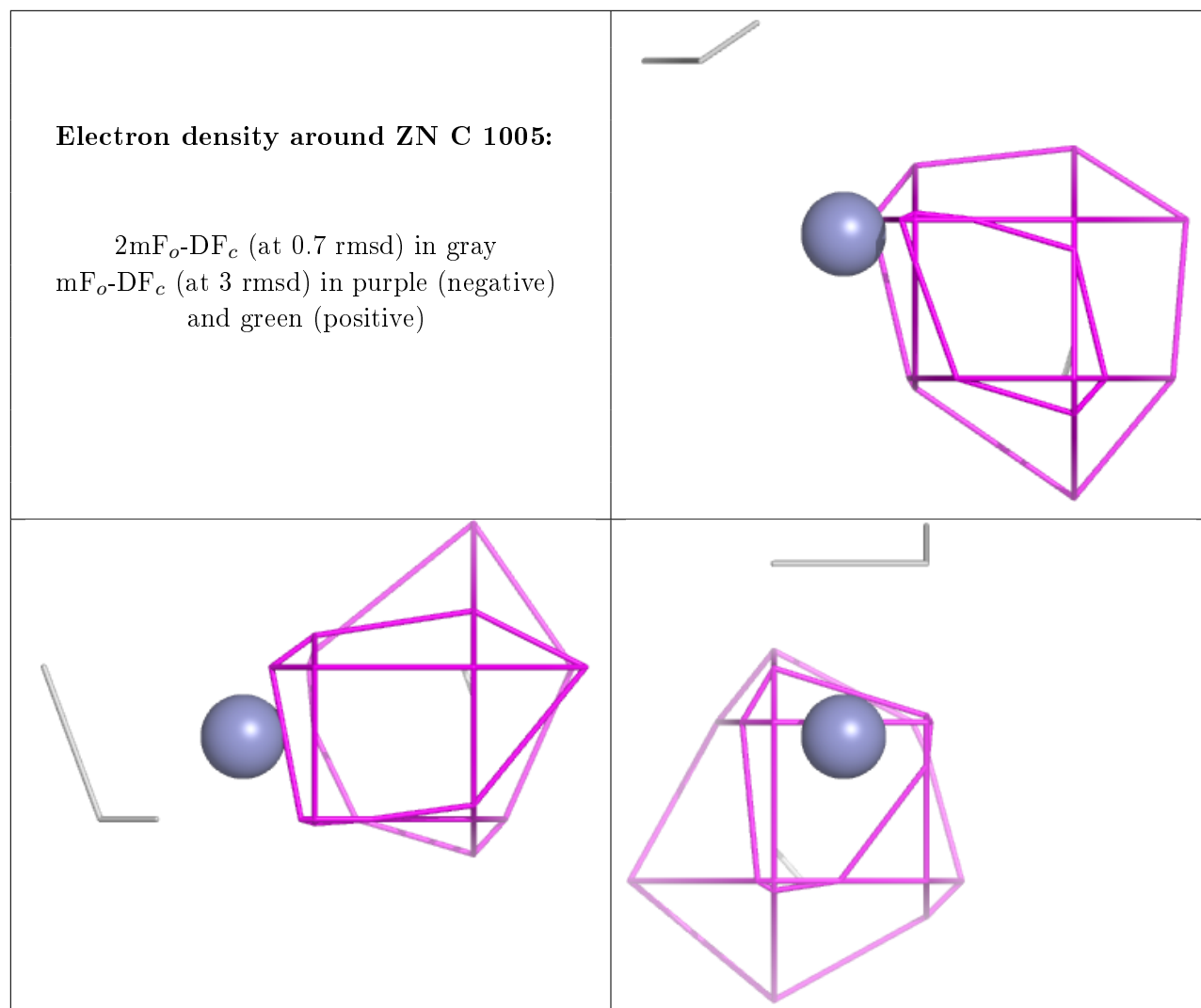

Electron density around ZN E 1006:

$2mF_o-DF_c$ (at 0.7 rmsd) in gray
 mF_o-DF_c (at 3 rmsd) in purple (negative)
and green (positive)

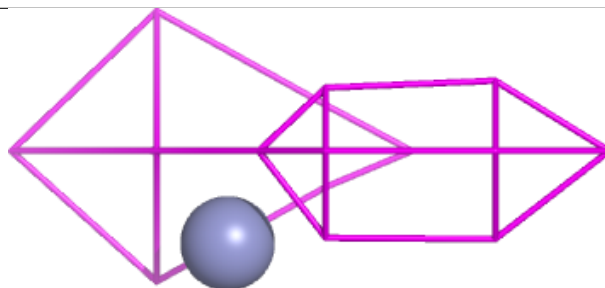
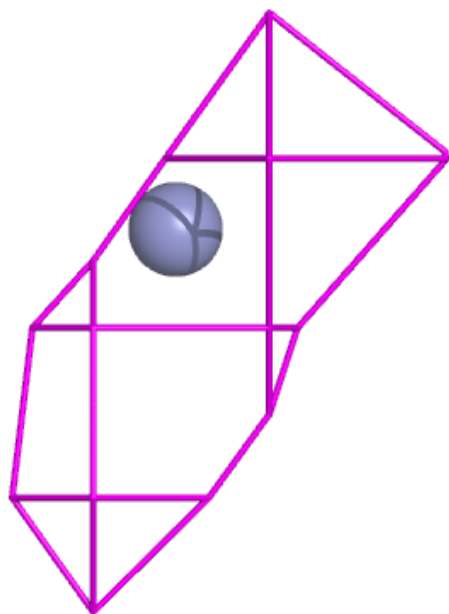
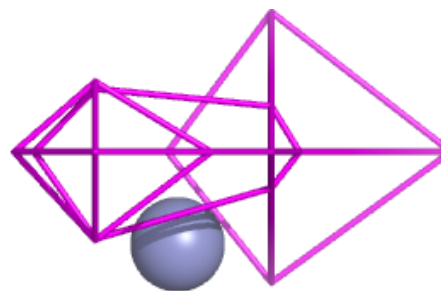

Electron density around ZN E 1005:

$2mF_o-DF_c$ (at 0.7 rmsd) in gray
 mF_o-DF_c (at 3 rmsd) in purple (negative)
and green (positive)

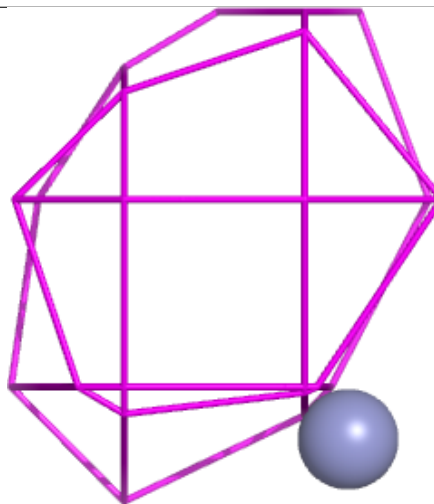
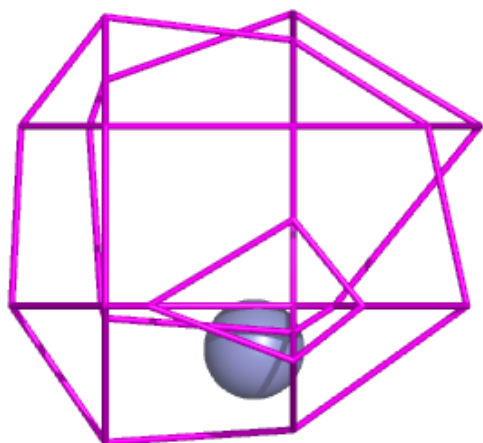
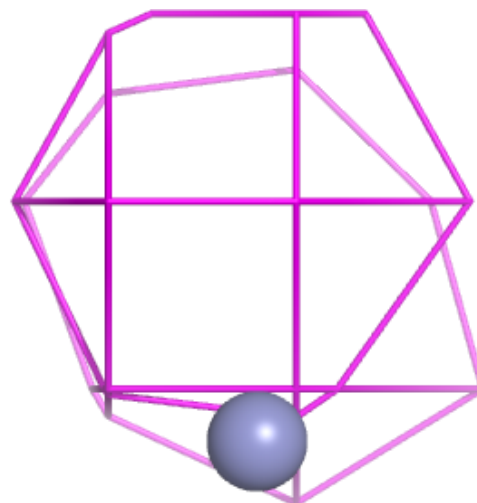

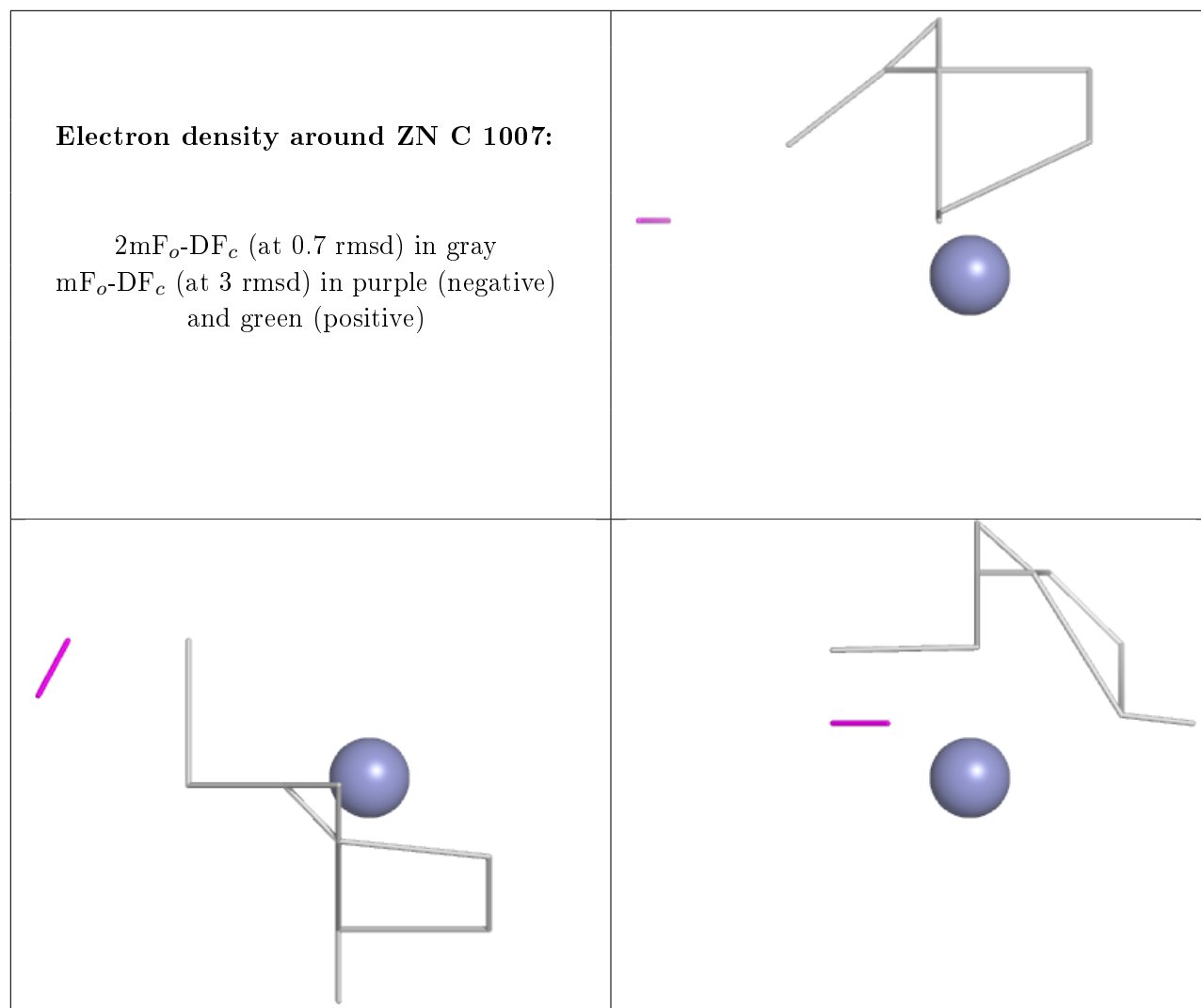

Electron density around ZN D 1003:

$2mF_o-DF_c$ (at 0.7 rmsd) in gray
 mF_o-DF_c (at 3 rmsd) in purple (negative)
and green (positive)

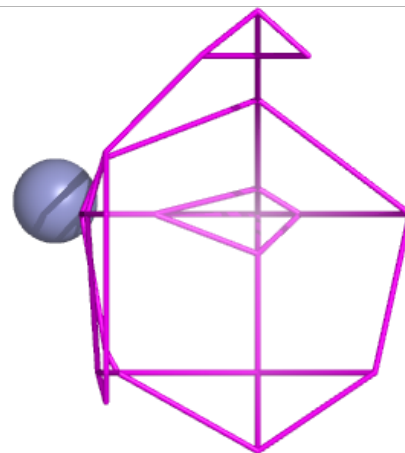
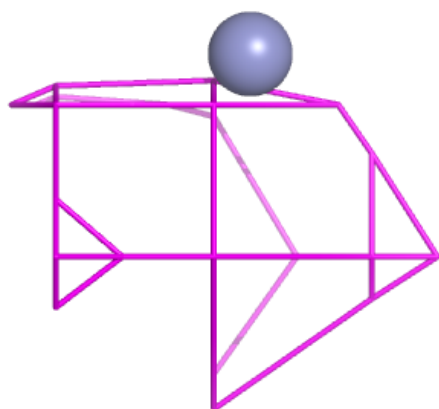
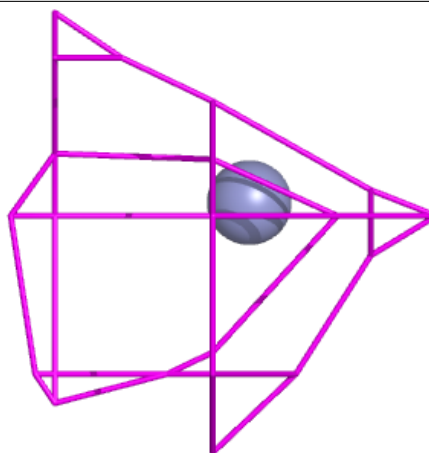

Electron density around ZN D 1006:

$2mF_o-DF_c$ (at 0.7 rmsd) in gray
 mF_o-DF_c (at 3 rmsd) in purple (negative)
and green (positive)

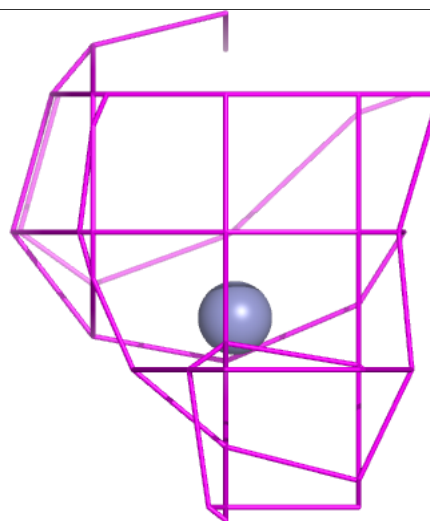
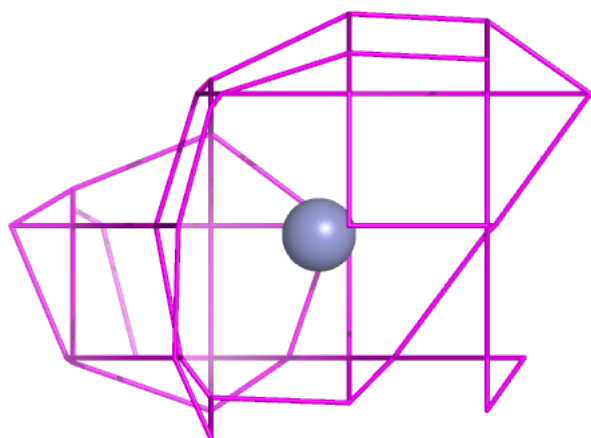
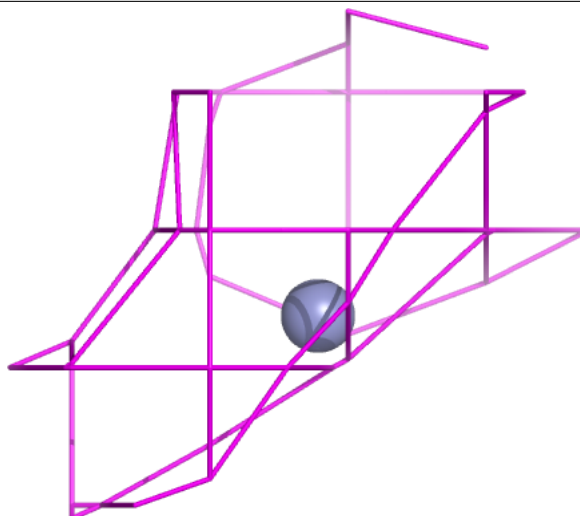

Electron density around ZN D 1002:

$2mF_o-DF_c$ (at 0.7 rmsd) in gray
 mF_o-DF_c (at 3 rmsd) in purple (negative)
and green (positive)

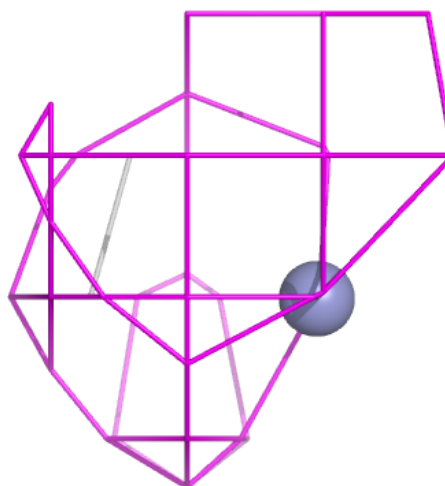
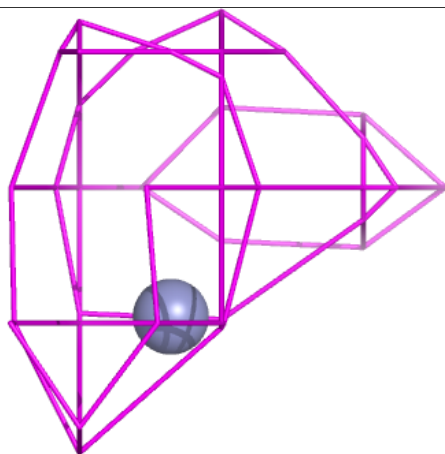
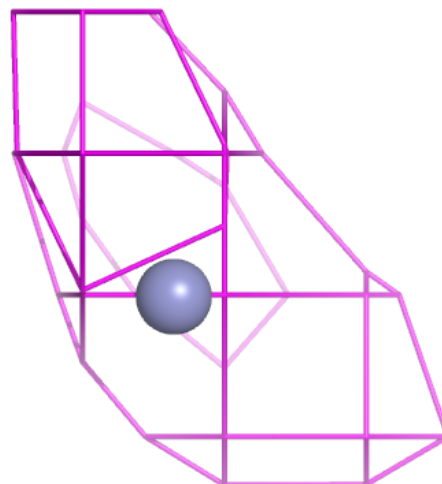

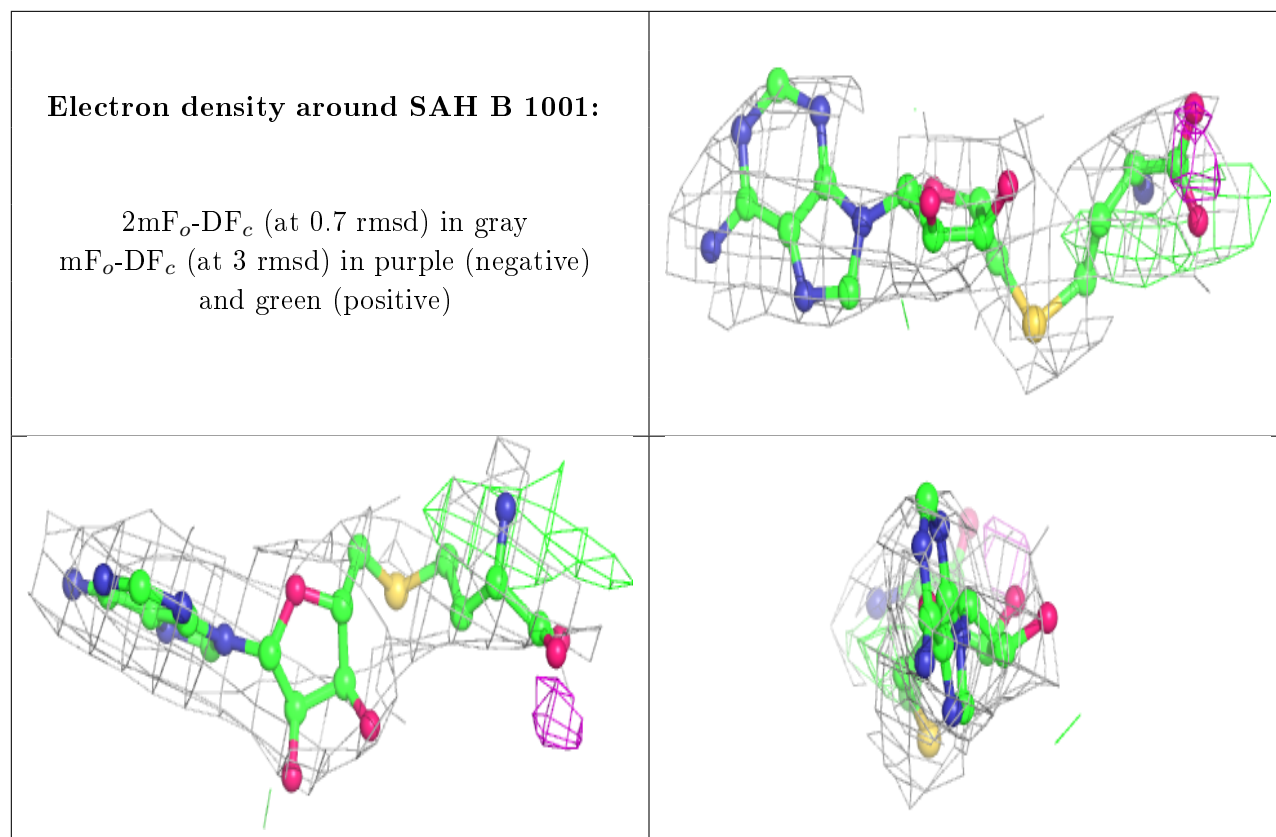

Electron density around ZN A 1006:

$2mF_o-DF_c$ (at 0.7 rmsd) in gray
 mF_o-DF_c (at 3 rmsd) in purple (negative)
and green (positive)

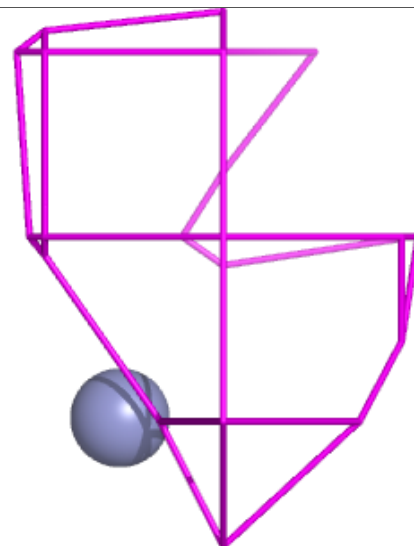
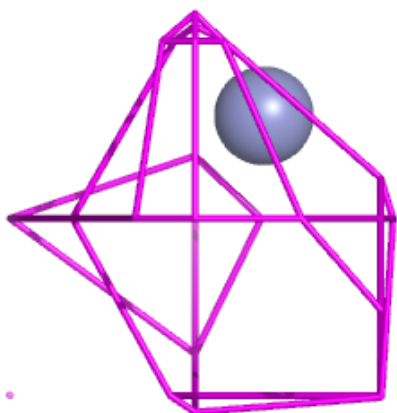
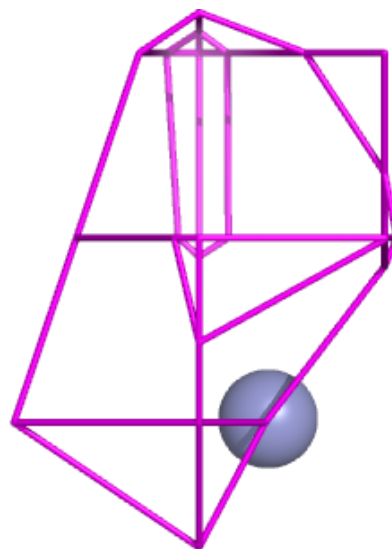

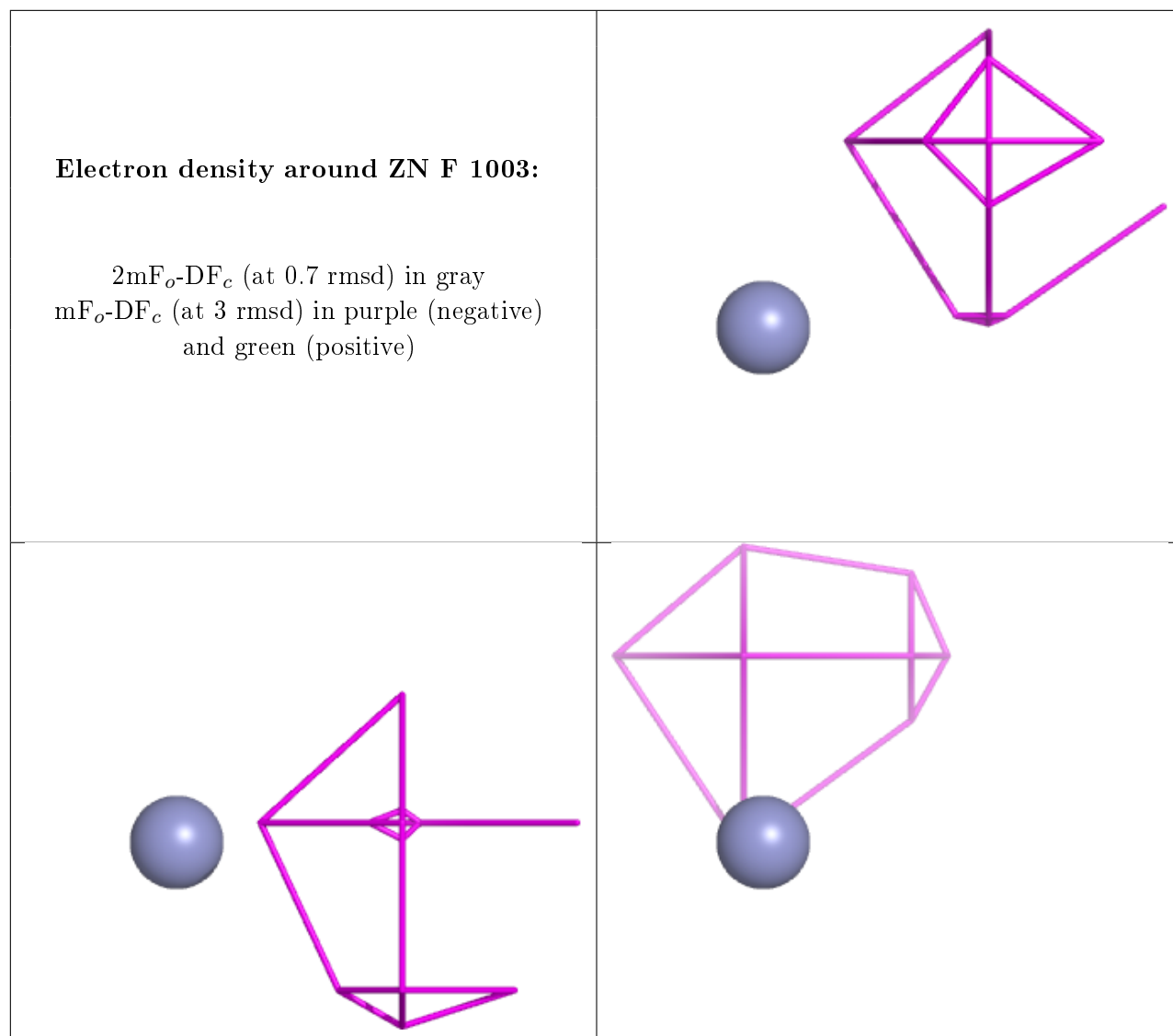

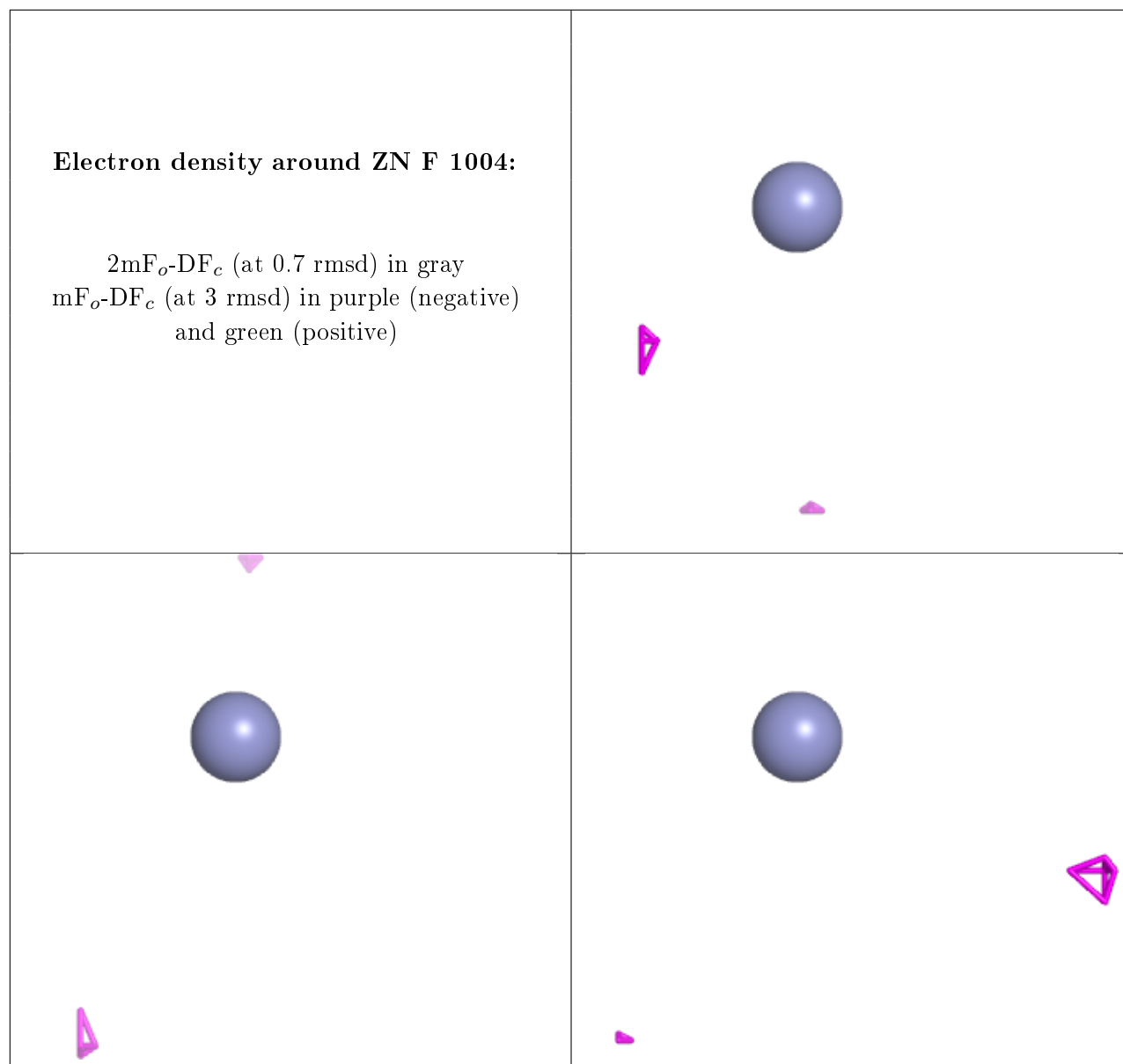

Electron density around ZN A 1005:

$2mF_o-DF_c$ (at 0.7 rmsd) in gray
 mF_o-DF_c (at 3 rmsd) in purple (negative)
and green (positive)

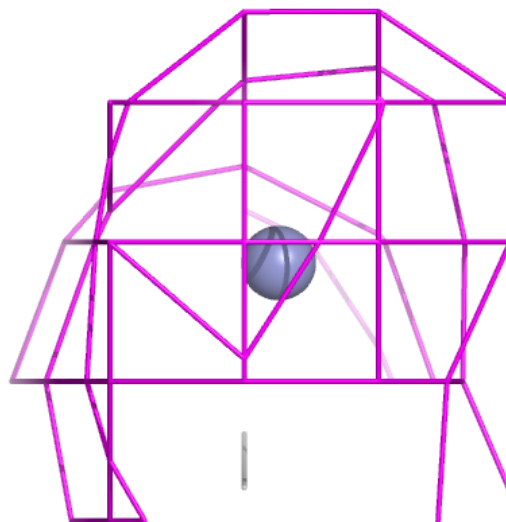
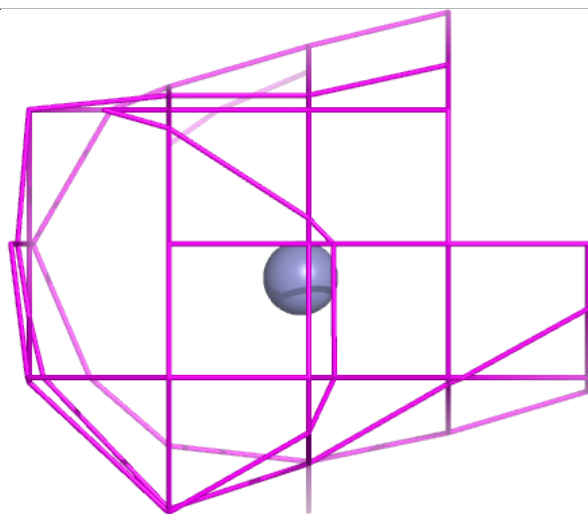
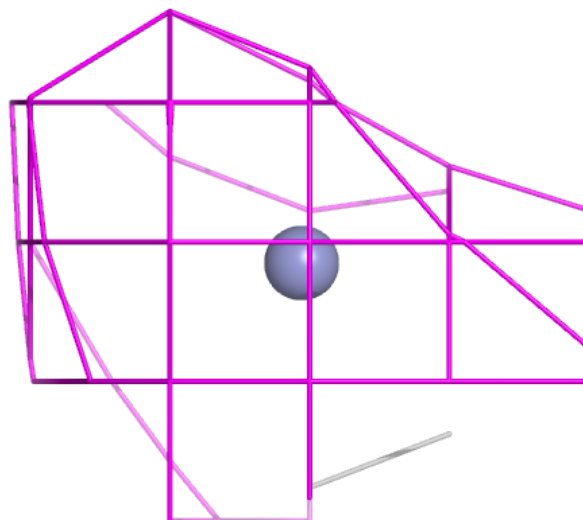

Electron density around ZN C 1004:

$2mF_o-DF_c$ (at 0.7 rmsd) in gray
 mF_o-DF_c (at 3 rmsd) in purple (negative)
and green (positive)

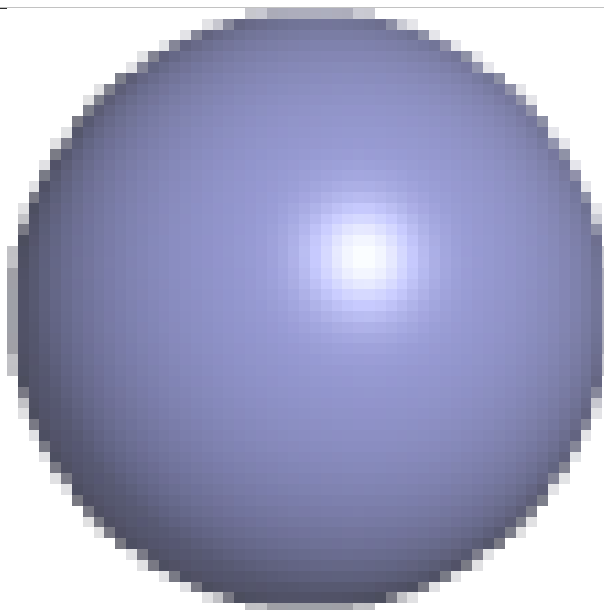
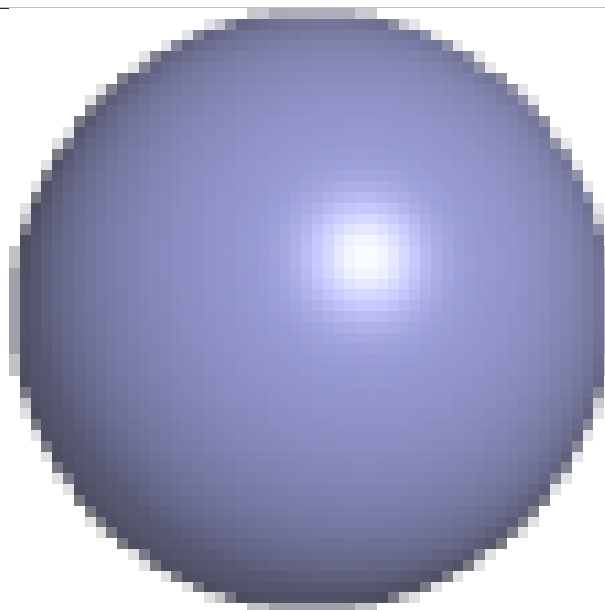
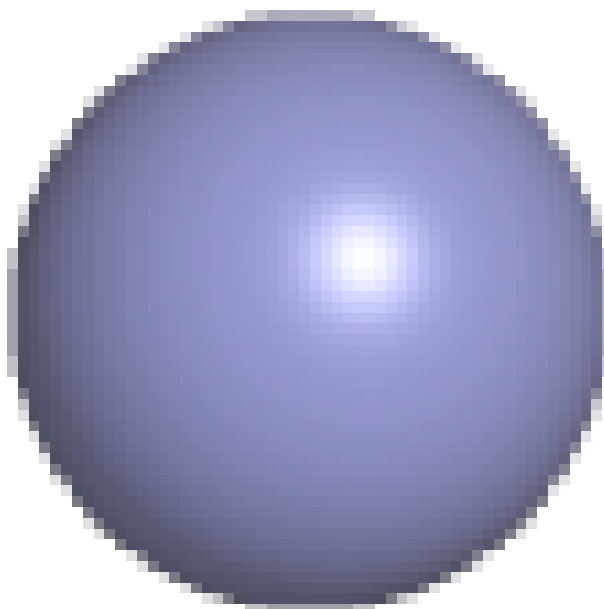

Electron density around ZN F 1005:

$2mF_o-DF_c$ (at 0.7 rmsd) in gray
 mF_o-DF_c (at 3 rmsd) in purple (negative)
and green (positive)

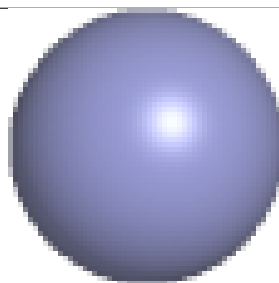
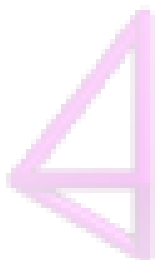
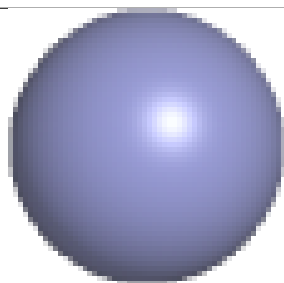
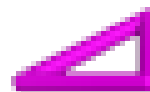
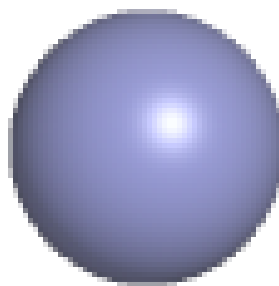

Electron density around ZN B 1006:

$2mF_o-DF_c$ (at 0.7 rmsd) in gray
 mF_o-DF_c (at 3 rmsd) in purple (negative)
and green (positive)

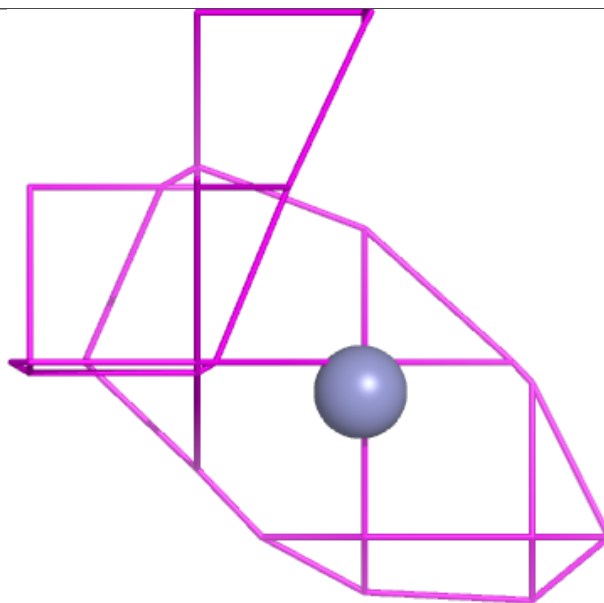
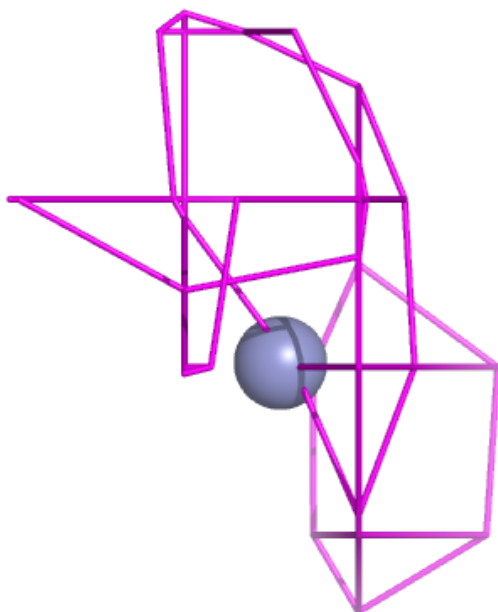
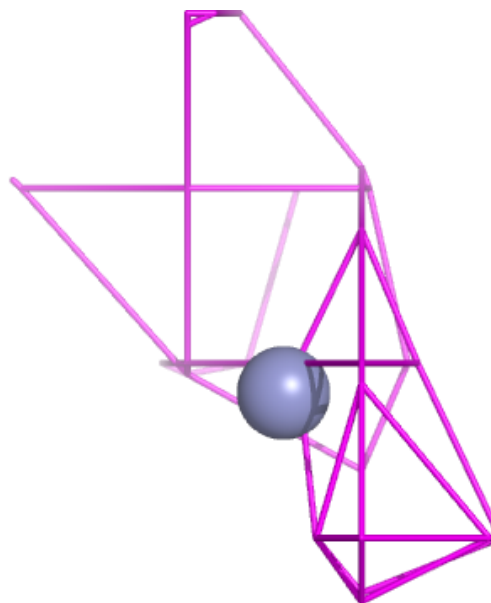

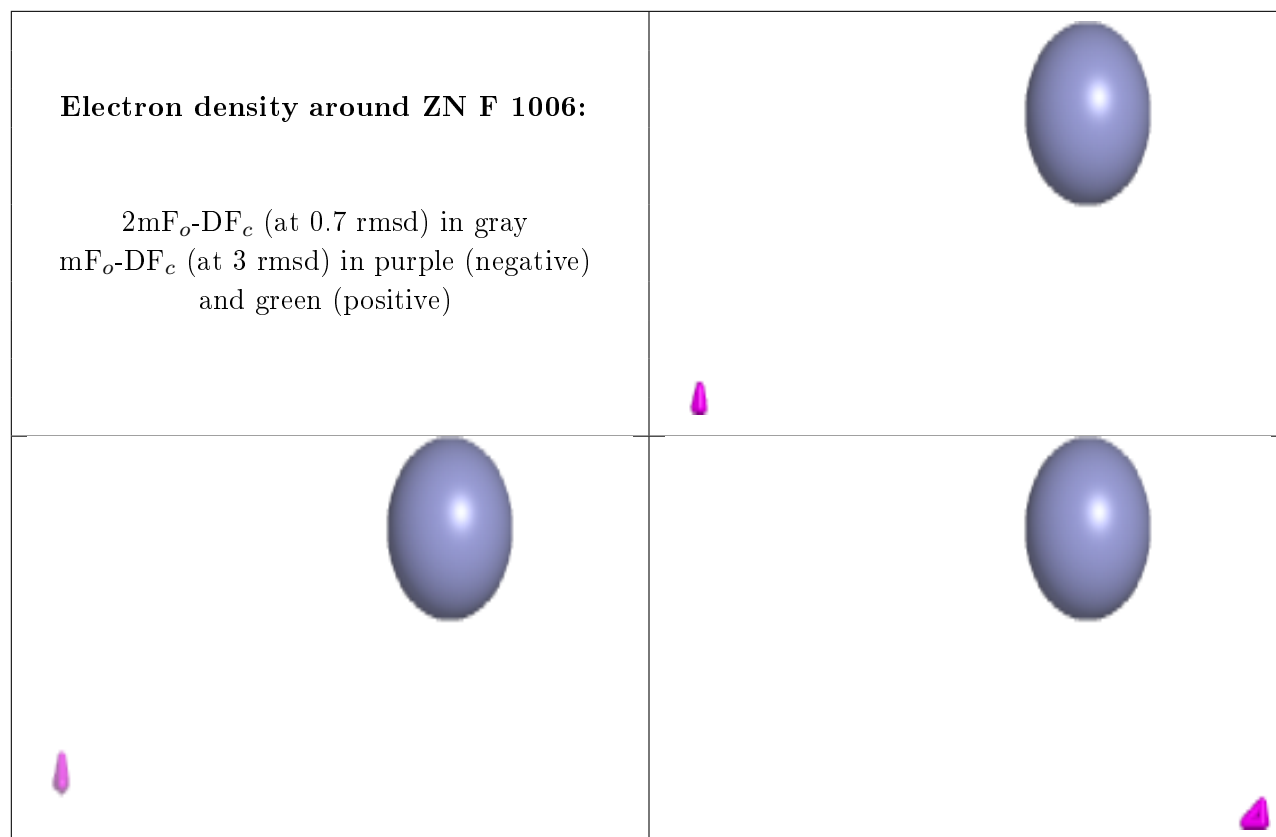

Electron density around ZN B 1003:

$2mF_o-DF_c$ (at 0.7 rmsd) in gray
 mF_o-DF_c (at 3 rmsd) in purple (negative)
and green (positive)

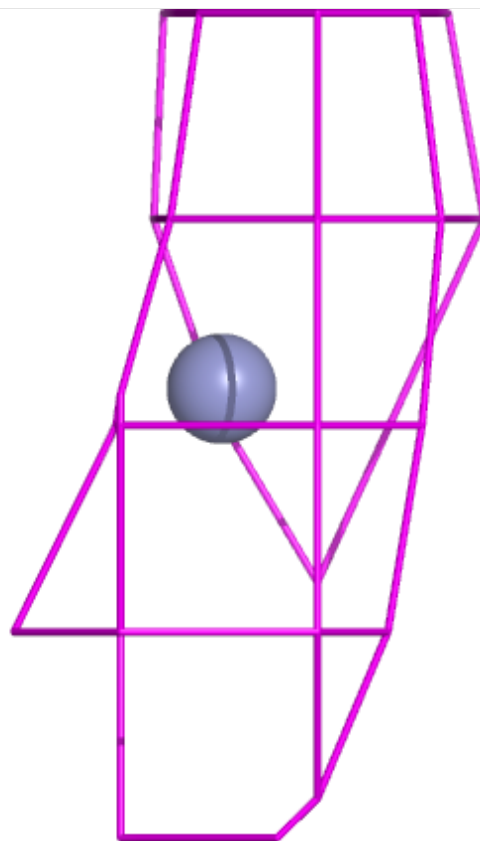
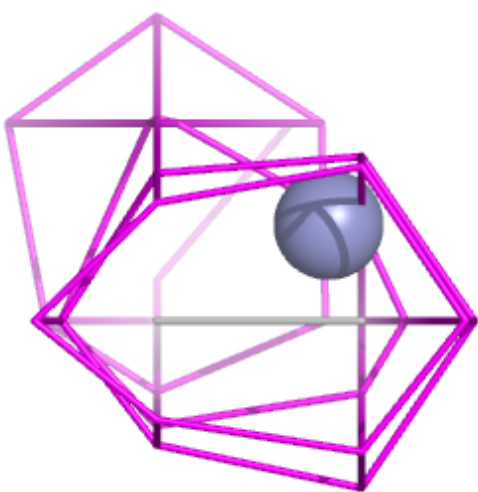
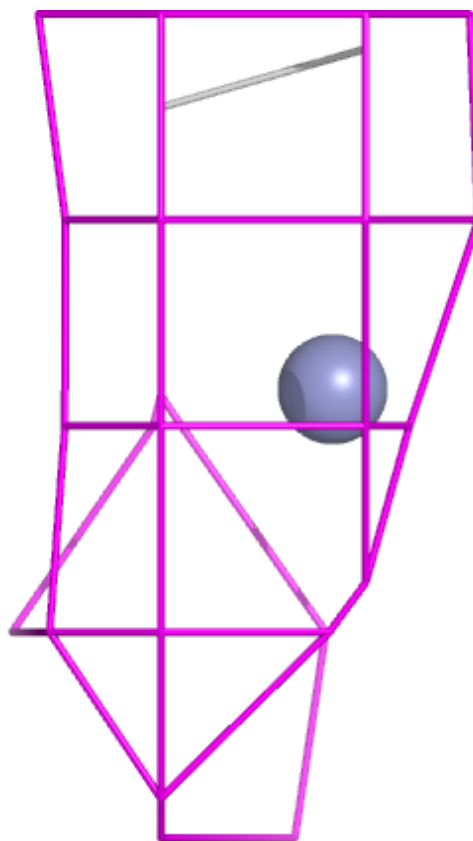

Electron density around ZN B 1005:

$2mF_o-DF_c$ (at 0.7 rmsd) in gray
 mF_o-DF_c (at 3 rmsd) in purple (negative)
and green (positive)

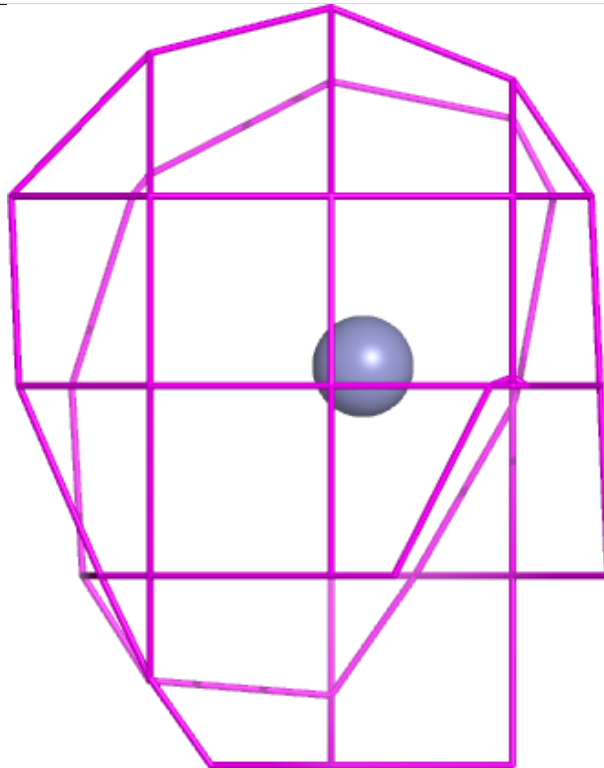
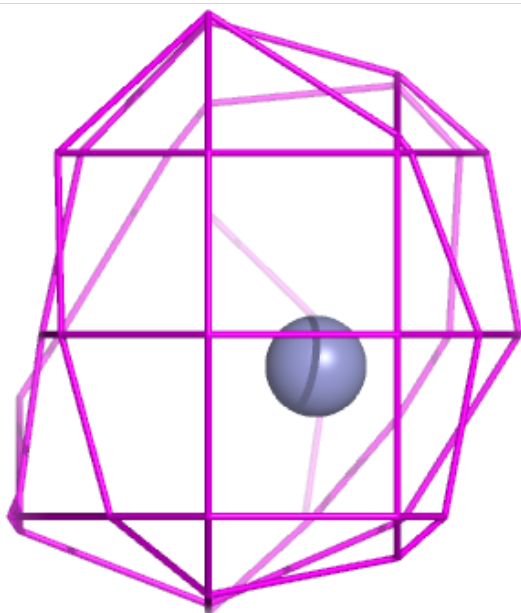
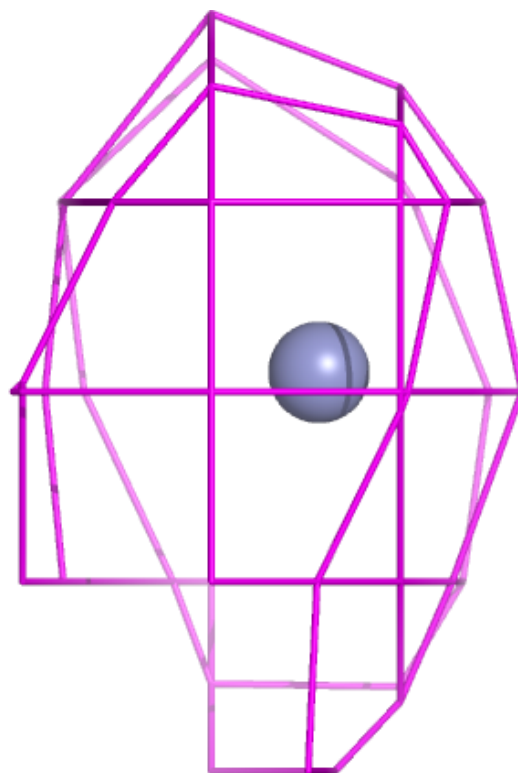

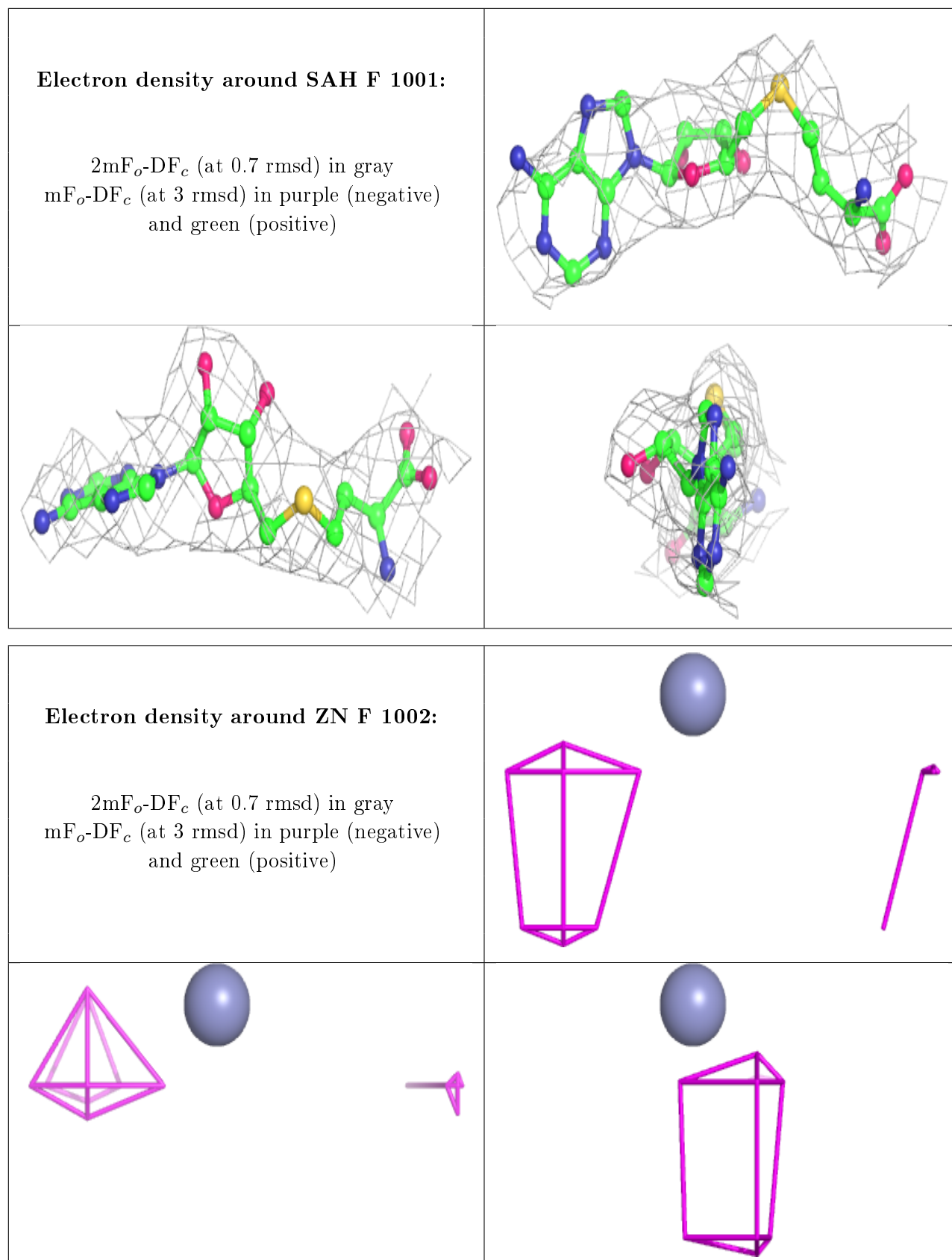

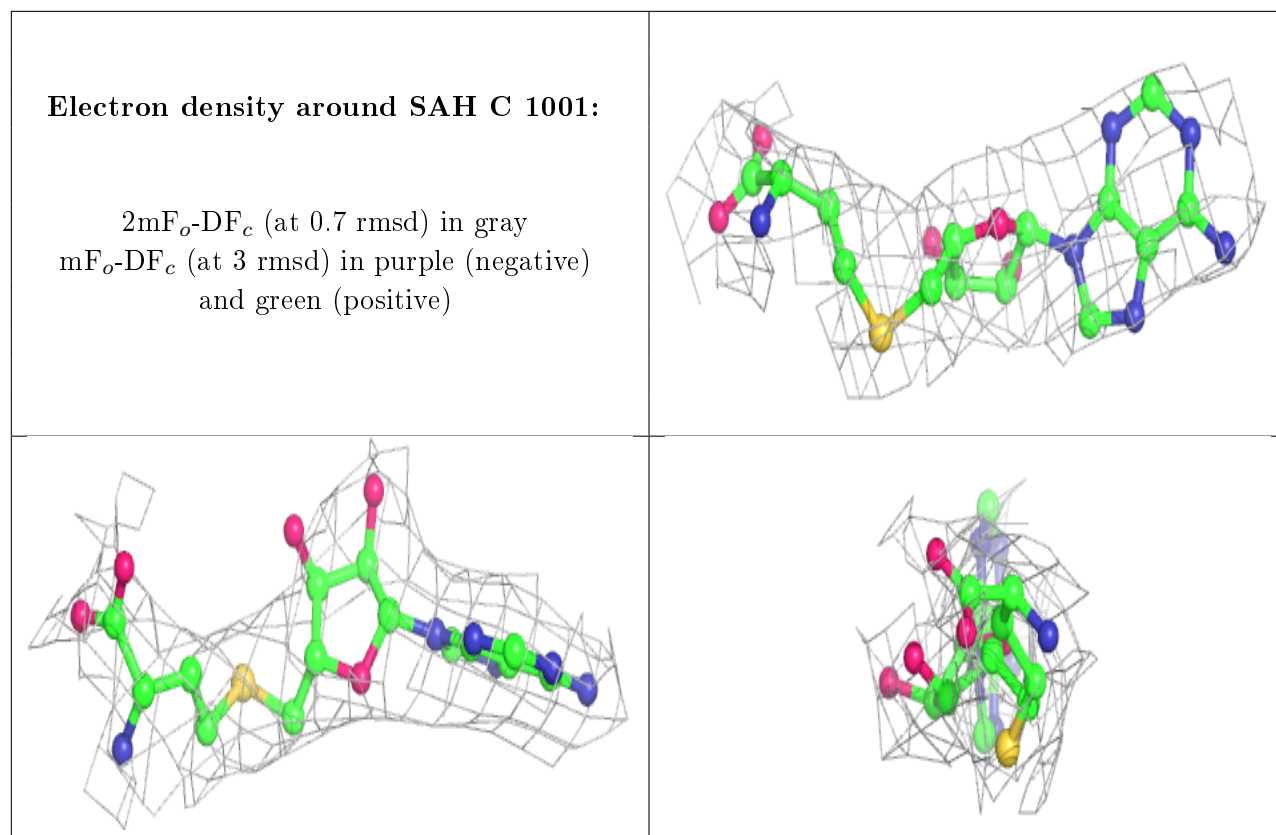

Electron density around ZN E 1007:

$2mF_o-DF_c$ (at 0.7 rmsd) in gray
 mF_o-DF_c (at 3 rmsd) in purple (negative)
and green (positive)

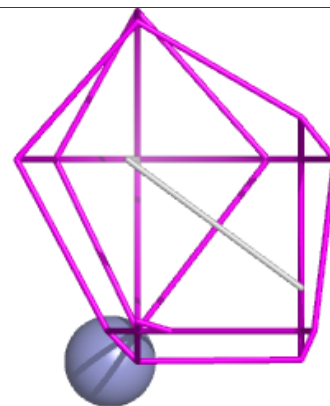
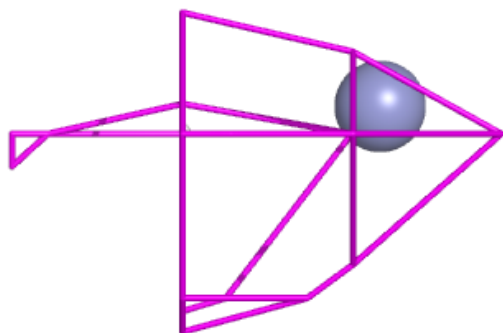
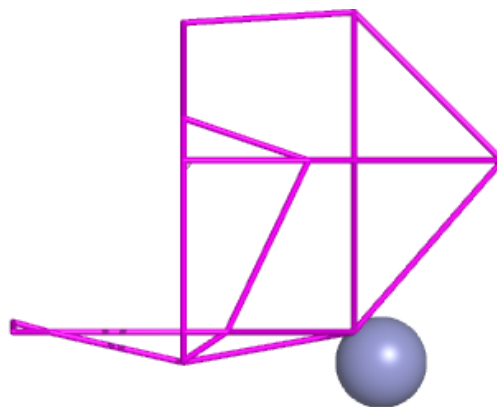

Electron density around ZN D 1004:

$2mF_o-DF_c$ (at 0.7 rmsd) in gray
 mF_o-DF_c (at 3 rmsd) in purple (negative)
and green (positive)

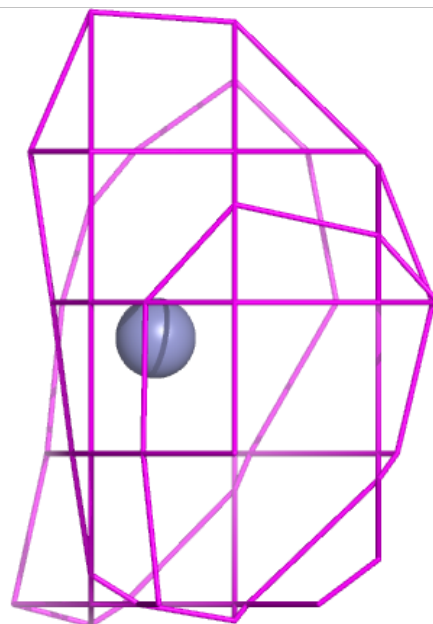
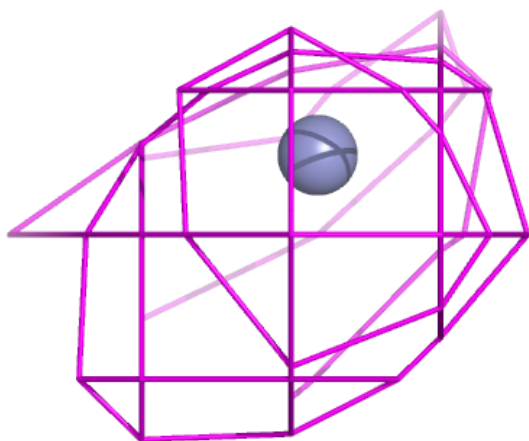
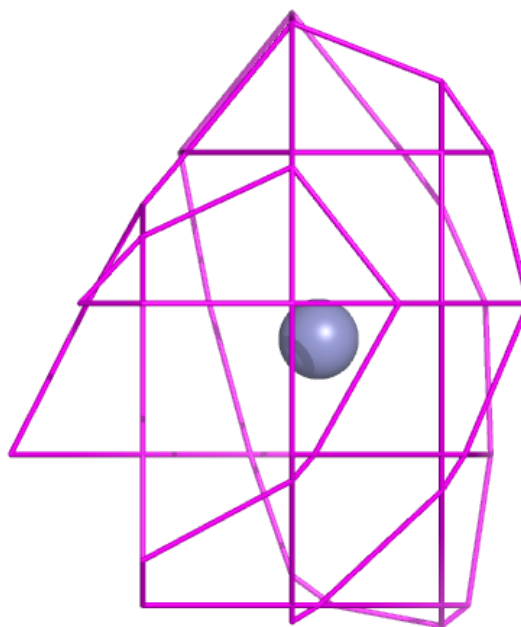

Electron density around SAH E 1001:

$2mF_o-DF_c$ (at 0.7 rmsd) in gray
 mF_o-DF_c (at 3 rmsd) in purple (negative)
and green (positive)

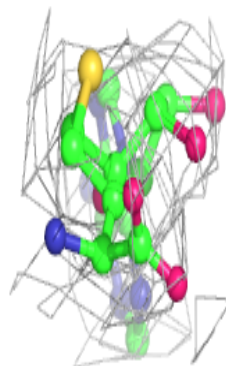
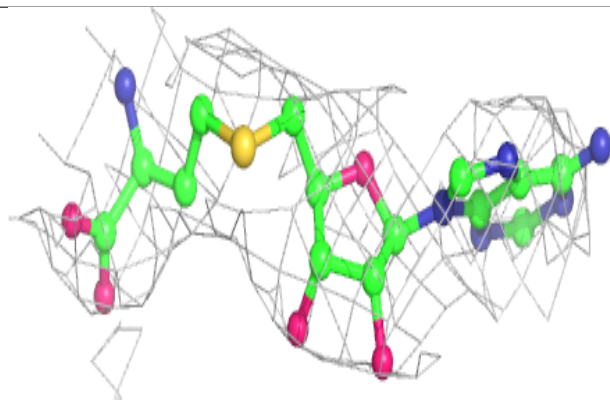
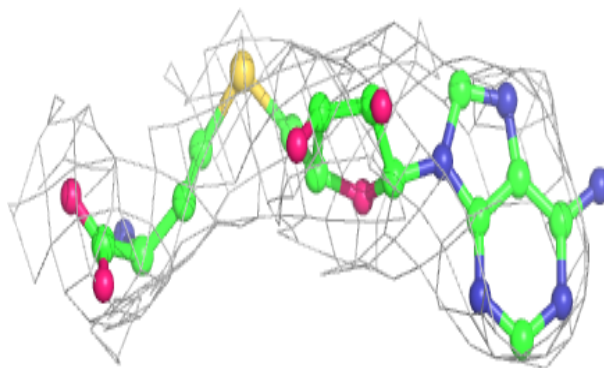
**Electron density around SAH A 1001:**

$2mF_o-DF_c$ (at 0.7 rmsd) in gray
 mF_o-DF_c (at 3 rmsd) in purple (negative)
and green (positive)

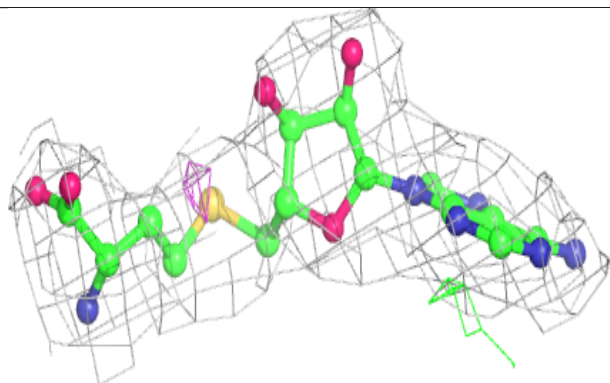
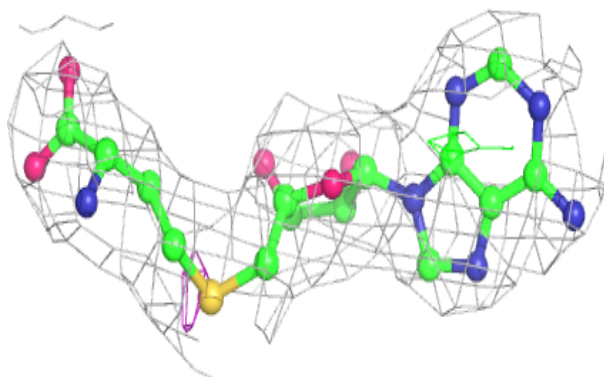

Electron density around ZN E 1003:

$2mF_o-DF_c$ (at 0.7 rmsd) in gray
 mF_o-DF_c (at 3 rmsd) in purple (negative)
and green (positive)

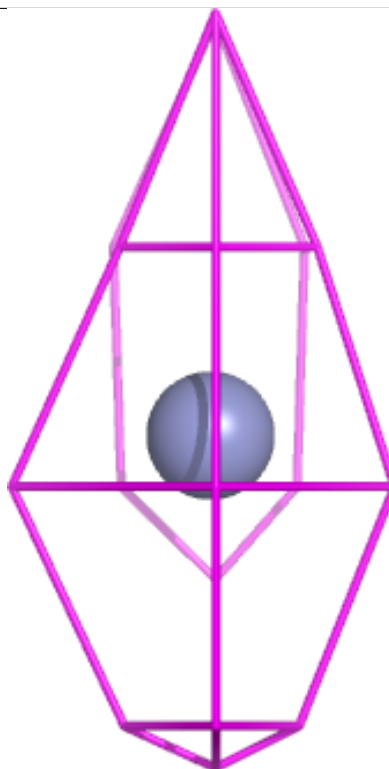
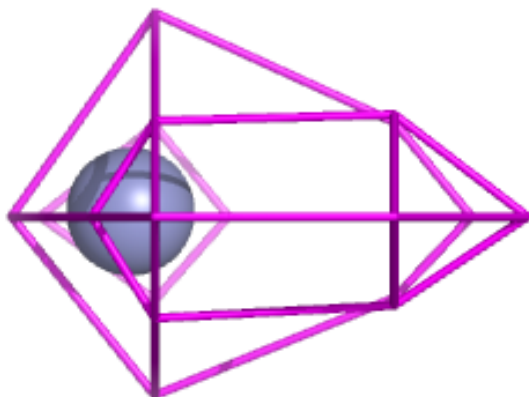
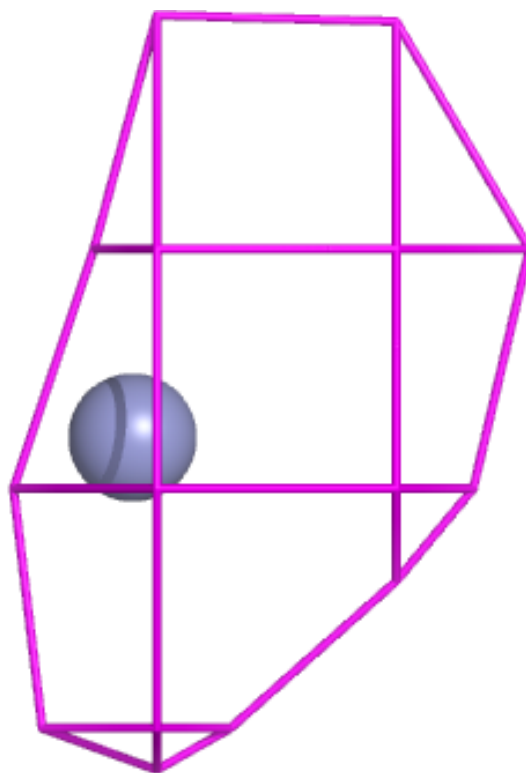

Electron density around ZN B 1004:

$2mF_o-DF_c$ (at 0.7 rmsd) in gray
 mF_o-DF_c (at 3 rmsd) in purple (negative)
and green (positive)

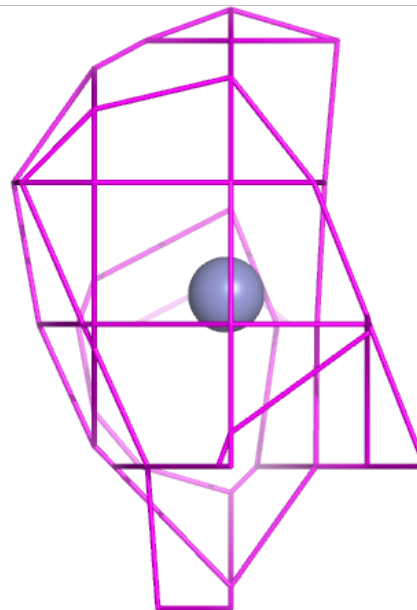
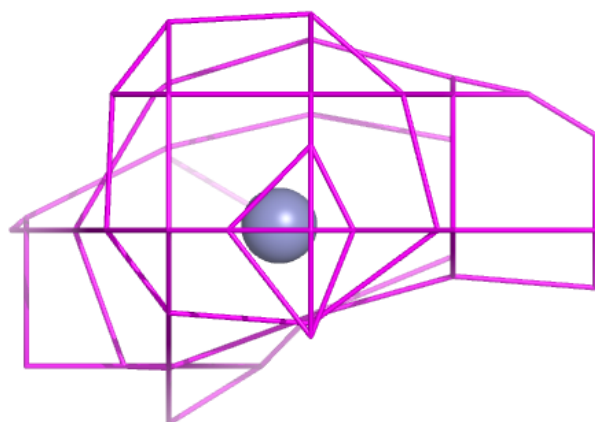
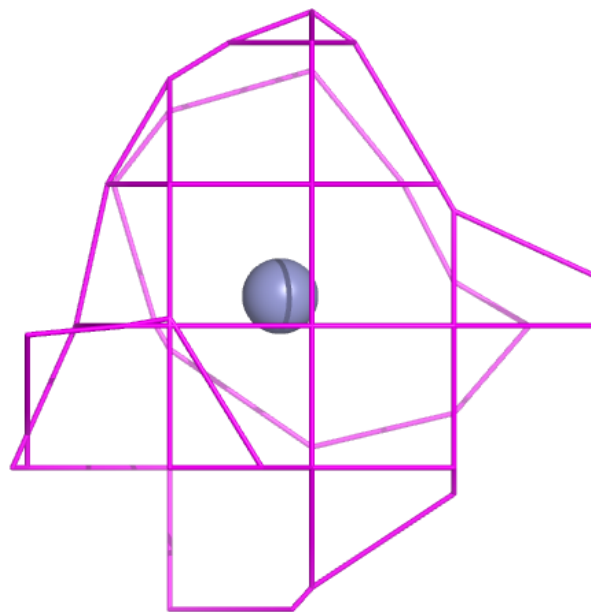

Electron density around ZN A 1004:

$2mF_o-DF_c$ (at 0.7 rmsd) in gray
 mF_o-DF_c (at 3 rmsd) in purple (negative)
and green (positive)

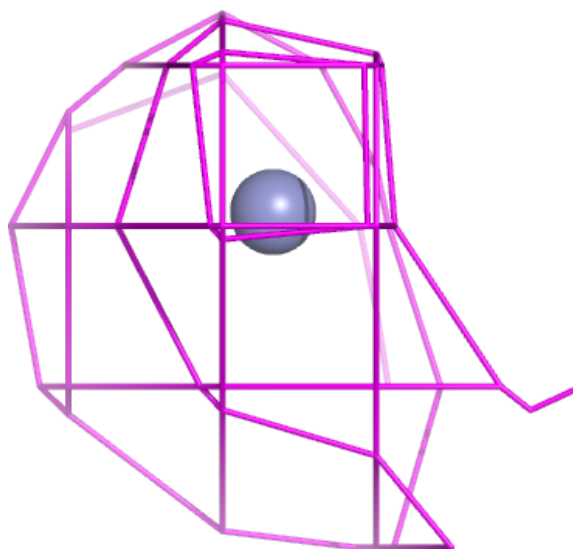
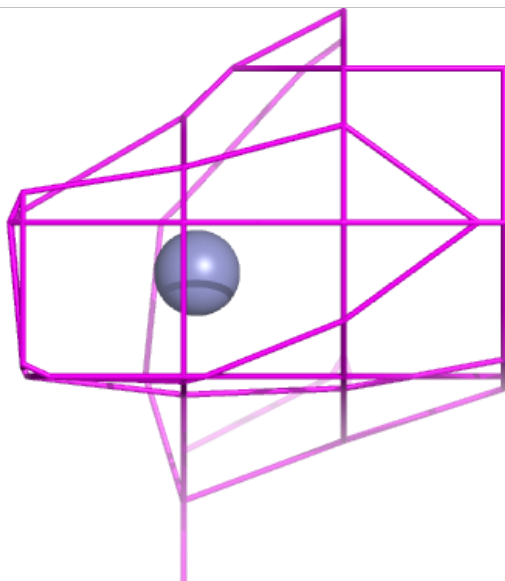
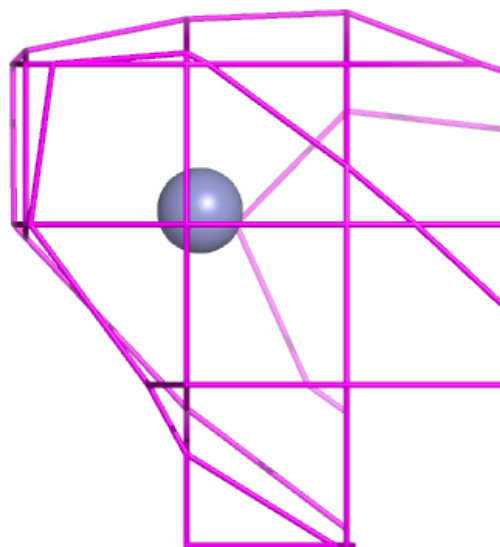

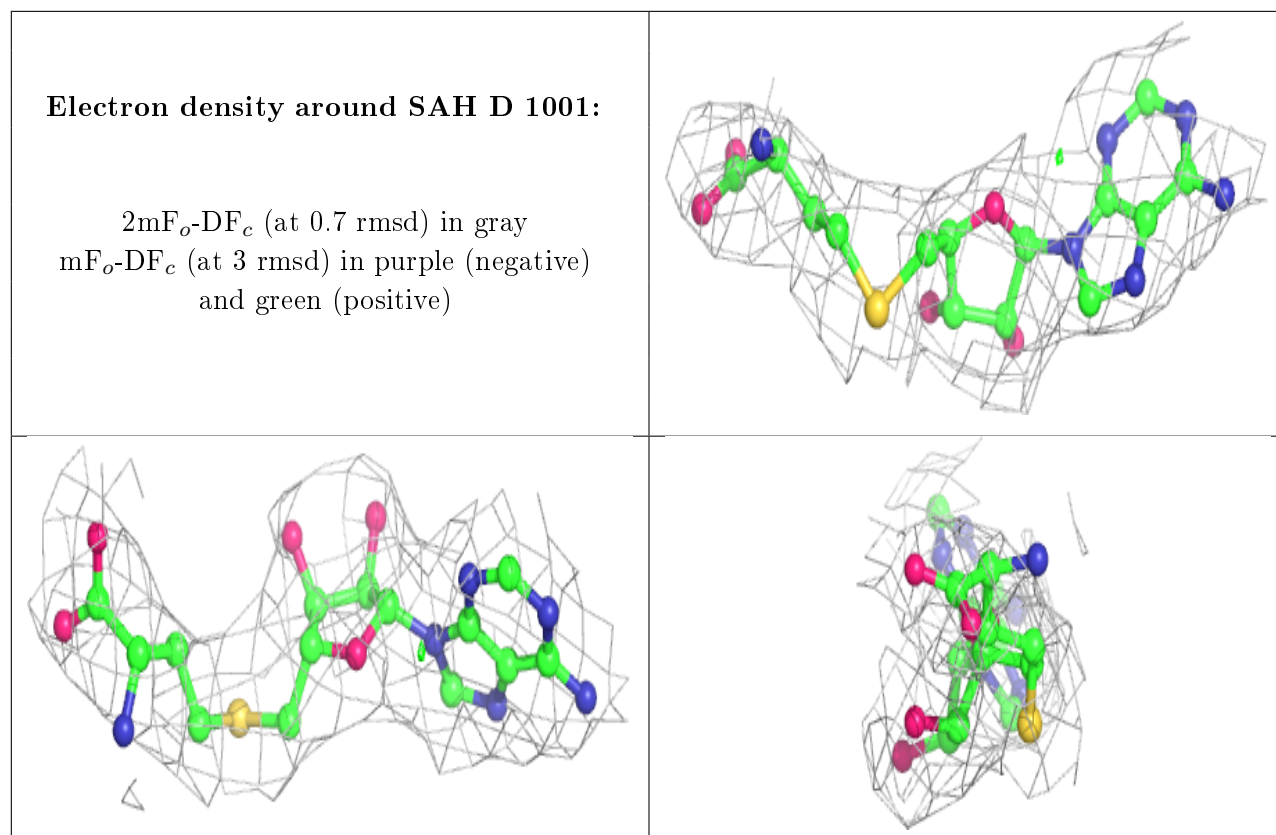

Electron density around ZN C 1003:

$2mF_o-DF_c$ (at 0.7 rmsd) in gray
 mF_o-DF_c (at 3 rmsd) in purple (negative)
and green (positive)

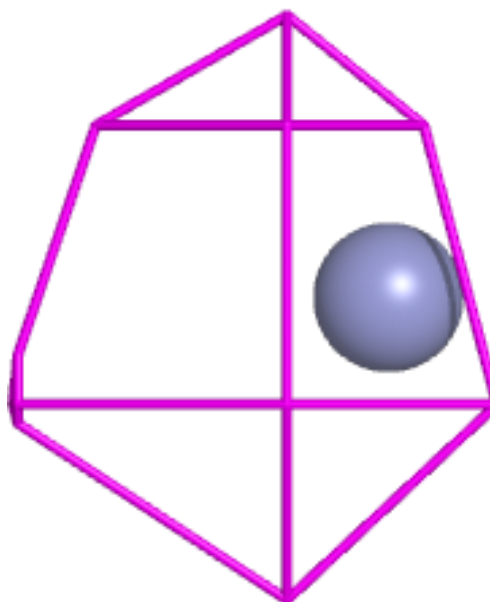
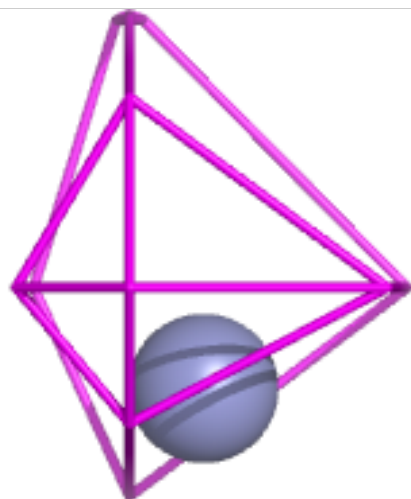
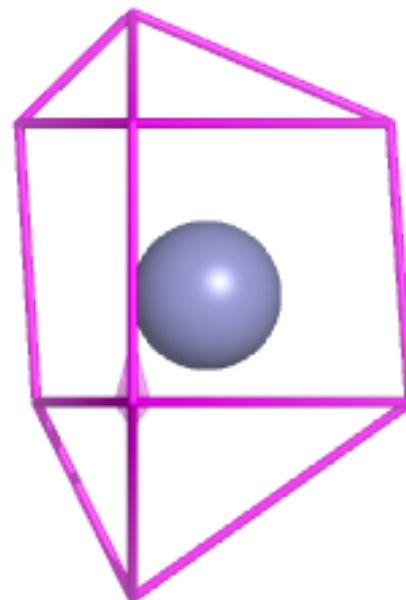

Electron density around ZN D 1005:

$2mF_o-DF_c$ (at 0.7 rmsd) in gray
 mF_o-DF_c (at 3 rmsd) in purple (negative)
and green (positive)

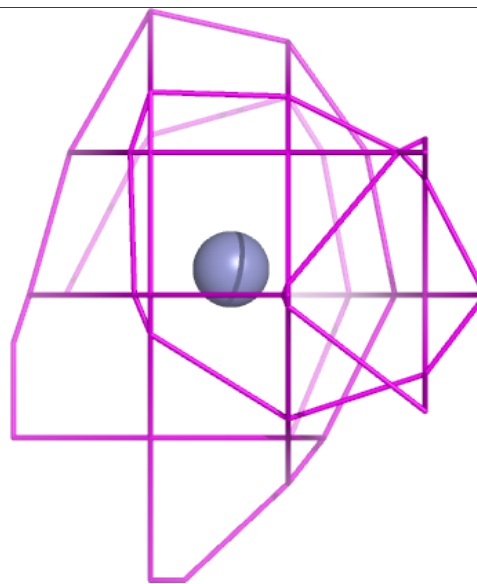
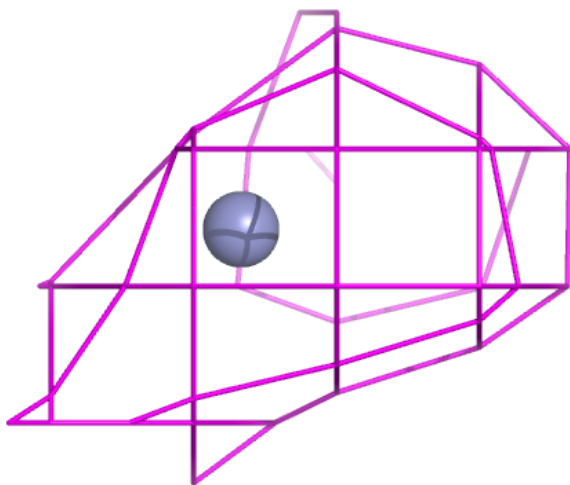
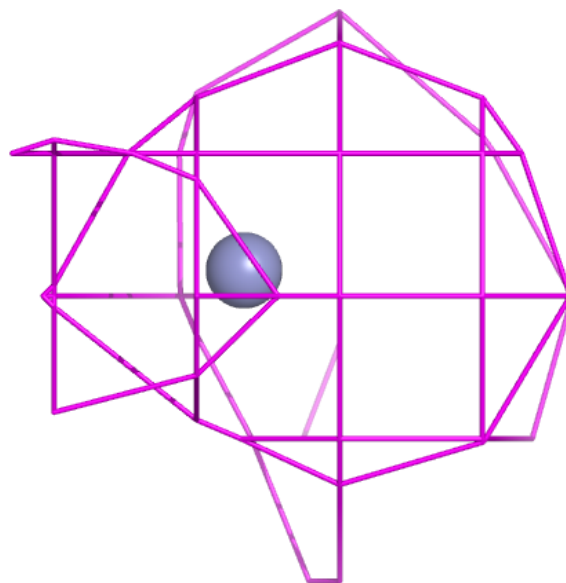

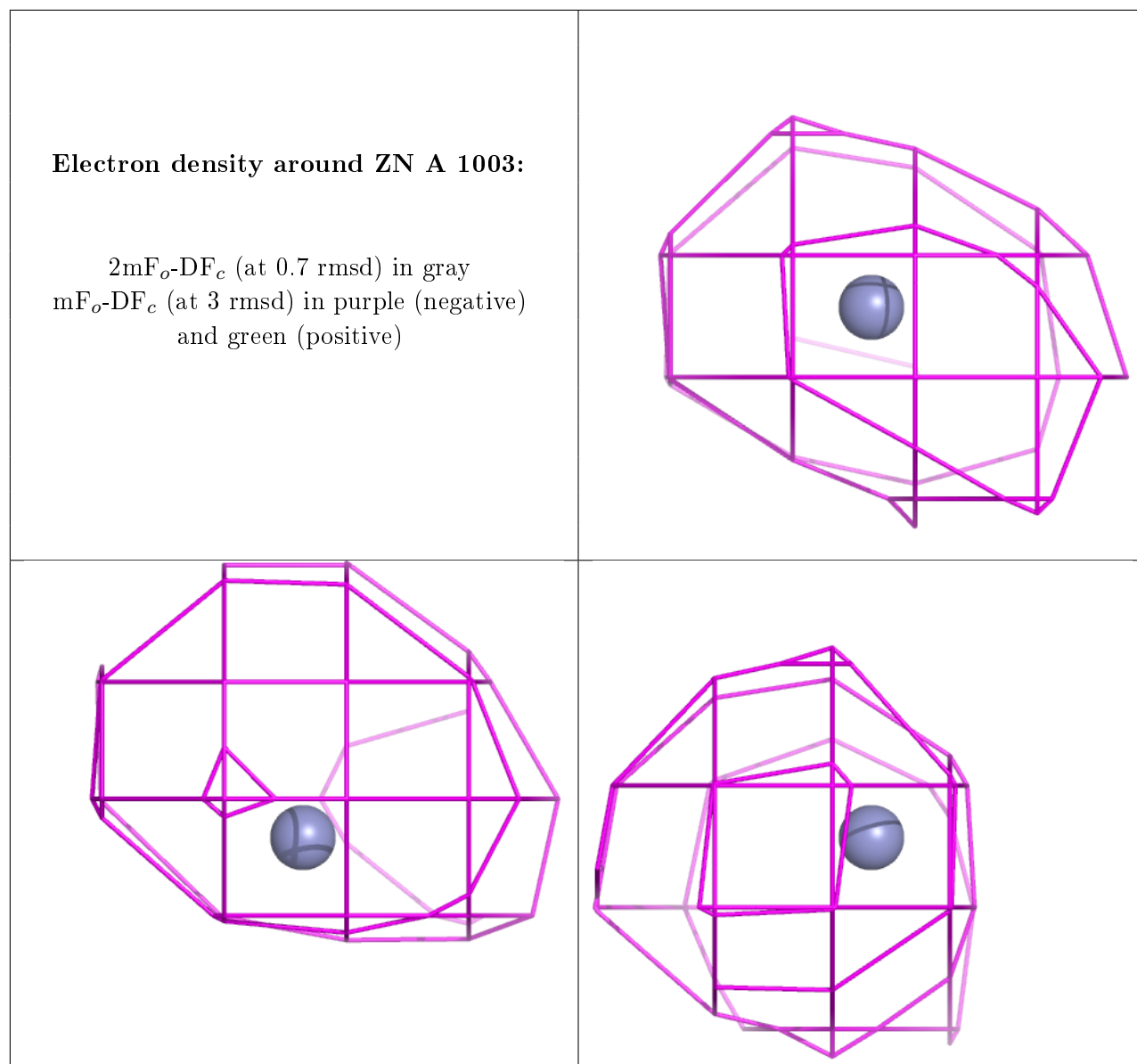

6.5 Other polymers [i](#)

There are no such residues in this entry.