



Full wwPDB X-ray Structure Validation Report ⓘ

Oct 14, 2023 – 03:16 PM EDT

PDB ID : 7UKZ
Title : CDK11 in complex with small molecule inhibitor OTS964
Authors : Kelso, S.; Sicheri, F.
Deposited on : 2022-04-03
Resolution : 2.60 Å(reported)

This is a Full wwPDB X-ray Structure Validation Report for a publicly released PDB entry.

We welcome your comments at validation@mail.wwpdb.org

A user guide is available at

<https://www.wwpdb.org/validation/2017/XrayValidationReportHelp>

with specific help available everywhere you see the ⓘ symbol.

The types of validation reports are described at

<http://www.wwpdb.org/validation/2017/FAQs#types>.

The following versions of software and data (see [references ⓘ](#)) were used in the production of this report:

MolProbity : 4.02b-467
Mogul : 1.8.5 (274361), CSD as541be (2020)
Xtriage (Phenix) : 1.13
EDS : 2.36
buster-report : 1.1.7 (2018)
Percentile statistics : 20191225.v01 (using entries in the PDB archive December 25th 2019)
Refmac : 5.8.0158
CCP4 : 7.0.044 (Gargrove)
Ideal geometry (proteins) : Engh & Huber (2001)
Ideal geometry (DNA, RNA) : Parkinson et al. (1996)
Validation Pipeline (wwPDB-VP) : 2.36

1 Overall quality at a glance i

The following experimental techniques were used to determine the structure:

X-RAY DIFFRACTION

The reported resolution of this entry is 2.60 Å.

Percentile scores (ranging between 0-100) for global validation metrics of the entry are shown in the following graphic. The table shows the number of entries on which the scores are based.

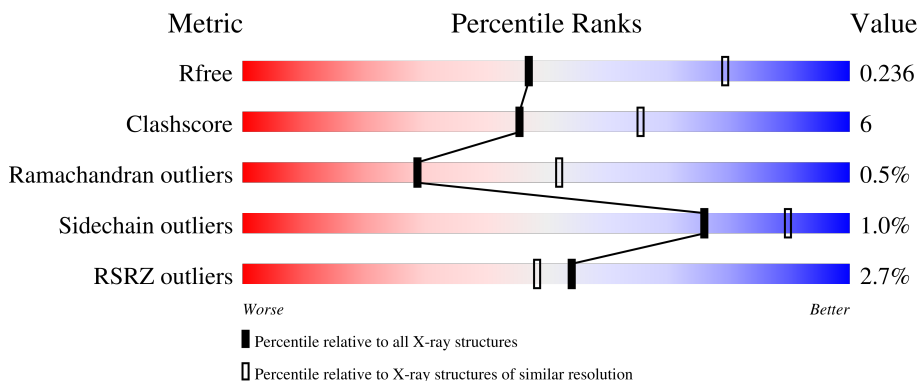

Metric	Whole archive (#Entries)	Similar resolution (#Entries, resolution range(Å))
R_{free}	130704	3163 (2.60-2.60)
Clashscore	141614	3518 (2.60-2.60)
Ramachandran outliers	138981	3455 (2.60-2.60)
Sidechain outliers	138945	3455 (2.60-2.60)
RSRZ outliers	127900	3104 (2.60-2.60)

The table below summarises the geometric issues observed across the polymeric chains and their fit to the electron density. The red, orange, yellow and green segments of the lower bar indicate the fraction of residues that contain outliers for ≥ 3 , 2, 1 and 0 types of geometric quality criteria respectively. A grey segment represents the fraction of residues that are not modelled. The numeric value for each fraction is indicated below the corresponding segment, with a dot representing fractions $\leq 5\%$. The upper red bar (where present) indicates the fraction of residues that have poor fit to the electron density. The numeric value is given above the bar.

Mol	Chain	Length	Quality of chain
1	A	319	<div style="display: flex; align-items: center;"> <div style="width: 2%; height: 10px; background-color: red; margin-right: 2px;"></div> <div style="width: 78%; height: 10px; background-color: green; margin-right: 2px;"></div> <div style="width: 15%; height: 10px; background-color: yellow; margin-right: 2px;"></div> <div style="width: 7%; height: 10px; background-color: grey;"></div> </div> <p style="margin-left: 20px;">2% 78% 15% 7%</p>
1	B	319	<div style="display: flex; align-items: center;"> <div style="width: 2%; height: 10px; background-color: red; margin-right: 2px;"></div> <div style="width: 79%; height: 10px; background-color: green; margin-right: 2px;"></div> <div style="width: 13%; height: 10px; background-color: yellow; margin-right: 2px;"></div> <div style="width: 7%; height: 10px; background-color: grey;"></div> </div> <p style="margin-left: 20px;">2% 79% 13% 7%</p>
1	C	319	<div style="display: flex; align-items: center;"> <div style="width: 2%; height: 10px; background-color: red; margin-right: 2px;"></div> <div style="width: 80%; height: 10px; background-color: green; margin-right: 2px;"></div> <div style="width: 12%; height: 10px; background-color: yellow; margin-right: 2px;"></div> <div style="width: 8%; height: 10px; background-color: grey;"></div> </div> <p style="margin-left: 20px;">2% 80% 12% 8%</p>
1	D	319	<div style="display: flex; align-items: center;"> <div style="width: 3%; height: 10px; background-color: red; margin-right: 2px;"></div> <div style="width: 77%; height: 10px; background-color: green; margin-right: 2px;"></div> <div style="width: 15%; height: 10px; background-color: yellow; margin-right: 2px;"></div> <div style="width: 8%; height: 10px; background-color: grey;"></div> </div> <p style="margin-left: 20px;">3% 77% 15% 8%</p>
1	E	319	<div style="display: flex; align-items: center;"> <div style="width: 3%; height: 10px; background-color: red; margin-right: 2px;"></div> <div style="width: 76%; height: 10px; background-color: green; margin-right: 2px;"></div> <div style="width: 16%; height: 10px; background-color: yellow; margin-right: 2px;"></div> <div style="width: 6%; height: 10px; background-color: grey;"></div> </div> <p style="margin-left: 20px;">3% 76% 16% 6%</p>

Continued on next page...

Continued from previous page...

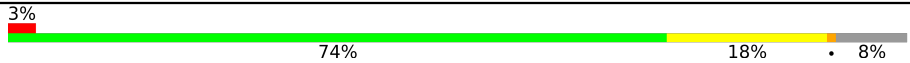
Mol	Chain	Length	Quality of chain
1	F	319	 <p>A horizontal bar chart representing the quality of chain. The bar is divided into four segments: a small red segment on the left labeled '3%', a large green segment labeled '74%', a yellow segment labeled '18%', and a small grey segment on the right labeled '8%'. The segments are separated by thin white lines.</p>

2 Entry composition [i](#)

There are 3 unique types of molecules in this entry. The entry contains 13429 atoms, of which 0 are hydrogens and 0 are deuteriums.

In the tables below, the ZeroOcc column contains the number of atoms modelled with zero occupancy, the AltConf column contains the number of residues with at least one atom in alternate conformation and the Trace column contains the number of residues modelled with at most 2 atoms.

- Molecule 1 is a protein called Cyclin-dependent kinase 11B.

Mol	Chain	Residues	Atoms						ZeroOcc	AltConf	Trace
			Total	C	N	O	P	S			
1	A	296	2247	1453	371	410	1	12	2	0	0
1	B	296	2177	1397	365	404	1	10	4	0	0
1	C	294	2185	1417	359	397	1	11	5	0	0
1	D	294	2170	1409	357	392	1	11	3	0	0
1	E	299	2254	1455	373	413	1	12	6	0	0
1	F	295	2198	1430	352	404	1	11	12	0	0

There are 60 discrepancies between the modelled and reference sequences:

Chain	Residue	Modelled	Actual	Comment	Reference
A	68	GLY	-	expression tag	UNP P21127
A	69	ALA	-	expression tag	UNP P21127
A	70	MET	-	expression tag	UNP P21127
A	71	GLY	-	expression tag	UNP P21127
A	381	LYS	-	expression tag	UNP P21127
A	382	LEU	-	expression tag	UNP P21127
A	383	VAL	-	expression tag	UNP P21127
A	384	GLU	-	expression tag	UNP P21127
A	385	LYS	-	expression tag	UNP P21127
A	386	TYR	-	expression tag	UNP P21127
B	68	GLY	-	expression tag	UNP P21127
B	69	ALA	-	expression tag	UNP P21127
B	70	MET	-	expression tag	UNP P21127
B	71	GLY	-	expression tag	UNP P21127
B	381	LYS	-	expression tag	UNP P21127
B	382	LEU	-	expression tag	UNP P21127
B	383	VAL	-	expression tag	UNP P21127

Continued on next page...

Continued from previous page...

Chain	Residue	Modelled	Actual	Comment	Reference
B	384	GLU	-	expression tag	UNP P21127
B	385	LYS	-	expression tag	UNP P21127
B	386	TYR	-	expression tag	UNP P21127
C	68	GLY	-	expression tag	UNP P21127
C	69	ALA	-	expression tag	UNP P21127
C	70	MET	-	expression tag	UNP P21127
C	71	GLY	-	expression tag	UNP P21127
C	381	LYS	-	expression tag	UNP P21127
C	382	LEU	-	expression tag	UNP P21127
C	383	VAL	-	expression tag	UNP P21127
C	384	GLU	-	expression tag	UNP P21127
C	385	LYS	-	expression tag	UNP P21127
C	386	TYR	-	expression tag	UNP P21127
D	68	GLY	-	expression tag	UNP P21127
D	69	ALA	-	expression tag	UNP P21127
D	70	MET	-	expression tag	UNP P21127
D	71	GLY	-	expression tag	UNP P21127
D	381	LYS	-	expression tag	UNP P21127
D	382	LEU	-	expression tag	UNP P21127
D	383	VAL	-	expression tag	UNP P21127
D	384	GLU	-	expression tag	UNP P21127
D	385	LYS	-	expression tag	UNP P21127
D	386	TYR	-	expression tag	UNP P21127
E	68	GLY	-	expression tag	UNP P21127
E	69	ALA	-	expression tag	UNP P21127
E	70	MET	-	expression tag	UNP P21127
E	71	GLY	-	expression tag	UNP P21127
E	381	LYS	-	expression tag	UNP P21127
E	382	LEU	-	expression tag	UNP P21127
E	383	VAL	-	expression tag	UNP P21127
E	384	GLU	-	expression tag	UNP P21127
E	385	LYS	-	expression tag	UNP P21127
E	386	TYR	-	expression tag	UNP P21127
F	68	GLY	-	expression tag	UNP P21127
F	69	ALA	-	expression tag	UNP P21127
F	70	MET	-	expression tag	UNP P21127
F	71	GLY	-	expression tag	UNP P21127
F	381	LYS	-	expression tag	UNP P21127
F	382	LEU	-	expression tag	UNP P21127
F	383	VAL	-	expression tag	UNP P21127
F	384	GLU	-	expression tag	UNP P21127
F	385	LYS	-	expression tag	UNP P21127

Continued on next page...

Continued from previous page...

Chain	Residue	Modelled	Actual	Comment	Reference
F	386	TYR	-	expression tag	UNP P21127

- Molecule 2 is OTS964 (three-letter code: NK3) (formula: C₂₃H₂₄N₂O₂S) (labeled as "Ligand of Interest" by depositor).

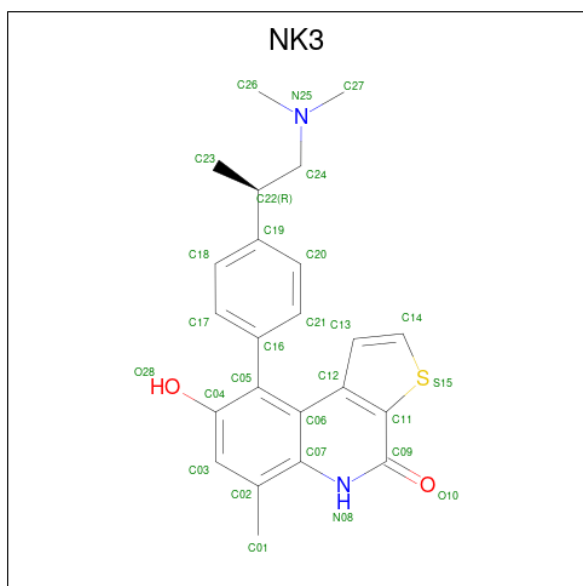

Mol	Chain	Residues	Atoms					ZeroOcc	AltConf
			Total	C	N	O	S		
2	A	1	Total	C	N	O	S	0	0
			28	23	2	2	1		
2	B	1	Total	C	N	O	S	0	0
			28	23	2	2	1		
2	C	1	Total	C	N	O	S	0	0
			28	23	2	2	1		
2	D	1	Total	C	N	O	S	0	0
			28	23	2	2	1		
2	E	1	Total	C	N	O	S	0	0
			28	23	2	2	1		
2	F	1	Total	C	N	O	S	0	0
			28	23	2	2	1		

- Molecule 3 is SULFATE ION (three-letter code: SO4) (formula: O₄S).



Mol	Chain	Residues	Atoms			ZeroOcc	AltConf
3	A	1	Total	O	S	0	0
			5	4	1		
3	B	1	Total	O	S	0	0
			5	4	1		
3	C	1	Total	O	S	0	0
			5	4	1		
3	D	1	Total	O	S	0	0
			5	4	1		
3	E	1	Total	O	S	0	0
			5	4	1		
3	F	1	Total	O	S	0	0
			5	4	1		

3 Residue-property plots [i](#)

These plots are drawn for all protein, RNA, DNA and oligosaccharide chains in the entry. The first graphic for a chain summarises the proportions of the various outlier classes displayed in the second graphic. The second graphic shows the sequence view annotated by issues in geometry and electron density. Residues are color-coded according to the number of geometric quality criteria for which they contain at least one outlier: green = 0, yellow = 1, orange = 2 and red = 3 or more. A red dot above a residue indicates a poor fit to the electron density ($RSRZ > 2$). Stretches of 2 or more consecutive residues without any outlier are shown as a green connector. Residues present in the sample, but not in the model, are shown in grey.

- Molecule 1: Cyclin-dependent kinase 11B

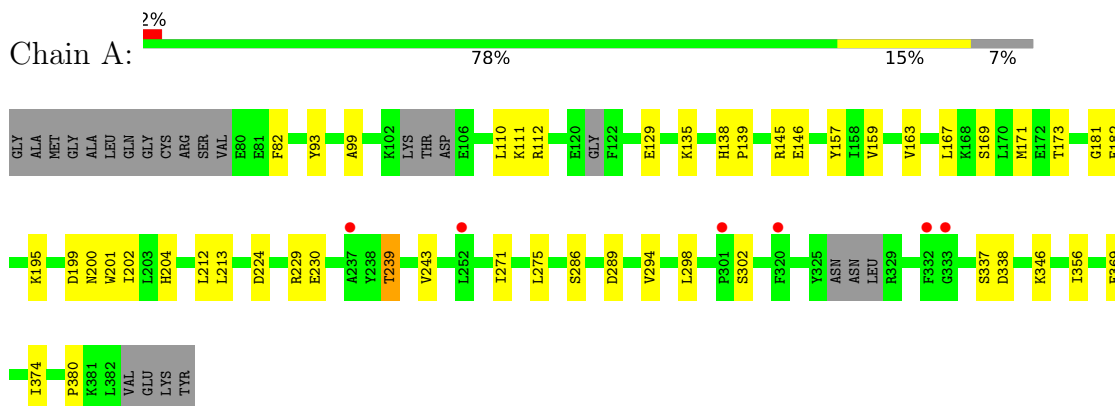

- Molecule 1: Cyclin-dependent kinase 11B

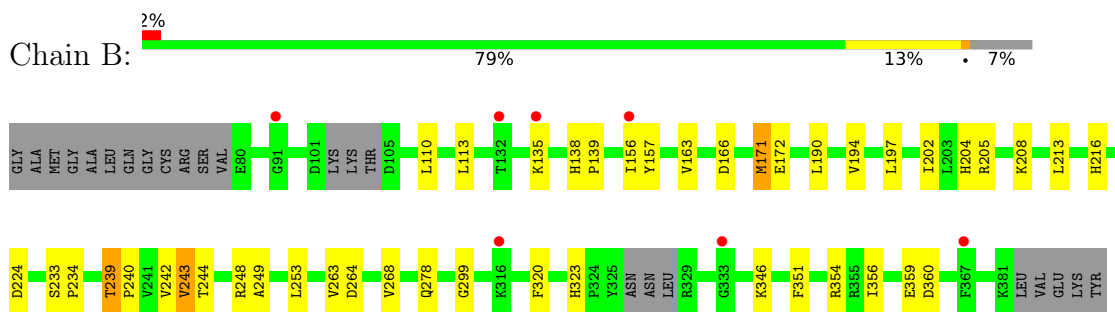

- Molecule 1: Cyclin-dependent kinase 11B

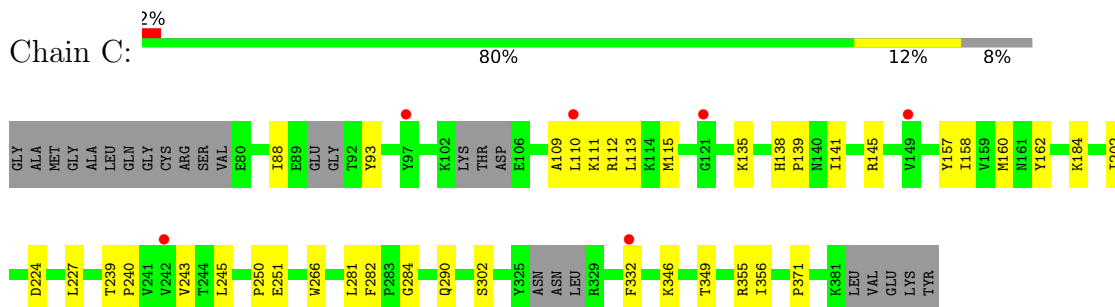

- Molecule 1: Cyclin-dependent kinase 11B

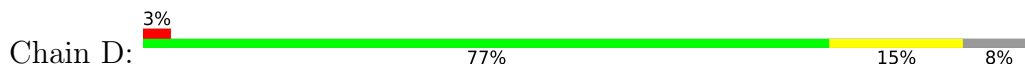

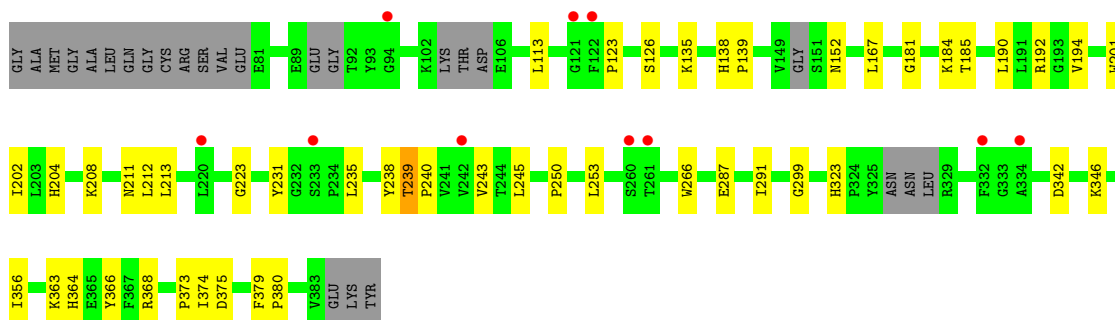

- Molecule 1: Cyclin-dependent kinase 11B

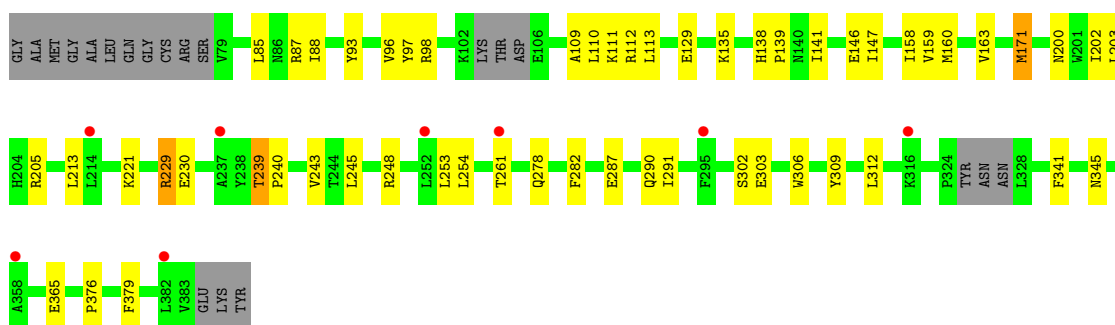
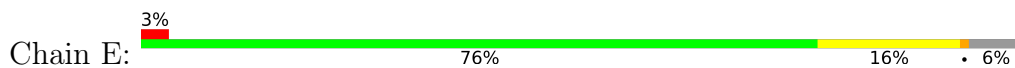

- Molecule 1: Cyclin-dependent kinase 11B

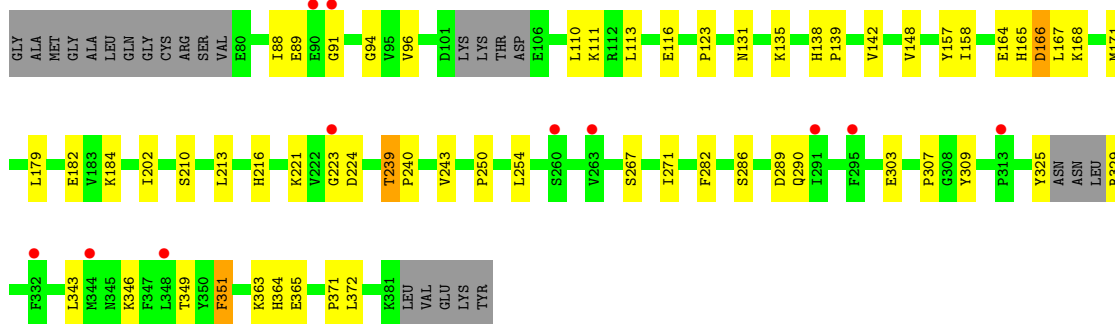
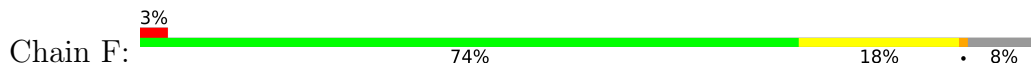

4 Data and refinement statistics i

Property	Value	Source
Space group	P 65	Depositor
Cell constants a, b, c, α , β , γ	146.68Å 146.68Å 230.94Å 90.00° 90.00° 120.00°	Depositor
Resolution (Å)	127.03 – 2.60 127.03 – 2.60	Depositor EDS
% Data completeness (in resolution range)	99.6 (127.03-2.60) 99.7 (127.03-2.60)	Depositor EDS
R_{merge}	0.11	Depositor
R_{sym}	(Not available)	Depositor
$\langle I/\sigma(I) \rangle$ ¹	0.97 (at 2.58Å)	Xtrriage
Refinement program	PHENIX 1.20.1	Depositor
R, R_{free}	0.222 , 0.236 0.224 , 0.236	Depositor DCC
R_{free} test set	4315 reflections (5.00%)	wwPDB-VP
Wilson B-factor (Å ²)	76.2	Xtrriage
Anisotropy	0.187	Xtrriage
Bulk solvent k_{sol} (e/Å ³), B_{sol} (Å ²)	0.34 , 56.8	EDS
L-test for twinning ²	$\langle L \rangle = 0.42$, $\langle L^2 \rangle = 0.25$	Xtrriage
Estimated twinning fraction	0.309 for h,-h-k,-l	Xtrriage
Reported twinning fraction	0.650 for h,-h-k,-l	Depositor
Outliers	0 of 86274 reflections	Xtrriage
F_o, F_c correlation	0.94	EDS
Total number of atoms	13429	wwPDB-VP
Average B, all atoms (Å ²)	73.0	wwPDB-VP

Xtrriage's analysis on translational NCS is as follows: *The largest off-origin peak in the Patterson function is 6.36% of the height of the origin peak. No significant pseudotranslation is detected.*

¹Intensities estimated from amplitudes.

²Theoretical values of $\langle |L| \rangle$, $\langle L^2 \rangle$ for acentric reflections are 0.5, 0.333 respectively for untwinned datasets, and 0.375, 0.2 for perfectly twinned datasets.

5 Model quality [i](#)

5.1 Standard geometry [i](#)

Bond lengths and bond angles in the following residue types are not validated in this section: SO4, NK3, TPO

The Z score for a bond length (or angle) is the number of standard deviations the observed value is removed from the expected value. A bond length (or angle) with $|Z| > 5$ is considered an outlier worth inspection. RMSZ is the root-mean-square of all Z scores of the bond lengths (or angles).

Mol	Chain	Bond lengths		Bond angles	
		RMSZ	# Z >5	RMSZ	# Z >5
1	A	0.23	0/2288	0.44	0/3108
1	B	0.24	0/2217	0.44	0/3021
1	C	0.23	0/2226	0.42	0/3033
1	D	0.24	0/2209	0.45	0/3007
1	E	0.24	0/2296	0.46	0/3124
1	F	0.24	0/2242	0.44	0/3057
All	All	0.24	0/13478	0.44	0/18350

There are no bond length outliers.

There are no bond angle outliers.

There are no chirality outliers.

There are no planarity outliers.

5.2 Too-close contacts [i](#)

In the following table, the Non-H and H(model) columns list the number of non-hydrogen atoms and hydrogen atoms in the chain respectively. The H(added) column lists the number of hydrogen atoms added and optimized by MolProbity. The Clashes column lists the number of clashes within the asymmetric unit, whereas Symm-Clashes lists symmetry-related clashes.

Mol	Chain	Non-H	H(model)	H(added)	Clashes	Symm-Clashes
1	A	2247	0	2103	26	0
1	B	2177	0	1958	22	0
1	C	2185	0	2003	22	0
1	D	2170	0	1986	30	0
1	E	2254	0	2093	31	0
1	F	2198	0	2006	41	0
2	A	28	0	0	0	0

Continued on next page...

Continued from previous page...

Mol	Chain	Non-H	H(model)	H(added)	Clashes	Symm-Clashes
2	B	28	0	0	0	0
2	C	28	0	0	0	0
2	D	28	0	0	0	0
2	E	28	0	0	0	0
2	F	28	0	0	1	0
3	A	5	0	0	0	0
3	B	5	0	0	0	0
3	C	5	0	0	0	0
3	D	5	0	0	0	0
3	E	5	0	0	0	0
3	F	5	0	0	0	0
All	All	13429	0	12149	164	0

The all-atom clashscore is defined as the number of clashes found per 1000 atoms (including hydrogen atoms). The all-atom clashscore for this structure is 6.

All (164) close contacts within the same asymmetric unit are listed below, sorted by their clash magnitude.

Atom-1	Atom-2	Interatomic distance (Å)	Clash overlap (Å)
1:D:363:LYS:HB3	1:F:363:LYS:HD2	1.68	0.75
1:C:349:THR:O	1:C:355:ARG:NH1	2.20	0.73
1:C:282:PHE:O	1:C:290:GLN:NE2	2.22	0.73
1:F:135:LYS:HB2	1:F:202:ILE:HD11	1.70	0.73
1:B:243:VAL:HB	1:B:248:ARG:HG3	1.72	0.71
1:A:135:LYS:HD3	1:A:200:ASN:HB3	1.74	0.68
1:D:192:ARG:HH12	1:F:365:GLU:HG2	1.61	0.65
1:F:168:LYS:HD3	1:F:210:SER:HB3	1.79	0.65
1:F:113:LEU:HD21	1:F:158:ILE:HG13	1.78	0.64
1:F:111:LYS:NZ	1:F:224:ASP:OD1	2.30	0.63
1:F:142:VAL:HA	1:F:221:LYS:HD3	1.80	0.63
1:C:93:TYR:O	1:C:112:ARG:NH2	2.31	0.62
1:C:110:LEU:HD11	1:C:157:TYR:HB3	1.81	0.62
1:E:365:GLU:OE1	1:E:365:GLU:N	2.30	0.62
1:F:110:LEU:HD11	1:F:157:TYR:HB3	1.81	0.62
1:D:346:LYS:HB3	1:D:356:ILE:HB	1.82	0.61
1:C:284:GLY:HA3	1:C:290:GLN:HG2	1.82	0.61
1:E:309:TYR:HA	1:E:312:LEU:HD12	1.83	0.61
1:B:346:LYS:HB3	1:B:356:ILE:HB	1.84	0.60
1:E:163:VAL:HG11	1:E:213:LEU:HB3	1.84	0.60
1:C:346:LYS:HB3	1:C:356:ILE:HB	1.84	0.59
1:A:294:VAL:HG13	1:A:298:LEU:HD12	1.85	0.58

Continued on next page...

Continued from previous page...

Atom-1	Atom-2	Interatomic distance (Å)	Clash overlap (Å)
1:A:302:SER:HB2	1:D:380:PRO:HB3	1.84	0.58
1:A:111:LYS:NZ	1:A:224:ASP:OD1	2.33	0.57
1:A:169:SER:O	1:A:173:THR:OG1	2.22	0.57
1:F:184:LYS:HE3	1:F:371:PRO:O	2.06	0.56
1:B:204:HIS:NE2	1:B:224:ASP:O	2.31	0.55
1:F:88:ILE:HD12	1:F:89:GLU:HB2	1.87	0.55
1:F:267:SER:O	1:F:271:ILE:HG13	2.06	0.55
1:A:171:MET:HE1	1:A:275:LEU:HA	1.88	0.55
1:C:145:ARG:H	1:C:160:MET:HA	1.70	0.55
1:B:351:PHE:HD2	1:B:354:ARG:H	1.55	0.55
1:A:135:LYS:HB3	1:A:202:ILE:HD11	1.89	0.54
1:C:88:ILE:H	1:C:88:ILE:HD12	1.71	0.54
1:E:254:LEU:HD23	1:E:312:LEU:HD13	1.89	0.54
1:E:135:LYS:HG2	1:E:202:ILE:HD11	1.88	0.54
1:E:113:LEU:HD21	1:E:158:ILE:HG13	1.89	0.54
1:E:248:ARG:HB3	1:E:253:LEU:HD21	1.89	0.54
1:F:325:TYR:O	1:F:329:ARG:N	2.41	0.54
1:E:138:HIS:HB3	1:E:141:ILE:HG12	1.90	0.53
1:D:123:PRO:HB2	1:D:126:SER:OG	2.08	0.53
1:F:148:VAL:HG23	1:F:157:TYR:HB2	1.89	0.53
1:D:181:GLY:HA3	1:D:374:ILE:HG13	1.91	0.53
1:F:179:LEU:HB2	1:F:182:GLU:HG3	1.90	0.52
1:D:208:LYS:HG2	1:D:211:ASN:HB2	1.92	0.52
1:F:250:PRO:O	1:F:254:LEU:HD12	2.09	0.52
1:F:307:PRO:HD2	1:F:351:PHE:CD2	2.43	0.52
1:A:93:TYR:O	1:A:112:ARG:NH2	2.42	0.52
1:A:346:LYS:HB3	1:A:356:ILE:HB	1.91	0.52
1:D:201:TRP:HA	1:D:231:TYR:CE1	2.45	0.52
1:C:251:GLU:OE2	1:C:355:ARG:NH2	2.42	0.52
1:B:171:MET:O	1:B:278:GLN:NE2	2.44	0.51
1:B:110:LEU:HD11	1:B:157:TYR:HB3	1.92	0.51
1:A:111:LYS:NZ	1:A:129:GLU:OE2	2.38	0.51
1:E:303:GLU:HG2	1:E:309:TYR:HB3	1.92	0.51
1:A:181:GLY:HA3	1:A:374:ILE:HG13	1.93	0.50
1:B:163:VAL:HG11	1:B:213:LEU:HB3	1.92	0.50
1:E:147:ILE:HG12	1:E:158:ILE:HG12	1.92	0.50
1:B:194:VAL:HA	1:B:197:LEU:HD12	1.94	0.50
1:B:208:LYS:HD2	1:B:244:THR:OG1	2.12	0.50
1:A:163:VAL:HG11	1:A:213:LEU:HB3	1.94	0.50
1:E:111:LYS:NZ	1:E:129:GLU:OE2	2.38	0.49
1:F:239:TPO:N	1:F:239:TPO:O2P	2.45	0.49

Continued on next page...

Continued from previous page...

Atom-1	Atom-2	Interatomic distance (Å)	Clash overlap (Å)
1:B:299:GLY:HA2	1:B:323:HIS:O	2.13	0.49
1:E:302:SER:O	1:E:306:TRP:N	2.46	0.49
1:B:113:LEU:HD23	1:B:156:ILE:HG22	1.96	0.48
1:D:167:LEU:HD12	1:D:212:LEU:HB2	1.95	0.48
1:E:203:LEU:HD21	1:E:261:THR:H	1.79	0.48
1:F:131:ASN:O	1:F:135:LYS:HG3	2.14	0.48
1:D:135:LYS:HB3	1:D:202:ILE:HD11	1.96	0.47
1:E:171:MET:O	1:E:278:GLN:NE2	2.44	0.47
1:E:282:PHE:HB3	1:E:290:GLN:NE2	2.29	0.47
1:C:111:LYS:NZ	1:C:224:ASP:OD1	2.46	0.47
1:F:282:PHE:HB3	1:F:290:GLN:NE2	2.30	0.47
1:F:346:LYS:O	1:F:349:THR:OG1	2.32	0.47
1:F:91:GLY:O	1:F:94:GLY:N	2.45	0.47
1:F:111:LYS:HG2	1:F:113:LEU:HD13	1.96	0.47
1:D:363:LYS:HG2	1:F:363:LYS:HB3	1.97	0.47
1:E:287:GLU:O	1:E:291:ILE:HD12	2.15	0.47
1:F:179:LEU:N	1:F:182:GLU:OE1	2.35	0.47
1:F:166:ASP:HA	1:F:213:LEU:HA	1.97	0.47
1:D:245:LEU:HD11	1:D:287:GLU:HA	1.97	0.46
1:F:164:GLU:HB3	1:F:165:HIS:CD2	2.51	0.46
1:D:287:GLU:O	1:D:291:ILE:HG13	2.15	0.46
1:B:190:LEU:HD21	1:B:268:VAL:HG13	1.98	0.46
1:E:109:ALA:HB3	1:E:160:MET:HG3	1.97	0.46
1:C:138:HIS:HB3	1:C:141:ILE:HG12	1.98	0.46
1:E:229:ARG:HG3	1:E:230:GLU:N	2.30	0.46
1:F:88:ILE:HD11	2:F:401:NK3:C21	2.46	0.46
1:B:239:TPO:HA	1:B:240:PRO:HD3	1.79	0.46
1:B:249:ALA:HB2	1:B:263:VAL:HA	1.98	0.46
1:F:138:HIS:CG	1:F:139:PRO:HD2	2.51	0.45
1:B:205:ARG:HD2	1:B:242:VAL:HG21	1.98	0.45
1:D:213:LEU:HD11	1:D:223:GLY:HA3	1.97	0.45
1:A:337:SER:OG	1:A:369:GLU:OE2	2.34	0.45
1:E:110:LEU:HD12	1:E:159:VAL:HG22	1.98	0.45
1:D:190:LEU:O	1:D:194:VAL:HG23	2.17	0.45
1:D:373:PRO:HB2	1:F:372:LEU:HD13	1.97	0.45
1:C:245:LEU:HG	1:C:290:GLN:HG3	1.99	0.45
1:F:286:SER:H	1:F:289:ASP:HB3	1.82	0.45
1:E:112:ARG:NH1	1:E:113:LEU:O	2.50	0.45
1:A:212:LEU:HD11	1:A:271:ILE:HD13	1.98	0.44
1:D:368:ARG:HH12	1:F:363:LYS:HD3	1.82	0.44
1:F:213:LEU:HD11	1:F:223:GLY:HA3	1.98	0.44

Continued on next page...

Continued from previous page...

Atom-1	Atom-2	Interatomic distance (Å)	Clash overlap (Å)
1:F:303:GLU:OE2	1:F:309:TYR:N	2.49	0.44
1:B:172:GLU:H	1:B:172:GLU:HG2	1.64	0.44
1:E:146:GLU:HB3	1:E:159:VAL:HB	2.00	0.44
1:B:264:ASP:O	1:B:268:VAL:HG23	2.18	0.44
1:C:281:LEU:HD13	1:C:332:PHE:HZ	1.82	0.44
1:D:375:ASP:OD1	1:F:372:LEU:N	2.49	0.44
1:D:250:PRO:HD3	1:D:266:TRP:CE2	2.53	0.44
1:E:85:LEU:N	1:E:98:ARG:O	2.48	0.44
1:B:135:LYS:HB3	1:B:202:ILE:HD11	2.00	0.43
1:A:138:HIS:CG	1:A:139:PRO:HD2	2.54	0.43
1:D:250:PRO:HA	1:D:253:LEU:HD12	2.00	0.43
1:F:167:LEU:O	1:F:171:MET:HG2	2.18	0.43
1:F:343:LEU:HB2	1:F:364:HIS:CE1	2.53	0.43
1:A:146:GLU:O	1:A:159:VAL:N	2.44	0.43
1:C:112:ARG:NE	1:C:115:MET:SD	2.91	0.43
1:C:138:HIS:CG	1:C:139:PRO:HD2	2.53	0.43
1:E:87:ARG:HA	1:E:97:TYR:HA	1.99	0.43
1:F:164:GLU:HB3	1:F:165:HIS:HD2	1.82	0.43
1:A:201:TRP:O	1:A:230:GLU:HG3	2.18	0.43
1:A:338:ASP:OD1	1:A:338:ASP:N	2.52	0.43
1:B:359:GLU:HG3	1:B:360:ASP:N	2.34	0.43
1:D:138:HIS:CG	1:D:139:PRO:HD2	2.54	0.43
1:D:185:THR:HB	1:D:379:PHE:HZ	1.84	0.43
1:C:113:LEU:HD21	1:C:158:ILE:HD12	2.01	0.43
1:E:88:ILE:HD12	1:E:96:VAL:HG12	2.00	0.43
1:B:248:ARG:HB3	1:B:253:LEU:CD1	2.49	0.42
1:A:110:LEU:HD11	1:A:157:TYR:HB3	2.01	0.42
1:C:227:LEU:HD23	1:C:227:LEU:HA	1.86	0.42
1:F:116:GLU:HG3	1:F:123:PRO:HB3	2.01	0.42
1:D:113:LEU:HD23	1:D:126:SER:HB2	2.02	0.42
1:F:167:LEU:HD23	1:F:167:LEU:HA	1.84	0.42
1:A:286:SER:H	1:A:289:ASP:HB3	1.84	0.42
1:D:204:HIS:HE1	1:D:211:ASN:HD22	1.68	0.42
1:E:341:PHE:O	1:E:345:ASN:ND2	2.40	0.42
1:A:195:LYS:NZ	1:A:199:ASP:OD2	2.42	0.42
1:D:238:TYR:O	1:D:240:PRO:HD3	2.20	0.42
1:D:239:TPO:O3P	1:D:239:TPO:N	2.53	0.42
1:C:184:LYS:NZ	1:C:371:PRO:O	2.33	0.42
1:D:184:LYS:HE2	1:D:366:TYR:CZ	2.55	0.42
1:D:342:ASP:OD2	1:D:364:HIS:NE2	2.42	0.42
1:A:239:TPO:O2P	1:A:239:TPO:N	2.52	0.41

Continued on next page...

Continued from previous page...

Atom-1	Atom-2	Interatomic distance (Å)	Clash overlap (Å)
1:A:380:PRO:HB3	1:C:302:SER:HB2	2.03	0.41
1:B:233:SER:HB3	1:B:234:PRO:HD3	2.02	0.41
1:C:109:ALA:HB2	1:C:162:TYR:HD1	1.85	0.41
1:F:96:VAL:HG22	1:F:111:LYS:HD2	2.02	0.41
1:E:138:HIS:CG	1:E:139:PRO:HD2	2.55	0.41
1:F:164:GLU:HG2	1:F:216:HIS:HB2	2.02	0.41
1:A:182:GLU:HG3	1:A:374:ILE:HD12	2.03	0.41
1:D:299:GLY:HA2	1:D:323:HIS:O	2.20	0.41
1:B:138:HIS:CG	1:B:139:PRO:HD2	2.56	0.41
1:C:135:LYS:HG2	1:C:202:ILE:HD11	2.03	0.41
1:E:376:PRO:HA	1:E:379:PHE:HD2	1.85	0.41
1:E:205:ARG:HH12	1:E:239:TPO:P	2.44	0.41
1:A:204:HIS:NE2	1:A:224:ASP:O	2.40	0.40
1:C:250:PRO:HD3	1:C:266:TRP:CE2	2.56	0.40
1:D:235:LEU:HD12	1:D:235:LEU:HA	1.96	0.40
1:E:135:LYS:HE3	1:E:200:ASN:O	2.20	0.40
1:E:213:LEU:O	1:E:221:LYS:N	2.42	0.40
1:A:82:PHE:HB3	1:A:99:ALA:HB1	2.03	0.40
1:E:245:LEU:HD11	1:E:287:GLU:HA	2.04	0.40

There are no symmetry-related clashes.

5.3 Torsion angles [i](#)

5.3.1 Protein backbone [i](#)

In the following table, the Percentiles column shows the percent Ramachandran outliers of the chain as a percentile score with respect to all X-ray entries followed by that with respect to entries of similar resolution.

The Analysed column shows the number of residues for which the backbone conformation was analysed, and the total number of residues.

Mol	Chain	Analysed	Favoured	Allowed	Outliers	Percentiles
1	A	287/319 (90%)	279 (97%)	7 (2%)	1 (0%)	41 64
1	B	289/319 (91%)	280 (97%)	8 (3%)	1 (0%)	41 64
1	C	285/319 (89%)	272 (95%)	11 (4%)	2 (1%)	22 43
1	D	283/319 (89%)	274 (97%)	8 (3%)	1 (0%)	34 57
1	E	292/319 (92%)	280 (96%)	10 (3%)	2 (1%)	22 43

Continued on next page...

Continued from previous page...

Mol	Chain	Analysed	Favoured	Allowed	Outliers	Percentiles	
1	F	288/319 (90%)	276 (96%)	10 (4%)	2 (1%)	22	43
All	All	1724/1914 (90%)	1661 (96%)	54 (3%)	9 (0%)	29	52

All (9) Ramachandran outliers are listed below:

Mol	Chain	Res	Type
1	E	243	VAL
1	F	243	VAL
1	A	243	VAL
1	B	243	VAL
1	C	243	VAL
1	D	243	VAL
1	C	240	PRO
1	E	240	PRO
1	F	240	PRO

5.3.2 Protein sidechains [i](#)

In the following table, the Percentiles column shows the percent sidechain outliers of the chain as a percentile score with respect to all X-ray entries followed by that with respect to entries of similar resolution.

The Analysed column shows the number of residues for which the sidechain conformation was analysed, and the total number of residues.

Mol	Chain	Analysed	Rotameric	Outliers	Percentiles	
1	A	217/281 (77%)	214 (99%)	3 (1%)	67	85
1	B	200/281 (71%)	196 (98%)	4 (2%)	55	78
1	C	204/281 (73%)	204 (100%)	0	100	100
1	D	201/281 (72%)	200 (100%)	1 (0%)	88	96
1	E	217/281 (77%)	214 (99%)	3 (1%)	67	85
1	F	208/281 (74%)	206 (99%)	2 (1%)	76	90
All	All	1247/1686 (74%)	1234 (99%)	13 (1%)	76	90

All (13) residues with a non-rotameric sidechain are listed below:

Mol	Chain	Res	Type
1	A	145	ARG
1	A	167	LEU

Continued on next page...

Continued from previous page...

Mol	Chain	Res	Type
1	A	229	ARG
1	B	166	ASP
1	B	171	MET
1	B	216	HIS
1	B	320	PHE
1	D	152	ASN
1	E	93	TYR
1	E	171	MET
1	E	229	ARG
1	F	166	ASP
1	F	351	PHE

Sometimes sidechains can be flipped to improve hydrogen bonding and reduce clashes. All (4) such sidechains are listed below:

Mol	Chain	Res	Type
1	B	216	HIS
1	C	278	GLN
1	E	165	HIS
1	F	165	HIS

5.3.3 RNA [i](#)

There are no RNA molecules in this entry.

5.4 Non-standard residues in protein, DNA, RNA chains [i](#)

6 non-standard protein/DNA/RNA residues are modelled in this entry.

In the following table, the Counts columns list the number of bonds (or angles) for which Mogul statistics could be retrieved, the number of bonds (or angles) that are observed in the model and the number of bonds (or angles) that are defined in the Chemical Component Dictionary. The Link column lists molecule types, if any, to which the group is linked. The Z score for a bond length (or angle) is the number of standard deviations the observed value is removed from the expected value. A bond length (or angle) with $|Z| > 2$ is considered an outlier worth inspection. RMSZ is the root-mean-square of all Z scores of the bond lengths (or angles).

Mol	Type	Chain	Res	Link	Bond lengths			Bond angles		
					Counts	RMSZ	# $ Z > 2$	Counts	RMSZ	# $ Z > 2$
1	TPO	D	239	1	8,10,11	1.59	1 (12%)	10,14,16	1.80	1 (10%)
1	TPO	A	239	1	8,10,11	1.60	1 (12%)	10,14,16	1.58	1 (10%)
1	TPO	B	239	1	8,10,11	1.60	1 (12%)	10,14,16	1.75	1 (10%)

Mol	Type	Chain	Res	Link	Bond lengths			Bond angles		
					Counts	RMSZ	# Z > 2	Counts	RMSZ	# Z > 2
1	TPO	F	239	1	8,10,11	1.59	1 (12%)	10,14,16	1.67	1 (10%)
1	TPO	E	239	1	8,10,11	1.07	0	10,14,16	1.85	1 (10%)
1	TPO	C	239	1	8,10,11	1.59	1 (12%)	10,14,16	1.75	1 (10%)

In the following table, the Chirals column lists the number of chiral outliers, the number of chiral centers analysed, the number of these observed in the model and the number defined in the Chemical Component Dictionary. Similar counts are reported in the Torsion and Rings columns. '-' means no outliers of that kind were identified.

Mol	Type	Chain	Res	Link	Chirals	Torsions	Rings
1	TPO	D	239	1	-	1/9/11/13	-
1	TPO	A	239	1	-	3/9/11/13	-
1	TPO	B	239	1	-	2/9/11/13	-
1	TPO	F	239	1	-	2/9/11/13	-
1	TPO	E	239	1	-	1/9/11/13	-
1	TPO	C	239	1	-	3/9/11/13	-

All (5) bond length outliers are listed below:

Mol	Chain	Res	Type	Atoms	Z	Observed(Å)	Ideal(Å)
1	B	239	TPO	P-O1P	3.40	1.61	1.50
1	D	239	TPO	P-O1P	3.38	1.61	1.50
1	C	239	TPO	P-O1P	3.36	1.61	1.50
1	F	239	TPO	P-O1P	3.34	1.61	1.50
1	A	239	TPO	P-O1P	3.34	1.61	1.50

All (6) bond angle outliers are listed below:

Mol	Chain	Res	Type	Atoms	Z	Observed(°)	Ideal(°)
1	E	239	TPO	P-OG1-CB	-5.10	107.79	123.21
1	C	239	TPO	P-OG1-CB	-4.98	108.17	123.21
1	D	239	TPO	P-OG1-CB	-4.98	108.18	123.21
1	B	239	TPO	P-OG1-CB	-4.84	108.58	123.21
1	F	239	TPO	P-OG1-CB	-4.52	109.55	123.21
1	A	239	TPO	P-OG1-CB	-4.43	109.82	123.21

There are no chirality outliers.

All (12) torsion outliers are listed below:

Mol	Chain	Res	Type	Atoms
1	A	239	TPO	N-CA-CB-OG1
1	A	239	TPO	C-CA-CB-CG2
1	B	239	TPO	CB-OG1-P-O2P
1	C	239	TPO	C-CA-CB-CG2
1	C	239	TPO	CB-OG1-P-O1P
1	C	239	TPO	CB-OG1-P-O2P
1	E	239	TPO	CB-OG1-P-O2P
1	F	239	TPO	C-CA-CB-CG2
1	F	239	TPO	CA-CB-OG1-P
1	A	239	TPO	O-C-CA-CB
1	B	239	TPO	O-C-CA-CB
1	D	239	TPO	O-C-CA-CB

There are no ring outliers.

5 monomers are involved in 5 short contacts:

Mol	Chain	Res	Type	Clashes	Symm-Clashes
1	D	239	TPO	1	0
1	A	239	TPO	1	0
1	B	239	TPO	1	0
1	F	239	TPO	1	0
1	E	239	TPO	1	0

5.5 Carbohydrates [i](#)

There are no monosaccharides in this entry.

5.6 Ligand geometry [i](#)

12 ligands are modelled in this entry.

In the following table, the Counts columns list the number of bonds (or angles) for which Mogul statistics could be retrieved, the number of bonds (or angles) that are observed in the model and the number of bonds (or angles) that are defined in the Chemical Component Dictionary. The Link column lists molecule types, if any, to which the group is linked. The Z score for a bond length (or angle) is the number of standard deviations the observed value is removed from the expected value. A bond length (or angle) with $|Z| > 2$ is considered an outlier worth inspection. RMSZ is the root-mean-square of all Z scores of the bond lengths (or angles).

Mol	Type	Chain	Res	Link	Bond lengths			Bond angles		
					Counts	RMSZ	$\# Z > 2$	Counts	RMSZ	$\# Z > 2$
3	SO4	D	402	-	4,4,4	0.14	0	6,6,6	0.05	0

Mol	Type	Chain	Res	Link	Bond lengths			Bond angles		
					Counts	RMSZ	# Z > 2	Counts	RMSZ	# Z > 2
2	NK3	A	401	-	29,31,31	1.85	7 (24%)	36,46,46	1.77	8 (22%)
2	NK3	B	401	-	29,31,31	1.86	7 (24%)	36,46,46	1.76	8 (22%)
3	SO4	A	402	-	4,4,4	0.14	0	6,6,6	0.05	0
3	SO4	E	402	-	4,4,4	0.14	0	6,6,6	0.05	0
2	NK3	E	401	-	29,31,31	1.86	7 (24%)	36,46,46	1.75	8 (22%)
2	NK3	F	401	-	29,31,31	1.87	7 (24%)	36,46,46	1.79	9 (25%)
3	SO4	B	402	-	4,4,4	0.14	0	6,6,6	0.05	0
2	NK3	C	401	-	29,31,31	1.87	7 (24%)	36,46,46	1.76	8 (22%)
3	SO4	F	402	-	4,4,4	0.14	0	6,6,6	0.05	0
2	NK3	D	401	-	29,31,31	1.86	7 (24%)	36,46,46	1.76	8 (22%)
3	SO4	C	402	-	4,4,4	0.14	0	6,6,6	0.04	0

In the following table, the Chirals column lists the number of chiral outliers, the number of chiral centers analysed, the number of these observed in the model and the number defined in the Chemical Component Dictionary. Similar counts are reported in the Torsion and Rings columns. '-' means no outliers of that kind were identified.

Mol	Type	Chain	Res	Link	Chirals	Torsions	Rings
2	NK3	A	401	-	-	3/12/12/12	0/4/4/4
2	NK3	B	401	-	-	4/12/12/12	0/4/4/4
2	NK3	E	401	-	-	0/12/12/12	0/4/4/4
2	NK3	F	401	-	-	1/12/12/12	0/4/4/4
2	NK3	C	401	-	-	3/12/12/12	0/4/4/4
2	NK3	D	401	-	-	2/12/12/12	0/4/4/4

All (42) bond length outliers are listed below:

Mol	Chain	Res	Type	Atoms	Z	Observed(Å)	Ideal(Å)
2	E	401	NK3	C24-C22	4.65	1.57	1.53
2	F	401	NK3	C24-C22	4.58	1.57	1.53
2	B	401	NK3	C24-C22	4.58	1.57	1.53
2	D	401	NK3	C24-C22	4.57	1.57	1.53
2	C	401	NK3	C24-C22	4.55	1.57	1.53
2	A	401	NK3	C24-C22	4.49	1.57	1.53
2	C	401	NK3	C09-N08	3.61	1.41	1.36
2	D	401	NK3	C09-N08	3.45	1.41	1.36
2	E	401	NK3	C09-N08	3.44	1.41	1.36
2	B	401	NK3	C09-N08	3.42	1.41	1.36
2	A	401	NK3	C09-N08	3.38	1.41	1.36
2	F	401	NK3	C09-N08	3.35	1.41	1.36

Continued on next page...

Continued from previous page...

Mol	Chain	Res	Type	Atoms	Z	Observed(Å)	Ideal(Å)
2	C	401	NK3	C07-C02	3.35	1.45	1.40
2	F	401	NK3	C07-C02	3.30	1.45	1.40
2	E	401	NK3	C07-C02	3.25	1.45	1.40
2	B	401	NK3	C07-C02	3.22	1.44	1.40
2	A	401	NK3	C07-C02	3.21	1.44	1.40
2	D	401	NK3	C07-C02	3.18	1.44	1.40
2	F	401	NK3	C06-C07	2.88	1.46	1.40
2	F	401	NK3	C05-C16	2.85	1.55	1.50
2	C	401	NK3	C06-C07	2.84	1.46	1.40
2	D	401	NK3	C06-C07	2.81	1.46	1.40
2	A	401	NK3	C06-C07	2.79	1.46	1.40
2	A	401	NK3	C05-C16	2.79	1.55	1.50
2	E	401	NK3	C06-C07	2.79	1.46	1.40
2	B	401	NK3	C05-C16	2.79	1.55	1.50
2	B	401	NK3	C06-C07	2.77	1.46	1.40
2	D	401	NK3	C05-C16	2.75	1.54	1.50
2	A	401	NK3	C03-C04	2.74	1.42	1.38
2	C	401	NK3	C05-C16	2.71	1.54	1.50
2	B	401	NK3	C03-C04	2.71	1.42	1.38
2	D	401	NK3	C03-C04	2.69	1.42	1.38
2	E	401	NK3	C05-C16	2.66	1.54	1.50
2	C	401	NK3	C03-C04	2.66	1.42	1.38
2	E	401	NK3	C03-C04	2.66	1.42	1.38
2	F	401	NK3	C03-C04	2.63	1.42	1.38
2	C	401	NK3	C24-N25	2.18	1.52	1.46
2	A	401	NK3	C24-N25	2.16	1.52	1.46
2	D	401	NK3	C24-N25	2.16	1.52	1.46
2	F	401	NK3	C24-N25	2.15	1.52	1.46
2	E	401	NK3	C24-N25	2.15	1.52	1.46
2	B	401	NK3	C24-N25	2.15	1.52	1.46

All (49) bond angle outliers are listed below:

Mol	Chain	Res	Type	Atoms	Z	Observed(°)	Ideal(°)
2	A	401	NK3	C20-C19-C18	-5.18	111.83	118.29
2	C	401	NK3	C20-C19-C18	-5.14	111.87	118.29
2	F	401	NK3	C20-C19-C18	-5.14	111.89	118.29
2	B	401	NK3	C20-C19-C18	-5.12	111.91	118.29
2	D	401	NK3	C20-C19-C18	-5.11	111.92	118.29
2	E	401	NK3	C20-C19-C18	-5.03	112.02	118.29
2	F	401	NK3	C17-C16-C21	-3.49	110.63	117.59
2	A	401	NK3	C17-C16-C21	-3.41	110.79	117.59

Continued on next page...

Continued from previous page...

Mol	Chain	Res	Type	Atoms	Z	Observed(°)	Ideal(°)
2	C	401	NK3	C17-C16-C21	-3.39	110.83	117.59
2	E	401	NK3	C17-C16-C21	-3.38	110.85	117.59
2	D	401	NK3	C17-C16-C21	-3.38	110.85	117.59
2	B	401	NK3	C17-C16-C21	-3.37	110.87	117.59
2	C	401	NK3	C21-C20-C19	3.14	124.36	121.20
2	A	401	NK3	C21-C20-C19	3.11	124.33	121.20
2	F	401	NK3	C17-C16-C05	3.09	125.93	120.79
2	B	401	NK3	C21-C20-C19	3.07	124.29	121.20
2	E	401	NK3	C17-C16-C05	3.07	125.89	120.79
2	C	401	NK3	C17-C16-C05	3.06	125.86	120.79
2	D	401	NK3	C21-C20-C19	3.05	124.27	121.20
2	D	401	NK3	C17-C16-C05	3.05	125.85	120.79
2	B	401	NK3	C17-C16-C05	3.02	125.81	120.79
2	E	401	NK3	C21-C20-C19	3.02	124.23	121.20
2	A	401	NK3	C17-C16-C05	2.99	125.76	120.79
2	F	401	NK3	C21-C20-C19	2.96	124.17	121.20
2	F	401	NK3	C17-C18-C19	2.60	123.81	121.20
2	A	401	NK3	C17-C18-C19	2.60	123.81	121.20
2	D	401	NK3	C17-C18-C19	2.59	123.80	121.20
2	B	401	NK3	C17-C18-C19	2.58	123.80	121.20
2	E	401	NK3	C18-C17-C16	2.57	124.84	121.13
2	F	401	NK3	C18-C17-C16	2.56	124.81	121.13
2	A	401	NK3	C18-C17-C16	2.55	124.80	121.13
2	C	401	NK3	C17-C18-C19	2.53	123.75	121.20
2	B	401	NK3	C18-C17-C16	2.51	124.74	121.13
2	C	401	NK3	C18-C17-C16	2.50	124.74	121.13
2	D	401	NK3	C18-C17-C16	2.50	124.73	121.13
2	F	401	NK3	C20-C21-C16	2.46	124.68	121.13
2	F	401	NK3	C06-C05-C16	2.46	123.97	120.06
2	E	401	NK3	C17-C18-C19	2.44	123.66	121.20
2	C	401	NK3	C20-C21-C16	2.30	124.45	121.13
2	A	401	NK3	C20-C21-C16	2.30	124.44	121.13
2	D	401	NK3	C20-C21-C16	2.28	124.42	121.13
2	E	401	NK3	C20-C21-C16	2.27	124.41	121.13
2	B	401	NK3	C20-C21-C16	2.27	124.40	121.13
2	D	401	NK3	C06-C05-C16	2.21	123.58	120.06
2	B	401	NK3	C06-C05-C16	2.14	123.47	120.06
2	A	401	NK3	C06-C05-C16	2.12	123.44	120.06
2	E	401	NK3	C06-C05-C16	2.12	123.44	120.06
2	F	401	NK3	C12-C06-C07	-2.10	116.22	118.20
2	C	401	NK3	C06-C05-C16	2.01	123.26	120.06

There are no chirality outliers.

All (13) torsion outliers are listed below:

Mol	Chain	Res	Type	Atoms
2	A	401	NK3	C19-C22-C24-N25
2	A	401	NK3	C23-C22-C24-N25
2	B	401	NK3	C19-C22-C24-N25
2	B	401	NK3	C23-C22-C24-N25
2	C	401	NK3	C19-C22-C24-N25
2	D	401	NK3	C19-C22-C24-N25
2	D	401	NK3	C23-C22-C24-N25
2	B	401	NK3	C22-C24-N25-C26
2	B	401	NK3	C22-C24-N25-C27
2	C	401	NK3	C23-C22-C24-N25
2	A	401	NK3	C22-C24-N25-C27
2	C	401	NK3	C22-C24-N25-C27
2	F	401	NK3	C22-C24-N25-C27

There are no ring outliers.

1 monomer is involved in 1 short contact:

Mol	Chain	Res	Type	Clashes	Symm-Clashes
2	F	401	NK3	1	0

The following is a two-dimensional graphical depiction of Mogul quality analysis of bond lengths, bond angles, torsion angles, and ring geometry for all instances of the Ligand of Interest. In addition, ligands with molecular weight > 250 and outliers as shown on the validation Tables will also be included. For torsion angles, if less than 5% of the Mogul distribution of torsion angles is within 10 degrees of the torsion angle in question, then that torsion angle is considered an outlier. Any bond that is central to one or more torsion angles identified as an outlier by Mogul will be highlighted in the graph. For rings, the root-mean-square deviation (RMSD) between the ring in question and similar rings identified by Mogul is calculated over all ring torsion angles. If the average RMSD is greater than 60 degrees and the minimal RMSD between the ring in question and any Mogul-identified rings is also greater than 60 degrees, then that ring is considered an outlier. The outliers are highlighted in purple. The color gray indicates Mogul did not find sufficient equivalents in the CSD to analyse the geometry.

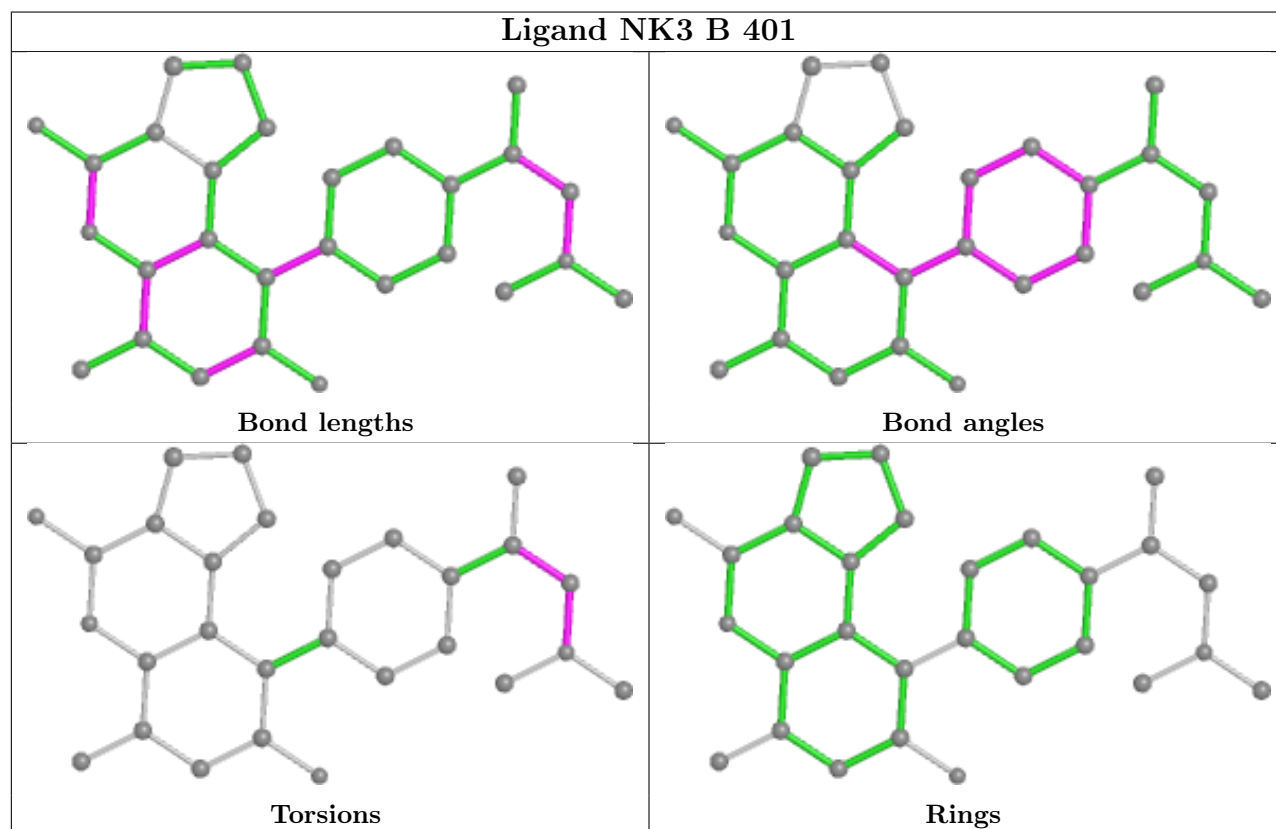
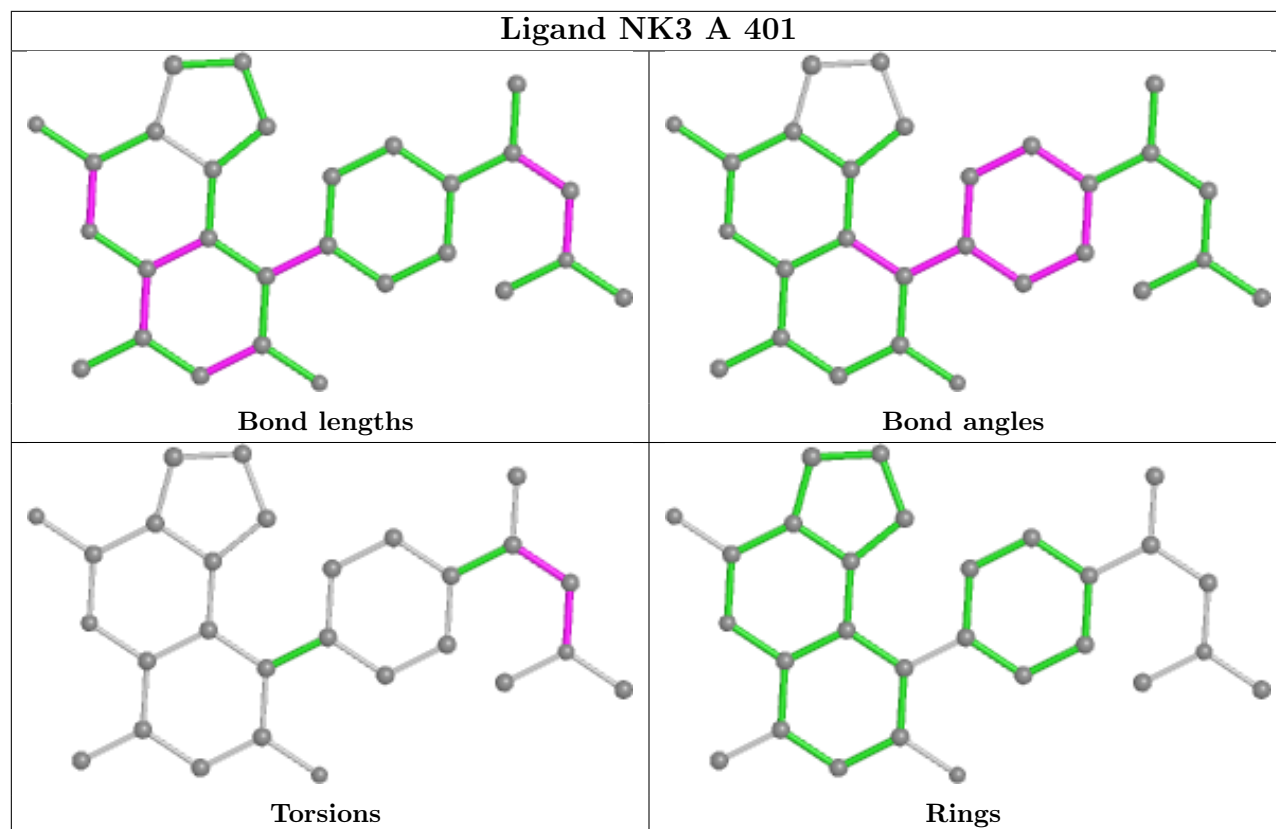

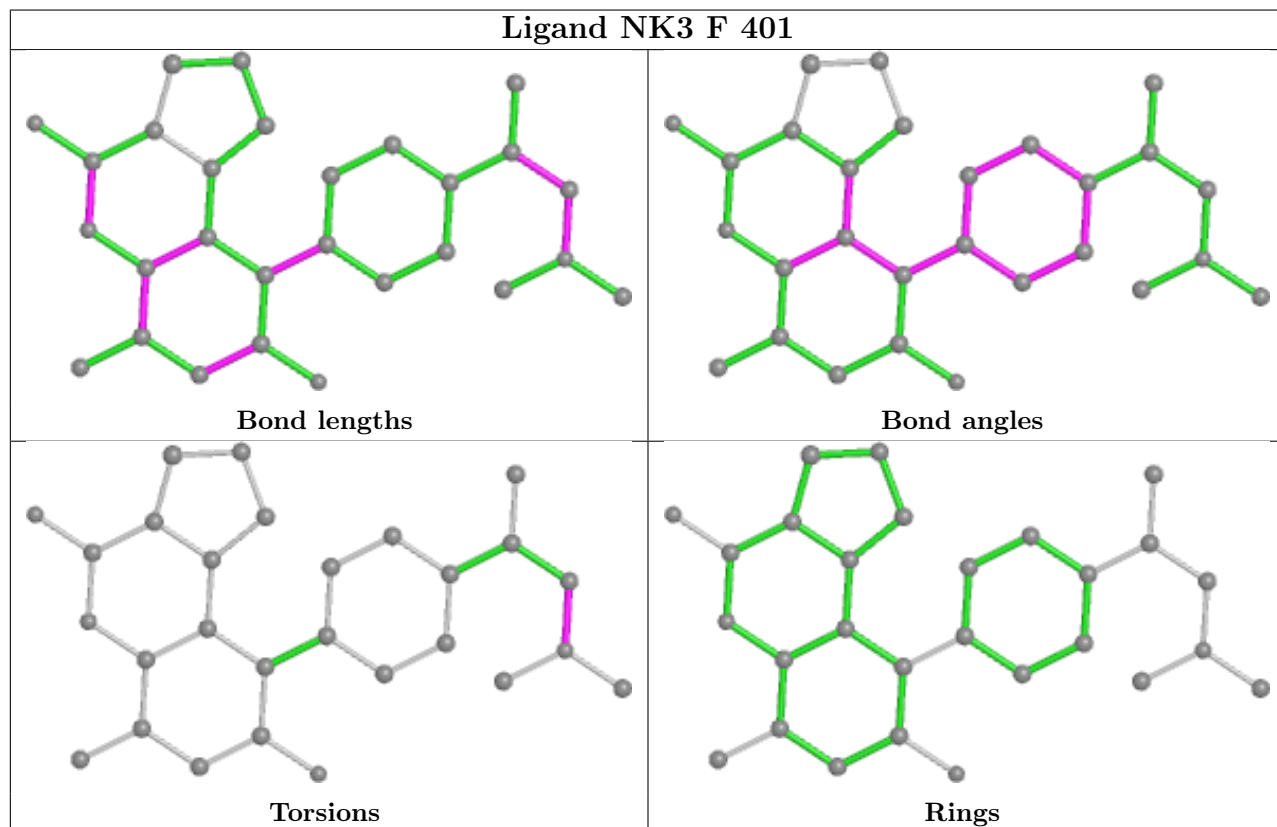
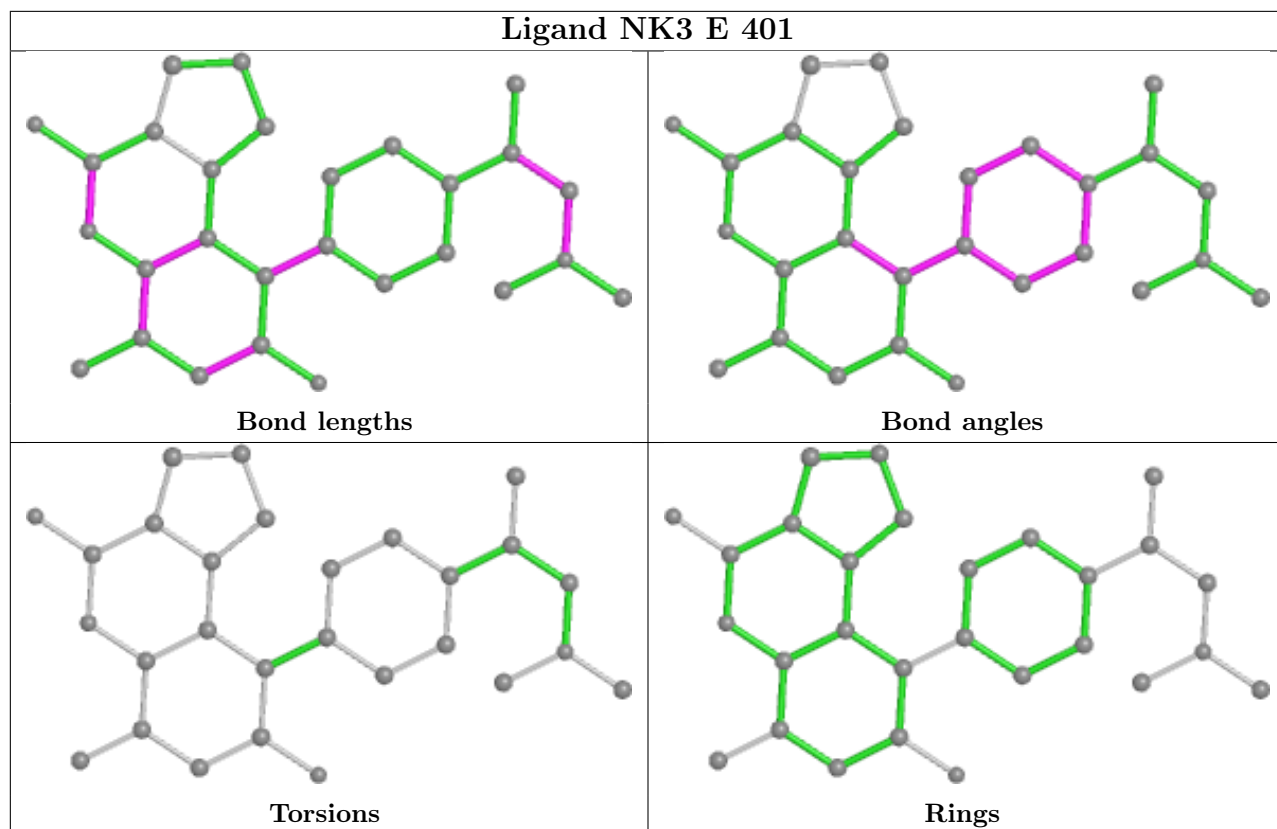

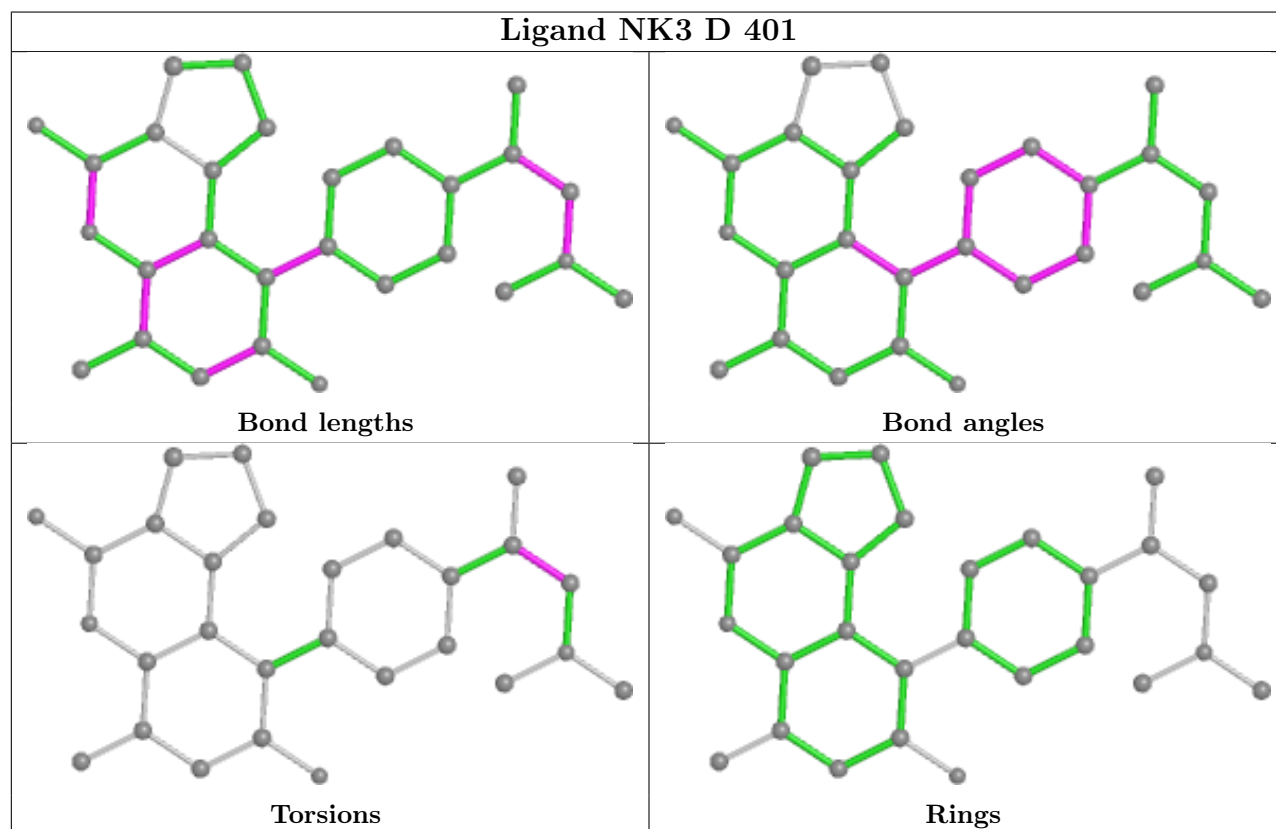
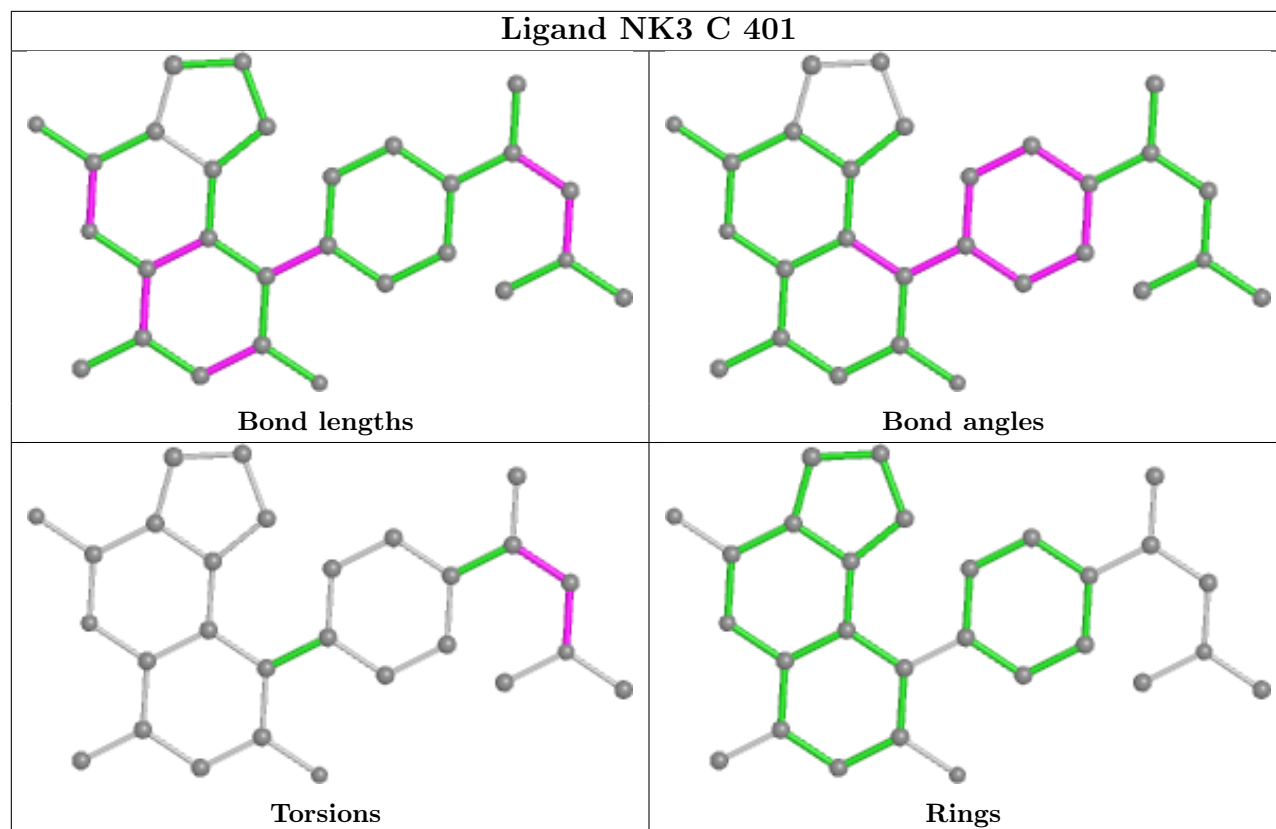

5.7 Other polymers [i](#)

There are no such residues in this entry.

5.8 Polymer linkage issues [i](#)

There are no chain breaks in this entry.

6 Fit of model and data

6.1 Protein, DNA and RNA chains

In the following table, the column labelled ‘#RSRZ> 2’ contains the number (and percentage) of RSRZ outliers, followed by percent RSRZ outliers for the chain as percentile scores relative to all X-ray entries and entries of similar resolution. The OWAB column contains the minimum, median, 95th percentile and maximum values of the occupancy-weighted average B-factor per residue. The column labelled ‘Q< 0.9’ lists the number of (and percentage) of residues with an average occupancy less than 0.9.

Mol	Chain	Analysed	<RSRZ>	#RSRZ>2	OWAB(Å ²)	Q<0.9
1	A	295/319 (92%)	0.34	6 (2%) 65 60	52, 68, 96, 121	1 (0%)
1	B	295/319 (92%)	0.39	7 (2%) 59 53	54, 74, 102, 120	1 (0%)
1	C	293/319 (91%)	0.23	6 (2%) 65 60	48, 67, 94, 110	2 (0%)
1	D	293/319 (91%)	0.34	10 (3%) 45 38	52, 73, 101, 124	2 (0%)
1	E	298/319 (93%)	0.40	8 (2%) 54 48	51, 74, 97, 106	3 (1%)
1	F	294/319 (92%)	0.41	11 (3%) 41 34	57, 78, 103, 115	6 (2%)
All	All	1768/1914 (92%)	0.35	48 (2%) 54 48	48, 73, 99, 124	15 (0%)

All (48) RSRZ outliers are listed below:

Mol	Chain	Res	Type	RSRZ
1	A	333	GLY	4.2
1	D	261	THR	4.1
1	F	313	PRO	3.4
1	B	91	GLY	3.3
1	D	332	PHE	3.1
1	F	295	PHE	3.0
1	C	332	PHE	3.0
1	A	320	PHE	2.9
1	C	242	VAL	2.9
1	D	233	SER	2.7
1	F	223	GLY	2.7
1	F	263	VAL	2.6
1	C	110	LEU	2.6
1	D	242	VAL	2.5
1	F	332	PHE	2.5
1	D	122	PHE	2.5
1	D	121	GLY	2.4
1	A	237	ALA	2.4
1	E	237	ALA	2.4

Continued on next page...

Continued from previous page...

Mol	Chain	Res	Type	RSRZ
1	D	260	SER	2.4
1	B	156	ILE	2.4
1	C	149	VAL	2.3
1	B	316	LYS	2.3
1	B	132	THR	2.3
1	E	261	THR	2.3
1	A	332	PHE	2.3
1	B	333	GLY	2.3
1	E	382	LEU	2.3
1	C	97	TYR	2.3
1	C	121	GLY	2.2
1	F	348	LEU	2.2
1	E	214	LEU	2.2
1	D	220	LEU	2.2
1	D	334	ALA	2.2
1	F	90	GLU	2.1
1	F	91	GLY	2.1
1	E	316	LYS	2.1
1	F	260	SER	2.1
1	B	367	PHE	2.1
1	A	301	PRO	2.1
1	E	358	ALA	2.1
1	D	94	GLY	2.1
1	F	291	ILE	2.1
1	B	135	LYS	2.1
1	E	295	PHE	2.1
1	A	252	LEU	2.0
1	F	344	MET	2.0
1	E	252	LEU	2.0

6.2 Non-standard residues in protein, DNA, RNA chains [i](#)

In the following table, the Atoms column lists the number of modelled atoms in the group and the number defined in the chemical component dictionary. The B-factors column lists the minimum, median, 95th percentile and maximum values of B factors of atoms in the group. The column labelled 'Q< 0.9' lists the number of atoms with occupancy less than 0.9.

Mol	Type	Chain	Res	Atoms	RSCC	RSR	B-factors(Å ²)	Q<0.9
1	TPO	B	239	11/12	0.89	0.20	57,64,69,85	0
1	TPO	E	239	11/12	0.89	0.18	54,66,76,81	0
1	TPO	A	239	11/12	0.90	0.21	62,72,85,87	0
1	TPO	C	239	11/12	0.91	0.15	56,65,77,78	0

Continued on next page...

Continued from previous page...

Mol	Type	Chain	Res	Atoms	RSCC	RSR	B-factors(\AA^2)	Q<0.9
1	TPO	D	239	11/12	0.92	0.15	71,80,90,104	0
1	TPO	F	239	11/12	0.94	0.18	54,65,71,76	0

6.3 Carbohydrates [i](#)

There are no monosaccharides in this entry.

6.4 Ligands [i](#)

In the following table, the Atoms column lists the number of modelled atoms in the group and the number defined in the chemical component dictionary. The B-factors column lists the minimum, median, 95th percentile and maximum values of B factors of atoms in the group. The column labelled 'Q< 0.9' lists the number of atoms with occupancy less than 0.9.

Mol	Type	Chain	Res	Atoms	RSCC	RSR	B-factors(\AA^2)	Q<0.9
2	NK3	F	401	28/28	0.86	0.23	67,77,86,89	0
2	NK3	C	401	28/28	0.91	0.27	62,71,88,94	0
2	NK3	A	401	28/28	0.92	0.23	53,65,73,76	0
2	NK3	E	401	28/28	0.93	0.26	57,67,75,78	0
2	NK3	B	401	28/28	0.94	0.30	60,72,80,86	0
3	SO4	D	402	5/5	0.94	0.14	71,73,76,84	0
2	NK3	D	401	28/28	0.95	0.21	57,66,69,90	0
3	SO4	E	402	5/5	0.95	0.12	70,71,72,81	0
3	SO4	F	402	5/5	0.95	0.15	70,71,74,91	0
3	SO4	C	402	5/5	0.97	0.10	61,61,72,100	0
3	SO4	A	402	5/5	0.97	0.13	54,61,61,99	0
3	SO4	B	402	5/5	0.98	0.08	62,64,65,68	0

The following is a graphical depiction of the model fit to experimental electron density of all instances of the Ligand of Interest. In addition, ligands with molecular weight > 250 and outliers as shown on the geometry validation Tables will also be included. Each fit is shown from different orientation to approximate a three-dimensional view.

Electron density around NK3 F 401:

$2mF_o-DF_c$ (at 0.7 rmsd) in gray
 mF_o-DF_c (at 3 rmsd) in purple (negative)
and green (positive)

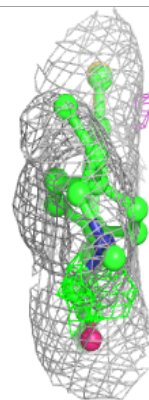
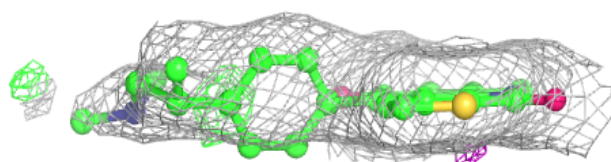
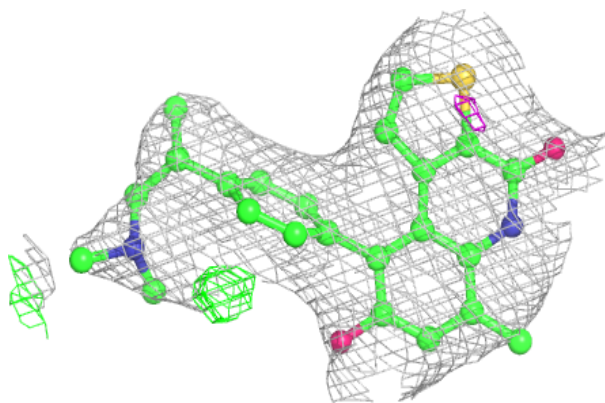
**Electron density around NK3 C 401:**

$2mF_o-DF_c$ (at 0.7 rmsd) in gray
 mF_o-DF_c (at 3 rmsd) in purple (negative)
and green (positive)

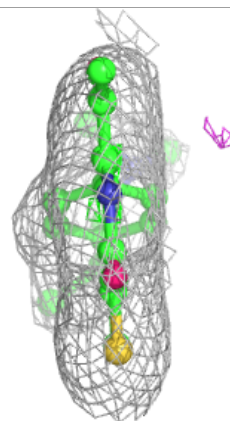
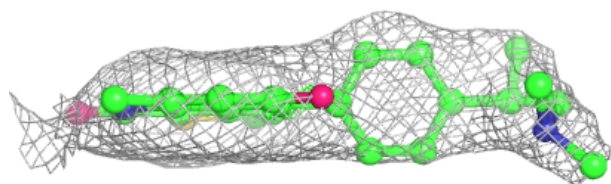
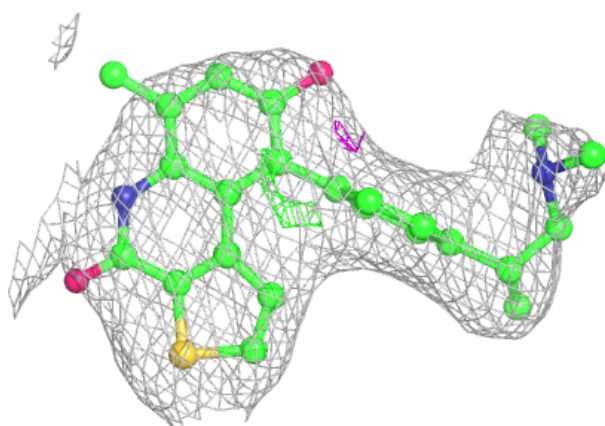

Electron density around NK3 A 401:

$2mF_o-DF_c$ (at 0.7 rmsd) in gray
 mF_o-DF_c (at 3 rmsd) in purple (negative)
and green (positive)

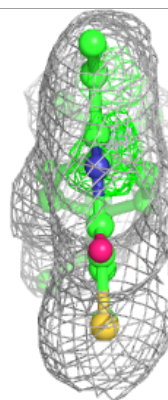
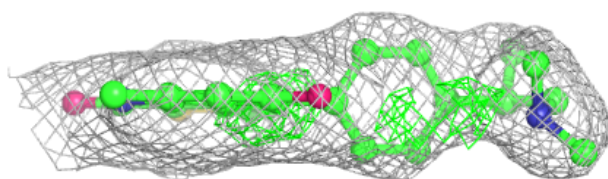
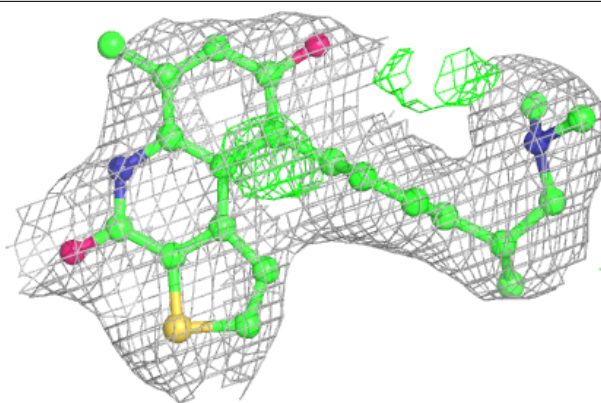
**Electron density around NK3 E 401:**

$2mF_o-DF_c$ (at 0.7 rmsd) in gray
 mF_o-DF_c (at 3 rmsd) in purple (negative)
and green (positive)

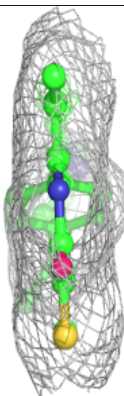
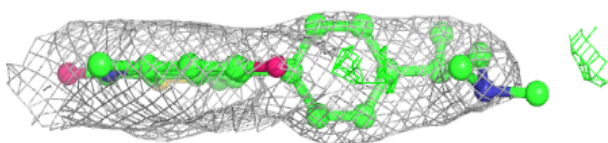
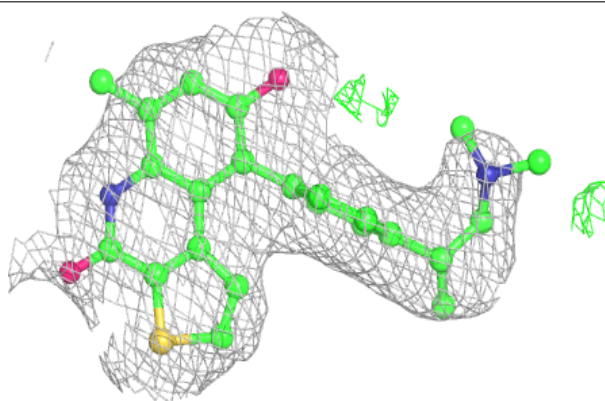

Electron density around NK3 B 401:

$2mF_o-DF_c$ (at 0.7 rmsd) in gray
 mF_o-DF_c (at 3 rmsd) in purple (negative)
and green (positive)

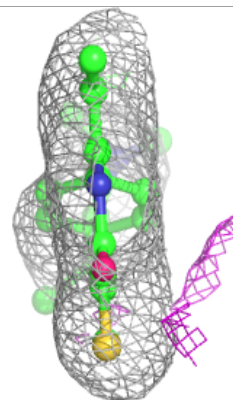
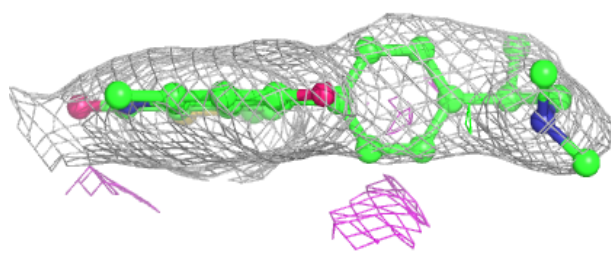
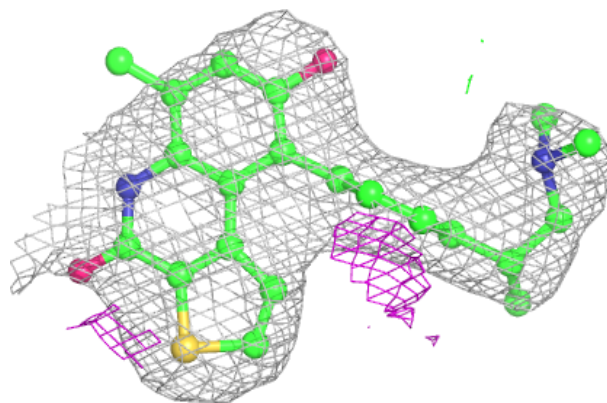
**Electron density around NK3 D 401:**

$2mF_o-DF_c$ (at 0.7 rmsd) in gray
 mF_o-DF_c (at 3 rmsd) in purple (negative)
and green (positive)

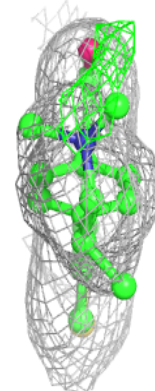
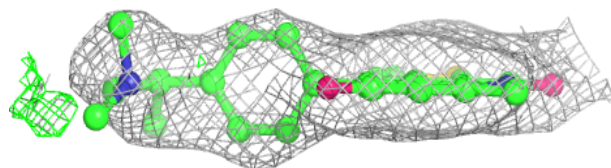
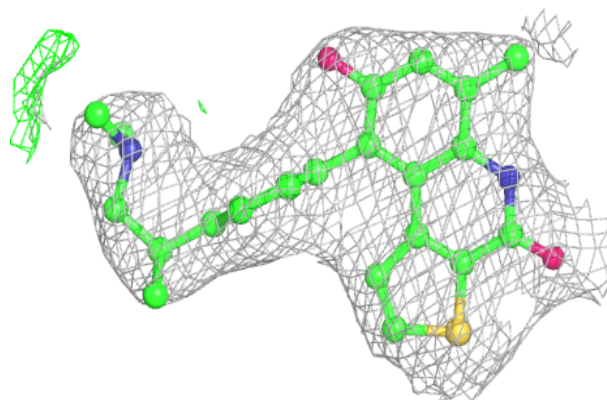

6.5 Other polymers [i](#)

There are no such residues in this entry.