



wwPDB EM Validation Summary Report ⓘ

Mar 11, 2024 – 06:30 PM EDT

PDB ID : 8UOX
EMDB ID : EMD-42439
Title : Cryo-EM structure of a Counterclockwise locked form of the Salmonella enterica Typhimurium flagellar C-ring, with C34 symmetry applied
Authors : Johnson, S.; Deme, J.C.; Lea, S.M.
Deposited on : 2023-10-20
Resolution : 4.60 Å(reported)

This is a wwPDB EM Validation Summary Report for a publicly released PDB entry.

We welcome your comments at validation@mail.wwpdb.org

A user guide is available at

<https://www.wwpdb.org/validation/2017/EMValidationReportHelp>

with specific help available everywhere you see the ⓘ symbol.

The types of validation reports are described at

<http://www.wwpdb.org/validation/2017/FAQs#types>.

The following versions of software and data (see [references ⓘ](#)) were used in the production of this report:

EMDB validation analysis : 0.0.1.dev70
MolProbity : 4.02b-467
Percentile statistics : 20191225.v01 (using entries in the PDB archive December 25th 2019)
MapQ : 1.9.13
Ideal geometry (proteins) : Engh & Huber (2001)
Ideal geometry (DNA, RNA) : Parkinson et al. (1996)
Validation Pipeline (wwPDB-VP) : 2.36

1 Overall quality at a glance

The following experimental techniques were used to determine the structure:
ELECTRON MICROSCOPY

The reported resolution of this entry is 4.60 Å.

Percentile scores (ranging between 0-100) for global validation metrics of the entry are shown in the following graphic. The table shows the number of entries on which the scores are based.

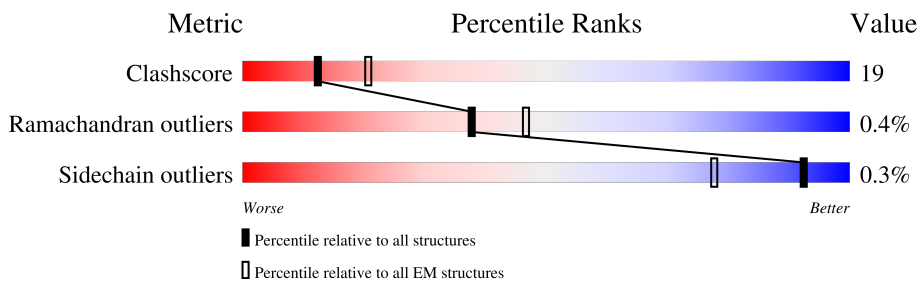

Metric	Whole archive (#Entries)	EM structures (#Entries)
Clashscore	158937	4297
Ramachandran outliers	154571	4023
Sidechain outliers	154315	3826

The table below summarises the geometric issues observed across the polymeric chains and their fit to the map. The red, orange, yellow and green segments of the bar indicate the fraction of residues that contain outliers for ≥ 3 , 2, 1 and 0 types of geometric quality criteria respectively. A grey segment represents the fraction of residues that are not modelled. The numeric value for each fraction is indicated below the corresponding segment, with a dot representing fractions $\leq 5\%$. The upper red bar (where present) indicates the fraction of residues that have poor fit to the EM map (all-atom inclusion $< 40\%$). The numeric value is given above the bar.

Mol	Chain	Length	Quality of chain
1	A1	560	 6% 92%
1	A2	560	 6% 92%
1	A3	560	 6% 92%
1	A4	560	 6% 92%
1	A5	560	 6% 92%
1	A6	560	 6% 92%
1	A7	560	 6% 92%
1	A8	560	 6% 92%

Continued on next page...

Continued from previous page...

Mol	Chain	Length	Quality of chain
1	A9	560	 92%
1	AA	560	 92%
1	AB	560	 92%
1	AC	560	 92%
1	AD	560	 92%
1	AE	560	 92%
1	AF	560	 92%
1	AG	560	 92%
1	AH	560	 92%
1	AI	560	 92%
1	AJ	560	 92%
1	AK	560	 92%
1	AL	560	 92%
1	AM	560	 92%
1	AN	560	 92%
1	AO	560	 92%
1	AP	560	 92%
1	AQ	560	 92%
1	AR	560	 92%
1	AS	560	 92%
1	AT	560	 92%
1	AU	560	 92%
1	AV	560	 92%
1	AW	560	 92%
1	AX	560	 92%

Continued on next page...

Continued from previous page...

Mol	Chain	Length	Quality of chain
1	AY	560	 6%
2	B1	331	 47% 61% 39%
2	B2	331	 47% 61% 38%
2	B3	331	 47% 61% 39%
2	B4	331	 47% 64% 35%
2	B5	331	 47% 65% 34%
2	B6	331	 47% 60% 39%
2	B7	331	 46% 64% 36%
2	B8	331	 47% 62% 38%
2	B9	331	 47% 64% 35%
2	BA	331	 47% 62% 38%
2	BB	331	 46% 61% 39%
2	BC	331	 47% 62% 37%
2	BD	331	 47% 64% 36%
2	BE	331	 47% 64% 36%
2	BF	331	 47% 65% 34%
2	BG	331	 47% 60% 39%
2	BH	331	 47% 60% 40%
2	BI	331	 47% 63% 37%
2	BJ	331	 47% 65% 35%
2	BK	331	 48% 61% 38%
2	BL	331	 48% 63% 36%
2	BM	331	 47% 65% 35%
2	BN	331	 47% 62% 38%
2	BO	331	 46% 63% 36%

Continued on next page...

Continued from previous page...

Mol	Chain	Length	Quality of chain
2	BP	331	47% 61% 39%
2	BQ	331	47% 63% 37%
2	BR	331	46% 60% 40%
2	BS	331	46% 60% 40%
2	BT	331	47% 61% 39%
2	BU	331	47% 61% 38%
2	BV	331	48% 62% 38%
2	BW	331	47% 62% 37%
2	BX	331	47% 63% 37%
2	BY	331	47% 60% 40%
3	C1	334	14% 54% 33% 13%
3	C2	334	15% 51% 35% 13%
3	C3	334	15% 52% 34% 13%
3	C4	334	15% 51% 36% 13%
3	C5	334	14% 54% 33% 13%
3	C6	334	14% 51% 36% 13%
3	C7	334	15% 52% 35% 13%
3	C8	334	14% 54% 33% 13%
3	C9	334	15% 52% 34% 13%
3	CA	334	15% 53% 34% 13%
3	CB	334	15% 51% 35% 13%
3	CC	334	15% 53% 34% 13%
3	CD	334	14% 50% 37% 13%
3	CE	334	14% 52% 34% 13%
3	CF	334	15% 51% 36% 13%

Continued on next page...

Continued from previous page...

Mol	Chain	Length	Quality of chain
3	CG	334	15% 53% 34% 13%
3	CH	334	15% 52% 35% 13%
3	CI	334	14% 53% 34% 13%
3	CJ	334	15% 52% 34% 13%
3	CK	334	15% 54% 33% 13%
3	CL	334	15% 54% 33% 13%
3	CM	334	14% 52% 35% 13%
3	CN	334	14% 53% 34% 13%
3	CO	334	15% 55% 32% 13%
3	CP	334	15% 53% 34% 13%
3	CQ	334	15% 49% 37% 13%
3	CR	334	15% 54% 33% 13%
3	CS	334	15% 51% 36% 13%
3	CT	334	15% 54% 33% 13%
3	CU	334	14% 51% 36% 13%
3	CV	334	14% 51% 35% 13%
3	CW	334	15% 54% 33% 13%
3	CX	334	15% 52% 34% 13%
3	CY	334	15% 51% 36% 13%
4	D1	137	12% 34% 25% 41%
4	D2	137	12% 36% 23% 41%
4	D3	137	12% 36% 23% 41%
4	D4	137	12% 34% 26% 41%
4	D5	137	12% 34% 26% 41%
4	D6	137	11% 31% 28% 41%





Continued on next page...

Continued from previous page...

Mol	Chain	Length	Quality of chain
4	D7	137	11% 35% 24% 41%
4	D8	137	12% 34% 25% 41%
4	D9	137	12% 33% 26% 41%
4	DA	137	12% 35% 24% 41%
4	DB	137	12% 36% 23% 41%
4	DC	137	12% 32% 27% 41%
4	DD	137	12% 33% 26% 41%
4	DE	137	12% 31% 28% 41%
4	DF	137	12% 34% 25% 41%
4	DG	137	12% 35% 24% 41%
4	DH	137	12% 36% 23% 41%
4	DI	137	12% 34% 26% 41%
4	DJ	137	12% 34% 26% 41%
4	DK	137	12% 34% 25% 41%
4	DL	137	12% 35% 24% 41%
4	DM	137	11% 34% 25% 41%
4	DN	137	11% 36% 23% 41%
4	DO	137	12% 37% 22% 41%
4	DP	137	12% 32% 27% 41%
4	DQ	137	12% 34% 25% 41%
4	DR	137	12% 32% 27% 41%
4	DS	137	12% 34% 25% 41%
4	DT	137	11% 32% 27% 41%
4	DU	137	12% 34% 25% 41%
4	DV	137	12% 34% 25% 41%

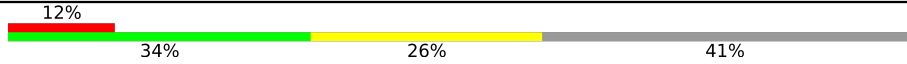
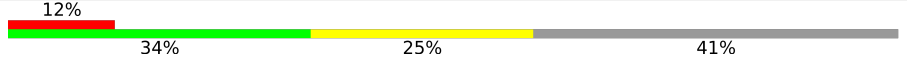
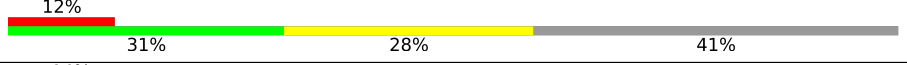
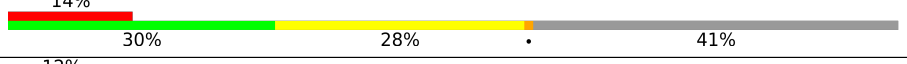
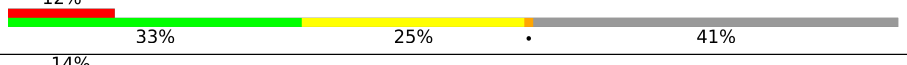
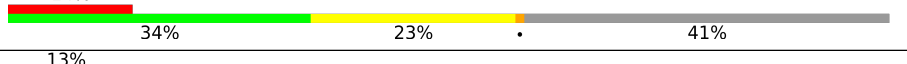
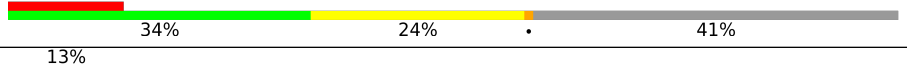
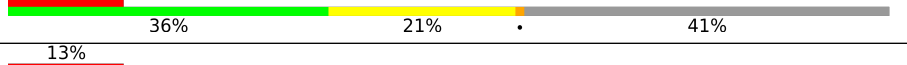
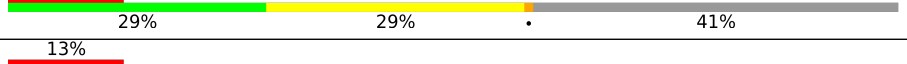
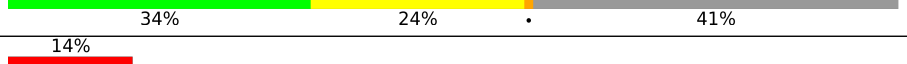
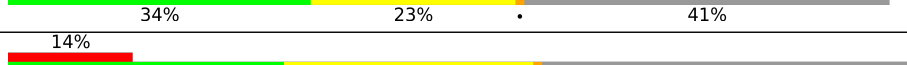
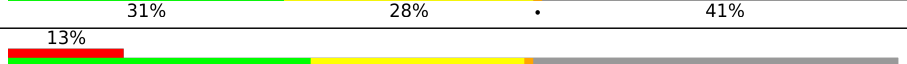
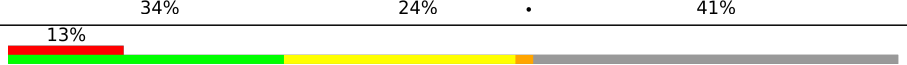
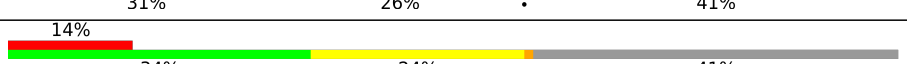
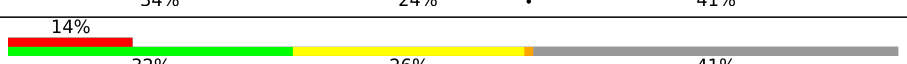
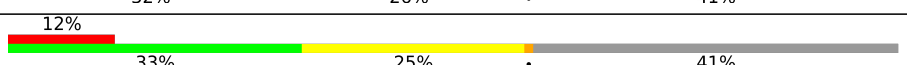
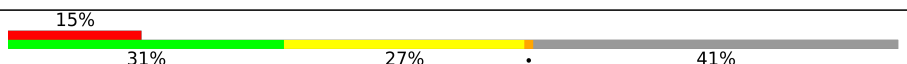
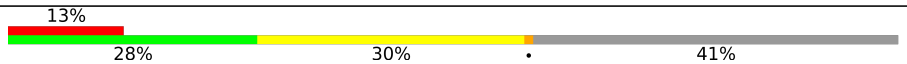
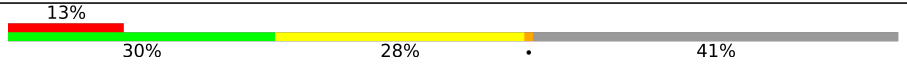
Continued on next page...

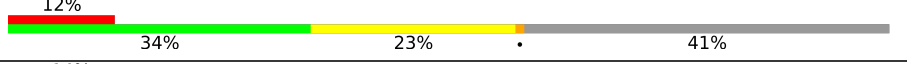
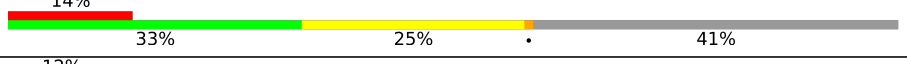
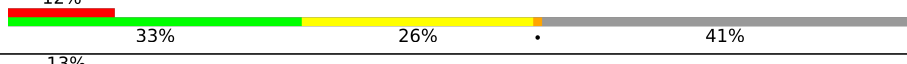
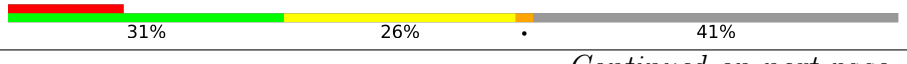
Continued from previous page...

Mol	Chain	Length	Quality of chain
4	DW	137	
4	DX	137	
4	DY	137	
4	E1	137	
4	E2	137	
4	E3	137	
4	E4	137	
4	E5	137	
4	E6	137	
4	E7	137	
4	E8	137	
4	E9	137	
4	EA	137	
4	EB	137	
4	EC	137	
4	ED	137	
4	EE	137	
4	EF	137	
4	EG	137	
4	EH	137	
4	EI	137	
4	EJ	137	
4	EK	137	
4	EL	137	
4	EM	137	







Continued on next page...

Continued from previous page...

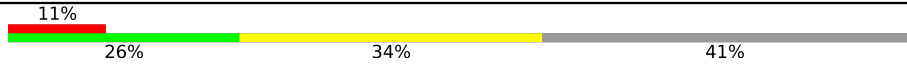
Mol	Chain	Length	Quality of chain
4	EN	137	
4	EO	137	
4	EP	137	
4	EQ	137	
4	ER	137	
4	ES	137	
4	ET	137	
4	EU	137	
4	EV	137	
4	EW	137	
4	EX	137	
4	EY	137	
4	F1	137	
4	F2	137	
4	F3	137	
4	F4	137	
4	F5	137	
4	F6	137	
4	F7	137	
4	F8	137	
4	F9	137	
4	FA	137	
4	FB	137	
4	FC	137	
4	FD	137	

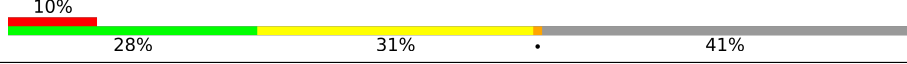
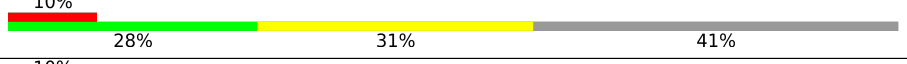
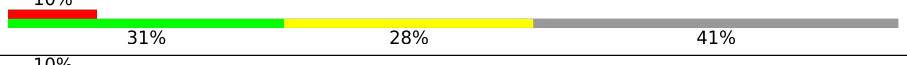
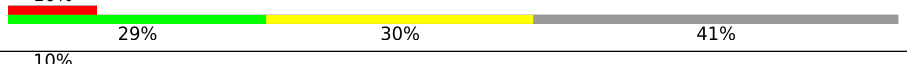
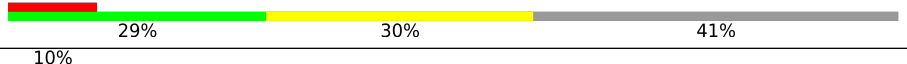
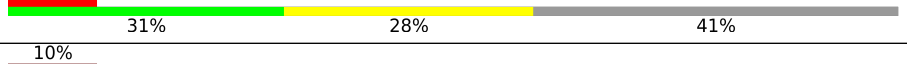
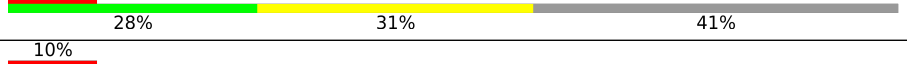
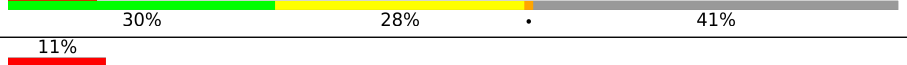
Continued on next page...

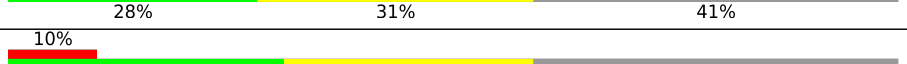
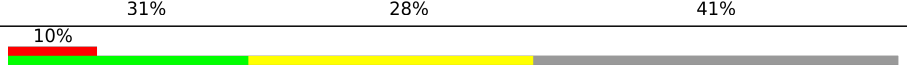
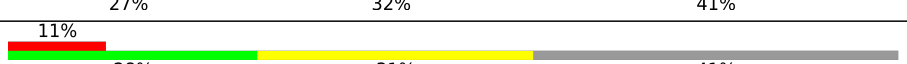
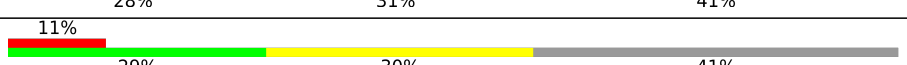
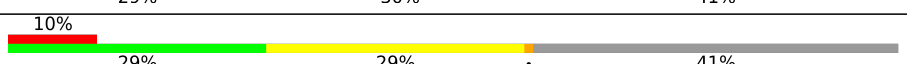
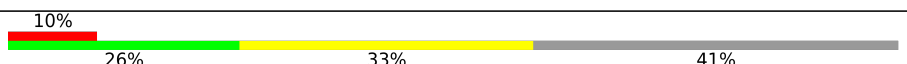
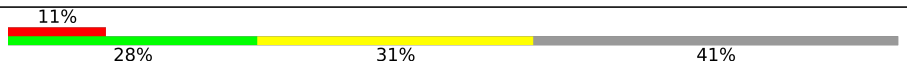
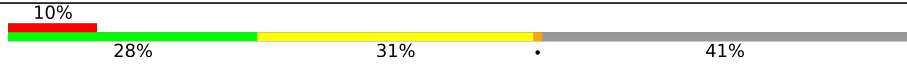
Continued from previous page...

Mol	Chain	Length	Quality of chain
4	FE	137	
4	FF	137	
4	FG	137	
4	FH	137	
4	FI	137	
4	FJ	137	
4	FK	137	
4	FL	137	
4	FM	137	
4	FN	137	
4	FO	137	
4	FP	137	
4	FQ	137	
4	FR	137	
4	FS	137	
4	FT	137	
4	FU	137	
4	FV	137	
4	FW	137	
4	FX	137	
4	FY	137	

2 Entry composition [i](#)

There are 4 unique types of molecules in this entry. The entry contains 244834 atoms, of which 0 are hydrogens and 0 are deuteriums.

In the tables below, the AltConf column contains the number of residues with at least one atom in alternate conformation and the Trace column contains the number of residues modelled with at most 2 atoms.

- Molecule 1 is a protein called Flagellar M-ring protein.

Mol	Chain	Residues	Atoms					AltConf	Trace
			Total	C	N	O	S		
1	A1	47	393	233	81	76	3	0	0
1	A2	47	393	233	81	76	3	0	0
1	A3	47	393	233	81	76	3	0	0
1	A4	47	393	233	81	76	3	0	0
1	A5	47	393	233	81	76	3	0	0
1	A6	47	393	233	81	76	3	0	0
1	A7	47	393	233	81	76	3	0	0
1	A8	47	393	233	81	76	3	0	0
1	A9	47	393	233	81	76	3	0	0
1	AA	47	393	233	81	76	3	0	0
1	AB	47	393	233	81	76	3	0	0
1	AC	47	393	233	81	76	3	0	0
1	AD	47	393	233	81	76	3	0	0
1	AE	47	393	233	81	76	3	0	0
1	AF	47	393	233	81	76	3	0	0
1	AG	47	393	233	81	76	3	0	0
1	AH	47	393	233	81	76	3	0	0

Continued on next page...

Continued from previous page...

Mol	Chain	Residues	Atoms					AltConf	Trace
1	AI	47	Total	C	N	O	S	0	0
			393	233	81	76	3		
1	AJ	47	Total	C	N	O	S	0	0
			393	233	81	76	3		
1	AK	47	Total	C	N	O	S	0	0
			393	233	81	76	3		
1	AL	47	Total	C	N	O	S	0	0
			393	233	81	76	3		
1	AM	47	Total	C	N	O	S	0	0
			393	233	81	76	3		
1	AN	47	Total	C	N	O	S	0	0
			393	233	81	76	3		
1	AO	47	Total	C	N	O	S	0	0
			393	233	81	76	3		
1	AP	47	Total	C	N	O	S	0	0
			393	233	81	76	3		
1	AQ	47	Total	C	N	O	S	0	0
			393	233	81	76	3		
1	AR	47	Total	C	N	O	S	0	0
			393	233	81	76	3		
1	AS	47	Total	C	N	O	S	0	0
			393	233	81	76	3		
1	AT	47	Total	C	N	O	S	0	0
			393	233	81	76	3		
1	AU	47	Total	C	N	O	S	0	0
			393	233	81	76	3		
1	AV	47	Total	C	N	O	S	0	0
			393	233	81	76	3		
1	AW	47	Total	C	N	O	S	0	0
			393	233	81	76	3		
1	AX	47	Total	C	N	O	S	0	0
			393	233	81	76	3		
1	AY	47	Total	C	N	O	S	0	0
			393	233	81	76	3		

- Molecule 2 is a protein called Flagellar motor switch protein FliG.

Mol	Chain	Residues	Atoms					AltConf	Trace
2	B1	331	Total	C	N	O	S	0	0
			2583	1605	455	513	10		
2	B2	331	Total	C	N	O	S	0	0
			2583	1605	455	513	10		

Continued on next page...

Continued from previous page...

Mol	Chain	Residues	Atoms					AltConf	Trace
2	B3	331	Total	C	N	O	S	0	0
			2583	1605	455	513	10		
2	B4	331	Total	C	N	O	S	0	0
			2583	1605	455	513	10		
2	B5	331	Total	C	N	O	S	0	0
			2583	1605	455	513	10		
2	B6	331	Total	C	N	O	S	0	0
			2583	1605	455	513	10		
2	B7	331	Total	C	N	O	S	0	0
			2583	1605	455	513	10		
2	B8	331	Total	C	N	O	S	0	0
			2583	1605	455	513	10		
2	B9	331	Total	C	N	O	S	0	0
			2583	1605	455	513	10		
2	BA	331	Total	C	N	O	S	0	0
			2583	1605	455	513	10		
2	BB	331	Total	C	N	O	S	0	0
			2583	1605	455	513	10		
2	BC	331	Total	C	N	O	S	0	0
			2583	1605	455	513	10		
2	BD	331	Total	C	N	O	S	0	0
			2583	1605	455	513	10		
2	BE	331	Total	C	N	O	S	0	0
			2583	1605	455	513	10		
2	BF	331	Total	C	N	O	S	0	0
			2583	1605	455	513	10		
2	BG	331	Total	C	N	O	S	0	0
			2583	1605	455	513	10		
2	BH	331	Total	C	N	O	S	0	0
			2583	1605	455	513	10		
2	BI	331	Total	C	N	O	S	0	0
			2583	1605	455	513	10		
2	BJ	331	Total	C	N	O	S	0	0
			2583	1605	455	513	10		
2	BK	331	Total	C	N	O	S	0	0
			2583	1605	455	513	10		
2	BL	331	Total	C	N	O	S	0	0
			2583	1605	455	513	10		
2	BM	331	Total	C	N	O	S	0	0
			2583	1605	455	513	10		
2	BN	331	Total	C	N	O	S	0	0
			2583	1605	455	513	10		

Continued on next page...

Continued from previous page...

Mol	Chain	Residues	Atoms					AltConf	Trace
2	BO	331	Total	C	N	O	S	0	0
			2583	1605	455	513	10		
2	BP	331	Total	C	N	O	S	0	0
			2583	1605	455	513	10		
2	BQ	331	Total	C	N	O	S	0	0
			2583	1605	455	513	10		
2	BR	331	Total	C	N	O	S	0	0
			2583	1605	455	513	10		
2	BS	331	Total	C	N	O	S	0	0
			2583	1605	455	513	10		
2	BT	331	Total	C	N	O	S	0	0
			2583	1605	455	513	10		
2	BU	331	Total	C	N	O	S	0	0
			2583	1605	455	513	10		
2	BV	331	Total	C	N	O	S	0	0
			2583	1605	455	513	10		
2	BW	331	Total	C	N	O	S	0	0
			2583	1605	455	513	10		
2	BX	331	Total	C	N	O	S	0	0
			2583	1605	455	513	10		
2	BY	331	Total	C	N	O	S	0	0
			2583	1605	455	513	10		

- Molecule 3 is a protein called Flagellar motor switch protein FlIM.

Mol	Chain	Residues	Atoms					AltConf	Trace
3	C1	290	Total	C	N	O	S	0	0
			2348	1497	424	422	5		
3	C2	290	Total	C	N	O	S	0	0
			2348	1497	424	422	5		
3	C3	290	Total	C	N	O	S	0	0
			2348	1497	424	422	5		
3	C4	290	Total	C	N	O	S	0	0
			2348	1497	424	422	5		
3	C5	290	Total	C	N	O	S	0	0
			2348	1497	424	422	5		
3	C6	290	Total	C	N	O	S	0	0
			2348	1497	424	422	5		
3	C7	290	Total	C	N	O	S	0	0
			2348	1497	424	422	5		
3	C8	290	Total	C	N	O	S	0	0
			2348	1497	424	422	5		

Continued on next page...

Continued from previous page...

Mol	Chain	Residues	Atoms					AltConf	Trace
			Total	C	N	O	S		
3	C9	290	Total 2348	C 1497	N 424	O 422	S 5	0	0
3	CA	290	Total 2348	C 1497	N 424	O 422	S 5	0	0
3	CB	290	Total 2348	C 1497	N 424	O 422	S 5	0	0
3	CC	290	Total 2348	C 1497	N 424	O 422	S 5	0	0
3	CD	290	Total 2348	C 1497	N 424	O 422	S 5	0	0
3	CE	290	Total 2348	C 1497	N 424	O 422	S 5	0	0
3	CF	290	Total 2348	C 1497	N 424	O 422	S 5	0	0
3	CG	290	Total 2348	C 1497	N 424	O 422	S 5	0	0
3	CH	290	Total 2348	C 1497	N 424	O 422	S 5	0	0
3	CI	290	Total 2348	C 1497	N 424	O 422	S 5	0	0
3	CJ	290	Total 2348	C 1497	N 424	O 422	S 5	0	0
3	CK	290	Total 2348	C 1497	N 424	O 422	S 5	0	0
3	CL	290	Total 2348	C 1497	N 424	O 422	S 5	0	0
3	CM	290	Total 2348	C 1497	N 424	O 422	S 5	0	0
3	CN	290	Total 2348	C 1497	N 424	O 422	S 5	0	0
3	CO	290	Total 2348	C 1497	N 424	O 422	S 5	0	0
3	CP	290	Total 2348	C 1497	N 424	O 422	S 5	0	0
3	CQ	290	Total 2348	C 1497	N 424	O 422	S 5	0	0
3	CR	290	Total 2348	C 1497	N 424	O 422	S 5	0	0
3	CS	290	Total 2348	C 1497	N 424	O 422	S 5	0	0
3	CT	290	Total 2348	C 1497	N 424	O 422	S 5	0	0

Continued on next page...

Continued from previous page...

Mol	Chain	Residues	Atoms					AltConf	Trace
3	CU	290	Total	C	N	O	S	0	0
			2348	1497	424	422	5		
3	CV	290	Total	C	N	O	S	0	0
			2348	1497	424	422	5		
3	CW	290	Total	C	N	O	S	0	0
			2348	1497	424	422	5		
3	CX	290	Total	C	N	O	S	0	0
			2348	1497	424	422	5		
3	CY	290	Total	C	N	O	S	0	0
			2348	1497	424	422	5		

- Molecule 4 is a protein called Flagellar motor switch protein FliN.

Mol	Chain	Residues	Atoms					AltConf	Trace
4	D1	81	Total	C	N	O	S	0	0
			625	398	108	116	3		
4	E1	81	Total	C	N	O	S	0	0
			625	398	108	116	3		
4	F1	81	Total	C	N	O	S	0	0
			627	397	111	116	3		
4	D2	81	Total	C	N	O	S	0	0
			625	398	108	116	3		
4	E2	81	Total	C	N	O	S	0	0
			625	398	108	116	3		
4	F2	81	Total	C	N	O	S	0	0
			627	397	111	116	3		
4	D3	81	Total	C	N	O	S	0	0
			625	398	108	116	3		
4	E3	81	Total	C	N	O	S	0	0
			625	398	108	116	3		
4	F3	81	Total	C	N	O	S	0	0
			627	397	111	116	3		
4	D4	81	Total	C	N	O	S	0	0
			625	398	108	116	3		
4	E4	81	Total	C	N	O	S	0	0
			625	398	108	116	3		
4	F4	81	Total	C	N	O	S	0	0
			627	397	111	116	3		
4	D5	81	Total	C	N	O	S	0	0
			625	398	108	116	3		
4	E5	81	Total	C	N	O	S	0	0
			625	398	108	116	3		

Continued on next page...

Continued from previous page...

Mol	Chain	Residues	Atoms					AltConf	Trace
			Total	C	N	O	S		
4	F5	81	627	397	111	116	3	0	0
4	D6	81	625	398	108	116	3	0	0
4	E6	81	625	398	108	116	3	0	0
4	F6	81	627	397	111	116	3	0	0
4	D7	81	625	398	108	116	3	0	0
4	E7	81	625	398	108	116	3	0	0
4	F7	81	627	397	111	116	3	0	0
4	D8	81	625	398	108	116	3	0	0
4	E8	81	625	398	108	116	3	0	0
4	F8	81	627	397	111	116	3	0	0
4	D9	81	625	398	108	116	3	0	0
4	E9	81	625	398	108	116	3	0	0
4	F9	81	627	397	111	116	3	0	0
4	DA	81	625	398	108	116	3	0	0
4	EA	81	625	398	108	116	3	0	0
4	FA	81	627	397	111	116	3	0	0
4	DB	81	625	398	108	116	3	0	0
4	EB	81	625	398	108	116	3	0	0
4	FB	81	627	397	111	116	3	0	0
4	DC	81	625	398	108	116	3	0	0
4	EC	81	625	398	108	116	3	0	0

Continued on next page...

Continued from previous page...

Mol	Chain	Residues	Atoms					AltConf	Trace
			Total	C	N	O	S		
4	FC	81	627	397	111	116	3	0	0
4	DD	81	625	398	108	116	3	0	0
4	ED	81	625	398	108	116	3	0	0
4	FD	81	627	397	111	116	3	0	0
4	DE	81	625	398	108	116	3	0	0
4	EE	81	625	398	108	116	3	0	0
4	FE	81	627	397	111	116	3	0	0
4	DF	81	625	398	108	116	3	0	0
4	EF	81	625	398	108	116	3	0	0
4	FF	81	627	397	111	116	3	0	0
4	DG	81	625	398	108	116	3	0	0
4	EG	81	625	398	108	116	3	0	0
4	FG	81	627	397	111	116	3	0	0
4	DH	81	625	398	108	116	3	0	0
4	EH	81	625	398	108	116	3	0	0
4	FH	81	627	397	111	116	3	0	0
4	DI	81	625	398	108	116	3	0	0
4	EI	81	625	398	108	116	3	0	0
4	FI	81	627	397	111	116	3	0	0
4	DJ	81	625	398	108	116	3	0	0
4	EJ	81	625	398	108	116	3	0	0

Continued on next page...

Continued from previous page...

Mol	Chain	Residues	Atoms					AltConf	Trace
			Total	C	N	O	S		
4	FJ	81	627	397	111	116	3	0	0
4	DK	81	625	398	108	116	3	0	0
4	EK	81	625	398	108	116	3	0	0
4	FK	81	627	397	111	116	3	0	0
4	DL	81	625	398	108	116	3	0	0
4	EL	81	625	398	108	116	3	0	0
4	FL	81	627	397	111	116	3	0	0
4	DM	81	625	398	108	116	3	0	0
4	EM	81	625	398	108	116	3	0	0
4	FM	81	627	397	111	116	3	0	0
4	DN	81	625	398	108	116	3	0	0
4	EN	81	625	398	108	116	3	0	0
4	FN	81	627	397	111	116	3	0	0
4	DO	81	625	398	108	116	3	0	0
4	EO	81	625	398	108	116	3	0	0
4	FO	81	627	397	111	116	3	0	0
4	DP	81	625	398	108	116	3	0	0
4	EP	81	625	398	108	116	3	0	0
4	FP	81	627	397	111	116	3	0	0
4	DQ	81	625	398	108	116	3	0	0
4	EQ	81	625	398	108	116	3	0	0

Continued on next page...

Continued from previous page...

Mol	Chain	Residues	Atoms					AltConf	Trace
			Total	C	N	O	S		
4	FQ	81	627	397	111	116	3	0	0
4	DR	81	625	398	108	116	3	0	0
4	ER	81	625	398	108	116	3	0	0
4	FR	81	627	397	111	116	3	0	0
4	DS	81	625	398	108	116	3	0	0
4	ES	81	625	398	108	116	3	0	0
4	FS	81	627	397	111	116	3	0	0
4	DT	81	625	398	108	116	3	0	0
4	ET	81	625	398	108	116	3	0	0
4	FT	81	627	397	111	116	3	0	0
4	DU	81	625	398	108	116	3	0	0
4	EU	81	625	398	108	116	3	0	0
4	FU	81	627	397	111	116	3	0	0
4	DV	81	625	398	108	116	3	0	0
4	EV	81	625	398	108	116	3	0	0
4	FV	81	627	397	111	116	3	0	0
4	DW	81	625	398	108	116	3	0	0
4	EW	81	625	398	108	116	3	0	0
4	FW	81	627	397	111	116	3	0	0
4	DX	81	625	398	108	116	3	0	0
4	EX	81	625	398	108	116	3	0	0

Continued on next page...

Continued from previous page...

Mol	Chain	Residues	Atoms					AltConf	Trace
4	FX	81	Total	C	N	O	S	0	0
			627	397	111	116	3		
4	DY	81	Total	C	N	O	S	0	0
			625	398	108	116	3		
4	EY	81	Total	C	N	O	S	0	0
			625	398	108	116	3		
4	FY	81	Total	C	N	O	S	0	0
			627	397	111	116	3		

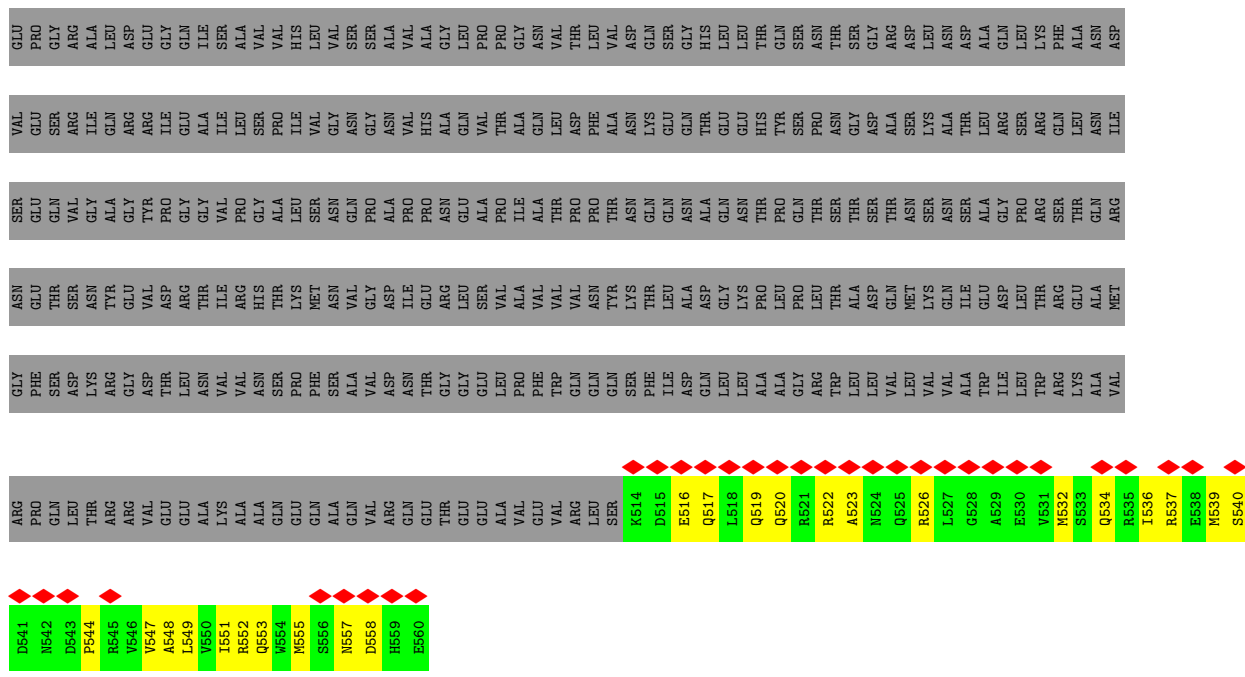

• Molecule 1: Flagellar M-ring protein

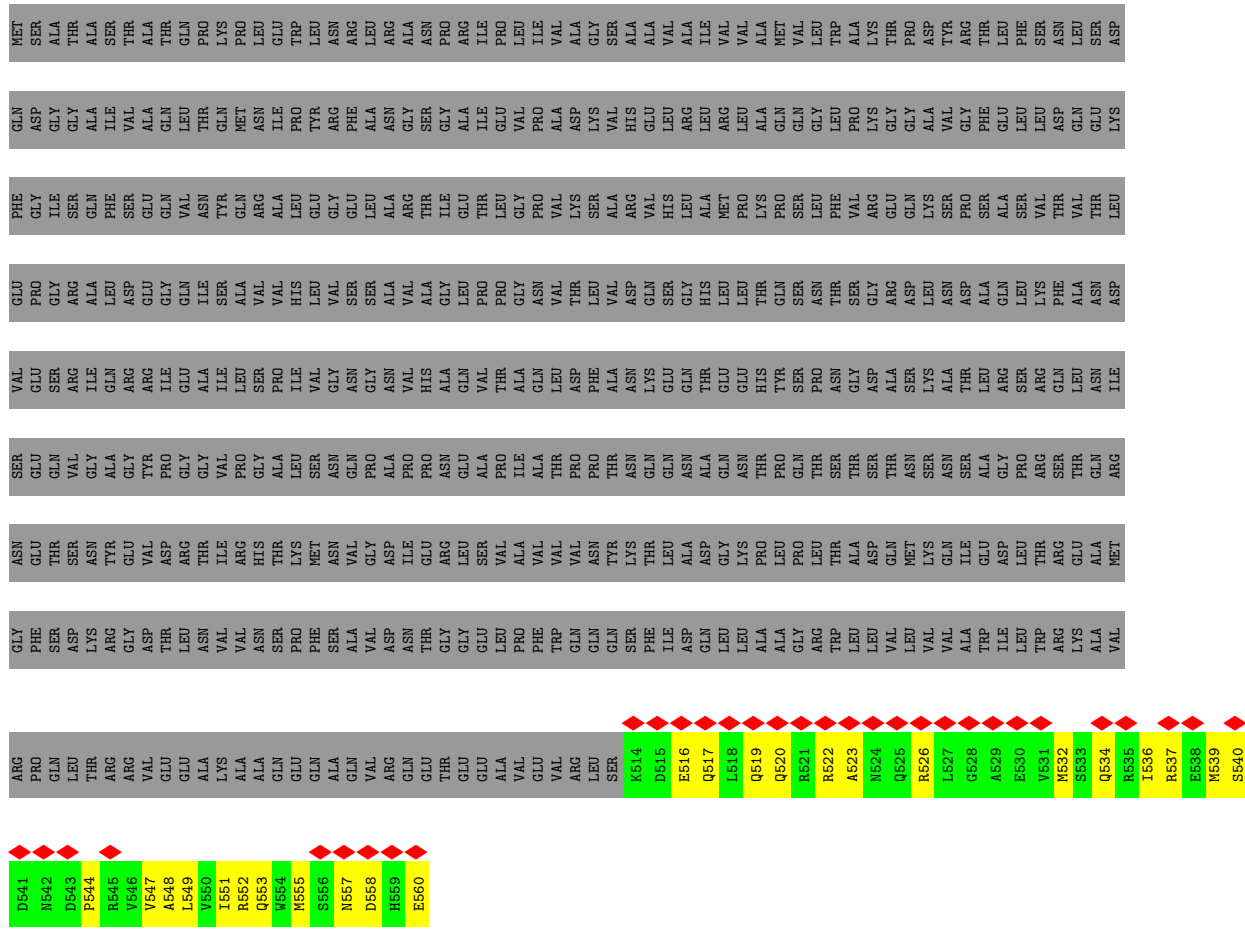

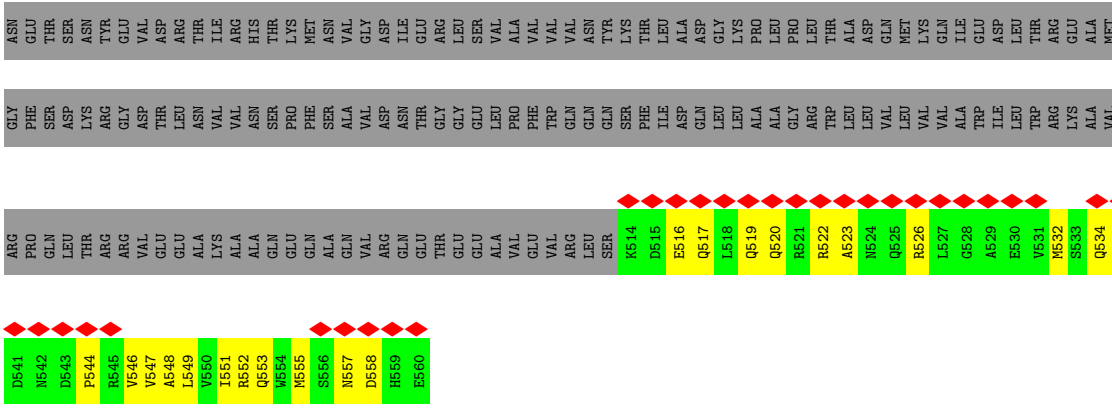

● Molecule 1: Flagellar M-ring protein

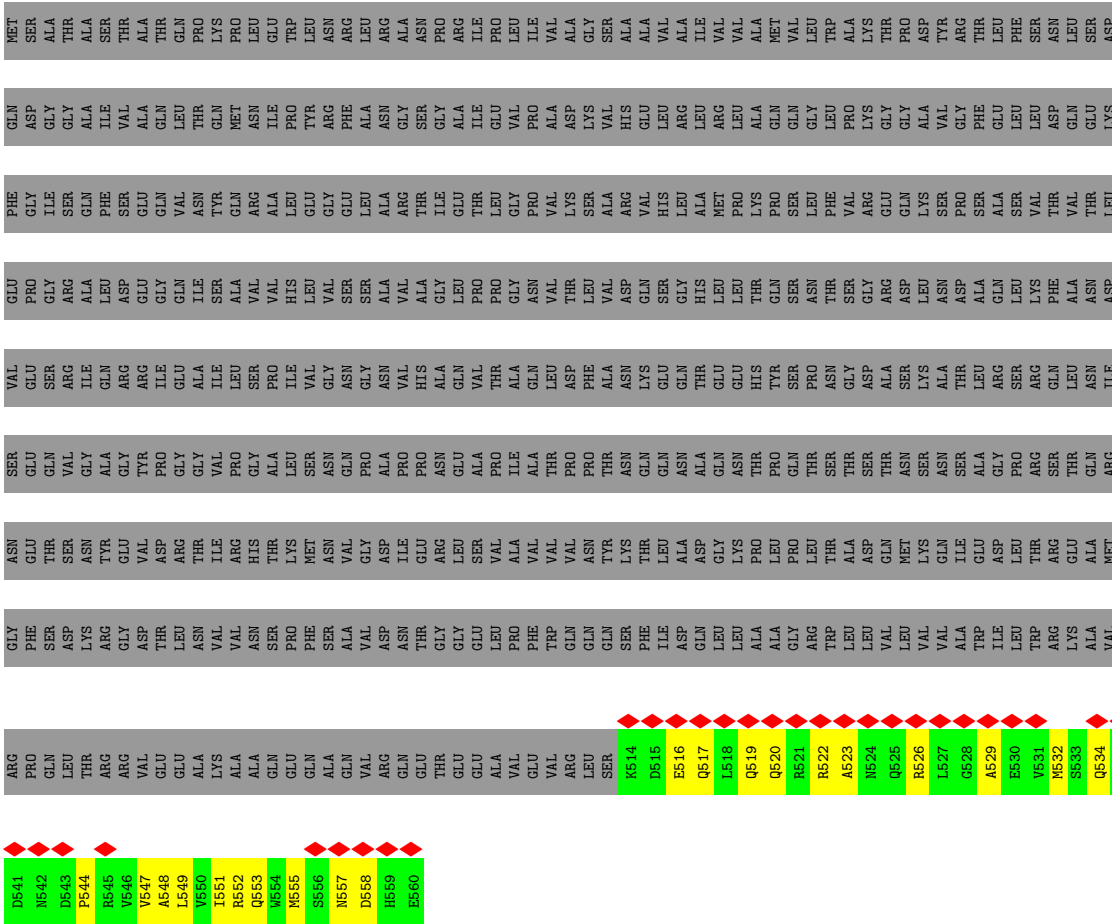

● Molecule 1: Flagellar M-ring protein

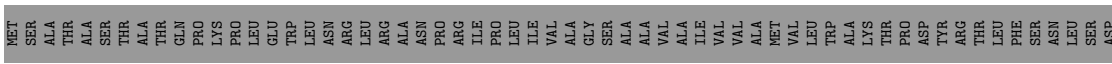

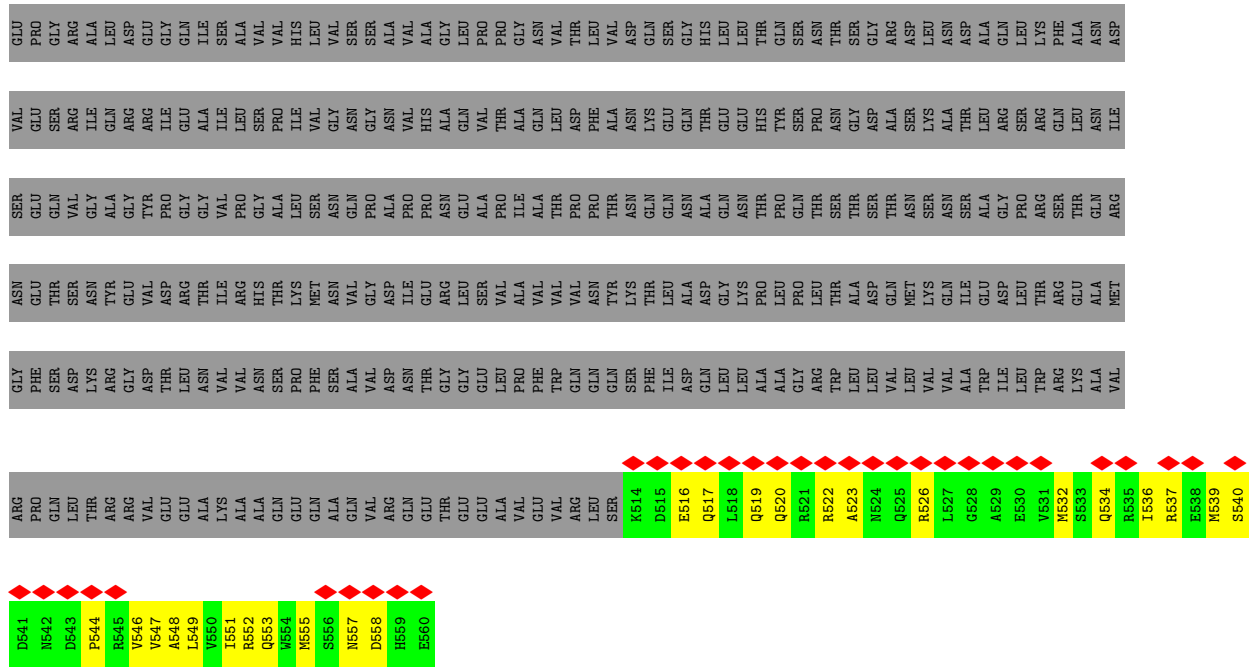

• Molecule 1: Flagellar M-ring protein

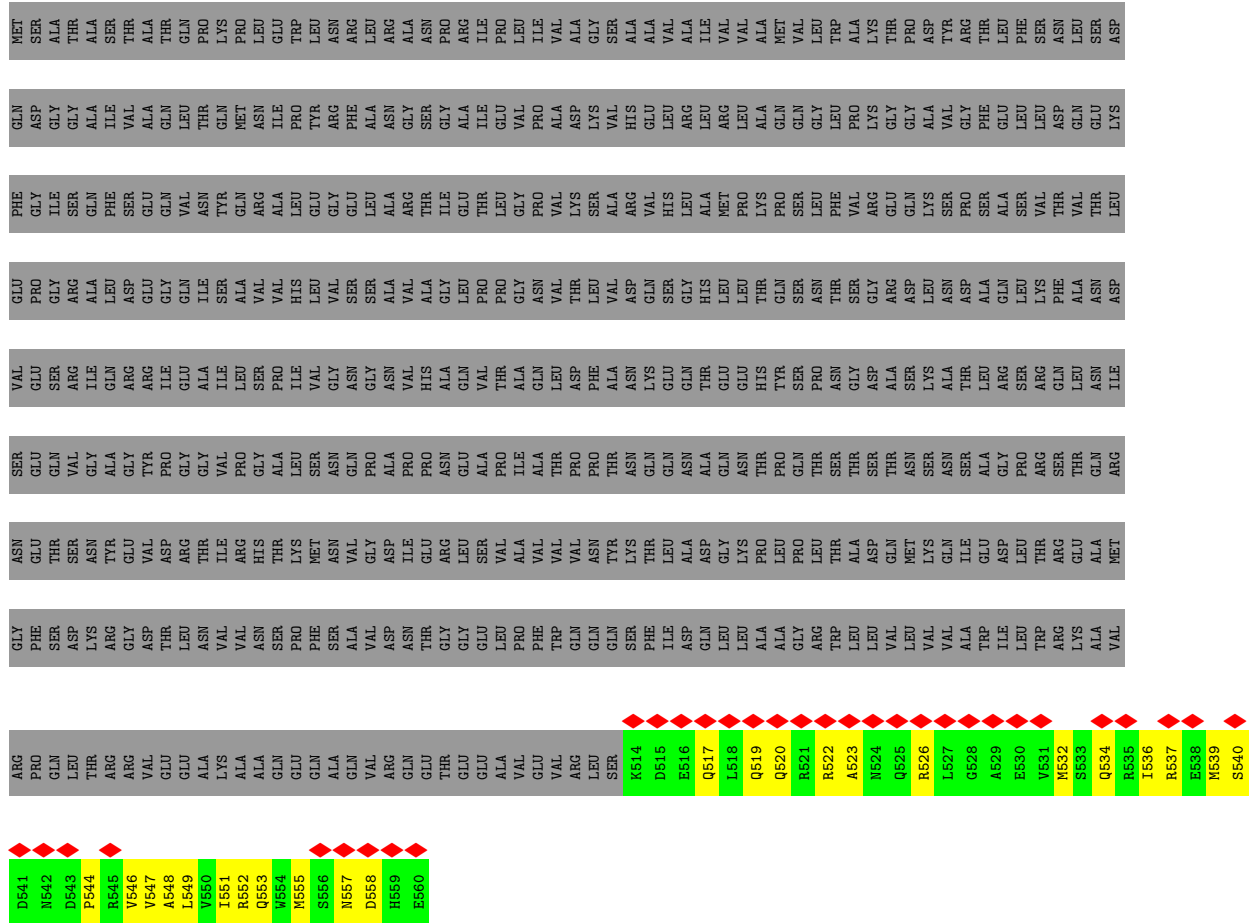

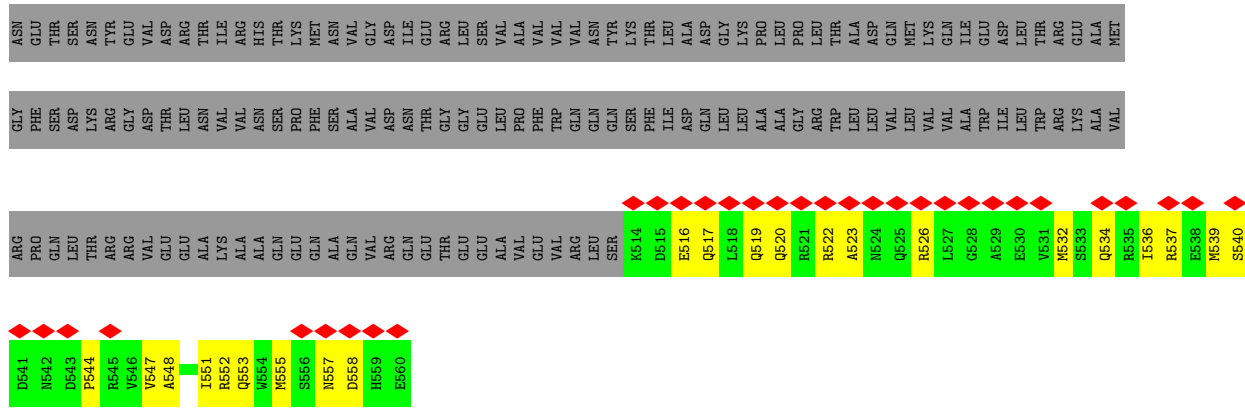

• Molecule 1: Flagellar M-ring protein

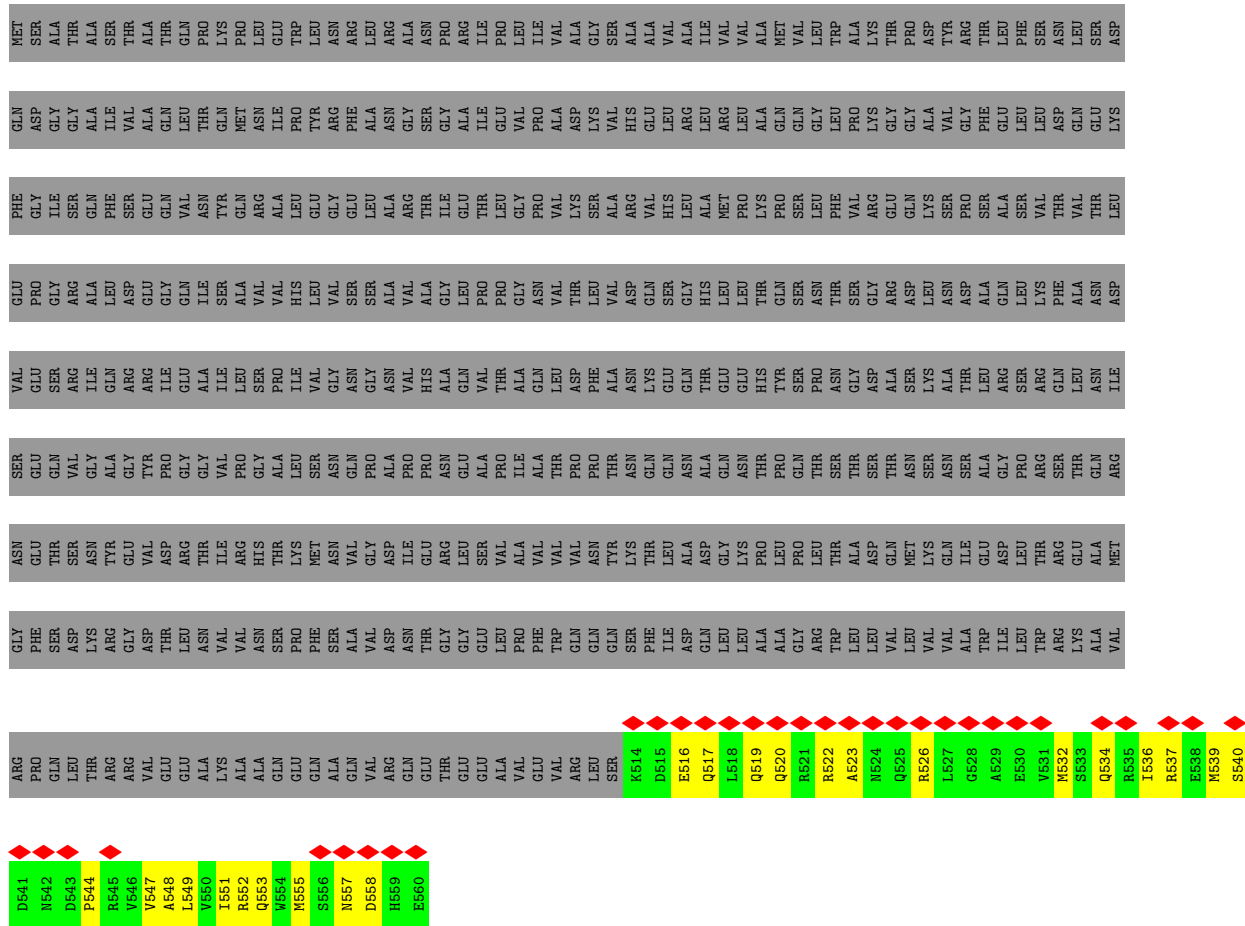

• Molecule 1: Flagellar M-ring protein

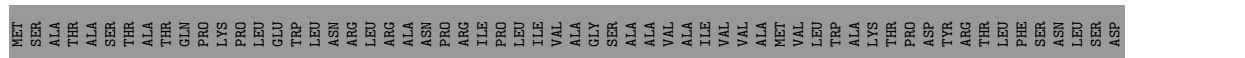

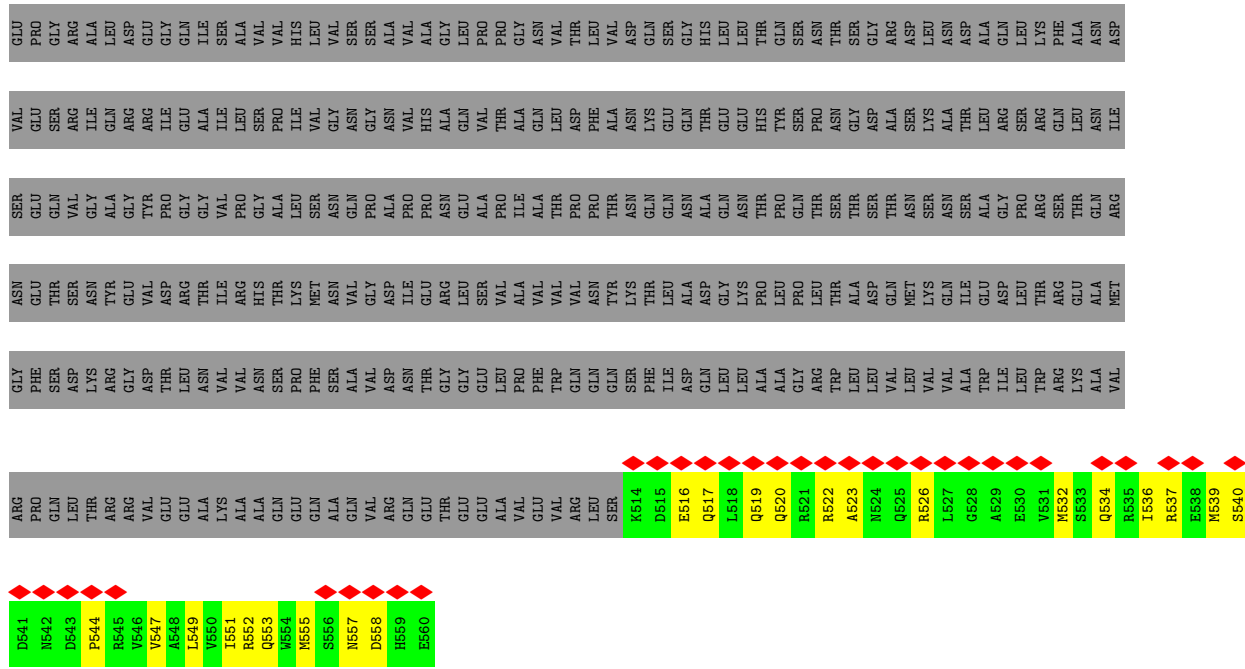

● Molecule 1: Flagellar M-ring protein

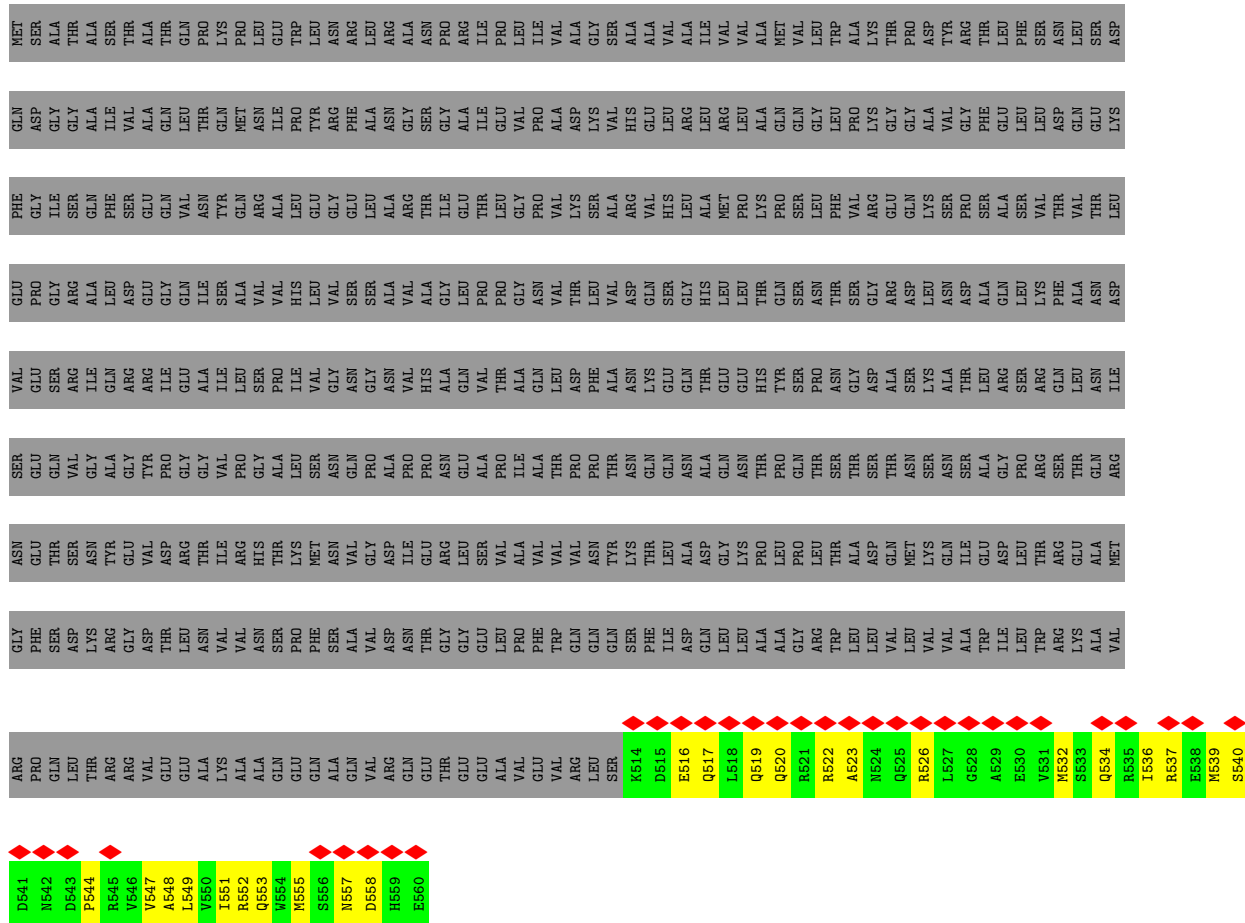

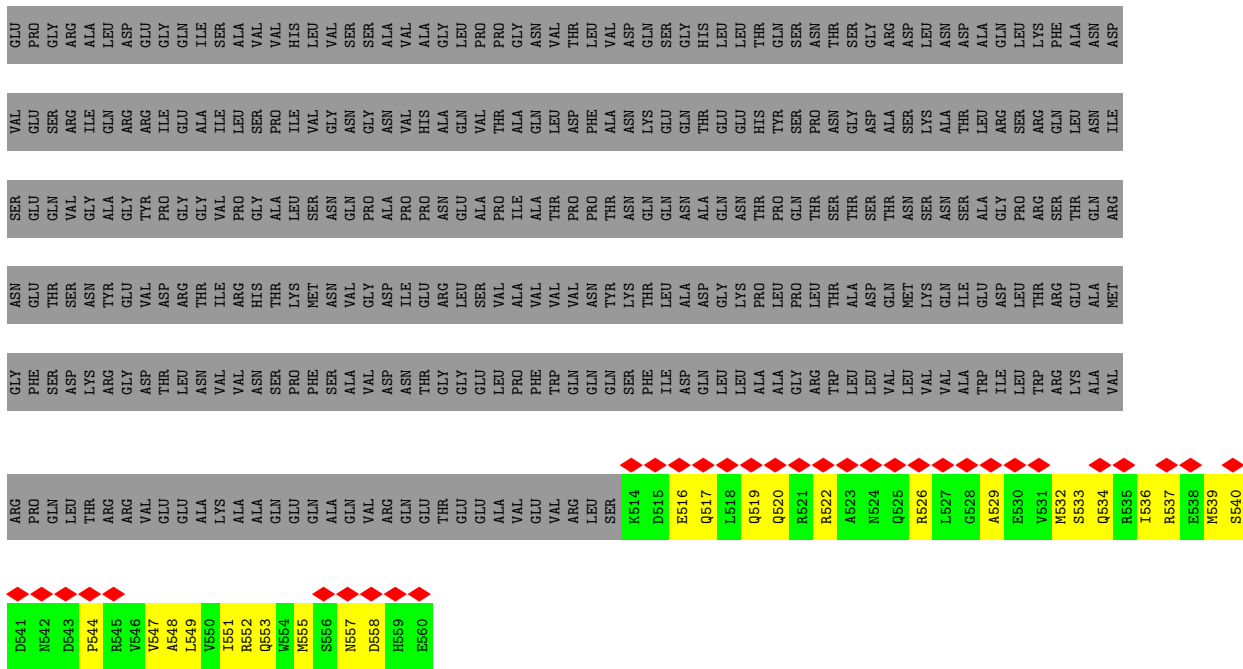

• Molecule 1: Flagellar M-ring protein

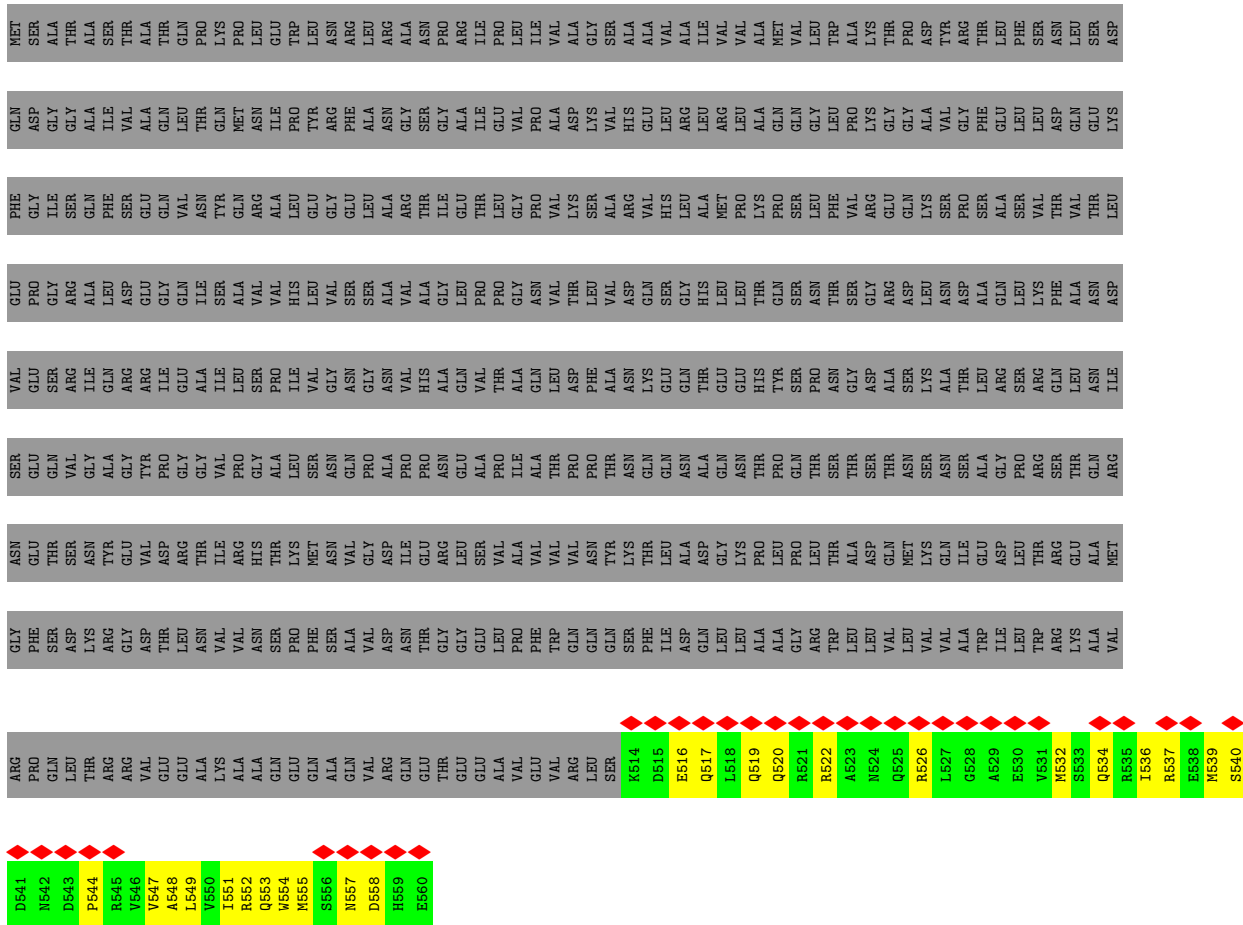

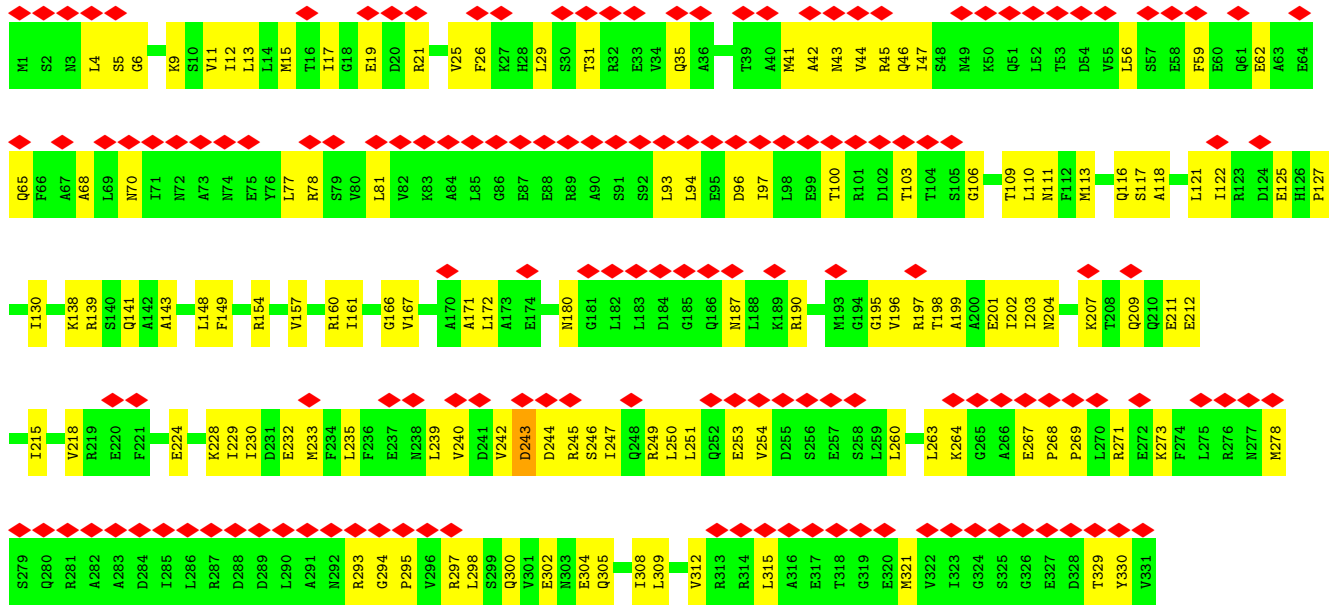

• Molecule 2: Flagellar motor switch protein FlIG

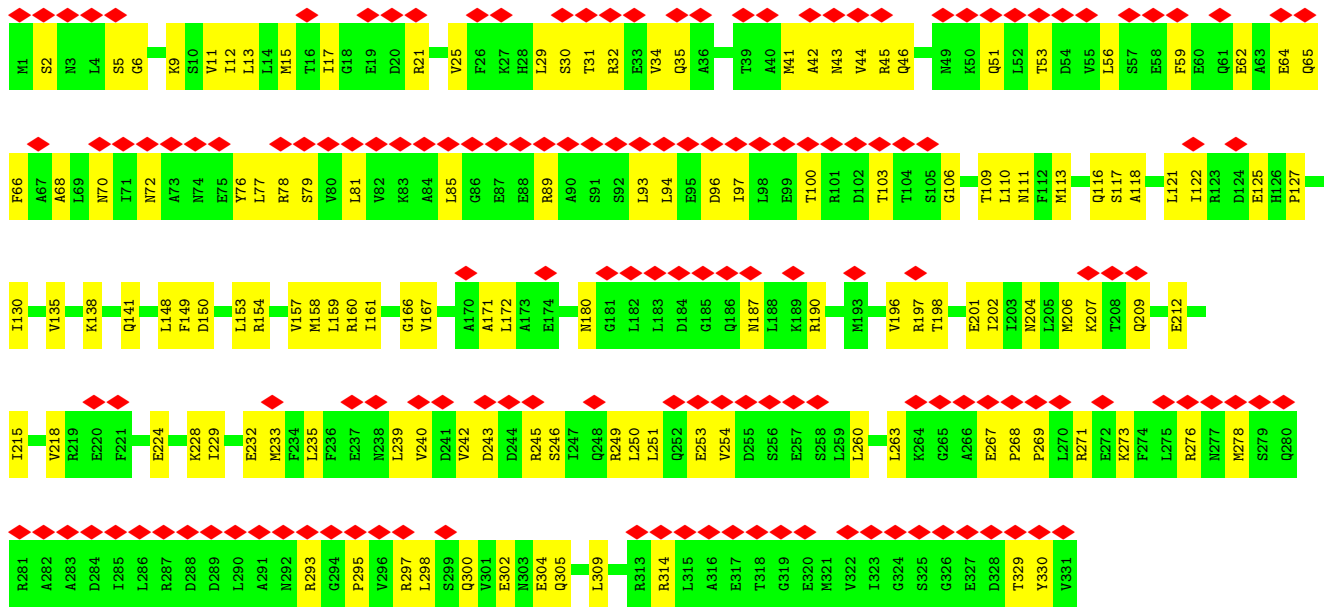

• Molecule 2: Flagellar motor switch protein FlIG

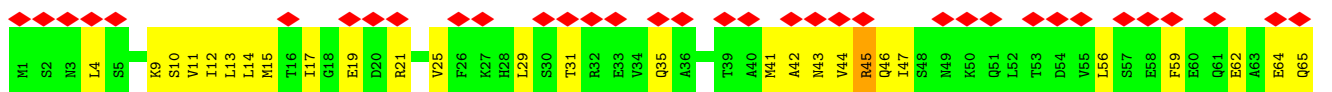

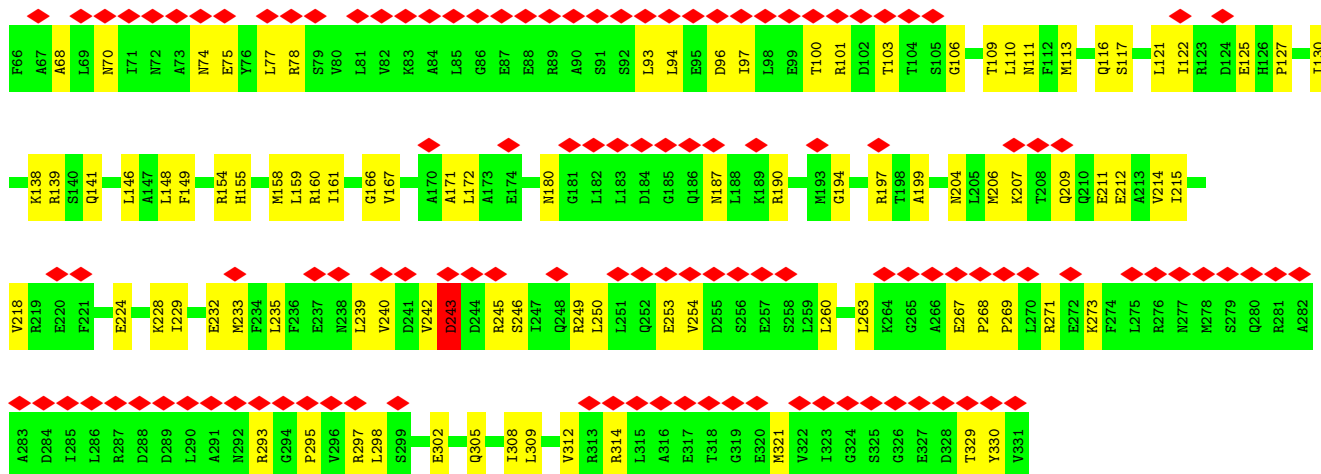

• Molecule 2: Flagellar motor switch protein FlIG

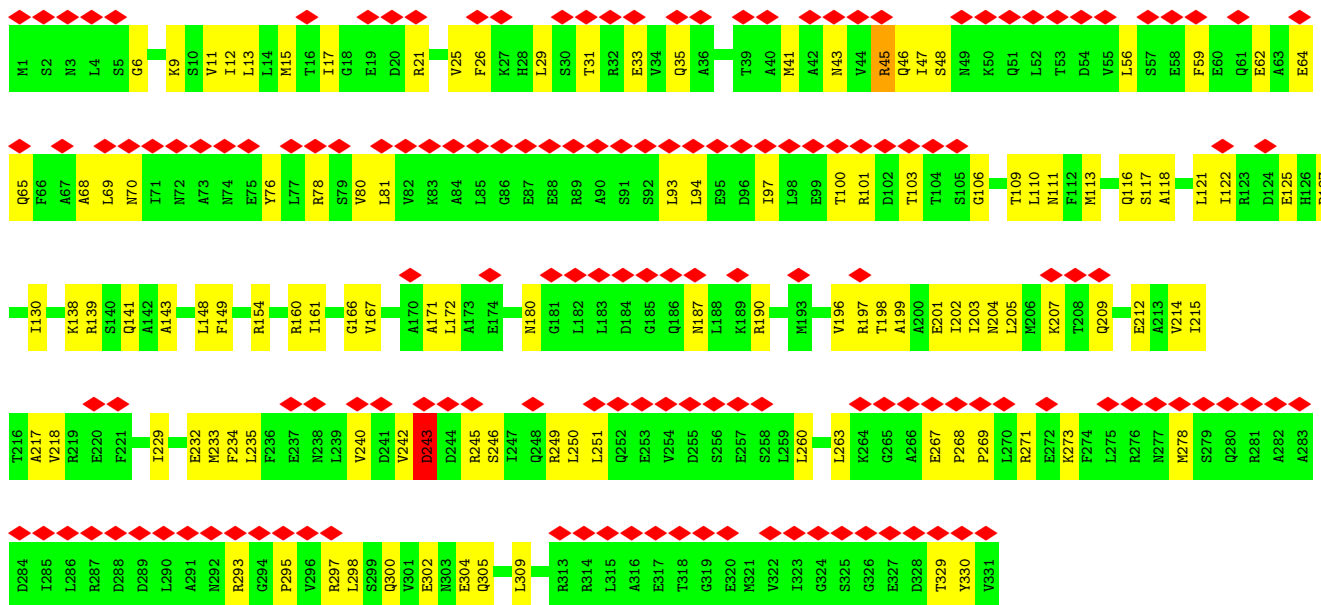

• Molecule 2: Flagellar motor switch protein FlIG

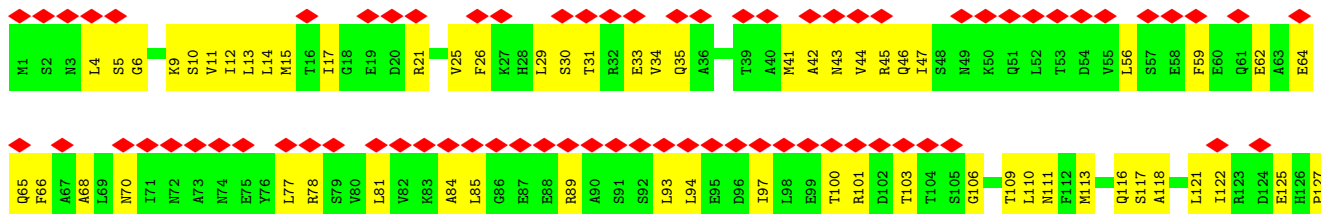

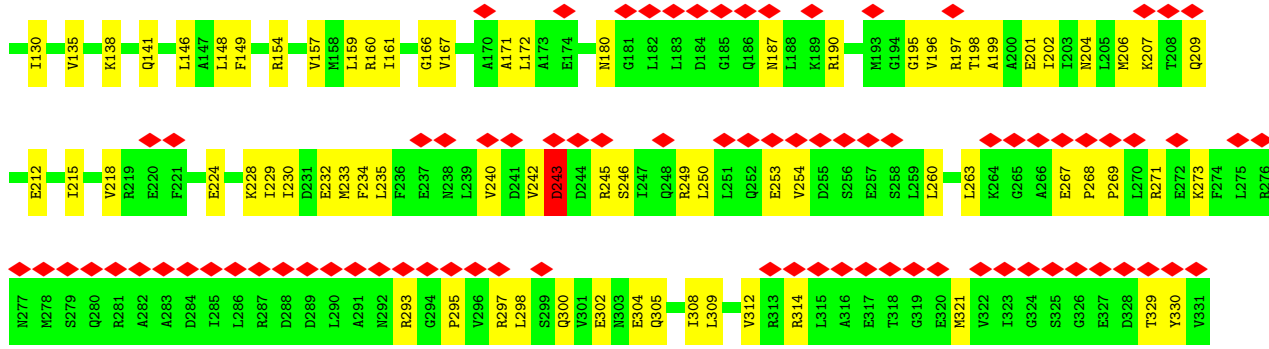

• Molecule 2: Flagellar motor switch protein FliG

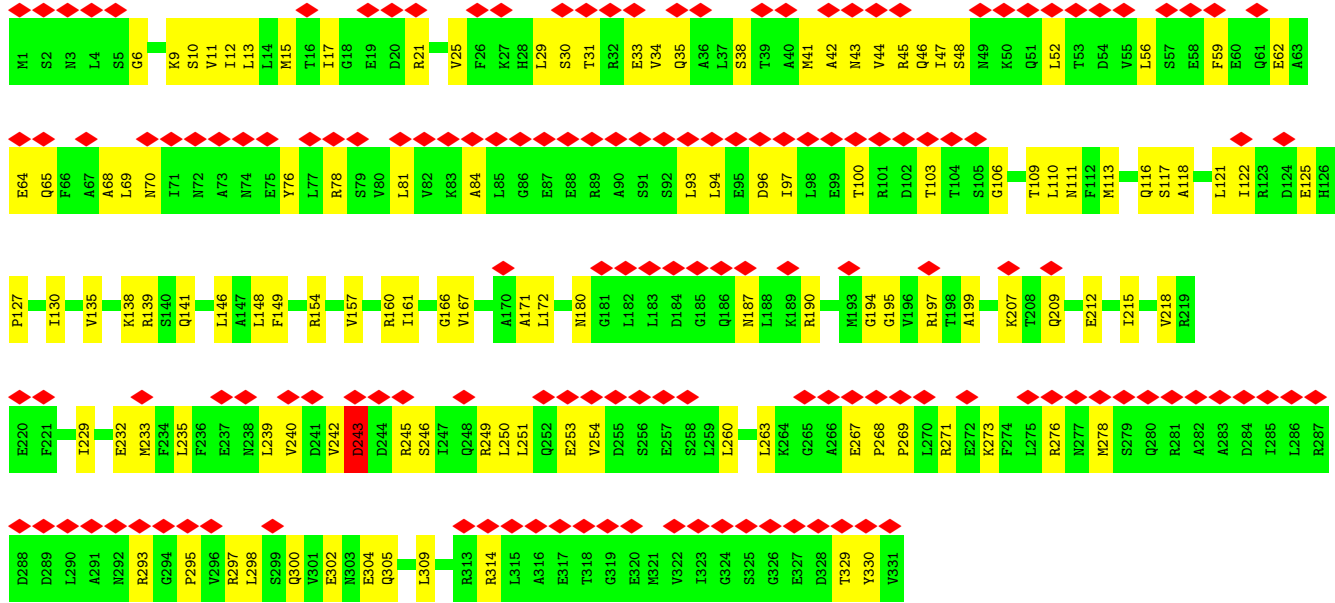

• Molecule 2: Flagellar motor switch protein FliG

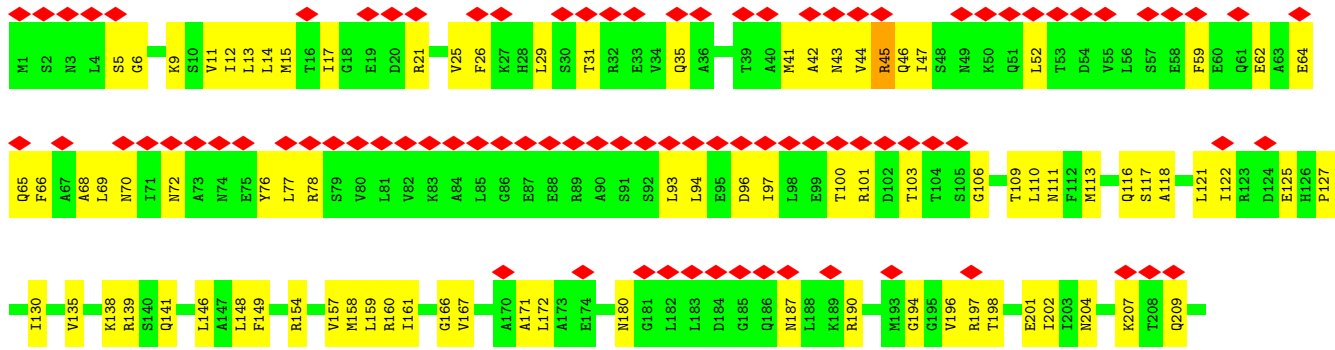

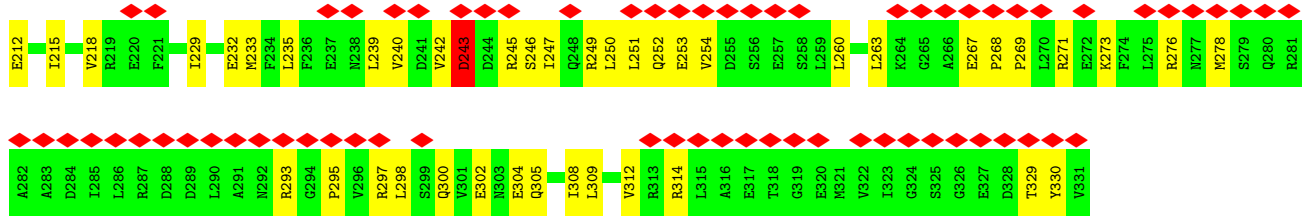

• Molecule 2: Flagellar motor switch protein FliG

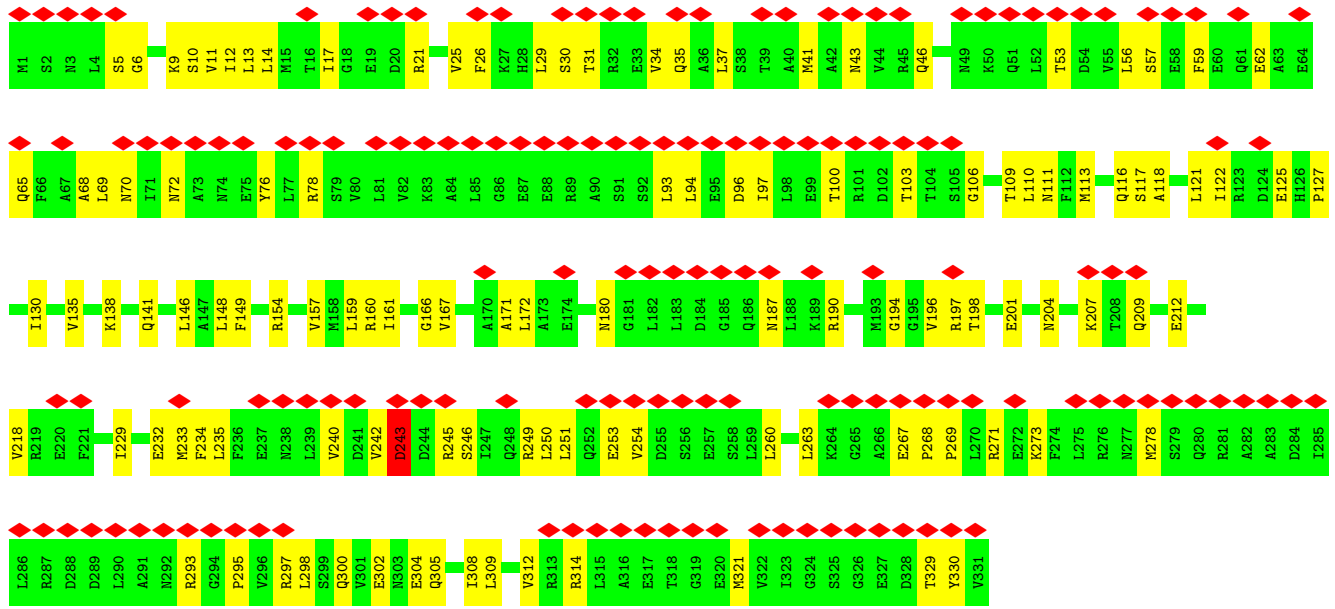

• Molecule 2: Flagellar motor switch protein FliG

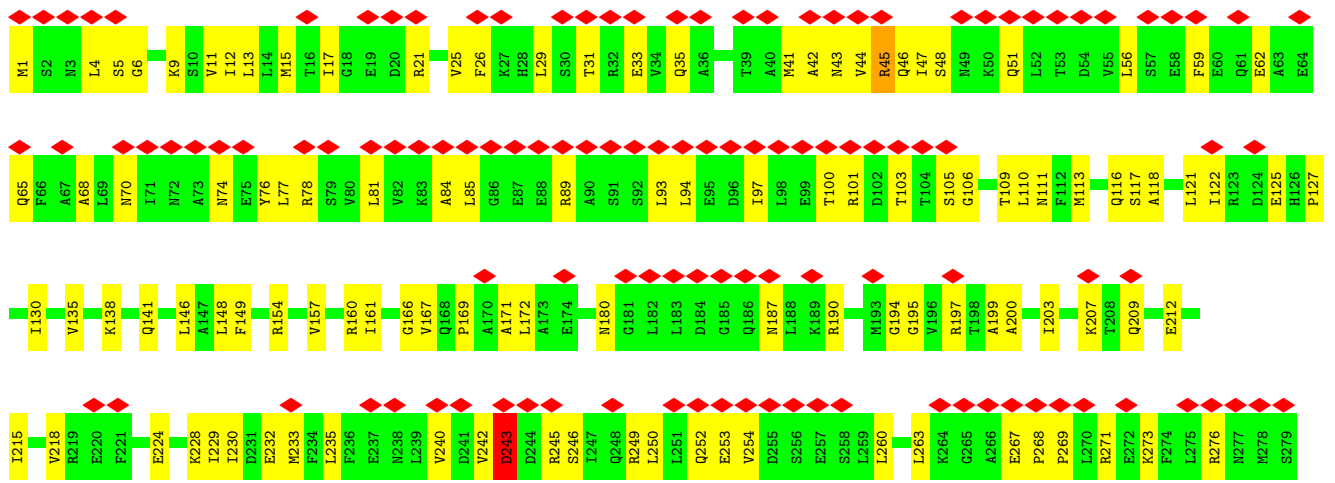

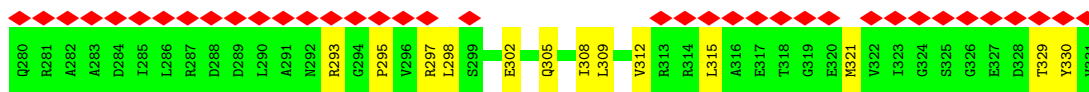

• Molecule 2: Flagellar motor switch protein FliG

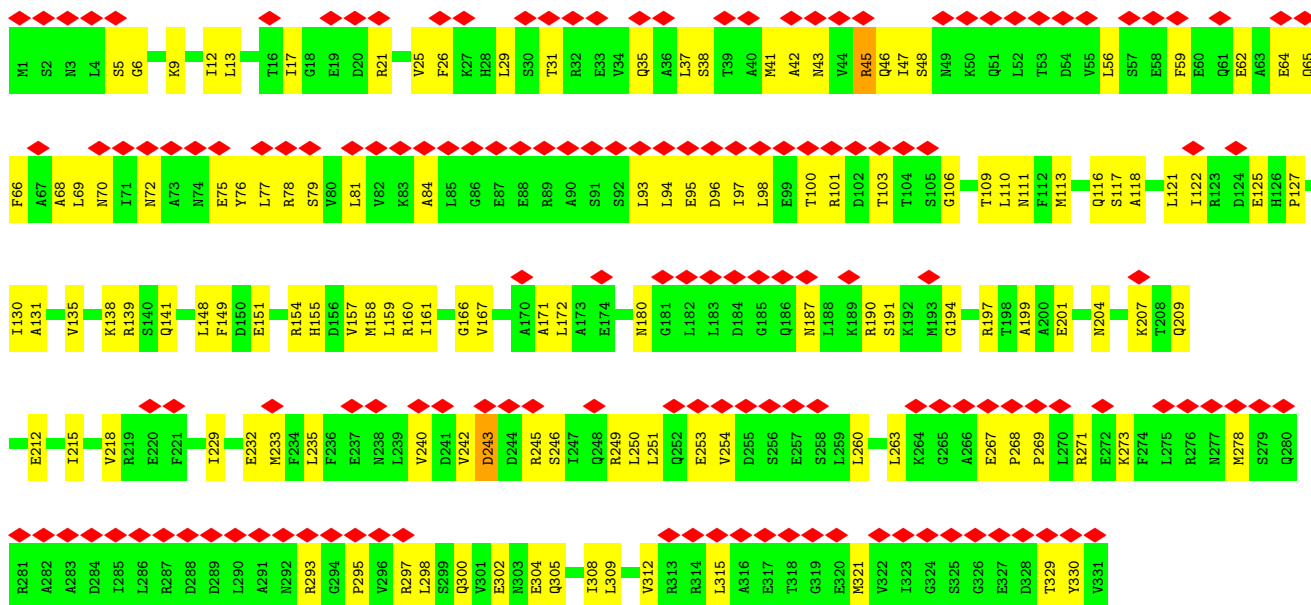

• Molecule 2: Flagellar motor switch protein FliG

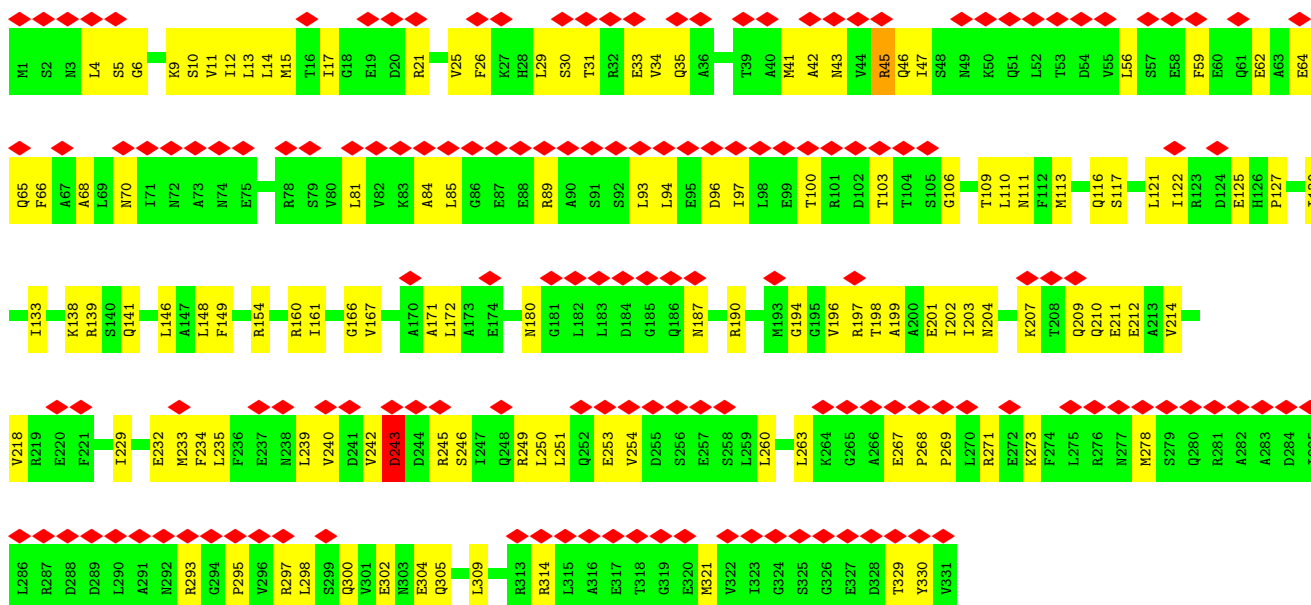

• Molecule 2: Flagellar motor switch protein FliG

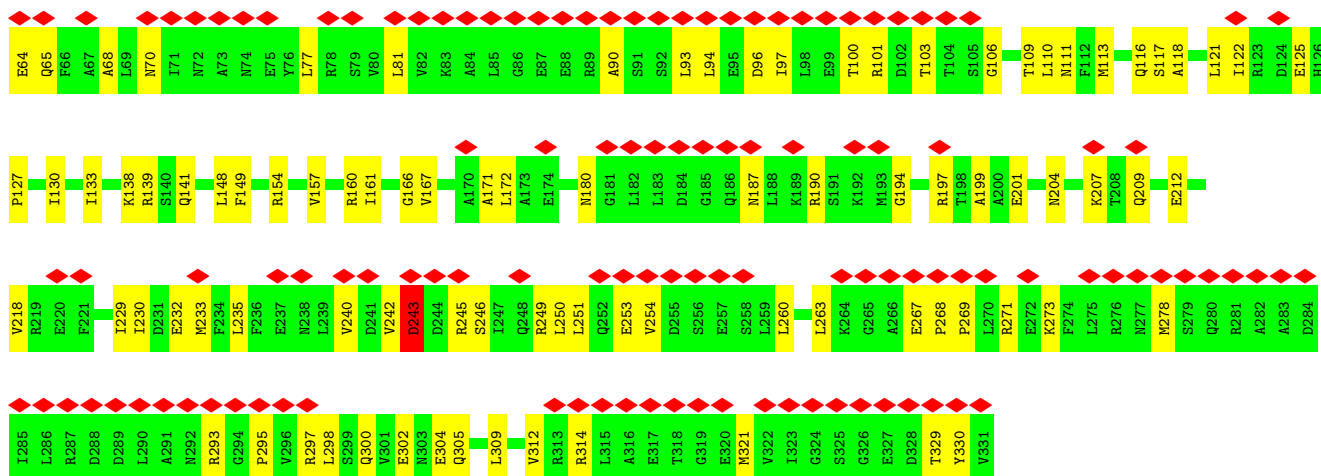

• Molecule 2: Flagellar motor switch protein FlIG

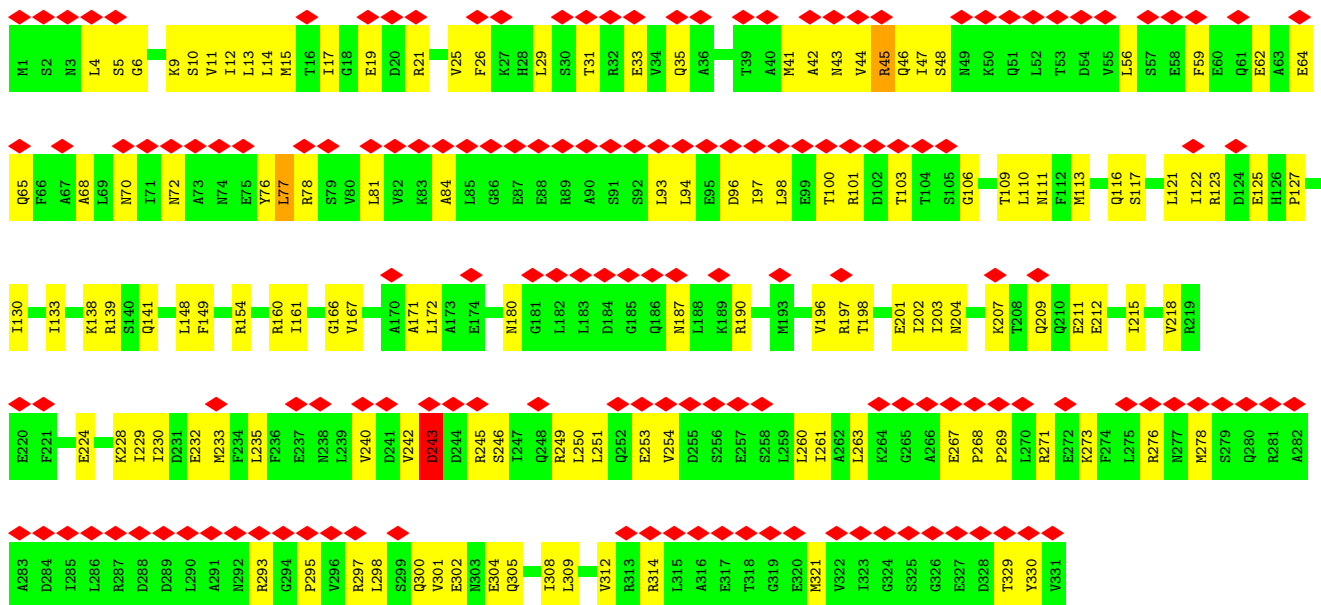

• Molecule 2: Flagellar motor switch protein FlIG

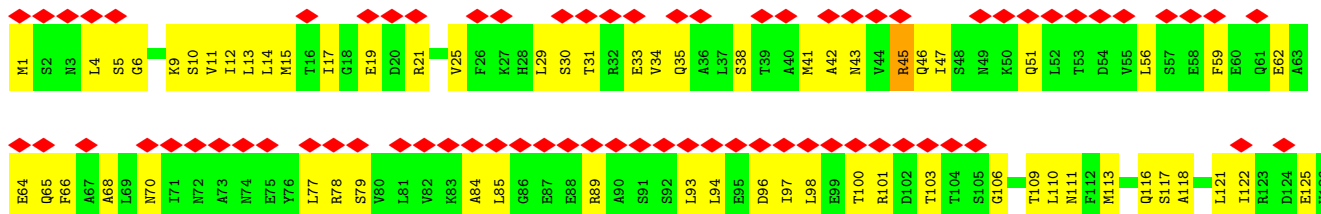

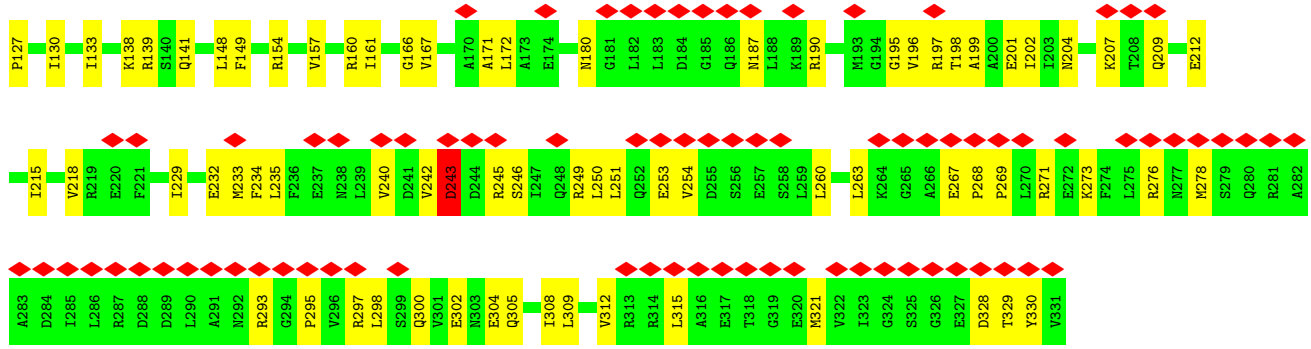

• Molecule 2: Flagellar motor switch protein FliG

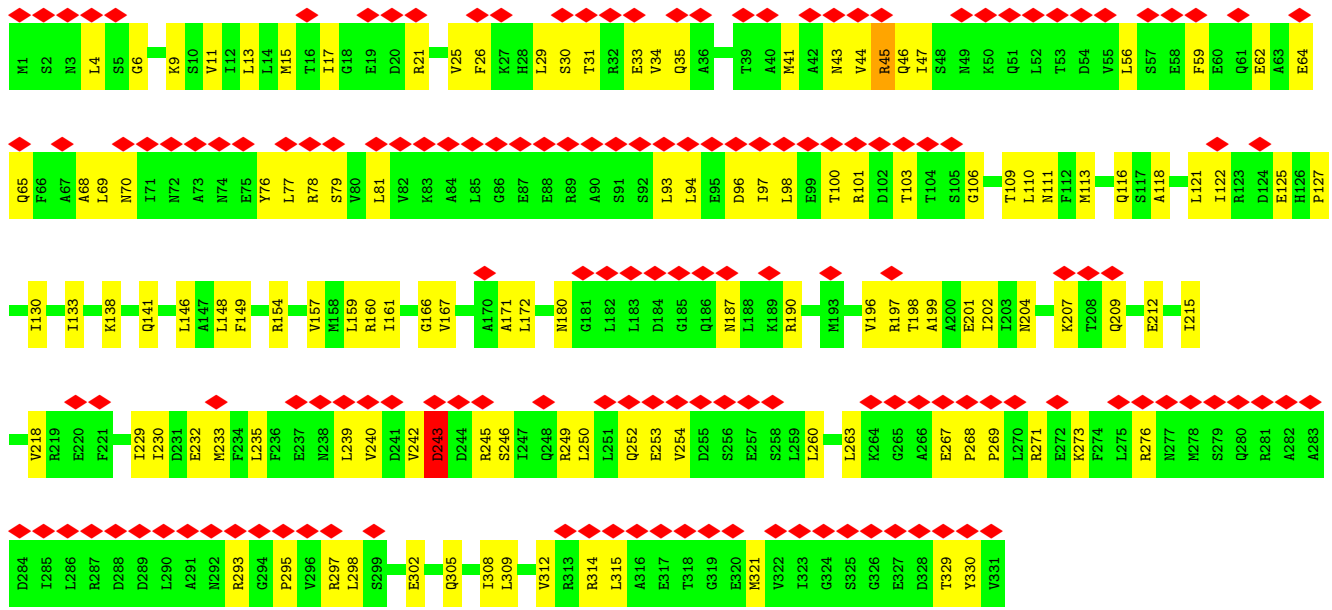

• Molecule 2: Flagellar motor switch protein FliG

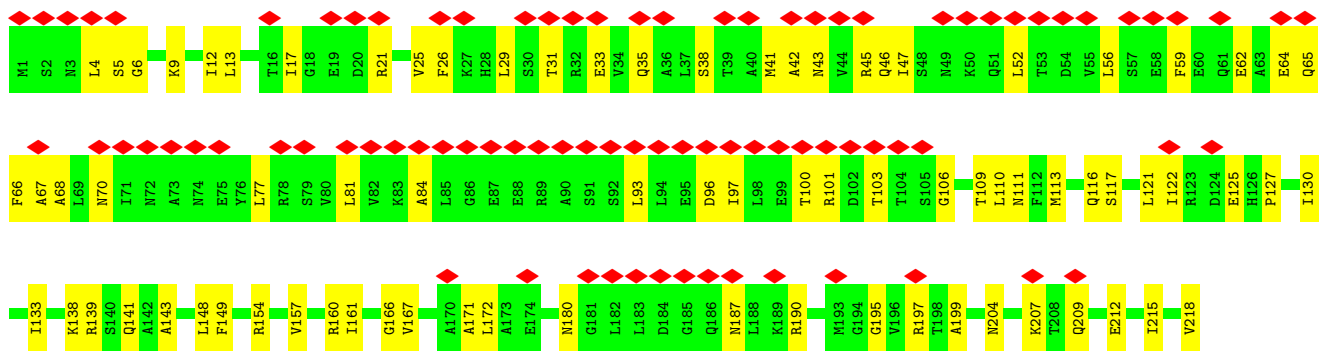

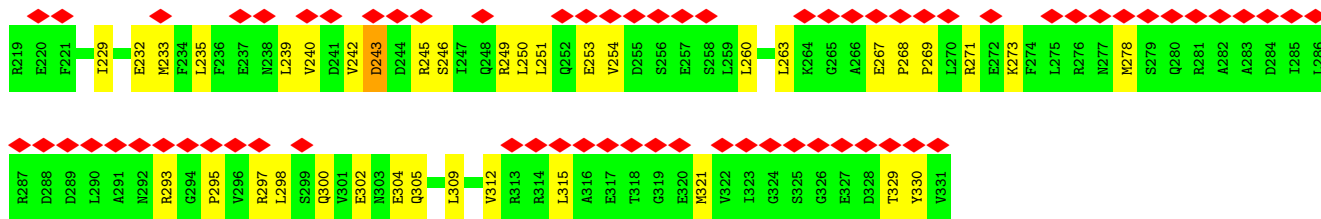

• Molecule 2: Flagellar motor switch protein FliG

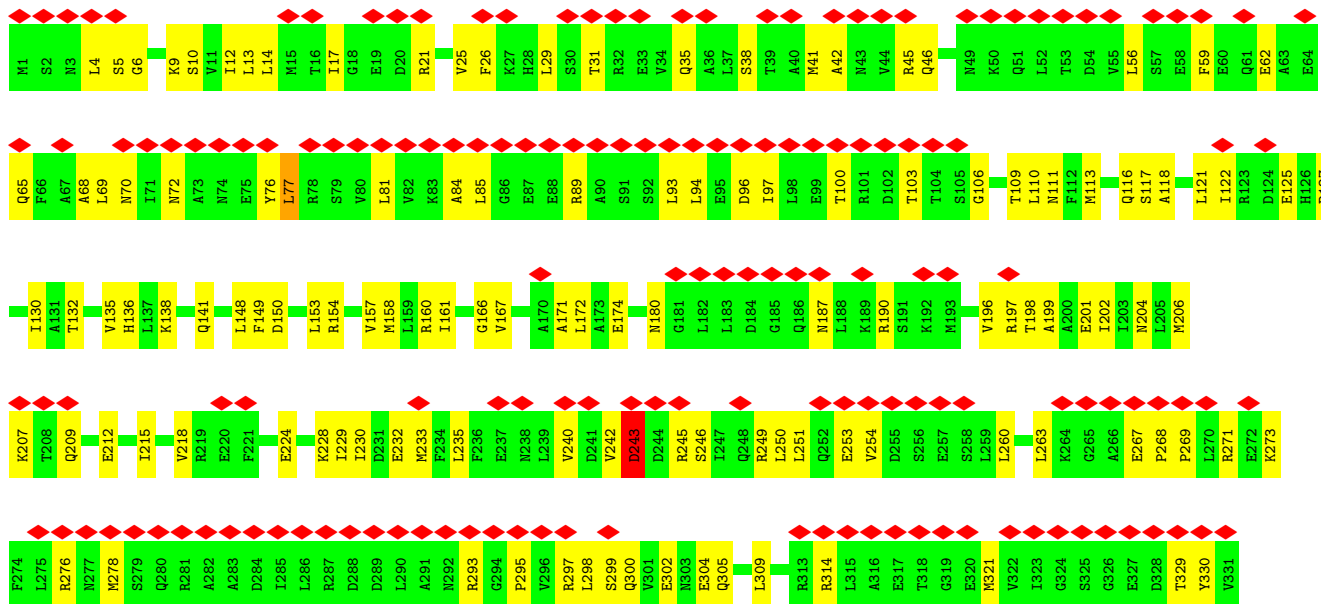

• Molecule 2: Flagellar motor switch protein FliG

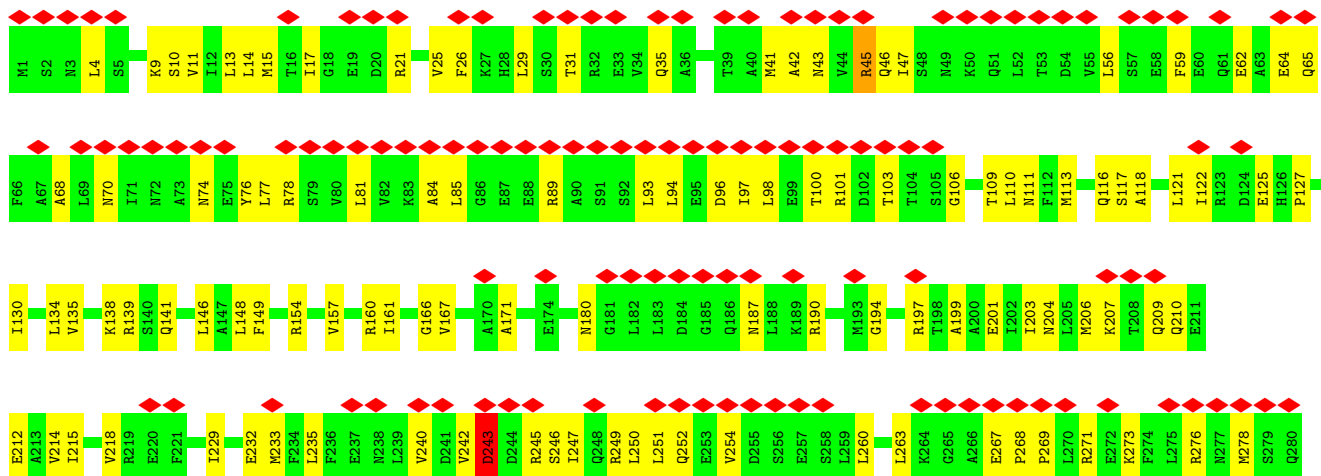

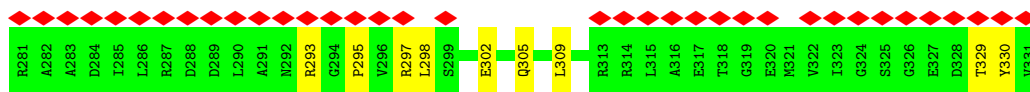

• Molecule 2: Flagellar motor switch protein FliG

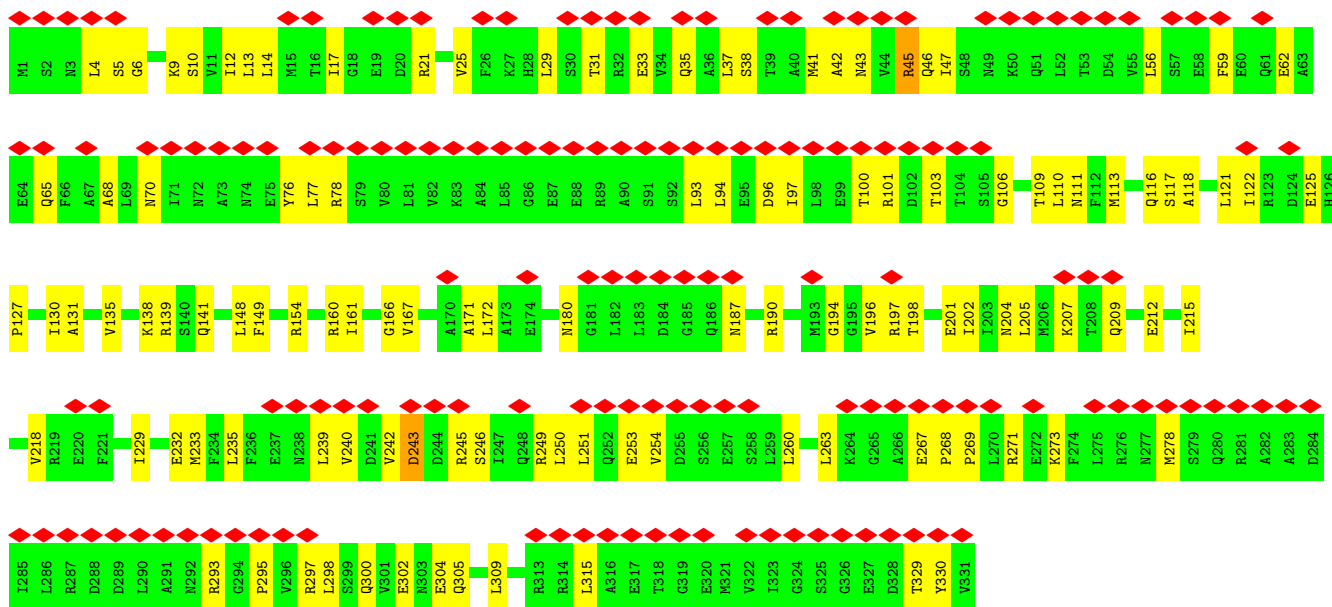

• Molecule 2: Flagellar motor switch protein FliG

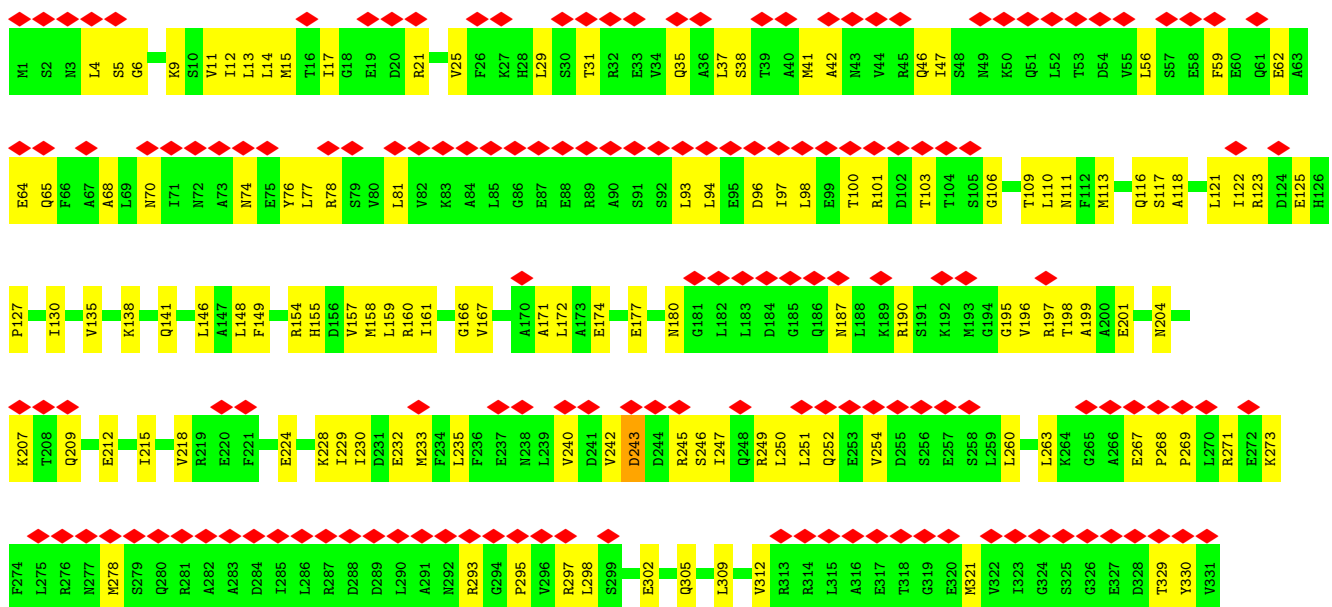

• Molecule 2: Flagellar motor switch protein FliG

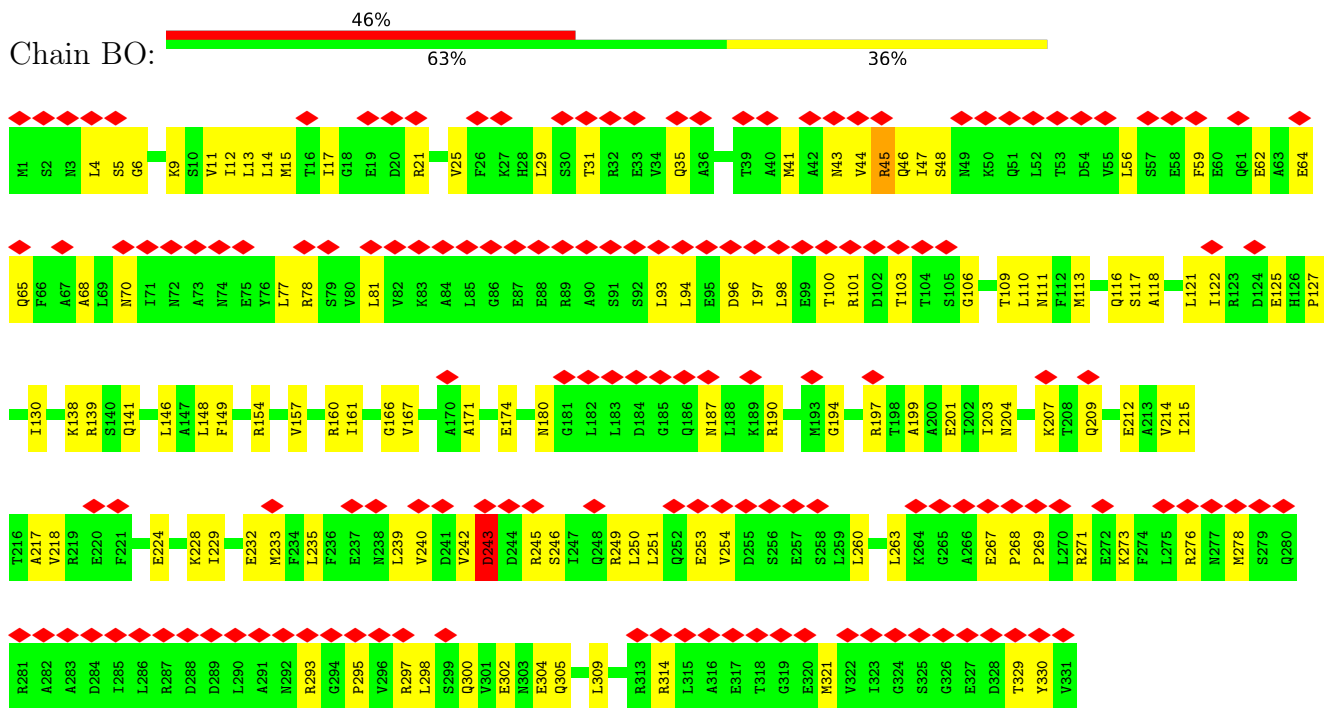

• Molecule 2: Flagellar motor switch protein FliG

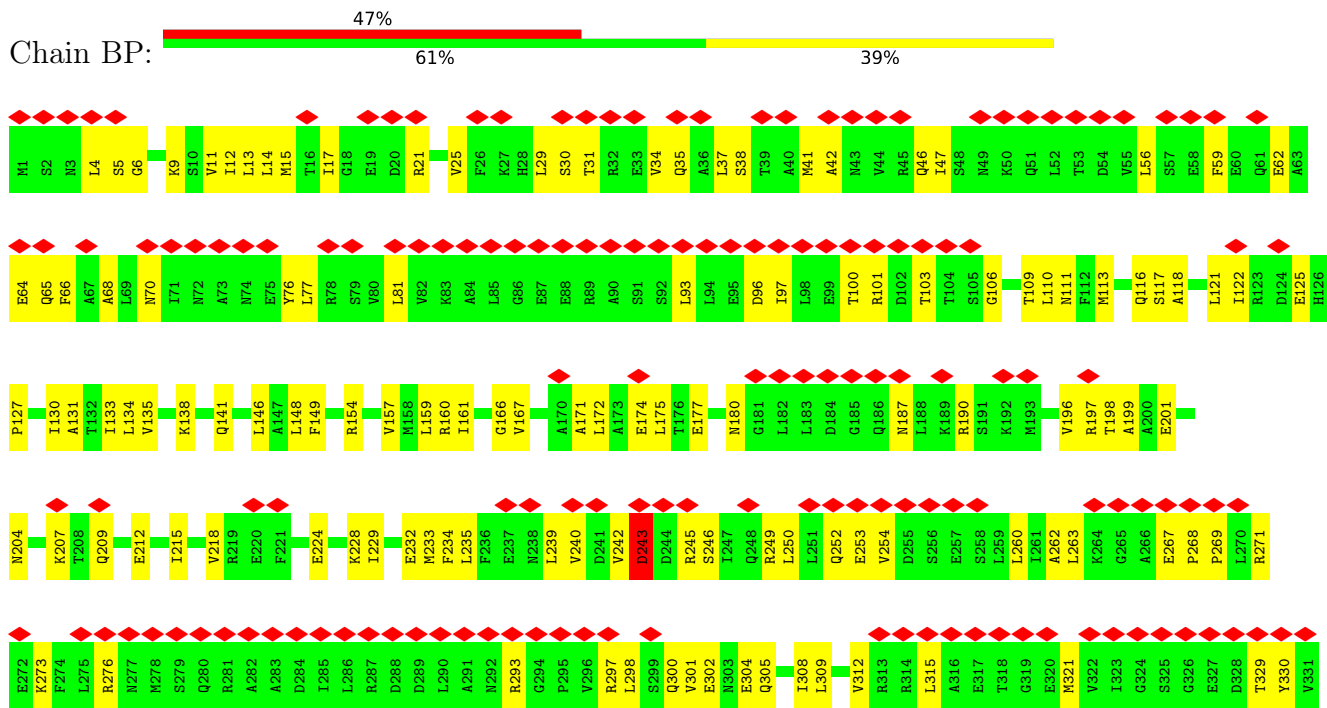

• Molecule 2: Flagellar motor switch protein FliG

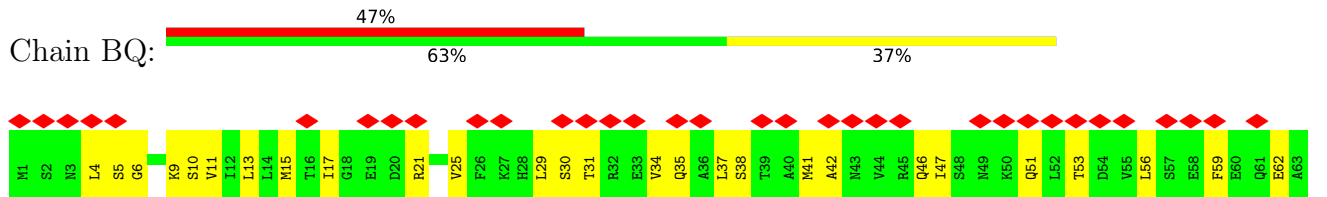

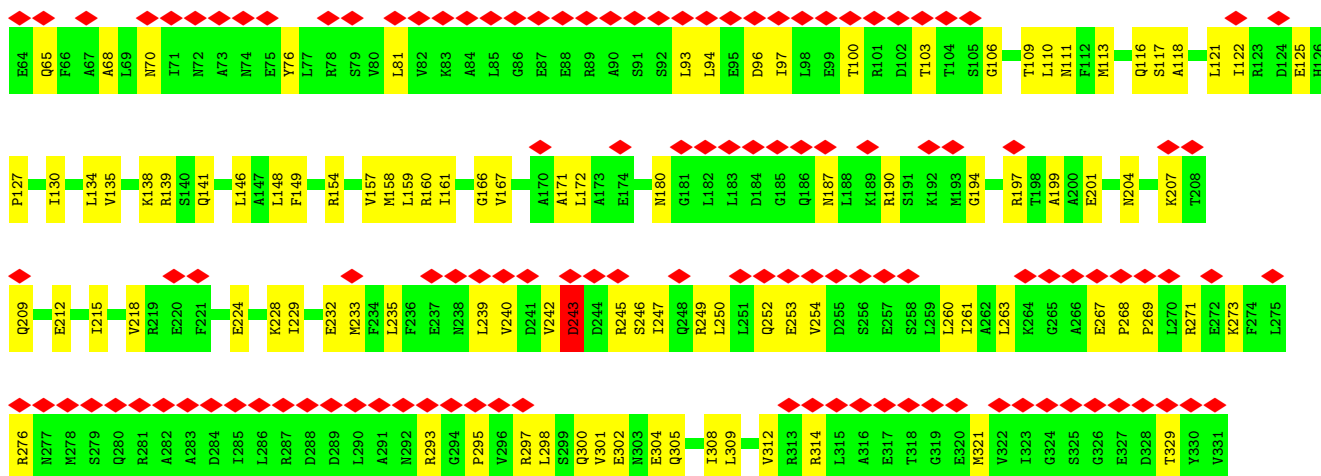

• Molecule 2: Flagellar motor switch protein FlIG

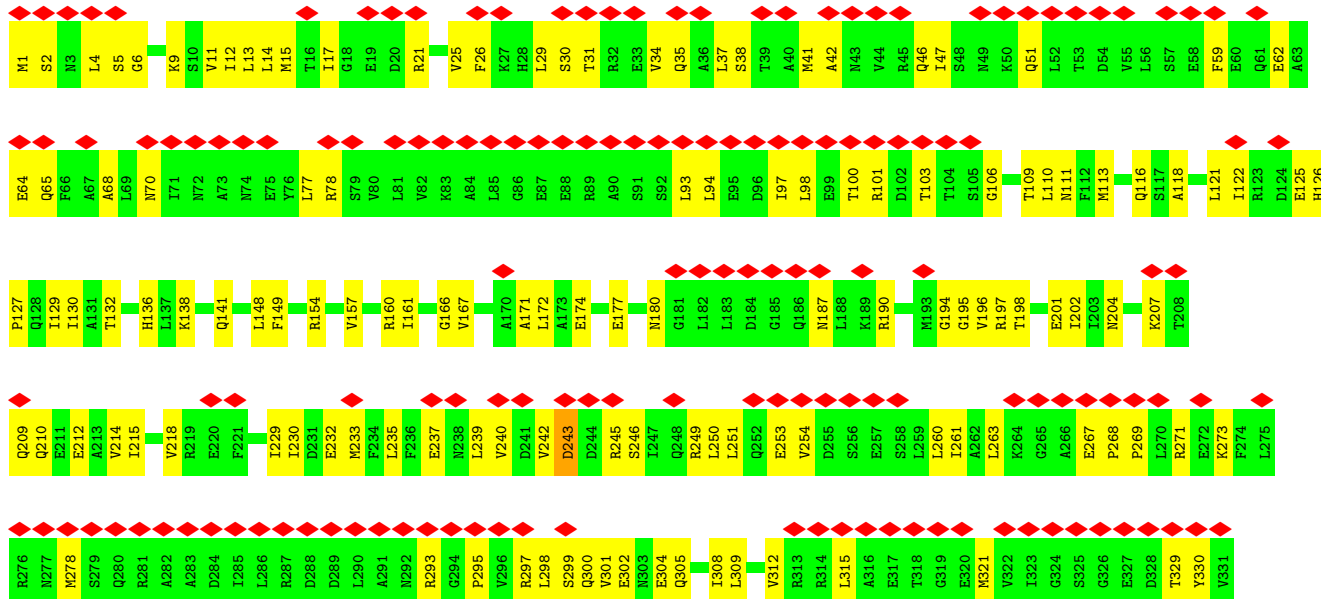

• Molecule 2: Flagellar motor switch protein FlIG

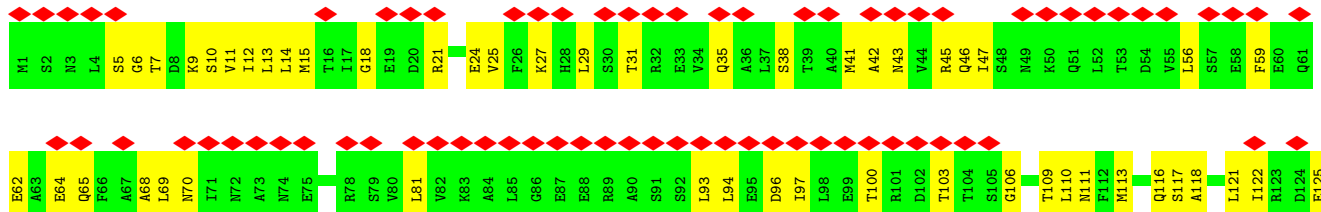

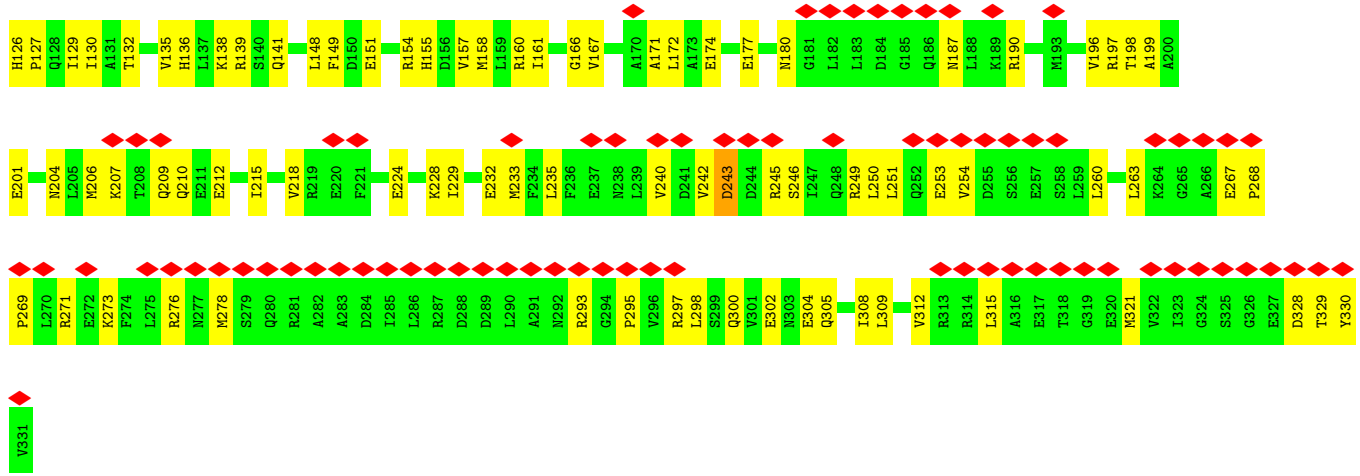

• Molecule 2: Flagellar motor switch protein FlIG

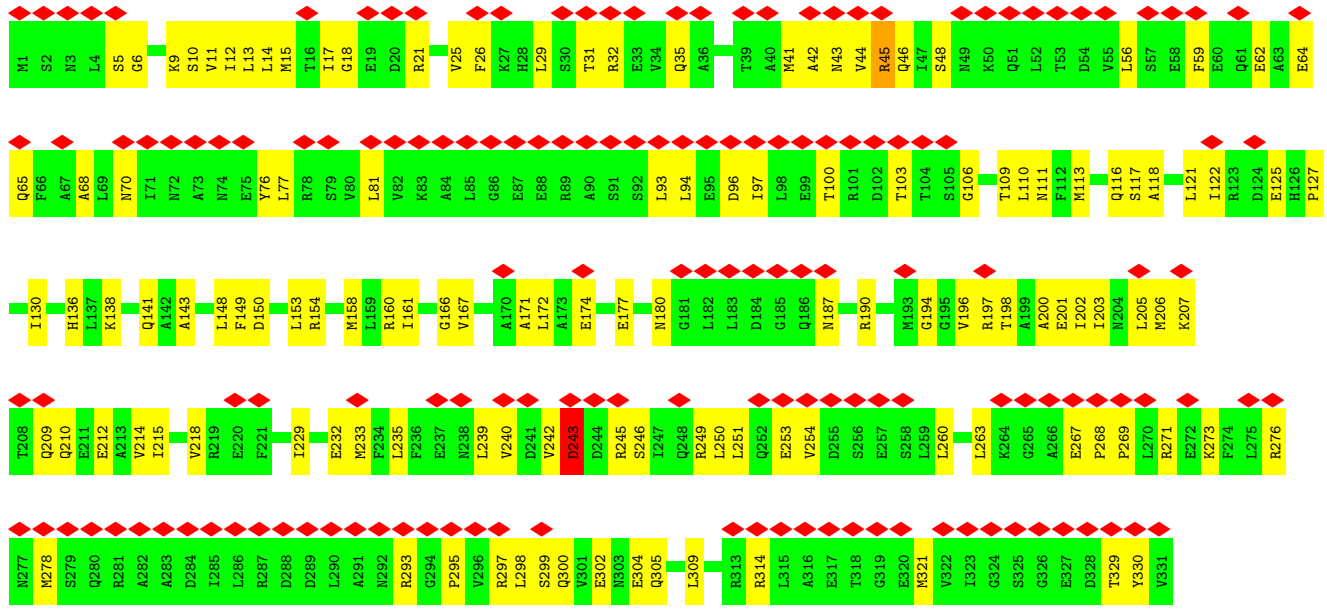

• Molecule 2: Flagellar motor switch protein FlIG

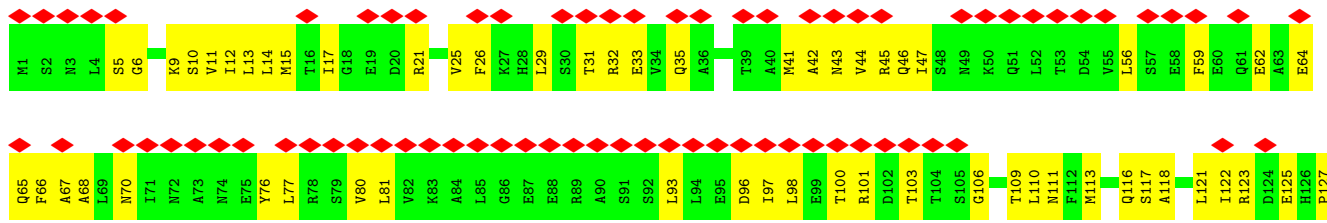

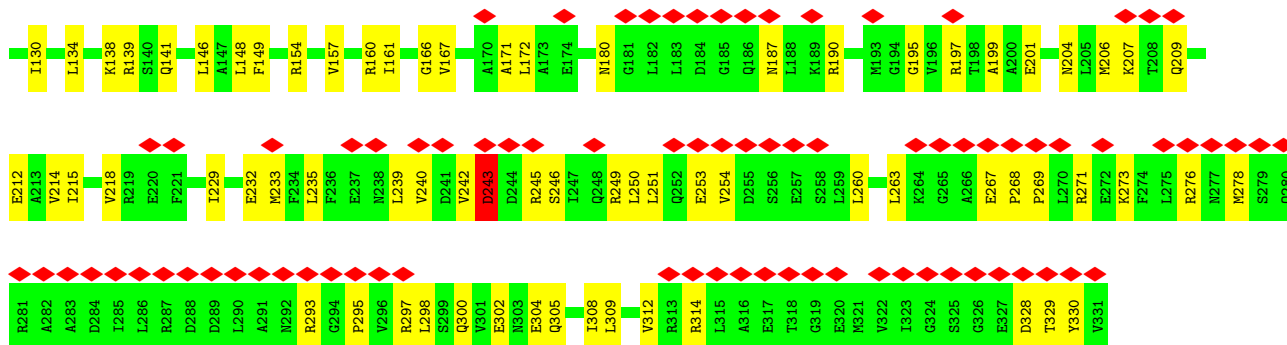

• Molecule 2: Flagellar motor switch protein FliG

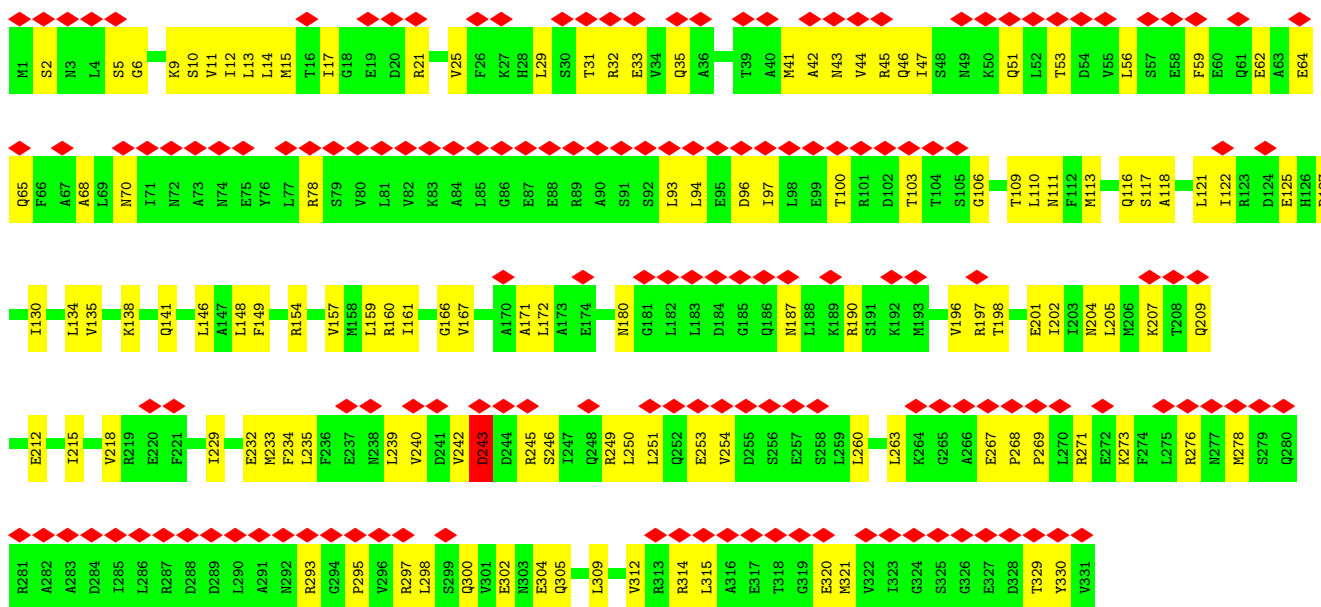

• Molecule 2: Flagellar motor switch protein FliG

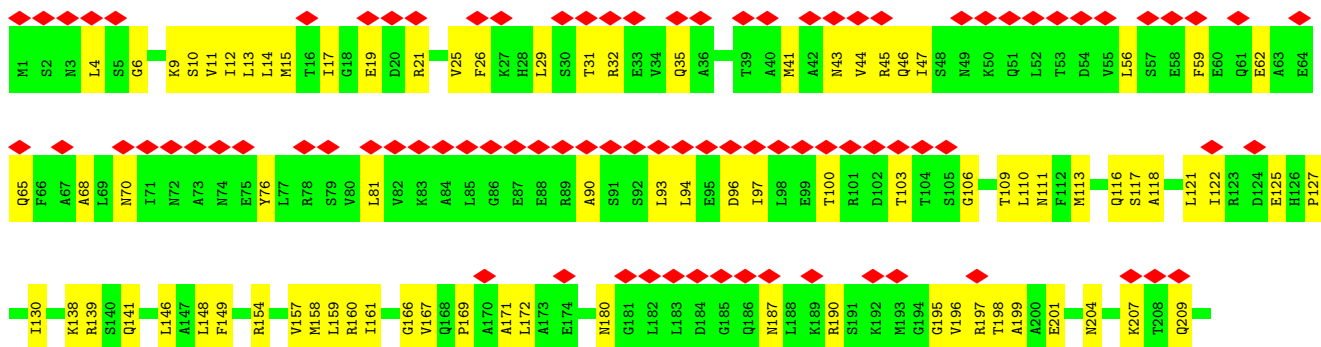

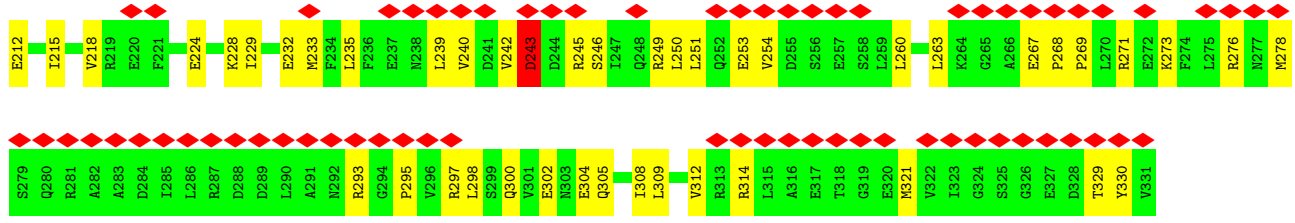

• Molecule 2: Flagellar motor switch protein FliG

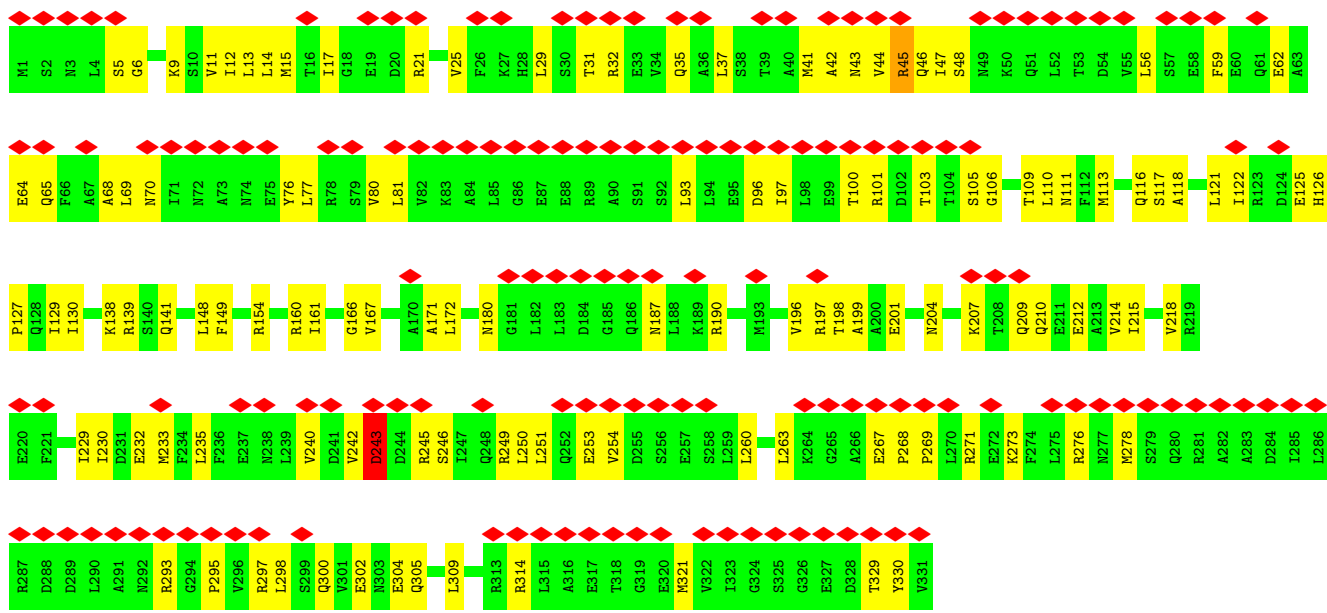

• Molecule 2: Flagellar motor switch protein FliG

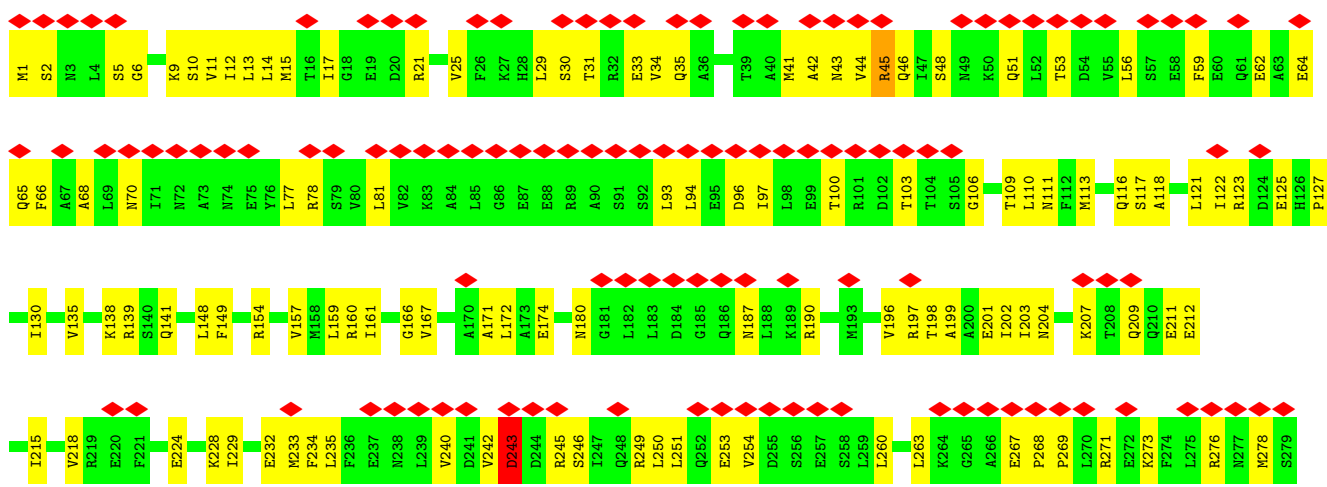

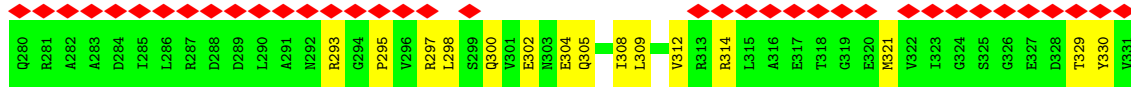

• Molecule 3: Flagellar motor switch protein FlIM

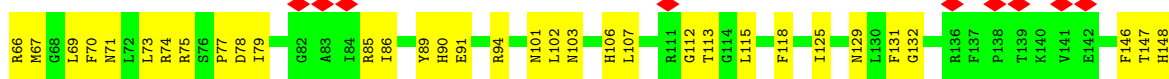
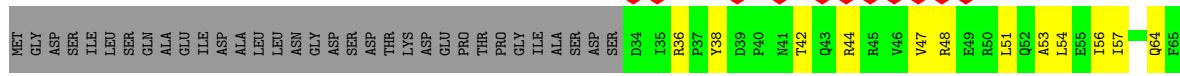

• Molecule 3: Flagellar motor switch protein FlIM

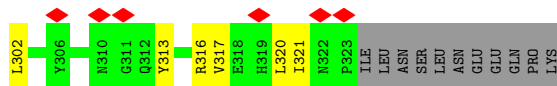
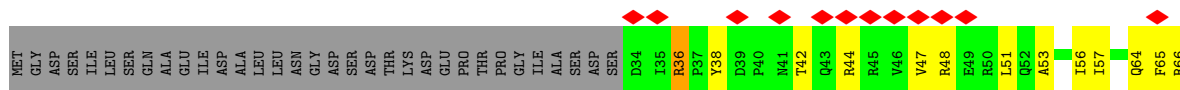

• Molecule 3: Flagellar motor switch protein FlIM

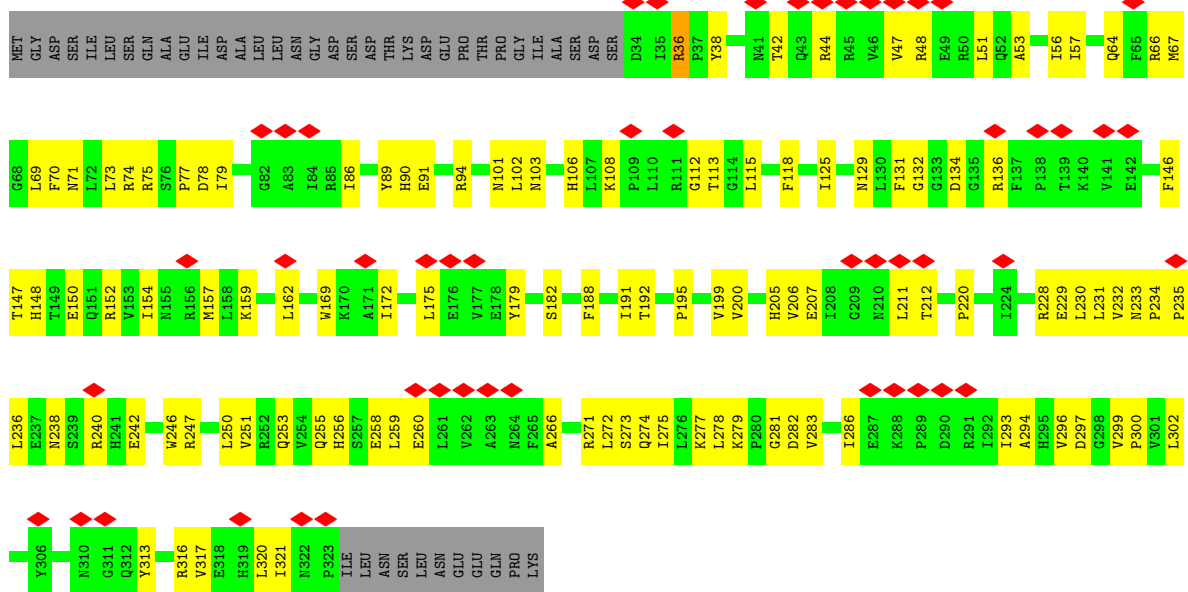

• Molecule 3: Flagellar motor switch protein FlIM

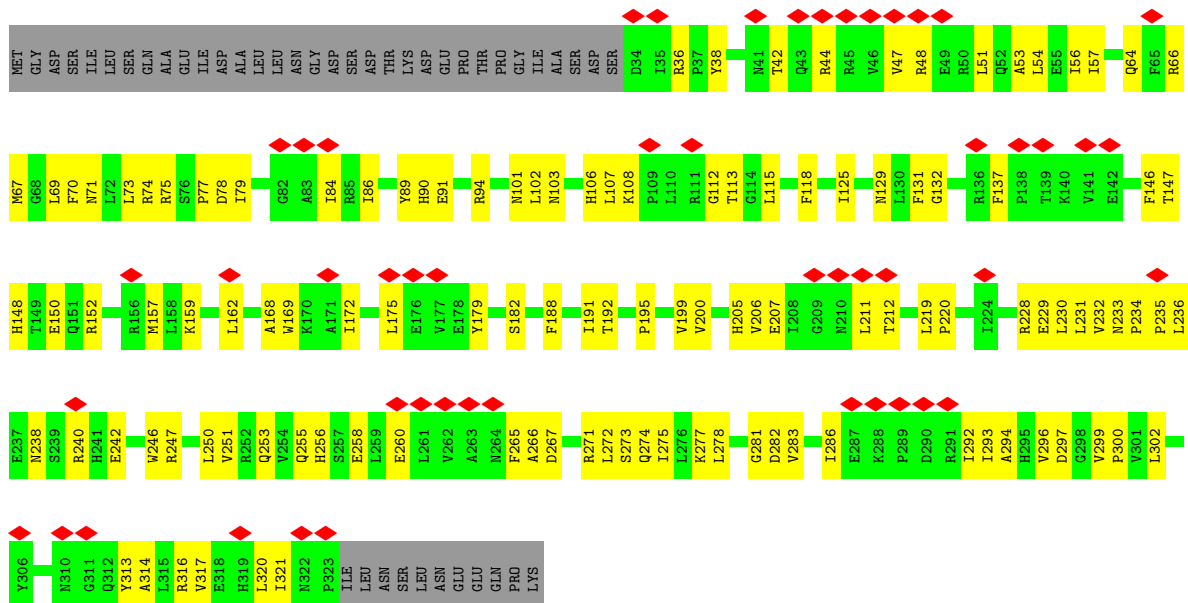

• Molecule 3: Flagellar motor switch protein FlIM

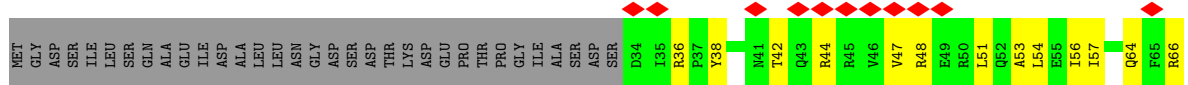

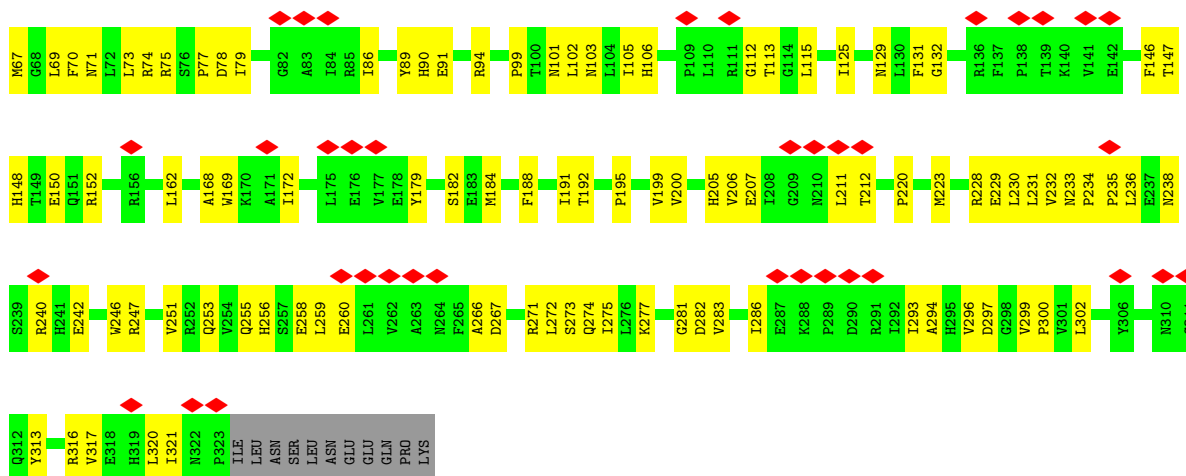

• Molecule 3: Flagellar motor switch protein FlIM

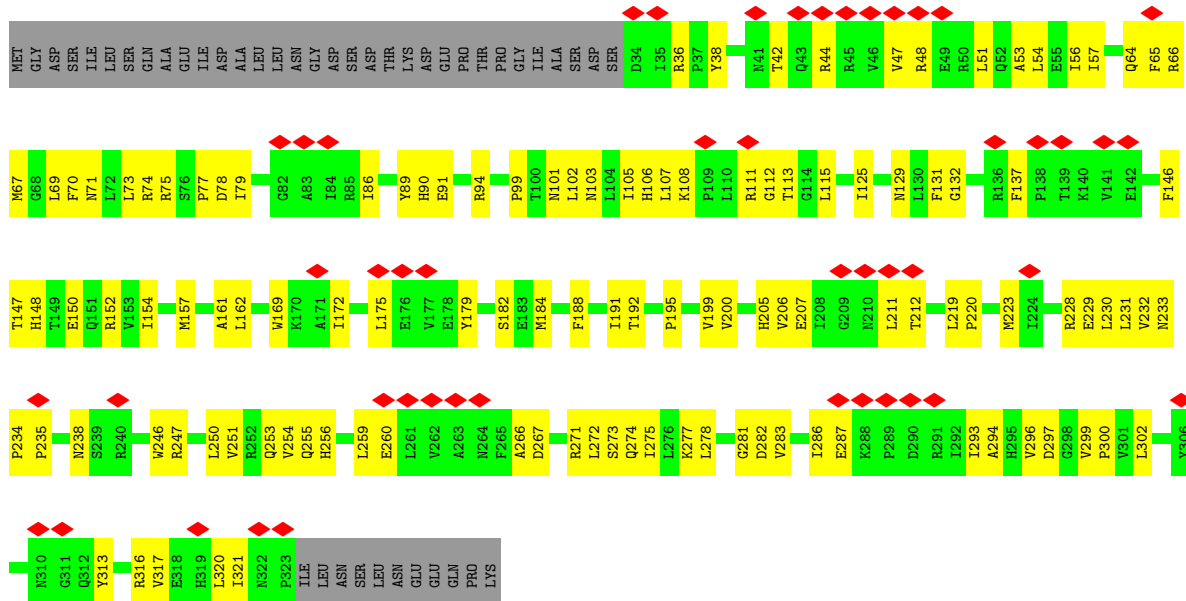

• Molecule 3: Flagellar motor switch protein FlIM

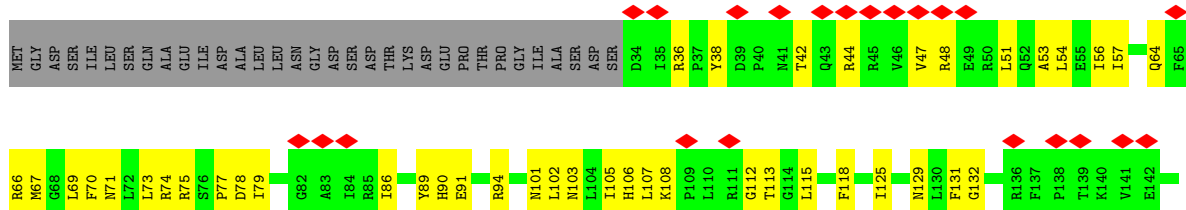

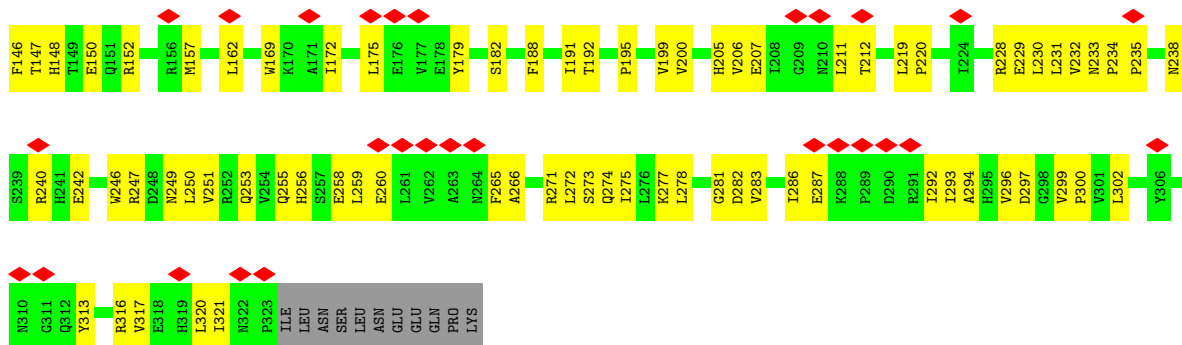

• Molecule 3: Flagellar motor switch protein FlIM

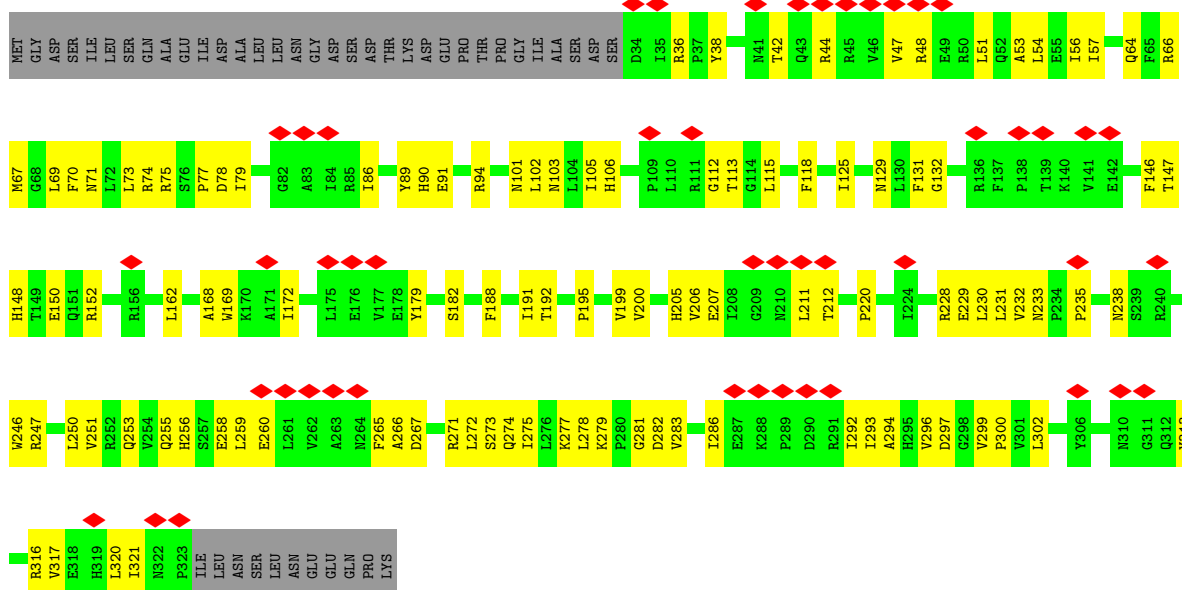

• Molecule 3: Flagellar motor switch protein FlIM

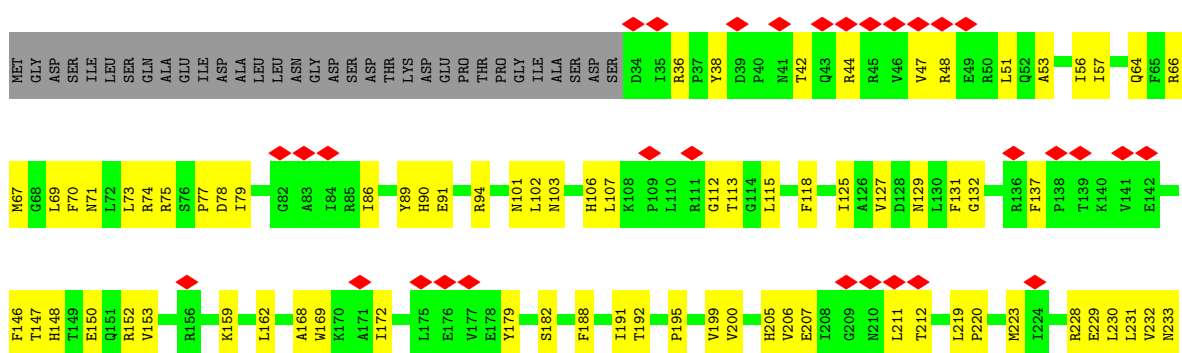

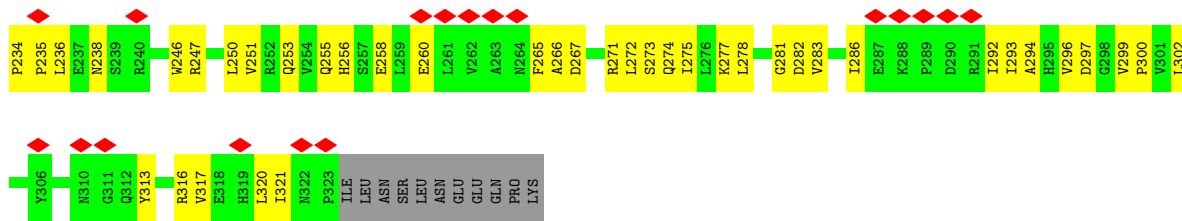

• Molecule 3: Flagellar motor switch protein FlIM

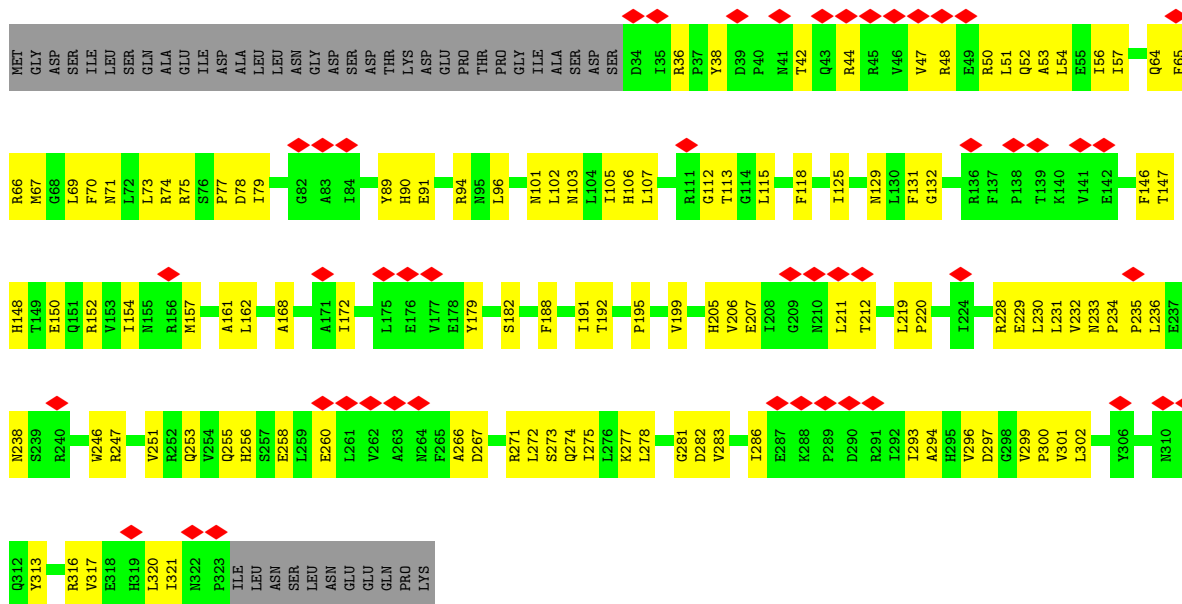

• Molecule 3: Flagellar motor switch protein FlIM

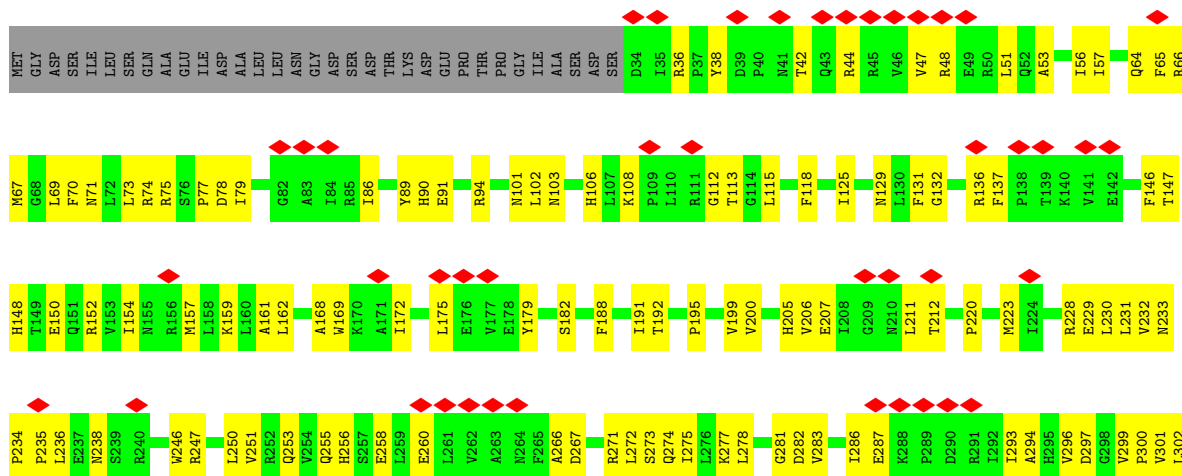

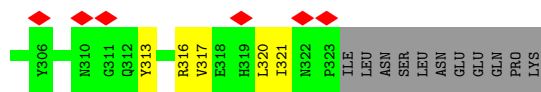

- Molecule 3: Flagellar motor switch protein FlIM

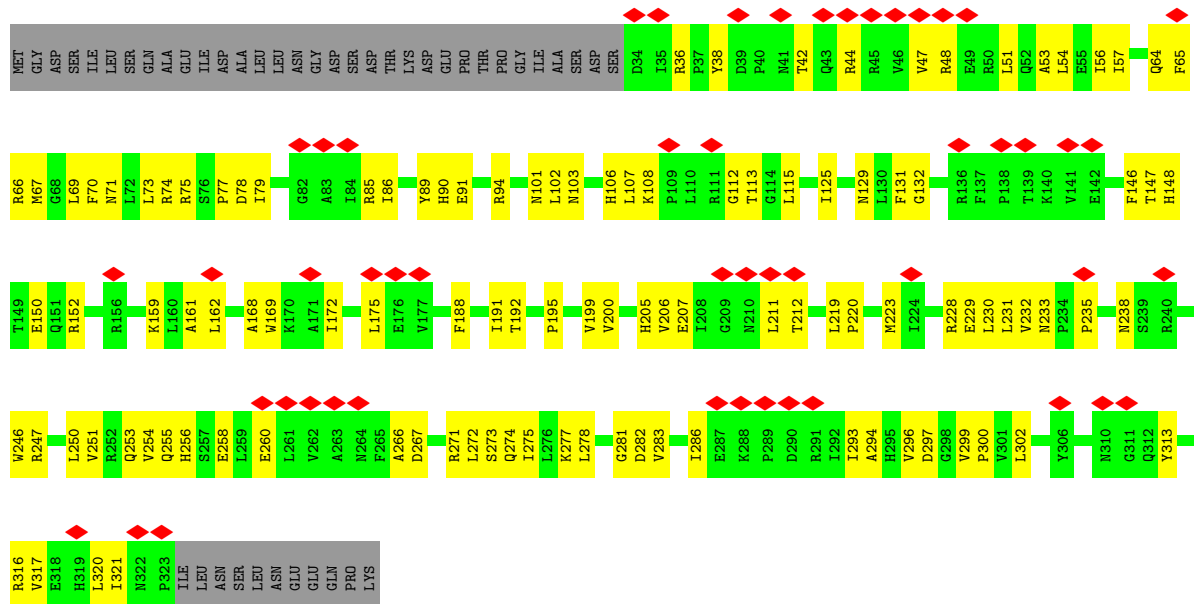

- Molecule 3: Flagellar motor switch protein FlIM

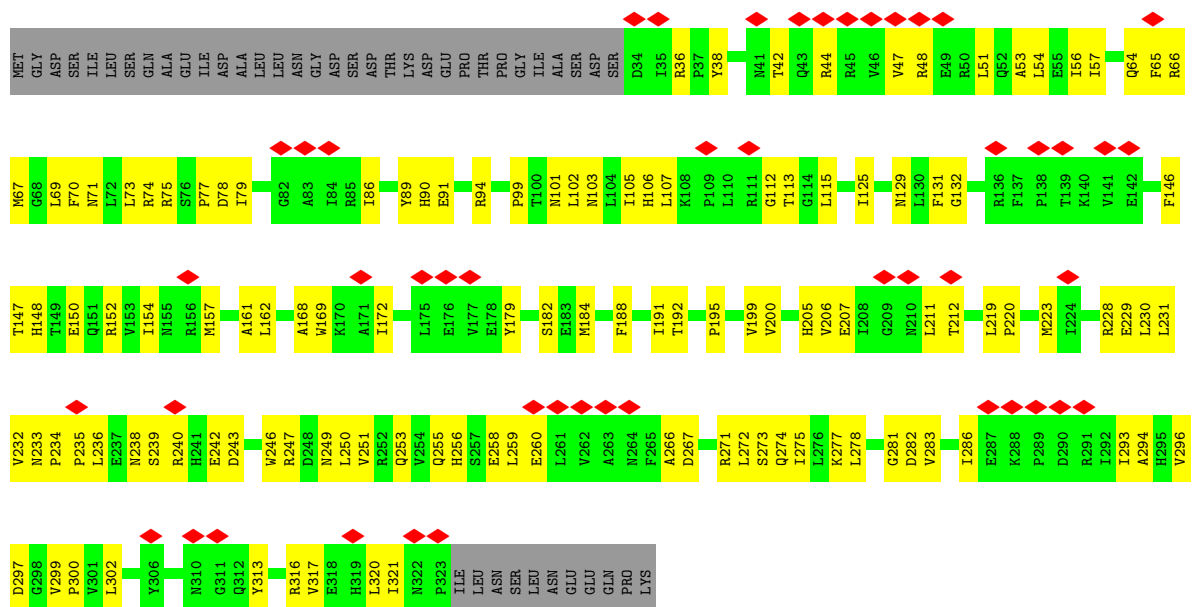

- Molecule 3: Flagellar motor switch protein FlIM

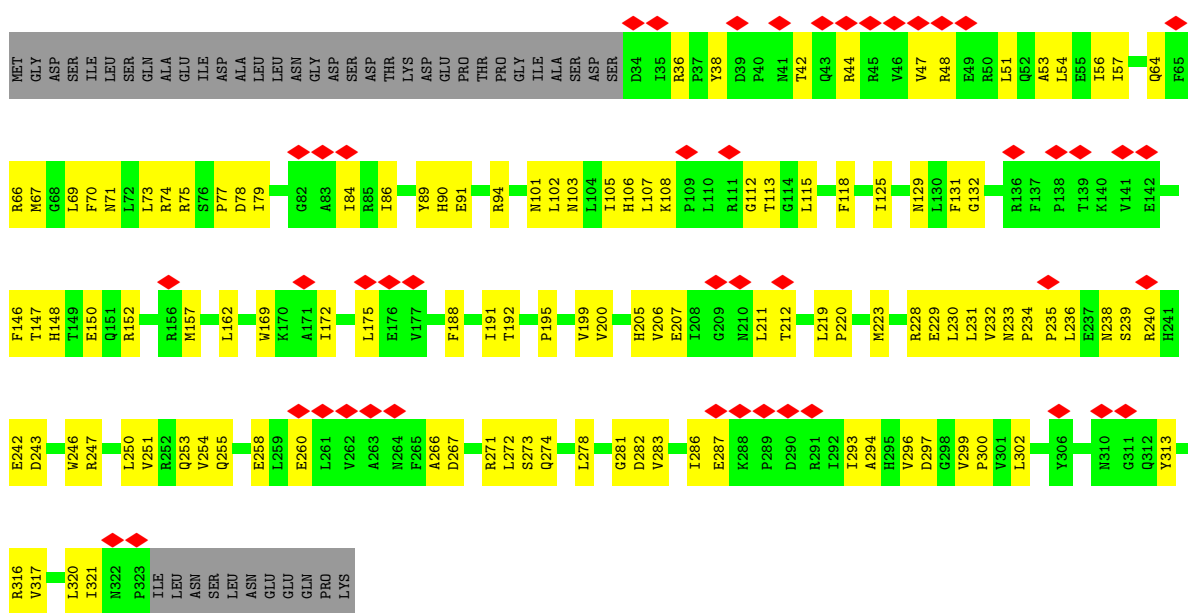

• Molecule 3: Flagellar motor switch protein FlIM

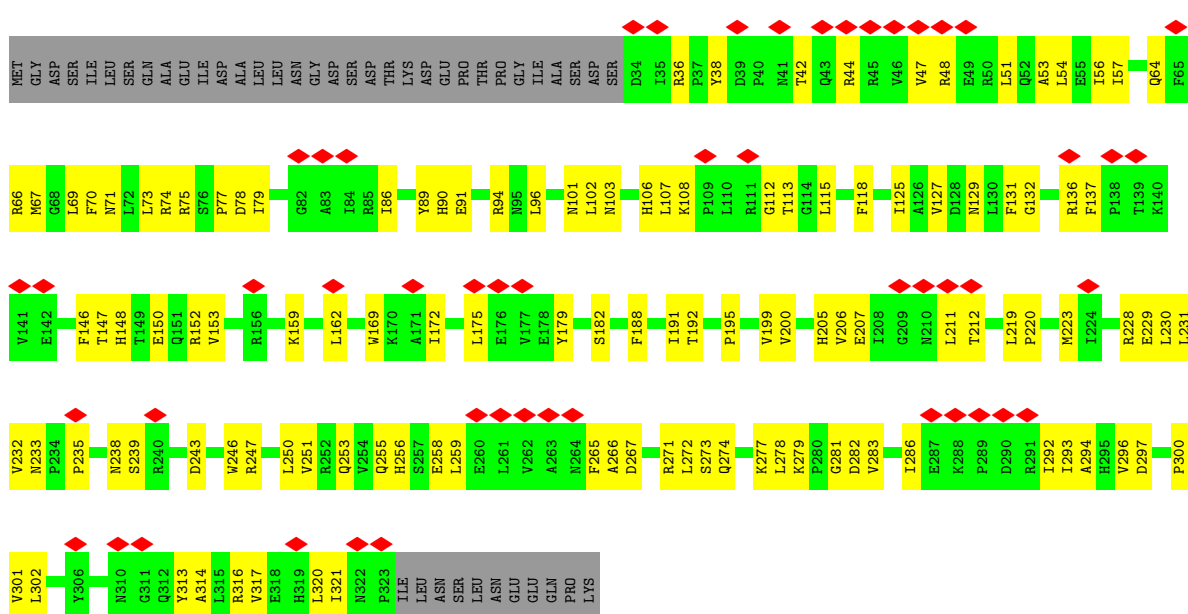

• Molecule 3: Flagellar motor switch protein FlIM

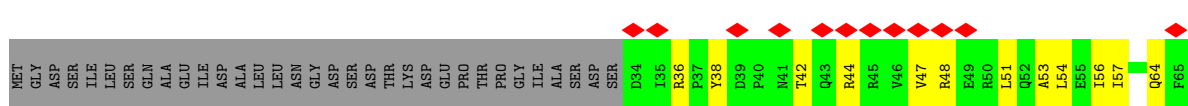

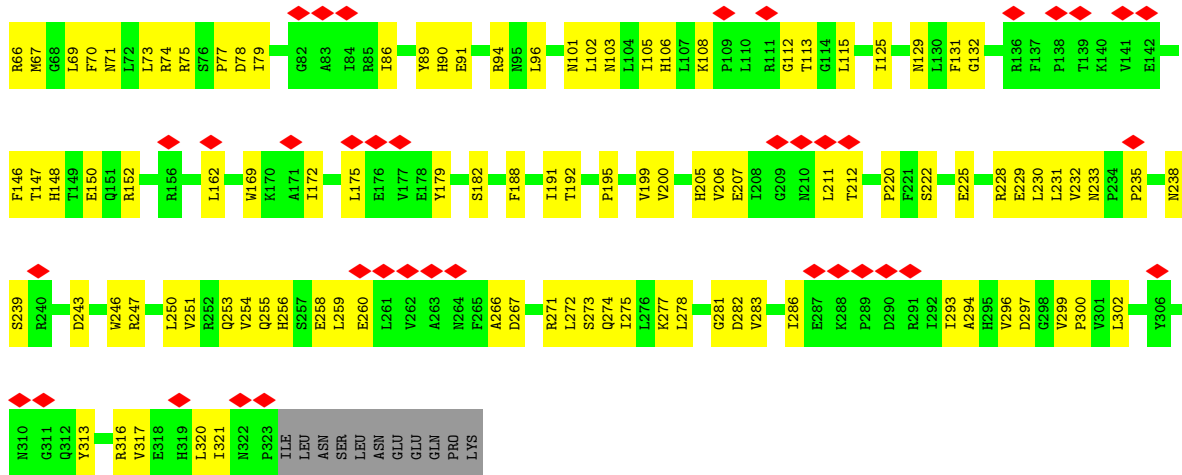

• Molecule 3: Flagellar motor switch protein FlIM

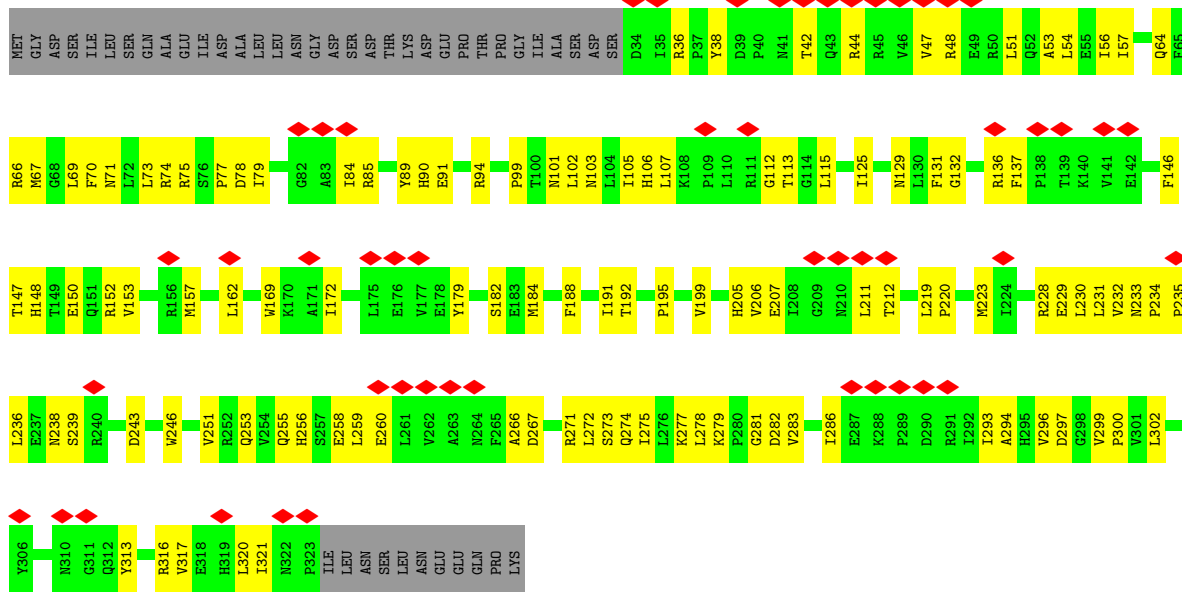

• Molecule 3: Flagellar motor switch protein FlIM

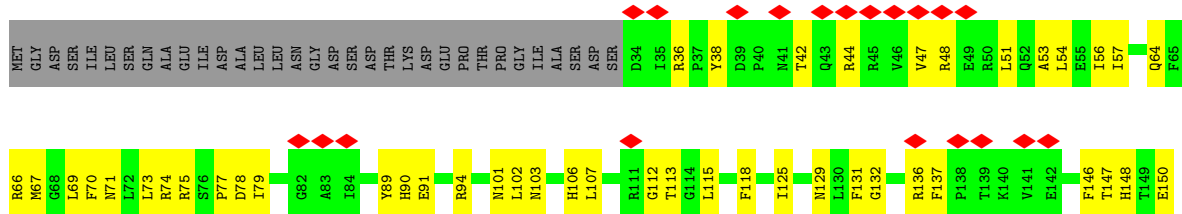

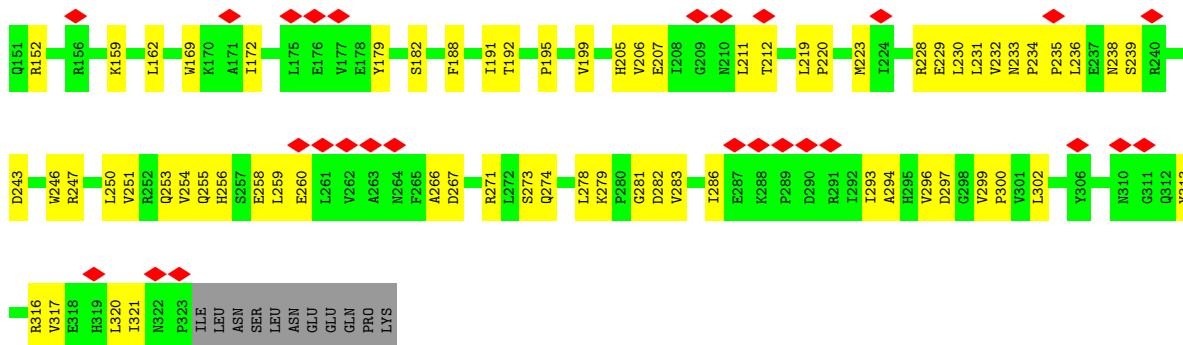

• Molecule 3: Flagellar motor switch protein FlIM

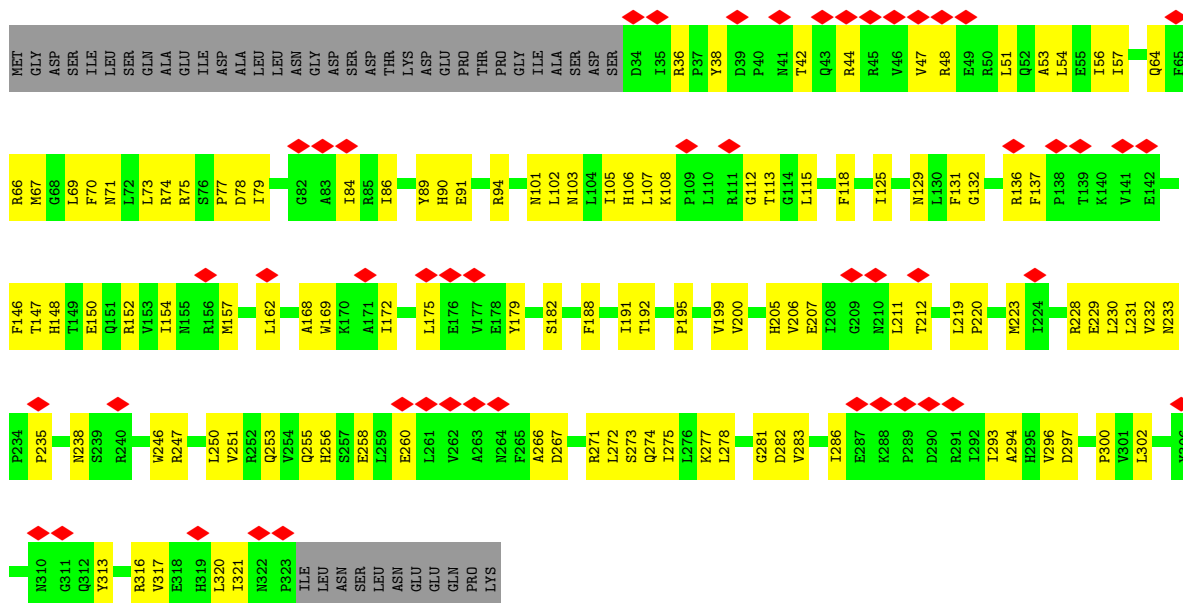

• Molecule 3: Flagellar motor switch protein FlIM

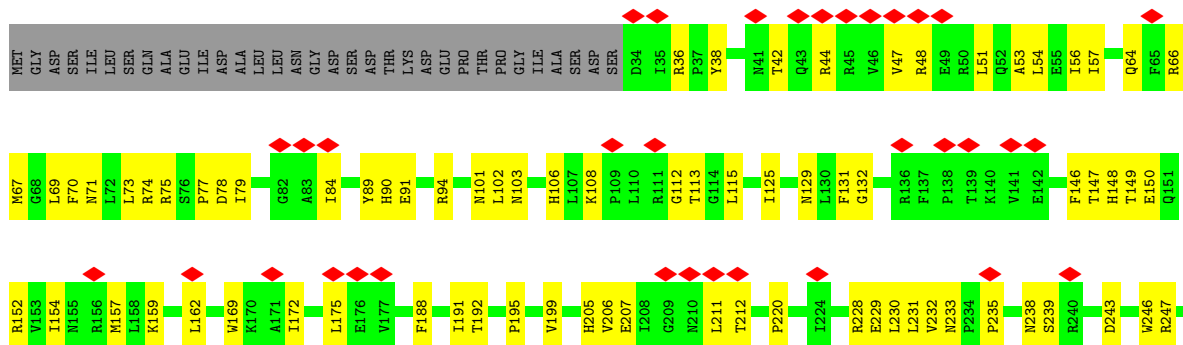

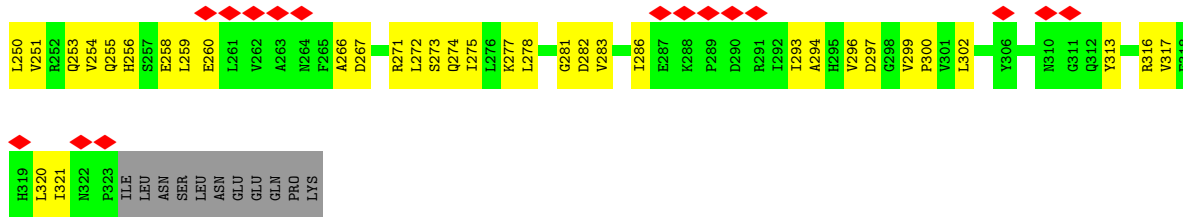

• Molecule 3: Flagellar motor switch protein FlIM

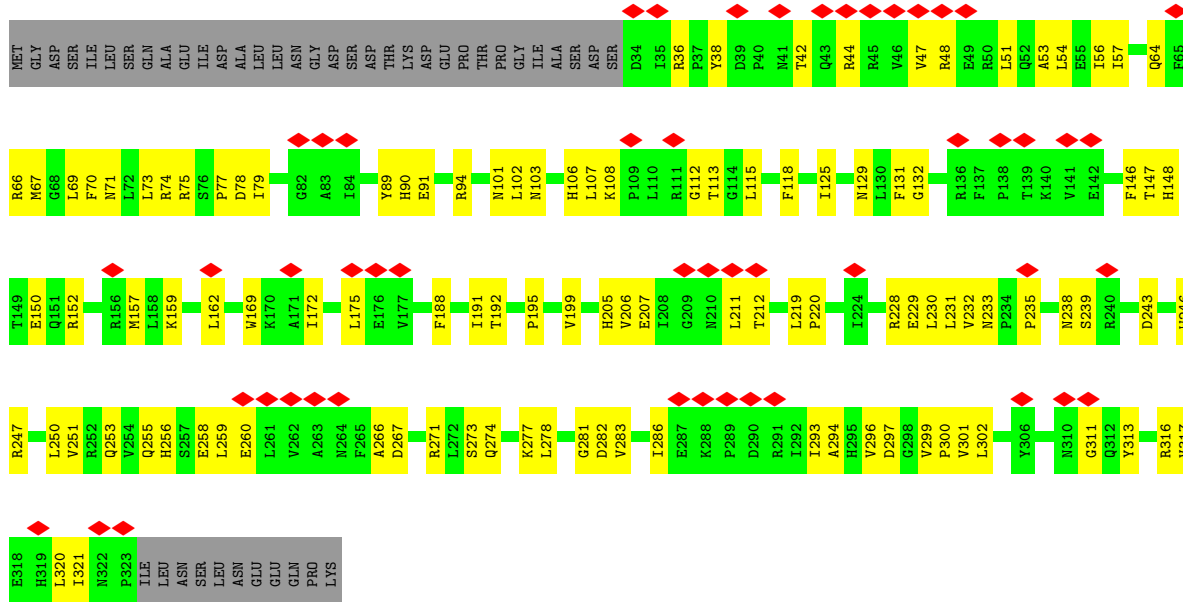

• Molecule 3: Flagellar motor switch protein FlIM

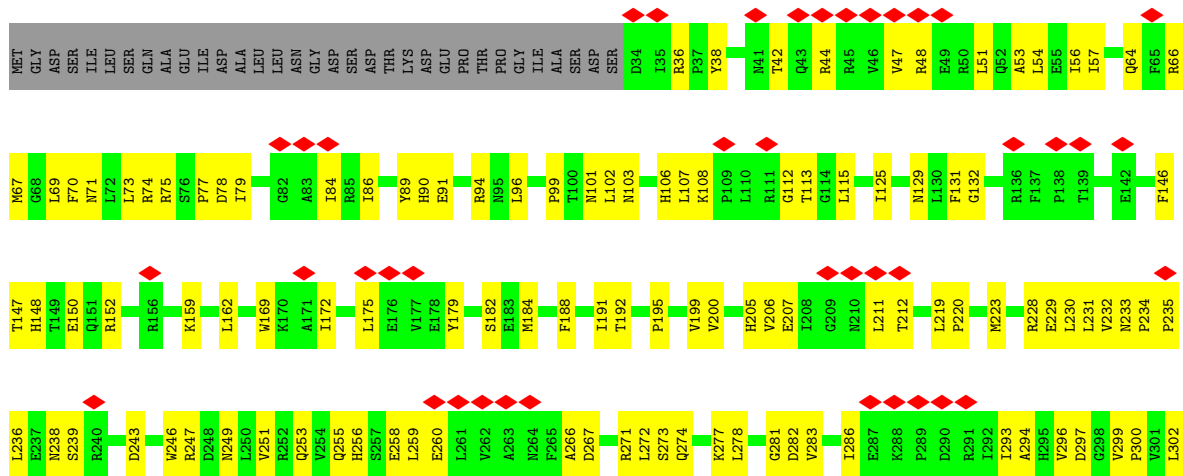



• Molecule 3: Flagellar motor switch protein FliM

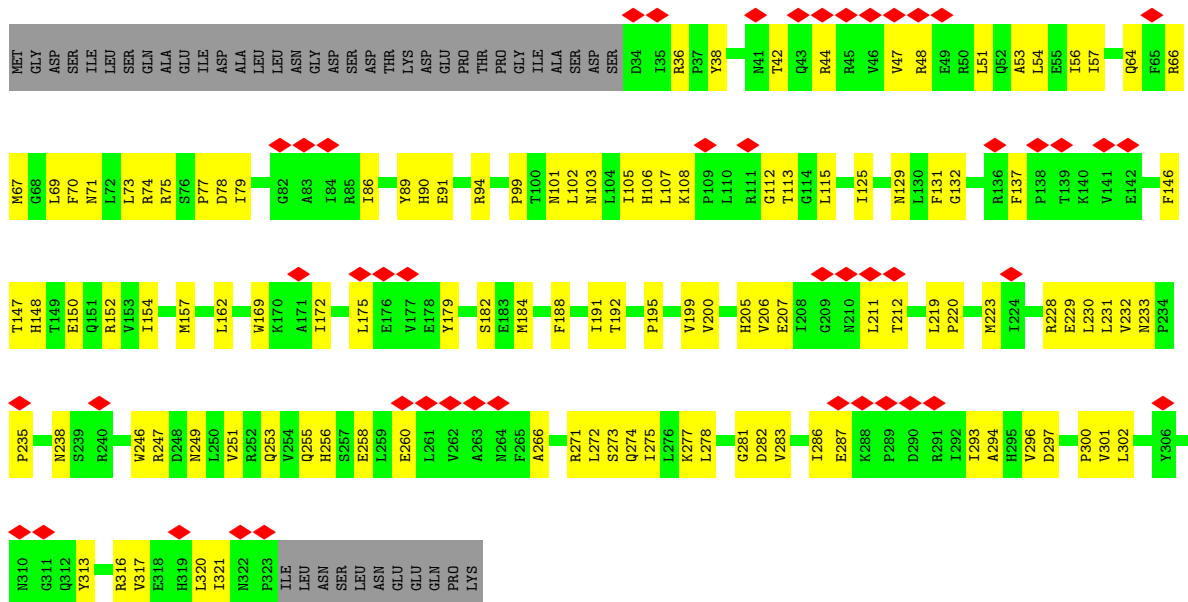

• Molecule 3: Flagellar motor switch protein FliM

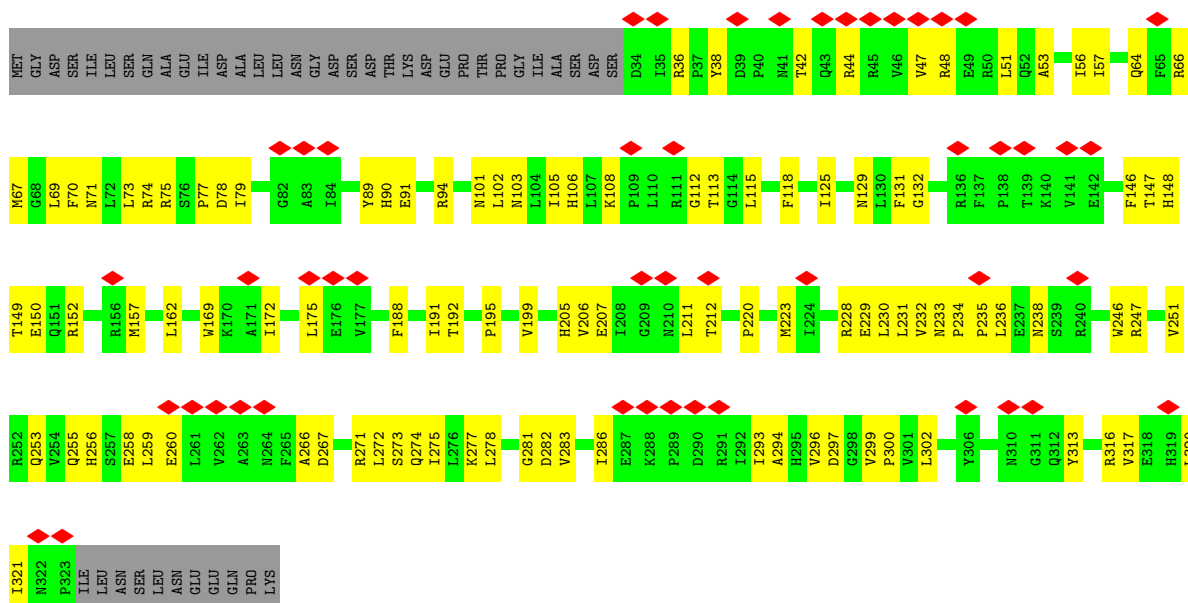

• Molecule 3: Flagellar motor switch protein FliM

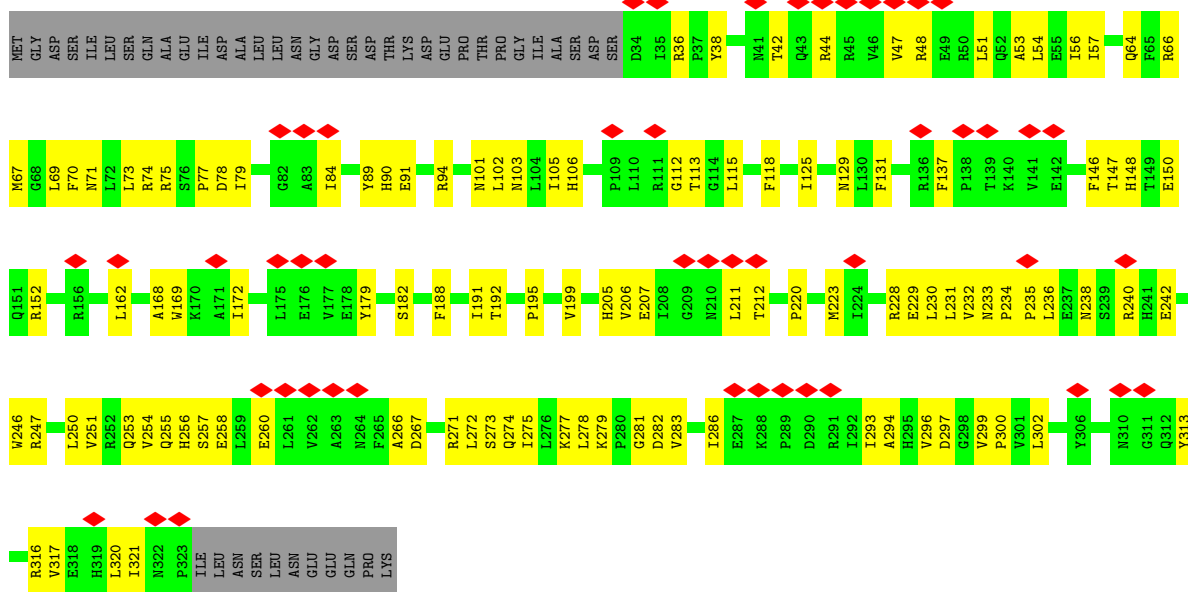

• Molecule 3: Flagellar motor switch protein FliM

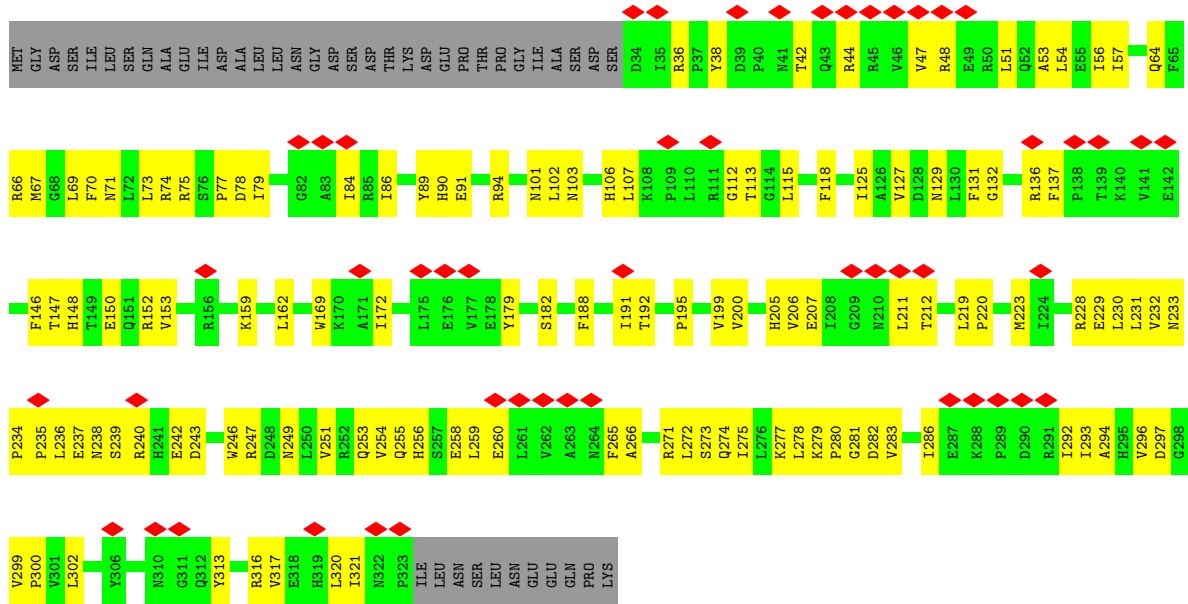

• Molecule 3: Flagellar motor switch protein FliM

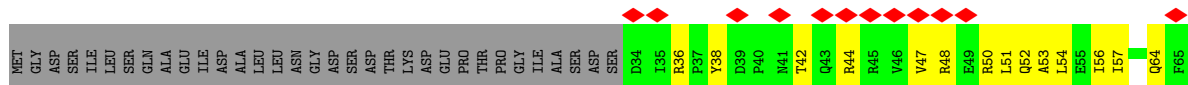

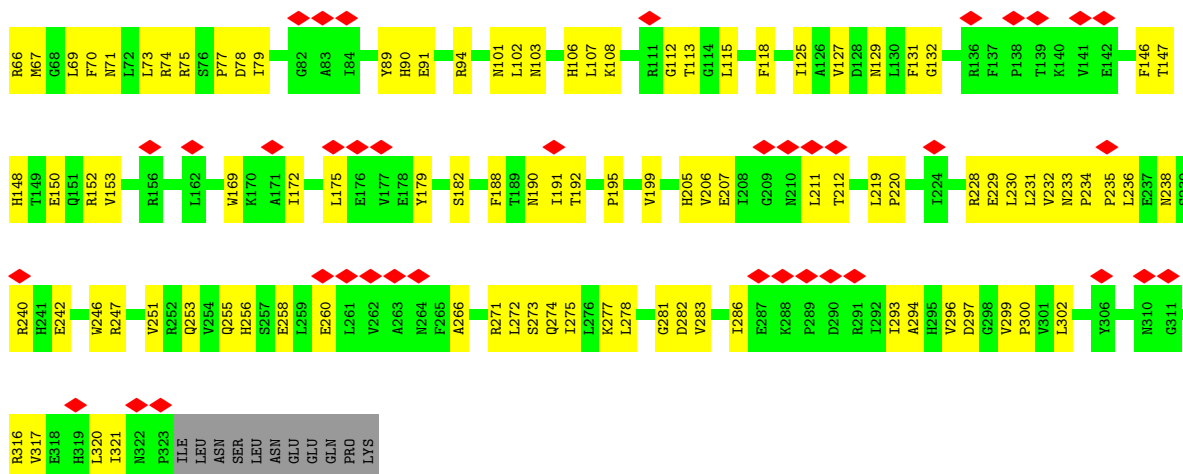

• Molecule 3: Flagellar motor switch protein FlIM

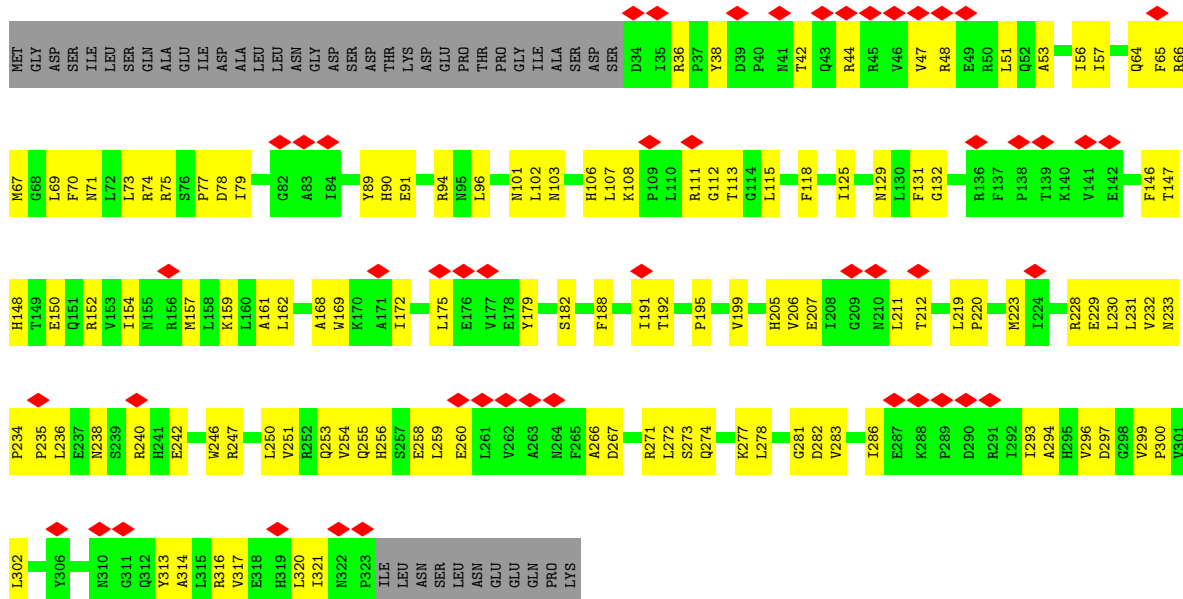

• Molecule 3: Flagellar motor switch protein FlIM

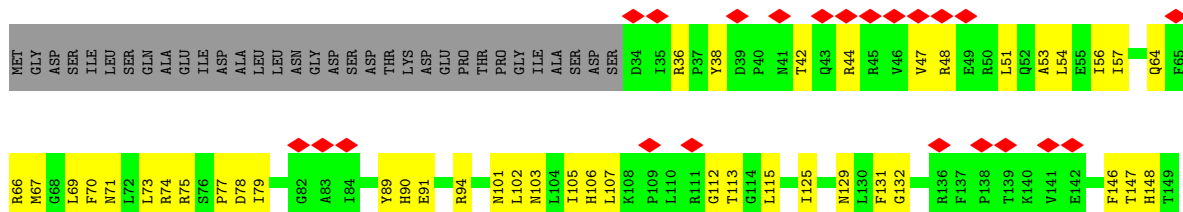

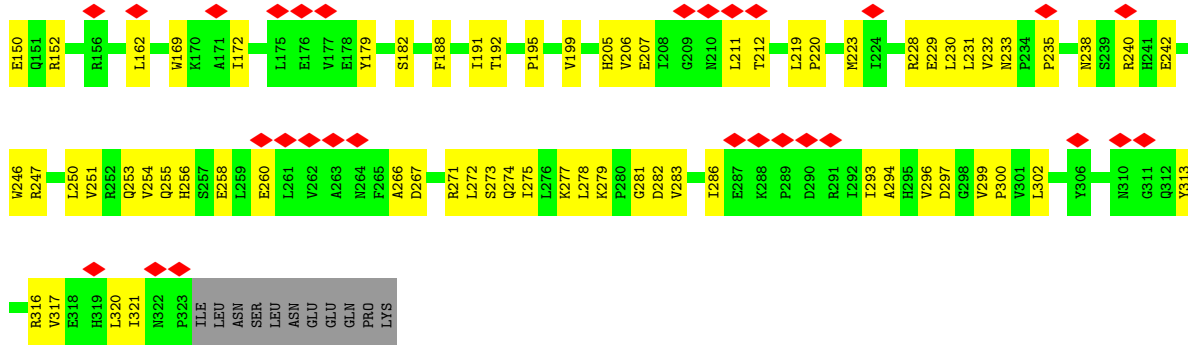

• Molecule 3: Flagellar motor switch protein FlIM

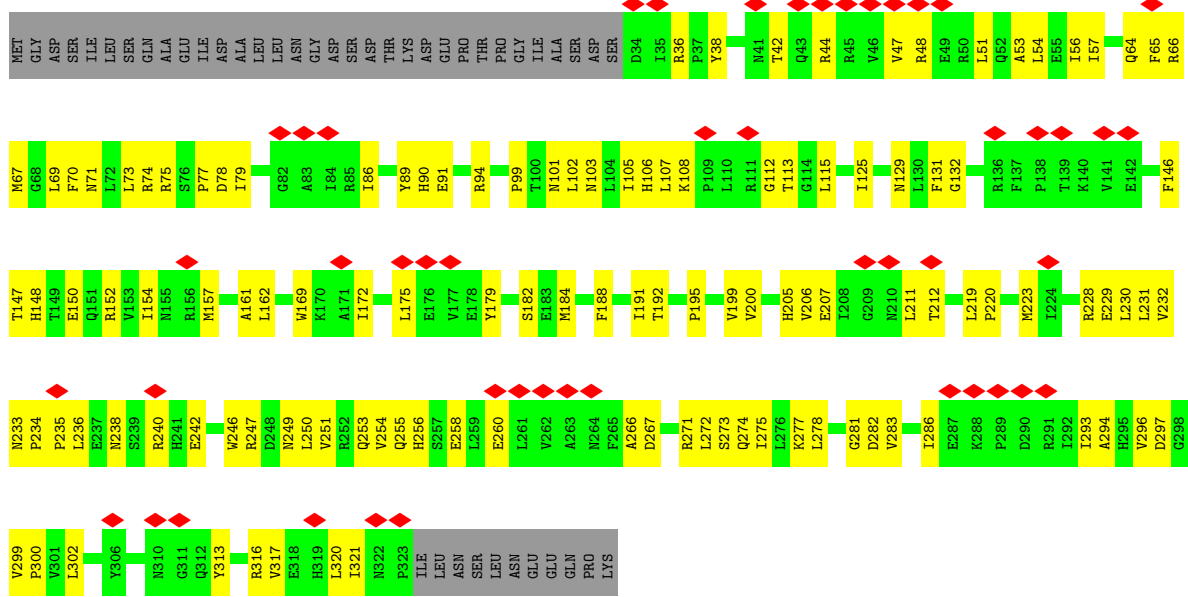

• Molecule 3: Flagellar motor switch protein FlIM

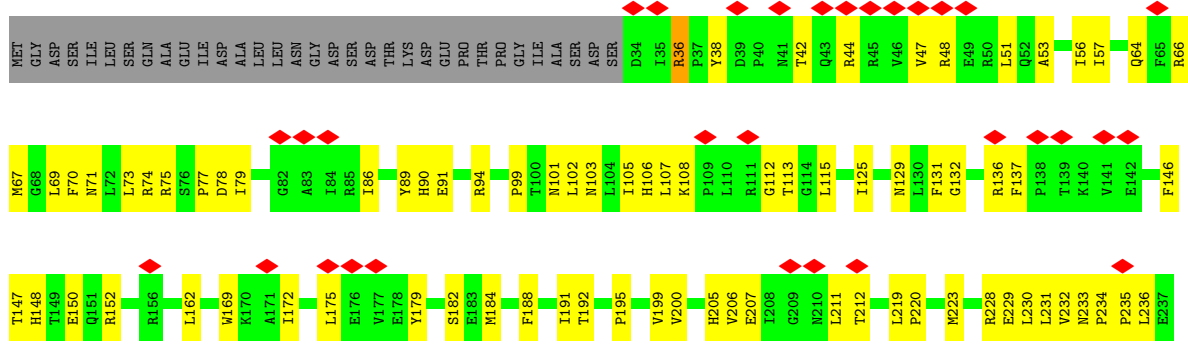



• Molecule 3: Flagellar motor switch protein FlIM

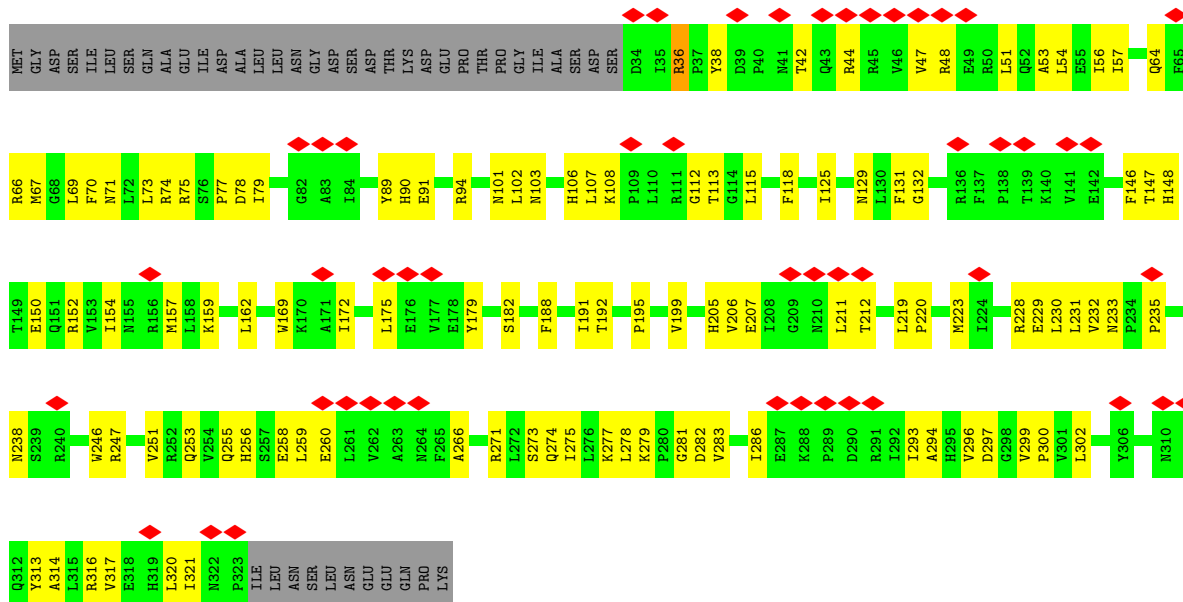

• Molecule 3: Flagellar motor switch protein FlIM

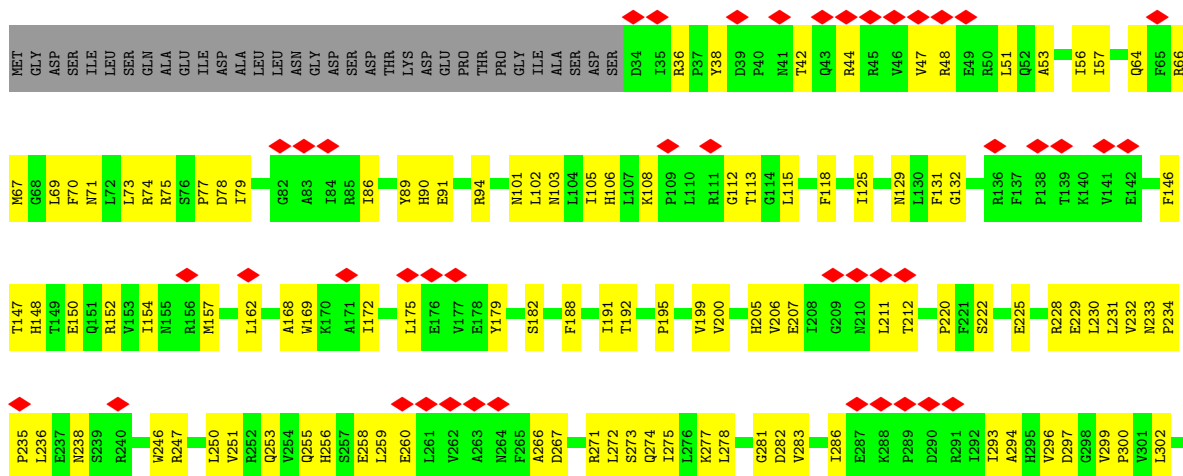

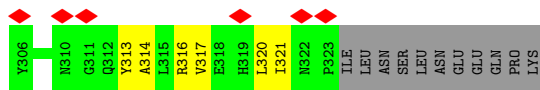

• Molecule 3: Flagellar motor switch protein FlIM

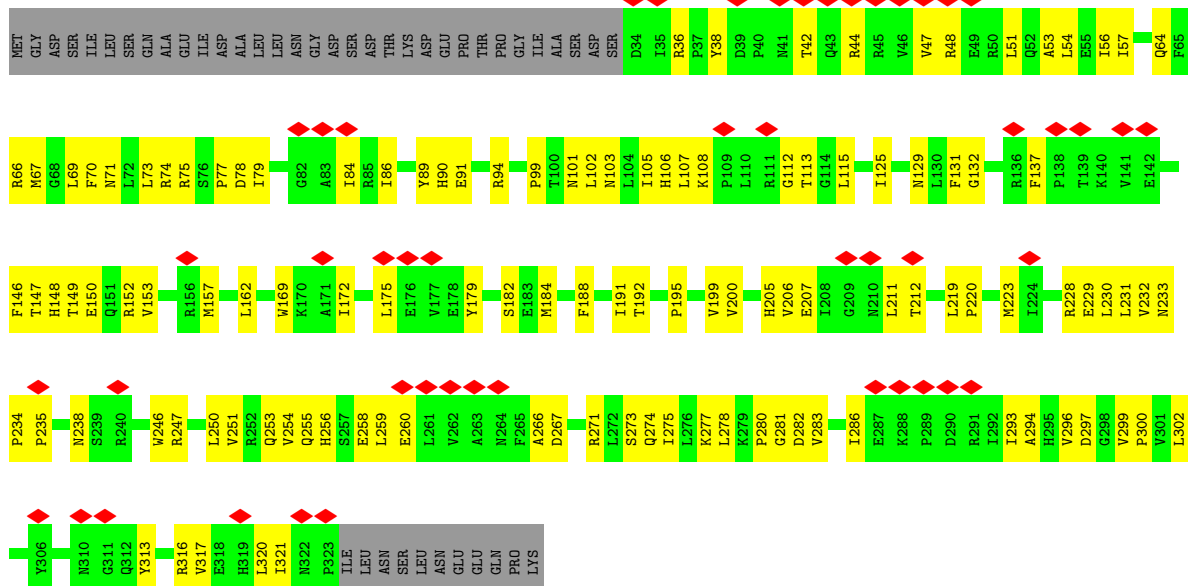

• Molecule 4: Flagellar motor switch protein FlIN

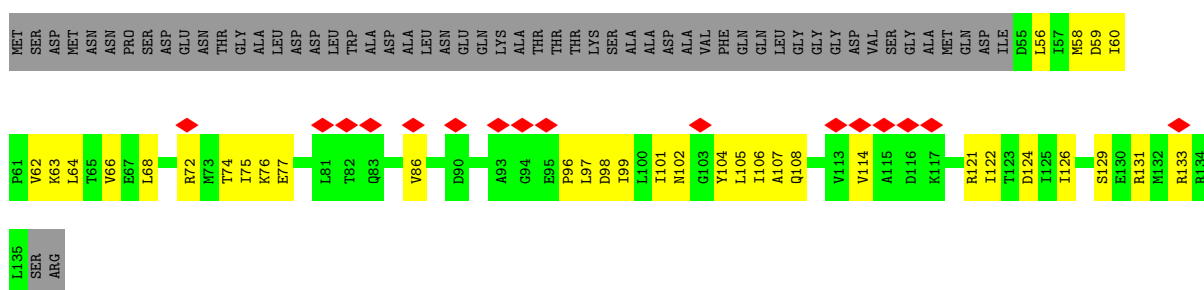

• Molecule 4: Flagellar motor switch protein FlIN

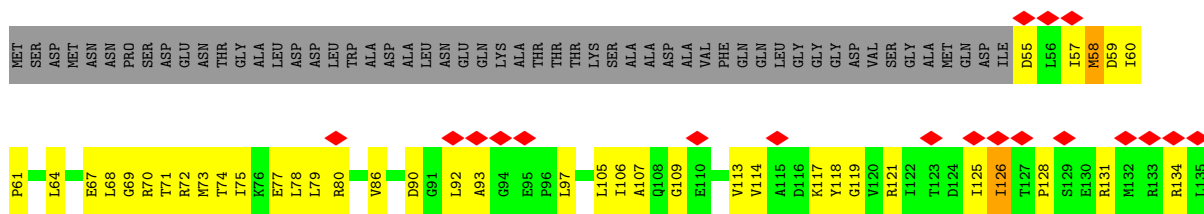
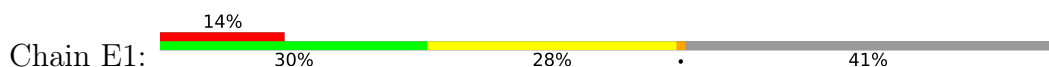

SER
ARG

• Molecule 4: Flagellar motor switch protein FliN

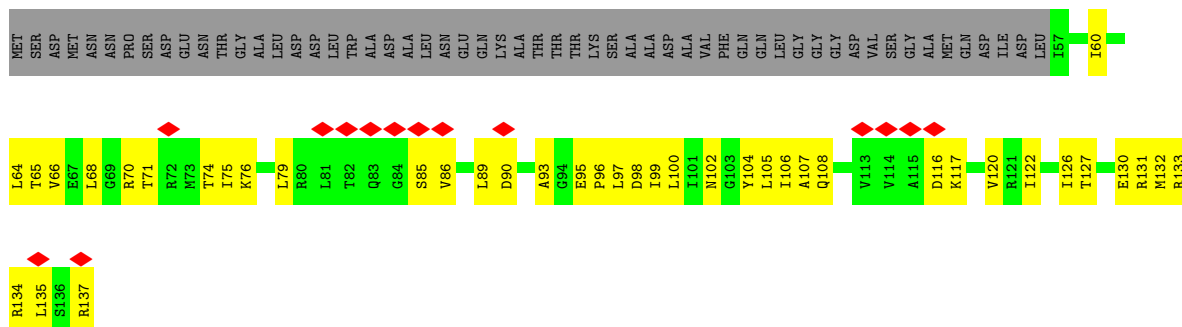
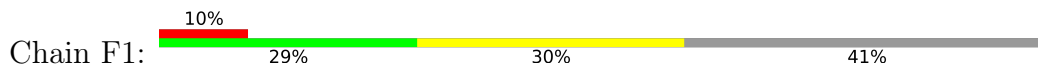

• Molecule 4: Flagellar motor switch protein FliN

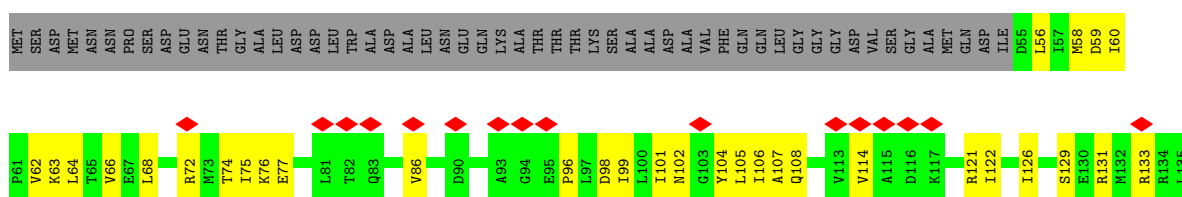

ARG

• Molecule 4: Flagellar motor switch protein FliN

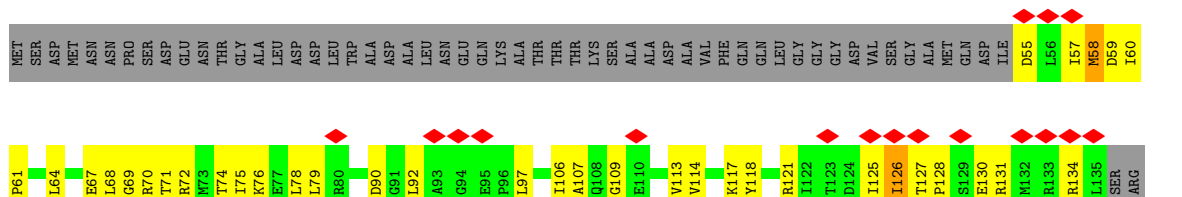
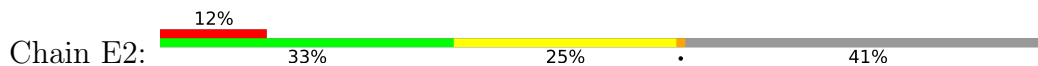

• Molecule 4: Flagellar motor switch protein FliN

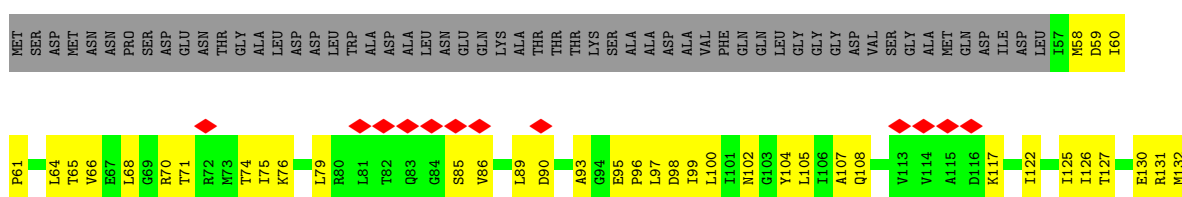
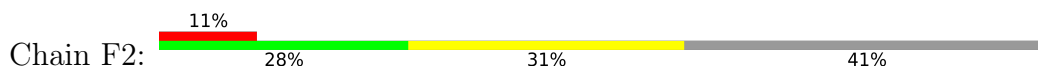

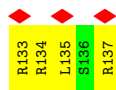

- Molecule 4: Flagellar motor switch protein FliN

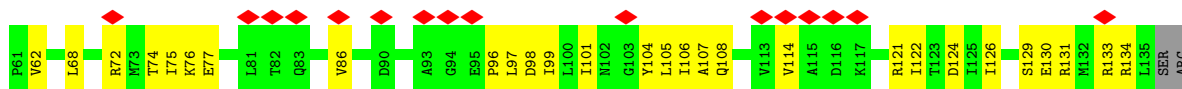
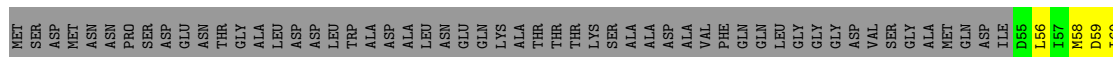
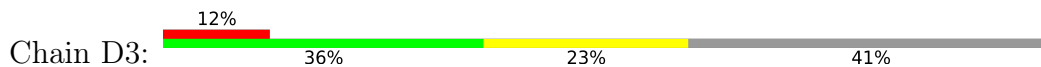

- Molecule 4: Flagellar motor switch protein FliN

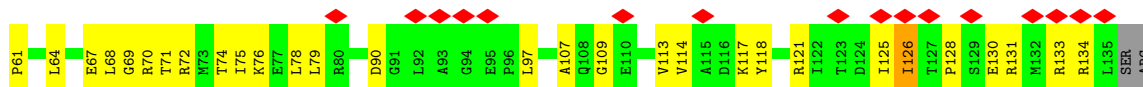
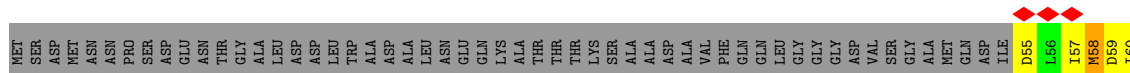
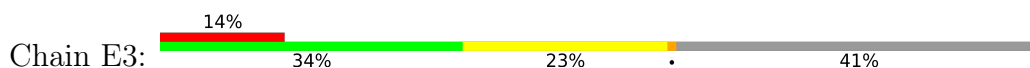

- Molecule 4: Flagellar motor switch protein FliN

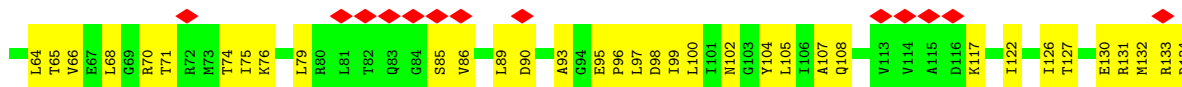
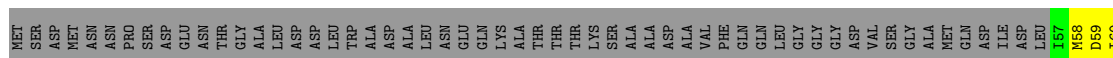
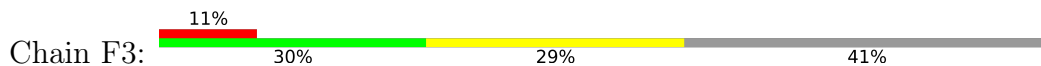

- Molecule 4: Flagellar motor switch protein FliN

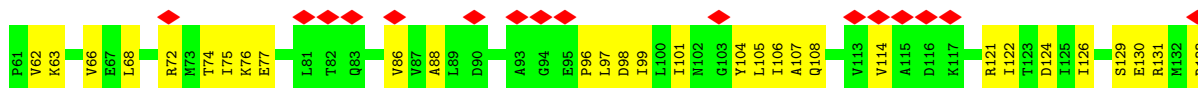
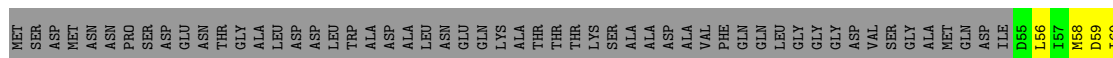

● Molecule 4: Flagellar motor switch protein FlIN

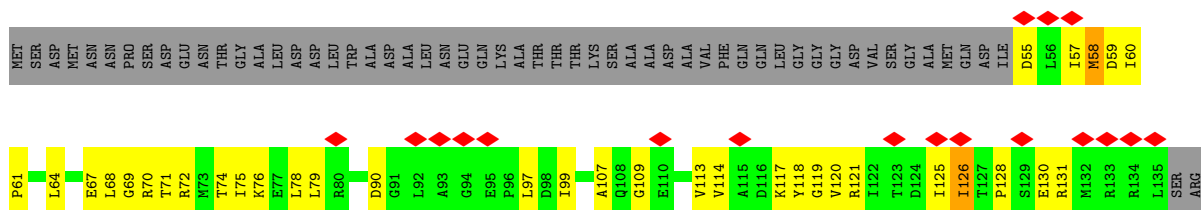
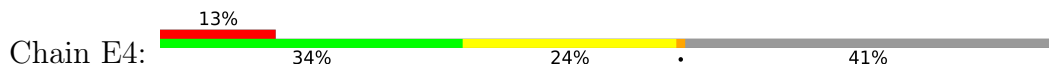

● Molecule 4: Flagellar motor switch protein FlIN

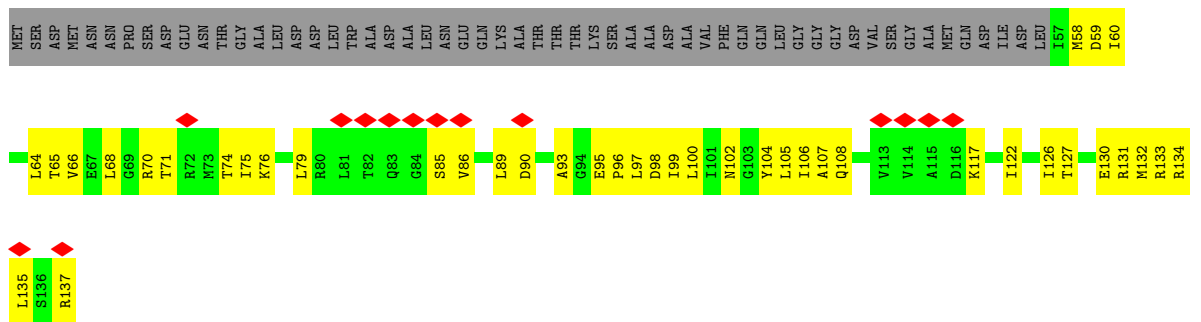
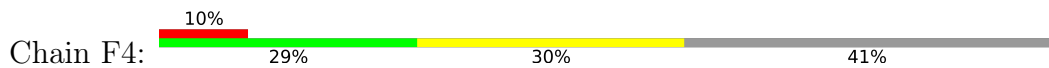

● Molecule 4: Flagellar motor switch protein FlIN

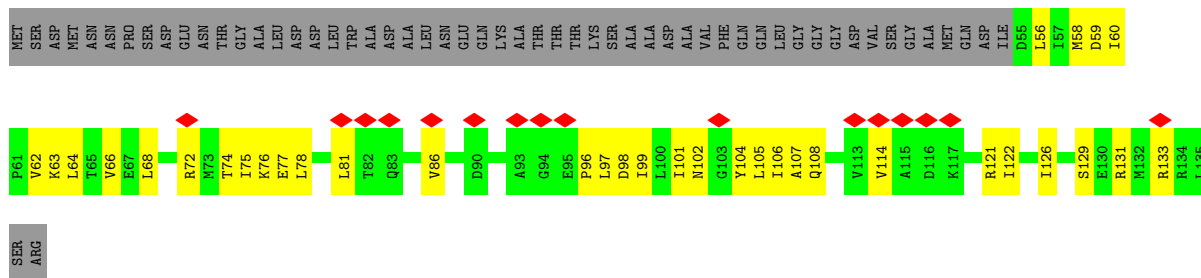

● Molecule 4: Flagellar motor switch protein FlIN

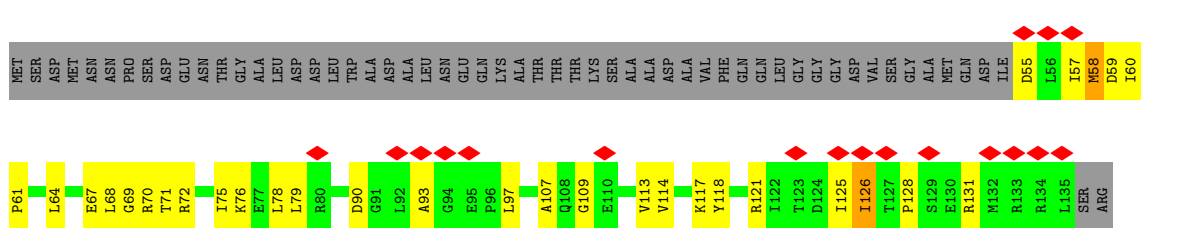

● Molecule 4: Flagellar motor switch protein FlIN

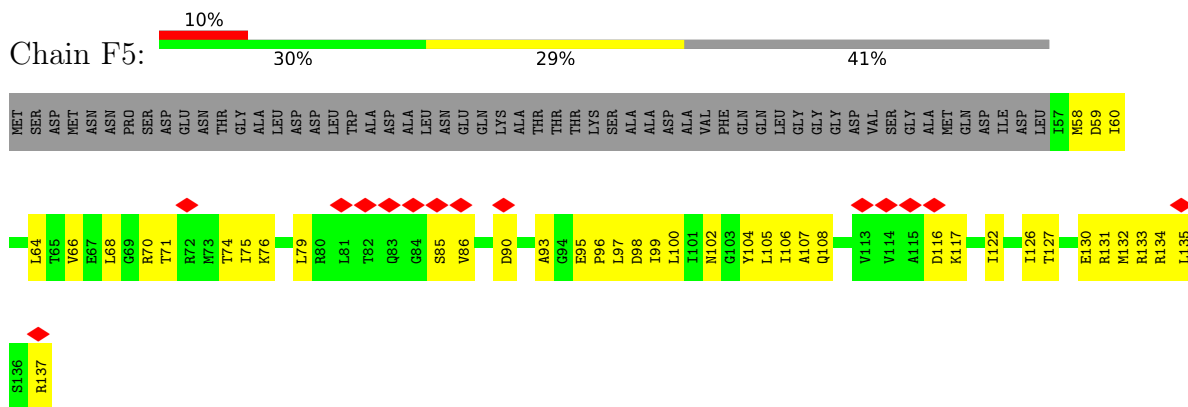

• Molecule 4: Flagellar motor switch protein FliN

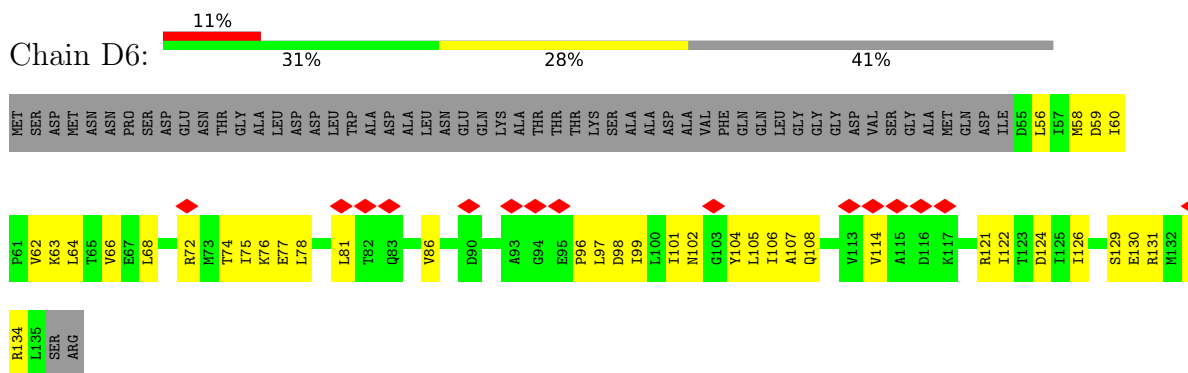

• Molecule 4: Flagellar motor switch protein FliN

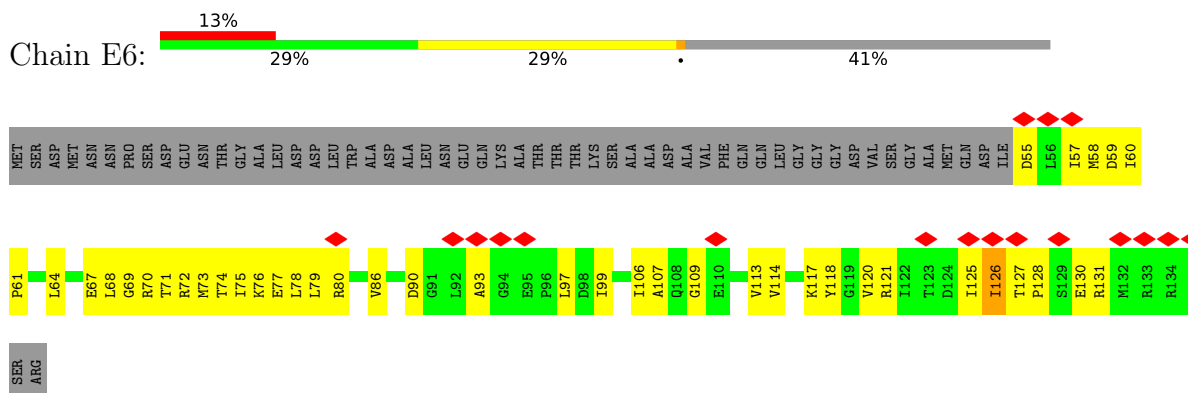

• Molecule 4: Flagellar motor switch protein FliN

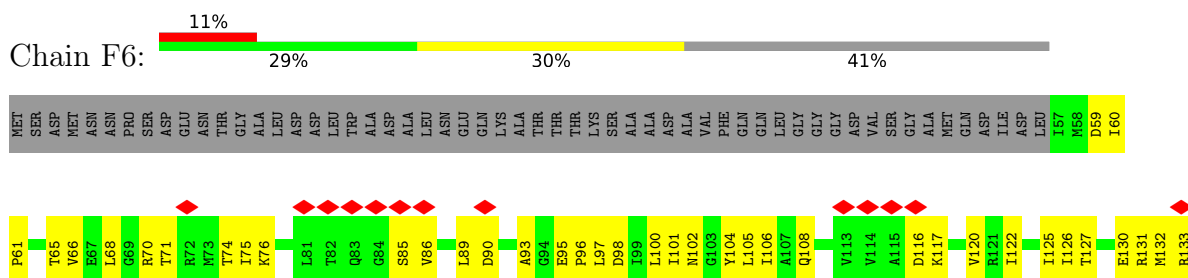



• Molecule 4: Flagellar motor switch protein FliN

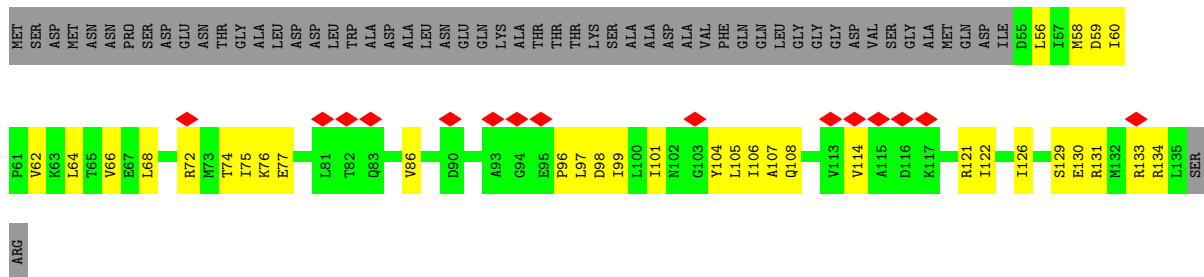
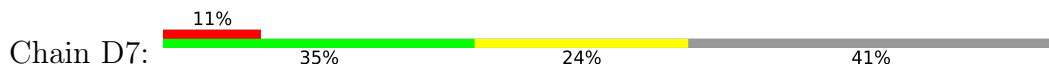

• Molecule 4: Flagellar motor switch protein FliN

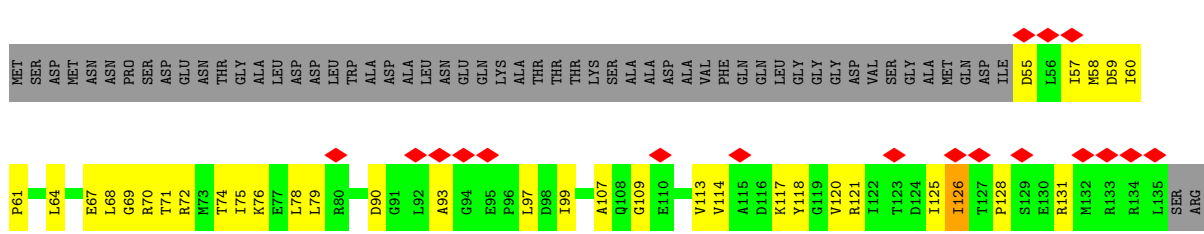
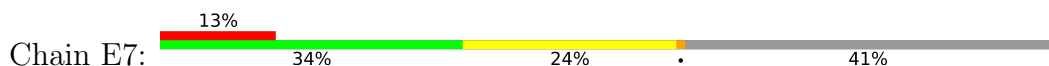

• Molecule 4: Flagellar motor switch protein FliN

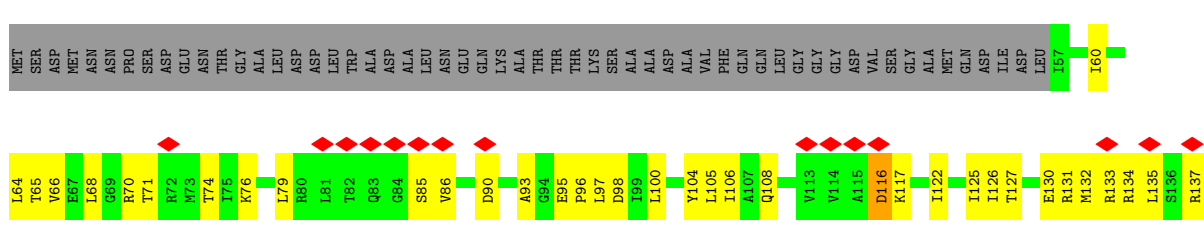
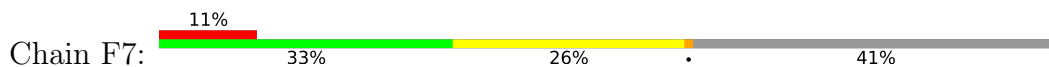

• Molecule 4: Flagellar motor switch protein FliN

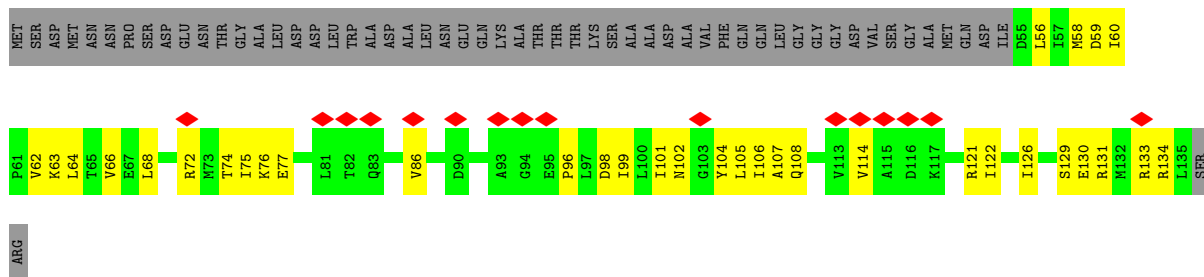

• Molecule 4: Flagellar motor switch protein FlIN

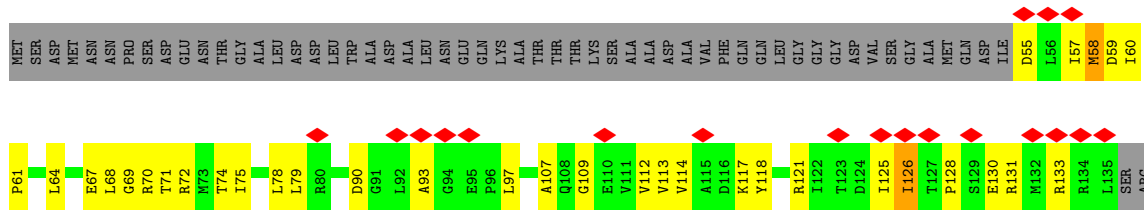
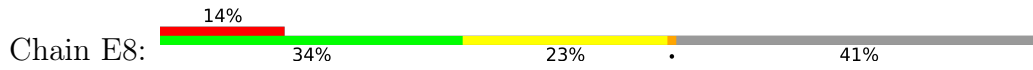

• Molecule 4: Flagellar motor switch protein FlIN

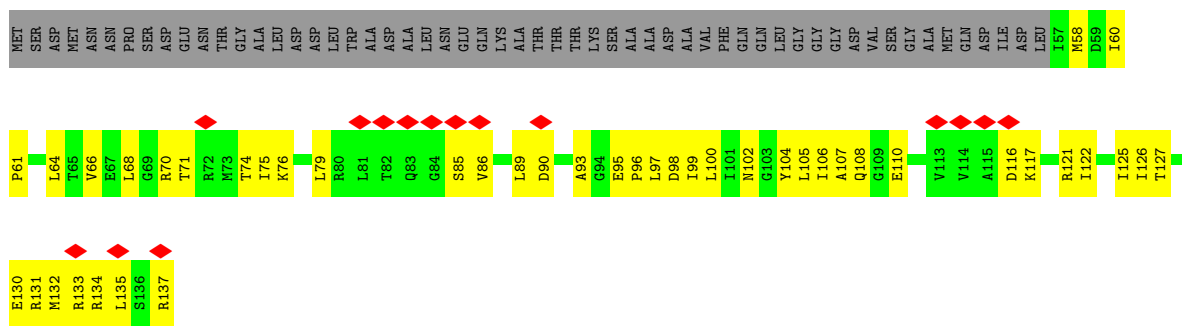
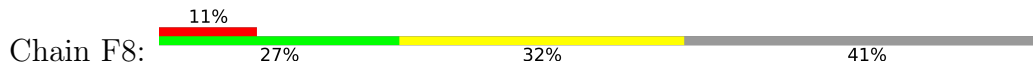

• Molecule 4: Flagellar motor switch protein FlIN

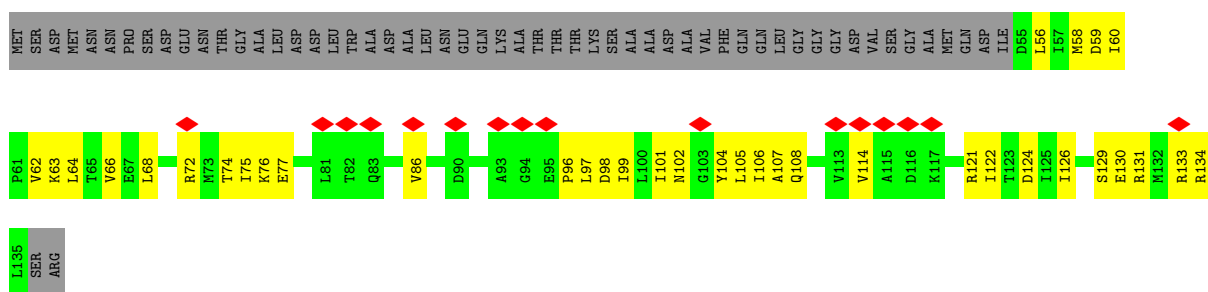

• Molecule 4: Flagellar motor switch protein FlIN

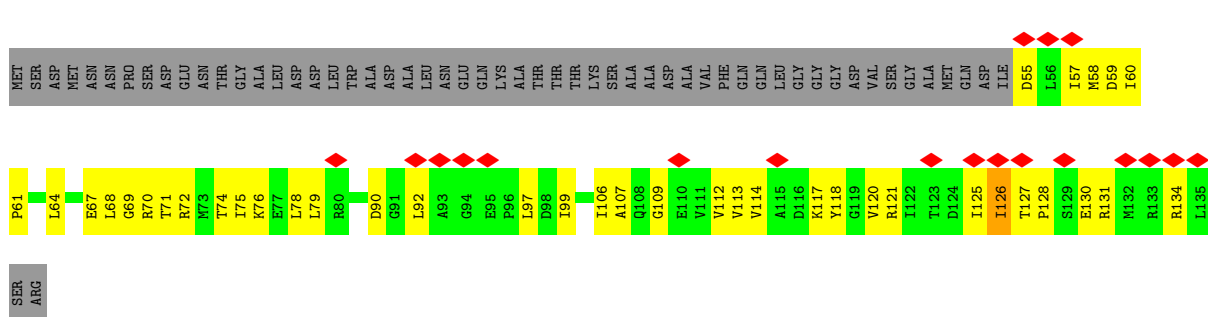
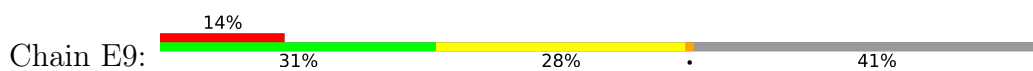

Molecule 4: Flagellar motor switch protein FliN

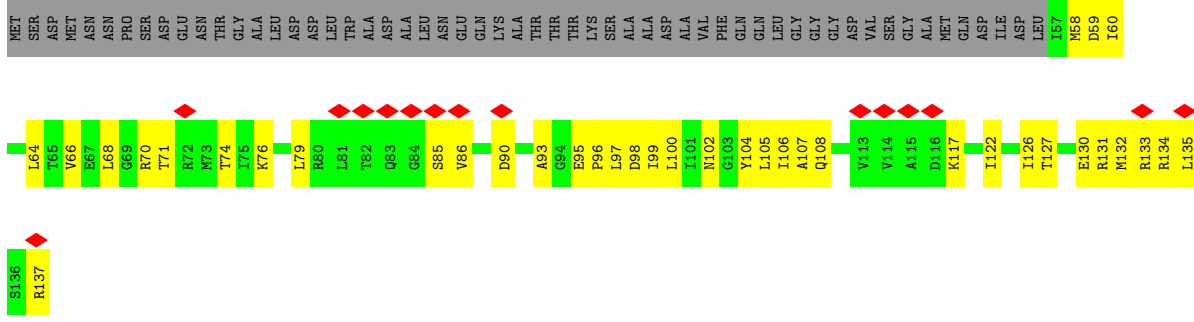
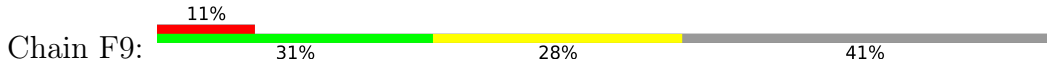

Molecule 4: Flagellar motor switch protein FliN

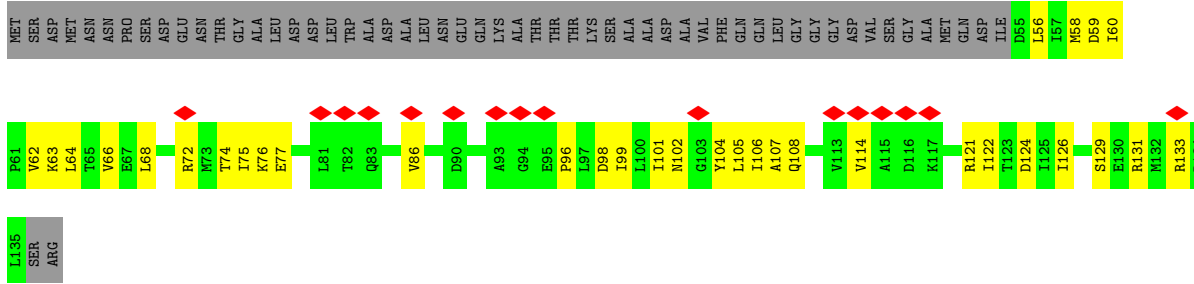

Molecule 4: Flagellar motor switch protein FliN

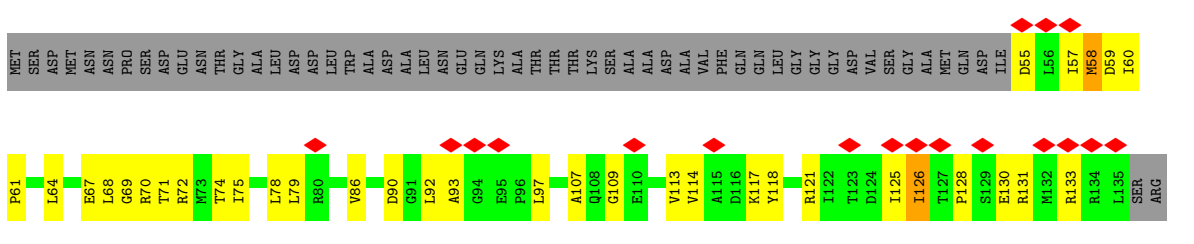
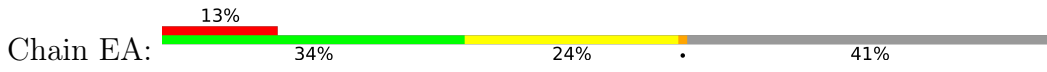

Molecule 4: Flagellar motor switch protein FliN

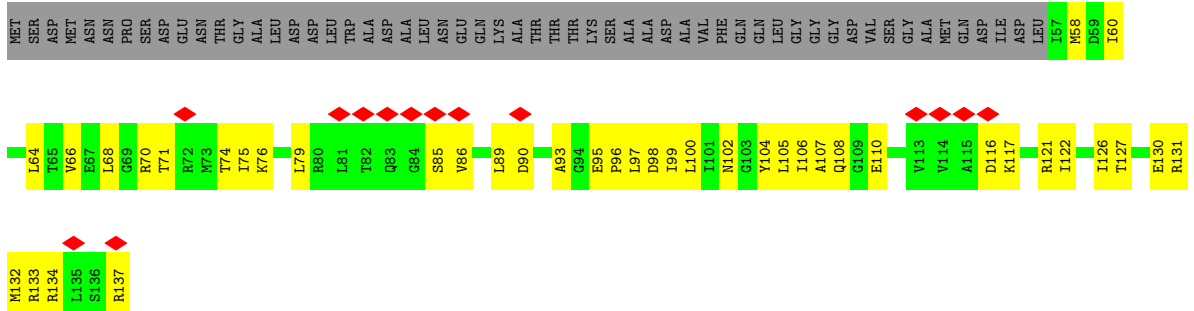
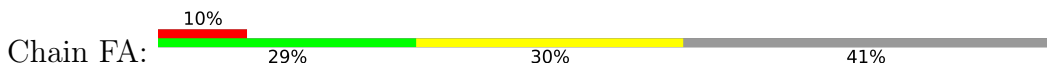

• Molecule 4: Flagellar motor switch protein FlIN

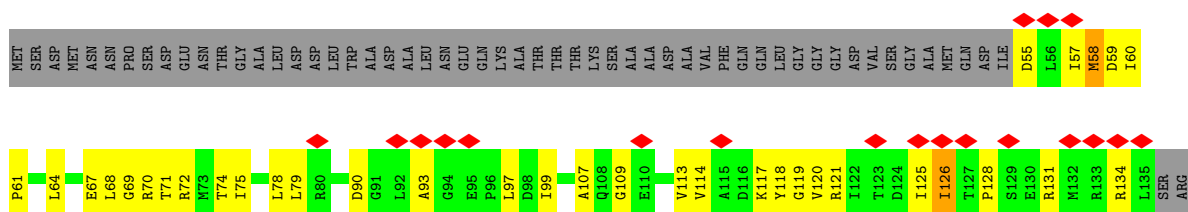
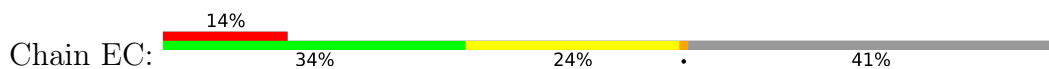

• Molecule 4: Flagellar motor switch protein FlIN

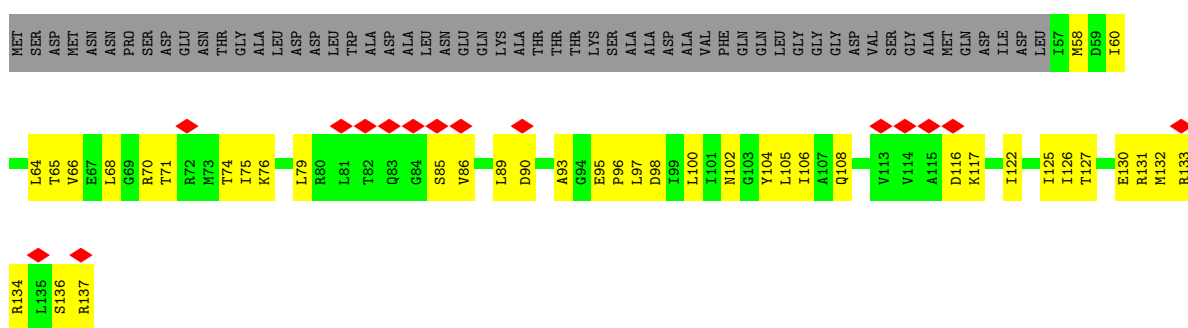
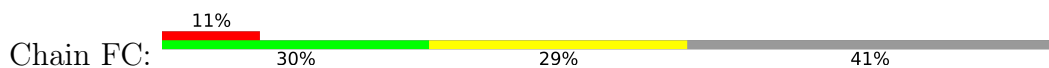

• Molecule 4: Flagellar motor switch protein FlIN

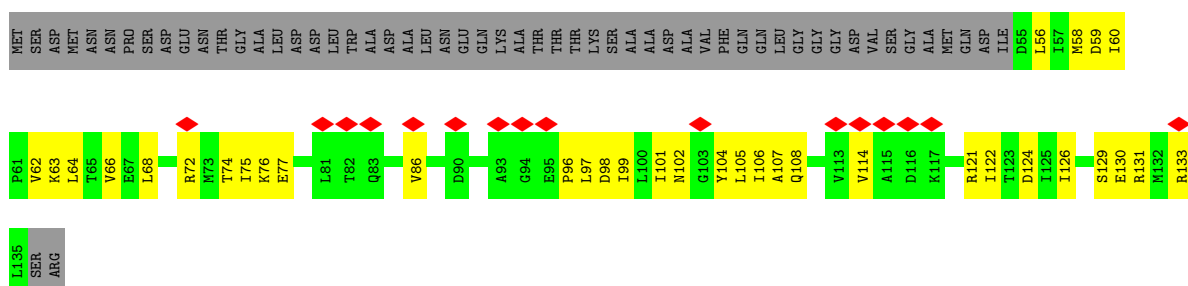

• Molecule 4: Flagellar motor switch protein FlIN

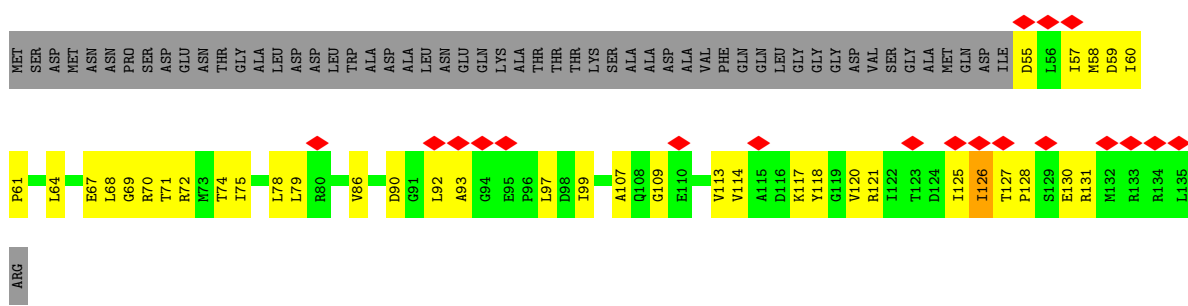
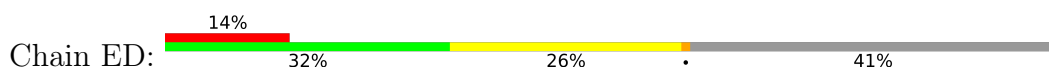

• Molecule 4: Flagellar motor switch protein FliN

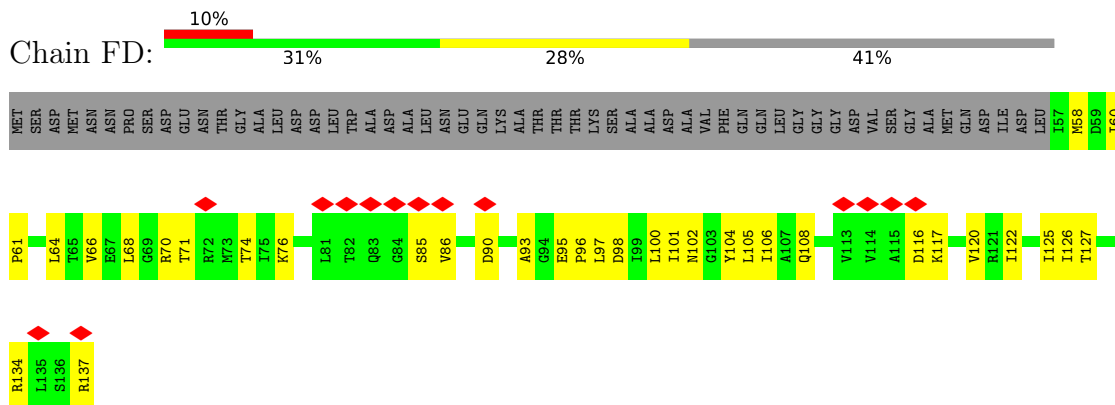

• Molecule 4: Flagellar motor switch protein FliN

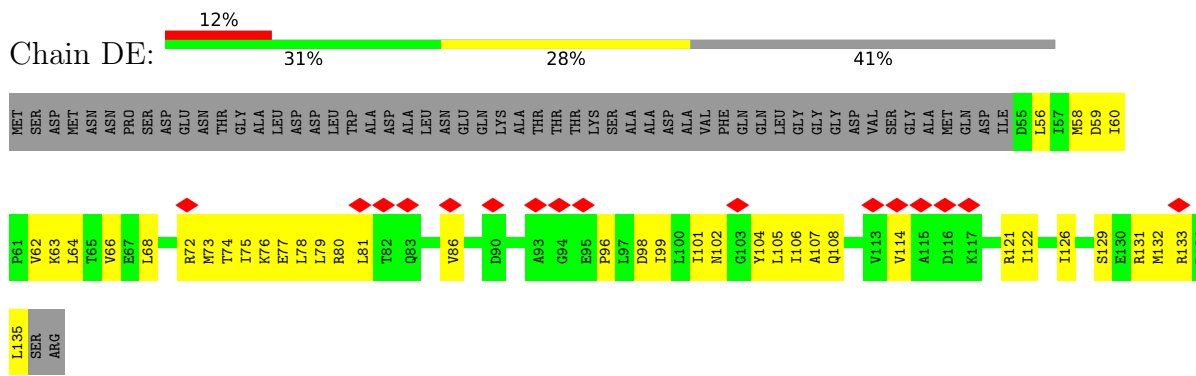

• Molecule 4: Flagellar motor switch protein FliN

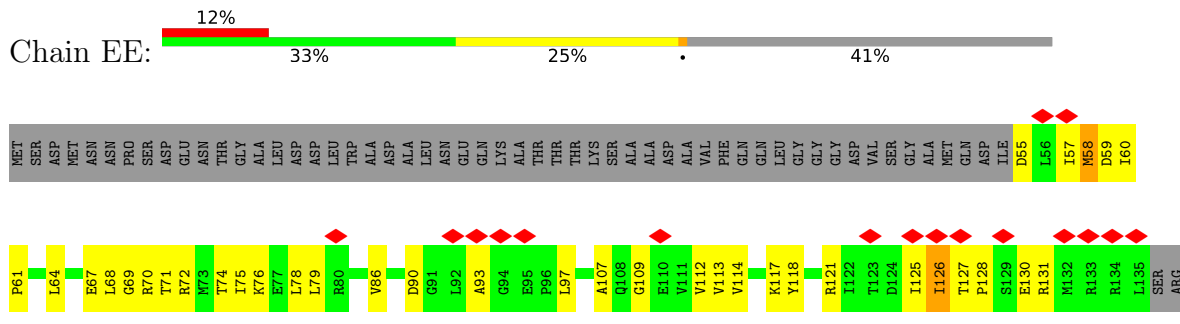

• Molecule 4: Flagellar motor switch protein FliN

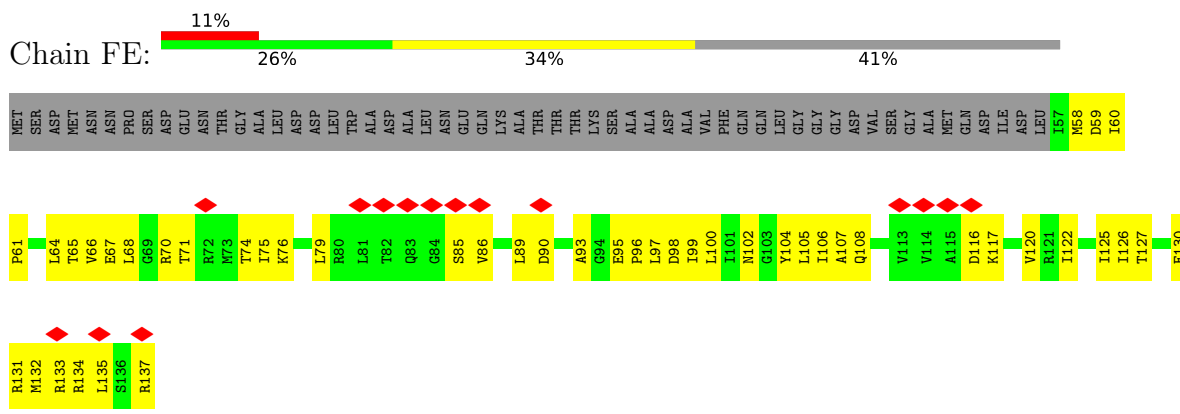

• Molecule 4: Flagellar motor switch protein FliN

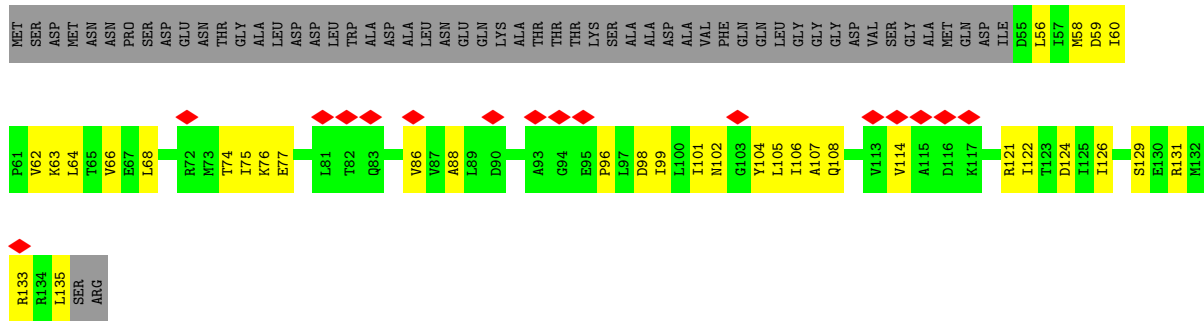

• Molecule 4: Flagellar motor switch protein FliN

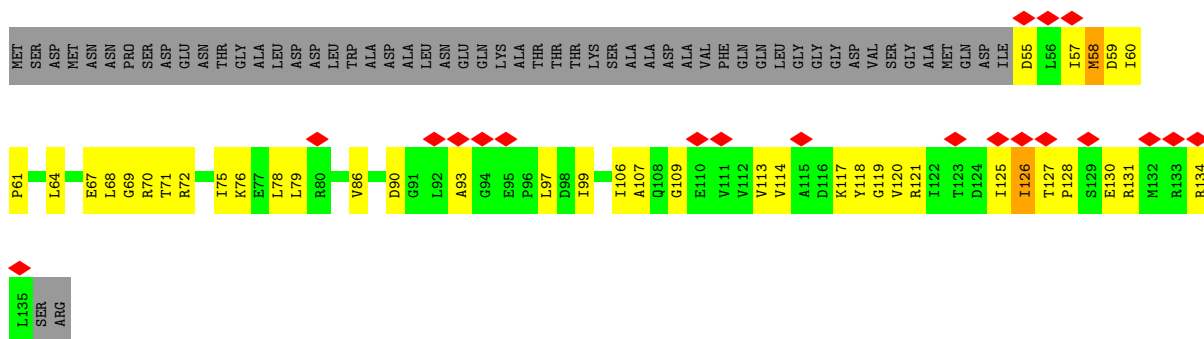
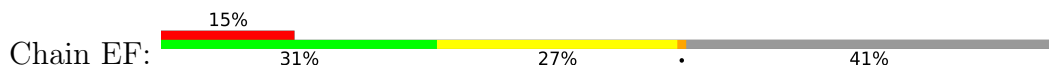

• Molecule 4: Flagellar motor switch protein FliN

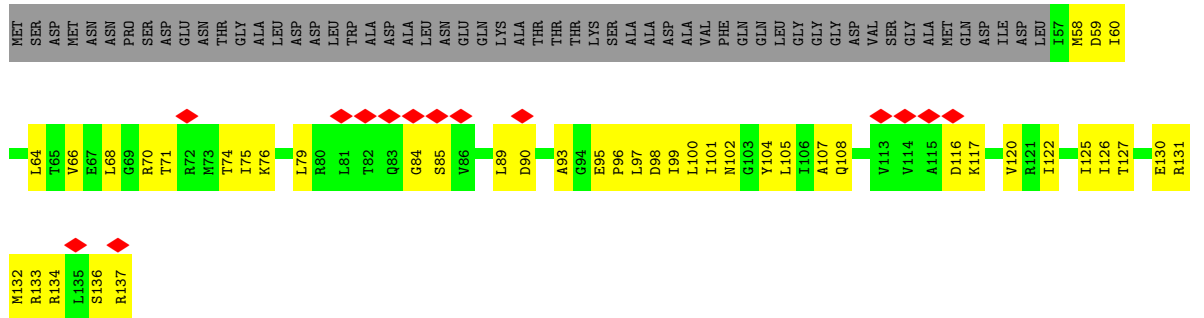
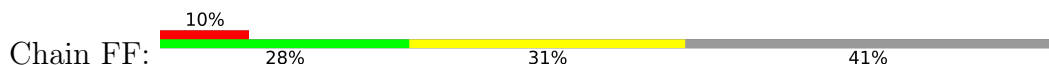

• Molecule 4: Flagellar motor switch protein FliN



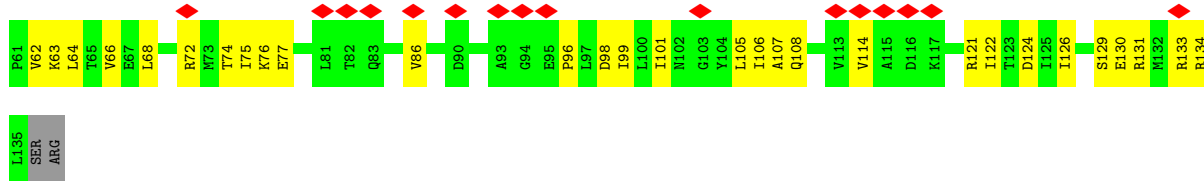

• Molecule 4: Flagellar motor switch protein FliN

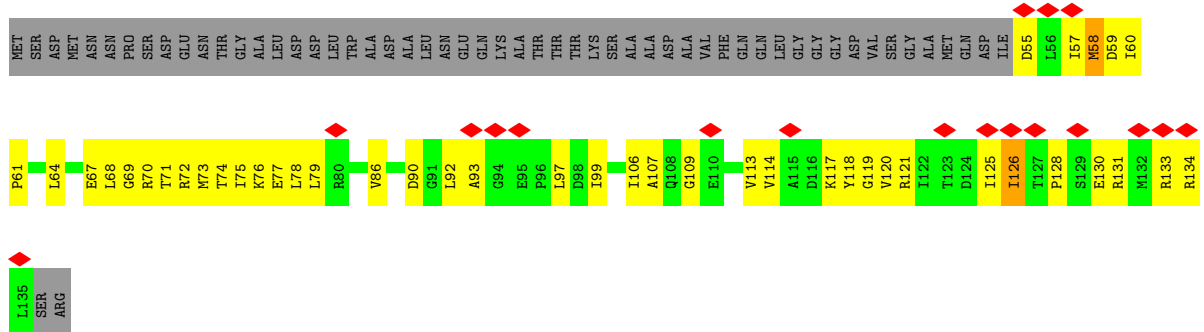
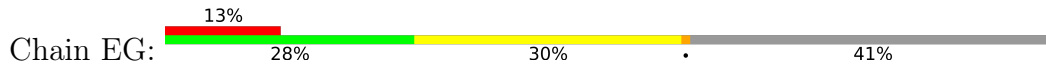

• Molecule 4: Flagellar motor switch protein FliN

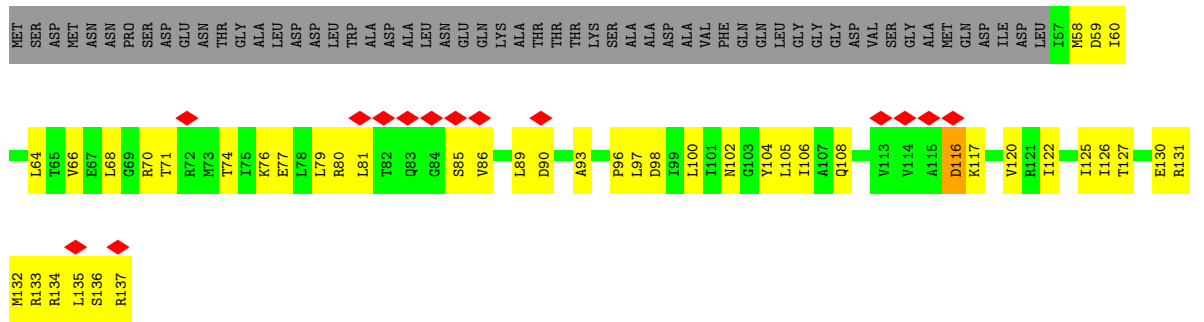
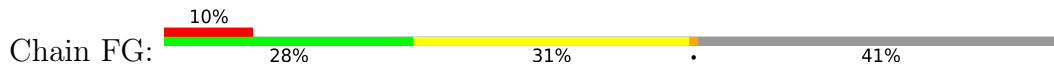

• Molecule 4: Flagellar motor switch protein FliN

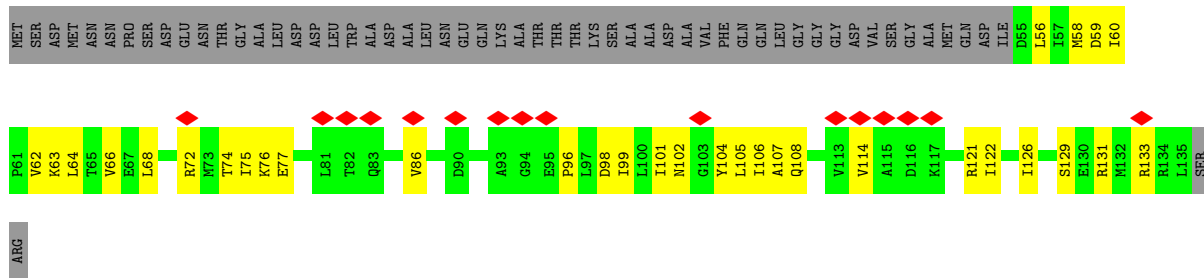

• Molecule 4: Flagellar motor switch protein FliN

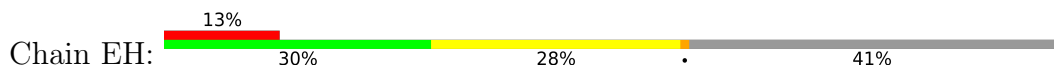

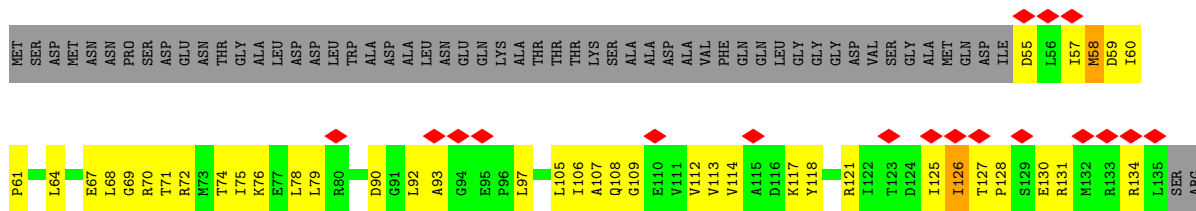

• Molecule 4: Flagellar motor switch protein FliN

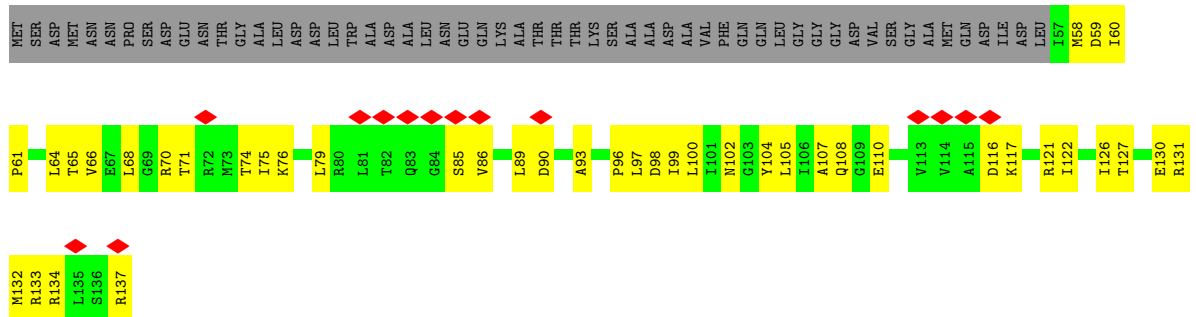
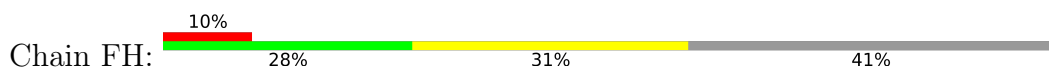

• Molecule 4: Flagellar motor switch protein FliN

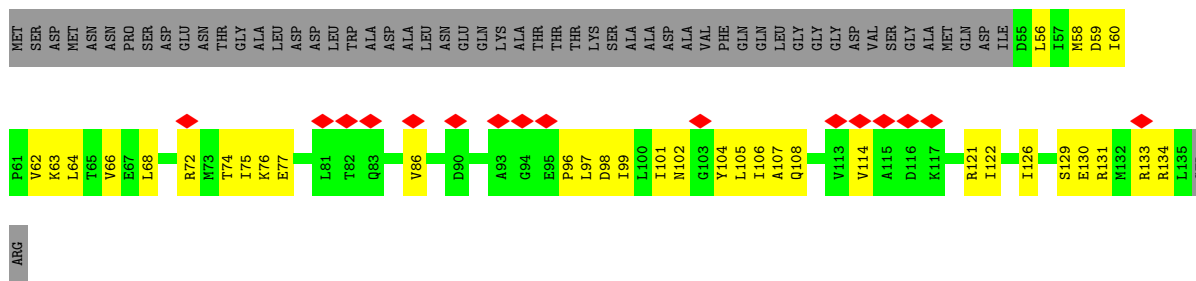

• Molecule 4: Flagellar motor switch protein FliN

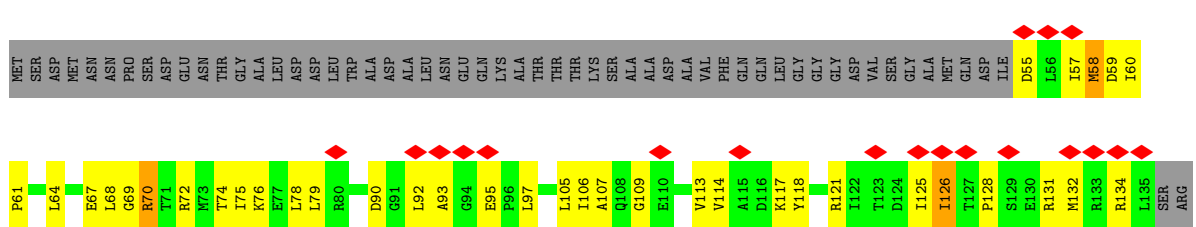
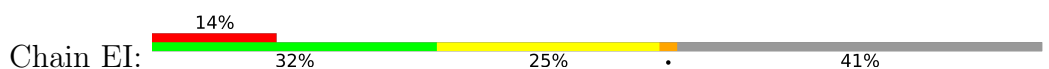

• Molecule 4: Flagellar motor switch protein FliN

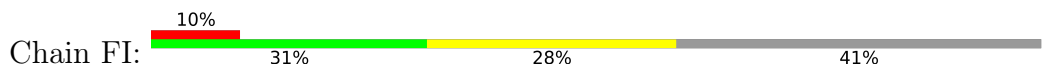

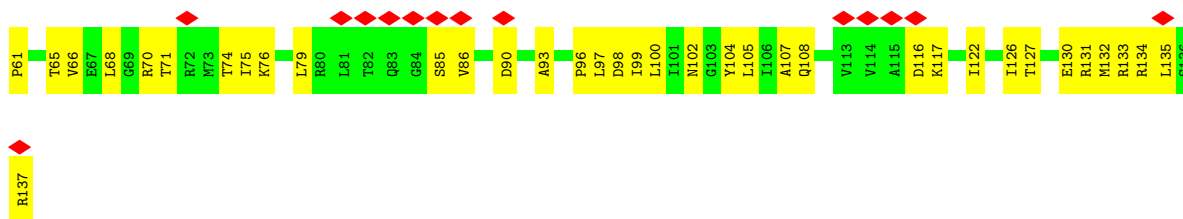

• Molecule 4: Flagellar motor switch protein FliN

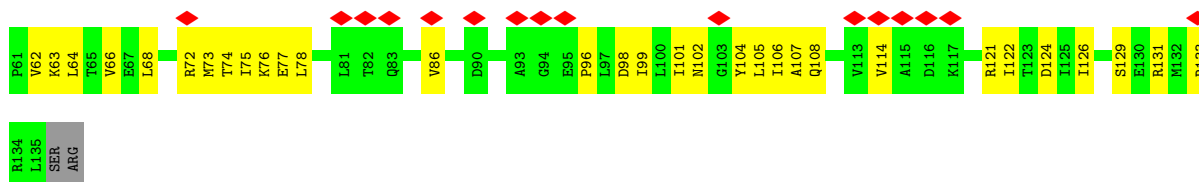
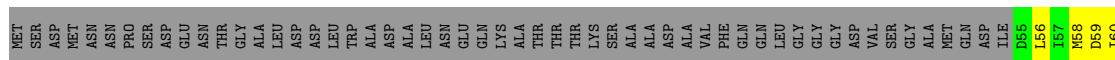

• Molecule 4: Flagellar motor switch protein FliN

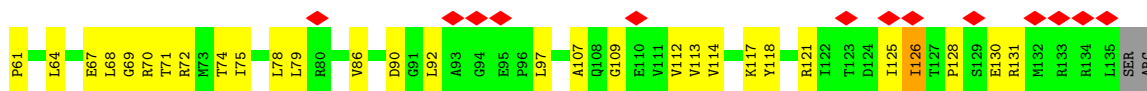
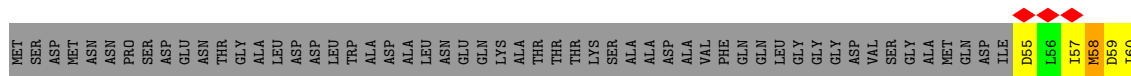
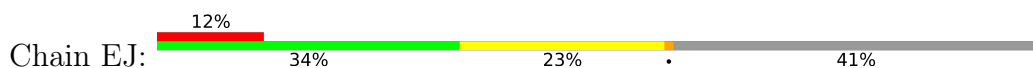

• Molecule 4: Flagellar motor switch protein FliN

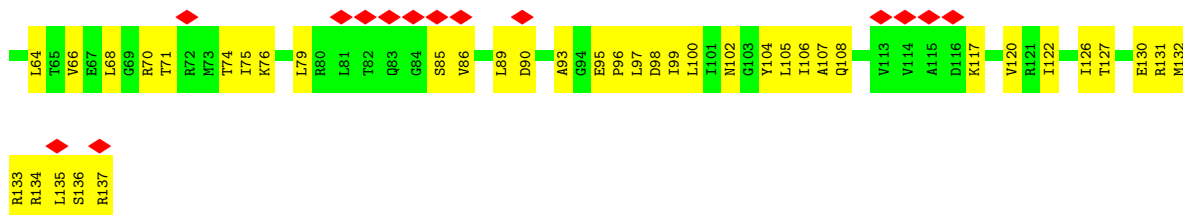
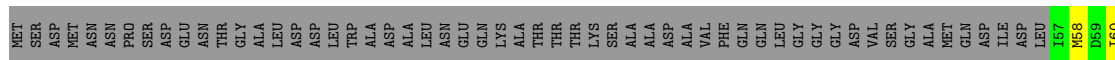
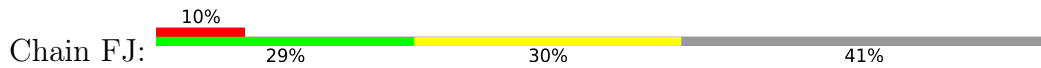

• Molecule 4: Flagellar motor switch protein FliN



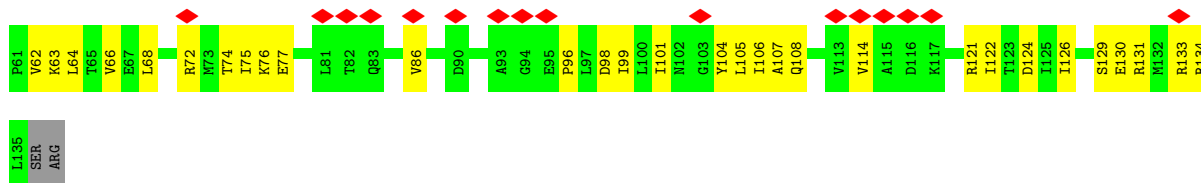

• Molecule 4: Flagellar motor switch protein FliN

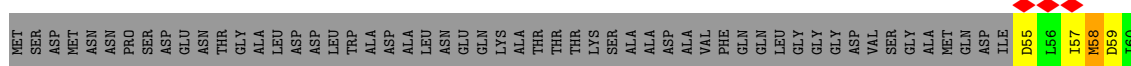
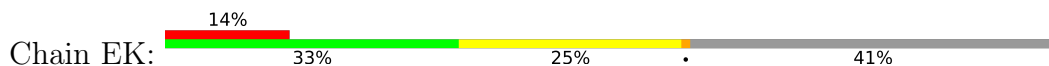

• Molecule 4: Flagellar motor switch protein FliN

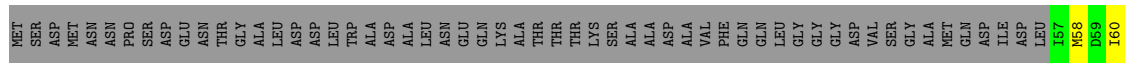
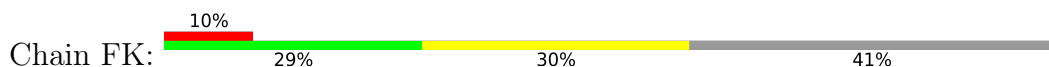

• Molecule 4: Flagellar motor switch protein FliN



• Molecule 4: Flagellar motor switch protein FliN

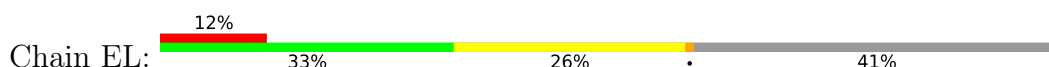

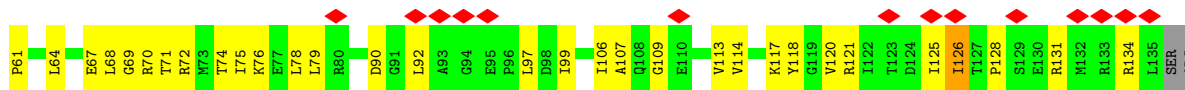

• Molecule 4: Flagellar motor switch protein FliN

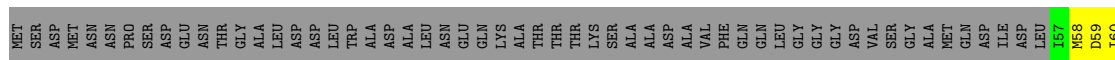
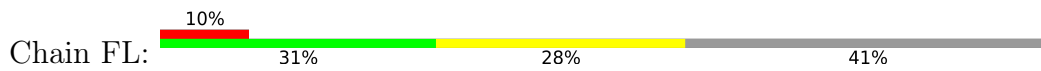

• Molecule 4: Flagellar motor switch protein FliN

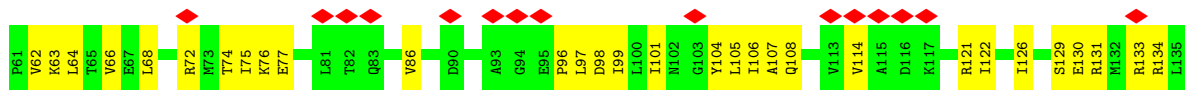
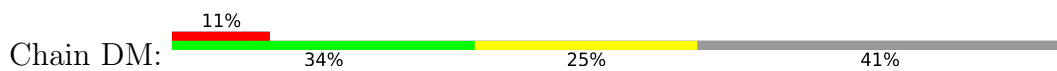

• Molecule 4: Flagellar motor switch protein FliN

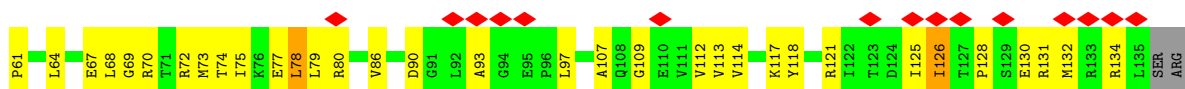
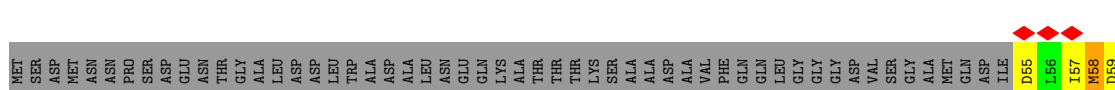
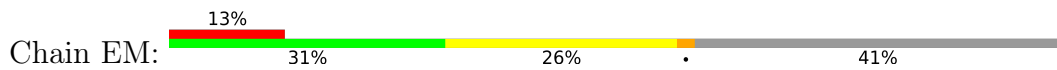

• Molecule 4: Flagellar motor switch protein FliN

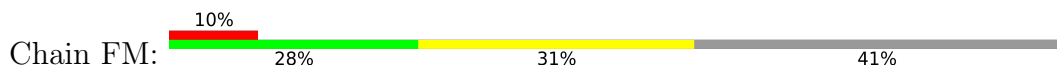

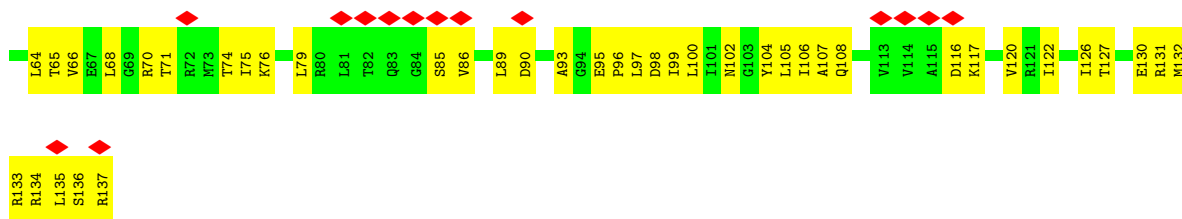

• Molecule 4: Flagellar motor switch protein FliN

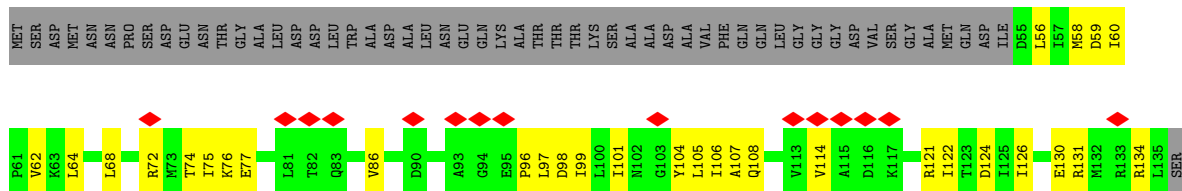

• Molecule 4: Flagellar motor switch protein FliN

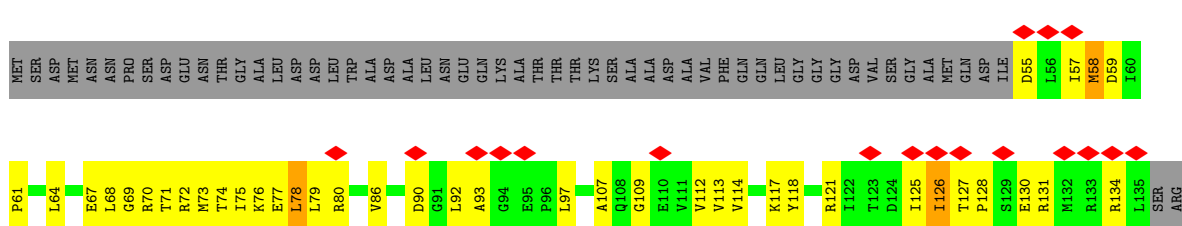
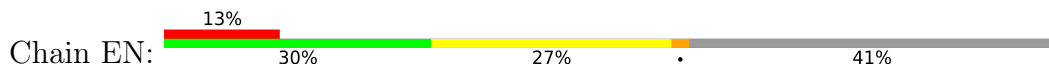

• Molecule 4: Flagellar motor switch protein FliN

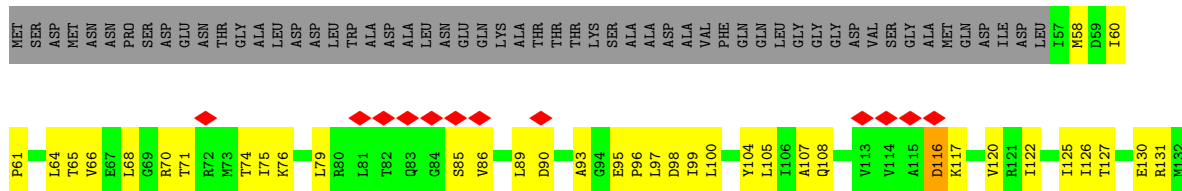
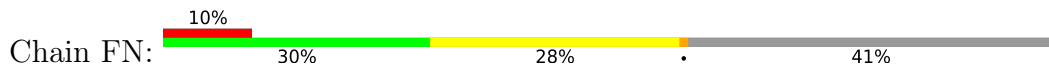

• Molecule 4: Flagellar motor switch protein FliN

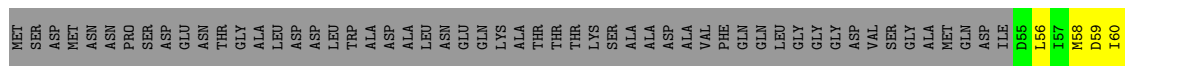



• Molecule 4: Flagellar motor switch protein FliN

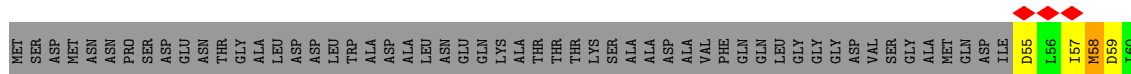
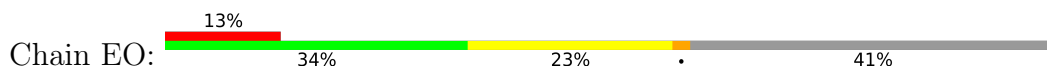

• Molecule 4: Flagellar motor switch protein FliN

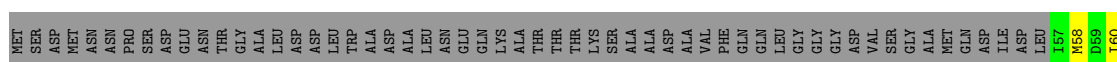

• Molecule 4: Flagellar motor switch protein FliN

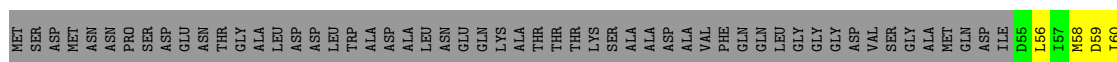
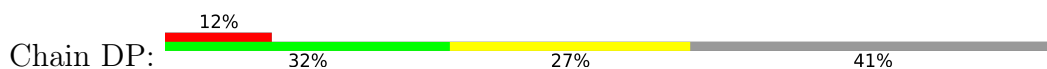

• Molecule 4: Flagellar motor switch protein FliN

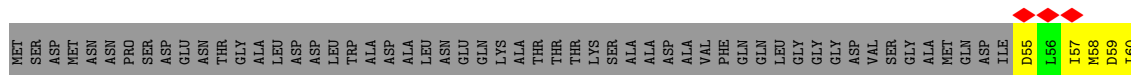
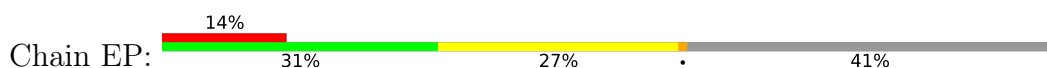



• Molecule 4: Flagellar motor switch protein FliN

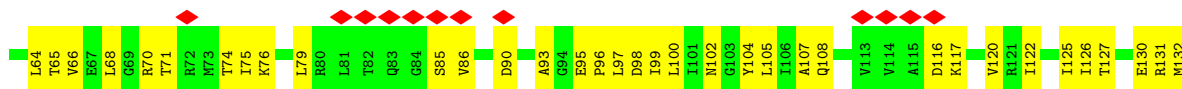
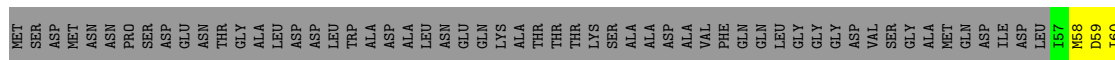
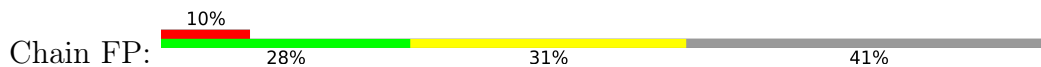

• Molecule 4: Flagellar motor switch protein FliN



ARG

• Molecule 4: Flagellar motor switch protein FliN

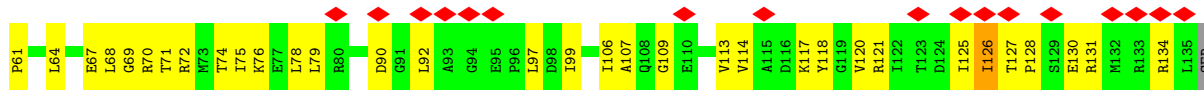
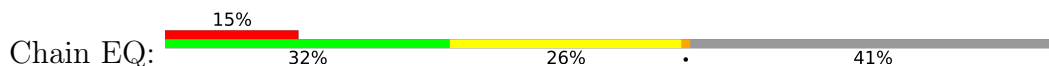

ARG

• Molecule 4: Flagellar motor switch protein FliN

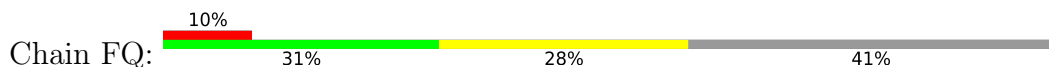

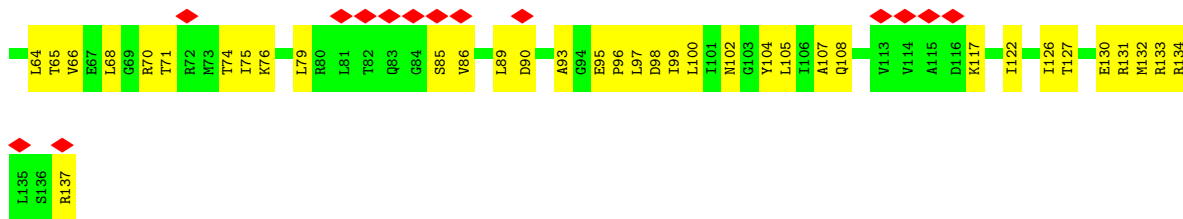

• Molecule 4: Flagellar motor switch protein FliN

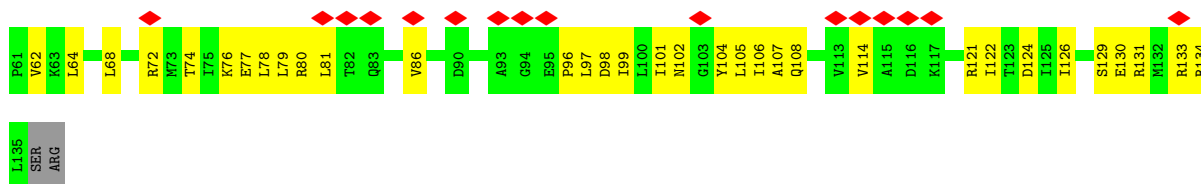
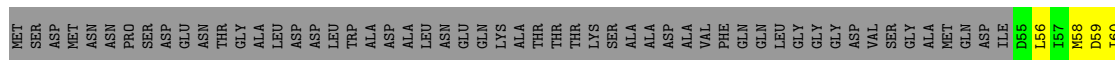
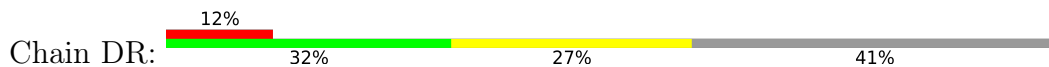

• Molecule 4: Flagellar motor switch protein FliN

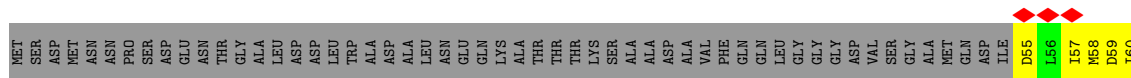
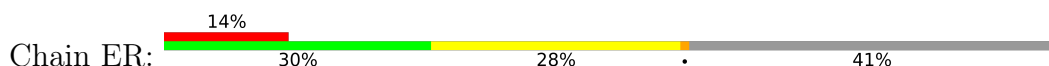

• Molecule 4: Flagellar motor switch protein FliN

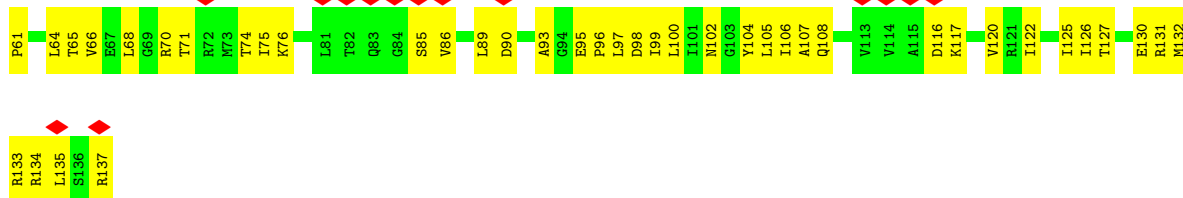
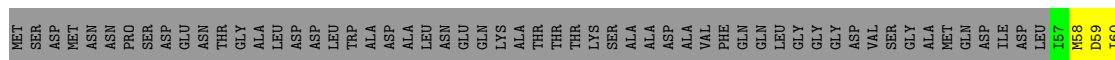
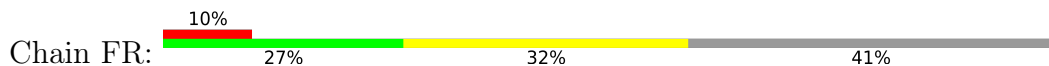

• Molecule 4: Flagellar motor switch protein FliN



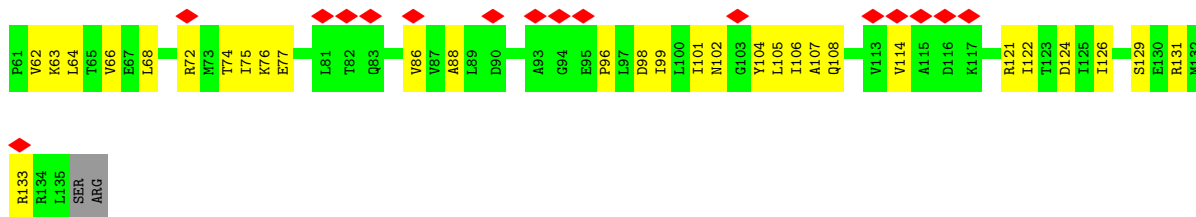

• Molecule 4: Flagellar motor switch protein FliN

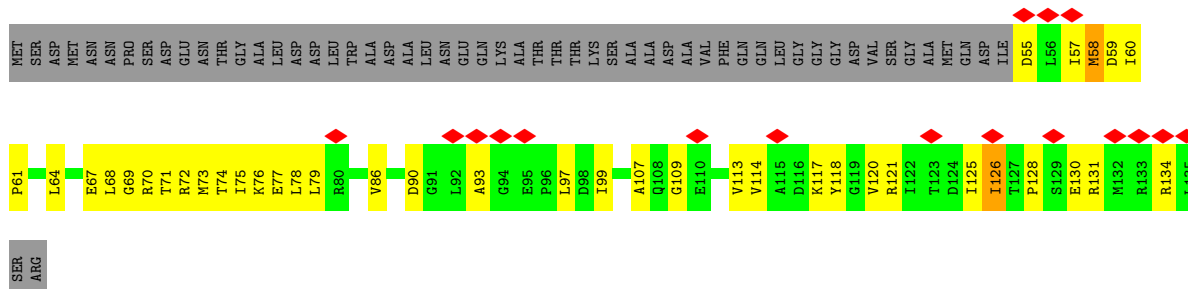
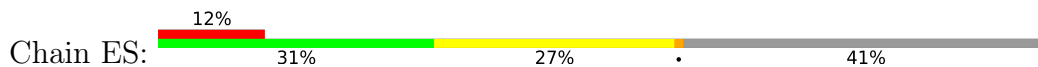

• Molecule 4: Flagellar motor switch protein FliN

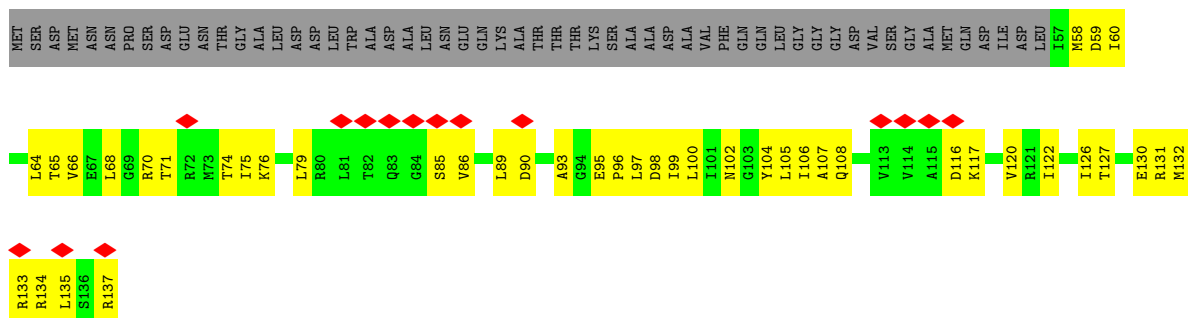
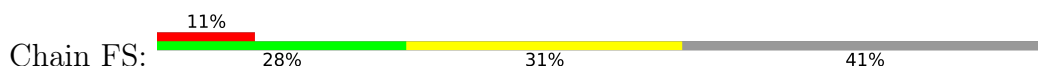

• Molecule 4: Flagellar motor switch protein FliN

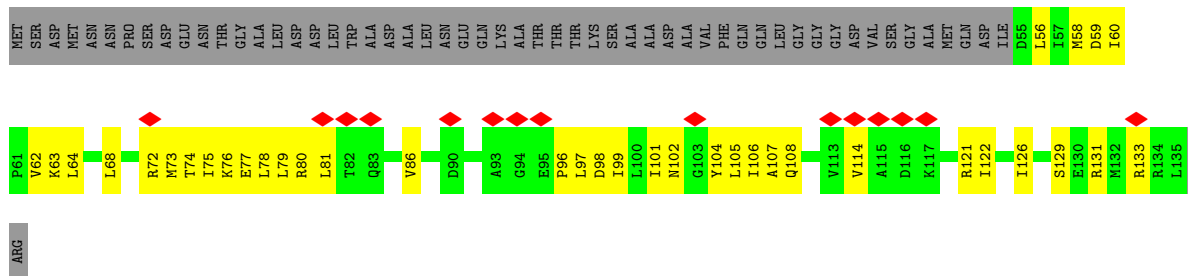

• Molecule 4: Flagellar motor switch protein FliN



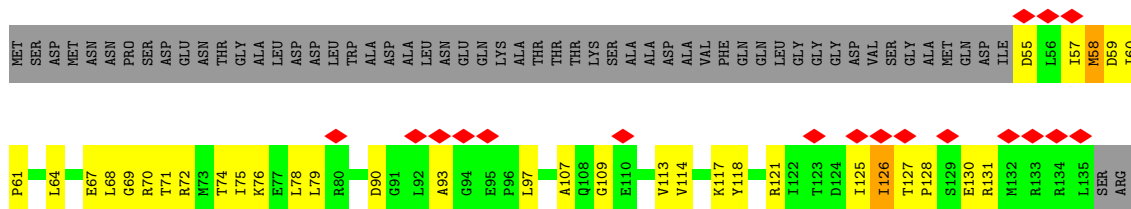

• Molecule 4: Flagellar motor switch protein FliN

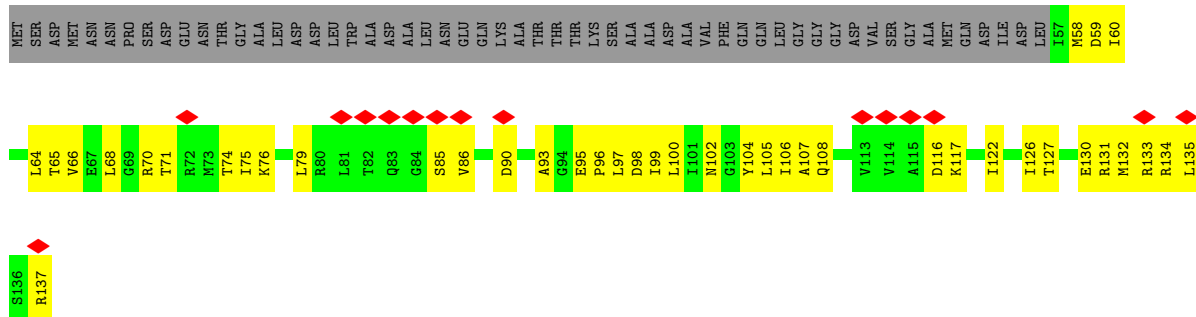

• Molecule 4: Flagellar motor switch protein FliN

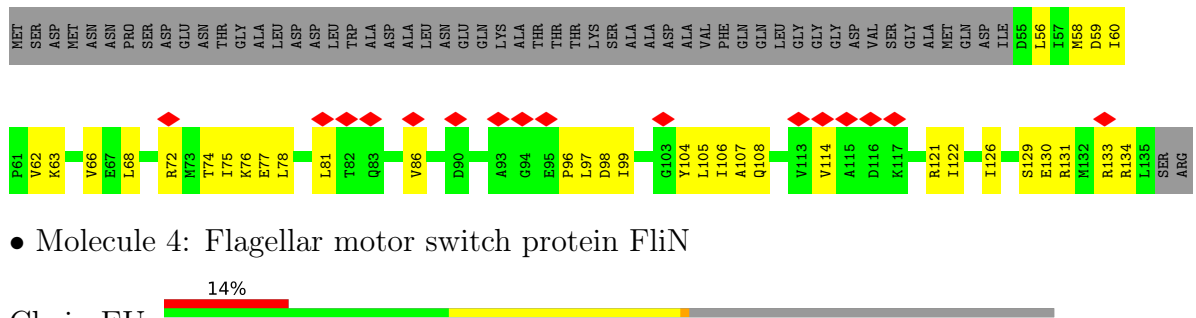

• Molecule 4: Flagellar motor switch protein FliN

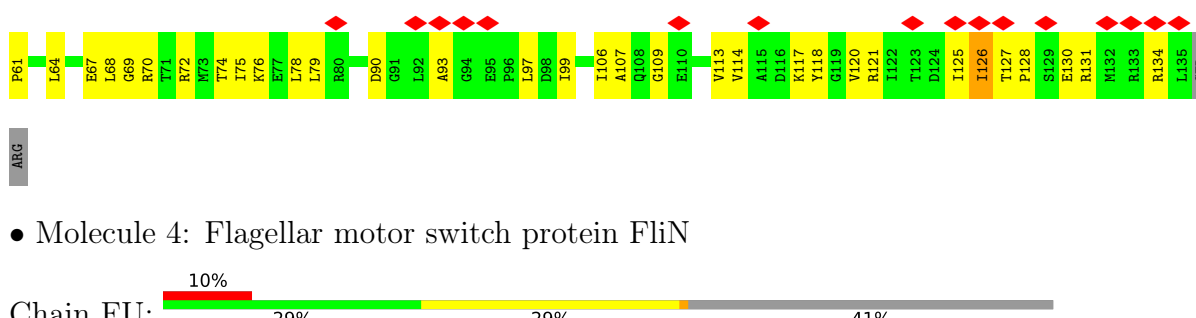
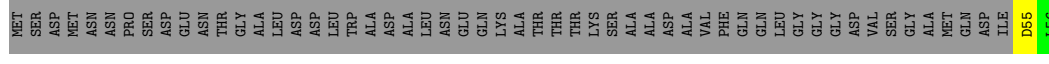

• Molecule 4: Flagellar motor switch protein FliN



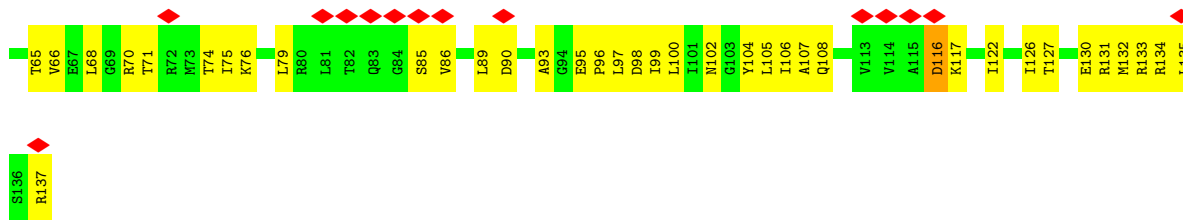

• Molecule 4: Flagellar motor switch protein FliN

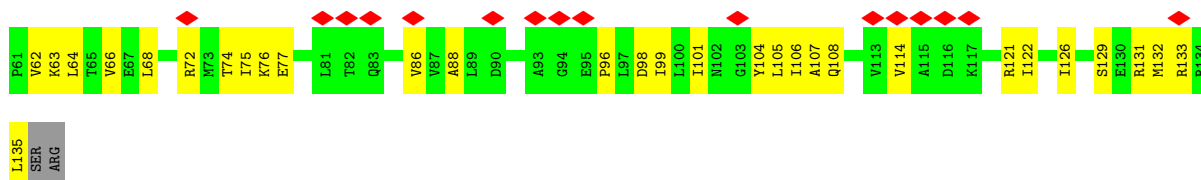
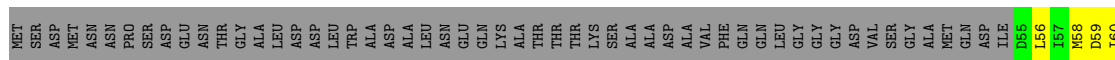

• Molecule 4: Flagellar motor switch protein FliN

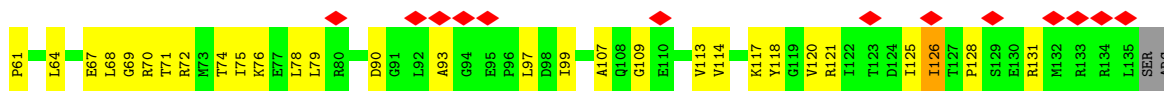
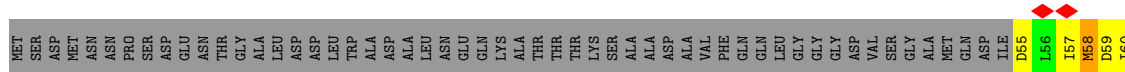

• Molecule 4: Flagellar motor switch protein FliN

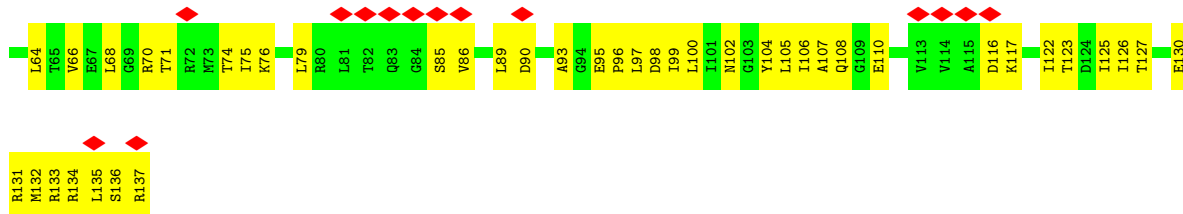
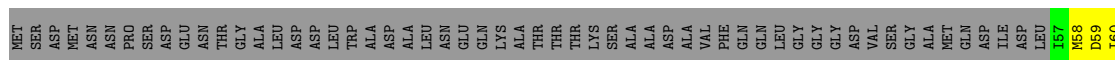
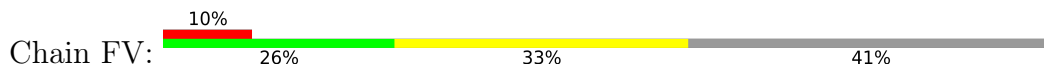

• Molecule 4: Flagellar motor switch protein FliN

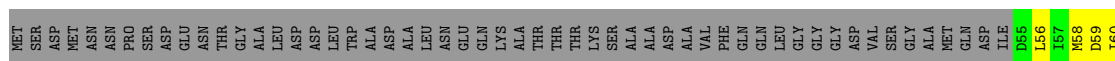

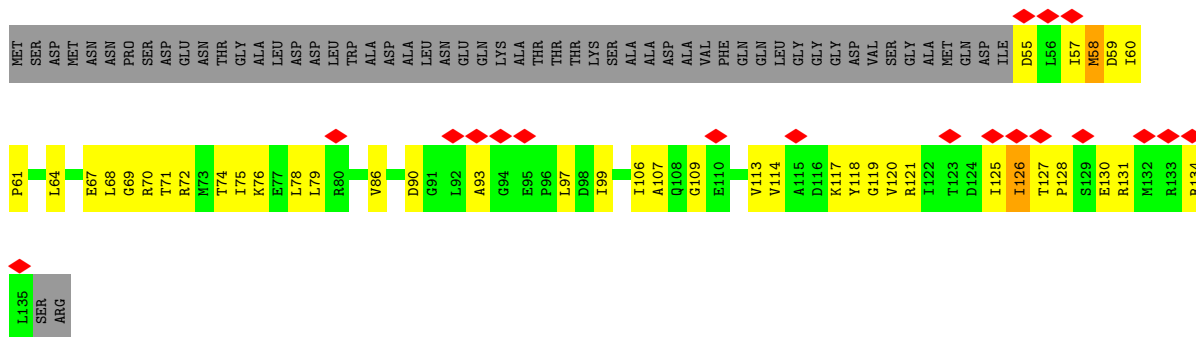

● Molecule 4: Flagellar motor switch protein FliN

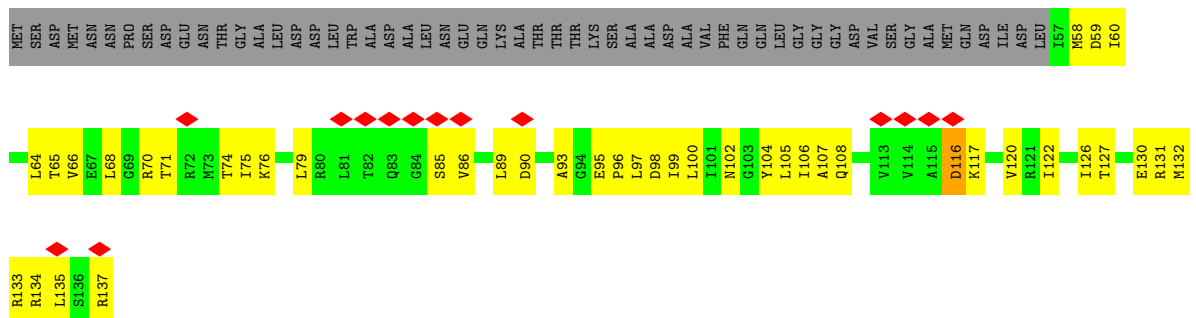
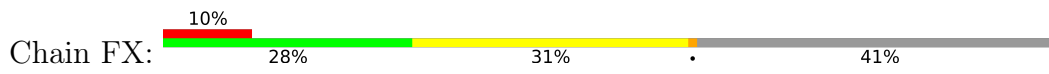

● Molecule 4: Flagellar motor switch protein FliN

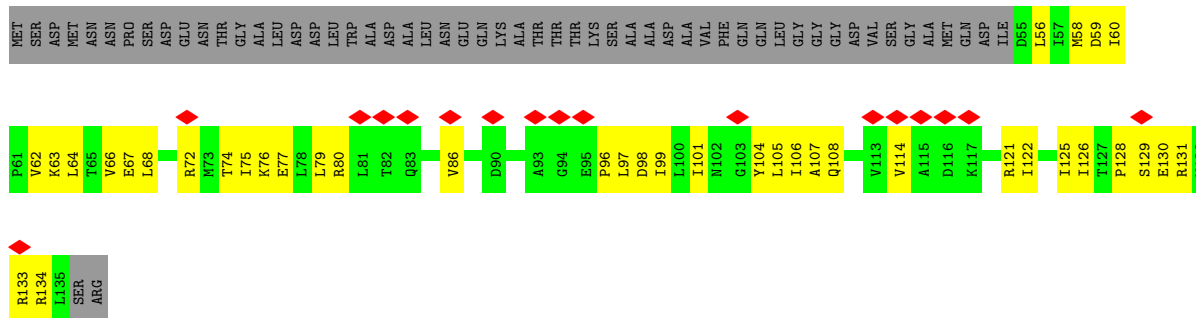
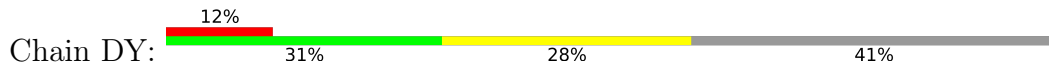

● Molecule 4: Flagellar motor switch protein FliN

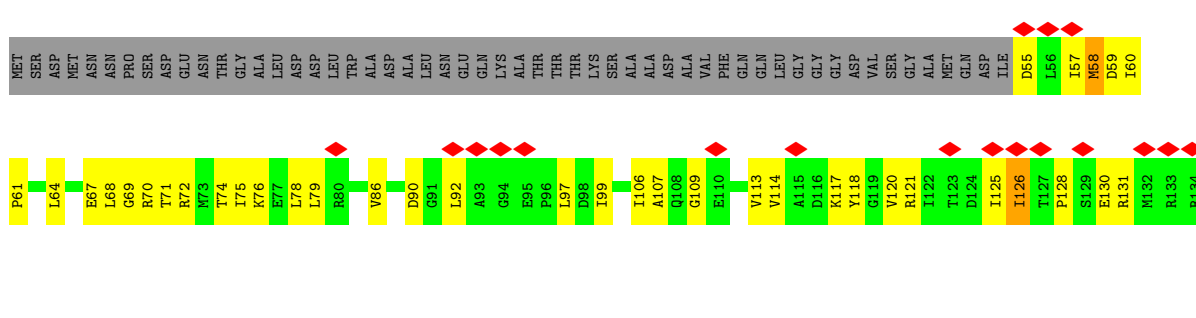
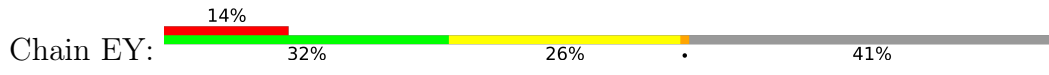



• Molecule 4: Flagellar motor switch protein FliN

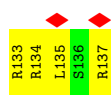
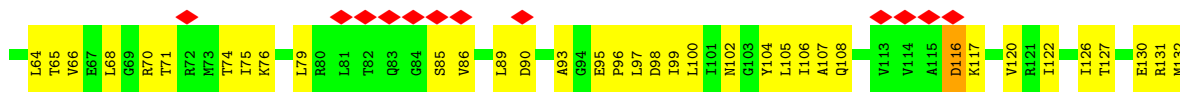
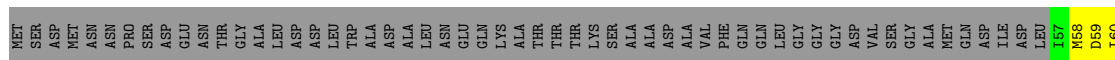
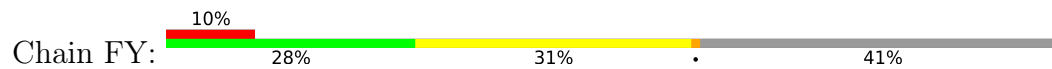

4 Experimental information

Property	Value	Source
EM reconstruction method	SINGLE PARTICLE	Depositor
Imposed symmetry	POINT, Not provided	
Number of particles used	15952	Depositor
Resolution determination method	FSC 0.143 CUT-OFF	Depositor
CTF correction method	PHASE FLIPPING AND AMPLITUDE CORRECTION	Depositor
Microscope	FEI TITAN KRIOS	Depositor
Voltage (kV)	300	Depositor
Electron dose ($e^-/\text{\AA}^2$)	58.5	Depositor
Minimum defocus (nm)	500	Depositor
Maximum defocus (nm)	2000	Depositor
Magnification	Not provided	
Image detector	GATAN K3 BIOQUANTUM (6k x 4k)	Depositor
Maximum map value	1.345	Depositor
Minimum map value	-0.228	Depositor
Average map value	0.003	Depositor
Map value standard deviation	0.090	Depositor
Recommended contour level	0.7	Depositor
Map size (\AA)	851.968, 851.968, 851.968	wwPDB
Map dimensions	512, 512, 512	wwPDB
Map angles ($^\circ$)	90.0, 90.0, 90.0	wwPDB
Pixel spacing (\AA)	1.664, 1.664, 1.664	Depositor

5 Model quality [i](#)

5.1 Standard geometry [i](#)

The Z score for a bond length (or angle) is the number of standard deviations the observed value is removed from the expected value. A bond length (or angle) with $|Z| > 5$ is considered an outlier worth inspection. RMSZ is the root-mean-square of all Z scores of the bond lengths (or angles).

Mol	Chain	Bond lengths		Bond angles	
		RMSZ	# Z >5	RMSZ	# Z >5
1	A1	0.24	0/396	0.58	0/528
1	A2	0.24	0/396	0.60	0/528
1	A3	0.25	0/396	0.59	0/528
1	A4	0.24	0/396	0.61	0/528
1	A5	0.24	0/396	0.61	0/528
1	A6	0.24	0/396	0.63	0/528
1	A7	0.24	0/396	0.60	0/528
1	A8	0.25	0/396	0.63	0/528
1	A9	0.24	0/396	0.62	0/528
1	AA	0.24	0/396	0.60	0/528
1	AB	0.24	0/396	0.60	0/528
1	AC	0.24	0/396	0.60	0/528
1	AD	0.24	0/396	0.59	0/528
1	AE	0.25	0/396	0.59	0/528
1	AF	0.24	0/396	0.60	0/528
1	AG	0.24	0/396	0.61	0/528
1	AH	0.24	0/396	0.61	0/528
1	AI	0.25	0/396	0.62	0/528
1	AJ	0.24	0/396	0.61	0/528
1	AK	0.24	0/396	0.61	0/528
1	AL	0.24	0/396	0.61	0/528
1	AM	0.24	0/396	0.62	0/528
1	AN	0.23	0/396	0.60	0/528
1	AO	0.24	0/396	0.61	0/528
1	AP	0.24	0/396	0.61	0/528
1	AQ	0.24	0/396	0.60	0/528
1	AR	0.24	0/396	0.60	0/528
1	AS	0.23	0/396	0.61	0/528
1	AT	0.23	0/396	0.61	0/528
1	AU	0.23	0/396	0.58	0/528
1	AV	0.26	0/396	0.61	0/528
1	AW	0.24	0/396	0.60	0/528
1	AX	0.24	0/396	0.58	0/528
1	AY	0.24	0/396	0.63	0/528

Mol	Chain	Bond lengths		Bond angles	
		RMSZ	# Z >5	RMSZ	# Z >5
2	B1	0.26	0/2604	0.54	1/3511 (0.0%)
2	B2	0.25	0/2604	0.53	1/3511 (0.0%)
2	B3	0.25	0/2604	0.53	0/3511
2	B4	0.27	0/2604	0.54	1/3511 (0.0%)
2	B5	0.26	0/2604	0.55	1/3511 (0.0%)
2	B6	0.25	0/2604	0.54	1/3511 (0.0%)
2	B7	0.26	0/2604	0.54	1/3511 (0.0%)
2	B8	0.25	0/2604	0.54	1/3511 (0.0%)
2	B9	0.26	0/2604	0.54	1/3511 (0.0%)
2	BA	0.26	0/2604	0.54	1/3511 (0.0%)
2	BB	0.26	0/2604	0.55	1/3511 (0.0%)
2	BC	0.26	0/2604	0.55	1/3511 (0.0%)
2	BD	0.25	0/2604	0.54	1/3511 (0.0%)
2	BE	0.26	0/2604	0.55	1/3511 (0.0%)
2	BF	0.26	0/2604	0.54	1/3511 (0.0%)
2	BG	0.25	0/2604	0.55	2/3511 (0.1%)
2	BH	0.25	0/2604	0.55	2/3511 (0.1%)
2	BI	0.25	0/2604	0.54	2/3511 (0.1%)
2	BJ	0.26	0/2604	0.55	1/3511 (0.0%)
2	BK	0.25	0/2604	0.55	2/3511 (0.1%)
2	BL	0.26	0/2604	0.54	1/3511 (0.0%)
2	BM	0.25	0/2604	0.55	2/3511 (0.1%)
2	BN	0.25	0/2604	0.54	1/3511 (0.0%)
2	BO	0.25	0/2604	0.54	1/3511 (0.0%)
2	BP	0.26	0/2604	0.55	1/3511 (0.0%)
2	BQ	0.26	0/2604	0.55	1/3511 (0.0%)
2	BR	0.26	0/2604	0.55	2/3511 (0.1%)
2	BS	0.26	0/2604	0.56	1/3511 (0.0%)
2	BT	0.25	0/2604	0.53	1/3511 (0.0%)
2	BU	0.26	0/2604	0.54	1/3511 (0.0%)
2	BV	0.25	0/2604	0.54	1/3511 (0.0%)
2	BW	0.26	0/2604	0.54	1/3511 (0.0%)
2	BX	0.26	0/2604	0.53	1/3511 (0.0%)
2	BY	0.25	0/2604	0.54	1/3511 (0.0%)
3	C1	0.27	0/2401	0.52	0/3267
3	C2	0.27	0/2401	0.52	0/3267
3	C3	0.27	0/2401	0.52	0/3267
3	C4	0.27	0/2401	0.52	0/3267
3	C5	0.27	0/2401	0.52	0/3267
3	C6	0.27	0/2401	0.52	0/3267
3	C7	0.27	0/2401	0.53	0/3267
3	C8	0.27	0/2401	0.52	0/3267
3	C9	0.27	0/2401	0.52	0/3267

Mol	Chain	Bond lengths		Bond angles	
		RMSZ	# Z >5	RMSZ	# Z >5
3	CA	0.27	0/2401	0.53	0/3267
3	CB	0.27	0/2401	0.53	0/3267
3	CC	0.27	0/2401	0.53	0/3267
3	CD	0.27	0/2401	0.53	0/3267
3	CE	0.27	0/2401	0.52	0/3267
3	CF	0.27	0/2401	0.52	0/3267
3	CG	0.27	0/2401	0.52	0/3267
3	CH	0.27	0/2401	0.52	0/3267
3	CI	0.27	0/2401	0.52	0/3267
3	CJ	0.27	0/2401	0.52	0/3267
3	CK	0.27	0/2401	0.52	0/3267
3	CL	0.27	0/2401	0.52	0/3267
3	CM	0.27	0/2401	0.52	0/3267
3	CN	0.27	0/2401	0.52	0/3267
3	CO	0.27	0/2401	0.52	0/3267
3	CP	0.27	0/2401	0.52	0/3267
3	CQ	0.27	0/2401	0.52	0/3267
3	CR	0.27	0/2401	0.53	0/3267
3	CS	0.27	0/2401	0.53	0/3267
3	CT	0.27	0/2401	0.52	0/3267
3	CU	0.27	0/2401	0.53	0/3267
3	CV	0.27	0/2401	0.52	0/3267
3	CW	0.27	0/2401	0.52	0/3267
3	CX	0.27	0/2401	0.52	0/3267
3	CY	0.27	0/2401	0.52	0/3267
4	D1	0.25	0/629	0.59	0/851
4	D2	0.25	0/629	0.58	0/851
4	D3	0.25	0/629	0.58	0/851
4	D4	0.26	0/629	0.59	0/851
4	D5	0.26	0/629	0.59	0/851
4	D6	0.25	0/629	0.59	0/851
4	D7	0.25	0/629	0.58	0/851
4	D8	0.25	0/629	0.59	0/851
4	D9	0.25	0/629	0.59	0/851
4	DA	0.25	0/629	0.58	0/851
4	DB	0.25	0/629	0.58	0/851
4	DC	0.25	0/629	0.59	0/851
4	DD	0.26	0/629	0.59	0/851
4	DE	0.26	0/629	0.60	0/851
4	DF	0.25	0/629	0.59	0/851
4	DG	0.26	0/629	0.60	0/851
4	DH	0.25	0/629	0.58	0/851
4	DI	0.25	0/629	0.59	0/851

Mol	Chain	Bond lengths		Bond angles	
		RMSZ	# Z >5	RMSZ	# Z >5
4	DJ	0.26	0/629	0.59	0/851
4	DK	0.25	0/629	0.58	0/851
4	DL	0.26	0/629	0.59	0/851
4	DM	0.25	0/629	0.59	0/851
4	DN	0.25	0/629	0.59	0/851
4	DO	0.25	0/629	0.59	0/851
4	DP	0.25	0/629	0.59	0/851
4	DQ	0.28	0/629	0.62	0/851
4	DR	0.25	0/629	0.59	0/851
4	DS	0.26	0/629	0.59	0/851
4	DT	0.25	0/629	0.59	0/851
4	DU	0.26	0/629	0.60	0/851
4	DV	0.26	0/629	0.59	0/851
4	DW	0.25	0/629	0.58	0/851
4	DX	0.26	0/629	0.60	0/851
4	DY	0.29	0/629	0.61	0/851
4	E1	0.27	0/629	0.66	1/851 (0.1%)
4	E2	0.27	0/629	0.67	1/851 (0.1%)
4	E3	0.27	0/629	0.67	1/851 (0.1%)
4	E4	0.26	0/629	0.66	1/851 (0.1%)
4	E5	0.26	0/629	0.67	1/851 (0.1%)
4	E6	0.27	0/629	0.68	0/851
4	E7	0.27	0/629	0.66	1/851 (0.1%)
4	E8	0.26	0/629	0.67	1/851 (0.1%)
4	E9	0.27	0/629	0.68	1/851 (0.1%)
4	EA	0.26	0/629	0.67	1/851 (0.1%)
4	EB	0.29	0/629	0.75	2/851 (0.2%)
4	EC	0.26	0/629	0.66	1/851 (0.1%)
4	ED	0.29	0/629	0.65	0/851
4	EE	0.27	0/629	0.67	1/851 (0.1%)
4	EF	0.27	0/629	0.66	1/851 (0.1%)
4	EG	0.27	0/629	0.68	1/851 (0.1%)
4	EH	0.26	0/629	0.67	1/851 (0.1%)
4	EI	0.28	0/629	0.69	1/851 (0.1%)
4	EJ	0.26	0/629	0.66	1/851 (0.1%)
4	EK	0.26	0/629	0.67	1/851 (0.1%)
4	EL	0.27	0/629	0.66	1/851 (0.1%)
4	EM	0.28	0/629	0.69	2/851 (0.2%)
4	EN	0.28	0/629	0.70	2/851 (0.2%)
4	EO	0.28	0/629	0.71	2/851 (0.2%)
4	EP	0.28	0/629	0.66	1/851 (0.1%)
4	EQ	0.26	0/629	0.66	1/851 (0.1%)
4	ER	0.28	0/629	0.68	1/851 (0.1%)

Mol	Chain	Bond lengths		Bond angles	
		RMSZ	# Z >5	RMSZ	# Z >5
4	ES	0.26	0/629	0.66	1/851 (0.1%)
4	ET	0.27	0/629	0.66	1/851 (0.1%)
4	EU	0.27	0/629	0.68	1/851 (0.1%)
4	EV	0.27	0/629	0.66	1/851 (0.1%)
4	EW	0.27	0/629	0.67	1/851 (0.1%)
4	EX	0.27	0/629	0.67	1/851 (0.1%)
4	EY	0.27	0/629	0.67	1/851 (0.1%)
4	F1	0.26	0/631	0.64	0/851
4	F2	0.26	0/631	0.65	0/851
4	F3	0.26	0/631	0.64	0/851
4	F4	0.26	0/631	0.64	0/851
4	F5	0.27	0/631	0.67	0/851
4	F6	0.27	0/631	0.69	0/851
4	F7	0.29	0/631	0.70	1/851 (0.1%)
4	F8	0.28	0/631	0.68	0/851
4	F9	0.26	0/631	0.65	0/851
4	FA	0.27	0/631	0.65	0/851
4	FB	0.27	0/631	0.67	0/851
4	FC	0.28	0/631	0.66	0/851
4	FD	0.27	0/631	0.67	0/851
4	FE	0.27	0/631	0.67	0/851
4	FF	0.27	0/631	0.66	0/851
4	FG	0.28	0/631	0.69	1/851 (0.1%)
4	FH	0.27	0/631	0.66	0/851
4	FI	0.27	0/631	0.65	0/851
4	FJ	0.26	0/631	0.64	0/851
4	FK	0.28	0/631	0.65	0/851
4	FL	0.26	0/631	0.61	0/851
4	FM	0.27	0/631	0.65	0/851
4	FN	0.27	0/631	0.65	1/851 (0.1%)
4	FO	0.27	0/631	0.68	1/851 (0.1%)
4	FP	0.27	0/631	0.65	0/851
4	FQ	0.26	0/631	0.65	0/851
4	FR	0.27	0/631	0.65	0/851
4	FS	0.27	0/631	0.66	0/851
4	FT	0.27	0/631	0.67	0/851
4	FU	0.27	0/631	0.67	1/851 (0.1%)
4	FV	0.27	0/631	0.65	0/851
4	FW	0.27	0/631	0.66	0/851
4	FX	0.27	0/631	0.69	1/851 (0.1%)
4	FY	0.27	0/631	0.70	1/851 (0.1%)
All	All	0.26	0/247860	0.57	82/335206 (0.0%)

There are no bond length outliers.

The worst 5 of 82 bond angle outliers are listed below:

Mol	Chain	Res	Type	Atoms	Z	Observed(°)	Ideal(°)
4	EB	78	LEU	CA-CB-CG	9.15	136.36	115.30
4	E9	58	MET	CA-CB-CG	6.50	124.34	113.30
4	EL	58	MET	CA-CB-CG	6.20	123.84	113.30
4	EX	58	MET	CA-CB-CG	6.20	123.83	113.30
4	EA	58	MET	CA-CB-CG	6.18	123.81	113.30

There are no chirality outliers.

There are no planarity outliers.

5.2 Too-close contacts [i](#)

In the following table, the Non-H and H(model) columns list the number of non-hydrogen atoms and hydrogen atoms in the chain respectively. The H(added) column lists the number of hydrogen atoms added and optimized by MolProbity. The Clashes column lists the number of clashes within the asymmetric unit, whereas Symm-Clashes lists symmetry-related clashes.

Mol	Chain	Non-H	H(model)	H(added)	Clashes	Symm-Clashes
1	A1	393	0	384	24	0
1	A2	393	0	384	22	0
1	A3	393	0	384	23	0
1	A4	393	0	384	24	0
1	A5	393	0	384	23	0
1	A6	393	0	384	27	0
1	A7	393	0	384	24	0
1	A8	393	0	384	21	0
1	A9	393	0	384	25	0
1	AA	393	0	384	24	0
1	AB	393	0	384	20	0
1	AC	393	0	384	24	0
1	AD	393	0	384	20	0
1	AE	393	0	384	22	0
1	AF	393	0	384	24	0
1	AG	393	0	384	22	0
1	AH	393	0	384	25	0
1	AI	393	0	384	25	0
1	AJ	393	0	384	26	0
1	AK	393	0	384	22	0
1	AL	393	0	384	21	0
1	AM	393	0	384	24	0

Continued on next page...

Continued from previous page...

Mol	Chain	Non-H	H(model)	H(added)	Clashes	Symm-Clashes
1	AN	393	0	384	24	0
1	AO	393	0	384	25	0
1	AP	393	0	384	19	0
1	AQ	393	0	384	23	0
1	AR	393	0	384	20	0
1	AS	393	0	384	21	0
1	AT	393	0	384	24	0
1	AU	393	0	384	23	0
1	AV	393	0	384	21	0
1	AW	393	0	384	23	0
1	AX	393	0	384	21	0
1	AY	393	0	384	24	0
2	B1	2583	0	2632	118	0
2	B2	2583	0	2632	115	0
2	B3	2583	0	2632	114	0
2	B4	2583	0	2632	112	0
2	B5	2583	0	2632	110	0
2	B6	2583	0	2632	121	0
2	B7	2583	0	2632	113	0
2	B8	2583	0	2632	118	0
2	B9	2583	0	2632	110	0
2	BA	2583	0	2632	111	0
2	BB	2583	0	2632	130	0
2	BC	2583	0	2632	126	0
2	BD	2583	0	2632	118	0
2	BE	2583	0	2632	109	0
2	BF	2583	0	2632	106	0
2	BG	2583	0	2632	130	0
2	BH	2583	0	2632	126	0
2	BI	2583	0	2632	118	0
2	BJ	2583	0	2632	112	0
2	BK	2583	0	2632	119	0
2	BL	2583	0	2632	109	0
2	BM	2583	0	2632	102	0
2	BN	2583	0	2632	119	0
2	BO	2583	0	2632	116	0
2	BP	2583	0	2632	113	0
2	BQ	2583	0	2632	111	0
2	BR	2583	0	2632	117	0
2	BS	2583	0	2632	130	0
2	BT	2583	0	2632	129	0
2	BU	2583	0	2632	119	0

Continued on next page...

Continued from previous page...

Mol	Chain	Non-H	H(model)	H(added)	Clashes	Symm-Clashes
2	BV	2583	0	2632	112	0
2	BW	2583	0	2632	111	0
2	BX	2583	0	2632	111	0
2	BY	2583	0	2632	124	0
3	C1	2348	0	2376	94	0
3	C2	2348	0	2376	97	0
3	C3	2348	0	2376	96	0
3	C4	2348	0	2376	102	0
3	C5	2348	0	2376	93	0
3	C6	2348	0	2376	100	0
3	C7	2348	0	2376	96	0
3	C8	2348	0	2376	96	0
3	C9	2348	0	2376	96	0
3	CA	2348	0	2376	92	0
3	CB	2348	0	2376	103	0
3	CC	2348	0	2376	96	0
3	CD	2348	0	2376	100	0
3	CE	2348	0	2376	98	0
3	CF	2348	0	2376	99	0
3	CG	2348	0	2376	96	0
3	CH	2348	0	2376	97	0
3	CI	2348	0	2376	95	0
3	CJ	2348	0	2376	99	0
3	CK	2348	0	2376	94	0
3	CL	2348	0	2376	90	0
3	CM	2348	0	2376	99	0
3	CN	2348	0	2376	94	0
3	CO	2348	0	2376	91	0
3	CP	2348	0	2376	93	0
3	CQ	2348	0	2376	100	0
3	CR	2348	0	2376	91	0
3	CS	2348	0	2376	99	0
3	CT	2348	0	2376	96	0
3	CU	2348	0	2376	100	0
3	CV	2348	0	2376	101	0
3	CW	2348	0	2376	94	0
3	CX	2348	0	2376	98	0
3	CY	2348	0	2376	99	0
4	D1	625	0	676	38	0
4	D2	625	0	676	36	0
4	D3	625	0	676	33	0
4	D4	625	0	676	37	0

Continued on next page...

Continued from previous page...

Mol	Chain	Non-H	H(model)	H(added)	Clashes	Symm-Clashes
4	D5	625	0	676	36	0
4	D6	625	0	676	37	0
4	D7	625	0	676	37	0
4	D8	625	0	676	36	0
4	D9	625	0	676	36	0
4	DA	625	0	676	36	0
4	DB	625	0	676	36	0
4	DC	625	0	676	39	0
4	DD	625	0	676	37	0
4	DE	625	0	676	42	0
4	DF	625	0	676	36	0
4	DG	625	0	676	36	0
4	DH	625	0	676	36	0
4	DI	625	0	676	36	0
4	DJ	625	0	676	38	0
4	DK	625	0	676	36	0
4	DL	625	0	676	36	0
4	DM	625	0	676	37	0
4	DN	625	0	676	32	0
4	DO	625	0	676	33	0
4	DP	625	0	676	40	0
4	DQ	625	0	676	34	0
4	DR	625	0	676	37	0
4	DS	625	0	676	37	0
4	DT	625	0	676	39	0
4	DU	625	0	676	35	0
4	DV	625	0	676	39	0
4	DW	625	0	676	37	0
4	DX	625	0	676	36	0
4	DY	625	0	676	41	0
4	E1	625	0	676	43	0
4	E2	625	0	676	44	0
4	E3	625	0	676	40	0
4	E4	625	0	676	38	0
4	E5	625	0	676	40	0
4	E6	625	0	676	38	0
4	E7	625	0	676	40	0
4	E8	625	0	676	43	0
4	E9	625	0	676	41	0
4	EA	625	0	676	41	0
4	EB	625	0	676	45	0
4	EC	625	0	676	39	0

Continued on next page...

Continued from previous page...

Mol	Chain	Non-H	H(model)	H(added)	Clashes	Symm-Clashes
4	ED	625	0	676	40	0
4	EE	625	0	676	41	0
4	EF	625	0	676	43	0
4	EG	625	0	676	47	0
4	EH	625	0	676	46	0
4	EI	625	0	676	37	0
4	EJ	625	0	676	43	0
4	EK	625	0	676	39	0
4	EL	625	0	676	42	0
4	EM	625	0	676	47	0
4	EN	625	0	676	43	0
4	EO	625	0	676	37	0
4	EP	625	0	676	49	0
4	EQ	625	0	676	38	0
4	ER	625	0	676	50	0
4	ES	625	0	676	43	0
4	ET	625	0	676	38	0
4	EU	625	0	676	43	0
4	EV	625	0	676	41	0
4	EW	625	0	676	39	0
4	EX	625	0	676	44	0
4	EY	625	0	676	44	0
4	F1	627	0	679	48	0
4	F2	627	0	679	48	0
4	F3	627	0	679	45	0
4	F4	627	0	679	47	0
4	F5	627	0	679	46	0
4	F6	627	0	679	47	0
4	F7	627	0	679	42	0
4	F8	627	0	679	48	0
4	F9	627	0	679	45	0
4	FA	627	0	679	45	0
4	FB	627	0	679	45	0
4	FC	627	0	679	49	0
4	FD	627	0	679	47	0
4	FE	627	0	679	54	0
4	FF	627	0	679	44	0
4	FG	627	0	679	54	0
4	FH	627	0	679	48	0
4	FI	627	0	679	43	0
4	FJ	627	0	679	49	0
4	FK	627	0	679	45	0

Continued on next page...

Continued from previous page...

Mol	Chain	Non-H	H(model)	H(added)	Clashes	Symm-Clashes
4	FL	627	0	679	45	0
4	FM	627	0	679	48	0
4	FN	627	0	679	47	0
4	FO	627	0	679	45	0
4	FP	627	0	679	44	0
4	FQ	627	0	679	45	0
4	FR	627	0	679	49	0
4	FS	627	0	679	47	0
4	FT	627	0	679	44	0
4	FU	627	0	679	46	0
4	FV	627	0	679	46	0
4	FW	627	0	679	46	0
4	FX	627	0	679	49	0
4	FY	627	0	679	50	0
All	All	244834	0	252382	9447	0

The all-atom clashscore is defined as the number of clashes found per 1000 atoms (including hydrogen atoms). The all-atom clashscore for this structure is 19.

The worst 5 of 9447 close contacts within the same asymmetric unit are listed below, sorted by their clash magnitude.

Atom-1	Atom-2	Interatomic distance (Å)	Clash overlap (Å)
2:BW:251:LEU:HD22	2:BW:278:MET:HG2	1.50	0.94
2:BK:251:LEU:HD22	2:BK:278:MET:HG2	1.49	0.94
2:BF:251:LEU:HD22	2:BF:278:MET:HG2	1.50	0.93
2:B5:251:LEU:HD22	2:B5:278:MET:HG2	1.50	0.93
2:BD:251:LEU:HD22	2:BD:278:MET:HG2	1.49	0.93

There are no symmetry-related clashes.

5.3 Torsion angles [i](#)

5.3.1 Protein backbone [i](#)

In the following table, the Percentiles column shows the percent Ramachandran outliers of the chain as a percentile score with respect to all PDB entries followed by that with respect to all EM entries.

The Analysed column shows the number of residues for which the backbone conformation was analysed, and the total number of residues.

Mol	Chain	Analysed	Favoured	Allowed	Outliers	Percentiles	
1	A1	45/560 (8%)	45 (100%)	0	0	100	100
1	A2	45/560 (8%)	45 (100%)	0	0	100	100
1	A3	45/560 (8%)	45 (100%)	0	0	100	100
1	A4	45/560 (8%)	45 (100%)	0	0	100	100
1	A5	45/560 (8%)	45 (100%)	0	0	100	100
1	A6	45/560 (8%)	45 (100%)	0	0	100	100
1	A7	45/560 (8%)	45 (100%)	0	0	100	100
1	A8	45/560 (8%)	45 (100%)	0	0	100	100
1	A9	45/560 (8%)	45 (100%)	0	0	100	100
1	AA	45/560 (8%)	45 (100%)	0	0	100	100
1	AB	45/560 (8%)	45 (100%)	0	0	100	100
1	AC	45/560 (8%)	45 (100%)	0	0	100	100
1	AD	45/560 (8%)	45 (100%)	0	0	100	100
1	AE	45/560 (8%)	45 (100%)	0	0	100	100
1	AF	45/560 (8%)	45 (100%)	0	0	100	100
1	AG	45/560 (8%)	44 (98%)	1 (2%)	0	100	100
1	AH	45/560 (8%)	45 (100%)	0	0	100	100
1	AI	45/560 (8%)	45 (100%)	0	0	100	100
1	AJ	45/560 (8%)	45 (100%)	0	0	100	100
1	AK	45/560 (8%)	45 (100%)	0	0	100	100
1	AL	45/560 (8%)	45 (100%)	0	0	100	100
1	AM	45/560 (8%)	45 (100%)	0	0	100	100
1	AN	45/560 (8%)	45 (100%)	0	0	100	100
1	AO	45/560 (8%)	45 (100%)	0	0	100	100
1	AP	45/560 (8%)	45 (100%)	0	0	100	100
1	AQ	45/560 (8%)	45 (100%)	0	0	100	100
1	AR	45/560 (8%)	45 (100%)	0	0	100	100
1	AS	45/560 (8%)	45 (100%)	0	0	100	100
1	AT	45/560 (8%)	45 (100%)	0	0	100	100
1	AU	45/560 (8%)	45 (100%)	0	0	100	100
1	AV	45/560 (8%)	45 (100%)	0	0	100	100
1	AW	45/560 (8%)	45 (100%)	0	0	100	100

Continued on next page...

Continued from previous page...

Mol	Chain	Analysed	Favoured	Allowed	Outliers	Percentiles	
1	AX	45/560 (8%)	44 (98%)	1 (2%)	0	100	100
1	AY	45/560 (8%)	45 (100%)	0	0	100	100
2	B1	329/331 (99%)	315 (96%)	11 (3%)	3 (1%)	17	56
2	B2	329/331 (99%)	312 (95%)	15 (5%)	2 (1%)	25	65
2	B3	329/331 (99%)	315 (96%)	12 (4%)	2 (1%)	25	65
2	B4	329/331 (99%)	312 (95%)	14 (4%)	3 (1%)	17	56
2	B5	329/331 (99%)	314 (95%)	12 (4%)	3 (1%)	17	56
2	B6	329/331 (99%)	315 (96%)	11 (3%)	3 (1%)	17	56
2	B7	329/331 (99%)	313 (95%)	13 (4%)	3 (1%)	17	56
2	B8	329/331 (99%)	311 (94%)	15 (5%)	3 (1%)	17	56
2	B9	329/331 (99%)	315 (96%)	11 (3%)	3 (1%)	17	56
2	BA	329/331 (99%)	313 (95%)	13 (4%)	3 (1%)	17	56
2	BB	329/331 (99%)	312 (95%)	15 (5%)	2 (1%)	25	65
2	BC	329/331 (99%)	315 (96%)	11 (3%)	3 (1%)	17	56
2	BD	329/331 (99%)	315 (96%)	11 (3%)	3 (1%)	17	56
2	BE	329/331 (99%)	314 (95%)	12 (4%)	3 (1%)	17	56
2	BF	329/331 (99%)	311 (94%)	15 (5%)	3 (1%)	17	56
2	BG	329/331 (99%)	313 (95%)	13 (4%)	3 (1%)	17	56
2	BH	329/331 (99%)	313 (95%)	13 (4%)	3 (1%)	17	56
2	BI	329/331 (99%)	314 (95%)	12 (4%)	3 (1%)	17	56
2	BJ	329/331 (99%)	312 (95%)	15 (5%)	2 (1%)	25	65
2	BK	329/331 (99%)	311 (94%)	15 (5%)	3 (1%)	17	56
2	BL	329/331 (99%)	315 (96%)	11 (3%)	3 (1%)	17	56
2	BM	329/331 (99%)	310 (94%)	17 (5%)	2 (1%)	25	65
2	BN	329/331 (99%)	314 (95%)	13 (4%)	2 (1%)	25	65
2	BO	329/331 (99%)	314 (95%)	12 (4%)	3 (1%)	17	56
2	BP	329/331 (99%)	313 (95%)	13 (4%)	3 (1%)	17	56
2	BQ	329/331 (99%)	314 (95%)	12 (4%)	3 (1%)	17	56
2	BR	329/331 (99%)	313 (95%)	14 (4%)	2 (1%)	25	65
2	BS	329/331 (99%)	313 (95%)	14 (4%)	2 (1%)	25	65
2	BT	329/331 (99%)	313 (95%)	13 (4%)	3 (1%)	17	56

Continued on next page...

Continued from previous page...

Mol	Chain	Analysed	Favoured	Allowed	Outliers	Percentiles	
2	BU	329/331 (99%)	314 (95%)	12 (4%)	3 (1%)	17	56
2	BV	329/331 (99%)	314 (95%)	12 (4%)	3 (1%)	17	56
2	BW	329/331 (99%)	317 (96%)	9 (3%)	3 (1%)	17	56
2	BX	329/331 (99%)	311 (94%)	15 (5%)	3 (1%)	17	56
2	BY	329/331 (99%)	313 (95%)	13 (4%)	3 (1%)	17	56
3	C1	288/334 (86%)	278 (96%)	10 (4%)	0	100	100
3	C2	288/334 (86%)	277 (96%)	11 (4%)	0	100	100
3	C3	288/334 (86%)	277 (96%)	11 (4%)	0	100	100
3	C4	288/334 (86%)	278 (96%)	10 (4%)	0	100	100
3	C5	288/334 (86%)	277 (96%)	11 (4%)	0	100	100
3	C6	288/334 (86%)	278 (96%)	10 (4%)	0	100	100
3	C7	288/334 (86%)	277 (96%)	11 (4%)	0	100	100
3	C8	288/334 (86%)	275 (96%)	13 (4%)	0	100	100
3	C9	288/334 (86%)	277 (96%)	11 (4%)	0	100	100
3	CA	288/334 (86%)	277 (96%)	11 (4%)	0	100	100
3	CB	288/334 (86%)	275 (96%)	13 (4%)	0	100	100
3	CC	288/334 (86%)	277 (96%)	11 (4%)	0	100	100
3	CD	288/334 (86%)	279 (97%)	9 (3%)	0	100	100
3	CE	288/334 (86%)	277 (96%)	11 (4%)	0	100	100
3	CF	288/334 (86%)	277 (96%)	11 (4%)	0	100	100
3	CG	288/334 (86%)	275 (96%)	13 (4%)	0	100	100
3	CH	288/334 (86%)	277 (96%)	11 (4%)	0	100	100
3	CI	288/334 (86%)	278 (96%)	10 (4%)	0	100	100
3	CJ	288/334 (86%)	277 (96%)	11 (4%)	0	100	100
3	CK	288/334 (86%)	276 (96%)	12 (4%)	0	100	100
3	CL	288/334 (86%)	276 (96%)	12 (4%)	0	100	100
3	CM	288/334 (86%)	276 (96%)	12 (4%)	0	100	100
3	CN	288/334 (86%)	278 (96%)	10 (4%)	0	100	100
3	CO	288/334 (86%)	277 (96%)	11 (4%)	0	100	100
3	CP	288/334 (86%)	277 (96%)	11 (4%)	0	100	100
3	CQ	288/334 (86%)	278 (96%)	10 (4%)	0	100	100

Continued on next page...

Continued from previous page...

Mol	Chain	Analysed	Favoured	Allowed	Outliers	Percentiles	
3	CR	288/334 (86%)	278 (96%)	10 (4%)	0	100	100
3	CS	288/334 (86%)	278 (96%)	10 (4%)	0	100	100
3	CT	288/334 (86%)	277 (96%)	11 (4%)	0	100	100
3	CU	288/334 (86%)	278 (96%)	10 (4%)	0	100	100
3	CV	288/334 (86%)	277 (96%)	11 (4%)	0	100	100
3	CW	288/334 (86%)	275 (96%)	13 (4%)	0	100	100
3	CX	288/334 (86%)	276 (96%)	12 (4%)	0	100	100
3	CY	288/334 (86%)	275 (96%)	13 (4%)	0	100	100
4	D1	79/137 (58%)	71 (90%)	8 (10%)	0	100	100
4	D2	79/137 (58%)	71 (90%)	8 (10%)	0	100	100
4	D3	79/137 (58%)	70 (89%)	9 (11%)	0	100	100
4	D4	79/137 (58%)	71 (90%)	8 (10%)	0	100	100
4	D5	79/137 (58%)	71 (90%)	8 (10%)	0	100	100
4	D6	79/137 (58%)	71 (90%)	8 (10%)	0	100	100
4	D7	79/137 (58%)	71 (90%)	8 (10%)	0	100	100
4	D8	79/137 (58%)	71 (90%)	8 (10%)	0	100	100
4	D9	79/137 (58%)	71 (90%)	8 (10%)	0	100	100
4	DA	79/137 (58%)	71 (90%)	8 (10%)	0	100	100
4	DB	79/137 (58%)	71 (90%)	8 (10%)	0	100	100
4	DC	79/137 (58%)	71 (90%)	8 (10%)	0	100	100
4	DD	79/137 (58%)	71 (90%)	8 (10%)	0	100	100
4	DE	79/137 (58%)	72 (91%)	7 (9%)	0	100	100
4	DF	79/137 (58%)	71 (90%)	8 (10%)	0	100	100
4	DG	79/137 (58%)	71 (90%)	8 (10%)	0	100	100
4	DH	79/137 (58%)	71 (90%)	8 (10%)	0	100	100
4	DI	79/137 (58%)	71 (90%)	8 (10%)	0	100	100
4	DJ	79/137 (58%)	71 (90%)	8 (10%)	0	100	100
4	DK	79/137 (58%)	71 (90%)	8 (10%)	0	100	100
4	DL	79/137 (58%)	71 (90%)	8 (10%)	0	100	100
4	DM	79/137 (58%)	71 (90%)	8 (10%)	0	100	100
4	DN	79/137 (58%)	70 (89%)	9 (11%)	0	100	100

Continued on next page...

Continued from previous page...

Mol	Chain	Analysed	Favoured	Allowed	Outliers	Percentiles	
4	DO	79/137 (58%)	71 (90%)	8 (10%)	0	100	100
4	DP	79/137 (58%)	71 (90%)	8 (10%)	0	100	100
4	DQ	79/137 (58%)	70 (89%)	9 (11%)	0	100	100
4	DR	79/137 (58%)	70 (89%)	9 (11%)	0	100	100
4	DS	79/137 (58%)	71 (90%)	8 (10%)	0	100	100
4	DT	79/137 (58%)	71 (90%)	8 (10%)	0	100	100
4	DU	79/137 (58%)	71 (90%)	8 (10%)	0	100	100
4	DV	79/137 (58%)	72 (91%)	7 (9%)	0	100	100
4	DW	79/137 (58%)	70 (89%)	9 (11%)	0	100	100
4	DX	79/137 (58%)	71 (90%)	8 (10%)	0	100	100
4	DY	79/137 (58%)	72 (91%)	7 (9%)	0	100	100
4	E1	79/137 (58%)	74 (94%)	4 (5%)	1 (1%)	12	48
4	E2	79/137 (58%)	74 (94%)	4 (5%)	1 (1%)	12	48
4	E3	79/137 (58%)	74 (94%)	4 (5%)	1 (1%)	12	48
4	E4	79/137 (58%)	74 (94%)	4 (5%)	1 (1%)	12	48
4	E5	79/137 (58%)	74 (94%)	4 (5%)	1 (1%)	12	48
4	E6	79/137 (58%)	75 (95%)	3 (4%)	1 (1%)	12	48
4	E7	79/137 (58%)	74 (94%)	4 (5%)	1 (1%)	12	48
4	E8	79/137 (58%)	74 (94%)	4 (5%)	1 (1%)	12	48
4	E9	79/137 (58%)	74 (94%)	4 (5%)	1 (1%)	12	48
4	EA	79/137 (58%)	74 (94%)	4 (5%)	1 (1%)	12	48
4	EB	79/137 (58%)	75 (95%)	3 (4%)	1 (1%)	12	48
4	EC	79/137 (58%)	75 (95%)	3 (4%)	1 (1%)	12	48
4	ED	79/137 (58%)	77 (98%)	1 (1%)	1 (1%)	12	48
4	EE	79/137 (58%)	74 (94%)	4 (5%)	1 (1%)	12	48
4	EF	79/137 (58%)	73 (92%)	5 (6%)	1 (1%)	12	48
4	EG	79/137 (58%)	74 (94%)	4 (5%)	1 (1%)	12	48
4	EH	79/137 (58%)	73 (92%)	5 (6%)	1 (1%)	12	48
4	EI	79/137 (58%)	74 (94%)	4 (5%)	1 (1%)	12	48
4	EJ	79/137 (58%)	74 (94%)	4 (5%)	1 (1%)	12	48
4	EK	79/137 (58%)	74 (94%)	4 (5%)	1 (1%)	12	48

Continued on next page...

Continued from previous page...

Mol	Chain	Analysed	Favoured	Allowed	Outliers	Percentiles	
4	EL	79/137 (58%)	74 (94%)	4 (5%)	1 (1%)	12	48
4	EM	79/137 (58%)	74 (94%)	4 (5%)	1 (1%)	12	48
4	EN	79/137 (58%)	75 (95%)	3 (4%)	1 (1%)	12	48
4	EO	79/137 (58%)	73 (92%)	5 (6%)	1 (1%)	12	48
4	EP	79/137 (58%)	75 (95%)	3 (4%)	1 (1%)	12	48
4	EQ	79/137 (58%)	74 (94%)	4 (5%)	1 (1%)	12	48
4	ER	79/137 (58%)	76 (96%)	2 (2%)	1 (1%)	12	48
4	ES	79/137 (58%)	74 (94%)	4 (5%)	1 (1%)	12	48
4	ET	79/137 (58%)	75 (95%)	3 (4%)	1 (1%)	12	48
4	EU	79/137 (58%)	74 (94%)	4 (5%)	1 (1%)	12	48
4	EV	79/137 (58%)	74 (94%)	4 (5%)	1 (1%)	12	48
4	EW	79/137 (58%)	74 (94%)	4 (5%)	1 (1%)	12	48
4	EX	79/137 (58%)	74 (94%)	4 (5%)	1 (1%)	12	48
4	EY	79/137 (58%)	74 (94%)	4 (5%)	1 (1%)	12	48
4	F1	79/137 (58%)	76 (96%)	3 (4%)	0	100	100
4	F2	79/137 (58%)	76 (96%)	3 (4%)	0	100	100
4	F3	79/137 (58%)	76 (96%)	3 (4%)	0	100	100
4	F4	79/137 (58%)	76 (96%)	3 (4%)	0	100	100
4	F5	79/137 (58%)	76 (96%)	3 (4%)	0	100	100
4	F6	79/137 (58%)	75 (95%)	4 (5%)	0	100	100
4	F7	79/137 (58%)	75 (95%)	4 (5%)	0	100	100
4	F8	79/137 (58%)	76 (96%)	3 (4%)	0	100	100
4	F9	79/137 (58%)	76 (96%)	3 (4%)	0	100	100
4	FA	79/137 (58%)	77 (98%)	2 (2%)	0	100	100
4	FB	79/137 (58%)	75 (95%)	4 (5%)	0	100	100
4	FC	79/137 (58%)	74 (94%)	5 (6%)	0	100	100
4	FD	79/137 (58%)	74 (94%)	5 (6%)	0	100	100
4	FE	79/137 (58%)	76 (96%)	3 (4%)	0	100	100
4	FF	79/137 (58%)	75 (95%)	4 (5%)	0	100	100
4	FG	79/137 (58%)	76 (96%)	3 (4%)	0	100	100
4	FH	79/137 (58%)	77 (98%)	2 (2%)	0	100	100

Continued on next page...

Continued from previous page...

Mol	Chain	Analysed	Favoured	Allowed	Outliers	Percentiles	
4	FI	79/137 (58%)	76 (96%)	3 (4%)	0	100	100
4	FJ	79/137 (58%)	75 (95%)	4 (5%)	0	100	100
4	FK	79/137 (58%)	76 (96%)	3 (4%)	0	100	100
4	FL	79/137 (58%)	76 (96%)	3 (4%)	0	100	100
4	FM	79/137 (58%)	76 (96%)	3 (4%)	0	100	100
4	FN	79/137 (58%)	76 (96%)	3 (4%)	0	100	100
4	FO	79/137 (58%)	76 (96%)	3 (4%)	0	100	100
4	FP	79/137 (58%)	75 (95%)	4 (5%)	0	100	100
4	FQ	79/137 (58%)	76 (96%)	3 (4%)	0	100	100
4	FR	79/137 (58%)	76 (96%)	3 (4%)	0	100	100
4	FS	79/137 (58%)	76 (96%)	3 (4%)	0	100	100
4	FT	79/137 (58%)	76 (96%)	3 (4%)	0	100	100
4	FU	79/137 (58%)	76 (96%)	3 (4%)	0	100	100
4	FV	79/137 (58%)	76 (96%)	3 (4%)	0	100	100
4	FW	79/137 (58%)	76 (96%)	3 (4%)	0	100	100
4	FX	79/137 (58%)	76 (96%)	3 (4%)	0	100	100
4	FY	79/137 (58%)	76 (96%)	3 (4%)	0	100	100
All	All	30566/55624 (55%)	29108 (95%)	1330 (4%)	128 (0%)	38	72

5 of 128 Ramachandran outliers are listed below:

Mol	Chain	Res	Type
4	E1	126	ILE
4	E2	126	ILE
4	E3	126	ILE
4	E4	126	ILE
4	E5	126	ILE

5.3.2 Protein sidechains [i](#)

In the following table, the Percentiles column shows the percent sidechain outliers of the chain as a percentile score with respect to all PDB entries followed by that with respect to all EM entries.

The Analysed column shows the number of residues for which the sidechain conformation was analysed, and the total number of residues.

Mol	Chain	Analysed	Rotameric	Outliers	Percentiles	
1	A1	43/467 (9%)	43 (100%)	0	100	100
1	A2	43/467 (9%)	43 (100%)	0	100	100
1	A3	43/467 (9%)	43 (100%)	0	100	100
1	A4	43/467 (9%)	43 (100%)	0	100	100
1	A5	43/467 (9%)	43 (100%)	0	100	100
1	A6	43/467 (9%)	43 (100%)	0	100	100
1	A7	43/467 (9%)	43 (100%)	0	100	100
1	A8	43/467 (9%)	43 (100%)	0	100	100
1	A9	43/467 (9%)	43 (100%)	0	100	100
1	AA	43/467 (9%)	43 (100%)	0	100	100
1	AB	43/467 (9%)	43 (100%)	0	100	100
1	AC	43/467 (9%)	43 (100%)	0	100	100
1	AD	43/467 (9%)	43 (100%)	0	100	100
1	AE	43/467 (9%)	43 (100%)	0	100	100
1	AF	43/467 (9%)	43 (100%)	0	100	100
1	AG	43/467 (9%)	43 (100%)	0	100	100
1	AH	43/467 (9%)	43 (100%)	0	100	100
1	AI	43/467 (9%)	43 (100%)	0	100	100
1	AJ	43/467 (9%)	43 (100%)	0	100	100
1	AK	43/467 (9%)	43 (100%)	0	100	100
1	AL	43/467 (9%)	43 (100%)	0	100	100
1	AM	43/467 (9%)	43 (100%)	0	100	100
1	AN	43/467 (9%)	43 (100%)	0	100	100
1	AO	43/467 (9%)	43 (100%)	0	100	100
1	AP	43/467 (9%)	43 (100%)	0	100	100
1	AQ	43/467 (9%)	43 (100%)	0	100	100
1	AR	43/467 (9%)	43 (100%)	0	100	100
1	AS	43/467 (9%)	43 (100%)	0	100	100
1	AT	43/467 (9%)	43 (100%)	0	100	100
1	AU	43/467 (9%)	43 (100%)	0	100	100
1	AV	43/467 (9%)	43 (100%)	0	100	100
1	AW	43/467 (9%)	43 (100%)	0	100	100

Continued on next page...

Continued from previous page...

Mol	Chain	Analysed	Rotameric	Outliers	Percentiles	
1	AX	43/467 (9%)	43 (100%)	0	100	100
1	AY	43/467 (9%)	43 (100%)	0	100	100
2	B1	282/282 (100%)	280 (99%)	2 (1%)	84	90
2	B2	282/282 (100%)	282 (100%)	0	100	100
2	B3	282/282 (100%)	281 (100%)	1 (0%)	91	94
2	B4	282/282 (100%)	281 (100%)	1 (0%)	91	94
2	B5	282/282 (100%)	281 (100%)	1 (0%)	91	94
2	B6	282/282 (100%)	282 (100%)	0	100	100
2	B7	282/282 (100%)	282 (100%)	0	100	100
2	B8	282/282 (100%)	281 (100%)	1 (0%)	91	94
2	B9	282/282 (100%)	282 (100%)	0	100	100
2	BA	282/282 (100%)	281 (100%)	1 (0%)	91	94
2	BB	282/282 (100%)	281 (100%)	1 (0%)	91	94
2	BC	282/282 (100%)	281 (100%)	1 (0%)	91	94
2	BD	282/282 (100%)	282 (100%)	0	100	100
2	BE	282/282 (100%)	280 (99%)	2 (1%)	84	90
2	BF	282/282 (100%)	281 (100%)	1 (0%)	91	94
2	BG	282/282 (100%)	281 (100%)	1 (0%)	91	94
2	BH	282/282 (100%)	281 (100%)	1 (0%)	91	94
2	BI	282/282 (100%)	281 (100%)	1 (0%)	91	94
2	BJ	282/282 (100%)	282 (100%)	0	100	100
2	BK	282/282 (100%)	281 (100%)	1 (0%)	91	94
2	BL	282/282 (100%)	281 (100%)	1 (0%)	91	94
2	BM	282/282 (100%)	281 (100%)	1 (0%)	91	94
2	BN	282/282 (100%)	282 (100%)	0	100	100
2	BO	282/282 (100%)	281 (100%)	1 (0%)	91	94
2	BP	282/282 (100%)	282 (100%)	0	100	100
2	BQ	282/282 (100%)	282 (100%)	0	100	100
2	BR	282/282 (100%)	282 (100%)	0	100	100
2	BS	282/282 (100%)	282 (100%)	0	100	100
2	BT	282/282 (100%)	280 (99%)	2 (1%)	84	90

Continued on next page...

Continued from previous page...

Mol	Chain	Analysed	Rotameric	Outliers	Percentiles	
2	BU	282/282 (100%)	281 (100%)	1 (0%)	91	94
2	BV	282/282 (100%)	281 (100%)	1 (0%)	91	94
2	BW	282/282 (100%)	281 (100%)	1 (0%)	91	94
2	BX	282/282 (100%)	280 (99%)	2 (1%)	84	90
2	BY	282/282 (100%)	281 (100%)	1 (0%)	91	94
3	C1	263/301 (87%)	261 (99%)	2 (1%)	81	89
3	C2	263/301 (87%)	262 (100%)	1 (0%)	91	94
3	C3	263/301 (87%)	262 (100%)	1 (0%)	91	94
3	C4	263/301 (87%)	262 (100%)	1 (0%)	91	94
3	C5	263/301 (87%)	261 (99%)	2 (1%)	81	89
3	C6	263/301 (87%)	261 (99%)	2 (1%)	81	89
3	C7	263/301 (87%)	262 (100%)	1 (0%)	91	94
3	C8	263/301 (87%)	262 (100%)	1 (0%)	91	94
3	C9	263/301 (87%)	262 (100%)	1 (0%)	91	94
3	CA	263/301 (87%)	262 (100%)	1 (0%)	91	94
3	CB	263/301 (87%)	262 (100%)	1 (0%)	91	94
3	CC	263/301 (87%)	261 (99%)	2 (1%)	81	89
3	CD	263/301 (87%)	262 (100%)	1 (0%)	91	94
3	CE	263/301 (87%)	262 (100%)	1 (0%)	91	94
3	CF	263/301 (87%)	261 (99%)	2 (1%)	81	89
3	CG	263/301 (87%)	262 (100%)	1 (0%)	91	94
3	CH	263/301 (87%)	261 (99%)	2 (1%)	81	89
3	CI	263/301 (87%)	262 (100%)	1 (0%)	91	94
3	CJ	263/301 (87%)	262 (100%)	1 (0%)	91	94
3	CK	263/301 (87%)	262 (100%)	1 (0%)	91	94
3	CL	263/301 (87%)	262 (100%)	1 (0%)	91	94
3	CM	263/301 (87%)	262 (100%)	1 (0%)	91	94
3	CN	263/301 (87%)	262 (100%)	1 (0%)	91	94
3	CO	263/301 (87%)	262 (100%)	1 (0%)	91	94
3	CP	263/301 (87%)	261 (99%)	2 (1%)	81	89
3	CQ	263/301 (87%)	262 (100%)	1 (0%)	91	94

Continued on next page...

Continued from previous page...

Mol	Chain	Analysed	Rotameric	Outliers	Percentiles	
3	CR	263/301 (87%)	262 (100%)	1 (0%)	91	94
3	CS	263/301 (87%)	262 (100%)	1 (0%)	91	94
3	CT	263/301 (87%)	262 (100%)	1 (0%)	91	94
3	CU	263/301 (87%)	262 (100%)	1 (0%)	91	94
3	CV	263/301 (87%)	262 (100%)	1 (0%)	91	94
3	CW	263/301 (87%)	261 (99%)	2 (1%)	81	89
3	CX	263/301 (87%)	262 (100%)	1 (0%)	91	94
3	CY	263/301 (87%)	262 (100%)	1 (0%)	91	94
4	D1	70/113 (62%)	70 (100%)	0	100	100
4	D2	70/113 (62%)	70 (100%)	0	100	100
4	D3	70/113 (62%)	70 (100%)	0	100	100
4	D4	70/113 (62%)	70 (100%)	0	100	100
4	D5	70/113 (62%)	70 (100%)	0	100	100
4	D6	70/113 (62%)	70 (100%)	0	100	100
4	D7	70/113 (62%)	70 (100%)	0	100	100
4	D8	70/113 (62%)	70 (100%)	0	100	100
4	D9	70/113 (62%)	70 (100%)	0	100	100
4	DA	70/113 (62%)	70 (100%)	0	100	100
4	DB	70/113 (62%)	70 (100%)	0	100	100
4	DC	70/113 (62%)	70 (100%)	0	100	100
4	DD	70/113 (62%)	70 (100%)	0	100	100
4	DE	70/113 (62%)	70 (100%)	0	100	100
4	DF	70/113 (62%)	70 (100%)	0	100	100
4	DG	70/113 (62%)	70 (100%)	0	100	100
4	DH	70/113 (62%)	70 (100%)	0	100	100
4	DI	70/113 (62%)	70 (100%)	0	100	100
4	DJ	70/113 (62%)	70 (100%)	0	100	100
4	DK	70/113 (62%)	70 (100%)	0	100	100
4	DL	70/113 (62%)	70 (100%)	0	100	100
4	DM	70/113 (62%)	70 (100%)	0	100	100
4	DN	70/113 (62%)	70 (100%)	0	100	100

Continued on next page...

Continued from previous page...

Mol	Chain	Analysed	Rotameric	Outliers	Percentiles	
4	DO	70/113 (62%)	70 (100%)	0	100	100
4	DP	70/113 (62%)	70 (100%)	0	100	100
4	DQ	70/113 (62%)	70 (100%)	0	100	100
4	DR	70/113 (62%)	70 (100%)	0	100	100
4	DS	70/113 (62%)	70 (100%)	0	100	100
4	DT	70/113 (62%)	70 (100%)	0	100	100
4	DU	70/113 (62%)	70 (100%)	0	100	100
4	DV	70/113 (62%)	70 (100%)	0	100	100
4	DW	70/113 (62%)	70 (100%)	0	100	100
4	DX	70/113 (62%)	70 (100%)	0	100	100
4	DY	70/113 (62%)	70 (100%)	0	100	100
4	E1	70/113 (62%)	70 (100%)	0	100	100
4	E2	70/113 (62%)	70 (100%)	0	100	100
4	E3	70/113 (62%)	70 (100%)	0	100	100
4	E4	70/113 (62%)	70 (100%)	0	100	100
4	E5	70/113 (62%)	70 (100%)	0	100	100
4	E6	70/113 (62%)	70 (100%)	0	100	100
4	E7	70/113 (62%)	70 (100%)	0	100	100
4	E8	70/113 (62%)	70 (100%)	0	100	100
4	E9	70/113 (62%)	70 (100%)	0	100	100
4	EA	70/113 (62%)	70 (100%)	0	100	100
4	EB	70/113 (62%)	70 (100%)	0	100	100
4	EC	70/113 (62%)	70 (100%)	0	100	100
4	ED	70/113 (62%)	70 (100%)	0	100	100
4	EE	70/113 (62%)	70 (100%)	0	100	100
4	EF	70/113 (62%)	70 (100%)	0	100	100
4	EG	70/113 (62%)	70 (100%)	0	100	100
4	EH	70/113 (62%)	70 (100%)	0	100	100
4	EI	70/113 (62%)	69 (99%)	1 (1%)	67	81
4	EJ	70/113 (62%)	70 (100%)	0	100	100
4	EK	70/113 (62%)	70 (100%)	0	100	100

Continued on next page...

Continued from previous page...

Mol	Chain	Analysed	Rotameric	Outliers	Percentiles	
4	EL	70/113 (62%)	70 (100%)	0	100	100
4	EM	70/113 (62%)	70 (100%)	0	100	100
4	EN	70/113 (62%)	70 (100%)	0	100	100
4	EO	70/113 (62%)	70 (100%)	0	100	100
4	EP	70/113 (62%)	70 (100%)	0	100	100
4	EQ	70/113 (62%)	70 (100%)	0	100	100
4	ER	70/113 (62%)	70 (100%)	0	100	100
4	ES	70/113 (62%)	70 (100%)	0	100	100
4	ET	70/113 (62%)	70 (100%)	0	100	100
4	EU	70/113 (62%)	70 (100%)	0	100	100
4	EV	70/113 (62%)	70 (100%)	0	100	100
4	EW	70/113 (62%)	70 (100%)	0	100	100
4	EX	70/113 (62%)	70 (100%)	0	100	100
4	EY	70/113 (62%)	70 (100%)	0	100	100
4	F1	70/113 (62%)	70 (100%)	0	100	100
4	F2	70/113 (62%)	70 (100%)	0	100	100
4	F3	70/113 (62%)	70 (100%)	0	100	100
4	F4	70/113 (62%)	70 (100%)	0	100	100
4	F5	70/113 (62%)	70 (100%)	0	100	100
4	F6	70/113 (62%)	70 (100%)	0	100	100
4	F7	70/113 (62%)	70 (100%)	0	100	100
4	F8	70/113 (62%)	70 (100%)	0	100	100
4	F9	70/113 (62%)	70 (100%)	0	100	100
4	FA	70/113 (62%)	70 (100%)	0	100	100
4	FB	70/113 (62%)	70 (100%)	0	100	100
4	FC	70/113 (62%)	70 (100%)	0	100	100
4	FD	70/113 (62%)	70 (100%)	0	100	100
4	FE	70/113 (62%)	70 (100%)	0	100	100
4	FF	70/113 (62%)	70 (100%)	0	100	100
4	FG	70/113 (62%)	70 (100%)	0	100	100
4	FH	70/113 (62%)	70 (100%)	0	100	100

Continued on next page...

Continued from previous page...

Mol	Chain	Analysed	Rotameric	Outliers	Percentiles	
4	FI	70/113 (62%)	70 (100%)	0	100	100
4	FJ	70/113 (62%)	70 (100%)	0	100	100
4	FK	70/113 (62%)	70 (100%)	0	100	100
4	FL	70/113 (62%)	70 (100%)	0	100	100
4	FM	70/113 (62%)	70 (100%)	0	100	100
4	FN	70/113 (62%)	70 (100%)	0	100	100
4	FO	70/113 (62%)	70 (100%)	0	100	100
4	FP	70/113 (62%)	70 (100%)	0	100	100
4	FQ	70/113 (62%)	70 (100%)	0	100	100
4	FR	70/113 (62%)	70 (100%)	0	100	100
4	FS	70/113 (62%)	70 (100%)	0	100	100
4	FT	70/113 (62%)	70 (100%)	0	100	100
4	FU	70/113 (62%)	70 (100%)	0	100	100
4	FV	70/113 (62%)	70 (100%)	0	100	100
4	FW	70/113 (62%)	70 (100%)	0	100	100
4	FX	70/113 (62%)	70 (100%)	0	100	100
4	FY	70/113 (62%)	70 (100%)	0	100	100
All	All	27132/47226 (58%)	27062 (100%)	70 (0%)	92	95

5 of 70 residues with a non-rotameric sidechain are listed below:

Mol	Chain	Res	Type
3	CT	36	ARG
3	CU	36	ARG
2	BX	32	ARG
3	CC	85	ARG
3	CC	36	ARG

Sometimes sidechains can be flipped to improve hydrogen bonding and reduce clashes. 5 of 297 such sidechains are listed below:

Mol	Chain	Res	Type
3	CR	64	GLN
1	AY	525	GLN
2	BS	204	ASN
1	AV	525	GLN

Continued on next page...

Continued from previous page...

Mol	Chain	Res	Type
2	BC	46	GLN

5.3.3 RNA [i](#)

There are no RNA molecules in this entry.

5.4 Non-standard residues in protein, DNA, RNA chains [i](#)

There are no non-standard protein/DNA/RNA residues in this entry.

5.5 Carbohydrates [i](#)

There are no monosaccharides in this entry.

5.6 Ligand geometry [i](#)

There are no ligands in this entry.

5.7 Other polymers [i](#)

There are no such residues in this entry.

5.8 Polymer linkage issues [i](#)

There are no chain breaks in this entry.

6 Map visualisation [i](#)

This section contains visualisations of the EMDB entry EMD-42439. These allow visual inspection of the internal detail of the map and identification of artifacts.

Images derived from a raw map, generated by summing the deposited half-maps, are presented below the corresponding image components of the primary map to allow further visual inspection and comparison with those of the primary map.

6.1 Orthogonal projections [i](#)

6.1.1 Primary map

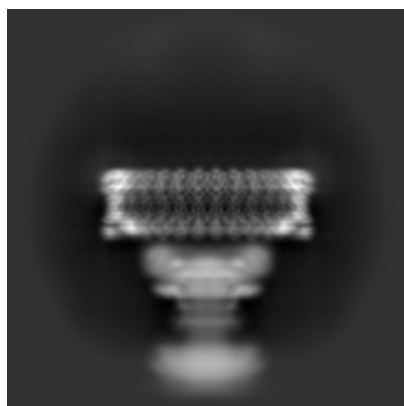

X

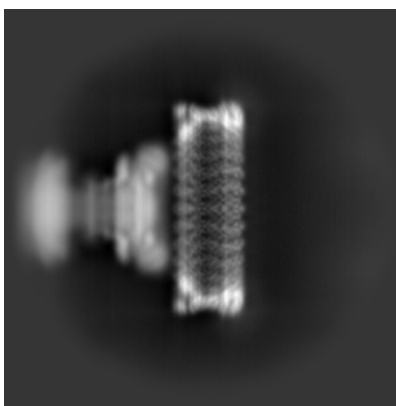

Y



Z

6.1.2 Raw map

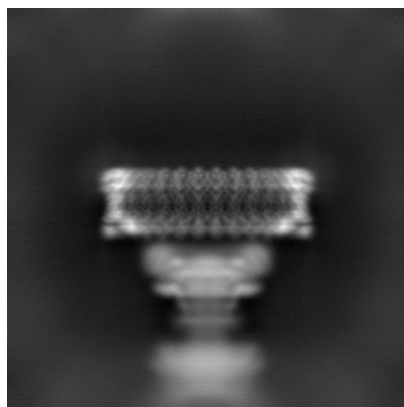

X

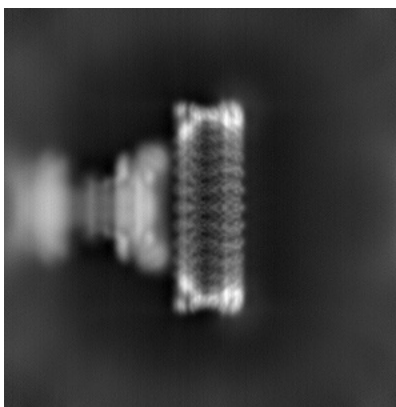

Y

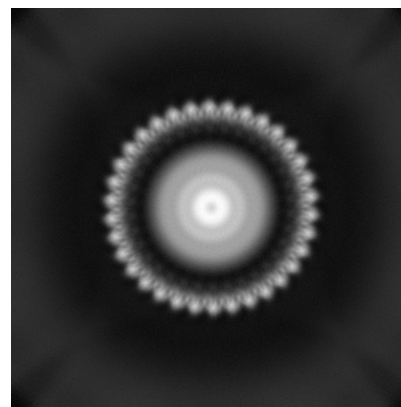

Z

The images above show the map projected in three orthogonal directions.

6.2 Central slices [i](#)

6.2.1 Primary map

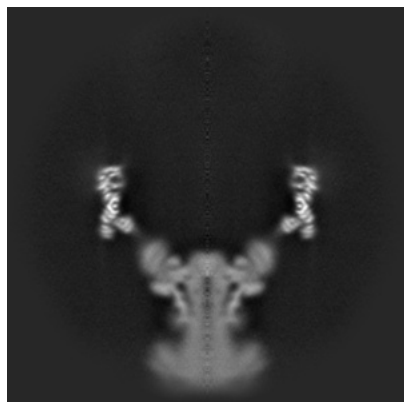

X Index: 256

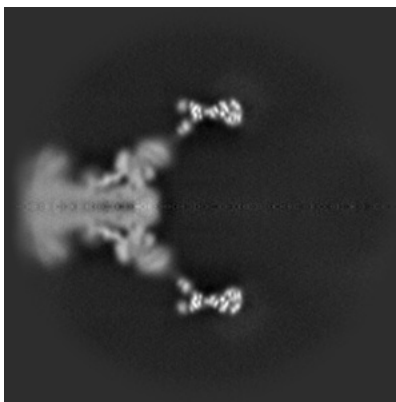

Y Index: 256

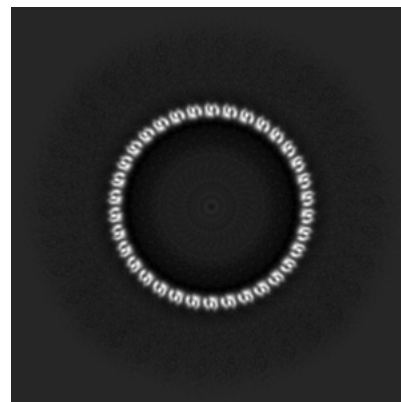

Z Index: 256

6.2.2 Raw map

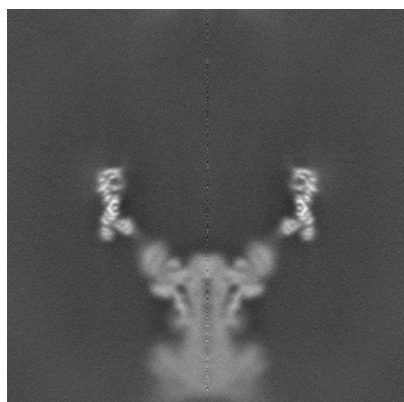

X Index: 256

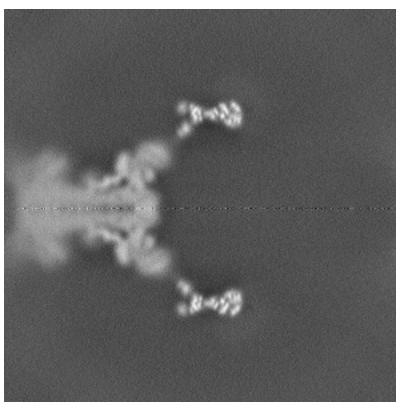

Y Index: 256

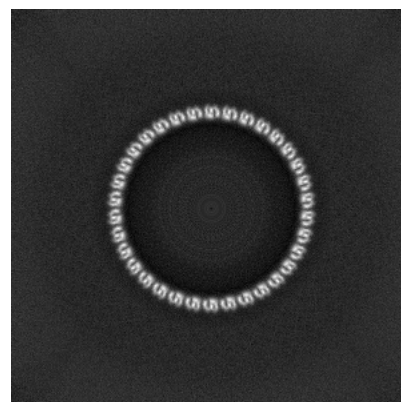

Z Index: 256

The images above show central slices of the map in three orthogonal directions.

6.3 Largest variance slices [i](#)

6.3.1 Primary map

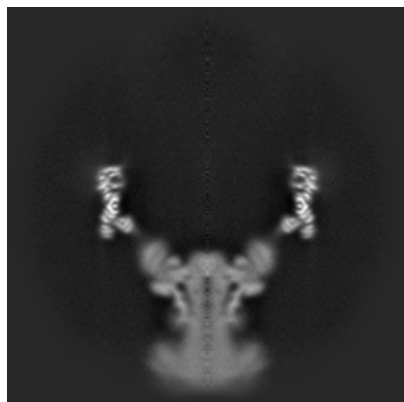

X Index: 256

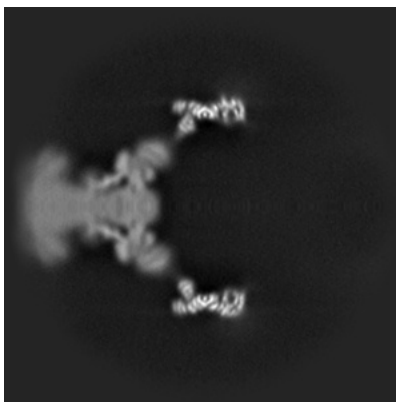

Y Index: 267

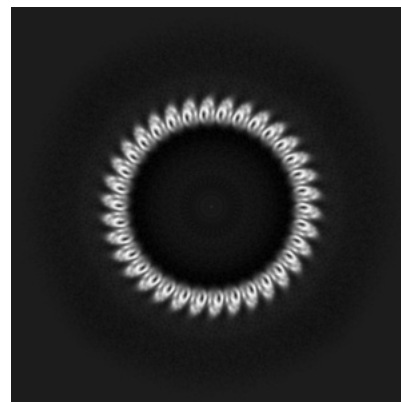

Z Index: 284

6.3.2 Raw map

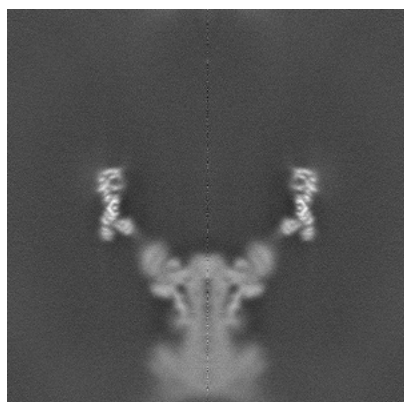

X Index: 256

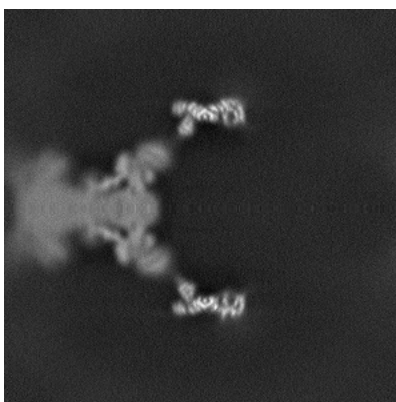

Y Index: 245

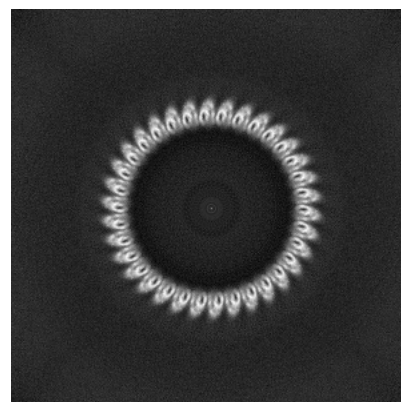

Z Index: 284

The images above show the largest variance slices of the map in three orthogonal directions.

6.4 Orthogonal standard-deviation projections (False-color) [i](#)

6.4.1 Primary map

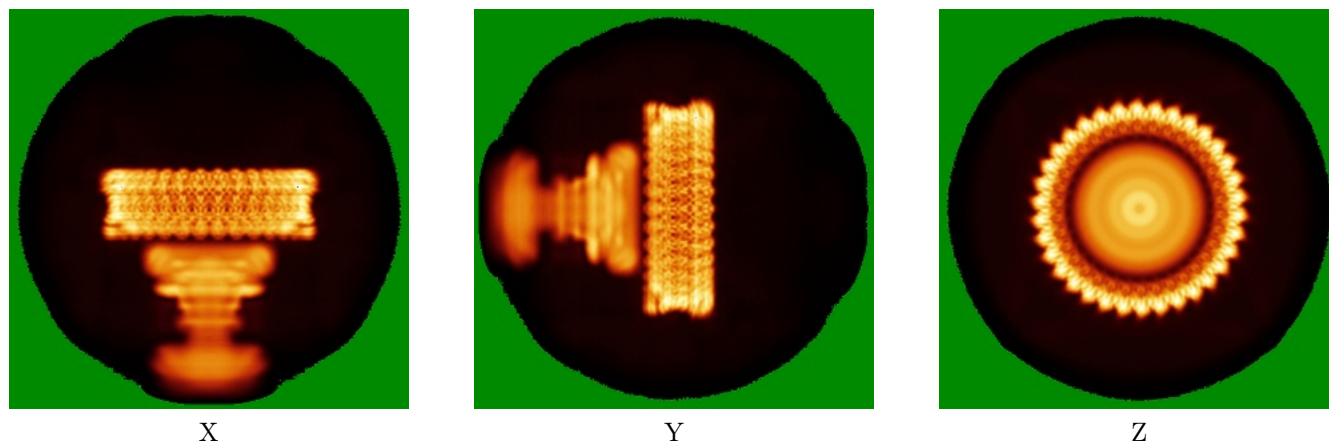

6.4.2 Raw map

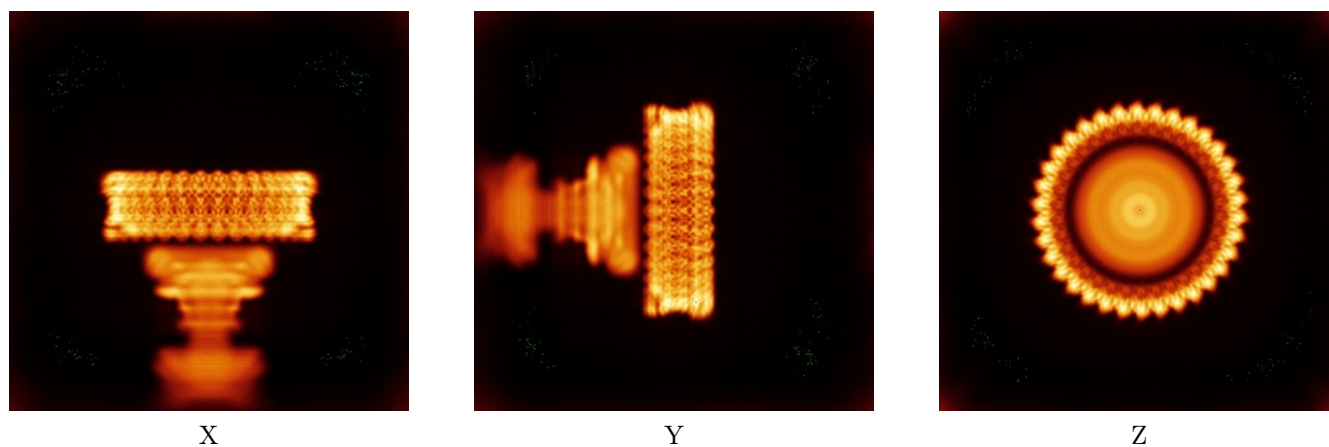

The images above show the map standard deviation projections with false color in three orthogonal directions. Minimum values are shown in green, max in blue, and dark to light orange shades represent small to large values respectively.

6.5 Orthogonal surface views [i](#)

6.5.1 Primary map



The images above show the 3D surface view of the map at the recommended contour level 0.7. These images, in conjunction with the slice images, may facilitate assessment of whether an appropriate contour level has been provided.

6.5.2 Raw map

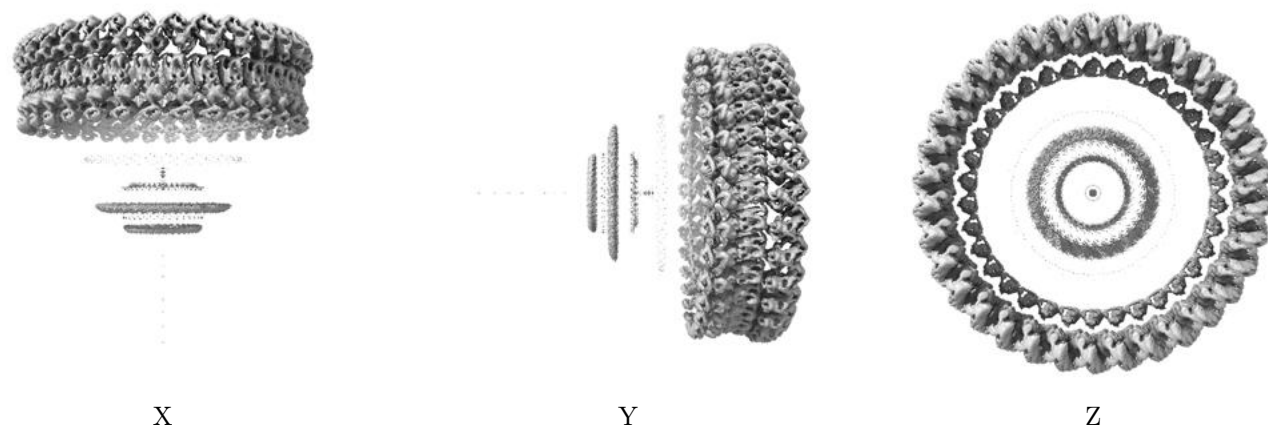

These images show the 3D surface of the raw map. The raw map's contour level was selected so that its surface encloses the same volume as the primary map does at its recommended contour level.

6.6 Mask visualisation [i](#)

This section shows the 3D surface view of the primary map at 50% transparency overlaid with the specified mask at 0% transparency

A mask typically either:

- Encompasses the whole structure
- Separates out a domain, a functional unit, a monomer or an area of interest from a larger structure

6.6.1 emd_42439_msk_1.map [i](#)



X



Y

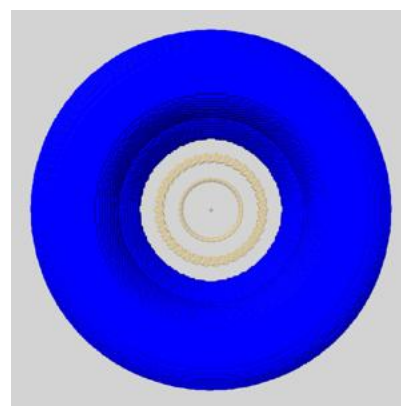

Z

7 Map analysis [i](#)

This section contains the results of statistical analysis of the map.

7.1 Map-value distribution [i](#)

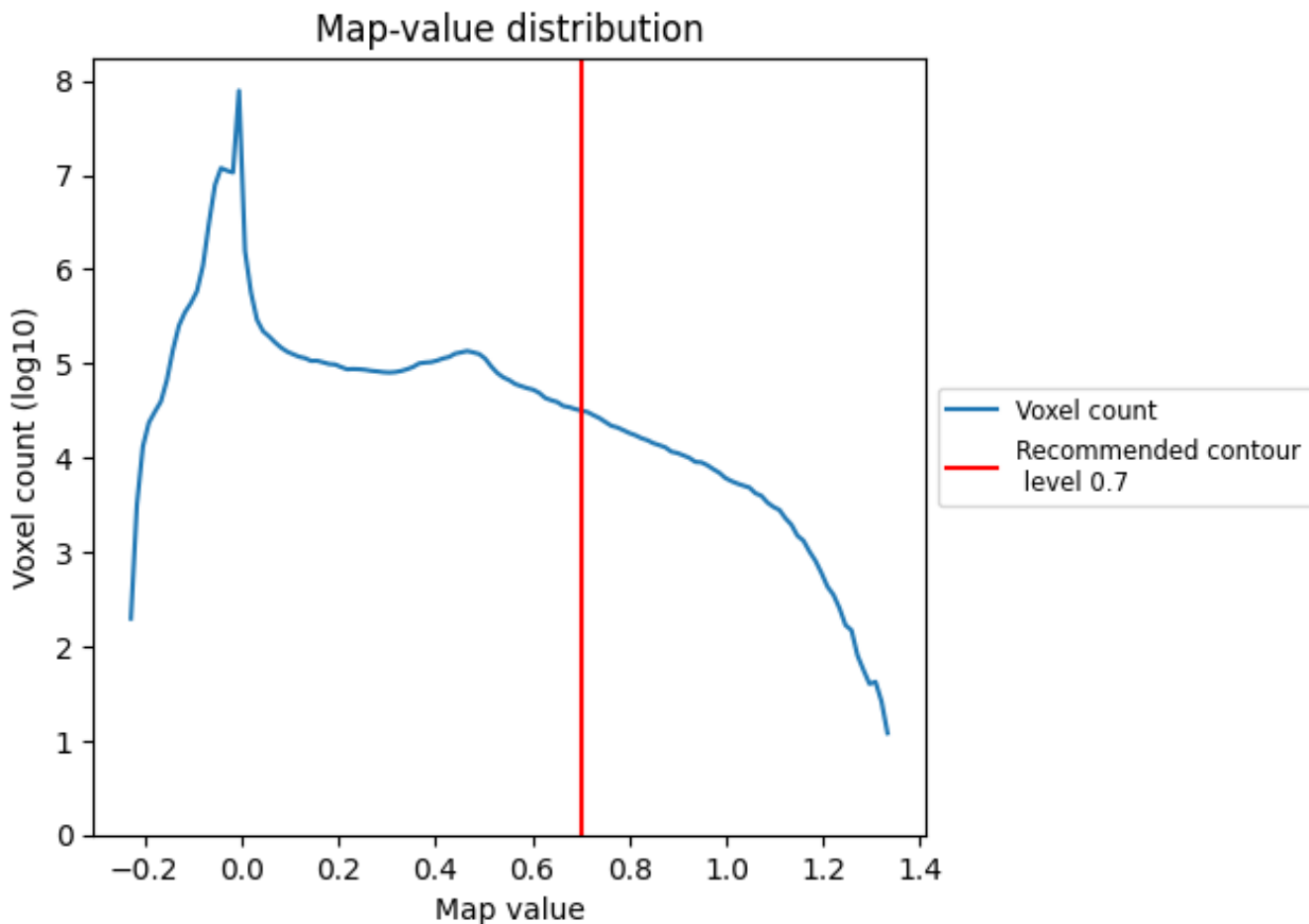

The map-value distribution is plotted in 128 intervals along the x-axis. The y-axis is logarithmic. A spike in this graph at zero usually indicates that the volume has been masked.

7.2 Volume estimate [i](#)

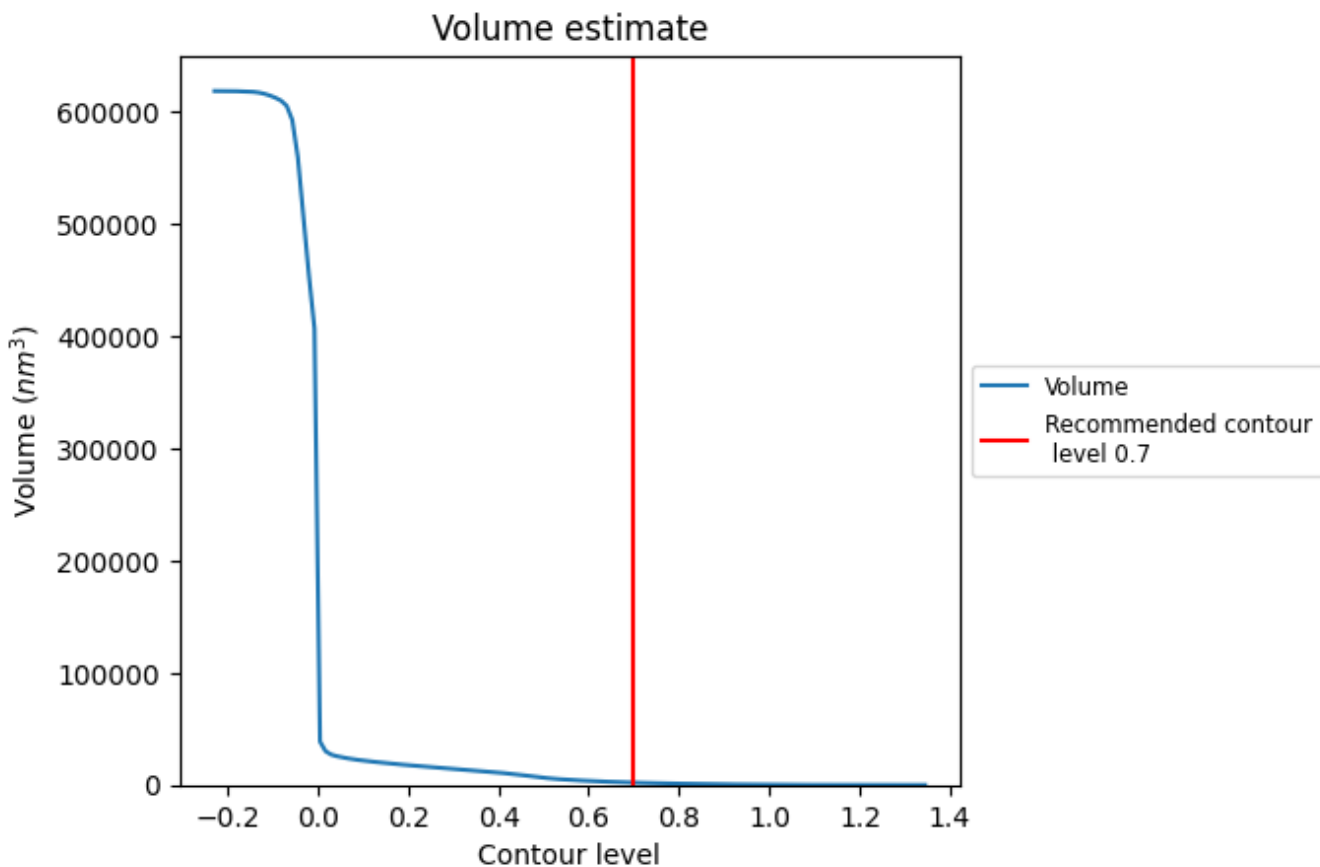

The volume at the recommended contour level is 2092 nm^3 ; this corresponds to an approximate mass of 1890 kDa.

The volume estimate graph shows how the enclosed volume varies with the contour level. The recommended contour level is shown as a vertical line and the intersection between the line and the curve gives the volume of the enclosed surface at the given level.

7.3 Rotationally averaged power spectrum i

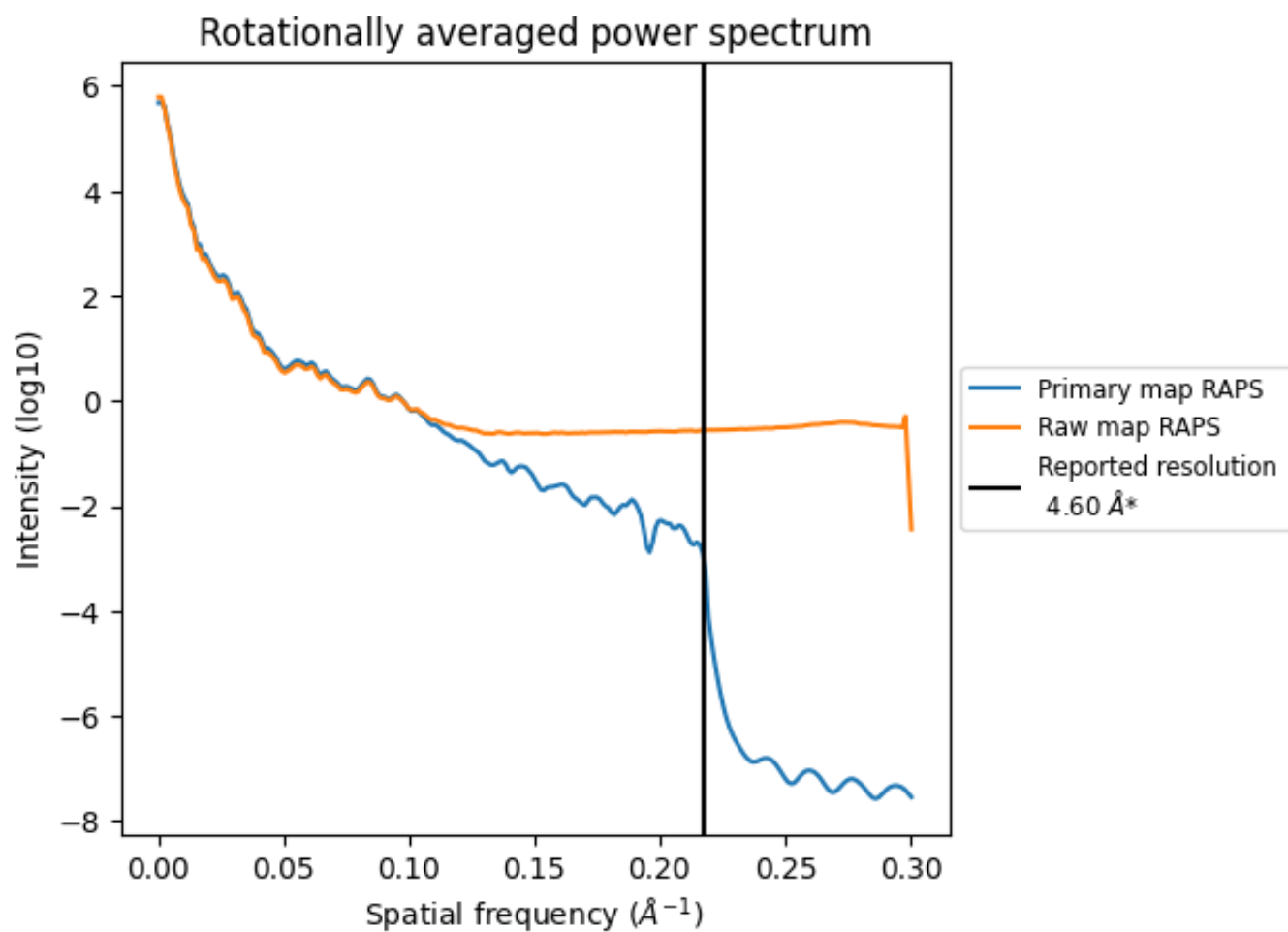

*Reported resolution corresponds to spatial frequency of 0.217 Å⁻¹

8 Fourier-Shell correlation [i](#)

Fourier-Shell Correlation (FSC) is the most commonly used method to estimate the resolution of single-particle and subtomogram-averaged maps. The shape of the curve depends on the imposed symmetry, mask and whether or not the two 3D reconstructions used were processed from a common reference. The reported resolution is shown as a black line. A curve is displayed for the half-bit criterion in addition to lines showing the 0.143 gold standard cut-off and 0.5 cut-off.

8.1 FSC [i](#)

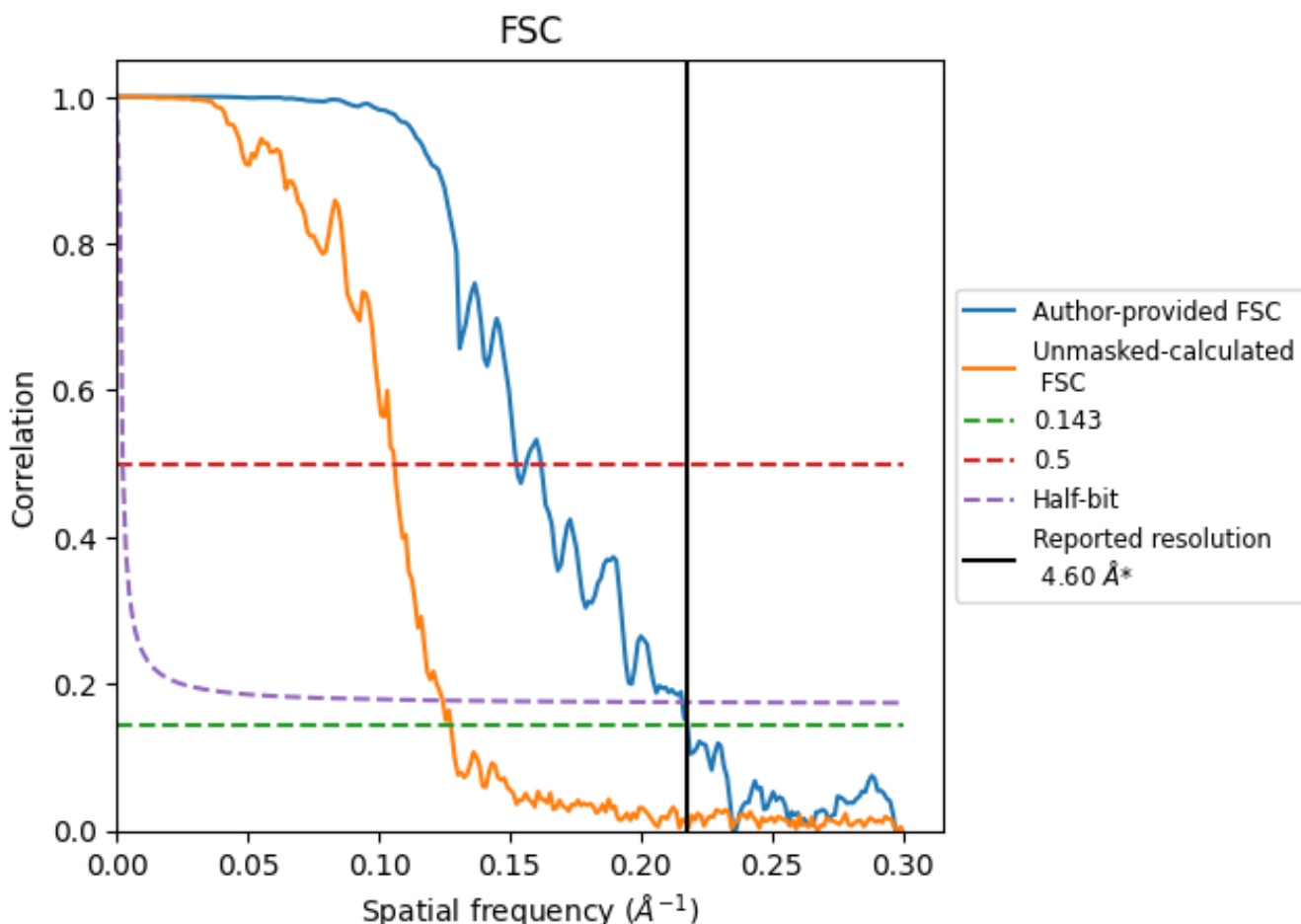

*Reported resolution corresponds to spatial frequency of 0.217 \AA^{-1}

8.2 Resolution estimates [i](#)

Resolution estimate (Å)	Estimation criterion (FSC cut-off)		
	0.143	0.5	Half-bit
Reported by author	4.60	-	-
Author-provided FSC curve	4.59	6.56	4.63
Unmasked-calculated*	7.84	9.43	8.03

*Resolution estimate based on FSC curve calculated by comparison of deposited half-maps. The value from deposited half-maps intersecting FSC 0.143 CUT-OFF 7.84 differs from the reported value 4.6 by more than 10 %

9 Map-model fit [i](#)

This section contains information regarding the fit between EMDB map EMD-42439 and PDB model 8UOX. Per-residue inclusion information can be found in section [3](#) on page [22](#).

9.1 Map-model overlay [i](#)



The images above show the 3D surface view of the map at the recommended contour level 0.7 at 50% transparency in yellow overlaid with a ribbon representation of the model coloured in blue. These images allow for the visual assessment of the quality of fit between the atomic model and the map.

9.2 Q-score mapped to coordinate model [i](#)

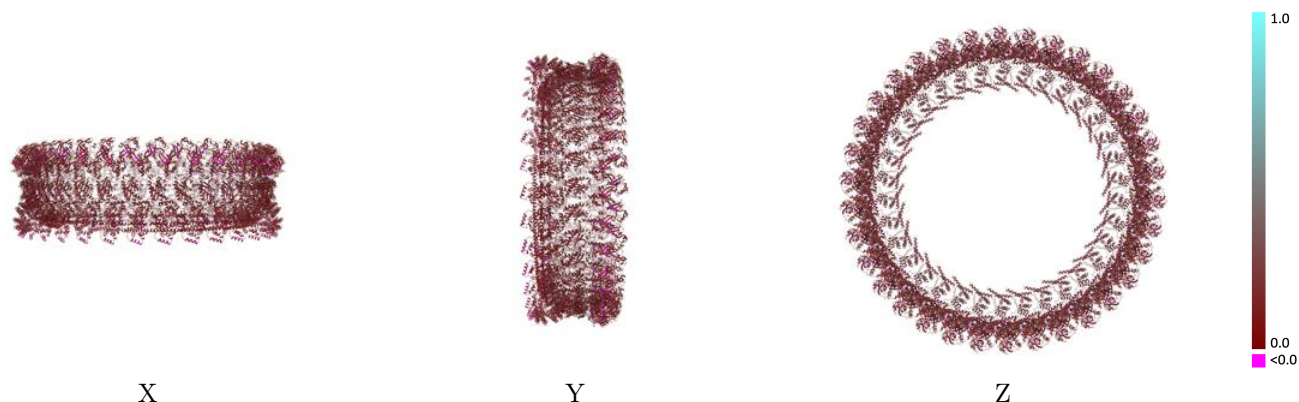

The images above show the model with each residue coloured according to its Q-score. This shows their resolvability in the map with higher Q-score values reflecting better resolvability. Please note: Q-score is calculating the resolvability of atoms, and thus high values are only expected at resolutions at which atoms can be resolved. Low Q-score values may therefore be expected for many entries.

9.3 Atom inclusion mapped to coordinate model [i](#)

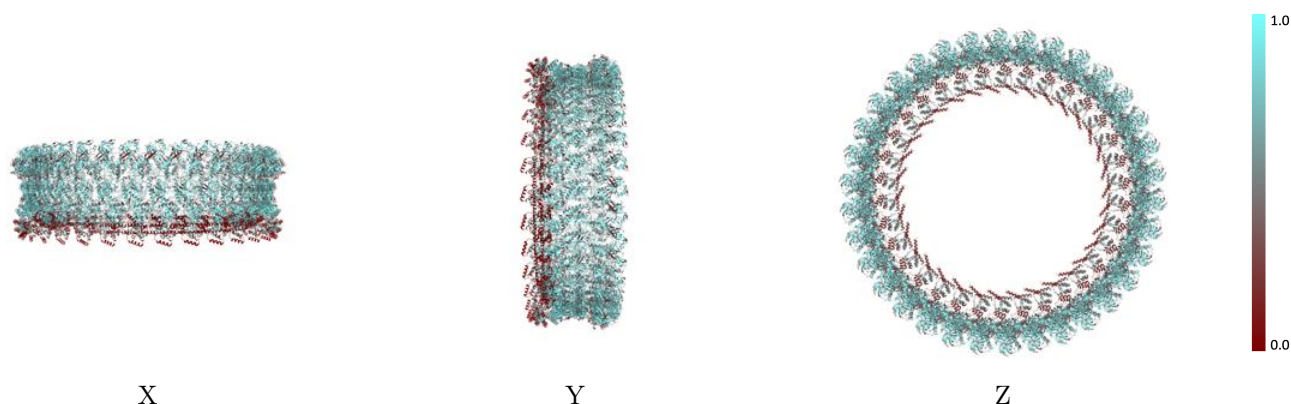

The images above show the model with each residue coloured according to its atom inclusion. This shows to what extent they are inside the map at the recommended contour level (0.7).



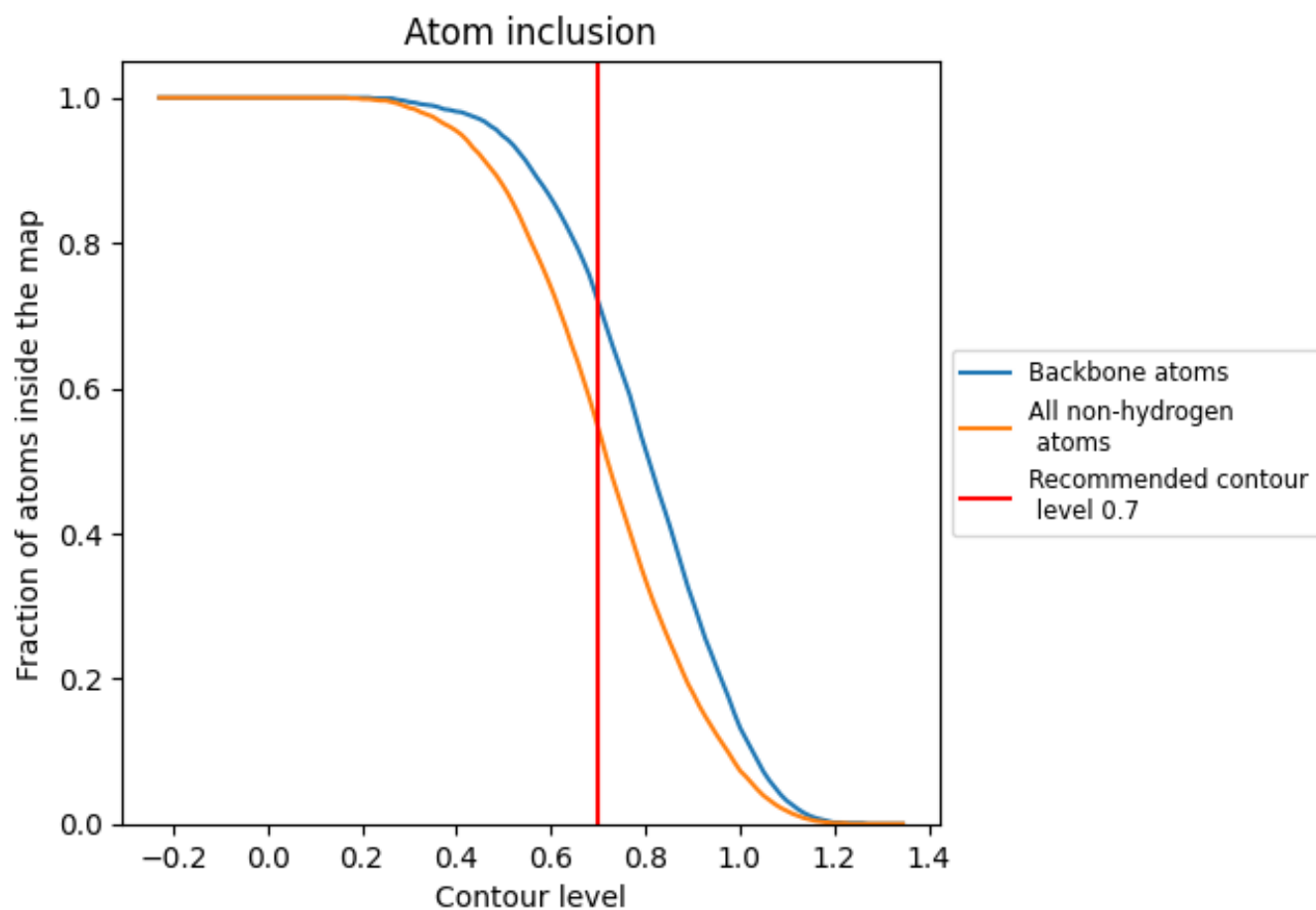



































































9.4 Atom inclusion [i](#)



At the recommended contour level, 72% of all backbone atoms, 55% of all non-hydrogen atoms, are inside the map.

9.5 Map-model fit summary

The table lists the average atom inclusion at the recommended contour level (0.7) and Q-score for the entire model and for each chain.

Chain	Atom inclusion	Q-score
All	 0.5460	 0.1760
A1	 0.2800	 0.1570
A2	 0.2670	 0.1540
A3	 0.2700	 0.1520
A4	 0.2730	 0.1590
A5	 0.2780	 0.1570
A6	 0.2750	 0.1570
A7	 0.2730	 0.1580
A8	 0.2730	 0.1550
A9	 0.2730	 0.1570
AA	 0.2800	 0.1570
AB	 0.2670	 0.1530
AC	 0.2800	 0.1570
AD	 0.2780	 0.1570
AE	 0.2730	 0.1590
AF	 0.2670	 0.1590
AG	 0.2780	 0.1560
AH	 0.2800	 0.1570
AI	 0.2830	 0.1580
AJ	 0.2700	 0.1590
AK	 0.2730	 0.1600
AL	 0.2730	 0.1610
AM	 0.2730	 0.1580
AN	 0.2730	 0.1550
AO	 0.2730	 0.1600
AP	 0.2800	 0.1620
AQ	 0.2780	 0.1570
AR	 0.2700	 0.1590
AS	 0.2750	 0.1560
AT	 0.2730	 0.1570
AU	 0.2750	 0.1550
AV	 0.2730	 0.1550
AW	 0.2780	 0.1580
AX	 0.2780	 0.1550
AY	 0.2670	 0.1570























































































Continued on next page...

Continued from previous page...

Chain	Atom inclusion	Q-score
B1	■ 0.4350	■ 0.1620
B2	■ 0.4350	■ 0.1610
B3	■ 0.4350	■ 0.1610
B4	■ 0.4380	■ 0.1630
B5	■ 0.4330	■ 0.1610
B6	■ 0.4350	■ 0.1620
B7	■ 0.4400	■ 0.1620
B8	■ 0.4360	■ 0.1610
B9	■ 0.4340	■ 0.1630
BA	■ 0.4380	■ 0.1610
BB	■ 0.4430	■ 0.1620
BC	■ 0.4390	■ 0.1640
BD	■ 0.4340	■ 0.1620
BE	■ 0.4350	■ 0.1630
BF	■ 0.4370	■ 0.1600
BG	■ 0.4350	■ 0.1630
BH	■ 0.4350	■ 0.1620
BI	■ 0.4330	■ 0.1620
BJ	■ 0.4380	■ 0.1640
BK	■ 0.4360	■ 0.1620
BL	■ 0.4350	■ 0.1620
BM	■ 0.4330	■ 0.1620
BN	■ 0.4360	■ 0.1620
BO	■ 0.4390	■ 0.1630
BP	■ 0.4360	■ 0.1620
BQ	■ 0.4360	■ 0.1630
BR	■ 0.4350	■ 0.1620
BS	■ 0.4380	■ 0.1610
BT	■ 0.4370	■ 0.1620
BU	■ 0.4350	■ 0.1620
BV	■ 0.4360	■ 0.1610
BW	■ 0.4390	■ 0.1610
BX	■ 0.4370	■ 0.1610
BY	■ 0.4350	■ 0.1620
C1	■ 0.6370	■ 0.1900
C2	■ 0.6370	■ 0.1870
C3	■ 0.6370	■ 0.1890
C4	■ 0.6350	■ 0.1890
C5	■ 0.6340	■ 0.1880
C6	■ 0.6380	■ 0.1870
C7	■ 0.6350	■ 0.1890
C8	■ 0.6360	■ 0.1880





















































































Continued on next page...

Continued from previous page...

Chain	Atom inclusion	Q-score
C9	 0.6370	 0.1880
CA	 0.6380	 0.1880
CB	 0.6380	 0.1890
CC	 0.6350	 0.1880
CD	 0.6350	 0.1880
CE	 0.6390	 0.1880
CF	 0.6340	 0.1890
CG	 0.6310	 0.1880
CH	 0.6340	 0.1880
CI	 0.6380	 0.1890
CJ	 0.6350	 0.1880
CK	 0.6350	 0.1880
CL	 0.6350	 0.1880
CM	 0.6360	 0.1870
CN	 0.6370	 0.1880
CO	 0.6370	 0.1890
CP	 0.6340	 0.1870
CQ	 0.6390	 0.1870
CR	 0.6390	 0.1860
CS	 0.6360	 0.1860
CT	 0.6330	 0.1870
CU	 0.6360	 0.1890
CV	 0.6400	 0.1890
CW	 0.6370	 0.1880
CX	 0.6320	 0.1880
CY	 0.6350	 0.1880
D1	 0.6440	 0.1860
D2	 0.6420	 0.1870
D3	 0.6390	 0.1890
D4	 0.6400	 0.1890
D5	 0.6400	 0.1840
D6	 0.6420	 0.1850
D7	 0.6440	 0.1870
D8	 0.6350	 0.1890
D9	 0.6340	 0.1840
DA	 0.6390	 0.1850
DB	 0.6350	 0.1850
DC	 0.6400	 0.1860
DD	 0.6390	 0.1860
DE	 0.6400	 0.1840
DF	 0.6390	 0.1840
DG	 0.6370	 0.1860





















































































Continued on next page...

Continued from previous page...

Chain	Atom inclusion	Q-score
DH	 0.6420	 0.1830
DI	 0.6420	 0.1860
DJ	 0.6390	 0.1840
DK	 0.6370	 0.1850
DL	 0.6440	 0.1850
DM	 0.6440	 0.1850
DN	 0.6420	 0.1850
DO	 0.6390	 0.1870
DP	 0.6420	 0.1870
DQ	 0.6400	 0.1840
DR	 0.6420	 0.1880
DS	 0.6350	 0.1870
DT	 0.6440	 0.1860
DU	 0.6370	 0.1890
DV	 0.6400	 0.1890
DW	 0.6420	 0.1880
DX	 0.6390	 0.1890
DY	 0.6400	 0.1850
E1	 0.6320	 0.1770
E2	 0.6440	 0.1760
E3	 0.6340	 0.1780
E4	 0.6320	 0.1750
E5	 0.6390	 0.1740
E6	 0.6350	 0.1750
E7	 0.6260	 0.1710
E8	 0.6290	 0.1750
E9	 0.6240	 0.1760
EA	 0.6420	 0.1760
EB	 0.6420	 0.1770
EC	 0.6290	 0.1760
ED	 0.6270	 0.1790
EE	 0.6350	 0.1760
EF	 0.6270	 0.1800
EG	 0.6270	 0.1800
EH	 0.6260	 0.1790
EI	 0.6340	 0.1820
EJ	 0.6440	 0.1770
EK	 0.6300	 0.1780
EL	 0.6300	 0.1810
EM	 0.6450	 0.1820
EN	 0.6400	 0.1820
EO	 0.6320	 0.1790





Continued on next page...

Continued from previous page...

Chain	Atom inclusion	Q-score
EP	 0.6320	 0.1800
EQ	 0.6220	 0.1780
ER	 0.6420	 0.1780
ES	 0.6390	 0.1770
ET	 0.6320	 0.1770
EU	 0.6300	 0.1810
EV	 0.6370	 0.1770
EW	 0.6340	 0.1780
EX	 0.6270	 0.1770
EY	 0.6260	 0.1750
F1	 0.6490	 0.1850
F2	 0.6530	 0.1860
F3	 0.6530	 0.1830
F4	 0.6500	 0.1850
F5	 0.6530	 0.1850
F6	 0.6620	 0.1850
F7	 0.6570	 0.1820
F8	 0.6530	 0.1860
F9	 0.6490	 0.1830
FA	 0.6550	 0.1870
FB	 0.6500	 0.1850
FC	 0.6500	 0.1870
FD	 0.6580	 0.1850
FE	 0.6550	 0.1860
FF	 0.6500	 0.1850
FG	 0.6490	 0.1850
FH	 0.6530	 0.1850
FI	 0.6470	 0.1840
FJ	 0.6530	 0.1820
FK	 0.6550	 0.1840
FL	 0.6490	 0.1850
FM	 0.6530	 0.1860
FN	 0.6500	 0.1840
FO	 0.6570	 0.1840
FP	 0.6490	 0.1840
FQ	 0.6490	 0.1820
FR	 0.6490	 0.1820
FS	 0.6520	 0.1850
FT	 0.6520	 0.1830
FU	 0.6470	 0.1840
FV	 0.6530	 0.1820
FW	 0.6500	 0.1840

Continued on next page...

Continued from previous page...

Chain	Atom inclusion	Q-score
FX	 0.6500	 0.1830
FY	 0.6450	 0.1820