



Full wwPDB EM Validation Report ⓘ

Jul 25, 2024 – 04:26 PM EDT

PDB ID : 8VCT
EMDB ID : EMD-43140
Title : CryoEM structure of the TnsC(1-503)-TnsD(1-318)-DNA complex in a 6:2:1 stoichiometry from *E. coli* Tn7 bound to ATPgS and ADP
Authors : Shen, Y.; Guarne, A.
Deposited on : 2023-12-14
Resolution : 3.83 Å(reported)

This is a Full wwPDB EM Validation Report for a publicly released PDB entry.

We welcome your comments at validation@mail.wwpdb.org

A user guide is available at

<https://www.wwpdb.org/validation/2017/EMValidationReportHelp>

with specific help available everywhere you see the ⓘ symbol.

The types of validation reports are described at

<http://www.wwpdb.org/validation/2017/FAQs#types>.

The following versions of software and data (see [references ⓘ](#)) were used in the production of this report:

EMDB validation analysis : 0.0.1.dev92
Mogul : 1.8.5 (274361), CSD as541be (2020)
MolProbity : 4.02b-467
buster-report : 1.1.7 (2018)
Percentile statistics : 20191225.v01 (using entries in the PDB archive December 25th 2019)
MapQ : 1.9.13
Ideal geometry (proteins) : Engh & Huber (2001)
Ideal geometry (DNA, RNA) : Parkinson et al. (1996)
Validation Pipeline (wwPDB-VP) : 2.37.1

1 Overall quality at a glance i

The following experimental techniques were used to determine the structure:

ELECTRON MICROSCOPY

The reported resolution of this entry is 3.83 Å.

Percentile scores (ranging between 0-100) for global validation metrics of the entry are shown in the following graphic. The table shows the number of entries on which the scores are based.

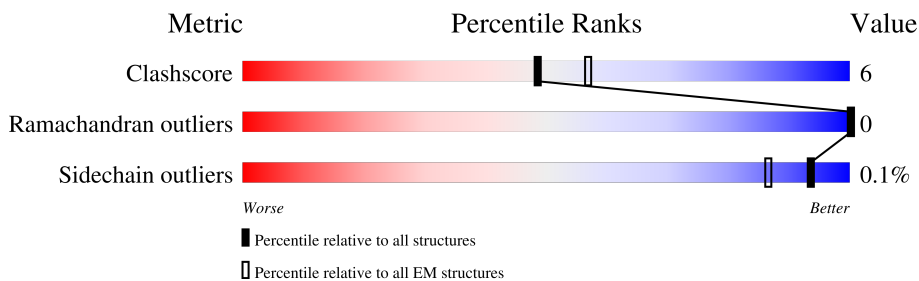

| Metric | Whole archive (#Entries) | EM structures (#Entries) |
|-----------------------|--------------------------|--------------------------|
| Clashscore | 158937 | 4297 |
| Ramachandran outliers | 154571 | 4023 |
| Sidechain outliers | 154315 | 3826 |

The table below summarises the geometric issues observed across the polymeric chains and their fit to the map. The red, orange, yellow and green segments of the bar indicate the fraction of residues that contain outliers for ≥ 3 , 2, 1 and 0 types of geometric quality criteria respectively. A grey segment represents the fraction of residues that are not modelled. The numeric value for each fraction is indicated below the corresponding segment, with a dot representing fractions $\leq 5\%$. The upper red bar (where present) indicates the fraction of residues that have poor fit to the EM map (all-atom inclusion $< 40\%$). The numeric value is given above the bar.

| Mol | Chain | Length | Quality of chain |
|-----|-------|--------|------------------|
| 1 | A | 523 | |
| 1 | B | 523 | |
| 1 | C | 523 | |
| 1 | E | 523 | |
| 1 | F | 523 | |
| 1 | G | 523 | |
| 2 | X | 318 | |
| 2 | Y | 318 | |

Continued on next page...

Continued from previous page...

| Mol | Chain | Length | Quality of chain |
|-----|-------|--------|------------------|
| 3 | H | 50 | |
| 4 | I | 50 | |

2 Entry composition [i](#)

There are 8 unique types of molecules in this entry. The entry contains 29000 atoms, of which 0 are hydrogens and 0 are deuteriums.

In the tables below, the AltConf column contains the number of residues with at least one atom in alternate conformation and the Trace column contains the number of residues modelled with at most 2 atoms.

- Molecule 1 is a protein called Transposon Tn7 transposition protein TnsC.

| Mol | Chain | Residues | Atoms | | | | | AltConf | Trace |
|-----|-------|----------|-------|------|-----|-----|----|---------|-------|
| | | | Total | C | N | O | S | | |
| 1 | G | 394 | 3138 | 1986 | 563 | 577 | 12 | 0 | 0 |
| 1 | E | 483 | 3865 | 2446 | 689 | 715 | 15 | 0 | 0 |
| 1 | F | 482 | 3860 | 2443 | 688 | 714 | 15 | 0 | 0 |
| 1 | C | 394 | 3138 | 1986 | 563 | 577 | 12 | 0 | 0 |
| 1 | B | 482 | 3860 | 2443 | 688 | 714 | 15 | 0 | 0 |
| 1 | A | 483 | 3865 | 2446 | 689 | 715 | 15 | 0 | 0 |

There are 126 discrepancies between the modelled and reference sequences:

| Chain | Residue | Modelled | Actual | Comment | Reference |
|-------|---------|----------|--------|---------------------|------------|
| G | 2 | GLY | SER | engineered mutation | UNP P05846 |
| G | 504 | PRO | - | expression tag | UNP P05846 |
| G | 505 | ASN | - | expression tag | UNP P05846 |
| G | 506 | SER | - | expression tag | UNP P05846 |
| G | 507 | SER | - | expression tag | UNP P05846 |
| G | 508 | SER | - | expression tag | UNP P05846 |
| G | 509 | VAL | - | expression tag | UNP P05846 |
| G | 510 | ASP | - | expression tag | UNP P05846 |
| G | 511 | LYS | - | expression tag | UNP P05846 |
| G | 512 | LEU | - | expression tag | UNP P05846 |
| G | 513 | ALA | - | expression tag | UNP P05846 |
| G | 514 | ALA | - | expression tag | UNP P05846 |
| G | 515 | ALA | - | expression tag | UNP P05846 |
| G | 516 | LEU | - | expression tag | UNP P05846 |
| G | 517 | GLU | - | expression tag | UNP P05846 |
| G | 518 | HIS | - | expression tag | UNP P05846 |
| G | 519 | HIS | - | expression tag | UNP P05846 |
| G | 520 | HIS | - | expression tag | UNP P05846 |

Continued on next page...

Continued from previous page...

| Chain | Residue | Modelled | Actual | Comment | Reference |
|-------|---------|----------|--------|---------------------|------------|
| G | 521 | HIS | - | expression tag | UNP P05846 |
| G | 522 | HIS | - | expression tag | UNP P05846 |
| G | 523 | HIS | - | expression tag | UNP P05846 |
| E | 2 | GLY | SER | engineered mutation | UNP P05846 |
| E | 504 | PRO | - | expression tag | UNP P05846 |
| E | 505 | ASN | - | expression tag | UNP P05846 |
| E | 506 | SER | - | expression tag | UNP P05846 |
| E | 507 | SER | - | expression tag | UNP P05846 |
| E | 508 | SER | - | expression tag | UNP P05846 |
| E | 509 | VAL | - | expression tag | UNP P05846 |
| E | 510 | ASP | - | expression tag | UNP P05846 |
| E | 511 | LYS | - | expression tag | UNP P05846 |
| E | 512 | LEU | - | expression tag | UNP P05846 |
| E | 513 | ALA | - | expression tag | UNP P05846 |
| E | 514 | ALA | - | expression tag | UNP P05846 |
| E | 515 | ALA | - | expression tag | UNP P05846 |
| E | 516 | LEU | - | expression tag | UNP P05846 |
| E | 517 | GLU | - | expression tag | UNP P05846 |
| E | 518 | HIS | - | expression tag | UNP P05846 |
| E | 519 | HIS | - | expression tag | UNP P05846 |
| E | 520 | HIS | - | expression tag | UNP P05846 |
| E | 521 | HIS | - | expression tag | UNP P05846 |
| E | 522 | HIS | - | expression tag | UNP P05846 |
| E | 523 | HIS | - | expression tag | UNP P05846 |
| F | 2 | GLY | SER | engineered mutation | UNP P05846 |
| F | 504 | PRO | - | expression tag | UNP P05846 |
| F | 505 | ASN | - | expression tag | UNP P05846 |
| F | 506 | SER | - | expression tag | UNP P05846 |
| F | 507 | SER | - | expression tag | UNP P05846 |
| F | 508 | SER | - | expression tag | UNP P05846 |
| F | 509 | VAL | - | expression tag | UNP P05846 |
| F | 510 | ASP | - | expression tag | UNP P05846 |
| F | 511 | LYS | - | expression tag | UNP P05846 |
| F | 512 | LEU | - | expression tag | UNP P05846 |
| F | 513 | ALA | - | expression tag | UNP P05846 |
| F | 514 | ALA | - | expression tag | UNP P05846 |
| F | 515 | ALA | - | expression tag | UNP P05846 |
| F | 516 | LEU | - | expression tag | UNP P05846 |
| F | 517 | GLU | - | expression tag | UNP P05846 |
| F | 518 | HIS | - | expression tag | UNP P05846 |
| F | 519 | HIS | - | expression tag | UNP P05846 |
| F | 520 | HIS | - | expression tag | UNP P05846 |

Continued on next page...

Continued from previous page...

| Chain | Residue | Modelled | Actual | Comment | Reference |
|-------|---------|----------|--------|---------------------|------------|
| F | 521 | HIS | - | expression tag | UNP P05846 |
| F | 522 | HIS | - | expression tag | UNP P05846 |
| F | 523 | HIS | - | expression tag | UNP P05846 |
| C | 2 | GLY | SER | engineered mutation | UNP P05846 |
| C | 504 | PRO | - | expression tag | UNP P05846 |
| C | 505 | ASN | - | expression tag | UNP P05846 |
| C | 506 | SER | - | expression tag | UNP P05846 |
| C | 507 | SER | - | expression tag | UNP P05846 |
| C | 508 | SER | - | expression tag | UNP P05846 |
| C | 509 | VAL | - | expression tag | UNP P05846 |
| C | 510 | ASP | - | expression tag | UNP P05846 |
| C | 511 | LYS | - | expression tag | UNP P05846 |
| C | 512 | LEU | - | expression tag | UNP P05846 |
| C | 513 | ALA | - | expression tag | UNP P05846 |
| C | 514 | ALA | - | expression tag | UNP P05846 |
| C | 515 | ALA | - | expression tag | UNP P05846 |
| C | 516 | LEU | - | expression tag | UNP P05846 |
| C | 517 | GLU | - | expression tag | UNP P05846 |
| C | 518 | HIS | - | expression tag | UNP P05846 |
| C | 519 | HIS | - | expression tag | UNP P05846 |
| C | 520 | HIS | - | expression tag | UNP P05846 |
| C | 521 | HIS | - | expression tag | UNP P05846 |
| C | 522 | HIS | - | expression tag | UNP P05846 |
| C | 523 | HIS | - | expression tag | UNP P05846 |
| B | 2 | GLY | SER | engineered mutation | UNP P05846 |
| B | 504 | PRO | - | expression tag | UNP P05846 |
| B | 505 | ASN | - | expression tag | UNP P05846 |
| B | 506 | SER | - | expression tag | UNP P05846 |
| B | 507 | SER | - | expression tag | UNP P05846 |
| B | 508 | SER | - | expression tag | UNP P05846 |
| B | 509 | VAL | - | expression tag | UNP P05846 |
| B | 510 | ASP | - | expression tag | UNP P05846 |
| B | 511 | LYS | - | expression tag | UNP P05846 |
| B | 512 | LEU | - | expression tag | UNP P05846 |
| B | 513 | ALA | - | expression tag | UNP P05846 |
| B | 514 | ALA | - | expression tag | UNP P05846 |
| B | 515 | ALA | - | expression tag | UNP P05846 |
| B | 516 | LEU | - | expression tag | UNP P05846 |
| B | 517 | GLU | - | expression tag | UNP P05846 |
| B | 518 | HIS | - | expression tag | UNP P05846 |
| B | 519 | HIS | - | expression tag | UNP P05846 |
| B | 520 | HIS | - | expression tag | UNP P05846 |

Continued on next page...

Continued from previous page...

| Chain | Residue | Modelled | Actual | Comment | Reference |
|-------|---------|----------|--------|---------------------|------------|
| B | 521 | HIS | - | expression tag | UNP P05846 |
| B | 522 | HIS | - | expression tag | UNP P05846 |
| B | 523 | HIS | - | expression tag | UNP P05846 |
| A | 2 | GLY | SER | engineered mutation | UNP P05846 |
| A | 504 | PRO | - | expression tag | UNP P05846 |
| A | 505 | ASN | - | expression tag | UNP P05846 |
| A | 506 | SER | - | expression tag | UNP P05846 |
| A | 507 | SER | - | expression tag | UNP P05846 |
| A | 508 | SER | - | expression tag | UNP P05846 |
| A | 509 | VAL | - | expression tag | UNP P05846 |
| A | 510 | ASP | - | expression tag | UNP P05846 |
| A | 511 | LYS | - | expression tag | UNP P05846 |
| A | 512 | LEU | - | expression tag | UNP P05846 |
| A | 513 | ALA | - | expression tag | UNP P05846 |
| A | 514 | ALA | - | expression tag | UNP P05846 |
| A | 515 | ALA | - | expression tag | UNP P05846 |
| A | 516 | LEU | - | expression tag | UNP P05846 |
| A | 517 | GLU | - | expression tag | UNP P05846 |
| A | 518 | HIS | - | expression tag | UNP P05846 |
| A | 519 | HIS | - | expression tag | UNP P05846 |
| A | 520 | HIS | - | expression tag | UNP P05846 |
| A | 521 | HIS | - | expression tag | UNP P05846 |
| A | 522 | HIS | - | expression tag | UNP P05846 |
| A | 523 | HIS | - | expression tag | UNP P05846 |

- Molecule 2 is a protein called Transposon Tn7 transposition protein TnsD.

| Mol | Chain | Residues | Atoms | | | | | AltConf | Trace |
|-----|-------|----------|-------|------|-----|-----|---|---------|-------|
| | | | Total | C | N | O | S | | |
| 2 | X | 310 | Total | C | N | O | S | 0 | 0 |
| | | | 2523 | 1625 | 449 | 442 | 7 | | |
| 2 | Y | 310 | Total | C | N | O | S | 0 | 0 |
| | | | 2523 | 1625 | 449 | 442 | 7 | | |

- Molecule 3 is a DNA chain called DNA (50-MER).

| Mol | Chain | Residues | Atoms | | | | | AltConf | Trace |
|-----|-------|----------|-------|-----|-----|-----|----|---------|-------|
| | | | Total | C | N | O | P | | |
| 3 | H | 50 | Total | C | N | O | P | 0 | 0 |
| | | | 1029 | 487 | 200 | 292 | 50 | | |

- Molecule 4 is a DNA chain called DNA (50-MER).

| Mol | Chain | Residues | Atoms | | | | | AltConf | Trace |
|-----|-------|----------|-------|-----|-----|-----|----|---------|-------|
| | | | Total | C | N | O | P | | |
| 4 | I | 50 | 1021 | 487 | 176 | 308 | 50 | 0 | 0 |

- Molecule 5 is PHOSPHOTHIOPHOSPHORIC ACID-ADENYLATE ESTER (three-letter code: AGS) (formula: C₁₀H₁₆N₅O₁₂P₃S) (labeled as "Ligand of Interest" by depositor).

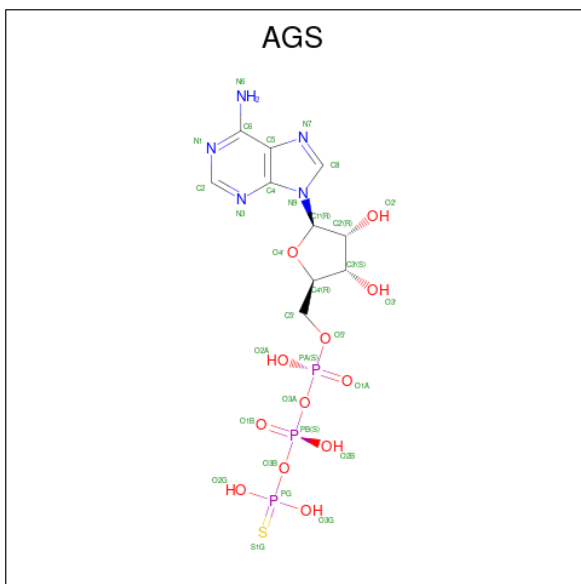

| Mol | Chain | Residues | Atoms | | | | | | AltConf |
|-----|-------|----------|-------|----|---|----|---|---|---------|
| | | | Total | C | N | O | P | S | |
| 5 | G | 1 | 31 | 10 | 5 | 12 | 3 | 1 | 0 |
| 5 | C | 1 | 31 | 10 | 5 | 12 | 3 | 1 | 0 |

- Molecule 6 is MAGNESIUM ION (three-letter code: MG) (formula: Mg) (labeled as "Ligand of Interest" by depositor).

| Mol | Chain | Residues | Atoms | AltConf |
|-----|-------|----------|-----------------|---------|
| 6 | G | 1 | Total Mg 1 1 | 0 |
| 6 | E | 1 | Total Mg 1 1 | 0 |
| 6 | F | 1 | Total Mg 1 1 | 0 |
| 6 | C | 1 | Total Mg 1 1 | 0 |
| 6 | B | 1 | Total Mg 1 1 | 0 |
| 6 | A | 1 | Total Mg 1 1 | 0 |

- Molecule 7 is ZINC ION (three-letter code: ZN) (formula: Zn) (labeled as "Ligand of Interest" by depositor).

| Mol | Chain | Residues | Atoms | | AltConf |
|-----|-------|----------|-------|----|---------|
| 7 | X | 1 | Total | Zn | 0 |
| | | | 1 | 1 | |
| 7 | Y | 1 | Total | Zn | 0 |
| | | | 1 | 1 | |

- Molecule 8 is ADENOSINE-5'-DIPHOSPHATE (three-letter code: ADP) (formula: C₁₀H₁₅N₅O₁₀P₂) (labeled as "Ligand of Interest" by depositor).

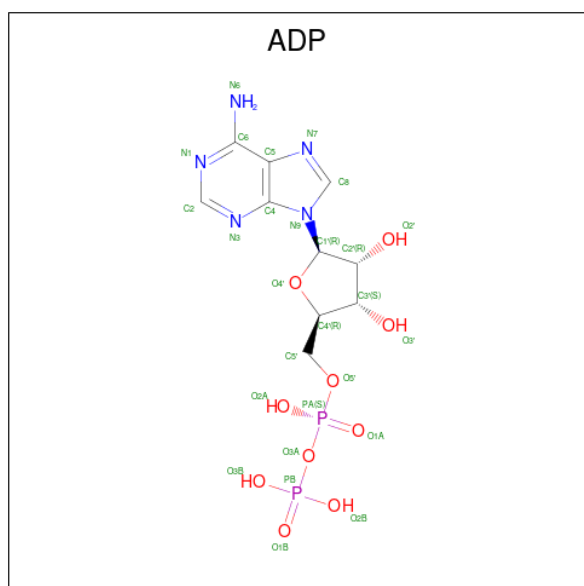

| Mol | Chain | Residues | Atoms | | | | | AltConf |
|-----|-------|----------|-------|----|---|----|---|---------|
| 8 | E | 1 | Total | C | N | O | P | 0 |
| | | | 27 | 10 | 5 | 10 | 2 | |
| 8 | F | 1 | Total | C | N | O | P | 0 |
| | | | 27 | 10 | 5 | 10 | 2 | |
| 8 | B | 1 | Total | C | N | O | P | 0 |
| | | | 27 | 10 | 5 | 10 | 2 | |
| 8 | A | 1 | Total | C | N | O | P | 0 |
| | | | 27 | 10 | 5 | 10 | 2 | |

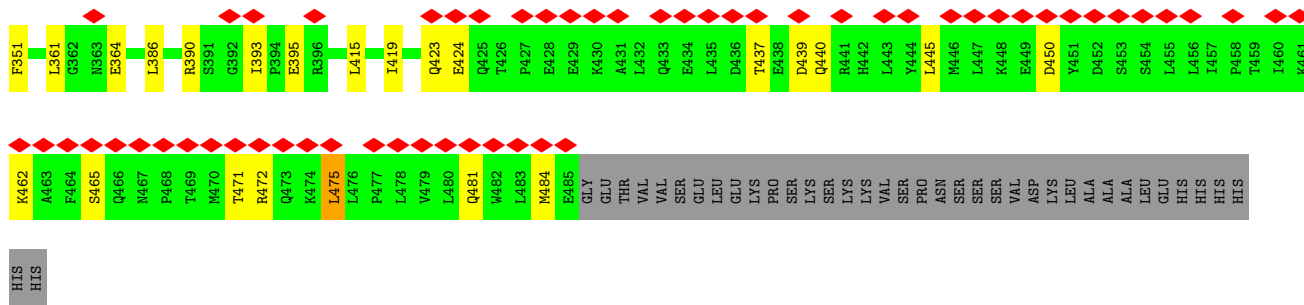

• Molecule 1: Transposon Tn7 transposition protein TnsC

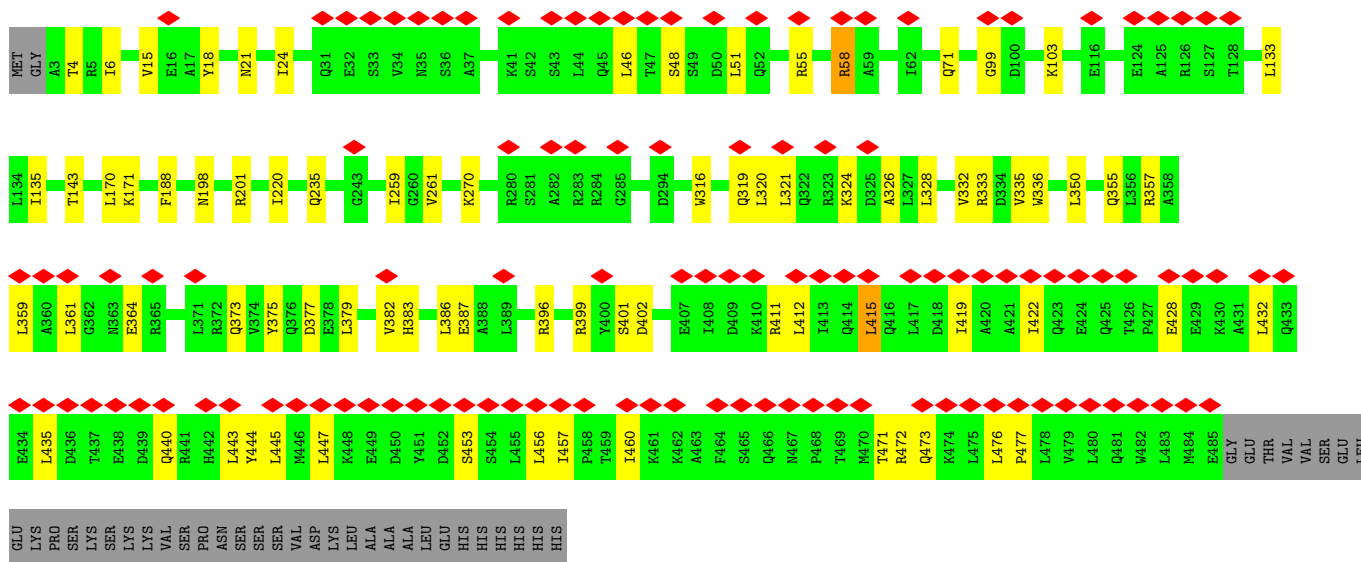
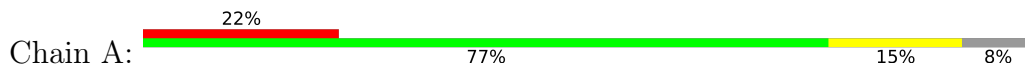

• Molecule 2: Transposon Tn7 transposition protein TnsD

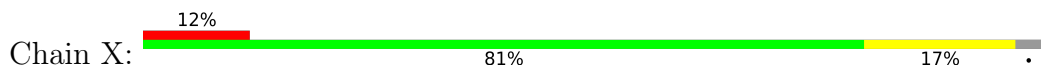

• Molecule 2: Transposon Tn7 transposition protein TnsD

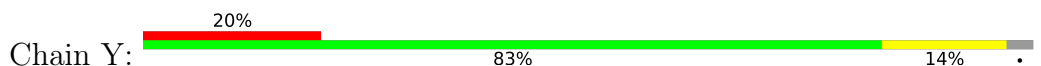

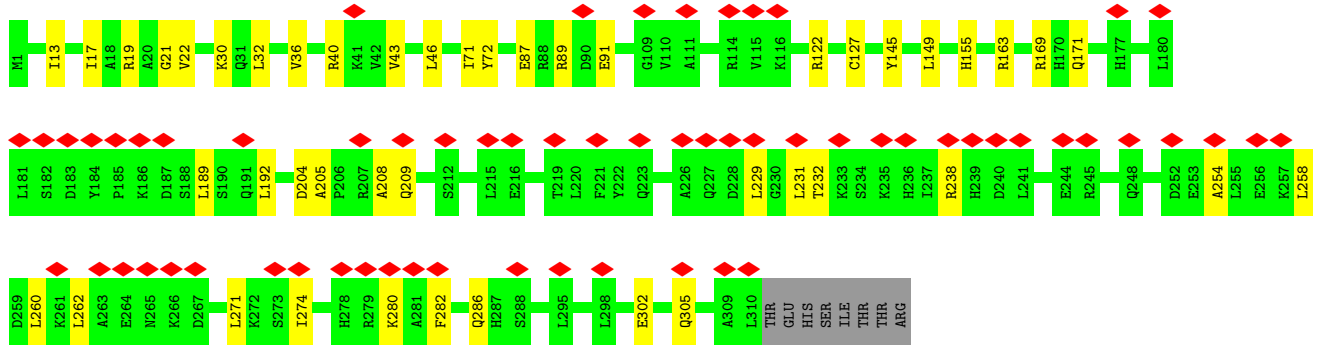

• Molecule 3: DNA (50-MER)

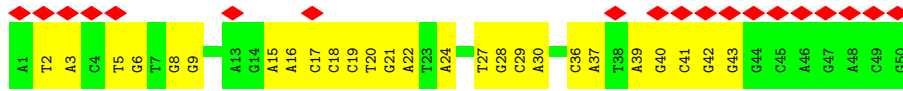

• Molecule 4: DNA (50-MER)

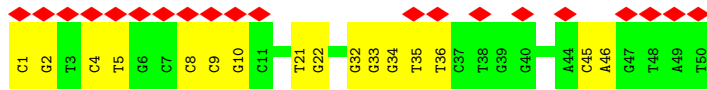

4 Experimental information

| Property | Value | Source |
|--------------------------------------|---------------------------------|-----------|
| EM reconstruction method | SINGLE PARTICLE | Depositor |
| Imposed symmetry | POINT, Not provided | |
| Number of particles used | 82254 | Depositor |
| Resolution determination method | FSC 0.143 CUT-OFF | Depositor |
| CTF correction method | NONE | Depositor |
| Microscope | FEI TITAN KRIOS | Depositor |
| Voltage (kV) | 300 | Depositor |
| Electron dose ($e^-/\text{\AA}^2$) | 60 | Depositor |
| Minimum defocus (nm) | 1250 | Depositor |
| Maximum defocus (nm) | 2500 | Depositor |
| Magnification | Not provided | |
| Image detector | GATAN K3 BIOQUANTUM (6k x 4k) | Depositor |
| Maximum map value | 41.924 | Depositor |
| Minimum map value | -28.691 | Depositor |
| Average map value | -0.000 | Depositor |
| Map value standard deviation | 1.000 | Depositor |
| Recommended contour level | 4.0 | Depositor |
| Map size (\AA) | 307.80002, 307.80002, 307.80002 | wwPDB |
| Map dimensions | 360, 360, 360 | wwPDB |
| Map angles ($^\circ$) | 90.0, 90.0, 90.0 | wwPDB |
| Pixel spacing (\AA) | 0.8550001, 0.8550001, 0.8550001 | Depositor |

5 Model quality

5.1 Standard geometry

Bond lengths and bond angles in the following residue types are not validated in this section: ADP, MG, AGS, ZN

The Z score for a bond length (or angle) is the number of standard deviations the observed value is removed from the expected value. A bond length (or angle) with $|Z| > 5$ is considered an outlier worth inspection. RMSZ is the root-mean-square of all Z scores of the bond lengths (or angles).

| Mol | Chain | Bond lengths | | Bond angles | |
|-----|-------|--------------|---------|-------------|----------------|
| | | RMSZ | # Z >5 | RMSZ | # Z >5 |
| 1 | A | 0.25 | 0/3933 | 0.55 | 1/5320 (0.0%) |
| 1 | B | 0.25 | 0/3928 | 0.54 | 1/5313 (0.0%) |
| 1 | C | 0.25 | 0/3194 | 0.55 | 0/4320 |
| 1 | E | 0.25 | 0/3933 | 0.53 | 0/5320 |
| 1 | F | 0.25 | 0/3928 | 0.53 | 0/5313 |
| 1 | G | 0.25 | 0/3194 | 0.53 | 0/4320 |
| 2 | X | 0.25 | 0/2590 | 0.52 | 0/3517 |
| 2 | Y | 0.24 | 0/2590 | 0.53 | 0/3517 |
| 3 | H | 0.52 | 0/1157 | 0.88 | 0/1783 |
| 4 | I | 0.50 | 0/1141 | 0.96 | 0/1759 |
| All | All | 0.28 | 0/29588 | 0.58 | 2/40482 (0.0%) |

There are no bond length outliers.

All (2) bond angle outliers are listed below:

| Mol | Chain | Res | Type | Atoms | Z | Observed(°) | Ideal(°) |
|-----|-------|-----|------|----------|------|-------------|----------|
| 1 | B | 475 | LEU | CA-CB-CG | 5.84 | 128.74 | 115.30 |
| 1 | A | 415 | LEU | CA-CB-CG | 5.68 | 128.36 | 115.30 |

There are no chirality outliers.

There are no planarity outliers.

5.2 Too-close contacts

In the following table, the Non-H and H(model) columns list the number of non-hydrogen atoms and hydrogen atoms in the chain respectively. The H(added) column lists the number of hydrogen atoms added and optimized by MolProbity. The Clashes column lists the number of clashes within the asymmetric unit, whereas Symm-Clashes lists symmetry-related clashes.

| Mol | Chain | Non-H | H(model) | H(added) | Clashes | Symm-Clashes |
|-----|-------|-------|----------|----------|---------|--------------|
| 1 | A | 3865 | 0 | 3931 | 55 | 0 |
| 1 | B | 3860 | 0 | 3926 | 28 | 0 |
| 1 | C | 3138 | 0 | 3175 | 49 | 0 |
| 1 | E | 3865 | 0 | 3930 | 62 | 0 |
| 1 | F | 3860 | 0 | 3926 | 54 | 0 |
| 1 | G | 3138 | 0 | 3175 | 30 | 0 |
| 2 | X | 2523 | 0 | 2522 | 38 | 0 |
| 2 | Y | 2523 | 0 | 2522 | 24 | 0 |
| 3 | H | 1029 | 0 | 559 | 18 | 0 |
| 4 | I | 1021 | 0 | 567 | 13 | 0 |
| 5 | C | 31 | 0 | 12 | 3 | 0 |
| 5 | G | 31 | 0 | 12 | 2 | 0 |
| 6 | A | 1 | 0 | 0 | 0 | 0 |
| 6 | B | 1 | 0 | 0 | 0 | 0 |
| 6 | C | 1 | 0 | 0 | 0 | 0 |
| 6 | E | 1 | 0 | 0 | 0 | 0 |
| 6 | F | 1 | 0 | 0 | 0 | 0 |
| 6 | G | 1 | 0 | 0 | 0 | 0 |
| 7 | X | 1 | 0 | 0 | 0 | 0 |
| 7 | Y | 1 | 0 | 0 | 0 | 0 |
| 8 | A | 27 | 0 | 12 | 2 | 0 |
| 8 | B | 27 | 0 | 12 | 0 | 0 |
| 8 | E | 27 | 0 | 12 | 0 | 0 |
| 8 | F | 27 | 0 | 12 | 0 | 0 |
| All | All | 29000 | 0 | 28305 | 354 | 0 |

The all-atom clashscore is defined as the number of clashes found per 1000 atoms (including hydrogen atoms). The all-atom clashscore for this structure is 6.

All (354) close contacts within the same asymmetric unit are listed below, sorted by their clash magnitude.

| Atom-1 | Atom-2 | Interatomic distance (Å) | Clash overlap (Å) |
|------------------|------------------|--------------------------|-------------------|
| 1:C:134:LEU:HB3 | 1:C:266:ILE:HG12 | 1.65 | 0.79 |
| 1:F:429:GLU:HB2 | 1:F:433:GLN:HB2 | 1.65 | 0.78 |
| 1:A:18:TYR:HD1 | 1:A:24:ILE:HD13 | 1.56 | 0.71 |
| 1:G:86:MET:HG3 | 1:G:130:GLN:HB2 | 1.72 | 0.70 |
| 1:E:338:GLU:HB2 | 1:E:390:ARG:HH22 | 1.56 | 0.69 |
| 1:E:349:LYS:HE3 | 1:E:408:ILE:HG21 | 1.74 | 0.69 |
| 1:C:316:TRP:NE1 | 1:C:319:GLN:OE1 | 2.25 | 0.69 |
| 1:F:214:LEU:HD21 | 1:F:251:PHE:HE1 | 1.59 | 0.69 |
| 1:A:332:VAL:HA | 1:A:335:VAL:HG12 | 1.74 | 0.68 |
| 1:F:253:VAL:HG11 | 1:F:280:ARG:HH12 | 1.57 | 0.68 |

Continued on next page...

Continued from previous page...

| Atom-1 | Atom-2 | Interatomic distance (Å) | Clash overlap (Å) |
|------------------|------------------|--------------------------|-------------------|
| 1:B:423:GLN:HG2 | 1:B:424:GLU:H | 1.58 | 0.68 |
| 1:C:316:TRP:HZ3 | 1:C:328:LEU:HD13 | 1.59 | 0.67 |
| 2:X:91:GLU:HG2 | 2:X:94:ARG:HD3 | 1.77 | 0.67 |
| 3:H:24:DA:H5' | 1:C:241:ARG:HH12 | 1.59 | 0.66 |
| 1:E:428:GLU:OE1 | 1:E:441:ARG:NH2 | 2.28 | 0.66 |
| 1:G:341:GLN:HG2 | 1:G:389:LEU:HB3 | 1.77 | 0.65 |
| 1:C:234:ILE:HG22 | 1:C:267:GLY:HA3 | 1.79 | 0.65 |
| 1:F:376:GLN:O | 1:F:380:LYS:NZ | 2.25 | 0.64 |
| 1:E:18:TYR:HB3 | 1:E:24:ILE:HG21 | 1.80 | 0.64 |
| 1:F:28:PRO:O | 1:F:88:ARG:NH2 | 2.31 | 0.63 |
| 1:B:437:THR:HB | 1:B:440:GLN:HG2 | 1.81 | 0.63 |
| 1:E:336:TRP:HB3 | 1:E:371:LEU:HD13 | 1.80 | 0.63 |
| 1:F:441:ARG:HA | 1:F:444:TYR:HB3 | 1.78 | 0.63 |
| 1:C:11:ARG:NH2 | 1:C:27:LEU:O | 2.31 | 0.63 |
| 1:G:103:LYS:O | 1:G:107:ASN:ND2 | 2.32 | 0.62 |
| 4:I:4:DC:H2'' | 4:I:5:DT:C5 | 2.35 | 0.62 |
| 1:E:429:GLU:O | 1:E:433:GLN:NE2 | 2.32 | 0.62 |
| 2:Y:232:THR:HA | 2:Y:238:ARG:HB2 | 1.82 | 0.62 |
| 1:A:375:TYR:HD1 | 1:A:379:LEU:HD12 | 1.65 | 0.61 |
| 1:G:345:ASP:OD2 | 1:F:283:ARG:NH1 | 2.34 | 0.61 |
| 2:X:118:ASP:O | 2:X:122:ARG:NH1 | 2.33 | 0.61 |
| 1:F:429:GLU:HA | 1:F:432:LEU:HB3 | 1.81 | 0.61 |
| 2:Y:19:ARG:HA | 2:Y:22:VAL:HB | 1.80 | 0.61 |
| 2:Y:89:ARG:NH1 | 2:Y:209:GLN:O | 2.34 | 0.61 |
| 1:F:177:ASN:OD1 | 1:F:178:GLY:N | 2.33 | 0.60 |
| 1:A:319:GLN:HG3 | 1:A:355:GLN:HE21 | 1.65 | 0.60 |
| 1:G:389:LEU:HD23 | 1:G:397:ILE:HD11 | 1.82 | 0.60 |
| 1:A:440:GLN:HE21 | 1:A:460:ILE:HG22 | 1.66 | 0.60 |
| 3:H:29:DC:H2'' | 3:H:30:DA:N7 | 2.16 | 0.60 |
| 1:B:439:ASP:OD1 | 1:B:472:ARG:NE | 2.33 | 0.60 |
| 1:C:233:GLU:OE1 | 1:C:236:HIS:ND1 | 2.35 | 0.60 |
| 1:C:399:ARG:HG2 | 1:C:400:TYR:H | 1.66 | 0.60 |
| 1:E:177:ASN:O | 1:E:241:ARG:NH2 | 2.34 | 0.60 |
| 1:E:132:LEU:HD11 | 1:E:291:ILE:HG13 | 1.84 | 0.59 |
| 1:E:321:LEU:HD22 | 1:E:364:GLU:HB3 | 1.84 | 0.59 |
| 1:C:316:TRP:CZ3 | 1:C:328:LEU:HD13 | 2.36 | 0.59 |
| 1:A:373:GLN:NE2 | 1:A:377:ASP:OD2 | 2.36 | 0.59 |
| 1:E:425:GLN:NE2 | 1:E:429:GLU:OE2 | 2.29 | 0.58 |
| 1:G:31:GLN:NE2 | 1:F:118:GLU:OE1 | 2.32 | 0.58 |
| 1:G:393:ILE:HB | 1:G:396:ARG:HB3 | 1.84 | 0.58 |
| 1:F:131:SER:OG | 1:F:284:ARG:O | 2.21 | 0.58 |

Continued on next page...

Continued from previous page...

| Atom-1 | Atom-2 | Interatomic distance (Å) | Clash overlap (Å) |
|------------------|------------------|--------------------------|-------------------|
| 2:X:71:ILE:O | 2:X:75:THR:OG1 | 2.20 | 0.58 |
| 1:E:435:LEU:HD13 | 1:E:440:GLN:HG2 | 1.85 | 0.58 |
| 3:H:27:DT:H2'' | 3:H:28:DG:N7 | 2.19 | 0.58 |
| 1:B:322:GLN:N | 1:B:364:GLU:OE2 | 2.31 | 0.57 |
| 1:E:441:ARG:HA | 1:E:444:TYR:HB3 | 1.85 | 0.57 |
| 1:E:44:LEU:HD21 | 1:E:64:ARG:HH22 | 1.69 | 0.57 |
| 1:C:235:GLN:HE21 | 1:C:270:LYS:HD2 | 1.69 | 0.57 |
| 2:X:86:LYS:HG3 | 2:X:89:ARG:HH21 | 1.70 | 0.57 |
| 4:I:32:DG:H2'' | 4:I:33:DG:C8 | 2.40 | 0.57 |
| 3:H:17:DC:H2'' | 3:H:18:DC:C6 | 2.39 | 0.57 |
| 3:H:41:DC:H2'' | 3:H:42:DG:N7 | 2.20 | 0.56 |
| 1:F:328:LEU:HD21 | 1:F:333:ARG:HB2 | 1.87 | 0.56 |
| 1:A:270:LYS:HG3 | 1:A:401:SER:HB2 | 1.86 | 0.56 |
| 1:C:64:ARG:HH12 | 1:B:92:VAL:HG21 | 1.70 | 0.56 |
| 3:H:18:DC:H4' | 3:H:19:DC:H5' | 1.88 | 0.56 |
| 1:C:46:LEU:HD11 | 1:C:320:LEU:HD21 | 1.86 | 0.56 |
| 1:C:21:ASN:HB2 | 1:C:24:ILE:HG22 | 1.86 | 0.56 |
| 1:A:99:GLY:HA3 | 1:A:103:LYS:HD3 | 1.87 | 0.55 |
| 1:A:444:TYR:HD2 | 1:A:445:LEU:HD12 | 1.72 | 0.55 |
| 1:F:179:SER:N | 1:F:182:GLU:OE2 | 2.40 | 0.55 |
| 1:A:71:GLN:H | 8:A:601:ADP:HN62 | 1.54 | 0.55 |
| 1:E:273:GLU:HA | 1:E:276:GLU:HG2 | 1.89 | 0.55 |
| 2:X:231:LEU:HD21 | 2:X:245:ARG:HH12 | 1.70 | 0.55 |
| 1:F:361:LEU:HD22 | 1:F:363:ASN:HB2 | 1.89 | 0.55 |
| 1:E:360:ALA:HB2 | 1:E:419:ILE:HG12 | 1.88 | 0.55 |
| 1:E:146:LEU:HD22 | 1:E:266:ILE:HD11 | 1.88 | 0.54 |
| 1:C:316:TRP:HD1 | 1:C:316:TRP:O | 1.91 | 0.54 |
| 1:B:100:ASP:HB2 | 1:B:103:LYS:HE2 | 1.89 | 0.54 |
| 1:E:373:GLN:NE2 | 1:E:377:ASP:OD2 | 2.41 | 0.54 |
| 1:C:127:SER:OG | 1:C:257:ASN:O | 2.25 | 0.54 |
| 1:C:380:LYS:HA | 1:C:383:HIS:CE1 | 2.43 | 0.54 |
| 1:G:13:THR:HG21 | 1:G:18:TYR:HB2 | 1.88 | 0.54 |
| 2:X:224:ARG:NH1 | 2:X:224:ARG:HA | 2.22 | 0.54 |
| 4:I:35:DT:H2'' | 4:I:36:DT:C5 | 2.42 | 0.54 |
| 1:E:40:LEU:HD11 | 1:E:148:ARG:HG2 | 1.89 | 0.54 |
| 1:F:271:ALA:O | 1:F:275:PHE:HB3 | 2.08 | 0.54 |
| 2:X:88:ARG:HG3 | 2:X:107:MET:SD | 2.48 | 0.54 |
| 1:F:235:GLN:HG2 | 1:F:268:THR:H | 1.73 | 0.54 |
| 2:Y:258:LEU:HB3 | 2:Y:260:LEU:HD23 | 1.90 | 0.54 |
| 1:E:480:LEU:HD13 | 1:F:477:PRO:HG3 | 1.90 | 0.53 |
| 1:F:177:ASN:HB2 | 1:F:241:ARG:HH12 | 1.73 | 0.53 |

Continued on next page...

Continued from previous page...

| Atom-1 | Atom-2 | Interatomic distance (Å) | Clash overlap (Å) |
|------------------|------------------|--------------------------|-------------------|
| 1:F:22:PRO:HG2 | 1:F:96:PRO:HG2 | 1.91 | 0.53 |
| 2:X:71:ILE:HG21 | 2:X:93:ILE:HD13 | 1.91 | 0.53 |
| 1:B:481:GLN:HA | 1:B:484:MET:HE3 | 1.90 | 0.53 |
| 2:Y:149:LEU:HD13 | 2:Y:192:LEU:HD12 | 1.90 | 0.53 |
| 1:C:110:GLU:HG3 | 1:C:121:ARG:HH21 | 1.73 | 0.53 |
| 2:X:230:GLY:O | 2:X:238:ARG:NH1 | 2.42 | 0.53 |
| 1:E:336:TRP:HZ3 | 1:E:347:VAL:HG13 | 1.74 | 0.53 |
| 1:C:319:GLN:HG2 | 1:C:351:PHE:HZ | 1.74 | 0.53 |
| 1:C:172:ILE:HG13 | 1:C:231:ILE:HG22 | 1.89 | 0.52 |
| 1:C:95:ASN:HB3 | 1:C:98:THR:HG22 | 1.90 | 0.52 |
| 1:C:41:LYS:HE3 | 1:C:71:GLN:HG2 | 1.91 | 0.52 |
| 1:G:55:ARG:HG3 | 1:G:359:LEU:HD11 | 1.91 | 0.52 |
| 5:G:601:AGS:O1B | 5:G:601:AGS:O2A | 2.27 | 0.52 |
| 4:I:21:DT:H2'' | 4:I:22:DG:N7 | 2.24 | 0.52 |
| 1:A:453:SER:HA | 1:A:456:LEU:HD12 | 1.92 | 0.52 |
| 1:B:415:LEU:O | 1:B:419:ILE:HG12 | 2.10 | 0.52 |
| 1:E:79:LEU:HD22 | 1:E:293:TRP:HZ2 | 1.76 | 0.51 |
| 1:E:382:VAL:HA | 1:E:403:LEU:HD11 | 1.92 | 0.51 |
| 1:F:357:ARG:HD3 | 1:F:374:VAL:HG22 | 1.92 | 0.51 |
| 1:F:432:LEU:HD12 | 1:F:441:ARG:HH12 | 1.75 | 0.51 |
| 2:Y:205:ALA:HB3 | 2:Y:208:ALA:HB2 | 1.92 | 0.51 |
| 1:A:46:LEU:HD12 | 1:A:320:LEU:HD21 | 1.91 | 0.51 |
| 1:A:55:ARG:HE | 1:A:419:ILE:HG23 | 1.75 | 0.51 |
| 1:F:235:GLN:HG2 | 1:F:268:THR:HG22 | 1.92 | 0.51 |
| 1:B:445:LEU:HD13 | 1:A:326:ALA:HB1 | 1.91 | 0.51 |
| 2:X:224:ARG:HA | 2:X:224:ARG:HH11 | 1.76 | 0.51 |
| 1:A:328:LEU:HD23 | 1:A:333:ARG:HE | 1.76 | 0.51 |
| 1:C:141:GLY:HA3 | 5:C:601:AGS:H8 | 1.92 | 0.51 |
| 1:B:319:GLN:HB3 | 1:B:351:PHE:HZ | 1.75 | 0.51 |
| 2:Y:262:LEU:HD11 | 2:Y:271:LEU:HD13 | 1.92 | 0.51 |
| 3:H:39:DA:H2'' | 3:H:40:DG:C8 | 2.46 | 0.50 |
| 2:X:114:ARG:HH12 | 3:H:18:DC:P | 2.33 | 0.50 |
| 1:F:445:LEU:HA | 1:F:448:LYS:HE2 | 1.92 | 0.50 |
| 2:X:216:GLU:O | 2:X:220:LEU:HG | 2.11 | 0.50 |
| 1:B:471:THR:O | 1:B:475:LEU:N | 2.45 | 0.50 |
| 3:H:2:DT:H2'' | 3:H:3:DA:N7 | 2.26 | 0.50 |
| 1:F:202:ARG:HE | 1:F:203:TYR:HE1 | 1.59 | 0.50 |
| 1:E:64:ARG:NH2 | 1:E:68:ASP:OD2 | 2.44 | 0.49 |
| 1:F:44:LEU:HB3 | 1:F:46:LEU:HD23 | 1.94 | 0.49 |
| 1:F:250:ASN:HA | 1:F:253:VAL:HG12 | 1.95 | 0.49 |
| 1:C:228:LEU:HG | 1:C:230:VAL:HG13 | 1.94 | 0.49 |

Continued on next page...

Continued from previous page...

| Atom-1 | Atom-2 | Interatomic distance (Å) | Clash overlap (Å) |
|------------------|------------------|--------------------------|-------------------|
| 1:A:411:ARG:O | 1:A:415:LEU:HG | 2.12 | 0.49 |
| 1:C:366:ILE:HA | 1:C:370:LEU:HD12 | 1.94 | 0.49 |
| 1:G:328:LEU:HD23 | 1:G:333:ARG:HE | 1.77 | 0.49 |
| 4:I:8:DC:H2'' | 4:I:9:DC:C6 | 2.47 | 0.49 |
| 1:A:133:LEU:HG | 1:A:135:ILE:HG13 | 1.94 | 0.49 |
| 1:G:56:VAL:HG11 | 1:F:30:LEU:HB3 | 1.94 | 0.49 |
| 2:Y:302:GLU:HA | 2:Y:305:GLN:NE2 | 2.28 | 0.49 |
| 5:C:601:AGS:H8 | 5:C:601:AGS:H5'2 | 1.95 | 0.49 |
| 5:G:601:AGS:O2A | 1:F:283:ARG:NH2 | 2.46 | 0.49 |
| 1:A:55:ARG:NH2 | 1:A:359:LEU:O | 2.46 | 0.49 |
| 4:I:8:DC:H2'' | 4:I:9:DC:C5 | 2.48 | 0.49 |
| 1:F:230:VAL:HG12 | 1:F:264:MET:HB3 | 1.94 | 0.49 |
| 2:Y:280:LYS:HE2 | 2:Y:282:PHE:HE1 | 1.78 | 0.49 |
| 2:X:11:GLU:OE2 | 2:X:19:ARG:NH2 | 2.46 | 0.49 |
| 1:A:316:TRP:CE2 | 1:A:328:LEU:HD13 | 2.48 | 0.49 |
| 1:A:379:LEU:O | 1:A:383:HIS:ND1 | 2.44 | 0.49 |
| 2:X:34:ASP:OD2 | 2:X:40:ARG:NH2 | 2.45 | 0.49 |
| 3:H:20:DT:H2'' | 3:H:21:DG:C8 | 2.47 | 0.49 |
| 1:E:435:LEU:HD12 | 1:E:436:ASP:N | 2.28 | 0.48 |
| 2:X:94:ARG:NH2 | 1:A:387:GLU:OE2 | 2.39 | 0.48 |
| 1:F:458:PRO:HA | 1:F:461:LYS:HB3 | 1.94 | 0.48 |
| 1:C:70:PHE:CD2 | 1:C:148:ARG:HD2 | 2.49 | 0.48 |
| 1:B:230:VAL:HG12 | 1:B:264:MET:HB3 | 1.96 | 0.48 |
| 1:G:126:ARG:HA | 1:G:126:ARG:HD3 | 1.72 | 0.48 |
| 1:E:479:VAL:HA | 1:E:482:TRP:HE3 | 1.78 | 0.48 |
| 1:E:303:LYS:HG2 | 1:E:304:PRO:HD2 | 1.94 | 0.48 |
| 2:X:84:VAL:HG11 | 2:X:88:ARG:HD2 | 1.96 | 0.48 |
| 1:C:45:GLN:HG2 | 1:C:46:LEU:N | 2.29 | 0.48 |
| 4:I:33:DG:H2'' | 4:I:34:DG:C8 | 2.49 | 0.48 |
| 2:X:295:LEU:HD23 | 2:X:297:LYS:H | 1.78 | 0.47 |
| 1:E:256:VAL:HG22 | 1:E:263:VAL:HG11 | 1.96 | 0.47 |
| 1:C:11:ARG:HG2 | 1:C:12:ASP:N | 2.28 | 0.47 |
| 1:A:143:THR:OG1 | 8:A:601:ADP:O2B | 2.31 | 0.47 |
| 1:A:435:LEU:HD13 | 1:A:457:ILE:HG23 | 1.96 | 0.47 |
| 3:H:15:DA:H2'' | 3:H:16:DA:N7 | 2.28 | 0.47 |
| 4:I:34:DG:H2'' | 4:I:35:DT:H72 | 1.96 | 0.47 |
| 2:Y:71:ILE:HG22 | 2:Y:72:TYR:CD1 | 2.50 | 0.47 |
| 2:Y:204:ASP:OD1 | 2:Y:204:ASP:N | 2.46 | 0.47 |
| 2:X:138:ALA:HB1 | 2:X:175:LEU:HD23 | 1.97 | 0.47 |
| 1:C:54:SER:HB3 | 1:C:57:ILE:HG12 | 1.95 | 0.47 |
| 1:E:476:LEU:HA | 1:E:479:VAL:HG12 | 1.96 | 0.47 |

Continued on next page...

Continued from previous page...

| Atom-1 | Atom-2 | Interatomic distance (Å) | Clash overlap (Å) |
|------------------|------------------|--------------------------|-------------------|
| 2:X:159:VAL:HG22 | 2:X:184:TYR:HE1 | 1.79 | 0.47 |
| 1:C:316:TRP:CD1 | 1:C:319:GLN:HG3 | 2.50 | 0.47 |
| 1:B:208:HIS:HB3 | 1:B:212:THR:HB | 1.97 | 0.47 |
| 1:A:432:LEU:HD11 | 1:A:445:LEU:HD11 | 1.97 | 0.47 |
| 1:G:382:VAL:HG12 | 1:G:386:LEU:HD23 | 1.96 | 0.47 |
| 1:C:198:ASN:OD1 | 1:C:201:ARG:HB2 | 2.15 | 0.47 |
| 1:A:321:LEU:HB2 | 1:A:324:LYS:HB2 | 1.97 | 0.47 |
| 3:H:8:DG:H2'' | 3:H:9:DG:C8 | 2.50 | 0.46 |
| 1:F:126:ARG:NH2 | 1:F:128:THR:OG1 | 2.49 | 0.46 |
| 1:A:350:LEU:HD21 | 1:A:379:LEU:HD11 | 1.96 | 0.46 |
| 1:A:21:ASN:HD22 | 1:A:24:ILE:HD12 | 1.80 | 0.46 |
| 3:H:36:DC:H2'' | 3:H:37:DA:C8 | 2.51 | 0.46 |
| 1:E:172:ILE:HD11 | 1:E:187:PHE:HD1 | 1.80 | 0.46 |
| 2:Y:21:GLY:HA3 | 2:Y:32:LEU:HD21 | 1.96 | 0.46 |
| 2:X:116:LYS:HB3 | 2:X:119:ASN:HB2 | 1.96 | 0.46 |
| 2:Y:46:LEU:HD21 | 2:Y:145:TYR:HE2 | 1.81 | 0.46 |
| 2:Y:30:LYS:HD2 | 2:Y:40:ARG:HD3 | 1.97 | 0.46 |
| 1:E:107:ASN:HA | 1:E:110:GLU:HG3 | 1.98 | 0.46 |
| 1:F:443:LEU:HD22 | 1:F:476:LEU:HG | 1.97 | 0.46 |
| 2:X:233:LYS:HG2 | 2:X:234:SER:H | 1.81 | 0.46 |
| 1:E:428:GLU:HB3 | 1:E:441:ARG:HH22 | 1.79 | 0.46 |
| 2:Y:189:LEU:HD22 | 2:Y:254:ALA:HB2 | 1.98 | 0.46 |
| 2:X:114:ARG:CZ | 3:H:17:DC:H5'' | 2.45 | 0.46 |
| 1:F:444:TYR:HA | 1:F:447:LEU:HB2 | 1.98 | 0.46 |
| 1:G:383:HIS:O | 1:G:387:GLU:HG2 | 2.16 | 0.45 |
| 2:X:274:ILE:HD11 | 2:X:286:GLN:HB3 | 1.97 | 0.45 |
| 1:E:117:LEU:HD12 | 1:E:117:LEU:HA | 1.82 | 0.45 |
| 1:F:316:TRP:CD2 | 1:F:328:LEU:HD12 | 2.51 | 0.45 |
| 1:C:145:SER:O | 1:C:149:ILE:HG12 | 2.16 | 0.45 |
| 1:A:48:SER:HA | 1:A:51:LEU:HD13 | 1.98 | 0.45 |
| 1:A:319:GLN:HG3 | 1:A:355:GLN:NE2 | 2.31 | 0.45 |
| 1:A:415:LEU:O | 1:A:419:ILE:HG12 | 2.16 | 0.45 |
| 2:Y:13:ILE:O | 2:Y:17:ILE:HG13 | 2.15 | 0.45 |
| 4:I:4:DC:H2'' | 4:I:5:DT:C4 | 2.52 | 0.45 |
| 1:F:320:LEU:O | 1:F:321:LEU:HD12 | 2.16 | 0.45 |
| 3:H:22:DA:OP1 | 1:B:179:SER:OG | 2.35 | 0.45 |
| 1:E:49:SER:HA | 1:E:442:HIS:HE1 | 1.82 | 0.45 |
| 1:E:333:ARG:HA | 1:E:336:TRP:HE1 | 1.82 | 0.45 |
| 2:Y:127:CYS:SG | 2:Y:155:HIS:CE1 | 3.09 | 0.45 |
| 1:G:171:LYS:HG3 | 1:G:230:VAL:HG13 | 1.98 | 0.45 |
| 3:H:21:DG:H2'' | 3:H:22:DA:C8 | 2.52 | 0.45 |

Continued on next page...

Continued from previous page...

| Atom-1 | Atom-2 | Interatomic distance (Å) | Clash overlap (Å) |
|------------------|------------------|--------------------------|-------------------|
| 5:C:601:AGS:O2A | 5:C:601:AGS:O1B | 2.34 | 0.45 |
| 1:B:472:ARG:HA | 1:B:475:LEU:HD12 | 1.99 | 0.45 |
| 1:G:48:SER:HA | 1:G:51:LEU:HD23 | 1.97 | 0.45 |
| 1:C:330:ASP:OD1 | 1:C:333:ARG:NH1 | 2.50 | 0.45 |
| 1:B:437:THR:HG22 | 1:B:439:ASP:H | 1.81 | 0.45 |
| 2:Y:46:LEU:HD21 | 2:Y:145:TYR:CE2 | 2.51 | 0.45 |
| 2:X:152:CYS:HB3 | 2:X:155:HIS:O | 2.17 | 0.45 |
| 1:A:198:ASN:HB2 | 1:A:201:ARG:HG2 | 1.97 | 0.45 |
| 4:I:45:DC:H2'' | 4:I:46:DA:C8 | 2.52 | 0.45 |
| 1:F:367:THR:HG23 | 1:F:370:LEU:H | 1.81 | 0.45 |
| 1:C:9:VAL:HG23 | 1:B:113:GLN:HG2 | 1.99 | 0.45 |
| 1:B:450:ASP:HB3 | 1:A:473:GLN:HE22 | 1.82 | 0.45 |
| 1:A:4:THR:HG22 | 1:A:6:ILE:HG23 | 1.98 | 0.45 |
| 1:E:349:LYS:HA | 1:E:352:VAL:HG12 | 1.98 | 0.45 |
| 2:Y:274:ILE:HD11 | 2:Y:286:GLN:OE1 | 2.17 | 0.45 |
| 1:F:37:ALA:HB2 | 1:F:77:LEU:HB3 | 1.99 | 0.45 |
| 1:C:158:TYR:HD1 | 1:C:165:GLU:HG2 | 1.82 | 0.45 |
| 2:X:247:ARG:NH1 | 2:X:264:GLU:OE2 | 2.49 | 0.44 |
| 2:X:270:TRP:O | 2:X:274:ILE:HG13 | 2.17 | 0.44 |
| 2:Y:32:LEU:O | 2:Y:36:VAL:HG12 | 2.18 | 0.44 |
| 1:E:49:SER:HA | 1:E:442:HIS:CE1 | 2.53 | 0.44 |
| 1:F:271:ALA:O | 1:F:275:PHE:CB | 2.65 | 0.44 |
| 1:C:380:LYS:HD2 | 1:B:292:PHE:CE2 | 2.53 | 0.44 |
| 1:B:393:ILE:HG22 | 1:B:395:GLU:HG3 | 2.00 | 0.44 |
| 1:G:186:ASN:OD1 | 1:G:189:ARG:NH2 | 2.40 | 0.44 |
| 1:F:102:GLN:NE2 | 1:F:106:GLN:OE1 | 2.41 | 0.44 |
| 1:F:172:ILE:HB | 1:F:231:ILE:HD13 | 1.99 | 0.44 |
| 1:E:346:ILE:HA | 1:E:349:LYS:HB2 | 2.00 | 0.44 |
| 1:E:393:ILE:HG22 | 1:E:396:ARG:H | 1.82 | 0.44 |
| 1:C:380:LYS:HA | 1:C:383:HIS:ND1 | 2.32 | 0.44 |
| 1:F:383:HIS:O | 1:F:387:GLU:HG3 | 2.18 | 0.44 |
| 1:C:235:GLN:HA | 1:C:271:ALA:HB2 | 2.00 | 0.44 |
| 1:B:462:LYS:HA | 1:B:465:SER:OG | 2.18 | 0.44 |
| 1:E:452:ASP:O | 1:E:456:LEU:HG | 2.18 | 0.44 |
| 1:A:170:LEU:HD12 | 1:A:170:LEU:HA | 1.90 | 0.44 |
| 1:A:412:LEU:HD23 | 1:A:415:LEU:HD12 | 2.00 | 0.44 |
| 1:F:472:ARG:HA | 1:F:475:LEU:HD12 | 2.00 | 0.44 |
| 1:C:298:GLN:HG3 | 1:C:299:THR:HG23 | 1.99 | 0.44 |
| 1:E:52:GLN:HE22 | 1:E:441:ARG:HB3 | 1.83 | 0.43 |
| 1:A:55:ARG:HA | 1:A:58:ARG:HE | 1.84 | 0.43 |
| 1:G:64:ARG:HH22 | 1:F:92:VAL:HG21 | 1.83 | 0.43 |

Continued on next page...

Continued from previous page...

| Atom-1 | Atom-2 | Interatomic distance (Å) | Clash overlap (Å) |
|------------------|------------------|--------------------------|-------------------|
| 2:X:253:GLU:HA | 2:X:256:GLU:HG3 | 2.00 | 0.43 |
| 3:H:42:DG:H2'' | 3:H:43:DG:N7 | 2.33 | 0.43 |
| 2:X:219:THR:HG21 | 2:X:277:LYS:HG3 | 2.00 | 0.43 |
| 1:E:241:ARG:H | 1:E:241:ARG:HG2 | 1.68 | 0.43 |
| 1:B:386:LEU:O | 1:B:390:ARG:HG3 | 2.18 | 0.43 |
| 1:C:46:LEU:HG | 1:C:47:THR:H | 1.83 | 0.43 |
| 1:C:197:SER:OG | 1:C:198:ASN:N | 2.51 | 0.43 |
| 1:A:476:LEU:HB3 | 1:A:477:PRO:HD3 | 2.01 | 0.43 |
| 1:G:396:ARG:O | 1:G:399:ARG:HG2 | 2.19 | 0.43 |
| 1:E:55:ARG:HH22 | 1:E:422:ILE:HG21 | 1.83 | 0.43 |
| 1:F:268:THR:HG23 | 1:F:270:LYS:H | 1.83 | 0.43 |
| 1:C:70:PHE:HD2 | 1:C:148:ARG:HD2 | 1.83 | 0.43 |
| 1:C:104:HIS:NE2 | 1:C:126:ARG:O | 2.39 | 0.43 |
| 1:C:110:GLU:O | 1:C:114:THR:HG22 | 2.18 | 0.43 |
| 1:E:443:LEU:O | 1:E:447:LEU:HG | 2.19 | 0.43 |
| 1:B:253:VAL:HG11 | 1:B:280:ARG:NH1 | 2.34 | 0.43 |
| 1:G:75:THR:HG21 | 1:G:293:TRP:HE1 | 1.84 | 0.43 |
| 2:Y:43:VAL:HG23 | 2:Y:169:ARG:HB2 | 2.00 | 0.43 |
| 2:X:159:VAL:HG22 | 2:X:184:TYR:CE1 | 2.54 | 0.42 |
| 1:B:45:GLN:HG2 | 1:B:46:LEU:N | 2.33 | 0.42 |
| 1:A:443:LEU:O | 1:A:447:LEU:HG | 2.19 | 0.42 |
| 2:X:245:ARG:O | 2:X:249:THR:HG22 | 2.19 | 0.42 |
| 1:E:443:LEU:HD21 | 1:E:472:ARG:HG2 | 2.00 | 0.42 |
| 1:G:316:TRP:CD2 | 1:G:328:LEU:HD13 | 2.55 | 0.42 |
| 1:A:55:ARG:NH1 | 1:A:422:ILE:HG21 | 2.34 | 0.42 |
| 1:A:357:ARG:HA | 1:A:357:ARG:HD3 | 1.81 | 0.42 |
| 1:E:52:GLN:NE2 | 1:E:441:ARG:HB3 | 2.34 | 0.42 |
| 1:F:179:SER:HB3 | 1:F:182:GLU:OE1 | 2.18 | 0.42 |
| 2:X:91:GLU:O | 2:X:94:ARG:HG2 | 2.19 | 0.42 |
| 3:H:5:DT:H2'' | 3:H:6:DG:C8 | 2.55 | 0.42 |
| 1:E:13:THR:HG22 | 1:E:15:VAL:H | 1.84 | 0.42 |
| 1:E:476:LEU:HD22 | 1:F:480:LEU:HD11 | 2.01 | 0.42 |
| 1:E:177:ASN:HB3 | 1:E:241:ARG:HH21 | 1.85 | 0.42 |
| 1:E:358:ALA:HB2 | 1:E:370:LEU:HD21 | 2.02 | 0.42 |
| 1:F:357:ARG:NH1 | 1:F:373:GLN:OE1 | 2.52 | 0.42 |
| 2:X:256:GLU:HB3 | 2:X:261:LYS:NZ | 2.34 | 0.42 |
| 1:F:386:LEU:O | 1:F:390:ARG:HG3 | 2.20 | 0.42 |
| 1:C:21:ASN:O | 1:C:25:GLU:HB2 | 2.19 | 0.42 |
| 1:A:259:ILE:HG22 | 1:A:261:VAL:HG22 | 2.02 | 0.42 |
| 2:X:18:ALA:O | 2:X:22:VAL:HG23 | 2.20 | 0.42 |
| 4:I:1:DC:H2'' | 4:I:2:DG:N7 | 2.35 | 0.42 |

Continued on next page...

Continued from previous page...

| Atom-1 | Atom-2 | Interatomic distance (Å) | Clash overlap (Å) |
|------------------|------------------|--------------------------|-------------------|
| 1:G:53:LYS:HE2 | 1:G:57:ILE:HG21 | 2.02 | 0.41 |
| 2:X:231:LEU:HD12 | 2:X:242:VAL:HG13 | 2.02 | 0.41 |
| 4:I:9:DC:H2' | 4:I:10:DG:N7 | 2.35 | 0.41 |
| 1:F:229:LEU:HB3 | 1:F:263:VAL:HG12 | 2.01 | 0.41 |
| 1:G:110:GLU:O | 1:G:114:THR:HG22 | 2.20 | 0.41 |
| 1:G:46:LEU:O | 1:G:47:THR:OG1 | 2.29 | 0.41 |
| 2:X:132:LEU:HD11 | 2:X:177:HIS:CD2 | 2.55 | 0.41 |
| 1:E:268:THR:HG23 | 1:E:270:LYS:H | 1.86 | 0.41 |
| 1:A:171:LYS:HE2 | 1:A:171:LYS:HB3 | 1.91 | 0.41 |
| 2:X:244:GLU:OE2 | 2:X:245:ARG:HD2 | 2.21 | 0.41 |
| 1:E:218:SER:HB2 | 1:E:258:ILE:HG22 | 2.02 | 0.41 |
| 1:E:336:TRP:CZ3 | 1:E:347:VAL:HG13 | 2.52 | 0.41 |
| 1:E:435:LEU:HD12 | 1:E:436:ASP:H | 1.85 | 0.41 |
| 1:C:56:VAL:HG11 | 1:B:30:LEU:HB3 | 2.02 | 0.41 |
| 1:C:218:SER:OG | 1:C:259:ILE:HG12 | 2.20 | 0.41 |
| 1:A:15:VAL:HB | 1:A:18:TYR:HD2 | 1.84 | 0.41 |
| 1:G:37:ALA:HB2 | 1:G:77:LEU:HD21 | 2.02 | 0.41 |
| 1:G:226:LEU:HD23 | 1:G:261:VAL:HG11 | 2.01 | 0.41 |
| 1:F:245:SER:O | 1:F:248:MET:HG3 | 2.20 | 0.41 |
| 1:A:399:ARG:HA | 1:A:399:ARG:HD2 | 1.85 | 0.41 |
| 1:A:328:LEU:HD21 | 1:A:336:TRP:HH2 | 1.85 | 0.41 |
| 2:X:94:ARG:HH21 | 1:A:396:ARG:HD2 | 1.86 | 0.41 |
| 1:B:278:ASP:OD1 | 1:B:279:LEU:N | 2.54 | 0.41 |
| 1:A:321:LEU:HD21 | 1:A:355:GLN:HG2 | 2.03 | 0.41 |
| 1:A:471:THR:HG22 | 1:A:473:GLN:H | 1.85 | 0.41 |
| 2:X:71:ILE:HG23 | 2:X:72:TYR:HD1 | 1.86 | 0.41 |
| 1:E:298:GLN:O | 1:E:305:ASN:N | 2.54 | 0.41 |
| 1:E:381:PRO:HG2 | 1:E:405:VAL:HG23 | 2.02 | 0.41 |
| 1:E:403:LEU:H | 1:E:403:LEU:HD23 | 1.85 | 0.41 |
| 1:E:409:ASP:O | 1:E:413:ILE:HG12 | 2.21 | 0.41 |
| 1:F:350:LEU:HD23 | 1:F:350:LEU:HA | 1.90 | 0.41 |
| 1:G:187:PHE:CD2 | 1:G:217:MET:HG3 | 2.56 | 0.41 |
| 4:I:21:DT:H6 | 4:I:21:DT:H2' | 1.72 | 0.41 |
| 2:Y:229:LEU:HB3 | 2:Y:231:LEU:HG | 2.03 | 0.41 |
| 1:A:428:GLU:O | 1:A:432:LEU:HD23 | 2.21 | 0.41 |
| 1:C:133:LEU:HA | 1:C:265:LEU:O | 2.21 | 0.40 |
| 1:C:139:GLY:O | 1:C:344:MET:HB3 | 2.22 | 0.40 |
| 1:G:376:GLN:HA | 1:G:383:HIS:HE1 | 1.87 | 0.40 |
| 1:E:478:LEU:HG | 1:E:482:TRP:CZ3 | 2.56 | 0.40 |
| 1:C:316:TRP:O | 1:C:316:TRP:CD1 | 2.72 | 0.40 |
| 1:B:361:LEU:HD23 | 1:B:361:LEU:HA | 1.89 | 0.40 |

Continued on next page...

Continued from previous page...

| Atom-1 | Atom-2 | Interatomic distance (Å) | Clash overlap (Å) |
|------------------|------------------|--------------------------|-------------------|
| 1:A:188:PHE:HE1 | 1:A:220:ILE:HD12 | 1.86 | 0.40 |
| 1:A:382:VAL:O | 1:A:386:LEU:HD23 | 2.21 | 0.40 |
| 1:E:447:LEU:HD11 | 1:E:475:LEU:HD21 | 2.04 | 0.40 |
| 1:E:480:LEU:HD22 | 1:F:477:PRO:HB2 | 2.03 | 0.40 |
| 1:F:477:PRO:HA | 1:F:480:LEU:HD12 | 2.03 | 0.40 |
| 1:G:15:VAL:HG12 | 1:G:17:ALA:H | 1.86 | 0.40 |
| 1:G:71:GLN:HA | 1:G:72:PRO:HD3 | 1.95 | 0.40 |
| 1:E:432:LEU:HB2 | 1:E:441:ARG:HD2 | 2.02 | 0.40 |
| 1:B:222:ASN:HD21 | 1:B:259:ILE:HG21 | 1.86 | 0.40 |
| 2:Y:163:ARG:NH2 | 2:Y:171:GLN:OE1 | 2.36 | 0.40 |
| 1:E:81:GLU:OE2 | 1:F:60:HIS:ND1 | 2.54 | 0.40 |
| 2:Y:87:GLU:O | 2:Y:91:GLU:HG2 | 2.21 | 0.40 |
| 1:A:235:GLN:HB2 | 1:A:402:ASP:OD2 | 2.21 | 0.40 |
| 1:A:321:LEU:HD12 | 1:A:364:GLU:HB3 | 2.04 | 0.40 |
| 1:A:357:ARG:HD2 | 1:A:361:LEU:HG | 2.03 | 0.40 |
| 1:A:472:ARG:HA | 1:A:472:ARG:HD3 | 1.92 | 0.40 |

There are no symmetry-related clashes.

5.3 Torsion angles [i](#)

5.3.1 Protein backbone [i](#)

In the following table, the Percentiles column shows the percent Ramachandran outliers of the chain as a percentile score with respect to all PDB entries followed by that with respect to all EM entries.

The Analysed column shows the number of residues for which the backbone conformation was analysed, and the total number of residues.

| Mol | Chain | Analysed | Favoured | Allowed | Outliers | Percentiles | |
|-----|-------|---------------|-----------|---------|----------|-------------|-----|
| 1 | A | 481/523 (92%) | 469 (98%) | 12 (2%) | 0 | 100 | 100 |
| 1 | B | 480/523 (92%) | 461 (96%) | 19 (4%) | 0 | 100 | 100 |
| 1 | C | 390/523 (75%) | 378 (97%) | 12 (3%) | 0 | 100 | 100 |
| 1 | E | 481/523 (92%) | 457 (95%) | 24 (5%) | 0 | 100 | 100 |
| 1 | F | 480/523 (92%) | 457 (95%) | 23 (5%) | 0 | 100 | 100 |
| 1 | G | 390/523 (75%) | 375 (96%) | 15 (4%) | 0 | 100 | 100 |
| 2 | X | 308/318 (97%) | 295 (96%) | 13 (4%) | 0 | 100 | 100 |

Continued on next page...

Continued from previous page...

| Mol | Chain | Analysed | Favoured | Allowed | Outliers | Percentiles | |
|-----|-------|-----------------|------------|----------|----------|-------------|-----|
| 2 | Y | 308/318 (97%) | 294 (96%) | 14 (4%) | 0 | 100 | 100 |
| All | All | 3318/3774 (88%) | 3186 (96%) | 132 (4%) | 0 | 100 | 100 |

There are no Ramachandran outliers to report.

5.3.2 Protein sidechains [i](#)

In the following table, the Percentiles column shows the percent sidechain outliers of the chain as a percentile score with respect to all PDB entries followed by that with respect to all EM entries.

The Analysed column shows the number of residues for which the sidechain conformation was analysed, and the total number of residues.

| Mol | Chain | Analysed | Rotameric | Outliers | Percentiles | |
|-----|-------|-----------------|-------------|----------|-------------|-----|
| 1 | A | 422/457 (92%) | 421 (100%) | 1 (0%) | 93 | 97 |
| 1 | B | 422/457 (92%) | 421 (100%) | 1 (0%) | 93 | 97 |
| 1 | C | 341/457 (75%) | 341 (100%) | 0 | 100 | 100 |
| 1 | E | 422/457 (92%) | 421 (100%) | 1 (0%) | 93 | 97 |
| 1 | F | 422/457 (92%) | 422 (100%) | 0 | 100 | 100 |
| 1 | G | 341/457 (75%) | 341 (100%) | 0 | 100 | 100 |
| 2 | X | 265/273 (97%) | 265 (100%) | 0 | 100 | 100 |
| 2 | Y | 265/273 (97%) | 264 (100%) | 1 (0%) | 91 | 95 |
| All | All | 2900/3288 (88%) | 2896 (100%) | 4 (0%) | 93 | 97 |

All (4) residues with a non-rotameric sidechain are listed below:

| Mol | Chain | Res | Type |
|-----|-------|-----|------|
| 1 | E | 324 | LYS |
| 1 | B | 314 | ASN |
| 2 | Y | 122 | ARG |
| 1 | A | 58 | ARG |

Sometimes sidechains can be flipped to improve hydrogen bonding and reduce clashes. All (5) such sidechains are listed below:

| Mol | Chain | Res | Type |
|-----|-------|-----|------|
| 1 | G | 52 | GLN |

Continued on next page...

Continued from previous page...

| Mol | Chain | Res | Type |
|-----|-------|-----|------|
| 2 | X | 155 | HIS |
| 1 | E | 433 | GLN |
| 1 | C | 235 | GLN |
| 1 | C | 246 | GLN |

5.3.3 RNA [i](#)

There are no RNA molecules in this entry.

5.4 Non-standard residues in protein, DNA, RNA chains [i](#)

There are no non-standard protein/DNA/RNA residues in this entry.

5.5 Carbohydrates [i](#)

There are no monosaccharides in this entry.

5.6 Ligand geometry [i](#)

Of 14 ligands modelled in this entry, 8 are monoatomic - leaving 6 for Mogul analysis.

In the following table, the Counts columns list the number of bonds (or angles) for which Mogul statistics could be retrieved, the number of bonds (or angles) that are observed in the model and the number of bonds (or angles) that are defined in the Chemical Component Dictionary. The Link column lists molecule types, if any, to which the group is linked. The Z score for a bond length (or angle) is the number of standard deviations the observed value is removed from the expected value. A bond length (or angle) with $|Z| > 2$ is considered an outlier worth inspection. RMSZ is the root-mean-square of all Z scores of the bond lengths (or angles).

| Mol | Type | Chain | Res | Link | Bond lengths | | | Bond angles | | |
|-----|------|-------|-----|------|--------------|------|----------|-------------|------|----------|
| | | | | | Counts | RMSZ | # Z > 2 | Counts | RMSZ | # Z > 2 |
| 8 | ADP | F | 601 | 6 | 24,29,29 | 0.94 | 1 (4%) | 29,45,45 | 1.48 | 4 (13%) |
| 8 | ADP | E | 601 | 6 | 24,29,29 | 0.94 | 1 (4%) | 29,45,45 | 1.48 | 4 (13%) |
| 8 | ADP | A | 601 | 6 | 24,29,29 | 0.95 | 1 (4%) | 29,45,45 | 1.47 | 4 (13%) |
| 5 | AGS | G | 601 | - | 26,33,33 | 0.71 | 1 (3%) | 26,52,52 | 1.08 | 2 (7%) |
| 5 | AGS | C | 601 | - | 26,33,33 | 0.71 | 1 (3%) | 26,52,52 | 1.08 | 2 (7%) |
| 8 | ADP | B | 601 | 6 | 24,29,29 | 0.94 | 1 (4%) | 29,45,45 | 1.46 | 4 (13%) |

In the following table, the Chirals column lists the number of chiral outliers, the number of chiral

centers analysed, the number of these observed in the model and the number defined in the Chemical Component Dictionary. Similar counts are reported in the Torsion and Rings columns. '-' means no outliers of that kind were identified.

| Mol | Type | Chain | Res | Link | Chirals | Torsions | Rings |
|-----|------|-------|-----|------|---------|------------|---------|
| 8 | ADP | F | 601 | 6 | - | 1/12/32/32 | 0/3/3/3 |
| 8 | ADP | E | 601 | 6 | - | 5/12/32/32 | 0/3/3/3 |
| 8 | ADP | A | 601 | 6 | - | 4/12/32/32 | 0/3/3/3 |
| 5 | AGS | G | 601 | - | - | 6/17/38/38 | 0/3/3/3 |
| 5 | AGS | C | 601 | - | - | 8/17/38/38 | 0/3/3/3 |
| 8 | ADP | B | 601 | 6 | - | 0/12/32/32 | 0/3/3/3 |

All (6) bond length outliers are listed below:

| Mol | Chain | Res | Type | Atoms | Z | Observed(Å) | Ideal(Å) |
|-----|-------|-----|------|--------|------|-------------|----------|
| 8 | F | 601 | ADP | C5-C4 | 2.45 | 1.47 | 1.40 |
| 8 | A | 601 | ADP | C5-C4 | 2.43 | 1.47 | 1.40 |
| 8 | B | 601 | ADP | C5-C4 | 2.42 | 1.47 | 1.40 |
| 8 | E | 601 | ADP | C5-C4 | 2.41 | 1.47 | 1.40 |
| 5 | G | 601 | AGS | PG-S1G | 2.11 | 1.95 | 1.90 |
| 5 | C | 601 | AGS | PG-S1G | 2.09 | 1.95 | 1.90 |

All (20) bond angle outliers are listed below:

| Mol | Chain | Res | Type | Atoms | Z | Observed(°) | Ideal(°) |
|-----|-------|-----|------|-------------|-------|-------------|----------|
| 5 | C | 601 | AGS | PA-O3A-PB | -3.97 | 119.19 | 132.83 |
| 8 | A | 601 | ADP | PA-O3A-PB | -3.97 | 119.20 | 132.83 |
| 5 | G | 601 | AGS | PA-O3A-PB | -3.89 | 119.47 | 132.83 |
| 8 | E | 601 | ADP | PA-O3A-PB | -3.85 | 119.61 | 132.83 |
| 8 | F | 601 | ADP | PA-O3A-PB | -3.78 | 119.84 | 132.83 |
| 8 | B | 601 | ADP | PA-O3A-PB | -3.60 | 120.47 | 132.83 |
| 8 | B | 601 | ADP | C3'-C2'-C1' | 3.23 | 105.85 | 100.98 |
| 8 | A | 601 | ADP | N3-C2-N1 | -3.19 | 123.69 | 128.68 |
| 8 | E | 601 | ADP | C3'-C2'-C1' | 3.18 | 105.76 | 100.98 |
| 8 | B | 601 | ADP | N3-C2-N1 | -3.17 | 123.72 | 128.68 |
| 8 | F | 601 | ADP | N3-C2-N1 | -3.17 | 123.73 | 128.68 |
| 8 | F | 601 | ADP | C3'-C2'-C1' | 3.09 | 105.63 | 100.98 |
| 8 | E | 601 | ADP | N3-C2-N1 | -3.05 | 123.91 | 128.68 |
| 8 | A | 601 | ADP | C3'-C2'-C1' | 2.94 | 105.41 | 100.98 |
| 8 | E | 601 | ADP | C4-C5-N7 | -2.75 | 106.53 | 109.40 |
| 8 | A | 601 | ADP | C4-C5-N7 | -2.63 | 106.66 | 109.40 |
| 8 | F | 601 | ADP | C4-C5-N7 | -2.61 | 106.68 | 109.40 |
| 8 | B | 601 | ADP | C4-C5-N7 | -2.60 | 106.69 | 109.40 |
| 5 | G | 601 | AGS | C5-C6-N6 | 2.25 | 123.77 | 120.35 |

Continued on next page...

Continued from previous page...

| Mol | Chain | Res | Type | Atoms | Z | Observed(°) | Ideal(°) |
|-----|-------|-----|------|----------|------|-------------|----------|
| 5 | C | 601 | AGS | C5-C6-N6 | 2.20 | 123.70 | 120.35 |

There are no chirality outliers.

All (24) torsion outliers are listed below:

| Mol | Chain | Res | Type | Atoms |
|-----|-------|-----|------|-----------------|
| 5 | G | 601 | AGS | C5'-O5'-PA-O1A |
| 5 | G | 601 | AGS | C3'-C4'-C5'-O5' |
| 5 | C | 601 | AGS | PB-O3B-PG-O2G |
| 5 | C | 601 | AGS | PB-O3B-PG-O3G |
| 5 | C | 601 | AGS | C5'-O5'-PA-O1A |
| 5 | C | 601 | AGS | C5'-O5'-PA-O2A |
| 5 | C | 601 | AGS | C3'-C4'-C5'-O5' |
| 8 | E | 601 | ADP | C5'-O5'-PA-O1A |
| 8 | E | 601 | ADP | C5'-O5'-PA-O2A |
| 8 | A | 601 | ADP | C5'-O5'-PA-O1A |
| 5 | G | 601 | AGS | O4'-C4'-C5'-O5' |
| 5 | C | 601 | AGS | O4'-C4'-C5'-O5' |
| 8 | E | 601 | ADP | O4'-C4'-C5'-O5' |
| 5 | G | 601 | AGS | C5'-O5'-PA-O3A |
| 8 | A | 601 | ADP | C5'-O5'-PA-O3A |
| 8 | A | 601 | ADP | C4'-C5'-O5'-PA |
| 5 | G | 601 | AGS | C5'-O5'-PA-O2A |
| 8 | A | 601 | ADP | C5'-O5'-PA-O2A |
| 5 | C | 601 | AGS | PA-O3A-PB-O1B |
| 8 | E | 601 | ADP | C3'-C4'-C5'-O5' |
| 5 | G | 601 | AGS | PB-O3B-PG-O3G |
| 5 | C | 601 | AGS | C5'-O5'-PA-O3A |
| 8 | E | 601 | ADP | C5'-O5'-PA-O3A |
| 8 | F | 601 | ADP | C5'-O5'-PA-O1A |

There are no ring outliers.

3 monomers are involved in 7 short contacts:

| Mol | Chain | Res | Type | Clashes | Symm-Clashes |
|-----|-------|-----|------|---------|--------------|
| 8 | A | 601 | ADP | 2 | 0 |
| 5 | G | 601 | AGS | 2 | 0 |
| 5 | C | 601 | AGS | 3 | 0 |

The following is a two-dimensional graphical depiction of Mogul quality analysis of bond lengths, bond angles, torsion angles, and ring geometry for all instances of the Ligand of Interest. In

addition, ligands with molecular weight > 250 and outliers as shown on the validation Tables will also be included. For torsion angles, if less than 5% of the Mogul distribution of torsion angles is within 10 degrees of the torsion angle in question, then that torsion angle is considered an outlier. Any bond that is central to one or more torsion angles identified as an outlier by Mogul will be highlighted in the graph. For rings, the root-mean-square deviation (RMSD) between the ring in question and similar rings identified by Mogul is calculated over all ring torsion angles. If the average RMSD is greater than 60 degrees and the minimal RMSD between the ring in question and any Mogul-identified rings is also greater than 60 degrees, then that ring is considered an outlier. The outliers are highlighted in purple. The color gray indicates Mogul did not find sufficient equivalents in the CSD to analyse the geometry.

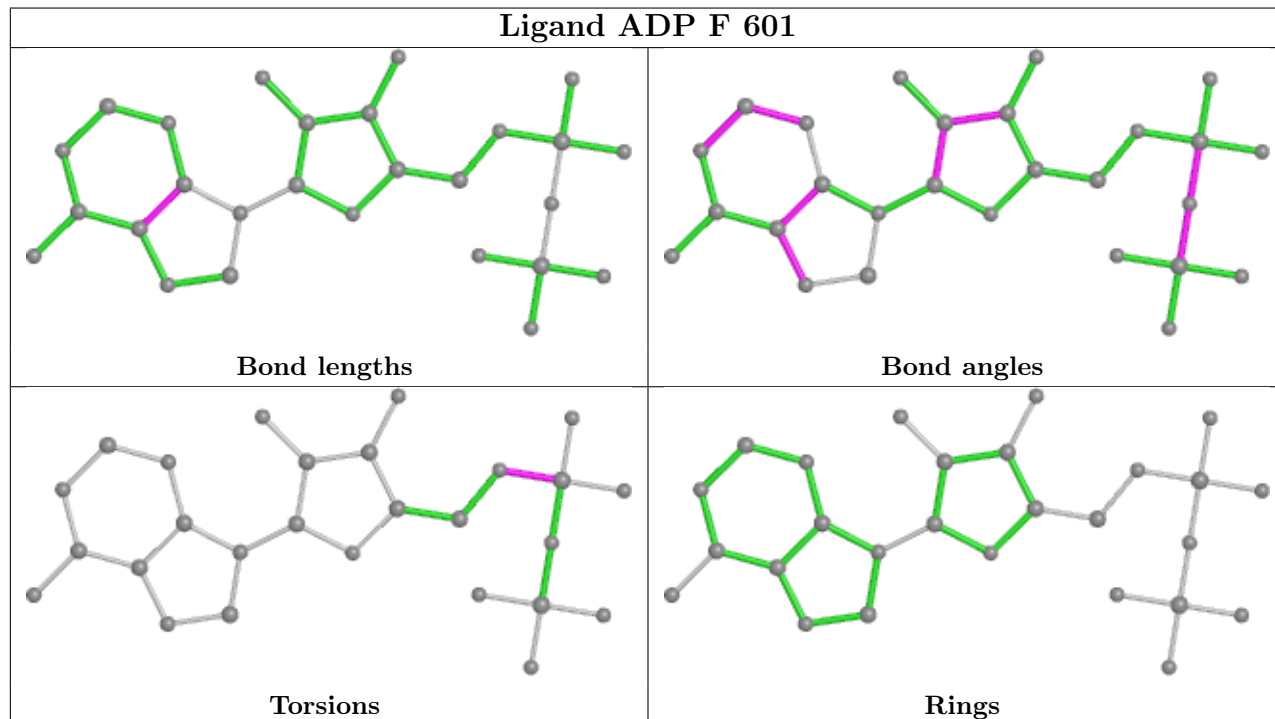

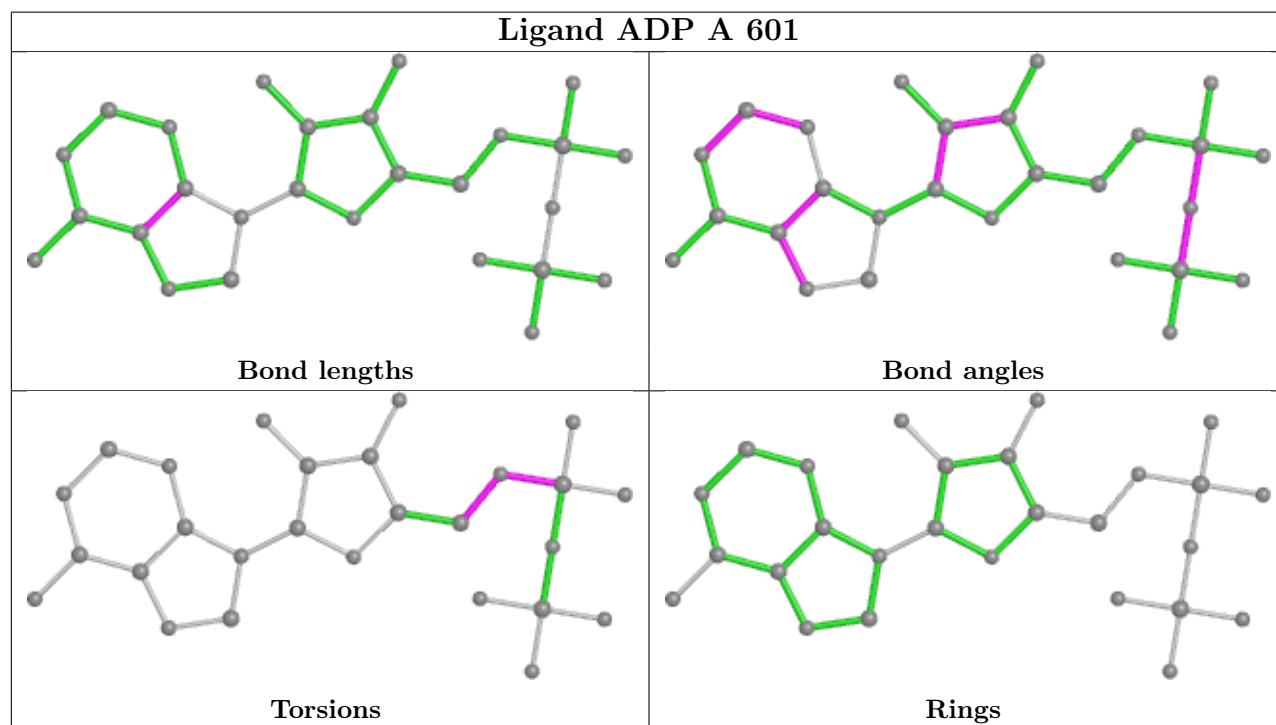
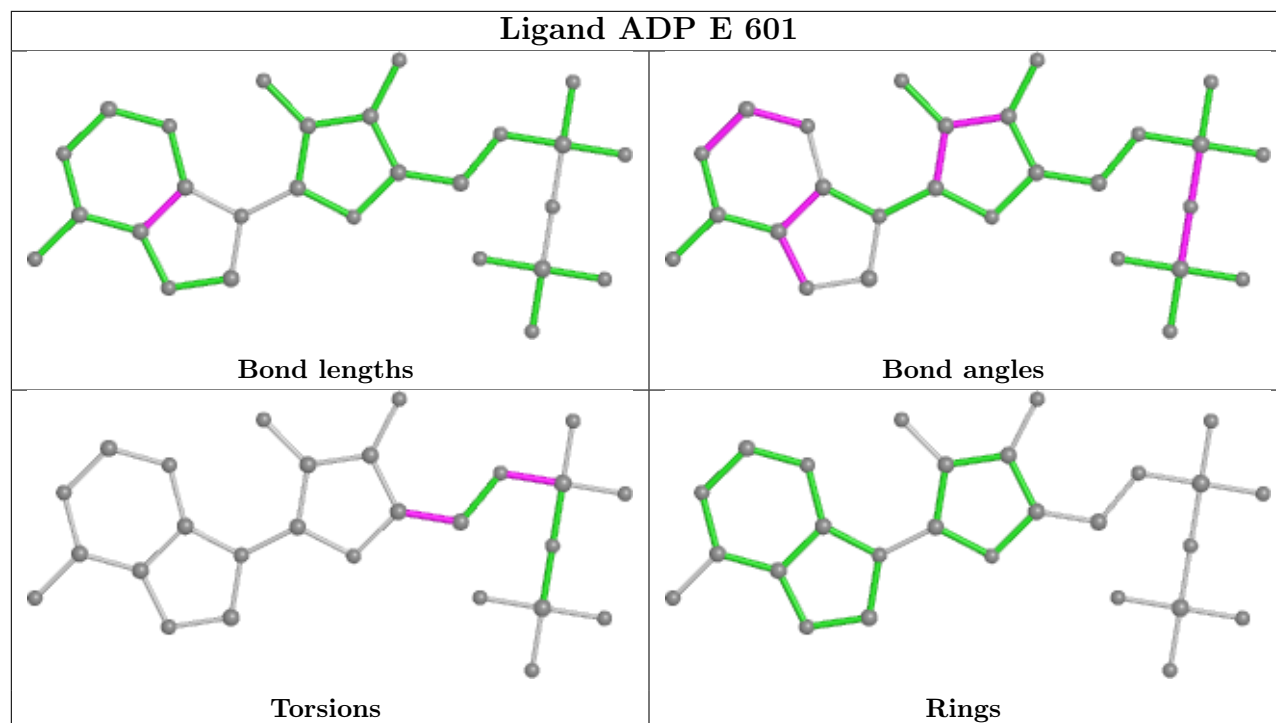

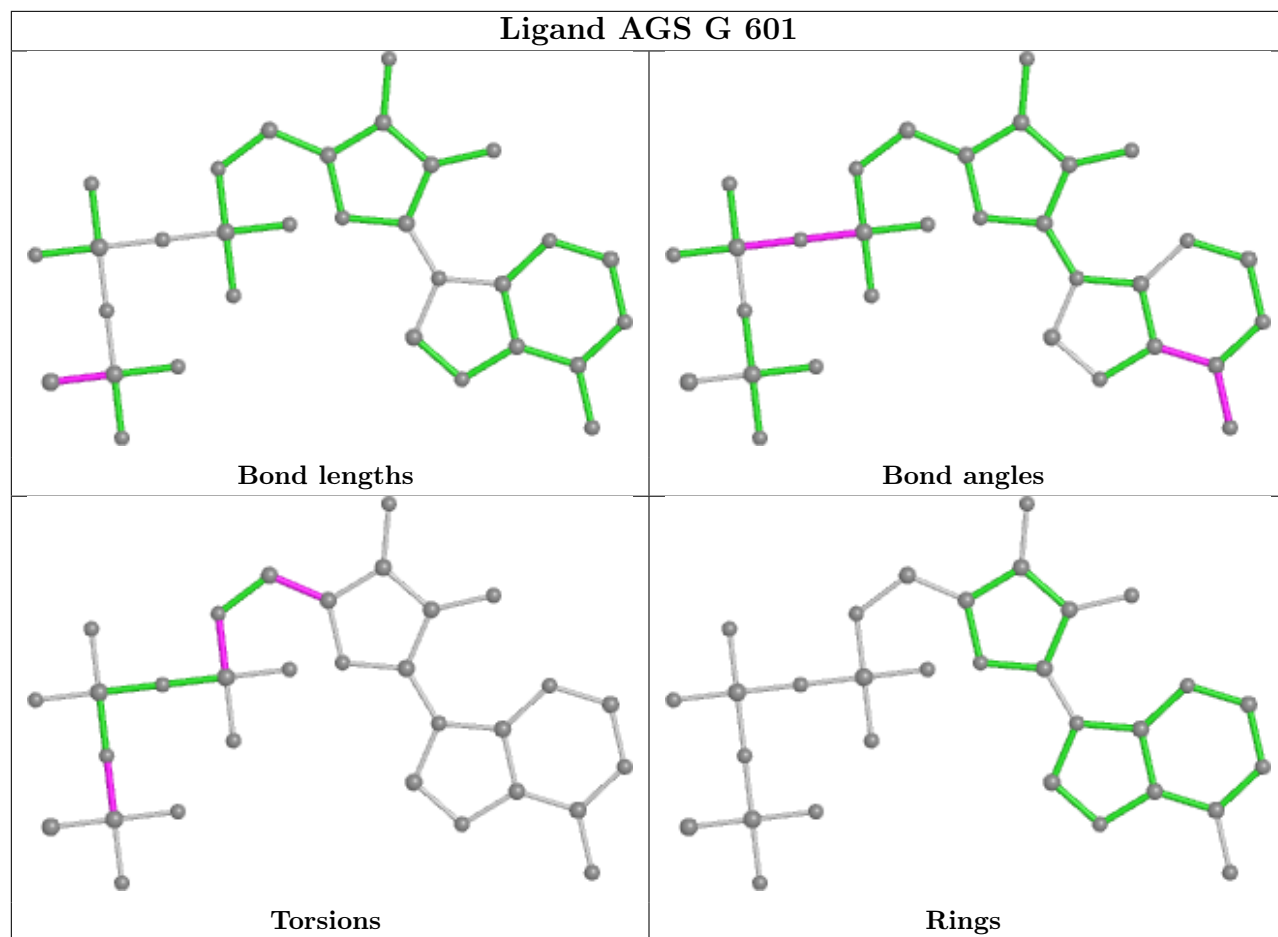

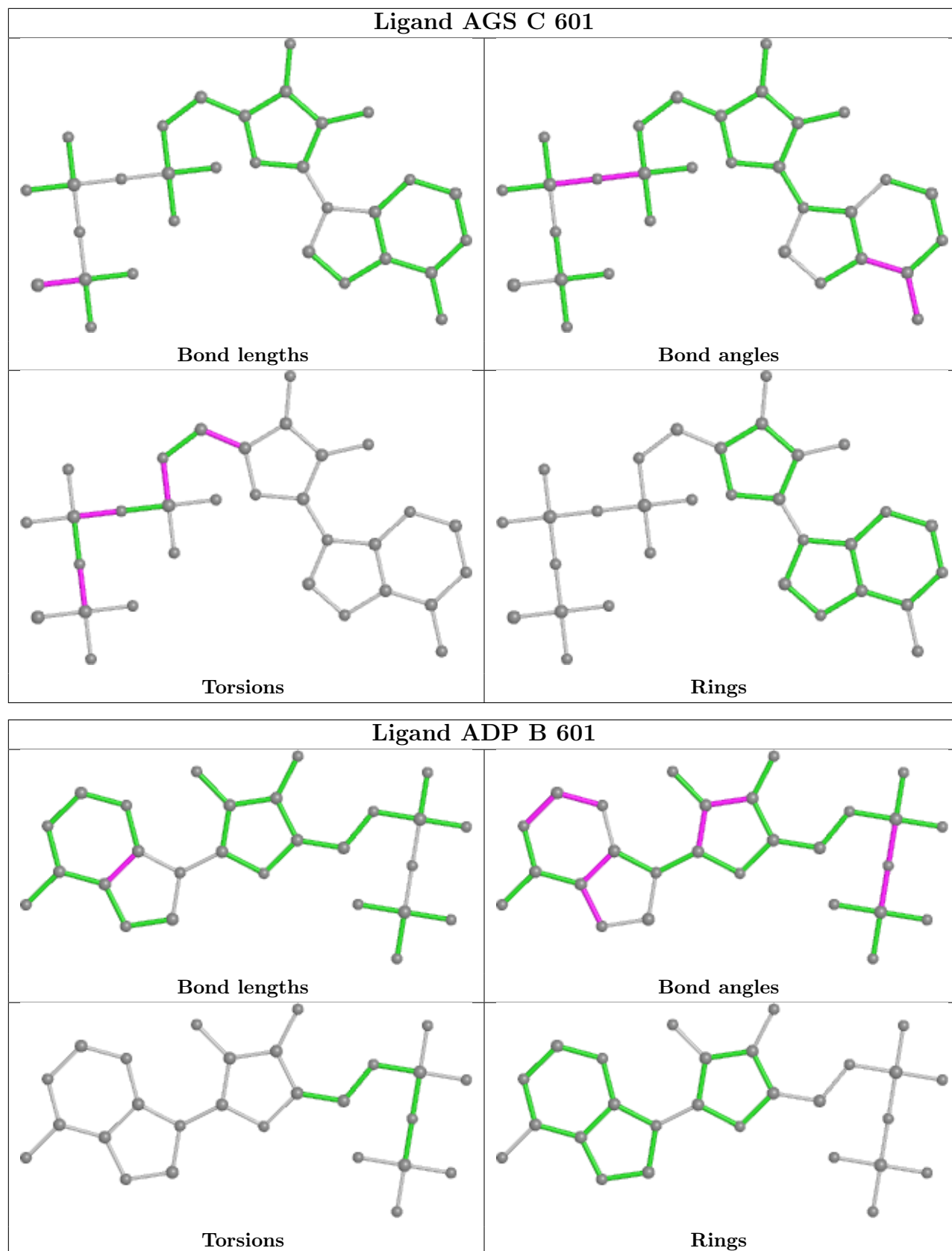

5.7 Other polymers [i](#)

There are no such residues in this entry.

5.8 Polymer linkage issues [i](#)

There are no chain breaks in this entry.

6 Map visualisation [i](#)

This section contains visualisations of the EMDB entry EMD-43140. These allow visual inspection of the internal detail of the map and identification of artifacts.

Images derived from a raw map, generated by summing the deposited half-maps, are presented below the corresponding image components of the primary map to allow further visual inspection and comparison with those of the primary map.

6.1 Orthogonal projections [i](#)

6.1.1 Primary map

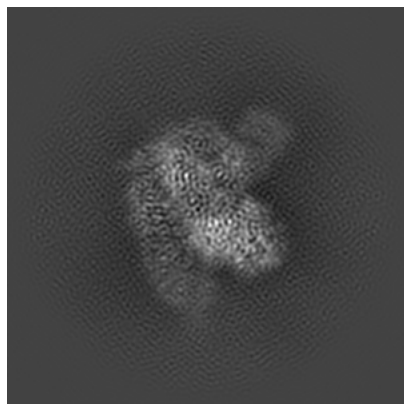

X

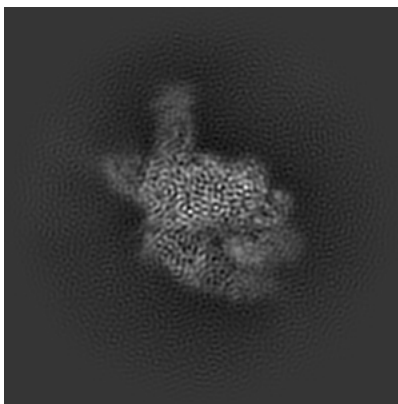

Y

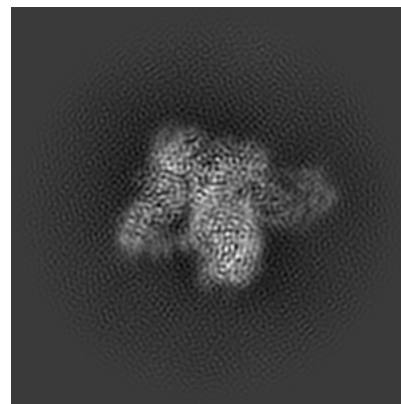

Z

6.1.2 Raw map

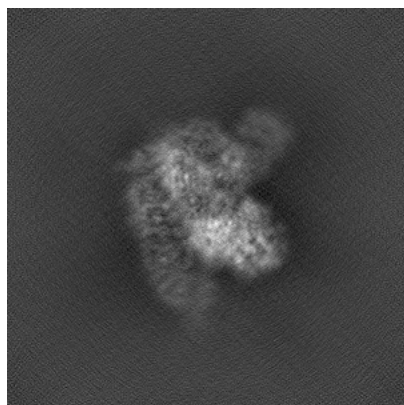

X

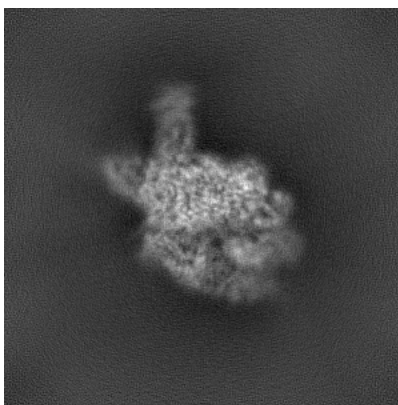

Y

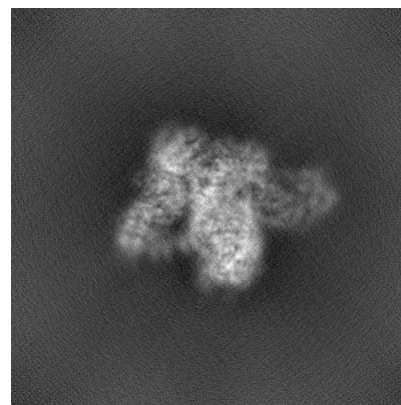

Z

The images above show the map projected in three orthogonal directions.

6.2 Central slices [i](#)

6.2.1 Primary map

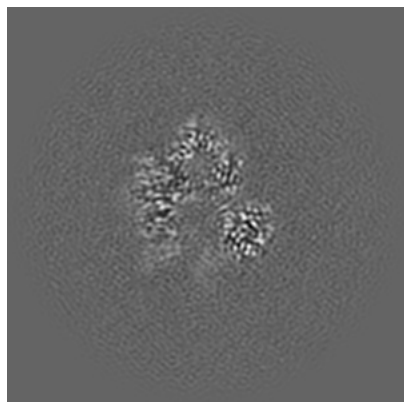

X Index: 180

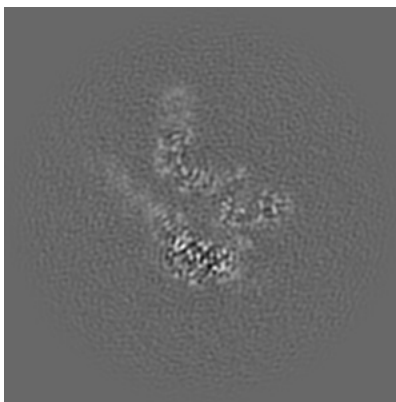

Y Index: 180

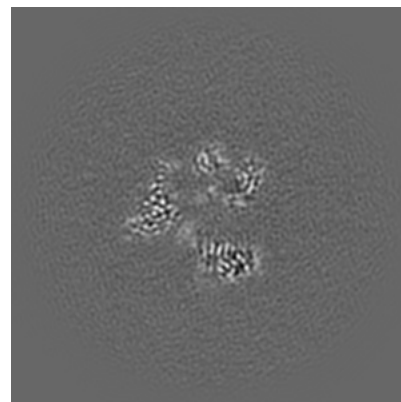

Z Index: 180

6.2.2 Raw map

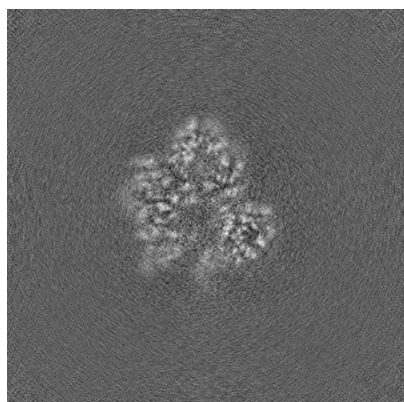

X Index: 180

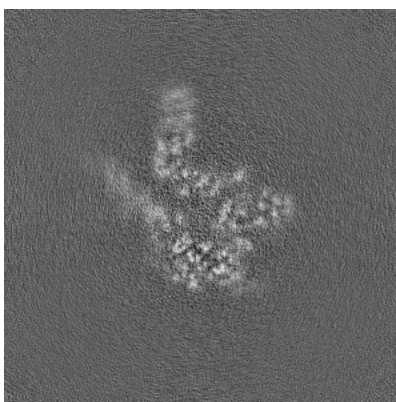

Y Index: 180

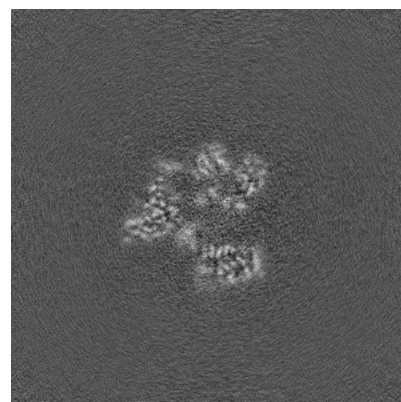

Z Index: 180

The images above show central slices of the map in three orthogonal directions.

6.3 Largest variance slices [i](#)

6.3.1 Primary map

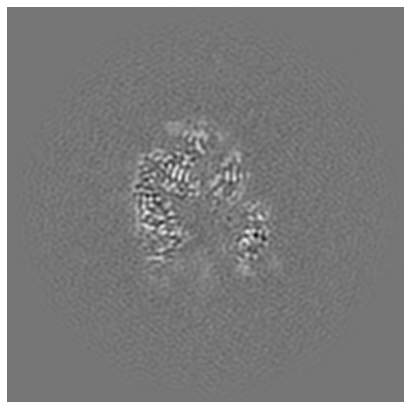

X Index: 189

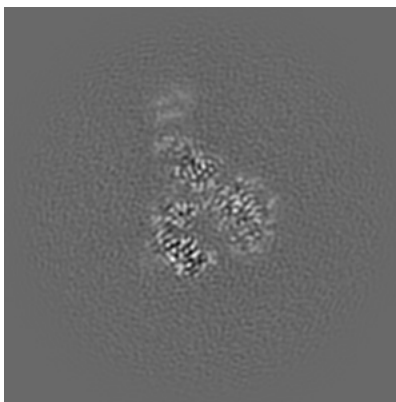

Y Index: 197

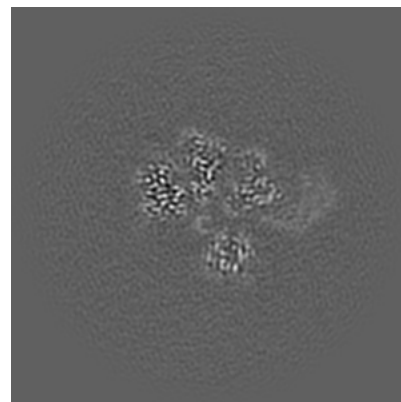

Z Index: 161

6.3.2 Raw map

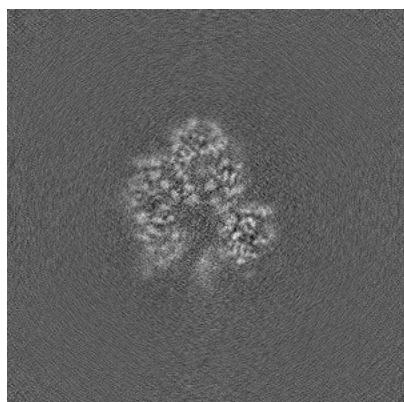

X Index: 182

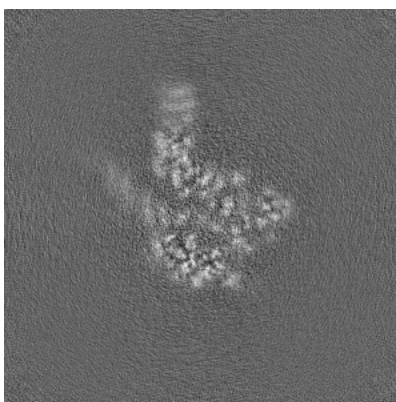

Y Index: 183

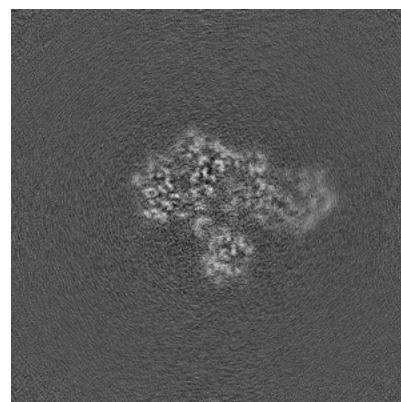

Z Index: 158

The images above show the largest variance slices of the map in three orthogonal directions.

6.4 Orthogonal standard-deviation projections (False-color) [i](#)

6.4.1 Primary map

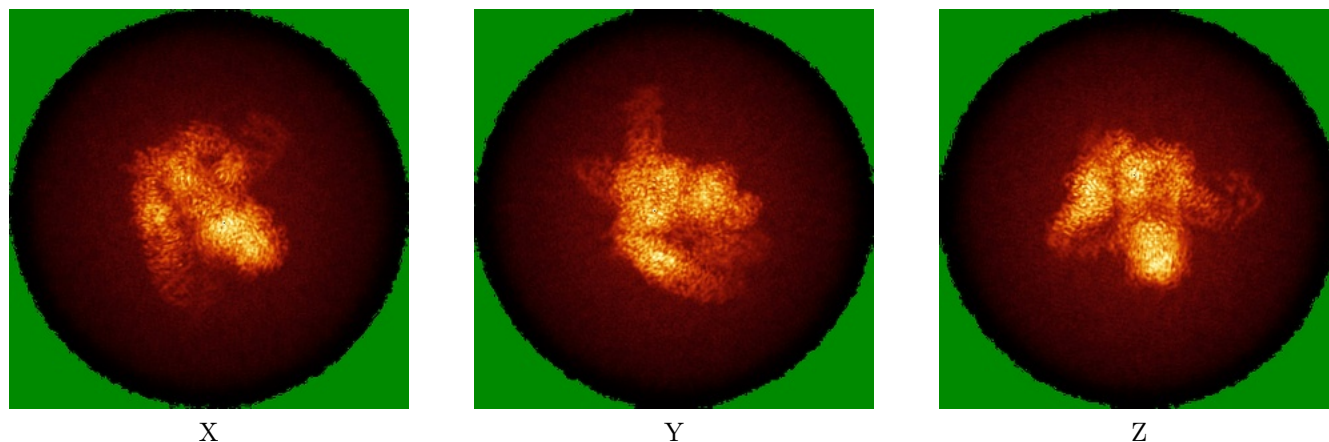

6.4.2 Raw map

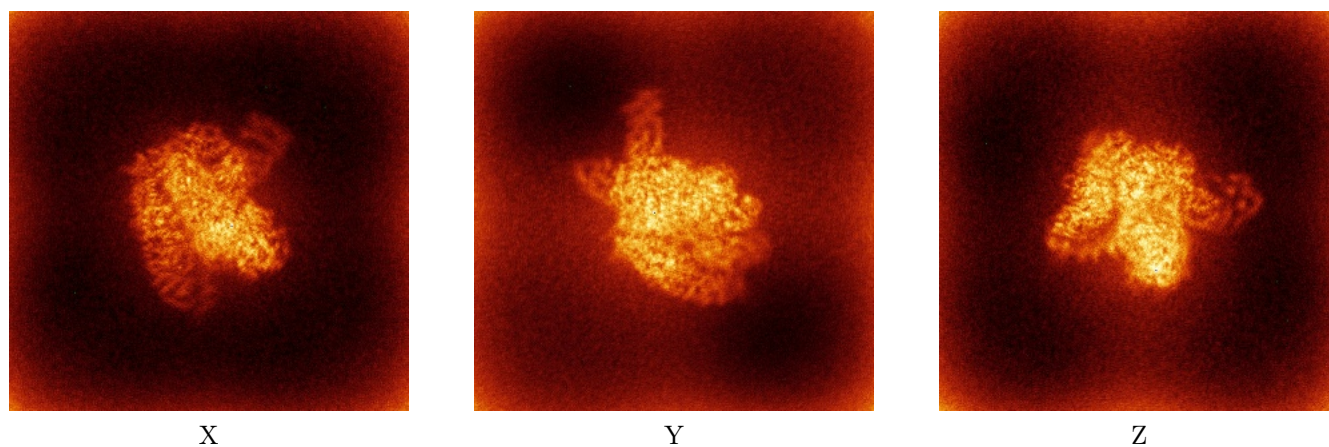

The images above show the map standard deviation projections with false color in three orthogonal directions. Minimum values are shown in green, max in blue, and dark to light orange shades represent small to large values respectively.

6.5 Orthogonal surface views [i](#)

6.5.1 Primary map

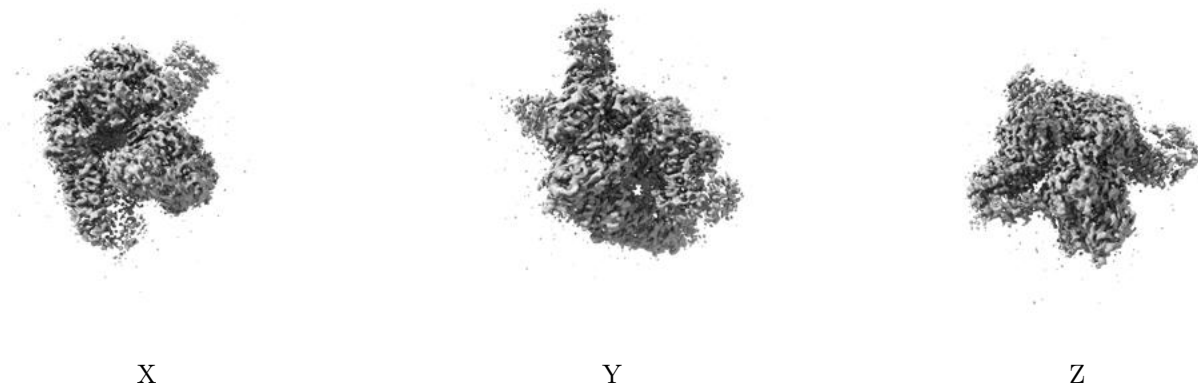

The images above show the 3D surface view of the map at the recommended contour level 4.0. These images, in conjunction with the slice images, may facilitate assessment of whether an appropriate contour level has been provided.

6.5.2 Raw map

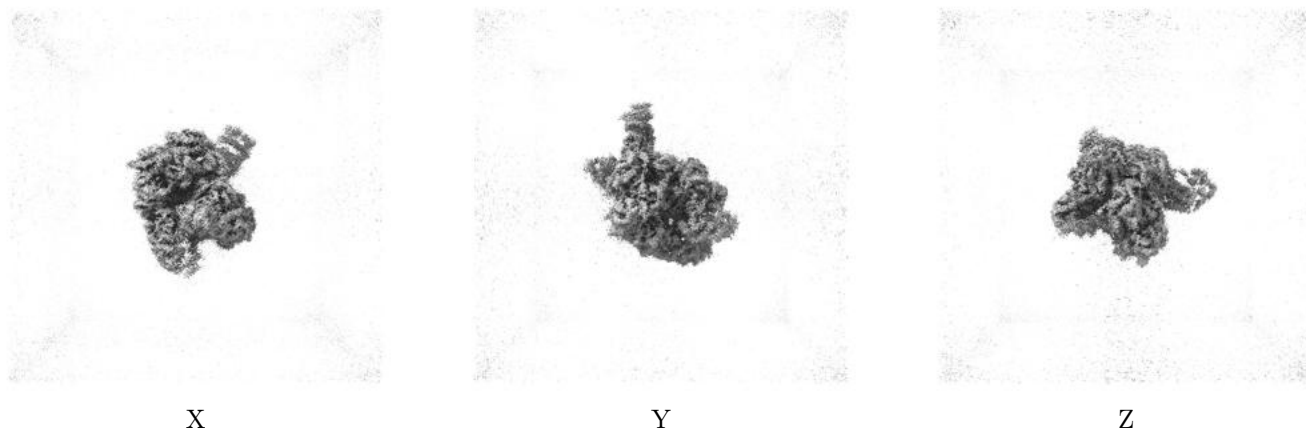

These images show the 3D surface of the raw map. The raw map's contour level was selected so that its surface encloses the same volume as the primary map does at its recommended contour level.

6.6 Mask visualisation [i](#)

This section was not generated. No masks/segmentation were deposited.

7 Map analysis [i](#)

This section contains the results of statistical analysis of the map.

7.1 Map-value distribution [i](#)

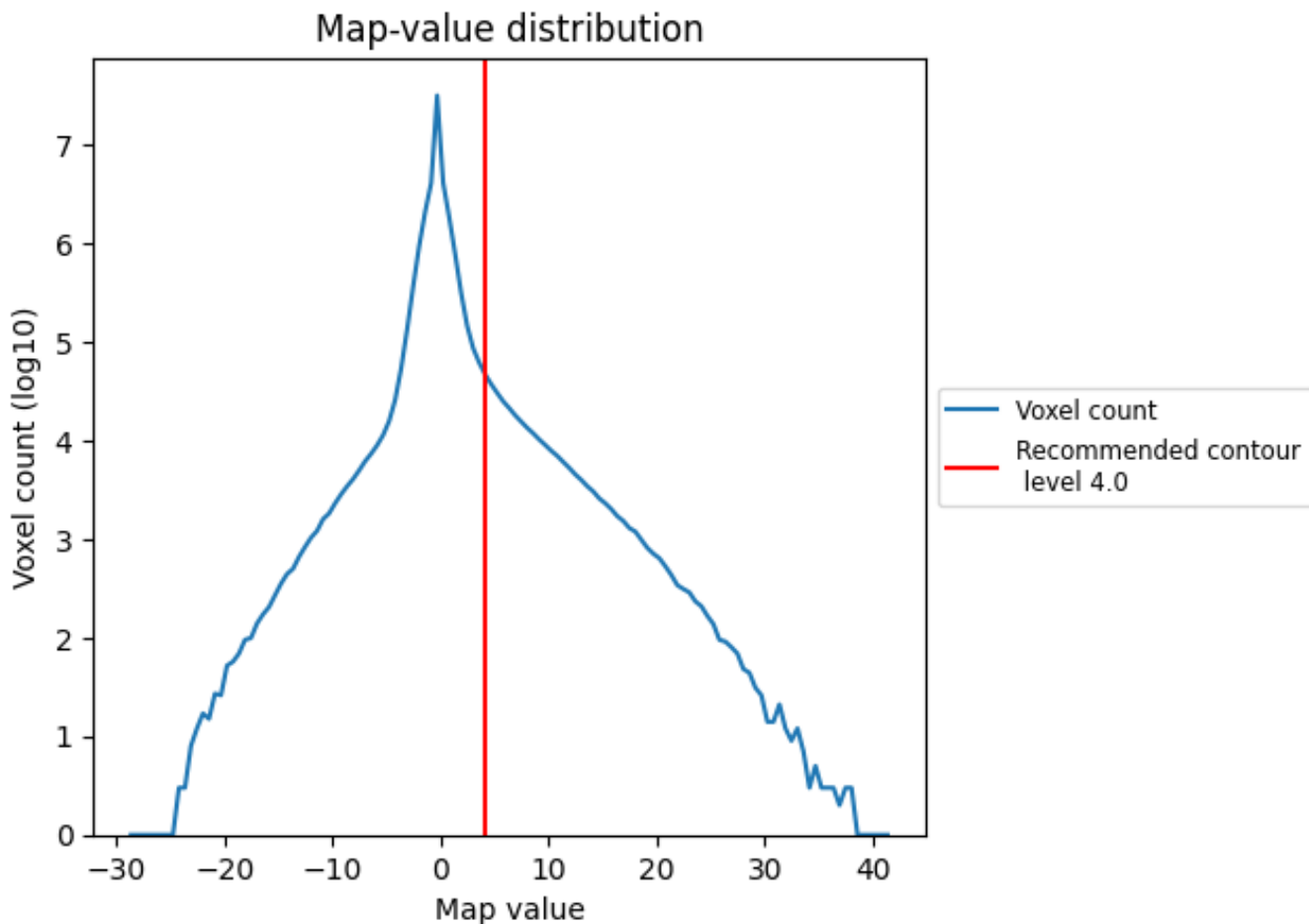

The map-value distribution is plotted in 128 intervals along the x-axis. The y-axis is logarithmic. A spike in this graph at zero usually indicates that the volume has been masked.

7.2 Volume estimate [i](#)

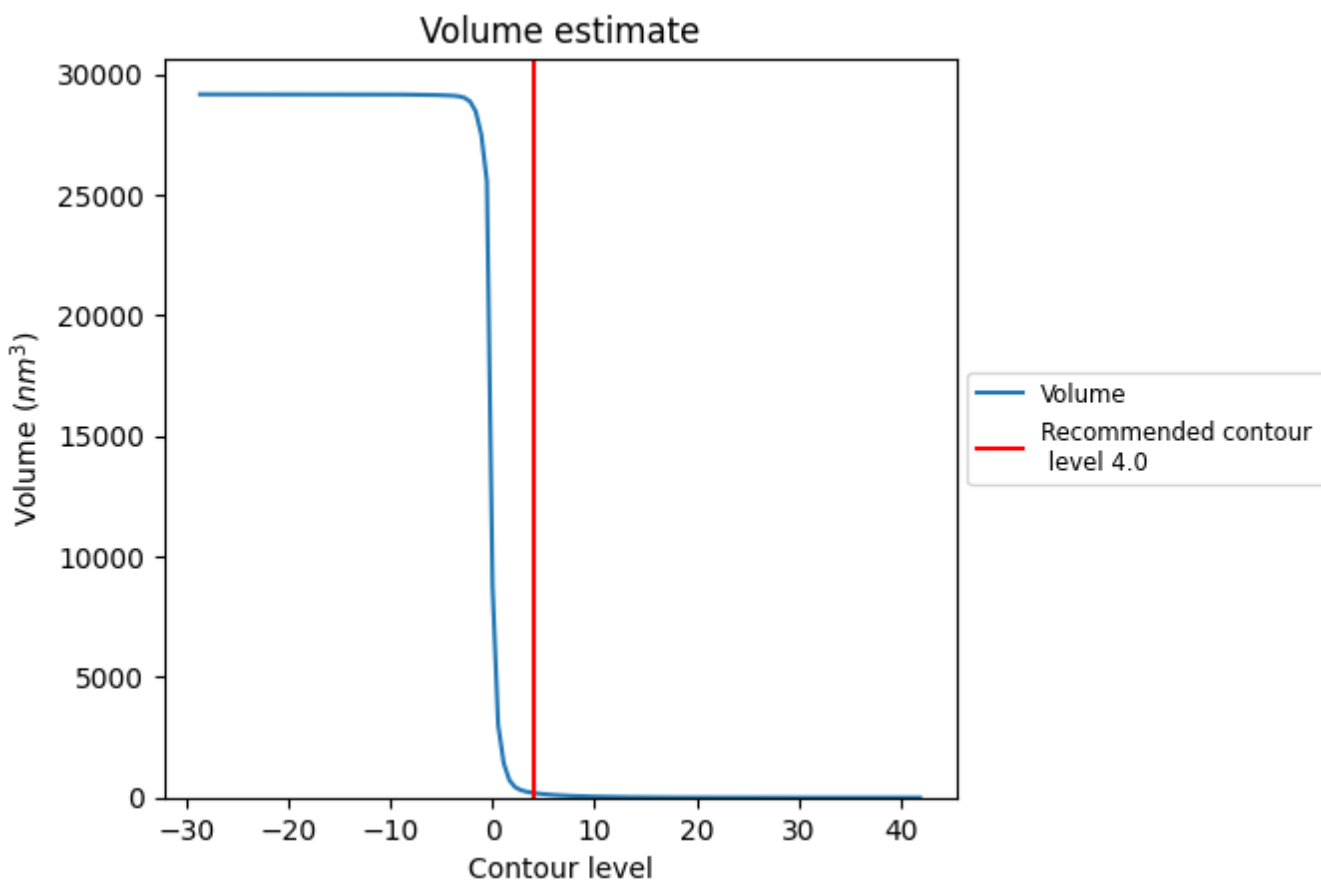

The volume at the recommended contour level is 194 nm³; this corresponds to an approximate mass of 175 kDa.

The volume estimate graph shows how the enclosed volume varies with the contour level. The recommended contour level is shown as a vertical line and the intersection between the line and the curve gives the volume of the enclosed surface at the given level.

7.3 Rotationally averaged power spectrum [i](#)

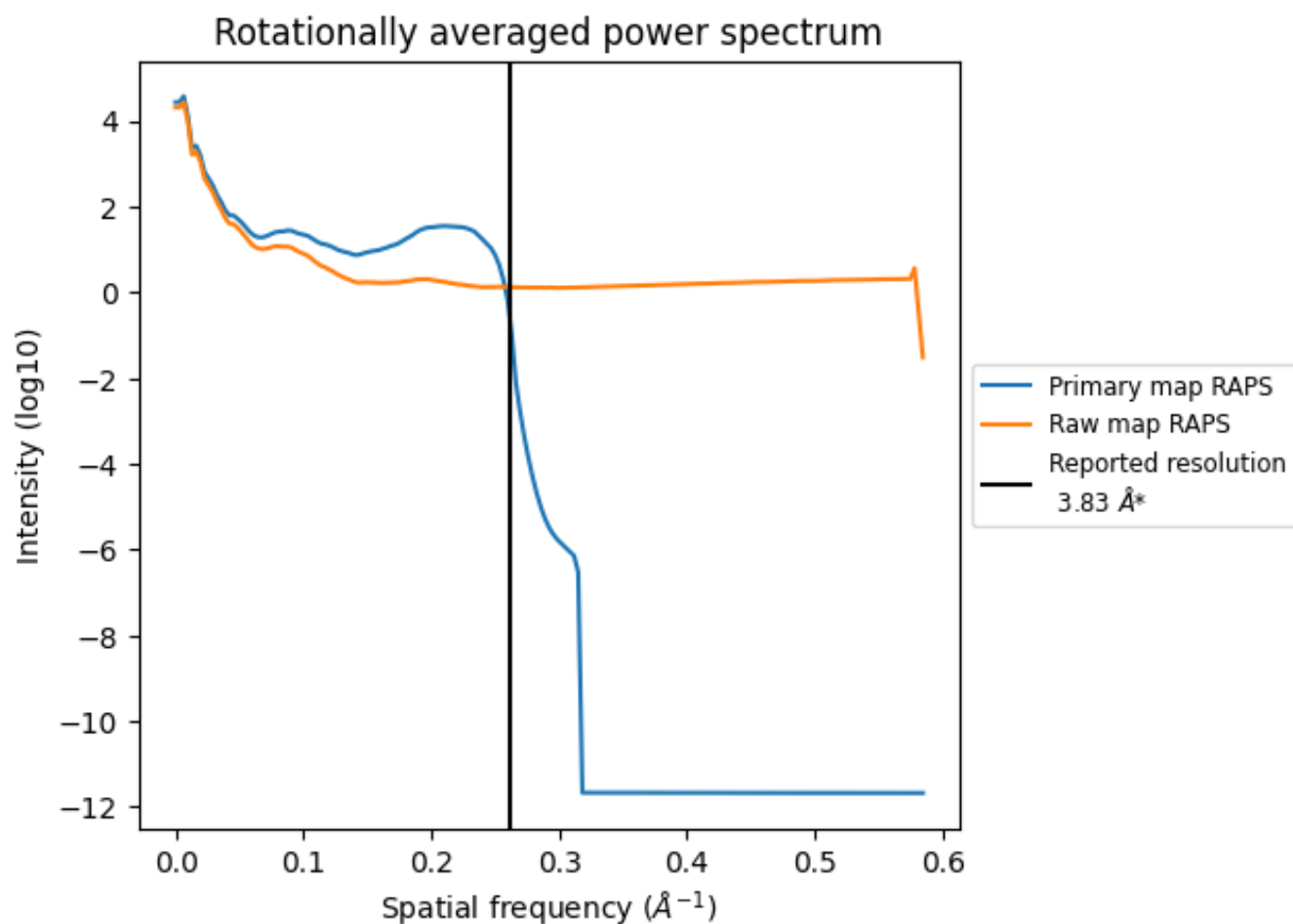

*Reported resolution corresponds to spatial frequency of 0.261 Å⁻¹

8 Fourier-Shell correlation [i](#)

Fourier-Shell Correlation (FSC) is the most commonly used method to estimate the resolution of single-particle and subtomogram-averaged maps. The shape of the curve depends on the imposed symmetry, mask and whether or not the two 3D reconstructions used were processed from a common reference. The reported resolution is shown as a black line. A curve is displayed for the half-bit criterion in addition to lines showing the 0.143 gold standard cut-off and 0.5 cut-off.

8.1 FSC [i](#)

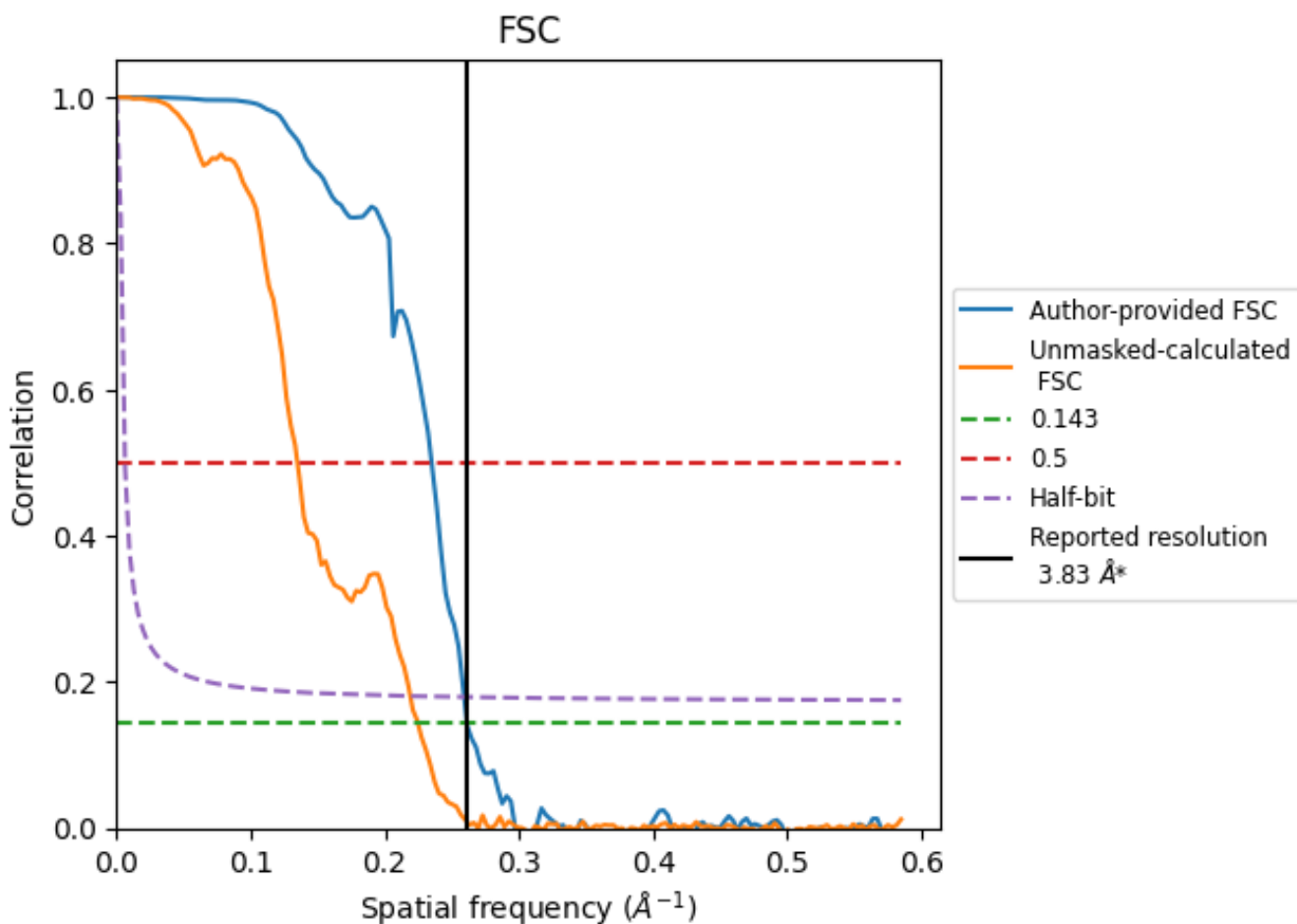

*Reported resolution corresponds to spatial frequency of 0.261 Å⁻¹

8.2 Resolution estimates [i](#)

| Resolution estimate (Å) | Estimation criterion (FSC cut-off) | | |
|---------------------------|------------------------------------|------|----------|
| | 0.143 | 0.5 | Half-bit |
| Reported by author | 3.83 | - | - |
| Author-provided FSC curve | 3.83 | 4.26 | 3.86 |
| Unmasked-calculated* | 4.45 | 7.41 | 4.57 |

*Resolution estimate based on FSC curve calculated by comparison of deposited half-maps. The value from deposited half-maps intersecting FSC 0.143 CUT-OFF 4.45 differs from the reported value 3.83 by more than 10 %

9 Map-model fit [i](#)

This section contains information regarding the fit between EMDB map EMD-43140 and PDB model 8VCT. Per-residue inclusion information can be found in section 3 on page 10.

9.1 Map-model overlay [i](#)

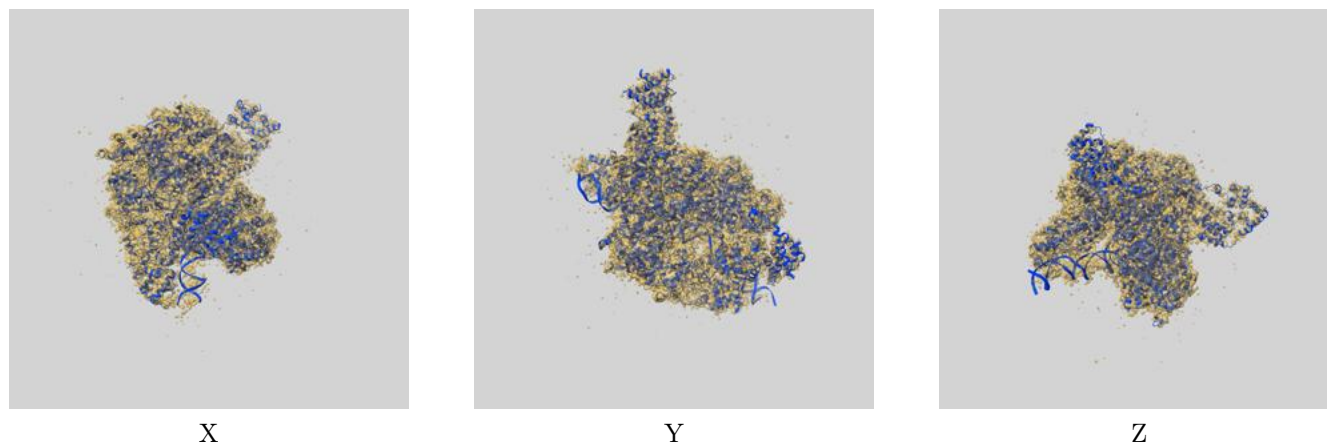

The images above show the 3D surface view of the map at the recommended contour level 4.0 at 50% transparency in yellow overlaid with a ribbon representation of the model coloured in blue. These images allow for the visual assessment of the quality of fit between the atomic model and the map.

9.2 Q-score mapped to coordinate model [i](#)

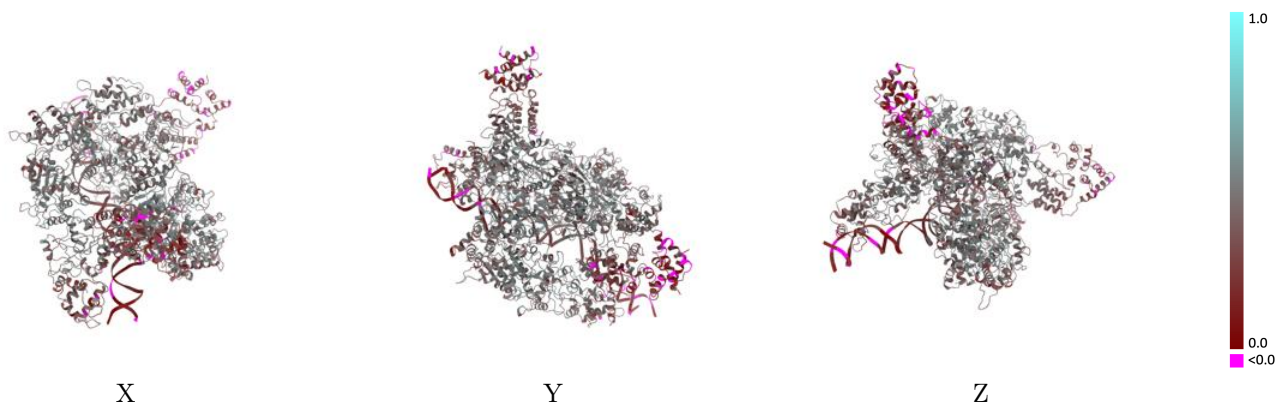

The images above show the model with each residue coloured according to its Q-score. This shows their resolvability in the map with higher Q-score values reflecting better resolvability. Please note: Q-score is calculating the resolvability of atoms, and thus high values are only expected at resolutions at which atoms can be resolved. Low Q-score values may therefore be expected for many entries.

9.3 Atom inclusion mapped to coordinate model [i](#)

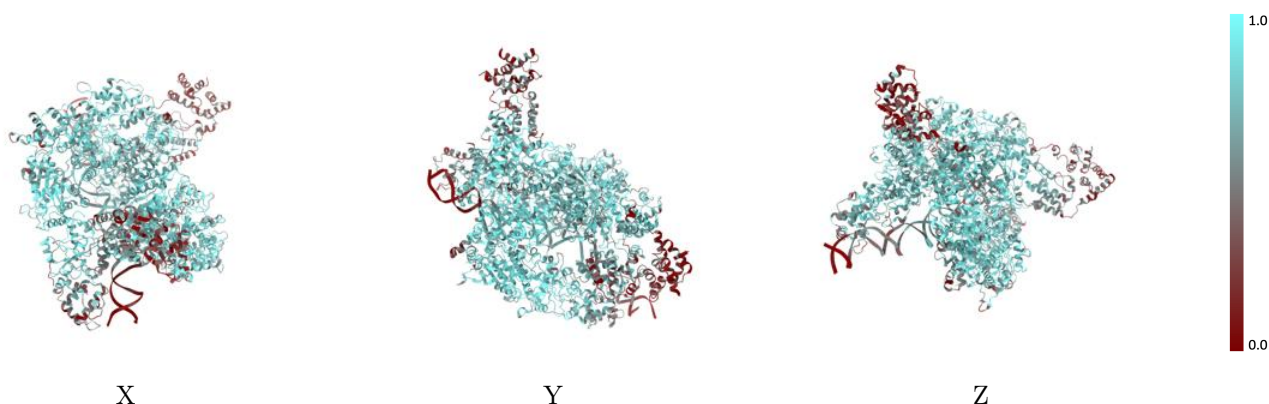

The images above show the model with each residue coloured according to its atom inclusion. This shows to what extent they are inside the map at the recommended contour level (4.0).



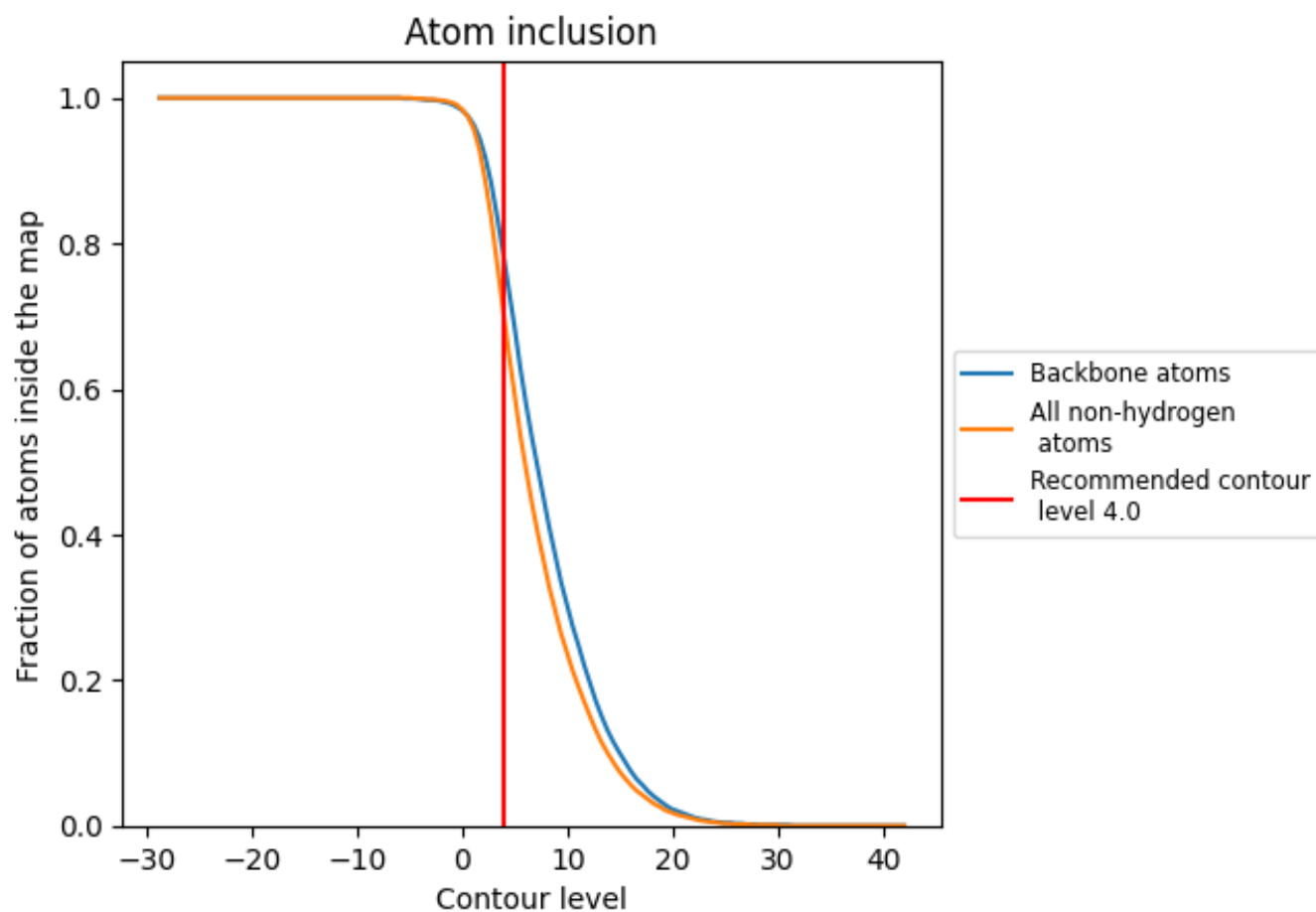



















9.4 Atom inclusion [i](#)



At the recommended contour level, 78% of all backbone atoms, 70% of all non-hydrogen atoms, are inside the map.

9.5 Map-model fit summary

The table lists the average atom inclusion at the recommended contour level (4.0) and Q-score for the entire model and for each chain.

| Chain | Atom inclusion | Q-score |
|-------|--|--|
| All |  0.6950 |  0.3960 |
| A |  0.6300 |  0.3640 |
| B |  0.7230 |  0.4070 |
| C |  0.7790 |  0.4480 |
| E |  0.6550 |  0.3880 |
| F |  0.7610 |  0.4420 |
| G |  0.8010 |  0.4520 |
| H |  0.4410 |  0.1670 |
| I |  0.4480 |  0.1810 |
| X |  0.7380 |  0.4210 |
| Y |  0.6380 |  0.3860 |

