



wwPDB X-ray Structure Validation Summary Report ⓘ

Aug 15, 2023 – 02:57 PM EDT

PDB ID : 1VQM
Title : The structure of the transition state analogue "DAN" bound to the large ribosomal subunit of haloarcula marismortui
Authors : Schmeing, T.M.; Steitz, T.A.
Deposited on : 2004-12-16
Resolution : 2.30 Å(reported)

This is a wwPDB X-ray Structure Validation Summary Report for a publicly released PDB entry.

We welcome your comments at validation@mail.wwpdb.org

A user guide is available at

<https://www.wwpdb.org/validation/2017/XrayValidationReportHelp>

with specific help available everywhere you see the ⓘ symbol.

The types of validation reports are described at

<http://www.wwpdb.org/validation/2017/FAQs#types>.

The following versions of software and data (see [references ⓘ](#)) were used in the production of this report:

MolProbity : 4.02b-467
Mogul : 1.8.5 (274361), CSD as541be (2020)
Xtriage (Phenix) : 1.13
EDS : 2.35
Percentile statistics : 20191225.v01 (using entries in the PDB archive December 25th 2019)
Refmac : 5.8.0158
CCP4 : 7.0.044 (Gargrove)
Ideal geometry (proteins) : Engh & Huber (2001)
Ideal geometry (DNA, RNA) : Parkinson et al. (1996)
Validation Pipeline (wwPDB-VP) : 2.35

1 Overall quality at a glance

The following experimental techniques were used to determine the structure:

X-RAY DIFFRACTION

The reported resolution of this entry is 2.30 Å.

Percentile scores (ranging between 0-100) for global validation metrics of the entry are shown in the following graphic. The table shows the number of entries on which the scores are based.

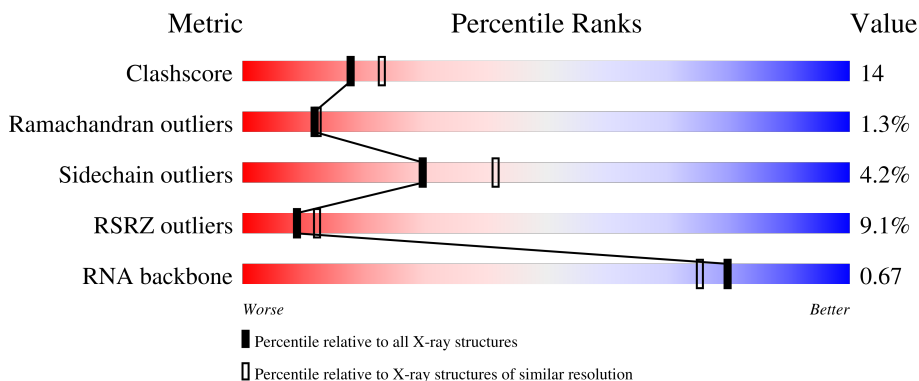

Metric	Whole archive (#Entries)	Similar resolution (#Entries, resolution range(Å))
Clashscore	141614	5643 (2.30-2.30)
Ramachandran outliers	138981	5575 (2.30-2.30)
Sidechain outliers	138945	5575 (2.30-2.30)
RSRZ outliers	127900	4938 (2.30-2.30)
RNA backbone	3102	1090 (2.70-1.90)

The table below summarises the geometric issues observed across the polymeric chains and their fit to the electron density. The red, orange, yellow and green segments of the lower bar indicate the fraction of residues that contain outliers for ≥ 3 , 2, 1 and 0 types of geometric quality criteria respectively. A grey segment represents the fraction of residues that are not modelled. The numeric value for each fraction is indicated below the corresponding segment, with a dot representing fractions $\leq 5\%$. The upper red bar (where present) indicates the fraction of residues that have poor fit to the electron density. The numeric value is given above the bar.

Mol	Chain	Length	Quality of chain
1	0	2922	 3% 64% 25% 5% 6%
2	9	122	 4% 61% 29% 10%
3	4	7	 57% 29% 14%
4	A	240	 8% 59% 36%
5	B	338	 4% 56% 41%

Continued on next page...

Continued from previous page...

Mol	Chain	Length	Quality of chain
6	C	246	2% 68% 27% .
7	D	177	37% 36% 36% 6% 21%
8	E	178	21% 57% 38% ..
9	F	120	34% 54% 42% ..
10	G	348	5% 92%
11	H	171	15% 60% 33% 6%
12	J	145	3% 60% 33% 5% .
13	K	132	2% 68% 30% .
14	L	165	18% 59% 27% 12%
15	M	195	12% 63% 35% ..
16	N	187	23% 53% 40% 6% .
17	O	116	3% 68% 29% ..
18	P	149	3% 70% 24% ..
19	Q	96	6% 77% 21% ..
20	R	155	2% 73% 23% ..
21	S	85	6% 76% 19% 5%
22	T	120	12% 62% 33% ..
23	U	66	5% 48% 30% 20%
24	V	71	24% 55% 35% 8%
25	W	154	3% 58% 39% .
26	X	92	12% 48% 39% 11%
27	Y	241	5% 38% 17% 41%
28	Z	83	35% 47% 37% 12%
29	1	57	65% 33% .
30	2	50	16% 52% 38% 8%

Continued on next page...

Continued from previous page...

Mol	Chain	Length	Quality of chain
31	3	92	
32	I	162	

The following table lists non-polymeric compounds, carbohydrate monomers and non-standard residues in protein, DNA, RNA chains that are outliers for geometric or electron-density-fit criteria:

Mol	Type	Chain	Res	Chirality	Geometry	Clashes	Electron density
33	MG	0	8014	-	-	-	X
33	MG	0	8022	-	-	-	X
33	MG	0	8040	-	-	-	X
33	MG	0	8047	-	-	-	X
33	MG	0	8052	-	-	-	X
33	MG	0	8065	-	-	-	X
33	MG	0	8094	-	-	-	X
35	NA	0	9140	-	-	-	X
35	NA	0	9179	-	-	-	X
35	NA	0	9185	-	-	-	X
37	SR	0	9500	-	-	-	X

2 Entry composition [i](#)

There are 39 unique types of molecules in this entry. The entry contains 99045 atoms, of which 0 are hydrogens and 0 are deuteriums.

In the tables below, the ZeroOcc column contains the number of atoms modelled with zero occupancy, the AltConf column contains the number of residues with at least one atom in alternate conformation and the Trace column contains the number of residues modelled with at most 2 atoms.

- Molecule 1 is a RNA chain called 23S ribosomal rna.

Mol	Chain	Residues	Atoms					ZeroOcc	AltConf	Trace
			Total	C	N	O	P			
1	0	2754	59021	26350	10878	19048	2745	0	0	0

There are 5 discrepancies between the modelled and reference sequences:

Chain	Residue	Modelled	Actual	Comment	Reference
0	628	1MA	A	modified residue	GB 3377779
0	2587	OMU	U	modified residue	GB 3377779
0	2588	OMG	G	modified residue	GB 3377779
0	2619	UR3	U	modified residue	GB 3377779
0	2621	PSU	U	modified residue	GB 3377779

- Molecule 2 is a RNA chain called 5S ribosomal RNA.

Mol	Chain	Residues	Atoms					ZeroOcc	AltConf	Trace
			Total	C	N	O	P			
2	9	122	2600	1160	472	847	121	0	0	0

- Molecule 3 is a RNA chain called 5'-R(*CP*CP*(PPU)P*(PO2)P*(DA)P*C*C)-3').

Mol	Chain	Residues	Atoms					ZeroOcc	AltConf	Trace
			Total	C	N	O	P			
3	4	7	135	68	24	38	5	0	0	0

- Molecule 4 is a protein called 50S ribosomal protein L2P.

Mol	Chain	Residues	Atoms					ZeroOcc	AltConf	Trace
			Total	C	N	O	S			
4	A	237	1753	1072	352	324	5	0	0	0

- Molecule 5 is a protein called 50S ribosomal protein L3P.

Mol	Chain	Residues	Atoms					ZeroOcc	AltConf	Trace
			Total	C	N	O	S			
5	B	337	2625	1616	493	511	5	0	0	0

- Molecule 6 is a protein called 50S ribosomal protein L4E.

Mol	Chain	Residues	Atoms					ZeroOcc	AltConf	Trace
			Total	C	N	O	S			
6	C	246	1859	1131	344	383	1	0	0	0

- Molecule 7 is a protein called 50S ribosomal protein L5P.

Mol	Chain	Residues	Atoms					ZeroOcc	AltConf	Trace
			Total	C	N	O	S			
7	D	140	1094	685	195	210	4	0	0	0

- Molecule 8 is a protein called 50S ribosomal protein L6P.

Mol	Chain	Residues	Atoms					ZeroOcc	AltConf	Trace
			Total	C	N	O	S			
8	E	172	1357	840	224	289	4	0	0	0

- Molecule 9 is a protein called 50S ribosomal protein L7AE.

Mol	Chain	Residues	Atoms					ZeroOcc	AltConf	Trace
			Total	C	N	O	S			
9	F	119	890	551	141	197	1	0	0	0

- Molecule 10 is a protein called ACIDIC RIBOSOMAL PROTEIN P0 HOMOLOG.

Mol	Chain	Residues	Atoms					ZeroOcc	AltConf	Trace
			Total	C	N	O	S			
10	G	29	240	149	39	51	1	0	0	0

- Molecule 11 is a protein called 50S RIBOSOMAL PROTEIN L10E.

Mol	Chain	Residues	Atoms					ZeroOcc	AltConf	Trace
			Total	C	N	O	S			
11	H	160	1266	785	237	238	6	0	0	0

- Molecule 12 is a protein called 50S ribosomal protein L13P.

Mol	Chain	Residues	Atoms					ZeroOcc	AltConf	Trace
			Total	C	N	O	S			
12	J	142	1120	696	199	222	3	0	0	0

- Molecule 13 is a protein called 50S ribosomal protein L14P.

Mol	Chain	Residues	Atoms					ZeroOcc	AltConf	Trace
			Total	C	N	O	S			
13	K	132	992	609	187	192	4	0	0	0

There is a discrepancy between the modelled and reference sequences:

Chain	Residue	Modelled	Actual	Comment	Reference
K	44	LEU	HIS	conflict	UNP P22450

- Molecule 14 is a protein called 50S ribosomal protein L15P.

Mol	Chain	Residues	Atoms				ZeroOcc	AltConf	Trace
			Total	C	N	O			
14	L	145	1118	670	222	226	0	0	0

- Molecule 15 is a protein called 50S Ribosomal Protein L15E.

Mol	Chain	Residues	Atoms					ZeroOcc	AltConf	Trace
			Total	C	N	O	S			
15	M	194	1560	943	332	284	1	0	0	0

There are 2 discrepancies between the modelled and reference sequences:

Chain	Residue	Modelled	Actual	Comment	Reference
M	13	GLU	LYS	conflict	GB 55231501
M	194	ALA	GLY	conflict	GB 55231501

- Molecule 16 is a protein called 50S ribosomal protein L18P.

Mol	Chain	Residues	Atoms					ZeroOcc	AltConf	Trace
			Total	C	N	O	S			
16	N	186	1445	895	262	286	2	0	0	0

- Molecule 17 is a protein called 50S ribosomal protein L18e.

Mol	Chain	Residues	Atoms				ZeroOcc	AltConf	Trace
			Total	C	N	O			
17	O	115	865	529	161	175	0	0	0

- Molecule 18 is a protein called 50S ribosomal protein L19E.

Mol	Chain	Residues	Atoms				ZeroOcc	AltConf	Trace
			Total	C	N	O			
18	P	143	1136	683	229	224	0	0	0

- Molecule 19 is a protein called 50S ribosomal protein L21e.

Mol	Chain	Residues	Atoms				ZeroOcc	AltConf	Trace
			Total	C	N	O			
19	Q	95	735	450	141	144	0	0	0

- Molecule 20 is a protein called 50S ribosomal protein L22P.

Mol	Chain	Residues	Atoms					ZeroOcc	AltConf	Trace
			Total	C	N	O	S			
20	R	150	1149	713	209	223	4	0	0	0

- Molecule 21 is a protein called 50S ribosomal protein L23P.

Mol	Chain	Residues	Atoms					ZeroOcc	AltConf	Trace
			Total	C	N	O	S			
21	S	81	641	389	111	138	3	0	0	0

- Molecule 22 is a protein called 50S ribosomal protein L24P.

Mol	Chain	Residues	Atoms				ZeroOcc	AltConf	Trace
			Total	C	N	O			
22	T	119	950	568	180	202	0	0	0

- Molecule 23 is a protein called 50S ribosomal protein L24E.

Mol	Chain	Residues	Atoms					ZeroOcc	AltConf	Trace
			Total	C	N	O	S			
23	U	53	410	244	75	86	5	0	0	0

- Molecule 24 is a protein called 50S ribosomal protein L29P.

Mol	Chain	Residues	Atoms					ZeroOcc	AltConf	Trace
			Total	C	N	O	S			
24	V	65	499	304	94	100	1	0	0	0

- Molecule 25 is a protein called 50S ribosomal protein L30P.

Mol	Chain	Residues	Atoms					ZeroOcc	AltConf	Trace
			Total	C	N	O	S			
25	W	154	1196	737	209	244	6	0	0	0

- Molecule 26 is a protein called 50S ribosomal protein L31e.

Mol	Chain	Residues	Atoms					ZeroOcc	AltConf	Trace
			Total	C	N	O	S			
26	X	82	654	402	129	122	1	0	0	0

- Molecule 27 is a protein called 50S ribosomal protein L32E.

Mol	Chain	Residues	Atoms					ZeroOcc	AltConf	Trace
			Total	C	N	O	S			
27	Y	142	1130	686	228	216		0	0	0

- Molecule 28 is a protein called 50S ribosomal protein L37Ae.

Mol	Chain	Residues	Atoms					ZeroOcc	AltConf	Trace
			Total	C	N	O	S			
28	Z	73	578	346	116	111	5	0	0	0

There is a discrepancy between the modelled and reference sequences:

Chain	Residue	Modelled	Actual	Comment	Reference
Z	10	ARG	SER	conflict	GB 55231162

- Molecule 29 is a protein called 50S ribosomal protein L37e.

Mol	Chain	Residues	Atoms					ZeroOcc	AltConf	Trace
			Total	C	N	O	S			
29	1	56	431	258	86	83	4	0	0	0

- Molecule 30 is a protein called 50S ribosomal protein L39e.

Mol	Chain	Residues	Atoms					ZeroOcc	AltConf	Trace
30	2	46	Total	C	N	O	S	0	0	0
			396	239	89	67	1			

- Molecule 31 is a protein called 50S ribosomal protein L44E.

Mol	Chain	Residues	Atoms					ZeroOcc	AltConf	Trace
31	3	92	Total	C	N	O	S	0	0	0
			755	458	153	137	7			

- Molecule 32 is a protein called 50S RIBOSOMAL PROTEIN L11P.

Mol	Chain	Residues	Atoms					ZeroOcc	AltConf	Trace
32	I	70	Total	C	N	O	S	0	0	0
			519	323	81	114	1			

- Molecule 33 is MAGNESIUM ION (three-letter code: MG) (formula: Mg).

Mol	Chain	Residues	Atoms		ZeroOcc	AltConf
33	0	87	Total	Mg	0	0
			87	87		
33	9	1	Total	Mg	0	0
			1	1		
33	A	1	Total	Mg	0	0
			1	1		
33	B	1	Total	Mg	0	0
			1	1		
33	K	1	Total	Mg	0	0
			1	1		
33	T	1	Total	Mg	0	0
			1	1		
33	Y	1	Total	Mg	0	0
			1	1		
33	2	1	Total	Mg	0	0
			1	1		

- Molecule 34 is POTASSIUM ION (three-letter code: K) (formula: K).

Mol	Chain	Residues	Atoms		ZeroOcc	AltConf
34	0	2	Total	K	0	0
			2	2		

- Molecule 35 is SODIUM ION (three-letter code: NA) (formula: Na).

Mol	Chain	Residues	Atoms	ZeroOcc	AltConf
35	0	62	Total Na 62 62	0	0
35	9	3	Total Na 3 3	0	0
35	C	1	Total Na 1 1	0	0
35	H	1	Total Na 1 1	0	0
35	J	1	Total Na 1 1	0	0
35	M	1	Total Na 1 1	0	0
35	Q	1	Total Na 1 1	0	0
35	R	3	Total Na 3 3	0	0
35	S	1	Total Na 1 1	0	0
35	3	1	Total Na 1 1	0	0

- Molecule 36 is CHLORIDE ION (three-letter code: CL) (formula: Cl).

Mol	Chain	Residues	Atoms	ZeroOcc	AltConf
36	0	10	Total Cl 10 10	0	0
36	A	1	Total Cl 1 1	0	0
36	B	1	Total Cl 1 1	0	0
36	J	3	Total Cl 3 3	0	0
36	L	1	Total Cl 1 1	0	0
36	M	1	Total Cl 1 1	0	0
36	N	1	Total Cl 1 1	0	0
36	O	1	Total Cl 1 1	0	0
36	R	1	Total Cl 1 1	0	0
36	Y	1	Total Cl 1 1	0	0

Continued on next page...

Continued from previous page...

Mol	Chain	Residues	Atoms	ZeroOcc	AltConf
36	3	1	Total Cl 1 1	0	0

- Molecule 37 is STRONTIUM ION (three-letter code: SR) (formula: Sr).

Mol	Chain	Residues	Atoms	ZeroOcc	AltConf
37	0	98	Total Sr 98 98	0	0
37	9	3	Total Sr 3 3	0	0
37	A	3	Total Sr 3 3	0	0
37	B	2	Total Sr 2 2	0	0
37	F	1	Total Sr 1 1	0	0
37	H	1	Total Sr 1 1	0	0
37	L	1	Total Sr 1 1	0	0
37	R	1	Total Sr 1 1	0	0
37	S	1	Total Sr 1 1	0	0
37	1	2	Total Sr 2 2	0	0
37	3	1	Total Sr 1 1	0	0

- Molecule 38 is CADMIUM ION (three-letter code: CD) (formula: Cd).

Mol	Chain	Residues	Atoms	ZeroOcc	AltConf
38	O	1	Total Cd 1 1	0	0
38	U	1	Total Cd 1 1	0	0
38	Z	1	Total Cd 1 1	0	0
38	1	1	Total Cd 1 1	0	0
38	3	1	Total Cd 1 1	0	0

- Molecule 39 is water.

Mol	Chain	Residues	Atoms		ZeroOcc	AltConf
39	0	5739	Total 5739	O 5739	0	0
39	9	132	Total 132	O 132	0	0
39	4	8	Total 8	O 8	0	0
39	A	123	Total 123	O 123	0	0
39	B	139	Total 139	O 139	0	0
39	C	177	Total 177	O 177	0	0
39	D	50	Total 50	O 50	0	0
39	E	43	Total 43	O 43	0	0
39	F	28	Total 28	O 28	0	0
39	G	16	Total 16	O 16	0	0
39	H	71	Total 71	O 71	0	0
39	J	53	Total 53	O 53	0	0
39	K	57	Total 57	O 57	0	0
39	L	82	Total 82	O 82	0	0
39	M	125	Total 125	O 125	0	0
39	N	59	Total 59	O 59	0	0
39	O	35	Total 35	O 35	0	0
39	P	59	Total 59	O 59	0	0
39	Q	48	Total 48	O 48	0	0
39	R	86	Total 86	O 86	0	0
39	S	31	Total 31	O 31	0	0

Continued on next page...

Continued from previous page...

Mol	Chain	Residues	Atoms		ZeroOcc	AltConf
39	T	36	Total 36	O 36	0	0
39	U	26	Total 26	O 26	0	0
39	V	11	Total 11	O 11	0	0
39	W	68	Total 68	O 68	0	0
39	X	23	Total 23	O 23	0	0
39	Y	93	Total 93	O 93	0	0
39	Z	28	Total 28	O 28	0	0
39	1	51	Total 51	O 51	0	0
39	2	41	Total 41	O 41	0	0
39	3	67	Total 67	O 67	0	0
39	I	9	Total 9	O 9	0	0

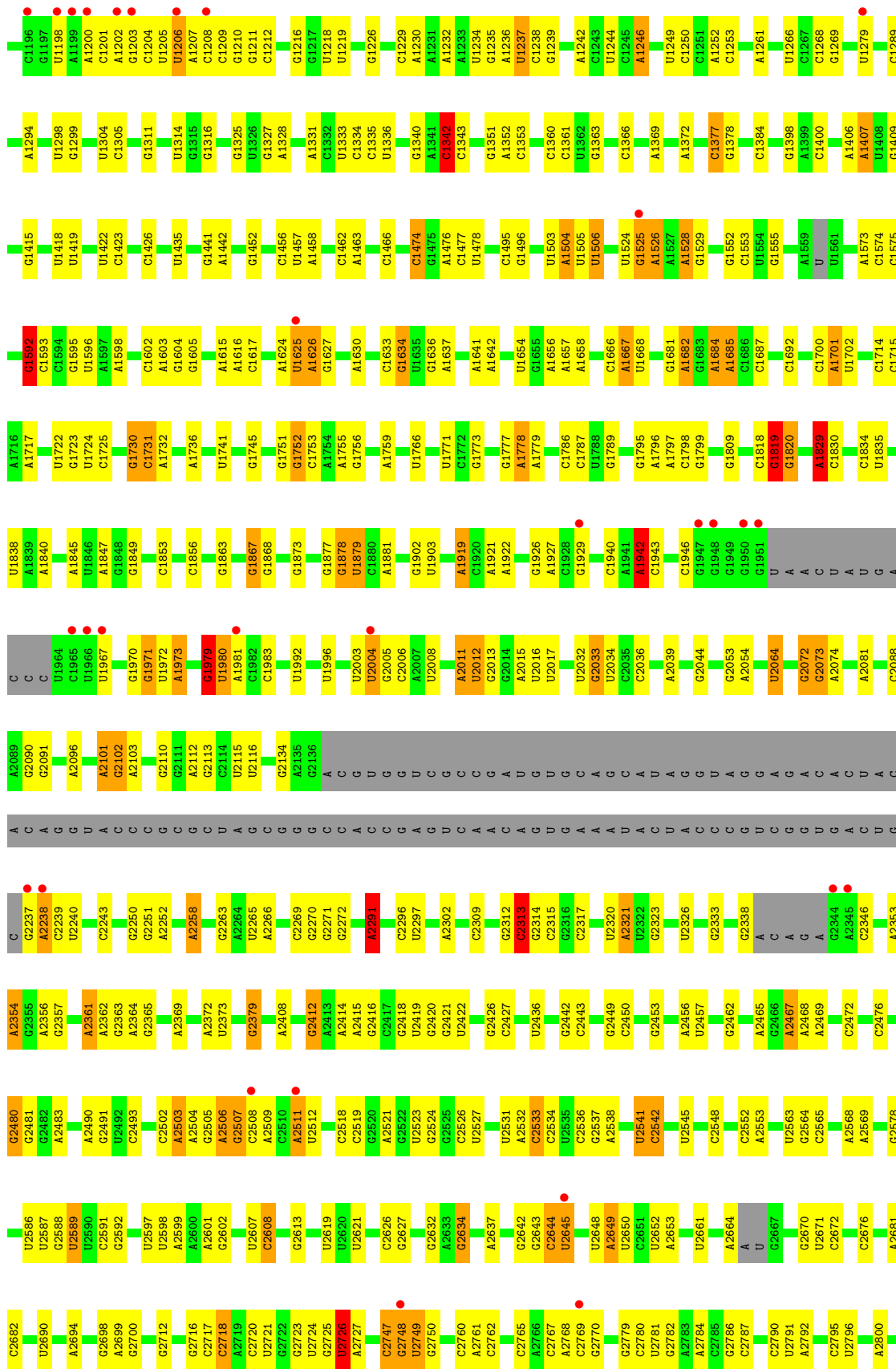

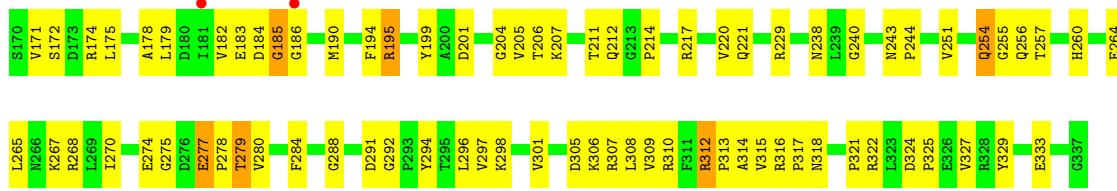

• Molecule 6: 50S ribosomal protein L4E

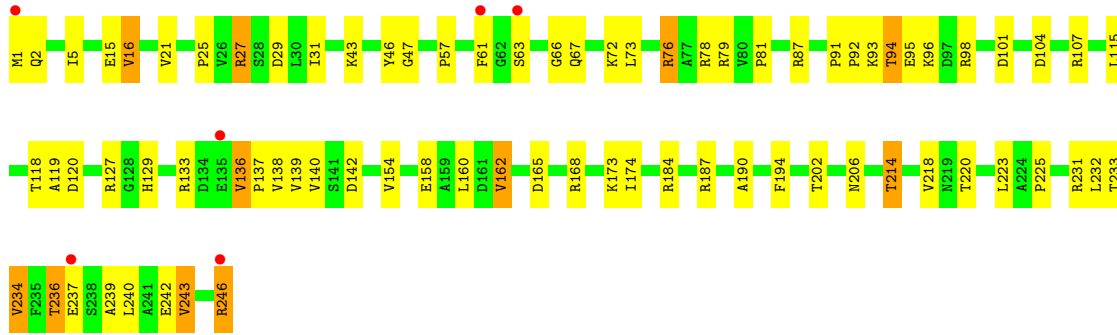

• Molecule 7: 50S ribosomal protein L5P

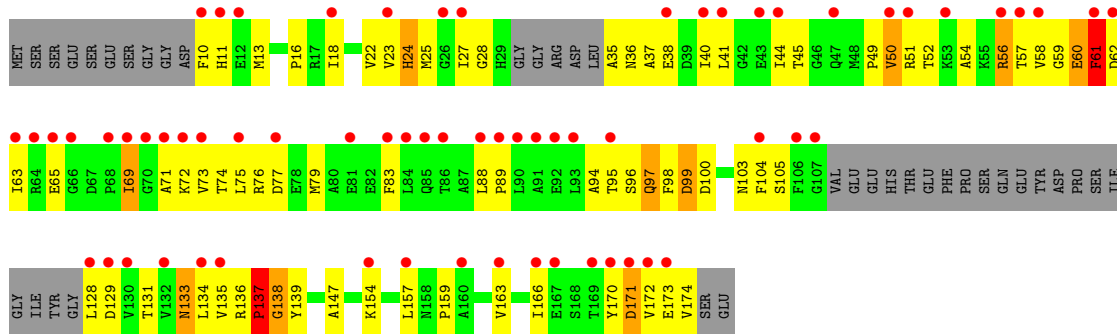

• Molecule 8: 50S ribosomal protein L6P

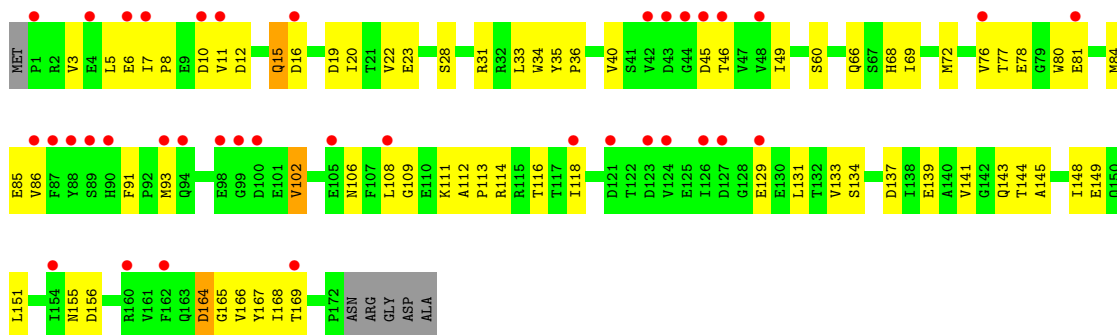

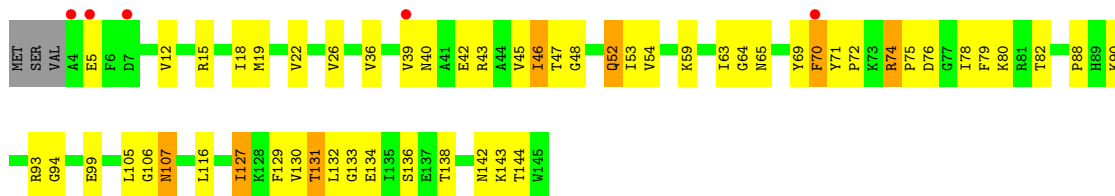

• Molecule 13: 50S ribosomal protein L14P

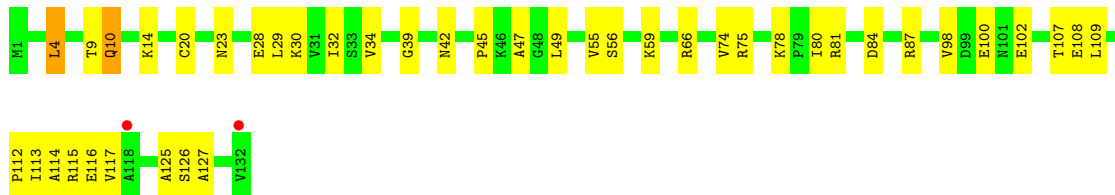

• Molecule 14: 50S ribosomal protein L15P

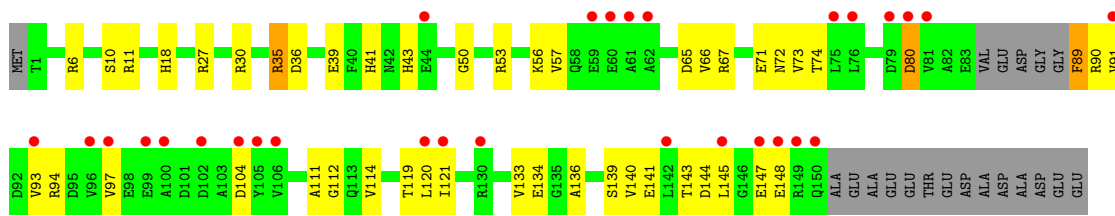

• Molecule 15: 50S Ribosomal Protein L15E

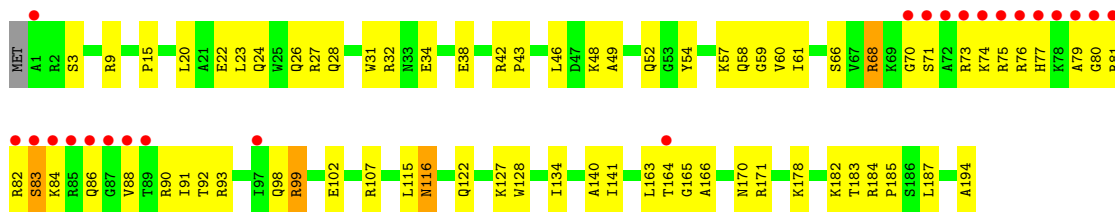

• Molecule 16: 50S ribosomal protein L18P

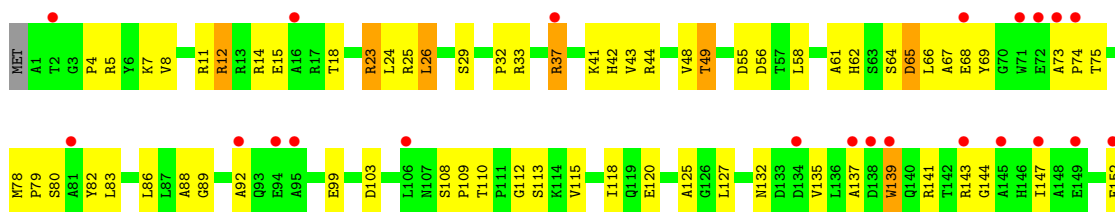

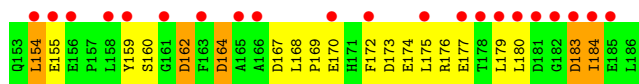

- Molecule 17: 50S ribosomal protein L18e



- Molecule 18: 50S ribosomal protein L19E

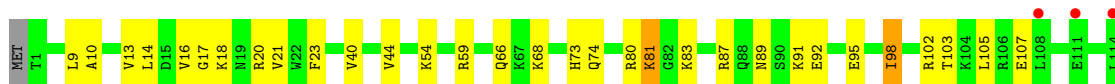

- Molecule 19: 50S ribosomal protein L21e

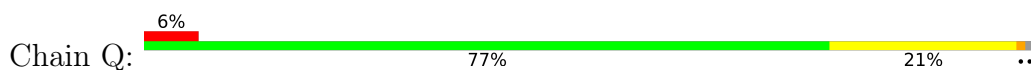

- Molecule 20: 50S ribosomal protein L22P

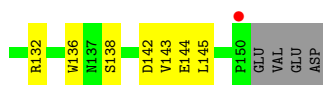
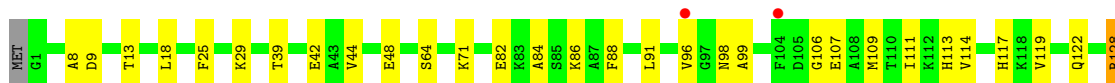
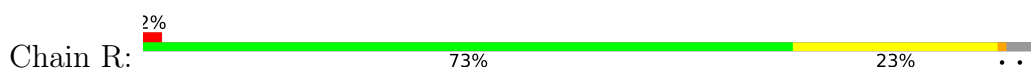

- Molecule 21: 50S ribosomal protein L23P

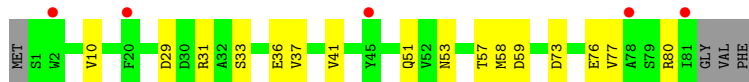
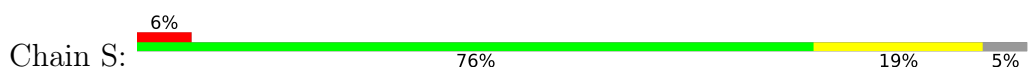

- Molecule 22: 50S ribosomal protein L24P

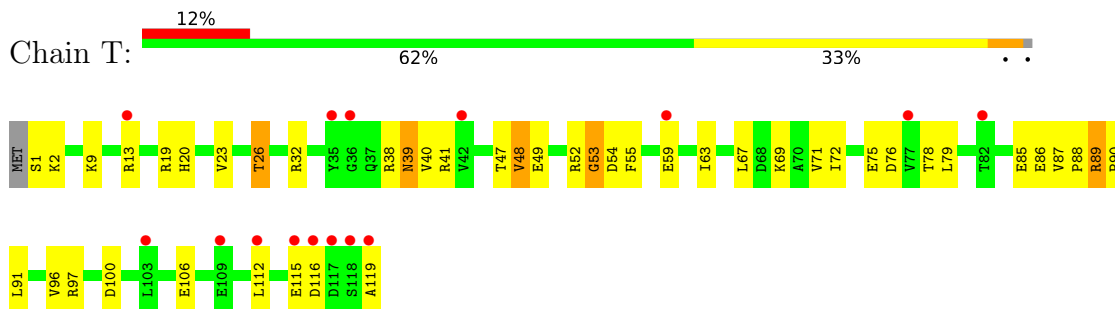

- Molecule 23: 50S ribosomal protein L24E

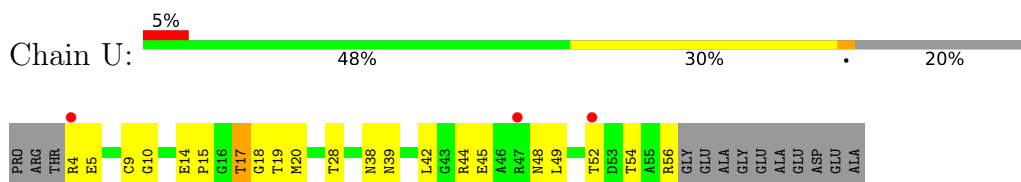

- Molecule 24: 50S ribosomal protein L29P

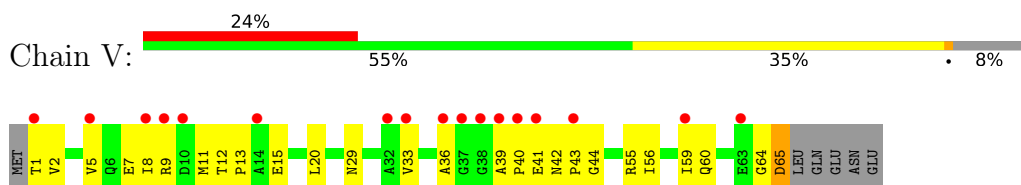

- Molecule 25: 50S ribosomal protein L30P

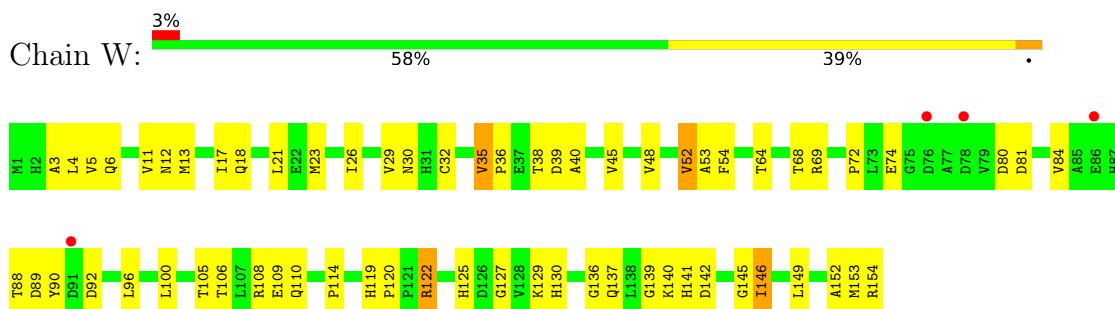

- Molecule 26: 50S ribosomal protein L31e

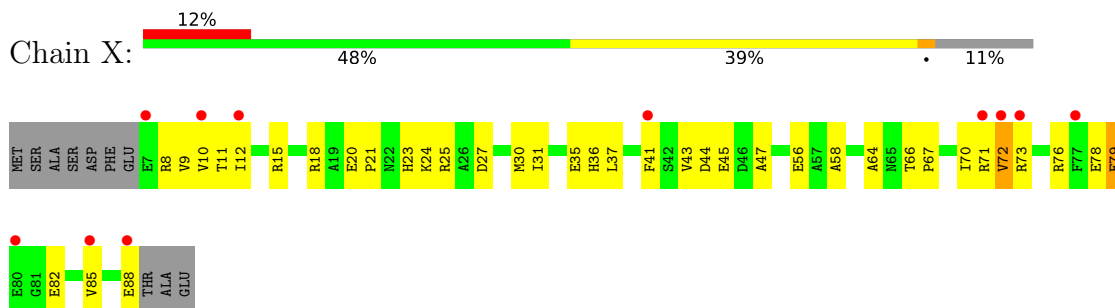

- Molecule 27: 50S ribosomal protein L32E

MET	ALA	GLY	THR	ILE	GLU	VAL	LEU	VAL	PRO	GLY	GLY	PRO	PRO	LEU	GLY	LEU	GLY	PRO	THR	THR	VAL	ASP	ASP	GLN	GLN	THR	ALA	ALA	PHE	ASP	GLY	THR	GLU	VAL	VAL	PRO	VAL	THR	VAL	LYS	TYR	ASP	ASP	GLY															
SER	PHE	GLU	ILE	GLU	VAL	G71	V72	V73	P74	T75	A76	E77	L78	I79	K80	D81	E82	A83	G84	F85	E86	T87	G88	S89	G90	E91	P92	Q93	E94	D95	F96	V97	A98	D99	L100	S101	V102	D103	Q104	V105	K106	Q107	I108	A109	E110	Q111	K112	H113	P114	D115	L116	L117	S118	Y119	D120	L121	T122	N123	A124
A125	K126	E127	V128	V129	G130	T131	C132	T133	S134	L135	G136	V137	T138	I139	E140	GLY	GLU	ASN	PRO	ARG	GLU	PHE	LYS	GLU	ARG	ILE	ASP	ALA	GLY	GLU	TYR	ASP	ASP	VAL	PHE	ALA	ALA	GLU	ALA	GLN	ALA																		

4 Data and refinement statistics

Property	Value	Source
Space group	C 2 2 21	Depositor
Cell constants a, b, c, α , β , γ	211.44Å 298.56Å 574.49Å 90.00° 90.00° 90.00°	Depositor
Resolution (Å)	50.00 – 2.30 49.61 – 2.30	Depositor EDS
% Data completeness (in resolution range)	99.3 (50.00-2.30) 89.8 (49.61-2.30)	Depositor EDS
R_{merge}	(Not available)	Depositor
R_{sym}	(Not available)	Depositor
$\langle I/\sigma(I) \rangle$ ¹	1.13 (at 2.29Å)	Xtrriage
Refinement program	CNS	Depositor
R, R_{free}	0.214 , 0.247 0.206 , (Not available)	Depositor DCC
R_{free} test set	No test flags present.	wwPDB-VP
Wilson B-factor (Å ²)	47.8	Xtrriage
Anisotropy	0.180	Xtrriage
Bulk solvent k_{sol} (e/Å ³), B_{sol} (Å ²)	0.32 , 61.6	EDS
L-test for twinning ²	$\langle L \rangle = 0.47$, $\langle L^2 \rangle = 0.30$	Xtrriage
Estimated twinning fraction	No twinning to report.	Xtrriage
F_o, F_c correlation	0.95	EDS
Total number of atoms	99045	wwPDB-VP
Average B, all atoms (Å ²)	58.0	wwPDB-VP

Xtrriage's analysis on translational NCS is as follows: *The largest off-origin peak in the Patterson function is 1.41% of the height of the origin peak. No significant pseudotranslation is detected.*

¹Intensities estimated from amplitudes.

²Theoretical values of $\langle |L| \rangle$, $\langle L^2 \rangle$ for acentric reflections are 0.5, 0.333 respectively for untwinned datasets, and 0.375, 0.2 for perfectly twinned datasets.

5 Model quality [i](#)

5.1 Standard geometry [i](#)

Bond lengths and bond angles in the following residue types are not validated in this section: OMG, NA, PPU, SR, PSU, 1MA, PO2, CL, OMU, UR3, MG, CD, K

The Z score for a bond length (or angle) is the number of standard deviations the observed value is removed from the expected value. A bond length (or angle) with $|Z| > 5$ is considered an outlier worth inspection. RMSZ is the root-mean-square of all Z scores of the bond lengths (or angles).

Mol	Chain	Bond lengths		Bond angles	
		RMSZ	# Z >5	RMSZ	# Z >5
1	0	0.38	0/65959	0.70	24/102870 (0.0%)
2	9	0.32	0/2905	0.70	1/4528 (0.0%)
3	4	0.48	0/102	0.75	0/149
4	A	0.33	0/1786	0.65	0/2408
5	B	0.32	0/2690	0.64	0/3652
6	C	0.37	0/1884	0.65	0/2551
7	D	0.29	0/1111	0.53	0/1498
8	E	0.31	0/1382	0.56	0/1880
9	F	0.30	0/901	0.53	0/1224
10	G	0.27	0/241	0.46	0/324
11	H	0.33	0/1287	0.64	0/1725
12	J	0.34	0/1136	0.60	0/1530
13	K	0.35	0/1001	0.66	0/1347
14	L	0.32	0/1130	0.63	0/1509
15	M	0.35	0/1584	0.60	0/2119
16	N	0.28	0/1474	0.60	0/1999
17	O	0.32	0/874	0.58	1/1181 (0.1%)
18	P	0.34	0/1147	0.55	0/1528
19	Q	0.35	0/749	0.68	0/1005
20	R	0.35	0/1172	0.66	1/1578 (0.1%)
21	S	0.32	0/648	0.58	0/875
22	T	0.30	0/958	0.62	0/1289
23	U	0.34	0/417	0.56	0/562
24	V	0.26	0/502	0.50	0/675
25	W	0.33	0/1219	0.59	0/1655
26	X	0.32	0/664	0.59	0/895
27	Y	0.35	0/1146	0.65	0/1536
28	Z	0.33	0/589	0.59	0/787
29	1	0.44	0/438	0.66	0/578
30	2	0.34	0/401	0.58	0/529
31	3	0.35	0/771	0.58	0/1024
32	I	0.28	0/526	0.50	0/716

Mol	Chain	Bond lengths		Bond angles	
		RMSZ	# Z >5	RMSZ	# Z >5
All	All	0.36	0/98794	0.67	27/147726 (0.0%)

Chiral center outliers are detected by calculating the chiral volume of a chiral center and verifying if the center is modelled as a planar moiety or with the opposite hand. A planarity outlier is detected by checking planarity of atoms in a peptide group, atoms in a mainchain group or atoms of a sidechain that are expected to be planar.

Mol	Chain	#Chirality outliers	#Planarity outliers
1	0	0	44
2	9	0	1
All	All	0	45

There are no bond length outliers.

The worst 5 of 27 bond angle outliers are listed below:

Mol	Chain	Res	Type	Atoms	Z	Observed(°)	Ideal(°)
1	0	1819	G	C5'-C4'-C3'	7.74	128.38	116.00
1	0	871	G	C5'-C4'-O4'	-7.70	99.86	109.10
1	0	1942	A	C5'-C4'-C3'	7.40	127.83	116.00
2	9	3039	U	N1-C1'-C2'	6.97	123.06	114.00
1	0	1979	G	C2'-C3'-O3'	6.95	124.81	113.70

There are no chirality outliers.

5 of 45 planarity outliers are listed below:

Mol	Chain	Res	Type	Group
1	0	182	G	Sidechain
1	0	396	U	Sidechain
1	0	460	A	Sidechain
1	0	469	G	Sidechain
1	0	470	U	Sidechain

5.2 Too-close contacts

In the following table, the Non-H and H(model) columns list the number of non-hydrogen atoms and hydrogen atoms in the chain respectively. The H(added) column lists the number of hydrogen atoms added and optimized by MolProbity. The Clashes column lists the number of clashes within the asymmetric unit, whereas Symm-Clashes lists symmetry-related clashes.

Mol	Chain	Non-H	H(model)	H(added)	Clashes	Symm-Clashes
1	0	59021	0	29813	714	0
2	9	2600	0	1326	52	0
3	4	135	0	83	3	0
4	A	1753	0	1766	108	0
5	B	2625	0	2532	133	0
6	C	1859	0	1816	89	0
7	D	1094	0	1085	77	0
8	E	1357	0	1266	55	0
9	F	890	0	843	47	0
10	G	240	0	231	14	0
11	H	1266	0	1268	57	0
12	J	1120	0	1098	78	0
13	K	992	0	1031	46	0
14	L	1118	0	1076	50	0
15	M	1560	0	1568	72	0
16	N	1445	0	1401	86	0
17	O	865	0	873	37	0
18	P	1136	0	1123	38	0
19	Q	735	0	729	17	0
20	R	1149	0	1122	36	0
21	S	641	0	605	16	0
22	T	950	0	924	49	0
23	U	410	0	364	21	0
24	V	499	0	511	31	0
25	W	1196	0	1137	91	0
26	X	654	0	653	38	0
27	Y	1130	0	1133	61	0
28	Z	578	0	539	39	0
29	1	431	0	426	26	0
30	2	396	0	413	28	0
31	3	755	0	728	28	0
32	I	519	0	500	50	0
33	0	87	0	0	0	0
33	2	1	0	0	0	0
33	9	1	0	0	0	0
33	A	1	0	0	0	0
33	B	1	0	0	0	0
33	K	1	0	0	0	0
33	T	1	0	0	0	0
33	Y	1	0	0	0	0
34	0	2	0	0	0	0
35	0	62	0	0	0	0
35	3	1	0	0	0	0

Continued on next page...

Continued from previous page...

Mol	Chain	Non-H	H(model)	H(added)	Clashes	Symm-Clashes
35	9	3	0	0	0	0
35	C	1	0	0	0	0
35	H	1	0	0	0	0
35	J	1	0	0	0	0
35	M	1	0	0	0	0
35	Q	1	0	0	0	0
35	R	3	0	0	0	0
35	S	1	0	0	0	0
36	0	10	0	0	0	0
36	3	1	0	0	0	0
36	A	1	0	0	0	0
36	B	1	0	0	0	0
36	J	3	0	0	1	0
36	L	1	0	0	0	0
36	M	1	0	0	0	0
36	N	1	0	0	1	0
36	O	1	0	0	0	0
36	R	1	0	0	0	0
36	Y	1	0	0	0	0
37	0	98	0	0	0	0
37	1	2	0	0	0	0
37	3	1	0	0	0	0
37	9	3	0	0	0	0
37	A	3	0	0	0	0
37	B	2	0	0	0	0
37	F	1	0	0	0	0
37	H	1	0	0	0	0
37	L	1	0	0	0	0
37	R	1	0	0	0	0
37	S	1	0	0	0	0
38	1	1	0	0	0	0
38	3	1	0	0	0	0
38	O	1	0	0	0	0
38	U	1	0	0	0	0
38	Z	1	0	0	0	0
39	0	5739	0	0	94	0
39	1	51	0	0	1	0
39	2	41	0	0	1	0
39	3	67	0	0	3	0
39	4	8	0	0	0	0
39	9	132	0	0	8	0
39	A	123	0	0	14	0

Continued on next page...

Continued from previous page...

Mol	Chain	Non-H	H(model)	H(added)	Clashes	Symm-Clashes
39	B	139	0	0	19	0
39	C	177	0	0	16	0
39	D	50	0	0	5	0
39	E	43	0	0	2	0
39	F	28	0	0	2	0
39	G	16	0	0	2	0
39	H	71	0	0	8	0
39	I	9	0	0	1	0
39	J	53	0	0	3	0
39	K	57	0	0	4	0
39	L	82	0	0	11	0
39	M	125	0	0	7	0
39	N	59	0	0	7	0
39	O	35	0	0	3	0
39	P	59	0	0	0	0
39	Q	48	0	0	5	0
39	R	86	0	0	2	0
39	S	31	0	0	1	0
39	T	36	0	0	1	0
39	U	26	0	0	1	0
39	V	11	0	0	1	0
39	W	68	0	0	3	0
39	X	23	0	0	3	0
39	Y	93	0	0	9	0
39	Z	28	0	0	3	0
All	All	99045	0	59983	2061	0

The all-atom clashscore is defined as the number of clashes found per 1000 atoms (including hydrogen atoms). The all-atom clashscore for this structure is 14.

The worst 5 of 2061 close contacts within the same asymmetric unit are listed below, sorted by their clash magnitude.

Atom-1	Atom-2	Interatomic distance (Å)	Clash overlap (Å)
25:W:21:LEU:HD21	25:W:48:VAL:HG11	1.23	1.17
26:X:37:LEU:HD13	26:X:85:VAL:HG21	1.31	1.10
2:9:3076:G:H3'	2:9:3077:A:H5''	1.35	1.08
6:C:236:THR:HG22	6:C:239:ALA:H	1.14	1.06
1:0:133:U:H2'	1:0:134:U:H5''	1.37	1.02

There are no symmetry-related clashes.

5.3 Torsion angles [i](#)

5.3.1 Protein backbone [i](#)

In the following table, the Percentiles column shows the percent Ramachandran outliers of the chain as a percentile score with respect to all X-ray entries followed by that with respect to entries of similar resolution.

The Analysed column shows the number of residues for which the backbone conformation was analysed, and the total number of residues.

Mol	Chain	Analysed	Favoured	Allowed	Outliers	Percentiles
4	A	235/240 (98%)	213 (91%)	17 (7%)	5 (2%)	7 5
5	B	335/338 (99%)	312 (93%)	18 (5%)	5 (2%)	10 10
6	C	244/246 (99%)	226 (93%)	18 (7%)	0	100 100
7	D	134/177 (76%)	104 (78%)	18 (13%)	12 (9%)	1 0
8	E	170/178 (96%)	164 (96%)	6 (4%)	0	100 100
9	F	117/120 (98%)	104 (89%)	11 (9%)	2 (2%)	9 8
10	G	25/348 (7%)	24 (96%)	1 (4%)	0	100 100
11	H	156/171 (91%)	141 (90%)	13 (8%)	2 (1%)	12 12
12	J	140/145 (97%)	132 (94%)	5 (4%)	3 (2%)	7 5
13	K	130/132 (98%)	121 (93%)	8 (6%)	1 (1%)	19 23
14	L	141/165 (86%)	120 (85%)	20 (14%)	1 (1%)	22 26
15	M	192/195 (98%)	180 (94%)	11 (6%)	1 (0%)	29 35
16	N	184/187 (98%)	162 (88%)	15 (8%)	7 (4%)	3 1
17	O	113/116 (97%)	107 (95%)	6 (5%)	0	100 100
18	P	141/149 (95%)	137 (97%)	4 (3%)	0	100 100
19	Q	93/96 (97%)	88 (95%)	5 (5%)	0	100 100
20	R	148/155 (96%)	142 (96%)	6 (4%)	0	100 100
21	S	79/85 (93%)	74 (94%)	5 (6%)	0	100 100
22	T	117/120 (98%)	108 (92%)	8 (7%)	1 (1%)	17 20
23	U	51/66 (77%)	47 (92%)	4 (8%)	0	100 100
24	V	63/71 (89%)	55 (87%)	7 (11%)	1 (2%)	9 9
25	W	152/154 (99%)	149 (98%)	3 (2%)	0	100 100
26	X	80/92 (87%)	71 (89%)	9 (11%)	0	100 100
27	Y	140/241 (58%)	139 (99%)	1 (1%)	0	100 100
28	Z	71/83 (86%)	58 (82%)	10 (14%)	3 (4%)	3 1

Continued on next page...

Continued from previous page...

Mol	Chain	Analysed	Favoured	Allowed	Outliers	Percentiles	
29	1	54/57 (95%)	52 (96%)	2 (4%)	0	100	100
30	2	42/50 (84%)	40 (95%)	2 (5%)	0	100	100
31	3	90/92 (98%)	87 (97%)	2 (2%)	1 (1%)	14	15
32	I	68/162 (42%)	52 (76%)	14 (21%)	2 (3%)	4	3
All	All	3705/4431 (84%)	3409 (92%)	249 (7%)	47 (1%)	12	12

5 of 47 Ramachandran outliers are listed below:

Mol	Chain	Res	Type
4	A	37	VAL
7	D	137	PRO
9	F	101	ALA
11	H	166	SER
12	J	143	LYS

5.3.2 Protein sidechains [i](#)

In the following table, the Percentiles column shows the percent sidechain outliers of the chain as a percentile score with respect to all X-ray entries followed by that with respect to entries of similar resolution.

The Analysed column shows the number of residues for which the sidechain conformation was analysed, and the total number of residues.

Mol	Chain	Analysed	Rotameric	Outliers	Percentiles	
4	A	179/182 (98%)	169 (94%)	10 (6%)	21	29
5	B	282/283 (100%)	268 (95%)	14 (5%)	24	34
6	C	193/193 (100%)	174 (90%)	19 (10%)	8	9
7	D	117/148 (79%)	110 (94%)	7 (6%)	19	26
8	E	152/156 (97%)	145 (95%)	7 (5%)	27	38
9	F	93/94 (99%)	90 (97%)	3 (3%)	39	54
10	G	27/283 (10%)	27 (100%)	0	100	100
11	H	132/138 (96%)	130 (98%)	2 (2%)	65	79
12	J	118/121 (98%)	110 (93%)	8 (7%)	16	21
13	K	106/106 (100%)	102 (96%)	4 (4%)	33	47
14	L	113/127 (89%)	109 (96%)	4 (4%)	36	50
15	M	158/159 (99%)	153 (97%)	5 (3%)	39	54

Continued on next page...

Continued from previous page...

Mol	Chain	Analysed	Rotameric	Outliers	Percentiles	
16	N	149/150 (99%)	142 (95%)	7 (5%)	26	37
17	O	93/94 (99%)	91 (98%)	2 (2%)	52	69
18	P	113/117 (97%)	110 (97%)	3 (3%)	44	61
19	Q	79/80 (99%)	75 (95%)	4 (5%)	24	33
20	R	117/122 (96%)	117 (100%)	0	100	100
21	S	71/74 (96%)	71 (100%)	0	100	100
22	T	105/106 (99%)	101 (96%)	4 (4%)	33	47
23	U	44/52 (85%)	43 (98%)	1 (2%)	50	67
24	V	51/57 (90%)	50 (98%)	1 (2%)	55	72
25	W	130/130 (100%)	126 (97%)	4 (3%)	40	55
26	X	66/74 (89%)	62 (94%)	4 (6%)	18	25
27	Y	120/196 (61%)	109 (91%)	11 (9%)	9	11
28	Z	60/68 (88%)	59 (98%)	1 (2%)	60	76
29	1	46/47 (98%)	45 (98%)	1 (2%)	52	69
30	2	42/46 (91%)	41 (98%)	1 (2%)	49	66
31	3	79/79 (100%)	77 (98%)	2 (2%)	47	65
32	I	58/130 (45%)	58 (100%)	0	100	100
All	All	3093/3612 (86%)	2964 (96%)	129 (4%)	30	42

5 of 129 residues with a non-rotameric sidechain are listed below:

Mol	Chain	Res	Type
27	Y	141	THR
27	Y	189	ASN
7	D	133	ASN
7	D	100	ASP
27	Y	203	VAL

Sometimes sidechains can be flipped to improve hydrogen bonding and reduce clashes. 5 of 82 such sidechains are listed below:

Mol	Chain	Res	Type
23	U	39	ASN
28	Z	41	ASN
24	V	29	ASN
25	W	141	HIS

Continued on next page...

Continued from previous page...

Mol	Chain	Res	Type
30	2	16	ASN

5.3.3 RNA [i](#)

Mol	Chain	Analysed	Backbone Outliers	Pucker Outliers
1	0	2745/2922 (93%)	235 (8%)	36 (1%)
2	9	121/122 (99%)	14 (11%)	1 (0%)
3	4	1/7 (14%)	0	0
All	All	2867/3051 (93%)	249 (8%)	37 (1%)

5 of 249 RNA backbone outliers are listed below:

Mol	Chain	Res	Type
1	0	31	C
1	0	67	A
1	0	69	A
1	0	70	A
1	0	71	G

5 of 37 RNA pucker outliers are listed below:

Mol	Chain	Res	Type
1	0	2536	C
1	0	2852	A
1	0	2541	U
1	0	2726	U
1	0	1232	A

5.4 Non-standard residues in protein, DNA, RNA chains [i](#)

6 non-standard protein/DNA/RNA residues are modelled in this entry.

In the following table, the Counts columns list the number of bonds (or angles) for which Mogul statistics could be retrieved, the number of bonds (or angles) that are observed in the model and the number of bonds (or angles) that are defined in the Chemical Component Dictionary. The Link column lists molecule types, if any, to which the group is linked. The Z score for a bond length (or angle) is the number of standard deviations the observed value is removed from the expected value. A bond length (or angle) with $|Z| > 2$ is considered an outlier worth inspection. RMSZ is the root-mean-square of all Z scores of the bond lengths (or angles).

Mol	Type	Chain	Res	Link	Bond lengths			Bond angles		
					Counts	RMSZ	# Z > 2	Counts	RMSZ	# Z > 2
1	OMG	0	2588	3,1	18,26,27	0.97	2 (11%)	19,38,41	0.77	1 (5%)
1	1MA	0	628	1	16,25,26	1.37	3 (18%)	18,37,40	1.13	2 (11%)
1	OMU	0	2587	1	19,22,23	0.28	0	26,31,34	0.41	0
1	PSU	0	2621	1	18,21,22	1.62	2 (11%)	22,30,33	1.28	3 (13%)
3	PPU	4	76	3,1	32,40,41	1.19	1 (3%)	33,57,60	0.84	2 (6%)
1	UR3	0	2619	1	19,22,23	0.40	0	26,32,35	0.64	1 (3%)

In the following table, the Chirals column lists the number of chiral outliers, the number of chiral centers analysed, the number of these observed in the model and the number defined in the Chemical Component Dictionary. Similar counts are reported in the Torsion and Rings columns. '-' means no outliers of that kind were identified.

Mol	Type	Chain	Res	Link	Chirals	Torsions	Rings
1	OMG	0	2588	3,1	-	2/5/27/28	0/3/3/3
1	1MA	0	628	1	-	0/3/25/26	0/3/3/3
1	OMU	0	2587	1	-	0/9/27/28	0/2/2/2
1	PSU	0	2621	1	-	0/7/25/26	0/2/2/2
3	PPU	4	76	3,1	-	0/21/43/44	0/4/4/4
1	UR3	0	2619	1	-	0/7/25/26	0/2/2/2

The worst 5 of 8 bond length outliers are listed below:

Mol	Chain	Res	Type	Atoms	Z	Observed(Å)	Ideal(Å)
3	4	76	PPU	OC-CM	-5.45	1.26	1.42
1	0	2621	PSU	C2-N1	5.15	1.43	1.36
1	0	628	1MA	C2-N3	3.75	1.33	1.29
1	0	2621	PSU	C6-C5	3.45	1.39	1.35
1	0	628	1MA	C6-N6	2.61	1.34	1.27

The worst 5 of 9 bond angle outliers are listed below:

Mol	Chain	Res	Type	Atoms	Z	Observed(°)	Ideal(°)
1	0	2621	PSU	C6-C5-C4	3.44	120.60	118.20
1	0	2621	PSU	C6-N1-C2	-3.10	119.51	122.68
1	0	628	1MA	N1-C2-N3	2.79	129.27	126.02
1	0	2621	PSU	O2-C2-N1	2.58	125.64	122.79
1	0	628	1MA	C5-C6-N1	2.54	117.68	113.90

There are no chirality outliers.

All (2) torsion outliers are listed below:

Mol	Chain	Res	Type	Atoms
1	0	2588	OMG	C3'-C2'-O2'-CM2
1	0	2588	OMG	C1'-C2'-O2'-CM2

There are no ring outliers.

2 monomers are involved in 3 short contacts:

Mol	Chain	Res	Type	Clashes	Symm-Clashes
1	0	2587	OMU	2	0
3	4	76	PPU	1	0

5.5 Carbohydrates [i](#)

There are no monosaccharides in this entry.

5.6 Ligand geometry [i](#)

Of 312 ligands modelled in this entry, 312 are monoatomic - leaving 0 for Mogul analysis.

There are no bond length outliers.

There are no bond angle outliers.

There are no chirality outliers.

There are no torsion outliers.

There are no ring outliers.

No monomer is involved in short contacts.

5.7 Other polymers [i](#)

There are no such residues in this entry.

5.8 Polymer linkage issues [i](#)

There are no chain breaks in this entry.

6 Fit of model and data [i](#)

6.1 Protein, DNA and RNA chains [i](#)

In the following table, the column labelled ‘#RSRZ > 2’ contains the number (and percentage) of RSRZ outliers, followed by percent RSRZ outliers for the chain as percentile scores relative to all X-ray entries and entries of similar resolution. The OWAB column contains the minimum, median, 95th percentile and maximum values of the occupancy-weighted average B-factor per residue. The column labelled ‘Q < 0.9’ lists the number of (and percentage) of residues with an average occupancy less than 0.9.

Mol	Chain	Analysed	<RSRZ>	#RSRZ>2	OWAB(Å ²)	Q<0.9
1	0	2749/2922 (94%)	-0.12	75 (2%) 54 62	26, 50, 94, 154	0
2	9	122/122 (100%)	0.14	5 (4%) 37 44	45, 70, 97, 154	0
3	4	5/7 (71%)	-0.62	0 100 100	46, 48, 54, 54	0
4	A	237/240 (98%)	0.54	18 (7%) 13 18	31, 55, 88, 108	0
5	B	337/338 (99%)	0.41	15 (4%) 33 40	32, 57, 83, 94	0
6	C	246/246 (100%)	0.19	6 (2%) 59 66	29, 51, 76, 90	0
7	D	140/177 (79%)	2.40	65 (46%) 0 0	64, 100, 128, 135	0
8	E	172/178 (96%)	1.14	38 (22%) 0 1	47, 71, 89, 96	0
9	F	119/120 (99%)	1.46	41 (34%) 0 0	51, 76, 106, 112	0
10	G	29/348 (8%)	2.78	19 (65%) 0 0	75, 97, 105, 106	0
11	H	160/171 (93%)	0.89	25 (15%) 2 2	49, 66, 97, 105	0
12	J	142/145 (97%)	0.28	5 (3%) 44 51	40, 55, 76, 95	0
13	K	132/132 (100%)	0.08	2 (1%) 73 79	36, 52, 74, 83	0
14	L	145/165 (87%)	1.00	29 (20%) 1 1	29, 70, 114, 125	0
15	M	194/195 (99%)	0.99	23 (11%) 4 6	36, 49, 90, 98	0
16	N	186/187 (99%)	1.27	43 (23%) 0 1	48, 70, 117, 121	0
17	O	115/116 (99%)	0.39	4 (3%) 44 51	42, 60, 75, 81	0
18	P	143/149 (95%)	0.30	4 (2%) 53 60	41, 56, 69, 81	0
19	Q	95/96 (98%)	0.38	6 (6%) 20 25	42, 54, 70, 78	0
20	R	150/155 (96%)	0.12	3 (2%) 65 71	33, 48, 69, 77	0
21	S	81/85 (95%)	0.43	5 (6%) 20 26	42, 60, 81, 98	0
22	T	119/120 (99%)	0.89	15 (12%) 3 5	46, 59, 89, 113	0
23	U	53/66 (80%)	0.38	3 (5%) 23 30	46, 57, 77, 84	0
24	V	65/71 (91%)	1.83	17 (26%) 0 0	55, 80, 116, 121	0

Continued on next page...

Continued from previous page...

Mol	Chain	Analysed	<RSRZ>	#RSRZ>2	OWAB(Å ²)	Q<0.9
25	W	154/154 (100%)	0.34	4 (2%) 56 63	42, 56, 79, 88	0
26	X	82/92 (89%)	0.91	11 (13%) 3 4	46, 60, 88, 105	0
27	Y	142/241 (58%)	0.40	12 (8%) 10 14	32, 49, 70, 90	0
28	Z	73/83 (87%)	2.19	29 (39%) 0 0	51, 83, 99, 106	0
29	1	56/57 (98%)	-0.28	0 100 100	30, 36, 45, 54	0
30	2	46/50 (92%)	1.06	8 (17%) 1 1	39, 63, 88, 100	0
31	3	92/92 (100%)	0.62	9 (9%) 7 10	39, 61, 76, 90	0
32	I	70/162 (43%)	6.05	66 (94%) 0 0	114, 127, 144, 146	0
All	All	6651/7482 (88%)	0.43	605 (9%) 9 12	26, 56, 102, 154	0

The worst 5 of 605 RSRZ outliers are listed below:

Mol	Chain	Res	Type	RSRZ
32	I	71	GLY	20.6
24	V	1	THR	16.1
7	D	63	ILE	14.8
15	M	70	GLY	13.7
32	I	133	THR	13.6

6.2 Non-standard residues in protein, DNA, RNA chains [i](#)

In the following table, the Atoms column lists the number of modelled atoms in the group and the number defined in the chemical component dictionary. The B-factors column lists the minimum, median, 95th percentile and maximum values of B factors of atoms in the group. The column labelled 'Q< 0.9' lists the number of atoms with occupancy less than 0.9.

Mol	Type	Chain	Res	Atoms	RSCC	RSR	B-factors(Å ²)	Q<0.9
1	OMG	0	2588	24/25	0.97	0.12	34,37,42,43	0
1	OMU	0	2587	21/22	0.98	0.12	35,40,43,43	0
1	1MA	0	628	23/24	0.98	0.15	35,37,40,44	0
1	UR3	0	2619	21/22	0.98	0.14	39,40,43,47	0
1	PSU	0	2621	20/21	0.98	0.13	35,39,43,44	0
3	PPU	4	76	37/38	0.98	0.12	38,43,49,54	0

6.3 Carbohydrates [i](#)

There are no monosaccharides in this entry.

6.4 Ligands i

In the following table, the Atoms column lists the number of modelled atoms in the group and the number defined in the chemical component dictionary. The B-factors column lists the minimum, median, 95th percentile and maximum values of B factors of atoms in the group. The column labelled 'Q< 0.9' lists the number of atoms with occupancy less than 0.9.

Mol	Type	Chain	Res	Atoms	RSCC	RSR	B-factors(Å ²)	Q<0.9
37	SR	0	9537	1/1	0.14	0.21	159,159,159,159	0
33	MG	0	8047	1/1	0.18	1.13	111,111,111,111	0
35	NA	0	9129	1/1	0.29	0.32	82,82,82,82	0
37	SR	0	9547	1/1	0.38	0.28	184,184,184,184	0
33	MG	0	8102	1/1	0.43	0.16	76,76,76,76	0
33	MG	0	8108	1/1	0.47	0.13	107,107,107,107	0
38	CD	Z	9203	1/1	0.48	0.19	93,93,93,93	0
33	MG	0	8094	1/1	0.51	0.68	93,93,93,93	0
35	NA	0	9184	1/1	0.56	0.21	83,83,83,83	0
35	NA	0	9185	1/1	0.67	0.47	62,62,62,62	0
35	NA	0	9111	1/1	0.67	0.27	70,70,70,70	0
35	NA	0	9179	1/1	0.69	1.23	96,96,96,96	0
35	NA	9	9151	1/1	0.71	0.23	83,83,83,83	0
33	MG	0	8059	1/1	0.72	0.40	71,71,71,71	0
33	MG	0	8050	1/1	0.72	0.18	86,86,86,86	0
35	NA	S	9112	1/1	0.72	0.31	85,85,85,85	0
33	MG	0	8065	1/1	0.74	0.47	90,90,90,90	0
35	NA	0	9178	1/1	0.75	0.26	57,57,57,57	0
33	MG	0	8042	1/1	0.76	0.09	58,58,58,58	0
33	MG	0	8052	1/1	0.76	0.41	87,87,87,87	0
33	MG	0	8022	1/1	0.76	1.07	123,123,123,123	0
37	SR	0	9484	1/1	0.77	0.08	139,139,139,139	0
33	MG	0	8091	1/1	0.77	0.08	58,58,58,58	0
33	MG	0	8014	1/1	0.77	0.86	94,94,94,94	0
36	CL	0	9316	1/1	0.77	0.24	86,86,86,86	0
33	MG	0	8040	1/1	0.78	0.44	100,100,100,100	0
37	SR	9	9588	1/1	0.78	0.14	141,141,141,141	0
33	MG	0	8032	1/1	0.78	0.10	47,47,47,47	0
35	NA	0	9140	1/1	0.79	0.55	67,67,67,67	0
37	SR	0	9500	1/1	0.79	1.25	200,200,200,200	0
33	MG	0	8072	1/1	0.79	0.33	78,78,78,78	0
35	NA	H	9122	1/1	0.81	0.19	78,78,78,78	0
35	NA	0	9171	1/1	0.81	0.25	66,66,66,66	0
33	MG	0	8089	1/1	0.81	0.23	64,64,64,64	0
35	NA	0	9168	1/1	0.82	0.15	68,68,68,68	0
33	MG	0	8107	1/1	0.82	0.16	67,67,67,67	0

Continued on next page...

Continued from previous page...

Mol	Type	Chain	Res	Atoms	RSCC	RSR	B-factors(Å ²)	Q<0.9
35	NA	0	9182	1/1	0.82	0.14	81,81,81,81	0
35	NA	0	9174	1/1	0.83	0.51	71,71,71,71	0
35	NA	0	9163	1/1	0.83	0.19	65,65,65,65	0
35	NA	0	9102	1/1	0.83	0.24	64,64,64,64	0
33	MG	0	8084	1/1	0.83	0.33	84,84,84,84	0
33	MG	0	8092	1/1	0.84	0.49	79,79,79,79	0
35	NA	0	9164	1/1	0.84	0.34	62,62,62,62	0
33	MG	0	8041	1/1	0.84	0.12	56,56,56,56	0
35	NA	0	9170	1/1	0.84	0.38	87,87,87,87	0
33	MG	0	8099	1/1	0.84	0.19	74,74,74,74	0
33	MG	0	8116	1/1	0.84	0.08	59,59,59,59	0
35	NA	0	9158	1/1	0.84	0.23	62,62,62,62	0
33	MG	0	8054	1/1	0.85	0.14	60,60,60,60	0
33	MG	0	8101	1/1	0.85	0.15	68,68,68,68	0
35	NA	0	9125	1/1	0.85	0.56	87,87,87,87	0
33	MG	0	8114	1/1	0.86	0.39	79,79,79,79	0
35	NA	0	9157	1/1	0.86	0.17	52,52,52,52	0
33	MG	0	8093	1/1	0.86	0.18	52,52,52,52	0
35	NA	9	9152	1/1	0.87	0.48	76,76,76,76	0
33	MG	0	8113	1/1	0.87	0.13	49,49,49,49	0
35	NA	9	9183	1/1	0.88	0.13	80,80,80,80	0
37	SR	0	9504	1/1	0.88	0.12	107,107,107,107	0
35	NA	0	9161	1/1	0.88	0.20	61,61,61,61	0
35	NA	0	9118	1/1	0.88	0.30	71,71,71,71	0
37	SR	0	9626	1/1	0.88	0.38	147,147,147,147	0
34	K	0	9001	1/1	0.88	0.71	92,92,92,92	0
35	NA	0	9172	1/1	0.88	0.36	78,78,78,78	0
35	NA	0	9107	1/1	0.89	0.25	59,59,59,59	0
33	MG	0	8117	1/1	0.89	0.15	48,48,48,48	0
33	MG	0	8063	1/1	0.89	0.12	67,67,67,67	0
34	K	0	9002	1/1	0.89	0.12	90,90,90,90	0
35	NA	R	9137	1/1	0.89	0.11	43,43,43,43	0
33	MG	0	8090	1/1	0.89	0.18	67,67,67,67	0
35	NA	3	9169	1/1	0.89	0.40	98,98,98,98	0
37	SR	B	9521	1/1	0.89	0.40	184,184,184,184	0
38	CD	O	9205	1/1	0.89	0.04	138,138,138,138	0
35	NA	0	9173	1/1	0.89	0.37	69,69,69,69	0
35	NA	0	9156	1/1	0.90	0.34	59,59,59,59	0
33	MG	0	8046	1/1	0.90	0.10	47,47,47,47	0
33	MG	0	8024	1/1	0.90	0.42	76,76,76,76	0
35	NA	0	9126	1/1	0.90	0.11	64,64,64,64	0
35	NA	0	9110	1/1	0.90	0.15	49,49,49,49	0

Continued on next page...

Continued from previous page...

Mol	Type	Chain	Res	Atoms	RSCC	RSR	B-factors(Å ²)	Q<0.9
35	NA	0	9130	1/1	0.90	0.14	53,53,53,53	0
33	MG	0	8045	1/1	0.90	0.32	82,82,82,82	0
37	SR	0	9459	1/1	0.91	0.07	107,107,107,107	0
33	MG	0	8051	1/1	0.91	0.29	33,33,33,33	0
33	MG	0	8079	1/1	0.91	0.14	33,33,33,33	0
35	NA	0	9113	1/1	0.91	0.11	74,74,74,74	0
35	NA	0	9131	1/1	0.91	0.21	52,52,52,52	0
35	NA	0	9175	1/1	0.91	0.19	55,55,55,55	0
33	MG	9	8095	1/1	0.91	0.26	61,61,61,61	0
35	NA	0	9167	1/1	0.91	0.16	57,57,57,57	0
35	NA	0	9149	1/1	0.91	0.21	52,52,52,52	0
33	MG	B	8055	1/1	0.91	0.27	94,94,94,94	0
36	CL	B	9319	1/1	0.91	0.23	62,62,62,62	0
37	SR	0	9529	1/1	0.92	0.09	120,120,120,120	0
33	MG	0	8021	1/1	0.92	0.18	58,58,58,58	0
33	MG	0	8080	1/1	0.92	0.20	58,58,58,58	0
37	SR	0	9467	1/1	0.92	0.10	91,91,91,91	0
35	NA	0	9154	1/1	0.92	0.26	57,57,57,57	0
33	MG	0	8115	1/1	0.92	0.17	61,61,61,61	0
33	MG	0	8082	1/1	0.92	0.41	89,89,89,89	0
37	SR	0	9517	1/1	0.92	0.04	117,117,117,117	0
35	NA	C	9104	1/1	0.93	0.11	33,33,33,33	0
35	NA	0	9177	1/1	0.93	0.35	78,78,78,78	0
35	NA	J	9146	1/1	0.93	0.12	58,58,58,58	0
33	MG	0	8085	1/1	0.93	0.32	68,68,68,68	0
37	SR	0	9532	1/1	0.93	0.05	127,127,127,127	0
35	NA	0	9155	1/1	0.93	0.29	62,62,62,62	0
37	SR	0	9539	1/1	0.93	0.50	162,162,162,162	0
33	MG	0	8039	1/1	0.93	0.09	66,66,66,66	0
33	MG	T	8073	1/1	0.93	0.12	52,52,52,52	0
33	MG	0	8103	1/1	0.93	0.20	74,74,74,74	0
35	NA	0	9132	1/1	0.93	0.15	57,57,57,57	0
33	MG	0	8075	1/1	0.93	0.05	41,41,41,41	0
33	MG	0	8043	1/1	0.93	0.06	57,57,57,57	0
35	NA	0	9127	1/1	0.94	0.19	71,71,71,71	0
33	MG	0	8097	1/1	0.94	0.23	63,63,63,63	0
33	MG	0	8106	1/1	0.94	0.08	50,50,50,50	0
35	NA	0	9159	1/1	0.94	0.21	54,54,54,54	0
33	MG	Y	8109	1/1	0.94	0.12	47,47,47,47	0
33	MG	2	8076	1/1	0.94	0.20	64,64,64,64	0
33	MG	0	8060	1/1	0.94	0.17	97,97,97,97	0
35	NA	0	9181	1/1	0.94	0.20	55,55,55,55	0

Continued on next page...

Continued from previous page...

Mol	Type	Chain	Res	Atoms	RSCC	RSR	B-factors(\AA^2)	Q<0.9
35	NA	0	9141	1/1	0.94	0.08	64,64,64,64	0
37	SR	0	9581	1/1	0.94	0.10	136,136,136,136	0
37	SR	0	9590	1/1	0.94	0.10	98,98,98,98	0
36	CL	0	9322	1/1	0.94	0.20	58,58,58,58	0
35	NA	0	9124	1/1	0.94	0.12	54,54,54,54	0
33	MG	0	8083	1/1	0.94	0.08	59,59,59,59	0
33	MG	0	8096	1/1	0.94	0.12	51,51,51,51	0
37	SR	0	9475	1/1	0.94	0.12	84,84,84,84	0
33	MG	0	8027	1/1	0.95	0.25	40,40,40,40	0
35	NA	0	9162	1/1	0.95	0.18	50,50,50,50	0
33	MG	0	8104	1/1	0.95	0.10	59,59,59,59	0
35	NA	Q	9148	1/1	0.95	0.12	48,48,48,48	0
37	SR	0	9505	1/1	0.95	0.08	91,91,91,91	0
33	MG	0	8015	1/1	0.95	0.10	33,33,33,33	0
35	NA	0	9128	1/1	0.95	0.09	48,48,48,48	0
33	MG	0	8058	1/1	0.95	0.56	92,92,92,92	0
36	CL	0	9315	1/1	0.95	0.10	59,59,59,59	0
35	NA	0	9116	1/1	0.95	0.45	55,55,55,55	0
33	MG	0	8088	1/1	0.95	0.08	39,39,39,39	0
37	SR	0	9560	1/1	0.95	0.08	98,98,98,98	0
33	MG	0	8002	1/1	0.95	0.10	37,37,37,37	0
36	CL	J	9302	1/1	0.95	0.08	63,63,63,63	0
36	CL	J	9321	1/1	0.95	0.13	68,68,68,68	0
36	CL	N	9307	1/1	0.95	0.14	65,65,65,65	0
35	NA	0	9134	1/1	0.95	0.06	52,52,52,52	0
35	NA	0	9160	1/1	0.95	0.16	45,45,45,45	0
37	SR	0	9468	1/1	0.95	0.03	120,120,120,120	0
35	NA	0	9166	1/1	0.96	0.08	68,68,68,68	0
37	SR	0	9452	1/1	0.96	0.11	107,107,107,107	0
35	NA	0	9120	1/1	0.96	0.26	61,61,61,61	0
37	SR	0	9465	1/1	0.96	0.09	101,101,101,101	0
33	MG	0	8057	1/1	0.96	0.34	68,68,68,68	0
35	NA	0	9150	1/1	0.96	0.16	52,52,52,52	0
33	MG	0	8067	1/1	0.96	0.10	44,44,44,44	0
33	MG	0	8068	1/1	0.96	0.13	55,55,55,55	0
37	SR	0	9489	1/1	0.96	0.08	92,92,92,92	0
35	NA	M	9147	1/1	0.96	0.18	45,45,45,45	0
33	MG	0	8098	1/1	0.96	0.07	47,47,47,47	0
33	MG	0	8019	1/1	0.96	0.05	51,51,51,51	0
37	SR	0	9515	1/1	0.96	0.16	94,94,94,94	0
35	NA	R	9138	1/1	0.96	0.11	76,76,76,76	0
37	SR	0	9522	1/1	0.96	0.07	118,118,118,118	0

Continued on next page...

Continued from previous page...

Mol	Type	Chain	Res	Atoms	RSCC	RSR	B-factors(\AA^2)	Q<0.9
35	NA	R	9186	1/1	0.96	0.19	71,71,71,71	0
33	MG	0	8074	1/1	0.96	0.19	32,32,32,32	0
33	MG	0	8012	1/1	0.96	0.22	46,46,46,46	0
36	CL	0	9311	1/1	0.96	0.10	64,64,64,64	0
33	MG	0	8028	1/1	0.96	0.12	37,37,37,37	0
33	MG	A	8066	1/1	0.96	0.13	53,53,53,53	0
36	CL	0	9317	1/1	0.96	0.07	57,57,57,57	0
37	SR	0	9585	1/1	0.96	0.10	94,94,94,94	0
33	MG	0	8061	1/1	0.96	0.12	81,81,81,81	0
36	CL	A	9309	1/1	0.96	0.11	60,60,60,60	0
37	SR	9	9503	1/1	0.96	0.04	116,116,116,116	0
35	NA	0	9139	1/1	0.96	0.08	50,50,50,50	0
36	CL	J	9301	1/1	0.96	0.10	59,59,59,59	0
37	SR	F	9595	1/1	0.96	0.15	104,104,104,104	0
33	MG	0	8013	1/1	0.96	0.37	24,24,24,24	0
35	NA	0	9165	1/1	0.96	0.23	46,46,46,46	0
36	CL	Y	9320	1/1	0.97	0.10	49,49,49,49	0
37	SR	0	9508	1/1	0.97	0.07	91,91,91,91	0
37	SR	0	9509	1/1	0.97	0.12	91,91,91,91	0
37	SR	0	9417	1/1	0.97	0.13	61,61,61,61	0
37	SR	0	9429	1/1	0.97	0.11	71,71,71,71	0
37	SR	0	9442	1/1	0.97	0.11	65,65,65,65	0
33	MG	0	8030	1/1	0.97	0.05	37,37,37,37	0
37	SR	0	9530	1/1	0.97	0.14	73,73,73,73	0
37	SR	0	9455	1/1	0.97	0.07	77,77,77,77	0
37	SR	0	9534	1/1	0.97	0.17	108,108,108,108	0
33	MG	0	8031	1/1	0.97	0.09	55,55,55,55	0
37	SR	0	9464	1/1	0.97	0.05	83,83,83,83	0
35	NA	0	9106	1/1	0.97	0.37	44,44,44,44	0
35	NA	0	9114	1/1	0.97	0.13	46,46,46,46	0
37	SR	0	9566	1/1	0.97	0.07	80,80,80,80	0
35	NA	0	9115	1/1	0.97	0.17	47,47,47,47	0
37	SR	0	9469	1/1	0.97	0.03	91,91,91,91	0
37	SR	0	9473	1/1	0.97	0.02	79,79,79,79	0
33	MG	0	8017	1/1	0.97	0.12	30,30,30,30	0
37	SR	0	9629	1/1	0.97	0.08	77,77,77,77	0
37	SR	0	9477	1/1	0.97	0.07	83,83,83,83	0
37	SR	0	9482	1/1	0.97	0.26	122,122,122,122	0
37	SR	A	9437	1/1	0.97	0.12	73,73,73,73	0
35	NA	0	9135	1/1	0.97	0.18	54,54,54,54	0
36	CL	0	9314	1/1	0.97	0.09	55,55,55,55	0
37	SR	H	9486	1/1	0.97	0.22	114,114,114,114	0

Continued on next page...

Continued from previous page...

Mol	Type	Chain	Res	Atoms	RSCC	RSR	B-factors(\AA^2)	Q<0.9
36	CL	L	9310	1/1	0.97	0.09	58,58,58,58	0
35	NA	0	9136	1/1	0.97	0.14	38,38,38,38	0
33	MG	0	8026	1/1	0.98	0.18	35,35,35,35	0
37	SR	0	9483	1/1	0.98	0.07	80,80,80,80	0
35	NA	0	9143	1/1	0.98	0.08	46,46,46,46	0
37	SR	0	9488	1/1	0.98	0.12	84,84,84,84	0
33	MG	0	8036	1/1	0.98	0.10	60,60,60,60	0
37	SR	0	9490	1/1	0.98	0.09	108,108,108,108	0
37	SR	0	9495	1/1	0.98	0.10	102,102,102,102	0
35	NA	0	9123	1/1	0.98	0.09	42,42,42,42	0
36	CL	O	9308	1/1	0.98	0.08	66,66,66,66	0
33	MG	0	8037	1/1	0.98	0.07	42,42,42,42	0
37	SR	0	9405	1/1	0.98	0.15	59,59,59,59	0
37	SR	0	9414	1/1	0.98	0.11	58,58,58,58	0
33	MG	0	8003	1/1	0.98	0.16	38,38,38,38	0
37	SR	0	9420	1/1	0.98	0.14	73,73,73,73	0
37	SR	0	9426	1/1	0.98	0.08	72,72,72,72	0
37	SR	0	9427	1/1	0.98	0.13	58,58,58,58	0
33	MG	0	8008	1/1	0.98	0.19	22,22,22,22	0
37	SR	0	9431	1/1	0.98	0.15	66,66,66,66	0
37	SR	0	9433	1/1	0.98	0.13	75,75,75,75	0
37	SR	0	9435	1/1	0.98	0.08	75,75,75,75	0
35	NA	0	9105	1/1	0.98	0.10	45,45,45,45	0
37	SR	0	9446	1/1	0.98	0.11	93,93,93,93	0
37	SR	0	9447	1/1	0.98	0.11	69,69,69,69	0
37	SR	0	9449	1/1	0.98	0.07	66,66,66,66	0
37	SR	0	9568	1/1	0.98	0.07	77,77,77,77	0
37	SR	0	9570	1/1	0.98	0.04	105,105,105,105	0
37	SR	0	9450	1/1	0.98	0.07	76,76,76,76	0
33	MG	0	8029	1/1	0.98	0.31	37,37,37,37	0
36	CL	0	9305	1/1	0.98	0.07	58,58,58,58	0
33	MG	0	8020	1/1	0.98	0.19	38,38,38,38	0
35	NA	0	9108	1/1	0.98	0.15	35,35,35,35	0
33	MG	0	8118	1/1	0.98	0.15	30,30,30,30	0
37	SR	0	9466	1/1	0.98	0.04	101,101,101,101	0
33	MG	0	8070	1/1	0.98	0.16	28,28,28,28	0
37	SR	B	9458	1/1	0.98	0.08	83,83,83,83	0
33	MG	0	8056	1/1	0.98	0.18	47,47,47,47	0
33	MG	0	8025	1/1	0.98	0.40	33,33,33,33	0
33	MG	K	8069	1/1	0.98	0.19	26,26,26,26	0
37	SR	S	9470	1/1	0.98	0.12	99,99,99,99	0
33	MG	0	8044	1/1	0.98	0.06	44,44,44,44	0

Continued on next page...

Continued from previous page...

Mol	Type	Chain	Res	Atoms	RSCC	RSR	B-factors(\AA^2)	Q<0.9
35	NA	0	9117	1/1	0.98	0.12	44,44,44,44	0
33	MG	0	8038	1/1	0.99	0.26	27,27,27,27	0
33	MG	0	8004	1/1	0.99	0.11	36,36,36,36	0
36	CL	0	9312	1/1	0.99	0.09	60,60,60,60	0
36	CL	0	9313	1/1	0.99	0.07	57,57,57,57	0
37	SR	0	9432	1/1	0.99	0.13	67,67,67,67	0
36	CL	M	9318	1/1	0.99	0.18	43,43,43,43	0
37	SR	0	9498	1/1	0.99	0.05	66,66,66,66	0
37	SR	0	9434	1/1	0.99	0.13	68,68,68,68	0
37	SR	0	9501	1/1	0.99	0.11	76,76,76,76	0
33	MG	0	8110	1/1	0.99	0.10	46,46,46,46	0
37	SR	0	9438	1/1	0.99	0.10	68,68,68,68	0
37	SR	0	9506	1/1	0.99	0.04	71,71,71,71	0
37	SR	0	9440	1/1	0.99	0.04	73,73,73,73	0
37	SR	0	9441	1/1	0.99	0.07	68,68,68,68	0
33	MG	0	8112	1/1	0.99	0.07	43,43,43,43	0
37	SR	0	9443	1/1	0.99	0.09	59,59,59,59	0
37	SR	0	9445	1/1	0.99	0.10	59,59,59,59	0
36	CL	R	9306	1/1	0.99	0.07	48,48,48,48	0
33	MG	0	8005	1/1	0.99	0.10	34,34,34,34	0
37	SR	0	9448	1/1	0.99	0.06	63,63,63,63	0
36	CL	3	9304	1/1	0.99	0.10	65,65,65,65	0
35	NA	0	9101	1/1	0.99	0.17	50,50,50,50	0
37	SR	0	9407	1/1	0.99	0.15	46,46,46,46	0
37	SR	0	9545	1/1	0.99	0.05	79,79,79,79	0
37	SR	0	9453	1/1	0.99	0.07	71,71,71,71	0
37	SR	0	9454	1/1	0.99	0.07	83,83,83,83	0
37	SR	0	9410	1/1	0.99	0.12	41,41,41,41	0
37	SR	0	9456	1/1	0.99	0.09	64,64,64,64	0
37	SR	0	9457	1/1	0.99	0.10	54,54,54,54	0
37	SR	0	9411	1/1	0.99	0.18	46,46,46,46	0
37	SR	0	9461	1/1	0.99	0.04	80,80,80,80	0
37	SR	0	9462	1/1	0.99	0.12	73,73,73,73	0
37	SR	0	9601	1/1	0.99	0.04	95,95,95,95	0
37	SR	0	9412	1/1	0.99	0.12	46,46,46,46	0
37	SR	0	9413	1/1	0.99	0.12	50,50,50,50	0
33	MG	0	8001	1/1	0.99	0.24	19,19,19,19	0
37	SR	0	9415	1/1	0.99	0.11	58,58,58,58	0
37	SR	A	9436	1/1	0.99	0.07	57,57,57,57	0
37	SR	0	9416	1/1	0.99	0.10	47,47,47,47	0
37	SR	A	9497	1/1	0.99	0.10	91,91,91,91	0
33	MG	0	8009	1/1	0.99	0.13	26,26,26,26	0

Continued on next page...

Continued from previous page...

Mol	Type	Chain	Res	Atoms	RSCC	RSR	B-factors(\AA^2)	Q<0.9
36	CL	0	9303	1/1	0.99	0.10	50,50,50,50	0
37	SR	0	9474	1/1	0.99	0.11	61,61,61,61	0
37	SR	0	9422	1/1	0.99	0.12	59,59,59,59	0
37	SR	R	9418	1/1	0.99	0.14	59,59,59,59	0
37	SR	0	9423	1/1	0.99	0.09	58,58,58,58	0
37	SR	1	9419	1/1	0.99	0.11	42,42,42,42	0
37	SR	1	9460	1/1	0.99	0.11	53,53,53,53	0
37	SR	3	9439	1/1	0.99	0.03	74,74,74,74	0
37	SR	0	9480	1/1	0.99	0.05	95,95,95,95	0
38	CD	U	9201	1/1	0.99	0.09	60,60,60,60	0
37	SR	0	9425	1/1	0.99	0.12	59,59,59,59	0
38	CD	3	9204	1/1	0.99	0.05	63,63,63,63	0
37	SR	0	9421	1/1	1.00	0.11	74,74,74,74	0
37	SR	L	9409	1/1	1.00	0.13	44,44,44,44	0
37	SR	9	9481	1/1	1.00	0.06	88,88,88,88	0
37	SR	0	9408	1/1	1.00	0.16	41,41,41,41	0
37	SR	0	9406	1/1	1.00	0.17	36,36,36,36	0
37	SR	0	9428	1/1	1.00	0.07	55,55,55,55	0
37	SR	0	9451	1/1	1.00	0.11	60,60,60,60	0
37	SR	0	9444	1/1	1.00	0.09	56,56,56,56	0
37	SR	0	9424	1/1	1.00	0.14	47,47,47,47	0
37	SR	0	9430	1/1	1.00	0.10	50,50,50,50	0
38	CD	1	9202	1/1	1.00	0.04	55,55,55,55	0
37	SR	0	9478	1/1	1.00	0.06	76,76,76,76	0

6.5 Other polymers [\(i\)](#)

There are no such residues in this entry.