



Full wwPDB X-ray Structure Validation Report ⓘ

Sep 25, 2023 – 11:18 AM EDT

PDB ID : 5W5C
Title : Crystal structure of the primed SNARE-Complexin-Synaptotagmin-1 C2AB complex
Authors : Zhou, Q.; Brunger, A.T.
Deposited on : 2017-06-14
Resolution : 1.85 Å(reported)

This is a Full wwPDB X-ray Structure Validation Report for a publicly released PDB entry.

We welcome your comments at validation@mail.wwpdb.org

A user guide is available at

<https://www.wwpdb.org/validation/2017/XrayValidationReportHelp>

with specific help available everywhere you see the ⓘ symbol.

The types of validation reports are described at

<http://www.wwpdb.org/validation/2017/FAQs#types>.

The following versions of software and data (see [references ⓘ](#)) were used in the production of this report:

MolProbity : 4.02b-467
Mogul : 1.8.5 (274361), CSD as541be (2020)
Xtriage (Phenix) : 1.13
EDS : 2.35.1
Percentile statistics : 20191225.v01 (using entries in the PDB archive December 25th 2019)
Refmac : 5.8.0158
CCP4 : 7.0.044 (Gargrove)
Ideal geometry (proteins) : Engh & Huber (2001)
Ideal geometry (DNA, RNA) : Parkinson et al. (1996)
Validation Pipeline (wwPDB-VP) : 2.35.1

1 Overall quality at a glance

The following experimental techniques were used to determine the structure:

X-RAY DIFFRACTION

The reported resolution of this entry is 1.85 Å.

Percentile scores (ranging between 0-100) for global validation metrics of the entry are shown in the following graphic. The table shows the number of entries on which the scores are based.

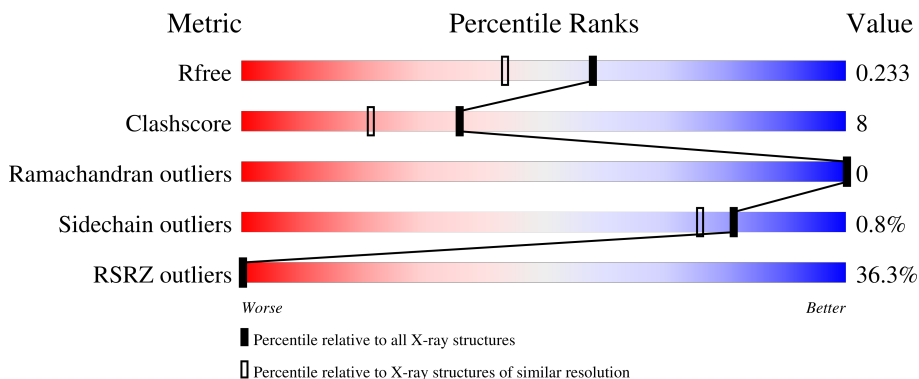

Metric	Whole archive (#Entries)	Similar resolution (#Entries, resolution range(Å))
R_{free}	130704	2469 (1.86-1.86)
Clashscore	141614	2625 (1.86-1.86)
Ramachandran outliers	138981	2592 (1.86-1.86)
Sidechain outliers	138945	2592 (1.86-1.86)
RSRZ outliers	127900	2436 (1.86-1.86)

The table below summarises the geometric issues observed across the polymeric chains and their fit to the electron density. The red, orange, yellow and green segments of the lower bar indicate the fraction of residues that contain outliers for ≥ 3 , 2, 1 and 0 types of geometric quality criteria respectively. A grey segment represents the fraction of residues that are not modelled. The numeric value for each fraction is indicated below the corresponding segment, with a dot representing fractions $\leq 5\%$. The upper red bar (where present) indicates the fraction of residues that have poor fit to the electron density. The numeric value is given above the bar.

Mol	Chain	Length	Quality of chain
1	A	40	
2	B	67	
3	C	77	
4	D	65	
5	E	83	

Continued on next page...

Continued from previous page...

Mol	Chain	Length	Quality of chain
6	F	282	 <p>A horizontal bar chart representing the quality of chain. The bar is divided into four segments: a red segment (45%), a green segment (74%), a yellow segment (17%), and a grey segment (7%). The percentages are labeled above or below the corresponding segments.</p>

2 Entry composition [i](#)

There are 9 unique types of molecules in this entry. The entry contains 4044 atoms, of which 0 are hydrogens and 0 are deuteriums.

In the tables below, the ZeroOcc column contains the number of atoms modelled with zero occupancy, the AltConf column contains the number of residues with at least one atom in alternate conformation and the Trace column contains the number of residues modelled with at most 2 atoms.

- Molecule 1 is a protein called Vesicle-associated membrane protein 2.

Mol	Chain	Residues	Atoms					ZeroOcc	AltConf	Trace
			Total	C	N	O	S			
1	A	38	319	191	62	65	1	0	1	0

There is a discrepancy between the modelled and reference sequences:

Chain	Residue	Modelled	Actual	Comment	Reference
A	27	GLY	-	expression tag	UNP P63045

- Molecule 2 is a protein called Syntaxin-1A.

Mol	Chain	Residues	Atoms					ZeroOcc	AltConf	Trace
			Total	C	N	O	S			
2	B	54	433	268	73	87	5	0	0	0

There is a discrepancy between the modelled and reference sequences:

Chain	Residue	Modelled	Actual	Comment	Reference
B	190	MET	-	initiating methionine	UNP P32851

- Molecule 3 is a protein called Synaptosomal-associated protein 25.

Mol	Chain	Residues	Atoms					ZeroOcc	AltConf	Trace
			Total	C	N	O	S			
3	C	65	501	297	91	108	5	0	1	0

- Molecule 4 is a protein called Synaptosomal-associated protein 25.

Mol	Chain	Residues	Atoms					ZeroOcc	AltConf	Trace
			Total	C	N	O	S			
4	D	55	407	241	77	85	4	1	0	0

There is a discrepancy between the modelled and reference sequences:

Chain	Residue	Modelled	Actual	Comment	Reference
D	140	MET	-	initiating methionine	UNP P60881

- Molecule 5 is a protein called Complexin-1.

Mol	Chain	Residues	Atoms					ZeroOcc	AltConf	Trace
			Total	C	N	O	S			
5	E	25	193	118	40	33	2	0	1	0

- Molecule 6 is a protein called Synaptotagmin-1.

Mol	Chain	Residues	Atoms					ZeroOcc	AltConf	Trace
			Total	C	N	O	S			
6	F	261	1881	1201	320	355	5	2	1	0

- Molecule 7 is MAGNESIUM ION (three-letter code: MG) (formula: Mg).

Mol	Chain	Residues	Atoms		ZeroOcc	AltConf
7	C	1	Total	Mg	0	0
			1	1		

- Molecule 8 is GLYCEROL (three-letter code: GOL) (formula: C₃H₈O₃).

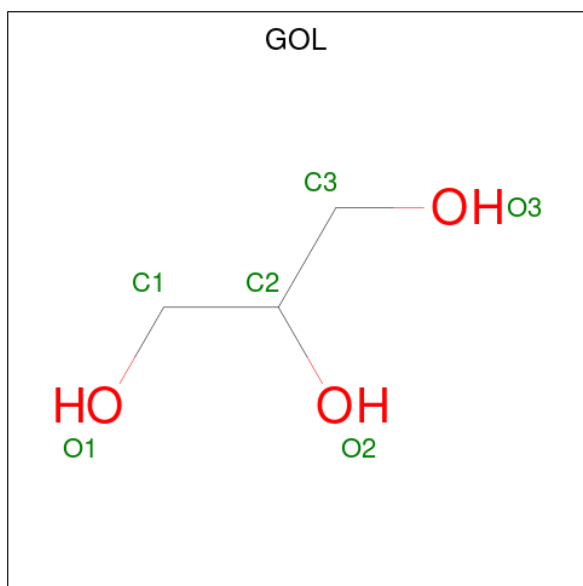

Mol	Chain	Residues	Atoms			ZeroOcc	AltConf
8	D	1	Total	C	O	0	0
			6	3	3		
8	F	1	Total	C	O	0	0
			6	3	3		

Continued on next page...

Continued from previous page...

Mol	Chain	Residues	Atoms			ZeroOcc	AltConf
8	F	1	Total	C	O	0	0
			6	3	3		
8	F	1	Total	C	O	0	0
			6	3	3		
8	F	1	Total	C	O	0	0
			6	3	3		

- Molecule 9 is water.

Mol	Chain	Residues	Atoms		ZeroOcc	AltConf
9	A	23	Total	O	0	0
			23	23		
9	B	21	Total	O	0	0
			21	21		
9	C	43	Total	O	0	0
			43	43		
9	D	35	Total	O	0	0
			35	35		
9	E	12	Total	O	0	0
			12	12		
9	F	145	Total	O	0	0
			145	145		

3 Residue-property plots [i](#)

These plots are drawn for all protein, RNA, DNA and oligosaccharide chains in the entry. The first graphic for a chain summarises the proportions of the various outlier classes displayed in the second graphic. The second graphic shows the sequence view annotated by issues in geometry and electron density. Residues are color-coded according to the number of geometric quality criteria for which they contain at least one outlier: green = 0, yellow = 1, orange = 2 and red = 3 or more. A red dot above a residue indicates a poor fit to the electron density ($RSRZ > 2$). Stretches of 2 or more consecutive residues without any outlier are shown as a green connector. Residues present in the sample, but not in the model, are shown in grey.

- Molecule 1: Vesicle-associated membrane protein 2

Chain A: 



- Molecule 2: Syntaxin-1A

Chain B: 

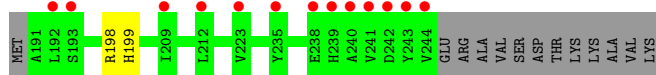

- Molecule 3: Synaptosomal-associated protein 25

Chain C: 



- Molecule 4: Synaptosomal-associated protein 25

Chain D: 

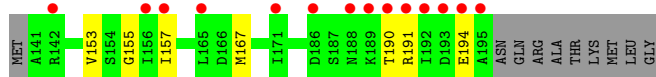

- Molecule 5: Complexin-1

Chain E: 

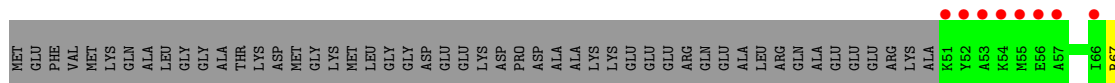

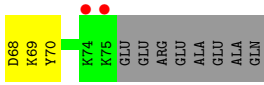

● Molecule 6: Synaptotagmin-1

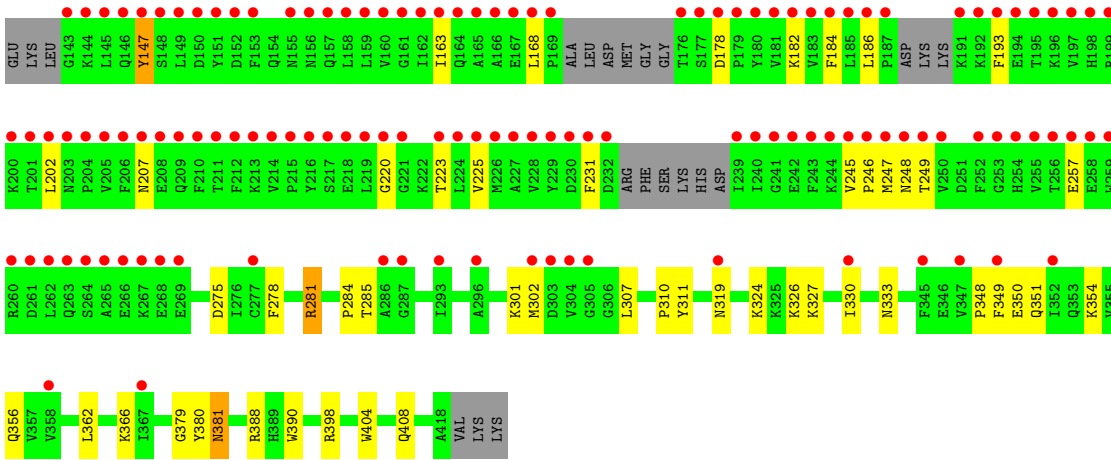
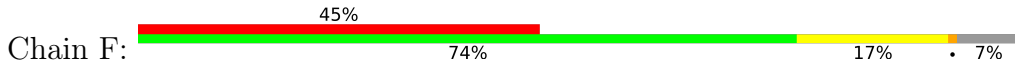

4 Data and refinement statistics

Property	Value	Source
Space group	P 21 21 2	Depositor
Cell constants a, b, c, α , β , γ	85.66Å 89.68Å 91.73Å 90.00° 90.00° 90.00°	Depositor
Resolution (Å)	64.13 – 1.85 64.13 – 1.85	Depositor EDS
% Data completeness (in resolution range)	99.6 (64.13-1.85) 99.7 (64.13-1.85)	Depositor EDS
R_{merge}	0.10	Depositor
R_{sym}	(Not available)	Depositor
$\langle I/\sigma(I) \rangle$ ¹	1.05 (at 1.86Å)	Xtrriage
Refinement program	PHENIX 1.11.1_2575	Depositor
R, R_{free}	0.195 , 0.232 0.195 , 0.233	Depositor DCC
R_{free} test set	2007 reflections (3.30%)	wwPDB-VP
Wilson B-factor (Å ²)	41.5	Xtrriage
Anisotropy	0.546	Xtrriage
Bulk solvent k_{sol} (e/Å ³), B_{sol} (Å ²)	0.30 , 75.5	EDS
L-test for twinning ²	$\langle L \rangle = 0.49$, $\langle L^2 \rangle = 0.33$	Xtrriage
Estimated twinning fraction	0.010 for -h,l,k	Xtrriage
F_o, F_c correlation	0.97	EDS
Total number of atoms	4044	wwPDB-VP
Average B, all atoms (Å ²)	75.0	wwPDB-VP

Xtrriage's analysis on translational NCS is as follows: *The largest off-origin peak in the Patterson function is 6.14% of the height of the origin peak. No significant pseudotranslation is detected.*

¹Intensities estimated from amplitudes.

²Theoretical values of $\langle |L| \rangle$, $\langle L^2 \rangle$ for acentric reflections are 0.5, 0.333 respectively for untwinned datasets, and 0.375, 0.2 for perfectly twinned datasets.

5 Model quality [i](#)

5.1 Standard geometry [i](#)

Bond lengths and bond angles in the following residue types are not validated in this section: GOL, MG

The Z score for a bond length (or angle) is the number of standard deviations the observed value is removed from the expected value. A bond length (or angle) with $|Z| > 5$ is considered an outlier worth inspection. RMSZ is the root-mean-square of all Z scores of the bond lengths (or angles).

Mol	Chain	Bond lengths		Bond angles	
		RMSZ	# $ Z > 5$	RMSZ	# $ Z > 5$
1	A	0.72	0/321	0.84	1/430 (0.2%)
2	B	0.72	0/437	0.74	0/586
3	C	0.64	0/504	0.65	0/675
4	D	0.70	0/407	0.76	1/547 (0.2%)
5	E	0.57	0/196	0.73	0/258
6	F	0.77	3/1920 (0.2%)	0.74	2/2616 (0.1%)
All	All	0.73	3/3785 (0.1%)	0.74	4/5112 (0.1%)

All (3) bond length outliers are listed below:

Mol	Chain	Res	Type	Atoms	Z	Observed(Å)	Ideal(Å)
6	F	278	PHE	CD2-CE2	5.67	1.50	1.39
6	F	404	TRP	CB-CG	5.24	1.59	1.50
6	F	356	GLN	CB-CG	5.23	1.66	1.52

All (4) bond angle outliers are listed below:

Mol	Chain	Res	Type	Atoms	Z	Observed(°)	Ideal(°)
6	F	281	ARG	NE-CZ-NH2	-6.91	116.85	120.30
6	F	281	ARG	NE-CZ-NH1	6.56	123.58	120.30
4	D	167	MET	CA-CB-CG	6.12	123.70	113.30
1	A	56	ARG	NE-CZ-NH1	5.22	122.91	120.30

There are no chirality outliers.

There are no planarity outliers.

5.2 Too-close contacts [i](#)

In the following table, the Non-H and H(model) columns list the number of non-hydrogen atoms and hydrogen atoms in the chain respectively. The H(added) column lists the number of hydrogen atoms added and optimized by MolProbity. The Clashes column lists the number of clashes within the asymmetric unit, whereas Symm-Clashes lists symmetry-related clashes.

Mol	Chain	Non-H	H(model)	H(added)	Clashes	Symm-Clashes
1	A	319	0	321	4	0
2	B	433	0	416	3	0
3	C	501	0	463	9	0
4	D	407	0	371	4	0
5	E	193	0	187	4	0
6	F	1881	0	1676	42	0
7	C	1	0	0	0	0
8	D	6	0	8	1	0
8	F	24	0	32	6	0
9	A	23	0	0	3	0
9	B	21	0	0	0	0
9	C	43	0	0	1	1
9	D	35	0	0	0	2
9	E	12	0	0	1	0
9	F	145	0	0	8	3
All	All	4044	0	3474	58	3

The all-atom clashscore is defined as the number of clashes found per 1000 atoms (including hydrogen atoms). The all-atom clashscore for this structure is 8.

All (58) close contacts within the same asymmetric unit are listed below, sorted by their clash magnitude.

Atom-1	Atom-2	Interatomic distance (Å)	Clash overlap (Å)
6:F:366:LYS:NZ	9:F:601:HOH:O	2.01	0.92
3:C:41[B]:ASP:OD2	3:C:45:ARG:NH2	2.03	0.92
6:F:324:LYS:HE2	6:F:326:LYS:HE2	1.67	0.77
6:F:381:ASN:O	6:F:381:ASN:ND2	2.18	0.76
3:C:52:GLU:OE1	9:C:201:HOH:O	2.08	0.72
6:F:327:LYS:NZ	9:F:603:HOH:O	2.24	0.70
6:F:281:ARG:NH2	9:F:604:HOH:O	2.26	0.68
1:A:44[A]:ASP:OD1	9:A:101:HOH:O	2.11	0.67
6:F:319:ASN:H	8:F:503:GOL:H2	1.63	0.63
6:F:354:LYS:HG2	8:F:504:GOL:H2	1.81	0.61
3:C:71:MET:HB3	4:D:191:ARG:HG2	1.85	0.59
4:D:155:GLY:HA2	8:D:301:GOL:H11	1.85	0.59

Continued on next page...

Continued from previous page...

Atom-1	Atom-2	Interatomic distance (Å)	Clash overlap (Å)
1:A:44[B]:ASP:OD1	9:A:102:HOH:O	2.17	0.59
1:A:51:ASP:OD1	5:E:67[A]:ARG:NH1	2.35	0.59
6:F:246:PRO:O	6:F:249:THR:HG2	2.03	0.59
6:F:348:PRO:HG2	6:F:351:GLN:HG2	1.85	0.57
6:F:380:TYR:CE2	8:F:503:GOL:H32	2.42	0.54
2:B:199:HIS:HE1	3:C:24:GLU:HB3	1.73	0.54
6:F:184:PHE:CB	6:F:225:VAL:O	2.56	0.53
6:F:281:ARG:NH2	6:F:398:ARG:O	2.42	0.53
3:C:20:GLN:NE2	6:F:350:GLU:HG2	2.23	0.53
6:F:324:LYS:HG3	9:F:719:HOH:O	2.09	0.53
3:C:17:ARG:NH1	6:F:349:PHE:HB3	2.26	0.51
6:F:182:LYS:HA	6:F:193:PHE:O	2.11	0.51
6:F:275:ASP:OD2	9:F:602:HOH:O	2.20	0.50
5:E:69:LYS:HE3	5:E:70:TYR:CZ	2.47	0.50
5:E:68:ASP:OD1	9:E:101:HOH:O	2.18	0.50
3:C:17:ARG:HH12	6:F:349:PHE:HB3	1.76	0.50
6:F:307:LEU:O	9:F:601:HOH:O	2.20	0.49
1:A:31:ARG:HD2	9:A:111:HOH:O	2.12	0.48
2:B:199:HIS:CE1	3:C:24:GLU:HB3	2.49	0.48
6:F:220:GLY:HA2	6:F:247:MET:CB	2.44	0.47
6:F:220:GLY:HA3	6:F:248:ASN:HB3	1.95	0.47
6:F:388[A]:ARG:NH2	9:F:616:HOH:O	2.46	0.47
6:F:354:LYS:HG2	8:F:504:GOL:C2	2.44	0.46
4:D:190:THR:O	4:D:194:GLU:HG3	2.16	0.46
6:F:327:LYS:HG3	8:F:502:GOL:H32	1.97	0.46
8:F:502:GOL:H11	9:F:664:HOH:O	2.15	0.46
3:C:20:GLN:HE22	6:F:350:GLU:HG2	1.81	0.45
6:F:223:THR:HG23	6:F:245:VAL:O	2.16	0.45
6:F:348:PRO:HB2	6:F:350:GLU:OE1	2.15	0.45
6:F:307:LEU:HD22	6:F:333:ASN:OD1	2.17	0.45
6:F:178:ASP:O	6:F:231:PHE:N	2.42	0.45
6:F:186:LEU:CB	6:F:223:THR:H	2.29	0.44
6:F:301:LYS:HE3	6:F:301:LYS:HB3	1.69	0.44
6:F:379:GLY:HA2	6:F:390:TRP:CE2	2.53	0.43
6:F:311:TYR:HB3	6:F:330:ILE:HD13	2.00	0.43
6:F:168:LEU:HB2	6:F:202:LEU:O	2.19	0.43
6:F:284:PRO:HB3	6:F:349:PHE:CD2	2.53	0.43
6:F:310:PRO:HA	6:F:362:LEU:O	2.19	0.42
6:F:163:ILE:HA	6:F:207:ASN:H	1.84	0.41
4:D:153:VAL:O	4:D:157:ILE:HG12	2.21	0.41
2:B:198:ARG:HD3	2:B:198:ARG:HA	1.93	0.41

Continued on next page...

Continued from previous page...

Atom-1	Atom-2	Interatomic distance (Å)	Clash overlap (Å)
6:F:302:MET:HB2	6:F:366:LYS:HE2	2.02	0.41
5:E:68:ASP:HB3	6:F:408:GLN:HG2	2.03	0.40
6:F:147:TYR:O	6:F:257:GLU:HA	2.20	0.40
6:F:223:THR:OG1	6:F:246:PRO:HA	2.21	0.40
6:F:285:THR:H	6:F:285:THR:HG23	1.64	0.40

All (3) symmetry-related close contacts are listed below. The label for Atom-2 includes the symmetry operator and encoded unit-cell translations to be applied.

Atom-1	Atom-2	Interatomic distance (Å)	Clash overlap (Å)
9:D:432:HOH:O	9:F:713:HOH:O[3_444]	2.04	0.16
9:C:233:HOH:O	9:F:666:HOH:O[3_444]	2.10	0.10
9:D:435:HOH:O	9:F:704:HOH:O[3_444]	2.17	0.03

5.3 Torsion angles [i](#)

5.3.1 Protein backbone [i](#)

In the following table, the Percentiles column shows the percent Ramachandran outliers of the chain as a percentile score with respect to all X-ray entries followed by that with respect to entries of similar resolution.

The Analysed column shows the number of residues for which the backbone conformation was analysed, and the total number of residues.

Mol	Chain	Analysed	Favoured	Allowed	Outliers	Percentiles	
1	A	37/40 (92%)	36 (97%)	1 (3%)	0	100	100
2	B	52/67 (78%)	51 (98%)	1 (2%)	0	100	100
3	C	64/77 (83%)	63 (98%)	1 (2%)	0	100	100
4	D	53/65 (82%)	53 (100%)	0	0	100	100
5	E	24/83 (29%)	24 (100%)	0	0	100	100
6	F	254/282 (90%)	237 (93%)	17 (7%)	0	100	100
All	All	484/614 (79%)	464 (96%)	20 (4%)	0	100	100

There are no Ramachandran outliers to report.

5.3.2 Protein sidechains [i](#)

In the following table, the Percentiles column shows the percent sidechain outliers of the chain as a percentile score with respect to all X-ray entries followed by that with respect to entries of similar resolution.

The Analysed column shows the number of residues for which the sidechain conformation was analysed, and the total number of residues.

Mol	Chain	Analysed	Rotameric	Outliers	Percentiles	
1	A	37/38 (97%)	37 (100%)	0	100	100
2	B	48/61 (79%)	48 (100%)	0	100	100
3	C	52/69 (75%)	51 (98%)	1 (2%)	57	43
4	D	40/56 (71%)	40 (100%)	0	100	100
5	E	16/65 (25%)	16 (100%)	0	100	100
6	F	170/252 (68%)	168 (99%)	2 (1%)	71	62
All	All	363/541 (67%)	360 (99%)	3 (1%)	81	76

All (3) residues with a non-rotameric sidechain are listed below:

Mol	Chain	Res	Type
3	C	14	MET
6	F	147	TYR
6	F	381	ASN

Sometimes sidechains can be flipped to improve hydrogen bonding and reduce clashes. There are no such sidechains identified.

5.3.3 RNA [i](#)

There are no RNA molecules in this entry.

5.4 Non-standard residues in protein, DNA, RNA chains [i](#)

There are no non-standard protein/DNA/RNA residues in this entry.

5.5 Carbohydrates [i](#)

There are no monosaccharides in this entry.

5.6 Ligand geometry

Of 6 ligands modelled in this entry, 1 is monoatomic - leaving 5 for Mogul analysis.

In the following table, the Counts columns list the number of bonds (or angles) for which Mogul statistics could be retrieved, the number of bonds (or angles) that are observed in the model and the number of bonds (or angles) that are defined in the Chemical Component Dictionary. The Link column lists molecule types, if any, to which the group is linked. The Z score for a bond length (or angle) is the number of standard deviations the observed value is removed from the expected value. A bond length (or angle) with $|Z| > 2$ is considered an outlier worth inspection. RMSZ is the root-mean-square of all Z scores of the bond lengths (or angles).

Mol	Type	Chain	Res	Link	Bond lengths			Bond angles		
					Counts	RMSZ	# Z > 2	Counts	RMSZ	# Z > 2
8	GOL	F	501	-	5,5,5	0.31	0	5,5,5	0.61	0
8	GOL	D	301	-	5,5,5	0.61	0	5,5,5	1.37	1 (20%)
8	GOL	F	504	-	5,5,5	0.43	0	5,5,5	0.50	0
8	GOL	F	503	-	5,5,5	0.38	0	5,5,5	0.60	0
8	GOL	F	502	-	5,5,5	0.35	0	5,5,5	1.19	1 (20%)

In the following table, the Chirals column lists the number of chiral outliers, the number of chiral centers analysed, the number of these observed in the model and the number defined in the Chemical Component Dictionary. Similar counts are reported in the Torsion and Rings columns. '-' means no outliers of that kind were identified.

Mol	Type	Chain	Res	Link	Chirals	Torsions	Rings
8	GOL	F	501	-	-	2/4/4/4	-
8	GOL	D	301	-	-	2/4/4/4	-
8	GOL	F	504	-	-	4/4/4/4	-
8	GOL	F	503	-	-	2/4/4/4	-
8	GOL	F	502	-	-	2/4/4/4	-

There are no bond length outliers.

All (2) bond angle outliers are listed below:

Mol	Chain	Res	Type	Atoms	Z	Observed(°)	Ideal(°)
8	F	502	GOL	C3-C2-C1	-2.08	103.63	111.70
8	D	301	GOL	O3-C3-C2	2.02	119.90	110.20

There are no chirality outliers.

All (12) torsion outliers are listed below:

Mol	Chain	Res	Type	Atoms
8	D	301	GOL	O1-C1-C2-C3
8	F	501	GOL	O1-C1-C2-C3
8	F	502	GOL	O1-C1-C2-C3
8	F	503	GOL	O1-C1-C2-C3
8	F	504	GOL	O1-C1-C2-C3
8	F	504	GOL	C1-C2-C3-O3
8	F	501	GOL	O1-C1-C2-O2
8	F	502	GOL	O1-C1-C2-O2
8	F	503	GOL	O1-C1-C2-O2
8	D	301	GOL	O1-C1-C2-O2
8	F	504	GOL	O1-C1-C2-O2
8	F	504	GOL	O2-C2-C3-O3

There are no ring outliers.

4 monomers are involved in 7 short contacts:

Mol	Chain	Res	Type	Clashes	Symm-Clashes
8	D	301	GOL	1	0
8	F	504	GOL	2	0
8	F	503	GOL	2	0
8	F	502	GOL	2	0

5.7 Other polymers [i](#)

There are no such residues in this entry.

5.8 Polymer linkage issues [i](#)

There are no chain breaks in this entry.

6 Fit of model and data

6.1 Protein, DNA and RNA chains

In the following table, the column labelled '#RSRZ > 2' contains the number (and percentage) of RSRZ outliers, followed by percent RSRZ outliers for the chain as percentile scores relative to all X-ray entries and entries of similar resolution. The OWAB column contains the minimum, median, 95th percentile and maximum values of the occupancy-weighted average B-factor per residue. The column labelled 'Q < 0.9' lists the number of (and percentage) of residues with an average occupancy less than 0.9.

Mol	Chain	Analysed	<RSRZ>	#RSRZ>2	OWAB(Å ²)	Q<0.9
1	A	38/40 (95%)	1.03	2 (5%) 26 25	34, 52, 94, 122	0
2	B	54/67 (80%)	1.43	13 (24%) 0 0	35, 62, 113, 128	1 (1%)
3	C	65/77 (84%)	1.47	16 (24%) 0 0	35, 64, 134, 154	2 (3%)
4	D	55/65 (84%)	1.81	14 (25%) 0 0	33, 56, 140, 142	1 (1%)
5	E	25/83 (30%)	2.22	10 (40%) 0 0	40, 66, 129, 135	0
6	F	261/282 (92%)	3.56	126 (48%) 0 0	32, 73, 166, 181	4 (1%)
All	All	498/614 (81%)	2.60	181 (36%) 0 0	32, 66, 159, 181	8 (1%)

All (181) RSRZ outliers are listed below:

Mol	Chain	Res	Type	RSRZ
6	F	204	PRO	18.0
6	F	243	PHE	17.2
6	F	227	ALA	15.9
6	F	228	VAL	15.7
6	F	221	GLY	14.8
6	F	259	TRP	14.5
6	F	203	ASN	14.3
6	F	179	PRO	14.0
6	F	229	TYR	14.0
6	F	183	VAL	13.5
6	F	197	VAL	13.0
6	F	145	LEU	12.9
6	F	219	LEU	12.5
6	F	262	LEU	12.0
6	F	205	VAL	12.0
6	F	165	ALA	11.9
4	D	193	ASP	11.4
6	F	163	ILE	11.4
6	F	143	GLY	11.1

Continued on next page...

Continued from previous page...

Mol	Chain	Res	Type	RSRZ
6	F	241	GLY	10.9
6	F	178	ASP	10.1
6	F	261	ASP	10.0
6	F	166	ALA	9.9
5	E	53	ALA	9.2
6	F	180	TYR	9.2
6	F	162	ILE	9.2
6	F	144	LYS	9.0
6	F	263	GLN	8.9
6	F	226	MET	8.8
6	F	256	THR	8.7
6	F	184	PHE	8.7
6	F	158	LEU	8.7
6	F	246	PRO	8.6
4	D	192	ILE	8.4
6	F	153	PHE	8.3
6	F	181	VAL	8.0
6	F	186	LEU	7.9
6	F	220	GLY	7.9
6	F	193	PHE	7.8
2	B	241	VAL	7.7
4	D	190	THR	7.6
6	F	160	VAL	7.4
6	F	212	PHE	7.4
5	E	52	TYR	7.2
6	F	200	LYS	7.2
6	F	201	THR	7.2
6	F	224	LEU	7.1
6	F	161	GLY	7.1
5	E	55	MET	7.1
6	F	199	ARG	7.0
6	F	147	TYR	6.7
6	F	252	PHE	6.7
6	F	230	ASP	6.7
3	C	71	MET	6.7
6	F	168	LEU	6.7
6	F	196	LYS	6.6
3	C	10	GLU	6.5
6	F	264	SER	6.5
6	F	245	VAL	6.5
4	D	142	ARG	6.4
1	A	65	ASP	6.3

Continued on next page...

Continued from previous page...

Mol	Chain	Res	Type	RSRZ
6	F	177	SER	6.3
6	F	208	GLU	6.2
6	F	202	LEU	6.1
3	C	69	GLN	6.1
6	F	198	HIS	6.1
3	C	72	LYS	5.9
6	F	217	SER	5.9
6	F	244	LYS	5.8
6	F	225	VAL	5.8
6	F	195	THR	5.7
6	F	192	LYS	5.7
6	F	260	ARG	5.7
6	F	185	LEU	5.7
6	F	210	PHE	5.6
6	F	258	GLU	5.6
6	F	146	GLN	5.5
6	F	206	PHE	5.5
6	F	249	THR	5.5
6	F	169	PRO	5.4
6	F	159	LEU	5.3
3	C	70	ASP	5.3
6	F	207	ASN	5.3
6	F	164	GLN	5.3
6	F	187	PRO	5.2
6	F	176	THR	5.2
6	F	231	PHE	5.1
6	F	167	GLU	5.0
4	D	189	LYS	5.0
3	C	73	GLU	5.0
6	F	267	LYS	5.0
4	D	191	ARG	5.0
4	D	195	ALA	4.9
6	F	257	GLU	4.9
6	F	150	ASP	4.8
6	F	349	PHE	4.7
6	F	148	SER	4.7
2	B	244	VAL	4.7
6	F	151	TYR	4.6
6	F	209	GLN	4.6
5	E	54	LYS	4.5
6	F	247	MET	4.5
6	F	253	GLY	4.5

Continued on next page...

Continued from previous page...

Mol	Chain	Res	Type	RSRZ
6	F	240	ILE	4.4
6	F	248	ASN	4.2
2	B	239	HIS	4.2
2	B	235	TYR	4.2
6	F	255	VAL	4.1
2	B	240	ALA	3.8
6	F	303	ASP	3.8
6	F	157	GLN	3.7
3	C	67	ILE	3.7
3	C	11	LEU	3.7
6	F	250	VAL	3.7
5	E	51	LYS	3.6
6	F	232	ASP	3.6
6	F	149	LEU	3.6
6	F	211	THR	3.5
3	C	14	MET	3.5
2	B	243	TYR	3.4
4	D	194	GLU	3.4
3	C	68	ASN	3.4
6	F	155	ASN	3.3
6	F	194	GLU	3.3
6	F	223	THR	3.3
2	B	242	ASP	3.2
6	F	352	ILE	3.2
6	F	213	LYS	3.1
6	F	286	ALA	3.1
6	F	305	GLY	3.1
6	F	242	GLU	3.0
6	F	182	LYS	3.0
4	D	188	ASN	2.9
6	F	265	ALA	2.9
6	F	218	GLU	2.8
6	F	214	VAL	2.8
6	F	347	VAL	2.8
6	F	216	TYR	2.8
6	F	191	LYS	2.8
6	F	277	CYS	2.8
6	F	152	ASP	2.7
5	E	75	LYS	2.7
6	F	215	PRO	2.7
6	F	302	MET	2.7
5	E	56	GLU	2.7

Continued on next page...

Continued from previous page...

Mol	Chain	Res	Type	RSRZ
6	F	266	GLU	2.6
2	B	212	LEU	2.6
6	F	239	ILE	2.6
2	B	192	LEU	2.5
6	F	268	GLU	2.5
3	C	13	GLU	2.5
6	F	287	GLY	2.5
6	F	254	HIS	2.5
4	D	186	ASP	2.5
6	F	296	ALA	2.4
3	C	47	LEU	2.4
4	D	171	ILE	2.4
6	F	269	GLU	2.3
1	A	42	VAL	2.3
6	F	293	ILE	2.3
6	F	156	ASN	2.3
4	D	165	LEU	2.3
3	C	44	ILE	2.3
5	E	57	ALA	2.3
5	E	66	ILE	2.2
2	B	223	VAL	2.2
6	F	330	ILE	2.2
6	F	319	ASN	2.2
6	F	358	VAL	2.2
2	B	209	ILE	2.2
4	D	157	ILE	2.2
4	D	156	ILE	2.1
5	E	74	LYS	2.1
6	F	345	PHE	2.1
2	B	238	GLU	2.1
3	C	42	ALA	2.1
6	F	304	VAL	2.1
2	B	193	SER	2.1
3	C	66	HIS	2.0
6	F	367	ILE	2.0
3	C	64	MET	2.0

6.2 Non-standard residues in protein, DNA, RNA chains

There are no non-standard protein/DNA/RNA residues in this entry.

6.3 Carbohydrates [i](#)

There are no monosaccharides in this entry.

6.4 Ligands [i](#)

In the following table, the Atoms column lists the number of modelled atoms in the group and the number defined in the chemical component dictionary. The B-factors column lists the minimum, median, 95th percentile and maximum values of B factors of atoms in the group. The column labelled 'Q<0.9' lists the number of atoms with occupancy less than 0.9.

Mol	Type	Chain	Res	Atoms	RSCC	RSR	B-factors(Å ²)	Q<0.9
8	GOL	F	503	6/6	0.55	0.28	72,75,79,82	0
8	GOL	F	504	6/6	0.56	0.27	83,93,96,99	0
8	GOL	D	301	6/6	0.65	0.35	59,70,73,79	0
8	GOL	F	502	6/6	0.77	0.20	41,65,71,79	0
7	MG	C	101	1/1	0.84	0.04	68,68,68,68	0
8	GOL	F	501	6/6	0.87	0.22	53,72,88,89	0

6.5 Other polymers [i](#)

There are no such residues in this entry.