



# wwPDB EM Validation Summary Report ⓘ

Nov 29, 2022 – 10:50 AM JST

PDB ID : 7W85  
EMDB ID : EMD-32352  
Title : Structural of the filamentous Escherichia coli glutamine synthetase  
Authors : Huang, P.-C.; Chen, S.-K.; Wu, K.-P.  
Deposited on : 2021-12-07  
Resolution : 2.94 Å (reported)  
Based on initial model : 2LGS

This is a wwPDB EM Validation Summary Report for a publicly released PDB entry.

We welcome your comments at [validation@mail.wwpdb.org](mailto:validation@mail.wwpdb.org)

A user guide is available at

<https://www.wwpdb.org/validation/2017/EMValidationReportHelp>

with specific help available everywhere you see the ⓘ symbol.

The types of validation reports are described at

<http://www.wwpdb.org/validation/2017/FAQs#types>.

---

The following versions of software and data (see [references ⓘ](#)) were used in the production of this report:

EMDB validation analysis : 0.0.1.dev43  
MolProbity : 4.02b-467  
Percentile statistics : 20191225.v01 (using entries in the PDB archive December 25th 2019)  
MapQ : 1.9.9  
Ideal geometry (proteins) : Engh & Huber (2001)  
Ideal geometry (DNA, RNA) : Parkinson et al. (1996)  
Validation Pipeline (wwPDB-VP) : 2.31.3

# 1 Overall quality at a glance

The following experimental techniques were used to determine the structure:  
*ELECTRON MICROSCOPY*

The reported resolution of this entry is 2.94 Å.

Percentile scores (ranging between 0-100) for global validation metrics of the entry are shown in the following graphic. The table shows the number of entries on which the scores are based.

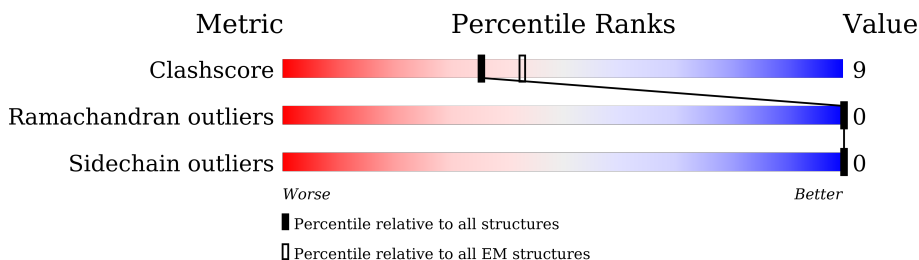

Metric	Whole archive (#Entries)	EM structures (#Entries)
Clashscore	158937	4297
Ramachandran outliers	154571	4023
Sidechain outliers	154315	3826

The table below summarises the geometric issues observed across the polymeric chains and their fit to the map. The red, orange, yellow and green segments of the bar indicate the fraction of residues that contain outliers for  $\geq 3$ , 2, 1 and 0 types of geometric quality criteria respectively. A grey segment represents the fraction of residues that are not modelled. The numeric value for each fraction is indicated below the corresponding segment, with a dot representing fractions  $\leq 5\%$ . The upper red bar (where present) indicates the fraction of residues that have poor fit to the EM map (all-atom inclusion  $< 40\%$ ). The numeric value is given above the bar.

Mol	Chain	Length	Quality of chain
1	A	469	7% 72% 20% 7%
1	B	469	7% 73% 19% 7%
1	C	469	7% 74% 19% 7%
1	D	469	7% 74% 19% 7%
1	E	469	7% 73% 19% 7%
1	F	469	7% 74% 19% 7%
1	G	469	7% 73% 19% 7%
1	H	469	7% 72% 20% 7%

*Continued on next page...*

Continued from previous page...

Mol	Chain	Length	Quality of chain			
1	I	469	6%	72%	21%	7%
1	J	469	6%	73%	20%	7%
1	K	469	6%	72%	21%	7%
1	L	469	6%	73%	19%	7%
1	M	469	89%	73%	20%	7%
1	N	469	89%	74%	18%	7%
1	O	469	89%	73%	20%	7%
1	P	469	89%	73%	19%	7%
1	Q	469	89%	73%	20%	7%
1	R	469	89%	72%	21%	7%
1	S	469	93%	72%	21%	7%
1	U	469	93%	73%	19%	7%
1	V	469	93%	72%	20%	7%
1	W	469	93%	73%	19%	7%
1	X	469	93%	72%	21%	7%
1	Y	469	93%	75%	18%	7%

## 2 Entry composition [i](#)

There are 2 unique types of molecules in this entry. The entry contains 81522 atoms, of which 0 are hydrogens and 0 are deuteriums.

In the tables below, the AltConf column contains the number of residues with at least one atom in alternate conformation and the Trace column contains the number of residues modelled with at most 2 atoms.

- Molecule 1 is a protein called Glutamine synthetase.

Mol	Chain	Residues	Atoms					AltConf	Trace
			Total	C	N	O	S		
1	A	435	3395	2146	580	648	21	0	0
1	B	435	3395	2146	580	648	21	0	0
1	C	435	3395	2146	580	648	21	0	0
1	D	435	3395	2146	580	648	21	0	0
1	E	435	3395	2146	580	648	21	0	0
1	F	435	3395	2146	580	648	21	0	0
1	G	435	3395	2146	580	648	21	0	0
1	H	435	3395	2146	580	648	21	0	0
1	I	435	3395	2146	580	648	21	0	0
1	J	435	3395	2146	580	648	21	0	0
1	K	435	3395	2146	580	648	21	0	0
1	L	435	3395	2146	580	648	21	0	0
1	M	435	3395	2146	580	648	21	0	0
1	N	435	3395	2146	580	648	21	0	0
1	O	435	3395	2146	580	648	21	0	0
1	P	435	3395	2146	580	648	21	0	0
1	Q	435	3395	2146	580	648	21	0	0

*Continued on next page...*

*Continued from previous page...*

Mol	Chain	Residues	Atoms					AltConf	Trace
1	R	435	Total 3395	C 2146	N 580	O 648	S 21	0	0
1	S	435	Total 3395	C 2146	N 580	O 648	S 21	0	0
1	U	435	Total 3395	C 2146	N 580	O 648	S 21	0	0
1	V	435	Total 3395	C 2146	N 580	O 648	S 21	0	0
1	W	435	Total 3395	C 2146	N 580	O 648	S 21	0	0
1	X	435	Total 3395	C 2146	N 580	O 648	S 21	0	0
1	Y	435	Total 3395	C 2146	N 580	O 648	S 21	0	0

- Molecule 2 is NICKEL (II) ION (three-letter code: NI) (formula: Ni) (labeled as "Ligand of Interest" by depositor).

Mol	Chain	Residues	Atoms		AltConf
2	A	2	Total 2	Ni 2	0
2	B	2	Total 2	Ni 2	0
2	C	2	Total 2	Ni 2	0
2	D	2	Total 2	Ni 2	0
2	E	2	Total 2	Ni 2	0
2	F	2	Total 2	Ni 2	0
2	G	2	Total 2	Ni 2	0
2	H	2	Total 2	Ni 2	0
2	I	2	Total 2	Ni 2	0
2	J	2	Total 2	Ni 2	0
2	K	2	Total 2	Ni 2	0
2	L	2	Total 2	Ni 2	0

*Continued on next page...*

*Continued from previous page...*

<b>Mol</b>	<b>Chain</b>	<b>Residues</b>	<b>Atoms</b>		<b>AltConf</b>
2	M	1	Total 1	Ni 1	0
2	N	1	Total 1	Ni 1	0
2	O	1	Total 1	Ni 1	0
2	P	1	Total 1	Ni 1	0
2	Q	1	Total 1	Ni 1	0
2	R	1	Total 1	Ni 1	0
2	S	2	Total 2	Ni 2	0
2	U	2	Total 2	Ni 2	0
2	V	2	Total 2	Ni 2	0
2	W	2	Total 2	Ni 2	0
2	X	2	Total 2	Ni 2	0
2	Y	2	Total 2	Ni 2	0

### 3 Residue-property plots

These plots are drawn for all protein, RNA, DNA and oligosaccharide chains in the entry. The first graphic for a chain summarises the proportions of the various outlier classes displayed in the second graphic. The second graphic shows the sequence view annotated by issues in geometry and atom inclusion in map density. Residues are color-coded according to the number of geometric quality criteria for which they contain at least one outlier: green = 0, yellow = 1, orange = 2 and red = 3 or more. A red diamond above a residue indicates a poor fit to the EM map for this residue (all-atom inclusion < 40%). Stretches of 2 or more consecutive residues without any outlier are shown as a green connector. Residues present in the sample, but not in the model, are shown in grey.

- Molecule 1: Glutamine synthetase

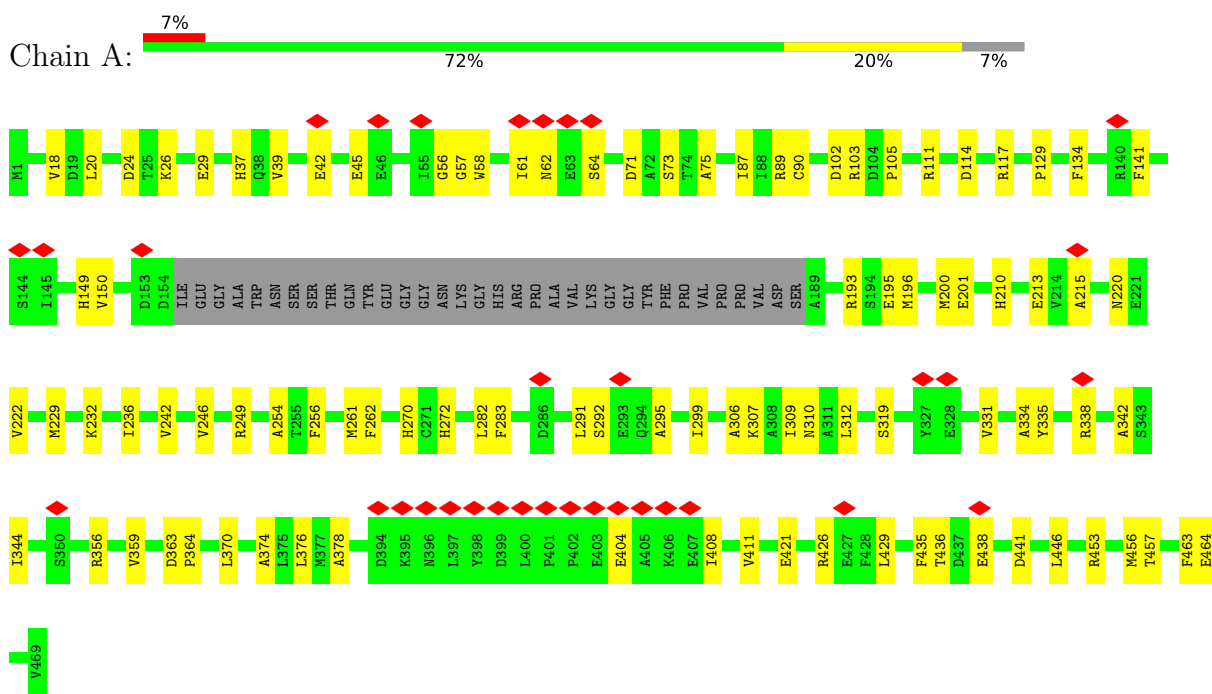

- Molecule 1: Glutamine synthetase

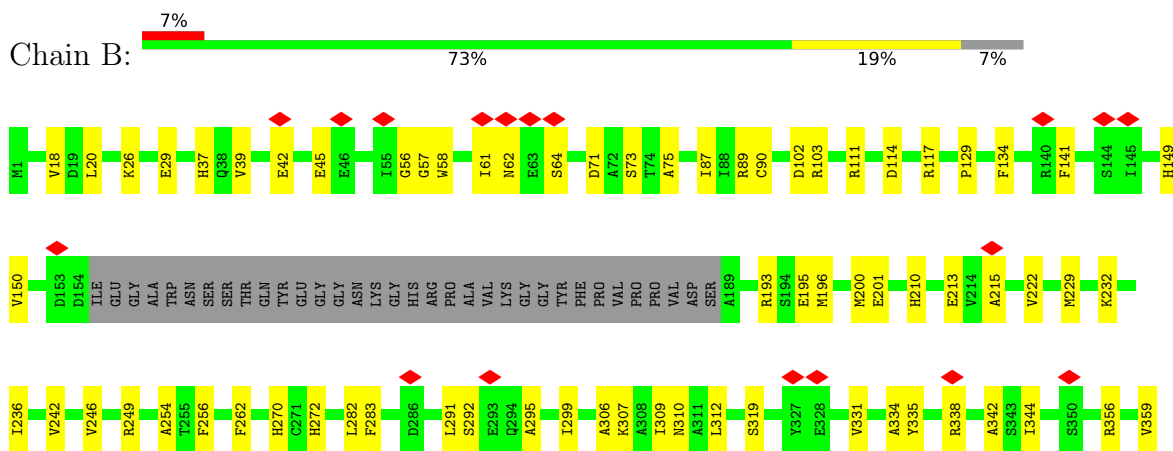

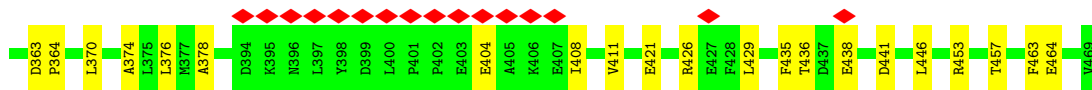

• Molecule 1: Glutamine synthetase

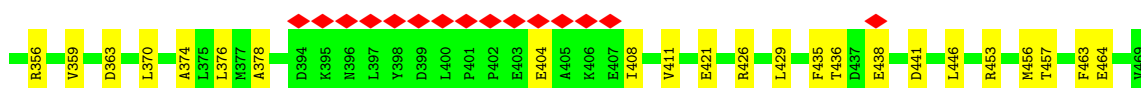
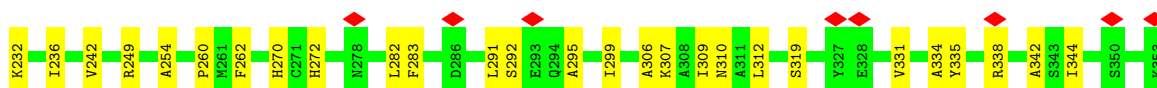
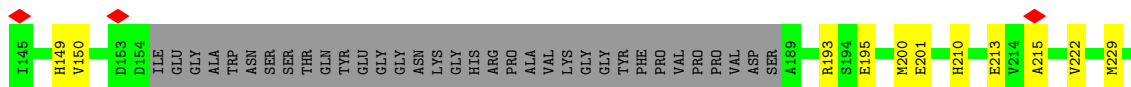
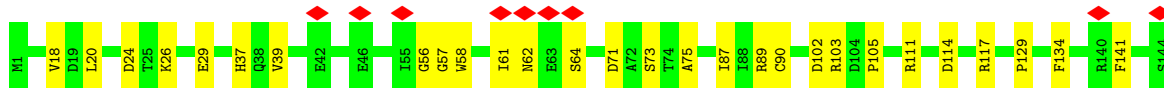
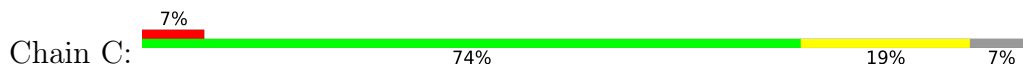

• Molecule 1: Glutamine synthetase

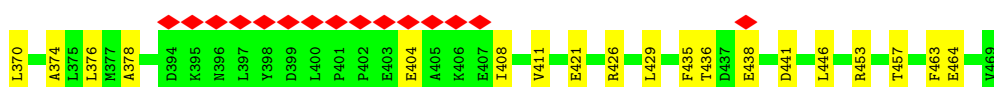
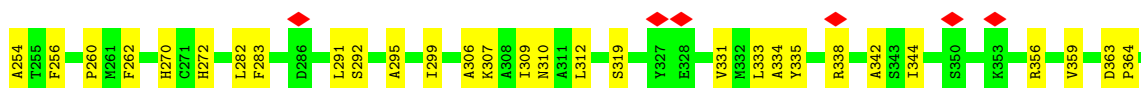
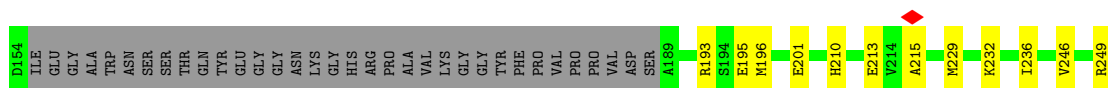
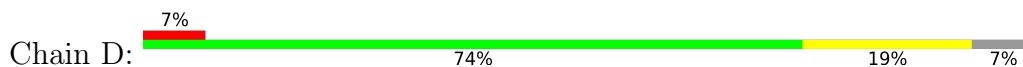

• Molecule 1: Glutamine synthetase





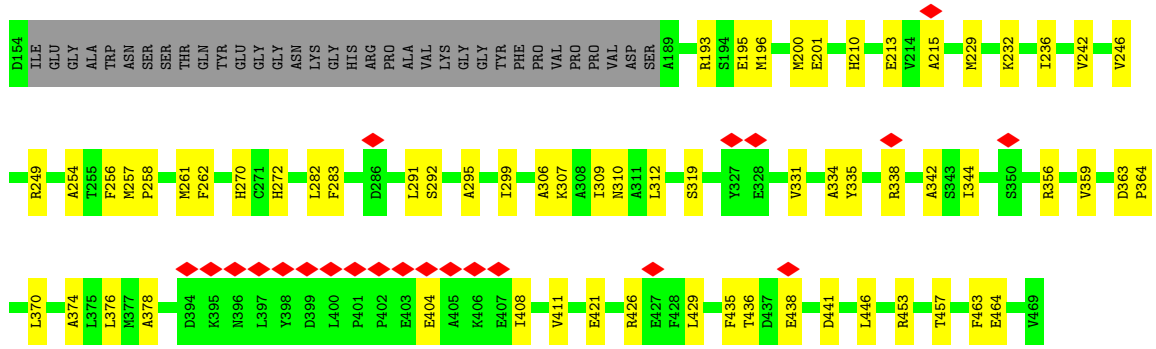

• Molecule 1: Glutamine synthetase

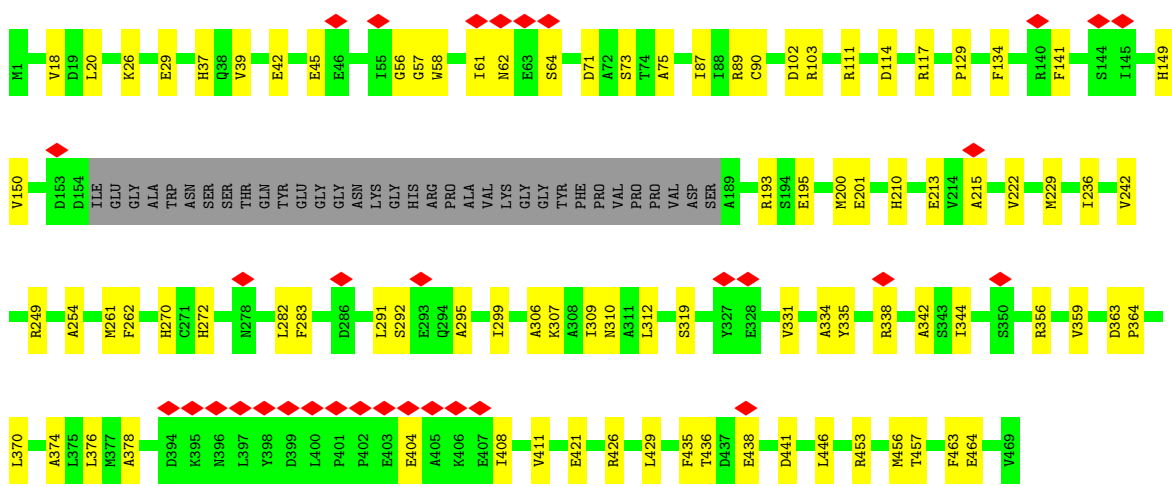
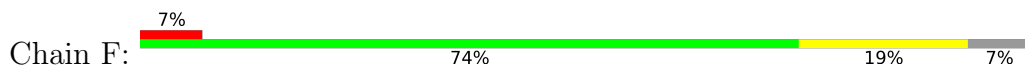

• Molecule 1: Glutamine synthetase

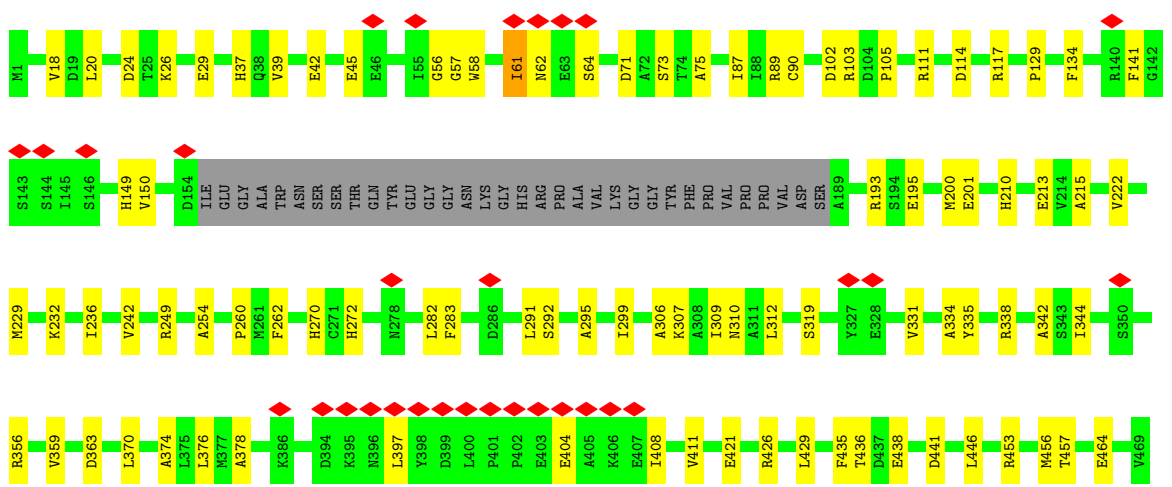
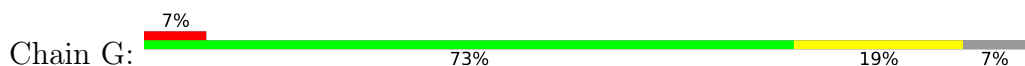

• Molecule 1: Glutamine synthetase

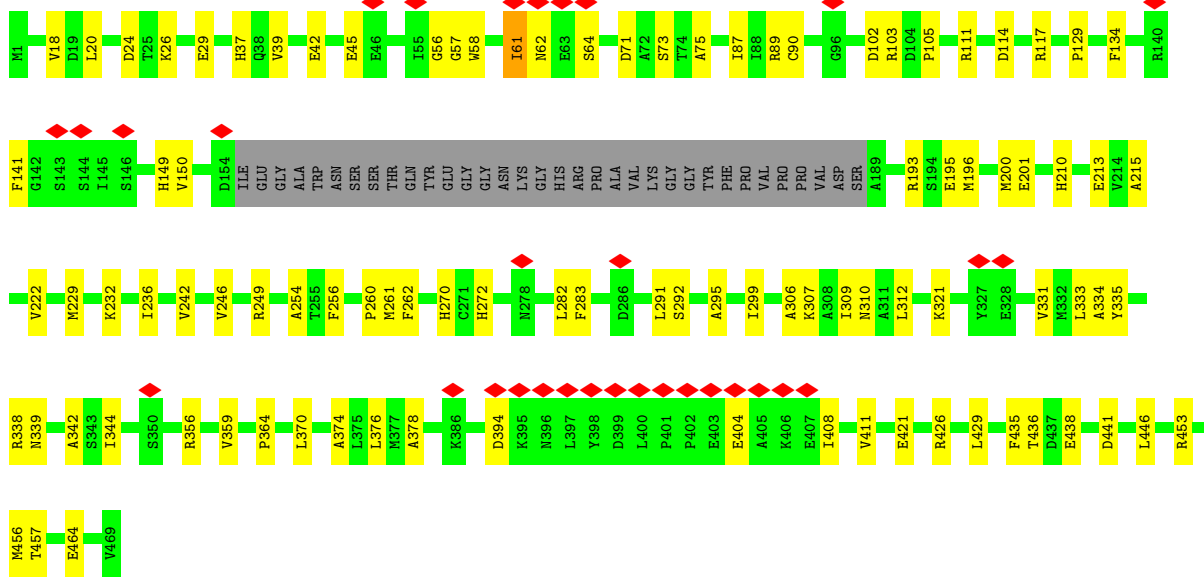
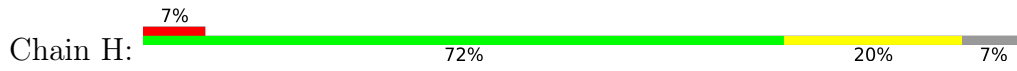

• Molecule 1: Glutamine synthetase

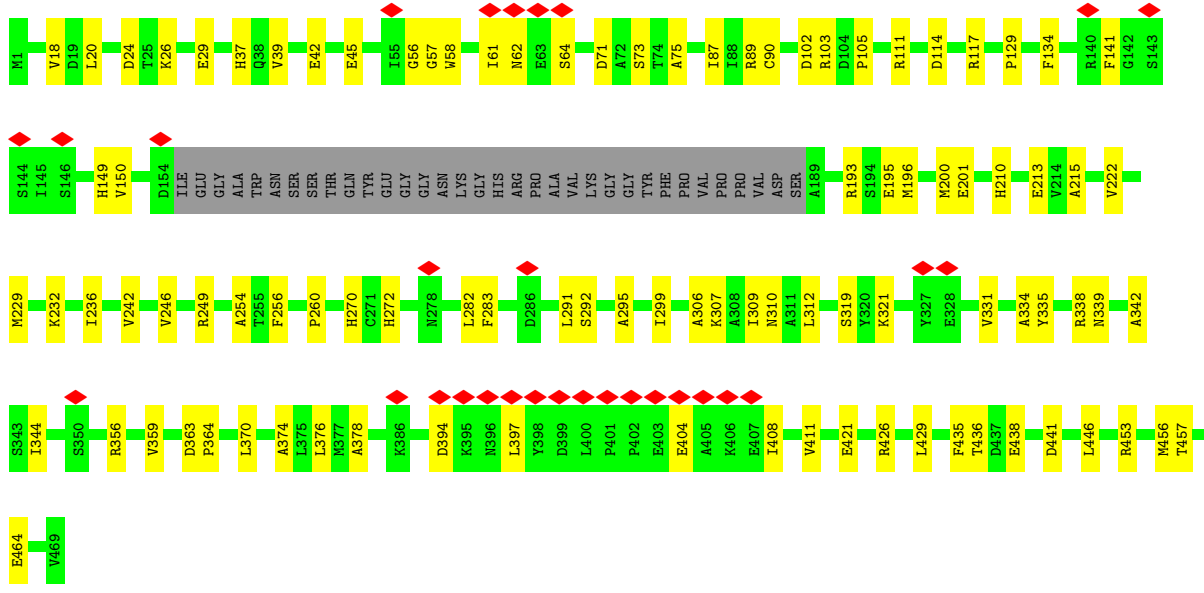

• Molecule 1: Glutamine synthetase

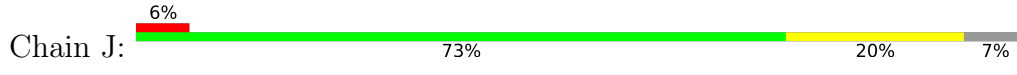

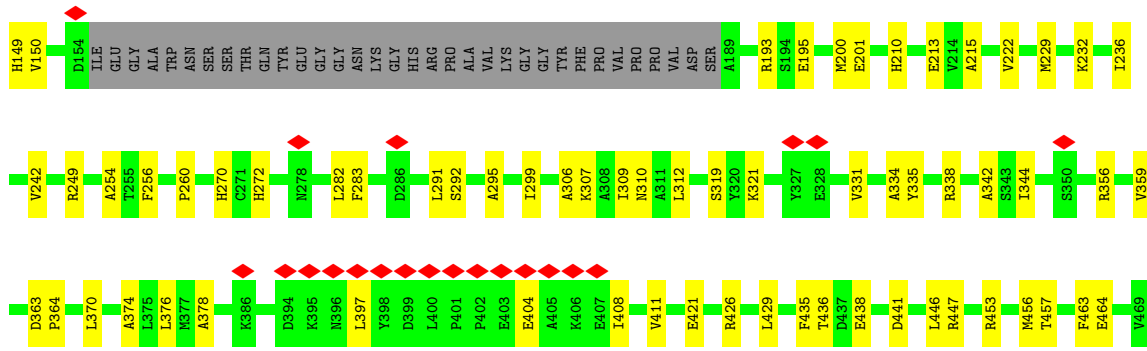

• Molecule 1: Glutamine synthetase

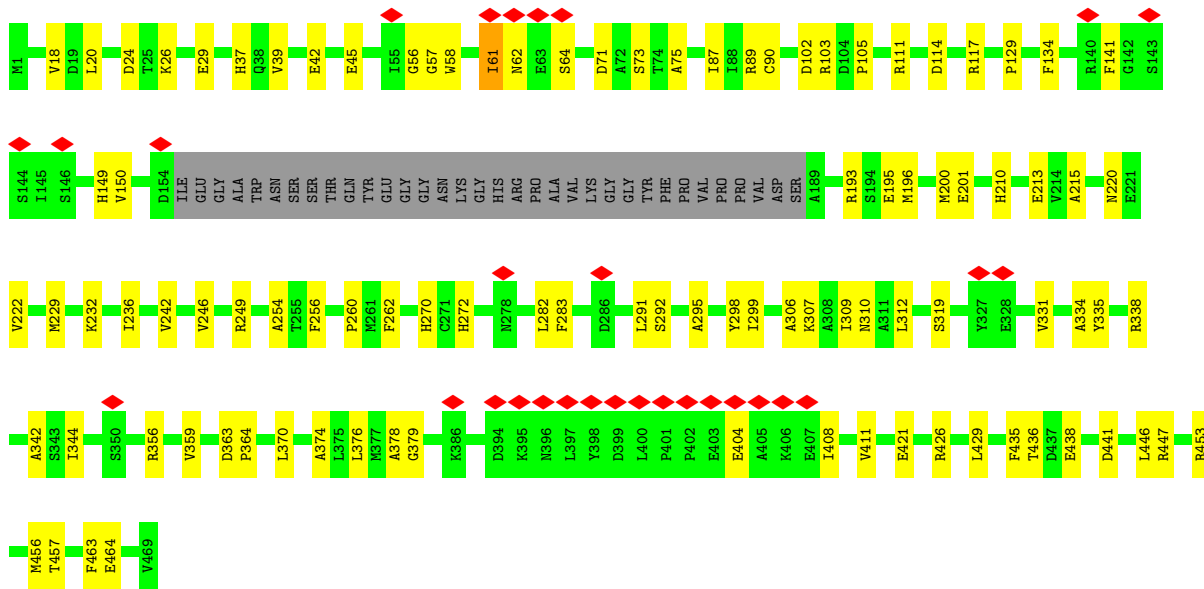

• Molecule 1: Glutamine synthetase

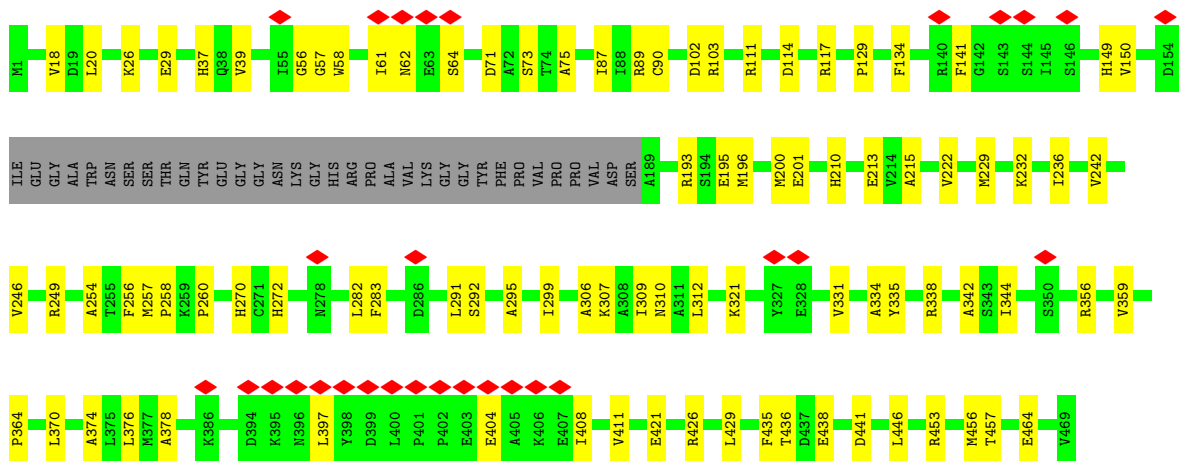
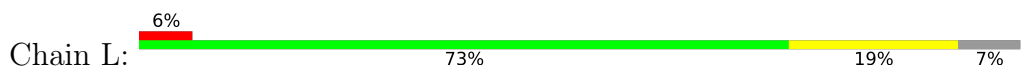



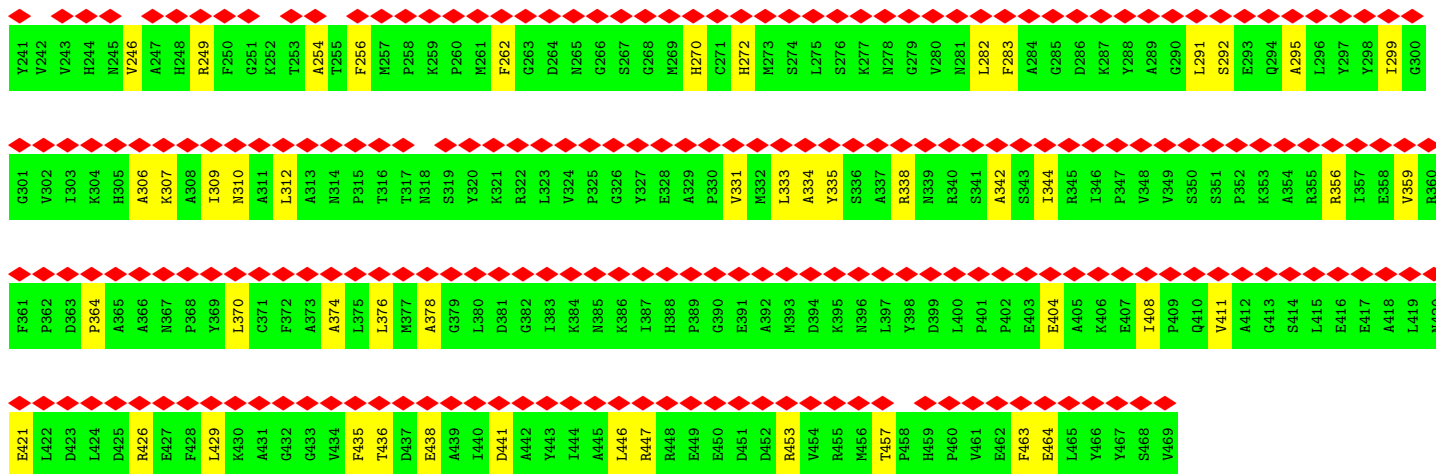

● Molecule 1: Glutamine synthetase

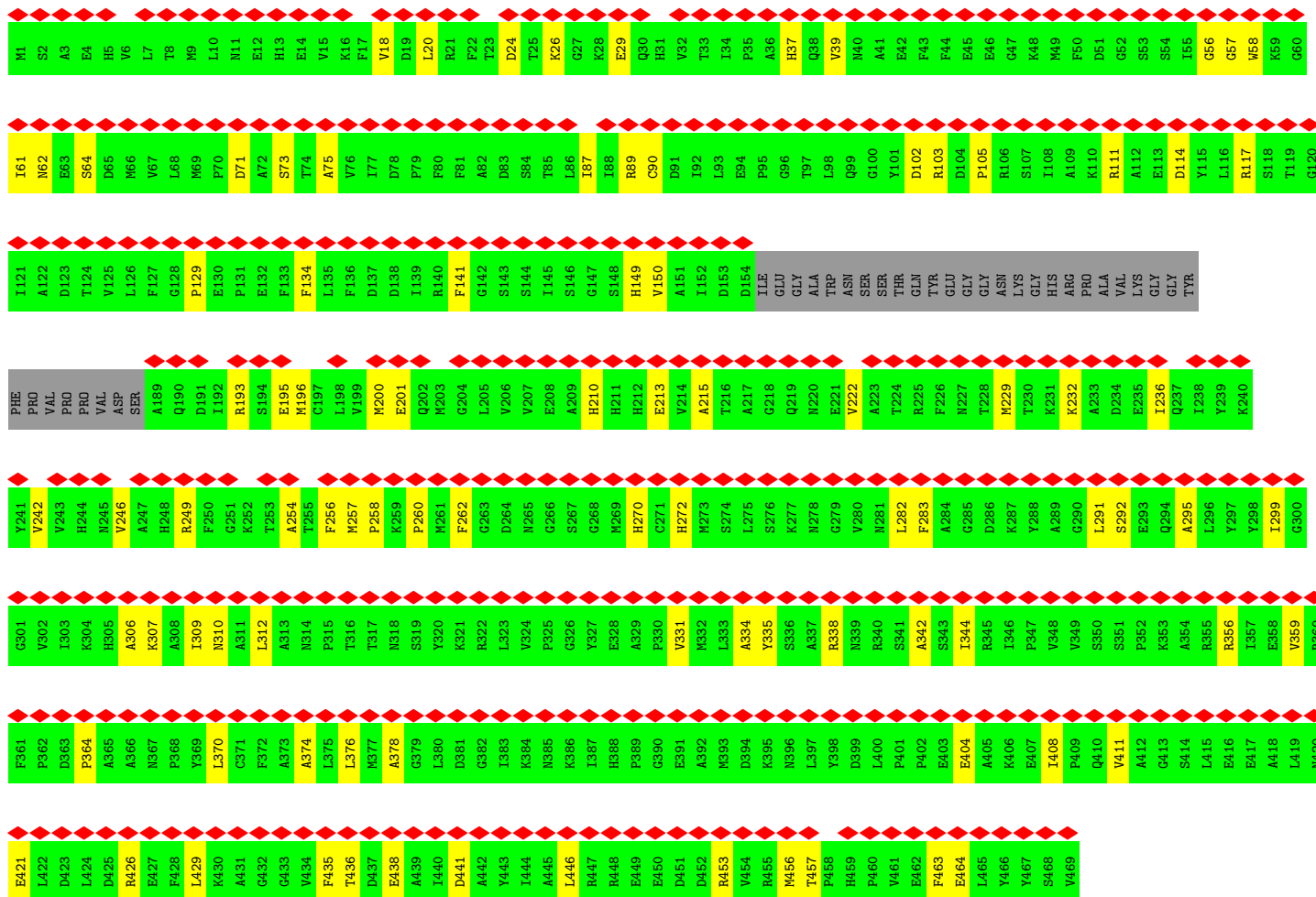
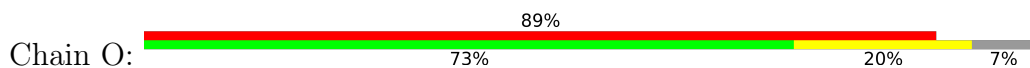

● Molecule 1: Glutamine synthetase

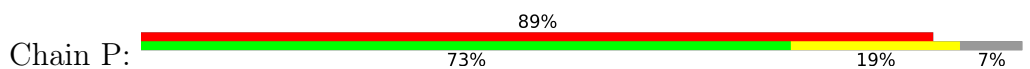

M1	S2	A3	E4	H5	V6	L7	T8	H9	L10	H11	E12	H13	E14	V15	K16	F17	V18	D19	L20	R21	F22	T23	D24	T25	K26	G27	K28	E29	Q30	H31	V32	T33	I34	P35	A36	H37	Q38	V39	N40	A41	E42	F43	F44	E45	E46	G47	K48	H49	F50	D51	G52	S53	L54	S55	G56	G57	W58	K59	G60				
I121	A122	D123	T124	V125	L126	F127	G128	P129	E130	P131	E132	F133	F134	L135	F136	D137	I138	I139	R140	F141	G142	S143	S144	T85	S146	G147	S148	H89	C90	D91	I92	L93	E94	P95	G96	T97	L98	N99	A100	SER	SER	THR	GLN	GLU	GLY	GLY	ASN	LYS	HIS	ARG	PRO	ALA	VAL	LYS	GLY	GLY	D114	Y115	L116	R117	S118	T119	G120
PHE	VAL	PRO	VAL	VAL	ASP	SER	A189	Q190	D191	I192	R193	S194	E195	L196	L198	V199	M200	E201	Q202	M203	G204	L205	V206	V207	E208	A209	H210	H211	H212	E213	V214	A215	T216	A217	G218	Q219	M220	E221	V222	T223	T224	R225	F226	N227	T228	M229	T230	K231	K232	A233	D234	E235	I236	Q237	I238	Y239	K240	Y241					
V242	V243	H244	N245	V246	A247	H248	R249	F250	G251	D191	K252	T253	A254	T255	F256	M257	P258	K259	P260	M261	G262	D263	D264	N265	G266	S267	G268	M269	H270	C271	H272	M273	S274	L275	E276	K277	M278	G279	E221	V222	T223	F226	N227	T228	M229	T230	K231	K232	A233	D234	E235	I236	Q237	I238	Y239	K240	Y241						
V302	I303	K304	H305	A306	K307	A308	I309	N310	A311	L312	A313	N314	P315	T316	T317	N318	S319	Y320	K321	R322	L323	V324	P325	G326	Y327	E328	A329	P330	V331	M332	L333	A334	Y335	S336	A337	R338	N339	R340	S341	A342	S343	I344	R345	I346	P347	V348	V349	S350	S351	P352	K353	A354	R355	R356	I357	V358	R360	F361					
P362	D363	P364	A365	A366	N367	F368	Y369	L370	K371	F372	A373	A374	L375	L376	M377	A378	G379	L380	K381	G382	I383	K384	N385	K386	I387	H388	P389	G390	E391	A392	M393	D394	K395	N396	L397	Y398	D399	L400	P401	P402	E403	E404	A405	K406	E407	I408	P409	Q410	V411	A412	G413	S414	L415	E416	E417	A418	L419	M420	E421				
L422	D423	L424	D425	R426	F427	F428	L429	K430	A431	G432	G433	V434	F435	T436	D437	E438	A439	I440	D441	A442	Y443	I444	A445	L446	R447	R448	E449	E450	D451	D452	R453	V454	R455	M456	T457	P458	H459	P460	V461	E462	F463	E464	L465	Y466	E467	S468	V469																

• Molecule 1: Glutamine synthetase

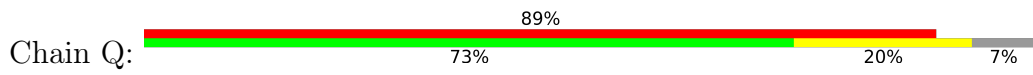

M1	S2	A3	E4	H5	V6	L7	T8	H9	L10	H11	E12	H13	E14	V15	K16	F17	V18	D19	L20	R21	F22	T23	D24	T25	K26	G27	K28	E29	Q30	H31	V32	T33	I34	P35	A36	H37	Q38	V39	N40	A41	E42	F43	F44	E45	E46	G47	K48	H49	F50	D51	G52	S53	L54	S55	G56	G57	W58	K59	G60				
I121	A122	D123	T124	V125	L126	F127	G128	P129	E130	P131	E132	F133	F134	L135	F136	D137	I138	I139	R140	F141	G142	S143	S144	T85	S146	G147	S148	H89	C90	D91	I92	L93	E94	P95	G96	T97	L98	N99	A100	SER	SER	THR	GLN	GLU	GLY	GLY	ASN	LYS	HIS	ARG	PRO	ALA	VAL	LYS	GLY	GLY	D114	Y115	L116	R117	S118	T119	G120
PHE	VAL	PRO	VAL	VAL	ASP	SER	A189	Q190	D191	I192	R193	S194	E195	L196	L198	V199	M200	E201	Q202	M203	G204	L205	V206	V207	E208	A209	H210	H211	H212	E213	V214	A215	T216	A217	G218	Q219	M220	E221	V222	T223	T224	R225	F226	N227	T228	M229	T230	K231	K232	A233	D234	E235	I236	Q237	I238	Y239	K240	Y241					
Y241	V242	V243	H244	N245	V246	A247	H248	R249	F250	G251	D191	K252	T253	A254	T255	F256	M257	P258	K259	P260	M261	G262	D263	D264	N265	G266	S267	G268	M269	H270	C271	H272	M273	S274	L275	E276	K277	M278	G279	E221	V222	T223	F226	N227	T228	M229	T230	K231	K232	A233	D234	E235	I236	Q237	I238	Y239	K240	Y241					



I61	M62	E63	S64	D65	M66	V67	L68	M69	P70	D71	A72	S73	T74	A75	V76	I77	D78	P79	F80	F81	A82	D83	S84	T85	L86	I87	I88	R89	C90	D91	I92	L93	E94	P95	G96	T97	L98	Q99	G100	Y101	D102	R103	D104	P105	R106	S107	I108	A109	K110	R111	A112	E113	D114	Y115	L116	R117	S118	T119	G120																																																												
I121	A122	D123	T124	V125	L126	F127	G128	P129	E130	P131	E132	F133	F134	L135	F136	D137	D138	I139	R140	F141	G142	S143	S144	T145	S146	G147	S148	H149	V150	A151	I152	D153	E154	I155	G156	A157	A158	A159	A160	A161	A162	A163	A164	A165	A166	A167	A168	A169	A170	A171	A172	A173	A174	A175	A176	A177	A178	A179	A180	A181	A182	A183	A184	A185	A186	A187	A188	A189	A190	A191	A192	A193	A194	A195	A196	A197	A198	A199	A200	A201	A202	A203	A204	A205	A206	A207	A208	A209	A210	A211	A212	A213	A214	A215	A216	A217	A218	A219	A220	A221	A222	A223	A224	A225	A226	A227	A228	A229	A230	A231	A232	A233	A234	A235	A236	A237	A238	A239	A240
Y241	V242	V243	H244	M245	V246	A247	H248	R249	F250	G251	K252	T253	A254	T255	F256	M257	P258	K259	P260	M261	G262	G263	D264	M265	G266	S267	G268	M269	H270	H271	H272	M273	M274	S275	L276	S277	K278	N279	G280	M281	L282	F283	A284	G285	D286	K287	Y288	A289	G290	L291	S292	D293	E294	A295	L296	Y297	Y298	I299	G300																																																												
G301	V302	I303	K304	H305	A306	K307	A308	I309	N310	A311	L312	A313	N314	P315	T316	T317	N318	S319	Y320	K321	R322	L323	V324	P325	G326	Y327	E328	A329	P330	V331	M332	L333	A334	Y335	S336	A337	R338	N339	R340	S341	A342	S343	I344	R345	I346	F347	V348	V349	S350	S351	P352	K353	A354	R355	R356	I357	E358	V359	R360																																																												
F361	P362	D363	P364	A365	A366	N367	P368	Y369	L370	C371	F372	A373	A374	L375	L376	M377	A378	G379	L380	D381	G382	I383	K384	N385	K386	I387	H388	P389	G390	E391	A392	M393	D394	K395	N396	L397	Y398	D399	L400	F401	E402	E403	E404	A405	K406	E407	I408	F409	Q410	V411	A412	G413	S414	L415	E416	E417	A418	L419	N420																																																												
E421	L422	D423	L424	R425	D426	E427	F428	L429	K430	A431	G432	G433	V434	F435	T436	D437	E438	A439	L440	D441	A442	Y443	L444	A445	L446	R447	R448	E449	E450	D451	A452	R453	V454	R455	M456	T457	P458	H459	P460	V461	E462	F463	E464	L465	V466	Y467	S468	V469																																																																							

• Molecule 1: Glutamine synthetase

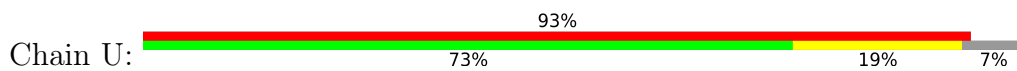

M1	S2	A3	E4	H5	V6	L7	T8	M9	L10	M11	E12	H13	E14	V15	K16	F17	V18	D19	L20	R21	F22	T23	D24	T25	K26	G27	K28	E29	Q30	H31	V32	T33	I34	P35	A36	H37	Q38	V39	M40	A41	E42	F43	F44	E45	E46	G47	K48	M49	F50	D51	G52	S53	S54	L55	G56	V57	M58	M59	G60																																																												
I61	M62	E63	S64	D65	M66	V67	L68	M69	P70	D71	A72	S73	T74	A75	V76	I77	D78	P79	F80	F81	A82	D83	S84	T85	L86	I87	I88	R89	C90	D91	I92	L93	E94	P95	G96	T97	L98	Q99	G100	Y101	D102	R103	D104	P105	R106	S107	I108	A109	K110	R111	A112	E113	D114	Y115	L116	R117	S118	T119	G120																																																												
I121	A122	D123	T124	V125	L126	F127	G128	P129	E130	P131	E132	F133	F134	L135	F136	D137	D138	I139	R140	F141	G142	S143	S144	T145	S146	G147	S148	H149	V150	A151	I152	D153	E154	I155	G156	A157	A158	A159	A160	A161	A162	A163	A164	A165	A166	A167	A168	A169	A170	A171	A172	A173	A174	A175	A176	A177	A178	A179	A180	A181	A182	A183	A184	A185	A186	A187	A188	A189	A190	A191	A192	A193	A194	A195	A196	A197	A198	A199	A200	A201	A202	A203	A204	A205	A206	A207	A208	A209	A210	A211	A212	A213	A214	A215	A216	A217	A218	A219	A220	A221	A222	A223	A224	A225	A226	A227	A228	A229	A230	A231	A232	A233	A234	A235	A236	A237	A238	A239	A240
Y241	V242	V243	H244	M245	V246	A247	H248	R249	F250	G251	K252	T253	A254	T255	F256	M257	P258	K259	P260	M261	G262	G263	D264	M265	G266	S267	G268	M269	H270	H271	H272	M273	M274	S275	L276	S277	K278	N279	G280	M281	L282	F283	A284	G285	D286	K287	Y288	A289	G290	L291	S292	D293	E294	A295	L296	Y297	Y298	I299	G300																																																												
G301	V302	I303	K304	H305	A306	K307	A308	I309	N310	A311	L312	A313	N314	P315	T316	T317	N318	S319	Y320	K321	R322	L323	V324	P325	G326	Y327	E328	A329	P330	V331	M332	L333	A334	Y335	S336	A337	R338	N339	R340	S341	A342	S343	I344	R345	I346	F347	V348	V349	S350	S351	P352	K353	A354	R355	R356	I357	E358	V359	R360																																																												



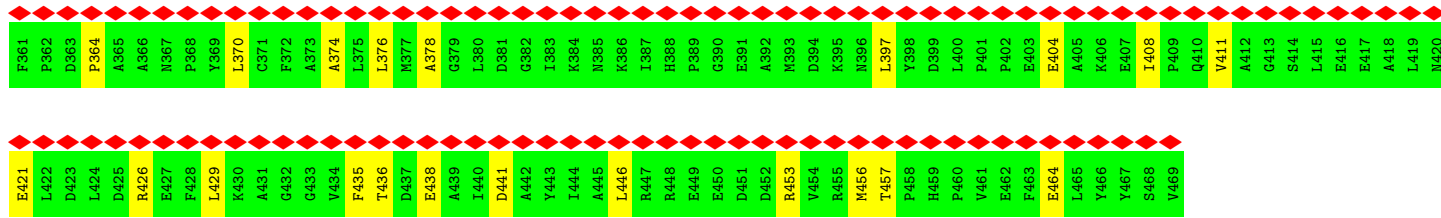

• Molecule 1: Glutamine synthetase

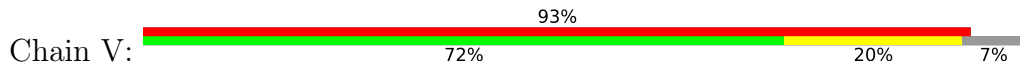

• Molecule 1: Glutamine synthetase

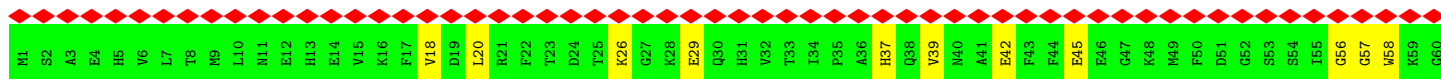
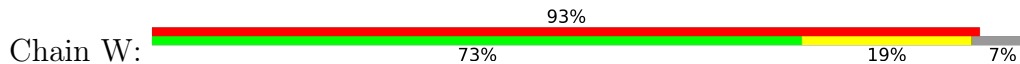

I121	A122	D123	T124	V125	L126	F127	G128	P129	E130	P131	E132	F133	L134	L135	F136	D137	I138	I139	R140	F141	G142	S143	S144	I145	S146	G147	S148	H149	V150	A151	I152	D153	D154	I155	GLY	GLY	ALA	TRP	ASN	SER	SER	THR	GLN	GLU	GLY	GLY	ASN	LYS	GLY	HIS	ARG	PRO	PRO	ALA	VAL	LYS	GLY	GLY	TYR
Y241	V242	V243	H244	H245	V246	A247	H248	R249	F250	G251	K252	T253	A254	T255	F256	M257	P258	K259	P260	M261	F262	G263	D264	N265	G266	S267	G268	M269	H270	C271	H272	M273	S274	L275	S276	K277	N278	G279	E221	V222	A223	T224	R225	F226	G227	T228	M229	T230	A231	K232	A233	D234	E235	Q236	Q237	I238	Y239	K240	
G301	V302	I303	K304	H305	A306	K307	A308	I309	N310	A311	L312	T313	N314	P315	T316	T317	N318	S319	Y320	K321	R322	L323	V324	P325	G326	Y327	E328	A329	P330	V331	M332	L333	A334	Y335	S336	A337	R338	N339	R340	S341	A342	S343	I344	R345	I346	P347	V348	V349	S350	S351	P352	K353	A354	R355	R356	I357	E358	V359	R360
F361	P362	D363	P364	A365	A366	N367	P368	Y369	L370	C371	F372	A373	A374	L375	L376	M377	A378	G379	L380	D381	G382	I383	K384	N385	K386	I387	H388	P389	G390	E391	A392	M393	D394	K395	N396	L397	Y398	D399	L400	F401	P402	E403	E404	A405	K406	E407	I408	F409	Q410	V411	A412	G413	S414	L415	E416	E417	A418	L419	N420
E421	L422	D423	L424	D425	R426	E427	F428	L429	K430	A431	G432	G433	V434	F435	T436	D437	E438	A439	I440	D441	A442	Y443	I444	A445	L446	R447	R448	E449	E450	D451	D452	R453	V454	R455	M456	T457	P458	H459	P460	V461	E462	F463	E464	L465	V466	Y467	S468	V469											

• Molecule 1: Glutamine synthetase

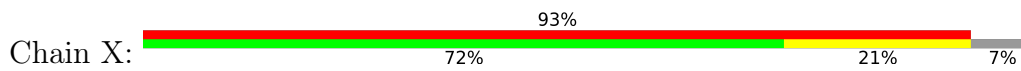

M1	S2	A3	E4	H5	V6	L7	T8	H9	L10	M11	E12	H13	E14	V15	K16	F17	V18	D19	L20	R21	F22	T23	D24	T25	K26	G27	K28	E29	Q30	H31	V32	T33	I34	P35	A36	H37	O38	V39	N40	A41	E42	F43	F44	E45	E46	L466	Y467	S468	V469										
I61	N62	E63	S64	D65	M66	V67	L68	H69	P70	D71	A72	S73	T74	A75	V76	I77	D78	F79	F80	F81	A82	D83	S84	T85	L86	I87	H88	R89	D90	I91	L92	L93	E94	P95	G96	T97	L98	Q99	G100	Y101	D102	R103	D104	P105	R106	S107	I108	A109	K110	R111	A112	S113	E114	D115	Y116	L117	S118	T119	G120
I121	A122	D123	T124	V125	L126	F127	G128	P129	E130	P131	E132	F133	L134	L135	F136	D137	I138	I139	R140	F141	G142	S143	S144	I145	S146	G147	S148	H149	V150	A151	I152	D153	D154	I155	GLY	GLY	ALA	TRP	ASN	SER	SER	THR	GLN	GLU	GLY	GLY	ASN	LYS	GLY	HIS	ARG	PRO	PRO	ALA	VAL	LYS	GLY	GLY	TYR
PHE	PRO	VAL	PRO	VAL	ASP	SER	A189	Q190	D191	I192	R193	S194	E195	M196	C197	L198	V199	M200	E201	Q202	M203	G204	L205	V206	V207	E208	A209	H210	H211	H212	E213	V214	A215	T216	A217	G218	Q219	N220	E221	V222	A223	T224	R225	F226	G227	T228	M229	T230	A231	K232	A233	D234	E235	Q236	Q237	I238	Y239	K240	
Y241	V242	V243	H244	H245	V246	A247	H248	R249	F250	G251	K252	T253	A254	T255	F256	M257	P258	K259	P260	M261	F262	G263	D264	N265	G266	S267	G268	M269	H270	C271	H272	M273	S274	L275	S276	K277	N278	G279	E221	V222	A223	T224	R225	F226	G227	T228	M229	T230	A231	K232	A233	D234	E235	Q236	Q237	I238	Y239	K240	
G301	V302	I303	K304	H305	A306	K307	A308	I309	N310	A311	L312	T313	N314	P315	T316	T317	N318	S319	Y320	K321	R322	L323	V324	P325	G326	Y327	E328	A329	P330	V331	M332	L333	A334	Y335	S336	A337	R338	N339	R340	S341	A342	S343	I344	R345	I346	P347	V348	V349	S350	S351	P352	K353	A354	R355	R356	I357	E358	V359	R360
F361	P362	D363	P364	A365	A366	N367	P368	Y369	L370	C371	F372	A373	A374	L375	L376	M377	A378	G379	L380	D381	G382	I383	K384	N385	K386	I387	H388	P389	G390	E391	A392	M393	D394	K395	N396	L397	Y398	D399	L400	F401	P402	E403	E404	A405	K406	E407	I408	F409	Q410	V411	A412	G413	S414	L415	E416	E417	A418	L419	N420

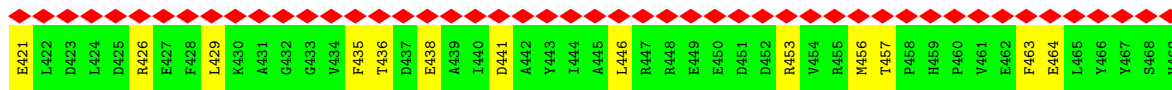

• Molecule 1: Glutamine synthetase

Chain Y:

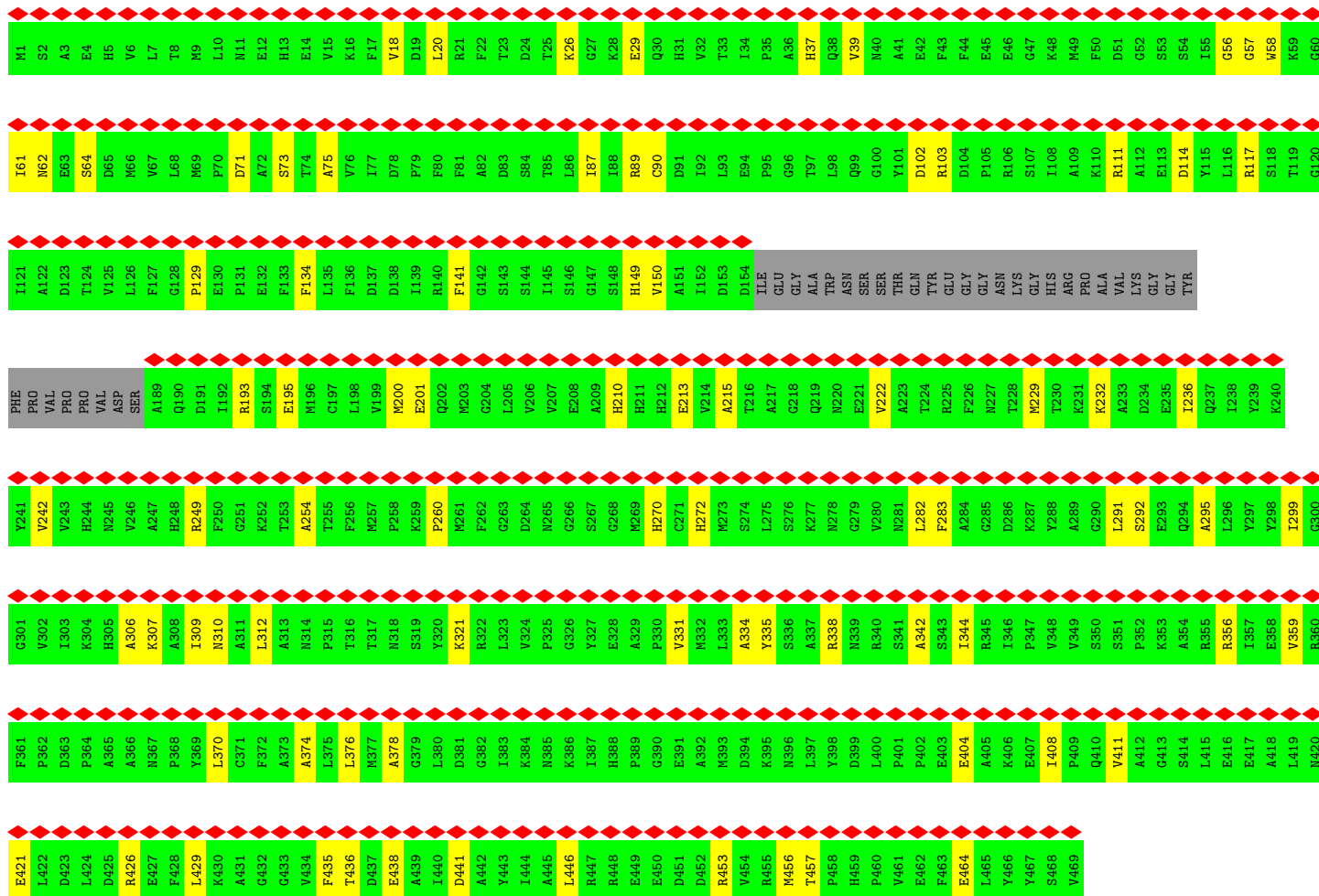

## 4 Experimental information

Property	Value	Source
EM reconstruction method	SINGLE PARTICLE	Depositor
Imposed symmetry	POINT, C6	Depositor
Number of particles used	117242	Depositor
Resolution determination method	FSC 0.143 CUT-OFF	Depositor
CTF correction method	PHASE FLIPPING AND AMPLITUDE CORRECTION	Depositor
Microscope	TFS KRIOS	Depositor
Voltage (kV)	300	Depositor
Electron dose ( $e^-/\text{\AA}^2$ )	59.6	Depositor
Minimum defocus (nm)	1000	Depositor
Maximum defocus (nm)	2000	Depositor
Magnification	Not provided	
Image detector	GATAN K2 SUMMIT (4k x 4k)	Depositor
Maximum map value	3.228	Depositor
Minimum map value	-2.136	Depositor
Average map value	0.020	Depositor
Map value standard deviation	0.096	Depositor
Recommended contour level	0.4	Depositor
Map size (Å)	353.46002, 353.46002, 353.46002	wwPDB
Map dimensions	430, 430, 430	wwPDB
Map angles (°)	90.0, 90.0, 90.0	wwPDB
Pixel spacing (Å)	0.822, 0.822, 0.822	Depositor

## 5 Model quality [i](#)

### 5.1 Standard geometry [i](#)

Bond lengths and bond angles in the following residue types are not validated in this section: NI

The Z score for a bond length (or angle) is the number of standard deviations the observed value is removed from the expected value. A bond length (or angle) with  $|Z| > 5$  is considered an outlier worth inspection. RMSZ is the root-mean-square of all Z scores of the bond lengths (or angles).

Mol	Chain	Bond lengths		Bond angles	
		RMSZ	# Z  >5	RMSZ	# Z  >5
1	A	0.41	0/3470	0.49	0/4694
1	B	0.41	0/3470	0.49	0/4694
1	C	0.41	0/3470	0.49	0/4694
1	D	0.41	0/3470	0.49	0/4694
1	E	0.41	0/3470	0.49	0/4694
1	F	0.41	0/3470	0.49	0/4694
1	G	0.41	0/3470	0.49	0/4694
1	H	0.41	0/3470	0.49	0/4694
1	I	0.41	0/3470	0.49	0/4694
1	J	0.41	0/3470	0.49	0/4694
1	K	0.41	0/3470	0.49	0/4694
1	L	0.41	0/3470	0.49	0/4694
1	M	0.41	0/3470	0.49	0/4694
1	N	0.41	0/3470	0.49	0/4694
1	O	0.41	0/3470	0.49	0/4694
1	P	0.41	0/3470	0.49	0/4694
1	Q	0.41	0/3470	0.49	0/4694
1	R	0.41	0/3470	0.49	0/4694
1	S	0.41	0/3470	0.49	0/4694
1	U	0.41	0/3470	0.49	0/4694
1	V	0.41	0/3470	0.49	0/4694
1	W	0.41	0/3470	0.49	0/4694
1	X	0.41	0/3470	0.49	0/4694
1	Y	0.41	0/3470	0.49	0/4694
All	All	0.41	0/83280	0.49	0/112656

Chiral center outliers are detected by calculating the chiral volume of a chiral center and verifying if the center is modelled as a planar moiety or with the opposite hand. A planarity outlier is detected by checking planarity of atoms in a peptide group, atoms in a mainchain group or atoms of a sidechain that are expected to be planar.

Mol	Chain	#Chirality outliers	#Planarity outliers
1	A	0	2
1	B	0	2
1	C	0	2
1	D	0	2
1	E	0	2
1	F	0	2
1	G	0	2
1	H	0	2
1	I	0	2
1	J	0	2
1	K	0	2
1	L	0	2
1	M	0	2
1	N	0	2
1	O	0	2
1	P	0	2
1	Q	0	2
1	R	0	2
1	S	0	2
1	U	0	2
1	V	0	2
1	W	0	2
1	X	0	2
1	Y	0	2
All	All	0	48

There are no bond length outliers.

There are no bond angle outliers.

There are no chirality outliers.

5 of 48 planarity outliers are listed below:

Mol	Chain	Res	Type	Group
1	A	61	ILE	Peptide
1	A	62	ASN	Peptide
1	B	61	ILE	Peptide
1	B	62	ASN	Peptide
1	C	61	ILE	Peptide

## 5.2 Too-close contacts

In the following table, the Non-H and H(model) columns list the number of non-hydrogen atoms and hydrogen atoms in the chain respectively. The H(added) column lists the number of hydrogen atoms added and optimized by MolProbity. The Clashes column lists the number of clashes within the asymmetric unit, whereas Symm-Clashes lists symmetry-related clashes.

Mol	Chain	Non-H	H(model)	H(added)	Clashes	Symm-Clashes
1	A	3395	0	3315	65	0
1	B	3395	0	3315	61	0
1	C	3395	0	3315	61	0
1	D	3395	0	3315	61	0
1	E	3395	0	3315	61	0
1	F	3395	0	3315	62	0
1	G	3395	0	3315	63	0
1	H	3395	0	3315	67	0
1	I	3395	0	3315	64	0
1	J	3395	0	3315	67	0
1	K	3395	0	3315	69	0
1	L	3395	0	3315	61	0
1	M	3395	0	3315	64	0
1	N	3395	0	3315	60	0
1	O	3395	0	3315	63	0
1	P	3395	0	3315	62	0
1	Q	3395	0	3315	64	0
1	R	3395	0	3315	66	0
1	S	3395	0	3315	69	0
1	U	3395	0	3315	62	0
1	V	3395	0	3315	66	0
1	W	3395	0	3315	62	0
1	X	3395	0	3315	68	0
1	Y	3395	0	3315	58	0
2	A	2	0	0	0	0
2	B	2	0	0	0	0
2	C	2	0	0	0	0
2	D	2	0	0	0	0
2	E	2	0	0	0	0
2	F	2	0	0	0	0
2	G	2	0	0	0	0
2	H	2	0	0	0	0
2	I	2	0	0	0	0
2	J	2	0	0	0	0
2	K	2	0	0	0	0
2	L	2	0	0	0	0
2	M	1	0	0	0	0

*Continued on next page...*

Continued from previous page...

Mol	Chain	Non-H	H(model)	H(added)	Clashes	Symm-Clashes
2	N	1	0	0	0	0
2	O	1	0	0	0	0
2	P	1	0	0	0	0
2	Q	1	0	0	0	0
2	R	1	0	0	0	0
2	S	2	0	0	0	0
2	U	2	0	0	0	0
2	V	2	0	0	0	0
2	W	2	0	0	0	0
2	X	2	0	0	0	0
2	Y	2	0	0	0	0
All	All	81522	0	79560	1392	0

The all-atom clashscore is defined as the number of clashes found per 1000 atoms (including hydrogen atoms). The all-atom clashscore for this structure is 9.

The worst 5 of 1392 close contacts within the same asymmetric unit are listed below, sorted by their clash magnitude.

Atom-1	Atom-2	Interatomic distance (Å)	Clash overlap (Å)
1:D:57:GLY:O	1:D:103:ARG:NH1	2.07	0.88
1:P:57:GLY:O	1:P:103:ARG:NH1	2.07	0.88
1:H:57:GLY:O	1:H:103:ARG:NH1	2.07	0.88
1:V:57:GLY:O	1:V:103:ARG:NH1	2.07	0.88
1:U:57:GLY:O	1:U:103:ARG:NH1	2.07	0.87

There are no symmetry-related clashes.

## 5.3 Torsion angles [i](#)

### 5.3.1 Protein backbone [i](#)

In the following table, the Percentiles column shows the percent Ramachandran outliers of the chain as a percentile score with respect to all PDB entries followed by that with respect to all EM entries.

The Analysed column shows the number of residues for which the backbone conformation was analysed, and the total number of residues.

Mol	Chain	Analysed	Favoured	Allowed	Outliers	Percentiles
1	A	431/469 (92%)	407 (94%)	24 (6%)	0	<b>100</b> <b>100</b>

Continued on next page...



Continued from previous page...

Mol	Chain	Analysed	Favoured	Allowed	Outliers	Percentiles	
1	B	431/469 (92%)	407 (94%)	24 (6%)	0	100	100
1	C	431/469 (92%)	407 (94%)	24 (6%)	0	100	100
1	D	431/469 (92%)	407 (94%)	24 (6%)	0	100	100
1	E	431/469 (92%)	407 (94%)	24 (6%)	0	100	100
1	F	431/469 (92%)	407 (94%)	24 (6%)	0	100	100
1	G	431/469 (92%)	407 (94%)	24 (6%)	0	100	100
1	H	431/469 (92%)	407 (94%)	24 (6%)	0	100	100
1	I	431/469 (92%)	407 (94%)	24 (6%)	0	100	100
1	J	431/469 (92%)	407 (94%)	24 (6%)	0	100	100
1	K	431/469 (92%)	407 (94%)	24 (6%)	0	100	100
1	L	431/469 (92%)	407 (94%)	24 (6%)	0	100	100
1	M	431/469 (92%)	408 (95%)	23 (5%)	0	100	100
1	N	431/469 (92%)	407 (94%)	24 (6%)	0	100	100
1	O	431/469 (92%)	407 (94%)	24 (6%)	0	100	100
1	P	431/469 (92%)	407 (94%)	24 (6%)	0	100	100
1	Q	431/469 (92%)	407 (94%)	24 (6%)	0	100	100
1	R	431/469 (92%)	407 (94%)	24 (6%)	0	100	100
1	S	431/469 (92%)	407 (94%)	24 (6%)	0	100	100
1	U	431/469 (92%)	407 (94%)	24 (6%)	0	100	100
1	V	431/469 (92%)	407 (94%)	24 (6%)	0	100	100
1	W	431/469 (92%)	407 (94%)	24 (6%)	0	100	100
1	X	431/469 (92%)	407 (94%)	24 (6%)	0	100	100
1	Y	431/469 (92%)	407 (94%)	24 (6%)	0	100	100
All	All	10344/11256 (92%)	9769 (94%)	575 (6%)	0	100	100

There are no Ramachandran outliers to report.

### 5.3.2 Protein sidechains

In the following table, the Percentiles column shows the percent sidechain outliers of the chain as a percentile score with respect to all PDB entries followed by that with respect to all EM entries.

The Analysed column shows the number of residues for which the sidechain conformation was analysed, and the total number of residues.

Mol	Chain	Analysed	Rotameric	Outliers	Percentiles	
1	A	362/388 (93%)	362 (100%)	0	100	100
1	B	362/388 (93%)	362 (100%)	0	100	100
1	C	362/388 (93%)	362 (100%)	0	100	100
1	D	362/388 (93%)	362 (100%)	0	100	100
1	E	362/388 (93%)	362 (100%)	0	100	100
1	F	362/388 (93%)	362 (100%)	0	100	100
1	G	362/388 (93%)	362 (100%)	0	100	100
1	H	362/388 (93%)	362 (100%)	0	100	100
1	I	362/388 (93%)	362 (100%)	0	100	100
1	J	362/388 (93%)	362 (100%)	0	100	100
1	K	362/388 (93%)	362 (100%)	0	100	100
1	L	362/388 (93%)	362 (100%)	0	100	100
1	M	362/388 (93%)	362 (100%)	0	100	100
1	N	362/388 (93%)	362 (100%)	0	100	100
1	O	362/388 (93%)	362 (100%)	0	100	100
1	P	362/388 (93%)	362 (100%)	0	100	100
1	Q	362/388 (93%)	362 (100%)	0	100	100
1	R	362/388 (93%)	362 (100%)	0	100	100
1	S	362/388 (93%)	362 (100%)	0	100	100
1	U	362/388 (93%)	362 (100%)	0	100	100
1	V	362/388 (93%)	362 (100%)	0	100	100
1	W	362/388 (93%)	362 (100%)	0	100	100
1	X	362/388 (93%)	362 (100%)	0	100	100
1	Y	362/388 (93%)	362 (100%)	0	100	100
All	All	8688/9312 (93%)	8688 (100%)	0	100	100

There are no protein residues with a non-rotameric sidechain to report.

Sometimes sidechains can be flipped to improve hydrogen bonding and reduce clashes. 5 of 24 such sidechains are listed below:

Mol	Chain	Res	Type
1	O	210	HIS
1	R	210	HIS
1	Q	210	HIS

*Continued on next page...*

*Continued from previous page...*

Mol	Chain	Res	Type
1	S	210	HIS
1	G	210	HIS

### 5.3.3 RNA [i](#)

There are no RNA molecules in this entry.

## 5.4 Non-standard residues in protein, DNA, RNA chains [i](#)

There are no non-standard protein/DNA/RNA residues in this entry.

## 5.5 Carbohydrates [i](#)

There are no monosaccharides in this entry.

## 5.6 Ligand geometry [i](#)

Of 42 ligands modelled in this entry, 42 are monoatomic - leaving 0 for Mogul analysis.

There are no bond length outliers.

There are no bond angle outliers.

There are no chirality outliers.

There are no torsion outliers.

There are no ring outliers.

No monomer is involved in short contacts.

## 5.7 Other polymers [i](#)

There are no such residues in this entry.

## 5.8 Polymer linkage issues [i](#)

There are no chain breaks in this entry.

## 6 Map visualisation [i](#)

This section contains visualisations of the EMDB entry EMD-32352. These allow visual inspection of the internal detail of the map and identification of artifacts.

No raw map or half-maps were deposited for this entry and therefore no images, graphs, etc. pertaining to the raw map can be shown.

### 6.1 Orthogonal projections [i](#)

#### 6.1.1 Primary map

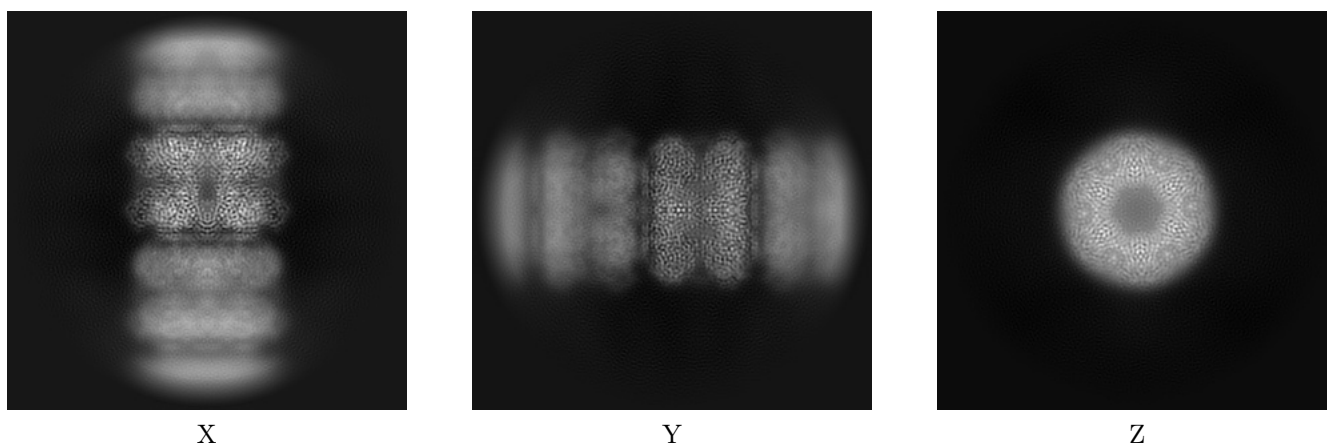

The images above show the map projected in three orthogonal directions.

### 6.2 Central slices [i](#)

#### 6.2.1 Primary map

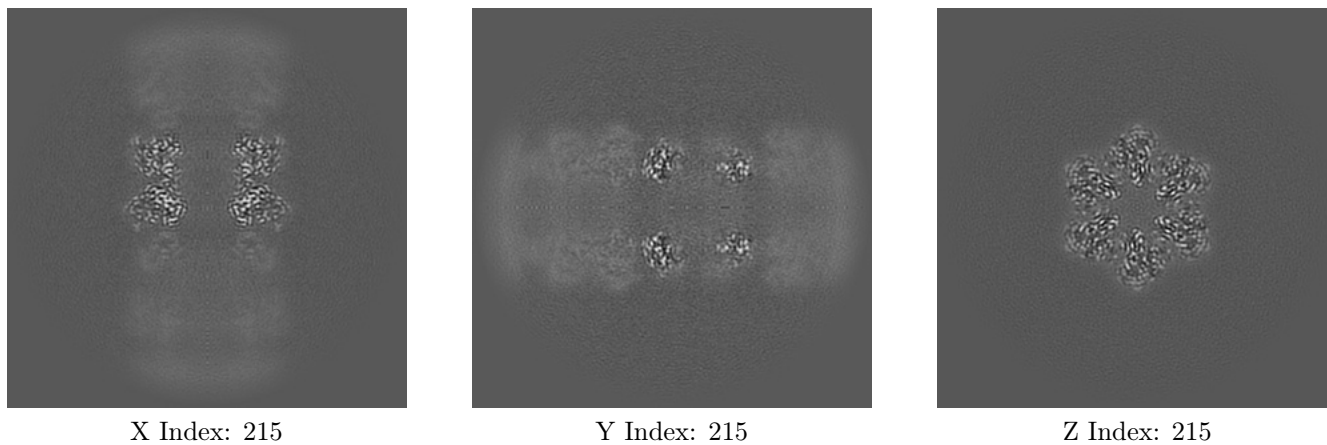

The images above show central slices of the map in three orthogonal directions.

## 6.3 Largest variance slices [i](#)

### 6.3.1 Primary map

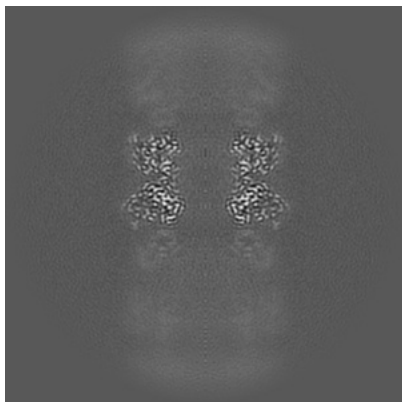

X Index: 215

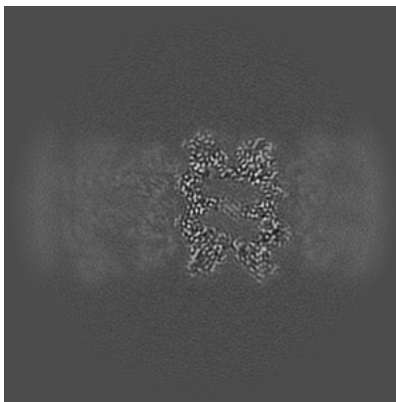

Y Index: 248

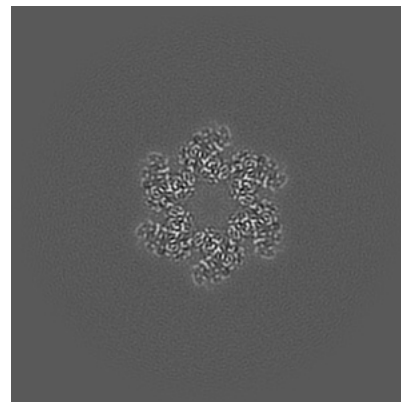

Z Index: 210

The images above show the largest variance slices of the map in three orthogonal directions.

## 6.4 Orthogonal surface views [i](#)

### 6.4.1 Primary map

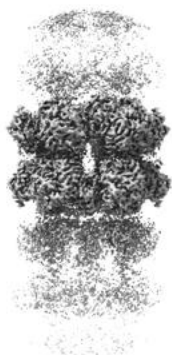

X

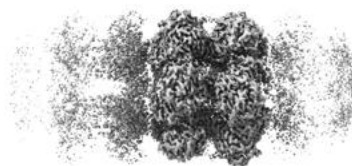

Y



Z

The images above show the 3D surface view of the map at the recommended contour level 0.4. These images, in conjunction with the slice images, may facilitate assessment of whether an appropriate contour level has been provided.

## 6.5 Mask visualisation

This section was not generated. No masks/segmentation were deposited.

## 7 Map analysis [i](#)

This section contains the results of statistical analysis of the map.

### 7.1 Map-value distribution [i](#)

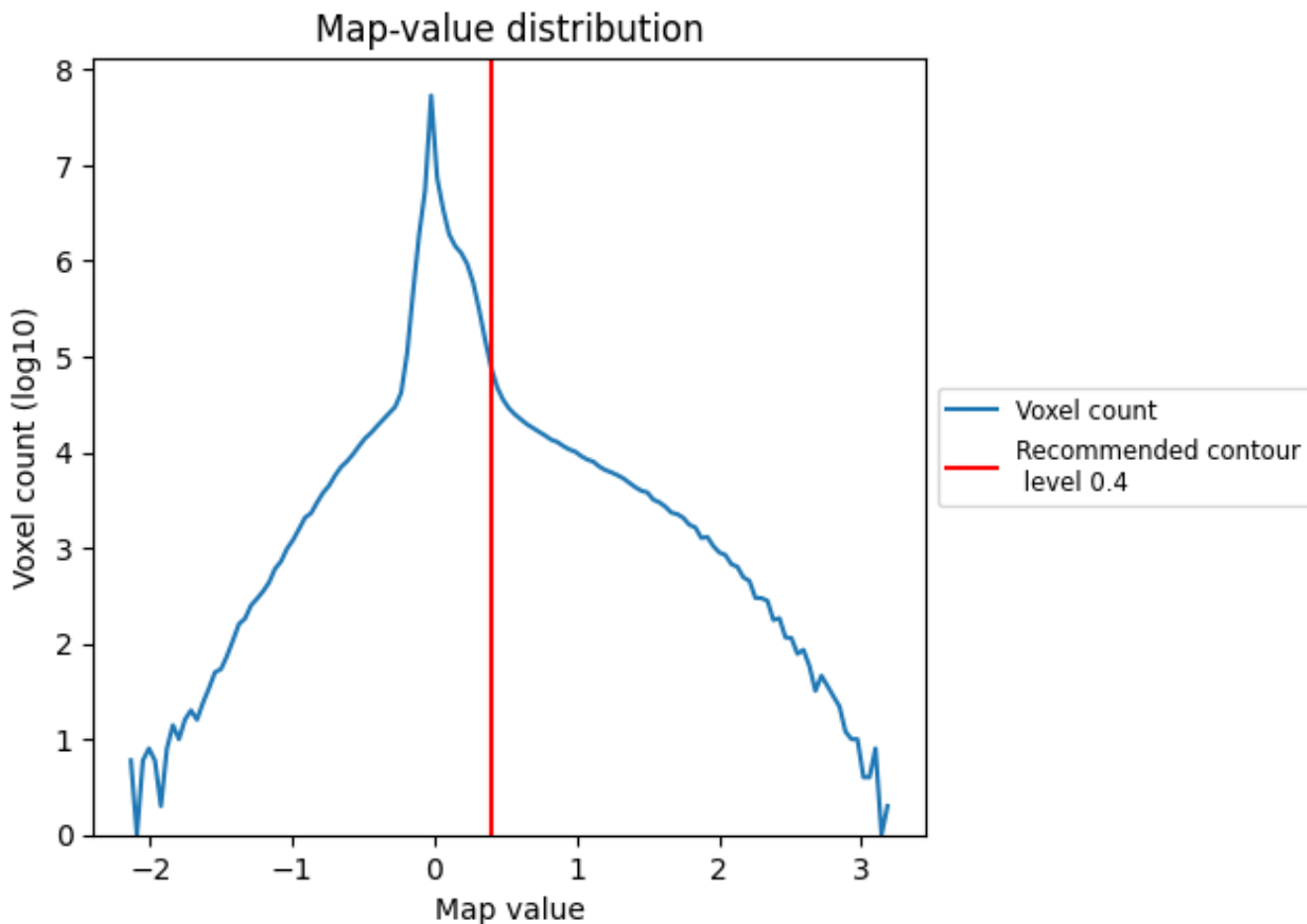

The map-value distribution is plotted in 128 intervals along the x-axis. The y-axis is logarithmic. A spike in this graph at zero usually indicates that the volume has been masked.

## 7.2 Volume estimate [i](#)

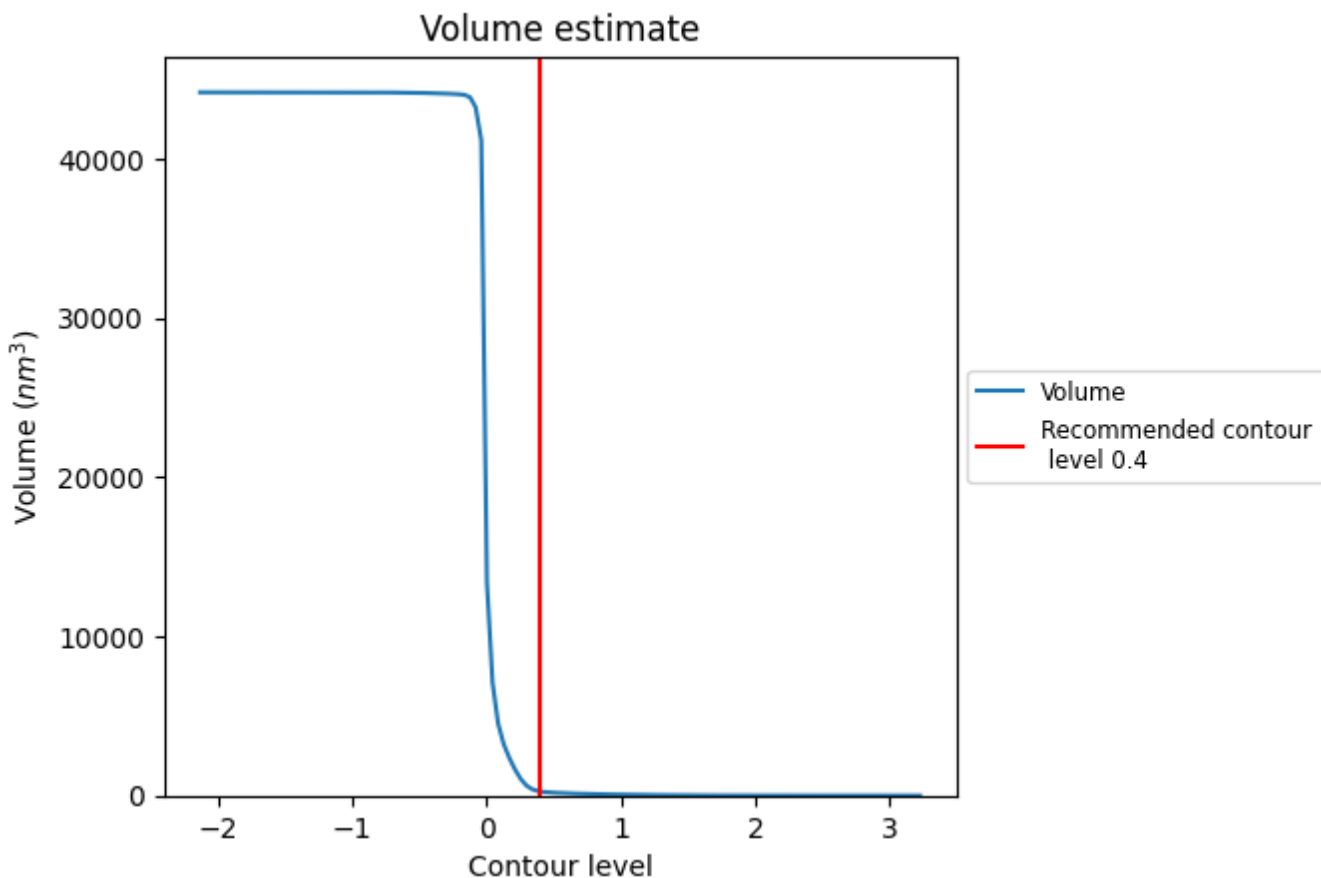

The volume at the recommended contour level is 259  $\text{nm}^3$ ; this corresponds to an approximate mass of 234 kDa.

The volume estimate graph shows how the enclosed volume varies with the contour level. The recommended contour level is shown as a vertical line and the intersection between the line and the curve gives the volume of the enclosed surface at the given level.



### 7.3 Rotationally averaged power spectrum [i](#)

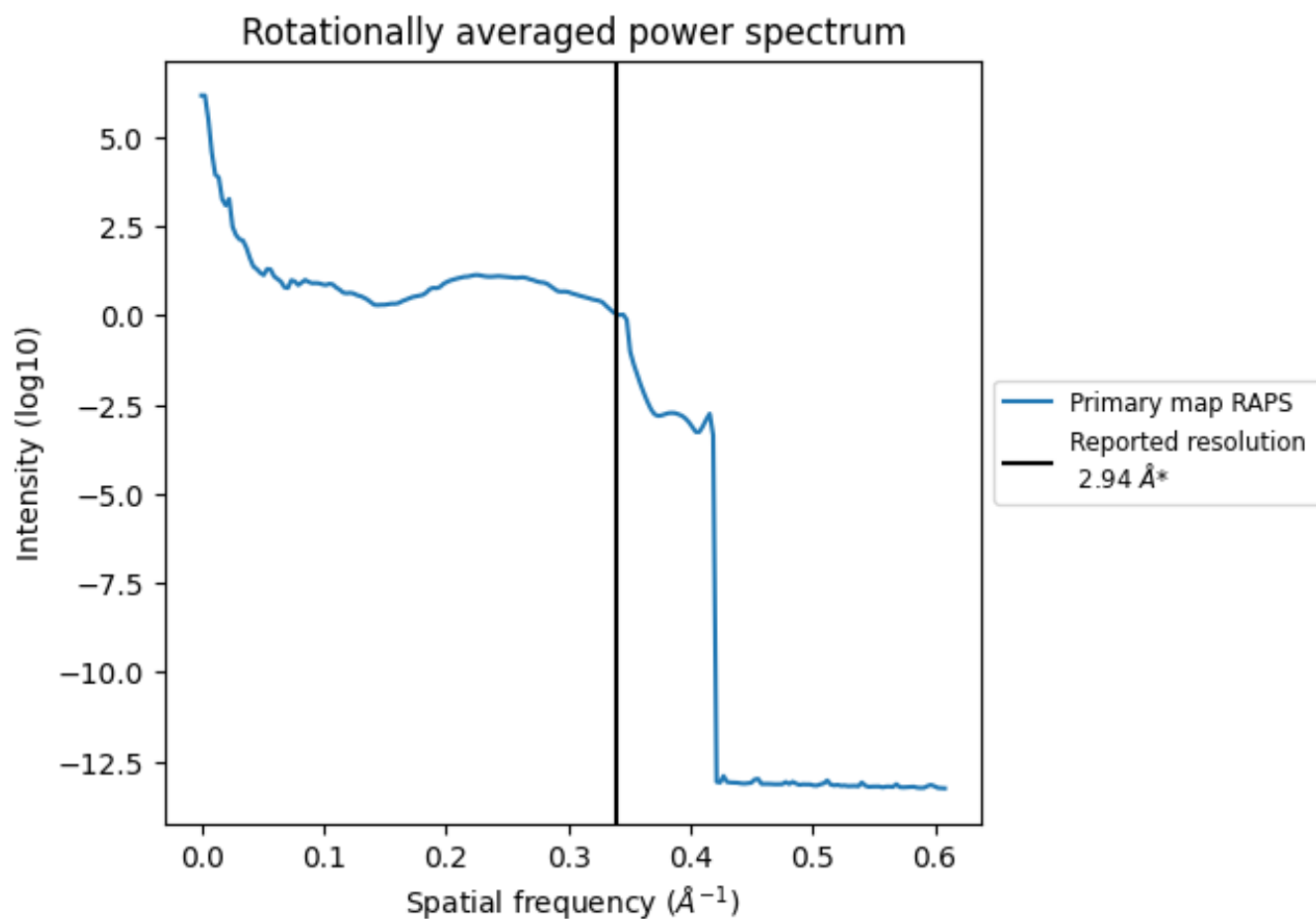

\*Reported resolution corresponds to spatial frequency of  $0.340 \text{\AA}^{-1}$

## 8 Fourier-Shell correlation

This section was not generated. No FSC curve or half-maps provided.

## 9 Map-model fit [i](#)

This section contains information regarding the fit between EMDB map EMD-32352 and PDB model 7W85. Per-residue inclusion information can be found in section 3 on page 7.

### 9.1 Map-model overlay [i](#)

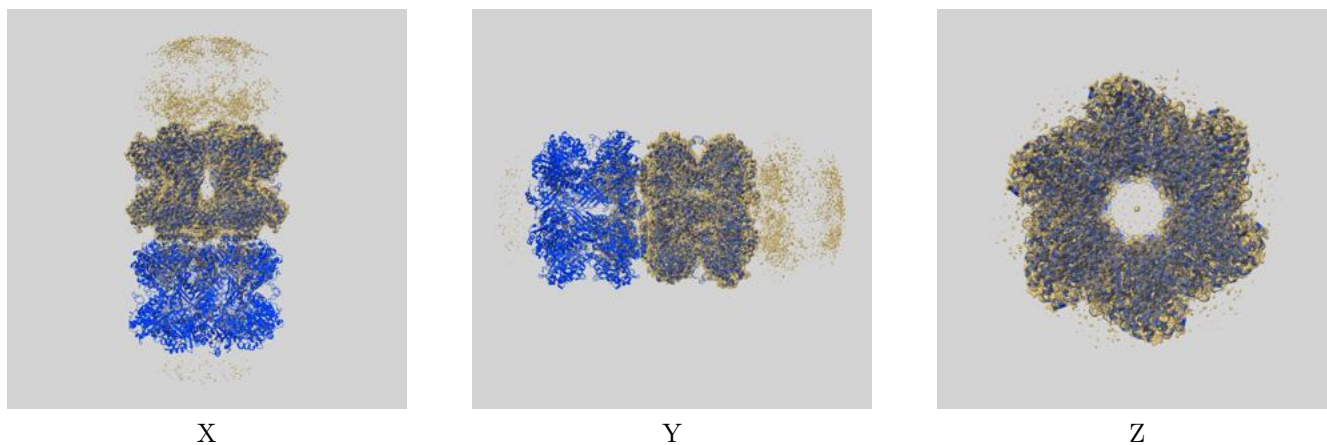

The images above show the 3D surface view of the map at the recommended contour level 0.4 at 50% transparency in yellow overlaid with a ribbon representation of the model coloured in blue. These images allow for the visual assessment of the quality of fit between the atomic model and the map.

## 9.2 Q-score mapped to coordinate model [i](#)

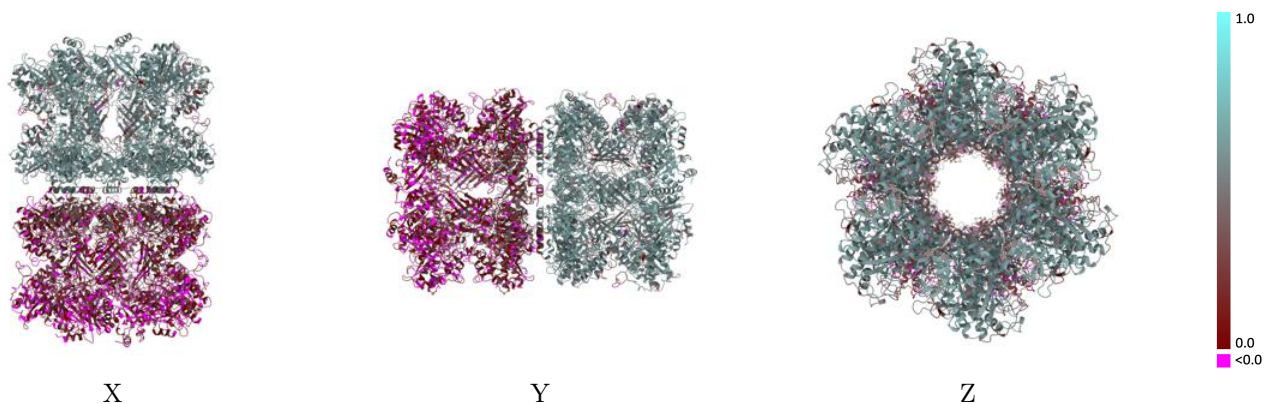

The images above show the model with each residue coloured according to its Q-score. This shows their resolvability in the map with higher Q-score values reflecting better resolvability. Please note: Q-score is calculating the resolvability of atoms, and thus high values are only expected at resolutions at which atoms can be resolved. Low Q-score values may therefore be expected for many entries.

## 9.3 Atom inclusion mapped to coordinate model [i](#)

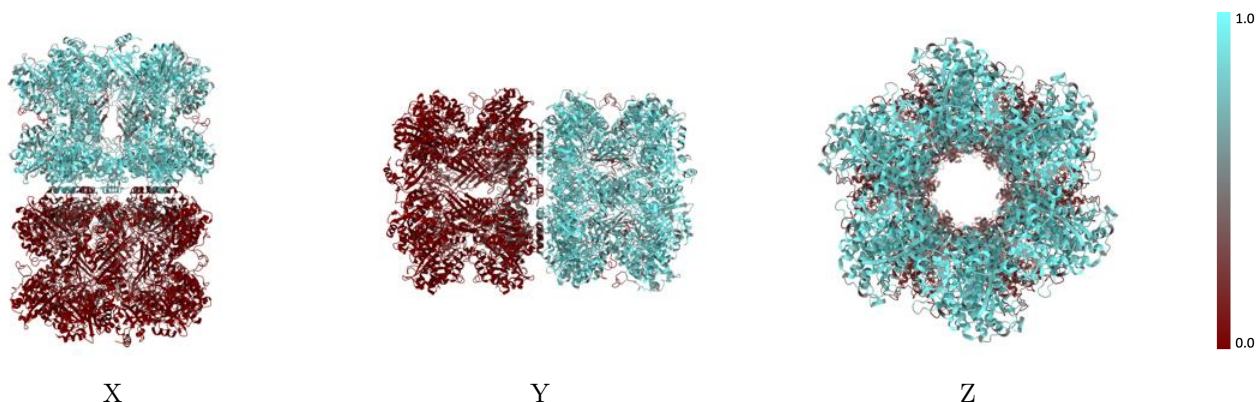

The images above show the model with each residue coloured according to its atom inclusion. This shows to what extent they are inside the map at the recommended contour level (0.4).



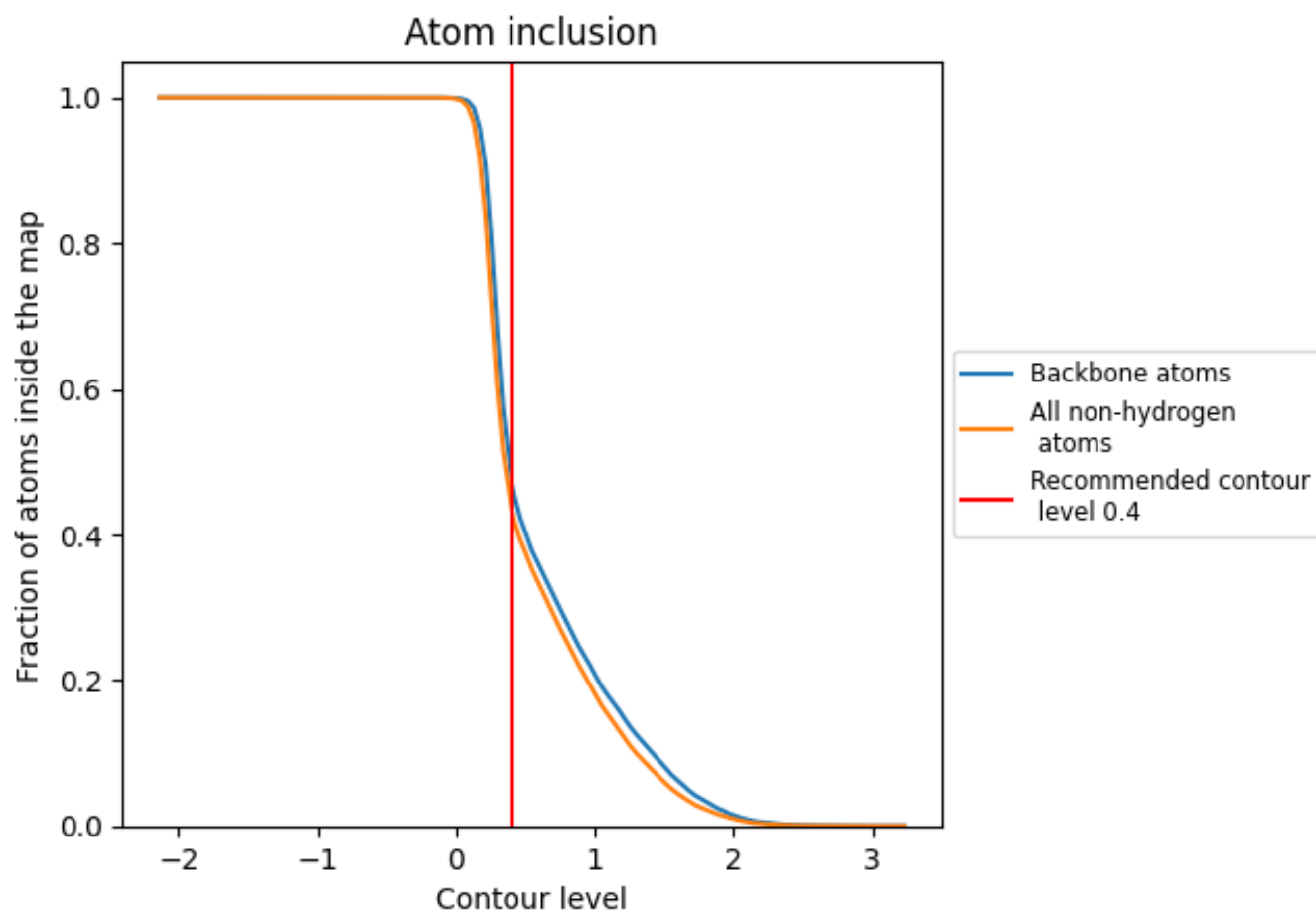















































## 9.4 Atom inclusion [i](#)



At the recommended contour level, 47% of all backbone atoms, 43% of all non-hydrogen atoms, are inside the map.

## 9.5 Map-model fit summary

The table lists the average atom inclusion at the recommended contour level (0.4) and Q-score for the entire model and for each chain.

Chain	Atom inclusion	Q-score
All	 0.4338	 0.3450
A	 0.8082	 0.5480
B	 0.8085	 0.5480
C	 0.8064	 0.5470
D	 0.8094	 0.5480
E	 0.8091	 0.5460
F	 0.8082	 0.5470
G	 0.8265	 0.5620
H	 0.8253	 0.5610
I	 0.8250	 0.5610
J	 0.8262	 0.5600
K	 0.8244	 0.5600
L	 0.8265	 0.5610
M	 0.0902	 0.1840
N	 0.0887	 0.1830
O	 0.0878	 0.1820
P	 0.0899	 0.1820
Q	 0.0884	 0.1850
R	 0.0881	 0.1850
S	 0.0126	 0.0850
U	 0.0132	 0.0880
V	 0.0126	 0.0860
W	 0.0114	 0.0850
X	 0.0129	 0.0870
Y	 0.0114	 0.0880

