



Full wwPDB X-ray Structure Validation Report ⓘ

Feb 21, 2024 – 08:33 AM EST

PDB ID : 4XDS
Title : Deoxyguanosinetriphosphate Triphosphohydrolase from Escherichia coli with Nickel
Authors : Singh, D.; Gawel, D.; Itsko, M.; Krahn, J.M.; London, R.E.; Schaaper, R.M.
Deposited on : 2014-12-19
Resolution : 3.35 Å(reported)

This is a Full wwPDB X-ray Structure Validation Report for a publicly released PDB entry.

We welcome your comments at validation@mail.wwpdb.org

A user guide is available at

<https://www.wwpdb.org/validation/2017/XrayValidationReportHelp>

with specific help available everywhere you see the ⓘ symbol.

The types of validation reports are described at

<http://www.wwpdb.org/validation/2017/FAQs#types>.

The following versions of software and data (see [references ⓘ](#)) were used in the production of this report:

MolProbity : 4.02b-467
Mogul : 1.8.5 (274361), CSD as541be (2020)
Xtriage (Phenix) : 1.13
EDS : 2.36
Percentile statistics : 20191225.v01 (using entries in the PDB archive December 25th 2019)
Refmac : 5.8.0158
CCP4 : 7.0.044 (Gargrove)
Ideal geometry (proteins) : Engh & Huber (2001)
Ideal geometry (DNA, RNA) : Parkinson et al. (1996)
Validation Pipeline (wwPDB-VP) : 2.36

1 Overall quality at a glance i

The following experimental techniques were used to determine the structure:

X-RAY DIFFRACTION

The reported resolution of this entry is 3.35 Å.

Percentile scores (ranging between 0-100) for global validation metrics of the entry are shown in the following graphic. The table shows the number of entries on which the scores are based.

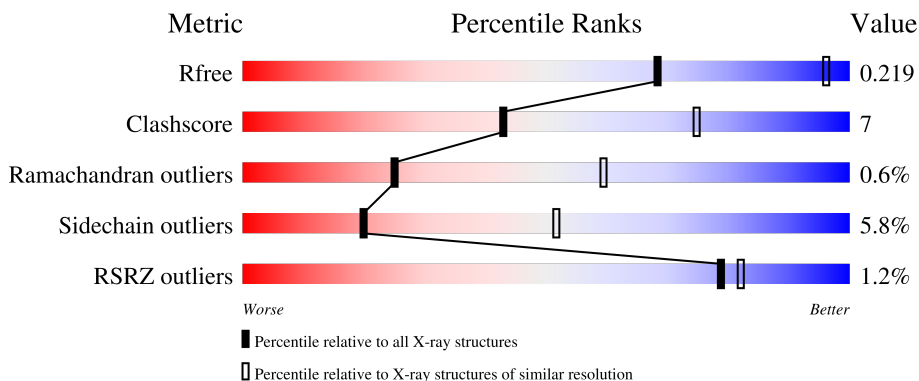

Metric	Whole archive (#Entries)	Similar resolution (#Entries, resolution range(Å))
R_{free}	130704	1558 (3.42-3.30)
Clashscore	141614	1627 (3.42-3.30)
Ramachandran outliers	138981	1599 (3.42-3.30)
Sidechain outliers	138945	1598 (3.42-3.30)
RSRZ outliers	127900	1507 (3.42-3.30)

The table below summarises the geometric issues observed across the polymeric chains and their fit to the electron density. The red, orange, yellow and green segments of the lower bar indicate the fraction of residues that contain outliers for ≥ 3 , 2, 1 and 0 types of geometric quality criteria respectively. A grey segment represents the fraction of residues that are not modelled. The numeric value for each fraction is indicated below the corresponding segment, with a dot representing fractions $\leq 5\%$. The upper red bar (where present) indicates the fraction of residues that have poor fit to the electron density. The numeric value is given above the bar.

Mol	Chain	Length	Quality of chain
1	A	505	 3% 78% 18% ..
1	B	505	 2% 81% 16% ..
1	C	505	 % 79% 19% .
1	D	505	 % 76% 20% ..
1	E	505	 % 76% 21% .

Continued on next page...

Continued from previous page...

Mol	Chain	Length	Quality of chain
1	F	505	 73% 23%

The following table lists non-polymeric compounds, carbohydrate monomers and non-standard residues in protein, DNA, RNA chains that are outliers for geometric or electron-density-fit criteria:

Mol	Type	Chain	Res	Chirality	Geometry	Clashes	Electron density
3	SO4	A	610	-	-	-	X
3	SO4	B	609	-	-	-	X
3	SO4	C	614	-	-	-	X
3	SO4	D	607	-	-	-	X
3	SO4	E	610	-	-	-	X
3	SO4	E	612	-	-	-	X
3	SO4	E	613	-	-	-	X
3	SO4	F	610	-	-	-	X
3	SO4	F	612	-	-	-	X
3	SO4	F	613	-	-	-	X
3	SO4	F	615	-	-	-	X
3	SO4	F	617	-	-	-	X
3	SO4	F	620	-	-	-	X

2 Entry composition [i](#)

There are 4 unique types of molecules in this entry. The entry contains 24538 atoms, of which 0 are hydrogens and 0 are deuteriums.

In the tables below, the ZeroOcc column contains the number of atoms modelled with zero occupancy, the AltConf column contains the number of residues with at least one atom in alternate conformation and the Trace column contains the number of residues modelled with at most 2 atoms.

- Molecule 1 is a protein called Deoxyguanosinetriphosphate triphosphohydrolase.

Mol	Chain	Residues	Atoms					ZeroOcc	AltConf	Trace
			Total	C	N	O	S			
1	A	492	3952	2533	692	712	15	0	0	0
1	B	494	3981	2554	698	713	16	0	0	0
1	C	503	4062	2598	720	727	17	0	0	0
1	D	494	4010	2571	704	719	16	0	0	0
1	E	503	4086	2614	720	736	16	0	0	0
1	F	494	4028	2582	713	717	16	0	0	0

- Molecule 2 is NICKEL (II) ION (three-letter code: NI) (formula: Ni).

Mol	Chain	Residues	Atoms		ZeroOcc	AltConf
2	A	1	Total	Ni	0	0
			1	1		
2	B	1	Total	Ni	0	0
			1	1		
2	C	1	Total	Ni	0	0
			1	1		
2	D	1	Total	Ni	0	0
			1	1		
2	E	1	Total	Ni	0	0
			1	1		
2	F	1	Total	Ni	0	0
			1	1		

- Molecule 3 is SULFATE ION (three-letter code: SO4) (formula: O₄S).



Mol	Chain	Residues	Atoms			ZeroOcc	AltConf
3	A	1	Total	O	S	0	0
			5	4	1		
3	A	1	Total	O	S	0	0
			5	4	1		
3	A	1	Total	O	S	0	0
			5	4	1		
3	A	1	Total	O	S	0	0
			5	4	1		
3	A	1	Total	O	S	0	0
			5	4	1		
3	A	1	Total	O	S	0	0
			5	4	1		
3	A	1	Total	O	S	0	0
			5	4	1		
3	A	1	Total	O	S	0	0
			5	4	1		
3	B	1	Total	O	S	0	0
			5	4	1		
3	B	1	Total	O	S	0	0
			5	4	1		
3	B	1	Total	O	S	0	0
			5	4	1		
3	B	1	Total	O	S	0	0
			5	4	1		

Continued on next page...

Continued from previous page...

Mol	Chain	Residues	Atoms			ZeroOcc	AltConf
3	B	1	Total	O	S	0	0
			5	4	1		
3	B	1	Total	O	S	0	0
			5	4	1		
3	B	1	Total	O	S	0	0
			5	4	1		
3	B	1	Total	O	S	0	0
			5	4	1		
3	C	1	Total	O	S	0	0
			5	4	1		
3	C	1	Total	O	S	0	0
			5	4	1		
3	C	1	Total	O	S	0	0
			5	4	1		
3	C	1	Total	O	S	0	0
			5	4	1		
3	C	1	Total	O	S	0	0
			5	4	1		
3	C	1	Total	O	S	0	0
			5	4	1		
3	C	1	Total	O	S	0	0
			5	4	1		
3	C	1	Total	O	S	0	0
			5	4	1		
3	C	1	Total	O	S	0	0
			5	4	1		
3	C	1	Total	O	S	0	0
			5	4	1		
3	C	1	Total	O	S	0	0
			5	4	1		
3	C	1	Total	O	S	0	0
			5	4	1		
3	D	1	Total	O	S	0	0
			5	4	1		
3	D	1	Total	O	S	0	0
			5	4	1		
3	D	1	Total	O	S	0	0
			5	4	1		

Continued on next page...

Continued from previous page...

Mol	Chain	Residues	Atoms			ZeroOcc	AltConf
			Total	O	S		
3	D	1	Total 5	O 4	S 1	0	0
3	D	1	Total 5	O 4	S 1	0	0
3	D	1	Total 5	O 4	S 1	0	0
3	D	1	Total 5	O 4	S 1	0	0
3	D	1	Total 5	O 4	S 1	0	0
3	D	1	Total 5	O 4	S 1	0	0
3	D	1	Total 5	O 4	S 1	0	0
3	D	1	Total 5	O 4	S 1	0	0
3	D	1	Total 5	O 4	S 1	0	0
3	D	1	Total 5	O 4	S 1	0	0
3	D	1	Total 5	O 4	S 1	0	0
3	D	1	Total 5	O 4	S 1	0	0
3	D	1	Total 5	O 4	S 1	0	0
3	E	1	Total 5	O 4	S 1	0	0
3	E	1	Total 5	O 4	S 1	0	0
3	E	1	Total 5	O 4	S 1	0	0
3	E	1	Total 5	O 4	S 1	0	0
3	E	1	Total 5	O 4	S 1	0	0
3	E	1	Total 5	O 4	S 1	0	0
3	E	1	Total 5	O 4	S 1	0	0
3	E	1	Total 5	O 4	S 1	0	0
3	E	1	Total 5	O 4	S 1	0	0
3	E	1	Total 5	O 4	S 1	0	0
3	E	1	Total 5	O 4	S 1	0	0
3	E	1	Total 5	O 4	S 1	0	0

Continued on next page...

Continued from previous page...

Mol	Chain	Residues	Atoms			ZeroOcc	AltConf
3	E	1	Total	O	S	0	0
			5	4	1		
3	E	1	Total	O	S	0	0
			5	4	1		
3	E	1	Total	O	S	0	0
			5	4	1		
3	E	1	Total	O	S	0	0
			5	4	1		
3	F	1	Total	O	S	0	0
			5	4	1		
3	F	1	Total	O	S	0	0
			5	4	1		
3	F	1	Total	O	S	0	0
			5	4	1		
3	F	1	Total	O	S	0	0
			5	4	1		
3	F	1	Total	O	S	0	0
			5	4	1		
3	F	1	Total	O	S	0	0
			5	4	1		
3	F	1	Total	O	S	0	0
			5	4	1		
3	F	1	Total	O	S	0	0
			5	4	1		
3	F	1	Total	O	S	0	0
			5	4	1		
3	F	1	Total	O	S	0	0
			5	4	1		
3	F	1	Total	O	S	0	0
			5	4	1		
3	F	1	Total	O	S	0	0
			5	4	1		

Continued on next page...

Continued from previous page...

Mol	Chain	Residues	Atoms			ZeroOcc	AltConf
3	F	1	Total	O	S	0	0
			5	4	1		
3	F	1	Total	O	S	0	0
			5	4	1		

- Molecule 4 is water.

Mol	Chain	Residues	Atoms		ZeroOcc	AltConf
4	A	3	Total	O	0	0
			3	3		
4	B	3	Total	O	0	0
			3	3		
4	C	3	Total	O	0	0
			3	3		
4	D	3	Total	O	0	0
			3	3		
4	E	3	Total	O	0	0
			3	3		
4	F	3	Total	O	0	0
			3	3		

3 Residue-property plots [i](#)

These plots are drawn for all protein, RNA, DNA and oligosaccharide chains in the entry. The first graphic for a chain summarises the proportions of the various outlier classes displayed in the second graphic. The second graphic shows the sequence view annotated by issues in geometry and electron density. Residues are color-coded according to the number of geometric quality criteria for which they contain at least one outlier: green = 0, yellow = 1, orange = 2 and red = 3 or more. A red dot above a residue indicates a poor fit to the electron density ($RSRZ > 2$). Stretches of 2 or more consecutive residues without any outlier are shown as a green connector. Residues present in the sample, but not in the model, are shown in grey.

- Molecule 1: Deoxyguanosinetriphosphate triphosphohydrolase

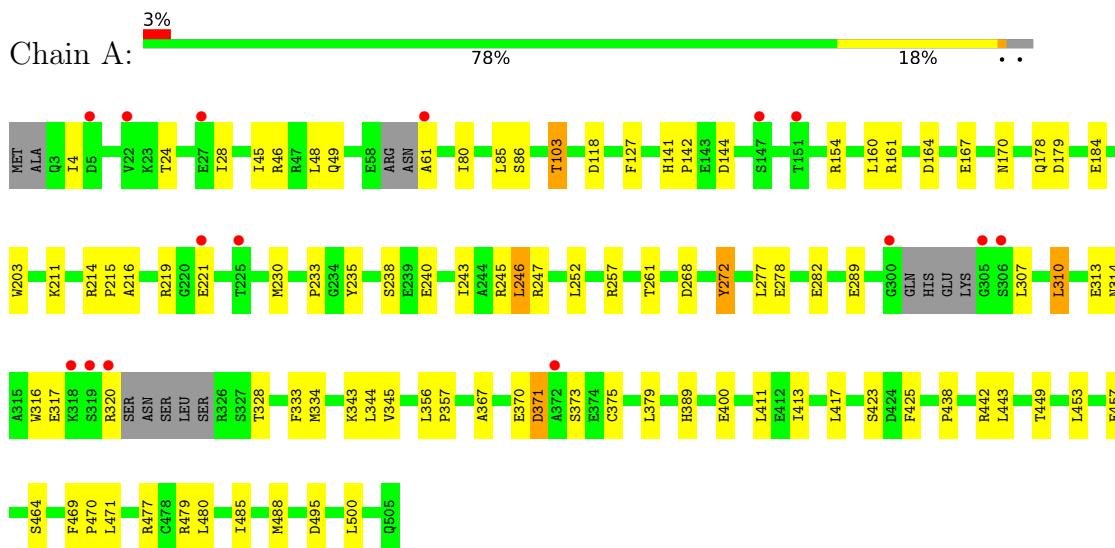

- Molecule 1: Deoxyguanosinetriphosphate triphosphohydrolase

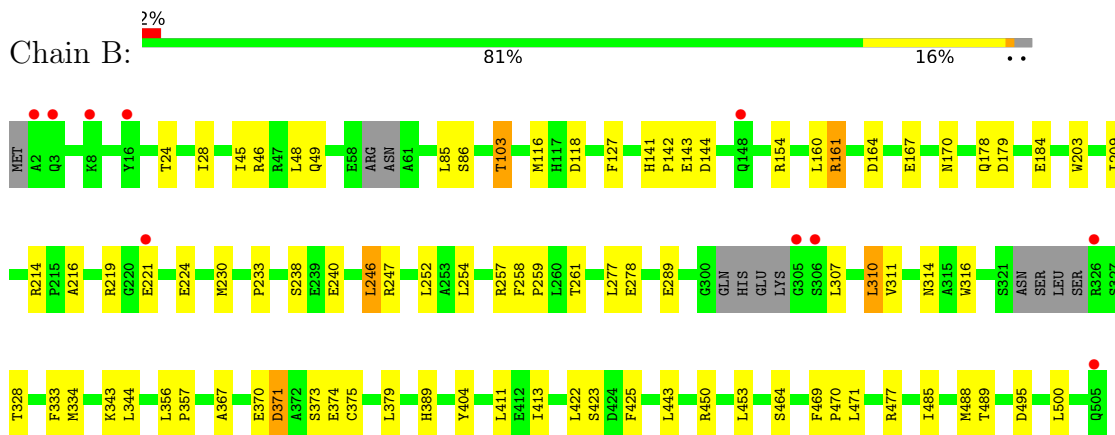

- Molecule 1: Deoxyguanosinetriphosphate triphosphohydrolase

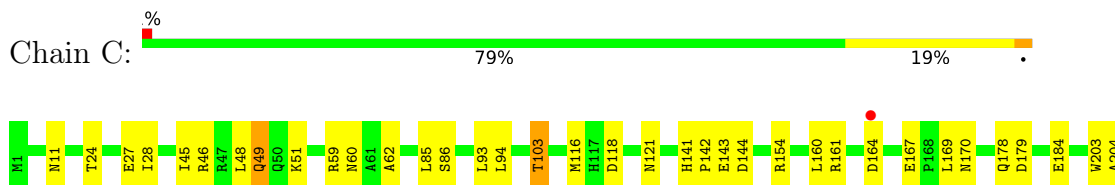

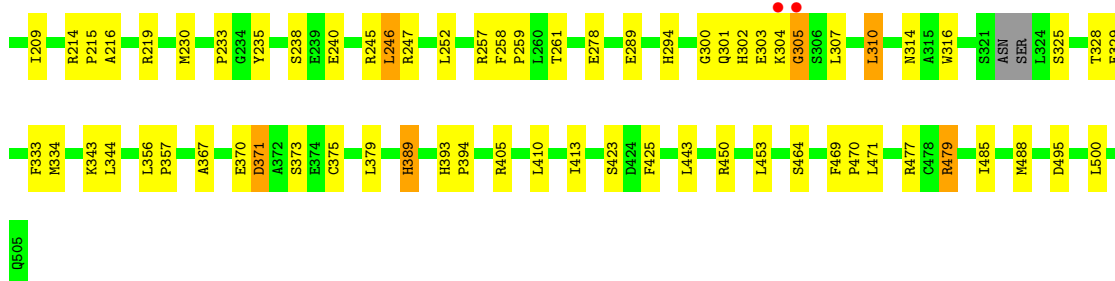

- Molecule 1: Deoxyguanosinetriphosphate triphosphohydrolase

Chain D: 76% 20%

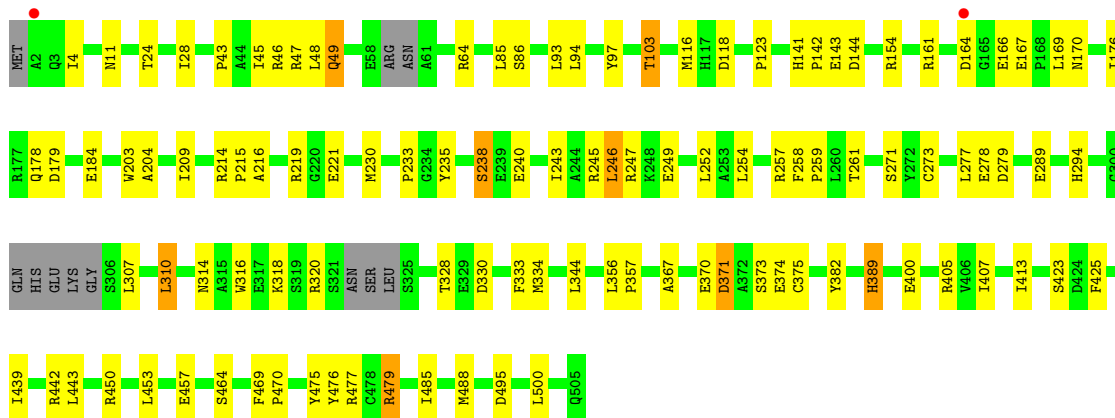

- Molecule 1: Deoxyguanosinetriphosphate triphosphohydrolase

Chain E: 76% 21%

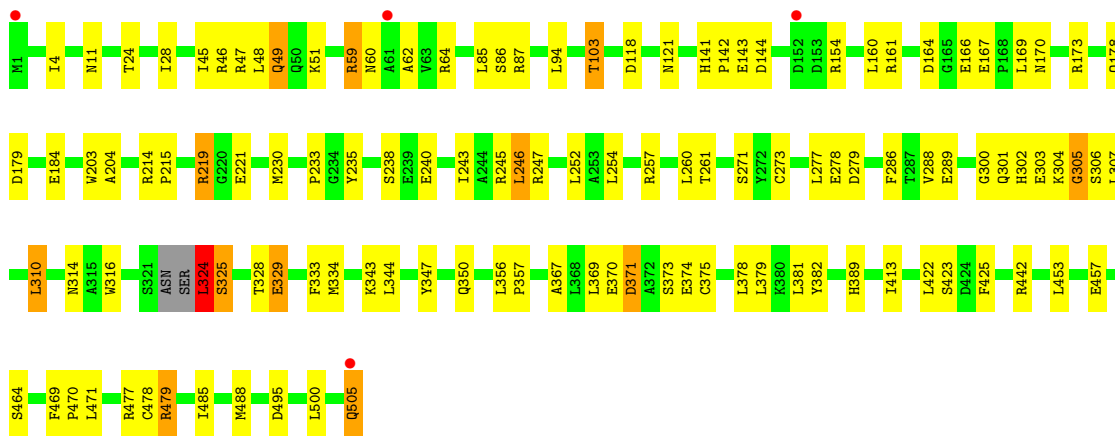

- Molecule 1: Deoxyguanosinetriphosphate triphosphohydrolase

Chain F: 73% 23%

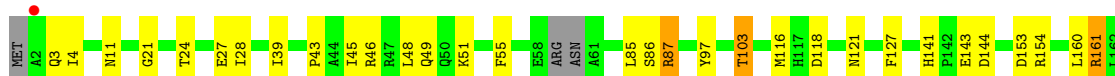

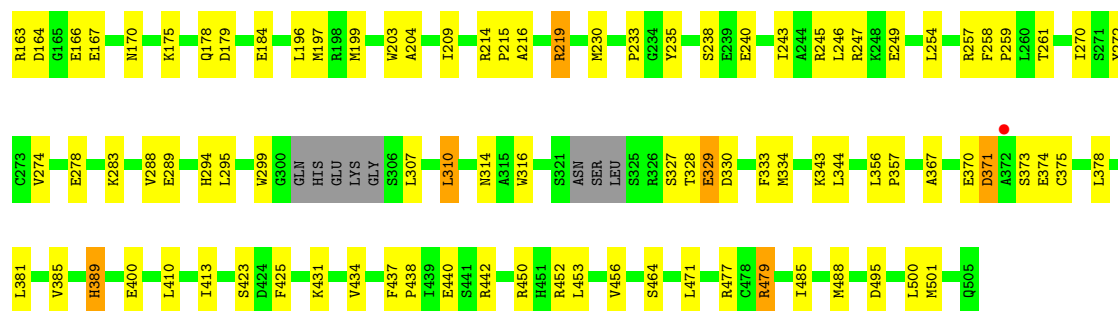

4 Data and refinement statistics

Property	Value	Source
Space group	P 43 21 2	Depositor
Cell constants a, b, c, α , β , γ	189.80Å 189.80Å 296.80Å 90.00° 90.00° 90.00°	Depositor
Resolution (Å)	19.99 – 3.35 20.02 – 3.35	Depositor EDS
% Data completeness (in resolution range)	85.2 (19.99-3.35) 97.5 (20.02-3.35)	Depositor EDS
R_{merge}	0.15	Depositor
R_{sym}	(Not available)	Depositor
$\langle I/\sigma(I) \rangle$ ¹	2.57 (at 3.36Å)	Xtrriage
Refinement program	PHENIX (phenix.refine: 1.9_1692)	Depositor
R, R_{free}	0.172 , 0.209 0.188 , 0.219	Depositor DCC
R_{free} test set	3889 reflections (5.13%)	wwPDB-VP
Wilson B-factor (Å ²)	86.4	Xtrriage
Anisotropy	0.078	Xtrriage
Bulk solvent k_{sol} (e/Å ³), B_{sol} (Å ²)	0.27 , 39.9	EDS
L-test for twinning ²	$\langle L \rangle = 0.55$, $\langle L^2 \rangle = 0.39$	Xtrriage
Estimated twinning fraction	No twinning to report.	Xtrriage
F_o, F_c correlation	0.94	EDS
Total number of atoms	24538	wwPDB-VP
Average B, all atoms (Å ²)	96.0	wwPDB-VP

Xtrriage's analysis on translational NCS is as follows: *The largest off-origin peak in the Patterson function is 2.05% of the height of the origin peak. No significant pseudotranslation is detected.*

¹Intensities estimated from amplitudes.

²Theoretical values of $\langle |L| \rangle$, $\langle L^2 \rangle$ for acentric reflections are 0.5, 0.333 respectively for untwinned datasets, and 0.375, 0.2 for perfectly twinned datasets.

5 Model quality [i](#)

5.1 Standard geometry [i](#)

Bond lengths and bond angles in the following residue types are not validated in this section: NI, SO4

The Z score for a bond length (or angle) is the number of standard deviations the observed value is removed from the expected value. A bond length (or angle) with $|Z| > 5$ is considered an outlier worth inspection. RMSZ is the root-mean-square of all Z scores of the bond lengths (or angles).

Mol	Chain	Bond lengths		Bond angles	
		RMSZ	# Z >5	RMSZ	# Z >5
1	A	0.44	0/4051	0.55	0/5499
1	B	0.47	0/4079	0.57	0/5529
1	C	0.55	0/4162	0.62	0/5642
1	D	0.56	0/4109	0.63	0/5568
1	E	0.56	1/4187 (0.0%)	0.62	1/5673 (0.0%)
1	F	0.57	0/4127	0.64	0/5587
All	All	0.53	1/24715 (0.0%)	0.61	1/33498 (0.0%)

All (1) bond length outliers are listed below:

Mol	Chain	Res	Type	Atoms	Z	Observed(Å)	Ideal(Å)
1	E	478	CYS	CB-SG	-6.08	1.72	1.82

All (1) bond angle outliers are listed below:

Mol	Chain	Res	Type	Atoms	Z	Observed(°)	Ideal(°)
1	E	324	LEU	CA-CB-CG	5.11	127.06	115.30

There are no chirality outliers.

There are no planarity outliers.

5.2 Too-close contacts [i](#)

In the following table, the Non-H and H(model) columns list the number of non-hydrogen atoms and hydrogen atoms in the chain respectively. The H(added) column lists the number of hydrogen atoms added and optimized by MolProbity. The Clashes column lists the number of clashes within the asymmetric unit, whereas Symm-Clashes lists symmetry-related clashes.

Mol	Chain	Non-H	H(model)	H(added)	Clashes	Symm-Clashes
1	A	3952	0	3785	51	0
1	B	3981	0	3844	42	0
1	C	4062	0	3946	52	0
1	D	4010	0	3890	62	0
1	E	4086	0	3974	57	0
1	F	4028	0	3938	68	0
2	A	1	0	0	0	0
2	B	1	0	0	0	0
2	C	1	0	0	0	0
2	D	1	0	0	0	0
2	E	1	0	0	0	0
2	F	1	0	0	0	0
3	A	50	0	0	3	0
3	B	40	0	0	1	0
3	C	70	0	0	2	0
3	D	65	0	0	2	0
3	E	75	0	0	3	0
3	F	95	0	0	5	0
4	A	3	0	0	0	0
4	B	3	0	0	0	0
4	C	3	0	0	0	0
4	D	3	0	0	0	0
4	E	3	0	0	0	0
4	F	3	0	0	0	0
All	All	24538	0	23377	324	0

The all-atom clashscore is defined as the number of clashes found per 1000 atoms (including hydrogen atoms). The all-atom clashscore for this structure is 7.

All (324) close contacts within the same asymmetric unit are listed below, sorted by their clash magnitude.

Atom-1	Atom-2	Interatomic distance (Å)	Clash overlap (Å)
1:F:247:ARG:NH1	3:F:609:SO4:O3	2.14	0.78
1:C:247:ARG:NH1	3:C:610:SO4:O4	2.17	0.77
1:C:485:ILE:HD13	1:C:488:MET:HE3	1.67	0.76
1:F:485:ILE:HD13	1:F:488:MET:HE3	1.66	0.76
1:A:371:ASP:HB3	1:A:373:SER:H	1.51	0.75
1:C:450:ARG:NH2	1:D:330:ASP:OD1	2.19	0.75
1:B:485:ILE:HD13	1:B:488:MET:HE3	1.69	0.74
1:B:371:ASP:HB3	1:B:373:SER:H	1.53	0.74
1:E:310:LEU:O	1:E:314:ASN:HB3	1.88	0.73
1:A:485:ILE:HD13	1:A:488:MET:HE3	1.70	0.73

Continued on next page...

Continued from previous page...

Atom-1	Atom-2	Interatomic distance (Å)	Clash overlap (Å)
1:E:371:ASP:HB3	1:E:373:SER:H	1.53	0.73
1:C:371:ASP:HB3	1:C:373:SER:H	1.54	0.72
1:F:371:ASP:HB3	1:F:373:SER:H	1.53	0.72
1:F:184:GLU:HG3	1:F:233:PRO:HD2	1.70	0.72
1:D:371:ASP:HB3	1:D:373:SER:H	1.54	0.72
1:A:310:LEU:O	1:A:314:ASN:HB3	1.90	0.72
1:E:247:ARG:NH1	3:E:616:SO4:O1	2.24	0.71
1:C:184:GLU:HG3	1:C:233:PRO:HD2	1.72	0.71
1:D:485:ILE:HD13	1:D:488:MET:HE3	1.73	0.70
1:C:310:LEU:O	1:C:314:ASN:HB3	1.92	0.70
1:D:184:GLU:HG3	1:D:233:PRO:HD2	1.74	0.69
1:E:85:LEU:HD13	1:E:103:THR:HG22	1.74	0.69
1:B:310:LEU:O	1:B:314:ASN:HB3	1.92	0.69
1:D:310:LEU:O	1:D:314:ASN:HB3	1.92	0.69
1:F:294:HIS:CD2	1:F:389:HIS:HD2	2.13	0.67
1:F:310:LEU:O	1:F:314:ASN:HB3	1.93	0.67
1:C:303:GLU:O	1:C:305:GLY:N	2.27	0.67
1:A:85:LEU:HD13	1:A:103:THR:HG22	1.75	0.67
1:C:85:LEU:HD13	1:C:103:THR:HG22	1.76	0.66
1:E:303:GLU:O	1:E:305:GLY:N	2.29	0.65
1:D:214:ARG:NH2	3:D:612:SO4:O2	2.29	0.65
1:B:85:LEU:HD13	1:B:103:THR:HG22	1.78	0.65
1:C:344:LEU:HD22	1:C:375:CYS:HB3	1.80	0.64
1:F:163:ARG:NH2	3:F:616:SO4:O3	2.30	0.64
1:E:184:GLU:HG3	1:E:233:PRO:HD2	1.80	0.64
1:E:485:ILE:HD13	1:E:488:MET:HE3	1.80	0.64
1:D:85:LEU:HD13	1:D:103:THR:HG22	1.81	0.63
1:D:405:ARG:NH1	1:F:501:MET:SD	2.67	0.63
1:A:184:GLU:HG3	1:A:233:PRO:HD2	1.80	0.62
1:E:64:ARG:NH1	1:E:279:ASP:OD2	2.32	0.62
1:C:46:ARG:O	1:C:49:GLN:N	2.33	0.61
1:A:307:LEU:HD11	1:A:343:LYS:HG2	1.82	0.61
1:B:257:ARG:HD2	1:B:261:THR:HG21	1.82	0.61
1:F:85:LEU:HD13	1:F:103:THR:HG22	1.83	0.60
1:B:184:GLU:HG3	1:B:233:PRO:HD2	1.83	0.60
1:C:300:GLY:O	1:C:302:HIS:N	2.30	0.60
1:E:300:GLY:O	1:E:302:HIS:N	2.30	0.60
1:D:179:ASP:OD2	1:D:479:ARG:NH2	2.34	0.59
1:D:344:LEU:HD22	1:D:375:CYS:HB3	1.84	0.59
1:E:344:LEU:HD22	1:E:375:CYS:HB3	1.84	0.59
1:D:214:ARG:HB2	1:D:230:MET:HB3	1.84	0.59

Continued on next page...

Continued from previous page...

Atom-1	Atom-2	Interatomic distance (Å)	Clash overlap (Å)
1:B:46:ARG:O	1:B:49:GLN:N	2.36	0.59
1:E:214:ARG:HB2	1:E:230:MET:HB3	1.85	0.58
1:B:289:GLU:HG3	1:B:316:TRP:HH2	1.69	0.57
1:D:294:HIS:CD2	1:D:389:HIS:HD2	2.22	0.57
1:F:344:LEU:HD22	1:F:375:CYS:HB3	1.86	0.57
1:A:344:LEU:HD22	1:A:375:CYS:HB3	1.87	0.56
1:B:307:LEU:HD11	1:B:343:LYS:HG2	1.87	0.56
1:A:214:ARG:HB2	1:A:230:MET:HB3	1.88	0.55
1:F:257:ARG:HD2	1:F:261:THR:HG21	1.89	0.55
1:F:294:HIS:CD2	1:F:389:HIS:CD2	2.94	0.55
1:D:289:GLU:HG3	1:D:316:TRP:HH2	1.72	0.55
1:A:45:ILE:O	1:A:48:LEU:HB2	2.06	0.55
1:C:160:LEU:HD23	1:C:471:LEU:HD22	1.89	0.54
1:C:289:GLU:HG3	1:C:316:TRP:HH2	1.73	0.54
1:B:45:ILE:O	1:B:48:LEU:HB2	2.08	0.54
1:F:144:ASP:OD2	1:F:154:ARG:HB2	2.06	0.54
1:A:289:GLU:HG3	1:A:316:TRP:HH2	1.72	0.54
1:F:289:GLU:HG3	1:F:316:TRP:HH2	1.73	0.54
1:A:211:LYS:NZ	3:A:602:SO4:O1	2.31	0.53
1:C:257:ARG:HD2	1:C:261:THR:HG21	1.89	0.53
1:C:307:LEU:HD11	1:C:343:LYS:HG2	1.90	0.53
1:F:214:ARG:HB2	1:F:230:MET:HB3	1.90	0.53
1:B:344:LEU:HD22	1:B:375:CYS:HB3	1.89	0.53
1:B:116:MET:SD	1:B:209:ILE:HD11	2.48	0.53
1:D:46:ARG:O	1:D:49:GLN:N	2.41	0.53
1:E:257:ARG:HD2	1:E:261:THR:HG21	1.90	0.53
1:E:425:PHE:CZ	1:E:477:ARG:HD3	2.44	0.53
1:E:46:ARG:O	1:E:49:GLN:N	2.41	0.53
1:E:289:GLU:HG3	1:E:316:TRP:HH2	1.73	0.52
1:F:178:GLN:HB2	1:F:219:ARG:NH1	2.24	0.52
1:E:144:ASP:OD2	1:E:154:ARG:HB2	2.09	0.52
1:F:196:LEU:O	1:F:450:ARG:HD3	2.09	0.52
1:C:214:ARG:HB2	1:C:230:MET:HB3	1.90	0.52
1:C:141:HIS:CD2	1:C:154:ARG:HH11	2.27	0.52
1:D:4:ILE:HD13	1:D:356:LEU:HG	1.91	0.52
1:F:46:ARG:O	1:F:49:GLN:N	2.43	0.52
1:F:245:ARG:NH2	3:F:606:SO4:O4	2.42	0.52
1:A:179:ASP:OD2	1:A:479:ARG:NH2	2.42	0.52
1:E:11:ASN:H	1:E:204:ALA:HB2	1.74	0.52
1:F:11:ASN:ND2	1:F:249:GLU:HB3	2.25	0.52
1:A:144:ASP:OD2	1:A:154:ARG:HB2	2.10	0.52

Continued on next page...

Continued from previous page...

Atom-1	Atom-2	Interatomic distance (Å)	Clash overlap (Å)
1:D:11:ASN:ND2	1:D:249:GLU:HB3	2.25	0.52
1:D:144:ASP:OD2	1:D:154:ARG:HB2	2.09	0.52
1:A:46:ARG:O	1:A:49:GLN:N	2.42	0.51
1:D:425:PHE:CZ	1:D:477:ARG:HD3	2.45	0.51
1:B:144:ASP:OD2	1:B:154:ARG:HB2	2.10	0.51
1:C:144:ASP:OD2	1:C:154:ARG:HB2	2.10	0.51
1:D:245:ARG:NH2	3:D:606:SO4:O4	2.43	0.51
1:A:61:ALA:CB	1:B:489:THR:HG21	2.41	0.51
1:C:45:ILE:O	1:C:48:LEU:HB2	2.10	0.51
1:C:116:MET:SD	1:C:209:ILE:HD11	2.51	0.50
1:E:273:CYS:HB3	1:E:382:TYR:HB2	1.93	0.50
1:B:127:PHE:HZ	1:D:442:ARG:CZ	2.24	0.50
1:F:4:ILE:HD13	1:F:356:LEU:HG	1.92	0.50
1:B:214:ARG:HB2	1:B:230:MET:HB3	1.94	0.50
1:C:245:ARG:NH2	3:C:605:SO4:O1	2.43	0.50
1:E:179:ASP:OD2	1:E:479:ARG:NH2	2.42	0.50
1:F:367:ALA:HB3	1:F:370:GLU:HB3	1.93	0.50
1:E:142:PRO:O	1:E:219:ARG:NH2	2.44	0.50
1:F:425:PHE:CZ	1:F:477:ARG:HD3	2.46	0.50
1:A:245:ARG:NH2	3:A:606:SO4:O2	2.41	0.50
1:D:141:HIS:CD2	1:D:154:ARG:HH11	2.30	0.50
1:D:316:TRP:CZ2	1:D:320:ARG:HD2	2.47	0.50
1:A:127:PHE:CE1	1:A:400:GLU:HB3	2.47	0.50
1:E:45:ILE:O	1:E:48:LEU:HB2	2.11	0.49
1:C:142:PRO:O	1:C:219:ARG:NH2	2.42	0.49
1:E:245:ARG:NH2	3:E:605:SO4:O4	2.43	0.49
1:E:307:LEU:HD11	1:E:343:LYS:HG2	1.94	0.49
1:F:116:MET:SD	1:F:209:ILE:HD11	2.53	0.49
1:A:425:PHE:CZ	1:A:477:ARG:HD3	2.47	0.49
1:F:278:GLU:HA	1:F:333:PHE:CZ	2.48	0.49
1:D:45:ILE:O	1:D:48:LEU:HB2	2.12	0.49
1:C:294:HIS:CD2	1:C:389:HIS:HD2	2.31	0.48
1:D:178:GLN:HB2	1:D:219:ARG:NH1	2.28	0.48
1:B:425:PHE:CZ	1:B:477:ARG:HD3	2.48	0.48
1:C:278:GLU:HA	1:C:333:PHE:CZ	2.48	0.48
1:E:273:CYS:HB3	1:E:382:TYR:CB	2.43	0.48
1:E:278:GLU:HA	1:E:333:PHE:CZ	2.48	0.48
1:D:257:ARG:HD2	1:D:261:THR:HG21	1.94	0.48
1:C:178:GLN:HB2	1:C:219:ARG:NH1	2.28	0.48
1:D:400:GLU:OE1	1:F:442:ARG:NE	2.47	0.48
1:C:413:ILE:HG21	1:C:500:LEU:HD13	1.96	0.48

Continued on next page...

Continued from previous page...

Atom-1	Atom-2	Interatomic distance (Å)	Clash overlap (Å)
1:B:24:THR:O	1:B:28:ILE:HG12	2.13	0.48
1:B:178:GLN:HB2	1:B:219:ARG:NH1	2.29	0.48
1:C:425:PHE:CZ	1:C:477:ARG:HD3	2.48	0.48
1:D:413:ILE:HG21	1:D:500:LEU:HD13	1.96	0.48
1:A:24:THR:O	1:A:28:ILE:HG12	2.13	0.47
1:A:313:GLU:O	1:A:317:GLU:HG2	2.13	0.47
1:D:11:ASN:H	1:D:204:ALA:HB2	1.78	0.47
1:E:247:ARG:HG2	1:E:252:LEU:HB2	1.95	0.47
1:C:51:LYS:HE2	1:C:121:ASN:O	2.13	0.47
1:F:141:HIS:CD2	1:F:154:ARG:HH11	2.33	0.47
1:A:61:ALA:HB3	1:B:489:THR:HG21	1.95	0.47
1:D:356:LEU:N	1:D:357:PRO:HD2	2.30	0.47
1:E:60:ASN:HD21	1:E:62:ALA:HB3	1.80	0.47
1:E:324:LEU:HG	1:E:325:SER:H	1.79	0.47
1:F:307:LEU:HD11	1:F:343:LYS:HG2	1.97	0.47
1:D:215:PRO:HG3	1:D:235:TYR:OH	2.14	0.47
1:E:413:ILE:HG21	1:E:500:LEU:HD13	1.97	0.47
1:A:142:PRO:O	1:A:219:ARG:NH2	2.47	0.47
1:D:123:PRO:HG2	1:D:407:ILE:HD11	1.96	0.47
1:E:178:GLN:HB2	1:E:219:ARG:NH1	2.30	0.47
1:A:4:ILE:HD13	1:A:356:LEU:HG	1.98	0.46
1:B:141:HIS:CD2	1:B:154:ARG:HH11	2.33	0.46
1:B:167:GLU:HA	1:B:170:ASN:HB2	1.97	0.46
1:F:175:LYS:NZ	3:F:613:SO4:O4	2.47	0.46
1:F:215:PRO:HG3	1:F:235:TYR:OH	2.15	0.46
1:F:216:ALA:HA	1:F:233:PRO:HB3	1.97	0.46
1:A:141:HIS:CD2	1:A:154:ARG:HH11	2.33	0.46
1:B:247:ARG:HG2	1:B:252:LEU:HB2	1.97	0.46
1:D:238:SER:HB3	1:D:476:TYR:HE2	1.80	0.46
1:F:295:LEU:HD23	1:F:385:VAL:HG21	1.97	0.46
1:F:299:TRP:CE3	1:F:381:LEU:HD22	2.51	0.46
1:C:141:HIS:HD2	1:C:143:GLU:OE1	1.99	0.46
1:C:356:LEU:N	1:C:357:PRO:HD2	2.31	0.46
1:F:24:THR:O	1:F:28:ILE:HG12	2.16	0.46
1:D:116:MET:SD	1:D:209:ILE:HD11	2.56	0.46
1:D:64:ARG:NH1	1:D:279:ASP:OD2	2.46	0.45
1:A:268:ASP:O	1:A:272:TYR:HB3	2.16	0.45
1:A:449:THR:N	3:A:611:SO4:O1	2.37	0.45
1:B:413:ILE:HG21	1:B:500:LEU:HD13	1.97	0.45
1:C:167:GLU:HA	1:C:170:ASN:HB2	1.97	0.45
1:C:216:ALA:HA	1:C:233:PRO:HB3	1.99	0.45

Continued on next page...

Continued from previous page...

Atom-1	Atom-2	Interatomic distance (Å)	Clash overlap (Å)
1:C:479:ARG:HA	1:C:479:ARG:HD3	1.66	0.45
1:B:411:LEU:HD23	1:B:411:LEU:HA	1.83	0.45
1:D:294:HIS:CD2	1:D:389:HIS:CD2	3.03	0.45
1:A:257:ARG:HD2	1:A:261:THR:HG21	1.99	0.45
1:A:127:PHE:HZ	1:E:442:ARG:CZ	2.29	0.45
1:C:367:ALA:HB3	1:C:370:GLU:HB3	1.98	0.45
1:C:11:ASN:H	1:C:204:ALA:HB2	1.81	0.45
1:B:216:ALA:HA	1:B:233:PRO:HB3	1.99	0.45
1:B:367:ALA:HB3	1:B:370:GLU:HB3	1.99	0.45
1:C:258:PHE:HA	1:C:259:PRO:HD3	1.82	0.45
1:A:178:GLN:HB2	1:A:219:ARG:NH1	2.31	0.45
1:A:411:LEU:HD23	1:A:411:LEU:HA	1.80	0.45
1:D:167:GLU:HA	1:D:170:ASN:HB2	1.99	0.45
1:E:141:HIS:CD2	1:E:154:ARG:HH11	2.35	0.45
1:B:278:GLU:HA	1:B:333:PHE:CZ	2.52	0.44
1:D:94:LEU:HD12	1:D:94:LEU:HA	1.83	0.44
1:F:55:PHE:CD1	1:F:283:LYS:HG3	2.51	0.44
1:A:247:ARG:HG2	1:A:252:LEU:HB2	1.98	0.44
1:E:24:THR:O	1:E:28:ILE:HG12	2.17	0.44
1:B:142:PRO:O	1:B:219:ARG:NH2	2.46	0.44
1:F:258:PHE:HA	1:F:259:PRO:HD3	1.89	0.44
1:A:167:GLU:HA	1:A:170:ASN:HB2	2.00	0.44
1:E:160:LEU:HD23	1:E:471:LEU:HD22	1.99	0.44
1:F:45:ILE:O	1:F:48:LEU:HB2	2.18	0.44
1:D:24:THR:O	1:D:28:ILE:HG12	2.17	0.44
1:E:243:ILE:HD13	1:E:243:ILE:HA	1.82	0.44
1:F:167:GLU:HA	1:F:170:ASN:HB2	2.00	0.44
1:F:410:LEU:HD23	1:F:410:LEU:HA	1.82	0.44
1:B:160:LEU:HD23	1:B:471:LEU:HD22	2.00	0.44
1:D:273:CYS:HB3	1:D:382:TYR:HB2	2.00	0.44
1:E:215:PRO:HG3	1:E:235:TYR:OH	2.18	0.44
1:D:141:HIS:HD2	1:D:143:GLU:OE1	2.01	0.44
1:E:141:HIS:HD2	1:E:143:GLU:OE1	2.00	0.44
1:F:21:GLY:N	3:F:614:SO4:O1	2.41	0.44
1:A:413:ILE:HG21	1:A:500:LEU:HD13	2.00	0.43
1:B:141:HIS:HD2	1:B:143:GLU:OE1	2.00	0.43
1:B:443:LEU:HD23	1:B:443:LEU:HA	1.75	0.43
1:E:87:ARG:NH1	1:E:350:GLN:OE1	2.51	0.43
1:A:215:PRO:HG3	1:A:235:TYR:OH	2.19	0.43
1:B:203:TRP:HE3	1:B:246:LEU:HD12	1.83	0.43
1:A:367:ALA:HB3	1:A:370:GLU:HB3	2.00	0.43

Continued on next page...

Continued from previous page...

Atom-1	Atom-2	Interatomic distance (Å)	Clash overlap (Å)
1:A:438:PRO:O	1:A:442:ARG:HG3	2.18	0.43
1:C:60:ASN:HD21	1:C:62:ALA:HB3	1.83	0.43
1:C:94:LEU:HD12	1:C:94:LEU:HA	1.79	0.43
1:D:216:ALA:HA	1:D:233:PRO:HB3	2.00	0.43
1:F:43:PRO:HD2	1:F:197:MET:HE1	2.00	0.43
1:F:431:LYS:HE2	1:F:434:VAL:HG22	2.01	0.43
1:C:215:PRO:HG3	1:C:235:TYR:OH	2.18	0.43
1:F:127:PHE:CE1	1:F:400:GLU:HB3	2.54	0.43
1:A:469:PHE:HB3	1:A:470:PRO:HD3	2.01	0.43
1:D:367:ALA:HB3	1:D:370:GLU:HB3	2.00	0.43
1:D:278:GLU:HA	1:D:333:PHE:CZ	2.53	0.43
1:F:39:ILE:HA	1:F:199:MET:HE3	2.00	0.43
1:D:316:TRP:CE2	1:D:320:ARG:HD2	2.54	0.43
1:F:356:LEU:N	1:F:357:PRO:HD2	2.34	0.43
1:C:169:LEU:HD23	1:C:169:LEU:HA	1.83	0.43
1:D:371:ASP:CB	1:D:373:SER:H	2.29	0.43
1:E:254:LEU:HD12	1:E:254:LEU:HA	1.80	0.43
1:F:179:ASP:OD2	1:F:479:ARG:NH2	2.44	0.43
1:C:247:ARG:HG2	1:C:252:LEU:HB2	2.00	0.42
1:D:142:PRO:O	1:D:219:ARG:NH2	2.46	0.42
1:F:179:ASP:OD1	1:F:216:ALA:HB3	2.18	0.42
1:F:413:ILE:HG21	1:F:500:LEU:HD13	2.01	0.42
1:D:425:PHE:CE1	1:D:477:ARG:HD3	2.54	0.42
1:D:243:ILE:HD13	1:D:243:ILE:HA	1.86	0.42
1:D:443:LEU:HD23	1:D:443:LEU:HA	1.74	0.42
1:E:479:ARG:HD3	1:E:479:ARG:HA	1.72	0.42
1:B:179:ASP:OD1	1:B:216:ALA:HB3	2.20	0.42
1:E:94:LEU:HD12	1:E:94:LEU:HA	1.82	0.42
1:B:356:LEU:N	1:B:357:PRO:HD2	2.33	0.42
1:D:469:PHE:HB3	1:D:470:PRO:HD3	2.01	0.42
1:E:167:GLU:HA	1:E:170:ASN:HB2	2.00	0.42
1:E:169:LEU:HB3	1:E:173:ARG:NH1	2.35	0.42
1:C:393:HIS:CG	1:C:394:PRO:HD2	2.55	0.42
1:F:437:PHE:HB3	1:F:440:GLU:HG2	2.02	0.42
1:A:203:TRP:HE3	1:A:246:LEU:HD12	1.85	0.42
1:B:161:ARG:NH2	3:B:609:SO4:O1	2.47	0.42
1:D:258:PHE:HA	1:D:259:PRO:HD3	1.87	0.42
1:D:277:LEU:HA	1:D:277:LEU:HD23	1.79	0.42
1:E:4:ILE:HD13	1:E:356:LEU:HG	2.02	0.42
1:E:203:TRP:HE3	1:E:246:LEU:HD12	1.85	0.42
1:F:85:LEU:HD23	1:F:85:LEU:HA	1.90	0.42

Continued on next page...

Continued from previous page...

Atom-1	Atom-2	Interatomic distance (Å)	Clash overlap (Å)
1:F:87:ARG:HH11	1:F:87:ARG:HG2	1.83	0.42
1:F:270:ILE:O	1:F:274:VAL:HG23	2.20	0.42
1:A:356:LEU:N	1:A:357:PRO:HD2	2.35	0.42
1:A:216:ALA:HA	1:A:233:PRO:HB3	2.01	0.42
1:A:479:ARG:HA	1:A:479:ARG:HD3	1.63	0.42
1:D:203:TRP:HE3	1:D:246:LEU:HD12	1.85	0.42
1:C:179:ASP:OD2	1:C:479:ARG:NH2	2.49	0.41
1:D:43:PRO:O	1:D:47:ARG:HG3	2.20	0.41
1:D:247:ARG:HG2	1:D:252:LEU:HB2	2.01	0.41
1:E:367:ALA:HB3	1:E:370:GLU:HB3	2.01	0.41
1:A:278:GLU:HA	1:A:333:PHE:CZ	2.55	0.41
1:B:277:LEU:HD23	1:B:277:LEU:HA	1.87	0.41
1:D:307:LEU:HD12	1:D:307:LEU:HA	1.85	0.41
1:E:356:LEU:N	1:E:357:PRO:HD2	2.35	0.41
1:F:141:HIS:HD2	1:F:143:GLU:OE1	2.03	0.41
1:C:93:LEU:HD23	1:C:93:LEU:HA	1.83	0.41
1:F:51:LYS:HE2	1:F:121:ASN:O	2.20	0.41
1:C:443:LEU:HA	1:C:443:LEU:HD23	1.77	0.41
1:C:469:PHE:HB3	1:C:470:PRO:HD3	2.01	0.41
1:E:469:PHE:HB3	1:E:470:PRO:HD3	2.03	0.41
1:F:425:PHE:CE1	1:F:477:ARG:HD3	2.55	0.41
1:A:277:LEU:HD23	1:A:277:LEU:HA	1.85	0.41
1:F:160:LEU:HD23	1:F:471:LEU:HD22	2.03	0.41
1:F:327:SER:OG	1:F:330:ASP:HB2	2.20	0.41
1:B:258:PHE:HA	1:B:259:PRO:HD3	1.84	0.41
1:C:500:LEU:HD23	1:C:500:LEU:HA	1.89	0.41
1:F:24:THR:HB	1:F:27:GLU:H	1.85	0.41
1:A:477:ARG:O	1:A:480:LEU:HB3	2.21	0.41
1:B:469:PHE:HB3	1:B:470:PRO:HD3	2.03	0.41
1:C:24:THR:O	1:C:28:ILE:HG12	2.20	0.41
1:E:378:LEU:O	1:E:381:LEU:HB3	2.20	0.41
1:F:97:TYR:CE2	1:F:356:LEU:HD23	2.55	0.41
1:F:203:TRP:CE2	1:F:249:GLU:HG3	2.55	0.41
1:A:307:LEU:HD11	1:A:343:LYS:CG	2.49	0.41
1:D:479:ARG:HD3	1:D:479:ARG:HA	1.64	0.41
1:A:160:LEU:HD23	1:A:471:LEU:HD22	2.02	0.41
1:C:24:THR:HB	1:C:27:GLU:H	1.85	0.41
1:C:410:LEU:HD23	1:C:410:LEU:HA	1.82	0.41
1:E:347:TYR:HA	3:E:609:SO4:O1	2.21	0.41
1:E:369:LEU:HD23	1:E:369:LEU:HA	1.87	0.41
1:F:153:ASP:HB3	1:F:161:ARG:HG2	2.03	0.41

Continued on next page...

Continued from previous page...

Atom-1	Atom-2	Interatomic distance (Å)	Clash overlap (Å)
1:F:254:LEU:HD12	1:F:254:LEU:HA	1.85	0.41
1:A:80:ILE:HA	1:A:345:VAL:HG13	2.03	0.41
1:E:59:ARG:HG3	1:E:60:ASN:H	1.86	0.41
1:E:277:LEU:HD23	1:E:277:LEU:HA	1.85	0.41
1:E:288:VAL:HG21	1:E:329:GLU:HA	2.03	0.41
1:F:438:PRO:O	1:F:442:ARG:HG3	2.20	0.41
1:A:417:LEU:HD23	1:A:417:LEU:HA	1.86	0.40
1:E:260:LEU:N	1:E:260:LEU:HD23	2.35	0.40
1:E:505:GLN:HE21	1:E:505:GLN:HB3	1.64	0.40
1:F:452:ARG:O	1:F:456:VAL:HG23	2.21	0.40
1:A:179:ASP:OD1	1:A:216:ALA:HB3	2.21	0.40
1:B:404:TYR:CG	1:D:439:ILE:HD11	2.57	0.40
1:A:243:ILE:HA	1:A:243:ILE:HD13	1.85	0.40
1:A:443:LEU:HA	1:A:443:LEU:HD23	1.78	0.40
1:B:254:LEU:HD12	1:B:254:LEU:HA	1.79	0.40
1:D:169:LEU:HD23	1:D:169:LEU:HA	1.85	0.40
1:D:254:LEU:HD12	1:D:254:LEU:HA	1.81	0.40
1:F:11:ASN:H	1:F:204:ALA:HB2	1.87	0.40
1:F:243:ILE:HA	1:F:243:ILE:HD13	1.80	0.40
1:F:378:LEU:O	1:F:381:LEU:HB3	2.21	0.40
1:B:371:ASP:CB	1:B:373:SER:H	2.29	0.40
1:C:28:ILE:HG12	1:C:28:ILE:H	1.77	0.40
1:C:203:TRP:HE3	1:C:246:LEU:HD12	1.87	0.40
1:D:93:LEU:HD13	1:D:97:TYR:CZ	2.56	0.40
1:D:176:ILE:HD13	1:D:475:TYR:HB2	2.04	0.40
1:F:288:VAL:HG21	1:F:329:GLU:HA	2.03	0.40
1:E:51:LYS:HE2	1:E:121:ASN:O	2.21	0.40

There are no symmetry-related clashes.

5.3 Torsion angles [i](#)

5.3.1 Protein backbone [i](#)

In the following table, the Percentiles column shows the percent Ramachandran outliers of the chain as a percentile score with respect to all X-ray entries followed by that with respect to entries of similar resolution.

The Analysed column shows the number of residues for which the backbone conformation was analysed, and the total number of residues.

Mol	Chain	Analysed	Favoured	Allowed	Outliers	Percentiles
1	A	484/505 (96%)	457 (94%)	26 (5%)	1 (0%)	47 78
1	B	486/505 (96%)	460 (95%)	24 (5%)	2 (0%)	34 68
1	C	499/505 (99%)	467 (94%)	26 (5%)	6 (1%)	13 44
1	D	486/505 (96%)	459 (94%)	26 (5%)	1 (0%)	47 78
1	E	499/505 (99%)	465 (93%)	27 (5%)	7 (1%)	11 40
1	F	486/505 (96%)	461 (95%)	24 (5%)	1 (0%)	47 78
All	All	2940/3030 (97%)	2769 (94%)	153 (5%)	18 (1%)	25 59

All (18) Ramachandran outliers are listed below:

Mol	Chain	Res	Type
1	C	301	GLN
1	C	304	LYS
1	E	301	GLN
1	E	304	LYS
1	A	310	LEU
1	B	310	LEU
1	C	310	LEU
1	D	310	LEU
1	E	59	ARG
1	F	310	LEU
1	C	325	SER
1	E	310	LEU
1	E	325	SER
1	C	305	GLY
1	E	305	GLY
1	C	59	ARG
1	E	306	SER
1	B	311	VAL

5.3.2 Protein sidechains [i](#)

In the following table, the Percentiles column shows the percent sidechain outliers of the chain as a percentile score with respect to all X-ray entries followed by that with respect to entries of similar resolution.

The Analysed column shows the number of residues for which the sidechain conformation was analysed, and the total number of residues.

Continued on next page...

Continued from previous page...

Mol	Chain	Analysed	Rotameric	Outliers	Percentiles	
1	A	404/450 (90%)	382 (95%)	22 (5%)	22	54
1	B	407/450 (90%)	385 (95%)	22 (5%)	22	54
1	C	420/450 (93%)	399 (95%)	21 (5%)	24	56
1	D	415/450 (92%)	390 (94%)	25 (6%)	19	50
1	E	425/450 (94%)	394 (93%)	31 (7%)	14	43
1	F	419/450 (93%)	395 (94%)	24 (6%)	20	52
All	All	2490/2700 (92%)	2345 (94%)	145 (6%)	20	52

All (145) residues with a non-rotameric sidechain are listed below:

Mol	Chain	Res	Type
1	A	86	SER
1	A	103	THR
1	A	118	ASP
1	A	161	ARG
1	A	164	ASP
1	A	221	GLU
1	A	238	SER
1	A	240	GLU
1	A	246	LEU
1	A	272	TYR
1	A	282	GLU
1	A	320	ARG
1	A	328	THR
1	A	334	MET
1	A	371	ASP
1	A	379	LEU
1	A	389	HIS
1	A	423	SER
1	A	453	LEU
1	A	457	GLU
1	A	464	SER
1	A	495	ASP
1	B	86	SER
1	B	103	THR
1	B	118	ASP
1	B	161	ARG
1	B	164	ASP

Continued on next page...

Continued from previous page...

Mol	Chain	Res	Type
1	B	221	GLU
1	B	224	GLU
1	B	238	SER
1	B	240	GLU
1	B	246	LEU
1	B	328	THR
1	B	334	MET
1	B	371	ASP
1	B	374	GLU
1	B	379	LEU
1	B	389	HIS
1	B	422	LEU
1	B	423	SER
1	B	450	ARG
1	B	453	LEU
1	B	464	SER
1	B	495	ASP
1	C	49	GLN
1	C	86	SER
1	C	103	THR
1	C	118	ASP
1	C	161	ARG
1	C	164	ASP
1	C	238	SER
1	C	240	GLU
1	C	246	LEU
1	C	328	THR
1	C	329	GLU
1	C	334	MET
1	C	371	ASP
1	C	379	LEU
1	C	389	HIS
1	C	405	ARG
1	C	423	SER
1	C	453	LEU
1	C	464	SER
1	C	479	ARG
1	C	495	ASP
1	D	49	GLN
1	D	86	SER
1	D	103	THR
1	D	118	ASP

Continued on next page...

Continued from previous page...

Mol	Chain	Res	Type
1	D	161	ARG
1	D	164	ASP
1	D	166	GLU
1	D	221	GLU
1	D	238	SER
1	D	240	GLU
1	D	246	LEU
1	D	271	SER
1	D	318	LYS
1	D	328	THR
1	D	334	MET
1	D	371	ASP
1	D	374	GLU
1	D	389	HIS
1	D	423	SER
1	D	450	ARG
1	D	453	LEU
1	D	457	GLU
1	D	464	SER
1	D	479	ARG
1	D	495	ASP
1	E	47	ARG
1	E	49	GLN
1	E	86	SER
1	E	103	THR
1	E	118	ASP
1	E	161	ARG
1	E	164	ASP
1	E	166	GLU
1	E	219	ARG
1	E	221	GLU
1	E	238	SER
1	E	240	GLU
1	E	246	LEU
1	E	271	SER
1	E	286	PHE
1	E	324	LEU
1	E	328	THR
1	E	329	GLU
1	E	334	MET
1	E	371	ASP
1	E	374	GLU

Continued on next page...

Continued from previous page...

Mol	Chain	Res	Type
1	E	379	LEU
1	E	389	HIS
1	E	422	LEU
1	E	423	SER
1	E	453	LEU
1	E	457	GLU
1	E	464	SER
1	E	479	ARG
1	E	495	ASP
1	E	505	GLN
1	F	3	GLN
1	F	86	SER
1	F	87	ARG
1	F	103	THR
1	F	118	ASP
1	F	161	ARG
1	F	164	ASP
1	F	166	GLU
1	F	219	ARG
1	F	238	SER
1	F	240	GLU
1	F	246	LEU
1	F	272	TYR
1	F	328	THR
1	F	329	GLU
1	F	334	MET
1	F	371	ASP
1	F	374	GLU
1	F	389	HIS
1	F	423	SER
1	F	453	LEU
1	F	464	SER
1	F	479	ARG
1	F	495	ASP

Sometimes sidechains can be flipped to improve hydrogen bonding and reduce clashes. All (31) such sidechains are listed below:

Mol	Chain	Res	Type
1	A	121	ASN
1	A	126	HIS
1	A	141	HIS
1	A	290	GLN

Continued on next page...

Continued from previous page...

Mol	Chain	Res	Type
1	B	121	ASN
1	B	126	HIS
1	B	141	HIS
1	B	290	GLN
1	B	294	HIS
1	C	121	ASN
1	C	126	HIS
1	C	141	HIS
1	C	290	GLN
1	C	294	HIS
1	D	121	ASN
1	D	126	HIS
1	D	141	HIS
1	D	290	GLN
1	D	294	HIS
1	D	389	HIS
1	E	121	ASN
1	E	141	HIS
1	E	290	GLN
1	E	294	HIS
1	E	505	GLN
1	F	121	ASN
1	F	126	HIS
1	F	141	HIS
1	F	290	GLN
1	F	294	HIS
1	F	389	HIS

5.3.3 RNA [i](#)

There are no RNA molecules in this entry.

5.4 Non-standard residues in protein, DNA, RNA chains [i](#)

There are no non-standard protein/DNA/RNA residues in this entry.

5.5 Carbohydrates [i](#)

There are no monosaccharides in this entry.

5.6 Ligand geometry

Of 85 ligands modelled in this entry, 6 are monoatomic - leaving 79 for Mogul analysis.

In the following table, the Counts columns list the number of bonds (or angles) for which Mogul statistics could be retrieved, the number of bonds (or angles) that are observed in the model and the number of bonds (or angles) that are defined in the Chemical Component Dictionary. The Link column lists molecule types, if any, to which the group is linked. The Z score for a bond length (or angle) is the number of standard deviations the observed value is removed from the expected value. A bond length (or angle) with $|Z| > 2$ is considered an outlier worth inspection. RMSZ is the root-mean-square of all Z scores of the bond lengths (or angles).

Mol	Type	Chain	Res	Link	Bond lengths			Bond angles		
					Counts	RMSZ	$\# Z > 2$	Counts	RMSZ	$\# Z > 2$
3	SO4	C	606	-	4,4,4	0.15	0	6,6,6	0.13	0
3	SO4	E	609	-	4,4,4	0.13	0	6,6,6	0.18	0
3	SO4	A	602	-	4,4,4	0.13	0	6,6,6	0.20	0
3	SO4	D	612	-	4,4,4	0.19	0	6,6,6	0.33	0
3	SO4	C	612	-	4,4,4	0.16	0	6,6,6	0.17	0
3	SO4	F	616	-	4,4,4	0.14	0	6,6,6	0.14	0
3	SO4	E	613	-	4,4,4	0.12	0	6,6,6	0.11	0
3	SO4	E	602	-	4,4,4	0.15	0	6,6,6	0.10	0
3	SO4	B	602	-	4,4,4	0.11	0	6,6,6	0.17	0
3	SO4	E	607	-	4,4,4	0.15	0	6,6,6	0.21	0
3	SO4	C	615	-	4,4,4	0.21	0	6,6,6	0.21	0
3	SO4	E	614	-	4,4,4	0.16	0	6,6,6	0.09	0
3	SO4	E	606	-	4,4,4	0.15	0	6,6,6	0.22	0
3	SO4	D	605	-	4,4,4	0.16	0	6,6,6	0.21	0
3	SO4	A	611	-	4,4,4	0.10	0	6,6,6	0.20	0
3	SO4	F	619	-	4,4,4	0.22	0	6,6,6	0.26	0
3	SO4	F	612	-	4,4,4	0.17	0	6,6,6	0.11	0
3	SO4	E	612	-	4,4,4	0.13	0	6,6,6	0.14	0
3	SO4	F	608	-	4,4,4	0.10	0	6,6,6	0.16	0
3	SO4	F	620	-	4,4,4	0.15	0	6,6,6	0.19	0
3	SO4	C	605	-	4,4,4	0.23	0	6,6,6	0.17	0
3	SO4	B	605	-	4,4,4	0.12	0	6,6,6	0.12	0
3	SO4	D	603	-	4,4,4	0.16	0	6,6,6	0.10	0
3	SO4	D	601	-	4,4,4	0.14	0	6,6,6	0.28	0
3	SO4	C	604	-	4,4,4	0.12	0	6,6,6	0.24	0
3	SO4	E	608	-	4,4,4	0.17	0	6,6,6	0.25	0
3	SO4	F	606	-	4,4,4	0.15	0	6,6,6	0.25	0
3	SO4	E	616	-	4,4,4	0.14	0	6,6,6	0.30	0
3	SO4	B	603	-	4,4,4	0.10	0	6,6,6	0.17	0
3	SO4	A	603	-	4,4,4	0.15	0	6,6,6	0.16	0
3	SO4	F	611	-	4,4,4	0.16	0	6,6,6	0.35	0
3	SO4	B	604	-	4,4,4	0.09	0	6,6,6	0.19	0

Mol	Type	Chain	Res	Link	Bond lengths			Bond angles		
					Counts	RMSZ	# Z > 2	Counts	RMSZ	# Z > 2
3	SO4	B	608	-	4,4,4	0.18	0	6,6,6	0.18	0
3	SO4	F	609	-	4,4,4	0.15	0	6,6,6	0.37	0
3	SO4	A	604	-	4,4,4	0.13	0	6,6,6	0.12	0
3	SO4	C	614	-	4,4,4	0.13	0	6,6,6	0.31	0
3	SO4	D	611	-	4,4,4	0.12	0	6,6,6	0.30	0
3	SO4	A	605	-	4,4,4	0.17	0	6,6,6	0.16	0
3	SO4	C	603	-	4,4,4	0.19	0	6,6,6	0.11	0
3	SO4	C	602	-	4,4,4	0.17	0	6,6,6	0.16	0
3	SO4	F	617	-	4,4,4	0.13	0	6,6,6	0.19	0
3	SO4	F	615	-	4,4,4	0.17	0	6,6,6	0.29	0
3	SO4	A	608	-	4,4,4	0.15	0	6,6,6	0.09	0
3	SO4	D	613	-	4,4,4	0.15	0	6,6,6	0.13	0
3	SO4	B	609	-	4,4,4	0.14	0	6,6,6	0.18	0
3	SO4	F	613	-	4,4,4	0.14	0	6,6,6	0.09	0
3	SO4	D	607	-	4,4,4	0.11	0	6,6,6	0.22	0
3	SO4	A	609	-	4,4,4	0.18	0	6,6,6	0.19	0
3	SO4	A	610	-	4,4,4	0.15	0	6,6,6	0.09	0
3	SO4	C	607	-	4,4,4	0.23	0	6,6,6	0.27	0
3	SO4	D	606	-	4,4,4	0.10	0	6,6,6	0.28	0
3	SO4	E	605	-	4,4,4	0.18	0	6,6,6	0.15	0
3	SO4	C	610	-	4,4,4	0.18	0	6,6,6	0.33	0
3	SO4	E	615	-	4,4,4	0.19	0	6,6,6	0.28	0
3	SO4	F	607	-	4,4,4	0.12	0	6,6,6	0.27	0
3	SO4	F	604	-	4,4,4	0.15	0	6,6,6	0.16	0
3	SO4	D	608	-	4,4,4	0.16	0	6,6,6	0.19	0
3	SO4	A	607	-	4,4,4	0.16	0	6,6,6	0.17	0
3	SO4	E	610	-	4,4,4	0.14	0	6,6,6	0.16	0
3	SO4	C	609	-	4,4,4	0.21	0	6,6,6	0.17	0
3	SO4	B	607	-	4,4,4	0.11	0	6,6,6	0.23	0
3	SO4	A	606	-	4,4,4	0.13	0	6,6,6	0.17	0
3	SO4	E	604	-	4,4,4	0.15	0	6,6,6	0.18	0
3	SO4	C	608	-	4,4,4	0.13	0	6,6,6	0.18	0
3	SO4	D	609	-	4,4,4	0.18	0	6,6,6	0.17	0
3	SO4	B	606	-	4,4,4	0.24	0	6,6,6	0.18	0
3	SO4	F	610	-	4,4,4	0.17	0	6,6,6	0.21	0
3	SO4	E	603	-	4,4,4	0.13	0	6,6,6	0.13	0
3	SO4	F	618	-	4,4,4	0.17	0	6,6,6	0.26	0
3	SO4	D	604	-	4,4,4	0.13	0	6,6,6	0.32	0
3	SO4	F	614	-	4,4,4	0.19	0	6,6,6	0.34	0
3	SO4	D	614	-	4,4,4	0.13	0	6,6,6	0.28	0
3	SO4	C	613	-	4,4,4	0.18	0	6,6,6	0.18	0
3	SO4	F	603	-	4,4,4	0.15	0	6,6,6	0.09	0
3	SO4	E	611	-	4,4,4	0.15	0	6,6,6	0.28	0

Mol	Type	Chain	Res	Link	Bond lengths			Bond angles		
					Counts	RMSZ	# Z > 2	Counts	RMSZ	# Z > 2
3	SO4	F	605	-	4,4,4	0.16	0	6,6,6	0.27	0
3	SO4	C	611	-	4,4,4	0.10	0	6,6,6	0.16	0
3	SO4	F	601	-	4,4,4	0.24	0	6,6,6	0.26	0
3	SO4	D	610	-	4,4,4	0.15	0	6,6,6	0.30	0

There are no bond length outliers.

There are no bond angle outliers.

There are no chirality outliers.

There are no torsion outliers.

There are no ring outliers.

16 monomers are involved in 16 short contacts:

Mol	Chain	Res	Type	Clashes	Symm-Clashes
3	E	609	SO4	1	0
3	A	602	SO4	1	0
3	D	612	SO4	1	0
3	F	616	SO4	1	0
3	A	611	SO4	1	0
3	C	605	SO4	1	0
3	F	606	SO4	1	0
3	E	616	SO4	1	0
3	F	609	SO4	1	0
3	B	609	SO4	1	0
3	F	613	SO4	1	0
3	D	606	SO4	1	0
3	E	605	SO4	1	0
3	C	610	SO4	1	0
3	A	606	SO4	1	0
3	F	614	SO4	1	0

5.7 Other polymers [i](#)

There are no such residues in this entry.

5.8 Polymer linkage issues [i](#)

There are no chain breaks in this entry.

6 Fit of model and data

6.1 Protein, DNA and RNA chains

In the following table, the column labelled ‘#RSRZ> 2’ contains the number (and percentage) of RSRZ outliers, followed by percent RSRZ outliers for the chain as percentile scores relative to all X-ray entries and entries of similar resolution. The OWAB column contains the minimum, median, 95th percentile and maximum values of the occupancy-weighted average B-factor per residue. The column labelled ‘Q< 0.9’ lists the number of (and percentage) of residues with an average occupancy less than 0.9.

Mol	Chain	Analysed	<RSRZ>	#RSRZ>2	OWAB(Å ²)	Q<0.9
1	A	492/505 (97%)	-0.12	15 (3%) 50 53	68, 133, 179, 210	0
1	B	494/505 (97%)	-0.20	10 (2%) 65 68	56, 120, 170, 202	0
1	C	503/505 (99%)	-0.50	3 (0%) 89 92	44, 79, 129, 180	0
1	D	494/505 (97%)	-0.52	2 (0%) 92 94	46, 75, 118, 163	0
1	E	503/505 (99%)	-0.45	4 (0%) 86 89	45, 79, 129, 174	0
1	F	494/505 (97%)	-0.51	2 (0%) 92 94	43, 71, 117, 151	0
All	All	2980/3030 (98%)	-0.38	36 (1%) 79 82	43, 89, 160, 210	0

All (36) RSRZ outliers are listed below:

Mol	Chain	Res	Type	RSRZ
1	B	2	ALA	4.5
1	F	2	ALA	3.7
1	D	2	ALA	3.7
1	A	147	SER	3.3
1	B	505	GLN	3.3
1	B	16	TYR	3.2
1	A	61	ALA	3.1
1	E	152	ASP	3.0
1	A	22	VAL	2.9
1	A	151	THR	2.9
1	A	306	SER	2.8
1	C	164	ASP	2.8
1	B	3	GLN	2.7
1	A	300	GLY	2.7
1	A	225	THR	2.7
1	B	326	ARG	2.6
1	A	372	ALA	2.5
1	A	318	LYS	2.4
1	A	319	SER	2.4

Continued on next page...

Continued from previous page...

Mol	Chain	Res	Type	RSRZ
1	B	305	GLY	2.4
1	A	27	GLU	2.4
1	B	221	GLU	2.4
1	E	505	GLN	2.3
1	A	5	ASP	2.3
1	E	1	MET	2.3
1	A	305	GLY	2.3
1	F	372	ALA	2.2
1	C	305	GLY	2.2
1	E	61	ALA	2.1
1	C	304	LYS	2.1
1	A	221	GLU	2.1
1	A	320	ARG	2.1
1	D	164	ASP	2.0
1	B	306	SER	2.0
1	B	8	LYS	2.0
1	B	148	GLN	2.0

6.2 Non-standard residues in protein, DNA, RNA chains [i](#)

There are no non-standard protein/DNA/RNA residues in this entry.

6.3 Carbohydrates [i](#)

There are no monosaccharides in this entry.

6.4 Ligands [i](#)

In the following table, the Atoms column lists the number of modelled atoms in the group and the number defined in the chemical component dictionary. The B-factors column lists the minimum, median, 95th percentile and maximum values of B factors of atoms in the group. The column labelled 'Q< 0.9' lists the number of atoms with occupancy less than 0.9.

Mol	Type	Chain	Res	Atoms	RSCC	RSR	B-factors(Å ²)	Q<0.9
3	SO4	B	609	5/5	0.50	0.57	190,191,192,194	5
3	SO4	E	613	5/5	0.51	0.45	216,216,217,217	0
3	SO4	C	609	5/5	0.53	0.36	163,164,167,168	0
3	SO4	A	610	5/5	0.61	0.53	197,198,199,200	0
3	SO4	C	614	5/5	0.65	0.46	149,156,158,159	5
3	SO4	F	613	5/5	0.65	0.45	204,204,205,206	0

Continued on next page...

Continued from previous page...

Mol	Type	Chain	Res	Atoms	RSCC	RSR	B-factors(Å ²)	Q<0.9
3	SO4	F	615	5/5	0.66	0.49	154,162,163,167	0
3	SO4	F	617	5/5	0.68	0.63	133,134,136,136	5
3	SO4	E	612	5/5	0.69	0.40	204,205,205,206	0
3	SO4	F	610	5/5	0.73	0.48	177,177,177,178	0
3	SO4	D	607	5/5	0.73	0.46	117,124,129,132	5
3	SO4	F	620	5/5	0.73	0.43	154,157,158,159	0
3	SO4	C	615	5/5	0.74	0.35	139,139,141,143	5
3	SO4	F	612	5/5	0.75	0.42	167,167,170,170	0
3	SO4	E	610	5/5	0.76	0.51	173,173,174,175	0
3	SO4	B	606	5/5	0.78	0.38	119,120,123,128	5
3	SO4	E	604	5/5	0.80	0.34	166,169,171,174	0
3	SO4	A	602	5/5	0.81	0.43	120,129,132,133	5
3	SO4	D	612	5/5	0.82	0.43	85,90,94,94	5
3	SO4	F	616	5/5	0.82	0.49	140,140,142,144	5
3	SO4	E	615	5/5	0.83	0.23	161,162,163,163	0
3	SO4	F	611	5/5	0.83	0.34	115,116,118,118	5
3	SO4	F	607	5/5	0.84	0.25	119,126,129,133	5
3	SO4	B	608	5/5	0.84	0.44	178,178,180,181	0
3	SO4	F	619	5/5	0.84	0.45	99,101,102,103	5
3	SO4	A	611	5/5	0.84	0.38	171,172,173,175	0
3	SO4	D	613	5/5	0.85	0.41	134,138,139,139	5
3	SO4	D	605	5/5	0.85	0.27	154,155,155,156	0
3	SO4	E	607	5/5	0.86	0.28	110,112,117,123	5
3	SO4	D	611	5/5	0.86	0.34	139,140,141,145	5
3	SO4	B	607	5/5	0.86	0.33	200,201,205,215	0
3	SO4	D	606	5/5	0.88	0.26	132,134,137,138	0
3	SO4	E	606	5/5	0.88	0.21	166,174,176,179	0
3	SO4	A	606	5/5	0.88	0.22	168,173,173,176	0
3	SO4	D	609	5/5	0.88	0.29	133,135,137,139	0
3	SO4	F	614	5/5	0.88	0.21	140,140,143,148	0
3	SO4	D	610	5/5	0.89	0.24	103,107,109,116	5
3	SO4	E	616	5/5	0.89	0.26	111,114,114,116	5
3	SO4	F	605	5/5	0.89	0.36	145,146,150,153	0
3	SO4	A	607	5/5	0.89	0.22	141,142,144,145	5
3	SO4	C	611	5/5	0.89	0.38	170,171,172,173	0
3	SO4	F	618	5/5	0.89	0.30	128,131,132,134	5
3	SO4	A	608	5/5	0.89	0.31	219,222,227,229	0
3	SO4	C	606	5/5	0.89	0.36	136,139,147,150	0
3	SO4	A	604	5/5	0.90	0.35	150,151,152,154	0
3	SO4	E	609	5/5	0.90	0.59	178,179,181,181	0
3	SO4	B	605	5/5	0.91	0.29	173,175,177,182	0
3	SO4	A	603	5/5	0.92	0.31	109,111,114,116	5

Continued on next page...

Continued from previous page...

Mol	Type	Chain	Res	Atoms	RSCC	RSR	B-factors(\AA^2)	Q<0.9
3	SO4	C	613	5/5	0.92	0.42	113,115,116,116	5
3	SO4	E	611	5/5	0.92	0.32	131,134,136,137	0
3	SO4	C	604	5/5	0.92	0.31	152,155,156,156	0
3	SO4	E	605	5/5	0.93	0.34	137,137,138,142	0
3	SO4	B	604	5/5	0.93	0.22	137,142,144,146	0
3	SO4	E	603	5/5	0.93	0.27	102,109,112,113	5
3	SO4	A	609	5/5	0.93	0.21	130,133,136,138	5
3	SO4	E	614	5/5	0.93	0.32	106,106,108,110	5
3	SO4	D	604	5/5	0.94	0.22	110,111,115,118	5
3	SO4	C	612	5/5	0.94	0.40	172,173,174,174	0
3	SO4	A	605	5/5	0.94	0.22	118,125,129,129	5
3	SO4	F	608	5/5	0.94	0.22	118,119,122,126	0
3	SO4	D	614	5/5	0.94	0.20	94,96,99,100	5
3	SO4	F	609	5/5	0.95	0.30	105,110,111,111	5
3	SO4	C	610	5/5	0.95	0.20	90,93,94,96	5
3	SO4	B	602	5/5	0.95	0.24	124,127,128,130	0
3	SO4	F	606	5/5	0.95	0.13	104,107,109,112	0
3	SO4	C	608	5/5	0.95	0.28	145,145,147,147	0
3	SO4	C	605	5/5	0.95	0.21	113,115,117,118	0
3	SO4	B	603	5/5	0.96	0.21	105,108,110,111	0
3	SO4	D	603	5/5	0.96	0.25	114,115,117,121	0
3	SO4	C	602	5/5	0.96	0.13	110,118,119,121	0
3	SO4	F	604	5/5	0.96	0.24	114,117,119,120	0
3	SO4	D	608	5/5	0.96	0.18	87,91,93,96	5
2	NI	C	601	1/1	0.97	0.04	91,91,91,91	0
3	SO4	E	602	5/5	0.97	0.21	132,133,135,135	0
3	SO4	C	607	5/5	0.97	0.11	84,86,87,93	0
3	SO4	C	603	5/5	0.97	0.20	113,122,126,127	0
3	SO4	F	603	5/5	0.98	0.31	119,124,125,129	0
3	SO4	D	601	5/5	0.98	0.12	69,73,75,80	0
3	SO4	F	601	5/5	0.98	0.16	76,83,90,95	0
2	NI	F	602	1/1	0.99	0.05	85,85,85,85	0
2	NI	B	601	1/1	0.99	0.04	124,124,124,124	0
3	SO4	E	608	5/5	0.99	0.07	51,62,67,74	0
2	NI	A	601	1/1	0.99	0.03	114,114,114,114	0
2	NI	D	602	1/1	0.99	0.04	88,88,88,88	0
2	NI	E	601	1/1	0.99	0.04	73,73,73,73	0

6.5 Other polymers i

There are no such residues in this entry.