



# Full wwPDB EM Validation Report ⓘ

Aug 27, 2024 – 02:58 PM JST

PDB ID : 8XP1  
EMDB ID : EMD-38547  
Title : Cryo-EM structure of the protomers of the C ring in the CW state  
Authors : Tan, J.X.; Zhang, L.; Zhou, Y.; Zhu, Y.Q.  
Deposited on : 2024-01-02  
Resolution : 4.40 Å(reported)  
Based on initial models : ., ?

This is a Full wwPDB EM Validation Report for a publicly released PDB entry.

We welcome your comments at [validation@mail.wwpdb.org](mailto:validation@mail.wwpdb.org)

A user guide is available at

<https://www.wwpdb.org/validation/2017/EMValidationReportHelp>

with specific help available everywhere you see the ⓘ symbol.

The types of validation reports are described at

<http://www.wwpdb.org/validation/2017/FAQs#types>.

---

The following versions of software and data (see [references ⓘ](#)) were used in the production of this report:

EMDB validation analysis : 0.0.1.dev112  
MolProbity : 4.02b-467  
Percentile statistics : 20231227.v01 (using entries in the PDB archive December 27th 2023)  
MapQ : 1.9.13  
Ideal geometry (proteins) : Engh & Huber (2001)  
Ideal geometry (DNA, RNA) : Parkinson et al. (1996)  
Validation Pipeline (wwPDB-VP) : 2.38.2

# 1 Overall quality at a glance

The following experimental techniques were used to determine the structure:  
*ELECTRON MICROSCOPY*

The reported resolution of this entry is 4.40 Å.

Percentile scores (ranging between 0-100) for global validation metrics of the entry are shown in the following graphic. The table shows the number of entries on which the scores are based.

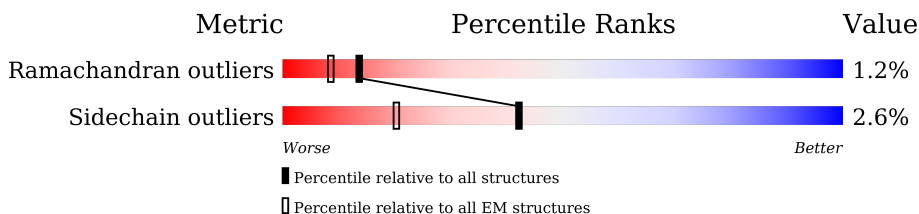



Metric	Whole archive (#Entries)	EM structures (#Entries)
Ramachandran outliers	207382	16835
Sidechain outliers	206894	16415

The table below summarises the geometric issues observed across the polymeric chains and their fit to the map. The red, orange, yellow and green segments of the bar indicate the fraction of residues that contain outliers for  $\geq 3$ , 2, 1 and 0 types of geometric quality criteria respectively. A grey segment represents the fraction of residues that are not modelled. The numeric value for each fraction is indicated below the corresponding segment, with a dot representing fractions  $\leq 5\%$ . The upper red bar (where present) indicates the fraction of residues that have poor fit to the EM map (all-atom inclusion  $< 40\%$ ). The numeric value is given above the bar.

Mol	Chain	Length	Quality of chain
1	0	137	61% 36%
1	AA	137	61% 36%
1	AB	137	61% 36%
1	o	137	57% 36% 7%
1	p	137	57% 36% 7%
1	q	137	57% 36% 7%
1	u	137	61% 36%
1	v	137	61% 36%
1	w	137	61% 36%

*Continued on next page...*

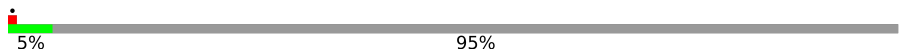
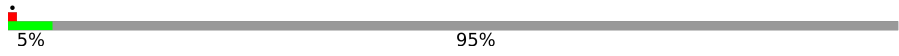
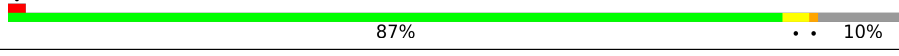
Continued from previous page...

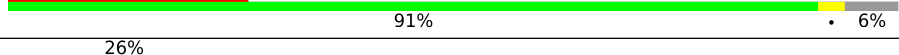
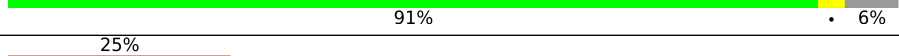
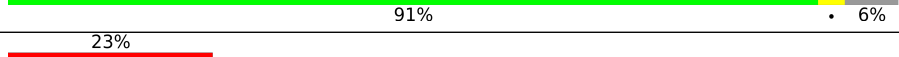
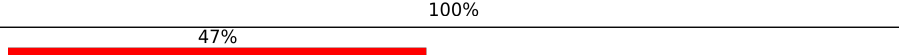
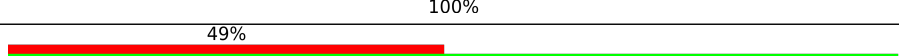
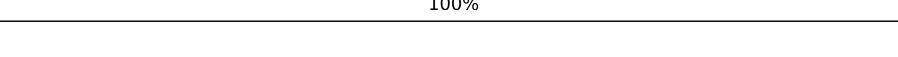
Mol	Chain	Length	Quality of chain
2	C	560	 5% 95%
2	D	560	 5% 95%
2	E	560	 5% 95%
3	S	334	 87% 10%
3	T	334	 87% 10%
3	U	334	 87% 10%
4	Z	331	 27% 91% 6%
4	a	331	 26% 91% 6%
4	b	331	 25% 91% 6%
5	h	129	 23% 100%
5	i	129	 47% 100%
5	j	129	 49% 100%

## 2 Entry composition i

There are 5 unique types of molecules in this entry. The entry contains 24297 atoms, of which 0 are hydrogens and 0 are deuteriums.

In the tables below, the AltConf column contains the number of residues with at least one atom in alternate conformation and the Trace column contains the number of residues modelled with at most 2 atoms.

- Molecule 1 is a protein called Flagellar motor switch protein FliN.

Mol	Chain	Residues	Atoms					AltConf	Trace
			Total	C	N	O	S		
1	o	87	Total 675	C 427	N 118	O 126	S 4	0	0
1	o	87	Total 675	C 427	N 118	O 126	S 4	0	0
1	u	87	Total 675	C 427	N 118	O 126	S 4	0	0
1	AA	87	Total 675	C 427	N 118	O 126	S 4	0	0
1	p	87	Total 675	C 427	N 118	O 126	S 4	0	0
1	v	87	Total 675	C 427	N 118	O 126	S 4	0	0
1	AB	87	Total 675	C 427	N 118	O 126	S 4	0	0
1	q	87	Total 675	C 427	N 118	O 126	S 4	0	0
1	w	87	Total 675	C 427	N 118	O 126	S 4	0	0

- Molecule 2 is a protein called Flagellar M-ring protein.

Mol	Chain	Residues	Atoms					AltConf	Trace
			Total	C	N	O	S		
2	C	27	Total 224	C 135	N 44	O 42	S 3	0	0
2	D	27	Total 224	C 135	N 44	O 42	S 3	0	0
2	E	27	Total 224	C 135	N 44	O 42	S 3	0	0

- Molecule 3 is a protein called Flagellar motor switch protein FliM.

Mol	Chain	Residues	Atoms					AltConf	Trace
			Total	C	N	O	S		
3	S	301	Total 2431	C 1549	N 437	O 440	S 5	0	0

*Continued on next page...*

*Continued from previous page...*

Mol	Chain	Residues	Atoms					AltConf	Trace
3	T	301	Total	C	N	O	S	0	0
			2431	1549	437	440	5		
3	U	301	Total	C	N	O	S	0	0
			2431	1549	437	440	5		

- Molecule 4 is a protein called Flagellar motor switch protein FliG.

Mol	Chain	Residues	Atoms					AltConf	Trace
4	Z	310	Total	C	N	O	S	0	0
			2428	1515	430	474	9		
4	a	310	Total	C	N	O	S	0	0
			2428	1515	430	474	9		
4	b	310	Total	C	N	O	S	0	0
			2428	1515	430	474	9		

- Molecule 5 is a protein called Chemotaxis protein CheY.

Mol	Chain	Residues	Atoms					AltConf	Trace
5	h	129	Total	C	N	O	S	0	0
			991	634	165	185	7		
5	i	129	Total	C	N	O	S	0	0
			991	634	165	185	7		
5	j	129	Total	C	N	O	S	0	0
			991	634	165	185	7		

There are 6 discrepancies between the modelled and reference sequences:

Chain	Residue	Modelled	Actual	Comment	Reference
h	13	LYS	ASP	engineered mutation	UNP P0A2D5
h	106	TRP	TYR	engineered mutation	UNP P0A2D5
i	13	LYS	ASP	engineered mutation	UNP P0A2D5
i	106	TRP	TYR	engineered mutation	UNP P0A2D5
j	13	LYS	ASP	engineered mutation	UNP P0A2D5
j	106	TRP	TYR	engineered mutation	UNP P0A2D5



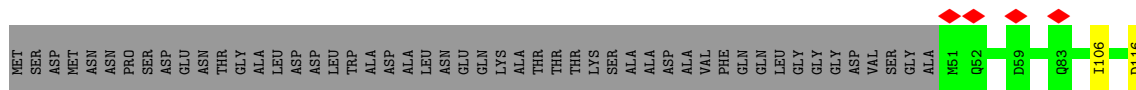

• Molecule 1: Flagellar motor switch protein FliN

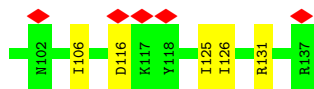
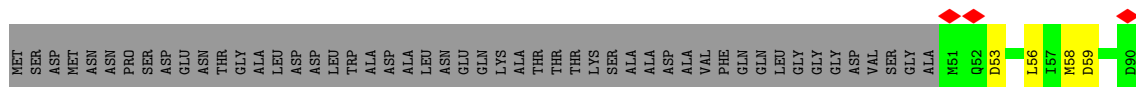

• Molecule 1: Flagellar motor switch protein FliN

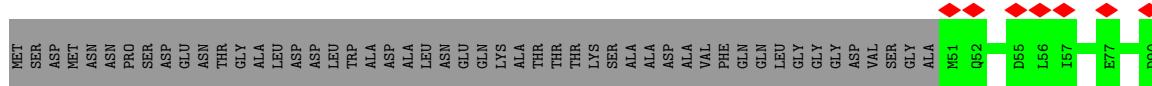

• Molecule 1: Flagellar motor switch protein FliN

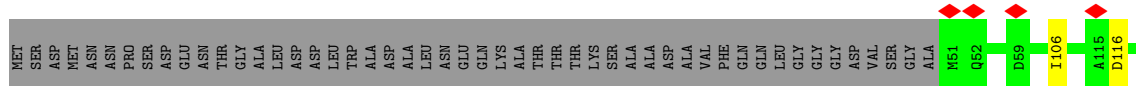

• Molecule 1: Flagellar motor switch protein FliN

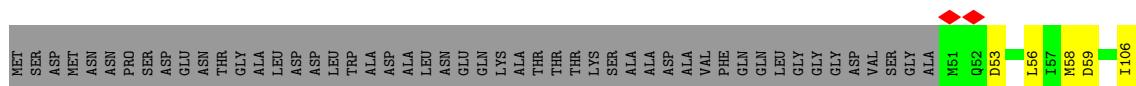







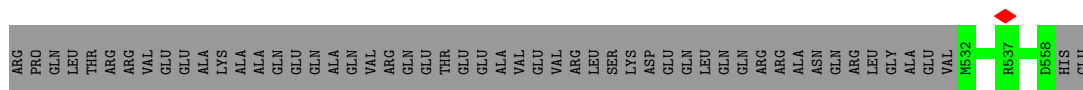

• Molecule 3: Flagellar motor switch protein FliM

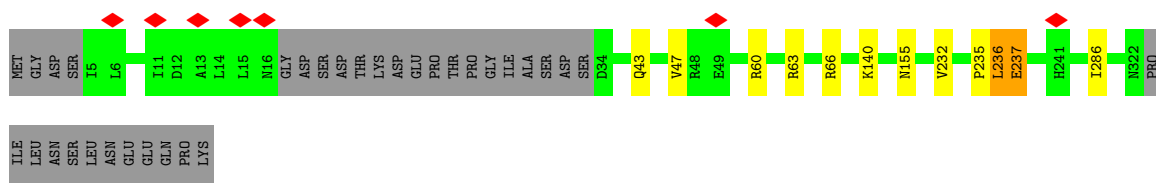
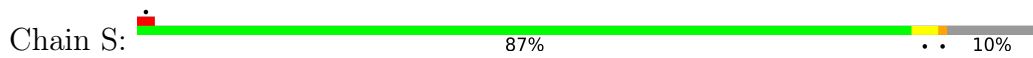

• Molecule 3: Flagellar motor switch protein FliM

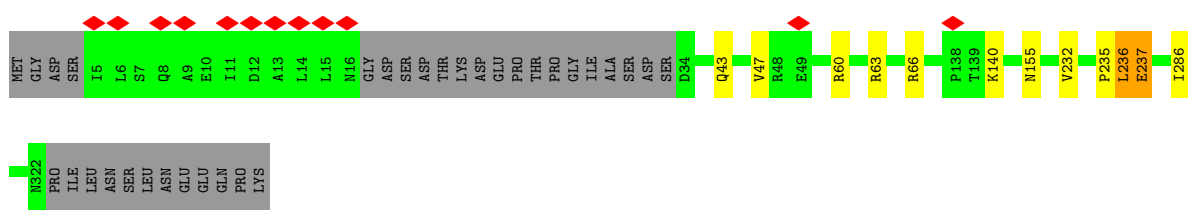
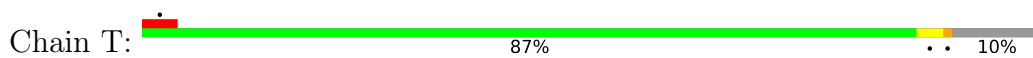

• Molecule 3: Flagellar motor switch protein FliM

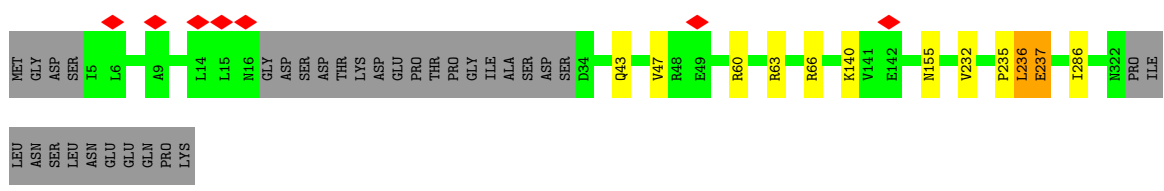
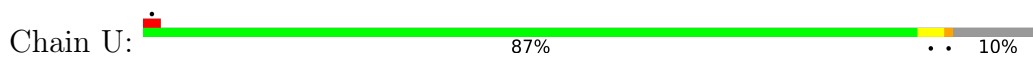

• Molecule 4: Flagellar motor switch protein FliG

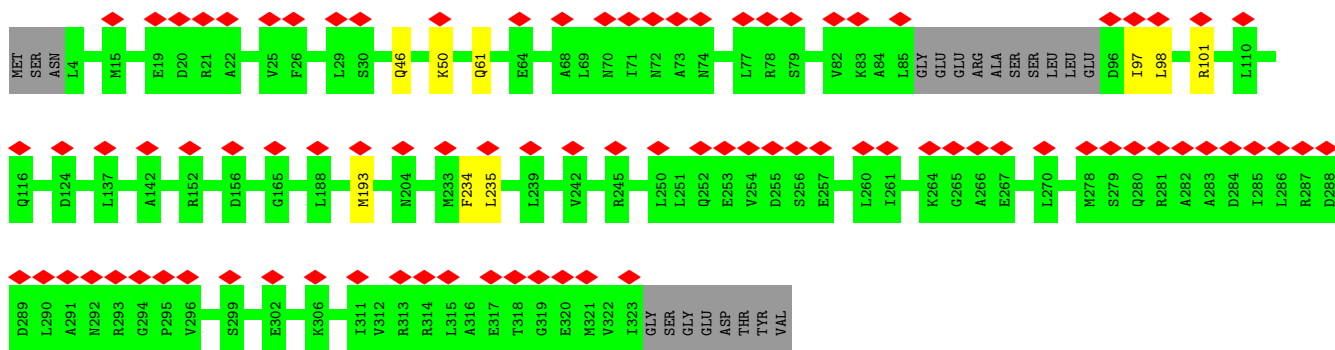
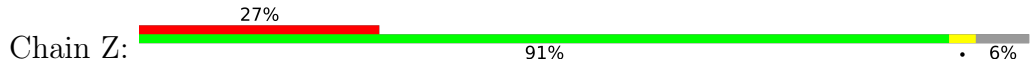

• Molecule 4: Flagellar motor switch protein FliG

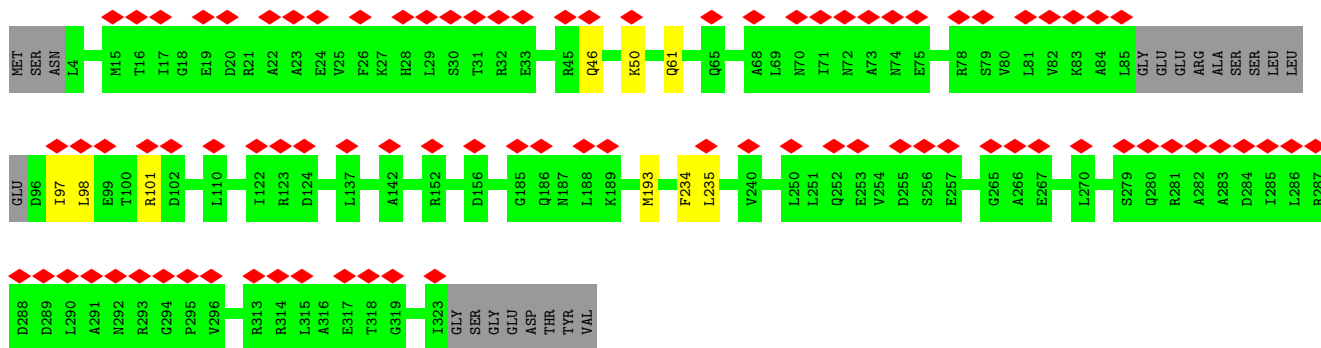
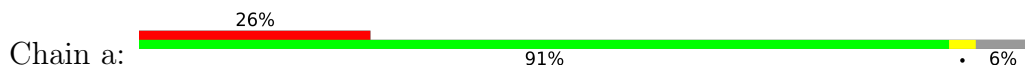

• Molecule 4: Flagellar motor switch protein FliG

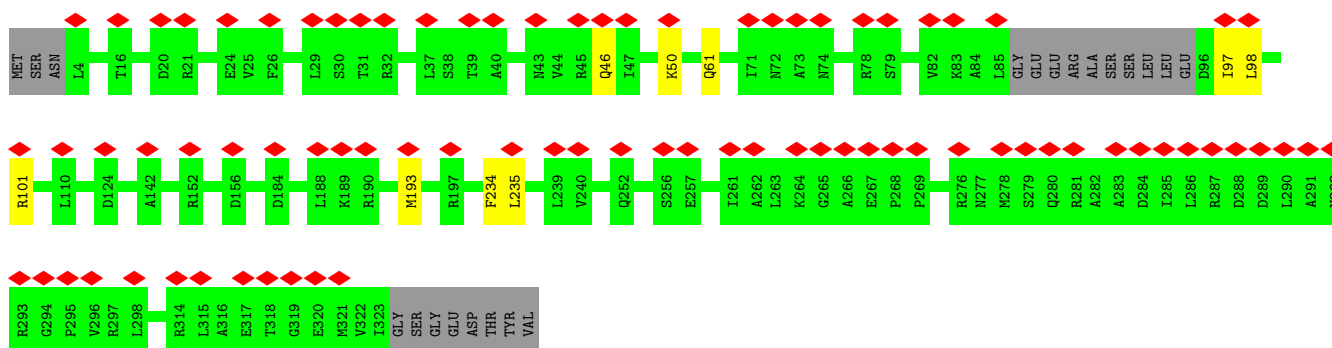

• Molecule 5: Chemotaxis protein CheY

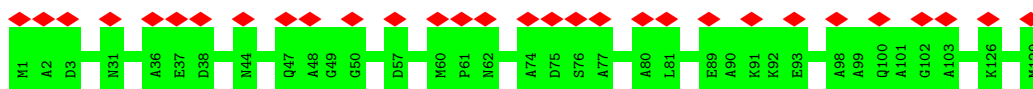

• Molecule 5: Chemotaxis protein CheY

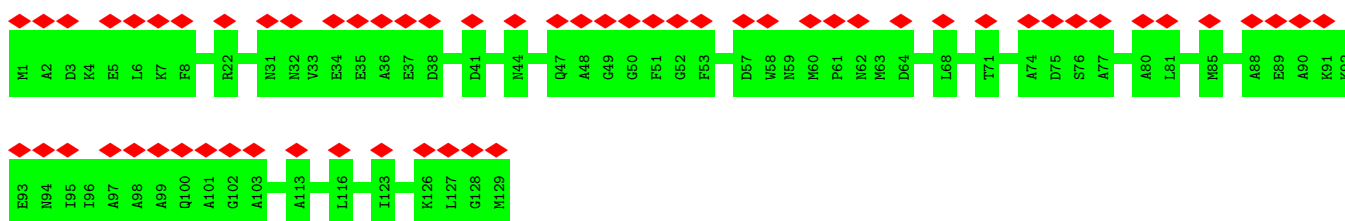

• Molecule 5: Chemotaxis protein CheY



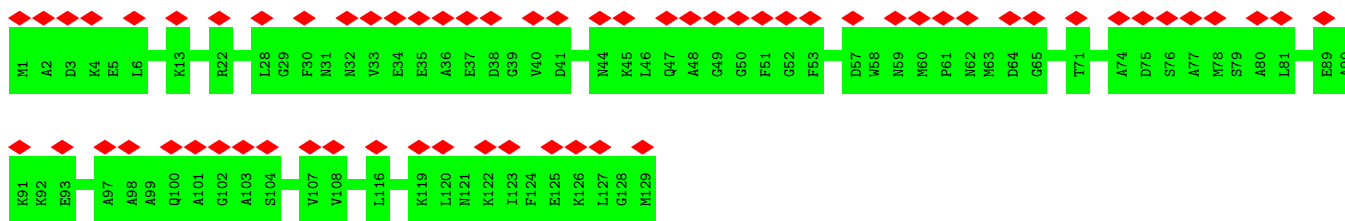

## 4 Experimental information

Property	Value	Source
EM reconstruction method	SINGLE PARTICLE	Depositor
Imposed symmetry	POINT, C1	Depositor
Number of particles used	956046	Depositor
Resolution determination method	FSC 0.143 CUT-OFF	Depositor
CTF correction method	PHASE FLIPPING AND AMPLITUDE CORRECTION	Depositor
Microscope	FEI TITAN KRIOS	Depositor
Voltage (kV)	300	Depositor
Electron dose ( $e^-/\text{\AA}^2$ )	50	Depositor
Minimum defocus (nm)	1200	Depositor
Maximum defocus (nm)	1800	Depositor
Magnification	105000	Depositor
Image detector	FEI FALCON IV (4k x 4k)	Depositor
Maximum map value	0.887	Depositor
Minimum map value	-0.433	Depositor
Average map value	-0.000	Depositor
Map value standard deviation	0.018	Depositor
Recommended contour level	0.15	Depositor
Map size (Å)	720.0, 720.0, 720.0	wwPDB
Map dimensions	600, 600, 600	wwPDB
Map angles (°)	90.0, 90.0, 90.0	wwPDB
Pixel spacing (Å)	1.2, 1.2, 1.2	Depositor

## 5 Model quality [i](#)

### 5.1 Standard geometry [i](#)

The Z score for a bond length (or angle) is the number of standard deviations the observed value is removed from the expected value. A bond length (or angle) with  $|Z| > 5$  is considered an outlier worth inspection. RMSZ is the root-mean-square of all Z scores of the bond lengths (or angles).

Mol	Chain	Bond lengths		Bond angles	
		RMSZ	# Z  >5	RMSZ	# Z  >5
1	0	0.29	0/679	0.53	0/917
1	AA	0.29	0/679	0.53	0/917
1	AB	0.29	0/679	0.53	0/917
1	o	0.39	0/679	0.57	0/917
1	p	0.39	0/679	0.57	0/917
1	q	0.39	0/679	0.57	0/917
1	u	0.31	0/679	0.54	0/917
1	v	0.31	0/679	0.54	0/917
1	w	0.31	0/679	0.54	0/917
2	C	0.22	0/226	0.49	0/303
2	D	0.22	0/226	0.49	0/303
2	E	0.22	0/226	0.49	0/303
3	S	0.28	0/2482	0.50	0/3375
3	T	0.28	0/2482	0.50	0/3375
3	U	0.27	0/2482	0.50	0/3375
4	Z	0.23	0/2447	0.46	0/3300
4	a	0.23	0/2447	0.46	0/3300
4	b	0.23	0/2447	0.46	0/3300
5	h	0.23	0/1004	0.41	0/1349
5	i	0.24	0/1004	0.41	0/1349
5	j	0.24	0/1004	0.40	0/1349
All	All	0.27	0/24588	0.49	0/33234

Chiral center outliers are detected by calculating the chiral volume of a chiral center and verifying if the center is modelled as a planar moiety or with the opposite hand. A planarity outlier is detected by checking planarity of atoms in a peptide group, atoms in a mainchain group or atoms of a sidechain that are expected to be planar.

Mol	Chain	#Chirality outliers	#Planarity outliers
1	0	0	1
1	AA	0	1
1	AB	0	1
1	o	0	1

*Continued on next page...*

*Continued from previous page...*

Mol	Chain	#Chirality outliers	#Planarity outliers
1	p	0	1
1	q	0	1
1	u	0	1
1	v	0	1
1	w	0	1
3	S	0	2
3	T	0	2
3	U	0	2
All	All	0	15

There are no bond length outliers.

There are no bond angle outliers.

There are no chirality outliers.

All (15) planarity outliers are listed below:

Mol	Chain	Res	Type	Group
1	o	131	ARG	Sidechain
1	p	131	ARG	Sidechain
1	q	131	ARG	Sidechain
1	u	131	ARG	Sidechain
1	v	131	ARG	Sidechain
1	w	131	ARG	Sidechain
3	S	60	ARG	Sidechain
3	S	63	ARG	Sidechain
3	T	60	ARG	Sidechain
3	T	63	ARG	Sidechain
3	U	60	ARG	Sidechain
3	U	63	ARG	Sidechain
1	o	131	ARG	Sidechain
1	p	131	ARG	Sidechain
1	q	131	ARG	Sidechain
1	u	131	ARG	Sidechain
1	v	131	ARG	Sidechain
1	w	131	ARG	Sidechain

## 5.2 Too-close contacts [i](#)

Due to software issues we are unable to calculate clashes - this section is therefore empty.

## 5.3 Torsion angles

### 5.3.1 Protein backbone

In the following table, the Percentiles column shows the percent Ramachandran outliers of the chain as a percentile score with respect to all PDB entries followed by that with respect to all EM entries.

The Analysed column shows the number of residues for which the backbone conformation was analysed, and the total number of residues.

Mol	Chain	Analysed	Favoured	Allowed	Outliers	Percentiles	
1	0	85/137 (62%)	80 (94%)	4 (5%)	1 (1%)	11	43
1	AA	85/137 (62%)	80 (94%)	4 (5%)	1 (1%)	11	43
1	AB	85/137 (62%)	80 (94%)	4 (5%)	1 (1%)	11	43
1	o	85/137 (62%)	78 (92%)	3 (4%)	4 (5%)	2	17
1	p	85/137 (62%)	78 (92%)	3 (4%)	4 (5%)	2	17
1	q	85/137 (62%)	78 (92%)	3 (4%)	4 (5%)	2	17
1	u	85/137 (62%)	81 (95%)	2 (2%)	2 (2%)	5	28
1	v	85/137 (62%)	81 (95%)	2 (2%)	2 (2%)	5	28
1	w	85/137 (62%)	81 (95%)	2 (2%)	2 (2%)	5	28
2	C	25/560 (4%)	24 (96%)	1 (4%)	0	100	100
2	D	25/560 (4%)	24 (96%)	1 (4%)	0	100	100
2	E	25/560 (4%)	24 (96%)	1 (4%)	0	100	100
3	S	297/334 (89%)	285 (96%)	8 (3%)	4 (1%)	10	42
3	T	297/334 (89%)	285 (96%)	8 (3%)	4 (1%)	10	42
3	U	297/334 (89%)	285 (96%)	8 (3%)	4 (1%)	10	42
4	Z	306/331 (92%)	295 (96%)	10 (3%)	1 (0%)	37	72
4	a	306/331 (92%)	295 (96%)	10 (3%)	1 (0%)	37	72
4	b	306/331 (92%)	295 (96%)	10 (3%)	1 (0%)	37	72
5	h	127/129 (98%)	125 (98%)	2 (2%)	0	100	100
5	i	127/129 (98%)	125 (98%)	2 (2%)	0	100	100
5	j	127/129 (98%)	125 (98%)	2 (2%)	0	100	100
All	All	3030/5295 (57%)	2904 (96%)	90 (3%)	36 (1%)	14	43

All (36) Ramachandran outliers are listed below:



Mol	Chain	Res	Type
1	0	116	ASP
1	o	116	ASP
1	u	116	ASP
1	AA	116	ASP
1	p	116	ASP
1	v	116	ASP
1	AB	116	ASP
1	q	116	ASP
1	w	116	ASP
3	S	232	VAL
1	o	125	ILE
1	o	126	ILE
3	T	232	VAL
1	p	125	ILE
1	p	126	ILE
3	U	232	VAL
1	q	125	ILE
1	q	126	ILE
1	o	59	ASP
1	p	59	ASP
1	q	59	ASP
3	S	236	LEU
4	Z	97	ILE
3	T	236	LEU
4	a	97	ILE
3	U	236	LEU
4	b	97	ILE
3	T	237	GLU
3	S	235	PRO
3	S	237	GLU
1	u	127	THR
3	T	235	PRO
1	v	127	THR
3	U	235	PRO
3	U	237	GLU
1	w	127	THR

### 5.3.2 Protein sidechains [i](#)

In the following table, the Percentiles column shows the percent sidechain outliers of the chain as a percentile score with respect to all PDB entries followed by that with respect to all EM entries.

The Analysed column shows the number of residues for which the sidechain conformation was

analysed, and the total number of residues.

Mol	Chain	Analysed	Rotameric	Outliers	Percentiles	
1	0	76/113 (67%)	74 (97%)	2 (3%)	41	61
1	AA	76/113 (67%)	74 (97%)	2 (3%)	41	61
1	AB	76/113 (67%)	74 (97%)	2 (3%)	41	61
1	o	76/113 (67%)	72 (95%)	4 (5%)	19	41
1	p	76/113 (67%)	72 (95%)	4 (5%)	19	41
1	q	76/113 (67%)	72 (95%)	4 (5%)	19	41
1	u	76/113 (67%)	75 (99%)	1 (1%)	65	77
1	v	76/113 (67%)	75 (99%)	1 (1%)	65	77
1	w	76/113 (67%)	75 (99%)	1 (1%)	65	77
2	C	26/467 (6%)	26 (100%)	0	100	100
2	D	26/467 (6%)	26 (100%)	0	100	100
2	E	26/467 (6%)	26 (100%)	0	100	100
3	S	272/301 (90%)	264 (97%)	8 (3%)	37	58
3	T	272/301 (90%)	264 (97%)	8 (3%)	37	58
3	U	272/301 (90%)	264 (97%)	8 (3%)	37	58
4	Z	265/282 (94%)	257 (97%)	8 (3%)	36	57
4	a	265/282 (94%)	257 (97%)	8 (3%)	36	57
4	b	265/282 (94%)	257 (97%)	8 (3%)	36	57
5	h	104/104 (100%)	104 (100%)	0	100	100
5	i	104/104 (100%)	104 (100%)	0	100	100
5	j	104/104 (100%)	104 (100%)	0	100	100
All	All	2685/4479 (60%)	2616 (97%)	69 (3%)	42	61

All (69) residues with a non-rotameric sidechain are listed below:

Mol	Chain	Res	Type
1	0	106	ILE
1	0	132	MET
3	S	43	GLN
3	S	47	VAL
3	S	66	ARG
3	S	140	LYS
3	S	155	ASN
3	S	236	LEU

*Continued on next page...*

*Continued from previous page...*

<b>Mol</b>	<b>Chain</b>	<b>Res</b>	<b>Type</b>
3	S	237	GLU
3	S	286	ILE
4	Z	46	GLN
4	Z	50	LYS
4	Z	61	GLN
4	Z	98	LEU
4	Z	101	ARG
4	Z	193	MET
4	Z	234	PHE
4	Z	235	LEU
1	o	53	ASP
1	o	56	LEU
1	o	58	MET
1	o	106	ILE
1	u	106	ILE
1	AA	106	ILE
1	AA	132	MET
3	T	43	GLN
3	T	47	VAL
3	T	66	ARG
3	T	140	LYS
3	T	155	ASN
3	T	236	LEU
3	T	237	GLU
3	T	286	ILE
4	a	46	GLN
4	a	50	LYS
4	a	61	GLN
4	a	98	LEU
4	a	101	ARG
4	a	193	MET
4	a	234	PHE
4	a	235	LEU
1	p	53	ASP
1	p	56	LEU
1	p	58	MET
1	p	106	ILE
1	v	106	ILE
1	AB	106	ILE
1	AB	132	MET
3	U	43	GLN
3	U	47	VAL

*Continued on next page...*

*Continued from previous page...*

Mol	Chain	Res	Type
3	U	66	ARG
3	U	140	LYS
3	U	155	ASN
3	U	236	LEU
3	U	237	GLU
3	U	286	ILE
4	b	46	GLN
4	b	50	LYS
4	b	61	GLN
4	b	98	LEU
4	b	101	ARG
4	b	193	MET
4	b	234	PHE
4	b	235	LEU
1	q	53	ASP
1	q	56	LEU
1	q	58	MET
1	q	106	ILE
1	w	106	ILE

Sometimes sidechains can be flipped to improve hydrogen bonding and reduce clashes. All (19) such sidechains are listed below:

Mol	Chain	Res	Type
2	C	542	ASN
3	S	8	GLN
3	S	238	ASN
3	S	245	ASN
4	Z	46	GLN
4	Z	186	GLN
2	D	542	ASN
3	T	8	GLN
3	T	238	ASN
3	T	245	ASN
4	a	46	GLN
4	a	70	ASN
4	a	186	GLN
2	E	542	ASN
3	U	8	GLN
3	U	238	ASN
3	U	245	ASN
4	b	46	GLN
4	b	186	GLN

### 5.3.3 RNA [i](#)

There are no RNA molecules in this entry.

### 5.4 Non-standard residues in protein, DNA, RNA chains [i](#)

There are no non-standard protein/DNA/RNA residues in this entry.

### 5.5 Carbohydrates [i](#)

There are no oligosaccharides in this entry.

### 5.6 Ligand geometry [i](#)

There are no ligands in this entry.

### 5.7 Other polymers [i](#)

There are no such residues in this entry.

### 5.8 Polymer linkage issues [i](#)

There are no chain breaks in this entry.

## 6 Map visualisation [i](#)

This section contains visualisations of the EMDB entry EMD-38547. These allow visual inspection of the internal detail of the map and identification of artifacts.

Images derived from a raw map, generated by summing the deposited half-maps, are presented below the corresponding image components of the primary map to allow further visual inspection and comparison with those of the primary map.

### 6.1 Orthogonal projections [i](#)

#### 6.1.1 Primary map

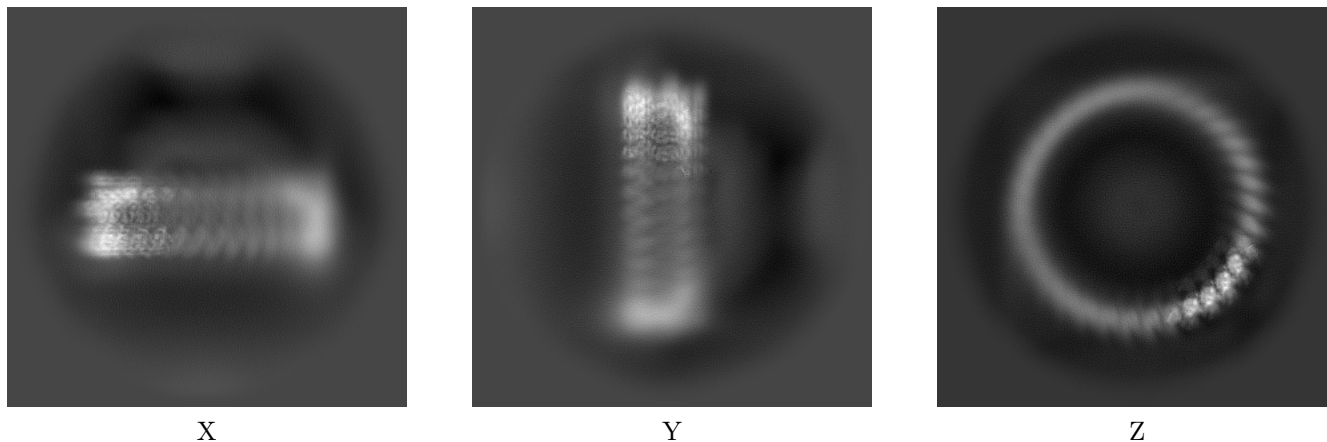

#### 6.1.2 Raw map

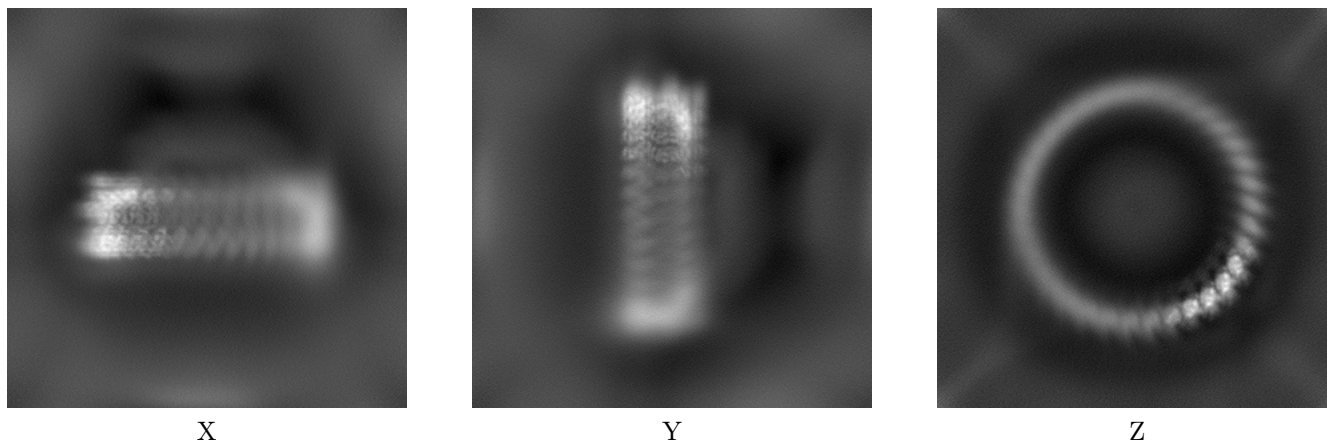

The images above show the map projected in three orthogonal directions.

## 6.2 Central slices [i](#)

### 6.2.1 Primary map

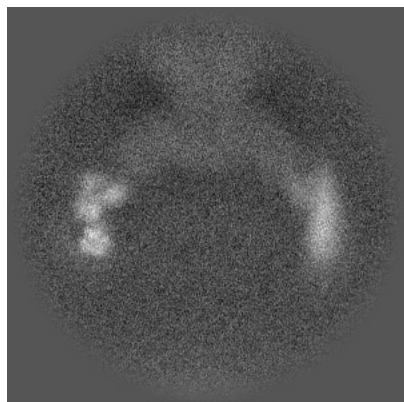

X Index: 300

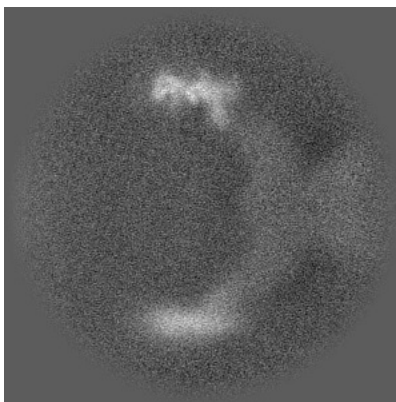

Y Index: 300

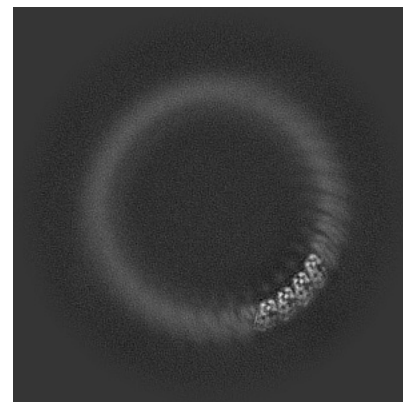

Z Index: 300

### 6.2.2 Raw map

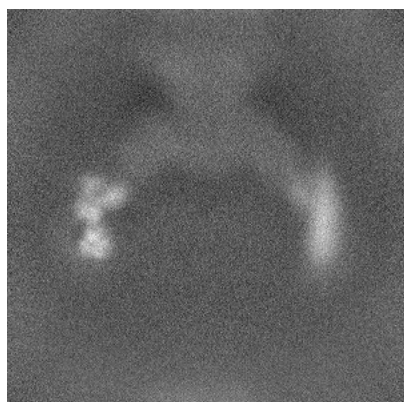

X Index: 300

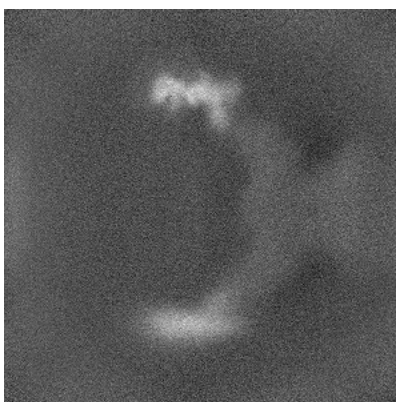

Y Index: 300

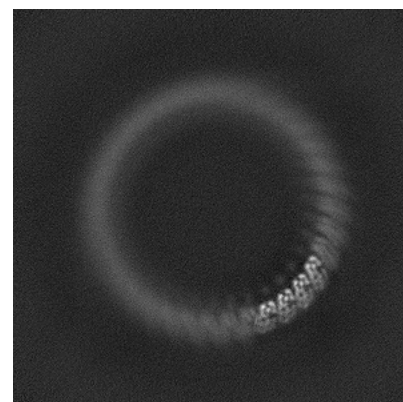

Z Index: 300

The images above show central slices of the map in three orthogonal directions.

## 6.3 Largest variance slices [i](#)

### 6.3.1 Primary map

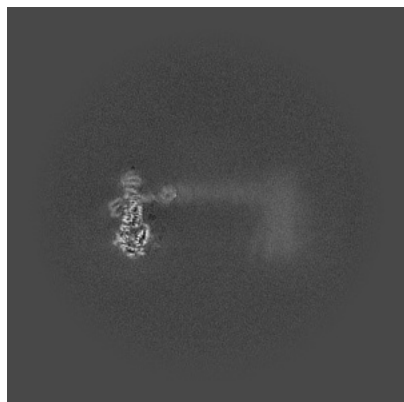

X Index: 431

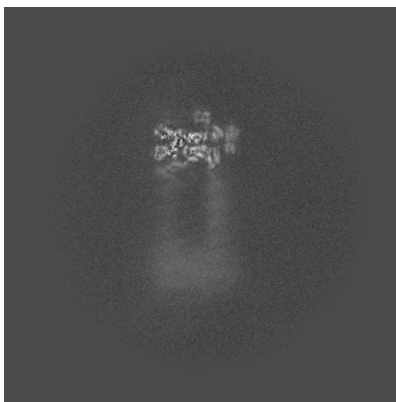

Y Index: 156

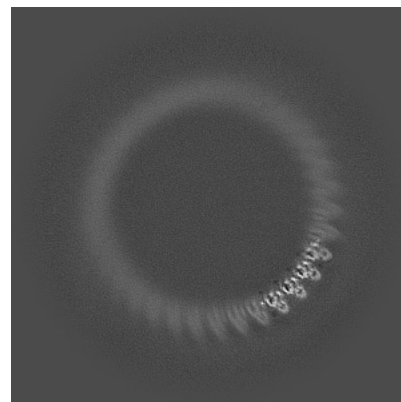

Z Index: 256

### 6.3.2 Raw map



X Index: 432



Y Index: 156

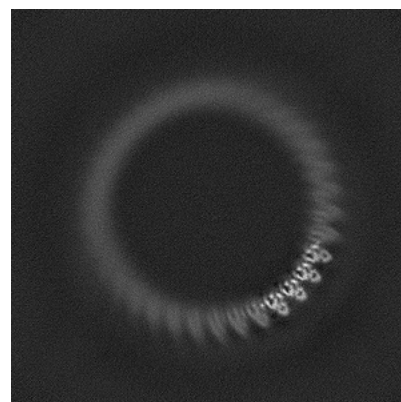

Z Index: 256

The images above show the largest variance slices of the map in three orthogonal directions.



## 6.4 Orthogonal standard-deviation projections (False-color) [i](#)

### 6.4.1 Primary map

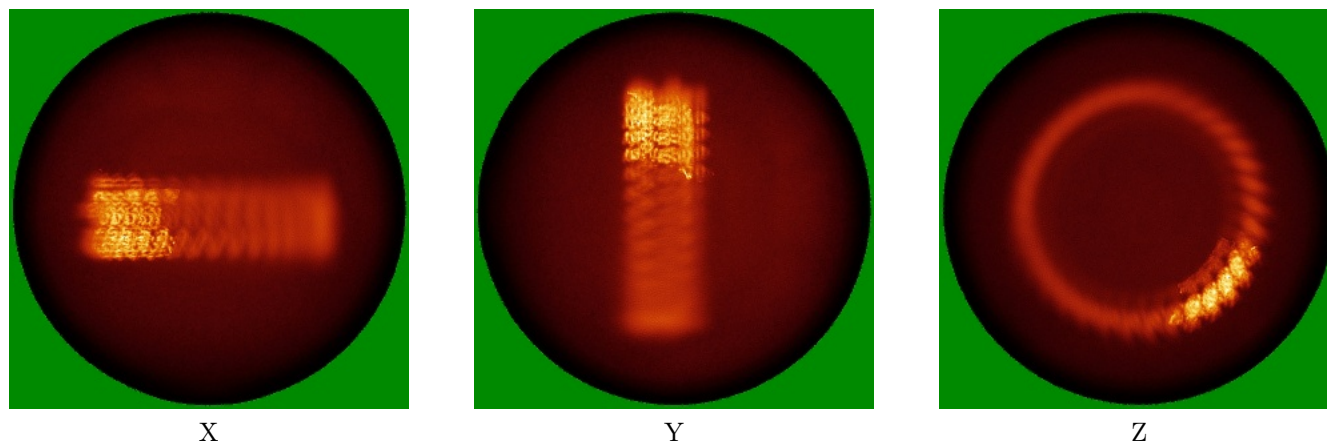

### 6.4.2 Raw map

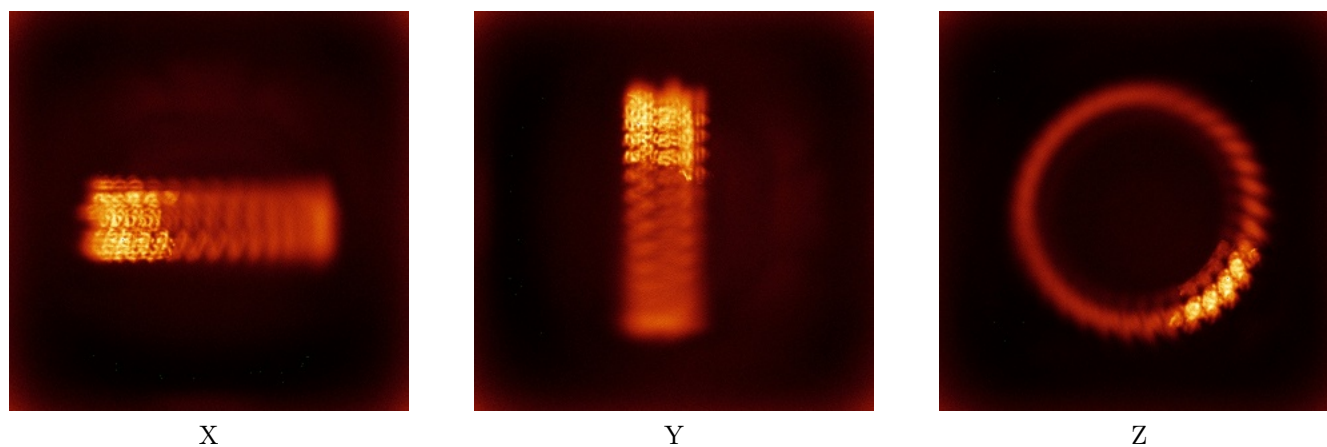

The images above show the map standard deviation projections with false color in three orthogonal directions. Minimum values are shown in green, max in blue, and dark to light orange shades represent small to large values respectively.

## 6.5 Orthogonal surface views [i](#)

### 6.5.1 Primary map

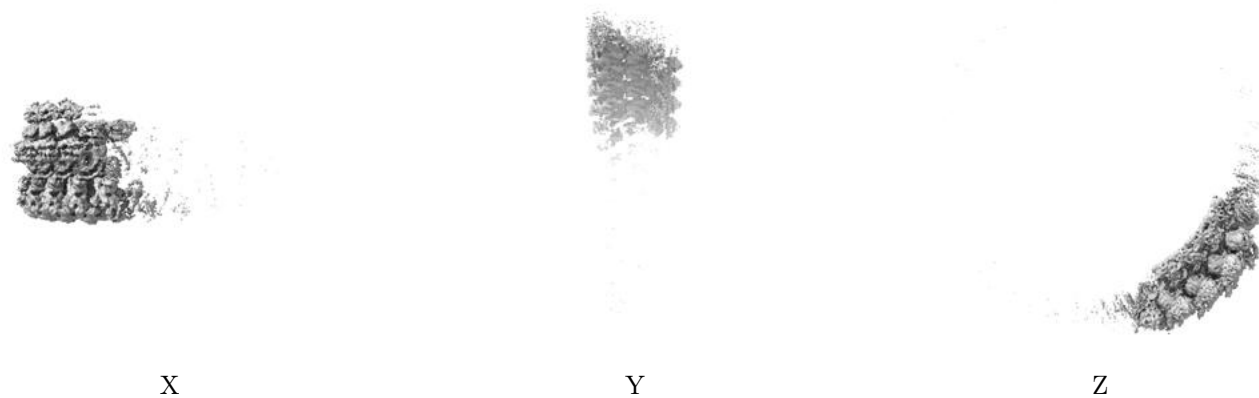

The images above show the 3D surface view of the map at the recommended contour level 0.15. These images, in conjunction with the slice images, may facilitate assessment of whether an appropriate contour level has been provided.

### 6.5.2 Raw map

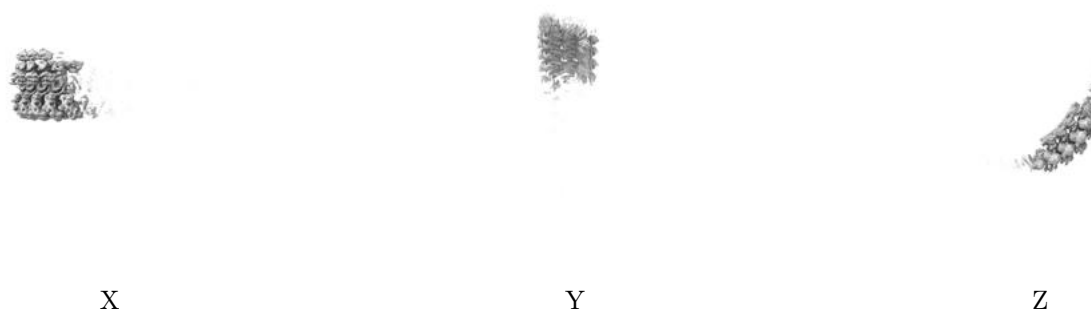

These images show the 3D surface of the raw map. The raw map's contour level was selected so that its surface encloses the same volume as the primary map does at its recommended contour level.

## 6.6 Mask visualisation [i](#)

This section was not generated. No masks/segmentation were deposited.

## 7 Map analysis [i](#)

This section contains the results of statistical analysis of the map.

### 7.1 Map-value distribution [i](#)

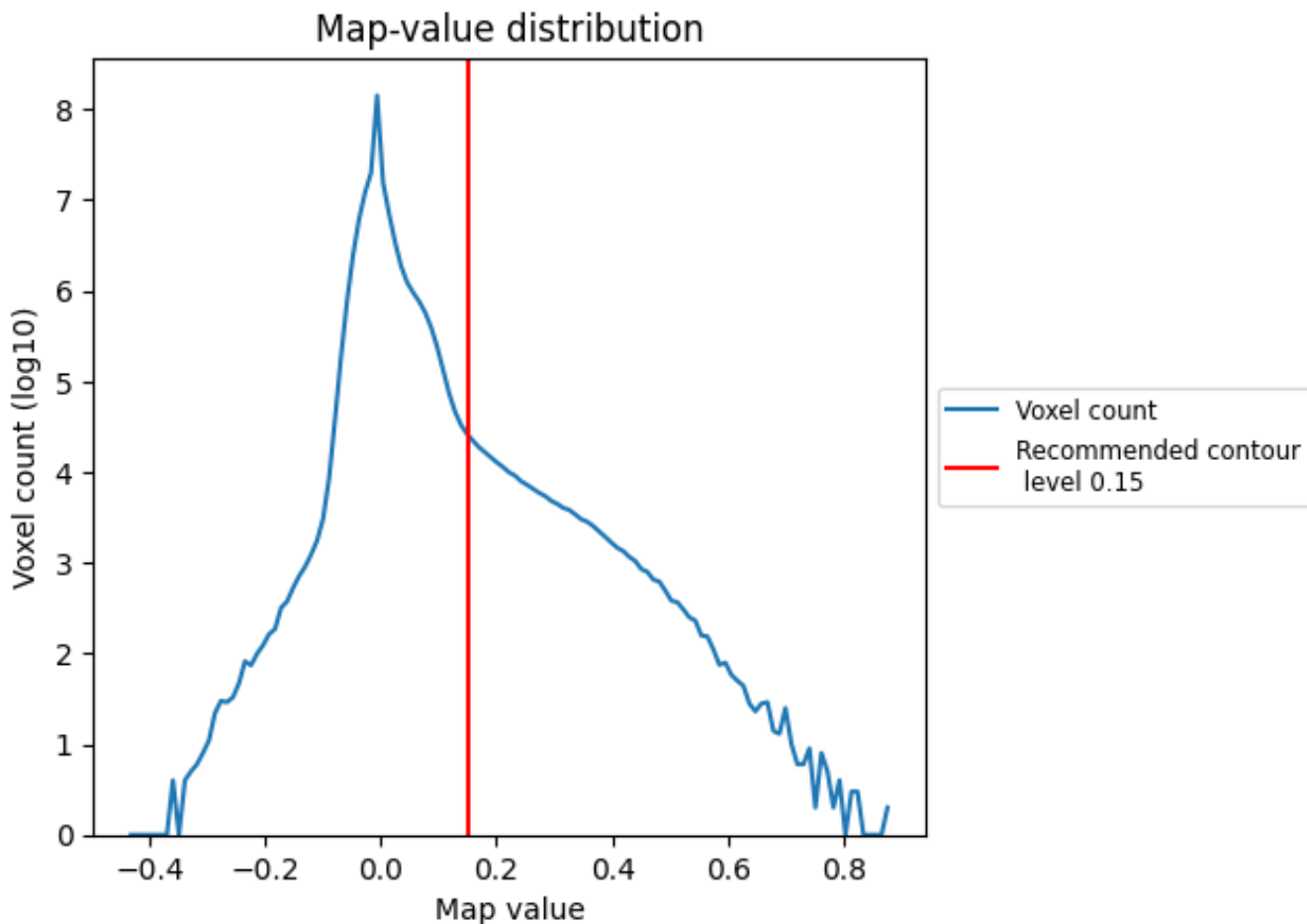

The map-value distribution is plotted in 128 intervals along the x-axis. The y-axis is logarithmic. A spike in this graph at zero usually indicates that the volume has been masked.

## 7.2 Volume estimate [\(i\)](#)

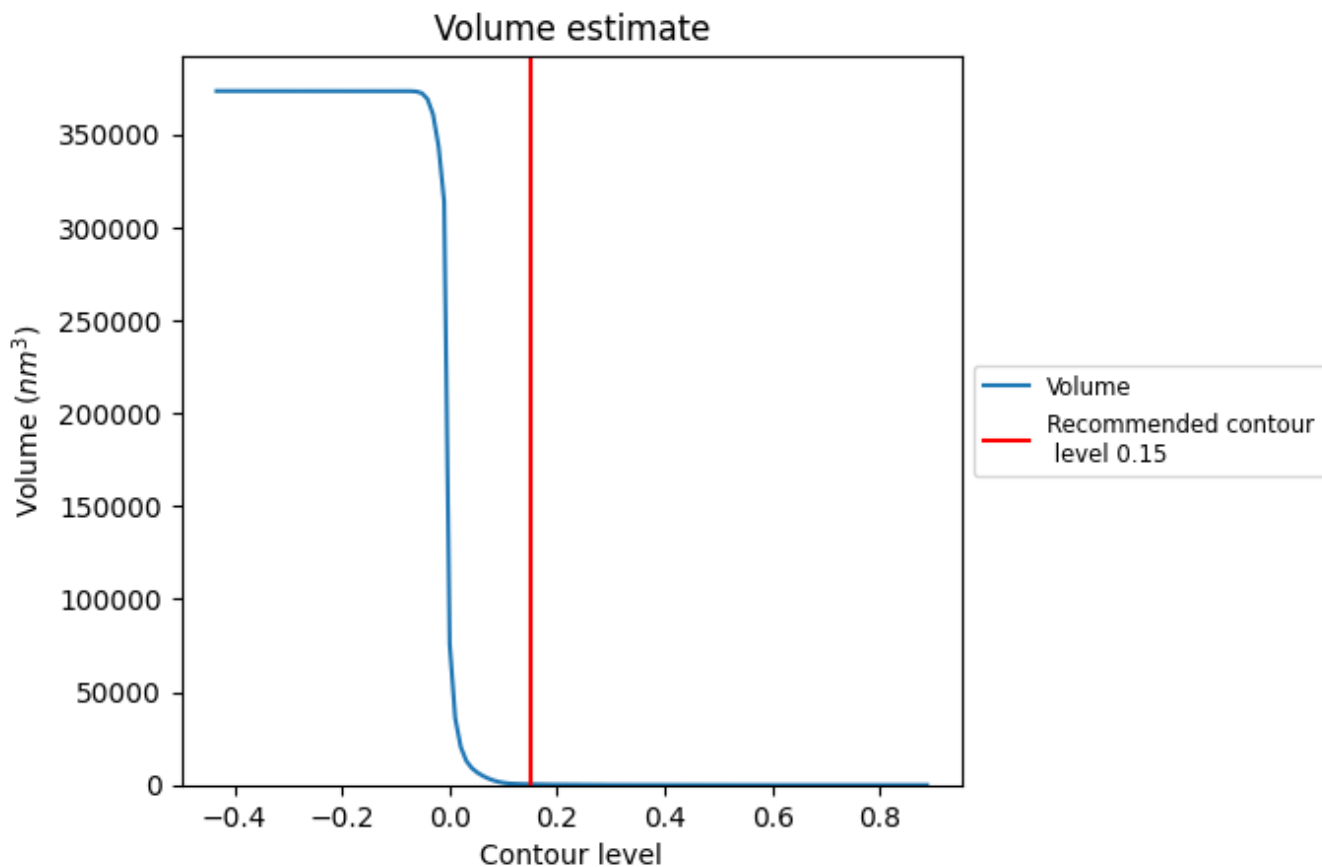

The volume at the recommended contour level is 377 nm<sup>3</sup>; this corresponds to an approximate mass of 340 kDa.

The volume estimate graph shows how the enclosed volume varies with the contour level. The recommended contour level is shown as a vertical line and the intersection between the line and the curve gives the volume of the enclosed surface at the given level.

### 7.3 Rotationally averaged power spectrum [i](#)

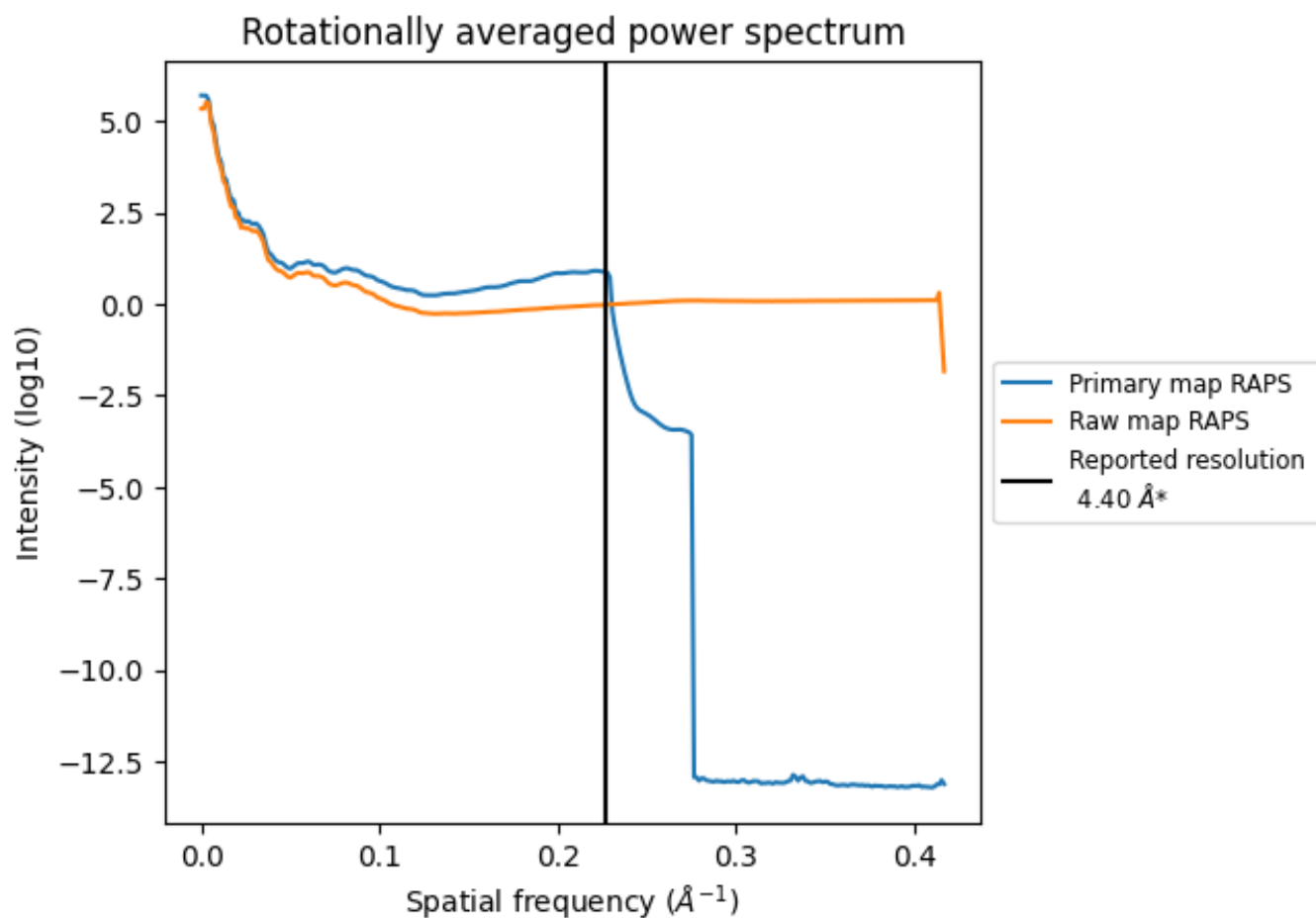

\*Reported resolution corresponds to spatial frequency of 0.227 Å<sup>-1</sup>

## 8 Fourier-Shell correlation [i](#)

Fourier-Shell Correlation (FSC) is the most commonly used method to estimate the resolution of single-particle and subtomogram-averaged maps. The shape of the curve depends on the imposed symmetry, mask and whether or not the two 3D reconstructions used were processed from a common reference. The reported resolution is shown as a black line. A curve is displayed for the half-bit criterion in addition to lines showing the 0.143 gold standard cut-off and 0.5 cut-off.

### 8.1 FSC [i](#)

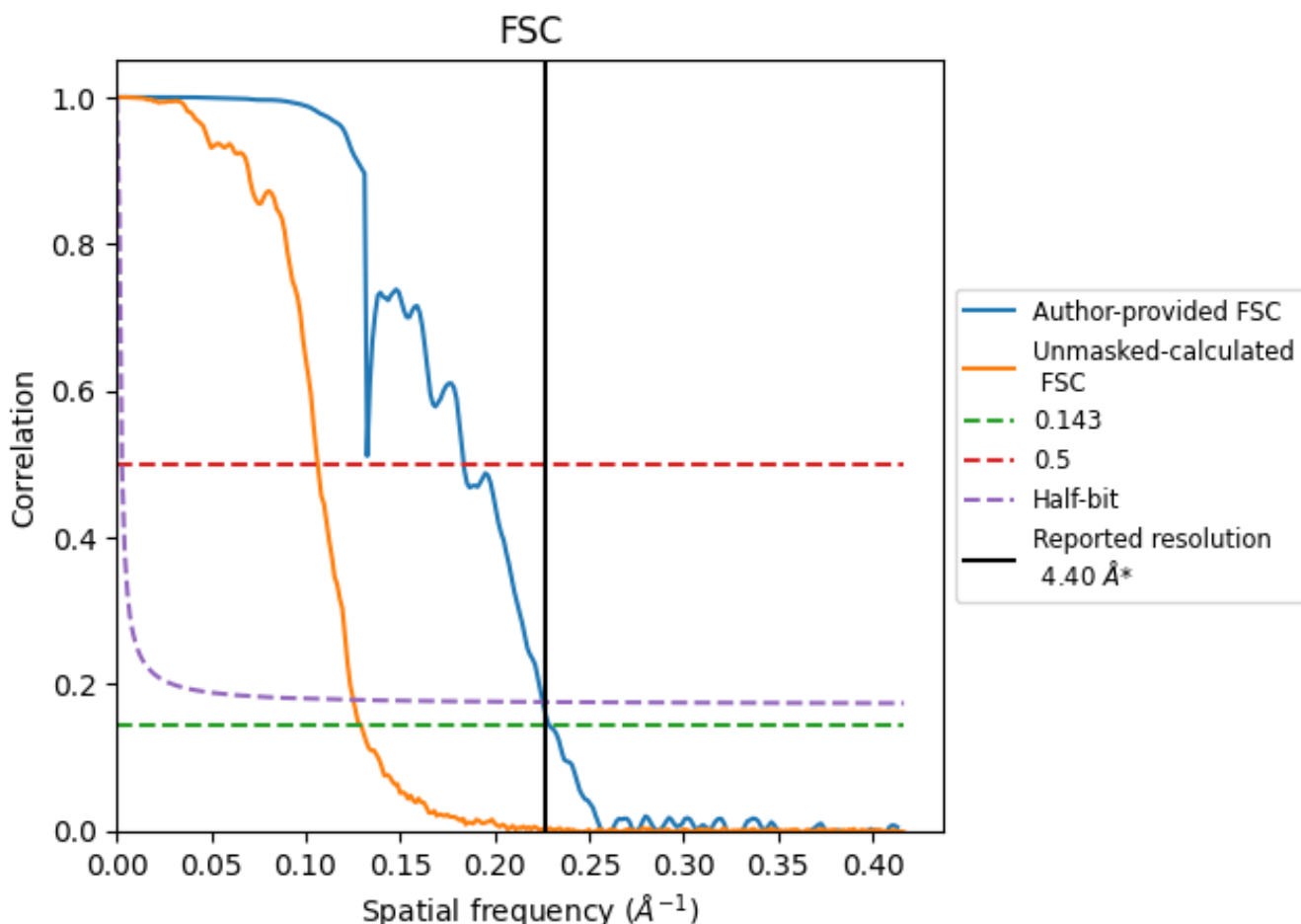

\*Reported resolution corresponds to spatial frequency of  $0.227 \text{\AA}^{-1}$

## 8.2 Resolution estimates [i](#)

Resolution estimate (Å)	Estimation criterion (FSC cut-off)		
	0.143	0.5	Half-bit
Reported by author	4.40	-	-
Author-provided FSC curve	4.36	5.44	4.43
Unmasked-calculated*	7.73	9.40	7.99

\*Resolution estimate based on FSC curve calculated by comparison of deposited half-maps. The value from deposited half-maps intersecting FSC 0.143 CUT-OFF 7.73 differs from the reported value 4.4 by more than 10 %

## 9 Map-model fit [i](#)

This section contains information regarding the fit between EMDB map EMD-38547 and PDB model 8XP1. Per-residue inclusion information can be found in section 3 on page 6.

### 9.1 Map-model overlay [i](#)

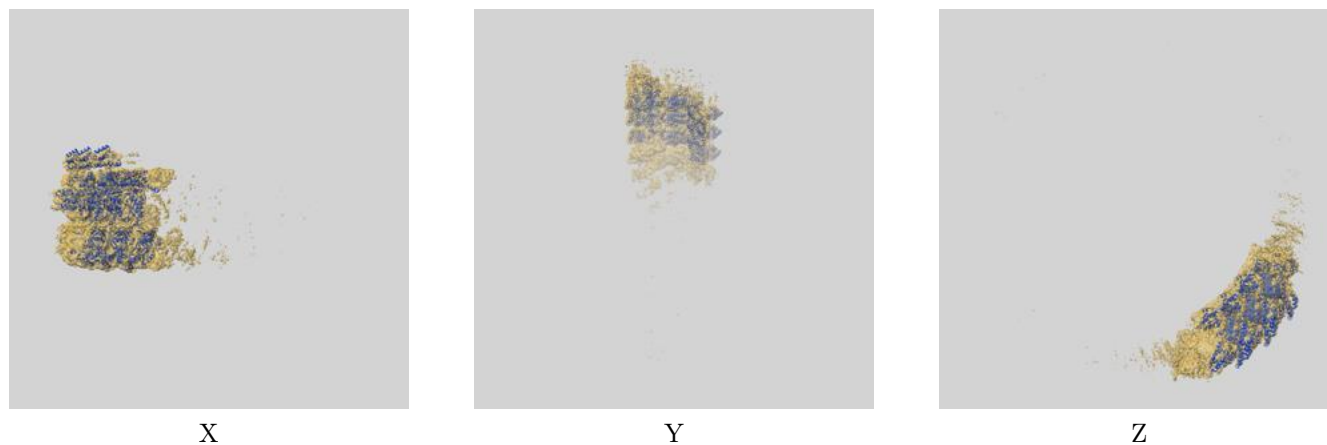

The images above show the 3D surface view of the map at the recommended contour level 0.15 at 50% transparency in yellow overlaid with a ribbon representation of the model coloured in blue. These images allow for the visual assessment of the quality of fit between the atomic model and the map.



## 9.2 Q-score mapped to coordinate model [i](#)

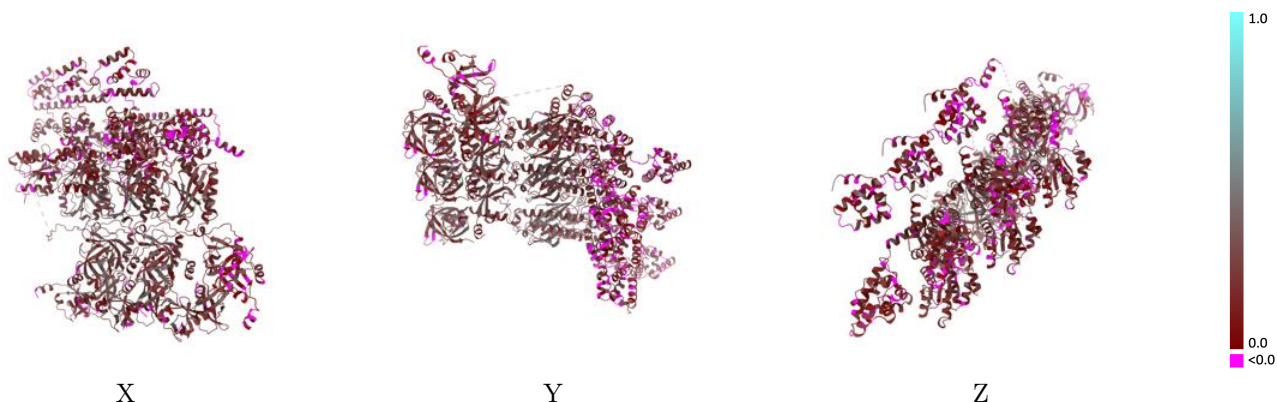

The images above show the model with each residue coloured according to its Q-score. This shows their resolvability in the map with higher Q-score values reflecting better resolvability. Please note: Q-score is calculating the resolvability of atoms, and thus high values are only expected at resolutions at which atoms can be resolved. Low Q-score values may therefore be expected for many entries.

## 9.3 Atom inclusion mapped to coordinate model [i](#)

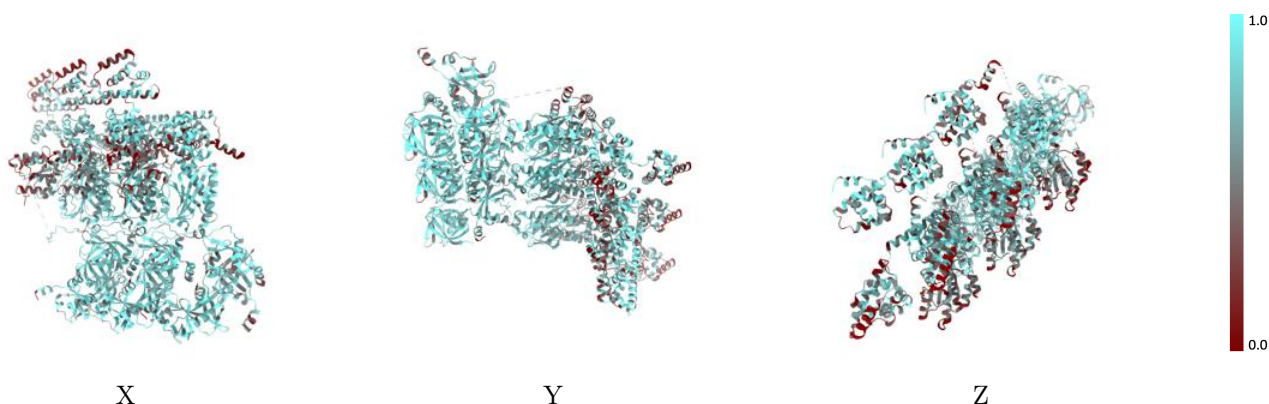

The images above show the model with each residue coloured according to its atom inclusion. This shows to what extent they are inside the map at the recommended contour level (0.15).



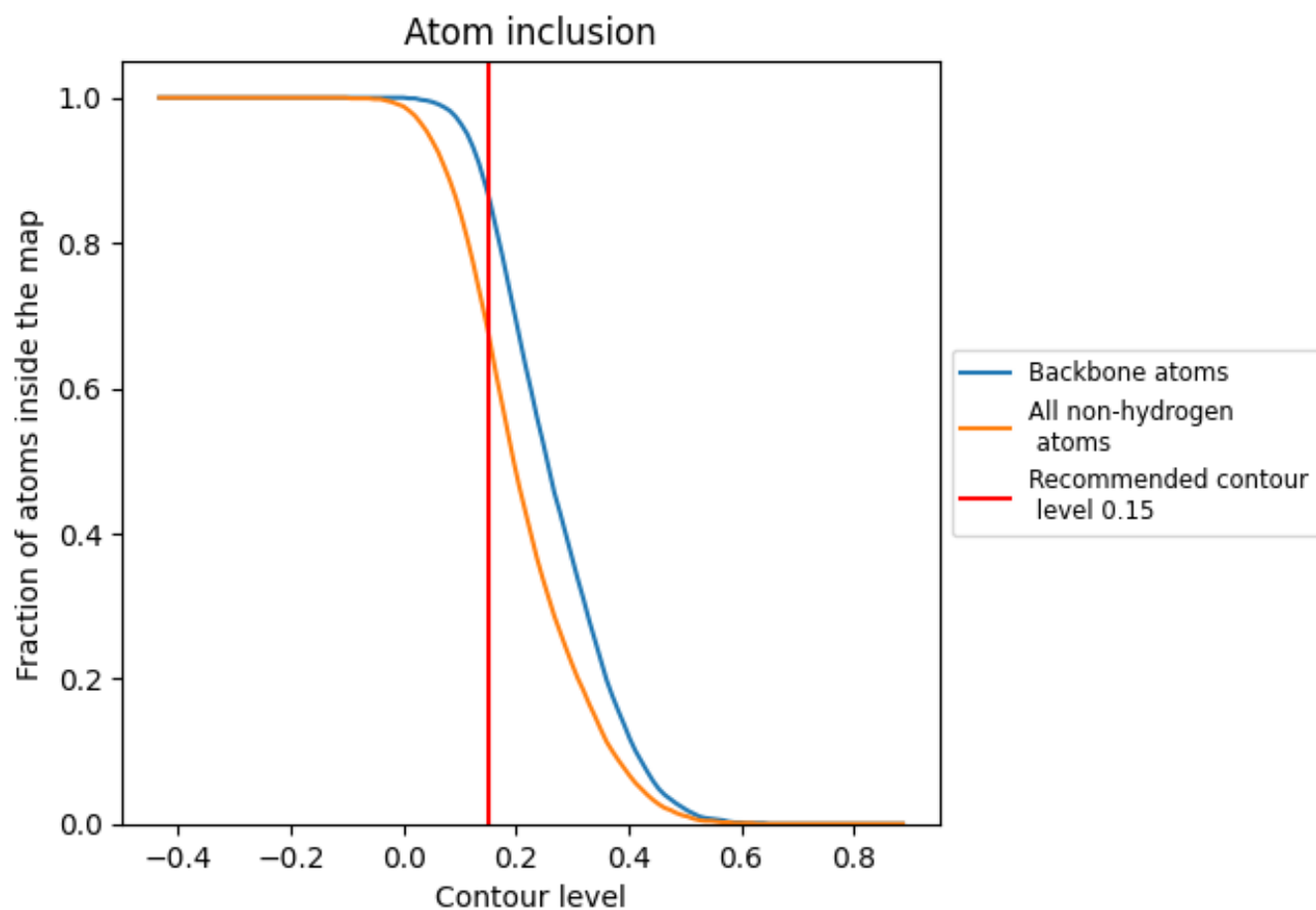









































## 9.4 Atom inclusion [i](#)



At the recommended contour level, 87% of all backbone atoms, 68% of all non-hydrogen atoms, are inside the map.

## 9.5 Map-model fit summary

The table lists the average atom inclusion at the recommended contour level (0.15) and Q-score for the entire model and for each chain.

Chain	Atom inclusion	Q-score
All	 0.6810	 0.2040
0	 0.7690	 0.2710
AA	 0.7150	 0.1900
AB	 0.7840	 0.2660
C	 0.6790	 0.0880
D	 0.6840	 0.1360
E	 0.7440	 0.1140
S	 0.8030	 0.2910
T	 0.7860	 0.2470
U	 0.7990	 0.2880
Z	 0.5920	 0.1340
a	 0.6050	 0.1130
b	 0.5960	 0.1390
h	 0.5320	 0.1910
i	 0.4110	 0.1700
j	 0.4220	 0.1900
o	 0.7790	 0.2320
p	 0.7430	 0.1950
q	 0.7760	 0.2280
u	 0.7550	 0.2640
v	 0.6510	 0.1430
w	 0.7980	 0.2510

