



# wwPDB X-ray Structure Validation Summary Report ⓘ

Sep 17, 2023 – 11:18 PM EDT

PDB ID : 4XSZ  
Title : Crystal structure of CBR 9393 bound to Escherichia coli RNA polymerase holoenzyme  
Authors : Bae, B.; Darst, S.A.  
Deposited on : 2015-01-22  
Resolution : 3.68 Å(reported)

This is a wwPDB X-ray Structure Validation Summary Report for a publicly released PDB entry.

We welcome your comments at [validation@mail.wwpdb.org](mailto:validation@mail.wwpdb.org)

A user guide is available at

<https://www.wwpdb.org/validation/2017/XrayValidationReportHelp>

with specific help available everywhere you see the ⓘ symbol.

The types of validation reports are described at

<http://www.wwpdb.org/validation/2017/FAQs#types>.

---

The following versions of software and data (see [references ⓘ](#)) were used in the production of this report:

MolProbity : 4.02b-467  
Mogul : 1.8.5 (274361), CSD as541be (2020)  
Xtrriage (Phenix) : 1.13  
EDS : 2.35.1  
buster-report : 1.1.7 (2018)  
Percentile statistics : 20191225.v01 (using entries in the PDB archive December 25th 2019)  
Refmac : 5.8.0158  
CCP4 : 7.0.044 (Gargrove)  
Ideal geometry (proteins) : Engh & Huber (2001)  
Ideal geometry (DNA, RNA) : Parkinson et al. (1996)  
Validation Pipeline (wwPDB-VP) : 2.35.1

# 1 Overall quality at a glance i

The following experimental techniques were used to determine the structure:

*X-RAY DIFFRACTION*

The reported resolution of this entry is 3.68 Å.

Percentile scores (ranging between 0-100) for global validation metrics of the entry are shown in the following graphic. The table shows the number of entries on which the scores are based.

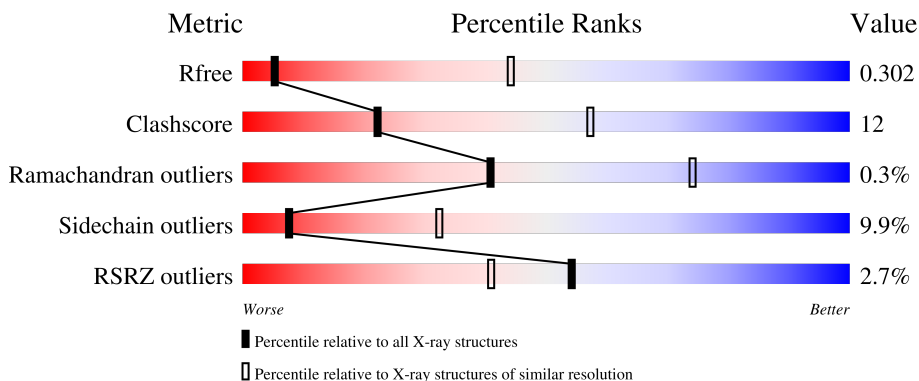

Metric	Whole archive (#Entries)	Similar resolution (#Entries, resolution range(Å))
$R_{free}$	130704	1013 (3.84-3.52)
Clashscore	141614	1070 (3.84-3.52)
Ramachandran outliers	138981	1036 (3.84-3.52)
Sidechain outliers	138945	1033 (3.84-3.52)
RSRZ outliers	127900	1471 (3.86-3.50)

The table below summarises the geometric issues observed across the polymeric chains and their fit to the electron density. The red, orange, yellow and green segments of the lower bar indicate the fraction of residues that contain outliers for  $\geq 3$ , 2, 1 and 0 types of geometric quality criteria respectively. A grey segment represents the fraction of residues that are not modelled. The numeric value for each fraction is indicated below the corresponding segment, with a dot representing fractions  $\leq 5\%$ . The upper red bar (where present) indicates the fraction of residues that have poor fit to the electron density. The numeric value is given above the bar.

Mol	Chain	Length	Quality of chain
1	A	239	<div style="display: flex; align-items: center;"> <div style="width: 2%; height: 10px; background-color: red; margin-right: 2px;"></div> <div style="width: 64%; height: 10px; background-color: green; margin-right: 2px;"></div> <div style="width: 26%; height: 10px; background-color: yellow; margin-right: 2px;"></div> <div style="width: 6%; height: 10px; background-color: orange; margin-right: 2px;"></div> <div style="width: 2%; height: 10px; background-color: grey;"></div> </div> <p style="margin-left: 20px;">2%      64%      26%      • 6%</p>
1	B	239	<div style="display: flex; align-items: center;"> <div style="width: 4%; height: 10px; background-color: red; margin-right: 2px;"></div> <div style="width: 63%; height: 10px; background-color: green; margin-right: 2px;"></div> <div style="width: 26%; height: 10px; background-color: yellow; margin-right: 2px;"></div> <div style="width: 8%; height: 10px; background-color: orange; margin-right: 2px;"></div> <div style="width: 2%; height: 10px; background-color: grey;"></div> </div> <p style="margin-left: 20px;">4%      63%      26%      • 8%</p>
1	G	239	<div style="display: flex; align-items: center;"> <div style="width: 3%; height: 10px; background-color: red; margin-right: 2px;"></div> <div style="width: 67%; height: 10px; background-color: green; margin-right: 2px;"></div> <div style="width: 24%; height: 10px; background-color: yellow; margin-right: 2px;"></div> <div style="width: 5%; height: 10px; background-color: orange; margin-right: 2px;"></div> <div style="width: 2%; height: 10px; background-color: grey;"></div> </div> <p style="margin-left: 20px;">3%      67%      24%      • 5%</p>
1	H	239	<div style="display: flex; align-items: center;"> <div style="width: 7%; height: 10px; background-color: red; margin-right: 2px;"></div> <div style="width: 61%; height: 10px; background-color: green; margin-right: 2px;"></div> <div style="width: 27%; height: 10px; background-color: yellow; margin-right: 2px;"></div> <div style="width: 9%; height: 10px; background-color: orange; margin-right: 2px;"></div> <div style="width: 2%; height: 10px; background-color: grey;"></div> </div> <p style="margin-left: 20px;">7%      61%      27%      • 9%</p>
2	C	1342	<div style="display: flex; align-items: center;"> <div style="width: 0%; height: 10px; background-color: red; margin-right: 2px;"></div> <div style="width: 66%; height: 10px; background-color: green; margin-right: 2px;"></div> <div style="width: 30%; height: 10px; background-color: yellow; margin-right: 2px;"></div> <div style="width: 2%; height: 10px; background-color: orange; margin-right: 2px;"></div> <div style="width: 2%; height: 10px; background-color: grey;"></div> </div> <p style="margin-left: 20px;">%      66%      30%      •</p>

*Continued on next page...*

*Continued from previous page...*

Mol	Chain	Length	Quality of chain
2	I	1342	
3	D	1407	
3	J	1407	
4	E	91	
4	K	91	
5	F	522	
5	L	522	

## 2 Entry composition

There are 8 unique types of molecules in this entry. The entry contains 55744 atoms, of which 0 are hydrogens and 0 are deuteriums.

In the tables below, the ZeroOcc column contains the number of atoms modelled with zero occupancy, the AltConf column contains the number of residues with at least one atom in alternate conformation and the Trace column contains the number of residues modelled with at most 2 atoms.

- Molecule 1 is a protein called DNA-directed RNA polymerase subunit alpha.

Mol	Chain	Residues	Atoms					ZeroOcc	AltConf	Trace
			Total	C	N	O	S			
1	A	224	Total 1730	C 1076	N 308	O 340	S 6	0	0	0
1	B	220	Total 1687	C 1053	N 298	O 330	S 6	0	0	0
1	G	228	Total 1750	C 1088	N 312	O 344	S 6	0	0	0
1	H	217	Total 1667	C 1041	N 293	O 327	S 6	0	0	0

There are 20 discrepancies between the modelled and reference sequences:

Chain	Residue	Modelled	Actual	Comment	Reference
A	235	GLU	-	expression tag	UNP A7ZSI4
A	236	VAL	-	expression tag	UNP A7ZSI4
A	237	LEU	-	expression tag	UNP A7ZSI4
A	238	PHE	-	expression tag	UNP A7ZSI4
A	239	GLN	-	expression tag	UNP A7ZSI4
B	235	GLU	-	expression tag	UNP A7ZSI4
B	236	VAL	-	expression tag	UNP A7ZSI4
B	237	LEU	-	expression tag	UNP A7ZSI4
B	238	PHE	-	expression tag	UNP A7ZSI4
B	239	GLN	-	expression tag	UNP A7ZSI4
G	235	GLU	-	expression tag	UNP A7ZSI4
G	236	VAL	-	expression tag	UNP A7ZSI4
G	237	LEU	-	expression tag	UNP A7ZSI4
G	238	PHE	-	expression tag	UNP A7ZSI4
G	239	GLN	-	expression tag	UNP A7ZSI4
H	235	GLU	-	expression tag	UNP A7ZSI4
H	236	VAL	-	expression tag	UNP A7ZSI4
H	237	LEU	-	expression tag	UNP A7ZSI4
H	238	PHE	-	expression tag	UNP A7ZSI4
H	239	GLN	-	expression tag	UNP A7ZSI4

- Molecule 2 is a protein called DNA-directed RNA polymerase subunit beta.

Mol	Chain	Residues	Atoms					ZeroOcc	AltConf	Trace
			Total	C	N	O	S			
2	C	1340	Total	C	N	O	S	0	0	0
			10570	6631	1841	2055	43			
2	I	1340	Total	C	N	O	S	0	0	0
			10566	6629	1840	2054	43			

- Molecule 3 is a protein called DNA-directed RNA polymerase subunit beta'.

Mol	Chain	Residues	Atoms					ZeroOcc	AltConf	Trace
			Total	C	N	O	S			
3	D	1166	Total	C	N	O	S	0	0	0
			9107	5723	1634	1704	46			
3	J	1236	Total	C	N	O	S	0	0	0
			9638	6058	1726	1807	47			

- Molecule 4 is a protein called DNA-directed RNA polymerase subunit omega.

Mol	Chain	Residues	Atoms					ZeroOcc	AltConf	Trace
			Total	C	N	O	S			
4	E	89	Total	C	N	O	S	0	0	0
			691	421	129	140	1			
4	K	79	Total	C	N	O	S	0	0	0
			627	382	118	126	1			

- Molecule 5 is a protein called RNA polymerase sigma factor RpoD.

Mol	Chain	Residues	Atoms					ZeroOcc	AltConf	Trace
			Total	C	N	O	S			
5	F	470	Total	C	N	O	S	0	0	0
			3822	2394	680	725	23			
5	L	469	Total	C	N	O	S	0	0	0
			3821	2393	679	726	23			

- Molecule 6 is 4-[3-(4-fluorophenyl)-1H-pyrazol-4-yl]-N-[2-(piperazin-1-yl)ethyl]-2-(trifluoromethyl)aniline (three-letter code: 42U) (formula: C<sub>22</sub>H<sub>23</sub>F<sub>4</sub>N<sub>5</sub>).

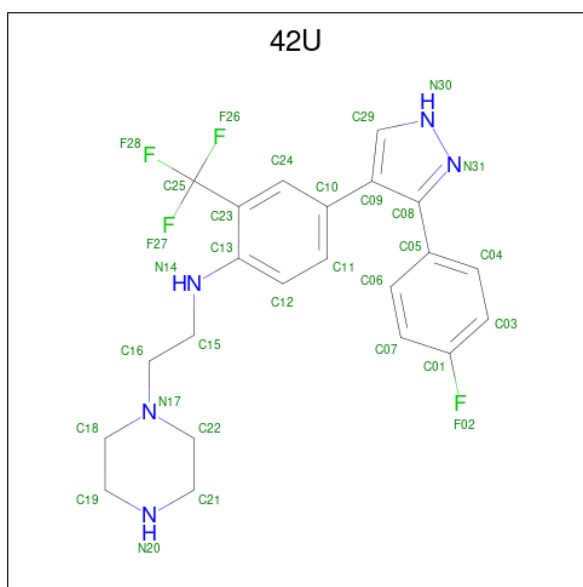

Mol	Chain	Residues	Atoms				ZeroOcc	AltConf
			Total	C	F	N		
6	C	1	31	22	4	5	0	0
6	I	1	31	22	4	5	0	0

- Molecule 7 is MAGNESIUM ION (three-letter code: MG) (formula: Mg).

Mol	Chain	Residues	Atoms		ZeroOcc	AltConf
			Total	Mg		
7	D	1	1	1	0	0
7	J	1	1	1	0	0

- Molecule 8 is ZINC ION (three-letter code: ZN) (formula: Zn).

Mol	Chain	Residues	Atoms		ZeroOcc	AltConf
			Total	Zn		
8	D	2	2	2	0	0
8	J	2	2	2	0	0

### 3 Residue-property plots [i](#)

These plots are drawn for all protein, RNA, DNA and oligosaccharide chains in the entry. The first graphic for a chain summarises the proportions of the various outlier classes displayed in the second graphic. The second graphic shows the sequence view annotated by issues in geometry and electron density. Residues are color-coded according to the number of geometric quality criteria for which they contain at least one outlier: green = 0, yellow = 1, orange = 2 and red = 3 or more. A red dot above a residue indicates a poor fit to the electron density ( $RSRZ > 2$ ). Stretches of 2 or more consecutive residues without any outlier are shown as a green connector. Residues present in the sample, but not in the model, are shown in grey.

- Molecule 1: DNA-directed RNA polymerase subunit alpha

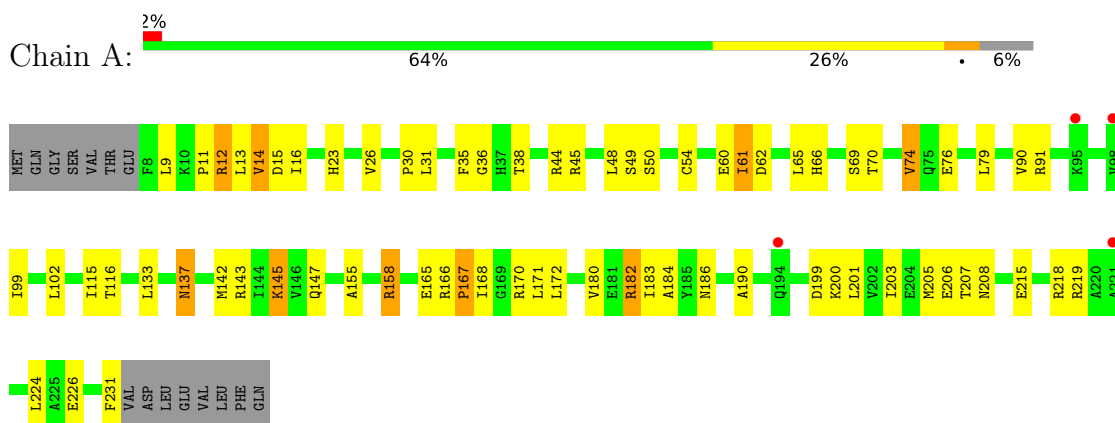

- Molecule 1: DNA-directed RNA polymerase subunit alpha

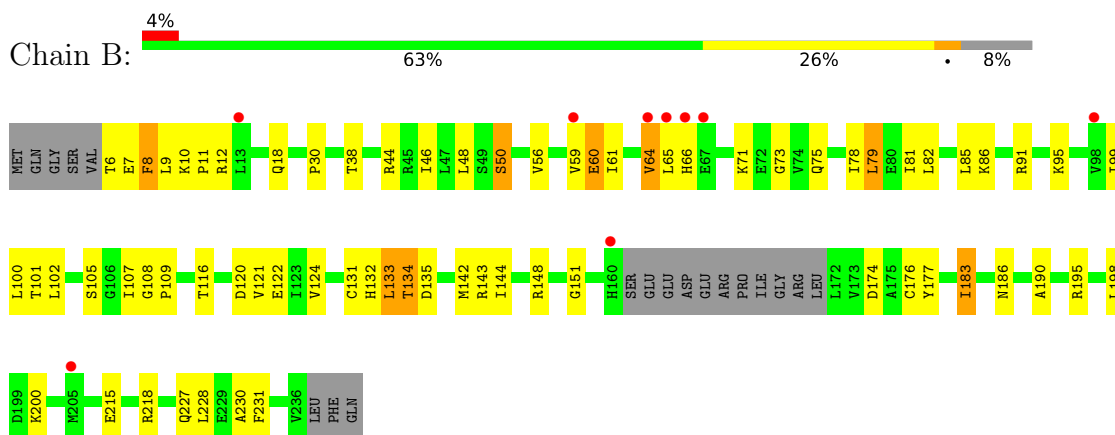

- Molecule 1: DNA-directed RNA polymerase subunit alpha

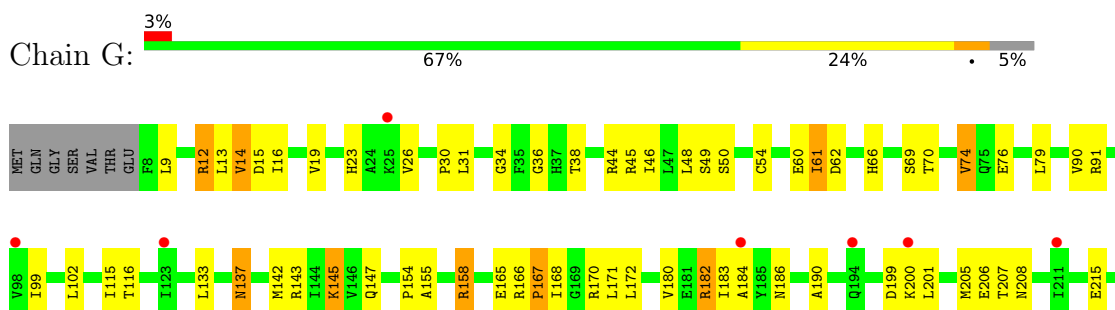

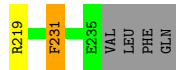

● Molecule 1: DNA-directed RNA polymerase subunit alpha

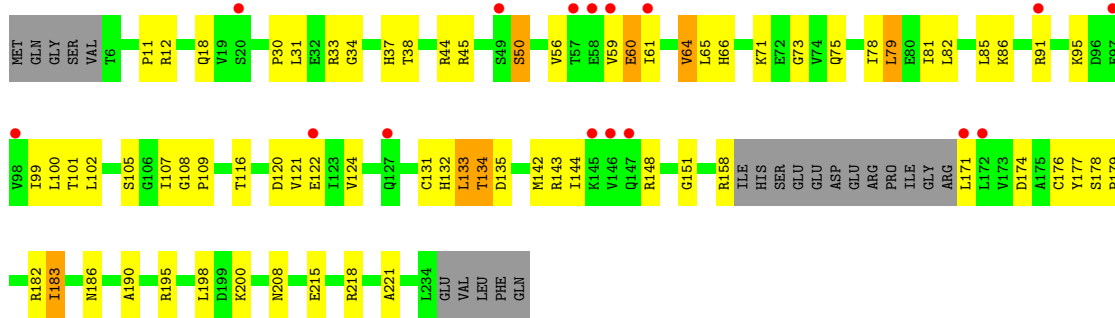

● Molecule 2: DNA-directed RNA polymerase subunit beta

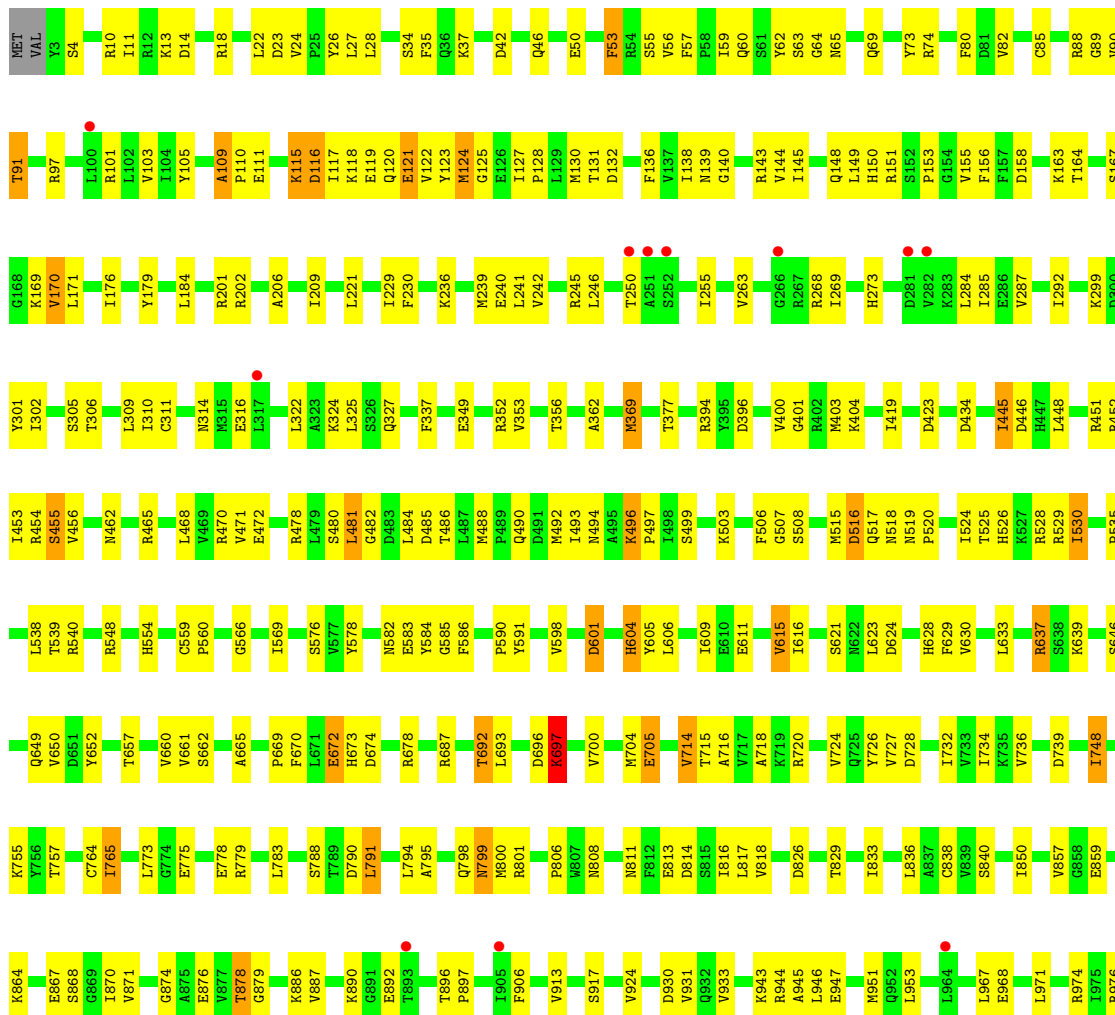



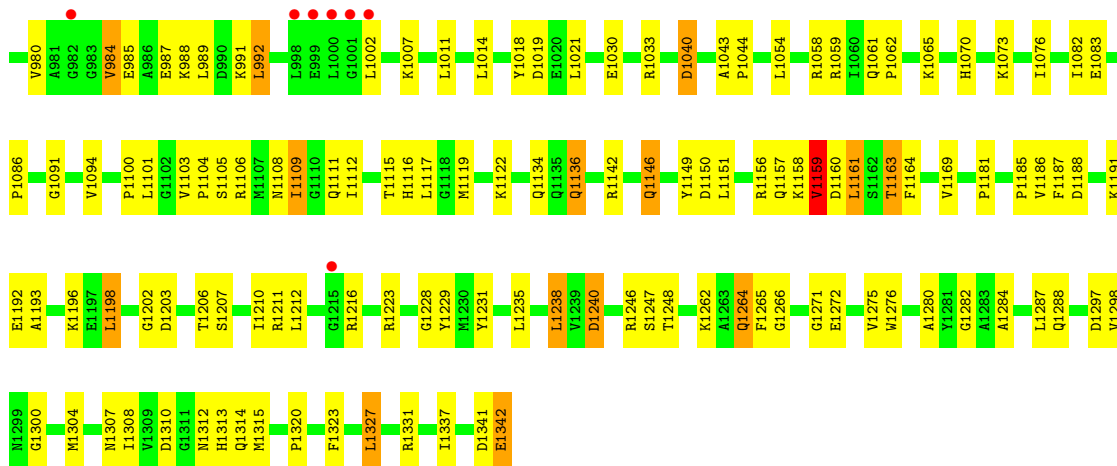

• Molecule 2: DNA-directed RNA polymerase subunit beta

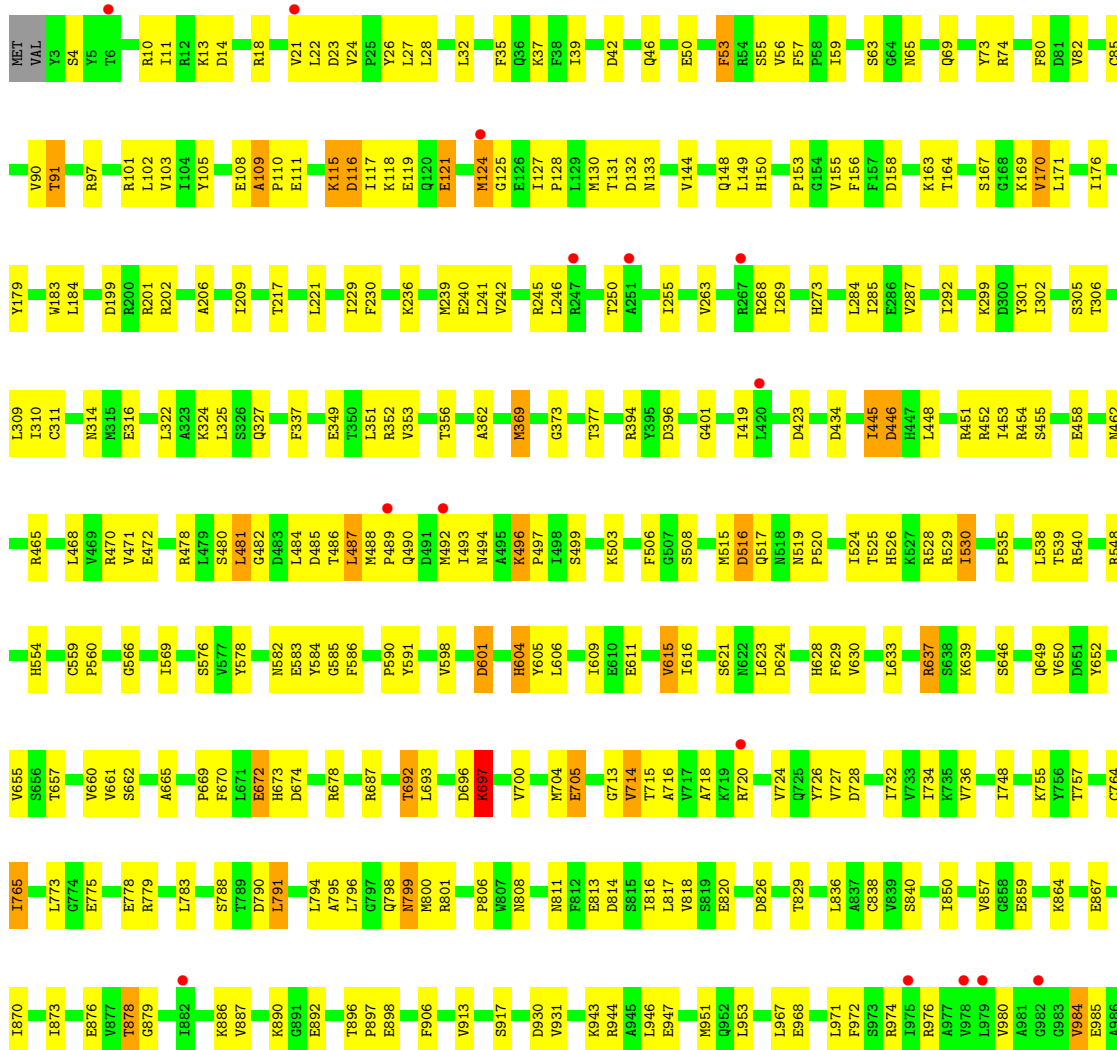

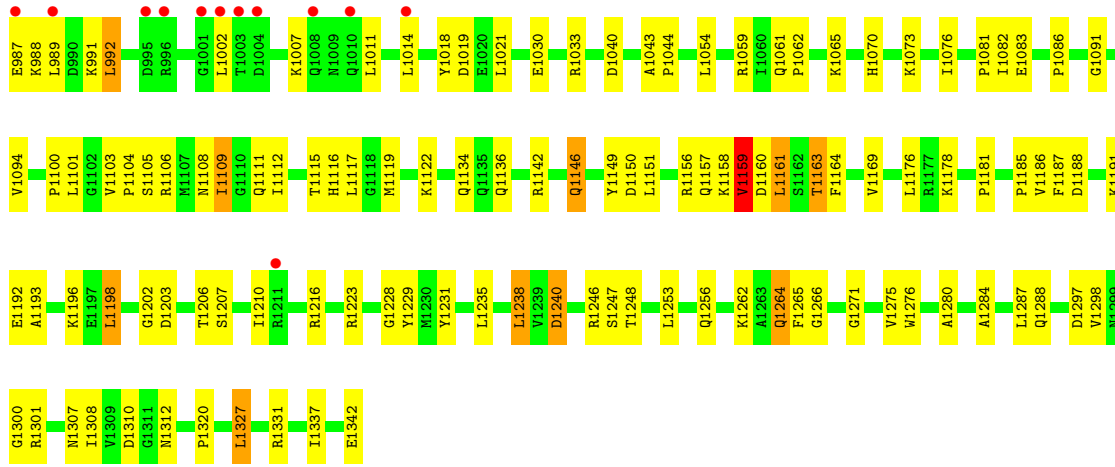

● Molecule 3: DNA-directed RNA polymerase subunit beta'

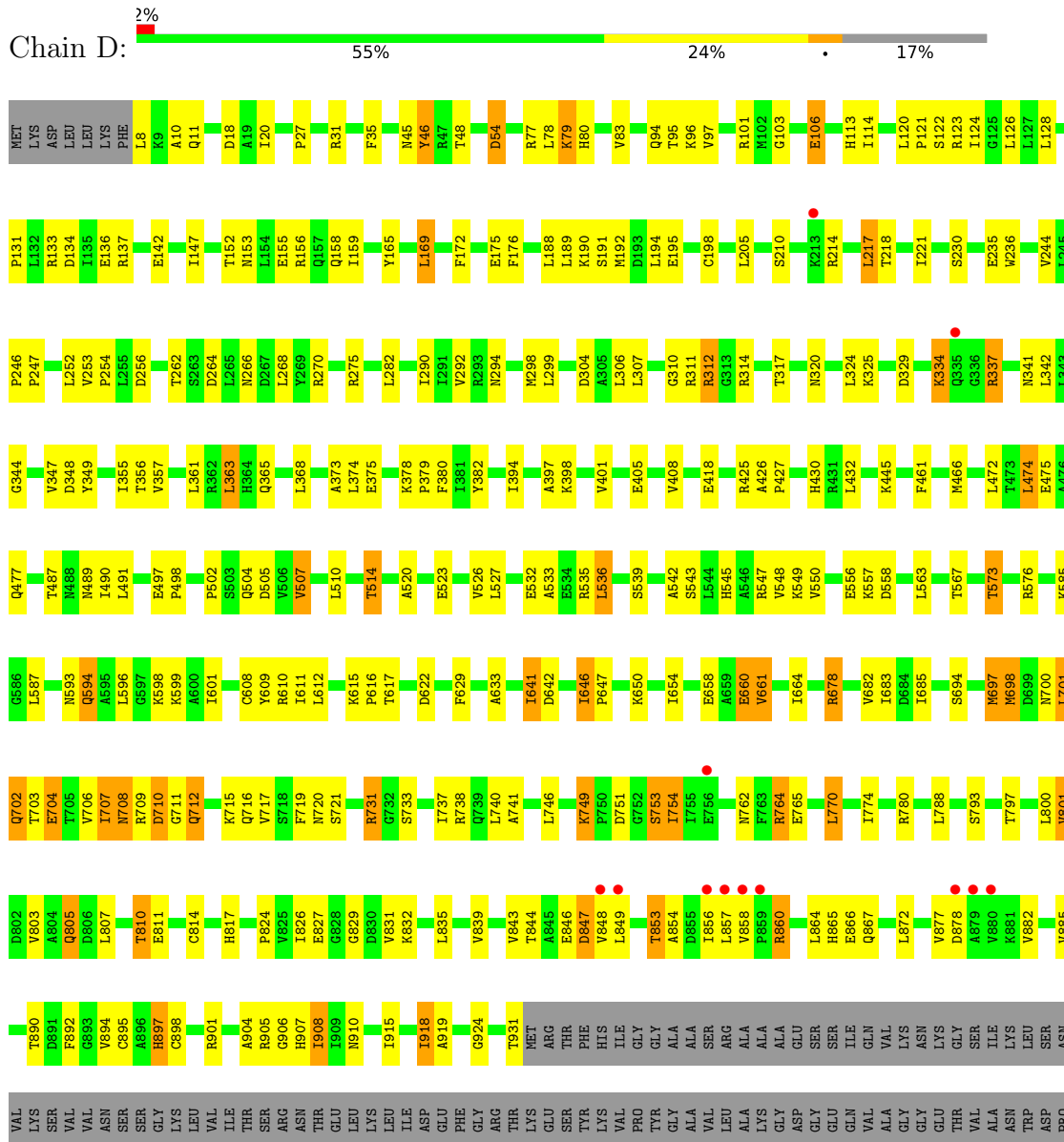



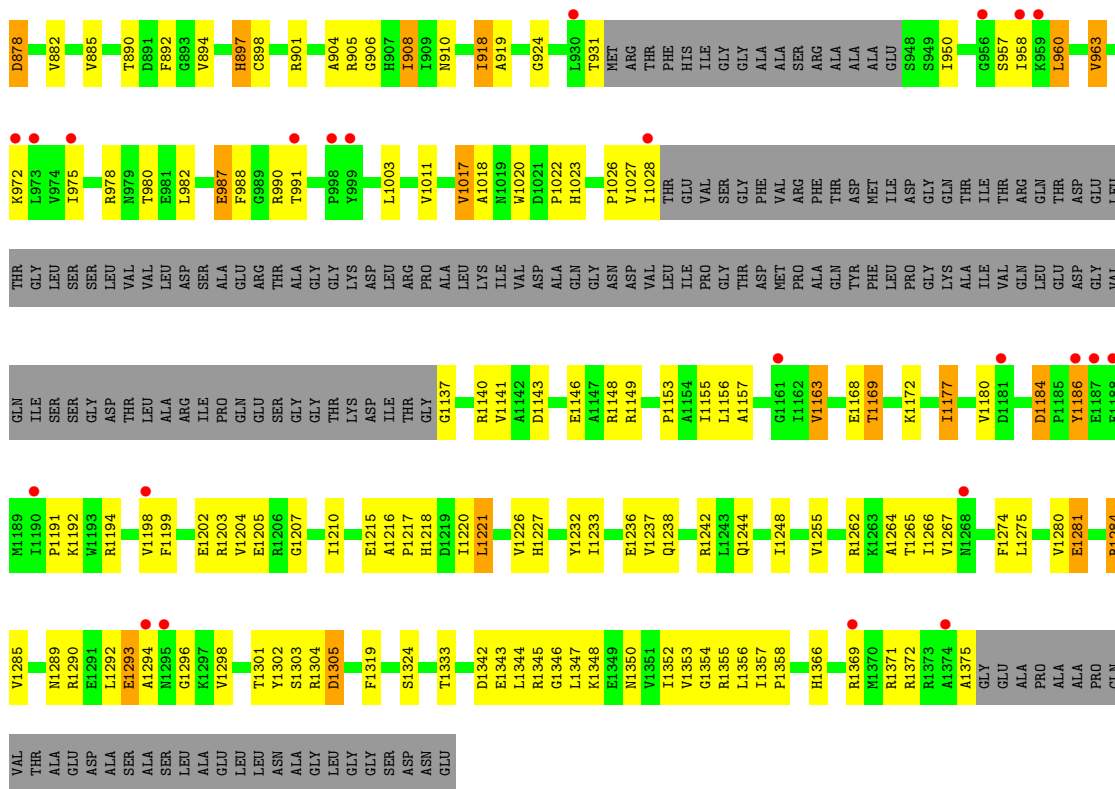

- Molecule 4: DNA-directed RNA polymerase subunit omega

Chain E: 74% 21% . .



- Molecule 4: DNA-directed RNA polymerase subunit omega

Chain K: 65% 18% . 13%



- Molecule 5: RNA polymerase sigma factor RpoD

Chain F: 5% 62% 24% . 10%

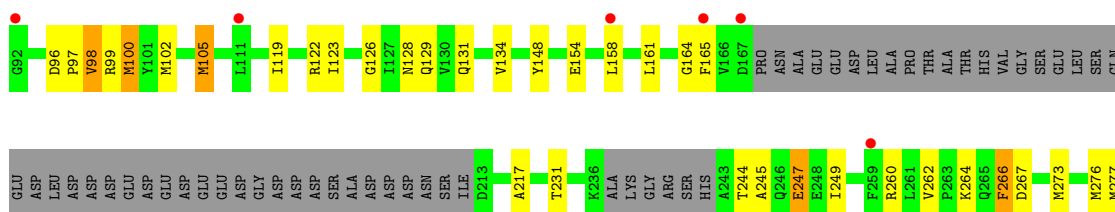

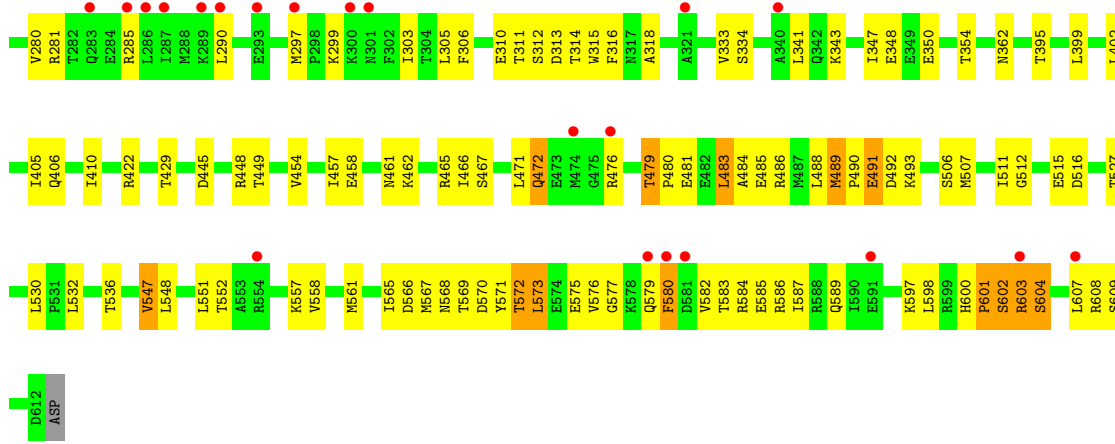

• Molecule 5: RNA polymerase sigma factor RpoD

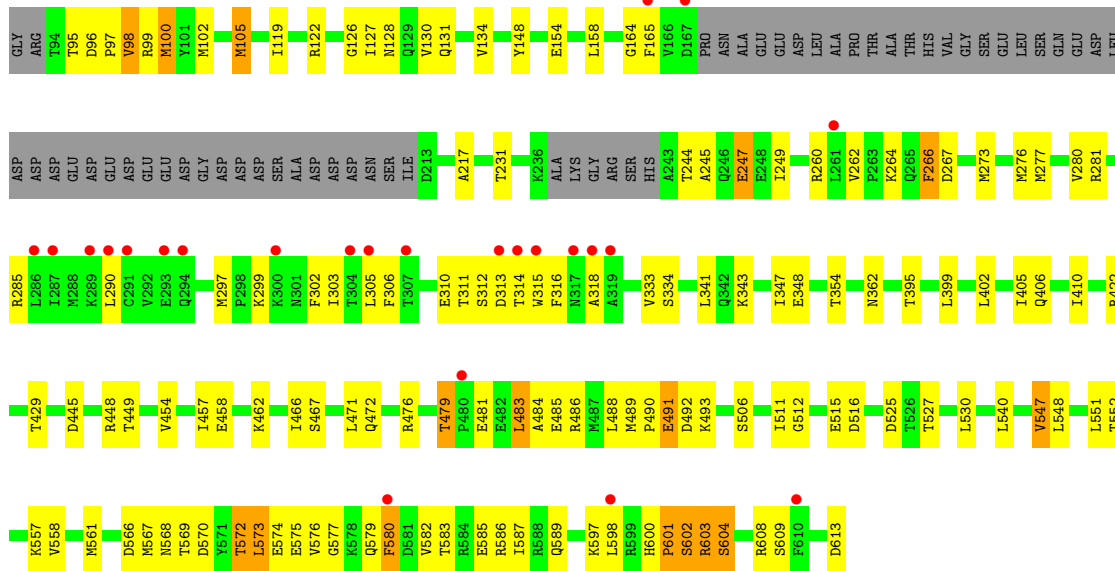

## 4 Data and refinement statistics

Property	Value	Source
Space group	P 21 21 21	Depositor
Cell constants a, b, c, $\alpha$ , $\beta$ , $\gamma$	184.44Å 206.33Å 309.61Å 90.00° 90.00° 90.00°	Depositor
Resolution (Å)	39.93 – 3.68 39.93 – 3.68	Depositor EDS
% Data completeness (in resolution range)	88.5 (39.93-3.68) 88.5 (39.93-3.68)	Depositor EDS
$R_{merge}$	0.15	Depositor
$R_{sym}$	(Not available)	Depositor
$\langle I/\sigma(I) \rangle$ <sup>1</sup>	1.52 (at 3.66Å)	Xtrriage
Refinement program	PHENIX	Depositor
R, $R_{free}$	0.240 , 0.286 0.263 , 0.302	Depositor DCC
$R_{free}$ test set	5687 reflections (5.02%)	wwPDB-VP
Wilson B-factor (Å <sup>2</sup> )	139.9	Xtrriage
Anisotropy	0.373	Xtrriage
Bulk solvent $k_{sol}$ (e/Å <sup>3</sup> ), $B_{sol}$ (Å <sup>2</sup> )	0.25 , 46.7	EDS
L-test for twinning <sup>2</sup>	$\langle  L  \rangle = 0.49$ , $\langle L^2 \rangle = 0.32$	Xtrriage
Estimated twinning fraction	No twinning to report.	Xtrriage
$F_o, F_c$ correlation	0.93	EDS
Total number of atoms	55744	wwPDB-VP
Average B, all atoms (Å <sup>2</sup> )	97.0	wwPDB-VP

Xtrriage's analysis on translational NCS is as follows: *The largest off-origin peak in the Patterson function is 1.95% of the height of the origin peak. No significant pseudotranslation is detected.*

<sup>1</sup>Intensities estimated from amplitudes.

<sup>2</sup>Theoretical values of  $\langle |L| \rangle$ ,  $\langle L^2 \rangle$  for acentric reflections are 0.5, 0.333 respectively for untwinned datasets, and 0.375, 0.2 for perfectly twinned datasets.

## 5 Model quality [i](#)

### 5.1 Standard geometry [i](#)

Bond lengths and bond angles in the following residue types are not validated in this section: 42U, MG, ZN

The Z score for a bond length (or angle) is the number of standard deviations the observed value is removed from the expected value. A bond length (or angle) with  $|Z| > 5$  is considered an outlier worth inspection. RMSZ is the root-mean-square of all Z scores of the bond lengths (or angles).

Mol	Chain	Bond lengths		Bond angles	
		RMSZ	# Z  >5	RMSZ	# Z  >5
1	A	0.25	0/1751	0.54	0/2373
1	B	0.27	0/1707	0.53	0/2314
1	G	0.26	0/1771	0.56	0/2401
1	H	0.27	0/1686	0.51	0/2285
2	C	0.27	0/10739	0.52	0/14489
2	I	0.27	0/10735	0.51	0/14484
3	D	0.26	0/9246	0.51	0/12478
3	J	0.26	0/9785	0.51	0/13206
4	E	0.27	0/693	0.52	0/935
4	K	0.28	0/629	0.51	0/847
5	F	0.29	0/3873	0.51	1/5206 (0.0%)
5	L	0.29	0/3872	0.51	1/5205 (0.0%)
All	All	0.27	0/56487	0.52	2/76223 (0.0%)

Chiral center outliers are detected by calculating the chiral volume of a chiral center and verifying if the center is modelled as a planar moiety or with the opposite hand. A planarity outlier is detected by checking planarity of atoms in a peptide group, atoms in a mainchain group or atoms of a sidechain that are expected to be planar.

Mol	Chain	#Chirality outliers	#Planarity outliers
2	C	0	3
2	I	0	3
3	D	0	3
3	J	0	3
5	F	0	1
5	L	0	1
All	All	0	14

There are no bond length outliers.

All (2) bond angle outliers are listed below:

Mol	Chain	Res	Type	Atoms	Z	Observed(°)	Ideal(°)
5	F	602	SER	N-CA-C	-6.49	93.48	111.00
5	L	602	SER	N-CA-C	-6.47	93.53	111.00

There are no chirality outliers.

5 of 14 planarity outliers are listed below:

Mol	Chain	Res	Type	Group
2	C	109	ALA	Peptide
2	C	1161	LEU	Peptide
2	C	236	LYS	Peptide
3	D	1168	GLU	Peptide
3	D	1184	ASP	Peptide

## 5.2 Too-close contacts [i](#)

In the following table, the Non-H and H(model) columns list the number of non-hydrogen atoms and hydrogen atoms in the chain respectively. The H(added) column lists the number of hydrogen atoms added and optimized by MolProbity. The Clashes column lists the number of clashes within the asymmetric unit, whereas Symm-Clashes lists symmetry-related clashes.

Mol	Chain	Non-H	H(model)	H(added)	Clashes	Symm-Clashes
1	A	1730	0	1756	49	0
1	B	1687	0	1700	47	0
1	G	1750	0	1764	45	0
1	H	1667	0	1689	55	0
2	C	10570	0	10582	277	0
2	I	10566	0	10576	256	0
3	D	9107	0	9309	251	0
3	J	9638	0	9853	261	0
4	E	691	0	695	19	0
4	K	627	0	634	10	0
5	F	3822	0	3885	91	0
5	L	3821	0	3884	81	0
6	C	31	0	23	0	0
6	I	31	0	23	0	0
7	D	1	0	0	0	0
7	J	1	0	0	0	0
8	D	2	0	0	0	0
8	J	2	0	0	0	0
All	All	55744	0	56373	1308	0

The all-atom clashscore is defined as the number of clashes found per 1000 atoms (including



hydrogen atoms). The all-atom clashscore for this structure is 12.

The worst 5 of 1308 close contacts within the same asymmetric unit are listed below, sorted by their clash magnitude.

Atom-1	Atom-2	Interatomic distance (Å)	Clash overlap (Å)
3:D:660:GLU:HB3	3:D:685:ILE:HD12	1.50	0.94
3:J:660:GLU:HB3	3:J:685:ILE:HD12	1.51	0.93
1:G:45:ARG:NH1	1:H:34:GLY:O	2.11	0.83
3:D:1372:ARG:HH21	3:J:854:ALA:HB3	1.42	0.83
2:C:10:ARG:HD3	2:C:1181:PRO:HG2	1.62	0.81

There are no symmetry-related clashes.

## 5.3 Torsion angles [i](#)

### 5.3.1 Protein backbone [i](#)

In the following table, the Percentiles column shows the percent Ramachandran outliers of the chain as a percentile score with respect to all X-ray entries followed by that with respect to entries of similar resolution.

The Analysed column shows the number of residues for which the backbone conformation was analysed, and the total number of residues.

Mol	Chain	Analysed	Favoured	Allowed	Outliers	Percentiles	
1	A	222/239 (93%)	194 (87%)	26 (12%)	2 (1%)	17	54
1	B	216/239 (90%)	192 (89%)	24 (11%)	0	100	100
1	G	226/239 (95%)	196 (87%)	28 (12%)	2 (1%)	17	54
1	H	213/239 (89%)	190 (89%)	23 (11%)	0	100	100
2	C	1338/1342 (100%)	1231 (92%)	102 (8%)	5 (0%)	34	69
2	I	1338/1342 (100%)	1230 (92%)	103 (8%)	5 (0%)	34	69
3	D	1162/1407 (83%)	1077 (93%)	81 (7%)	4 (0%)	41	74
3	J	1230/1407 (87%)	1145 (93%)	81 (7%)	4 (0%)	41	74
4	E	87/91 (96%)	82 (94%)	5 (6%)	0	100	100
4	K	77/91 (85%)	74 (96%)	3 (4%)	0	100	100
5	F	464/522 (89%)	429 (92%)	35 (8%)	0	100	100
5	L	463/522 (89%)	427 (92%)	36 (8%)	0	100	100
All	All	7036/7680 (92%)	6467 (92%)	547 (8%)	22 (0%)	41	74

5 of 22 Ramachandran outliers are listed below:

Mol	Chain	Res	Type
2	C	1159	VAL
2	I	1159	VAL
2	C	170	VAL
2	I	170	VAL
3	J	340	GLN

### 5.3.2 Protein sidechains [i](#)

In the following table, the Percentiles column shows the percent sidechain outliers of the chain as a percentile score with respect to all X-ray entries followed by that with respect to entries of similar resolution.

The Analysed column shows the number of residues for which the sidechain conformation was analysed, and the total number of residues.

Mol	Chain	Analysed	Rotameric	Outliers	Percentiles	
1	A	191/206 (93%)	174 (91%)	17 (9%)	9	37
1	B	184/206 (89%)	165 (90%)	19 (10%)	7	31
1	G	191/206 (93%)	174 (91%)	17 (9%)	9	37
1	H	183/206 (89%)	165 (90%)	18 (10%)	8	33
2	C	1155/1157 (100%)	1043 (90%)	112 (10%)	8	33
2	I	1154/1157 (100%)	1040 (90%)	114 (10%)	8	32
3	D	975/1168 (84%)	874 (90%)	101 (10%)	7	30
3	J	1036/1168 (89%)	929 (90%)	107 (10%)	7	31
4	E	72/75 (96%)	66 (92%)	6 (8%)	11	40
4	K	67/75 (89%)	60 (90%)	7 (10%)	7	30
5	F	417/462 (90%)	377 (90%)	40 (10%)	8	34
5	L	418/462 (90%)	376 (90%)	42 (10%)	7	32
All	All	6043/6548 (92%)	5443 (90%)	600 (10%)	8	32

5 of 600 residues with a non-rotameric sidechain are listed below:

Mol	Chain	Res	Type
3	J	312	ARG
5	L	445	ASP
3	J	545	HIS
3	J	299	LEU

*Continued on next page...*

*Continued from previous page...*

Mol	Chain	Res	Type
3	J	878	ASP

Sometimes sidechains can be flipped to improve hydrogen bonding and reduce clashes. 5 of 63 such sidechains are listed below:

Mol	Chain	Res	Type
5	F	518	HIS
3	J	1244	GLN
2	I	628	HIS
3	J	1218	HIS
5	L	383	ASN

### 5.3.3 RNA [i](#)

There are no RNA molecules in this entry.

## 5.4 Non-standard residues in protein, DNA, RNA chains [i](#)

There are no non-standard protein/DNA/RNA residues in this entry.

## 5.5 Carbohydrates [i](#)

There are no monosaccharides in this entry.

## 5.6 Ligand geometry [i](#)

Of 8 ligands modelled in this entry, 6 are monoatomic - leaving 2 for Mogul analysis.

In the following table, the Counts columns list the number of bonds (or angles) for which Mogul statistics could be retrieved, the number of bonds (or angles) that are observed in the model and the number of bonds (or angles) that are defined in the Chemical Component Dictionary. The Link column lists molecule types, if any, to which the group is linked. The Z score for a bond length (or angle) is the number of standard deviations the observed value is removed from the expected value. A bond length (or angle) with  $|Z| > 2$  is considered an outlier worth inspection. RMSZ is the root-mean-square of all Z scores of the bond lengths (or angles).

Mol	Type	Chain	Res	Link	Bond lengths			Bond angles		
					Counts	RMSZ	# Z  > 2	Counts	RMSZ	# Z  > 2
6	42U	I	1401	-	31,34,34	1.40	7 (22%)	41,48,48	2.92	20 (48%)
6	42U	C	1401	-	31,34,34	1.42	7 (22%)	41,48,48	2.88	19 (46%)

In the following table, the Chirals column lists the number of chiral outliers, the number of chiral centers analysed, the number of these observed in the model and the number defined in the Chemical Component Dictionary. Similar counts are reported in the Torsion and Rings columns. '-' means no outliers of that kind were identified.

Mol	Type	Chain	Res	Link	Chirals	Torsions	Rings
6	42U	I	1401	-	-	7/20/28/28	1/4/4/4
6	42U	C	1401	-	-	7/20/28/28	1/4/4/4

The worst 5 of 14 bond length outliers are listed below:

Mol	Chain	Res	Type	Atoms	Z	Observed(Å)	Ideal(Å)
6	C	1401	42U	C13-C23	3.10	1.43	1.40
6	I	1401	42U	C13-C23	2.90	1.43	1.40
6	C	1401	42U	C25-C23	2.57	1.56	1.50
6	I	1401	42U	C25-C23	2.51	1.55	1.50
6	I	1401	42U	C12-C13	2.40	1.43	1.39

The worst 5 of 39 bond angle outliers are listed below:

Mol	Chain	Res	Type	Atoms	Z	Observed(°)	Ideal(°)
6	I	1401	42U	C12-C13-C23	-9.18	110.85	119.88
6	C	1401	42U	C12-C13-C23	-8.95	111.08	119.88
6	I	1401	42U	C04-C05-C08	6.53	130.96	120.61
6	C	1401	42U	C04-C05-C08	6.42	130.78	120.61
6	I	1401	42U	C05-C08-N31	-5.50	111.37	120.78

There are no chirality outliers.

5 of 14 torsion outliers are listed below:

Mol	Chain	Res	Type	Atoms
6	C	1401	42U	N14-C15-C16-N17
6	I	1401	42U	N14-C15-C16-N17
6	C	1401	42U	C13-C23-C25-F27
6	I	1401	42U	C13-C23-C25-F27
6	C	1401	42U	C13-C23-C25-F28

All (2) ring outliers are listed below:

Mol	Chain	Res	Type	Atoms
6	C	1401	42U	C18-C19-C21-C22-N17-N20
6	I	1401	42U	C18-C19-C21-C22-N17-N20

No monomer is involved in short contacts.

The following is a two-dimensional graphical depiction of Mogul quality analysis of bond lengths, bond angles, torsion angles, and ring geometry for all instances of the Ligand of Interest. In addition, ligands with molecular weight > 250 and outliers as shown on the validation Tables will also be included. For torsion angles, if less than 5% of the Mogul distribution of torsion angles is within 10 degrees of the torsion angle in question, then that torsion angle is considered an outlier. Any bond that is central to one or more torsion angles identified as an outlier by Mogul will be highlighted in the graph. For rings, the root-mean-square deviation (RMSD) between the ring in question and similar rings identified by Mogul is calculated over all ring torsion angles. If the average RMSD is greater than 60 degrees and the minimal RMSD between the ring in question and any Mogul-identified rings is also greater than 60 degrees, then that ring is considered an outlier. The outliers are highlighted in purple. The color gray indicates Mogul did not find sufficient equivalents in the CSD to analyse the geometry.

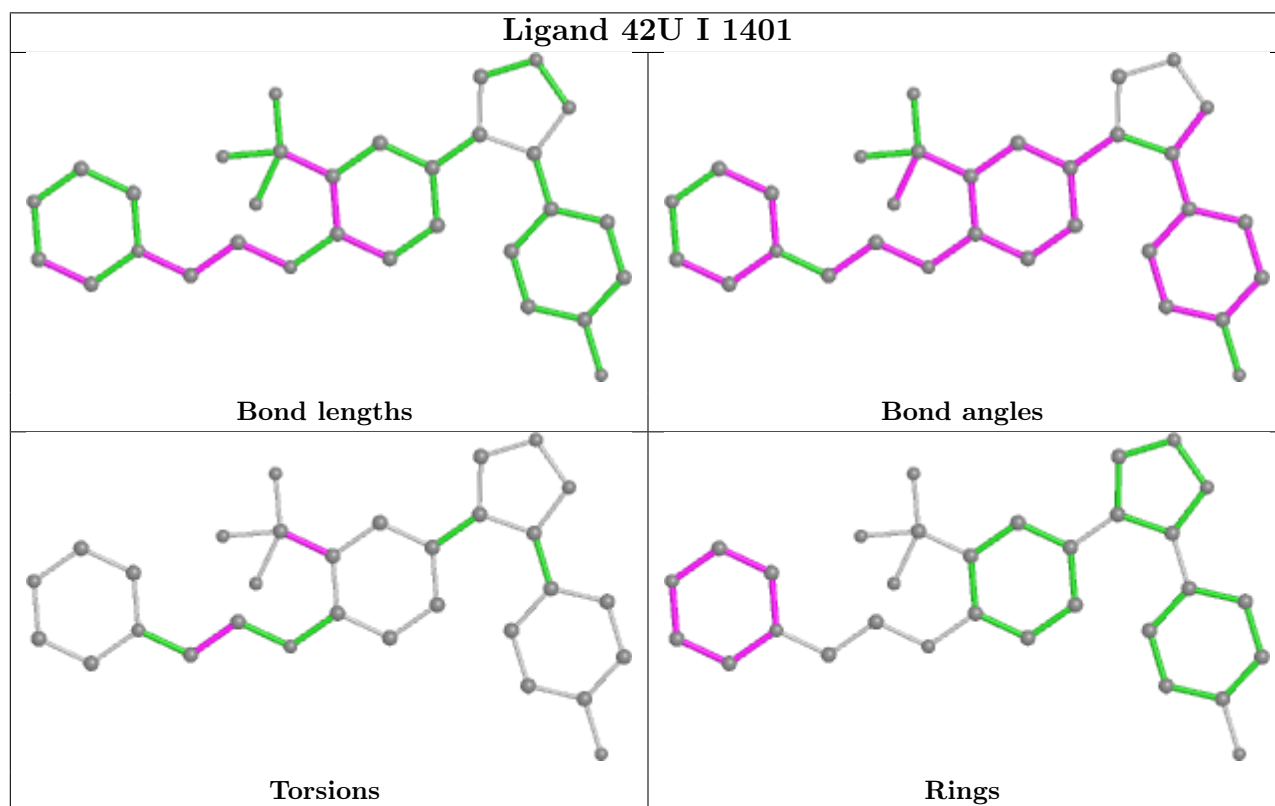

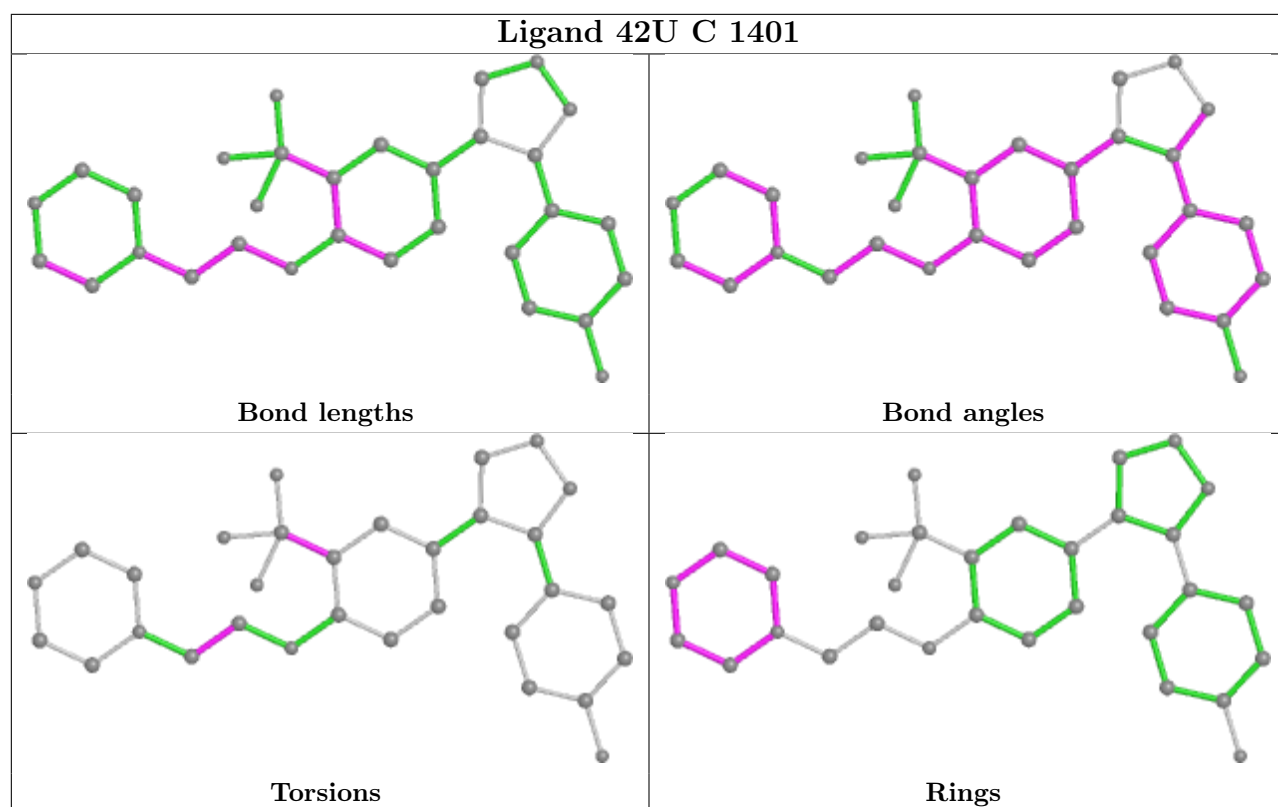

## 5.7 Other polymers [i](#)

There are no such residues in this entry.

## 5.8 Polymer linkage issues [i](#)

There are no chain breaks in this entry.

## 6 Fit of model and data [i](#)

### 6.1 Protein, DNA and RNA chains [i](#)

In the following table, the column labelled ‘#RSRZ> 2’ contains the number (and percentage) of RSRZ outliers, followed by percent RSRZ outliers for the chain as percentile scores relative to all X-ray entries and entries of similar resolution. The OWAB column contains the minimum, median, 95<sup>th</sup> percentile and maximum values of the occupancy-weighted average B-factor per residue. The column labelled ‘Q< 0.9’ lists the number of (and percentage) of residues with an average occupancy less than 0.9.

Mol	Chain	Analysed	<RSRZ>	#RSRZ>2	OWAB(Å <sup>2</sup> )	Q<0.9
1	A	224/239 (93%)	-0.18	4 (1%) 68 56	54, 87, 128, 162	0
1	B	220/239 (92%)	0.06	9 (4%) 37 26	71, 115, 149, 168	0
1	G	228/239 (95%)	-0.03	7 (3%) 49 35	74, 113, 149, 176	0
1	H	217/239 (90%)	0.23	16 (7%) 14 10	73, 129, 157, 174	0
2	C	1340/1342 (99%)	-0.20	18 (1%) 77 66	29, 79, 134, 171	0
2	I	1340/1342 (99%)	-0.11	27 (2%) 65 52	32, 96, 144, 171	0
3	D	1166/1407 (82%)	-0.13	25 (2%) 63 50	24, 78, 144, 177	0
3	J	1236/1407 (87%)	-0.04	34 (2%) 53 39	33, 95, 148, 172	0
4	E	89/91 (97%)	-0.37	0 100 100	40, 86, 123, 133	0
4	K	79/91 (86%)	-0.27	0 100 100	60, 92, 142, 160	0
5	F	470/522 (90%)	-0.02	27 (5%) 23 16	45, 121, 158, 182	0
5	L	469/522 (89%)	-0.13	24 (5%) 28 19	49, 117, 159, 180	0
All	All	7078/7680 (92%)	-0.10	191 (2%) 54 41	24, 96, 149, 182	0

The worst 5 of 191 RSRZ outliers are listed below:

Mol	Chain	Res	Type	RSRZ
1	B	160	HIS	6.5
3	D	1204	VAL	6.2
1	H	146	VAL	6.0
3	D	1198	VAL	5.4
5	F	167	ASP	5.3

### 6.2 Non-standard residues in protein, DNA, RNA chains [i](#)

There are no non-standard protein/DNA/RNA residues in this entry.

### 6.3 Carbohydrates [i](#)

There are no monosaccharides in this entry.

### 6.4 Ligands [i](#)

In the following table, the Atoms column lists the number of modelled atoms in the group and the number defined in the chemical component dictionary. The B-factors column lists the minimum, median, 95<sup>th</sup> percentile and maximum values of B factors of atoms in the group. The column labelled 'Q< 0.9' lists the number of atoms with occupancy less than 0.9.

Mol	Type	Chain	Res	Atoms	RSCC	RSR	B-factors( $\text{\AA}^2$ )	Q<0.9
7	MG	J	1501	1/1	0.84	0.61	75,75,75,75	0
6	42U	C	1401	31/31	0.89	0.33	31,71,93,105	0
6	42U	I	1401	31/31	0.91	0.33	48,83,117,134	0
7	MG	D	1501	1/1	0.93	0.36	42,42,42,42	0
8	ZN	J	1502	1/1	0.93	0.16	160,160,160,160	0
8	ZN	D	1503	1/1	0.94	0.25	76,76,76,76	0
8	ZN	D	1502	1/1	0.96	0.17	176,176,176,176	0
8	ZN	J	1503	1/1	0.98	0.27	126,126,126,126	0

The following is a graphical depiction of the model fit to experimental electron density of all instances of the Ligand of Interest. In addition, ligands with molecular weight > 250 and outliers as shown on the geometry validation Tables will also be included. Each fit is shown from different orientation to approximate a three-dimensional view.



**Electron density around 42U C 1401:**

$2mF_o-DF_c$  (at 0.7 rmsd) in gray  
 $mF_o-DF_c$  (at 3 rmsd) in purple (negative)  
and green (positive)

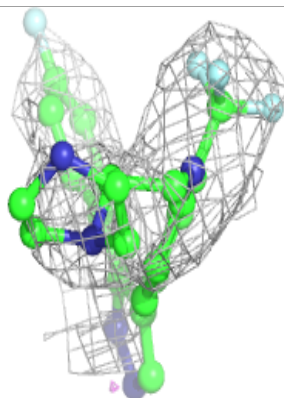
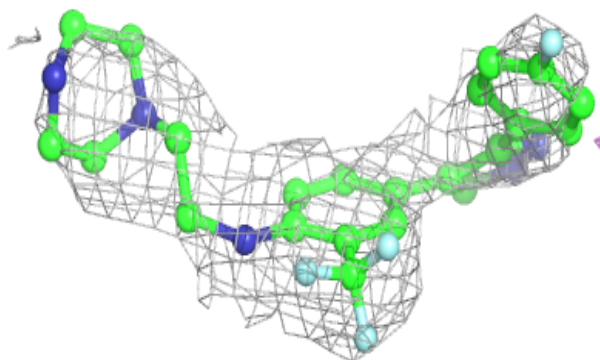
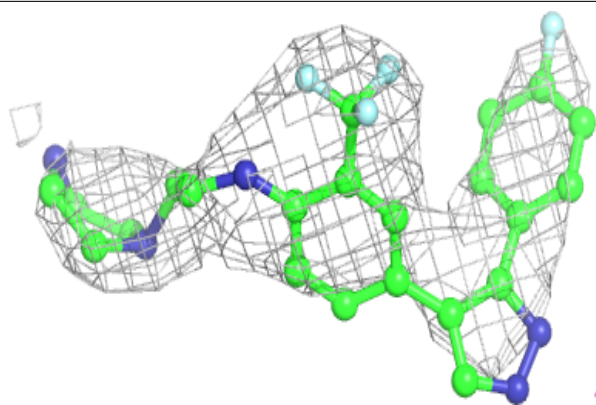
**Electron density around 42U I 1401:**

$2mF_o-DF_c$  (at 0.7 rmsd) in gray  
 $mF_o-DF_c$  (at 3 rmsd) in purple (negative)  
and green (positive)

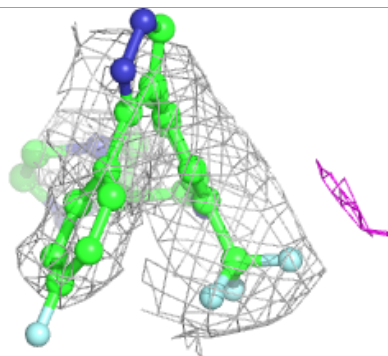
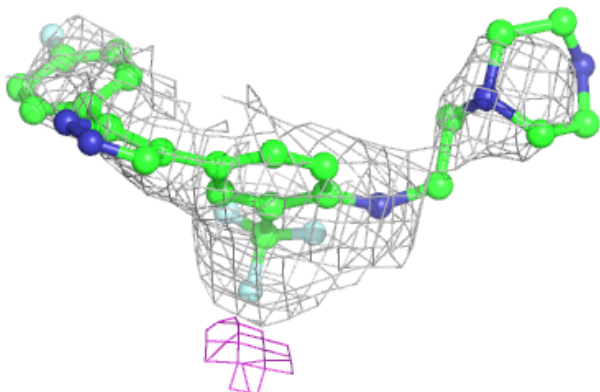
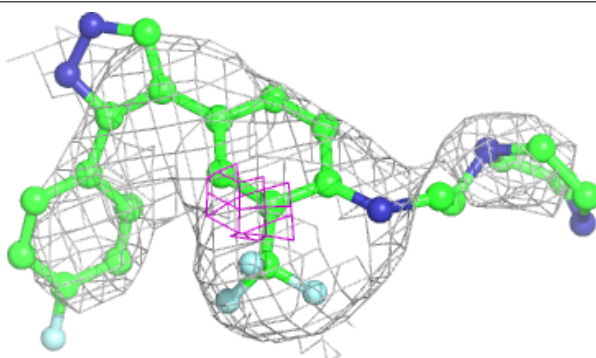

## 6.5 Other polymers [i](#)

There are no such residues in this entry.