



wwPDB X-ray Structure Validation Summary Report ⓘ

Sep 17, 2023 – 11:56 AM EDT

PDB ID : 4XWO
Title : Structure of Get3 bound to the transmembrane domain of Sec22
Authors : Mateja, A.; Paduch, M.; Chang, H.-Y.; Szydłowska, A.; Kossiakoff, A.A.; Hegde, R.S.; Keenan, R.J.
Deposited on : 2015-01-29
Resolution : 2.75 Å (reported)

This is a wwPDB X-ray Structure Validation Summary Report for a publicly released PDB entry.

We welcome your comments at validation@mail.wwpdb.org

A user guide is available at

<https://www.wwpdb.org/validation/2017/XrayValidationReportHelp>

with specific help available everywhere you see the ⓘ symbol.

The types of validation reports are described at

<http://www.wwpdb.org/validation/2017/FAQs#types>.

The following versions of software and data (see [references ⓘ](#)) were used in the production of this report:

MolProbity : 4.02b-467
Mogul : 1.8.5 (274361), CSD as541be (2020)
Xtrriage (Phenix) : 1.13
EDS : 2.35.1
buster-report : 1.1.7 (2018)
Percentile statistics : 20191225.v01 (using entries in the PDB archive December 25th 2019)
Refmac : 5.8.0158
CCP4 : 7.0.044 (Gargrove)
Ideal geometry (proteins) : Engh & Huber (2001)
Ideal geometry (DNA, RNA) : Parkinson et al. (1996)
Validation Pipeline (wwPDB-VP) : 2.35.1

1 Overall quality at a glance

The following experimental techniques were used to determine the structure:

X-RAY DIFFRACTION

The reported resolution of this entry is 2.75 Å.

Percentile scores (ranging between 0-100) for global validation metrics of the entry are shown in the following graphic. The table shows the number of entries on which the scores are based.

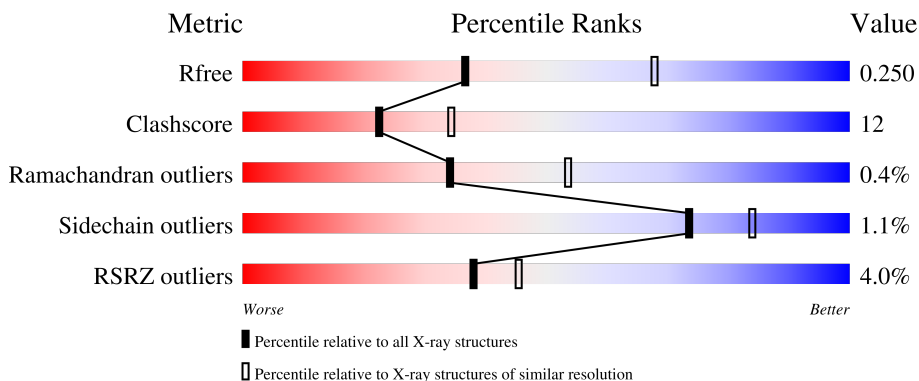

Metric	Whole archive (#Entries)	Similar resolution (#Entries, resolution range(Å))
R_{free}	130704	1235 (2.78-2.74)
Clashscore	141614	1277 (2.78-2.74)
Ramachandran outliers	138981	1257 (2.78-2.74)
Sidechain outliers	138945	1257 (2.78-2.74)
RSRZ outliers	127900	1207 (2.78-2.74)

The table below summarises the geometric issues observed across the polymeric chains and their fit to the electron density. The red, orange, yellow and green segments of the lower bar indicate the fraction of residues that contain outliers for ≥ 3 , 2, 1 and 0 types of geometric quality criteria respectively. A grey segment represents the fraction of residues that are not modelled. The numeric value for each fraction is indicated below the corresponding segment, with a dot representing fractions $\leq 5\%$. The upper red bar (where present) indicates the fraction of residues that have poor fit to the electron density. The numeric value is given above the bar.

Mol	Chain	Length	Quality of chain
1	A	354	 2% 61% 20% 17%
1	B	354	 4% 61% 22% 16%
1	G	354	 2% 64% 19% 17%
1	H	354	 4% 63% 21% 15%
1	M	354	 3% 64% 21% 14%

Continued on next page...

Continued from previous page...

Mol	Chain	Length	Quality of chain
1	N	354	2% 64% 20% 15%
1	S	354	2% 66% 17% 16%
1	T	354	5% 66% 20% 14%
2	C	230	2% 75% 19% 5%
2	E	230	2% 76% 20% ..
2	I	230	2% 78% 18% .
2	K	230	2% 77% 17% 6%
2	O	230	2% 79% 16% 5%
2	Q	230	3% 72% 22% ..
2	U	230	17% 71% 21% 7%
2	W	230	5% 71% 25% .
3	D	217	80% 19% .
3	F	217	73% 25% ..
3	J	217	75% 24% .
3	L	217	77% 21% ..
3	P	217	5% 74% 25% .
3	R	217	2% 77% 22%
3	V	217	19% 71% 27% ..
3	X	217	6% 75% 24% .
4	a	41	49% 51%
4	g	41	34% 66%
4	m	41	46% 54%
4	s	41	51% 49%

2 Entry composition [i](#)

There are 9 unique types of molecules in this entry. The entry contains 46697 atoms, of which 184 are hydrogens and 0 are deuteriums.

In the tables below, the ZeroOcc column contains the number of atoms modelled with zero occupancy, the AltConf column contains the number of residues with at least one atom in alternate conformation and the Trace column contains the number of residues modelled with at most 2 atoms.

- Molecule 1 is a protein called ATPase GET3.

Mol	Chain	Residues	Atoms					ZeroOcc	AltConf	Trace
			Total	C	N	O	S			
1	A	293	2319	1472	384	446	17	0	0	0
1	B	297	2336	1483	386	451	16	0	0	0
1	G	294	2323	1473	386	447	17	0	0	0
1	H	300	2371	1502	394	459	16	0	0	0
1	M	304	2405	1521	400	468	16	0	0	0
1	N	300	2375	1505	393	461	16	0	0	0
1	S	296	2330	1477	387	450	16	0	0	0
1	T	306	2402	1523	398	465	16	0	0	0

There are 8 discrepancies between the modelled and reference sequences:

Chain	Residue	Modelled	Actual	Comment	Reference
A	57	ASN	ASP	engineered mutation	UNP Q12154
B	57	ASN	ASP	engineered mutation	UNP Q12154
G	57	ASN	ASP	engineered mutation	UNP Q12154
H	57	ASN	ASP	engineered mutation	UNP Q12154
M	57	ASN	ASP	engineered mutation	UNP Q12154
N	57	ASN	ASP	engineered mutation	UNP Q12154
S	57	ASN	ASP	engineered mutation	UNP Q12154
T	57	ASN	ASP	engineered mutation	UNP Q12154

- Molecule 2 is a protein called Antibody heavy chain.

Mol	Chain	Residues	Atoms					ZeroOcc	AltConf	Trace
2	C	218	Total	C	N	O	S	0	0	0
			1641	1038	278	319	6			
2	E	222	Total	C	N	O	S	0	0	0
			1664	1050	282	326	6			
2	I	220	Total	C	N	O	S	0	0	0
			1655	1046	279	324	6			
2	K	216	Total	C	N	O	S	0	0	0
			1628	1031	276	315	6			
2	O	218	Total	C	N	O	S	0	0	0
			1635	1034	277	318	6			
2	Q	221	Total	C	N	O	S	0	0	0
			1655	1045	281	323	6			
2	U	214	Total	C	N	O	S	0	0	0
			1616	1024	273	313	6			
2	W	221	Total	C	N	O	S	0	0	0
			1655	1045	281	323	6			

- Molecule 3 is a protein called Antibody light chain.

Mol	Chain	Residues	Atoms					ZeroOcc	AltConf	Trace
3	D	216	Total	C	N	O	S	0	0	0
			1658	1038	276	338	6			
3	F	215	Total	C	N	O	S	0	0	0
			1650	1034	275	335	6			
3	J	215	Total	C	N	O	S	0	0	0
			1650	1034	275	335	6			
3	L	215	Total	C	N	O	S	0	0	0
			1650	1034	275	335	6			
3	P	216	Total	C	N	O	S	0	0	0
			1658	1038	276	338	6			
3	R	216	Total	C	N	O	S	0	0	0
			1658	1038	276	338	6			
3	V	215	Total	C	N	O	S	0	0	0
			1650	1034	275	335	6			
3	X	216	Total	C	N	O	S	0	0	0
			1658	1038	276	338	6			

- Molecule 4 is a protein called Sec22.

Mol	Chain	Residues	Atoms				ZeroOcc	AltConf	Trace
4	a	20	Total	C	N	O	0	0	0
			100	60	20	20			
4	g	14	Total	C	N	O	0	0	0
			70	42	14	14			

Continued on next page...

Continued from previous page...

Mol	Chain	Residues	Atoms				ZeroOcc	AltConf	Trace
4	m	19	Total	C	N	O	0	0	0
			95	57	19	19			
4	s	21	Total	C	N	O	0	0	0
			105	63	21	21			

- Molecule 5 is MAGNESIUM ION (three-letter code: MG) (formula: Mg).

Mol	Chain	Residues	Atoms		ZeroOcc	AltConf
5	A	1	Total	Mg	0	0
			1	1		
5	B	1	Total	Mg	0	0
			1	1		
5	G	1	Total	Mg	0	0
			1	1		
5	H	1	Total	Mg	0	0
			1	1		
5	M	1	Total	Mg	0	0
			1	1		
5	N	1	Total	Mg	0	0
			1	1		
5	S	1	Total	Mg	0	0
			1	1		
5	T	1	Total	Mg	0	0
			1	1		

- Molecule 6 is ZINC ION (three-letter code: ZN) (formula: Zn).

Mol	Chain	Residues	Atoms		ZeroOcc	AltConf
6	A	1	Total	Zn	0	0
			1	1		
6	G	1	Total	Zn	0	0
			1	1		
6	M	1	Total	Zn	0	0
			1	1		
6	S	1	Total	Zn	0	0
			1	1		

- Molecule 7 is ADENOSINE-5'-DIPHOSPHATE (three-letter code: ADP) (formula: C₁₀H₁₅N₅O₁₀P₂).



Mol	Chain	Residues	Atoms					ZeroOcc	AltConf	
			Total	C	H	N	O			P
7	A	1	38	10	11	5	10	2	0	1
7	B	1	39	10	12	5	10	2	0	1
7	G	1	38	10	11	5	10	2	0	1
7	H	1	39	10	12	5	10	2	0	1
7	M	1	38	10	11	5	10	2	0	1
7	N	1	39	10	12	5	10	2	0	1
7	S	1	38	10	11	5	10	2	0	1
7	T	1	39	10	12	5	10	2	0	1

- Molecule 8 is ADENOSINE-5'-TRIPHOSPHATE (three-letter code: ATP) (formula: $C_{10}H_{16}N_5O_{13}P_3$).

Continued from previous page...

Mol	Chain	Residues	Atoms	ZeroOcc	AltConf
9	E	14	Total O 14 14	0	0
9	F	23	Total O 23 23	0	0
9	G	20	Total O 20 20	0	0
9	H	25	Total O 25 25	0	0
9	I	25	Total O 25 25	0	0
9	J	34	Total O 34 34	0	0
9	K	15	Total O 15 15	0	0
9	L	19	Total O 19 19	0	0
9	M	20	Total O 20 20	0	0
9	N	29	Total O 29 29	0	0
9	O	12	Total O 12 12	0	0
9	P	15	Total O 15 15	0	0
9	Q	13	Total O 13 13	0	0
9	R	9	Total O 9 9	0	0
9	S	16	Total O 16 16	0	0
9	T	22	Total O 22 22	0	0
9	U	8	Total O 8 8	0	0
9	V	9	Total O 9 9	0	0
9	W	16	Total O 16 16	0	0
9	X	9	Total O 9 9	0	0

3 Residue-property plots

These plots are drawn for all protein, RNA, DNA and oligosaccharide chains in the entry. The first graphic for a chain summarises the proportions of the various outlier classes displayed in the second graphic. The second graphic shows the sequence view annotated by issues in geometry and electron density. Residues are color-coded according to the number of geometric quality criteria for which they contain at least one outlier: green = 0, yellow = 1, orange = 2 and red = 3 or more. A red dot above a residue indicates a poor fit to the electron density ($RSRZ > 2$). Stretches of 2 or more consecutive residues without any outlier are shown as a green connector. Residues present in the sample, but not in the model, are shown in grey.

• Molecule 1: ATPase GET3

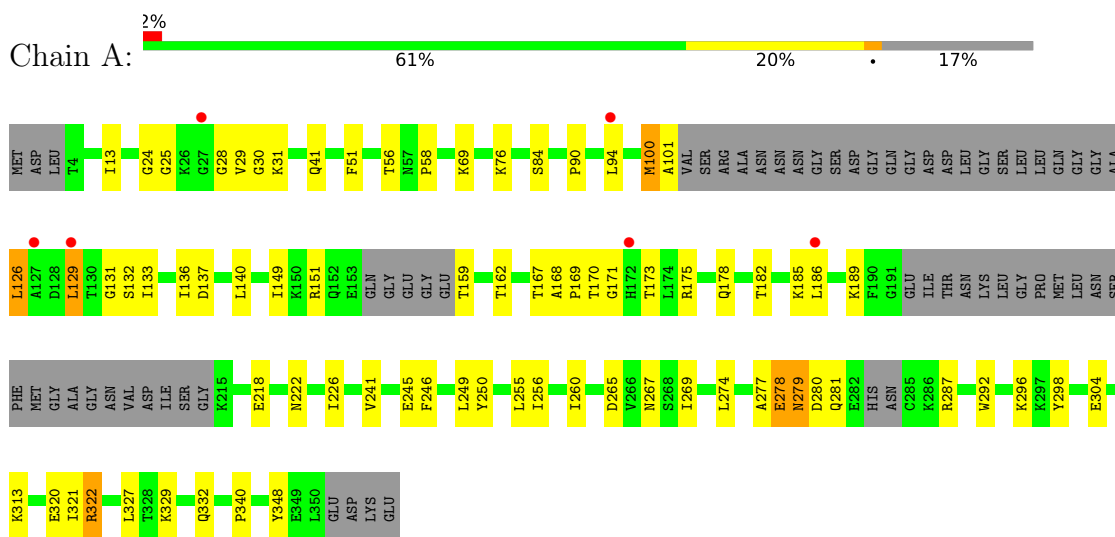

• Molecule 1: ATPase GET3

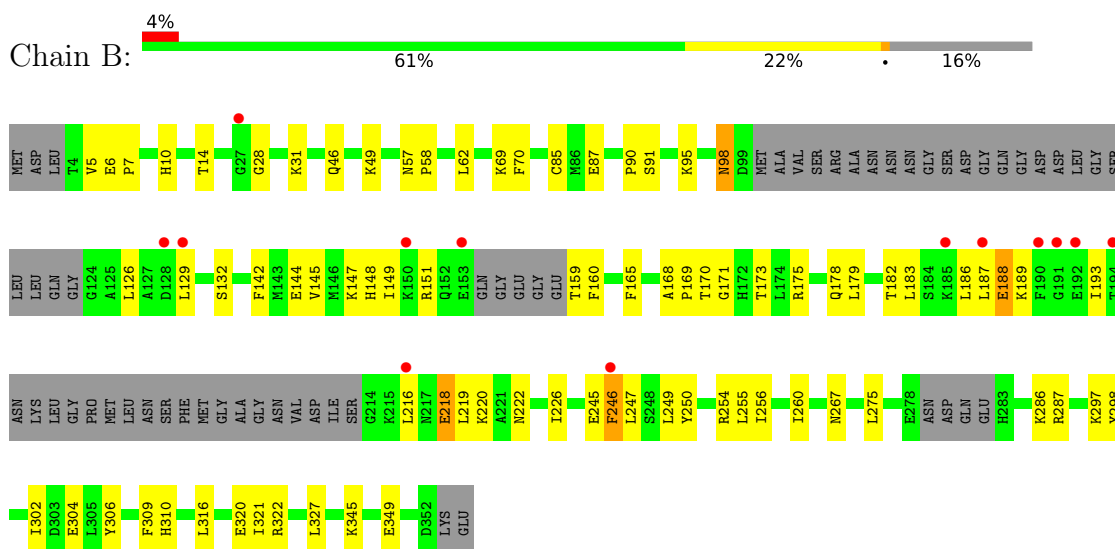

• Molecule 1: ATPase GET3



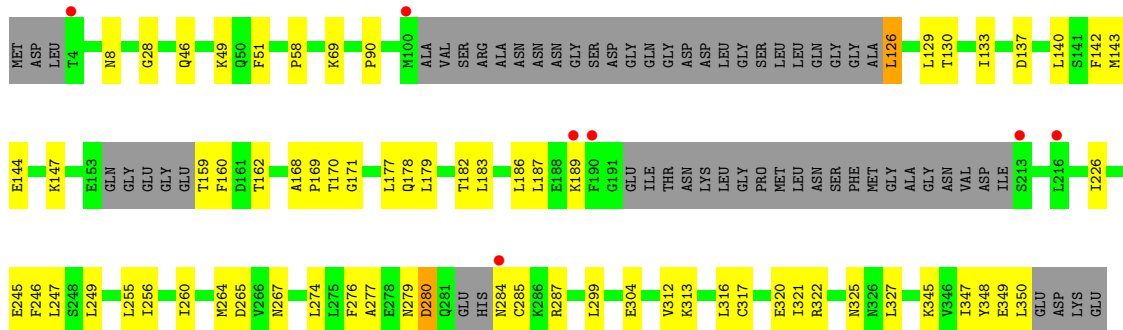

● Molecule 1: ATPase GET3

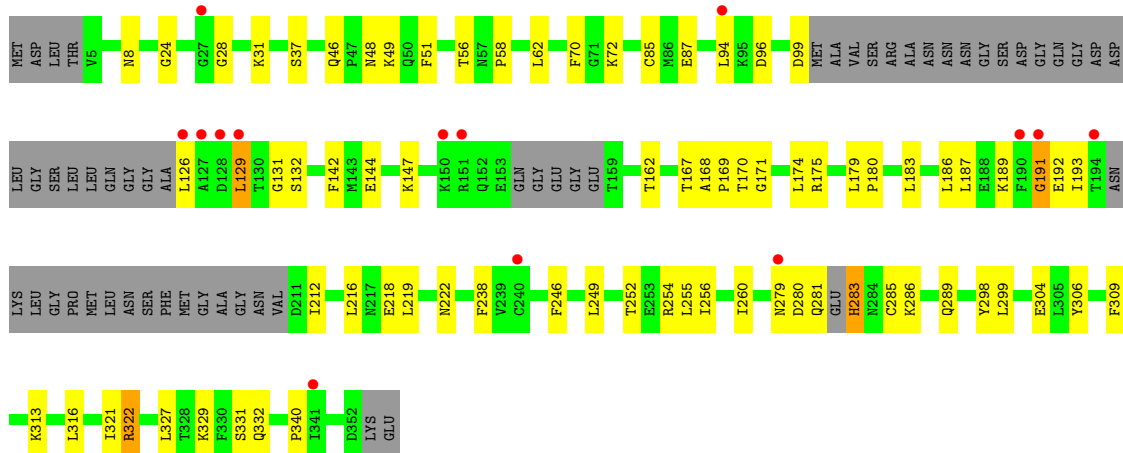

● Molecule 1: ATPase GET3

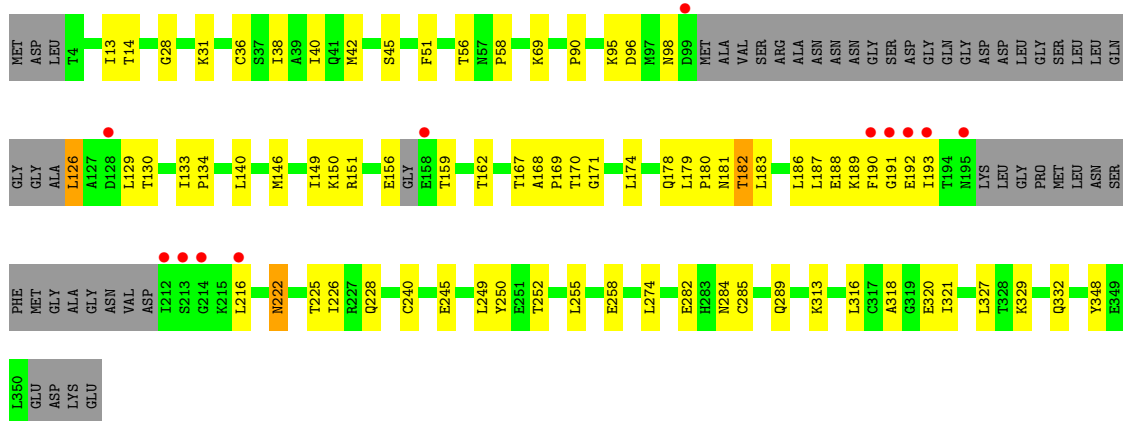

● Molecule 1: ATPase GET3



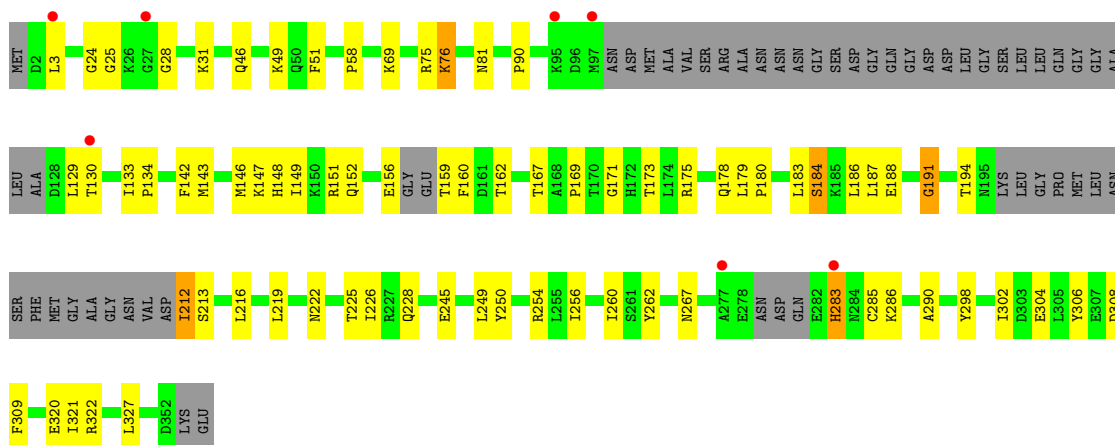

- Molecule 1: ATPase GET3

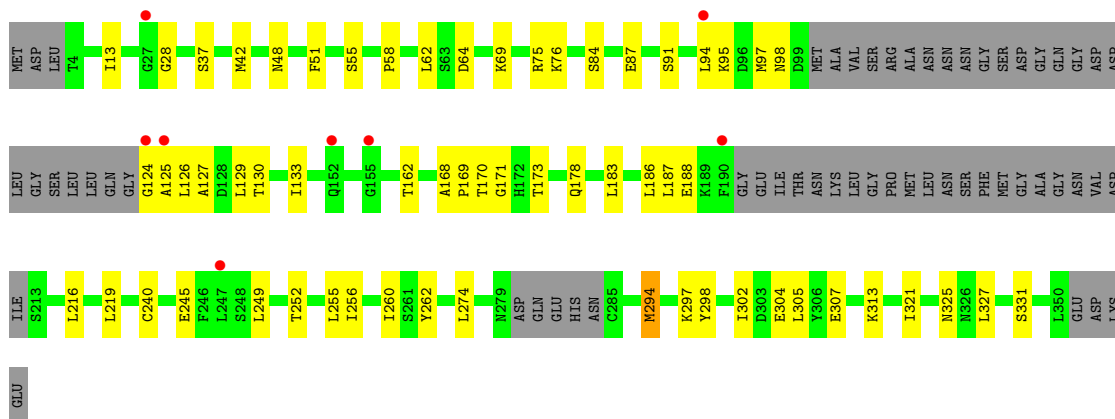

- Molecule 1: ATPase GET3

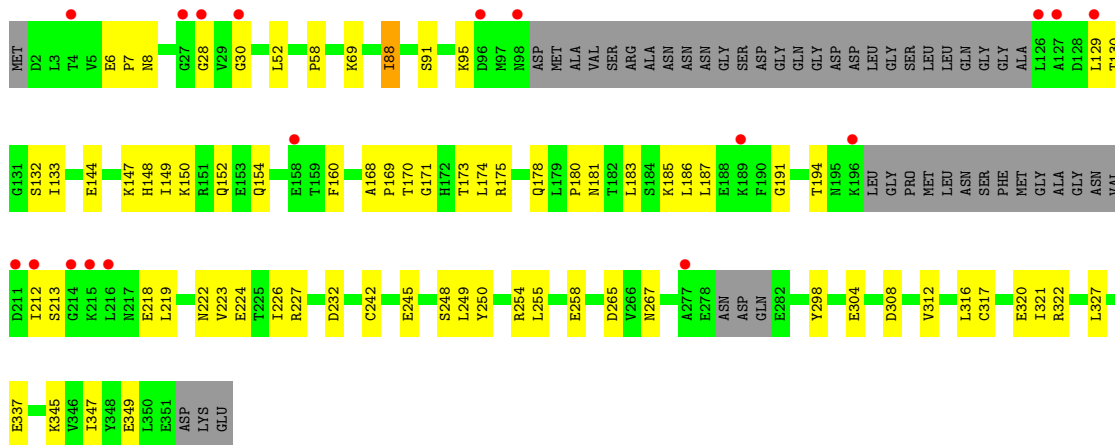

- Molecule 2: Antibody heavy chain

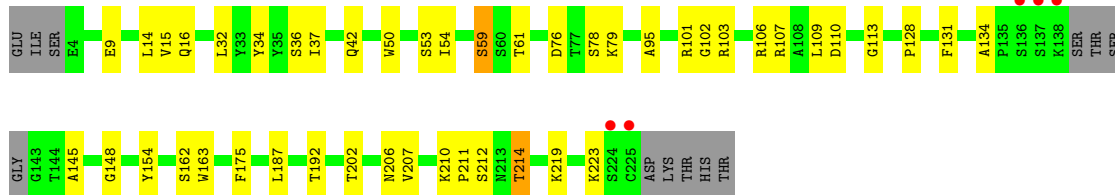
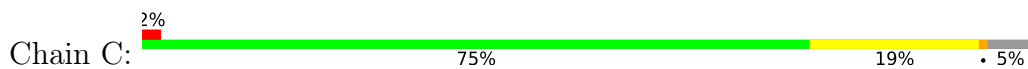

• Molecule 2: Antibody heavy chain

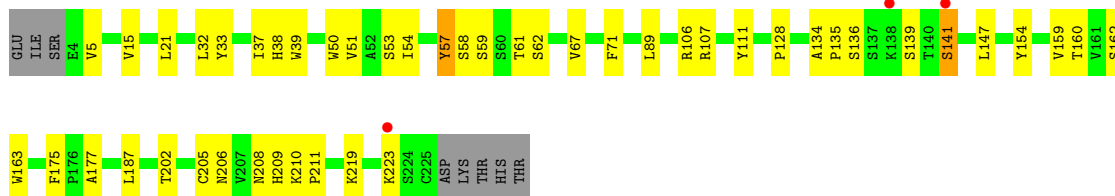
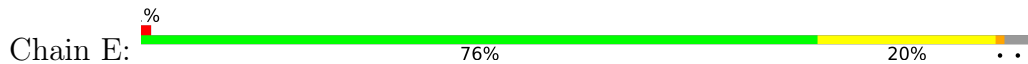

• Molecule 2: Antibody heavy chain

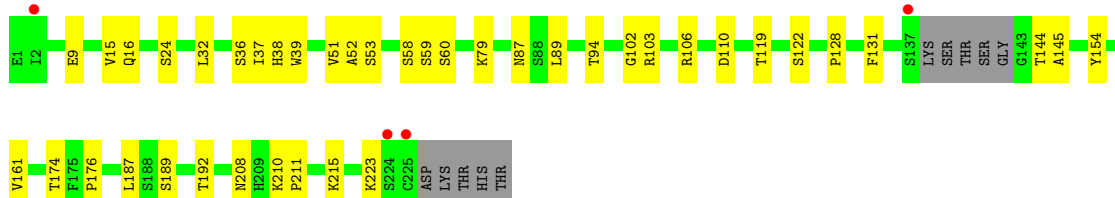
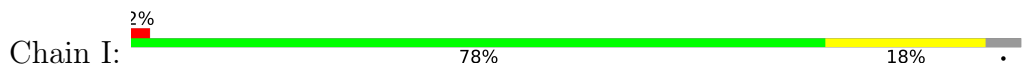

• Molecule 2: Antibody heavy chain

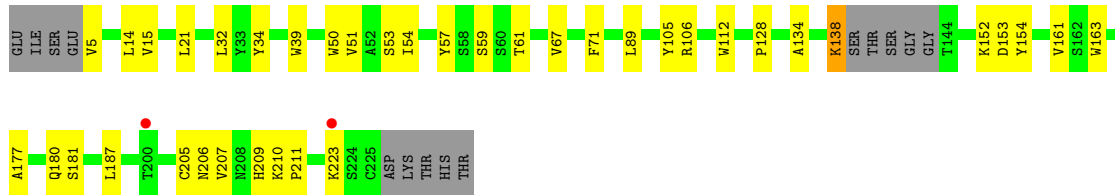
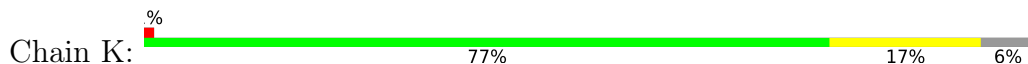

• Molecule 2: Antibody heavy chain

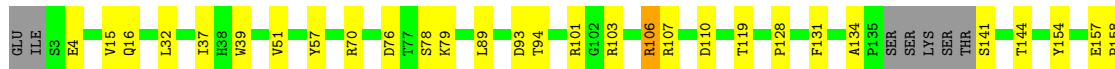
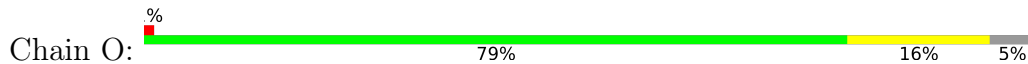

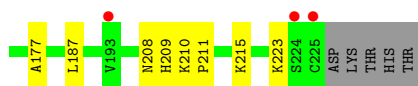

• Molecule 2: Antibody heavy chain

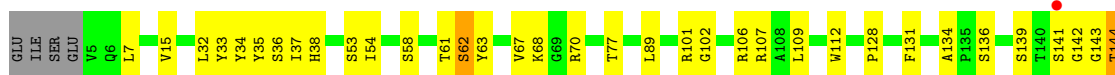
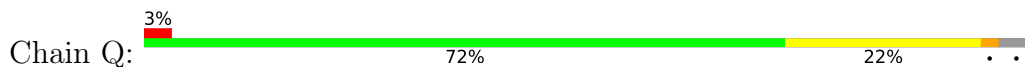

• Molecule 2: Antibody heavy chain

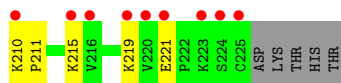
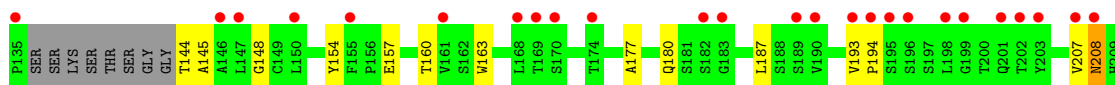

• Molecule 2: Antibody heavy chain

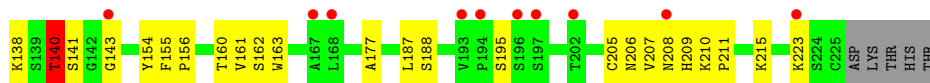

• Molecule 3: Antibody light chain

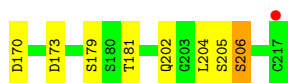
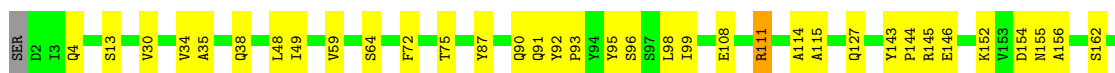
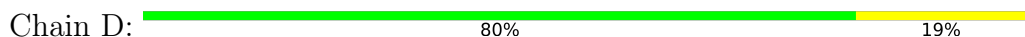

- Molecule 3: Antibody light chain

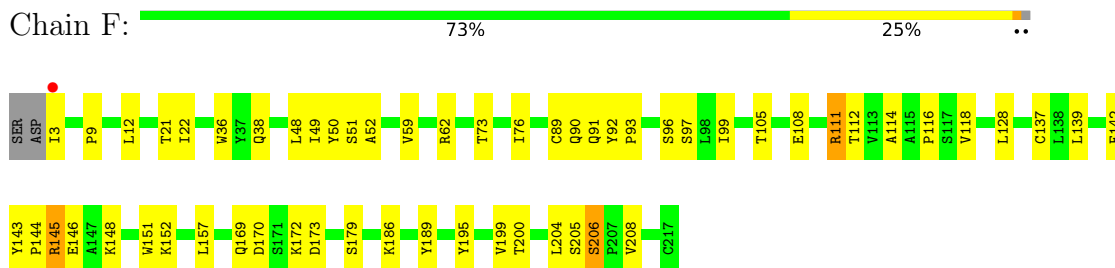

- Molecule 3: Antibody light chain

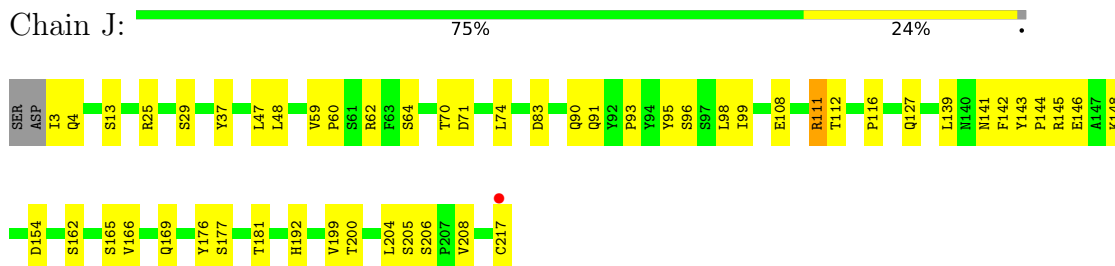

- Molecule 3: Antibody light chain

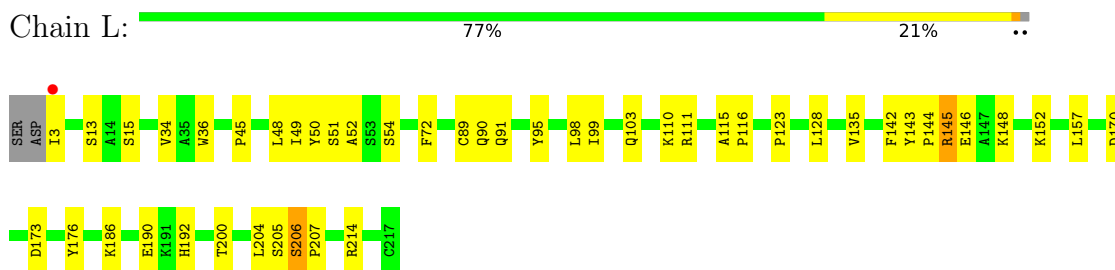

- Molecule 3: Antibody light chain

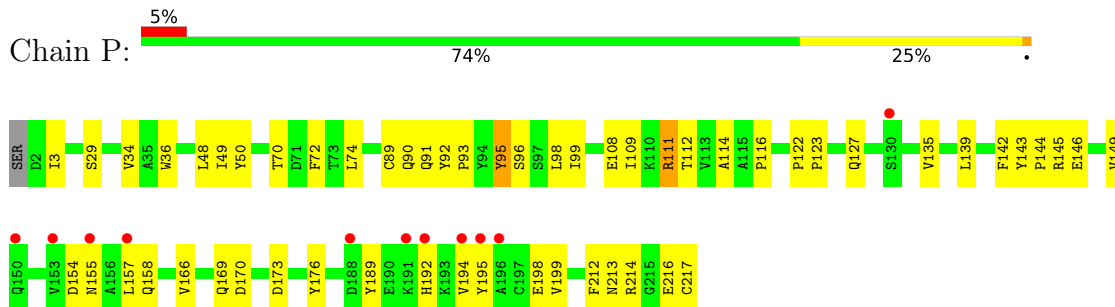

- Molecule 3: Antibody light chain

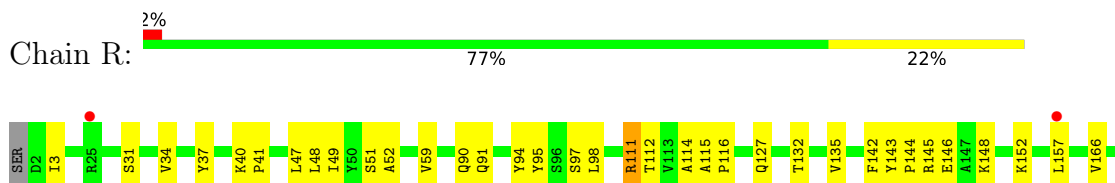

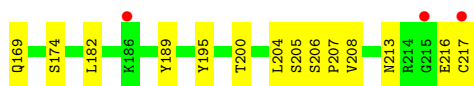

• Molecule 3: Antibody light chain

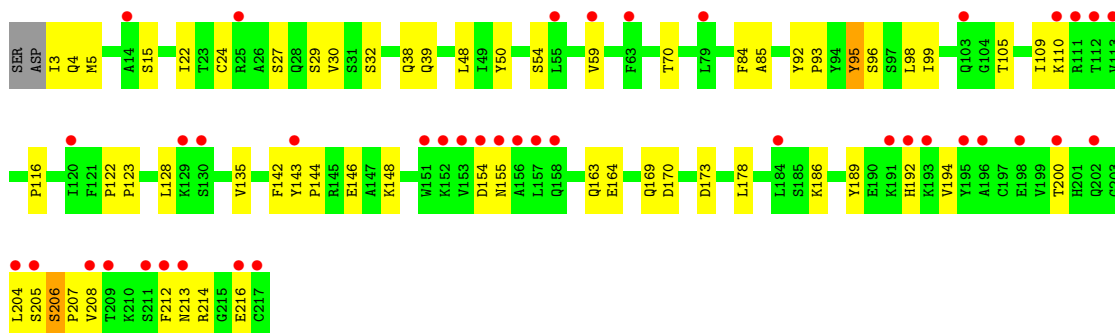

• Molecule 3: Antibody light chain

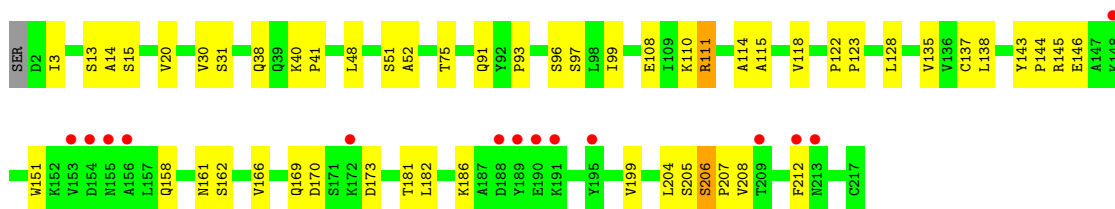
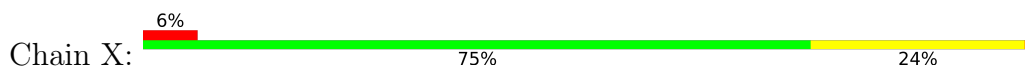

• Molecule 4: Sec22

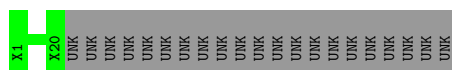

• Molecule 4: Sec22

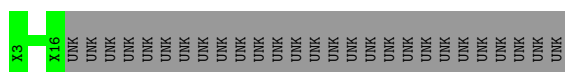

• Molecule 4: Sec22



4 Data and refinement statistics

Property	Value	Source
Space group	P 1	Depositor
Cell constants a, b, c, α , β , γ	112.58Å 119.45Å 147.57Å 71.89° 89.86° 66.61°	Depositor
Resolution (Å)	39.72 – 2.75 39.72 – 2.75	Depositor EDS
% Data completeness (in resolution range)	90.6 (39.72-2.75) 84.3 (39.72-2.75)	Depositor EDS
R_{merge}	(Not available)	Depositor
R_{sym}	(Not available)	Depositor
$\langle I/\sigma(I) \rangle$ ¹	1.25 (at 2.77Å)	Xtrriage
Refinement program	PHENIX	Depositor
R, R_{free}	0.196 , 0.247 0.200 , 0.250	Depositor DCC
R_{free} test set	7827 reflections (5.01%)	wwPDB-VP
Wilson B-factor (Å ²)	48.6	Xtrriage
Anisotropy	0.429	Xtrriage
Bulk solvent k_{sol} (e/Å ³), B_{sol} (Å ²)	0.27 , 45.6	EDS
L-test for twinning ²	$\langle L \rangle = 0.48$, $\langle L^2 \rangle = 0.31$	Xtrriage
Estimated twinning fraction	No twinning to report.	Xtrriage
F_o, F_c correlation	0.94	EDS
Total number of atoms	46697	wwPDB-VP
Average B, all atoms (Å ²)	74.0	wwPDB-VP

Xtrriage's analysis on translational NCS is as follows: *The analyses of the Patterson function reveals a significant off-origin peak that is 25.88 % of the origin peak, indicating pseudo-translational symmetry. The chance of finding a peak of this or larger height randomly in a structure without pseudo-translational symmetry is equal to 2.9213e-03. The detected translational NCS is most likely also responsible for the elevated intensity ratio.*

¹Intensities estimated from amplitudes.

²Theoretical values of $\langle |L| \rangle$, $\langle L^2 \rangle$ for acentric reflections are 0.5, 0.333 respectively for untwinned datasets, and 0.375, 0.2 for perfectly twinned datasets.

5 Model quality

5.1 Standard geometry

Bond lengths and bond angles in the following residue types are not validated in this section: ADP, ZN, MG, ATP

The Z score for a bond length (or angle) is the number of standard deviations the observed value is removed from the expected value. A bond length (or angle) with $|Z| > 5$ is considered an outlier worth inspection. RMSZ is the root-mean-square of all Z scores of the bond lengths (or angles).

Mol	Chain	Bond lengths		Bond angles	
		RMSZ	# Z >5	RMSZ	# Z >5
1	A	0.25	0/2356	0.43	0/3175
1	B	0.27	0/2373	0.45	0/3199
1	G	0.27	0/2360	0.44	0/3180
1	H	0.27	0/2409	0.45	0/3247
1	M	0.28	0/2444	0.47	0/3296
1	N	0.28	0/2413	0.46	0/3252
1	S	0.25	0/2368	0.43	0/3192
1	T	0.25	0/2440	0.44	0/3289
2	C	0.28	0/1682	0.47	0/2292
2	E	0.27	0/1706	0.47	0/2326
2	I	0.29	0/1696	0.48	0/2312
2	K	0.26	0/1669	0.46	0/2275
2	O	0.26	0/1676	0.44	0/2285
2	Q	0.26	0/1697	0.48	0/2314
2	U	0.23	0/1657	0.42	0/2260
2	W	0.25	0/1697	0.47	0/2314
3	D	0.27	0/1694	0.47	0/2299
3	F	0.28	0/1686	0.46	0/2288
3	J	0.29	0/1686	0.47	0/2288
3	L	0.26	0/1686	0.46	0/2288
3	P	0.25	0/1694	0.44	0/2299
3	R	0.26	0/1694	0.44	0/2299
3	V	0.23	0/1686	0.41	0/2288
3	X	0.25	0/1694	0.45	0/2299
All	All	0.26	0/46163	0.45	0/62556

There are no bond length outliers.

There are no bond angle outliers.

There are no chirality outliers.

There are no planarity outliers.

5.2 Too-close contacts [i](#)

In the following table, the Non-H and H(model) columns list the number of non-hydrogen atoms and hydrogen atoms in the chain respectively. The H(added) column lists the number of hydrogen atoms added and optimized by MolProbity. The Clashes column lists the number of clashes within the asymmetric unit, whereas Symm-Clashes lists symmetry-related clashes.

Mol	Chain	Non-H	H(model)	H(added)	Clashes	Symm-Clashes
1	A	2319	0	2316	77	0
1	B	2336	0	2325	92	0
1	G	2323	0	2319	65	0
1	H	2371	0	2354	66	1
1	M	2405	0	2388	60	1
1	N	2375	0	2362	64	0
1	S	2330	0	2324	65	1
1	T	2402	0	2390	61	0
2	C	1641	0	1604	31	0
2	E	1664	0	1625	38	0
2	I	1655	0	1616	30	0
2	K	1628	0	1595	32	0
2	O	1635	0	1591	33	0
2	Q	1655	0	1619	58	1
2	U	1616	0	1579	40	0
2	W	1655	0	1619	53	2
3	D	1658	0	1611	31	0
3	F	1650	0	1607	44	0
3	J	1650	0	1607	36	0
3	L	1650	0	1607	40	0
3	P	1658	0	1611	46	0
3	R	1658	0	1611	35	0
3	V	1650	0	1608	44	0
3	X	1658	0	1611	39	0
4	a	100	0	22	0	0
4	g	70	0	16	0	0
4	m	95	0	21	0	0
4	s	105	0	23	0	0
5	A	1	0	0	0	0
5	B	1	0	0	0	0
5	G	1	0	0	0	0
5	H	1	0	0	0	0
5	M	1	0	0	0	0
5	N	1	0	0	0	0
5	S	1	0	0	0	0
5	T	1	0	0	0	0
6	A	1	0	0	0	0

Continued on next page...

Continued from previous page...

Mol	Chain	Non-H	H(model)	H(added)	Clashes	Symm-Clashes
6	G	1	0	0	0	0
6	M	1	0	0	0	0
6	S	1	0	0	0	0
7	A	27	11	12	0	0
7	B	27	12	12	1	0
7	G	27	11	12	0	0
7	H	27	12	12	1	0
7	M	27	11	9	0	0
7	N	27	12	12	0	0
7	S	27	11	11	0	0
7	T	27	12	12	1	0
8	A	31	11	12	2	0
8	B	31	12	12	2	0
8	G	31	11	12	1	0
8	H	31	12	12	2	0
8	M	31	11	10	1	0
8	N	31	12	12	0	0
8	S	31	11	11	0	0
8	T	31	12	12	2	0
9	A	20	0	0	2	0
9	B	17	0	0	0	0
9	C	16	0	0	0	0
9	D	19	0	0	1	0
9	E	14	0	0	3	0
9	F	23	0	0	1	0
9	G	20	0	0	6	0
9	H	25	0	0	1	0
9	I	25	0	0	2	0
9	J	34	0	0	2	0
9	K	15	0	0	2	0
9	L	19	0	0	1	0
9	M	20	0	0	1	0
9	N	29	0	0	1	0
9	O	12	0	0	0	0
9	P	15	0	0	0	0
9	Q	13	0	0	4	0
9	R	9	0	0	0	0
9	S	16	0	0	3	0
9	T	22	0	0	2	0
9	U	8	0	0	2	0
9	V	9	0	0	1	0
9	W	16	0	0	2	0

Continued on next page...

Continued from previous page...

Mol	Chain	Non-H	H(model)	H(added)	Clashes	Symm-Clashes
9	X	9	0	0	2	0
All	All	46513	184	44766	1043	3

The all-atom clashscore is defined as the number of clashes found per 1000 atoms (including hydrogen atoms). The all-atom clashscore for this structure is 12.

The worst 5 of 1043 close contacts within the same asymmetric unit are listed below, sorted by their clash magnitude.

Atom-1	Atom-2	Interatomic distance (Å)	Clash overlap (Å)
3:F:145:ARG:HH11	3:F:145:ARG:HG2	1.20	1.05
2:Q:209:HIS:H	2:Q:215:LYS:HZ1	1.07	1.02
1:G:137:ASP:OD2	1:H:175:ARG:NH1	1.97	0.98
1:N:69:LYS:O	1:N:75:ARG:NH1	1.94	0.98
3:L:145:ARG:HG2	3:L:145:ARG:HH11	1.31	0.94

All (3) symmetry-related close contacts are listed below. The label for Atom-2 includes the symmetry operator and encoded unit-cell translations to be applied.

Atom-1	Atom-2	Interatomic distance (Å)	Clash overlap (Å)
2:Q:141:SER:OG	1:S:188:GLU:OE2[1_564]	1.82	0.38
1:H:48:ASN:OD1	2:W:24:SER:OG[1_455]	2.13	0.07
1:M:188:GLU:OE1	2:W:138:LYS:NZ[1_455]	2.15	0.05

5.3 Torsion angles [i](#)

5.3.1 Protein backbone [i](#)

In the following table, the Percentiles column shows the percent Ramachandran outliers of the chain as a percentile score with respect to all X-ray entries followed by that with respect to entries of similar resolution.

The Analysed column shows the number of residues for which the backbone conformation was analysed, and the total number of residues.

Mol	Chain	Analysed	Favoured	Allowed	Outliers	Percentiles	
1	A	283/354 (80%)	277 (98%)	6 (2%)	0	100	100
1	B	287/354 (81%)	280 (98%)	7 (2%)	0	100	100
1	G	284/354 (80%)	278 (98%)	5 (2%)	1 (0%)	34	53

Continued on next page...

Continued from previous page...

Mol	Chain	Analysed	Favoured	Allowed	Outliers	Percentiles	
1	H	290/354 (82%)	285 (98%)	4 (1%)	1 (0%)	41	60
1	M	296/354 (84%)	289 (98%)	6 (2%)	1 (0%)	41	60
1	N	290/354 (82%)	282 (97%)	4 (1%)	4 (1%)	11	19
1	S	288/354 (81%)	284 (99%)	3 (1%)	1 (0%)	41	60
1	T	298/354 (84%)	293 (98%)	4 (1%)	1 (0%)	41	60
2	C	214/230 (93%)	204 (95%)	9 (4%)	1 (0%)	29	47
2	E	220/230 (96%)	207 (94%)	12 (6%)	1 (0%)	29	47
2	I	216/230 (94%)	207 (96%)	8 (4%)	1 (0%)	29	47
2	K	212/230 (92%)	205 (97%)	7 (3%)	0	100	100
2	O	214/230 (93%)	204 (95%)	10 (5%)	0	100	100
2	Q	219/230 (95%)	205 (94%)	12 (6%)	2 (1%)	17	31
2	U	210/230 (91%)	199 (95%)	9 (4%)	2 (1%)	15	27
2	W	219/230 (95%)	206 (94%)	12 (6%)	1 (0%)	29	47
3	D	214/217 (99%)	209 (98%)	4 (2%)	1 (0%)	29	47
3	F	213/217 (98%)	207 (97%)	5 (2%)	1 (0%)	29	47
3	J	213/217 (98%)	208 (98%)	5 (2%)	0	100	100
3	L	213/217 (98%)	206 (97%)	5 (2%)	2 (1%)	17	31
3	P	214/217 (99%)	208 (97%)	5 (2%)	1 (0%)	29	47
3	R	214/217 (99%)	208 (97%)	6 (3%)	0	100	100
3	V	213/217 (98%)	205 (96%)	6 (3%)	2 (1%)	17	31
3	X	214/217 (99%)	208 (97%)	5 (2%)	1 (0%)	29	47
All	All	5748/6408 (90%)	5564 (97%)	159 (3%)	25 (0%)	34	53

5 of 25 Ramachandran outliers are listed below:

Mol	Chain	Res	Type
3	D	206	SER
3	F	206	SER
2	I	59	SER
3	L	206	SER
1	N	283	HIS

5.3.2 Protein sidechains [i](#)

In the following table, the Percentiles column shows the percent sidechain outliers of the chain as a percentile score with respect to all X-ray entries followed by that with respect to entries of similar resolution.

The Analysed column shows the number of residues for which the sidechain conformation was analysed, and the total number of residues.

Mol	Chain	Analysed	Rotameric	Outliers	Percentiles	
1	A	263/309 (85%)	257 (98%)	6 (2%)	50	69
1	B	263/309 (85%)	258 (98%)	5 (2%)	57	73
1	G	264/309 (85%)	262 (99%)	2 (1%)	81	88
1	H	269/309 (87%)	263 (98%)	6 (2%)	52	70
1	M	273/309 (88%)	266 (97%)	7 (3%)	46	66
1	N	270/309 (87%)	267 (99%)	3 (1%)	73	84
1	S	263/309 (85%)	262 (100%)	1 (0%)	91	93
1	T	270/309 (87%)	268 (99%)	2 (1%)	84	89
2	C	182/193 (94%)	180 (99%)	2 (1%)	73	84
2	E	185/193 (96%)	184 (100%)	1 (0%)	88	92
2	I	184/193 (95%)	184 (100%)	0	100	100
2	K	181/193 (94%)	179 (99%)	2 (1%)	73	84
2	O	180/193 (93%)	178 (99%)	2 (1%)	73	84
2	Q	184/193 (95%)	181 (98%)	3 (2%)	62	77
2	U	179/193 (93%)	178 (99%)	1 (1%)	86	90
2	W	184/193 (95%)	181 (98%)	3 (2%)	62	77
3	D	191/192 (100%)	189 (99%)	2 (1%)	76	85
3	F	190/192 (99%)	188 (99%)	2 (1%)	73	84
3	J	190/192 (99%)	189 (100%)	1 (0%)	88	92
3	L	190/192 (99%)	188 (99%)	2 (1%)	73	84
3	P	191/192 (100%)	189 (99%)	2 (1%)	76	85
3	R	191/192 (100%)	189 (99%)	2 (1%)	76	85
3	V	190/192 (99%)	190 (100%)	0	100	100
3	X	191/192 (100%)	190 (100%)	1 (0%)	88	92
All	All	5118/5552 (92%)	5060 (99%)	58 (1%)	73	84

5 of 58 residues with a non-rotameric sidechain are listed below:

Mol	Chain	Res	Type
2	K	207	VAL
2	W	140	THR
1	M	190	PHE
2	W	57	TYR
3	R	217	CYS

Sometimes sidechains can be flipped to improve hydrogen bonding and reduce clashes. 5 of 18 such sidechains are listed below:

Mol	Chain	Res	Type
1	T	154	GLN
3	X	140	ASN
2	W	173	HIS
3	R	127	GLN
1	S	148	HIS

5.3.3 RNA [i](#)

There are no RNA molecules in this entry.

5.4 Non-standard residues in protein, DNA, RNA chains [i](#)

There are no non-standard protein/DNA/RNA residues in this entry.

5.5 Carbohydrates [i](#)

There are no monosaccharides in this entry.

5.6 Ligand geometry [i](#)

Of 28 ligands modelled in this entry, 12 are monoatomic - leaving 16 for Mogul analysis.

In the following table, the Counts columns list the number of bonds (or angles) for which Mogul statistics could be retrieved, the number of bonds (or angles) that are observed in the model and the number of bonds (or angles) that are defined in the Chemical Component Dictionary. The Link column lists molecule types, if any, to which the group is linked. The Z score for a bond length (or angle) is the number of standard deviations the observed value is removed from the expected value. A bond length (or angle) with $|Z| > 2$ is considered an outlier worth inspection. RMSZ is the root-mean-square of all Z scores of the bond lengths (or angles).

Mol	Type	Chain	Res	Link	Bond lengths			Bond angles		
					Counts	RMSZ	# Z > 2	Counts	RMSZ	# Z > 2
7	ADP	H	402[B]	5,1	24,29,29	4.67	9 (37%)	29,45,45	2.58	5 (17%)
7	ADP	G	403[B]	5	24,29,29	4.69	9 (37%)	29,45,45	2.62	4 (13%)
8	ATP	T	403[A]	5,1	26,33,33	2.28	9 (34%)	31,52,52	1.84	9 (29%)
7	ADP	A	403[B]	5	24,29,29	4.68	10 (41%)	29,45,45	2.61	4 (13%)
7	ADP	N	402[B]	5	24,29,29	4.72	9 (37%)	29,45,45	2.67	5 (17%)
8	ATP	B	403[A]	5	26,33,33	2.28	9 (34%)	31,52,52	1.83	9 (29%)
7	ADP	T	402[B]	5,1	24,29,29	4.71	9 (37%)	29,45,45	2.63	5 (17%)
8	ATP	G	404[A]	5	26,33,33	2.26	9 (34%)	31,52,52	1.89	9 (29%)
8	ATP	M	404[A]	5,1	26,33,33	2.43	9 (34%)	31,52,52	2.19	11 (35%)
7	ADP	B	402[B]	5,1	24,29,29	4.69	9 (37%)	29,45,45	2.63	5 (17%)
7	ADP	S	403[B]	5	24,29,29	4.73	9 (37%)	29,45,45	2.60	4 (13%)
8	ATP	H	403[A]	5	26,33,33	2.25	10 (38%)	31,52,52	1.81	8 (25%)
7	ADP	M	403[B]	5,1	24,29,29	4.76	8 (33%)	29,45,45	3.23	5 (17%)
8	ATP	S	404[A]	5	26,33,33	2.32	9 (34%)	31,52,52	1.82	8 (25%)
8	ATP	A	404[A]	5	26,33,33	2.26	9 (34%)	31,52,52	1.83	9 (29%)
8	ATP	N	403[A]	5	26,33,33	2.30	9 (34%)	31,52,52	1.88	9 (29%)

In the following table, the Chirals column lists the number of chiral outliers, the number of chiral centers analysed, the number of these observed in the model and the number defined in the Chemical Component Dictionary. Similar counts are reported in the Torsion and Rings columns. '2' means no outliers of that kind were identified.

Mol	Type	Chain	Res	Link	Chirals	Torsions	Rings
7	ADP	H	402[B]	5,1	-	0/12/32/32	0/3/3/3
7	ADP	G	403[B]	5	-	0/12/32/32	0/3/3/3
8	ATP	T	403[A]	5,1	-	3/18/38/38	0/3/3/3
7	ADP	A	403[B]	5	-	0/12/32/32	0/3/3/3
7	ADP	N	402[B]	5	-	0/12/32/32	0/3/3/3
8	ATP	B	403[A]	5	-	0/18/38/38	0/3/3/3
7	ADP	T	402[B]	5,1	-	1/12/32/32	0/3/3/3
8	ATP	G	404[A]	5	-	0/18/38/38	0/3/3/3
8	ATP	M	404[A]	5,1	-	1/18/38/38	0/3/3/3
7	ADP	B	402[B]	5,1	-	0/12/32/32	0/3/3/3
7	ADP	S	403[B]	5	-	2/12/32/32	0/3/3/3
8	ATP	H	403[A]	5	-	1/18/38/38	0/3/3/3
7	ADP	M	403[B]	5,1	-	1/12/32/32	0/3/3/3
8	ATP	S	404[A]	5	-	6/18/38/38	0/3/3/3
8	ATP	A	404[A]	5	-	0/18/38/38	0/3/3/3

Continued on next page...

Continued from previous page...

Mol	Type	Chain	Res	Link	Chirals	Torsions	Rings
8	ATP	N	403[A]	5	-	1/18/38/38	0/3/3/3

The worst 5 of 145 bond length outliers are listed below:

Mol	Chain	Res	Type	Atoms	Z	Observed(Å)	Ideal(Å)
7	M	403[B]	ADP	O4'-C1'	15.06	1.62	1.41
7	T	402[B]	ADP	O4'-C1'	14.92	1.61	1.41
7	N	402[B]	ADP	O4'-C1'	14.91	1.61	1.41
7	S	403[B]	ADP	C2'-C1'	-14.85	1.31	1.53
7	B	402[B]	ADP	O4'-C1'	14.83	1.61	1.41

The worst 5 of 109 bond angle outliers are listed below:

Mol	Chain	Res	Type	Atoms	Z	Observed(°)	Ideal(°)
7	M	403[B]	ADP	C5-C6-N6	13.08	140.23	120.35
7	N	402[B]	ADP	C5-C6-N6	10.23	135.90	120.35
7	T	402[B]	ADP	C5-C6-N6	10.12	135.73	120.35
7	A	403[B]	ADP	C5-C6-N6	10.09	135.68	120.35
7	G	403[B]	ADP	C5-C6-N6	10.02	135.58	120.35

There are no chirality outliers.

5 of 16 torsion outliers are listed below:

Mol	Chain	Res	Type	Atoms
8	S	404[A]	ATP	PB-O3B-PG-O2G
8	S	404[A]	ATP	PB-O3B-PG-O3G
8	S	404[A]	ATP	C5'-O5'-PA-O1A
8	T	403[A]	ATP	C5'-O5'-PA-O1A
8	H	403[A]	ATP	PA-O3A-PB-O1B

There are no ring outliers.

9 monomers are involved in 13 short contacts:

Mol	Chain	Res	Type	Clashes	Symm-Clashes
7	H	402[B]	ADP	1	0
8	T	403[A]	ATP	2	0
8	B	403[A]	ATP	2	0
7	T	402[B]	ADP	1	0
8	G	404[A]	ATP	1	0
8	M	404[A]	ATP	1	0
7	B	402[B]	ADP	1	0

Continued on next page...

Continued from previous page...

Mol	Chain	Res	Type	Clashes	Symm-Clashes
8	H	403[A]	ATP	2	0
8	A	404[A]	ATP	2	0

The following is a two-dimensional graphical depiction of Mogul quality analysis of bond lengths, bond angles, torsion angles, and ring geometry for all instances of the Ligand of Interest. In addition, ligands with molecular weight > 250 and outliers as shown on the validation Tables will also be included. For torsion angles, if less than 5% of the Mogul distribution of torsion angles is within 10 degrees of the torsion angle in question, then that torsion angle is considered an outlier. Any bond that is central to one or more torsion angles identified as an outlier by Mogul will be highlighted in the graph. For rings, the root-mean-square deviation (RMSD) between the ring in question and similar rings identified by Mogul is calculated over all ring torsion angles. If the average RMSD is greater than 60 degrees and the minimal RMSD between the ring in question and any Mogul-identified rings is also greater than 60 degrees, then that ring is considered an outlier. The outliers are highlighted in purple. The color gray indicates Mogul did not find sufficient equivalents in the CSD to analyse the geometry.

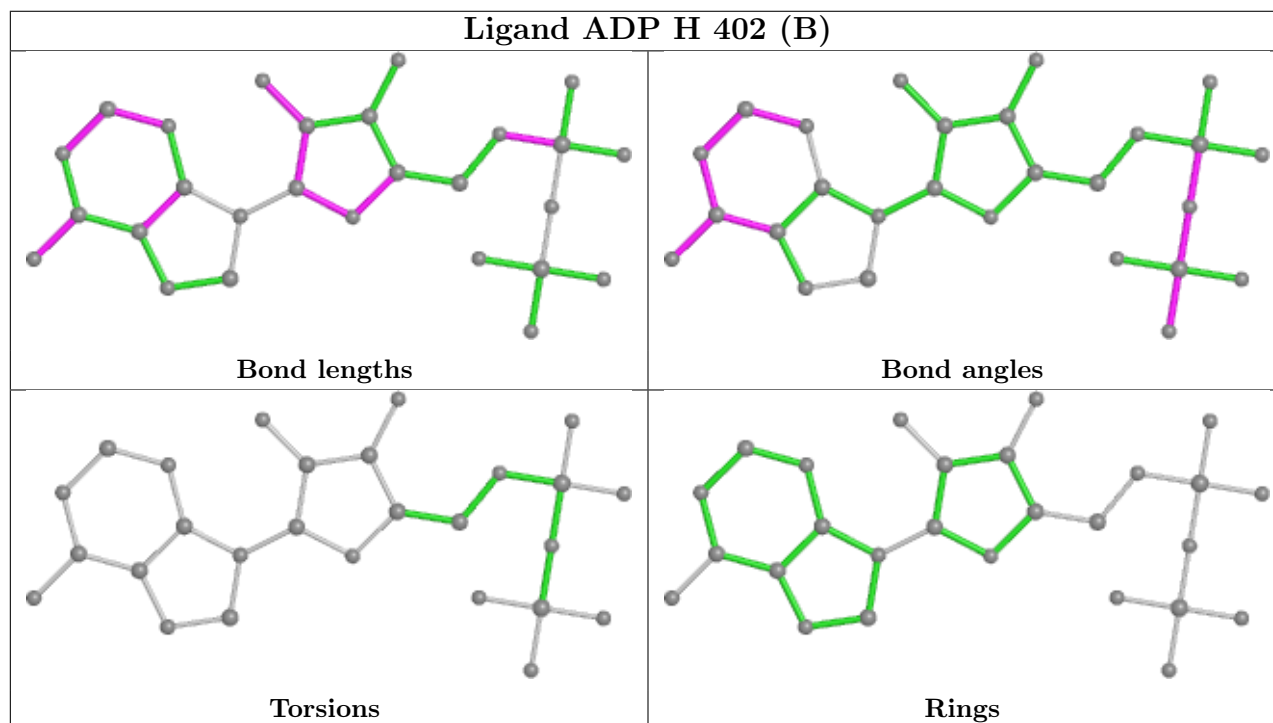

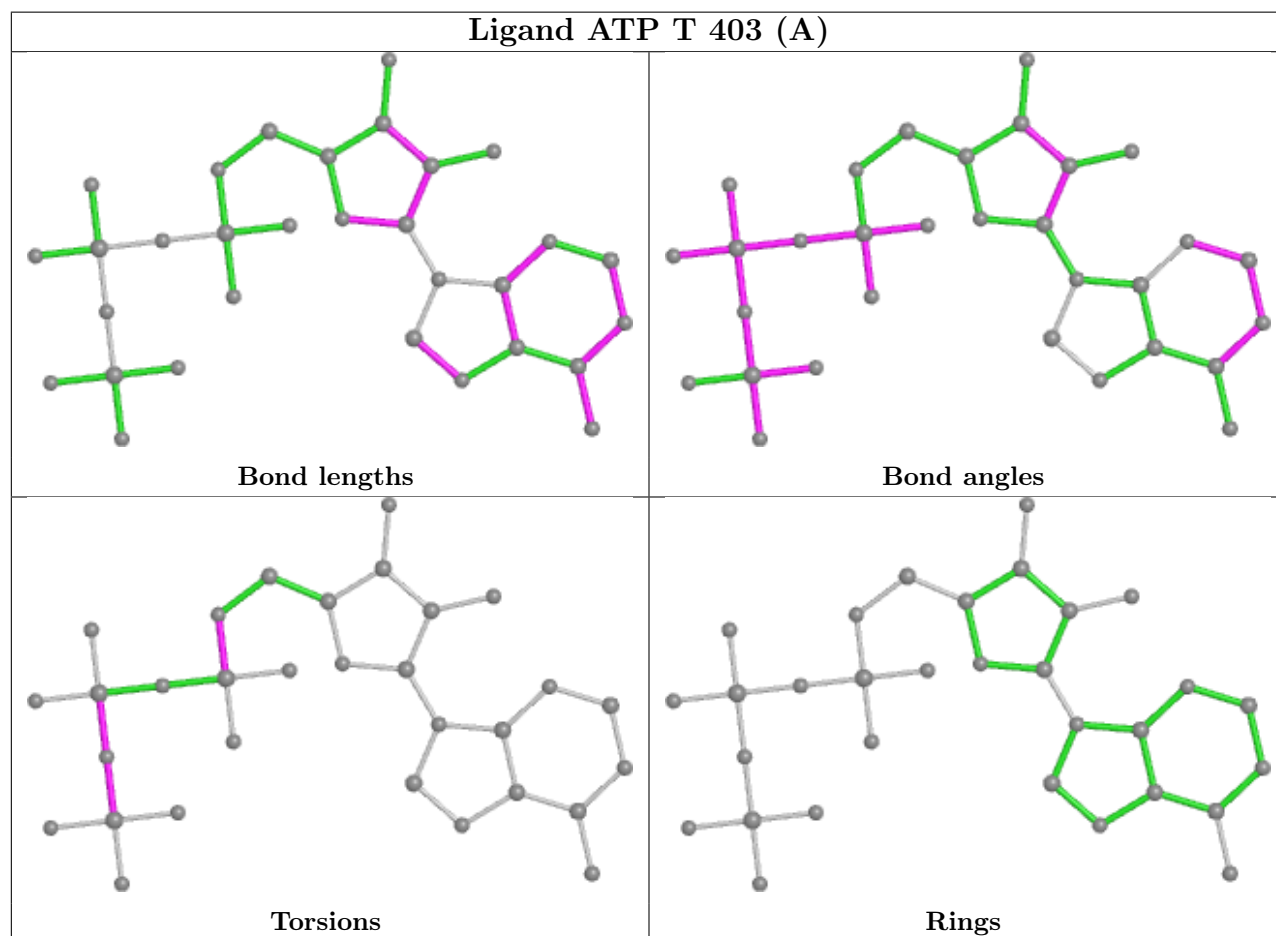
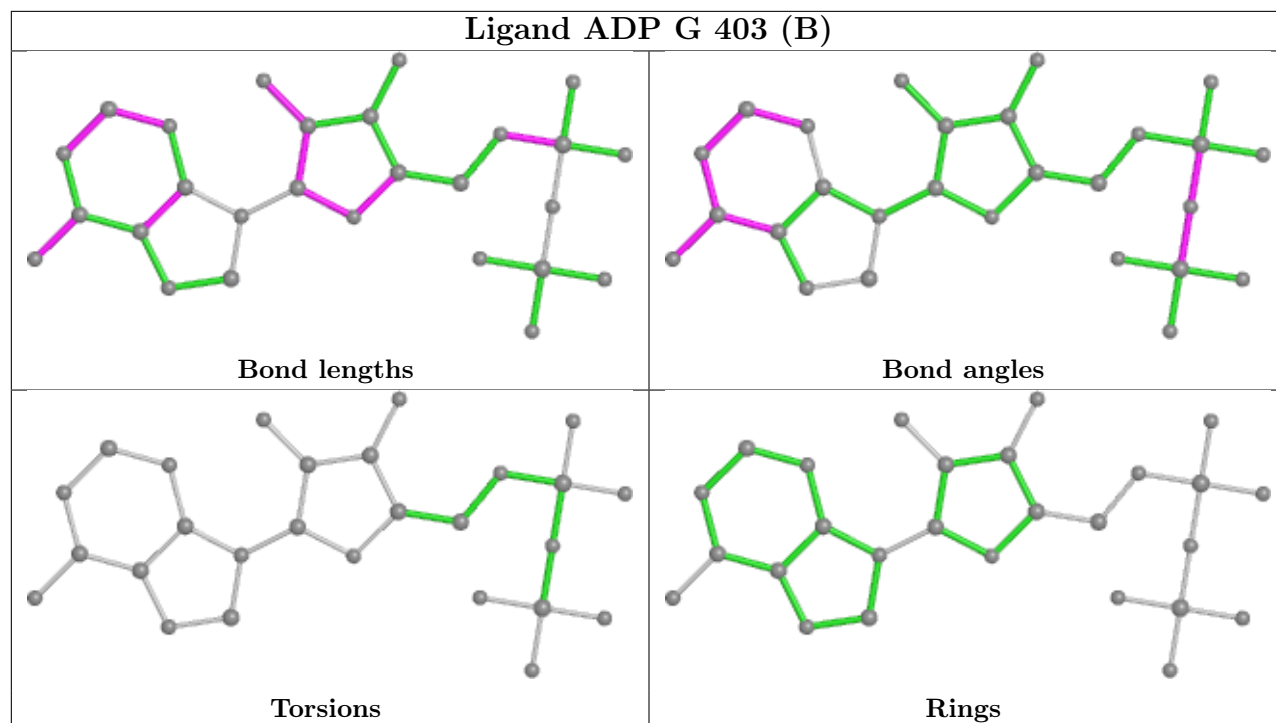

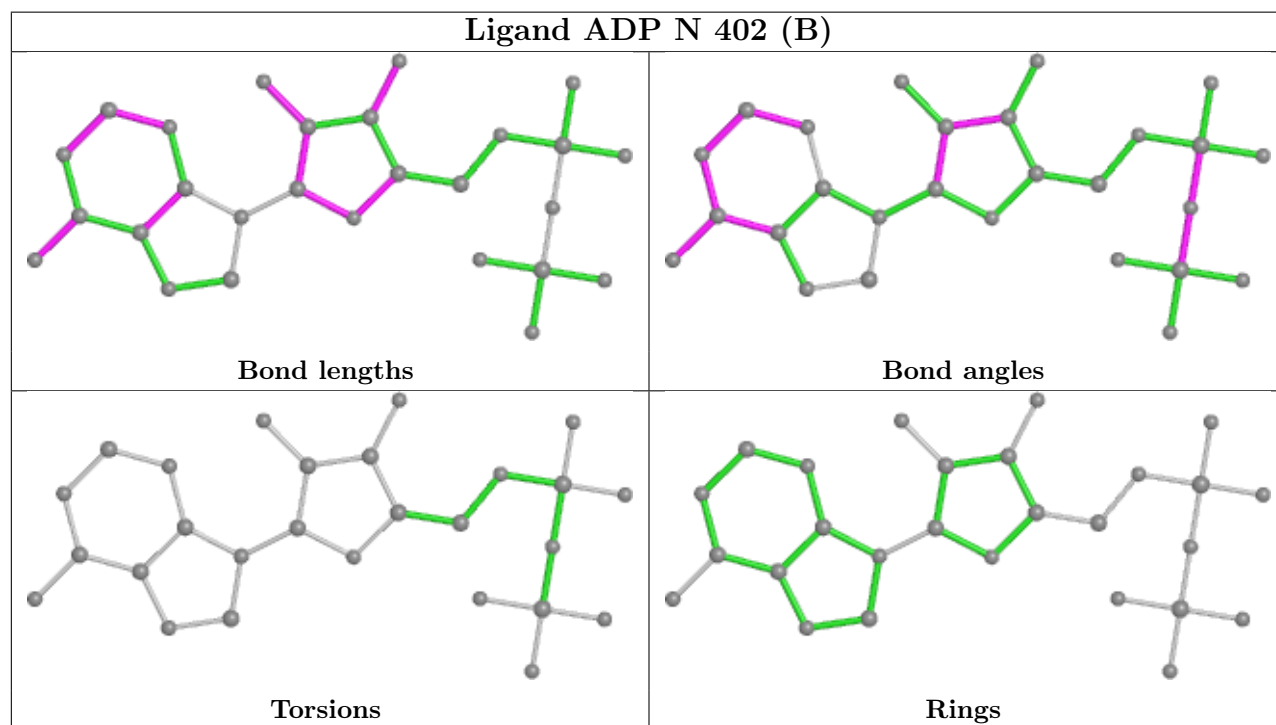
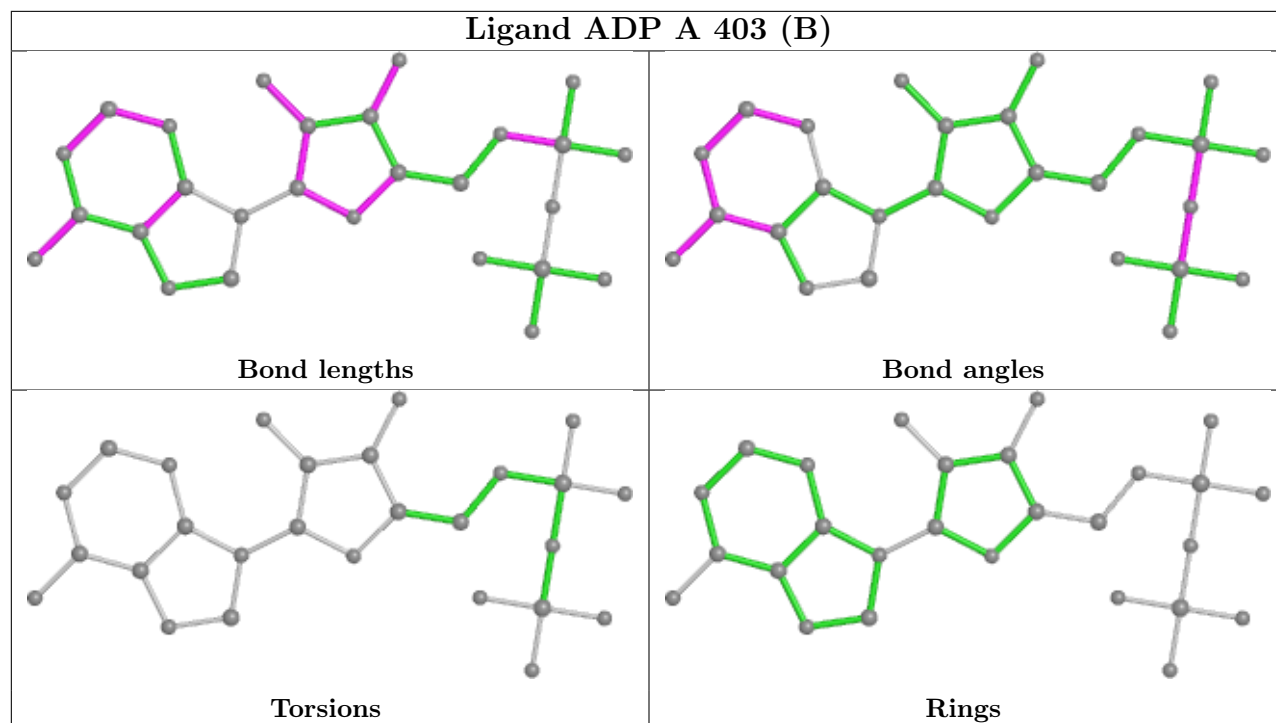

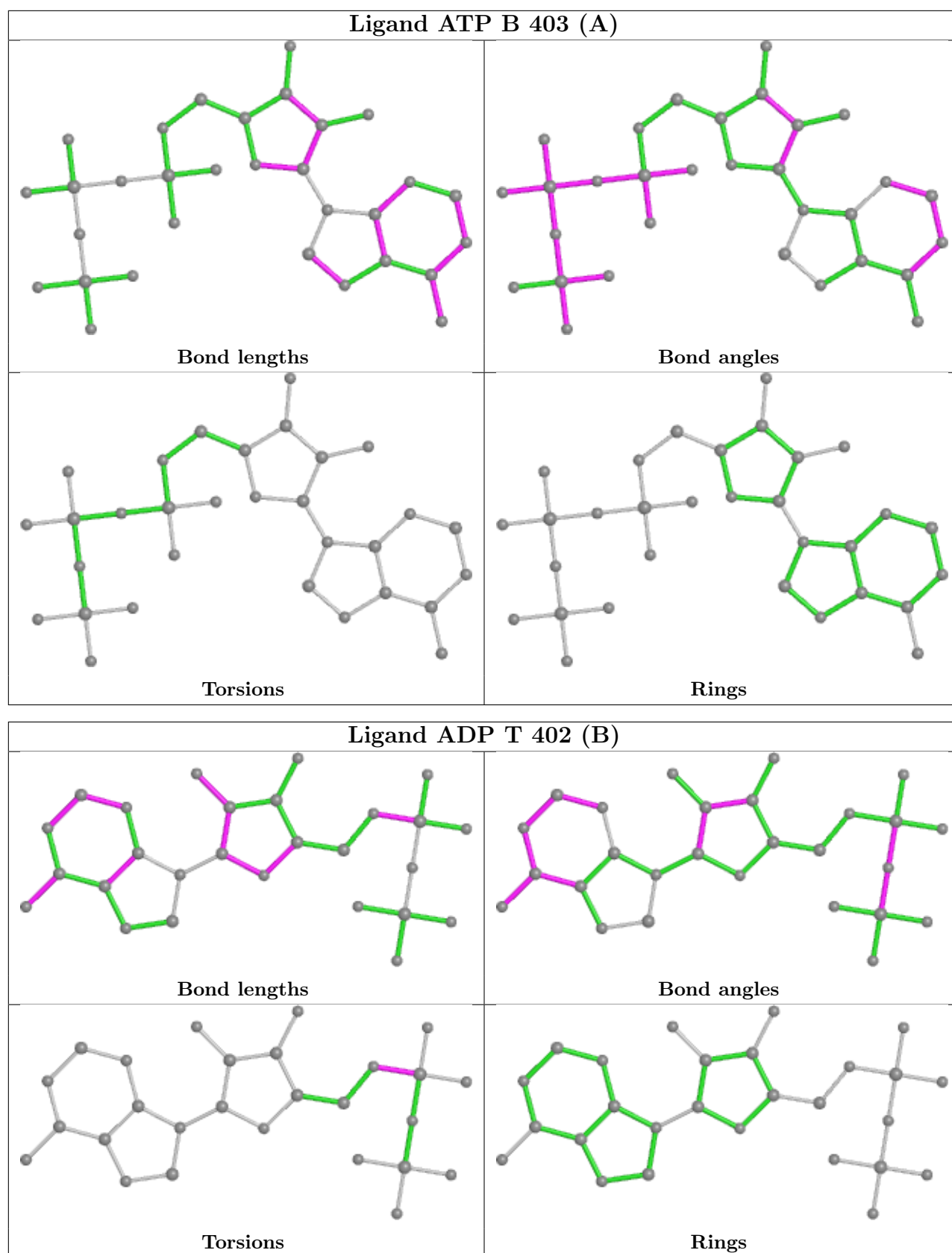

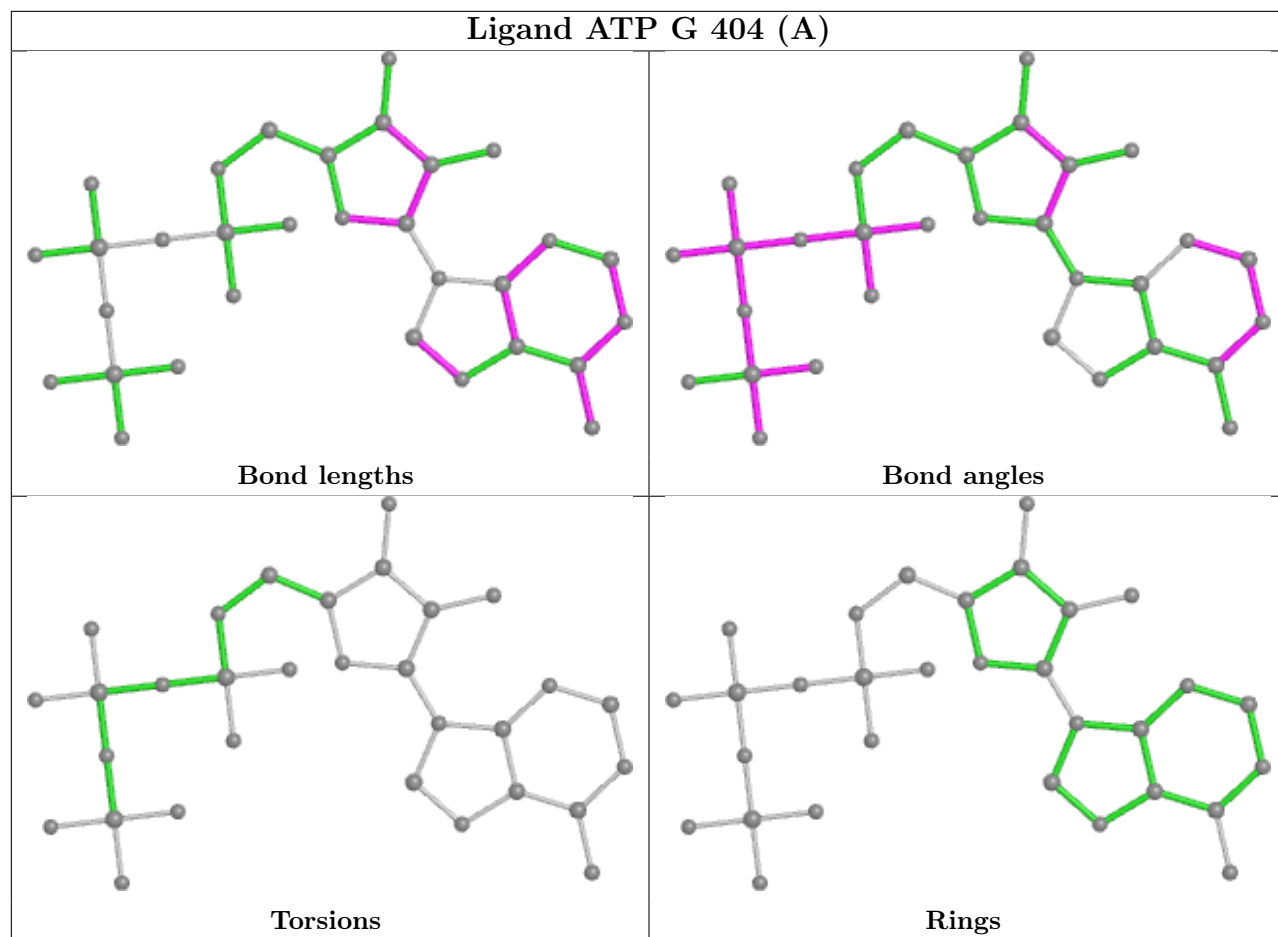

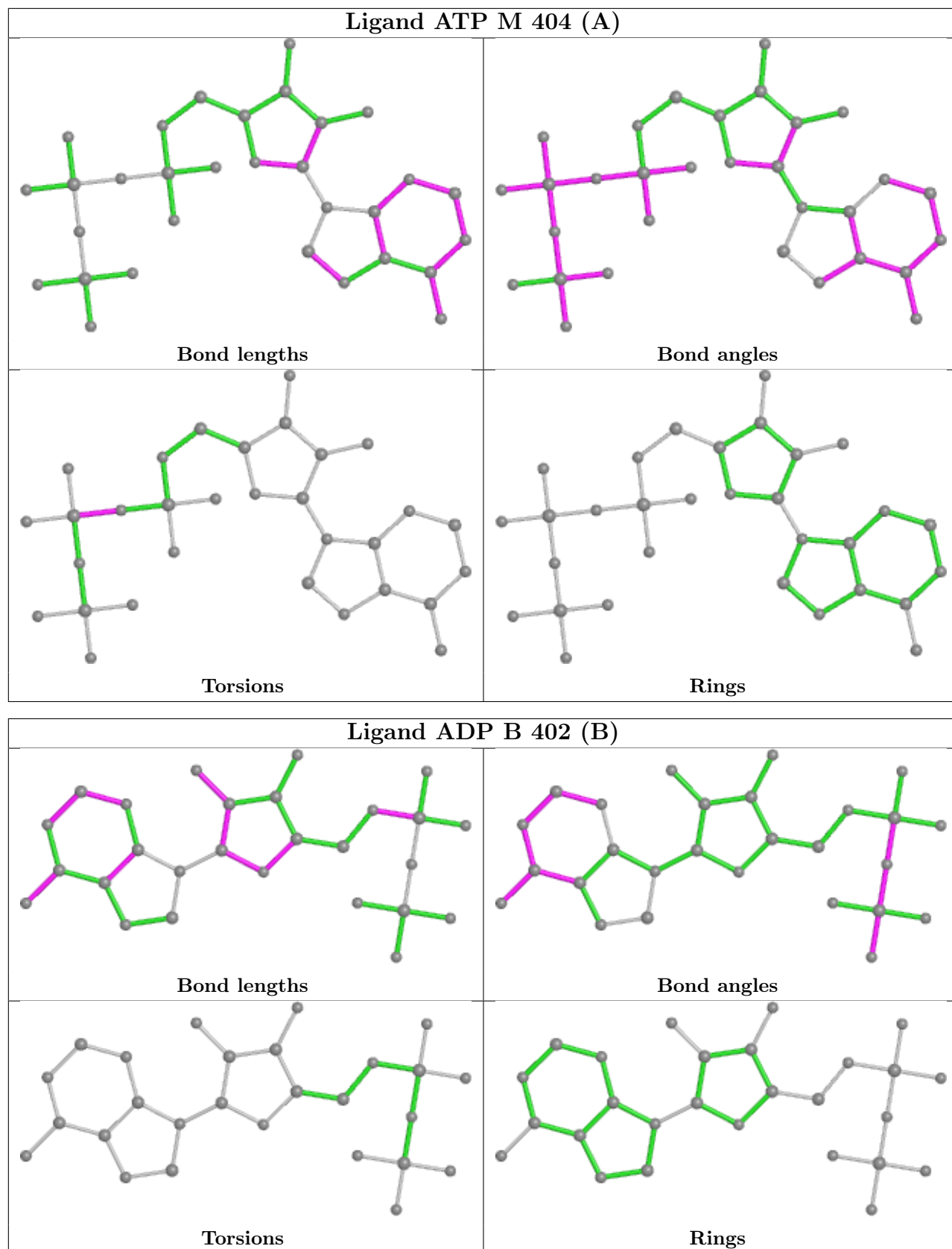

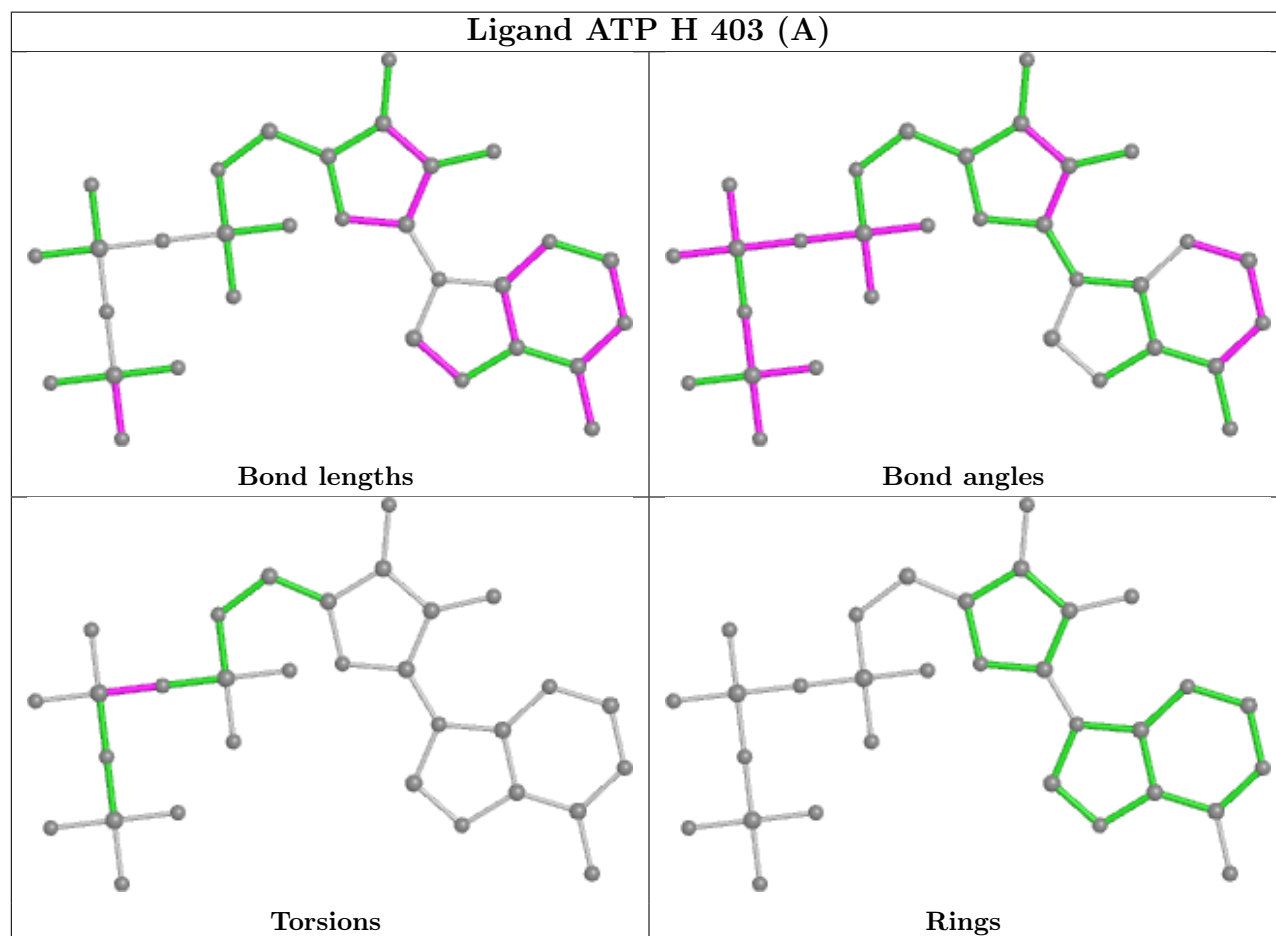
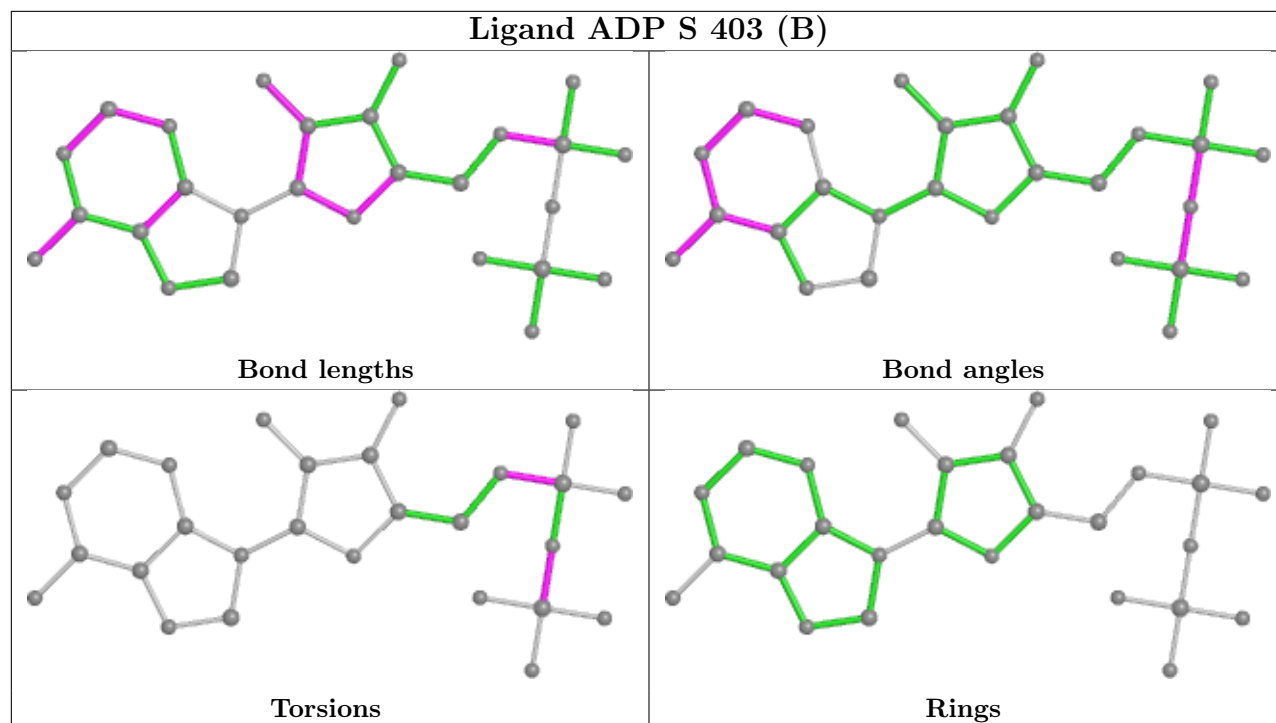

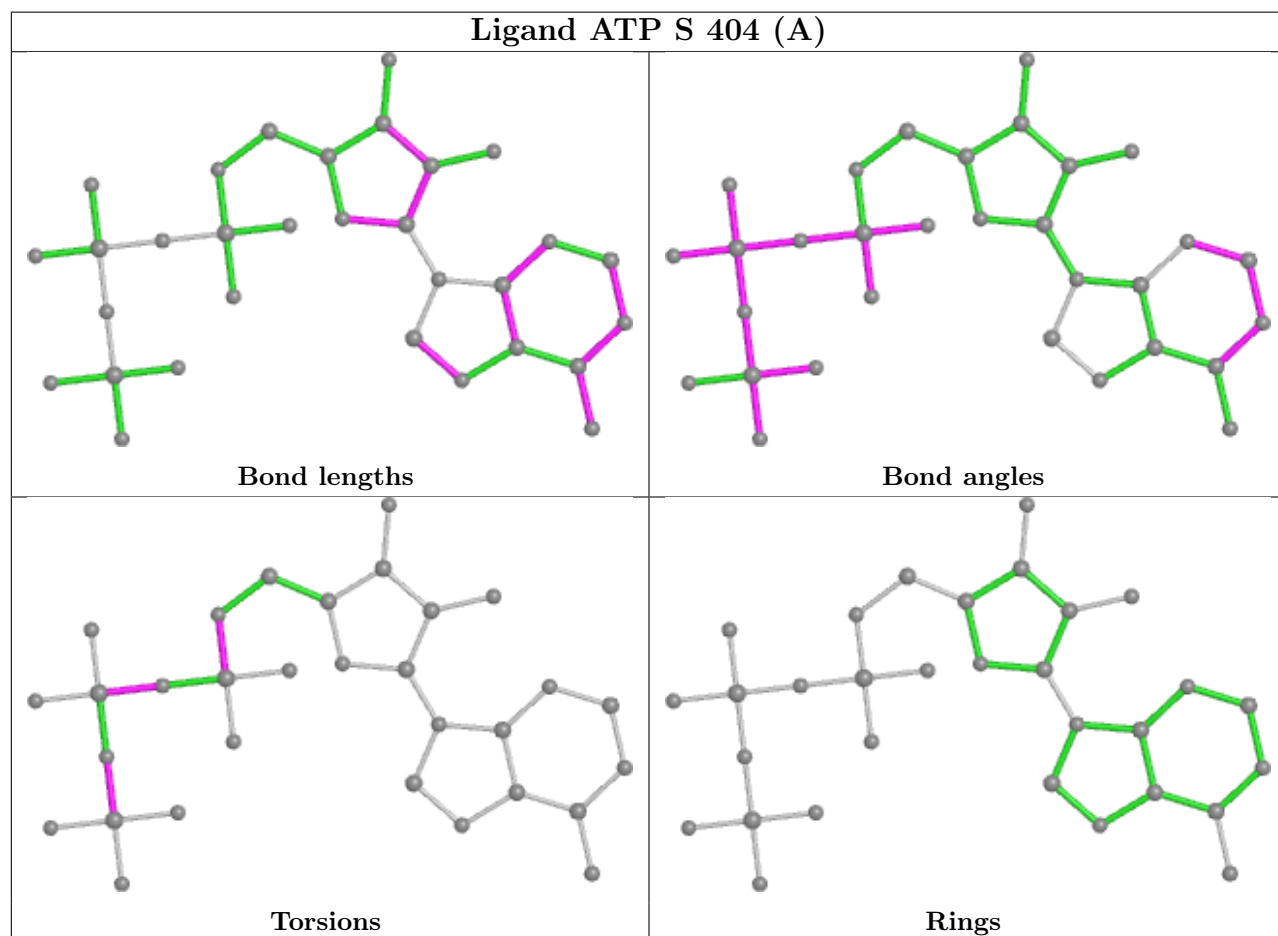
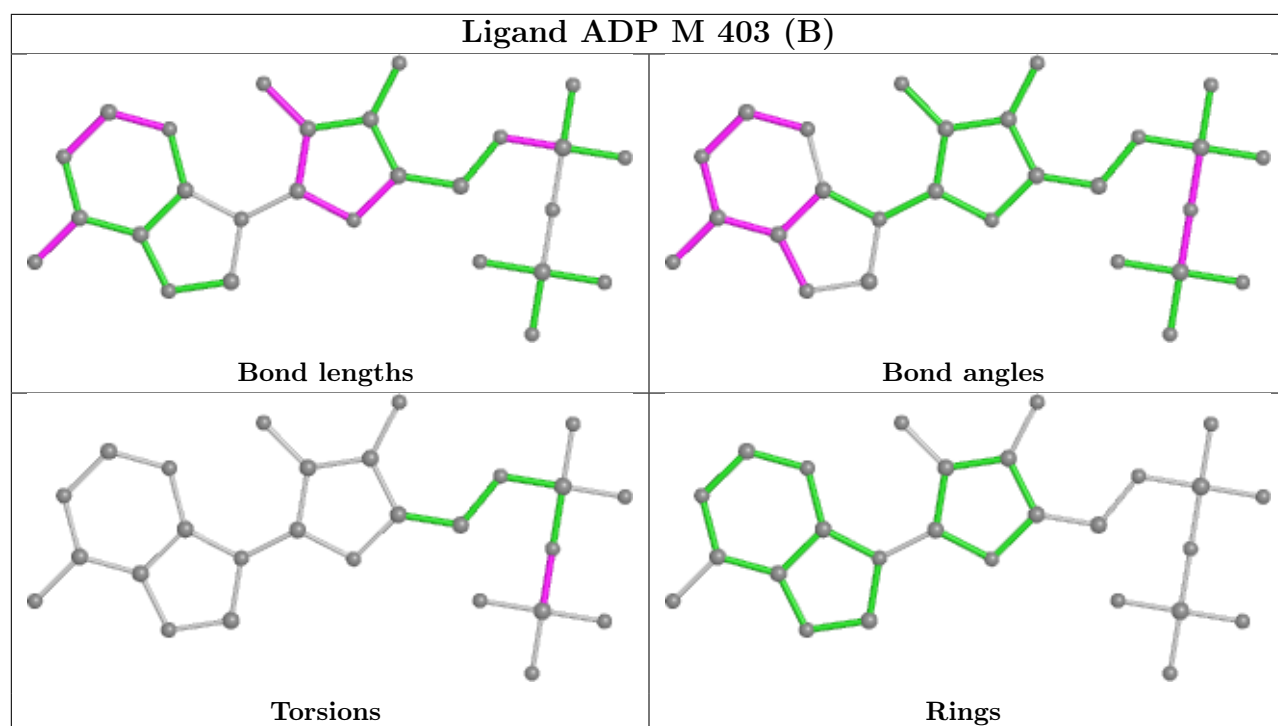

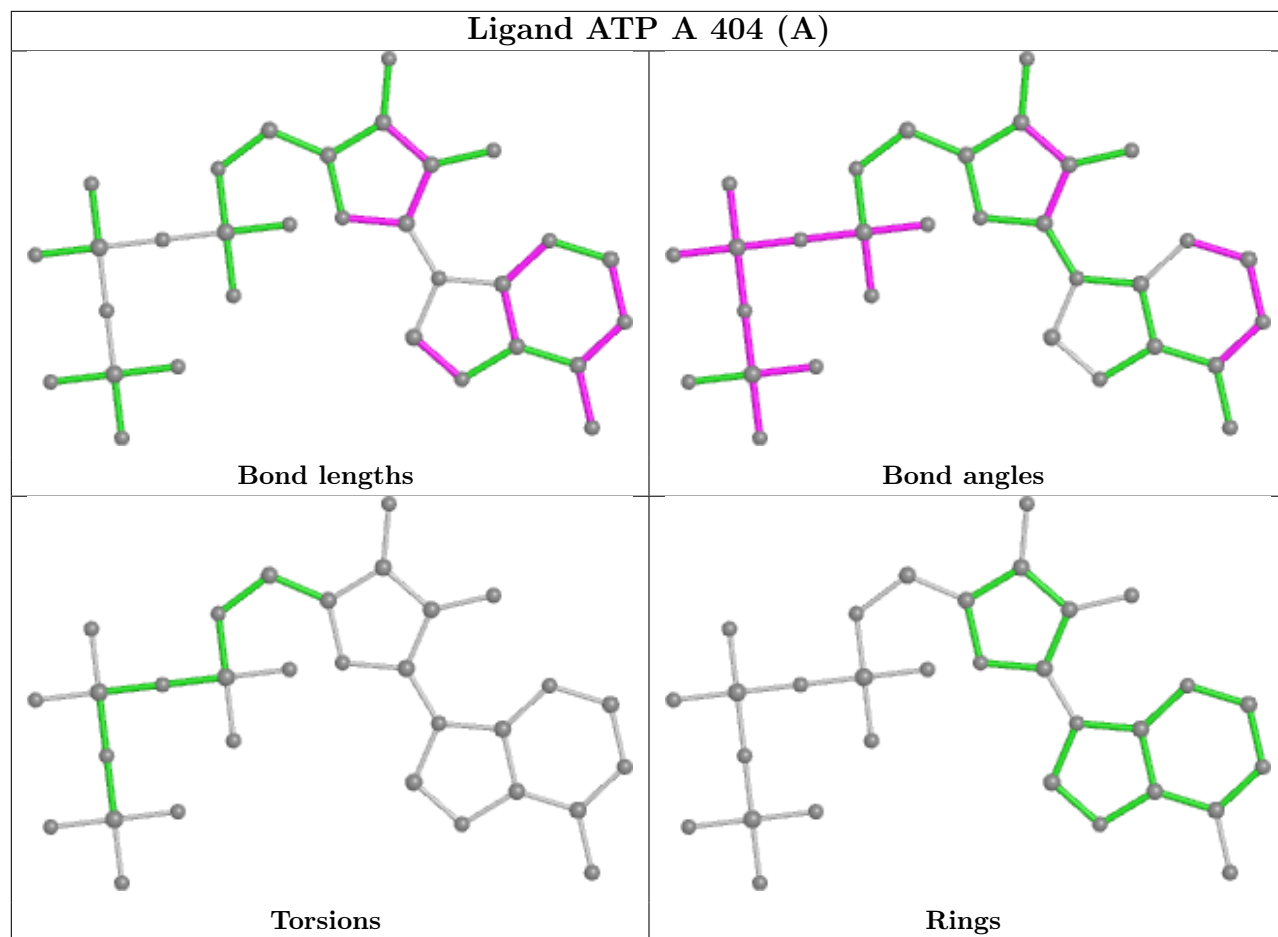

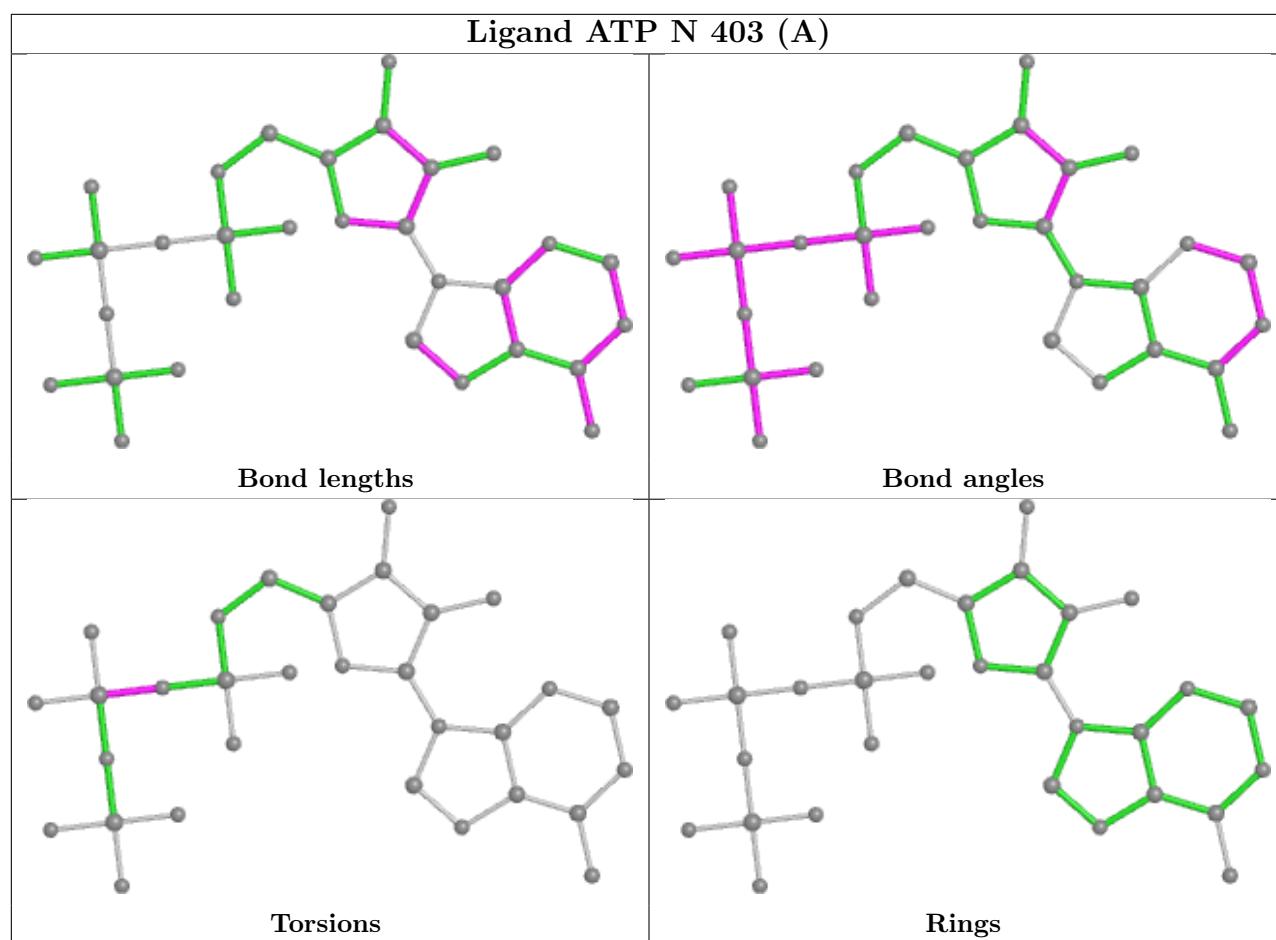

5.7 Other polymers [i](#)

There are no such residues in this entry.

5.8 Polymer linkage issues [i](#)

There are no chain breaks in this entry.

6 Fit of model and data [i](#)

6.1 Protein, DNA and RNA chains [i](#)

In the following table, the column labelled '#RSRZ > 2' contains the number (and percentage) of RSRZ outliers, followed by percent RSRZ outliers for the chain as percentile scores relative to all X-ray entries and entries of similar resolution. The OWAB column contains the minimum, median, 95th percentile and maximum values of the occupancy-weighted average B-factor per residue. The column labelled 'Q < 0.9' lists the number of (and percentage) of residues with an average occupancy less than 0.9.

Mol	Chain	Analysed	<RSRZ>	#RSRZ>2	OWAB(Å ²)	Q<0.9
1	A	293/354 (82%)	-0.06	6 (2%) 65 73	39, 68, 136, 194	0
1	B	297/354 (83%)	0.03	13 (4%) 34 41	29, 56, 148, 213	0
1	G	294/354 (83%)	-0.14	7 (2%) 59 68	28, 56, 134, 178	0
1	H	300/354 (84%)	0.01	14 (4%) 31 37	30, 59, 143, 244	0
1	M	304/354 (85%)	-0.09	12 (3%) 39 46	32, 57, 152, 226	0
1	N	300/354 (84%)	-0.07	7 (2%) 60 69	28, 52, 136, 183	0
1	S	296/354 (83%)	-0.04	8 (2%) 54 63	48, 77, 141, 197	0
1	T	306/354 (86%)	0.03	18 (5%) 22 27	43, 64, 139, 201	0
2	C	218/230 (94%)	-0.47	5 (2%) 60 69	32, 55, 96, 150	0
2	E	222/230 (96%)	-0.55	3 (1%) 75 82	33, 53, 98, 150	0
2	I	220/230 (95%)	-0.52	4 (1%) 68 76	28, 49, 95, 190	0
2	K	216/230 (93%)	-0.39	2 (0%) 84 89	42, 62, 119, 165	0
2	O	218/230 (94%)	-0.30	3 (1%) 75 82	36, 64, 142, 199	0
2	Q	221/230 (96%)	-0.31	6 (2%) 54 63	35, 63, 132, 223	0
2	U	214/230 (93%)	0.91	40 (18%) 1 1	55, 112, 204, 273	0
2	W	221/230 (96%)	0.09	11 (4%) 28 35	50, 82, 133, 172	0
3	D	216/217 (99%)	-0.44	1 (0%) 91 94	39, 62, 91, 165	0
3	F	215/217 (99%)	-0.56	1 (0%) 91 94	35, 52, 78, 129	0
3	J	215/217 (99%)	-0.51	1 (0%) 91 94	29, 50, 81, 178	0
3	L	215/217 (99%)	-0.45	1 (0%) 91 94	42, 71, 100, 182	0
3	P	216/217 (99%)	-0.05	11 (5%) 28 34	42, 88, 149, 231	0
3	R	216/217 (99%)	-0.29	5 (2%) 60 69	42, 69, 108, 167	0
3	V	215/217 (99%)	0.97	41 (19%) 1 1	74, 141, 202, 241	0
3	X	216/217 (99%)	0.31	14 (6%) 18 22	53, 86, 166, 200	0

Continued on next page...

Continued from previous page...

Mol	Chain	Analysed	<RSRZ>	#RSRZ>2	OWAB(Å ²)	Q<0.9
4	a	0/41	-	-	-	-
4	g	0/41	-	-	-	-
4	m	0/41	-	-	-	-
4	s	0/41	-	-	-	-
All	All	5864/6572 (89%)	-0.11	234 (3%) 38 45	28, 65, 151, 273	0

The worst 5 of 234 RSRZ outliers are listed below:

Mol	Chain	Res	Type	RSRZ
2	U	225	CYS	16.7
1	M	214	GLY	13.3
3	V	157	LEU	11.5
2	U	207	VAL	11.0
3	V	156	ALA	9.3

6.2 Non-standard residues in protein, DNA, RNA chains [i](#)

There are no non-standard protein/DNA/RNA residues in this entry.

6.3 Carbohydrates [i](#)

There are no monosaccharides in this entry.

6.4 Ligands [i](#)

In the following table, the Atoms column lists the number of modelled atoms in the group and the number defined in the chemical component dictionary. The B-factors column lists the minimum, median, 95th percentile and maximum values of B factors of atoms in the group. The column labelled 'Q< 0.9' lists the number of atoms with occupancy less than 0.9.

Mol	Type	Chain	Res	Atoms	RSCC	RSR	B-factors(Å ²)	Q<0.9
5	MG	S	401	1/1	0.91	0.15	53,53,53,53	0
5	MG	H	401	1/1	0.93	0.21	43,43,43,43	0
6	ZN	M	402	1/1	0.94	0.06	72,72,72,72	0
5	MG	A	401	1/1	0.95	0.18	57,57,57,57	0
7	ADP	M	403[B]	27/27	0.95	0.17	34,42,49,52	38
8	ATP	M	404[A]	31/31	0.95	0.18	34,42,49,52	42
8	ATP	S	404[A]	31/31	0.95	0.18	49,57,68,72	42
6	ZN	S	402	1/1	0.96	0.05	97,97,97,97	0
7	ADP	N	402[B]	27/27	0.96	0.23	41,49,61,64	39

Continued on next page...

Continued from previous page...

Mol	Type	Chain	Res	Atoms	RSCC	RSR	B-factors(Å ²)	Q<0.9
7	ADP	S	403[B]	27/27	0.96	0.17	49,57,69,71	38
7	ADP	T	402[B]	27/27	0.96	0.17	48,56,70,73	39
8	ATP	A	404[A]	31/31	0.96	0.19	44,50,59,60	42
8	ATP	B	403[A]	31/31	0.96	0.19	34,42,53,62	43
7	ADP	A	403[B]	27/27	0.96	0.18	44,50,60,60	38
8	ATP	N	403[A]	31/31	0.96	0.23	41,49,60,64	43
7	ADP	B	402[B]	27/27	0.96	0.18	34,42,55,62	39
8	ATP	T	403[A]	31/31	0.96	0.19	48,56,68,73	43
8	ATP	G	404[A]	31/31	0.97	0.17	36,44,54,60	42
8	ATP	H	403[A]	31/31	0.97	0.20	35,46,57,62	43
7	ADP	G	403[B]	27/27	0.97	0.17	38,45,56,60	38
7	ADP	H	402[B]	27/27	0.97	0.18	36,45,62,62	39
5	MG	G	401	1/1	0.97	0.17	32,32,32,32	0
6	ZN	A	402	1/1	0.97	0.04	65,65,65,65	0
5	MG	N	401	1/1	0.98	0.15	50,50,50,50	0
6	ZN	G	402	1/1	0.98	0.05	67,67,67,67	0
5	MG	B	401	1/1	0.98	0.23	54,54,54,54	0
5	MG	T	401	1/1	0.98	0.23	55,55,55,55	0
5	MG	M	401	1/1	0.99	0.07	50,50,50,50	0

The following is a graphical depiction of the model fit to experimental electron density of all instances of the Ligand of Interest. In addition, ligands with molecular weight > 250 and outliers as shown on the geometry validation Tables will also be included. Each fit is shown from different orientation to approximate a three-dimensional view.

Electron density around ADP M 403 (B):

$2mF_o-DF_c$ (at 0.7 rmsd) in gray
 mF_o-DF_c (at 3 rmsd) in purple (negative)
and green (positive)

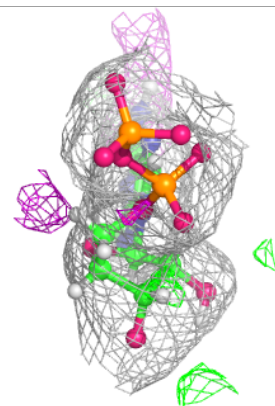
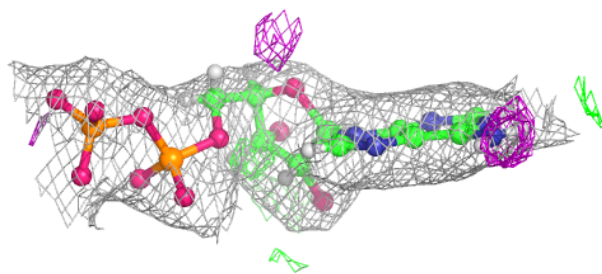
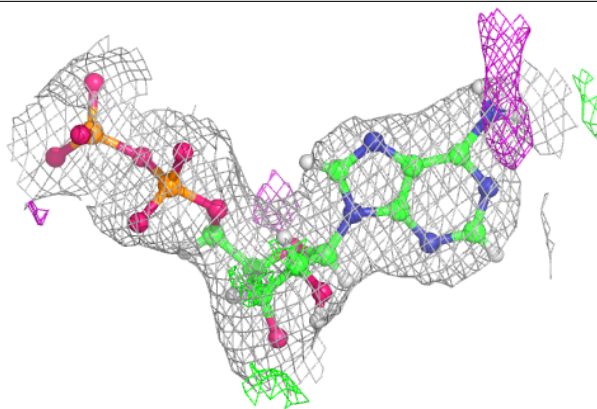
**Electron density around ATP M 404 (A):**

$2mF_o-DF_c$ (at 0.7 rmsd) in gray
 mF_o-DF_c (at 3 rmsd) in purple (negative)
and green (positive)

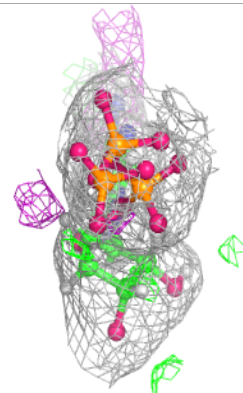
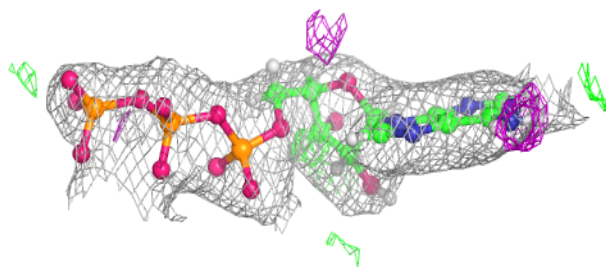
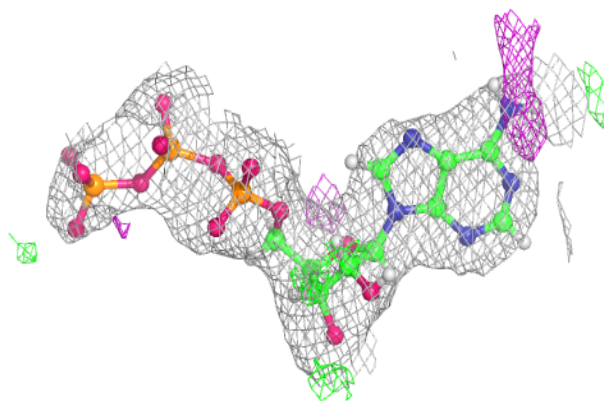

Electron density around ATP S 404 (A):

$2mF_o-DF_c$ (at 0.7 rmsd) in gray
 mF_o-DF_c (at 3 rmsd) in purple (negative)
and green (positive)

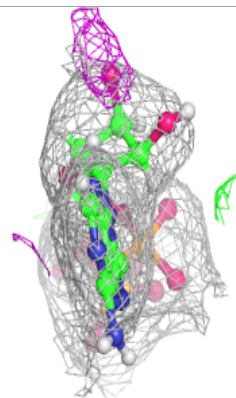
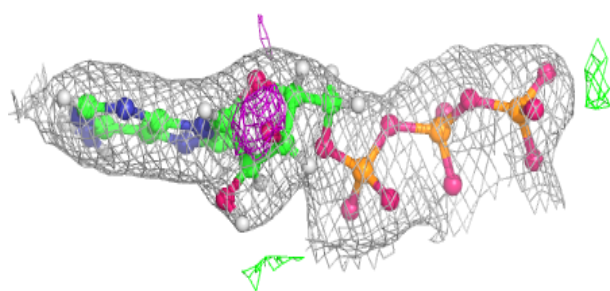
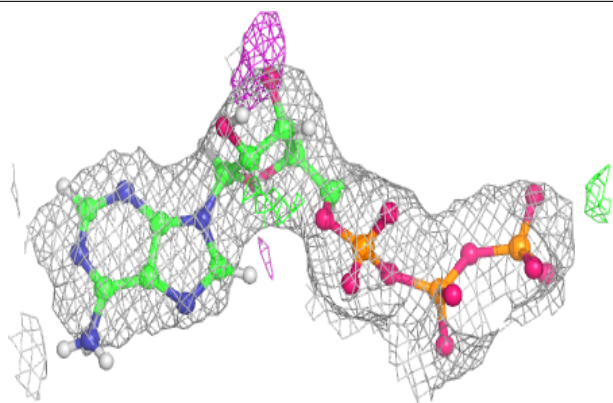
**Electron density around ADP N 402 (B):**

$2mF_o-DF_c$ (at 0.7 rmsd) in gray
 mF_o-DF_c (at 3 rmsd) in purple (negative)
and green (positive)

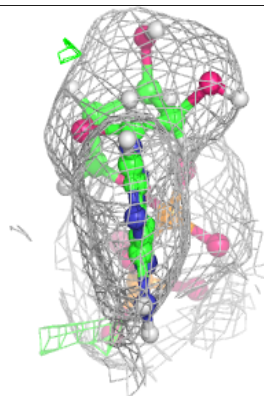
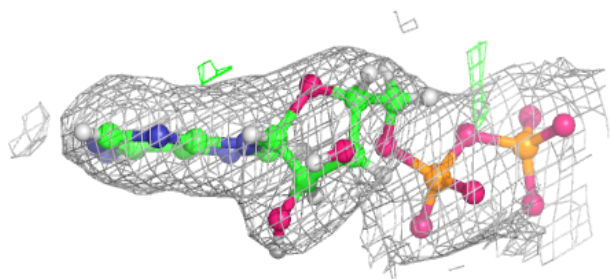
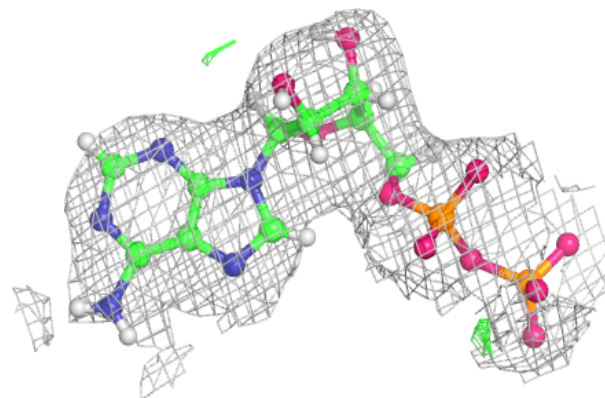

Electron density around ADP S 403 (B):

$2mF_o-DF_c$ (at 0.7 rmsd) in gray
 mF_o-DF_c (at 3 rmsd) in purple (negative)
and green (positive)

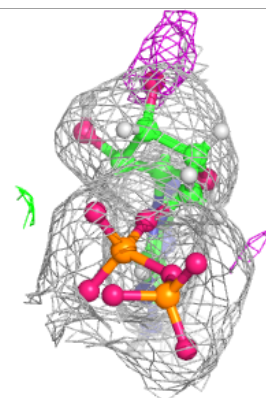
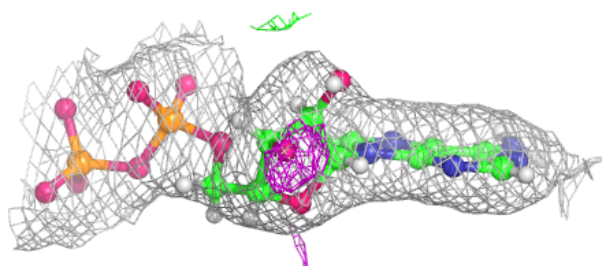
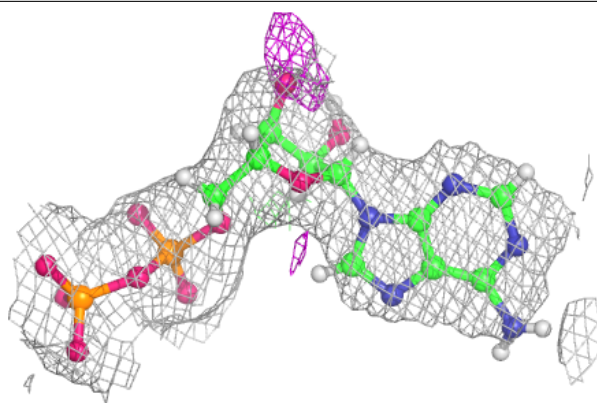
**Electron density around ADP T 402 (B):**

$2mF_o-DF_c$ (at 0.7 rmsd) in gray
 mF_o-DF_c (at 3 rmsd) in purple (negative)
and green (positive)

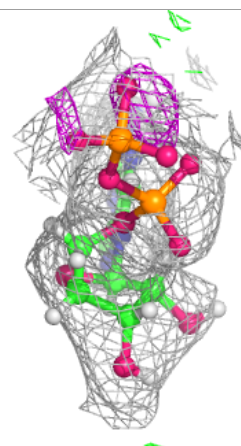
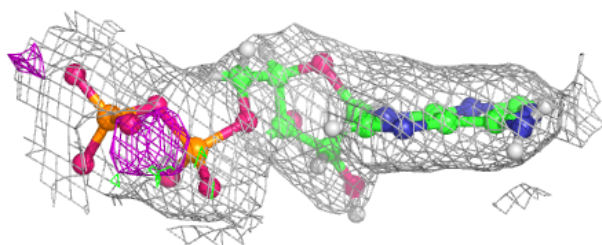
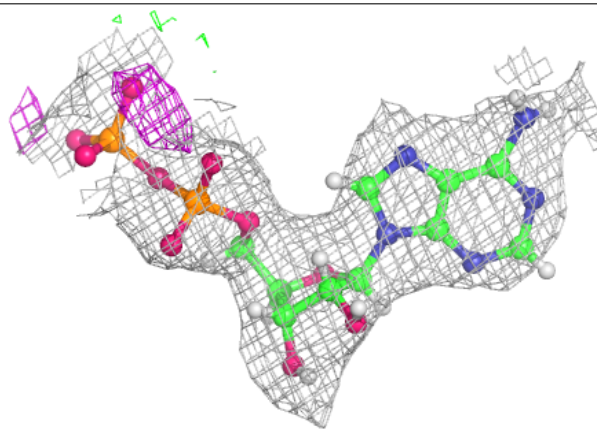

Electron density around ATP A 404 (A):

$2mF_o-DF_c$ (at 0.7 rmsd) in gray
 mF_o-DF_c (at 3 rmsd) in purple (negative)
and green (positive)

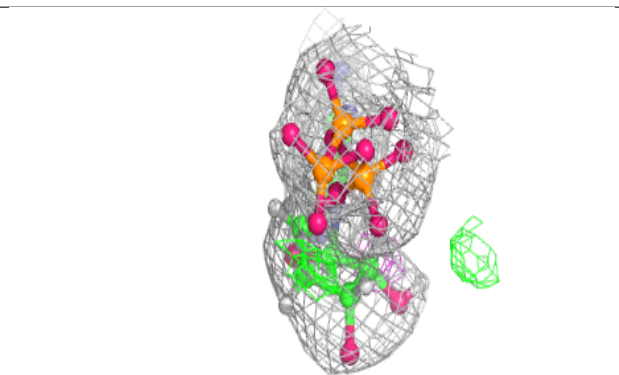
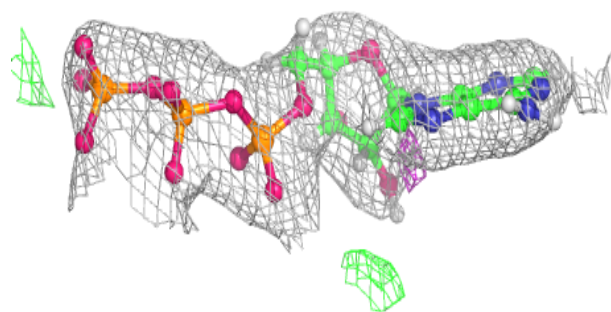
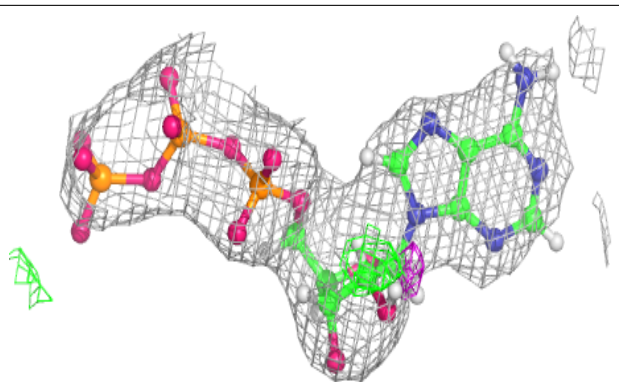
**Electron density around ATP B 403 (A):**

$2mF_o-DF_c$ (at 0.7 rmsd) in gray
 mF_o-DF_c (at 3 rmsd) in purple (negative)
and green (positive)

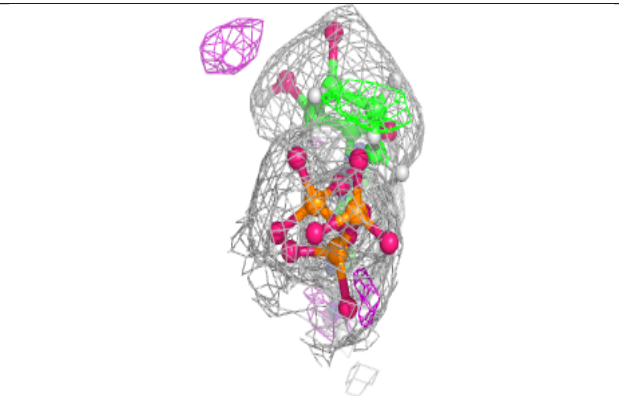
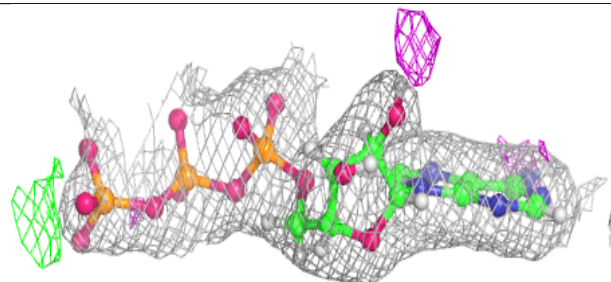
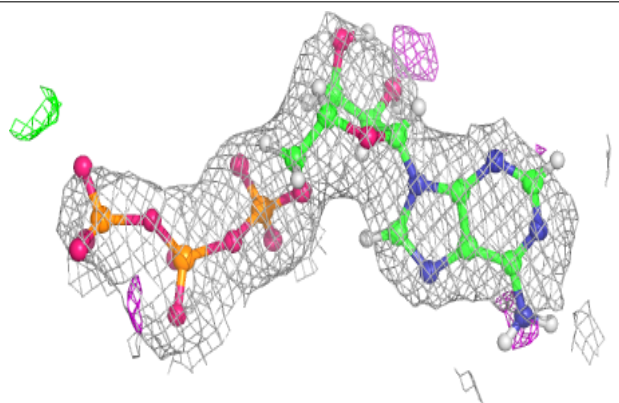

Electron density around ADP A 403 (B):

$2mF_o-DF_c$ (at 0.7 rmsd) in gray
 mF_o-DF_c (at 3 rmsd) in purple (negative)
and green (positive)

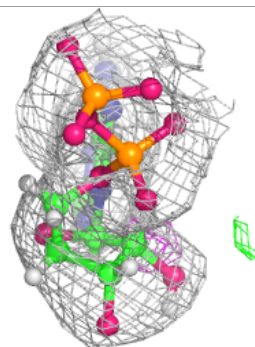
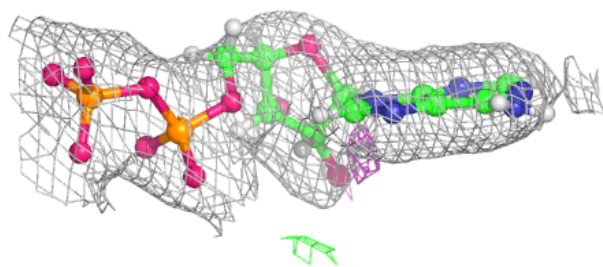
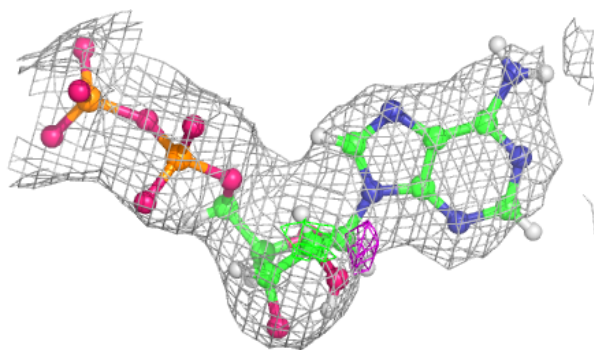
**Electron density around ATP N 403 (A):**

$2mF_o-DF_c$ (at 0.7 rmsd) in gray
 mF_o-DF_c (at 3 rmsd) in purple (negative)
and green (positive)

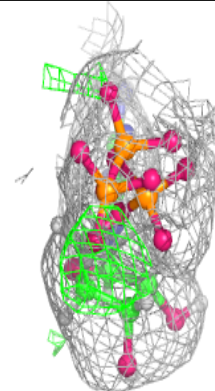
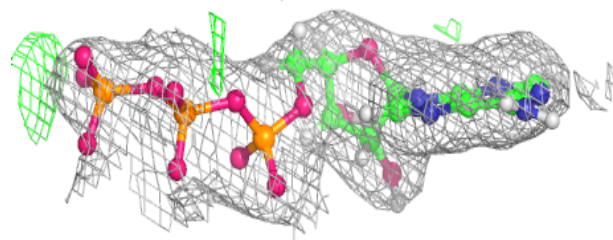
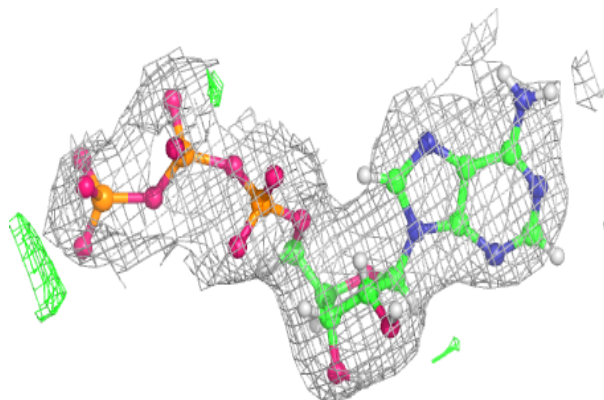

Electron density around ADP B 402 (B):

$2mF_o-DF_c$ (at 0.7 rmsd) in gray
 mF_o-DF_c (at 3 rmsd) in purple (negative)
and green (positive)

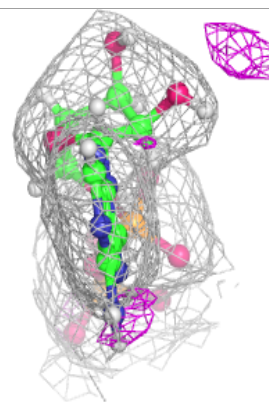
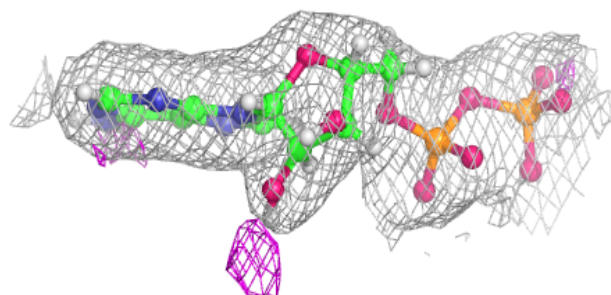
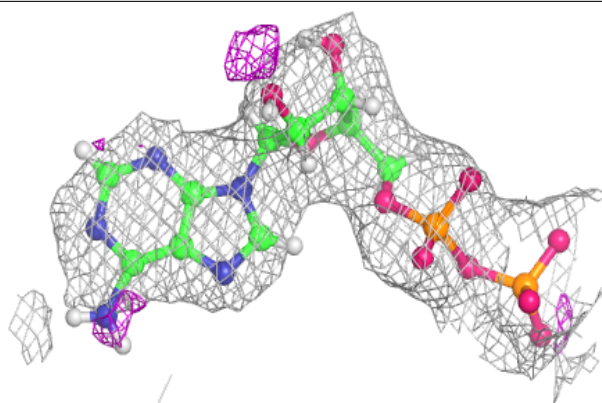
**Electron density around ATP T 403 (A):**

$2mF_o-DF_c$ (at 0.7 rmsd) in gray
 mF_o-DF_c (at 3 rmsd) in purple (negative)
and green (positive)

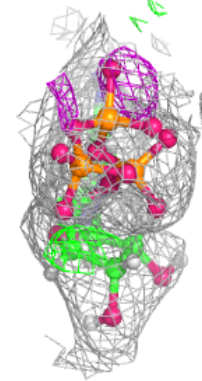
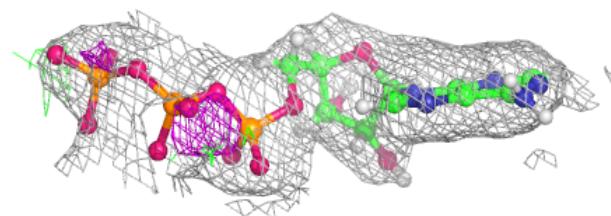
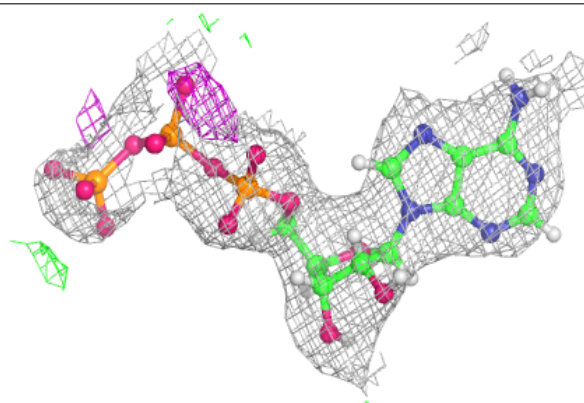

Electron density around ATP G 404 (A):

$2mF_o-DF_c$ (at 0.7 rmsd) in gray
 mF_o-DF_c (at 3 rmsd) in purple (negative)
and green (positive)

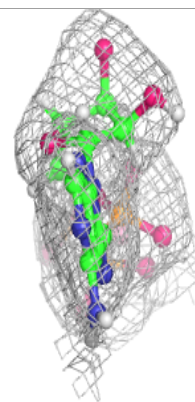
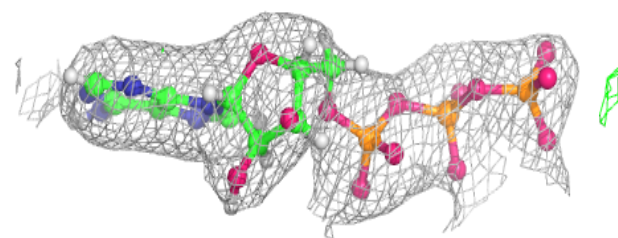
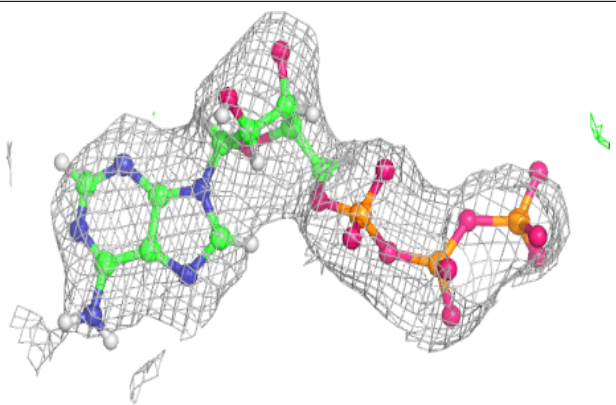
**Electron density around ATP H 403 (A):**

$2mF_o-DF_c$ (at 0.7 rmsd) in gray
 mF_o-DF_c (at 3 rmsd) in purple (negative)
and green (positive)

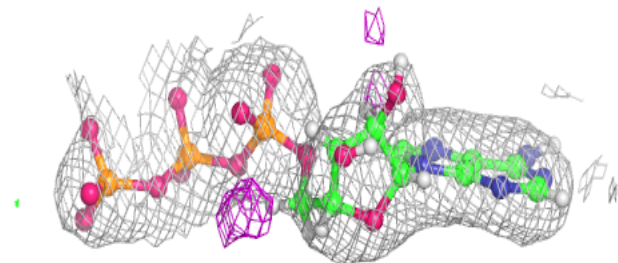
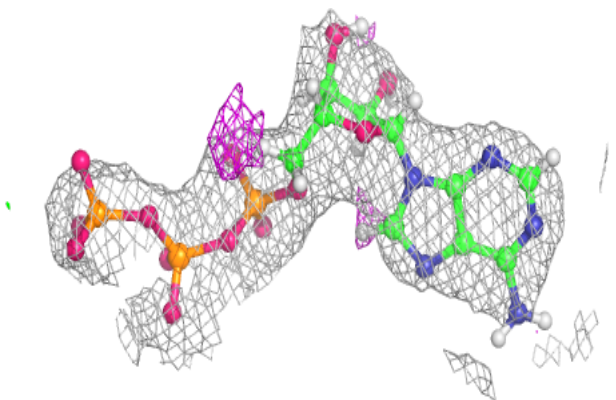

Electron density around ADP G 403 (B):

$2mF_o-DF_c$ (at 0.7 rmsd) in gray
 mF_o-DF_c (at 3 rmsd) in purple (negative)
and green (positive)

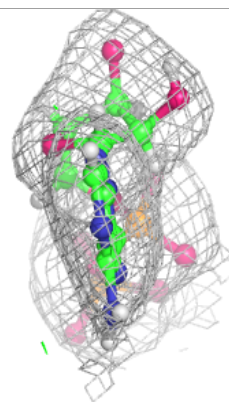
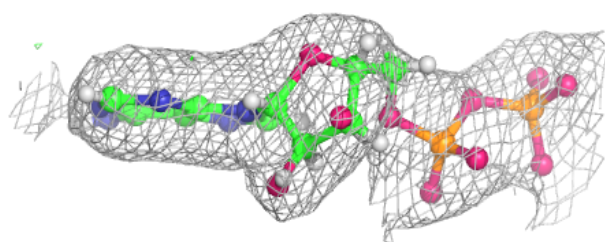
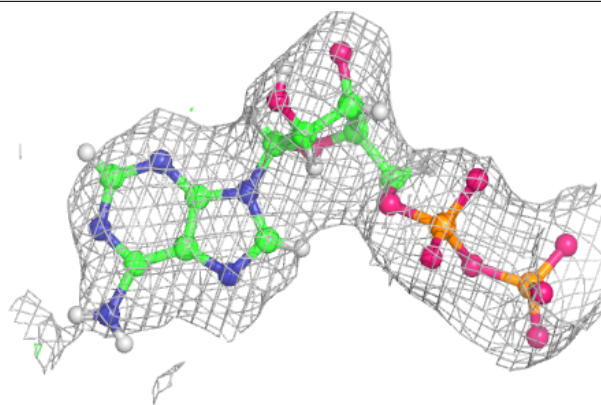
**Electron density around ADP H 402 (B):**

$2mF_o-DF_c$ (at 0.7 rmsd) in gray
 mF_o-DF_c (at 3 rmsd) in purple (negative)
and green (positive)

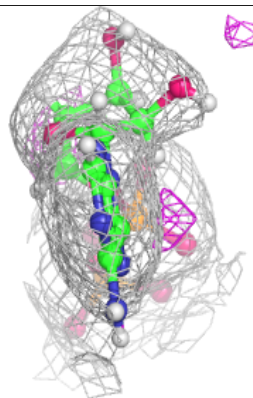
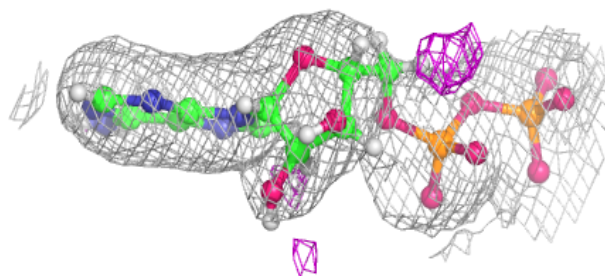
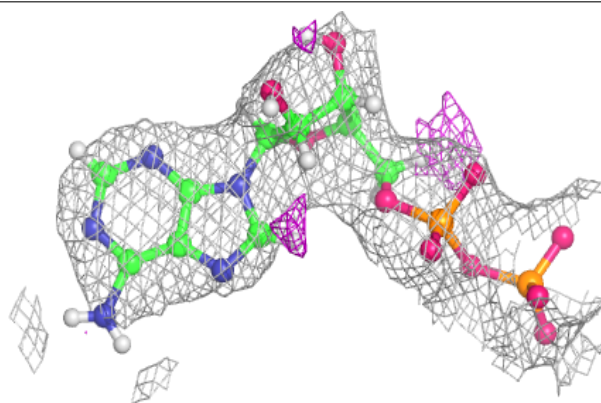

6.5 Other polymers [i](#)

There are no such residues in this entry.