



## wwPDB EM Validation Summary Report ⓘ

Dec 12, 2022 – 07:11 am GMT

PDB ID : 6YEF  
EMDB ID : EMD-10791  
Title : 70S initiation complex with assigned rRNA modifications from *Staphylococcus aureus*  
Authors : Fatkhullin, B.; Golubev, A.; Khusainov, I.; Yusupova, G.; Yusupov, M.  
Deposited on : 2020-03-24  
Resolution : 3.20 Å (reported)  
Based on initial model : 5LI0

This is a wwPDB EM Validation Summary Report for a publicly released PDB entry.

We welcome your comments at [validation@mail.wwpdb.org](mailto:validation@mail.wwpdb.org)

A user guide is available at

<https://www.wwpdb.org/validation/2017/EMValidationReportHelp>

with specific help available everywhere you see the ⓘ symbol.

The types of validation reports are described at

<http://www.wwpdb.org/validation/2017/FAQs#types>.

---

The following versions of software and data (see [references ⓘ](#)) were used in the production of this report:

EMDB validation analysis : 0.0.1.dev43  
Mogul : 1.8.4, CSD as541be (2020)  
MolProbity : 4.02b-467  
Percentile statistics : 20191225.v01 (using entries in the PDB archive December 25th 2019)  
MapQ : 1.9.9  
Ideal geometry (proteins) : Engh & Huber (2001)  
Ideal geometry (DNA, RNA) : Parkinson et al. (1996)  
Validation Pipeline (wwPDB-VP) : 2.31.3

# 1 Overall quality at a glance

The following experimental techniques were used to determine the structure:  
*ELECTRON MICROSCOPY*

The reported resolution of this entry is 3.20 Å.

Percentile scores (ranging between 0-100) for global validation metrics of the entry are shown in the following graphic. The table shows the number of entries on which the scores are based.

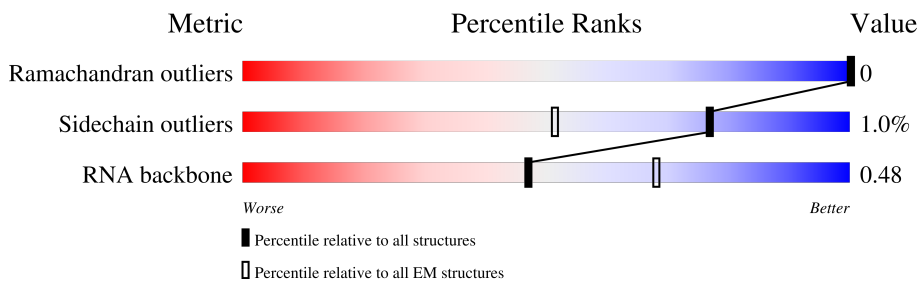





Metric	Whole archive (#Entries)	EM structures (#Entries)
Ramachandran outliers	154571	4023
Sidechain outliers	154315	3826
RNA backbone	4643	859

The table below summarises the geometric issues observed across the polymeric chains and their fit to the map. The red, orange, yellow and green segments of the bar indicate the fraction of residues that contain outliers for  $\geq 3$ , 2, 1 and 0 types of geometric quality criteria respectively. A grey segment represents the fraction of residues that are not modelled. The numeric value for each fraction is indicated below the corresponding segment, with a dot representing fractions  $\leq 5\%$ . The upper red bar (where present) indicates the fraction of residues that have poor fit to the EM map (all-atom inclusion  $< 40\%$ ). The numeric value is given above the bar.

Mol	Chain	Length	Quality of chain
1	a	1556	
2	b	255	
3	c	217	
4	d	200	
5	e	166	
6	f	98	
7	g	156	
8	h	132	

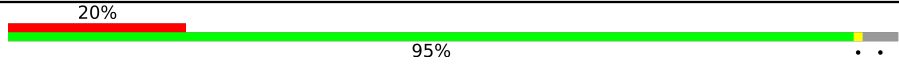
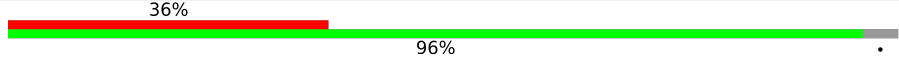
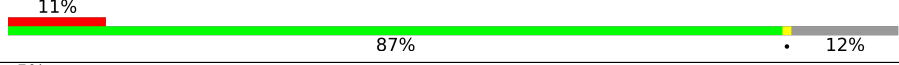
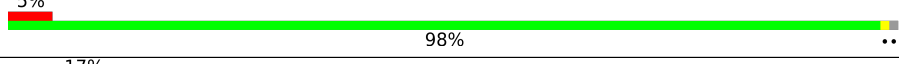
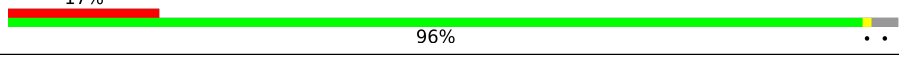
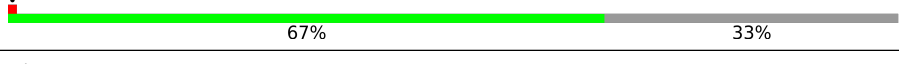
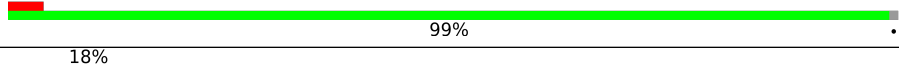
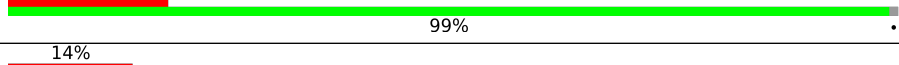
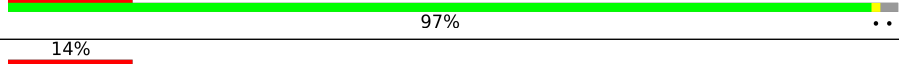
Continued on next page...

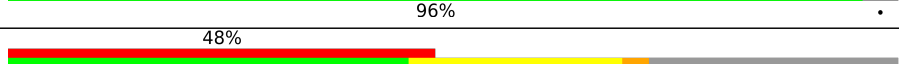
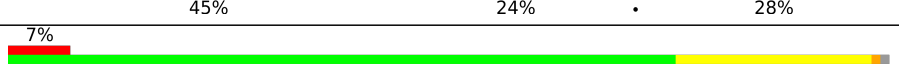
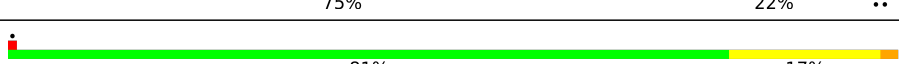
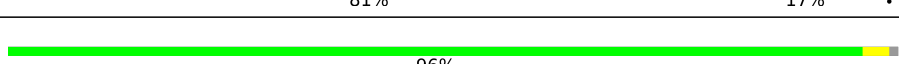
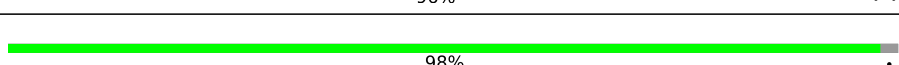
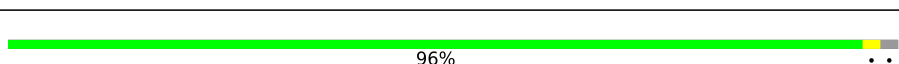
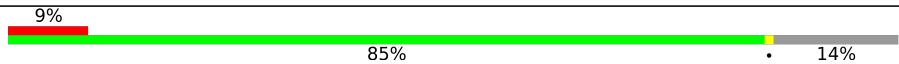
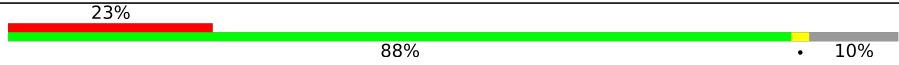
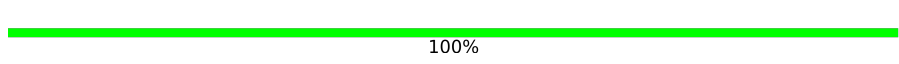
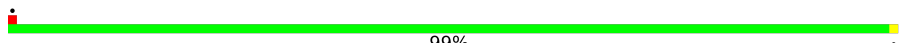
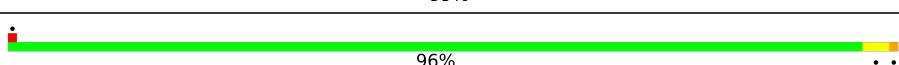
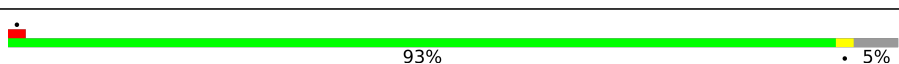
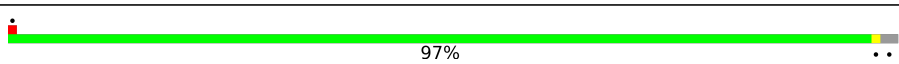
Continued from previous page...

Mol	Chain	Length	Quality of chain
9	i	132	
10	j	102	
11	k	129	
12	l	137	
13	m	121	
14	n	89	
15	o	89	
16	p	91	
17	q	87	
18	r	80	
19	s	92	
20	t	83	
21	v	29	
22	A	2923	
23	B	115	
24	D	277	
25	E	220	
26	F	207	
27	G	179	
28	H	178	
29	M	145	
30	N	122	
31	O	146	
32	P	144	
33	Q	122	

Continued on next page...

Continued from previous page...

Mol	Chain	Length	Quality of chain
34	R	119	5% 99% 6%
35	S	116	94% 6%
36	T	118	97% 2% 1%
37	U	102	98% 2%
38	V	117	96% 4%
39	W	91	98% 2%
40	X	105	7% 81% 17% 2%
41	Y	217	12% 43% 57%
42	Z	94	87% 13%
43	0	62	73% 27%
44	1	69	91% 6% 3%
45	2	59	93% 6% 1%
46	3	84	50% 87% 11% 2%
47	4	58	7% 84% 5% 10%
48	5	49	84% 6% 10%
49	6	45	98% 2%
50	7	66	94% 4% 2%
51	8	37	100%
52	x	77	8% 62% 32% 5%

## 2 Entry composition [i](#)

There are 54 unique types of molecules in this entry. The entry contains 141837 atoms, of which 0 are hydrogens and 0 are deuteriums.

In the tables below, the AltConf column contains the number of residues with at least one atom in alternate conformation and the Trace column contains the number of residues modelled with at most 2 atoms.

- Molecule 1 is a RNA chain called 16S rRNA.

Mol	Chain	Residues	Atoms					AltConf	Trace
			Total	C	N	O	P		
1	a	1545	33097	14781	6034	10737	1545	0	0

- Molecule 2 is a protein called 30S ribosomal protein S2.

Mol	Chain	Residues	Atoms					AltConf	Trace
			Total	C	N	O	S		
2	b	219	1762	1123	307	325	7	0	0

- Molecule 3 is a protein called 30S ribosomal protein S3.

Mol	Chain	Residues	Atoms					AltConf	Trace
			Total	C	N	O	S		
3	c	200	1578	993	296	287	2	0	0

- Molecule 4 is a protein called 30S ribosomal protein S4.

Mol	Chain	Residues	Atoms					AltConf	Trace
			Total	C	N	O	S		
4	d	197	1600	1009	300	289	2	0	0

- Molecule 5 is a protein called 30S ribosomal protein S5.

Mol	Chain	Residues	Atoms					AltConf	Trace
			Total	C	N	O	S		
5	e	157	1169	735	214	218	2	0	0

- Molecule 6 is a protein called 30S ribosomal protein S6.

Mol	Chain	Residues	Atoms					AltConf	Trace
			Total	C	N	O	S		
6	f	96	798	503	139	153	3	0	0

- Molecule 7 is a protein called 30S ribosomal protein S7.

Mol	Chain	Residues	Atoms					AltConf	Trace
			Total	C	N	O	S		
7	g	146	1176	733	225	214	4	0	0

- Molecule 8 is a protein called 30S ribosomal protein S8.

Mol	Chain	Residues	Atoms					AltConf	Trace
			Total	C	N	O	S		
8	h	131	1032	652	183	193	4	0	0

- Molecule 9 is a protein called 30S ribosomal protein S9.

Mol	Chain	Residues	Atoms					AltConf	Trace
			Total	C	N	O	S		
9	i	127	1008	623	201	183	1	0	0

- Molecule 10 is a protein called ribosomal protein uS10.

Mol	Chain	Residues	Atoms					AltConf	Trace
			Total	C	N	O	S		
10	j	98	783	494	143	145	1	0	0

- Molecule 11 is a protein called 30S ribosomal protein S11.

Mol	Chain	Residues	Atoms					AltConf	Trace
			Total	C	N	O	S		
11	k	113	833	514	156	160	3	0	0

- Molecule 12 is a protein called 30S ribosomal protein S12.

Mol	Chain	Residues	Atoms					AltConf	Trace
			Total	C	N	O	S		
12	l	135	1058	658	214	184	2	0	0

- Molecule 13 is a protein called 30S ribosomal protein S13.

Mol	Chain	Residues	Atoms					AltConf	Trace
			Total	C	N	O	S		
13	m	117	927	569	184	173	1	0	0

- Molecule 14 is a protein called 30S ribosomal protein S14.

Mol	Chain	Residues	Atoms					AltConf	Trace
14	n	60	Total	C	N	O	S	0	0
			481	296	103	80	2		

- Molecule 15 is a protein called 30S ribosomal protein S15.

Mol	Chain	Residues	Atoms					AltConf	Trace
15	o	88	Total	C	N	O	S	0	0
			738	454	153	130	1		

- Molecule 16 is a protein called 30S ribosomal protein S16.

Mol	Chain	Residues	Atoms					AltConf	Trace
16	p	90	Total	C	N	O	S	0	0
			712	448	132	131	1		

- Molecule 17 is a protein called 30S ribosomal protein S17.

Mol	Chain	Residues	Atoms					AltConf	Trace
17	q	85	Total	C	N	O	S	0	0
			698	441	125	131	1		

- Molecule 18 is a protein called 30S ribosomal protein S18.

Mol	Chain	Residues	Atoms					AltConf	Trace
18	r	64	Total	C	N	O	S	0	0
			527	335	97	92	3		

- Molecule 19 is a protein called 30S ribosomal protein S19.

Mol	Chain	Residues	Atoms					AltConf	Trace
19	s	82	Total	C	N	O	S	0	0
			661	426	118	115	2		

- Molecule 20 is a protein called 30S ribosomal protein S20.

Mol	Chain	Residues	Atoms					AltConf	Trace
20	t	80	Total	C	N	O	S	0	0
			606	367	119	118	2		

- Molecule 21 is a RNA chain called mRNA.

Mol	Chain	Residues	Atoms					AltConf	Trace
21	v	21	Total	C	N	O	P	0	0
			462	207	96	138	21		

- Molecule 22 is a RNA chain called 23S rRNA.

Mol	Chain	Residues	Atoms					AltConf	Trace
22	A	2881	Total	C	N	O	P	0	0
			61802	27593	11324	20004	2881		

- Molecule 23 is a RNA chain called 5S rRNA.

Mol	Chain	Residues	Atoms					AltConf	Trace
23	B	115	Total	C	N	O	P	0	0
			2445	1094	436	801	114		

- Molecule 24 is a protein called 50S ribosomal protein L2.

Mol	Chain	Residues	Atoms					AltConf	Trace
24	D	274	Total	C	N	O	S	0	0
			2094	1303	415	371	5		

- Molecule 25 is a protein called 50S ribosomal protein L3.

Mol	Chain	Residues	Atoms					AltConf	Trace
25	E	216	Total	C	N	O	S	0	0
			1635	1023	301	306	5		

- Molecule 26 is a protein called 50S ribosomal protein L4.

Mol	Chain	Residues	Atoms					AltConf	Trace
26	F	203	Total	C	N	O	S	0	0
			1540	966	284	288	2		

- Molecule 27 is a protein called 50S ribosomal protein L5.

Mol	Chain	Residues	Atoms					AltConf	Trace
27	G	154	Total	C	N	O	S	0	0
			1191	751	206	228	6		

- Molecule 28 is a protein called 50S ribosomal protein L6.



Mol	Chain	Residues	Atoms					AltConf	Trace
28	H	160	Total	C	N	O	S	0	0
			1250	781	222	244	3		

- Molecule 29 is a protein called 50S ribosomal protein L13.

Mol	Chain	Residues	Atoms					AltConf	Trace
29	M	145	Total	C	N	O	S	0	0
			1151	717	211	220	3		

- Molecule 30 is a protein called 50S ribosomal protein L14.

Mol	Chain	Residues	Atoms					AltConf	Trace
30	N	122	Total	C	N	O	S	0	0
			920	572	174	170	4		

- Molecule 31 is a protein called 50S ribosomal protein L15.

Mol	Chain	Residues	Atoms					AltConf	Trace
31	O	146	Total	C	N	O	S	0	0
			1098	680	215	202	1		

- Molecule 32 is a protein called 50S ribosomal protein L16.

Mol	Chain	Residues	Atoms					AltConf	Trace
32	P	137	Total	C	N	O	S	0	0
			1097	704	207	182	4		

- Molecule 33 is a protein called 50S ribosomal protein L17.

Mol	Chain	Residues	Atoms					AltConf	Trace
33	Q	119	Total	C	N	O	S	0	0
			940	575	181	183	1		

- Molecule 34 is a protein called 50S ribosomal protein L18.

Mol	Chain	Residues	Atoms				AltConf	Trace
34	R	118	Total	C	N	O	0	0
			911	568	173	170		

- Molecule 35 is a protein called 50S ribosomal protein L19.

Mol	Chain	Residues	Atoms				AltConf	Trace
35	S	109	Total	C	N	O	0	0
			877	552	176	149		

- Molecule 36 is a protein called 50S ribosomal protein L20.

Mol	Chain	Residues	Atoms					AltConf	Trace
36	T	116	Total	C	N	O	S	0	0
			943	593	189	157	4		

- Molecule 37 is a protein called 50S ribosomal protein L21.

Mol	Chain	Residues	Atoms					AltConf	Trace
37	U	100	Total	C	N	O	S	0	0
			784	497	140	146	1		

- Molecule 38 is a protein called 50S ribosomal protein L22.

Mol	Chain	Residues	Atoms					AltConf	Trace
38	V	112	Total	C	N	O	S	0	0
			862	537	164	158	3		

- Molecule 39 is a protein called 50S ribosomal protein L23.

Mol	Chain	Residues	Atoms					AltConf	Trace
39	W	89	Total	C	N	O	S	0	0
			725	457	130	134	4		

- Molecule 40 is a protein called 50S ribosomal protein L24.

Mol	Chain	Residues	Atoms					AltConf	Trace
40	X	87	Total	C	N	O	S	0	0
			662	420	119	122	1		

- Molecule 41 is a protein called 50S ribosomal protein L25.

Mol	Chain	Residues	Atoms					AltConf	Trace
41	Y	94	Total	C	N	O	S	0	0
			731	465	131	133	2		

- Molecule 42 is a protein called 50S ribosomal protein L27.

Mol	Chain	Residues	Atoms				AltConf	Trace
42	Z	82	Total	C	N	O	0	0
			626	386	122	118		

- Molecule 43 is a protein called 50S ribosomal protein L28.

Mol	Chain	Residues	Atoms				AltConf	Trace
43	0	45	Total	C	N	O	0	0
			358	222	78	58		

- Molecule 44 is a protein called 50S ribosomal protein L29.

Mol	Chain	Residues	Atoms				AltConf	Trace
44	1	65	Total	C	N	O	0	0
			536	330	101	105		

- Molecule 45 is a protein called 50S ribosomal protein L30.

Mol	Chain	Residues	Atoms				AltConf	Trace
45	2	57	Total	C	N	O	0	0
			441	274	83	84		

- Molecule 46 is a protein called 50S ribosomal protein L31 type B.

Mol	Chain	Residues	Atoms					AltConf	Trace
46	3	75	Total	C	N	O	S	0	0
			593	371	106	113	3		

- Molecule 47 is a protein called 50S ribosomal protein L32.

Mol	Chain	Residues	Atoms					AltConf	Trace
47	4	52	Total	C	N	O	S	0	0
			411	249	85	72	5		

- Molecule 48 is a protein called 50S ribosomal protein L33 2.

Mol	Chain	Residues	Atoms					AltConf	Trace
48	5	44	Total	C	N	O	S	0	0
			371	223	76	68	4		

- Molecule 49 is a protein called 50S ribosomal protein L34.

Mol	Chain	Residues	Atoms					AltConf	Trace
49	6	44	Total	C	N	O	S	0	0
			373	228	90	54	1		

- Molecule 50 is a protein called 50S ribosomal protein L35.

Mol	Chain	Residues	Atoms					AltConf	Trace
50	7	64	Total	C	N	O	S	0	0
			521	324	113	82	2		

- Molecule 51 is a protein called 50S ribosomal protein L36.

Mol	Chain	Residues	Atoms					AltConf	Trace
51	8	37	Total	C	N	O	S	0	0
			296	186	60	46	4		

- Molecule 52 is a RNA chain called P-site tRNA.

Mol	Chain	Residues	Atoms					AltConf	Trace	
52	x	77	Total	C	N	O	P	S	0	0
			1659	741	299	541	76	2		

- Molecule 53 is MAGNESIUM ION (three-letter code: MG) (formula: Mg).

Mol	Chain	Residues	Atoms		AltConf
53	a	54	Total	Mg	0
			54	54	
53	v	1	Total	Mg	0
			1	1	
53	A	207	Total	Mg	0
			207	207	
53	B	2	Total	Mg	0
			2	2	
53	D	1	Total	Mg	0
			1	1	
53	O	1	Total	Mg	0
			1	1	
53	X	1	Total	Mg	0
			1	1	
53	x	1	Total	Mg	0
			1	1	

- Molecule 54 is POTASSIUM ION (three-letter code: K) (formula: K).

<b>Mol</b>	<b>Chain</b>	<b>Residues</b>	<b>Atoms</b>		<b>AltConf</b>
54	a	2	Total 2	K 2	0
54	A	18	Total 18	K 18	0

### 3 Residue-property plots

These plots are drawn for all protein, RNA, DNA and oligosaccharide chains in the entry. The first graphic for a chain summarises the proportions of the various outlier classes displayed in the second graphic. The second graphic shows the sequence view annotated by issues in geometry and atom inclusion in map density. Residues are color-coded according to the number of geometric quality criteria for which they contain at least one outlier: green = 0, yellow = 1, orange = 2 and red = 3 or more. A red diamond above a residue indicates a poor fit to the EM map for this residue (all-atom inclusion < 40%). Stretches of 2 or more consecutive residues without any outlier are shown as a green connector. Residues present in the sample, but not in the model, are shown in grey.

- Molecule 1: 16S rRNA

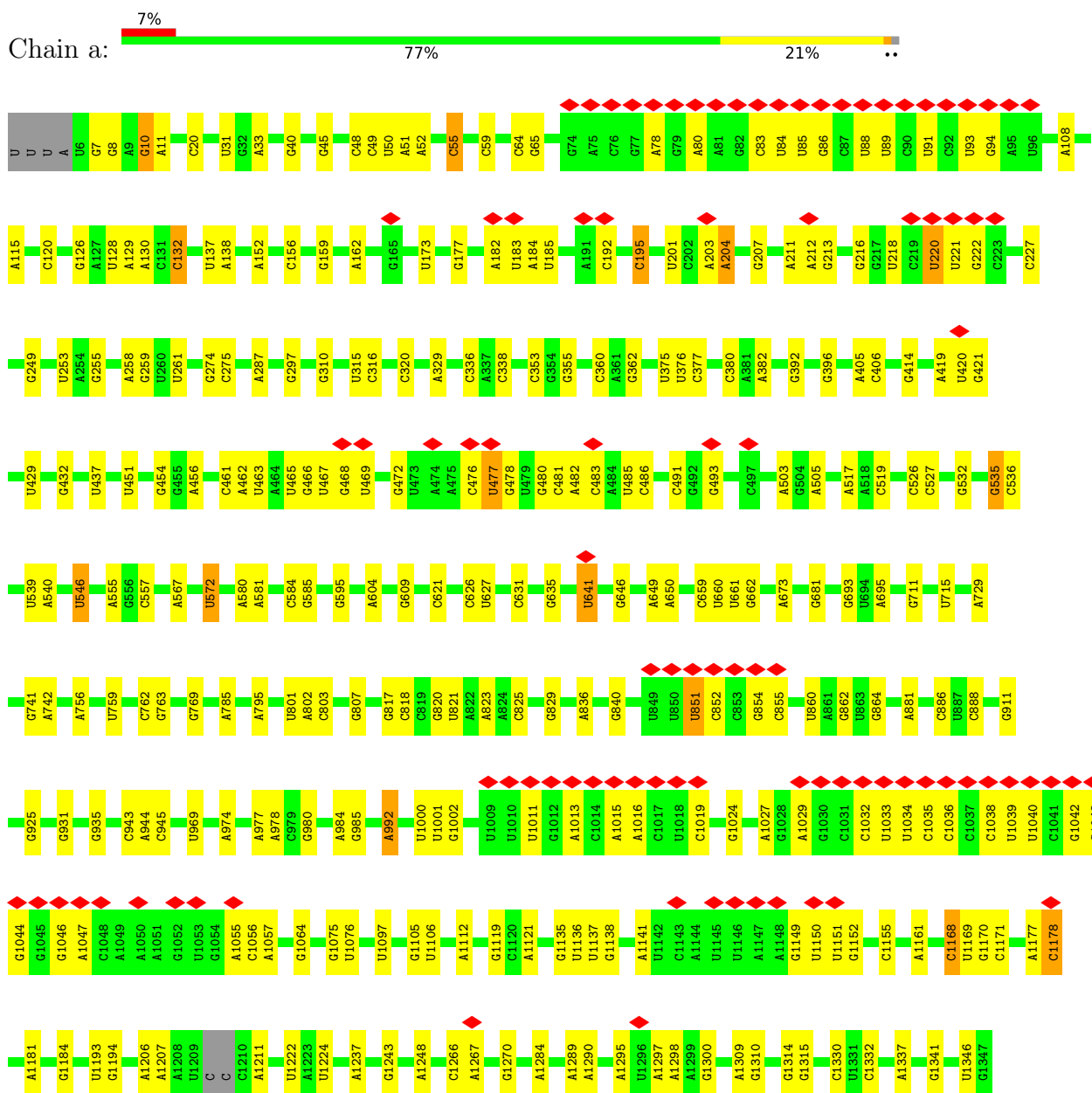

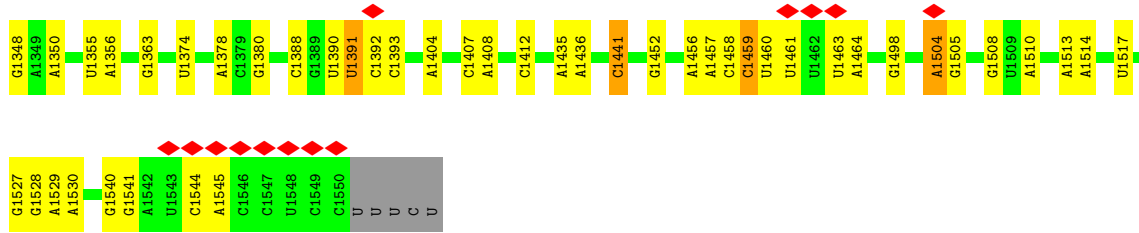

• Molecule 2: 30S ribosomal protein S2

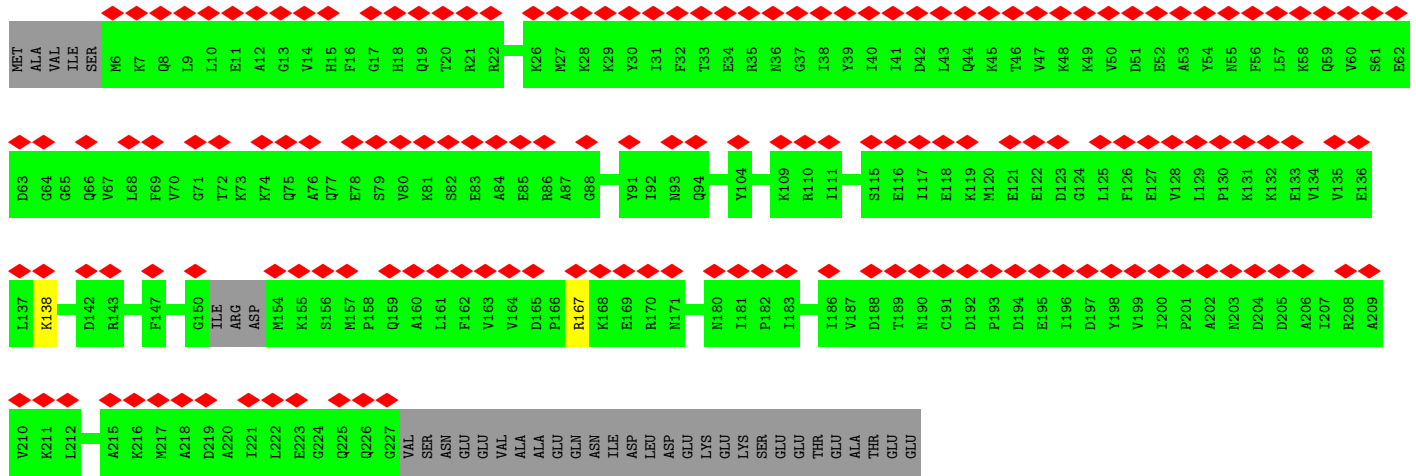
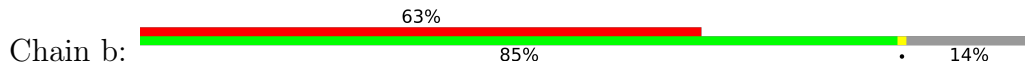

• Molecule 3: 30S ribosomal protein S3

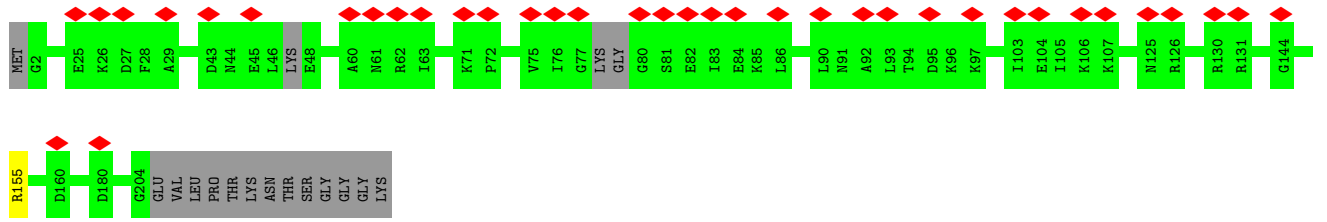
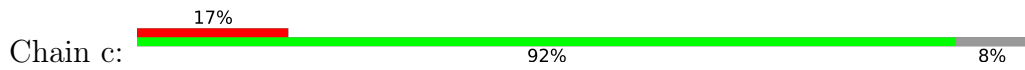

• Molecule 4: 30S ribosomal protein S4

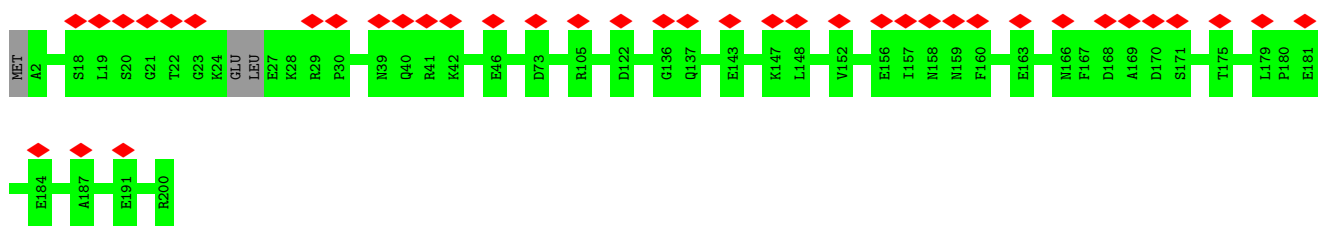

• Molecule 5: 30S ribosomal protein S5

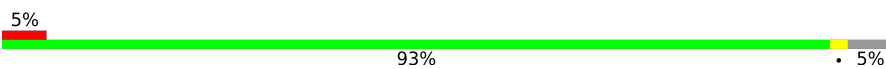
Chain e: 

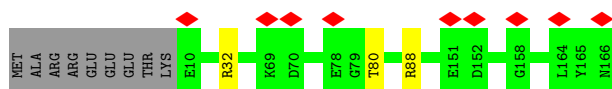

- Molecule 6: 30S ribosomal protein S6

Chain f: 

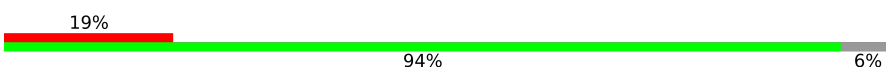

- Molecule 7: 30S ribosomal protein S7

Chain g: 

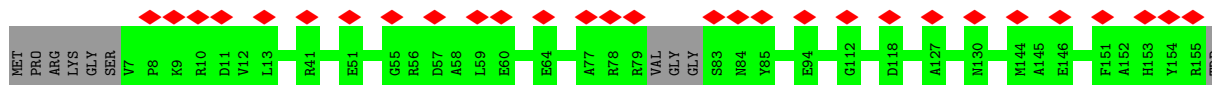

- Molecule 8: 30S ribosomal protein S8

Chain h: 

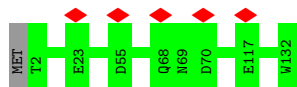

- Molecule 9: 30S ribosomal protein S9

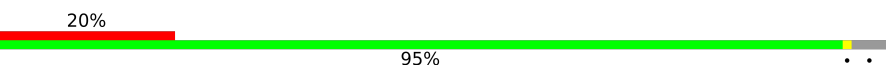
Chain i: 

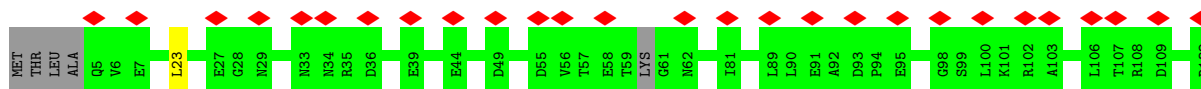

- Molecule 10: ribosomal protein uS10

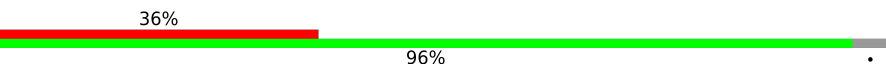
Chain j: 

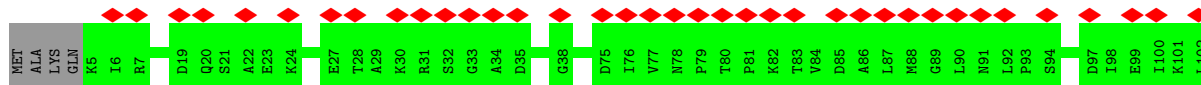

- Molecule 11: 30S ribosomal protein S11

Chain k: 



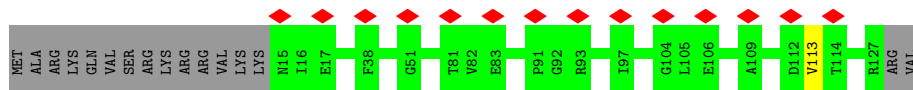

- Molecule 12: 30S ribosomal protein S12

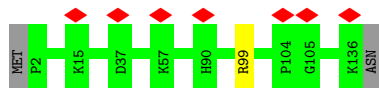

- Molecule 13: 30S ribosomal protein S13

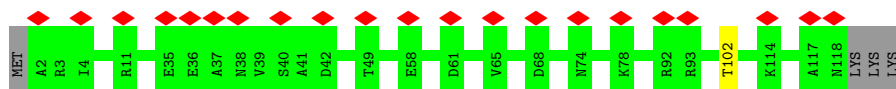

- Molecule 14: 30S ribosomal protein S14

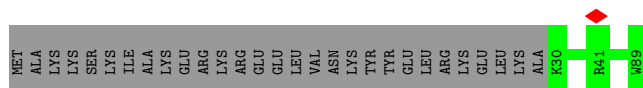

- Molecule 15: 30S ribosomal protein S15

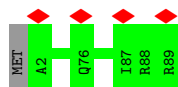

- Molecule 16: 30S ribosomal protein S16

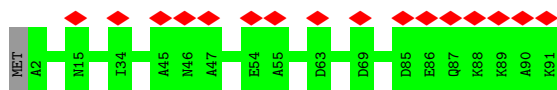

- Molecule 17: 30S ribosomal protein S17

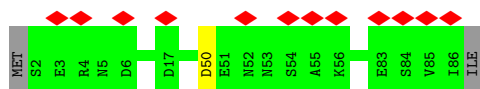

- Molecule 18: 30S ribosomal protein S18

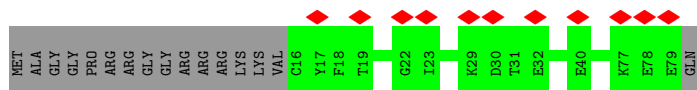
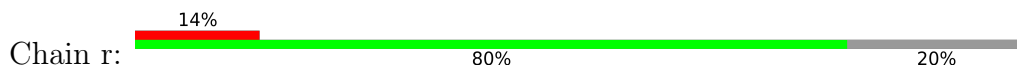

• Molecule 19: 30S ribosomal protein S19

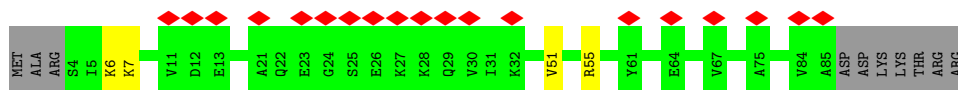
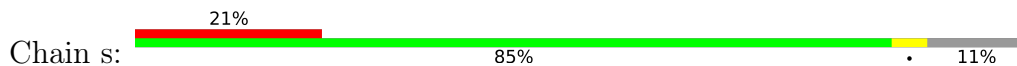

• Molecule 20: 30S ribosomal protein S20

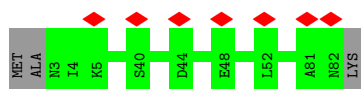

• Molecule 21: mRNA

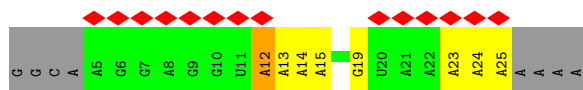
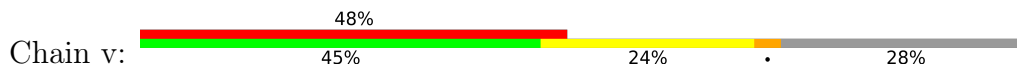

• Molecule 22: 23S rRNA

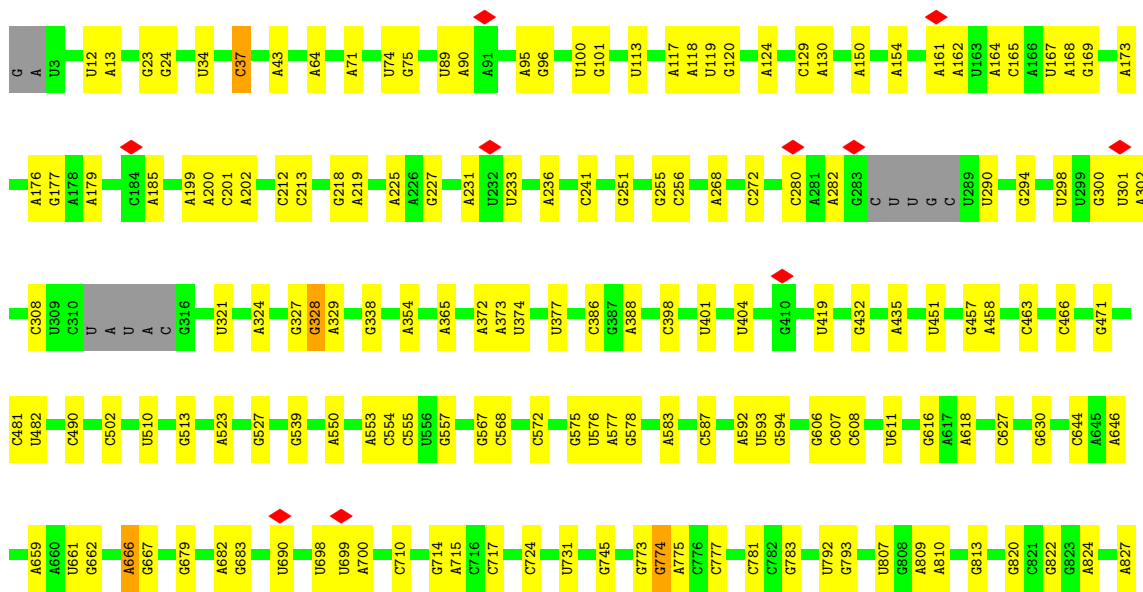
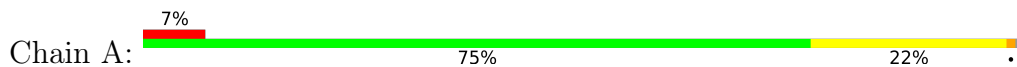

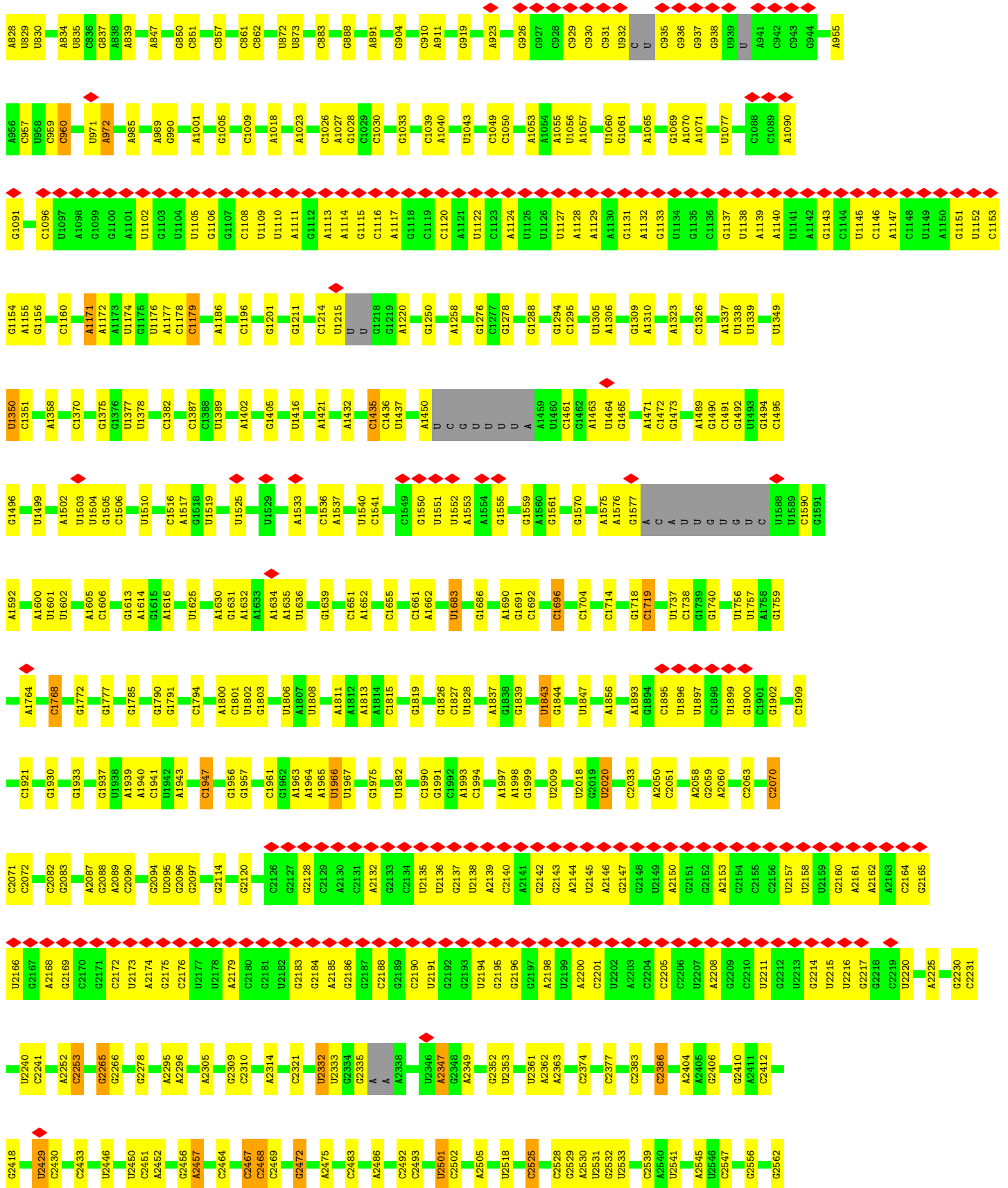

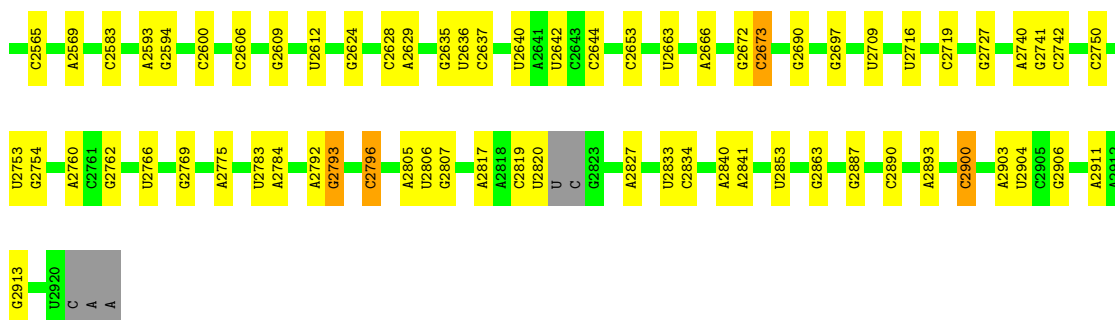

• Molecule 23: 5S rRNA

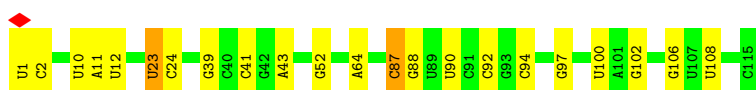
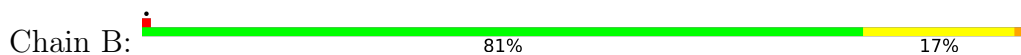

• Molecule 24: 50S ribosomal protein L2



• Molecule 25: 50S ribosomal protein L3



• Molecule 26: 50S ribosomal protein L4

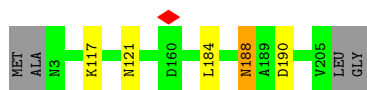

• Molecule 27: 50S ribosomal protein L5

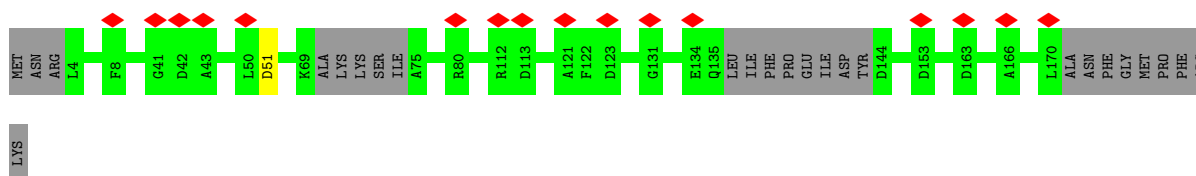
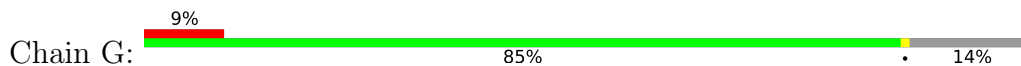

- Molecule 28: 50S ribosomal protein L6

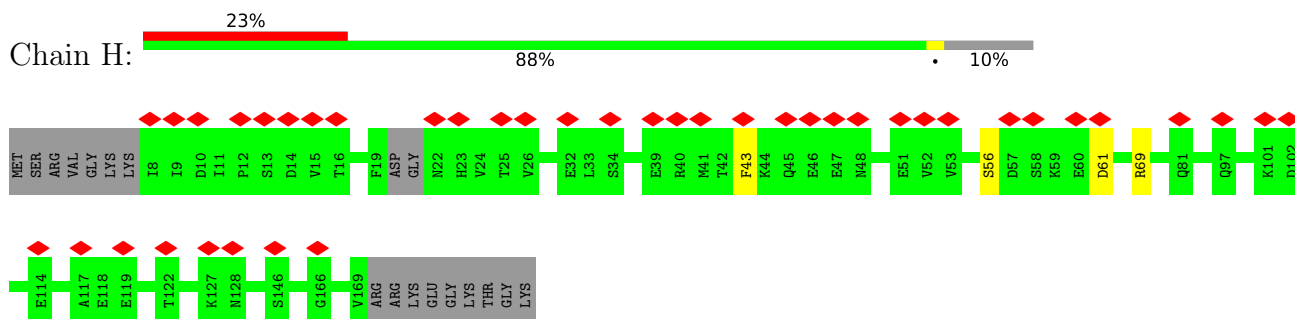

- Molecule 29: 50S ribosomal protein L13



There are no outlier residues recorded for this chain.

- Molecule 30: 50S ribosomal protein L14



- Molecule 31: 50S ribosomal protein L15

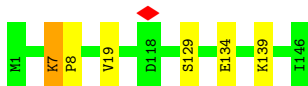

- Molecule 32: 50S ribosomal protein L16

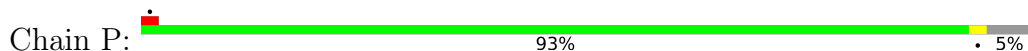

- Molecule 33: 50S ribosomal protein L17



- Molecule 34: 50S ribosomal protein L18



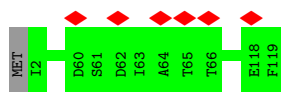

- Molecule 35: 50S ribosomal protein L19

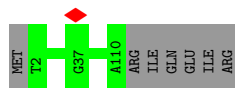

- Molecule 36: 50S ribosomal protein L20

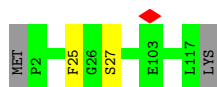

- Molecule 37: 50S ribosomal protein L21

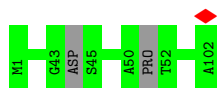

- Molecule 38: 50S ribosomal protein L22

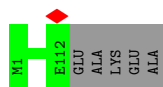

- Molecule 39: 50S ribosomal protein L23

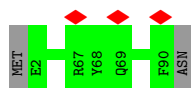

- Molecule 40: 50S ribosomal protein L24

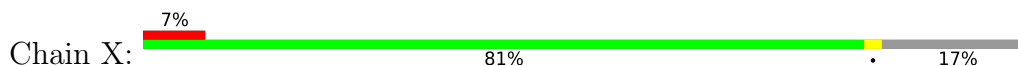

- Molecule 41: 50S ribosomal protein L25



- Molecule 47: 50S ribosomal protein L32

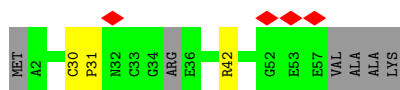
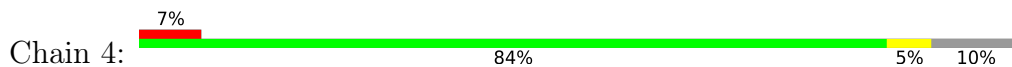

- Molecule 48: 50S ribosomal protein L33 2

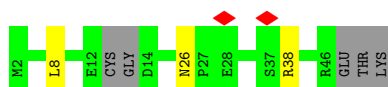
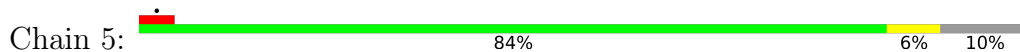

- Molecule 49: 50S ribosomal protein L34



- Molecule 50: 50S ribosomal protein L35



- Molecule 51: 50S ribosomal protein L36



There are no outlier residues recorded for this chain.

- Molecule 52: P-site tRNA

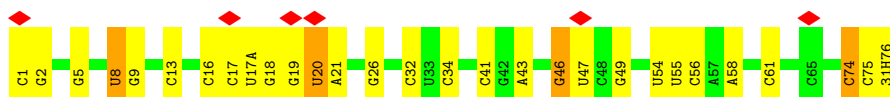



## 4 Experimental information

Property	Value	Source
EM reconstruction method	SINGLE PARTICLE	Depositor
Imposed symmetry	POINT, C1	Depositor
Number of particles used	83000	Depositor
Resolution determination method	FSC 0.143 CUT-OFF	Depositor
CTF correction method	PHASE FLIPPING AND AMPLITUDE CORRECTION	Depositor
Microscope	FEI TITAN KRIOS	Depositor
Voltage (kV)	300	Depositor
Electron dose ( $e^-/\text{\AA}^2$ )	1.5	Depositor
Minimum defocus (nm)	Not provided	
Maximum defocus (nm)	Not provided	
Magnification	Not provided	
Image detector	GATAN K2 SUMMIT (4k x 4k)	Depositor
Maximum map value	0.682	Depositor
Minimum map value	-0.428	Depositor
Average map value	0.002	Depositor
Map value standard deviation	0.028	Depositor
Recommended contour level	0.0524	Depositor
Map size (Å)	330.0, 330.0, 330.0	wwPDB
Map dimensions	300, 300, 300	wwPDB
Map angles (°)	90.0, 90.0, 90.0	wwPDB
Pixel spacing (Å)	1.1, 1.1, 1.1	Depositor

## 5 Model quality i

### 5.1 Standard geometry i

Bond lengths and bond angles in the following residue types are not validated in this section: H2U, 5MU, PSU, MG, OMG, 2MG, MA6, OMC, 31H, 7MG, 4OC, 4SU, K, 2MA

The Z score for a bond length (or angle) is the number of standard deviations the observed value is removed from the expected value. A bond length (or angle) with  $|Z| > 5$  is considered an outlier worth inspection. RMSZ is the root-mean-square of all Z scores of the bond lengths (or angles).

Mol	Chain	Bond lengths		Bond angles	
		RMSZ	# Z  >5	RMSZ	# Z  >5
1	a	0.47	1/36920 (0.0%)	0.98	103/57570 (0.2%)
2	b	0.29	0/1788	0.53	0/2397
3	c	0.27	0/1598	0.52	0/2145
4	d	0.30	0/1629	0.54	0/2185
5	e	0.30	0/1183	0.57	1/1595 (0.1%)
6	f	0.30	0/809	0.51	0/1085
7	g	0.29	0/1192	0.50	0/1603
8	h	0.29	0/1044	0.56	0/1401
9	i	0.30	0/1023	0.58	1/1372 (0.1%)
10	j	0.28	0/795	0.55	0/1071
11	k	0.28	0/848	0.50	0/1147
12	l	0.30	0/1075	0.58	0/1439
13	m	0.28	0/934	0.56	0/1253
14	n	0.26	0/490	0.49	0/650
15	o	0.25	0/747	0.45	0/996
16	p	0.30	0/723	0.56	0/971
17	q	0.28	0/706	0.56	0/944
18	r	0.28	0/536	0.51	0/718
19	s	0.27	0/679	0.50	0/912
20	t	0.23	0/606	0.47	0/810
21	v	0.43	0/521	1.02	1/812 (0.1%)
22	A	0.78	4/69062 (0.0%)	1.06	202/107697 (0.2%)
23	B	0.49	0/2733	1.06	21/4257 (0.5%)
24	D	0.45	2/2129 (0.1%)	0.64	2/2858 (0.1%)
25	E	0.40	0/1659	0.59	1/2224 (0.0%)
26	F	0.39	0/1563	0.56	0/2113
27	G	0.29	0/1201	0.53	0/1610
28	H	0.29	0/1267	0.53	0/1710
29	M	0.35	0/1173	0.52	0/1578
30	N	0.39	0/927	0.58	0/1243
31	O	0.42	1/1112 (0.1%)	0.63	1/1482 (0.1%)
32	P	0.39	0/1121	0.58	1/1504 (0.1%)

Mol	Chain	Bond lengths		Bond angles	
		RMSZ	# Z  >5	RMSZ	# Z  >5
33	Q	0.34	0/943	0.57	0/1259
34	R	0.29	0/920	0.53	0/1230
35	S	0.37	0/889	0.61	0/1189
36	T	0.40	0/955	0.52	0/1265
37	U	0.37	0/791	0.55	0/1051
38	V	0.36	0/870	0.58	0/1171
39	W	0.36	0/733	0.57	0/978
40	X	0.32	0/666	0.66	1/886 (0.1%)
41	Y	0.29	0/738	0.54	0/989
42	Z	0.43	0/632	0.55	0/838
43	0	0.39	0/363	0.66	0/486
44	1	0.29	0/537	0.49	0/714
45	2	0.34	0/443	0.61	1/597 (0.2%)
46	3	0.31	0/602	0.61	1/802 (0.1%)
47	4	0.52	1/416 (0.2%)	0.63	1/550 (0.2%)
48	5	0.31	0/373	0.69	1/495 (0.2%)
49	6	0.41	0/377	0.56	0/491
50	7	0.37	0/526	0.56	0/690
51	8	0.36	0/299	0.53	0/392
52	x	0.46	0/1671	1.08	10/2605 (0.4%)
All	All	0.61	9/153537 (0.0%)	0.94	349/230030 (0.2%)

Chiral center outliers are detected by calculating the chiral volume of a chiral center and verifying if the center is modelled as a planar moiety or with the opposite hand. A planarity outlier is detected by checking planarity of atoms in a peptide group, atoms in a mainchain group or atoms of a sidechain that are expected to be planar.

Mol	Chain	#Chirality outliers	#Planarity outliers
3	c	0	1
5	e	0	1
26	F	0	1
30	N	0	1
36	T	0	1
44	1	0	2
48	5	0	1
All	All	0	8

The worst 5 of 9 bond length outliers are listed below:

Mol	Chain	Res	Type	Atoms	Z	Observed(Å)	Ideal(Å)
22	A	774	G	N9-C4	-6.94	1.32	1.38
22	A	774	G	C2-N3	-6.62	1.27	1.32

*Continued on next page...*

Continued from previous page...

Mol	Chain	Res	Type	Atoms	Z	Observed(Å)	Ideal(Å)
22	A	774	G	N3-C4	-5.88	1.31	1.35
1	a	204	A	N9-C4	5.49	1.41	1.37
31	O	8	PRO	N-CD	5.43	1.55	1.47

The worst 5 of 349 bond angle outliers are listed below:

Mol	Chain	Res	Type	Atoms	Z	Observed(°)	Ideal(°)
22	A	774	G	N3-C4-N9	-13.61	117.83	126.00
22	A	12	U	N1-C2-O2	12.05	131.24	122.80
22	A	12	U	N3-C2-O2	-11.78	113.95	122.20
22	A	12	U	C2-N1-C1'	11.58	131.59	117.70
23	B	87	C	N1-C2-O2	10.47	125.19	118.90

There are no chirality outliers.

5 of 8 planarity outliers are listed below:

Mol	Chain	Res	Type	Group
26	F	188	ASN	Peptide
30	N	17	ARG	Sidechain
36	T	25	PHE	Peptide
3	c	155	ARG	Sidechain
5	e	32	ARG	Sidechain

## 5.2 Too-close contacts [i](#)

Due to software issues we are unable to calculate clashes - this section is therefore empty.

## 5.3 Torsion angles [i](#)

### 5.3.1 Protein backbone [i](#)

In the following table, the Percentiles column shows the percent Ramachandran outliers of the chain as a percentile score with respect to all PDB entries followed by that with respect to all EM entries.

The Analysed column shows the number of residues for which the backbone conformation was analysed, and the total number of residues.

Mol	Chain	Analysed	Favoured	Allowed	Outliers	Percentiles
2	b	215/255 (84%)	202 (94%)	13 (6%)	0	<b>100</b> <b>100</b>

Continued on next page...

*Continued from previous page...*

Mol	Chain	Analysed	Favoured	Allowed	Outliers	Percentiles	
3	c	194/217 (89%)	186 (96%)	8 (4%)	0	100	100
4	d	193/200 (96%)	187 (97%)	6 (3%)	0	100	100
5	e	155/166 (93%)	151 (97%)	4 (3%)	0	100	100
6	f	94/98 (96%)	92 (98%)	2 (2%)	0	100	100
7	g	142/156 (91%)	137 (96%)	5 (4%)	0	100	100
8	h	129/132 (98%)	125 (97%)	4 (3%)	0	100	100
9	i	123/132 (93%)	117 (95%)	6 (5%)	0	100	100
10	j	96/102 (94%)	90 (94%)	6 (6%)	0	100	100
11	k	111/129 (86%)	105 (95%)	6 (5%)	0	100	100
12	l	133/137 (97%)	126 (95%)	7 (5%)	0	100	100
13	m	115/121 (95%)	113 (98%)	2 (2%)	0	100	100
14	n	58/89 (65%)	58 (100%)	0	0	100	100
15	o	86/89 (97%)	84 (98%)	2 (2%)	0	100	100
16	p	88/91 (97%)	83 (94%)	5 (6%)	0	100	100
17	q	83/87 (95%)	75 (90%)	8 (10%)	0	100	100
18	r	62/80 (78%)	60 (97%)	2 (3%)	0	100	100
19	s	80/92 (87%)	78 (98%)	2 (2%)	0	100	100
20	t	78/83 (94%)	77 (99%)	1 (1%)	0	100	100
24	D	272/277 (98%)	265 (97%)	7 (3%)	0	100	100
25	E	214/220 (97%)	205 (96%)	9 (4%)	0	100	100
26	F	201/207 (97%)	192 (96%)	9 (4%)	0	100	100
27	G	148/179 (83%)	139 (94%)	9 (6%)	0	100	100
28	H	156/178 (88%)	145 (93%)	11 (7%)	0	100	100
29	M	143/145 (99%)	138 (96%)	5 (4%)	0	100	100
30	N	120/122 (98%)	115 (96%)	5 (4%)	0	100	100
31	O	144/146 (99%)	139 (96%)	5 (4%)	0	100	100
32	P	135/144 (94%)	134 (99%)	1 (1%)	0	100	100
33	Q	117/122 (96%)	114 (97%)	3 (3%)	0	100	100
34	R	116/119 (98%)	114 (98%)	2 (2%)	0	100	100
35	S	107/116 (92%)	101 (94%)	6 (6%)	0	100	100
36	T	114/118 (97%)	110 (96%)	4 (4%)	0	100	100

*Continued on next page...*

Continued from previous page...

Mol	Chain	Analysed	Favoured	Allowed	Outliers	Percentiles	
37	U	94/102 (92%)	90 (96%)	4 (4%)	0	100	100
38	V	110/117 (94%)	106 (96%)	4 (4%)	0	100	100
39	W	87/91 (96%)	84 (97%)	3 (3%)	0	100	100
40	X	81/105 (77%)	75 (93%)	6 (7%)	0	100	100
41	Y	92/217 (42%)	90 (98%)	2 (2%)	0	100	100
42	Z	80/94 (85%)	76 (95%)	4 (5%)	0	100	100
43	0	43/62 (69%)	38 (88%)	5 (12%)	0	100	100
44	1	63/69 (91%)	62 (98%)	1 (2%)	0	100	100
45	2	55/59 (93%)	51 (93%)	4 (7%)	0	100	100
46	3	67/84 (80%)	62 (92%)	5 (8%)	0	100	100
47	4	47/58 (81%)	45 (96%)	2 (4%)	0	100	100
48	5	40/49 (82%)	36 (90%)	4 (10%)	0	100	100
49	6	42/45 (93%)	40 (95%)	2 (5%)	0	100	100
50	7	62/66 (94%)	56 (90%)	6 (10%)	0	100	100
51	8	35/37 (95%)	35 (100%)	0	0	100	100
All	All	5220/5804 (90%)	5003 (96%)	217 (4%)	0	100	100

There are no Ramachandran outliers to report.

### 5.3.2 Protein sidechains [i](#)

In the following table, the Percentiles column shows the percent sidechain outliers of the chain as a percentile score with respect to all PDB entries followed by that with respect to all EM entries.

The Analysed column shows the number of residues for which the sidechain conformation was analysed, and the total number of residues.

Mol	Chain	Analysed	Rotameric	Outliers	Percentiles	
2	b	189/221 (86%)	187 (99%)	2 (1%)	73	88
3	c	162/175 (93%)	162 (100%)	0	100	100
4	d	172/175 (98%)	172 (100%)	0	100	100
5	e	123/131 (94%)	122 (99%)	1 (1%)	81	93
6	f	84/86 (98%)	82 (98%)	2 (2%)	49	77
7	g	125/132 (95%)	125 (100%)	0	100	100

Continued on next page...

*Continued from previous page...*

Mol	Chain	Analysed	Rotameric	Outliers	Percentiles	
8	h	112/113 (99%)	112 (100%)	0	100	100
9	i	105/109 (96%)	105 (100%)	0	100	100
10	j	88/91 (97%)	88 (100%)	0	100	100
11	k	89/104 (86%)	88 (99%)	1 (1%)	73	88
12	l	117/119 (98%)	116 (99%)	1 (1%)	78	91
13	m	100/104 (96%)	99 (99%)	1 (1%)	76	90
14	n	50/78 (64%)	50 (100%)	0	100	100
15	o	80/81 (99%)	80 (100%)	0	100	100
16	p	76/77 (99%)	76 (100%)	0	100	100
17	q	80/82 (98%)	79 (99%)	1 (1%)	69	87
18	r	57/68 (84%)	57 (100%)	0	100	100
19	s	71/80 (89%)	67 (94%)	4 (6%)	21	57
20	t	67/69 (97%)	67 (100%)	0	100	100
24	D	221/224 (99%)	218 (99%)	3 (1%)	67	86
25	E	173/177 (98%)	173 (100%)	0	100	100
26	F	163/169 (96%)	158 (97%)	5 (3%)	40	72
27	G	131/158 (83%)	130 (99%)	1 (1%)	81	93
28	H	141/155 (91%)	137 (97%)	4 (3%)	43	74
29	M	123/123 (100%)	123 (100%)	0	100	100
30	N	100/100 (100%)	100 (100%)	0	100	100
31	O	112/112 (100%)	107 (96%)	5 (4%)	27	63
32	P	114/119 (96%)	112 (98%)	2 (2%)	59	82
33	Q	100/102 (98%)	99 (99%)	1 (1%)	76	90
34	R	93/95 (98%)	93 (100%)	0	100	100
35	S	95/102 (93%)	95 (100%)	0	100	100
36	T	96/98 (98%)	95 (99%)	1 (1%)	76	90
37	U	84/86 (98%)	84 (100%)	0	100	100
38	V	91/94 (97%)	91 (100%)	0	100	100
39	W	80/82 (98%)	80 (100%)	0	100	100
40	X	72/90 (80%)	71 (99%)	1 (1%)	67	86
41	Y	82/190 (43%)	81 (99%)	1 (1%)	71	88

*Continued on next page...*

Continued from previous page...

Mol	Chain	Analysed	Rotameric	Outliers	Percentiles	
42	Z	64/75 (85%)	64 (100%)	0	100	100
43	0	37/52 (71%)	37 (100%)	0	100	100
44	1	59/62 (95%)	59 (100%)	0	100	100
45	2	51/53 (96%)	50 (98%)	1 (2%)	55	80
46	3	63/75 (84%)	61 (97%)	2 (3%)	39	71
47	4	46/51 (90%)	45 (98%)	1 (2%)	52	79
48	5	43/47 (92%)	42 (98%)	1 (2%)	50	78
49	6	39/40 (98%)	39 (100%)	0	100	100
50	7	55/57 (96%)	53 (96%)	2 (4%)	35	69
51	8	34/35 (97%)	34 (100%)	0	100	100
All	All	4509/4918 (92%)	4465 (99%)	44 (1%)	77	90

5 of 44 residues with a non-rotameric sidechain are listed below:

Mol	Chain	Res	Type
31	O	129	SER
40	X	72	ASP
31	O	134	GLU
32	P	27	VAL
45	2	54	VAL

Sometimes sidechains can be flipped to improve hydrogen bonding and reduce clashes. 5 of 68 such sidechains are listed below:

Mol	Chain	Res	Type
46	3	55	HIS
46	3	83	ASN
50	7	31	HIS
17	q	49	HIS
15	o	68	ASN

### 5.3.3 RNA [i](#)

Mol	Chain	Analysed	Backbone Outliers	Pucker Outliers
1	a	1541/1556 (99%)	310 (20%)	0
21	v	20/29 (68%)	8 (40%)	0
22	A	2870/2923 (98%)	584 (20%)	8 (0%)

Continued on next page...



Continued from previous page...

Mol	Chain	Analysed	Backbone Outliers	Pucker Outliers
23	B	114/115 (99%)	17 (14%)	1 (0%)
52	x	75/77 (97%)	21 (28%)	0
All	All	4620/4700 (98%)	940 (20%)	9 (0%)

5 of 940 RNA backbone outliers are listed below:

Mol	Chain	Res	Type
1	a	7	G
1	a	8	G
1	a	10	G
1	a	11	A
1	a	31	U

5 of 9 RNA pucker outliers are listed below:

Mol	Chain	Res	Type
22	A	2783	U
23	B	23	U
22	A	971	U
22	A	1503	U
22	A	1550	G

## 5.4 Non-standard residues in protein, DNA, RNA chains [i](#)

18 non-standard protein/DNA/RNA residues are modelled in this entry.

In the following table, the Counts columns list the number of bonds (or angles) for which Mogul statistics could be retrieved, the number of bonds (or angles) that are observed in the model and the number of bonds (or angles) that are defined in the Chemical Component Dictionary. The Link column lists molecule types, if any, to which the group is linked. The Z score for a bond length (or angle) is the number of standard deviations the observed value is removed from the expected value. A bond length (or angle) with  $|Z| > 2$  is considered an outlier worth inspection. RMSZ is the root-mean-square of all Z scores of the bond lengths (or angles).

Mol	Type	Chain	Res	Link	Bond lengths			Bond angles		
					Counts	RMSZ	# Z  > 2	Counts	RMSZ	# Z  > 2
22	2MA	A	2530	53,22,54	17,25,26	2.41	5 (29%)	17,37,40	1.55	4 (23%)
1	4OC	a	1412	1	20,23,24	3.07	8 (40%)	26,32,35	1.04	2 (7%)
52	H2U	x	20	52	22,22,22	0.94	2 (9%)	28,33,33	2.84	6 (21%)
52	OMC	x	32	52	23,23,23	2.73	8 (34%)	33,34,34	2.28	8 (24%)
1	7MG	a	535	1	22,26,27	3.80	10 (45%)	29,39,42	2.07	9 (31%)

Mol	Type	Chain	Res	Link	Bond lengths			Bond angles		
					Counts	RMSZ	# Z  > 2	Counts	RMSZ	# Z  > 2
52	5MU	x	54	52	23,23,23	4.53	7 (30%)	35,35,35	3.83	15 (42%)
22	2MG	A	2472	22	18,26,27	2.25	7 (38%)	16,38,41	1.66	4 (25%)
22	5MU	A	1966	22,54	19,22,23	4.82	7 (36%)	28,32,35	3.83	9 (32%)
1	MA6	a	1529	1	19,26,27	1.05	2 (10%)	18,38,41	3.20	2 (11%)
22	OMC	A	2525	22	19,22,23	2.75	7 (36%)	26,31,34	0.99	1 (3%)
52	4SU	x	8	52	22,22,22	1.71	4 (18%)	33,33,33	2.82	13 (39%)
52	31H	x	76	52,53	28,34,35	4.57	13 (46%)	23,47,50	2.80	6 (26%)
1	2MG	a	1527	1	18,26,27	2.37	7 (38%)	16,38,41	1.43	3 (18%)
52	PSU	x	55	52	22,22,22	1.25	3 (13%)	29,33,33	2.75	11 (37%)
1	MA6	a	1530	1	19,26,27	1.04	2 (10%)	18,38,41	3.61	2 (11%)
52	7MG	x	46	52	26,27,27	3.49	10 (38%)	36,42,42	2.74	15 (41%)
22	OMC	A	1947	22	19,22,23	2.84	8 (42%)	26,31,34	0.88	1 (3%)
22	OMG	A	2278	52,22	18,26,27	2.31	7 (38%)	19,38,41	1.51	4 (21%)

In the following table, the Chirals column lists the number of chiral outliers, the number of chiral centers analysed, the number of these observed in the model and the number defined in the Chemical Component Dictionary. Similar counts are reported in the Torsion and Rings columns. '-' means no outliers of that kind were identified.

Mol	Type	Chain	Res	Link	Chirals	Torsions	Rings
22	2MA	A	2530	53,22,54	-	2/3/25/26	0/3/3/3
1	4OC	a	1412	1	-	2/9/29/30	0/2/2/2
52	H2U	x	20	52	-	4/10/39/39	0/2/2/2
52	OMC	x	32	52	-	4/12/28/28	0/2/2/2
1	7MG	a	535	1	-	2/7/37/38	0/3/3/3
52	5MU	x	54	52	-	2/10/26/26	0/2/2/2
22	2MG	A	2472	22	-	2/5/27/28	0/3/3/3
22	5MU	A	1966	22,54	-	2/7/25/26	0/2/2/2
1	MA6	a	1529	1	-	1/7/29/30	0/3/3/3
22	OMC	A	2525	22	-	2/9/27/28	0/2/2/2
52	4SU	x	8	52	-	1/10/26/26	0/2/2/2
52	31H	x	76	52,53	-	14/18/40/41	0/3/3/3
1	2MG	a	1527	1	-	0/5/27/28	0/3/3/3
52	PSU	x	55	52	-	4/10/26/26	0/2/2/2
1	MA6	a	1530	1	-	2/7/29/30	0/3/3/3
52	7MG	x	46	52	-	5/10/38/38	0/3/3/3

Continued on next page...

Continued from previous page...

Mol	Type	Chain	Res	Link	Chirals	Torsions	Rings
22	OMC	A	1947	22	-	2/9/27/28	0/2/2/2
22	OMG	A	2278	52,22	-	0/5/27/28	0/3/3/3

The worst 5 of 117 bond length outliers are listed below:

Mol	Chain	Res	Type	Atoms	Z	Observed(Å)	Ideal(Å)
52	x	76	31H	C4'-C3'	-13.83	1.28	1.52
52	x	54	5MU	C2-N1	11.56	1.57	1.38
52	x	54	5MU	C6-N1	11.11	1.57	1.38
22	A	1966	5MU	C6-N1	10.80	1.56	1.38
22	A	1966	5MU	C2-N1	10.59	1.55	1.38

The worst 5 of 115 bond angle outliers are listed below:

Mol	Chain	Res	Type	Atoms	Z	Observed(°)	Ideal(°)
1	a	1530	MA6	N1-C6-N6	-13.63	102.72	117.06
22	A	1966	5MU	C5-C4-N3	12.76	126.20	115.31
52	x	54	5MU	C5-C4-N3	12.34	125.84	115.31
1	a	1529	MA6	N1-C6-N6	-12.04	104.38	117.06
22	A	1966	5MU	C5-C6-N1	-11.02	112.00	123.34

There are no chirality outliers.

5 of 51 torsion outliers are listed below:

Mol	Chain	Res	Type	Atoms
1	a	1530	MA6	O4'-C4'-C5'-O5'
22	A	1947	OMC	O4'-C4'-C5'-O5'
52	x	20	H2U	O4'-C4'-C5'-O5'
52	x	32	OMC	C5'-O5'-P-OP1
52	x	46	7MG	C5'-O5'-P-OP3

There are no ring outliers.

No monomer is involved in short contacts.

## 5.5 Carbohydrates [i](#)

There are no monosaccharides in this entry.

## 5.6 Ligand geometry [i](#)

Of 288 ligands modelled in this entry, 288 are monoatomic - leaving 0 for Mogul analysis.

There are no bond length outliers.

There are no bond angle outliers.

There are no chirality outliers.

There are no torsion outliers.

There are no ring outliers.

No monomer is involved in short contacts.

## 5.7 Other polymers [i](#)

There are no such residues in this entry.

## 5.8 Polymer linkage issues [i](#)

The following chains have linkage breaks:

Mol	Chain	Number of breaks
47	4	1

All chain breaks are listed below:

Model	Chain	Residue-1	Atom-1	Residue-2	Atom-2	Distance (Å)
1	4	53:GLU	C	57:GLU	N	9.89

## 6 Map visualisation [i](#)

This section contains visualisations of the EMDB entry EMD-10791. These allow visual inspection of the internal detail of the map and identification of artifacts.

No raw map or half-maps were deposited for this entry and therefore no images, graphs, etc. pertaining to the raw map can be shown.

### 6.1 Orthogonal projections [i](#)

#### 6.1.1 Primary map

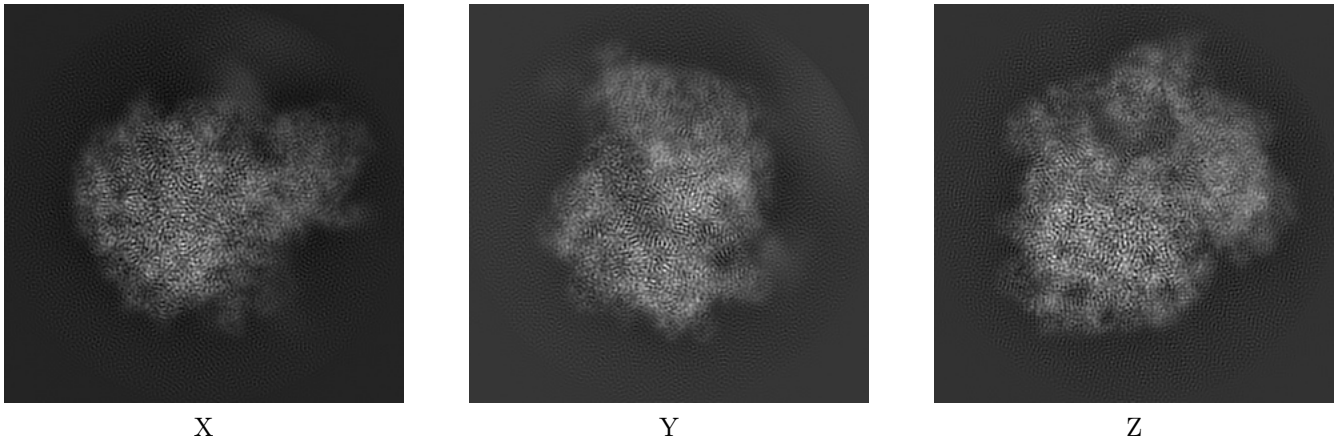

The images above show the map projected in three orthogonal directions.

### 6.2 Central slices [i](#)

#### 6.2.1 Primary map

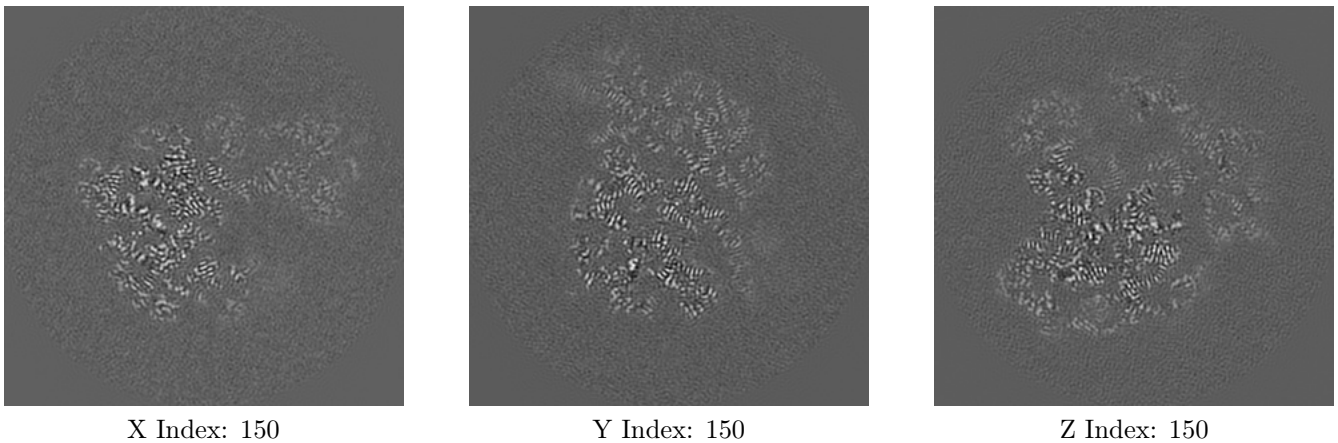

The images above show central slices of the map in three orthogonal directions.

## 6.3 Largest variance slices [i](#)

### 6.3.1 Primary map

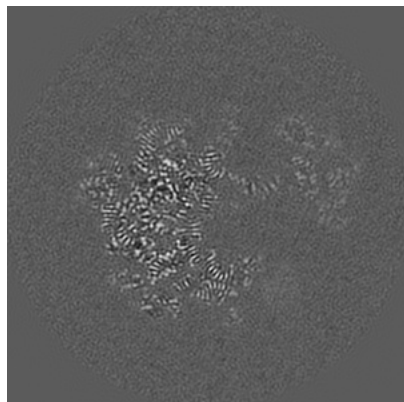

X Index: 143

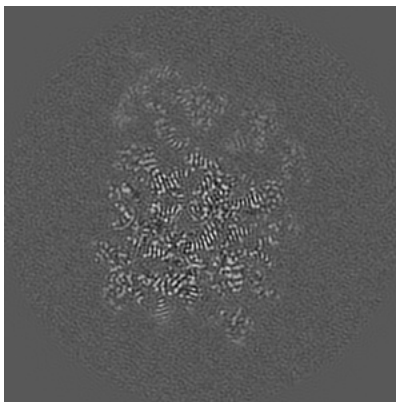

Y Index: 134

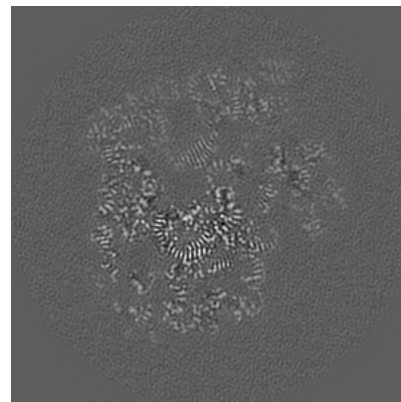

Z Index: 163

The images above show the largest variance slices of the map in three orthogonal directions.

## 6.4 Orthogonal surface views [i](#)

### 6.4.1 Primary map

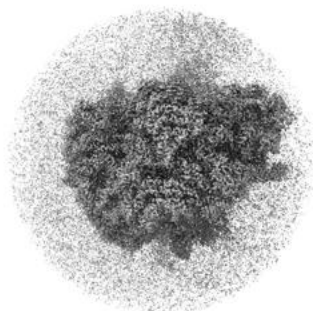

X

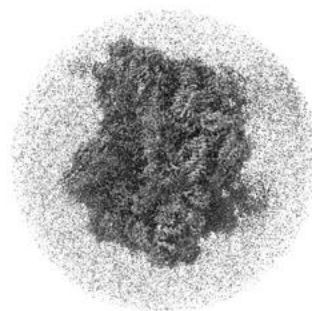

Y



Z

The images above show the 3D surface view of the map at the recommended contour level 0.0524. These images, in conjunction with the slice images, may facilitate assessment of whether an appropriate contour level has been provided.

## 6.5 Mask visualisation

This section was not generated. No masks/segmentation were deposited.

## 7 Map analysis [i](#)

This section contains the results of statistical analysis of the map.

### 7.1 Map-value distribution [i](#)

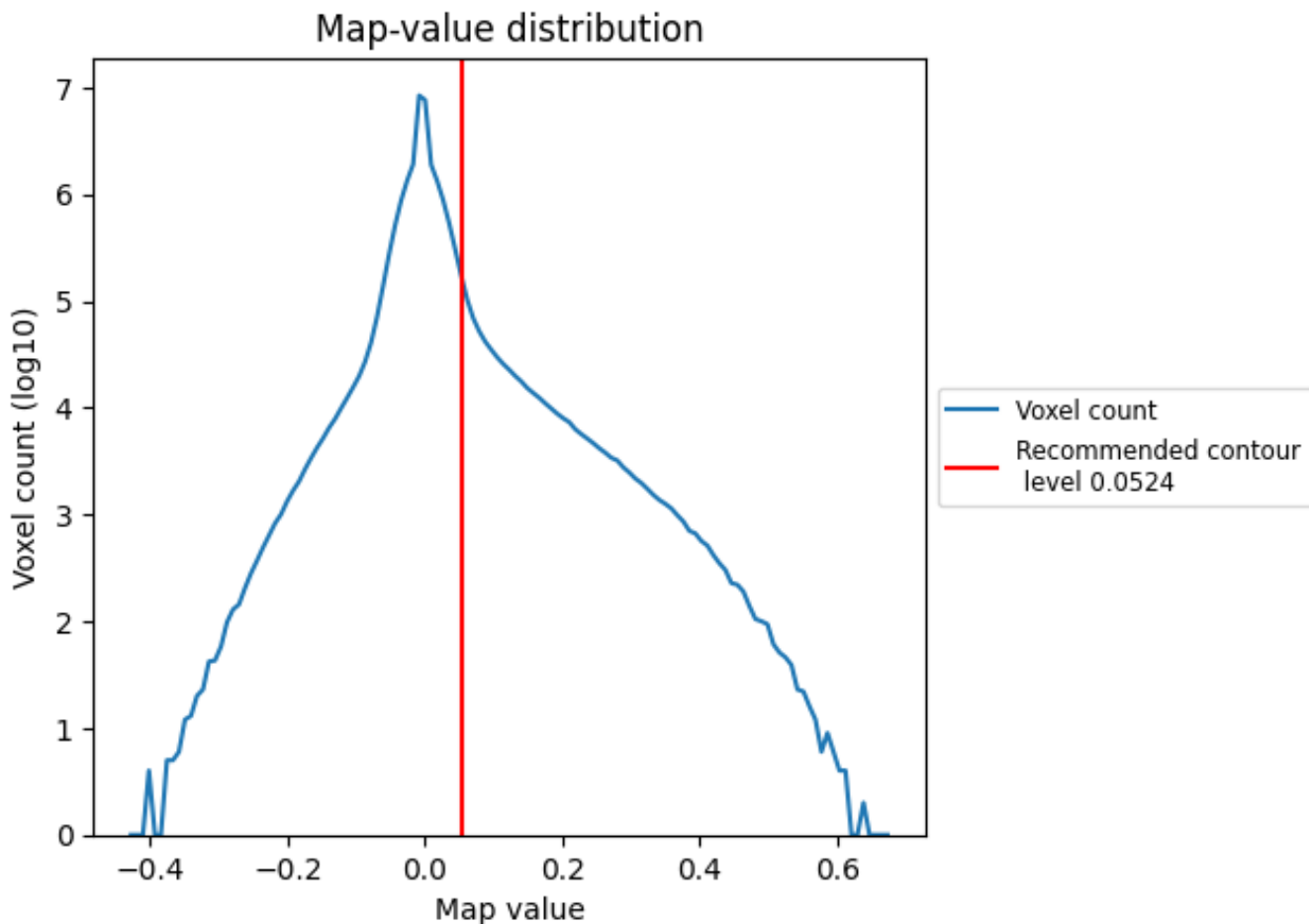

The map-value distribution is plotted in 128 intervals along the x-axis. The y-axis is logarithmic. A spike in this graph at zero usually indicates that the volume has been masked.



## 7.2 Volume estimate [i](#)

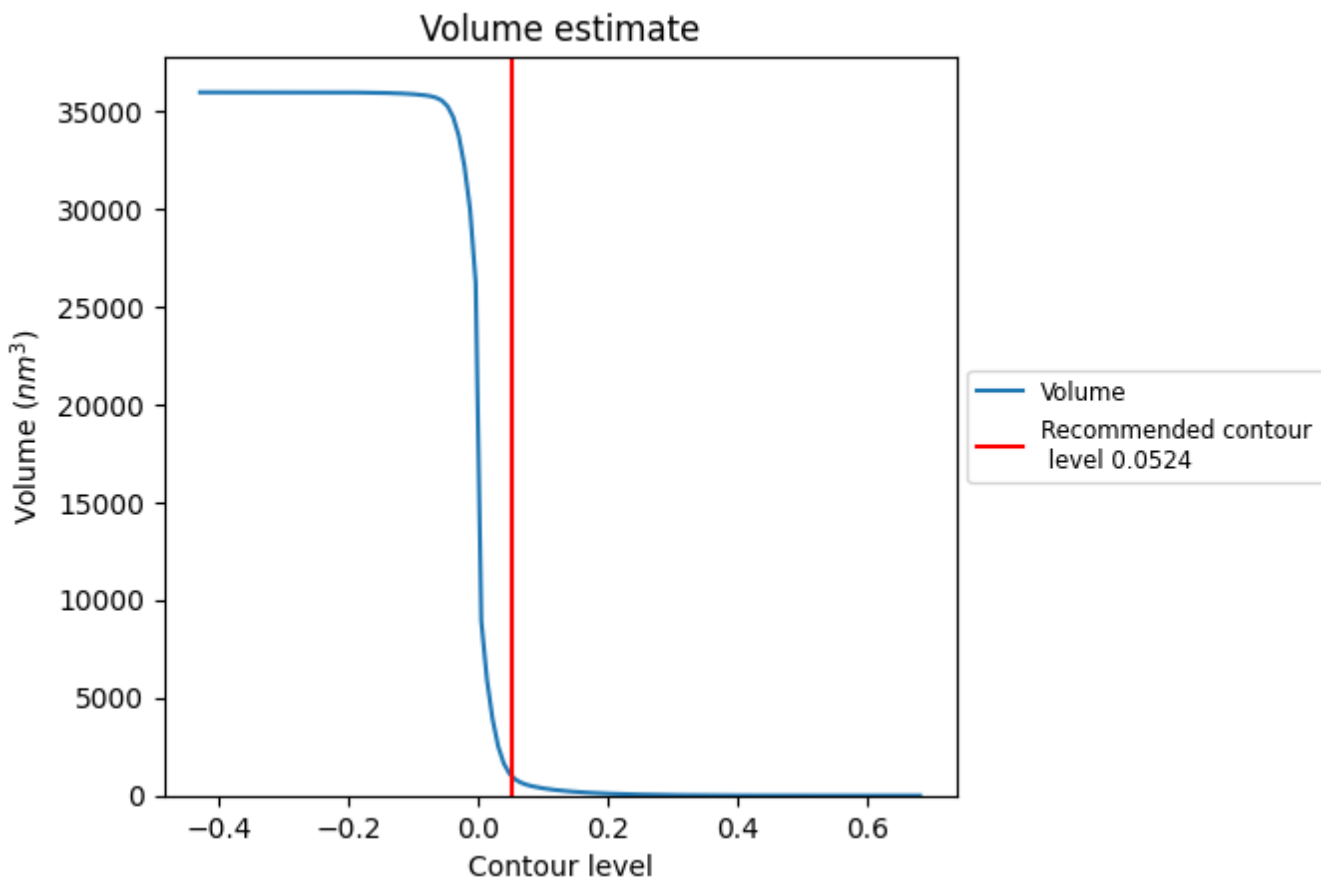

The volume at the recommended contour level is 1006 nm<sup>3</sup>; this corresponds to an approximate mass of 909 kDa.

The volume estimate graph shows how the enclosed volume varies with the contour level. The recommended contour level is shown as a vertical line and the intersection between the line and the curve gives the volume of the enclosed surface at the given level.

### 7.3 Rotationally averaged power spectrum [i](#)

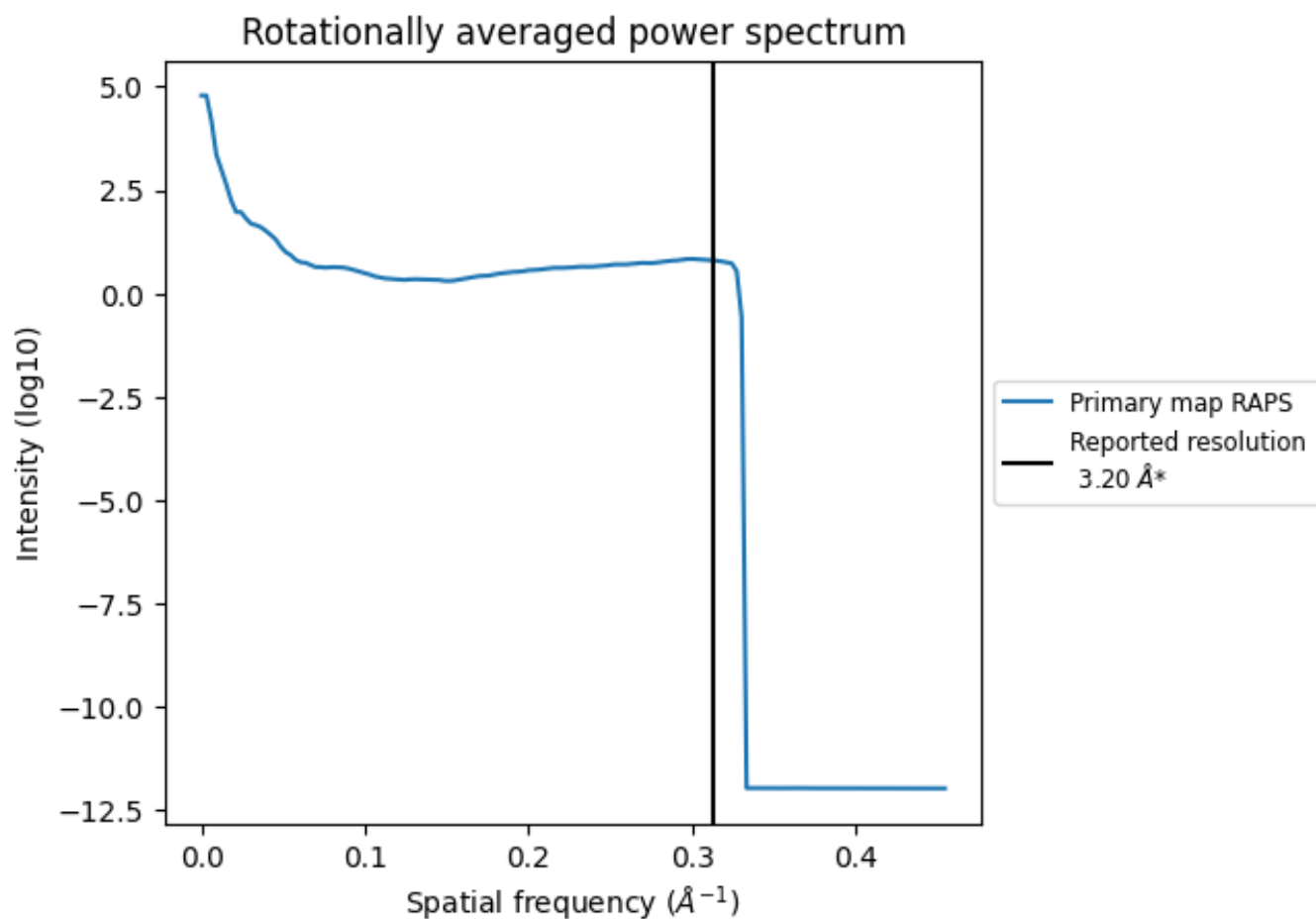

\*Reported resolution corresponds to spatial frequency of 0.312 Å<sup>-1</sup>

## 8 Fourier-Shell correlation [i](#)

Fourier-Shell Correlation (FSC) is the most commonly used method to estimate the resolution of single-particle and subtomogram-averaged maps. The shape of the curve depends on the imposed symmetry, mask and whether or not the two 3D reconstructions used were processed from a common reference. The reported resolution is shown as a black line. A curve is displayed for the half-bit criterion in addition to lines showing the 0.143 gold standard cut-off and 0.5 cut-off.

### 8.1 FSC [i](#)

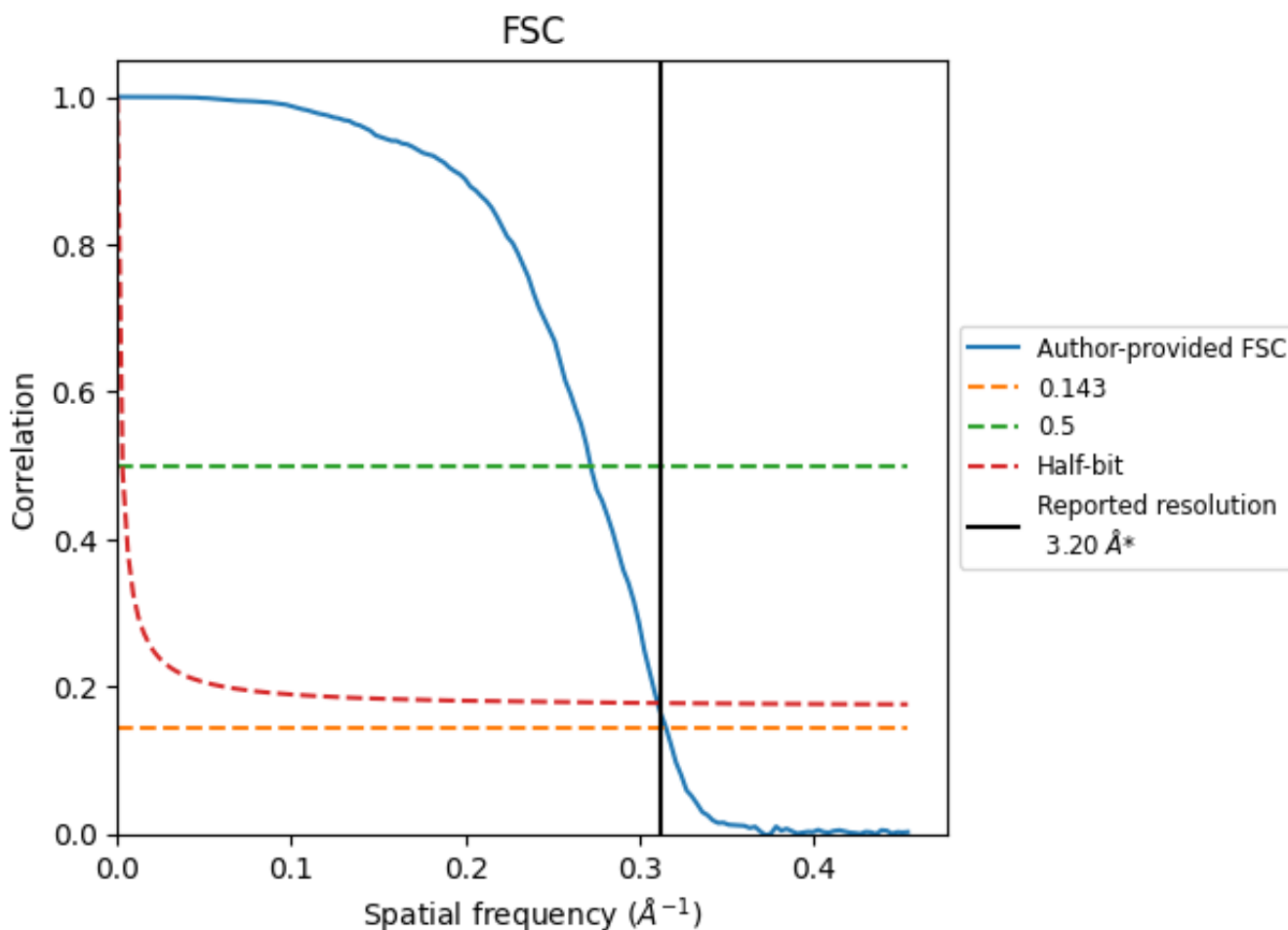

\*Reported resolution corresponds to spatial frequency of 0.312 Å<sup>-1</sup>

## 8.2 Resolution estimates [i](#)

Resolution estimate (Å)	Estimation criterion (FSC cut-off)		
	0.143	0.5	Half-bit
Reported by author	3.20	-	-
Author-provided FSC curve	3.17	3.68	3.22
Unmasked-calculated*	-	-	-

\*Resolution estimate based on FSC curve calculated by comparison of deposited half-maps.

## 9 Map-model fit [i](#)

This section contains information regarding the fit between EMDB map EMD-10791 and PDB model 6YEF. Per-residue inclusion information can be found in section 3 on page 14.

### 9.1 Map-model overlay [i](#)

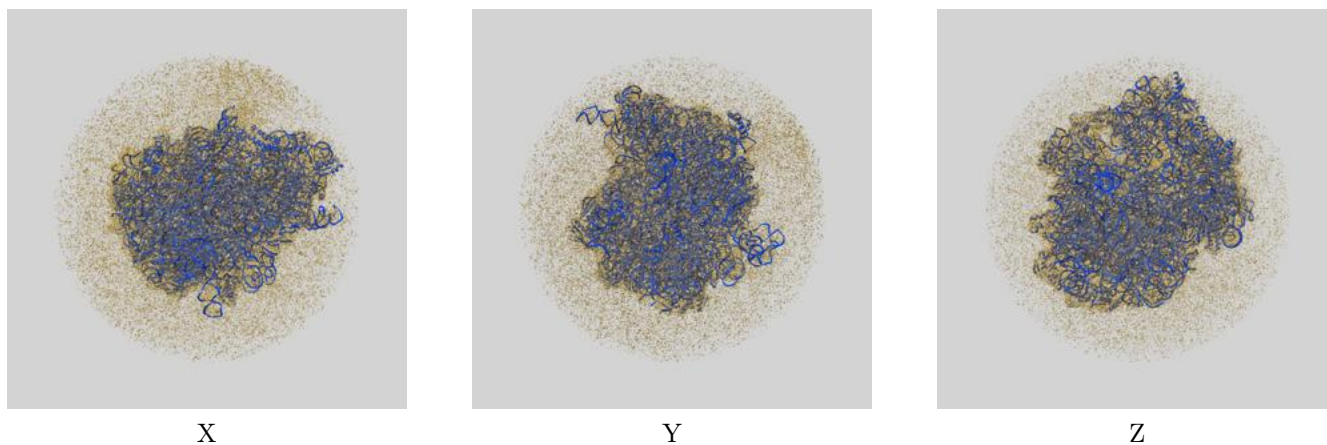

The images above show the 3D surface view of the map at the recommended contour level 0.0524 at 50% transparency in yellow overlaid with a ribbon representation of the model coloured in blue. These images allow for the visual assessment of the quality of fit between the atomic model and the map.

## 9.2 Q-score mapped to coordinate model [i](#)

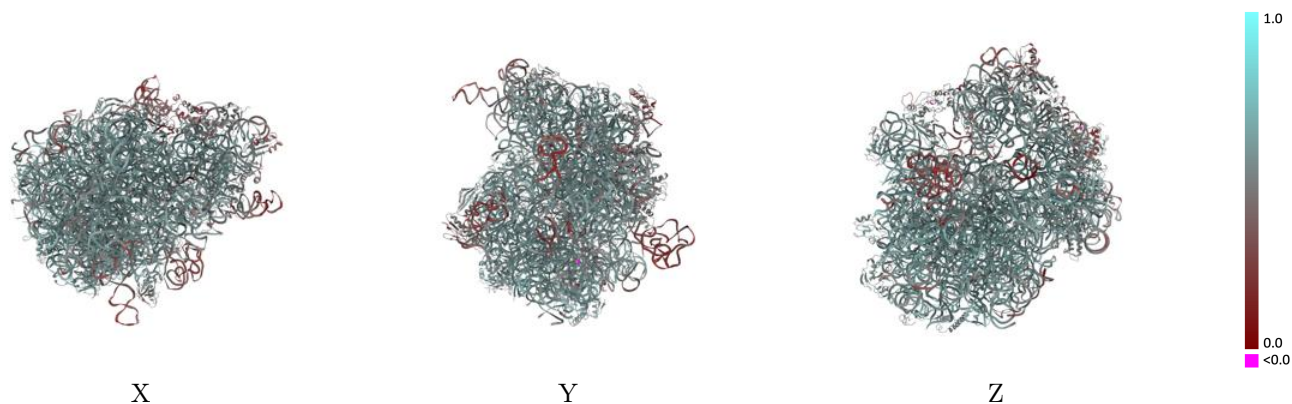

The images above show the model with each residue coloured according to its Q-score. This shows their resolvability in the map with higher Q-score values reflecting better resolvability. Please note: Q-score is calculating the resolvability of atoms, and thus high values are only expected at resolutions at which atoms can be resolved. Low Q-score values may therefore be expected for many entries.

## 9.3 Atom inclusion mapped to coordinate model [i](#)

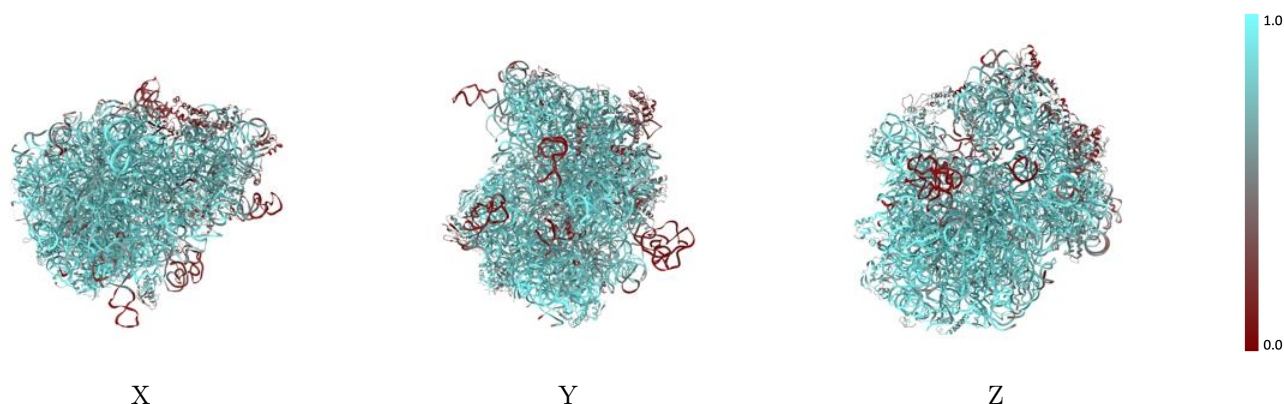

The images above show the model with each residue coloured according to its atom inclusion. This shows to what extent they are inside the map at the recommended contour level (0.0524).



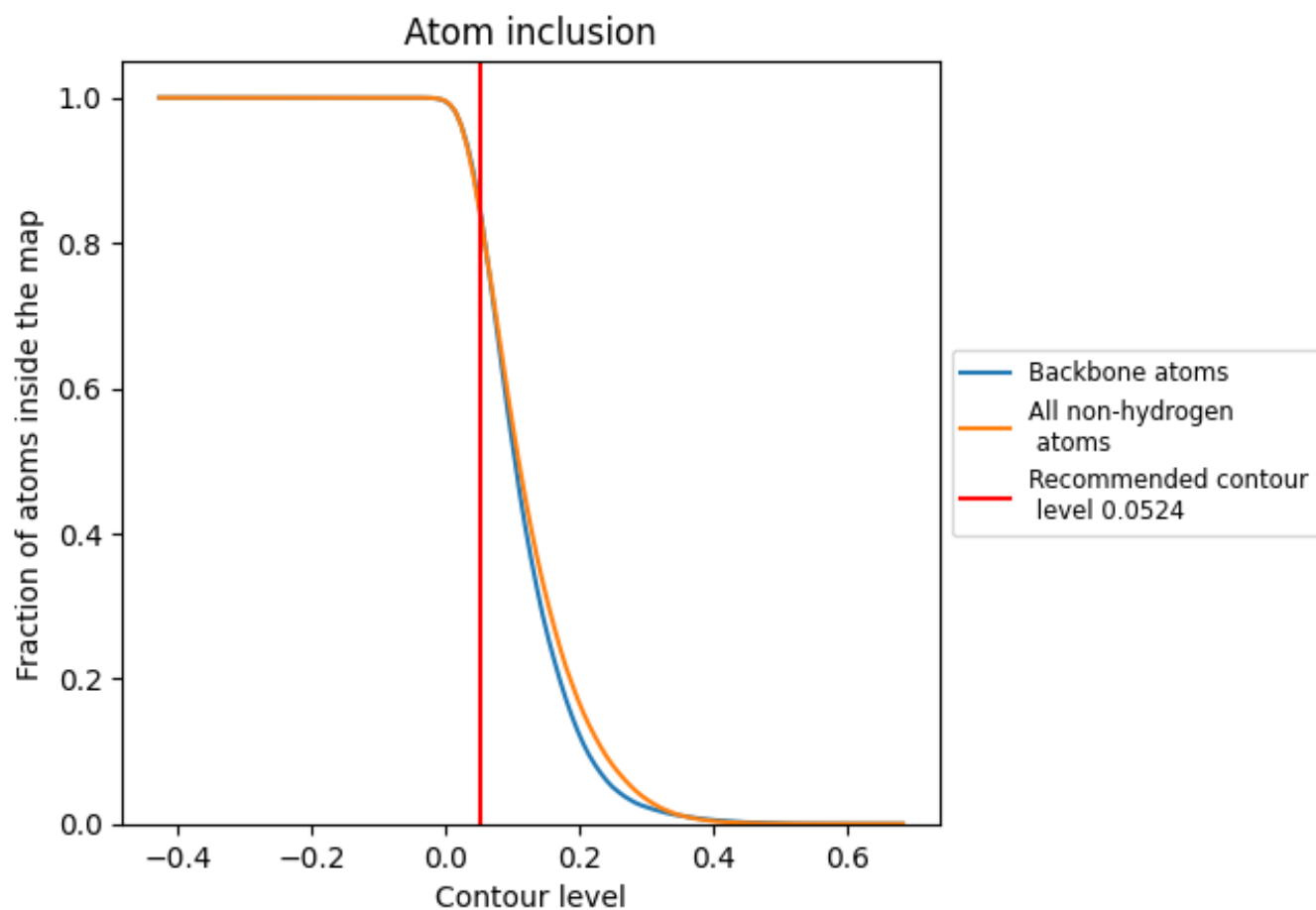



































































## 9.4 Atom inclusion [i](#)



At the recommended contour level, 84% of all backbone atoms, 83% of all non-hydrogen atoms, are inside the map.

## 9.5 Map-model fit summary

The table lists the average atom inclusion at the recommended contour level (0.0524) and Q-score for the entire model and for each chain.





































Chain	Atom inclusion	Q-score
All	 0.8313	 0.5690
0	 0.7994	 0.5440
1	 0.7942	 0.5600
2	 0.9169	 0.6130
3	 0.3448	 0.3840
4	 0.8388	 0.5780
5	 0.7654	 0.5500
6	 0.9659	 0.6410
7	 0.9502	 0.6220
8	 0.8724	 0.6080
A	 0.8934	 0.5900
B	 0.8970	 0.5720
D	 0.9255	 0.6190
E	 0.9193	 0.6130
F	 0.8748	 0.5950
G	 0.6698	 0.5000
H	 0.5791	 0.4830
M	 0.9181	 0.6220
N	 0.9164	 0.6040
O	 0.8745	 0.5840
P	 0.8945	 0.6050
Q	 0.8932	 0.6070
R	 0.7750	 0.5640
S	 0.8932	 0.6010
T	 0.9297	 0.6220
U	 0.9028	 0.6100
V	 0.9060	 0.6160
W	 0.8388	 0.5930
X	 0.7371	 0.5260
Y	 0.5828	 0.5130
Z	 0.9176	 0.6170
a	 0.8260	 0.5530
b	 0.2880	 0.4170
c	 0.6326	 0.5170
d	 0.6329	 0.5250



*Continued on next page...*



*Continued from previous page...*

Chain	Atom inclusion	Q-score
e	 0.7869	 0.5680
f	 0.6718	 0.5380
g	 0.5953	 0.5020
h	 0.7740	 0.5650
i	 0.6196	 0.5020
j	 0.5314	 0.4860
k	 0.6479	 0.5210
l	 0.7622	 0.5570
m	 0.5982	 0.5000
n	 0.7696	 0.5520
o	 0.7743	 0.5720
p	 0.6633	 0.5320
q	 0.6799	 0.5430
r	 0.6503	 0.5310
s	 0.5877	 0.4870
t	 0.6706	 0.5430
v	 0.3391	 0.2870
x	 0.7422	 0.5240