



Full wwPDB EM Validation Report ⓘ

Dec 17, 2022 – 10:13 am GMT

PDB ID : 6Z1U
EMDB ID : EMD-11040
Title : bovine ATP synthase F1c8-peripheral stalk domain, state 3
Authors : Spikes, T.; Montgomery, M.G.; Walker, J.E.
Deposited on : 2020-05-14
Resolution : 3.47 Å(reported)
Based on initial models : 2V7Q, 2XND, 2CLY

This is a Full wwPDB EM Validation Report for a publicly released PDB entry.

We welcome your comments at validation@mail.wwpdb.org

A user guide is available at

<https://www.wwpdb.org/validation/2017/EMValidationReportHelp>

with specific help available everywhere you see the ⓘ symbol.

The types of validation reports are described at

<http://www.wwpdb.org/validation/2017/FAQs#types>.

The following versions of software and data (see [references ⓘ](#)) were used in the production of this report:

EMDB validation analysis : 0.0.1.dev43
Mogul : 1.8.4, CSD as541be (2020)
MolProbity : 4.02b-467
buster-report : 1.1.7 (2018)
Percentile statistics : 20191225.v01 (using entries in the PDB archive December 25th 2019)
MapQ : 1.9.9
Ideal geometry (proteins) : Engh & Huber (2001)
Ideal geometry (DNA, RNA) : Parkinson et al. (1996)
Validation Pipeline (wwPDB-VP) : 2.31.3

1 Overall quality at a glance

The following experimental techniques were used to determine the structure:

ELECTRON MICROSCOPY

The reported resolution of this entry is 3.47 Å.

Percentile scores (ranging between 0-100) for global validation metrics of the entry are shown in the following graphic. The table shows the number of entries on which the scores are based.

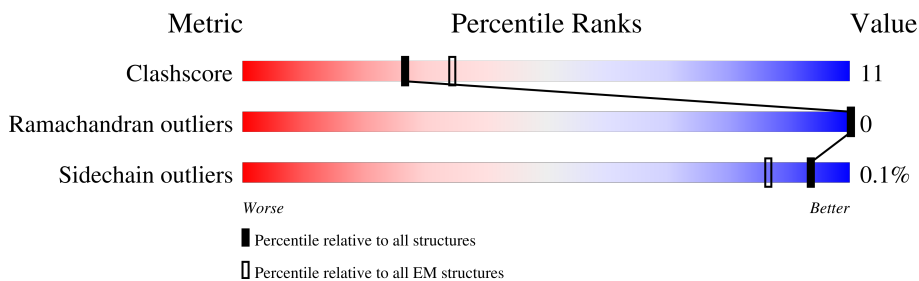

Metric	Whole archive (#Entries)	EM structures (#Entries)
Clashscore	158937	4297
Ramachandran outliers	154571	4023
Sidechain outliers	154315	3826

The table below summarises the geometric issues observed across the polymeric chains and their fit to the map. The red, orange, yellow and green segments of the bar indicate the fraction of residues that contain outliers for ≥ 3 , 2, 1 and 0 types of geometric quality criteria respectively. A grey segment represents the fraction of residues that are not modelled. The numeric value for each fraction is indicated below the corresponding segment, with a dot representing fractions $\leq 5\%$. The upper red bar (where present) indicates the fraction of residues that have poor fit to the EM map (all-atom inclusion $< 40\%$). The numeric value is given above the bar.

Mol	Chain	Length	Quality of chain
1	A	510	
1	B	510	
1	C	510	
2	D	482	
2	E	482	
2	F	482	
3	G	273	
4	H	146	

Continued on next page...

Continued from previous page...

Mol	Chain	Length	Quality of chain
5	I	50	
6	J	66	
7	K	75	
7	L	75	
7	M	75	
7	N	75	
7	O	75	
7	P	75	
7	Q	75	
7	R	75	
8	S	190	
9	b	214	
10	h	76	

2 Entry composition [i](#)

There are 14 unique types of molecules in this entry. The entry contains 65296 atoms, of which 33026 are hydrogens and 0 are deuteriums.

In the tables below, the AltConf column contains the number of residues with at least one atom in alternate conformation and the Trace column contains the number of residues modelled with at most 2 atoms.

- Molecule 1 is a protein called ATP synthase subunit alpha, mitochondrial.

Mol	Chain	Residues	Atoms					AltConf	Trace	
			Total	C	H	N	O			S
1	A	501	7742	2405	3924	673	728	12	0	0
1	B	502	7761	2408	3936	674	731	12	0	0
1	C	483	7489	2329	3799	652	697	12	0	0

There are 6 discrepancies between the modelled and reference sequences:

Chain	Residue	Modelled	Actual	Comment	Reference
A	1	GLU	GLN	variant	UNP P19483
A	481	GLY	SER	microheterogeneity	UNP P19483
B	1	GLU	GLN	variant	UNP P19483
B	481	GLY	SER	microheterogeneity	UNP P19483
C	1	GLU	GLN	variant	UNP P19483
C	481	GLY	SER	microheterogeneity	UNP P19483

- Molecule 2 is a protein called ATP synthase subunit beta, mitochondrial.

Mol	Chain	Residues	Atoms					AltConf	Trace	
			Total	C	H	N	O			S
2	D	469	7163	2254	3605	605	688	11	0	0
2	E	467	7132	2243	3593	601	684	11	0	0
2	F	467	7131	2243	3592	601	684	11	0	0

- Molecule 3 is a protein called ATP synthase subunit gamma, mitochondrial.

Mol	Chain	Residues	Atoms					AltConf	Trace	
			Total	C	H	N	O			S
3	G	272	4300	1330	2185	368	409	8	0	0

- Molecule 4 is a protein called ATP synthase subunit delta, mitochondrial.

Mol	Chain	Residues	Atoms					AltConf	Trace	
			Total	C	H	N	O			S
4	H	131	1940	609	970	163	196	2	0	0

- Molecule 5 is a protein called ATP synthase subunit epsilon, mitochondrial.

Mol	Chain	Residues	Atoms					AltConf	Trace	
			Total	C	H	N	O			S
5	I	47	764	237	395	66	64	2	0	0

- Molecule 6 is a protein called ATPase inhibitor, mitochondrial.

Mol	Chain	Residues	Atoms					AltConf	Trace	
			Total	C	H	N	O			
6	J	47	731	224	361	76	70		0	0

There are 6 discrepancies between the modelled and reference sequences:

Chain	Residue	Modelled	Actual	Comment	Reference
J	61	HIS	-	expression tag	UNP P01096
J	62	HIS	-	expression tag	UNP P01096
J	63	HIS	-	expression tag	UNP P01096
J	64	HIS	-	expression tag	UNP P01096
J	65	HIS	-	expression tag	UNP P01096
J	66	HIS	-	expression tag	UNP P01096

- Molecule 7 is a protein called ATP synthase F(0) complex subunit C2, mitochondrial.

Mol	Chain	Residues	Atoms					AltConf	Trace	
			Total	C	H	N	O			S
7	K	74	1079	351	550	82	93	3	0	0
7	L	74	1079	351	550	82	93	3	0	0
7	M	75	1095	356	558	83	94	4	0	0
7	N	75	1096	356	559	83	94	4	0	0
7	P	74	1079	351	550	82	93	3	0	0
7	Q	75	1096	356	559	83	94	4	0	0

Continued on next page...

Continued from previous page...

Mol	Chain	Residues	Atoms					AltConf	Trace	
			Total	C	H	N	O			S
7	R	75	Total	C	H	N	O	S	0	0
			1096	356	559	83	94	4		
7	O	75	Total	C	H	N	O	S	0	0
			1096	356	559	83	94	4		

- Molecule 8 is a protein called ATP synthase subunit O, mitochondrial.

Mol	Chain	Residues	Atoms					AltConf	Trace	
			Total	C	H	N	O			S
8	S	187	Total	C	H	N	O	S	0	0
			2989	915	1551	248	266	9		

- Molecule 9 is a protein called ATP synthase F(0) complex subunit B1, mitochondrial.

Mol	Chain	Residues	Atoms					AltConf	Trace	
			Total	C	H	N	O			S
9	b	47	Total	C	H	N	O	S	0	0
			789	238	405	71	71	4		

- Molecule 10 is a protein called ATP synthase-coupling factor 6, mitochondrial.

Mol	Chain	Residues	Atoms					AltConf	Trace
			Total	C	H	N	O		
10	h	22	Total	C	H	N	O	0	0
			381	117	194	36	34		

- Molecule 11 is ADENOSINE-5'-TRIPHOSPHATE (three-letter code: ATP) (formula: $C_{10}H_{16}N_5O_{13}P_3$).

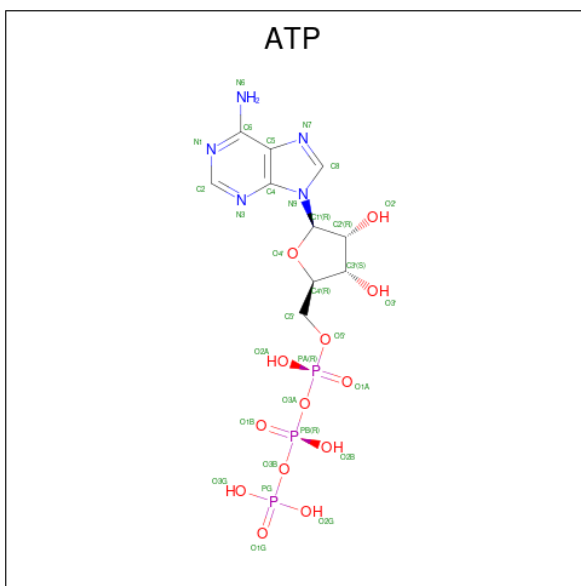

Mol	Chain	Residues	Atoms					AltConf	
			Total	C	H	N	O		P
11	A	1	43	10	12	5	13	3	0
11	B	1	43	10	12	5	13	3	0
11	C	1	43	10	12	5	13	3	0

- Molecule 12 is MAGNESIUM ION (three-letter code: MG) (formula: Mg).

Mol	Chain	Residues	Atoms		AltConf
			Total	Mg	
12	A	1	1	1	0
12	B	1	1	1	0
12	C	1	1	1	0
12	D	1	1	1	0
12	F	1	1	1	0

- Molecule 13 is ADENOSINE-5'-DIPHOSPHATE (three-letter code: ADP) (formula: C₁₀H₁₅N₅O₁₀P₂).

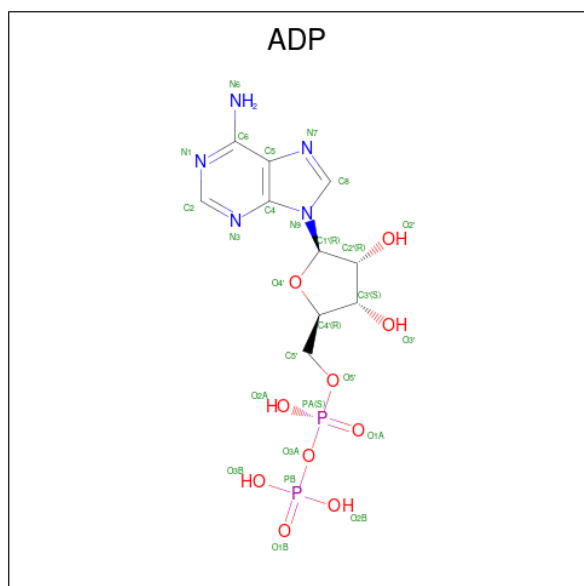

Mol	Chain	Residues	Atoms					AltConf	
			Total	C	H	N	O		P
13	D	1	39	10	12	5	10	2	0

Continued on next page...

Continued from previous page...

Mol	Chain	Residues	Atoms					AltConf	
13	E	1	Total	C	H	N	O	P	0
			39	10	12	5	10	2	
13	F	1	Total	C	H	N	O	P	0
			39	10	12	5	10	2	

- Molecule 14 is water.

Mol	Chain	Residues	Atoms		AltConf
14	A	3	Total	O	0
			3	3	
14	B	3	Total	O	0
			3	3	
14	C	3	Total	O	0
			3	3	
14	D	4	Total	O	0
			4	4	
14	F	4	Total	O	0
			4	4	

3 Residue-property plots

These plots are drawn for all protein, RNA, DNA and oligosaccharide chains in the entry. The first graphic for a chain summarises the proportions of the various outlier classes displayed in the second graphic. The second graphic shows the sequence view annotated by issues in geometry and atom inclusion in map density. Residues are color-coded according to the number of geometric quality criteria for which they contain at least one outlier: green = 0, yellow = 1, orange = 2 and red = 3 or more. A red diamond above a residue indicates a poor fit to the EM map for this residue (all-atom inclusion < 40%). Stretches of 2 or more consecutive residues without any outlier are shown as a green connector. Residues present in the sample, but not in the model, are shown in grey.

- Molecule 1: ATP synthase subunit alpha, mitochondrial

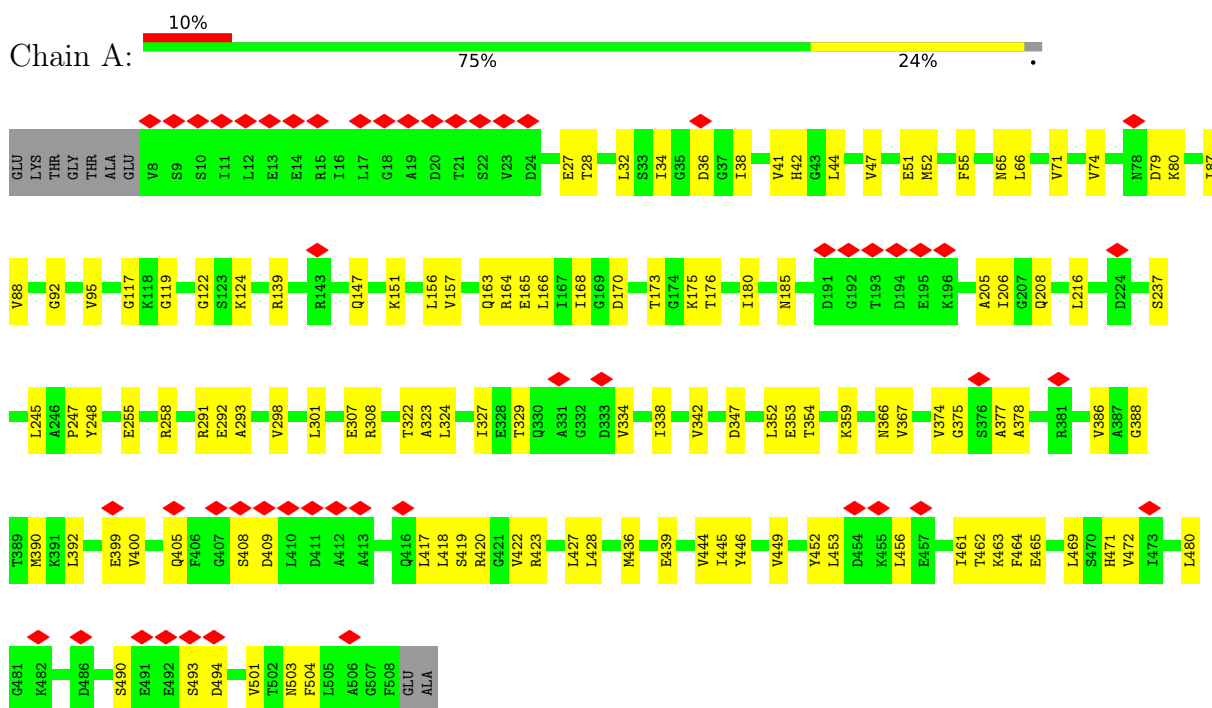

- Molecule 1: ATP synthase subunit alpha, mitochondrial

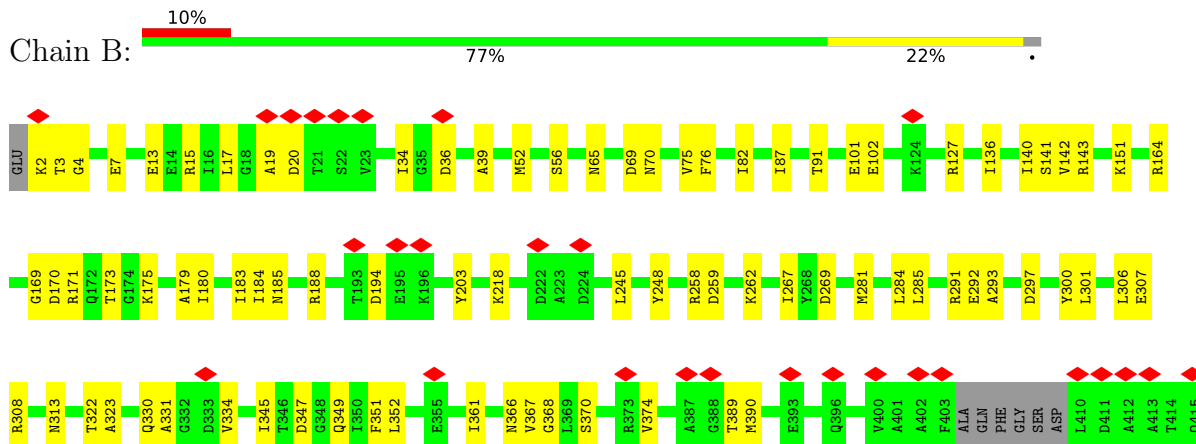

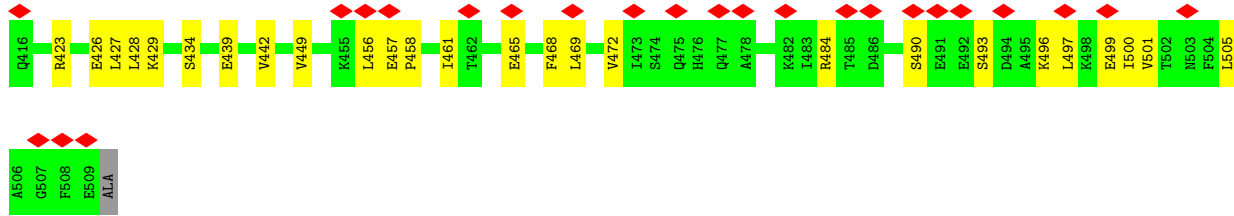

- Molecule 1: ATP synthase subunit alpha, mitochondrial

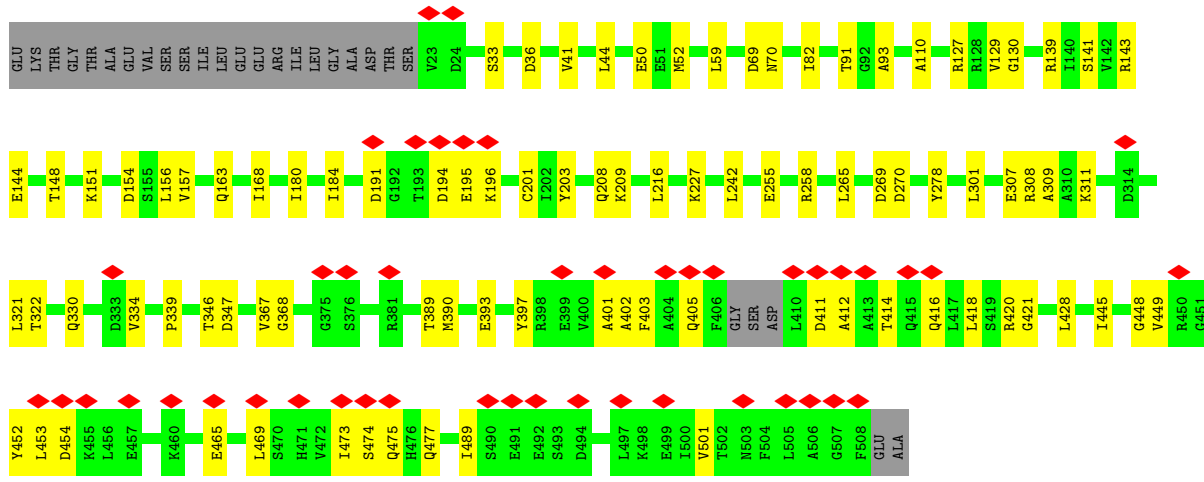
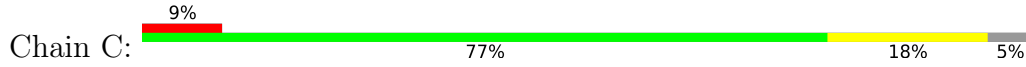

- Molecule 2: ATP synthase subunit beta, mitochondrial

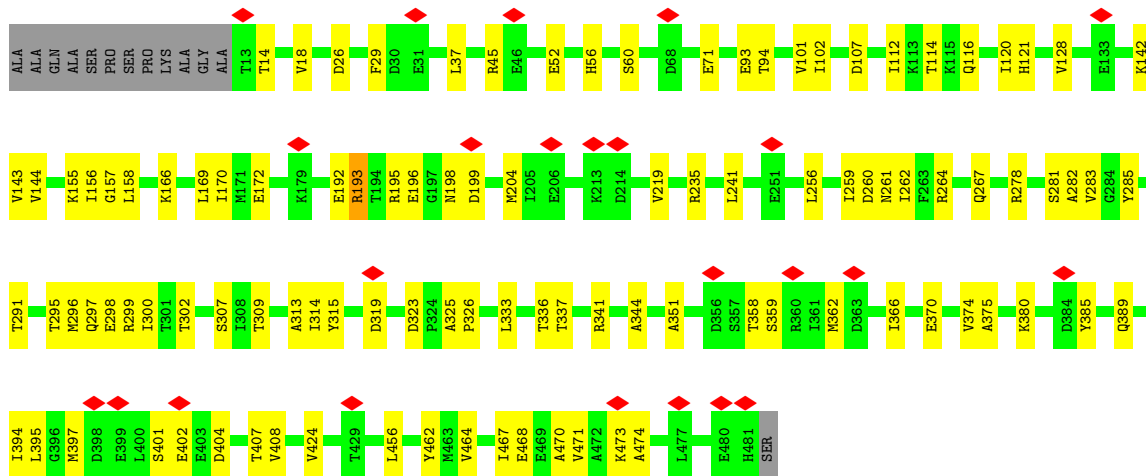
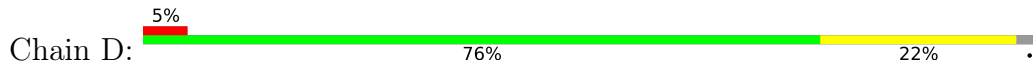

- Molecule 2: ATP synthase subunit beta, mitochondrial

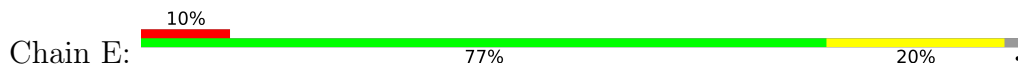

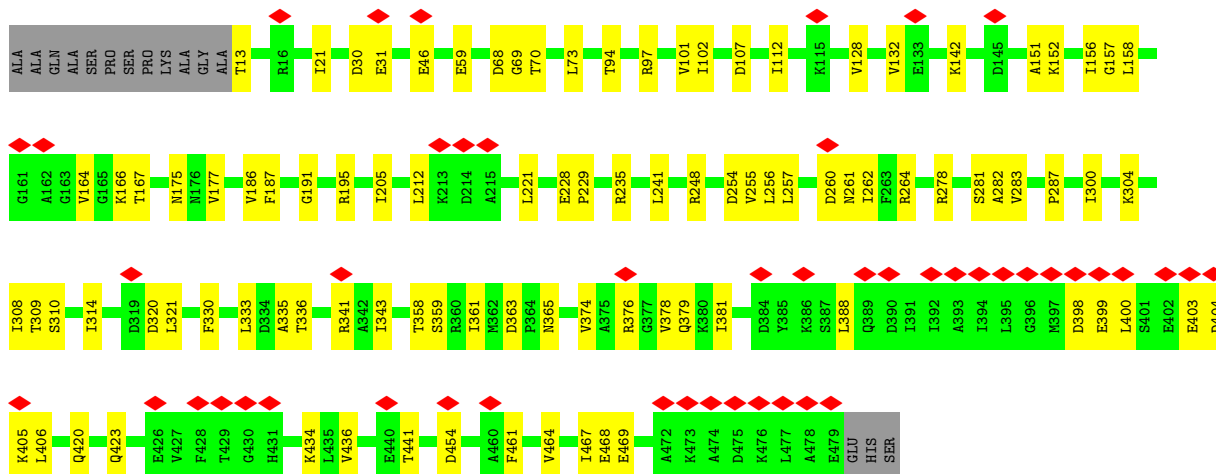

- Molecule 2: ATP synthase subunit beta, mitochondrial

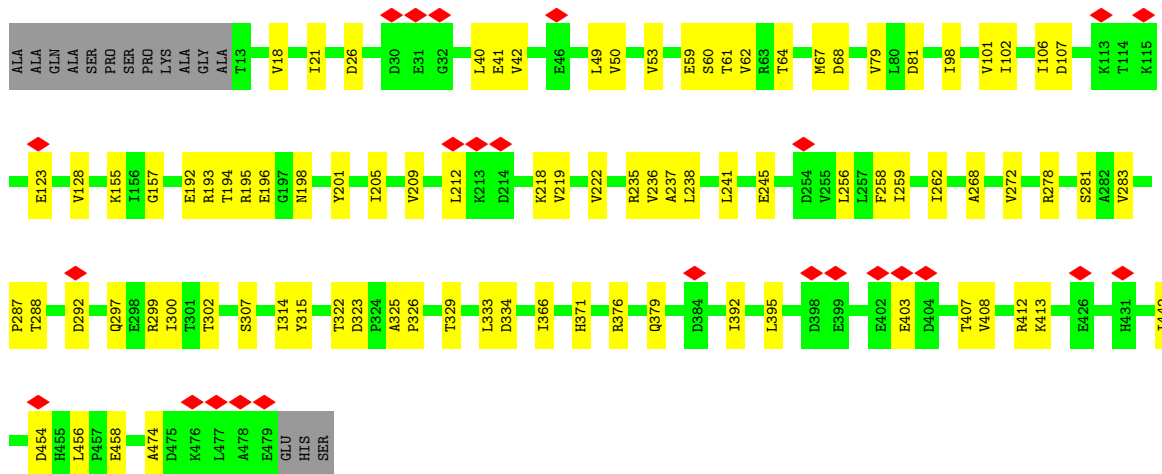
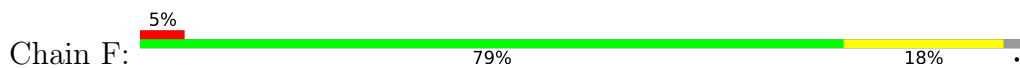

- Molecule 3: ATP synthase subunit gamma, mitochondrial

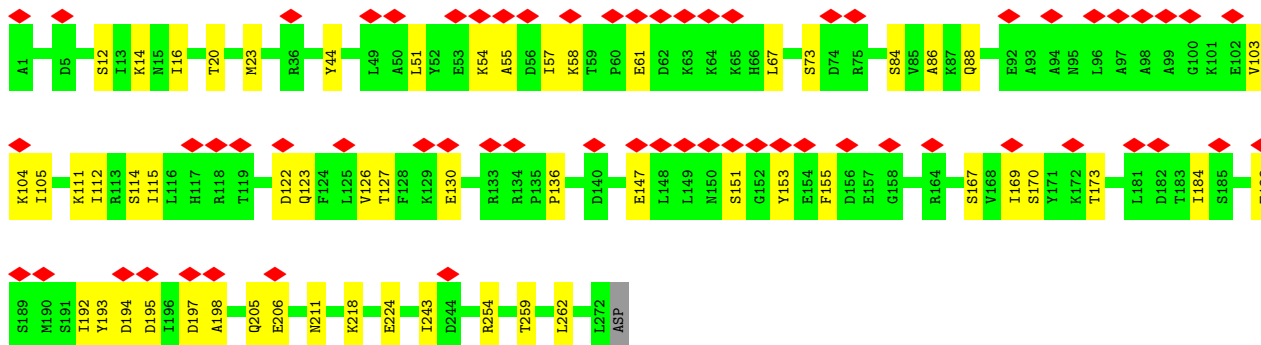
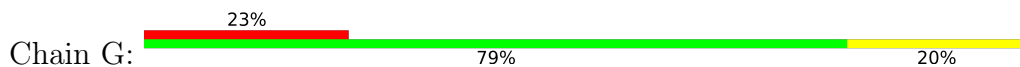

- Molecule 4: ATP synthase subunit delta, mitochondrial

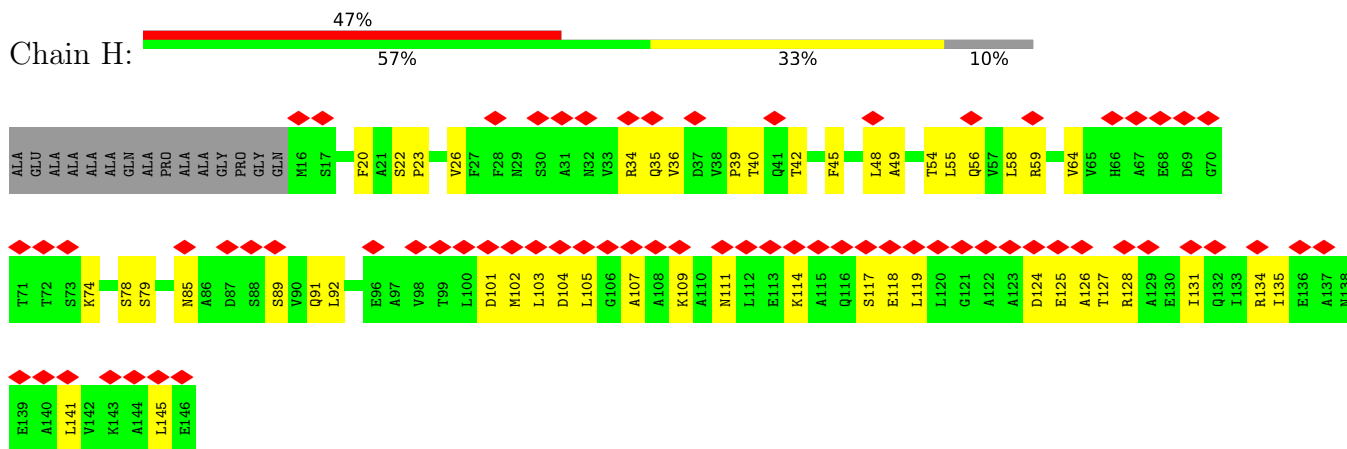

• Molecule 5: ATP synthase subunit epsilon, mitochondrial

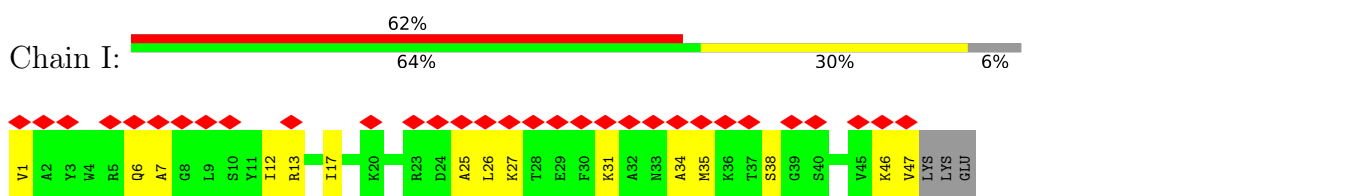

• Molecule 6: ATPase inhibitor, mitochondrial

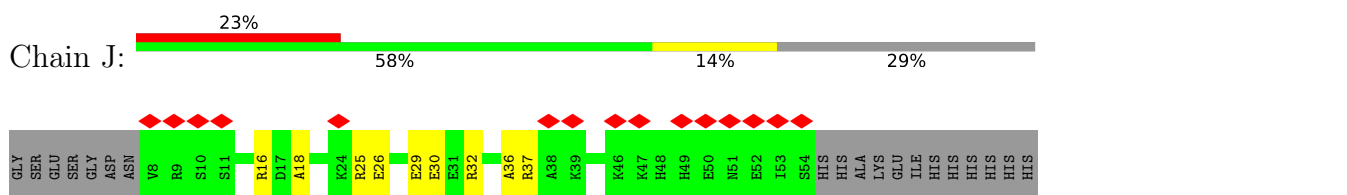

• Molecule 7: ATP synthase F(0) complex subunit C2, mitochondrial

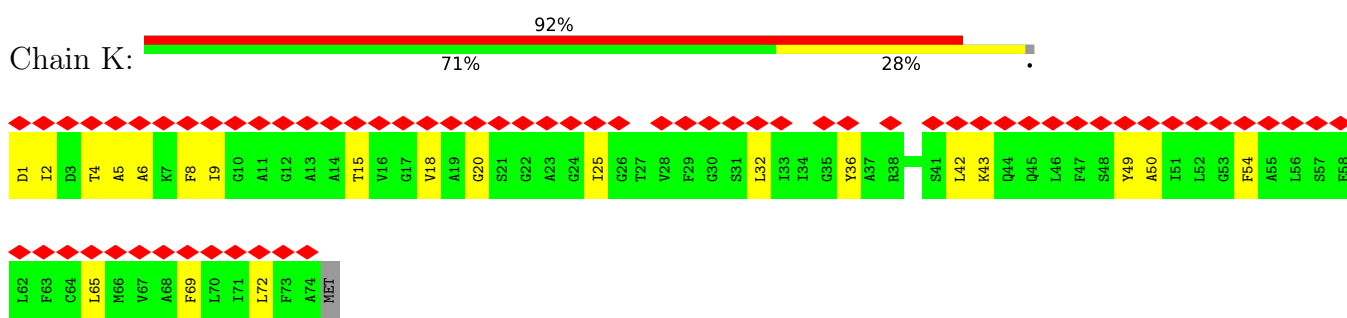

• Molecule 7: ATP synthase F(0) complex subunit C2, mitochondrial

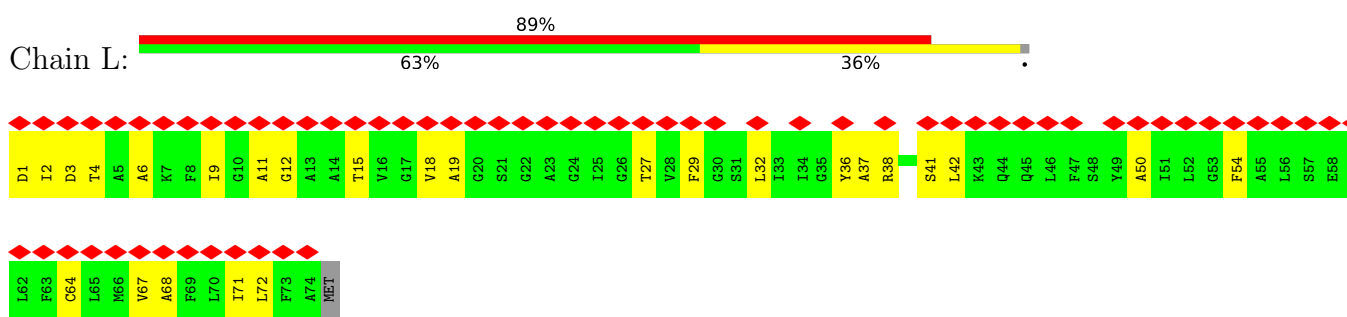

• Molecule 7: ATP synthase F(0) complex subunit C2, mitochondrial

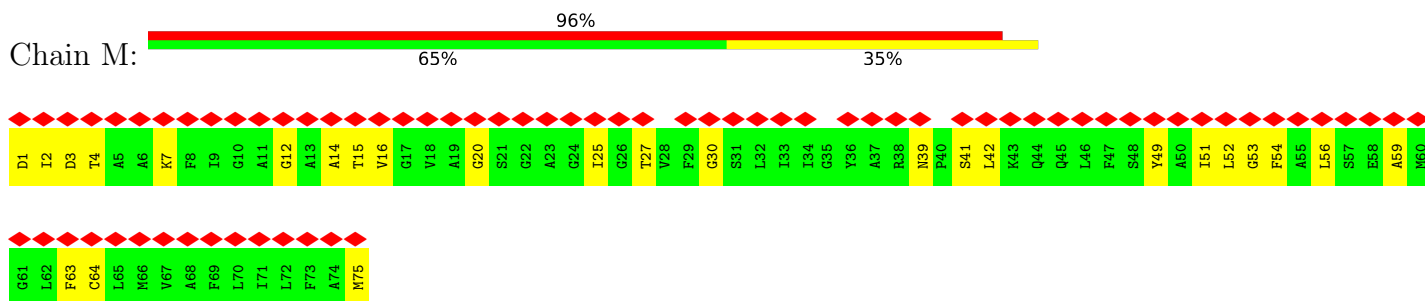

• Molecule 7: ATP synthase F(0) complex subunit C2, mitochondrial

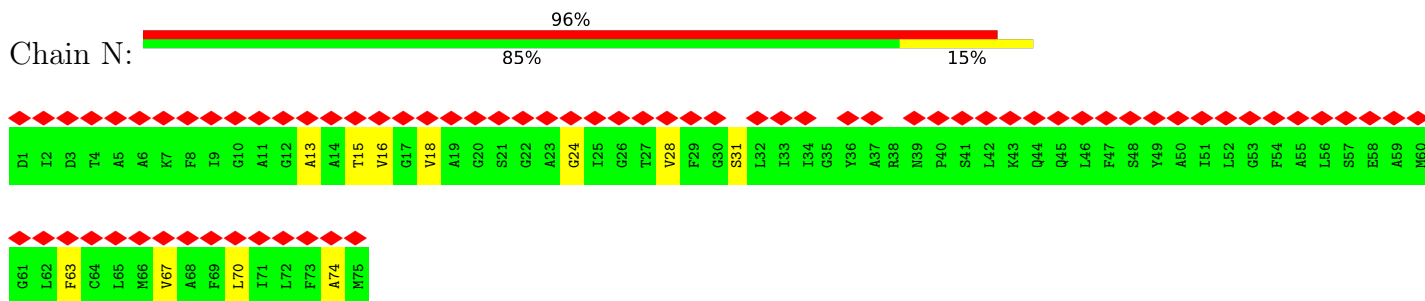

• Molecule 7: ATP synthase F(0) complex subunit C2, mitochondrial

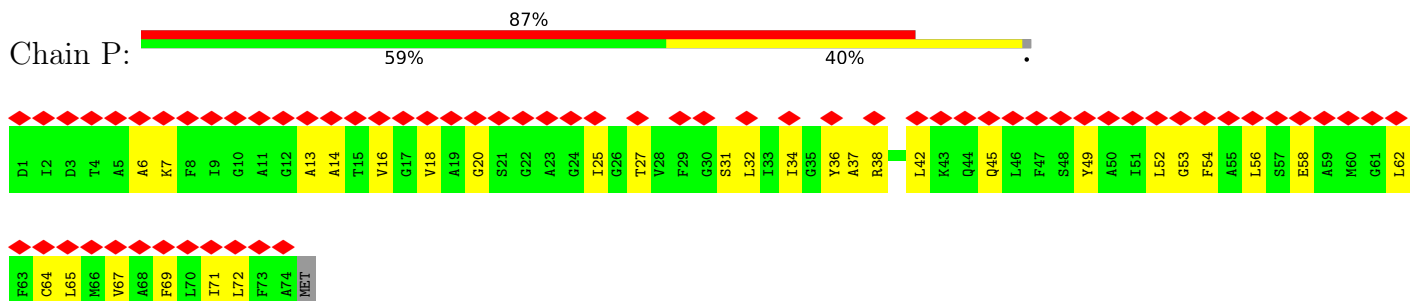

• Molecule 7: ATP synthase F(0) complex subunit C2, mitochondrial

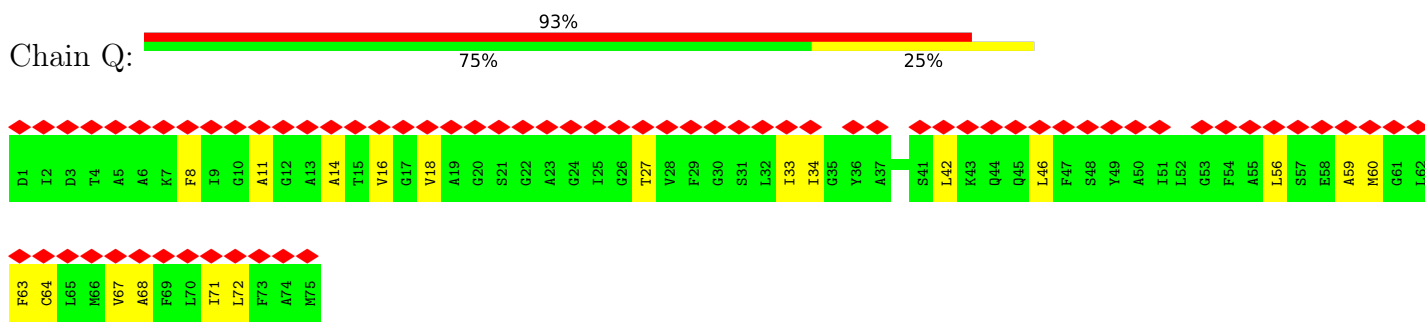

• Molecule 7: ATP synthase F(0) complex subunit C2, mitochondrial

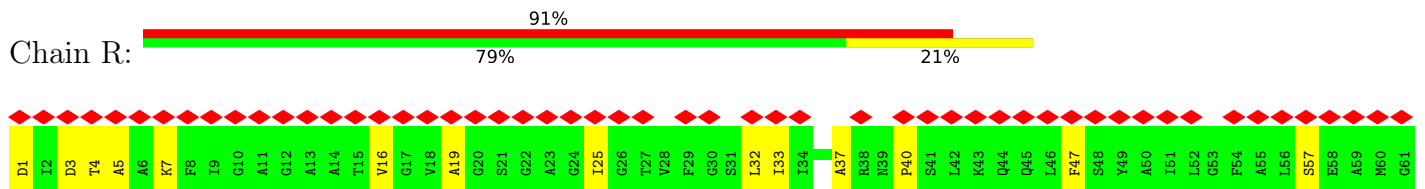

◆ ◆ ◆ ◆ ◆ ◆ ◆ ◆ ◆ ◆ ◆ ◆ ◆ ◆ ◆ ◆ ◆

ASN	LYS	GLU	LEU	D5	F6	Y7	Q8	K9	L10	F11	V12	D13	K14	I15	R16	E17	Y18	R19	T20	K21	R22	Q23	T24	S25	G26	GLY	PRO	VAL	ASP	ALA	GLY	PRO	GLU	TYR	GLN	GLN	ASP	LEU	ASP	ARG	GLU	LEU	PHE	LYS	LYS	GLN	MET	TYR	GLY	LYS	ALA	ASP	MET	ASN	THR	PHE	PRO	ASN
-----	-----	-----	-----	----	----	----	----	----	-----	-----	-----	-----	-----	-----	-----	-----	-----	-----	-----	-----	-----	-----	-----	-----	-----	-----	-----	-----	-----	-----	-----	-----	-----	-----	-----	-----	-----	-----	-----	-----	-----	-----	-----	-----	-----	-----	-----	-----	-----	-----	-----	-----	-----	-----	-----	-----	-----	-----

PHE	THR	PHE	GLU	ASP	PRO	LYS	PHE	GLU	VAL	VAL	GLU	LYS	PRO	GLN	SER
-----	-----	-----	-----	-----	-----	-----	-----	-----	-----	-----	-----	-----	-----	-----	-----

4 Experimental information

Property	Value	Source
EM reconstruction method	SINGLE PARTICLE	Depositor
Imposed symmetry	POINT, C2	Depositor
Number of particles used	61458	Depositor
Resolution determination method	FSC 0.143 CUT-OFF	Depositor
CTF correction method	PHASE FLIPPING AND AMPLITUDE CORRECTION	Depositor
Microscope	FEI TITAN KRIOS	Depositor
Voltage (kV)	300	Depositor
Electron dose ($e^-/\text{\AA}^2$)	4.6	Depositor
Minimum defocus (nm)	Not provided	
Maximum defocus (nm)	Not provided	
Magnification	Not provided	
Image detector	GATAN K2 QUANTUM (4k x 4k)	Depositor
Maximum map value	0.120	Depositor
Minimum map value	-0.072	Depositor
Average map value	-0.000	Depositor
Map value standard deviation	0.003	Depositor
Recommended contour level	0.0267	Depositor
Map size (Å)	524.0, 524.0, 524.0	wwPDB
Map dimensions	500, 500, 500	wwPDB
Map angles (°)	90.0, 90.0, 90.0	wwPDB
Pixel spacing (Å)	1.048, 1.048, 1.048	Depositor

5 Model quality

5.1 Standard geometry

Bond lengths and bond angles in the following residue types are not validated in this section: ADP, MG, ATP, M3L

The Z score for a bond length (or angle) is the number of standard deviations the observed value is removed from the expected value. A bond length (or angle) with $|Z| > 5$ is considered an outlier worth inspection. RMSZ is the root-mean-square of all Z scores of the bond lengths (or angles).

Mol	Chain	Bond lengths		Bond angles	
		RMSZ	# Z >5	RMSZ	# Z >5
1	A	0.43	0/3869	0.48	0/5220
1	B	0.43	0/3874	0.48	0/5225
1	C	0.43	0/3740	0.48	0/5044
2	D	0.44	0/3616	0.49	0/4906
2	E	0.41	0/3596	0.48	0/4879
2	F	0.43	0/3596	0.48	0/4879
3	G	0.36	0/2141	0.47	0/2876
4	H	0.31	0/982	0.48	0/1337
5	I	0.33	0/374	0.46	0/501
6	J	0.38	0/374	0.43	0/495
7	K	0.30	0/526	0.46	0/711
7	L	0.32	0/526	0.45	0/711
7	M	0.31	0/534	0.49	0/721
7	N	0.28	0/534	0.42	0/721
7	O	0.29	0/534	0.44	0/721
7	P	0.31	0/526	0.46	0/711
7	Q	0.31	0/534	0.44	0/721
7	R	0.29	0/534	0.43	0/721
8	S	0.33	0/1455	0.48	0/1957
9	b	0.26	0/386	0.40	0/512
10	h	0.30	0/189	0.43	0/251
All	All	0.40	0/32440	0.47	0/43820

There are no bond length outliers.

There are no bond angle outliers.

There are no chirality outliers.

There are no planarity outliers.

5.2 Too-close contacts

In the following table, the Non-H and H(model) columns list the number of non-hydrogen atoms and hydrogen atoms in the chain respectively. The H(added) column lists the number of hydrogen atoms added and optimized by MolProbity. The Clashes column lists the number of clashes within the asymmetric unit, whereas Symm-Clashes lists symmetry-related clashes.

Mol	Chain	Non-H	H(model)	H(added)	Clashes	Symm-Clashes
1	A	3818	3924	3924	92	0
1	B	3825	3936	3936	83	0
1	C	3690	3799	3799	62	0
2	D	3558	3605	3605	84	0
2	E	3539	3593	3593	72	0
2	F	3539	3592	3592	63	0
3	G	2115	2185	2185	50	0
4	H	970	970	970	44	0
5	I	369	395	395	12	0
6	J	370	361	361	10	0
7	K	529	550	549	23	0
7	L	529	550	550	34	0
7	M	537	558	559	21	0
7	N	537	559	559	6	0
7	O	537	559	559	33	0
7	P	529	550	550	44	0
7	Q	537	559	559	28	0
7	R	537	559	559	15	0
8	S	1438	1551	1551	39	0
9	b	384	405	405	0	0
10	h	187	194	194	0	0
11	A	31	12	12	0	0
11	B	31	12	12	1	0
11	C	31	12	12	1	0
12	A	1	0	0	0	0
12	B	1	0	0	0	0
12	C	1	0	0	0	0
12	D	1	0	0	0	0
12	F	1	0	0	0	0
13	D	27	12	12	1	0
13	E	27	12	12	2	0
13	F	27	12	12	0	0
14	A	3	0	0	1	0
14	B	3	0	0	1	0
14	C	3	0	0	2	0
14	D	4	0	0	2	0
14	F	4	0	0	4	0

Continued on next page...

Continued from previous page...

Mol	Chain	Non-H	H(model)	H(added)	Clashes	Symm-Clashes
All	All	32270	33026	33026	696	0

The all-atom clashscore is defined as the number of clashes found per 1000 atoms (including hydrogen atoms). The all-atom clashscore for this structure is 11.

All (696) close contacts within the same asymmetric unit are listed below, sorted by their clash magnitude.

Atom-1	Atom-2	Interatomic distance (Å)	Clash overlap (Å)
2:E:320:ASP:OD2	3:G:254:ARG:NH1	2.01	0.94
2:D:155:LYS:NZ	2:D:297:GLN:O	2.04	0.90
7:P:65:LEU:HD13	7:Q:63:PHE:CE2	2.08	0.89
1:B:291:ARG:NH2	2:F:323:ASP:OD1	2.05	0.89
2:E:282:ALA:O	3:G:259:THR:OG1	1.91	0.88
1:B:52:MET:O	1:B:91:THR:OG1	1.92	0.88
2:F:192:GLU:OE2	14:F:701:HOH:O	1.90	0.88
3:G:136:PRO:O	3:G:218:LYS:NZ	2.08	0.86
1:A:258:ARG:NH1	1:A:308:ARG:O	2.08	0.86
2:D:196:GLU:OE2	14:D:701:HOH:O	1.93	0.86
8:S:137:VAL:O	8:S:140:SER:OG	1.92	0.86
2:D:192:GLU:OE2	14:D:701:HOH:O	1.92	0.85
1:C:347:ASP:OD2	2:D:195:ARG:NE	2.10	0.85
8:S:155:ASP:OD1	8:S:157:SER:OG	1.93	0.85
7:L:11:ALA:HB2	7:L:72:LEU:HD21	1.57	0.84
2:F:193:ARG:NH1	14:F:702:HOH:O	2.11	0.84
1:C:203:TYR:OH	1:C:269:ASP:OD2	1.95	0.84
1:B:15:ARG:NH2	8:S:91:GLU:OE2	2.11	0.83
2:E:261:ASN:OD1	2:E:262:ILE:N	2.11	0.83
1:C:209:LYS:NZ	2:F:334:ASP:OD1	2.11	0.82
1:B:56:SER:OG	1:B:87:ILE:O	1.97	0.82
1:B:102:GLU:N	1:B:102:GLU:OE1	2.13	0.82
1:A:405:GLN:NE2	2:D:404:ASP:OD2	2.13	0.82
1:B:258:ARG:NH1	1:B:308:ARG:O	2.13	0.81
1:C:416:GLN:NE2	1:C:454:ASP:OD2	2.14	0.81
3:G:73:SER:OG	3:G:224:GLU:OE2	1.99	0.80
1:A:255:GLU:OE1	1:A:258:ARG:NH2	2.15	0.80
1:A:359:LYS:O	2:D:380:LYS:NZ	2.14	0.80
1:C:208:GLN:NE2	14:C:701:HOH:O	2.12	0.80
1:B:185:ASN:OD1	1:B:188:ARG:NH1	2.13	0.80
1:C:255:GLU:OE2	1:C:308:ARG:NE	2.15	0.80
2:E:59:GLU:OE1	8:S:17:ARG:NH1	2.15	0.80
1:C:144:GLU:OE1	1:C:311:LYS:NZ	2.14	0.80

Continued on next page...

Continued from previous page...

Atom-1	Atom-2	Interatomic distance (Å)	Clash overlap (Å)
4:H:101:ASP:O	5:I:27:LYS:NZ	2.12	0.80
2:F:412:ARG:NE	2:F:458:GLU:OE2	2.17	0.78
1:B:347:ASP:OD1	2:F:195:ARG:NE	2.18	0.77
11:B:600:ATP:O1G	14:B:701:HOH:O	2.02	0.77
1:C:448:GLY:HA2	1:C:453:LEU:HD12	1.67	0.76
2:D:385:TYR:OH	6:J:30:GLU:OE2	2.03	0.76
8:S:172:ASP:OD1	8:S:177:THR:HG21	1.86	0.76
4:H:124:ASP:OD1	4:H:125:GLU:N	2.18	0.76
2:D:319:ASP:OD2	2:D:341:ARG:NH2	2.18	0.75
2:F:155:LYS:NZ	2:F:297:GLN:O	2.18	0.75
1:A:503:ASN:OD1	1:A:504:PHE:N	2.19	0.75
1:B:164:ARG:NH1	1:B:306:LEU:O	2.19	0.75
7:L:32:LEU:HD12	7:L:50:ALA:HB2	1.68	0.75
1:A:237:SER:N	2:D:298:GLU:OE1	2.20	0.75
4:H:102:MET:O	5:I:26:LEU:HD23	1.87	0.74
4:H:42:THR:O	7:P:38:ARG:NH1	2.20	0.74
7:K:1:ASP:OD1	7:K:2:ILE:N	2.21	0.74
7:P:16:VAL:HG23	7:Q:16:VAL:HG13	1.68	0.74
2:D:285:TYR:OH	2:D:323:ASP:OD2	2.03	0.74
4:H:58:LEU:HD11	4:H:92:LEU:HD11	1.69	0.74
2:E:152:LYS:NZ	2:E:254:ASP:OD2	2.20	0.73
7:P:54:PHE:CE1	7:Q:56:LEU:HD21	2.23	0.73
2:E:403:GLU:N	2:E:403:GLU:OE1	2.22	0.72
7:M:30:GLY:O	7:N:31:SER:OG	2.05	0.72
4:H:40:THR:O	4:H:59:ARG:NH1	2.21	0.72
7:K:42:LEU:HD11	7:R:40:PRO:HG3	1.71	0.72
8:S:22:LEU:HD22	8:S:85:LEU:CD2	2.20	0.72
1:B:334:VAL:HG21	1:B:351:PHE:HZ	1.54	0.72
2:F:288:THR:OG1	2:F:292:ASP:OD2	2.05	0.72
8:S:22:LEU:HD22	8:S:85:LEU:HD22	1.72	0.72
2:F:237:ALA:O	2:F:241:LEU:HD23	1.89	0.72
2:D:45:ARG:NH1	2:D:71:GLU:O	2.23	0.72
1:C:180:ILE:HD11	1:C:216:LEU:HD11	1.72	0.72
2:E:420:GLN:NE2	2:E:434:LYS:O	2.23	0.71
8:S:41:ARG:NH2	8:S:76:GLU:O	2.22	0.71
2:F:53:VAL:HA	2:F:64:THR:HG22	1.71	0.71
1:B:101:GLU:OE2	1:B:262:LYS:NZ	2.22	0.71
1:B:334:VAL:HG21	1:B:351:PHE:CZ	2.26	0.71
4:H:127:THR:O	4:H:131:ILE:HD12	1.90	0.71
1:C:194:ASP:OD1	1:C:195:GLU:N	2.24	0.71
2:D:462:TYR:O	2:D:473:LYS:NZ	2.24	0.70

Continued on next page...

Continued from previous page...

Atom-1	Atom-2	Interatomic distance (Å)	Clash overlap (Å)
2:F:456:LEU:HD22	2:F:474:ALA:HB1	1.73	0.70
1:C:151:LYS:NZ	1:C:465:GLU:OE1	2.24	0.70
1:A:166:LEU:HD11	1:A:327:ILE:HG13	1.74	0.69
1:A:151:LYS:NZ	1:A:427:LEU:O	2.23	0.69
1:C:52:MET:O	1:C:91:THR:HG22	1.92	0.69
3:G:195:ASP:OD2	4:H:56:GLN:NE2	2.25	0.69
3:G:57:ILE:O	3:G:58:LYS:NZ	2.26	0.69
7:P:56:LEU:HD21	7:O:54:PHE:CE1	2.28	0.69
2:D:158:LEU:HD23	2:D:337:THR:CG2	2.23	0.69
3:G:16:ILE:O	3:G:20:THR:HG23	1.93	0.68
7:Q:11:ALA:HB2	7:Q:72:LEU:HD13	1.76	0.68
7:R:1:ASP:O	7:R:4:THR:OG1	2.12	0.68
3:G:51:LEU:CD1	4:H:55:LEU:HD11	2.23	0.68
7:O:1:ASP:OD1	7:O:2:ILE:N	2.26	0.68
2:E:400:LEU:O	2:E:405:LYS:NZ	2.25	0.68
7:L:1:ASP:OD1	7:L:3:ASP:N	2.26	0.68
1:B:36:ASP:OD1	2:E:278:ARG:NE	2.25	0.68
2:F:235:ARG:O	2:F:238:LEU:N	2.27	0.68
7:K:5:ALA:HB1	7:L:6:ALA:HB2	1.74	0.68
1:B:65:ASN:ND2	2:F:21:ILE:HG23	2.09	0.68
2:F:413:LYS:NZ	2:F:454:ASP:OD1	2.27	0.68
3:G:167:SER:N	3:G:170:SER:OG	2.27	0.67
2:D:291:THR:O	2:D:295:THR:HG23	1.94	0.67
2:D:283:VAL:HG12	2:D:283:VAL:O	1.94	0.67
8:S:15:GLU:N	8:S:15:GLU:OE1	2.25	0.67
2:D:158:LEU:HD23	2:D:337:THR:HG21	1.75	0.67
1:B:183:ILE:HD11	1:B:267:ILE:HD12	1.75	0.67
2:D:259:ILE:HG21	2:D:262:ILE:HD13	1.76	0.67
1:A:180:ILE:CD1	1:A:216:LEU:HD11	2.25	0.67
3:G:188:GLU:OE2	7:L:41:SER:OG	2.05	0.67
4:H:103:LEU:HD13	4:H:141:LEU:HD11	1.75	0.67
4:H:119:LEU:O	4:H:128:ARG:NH2	2.28	0.67
7:K:18:VAL:HG11	7:L:64:CYS:SG	2.34	0.67
1:B:423:ARG:NH2	1:B:456:LEU:O	2.28	0.67
8:S:118:CYS:SG	8:S:119:THR:N	2.68	0.67
1:B:169:GLY:O	1:B:175:LYS:NZ	2.22	0.66
1:B:426:GLU:OE2	1:B:429:LYS:NZ	2.24	0.66
2:D:262:ILE:HD11	2:D:296:MET:CE	2.25	0.66
7:Q:63:PHE:O	7:Q:67:VAL:HG23	1.95	0.66
2:E:175:ASN:ND2	2:E:423:GLN:OE1	2.29	0.66
1:C:59:LEU:HD12	1:C:82:ILE:HD11	1.78	0.66

Continued on next page...

Continued from previous page...

Atom-1	Atom-2	Interatomic distance (Å)	Clash overlap (Å)
1:C:110:ALA:HB3	1:C:242:LEU:HD22	1.78	0.66
2:D:94:THR:HG22	2:D:112:ILE:HG21	1.79	0.65
1:C:411:ASP:OD1	1:C:412:ALA:N	2.30	0.65
2:D:262:ILE:HD11	2:D:296:MET:HE2	1.78	0.65
8:S:122:THR:HG21	8:S:126:LEU:HD22	1.79	0.65
1:A:66:LEU:HD23	1:A:71:VAL:HG23	1.79	0.65
7:P:37:ALA:HB2	7:Q:46:LEU:HD21	1.79	0.64
7:P:65:LEU:HD11	7:Q:67:VAL:HG21	1.79	0.64
2:D:172:GLU:OE2	2:D:424:VAL:HG13	1.96	0.64
2:D:256:LEU:HD23	2:D:309:THR:HB	1.78	0.64
7:L:11:ALA:HB2	7:L:72:LEU:CD2	2.26	0.64
1:C:148:THR:OG1	1:C:154:ASP:OD1	2.15	0.64
3:G:122:ASP:OD1	3:G:123:GLN:N	2.30	0.64
1:B:136:ILE:O	2:F:198:ASN:ND2	2.31	0.64
7:L:68:ALA:O	7:L:72:LEU:HD23	1.98	0.64
7:P:13:ALA:O	7:P:16:VAL:HG12	1.98	0.63
2:E:177:VAL:HG21	2:E:256:LEU:HD21	1.79	0.63
2:F:395:LEU:HD11	6:J:25:ARG:NH1	2.14	0.63
1:A:347:ASP:OD2	2:E:195:ARG:NE	2.30	0.63
7:N:13:ALA:O	7:N:16:VAL:HG12	1.99	0.63
3:G:194:ASP:OD2	3:G:195:ASP:N	2.31	0.63
1:B:13:GLU:OE2	8:S:28:LYS:NZ	2.22	0.63
1:A:95:VAL:HG11	1:A:245:LEU:HD21	1.81	0.62
1:B:3:THR:HG22	1:B:4:GLY:H	1.63	0.62
2:E:167:THR:OG1	13:E:600:ADP:O1A	2.16	0.62
7:K:1:ASP:O	7:K:4:THR:OG1	2.15	0.62
2:E:283:VAL:HG12	2:E:283:VAL:O	1.98	0.62
2:F:283:VAL:HG12	2:F:283:VAL:O	1.99	0.62
4:H:40:THR:HG21	4:H:45:PHE:HE1	1.64	0.62
1:B:366:ASN:O	1:B:370:SER:OG	2.08	0.62
7:L:54:PHE:CE1	7:M:56:LEU:HD21	2.35	0.62
3:G:197:ASP:OD1	3:G:198:ALA:N	2.32	0.61
1:B:496:LYS:O	1:B:500:ILE:HD12	2.00	0.61
5:I:35:MET:O	5:I:38:SER:OG	2.17	0.61
3:G:126:VAL:HG22	5:I:46:LYS:NZ	2.14	0.61
1:A:41:VAL:HG11	1:A:44:LEU:HD12	1.82	0.61
1:A:175:LYS:HG2	1:A:352:LEU:HD12	1.82	0.61
1:B:170:ASP:O	1:B:175:LYS:NZ	2.34	0.61
2:E:46:GLU:OE1	2:E:46:GLU:N	2.34	0.60
3:G:51:LEU:HD13	4:H:55:LEU:HD11	1.84	0.60
2:F:192:GLU:OE2	14:F:703:HOH:O	2.16	0.60

Continued on next page...

Continued from previous page...

Atom-1	Atom-2	Interatomic distance (Å)	Clash overlap (Å)
2:D:142:LYS:NZ	2:D:464:VAL:O	2.35	0.60
1:A:47:VAL:HG23	1:A:51:GLU:OE2	2.02	0.60
2:D:337:THR:HG23	2:D:337:THR:O	2.02	0.60
1:B:505:LEU:O	1:B:505:LEU:HD23	2.02	0.59
7:K:36:TYR:CE2	7:L:42:LEU:HD23	2.37	0.59
7:L:11:ALA:CB	7:L:72:LEU:HD21	2.29	0.59
1:B:76:PHE:CZ	1:B:245:LEU:HD11	2.36	0.59
1:C:127:ARG:NH2	1:C:255:GLU:OE1	2.33	0.59
1:C:403:PHE:CE2	6:J:32:ARG:HG3	2.37	0.59
7:K:15:THR:O	7:K:18:VAL:HG12	2.03	0.59
2:E:398:ASP:OD1	2:E:399:GLU:N	2.36	0.59
1:A:322:THR:HG22	1:A:323:ALA:N	2.18	0.58
7:N:24:GLY:O	7:N:28:VAL:HG23	2.03	0.58
2:D:29:PHE:O	2:D:60:SER:OG	2.20	0.58
7:P:65:LEU:HD13	7:Q:63:PHE:CZ	2.37	0.58
7:O:43:M3L:HA	7:O:46:LEU:HD12	1.85	0.58
1:A:446:TYR:OH	1:A:494:ASP:OD1	2.13	0.58
1:A:399:GLU:HG3	1:A:400:VAL:HG13	1.85	0.58
7:P:16:VAL:HG13	7:O:16:VAL:HG13	1.85	0.58
2:F:272:VAL:HG22	2:F:272:VAL:O	2.04	0.58
2:D:468:GLU:O	2:D:471:VAL:HG22	2.03	0.58
2:E:358:THR:HG22	2:E:359:SER:N	2.19	0.58
7:K:18:VAL:HG23	7:L:60:MET:SD	2.43	0.58
1:B:439:GLU:OE2	1:B:484:ARG:NE	2.36	0.58
7:P:27:THR:HA	7:Q:27:THR:HG21	1.85	0.58
1:B:390:MET:CE	1:B:428:LEU:HD21	2.34	0.57
2:E:314:ILE:CD1	2:E:333:LEU:HD11	2.34	0.57
7:P:45:GLN:OE1	7:O:43:M3L:HM23	2.03	0.57
7:O:32:LEU:HD22	7:O:50:ALA:CB	2.33	0.57
1:C:201:CYS:SG	1:C:265:LEU:HD23	2.45	0.57
1:A:52:MET:SD	1:A:95:VAL:HG22	2.45	0.57
2:F:59:GLU:O	2:F:60:SER:OG	2.16	0.57
2:E:187:PHE:HB3	2:E:221:LEU:HD23	1.87	0.57
2:E:255:VAL:HG12	2:E:256:LEU:O	2.05	0.56
7:N:15:THR:O	7:N:18:VAL:HG22	2.04	0.56
1:B:307:GLU:OE2	2:F:194:THR:OG1	2.13	0.56
2:E:158:LEU:HD21	2:E:166:LYS:HG3	1.86	0.56
2:E:363:ASP:OD2	2:E:365:ASN:ND2	2.37	0.56
7:O:18:VAL:HG23	7:O:64:CYS:SG	2.46	0.56
2:E:30:ASP:OD1	2:E:31:GLU:N	2.38	0.56
4:H:39:PRO:O	4:H:40:THR:HG23	2.06	0.56

Continued on next page...

Continued from previous page...

Atom-1	Atom-2	Interatomic distance (Å)	Clash overlap (Å)
1:C:452:TYR:HD2	1:C:501:VAL:HG11	1.70	0.56
7:Q:18:VAL:HG21	7:R:64:CYS:SG	2.45	0.56
1:B:140:ILE:HD12	1:B:143:ARG:HE	1.71	0.56
1:B:389:THR:HG23	1:B:449:VAL:HG21	1.86	0.56
1:A:208:GLN:NE2	14:A:701:HOH:O	2.38	0.56
1:C:156:LEU:HD13	1:C:367:VAL:HG21	1.87	0.56
1:A:452:TYR:O	1:A:453:LEU:HD23	2.06	0.56
1:B:334:VAL:HG22	1:B:334:VAL:O	2.04	0.56
3:G:111:LYS:O	3:G:115:ILE:HG22	2.06	0.56
2:F:42:VAL:HG21	2:F:49:LEU:HD23	1.88	0.56
4:H:78:SER:O	4:H:79:SER:OG	2.22	0.56
1:A:206:ILE:HD11	1:A:247:PRO:HG3	1.87	0.55
7:K:9:ILE:HG23	7:L:9:ILE:HG21	1.87	0.55
1:C:473:ILE:O	1:C:477:GLN:NE2	2.38	0.55
7:P:36:TYR:CE2	7:Q:42:LEU:HD23	2.41	0.55
7:R:25:ILE:HD11	7:R:57:SER:HB2	1.87	0.55
4:H:107:ALA:O	4:H:111:ASN:ND2	2.39	0.55
4:H:126:ALA:HA	5:I:7:ALA:HB1	1.87	0.55
2:F:325:ALA:HB3	2:F:326:PRO:CD	2.36	0.55
2:D:395:LEU:HD21	3:G:23:MET:SD	2.47	0.55
1:B:2:LYS:O	1:B:3:THR:OG1	2.19	0.55
11:C:600:ATP:O1A	14:C:702:HOH:O	2.18	0.55
7:P:16:VAL:CG1	7:O:16:VAL:HG22	2.37	0.54
2:D:120:ILE:O	2:D:299:ARG:NH1	2.40	0.54
4:H:48:LEU:HG	4:H:49:ALA:H	1.71	0.54
1:A:419:SER:O	1:A:423:ARG:HD3	2.07	0.54
1:C:180:ILE:CD1	1:C:216:LEU:HD11	2.36	0.54
7:O:7:LYS:NZ	7:O:72:LEU:O	2.32	0.54
7:P:54:PHE:CD1	7:Q:56:LEU:HD21	2.42	0.54
1:B:300:TYR:O	1:B:300:TYR:CG	2.61	0.54
1:C:194:ASP:OD1	1:C:196:LYS:N	2.38	0.54
7:L:41:SER:O	7:L:42:LEU:HD12	2.07	0.54
7:P:16:VAL:HG12	7:O:16:VAL:HG22	1.88	0.54
3:G:88:GLN:HG3	3:G:173:THR:HG21	1.89	0.54
2:D:37:LEU:HD13	2:D:121:HIS:CG	2.42	0.54
3:G:206:GLU:O	5:I:12:ILE:HD11	2.07	0.54
7:L:29:PHE:CD2	7:M:53:GLY:HA3	2.43	0.54
1:B:164:ARG:NH2	1:B:345:ILE:O	2.41	0.53
1:A:28:THR:HG23	1:A:87:ILE:HG23	1.90	0.53
1:C:403:PHE:CZ	6:J:32:ARG:HG3	2.43	0.53
2:D:397:MET:HE1	2:D:408:VAL:HG11	1.89	0.53

Continued on next page...

Continued from previous page...

Atom-1	Atom-2	Interatomic distance (Å)	Clash overlap (Å)
7:P:65:LEU:HD21	7:P:69:PHE:CD2	2.44	0.53
1:A:323:ALA:O	1:A:324:LEU:HD23	2.07	0.53
7:P:18:VAL:HG11	7:Q:64:CYS:SG	2.49	0.53
1:A:41:VAL:CG2	1:A:88:VAL:HG21	2.37	0.53
1:B:203:TYR:OH	1:B:269:ASP:OD1	2.21	0.53
3:G:44:TYR:CE2	3:G:211:ASN:OD1	2.62	0.53
1:B:194:ASP:OD1	1:B:194:ASP:N	2.42	0.53
2:F:245:GLU:OE1	2:F:299:ARG:NH2	2.37	0.53
3:G:167:SER:HG	3:G:170:SER:CB	2.21	0.53
3:G:184:ILE:HG21	3:G:205:GLN:HE21	1.72	0.53
2:D:281:SER:OG	2:D:282:ALA:N	2.42	0.52
2:D:395:LEU:HD21	3:G:23:MET:CE	2.40	0.52
4:H:58:LEU:HD11	4:H:92:LEU:CD1	2.37	0.52
1:B:17:LEU:CD1	1:B:19:ALA:HB2	2.40	0.52
1:C:258:ARG:NH1	1:C:308:ARG:O	2.43	0.52
5:I:13:ARG:HH22	5:I:17:ILE:HD11	1.75	0.52
1:C:36:ASP:OD2	2:F:278:ARG:NH1	2.39	0.52
7:M:1:ASP:OD2	7:M:2:ILE:N	2.42	0.52
8:S:55:LEU:HD13	8:S:95:LEU:HD12	1.91	0.52
1:B:179:ALA:HB1	1:B:267:ILE:HD13	1.92	0.52
2:D:404:ASP:O	2:D:407:THR:N	2.42	0.52
7:P:32:LEU:HA	7:O:33:ILE:HG21	1.91	0.52
2:F:49:LEU:HD12	2:F:68:ASP:HB3	1.91	0.52
7:P:49:TYR:HB3	7:O:33:ILE:HD11	1.92	0.52
7:P:56:LEU:C	7:P:56:LEU:HD23	2.30	0.52
1:B:127:ARG:NH2	1:B:259:ASP:OD2	2.43	0.52
7:K:25:ILE:HD12	7:K:54:PHE:CD1	2.45	0.52
8:S:65:LYS:O	8:S:69:LEU:HD23	2.09	0.52
4:H:40:THR:HG21	4:H:45:PHE:CE1	2.43	0.52
7:M:25:ILE:HD12	7:M:54:PHE:CD1	2.45	0.52
2:E:97:ARG:NE	2:E:107:ASP:OD2	2.34	0.52
2:F:371:HIS:CD2	2:F:442:ILE:HD11	2.45	0.52
1:A:36:ASP:OD1	2:D:278:ARG:NH1	2.43	0.51
2:D:170:ILE:CD1	2:D:313:ALA:HB2	2.40	0.51
1:A:490:SER:O	1:A:493:SER:N	2.44	0.51
1:C:139:ARG:NH2	1:C:307:GLU:O	2.38	0.51
2:E:186:VAL:HG12	2:E:187:PHE:N	2.25	0.51
7:L:32:LEU:HD12	7:L:50:ALA:CB	2.36	0.51
1:A:38:ILE:CD1	1:A:74:VAL:HG12	2.40	0.51
2:D:193:ARG:NE	2:D:196:GLU:OE1	2.43	0.51
8:S:17:ARG:HH11	8:S:17:ARG:HG2	1.75	0.51

Continued on next page...

Continued from previous page...

Atom-1	Atom-2	Interatomic distance (Å)	Clash overlap (Å)
4:H:54:THR:O	4:H:55:LEU:HD22	2.11	0.51
8:S:127:ASP:OD2	8:S:129:ALA:N	2.44	0.51
2:E:70:THR:HB	2:E:73:LEU:HD12	1.93	0.51
7:L:4:THR:OG1	7:M:3:ASP:OD2	2.19	0.51
7:M:7:LYS:NZ	7:M:75:MET:O	2.30	0.51
2:D:93:GLU:HB2	2:D:114:THR:HG22	1.93	0.51
1:C:465:GLU:O	1:C:469:LEU:HD23	2.10	0.51
2:E:13:THR:HG23	2:E:31:GLU:CG	2.40	0.51
2:E:177:VAL:HG11	2:E:256:LEU:HD23	1.92	0.51
2:F:40:LEU:HD23	2:F:81:ASP:HA	1.91	0.51
2:F:128:VAL:HG22	2:F:128:VAL:O	2.11	0.51
1:C:414:THR:O	1:C:418:LEU:HD23	2.11	0.51
1:C:452:TYR:CD2	1:C:501:VAL:HG11	2.46	0.51
2:F:256:LEU:HD23	2:F:258:PHE:CZ	2.45	0.51
3:G:67:LEU:HD12	3:G:104:LYS:O	2.11	0.51
1:A:420:ARG:NH1	1:A:449:VAL:O	2.44	0.50
2:E:142:LYS:HG3	2:E:436:VAL:HG11	1.93	0.50
2:F:18:VAL:HG12	2:F:26:ASP:O	2.11	0.50
7:L:15:THR:O	7:L:18:VAL:HG12	2.11	0.50
1:A:322:THR:HG22	1:A:323:ALA:H	1.77	0.50
1:B:65:ASN:HD22	2:F:21:ILE:HG23	1.74	0.50
1:C:180:ILE:HG22	1:C:184:ILE:HD12	1.92	0.50
7:O:25:ILE:HD13	7:O:54:PHE:HD1	1.76	0.50
1:A:390:MET:CE	1:A:428:LEU:HD21	2.41	0.50
2:E:468:GLU:OE1	2:E:468:GLU:N	2.35	0.50
3:G:54:LYS:NZ	4:H:85:ASN:HA	2.27	0.50
7:M:41:SER:O	7:M:41:SER:OG	2.25	0.50
8:S:32:LEU:HD22	8:S:109:MET:SD	2.51	0.50
2:D:157:GLY:O	2:D:337:THR:HG22	2.10	0.50
1:B:3:THR:HG22	1:B:4:GLY:N	2.26	0.50
2:D:264:ARG:NH1	2:D:267:GLN:OE1	2.45	0.50
7:P:67:VAL:HG21	7:O:65:LEU:CD2	2.41	0.50
2:D:325:ALA:HB3	2:D:326:PRO:CD	2.42	0.49
2:F:241:LEU:CD1	2:F:300:ILE:HG13	2.41	0.49
4:H:64:VAL:O	4:H:64:VAL:HG23	2.12	0.49
1:B:322:THR:HG22	1:B:323:ALA:H	1.77	0.49
1:B:434:SER:O	1:B:434:SER:OG	2.29	0.49
2:F:222:VAL:HG12	2:F:236:VAL:HG23	1.94	0.49
2:E:94:THR:HG22	2:E:112:ILE:HG21	1.94	0.49
2:E:166:LYS:N	13:E:600:ADP:O3B	2.42	0.49
1:A:452:TYR:CD1	1:A:501:VAL:HG11	2.48	0.49

Continued on next page...

Continued from previous page...

Atom-1	Atom-2	Interatomic distance (Å)	Clash overlap (Å)
2:F:456:LEU:HD22	2:F:474:ALA:CB	2.42	0.49
7:K:6:ALA:HB2	7:R:5:ALA:HB1	1.94	0.49
1:A:38:ILE:HD13	1:A:74:VAL:HG12	1.94	0.49
2:D:166:LYS:N	13:D:600:ADP:O1B	2.45	0.49
2:E:156:ILE:HG22	2:E:157:GLY:N	2.27	0.49
1:A:27:GLU:O	1:A:28:THR:OG1	2.28	0.49
3:G:84:SER:HG	3:G:173:THR:HG1	1.56	0.49
7:L:36:TYR:CE2	7:M:42:LEU:HD21	2.47	0.49
1:B:17:LEU:HD11	1:B:19:ALA:HB2	1.94	0.49
7:Q:8:PHE:CD1	7:Q:72:LEU:HD11	2.47	0.49
1:B:390:MET:HE2	1:B:428:LEU:HD21	1.94	0.49
2:D:158:LEU:HD22	2:D:169:LEU:HD23	1.95	0.49
2:E:461:PHE:HE2	2:E:467:ILE:HD11	1.78	0.49
1:B:34:ILE:CD1	1:B:39:ALA:HB2	2.43	0.48
3:G:105:ILE:N	3:G:123:GLN:O	2.37	0.48
3:G:147:GLU:O	3:G:151:SER:OG	2.29	0.48
3:G:205:GLN:HA	3:G:205:GLN:OE1	2.13	0.48
2:E:205:ILE:HD11	2:E:212:LEU:HD11	1.93	0.48
2:D:300:ILE:O	2:D:300:ILE:HG22	2.12	0.48
2:F:209:VAL:HG12	2:F:209:VAL:O	2.14	0.48
1:A:156:LEU:CD1	1:A:367:VAL:HG11	2.44	0.48
1:B:439:GLU:O	1:B:442:VAL:HG22	2.13	0.48
2:E:309:THR:HG22	2:E:310:SER:N	2.28	0.48
1:A:117:GLY:O	1:A:119:GLY:N	2.46	0.48
8:S:120:VAL:HG23	8:S:150:LEU:HD11	1.95	0.48
2:D:198:ASN:OD1	2:D:199:ASP:N	2.47	0.48
3:G:54:LYS:NZ	4:H:85:ASN:HD22	2.12	0.48
2:D:358:THR:HG22	2:D:359:SER:N	2.29	0.48
1:A:418:LEU:O	1:A:422:VAL:HG23	2.14	0.48
1:A:74:VAL:O	1:A:74:VAL:HG23	2.13	0.48
1:B:34:ILE:HD13	1:B:39:ALA:HB2	1.96	0.48
2:D:156:ILE:HG22	2:D:157:GLY:N	2.29	0.48
8:S:87:ASN:O	8:S:90:ALA:N	2.47	0.48
1:A:298:VAL:HG21	1:A:338:ILE:HD11	1.95	0.47
2:F:262:ILE:O	2:F:262:ILE:HG13	2.14	0.47
7:M:56:LEU:O	7:M:56:LEU:HD23	2.14	0.47
1:C:390:MET:CE	1:C:428:LEU:HD21	2.43	0.47
1:C:390:MET:SD	1:C:445:ILE:HD12	2.54	0.47
7:P:6:ALA:HB2	7:O:5:ALA:HB1	1.95	0.47
2:E:142:LYS:HG2	2:E:441:THR:HG22	1.95	0.47
2:E:191:GLY:O	2:E:264:ARG:NE	2.48	0.47

Continued on next page...

Continued from previous page...

Atom-1	Atom-2	Interatomic distance (Å)	Clash overlap (Å)
1:B:465:GLU:O	1:B:469:LEU:HD23	2.14	0.47
3:G:192:ILE:O	7:L:38:ARG:NH1	2.47	0.47
1:B:330:GLN:O	1:B:331:ALA:C	2.53	0.47
1:C:334:VAL:HG12	1:C:334:VAL:O	2.15	0.47
2:D:366:ILE:HG22	2:D:366:ILE:O	2.14	0.47
2:E:281:SER:OG	2:E:282:ALA:N	2.48	0.47
2:E:128:VAL:O	2:E:304:LYS:NZ	2.39	0.47
7:P:67:VAL:HG21	7:O:65:LEU:HD23	1.95	0.47
7:Q:33:ILE:HG21	7:R:32:LEU:HA	1.95	0.47
1:A:462:THR:HG23	1:A:463:LYS:N	2.29	0.47
1:C:389:THR:OG1	1:C:449:VAL:HG21	2.15	0.47
2:D:172:GLU:OE2	2:D:424:VAL:HG22	2.14	0.47
2:E:164:VAL:HG13	2:E:341:ARG:HE	1.79	0.47
2:F:241:LEU:HD11	2:F:300:ILE:HG13	1.97	0.47
7:K:25:ILE:HD12	7:K:54:PHE:HD1	1.80	0.47
7:P:31:SER:OG	7:O:30:GLY:HA2	2.15	0.47
2:D:302:THR:HG23	2:D:307:SER:HA	1.96	0.47
8:S:177:THR:HA	8:S:180:GLN:OE1	2.15	0.47
4:H:114:LYS:O	4:H:117:SER:N	2.48	0.47
1:C:191:ASP:OD1	1:C:227:LYS:NZ	2.37	0.47
1:C:474:SER:OG	1:C:475:GLN:N	2.48	0.47
1:C:91:THR:HG23	1:C:93:ALA:H	1.80	0.46
7:P:34:ILE:HD12	7:Q:34:ILE:HG13	1.97	0.46
7:Q:8:PHE:HD1	7:Q:72:LEU:HD11	1.80	0.46
1:C:330:GLN:HB3	2:F:322:THR:HG23	1.97	0.46
2:F:403:GLU:O	2:F:407:THR:HG23	2.15	0.46
7:P:14:ALA:HB1	7:O:15:THR:HG21	1.97	0.46
1:C:50:GLU:OE2	2:D:71:GLU:OE2	2.32	0.46
2:D:394:ILE:HD11	3:G:16:ILE:HG12	1.96	0.46
2:E:388:LEU:HD21	2:E:404:ASP:OD2	2.16	0.46
1:A:436:MET:SD	1:A:469:LEU:HD11	2.56	0.46
2:E:309:THR:HG22	2:E:310:SER:H	1.79	0.46
2:F:366:ILE:O	2:F:366:ILE:HG22	2.16	0.46
5:I:31:LYS:HA	5:I:34:ALA:HB3	1.98	0.46
7:Q:16:VAL:HG23	7:R:16:VAL:HG13	1.97	0.46
1:A:388:GLY:O	1:A:392:LEU:HD23	2.14	0.46
2:D:14:THR:HG23	2:D:14:THR:O	2.16	0.46
7:P:42:LEU:HD13	7:O:36:TYR:CE2	2.51	0.46
1:B:322:THR:HG22	1:B:323:ALA:N	2.31	0.46
2:D:204:MET:HE1	2:D:219:VAL:HG11	1.97	0.46
2:D:262:ILE:HD11	2:D:296:MET:HE1	1.98	0.46

Continued on next page...

Continued from previous page...

Atom-1	Atom-2	Interatomic distance (Å)	Clash overlap (Å)
2:D:344:ALA:HB2	2:D:351:ALA:HB2	1.98	0.46
1:A:173:THR:HG22	1:A:354:THR:CG2	2.46	0.46
1:A:334:VAL:HG12	1:A:334:VAL:O	2.16	0.46
2:D:401:SER:OG	2:D:402:GLU:N	2.49	0.46
1:A:471:HIS:O	1:A:471:HIS:CG	2.69	0.45
1:B:281:MET:O	1:B:285:LEU:HG	2.16	0.45
1:C:157:VAL:HG13	1:C:157:VAL:O	2.16	0.45
1:C:367:VAL:HG12	1:C:368:GLY:N	2.31	0.45
7:Q:16:VAL:HG23	7:R:16:VAL:CG1	2.46	0.45
7:O:32:LEU:HD22	7:O:50:ALA:HB1	1.98	0.45
1:A:80:LYS:HE2	2:D:37:LEU:HD12	1.96	0.45
8:S:31:LYS:O	8:S:35:VAL:HG23	2.16	0.45
1:A:147:GLN:O	1:A:185:ASN:ND2	2.49	0.45
2:D:170:ILE:HD12	2:D:313:ALA:HB2	1.98	0.45
2:E:228:GLU:CG	2:E:229:PRO:HD2	2.47	0.45
7:P:56:LEU:HD22	7:O:25:ILE:HG12	1.97	0.45
1:A:377:ALA:O	1:A:378:ALA:HB3	2.16	0.45
1:A:472:VAL:HG12	1:A:480:LEU:HD11	1.98	0.45
1:B:140:ILE:HG23	1:B:313:ASN:HB3	1.99	0.45
1:A:139:ARG:NH2	1:A:307:GLU:O	2.42	0.45
2:E:341:ARG:HG2	2:E:341:ARG:HH11	1.81	0.45
3:G:126:VAL:HG12	3:G:127:THR:N	2.31	0.45
7:P:52:LEU:HD23	7:O:29:PHE:HE2	1.81	0.45
8:S:120:VAL:HG23	8:S:150:LEU:CD1	2.47	0.45
1:A:41:VAL:HG21	1:A:88:VAL:HG21	1.98	0.45
1:A:456:LEU:HD22	1:A:461:ILE:HD13	1.99	0.45
2:D:456:LEU:HD22	2:D:474:ALA:HB1	1.99	0.45
3:G:193:TYR:CD1	4:H:55:LEU:HD23	2.52	0.45
1:B:248:TYR:OH	1:B:301:LEU:HD12	2.17	0.45
1:C:397:TYR:O	1:C:401:ALA:HB2	2.17	0.45
2:D:101:VAL:HG13	2:D:102:ILE:HG23	1.99	0.45
2:F:392:ILE:HD11	2:F:408:VAL:HG21	1.98	0.45
3:G:103:VAL:HG12	3:G:104:LYS:N	2.31	0.45
7:K:15:THR:O	7:K:15:THR:HG22	2.17	0.45
1:C:397:TYR:CG	1:C:421:GLY:HA3	2.51	0.45
1:C:449:VAL:HG22	1:C:449:VAL:O	2.17	0.45
3:G:61:GLU:OE2	3:G:61:GLU:N	2.43	0.45
7:Q:60:MET:O	7:Q:63:PHE:HB3	2.16	0.45
8:S:5:VAL:HG23	8:S:5:VAL:O	2.17	0.45
3:G:12:SER:OG	6:J:18:ALA:HB2	2.16	0.45
1:A:157:VAL:HG13	1:A:157:VAL:O	2.16	0.45

Continued on next page...

Continued from previous page...

Atom-1	Atom-2	Interatomic distance (Å)	Clash overlap (Å)
1:A:180:ILE:HD11	1:A:216:LEU:HD11	1.98	0.45
1:B:218:LYS:HG3	2:E:132:VAL:HG21	1.99	0.45
7:L:11:ALA:CA	7:L:72:LEU:HD21	2.47	0.45
1:B:171:ARG:HA	1:B:175:LYS:HZ1	1.81	0.44
2:E:142:LYS:NZ	2:E:464:VAL:O	2.47	0.44
6:J:37:ARG:HA	6:J:37:ARG:NE	2.32	0.44
8:S:62:ARG:NH1	8:S:91:GLU:O	2.49	0.44
1:B:34:ILE:O	1:B:34:ILE:HG23	2.15	0.44
2:E:335:ALA:O	2:E:336:THR:OG1	2.26	0.44
3:G:55:ALA:HB3	3:G:57:ILE:HD11	1.99	0.44
2:E:260:ASP:HA	2:E:261:ASN:HA	1.81	0.44
2:F:61:THR:HG22	2:F:62:VAL:N	2.31	0.44
1:A:28:THR:CG2	1:A:87:ILE:HG23	2.46	0.44
2:E:241:LEU:HD23	2:E:257:LEU:CD2	2.47	0.44
2:E:376:ARG:NH1	2:E:379:GLN:OE1	2.51	0.44
5:I:1:VAL:O	5:I:6:GLN:NE2	2.51	0.44
1:A:390:MET:HE2	1:A:428:LEU:HD21	1.99	0.44
2:D:128:VAL:HG22	2:D:128:VAL:O	2.18	0.44
2:F:302:THR:HG23	2:F:307:SER:CB	2.48	0.44
1:B:20:ASP:N	1:B:20:ASP:OD1	2.50	0.44
1:B:180:ILE:HG22	1:B:184:ILE:HD12	1.99	0.44
1:C:41:VAL:HG11	1:C:44:LEU:HD12	2.00	0.44
2:E:142:LYS:CG	2:E:436:VAL:HG11	2.48	0.44
2:E:434:LYS:NZ	2:E:469:GLU:OE2	2.44	0.44
2:F:201:TYR:CZ	2:F:205:ILE:HD11	2.53	0.44
7:Q:14:ALA:HB3	7:Q:68:ALA:HB2	2.00	0.44
1:A:32:LEU:HD11	1:A:42:HIS:HB2	1.99	0.44
1:A:166:LEU:HD11	1:A:327:ILE:CG1	2.42	0.44
1:B:349:GLN:OE1	1:B:351:PHE:HE2	2.01	0.44
1:B:496:LYS:O	1:B:497:LEU:C	2.56	0.44
2:D:52:GLU:OE1	2:D:235:ARG:NE	2.51	0.44
2:E:13:THR:HG23	2:E:31:GLU:CD	2.38	0.44
4:H:105:LEU:HD13	4:H:145:LEU:HB2	1.99	0.44
7:M:1:ASP:O	7:M:4:THR:OG1	2.35	0.44
1:B:141:SER:OG	1:B:142:VAL:N	2.51	0.44
1:C:346:THR:O	2:D:193:ARG:NH1	2.50	0.44
2:D:467:ILE:O	2:D:470:ALA:HB3	2.17	0.44
2:E:321:LEU:HD22	2:E:330:PHE:HE2	1.82	0.44
1:A:47:VAL:O	1:A:47:VAL:HG13	2.18	0.44
1:B:151:LYS:NZ	1:B:465:GLU:OE2	2.50	0.44
1:C:180:ILE:CG1	1:C:216:LEU:HD11	2.48	0.44

Continued on next page...

Continued from previous page...

Atom-1	Atom-2	Interatomic distance (Å)	Clash overlap (Å)
2:E:374:VAL:O	2:E:378:VAL:HG23	2.17	0.44
2:E:436:VAL:HG13	2:E:436:VAL:O	2.18	0.44
1:A:151:LYS:NZ	1:A:465:GLU:OE2	2.32	0.43
1:A:342:VAL:HG12	1:A:342:VAL:O	2.18	0.43
2:D:107:ASP:OD1	2:D:107:ASP:N	2.44	0.43
3:G:14:LYS:HA	3:G:243:ILE:HD11	2.00	0.43
3:G:55:ALA:HB3	3:G:57:ILE:CD1	2.48	0.43
4:H:85:ASN:OD1	4:H:89:SER:C	2.57	0.43
7:K:42:LEU:O	7:K:43:M3L:C	2.65	0.43
7:R:3:ASP:N	7:R:3:ASP:OD1	2.50	0.43
1:A:66:LEU:CD2	1:A:71:VAL:HG23	2.45	0.43
1:A:439:GLU:HG3	1:A:480:LEU:HB3	2.00	0.43
7:M:12:GLY:O	7:M:15:THR:HG22	2.17	0.43
1:A:180:ILE:HD12	1:A:216:LEU:HD11	1.97	0.43
1:A:205:ALA:HB1	1:A:208:GLN:OE1	2.18	0.43
1:B:458:PRO:HA	1:B:461:ILE:CD1	2.49	0.43
2:F:268:ALA:O	2:F:272:VAL:HG12	2.18	0.43
5:I:46:LYS:HD3	5:I:47:VAL:H	1.82	0.43
8:S:175:ALA:O	8:S:179:ILE:HG12	2.18	0.43
1:B:496:LYS:O	1:B:499:GLU:HG3	2.19	0.43
7:L:18:VAL:HG11	7:M:64:CYS:SG	2.59	0.43
7:M:51:ILE:HG13	7:M:52:LEU:N	2.34	0.43
1:A:51:GLU:OE1	1:A:92:GLY:HA2	2.19	0.43
1:A:298:VAL:HG22	1:A:298:VAL:O	2.18	0.43
1:C:402:ALA:O	1:C:405:GLN:OE1	2.36	0.43
7:L:38:ARG:O	7:L:38:ARG:NH2	2.47	0.43
7:P:20:GLY:HA3	7:O:19:ALA:O	2.18	0.43
1:B:151:LYS:NZ	1:B:427:LEU:O	2.43	0.43
1:C:278:TYR:CD2	1:C:301:LEU:HD12	2.52	0.43
2:E:461:PHE:O	2:E:464:VAL:HG22	2.19	0.43
3:G:114:SER:OG	3:G:115:ILE:N	2.52	0.43
7:K:9:ILE:HG12	7:L:9:ILE:HG21	2.00	0.43
7:L:37:ALA:O	7:M:39:ASN:OD1	2.36	0.43
7:P:16:VAL:HG23	7:Q:16:VAL:CG1	2.45	0.43
7:P:18:VAL:HG13	7:Q:60:MET:CE	2.48	0.43
2:D:241:LEU:HD13	2:D:300:ILE:HG12	2.01	0.43
2:F:67:MET:CE	2:F:235:ARG:HG3	2.48	0.43
6:J:16:ARG:NH1	6:J:26:GLU:OE2	2.51	0.43
7:L:1:ASP:OD1	7:L:2:ILE:N	2.52	0.43
1:A:65:ASN:OD1	2:E:21:ILE:HG12	2.19	0.43
1:A:71:VAL:O	1:A:71:VAL:HG13	2.19	0.43

Continued on next page...

Continued from previous page...

Atom-1	Atom-2	Interatomic distance (Å)	Clash overlap (Å)
1:A:168:ILE:HD11	1:A:329:THR:HG21	2.01	0.43
2:D:344:ALA:HB2	2:D:351:ALA:CB	2.48	0.43
2:F:107:ASP:OD1	2:F:107:ASP:N	2.43	0.43
2:F:314:ILE:HG12	2:F:329:THR:HG21	2.00	0.43
4:H:127:THR:O	4:H:131:ILE:CD1	2.65	0.43
1:C:33:SER:O	1:C:33:SER:OG	2.36	0.43
7:K:65:LEU:CD1	7:K:69:PHE:HE2	2.31	0.43
7:L:19:ALA:O	7:M:20:GLY:HA3	2.19	0.43
7:O:63:PHE:O	7:O:67:VAL:HG23	2.18	0.43
1:C:163:GLN:O	1:C:322:THR:HG23	2.19	0.43
7:K:42:LEU:HD12	7:R:37:ALA:HA	2.01	0.43
7:P:53:GLY:HA3	7:O:29:PHE:HD2	1.84	0.43
1:B:7:GLU:OE2	8:S:94:ARG:NH2	2.52	0.42
8:S:56:LEU:HD12	8:S:56:LEU:O	2.19	0.42
8:S:87:ASN:O	8:S:91:GLU:OE1	2.37	0.42
1:B:468:PHE:O	1:B:472:VAL:HG22	2.19	0.42
2:D:116:GLN:OE1	2:D:116:GLN:N	2.52	0.42
2:D:362:MET:CE	2:D:375:ALA:CB	2.97	0.42
2:F:123:GLU:N	2:F:123:GLU:OE2	2.52	0.42
7:P:7:LYS:NZ	7:P:71:ILE:O	2.52	0.42
1:A:408:SER:OG	1:A:409:ASP:N	2.52	0.42
1:B:284:LEU:HD21	2:E:287:PRO:HG2	2.01	0.42
1:C:141:SER:OG	1:C:143:ARG:NH1	2.53	0.42
1:C:180:ILE:HD11	1:C:216:LEU:CD1	2.47	0.42
2:D:260:ASP:HA	2:D:261:ASN:HA	1.87	0.42
2:D:333:LEU:HD12	2:D:336:THR:HG22	2.02	0.42
3:G:153:TYR:CE2	3:G:155:PHE:HB3	2.54	0.42
4:H:22:SER:OG	4:H:23:PRO:HD2	2.18	0.42
4:H:131:ILE:HA	4:H:134:ARG:HG2	2.00	0.42
4:H:141:LEU:HD21	5:I:25:ALA:CB	2.49	0.42
7:L:29:PHE:HE2	7:M:49:TYR:O	2.01	0.42
7:N:63:PHE:O	7:N:67:VAL:HG23	2.19	0.42
7:P:25:ILE:HG21	7:Q:56:LEU:CD2	2.50	0.42
7:P:64:CYS:SG	7:O:18:VAL:HB	2.59	0.42
1:A:176:THR:O	1:A:180:ILE:HG12	2.18	0.42
2:D:71:GLU:OE2	2:D:71:GLU:HA	2.19	0.42
2:F:205:ILE:CD1	2:F:212:LEU:HD21	2.50	0.42
2:F:218:LYS:O	2:F:219:VAL:HG23	2.20	0.42
4:H:35:GLN:NE2	4:H:36:VAL:O	2.52	0.42
4:H:85:ASN:ND2	4:H:91:GLN:OE1	2.45	0.42
7:K:49:TYR:HB2	7:R:33:ILE:CD1	2.49	0.42

Continued on next page...

Continued from previous page...

Atom-1	Atom-2	Interatomic distance (Å)	Clash overlap (Å)
7:P:25:ILE:HG21	7:Q:56:LEU:HD21	2.00	0.42
7:R:7:LYS:HD2	7:R:71:ILE:O	2.19	0.42
8:S:118:CYS:O	8:S:119:THR:OG1	2.26	0.42
1:B:361:ILE:HG22	1:B:361:ILE:O	2.18	0.42
2:F:314:ILE:HG22	2:F:315:TYR:N	2.34	0.42
7:Q:11:ALA:CB	7:Q:72:LEU:HD13	2.45	0.42
8:S:131:LEU:CD2	8:S:152:VAL:HG21	2.50	0.42
7:O:11:ALA:O	7:O:15:THR:HG22	2.20	0.42
1:B:69:ASP:OD2	1:B:70:ASN:N	2.53	0.42
2:E:248:ARG:NH1	2:E:308:ILE:HD12	2.34	0.42
2:F:98:ILE:HG22	2:F:106:ILE:HG12	2.01	0.42
2:F:259:ILE:HG21	2:F:262:ILE:HD13	2.02	0.42
3:G:54:LYS:HZ3	4:H:85:ASN:HA	1.84	0.42
7:P:31:SER:CB	7:O:30:GLY:HA2	2.49	0.42
7:P:65:LEU:HD23	7:P:65:LEU:O	2.19	0.42
8:S:55:LEU:HD13	8:S:95:LEU:CD1	2.49	0.42
1:A:122:GLY:O	1:A:124:LYS:NZ	2.45	0.42
1:B:374:VAL:O	1:B:374:VAL:HG12	2.18	0.42
2:E:101:VAL:HG13	2:E:102:ILE:HG23	2.01	0.42
7:L:67:VAL:O	7:L:71:ILE:HG13	2.19	0.42
8:S:98:THR:N	8:S:99:PRO:HD2	2.35	0.42
1:A:291:ARG:HA	3:G:262:LEU:HD21	2.01	0.42
2:D:18:VAL:HG22	2:D:26:ASP:O	2.20	0.42
2:E:156:ILE:CG2	2:E:157:GLY:N	2.83	0.42
2:F:196:GLU:OE2	14:F:702:HOH:O	2.22	0.42
3:G:57:ILE:HD12	3:G:57:ILE:H	1.85	0.42
5:I:46:LYS:HA	5:I:46:LYS:HE2	2.02	0.42
1:A:163:GLN:NE2	1:A:165:GLU:OE1	2.53	0.42
1:A:353:GLU:OE1	1:A:366:ASN:ND2	2.53	0.42
1:A:170:ASP:O	1:A:175:LYS:NZ	2.51	0.42
1:B:75:VAL:HG11	1:B:82:ILE:CD1	2.50	0.42
1:B:173:THR:HG22	1:B:352:LEU:HB3	2.02	0.42
1:B:367:VAL:HG12	1:B:368:GLY:N	2.35	0.42
1:C:129:VAL:HG23	1:C:130:GLY:N	2.34	0.42
1:C:168:ILE:HD11	1:C:339:PRO:HB3	2.01	0.42
2:D:395:LEU:HD21	3:G:23:MET:HE2	2.01	0.42
7:Q:56:LEU:O	7:Q:59:ALA:HB3	2.20	0.42
1:A:173:THR:HG22	1:A:354:THR:HG23	2.02	0.41
2:F:40:LEU:HB3	2:F:79:VAL:CG1	2.50	0.41
7:K:8:PHE:HD1	7:K:72:LEU:HD11	1.85	0.41
1:C:269:ASP:HA	1:C:270:ASP:HA	1.82	0.41

Continued on next page...

Continued from previous page...

Atom-1	Atom-2	Interatomic distance (Å)	Clash overlap (Å)
2:D:283:VAL:O	2:D:283:VAL:CG1	2.66	0.41
7:L:27:THR:HA	7:M:27:THR:HG21	2.02	0.41
7:N:70:LEU:O	7:N:74:ALA:O	2.37	0.41
7:P:58:GLU:O	7:P:62:LEU:HG	2.20	0.41
7:O:25:ILE:HD13	7:O:54:PHE:CD1	2.54	0.41
1:A:374:VAL:HG23	1:A:375:GLY:N	2.35	0.41
2:D:112:ILE:HG22	2:D:114:THR:HG23	2.01	0.41
4:H:64:VAL:HG12	4:H:74:LYS:HG2	2.02	0.41
2:D:314:ILE:HG22	2:D:315:TYR:O	2.20	0.41
2:E:228:GLU:HG2	2:E:229:PRO:HD2	2.02	0.41
7:R:16:VAL:HG22	7:R:16:VAL:O	2.20	0.41
1:A:444:VAL:CG2	1:A:469:LEU:HD21	2.51	0.41
2:E:68:ASP:OD1	2:E:69:GLY:N	2.47	0.41
2:E:343:ILE:O	2:E:343:ILE:HG22	2.20	0.41
3:G:169:ILE:HG22	3:G:169:ILE:O	2.21	0.41
6:J:29:GLU:OE1	6:J:29:GLU:HA	2.21	0.41
8:S:176:LYS:O	8:S:180:GLN:OE1	2.39	0.41
1:A:34:ILE:HG22	2:D:56:HIS:HB2	2.02	0.41
1:A:248:TYR:OH	1:A:301:LEU:HD12	2.21	0.41
1:A:375:GLY:O	1:A:377:ALA:O	2.39	0.41
1:C:489:ILE:HG22	1:C:489:ILE:O	2.21	0.41
7:L:11:ALA:HB2	7:L:72:LEU:CG	2.51	0.41
7:O:14:ALA:O	7:O:64:CYS:HB2	2.21	0.41
1:C:69:ASP:OD1	1:C:70:ASN:N	2.53	0.41
2:D:389:GLN:HG2	6:J:26:GLU:OE1	2.20	0.41
2:E:406:LEU:HD11	2:E:454:ASP:OD1	2.20	0.41
2:F:157:GLY:HA3	2:F:333:LEU:HD13	2.01	0.41
4:H:105:LEU:HG	4:H:109:LYS:HZ2	1.86	0.41
1:A:464:PHE:O	1:A:465:GLU:C	2.59	0.41
4:H:104:ASP:HB3	4:H:107:ALA:HB3	2.03	0.41
7:L:12:GLY:HA2	7:M:14:ALA:HB2	2.01	0.41
1:A:55:PHE:CD2	1:A:88:VAL:HG22	2.56	0.41
1:A:79:ASP:N	1:A:79:ASP:OD1	2.50	0.41
1:A:386:VAL:HG11	1:A:445:ILE:HB	2.03	0.41
1:B:457:GLU:O	1:B:458:PRO:C	2.59	0.41
2:D:143:VAL:HG13	2:D:144:VAL:N	2.35	0.41
2:D:300:ILE:O	2:D:300:ILE:CG2	2.68	0.41
2:E:241:LEU:HD21	2:E:300:ILE:CG1	2.51	0.41
3:G:130:GLU:CD	3:G:130:GLU:O	2.59	0.41
4:H:34:ARG:HG3	4:H:35:GLN:N	2.36	0.41
6:J:36:ALA:HB1	6:J:37:ARG:NH2	2.36	0.41

Continued on next page...

Continued from previous page...

Atom-1	Atom-2	Interatomic distance (Å)	Clash overlap (Å)
7:L:11:ALA:N	7:L:72:LEU:HD21	2.35	0.41
7:M:59:ALA:O	7:M:63:PHE:CD1	2.74	0.41
7:P:6:ALA:CB	7:O:5:ALA:HB1	2.51	0.41
8:S:45:ILE:HD11	8:S:76:GLU:OE2	2.21	0.41
1:C:393:GLU:OE2	1:C:420:ARG:HG2	2.21	0.41
4:H:26:VAL:O	4:H:26:VAL:HG13	2.21	0.41
4:H:114:LYS:O	4:H:118:GLU:OE1	2.39	0.41
7:K:49:TYR:CG	7:R:47:PHE:HZ	2.39	0.41
7:M:16:VAL:O	7:M:16:VAL:HG12	2.19	0.41
8:S:130:THR:HA	8:S:133:GLU:HG2	2.03	0.41
1:B:292:GLU:O	1:B:293:ALA:HB3	2.21	0.40
2:E:378:VAL:O	2:E:381:ILE:HG22	2.21	0.40
3:G:86:ALA:CB	3:G:115:ILE:HD13	2.51	0.40
3:G:112:ILE:HA	3:G:115:ILE:HG22	2.04	0.40
4:H:20:PHE:HD1	4:H:92:LEU:O	2.05	0.40
4:H:131:ILE:HG22	4:H:135:ILE:HD12	2.02	0.40
7:K:8:PHE:N	7:K:8:PHE:CD1	2.89	0.40
7:K:32:LEU:HD22	7:K:50:ALA:CB	2.51	0.40
7:P:16:VAL:CG1	7:O:16:VAL:HG13	2.51	0.40
8:S:118:CYS:SG	8:S:150:LEU:HD13	2.61	0.40
1:A:453:LEU:HD13	1:A:461:ILE:HD12	2.02	0.40
1:B:136:ILE:HD13	2:F:194:THR:HG23	2.03	0.40
1:B:390:MET:HE1	1:B:428:LEU:HD21	2.00	0.40
1:B:490:SER:O	1:B:493:SER:N	2.53	0.40
1:C:309:ALA:HB1	1:C:321:LEU:O	2.21	0.40
2:F:41:GLU:OE2	2:F:50:VAL:HG22	2.21	0.40
2:F:376:ARG:NH1	2:F:379:GLN:OE1	2.50	0.40
8:S:147:VAL:HG12	8:S:148:LEU:N	2.36	0.40
2:D:204:MET:CE	2:D:219:VAL:HG11	2.52	0.40
2:E:101:VAL:HG23	2:E:235:ARG:O	2.21	0.40
2:F:281:SER:HB2	2:F:287:PRO:HA	2.02	0.40
8:S:174:SER:OG	8:S:177:THR:HG23	2.21	0.40
1:A:417:LEU:HD23	1:A:417:LEU:HA	1.97	0.40
1:A:463:LYS:O	1:A:464:PHE:C	2.59	0.40
1:B:297:ASP:OD2	1:B:297:ASP:O	2.39	0.40
2:D:456:LEU:HD22	2:D:474:ALA:CB	2.51	0.40
2:E:151:ALA:HB2	2:E:361:ILE:HD13	2.01	0.40
2:F:101:VAL:HG13	2:F:102:ILE:N	2.37	0.40
4:H:42:THR:OG1	4:H:56:GLN:NE2	2.55	0.40
7:O:60:MET:HA	7:O:63:PHE:CE2	2.57	0.40
1:A:292:GLU:O	1:A:293:ALA:HB3	2.21	0.40

Continued on next page...

Continued from previous page...

Atom-1	Atom-2	Interatomic distance (Å)	Clash overlap (Å)
1:B:497:LEU:O	1:B:501:VAL:HG12	2.22	0.40
2:D:370:GLU:O	2:D:374:VAL:HG23	2.22	0.40
2:E:13:THR:HG23	2:E:31:GLU:OE2	2.21	0.40
7:K:20:GLY:HA3	7:R:19:ALA:HA	2.04	0.40
7:L:32:LEU:C	7:L:32:LEU:HD23	2.42	0.40
7:P:72:LEU:HD11	7:Q:71:ILE:HD11	2.02	0.40
8:S:87:ASN:O	8:S:90:ALA:HB3	2.22	0.40

There are no symmetry-related clashes.

5.3 Torsion angles [i](#)

5.3.1 Protein backbone [i](#)

In the following table, the Percentiles column shows the percent Ramachandran outliers of the chain as a percentile score with respect to all PDB entries followed by that with respect to all EM entries.

The Analysed column shows the number of residues for which the backbone conformation was analysed, and the total number of residues.

Mol	Chain	Analysed	Favoured	Allowed	Outliers	Percentiles	
1	A	499/510 (98%)	449 (90%)	50 (10%)	0	100	100
1	B	498/510 (98%)	450 (90%)	48 (10%)	0	100	100
1	C	479/510 (94%)	430 (90%)	49 (10%)	0	100	100
2	D	467/482 (97%)	417 (89%)	50 (11%)	0	100	100
2	E	465/482 (96%)	415 (89%)	50 (11%)	0	100	100
2	F	465/482 (96%)	416 (90%)	49 (10%)	0	100	100
3	G	270/273 (99%)	256 (95%)	14 (5%)	0	100	100
4	H	129/146 (88%)	118 (92%)	11 (8%)	0	100	100
5	I	45/50 (90%)	42 (93%)	3 (7%)	0	100	100
6	J	45/66 (68%)	40 (89%)	5 (11%)	0	100	100
7	K	71/75 (95%)	67 (94%)	4 (6%)	0	100	100
7	L	71/75 (95%)	69 (97%)	2 (3%)	0	100	100
7	M	72/75 (96%)	70 (97%)	2 (3%)	0	100	100
7	N	72/75 (96%)	68 (94%)	4 (6%)	0	100	100

Continued on next page...

Continued from previous page...

Mol	Chain	Analysed	Favoured	Allowed	Outliers	Percentiles	
7	O	72/75 (96%)	68 (94%)	4 (6%)	0	100	100
7	P	71/75 (95%)	66 (93%)	5 (7%)	0	100	100
7	Q	72/75 (96%)	72 (100%)	0	0	100	100
7	R	72/75 (96%)	68 (94%)	4 (6%)	0	100	100
8	S	185/190 (97%)	169 (91%)	16 (9%)	0	100	100
9	b	45/214 (21%)	42 (93%)	3 (7%)	0	100	100
10	h	20/76 (26%)	19 (95%)	1 (5%)	0	100	100
All	All	4185/4591 (91%)	3811 (91%)	374 (9%)	0	100	100

There are no Ramachandran outliers to report.

5.3.2 Protein sidechains [i](#)

In the following table, the Percentiles column shows the percent sidechain outliers of the chain as a percentile score with respect to all PDB entries followed by that with respect to all EM entries.

The Analysed column shows the number of residues for which the sidechain conformation was analysed, and the total number of residues.

Mol	Chain	Analysed	Rotameric	Outliers	Percentiles	
1	A	406/412 (98%)	405 (100%)	1 (0%)	93	98
1	B	407/412 (99%)	407 (100%)	0	100	100
1	C	391/412 (95%)	391 (100%)	0	100	100
2	D	379/386 (98%)	378 (100%)	1 (0%)	92	97
2	E	377/386 (98%)	377 (100%)	0	100	100
2	F	377/386 (98%)	377 (100%)	0	100	100
3	G	230/231 (100%)	230 (100%)	0	100	100
4	H	104/109 (95%)	104 (100%)	0	100	100
5	I	38/41 (93%)	38 (100%)	0	100	100
6	J	34/50 (68%)	34 (100%)	0	100	100
7	K	49/50 (98%)	49 (100%)	0	100	100
7	L	49/50 (98%)	49 (100%)	0	100	100
7	M	50/50 (100%)	50 (100%)	0	100	100
7	N	50/50 (100%)	50 (100%)	0	100	100

Continued on next page...

Continued from previous page...

Mol	Chain	Analysed	Rotameric	Outliers	Percentiles	
7	O	50/50 (100%)	50 (100%)	0	100	100
7	P	49/50 (98%)	49 (100%)	0	100	100
7	Q	50/50 (100%)	50 (100%)	0	100	100
7	R	50/50 (100%)	50 (100%)	0	100	100
8	S	162/165 (98%)	162 (100%)	0	100	100
9	b	43/190 (23%)	43 (100%)	0	100	100
10	h	21/70 (30%)	21 (100%)	0	100	100
All	All	3366/3650 (92%)	3364 (100%)	2 (0%)	93	98

All (2) residues with a non-rotameric sidechain are listed below:

Mol	Chain	Res	Type
1	A	164	ARG
2	D	193	ARG

Sometimes sidechains can be flipped to improve hydrogen bonding and reduce clashes. All (4) such sidechains are listed below:

Mol	Chain	Res	Type
1	A	405	GLN
1	B	65	ASN
3	G	205	GLN
3	G	211	ASN

5.3.3 RNA [i](#)

There are no RNA molecules in this entry.

5.4 Non-standard residues in protein, DNA, RNA chains [i](#)

8 non-standard protein/DNA/RNA residues are modelled in this entry.

In the following table, the Counts columns list the number of bonds (or angles) for which Mogul statistics could be retrieved, the number of bonds (or angles) that are observed in the model and the number of bonds (or angles) that are defined in the Chemical Component Dictionary. The Link column lists molecule types, if any, to which the group is linked. The Z score for a bond length (or angle) is the number of standard deviations the observed value is removed from the expected value. A bond length (or angle) with $|Z| > 2$ is considered an outlier worth inspection. RMSZ is the root-mean-square of all Z scores of the bond lengths (or angles).

Mol	Type	Chain	Res	Link	Bond lengths			Bond angles		
					Counts	RMSZ	# Z > 2	Counts	RMSZ	# Z > 2
7	M3L	Q	43	7	10,11,12	0.50	0	9,14,16	0.46	0
7	M3L	P	43	7	10,11,12	0.50	0	9,14,16	0.48	0
7	M3L	R	43	7	10,11,12	0.51	0	9,14,16	0.61	0
7	M3L	K	43	7	10,11,12	0.45	0	9,14,16	0.62	0
7	M3L	N	43	7	10,11,12	0.57	0	9,14,16	0.64	0
7	M3L	L	43	7	10,11,12	0.48	0	9,14,16	0.66	0
7	M3L	M	43	7	10,11,12	0.46	0	9,14,16	0.49	0
7	M3L	O	43	7	10,11,12	0.45	0	9,14,16	0.41	0

In the following table, the Chirals column lists the number of chiral outliers, the number of chiral centers analysed, the number of these observed in the model and the number defined in the Chemical Component Dictionary. Similar counts are reported in the Torsion and Rings columns. '-' means no outliers of that kind were identified.

Mol	Type	Chain	Res	Link	Chirals	Torsions	Rings
7	M3L	Q	43	7	-	1/9/10/12	-
7	M3L	P	43	7	-	0/9/10/12	-
7	M3L	R	43	7	-	1/9/10/12	-
7	M3L	K	43	7	-	0/9/10/12	-
7	M3L	N	43	7	-	1/9/10/12	-
7	M3L	L	43	7	-	1/9/10/12	-
7	M3L	M	43	7	-	1/9/10/12	-
7	M3L	O	43	7	-	5/9/10/12	-

There are no bond length outliers.

There are no bond angle outliers.

There are no chirality outliers.

All (10) torsion outliers are listed below:

Mol	Chain	Res	Type	Atoms
7	L	43	M3L	CG-CD-CE-NZ
7	N	43	M3L	CG-CD-CE-NZ
7	R	43	M3L	CG-CD-CE-NZ
7	O	43	M3L	CE-CD-CG-CB
7	Q	43	M3L	CE-CD-CG-CB
7	O	43	M3L	N-CA-CB-CG
7	M	43	M3L	CE-CD-CG-CB
7	O	43	M3L	CD-CE-NZ-CM2
7	O	43	M3L	CD-CE-NZ-CM1
7	O	43	M3L	CD-CE-NZ-CM3

There are no ring outliers.

2 monomers are involved in 3 short contacts:

Mol	Chain	Res	Type	Clashes	Symm-Clashes
7	K	43	M3L	1	0
7	O	43	M3L	2	0

5.5 Carbohydrates [i](#)

There are no monosaccharides in this entry.

5.6 Ligand geometry [i](#)

Of 11 ligands modelled in this entry, 5 are monoatomic - leaving 6 for Mogul analysis.

In the following table, the Counts columns list the number of bonds (or angles) for which Mogul statistics could be retrieved, the number of bonds (or angles) that are observed in the model and the number of bonds (or angles) that are defined in the Chemical Component Dictionary. The Link column lists molecule types, if any, to which the group is linked. The Z score for a bond length (or angle) is the number of standard deviations the observed value is removed from the expected value. A bond length (or angle) with $|Z| > 2$ is considered an outlier worth inspection. RMSZ is the root-mean-square of all Z scores of the bond lengths (or angles).

Mol	Type	Chain	Res	Link	Bond lengths			Bond angles		
					Counts	RMSZ	# Z > 2	Counts	RMSZ	# Z > 2
11	ATP	B	600	12	26,33,33	0.91	1 (3%)	31,52,52	1.71	5 (16%)
13	ADP	F	600	12	24,29,29	0.95	1 (4%)	29,45,45	1.53	4 (13%)
11	ATP	C	600	12	26,33,33	0.94	1 (3%)	31,52,52	1.62	5 (16%)
13	ADP	D	600	12	24,29,29	0.96	1 (4%)	29,45,45	1.61	4 (13%)
11	ATP	A	600	12	26,33,33	0.90	1 (3%)	31,52,52	1.73	5 (16%)
13	ADP	E	600	-	24,29,29	0.93	1 (4%)	29,45,45	1.55	4 (13%)

In the following table, the Chirals column lists the number of chiral outliers, the number of chiral centers analysed, the number of these observed in the model and the number defined in the Chemical Component Dictionary. Similar counts are reported in the Torsion and Rings columns. '-' means no outliers of that kind were identified.

Mol	Type	Chain	Res	Link	Chirals	Torsions	Rings
11	ATP	B	600	12	-	1/18/38/38	0/3/3/3
13	ADP	F	600	12	-	2/12/32/32	0/3/3/3
11	ATP	C	600	12	-	4/18/38/38	0/3/3/3
13	ADP	D	600	12	-	2/12/32/32	0/3/3/3

Continued on next page...

Continued from previous page...

Mol	Type	Chain	Res	Link	Chirals	Torsions	Rings
11	ATP	A	600	12	-	0/18/38/38	0/3/3/3
13	ADP	E	600	-	-	5/12/32/32	0/3/3/3

All (6) bond length outliers are listed below:

Mol	Chain	Res	Type	Atoms	Z	Observed(Å)	Ideal(Å)
13	E	600	ADP	C5-C4	2.23	1.46	1.40
13	D	600	ADP	C5-C4	2.10	1.46	1.40
11	C	600	ATP	C5-C4	2.05	1.46	1.40
13	F	600	ADP	C5-C4	2.05	1.46	1.40
11	A	600	ATP	C5-C4	2.02	1.46	1.40
11	B	600	ATP	C5-C4	2.01	1.46	1.40

All (27) bond angle outliers are listed below:

Mol	Chain	Res	Type	Atoms	Z	Observed(°)	Ideal(°)
11	B	600	ATP	PB-O3B-PG	-5.08	115.41	132.83
11	C	600	ATP	PB-O3B-PG	-4.74	116.56	132.83
11	A	600	ATP	PB-O3B-PG	-4.49	117.41	132.83
13	D	600	ADP	PA-O3A-PB	-4.10	118.76	132.83
11	B	600	ATP	PA-O3A-PB	-4.08	118.82	132.83
11	A	600	ATP	PA-O3A-PB	-3.96	119.24	132.83
11	A	600	ATP	N3-C2-N1	-3.83	122.69	128.68
13	E	600	ADP	PA-O3A-PB	-3.78	119.84	132.83
11	B	600	ATP	N3-C2-N1	-3.75	122.82	128.68
13	D	600	ADP	C3'-C2'-C1'	3.74	106.61	100.98
13	F	600	ADP	N3-C2-N1	-3.62	123.02	128.68
13	E	600	ADP	N3-C2-N1	-3.61	123.04	128.68
13	D	600	ADP	N3-C2-N1	-3.59	123.06	128.68
13	F	600	ADP	C3'-C2'-C1'	3.57	106.35	100.98
13	E	600	ADP	C3'-C2'-C1'	3.51	106.26	100.98
11	C	600	ATP	N3-C2-N1	-3.48	123.24	128.68
13	F	600	ADP	PA-O3A-PB	-3.36	121.29	132.83
11	A	600	ATP	C3'-C2'-C1'	3.18	105.77	100.98
11	C	600	ATP	C3'-C2'-C1'	3.06	105.59	100.98
13	E	600	ADP	C4-C5-N7	-2.84	106.44	109.40
13	F	600	ADP	C4-C5-N7	-2.82	106.46	109.40
11	C	600	ATP	PA-O3A-PB	-2.77	123.33	132.83
13	D	600	ADP	C4-C5-N7	-2.65	106.64	109.40
11	C	600	ATP	C4-C5-N7	-2.49	106.81	109.40
11	B	600	ATP	C4-C5-N7	-2.42	106.88	109.40
11	A	600	ATP	C4-C5-N7	-2.16	107.15	109.40

Continued on next page...

Continued from previous page...

Mol	Chain	Res	Type	Atoms	Z	Observed(°)	Ideal(°)
11	B	600	ATP	O3G-PG-O2G	2.03	115.39	107.64

There are no chirality outliers.

All (14) torsion outliers are listed below:

Mol	Chain	Res	Type	Atoms
11	C	600	ATP	C5'-O5'-PA-O1A
13	D	600	ADP	C5'-O5'-PA-O3A
13	E	600	ADP	PB-O3A-PA-O5'
13	E	600	ADP	C5'-O5'-PA-O1A
13	F	600	ADP	C5'-O5'-PA-O1A
11	B	600	ATP	C5'-O5'-PA-O3A
11	C	600	ATP	C5'-O5'-PA-O3A
13	E	600	ADP	C5'-O5'-PA-O3A
11	C	600	ATP	C5'-O5'-PA-O2A
13	D	600	ADP	C5'-O5'-PA-O1A
13	E	600	ADP	C5'-O5'-PA-O2A
11	C	600	ATP	PB-O3B-PG-O1G
13	E	600	ADP	O4'-C4'-C5'-O5'
13	F	600	ADP	C5'-O5'-PA-O3A

There are no ring outliers.

4 monomers are involved in 5 short contacts:

Mol	Chain	Res	Type	Clashes	Symm-Clashes
11	B	600	ATP	1	0
11	C	600	ATP	1	0
13	D	600	ADP	1	0
13	E	600	ADP	2	0

The following is a two-dimensional graphical depiction of Mogul quality analysis of bond lengths, bond angles, torsion angles, and ring geometry for all instances of the Ligand of Interest. In addition, ligands with molecular weight > 250 and outliers as shown on the validation Tables will also be included. For torsion angles, if less than 5% of the Mogul distribution of torsion angles is within 10 degrees of the torsion angle in question, then that torsion angle is considered an outlier. Any bond that is central to one or more torsion angles identified as an outlier by Mogul will be highlighted in the graph. For rings, the root-mean-square deviation (RMSD) between the ring in question and similar rings identified by Mogul is calculated over all ring torsion angles. If the average RMSD is greater than 60 degrees and the minimal RMSD between the ring in question and any Mogul-identified rings is also greater than 60 degrees, then that ring is considered an outlier. The outliers are highlighted in purple. The color gray indicates Mogul did not find sufficient equivalents in the CSD to analyse the geometry.

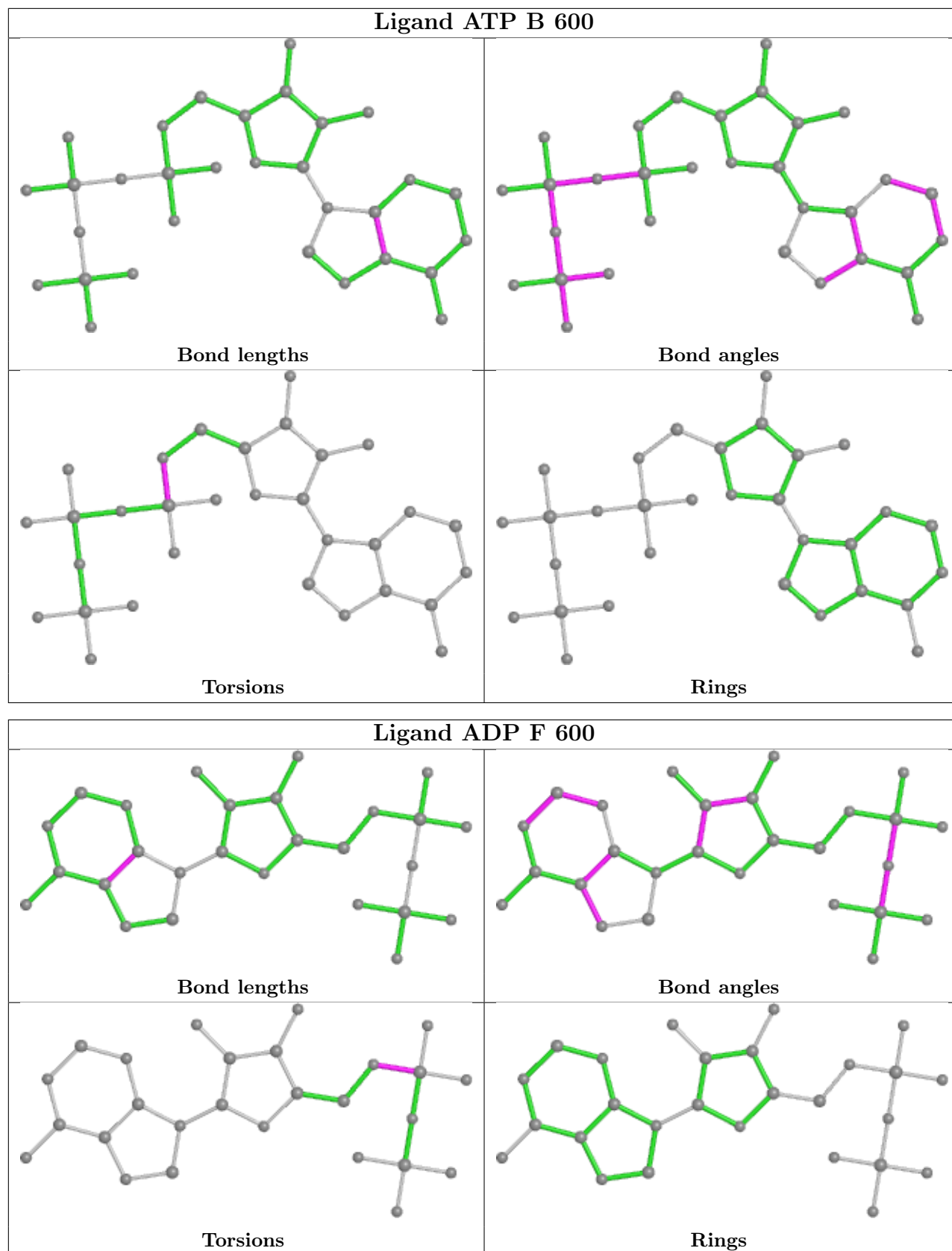

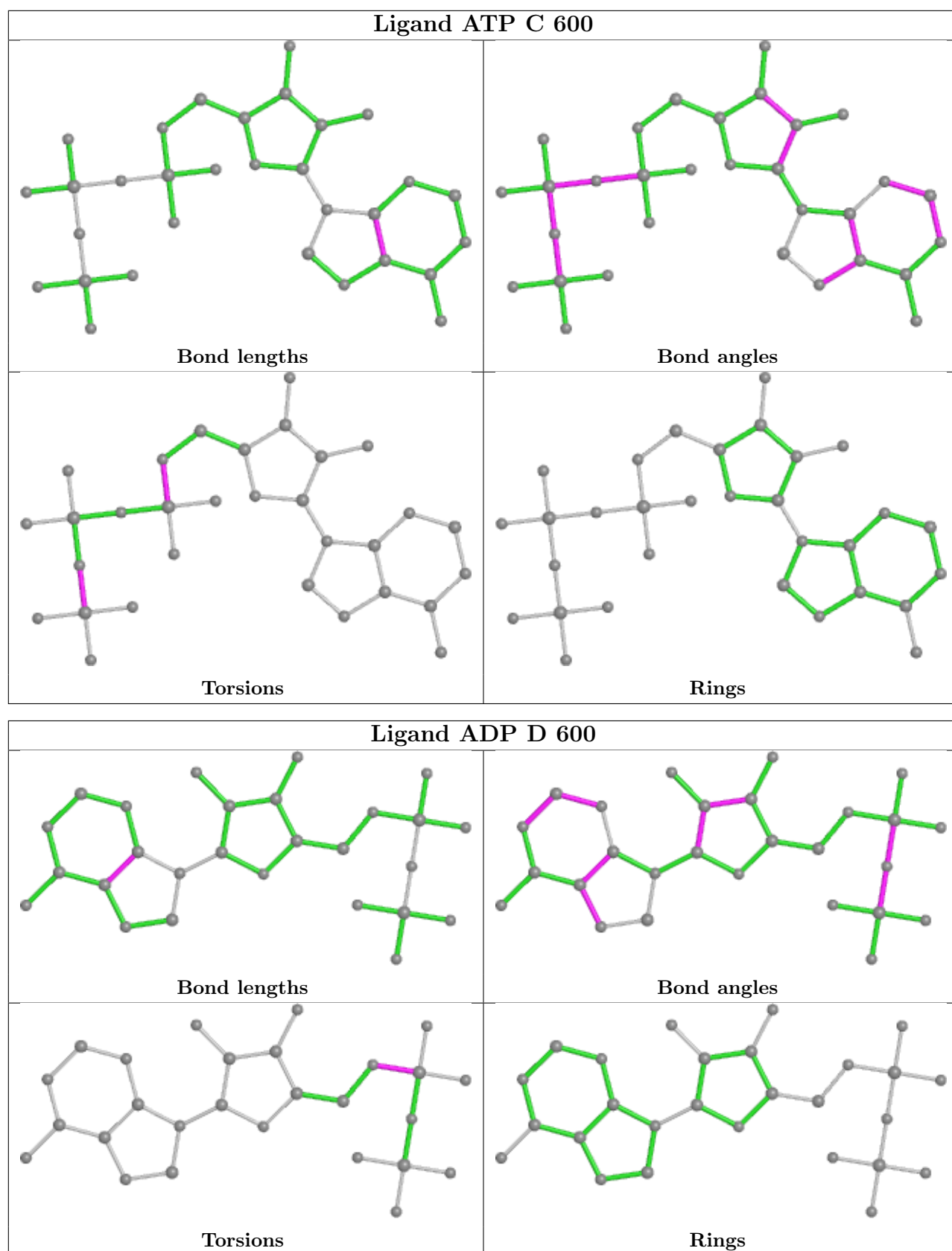

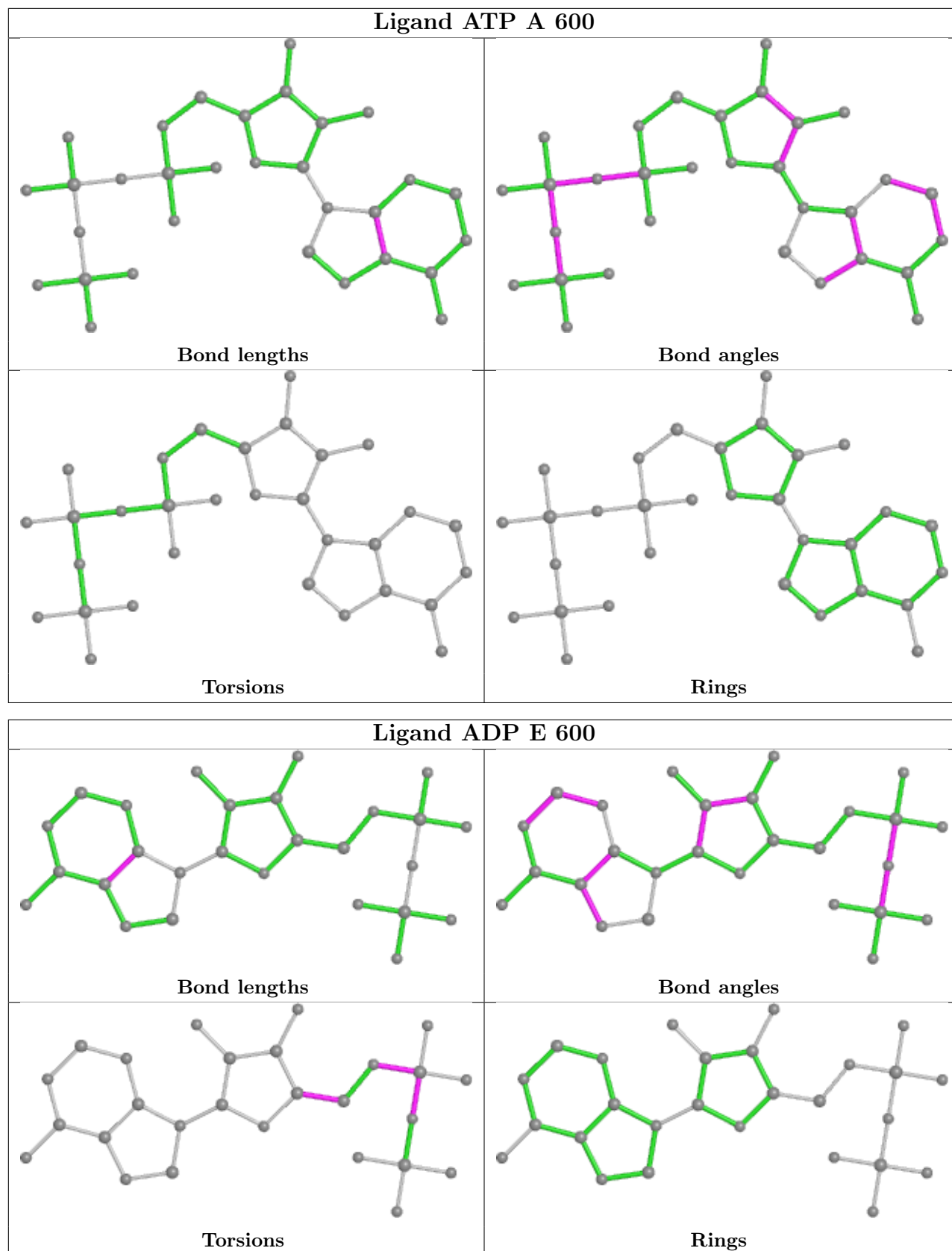

5.7 Other polymers [i](#)

There are no such residues in this entry.

5.8 Polymer linkage issues [i](#)

There are no chain breaks in this entry.

6 Map visualisation [i](#)

This section contains visualisations of the EMDB entry EMD-11040. These allow visual inspection of the internal detail of the map and identification of artifacts.

Images derived from a raw map, generated by summing the deposited half-maps, are presented below the corresponding image components of the primary map to allow further visual inspection and comparison with those of the primary map.

6.1 Orthogonal projections [i](#)

6.1.1 Primary map

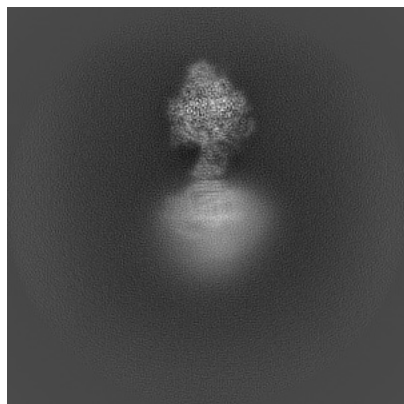

X

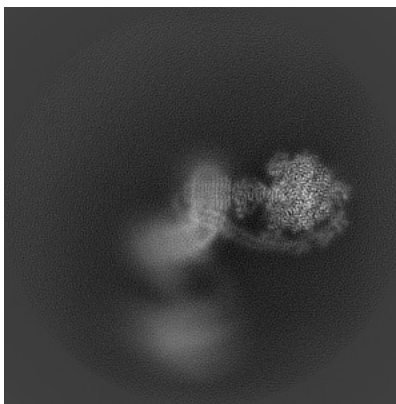

Y

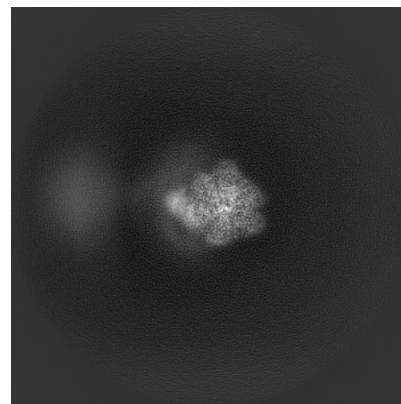

Z

6.1.2 Raw map

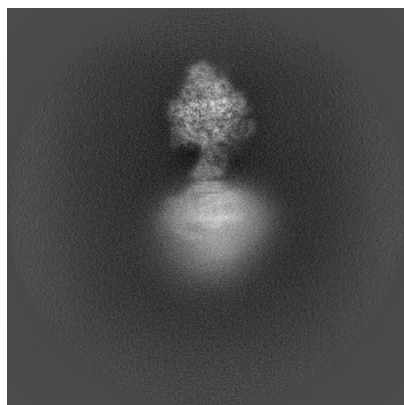

X

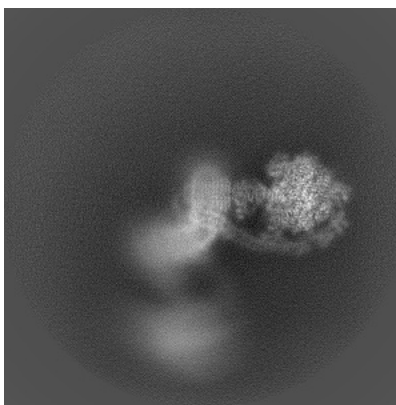

Y

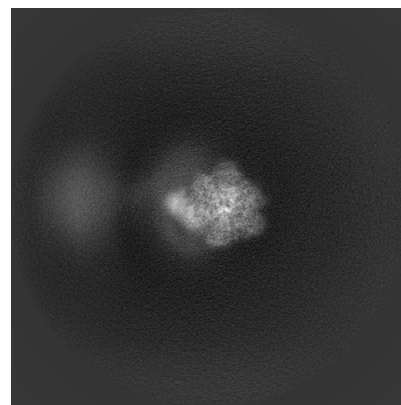

Z

The images above show the map projected in three orthogonal directions.

6.2 Central slices [i](#)

6.2.1 Primary map

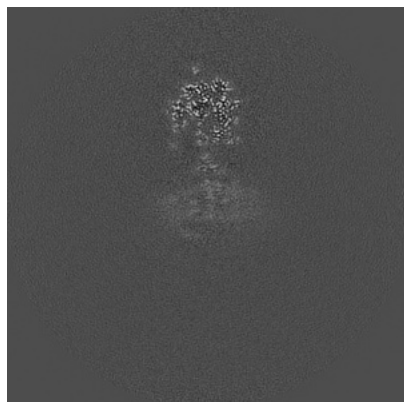

X Index: 250

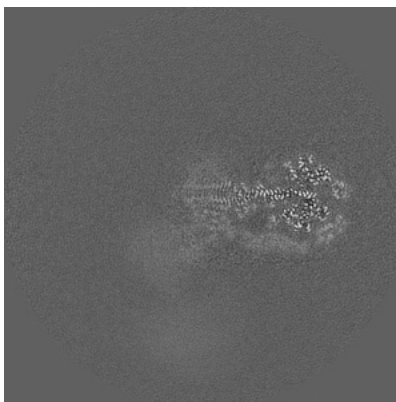

Y Index: 250

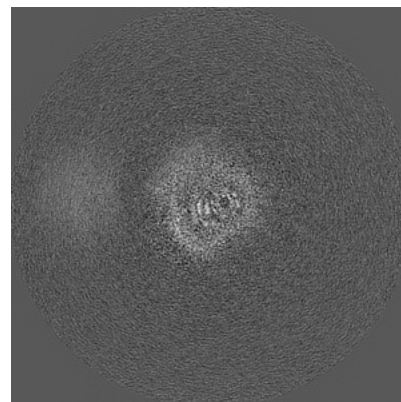

Z Index: 250

6.2.2 Raw map

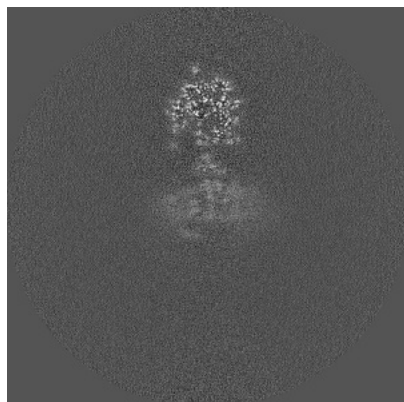

X Index: 250

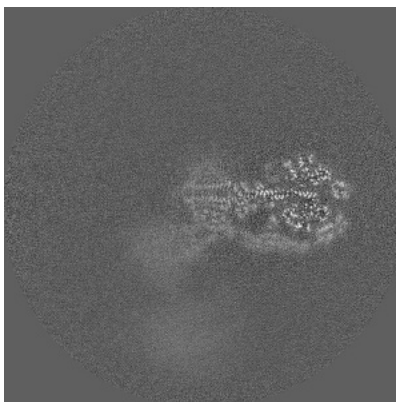

Y Index: 250

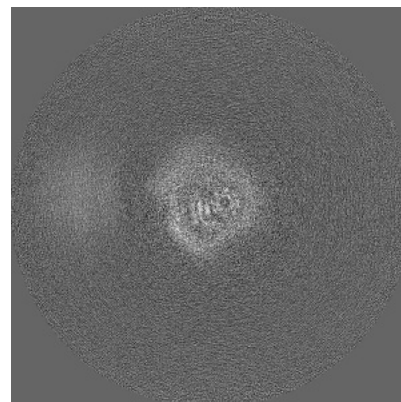

Z Index: 250

The images above show central slices of the map in three orthogonal directions.

6.3 Largest variance slices [i](#)

6.3.1 Primary map

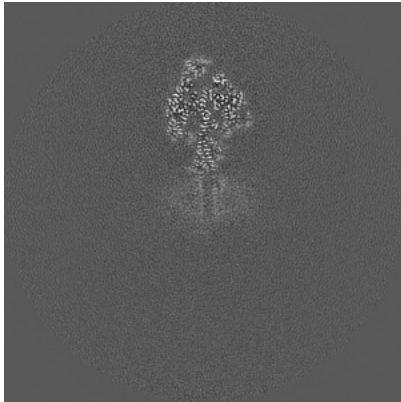

X Index: 264

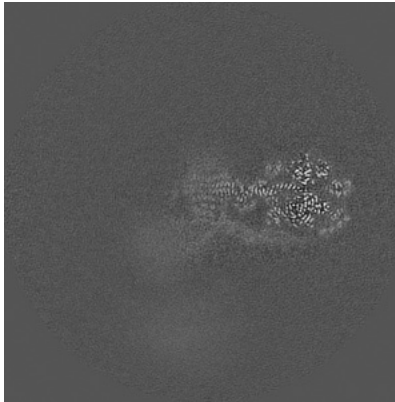

Y Index: 245

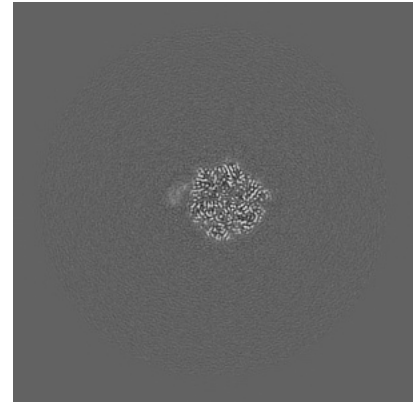

Z Index: 376

6.3.2 Raw map

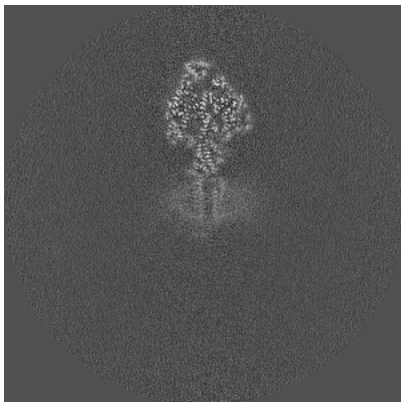

X Index: 264

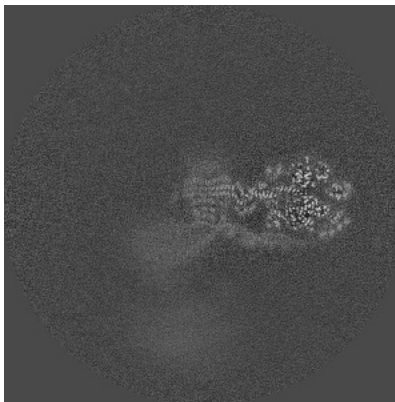

Y Index: 245

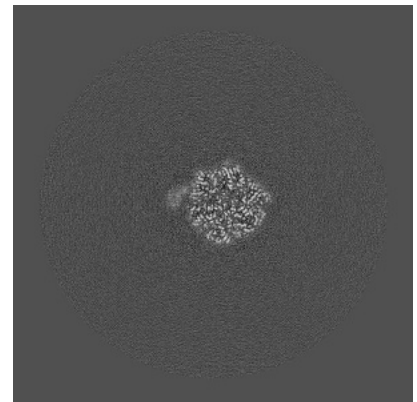

Z Index: 376

The images above show the largest variance slices of the map in three orthogonal directions.

6.4 Orthogonal surface views [i](#)

6.4.1 Primary map



X



Y



Z

The images above show the 3D surface view of the map at the recommended contour level 0.0267. These images, in conjunction with the slice images, may facilitate assessment of whether an appropriate contour level has been provided.

6.4.2 Raw map



X



Y

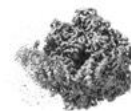

Z

These images show the 3D surface of the raw map. The raw map's contour level was selected so that its surface encloses the same volume as the primary map does at its recommended contour level.

6.5 Mask visualisation [i](#)

This section shows the 3D surface view of the primary map at 50% transparency overlaid with the specified mask at 0% transparency

A mask typically either:

- Encompasses the whole structure
- Separates out a domain, a functional unit, a monomer or an area of interest from a larger structure

6.5.1 emd_11040_msk_1.map [i](#)

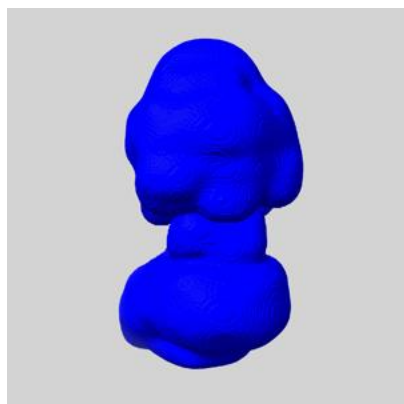

X

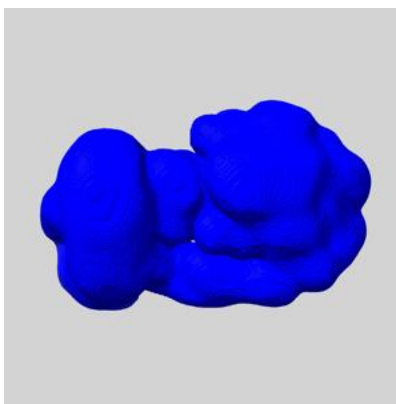

Y

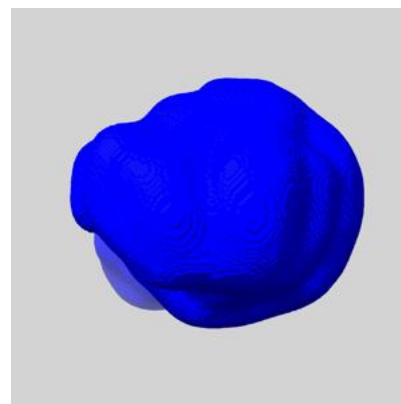

Z

7 Map analysis [i](#)

This section contains the results of statistical analysis of the map.

7.1 Map-value distribution [i](#)

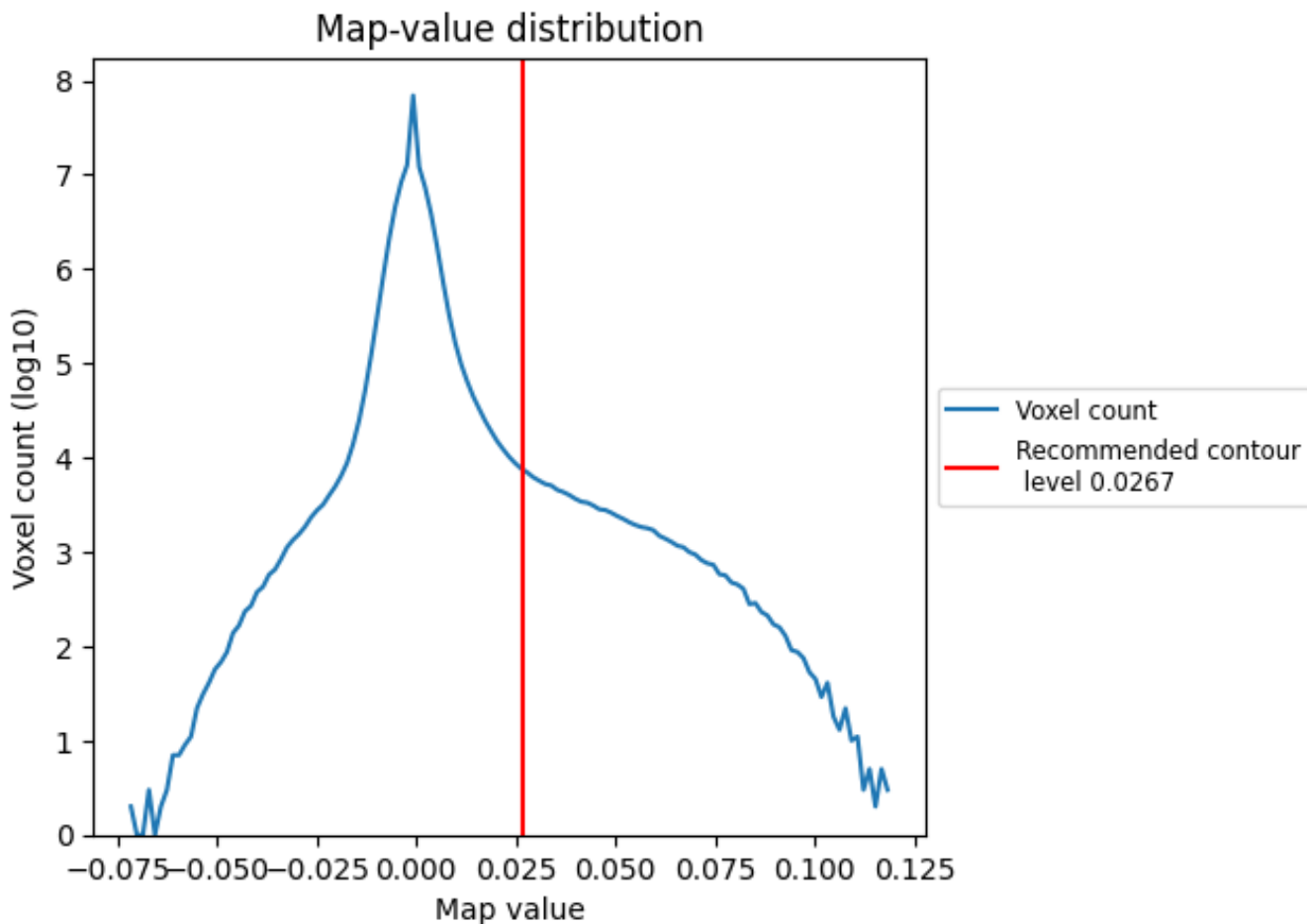

The map-value distribution is plotted in 128 intervals along the x-axis. The y-axis is logarithmic. A spike in this graph at zero usually indicates that the volume has been masked.

7.2 Volume estimate [i](#)

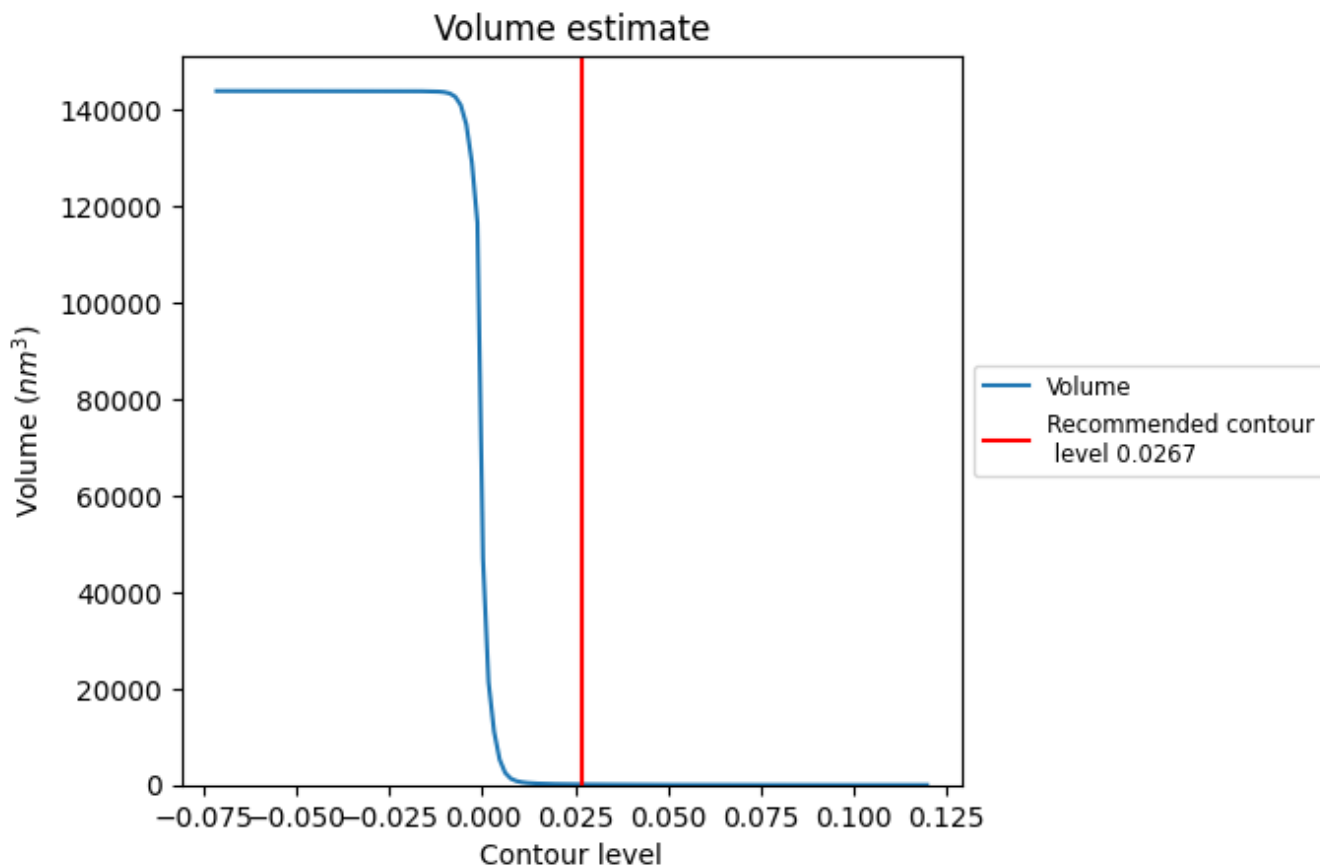

The volume at the recommended contour level is 114 nm^3 ; this corresponds to an approximate mass of 103 kDa.

The volume estimate graph shows how the enclosed volume varies with the contour level. The recommended contour level is shown as a vertical line and the intersection between the line and the curve gives the volume of the enclosed surface at the given level.

7.3 Rotationally averaged power spectrum [i](#)

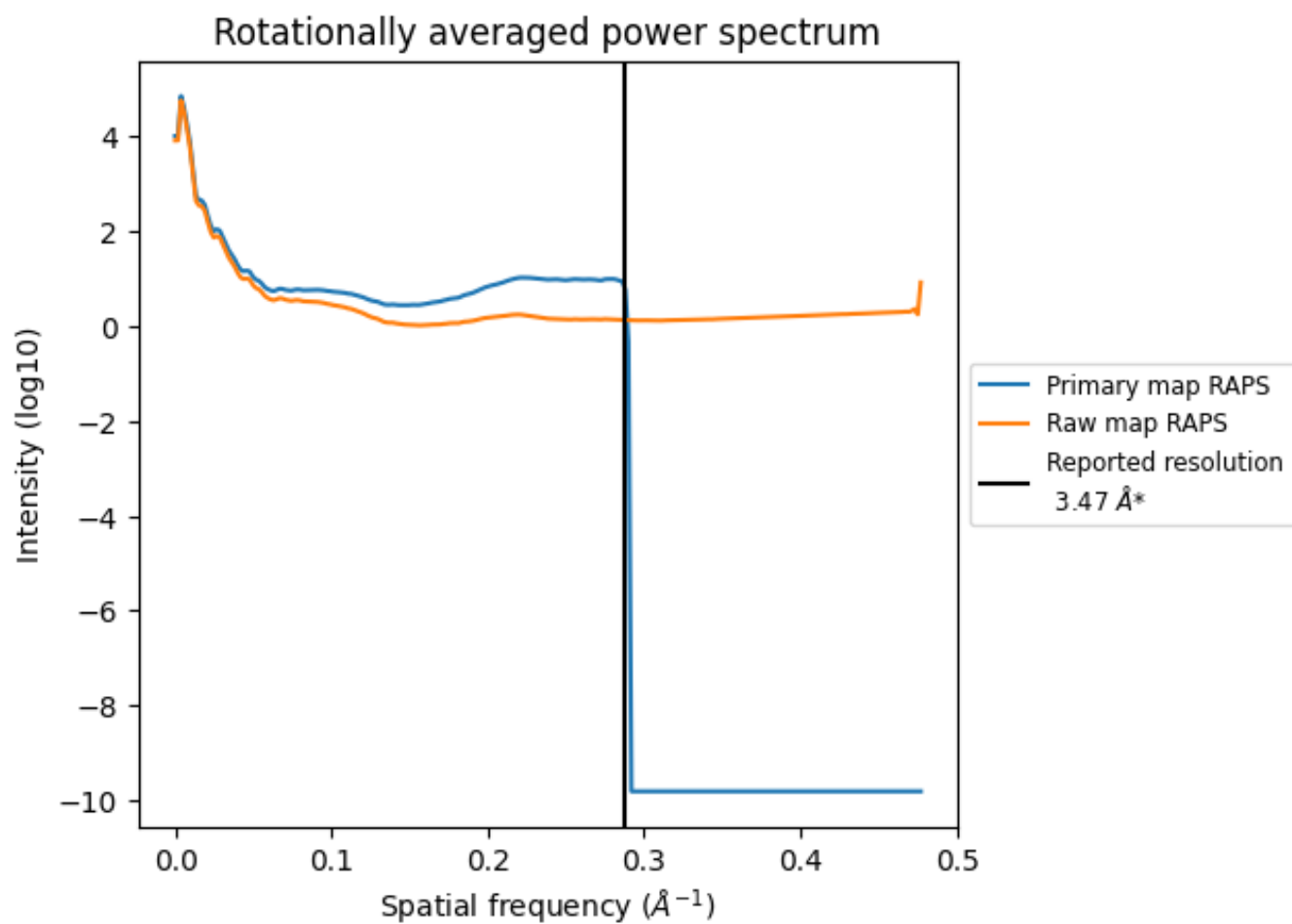

*Reported resolution corresponds to spatial frequency of 0.288 Å⁻¹

8 Fourier-Shell correlation [i](#)

Fourier-Shell Correlation (FSC) is the most commonly used method to estimate the resolution of single-particle and subtomogram-averaged maps. The shape of the curve depends on the imposed symmetry, mask and whether or not the two 3D reconstructions used were processed from a common reference. The reported resolution is shown as a black line. A curve is displayed for the half-bit criterion in addition to lines showing the 0.143 gold standard cut-off and 0.5 cut-off.

8.1 FSC [i](#)

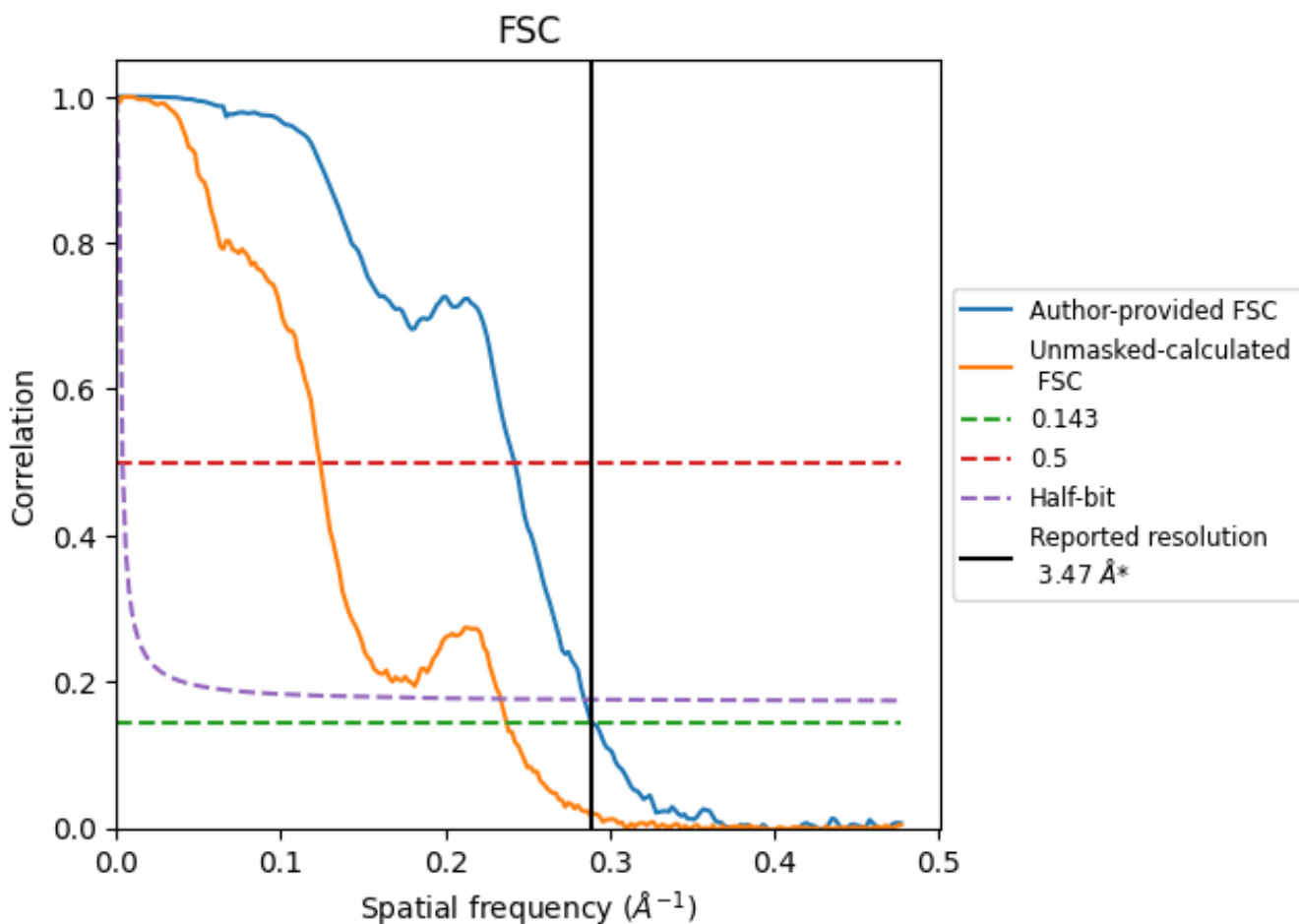

*Reported resolution corresponds to spatial frequency of 0.288 \AA^{-1}

8.2 Resolution estimates [i](#)

Resolution estimate (Å)	Estimation criterion (FSC cut-off)		
	0.143	0.5	Half-bit
Reported by author	3.47	-	-
Author-provided FSC curve	3.45	4.13	3.52
Unmasked-calculated*	4.21	8.08	4.28

*Resolution estimate based on FSC curve calculated by comparison of deposited half-maps. The value from deposited half-maps intersecting FSC 0.143 CUT-OFF 4.21 differs from the reported value 3.47 by more than 10 %

9 Map-model fit [i](#)

This section contains information regarding the fit between EMDB map EMD-11040 and PDB model 6Z1U. Per-residue inclusion information can be found in section 3 on page 9.

9.1 Map-model overlay [i](#)

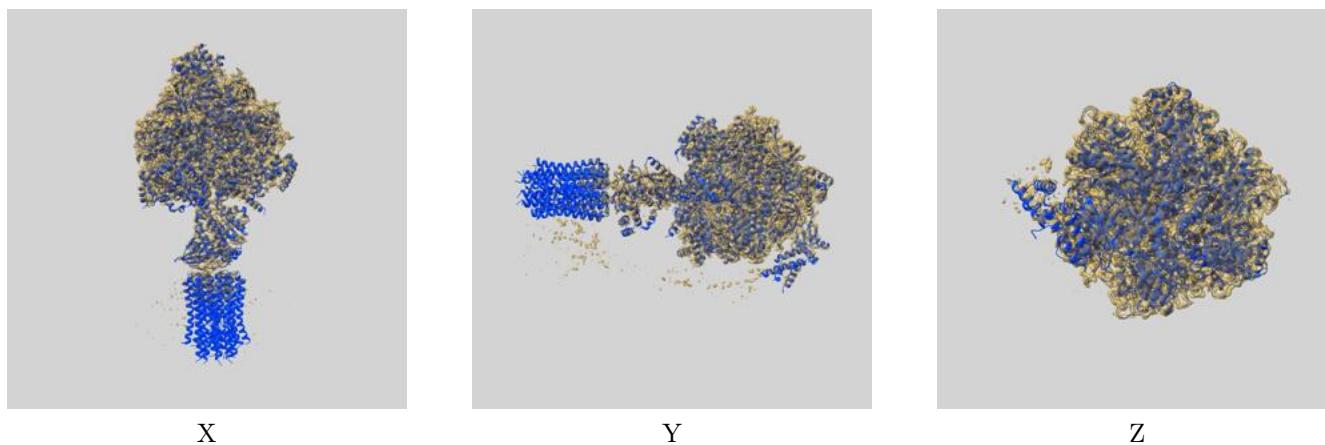

The images above show the 3D surface view of the map at the recommended contour level 0.0267 at 50% transparency in yellow overlaid with a ribbon representation of the model coloured in blue. These images allow for the visual assessment of the quality of fit between the atomic model and the map.

9.2 Q-score mapped to coordinate model [i](#)

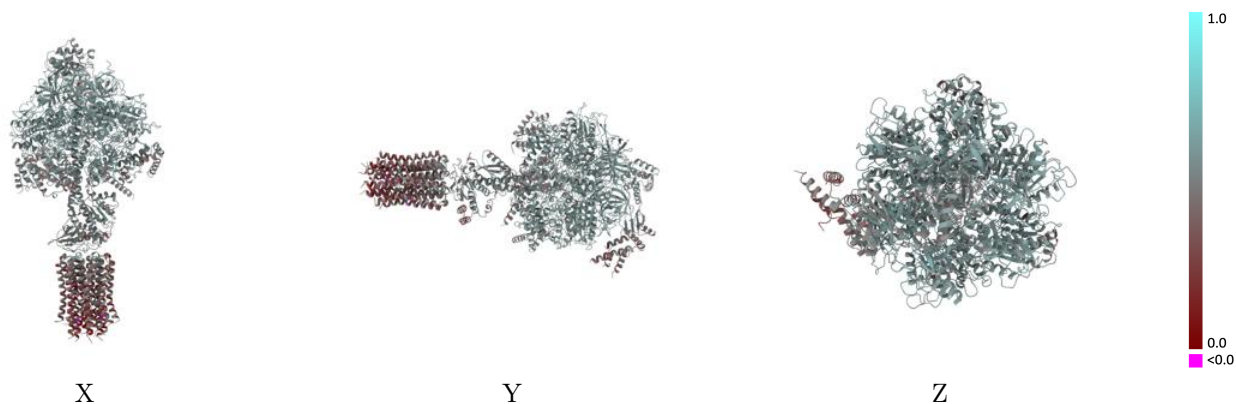

The images above show the model with each residue coloured according to its Q-score. This shows their resolvability in the map with higher Q-score values reflecting better resolvability. Please note: Q-score is calculating the resolvability of atoms, and thus high values are only expected at resolutions at which atoms can be resolved. Low Q-score values may therefore be expected for many entries.

9.3 Atom inclusion mapped to coordinate model [i](#)

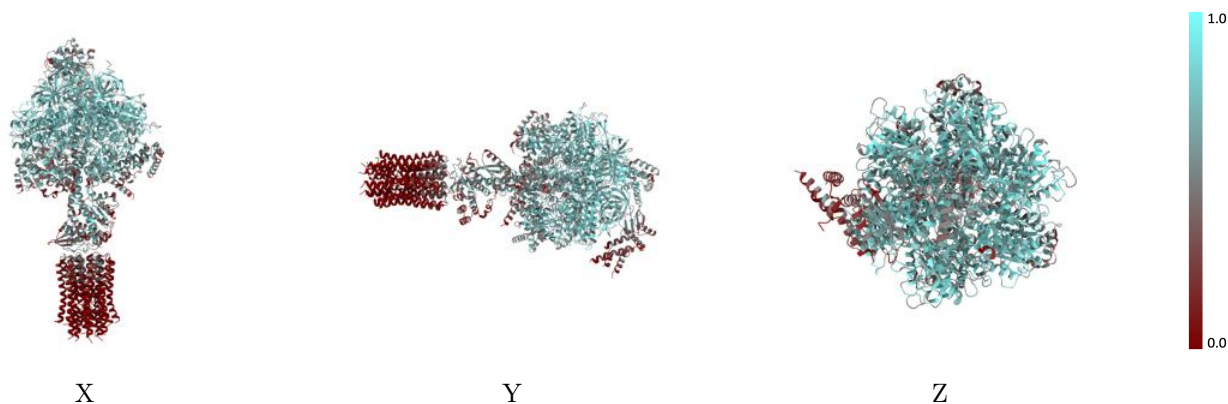

The images above show the model with each residue coloured according to its atom inclusion. This shows to what extent they are inside the map at the recommended contour level (0.0267).



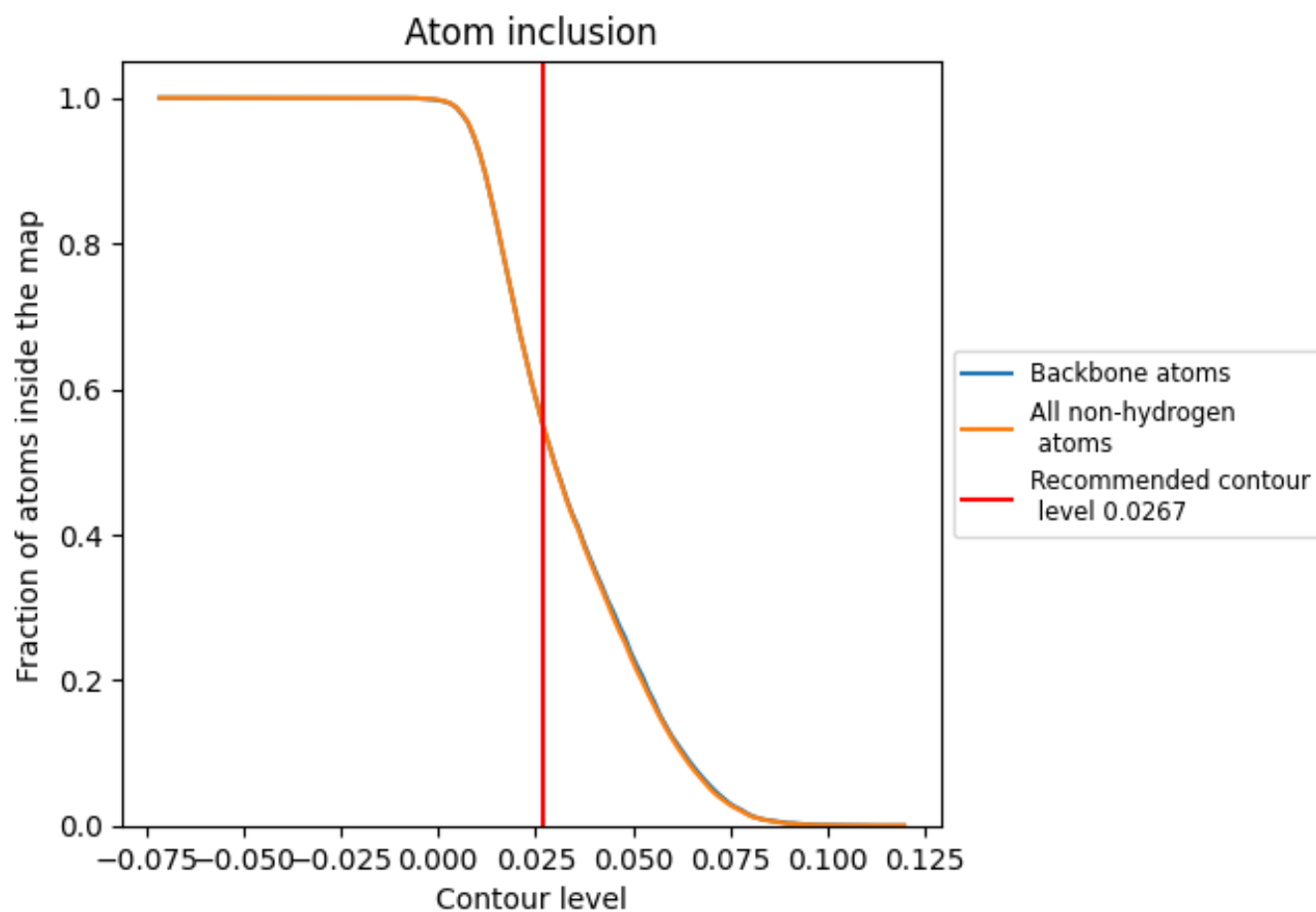









































9.4 Atom inclusion [i](#)



At the recommended contour level, 55% of all backbone atoms, 55% of all non-hydrogen atoms, are inside the map.

9.5 Map-model fit summary

The table lists the average atom inclusion at the recommended contour level (0.0267) and Q-score for the entire model and for each chain.

Chain	Atom inclusion	Q-score
All	 0.5536	 0.5150
A	 0.6748	 0.5510
B	 0.6709	 0.5490
C	 0.6693	 0.5470
D	 0.7062	 0.5580
E	 0.6667	 0.5480
F	 0.7081	 0.5570
G	 0.5605	 0.5150
H	 0.3684	 0.4500
I	 0.3175	 0.4860
J	 0.4930	 0.5010
K	 0.1067	 0.3460
L	 0.1010	 0.3720
M	 0.0901	 0.3810
N	 0.0694	 0.3640
O	 0.0844	 0.3670
P	 0.1086	 0.3480
Q	 0.1069	 0.3360
R	 0.1013	 0.3650
S	 0.4996	 0.5040
b	 0.2137	 0.3980
h	 0.2222	 0.4000

