



wwPDB X-ray Structure Validation Summary Report ⓘ

Aug 25, 2020 – 03:59 PM BST

PDB ID : 3ZHA
Title : Molecular basis for the action of the collagen-specific chaperone Hsp47 SER-PINH1 and its structure-specific client recognition.
Authors : Widmer, C.; Gebauer, J.M.; Baumann, U.
Deposited on : 2012-12-20
Resolution : 2.55 Å(reported)

This is a wwPDB X-ray Structure Validation Summary Report for a publicly released PDB entry.

We welcome your comments at validation@mail.wwpdb.org

A user guide is available at

<https://www.wwpdb.org/validation/2017/XrayValidationReportHelp>

with specific help available everywhere you see the ⓘ symbol.

The following versions of software and data (see [references ⓘ](#)) were used in the production of this report:

MolProbity : 4.02b-467
Mogul : 1.8.5 (274361), CSD as541be (2020)
Xtriage (Phenix) : 1.13
EDS : 2.13
Percentile statistics : 20191225.v01 (using entries in the PDB archive December 25th 2019)
Refmac : 5.8.0158
CCP4 : 7.0.044 (Gargrove)
Ideal geometry (proteins) : Engh & Huber (2001)
Ideal geometry (DNA, RNA) : Parkinson et al. (1996)
Validation Pipeline (wwPDB-VP) : 2.13

1 Overall quality at a glance

The following experimental techniques were used to determine the structure:

X-RAY DIFFRACTION

The reported resolution of this entry is 2.55 Å.

Percentile scores (ranging between 0-100) for global validation metrics of the entry are shown in the following graphic. The table shows the number of entries on which the scores are based.

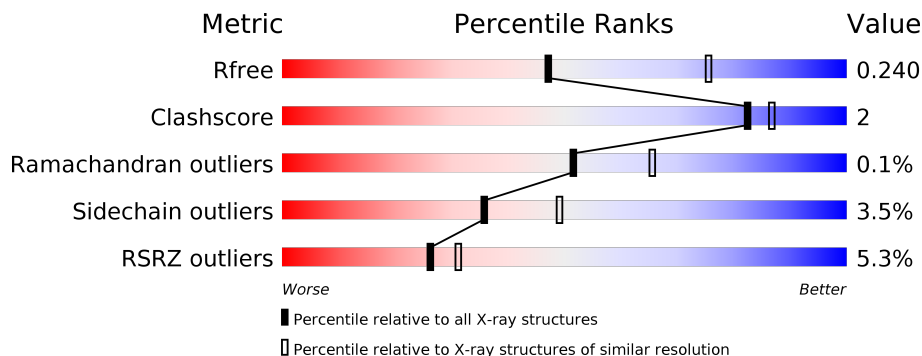

Metric	Whole archive (#Entries)	Similar resolution (#Entries, resolution range(Å))
R_{free}	130704	1284 (2.56-2.52)
Clashscore	141614	1332 (2.56-2.52)
Ramachandran outliers	138981	1315 (2.56-2.52)
Sidechain outliers	138945	1315 (2.56-2.52)
RSRZ outliers	127900	1272 (2.56-2.52)

The table below summarises the geometric issues observed across the polymeric chains and their fit to the electron density. The red, orange, yellow and green segments on the lower bar indicate the fraction of residues that contain outliers for ≥ 3 , 2, 1 and 0 types of geometric quality criteria respectively. A grey segment represents the fraction of residues that are not modelled. The numeric value for each fraction is indicated below the corresponding segment, with a dot representing fractions $\leq 5\%$. The upper red bar (where present) indicates the fraction of residues that have poor fit to the electron density. The numeric value is given above the bar.

Mol	Chain	Length	Quality of chain
1	A	392	
1	B	392	
1	C	392	
1	D	392	
1	K	392	
1	L	392	

Continued on next page...

Continued from previous page...

Mol	Chain	Length	Quality of chain
1	P	392	<p>4% 88% 7% 5%</p>
1	Q	392	<p>3% 85% 7% 7%</p>
2	E	19	<p>89% 5% 5%</p>
2	F	19	<p>84% 5% 11%</p>
2	G	19	<p>79% 5% 16%</p>
2	H	19	<p>84% 11% 5%</p>
2	I	19	<p>79% 11% 11%</p>
2	J	19	<p>74% 11% 16%</p>
2	M	19	<p>95% 5%</p>
2	N	19	<p>95% 5%</p>
2	O	19	<p>95% 5%</p>
2	R	19	<p>89% 5% 5%</p>
2	S	19	<p>95% 5%</p>
2	T	19	<p>84% 5% 11%</p>

2 Entry composition [i](#)

There are 4 unique types of molecules in this entry. The entry contains 24911 atoms, of which 8 are hydrogens and 0 are deuteriums.

In the tables below, the ZeroOcc column contains the number of atoms modelled with zero occupancy, the AltConf column contains the number of residues with at least one atom in alternate conformation and the Trace column contains the number of residues modelled with at most 2 atoms.

- Molecule 1 is a protein called HSP47.

Mol	Chain	Residues	Atoms					ZeroOcc	AltConf	Trace
			Total	C	N	O	S			
1	A	380	2981	1898	517	552	14	0	0	0
1	B	364	2855	1820	496	526	13	0	0	0
1	C	376	2961	1884	516	548	13	0	0	0
1	D	368	2894	1840	506	535	13	0	0	0
1	K	374	2955	1879	515	547	14	0	0	0
1	L	369	2902	1847	505	537	13	0	0	0
1	P	373	2938	1868	511	546	13	0	0	0
1	Q	365	2872	1828	500	531	13	0	0	0

There are 72 discrepancies between the modelled and reference sequences:

Chain	Residue	Modelled	Actual	Comment	Reference
A	35	MET	-	expression tag	UNP C7C419
A	419	LEU	-	expression tag	UNP C7C419
A	420	GLU	-	expression tag	UNP C7C419
A	421	HIS	-	expression tag	UNP C7C419
A	422	HIS	-	expression tag	UNP C7C419
A	423	HIS	-	expression tag	UNP C7C419
A	424	HIS	-	expression tag	UNP C7C419
A	425	HIS	-	expression tag	UNP C7C419
A	426	HIS	-	expression tag	UNP C7C419
B	35	MET	-	expression tag	UNP C7C419
B	419	LEU	-	expression tag	UNP C7C419
B	420	GLU	-	expression tag	UNP C7C419
B	421	HIS	-	expression tag	UNP C7C419

Continued on next page...

Continued from previous page...

Chain	Residue	Modelled	Actual	Comment	Reference
B	422	HIS	-	expression tag	UNP C7C419
B	423	HIS	-	expression tag	UNP C7C419
B	424	HIS	-	expression tag	UNP C7C419
B	425	HIS	-	expression tag	UNP C7C419
B	426	HIS	-	expression tag	UNP C7C419
C	35	MET	-	expression tag	UNP C7C419
C	419	LEU	-	expression tag	UNP C7C419
C	420	GLU	-	expression tag	UNP C7C419
C	421	HIS	-	expression tag	UNP C7C419
C	422	HIS	-	expression tag	UNP C7C419
C	423	HIS	-	expression tag	UNP C7C419
C	424	HIS	-	expression tag	UNP C7C419
C	425	HIS	-	expression tag	UNP C7C419
C	426	HIS	-	expression tag	UNP C7C419
D	35	MET	-	expression tag	UNP C7C419
D	419	LEU	-	expression tag	UNP C7C419
D	420	GLU	-	expression tag	UNP C7C419
D	421	HIS	-	expression tag	UNP C7C419
D	422	HIS	-	expression tag	UNP C7C419
D	423	HIS	-	expression tag	UNP C7C419
D	424	HIS	-	expression tag	UNP C7C419
D	425	HIS	-	expression tag	UNP C7C419
D	426	HIS	-	expression tag	UNP C7C419
K	35	MET	-	expression tag	UNP C7C419
K	419	LEU	-	expression tag	UNP C7C419
K	420	GLU	-	expression tag	UNP C7C419
K	421	HIS	-	expression tag	UNP C7C419
K	422	HIS	-	expression tag	UNP C7C419
K	423	HIS	-	expression tag	UNP C7C419
K	424	HIS	-	expression tag	UNP C7C419
K	425	HIS	-	expression tag	UNP C7C419
K	426	HIS	-	expression tag	UNP C7C419
L	35	MET	-	expression tag	UNP C7C419
L	419	LEU	-	expression tag	UNP C7C419
L	420	GLU	-	expression tag	UNP C7C419
L	421	HIS	-	expression tag	UNP C7C419
L	422	HIS	-	expression tag	UNP C7C419
L	423	HIS	-	expression tag	UNP C7C419
L	424	HIS	-	expression tag	UNP C7C419
L	425	HIS	-	expression tag	UNP C7C419
L	426	HIS	-	expression tag	UNP C7C419
P	35	MET	-	expression tag	UNP C7C419

Continued on next page...

Continued from previous page...

Chain	Residue	Modelled	Actual	Comment	Reference
P	419	LEU	-	expression tag	UNP C7C419
P	420	GLU	-	expression tag	UNP C7C419
P	421	HIS	-	expression tag	UNP C7C419
P	422	HIS	-	expression tag	UNP C7C419
P	423	HIS	-	expression tag	UNP C7C419
P	424	HIS	-	expression tag	UNP C7C419
P	425	HIS	-	expression tag	UNP C7C419
P	426	HIS	-	expression tag	UNP C7C419
Q	35	MET	-	expression tag	UNP C7C419
Q	419	LEU	-	expression tag	UNP C7C419
Q	420	GLU	-	expression tag	UNP C7C419
Q	421	HIS	-	expression tag	UNP C7C419
Q	422	HIS	-	expression tag	UNP C7C419
Q	423	HIS	-	expression tag	UNP C7C419
Q	424	HIS	-	expression tag	UNP C7C419
Q	425	HIS	-	expression tag	UNP C7C419
Q	426	HIS	-	expression tag	UNP C7C419

- Molecule 2 is a protein called COLLAGEN MODEL PEPTIDE 18-T8R11.

Mol	Chain	Residues	Atoms				ZeroOcc	AltConf	Trace
			Total	C	N	O			
2	E	18	111	72	20	19	0	0	0
2	F	17	104	67	19	18	0	0	0
2	G	16	97	62	18	17	0	0	0
2	H	18	111	72	20	19	0	0	0
2	I	17	104	67	19	18	0	0	0
2	J	16	97	62	18	17	0	0	0
2	M	18	111	72	20	19	0	0	0
2	N	18	111	72	20	19	0	0	0
2	O	18	111	72	20	19	0	0	0
2	R	18	111	72	20	19	0	0	0
2	S	18	111	72	20	19	0	0	0

Continued on next page...

Continued from previous page...

Mol	Chain	Residues	Atoms				ZeroOcc	AltConf	Trace
2	T	17	Total	C	N	O	0	0	0
			104	67	19	18			

- Molecule 3 is SUCCINIC ACID (three-letter code: SIN) (formula: C₄H₆O₄).

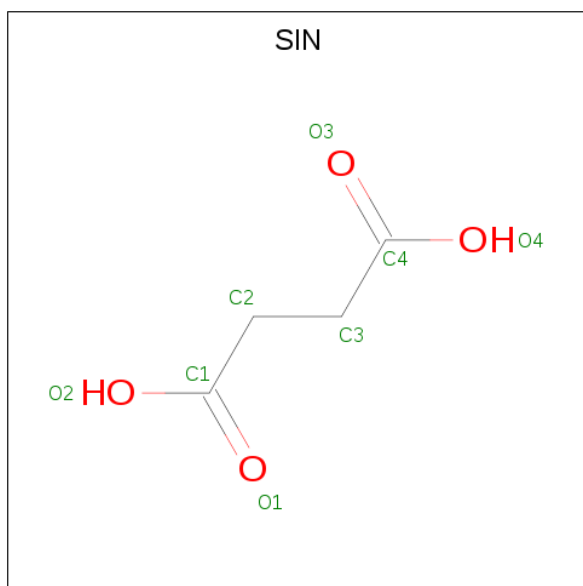

Mol	Chain	Residues	Atoms				ZeroOcc	AltConf
3	A	1	Total	C	O	0	0	
			8	4	4			
3	C	1	Total	C	O	0	0	
			8	4	4			
3	K	1	Total	C	O	0	0	
			8	4	4			
3	P	1	Total	C	H	O	0	0
			12	4	4	4		
3	Q	1	Total	C	H	O	0	0
			12	4	4	4		

- Molecule 4 is water.

Mol	Chain	Residues	Atoms		ZeroOcc	AltConf
4	A	23	Total	O	0	0
			23	23		
4	B	21	Total	O	0	0
			21	21		
4	C	33	Total	O	0	0
			33	33		

Continued on next page...

Continued from previous page...

Mol	Chain	Residues	Atoms	ZeroOcc	AltConf
4	D	37	Total O 37 37	0	0
4	E	2	Total O 2 2	0	0
4	F	1	Total O 1 1	0	0
4	I	2	Total O 2 2	0	0
4	K	24	Total O 24 24	0	0
4	L	27	Total O 27 27	0	0
4	N	3	Total O 3 3	0	0
4	P	18	Total O 18 18	0	0
4	Q	27	Total O 27 27	0	0
4	R	1	Total O 1 1	0	0
4	S	2	Total O 2 2	0	0
4	T	1	Total O 1 1	0	0

3 Residue-property plots [i](#)

These plots are drawn for all protein, RNA, DNA and oligosaccharide chains in the entry. The first graphic for a chain summarises the proportions of the various outlier classes displayed in the second graphic. The second graphic shows the sequence view annotated by issues in geometry and electron density. Residues are color-coded according to the number of geometric quality criteria for which they contain at least one outlier: green = 0, yellow = 1, orange = 2 and red = 3 or more. A red dot above a residue indicates a poor fit to the electron density ($RSRZ > 2$). Stretches of 2 or more consecutive residues without any outlier are shown as a green connector. Residues present in the sample, but not in the model, are shown in grey.

- Molecule 1: HSP47

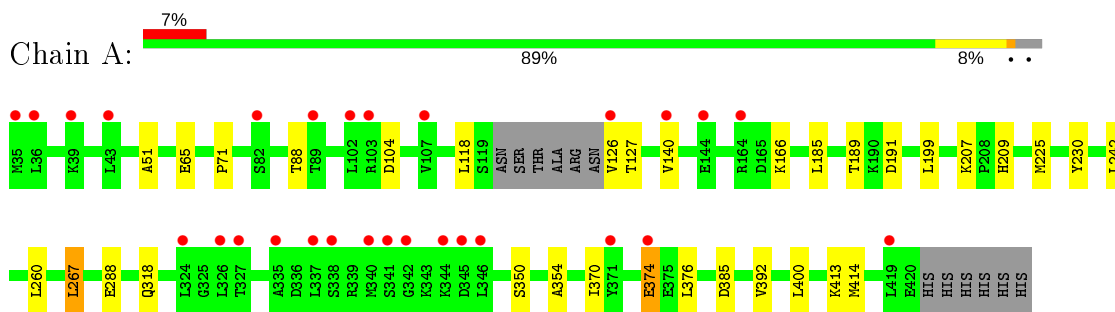

- Molecule 1: HSP47

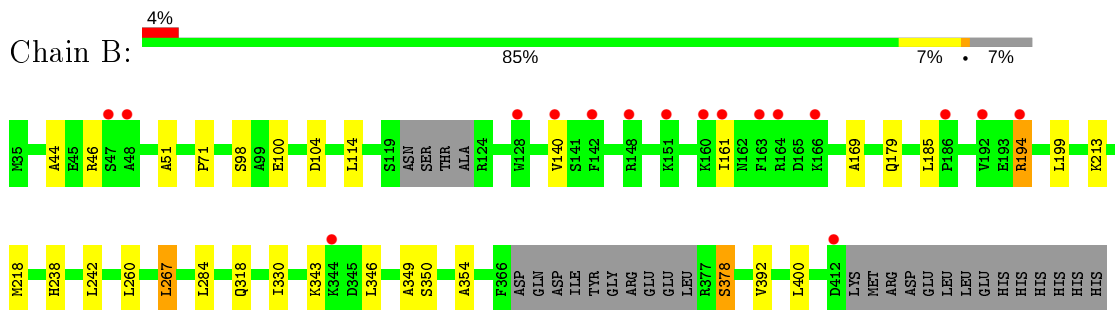

- Molecule 1: HSP47

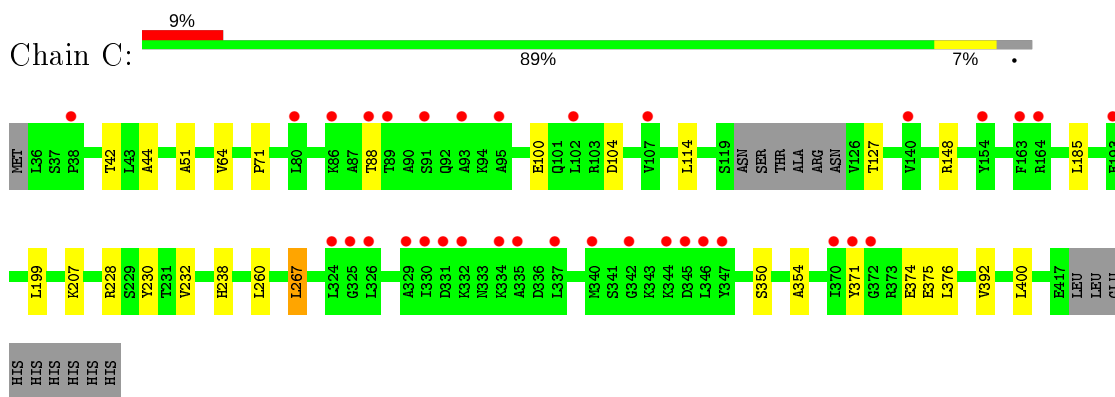

- Molecule 1: HSP47

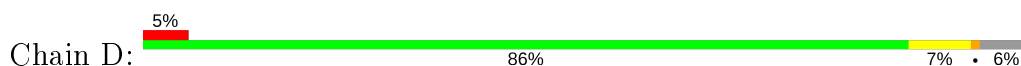

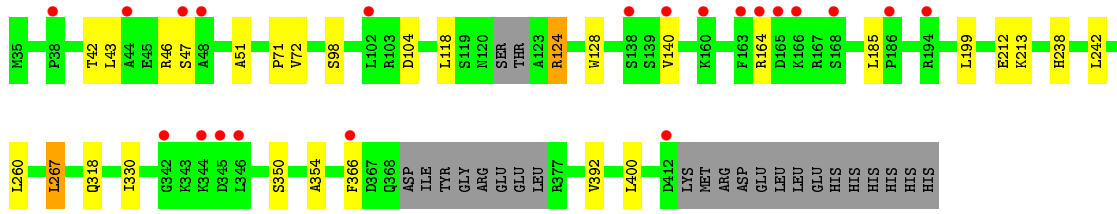

• Molecule 1: HSP47

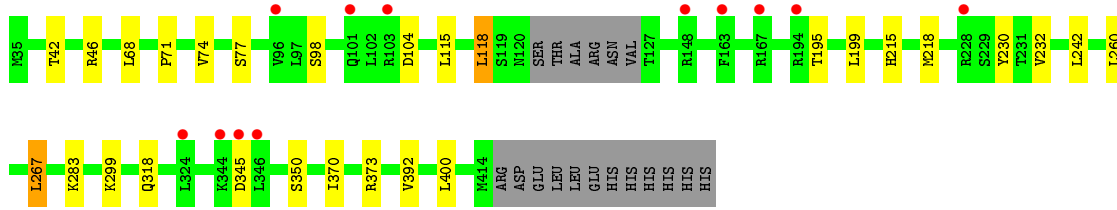
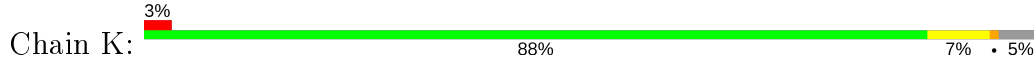

• Molecule 1: HSP47

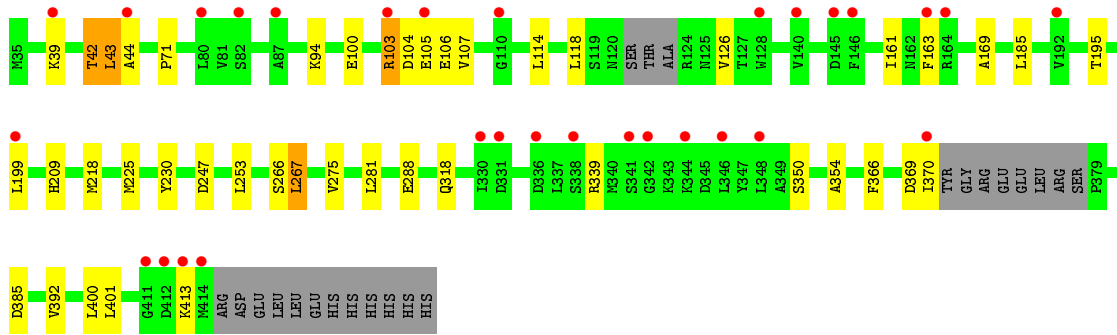
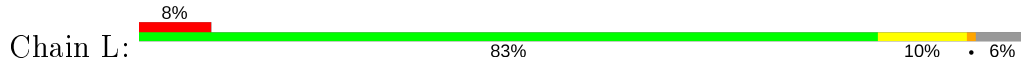

• Molecule 1: HSP47

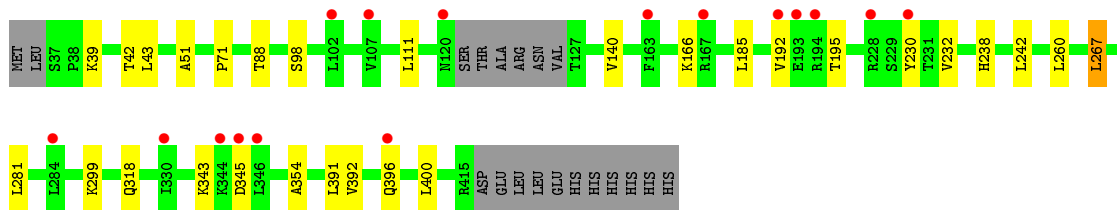
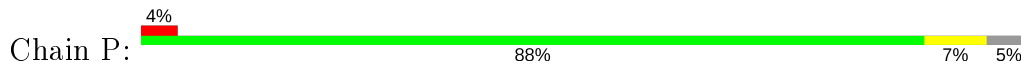

• Molecule 1: HSP47

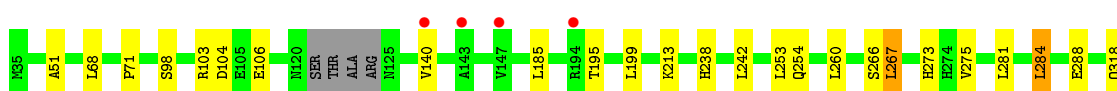
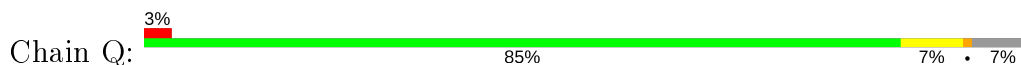

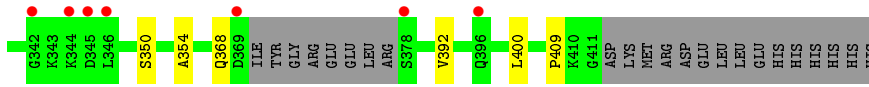

- Molecule 2: COLLAGEN MODEL PEPTIDE 18-T8R11

Chain E: 89% 5% 5%

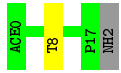

- Molecule 2: COLLAGEN MODEL PEPTIDE 18-T8R11

Chain F: 84% 5% 11%

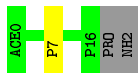

- Molecule 2: COLLAGEN MODEL PEPTIDE 18-T8R11

Chain G: 79% 5% 16%

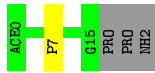

- Molecule 2: COLLAGEN MODEL PEPTIDE 18-T8R11

Chain H: 84% 11% 5%

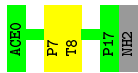

- Molecule 2: COLLAGEN MODEL PEPTIDE 18-T8R11

Chain I: 79% 11% 11%



- Molecule 2: COLLAGEN MODEL PEPTIDE 18-T8R11

Chain J: 74% 11% 16%



- Molecule 2: COLLAGEN MODEL PEPTIDE 18-T8R11

Chain M: 95% 5%



- Molecule 2: COLLAGEN MODEL PEPTIDE 18-T8R11



- Molecule 2: COLLAGEN MODEL PEPTIDE 18-T8R11



- Molecule 2: COLLAGEN MODEL PEPTIDE 18-T8R11

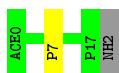
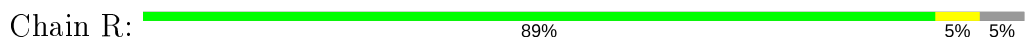

- Molecule 2: COLLAGEN MODEL PEPTIDE 18-T8R11



- Molecule 2: COLLAGEN MODEL PEPTIDE 18-T8R11

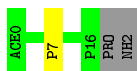
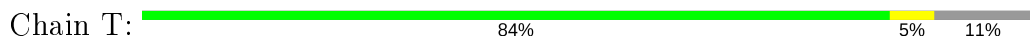

4 Data and refinement statistics

Property	Value	Source
Space group	P 1 2 1	Depositor
Cell constants a, b, c, α , β , γ	102.71Å 104.91Å 171.84Å 90.00° 103.71° 90.00°	Depositor
Resolution (Å)	49.16 – 2.55 49.16 – 2.55	Depositor EDS
% Data completeness (in resolution range)	98.0 (49.16-2.55) 98.1 (49.16-2.55)	Depositor EDS
R_{merge}	0.10	Depositor
R_{sym}	(Not available)	Depositor
$\langle I/\sigma(I) \rangle$ ¹	1.55 (at 2.54Å)	Xtrriage
Refinement program	BUSTER 2.10.0	Depositor
R, R_{free}	0.195 , 0.218 0.219 , 0.240	Depositor DCC
R_{free} test set	1780 reflections (1.57%)	wwPDB-VP
Wilson B-factor (Å ²)	40.1	Xtrriage
Anisotropy	0.190	Xtrriage
Bulk solvent k_{sol} (e/Å ³), B_{sol} (Å ²)	0.33 , 60.2	EDS
L-test for twinning ²	$\langle L \rangle = 0.54$, $\langle L^2 \rangle = 0.37$	Xtrriage
Estimated twinning fraction	No twinning to report.	Xtrriage
F_o, F_c correlation	0.95	EDS
Total number of atoms	24911	wwPDB-VP
Average B, all atoms (Å ²)	58.0	wwPDB-VP

Xtrriage's analysis on translational NCS is as follows: *The analyses of the Patterson function reveals a significant off-origin peak that is 47.19 % of the origin peak, indicating pseudo-translational symmetry. The chance of finding a peak of this or larger height randomly in a structure without pseudo-translational symmetry is equal to 1.0277e-04. The detected translational NCS is most likely also responsible for the elevated intensity ratio.*

¹Intensities estimated from amplitudes.

²Theoretical values of $\langle |L| \rangle$, $\langle L^2 \rangle$ for acentric reflections are 0.5, 0.333 respectively for untwinned datasets, and 0.375, 0.2 for perfectly twinned datasets.

5 Model quality

5.1 Standard geometry

Bond lengths and bond angles in the following residue types are not validated in this section: SIN, ACE

The Z score for a bond length (or angle) is the number of standard deviations the observed value is removed from the expected value. A bond length (or angle) with $|Z| > 5$ is considered an outlier worth inspection. RMSZ is the root-mean-square of all Z scores of the bond lengths (or angles).

Mol	Chain	Bond lengths		Bond angles	
		RMSZ	# Z >5	RMSZ	# Z >5
1	A	0.43	0/3041	0.69	0/4101
1	B	0.43	0/2913	0.69	0/3928
1	C	0.43	0/3021	0.70	0/4073
1	D	0.44	0/2952	0.69	0/3980
1	K	0.44	0/3015	0.68	0/4063
1	L	0.44	0/2960	0.70	0/3990
1	P	0.43	0/2998	0.70	0/4042
1	Q	0.45	0/2930	0.70	0/3951
2	E	0.49	0/118	0.47	0/168
2	F	0.42	0/110	0.43	0/156
2	G	0.39	0/102	0.45	0/144
2	H	0.46	0/118	0.50	0/168
2	I	0.43	0/110	0.39	0/156
2	J	0.42	0/102	0.50	0/144
2	M	0.45	0/118	0.47	0/168
2	N	0.46	0/118	0.44	0/168
2	O	0.45	0/118	0.47	0/168
2	R	0.47	0/118	0.46	0/168
2	S	0.50	0/118	0.40	0/168
2	T	0.43	0/110	0.43	0/156
All	All	0.44	0/25190	0.68	0/34060

There are no bond length outliers.

There are no bond angle outliers.

There are no chirality outliers.

There are no planarity outliers.

5.2 Too-close contacts [i](#)

In the following table, the Non-H and H(model) columns list the number of non-hydrogen atoms and hydrogen atoms in the chain respectively. The H(added) column lists the number of hydrogen atoms added and optimized by MolProbity. The Clashes column lists the number of clashes within the asymmetric unit, whereas Symm-Clashes lists symmetry related clashes.

Mol	Chain	Non-H	H(model)	H(added)	Clashes	Symm-Clashes
1	A	2981	0	2995	16	0
1	B	2855	0	2880	17	0
1	C	2961	0	2982	17	0
1	D	2894	0	2918	13	0
1	K	2955	0	2982	11	0
1	L	2902	0	2926	24	0
1	P	2938	0	2953	13	0
1	Q	2872	0	2895	11	0
2	E	111	0	108	1	0
2	F	104	0	101	1	0
2	G	97	0	94	1	0
2	H	111	0	108	3	0
2	I	104	0	101	2	0
2	J	97	0	94	2	0
2	M	111	0	108	0	0
2	N	111	0	108	0	0
2	O	111	0	108	0	0
2	R	111	0	108	2	0
2	S	111	0	108	0	0
2	T	104	0	101	1	0
3	A	8	0	4	1	0
3	C	8	0	4	1	0
3	K	8	0	4	0	0
3	P	8	4	4	0	0
3	Q	8	4	4	0	0
4	A	23	0	0	0	0
4	B	21	0	0	3	0
4	C	33	0	0	0	0
4	D	37	0	0	0	0
4	E	2	0	0	0	0
4	F	1	0	0	0	0
4	I	2	0	0	0	0
4	K	24	0	0	0	0
4	L	27	0	0	1	0
4	N	3	0	0	0	0
4	P	18	0	0	0	0
4	Q	27	0	0	0	0

Continued on next page...

Continued from previous page...

Mol	Chain	Non-H	H(model)	H(added)	Clashes	Symm-Clashes
4	R	1	0	0	0	0
4	S	2	0	0	0	0
4	T	1	0	0	0	0
All	All	24903	8	24798	123	0

The all-atom clashscore is defined as the number of clashes found per 1000 atoms (including hydrogen atoms). The all-atom clashscore for this structure is 2.

The worst 5 of 123 close contacts within the same asymmetric unit are listed below, sorted by their clash magnitude.

Atom-1	Atom-2	Interatomic distance (Å)	Clash overlap (Å)
1:C:127:THR:HG23	1:C:207:LYS:HB3	1.48	0.94
1:A:126:VAL:HG12	1:A:209:HIS:H	1.46	0.79
1:C:374:GLU:HG3	1:C:376:LEU:HB2	1.63	0.78
1:D:42:THR:HG22	1:D:46:ARG:HH12	1.53	0.73
1:B:218:MET:CE	4:B:2008:HOH:O	2.40	0.69

There are no symmetry-related clashes.

5.3 Torsion angles [i](#)

5.3.1 Protein backbone [i](#)

In the following table, the Percentiles column shows the percent Ramachandran outliers of the chain as a percentile score with respect to all X-ray entries followed by that with respect to entries of similar resolution.

The Analysed column shows the number of residues for which the backbone conformation was analysed, and the total number of residues.

Mol	Chain	Analysed	Favoured	Allowed	Outliers	Percentiles	
1	A	376/392 (96%)	363 (96%)	12 (3%)	1 (0%)	41	51
1	B	358/392 (91%)	350 (98%)	8 (2%)	0	100	100
1	C	372/392 (95%)	358 (96%)	14 (4%)	0	100	100
1	D	362/392 (92%)	351 (97%)	11 (3%)	0	100	100
1	K	370/392 (94%)	360 (97%)	10 (3%)	0	100	100
1	L	363/392 (93%)	348 (96%)	13 (4%)	2 (1%)	25	34
1	P	369/392 (94%)	359 (97%)	10 (3%)	0	100	100

Continued on next page...

Continued from previous page...

Mol	Chain	Analysed	Favoured	Allowed	Outliers	Percentiles	
1	Q	359/392 (92%)	348 (97%)	10 (3%)	1 (0%)	41	51
2	E	16/19 (84%)	16 (100%)	0	0	100	100
2	F	15/19 (79%)	15 (100%)	0	0	100	100
2	G	14/19 (74%)	14 (100%)	0	0	100	100
2	H	16/19 (84%)	16 (100%)	0	0	100	100
2	I	15/19 (79%)	15 (100%)	0	0	100	100
2	J	14/19 (74%)	14 (100%)	0	0	100	100
2	M	16/19 (84%)	16 (100%)	0	0	100	100
2	N	16/19 (84%)	16 (100%)	0	0	100	100
2	O	16/19 (84%)	16 (100%)	0	0	100	100
2	R	16/19 (84%)	16 (100%)	0	0	100	100
2	S	16/19 (84%)	16 (100%)	0	0	100	100
2	T	15/19 (79%)	15 (100%)	0	0	100	100
All	All	3114/3364 (93%)	3022 (97%)	88 (3%)	4 (0%)	51	65

All (4) Ramachandran outliers are listed below:

Mol	Chain	Res	Type
1	L	103	ARG
1	L	105	GLU
1	A	374	GLU
1	Q	368	GLN

5.3.2 Protein sidechains [i](#)

In the following table, the Percentiles column shows the percent sidechain outliers of the chain as a percentile score with respect to all X-ray entries followed by that with respect to entries of similar resolution.

The Analysed column shows the number of residues for which the sidechain conformation was analysed, and the total number of residues.

Mol	Chain	Analysed	Rotameric	Outliers	Percentiles	
1	A	320/337 (95%)	309 (97%)	11 (3%)	37	50
1	B	308/337 (91%)	297 (96%)	11 (4%)	35	47
1	C	319/337 (95%)	311 (98%)	8 (2%)	47	62

Continued on next page...

Continued from previous page...

Mol	Chain	Analysed	Rotameric	Outliers	Percentiles	
1	D	313/337 (93%)	300 (96%)	13 (4%)	30	40
1	K	320/337 (95%)	308 (96%)	12 (4%)	33	45
1	L	314/337 (93%)	304 (97%)	10 (3%)	39	53
1	P	317/337 (94%)	304 (96%)	13 (4%)	30	41
1	Q	311/337 (92%)	296 (95%)	15 (5%)	25	34
2	E	12/12 (100%)	12 (100%)	0	100	100
2	F	11/12 (92%)	11 (100%)	0	100	100
2	G	10/12 (83%)	10 (100%)	0	100	100
2	H	12/12 (100%)	12 (100%)	0	100	100
2	I	11/12 (92%)	11 (100%)	0	100	100
2	J	10/12 (83%)	10 (100%)	0	100	100
2	M	12/12 (100%)	12 (100%)	0	100	100
2	N	12/12 (100%)	12 (100%)	0	100	100
2	O	12/12 (100%)	12 (100%)	0	100	100
2	R	12/12 (100%)	12 (100%)	0	100	100
2	S	12/12 (100%)	12 (100%)	0	100	100
2	T	11/12 (92%)	11 (100%)	0	100	100
All	All	2659/2840 (94%)	2566 (96%)	93 (4%)	36	49

5 of 93 residues with a non-rotameric sidechain are listed below:

Mol	Chain	Res	Type
1	D	330	ILE
1	K	299	LYS
1	Q	260	LEU
1	K	42	THR
1	K	195	THR

Some sidechains can be flipped to improve hydrogen bonding and reduce clashes. 5 of 6 such sidechains are listed below:

Mol	Chain	Res	Type
1	K	108	HIS
1	Q	318	GLN
1	L	318	GLN
1	D	318	GLN

Continued on next page...

Continued from previous page...

Mol	Chain	Res	Type
1	P	108	HIS

5.3.3 RNA [i](#)

There are no RNA molecules in this entry.

5.4 Non-standard residues in protein, DNA, RNA chains [i](#)

There are no non-standard protein/DNA/RNA residues in this entry.

5.5 Carbohydrates [i](#)

There are no monosaccharides in this entry.

5.6 Ligand geometry [i](#)

5 ligands are modelled in this entry.

In the following table, the Counts columns list the number of bonds (or angles) for which Mogul statistics could be retrieved, the number of bonds (or angles) that are observed in the model and the number of bonds (or angles) that are defined in the Chemical Component Dictionary. The Link column lists molecule types, if any, to which the group is linked. The Z score for a bond length (or angle) is the number of standard deviations the observed value is removed from the expected value. A bond length (or angle) with $|Z| > 2$ is considered an outlier worth inspection. RMSZ is the root-mean-square of all Z scores of the bond lengths (or angles).

Mol	Type	Chain	Res	Link	Bond lengths			Bond angles		
					Counts	RMSZ	# Z > 2	Counts	RMSZ	# Z > 2
3	SIN	C	1418	-	1,7,7	0.02	0	2,8,8	1.07	0
3	SIN	K	1415	-	1,7,7	0.22	0	2,8,8	0.89	0
3	SIN	A	1421	-	1,7,7	0.21	0	2,8,8	0.88	0
3	SIN	P	1416	-	1,7,7	0.16	0	2,8,8	0.84	0
3	SIN	Q	1412	-	1,7,7	0.02	0	2,8,8	0.89	0

In the following table, the Chirals column lists the number of chiral outliers, the number of chiral centers analysed, the number of these observed in the model and the number defined in the Chemical Component Dictionary. Similar counts are reported in the Torsion and Rings columns. '-' means no outliers of that kind were identified.

Mol	Type	Chain	Res	Link	Chirals	Torsions	Rings
3	SIN	C	1418	-	-	0/1/5/5	-
3	SIN	K	1415	-	-	1/1/5/5	-
3	SIN	A	1421	-	-	1/1/5/5	-
3	SIN	P	1416	-	-	0/1/5/5	-
3	SIN	Q	1412	-	-	0/1/5/5	-

There are no bond length outliers.

There are no bond angle outliers.

There are no chirality outliers.

All (2) torsion outliers are listed below:

Mol	Chain	Res	Type	Atoms
3	K	1415	SIN	C1-C2-C3-C4
3	A	1421	SIN	C1-C2-C3-C4

There are no ring outliers.

2 monomers are involved in 2 short contacts:

Mol	Chain	Res	Type	Clashes	Symm-Clashes
3	C	1418	SIN	1	0
3	A	1421	SIN	1	0

5.7 Other polymers [i](#)

There are no such residues in this entry.

5.8 Polymer linkage issues [i](#)

There are no chain breaks in this entry.

6 Fit of model and data [i](#)

6.1 Protein, DNA and RNA chains [i](#)

In the following table, the column labelled '#RSRZ > 2' contains the number (and percentage) of RSRZ outliers, followed by percent RSRZ outliers for the chain as percentile scores relative to all X-ray entries and entries of similar resolution. The OWAB column contains the minimum, median, 95th percentile and maximum values of the occupancy-weighted average B-factor per residue. The column labelled 'Q < 0.9' lists the number of (and percentage) of residues with an average occupancy less than 0.9.

Mol	Chain	Analysed	<RSRZ>	#RSRZ>2	OWAB(Å ²)	Q<0.9
1	A	380/392 (96%)	0.37	28 (7%) 14 18	28, 57, 105, 133	0
1	B	364/392 (92%)	0.23	17 (4%) 31 38	22, 54, 107, 147	0
1	C	376/392 (95%)	0.41	34 (9%) 9 11	24, 57, 118, 148	0
1	D	368/392 (93%)	0.25	21 (5%) 23 28	22, 49, 102, 133	0
1	K	374/392 (95%)	0.21	12 (3%) 47 55	25, 53, 96, 125	0
1	L	369/392 (94%)	0.40	30 (8%) 12 15	22, 59, 119, 140	0
1	P	373/392 (95%)	0.30	16 (4%) 35 42	26, 59, 103, 131	0
1	Q	365/392 (93%)	0.13	11 (3%) 50 57	24, 50, 98, 125	0
2	E	17/19 (89%)	-0.18	0 100 100	24, 30, 66, 75	0
2	F	16/19 (84%)	-0.12	0 100 100	27, 35, 59, 68	0
2	G	15/19 (78%)	-0.30	0 100 100	26, 31, 56, 91	0
2	H	17/19 (89%)	-0.24	0 100 100	21, 29, 65, 76	0
2	I	16/19 (84%)	-0.27	0 100 100	22, 32, 63, 71	0
2	J	15/19 (78%)	-0.11	0 100 100	19, 30, 57, 90	0
2	M	17/19 (89%)	-0.16	0 100 100	23, 31, 68, 78	0
2	N	17/19 (89%)	-0.06	0 100 100	27, 32, 71, 78	0
2	O	17/19 (89%)	-0.22	0 100 100	24, 31, 87, 100	0
2	R	17/19 (89%)	-0.05	0 100 100	26, 32, 61, 67	0
2	S	17/19 (89%)	0.11	0 100 100	29, 34, 64, 76	0
2	T	16/19 (84%)	0.05	0 100 100	28, 33, 65, 92	0
All	All	3166/3364 (94%)	0.26	169 (5%) 26 31	19, 53, 106, 148	0

The worst 5 of 169 RSRZ outliers are listed below:

Mol	Chain	Res	Type	RSRZ
1	B	163	PHE	6.5
1	C	344	LYS	5.9
1	P	344	LYS	5.9
1	L	39	LYS	5.7
1	C	346	LEU	5.6

6.2 Non-standard residues in protein, DNA, RNA chains [i](#)

There are no non-standard protein/DNA/RNA residues in this entry.

6.3 Carbohydrates [i](#)

There are no monosaccharides in this entry.

6.4 Ligands [i](#)

In the following table, the Atoms column lists the number of modelled atoms in the group and the number defined in the chemical component dictionary. The B-factors column lists the minimum, median, 95th percentile and maximum values of B factors of atoms in the group. The column labelled 'Q< 0.9' lists the number of atoms with occupancy less than 0.9.

Mol	Type	Chain	Res	Atoms	RSCC	RSR	B-factors(\AA^2)	Q<0.9
3	SIN	C	1418	8/8	0.73	0.20	55,58,62,64	0
3	SIN	P	1416	8/8	0.73	0.20	71,73,76,77	0
3	SIN	A	1421	8/8	0.76	0.20	59,62,64,65	0
3	SIN	K	1415	8/8	0.78	0.20	56,60,63,64	0
3	SIN	Q	1412	8/8	0.88	0.15	50,60,68,71	0

6.5 Other polymers [i](#)

There are no such residues in this entry.