



wwPDB EM Validation Summary Report ⓘ

Dec 17, 2022 – 10:42 pm GMT

PDB ID : 6ZP4
EMDB ID : EMD-11335
Title : SARS-CoV-2 Nsp1 bound to a human 43S preinitiation ribosome complex - state 2
Authors : Thoms, M.; Buschauer, R.; Ameismeier, M.; Denk, T.; Kratzat, H.; Mackens-Kiani, T.; Cheng, J.; Berninghausen, O.; Becker, T.; Beckmann, R.
Deposited on : 2020-07-08
Resolution : 2.90 Å(reported)

This is a wwPDB EM Validation Summary Report for a publicly released PDB entry.

We welcome your comments at validation@mail.wwpdb.org

A user guide is available at

<https://www.wwpdb.org/validation/2017/EMValidationReportHelp>

with specific help available everywhere you see the ⓘ symbol.

The types of validation reports are described at

<http://www.wwpdb.org/validation/2017/FAQs#types>.

The following versions of software and data (see [references ⓘ](#)) were used in the production of this report:

EMDB validation analysis : 0.0.1.dev43
Mogul : 1.8.4, CSD as541be (2020)
MolProbity : 4.02b-467
buster-report : 1.1.7 (2018)
Percentile statistics : 20191225.v01 (using entries in the PDB archive December 25th 2019)
MapQ : 1.9.9
Ideal geometry (proteins) : Engh & Huber (2001)
Ideal geometry (DNA, RNA) : Parkinson et al. (1996)
Validation Pipeline (wwPDB-VP) : 2.31.3

1 Overall quality at a glance

The following experimental techniques were used to determine the structure:
ELECTRON MICROSCOPY

The reported resolution of this entry is 2.90 Å.

Percentile scores (ranging between 0-100) for global validation metrics of the entry are shown in the following graphic. The table shows the number of entries on which the scores are based.

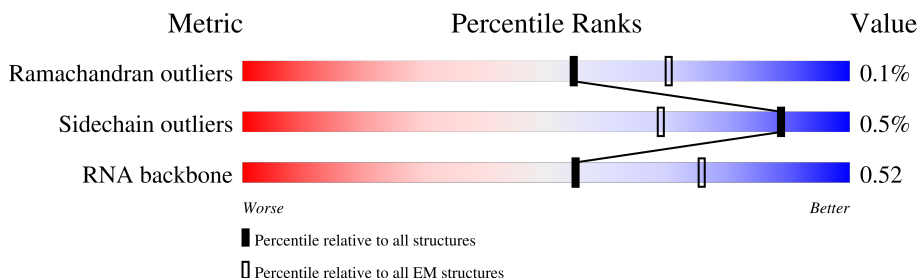











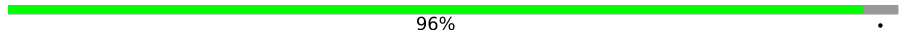
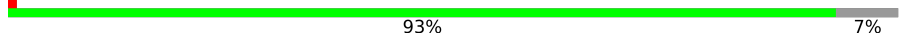

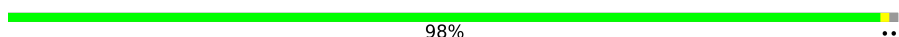

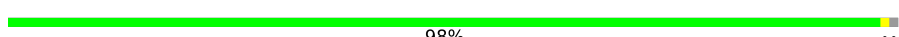



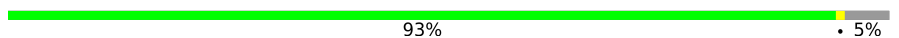



| Metric | Whole archive (#Entries) | EM structures (#Entries) |
|-----------------------|-----------------------------|-----------------------------|
| Ramachandran outliers | 154571 | 4023 |
| Sidechain outliers | 154315 | 3826 |
| RNA backbone | 4643 | 859 |

The table below summarises the geometric issues observed across the polymeric chains and their fit to the map. The red, orange, yellow and green segments of the bar indicate the fraction of residues that contain outliers for ≥ 3 , 2, 1 and 0 types of geometric quality criteria respectively. A grey segment represents the fraction of residues that are not modelled. The numeric value for each fraction is indicated below the corresponding segment, with a dot representing fractions $\leq 5\%$. The upper red bar (where present) indicates the fraction of residues that have poor fit to the EM map (all-atom inclusion $< 40\%$). The numeric value is given above the bar.

| Mol | Chain | Length | Quality of chain |
|-----|-------|--------|------------------|
| 1 | a | 295 | |
| 2 | p | 264 | |
| 3 | d | 293 | |
| 4 | Q | 115 | |
| 5 | q | 263 | |
| 6 | W | 25 | |
| 7 | r | 249 | |
| 8 | s | 194 | |



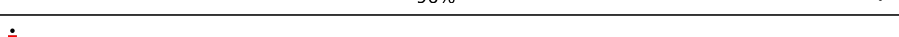





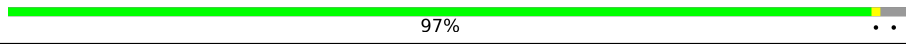

Continued on next page...

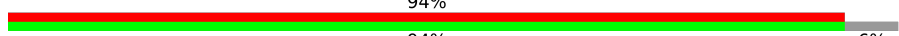
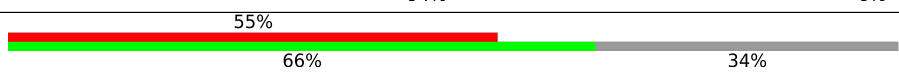
Continued from previous page...

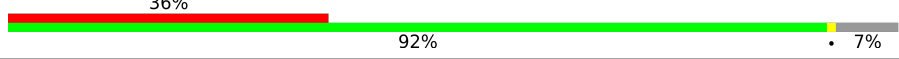
| Mol | Chain | Length | Quality of chain |
|-----|-------|--------|--|
| 9 | t | 208 |  96% |
| 10 | c | 194 |  93% 7% |
| 11 | n | 158 |  84% 15% |
| 12 | m | 151 |  98% |
| 13 | y | 83 |  99% |
| 14 | D | 130 |  98% |
| 15 | z | 133 |  92% 8% |
| 16 | R | 84 |  96% |
| 17 | T | 59 |  75% 25% |
| 18 | 2 | 1868 |  67% 23% 8% |
| 19 | w | 135 |  93% 5% |
| 20 | b | 243 |  92% 8% |
| 21 | e | 204 |  92% 7% |
| 22 | u | 165 |  58% 42% |
| 23 | v | 132 |  12% 84% 16% |
| 24 | o | 145 |  82% 18% |
| 25 | g | 146 |  94% 5% |
| 26 | k | 152 |  91% 8% |
| 27 | x | 145 |  97% |
| 28 | h | 119 |  82% 18% |
| 29 | P | 125 |  56% 44% |
| 30 | S | 69 |  88% 12% |
| 31 | l | 56 |  96% |
| 32 | U | 156 |  37% 63% |
| 33 | V | 317 |  93% 7% |

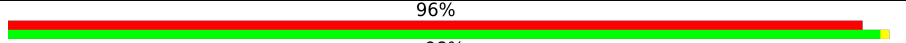
Continued on next page...

Continued from previous page...

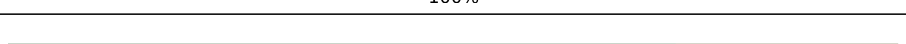
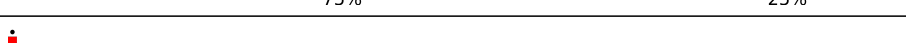
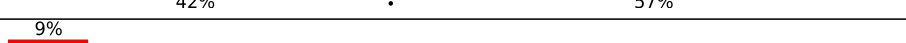
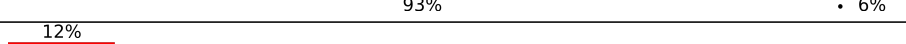
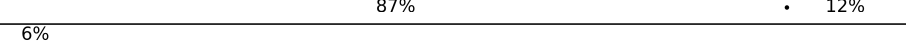
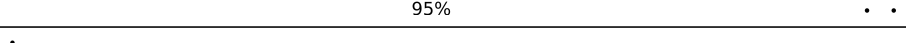
| Mol | Chain | Length | Quality of chain |
|-----|-------|--------|--|
| 34 | i | 151 |  83% 17% |
| 35 | j | 143 |  97% |
| 36 | G | 144 |  61% 39% |
| 37 | I | 325 |  94% 6% |
| 38 | B | 814 |  55% 66% 34% |
| 39 | A | 1382 |  15% 49% 50% |
| 40 | C | 913 |  69% 31% |
| 41 | E | 445 |  36% 92% 7% |
| 42 | F | 357 |  56% 74% 25% |
| 43 | H | 352 |  51% 82% 16% |
| 44 | K | 218 |  96% 98% |
| 45 | L | 564 |  59% 64% 34% |
| 46 | M | 374 |  71% 88% 10% |
| 47 | N | 548 |  11% 81% 18% |
| 48 | X | 78 |  15% 100% |
| 49 | 1 | 75 |  75% 25% |
| 50 | 4 | 333 |  42% 57% |
| 51 | O | 315 |  9% 93% 6% |
| 52 | Y | 472 |  12% 87% 12% |
| 53 | Z | 113 |  6% 95% |
| 54 | J | 180 |  18% 82% |

2 Entry composition [i](#)

There are 57 unique types of molecules in this entry. The entry contains 117784 atoms, of which 0 are hydrogens and 0 are deuteriums.

In the tables below, the AltConf column contains the number of residues with at least one atom in alternate conformation and the Trace column contains the number of residues modelled with at most 2 atoms.

- Molecule 1 is a protein called 40S ribosomal protein SA.

| Mol | Chain | Residues | Atoms | | | | | AltConf | Trace |
|-----|-------|----------|-------|------|-----|-----|---|---------|-------|
| | | | Total | C | N | O | S | | |
| 1 | a | 216 | 1705 | 1083 | 299 | 315 | 8 | 0 | 0 |

- Molecule 2 is a protein called 40S ribosomal protein S3a.

| Mol | Chain | Residues | Atoms | | | | | AltConf | Trace |
|-----|-------|----------|-------|------|-----|-----|----|---------|-------|
| | | | Total | C | N | O | S | | |
| 2 | p | 211 | 1715 | 1088 | 307 | 306 | 14 | 0 | 0 |

- Molecule 3 is a protein called 40S ribosomal protein S2.

| Mol | Chain | Residues | Atoms | | | | | AltConf | Trace |
|-----|-------|----------|-------|------|-----|-----|----|---------|-------|
| | | | Total | C | N | O | S | | |
| 3 | d | 216 | 1674 | 1085 | 287 | 292 | 10 | 0 | 0 |

- Molecule 4 is a protein called 40S ribosomal protein S26.

| Mol | Chain | Residues | Atoms | | | | | AltConf | Trace |
|-----|-------|----------|-------|-----|-----|-----|---|---------|-------|
| | | | Total | C | N | O | S | | |
| 4 | Q | 101 | 814 | 507 | 170 | 132 | 5 | 0 | 0 |

- Molecule 5 is a protein called 40S ribosomal protein S4, X isoform.

| Mol | Chain | Residues | Atoms | | | | | AltConf | Trace |
|-----|-------|----------|-------|------|-----|-----|---|---------|-------|
| | | | Total | C | N | O | S | | |
| 5 | q | 255 | 2031 | 1299 | 377 | 347 | 8 | 0 | 0 |

- Molecule 6 is a protein called 60S ribosomal protein L41.

| Mol | Chain | Residues | Atoms | | | | | AltConf | Trace |
|-----|-------|----------|-------|-----|----|----|---|---------|-------|
| | | | Total | C | N | O | S | | |
| 6 | W | 24 | 230 | 139 | 62 | 26 | 3 | 0 | 0 |

- Molecule 7 is a protein called 40S ribosomal protein S6.

| Mol | Chain | Residues | Atoms | | | | | AltConf | Trace |
|-----|-------|----------|-------|------|-----|-----|---|---------|-------|
| | | | Total | C | N | O | S | | |
| 7 | r | 222 | 1794 | 1123 | 357 | 308 | 6 | 0 | 0 |

- Molecule 8 is a protein called 40S ribosomal protein S7.

| Mol | Chain | Residues | Atoms | | | | | AltConf | Trace |
|-----|-------|----------|-------|-----|-----|-----|---|---------|-------|
| | | | Total | C | N | O | S | | |
| 8 | s | 173 | 1399 | 898 | 256 | 244 | 1 | 0 | 0 |

- Molecule 9 is a protein called 40S ribosomal protein S8.

| Mol | Chain | Residues | Atoms | | | | | AltConf | Trace |
|-----|-------|----------|-------|------|-----|-----|---|---------|-------|
| | | | Total | C | N | O | S | | |
| 9 | t | 199 | 1638 | 1027 | 322 | 284 | 5 | 0 | 0 |

- Molecule 10 is a protein called 40S ribosomal protein S9.

| Mol | Chain | Residues | Atoms | | | | | AltConf | Trace |
|-----|-------|----------|-------|-----|-----|-----|---|---------|-------|
| | | | Total | C | N | O | S | | |
| 10 | c | 180 | 1499 | 955 | 300 | 242 | 2 | 0 | 0 |

- Molecule 11 is a protein called 40S ribosomal protein S11.

| Mol | Chain | Residues | Atoms | | | | | AltConf | Trace |
|-----|-------|----------|-------|-----|-----|-----|---|---------|-------|
| | | | Total | C | N | O | S | | |
| 11 | n | 135 | 1119 | 715 | 211 | 187 | 6 | 0 | 0 |

- Molecule 12 is a protein called 40S ribosomal protein S13.

| Mol | Chain | Residues | Atoms | | | | | AltConf | Trace |
|-----|-------|----------|-------|-----|-----|-----|---|---------|-------|
| | | | Total | C | N | O | S | | |
| 12 | m | 149 | 1202 | 770 | 228 | 203 | 1 | 0 | 0 |

- Molecule 13 is a protein called 40S ribosomal protein S21.

| Mol | Chain | Residues | Atoms | | | | | AltConf | Trace |
|-----|-------|----------|-------|-----|-----|-----|---|---------|-------|
| | | | Total | C | N | O | S | | |
| 13 | y | 82 | 625 | 384 | 116 | 120 | 5 | 0 | 0 |

- Molecule 14 is a protein called 40S ribosomal protein S15a.

| Mol | Chain | Residues | Atoms | | | | | AltConf | Trace |
|-----|-------|----------|-------|-----|-----|-----|---|---------|-------|
| 14 | D | 129 | Total | C | N | O | S | 0 | 0 |
| | | | 1034 | 659 | 193 | 176 | 6 | | |

- Molecule 15 is a protein called 40S ribosomal protein S24.

| Mol | Chain | Residues | Atoms | | | | | AltConf | Trace |
|-----|-------|----------|-------|-----|-----|-----|---|---------|-------|
| 15 | z | 122 | Total | C | N | O | S | 0 | 0 |
| | | | 999 | 633 | 196 | 165 | 5 | | |

- Molecule 16 is a protein called 40S ribosomal protein S27.

| Mol | Chain | Residues | Atoms | | | | | AltConf | Trace |
|-----|-------|----------|-------|-----|-----|-----|---|---------|-------|
| 16 | R | 82 | Total | C | N | O | S | 0 | 0 |
| | | | 640 | 402 | 118 | 113 | 7 | | |

- Molecule 17 is a protein called 40S ribosomal protein S30.

| Mol | Chain | Residues | Atoms | | | | | AltConf | Trace |
|-----|-------|----------|-------|-----|----|----|---|---------|-------|
| 17 | T | 44 | Total | C | N | O | S | 0 | 0 |
| | | | 354 | 216 | 81 | 56 | 1 | | |

- Molecule 18 is a RNA chain called 18S ribosomal RNA.

| Mol | Chain | Residues | Atoms | | | | | AltConf | Trace |
|-----|-------|----------|-------|-------|------|-------|------|---------|-------|
| 18 | 2 | 1721 | Total | C | N | O | P | 0 | 0 |
| | | | 36718 | 16400 | 6603 | 12004 | 1711 | | |

There is a discrepancy between the modelled and reference sequences:

| Chain | Residue | Modelled | Actual | Comment | Reference |
|-------|---------|----------|--------|----------|-----------|
| 2 | 1772 | C | G | conflict | GB 337376 |

- Molecule 19 is a protein called 40S ribosomal protein S17.

| Mol | Chain | Residues | Atoms | | | | | AltConf | Trace |
|-----|-------|----------|-------|-----|-----|-----|---|---------|-------|
| 19 | w | 128 | Total | C | N | O | S | 0 | 0 |
| | | | 1011 | 641 | 182 | 184 | 4 | | |

- Molecule 20 is a protein called 40S ribosomal protein S3.

| Mol | Chain | Residues | Atoms | | | | | AltConf | Trace |
|-----|-------|----------|-------|------|-----|-----|---|---------|-------|
| 20 | b | 224 | Total | C | N | O | S | 0 | 0 |
| | | | 1745 | 1112 | 314 | 312 | 7 | | |

- Molecule 21 is a protein called 40S ribosomal protein S5.

| Mol | Chain | Residues | Atoms | | | | | AltConf | Trace |
|-----|-------|----------|-------|-----|-----|-----|---|---------|-------|
| 21 | e | 189 | Total | C | N | O | S | 0 | 0 |
| | | | 1495 | 934 | 284 | 270 | 7 | | |

- Molecule 22 is a protein called 40S ribosomal protein S10.

| Mol | Chain | Residues | Atoms | | | | | AltConf | Trace |
|-----|-------|----------|-------|-----|-----|-----|---|---------|-------|
| 22 | u | 95 | Total | C | N | O | S | 0 | 0 |
| | | | 799 | 524 | 139 | 130 | 6 | | |

- Molecule 23 is a protein called 40S ribosomal protein S12.

| Mol | Chain | Residues | Atoms | | | | | AltConf | Trace |
|-----|-------|----------|-------|-----|-----|-----|---|---------|-------|
| 23 | v | 111 | Total | C | N | O | S | 0 | 0 |
| | | | 861 | 544 | 151 | 159 | 7 | | |

- Molecule 24 is a protein called 40S ribosomal protein S15.

| Mol | Chain | Residues | Atoms | | | | | AltConf | Trace |
|-----|-------|----------|-------|-----|-----|-----|---|---------|-------|
| 24 | o | 119 | Total | C | N | O | S | 0 | 0 |
| | | | 980 | 623 | 183 | 167 | 7 | | |

- Molecule 25 is a protein called 40S ribosomal protein S16.

| Mol | Chain | Residues | Atoms | | | | | AltConf | Trace |
|-----|-------|----------|-------|-----|-----|-----|---|---------|-------|
| 25 | g | 138 | Total | C | N | O | S | 0 | 0 |
| | | | 1100 | 699 | 208 | 190 | 3 | | |

- Molecule 26 is a protein called 40S ribosomal protein S18.

| Mol | Chain | Residues | Atoms | | | | | AltConf | Trace |
|-----|-------|----------|-------|-----|-----|-----|---|---------|-------|
| 26 | k | 140 | Total | C | N | O | S | 0 | 0 |
| | | | 1162 | 731 | 234 | 196 | 1 | | |

- Molecule 27 is a protein called 40S ribosomal protein S19.

| Mol | Chain | Residues | Atoms | | | | | AltConf | Trace |
|-----|-------|----------|-------|-----|-----|-----|---|---------|-------|
| 27 | x | 141 | Total | C | N | O | S | 0 | 0 |
| | | | 1094 | 685 | 210 | 196 | 3 | | |

- Molecule 28 is a protein called 40S ribosomal protein S20.

| Mol | Chain | Residues | Atoms | | | | | AltConf | Trace |
|-----|-------|----------|-------|-----|-----|-----|---|---------|-------|
| 28 | h | 98 | Total | C | N | O | S | 0 | 0 |
| | | | 780 | 489 | 148 | 139 | 4 | | |

- Molecule 29 is a protein called 40S ribosomal protein S25.

| Mol | Chain | Residues | Atoms | | | | | AltConf | Trace |
|-----|-------|----------|-------|-----|-----|----|---|---------|-------|
| 29 | P | 70 | Total | C | N | O | S | 0 | 0 |
| | | | 557 | 358 | 101 | 97 | 1 | | |

- Molecule 30 is a protein called 40S ribosomal protein S28.

| Mol | Chain | Residues | Atoms | | | | | AltConf | Trace |
|-----|-------|----------|-------|-----|----|----|---|---------|-------|
| 30 | S | 61 | Total | C | N | O | S | 0 | 0 |
| | | | 479 | 292 | 95 | 90 | 2 | | |

- Molecule 31 is a protein called 40S ribosomal protein S29.

| Mol | Chain | Residues | Atoms | | | | | AltConf | Trace |
|-----|-------|----------|-------|-----|----|----|---|---------|-------|
| 31 | l | 54 | Total | C | N | O | S | 0 | 0 |
| | | | 450 | 282 | 93 | 70 | 5 | | |

- Molecule 32 is a protein called Ubiquitin-40S ribosomal protein S27a.

| Mol | Chain | Residues | Atoms | | | | | AltConf | Trace |
|-----|-------|----------|-------|-----|----|----|---|---------|-------|
| 32 | U | 57 | Total | C | N | O | S | 0 | 0 |
| | | | 465 | 295 | 89 | 74 | 7 | | |

- Molecule 33 is a protein called Receptor of activated protein C kinase 1.

| Mol | Chain | Residues | Atoms | | | | | AltConf | Trace |
|-----|-------|----------|-------|------|-----|-----|----|---------|-------|
| 33 | V | 296 | Total | C | N | O | S | 0 | 0 |
| | | | 2314 | 1464 | 404 | 434 | 12 | | |

- Molecule 34 is a protein called 40S ribosomal protein S14.

| Mol | Chain | Residues | Atoms | | | | | AltConf | Trace |
|-----|-------|----------|-------|-----|-----|-----|---|---------|-------|
| 34 | i | 125 | Total | C | N | O | S | 0 | 0 |
| | | | 939 | 574 | 187 | 172 | 6 | | |

- Molecule 35 is a protein called 40S ribosomal protein S23.

| Mol | Chain | Residues | Atoms | | | | | AltConf | Trace |
|-----|-------|----------|-------|-----|-----|-----|---|---------|-------|
| 35 | j | 139 | Total | C | N | O | S | 0 | 0 |
| | | | 1080 | 682 | 214 | 181 | 3 | | |

- Molecule 36 is a protein called Eukaryotic translation initiation factor 1A, X-chromosomal.

| Mol | Chain | Residues | Atoms | | | | | AltConf | Trace |
|-----|-------|----------|-------|-----|-----|-----|---|---------|-------|
| 36 | G | 88 | Total | C | N | O | S | 0 | 0 |
| | | | 712 | 451 | 129 | 128 | 4 | | |

- Molecule 37 is a protein called Eukaryotic translation initiation factor 3 subunit I.

| Mol | Chain | Residues | Atoms | | | | AltConf | Trace |
|-----|-------|----------|-------|-----|-----|-----|---------|-------|
| 37 | I | 305 | Total | C | N | O | 0 | 0 |
| | | | 1497 | 887 | 305 | 305 | | |

- Molecule 38 is a protein called Eukaryotic translation initiation factor 3 subunit B.

| Mol | Chain | Residues | Atoms | | | | | AltConf | Trace |
|-----|-------|----------|-------|------|-----|-----|---|---------|-------|
| 38 | B | 536 | Total | C | N | O | S | 0 | 0 |
| | | | 2966 | 1801 | 580 | 580 | 5 | | |

- Molecule 39 is a protein called Eukaryotic translation initiation factor 3 subunit A.

| Mol | Chain | Residues | Atoms | | | | | AltConf | Trace |
|-----|-------|----------|-------|------|-----|------|----|---------|-------|
| 39 | A | 692 | Total | C | N | O | S | 0 | 0 |
| | | | 5380 | 3375 | 980 | 1003 | 22 | | |

- Molecule 40 is a protein called Eukaryotic translation initiation factor 3 subunit C.

| Mol | Chain | Residues | Atoms | | | | | AltConf | Trace |
|-----|-------|----------|-------|------|-----|-----|----|---------|-------|
| 40 | C | 633 | Total | C | N | O | S | 0 | 0 |
| | | | 5110 | 3228 | 906 | 941 | 35 | | |

- Molecule 41 is a protein called Eukaryotic translation initiation factor 3 subunit E.

| Mol | Chain | Residues | Atoms | | | | | AltConf | Trace |
|-----|-------|----------|-------|------|-----|-----|----|---------|-------|
| | | | Total | C | N | O | S | | |
| 41 | E | 416 | 3437 | 2202 | 585 | 630 | 20 | 0 | 0 |

- Molecule 42 is a protein called Eukaryotic translation initiation factor 3 subunit F.

| Mol | Chain | Residues | Atoms | | | | | AltConf | Trace |
|-----|-------|----------|-------|------|-----|-----|----|---------|-------|
| | | | Total | C | N | O | S | | |
| 42 | F | 269 | 2090 | 1317 | 356 | 405 | 12 | 0 | 0 |

- Molecule 43 is a protein called Eukaryotic translation initiation factor 3 subunit H.

| Mol | Chain | Residues | Atoms | | | | | AltConf | Trace |
|-----|-------|----------|-------|------|-----|-----|----|---------|-------|
| | | | Total | C | N | O | S | | |
| 43 | H | 295 | 2413 | 1532 | 417 | 449 | 15 | 0 | 0 |

- Molecule 44 is a protein called Eukaryotic translation initiation factor 3 subunit K.

| Mol | Chain | Residues | Atoms | | | | | AltConf | Trace |
|-----|-------|----------|-------|------|-----|-----|----|---------|-------|
| | | | Total | C | N | O | S | | |
| 44 | K | 217 | 1750 | 1116 | 288 | 334 | 12 | 0 | 0 |

- Molecule 45 is a protein called Eukaryotic translation initiation factor 3 subunit L.

| Mol | Chain | Residues | Atoms | | | | | AltConf | Trace |
|-----|-------|----------|-------|------|-----|-----|----|---------|-------|
| | | | Total | C | N | O | S | | |
| 45 | L | 372 | 3111 | 2011 | 520 | 563 | 17 | 0 | 0 |

- Molecule 46 is a protein called Eukaryotic translation initiation factor 3 subunit M.

| Mol | Chain | Residues | Atoms | | | | | AltConf | Trace |
|-----|-------|----------|-------|------|-----|-----|----|---------|-------|
| | | | Total | C | N | O | S | | |
| 46 | M | 338 | 2705 | 1727 | 457 | 504 | 17 | 0 | 0 |

- Molecule 47 is a protein called Eukaryotic translation initiation factor 3 subunit D.

| Mol | Chain | Residues | Atoms | | | | | AltConf | Trace |
|-----|-------|----------|-------|------|-----|-----|----|---------|-------|
| | | | Total | C | N | O | S | | |
| 47 | N | 447 | 3617 | 2279 | 625 | 691 | 22 | 0 | 0 |

- Molecule 48 is a protein called Unknown factor.

| Mol | Chain | Residues | Atoms | | | | AltConf | Trace |
|-----|-------|----------|-------|-----|----|----|---------|-------|
| 48 | X | 78 | Total | C | N | O | 0 | 0 |
| | | | 390 | 234 | 78 | 78 | | |

- Molecule 49 is a RNA chain called tRNA.

| Mol | Chain | Residues | Atoms | | | | | AltConf | Trace |
|-----|-------|----------|-------|-----|-----|-----|----|---------|-------|
| 49 | 1 | 75 | Total | C | N | O | P | 0 | 0 |
| | | | 1603 | 717 | 298 | 514 | 74 | | |

- Molecule 50 is a protein called Eukaryotic translation initiation factor 2 subunit 2.

| Mol | Chain | Residues | Atoms | | | | | AltConf | Trace |
|-----|-------|----------|-------|-----|-----|-----|---|---------|-------|
| 50 | 4 | 144 | Total | C | N | O | S | 0 | 0 |
| | | | 1080 | 679 | 202 | 192 | 7 | | |

- Molecule 51 is a protein called Eukaryotic translation initiation factor 2 subunit 1.

| Mol | Chain | Residues | Atoms | | | | | AltConf | Trace |
|-----|-------|----------|-------|------|-----|-----|---|---------|-------|
| 51 | O | 296 | Total | C | N | O | S | 0 | 0 |
| | | | 2138 | 1342 | 384 | 404 | 8 | | |

- Molecule 52 is a protein called Eukaryotic translation initiation factor 2 subunit 3.

| Mol | Chain | Residues | Atoms | | | | AltConf | Trace |
|-----|-------|----------|-------|------|-----|-----|---------|-------|
| 52 | Y | 414 | Total | C | N | O | 0 | 0 |
| | | | 2156 | 1296 | 433 | 427 | | |

- Molecule 53 is a protein called Eukaryotic translation initiation factor 1.

| Mol | Chain | Residues | Atoms | | | | | AltConf | Trace |
|-----|-------|----------|-------|-----|-----|-----|---|---------|-------|
| 53 | Z | 110 | Total | C | N | O | S | 0 | 0 |
| | | | 830 | 524 | 150 | 154 | 2 | | |

- Molecule 54 is a protein called Non-structural protein 1.

| Mol | Chain | Residues | Atoms | | | | | AltConf | Trace |
|-----|-------|----------|-------|-----|----|----|---|---------|-------|
| 54 | J | 33 | Total | C | N | O | S | 0 | 0 |
| | | | 261 | 159 | 47 | 54 | 1 | | |

- Molecule 55 is ZINC ION (three-letter code: ZN) (formula: Zn).

| Mol | Chain | Residues | Atoms | | AltConf |
|-----|-------|----------|-------|----|---------|
| 55 | Q | 1 | Total | Zn | 0 |
| | | | 1 | 1 | |
| 55 | 1 | 1 | Total | Zn | 0 |
| | | | 1 | 1 | |
| 55 | U | 1 | Total | Zn | 0 |
| | | | 1 | 1 | |
| 55 | 4 | 1 | Total | Zn | 0 |
| | | | 1 | 1 | |

- Molecule 56 is GUANOSINE-5'-TRIPHOSPHATE (three-letter code: GTP) (formula: $C_{10}H_{16}N_5O_{14}P_3$).

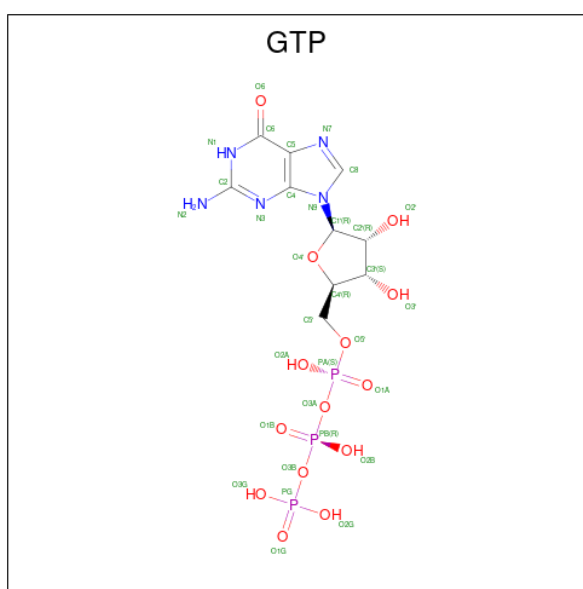

| Mol | Chain | Residues | Atoms | | | | | AltConf |
|-----|-------|----------|-------|----|---|----|---|---------|
| 56 | Y | 1 | Total | C | N | O | P | 0 |
| | | | 32 | 10 | 5 | 14 | 3 | |

- Molecule 57 is MAGNESIUM ION (three-letter code: MG) (formula: Mg).

| Mol | Chain | Residues | Atoms | | AltConf |
|-----|-------|----------|-------|----|---------|
| 57 | Y | 1 | Total | Mg | 0 |
| | | | 1 | 1 | |

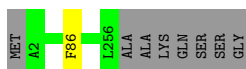

- Molecule 6: 60S ribosomal protein L41

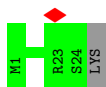

- Molecule 7: 40S ribosomal protein S6

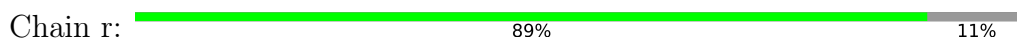

- Molecule 8: 40S ribosomal protein S7

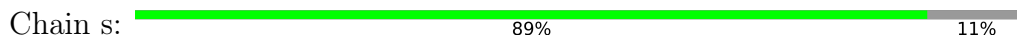

- Molecule 9: 40S ribosomal protein S8

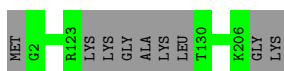

- Molecule 10: 40S ribosomal protein S9

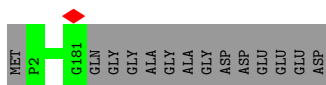

- Molecule 11: 40S ribosomal protein S11

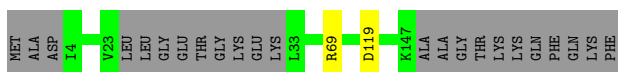
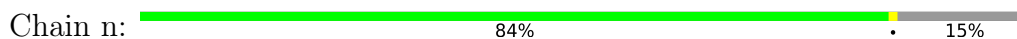

- Molecule 12: 40S ribosomal protein S13





- Molecule 13: 40S ribosomal protein S21



- Molecule 14: 40S ribosomal protein S15a



- Molecule 15: 40S ribosomal protein S24

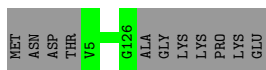

- Molecule 16: 40S ribosomal protein S27



- Molecule 17: 40S ribosomal protein S30

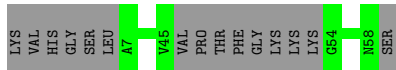

- Molecule 18: 18S ribosomal RNA

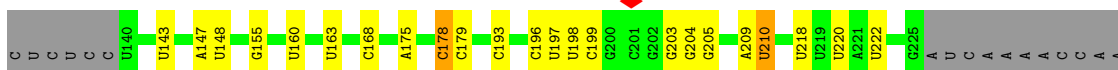
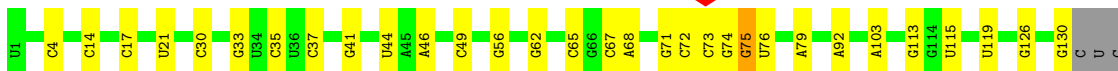

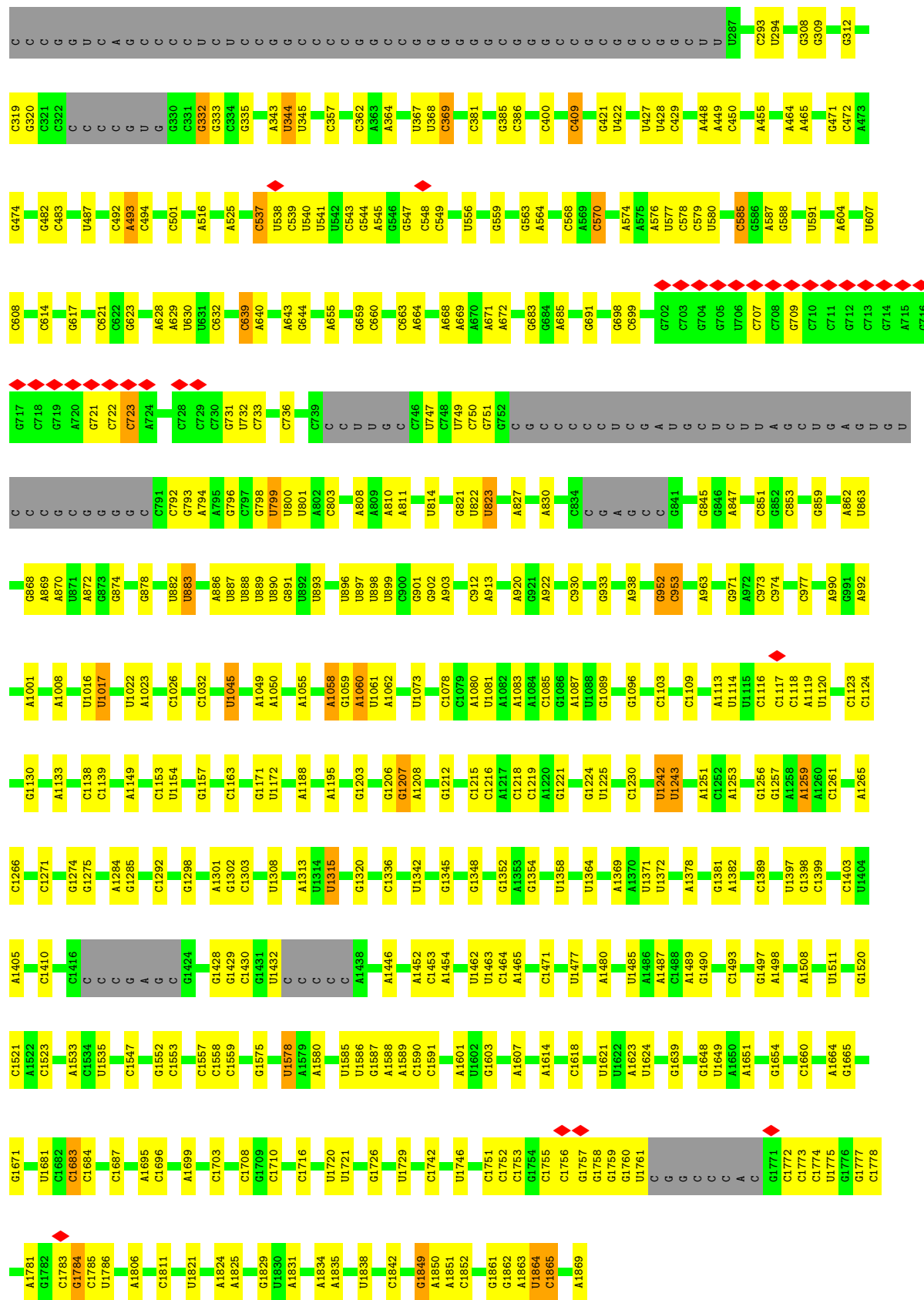

• Molecule 19: 40S ribosomal protein S17

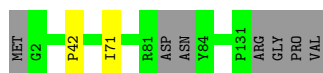

• Molecule 20: 40S ribosomal protein S3

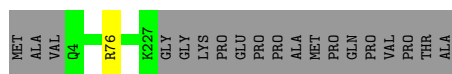

• Molecule 21: 40S ribosomal protein S5

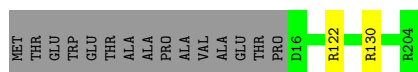

• Molecule 22: 40S ribosomal protein S10

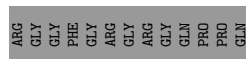
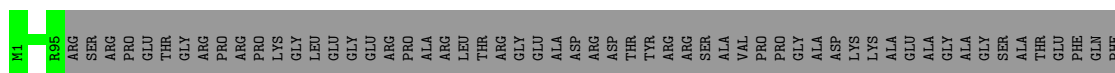

• Molecule 23: 40S ribosomal protein S12

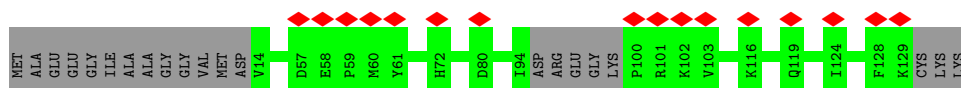
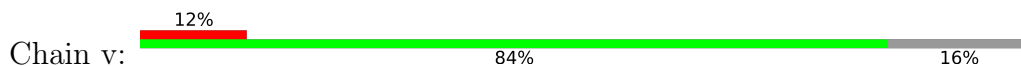

• Molecule 24: 40S ribosomal protein S15

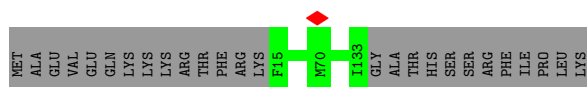
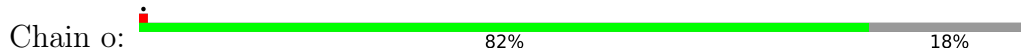

• Molecule 25: 40S ribosomal protein S16

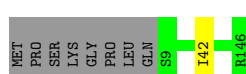

- Molecule 26: 40S ribosomal protein S18

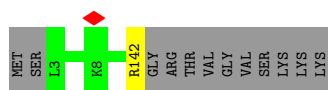
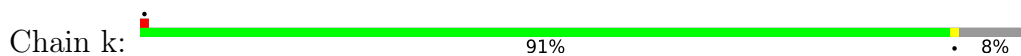

- Molecule 27: 40S ribosomal protein S19



- Molecule 28: 40S ribosomal protein S20

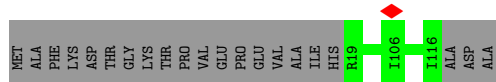
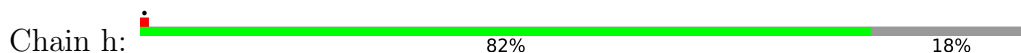

- Molecule 29: 40S ribosomal protein S25

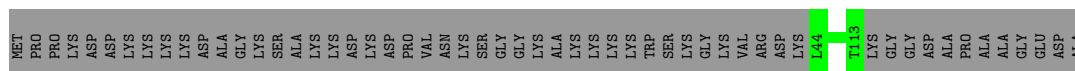

- Molecule 30: 40S ribosomal protein S28

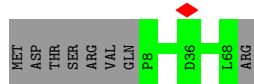
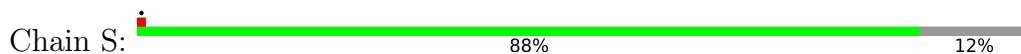

- Molecule 31: 40S ribosomal protein S29

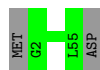

- Molecule 32: Ubiquitin-40S ribosomal protein S27a



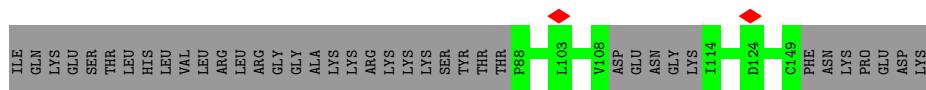

- Molecule 33: Receptor of activated protein C kinase 1

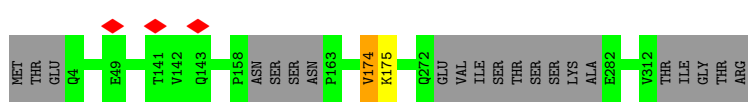
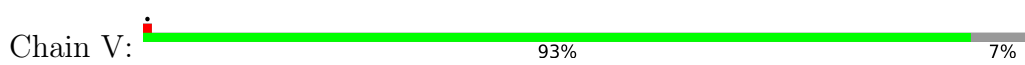

- Molecule 34: 40S ribosomal protein S14

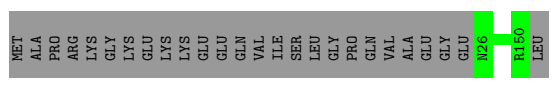
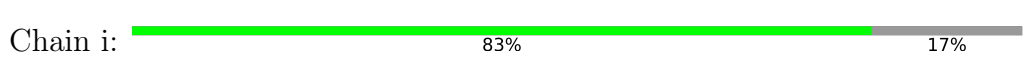

- Molecule 35: 40S ribosomal protein S23

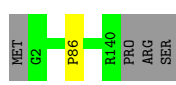

- Molecule 36: Eukaryotic translation initiation factor 1A, X-chromosomal

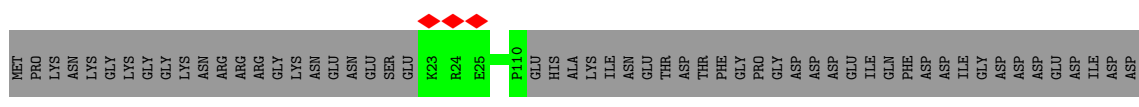

- Molecule 37: Eukaryotic translation initiation factor 3 subunit I

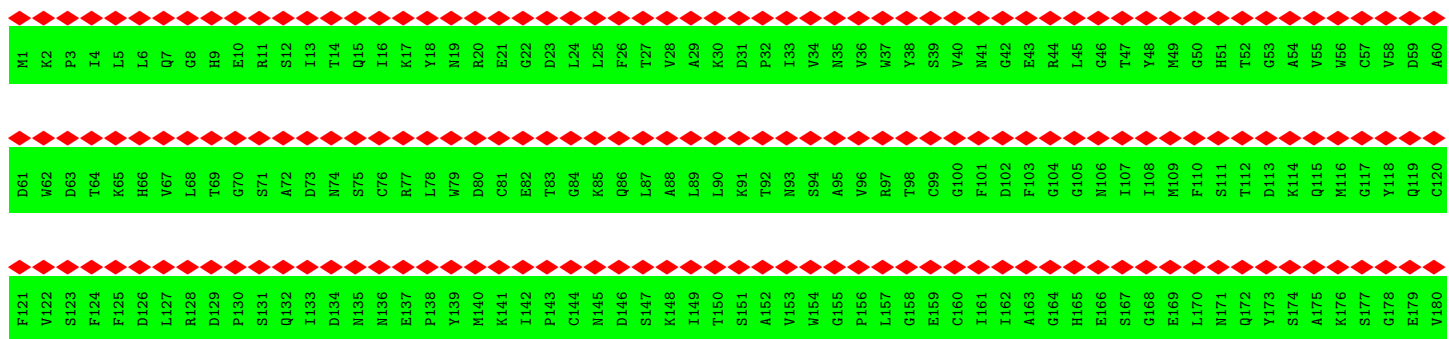

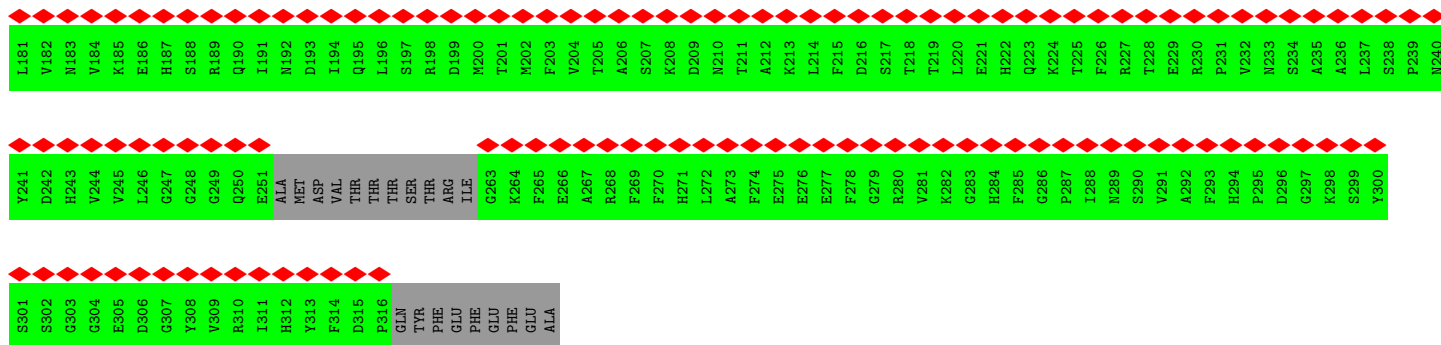

• Molecule 38: Eukaryotic translation initiation factor 3 subunit B

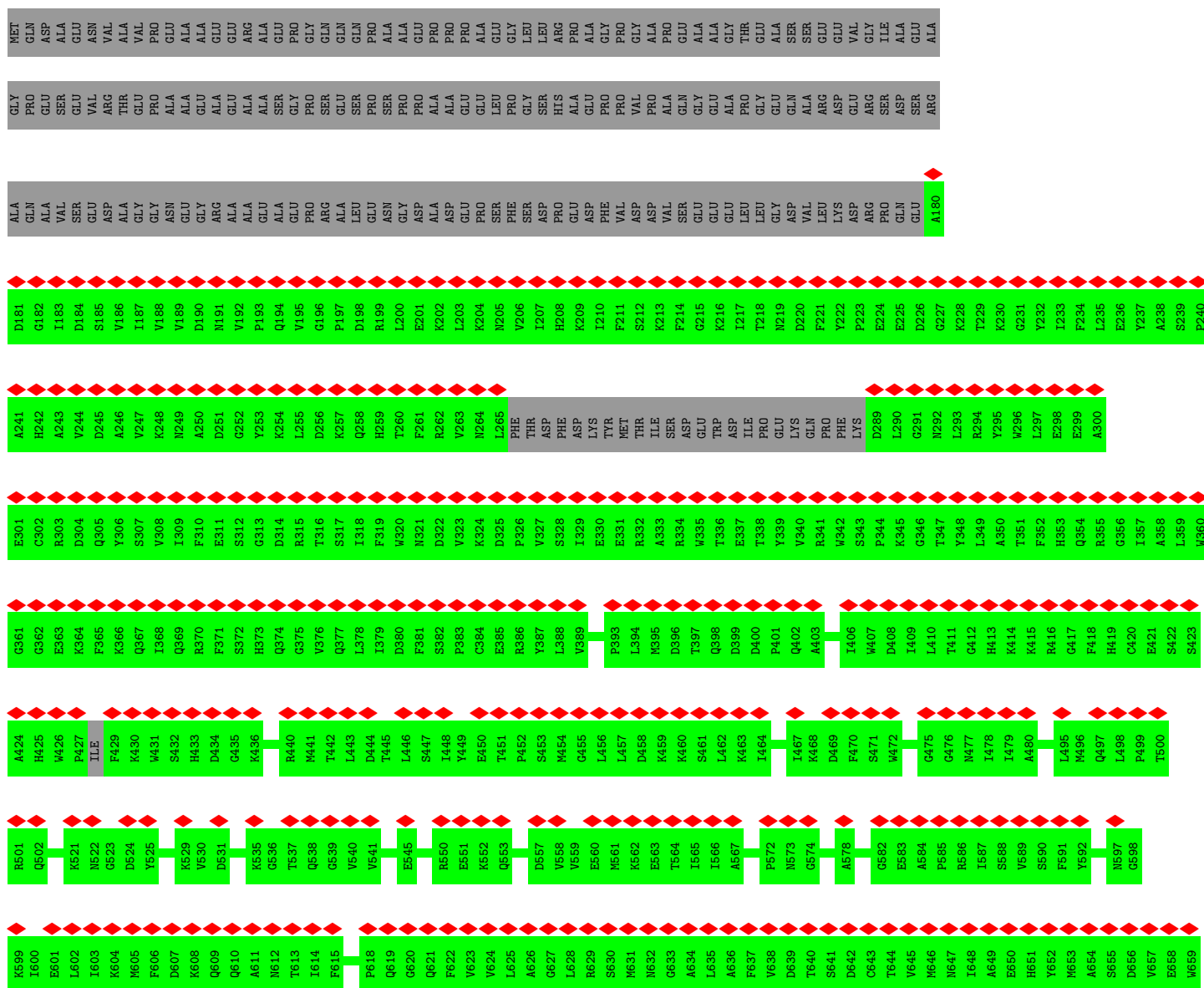

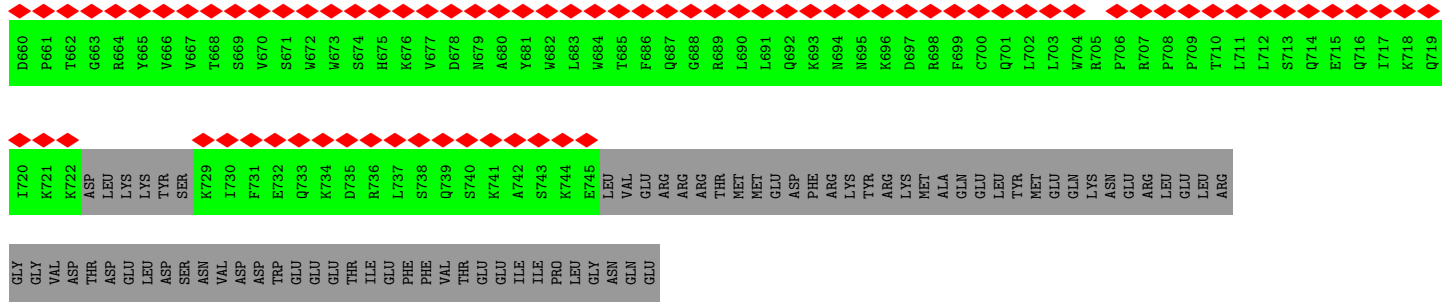

● Molecule 39: Eukaryotic translation initiation factor 3 subunit A

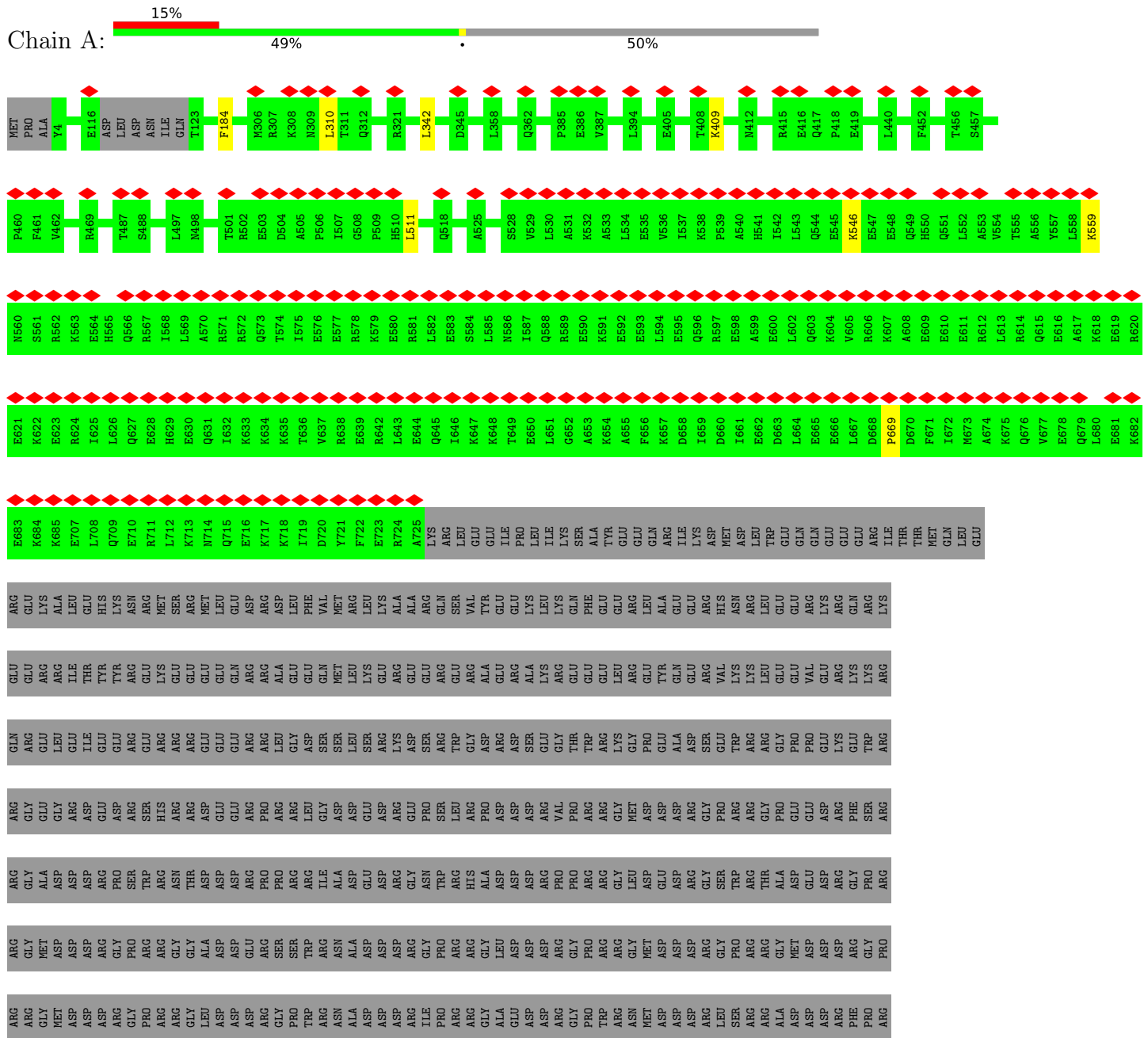

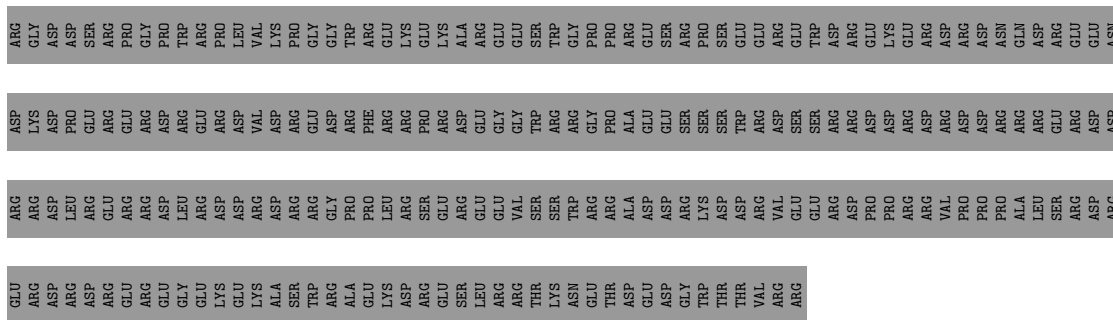

• Molecule 40: Eukaryotic translation initiation factor 3 subunit C

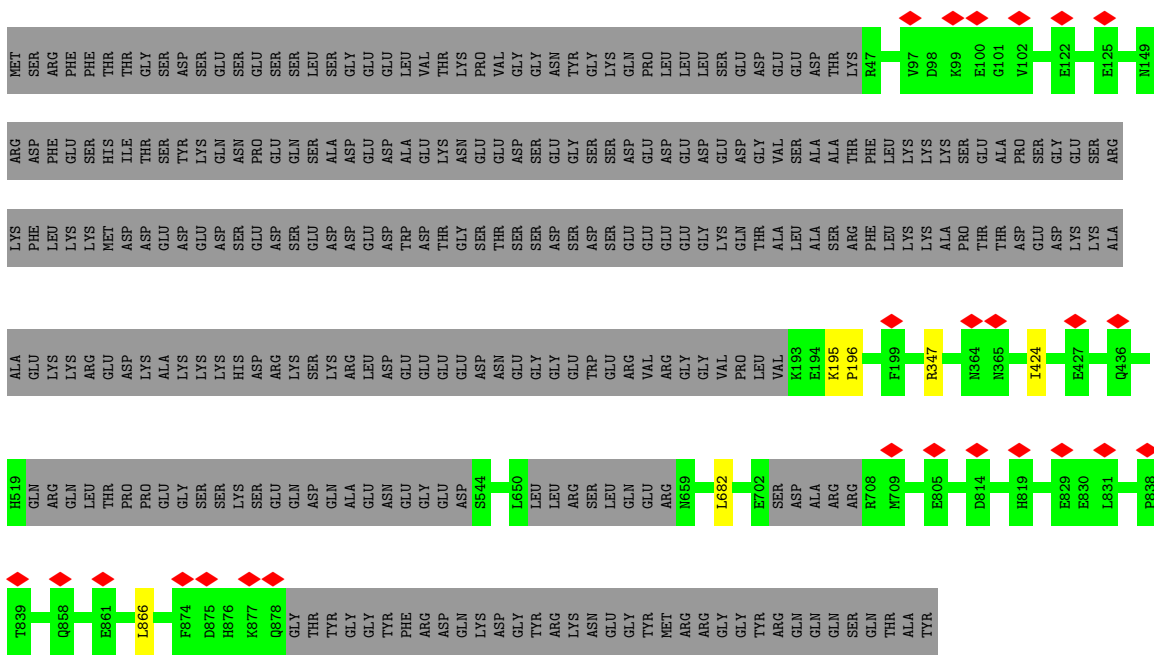

• Molecule 41: Eukaryotic translation initiation factor 3 subunit E

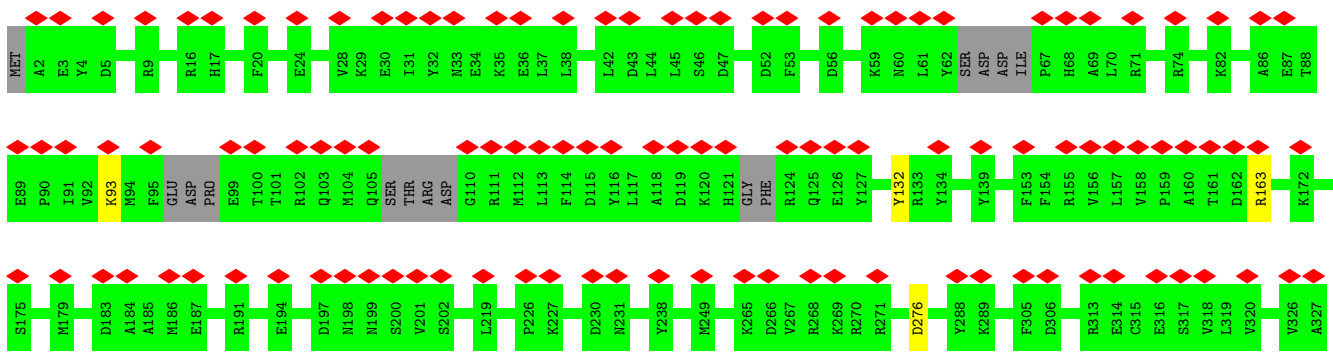
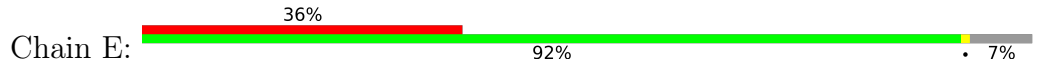

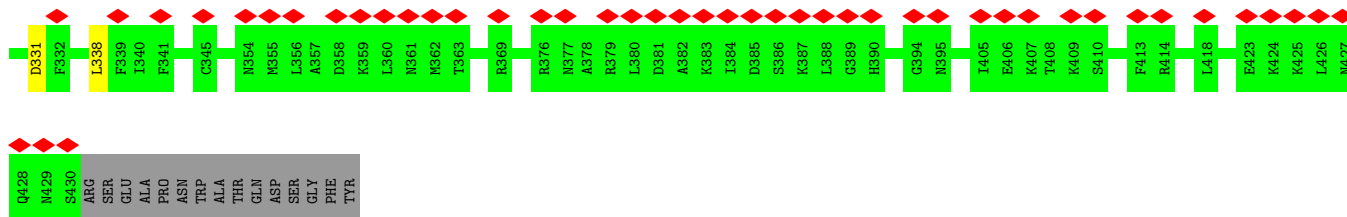

• Molecule 42: Eukaryotic translation initiation factor 3 subunit F

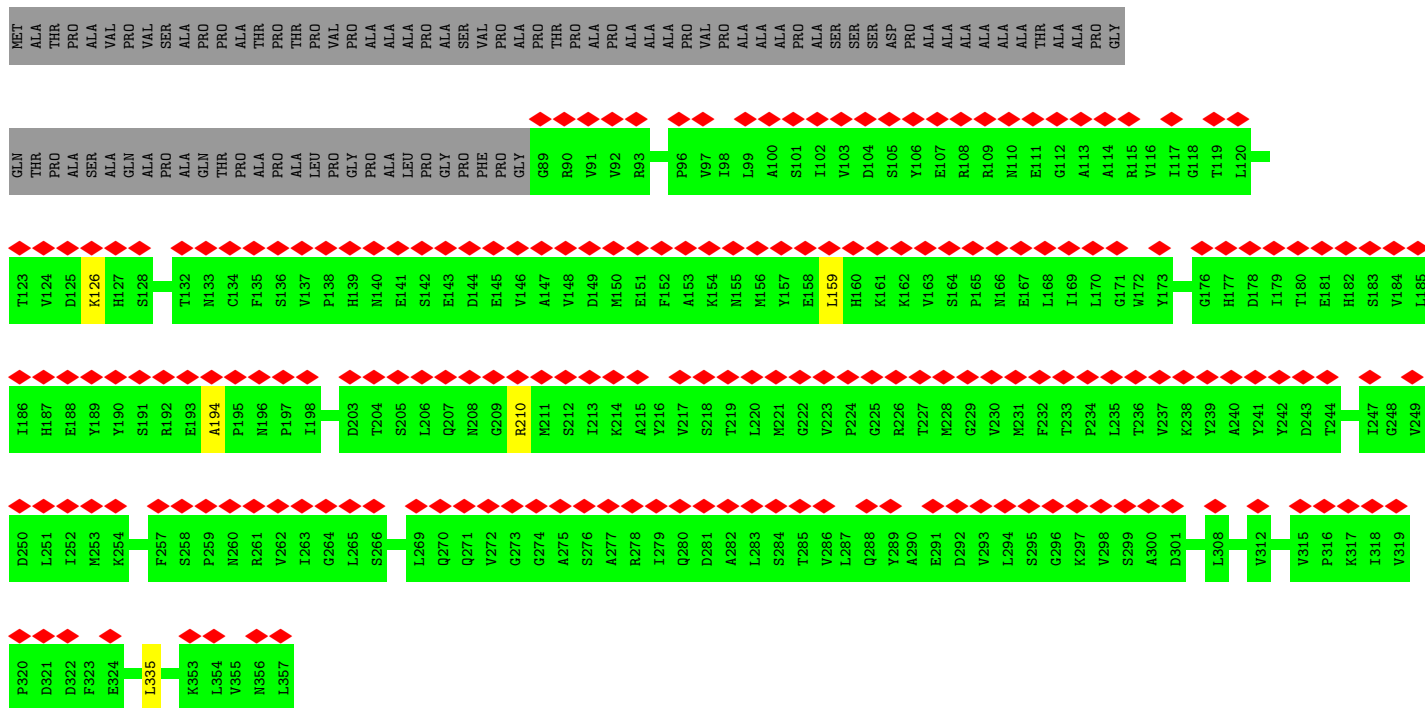
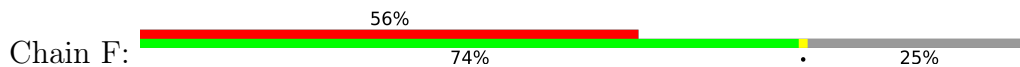

• Molecule 43: Eukaryotic translation initiation factor 3 subunit H

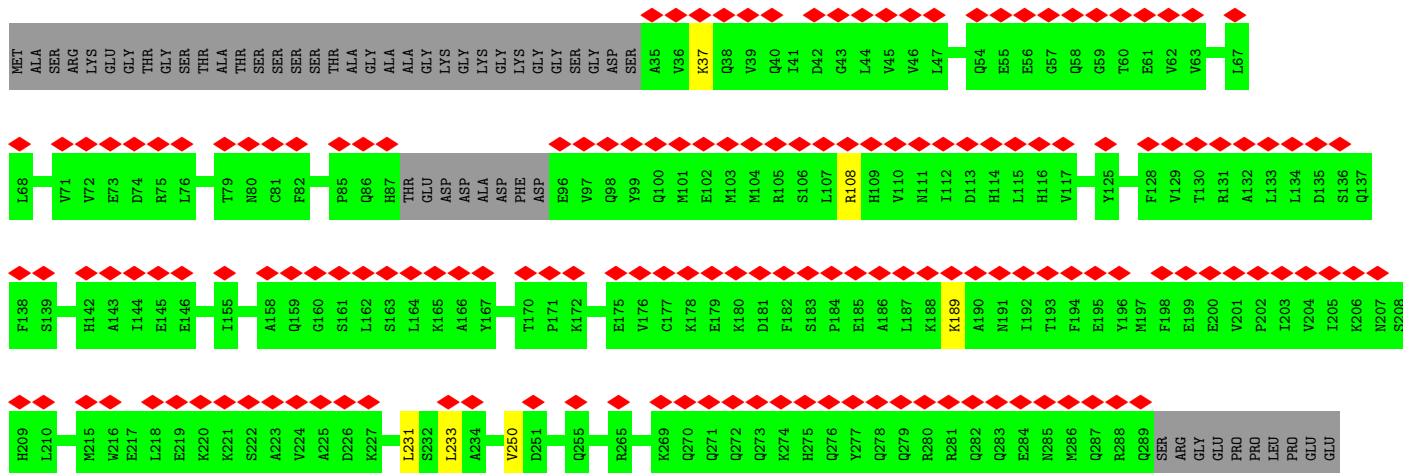
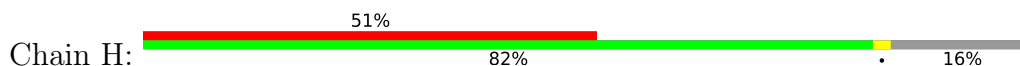

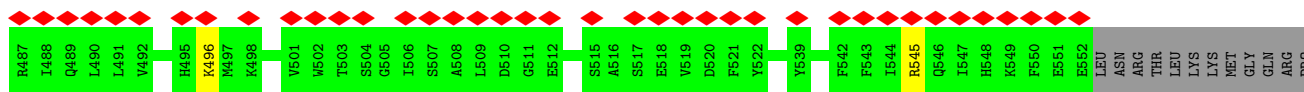

• Molecule 46: Eukaryotic translation initiation factor 3 subunit M

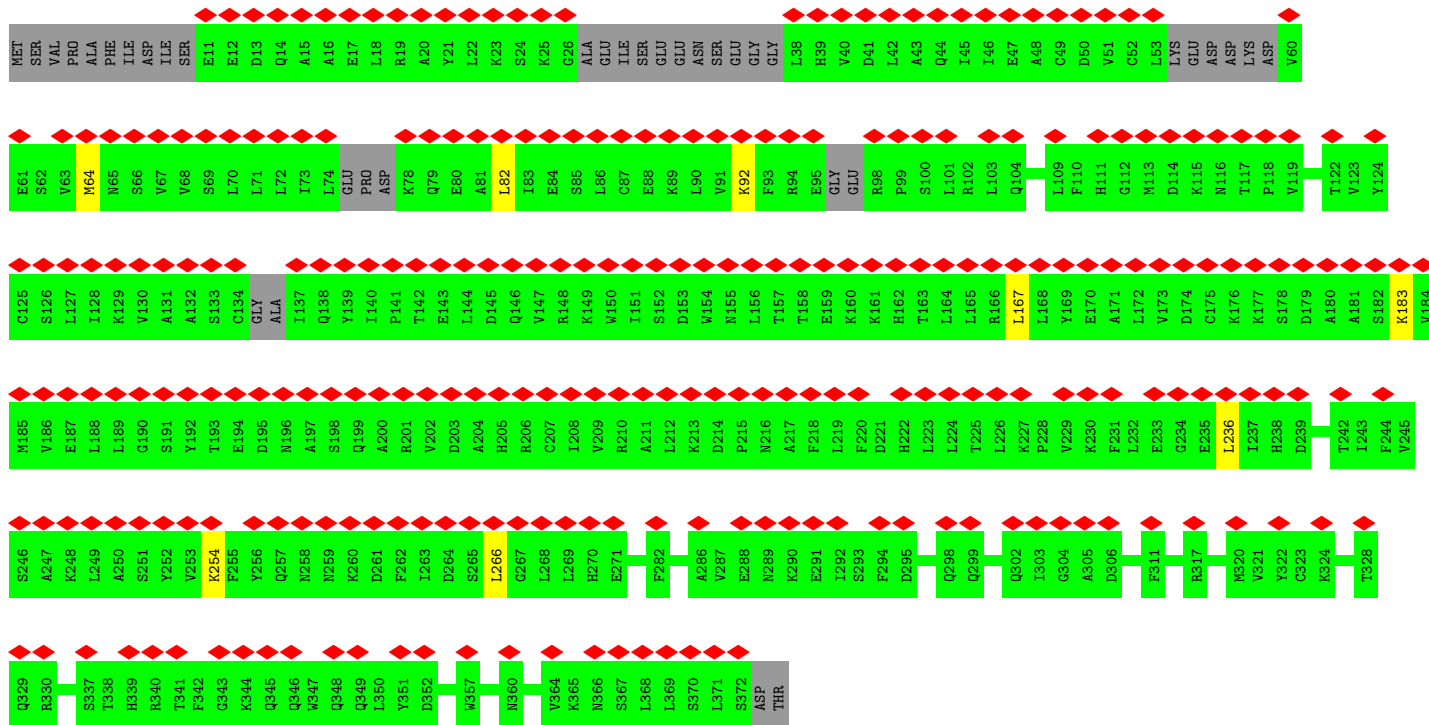
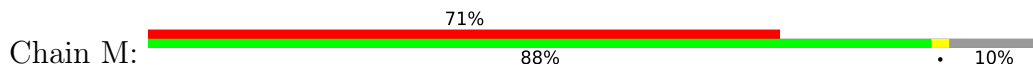

• Molecule 47: Eukaryotic translation initiation factor 3 subunit D

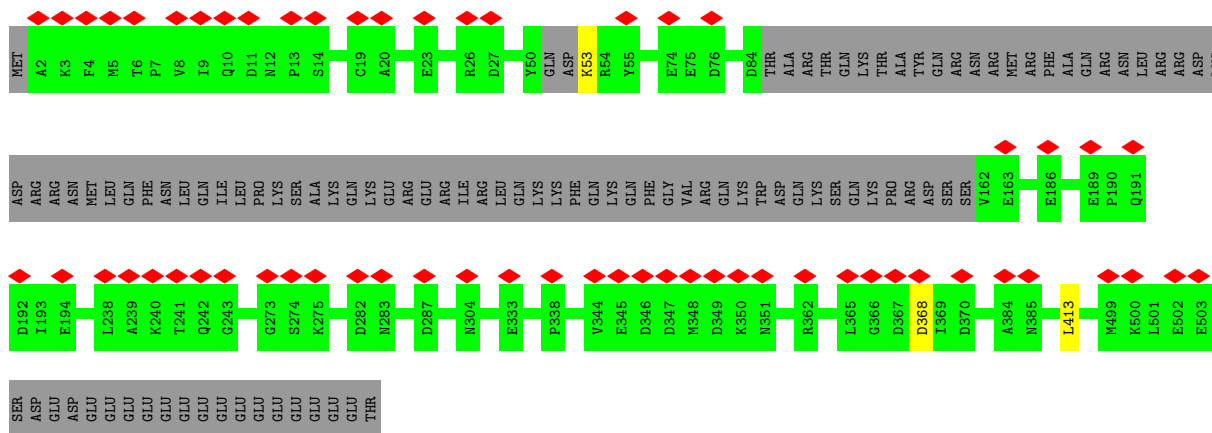
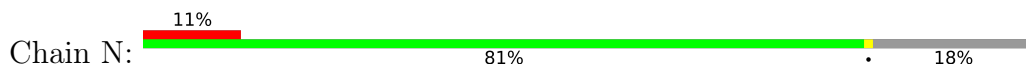

• Molecule 48: Unknown factor



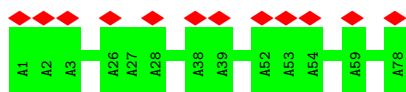

• Molecule 49: tRNA



• Molecule 50: Eukaryotic translation initiation factor 2 subunit 2

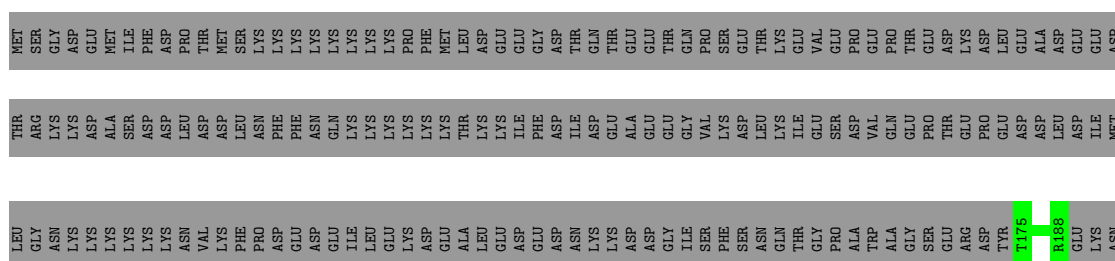

• Molecule 51: Eukaryotic translation initiation factor 2 subunit 1

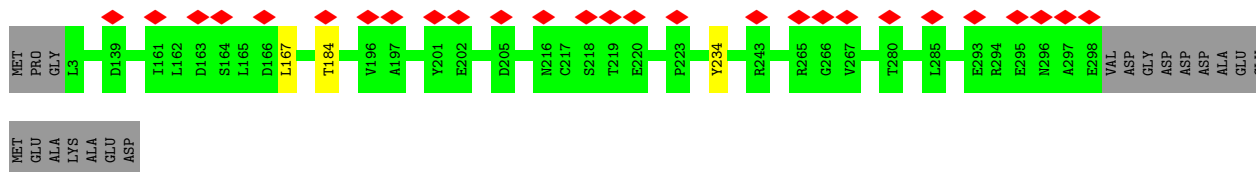

• Molecule 52: Eukaryotic translation initiation factor 2 subunit 3

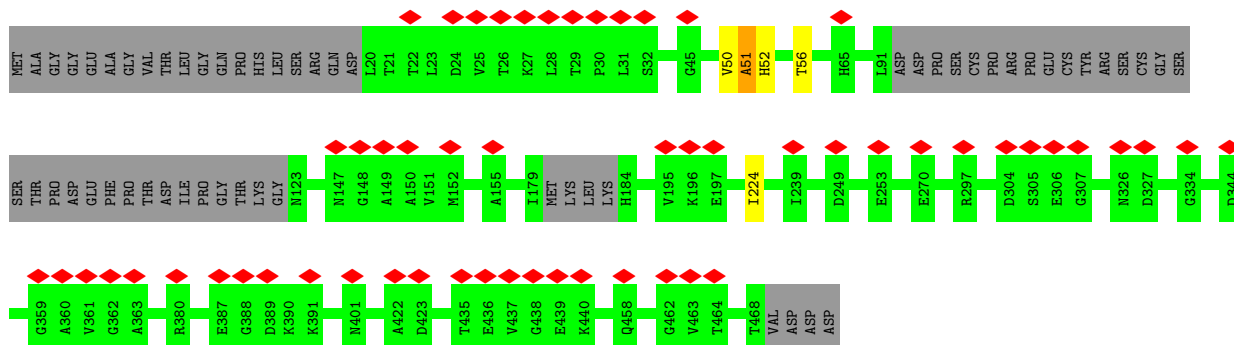
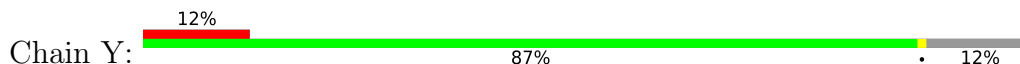

• Molecule 53: Eukaryotic translation initiation factor 1

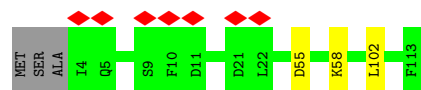
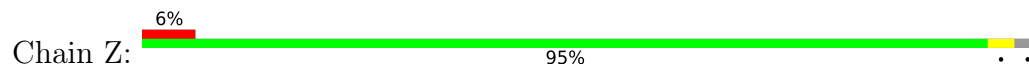

• Molecule 54: Non-structural protein 1

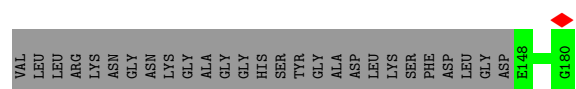
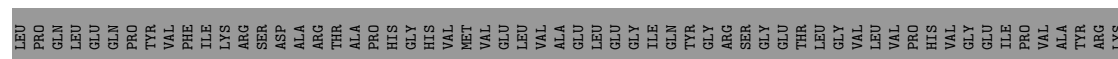

4 Experimental information

| Property | Value | Source |
|--------------------------------------|---|-----------|
| EM reconstruction method | SINGLE PARTICLE | Depositor |
| Imposed symmetry | POINT, Not provided | |
| Number of particles used | 53769 | Depositor |
| Resolution determination method | FSC 0.143 CUT-OFF | Depositor |
| CTF correction method | PHASE FLIPPING AND AMPLITUDE CORRECTION | Depositor |
| Microscope | FEI TITAN KRIOS | Depositor |
| Voltage (kV) | 300 | Depositor |
| Electron dose ($e^-/\text{\AA}^2$) | 44.8 | Depositor |
| Minimum defocus (nm) | Not provided | |
| Maximum defocus (nm) | Not provided | |
| Magnification | Not provided | |
| Image detector | GATAN K2 SUMMIT (4k x 4k) | Depositor |
| Maximum map value | 0.332 | Depositor |
| Minimum map value | -0.083 | Depositor |
| Average map value | 0.001 | Depositor |
| Map value standard deviation | 0.011 | Depositor |
| Recommended contour level | 0.03 | Depositor |
| Map size (Å) | 381.24, 381.24, 381.24 | wwPDB |
| Map dimensions | 360, 360, 360 | wwPDB |
| Map angles (°) | 90.0, 90.0, 90.0 | wwPDB |
| Pixel spacing (Å) | 1.059, 1.059, 1.059 | Depositor |

5 Model quality i

5.1 Standard geometry i

Bond lengths and bond angles in the following residue types are not validated in this section: GTP, ZN, MG

The Z score for a bond length (or angle) is the number of standard deviations the observed value is removed from the expected value. A bond length (or angle) with $|Z| > 5$ is considered an outlier worth inspection. RMSZ is the root-mean-square of all Z scores of the bond lengths (or angles).

| Mol | Chain | Bond lengths | | Bond angles | |
|-----|-------|--------------|----------------|-------------|------------------|
| | | RMSZ | # Z >5 | RMSZ | # Z >5 |
| 1 | a | 0.41 | 0/1742 | 0.51 | 0/2367 |
| 2 | p | 0.38 | 0/1742 | 0.54 | 1/2330 (0.0%) |
| 3 | d | 0.44 | 0/1710 | 0.55 | 0/2310 |
| 4 | Q | 0.41 | 0/828 | 0.54 | 0/1109 |
| 5 | q | 0.38 | 0/2073 | 0.54 | 0/2791 |
| 6 | W | 0.38 | 0/231 | 0.56 | 0/294 |
| 7 | r | 0.32 | 0/1817 | 0.50 | 0/2421 |
| 8 | s | 0.33 | 0/1418 | 0.52 | 0/1895 |
| 9 | t | 0.38 | 0/1666 | 0.51 | 0/2223 |
| 10 | c | 0.37 | 0/1524 | 0.50 | 0/2035 |
| 11 | n | 0.43 | 0/1139 | 0.54 | 1/1524 (0.1%) |
| 12 | m | 0.39 | 0/1226 | 0.51 | 0/1649 |
| 13 | y | 0.38 | 0/631 | 0.49 | 0/844 |
| 14 | D | 0.41 | 0/1051 | 0.54 | 0/1406 |
| 15 | z | 0.36 | 0/1016 | 0.53 | 0/1349 |
| 16 | R | 0.40 | 0/653 | 0.55 | 1/876 (0.1%) |
| 17 | T | 0.38 | 0/356 | 0.48 | 0/466 |
| 18 | 2 | 0.82 | 4/41061 (0.0%) | 1.14 | 317/64001 (0.5%) |
| 19 | w | 0.38 | 0/1024 | 0.57 | 0/1377 |
| 20 | b | 0.38 | 0/1773 | 0.52 | 0/2387 |
| 21 | e | 0.37 | 0/1516 | 0.52 | 0/2037 |
| 22 | u | 0.36 | 0/823 | 0.50 | 0/1111 |
| 23 | v | 0.29 | 0/870 | 0.62 | 0/1168 |
| 24 | o | 0.38 | 0/999 | 0.49 | 0/1336 |
| 25 | g | 0.43 | 0/1117 | 0.54 | 0/1494 |
| 26 | k | 0.38 | 0/1180 | 0.53 | 0/1581 |
| 27 | x | 0.39 | 0/1113 | 0.50 | 0/1493 |
| 28 | h | 0.37 | 0/789 | 0.57 | 0/1059 |
| 29 | P | 0.35 | 0/563 | 0.50 | 0/758 |
| 30 | S | 0.37 | 0/481 | 0.54 | 0/643 |
| 31 | l | 0.45 | 0/461 | 0.59 | 0/612 |
| 32 | U | 0.29 | 0/474 | 0.52 | 0/626 |

| Mol | Chain | Bond lengths | | Bond angles | |
|-----|-------|--------------|-----------------|-------------|-------------------|
| | | RMSZ | # Z >5 | RMSZ | # Z >5 |
| 33 | V | 0.34 | 0/2369 | 0.58 | 0/3221 |
| 34 | i | 0.38 | 0/951 | 0.55 | 0/1275 |
| 35 | j | 0.41 | 0/1097 | 0.53 | 0/1464 |
| 36 | G | 0.29 | 0/721 | 0.50 | 0/963 |
| 37 | I | 0.25 | 0/1495 | 0.48 | 0/2073 |
| 38 | B | 0.26 | 0/2981 | 0.50 | 0/4115 |
| 39 | A | 0.28 | 0/5464 | 0.57 | 4/7396 (0.1%) |
| 40 | C | 0.29 | 0/5193 | 0.56 | 3/6995 (0.0%) |
| 41 | E | 0.29 | 0/3503 | 0.64 | 1/4728 (0.0%) |
| 42 | F | 0.29 | 0/2126 | 0.65 | 2/2890 (0.1%) |
| 43 | H | 0.28 | 0/2458 | 0.63 | 2/3313 (0.1%) |
| 44 | K | 0.30 | 0/1785 | 0.62 | 2/2414 (0.1%) |
| 45 | L | 0.30 | 0/3187 | 0.64 | 2/4299 (0.0%) |
| 46 | M | 0.31 | 0/2743 | 0.69 | 4/3697 (0.1%) |
| 47 | N | 0.29 | 0/3699 | 0.52 | 2/5001 (0.0%) |
| 48 | X | 0.29 | 0/389 | 0.52 | 0/543 |
| 49 | 1 | 0.57 | 0/1794 | 1.05 | 7/2796 (0.3%) |
| 50 | 4 | 0.31 | 0/1095 | 0.55 | 0/1477 |
| 51 | O | 0.30 | 0/2167 | 0.51 | 1/2943 (0.0%) |
| 52 | Y | 0.26 | 0/2161 | 0.50 | 0/2985 |
| 53 | Z | 0.34 | 0/843 | 0.57 | 1/1134 (0.1%) |
| 54 | J | 0.40 | 0/266 | 0.48 | 0/358 |
| All | All | 0.55 | 4/123554 (0.0%) | 0.83 | 351/175652 (0.2%) |

Chiral center outliers are detected by calculating the chiral volume of a chiral center and verifying if the center is modelled as a planar moiety or with the opposite hand. A planarity outlier is detected by checking planarity of atoms in a peptide group, atoms in a mainchain group or atoms of a sidechain that are expected to be planar.

| Mol | Chain | #Chirality outliers | #Planarity outliers |
|-----|-------|---------------------|---------------------|
| 1 | a | 0 | 1 |
| 14 | D | 0 | 1 |
| 19 | w | 0 | 2 |
| 21 | e | 0 | 1 |
| 25 | g | 0 | 1 |
| 33 | V | 0 | 1 |
| 40 | C | 0 | 1 |
| 42 | F | 0 | 1 |
| 45 | L | 0 | 2 |
| 50 | 4 | 0 | 2 |
| 51 | O | 0 | 1 |
| 52 | Y | 0 | 3 |

Continued on next page...

Continued from previous page...

| Mol | Chain | #Chirality outliers | #Planarity outliers |
|-----|-------|---------------------|---------------------|
| 53 | Z | 0 | 2 |
| All | All | 0 | 19 |

All (4) bond length outliers are listed below:

| Mol | Chain | Res | Type | Atoms | Z | Observed(Å) | Ideal(Å) |
|-----|-------|------|------|-------|-------|-------------|----------|
| 18 | 2 | 367 | U | O3'-P | -7.75 | 1.51 | 1.61 |
| 18 | 2 | 1206 | G | O3'-P | -5.62 | 1.54 | 1.61 |
| 18 | 2 | 1681 | U | O3'-P | -5.41 | 1.54 | 1.61 |
| 18 | 2 | 1850 | A | O3'-P | -5.36 | 1.54 | 1.61 |

The worst 5 of 351 bond angle outliers are listed below:

| Mol | Chain | Res | Type | Atoms | Z | Observed(°) | Ideal(°) |
|-----|-------|-----|------|-----------|--------|-------------|----------|
| 18 | 2 | 501 | C | N1-C2-O2 | 14.65 | 127.69 | 118.90 |
| 18 | 2 | 501 | C | C2-N1-C1' | 13.15 | 133.26 | 118.80 |
| 18 | 2 | 293 | C | N1-C2-O2 | 12.41 | 126.35 | 118.90 |
| 18 | 2 | 501 | C | N3-C2-O2 | -11.69 | 113.71 | 121.90 |
| 18 | 2 | 119 | U | N3-C2-O2 | -11.46 | 114.18 | 122.20 |

There are no chirality outliers.

5 of 19 planarity outliers are listed below:

| Mol | Chain | Res | Type | Group |
|-----|-------|-----|------|---------|
| 14 | D | 54 | ASP | Peptide |
| 1 | a | 73 | ASP | Peptide |
| 21 | e | 130 | ARG | Peptide |
| 19 | w | 42 | PRO | Peptide |
| 19 | w | 71 | ILE | Peptide |

5.2 Too-close contacts [i](#)

Due to software issues we are unable to calculate clashes - this section is therefore empty.

5.3 Torsion angles [i](#)

5.3.1 Protein backbone [i](#)

In the following table, the Percentiles column shows the percent Ramachandran outliers of the chain as a percentile score with respect to all PDB entries followed by that with respect to all EM

entries.

The Analysed column shows the number of residues for which the backbone conformation was analysed, and the total number of residues.

| Mol | Chain | Analysed | Favoured | Allowed | Outliers | Percentiles | |
|-----|-------|---------------|-----------|---------|----------|-------------|-----|
| 1 | a | 214/295 (72%) | 212 (99%) | 2 (1%) | 0 | 100 | 100 |
| 2 | p | 209/264 (79%) | 199 (95%) | 10 (5%) | 0 | 100 | 100 |
| 3 | d | 214/293 (73%) | 202 (94%) | 12 (6%) | 0 | 100 | 100 |
| 4 | Q | 99/115 (86%) | 98 (99%) | 1 (1%) | 0 | 100 | 100 |
| 5 | q | 253/263 (96%) | 243 (96%) | 9 (4%) | 1 (0%) | 34 | 66 |
| 6 | W | 22/25 (88%) | 22 (100%) | 0 | 0 | 100 | 100 |
| 7 | r | 220/249 (88%) | 215 (98%) | 5 (2%) | 0 | 100 | 100 |
| 8 | s | 165/194 (85%) | 162 (98%) | 3 (2%) | 0 | 100 | 100 |
| 9 | t | 195/208 (94%) | 187 (96%) | 8 (4%) | 0 | 100 | 100 |
| 10 | c | 178/194 (92%) | 172 (97%) | 6 (3%) | 0 | 100 | 100 |
| 11 | n | 131/158 (83%) | 129 (98%) | 2 (2%) | 0 | 100 | 100 |
| 12 | m | 147/151 (97%) | 146 (99%) | 1 (1%) | 0 | 100 | 100 |
| 13 | y | 80/83 (96%) | 80 (100%) | 0 | 0 | 100 | 100 |
| 14 | D | 127/130 (98%) | 124 (98%) | 3 (2%) | 0 | 100 | 100 |
| 15 | z | 120/133 (90%) | 111 (92%) | 9 (8%) | 0 | 100 | 100 |
| 16 | R | 80/84 (95%) | 74 (92%) | 6 (8%) | 0 | 100 | 100 |
| 17 | T | 40/59 (68%) | 40 (100%) | 0 | 0 | 100 | 100 |
| 19 | w | 124/135 (92%) | 115 (93%) | 9 (7%) | 0 | 100 | 100 |
| 20 | b | 222/243 (91%) | 217 (98%) | 5 (2%) | 0 | 100 | 100 |
| 21 | e | 187/204 (92%) | 175 (94%) | 12 (6%) | 0 | 100 | 100 |
| 22 | u | 93/165 (56%) | 87 (94%) | 6 (6%) | 0 | 100 | 100 |
| 23 | v | 107/132 (81%) | 104 (97%) | 3 (3%) | 0 | 100 | 100 |
| 24 | o | 117/145 (81%) | 115 (98%) | 2 (2%) | 0 | 100 | 100 |
| 25 | g | 136/146 (93%) | 130 (96%) | 6 (4%) | 0 | 100 | 100 |
| 26 | k | 138/152 (91%) | 131 (95%) | 7 (5%) | 0 | 100 | 100 |
| 27 | x | 139/145 (96%) | 136 (98%) | 3 (2%) | 0 | 100 | 100 |
| 28 | h | 96/119 (81%) | 92 (96%) | 4 (4%) | 0 | 100 | 100 |
| 29 | P | 68/125 (54%) | 67 (98%) | 1 (2%) | 0 | 100 | 100 |
| 30 | S | 59/69 (86%) | 54 (92%) | 5 (8%) | 0 | 100 | 100 |

Continued on next page...

Continued from previous page...

| Mol | Chain | Analysed | Favoured | Allowed | Outliers | Percentiles | |
|-----|-------|-------------------|------------|----------|----------|-------------|-----|
| 31 | l | 52/56 (93%) | 48 (92%) | 4 (8%) | 0 | 100 | 100 |
| 32 | U | 53/156 (34%) | 47 (89%) | 6 (11%) | 0 | 100 | 100 |
| 33 | V | 290/317 (92%) | 260 (90%) | 28 (10%) | 2 (1%) | 22 | 54 |
| 34 | i | 123/151 (82%) | 115 (94%) | 8 (6%) | 0 | 100 | 100 |
| 35 | j | 137/143 (96%) | 133 (97%) | 3 (2%) | 1 (1%) | 22 | 54 |
| 36 | G | 86/144 (60%) | 84 (98%) | 2 (2%) | 0 | 100 | 100 |
| 37 | I | 301/325 (93%) | 293 (97%) | 8 (3%) | 0 | 100 | 100 |
| 38 | B | 528/814 (65%) | 503 (95%) | 25 (5%) | 0 | 100 | 100 |
| 39 | A | 682/1382 (49%) | 665 (98%) | 17 (2%) | 0 | 100 | 100 |
| 40 | C | 621/913 (68%) | 586 (94%) | 34 (6%) | 1 (0%) | 47 | 78 |
| 41 | E | 406/445 (91%) | 394 (97%) | 12 (3%) | 0 | 100 | 100 |
| 42 | F | 267/357 (75%) | 251 (94%) | 16 (6%) | 0 | 100 | 100 |
| 43 | H | 289/352 (82%) | 275 (95%) | 14 (5%) | 0 | 100 | 100 |
| 44 | K | 215/218 (99%) | 197 (92%) | 18 (8%) | 0 | 100 | 100 |
| 45 | L | 370/564 (66%) | 336 (91%) | 34 (9%) | 0 | 100 | 100 |
| 46 | M | 326/374 (87%) | 315 (97%) | 11 (3%) | 0 | 100 | 100 |
| 47 | N | 441/548 (80%) | 412 (93%) | 29 (7%) | 0 | 100 | 100 |
| 48 | X | 76/78 (97%) | 75 (99%) | 1 (1%) | 0 | 100 | 100 |
| 50 | 4 | 140/333 (42%) | 115 (82%) | 25 (18%) | 0 | 100 | 100 |
| 51 | O | 294/315 (93%) | 278 (95%) | 16 (5%) | 0 | 100 | 100 |
| 52 | Y | 408/472 (86%) | 334 (82%) | 71 (17%) | 3 (1%) | 22 | 54 |
| 53 | Z | 108/113 (96%) | 95 (88%) | 13 (12%) | 0 | 100 | 100 |
| 54 | J | 31/180 (17%) | 29 (94%) | 2 (6%) | 0 | 100 | 100 |
| All | All | 10224/13428 (76%) | 9679 (95%) | 537 (5%) | 8 (0%) | 54 | 82 |

5 of 8 Ramachandran outliers are listed below:

| Mol | Chain | Res | Type |
|-----|-------|-----|------|
| 33 | V | 175 | LYS |
| 52 | Y | 56 | THR |
| 5 | q | 86 | PHE |
| 52 | Y | 51 | ALA |
| 33 | V | 174 | VAL |

5.3.2 Protein sidechains [i](#)

In the following table, the Percentiles column shows the percent sidechain outliers of the chain as a percentile score with respect to all PDB entries followed by that with respect to all EM entries.

The Analysed column shows the number of residues for which the sidechain conformation was analysed, and the total number of residues.

| Mol | Chain | Analysed | Rotameric | Outliers | Percentiles | |
|-----|-------|---------------|------------|----------|-------------|-----|
| 1 | a | 180/243 (74%) | 180 (100%) | 0 | 100 | 100 |
| 2 | p | 192/231 (83%) | 192 (100%) | 0 | 100 | 100 |
| 3 | d | 182/225 (81%) | 182 (100%) | 0 | 100 | 100 |
| 4 | Q | 88/98 (90%) | 86 (98%) | 2 (2%) | 50 | 80 |
| 5 | q | 220/225 (98%) | 220 (100%) | 0 | 100 | 100 |
| 6 | W | 23/24 (96%) | 23 (100%) | 0 | 100 | 100 |
| 7 | r | 193/218 (88%) | 193 (100%) | 0 | 100 | 100 |
| 8 | s | 155/174 (89%) | 155 (100%) | 0 | 100 | 100 |
| 9 | t | 174/180 (97%) | 174 (100%) | 0 | 100 | 100 |
| 10 | c | 160/168 (95%) | 160 (100%) | 0 | 100 | 100 |
| 11 | n | 125/142 (88%) | 124 (99%) | 1 (1%) | 81 | 94 |
| 12 | m | 130/131 (99%) | 129 (99%) | 1 (1%) | 81 | 94 |
| 13 | y | 66/67 (98%) | 66 (100%) | 0 | 100 | 100 |
| 14 | D | 112/113 (99%) | 112 (100%) | 0 | 100 | 100 |
| 15 | z | 106/115 (92%) | 106 (100%) | 0 | 100 | 100 |
| 16 | R | 74/76 (97%) | 74 (100%) | 0 | 100 | 100 |
| 17 | T | 35/48 (73%) | 35 (100%) | 0 | 100 | 100 |
| 19 | w | 111/122 (91%) | 111 (100%) | 0 | 100 | 100 |
| 20 | b | 188/202 (93%) | 187 (100%) | 1 (0%) | 88 | 96 |
| 21 | e | 159/170 (94%) | 158 (99%) | 1 (1%) | 86 | 96 |
| 22 | u | 86/136 (63%) | 86 (100%) | 0 | 100 | 100 |
| 23 | v | 94/108 (87%) | 94 (100%) | 0 | 100 | 100 |
| 24 | o | 107/130 (82%) | 107 (100%) | 0 | 100 | 100 |
| 25 | g | 114/121 (94%) | 114 (100%) | 0 | 100 | 100 |
| 26 | k | 122/132 (92%) | 121 (99%) | 1 (1%) | 81 | 94 |
| 27 | x | 111/115 (96%) | 111 (100%) | 0 | 100 | 100 |

Continued on next page...

Continued from previous page...

| Mol | Chain | Analysed | Rotameric | Outliers | Percentiles | |
|-----|-------|------------------|-------------|----------|-------------|-----|
| 28 | h | 91/107 (85%) | 91 (100%) | 0 | 100 | 100 |
| 29 | P | 62/103 (60%) | 62 (100%) | 0 | 100 | 100 |
| 30 | S | 54/62 (87%) | 54 (100%) | 0 | 100 | 100 |
| 31 | l | 47/49 (96%) | 47 (100%) | 0 | 100 | 100 |
| 32 | U | 51/140 (36%) | 51 (100%) | 0 | 100 | 100 |
| 33 | V | 256/275 (93%) | 256 (100%) | 0 | 100 | 100 |
| 34 | i | 98/119 (82%) | 98 (100%) | 0 | 100 | 100 |
| 35 | j | 111/115 (96%) | 111 (100%) | 0 | 100 | 100 |
| 36 | G | 75/123 (61%) | 75 (100%) | 0 | 100 | 100 |
| 38 | B | 90/702 (13%) | 90 (100%) | 0 | 100 | 100 |
| 39 | A | 544/1259 (43%) | 540 (99%) | 4 (1%) | 84 | 95 |
| 40 | C | 553/811 (68%) | 552 (100%) | 1 (0%) | 93 | 98 |
| 41 | E | 380/406 (94%) | 375 (99%) | 5 (1%) | 69 | 90 |
| 42 | F | 237/289 (82%) | 235 (99%) | 2 (1%) | 81 | 94 |
| 43 | H | 269/310 (87%) | 265 (98%) | 4 (2%) | 65 | 87 |
| 44 | K | 192/193 (100%) | 191 (100%) | 1 (0%) | 88 | 96 |
| 45 | L | 342/515 (66%) | 337 (98%) | 5 (2%) | 65 | 87 |
| 46 | M | 304/335 (91%) | 300 (99%) | 4 (1%) | 69 | 90 |
| 47 | N | 398/494 (81%) | 397 (100%) | 1 (0%) | 92 | 98 |
| 50 | 4 | 109/304 (36%) | 106 (97%) | 3 (3%) | 43 | 76 |
| 51 | O | 190/280 (68%) | 189 (100%) | 1 (0%) | 88 | 96 |
| 52 | Y | 33/397 (8%) | 33 (100%) | 0 | 100 | 100 |
| 53 | Z | 79/96 (82%) | 79 (100%) | 0 | 100 | 100 |
| 54 | J | 27/151 (18%) | 27 (100%) | 0 | 100 | 100 |
| All | All | 7899/11349 (70%) | 7861 (100%) | 38 (0%) | 89 | 96 |

5 of 38 residues with a non-rotameric sidechain are listed below:

| Mol | Chain | Res | Type |
|-----|-------|-----|------|
| 45 | L | 545 | ARG |
| 50 | 4 | 261 | ARG |
| 46 | M | 64 | MET |
| 46 | M | 254 | LYS |
| 51 | O | 234 | TYR |

Sometimes sidechains can be flipped to improve hydrogen bonding and reduce clashes. 5 of 146 such sidechains are listed below:

| Mol | Chain | Res | Type |
|-----|-------|-----|------|
| 45 | L | 281 | HIS |
| 51 | O | 180 | ASN |
| 45 | L | 364 | ASN |
| 46 | M | 302 | GLN |
| 27 | x | 128 | GLN |

5.3.3 RNA [i](#)

| Mol | Chain | Analysed | Backbone Outliers | Pucker Outliers |
|-----|-------|-----------------|-------------------|-----------------|
| 18 | 2 | 1711/1868 (91%) | 362 (21%) | 8 (0%) |
| 49 | 1 | 74/75 (98%) | 15 (20%) | 0 |
| All | All | 1785/1943 (91%) | 377 (21%) | 8 (0%) |

5 of 377 RNA backbone outliers are listed below:

| Mol | Chain | Res | Type |
|-----|-------|-----|------|
| 18 | 2 | 17 | C |
| 18 | 2 | 33 | G |
| 18 | 2 | 41 | G |
| 18 | 2 | 44 | U |
| 18 | 2 | 46 | A |

5 of 8 RNA pucker outliers are listed below:

| Mol | Chain | Res | Type |
|-----|-------|------|------|
| 18 | 2 | 1060 | A |
| 18 | 2 | 1058 | A |
| 18 | 2 | 868 | G |
| 18 | 2 | 369 | C |
| 18 | 2 | 912 | C |

5.4 Non-standard residues in protein, DNA, RNA chains [i](#)

There are no non-standard protein/DNA/RNA residues in this entry.

5.5 Carbohydrates [i](#)

There are no monosaccharides in this entry.

5.6 Ligand geometry

Of 6 ligands modelled in this entry, 5 are monoatomic - leaving 1 for Mogul analysis.

In the following table, the Counts columns list the number of bonds (or angles) for which Mogul statistics could be retrieved, the number of bonds (or angles) that are observed in the model and the number of bonds (or angles) that are defined in the Chemical Component Dictionary. The Link column lists molecule types, if any, to which the group is linked. The Z score for a bond length (or angle) is the number of standard deviations the observed value is removed from the expected value. A bond length (or angle) with $|Z| > 2$ is considered an outlier worth inspection. RMSZ is the root-mean-square of all Z scores of the bond lengths (or angles).

| Mol | Type | Chain | Res | Link | Bond lengths | | | Bond angles | | |
|-----|------|-------|-----|------|--------------|------|----------|-------------|------|----------|
| | | | | | Counts | RMSZ | # Z > 2 | Counts | RMSZ | # Z > 2 |
| 56 | GTP | Y | 501 | 57 | 26,34,34 | 1.16 | 2 (7%) | 32,54,54 | 1.66 | 7 (21%) |

In the following table, the Chirals column lists the number of chiral outliers, the number of chiral centers analysed, the number of these observed in the model and the number defined in the Chemical Component Dictionary. Similar counts are reported in the Torsion and Rings columns. '-' means no outliers of that kind were identified.

| Mol | Type | Chain | Res | Link | Chirals | Torsions | Rings |
|-----|------|-------|-----|------|---------|------------|---------|
| 56 | GTP | Y | 501 | 57 | - | 6/18/38/38 | 0/3/3/3 |

All (2) bond length outliers are listed below:

| Mol | Chain | Res | Type | Atoms | Z | Observed(Å) | Ideal(Å) |
|-----|-------|-----|------|-------|-------|-------------|----------|
| 56 | Y | 501 | GTP | C5-C6 | -4.14 | 1.39 | 1.47 |
| 56 | Y | 501 | GTP | C2-N3 | 2.20 | 1.38 | 1.33 |

The worst 5 of 7 bond angle outliers are listed below:

| Mol | Chain | Res | Type | Atoms | Z | Observed(°) | Ideal(°) |
|-----|-------|-----|------|-----------|-------|-------------|----------|
| 56 | Y | 501 | GTP | PA-O3A-PB | -4.44 | 117.60 | 132.83 |
| 56 | Y | 501 | GTP | PB-O3B-PG | -3.61 | 120.45 | 132.83 |
| 56 | Y | 501 | GTP | C5-C6-N1 | 3.45 | 120.04 | 113.95 |
| 56 | Y | 501 | GTP | C2-N1-C6 | -3.19 | 119.23 | 125.10 |
| 56 | Y | 501 | GTP | C8-N7-C5 | 2.91 | 108.53 | 102.99 |

There are no chirality outliers.

5 of 6 torsion outliers are listed below:

| Mol | Chain | Res | Type | Atoms |
|-----|-------|-----|------|----------------|
| 56 | Y | 501 | GTP | C5'-O5'-PA-O1A |

Continued on next page...

Continued from previous page...

| Mol | Chain | Res | Type | Atoms |
|-----|-------|-----|------|----------------|
| 56 | Y | 501 | GTP | PB-O3B-PG-O1G |
| 56 | Y | 501 | GTP | PB-O3B-PG-O2G |
| 56 | Y | 501 | GTP | PB-O3B-PG-O3G |
| 56 | Y | 501 | GTP | C5'-O5'-PA-O3A |

There are no ring outliers.

No monomer is involved in short contacts.

The following is a two-dimensional graphical depiction of Mogul quality analysis of bond lengths, bond angles, torsion angles, and ring geometry for all instances of the Ligand of Interest. In addition, ligands with molecular weight > 250 and outliers as shown on the validation Tables will also be included. For torsion angles, if less than 5% of the Mogul distribution of torsion angles is within 10 degrees of the torsion angle in question, then that torsion angle is considered an outlier. Any bond that is central to one or more torsion angles identified as an outlier by Mogul will be highlighted in the graph. For rings, the root-mean-square deviation (RMSD) between the ring in question and similar rings identified by Mogul is calculated over all ring torsion angles. If the average RMSD is greater than 60 degrees and the minimal RMSD between the ring in question and any Mogul-identified rings is also greater than 60 degrees, then that ring is considered an outlier. The outliers are highlighted in purple. The color gray indicates Mogul did not find sufficient equivalents in the CSD to analyse the geometry.

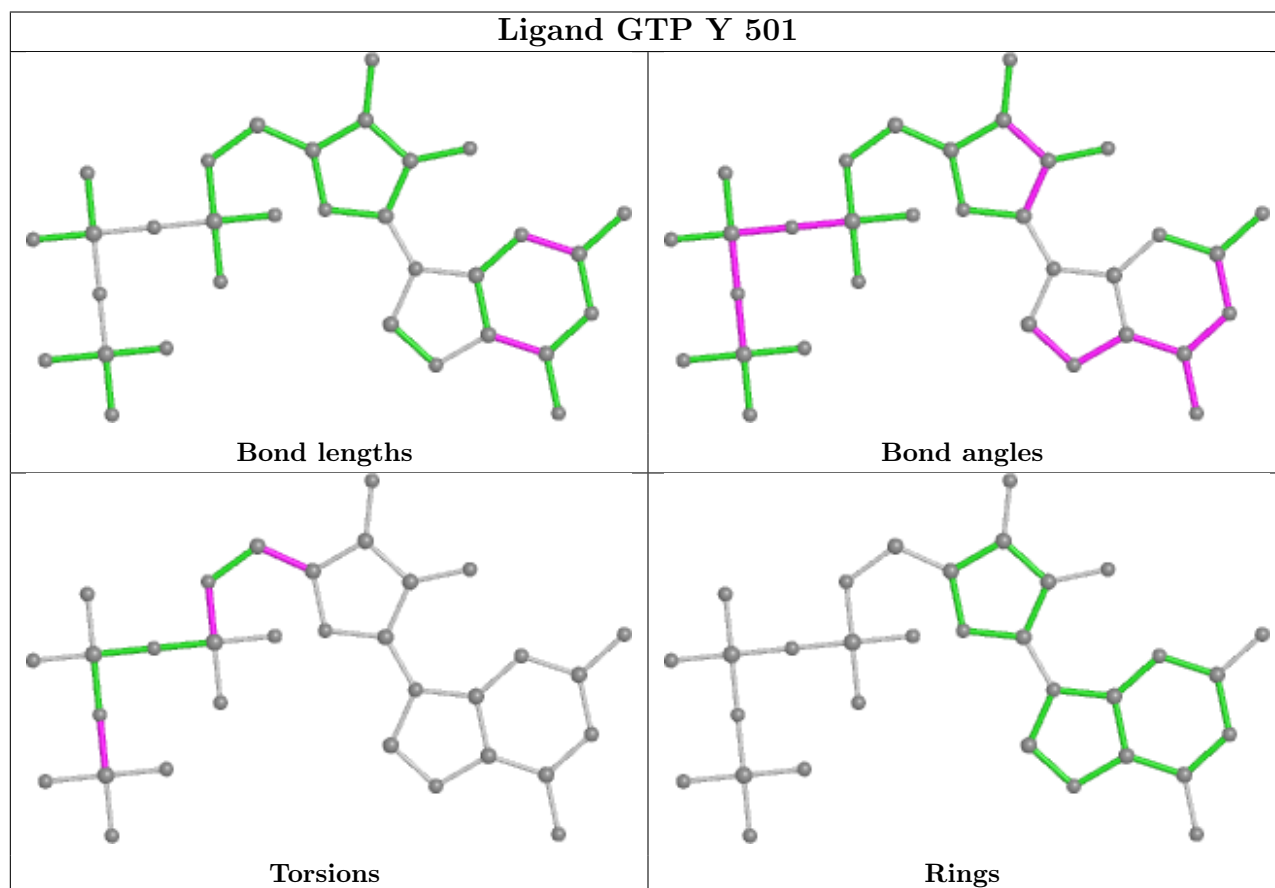

5.7 Other polymers [i](#)

There are no such residues in this entry.

5.8 Polymer linkage issues [i](#)

The following chains have linkage breaks:

| Mol | Chain | Number of breaks |
|-----|-------|------------------|
| 39 | A | 3 |
| 40 | C | 1 |

All chain breaks are listed below:

| Model | Chain | Residue-1 | Atom-1 | Residue-2 | Atom-2 | Distance (Å) |
|-------|-------|-----------|--------|-----------|--------|--------------|
| 1 | C | 200:ALA | C | 320:LYS | N | 76.80 |
| 1 | A | 685:LYS | C | 707:GLU | N | 37.30 |
| 1 | A | 639:GLU | C | 642:ARG | N | 9.91 |
| 1 | A | 600:GLU | C | 602:LEU | N | 9.04 |

6 Map visualisation [i](#)

This section contains visualisations of the EMDB entry EMD-11335. These allow visual inspection of the internal detail of the map and identification of artifacts.

No raw map or half-maps were deposited for this entry and therefore no images, graphs, etc. pertaining to the raw map can be shown.

6.1 Orthogonal projections [i](#)

6.1.1 Primary map

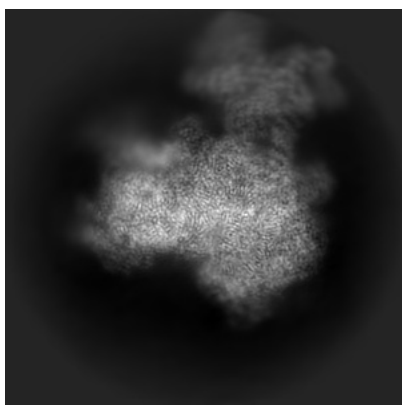

X

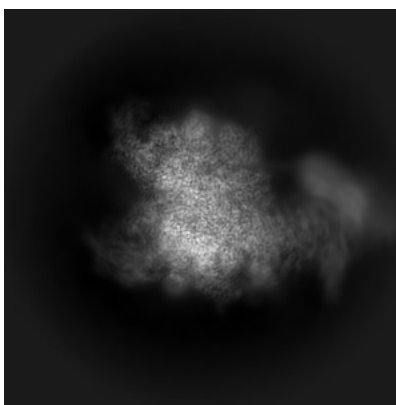

Y

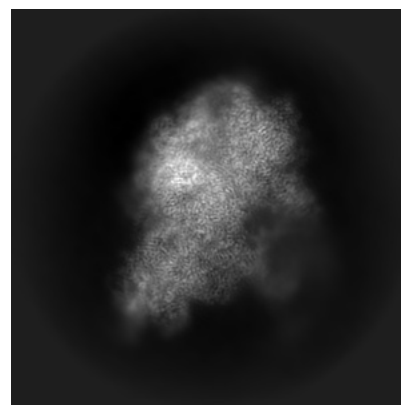

Z

The images above show the map projected in three orthogonal directions.

6.2 Central slices [i](#)

6.2.1 Primary map

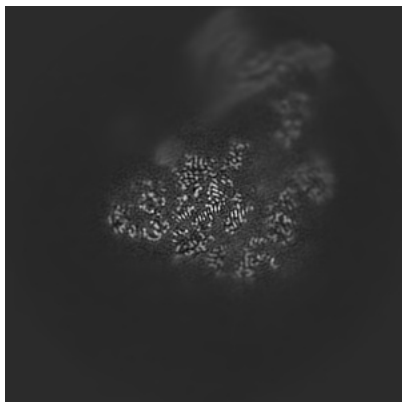

X Index: 180

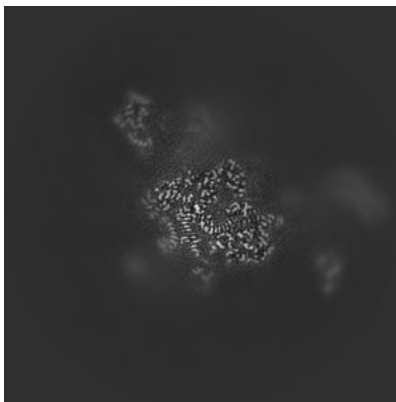

Y Index: 180

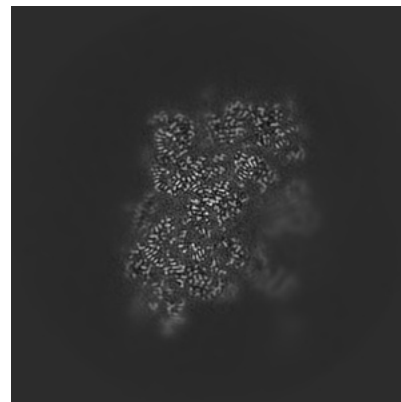

Z Index: 180

The images above show central slices of the map in three orthogonal directions.

6.3 Largest variance slices [i](#)

6.3.1 Primary map

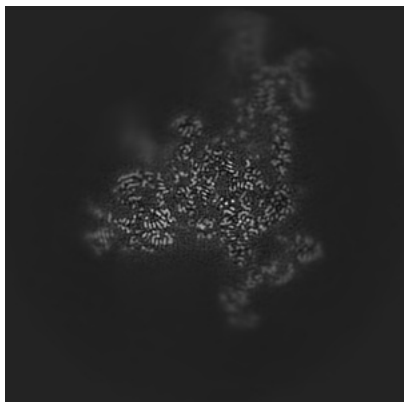

X Index: 157

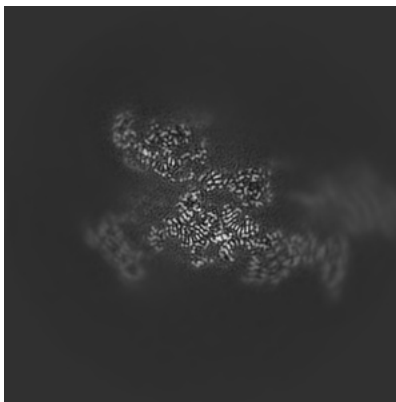

Y Index: 203

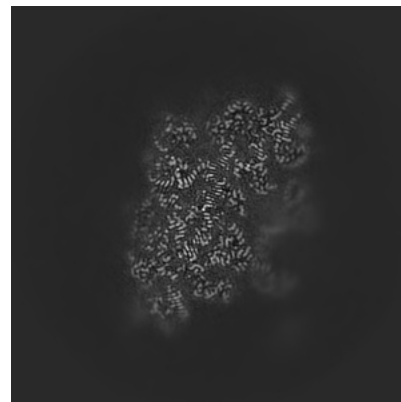

Z Index: 174

The images above show the largest variance slices of the map in three orthogonal directions.

6.4 Orthogonal surface views [i](#)

6.4.1 Primary map



X

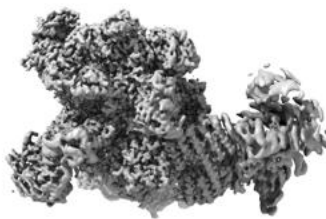

Y



Z

The images above show the 3D surface view of the map at the recommended contour level 0.03. These images, in conjunction with the slice images, may facilitate assessment of whether an appropriate contour level has been provided.

6.5 Mask visualisation

This section was not generated. No masks/segmentation were deposited.

7 Map analysis [i](#)

This section contains the results of statistical analysis of the map.

7.1 Map-value distribution [i](#)

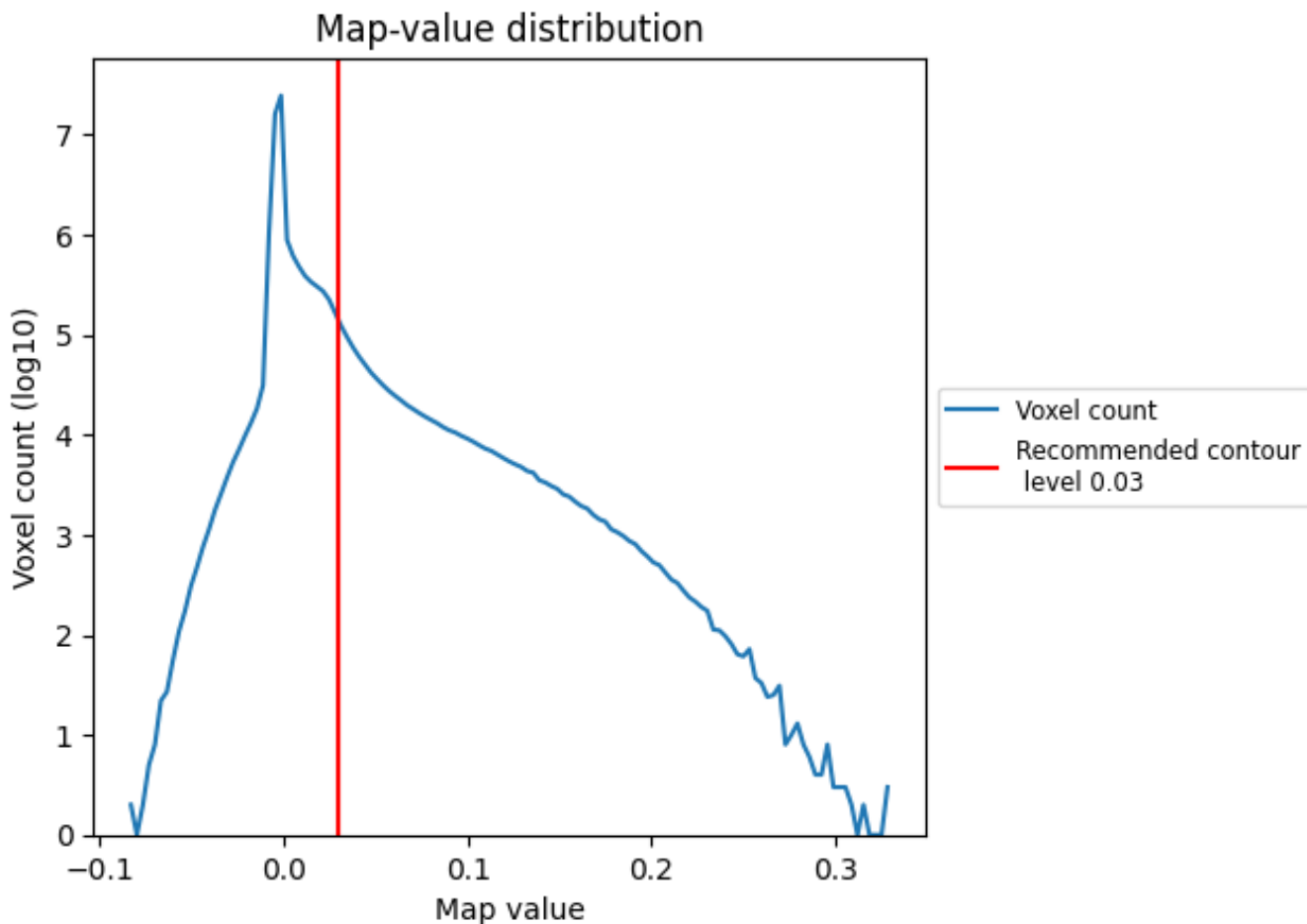

The map-value distribution is plotted in 128 intervals along the x-axis. The y-axis is logarithmic. A spike in this graph at zero usually indicates that the volume has been masked.

7.2 Volume estimate [i](#)

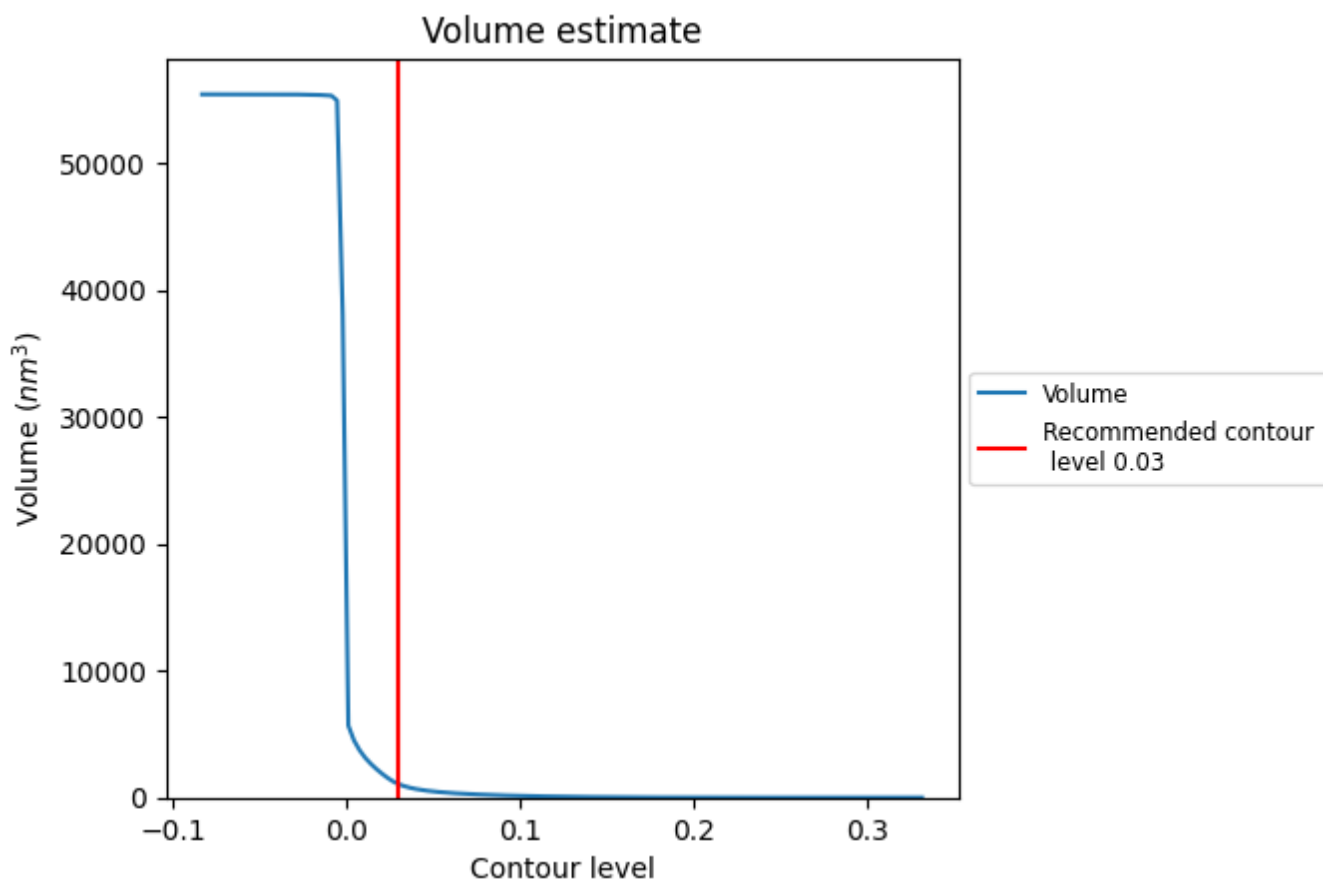

The volume at the recommended contour level is 1065 nm³; this corresponds to an approximate mass of 962 kDa.

The volume estimate graph shows how the enclosed volume varies with the contour level. The recommended contour level is shown as a vertical line and the intersection between the line and the curve gives the volume of the enclosed surface at the given level.

7.3 Rotationally averaged power spectrum [i](#)

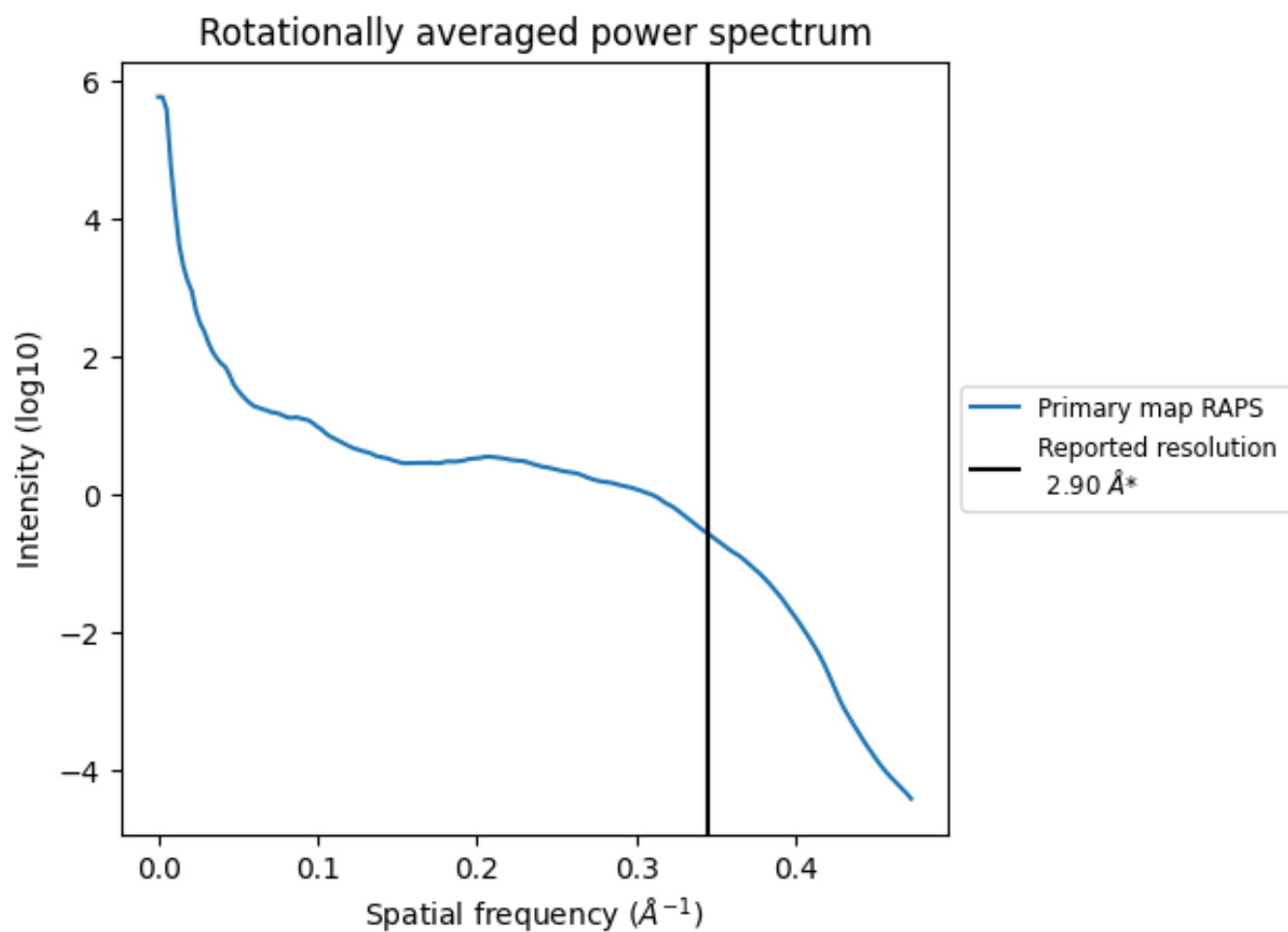

*Reported resolution corresponds to spatial frequency of 0.345 Å⁻¹

8 Fourier-Shell correlation [i](#)

Fourier-Shell Correlation (FSC) is the most commonly used method to estimate the resolution of single-particle and subtomogram-averaged maps. The shape of the curve depends on the imposed symmetry, mask and whether or not the two 3D reconstructions used were processed from a common reference. The reported resolution is shown as a black line. A curve is displayed for the half-bit criterion in addition to lines showing the 0.143 gold standard cut-off and 0.5 cut-off.

8.1 FSC [i](#)

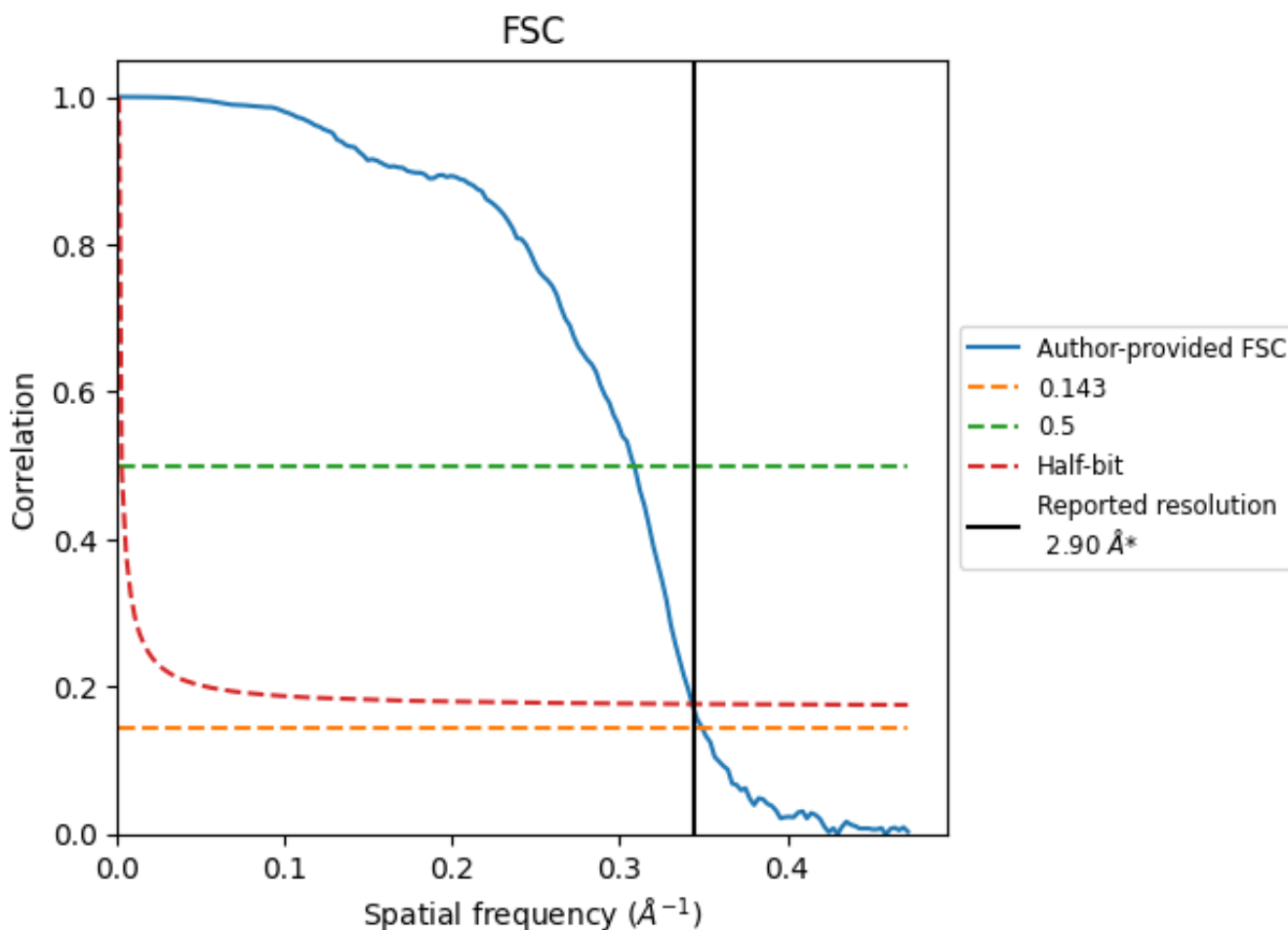

*Reported resolution corresponds to spatial frequency of 0.345 Å⁻¹

8.2 Resolution estimates [i](#)

| Resolution estimate (Å) | Estimation criterion (FSC cut-off) | | |
|---------------------------|------------------------------------|------|----------|
| | 0.143 | 0.5 | Half-bit |
| Reported by author | 2.90 | - | - |
| Author-provided FSC curve | 2.86 | 3.24 | 2.91 |
| Unmasked-calculated* | - | - | - |

*Resolution estimate based on FSC curve calculated by comparison of deposited half-maps.

9 Map-model fit [i](#)

This section contains information regarding the fit between EMDB map EMD-11335 and PDB model 6ZP4. Per-residue inclusion information can be found in section 3 on page 14.

9.1 Map-model overlay [i](#)

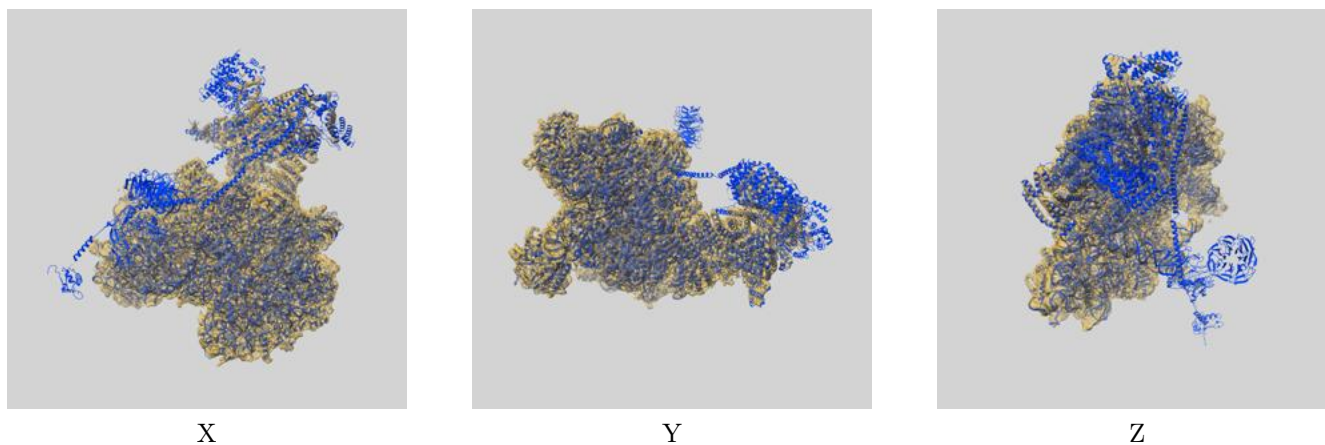

The images above show the 3D surface view of the map at the recommended contour level 0.03 at 50% transparency in yellow overlaid with a ribbon representation of the model coloured in blue. These images allow for the visual assessment of the quality of fit between the atomic model and the map.

9.2 Q-score mapped to coordinate model [i](#)

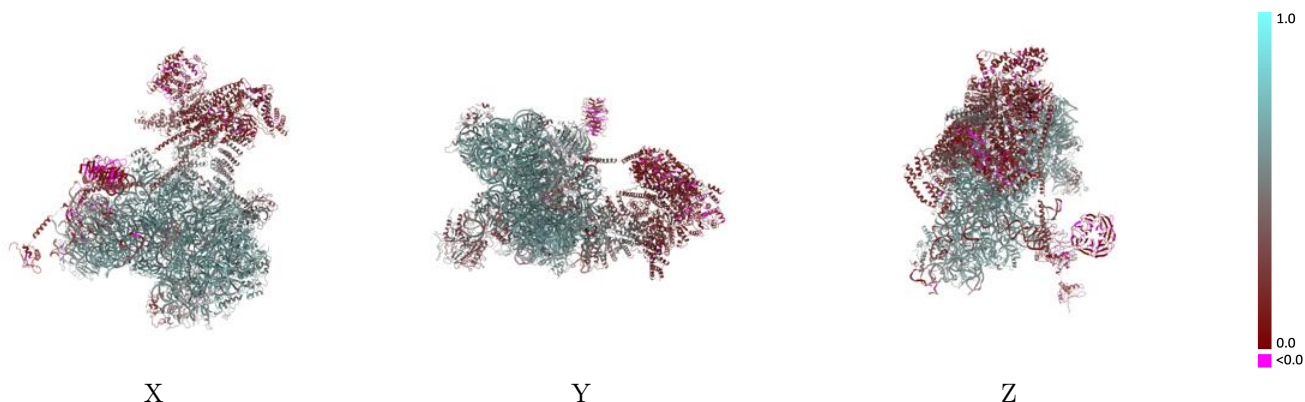

The images above show the model with each residue coloured according to its Q-score. This shows their resolvability in the map with higher Q-score values reflecting better resolvability. Please note: Q-score is calculating the resolvability of atoms, and thus high values are only expected at resolutions at which atoms can be resolved. Low Q-score values may therefore be expected for many entries.

9.3 Atom inclusion mapped to coordinate model [i](#)

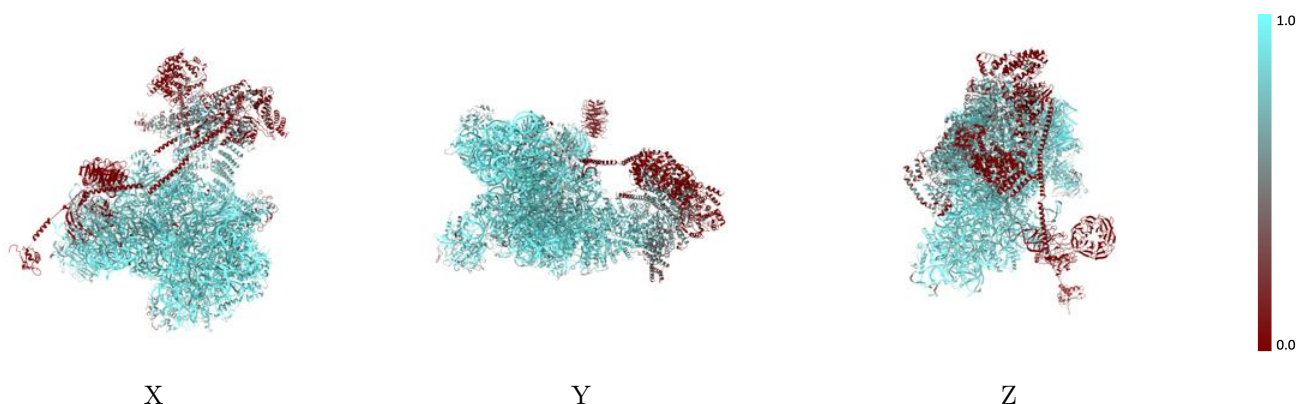

The images above show the model with each residue coloured according to its atom inclusion. This shows to what extent they are inside the map at the recommended contour level (0.03).



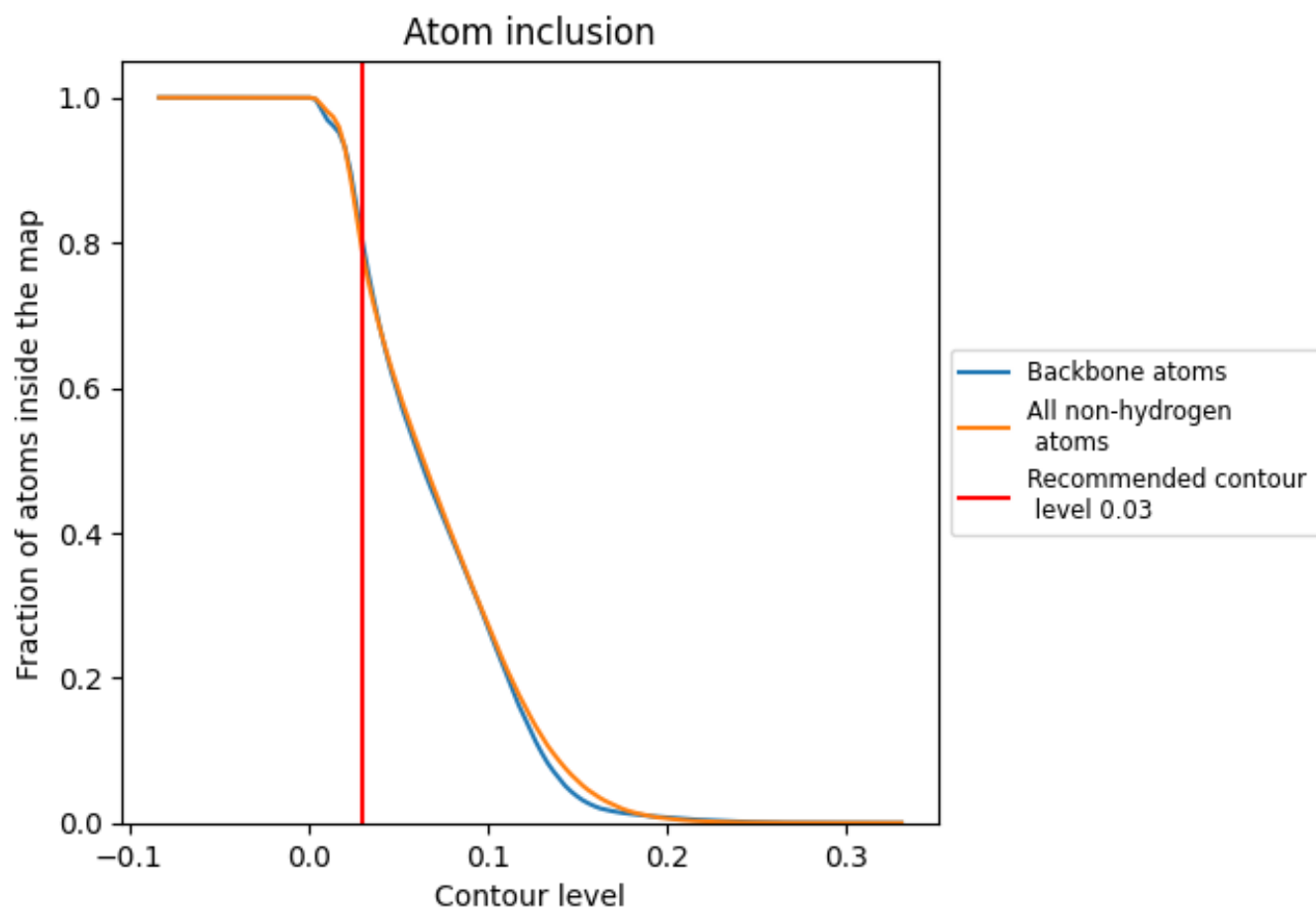



































































9.4 Atom inclusion [i](#)



At the recommended contour level, 81% of all backbone atoms, 79% of all non-hydrogen atoms, are inside the map.

9.5 Map-model fit summary









































The table lists the average atom inclusion at the recommended contour level (0.03) and Q-score for the entire model and for each chain.

| Chain | Atom inclusion | Q-score |
|-------|--|--|
| All |  0.7917 |  0.4760 |
| 1 |  0.9844 |  0.5230 |
| 2 |  0.9726 |  0.5860 |
| 4 |  0.9066 |  0.4890 |
| A |  0.5825 |  0.3170 |
| B |  0.1777 |  0.2080 |
| C |  0.8011 |  0.4020 |
| D |  0.9901 |  0.6430 |
| E |  0.4519 |  0.1970 |
| F |  0.2079 |  0.1340 |
| G |  0.8442 |  0.5510 |
| H |  0.2989 |  0.1580 |
| I |  0.0000 |  0.0540 |
| J |  0.9765 |  0.6310 |
| K |  0.0278 |  0.1220 |
| L |  0.0976 |  0.1200 |
| M |  0.1770 |  0.1630 |
| N |  0.7381 |  0.4130 |
| O |  0.7962 |  0.4200 |
| P |  0.9283 |  0.5630 |
| Q |  0.9731 |  0.6160 |
| R |  0.9697 |  0.5950 |
| S |  0.9306 |  0.5630 |
| T |  0.9794 |  0.6060 |
| U |  0.8252 |  0.4630 |
| V |  0.9335 |  0.5490 |
| W |  0.9474 |  0.5850 |
| X |  0.7821 |  0.3710 |
| Y |  0.7847 |  0.3630 |
| Z |  0.8816 |  0.5170 |
| a |  0.9513 |  0.6040 |
| b |  0.9577 |  0.5890 |
| c |  0.9743 |  0.6160 |
| d |  0.9823 |  0.6360 |
| e |  0.9746 |  0.6060 |



Continued on next page...

Continued from previous page...

| Chain | Atom inclusion | Q-score |
|-------|---|---|
| g |  0.9680 |  0.6230 |
| h |  0.9104 |  0.5670 |
| i |  0.9802 |  0.6130 |
| j |  0.9820 |  0.6300 |
| k |  0.9062 |  0.5710 |
| l |  0.9885 |  0.6450 |
| m |  0.9674 |  0.6060 |
| n |  0.9779 |  0.6160 |
| o |  0.9105 |  0.5770 |
| p |  0.9561 |  0.6050 |
| q |  0.9747 |  0.6100 |
| r |  0.9037 |  0.5250 |
| s |  0.9220 |  0.5360 |
| t |  0.9411 |  0.5660 |
| u |  0.9475 |  0.5760 |
| v |  0.5995 |  0.3280 |
| w |  0.9444 |  0.5850 |
| x |  0.9605 |  0.6170 |
| y |  0.9705 |  0.6220 |
| z |  0.9577 |  0.5790 |