



# wwPDB EM Validation Summary Report ⓘ

Apr 23, 2024 – 04:11 am BST

PDB ID : 6ZSA  
EMDB ID : EMD-11391  
Title : Human mitochondrial ribosome bound to mRNA, A-site tRNA and P-site tRNA  
Authors : Aibara, S.; Singh, V.; Modelska, A.; Amunts, A.  
Deposited on : 2020-07-15  
Resolution : 4.00 Å(reported)

This is a wwPDB EM Validation Summary Report for a publicly released PDB entry.

We welcome your comments at [validation@mail.wwpdb.org](mailto:validation@mail.wwpdb.org)

A user guide is available at

<https://www.wwpdb.org/validation/2017/EMValidationReportHelp>

with specific help available everywhere you see the ⓘ symbol.

The types of validation reports are described at

<http://www.wwpdb.org/validation/2017/FAQs#types>.

---

The following versions of software and data (see [references ⓘ](#)) were used in the production of this report:

EMDB validation analysis : 0.0.1.dev92  
Mogul : 1.8.4, CSD as541be (2020)  
MolProbity : 4.02b-467  
buster-report : 1.1.7 (2018)  
Percentile statistics : 20191225.v01 (using entries in the PDB archive December 25th 2019)  
MapQ : 1.9.13  
Ideal geometry (proteins) : Engh & Huber (2001)  
Ideal geometry (DNA, RNA) : Parkinson et al. (1996)  
Validation Pipeline (wwPDB-VP) : 2.36.2

# 1 Overall quality at a glance

The following experimental techniques were used to determine the structure:  
*ELECTRON MICROSCOPY*

The reported resolution of this entry is 4.00 Å.

Percentile scores (ranging between 0-100) for global validation metrics of the entry are shown in the following graphic. The table shows the number of entries on which the scores are based.

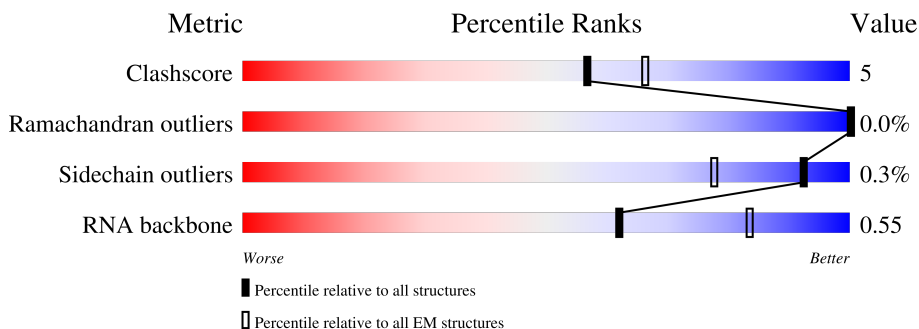













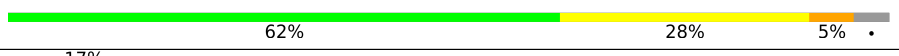
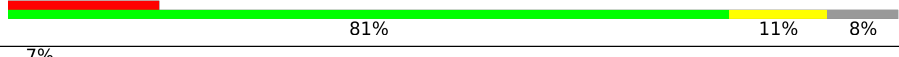



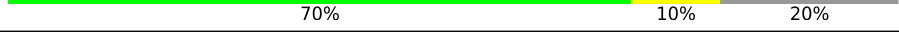
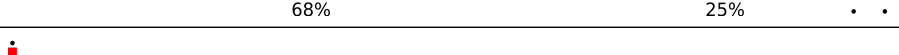
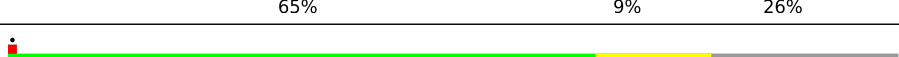
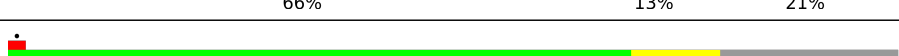

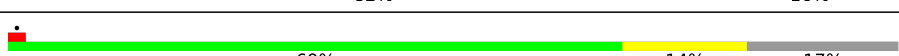
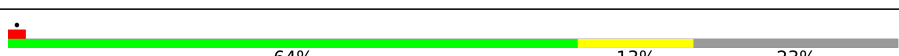
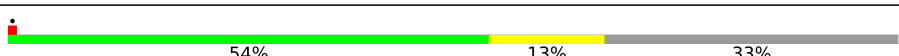
Metric	Whole archive (#Entries)	EM structures (#Entries)
Clashscore	158937	4297
Ramachandran outliers	154571	4023
Sidechain outliers	154315	3826
RNA backbone	4643	859

The table below summarises the geometric issues observed across the polymeric chains and their fit to the map. The red, orange, yellow and green segments of the bar indicate the fraction of residues that contain outliers for  $\geq 3$ , 2, 1 and 0 types of geometric quality criteria respectively. A grey segment represents the fraction of residues that are not modelled. The numeric value for each fraction is indicated below the corresponding segment, with a dot representing fractions  $\leq 5\%$ . The upper red bar (where present) indicates the fraction of residues that have poor fit to the EM map (all-atom inclusion  $< 40\%$ ). The numeric value is given above the bar.

Mol	Chain	Length	Quality of chain
1	0	188	
2	1	65	
3	2	92	
4	3	188	
5	4	103	
6	5	423	
7	6	380	

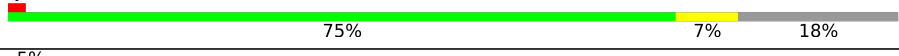











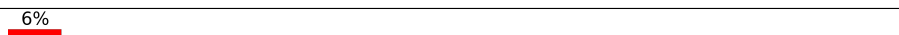
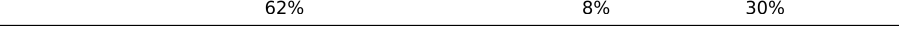

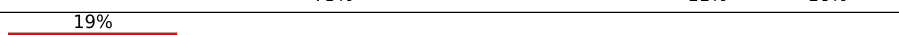



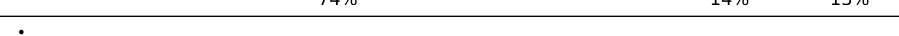



Continued on next page...

Continued from previous page...

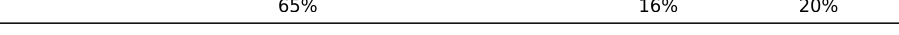
Mol	Chain	Length	Quality of chain
8	7	338	
9	8	206	
10	9	137	
11	XA	1559	
12	A0	218	
13	A1	323	
14	A2	118	
15	A3	199	
16	A4	689	
17	AA	954	
18	AB	296	
19	AC	167	
20	AD	430	
21	AE	125	
22	AF	242	
23	AG	396	
24	AH	201	
25	AI	194	
26	AJ	138	
27	AK	128	
28	AL	257	
29	AM	137	
30	AN	130	
31	AO	258	
32	AP	142	

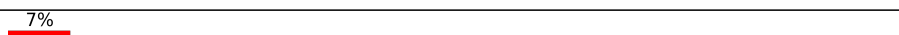























Continued on next page...

Continued from previous page...

Mol	Chain	Length	Quality of chain
33	AQ	87	
34	AR	360	
35	AS	190	
36	AT	173	
37	AU	205	
38	AV	414	
39	AW	187	
40	AX	398	
41	AY	395	
42	AZ	106	
43	XB	72	
44	XD	305	
45	XE	348	
46	XF	311	
47	XH	267	
48	XI	261	
49	XJ	192	
50	XK	178	
51	XL	145	
52	XM	296	
53	XN	251	
54	XO	175	
55	XP	180	
56	XQ	292	
57	XR	149	







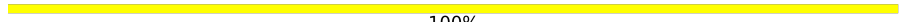

Continued on next page...

Continued from previous page...

Mol	Chain	Length	Quality of chain
58	XS	205	
59	XT	206	
60	XU	153	
61	XV	216	
62	XW	148	
63	XX	256	
64	XY	250	
65	XZ	161	
66	a	142	
67	b	215	
68	c	332	
69	d	306	
70	e	279	
71	f	212	
72	g	166	
73	h	158	
74	i	128	
75	j	123	
76	k	112	
77	l	138	
78	m	128	
79	o	102	
80	p	206	
81	q	222	
82	r	196	

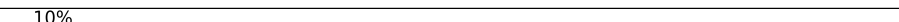
Continued on next page...

*Continued from previous page...*

Mol	Chain	Length	Quality of chain
83	r1	14	 100%
84	r2	76	 5% 100%
85	r3	75	 7% 100%
86	s	439	 84% 16%
87	t1	198	 16% 23% 77%
87	t2	198	 10% 15% 85%
87	t3	198	 15% 15% 85%
87	t4	198	 15% 15% 85%
87	t5	198	 15% 15% 85%
87	t6	198	 14% 14% 86%

## 2 Entry composition [i](#)

There are 92 unique types of molecules in this entry. The entry contains 313757 atoms, of which 143060 are hydrogens and 0 are deuteriums.

In the tables below, the AltConf column contains the number of residues with at least one atom in alternate conformation and the Trace column contains the number of residues modelled with at most 2 atoms.

- Molecule 1 is a protein called 39S ribosomal protein L32, mitochondrial.

Mol	Chain	Residues	Atoms					AltConf	Trace	
			Total	C	H	N	O			S
1	0	108	1783	545	903	172	157	6	0	0

- Molecule 2 is a protein called 39S ribosomal protein L33, mitochondrial.

Mol	Chain	Residues	Atoms					AltConf	Trace	
			Total	C	H	N	O			S
2	1	53	919	281	480	84	72	2	0	0

- Molecule 3 is a protein called 39S ribosomal protein L34, mitochondrial.

Mol	Chain	Residues	Atoms					AltConf	Trace	
			Total	C	H	N	O			S
3	2	46	782	233	406	83	59	1	0	0

- Molecule 4 is a protein called 39S ribosomal protein L35, mitochondrial.

Mol	Chain	Residues	Atoms					AltConf	Trace	
			Total	C	H	N	O			S
4	3	95	1714	539	883	162	127	3	0	0

- Molecule 5 is a protein called 39S ribosomal protein L36, mitochondrial.

Mol	Chain	Residues	Atoms					AltConf	Trace	
			Total	C	H	N	O			S
5	4	38	702	217	361	72	48	4	0	0

- Molecule 6 is a protein called 39S ribosomal protein L37, mitochondrial.

Mol	Chain	Residues	Atoms					AltConf	Trace	
			Total	C	H	N	O			S
6	5	393	6404	2070	3200	559	564	11	0	0

- Molecule 7 is a protein called 39S ribosomal protein L38, mitochondrial.

Mol	Chain	Residues	Atoms					AltConf	Trace	
			Total	C	H	N	O			S
7	6	354	5786	1881	2839	525	532	9	0	0

- Molecule 8 is a protein called 39S ribosomal protein L39, mitochondrial.

Mol	Chain	Residues	Atoms					AltConf	Trace	
			Total	C	H	N	O			S
8	7	291	4737	1514	2372	401	432	18	0	0

- Molecule 9 is a protein called 39S ribosomal protein L40, mitochondrial.

Mol	Chain	Residues	Atoms					AltConf	Trace	
			Total	C	H	N	O			S
9	8	139	2377	747	1202	208	218	2	0	0

- Molecule 10 is a protein called 39S ribosomal protein L41, mitochondrial.

Mol	Chain	Residues	Atoms					AltConf	Trace	
			Total	C	H	N	O			S
10	9	124	1983	644	987	170	180	2	0	0

- Molecule 11 is a RNA chain called 16S mitochondrial rRNA.

Mol	Chain	Residues	Atoms					AltConf	Trace	
			Total	C	H	N	O			P
11	XA	1499	48000	14284	16169	5756	10293	1498	0	0

There are 2 discrepancies between the modelled and reference sequences:

Chain	Residue	Modelled	Actual	Comment	Reference
XA	3107	U	UNK	conflict	GB 1025814679
XA	3200	A	U	conflict	GB 1025814679

- Molecule 12 is a protein called 28S ribosomal protein S34, mitochondrial.

Mol	Chain	Residues	Atoms					AltConf	Trace	
			Total	C	H	N	O			S
12	A0	201	3369	1065	1685	322	292	5	0	0

- Molecule 13 is a protein called 28S ribosomal protein S35, mitochondrial.



Mol	Chain	Residues	Atoms					AltConf	Trace	
			Total	C	H	N	O			S
13	A1	275	4491	1414	2261	380	425	11	0	0

- Molecule 14 is a protein called Coiled-coil-helix-coiled-coil-helix domain-containing protein 1.

Mol	Chain	Residues	Atoms					AltConf	Trace	
			Total	C	H	N	O			S
14	A2	116	1889	574	964	181	162	8	0	0

- Molecule 15 is a protein called Aurora kinase A-interacting protein.

Mol	Chain	Residues	Atoms					AltConf	Trace	
			Total	C	H	N	O			S
15	A3	69	1292	393	682	130	86	1	0	0

- Molecule 16 is a protein called Pentatricopeptide repeat domain-containing protein 3, mitochondrial.

Mol	Chain	Residues	Atoms					AltConf	Trace	
			Total	C	H	N	O			S
16	A4	552	8955	2866	4485	756	820	28	0	0

- Molecule 17 is a RNA chain called 12S mitochondrial rRNA.

Mol	Chain	Residues	Atoms					AltConf	Trace	
			Total	C	H	N	O			P
17	AA	924	29598	8800	9970	3540	6364	924	0	0

- Molecule 18 is a protein called 28S ribosomal protein S2, mitochondrial.

Mol	Chain	Residues	Atoms					AltConf	Trace	
			Total	C	H	N	O			S
18	AB	218	3545	1135	1769	322	309	10	0	0

- Molecule 19 is a protein called 28S ribosomal protein S24, mitochondrial.

Mol	Chain	Residues	Atoms					AltConf	Trace	
			Total	C	H	N	O			S
19	AC	132	2170	699	1088	195	184	4	0	0

- Molecule 20 is a protein called 28S ribosomal protein S5, mitochondrial.

Mol	Chain	Residues	Atoms					AltConf	Trace	
			Total	C	H	N	O			S
20	AD	343	5502	1706	2786	515	482	13	0	0

- Molecule 21 is a protein called 28S ribosomal protein S6, mitochondrial.

Mol	Chain	Residues	Atoms					AltConf	Trace	
			Total	C	H	N	O			S
21	AE	122	1973	614	1001	177	177	4	0	0

- Molecule 22 is a protein called 28S ribosomal protein S7, mitochondrial.

Mol	Chain	Residues	Atoms					AltConf	Trace	
			Total	C	H	N	O			S
22	AF	201	3384	1069	1716	305	283	11	0	0

- Molecule 23 is a protein called 28S ribosomal protein S9, mitochondrial.

Mol	Chain	Residues	Atoms					AltConf	Trace	
			Total	C	H	N	O			S
23	AG	304	4995	1593	2490	444	454	14	0	0

- Molecule 24 is a protein called 28S ribosomal protein S10, mitochondrial.

Mol	Chain	Residues	Atoms					AltConf	Trace	
			Total	C	H	N	O			S
24	AH	135	2241	712	1136	187	203	3	0	0

- Molecule 25 is a protein called 28S ribosomal protein S11, mitochondrial.

Mol	Chain	Residues	Atoms					AltConf	Trace	
			Total	C	H	N	O			S
25	AI	136	2063	637	1052	192	178	4	0	0

- Molecule 26 is a protein called 28S ribosomal protein S12, mitochondrial.

Mol	Chain	Residues	Atoms					AltConf	Trace	
			Total	C	H	N	O			S
26	AJ	108	1725	521	887	169	142	6	0	0

- Molecule 27 is a protein called 28S ribosomal protein S14, mitochondrial.

Mol	Chain	Residues	Atoms					AltConf	Trace	
			Total	C	H	N	O			S
27	AK	101	1746	537	885	179	140	5	0	0

- Molecule 28 is a protein called 28S ribosomal protein S15, mitochondrial.

Mol	Chain	Residues	Atoms					AltConf	Trace	
			Total	C	H	N	O			S
28	AL	164	2854	883	1472	257	235	7	0	0

- Molecule 29 is a protein called 28S ribosomal protein S16, mitochondrial.

Mol	Chain	Residues	Atoms					AltConf	Trace	
			Total	C	H	N	O			S
29	AM	116	1871	582	951	182	150	6	0	0

- Molecule 30 is a protein called 28S ribosomal protein S17, mitochondrial.

Mol	Chain	Residues	Atoms					AltConf	Trace	
			Total	C	H	N	O			S
30	AN	107	1754	549	908	153	141	3	0	0

- Molecule 31 is a protein called 28S ribosomal protein S18b, mitochondrial.

Mol	Chain	Residues	Atoms					AltConf	Trace	
			Total	C	H	N	O			S
31	AO	185	3017	970	1489	285	267	6	0	0

- Molecule 32 is a protein called 28S ribosomal protein S18c, mitochondrial.

Mol	Chain	Residues	Atoms					AltConf	Trace	
			Total	C	H	N	O			S
32	AP	95	1561	493	796	132	132	8	0	0

- Molecule 33 is a protein called 28S ribosomal protein S21, mitochondrial.

Mol	Chain	Residues	Atoms					AltConf	Trace	
			Total	C	H	N	O			S
33	AQ	85	1483	455	749	149	123	7	0	0

There is a discrepancy between the modelled and reference sequences:

Chain	Residue	Modelled	Actual	Comment	Reference
AQ	50	ARG	CYS	variant	UNP P82921

- Molecule 34 is a protein called 28S ribosomal protein S22, mitochondrial.

Mol	Chain	Residues	Atoms					AltConf	Trace	
			Total	C	H	N	O			S
34	AR	250	4134	1314	2074	353	385	8	0	0

- Molecule 35 is a protein called 28S ribosomal protein S23, mitochondrial.

Mol	Chain	Residues	Atoms					AltConf	Trace	
			Total	C	H	N	O			S
35	AS	133	2203	709	1103	196	194	1	0	0

- Molecule 36 is a protein called 28S ribosomal protein S25, mitochondrial.

Mol	Chain	Residues	Atoms					AltConf	Trace	
			Total	C	H	N	O			S
36	AT	162	2673	850	1343	231	238	11	0	0

- Molecule 37 is a protein called 28S ribosomal protein S26, mitochondrial.

Mol	Chain	Residues	Atoms					AltConf	Trace	
			Total	C	H	N	O			S
37	AU	173	2932	900	1471	294	263	4	0	0

- Molecule 38 is a protein called 28S ribosomal protein S27, mitochondrial.

Mol	Chain	Residues	Atoms					AltConf	Trace	
			Total	C	H	N	O			S
38	AV	349	5729	1841	2862	478	536	12	0	0

- Molecule 39 is a protein called 28S ribosomal protein S28, mitochondrial.

Mol	Chain	Residues	Atoms					AltConf	Trace	
			Total	C	H	N	O			S
39	AW	97	1551	486	785	137	139	4	0	0

- Molecule 40 is a protein called 28S ribosomal protein S29, mitochondrial.

Mol	Chain	Residues	Atoms					AltConf	Trace	
			Total	C	H	N	O			S
40	AX	348	5619	1802	2805	491	510	11	0	0

- Molecule 41 is a protein called 28S ribosomal protein S31, mitochondrial.

Mol	Chain	Residues	Atoms					AltConf	Trace	
			Total	C	H	N	O			S
41	AY	113	1868	621	912	157	176	2	0	0

- Molecule 42 is a protein called 28S ribosomal protein S33, mitochondrial.

Mol	Chain	Residues	Atoms					AltConf	Trace	
			Total	C	H	N	O			S
42	AZ	86	1465	467	734	131	129	4	0	0

- Molecule 43 is a RNA chain called mitochondrial tRNAVal.

Mol	Chain	Residues	Atoms					AltConf	Trace	
			Total	C	H	N	O			P
43	XB	59	1895	563	640	227	406	59	0	0

- Molecule 44 is a protein called 39S ribosomal protein L2, mitochondrial.

Mol	Chain	Residues	Atoms					AltConf	Trace	
			Total	C	H	N	O			S
44	XD	236	3739	1145	1897	373	315	9	0	0

- Molecule 45 is a protein called 39S ribosomal protein L3, mitochondrial.

Mol	Chain	Residues	Atoms					AltConf	Trace	
			Total	C	H	N	O			S
45	XE	304	4798	1539	2402	416	430	11	0	0

- Molecule 46 is a protein called 39S ribosomal protein L4, mitochondrial.

Mol	Chain	Residues	Atoms					AltConf	Trace	
			Total	C	H	N	O			S
46	XF	250	4058	1294	2045	365	348	6	0	0

- Molecule 47 is a protein called 39S ribosomal protein L9, mitochondrial.

Mol	Chain	Residues	Atoms					AltConf	Trace
47	XH	95	Total	C	H	N	O	0	0
			1616	498	832	152	134		

- Molecule 48 is a protein called 39S ribosomal protein L10, mitochondrial.

Mol	Chain	Residues	Atoms					AltConf	Trace	
48	XI	211	Total	C	H	N	O	S	0	0
			3474	1086	1783	303	291	11		

- Molecule 49 is a protein called 39S ribosomal protein L11, mitochondrial.

Mol	Chain	Residues	Atoms					AltConf	Trace	
49	XJ	170	Total	C	H	N	O	S	0	0
			2658	825	1367	230	234	2		

- Molecule 50 is a protein called 39S ribosomal protein L13, mitochondrial.

Mol	Chain	Residues	Atoms					AltConf	Trace	
50	XK	177	Total	C	H	N	O	S	0	0
			2899	934	1448	259	251	7		

- Molecule 51 is a protein called 39S ribosomal protein L14, mitochondrial.

Mol	Chain	Residues	Atoms					AltConf	Trace	
51	XL	115	Total	C	H	N	O	S	0	0
			1830	559	941	171	154	5		

- Molecule 52 is a protein called 39S ribosomal protein L15, mitochondrial.

Mol	Chain	Residues	Atoms					AltConf	Trace	
52	XM	287	Total	C	H	N	O	S	0	0
			4683	1472	2378	425	402	6		

- Molecule 53 is a protein called 39S ribosomal protein L16, mitochondrial.

Mol	Chain	Residues	Atoms					AltConf	Trace	
53	XN	221	Total	C	H	N	O	S	0	0
			3586	1138	1808	325	305	10		

- Molecule 54 is a protein called 39S ribosomal protein L17, mitochondrial.

Mol	Chain	Residues	Atoms						AltConf	Trace
54	XO	152	Total	C	H	N	O	S	0	0
			2528	784	1283	239	215	7		

- Molecule 55 is a protein called 39S ribosomal protein L18, mitochondrial.

Mol	Chain	Residues	Atoms						AltConf	Trace
55	XP	143	Total	C	H	N	O	S	0	0
			2326	729	1162	223	207	5		

- Molecule 56 is a protein called 39S ribosomal protein L19, mitochondrial.

Mol	Chain	Residues	Atoms						AltConf	Trace
56	XQ	238	Total	C	H	N	O	S	0	0
			4000	1268	2022	352	349	9		

- Molecule 57 is a protein called 39S ribosomal protein L20, mitochondrial.

Mol	Chain	Residues	Atoms						AltConf	Trace
57	XR	140	Total	C	H	N	O	S	0	0
			2367	732	1214	231	186	4		

- Molecule 58 is a protein called 39S ribosomal protein L21, mitochondrial.

Mol	Chain	Residues	Atoms						AltConf	Trace
58	XS	160	Total	C	H	N	O	S	0	0
			2639	829	1355	226	225	4		

- Molecule 59 is a protein called 39S ribosomal protein L22, mitochondrial.

Mol	Chain	Residues	Atoms						AltConf	Trace
59	XT	166	Total	C	H	N	O	S	0	0
			2778	875	1410	254	232	7		

- Molecule 60 is a protein called 39S ribosomal protein L23, mitochondrial.

Mol	Chain	Residues	Atoms						AltConf	Trace
60	XU	141	Total	C	H	N	O	S	0	0
			2335	743	1164	222	203	3		

- Molecule 61 is a protein called 39S ribosomal protein L24, mitochondrial.

Mol	Chain	Residues	Atoms					AltConf	Trace	
			Total	C	H	N	O			S
61	XV	202	3304	1051	1656	294	295	8	0	0

- Molecule 62 is a protein called 39S ribosomal protein L27, mitochondrial.

Mol	Chain	Residues	Atoms					AltConf	Trace	
			Total	C	H	N	O			S
62	XW	111	1769	558	898	164	146	3	0	0

- Molecule 63 is a protein called 39S ribosomal protein L28, mitochondrial.

Mol	Chain	Residues	Atoms					AltConf	Trace	
			Total	C	H	N	O			S
63	XX	243	4089	1317	2054	351	362	5	0	0

- Molecule 64 is a protein called 39S ribosomal protein L47, mitochondrial.

Mol	Chain	Residues	Atoms					AltConf	Trace	
			Total	C	H	N	O			S
64	XY	178	3109	981	1575	295	254	4	0	0

- Molecule 65 is a protein called 39S ribosomal protein L30, mitochondrial.

Mol	Chain	Residues	Atoms					AltConf	Trace	
			Total	C	H	N	O			S
65	XZ	120	2008	626	1030	183	166	3	0	0

- Molecule 66 is a protein called 39S ribosomal protein L42, mitochondrial.

Mol	Chain	Residues	Atoms					AltConf	Trace	
			Total	C	H	N	O			S
66	a	97	1590	512	777	145	151	5	0	0

- Molecule 67 is a protein called 39S ribosomal protein L43, mitochondrial.

Mol	Chain	Residues	Atoms					AltConf	Trace	
			Total	C	H	N	O			S
67	b	148	2358	733	1180	229	213	3	0	0

- Molecule 68 is a protein called 39S ribosomal protein L44, mitochondrial.



Mol	Chain	Residues	Atoms					AltConf	Trace	
			Total	C	H	N	O			S
68	c	275	4437	1415	2220	383	410	9	0	0

- Molecule 69 is a protein called 39S ribosomal protein L45, mitochondrial.

Mol	Chain	Residues	Atoms					AltConf	Trace	
			Total	C	H	N	O			S
69	d	216	3501	1125	1743	305	315	13	0	0

- Molecule 70 is a protein called 39S ribosomal protein L46, mitochondrial.

Mol	Chain	Residues	Atoms					AltConf	Trace	
			Total	C	H	N	O			S
70	e	217	3529	1124	1767	310	323	5	0	0

- Molecule 71 is a protein called 39S ribosomal protein L48, mitochondrial.

Mol	Chain	Residues	Atoms					AltConf	Trace	
			Total	C	H	N	O			S
71	f	143	2314	737	1165	187	221	4	0	0

- Molecule 72 is a protein called 39S ribosomal protein L49, mitochondrial.

Mol	Chain	Residues	Atoms					AltConf	Trace	
			Total	C	H	N	O			S
72	g	132	2183	710	1086	191	194	2	0	0

- Molecule 73 is a protein called 39S ribosomal protein L50, mitochondrial.

Mol	Chain	Residues	Atoms					AltConf	Trace	
			Total	C	H	N	O			S
73	h	108	1748	560	866	154	165	3	0	0

- Molecule 74 is a protein called 39S ribosomal protein L51, mitochondrial.

Mol	Chain	Residues	Atoms					AltConf	Trace	
			Total	C	H	N	O			S
74	i	97	1684	532	857	165	126	4	0	0

- Molecule 75 is a protein called 39S ribosomal protein L52, mitochondrial.

Mol	Chain	Residues	Atoms					AltConf	Trace	
			Total	C	H	N	O			S
75	j	86	1367	426	678	134	127	2	0	0

- Molecule 76 is a protein called 39S ribosomal protein L53, mitochondrial.

Mol	Chain	Residues	Atoms					AltConf	Trace	
			Total	C	H	N	O			S
76	k	95	1477	456	745	139	132	5	0	0

- Molecule 77 is a protein called 39S ribosomal protein L54, mitochondrial.

Mol	Chain	Residues	Atoms					AltConf	Trace	
			Total	C	H	N	O			S
77	l	80	1327	427	654	118	125	3	0	0

- Molecule 78 is a protein called 39S ribosomal protein L55, mitochondrial.

Mol	Chain	Residues	Atoms					AltConf	Trace	
			Total	C	H	N	O			S
78	m	60	1025	309	525	104	85	2	0	0

- Molecule 79 is a protein called Ribosomal protein 63, mitochondrial.

Mol	Chain	Residues	Atoms					AltConf	Trace	
			Total	C	H	N	O			S
79	o	94	1601	501	804	165	128	3	0	0

- Molecule 80 is a protein called Peptidyl-tRNA hydrolase ICT1, mitochondrial.

Mol	Chain	Residues	Atoms					AltConf	Trace	
			Total	C	H	N	O			S
80	p	127	2141	661	1083	201	192	4	0	0

- Molecule 81 is a protein called Growth arrest and DNA damage-inducible proteins-interacting protein 1.

Mol	Chain	Residues	Atoms					AltConf	Trace	
			Total	C	H	N	O			S
81	q	164	2738	858	1359	267	249	5	0	0

- Molecule 82 is a protein called 39S ribosomal protein S18a, mitochondrial.

Mol	Chain	Residues	Atoms					AltConf	Trace	
			Total	C	H	N	O			S
82	r	152	2514	792	1267	239	208	8	0	0

- Molecule 83 is a RNA chain called mRNA.

Mol	Chain	Residues	Atoms					AltConf	Trace
			Total	C	N	O	P		
83	r1	14	252	126	28	84	14	0	0

- Molecule 84 is a RNA chain called A-site tRNA.

Mol	Chain	Residues	Atoms					AltConf	Trace
			Total	C	N	O	P		
84	r2	76	1486	723	230	457	76	0	0

- Molecule 85 is a RNA chain called P-site tRNA.

Mol	Chain	Residues	Atoms					AltConf	Trace
			Total	C	N	O	P		
85	r3	75	1459	711	222	451	75	0	0

- Molecule 86 is a protein called 39S ribosomal protein S30, mitochondrial.

Mol	Chain	Residues	Atoms					AltConf	Trace	
			Total	C	H	N	O			S
86	s	370	6059	1946	3023	542	534	14	0	0

- Molecule 87 is a protein called 39S ribosomal protein L12, mitochondrial.

Mol	Chain	Residues	Atoms					AltConf	Trace
			Total	C	H	N	O		
87	t1	46	732	228	378	56	70	2	0
87	t2	30	502	154	265	37	46	0	0
87	t3	30	506	154	268	38	46	0	0
87	t4	29	484	148	255	36	45	0	0
87	t5	29	484	148	255	36	45	0	0
87	t6	27	450	137	236	34	43	0	0

- Molecule 88 is ZINC ION (three-letter code: ZN) (formula: Zn).

Mol	Chain	Residues	Atoms		AltConf
88	0	1	Total 1	Zn 1	0
88	4	1	Total 1	Zn 1	0
88	AB	1	Total 1	Zn 1	0
88	AO	1	Total 1	Zn 1	0
88	AP	1	Total 1	Zn 1	0
88	AT	1	Total 1	Zn 1	0
88	r	1	Total 1	Zn 1	0

- Molecule 89 is MAGNESIUM ION (three-letter code: MG) (formula: Mg).

Mol	Chain	Residues	Atoms		AltConf
89	9	1	Total 1	Mg 1	0
89	XA	143	Total 143	Mg 143	0
89	AA	46	Total 46	Mg 46	0
89	XD	1	Total 1	Mg 1	0
89	XI	1	Total 1	Mg 1	0
89	XM	2	Total 2	Mg 2	0
89	g	1	Total 1	Mg 1	0

- Molecule 90 is {N}-[(3 {S},6 {R},12 {R},15 {S},16 {S},19 {S},22 {S},25 {S})-25-[(3 {S})-1-azabicyclo[2.2.2]octan-3-yl]sulfanylmethyl]-3-[[4-(dimethylamino)phenyl]methyl]-12-ethyl-4,16-dimethyl-2,5,11,14,18,21,24-heptakis(oxidanylidene)-19-phenyl-17-oxa-1,4,10,13,20-pentazatricyclo[20.4.0.0<sup>^</sup>{6,10}]hexacosan-15-yl]-3-oxidanyl-pyridine-2-carboxamide (three-letter code: H8Q) (formula: C<sub>53</sub>H<sub>67</sub>N<sub>9</sub>O<sub>10</sub>S).

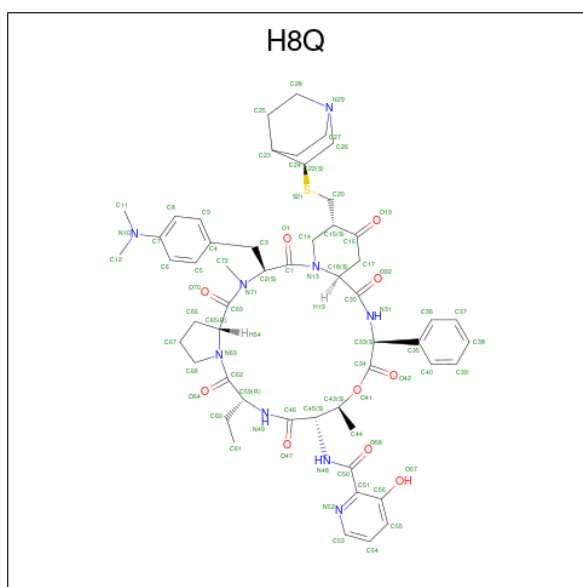

Mol	Chain	Residues	Atoms					AltConf	
			Total	C	H	N	O		S
90	XA	1	140	53	67	9	10	1	0

- Molecule 91 is 5-(2-DIETHYLAMINO-ETHANESULFONYL)-21-HYDROXY-10-ISOPROPYL-11,19-DIMETHYL-9,26-DIOXA-3,15,28-TRIAZA-TRICYCLO[23.2.1.00,255]OCTACOSA-1(27),12,17,19,25(28)-PENTAENE-2,8,14,23-TETRAONE (three-letter code: DOL) (formula:  $C_{34}H_{50}N_4O_9S$ ).

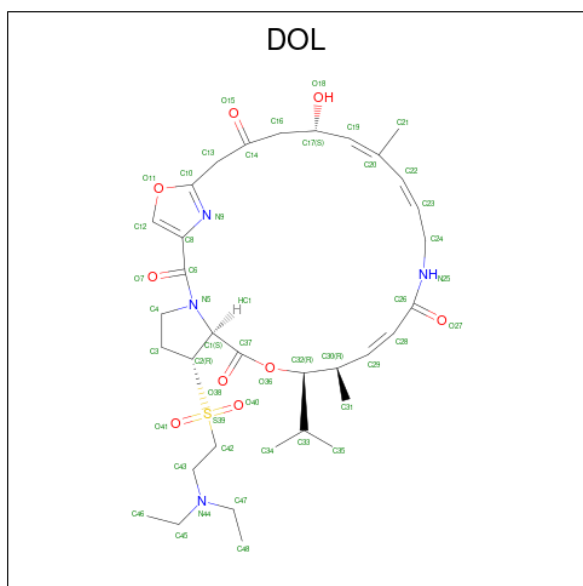

Mol	Chain	Residues	Atoms					AltConf	
			Total	C	H	N	O		S
91	XA	1	98	34	50	4	9	1	0

- Molecule 92 is GUANOSINE-5'-TRIPHOSPHATE (three-letter code: GTP) (formula:  $C_{10}H_{16}N_5O_{14}P_3$ ).

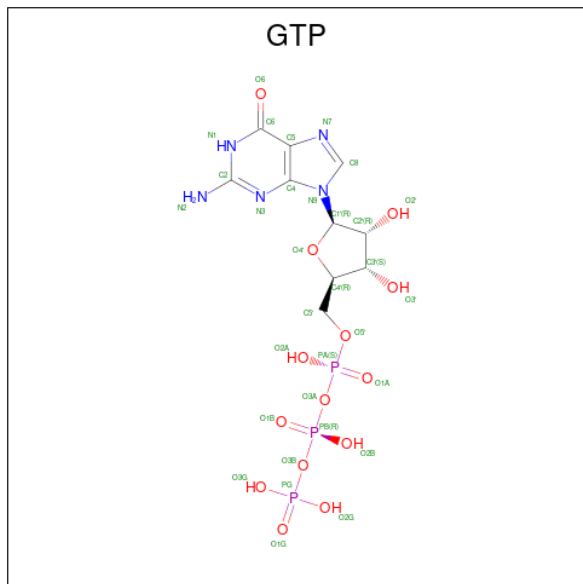

Mol	Chain	Residues	Atoms					AltConf	
			Total	C	H	N	O		P
92	AX	1	42	10	10	5	14	3	0

### 3 Residue-property plots [i](#)

These plots are drawn for all protein, RNA, DNA and oligosaccharide chains in the entry. The first graphic for a chain summarises the proportions of the various outlier classes displayed in the second graphic. The second graphic shows the sequence view annotated by issues in geometry and atom inclusion in map density. Residues are color-coded according to the number of geometric quality criteria for which they contain at least one outlier: green = 0, yellow = 1, orange = 2 and red = 3 or more. A red diamond above a residue indicates a poor fit to the EM map for this residue (all-atom inclusion < 40%). Stretches of 2 or more consecutive residues without any outlier are shown as a green connector. Residues present in the sample, but not in the model, are shown in grey.

- Molecule 1: 39S ribosomal protein L32, mitochondrial

Chain 0:  51% 7% 43%

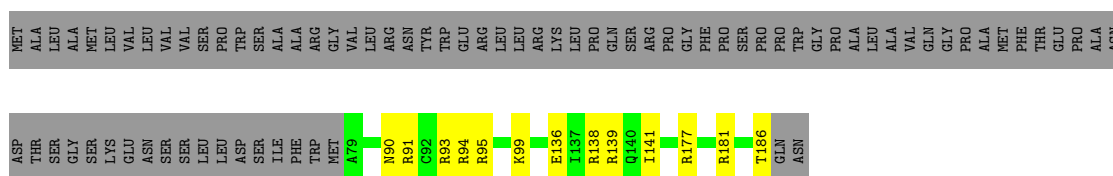

- Molecule 2: 39S ribosomal protein L33, mitochondrial

Chain 1:  71% 11% 18%



- Molecule 3: 39S ribosomal protein L34, mitochondrial

Chain 2:  46% 0% 50%

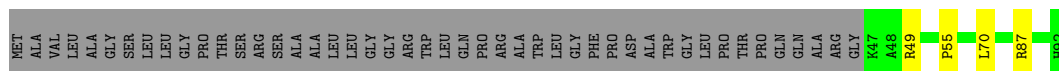

- Molecule 4: 39S ribosomal protein L35, mitochondrial

Chain 3:  38% 12% 49%

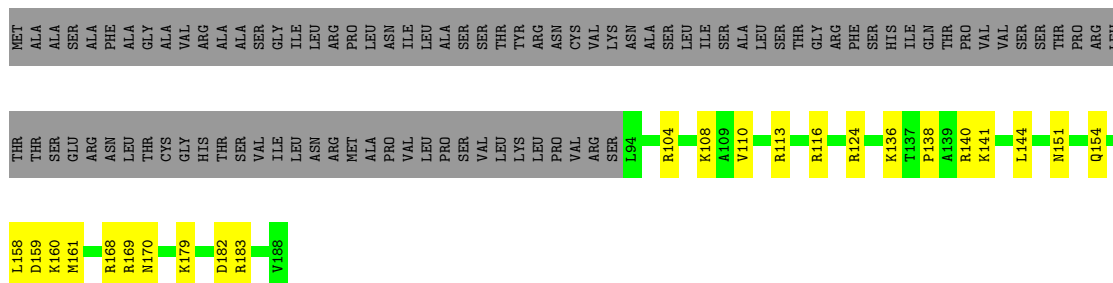

- Molecule 5: 39S ribosomal protein L36, mitochondrial

Chain 4: 33% 63%

MET ALA ASN LEU PHE ILE ARG LYS MET VAL ASN PRO LEU TYR SER ARG HIS THR VAL LYS PRO ARG ALA LEU THR PHE LEU PHE GLY SER ILE ARG GLY ALA ALA PRO VAL ALA VAL GLU PRO GLY ALA VAL ARG SER LEU LEU PRO GLY LEU HIS PRO LEU

LEU PRO ALA LEU GLY F66 K73 R84 W88 K89 M103

• Molecule 6: 39S ribosomal protein L37, mitochondrial

Chain 5: 82% 11% 7%

MET ALA LEU ALA SER GLY PRO ALA ARG ALA ARG ALA LEU ALA GLY SER LEU GLN LEU GLY LEU GLY PHE LEU GLY ALA PRO ARG ARG A30 Y31 E32 R39 D47 R48 G64 R72 W122 D141 D142 N149 E152 H160 W164 E174 C177 V178

I180 V181 D182 R201 N214 R215 E216 S217 L218 R242 I245 L270 L291 N298 L299 R300 R303 P306 D307 R310 A311 L315 K334 E337 S344 T361 T362 D363 L364 S378 L381 K407 P408 E409 Y418 L419 H420 G421 A422 ALA

• Molecule 7: 39S ribosomal protein L38, mitochondrial

Chain 6: 81% 12% 7%

MET ALA PRO TRP ARG ALA ALA LEU GLU CYS CYS ARG TRP ARG GLY PHE SER THR SER ALA VAL LEU R27 D39 I40 K50 Y57 R58 E62 T82 D83 P84 R85 P86 D89 R99 E105 E106 K107 Q108 R114 V117 E118 E119 R121

R124 G144 P145 Y146 Q149 D160 E161 A198 E210 P228 D229 N239 Y254 R267 Q275 S282 E283 R286 P287 P289 C290 Q295 Q308 M311 K355 R356 F357 R360 R364 R368 Y369 R370 D371 Y380

• Molecule 8: 39S ribosomal protein L39, mitochondrial

Chain 7: 77% 9% 14%

MET GLU ALA LEU ALA MET GLY SER ARG ALA LEU ARG ALA TRP VAL ALA PRO GLY GLY ILE LYS TRP ARG PHE ILE ALA THR SER SER ALA SER SER LEU S36 P37 T38 E42 E51 R54 R83 H94 T120 W143 H165 F179 C180 Y181 T203

H207 I210 V225 I229 Y235 K236 V237 D238 F239 I240 E241 S245 Q246 N247 I251 D259 F260 I261 D262 V263 E279 Q290 L306 D314 E326 ASP GLN SER LYS THR ALA THR GLU CYS THR

• Molecule 9: 39S ribosomal protein L40, mitochondrial

Chain 8: 61% 6% 33%

MET THR ALA SER VAL LEU ARG SER ILE SER LEU ALA LEU ARG PRO THR SER GLY LEU LEU GLY THR TRP GLN THR THR GLN ARG LEU HIS GLN ALA SER LEU LEU SER PHE TRP GLU ILE PRO MET ARG SER GLU PRO ARG LYS LYS VAL ASP PRO LYS K60





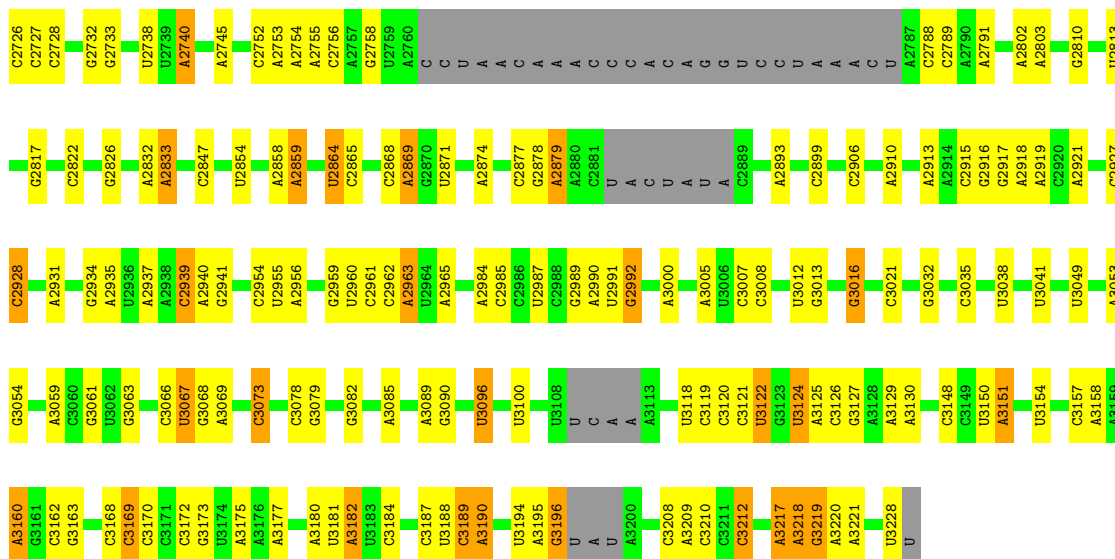

• Molecule 12: 28S ribosomal protein S34, mitochondrial

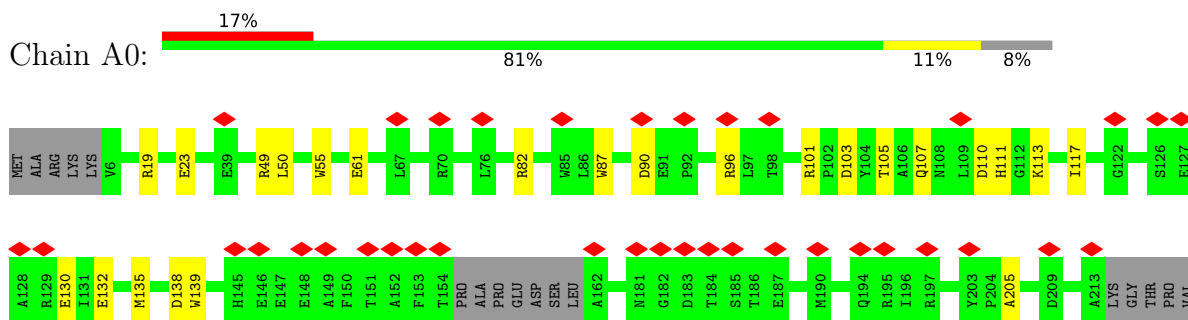

• Molecule 13: 28S ribosomal protein S35, mitochondrial

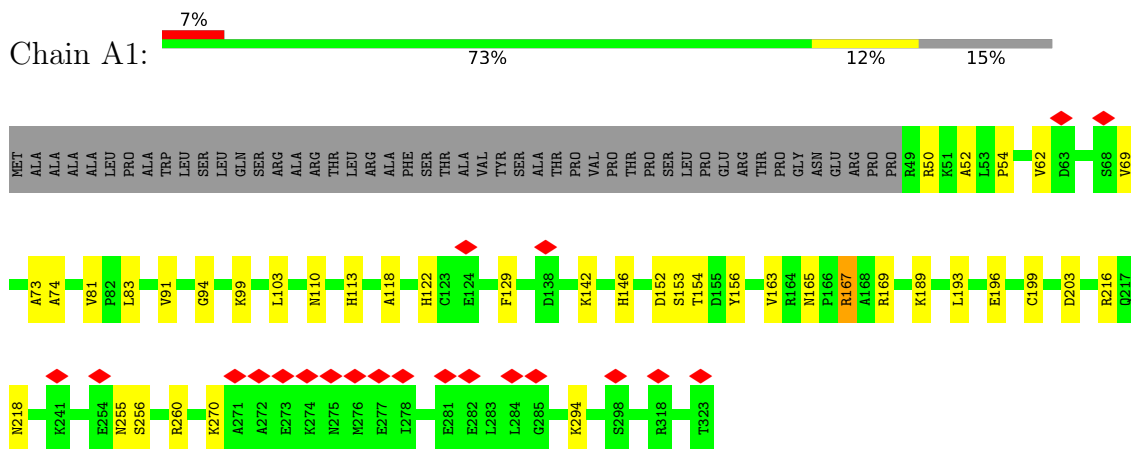

• Molecule 14: Coiled-coil-helix-coiled-coil-helix domain-containing protein 1

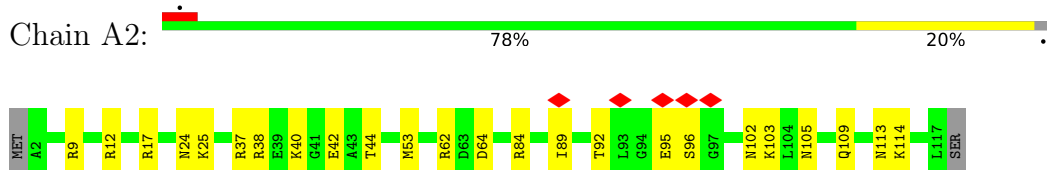



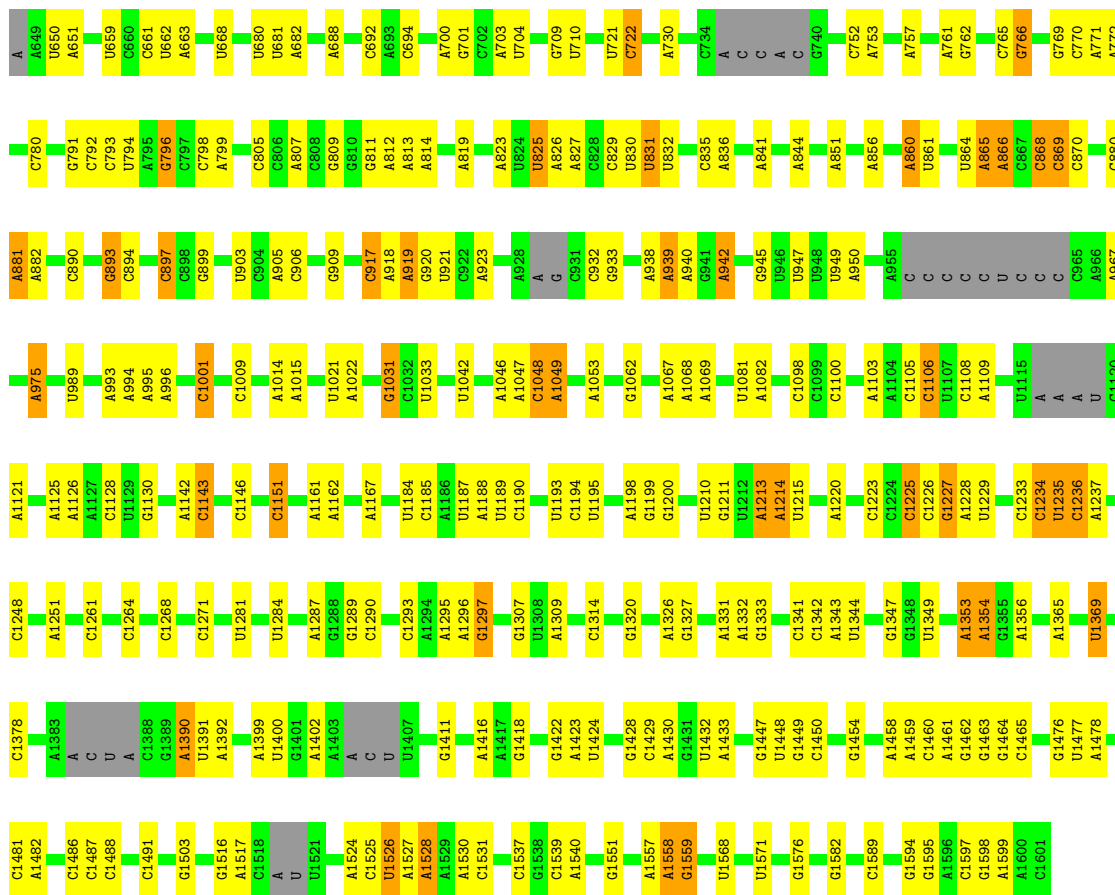

• Molecule 18: 28S ribosomal protein S2, mitochondrial

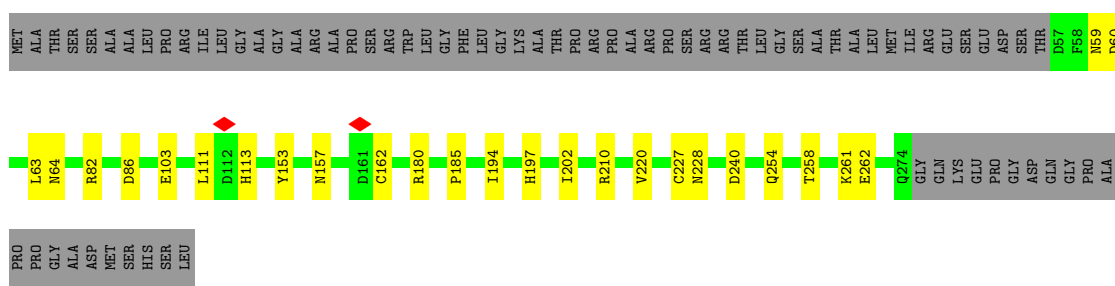

• Molecule 19: 28S ribosomal protein S24, mitochondrial

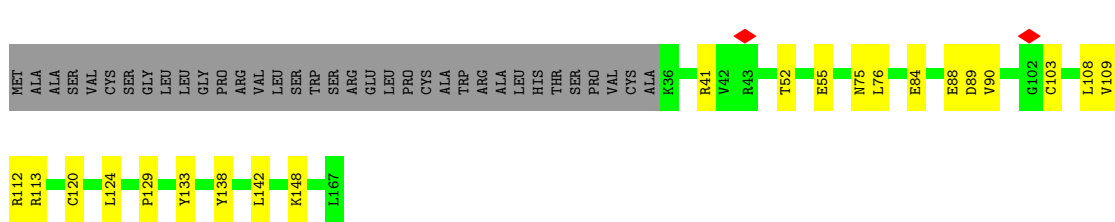

• Molecule 20: 28S ribosomal protein S5, mitochondrial





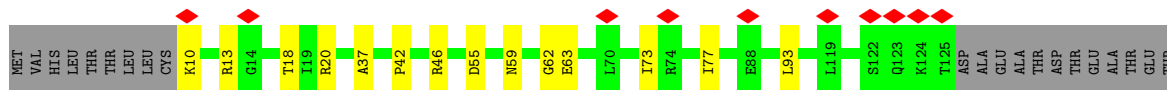

• Molecule 30: 28S ribosomal protein S17, mitochondrial

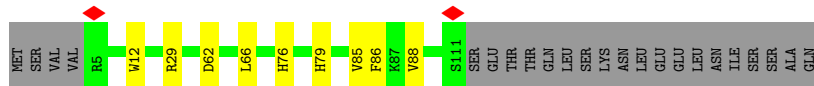
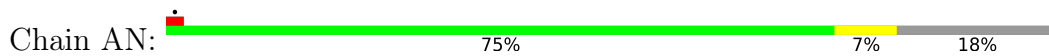

• Molecule 31: 28S ribosomal protein S18b, mitochondrial

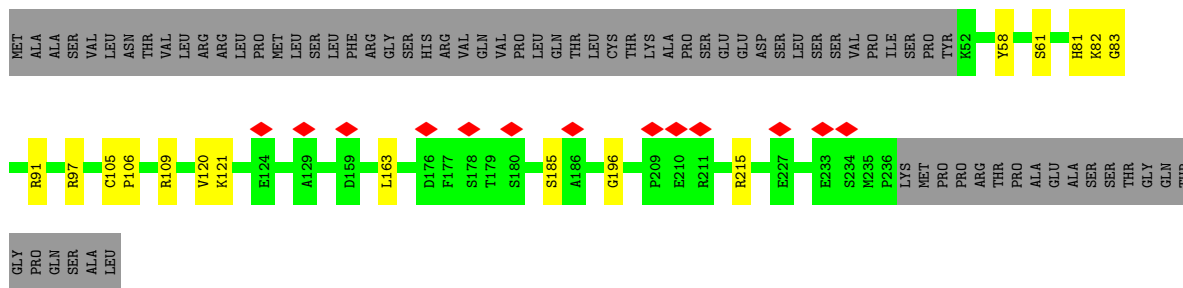

• Molecule 32: 28S ribosomal protein S18c, mitochondrial

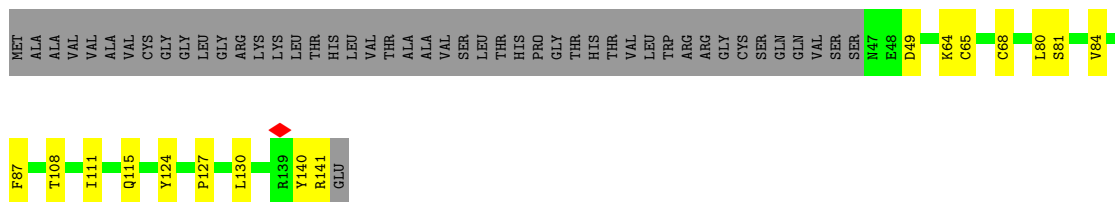

• Molecule 33: 28S ribosomal protein S21, mitochondrial

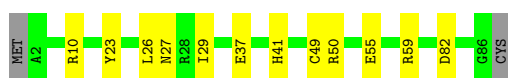
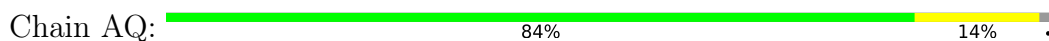

• Molecule 34: 28S ribosomal protein S22, mitochondrial



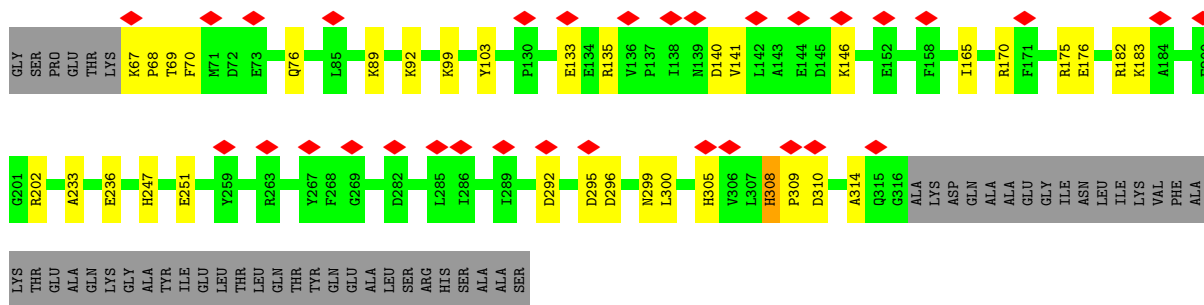

• Molecule 35: 28S ribosomal protein S23, mitochondrial

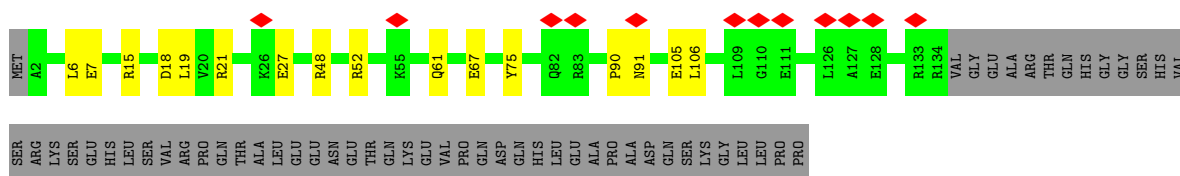

• Molecule 36: 28S ribosomal protein S25, mitochondrial

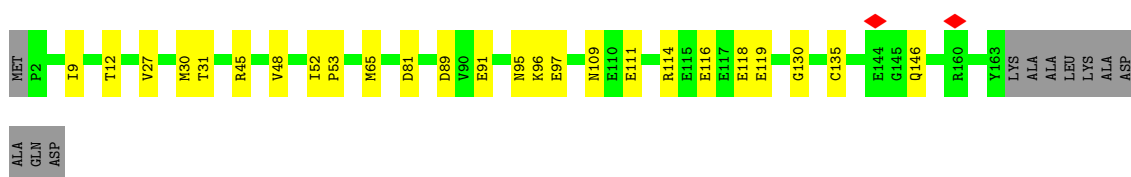
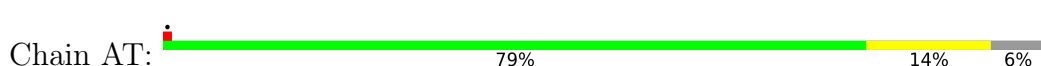

• Molecule 37: 28S ribosomal protein S26, mitochondrial

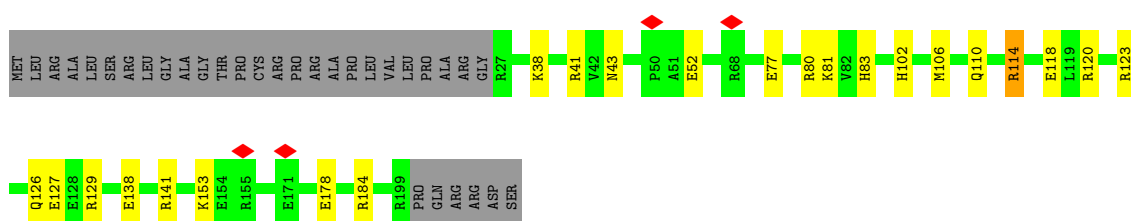
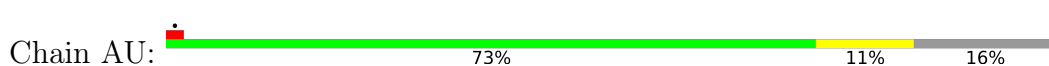

• Molecule 38: 28S ribosomal protein S27, mitochondrial

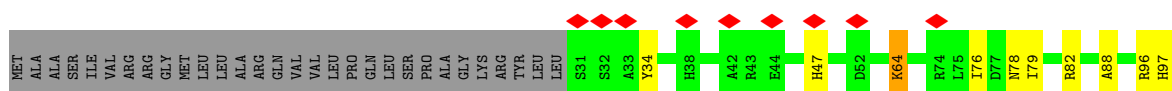



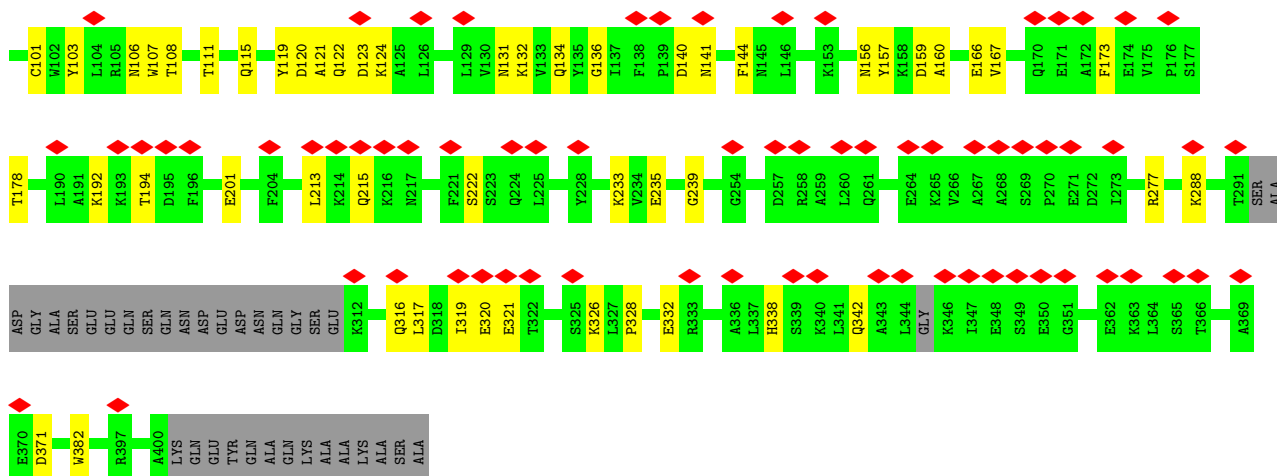

• Molecule 39: 28S ribosomal protein S28, mitochondrial



• Molecule 40: 28S ribosomal protein S29, mitochondrial

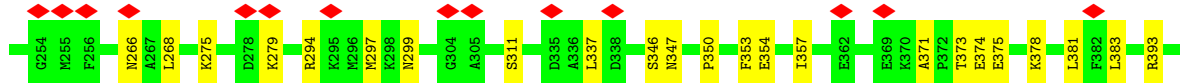
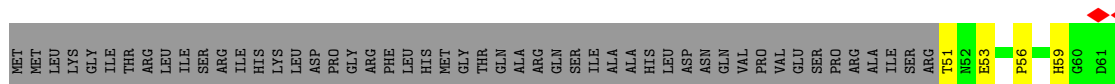
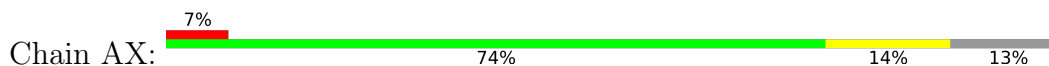

• Molecule 41: 28S ribosomal protein S31, mitochondrial

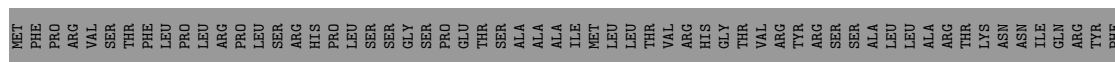

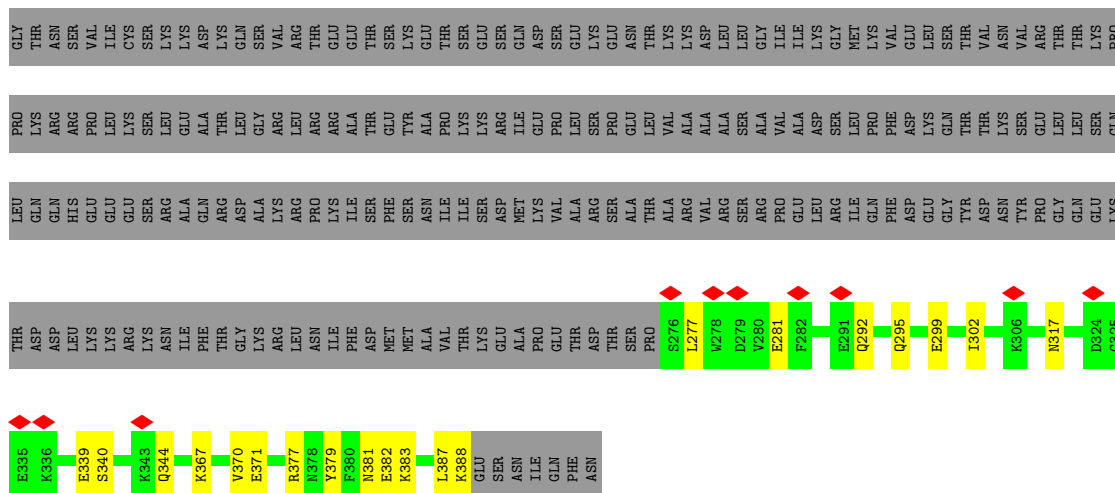

• Molecule 42: 28S ribosomal protein S33, mitochondrial

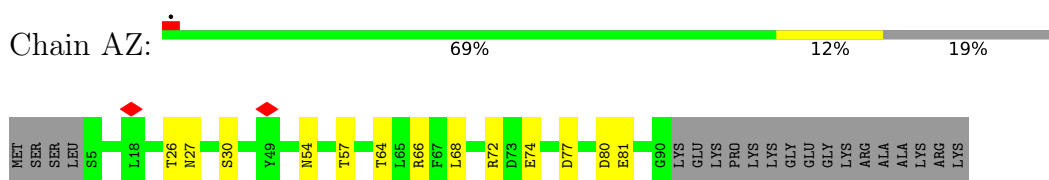

• Molecule 43: mitochondrial tRNA<sup>Val</sup>

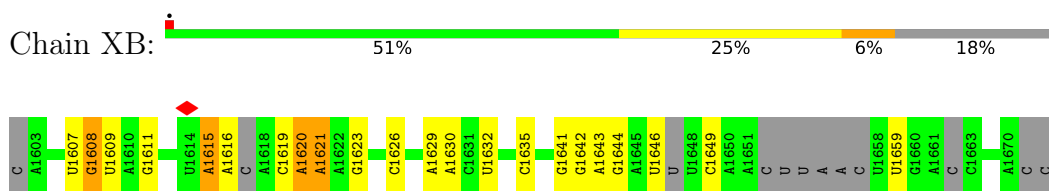

• Molecule 44: 39S ribosomal protein L2, mitochondrial

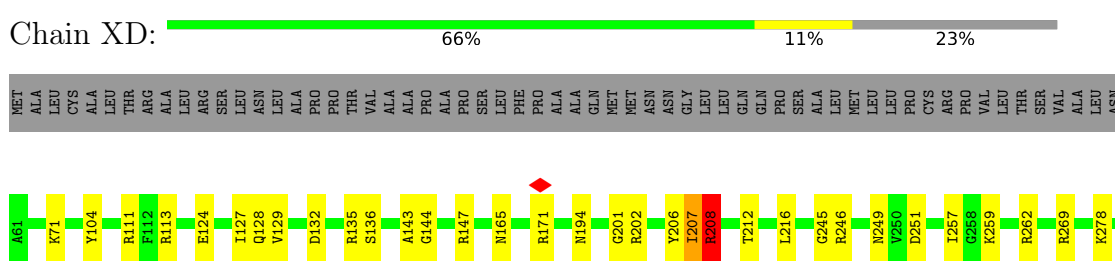

• Molecule 45: 39S ribosomal protein L3, mitochondrial

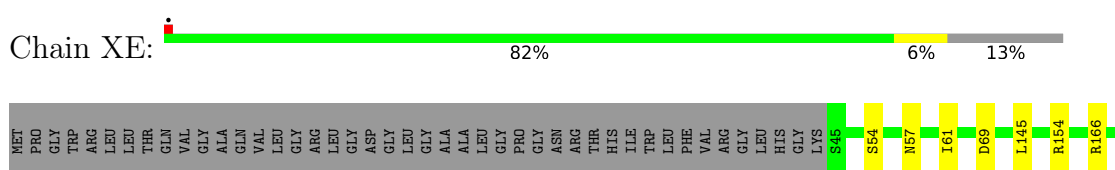

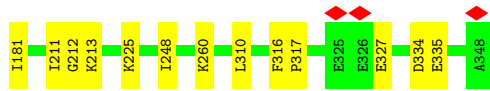

- Molecule 46: 39S ribosomal protein L4, mitochondrial

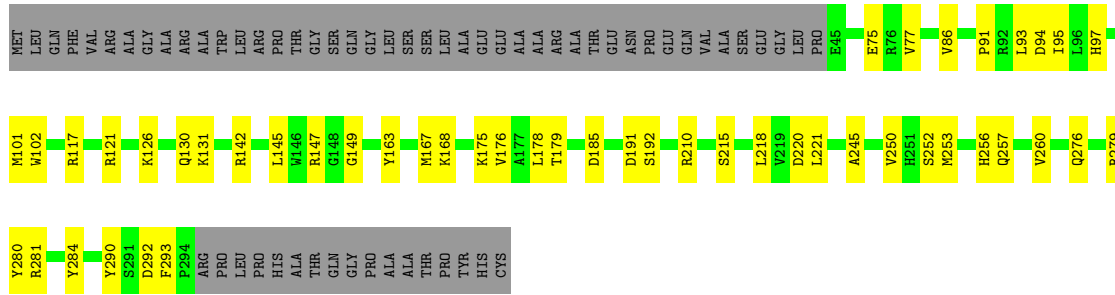

- Molecule 47: 39S ribosomal protein L9, mitochondrial

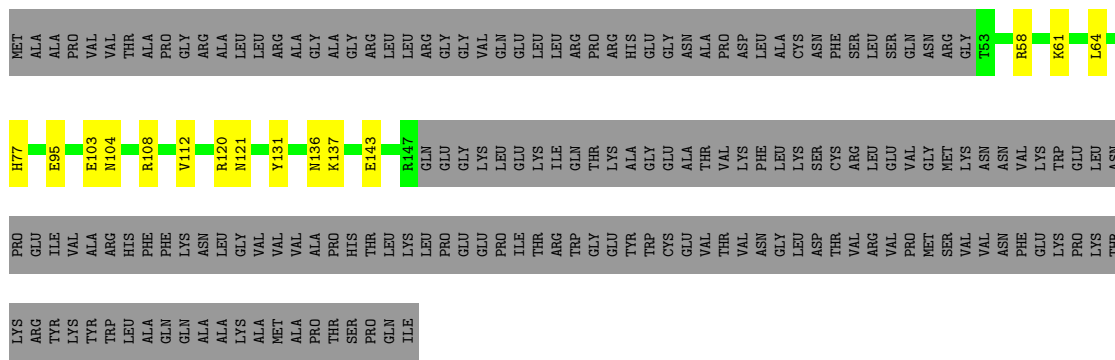

- Molecule 48: 39S ribosomal protein L10, mitochondrial

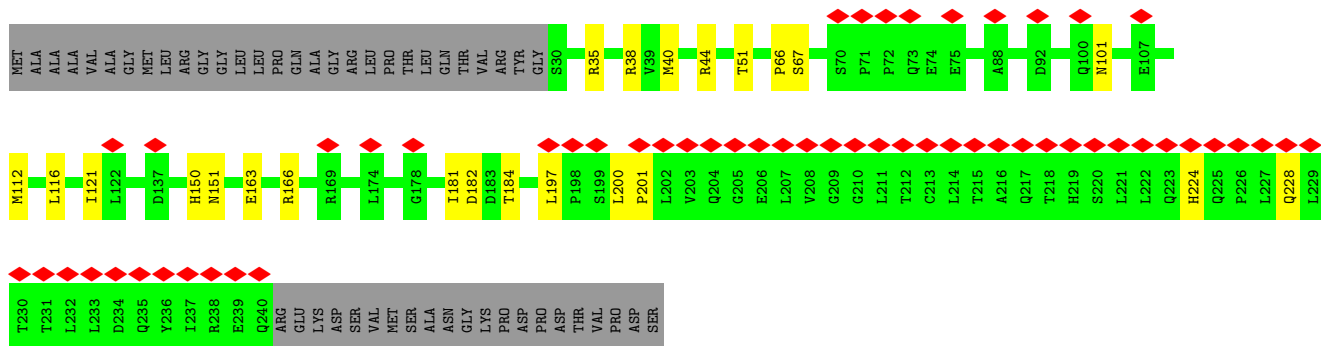
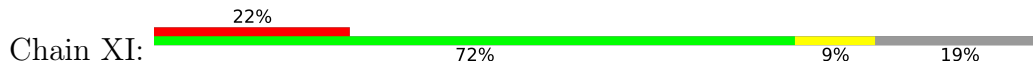

- Molecule 49: 39S ribosomal protein L11, mitochondrial

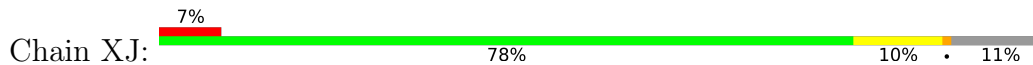

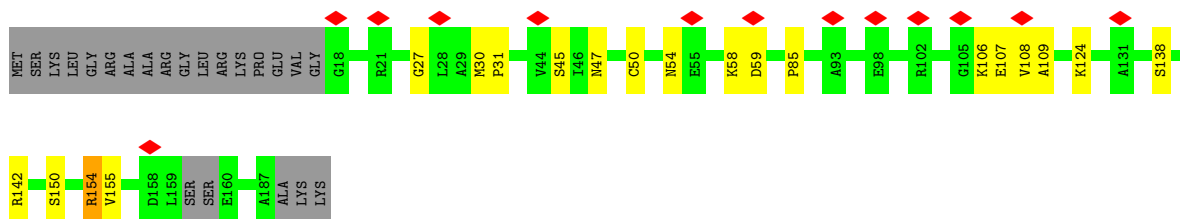

- Molecule 50: 39S ribosomal protein L13, mitochondrial



- Molecule 51: 39S ribosomal protein L14, mitochondrial

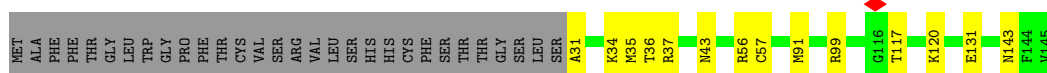

- Molecule 52: 39S ribosomal protein L15, mitochondrial

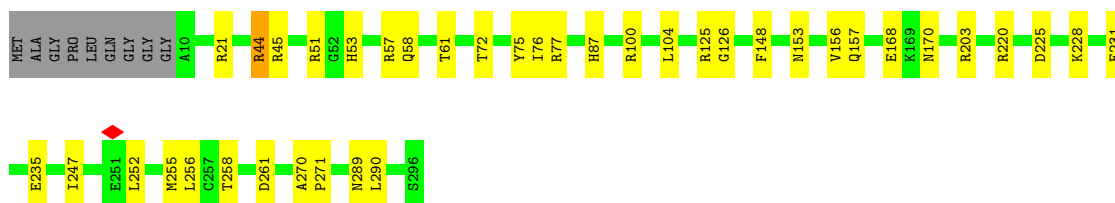
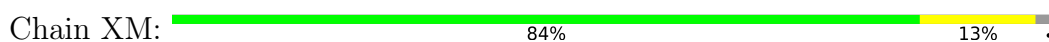

- Molecule 53: 39S ribosomal protein L16, mitochondrial

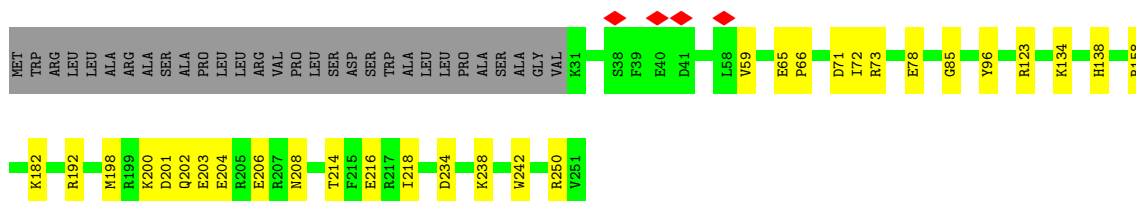
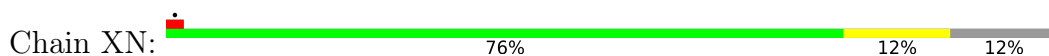

- Molecule 54: 39S ribosomal protein L17, mitochondrial

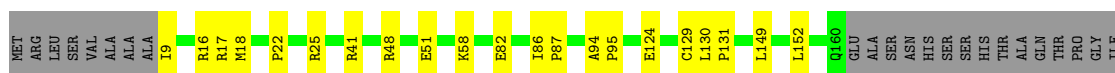
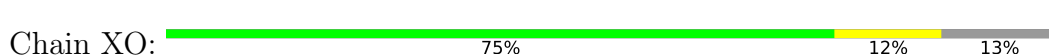

- Molecule 55: 39S ribosomal protein L18, mitochondrial

Chain XP:  71% 9% 21%

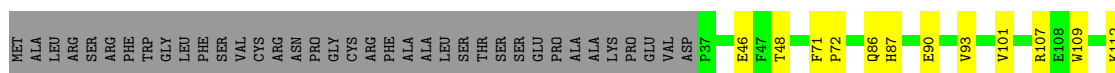

- Molecule 56: 39S ribosomal protein L19, mitochondrial

Chain XQ:  71% 10% 18%

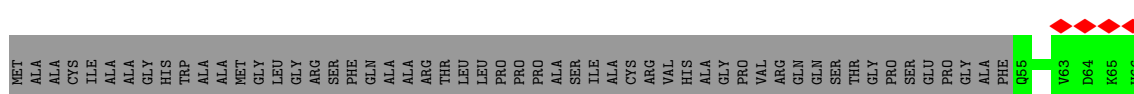

- Molecule 57: 39S ribosomal protein L20, mitochondrial

Chain XR:  77% 17% 6%



- Molecule 58: 39S ribosomal protein L21, mitochondrial

Chain XS:  72% 6% 22%

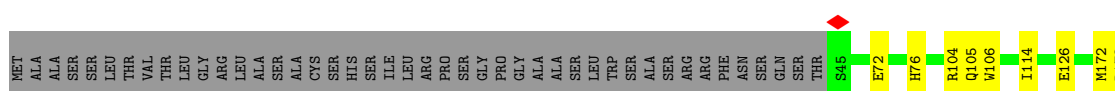

- Molecule 59: 39S ribosomal protein L22, mitochondrial

Chain XT:  75% 6% 19%

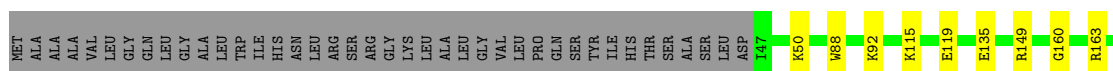



- Molecule 60: 39S ribosomal protein L23, mitochondrial

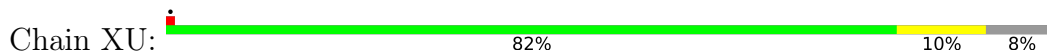

- Molecule 61: 39S ribosomal protein L24, mitochondrial

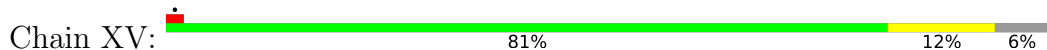

- Molecule 62: 39S ribosomal protein L27, mitochondrial

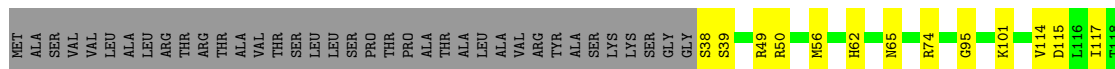

- Molecule 63: 39S ribosomal protein L28, mitochondrial

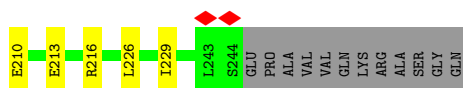
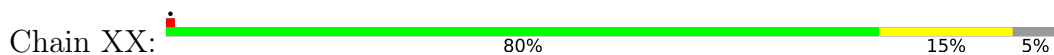

- Molecule 64: 39S ribosomal protein L47, mitochondrial

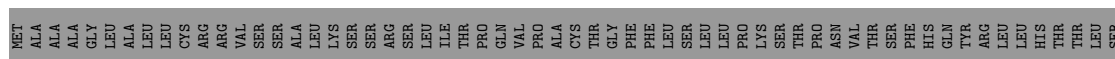

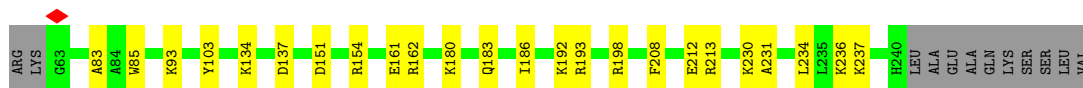

- Molecule 65: 39S ribosomal protein L30, mitochondrial

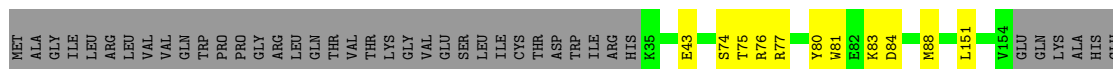

SER

- Molecule 66: 39S ribosomal protein L42, mitochondrial

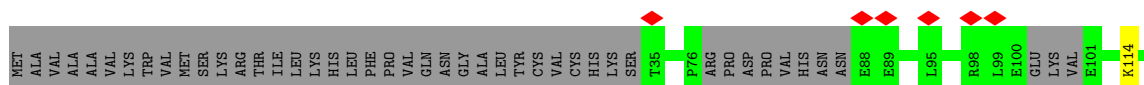

R142

- Molecule 67: 39S ribosomal protein L43, mitochondrial

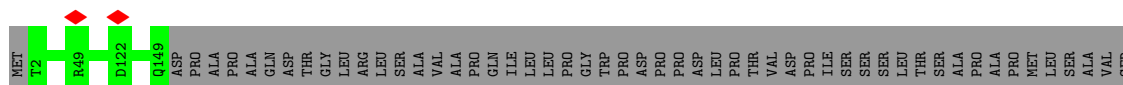

CYS

- Molecule 68: 39S ribosomal protein L44, mitochondrial

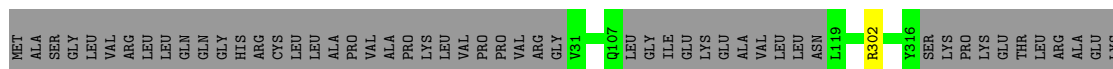
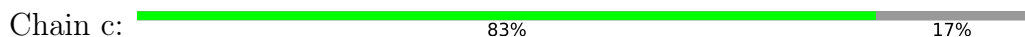

SER

- Molecule 69: 39S ribosomal protein L45, mitochondrial

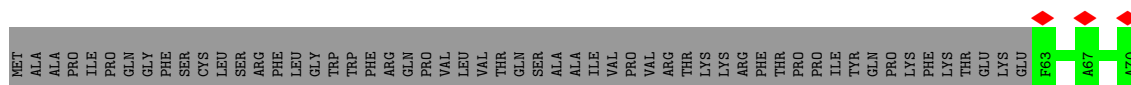

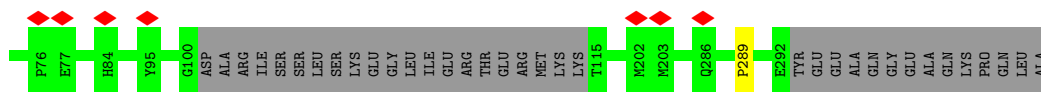

• Molecule 70: 39S ribosomal protein L46, mitochondrial

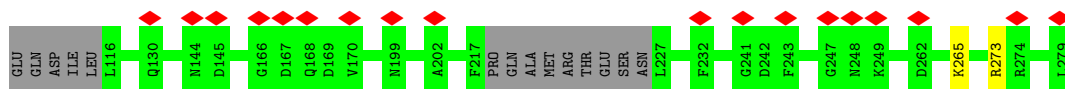
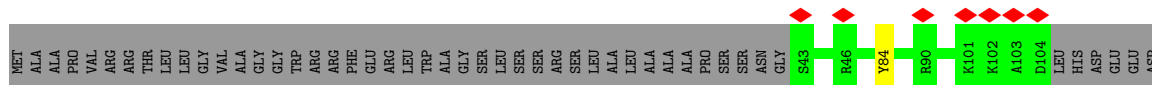
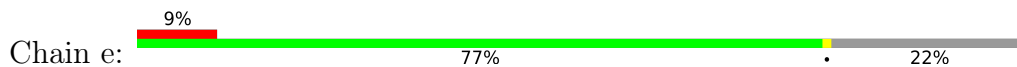

• Molecule 71: 39S ribosomal protein L48, mitochondrial

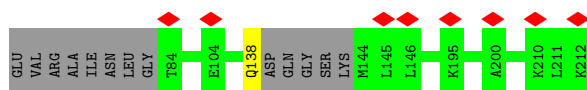
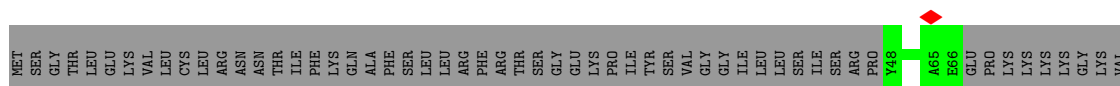

• Molecule 72: 39S ribosomal protein L49, mitochondrial

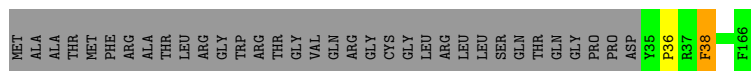
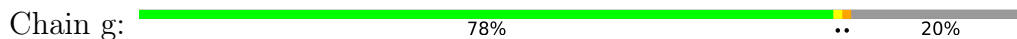

• Molecule 73: 39S ribosomal protein L50, mitochondrial

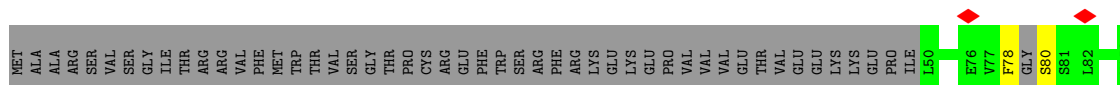

• Molecule 74: 39S ribosomal protein L51, mitochondrial

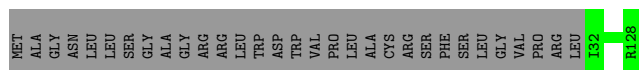

• Molecule 75: 39S ribosomal protein L52, mitochondrial



Chain j:  70% 30%

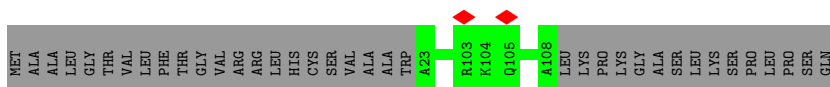

- Molecule 76: 39S ribosomal protein L53, mitochondrial

Chain k:  85% 15%

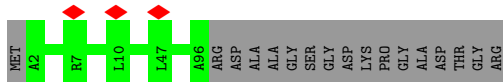

- Molecule 77: 39S ribosomal protein L54, mitochondrial

Chain l:  6% 58% 42%

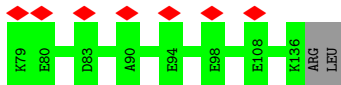
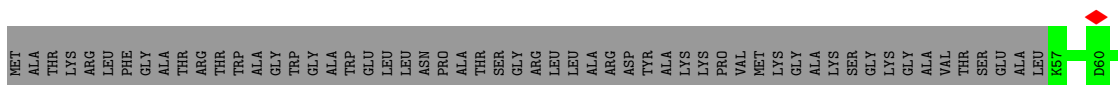

- Molecule 78: 39S ribosomal protein L55, mitochondrial

Chain m:  47% 53%

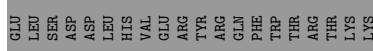
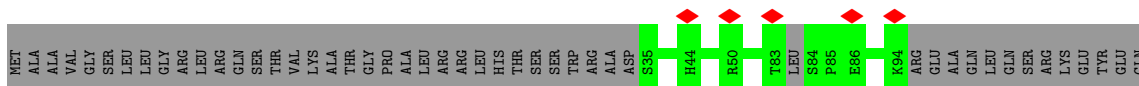

- Molecule 79: Ribosomal protein 63, mitochondrial

Chain o:  92% 8%

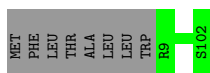

- Molecule 80: Peptidyl-tRNA hydrolase ICT1, mitochondrial

Chain p:  62% 38%

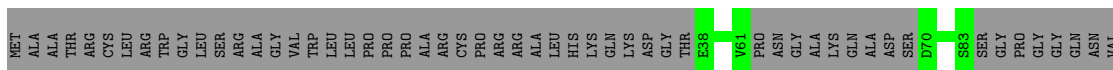







## 4 Experimental information

Property	Value	Source
EM reconstruction method	SINGLE PARTICLE	Depositor
Imposed symmetry	POINT, Not provided	
Number of particles used	14475	Depositor
Resolution determination method	FSC 0.143 CUT-OFF	Depositor
CTF correction method	PHASE FLIPPING AND AMPLITUDE CORRECTION	Depositor
Microscope	FEI TITAN KRIOS	Depositor
Voltage (kV)	300	Depositor
Electron dose ( $e^-/\text{\AA}^2$ )	30	Depositor
Minimum defocus (nm)	Not provided	
Maximum defocus (nm)	Not provided	
Magnification	Not provided	
Image detector	GATAN K2 SUMMIT (4k x 4k)	Depositor
Maximum map value	0.255	Depositor
Minimum map value	-0.136	Depositor
Average map value	-0.000	Depositor
Map value standard deviation	0.005	Depositor
Recommended contour level	0.02	Depositor
Map size (Å)	546.0, 546.0, 546.0	wwPDB
Map dimensions	520, 520, 520	wwPDB
Map angles (°)	90.0, 90.0, 90.0	wwPDB
Pixel spacing (Å)	1.05, 1.05, 1.05	Depositor

## 5 Model quality i

### 5.1 Standard geometry i

Bond lengths and bond angles in the following residue types are not validated in this section: GTP, H8Q, MG, P5P, ZN, DOL, Y5P

The Z score for a bond length (or angle) is the number of standard deviations the observed value is removed from the expected value. A bond length (or angle) with  $|Z| > 5$  is considered an outlier worth inspection. RMSZ is the root-mean-square of all Z scores of the bond lengths (or angles).

Mol	Chain	Bond lengths		Bond angles	
		RMSZ	# Z  >5	RMSZ	# Z  >5
1	0	0.29	0/895	0.45	0/1201
2	1	0.26	0/444	0.47	0/591
3	2	0.32	0/382	0.44	0/507
4	3	0.32	0/852	0.43	0/1136
5	4	0.28	0/349	0.45	0/461
6	5	0.27	0/3298	0.42	0/4492
7	6	0.27	0/3040	0.43	0/4134
8	7	0.26	0/2419	0.42	0/3267
9	8	1.79	1/1199 (0.1%)	0.46	2/1612 (0.1%)
10	9	0.28	0/1024	0.41	0/1379
11	XA	0.37	0/35612	0.78	0/55425
12	A0	0.23	0/1727	0.42	0/2338
13	A1	0.25	0/2276	0.40	0/3079
14	A2	0.25	0/939	0.42	0/1256
15	A3	0.28	0/621	0.47	0/820
16	A4	0.25	0/4559	0.41	0/6149
17	AA	0.26	0/21952	0.76	1/34164 (0.0%)
18	AB	0.26	0/1819	0.40	0/2462
19	AC	0.27	0/1112	0.43	0/1505
20	AD	0.26	0/2768	0.44	0/3707
21	AE	0.26	0/989	0.44	0/1335
22	AF	0.24	0/1708	0.40	0/2291
23	AG	0.26	0/2559	0.41	0/3429
24	AH	0.26	0/1128	0.45	0/1529
25	AI	0.26	0/1031	0.43	0/1390
26	AJ	0.26	0/854	0.48	0/1148
27	AK	0.24	0/879	0.42	0/1182
28	AL	0.25	0/1406	0.40	0/1878
29	AM	0.25	0/941	0.41	0/1265
30	AN	0.26	0/864	0.44	0/1169
31	AO	0.25	0/1580	0.39	0/2150
32	AP	0.27	0/782	0.41	0/1050

Mol	Chain	Bond lengths		Bond angles	
		RMSZ	# Z  >5	RMSZ	# Z  >5
33	AQ	0.26	0/746	0.42	0/993
34	AR	0.42	1/2103 (0.0%)	0.52	3/2842 (0.1%)
35	AS	0.26	0/1127	0.40	0/1518
36	AT	0.26	0/1361	0.43	0/1829
37	AU	0.24	0/1482	0.39	0/1987
38	AV	0.24	0/2925	0.39	0/3948
39	AW	0.25	0/778	0.44	0/1048
40	AX	0.25	0/2886	0.43	0/3909
41	AY	0.25	0/985	0.38	0/1329
42	AZ	0.25	0/748	0.39	0/1000
43	XB	0.22	0/1400	0.73	0/2168
44	XD	0.29	0/1879	0.46	0/2527
45	XE	0.29	0/2465	0.44	0/3344
46	XF	0.32	0/2071	0.46	0/2817
47	XH	0.27	0/798	0.44	0/1073
48	XI	0.26	0/1727	0.43	0/2340
49	XJ	0.24	0/1309	0.40	0/1764
50	XK	0.30	0/1495	0.42	0/2029
51	XL	0.28	0/904	0.44	0/1218
52	XM	0.30	0/2359	0.44	0/3185
53	XN	0.30	0/1825	0.45	0/2458
54	XO	0.27	0/1269	0.42	0/1708
55	XP	0.27	0/1190	0.44	0/1611
56	XQ	0.26	0/2026	0.44	0/2734
57	XR	0.32	0/1174	0.43	0/1572
58	XS	0.29	0/1311	0.47	0/1778
59	XT	0.32	0/1402	0.43	0/1886
60	XU	0.30	0/1200	0.43	0/1623
61	XV	0.27	0/1693	0.44	0/2297
62	XW	0.33	0/893	0.47	0/1204
63	XX	0.28	0/2090	0.42	0/2825
64	XY	0.28	0/1571	0.40	0/2106
65	XZ	0.31	0/1003	0.44	0/1354
66	a	0.28	0/838	0.45	0/1138
67	b	0.30	0/1202	0.46	0/1626
68	c	0.27	0/2264	0.42	0/3059
69	d	0.26	0/1807	0.42	0/2450
70	e	1.44	6/1797 (0.3%)	0.43	0/2422
71	f	0.27	0/1169	0.42	0/1576
72	g	0.36	1/1134 (0.1%)	0.48	0/1547
73	h	0.26	0/905	0.44	0/1233
74	i	0.32	0/849	0.47	0/1135
75	j	0.27	0/703	0.42	0/947

Mol	Chain	Bond lengths		Bond angles	
		RMSZ	# Z  >5	RMSZ	# Z  >5
76	k	0.24	0/743	0.44	0/1003
77	l	0.24	0/692	0.37	0/939
78	m	0.23	0/508	0.45	0/682
79	o	0.30	0/818	0.45	0/1097
80	p	0.24	0/1071	0.42	0/1433
81	q	0.26	0/1413	0.41	0/1906
82	r	0.27	0/1282	0.42	0/1734
86	s	0.28	0/3114	0.44	0/4225
87	t1	0.25	0/358	0.39	0/486
87	t2	0.22	0/236	0.37	0/315
87	t3	0.22	0/238	0.35	0/319
87	t4	0.22	0/229	0.36	0/308
87	t5	0.22	0/229	0.36	0/308
87	t6	0.25	0/213	0.42	0/286
All	All	0.36	9/176015 (0.0%)	0.58	6/249699 (0.0%)

Chiral center outliers are detected by calculating the chiral volume of a chiral center and verifying if the center is modelled as a planar moiety or with the opposite hand. A planarity outlier is detected by checking planarity of atoms in a peptide group, atoms in a mainchain group or atoms of a sidechain that are expected to be planar.

Mol	Chain	#Chirality outliers	#Planarity outliers
44	XD	0	1
48	XI	0	1
70	e	0	1
71	f	0	1
73	h	0	2
All	All	0	6

The worst 5 of 9 bond length outliers are listed below:

Mol	Chain	Res	Type	Atoms	Z	Observed(Å)	Ideal(Å)
9	8	99	ARG	CG-CD	61.27	3.05	1.51
70	e	84	TYR	CD2-CE2	32.04	1.87	1.39
70	e	84	TYR	CD1-CE1	31.60	1.86	1.39
70	e	84	TYR	CE2-CZ	22.61	1.68	1.38
70	e	84	TYR	CE1-CZ	21.06	1.66	1.38

The worst 5 of 6 bond angle outliers are listed below:

Mol	Chain	Res	Type	Atoms	Z	Observed(°)	Ideal(°)
34	AR	309	PRO	O-C-N	11.63	141.32	122.70

*Continued on next page...*



*Continued from previous page...*

Mol	Chain	Res	Type	Atoms	Z	Observed(°)	Ideal(°)
34	AR	309	PRO	CA-C-N	-8.78	97.89	117.20
34	AR	309	PRO	C-N-CA	-5.91	106.92	121.70
9	8	99	ARG	CG-CD-NE	5.82	124.02	111.80
9	8	99	ARG	CB-CG-CD	5.50	125.91	111.60

There are no chirality outliers.

5 of 6 planarity outliers are listed below:

Mol	Chain	Res	Type	Group
44	XD	206	TYR	Peptide
48	XI	197	LEU	Peptide
70	e	265	LYS	Peptide
71	f	138	GLN	Peptide
73	h	78	PHE	Peptide

## 5.2 Too-close contacts [i](#)

In the following table, the Non-H and H(model) columns list the number of non-hydrogen atoms and hydrogen atoms in the chain respectively. The H(added) column lists the number of hydrogen atoms added and optimized by MolProbity. The Clashes column lists the number of clashes within the asymmetric unit, whereas Symm-Clashes lists symmetry-related clashes.

Mol	Chain	Non-H	H(model)	H(added)	Clashes	Symm-Clashes
1	0	880	903	903	9	0
2	1	439	480	480	5	0
3	2	376	406	406	4	0
4	3	831	883	883	17	0
5	4	341	361	361	4	0
6	5	3204	3200	3200	34	0
7	6	2947	2839	2839	33	0
8	7	2365	2372	2371	18	0
9	8	1175	1202	1202	9	0
10	9	996	987	987	11	0
11	XA	31831	16169	16170	258	0
12	A0	1684	1685	1685	15	0
13	A1	2230	2261	2261	35	0
14	A2	925	964	964	16	0
15	A3	610	682	682	7	0
16	A4	4470	4485	4486	58	0
17	AA	19628	9970	9971	122	0
18	AB	1776	1769	1769	15	0

*Continued on next page...*

*Continued from previous page...*

Mol	Chain	Non-H	H(model)	H(added)	Clashes	Symm-Clashes
19	AC	1082	1088	1088	17	0
20	AD	2716	2786	2785	28	0
21	AE	972	1001	1001	14	0
22	AF	1668	1716	1716	28	0
23	AG	2505	2490	2490	36	0
24	AH	1105	1136	1136	23	0
25	AI	1011	1052	1052	12	0
26	AJ	838	887	887	12	0
27	AK	861	885	885	10	0
28	AL	1382	1472	1472	17	0
29	AM	920	951	951	10	0
30	AN	846	908	908	7	0
31	AO	1528	1489	1489	13	0
32	AP	765	796	796	11	0
33	AQ	734	749	749	7	0
34	AR	2060	2074	2074	25	0
35	AS	1100	1103	1103	13	0
36	AT	1330	1343	1343	17	0
37	AU	1461	1471	1471	17	0
38	AV	2867	2862	2862	36	0
39	AW	766	785	785	5	0
40	AX	2814	2805	2804	32	0
41	AY	956	912	911	19	0
42	AZ	731	734	734	9	0
43	XB	1255	640	640	11	0
44	XD	1842	1897	1896	27	0
45	XE	2396	2402	2402	17	0
46	XF	2013	2045	2044	34	0
47	XH	784	832	832	10	0
48	XI	1691	1783	1783	15	0
49	XJ	1291	1367	1364	14	0
50	XK	1451	1448	1448	14	0
51	XL	889	941	941	10	0
52	XM	2305	2378	2377	27	0
53	XN	1778	1808	1808	21	0
54	XO	1245	1283	1283	15	0
55	XP	1164	1162	1162	11	0
56	XQ	1978	2022	2022	22	0
57	XR	1153	1214	1214	19	0
58	XS	1284	1355	1354	10	0
59	XT	1368	1410	1410	8	0
60	XU	1171	1164	1164	12	0

*Continued on next page...*

*Continued from previous page...*

Mol	Chain	Non-H	H(model)	H(added)	Clashes	Symm-Clashes
61	XV	1648	1656	1654	19	0
62	XW	871	898	898	15	0
63	XX	2035	2054	2054	29	0
64	XY	1534	1575	1575	21	0
65	XZ	978	1030	1030	11	0
66	a	813	777	777	0	0
67	b	1178	1180	1180	0	0
68	c	2217	2220	2220	0	0
69	d	1758	1743	1742	0	0
70	e	1762	1767	1767	0	0
71	f	1149	1165	1165	0	0
72	g	1097	1086	1085	0	0
73	h	882	866	867	0	0
74	i	827	857	857	0	0
75	j	689	678	678	0	0
76	k	732	745	745	0	0
77	l	673	654	653	0	0
78	m	500	525	525	0	0
79	o	797	804	804	0	0
80	p	1058	1083	1083	0	0
81	q	1379	1359	1359	0	0
82	r	1247	1267	1267	0	0
83	r1	252	0	169	0	0
84	r2	1486	0	835	0	0
85	r3	1459	0	829	0	0
86	s	3036	3023	3022	0	0
87	t1	354	378	374	0	0
87	t2	237	265	265	0	0
87	t3	238	268	270	0	0
87	t4	229	255	257	0	0
87	t5	229	255	257	0	0
87	t6	214	236	236	0	0
88	0	1	0	0	0	0
88	4	1	0	0	0	0
88	AB	1	0	0	0	0
88	AO	1	0	0	0	0
88	AP	1	0	0	0	0
88	AT	1	0	0	0	0
88	r	1	0	0	0	0
89	9	1	0	0	0	0
89	AA	46	0	0	0	0
89	XA	143	0	0	0	0

*Continued on next page...*

Continued from previous page...

Mol	Chain	Non-H	H(model)	H(added)	Clashes	Symm-Clashes
89	XD	1	0	0	0	0
89	XI	1	0	0	0	0
89	XM	2	0	0	0	0
89	g	1	0	0	0	0
90	XA	73	67	0	4	0
91	XA	48	50	50	0	0
92	AX	32	10	12	1	0
All	All	170697	143060	144817	1192	0

The all-atom clashscore is defined as the number of clashes found per 1000 atoms (including hydrogen atoms). The all-atom clashscore for this structure is 5.

The worst 5 of 1192 close contacts within the same asymmetric unit are listed below, sorted by their clash magnitude.

Atom-1	Atom-2	Interatomic distance (Å)	Clash overlap (Å)
48:XI:51:THR:O	53:XI:250:ARG:NH1	1.96	0.98
38:AV:316:GLN:NE2	38:AV:317:LEU:O	2.02	0.93
4:3:113:ARG:NH2	11:XA:1750:G:OP2	2.04	0.91
11:XA:1844:A:OP2	57:XR:48:ARG:NH2	2.04	0.90
18:AB:103:GLU:OE2	35:AS:52:ARG:NH2	2.06	0.89

There are no symmetry-related clashes.

## 5.3 Torsion angles [\(i\)](#)

### 5.3.1 Protein backbone [\(i\)](#)

In the following table, the Percentiles column shows the percent Ramachandran outliers of the chain as a percentile score with respect to all PDB entries followed by that with respect to all EM entries.

The Analysed column shows the number of residues for which the backbone conformation was analysed, and the total number of residues.

Mol	Chain	Analysed	Favoured	Allowed	Outliers	Percentiles	
1	0	106/188 (56%)	103 (97%)	3 (3%)	0	100	100
2	1	51/65 (78%)	49 (96%)	2 (4%)	0	100	100
3	2	44/92 (48%)	43 (98%)	1 (2%)	0	100	100
4	3	93/188 (50%)	93 (100%)	0	0	100	100

Continued on next page...

*Continued from previous page...*

Mol	Chain	Analysed	Favoured	Allowed	Outliers	Percentiles	
5	4	36/103 (35%)	34 (94%)	2 (6%)	0	100	100
6	5	389/423 (92%)	364 (94%)	25 (6%)	0	100	100
7	6	348/380 (92%)	319 (92%)	29 (8%)	0	100	100
8	7	283/338 (84%)	265 (94%)	18 (6%)	0	100	100
9	8	137/206 (66%)	131 (96%)	6 (4%)	0	100	100
10	9	122/137 (89%)	116 (95%)	6 (5%)	0	100	100
12	A0	197/218 (90%)	191 (97%)	6 (3%)	0	100	100
13	A1	273/323 (84%)	262 (96%)	11 (4%)	0	100	100
14	A2	114/118 (97%)	107 (94%)	7 (6%)	0	100	100
15	A3	67/199 (34%)	66 (98%)	1 (2%)	0	100	100
16	A4	526/689 (76%)	493 (94%)	33 (6%)	0	100	100
18	AB	216/296 (73%)	211 (98%)	5 (2%)	0	100	100
19	AC	130/167 (78%)	127 (98%)	3 (2%)	0	100	100
20	AD	341/430 (79%)	320 (94%)	21 (6%)	0	100	100
21	AE	120/125 (96%)	115 (96%)	5 (4%)	0	100	100
22	AF	197/242 (81%)	191 (97%)	6 (3%)	0	100	100
23	AG	300/396 (76%)	285 (95%)	15 (5%)	0	100	100
24	AH	133/201 (66%)	125 (94%)	8 (6%)	0	100	100
25	AI	134/194 (69%)	131 (98%)	3 (2%)	0	100	100
26	AJ	106/138 (77%)	99 (93%)	7 (7%)	0	100	100
27	AK	99/128 (77%)	97 (98%)	2 (2%)	0	100	100
28	AL	162/257 (63%)	157 (97%)	5 (3%)	0	100	100
29	AM	114/137 (83%)	113 (99%)	1 (1%)	0	100	100
30	AN	105/130 (81%)	102 (97%)	3 (3%)	0	100	100
31	AO	183/258 (71%)	179 (98%)	4 (2%)	0	100	100
32	AP	93/142 (66%)	86 (92%)	7 (8%)	0	100	100
33	AQ	83/87 (95%)	79 (95%)	4 (5%)	0	100	100
34	AR	248/360 (69%)	237 (96%)	11 (4%)	0	100	100
35	AS	131/190 (69%)	122 (93%)	9 (7%)	0	100	100
36	AT	160/173 (92%)	150 (94%)	10 (6%)	0	100	100
37	AU	171/205 (83%)	169 (99%)	2 (1%)	0	100	100

*Continued on next page...*

*Continued from previous page...*

Mol	Chain	Analysed	Favoured	Allowed	Outliers	Percentiles	
38	AV	341/414 (82%)	322 (94%)	19 (6%)	0	100	100
39	AW	95/187 (51%)	90 (95%)	5 (5%)	0	100	100
40	AX	346/398 (87%)	327 (94%)	19 (6%)	0	100	100
41	AY	111/395 (28%)	102 (92%)	9 (8%)	0	100	100
42	AZ	84/106 (79%)	83 (99%)	1 (1%)	0	100	100
44	XD	234/305 (77%)	221 (94%)	11 (5%)	2 (1%)	17	55
45	XE	302/348 (87%)	291 (96%)	11 (4%)	0	100	100
46	XF	248/311 (80%)	241 (97%)	7 (3%)	0	100	100
47	XH	93/267 (35%)	85 (91%)	8 (9%)	0	100	100
48	XI	209/261 (80%)	193 (92%)	16 (8%)	0	100	100
49	XJ	168/192 (88%)	156 (93%)	12 (7%)	0	100	100
50	XK	175/178 (98%)	167 (95%)	8 (5%)	0	100	100
51	XL	113/145 (78%)	105 (93%)	8 (7%)	0	100	100
52	XM	285/296 (96%)	274 (96%)	11 (4%)	0	100	100
53	XN	219/251 (87%)	207 (94%)	12 (6%)	0	100	100
54	XO	150/175 (86%)	145 (97%)	5 (3%)	0	100	100
55	XP	141/180 (78%)	133 (94%)	8 (6%)	0	100	100
56	XQ	236/292 (81%)	227 (96%)	9 (4%)	0	100	100
57	XR	138/149 (93%)	134 (97%)	4 (3%)	0	100	100
58	XS	158/205 (77%)	155 (98%)	3 (2%)	0	100	100
59	XT	164/206 (80%)	159 (97%)	5 (3%)	0	100	100
60	XU	137/153 (90%)	131 (96%)	6 (4%)	0	100	100
61	XV	200/216 (93%)	191 (96%)	9 (4%)	0	100	100
62	XW	109/148 (74%)	104 (95%)	5 (5%)	0	100	100
63	XX	241/256 (94%)	234 (97%)	7 (3%)	0	100	100
64	XY	176/250 (70%)	170 (97%)	6 (3%)	0	100	100
65	XZ	118/161 (73%)	116 (98%)	2 (2%)	0	100	100
66	a	93/142 (66%)	89 (96%)	4 (4%)	0	100	100
67	b	146/215 (68%)	133 (91%)	13 (9%)	0	100	100
68	c	271/332 (82%)	262 (97%)	9 (3%)	0	100	100
69	d	212/306 (69%)	200 (94%)	11 (5%)	1 (0%)	29	67

*Continued on next page...*

Continued from previous page...

Mol	Chain	Analysed	Favoured	Allowed	Outliers	Percentiles	
70	e	211/279 (76%)	205 (97%)	6 (3%)	0	100	100
71	f	139/212 (66%)	133 (96%)	6 (4%)	0	100	100
72	g	130/166 (78%)	123 (95%)	6 (5%)	1 (1%)	19	58
73	h	106/158 (67%)	100 (94%)	6 (6%)	0	100	100
74	i	95/128 (74%)	90 (95%)	5 (5%)	0	100	100
75	j	84/123 (68%)	83 (99%)	1 (1%)	0	100	100
76	k	93/112 (83%)	87 (94%)	6 (6%)	0	100	100
77	l	78/138 (56%)	72 (92%)	6 (8%)	0	100	100
78	m	58/128 (45%)	52 (90%)	6 (10%)	0	100	100
79	o	92/102 (90%)	87 (95%)	5 (5%)	0	100	100
80	p	119/206 (58%)	114 (96%)	5 (4%)	0	100	100
81	q	162/222 (73%)	156 (96%)	6 (4%)	0	100	100
82	r	144/196 (74%)	138 (96%)	6 (4%)	0	100	100
86	s	366/439 (83%)	353 (96%)	13 (4%)	0	100	100
87	t1	44/198 (22%)	41 (93%)	3 (7%)	0	100	100
87	t2	28/198 (14%)	28 (100%)	0	0	100	100
87	t3	28/198 (14%)	28 (100%)	0	0	100	100
87	t4	27/198 (14%)	26 (96%)	1 (4%)	0	100	100
87	t5	27/198 (14%)	26 (96%)	1 (4%)	0	100	100
87	t6	25/198 (13%)	25 (100%)	0	0	100	100
All	All	13781/19160 (72%)	13145 (95%)	632 (5%)	4 (0%)	100	100

All (4) Ramachandran outliers are listed below:

Mol	Chain	Res	Type
72	g	38	PHE
44	XD	207	ILE
44	XD	208	ARG
69	d	289	PRO

### 5.3.2 Protein sidechains [i](#)

In the following table, the Percentiles column shows the percent sidechain outliers of the chain as a percentile score with respect to all PDB entries followed by that with respect to all EM entries.

The Analysed column shows the number of residues for which the sidechain conformation was analysed, and the total number of residues.

Mol	Chain	Analysed	Rotameric	Outliers	Percentiles	
1	0	97/164 (59%)	97 (100%)	0	100	100
2	1	50/60 (83%)	50 (100%)	0	100	100
3	2	40/72 (56%)	40 (100%)	0	100	100
4	3	88/166 (53%)	88 (100%)	0	100	100
5	4	37/89 (42%)	37 (100%)	0	100	100
6	5	353/368 (96%)	352 (100%)	1 (0%)	92	95
7	6	313/332 (94%)	312 (100%)	1 (0%)	92	95
8	7	267/303 (88%)	267 (100%)	0	100	100
9	8	128/190 (67%)	127 (99%)	1 (1%)	81	89
10	9	104/112 (93%)	104 (100%)	0	100	100
12	A0	176/190 (93%)	175 (99%)	1 (1%)	86	92
13	A1	253/291 (87%)	251 (99%)	2 (1%)	81	89
14	A2	99/101 (98%)	97 (98%)	2 (2%)	55	73
15	A3	63/166 (38%)	63 (100%)	0	100	100
16	A4	494/609 (81%)	490 (99%)	4 (1%)	81	89
18	AB	192/249 (77%)	192 (100%)	0	100	100
19	AC	115/143 (80%)	115 (100%)	0	100	100
20	AD	283/357 (79%)	281 (99%)	2 (1%)	84	90
21	AE	104/107 (97%)	103 (99%)	1 (1%)	76	86
22	AF	178/209 (85%)	178 (100%)	0	100	100
23	AG	264/342 (77%)	264 (100%)	0	100	100
24	AH	125/180 (69%)	125 (100%)	0	100	100
25	AI	104/147 (71%)	104 (100%)	0	100	100
26	AJ	93/118 (79%)	93 (100%)	0	100	100
27	AK	91/113 (80%)	91 (100%)	0	100	100
28	AL	152/226 (67%)	152 (100%)	0	100	100
29	AM	95/113 (84%)	95 (100%)	0	100	100
30	AN	93/115 (81%)	93 (100%)	0	100	100
31	AO	166/230 (72%)	166 (100%)	0	100	100
32	AP	86/123 (70%)	86 (100%)	0	100	100

*Continued on next page...*



*Continued from previous page...*

Mol	Chain	Analysed	Rotameric	Outliers	Percentiles	
33	AQ	77/79 (98%)	77 (100%)	0	100	100
34	AR	229/318 (72%)	228 (100%)	1 (0%)	91	94
35	AS	115/164 (70%)	114 (99%)	1 (1%)	78	88
36	AT	150/157 (96%)	150 (100%)	0	100	100
37	AU	149/174 (86%)	148 (99%)	1 (1%)	84	90
38	AV	315/364 (86%)	314 (100%)	1 (0%)	92	95
39	AW	84/158 (53%)	84 (100%)	0	100	100
40	AX	307/351 (88%)	305 (99%)	2 (1%)	84	90
41	AY	104/357 (29%)	104 (100%)	0	100	100
42	AZ	79/95 (83%)	79 (100%)	0	100	100
44	XD	190/245 (78%)	189 (100%)	1 (0%)	88	93
45	XE	259/290 (89%)	259 (100%)	0	100	100
46	XF	217/262 (83%)	217 (100%)	0	100	100
47	XH	86/228 (38%)	86 (100%)	0	100	100
48	XI	194/232 (84%)	194 (100%)	0	100	100
49	XJ	133/150 (89%)	132 (99%)	1 (1%)	81	89
50	XK	155/156 (99%)	155 (100%)	0	100	100
51	XL	98/124 (79%)	98 (100%)	0	100	100
52	XM	245/249 (98%)	244 (100%)	1 (0%)	91	94
53	XN	188/211 (89%)	188 (100%)	0	100	100
54	XO	133/150 (89%)	133 (100%)	0	100	100
55	XP	125/155 (81%)	125 (100%)	0	100	100
56	XQ	220/256 (86%)	220 (100%)	0	100	100
57	XR	118/126 (94%)	118 (100%)	0	100	100
58	XS	145/180 (81%)	145 (100%)	0	100	100
59	XT	146/176 (83%)	145 (99%)	1 (1%)	84	90
60	XU	126/135 (93%)	126 (100%)	0	100	100
61	XV	179/191 (94%)	178 (99%)	1 (1%)	86	92
62	XW	91/119 (76%)	90 (99%)	1 (1%)	73	85
63	XX	219/229 (96%)	219 (100%)	0	100	100
64	XY	161/223 (72%)	160 (99%)	1 (1%)	86	92

*Continued on next page...*

Continued from previous page...

Mol	Chain	Analysed	Rotameric	Outliers	Percentiles	
65	XZ	111/147 (76%)	111 (100%)	0	100	100
66	a	93/133 (70%)	92 (99%)	1 (1%)	73	85
67	b	130/186 (70%)	130 (100%)	0	100	100
68	c	241/288 (84%)	240 (100%)	1 (0%)	91	94
69	d	196/274 (72%)	196 (100%)	0	100	100
70	e	188/236 (80%)	187 (100%)	1 (0%)	88	93
71	f	128/188 (68%)	128 (100%)	0	100	100
72	g	122/148 (82%)	121 (99%)	1 (1%)	81	89
73	h	103/148 (70%)	103 (100%)	0	100	100
74	i	86/110 (78%)	86 (100%)	0	100	100
75	j	68/97 (70%)	68 (100%)	0	100	100
76	k	80/90 (89%)	80 (100%)	0	100	100
77	l	74/116 (64%)	74 (100%)	0	100	100
78	m	54/113 (48%)	54 (100%)	0	100	100
79	o	80/87 (92%)	80 (100%)	0	100	100
80	p	117/181 (65%)	117 (100%)	0	100	100
81	q	141/178 (79%)	140 (99%)	1 (1%)	84	90
82	r	138/169 (82%)	138 (100%)	0	100	100
86	s	326/381 (86%)	325 (100%)	1 (0%)	92	95
87	t1	40/158 (25%)	40 (100%)	0	100	100
87	t2	28/158 (18%)	28 (100%)	0	100	100
87	t3	29/158 (18%)	29 (100%)	0	100	100
87	t4	28/158 (18%)	28 (100%)	0	100	100
87	t5	28/158 (18%)	28 (100%)	0	100	100
87	t6	26/158 (16%)	26 (100%)	0	100	100
All	All	12395/16507 (75%)	12361 (100%)	34 (0%)	92	95

5 of 34 residues with a non-rotameric sidechain are listed below:

Mol	Chain	Res	Type
66	a	114	LYS
68	c	302	ARG
81	q	155	ARG

Continued on next page...

*Continued from previous page...*

Mol	Chain	Res	Type
20	AD	123	ARG
16	A4	594	LYS

Sometimes sidechains can be flipped to improve hydrogen bonding and reduce clashes. 5 of 18 such sidechains are listed below:

Mol	Chain	Res	Type
67	b	102	GLN
87	t3	22	ASN
76	k	15	GLN
31	AO	80	ASN
55	XP	96	GLN

### 5.3.3 RNA [i](#)

Mol	Chain	Analysed	Backbone Outliers	Pucker Outliers
11	XA	1490/1559 (95%)	269 (18%)	8 (0%)
17	AA	916/954 (96%)	163 (17%)	4 (0%)
43	XB	54/72 (75%)	11 (20%)	0
83	r1	0/14	-	-
84	r2	0/76	-	-
85	r3	0/75	-	-
All	All	2460/2750 (89%)	443 (18%)	12 (0%)

5 of 443 RNA backbone outliers are listed below:

Mol	Chain	Res	Type
11	XA	1681	G
11	XA	1685	C
11	XA	1689	C
11	XA	1692	A
11	XA	1693	C

5 of 12 RNA pucker outliers are listed below:

Mol	Chain	Res	Type
11	XA	2962	C
17	AA	770	C
17	AA	1558	A
17	AA	1048	C
11	XA	2558	A

## 5.4 Non-standard residues in protein, DNA, RNA chains [i](#)

165 non-standard protein/DNA/RNA residues are modelled in this entry.

In the following table, the Counts columns list the number of bonds (or angles) for which Mogul statistics could be retrieved, the number of bonds (or angles) that are observed in the model and the number of bonds (or angles) that are defined in the Chemical Component Dictionary. The Link column lists molecule types, if any, to which the group is linked. The Z score for a bond length (or angle) is the number of standard deviations the observed value is removed from the expected value. A bond length (or angle) with  $|Z| > 2$  is considered an outlier worth inspection. RMSZ is the root-mean-square of all Z scores of the bond lengths (or angles).

Mol	Type	Chain	Res	Link	Bond lengths			Bond angles		
					Counts	RMSZ	# Z  > 2	Counts	RMSZ	# Z  > 2
83	Y5P	r1	47	83	14,19,20	3.11	3 (21%)	18,26,29	0.57	0
85	Y5P	r3	7	85	14,19,20	3.11	3 (21%)	18,26,29	0.60	0
83	Y5P	r1	54	83	14,19,20	3.14	4 (28%)	18,26,29	0.58	0
85	P5P	r3	51	85	16,23,24	0.95	1 (6%)	14,33,36	1.99	3 (21%)
85	P5P	r3	17(A)	85	16,23,24	0.95	1 (6%)	14,33,36	2.03	3 (21%)
85	Y5P	r3	41	85	14,19,20	3.13	3 (21%)	18,26,29	0.58	0
85	P5P	r3	30	85	16,23,24	0.95	1 (6%)	14,33,36	1.99	3 (21%)
85	Y5P	r3	39	85	14,19,20	3.14	3 (21%)	18,26,29	0.57	0
84	P5P	r2	21	84	16,23,24	0.94	1 (6%)	14,33,36	2.00	3 (21%)
84	Y5P	r2	61	84	14,19,20	3.14	3 (21%)	18,26,29	0.58	0
84	Y5P	r2	59	84	14,19,20	3.15	3 (21%)	18,26,29	0.56	0
84	Y5P	r2	4	84	14,19,20	3.14	3 (21%)	18,26,29	0.58	0
84	P5P	r2	1	84	16,23,24	0.94	1 (6%)	14,33,36	1.96	3 (21%)
85	Y5P	r3	25	85	14,19,20	3.13	3 (21%)	18,26,29	0.61	0
84	Y5P	r2	50	84	14,19,20	3.14	3 (21%)	18,26,29	0.59	0
85	P5P	r3	57	85	16,23,24	0.94	1 (6%)	14,33,36	1.99	3 (21%)
84	Y5P	r2	39	84	14,19,20	3.13	3 (21%)	18,26,29	0.56	0
85	P5P	r3	46	85	16,23,24	0.95	1 (6%)	14,33,36	1.97	3 (21%)
85	Y5P	r3	17	85	14,19,20	3.14	3 (21%)	18,26,29	0.55	0
83	Y5P	r1	56	83	14,19,20	3.13	3 (21%)	18,26,29	0.60	0
85	Y5P	r3	54	85	14,19,20	3.14	3 (21%)	18,26,29	0.59	0
84	P5P	r2	71	84	16,23,24	0.95	1 (6%)	14,33,36	1.95	3 (21%)
84	P5P	r2	18	84	16,23,24	0.96	1 (6%)	14,33,36	2.00	3 (21%)
85	P5P	r3	52	85	16,23,24	0.95	1 (6%)	14,33,36	1.99	3 (21%)
84	P5P	r2	38	84	16,23,24	0.96	1 (6%)	14,33,36	1.99	3 (21%)
85	Y5P	r3	20	85	14,19,20	3.14	3 (21%)	18,26,29	0.57	0

Mol	Type	Chain	Res	Link	Bond lengths			Bond angles		
					Counts	RMSZ	# Z  > 2	Counts	RMSZ	# Z  > 2
84	P5P	r2	73	84	16,23,24	0.96	1 (6%)	14,33,36	1.99	3 (21%)
85	P5P	r3	55	85	16,23,24	0.96	1 (6%)	14,33,36	1.98	3 (21%)
85	P5P	r3	5	85	16,23,24	0.97	1 (6%)	14,33,36	1.99	3 (21%)
84	Y5P	r2	3	84	14,19,20	3.13	3 (21%)	18,26,29	0.56	0
83	Y5P	r1	57	83	14,19,20	3.14	3 (21%)	18,26,29	0.60	0
84	P5P	r2	22	84	16,23,24	0.96	1 (6%)	14,33,36	2.01	3 (21%)
85	P5P	r3	14	85	16,23,24	0.95	1 (6%)	14,33,36	2.02	3 (21%)
84	P5P	r2	37	84	20,24,24	0.88	1 (5%)	21,36,36	3.04	9 (42%)
85	Y5P	r3	27	85	14,19,20	3.15	3 (21%)	18,26,29	0.53	0
84	P5P	r2	64	84	16,23,24	0.96	1 (6%)	14,33,36	1.97	3 (21%)
84	Y5P	r2	20	84	14,19,20	3.14	3 (21%)	18,26,29	0.59	0
84	Y5P	r2	13	84	14,19,20	3.13	3 (21%)	18,26,29	0.60	0
84	P5P	r2	19	84	16,23,24	0.97	1 (6%)	14,33,36	1.99	3 (21%)
85	Y5P	r3	65	85	14,19,20	3.11	3 (21%)	18,26,29	0.63	0
85	Y5P	r3	67	85	14,19,20	3.13	3 (21%)	18,26,29	0.58	0
84	Y5P	r2	45	84	14,19,20	3.13	3 (21%)	18,26,29	0.54	0
84	P5P	r2	10	84	16,23,24	0.96	1 (6%)	14,33,36	1.99	3 (21%)
84	Y5P	r2	8	84	14,19,20	3.13	3 (21%)	18,26,29	0.57	0
84	Y5P	r2	25	84	14,19,20	3.14	3 (21%)	18,26,29	0.55	0
84	Y5P	r2	67	84	14,19,20	3.13	3 (21%)	18,26,29	0.55	0
85	P5P	r3	4	85	16,23,24	0.97	1 (6%)	14,33,36	2.01	3 (21%)
85	P5P	r3	9	85	16,23,24	0.97	1 (6%)	14,33,36	2.00	3 (21%)
85	P5P	r3	15	85	16,23,24	0.97	1 (6%)	14,33,36	1.99	3 (21%)
85	P5P	r3	29	85	16,23,24	0.95	1 (6%)	14,33,36	1.99	3 (21%)
85	P5P	r3	31	85	16,23,24	0.95	1 (6%)	14,33,36	1.96	3 (21%)
84	Y5P	r2	68	84	14,19,20	3.14	3 (21%)	18,26,29	0.55	0
85	P5P	r3	21	85	16,23,24	0.96	1 (6%)	14,33,36	1.98	3 (21%)
84	P5P	r2	58	84	16,23,24	0.95	1 (6%)	14,33,36	1.96	3 (21%)
85	Y5P	r3	1	85	18,20,20	2.76	3 (16%)	25,29,29	0.71	0
85	Y5P	r3	24	85	14,19,20	3.12	3 (21%)	18,26,29	0.62	0
84	Y5P	r2	48	84	14,19,20	3.14	3 (21%)	18,26,29	0.64	0
84	P5P	r2	31	84	16,23,24	0.96	1 (6%)	14,33,36	2.00	3 (21%)
84	Y5P	r2	11	84	14,19,20	3.14	3 (21%)	18,26,29	0.61	0
84	Y5P	r2	17	84	14,19,20	3.13	3 (21%)	18,26,29	0.57	0
85	Y5P	r3	32	85	14,19,20	3.10	3 (21%)	18,26,29	0.59	0

Mol	Type	Chain	Res	Link	Bond lengths			Bond angles		
					Counts	RMSZ	# Z  > 2	Counts	RMSZ	# Z  > 2
84	P5P	r2	35	84	16,23,24	0.95	1 (6%)	14,33,36	2.02	3 (21%)
83	Y5P	r1	55	83	14,19,20	3.13	3 (21%)	18,26,29	0.55	0
84	P5P	r2	69	84	16,23,24	0.96	1 (6%)	14,33,36	1.98	3 (21%)
84	P5P	r2	7	84	16,23,24	0.95	1 (6%)	14,33,36	2.02	3 (21%)
84	Y5P	r2	72	84	14,19,20	3.14	3 (21%)	18,26,29	0.60	0
84	Y5P	r2	32	84	14,19,20	3.14	3 (21%)	18,26,29	0.59	0
84	Y5P	r2	42	84	14,19,20	3.15	3 (21%)	18,26,29	0.58	0
85	Y5P	r3	47	85	14,19,20	3.12	3 (21%)	18,26,29	0.61	0
85	P5P	r3	68	85	16,23,24	0.96	1 (6%)	14,33,36	1.99	3 (21%)
85	P5P	r3	22	85	16,23,24	0.96	1 (6%)	14,33,36	1.97	3 (21%)
84	P5P	r2	23	84	16,23,24	0.96	1 (6%)	14,33,36	2.00	3 (21%)
84	P5P	r2	5	84	16,23,24	0.95	1 (6%)	14,33,36	2.00	3 (21%)
85	P5P	r3	74	85	16,23,24	0.96	1 (6%)	14,33,36	2.07	3 (21%)
85	P5P	r3	48	85	16,23,24	0.96	1 (6%)	14,33,36	2.01	3 (21%)
85	P5P	r3	26	85	16,23,24	0.96	1 (6%)	14,33,36	1.99	3 (21%)
84	Y5P	r2	40	84	14,19,20	3.12	3 (21%)	18,26,29	0.60	0
83	Y5P	r1	52	83	14,19,20	3.12	3 (21%)	18,26,29	0.57	0
84	P5P	r2	29	84	16,23,24	0.95	1 (6%)	14,33,36	2.00	3 (21%)
85	P5P	r3	45	85	16,23,24	0.95	1 (6%)	14,33,36	1.95	3 (21%)
85	Y5P	r3	70	85	14,19,20	3.12	3 (21%)	18,26,29	0.54	0
85	Y5P	r3	28	85	14,19,20	3.12	3 (21%)	18,26,29	0.58	0
85	P5P	r3	42	85	16,23,24	0.94	1 (6%)	14,33,36	1.98	3 (21%)
84	P5P	r2	28	84	16,23,24	0.96	1 (6%)	14,33,36	1.99	3 (21%)
85	P5P	r3	43	85	16,23,24	0.96	1 (6%)	14,33,36	1.97	3 (21%)
84	P5P	r2	76	84	16,23,24	0.94	1 (6%)	14,33,36	1.99	3 (21%)
84	P5P	r2	63	84	16,23,24	0.96	1 (6%)	14,33,36	2.00	3 (21%)
84	P5P	r2	30	84	16,23,24	0.94	1 (6%)	14,33,36	1.98	3 (21%)
83	Y5P	r1	49	83	14,19,20	3.11	3 (21%)	18,26,29	0.55	0
85	Y5P	r3	16	85	14,19,20	3.14	4 (28%)	18,26,29	0.59	0
85	Y5P	r3	62	85	14,19,20	3.13	3 (21%)	18,26,29	0.63	0
84	P5P	r2	9	84	16,23,24	0.95	1 (6%)	14,33,36	2.02	3 (21%)
85	Y5P	r3	63	85	14,19,20	3.12	3 (21%)	18,26,29	0.58	0
84	Y5P	r2	33	84	14,19,20	3.12	3 (21%)	18,26,29	0.68	0
84	Y5P	r2	16	84	14,19,20	3.15	3 (21%)	18,26,29	0.58	0
85	Y5P	r3	56	85	14,19,20	3.12	3 (21%)	18,26,29	0.64	0

Mol	Type	Chain	Res	Link	Bond lengths			Bond angles		
					Counts	RMSZ	# Z  > 2	Counts	RMSZ	# Z  > 2
85	P5P	r3	23	85	16,23,24	0.96	1 (6%)	14,33,36	1.99	3 (21%)
83	Y5P	r1	48	83	14,19,20	3.10	3 (21%)	18,26,29	0.60	0
85	P5P	r3	6	85	16,23,24	0.96	1 (6%)	14,33,36	1.98	3 (21%)
85	P5P	r3	66	85	16,23,24	0.95	1 (6%)	14,33,36	1.99	3 (21%)
85	Y5P	r3	72	85	14,19,20	3.10	3 (21%)	18,26,29	0.58	0
84	P5P	r2	53	84	16,23,24	0.96	1 (6%)	14,33,36	2.00	3 (21%)
85	Y5P	r3	69	85	14,19,20	3.13	3 (21%)	18,26,29	0.58	0
84	Y5P	r2	55	84	14,19,20	3.14	3 (21%)	18,26,29	0.58	0
84	P5P	r2	70	84	16,23,24	0.94	1 (6%)	14,33,36	1.99	3 (21%)
85	Y5P	r3	38	85	14,19,20	3.14	3 (21%)	18,26,29	0.55	0
84	P5P	r2	14	84	16,23,24	0.96	1 (6%)	14,33,36	1.98	3 (21%)
85	Y5P	r3	60	85	14,19,20	3.13	3 (21%)	18,26,29	0.56	0
84	P5P	r2	24	84	16,23,24	0.96	1 (6%)	14,33,36	1.99	3 (21%)
84	Y5P	r2	54	84	14,19,20	3.13	3 (21%)	18,26,29	0.56	0
84	Y5P	r2	56	84	14,19,20	3.14	3 (21%)	18,26,29	0.55	0
84	Y5P	r2	75	84	14,19,20	3.14	3 (21%)	18,26,29	0.54	0
85	Y5P	r3	64	85	14,19,20	3.12	3 (21%)	18,26,29	0.56	0
85	P5P	r3	11	85	16,23,24	0.96	1 (6%)	14,33,36	1.97	3 (21%)
85	Y5P	r3	2	85	14,19,20	3.13	3 (21%)	18,26,29	0.54	0
84	P5P	r2	44	84	16,23,24	0.96	1 (6%)	14,33,36	1.97	3 (21%)
84	Y5P	r2	62	84	14,19,20	3.14	3 (21%)	18,26,29	0.59	0
85	Y5P	r3	53	85	14,19,20	3.12	3 (21%)	18,26,29	0.56	0
84	P5P	r2	6	84	16,23,24	0.95	1 (6%)	14,33,36	2.00	3 (21%)
85	Y5P	r3	34	85	14,19,20	3.14	3 (21%)	18,26,29	0.53	0
84	P5P	r2	34	84	16,23,24	0.95	1 (6%)	14,33,36	2.00	3 (21%)
84	P5P	r2	15	84	16,23,24	0.96	1 (6%)	14,33,36	2.00	3 (21%)
84	P5P	r2	52	84	16,23,24	0.96	1 (6%)	14,33,36	1.98	3 (21%)
85	Y5P	r3	73	85	14,19,20	3.10	3 (21%)	18,26,29	0.53	0
84	Y5P	r2	47	84	14,19,20	3.16	3 (21%)	18,26,29	0.59	0
84	P5P	r2	57	84	16,23,24	0.96	1 (6%)	14,33,36	1.99	3 (21%)
83	Y5P	r1	51	83	14,19,20	3.11	3 (21%)	18,26,29	0.61	0
84	Y5P	r2	60	84	14,19,20	3.12	3 (21%)	18,26,29	0.59	0
85	Y5P	r3	33	85	14,19,20	3.12	3 (21%)	18,26,29	0.59	0
85	Y5P	r3	61	85	14,19,20	3.14	3 (21%)	18,26,29	0.57	0
84	Y5P	r2	41	84	14,19,20	3.11	3 (21%)	18,26,29	0.60	0

Mol	Type	Chain	Res	Link	Bond lengths			Bond angles		
					Counts	RMSZ	# Z  > 2	Counts	RMSZ	# Z  > 2
85	Y5P	r3	12	85	14,19,20	3.14	3 (21%)	18,26,29	0.57	0
84	P5P	r2	26	84	16,23,24	0.95	1 (6%)	14,33,36	1.98	3 (21%)
84	Y5P	r2	43	84	14,19,20	3.13	3 (21%)	18,26,29	0.59	0
83	Y5P	r1	53	83	14,19,20	3.10	3 (21%)	18,26,29	0.64	0
85	P5P	r3	37	85	16,23,24	0.95	1 (6%)	14,33,36	1.98	3 (21%)
85	Y5P	r3	40	85	14,19,20	3.09	3 (21%)	18,26,29	0.63	0
84	Y5P	r2	2	84	14,19,20	3.14	3 (21%)	18,26,29	0.56	0
84	Y5P	r2	51	84	14,19,20	3.14	3 (21%)	18,26,29	0.57	0
83	Y5P	r1	50	83	14,19,20	3.12	3 (21%)	18,26,29	0.59	0
84	Y5P	r2	74	84	14,19,20	3.14	3 (21%)	18,26,29	0.59	0
85	P5P	r3	3	85	16,23,24	0.95	1 (6%)	14,33,36	2.03	3 (21%)
85	P5P	r3	8	85	16,23,24	0.96	1 (6%)	14,33,36	1.99	3 (21%)
85	P5P	r3	10	85	16,23,24	0.96	1 (6%)	14,33,36	1.97	3 (21%)
85	P5P	r3	19	85	16,23,24	0.97	1 (6%)	14,33,36	1.99	3 (21%)
84	Y5P	r2	12	84	14,19,20	3.14	3 (21%)	18,26,29	0.63	0
85	P5P	r3	35	85	16,23,24	0.94	1 (6%)	14,33,36	2.00	3 (21%)
85	Y5P	r3	50	85	14,19,20	3.13	3 (21%)	18,26,29	0.57	0
85	Y5P	r3	13	85	14,19,20	3.13	3 (21%)	18,26,29	0.64	0
83	Y5P	r1	46	83	14,19,20	3.11	3 (21%)	18,26,29	0.63	0
85	P5P	r3	44	85	16,23,24	0.95	1 (6%)	14,33,36	1.96	3 (21%)
84	P5P	r2	46	84	16,23,24	0.97	1 (6%)	14,33,36	2.01	3 (21%)
84	Y5P	r2	66	84	14,19,20	3.14	3 (21%)	18,26,29	0.60	0
85	P5P	r3	18	85	16,23,24	0.97	1 (6%)	14,33,36	2.00	3 (21%)
85	Y5P	r3	59	85	14,19,20	3.13	3 (21%)	18,26,29	0.58	0
84	P5P	r2	27	84	16,23,24	0.95	1 (6%)	14,33,36	2.00	3 (21%)
84	Y5P	r2	49	84	14,19,20	3.12	3 (21%)	18,26,29	0.60	0
85	P5P	r3	71	85	16,23,24	0.94	1 (6%)	14,33,36	1.95	3 (21%)
84	P5P	r2	65	84	16,23,24	0.96	1 (6%)	14,33,36	2.00	3 (21%)
85	Y5P	r3	36	85	14,19,20	3.11	3 (21%)	18,26,29	0.61	0
85	Y5P	r3	58	85	14,19,20	3.12	3 (21%)	18,26,29	0.61	0
83	Y5P	r1	44	83	14,19,20	3.14	3 (21%)	18,26,29	0.59	0
84	P5P	r2	36	84	16,23,24	0.95	1 (6%)	14,33,36	2.04	3 (21%)
85	Y5P	r3	49	85	14,19,20	3.12	3 (21%)	18,26,29	0.57	0
83	Y5P	r1	45	83	14,19,20	3.13	3 (21%)	18,26,29	0.61	0



In the following table, the Chirals column lists the number of chiral outliers, the number of chiral centers analysed, the number of these observed in the model and the number defined in the Chemical Component Dictionary. Similar counts are reported in the Torsion and Rings columns. '-' means no outliers of that kind were identified.

Mol	Type	Chain	Res	Link	Chirals	Torsions	Rings
83	Y5P	r1	47	83	-	4/7/33/34	0/2/2/2
85	Y5P	r3	7	85	-	3/7/33/34	0/2/2/2
83	Y5P	r1	54	83	-	1/7/33/34	0/2/2/2
85	P5P	r3	51	85	-	2/3/25/26	0/3/3/3
85	P5P	r3	17(A)	85	-	3/3/25/26	0/3/3/3
85	Y5P	r3	41	85	-	1/7/33/34	0/2/2/2
85	P5P	r3	30	85	-	0/3/25/26	0/3/3/3
85	Y5P	r3	39	85	-	1/7/33/34	0/2/2/2
84	P5P	r2	21	84	-	2/3/25/26	0/3/3/3
84	Y5P	r2	61	84	-	2/7/33/34	0/2/2/2
84	Y5P	r2	59	84	-	2/7/33/34	0/2/2/2
84	Y5P	r2	4	84	-	1/7/33/34	0/2/2/2
84	P5P	r2	1	84	-	2/3/25/26	0/3/3/3
85	Y5P	r3	25	85	-	1/7/33/34	0/2/2/2
84	Y5P	r2	50	84	-	3/7/33/34	0/2/2/2
85	P5P	r3	57	85	-	0/3/25/26	0/3/3/3
84	Y5P	r2	39	84	-	1/7/33/34	0/2/2/2
85	P5P	r3	46	85	-	1/3/25/26	0/3/3/3
85	Y5P	r3	17	85	-	4/7/33/34	0/2/2/2
83	Y5P	r1	56	83	-	2/7/33/34	0/2/2/2
85	Y5P	r3	54	85	-	1/7/33/34	0/2/2/2
84	P5P	r2	71	84	-	0/3/25/26	0/3/3/3
84	P5P	r2	18	84	-	1/3/25/26	0/3/3/3
85	P5P	r3	52	85	-	0/3/25/26	0/3/3/3
84	P5P	r2	38	84	-	0/3/25/26	0/3/3/3
85	Y5P	r3	20	85	-	1/7/33/34	0/2/2/2
84	P5P	r2	73	84	-	3/3/25/26	0/3/3/3
85	P5P	r3	55	85	-	2/3/25/26	0/3/3/3
85	P5P	r3	5	85	-	2/3/25/26	0/3/3/3
84	Y5P	r2	3	84	-	1/7/33/34	0/2/2/2
83	Y5P	r1	57	83	-	1/7/33/34	0/2/2/2
84	P5P	r2	22	84	-	0/3/25/26	0/3/3/3
85	P5P	r3	14	85	-	1/3/25/26	0/3/3/3
84	P5P	r2	37	84	-	3/6/26/26	0/3/3/3
85	Y5P	r3	27	85	-	1/7/33/34	0/2/2/2

*Continued on next page...*

*Continued from previous page...*

Mol	Type	Chain	Res	Link	Chirals	Torsions	Rings
84	P5P	r2	64	84	-	0/3/25/26	0/3/3/3
84	Y5P	r2	20	84	-	1/7/33/34	0/2/2/2
84	Y5P	r2	13	84	-	3/7/33/34	0/2/2/2
84	P5P	r2	19	84	-	0/3/25/26	0/3/3/3
85	Y5P	r3	65	85	-	1/7/33/34	0/2/2/2
85	Y5P	r3	67	85	-	1/7/33/34	0/2/2/2
84	Y5P	r2	45	84	-	4/7/33/34	0/2/2/2
84	P5P	r2	10	84	-	0/3/25/26	0/3/3/3
84	Y5P	r2	8	84	-	1/7/33/34	0/2/2/2
84	Y5P	r2	25	84	-	1/7/33/34	0/2/2/2
84	Y5P	r2	67	84	-	3/7/33/34	0/2/2/2
85	P5P	r3	4	85	-	3/3/25/26	0/3/3/3
85	P5P	r3	9	85	-	0/3/25/26	0/3/3/3
85	P5P	r3	15	85	-	0/3/25/26	0/3/3/3
85	P5P	r3	29	85	-	2/3/25/26	0/3/3/3
85	P5P	r3	31	85	-	0/3/25/26	0/3/3/3
84	Y5P	r2	68	84	-	3/7/33/34	0/2/2/2
85	P5P	r3	21	85	-	3/3/25/26	0/3/3/3
84	P5P	r2	58	84	-	0/3/25/26	0/3/3/3
85	Y5P	r3	1	85	-	4/10/34/34	0/2/2/2
85	Y5P	r3	24	85	-	1/7/33/34	0/2/2/2
84	Y5P	r2	48	84	-	2/7/33/34	0/2/2/2
84	P5P	r2	31	84	-	0/3/25/26	0/3/3/3
84	Y5P	r2	11	84	-	1/7/33/34	0/2/2/2
84	Y5P	r2	17	84	-	4/7/33/34	0/2/2/2
85	Y5P	r3	32	85	-	1/7/33/34	0/2/2/2
84	P5P	r2	35	84	-	2/3/25/26	0/3/3/3
83	Y5P	r1	55	83	-	4/7/33/34	0/2/2/2
84	P5P	r2	69	84	-	2/3/25/26	0/3/3/3
84	P5P	r2	7	84	-	2/3/25/26	0/3/3/3
84	Y5P	r2	72	84	-	3/7/33/34	0/2/2/2
84	Y5P	r2	32	84	-	1/7/33/34	0/2/2/2
84	Y5P	r2	42	84	-	1/7/33/34	0/2/2/2
85	Y5P	r3	47	85	-	4/7/33/34	0/2/2/2
85	P5P	r3	68	85	-	0/3/25/26	0/3/3/3
85	P5P	r3	22	85	-	0/3/25/26	0/3/3/3
84	P5P	r2	23	84	-	1/3/25/26	0/3/3/3
84	P5P	r2	5	84	-	0/3/25/26	0/3/3/3

*Continued on next page...*

*Continued from previous page...*

Mol	Type	Chain	Res	Link	Chirals	Torsions	Rings
85	P5P	r3	74	85	-	0/3/25/26	0/3/3/3
85	P5P	r3	48	85	-	0/3/25/26	0/3/3/3
85	P5P	r3	26	85	-	0/3/25/26	0/3/3/3
84	Y5P	r2	40	84	-	1/7/33/34	0/2/2/2
83	Y5P	r1	52	83	-	3/7/33/34	0/2/2/2
84	P5P	r2	29	84	-	0/3/25/26	0/3/3/3
85	P5P	r3	45	85	-	0/3/25/26	0/3/3/3
85	Y5P	r3	70	85	-	1/7/33/34	0/2/2/2
85	Y5P	r3	28	85	-	1/7/33/34	0/2/2/2
85	P5P	r3	42	85	-	2/3/25/26	0/3/3/3
84	P5P	r2	28	84	-	0/3/25/26	0/3/3/3
85	P5P	r3	43	85	-	1/3/25/26	0/3/3/3
84	P5P	r2	76	84	-	1/3/25/26	0/3/3/3
84	P5P	r2	63	84	-	0/3/25/26	0/3/3/3
84	P5P	r2	30	84	-	0/3/25/26	0/3/3/3
83	Y5P	r1	49	83	-	3/7/33/34	0/2/2/2
85	Y5P	r3	16	85	-	2/7/33/34	0/2/2/2
85	Y5P	r3	62	85	-	1/7/33/34	0/2/2/2
84	P5P	r2	9	84	-	3/3/25/26	0/3/3/3
85	Y5P	r3	63	85	-	3/7/33/34	0/2/2/2
84	Y5P	r2	33	84	-	6/7/33/34	0/2/2/2
84	Y5P	r2	16	84	-	1/7/33/34	0/2/2/2
85	Y5P	r3	56	85	-	3/7/33/34	0/2/2/2
85	P5P	r3	23	85	-	0/3/25/26	0/3/3/3
83	Y5P	r1	48	83	-	1/7/33/34	0/2/2/2
85	P5P	r3	6	85	-	0/3/25/26	0/3/3/3
85	P5P	r3	66	85	-	0/3/25/26	0/3/3/3
85	Y5P	r3	72	85	-	2/7/33/34	0/2/2/2
84	P5P	r2	53	84	-	0/3/25/26	0/3/3/3
85	Y5P	r3	69	85	-	4/7/33/34	0/2/2/2
84	Y5P	r2	55	84	-	1/7/33/34	0/2/2/2
84	P5P	r2	70	84	-	3/3/25/26	0/3/3/3
85	Y5P	r3	38	85	-	1/7/33/34	0/2/2/2
84	P5P	r2	14	84	-	2/3/25/26	0/3/3/3
85	Y5P	r3	60	85	-	1/7/33/34	0/2/2/2
84	P5P	r2	24	84	-	0/3/25/26	0/3/3/3
84	Y5P	r2	54	84	-	1/7/33/34	0/2/2/2
84	Y5P	r2	56	84	-	1/7/33/34	0/2/2/2
84	Y5P	r2	75	84	-	4/7/33/34	0/2/2/2

*Continued on next page...*

*Continued from previous page...*

Mol	Type	Chain	Res	Link	Chirals	Torsions	Rings
85	Y5P	r3	64	85	-	1/7/33/34	0/2/2/2
85	P5P	r3	11	85	-	0/3/25/26	0/3/3/3
85	Y5P	r3	2	85	-	1/7/33/34	0/2/2/2
84	P5P	r2	44	84	-	0/3/25/26	0/3/3/3
84	Y5P	r2	62	84	-	1/7/33/34	0/2/2/2
85	Y5P	r3	53	85	-	3/7/33/34	0/2/2/2
84	P5P	r2	6	84	-	0/3/25/26	0/3/3/3
85	Y5P	r3	34	85	-	3/7/33/34	0/2/2/2
84	P5P	r2	34	84	-	0/3/25/26	0/3/3/3
84	P5P	r2	15	84	-	2/3/25/26	0/3/3/3
84	P5P	r2	52	84	-	0/3/25/26	0/3/3/3
85	Y5P	r3	73	85	-	1/7/33/34	0/2/2/2
84	Y5P	r2	47	84	-	3/7/33/34	0/2/2/2
84	P5P	r2	57	84	-	0/3/25/26	0/3/3/3
83	Y5P	r1	51	83	-	1/7/33/34	0/2/2/2
84	Y5P	r2	60	84	-	1/7/33/34	0/2/2/2
85	Y5P	r3	33	85	-	1/7/33/34	0/2/2/2
85	Y5P	r3	61	85	-	3/7/33/34	0/2/2/2
84	Y5P	r2	41	84	-	1/7/33/34	0/2/2/2
85	Y5P	r3	12	85	-	1/7/33/34	0/2/2/2
84	P5P	r2	26	84	-	0/3/25/26	0/3/3/3
84	Y5P	r2	43	84	-	1/7/33/34	0/2/2/2
83	Y5P	r1	53	83	-	3/7/33/34	0/2/2/2
85	P5P	r3	37	85	-	0/3/25/26	0/3/3/3
85	Y5P	r3	40	85	-	3/7/33/34	0/2/2/2
84	Y5P	r2	2	84	-	1/7/33/34	0/2/2/2
84	Y5P	r2	51	84	-	1/7/33/34	0/2/2/2
83	Y5P	r1	50	83	-	1/7/33/34	0/2/2/2
84	Y5P	r2	74	84	-	3/7/33/34	0/2/2/2
85	P5P	r3	3	85	-	3/3/25/26	0/3/3/3
85	P5P	r3	8	85	-	0/3/25/26	0/3/3/3
85	P5P	r3	10	85	-	0/3/25/26	0/3/3/3
85	P5P	r3	19	85	-	1/3/25/26	0/3/3/3
84	Y5P	r2	12	84	-	1/7/33/34	0/2/2/2
85	P5P	r3	35	85	-	0/3/25/26	0/3/3/3
85	Y5P	r3	50	85	-	4/7/33/34	0/2/2/2
85	Y5P	r3	13	85	-	5/7/33/34	0/2/2/2
83	Y5P	r1	46	83	-	4/7/33/34	0/2/2/2
85	P5P	r3	44	85	-	0/3/25/26	0/3/3/3

*Continued on next page...*

Continued from previous page...

Mol	Type	Chain	Res	Link	Chirals	Torsions	Rings
84	P5P	r2	46	84	-	3/3/25/26	0/3/3/3
84	Y5P	r2	66	84	-	3/7/33/34	0/2/2/2
85	P5P	r3	18	85	-	3/3/25/26	0/3/3/3
85	Y5P	r3	59	85	-	2/7/33/34	0/2/2/2
84	P5P	r2	27	84	-	0/3/25/26	0/3/3/3
84	Y5P	r2	49	84	-	3/7/33/34	0/2/2/2
85	P5P	r3	71	85	-	0/3/25/26	0/3/3/3
84	P5P	r2	65	84	-	0/3/25/26	0/3/3/3
85	Y5P	r3	36	85	-	1/7/33/34	0/2/2/2
85	Y5P	r3	58	85	-	1/7/33/34	0/2/2/2
83	Y5P	r1	44	83	-	3/7/33/34	0/2/2/2
84	P5P	r2	36	84	-	3/3/25/26	0/3/3/3
85	Y5P	r3	49	85	-	3/7/33/34	0/2/2/2
83	Y5P	r1	45	83	-	1/7/33/34	0/2/2/2

The worst 5 of 347 bond length outliers are listed below:

Mol	Chain	Res	Type	Atoms	Z	Observed(Å)	Ideal(Å)
84	r2	47	Y5P	C6-C5	10.58	1.52	1.33
85	r3	27	Y5P	C6-C5	10.58	1.52	1.33
85	r3	38	Y5P	C6-C5	10.57	1.52	1.33
85	r3	69	Y5P	C6-C5	10.57	1.52	1.33
85	r3	16	Y5P	C6-C5	10.56	1.52	1.33

The worst 5 of 231 bond angle outliers are listed below:

Mol	Chain	Res	Type	Atoms	Z	Observed(°)	Ideal(°)
84	r2	70	P5P	N1-C2-N3	-6.00	119.97	127.65
85	r3	3	P5P	N1-C2-N3	-6.00	119.97	127.65
85	r3	48	P5P	N1-C2-N3	-6.00	119.98	127.65
85	r3	42	P5P	N1-C2-N3	-5.99	119.99	127.65
84	r2	63	P5P	N1-C2-N3	-5.98	119.99	127.65

There are no chirality outliers.

5 of 245 torsion outliers are listed below:

Mol	Chain	Res	Type	Atoms
83	r1	44	Y5P	O4'-C4'-C5'-O5'
83	r1	46	Y5P	C4'-C5'-O5'-P
83	r1	51	Y5P	O4'-C1'-N1-C2

Continued on next page...

Continued from previous page...

Mol	Chain	Res	Type	Atoms
84	r2	1	P5P	O4'-C4'-C5'-O5'
84	r2	4	Y5P	O4'-C1'-N1-C2

There are no ring outliers.

No monomer is involved in short contacts.

## 5.5 Carbohydrates [i](#)

There are no monosaccharides in this entry.

## 5.6 Ligand geometry [i](#)

Of 205 ligands modelled in this entry, 202 are monoatomic - leaving 3 for Mogul analysis.

In the following table, the Counts columns list the number of bonds (or angles) for which Mogul statistics could be retrieved, the number of bonds (or angles) that are observed in the model and the number of bonds (or angles) that are defined in the Chemical Component Dictionary. The Link column lists molecule types, if any, to which the group is linked. The Z score for a bond length (or angle) is the number of standard deviations the observed value is removed from the expected value. A bond length (or angle) with  $|Z| > 2$  is considered an outlier worth inspection. RMSZ is the root-mean-square of all Z scores of the bond lengths (or angles).

Mol	Type	Chain	Res	Link	Bond lengths			Bond angles		
					Counts	RMSZ	# $ Z  > 2$	Counts	RMSZ	# $ Z  > 2$
91	DOL	XA	5145	-	43,50,50	3.57	16 (37%)	51,70,70	2.63	8 (15%)
92	GTP	AX	500	-	26,34,34	1.12	2 (7%)	32,54,54	1.53	6 (18%)
90	H8Q	XA	5144	-	77,80,80	1.08	5 (6%)	103,115,115	1.34	15 (14%)

In the following table, the Chirals column lists the number of chiral outliers, the number of chiral centers analysed, the number of these observed in the model and the number defined in the Chemical Component Dictionary. Similar counts are reported in the Torsion and Rings columns. '-' means no outliers of that kind were identified.

Mol	Type	Chain	Res	Link	Chirals	Torsions	Rings
91	DOL	XA	5145	-	-	21/58/77/77	0/2/3/3
92	GTP	AX	500	-	-	8/18/38/38	0/3/3/3
90	H8Q	XA	5144	-	-	31/83/127/127	0/8/8/8

The worst 5 of 23 bond length outliers are listed below:

Mol	Chain	Res	Type	Atoms	Z	Observed(Å)	Ideal(Å)
91	XA	5145	DOL	C28-C29	10.12	1.56	1.32
91	XA	5145	DOL	C22-C23	9.80	1.57	1.32
91	XA	5145	DOL	C19-C20	7.27	1.57	1.34
91	XA	5145	DOL	C26-N25	6.62	1.48	1.34
91	XA	5145	DOL	C6-N5	6.54	1.49	1.34

The worst 5 of 29 bond angle outliers are listed below:

Mol	Chain	Res	Type	Atoms	Z	Observed(°)	Ideal(°)
91	XA	5145	DOL	O40-S39-O41	-15.02	101.06	118.19
91	XA	5145	DOL	C24-N25-C26	-6.02	112.29	122.03
92	AX	500	GTP	PA-O3A-PB	-3.92	119.36	132.83
90	XA	5144	H8Q	O41-C34-C33	3.84	122.03	110.83
91	XA	5145	DOL	C32-O36-C37	-3.45	111.86	117.78

There are no chirality outliers.

5 of 60 torsion outliers are listed below:

Mol	Chain	Res	Type	Atoms
90	XA	5144	H8Q	C2-C1-N13-C14
90	XA	5144	H8Q	C2-C1-N13-C18
90	XA	5144	H8Q	O1-C1-N13-C14
90	XA	5144	H8Q	O1-C1-N13-C18
90	XA	5144	H8Q	C33-C34-O41-C43

There are no ring outliers.

2 monomers are involved in 5 short contacts:

Mol	Chain	Res	Type	Clashes	Symm-Clashes
92	AX	500	GTP	1	0
90	XA	5144	H8Q	4	0

The following is a two-dimensional graphical depiction of Mogul quality analysis of bond lengths, bond angles, torsion angles, and ring geometry for all instances of the Ligand of Interest. In addition, ligands with molecular weight > 250 and outliers as shown on the validation Tables will also be included. For torsion angles, if less than 5% of the Mogul distribution of torsion angles is within 10 degrees of the torsion angle in question, then that torsion angle is considered an outlier. Any bond that is central to one or more torsion angles identified as an outlier by Mogul will be highlighted in the graph. For rings, the root-mean-square deviation (RMSD) between the ring in question and similar rings identified by Mogul is calculated over all ring torsion angles. If the average RMSD is greater than 60 degrees and the minimal RMSD between the ring in question and any Mogul-identified rings is also greater than 60 degrees, then that ring is considered an outlier. The outliers are highlighted in purple. The color gray indicates Mogul did not find sufficient

equivalents in the CSD to analyse the geometry.

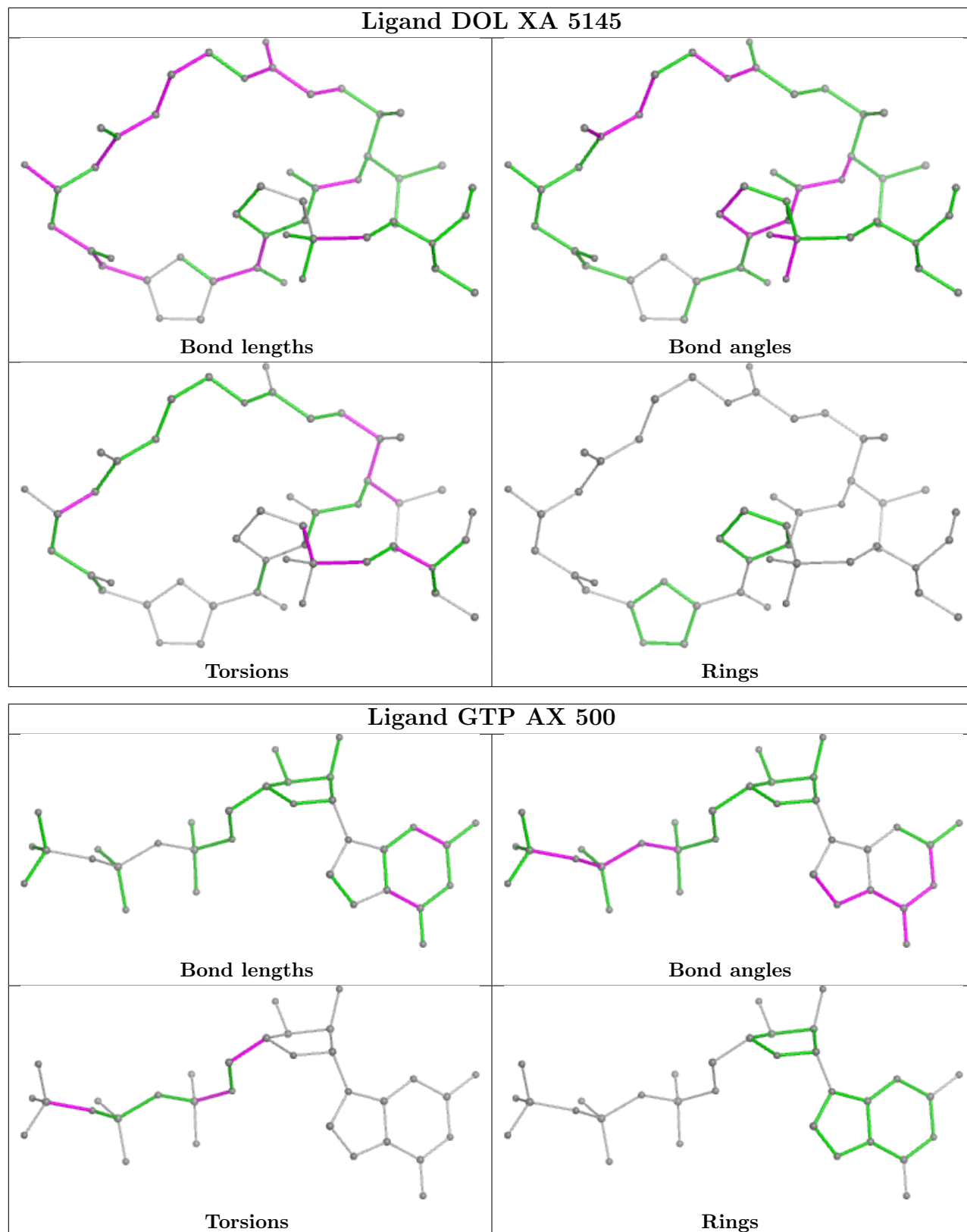



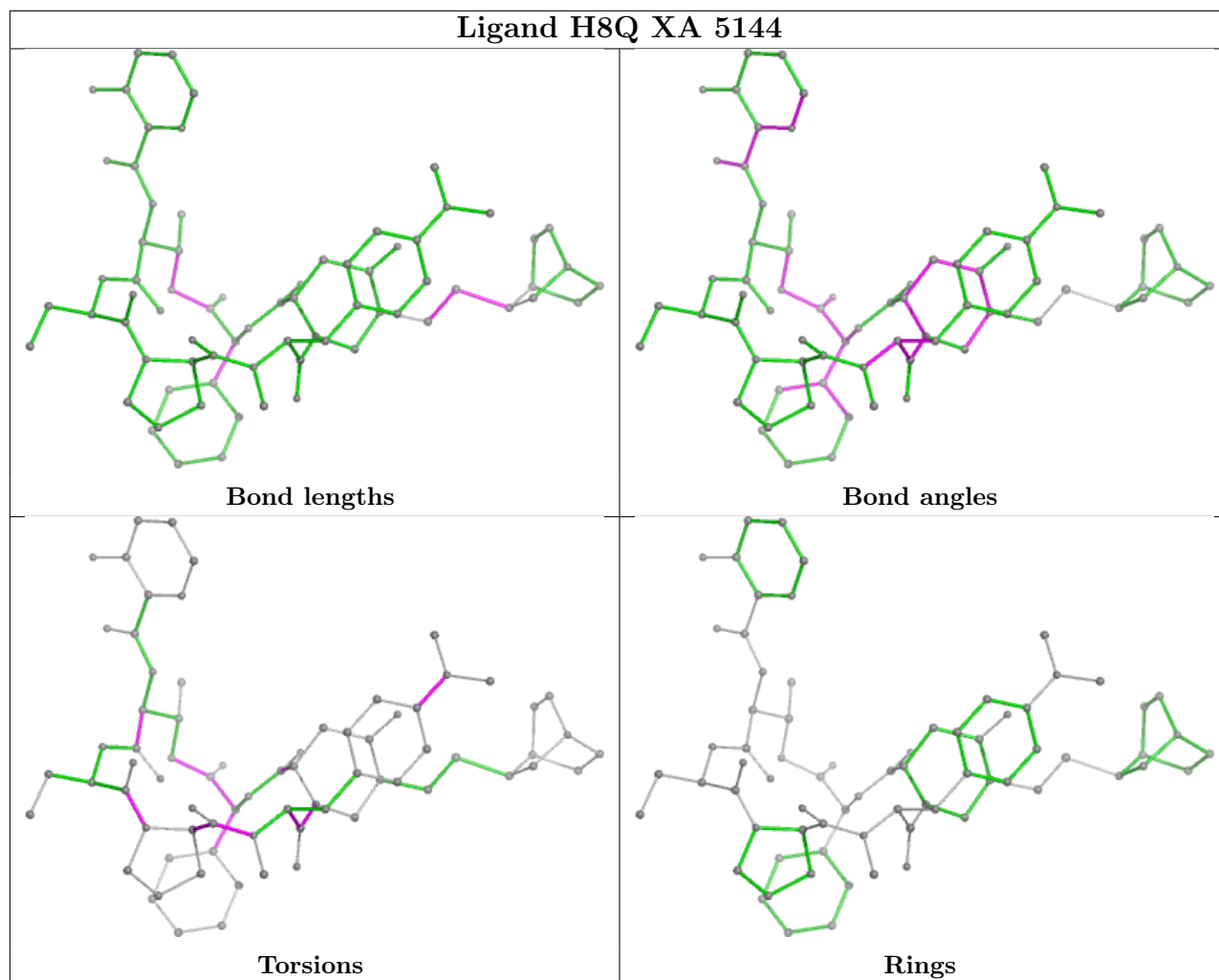

## 5.7 Other polymers [i](#)

There are no such residues in this entry.

## 5.8 Polymer linkage issues [i](#)

The following chains have linkage breaks:

Mol	Chain	Number of breaks
8	7	3
16	A4	2
7	6	2
82	r	1
38	AV	1
6	5	1
34	AR	1

The worst 5 of 11 chain breaks are listed below:

Model	Chain	Residue-1	Atom-1	Residue-2	Atom-2	Distance (Å)
1	7	285:ASN	C	286:LEU	N	6.42
1	A4	537:ARG	C	538:ASP	N	6.17
1	r	134:ARG	C	135:LEU	N	5.44
1	7	158:PHE	C	159:LYS	N	5.03
1	AV	269:SER	C	270:PRO	N	4.51

## 6 Map visualisation [i](#)

This section contains visualisations of the EMDB entry EMD-11391. These allow visual inspection of the internal detail of the map and identification of artifacts.

No raw map or half-maps were deposited for this entry and therefore no images, graphs, etc. pertaining to the raw map can be shown.

### 6.1 Orthogonal projections [i](#)

#### 6.1.1 Primary map

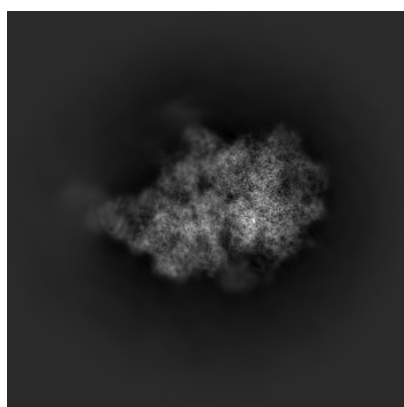

X

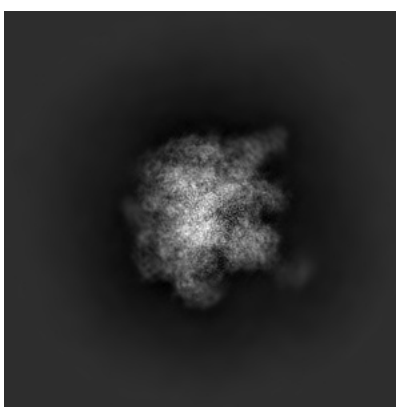

Y

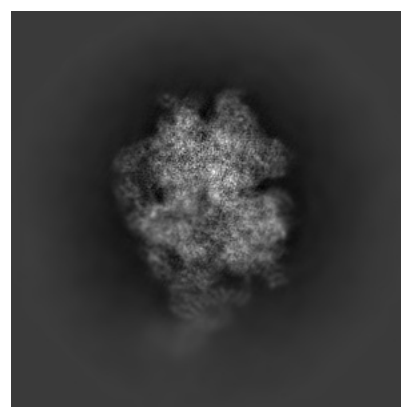

Z

The images above show the map projected in three orthogonal directions.

### 6.2 Central slices [i](#)

#### 6.2.1 Primary map

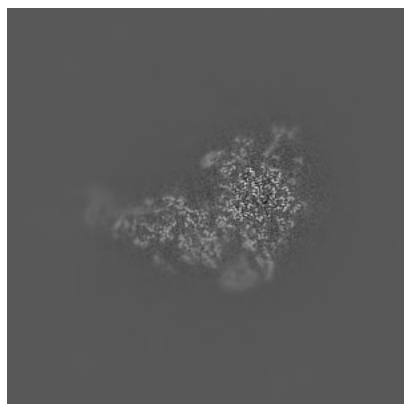

X Index: 260

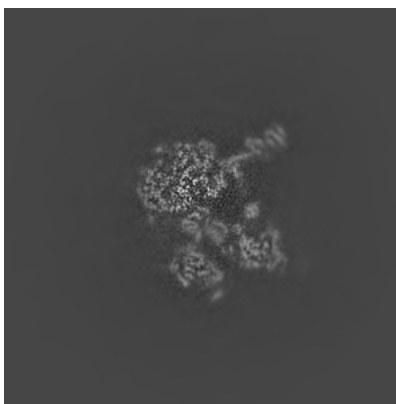

Y Index: 260

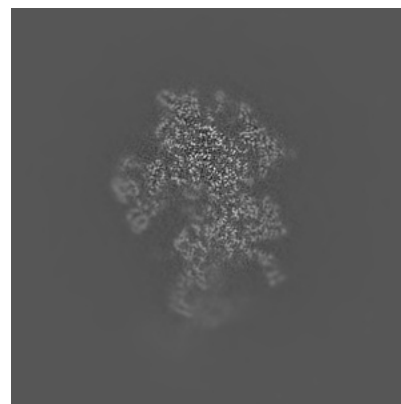

Z Index: 260

The images above show central slices of the map in three orthogonal directions.

## 6.3 Largest variance slices [\(i\)](#)

### 6.3.1 Primary map

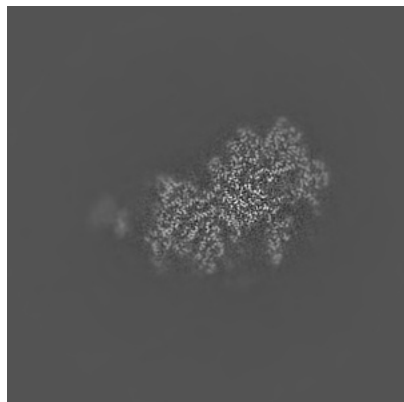

X Index: 281



Y Index: 321

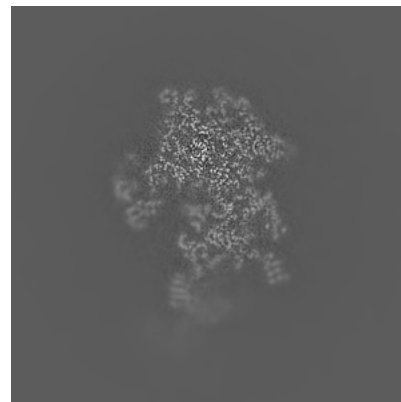

Z Index: 265

The images above show the largest variance slices of the map in three orthogonal directions.

## 6.4 Orthogonal standard-deviation projections (False-color) [\(i\)](#)

### 6.4.1 Primary map

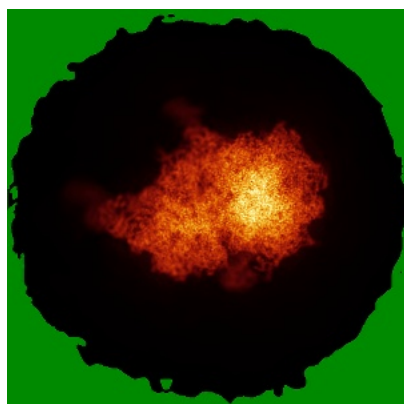

X

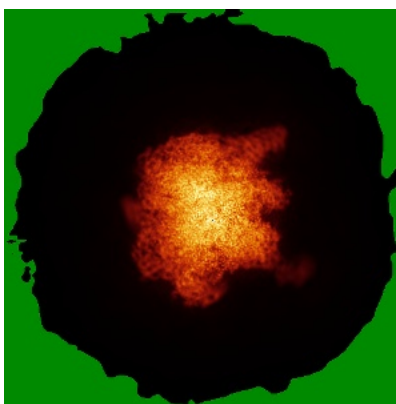

Y

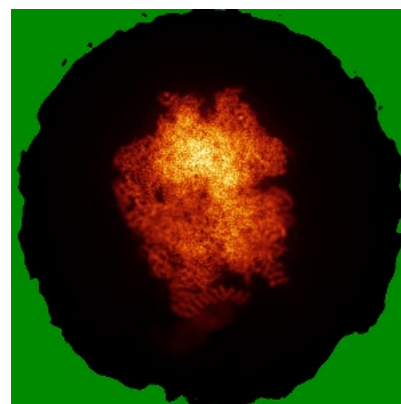

Z

The images above show the map standard deviation projections with false color in three orthogonal directions. Minimum values are shown in green, max in blue, and dark to light orange shades represent small to large values respectively.

## 6.5 Orthogonal surface views [i](#)

### 6.5.1 Primary map

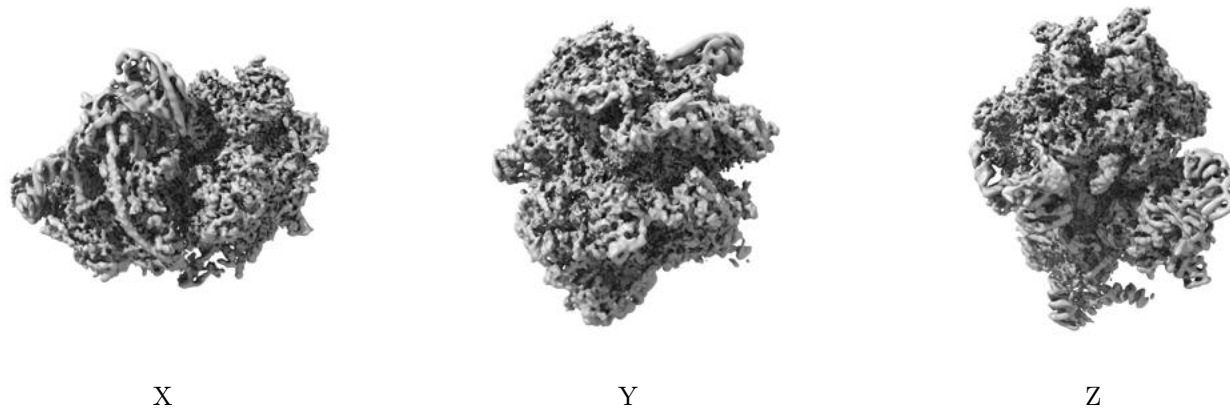

The images above show the 3D surface view of the map at the recommended contour level 0.02. These images, in conjunction with the slice images, may facilitate assessment of whether an appropriate contour level has been provided.

## 6.6 Mask visualisation [i](#)

This section was not generated. No masks/segmentation were deposited.

## 7 Map analysis [i](#)

This section contains the results of statistical analysis of the map.

### 7.1 Map-value distribution [i](#)

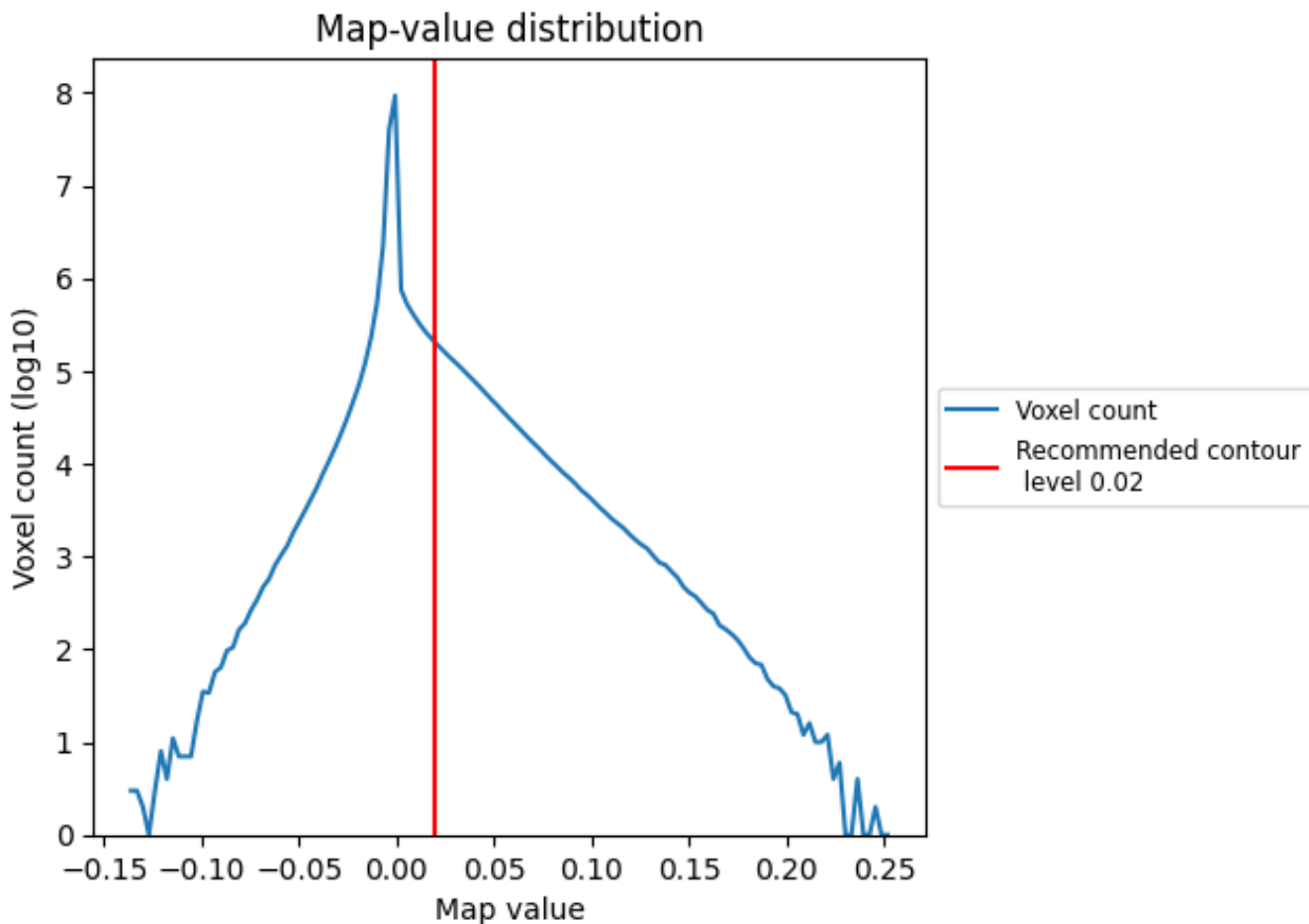

The map-value distribution is plotted in 128 intervals along the x-axis. The y-axis is logarithmic. A spike in this graph at zero usually indicates that the volume has been masked.

## 7.2 Volume estimate [\(i\)](#)

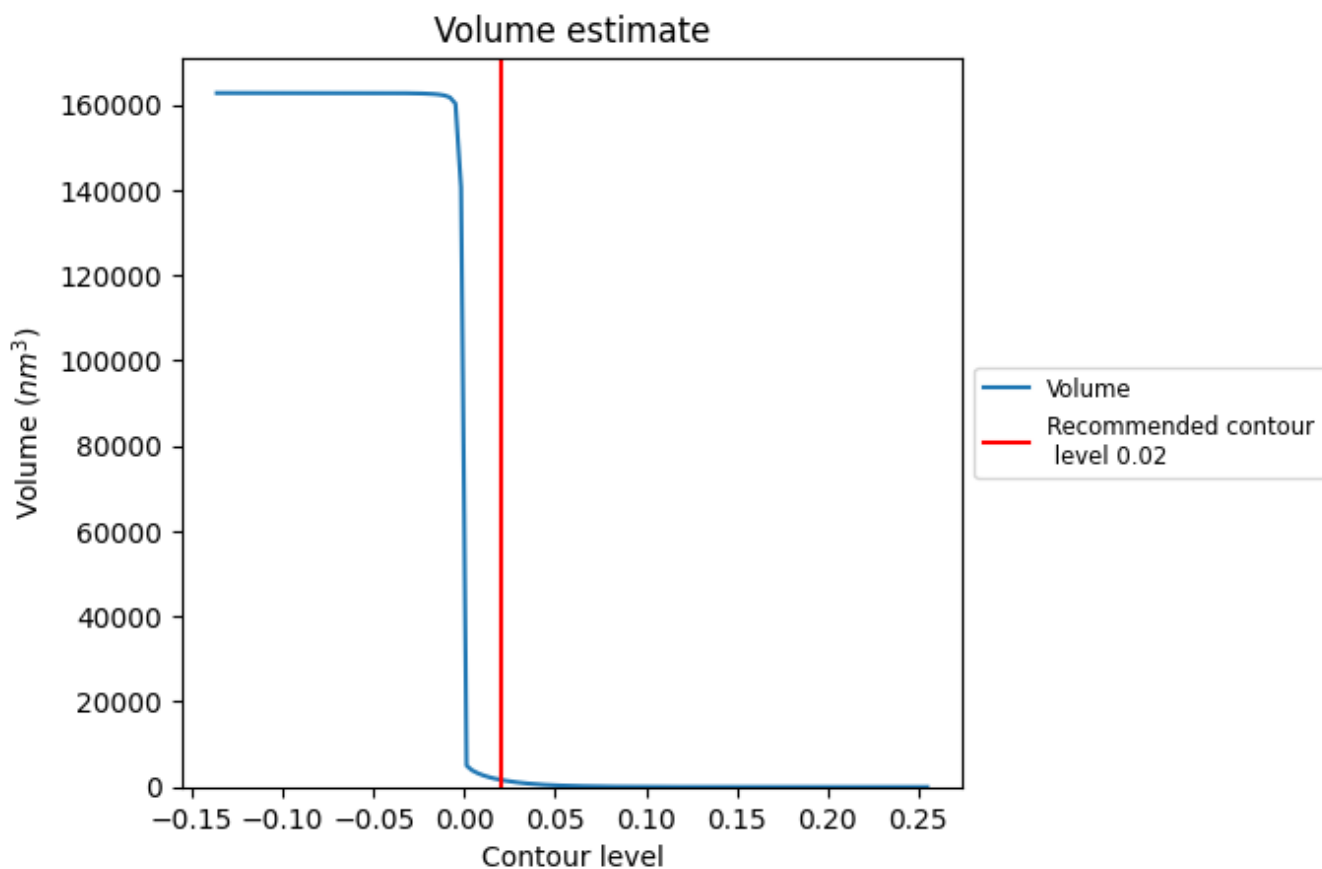

The volume at the recommended contour level is 1671  $\text{nm}^3$ ; this corresponds to an approximate mass of 1509 kDa.

The volume estimate graph shows how the enclosed volume varies with the contour level. The recommended contour level is shown as a vertical line and the intersection between the line and the curve gives the volume of the enclosed surface at the given level.

### 7.3 Rotationally averaged power spectrum [i](#)

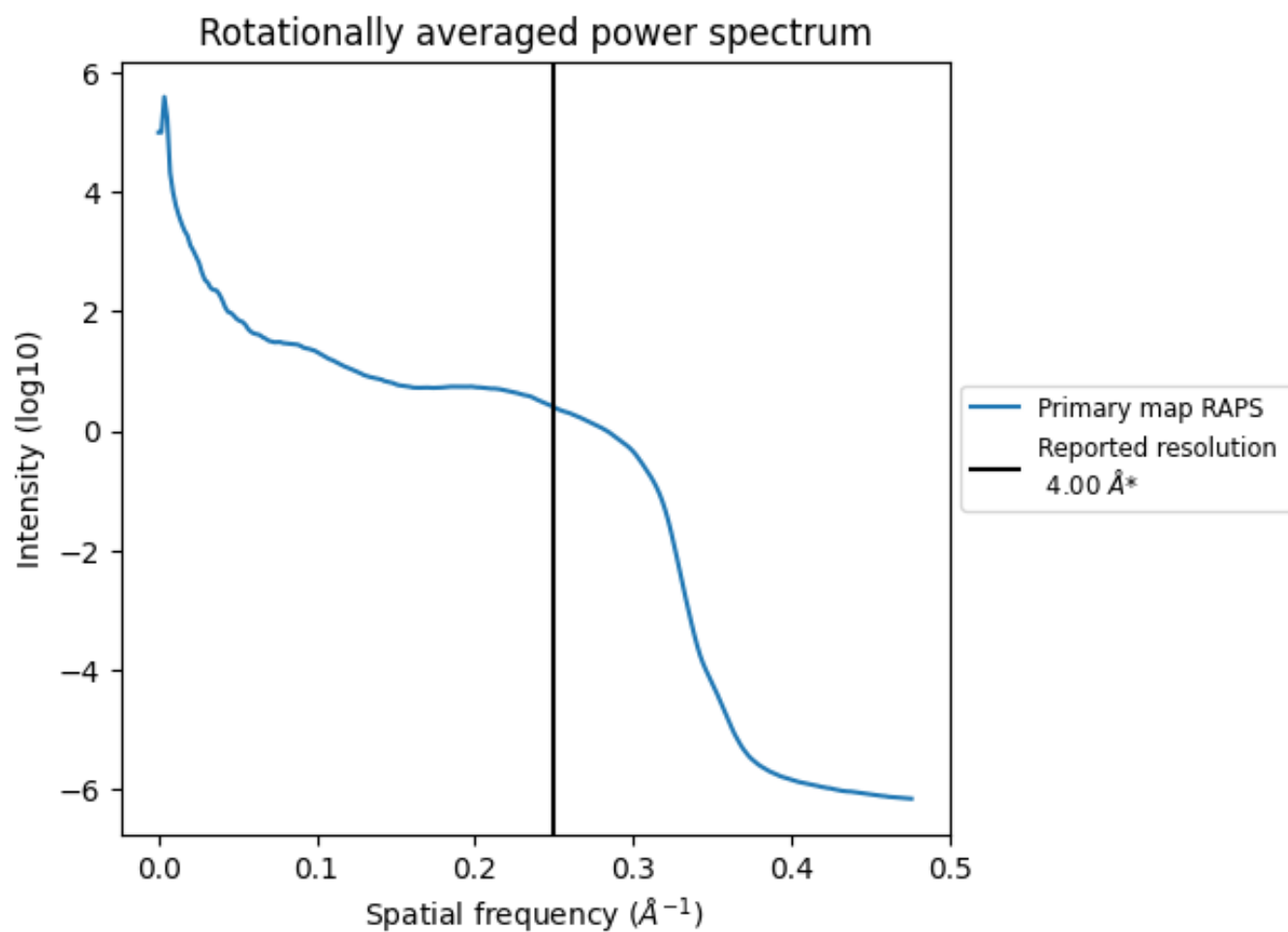

\*Reported resolution corresponds to spatial frequency of  $0.250 \text{\AA}^{-1}$



## 8 Fourier-Shell correlation

This section was not generated. No FSC curve or half-maps provided.

## 9 Map-model fit [i](#)

This section contains information regarding the fit between EMDB map EMD-11391 and PDB model 6ZSA. Per-residue inclusion information can be found in section 3 on page 23.

### 9.1 Map-model overlay [i](#)

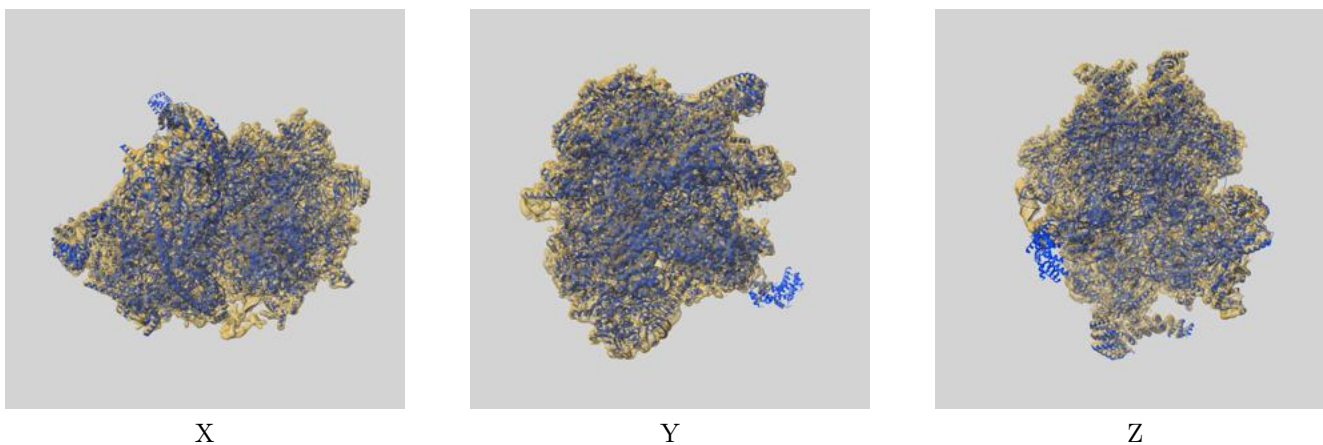

The images above show the 3D surface view of the map at the recommended contour level 0.02 at 50% transparency in yellow overlaid with a ribbon representation of the model coloured in blue. These images allow for the visual assessment of the quality of fit between the atomic model and the map.

## 9.2 Q-score mapped to coordinate model [i](#)

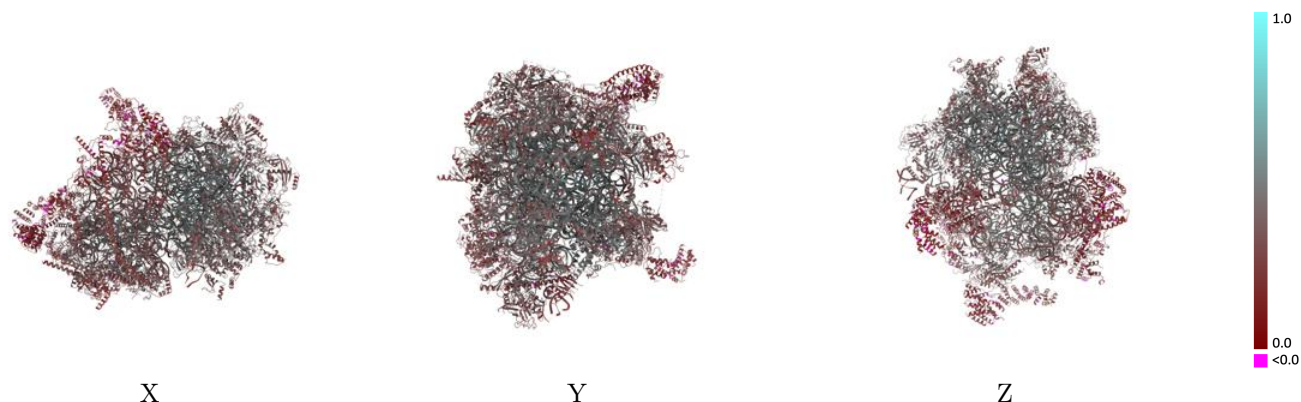

The images above show the model with each residue coloured according to its Q-score. This shows their resolvability in the map with higher Q-score values reflecting better resolvability. Please note: Q-score is calculating the resolvability of atoms, and thus high values are only expected at resolutions at which atoms can be resolved. Low Q-score values may therefore be expected for many entries.

## 9.3 Atom inclusion mapped to coordinate model [i](#)

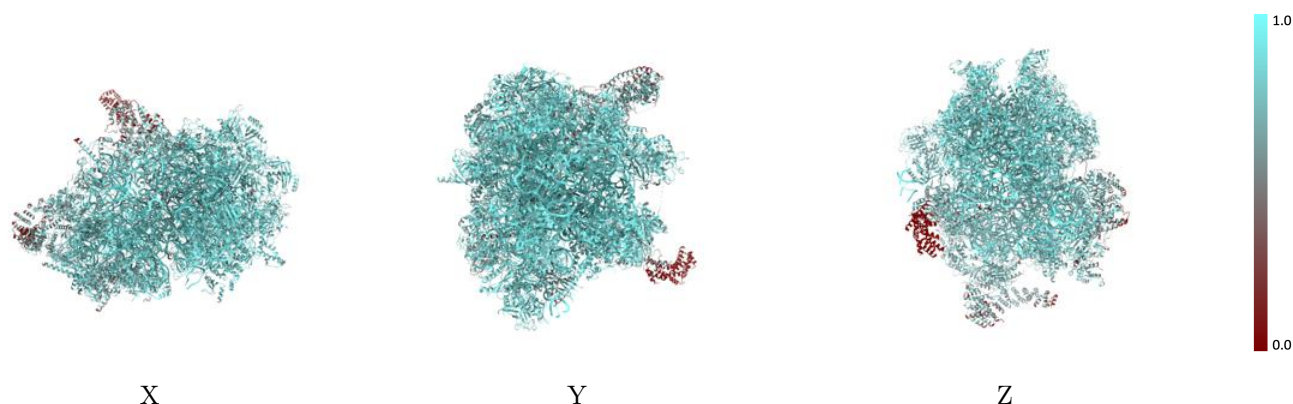

The images above show the model with each residue coloured according to its atom inclusion. This shows to what extent they are inside the map at the recommended contour level (0.02).



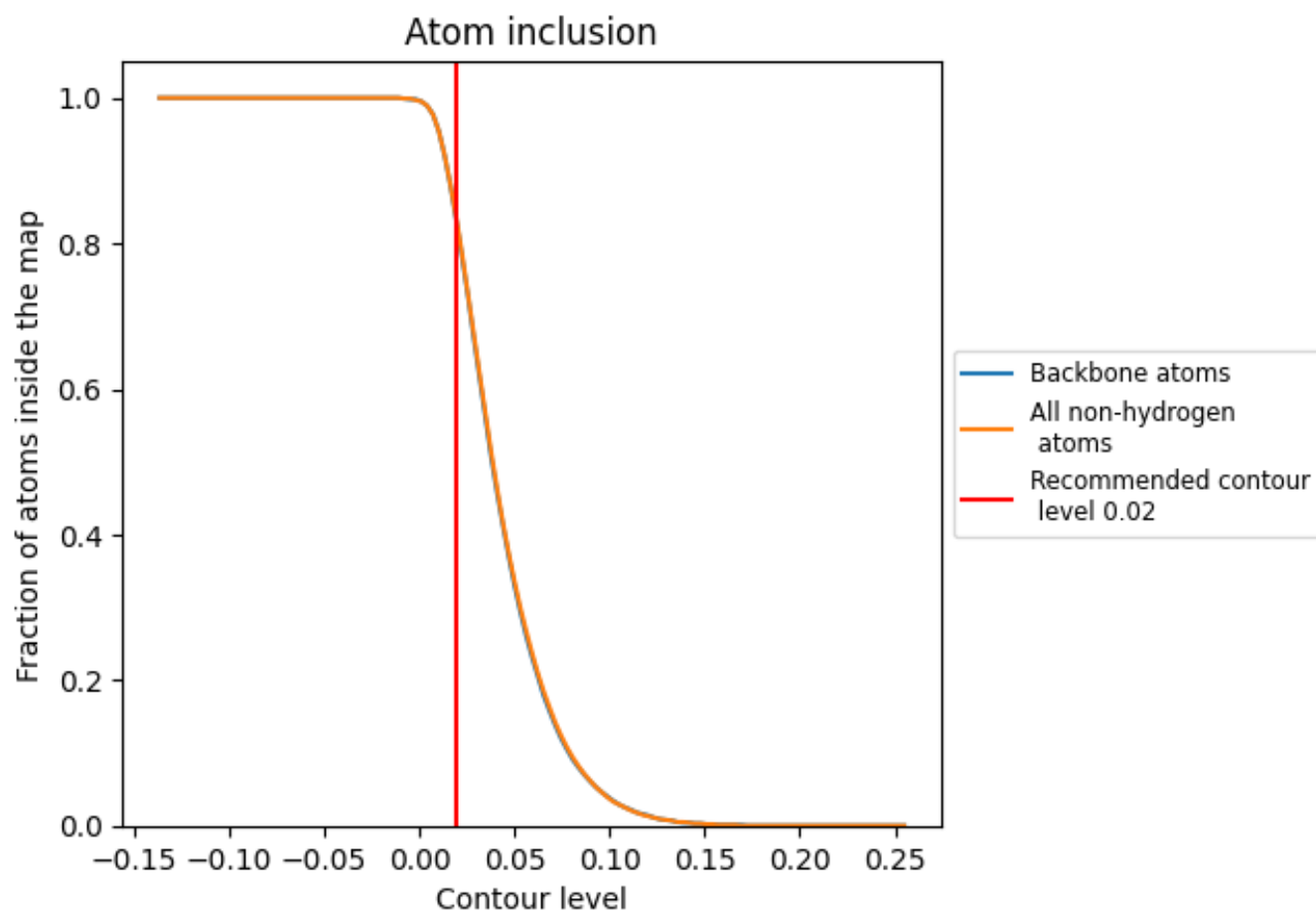



































































## 9.4 Atom inclusion [i](#)



At the recommended contour level, 82% of all backbone atoms, 83% of all non-hydrogen atoms, are inside the map.

## 9.5 Map-model fit summary





















































































The table lists the average atom inclusion at the recommended contour level (0.02) and Q-score for the entire model and for each chain.

Chain	Atom inclusion	Q-score
All	 0.8280	 0.3730
0	 0.8570	 0.4160
1	 0.8170	 0.3960
2	 0.9080	 0.5060
3	 0.8900	 0.4920
4	 0.8930	 0.4490
5	 0.8440	 0.3870
6	 0.8210	 0.3550
7	 0.8010	 0.3460
8	 0.7000	 0.2570
9	 0.8240	 0.3910
A0	 0.6440	 0.2010
A1	 0.7000	 0.2660
A2	 0.7480	 0.3320
A3	 0.8490	 0.4250
A4	 0.5500	 0.1770
AA	 0.9520	 0.3990
AB	 0.7980	 0.3570
AC	 0.7800	 0.3830
AD	 0.7830	 0.3650
AE	 0.7870	 0.3770
AF	 0.7610	 0.3070
AG	 0.7640	 0.3210
AH	 0.7730	 0.3530
AI	 0.8170	 0.3650
AJ	 0.8140	 0.3810
AK	 0.8050	 0.3430
AL	 0.7850	 0.3370
AM	 0.7350	 0.2570
AN	 0.8240	 0.3780
AO	 0.7570	 0.2970
AP	 0.8190	 0.3740
AQ	 0.8200	 0.3980
AR	 0.6730	 0.2250
AS	 0.7280	 0.2900



































*Continued on next page...*

*Continued from previous page...*

Chain	Atom inclusion	Q-score
AT	 0.7890	 0.3340
AU	 0.7160	 0.2470
AV	 0.5800	 0.1740
AW	 0.7830	 0.3380
AX	 0.6760	 0.2200
AY	 0.6810	 0.2510
AZ	 0.7700	 0.3010
XA	 0.9600	 0.4720
XB	 0.9600	 0.3310
XD	 0.8730	 0.4410
XE	 0.8570	 0.4270
XF	 0.8750	 0.4470
XH	 0.8100	 0.3720
XI	 0.5890	 0.2530
XJ	 0.6700	 0.2100
XK	 0.8690	 0.4400
XL	 0.8650	 0.4400
XM	 0.8560	 0.4280
XN	 0.8490	 0.4330
XO	 0.8620	 0.4220
XP	 0.8560	 0.3920
XQ	 0.7900	 0.3840
XR	 0.8740	 0.4590
XS	 0.8580	 0.4520
XT	 0.8800	 0.4590
XU	 0.8670	 0.4160
XV	 0.8200	 0.3710
XW	 0.8840	 0.4650
XX	 0.8390	 0.3900
XY	 0.8640	 0.4130
XZ	 0.8900	 0.4580
a	 0.8140	 0.3980
b	 0.8810	 0.4450
c	 0.8350	 0.3830
d	 0.7690	 0.3320
e	 0.6740	 0.2090
f	 0.7390	 0.2970
g	 0.8500	 0.4210
h	 0.8050	 0.3410
i	 0.8890	 0.4740
j	 0.8510	 0.4080
k	 0.7400	 0.2650

*Continued on next page...*

*Continued from previous page...*

Chain	Atom inclusion	Q-score
l	 0.7160	 0.2640
m	 0.7670	 0.2760
o	 0.9080	 0.4610
p	 0.8050	 0.3370
q	 0.7240	 0.2920
r	 0.8530	 0.4010
r1	 0.8570	 0.3870
r2	 0.8130	 0.2540
r3	 0.8600	 0.3070
s	 0.8550	 0.4030
t1	 0.2240	 0.2110
t2	 0.2400	 0.1750
t3	 0.0000	 0.1630
t4	 0.0000	 0.1450
t5	 0.0000	 0.1030
t6	 0.0000	 0.1260