



Full wwPDB X-ray Structure Validation Report ⓘ

Oct 6, 2021 – 07:38 am BST

PDB ID : 7ALB
Title : human GCH-GFRP stimulatory complex 7-deaza-GTP bound
Authors : Ebenhoch, R.; Nar, H.
Deposited on : 2020-10-06
Resolution : 1.98 Å(reported)

This is a Full wwPDB X-ray Structure Validation Report for a publicly released PDB entry.

We welcome your comments at validation@mail.wwpdb.org

A user guide is available at

<https://www.wwpdb.org/validation/2017/XrayValidationReportHelp>

with specific help available everywhere you see the ⓘ symbol.

The following versions of software and data (see [references ⓘ](#)) were used in the production of this report:

MolProbity : 4.02b-467
Mogul : 1.8.5 (274361), CSD as541be (2020)
Xtriage (Phenix) : 1.13
EDS : 2.23.2
buster-report : 1.1.7 (2018)
Percentile statistics : 20191225.v01 (using entries in the PDB archive December 25th 2019)
Refmac : 5.8.0267
CCP4 : 7.1.010 (Gargrove)
Ideal geometry (proteins) : Engh & Huber (2001)
Ideal geometry (DNA, RNA) : Parkinson et al. (1996)
Validation Pipeline (wwPDB-VP) : 2.23.2

1 Overall quality at a glance

The following experimental techniques were used to determine the structure:

X-RAY DIFFRACTION

The reported resolution of this entry is 1.98 Å.

Percentile scores (ranging between 0-100) for global validation metrics of the entry are shown in the following graphic. The table shows the number of entries on which the scores are based.

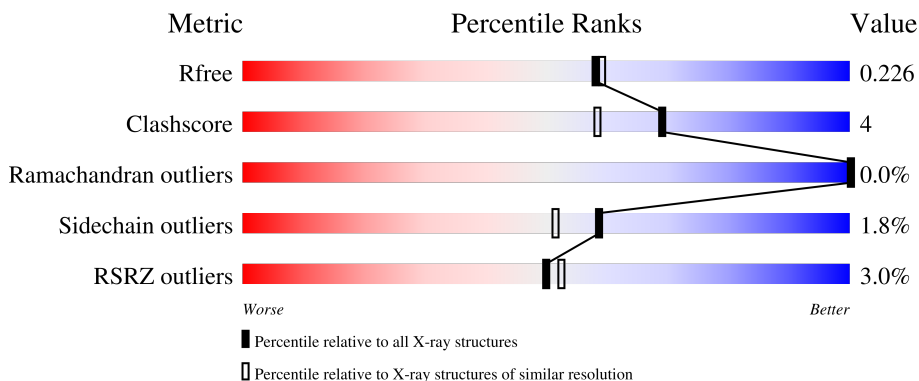









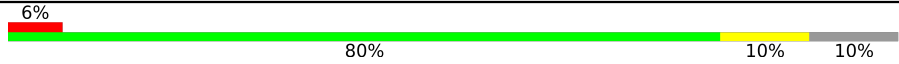

Metric	Whole archive (#Entries)	Similar resolution (#Entries, resolution range(Å))
R_{free}	130704	11647 (2.00-1.96)
Clashscore	141614	1014 (1.98-1.98)
Ramachandran outliers	138981	1006 (1.98-1.98)
Sidechain outliers	138945	1006 (1.98-1.98)
RSRZ outliers	127900	11410 (2.00-1.96)

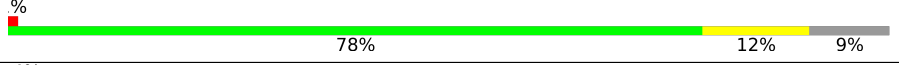
The table below summarises the geometric issues observed across the polymeric chains and their fit to the electron density. The red, orange, yellow and green segments of the lower bar indicate the fraction of residues that contain outliers for ≥ 3 , 2, 1 and 0 types of geometric quality criteria respectively. A grey segment represents the fraction of residues that are not modelled. The numeric value for each fraction is indicated below the corresponding segment, with a dot representing fractions $\leq 5\%$. The upper red bar (where present) indicates the fraction of residues that have poor fit to the electron density. The numeric value is given above the bar.

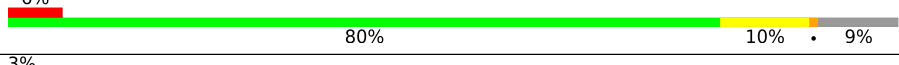
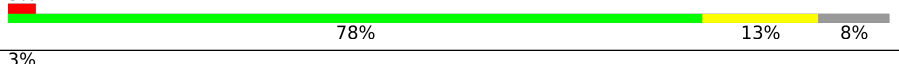
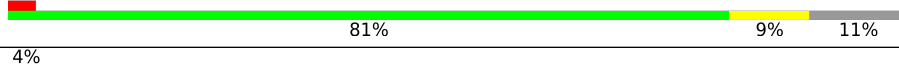
Mol	Chain	Length	Quality of chain
1	A	209	 5% 79% 11% 8%
1	B	209	 % 80% 9% 11%
1	C	209	 3% 78% 12% 9%
1	D	209	 % 81% 11% 8%
1	E	209	 3% 83% 9% 8%

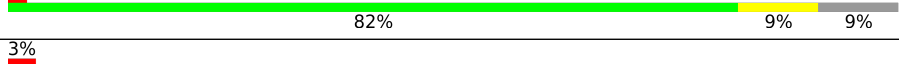
Continued on next page...

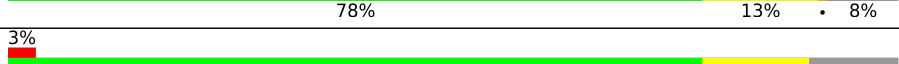
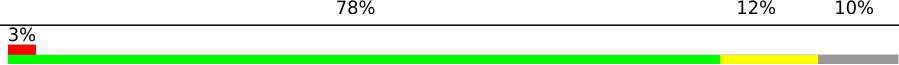
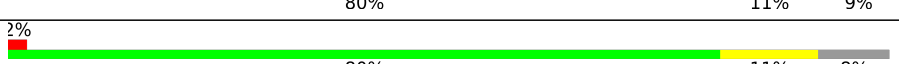
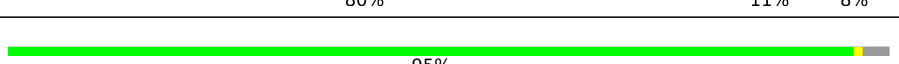
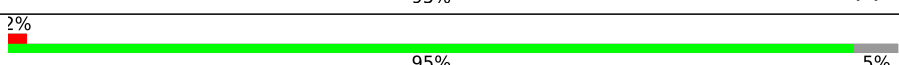
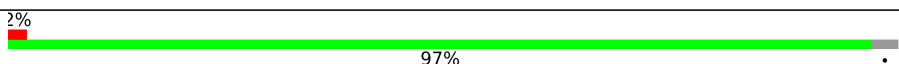
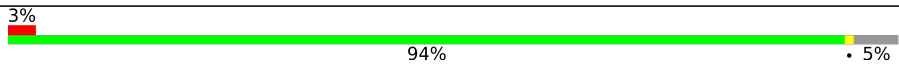
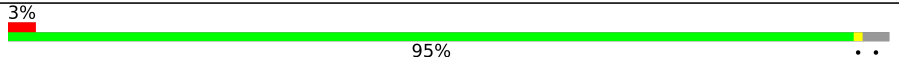
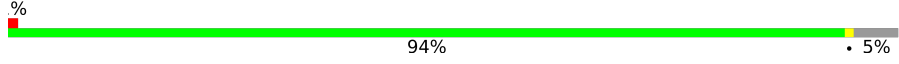
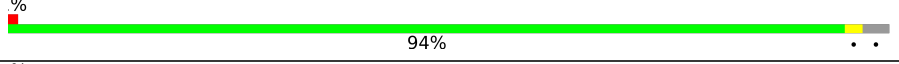
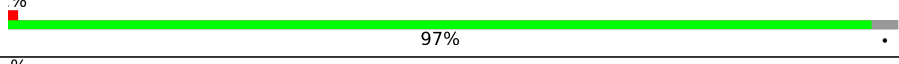
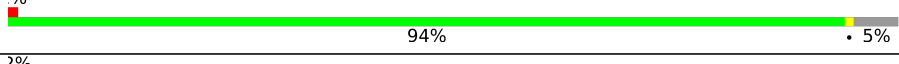
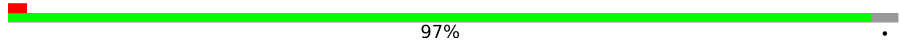
Continued from previous page...

Mol	Chain	Length	Quality of chain
1	F	209	
1	G	209	
1	H	209	
1	I	209	
1	J	209	
1	K	209	
1	L	209	
1	M	209	
1	N	209	
1	O	209	
1	P	209	
1	Q	209	
1	R	209	
1	S	209	
1	T	209	
2	a	87	
2	b	87	
2	c	87	
2	d	87	
2	e	87	
2	f	87	
2	g	87	
2	h	87	
2	i	87	
2	j	87	

Continued on next page...

Continued from previous page...

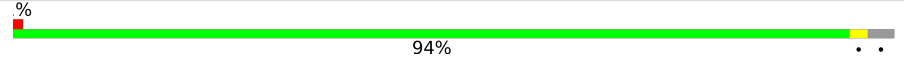
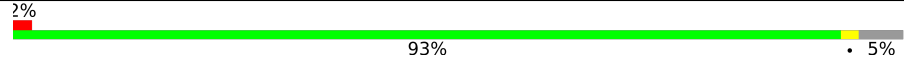
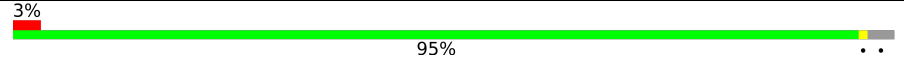
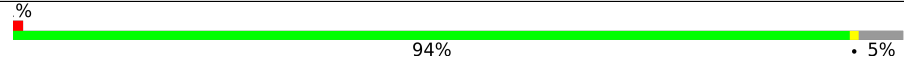
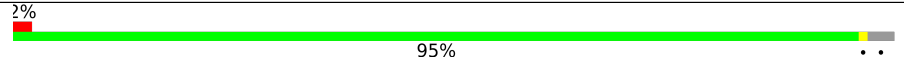
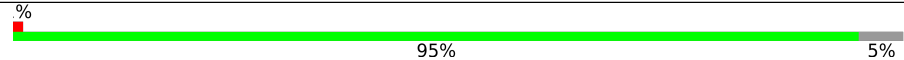
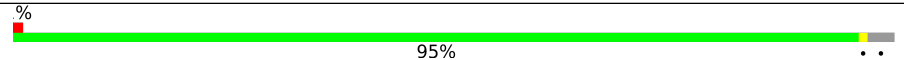
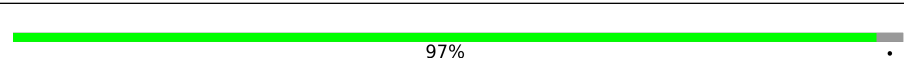
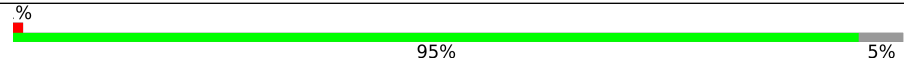
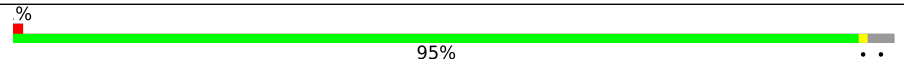
Mol	Chain	Length	Quality of chain
2	k	87	 <p>% 94% • 5%</p>
2	l	87	 <p>2% 93% • 5%</p>
2	m	87	 <p>3% 95% • •</p>
2	n	87	 <p>% 94% • 5%</p>
2	o	87	 <p>2% 95% • •</p>
2	p	87	 <p>% 95% 5%</p>
2	q	87	 <p>% 95% • •</p>
2	r	87	 <p>97% •</p>
2	s	87	 <p>% 95% 5%</p>
2	t	87	 <p>% 95% • •</p>

2 Entry composition

There are 6 unique types of molecules in this entry. The entry contains 45674 atoms, of which 340 are hydrogens and 0 are deuteriums.

In the tables below, the ZeroOcc column contains the number of atoms modelled with zero occupancy, the AltConf column contains the number of residues with at least one atom in alternate conformation and the Trace column contains the number of residues modelled with at most 2 atoms.

- Molecule 1 is a protein called GTP cyclohydrolase 1.

Mol	Chain	Residues	Atoms					ZeroOcc	AltConf	Trace
			Total	C	N	O	S			
1	A	192	Total 1515	C 956	N 265	O 283	S 11	0	0	0
1	B	187	Total 1473	C 932	N 257	O 273	S 11	0	0	0
1	C	190	Total 1497	C 945	N 260	O 281	S 11	0	0	0
1	D	192	Total 1523	C 961	N 266	O 284	S 12	0	1	0
1	E	192	Total 1515	C 956	N 265	O 283	S 11	0	0	0
1	F	189	Total 1496	C 946	N 261	O 277	S 12	0	1	0
1	G	189	Total 1488	C 941	N 260	O 276	S 11	0	0	0
1	H	190	Total 1498	C 947	N 263	O 277	S 11	0	0	0
1	I	190	Total 1497	C 945	N 260	O 281	S 11	0	0	0
1	J	190	Total 1498	C 947	N 263	O 277	S 11	0	0	0
1	K	192	Total 1515	C 956	N 265	O 283	S 11	0	0	0
1	L	187	Total 1473	C 932	N 257	O 273	S 11	0	0	0
1	M	190	Total 1497	C 945	N 260	O 281	S 11	0	0	0
1	N	190	Total 1497	C 946	N 261	O 279	S 11	0	0	0
1	O	192	Total 1515	C 956	N 265	O 283	S 11	0	0	0
1	P	192	Total 1515	C 956	N 265	O 283	S 11	0	0	0

Continued on next page...

Continued from previous page...

Mol	Chain	Residues	Atoms					ZeroOcc	AltConf	Trace
1	Q	192	Total	C	N	O	S	0	0	0
			1515	956	265	283	11			
1	R	188	Total	C	N	O	S	0	0	0
			1480	937	259	273	11			
1	S	190	Total	C	N	O	S	0	0	0
			1497	945	260	281	11			
1	T	192	Total	C	N	O	S	0	0	0
			1511	954	265	281	11			

- Molecule 2 is a protein called GTP cyclohydrolase 1 feedback regulatory protein.

Mol	Chain	Residues	Atoms					ZeroOcc	AltConf	Trace
2	a	84	Total	C	N	O	S	0	0	0
			678	429	119	124	6			
2	b	83	Total	C	N	O	S	0	0	0
			670	424	118	123	5			
2	c	84	Total	C	N	O	S	0	0	0
			678	429	119	124	6			
2	d	83	Total	C	N	O	S	0	0	0
			669	424	118	121	6			
2	e	84	Total	C	N	O	S	0	0	0
			678	429	119	124	6			
2	f	83	Total	C	N	O	S	0	0	0
			669	424	118	121	6			
2	g	84	Total	C	N	O	S	0	0	0
			678	429	119	124	6			
2	h	84	Total	C	N	O	S	0	0	0
			678	429	119	124	6			
2	i	83	Total	C	N	O	S	0	0	0
			669	424	118	121	6			
2	j	84	Total	C	N	O	S	0	0	0
			678	429	119	124	6			
2	k	84	Total	C	N	O	S	0	0	0
			678	429	119	124	6			
2	l	83	Total	C	N	O	S	0	0	0
			669	424	118	121	6			
2	m	84	Total	C	N	O	S	0	0	0
			678	429	119	124	6			
2	n	83	Total	C	N	O	S	0	0	0
			669	424	118	121	6			
2	o	84	Total	C	N	O	S	0	0	0
			678	429	119	124	6			

Continued on next page...

Continued from previous page...

Mol	Chain	Residues	Atoms					ZeroOcc	AltConf	Trace
2	p	83	Total	C	N	O	S	0	0	0
			669	424	118	121	6			
2	q	84	Total	C	N	O	S	0	0	0
			678	429	119	124	6			
2	r	84	Total	C	N	O	S	0	0	0
			678	429	119	124	6			
2	s	83	Total	C	N	O	S	0	0	0
			669	424	118	121	6			
2	t	84	Total	C	N	O	S	0	0	0
			678	429	119	124	6			

There are 60 discrepancies between the modelled and reference sequences:

Chain	Residue	Modelled	Actual	Comment	Reference
a	-2	GLY	-	expression tag	UNP P30047
a	-1	SER	-	expression tag	UNP P30047
a	0	HIS	-	expression tag	UNP P30047
b	-2	GLY	-	expression tag	UNP P30047
b	-1	SER	-	expression tag	UNP P30047
b	0	HIS	-	expression tag	UNP P30047
c	-2	GLY	-	expression tag	UNP P30047
c	-1	SER	-	expression tag	UNP P30047
c	0	HIS	-	expression tag	UNP P30047
d	-2	GLY	-	expression tag	UNP P30047
d	-1	SER	-	expression tag	UNP P30047
d	0	HIS	-	expression tag	UNP P30047
e	-2	GLY	-	expression tag	UNP P30047
e	-1	SER	-	expression tag	UNP P30047
e	0	HIS	-	expression tag	UNP P30047
f	-2	GLY	-	expression tag	UNP P30047
f	-1	SER	-	expression tag	UNP P30047
f	0	HIS	-	expression tag	UNP P30047
g	-2	GLY	-	expression tag	UNP P30047
g	-1	SER	-	expression tag	UNP P30047
g	0	HIS	-	expression tag	UNP P30047
h	-2	GLY	-	expression tag	UNP P30047
h	-1	SER	-	expression tag	UNP P30047
h	0	HIS	-	expression tag	UNP P30047
i	-2	GLY	-	expression tag	UNP P30047
i	-1	SER	-	expression tag	UNP P30047
i	0	HIS	-	expression tag	UNP P30047
j	-2	GLY	-	expression tag	UNP P30047
j	-1	SER	-	expression tag	UNP P30047

Continued on next page...

Continued from previous page...

Chain	Residue	Modelled	Actual	Comment	Reference
j	0	HIS	-	expression tag	UNP P30047
k	-2	GLY	-	expression tag	UNP P30047
k	-1	SER	-	expression tag	UNP P30047
k	0	HIS	-	expression tag	UNP P30047
l	-2	GLY	-	expression tag	UNP P30047
l	-1	SER	-	expression tag	UNP P30047
l	0	HIS	-	expression tag	UNP P30047
m	-2	GLY	-	expression tag	UNP P30047
m	-1	SER	-	expression tag	UNP P30047
m	0	HIS	-	expression tag	UNP P30047
n	-2	GLY	-	expression tag	UNP P30047
n	-1	SER	-	expression tag	UNP P30047
n	0	HIS	-	expression tag	UNP P30047
o	-2	GLY	-	expression tag	UNP P30047
o	-1	SER	-	expression tag	UNP P30047
o	0	HIS	-	expression tag	UNP P30047
p	-2	GLY	-	expression tag	UNP P30047
p	-1	SER	-	expression tag	UNP P30047
p	0	HIS	-	expression tag	UNP P30047
q	-2	GLY	-	expression tag	UNP P30047
q	-1	SER	-	expression tag	UNP P30047
q	0	HIS	-	expression tag	UNP P30047
r	-2	GLY	-	expression tag	UNP P30047
r	-1	SER	-	expression tag	UNP P30047
r	0	HIS	-	expression tag	UNP P30047
s	-2	GLY	-	expression tag	UNP P30047
s	-1	SER	-	expression tag	UNP P30047
s	0	HIS	-	expression tag	UNP P30047
t	-2	GLY	-	expression tag	UNP P30047
t	-1	SER	-	expression tag	UNP P30047
t	0	HIS	-	expression tag	UNP P30047

- Molecule 3 is ZINC ION (three-letter code: ZN) (formula: Zn) (labeled as "Ligand of Interest" by depositor).

Mol	Chain	Residues	Atoms	ZeroOcc	AltConf
3	A	1	Total Zn 1 1	0	0
3	B	1	Total Zn 1 1	0	0
3	C	1	Total Zn 1 1	0	0

Continued on next page...

Continued from previous page...

Mol	Chain	Residues	Atoms	ZeroOcc	AltConf
3	D	1	Total Zn 1 1	0	0
3	E	1	Total Zn 1 1	0	0
3	F	1	Total Zn 1 1	0	0
3	G	1	Total Zn 1 1	0	0
3	H	1	Total Zn 1 1	0	0
3	I	1	Total Zn 1 1	0	0
3	J	1	Total Zn 1 1	0	0
3	K	1	Total Zn 1 1	0	0
3	L	1	Total Zn 1 1	0	0
3	M	1	Total Zn 1 1	0	0
3	N	1	Total Zn 1 1	0	0
3	O	1	Total Zn 1 1	0	0
3	P	1	Total Zn 1 1	0	0
3	Q	1	Total Zn 1 1	0	0
3	R	1	Total Zn 1 1	0	0
3	S	1	Total Zn 1 1	0	0
3	T	1	Total Zn 1 1	0	0

- Molecule 4 is 7-deaza-GTP (three-letter code: QBQ) (formula: $C_{11}H_{17}N_4O_{14}P_3$) (labeled as "Ligand of Interest" by depositor).

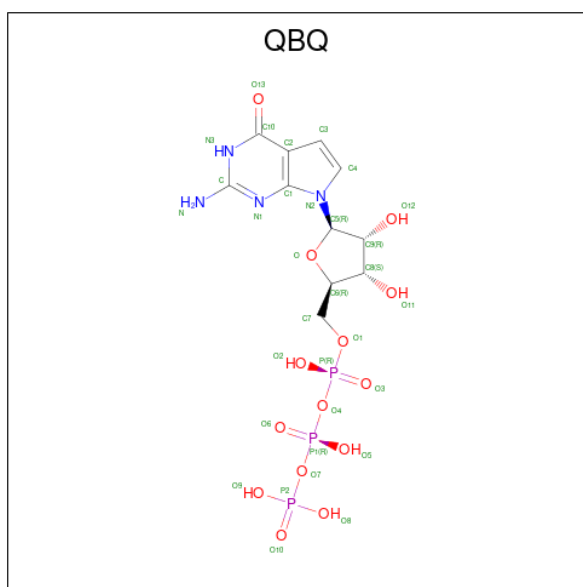

Mol	Chain	Residues	Atoms					ZeroOcc	AltConf	
			Total	C	H	N	O			P
4	A	1	Total 49	C 11	H 17	N 4	O 14	P 3	17	0
4	B	1	Total 49	C 11	H 17	N 4	O 14	P 3	17	0
4	C	1	Total 49	C 11	H 17	N 4	O 14	P 3	17	0
4	D	1	Total 49	C 11	H 17	N 4	O 14	P 3	17	0
4	E	1	Total 49	C 11	H 17	N 4	O 14	P 3	17	0
4	F	1	Total 49	C 11	H 17	N 4	O 14	P 3	17	0
4	G	1	Total 49	C 11	H 17	N 4	O 14	P 3	17	0
4	H	1	Total 49	C 11	H 17	N 4	O 14	P 3	17	0
4	I	1	Total 49	C 11	H 17	N 4	O 14	P 3	17	0
4	J	1	Total 49	C 11	H 17	N 4	O 14	P 3	17	0
4	K	1	Total 49	C 11	H 17	N 4	O 14	P 3	17	0
4	L	1	Total 49	C 11	H 17	N 4	O 14	P 3	17	0
4	M	1	Total 49	C 11	H 17	N 4	O 14	P 3	17	0
4	N	1	Total 49	C 11	H 17	N 4	O 14	P 3	17	0

Continued on next page...

Continued from previous page...

Mol	Chain	Residues	Atoms					ZeroOcc	AltConf	
			Total	C	H	N	O			P
4	O	1	Total 49	C 11	H 17	N 4	O 14	P 3	17	0
4	P	1	Total 49	C 11	H 17	N 4	O 14	P 3	17	0
4	Q	1	Total 49	C 11	H 17	N 4	O 14	P 3	17	0
4	R	1	Total 49	C 11	H 17	N 4	O 14	P 3	17	0
4	S	1	Total 49	C 11	H 17	N 4	O 14	P 3	17	0
4	T	1	Total 49	C 11	H 17	N 4	O 14	P 3	17	0

- Molecule 5 is PHENYLALANINE (three-letter code: PHE) (formula: $C_9H_{11}NO_2$) (labeled as "Ligand of Interest" by depositor).

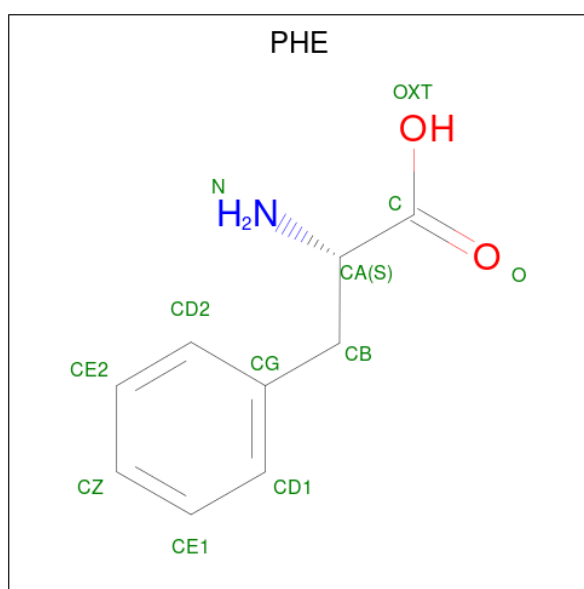

Mol	Chain	Residues	Atoms				ZeroOcc	AltConf
			Total	C	N	O		
5	a	1	Total 12	C 9	N 1	O 2	0	0
5	b	1	Total 12	C 9	N 1	O 2	0	0
5	c	1	Total 12	C 9	N 1	O 2	0	0
5	d	1	Total 12	C 9	N 1	O 2	0	0
5	e	1	Total 12	C 9	N 1	O 2	0	0

Continued on next page...

Continued from previous page...

Mol	Chain	Residues	Atoms				ZeroOcc	AltConf
5	f	1	Total	C	N	O	0	0
			12	9	1	2		
5	f	1	Total	C	N	O	0	0
			12	9	1	2		
5	g	1	Total	C	N	O	0	0
			12	9	1	2		
5	h	1	Total	C	N	O	0	0
			12	9	1	2		
5	i	1	Total	C	N	O	0	0
			12	9	1	2		
5	k	1	Total	C	N	O	0	0
			12	9	1	2		
5	l	1	Total	C	N	O	0	0
			12	9	1	2		
5	m	1	Total	C	N	O	0	0
			12	9	1	2		
5	n	1	Total	C	N	O	0	0
			12	9	1	2		
5	o	1	Total	C	N	O	0	0
			12	9	1	2		
5	p	1	Total	C	N	O	0	0
			12	9	1	2		
5	q	1	Total	C	N	O	0	0
			12	9	1	2		
5	r	1	Total	C	N	O	0	0
			12	9	1	2		
5	s	1	Total	C	N	O	0	0
			12	9	1	2		
5	t	1	Total	C	N	O	0	0
			12	9	1	2		

- Molecule 6 is water.

Mol	Chain	Residues	Atoms		ZeroOcc	AltConf
6	A	19	Total	O	0	0
			19	19		
6	B	15	Total	O	0	0
			15	15		
6	C	33	Total	O	0	0
			33	33		
6	D	40	Total	O	0	0
			40	40		

Continued on next page...

Continued from previous page...

Mol	Chain	Residues	Atoms	ZeroOcc	AltConf
6	E	28	Total O 28 28	0	0
6	F	26	Total O 26 26	0	0
6	G	48	Total O 48 48	0	0
6	H	32	Total O 32 32	0	0
6	I	24	Total O 24 24	0	0
6	J	8	Total O 8 8	0	0
6	K	29	Total O 29 29	0	0
6	L	22	Total O 22 22	0	0
6	M	29	Total O 29 29	0	0
6	N	33	Total O 33 33	0	0
6	O	25	Total O 25 25	0	0
6	P	40	Total O 40 40	0	0
6	Q	33	Total O 33 33	0	0
6	R	24	Total O 24 24	0	0
6	S	23	Total O 23 23	0	0
6	T	28	Total O 28 28	0	0
6	a	12	Total O 12 12	0	0
6	b	9	Total O 9 9	0	0
6	c	20	Total O 20 20	0	0
6	d	18	Total O 18 18	0	0
6	e	19	Total O 19 19	0	0

Continued on next page...

Continued from previous page...

Mol	Chain	Residues	Atoms		ZeroOcc	AltConf
6	f	23	Total 23	O 23	0	0
6	g	26	Total 26	O 26	0	0
6	h	28	Total 28	O 28	0	0
6	i	14	Total 14	O 14	0	0
6	j	4	Total 4	O 4	0	0
6	k	14	Total 14	O 14	0	0
6	l	16	Total 16	O 16	0	0
6	m	14	Total 14	O 14	0	0
6	n	18	Total 18	O 18	0	0
6	o	21	Total 21	O 21	0	0
6	p	22	Total 22	O 22	0	0
6	q	24	Total 24	O 24	0	0
6	r	25	Total 25	O 25	0	0
6	s	25	Total 25	O 25	0	0
6	t	19	Total 19	O 19	0	0

3 Residue-property plots [i](#)

These plots are drawn for all protein, RNA, DNA and oligosaccharide chains in the entry. The first graphic for a chain summarises the proportions of the various outlier classes displayed in the second graphic. The second graphic shows the sequence view annotated by issues in geometry and electron density. Residues are color-coded according to the number of geometric quality criteria for which they contain at least one outlier: green = 0, yellow = 1, orange = 2 and red = 3 or more. A red dot above a residue indicates a poor fit to the electron density ($RSRZ > 2$). Stretches of 2 or more consecutive residues without any outlier are shown as a green connector. Residues present in the sample, but not in the model, are shown in grey.

- Molecule 1: GTP cyclohydrolase 1

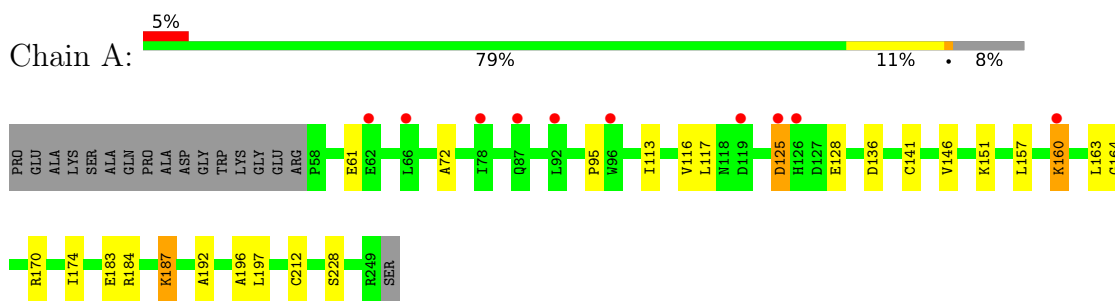

- Molecule 1: GTP cyclohydrolase 1

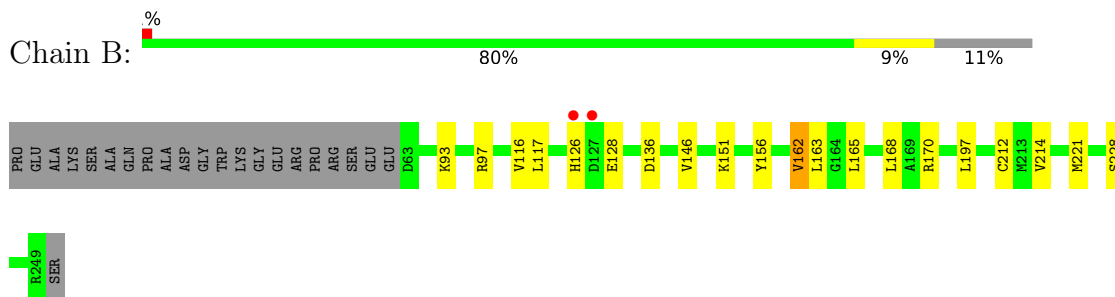

- Molecule 1: GTP cyclohydrolase 1

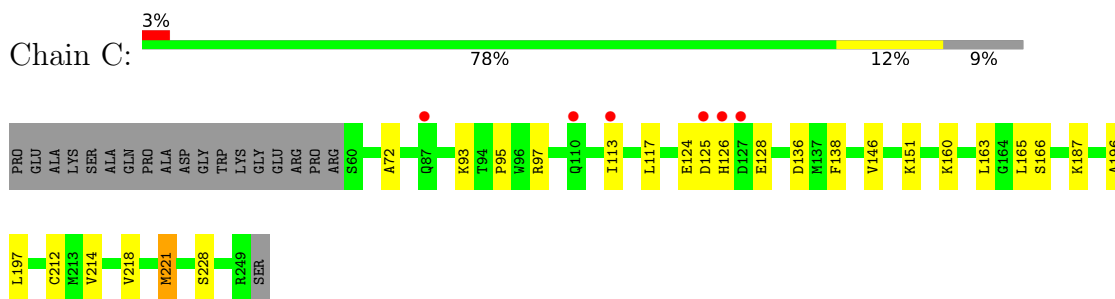

- Molecule 1: GTP cyclohydrolase 1

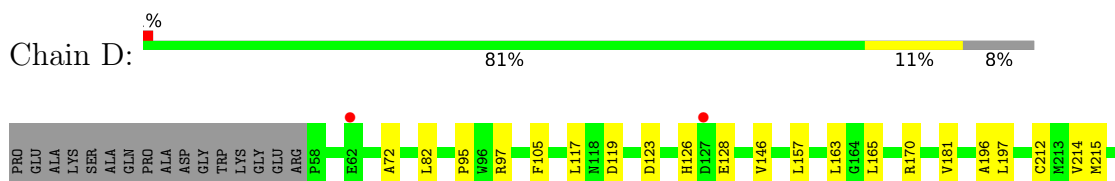



- Molecule 1: GTP cyclohydrolase 1

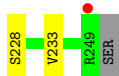
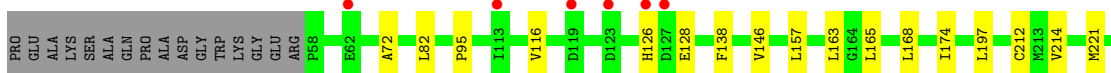
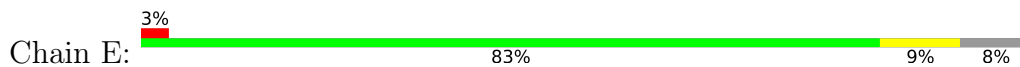

- Molecule 1: GTP cyclohydrolase 1

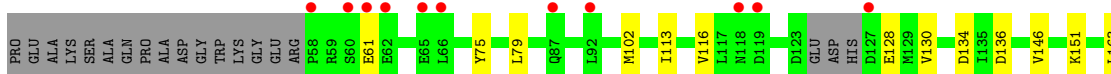
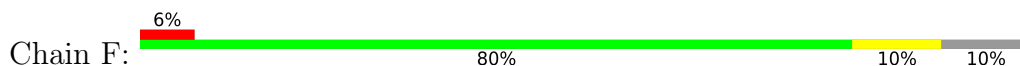

- Molecule 1: GTP cyclohydrolase 1

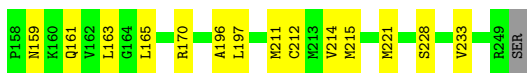
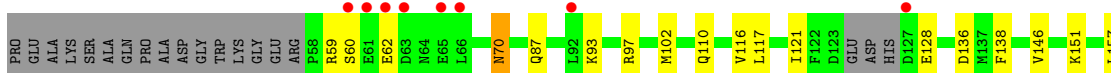
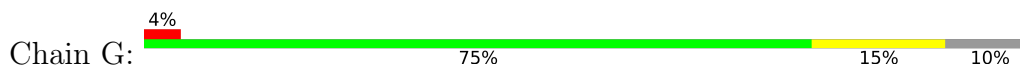

- Molecule 1: GTP cyclohydrolase 1

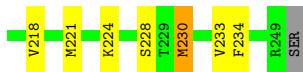
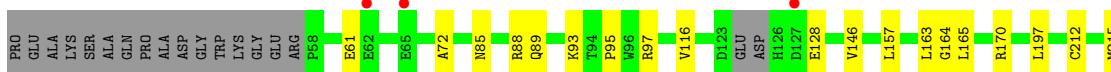
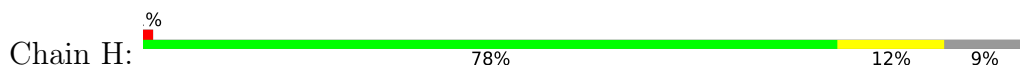

- Molecule 1: GTP cyclohydrolase 1

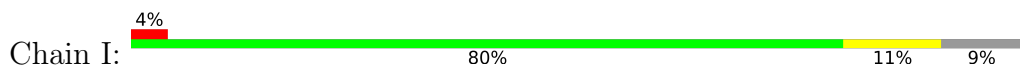

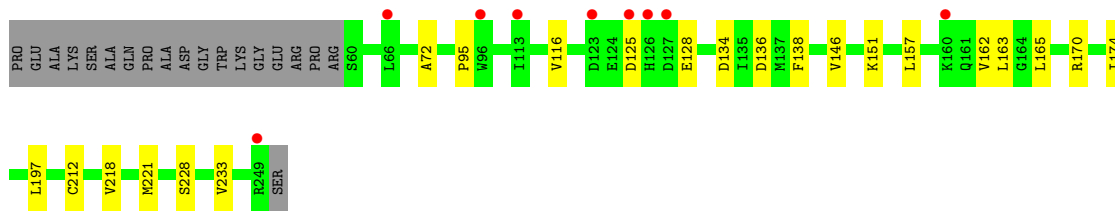

- Molecule 1: GTP cyclase 1

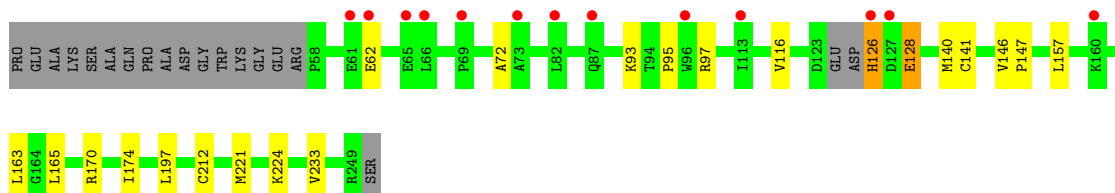
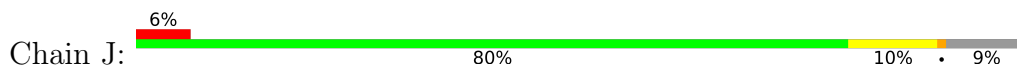

- Molecule 1: GTP cyclase 1

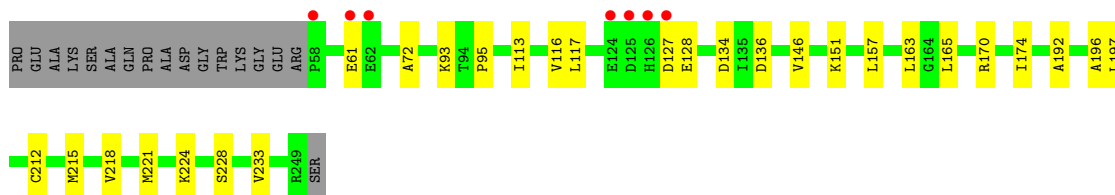
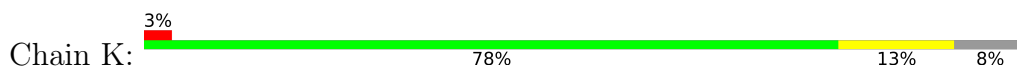

- Molecule 1: GTP cyclase 1

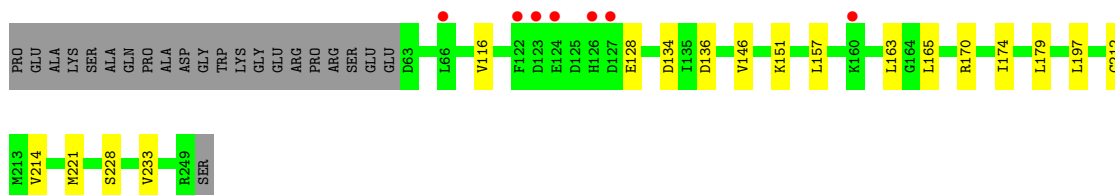
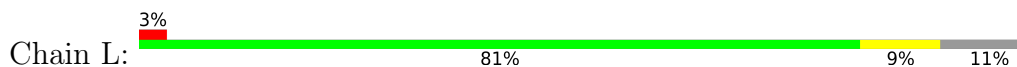

- Molecule 1: GTP cyclase 1

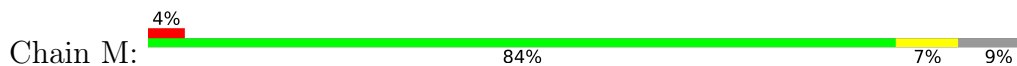

- Molecule 1: GTP cyclase 1

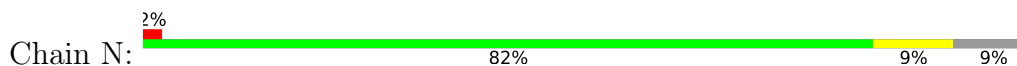

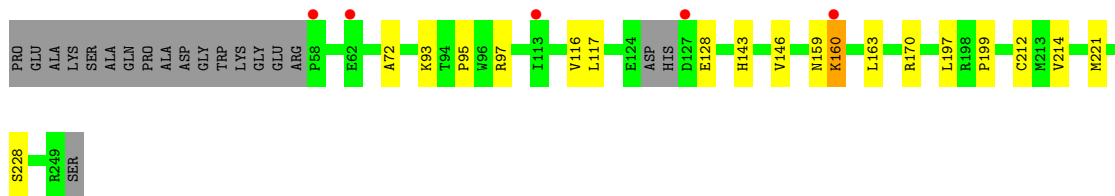

• Molecule 1: GTP cyclodolase 1

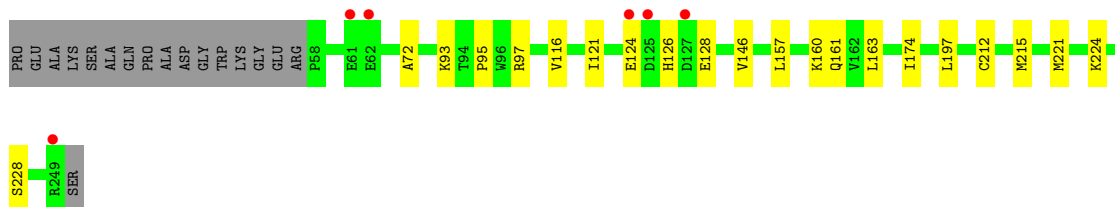
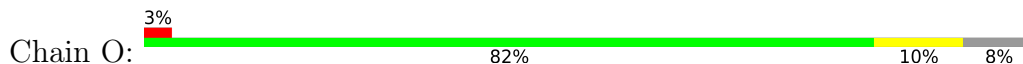

• Molecule 1: GTP cyclodolase 1

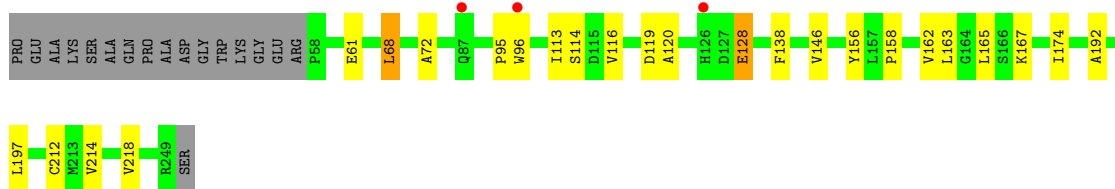
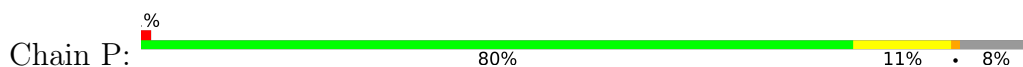

• Molecule 1: GTP cyclodolase 1

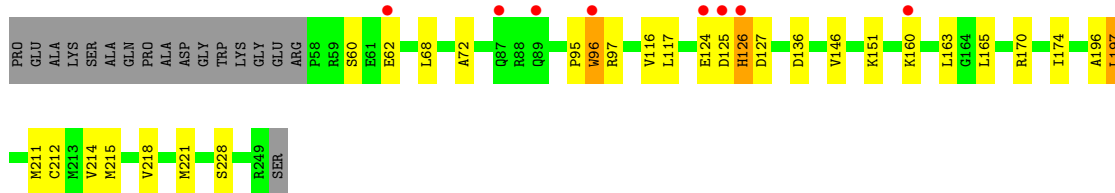
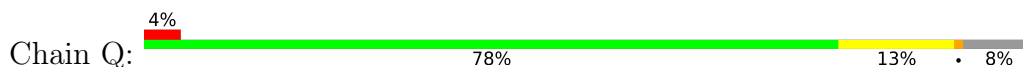

• Molecule 1: GTP cyclodolase 1

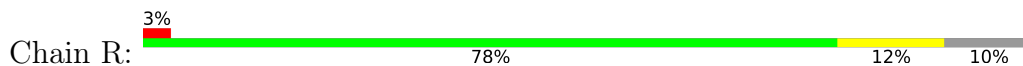

• Molecule 1: GTP cyclodolase 1

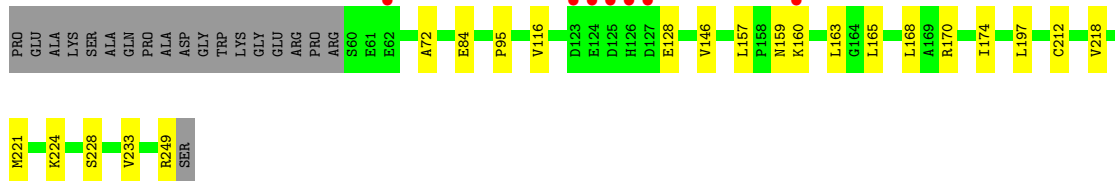
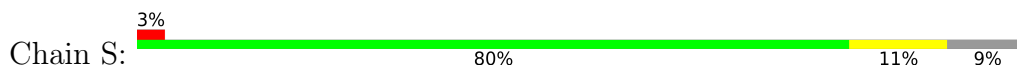

• Molecule 1: GTP cyclohydrolase 1

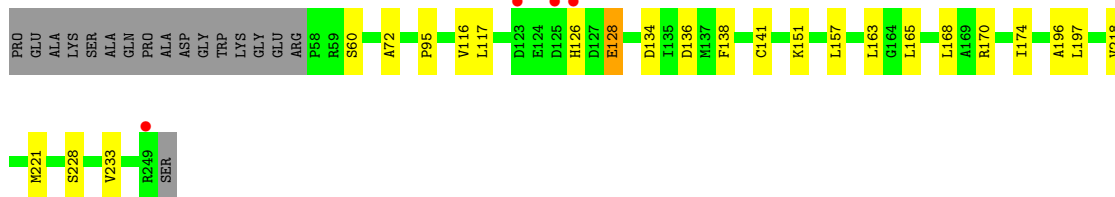
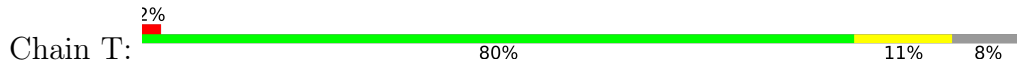

• Molecule 2: GTP cyclohydrolase 1 feedback regulatory protein



• Molecule 2: GTP cyclohydrolase 1 feedback regulatory protein



• Molecule 2: GTP cyclohydrolase 1 feedback regulatory protein



• Molecule 2: GTP cyclohydrolase 1 feedback regulatory protein

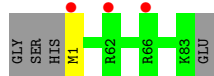

• Molecule 2: GTP cyclohydrolase 1 feedback regulatory protein

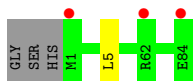

- Molecule 2: GTP cyclohydrolase 1 feedback regulatory protein

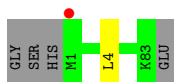

- Molecule 2: GTP cyclohydrolase 1 feedback regulatory protein

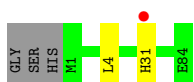

- Molecule 2: GTP cyclohydrolase 1 feedback regulatory protein



- Molecule 2: GTP cyclohydrolase 1 feedback regulatory protein

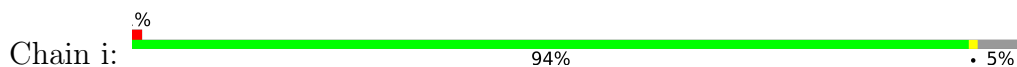

- Molecule 2: GTP cyclohydrolase 1 feedback regulatory protein

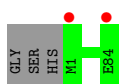

- Molecule 2: GTP cyclohydrolase 1 feedback regulatory protein

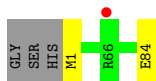

- Molecule 2: GTP cyclohydrolase 1 feedback regulatory protein

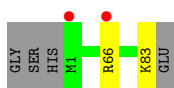
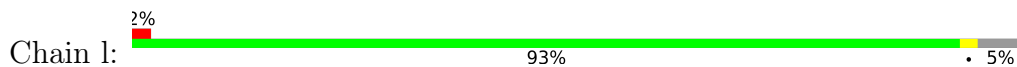

- Molecule 2: GTP cyclohydrolase 1 feedback regulatory protein

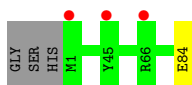

- Molecule 2: GTP cyclohydrolase 1 feedback regulatory protein

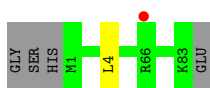

- Molecule 2: GTP cyclohydrolase 1 feedback regulatory protein

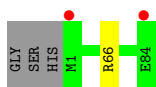

- Molecule 2: GTP cyclohydrolase 1 feedback regulatory protein

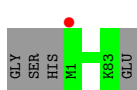

- Molecule 2: GTP cyclohydrolase 1 feedback regulatory protein

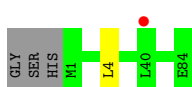

- Molecule 2: GTP cyclohydrolase 1 feedback regulatory protein





- Molecule 2: GTP cyclohydrolase 1 feedback regulatory protein

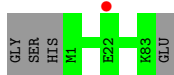
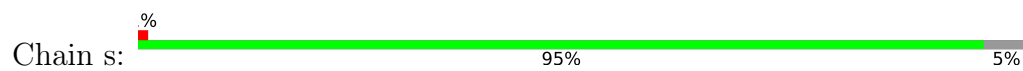

- Molecule 2: GTP cyclohydrolase 1 feedback regulatory protein



4 Data and refinement statistics

Property	Value	Source
Space group	P 1 21 1	Depositor
Cell constants a, b, c, α , β , γ	160.66Å 116.14Å 177.32Å 90.00° 94.94° 90.00°	Depositor
Resolution (Å)	160.06 – 1.98 160.06 – 1.98	Depositor EDS
% Data completeness (in resolution range)	72.5 (160.06-1.98) 72.5 (160.06-1.98)	Depositor EDS
R_{merge}	(Not available)	Depositor
R_{sym}	(Not available)	Depositor
$\langle I/\sigma(I) \rangle$ ¹	1.89 (at 1.98Å)	Xtrriage
Refinement program	BUSTER 2.11.7 (18-SEP-2020)	Depositor
R, R_{free}	0.206 , 0.225 0.208 , 0.226	Depositor DCC
R_{free} test set	3700 reflections (1.13%)	wwPDB-VP
Wilson B-factor (Å ²)	27.4	Xtrriage
Anisotropy	0.048	Xtrriage
Bulk solvent k_{sol} (e/Å ³), B_{sol} (Å ²)	(Not available) , (Not available)	EDS
L-test for twinning ²	$\langle L \rangle = 0.52$, $\langle L^2 \rangle = 0.35$	Xtrriage
Estimated twinning fraction	No twinning to report.	Xtrriage
F_o, F_c correlation	0.95	EDS
Total number of atoms	45674	wwPDB-VP
Average B, all atoms (Å ²)	33.0	wwPDB-VP

Xtrriage's analysis on translational NCS is as follows: *The analyses of the Patterson function reveals a significant off-origin peak that is 45.44 % of the origin peak, indicating pseudo-translational symmetry. The chance of finding a peak of this or larger height randomly in a structure without pseudo-translational symmetry is equal to 1.3204e-04. The detected translational NCS is most likely also responsible for the elevated intensity ratio.*

¹Intensities estimated from amplitudes.

²Theoretical values of $\langle |L| \rangle$, $\langle L^2 \rangle$ for acentric reflections are 0.5, 0.333 respectively for untwinned datasets, and 0.375, 0.2 for perfectly twinned datasets.

5 Model quality [i](#)

5.1 Standard geometry [i](#)

Bond lengths and bond angles in the following residue types are not validated in this section: QBQ, ZN

The Z score for a bond length (or angle) is the number of standard deviations the observed value is removed from the expected value. A bond length (or angle) with $|Z| > 5$ is considered an outlier worth inspection. RMSZ is the root-mean-square of all Z scores of the bond lengths (or angles).

Mol	Chain	Bond lengths		Bond angles	
		RMSZ	# Z >5	RMSZ	# Z >5
1	A	0.44	0/1540	0.62	0/2079
1	B	0.43	0/1497	0.64	0/2022
1	C	0.46	0/1521	0.63	0/2054
1	D	0.46	0/1548	0.64	0/2089
1	E	0.45	0/1540	0.62	0/2079
1	F	0.48	0/1519	0.65	0/2048
1	G	0.48	0/1511	0.64	0/2038
1	H	0.47	1/1522 (0.1%)	0.63	0/2053
1	I	0.46	0/1521	0.63	0/2054
1	J	0.44	0/1522	0.62	0/2053
1	K	0.45	0/1540	0.63	0/2079
1	L	0.45	0/1497	0.64	0/2022
1	M	0.44	0/1521	0.62	0/2054
1	N	0.43	0/1520	0.62	0/2050
1	O	0.44	0/1540	0.63	0/2079
1	P	0.48	0/1540	0.65	0/2079
1	Q	0.46	0/1540	0.65	0/2079
1	R	0.45	0/1503	0.62	0/2027
1	S	0.43	0/1521	0.62	0/2054
1	T	0.45	0/1536	0.62	0/2074
2	a	0.38	0/692	0.56	0/934
2	b	0.36	0/684	0.56	0/923
2	c	0.37	0/692	0.56	0/934
2	d	0.37	0/683	0.55	0/922
2	e	0.39	0/692	0.57	0/934
2	f	0.38	0/683	0.56	0/922
2	g	0.40	0/692	0.57	0/934
2	h	0.40	0/692	0.57	0/934
2	i	0.39	0/683	0.56	0/922
2	j	0.37	0/692	0.55	0/934
2	k	0.36	0/692	0.56	0/934
2	l	0.35	0/683	0.55	0/922

Mol	Chain	Bond lengths		Bond angles	
		RMSZ	# Z >5	RMSZ	# Z >5
2	m	0.35	0/692	0.55	0/934
2	n	0.36	0/683	0.55	0/922
2	o	0.39	0/692	0.56	0/934
2	p	0.38	0/683	0.55	0/922
2	q	0.40	0/692	0.57	0/934
2	r	0.40	0/692	0.58	0/934
2	s	0.40	0/683	0.57	0/922
2	t	0.38	0/692	0.57	0/934
All	All	0.43	1/44268 (0.0%)	0.61	0/59751

All (1) bond length outliers are listed below:

Mol	Chain	Res	Type	Atoms	Z	Observed(Å)	Ideal(Å)
1	H	230	MET	SD-CE	-5.01	1.49	1.77

There are no bond angle outliers.

There are no chirality outliers.

There are no planarity outliers.

5.2 Too-close contacts [i](#)

In the following table, the Non-H and H(model) columns list the number of non-hydrogen atoms and hydrogen atoms in the chain respectively. The H(added) column lists the number of hydrogen atoms added and optimized by MolProbity. The Clashes column lists the number of clashes within the asymmetric unit, whereas Symm-Clashes lists symmetry-related clashes.

Mol	Chain	Non-H	H(model)	H(added)	Clashes	Symm-Clashes
1	A	1515	0	1539	17	0
1	B	1473	0	1501	14	0
1	C	1497	0	1518	18	0
1	D	1523	0	1547	14	0
1	E	1515	0	1539	12	0
1	F	1496	0	1529	12	0
1	G	1488	0	1521	19	0
1	H	1498	0	1528	17	0
1	I	1497	0	1518	13	0
1	J	1498	0	1528	14	0
1	K	1515	0	1539	23	0
1	L	1473	0	1501	12	0
1	M	1497	0	1518	11	0

Continued on next page...

Continued from previous page...

Mol	Chain	Non-H	H(model)	H(added)	Clashes	Symm-Clashes
1	N	1497	0	1527	12	0
1	O	1515	0	1539	11	0
1	P	1515	0	1539	17	0
1	Q	1515	0	1539	19	0
1	R	1480	0	1517	18	0
1	S	1497	0	1518	16	0
1	T	1511	0	1535	15	0
2	a	678	0	680	0	0
2	b	670	0	669	0	0
2	c	678	0	680	0	0
2	d	669	0	674	0	0
2	e	678	0	680	0	0
2	f	669	0	674	0	0
2	g	678	0	680	0	0
2	h	678	0	680	0	0
2	i	669	0	674	0	0
2	j	678	0	680	0	0
2	k	678	0	680	0	0
2	l	669	0	674	0	0
2	m	678	0	680	0	0
2	n	669	0	674	0	0
2	o	678	0	680	0	0
2	p	669	0	674	0	0
2	q	678	0	680	0	0
2	r	678	0	680	0	0
2	s	669	0	674	0	0
2	t	678	0	680	0	0
3	A	1	0	0	0	0
3	B	1	0	0	0	0
3	C	1	0	0	0	0
3	D	1	0	0	0	0
3	E	1	0	0	0	0
3	F	1	0	0	0	0
3	G	1	0	0	0	0
3	H	1	0	0	0	0
3	I	1	0	0	0	0
3	J	1	0	0	0	0
3	K	1	0	0	0	0
3	L	1	0	0	0	0
3	M	1	0	0	0	0
3	N	1	0	0	0	0
3	O	1	0	0	0	0

Continued on next page...

Continued from previous page...

Mol	Chain	Non-H	H(model)	H(added)	Clashes	Symm-Clashes
3	P	1	0	0	0	0
3	Q	1	0	0	0	0
3	R	1	0	0	0	0
3	S	1	0	0	0	0
3	T	1	0	0	0	0
4	A	32	17	0	0	0
4	B	32	17	0	1	0
4	C	32	17	0	2	0
4	D	32	17	0	1	0
4	E	32	17	0	1	0
4	F	32	17	0	1	0
4	G	32	17	0	1	0
4	H	32	17	0	1	0
4	I	32	17	0	1	0
4	J	32	17	0	1	0
4	K	32	17	0	1	0
4	L	32	17	0	1	0
4	M	32	17	0	1	0
4	N	32	17	0	0	0
4	O	32	17	0	0	0
4	P	32	17	0	1	0
4	Q	32	17	0	1	0
4	R	32	17	0	1	0
4	S	32	17	0	1	0
4	T	32	17	0	1	0
5	a	12	0	8	0	0
5	b	12	0	8	0	0
5	c	12	0	8	0	0
5	d	12	0	8	0	0
5	e	12	0	8	0	0
5	f	24	0	16	0	0
5	g	12	0	8	0	0
5	h	12	0	8	0	0
5	i	12	0	8	0	0
5	k	12	0	8	0	0
5	l	12	0	8	0	0
5	m	12	0	8	0	0
5	n	12	0	8	0	0
5	o	12	0	8	0	0
5	p	12	0	8	0	0
5	q	12	0	8	0	0
5	r	12	0	8	0	0

Continued on next page...

Continued from previous page...

Mol	Chain	Non-H	H(model)	H(added)	Clashes	Symm-Clashes
5	s	12	0	8	0	0
5	t	12	0	8	0	0
6	A	19	0	0	0	0
6	B	15	0	0	0	0
6	C	33	0	0	0	0
6	D	40	0	0	0	0
6	E	28	0	0	0	0
6	F	26	0	0	1	0
6	G	48	0	0	0	0
6	H	32	0	0	1	0
6	I	24	0	0	0	0
6	J	8	0	0	0	0
6	K	29	0	0	0	0
6	L	22	0	0	0	0
6	M	29	0	0	0	0
6	N	33	0	0	0	0
6	O	25	0	0	0	0
6	P	40	0	0	0	0
6	Q	33	0	0	0	0
6	R	24	0	0	0	0
6	S	23	0	0	0	0
6	T	28	0	0	0	0
6	a	12	0	0	0	0
6	b	9	0	0	0	0
6	c	20	0	0	0	0
6	d	18	0	0	0	0
6	e	19	0	0	0	0
6	f	23	0	0	0	0
6	g	26	0	0	0	0
6	h	28	0	0	0	0
6	i	14	0	0	0	0
6	j	4	0	0	0	0
6	k	14	0	0	0	0
6	l	16	0	0	0	0
6	m	14	0	0	0	0
6	n	18	0	0	0	0
6	o	21	0	0	0	0
6	p	22	0	0	0	0
6	q	24	0	0	0	0
6	r	25	0	0	0	0
6	s	25	0	0	0	0
6	t	19	0	0	0	0

Continued on next page...

Continued from previous page...

Mol	Chain	Non-H	H(model)	H(added)	Clashes	Symm-Clashes
All	All	45334	340	44247	255	0

The all-atom clashscore is defined as the number of clashes found per 1000 atoms (including hydrogen atoms). The all-atom clashscore for this structure is 4.

All (255) close contacts within the same asymmetric unit are listed below, sorted by their clash magnitude.

Atom-1	Atom-2	Interatomic distance (Å)	Clash overlap (Å)
1:R:230:MET:HE3	1:R:234:PHE:HB3	1.35	1.07
1:H:230:MET:HE3	1:H:234:PHE:HB3	1.42	1.01
1:P:116:VAL:HG21	1:P:174:ILE:HD11	1.56	0.86
1:G:60:SER:OG	1:G:62:GLU:HG2	1.75	0.85
1:K:93:LYS:HE3	1:P:119:ASP:OD1	1.79	0.82
1:E:163:LEU:HB2	1:E:197:LEU:HD11	1.64	0.78
1:D:228:SER:O	1:E:128:GLU:HB3	1.84	0.77
1:B:163:LEU:HB2	1:B:197:LEU:HD11	1.67	0.77
1:T:163:LEU:HB2	1:T:197:LEU:HD11	1.67	0.76
1:Q:60:SER:OG	1:Q:62:GLU:HG2	1.85	0.75
1:N:228:SER:O	1:O:128:GLU:HB3	1.88	0.74
1:G:163:LEU:HB2	1:G:197:LEU:HD11	1.67	0.74
1:A:163:LEU:HB2	1:A:197:LEU:HD11	1.70	0.73
1:C:136:ASP:OD1	1:C:151:LYS:HE2	1.89	0.73
1:I:228:SER:O	1:J:128:GLU:HB2	1.89	0.72
1:M:228:SER:O	1:N:128:GLU:HB3	1.90	0.72
1:K:93:LYS:CE	1:P:119:ASP:OD1	2.38	0.71
1:H:163:LEU:HB2	1:H:197:LEU:HD11	1.71	0.71
1:P:163:LEU:HB2	1:P:197:LEU:HD11	1.72	0.70
1:C:228:SER:O	1:D:128:GLU:HB3	1.93	0.69
1:S:163:LEU:HB2	1:S:197:LEU:HD11	1.74	0.69
1:O:124:GLU:HG2	1:O:126:HIS:HB2	1.75	0.68
1:Q:228:SER:O	1:R:128:GLU:HB3	1.92	0.68
1:K:128:GLU:HB3	1:O:228:SER:O	1.93	0.68
1:Q:68:LEU:CD2	1:Q:96:TRP:HE1	2.07	0.68
1:M:163:LEU:HB2	1:M:197:LEU:HD11	1.75	0.68
1:K:228:SER:O	1:L:128:GLU:HB2	1.94	0.67
1:A:128:GLU:HB3	1:E:228:SER:O	1.94	0.67
1:K:117:LEU:HD21	1:K:196:ALA:HB1	1.76	0.67
1:D:82:LEU:HD21	1:G:102:MET:HG3	1.76	0.67
1:H:228:SER:O	1:I:128:GLU:HB3	1.95	0.67
1:I:163:LEU:HB2	1:I:197:LEU:HD11	1.76	0.67
1:G:228:SER:O	1:H:128:GLU:HB3	1.96	0.66

Continued on next page...

Continued from previous page...

Atom-1	Atom-2	Interatomic distance (Å)	Clash overlap (Å)
1:G:117:LEU:HD21	1:G:196:ALA:HB1	1.79	0.65
1:A:228:SER:O	1:B:128:GLU:HB2	1.97	0.65
1:R:230:MET:CE	1:R:234:PHE:HB3	2.22	0.64
1:L:163:LEU:HB2	1:L:197:LEU:HD11	1.79	0.63
1:C:125:ASP:HA	1:C:160:LYS:HE3	1.80	0.63
1:L:228:SER:O	1:M:128:GLU:HB3	1.97	0.63
1:B:228:SER:O	1:C:128:GLU:HB3	1.99	0.63
1:G:146:VAL:HB	1:G:212:CYS:SG	2.38	0.63
1:J:163:LEU:HB2	1:J:197:LEU:HD11	1.79	0.63
1:H:224:LYS:HE2	1:I:134:ASP:OD2	2.00	0.62
1:C:117:LEU:HD21	1:C:196:ALA:HB1	1.81	0.61
1:A:117:LEU:HD21	1:A:196:ALA:HB1	1.83	0.61
1:C:163:LEU:HB2	1:C:197:LEU:HD11	1.81	0.61
1:F:228:SER:O	1:G:128:GLU:HB3	2.01	0.61
1:J:146:VAL:HB	1:J:212:CYS:SG	2.42	0.60
1:P:128:GLU:HB2	1:T:228:SER:O	2.01	0.60
1:A:116:VAL:HG11	1:A:174:ILE:HD11	1.84	0.60
1:M:117:LEU:HD21	1:M:196:ALA:HB1	1.84	0.60
1:O:163:LEU:HB2	1:O:197:LEU:HD11	1.83	0.60
1:S:224:LYS:HE2	1:T:134:ASP:OD2	2.02	0.59
1:T:117:LEU:HD22	1:T:163:LEU:HD11	1.84	0.58
1:Q:117:LEU:HD21	1:Q:196:ALA:HB1	1.85	0.58
1:Q:68:LEU:HD21	1:Q:96:TRP:HE1	1.68	0.58
1:D:146:VAL:HB	1:D:212:CYS:SG	2.44	0.57
1:C:146:VAL:HB	1:C:212:CYS:SG	2.45	0.57
1:P:146:VAL:HB	1:P:212:CYS:SG	2.44	0.57
1:R:146:VAL:HB	1:R:212:CYS:SG	2.44	0.57
1:A:146:VAL:HB	1:A:212:CYS:SG	2.45	0.57
1:R:228:SER:O	1:S:128:GLU:HB3	2.05	0.57
1:F:163:LEU:HB2	1:F:197:LEU:HD11	1.87	0.57
1:L:146:VAL:HB	1:L:212:CYS:SG	2.45	0.57
1:F:146:VAL:HB	1:F:212:CYS:SG	2.45	0.56
1:N:163:LEU:HB2	1:N:197:LEU:HD11	1.85	0.56
1:B:146:VAL:HB	1:B:212:CYS:SG	2.44	0.56
1:E:146:VAL:HB	1:E:212:CYS:SG	2.46	0.56
1:A:187:LYS:HD2	1:B:126:HIS:HB2	1.87	0.56
1:I:146:VAL:HB	1:I:212:CYS:SG	2.45	0.56
1:L:116:VAL:HG21	1:L:174:ILE:HG12	1.88	0.56
1:R:163:LEU:HB2	1:R:197:LEU:HD11	1.88	0.56
1:G:60:SER:HG	1:G:62:GLU:HG2	1.69	0.55
1:K:116:VAL:HG11	1:K:174:ILE:HD11	1.90	0.54

Continued on next page...

Continued from previous page...

Atom-1	Atom-2	Interatomic distance (Å)	Clash overlap (Å)
1:D:163:LEU:HB2	1:D:197:LEU:HD11	1.89	0.54
1:K:224:LYS:HE2	1:L:134:ASP:OD2	2.08	0.54
1:S:116:VAL:HG13	1:S:170:ARG:HB3	1.89	0.54
1:R:116:VAL:HG13	1:R:170:ARG:HB3	1.90	0.54
1:H:116:VAL:HG13	1:H:170:ARG:HB3	1.88	0.54
1:A:125:ASP:HA	1:A:160:LYS:HE3	1.90	0.53
1:Q:116:VAL:HG11	1:Q:174:ILE:HD11	1.90	0.53
1:S:146:VAL:HB	1:S:212:CYS:SG	2.47	0.53
1:H:146:VAL:HB	1:H:212:CYS:SG	2.48	0.53
1:K:163:LEU:HB2	1:K:197:LEU:HD21	1.90	0.53
1:I:116:VAL:HG21	1:I:174:ILE:HG12	1.91	0.53
1:P:120:ALA:HB1	1:P:167:LYS:HG3	1.90	0.53
1:K:134:ASP:OD2	1:O:224:LYS:HE2	2.09	0.53
1:Q:146:VAL:HB	1:Q:212:CYS:SG	2.49	0.52
1:Q:124:GLU:HG3	1:Q:126:HIS:H	1.74	0.52
1:R:159:ASN:HB2	1:R:199:PRO:HA	1.91	0.52
1:F:134:ASP:OD2	1:J:224:LYS:HE2	2.08	0.52
1:K:146:VAL:HB	1:K:212:CYS:SG	2.49	0.52
1:P:113:ILE:HD12	1:P:192:ALA:HB1	1.91	0.52
1:P:156:TYR:CE2	1:P:158:PRO:HG3	2.45	0.52
1:R:249:ARG:CZ	1:S:249:ARG:HH22	2.23	0.51
1:S:157:LEU:HD12	1:S:233:VAL:HG21	1.93	0.51
1:G:59:ARG:HB3	1:G:110:GLN:HG2	1.93	0.51
1:D:123:ASP:H	1:H:89:GLN:HE22	1.57	0.51
1:E:82:LEU:HD21	1:F:102:MET:HG3	1.92	0.51
1:N:116:VAL:CG1	1:N:170:ARG:HB3	2.41	0.50
1:I:157:LEU:HD12	1:I:233:VAL:HG21	1.94	0.50
1:A:183:GLU:O	1:A:187:LYS:HG3	2.11	0.50
1:K:116:VAL:HG21	1:K:174:ILE:HG12	1.93	0.50
1:D:117:LEU:HD21	1:D:196:ALA:HB1	1.93	0.50
1:G:116:VAL:HG13	1:G:170:ARG:HB3	1.93	0.50
1:E:116:VAL:HG11	1:E:174:ILE:HD11	1.92	0.50
1:P:68:LEU:HG	1:P:96:TRP:CZ2	2.46	0.50
1:G:157:LEU:HD12	1:G:233:VAL:HG21	1.94	0.49
1:M:116:VAL:HG13	1:M:170:ARG:HB3	1.93	0.49
1:G:70:ASN:H	1:G:70:ASN:HD22	1.58	0.49
1:J:116:VAL:HG11	1:J:174:ILE:HD11	1.94	0.49
1:H:157:LEU:HD12	1:H:233:VAL:HG21	1.93	0.49
1:A:116:VAL:HG21	1:A:174:ILE:HG12	1.95	0.49
1:O:146:VAL:HB	1:O:212:CYS:SG	2.53	0.48
1:R:165:LEU:HG	4:R:302:QBQ:C	2.43	0.48

Continued on next page...

Continued from previous page...

Atom-1	Atom-2	Interatomic distance (Å)	Clash overlap (Å)
1:E:165:LEU:HG	4:E:302:QBQ:C	2.43	0.48
1:L:165:LEU:HG	4:L:1101:QBQ:C	2.44	0.48
1:S:116:VAL:HG21	1:S:174:ILE:HG12	1.96	0.48
1:B:156:TYR:OH	1:B:162:VAL:HG22	2.14	0.48
1:D:97:ARG:HE	1:D:97:ARG:HB2	1.48	0.48
1:D:105:PHE:CZ	1:G:215:MET:HE3	2.49	0.47
1:I:165:LEU:HG	4:I:302:QBQ:C	2.43	0.47
1:J:165:LEU:HG	4:J:302:QBQ:C	2.44	0.47
1:B:165:LEU:HG	4:B:302:QBQ:C	2.44	0.47
1:Q:211:MET:HB3	1:Q:215:MET:CE	2.43	0.47
1:N:159:ASN:O	1:N:160:LYS:HB2	2.14	0.47
1:C:165:LEU:HG	4:C:302:QBQ:C	2.44	0.47
1:K:113:ILE:HD12	1:K:192:ALA:HB1	1.95	0.47
1:Q:228:SER:O	1:R:128:GLU:CB	2.60	0.47
1:T:117:LEU:HD11	1:T:196:ALA:HB1	1.96	0.47
1:C:125:ASP:CA	1:C:160:LYS:HE3	2.44	0.47
1:K:93:LYS:NZ	1:P:119:ASP:OD1	2.48	0.47
1:K:165:LEU:HG	4:K:302:QBQ:C	2.45	0.47
1:C:113:ILE:HD11	1:C:196:ALA:HB2	1.97	0.47
1:N:93:LYS:HB2	1:N:97:ARG:CZ	2.44	0.47
1:T:165:LEU:HG	4:T:302:QBQ:C	2.45	0.47
1:G:165:LEU:HG	4:G:302:QBQ:C	2.44	0.47
1:Q:136:ASP:OD1	1:Q:151:LYS:HE2	2.15	0.46
1:N:163:LEU:HB2	1:N:197:LEU:HD21	1.96	0.46
1:A:113:ILE:HD12	1:A:192:ALA:HB1	1.98	0.46
1:H:93:LYS:HB2	1:H:97:ARG:CZ	2.45	0.46
1:H:230:MET:CE	1:H:234:PHE:HB3	2.30	0.46
1:M:165:LEU:HG	4:M:1101:QBQ:C	2.45	0.46
1:O:116:VAL:HG11	1:O:174:ILE:HD11	1.98	0.46
1:J:116:VAL:HG21	1:J:174:ILE:HG12	1.97	0.46
1:Q:163:LEU:HD13	1:Q:197:LEU:HD11	1.96	0.46
1:A:184:ARG:HA	1:A:187:LYS:HE3	1.97	0.46
1:F:116:VAL:HG21	1:F:174:ILE:HD11	1.97	0.46
1:K:163:LEU:HB2	1:K:197:LEU:HD11	1.98	0.46
1:A:116:VAL:HG13	1:A:170:ARG:HB3	1.97	0.46
1:E:126:HIS:NE2	1:E:128:GLU:HB2	2.31	0.46
1:L:179:LEU:HD12	1:S:84:GLU:HG3	1.97	0.46
1:J:157:LEU:HD12	1:J:233:VAL:HG21	1.98	0.46
1:O:215:MET:HG2	1:P:138:PHE:HB3	1.99	0.45
1:R:163:LEU:HB2	1:R:197:LEU:HD21	1.98	0.45
1:H:85:ASN:O	1:H:88:ARG:HG2	2.16	0.45

Continued on next page...

Continued from previous page...

Atom-1	Atom-2	Interatomic distance (Å)	Clash overlap (Å)
1:G:121:ILE:CG2	1:G:161:GLN:HB3	2.46	0.45
1:Q:165:LEU:HG	4:Q:302:QBQ:C	2.46	0.45
1:P:72:ALA:O	1:P:95:PRO:HB3	2.16	0.45
1:S:72:ALA:O	1:S:95:PRO:HB3	2.16	0.45
1:C:166:SER:OG	4:C:302:QBQ:O10	2.26	0.45
1:B:117:LEU:HD22	1:B:163:LEU:HD11	1.98	0.45
1:F:113:ILE:HD12	1:F:192:ALA:HB1	1.99	0.45
1:P:116:VAL:CG2	1:P:174:ILE:HD11	2.38	0.45
1:S:159:ASN:O	1:S:160:LYS:HB2	2.17	0.45
1:H:165:LEU:HG	4:H:302:QBQ:C	2.47	0.45
1:R:116:VAL:HG21	1:R:174:ILE:HG12	1.99	0.45
1:K:163:LEU:CB	1:K:197:LEU:HD11	2.46	0.44
1:B:163:LEU:HD23	1:B:168:LEU:CD2	2.47	0.44
1:R:157:LEU:HD12	1:R:233:VAL:HG21	1.99	0.44
1:H:218:VAL:CG1	1:I:170:ARG:HG2	2.47	0.44
1:C:93:LYS:HB2	1:C:97:ARG:CZ	2.47	0.44
1:C:221:MET:HG2	6:H:429:HOH:O	2.16	0.44
1:B:136:ASP:OD1	1:B:151:LYS:HE2	2.18	0.44
1:M:163:LEU:HB2	1:M:197:LEU:HD21	2.00	0.44
1:H:163:LEU:HD12	1:H:164:GLY:H	1.83	0.44
1:K:72:ALA:O	1:K:95:PRO:HB3	2.17	0.44
1:E:163:LEU:HD23	1:E:168:LEU:CD2	2.48	0.44
1:E:138:PHE:HB3	1:F:215:MET:HG2	2.00	0.43
1:K:215:MET:HG2	1:T:138:PHE:HB3	2.01	0.43
1:S:218:VAL:CG1	1:T:170:ARG:HG2	2.48	0.43
1:C:160:LYS:HA	1:C:160:LYS:HD3	1.80	0.43
1:G:136:ASP:OD1	1:G:151:LYS:HE2	2.18	0.43
1:P:163:LEU:HG	1:P:167:LYS:HB2	2.01	0.43
1:K:116:VAL:HG13	1:K:170:ARG:HB3	2.00	0.43
1:O:93:LYS:HB2	1:O:97:ARG:CZ	2.49	0.43
1:A:72:ALA:O	1:A:95:PRO:HB3	2.19	0.43
1:C:138:PHE:HB3	1:H:215:MET:HG2	2.00	0.43
1:J:93:LYS:HB2	1:J:97:ARG:CZ	2.48	0.43
1:Q:72:ALA:O	1:Q:95:PRO:HB3	2.18	0.43
1:S:165:LEU:HG	4:S:302:QBQ:C	2.48	0.43
1:A:163:LEU:HD12	1:A:164:GLY:H	1.83	0.43
1:R:93:LYS:HB2	1:R:97:ARG:CZ	2.49	0.43
1:G:93:LYS:HB2	1:G:97:ARG:CZ	2.48	0.43
1:L:116:VAL:HG13	1:L:170:ARG:HB3	2.01	0.43
1:A:136:ASP:OD1	1:A:151:LYS:HE2	2.18	0.42
1:E:157:LEU:HD12	1:E:233:VAL:HG21	2.01	0.42

Continued on next page...

Continued from previous page...

Atom-1	Atom-2	Interatomic distance (Å)	Clash overlap (Å)
1:T:116:VAL:HG11	1:T:174:ILE:HD11	2.01	0.42
1:P:218:VAL:CG1	1:Q:170:ARG:HG2	2.49	0.42
1:T:136:ASP:OD1	1:T:151:LYS:HE2	2.19	0.42
1:F:165:LEU:HG	4:F:302:QBQ:C	2.48	0.42
1:M:163:LEU:CB	1:M:197:LEU:HD11	2.48	0.42
1:N:159:ASN:HB2	1:N:199:PRO:HA	2.02	0.42
1:M:146:VAL:HB	1:M:212:CYS:SG	2.60	0.42
1:P:165:LEU:HG	4:P:302:QBQ:C	2.49	0.42
1:Q:163:LEU:HB2	1:Q:197:LEU:HD11	2.02	0.42
1:Q:218:VAL:CG1	1:R:170:ARG:HG3	2.50	0.42
1:D:72:ALA:O	1:D:95:PRO:HB3	2.20	0.42
1:H:72:ALA:O	1:H:95:PRO:HB3	2.20	0.42
1:N:146:VAL:HB	1:N:212:CYS:SG	2.59	0.42
1:R:72:ALA:O	1:R:95:PRO:HB3	2.20	0.42
1:I:218:VAL:CG1	1:J:170:ARG:HG2	2.50	0.42
1:M:126:HIS:NE2	1:M:128:GLU:HB2	2.35	0.42
1:C:72:ALA:O	1:C:95:PRO:HB3	2.20	0.42
1:I:72:ALA:O	1:I:95:PRO:HB3	2.20	0.42
1:K:157:LEU:HD12	1:K:233:VAL:HG21	2.01	0.42
1:K:218:VAL:CG1	1:L:170:ARG:HG2	2.49	0.42
1:K:117:LEU:HD21	1:K:196:ALA:CB	2.47	0.42
1:M:157:LEU:HD12	1:M:233:VAL:HG21	2.01	0.42
1:N:143:HIS:ND1	1:Q:97:ARG:NH2	2.68	0.42
1:A:187:LYS:CD	1:B:126:HIS:HB2	2.51	0.41
1:G:211:MET:HB3	1:G:215:MET:CE	2.50	0.41
1:J:72:ALA:O	1:J:95:PRO:HB3	2.21	0.41
1:S:228:SER:O	1:T:128:GLU:HB2	2.20	0.41
1:J:116:VAL:HG13	1:J:170:ARG:HB3	2.02	0.41
1:B:93:LYS:HB2	1:B:97:ARG:CZ	2.50	0.41
1:E:72:ALA:O	1:E:95:PRO:HB3	2.20	0.41
1:S:163:LEU:HD23	1:S:168:LEU:CD2	2.50	0.41
1:B:221:MET:SD	1:I:138:PHE:HZ	2.43	0.41
1:J:126:HIS:ND1	1:J:128:GLU:OE2	2.53	0.41
1:J:140:MET:HE1	1:J:147:PRO:HG3	2.03	0.41
1:S:170:ARG:HG2	1:S:170:ARG:HH11	1.85	0.41
1:T:72:ALA:O	1:T:95:PRO:HB3	2.21	0.41
1:T:163:LEU:HD23	1:T:168:LEU:CD2	2.50	0.41
1:F:75:TYR:O	1:F:79:LEU:HG	2.21	0.41
1:K:136:ASP:OD1	1:K:151:LYS:HE2	2.21	0.41
1:Q:116:VAL:HG21	1:Q:174:ILE:HG12	2.02	0.41
1:B:116:VAL:HG13	1:B:170:ARG:HB3	2.01	0.41

Continued on next page...

Continued from previous page...

Atom-1	Atom-2	Interatomic distance (Å)	Clash overlap (Å)
1:C:218:VAL:CG1	1:D:170:ARG:HG2	2.51	0.41
1:F:130:VAL:HG11	6:F:405:HOH:O	2.20	0.41
1:N:72:ALA:O	1:N:95:PRO:HB3	2.21	0.41
1:T:157:LEU:HD12	1:T:233:VAL:HG21	2.02	0.41
1:N:116:VAL:HG13	1:N:170:ARG:HB3	2.03	0.41
1:C:124:GLU:C	1:C:126:HIS:H	2.23	0.40
1:I:136:ASP:OD1	1:I:151:LYS:HE2	2.21	0.40
1:O:121:ILE:HG23	1:O:161:GLN:HB3	2.02	0.40
1:R:152:VAL:HG22	1:R:206:VAL:HG22	2.03	0.40
1:D:165:LEU:HG	4:D:302:QBQ:C	2.52	0.40
1:D:215:MET:HG2	1:G:138:PHE:HB3	2.03	0.40
1:F:136:ASP:OD1	1:F:151:LYS:HE2	2.21	0.40
1:L:157:LEU:HD12	1:L:233:VAL:HG21	2.03	0.40
1:T:157:LEU:HD23	1:T:157:LEU:HA	1.94	0.40
1:O:72:ALA:O	1:O:95:PRO:HB3	2.22	0.40
1:D:126:HIS:NE2	1:D:128:GLU:HB2	2.36	0.40
1:L:136:ASP:OD1	1:L:151:LYS:HE2	2.21	0.40

There are no symmetry-related clashes.

5.3 Torsion angles [i](#)

5.3.1 Protein backbone [i](#)

In the following table, the Percentiles column shows the percent Ramachandran outliers of the chain as a percentile score with respect to all X-ray entries followed by that with respect to entries of similar resolution.

The Analysed column shows the number of residues for which the backbone conformation was analysed, and the total number of residues.

Mol	Chain	Analysed	Favoured	Allowed	Outliers	Percentiles	
1	A	190/209 (91%)	187 (98%)	3 (2%)	0	100	100
1	B	185/209 (88%)	183 (99%)	2 (1%)	0	100	100
1	C	188/209 (90%)	185 (98%)	3 (2%)	0	100	100
1	D	191/209 (91%)	187 (98%)	4 (2%)	0	100	100
1	E	190/209 (91%)	187 (98%)	3 (2%)	0	100	100
1	F	186/209 (89%)	182 (98%)	4 (2%)	0	100	100
1	G	185/209 (88%)	184 (100%)	1 (0%)	0	100	100

Continued on next page...

Continued from previous page...

Mol	Chain	Analysed	Favoured	Allowed	Outliers	Percentiles	
1	H	186/209 (89%)	184 (99%)	2 (1%)	0	100	100
1	I	188/209 (90%)	185 (98%)	3 (2%)	0	100	100
1	J	186/209 (89%)	183 (98%)	3 (2%)	0	100	100
1	K	190/209 (91%)	188 (99%)	2 (1%)	0	100	100
1	L	185/209 (88%)	184 (100%)	1 (0%)	0	100	100
1	M	188/209 (90%)	183 (97%)	5 (3%)	0	100	100
1	N	186/209 (89%)	184 (99%)	1 (0%)	1 (0%)	29	16
1	O	190/209 (91%)	189 (100%)	1 (0%)	0	100	100
1	P	190/209 (91%)	187 (98%)	3 (2%)	0	100	100
1	Q	190/209 (91%)	188 (99%)	2 (1%)	0	100	100
1	R	184/209 (88%)	181 (98%)	3 (2%)	0	100	100
1	S	188/209 (90%)	185 (98%)	3 (2%)	0	100	100
1	T	190/209 (91%)	189 (100%)	1 (0%)	0	100	100
2	a	82/87 (94%)	80 (98%)	2 (2%)	0	100	100
2	b	81/87 (93%)	79 (98%)	2 (2%)	0	100	100
2	c	82/87 (94%)	80 (98%)	2 (2%)	0	100	100
2	d	81/87 (93%)	79 (98%)	2 (2%)	0	100	100
2	e	82/87 (94%)	80 (98%)	2 (2%)	0	100	100
2	f	81/87 (93%)	79 (98%)	2 (2%)	0	100	100
2	g	82/87 (94%)	80 (98%)	2 (2%)	0	100	100
2	h	82/87 (94%)	80 (98%)	2 (2%)	0	100	100
2	i	81/87 (93%)	79 (98%)	2 (2%)	0	100	100
2	j	82/87 (94%)	80 (98%)	2 (2%)	0	100	100
2	k	82/87 (94%)	80 (98%)	2 (2%)	0	100	100
2	l	81/87 (93%)	79 (98%)	2 (2%)	0	100	100
2	m	82/87 (94%)	80 (98%)	2 (2%)	0	100	100
2	n	81/87 (93%)	79 (98%)	2 (2%)	0	100	100
2	o	82/87 (94%)	80 (98%)	2 (2%)	0	100	100
2	p	81/87 (93%)	79 (98%)	2 (2%)	0	100	100
2	q	82/87 (94%)	80 (98%)	2 (2%)	0	100	100
2	r	82/87 (94%)	80 (98%)	2 (2%)	0	100	100

Continued on next page...

Continued from previous page...

Mol	Chain	Analysed	Favoured	Allowed	Outliers	Percentiles	
2	s	81/87 (93%)	79 (98%)	2 (2%)	0	100	100
2	t	82/87 (94%)	80 (98%)	2 (2%)	0	100	100
All	All	5388/5920 (91%)	5297 (98%)	90 (2%)	1 (0%)	100	100

All (1) Ramachandran outliers are listed below:

Mol	Chain	Res	Type
1	N	160	LYS

5.3.2 Protein sidechains [i](#)

In the following table, the Percentiles column shows the percent sidechain outliers of the chain as a percentile score with respect to all X-ray entries followed by that with respect to entries of similar resolution.

The Analysed column shows the number of residues for which the sidechain conformation was analysed, and the total number of residues.

Mol	Chain	Analysed	Rotameric	Outliers	Percentiles	
1	A	169/181 (93%)	163 (96%)	6 (4%)	35	23
1	B	164/181 (91%)	162 (99%)	2 (1%)	71	67
1	C	167/181 (92%)	164 (98%)	3 (2%)	59	51
1	D	170/181 (94%)	166 (98%)	4 (2%)	49	41
1	E	169/181 (93%)	167 (99%)	2 (1%)	71	67
1	F	167/181 (92%)	164 (98%)	3 (2%)	59	51
1	G	166/181 (92%)	161 (97%)	5 (3%)	41	29
1	H	167/181 (92%)	165 (99%)	2 (1%)	71	67
1	I	167/181 (92%)	164 (98%)	3 (2%)	59	51
1	J	167/181 (92%)	162 (97%)	5 (3%)	41	29
1	K	169/181 (93%)	166 (98%)	3 (2%)	59	51
1	L	164/181 (91%)	162 (99%)	2 (1%)	71	67
1	M	167/181 (92%)	166 (99%)	1 (1%)	86	85
1	N	167/181 (92%)	164 (98%)	3 (2%)	59	51
1	O	169/181 (93%)	166 (98%)	3 (2%)	59	51
1	P	169/181 (93%)	163 (96%)	6 (4%)	35	23

Continued on next page...

Continued from previous page...

Mol	Chain	Analysed	Rotameric	Outliers	Percentiles	
1	Q	169/181 (93%)	161 (95%)	8 (5%)	26	13
1	R	165/181 (91%)	163 (99%)	2 (1%)	71	67
1	S	167/181 (92%)	166 (99%)	1 (1%)	86	85
1	T	168/181 (93%)	162 (96%)	6 (4%)	35	23
2	a	75/77 (97%)	74 (99%)	1 (1%)	69	64
2	b	74/77 (96%)	74 (100%)	0	100	100
2	c	75/77 (97%)	75 (100%)	0	100	100
2	d	74/77 (96%)	73 (99%)	1 (1%)	67	62
2	e	75/77 (97%)	74 (99%)	1 (1%)	69	64
2	f	74/77 (96%)	73 (99%)	1 (1%)	67	62
2	g	75/77 (97%)	73 (97%)	2 (3%)	44	35
2	h	75/77 (97%)	75 (100%)	0	100	100
2	i	74/77 (96%)	73 (99%)	1 (1%)	67	62
2	j	75/77 (97%)	75 (100%)	0	100	100
2	k	75/77 (97%)	73 (97%)	2 (3%)	44	35
2	l	74/77 (96%)	72 (97%)	2 (3%)	44	35
2	m	75/77 (97%)	74 (99%)	1 (1%)	69	64
2	n	74/77 (96%)	73 (99%)	1 (1%)	67	62
2	o	75/77 (97%)	74 (99%)	1 (1%)	69	64
2	p	74/77 (96%)	74 (100%)	0	100	100
2	q	75/77 (97%)	74 (99%)	1 (1%)	69	64
2	r	75/77 (97%)	75 (100%)	0	100	100
2	s	74/77 (96%)	74 (100%)	0	100	100
2	t	75/77 (97%)	74 (99%)	1 (1%)	69	64
All	All	4839/5160 (94%)	4753 (98%)	86 (2%)	59	51

All (86) residues with a non-rotameric sidechain are listed below:

Mol	Chain	Res	Type
1	A	61	GLU
1	A	125	ASP
1	A	141	CYS
1	A	157	LEU
1	A	160	LYS

Continued on next page...

Continued from previous page...

Mol	Chain	Res	Type
1	A	187	LYS
1	B	162	VAL
1	B	214	VAL
1	C	187	LYS
1	C	214	VAL
1	C	221	MET
1	D	119	ASP
1	D	157	LEU
1	D	181	VAL
1	D	214	VAL
1	E	214	VAL
1	E	221	MET
1	F	61	GLU
1	F	128	GLU
1	F	166	SER
1	G	70	ASN
1	G	87	GLN
1	G	159	ASN
1	G	214	VAL
1	G	221	MET
1	H	61	GLU
1	H	221	MET
1	I	125	ASP
1	I	162	VAL
1	I	221	MET
1	J	62	GLU
1	J	126	HIS
1	J	128	GLU
1	J	141	CYS
1	J	221	MET
1	K	61	GLU
1	K	127	ASP
1	K	221	MET
1	L	214	VAL
1	L	221	MET
1	M	221	MET
1	N	117	LEU
1	N	214	VAL
1	N	221	MET
1	O	157	LEU
1	O	160	LYS
1	O	221	MET

Continued on next page...

Continued from previous page...

Mol	Chain	Res	Type
1	P	61	GLU
1	P	68	LEU
1	P	114	SER
1	P	128	GLU
1	P	162	VAL
1	P	214	VAL
1	Q	96	TRP
1	Q	125	ASP
1	Q	126	HIS
1	Q	127	ASP
1	Q	160	LYS
1	Q	197	LEU
1	Q	214	VAL
1	Q	221	MET
1	R	61	GLU
1	R	221	MET
1	S	221	MET
1	T	60	SER
1	T	126	HIS
1	T	128	GLU
1	T	141	CYS
1	T	218	VAL
1	T	221	MET
2	a	84	GLU
2	d	1	MET
2	e	5	LEU
2	f	4	LEU
2	g	4	LEU
2	g	31	HIS
2	i	66	ARG
2	k	1	MET
2	k	84	GLU
2	l	66	ARG
2	l	83	LYS
2	m	84	GLU
2	n	4	LEU
2	o	66	ARG
2	q	4	LEU
2	t	84	GLU

Sometimes sidechains can be flipped to improve hydrogen bonding and reduce clashes. All (44) such sidechains are listed below:

Mol	Chain	Res	Type
1	A	70	ASN
1	B	70	ASN
1	C	70	ASN
1	D	70	ASN
1	E	70	ASN
1	F	70	ASN
1	G	70	ASN
1	H	70	ASN
1	H	89	GLN
1	I	70	ASN
1	J	70	ASN
1	K	70	ASN
1	L	70	ASN
1	L	126	HIS
1	M	70	ASN
1	N	70	ASN
1	O	70	ASN
1	P	70	ASN
1	P	126	HIS
1	Q	70	ASN
1	Q	126	HIS
1	R	70	ASN
1	S	70	ASN
1	T	70	ASN
2	a	75	GLN
2	b	75	GLN
2	c	75	GLN
2	d	75	GLN
2	e	75	GLN
2	f	75	GLN
2	g	75	GLN
2	h	75	GLN
2	i	75	GLN
2	k	75	GLN
2	l	75	GLN
2	m	75	GLN
2	n	75	GLN
2	o	75	GLN
2	p	75	GLN
2	q	31	HIS
2	q	75	GLN
2	r	75	GLN
2	s	75	GLN

Continued on next page...

Continued from previous page...

Mol	Chain	Res	Type
2	t	75	GLN

5.3.3 RNA [i](#)

There are no RNA molecules in this entry.

5.4 Non-standard residues in protein, DNA, RNA chains [i](#)

There are no non-standard protein/DNA/RNA residues in this entry.

5.5 Carbohydrates [i](#)

There are no monosaccharides in this entry.

5.6 Ligand geometry [i](#)

Of 60 ligands modelled in this entry, 20 are monoatomic - leaving 40 for Mogul analysis.

In the following table, the Counts columns list the number of bonds (or angles) for which Mogul statistics could be retrieved, the number of bonds (or angles) that are observed in the model and the number of bonds (or angles) that are defined in the Chemical Component Dictionary. The Link column lists molecule types, if any, to which the group is linked. The Z score for a bond length (or angle) is the number of standard deviations the observed value is removed from the expected value. A bond length (or angle) with $|Z| > 2$ is considered an outlier worth inspection. RMSZ is the root-mean-square of all Z scores of the bond lengths (or angles).

Mol	Type	Chain	Res	Link	Bond lengths			Bond angles		
					Counts	RMSZ	# $ Z > 2$	Counts	RMSZ	# $ Z > 2$
5	PHE	n	101	-	9,12,12	0.22	0	10,15,15	0.33	0
5	PHE	h	101	-	9,12,12	0.23	0	10,15,15	0.18	0
5	PHE	t	101	-	9,12,12	0.21	0	10,15,15	0.13	0
4	QBQ	G	302	-	26,34,34	1.40	3 (11%)	34,54,54	2.95	5 (14%)
4	QBQ	L	1101	-	26,34,34	1.57	6 (23%)	34,54,54	3.03	6 (17%)
4	QBQ	O	302	-	26,34,34	0.84	1 (3%)	34,54,54	2.91	3 (8%)
5	PHE	b	101	-	9,12,12	0.33	0	10,15,15	0.23	0
4	QBQ	I	302	-	26,34,34	1.30	2 (7%)	34,54,54	2.96	6 (17%)
5	PHE	d	101	-	9,12,12	0.46	0	10,15,15	0.28	0
5	PHE	i	101	-	9,12,12	0.32	0	10,15,15	0.37	0
4	QBQ	E	302	-	26,34,34	1.47	3 (11%)	34,54,54	2.99	6 (17%)

Mol	Type	Chain	Res	Link	Bond lengths			Bond angles		
					Counts	RMSZ	# Z > 2	Counts	RMSZ	# Z > 2
4	QBQ	A	302	-	26,34,34	1.38	3 (11%)	34,54,54	2.98	3 (8%)
5	PHE	o	101	-	9,12,12	0.19	0	10,15,15	0.40	0
5	PHE	e	101	-	9,12,12	0.36	0	10,15,15	0.23	0
4	QBQ	N	1101	-	26,34,34	1.30	2 (7%)	34,54,54	3.05	3 (8%)
5	PHE	q	101	-	9,12,12	0.48	0	10,15,15	0.24	0
4	QBQ	C	302	-	26,34,34	1.39	4 (15%)	34,54,54	3.03	5 (14%)
5	PHE	g	101	-	9,12,12	0.26	0	10,15,15	0.20	0
4	QBQ	B	302	-	26,34,34	1.39	4 (15%)	34,54,54	3.00	6 (17%)
5	PHE	p	101	-	9,12,12	0.29	0	10,15,15	0.23	0
4	QBQ	H	302	-	26,34,34	1.46	5 (19%)	34,54,54	3.01	4 (11%)
4	QBQ	K	302	-	26,34,34	1.38	2 (7%)	34,54,54	2.98	4 (11%)
4	QBQ	F	302	-	26,34,34	1.28	2 (7%)	34,54,54	2.96	3 (8%)
4	QBQ	R	302	-	26,34,34	1.36	3 (11%)	34,54,54	2.97	5 (14%)
4	QBQ	T	302	-	26,34,34	1.47	3 (11%)	34,54,54	3.03	5 (14%)
4	QBQ	S	302	-	26,34,34	1.40	3 (11%)	34,54,54	2.98	4 (11%)
4	QBQ	M	1101	-	26,34,34	1.42	4 (15%)	34,54,54	2.94	3 (8%)
5	PHE	a	101	-	9,12,12	0.28	0	10,15,15	0.17	0
5	PHE	c	101	-	9,12,12	0.32	0	10,15,15	0.23	0
4	QBQ	D	302	-	26,34,34	1.58	6 (23%)	34,54,54	3.01	6 (17%)
4	QBQ	P	302	-	26,34,34	1.20	2 (7%)	34,54,54	2.99	3 (8%)
5	PHE	r	101	-	9,12,12	0.22	0	10,15,15	0.21	0
5	PHE	l	101	-	9,12,12	0.25	0	10,15,15	0.37	0
5	PHE	m	101	-	9,12,12	0.21	0	10,15,15	0.22	0
5	PHE	s	101	-	9,12,12	0.34	0	10,15,15	0.27	0
4	QBQ	J	302	-	26,34,34	1.44	3 (11%)	34,54,54	3.00	5 (14%)
5	PHE	k	101	-	9,12,12	0.24	0	10,15,15	0.33	0
5	PHE	f	101	-	9,12,12	0.32	0	10,15,15	0.21	0
4	QBQ	Q	302	-	26,34,34	1.35	3 (11%)	34,54,54	2.99	5 (14%)
5	PHE	f	102	-	9,12,12	0.27	0	10,15,15	0.33	0

In the following table, the Chirals column lists the number of chiral outliers, the number of chiral centers analysed, the number of these observed in the model and the number defined in the Chemical Component Dictionary. Similar counts are reported in the Torsion and Rings columns. '-' means no outliers of that kind were identified.

Mol	Type	Chain	Res	Link	Chirals	Torsions	Rings
5	PHE	n	101	-	-	0/4/8/8	0/1/1/1
5	PHE	h	101	-	-	0/4/8/8	0/1/1/1
5	PHE	t	101	-	-	0/4/8/8	0/1/1/1

Continued on next page...

Continued from previous page...

Mol	Type	Chain	Res	Link	Chirals	Torsions	Rings
4	QBQ	G	302	-	-	3/18/38/38	0/3/3/3
4	QBQ	L	1101	-	-	4/18/38/38	0/3/3/3
4	QBQ	O	302	-	-	4/18/38/38	0/3/3/3
5	PHE	b	101	-	-	0/4/8/8	0/1/1/1
4	QBQ	I	302	-	-	3/18/38/38	0/3/3/3
5	PHE	d	101	-	-	0/4/8/8	0/1/1/1
5	PHE	i	101	-	-	0/4/8/8	0/1/1/1
4	QBQ	E	302	-	-	6/18/38/38	0/3/3/3
4	QBQ	A	302	-	-	3/18/38/38	0/3/3/3
5	PHE	o	101	-	-	0/4/8/8	0/1/1/1
5	PHE	e	101	-	-	0/4/8/8	0/1/1/1
4	QBQ	N	1101	-	-	5/18/38/38	0/3/3/3
5	PHE	q	101	-	-	0/4/8/8	0/1/1/1
4	QBQ	C	302	-	-	2/18/38/38	0/3/3/3
5	PHE	g	101	-	-	0/4/8/8	0/1/1/1
4	QBQ	B	302	-	-	3/18/38/38	0/3/3/3
5	PHE	p	101	-	-	0/4/8/8	0/1/1/1
4	QBQ	H	302	-	-	3/18/38/38	0/3/3/3
4	QBQ	K	302	-	-	2/18/38/38	0/3/3/3
4	QBQ	F	302	-	-	6/18/38/38	0/3/3/3
4	QBQ	R	302	-	-	5/18/38/38	0/3/3/3
4	QBQ	T	302	-	-	5/18/38/38	0/3/3/3
4	QBQ	S	302	-	-	6/18/38/38	0/3/3/3
4	QBQ	M	1101	-	-	2/18/38/38	0/3/3/3
5	PHE	a	101	-	-	0/4/8/8	0/1/1/1
5	PHE	c	101	-	-	0/4/8/8	0/1/1/1
4	QBQ	D	302	-	-	3/18/38/38	0/3/3/3
4	QBQ	P	302	-	-	8/18/38/38	0/3/3/3
5	PHE	r	101	-	-	0/4/8/8	0/1/1/1
5	PHE	l	101	-	-	0/4/8/8	0/1/1/1
5	PHE	m	101	-	-	0/4/8/8	0/1/1/1
5	PHE	s	101	-	-	0/4/8/8	0/1/1/1
4	QBQ	J	302	-	-	4/18/38/38	0/3/3/3
5	PHE	k	101	-	-	0/4/8/8	0/1/1/1
5	PHE	f	101	-	-	0/4/8/8	0/1/1/1
4	QBQ	Q	302	-	-	2/18/38/38	0/3/3/3
5	PHE	f	102	-	-	0/4/8/8	0/1/1/1

All (64) bond length outliers are listed below:

Mol	Chain	Res	Type	Atoms	Z	Observed(Å)	Ideal(Å)
4	T	302	QBQ	P2-O8	-4.43	1.37	1.54
4	J	302	QBQ	P2-O8	-4.36	1.38	1.54
4	L	1101	QBQ	P2-O8	-4.18	1.38	1.54
4	D	302	QBQ	P2-O8	-4.08	1.39	1.54
4	E	302	QBQ	P2-O8	-4.00	1.39	1.54
4	M	1101	QBQ	P2-O8	-3.94	1.39	1.54
4	S	302	QBQ	P2-O8	-3.91	1.39	1.54
4	N	1101	QBQ	P2-O8	-3.89	1.39	1.54
4	K	302	QBQ	P2-O8	-3.84	1.40	1.54
4	G	302	QBQ	P2-O8	-3.76	1.40	1.54
4	R	302	QBQ	P2-O8	-3.70	1.40	1.54
4	H	302	QBQ	P2-O8	-3.64	1.40	1.54
4	A	302	QBQ	P2-O8	-3.40	1.41	1.54
4	B	302	QBQ	P2-O8	-3.38	1.41	1.54
4	I	302	QBQ	P2-O8	-3.32	1.42	1.54
4	Q	302	QBQ	P2-O8	-3.32	1.42	1.54
4	C	302	QBQ	P2-O8	-3.17	1.42	1.54
4	Q	302	QBQ	C10-N3	3.08	1.38	1.33
4	E	302	QBQ	C10-N3	3.07	1.38	1.33
4	F	302	QBQ	C10-N3	3.04	1.38	1.33
4	O	302	QBQ	C10-N3	3.03	1.38	1.33
4	P	302	QBQ	C10-N3	2.99	1.38	1.33
4	B	302	QBQ	C10-N3	2.97	1.38	1.33
4	F	302	QBQ	P2-O8	-2.94	1.43	1.54
4	P	302	QBQ	P2-O8	-2.94	1.43	1.54
4	S	302	QBQ	C10-N3	2.93	1.38	1.33
4	H	302	QBQ	C10-N3	2.93	1.38	1.33
4	C	302	QBQ	C10-N3	2.91	1.38	1.33
4	R	302	QBQ	C10-N3	2.91	1.38	1.33
4	G	302	QBQ	C10-N3	2.90	1.38	1.33
4	K	302	QBQ	C10-N3	2.89	1.38	1.33
4	T	302	QBQ	C10-N3	2.87	1.38	1.33
4	M	1101	QBQ	C10-N3	2.85	1.38	1.33
4	J	302	QBQ	C10-N3	2.84	1.38	1.33
4	L	1101	QBQ	C10-N3	2.82	1.37	1.33
4	I	302	QBQ	C10-N3	2.81	1.37	1.33
4	D	302	QBQ	C10-N3	2.81	1.37	1.33
4	L	1101	QBQ	P2-O10	-2.81	1.41	1.50
4	L	1101	QBQ	P-O2	-2.78	1.42	1.55
4	A	302	QBQ	C10-N3	2.77	1.37	1.33
4	N	1101	QBQ	C10-N3	2.73	1.37	1.33
4	D	302	QBQ	P2-O10	-2.62	1.42	1.50

Continued on next page...

Continued from previous page...

Mol	Chain	Res	Type	Atoms	Z	Observed(Å)	Ideal(Å)
4	J	302	QBQ	P2-O9	-2.43	1.45	1.54
4	D	302	QBQ	P1-O5	-2.40	1.44	1.55
4	L	1101	QBQ	P2-O9	-2.33	1.45	1.54
4	C	302	QBQ	P1-O5	-2.33	1.44	1.55
4	Q	302	QBQ	P1-O5	-2.26	1.44	1.55
4	H	302	QBQ	P1-O5	-2.24	1.44	1.55
4	C	302	QBQ	P2-O9	-2.22	1.46	1.54
4	H	302	QBQ	P-O2	-2.19	1.45	1.55
4	E	302	QBQ	P1-O5	-2.18	1.45	1.55
4	G	302	QBQ	P-O2	-2.17	1.45	1.55
4	B	302	QBQ	P2-O9	-2.17	1.46	1.54
4	B	302	QBQ	P-O3	-2.14	1.43	1.50
4	T	302	QBQ	P2-O9	-2.14	1.46	1.54
4	M	1101	QBQ	P-O2	-2.12	1.45	1.55
4	R	302	QBQ	P1-O5	-2.12	1.45	1.55
4	D	302	QBQ	P1-O6	-2.10	1.43	1.50
4	S	302	QBQ	P2-O9	-2.09	1.46	1.54
4	D	302	QBQ	P2-O9	-2.09	1.46	1.54
4	H	302	QBQ	P1-O6	-2.06	1.43	1.50
4	M	1101	QBQ	P2-O9	-2.02	1.47	1.54
4	A	302	QBQ	P2-O9	-2.01	1.47	1.54
4	L	1101	QBQ	P-O3	-2.00	1.43	1.50

All (90) bond angle outliers are listed below:

Mol	Chain	Res	Type	Atoms	Z	Observed(°)	Ideal(°)
4	N	1101	QBQ	C2-C10-N3	-16.06	113.20	124.40
4	P	302	QBQ	C2-C10-N3	-15.81	113.38	124.40
4	T	302	QBQ	C2-C10-N3	-15.69	113.46	124.40
4	C	302	QBQ	C2-C10-N3	-15.62	113.51	124.40
4	H	302	QBQ	C2-C10-N3	-15.62	113.51	124.40
4	L	1101	QBQ	C2-C10-N3	-15.56	113.55	124.40
4	A	302	QBQ	C2-C10-N3	-15.54	113.56	124.40
4	S	302	QBQ	C2-C10-N3	-15.53	113.58	124.40
4	D	302	QBQ	C2-C10-N3	-15.52	113.58	124.40
4	J	302	QBQ	C2-C10-N3	-15.50	113.59	124.40
4	Q	302	QBQ	C2-C10-N3	-15.50	113.59	124.40
4	B	302	QBQ	C2-C10-N3	-15.49	113.60	124.40
4	K	302	QBQ	C2-C10-N3	-15.45	113.63	124.40
4	R	302	QBQ	C2-C10-N3	-15.45	113.63	124.40
4	E	302	QBQ	C2-C10-N3	-15.44	113.64	124.40
4	M	1101	QBQ	C2-C10-N3	-15.43	113.64	124.40

Continued on next page...

Continued from previous page...

Mol	Chain	Res	Type	Atoms	Z	Observed(°)	Ideal(°)
4	F	302	QBQ	C2-C10-N3	-15.39	113.67	124.40
4	G	302	QBQ	C2-C10-N3	-15.29	113.74	124.40
4	I	302	QBQ	C2-C10-N3	-15.28	113.75	124.40
4	O	302	QBQ	C2-C10-N3	-15.28	113.75	124.40
4	O	302	QBQ	C10-N3-C	5.42	124.54	115.93
4	N	1101	QBQ	C10-N3-C	5.36	124.44	115.93
4	L	1101	QBQ	C10-N3-C	5.35	124.43	115.93
4	C	302	QBQ	C10-N3-C	5.32	124.38	115.93
4	J	302	QBQ	C10-N3-C	5.29	124.33	115.93
4	T	302	QBQ	C10-N3-C	5.28	124.32	115.93
4	S	302	QBQ	C10-N3-C	5.28	124.31	115.93
4	I	302	QBQ	C10-N3-C	5.27	124.31	115.93
4	G	302	QBQ	C10-N3-C	5.24	124.26	115.93
4	D	302	QBQ	C10-N3-C	5.23	124.23	115.93
4	R	302	QBQ	C10-N3-C	5.22	124.22	115.93
4	H	302	QBQ	C10-N3-C	5.20	124.20	115.93
4	P	302	QBQ	C10-N3-C	5.19	124.17	115.93
4	F	302	QBQ	C10-N3-C	5.19	124.17	115.93
4	M	1101	QBQ	C10-N3-C	5.17	124.15	115.93
4	K	302	QBQ	C10-N3-C	5.16	124.12	115.93
4	Q	302	QBQ	C10-N3-C	5.15	124.11	115.93
4	A	302	QBQ	C10-N3-C	5.13	124.08	115.93
4	E	302	QBQ	C10-N3-C	5.12	124.07	115.93
4	B	302	QBQ	C10-N3-C	5.12	124.06	115.93
4	P	302	QBQ	N1-C-N3	-2.87	123.40	127.22
4	G	302	QBQ	N1-C-N3	-2.82	123.46	127.22
4	F	302	QBQ	N1-C-N3	-2.82	123.47	127.22
4	O	302	QBQ	N1-C-N3	-2.81	123.48	127.22
4	R	302	QBQ	N1-C-N3	-2.80	123.49	127.22
4	T	302	QBQ	N1-C-N3	-2.79	123.50	127.22
4	C	302	QBQ	N1-C-N3	-2.78	123.52	127.22
4	I	302	QBQ	N1-C-N3	-2.77	123.52	127.22
4	H	302	QBQ	N1-C-N3	-2.77	123.52	127.22
4	M	1101	QBQ	N1-C-N3	-2.77	123.53	127.22
4	Q	302	QBQ	N1-C-N3	-2.76	123.54	127.22
4	J	302	QBQ	N1-C-N3	-2.76	123.55	127.22
4	K	302	QBQ	N1-C-N3	-2.75	123.56	127.22
4	E	302	QBQ	N1-C-N3	-2.74	123.56	127.22
4	L	1101	QBQ	N1-C-N3	-2.73	123.58	127.22
4	N	1101	QBQ	N1-C-N3	-2.73	123.58	127.22
4	A	302	QBQ	N1-C-N3	-2.72	123.59	127.22
4	D	302	QBQ	N1-C-N3	-2.72	123.59	127.22

Continued on next page...

Continued from previous page...

Mol	Chain	Res	Type	Atoms	Z	Observed(°)	Ideal(°)
4	S	302	QBQ	N1-C-N3	-2.71	123.61	127.22
4	B	302	QBQ	N1-C-N3	-2.65	123.68	127.22
4	B	302	QBQ	C4-N2-C5	2.48	128.01	125.49
4	L	1101	QBQ	C4-N2-C5	2.46	127.99	125.49
4	E	302	QBQ	C4-N2-C5	2.44	127.97	125.49
4	D	302	QBQ	C4-N2-C5	2.39	127.92	125.49
4	L	1101	QBQ	O8-P2-O7	2.38	112.62	104.64
4	T	302	QBQ	C4-N2-C5	2.35	127.88	125.49
4	G	302	QBQ	C5-N2-C1	-2.34	122.54	126.64
4	C	302	QBQ	C4-N2-C5	2.33	127.86	125.49
4	D	302	QBQ	C5-N2-C1	-2.30	122.59	126.64
4	G	302	QBQ	C4-N2-C5	2.28	127.81	125.49
4	C	302	QBQ	C5-N2-C1	-2.26	122.67	126.64
4	E	302	QBQ	C5-N2-C1	-2.25	122.69	126.64
4	R	302	QBQ	C5-N2-C1	-2.24	122.70	126.64
4	T	302	QBQ	C5-N2-C1	-2.22	122.73	126.64
4	B	302	QBQ	C5-N2-C1	-2.21	122.76	126.64
4	D	302	QBQ	O8-P2-O7	2.20	112.02	104.64
4	R	302	QBQ	C4-N2-C5	2.20	127.73	125.49
4	Q	302	QBQ	C4-N2-C5	2.20	127.72	125.49
4	E	302	QBQ	O8-P2-O7	2.17	111.92	104.64
4	B	302	QBQ	O8-P2-O7	2.15	111.84	104.64
4	H	302	QBQ	C5-N2-C1	-2.14	122.88	126.64
4	S	302	QBQ	O8-P2-O7	2.09	111.65	104.64
4	Q	302	QBQ	C5-N2-C1	-2.08	122.98	126.64
4	K	302	QBQ	C4-N2-C5	2.06	127.58	125.49
4	I	302	QBQ	O8-P2-O7	2.06	111.54	104.64
4	J	302	QBQ	C5-N2-C1	-2.06	123.03	126.64
4	I	302	QBQ	C4-N2-C5	2.04	127.56	125.49
4	I	302	QBQ	C5-N2-C1	-2.03	123.07	126.64
4	J	302	QBQ	C4-N2-C5	2.02	127.55	125.49
4	L	1101	QBQ	C5-N2-C1	-2.02	123.09	126.64

There are no chirality outliers.

All (79) torsion outliers are listed below:

Mol	Chain	Res	Type	Atoms
4	A	302	QBQ	P1-O7-P2-O8
4	B	302	QBQ	P1-O7-P2-O8
4	D	302	QBQ	P1-O7-P2-O8
4	E	302	QBQ	C7-O1-P-O4
4	F	302	QBQ	P1-O7-P2-O8

Continued on next page...

Continued from previous page...

Mol	Chain	Res	Type	Atoms
4	G	302	QBQ	P1-O7-P2-O8
4	H	302	QBQ	P1-O7-P2-O8
4	I	302	QBQ	P1-O7-P2-O8
4	J	302	QBQ	P1-O7-P2-O8
4	K	302	QBQ	P1-O7-P2-O9
4	M	1101	QBQ	P1-O7-P2-O8
4	O	302	QBQ	P1-O7-P2-O9
4	P	302	QBQ	P1-O7-P2-O8
4	P	302	QBQ	C7-O1-P-O3
4	P	302	QBQ	C7-O1-P-O4
4	Q	302	QBQ	P1-O7-P2-O8
4	T	302	QBQ	P1-O7-P2-O9
4	E	302	QBQ	P1-O7-P2-O10
4	S	302	QBQ	P1-O4-P-O3
4	T	302	QBQ	P1-O4-P-O3
4	P	302	QBQ	O-C6-C7-O1
4	A	302	QBQ	P1-O7-P2-O10
4	S	302	QBQ	P1-O7-P2-O10
4	E	302	QBQ	P1-O7-P2-O8
4	N	1101	QBQ	P1-O7-P2-O9
4	N	1101	QBQ	C7-O1-P-O4
4	R	302	QBQ	P1-O4-P-O2
4	P	302	QBQ	C7-O1-P-O2
4	L	1101	QBQ	P1-O7-P2-O10
4	L	1101	QBQ	P1-O4-P-O3
4	L	1101	QBQ	P1-O4-P-O2
4	O	302	QBQ	P1-O4-P-O3
4	O	302	QBQ	P1-O4-P-O2
4	P	302	QBQ	P1-O4-P-O3
4	P	302	QBQ	P1-O4-P-O2
4	E	302	QBQ	O-C6-C7-O1
4	B	302	QBQ	P1-O7-P2-O10
4	G	302	QBQ	P1-O7-P2-O10
4	H	302	QBQ	P1-O7-P2-O10
4	I	302	QBQ	P1-O7-P2-O10
4	E	302	QBQ	P1-O4-P-O2
4	F	302	QBQ	P1-O4-P-O3
4	G	302	QBQ	O-C6-C7-O1
4	N	1101	QBQ	O-C6-C7-O1
4	C	302	QBQ	P1-O7-P2-O10
4	D	302	QBQ	P1-O7-P2-O10
4	F	302	QBQ	P1-O7-P2-O10

Continued on next page...

Continued from previous page...

Mol	Chain	Res	Type	Atoms
4	J	302	QBQ	P1-O7-P2-O10
4	H	302	QBQ	O-C6-C7-O1
4	L	1101	QBQ	O-C6-C7-O1
4	M	1101	QBQ	O-C6-C7-O1
4	Q	302	QBQ	O-C6-C7-O1
4	F	302	QBQ	P1-O7-P2-O9
4	J	302	QBQ	P1-O7-P2-O9
4	N	1101	QBQ	P1-O7-P2-O8
4	P	302	QBQ	P1-O7-P2-O9
4	R	302	QBQ	P1-O7-P2-O9
4	S	302	QBQ	P1-O7-P2-O8
4	A	302	QBQ	O-C6-C7-O1
4	B	302	QBQ	O-C6-C7-O1
4	C	302	QBQ	O-C6-C7-O1
4	D	302	QBQ	O-C6-C7-O1
4	F	302	QBQ	O-C6-C7-O1
4	K	302	QBQ	O-C6-C7-O1
4	S	302	QBQ	O-C6-C7-O1
4	T	302	QBQ	O-C6-C7-O1
4	E	302	QBQ	P1-O4-P-O3
4	F	302	QBQ	P1-O4-P-O2
4	N	1101	QBQ	P1-O4-P-O2
4	R	302	QBQ	P1-O4-P-O3
4	S	302	QBQ	P1-O4-P-O2
4	T	302	QBQ	P1-O4-P-O2
4	R	302	QBQ	C7-O1-P-O3
4	S	302	QBQ	C7-O1-P-O3
4	T	302	QBQ	C7-O1-P-O3
4	I	302	QBQ	O-C6-C7-O1
4	J	302	QBQ	O-C6-C7-O1
4	O	302	QBQ	O-C6-C7-O1
4	R	302	QBQ	O-C6-C7-O1

There are no ring outliers.

17 monomers are involved in 18 short contacts:

Mol	Chain	Res	Type	Clashes	Symm-Clashes
4	G	302	QBQ	1	0
4	L	1101	QBQ	1	0
4	I	302	QBQ	1	0
4	E	302	QBQ	1	0
4	C	302	QBQ	2	0

Continued on next page...

Continued from previous page...

Mol	Chain	Res	Type	Clashes	Symm-Clashes
4	B	302	QBQ	1	0
4	H	302	QBQ	1	0
4	K	302	QBQ	1	0
4	F	302	QBQ	1	0
4	R	302	QBQ	1	0
4	T	302	QBQ	1	0
4	S	302	QBQ	1	0
4	M	1101	QBQ	1	0
4	D	302	QBQ	1	0
4	P	302	QBQ	1	0
4	J	302	QBQ	1	0
4	Q	302	QBQ	1	0

The following is a two-dimensional graphical depiction of Mogul quality analysis of bond lengths, bond angles, torsion angles, and ring geometry for all instances of the Ligand of Interest. In addition, ligands with molecular weight > 250 and outliers as shown on the validation Tables will also be included. For torsion angles, if less than 5% of the Mogul distribution of torsion angles is within 10 degrees of the torsion angle in question, then that torsion angle is considered an outlier. Any bond that is central to one or more torsion angles identified as an outlier by Mogul will be highlighted in the graph. For rings, the root-mean-square deviation (RMSD) between the ring in question and similar rings identified by Mogul is calculated over all ring torsion angles. If the average RMSD is greater than 60 degrees and the minimal RMSD between the ring in question and any Mogul-identified rings is also greater than 60 degrees, then that ring is considered an outlier. The outliers are highlighted in purple. The color gray indicates Mogul did not find sufficient equivalents in the CSD to analyse the geometry.

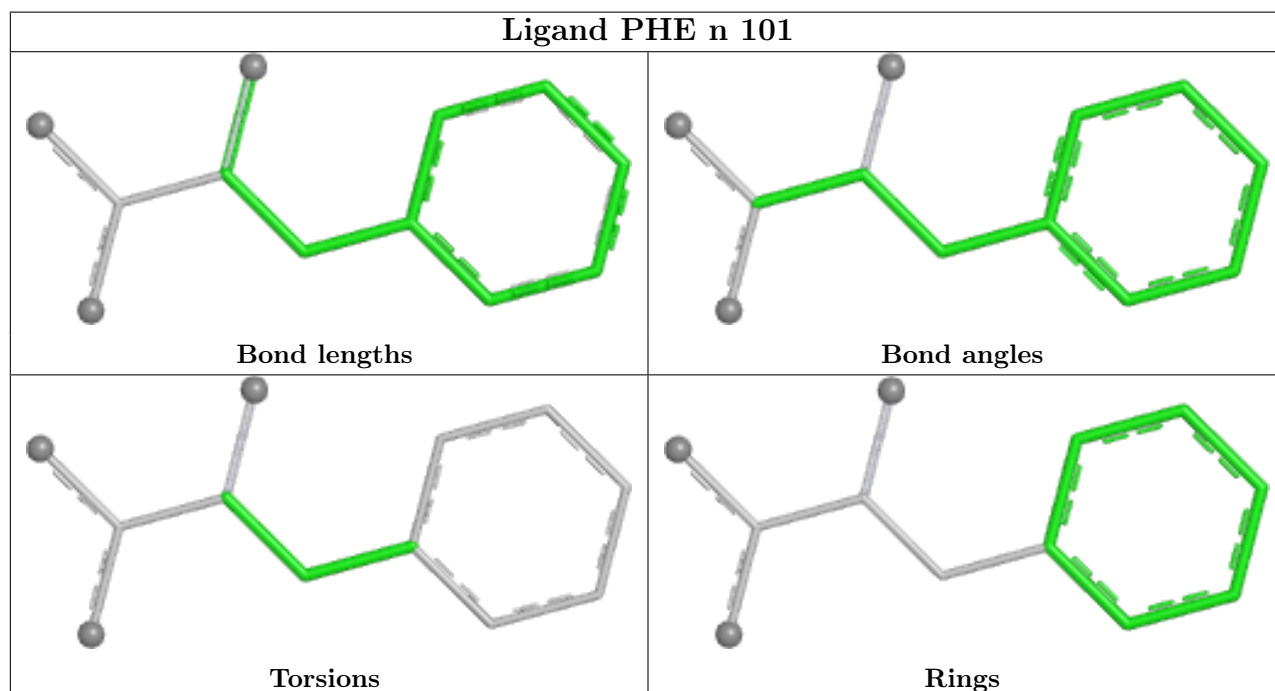

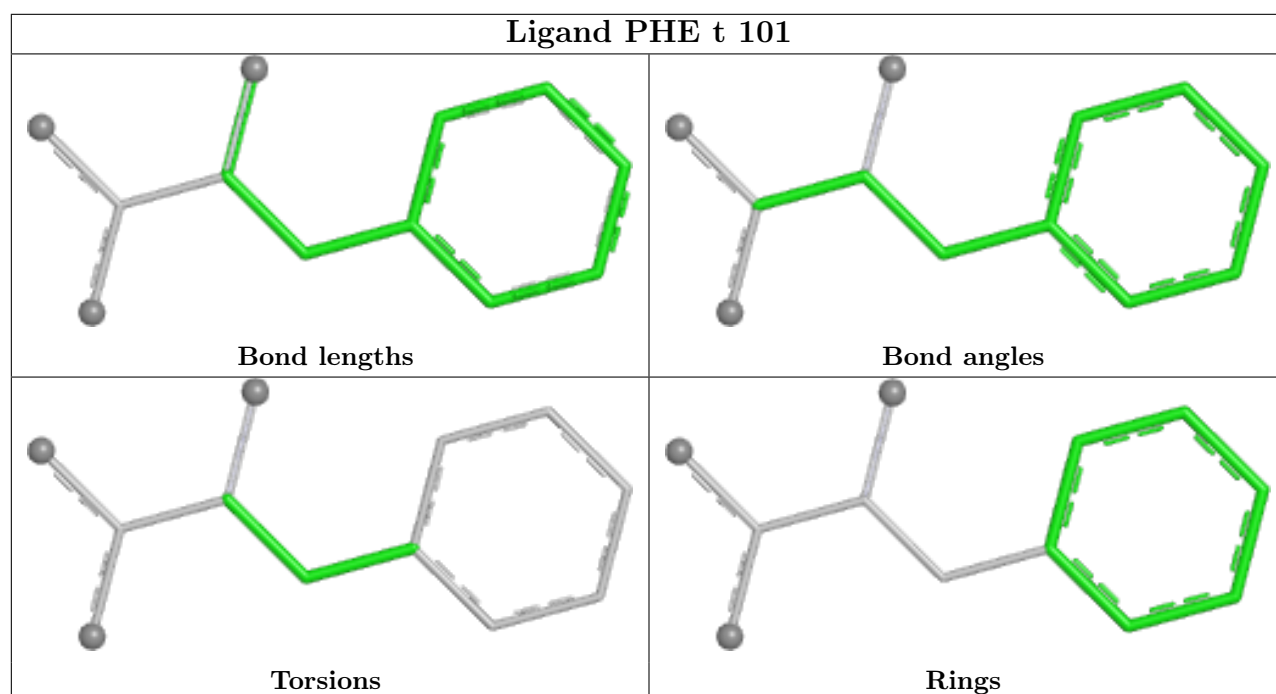
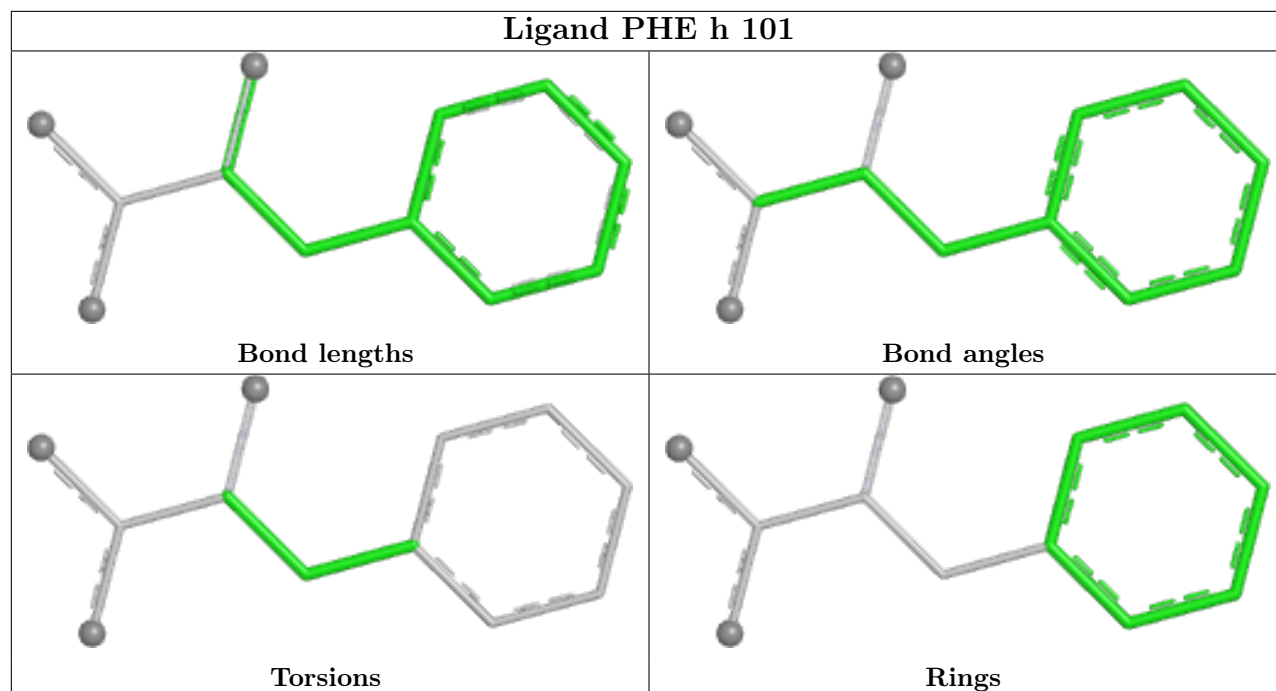

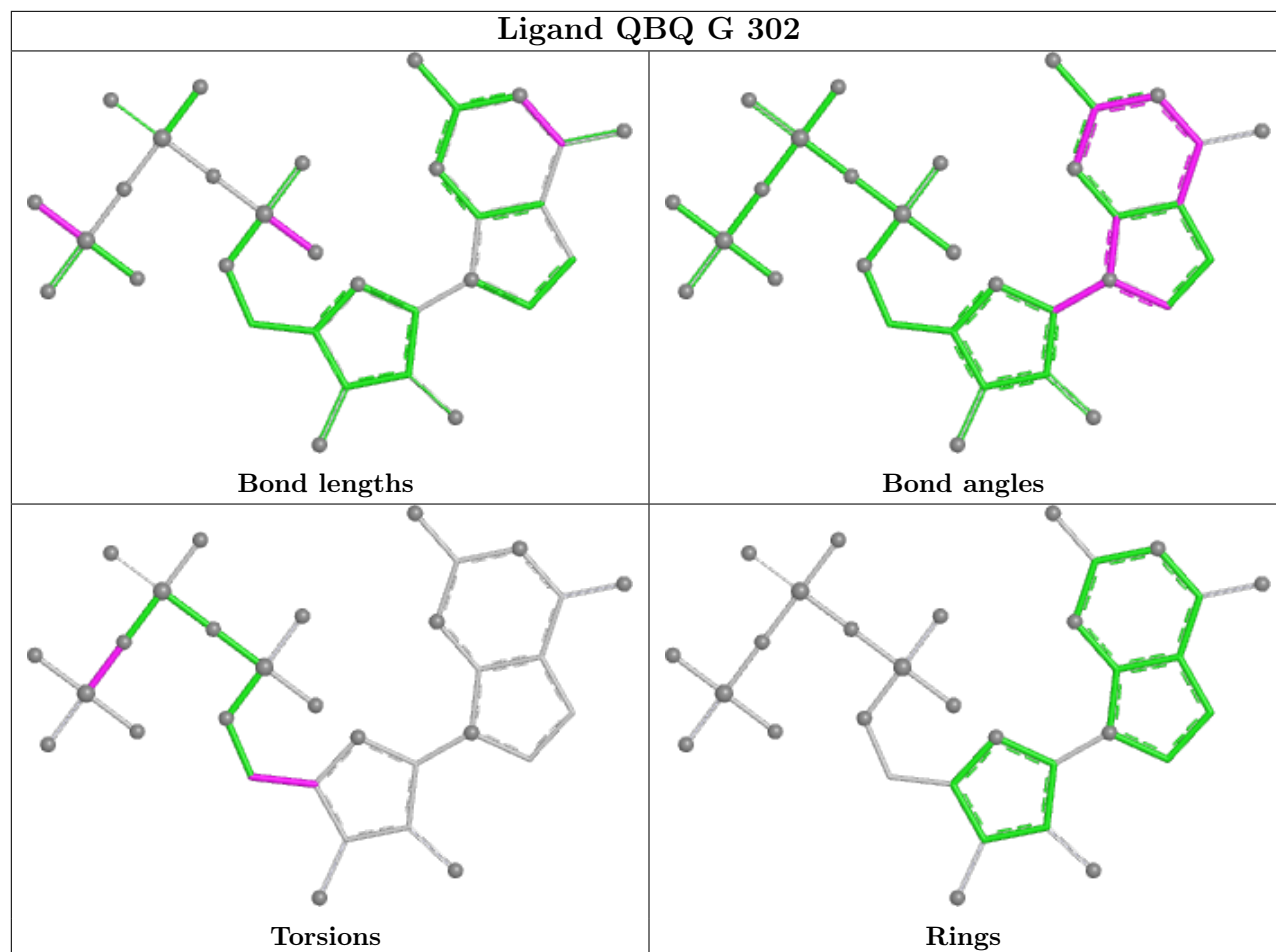

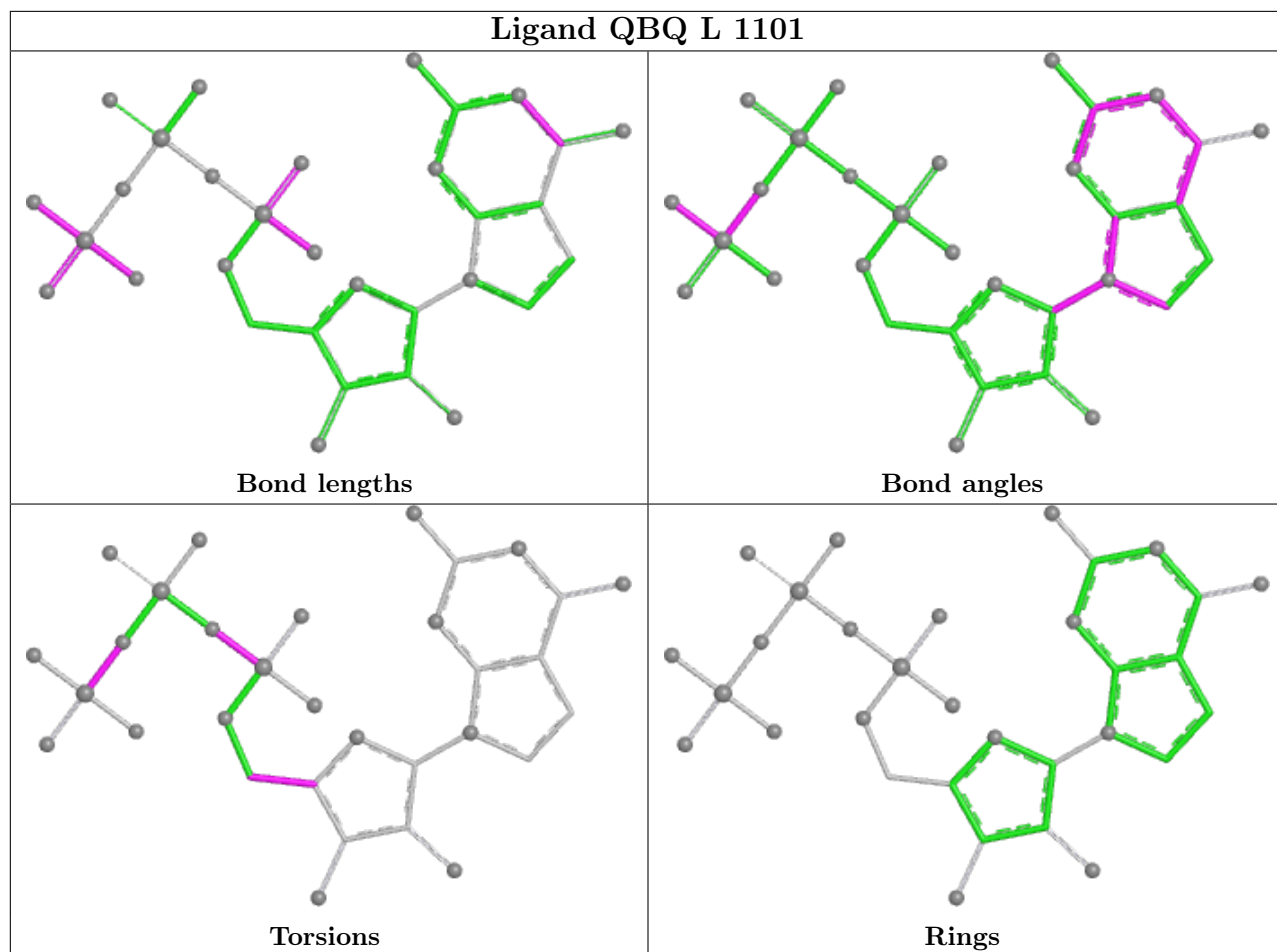

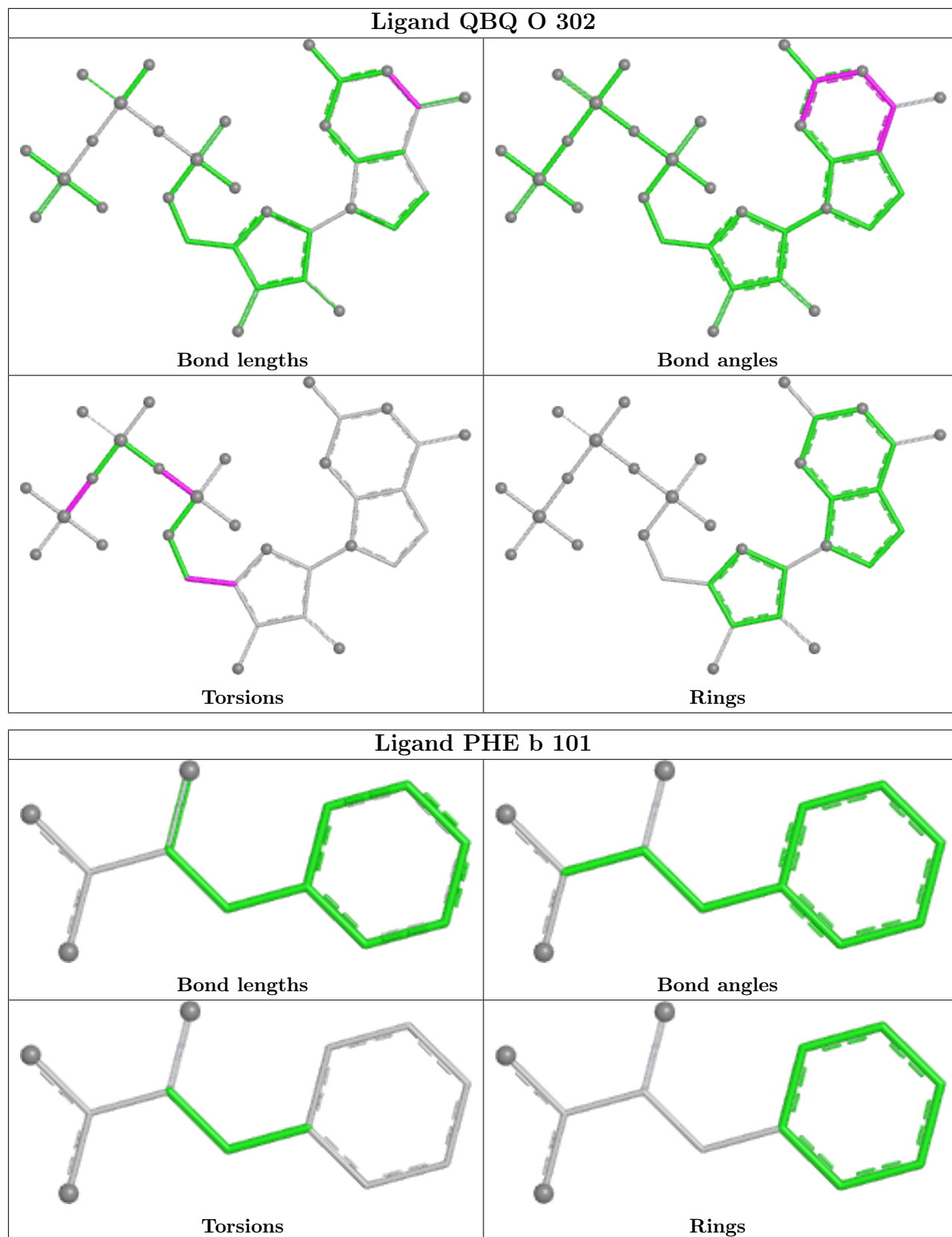

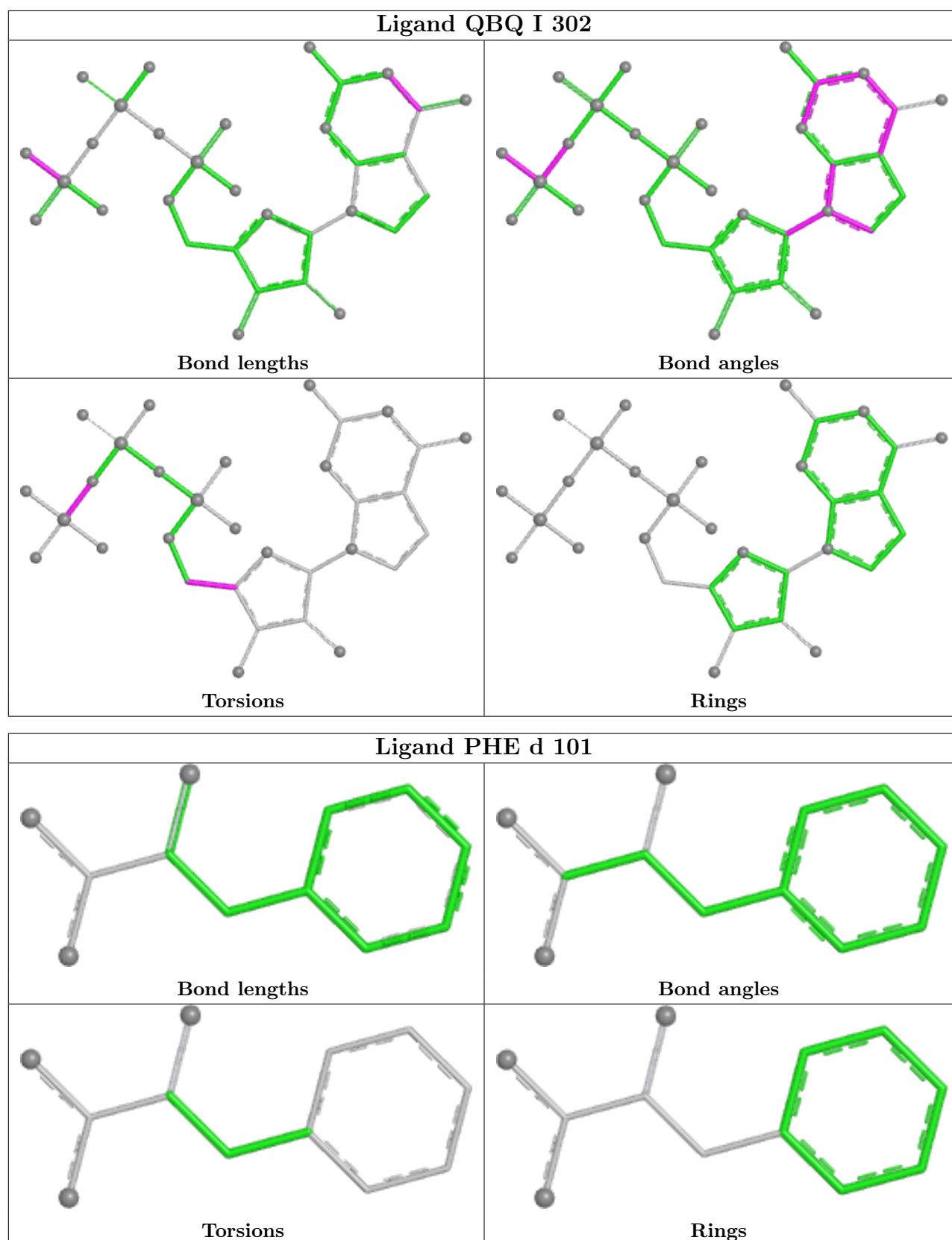

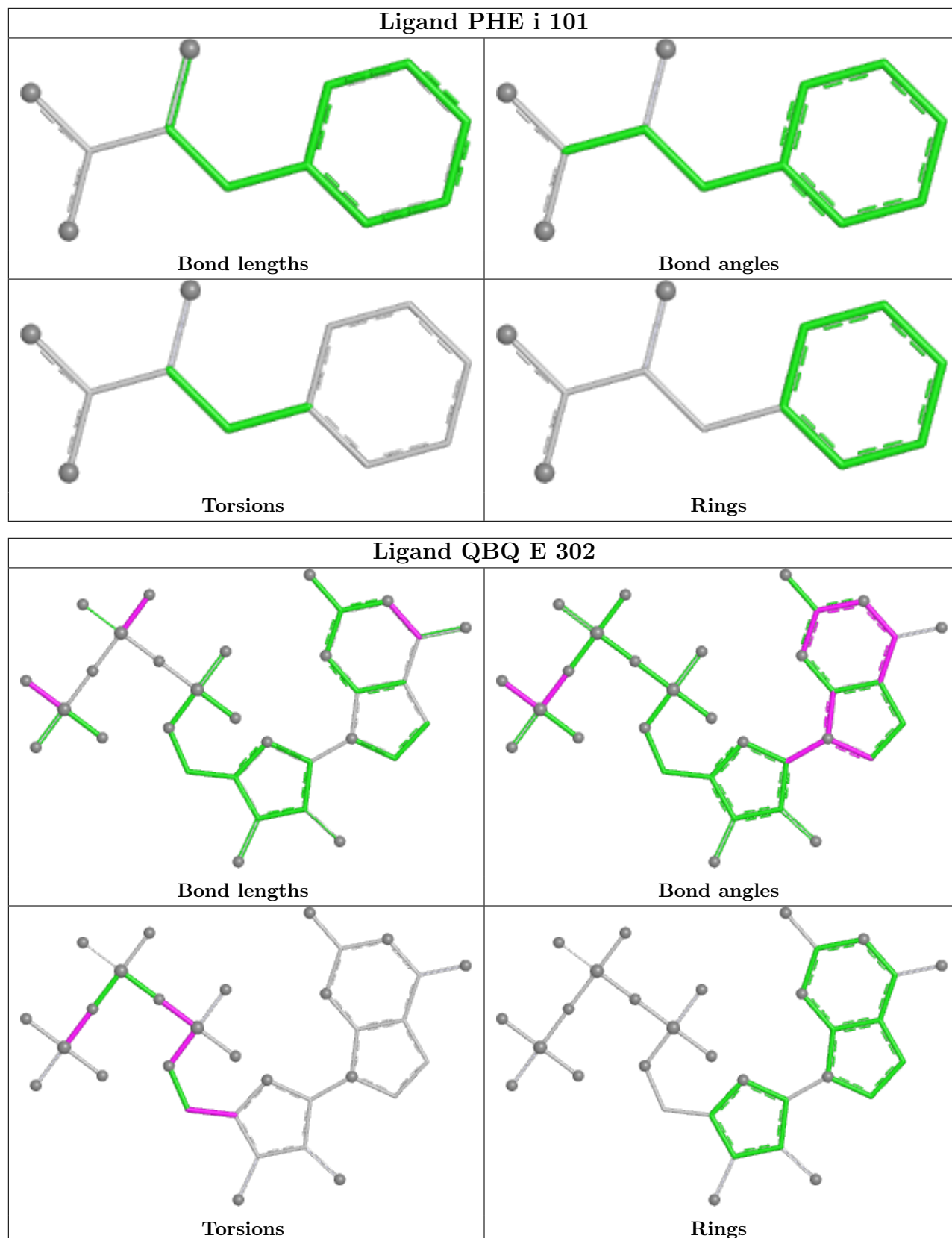

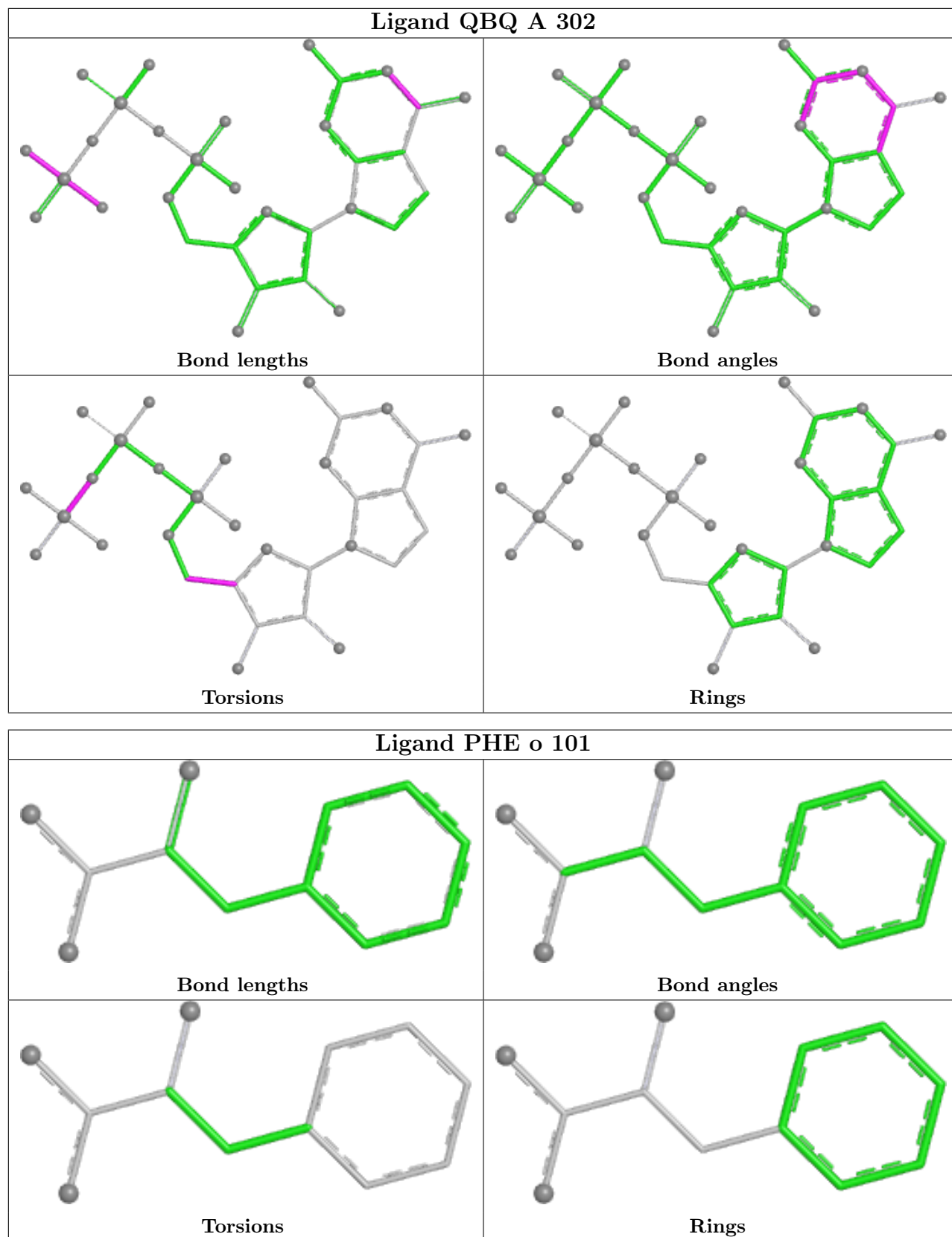

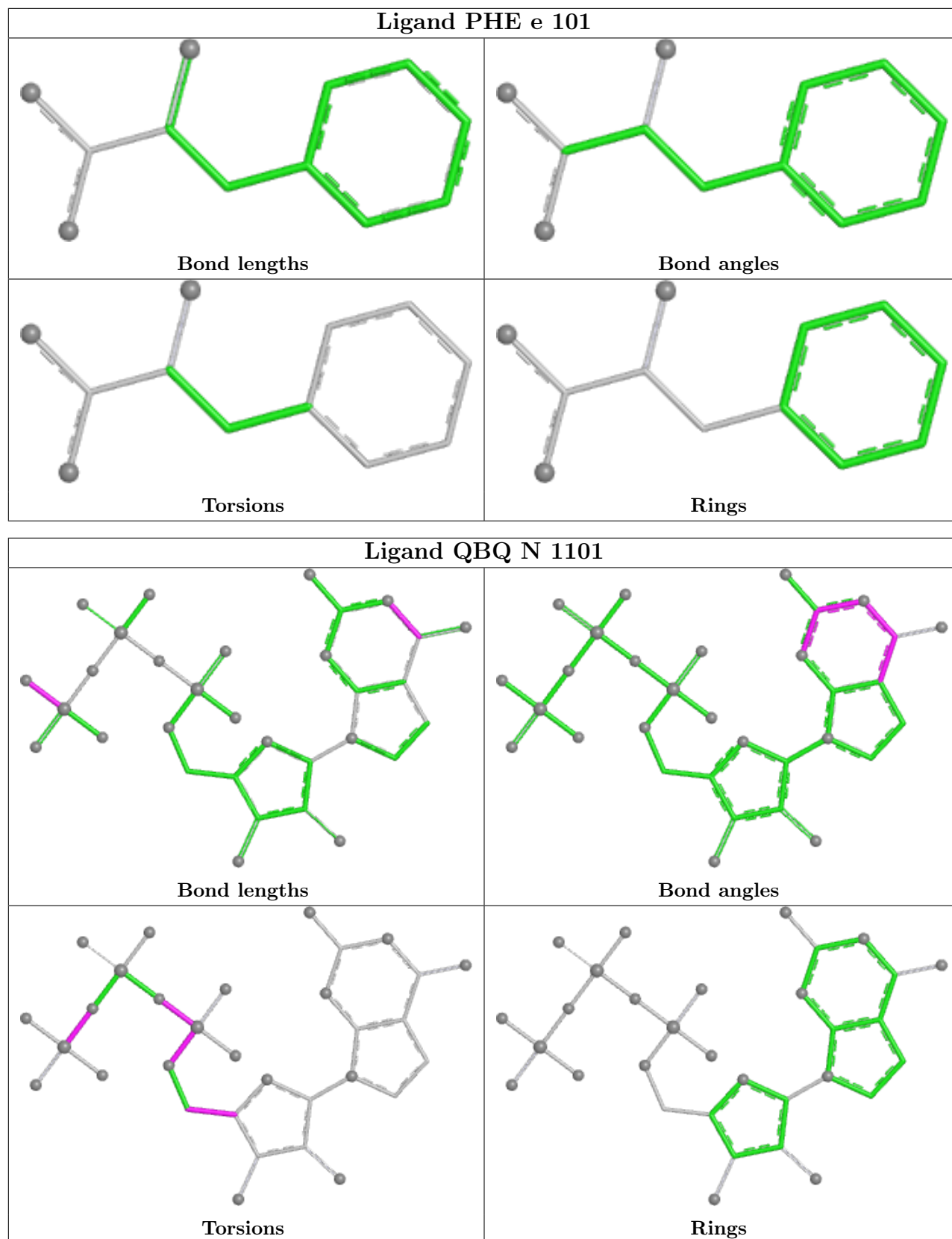

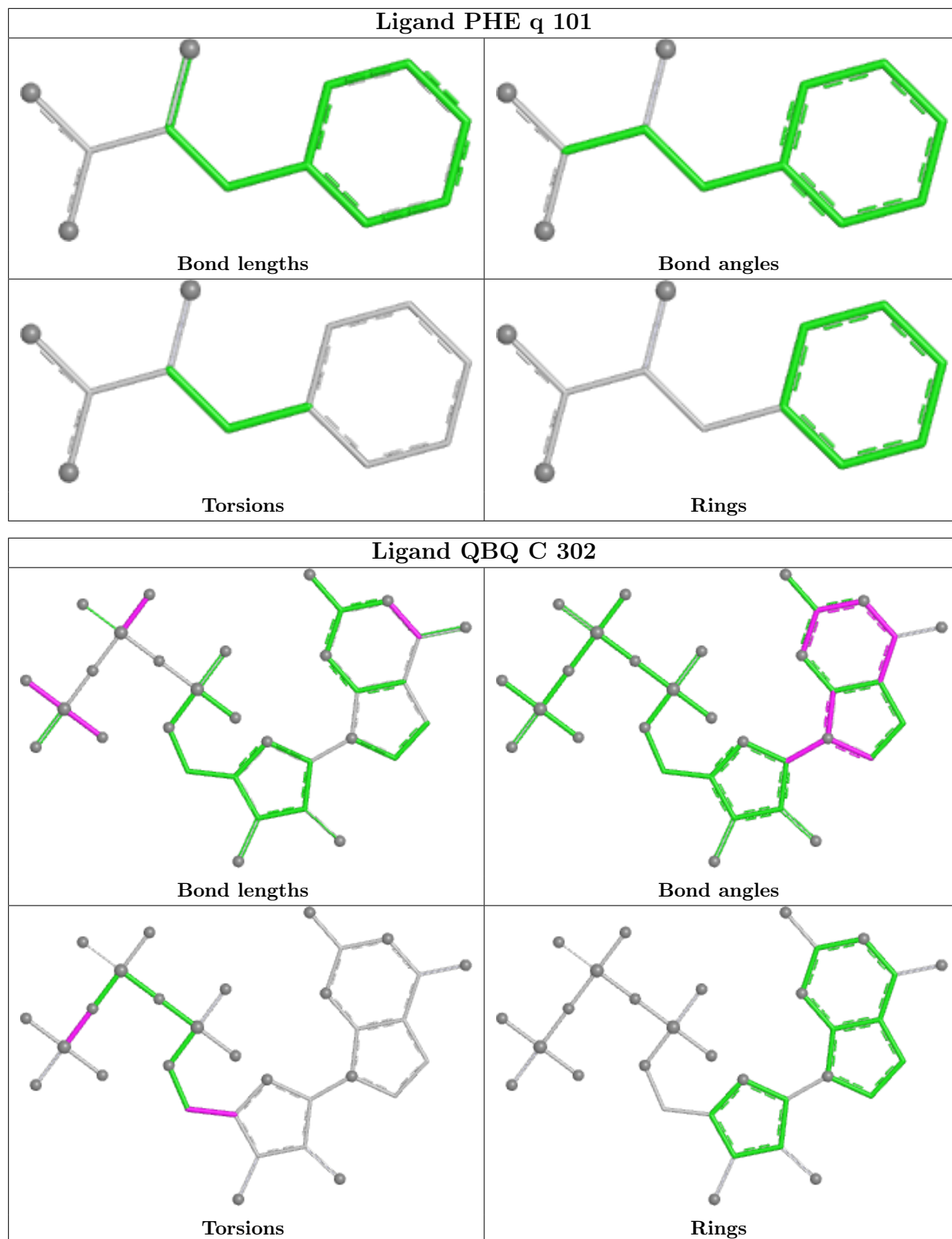

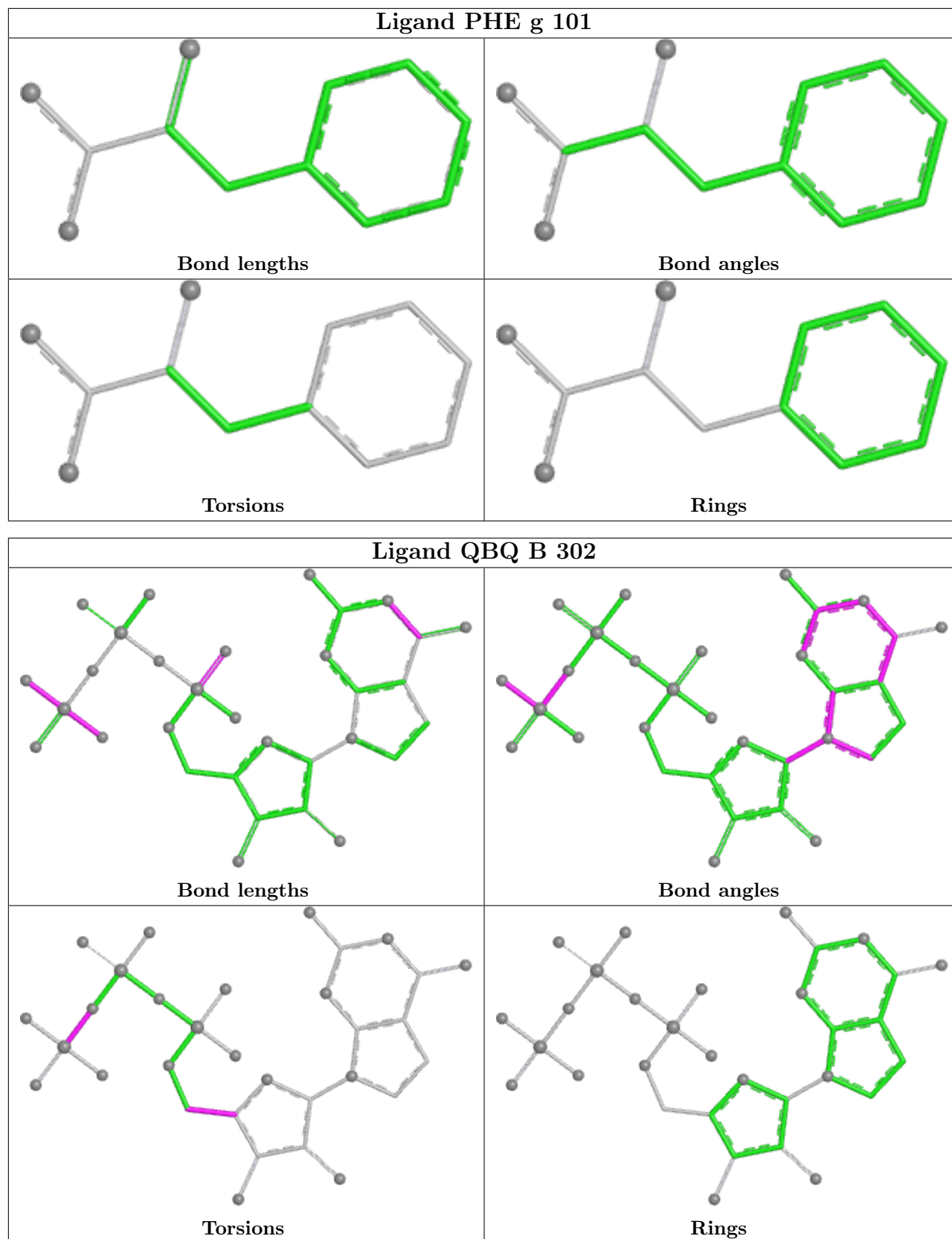

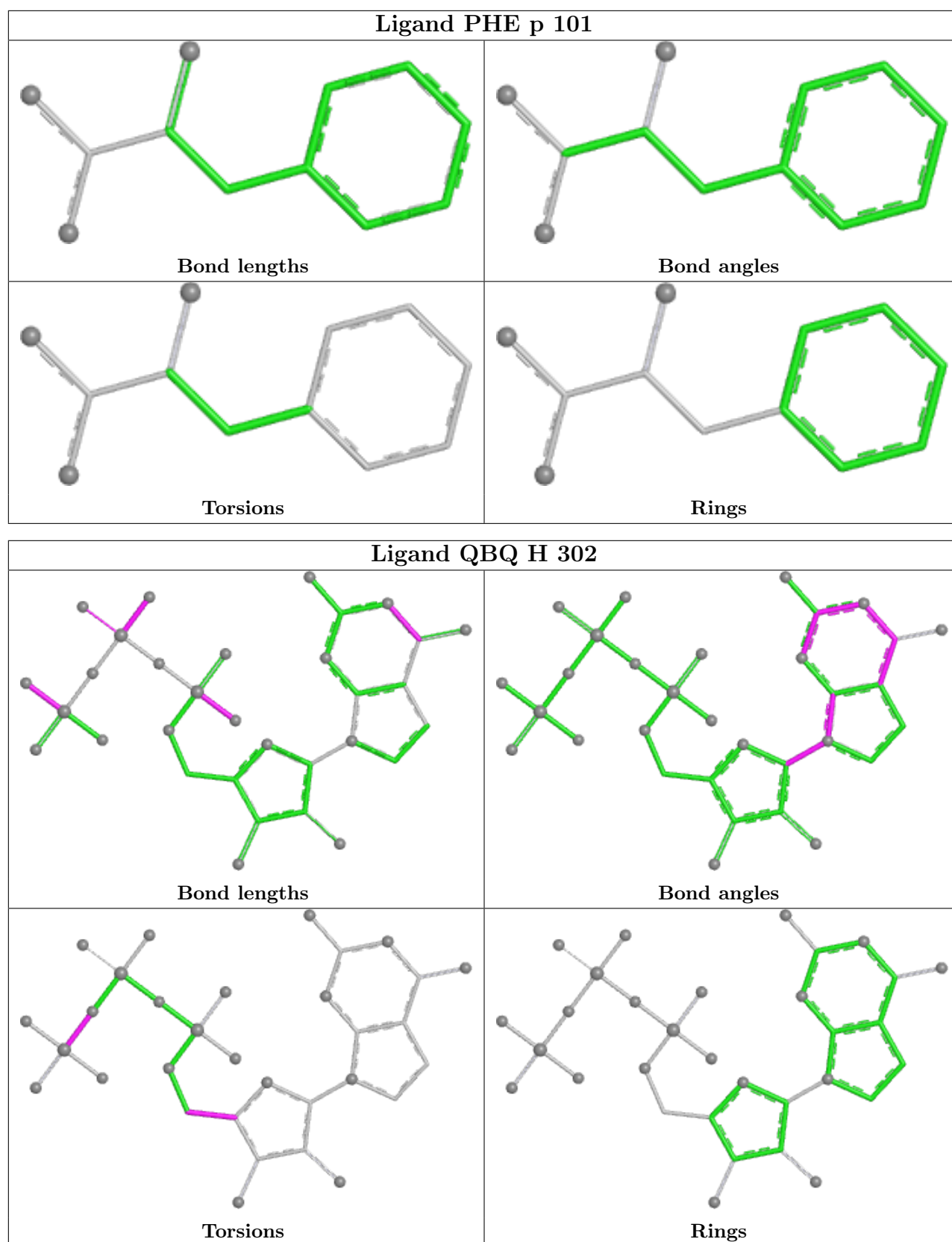

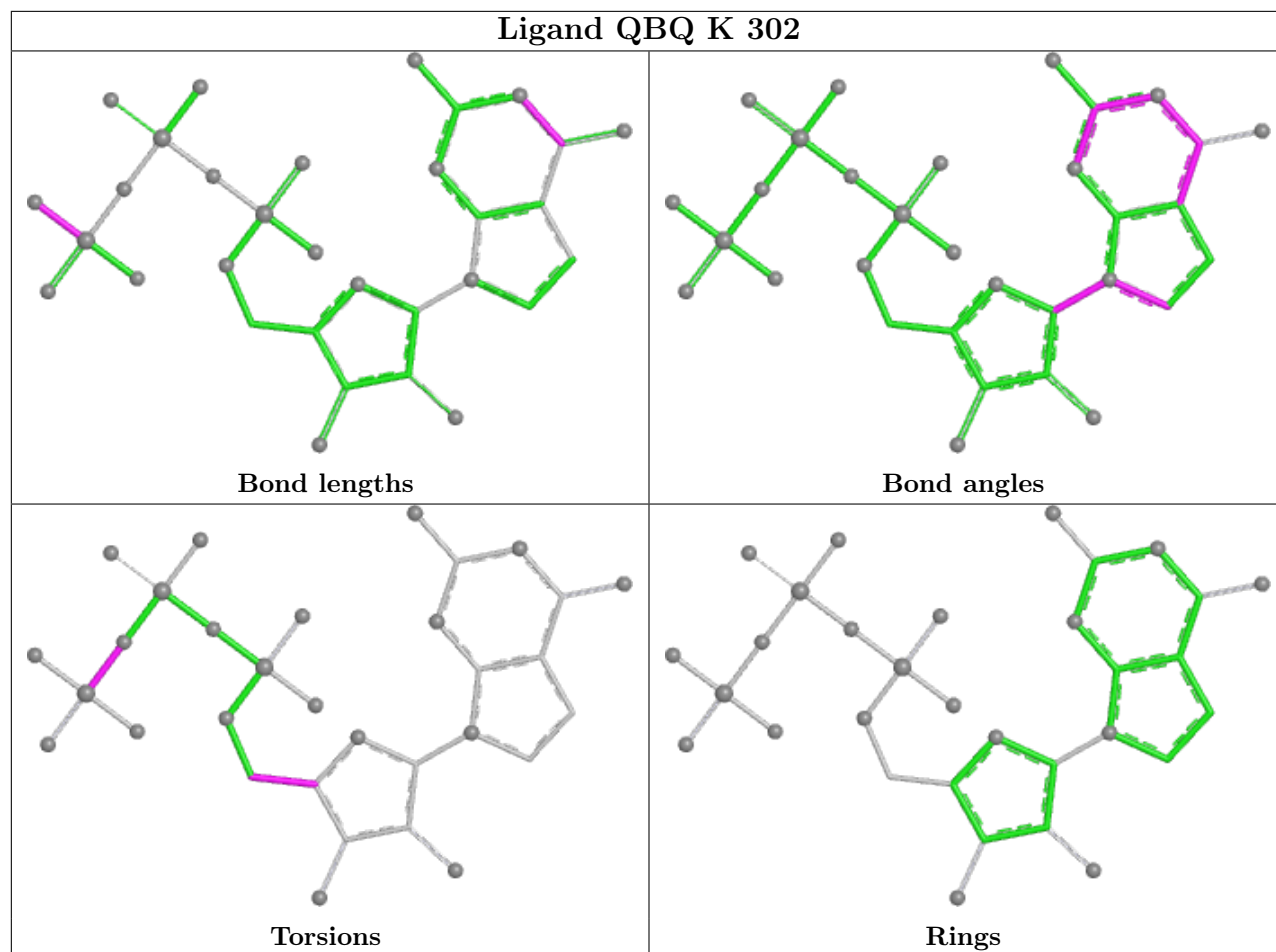

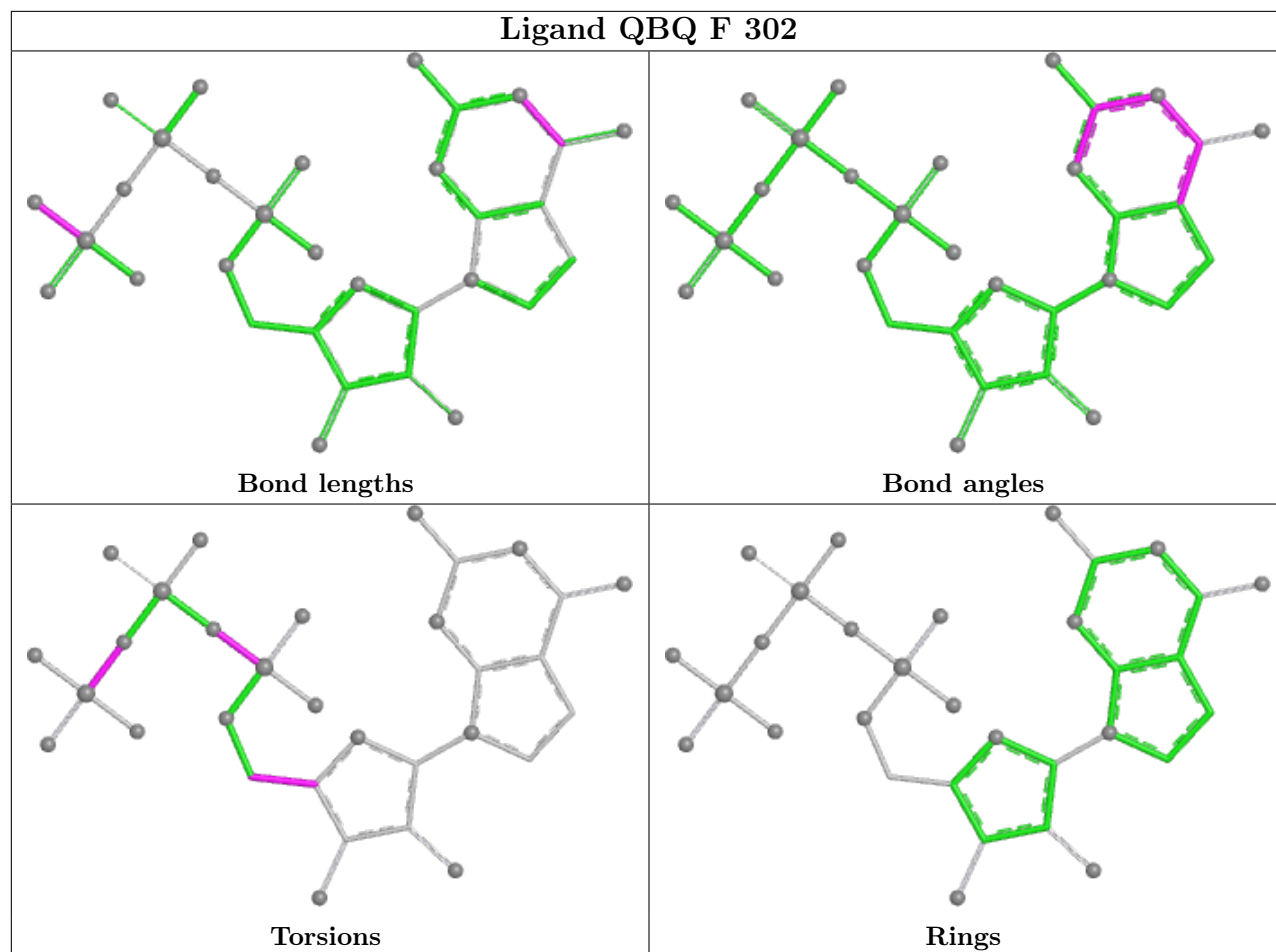

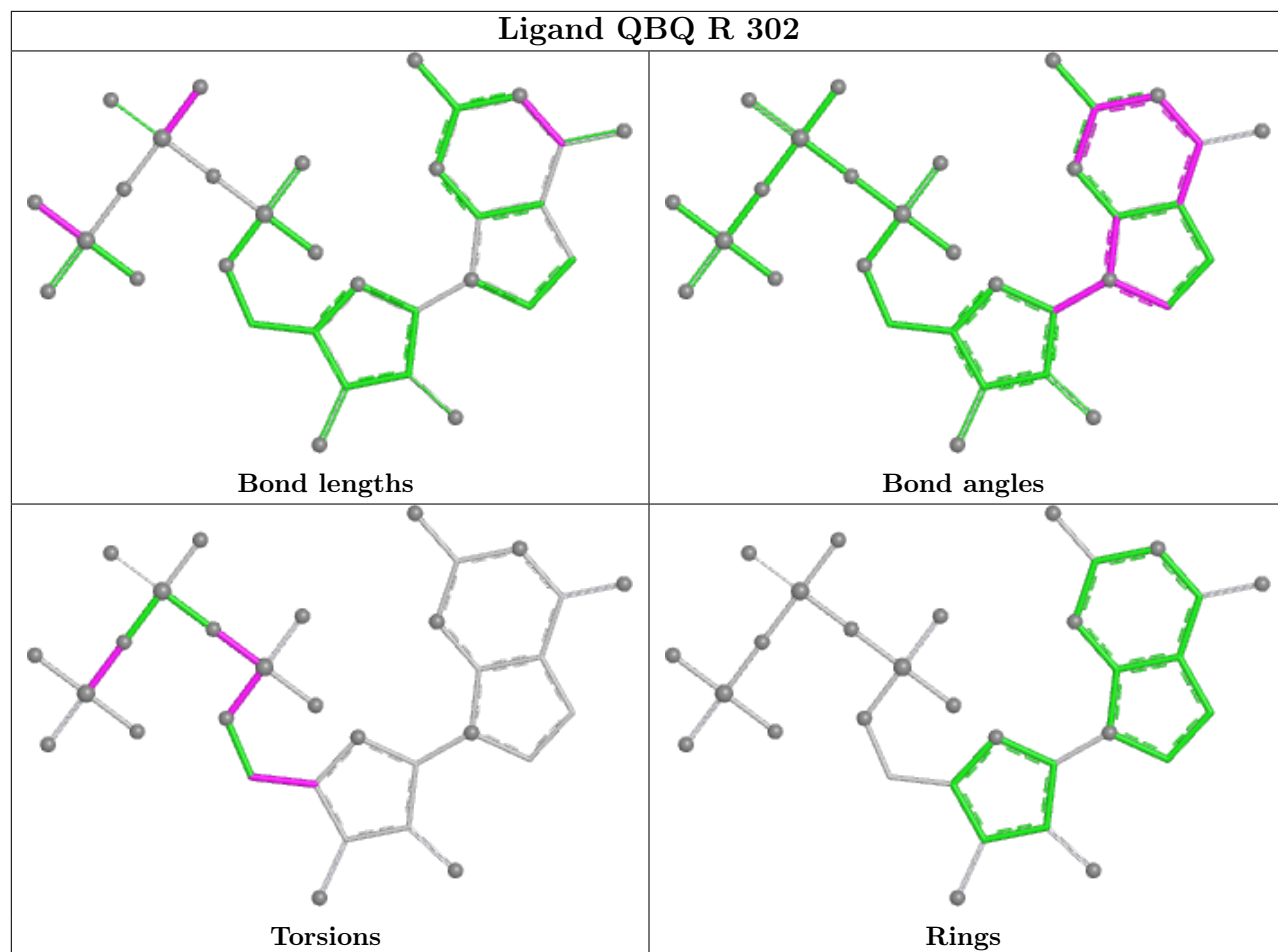

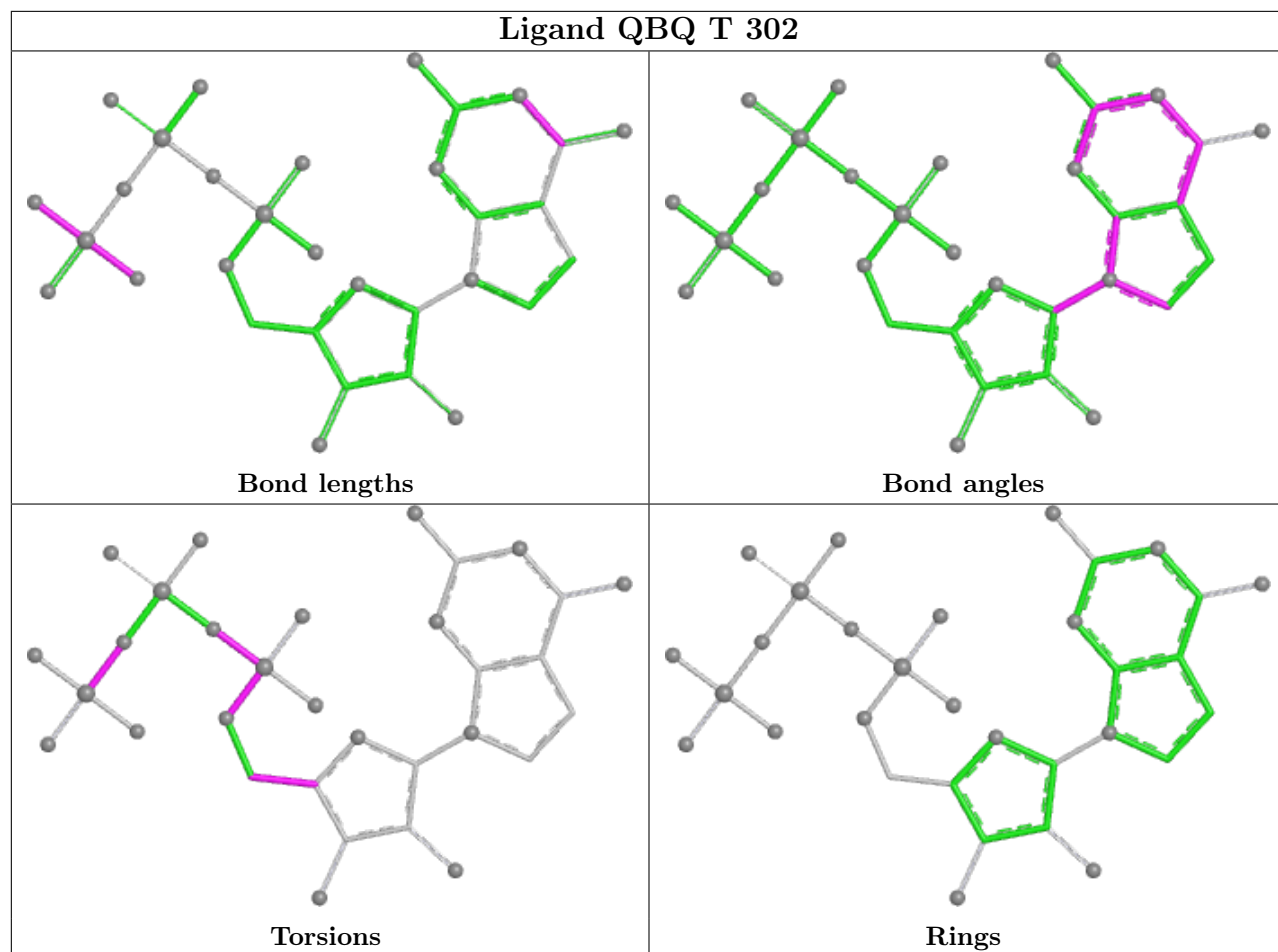

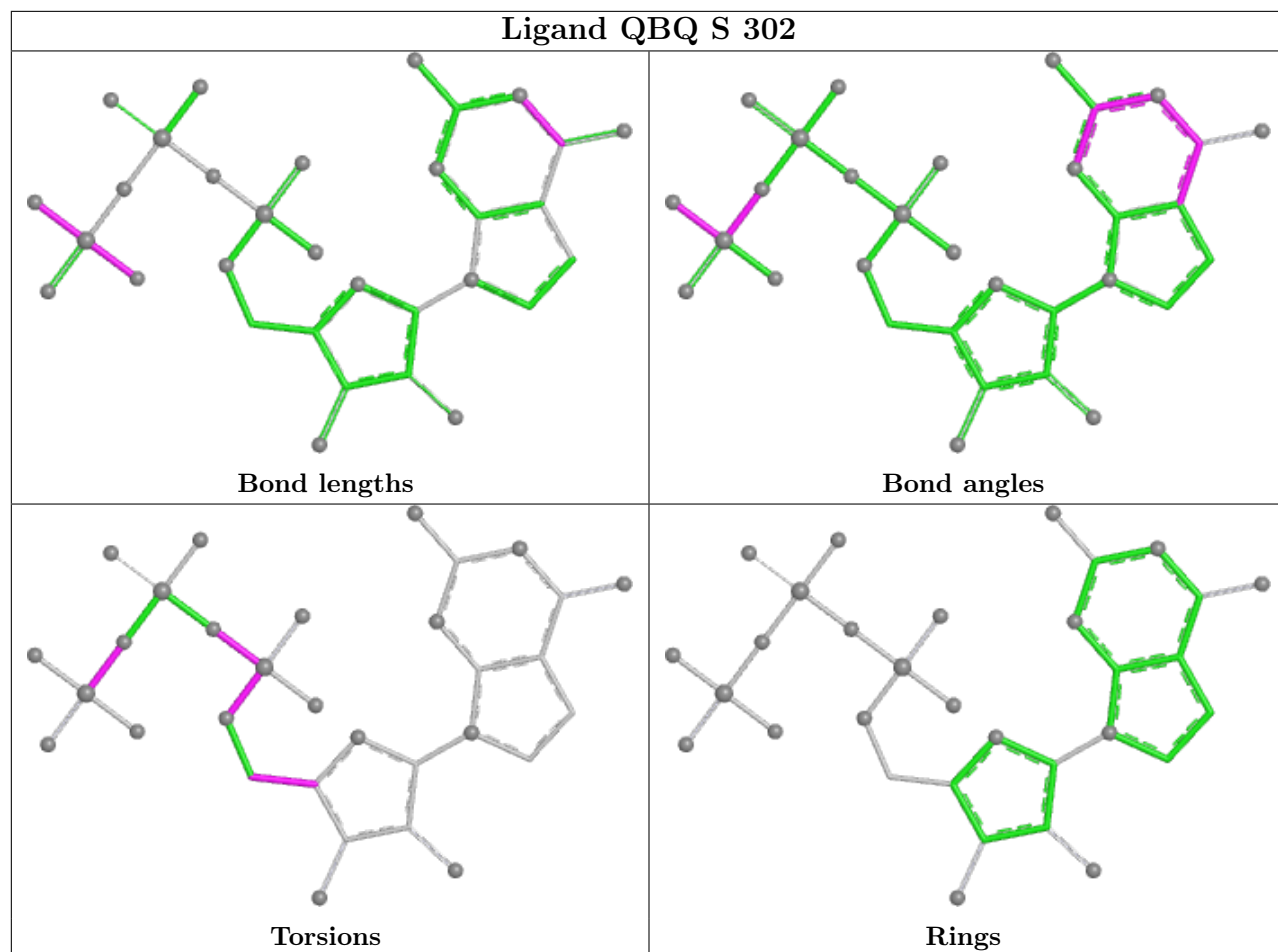

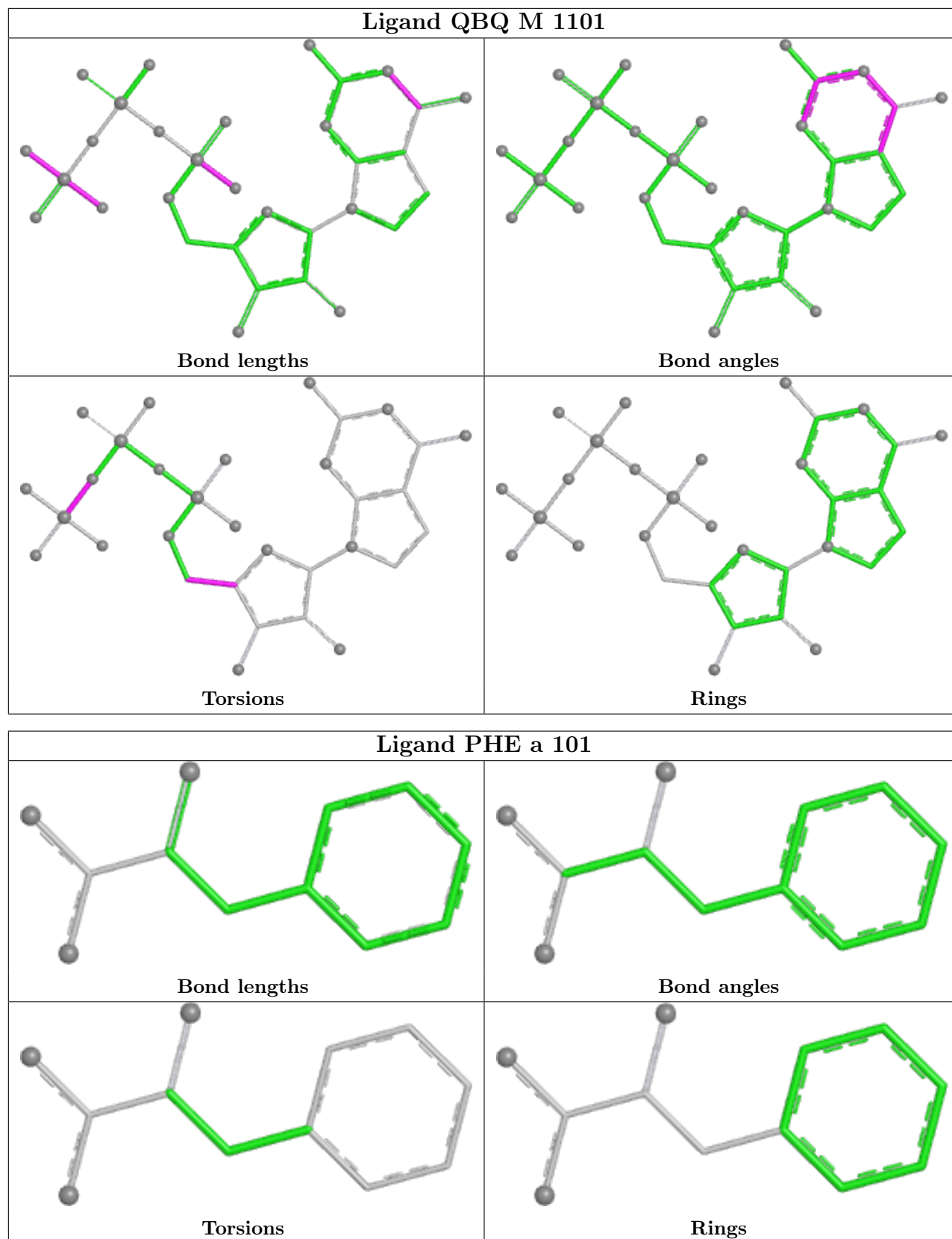

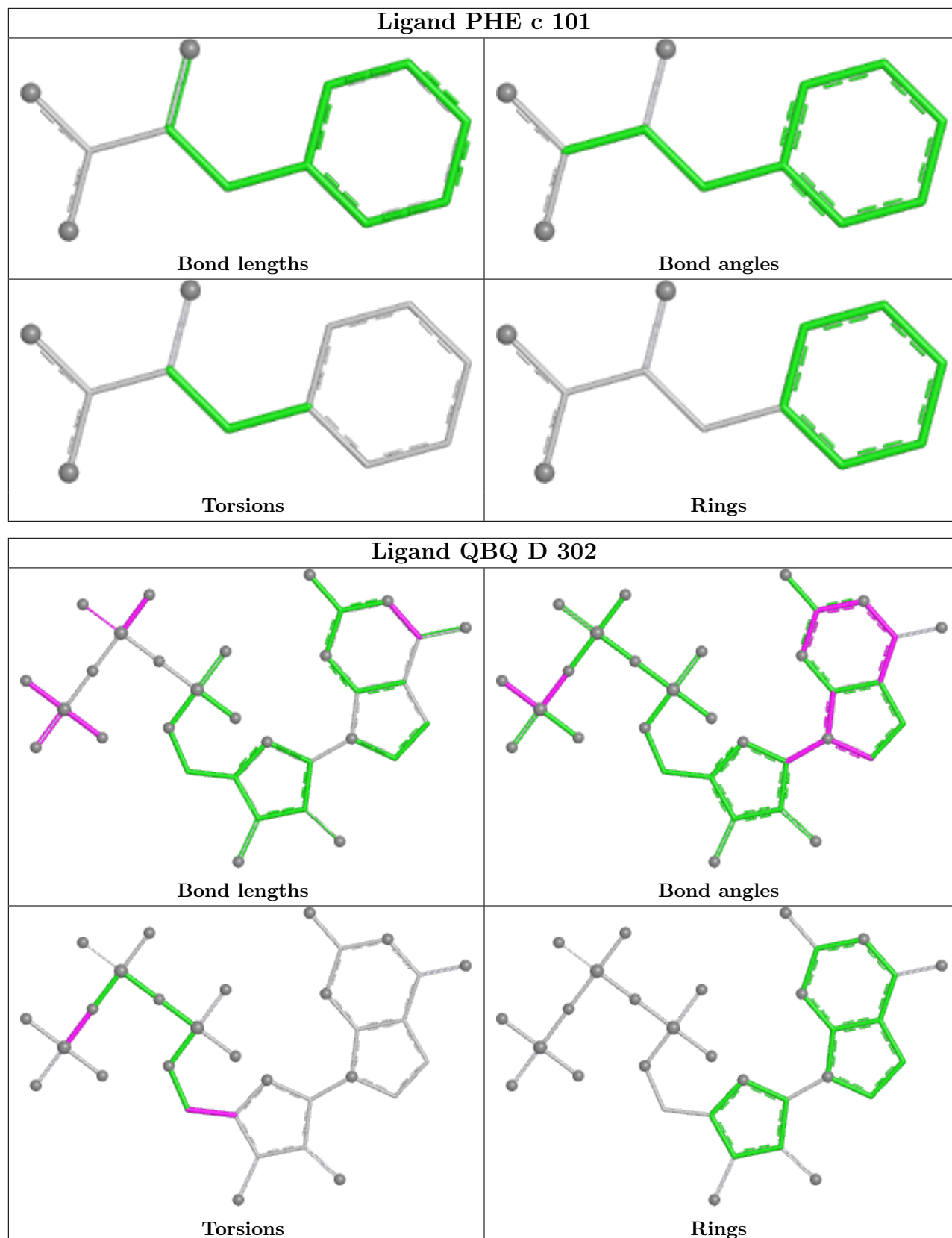

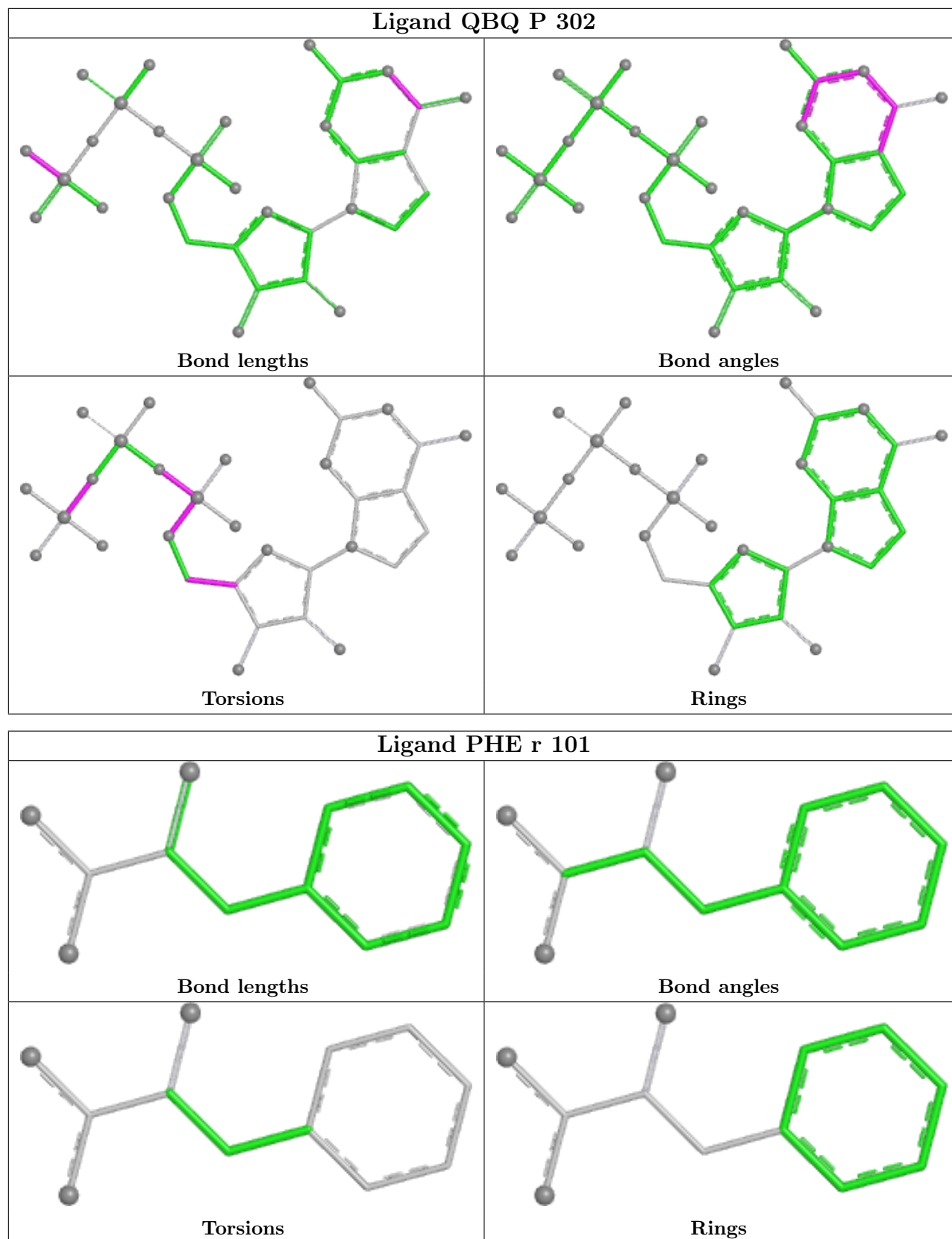

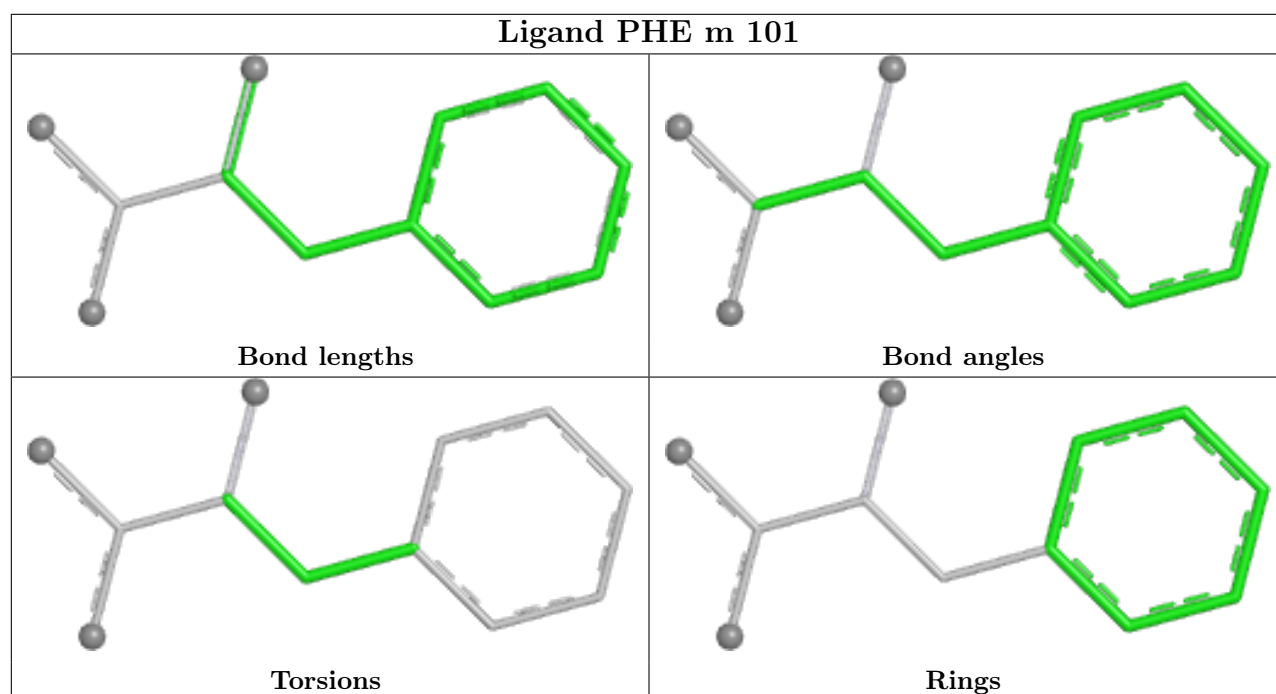
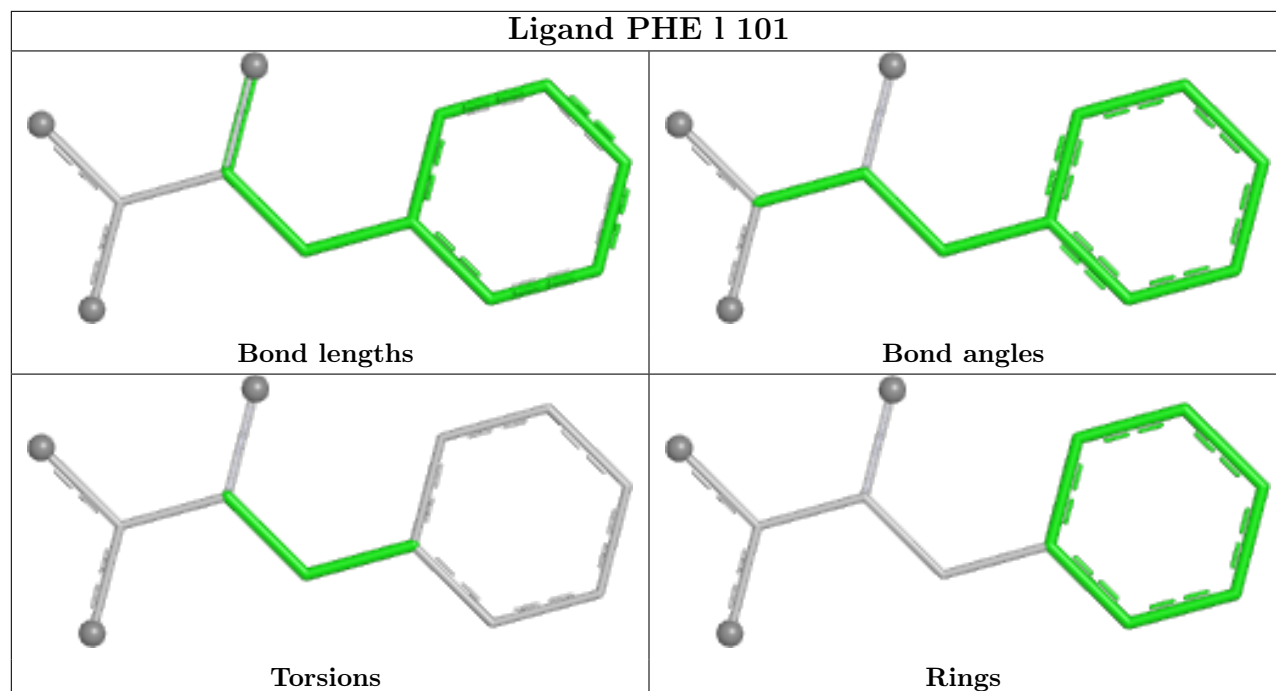

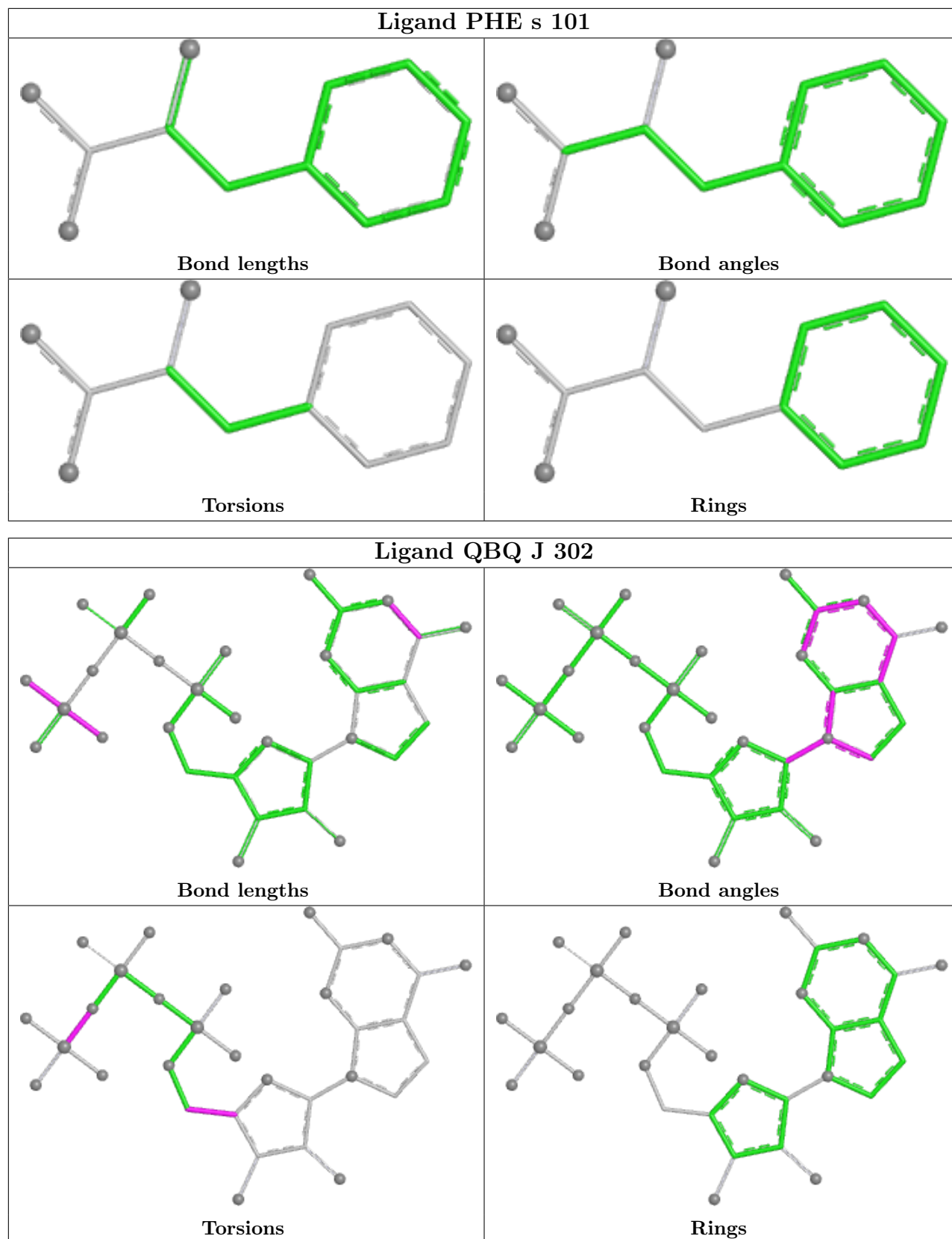

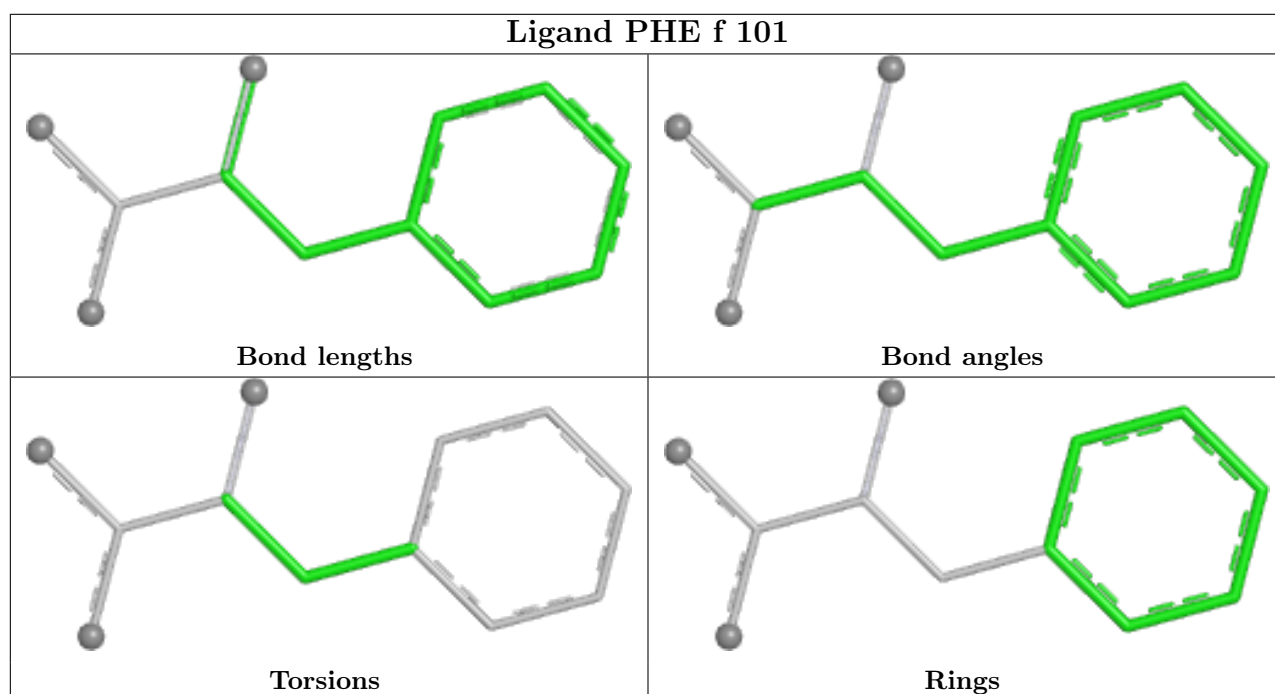
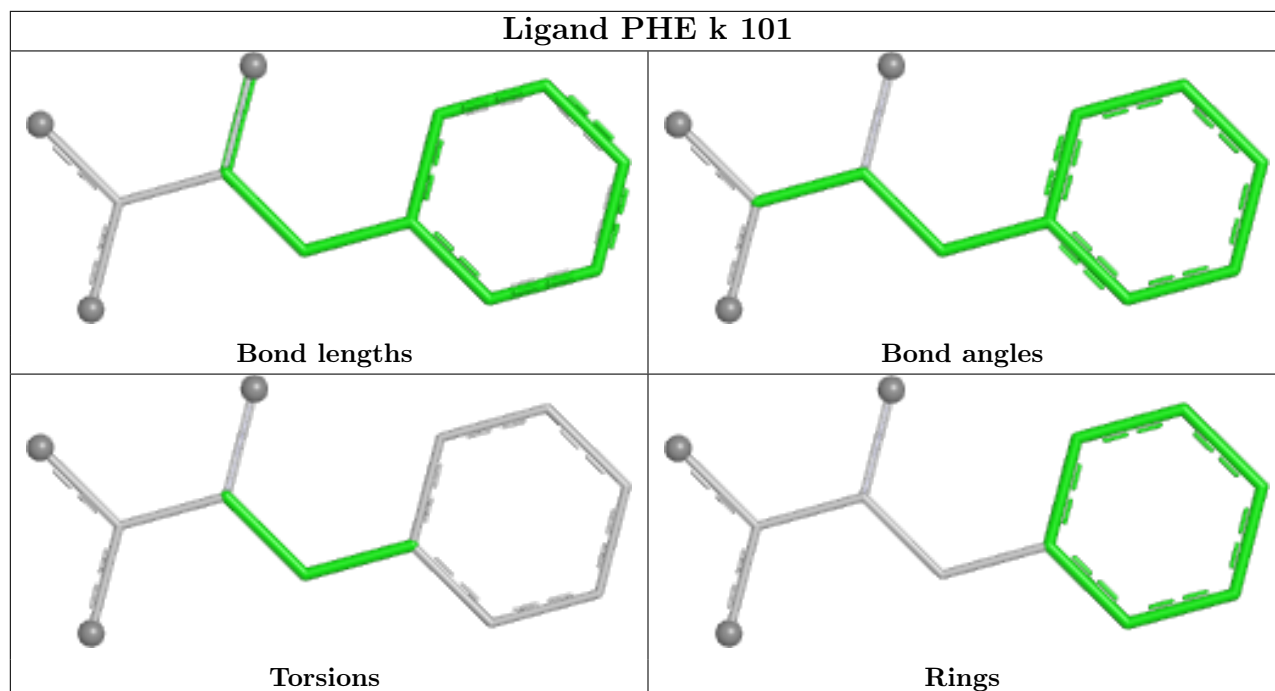

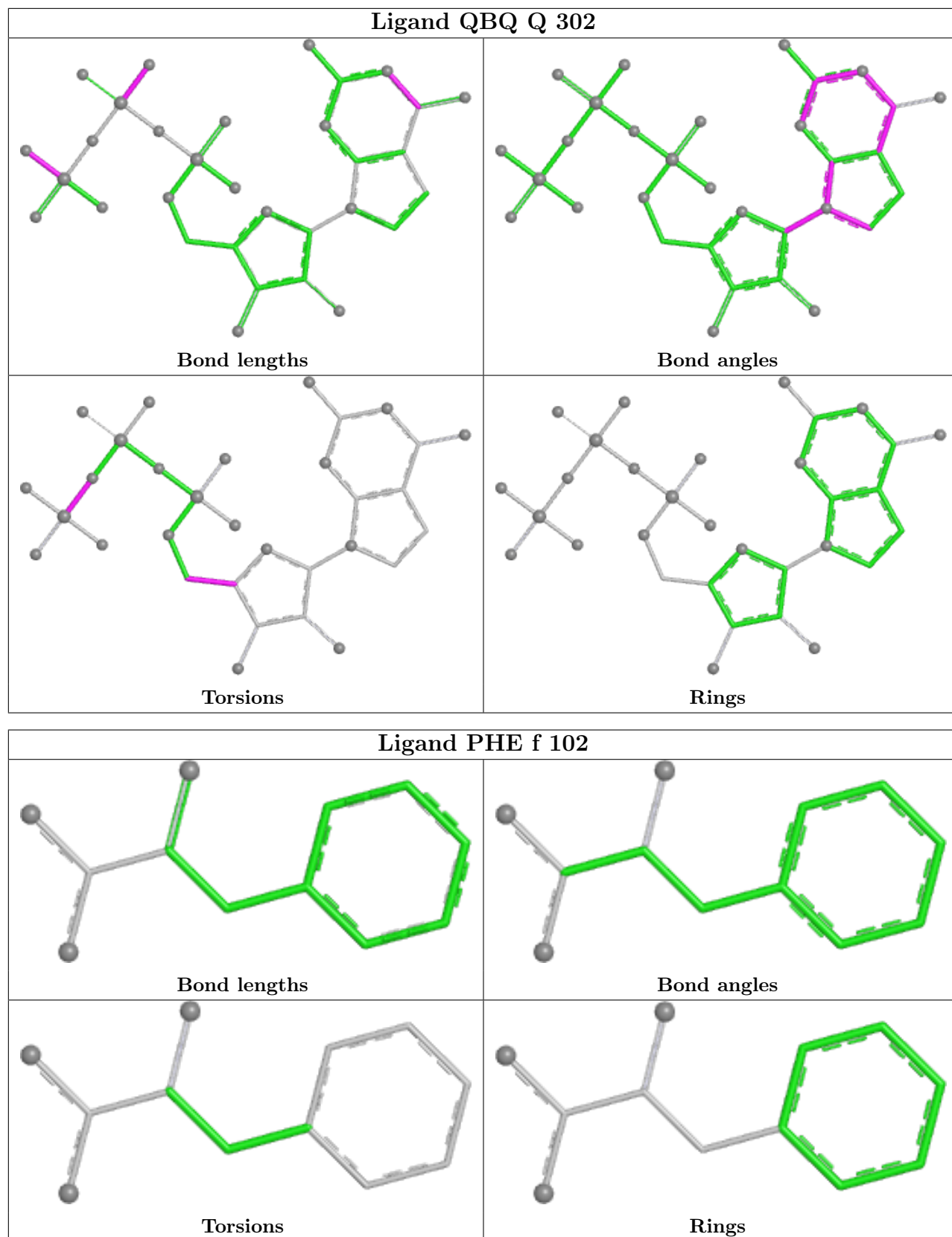

5.7 Other polymers [i](#)

There are no such residues in this entry.

5.8 Polymer linkage issues [i](#)

There are no chain breaks in this entry.

6 Fit of model and data [i](#)

6.1 Protein, DNA and RNA chains [i](#)

In the following table, the column labelled ‘#RSRZ> 2’ contains the number (and percentage) of RSRZ outliers, followed by percent RSRZ outliers for the chain as percentile scores relative to all X-ray entries and entries of similar resolution. The OWAB column contains the minimum, median, 95th percentile and maximum values of the occupancy-weighted average B-factor per residue. The column labelled ‘Q< 0.9’ lists the number of (and percentage) of residues with an average occupancy less than 0.9.

Mol	Chain	Analysed	<RSRZ>	#RSRZ>2	OWAB(Å ²)	Q<0.9
1	A	192/209 (91%)	0.28	10 (5%) 27 29	18, 30, 67, 80	0
1	B	187/209 (89%)	-0.01	2 (1%) 80 82	19, 29, 52, 64	0
1	C	190/209 (90%)	0.02	6 (3%) 47 50	17, 27, 54, 70	0
1	D	192/209 (91%)	-0.03	2 (1%) 82 83	17, 26, 47, 63	0
1	E	192/209 (91%)	0.06	7 (3%) 42 45	15, 28, 57, 72	0
1	F	189/209 (90%)	0.21	12 (6%) 20 22	19, 28, 59, 83	0
1	G	189/209 (90%)	0.05	8 (4%) 36 38	18, 26, 53, 79	0
1	H	190/209 (90%)	0.03	3 (1%) 72 73	17, 25, 51, 67	0
1	I	190/209 (90%)	0.12	9 (4%) 31 33	17, 28, 55, 73	0
1	J	190/209 (90%)	0.23	13 (6%) 17 19	18, 31, 63, 78	0
1	K	192/209 (91%)	0.04	7 (3%) 42 45	19, 28, 54, 75	0
1	L	187/209 (89%)	0.08	7 (3%) 41 44	20, 30, 52, 76	0
1	M	190/209 (90%)	0.11	8 (4%) 36 38	22, 32, 60, 74	0
1	N	190/209 (90%)	0.08	5 (2%) 56 58	20, 28, 56, 66	0
1	O	192/209 (91%)	0.04	6 (3%) 49 51	16, 28, 52, 72	0
1	P	192/209 (91%)	-0.00	3 (1%) 72 73	15, 27, 43, 54	0
1	Q	192/209 (91%)	0.12	8 (4%) 36 38	18, 28, 54, 76	0
1	R	188/209 (89%)	0.16	6 (3%) 47 50	18, 30, 61, 73	0
1	S	190/209 (90%)	0.07	7 (3%) 41 44	18, 28, 60, 77	0
1	T	192/209 (91%)	0.09	4 (2%) 63 65	18, 27, 55, 77	0
2	a	84/87 (96%)	0.02	0 100 100	23, 35, 53, 59	0
2	b	83/87 (95%)	0.05	2 (2%) 59 61	20, 39, 53, 65	0
2	c	84/87 (96%)	0.02	2 (2%) 59 61	22, 33, 49, 62	0
2	d	83/87 (95%)	0.03	3 (3%) 42 45	21, 36, 49, 55	0

Continued on next page...

Continued from previous page...

Mol	Chain	Analysed	<RSRZ>	#RSRZ>2	OWAB(Å ²)	Q<0.9
2	e	84/87 (96%)	0.21	3 (3%) 42 45	22, 35, 55, 64	0
2	f	83/87 (95%)	0.07	1 (1%) 79 80	19, 39, 53, 59	0
2	g	84/87 (96%)	0.06	1 (1%) 79 80	20, 32, 46, 58	0
2	h	84/87 (96%)	-0.05	1 (1%) 79 80	19, 30, 43, 62	0
2	i	83/87 (95%)	0.12	1 (1%) 79 80	20, 32, 48, 54	0
2	j	84/87 (96%)	0.09	2 (2%) 59 61	22, 35, 50, 62	0
2	k	84/87 (96%)	0.09	1 (1%) 79 80	25, 41, 61, 63	0
2	l	83/87 (95%)	0.09	2 (2%) 59 61	27, 44, 58, 61	0
2	m	84/87 (96%)	0.15	3 (3%) 42 45	24, 41, 56, 66	0
2	n	83/87 (95%)	0.06	1 (1%) 79 80	23, 39, 54, 58	0
2	o	84/87 (96%)	0.17	2 (2%) 59 61	23, 37, 53, 64	0
2	p	83/87 (95%)	0.02	1 (1%) 79 80	19, 36, 50, 55	0
2	q	84/87 (96%)	-0.10	1 (1%) 79 80	20, 30, 46, 58	0
2	r	84/87 (96%)	-0.08	0 100 100	20, 31, 45, 50	0
2	s	83/87 (95%)	0.16	1 (1%) 79 80	20, 32, 51, 55	0
2	t	84/87 (96%)	-0.02	1 (1%) 79 80	19, 33, 50, 64	0
All	All	5478/5920 (92%)	0.08	162 (2%) 50 52	15, 30, 55, 83	0

All (162) RSRZ outliers are listed below:

Mol	Chain	Res	Type	RSRZ
1	I	125	ASP	10.8
1	T	125	ASP	9.4
1	Q	125	ASP	7.2
1	F	58	PRO	6.4
1	S	125	ASP	5.7
1	Q	126	HIS	5.6
1	F	65	GLU	5.5
1	L	126	HIS	5.5
1	F	60	SER	5.3
1	H	62	GLU	5.2
1	R	160	LYS	5.1
1	F	62	GLU	5.0
1	T	126	HIS	4.7
1	K	125	ASP	4.6
1	F	66	LEU	4.6

Continued on next page...

Continued from previous page...

Mol	Chain	Res	Type	RSRZ
1	G	61	GLU	4.4
1	A	125	ASP	4.4
1	R	60	SER	4.3
1	R	121	ILE	4.3
2	b	84	GLU	4.3
1	C	125	ASP	4.2
1	J	62	GLU	4.2
1	J	66	LEU	4.1
1	O	124	GLU	4.1
1	G	65	GLU	4.0
1	B	126	HIS	4.0
2	h	84	GLU	4.0
1	T	123	ASP	4.0
1	J	82	LEU	3.8
1	F	61	GLU	3.8
1	G	62	GLU	3.7
1	G	127	ASP	3.7
1	O	125	ASP	3.7
1	A	87	GLN	3.7
2	g	31	HIS	3.7
1	M	125	ASP	3.7
1	Q	89	GLN	3.6
1	S	62	GLU	3.5
1	L	124	GLU	3.5
2	e	1	MET	3.5
1	K	124	GLU	3.4
1	J	87	GLN	3.4
1	O	61	GLU	3.4
1	H	127	ASP	3.4
1	R	62	GLU	3.3
1	R	122	PHE	3.3
1	A	78	ILE	3.3
1	F	92	LEU	3.3
1	C	127	ASP	3.3
2	o	1	MET	3.3
1	G	60	SER	3.2
1	N	127	ASP	3.2
1	G	92	LEU	3.2
2	n	66	ARG	3.2
1	M	96	TRP	3.2
1	I	127	ASP	3.2
2	e	84	GLU	3.1

Continued on next page...

Continued from previous page...

Mol	Chain	Res	Type	RSRZ
2	l	1	MET	3.1
1	Q	96	TRP	3.1
1	A	62	GLU	3.1
1	L	66	LEU	3.1
1	Q	62	GLU	3.0
2	j	1	MET	3.0
2	q	40	LEU	3.0
1	K	126	HIS	3.0
1	S	123	ASP	3.0
2	t	84	GLU	3.0
1	A	160	LYS	2.9
1	K	127	ASP	2.9
1	M	60	SER	2.9
1	A	66	LEU	2.9
1	O	127	ASP	2.9
1	E	123	ASP	2.8
2	f	1	MET	2.8
1	M	66	LEU	2.7
1	S	127	ASP	2.7
1	J	160	LYS	2.7
2	c	84	GLU	2.7
2	m	45	TYR	2.7
2	d	66	ARG	2.6
2	i	27	GLU	2.6
1	S	126	HIS	2.6
1	B	127	ASP	2.6
1	C	110	GLN	2.6
1	E	249	ARG	2.6
1	O	249	ARG	2.6
1	A	96	TRP	2.6
1	Q	87	GLN	2.6
2	o	84	GLU	2.6
1	I	66	LEU	2.6
1	Q	124	GLU	2.6
1	L	123	ASP	2.6
1	M	127	ASP	2.6
1	H	65	GLU	2.6
1	L	122	PHE	2.5
1	I	113	ILE	2.5
1	I	123	ASP	2.5
1	Q	160	LYS	2.5
1	F	119	ASP	2.5

Continued on next page...

Continued from previous page...

Mol	Chain	Res	Type	RSRZ
1	I	96	TRP	2.5
1	G	66	LEU	2.5
1	N	113	ILE	2.5
1	K	62	GLU	2.5
1	A	126	HIS	2.4
1	J	96	TRP	2.4
1	E	62	GLU	2.4
1	E	126	HIS	2.3
2	k	66	ARG	2.3
2	m	66	ARG	2.3
2	c	45	TYR	2.3
1	J	127	ASP	2.3
1	C	87	GLN	2.3
1	J	113	ILE	2.3
1	I	126	HIS	2.3
1	R	66	LEU	2.3
1	E	127	ASP	2.3
1	I	160	LYS	2.3
1	F	118	ASN	2.3
1	D	62	GLU	2.3
2	p	1	MET	2.3
1	F	87	GLN	2.3
1	S	160	LYS	2.3
1	A	119	ASP	2.3
1	E	113	ILE	2.3
1	T	249	ARG	2.2
1	P	126	HIS	2.2
1	P	87	GLN	2.2
1	P	96	TRP	2.2
1	I	249	ARG	2.2
1	F	127	ASP	2.2
2	j	84	GLU	2.2
1	C	113	ILE	2.2
1	A	92	LEU	2.2
1	J	73	ALA	2.2
2	d	62	ARG	2.2
2	e	62	ARG	2.2
1	E	119	ASP	2.2
1	C	126	HIS	2.1
1	S	124	GLU	2.1
2	l	66	ARG	2.1
1	G	63	ASP	2.1

Continued on next page...

Continued from previous page...

Mol	Chain	Res	Type	RSRZ
1	M	123	ASP	2.1
1	O	62	GLU	2.1
1	F	249	ARG	2.1
1	J	69	PRO	2.1
1	N	160	LYS	2.1
1	K	58	PRO	2.1
1	M	126	HIS	2.1
2	d	1	MET	2.1
2	m	1	MET	2.1
1	J	61	GLU	2.1
1	M	61	GLU	2.1
1	L	127	ASP	2.0
1	J	126	HIS	2.0
1	L	160	LYS	2.0
1	N	62	GLU	2.0
1	D	127	ASP	2.0
2	b	66	ARG	2.0
1	N	58	PRO	2.0
1	K	61	GLU	2.0
2	s	22	GLU	2.0
1	J	65	GLU	2.0

6.2 Non-standard residues in protein, DNA, RNA chains [i](#)

There are no non-standard protein/DNA/RNA residues in this entry.

6.3 Carbohydrates [i](#)

There are no monosaccharides in this entry.

6.4 Ligands [i](#)

In the following table, the Atoms column lists the number of modelled atoms in the group and the number defined in the chemical component dictionary. The B-factors column lists the minimum, median, 95th percentile and maximum values of B factors of atoms in the group. The column labelled 'Q< 0.9' lists the number of atoms with occupancy less than 0.9.

Mol	Type	Chain	Res	Atoms	RSCC	RSR	B-factors(\AA^2)	Q<0.9
4	QBQ	P	302	32/32	0.85	0.19	43,48,56,59	17
4	QBQ	F	302	32/32	0.92	0.12	31,38,49,55	17

Continued on next page...

Continued from previous page...

Mol	Type	Chain	Res	Atoms	RSCC	RSR	B-factors(Å ²)	Q<0.9
5	PHE	m	101	12/12	0.94	0.11	22,23,24,24	0
4	QBQ	K	302	32/32	0.95	0.10	34,38,47,48	17
5	PHE	c	101	12/12	0.95	0.11	18,19,21,21	0
5	PHE	d	101	12/12	0.95	0.11	19,21,22,23	0
5	PHE	l	101	12/12	0.95	0.11	24,25,27,28	0
4	QBQ	N	1101	32/32	0.95	0.10	32,37,44,48	17
4	QBQ	Q	302	32/32	0.96	0.10	27,31,38,42	17
4	QBQ	R	302	32/32	0.96	0.09	30,35,44,47	17
4	QBQ	S	302	32/32	0.96	0.10	30,33,45,47	17
5	PHE	a	101	12/12	0.96	0.09	22,23,24,24	0
5	PHE	b	101	12/12	0.96	0.10	20,20,22,22	0
4	QBQ	L	1101	32/32	0.96	0.10	30,34,44,47	17
4	QBQ	M	1101	32/32	0.96	0.11	31,35,44,47	17
3	ZN	T	301	1/1	0.96	0.11	34,34,34,34	0
4	QBQ	E	302	32/32	0.96	0.09	25,31,40,45	17
3	ZN	E	301	1/1	0.97	0.10	34,34,34,34	0
3	ZN	F	301	1/1	0.97	0.09	37,37,37,37	0
4	QBQ	G	302	32/32	0.97	0.09	25,31,41,47	17
4	QBQ	T	302	32/32	0.97	0.09	27,33,43,46	17
4	QBQ	I	302	32/32	0.97	0.09	25,30,41,45	17
3	ZN	J	301	1/1	0.97	0.13	37,37,37,37	0
3	ZN	P	301	1/1	0.97	0.10	32,32,32,32	0
3	ZN	C	301	1/1	0.97	0.11	30,30,30,30	0
5	PHE	e	101	12/12	0.97	0.08	21,22,23,23	0
5	PHE	f	101	12/12	0.97	0.10	19,21,21,22	0
5	PHE	f	102	12/12	0.97	0.10	18,20,20,21	0
5	PHE	g	101	12/12	0.97	0.10	18,20,20,21	0
5	PHE	h	101	12/12	0.97	0.10	18,19,21,21	0
5	PHE	k	101	12/12	0.97	0.10	25,26,28,28	0
4	QBQ	A	302	32/32	0.97	0.10	26,33,43,48	17
4	QBQ	C	302	32/32	0.97	0.08	27,32,43,46	17
5	PHE	n	101	12/12	0.97	0.10	21,22,22,23	0
5	PHE	o	101	12/12	0.97	0.10	22,22,24,24	0
5	PHE	q	101	12/12	0.97	0.08	20,21,22,23	0
3	ZN	S	301	1/1	0.98	0.09	35,35,35,35	0
3	ZN	M	1102	1/1	0.98	0.11	40,40,40,40	0
4	QBQ	H	302	32/32	0.98	0.09	22,28,36,40	17
3	ZN	O	301	1/1	0.98	0.10	35,35,35,35	0
5	PHE	i	101	12/12	0.98	0.08	19,21,23,24	0
4	QBQ	J	302	32/32	0.98	0.09	28,34,46,52	17
4	QBQ	B	302	32/32	0.98	0.08	22,30,38,43	17
3	ZN	L	1102	1/1	0.98	0.10	37,37,37,37	0

Continued on next page...

Continued from previous page...

Mol	Type	Chain	Res	Atoms	RSCC	RSR	B-factors(\AA^2)	Q<0.9
4	QBQ	D	302	32/32	0.98	0.09	21,24,30,35	17
3	ZN	Q	301	1/1	0.98	0.10	32,32,32,32	0
5	PHE	p	101	12/12	0.98	0.09	19,20,21,22	0
4	QBQ	O	302	32/32	0.98	0.09	23,30,38,41	17
5	PHE	r	101	12/12	0.98	0.10	19,21,21,21	0
5	PHE	s	101	12/12	0.98	0.09	18,19,19,20	0
5	PHE	t	101	12/12	0.98	0.09	17,18,19,19	0
3	ZN	H	301	1/1	0.99	0.09	30,30,30,30	0
3	ZN	I	301	1/1	0.99	0.11	35,35,35,35	0
3	ZN	R	301	1/1	0.99	0.10	36,36,36,36	0
3	ZN	D	301	1/1	0.99	0.08	34,34,34,34	0
3	ZN	K	301	1/1	0.99	0.11	31,31,31,31	0
3	ZN	B	301	1/1	0.99	0.09	34,34,34,34	0
3	ZN	A	301	1/1	0.99	0.09	35,35,35,35	0
3	ZN	N	1102	1/1	0.99	0.12	32,32,32,32	0
3	ZN	G	301	1/1	0.99	0.09	32,32,32,32	0

The following is a graphical depiction of the model fit to experimental electron density of all instances of the Ligand of Interest. In addition, ligands with molecular weight > 250 and outliers as shown on the geometry validation Tables will also be included. Each fit is shown from different orientation to approximate a three-dimensional view.

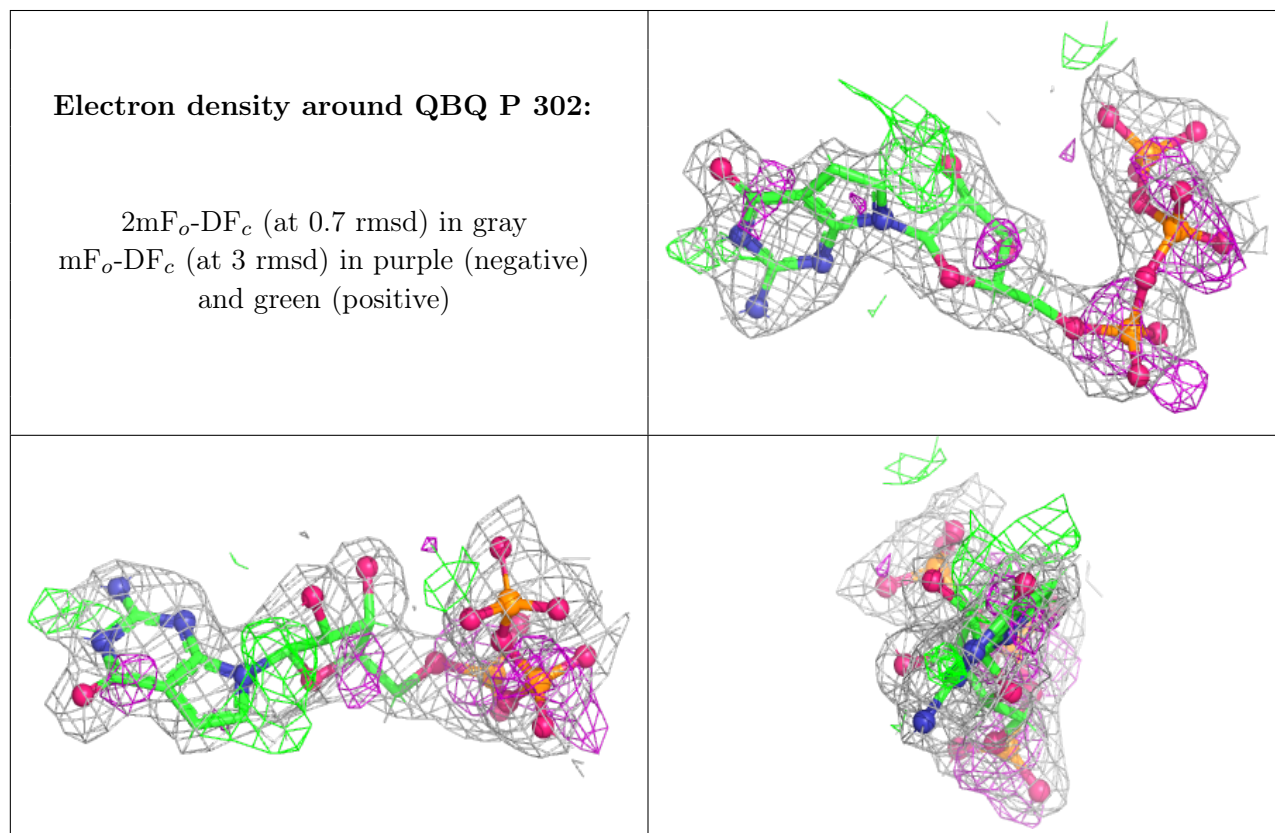

Electron density around QBQ F 302:

$2mF_o-DF_c$ (at 0.7 rmsd) in gray
 mF_o-DF_c (at 3 rmsd) in purple (negative)
and green (positive)

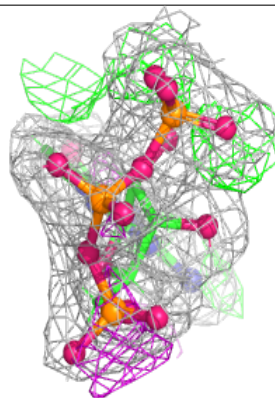
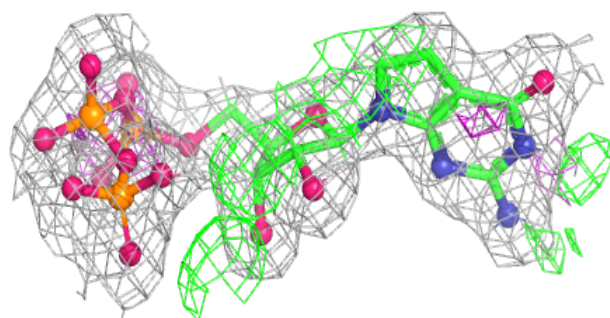
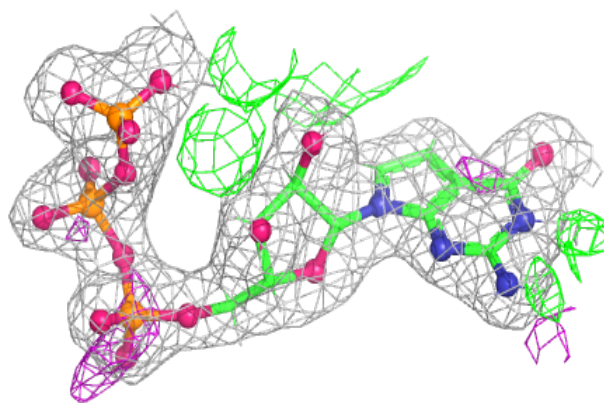
**Electron density around PHE m 101:**

$2mF_o-DF_c$ (at 0.7 rmsd) in gray
 mF_o-DF_c (at 3 rmsd) in purple (negative)
and green (positive)

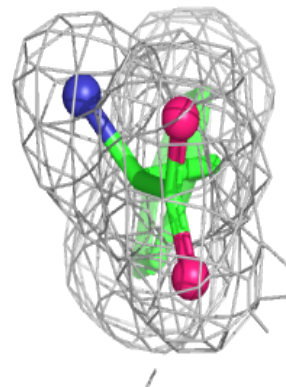
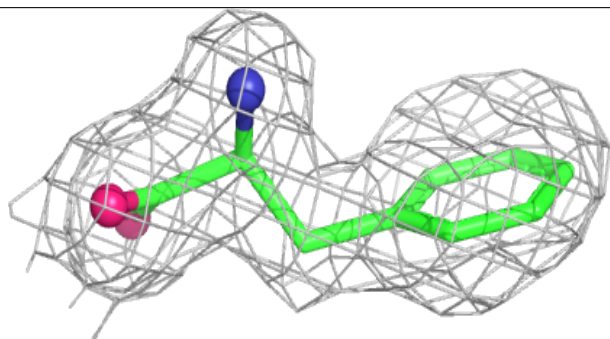
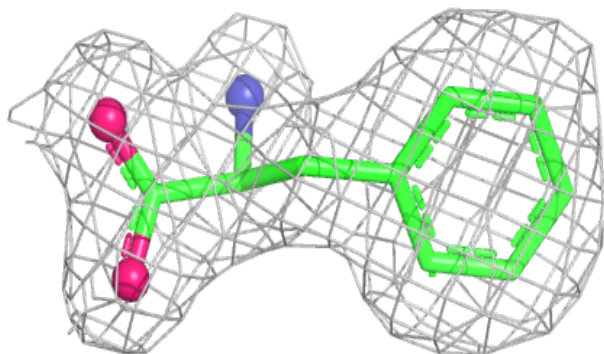

Electron density around QBQ K 302:

$2mF_o-DF_c$ (at 0.7 rmsd) in gray
 mF_o-DF_c (at 3 rmsd) in purple (negative)
and green (positive)

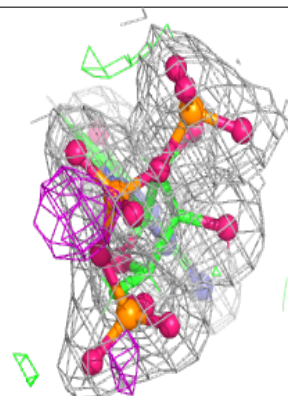
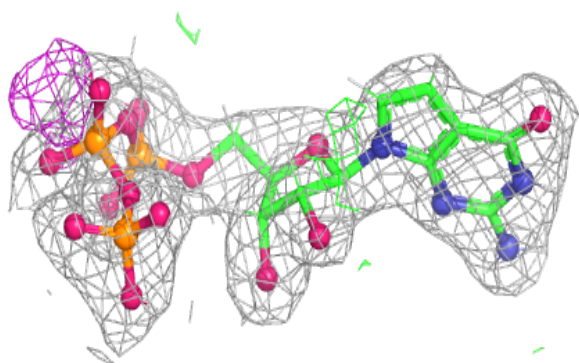
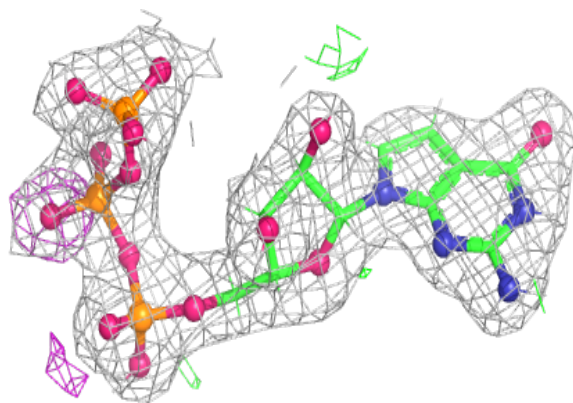
**Electron density around PHE c 101:**

$2mF_o-DF_c$ (at 0.7 rmsd) in gray
 mF_o-DF_c (at 3 rmsd) in purple (negative)
and green (positive)

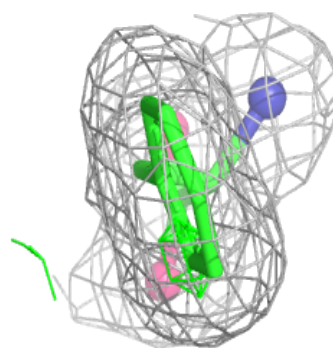
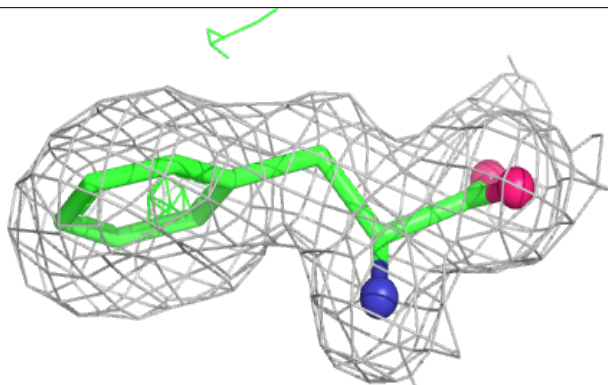
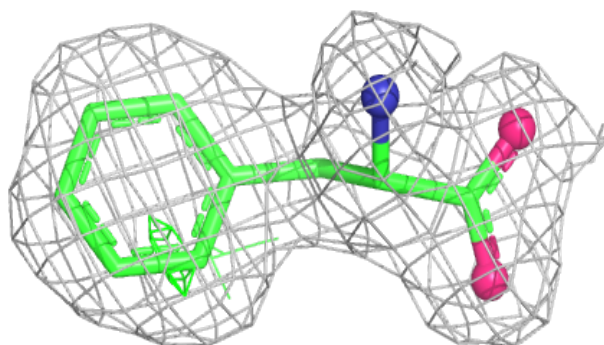

Electron density around PHE d 101:

$2mF_o-DF_c$ (at 0.7 rmsd) in gray
 mF_o-DF_c (at 3 rmsd) in purple (negative)
and green (positive)

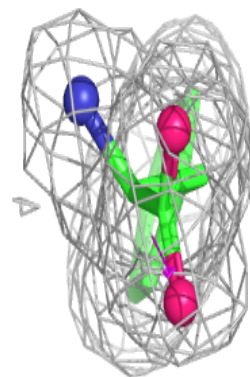
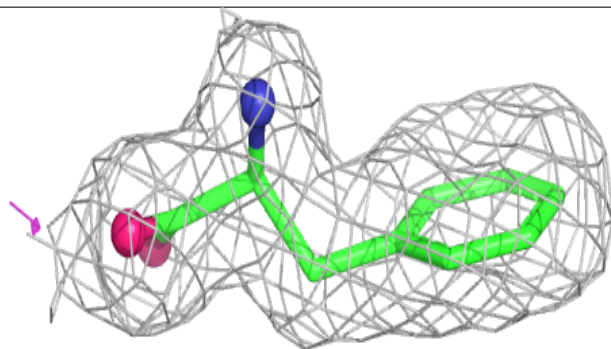
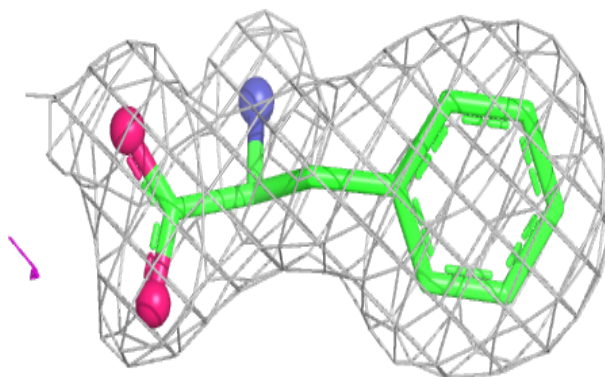
**Electron density around PHE l 101:**

$2mF_o-DF_c$ (at 0.7 rmsd) in gray
 mF_o-DF_c (at 3 rmsd) in purple (negative)
and green (positive)

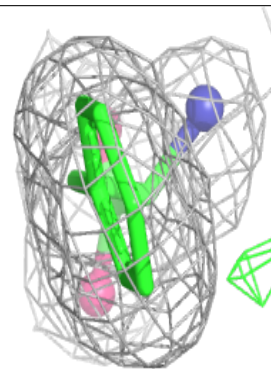
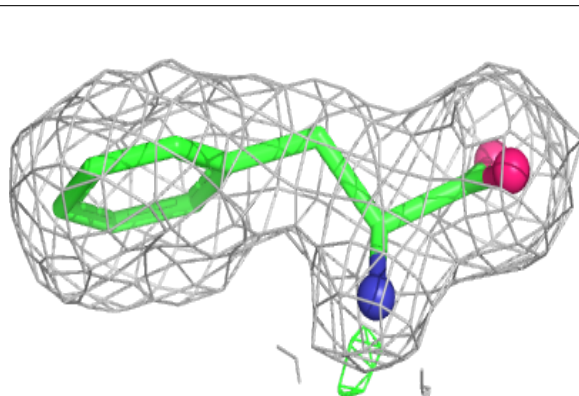
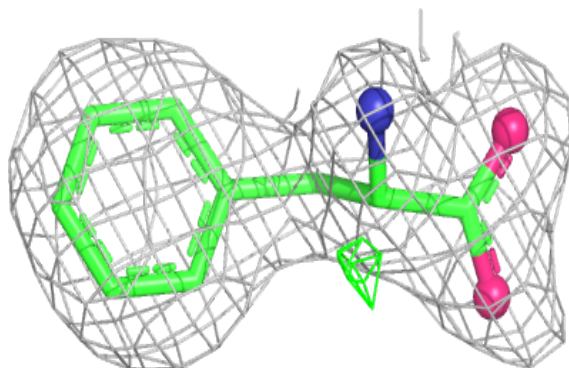

Electron density around QBQ N 1101:

$2mF_o-DF_c$ (at 0.7 rmsd) in gray
 mF_o-DF_c (at 3 rmsd) in purple (negative)
and green (positive)

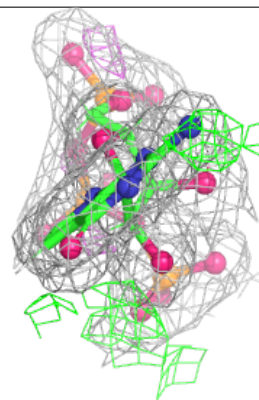
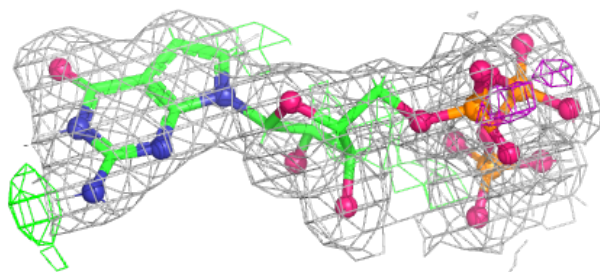
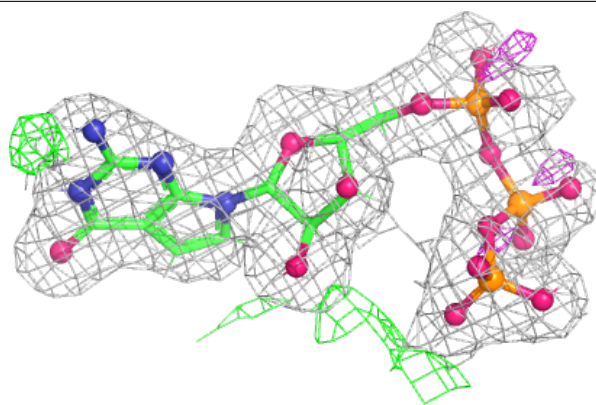
**Electron density around QBQ Q 302:**

$2mF_o-DF_c$ (at 0.7 rmsd) in gray
 mF_o-DF_c (at 3 rmsd) in purple (negative)
and green (positive)

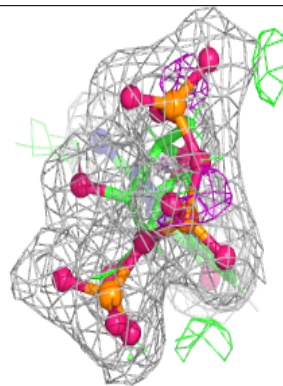
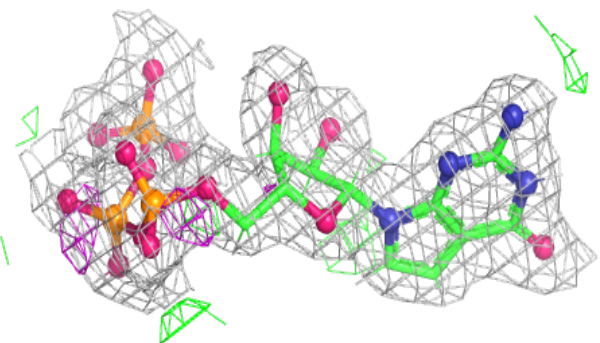
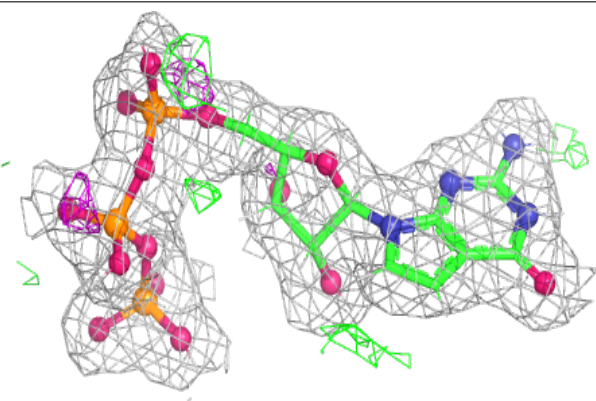

Electron density around QBQ R 302:

$2mF_o-DF_c$ (at 0.7 rmsd) in gray
 mF_o-DF_c (at 3 rmsd) in purple (negative)
and green (positive)

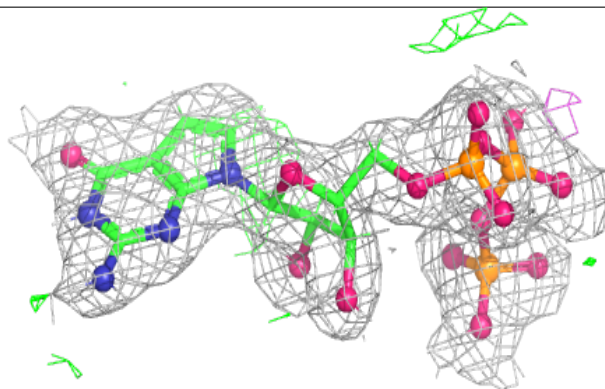
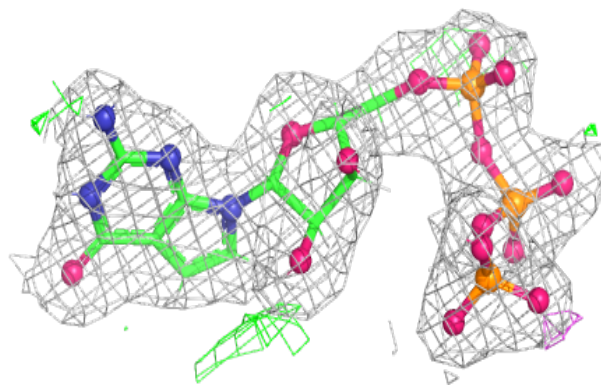
**Electron density around QBQ S 302:**

$2mF_o-DF_c$ (at 0.7 rmsd) in gray
 mF_o-DF_c (at 3 rmsd) in purple (negative)
and green (positive)

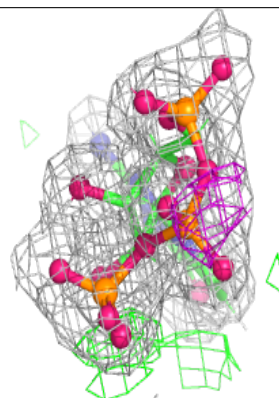
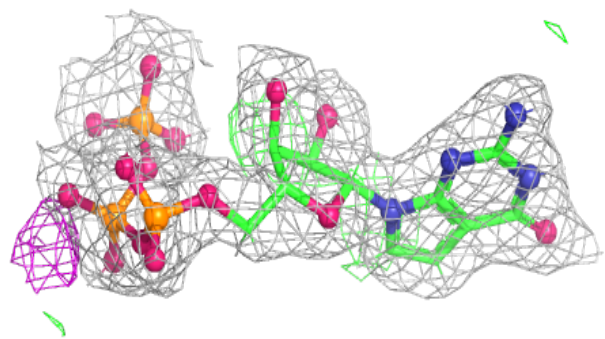
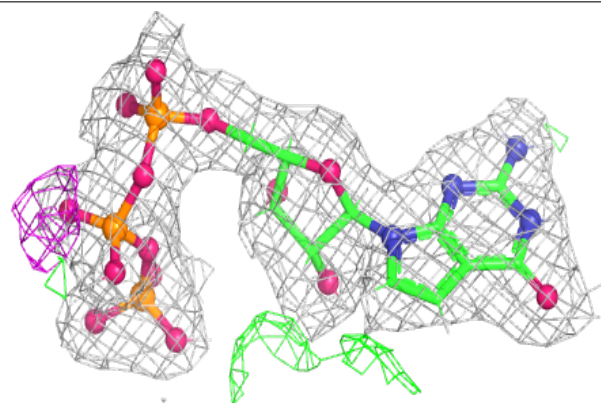

Electron density around PHE a 101:

$2mF_o-DF_c$ (at 0.7 rmsd) in gray
 mF_o-DF_c (at 3 rmsd) in purple (negative)
and green (positive)

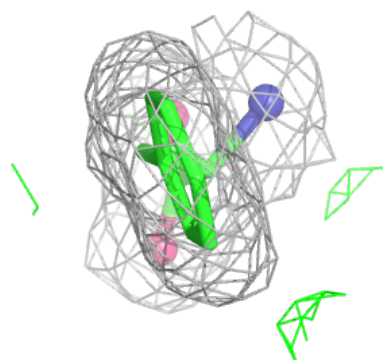
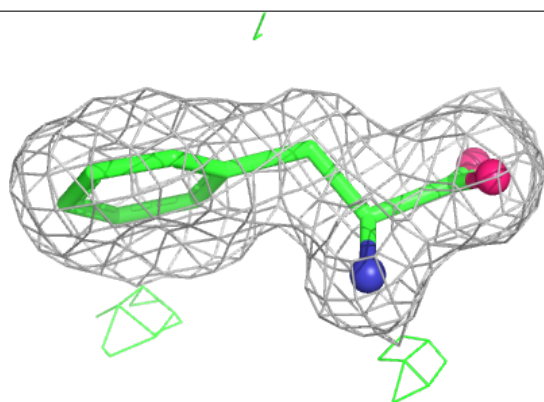
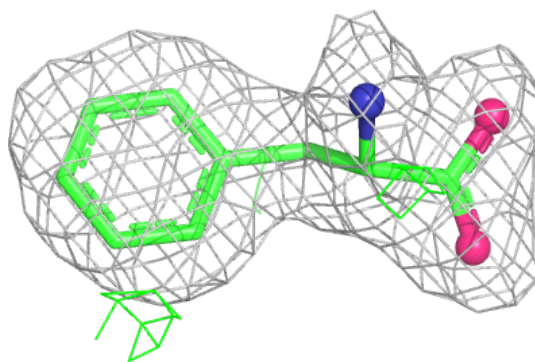
**Electron density around PHE b 101:**

$2mF_o-DF_c$ (at 0.7 rmsd) in gray
 mF_o-DF_c (at 3 rmsd) in purple (negative)
and green (positive)

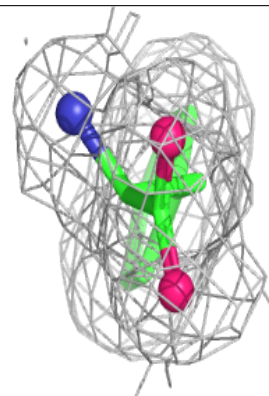
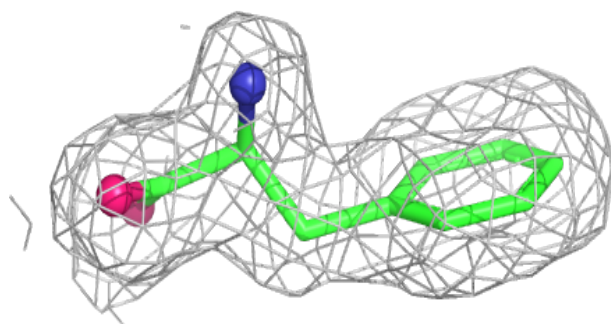
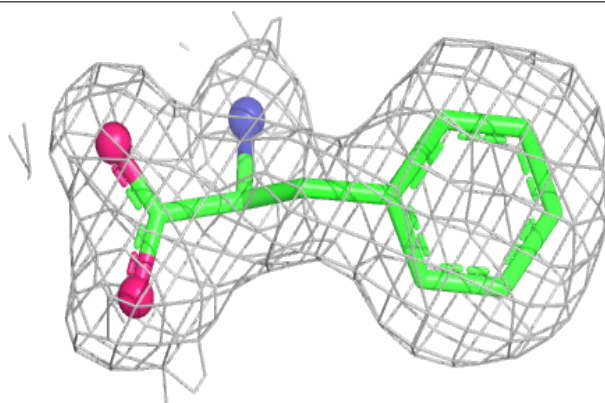

Electron density around QBQ L 1101:

$2mF_o-DF_c$ (at 0.7 rmsd) in gray
 mF_o-DF_c (at 3 rmsd) in purple (negative)
and green (positive)

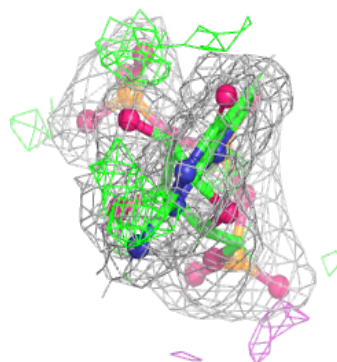
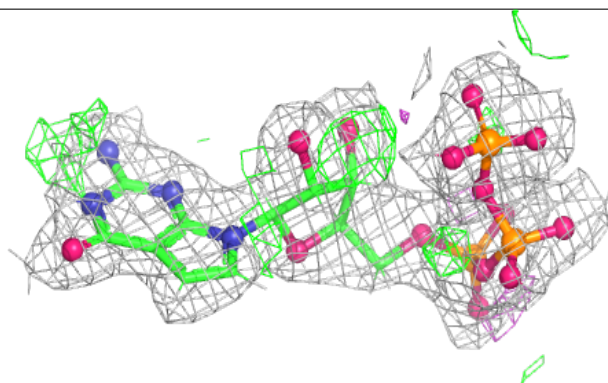
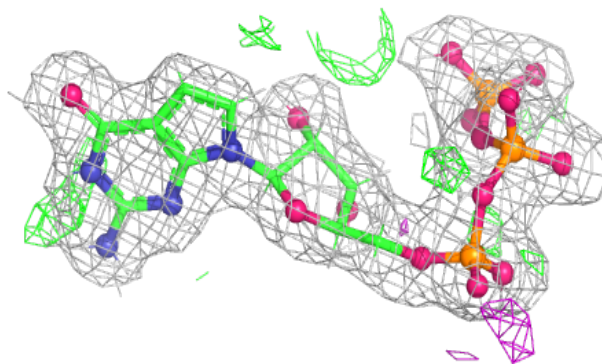
**Electron density around QBQ M 1101:**

$2mF_o-DF_c$ (at 0.7 rmsd) in gray
 mF_o-DF_c (at 3 rmsd) in purple (negative)
and green (positive)

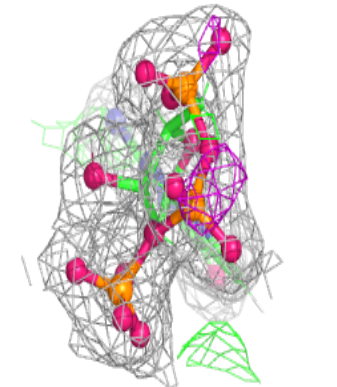
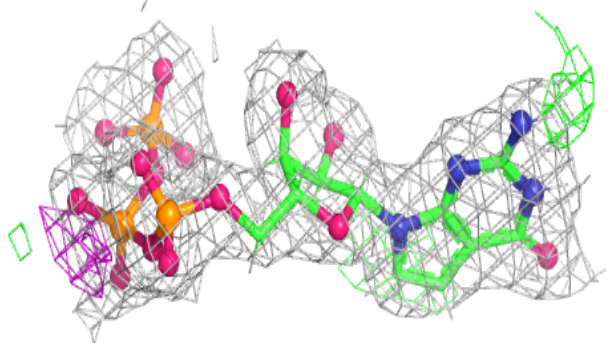
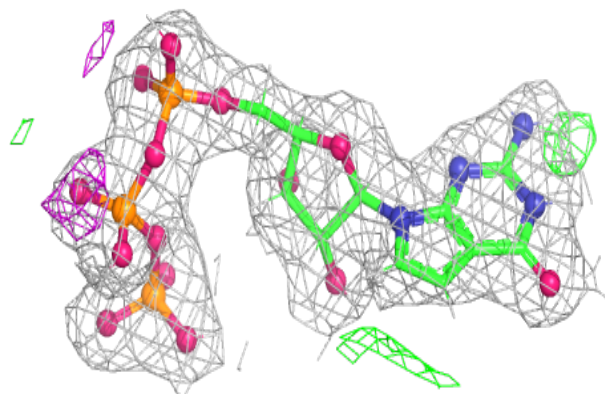

Electron density around ZN T 301:

$2mF_o-DF_c$ (at 0.7 rmsd) in gray
 mF_o-DF_c (at 3 rmsd) in purple (negative)
and green (positive)

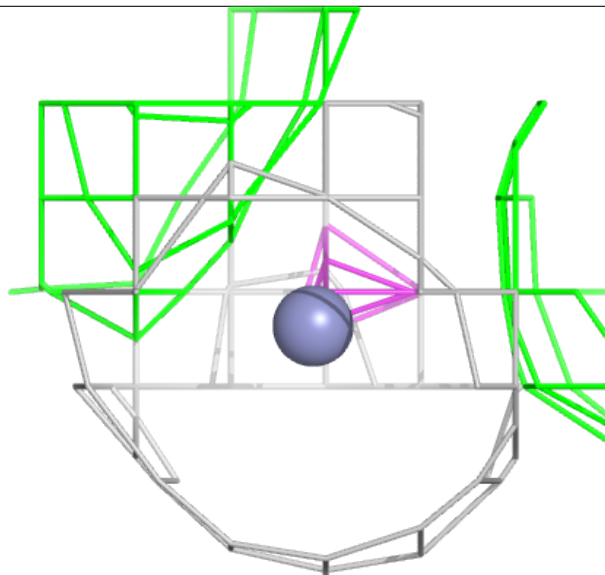
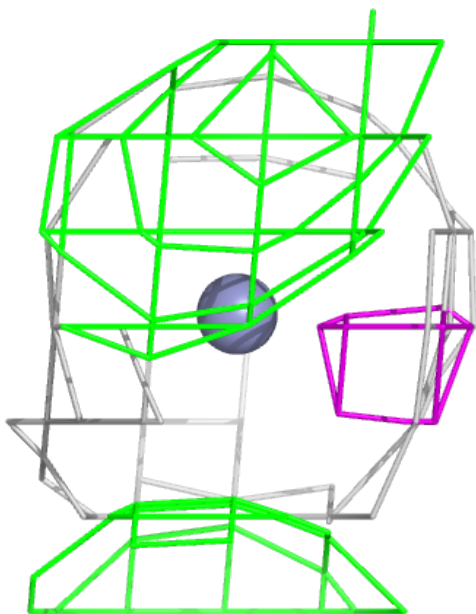
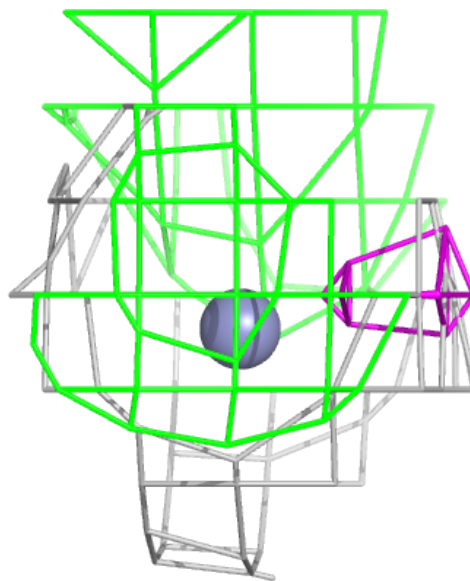

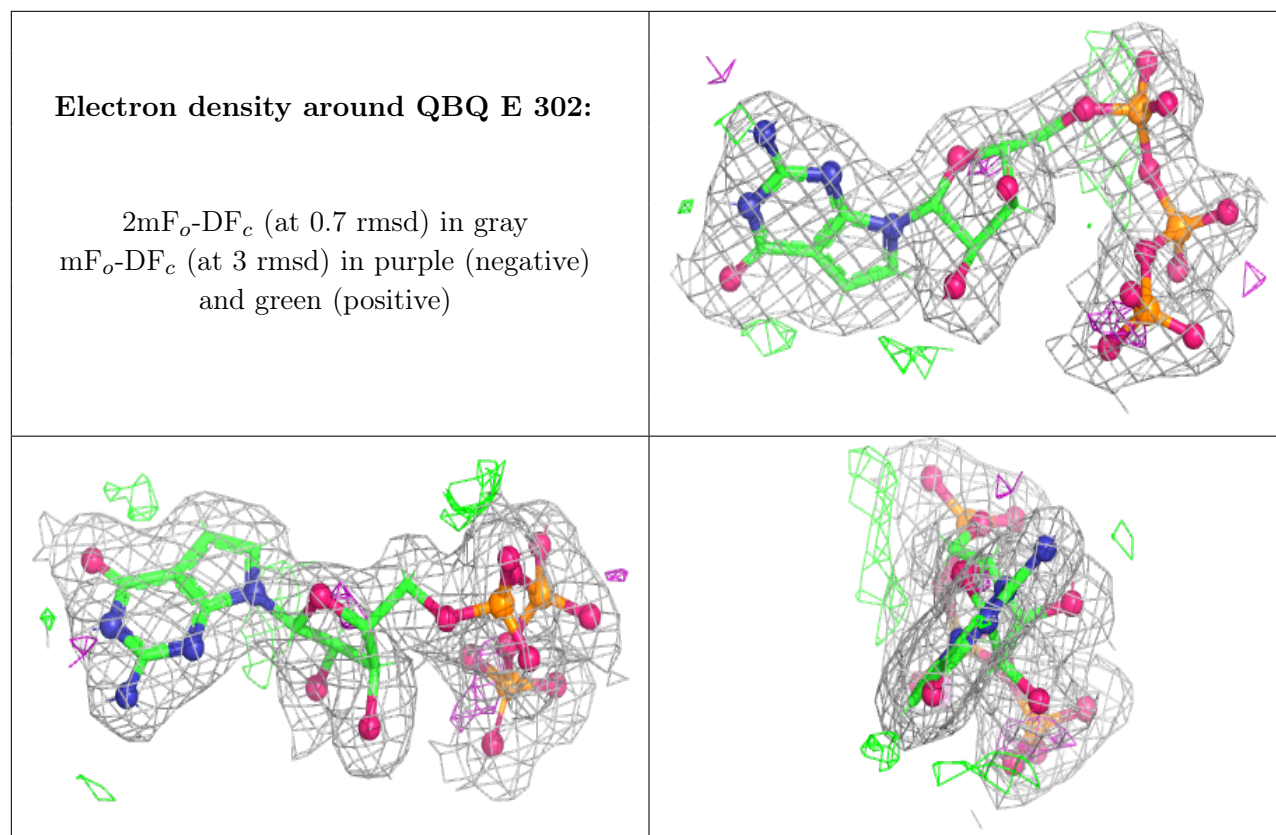

Electron density around ZN E 301:

$2mF_o-DF_c$ (at 0.7 rmsd) in gray
 mF_o-DF_c (at 3 rmsd) in purple (negative)
and green (positive)

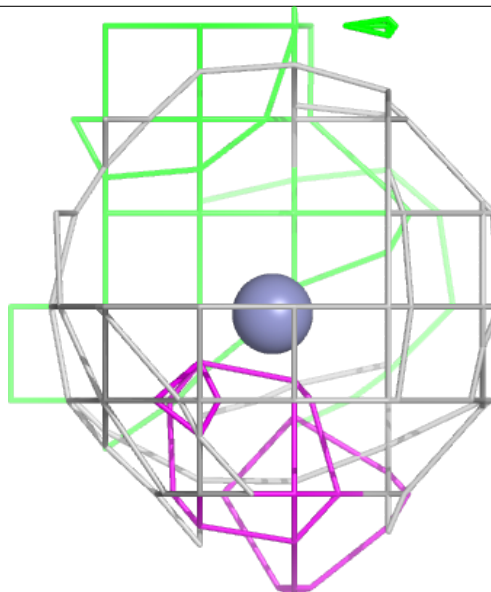
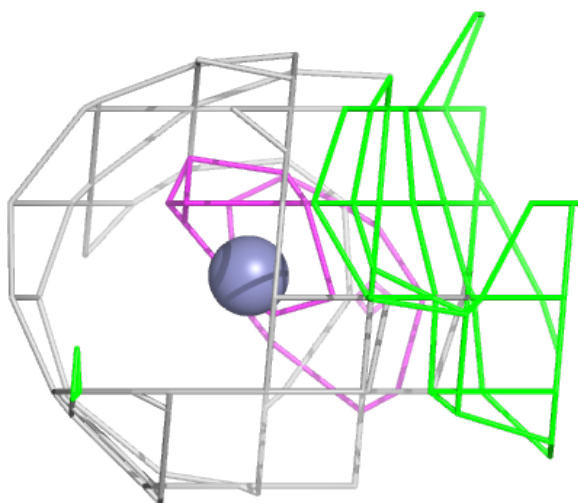
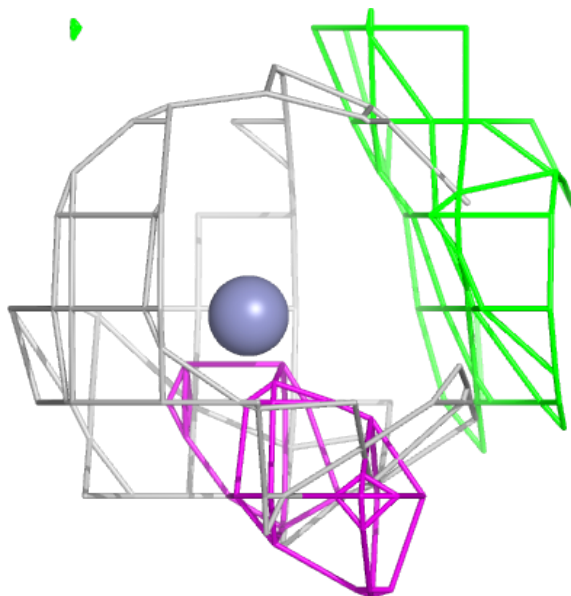

Electron density around ZN F 301:

$2mF_o-DF_c$ (at 0.7 rmsd) in gray
 mF_o-DF_c (at 3 rmsd) in purple (negative)
and green (positive)

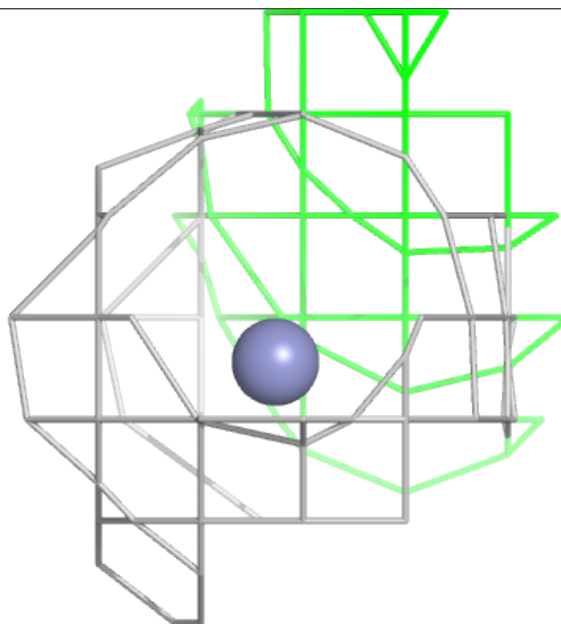
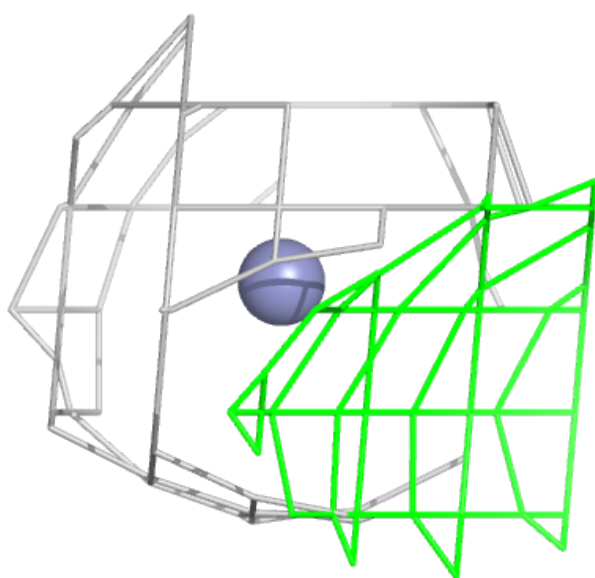
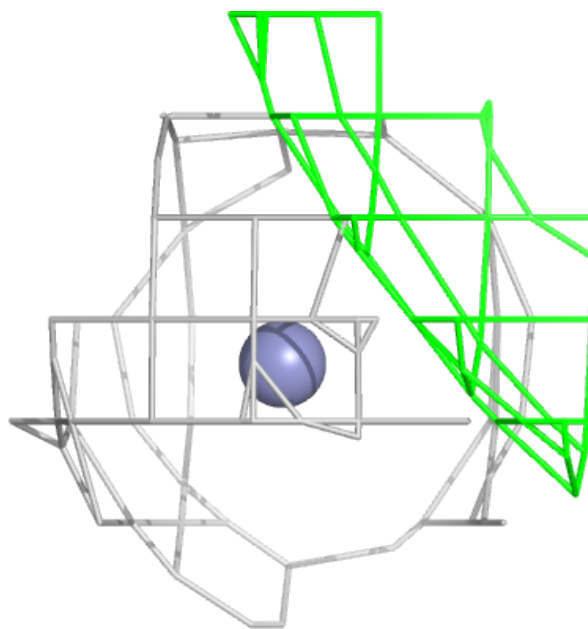

Electron density around QBQ G 302:

$2mF_o-DF_c$ (at 0.7 rmsd) in gray
 mF_o-DF_c (at 3 rmsd) in purple (negative)
and green (positive)

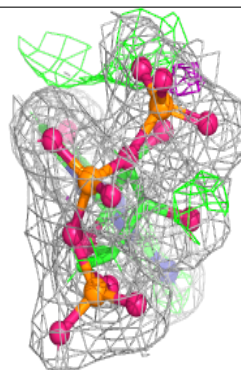
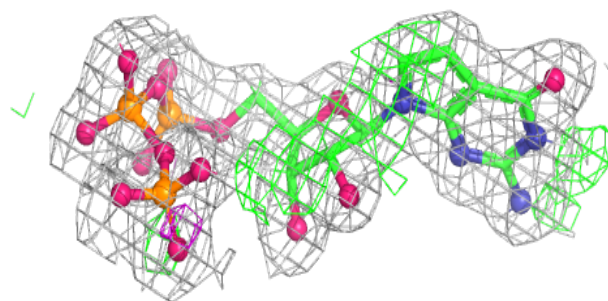
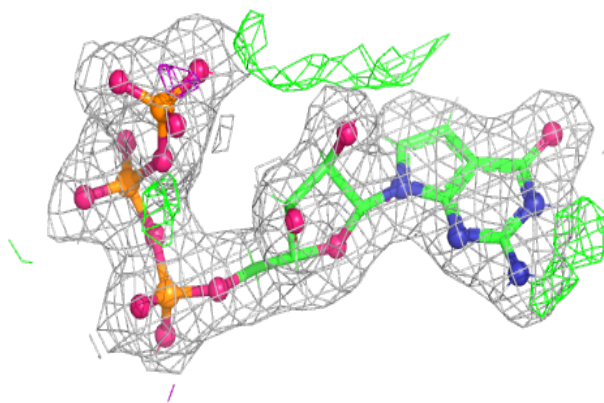
**Electron density around QBQ T 302:**

$2mF_o-DF_c$ (at 0.7 rmsd) in gray
 mF_o-DF_c (at 3 rmsd) in purple (negative)
and green (positive)

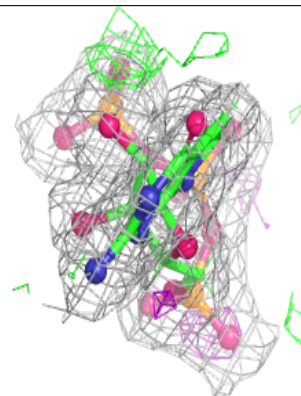
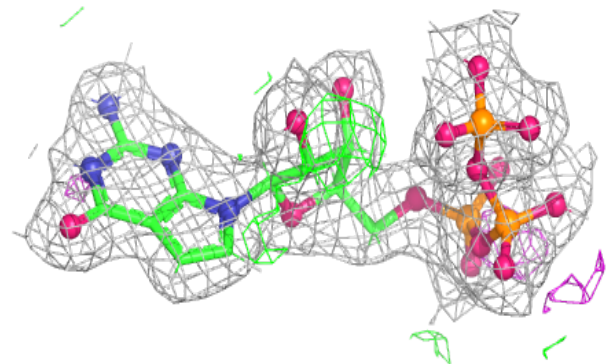
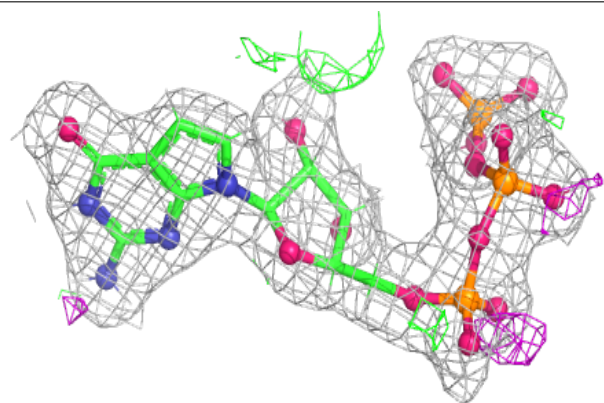

Electron density around QBQ I 302:

$2mF_o-DF_c$ (at 0.7 rmsd) in gray
 mF_o-DF_c (at 3 rmsd) in purple (negative)
and green (positive)

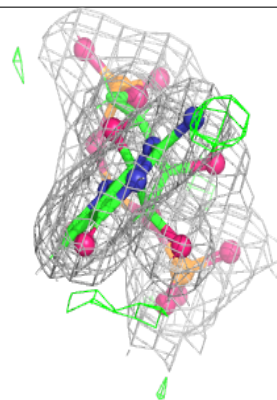
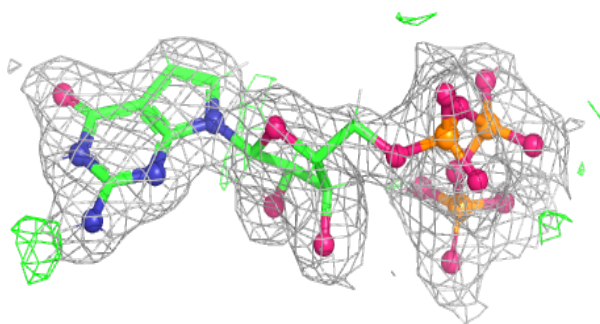
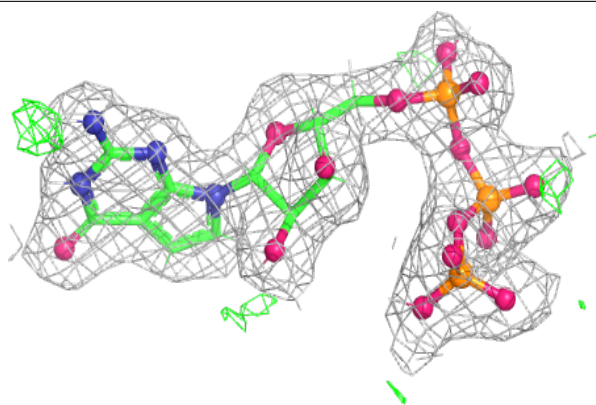

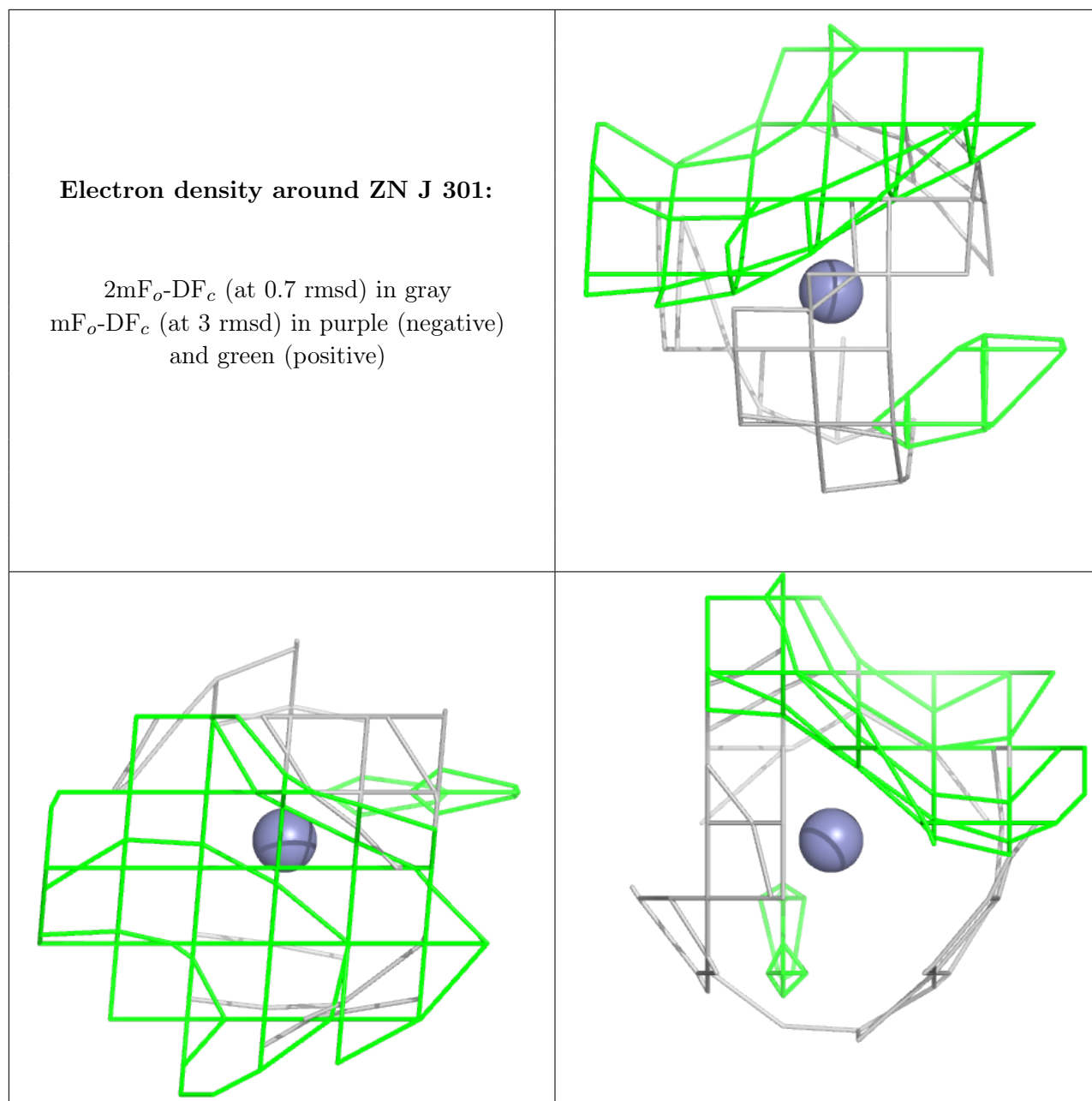

Electron density around ZN P 301:

$2mF_o-DF_c$ (at 0.7 rmsd) in gray
 mF_o-DF_c (at 3 rmsd) in purple (negative)
and green (positive)

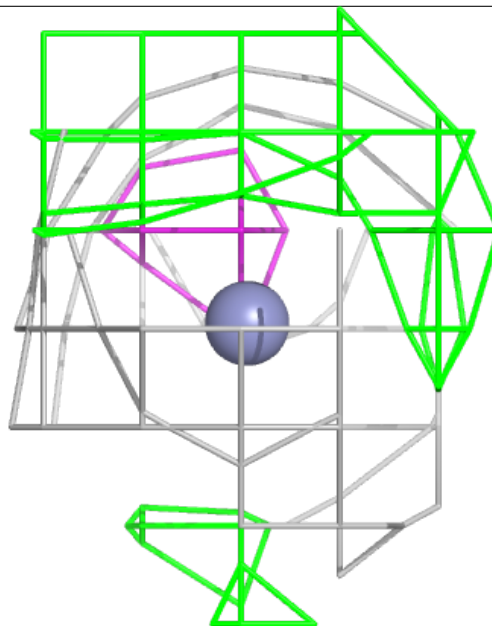
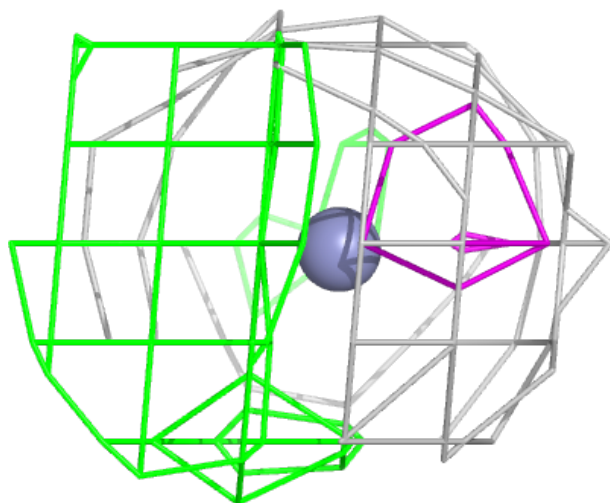
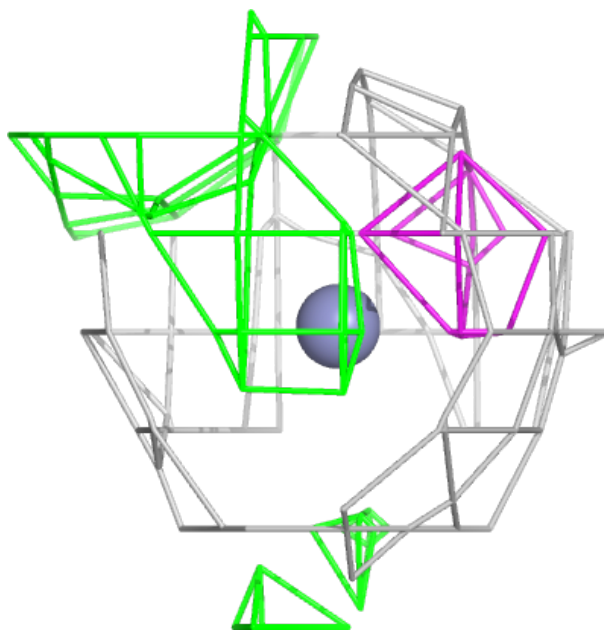

Electron density around ZN C 301:

$2mF_o-DF_c$ (at 0.7 rmsd) in gray
 mF_o-DF_c (at 3 rmsd) in purple (negative)
and green (positive)

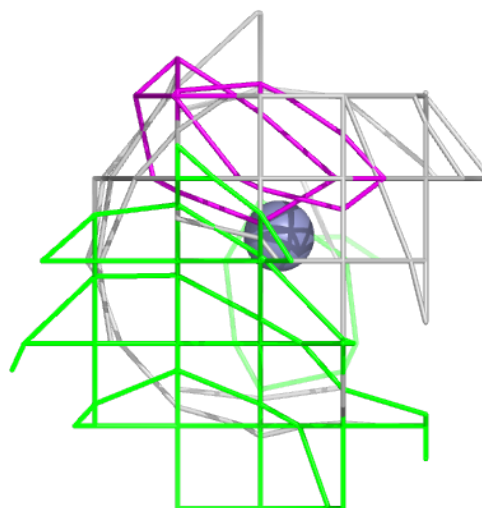
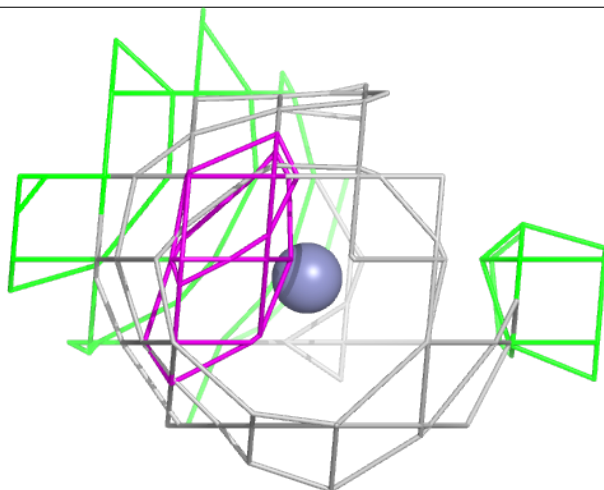
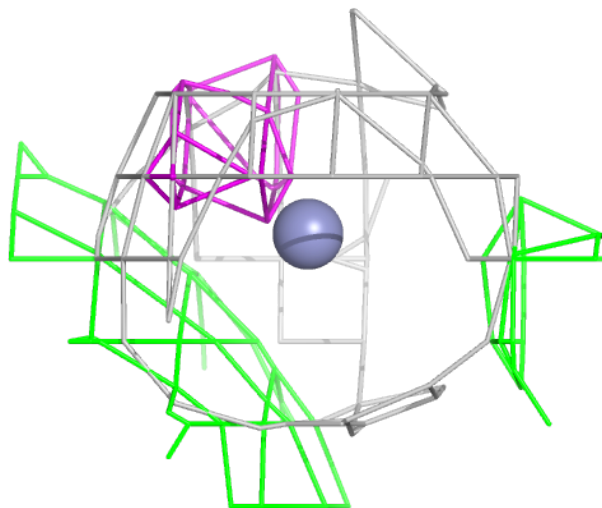

Electron density around PHE e 101:

$2mF_o-DF_c$ (at 0.7 rmsd) in gray
 mF_o-DF_c (at 3 rmsd) in purple (negative)
and green (positive)

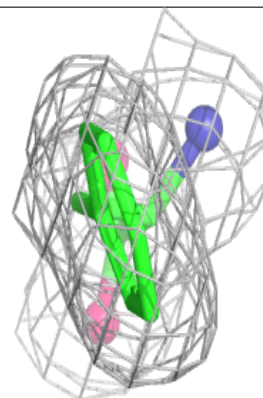
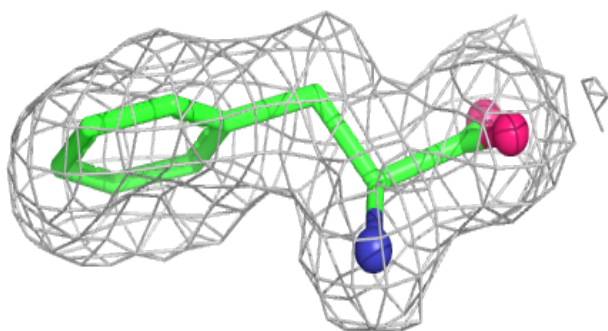
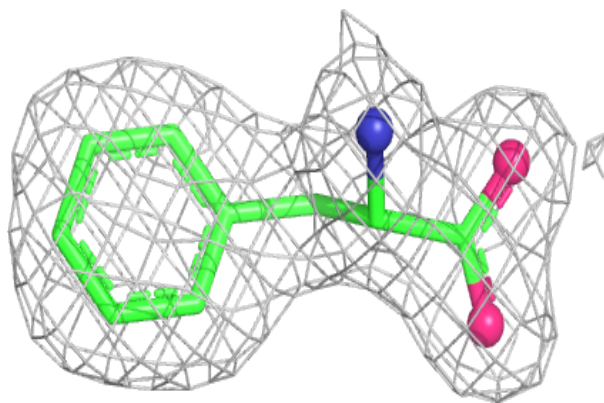
**Electron density around PHE f 101:**

$2mF_o-DF_c$ (at 0.7 rmsd) in gray
 mF_o-DF_c (at 3 rmsd) in purple (negative)
and green (positive)

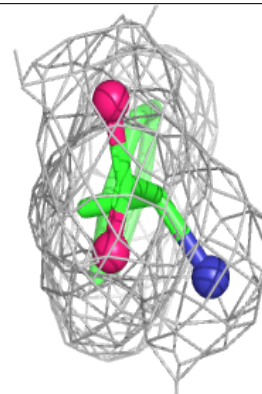
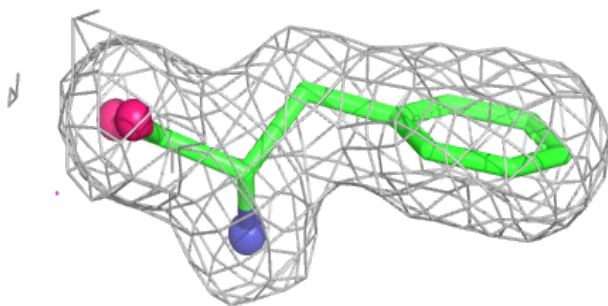
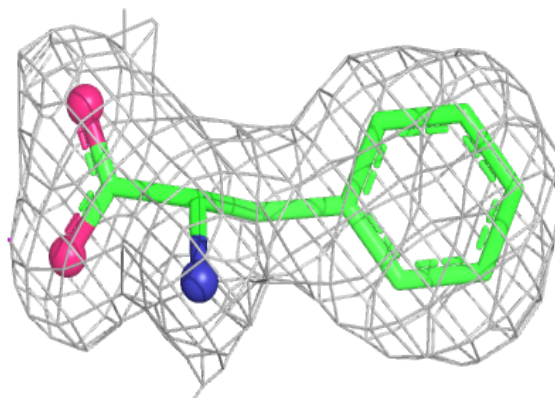

Electron density around PHE f 102:

$2mF_o-DF_c$ (at 0.7 rmsd) in gray
 mF_o-DF_c (at 3 rmsd) in purple (negative)
and green (positive)

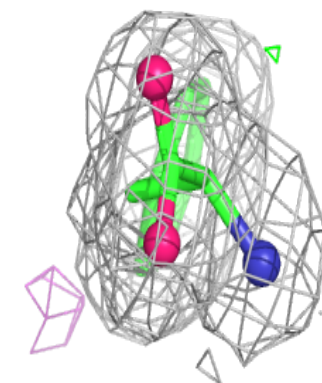
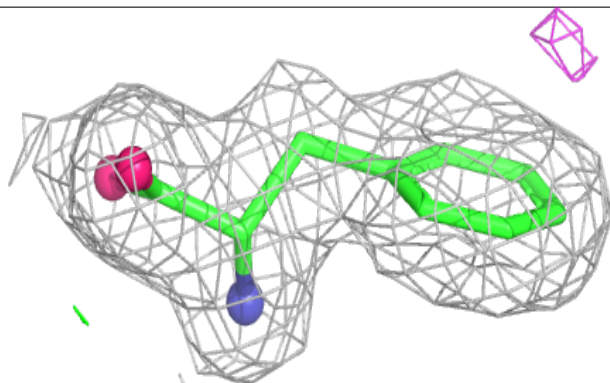
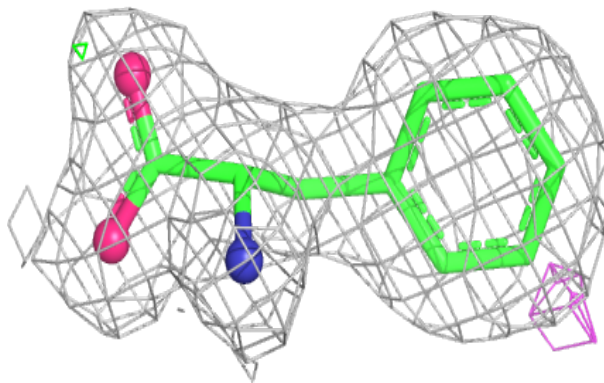
**Electron density around PHE g 101:**

$2mF_o-DF_c$ (at 0.7 rmsd) in gray
 mF_o-DF_c (at 3 rmsd) in purple (negative)
and green (positive)

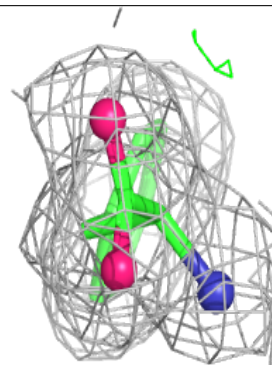
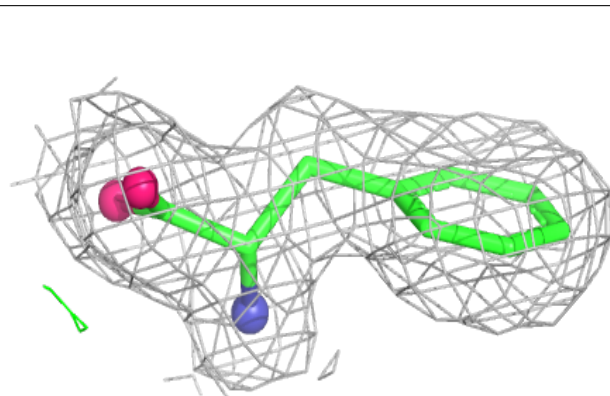
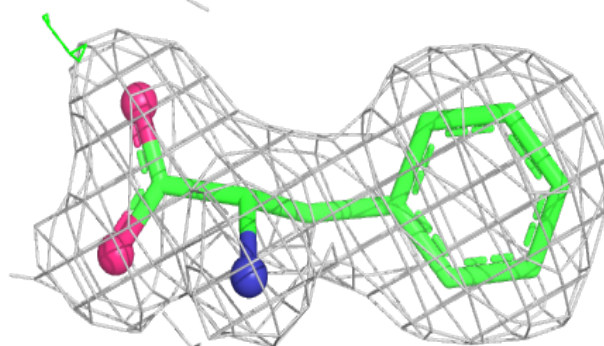

Electron density around PHE h 101:

$2mF_o-DF_c$ (at 0.7 rmsd) in gray
 mF_o-DF_c (at 3 rmsd) in purple (negative)
and green (positive)

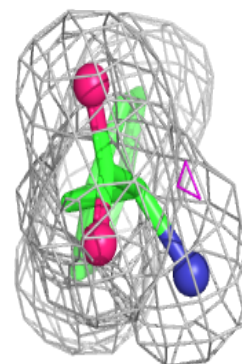
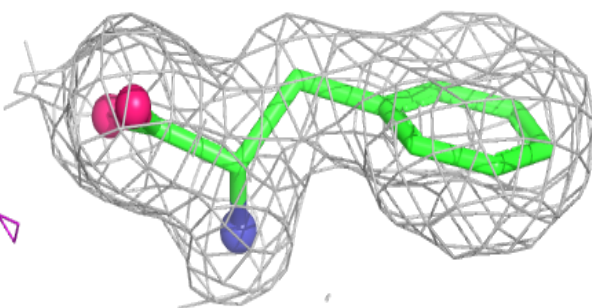
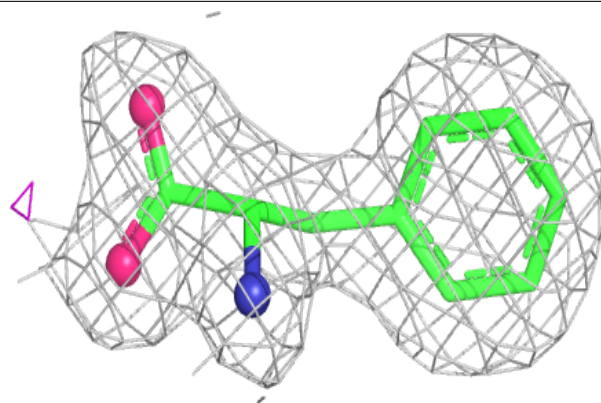
**Electron density around PHE k 101:**

$2mF_o-DF_c$ (at 0.7 rmsd) in gray
 mF_o-DF_c (at 3 rmsd) in purple (negative)
and green (positive)

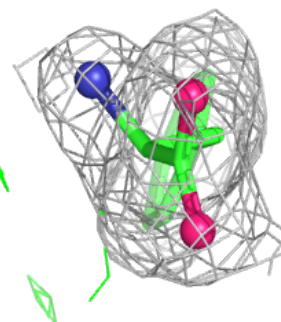
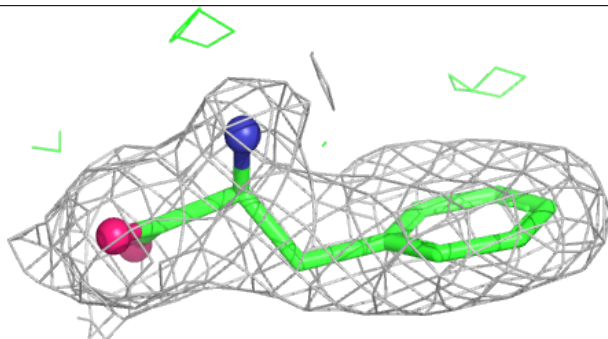
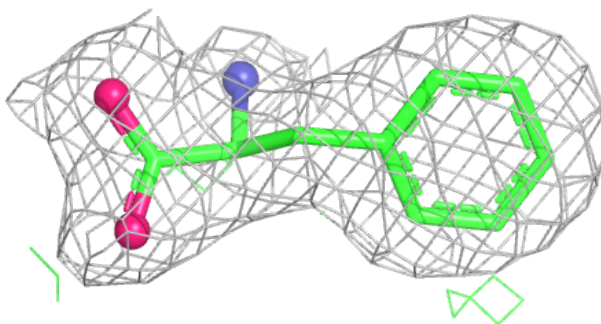

Electron density around QBQ A 302:

$2mF_o-DF_c$ (at 0.7 rmsd) in gray
 mF_o-DF_c (at 3 rmsd) in purple (negative)
and green (positive)

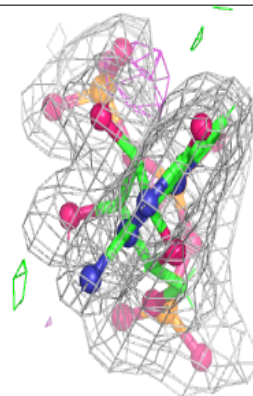
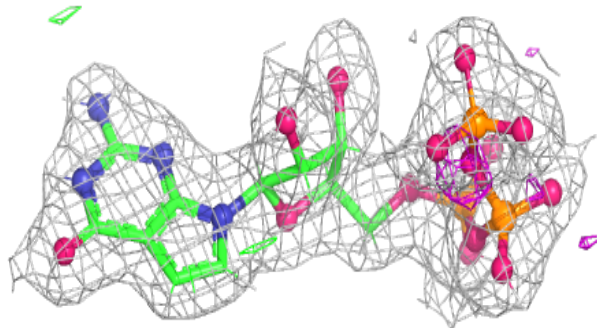
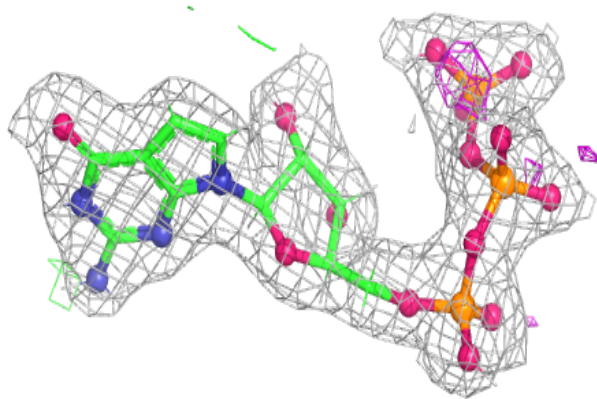
**Electron density around QBQ C 302:**

$2mF_o-DF_c$ (at 0.7 rmsd) in gray
 mF_o-DF_c (at 3 rmsd) in purple (negative)
and green (positive)

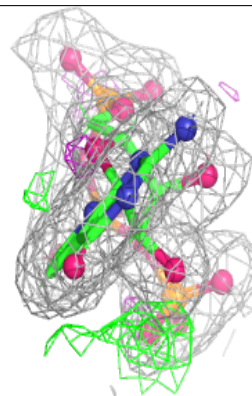
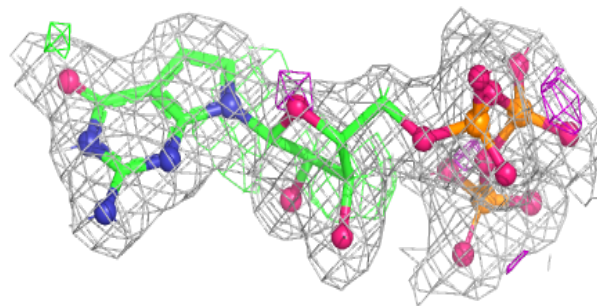
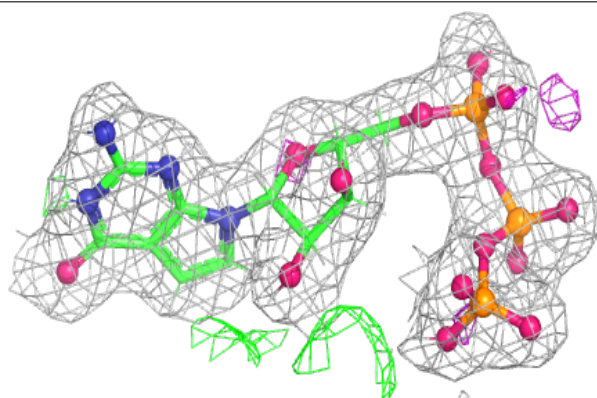

Electron density around PHE n 101:

$2mF_o-DF_c$ (at 0.7 rmsd) in gray
 mF_o-DF_c (at 3 rmsd) in purple (negative)
and green (positive)

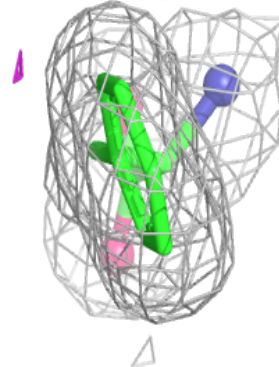
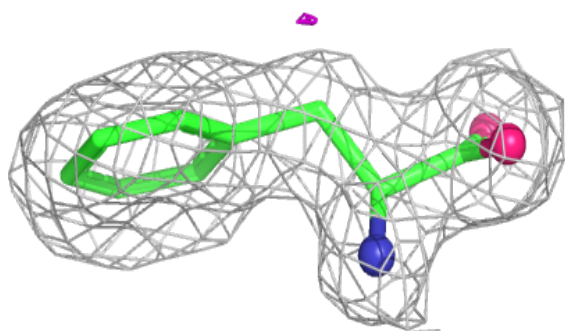
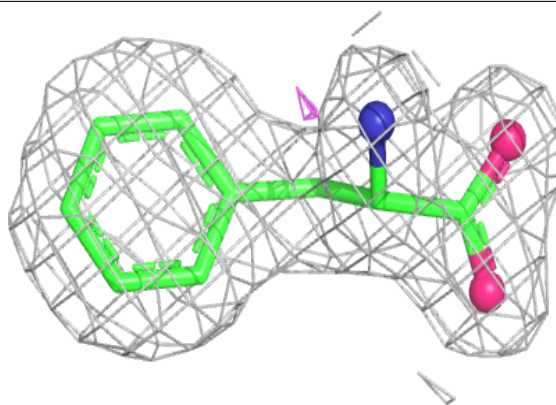
**Electron density around PHE o 101:**

$2mF_o-DF_c$ (at 0.7 rmsd) in gray
 mF_o-DF_c (at 3 rmsd) in purple (negative)
and green (positive)

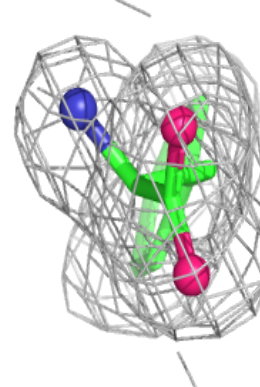
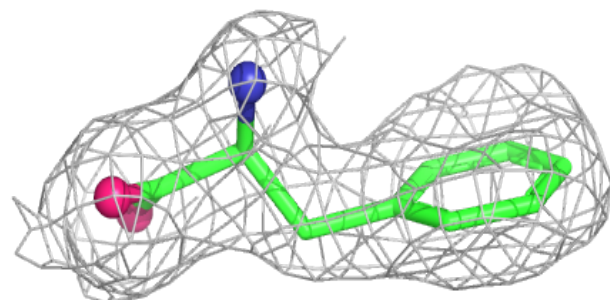
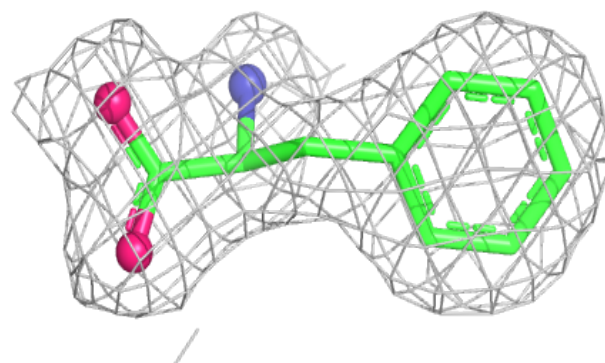

Electron density around PHE q 101:

$2mF_o-DF_c$ (at 0.7 rmsd) in gray
 mF_o-DF_c (at 3 rmsd) in purple (negative)
and green (positive)

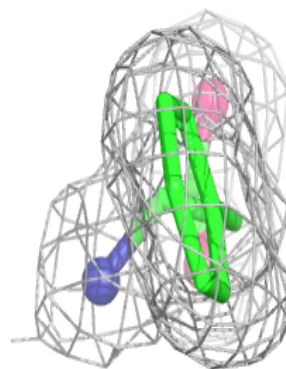
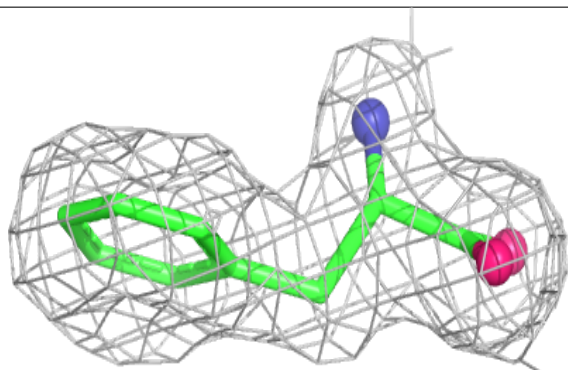
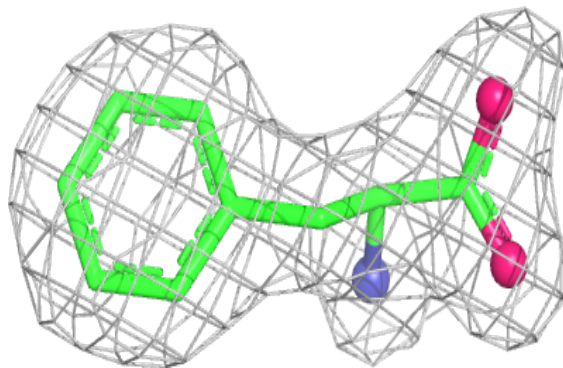

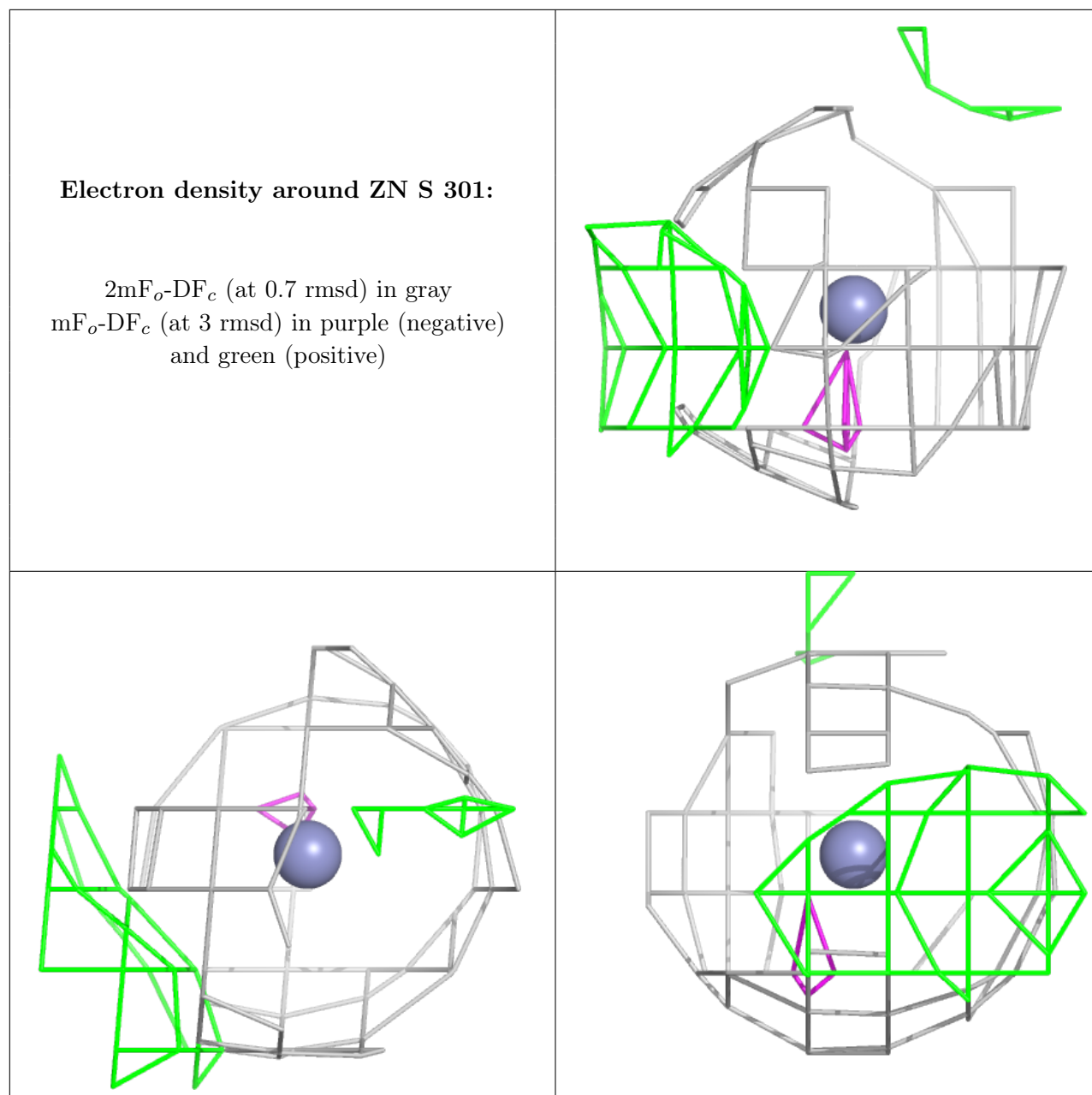

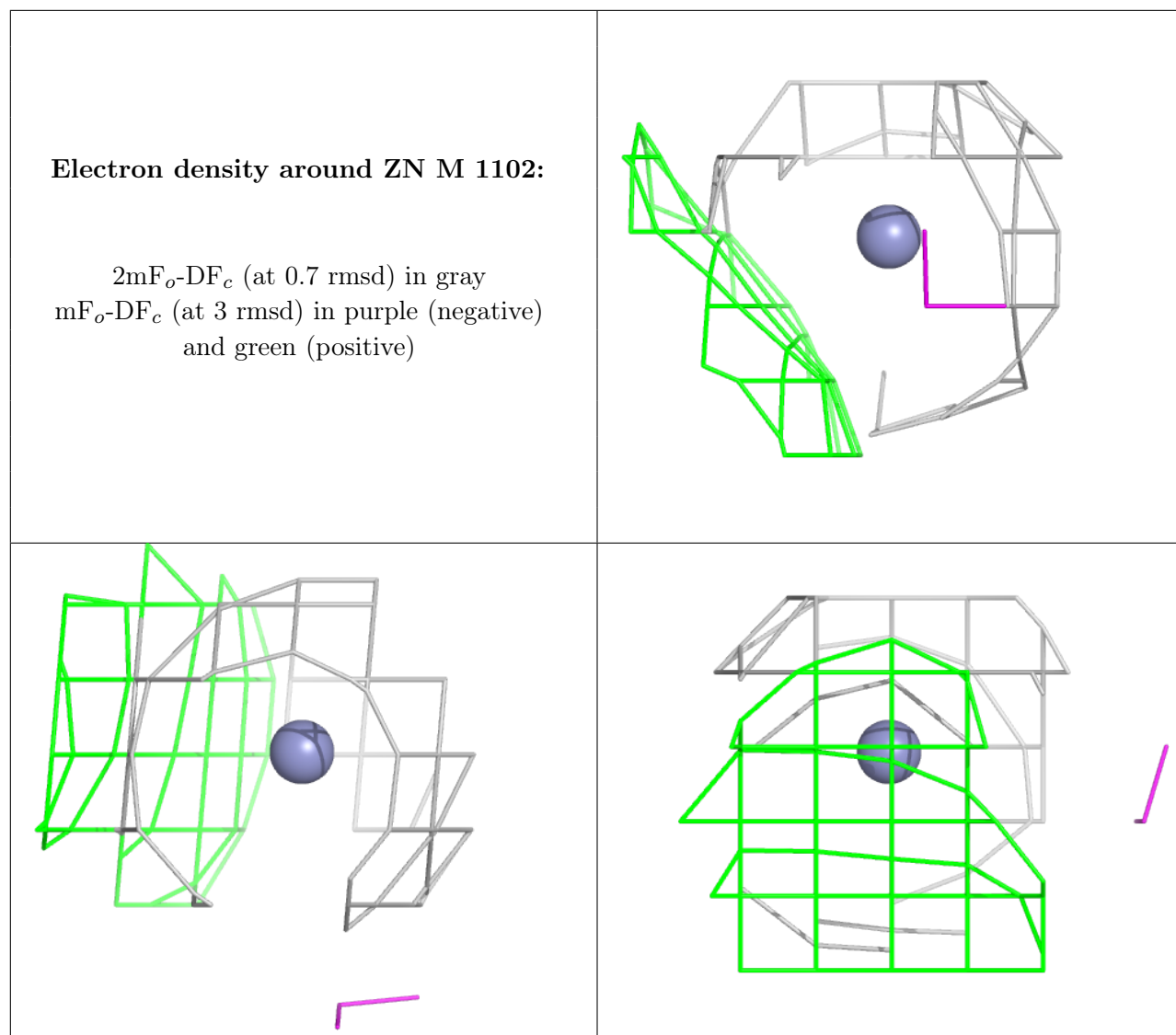

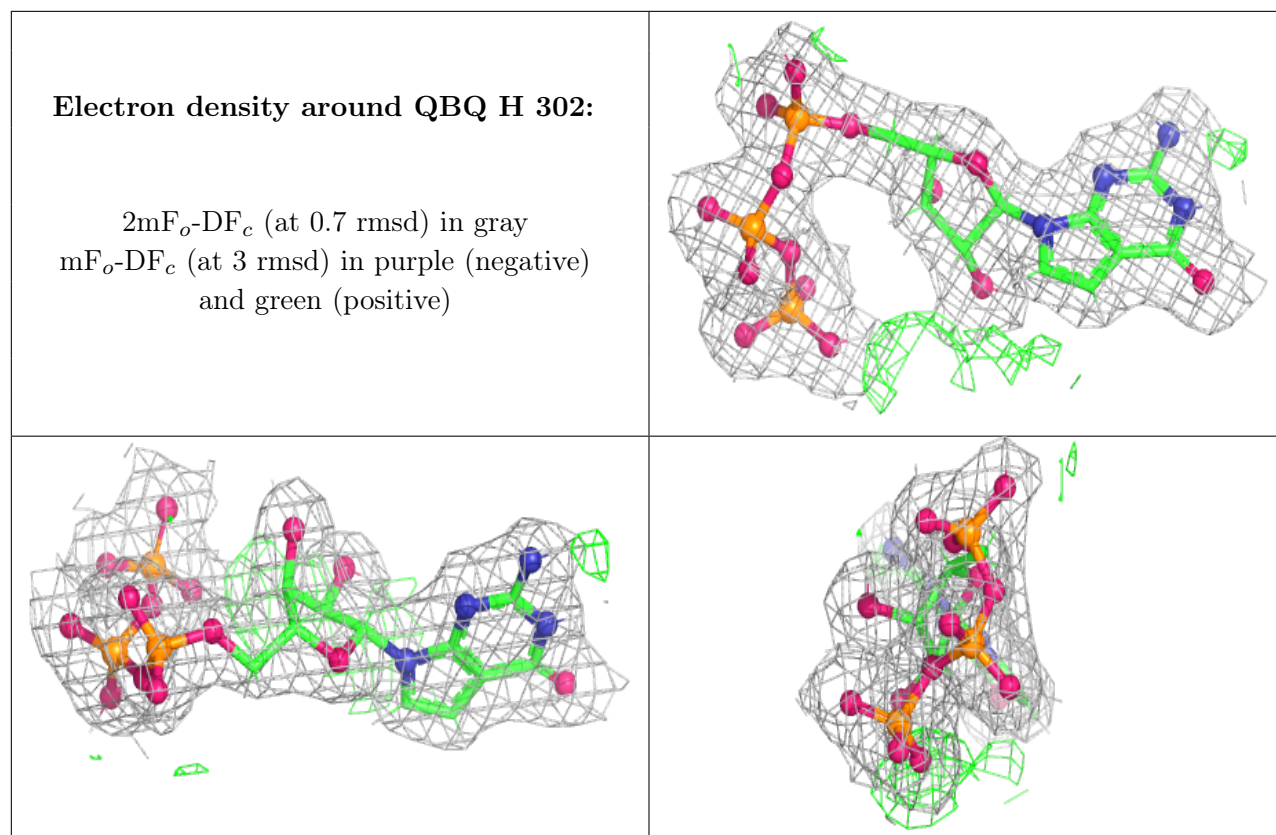

Electron density around ZN O 301:

$2mF_o-DF_c$ (at 0.7 rmsd) in gray
 mF_o-DF_c (at 3 rmsd) in purple (negative)
and green (positive)

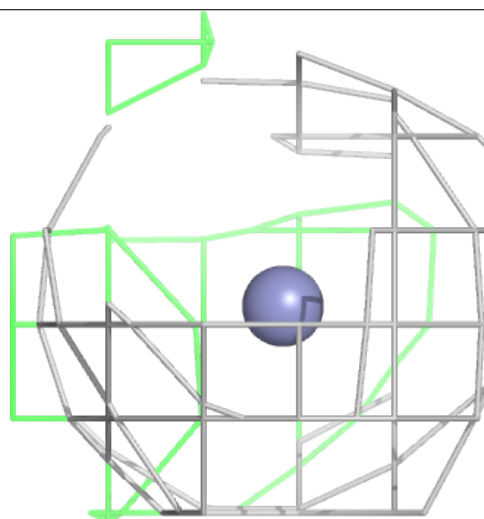
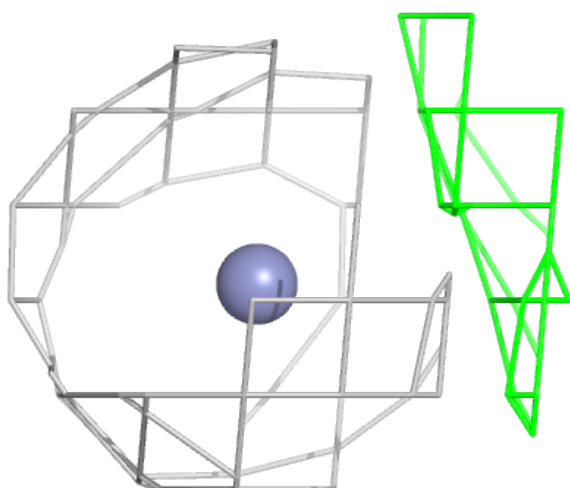
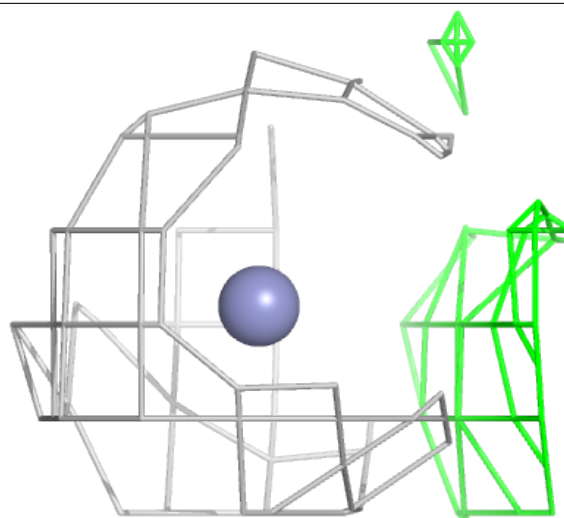

Electron density around PHE i 101:

$2mF_o-DF_c$ (at 0.7 rmsd) in gray
 mF_o-DF_c (at 3 rmsd) in purple (negative)
and green (positive)

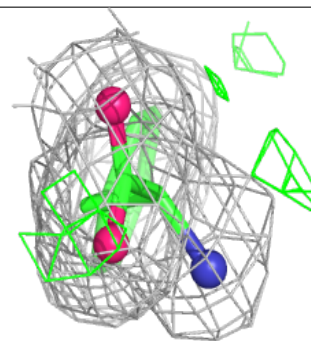
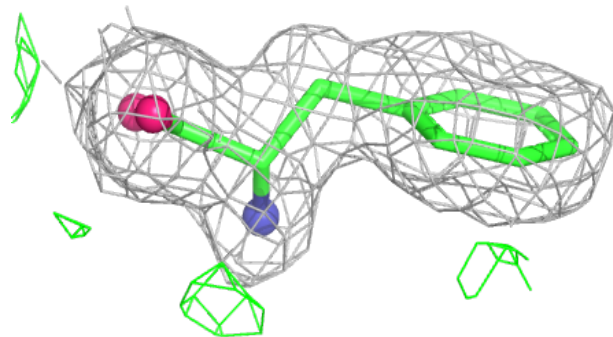
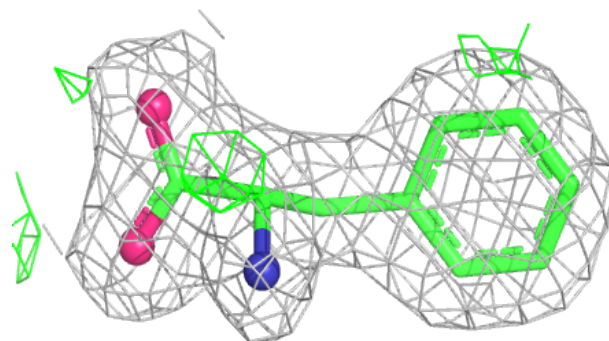
**Electron density around QBQ J 302:**

$2mF_o-DF_c$ (at 0.7 rmsd) in gray
 mF_o-DF_c (at 3 rmsd) in purple (negative)
and green (positive)

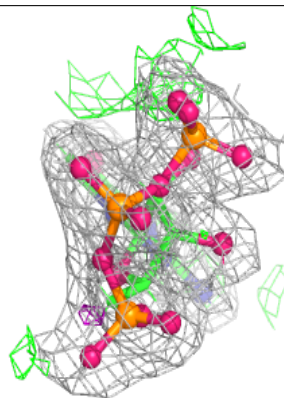
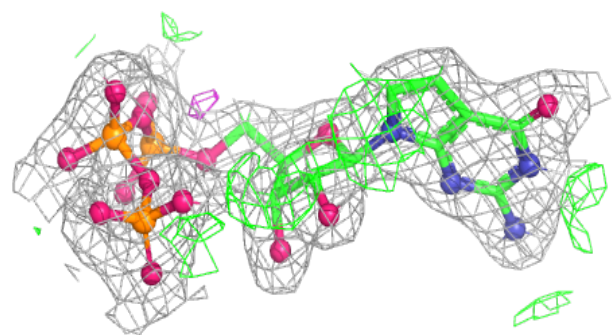
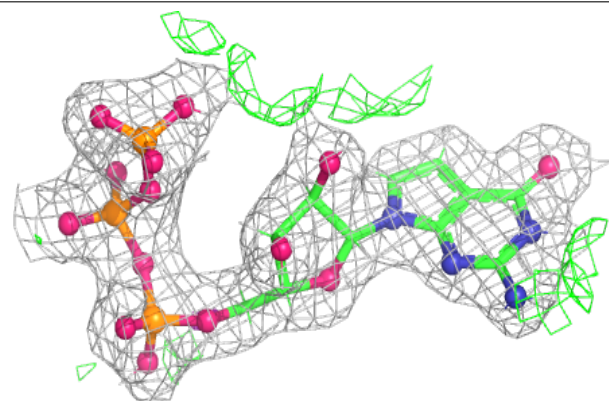

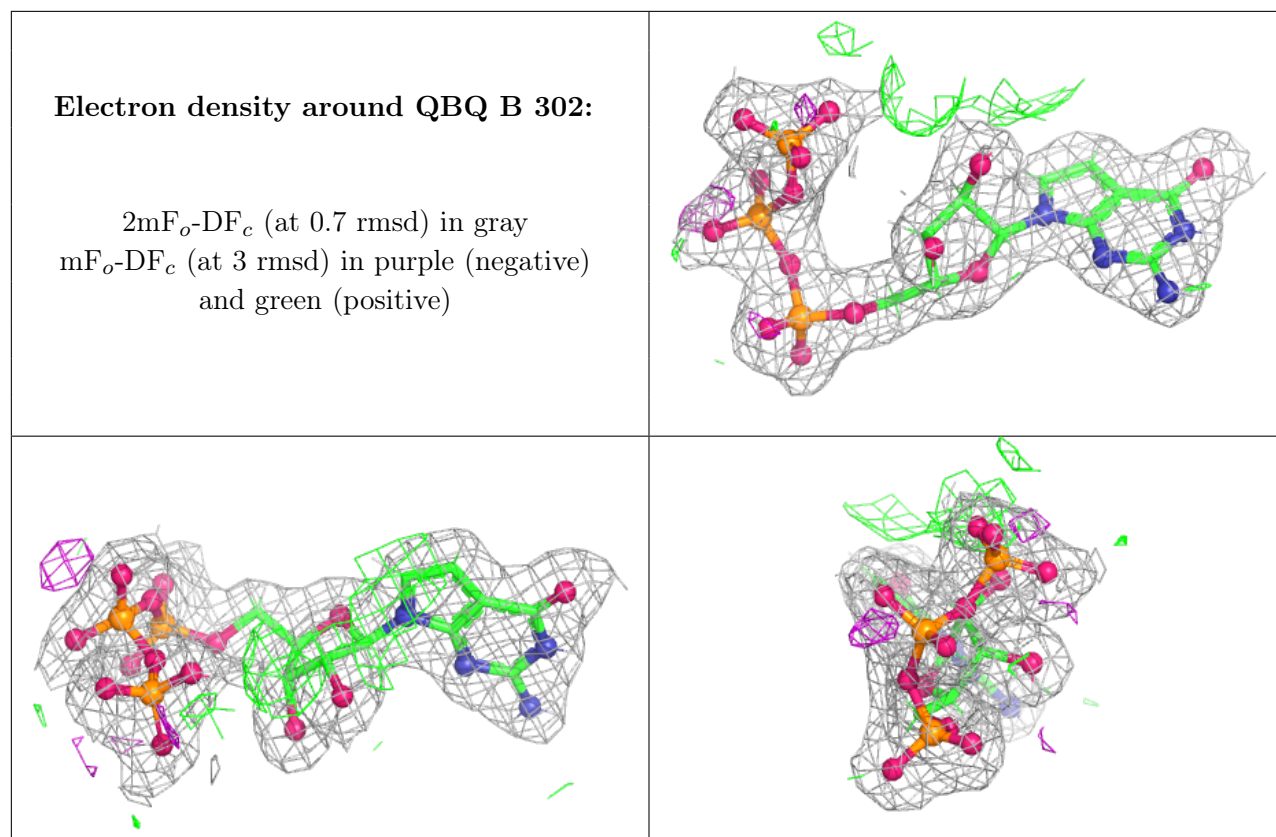

Electron density around ZN L 1102:

$2mF_o-DF_c$ (at 0.7 rmsd) in gray
 mF_o-DF_c (at 3 rmsd) in purple (negative)
and green (positive)

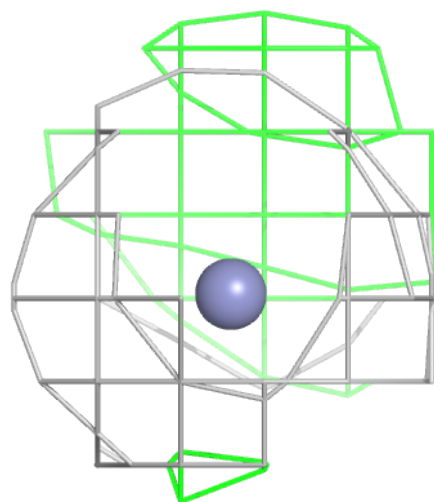
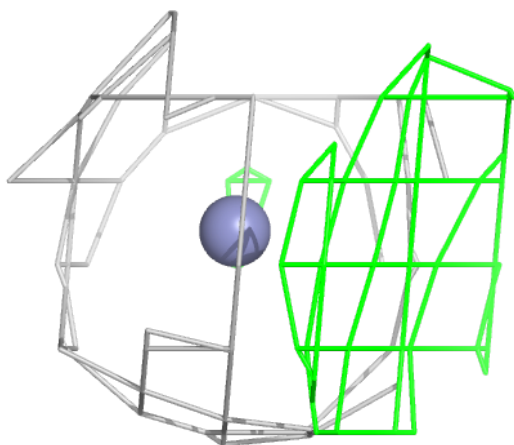
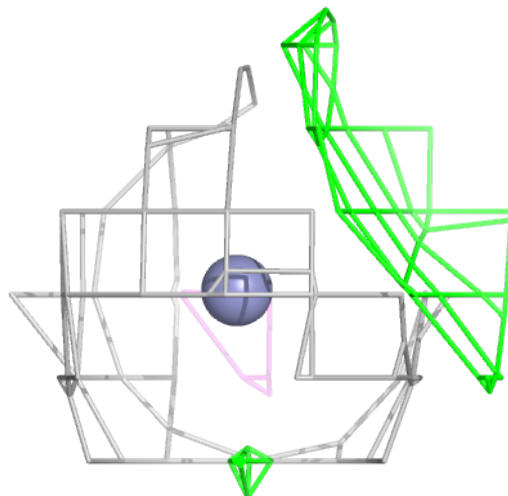

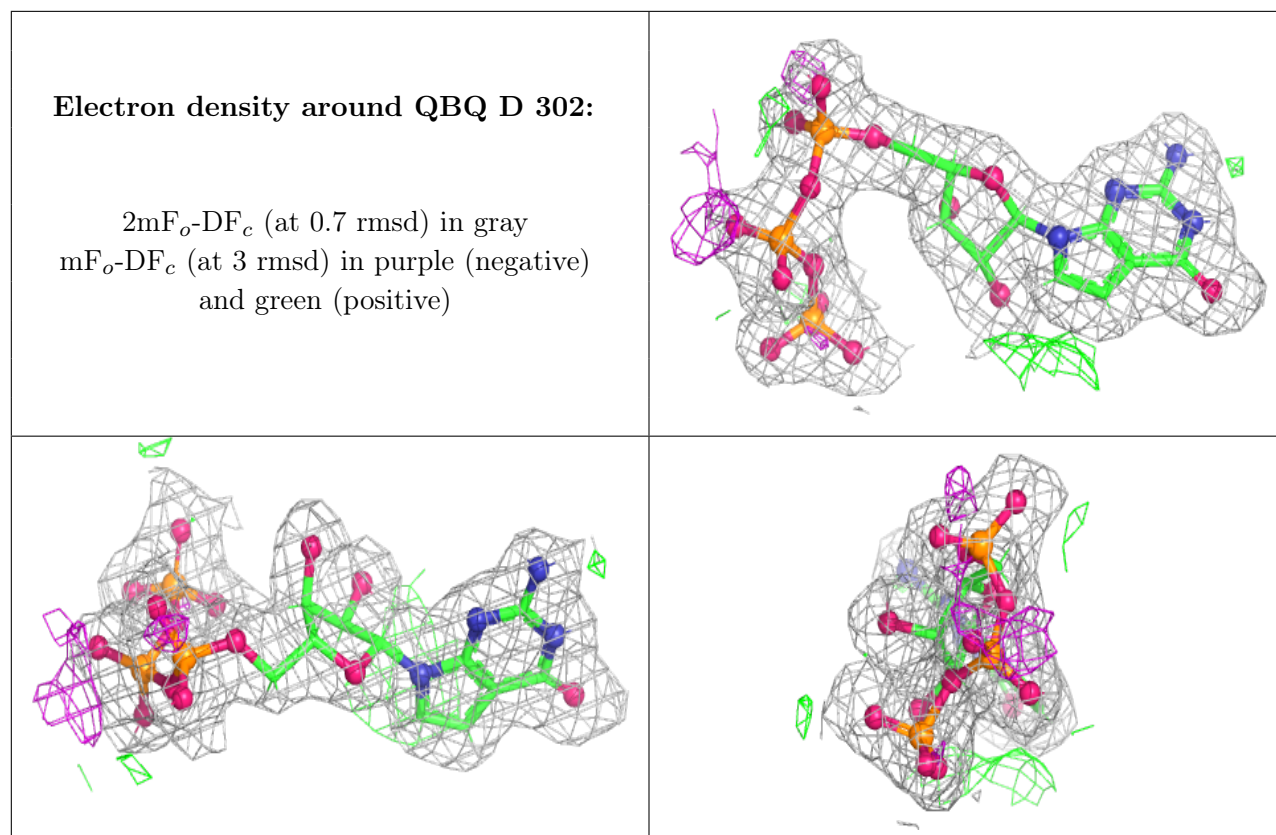

Electron density around ZN Q 301:

$2mF_o-DF_c$ (at 0.7 rmsd) in gray
 mF_o-DF_c (at 3 rmsd) in purple (negative)
and green (positive)

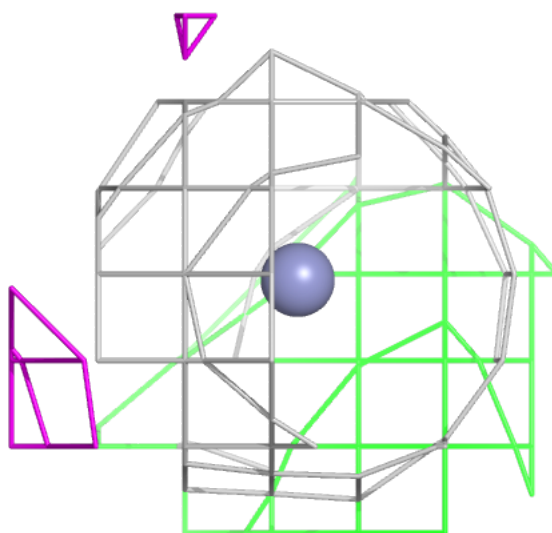
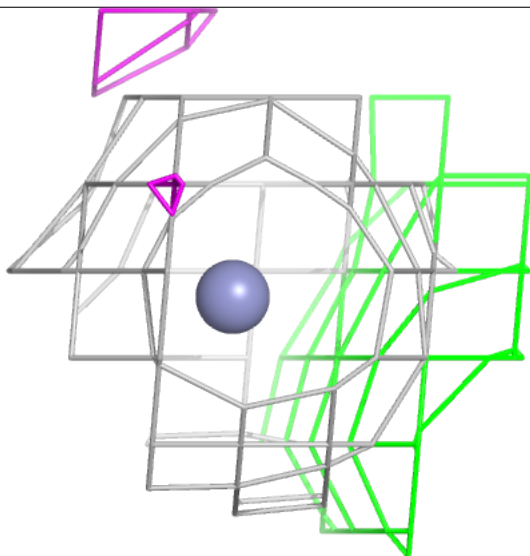
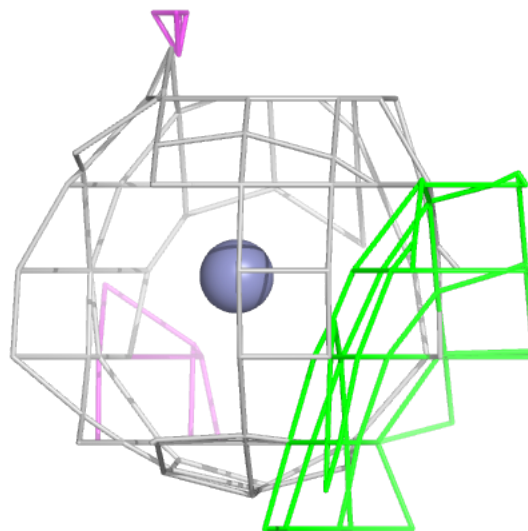

Electron density around PHE p 101:

$2mF_o-DF_c$ (at 0.7 rmsd) in gray
 mF_o-DF_c (at 3 rmsd) in purple (negative)
and green (positive)

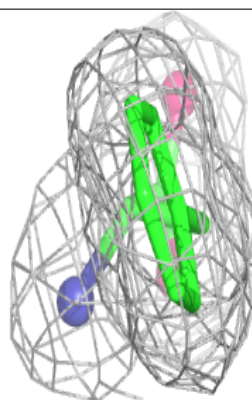
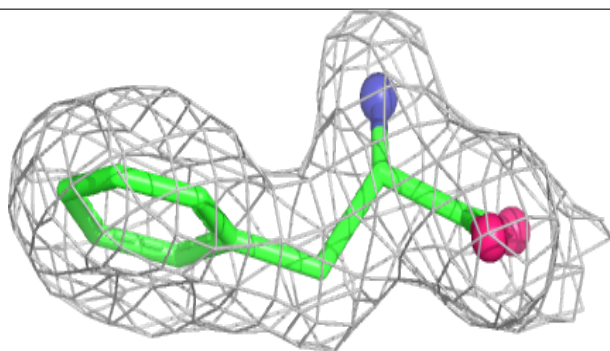
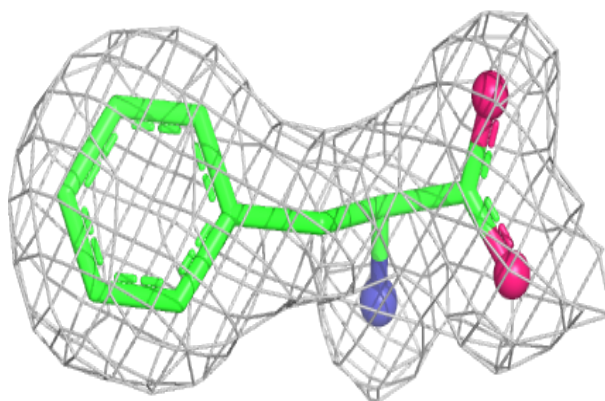
**Electron density around QBQ O 302:**

$2mF_o-DF_c$ (at 0.7 rmsd) in gray
 mF_o-DF_c (at 3 rmsd) in purple (negative)
and green (positive)

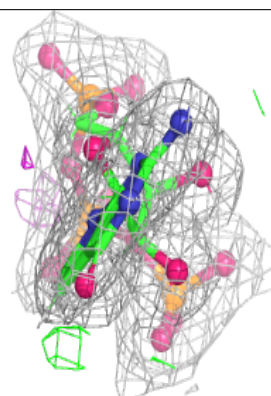
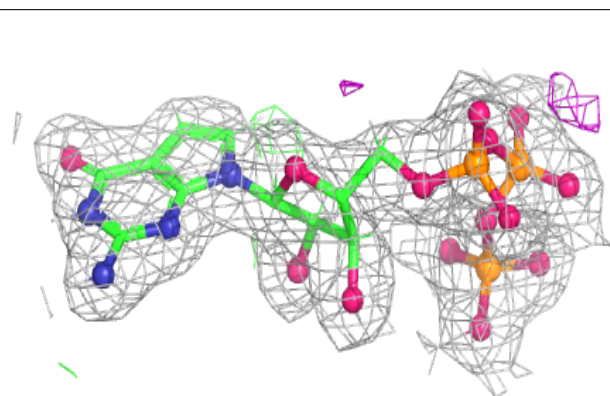
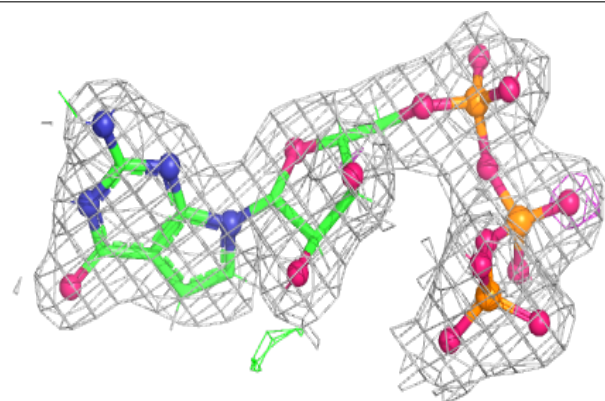

Electron density around PHE r 101:

$2mF_o-DF_c$ (at 0.7 rmsd) in gray
 mF_o-DF_c (at 3 rmsd) in purple (negative)
and green (positive)

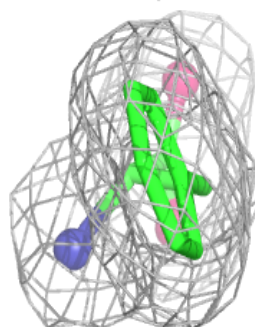
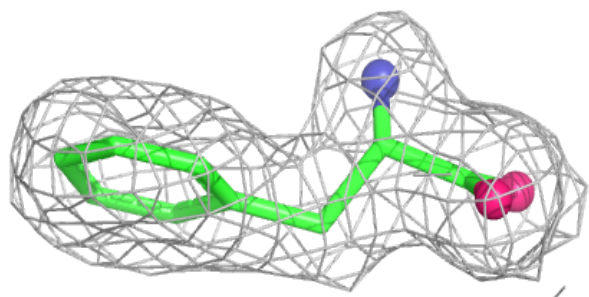
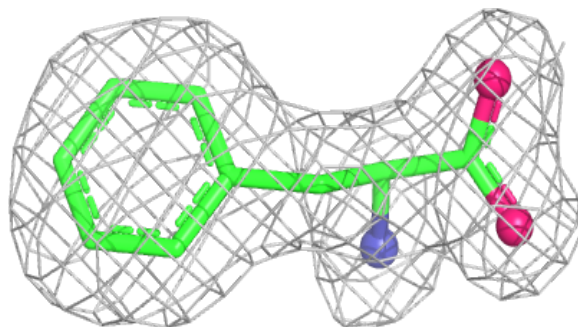
**Electron density around PHE s 101:**

$2mF_o-DF_c$ (at 0.7 rmsd) in gray
 mF_o-DF_c (at 3 rmsd) in purple (negative)
and green (positive)

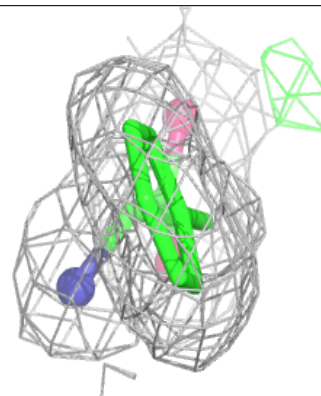
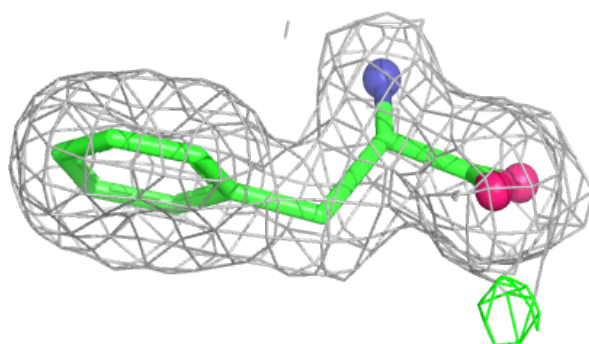
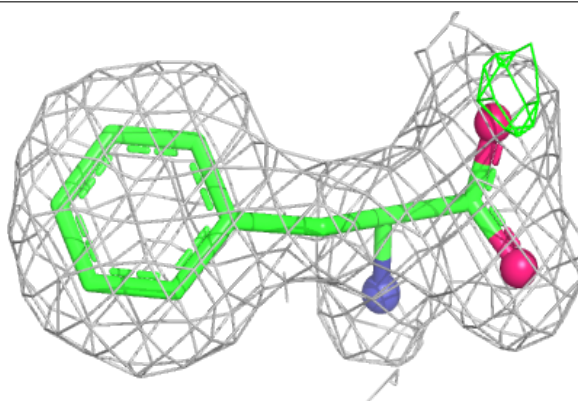

Electron density around PHE t 101:

$2mF_o-DF_c$ (at 0.7 rmsd) in gray
 mF_o-DF_c (at 3 rmsd) in purple (negative)
and green (positive)

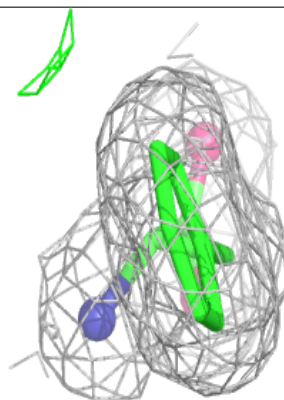
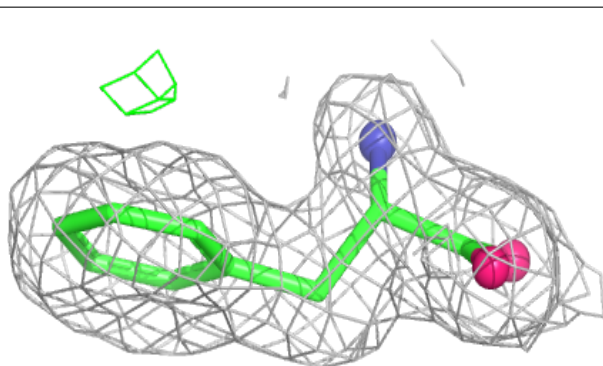
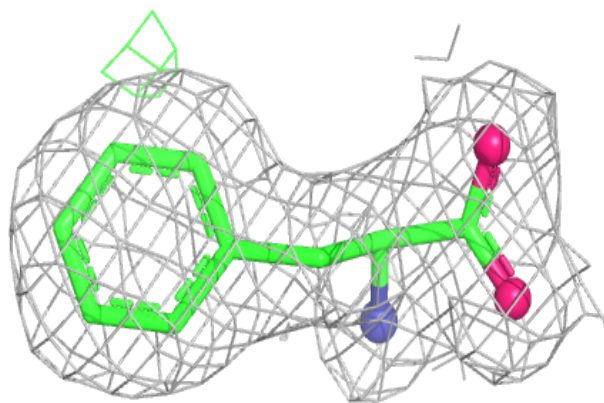

Electron density around ZN H 301:

$2mF_o-DF_c$ (at 0.7 rmsd) in gray
 mF_o-DF_c (at 3 rmsd) in purple (negative)
and green (positive)

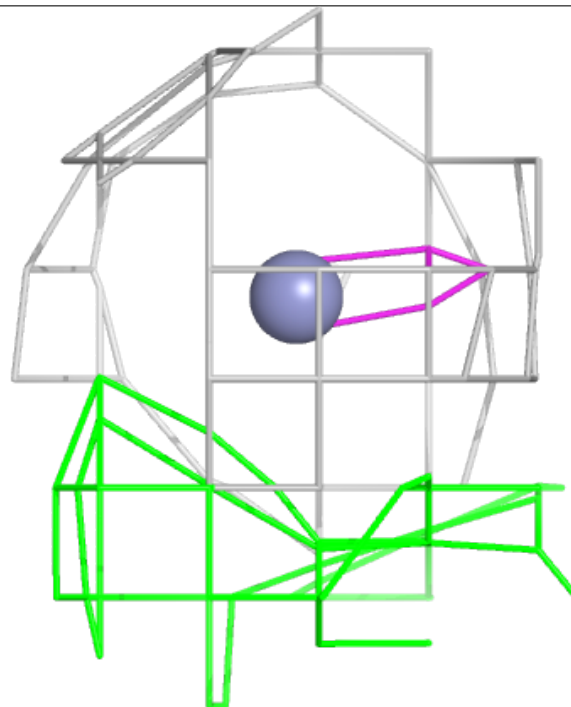
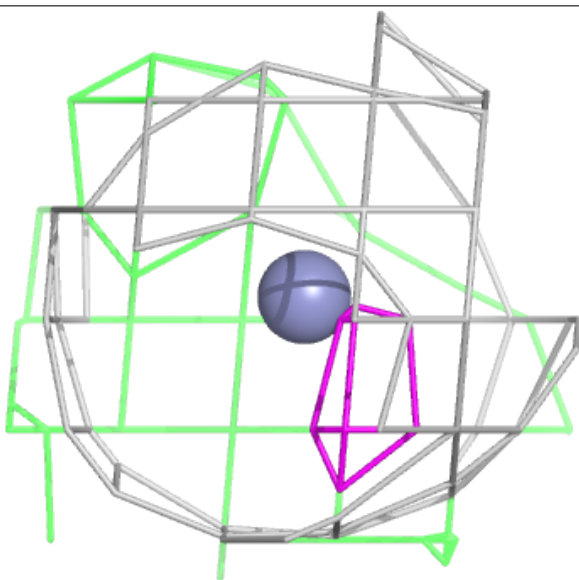
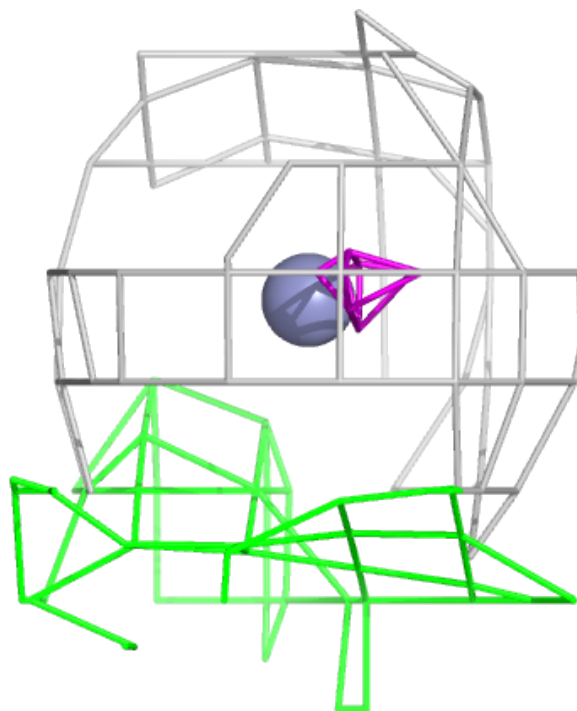

Electron density around ZN I 301:

$2mF_o-DF_c$ (at 0.7 rmsd) in gray
 mF_o-DF_c (at 3 rmsd) in purple (negative)
and green (positive)

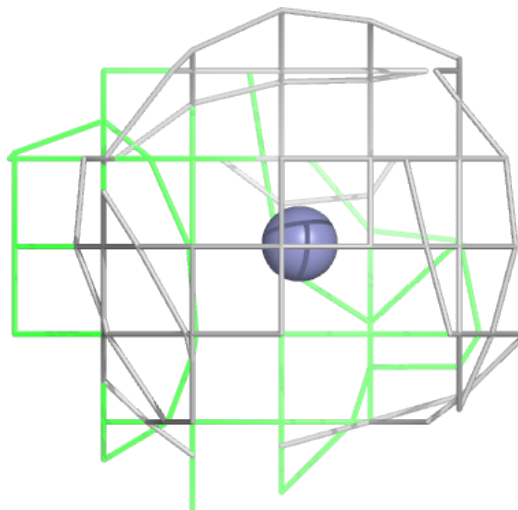
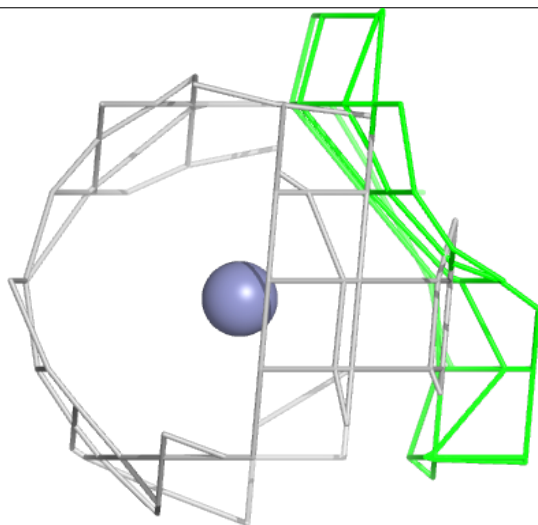
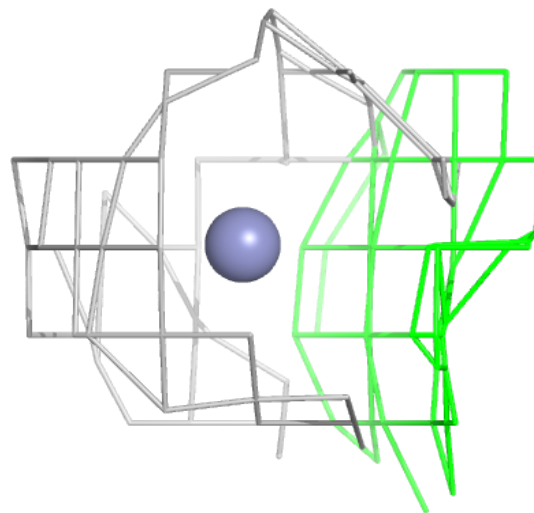

Electron density around ZN R 301:

$2mF_o-DF_c$ (at 0.7 rmsd) in gray
 mF_o-DF_c (at 3 rmsd) in purple (negative)
and green (positive)

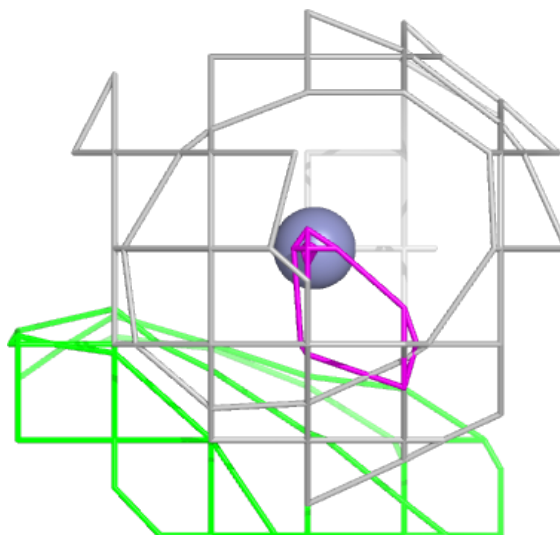
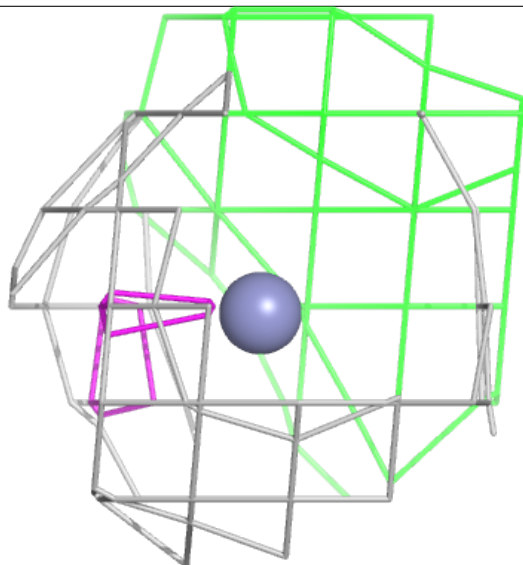
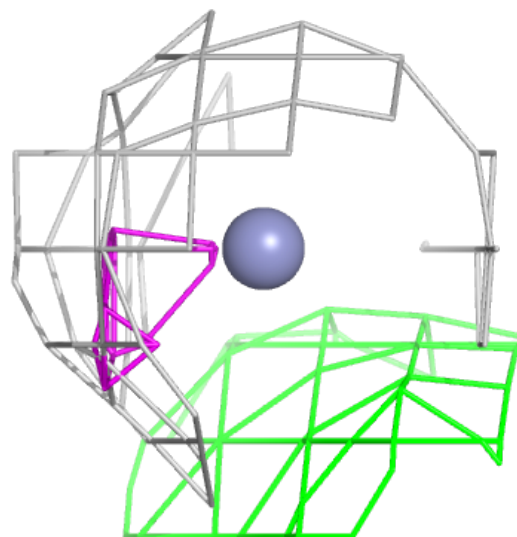

Electron density around ZN D 301:

$2mF_o-DF_c$ (at 0.7 rmsd) in gray
 mF_o-DF_c (at 3 rmsd) in purple (negative)
and green (positive)

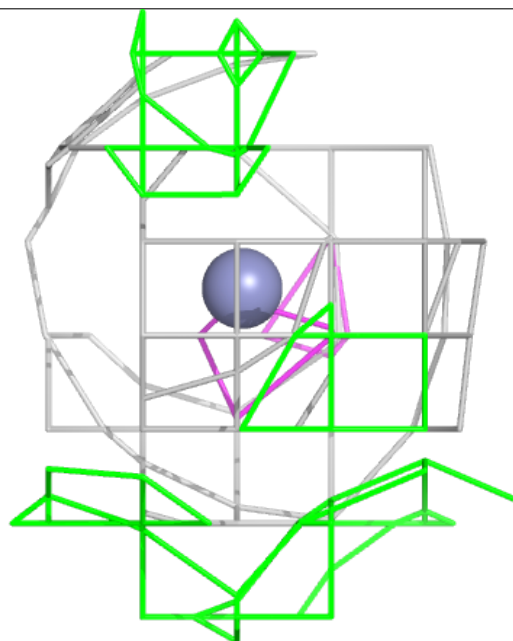
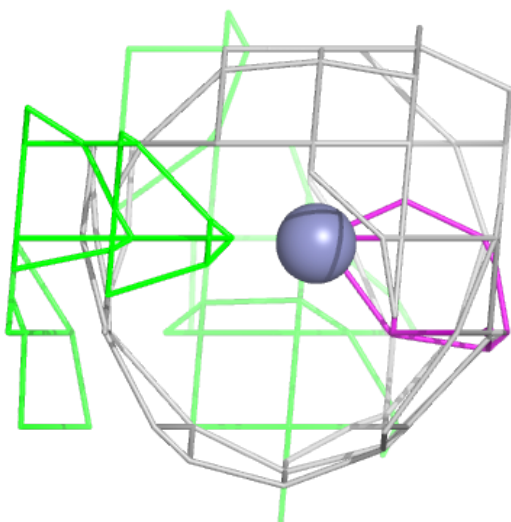
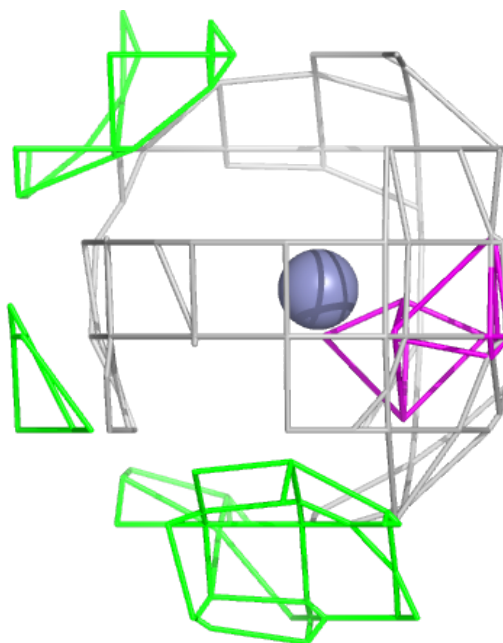

Electron density around ZN K 301:

$2mF_o-DF_c$ (at 0.7 rmsd) in gray
 mF_o-DF_c (at 3 rmsd) in purple (negative)
and green (positive)

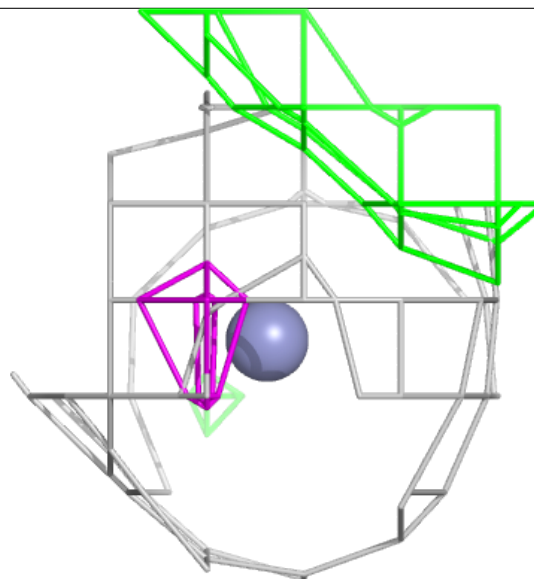
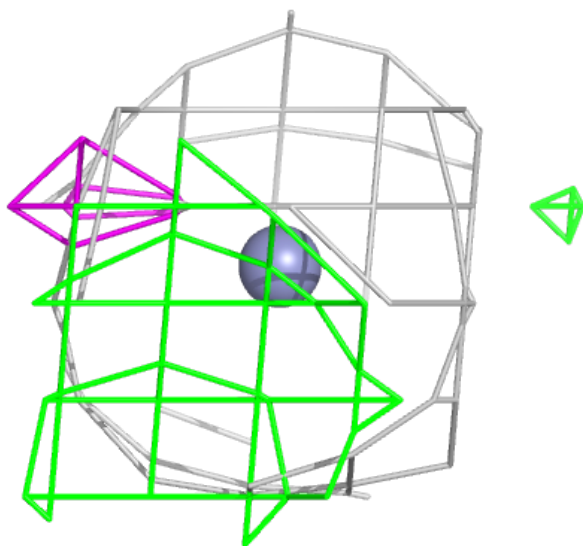
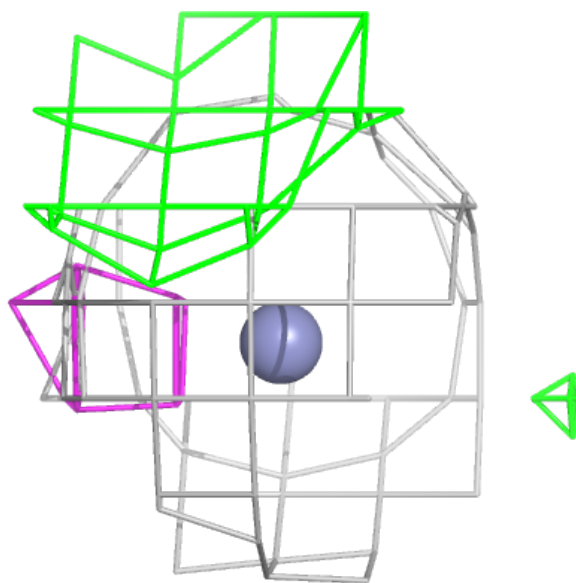

Electron density around ZN B 301:

$2mF_o-DF_c$ (at 0.7 rmsd) in gray
 mF_o-DF_c (at 3 rmsd) in purple (negative)
and green (positive)

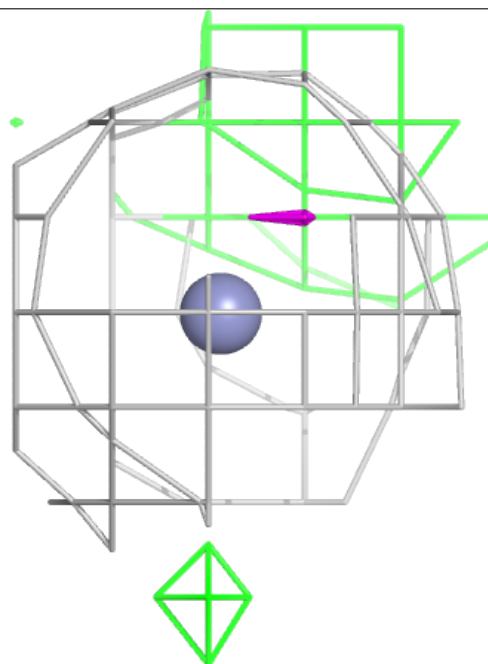
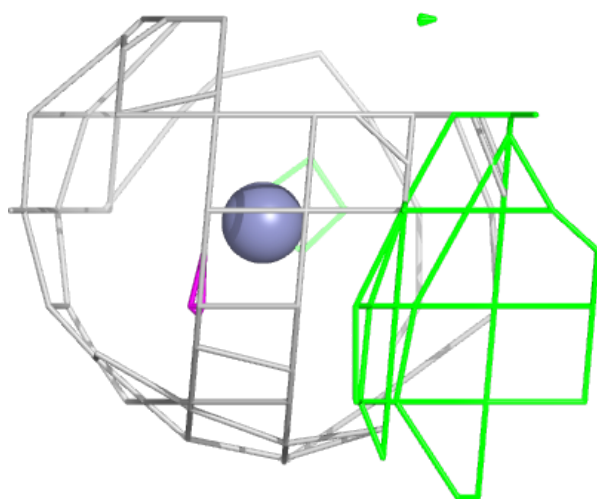
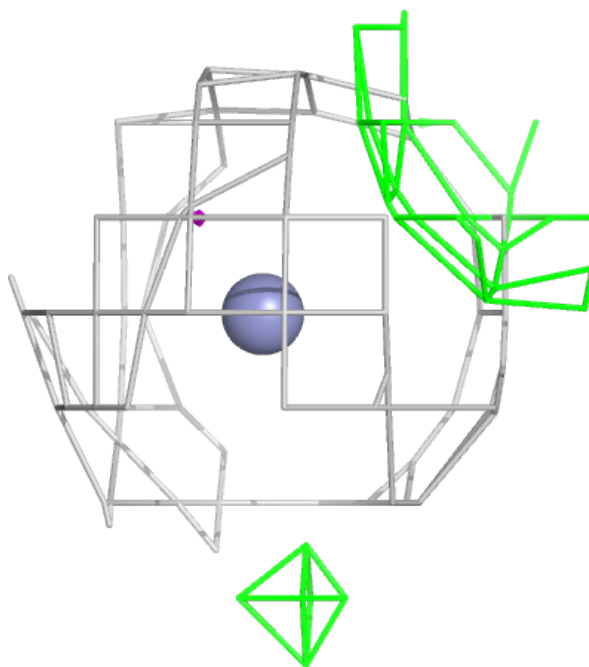

Electron density around ZN A 301:

$2mF_o-DF_c$ (at 0.7 rmsd) in gray
 mF_o-DF_c (at 3 rmsd) in purple (negative)
and green (positive)

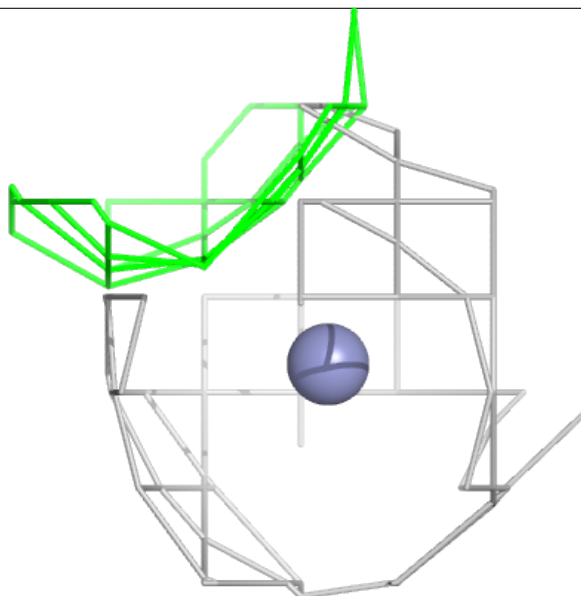
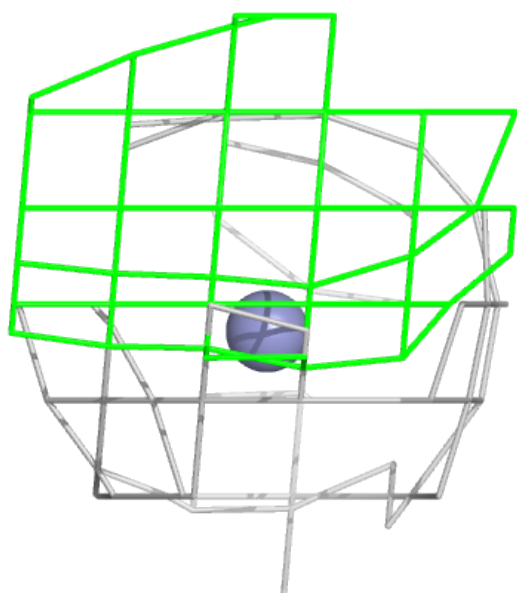
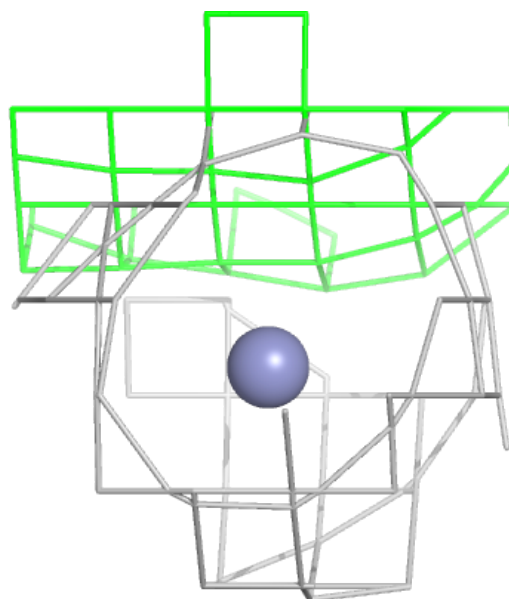

Electron density around ZN N 1102:

$2mF_o-DF_c$ (at 0.7 rmsd) in gray
 mF_o-DF_c (at 3 rmsd) in purple (negative)
and green (positive)

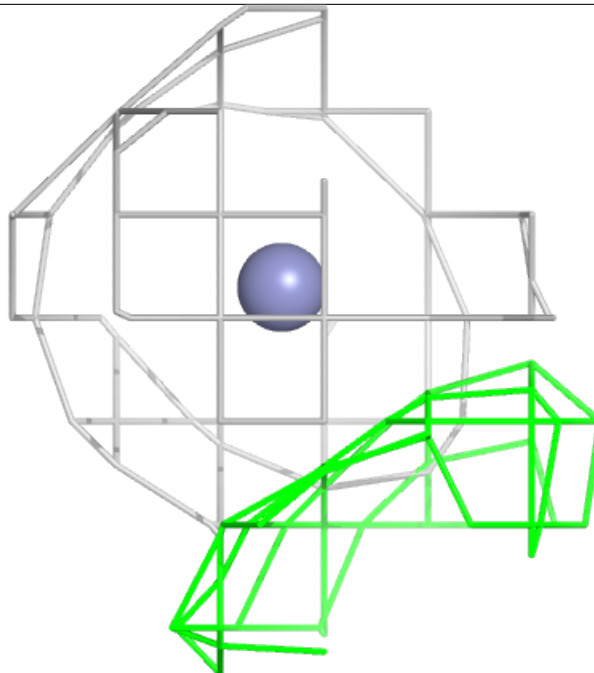
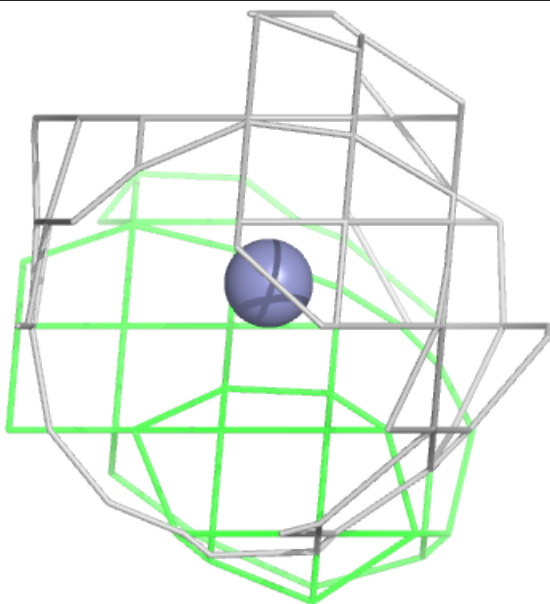
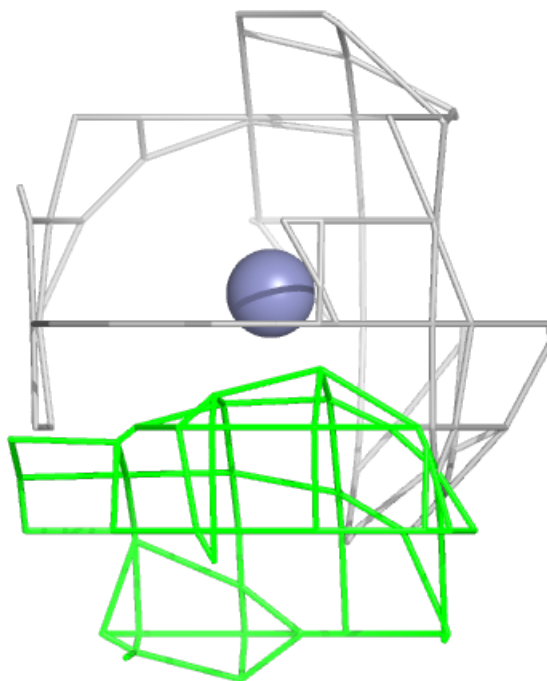

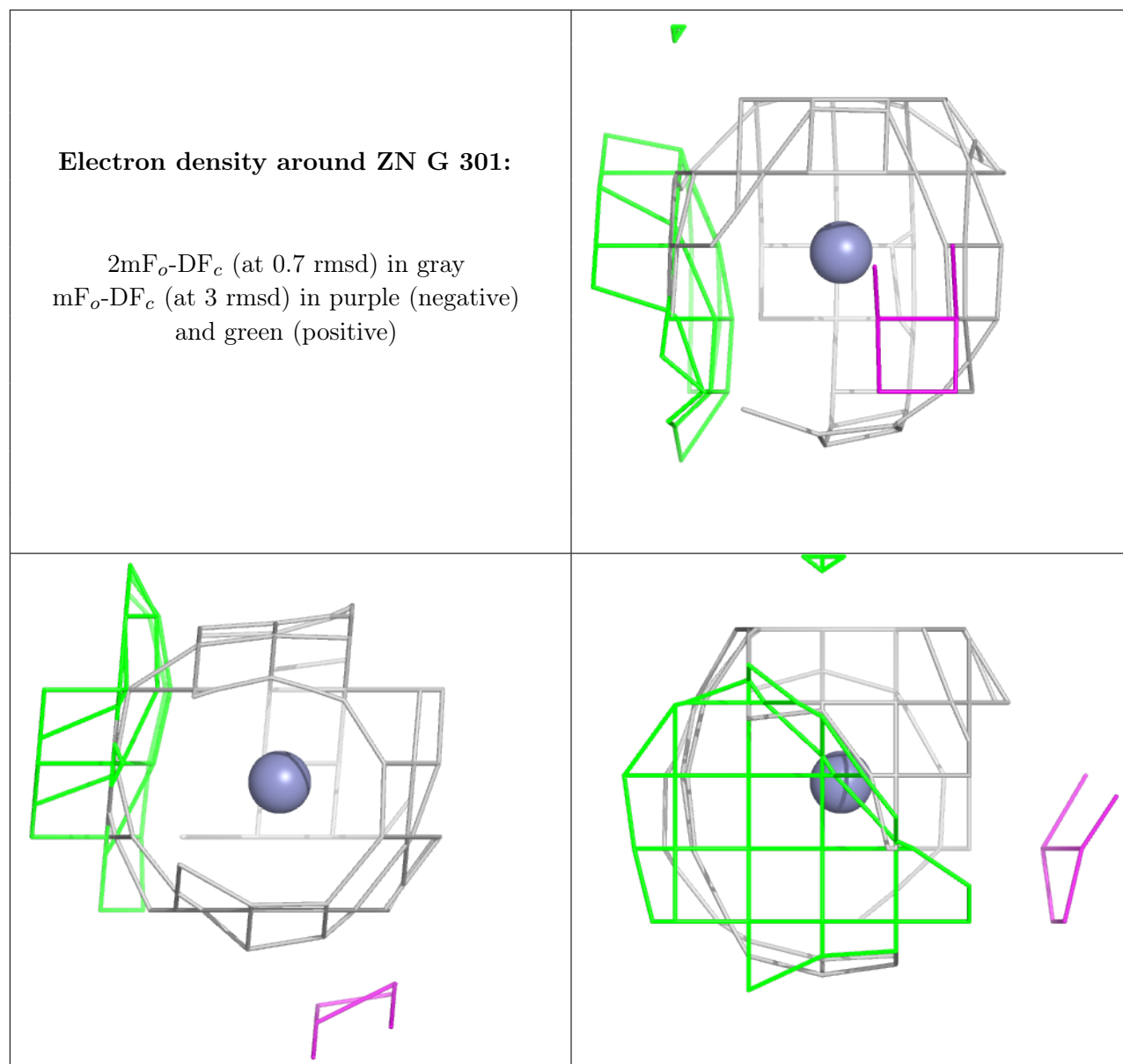

6.5 Other polymers [i](#)

There are no such residues in this entry.