



Full wwPDB X-ray Structure Validation Report ⓘ

Sep 25, 2023 – 04:47 PM EDT

PDB ID : 6AMO
Title : STRUCTURE OF HIV-1 REVERSE TRANSCRIPTASE (RT) TERNARY COMPLEX WITH A DOUBLE STRANDED DNA AND AN INCOMING D4TTP AT PH 7.0
Authors : Martinez, S.E.; Das, K.; Arnold, E.
Deposited on : 2017-08-10
Resolution : 2.50 Å(reported)

This is a Full wwPDB X-ray Structure Validation Report for a publicly released PDB entry.

We welcome your comments at validation@mail.wwpdb.org

A user guide is available at

<https://www.wwpdb.org/validation/2017/XrayValidationReportHelp>

with specific help available everywhere you see the ⓘ symbol.

The types of validation reports are described at

<http://www.wwpdb.org/validation/2017/FAQs#types>.

The following versions of software and data (see [references ⓘ](#)) were used in the production of this report:

MolProbity : 4.02b-467
Mogul : 1.8.5 (274361), CSD as541be (2020)
Xtrriage (Phenix) : 1.13
EDS : 2.35.1
buster-report : 1.1.7 (2018)
Percentile statistics : 20191225.v01 (using entries in the PDB archive December 25th 2019)
Refmac : 5.8.0158
CCP4 : 7.0.044 (Gargrove)
Ideal geometry (proteins) : Engh & Huber (2001)
Ideal geometry (DNA, RNA) : Parkinson et al. (1996)
Validation Pipeline (wwPDB-VP) : 2.35.1

1 Overall quality at a glance

The following experimental techniques were used to determine the structure:

X-RAY DIFFRACTION

The reported resolution of this entry is 2.50 Å.

Percentile scores (ranging between 0-100) for global validation metrics of the entry are shown in the following graphic. The table shows the number of entries on which the scores are based.

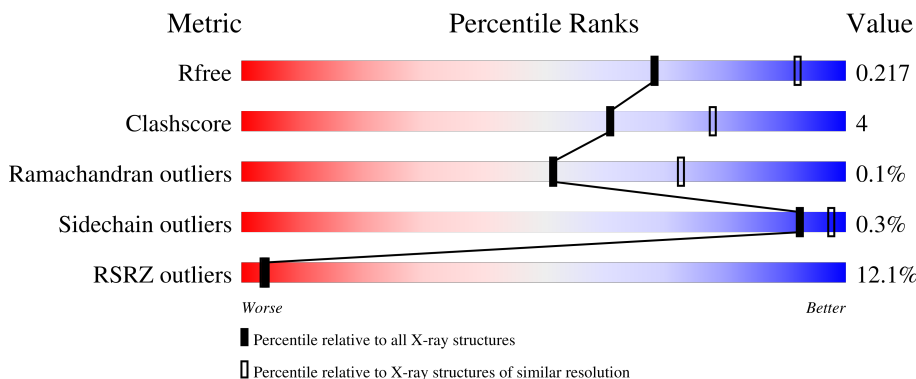

Metric	Whole archive (#Entries)	Similar resolution (#Entries, resolution range(Å))
R_{free}	130704	4661 (2.50-2.50)
Clashscore	141614	5346 (2.50-2.50)
Ramachandran outliers	138981	5231 (2.50-2.50)
Sidechain outliers	138945	5233 (2.50-2.50)
RSRZ outliers	127900	4559 (2.50-2.50)

The table below summarises the geometric issues observed across the polymeric chains and their fit to the electron density. The red, orange, yellow and green segments of the lower bar indicate the fraction of residues that contain outliers for ≥ 3 , 2, 1 and 0 types of geometric quality criteria respectively. A grey segment represents the fraction of residues that are not modelled. The numeric value for each fraction is indicated below the corresponding segment, with a dot representing fractions $\leq 5\%$. The upper red bar (where present) indicates the fraction of residues that have poor fit to the electron density. The numeric value is given above the bar.

Mol	Chain	Length	Quality of chain
1	A	556	 16% 88% 12%
1	C	556	 15% 85% 15%
2	B	444	 5% 84% 9% 7%
2	D	444	 8% 83% 7% 9%

Continued on next page...

Continued from previous page...

Mol	Chain	Length	Quality of chain
3	E	27	
3	T	27	
4	F	21	
4	P	21	

The following table lists non-polymeric compounds, carbohydrate monomers and non-standard residues in protein, DNA, RNA chains that are outliers for geometric or electron-density-fit criteria:

Mol	Type	Chain	Res	Chirality	Geometry	Clashes	Electron density
7	GOL	A	604	-	-	-	X
7	GOL	D	504	-	-	-	X

2 Entry composition [i](#)

There are 8 unique types of molecules in this entry. The entry contains 18285 atoms, of which 0 are hydrogens and 0 are deuteriums.

In the tables below, the ZeroOcc column contains the number of atoms modelled with zero occupancy, the AltConf column contains the number of residues with at least one atom in alternate conformation and the Trace column contains the number of residues modelled with at most 2 atoms.

- Molecule 1 is a protein called HIV-1 REVERSE TRANSCRIPTASE P66 SUBUNIT.

Mol	Chain	Residues	Atoms					ZeroOcc	AltConf	Trace
			Total	C	N	O	S			
1	A	555	4517	2923	751	834	9	0	0	0
1	C	555	4517	2923	751	834	9	0	0	0

There are 8 discrepancies between the modelled and reference sequences:

Chain	Residue	Modelled	Actual	Comment	Reference
A	-1	MET	-	initiating methionine	UNP P03366
A	0	VAL	-	expression tag	UNP P03366
A	63	CYS	ILE	engineered mutation	UNP P03366
A	280	SER	CYS	engineered mutation	UNP P03366
C	-1	MET	-	initiating methionine	UNP P03366
C	0	VAL	-	expression tag	UNP P03366
C	63	CYS	ILE	engineered mutation	UNP P03366
C	280	SER	CYS	engineered mutation	UNP P03366

- Molecule 2 is a protein called HIV-1 REVERSE TRANSCRIPTASE P51 SUBUNIT.

Mol	Chain	Residues	Atoms					ZeroOcc	AltConf	Trace
			Total	C	N	O	S			
2	B	412	3415	2227	564	617	7	0	0	0
2	D	402	3329	2169	548	607	5	0	0	0

There are 34 discrepancies between the modelled and reference sequences:

Chain	Residue	Modelled	Actual	Comment	Reference
B	-15	MET	-	initiating methionine	UNP P03366
B	-14	ALA	-	expression tag	UNP P03366
B	-13	HIS	-	expression tag	UNP P03366
B	-12	HIS	-	expression tag	UNP P03366

Continued on next page...

Continued from previous page...

Chain	Residue	Modelled	Actual	Comment	Reference
B	-11	HIS	-	expression tag	UNP P03366
B	-10	HIS	-	expression tag	UNP P03366
B	-9	HIS	-	expression tag	UNP P03366
B	-8	HIS	-	expression tag	UNP P03366
B	-7	ALA	-	expression tag	UNP P03366
B	-6	LEU	-	expression tag	UNP P03366
B	-5	GLU	-	expression tag	UNP P03366
B	-4	VAL	-	expression tag	UNP P03366
B	-3	LEU	-	expression tag	UNP P03366
B	-2	PHE	-	expression tag	UNP P03366
B	-1	GLN	-	expression tag	UNP P03366
B	0	GLY	-	expression tag	UNP P03366
B	280	SER	CYS	engineered mutation	UNP P03366
D	-15	MET	-	initiating methionine	UNP P03366
D	-14	ALA	-	expression tag	UNP P03366
D	-13	HIS	-	expression tag	UNP P03366
D	-12	HIS	-	expression tag	UNP P03366
D	-11	HIS	-	expression tag	UNP P03366
D	-10	HIS	-	expression tag	UNP P03366
D	-9	HIS	-	expression tag	UNP P03366
D	-8	HIS	-	expression tag	UNP P03366
D	-7	ALA	-	expression tag	UNP P03366
D	-6	LEU	-	expression tag	UNP P03366
D	-5	GLU	-	expression tag	UNP P03366
D	-4	VAL	-	expression tag	UNP P03366
D	-3	LEU	-	expression tag	UNP P03366
D	-2	PHE	-	expression tag	UNP P03366
D	-1	GLN	-	expression tag	UNP P03366
D	0	GLY	-	expression tag	UNP P03366
D	280	SER	CYS	engineered mutation	UNP P03366

- Molecule 3 is a DNA chain called DNA (27-MER).

Mol	Chain	Residues	Atoms					ZeroOcc	AltConf	Trace
3	T	22	Total	C	N	O	P	0	0	0
			455	213	93	127	22			
3	E	22	Total	C	N	O	P	0	0	0
			455	213	93	127	22			

- Molecule 4 is a DNA chain called DNA (5'-D(*A*CP*AP*GP*TP*CP*CP*CP*TP*GP*TP*TP*CP*GP*GP*GP*CP*GP*CP*CP*(DDG))-3').

Mol	Chain	Residues	Atoms					ZeroOcc	AltConf	Trace
4	P	20	Total	C	N	O	P	0	0	0
			403	192	72	120	19			
4	F	20	Total	C	N	O	P	0	0	0
			403	192	72	120	19			

- Molecule 5 is MAGNESIUM ION (three-letter code: MG) (formula: Mg).

Mol	Chain	Residues	Atoms		ZeroOcc	AltConf
5	A	2	Total	Mg	0	0
			2	2		
5	C	2	Total	Mg	0	0
			2	2		

- Molecule 6 is 2',3'-DEHYDRO-2',3'-DEOXY-THYMIDINE 5'-TRIPHOSPHATE (three-letter code: D4T) (formula: C₁₀H₁₅N₂O₁₃P₃).

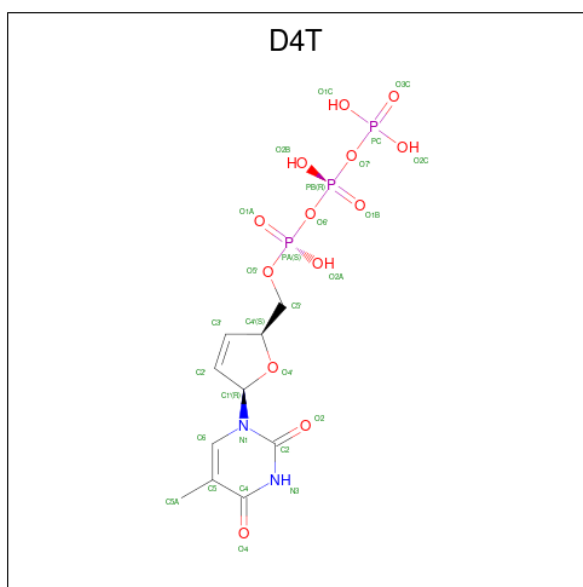

Mol	Chain	Residues	Atoms					ZeroOcc	AltConf
6	A	1	Total	C	N	O	P	0	0
			28	10	2	13	3		
6	C	1	Total	C	N	O	P	0	0
			28	10	2	13	3		

- Molecule 7 is GLYCEROL (three-letter code: GOL) (formula: C₃H₈O₃).



Mol	Chain	Residues	Atoms	ZeroOcc	AltConf
7	A	1	Total C O 6 3 3	0	0
7	B	1	Total C O 6 3 3	0	0
7	B	1	Total C O 6 3 3	0	0
7	B	1	Total C O 6 3 3	0	0
7	B	1	Total C O 6 3 3	0	0
7	B	1	Total C O 6 3 3	0	0
7	C	1	Total C O 6 3 3	0	0
7	C	1	Total C O 6 3 3	0	0
7	C	1	Total C O 6 3 3	0	0
7	D	1	Total C O 6 3 3	0	0
7	D	1	Total C O 6 3 3	0	0
7	D	1	Total C O 6 3 3	0	0
7	D	1	Total C O 6 3 3	0	0

- Molecule 8 is water.

Mol	Chain	Residues	Atoms	ZeroOcc	AltConf
8	A	179	Total O 179 179	0	0
8	B	178	Total O 178 178	0	0
8	T	12	Total O 12 12	0	0
8	P	7	Total O 7 7	0	0
8	C	151	Total O 151 151	0	0
8	D	106	Total O 106 106	0	0
8	E	12	Total O 12 12	0	0
8	F	8	Total O 8 8	0	0

3 Residue-property plots

These plots are drawn for all protein, RNA, DNA and oligosaccharide chains in the entry. The first graphic for a chain summarises the proportions of the various outlier classes displayed in the second graphic. The second graphic shows the sequence view annotated by issues in geometry and electron density. Residues are color-coded according to the number of geometric quality criteria for which they contain at least one outlier: green = 0, yellow = 1, orange = 2 and red = 3 or more. A red dot above a residue indicates a poor fit to the electron density ($RSRZ > 2$). Stretches of 2 or more consecutive residues without any outlier are shown as a green connector. Residues present in the sample, but not in the model, are shown in grey.

- Molecule 1: HIV-1 REVERSE TRANSCRIPTASE P66 SUBUNIT

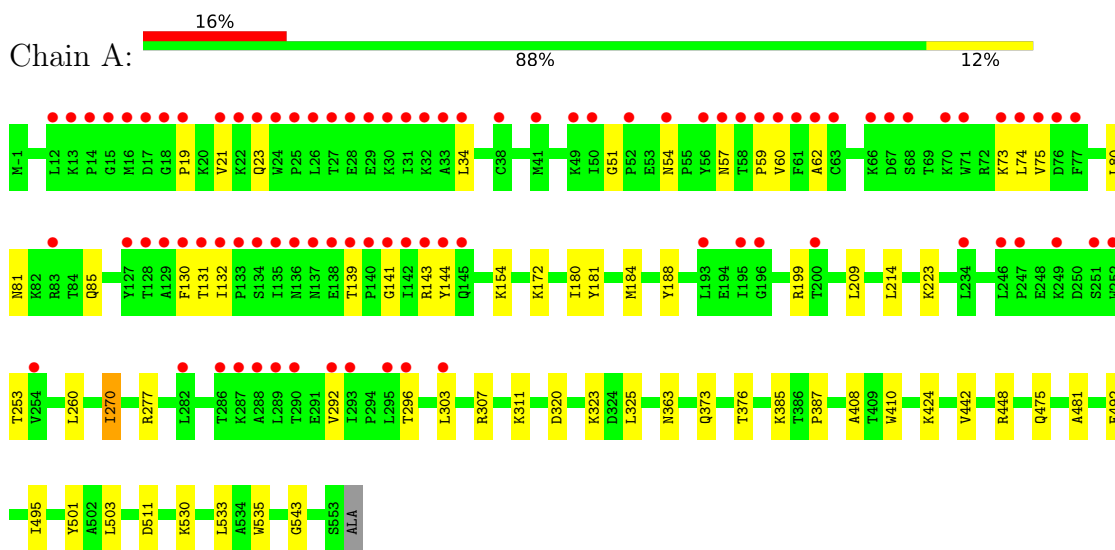

- Molecule 1: HIV-1 REVERSE TRANSCRIPTASE P66 SUBUNIT

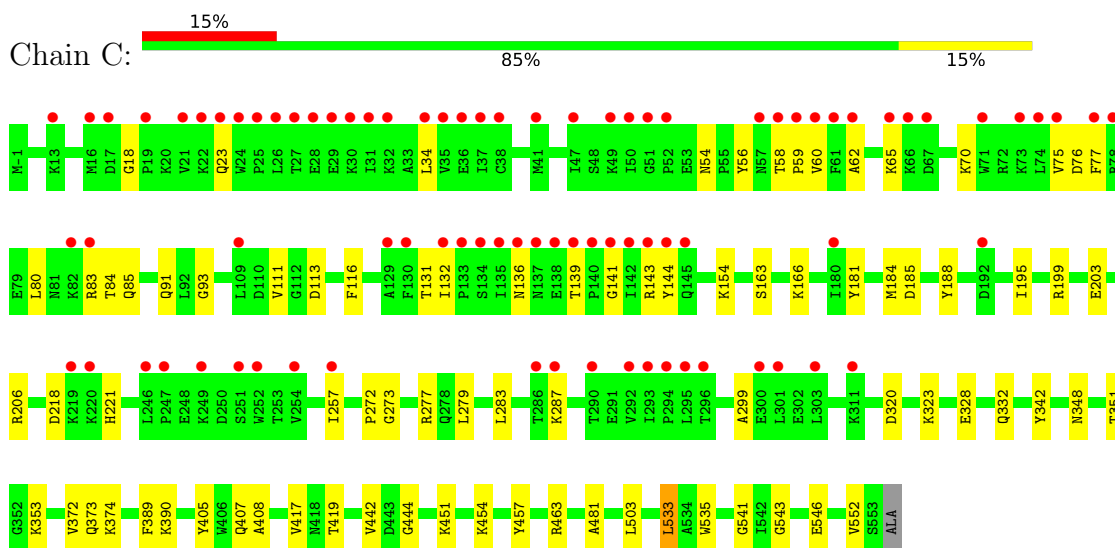

- Molecule 2: HIV-1 REVERSE TRANSCRIPTASE P51 SUBUNIT

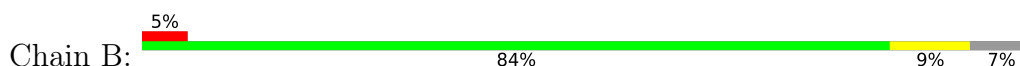

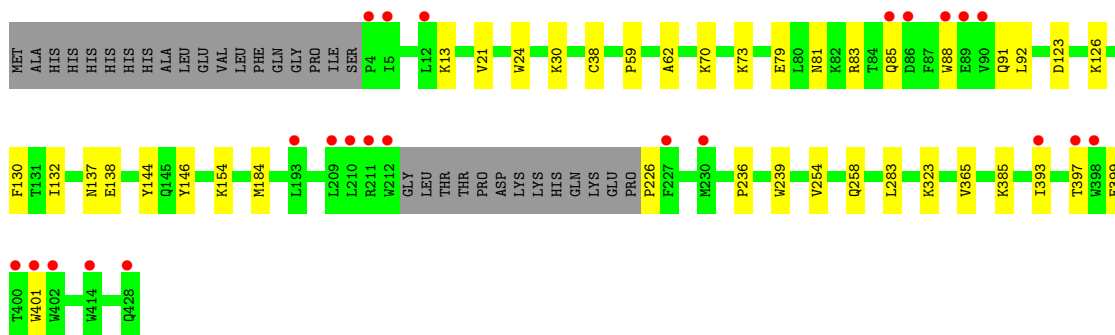

- Molecule 2: HIV-1 REVERSE TRANSCRIPTASE P51 SUBUNIT

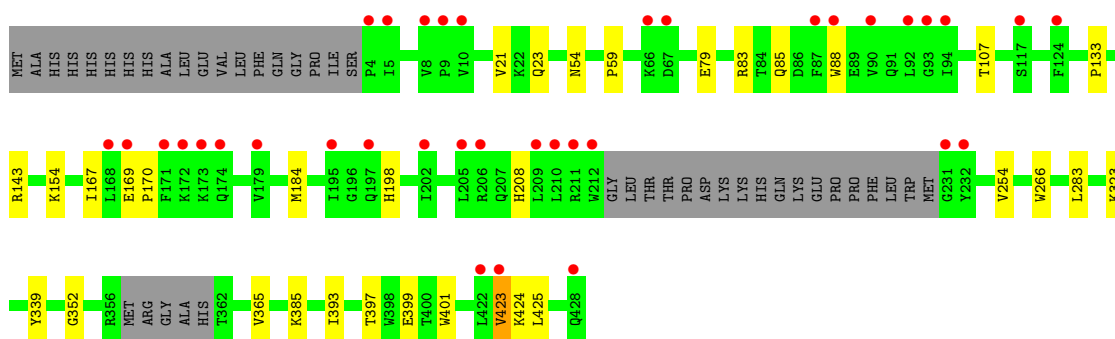
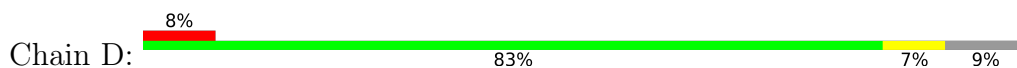

- Molecule 3: DNA (27-MER)



- Molecule 3: DNA (27-MER)

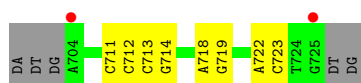

- Molecule 4: DNA (5'-D(*A*CP*AP*GP*TP*CP*CP*CP*TP*GP*TP*TP*CP*GP*GP*GP*CP*GP*CP*CP*(DDG))-3')

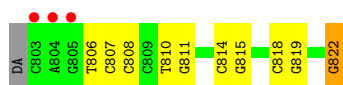

- Molecule 4: DNA (5'-D(*A*CP*AP*GP*TP*CP*CP*CP*TP*GP*TP*TP*CP*GP*GP*GP*CP*GP*CP*CP*(DDG))-3')

Chain F: 

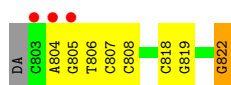

4 Data and refinement statistics

Property	Value	Source
Space group	P 1 21 1	Depositor
Cell constants a, b, c, α , β , γ	90.02Å 132.67Å 139.39Å 90.00° 98.40° 90.00°	Depositor
Resolution (Å)	43.52 – 2.50 43.52 – 2.50	Depositor EDS
% Data completeness (in resolution range)	98.8 (43.52-2.50) 96.3 (43.52-2.50)	Depositor EDS
R_{merge}	0.08	Depositor
R_{sym}	(Not available)	Depositor
$\langle I/\sigma(I) \rangle$ ¹	2.04 (at 2.51Å)	Xtrriage
Refinement program	PHENIX 1.11.1 2575	Depositor
R, R_{free}	0.181 , 0.217 0.181 , 0.217	Depositor DCC
R_{free} test set	1970 reflections (1.77%)	wwPDB-VP
Wilson B-factor (Å ²)	53.8	Xtrriage
Anisotropy	0.208	Xtrriage
Bulk solvent k_{sol} (e/Å ³), B_{sol} (Å ²)	0.31 , 68.6	EDS
L-test for twinning ²	$\langle L \rangle = 0.49$, $\langle L^2 \rangle = 0.32$	Xtrriage
Estimated twinning fraction	No twinning to report.	Xtrriage
F_o, F_c correlation	0.96	EDS
Total number of atoms	18285	wwPDB-VP
Average B, all atoms (Å ²)	93.0	wwPDB-VP

Xtrriage's analysis on translational NCS is as follows: *The largest off-origin peak in the Patterson function is 2.58% of the height of the origin peak. No significant pseudotranslation is detected.*

¹Intensities estimated from amplitudes.

²Theoretical values of $\langle |L| \rangle$, $\langle L^2 \rangle$ for acentric reflections are 0.5, 0.333 respectively for untwinned datasets, and 0.375, 0.2 for perfectly twinned datasets.

5 Model quality [i](#)

5.1 Standard geometry [i](#)

Bond lengths and bond angles in the following residue types are not validated in this section: D4T, MG, GOL, DDG

The Z score for a bond length (or angle) is the number of standard deviations the observed value is removed from the expected value. A bond length (or angle) with $|Z| > 5$ is considered an outlier worth inspection. RMSZ is the root-mean-square of all Z scores of the bond lengths (or angles).

Mol	Chain	Bond lengths		Bond angles	
		RMSZ	# Z >5	RMSZ	# Z >5
1	A	0.24	0/4635	0.41	0/6297
1	C	0.24	0/4635	0.40	0/6297
2	B	0.24	0/3515	0.40	0/4774
2	D	0.23	0/3423	0.40	0/4649
3	E	0.46	0/512	0.74	0/788
3	T	0.47	0/512	0.75	0/788
4	F	0.50	0/426	0.87	0/655
4	P	0.50	0/426	0.87	0/655
All	All	0.27	0/18084	0.47	0/24903

There are no bond length outliers.

There are no bond angle outliers.

There are no chirality outliers.

There are no planarity outliers.

5.2 Too-close contacts [i](#)

In the following table, the Non-H and H(model) columns list the number of non-hydrogen atoms and hydrogen atoms in the chain respectively. The H(added) column lists the number of hydrogen atoms added and optimized by MolProbity. The Clashes column lists the number of clashes within the asymmetric unit, whereas Symm-Clashes lists symmetry-related clashes.

Mol	Chain	Non-H	H(model)	H(added)	Clashes	Symm-Clashes
1	A	4517	0	4577	41	0
1	C	4517	0	4577	48	0
2	B	3415	0	3445	27	0
2	D	3329	0	3360	22	0
3	E	455	0	244	7	0

Continued on next page...

Continued from previous page...

Mol	Chain	Non-H	H(model)	H(added)	Clashes	Symm-Clashes
3	T	455	0	244	3	0
4	F	403	0	226	9	0
4	P	403	0	226	8	0
5	A	2	0	0	0	0
5	C	2	0	0	0	0
6	A	28	0	11	0	0
6	C	28	0	11	1	0
7	A	6	0	8	1	0
7	B	30	0	40	4	0
7	C	18	0	24	1	0
7	D	24	0	32	2	0
8	A	179	0	0	1	0
8	B	178	0	0	1	0
8	C	151	0	0	0	0
8	D	106	0	0	0	0
8	E	12	0	0	1	0
8	F	8	0	0	0	0
8	P	7	0	0	0	0
8	T	12	0	0	0	0
All	All	18285	0	17025	152	0

The all-atom clashscore is defined as the number of clashes found per 1000 atoms (including hydrogen atoms). The all-atom clashscore for this structure is 4.

All (152) close contacts within the same asymmetric unit are listed below, sorted by their clash magnitude.

Atom-1	Atom-2	Interatomic distance (Å)	Clash overlap (Å)
1:A:131:THR:HG22	1:A:143:ARG:HB3	1.72	0.72
1:A:424:LYS:HD3	7:A:604:GOL:H2	1.74	0.68
1:A:54:ASN:HB3	1:A:143:ARG:HH12	1.58	0.67
1:A:172:LYS:HE2	1:A:180:ILE:HB	1.78	0.64
1:C:54:ASN:HB3	1:C:143:ARG:HH12	1.63	0.63
1:C:184:MET:HG2	4:F:822:DDG:H2'	1.82	0.62
1:A:503:LEU:HD22	1:A:535:TRP:HB2	1.81	0.61
1:C:181:TYR:HB2	1:C:188:TYR:HB3	1.82	0.60
1:C:503:LEU:HD22	1:C:535:TRP:HB2	1.82	0.60
2:D:107:THR:OG1	2:D:198:HIS:NE2	2.35	0.59
1:C:56:TYR:O	1:C:143:ARG:NH2	2.34	0.59
2:B:79:GLU:HG3	2:B:83:ARG:HE	1.66	0.59
1:A:181:TYR:HB2	1:A:188:TYR:HB3	1.83	0.59
1:A:184:MET:HG2	4:P:822:DDG:H2'	1.85	0.58

Continued on next page...

Continued from previous page...

Atom-1	Atom-2	Interatomic distance (Å)	Clash overlap (Å)
1:C:353:LYS:O	1:C:374:LYS:NZ	2.36	0.58
1:A:320:ASP:OD2	1:A:323:LYS:NZ	2.33	0.58
2:B:258:GLN:NE2	8:B:611:HOH:O	2.34	0.58
2:D:323:LYS:O	2:D:385:LYS:NZ	2.37	0.58
1:C:131:THR:HG22	1:C:143:ARG:HB3	1.85	0.58
1:C:132:ILE:HD13	1:C:144:TYR:HD2	1.68	0.58
2:B:365:VAL:HG11	2:B:401:TRP:HB2	1.86	0.58
1:C:91:GLN:NE2	1:C:93:GLY:O	2.38	0.57
1:A:325:LEU:HB3	1:A:387:PRO:HB3	1.85	0.57
1:A:51:GLY:O	1:A:143:ARG:NH1	2.38	0.56
1:A:199:ARG:HH21	1:A:223:LYS:HB3	1.71	0.56
3:E:722:DA:H2''	3:E:723:DC:H5''	1.88	0.56
1:C:287:LYS:HE3	3:E:714:DG:H4'	1.89	0.55
2:B:73:LYS:NZ	2:B:146:TYR:OH	2.37	0.55
1:C:320:ASP:OD2	1:C:323:LYS:NZ	2.39	0.54
2:B:154:LYS:HG2	2:B:184:MET:SD	2.47	0.54
4:F:806:DT:H2'	4:F:807:DC:C6	2.42	0.54
1:A:85:GLN:O	1:A:154:LYS:NZ	2.37	0.53
1:A:34:LEU:HD21	1:A:62:ALA:HB2	1.88	0.53
1:C:457:TYR:HE1	1:C:463:ARG:HG2	1.73	0.53
1:A:543:GLY:HA2	2:B:283:LEU:O	2.08	0.52
4:P:807:DC:H2'	4:P:808:DC:C6	2.44	0.52
1:C:373:GLN:NE2	2:D:397:THR:OG1	2.41	0.52
1:A:442:VAL:HB	1:A:481:ALA:HB1	1.91	0.52
2:D:21:VAL:HB	2:D:59:PRO:HD3	1.91	0.52
1:C:444:GLY:HA2	1:C:552:VAL:HG11	1.92	0.51
2:B:91:GLN:HG2	2:B:92:LEU:HG	1.91	0.51
1:C:85:GLN:O	1:C:154:LYS:NZ	2.34	0.51
1:A:81:ASN:HB3	1:A:154:LYS:HD3	1.93	0.51
4:F:804:DA:H2'	4:F:805:DG:C8	2.46	0.51
1:A:19:PRO:HD3	1:A:80:LEU:HD13	1.92	0.50
1:C:328:GLU:HG3	1:C:390:LYS:HB2	1.93	0.50
2:B:21:VAL:HB	2:B:59:PRO:HD3	1.92	0.50
1:C:272:PRO:HG3	1:C:351:THR:HG21	1.94	0.50
4:F:807:DC:H2'	4:F:808:DC:C6	2.47	0.50
1:C:463:ARG:HG3	7:C:606:GOL:H11	1.93	0.50
4:F:807:DC:H2''	4:F:808:DC:O5'	2.12	0.50
4:F:818:DC:H2'	4:F:819:DG:H8	1.77	0.49
1:C:18:GLY:O	1:C:83:ARG:NH1	2.46	0.49
1:C:203:GLU:OE1	1:C:206:ARG:NH1	2.42	0.49
4:P:806:DT:H2'	4:P:807:DC:C6	2.48	0.49

Continued on next page...

Continued from previous page...

Atom-1	Atom-2	Interatomic distance (Å)	Clash overlap (Å)
4:F:818:DC:H2'	4:F:819:DG:C8	2.48	0.49
1:C:451:LYS:NZ	4:F:808:DC:OP1	2.45	0.49
1:A:495:ILE:HB	1:A:533:LEU:HD23	1.94	0.48
1:C:342:TYR:HB3	1:C:348:ASN:HA	1.94	0.48
2:B:13:LYS:HD3	2:B:85:GLN:HB3	1.94	0.48
2:B:137:ASN:HD21	7:B:501:GOL:H31	1.79	0.48
1:C:218:ASP:HA	1:C:221:HIS:HB2	1.95	0.48
2:B:254:VAL:HG13	2:B:283:LEU:HD22	1.96	0.47
1:C:417:VAL:HG22	1:C:419:THR:HG23	1.95	0.47
2:D:399:GLU:HB3	7:D:504:GOL:H12	1.96	0.47
2:D:170:PRO:HB2	2:D:208:HIS:HE1	1.77	0.47
1:C:195:ILE:HG22	1:C:199:ARG:HE	1.78	0.47
1:C:454:LYS:HB2	1:C:552:VAL:HG13	1.96	0.47
1:A:23:GLN:HA	1:A:59:PRO:HB3	1.97	0.47
4:P:818:DC:H2'	4:P:819:DG:C8	2.49	0.47
2:D:54:ASN:HB3	2:D:143:ARG:HH21	1.80	0.47
2:B:399:GLU:HB3	7:B:505:GOL:H12	1.97	0.47
1:C:60:VAL:HG12	1:C:75:VAL:HG13	1.95	0.47
1:C:405:TYR:CE2	1:C:407:GLN:HB2	2.50	0.47
3:E:718:DA:H2''	3:E:719:DG:C8	2.49	0.47
2:D:23:GLN:HG2	2:D:133:PRO:HD3	1.97	0.47
2:D:85:GLN:HA	2:D:88:TRP:CE2	2.50	0.47
2:B:70:LYS:HE2	2:B:226:PRO:HB2	1.97	0.47
1:A:253:THR:HA	1:A:292:VAL:HA	1.97	0.46
2:B:123:ASP:O	2:B:126:LYS:NZ	2.48	0.46
2:D:365:VAL:HG11	2:D:401:TRP:HB2	1.98	0.46
1:C:80:LEU:O	1:C:84:THR:OG1	2.30	0.46
2:D:254:VAL:HG13	2:D:283:LEU:HD22	1.97	0.46
1:A:74:LEU:HD13	3:T:705:DA:C5	2.50	0.46
1:A:448:ARG:NH1	4:P:807:DC:O4'	2.48	0.46
1:C:111:VAL:HB	1:C:185:ASP:HB2	1.97	0.46
1:C:543:GLY:HA2	2:D:283:LEU:O	2.16	0.46
1:C:503:LEU:HD12	1:C:533:LEU:HD13	1.97	0.46
1:C:139:THR:HG22	1:C:141:GLY:H	1.79	0.46
1:A:34:LEU:HD22	1:A:73:LYS:HD2	1.97	0.45
1:A:130:PHE:CE2	1:A:132:ILE:HD11	2.51	0.45
1:C:541:GLY:HA2	1:C:546:GLU:HB2	1.98	0.45
1:A:132:ILE:HD13	1:A:144:TYR:HD2	1.81	0.45
2:D:79:GLU:HG3	2:D:83:ARG:HE	1.81	0.45
6:C:603:D4T:H66	6:C:603:D4T:O5'	2.17	0.45
1:A:410:TRP:O	8:A:701:HOH:O	2.21	0.45

Continued on next page...

Continued from previous page...

Atom-1	Atom-2	Interatomic distance (Å)	Clash overlap (Å)
1:A:139:THR:HG22	1:A:141:GLY:H	1.81	0.45
3:E:718:DA:H2''	3:E:719:DG:H8	1.82	0.45
1:C:34:LEU:HD21	1:C:62:ALA:HB2	1.98	0.45
3:T:709:DC:H2'	3:T:710:DG:C8	2.52	0.44
1:C:279:LEU:HD23	1:C:299:ALA:HB1	1.99	0.44
1:C:257:ILE:HB	1:C:283:LEU:HD21	1.99	0.44
2:D:399:GLU:HB3	7:D:504:GOL:H32	1.99	0.44
1:C:65:LYS:HD2	1:C:70:LYS:HB2	1.98	0.44
2:D:154:LYS:HG2	2:D:184:MET:SD	2.58	0.44
4:P:818:DC:H2'	4:P:819:DG:H8	1.83	0.44
1:A:60:VAL:HG12	1:A:75:VAL:HG13	2.00	0.43
2:B:24:TRP:CD2	7:B:505:GOL:H2	2.53	0.43
1:A:373:GLN:NE2	2:B:397:THR:OG1	2.50	0.43
2:B:236:PRO:HA	2:B:239:TRP:CD2	2.53	0.43
2:D:169:GLU:HB3	2:D:170:PRO:HD3	2.01	0.43
3:T:714:DG:H2''	3:T:715:DA:C8	2.54	0.43
2:D:266:TRP:CE2	2:D:425:LEU:HD13	2.54	0.43
1:C:442:VAL:HB	1:C:481:ALA:HB1	2.01	0.43
4:F:807:DC:H4'	4:F:808:DC:OP1	2.20	0.42
4:P:810:DT:H2''	4:P:811:DG:H8	1.84	0.42
1:C:113:ASP:HB3	1:C:116:PHE:HB2	2.00	0.42
1:C:163:SER:HA	1:C:166:LYS:HE2	2.01	0.42
1:C:23:GLN:NE2	1:C:58:THR:O	2.52	0.42
1:A:325:LEU:HD12	1:A:385:LYS:HG3	2.00	0.42
1:A:363:ASN:HA	1:A:511:ASP:OD1	2.19	0.42
2:D:266:TRP:CE3	2:D:425:LEU:HD22	2.54	0.42
3:E:722:DA:OP1	8:E:801:HOH:O	2.21	0.42
1:A:21:VAL:O	1:A:57:ASN:ND2	2.36	0.42
2:B:81:ASN:CG	2:B:154:LYS:HG3	2.41	0.42
1:A:376:THR:HG21	2:B:401:TRP:CH2	2.55	0.42
2:B:38:CYS:SG	2:B:132:ILE:HD11	2.60	0.42
1:A:408:ALA:O	2:B:393:ILE:HG13	2.20	0.41
1:A:181:TYR:CD2	2:B:138:GLU:HA	2.55	0.41
1:A:475:GLN:HB3	1:A:501:TYR:CE2	2.55	0.41
1:A:492:GLU:HG2	1:A:530:LYS:HB2	2.01	0.41
2:B:130:PHE:CZ	2:B:144:TYR:HB2	2.55	0.41
2:D:167:ILE:O	2:D:208:HIS:NE2	2.50	0.41
3:E:713:DC:H2'	3:E:714:DG:C8	2.55	0.41
2:B:24:TRP:CE3	7:B:505:GOL:H2	2.55	0.41
1:A:307:ARG:O	1:A:311:LYS:HG3	2.20	0.41
4:P:814:DC:H2''	4:P:815:DG:C8	2.56	0.41

Continued on next page...

Continued from previous page...

Atom-1	Atom-2	Interatomic distance (Å)	Clash overlap (Å)
1:A:270:ILE:HD12	1:A:270:ILE:HA	1.89	0.41
1:C:58:THR:HG21	1:C:77:PHE:CE1	2.55	0.41
3:E:711:DC:H2'	3:E:712:DC:C6	2.56	0.41
2:B:88:TRP:CZ2	2:B:154:LYS:HD2	2.56	0.41
1:C:136:ASN:OD1	1:C:136:ASN:N	2.53	0.41
1:C:372:VAL:HG13	1:C:389:PHE:CZ	2.56	0.41
1:C:408:ALA:O	2:D:393:ILE:HG13	2.21	0.41
2:D:339:TYR:CZ	2:D:352:GLY:HA3	2.55	0.41
1:A:209:LEU:HB3	1:A:214:LEU:HB2	2.04	0.40
2:B:323:LYS:O	2:B:385:LYS:NZ	2.54	0.40
2:D:423:VAL:O	2:D:425:LEU:HG	2.21	0.40
1:A:260:LEU:HD21	1:A:303:LEU:HD13	2.04	0.40
2:B:30:LYS:HE3	2:B:62:ALA:O	2.22	0.40
1:C:59:PRO:HG2	1:C:76:ASP:HB3	2.04	0.40
1:C:273:GLY:HA2	1:C:332:GLN:NE2	2.37	0.40

There are no symmetry-related clashes.

5.3 Torsion angles [i](#)

5.3.1 Protein backbone [i](#)

In the following table, the Percentiles column shows the percent Ramachandran outliers of the chain as a percentile score with respect to all X-ray entries followed by that with respect to entries of similar resolution.

The Analysed column shows the number of residues for which the backbone conformation was analysed, and the total number of residues.

Mol	Chain	Analysed	Favoured	Allowed	Outliers	Percentiles	
1	A	553/556 (100%)	533 (96%)	19 (3%)	1 (0%)	47	68
1	C	553/556 (100%)	530 (96%)	23 (4%)	0	100	100
2	B	408/444 (92%)	392 (96%)	16 (4%)	0	100	100
2	D	396/444 (89%)	380 (96%)	15 (4%)	1 (0%)	41	61
All	All	1910/2000 (96%)	1835 (96%)	73 (4%)	2 (0%)	51	73

All (2) Ramachandran outliers are listed below:

Mol	Chain	Res	Type
2	D	424	LYS
1	A	270	ILE

5.3.2 Protein sidechains [i](#)

In the following table, the Percentiles column shows the percent sidechain outliers of the chain as a percentile score with respect to all X-ray entries followed by that with respect to entries of similar resolution.

The Analysed column shows the number of residues for which the sidechain conformation was analysed, and the total number of residues.

Mol	Chain	Analysed	Rotameric	Outliers	Percentiles	
1	A	497/497 (100%)	495 (100%)	2 (0%)	91	97
1	C	497/497 (100%)	495 (100%)	2 (0%)	91	97
2	B	375/403 (93%)	375 (100%)	0	100	100
2	D	367/403 (91%)	366 (100%)	1 (0%)	92	97
All	All	1736/1800 (96%)	1731 (100%)	5 (0%)	92	97

All (5) residues with a non-rotameric sidechain are listed below:

Mol	Chain	Res	Type
1	A	277	ARG
1	A	296	THR
1	C	277	ARG
1	C	533	LEU
2	D	423	VAL

Sometimes sidechains can be flipped to improve hydrogen bonding and reduce clashes. All (7) such sidechains are listed below:

Mol	Chain	Res	Type
1	A	315	HIS
1	A	373	GLN
2	B	137	ASN
1	C	207	GLN
1	C	332	GLN
1	C	373	GLN
2	D	161	GLN

5.3.3 RNA [i](#)

There are no RNA molecules in this entry.

5.4 Non-standard residues in protein, DNA, RNA chains [i](#)

2 non-standard protein/DNA/RNA residues are modelled in this entry.

In the following table, the Counts columns list the number of bonds (or angles) for which Mogul statistics could be retrieved, the number of bonds (or angles) that are observed in the model and the number of bonds (or angles) that are defined in the Chemical Component Dictionary. The Link column lists molecule types, if any, to which the group is linked. The Z score for a bond length (or angle) is the number of standard deviations the observed value is removed from the expected value. A bond length (or angle) with $|Z| > 2$ is considered an outlier worth inspection. RMSZ is the root-mean-square of all Z scores of the bond lengths (or angles).

Mol	Type	Chain	Res	Link	Bond lengths			Bond angles		
					Counts	RMSZ	# Z > 2	Counts	RMSZ	# Z > 2
4	DDG	F	822	3,4	17,23,24	4.11	10 (58%)	15,33,36	2.12	6 (40%)
4	DDG	P	822	3,4	17,23,24	4.12	10 (58%)	15,33,36	2.13	6 (40%)

In the following table, the Chirals column lists the number of chiral outliers, the number of chiral centers analysed, the number of these observed in the model and the number defined in the Chemical Component Dictionary. Similar counts are reported in the Torsion and Rings columns. '-' means no outliers of that kind were identified.

Mol	Type	Chain	Res	Link	Chirals	Torsions	Rings
4	DDG	F	822	3,4	-	0/3/18/19	0/3/3/3
4	DDG	P	822	3,4	-	0/3/18/19	0/3/3/3

All (20) bond length outliers are listed below:

Mol	Chain	Res	Type	Atoms	Z	Observed(Å)	Ideal(Å)
4	P	822	DDG	C2'-C3'	-9.68	1.27	1.54
4	F	822	DDG	C2'-C3'	-9.66	1.27	1.54
4	P	822	DDG	O4'-C4'	-7.90	1.29	1.44
4	F	822	DDG	O4'-C4'	-7.89	1.29	1.44
4	P	822	DDG	C1'-N9	-6.00	1.31	1.49
4	F	822	DDG	C1'-N9	-5.98	1.31	1.49
4	F	822	DDG	C2-N3	4.79	1.44	1.33
4	P	822	DDG	C2-N3	4.77	1.44	1.33
4	F	822	DDG	O4'-C1'	4.70	1.52	1.42
4	P	822	DDG	O4'-C1'	4.65	1.52	1.42
4	F	822	DDG	C4-N3	3.53	1.45	1.37

Continued on next page...

Continued from previous page...

Mol	Chain	Res	Type	Atoms	Z	Observed(Å)	Ideal(Å)
4	P	822	DDG	C4-N3	3.51	1.45	1.37
4	P	822	DDG	C2-N2	3.43	1.42	1.34
4	F	822	DDG	C2-N2	3.40	1.42	1.34
4	P	822	DDG	C5-C4	-2.58	1.36	1.43
4	F	822	DDG	C5-C4	-2.57	1.36	1.43
4	F	822	DDG	C2-N1	2.17	1.43	1.37
4	P	822	DDG	C2-N1	2.15	1.43	1.37
4	P	822	DDG	C3'-C4'	2.05	1.62	1.52
4	F	822	DDG	C3'-C4'	2.04	1.62	1.52

All (12) bond angle outliers are listed below:

Mol	Chain	Res	Type	Atoms	Z	Observed(°)	Ideal(°)
4	F	822	DDG	C4'-O4'-C1'	-4.19	105.85	109.81
4	P	822	DDG	C4'-O4'-C1'	-4.07	105.97	109.81
4	F	822	DDG	C5-C6-N1	3.39	119.93	113.95
4	P	822	DDG	C5-C6-N1	3.37	119.91	113.95
4	F	822	DDG	C2-N1-C6	-2.96	119.64	125.10
4	P	822	DDG	C2-N1-C6	-2.88	119.79	125.10
4	F	822	DDG	C8-N7-C5	2.65	108.03	102.99
4	P	822	DDG	C8-N7-C5	2.64	108.01	102.99
4	P	822	DDG	C3'-C2'-C1'	2.64	105.83	102.78
4	F	822	DDG	C3'-C2'-C1'	2.54	105.72	102.78
4	P	822	DDG	O6-C6-C5	-2.25	119.98	124.37
4	F	822	DDG	O6-C6-C5	-2.19	120.09	124.37

There are no chirality outliers.

There are no torsion outliers.

There are no ring outliers.

2 monomers are involved in 2 short contacts:

Mol	Chain	Res	Type	Clashes	Symm-Clashes
4	F	822	DDG	1	0
4	P	822	DDG	1	0

5.5 Carbohydrates [i](#)

There are no monosaccharides in this entry.

5.6 Ligand geometry [i](#)

Of 19 ligands modelled in this entry, 4 are monoatomic - leaving 15 for Mogul analysis.

In the following table, the Counts columns list the number of bonds (or angles) for which Mogul statistics could be retrieved, the number of bonds (or angles) that are observed in the model and the number of bonds (or angles) that are defined in the Chemical Component Dictionary. The Link column lists molecule types, if any, to which the group is linked. The Z score for a bond length (or angle) is the number of standard deviations the observed value is removed from the expected value. A bond length (or angle) with $|Z| > 2$ is considered an outlier worth inspection. RMSZ is the root-mean-square of all Z scores of the bond lengths (or angles).

Mol	Type	Chain	Res	Link	Bond lengths			Bond angles		
					Counts	RMSZ	# Z > 2	Counts	RMSZ	# Z > 2
7	GOL	D	502	-	5,5,5	0.37	0	5,5,5	0.32	0
7	GOL	B	502	-	5,5,5	0.38	0	5,5,5	0.26	0
7	GOL	B	501	-	5,5,5	0.36	0	5,5,5	0.24	0
6	D4T	C	603	5	22,29,29	1.23	2 (9%)	27,45,45	1.62	4 (14%)
7	GOL	C	605	-	5,5,5	0.38	0	5,5,5	0.28	0
7	GOL	C	606	-	5,5,5	0.37	0	5,5,5	0.22	0
6	D4T	A	603	5	22,29,29	1.25	3 (13%)	27,45,45	1.65	5 (18%)
7	GOL	D	503	-	5,5,5	0.36	0	5,5,5	0.30	0
7	GOL	B	503	-	5,5,5	0.35	0	5,5,5	0.30	0
7	GOL	B	505	-	5,5,5	0.36	0	5,5,5	0.24	0
7	GOL	B	504	-	5,5,5	0.39	0	5,5,5	0.26	0
7	GOL	D	501	-	5,5,5	0.36	0	5,5,5	0.31	0
7	GOL	C	604	-	5,5,5	0.37	0	5,5,5	0.28	0
7	GOL	D	504	-	5,5,5	0.36	0	5,5,5	0.25	0
7	GOL	A	604	-	5,5,5	0.37	0	5,5,5	0.26	0

In the following table, the Chirals column lists the number of chiral outliers, the number of chiral centers analysed, the number of these observed in the model and the number defined in the Chemical Component Dictionary. Similar counts are reported in the Torsion and Rings columns. '-' means no outliers of that kind were identified.

Mol	Type	Chain	Res	Link	Chirals	Torsions	Rings
7	GOL	D	502	-	-	2/4/4/4	-
7	GOL	B	502	-	-	2/4/4/4	-
7	GOL	B	501	-	-	2/4/4/4	-
6	D4T	C	603	5	-	5/19/31/31	0/2/2/2
7	GOL	C	605	-	-	2/4/4/4	-
7	GOL	C	606	-	-	0/4/4/4	-
6	D4T	A	603	5	-	3/19/31/31	0/2/2/2
7	GOL	D	503	-	-	2/4/4/4	-

Continued on next page...

Continued from previous page...

Mol	Type	Chain	Res	Link	Chirals	Torsions	Rings
7	GOL	B	503	-	-	4/4/4/4	-
7	GOL	B	505	-	-	2/4/4/4	-
7	GOL	B	504	-	-	2/4/4/4	-
7	GOL	D	501	-	-	2/4/4/4	-
7	GOL	C	604	-	-	2/4/4/4	-
7	GOL	D	504	-	-	2/4/4/4	-
7	GOL	A	604	-	-	2/4/4/4	-

All (5) bond length outliers are listed below:

Mol	Chain	Res	Type	Atoms	Z	Observed(Å)	Ideal(Å)
6	A	603	D4T	C5A-C5	2.90	1.56	1.51
6	C	603	D4T	C5A-C5	2.88	1.56	1.51
6	A	603	D4T	C5-C4	-2.88	1.35	1.41
6	C	603	D4T	C5-C4	-2.86	1.35	1.41
6	A	603	D4T	C5'-C4'	-2.21	1.48	1.51

All (9) bond angle outliers are listed below:

Mol	Chain	Res	Type	Atoms	Z	Observed(°)	Ideal(°)
6	C	603	D4T	C2-N3-C4	5.62	119.89	115.14
6	A	603	D4T	C2-N3-C4	5.58	119.86	115.14
6	A	603	D4T	C5'-C4'-C3'	-3.28	109.60	115.61
6	C	603	D4T	C5'-C4'-C3'	-3.13	109.88	115.61
6	C	603	D4T	PB-O7'-PC	-2.79	123.27	132.83
6	A	603	D4T	PA-O6'-PB	-2.76	123.36	132.83
6	A	603	D4T	PB-O7'-PC	-2.74	123.41	132.83
6	C	603	D4T	PA-O6'-PB	-2.69	123.61	132.83
6	A	603	D4T	C5-C6-N1	-2.18	119.85	122.19

There are no chirality outliers.

All (34) torsion outliers are listed below:

Mol	Chain	Res	Type	Atoms
6	A	603	D4T	C5'-O5'-PA-O1A
6	A	603	D4T	C5'-O5'-PA-O2A
6	C	603	D4T	C5'-O5'-PA-O1A
7	B	502	GOL	O1-C1-C2-C3
7	B	503	GOL	O1-C1-C2-C3
7	B	504	GOL	O1-C1-C2-C3

Continued on next page...

Continued from previous page...

Mol	Chain	Res	Type	Atoms
7	B	505	GOL	O1-C1-C2-C3
7	C	604	GOL	O1-C1-C2-C3
7	C	605	GOL	O1-C1-C2-C3
7	D	501	GOL	O1-C1-C2-C3
7	D	504	GOL	O1-C1-C2-C3
7	D	503	GOL	O1-C1-C2-O2
7	A	604	GOL	O1-C1-C2-C3
7	B	501	GOL	O1-C1-C2-C3
7	B	503	GOL	C1-C2-C3-O3
7	D	502	GOL	O1-C1-C2-C3
7	D	503	GOL	O1-C1-C2-C3
7	A	604	GOL	O1-C1-C2-O2
7	B	501	GOL	O1-C1-C2-O2
7	B	502	GOL	O1-C1-C2-O2
7	B	504	GOL	O1-C1-C2-O2
7	D	502	GOL	O1-C1-C2-O2
7	D	504	GOL	O1-C1-C2-O2
7	B	503	GOL	O1-C1-C2-O2
7	B	505	GOL	O1-C1-C2-O2
7	C	604	GOL	O1-C1-C2-O2
7	C	605	GOL	O1-C1-C2-O2
7	D	501	GOL	O1-C1-C2-O2
6	A	603	D4T	C5'-O5'-PA-O6'
6	C	603	D4T	C5'-O5'-PA-O6'
6	C	603	D4T	C5'-O5'-PA-O2A
6	C	603	D4T	PB-O7'-PC-O3C
6	C	603	D4T	PA-O6'-PB-O2B
7	B	503	GOL	O2-C2-C3-O3

There are no ring outliers.

6 monomers are involved in 9 short contacts:

Mol	Chain	Res	Type	Clashes	Symm-Clashes
7	B	501	GOL	1	0
6	C	603	D4T	1	0
7	C	606	GOL	1	0
7	B	505	GOL	3	0
7	D	504	GOL	2	0
7	A	604	GOL	1	0

The following is a two-dimensional graphical depiction of Mogul quality analysis of bond lengths, bond angles, torsion angles, and ring geometry for all instances of the Ligand of Interest. In

addition, ligands with molecular weight > 250 and outliers as shown on the validation Tables will also be included. For torsion angles, if less than 5% of the Mogul distribution of torsion angles is within 10 degrees of the torsion angle in question, then that torsion angle is considered an outlier. Any bond that is central to one or more torsion angles identified as an outlier by Mogul will be highlighted in the graph. For rings, the root-mean-square deviation (RMSD) between the ring in question and similar rings identified by Mogul is calculated over all ring torsion angles. If the average RMSD is greater than 60 degrees and the minimal RMSD between the ring in question and any Mogul-identified rings is also greater than 60 degrees, then that ring is considered an outlier. The outliers are highlighted in purple. The color gray indicates Mogul did not find sufficient equivalents in the CSD to analyse the geometry.

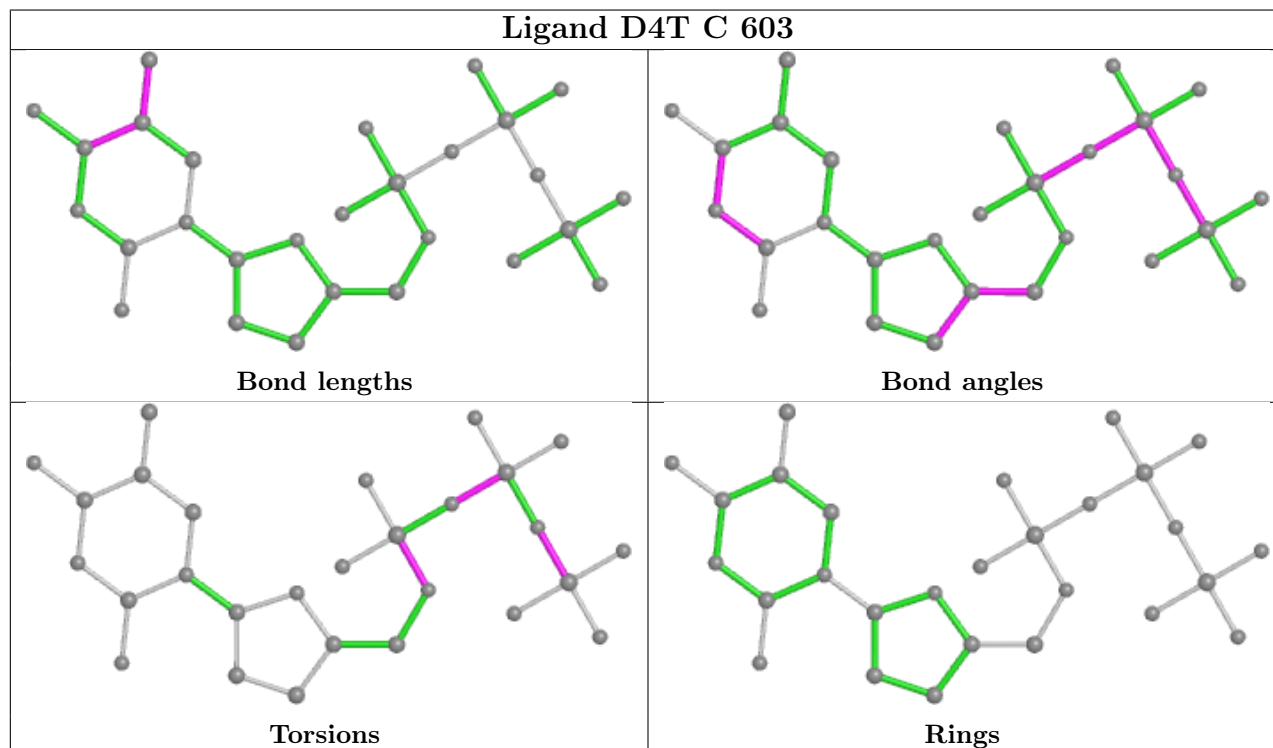

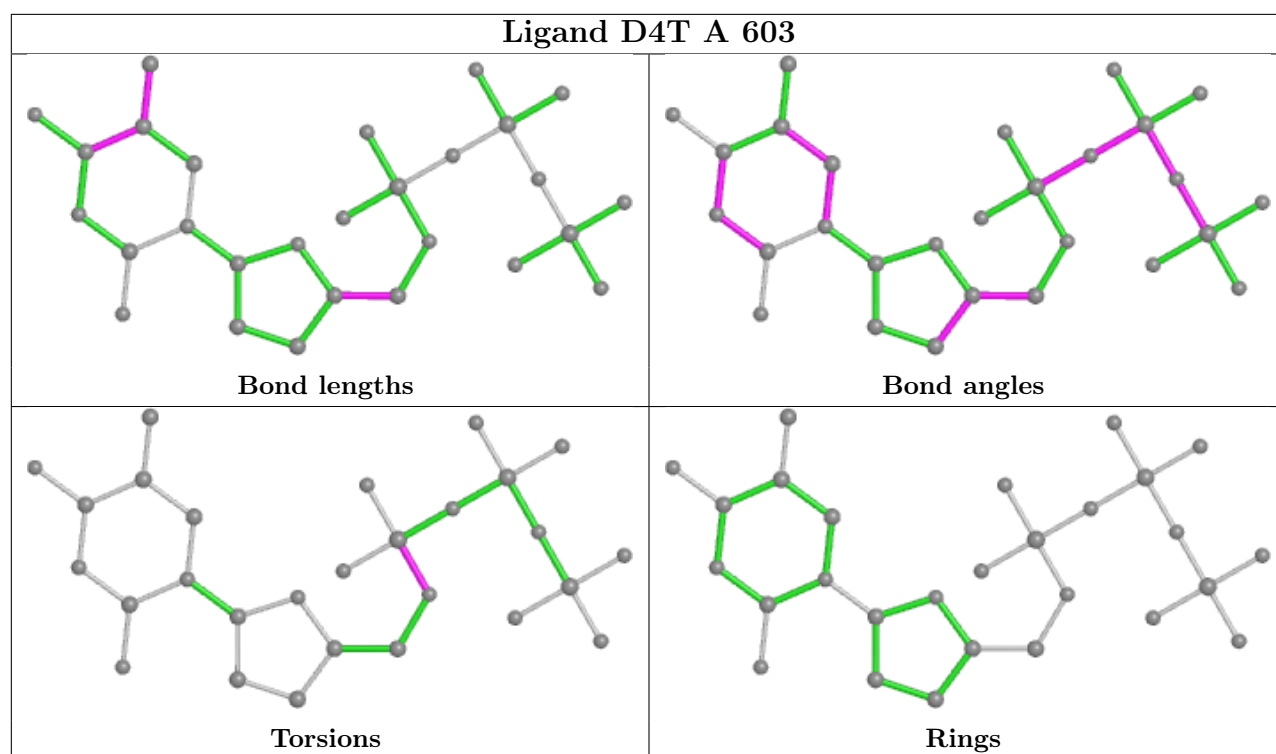

5.7 Other polymers [i](#)

There are no such residues in this entry.

5.8 Polymer linkage issues [i](#)

There are no chain breaks in this entry.

6 Fit of model and data

6.1 Protein, DNA and RNA chains

In the following table, the column labelled ‘#RSRZ > 2’ contains the number (and percentage) of RSRZ outliers, followed by percent RSRZ outliers for the chain as percentile scores relative to all X-ray entries and entries of similar resolution. The OWAB column contains the minimum, median, 95th percentile and maximum values of the occupancy-weighted average B-factor per residue. The column labelled ‘Q < 0.9’ lists the number of (and percentage) of residues with an average occupancy less than 0.9.

Mol	Chain	Analysed	<RSRZ>	#RSRZ>2	OWAB(Å ²)	Q<0.9
1	A	555/556 (99%)	0.95	88 (15%) 1 1	35, 86, 207, 300	0
1	C	555/556 (99%)	0.85	84 (15%) 2 1	36, 93, 184, 284	0
2	B	412/444 (92%)	0.40	23 (5%) 24 25	35, 71, 133, 174	0
2	D	402/444 (90%)	0.46	36 (8%) 9 9	41, 87, 152, 218	0
3	E	22/27 (81%)	0.36	2 (9%) 9 9	80, 120, 181, 213	0
3	T	22/27 (81%)	0.33	3 (13%) 3 2	79, 118, 174, 249	0
4	F	19/21 (90%)	0.28	3 (15%) 2 1	67, 110, 218, 226	0
4	P	19/21 (90%)	0.37	3 (15%) 2 1	73, 107, 180, 224	0
All	All	2006/2096 (95%)	0.69	242 (12%) 4 4	35, 84, 178, 300	0

All (242) RSRZ outliers are listed below:

Mol	Chain	Res	Type	RSRZ
1	C	142	ILE	18.7
1	C	132	ILE	14.9
1	A	132	ILE	14.7
2	D	231	GLY	13.1
1	A	26	LEU	11.8
1	C	24	TRP	11.5
1	C	61	PHE	11.1
1	A	135	ILE	10.8
1	A	131	THR	10.6
1	C	26	LEU	10.5
1	A	24	TRP	10.2
1	A	134	SER	10.0
2	D	4	PRO	9.9
1	A	133	PRO	9.9
1	A	61	PHE	9.4
1	A	30	LYS	9.2

Continued on next page...

Continued from previous page...

Mol	Chain	Res	Type	RSRZ
1	C	133	PRO	9.1
1	C	74	LEU	8.7
1	A	32	LYS	8.0
1	A	27	THR	7.8
1	A	33	ALA	7.6
1	C	139	THR	7.3
1	A	74	LEU	7.1
1	C	25	PRO	7.1
1	A	140	PRO	6.9
1	A	34	LEU	6.8
1	C	293	ILE	6.7
1	A	139	THR	6.7
1	A	142	ILE	6.7
1	C	30	LYS	6.7
1	C	34	LEU	6.7
1	C	144	TYR	6.7
1	C	135	ILE	6.5
1	C	62	ALA	6.4
1	A	59	PRO	6.3
1	A	28	GLU	6.3
1	A	22	LYS	6.3
1	C	136	ASN	6.1
1	A	21	VAL	6.1
1	C	138	GLU	5.9
2	B	4	PRO	5.9
1	A	295	LEU	5.9
2	D	232	TYR	5.9
1	A	62	ALA	5.8
1	A	138	GLU	5.8
1	C	32	LYS	5.7
1	A	144	TYR	5.6
1	C	31	ILE	5.5
2	B	212	TRP	5.4
1	A	19	PRO	5.4
1	C	134	SER	5.3
1	A	137	ASN	5.3
4	P	803	DC	5.2
1	A	52	PRO	5.2
3	T	725	DG	5.2
1	A	136	ASN	5.2
1	C	60	VAL	5.1
1	C	71	TRP	5.1

Continued on next page...

Continued from previous page...

Mol	Chain	Res	Type	RSRZ
1	C	295	LEU	4.8
1	A	289	LEU	4.8
1	C	21	VAL	4.8
2	D	66	LYS	4.8
1	A	71	TRP	4.8
1	A	49	LYS	4.7
1	A	75	VAL	4.7
1	A	141	GLY	4.7
1	A	60	VAL	4.7
1	C	130	PHE	4.7
1	C	137	ASN	4.7
1	A	287	LYS	4.6
1	A	31	ILE	4.6
1	C	292	VAL	4.5
1	A	54	ASN	4.5
1	A	25	PRO	4.5
1	A	128	THR	4.4
1	C	252	TRP	4.4
1	C	37	ILE	4.4
1	C	36	GLU	4.3
1	C	19	PRO	4.3
2	D	173	LYS	4.3
2	D	67	ASP	4.3
1	A	57	ASN	4.3
1	C	22	LYS	4.2
1	A	130	PHE	4.1
1	C	67	ASP	4.1
2	D	88	TRP	4.1
1	A	23	GLN	4.1
1	A	50	ILE	4.1
1	C	49	LYS	4.0
2	D	210	LEU	4.0
3	T	704	DA	4.0
1	A	56	TYR	4.0
1	A	254	VAL	3.9
1	C	140	PRO	3.9
1	C	247	PRO	3.9
2	D	212	TRP	3.9
1	A	73	LYS	3.8
1	A	296	THR	3.8
1	C	219	LYS	3.8
2	D	209	LEU	3.8

Continued on next page...

Continued from previous page...

Mol	Chain	Res	Type	RSRZ
2	D	5	ILE	3.8
1	C	28	GLU	3.8
1	A	193	LEU	3.8
1	C	16	MET	3.7
3	E	725	DG	3.7
2	D	8	VAL	3.7
1	A	286	THR	3.7
2	B	398	TRP	3.6
1	C	294	PRO	3.6
1	A	77	PHE	3.5
2	B	209	LEU	3.5
1	C	249	LYS	3.5
2	B	89	GLU	3.5
2	B	88	TRP	3.5
1	C	38	CYS	3.5
1	A	58	THR	3.5
1	C	145	GLN	3.5
1	A	67	ASP	3.4
1	C	66	LYS	3.4
1	C	83	ARG	3.4
1	C	141	GLY	3.4
2	B	5	ILE	3.4
1	A	303	LEU	3.4
2	D	197	GLN	3.4
1	A	129	ALA	3.4
1	C	35	VAL	3.3
1	A	29	GLU	3.3
1	A	292	VAL	3.3
1	A	12	LEU	3.3
1	C	257	ILE	3.2
1	A	66	LYS	3.2
1	A	143	ARG	3.2
2	D	10	VAL	3.2
1	A	68	SER	3.2
2	B	210	LEU	3.2
2	B	12	LEU	3.2
2	D	94	ILE	3.1
2	D	92	LEU	3.1
1	C	50	ILE	3.1
2	D	117	SER	3.1
2	B	86	ASP	3.1
2	D	90	VAL	3.1

Continued on next page...

Continued from previous page...

Mol	Chain	Res	Type	RSRZ
2	D	172	LYS	3.0
2	D	169	GLU	3.0
2	D	168	LEU	3.0
4	P	804	DA	3.0
2	B	428	GLN	3.0
1	A	17	ASP	3.0
1	C	251	SER	3.0
1	C	52	PRO	3.0
2	D	422	LEU	3.0
3	E	704	DA	2.9
1	C	286	THR	2.9
1	C	254	VAL	2.9
3	T	724	DT	2.9
4	F	804	DA	2.9
1	A	251	SER	2.9
1	A	290	THR	2.9
1	A	16	MET	2.8
1	C	27	THR	2.8
1	A	293	ILE	2.8
2	D	171	PHE	2.8
1	A	127	TYR	2.8
2	D	179	VAL	2.8
1	A	15	GLY	2.8
2	D	195	ILE	2.8
1	A	246	LEU	2.8
1	C	246	LEU	2.8
2	B	227	PHE	2.7
2	D	211	ARG	2.7
2	B	230	MET	2.7
2	B	85	GLN	2.7
1	C	220	LYS	2.7
1	C	51	GLY	2.7
1	C	13	LYS	2.7
1	C	287	LYS	2.7
1	C	109	LEU	2.7
1	A	145	GLN	2.7
1	C	300	GLU	2.6
2	B	400	THR	2.6
1	A	18	GLY	2.6
1	A	76	ASP	2.6
2	D	87	PHE	2.6
1	C	290	THR	2.6

Continued on next page...

Continued from previous page...

Mol	Chain	Res	Type	RSRZ
1	C	296	THR	2.6
1	A	13	LYS	2.6
1	A	83	ARG	2.6
2	D	206	ARG	2.6
1	A	247	PRO	2.6
1	A	70	LYS	2.6
2	D	428	GLN	2.6
1	C	82	LYS	2.5
1	C	29	GLU	2.5
1	A	41	MET	2.5
1	C	77	PHE	2.5
2	B	397	THR	2.5
1	C	143	ARG	2.5
1	C	17	ASP	2.5
1	C	41	MET	2.5
1	A	196	GLY	2.4
1	A	63	CYS	2.4
2	B	401	TRP	2.4
1	A	234	LEU	2.4
2	D	423	VAL	2.4
4	F	805	DG	2.4
1	C	65	LYS	2.4
1	C	47	ILE	2.4
1	C	59	PRO	2.4
1	C	192	ASP	2.4
2	D	174	GLN	2.4
1	A	252	TRP	2.4
2	B	402	TRP	2.4
1	A	14	PRO	2.3
1	C	73	LYS	2.3
1	C	129	ALA	2.3
1	C	58	THR	2.3
1	A	249	LYS	2.2
1	A	38	CYS	2.2
4	P	805	DG	2.2
1	A	288	ALA	2.2
2	B	90	VAL	2.2
1	A	195	ILE	2.2
1	C	303	LEU	2.2
2	B	393	ILE	2.1
1	A	282	LEU	2.1
1	C	57	ASN	2.1

Continued on next page...

Continued from previous page...

Mol	Chain	Res	Type	RSRZ
1	C	301	LEU	2.1
1	C	75	VAL	2.1
1	A	200	THR	2.1
1	C	78	ARG	2.1
4	F	803	DC	2.1
2	D	9	PRO	2.1
2	D	124	PHE	2.1
2	D	202	ILE	2.1
2	B	193	LEU	2.1
1	C	23	GLN	2.1
2	D	93	GLY	2.1
2	B	414	TRP	2.1
1	C	180	ILE	2.0
2	D	205	LEU	2.0
2	B	211	ARG	2.0
1	C	311	LYS	2.0

6.2 Non-standard residues in protein, DNA, RNA chains [i](#)

In the following table, the Atoms column lists the number of modelled atoms in the group and the number defined in the chemical component dictionary. The B-factors column lists the minimum, median, 95th percentile and maximum values of B factors of atoms in the group. The column labelled 'Q< 0.9' lists the number of atoms with occupancy less than 0.9.

Mol	Type	Chain	Res	Atoms	RSCC	RSR	B-factors(Å ²)	Q<0.9
4	DDG	P	822	21/22	0.94	0.14	78,82,97,99	0
4	DDG	F	822	21/22	0.94	0.17	70,77,90,95	0

6.3 Carbohydrates [i](#)

There are no monosaccharides in this entry.

6.4 Ligands [i](#)

In the following table, the Atoms column lists the number of modelled atoms in the group and the number defined in the chemical component dictionary. The B-factors column lists the minimum, median, 95th percentile and maximum values of B factors of atoms in the group. The column labelled 'Q< 0.9' lists the number of atoms with occupancy less than 0.9.

Mol	Type	Chain	Res	Atoms	RSCC	RSR	B-factors(Å ²)	Q<0.9
7	GOL	C	606	6/6	0.66	0.39	79,88,91,94	0
7	GOL	C	605	6/6	0.74	0.25	106,121,124,130	0
7	GOL	D	504	6/6	0.77	0.44	94,96,103,107	0
7	GOL	A	604	6/6	0.78	0.62	94,115,119,121	0
7	GOL	C	604	6/6	0.83	0.15	81,100,102,106	0
7	GOL	D	503	6/6	0.84	0.26	83,84,94,97	0
7	GOL	B	504	6/6	0.87	0.21	71,82,85,89	0
7	GOL	D	501	6/6	0.87	0.20	86,94,104,108	0
7	GOL	B	503	6/6	0.89	0.13	69,73,84,92	0
5	MG	C	601	1/1	0.91	0.04	75,75,75,75	0
7	GOL	B	505	6/6	0.92	0.27	67,76,79,81	0
5	MG	C	602	1/1	0.93	0.06	51,51,51,51	0
7	GOL	D	502	6/6	0.93	0.27	69,77,93,100	0
5	MG	A	601	1/1	0.93	0.04	93,93,93,93	0
7	GOL	B	502	6/6	0.93	0.30	70,80,85,88	0
5	MG	A	602	1/1	0.94	0.06	59,59,59,59	0
6	D4T	A	603	28/28	0.94	0.12	95,118,141,145	0
6	D4T	C	603	28/28	0.95	0.11	82,106,133,141	0
7	GOL	B	501	6/6	0.97	0.20	63,80,89,96	0

The following is a graphical depiction of the model fit to experimental electron density of all instances of the Ligand of Interest. In addition, ligands with molecular weight > 250 and outliers as shown on the geometry validation Tables will also be included. Each fit is shown from different orientation to approximate a three-dimensional view.

Electron density around D4T A 603:

$2mF_o-DF_c$ (at 0.7 rmsd) in gray
 mF_o-DF_c (at 3 rmsd) in purple (negative)
and green (positive)

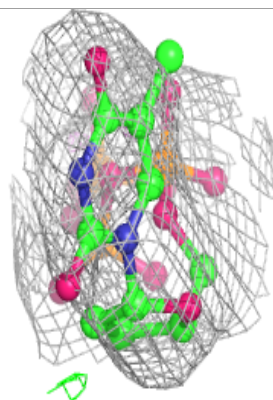
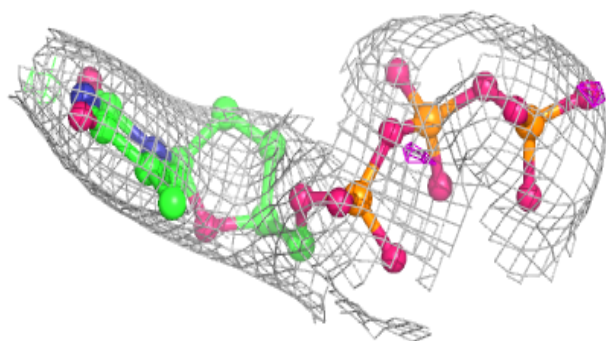
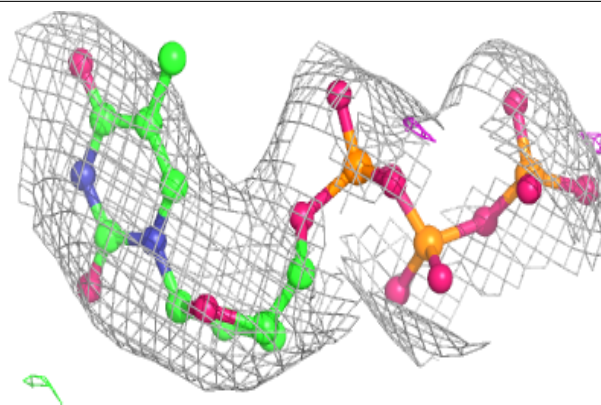
**Electron density around D4T C 603:**

$2mF_o-DF_c$ (at 0.7 rmsd) in gray
 mF_o-DF_c (at 3 rmsd) in purple (negative)
and green (positive)

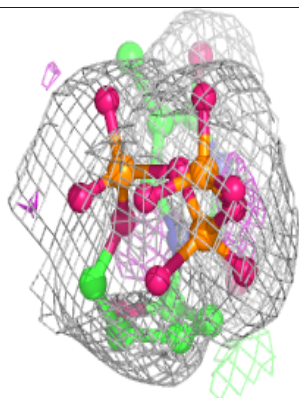
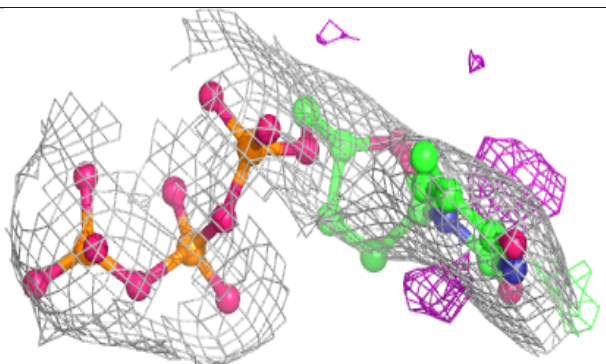
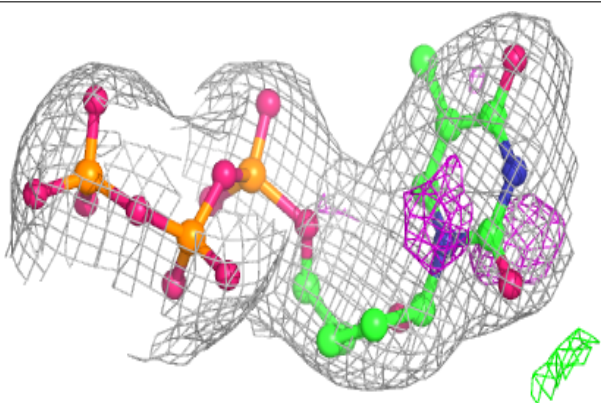

6.5 Other polymers [i](#)

There are no such residues in this entry.