



# Full wwPDB X-ray Structure Validation Report ⓘ

Oct 5, 2021 – 04:08 am BST

PDB ID : 7BJ4  
Title : Inulosucrase from *Halalkalicoccus jeotgali* bound to kestose  
Authors : Ghauri, K.; Pijning, T.; Munawar, N.; Ali, H.; Ghauri, M.A.; Anwar, M.A.; Wallis, R.  
Deposited on : 2021-01-14  
Resolution : 2.72 Å (reported)

This is a Full wwPDB X-ray Structure Validation Report for a publicly released PDB entry.

We welcome your comments at [validation@mail.wwpdb.org](mailto:validation@mail.wwpdb.org)

A user guide is available at

<https://www.wwpdb.org/validation/2017/XrayValidationReportHelp>

with specific help available everywhere you see the ⓘ symbol.

---

The following versions of software and data (see [references ⓘ](#)) were used in the production of this report:

MolProbity : 4.02b-467  
Mogul : 1.8.5 (274361), CSD as541be (2020)  
Xtriage (Phenix) : 1.13  
EDS : 2.23.2  
Percentile statistics : 20191225.v01 (using entries in the PDB archive December 25th 2019)  
Refmac : 5.8.0267  
CCP4 : 7.1.010 (Gargrove)  
Ideal geometry (proteins) : Engh & Huber (2001)  
Ideal geometry (DNA, RNA) : Parkinson et al. (1996)  
Validation Pipeline (wwPDB-VP) : 2.23.2

# 1 Overall quality at a glance

The following experimental techniques were used to determine the structure:

*X-RAY DIFFRACTION*

The reported resolution of this entry is 2.72 Å.

Percentile scores (ranging between 0-100) for global validation metrics of the entry are shown in the following graphic. The table shows the number of entries on which the scores are based.

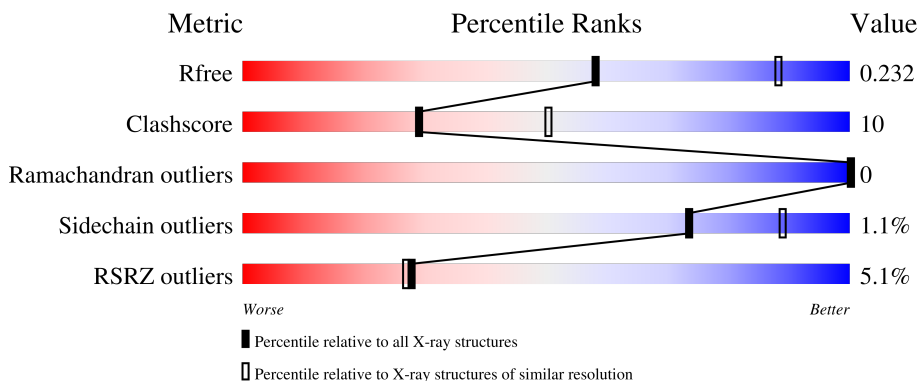

Metric	Whole archive (#Entries)	Similar resolution (#Entries, resolution range(Å))
$R_{free}$	130704	3359 (2.74-2.70)
Clashscore	141614	3686 (2.74-2.70)
Ramachandran outliers	138981	3622 (2.74-2.70)
Sidechain outliers	138945	3623 (2.74-2.70)
RSRZ outliers	127900	3276 (2.74-2.70)

The table below summarises the geometric issues observed across the polymeric chains and their fit to the electron density. The red, orange, yellow and green segments of the lower bar indicate the fraction of residues that contain outliers for  $\geq 3$ , 2, 1 and 0 types of geometric quality criteria respectively. A grey segment represents the fraction of residues that are not modelled. The numeric value for each fraction is indicated below the corresponding segment, with a dot representing fractions  $\leq 5\%$ . The upper red bar (where present) indicates the fraction of residues that have poor fit to the electron density. The numeric value is given above the bar.

Mol	Chain	Length	Quality of chain
1	A	428	
1	B	428	
1	C	428	
1	D	428	
1	E	428	

Continued on next page...

Continued from previous page...

Mol	Chain	Length	Quality of chain
1	F	428	
1	G	428	
1	H	428	
1	I	428	
1	J	428	
2	K	3	
2	L	3	
2	M	3	
2	N	3	
2	O	3	
2	P	3	
2	Q	3	
2	R	3	
2	T	3	
2	U	3	

The following table lists non-polymeric compounds, carbohydrate monomers and non-standard residues in protein, DNA, RNA chains that are outliers for geometric or electron-density-fit criteria:

Mol	Type	Chain	Res	Chirality	Geometry	Clashes	Electron density
2	FRU	M	3	-	-	X	X
2	GLC	O	1	-	-	-	X
2	FRU	O	3	-	-	-	X
2	GLC	Q	1	-	-	X	-
2	FRU	Q	3	-	-	X	X
2	GLC	T	1	-	-	-	X
2	FRU	T	2	-	-	-	X
2	FRU	T	3	-	-	X	-
2	GLC	U	1	-	-	-	X
2	FRU	U	3	-	-	-	X

## 2 Entry composition [i](#)

There are 3 unique types of molecules in this entry. The entry contains 32221 atoms, of which 0 are hydrogens and 0 are deuteriums.

In the tables below, the ZeroOcc column contains the number of atoms modelled with zero occupancy, the AltConf column contains the number of residues with at least one atom in alternate conformation and the Trace column contains the number of residues modelled with at most 2 atoms.

- Molecule 1 is a protein called Levansucrase.

Mol	Chain	Residues	Atoms					ZeroOcc	AltConf	Trace
			Total	C	N	O	S			
1	A	406	3180	2013	546	617	4	0	0	0
1	B	406	3180	2013	546	617	4	0	0	0
1	C	406	3180	2013	546	617	4	0	0	0
1	D	406	3180	2013	546	617	4	0	0	0
1	E	406	3180	2013	546	617	4	0	0	0
1	F	406	3180	2013	546	617	4	0	0	0
1	G	406	3180	2013	546	617	4	0	0	0
1	H	406	3180	2013	546	617	4	0	0	0
1	I	406	3180	2013	546	617	4	0	0	0
1	J	406	3180	2013	546	617	4	0	0	0

- Molecule 2 is an oligosaccharide called beta-D-fructofuranose-(2-1)-beta-D-fructofuranose-(2-1)-alpha-D-glucopyranose.



Mol	Chain	Residues	Atoms		ZeroOcc	AltConf	Trace
			Total	C O			
2	K	3	34	18 16	0	0	0
2	L	3	34	18 16	0	0	0

*Continued on next page...*

*Continued from previous page...*

Mol	Chain	Residues	Atoms			ZeroOcc	AltConf	Trace
2	M	3	Total	C	O	0	0	0
			34	18	16			
2	N	3	Total	C	O	0	0	0
			34	18	16			
2	O	3	Total	C	O	0	0	0
			34	18	16			
2	P	3	Total	C	O	0	0	0
			34	18	16			
2	Q	3	Total	C	O	0	0	0
			34	18	16			
2	R	3	Total	C	O	0	0	0
			34	18	16			
2	T	3	Total	C	O	0	0	0
			34	18	16			
2	U	3	Total	C	O	0	0	0
			34	18	16			

- Molecule 3 is water.

Mol	Chain	Residues	Atoms		ZeroOcc	AltConf
3	A	2	Total	O	0	0
			2	2		
3	B	9	Total	O	0	0
			9	9		
3	C	5	Total	O	0	0
			5	5		
3	D	8	Total	O	0	0
			8	8		
3	E	10	Total	O	0	0
			10	10		
3	F	8	Total	O	0	0
			8	8		
3	G	9	Total	O	0	0
			9	9		
3	H	10	Total	O	0	0
			10	10		
3	I	10	Total	O	0	0
			10	10		
3	J	10	Total	O	0	0
			10	10		

### 3 Residue-property plots [i](#)

These plots are drawn for all protein, RNA, DNA and oligosaccharide chains in the entry. The first graphic for a chain summarises the proportions of the various outlier classes displayed in the second graphic. The second graphic shows the sequence view annotated by issues in geometry and electron density. Residues are color-coded according to the number of geometric quality criteria for which they contain at least one outlier: green = 0, yellow = 1, orange = 2 and red = 3 or more. A red dot above a residue indicates a poor fit to the electron density ( $RSRZ > 2$ ). Stretches of 2 or more consecutive residues without any outlier are shown as a green connector. Residues present in the sample, but not in the model, are shown in grey.

- Molecule 1: Levansucrase

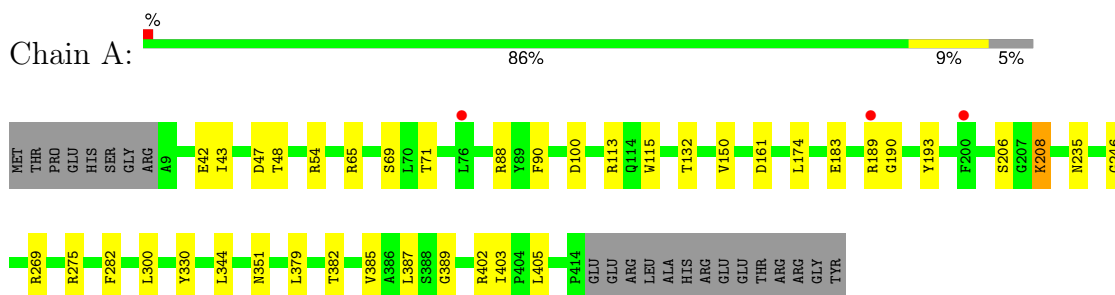

- Molecule 1: Levansucrase

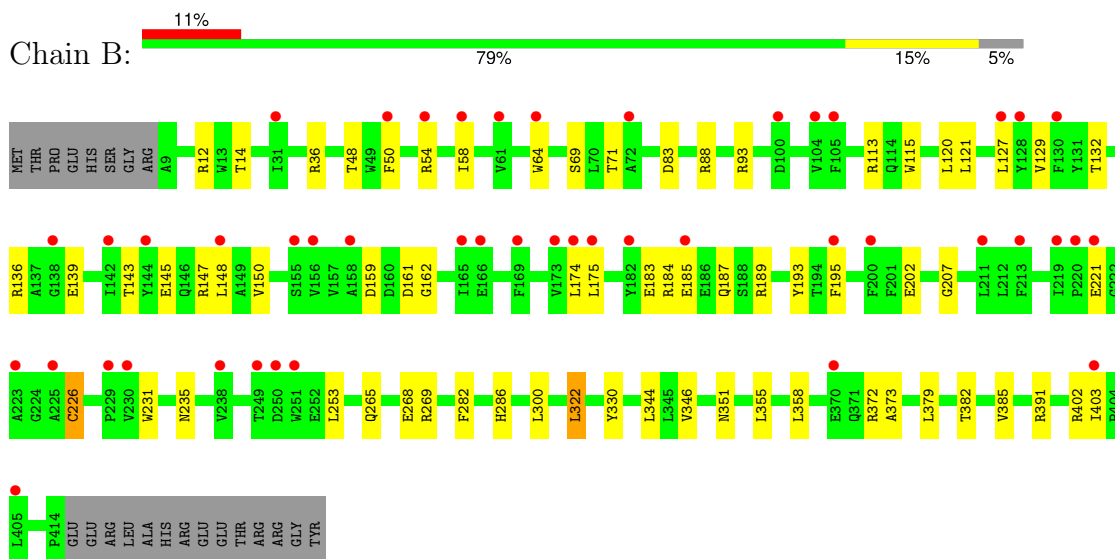

- Molecule 1: Levansucrase

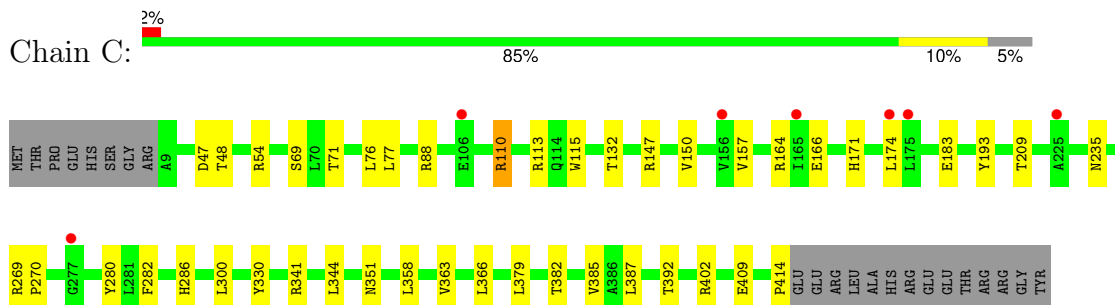

- Molecule 1: Levansucrase

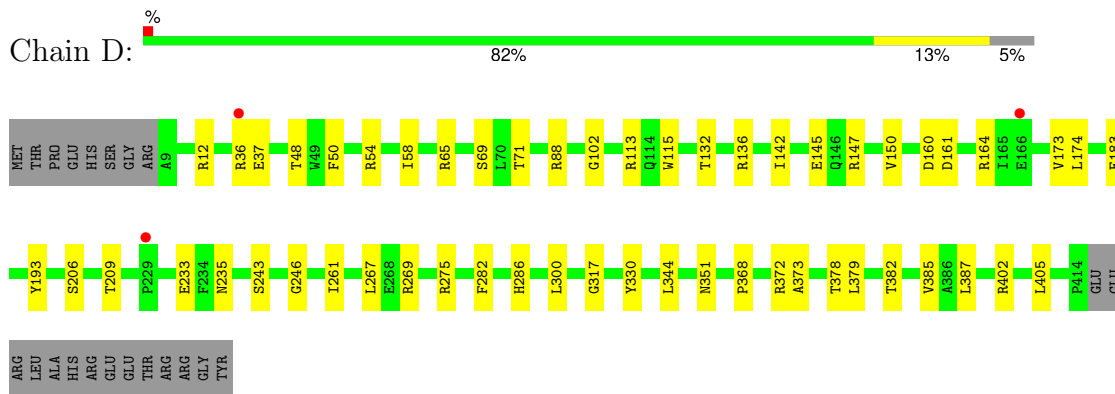

- Molecule 1: Levansucrase

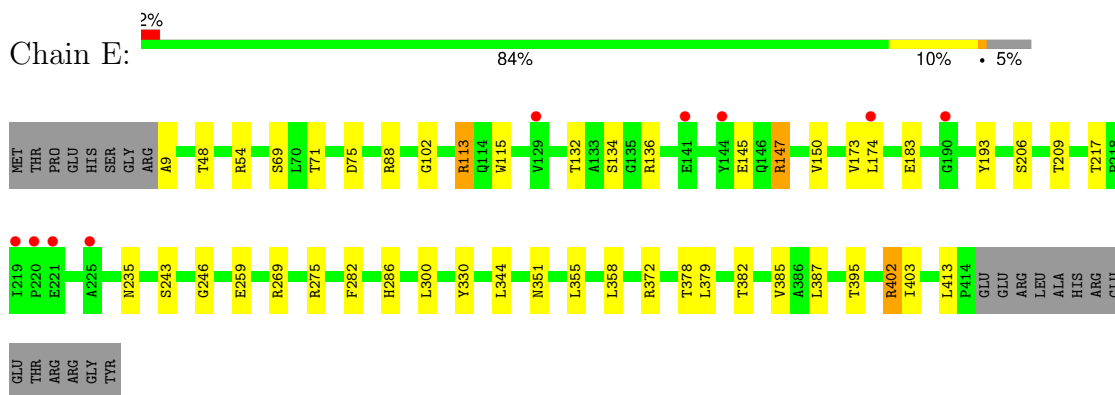

- Molecule 1: Levansucrase

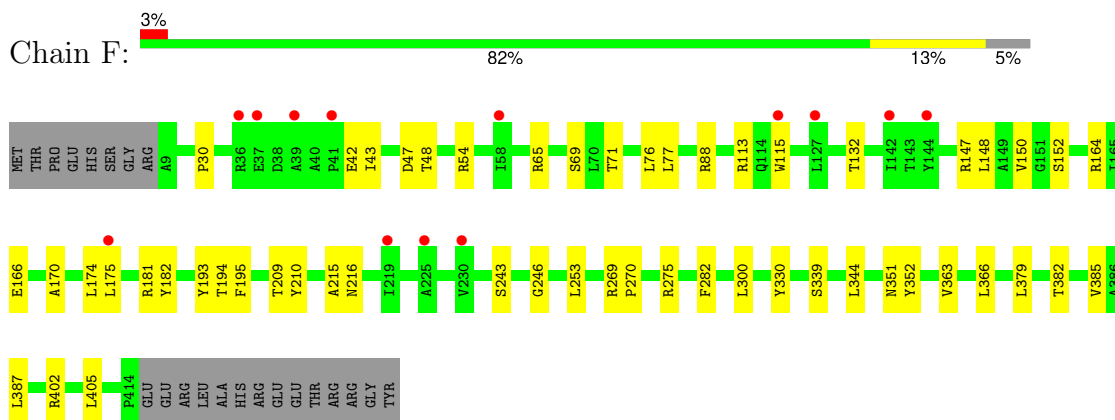

- Molecule 1: Levansucrase

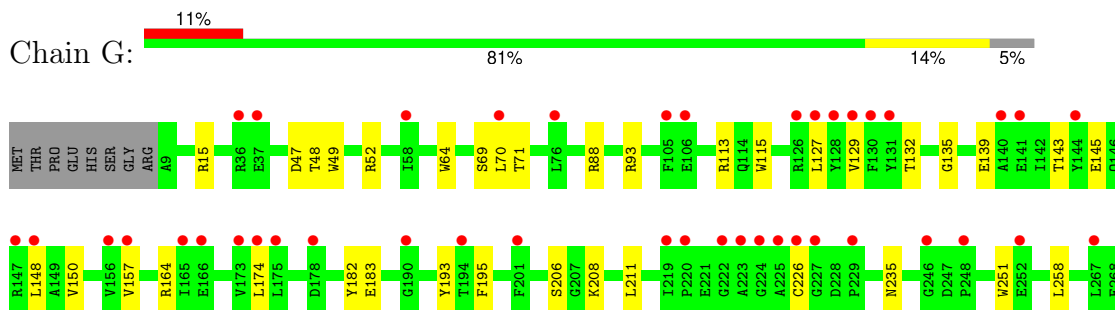

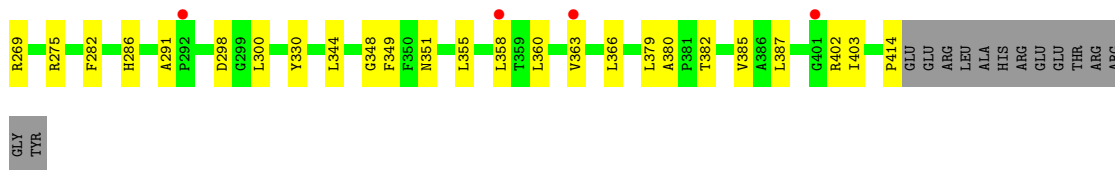

● Molecule 1: Levansucrase

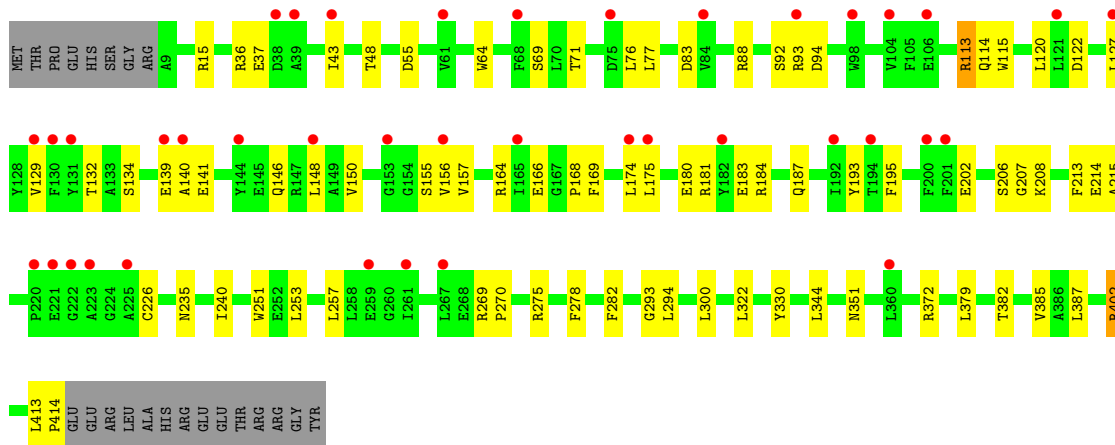
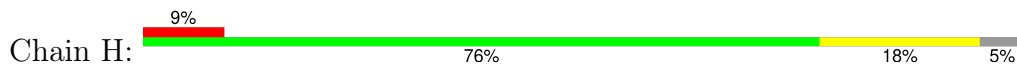

● Molecule 1: Levansucrase

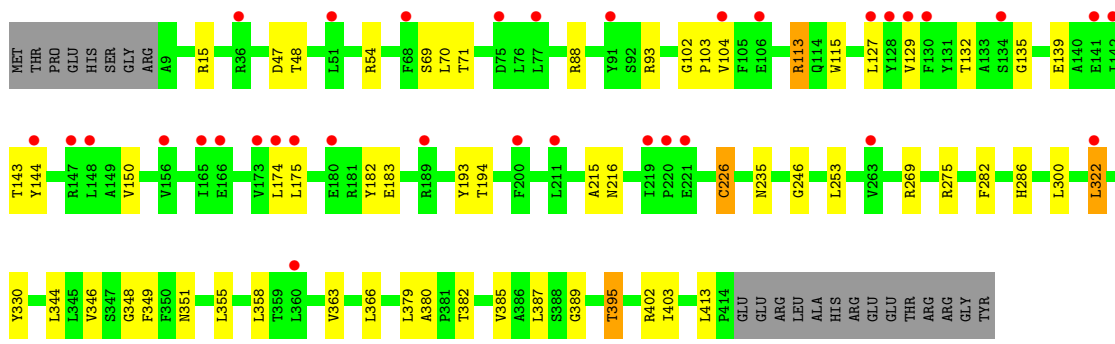
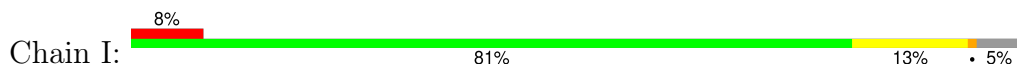

● Molecule 1: Levansucrase

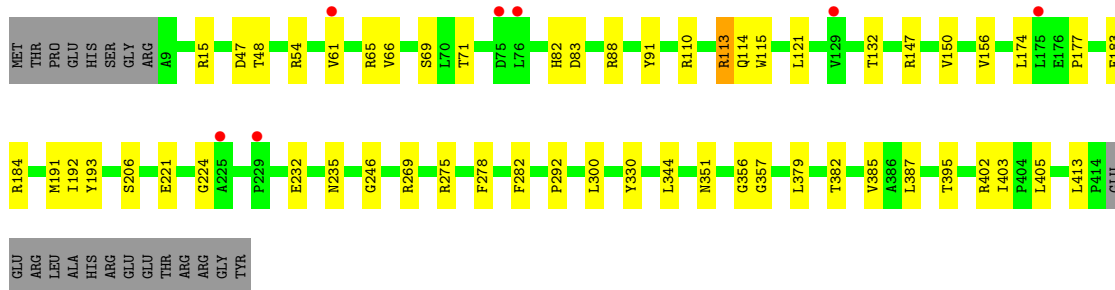
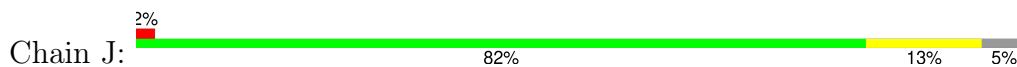



- Molecule 2: beta-D-fructofuranose-(2-1)-beta-D-fructofuranose-(2-1)-alpha-D-glucopyranose

Chain K:  67% 33%

GLC1  
FRU2  
FRU3

- Molecule 2: beta-D-fructofuranose-(2-1)-beta-D-fructofuranose-(2-1)-alpha-D-glucopyranose

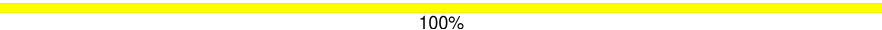
Chain L:  100%

GLC1  
FRU2  
FRU3

- Molecule 2: beta-D-fructofuranose-(2-1)-beta-D-fructofuranose-(2-1)-alpha-D-glucopyranose

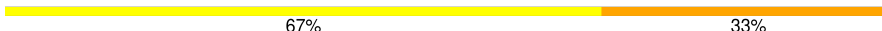
Chain M:  67% 33%

GLC1  
FRU2  
FRU3

- Molecule 2: beta-D-fructofuranose-(2-1)-beta-D-fructofuranose-(2-1)-alpha-D-glucopyranose

Chain N:  100%

GLC1  
FRU2  
FRU3

- Molecule 2: beta-D-fructofuranose-(2-1)-beta-D-fructofuranose-(2-1)-alpha-D-glucopyranose

Chain O:  100%

GLC1  
FRU2  
FRU3

- Molecule 2: beta-D-fructofuranose-(2-1)-beta-D-fructofuranose-(2-1)-alpha-D-glucopyranose

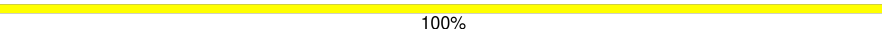
Chain P:  100%

GLC1  
FRU2  
FRU3

- Molecule 2: beta-D-fructofuranose-(2-1)-beta-D-fructofuranose-(2-1)-alpha-D-glucopyranose

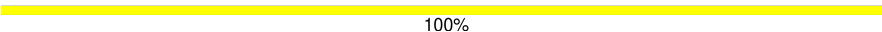
Chain Q:  100%

GLC1  
FRU2  
FRU3

- Molecule 2: beta-D-fructofuranose-(2-1)-beta-D-fructofuranose-(2-1)-alpha-D-glucopyranose

Chain R:  100%

GLC1  
FRU2  
FRU3

- Molecule 2: beta-D-fructofuranose-(2-1)-beta-D-fructofuranose-(2-1)-alpha-D-glucopyranose

Chain T:  100%

GLC1  
FRU2  
FRU3

- Molecule 2: beta-D-fructofuranose-(2-1)-beta-D-fructofuranose-(2-1)-alpha-D-glucopyranose

Chain U:  67%  33%

GLC1  
FRU2  
FRU3

## 4 Data and refinement statistics

Property	Value	Source
Space group	P 1 21 1	Depositor
Cell constants a, b, c, $\alpha$ , $\beta$ , $\gamma$	122.30Å 142.97Å 172.87Å 90.00° 98.64° 90.00°	Depositor
Resolution (Å)	106.54 – 2.72 170.91 – 2.72	Depositor EDS
% Data completeness (in resolution range)	59.0 (106.54-2.72) 59.1 (170.91-2.72)	Depositor EDS
$R_{merge}$	(Not available)	Depositor
$R_{sym}$	(Not available)	Depositor
$\langle I/\sigma(I) \rangle$ <sup>1</sup>	1.66 (at 2.73Å)	Xtrriage
Refinement program	PHENIX 1.17.1_3660	Depositor
R, $R_{free}$	0.197 , 0.225 0.206 , 0.232	Depositor DCC
$R_{free}$ test set	4758 reflections (5.09%)	wwPDB-VP
Wilson B-factor (Å <sup>2</sup> )	63.8	Xtrriage
Anisotropy	0.050	Xtrriage
Bulk solvent $k_{sol}$ (e/Å <sup>3</sup> ), $B_{sol}$ (Å <sup>2</sup> )	(Not available) , (Not available)	EDS
L-test for twinning <sup>2</sup>	$\langle  L  \rangle = 0.46$ , $\langle L^2 \rangle = 0.29$	Xtrriage
Estimated twinning fraction	No twinning to report.	Xtrriage
$F_o, F_c$ correlation	0.93	EDS
Total number of atoms	32221	wwPDB-VP
Average B, all atoms (Å <sup>2</sup> )	62.0	wwPDB-VP

Xtrriage's analysis on translational NCS is as follows: *The analyses of the Patterson function reveals a significant off-origin peak that is 35.34 % of the origin peak, indicating pseudo-translational symmetry. The chance of finding a peak of this or larger height randomly in a structure without pseudo-translational symmetry is equal to 5.9255e-04. The detected translational NCS is most likely also responsible for the elevated intensity ratio.*

<sup>1</sup>Intensities estimated from amplitudes.

<sup>2</sup>Theoretical values of  $\langle |L| \rangle$ ,  $\langle L^2 \rangle$  for acentric reflections are 0.5, 0.333 respectively for untwinned datasets, and 0.375, 0.2 for perfectly twinned datasets.

## 5 Model quality [i](#)

### 5.1 Standard geometry [i](#)

Bond lengths and bond angles in the following residue types are not validated in this section: GLC, FRU

The Z score for a bond length (or angle) is the number of standard deviations the observed value is removed from the expected value. A bond length (or angle) with  $|Z| > 5$  is considered an outlier worth inspection. RMSZ is the root-mean-square of all Z scores of the bond lengths (or angles).

Mol	Chain	Bond lengths		Bond angles	
		RMSZ	# Z  >5	RMSZ	# Z  >5
1	A	0.65	0/3274	0.79	1/4466 (0.0%)
1	B	0.65	0/3274	0.80	1/4466 (0.0%)
1	C	0.64	0/3274	0.80	1/4466 (0.0%)
1	D	0.65	0/3274	0.80	0/4466
1	E	0.64	0/3274	0.80	1/4466 (0.0%)
1	F	0.65	0/3274	0.78	0/4466
1	G	0.65	0/3274	0.81	0/4466
1	H	0.65	0/3274	0.83	1/4466 (0.0%)
1	I	0.64	0/3274	0.80	1/4466 (0.0%)
1	J	0.65	0/3274	0.80	0/4466
All	All	0.65	0/32740	0.80	6/44660 (0.0%)

There are no bond length outliers.

All (6) bond angle outliers are listed below:

Mol	Chain	Res	Type	Atoms	Z	Observed(°)	Ideal(°)
1	I	226	CYS	CA-CB-SG	-7.01	101.39	114.00
1	C	110	ARG	NE-CZ-NH2	-6.78	116.91	120.30
1	E	402	ARG	CG-CD-NE	6.57	125.59	111.80
1	H	402	ARG	CG-CD-NE	6.10	124.60	111.80
1	B	147	ARG	NE-CZ-NH2	-5.46	117.57	120.30
1	A	208	LYS	CB-CG-CD	5.24	125.23	111.60

There are no chirality outliers.

There are no planarity outliers.

## 5.2 Too-close contacts

In the following table, the Non-H and H(model) columns list the number of non-hydrogen atoms and hydrogen atoms in the chain respectively. The H(added) column lists the number of hydrogen atoms added and optimized by MolProbity. The Clashes column lists the number of clashes within the asymmetric unit, whereas Symm-Clashes lists symmetry-related clashes.

Mol	Chain	Non-H	H(model)	H(added)	Clashes	Symm-Clashes
1	A	3180	0	2977	30	0
1	B	3180	0	2977	67	0
1	C	3180	0	2977	40	0
1	D	3180	0	2977	40	0
1	E	3180	0	2977	42	0
1	F	3180	0	2977	74	0
1	G	3180	0	2977	66	0
1	H	3180	0	2977	90	0
1	I	3180	0	2977	72	0
1	J	3180	0	2977	55	0
2	K	34	0	31	4	0
2	L	34	0	31	6	0
2	M	34	0	31	10	0
2	N	34	0	31	4	0
2	O	34	0	31	6	0
2	P	34	0	31	5	0
2	Q	34	0	31	14	0
2	R	34	0	31	4	0
2	T	34	0	31	9	0
2	U	34	0	31	3	0
3	A	2	0	0	4	0
3	B	9	0	0	19	0
3	C	5	0	0	7	0
3	D	8	0	0	9	0
3	E	10	0	0	10	0
3	F	8	0	0	39	0
3	G	9	0	0	21	0
3	H	10	0	0	27	0
3	I	10	0	0	24	0
3	J	10	0	0	25	0
All	All	32221	0	30080	595	0

The all-atom clashscore is defined as the number of clashes found per 1000 atoms (including hydrogen atoms). The all-atom clashscore for this structure is 10.

All (595) close contacts within the same asymmetric unit are listed below, sorted by their clash magnitude.

Atom-1	Atom-2	Interatomic distance (Å)	Clash overlap (Å)
1:B:14:THR:HG23	3:B:503:HOH:O	1.17	1.26
1:I:349:PHE:HA	3:I:501:HOH:O	1.31	1.26
1:J:91:TYR:HA	3:J:501:HOH:O	1.35	1.26
1:F:170:ALA:HB3	3:F:506:HOH:O	1.35	1.24
1:H:155:SER:HA	3:H:503:HOH:O	1.27	1.24
1:G:349:PHE:HA	3:G:503:HOH:O	1.34	1.21
1:H:181:ARG:HA	3:H:506:HOH:O	1.38	1.20
1:G:349:PHE:CA	3:G:503:HOH:O	1.88	1.16
1:J:66:VAL:HA	3:J:501:HOH:O	1.47	1.15
1:H:15:ARG:CZ	1:H:294:LEU:HD11	1.80	1.12
1:G:52:ARG:NH1	3:G:501:HOH:O	1.83	1.11
1:D:164:ARG:NH1	3:D:501:HOH:O	1.80	1.11
1:B:391:ARG:NH2	3:B:502:HOH:O	1.82	1.10
1:B:14:THR:N	3:B:503:HOH:O	1.87	1.06
1:G:182:TYR:N	3:G:502:HOH:O	1.85	1.06
1:B:187:GLN:HB2	3:B:507:HOH:O	1.55	1.06
1:F:181:ARG:CD	3:F:503:HOH:O	2.03	1.03
1:F:181:ARG:NE	3:F:503:HOH:O	1.89	1.03
1:E:9:ALA:HB3	3:E:503:HOH:O	1.56	1.03
1:H:270:PRO:HD2	3:H:508:HOH:O	1.55	1.03
1:G:182:TYR:CB	3:G:502:HOH:O	2.08	1.02
1:J:113:ARG:NE	3:J:502:HOH:O	1.90	1.02
1:J:357:GLY:CA	3:J:503:HOH:O	2.07	1.02
1:F:270:PRO:HD2	3:F:505:HOH:O	1.60	1.02
1:I:104:VAL:N	3:I:503:HOH:O	1.93	1.02
1:H:215:ALA:HB2	3:H:504:HOH:O	1.60	0.99
1:H:413:LEU:O	3:H:501:HOH:O	1.81	0.98
1:H:414:PRO:O	3:H:501:HOH:O	1.82	0.98
1:B:175:LEU:HD22	1:B:253:LEU:HD11	1.46	0.98
1:F:270:PRO:N	3:F:505:HOH:O	1.96	0.97
1:B:83:ASP:OD1	3:B:501:HOH:O	1.81	0.97
3:G:505:HOH:O	2:Q:3:FRU:H5	1.65	0.97
1:C:270:PRO:N	3:C:502:HOH:O	1.98	0.96
1:F:181:ARG:CZ	3:F:503:HOH:O	2.12	0.96
1:F:270:PRO:CD	3:F:505:HOH:O	2.09	0.96
1:B:162:GLY:N	3:B:505:HOH:O	1.95	0.95
1:H:215:ALA:CB	3:H:504:HOH:O	2.13	0.95
1:J:65:ARG:O	3:J:501:HOH:O	1.85	0.94
1:D:37:GLU:OE2	3:D:502:HOH:O	1.85	0.93
1:H:140:ALA:N	3:H:505:HOH:O	2.01	0.93
1:J:83:ASP:HA	3:J:502:HOH:O	1.66	0.93
1:J:191:MET:HB3	3:J:505:HOH:O	1.67	0.93

*Continued on next page...*

*Continued from previous page...*

Atom-1	Atom-2	Interatomic distance (Å)	Clash overlap (Å)
1:G:348:GLY:O	3:G:503:HOH:O	1.87	0.93
1:G:182:TYR:CG	3:G:502:HOH:O	2.22	0.93
1:H:215:ALA:N	3:H:504:HOH:O	2.00	0.93
1:I:348:GLY:O	3:I:501:HOH:O	1.85	0.93
1:H:156:VAL:N	3:H:503:HOH:O	1.97	0.93
1:F:210:TYR:OH	3:F:501:HOH:O	1.86	0.92
1:F:216:ASN:N	3:F:504:HOH:O	1.89	0.92
1:J:113:ARG:CD	3:J:502:HOH:O	2.14	0.91
1:H:214:GLU:C	3:H:504:HOH:O	2.08	0.91
1:F:215:ALA:CA	3:F:504:HOH:O	2.19	0.91
1:F:30:PRO:O	3:F:502:HOH:O	1.88	0.90
1:G:298:ASP:OD2	3:G:504:HOH:O	1.87	0.90
1:B:300:LEU:HB3	1:B:322:LEU:HG	1.52	0.90
1:I:300:LEU:HB3	1:I:322:LEU:HG	1.53	0.90
1:G:182:TYR:CD2	3:G:502:HOH:O	2.25	0.90
1:B:202:GLU:OE2	1:B:207:GLY:O	1.89	0.90
1:G:145:GLU:N	3:G:506:HOH:O	2.06	0.88
1:C:270:PRO:CD	3:C:502:HOH:O	2.20	0.88
1:E:136:ARG:NE	3:E:501:HOH:O	2.03	0.87
1:J:357:GLY:N	3:J:503:HOH:O	2.06	0.87
1:B:175:LEU:HD22	1:B:253:LEU:CD1	2.03	0.87
1:C:47:ASP:OD2	2:M:3:FRU:H11	1.74	0.86
1:H:55:ASP:O	3:H:502:HOH:O	1.91	0.86
3:G:505:HOH:O	2:Q:3:FRU:C5	2.21	0.85
1:B:322:LEU:HD21	1:B:346:VAL:HG11	1.57	0.85
1:H:141:GLU:N	3:H:505:HOH:O	2.08	0.85
1:H:114:GLN:N	1:H:114:GLN:OE1	2.09	0.85
1:H:270:PRO:CD	3:H:508:HOH:O	2.17	0.85
1:B:127:LEU:HD21	1:B:129:VAL:HG23	1.58	0.84
1:G:348:GLY:C	3:G:503:HOH:O	2.14	0.84
1:E:145:GLU:OE1	3:E:501:HOH:O	1.94	0.84
1:A:189:ARG:C	3:A:501:HOH:O	2.17	0.83
1:B:64:TRP:CZ3	1:B:93:ARG:HG2	2.14	0.83
1:G:414:PRO:HA	3:G:507:HOH:O	1.77	0.83
1:E:136:ARG:NH2	3:E:501:HOH:O	2.12	0.82
1:F:269:ARG:C	3:F:505:HOH:O	2.17	0.82
1:C:270:PRO:HD2	3:C:502:HOH:O	1.77	0.82
1:H:64:TRP:CZ3	1:H:93:ARG:HG2	2.14	0.82
1:I:115:TRP:CG	2:T:3:FRU:H61	2.15	0.81
1:I:143:THR:O	3:I:504:HOH:O	1.97	0.81
1:G:64:TRP:CZ3	1:G:93:ARG:HG2	2.14	0.81

*Continued on next page...*

*Continued from previous page...*

Atom-1	Atom-2	Interatomic distance (Å)	Clash overlap (Å)
1:F:215:ALA:HB1	3:F:504:HOH:O	1.81	0.81
1:F:152:SER:OG	3:F:506:HOH:O	1.97	0.81
1:H:184:ARG:HG2	1:H:187:GLN:OE1	1.81	0.81
2:M:1:GLC:H2	2:M:2:FRU:H11	1.63	0.80
1:E:54:ARG:HH12	1:E:209:THR:HG21	1.46	0.80
1:A:190:GLY:N	3:A:501:HOH:O	2.15	0.80
1:G:360:LEU:HD21	2:Q:1:GLC:H5	1.62	0.80
1:J:83:ASP:C	3:J:502:HOH:O	2.20	0.79
1:I:150:VAL:HG12	1:I:174:LEU:HD11	1.64	0.79
1:F:30:PRO:C	3:F:502:HOH:O	2.20	0.79
1:B:12:ARG:O	3:B:503:HOH:O	2.01	0.79
1:G:150:VAL:HG12	1:G:174:LEU:HD11	1.63	0.79
1:I:113:ARG:NH2	3:I:504:HOH:O	2.03	0.79
1:I:127:LEU:HD21	1:I:129:VAL:HG23	1.65	0.78
1:F:170:ALA:O	3:F:506:HOH:O	2.01	0.78
1:I:175:LEU:HD22	1:I:253:LEU:HD11	1.65	0.78
1:C:270:PRO:O	3:C:502:HOH:O	2.00	0.77
1:F:30:PRO:CD	3:F:502:HOH:O	2.29	0.77
1:H:169:PHE:N	3:H:509:HOH:O	2.16	0.77
1:I:349:PHE:CA	3:I:501:HOH:O	2.05	0.77
1:E:9:ALA:CB	3:E:503:HOH:O	2.24	0.77
1:G:70:LEU:HD12	1:G:70:LEU:N	2.00	0.77
1:J:83:ASP:CA	3:J:502:HOH:O	2.27	0.77
1:C:269:ARG:C	3:C:502:HOH:O	2.24	0.76
1:D:164:ARG:CZ	3:D:501:HOH:O	2.18	0.76
1:F:54:ARG:HH12	1:F:209:THR:HG21	1.50	0.76
1:B:402:ARG:NE	3:B:504:HOH:O	1.87	0.76
1:H:139:GLU:C	3:H:505:HOH:O	2.21	0.76
1:E:147:ARG:NH1	1:E:173:VAL:HG21	1.99	0.76
1:E:9:ALA:N	3:E:503:HOH:O	2.19	0.76
1:F:269:ARG:HA	3:F:505:HOH:O	1.86	0.76
1:H:92:SER:OG	1:H:94:ASP:O	2.01	0.76
1:I:322:LEU:HD21	1:I:346:VAL:HG11	1.66	0.76
1:J:15:ARG:NH2	1:J:292:PRO:O	2.19	0.75
1:F:76:LEU:HD23	1:F:77:LEU:O	1.86	0.75
1:I:175:LEU:HD22	1:I:253:LEU:CD1	2.17	0.75
1:G:182:TYR:HB2	3:G:502:HOH:O	1.79	0.75
1:B:184:ARG:O	3:B:507:HOH:O	2.04	0.75
1:C:76:LEU:HD23	1:C:77:LEU:O	1.87	0.75
1:B:402:ARG:NH2	3:B:504:HOH:O	2.17	0.75
1:C:54:ARG:NH1	1:C:209:THR:OG1	2.19	0.75

*Continued on next page...*



*Continued from previous page...*

Atom-1	Atom-2	Interatomic distance (Å)	Clash overlap (Å)
1:F:30:PRO:CA	3:F:502:HOH:O	2.33	0.75
1:H:76:LEU:HD23	1:H:77:LEU:O	1.87	0.75
1:H:240:ILE:HG21	1:H:257:LEU:HD11	1.70	0.74
1:A:189:ARG:CA	3:A:501:HOH:O	2.36	0.74
1:F:170:ALA:CB	3:F:506:HOH:O	2.11	0.74
1:H:127:LEU:HD21	1:H:129:VAL:HG23	1.68	0.74
1:C:47:ASP:CG	2:M:3:FRU:H11	2.07	0.74
1:H:213:PHE:HD1	3:H:504:HOH:O	1.70	0.73
1:H:168:PRO:HB2	3:H:509:HOH:O	1.88	0.73
1:G:49:TRP:HZ3	1:G:70:LEU:HD11	1.52	0.73
1:F:210:TYR:CE1	3:F:501:HOH:O	2.41	0.73
1:I:216:ASN:N	3:I:502:HOH:O	1.92	0.72
1:H:15:ARG:NH1	1:H:294:LEU:HD11	2.04	0.72
1:H:15:ARG:NH2	1:H:294:LEU:HD11	2.04	0.72
1:J:110:ARG:NE	3:J:504:HOH:O	2.11	0.72
1:F:30:PRO:HD2	3:F:502:HOH:O	1.87	0.72
1:E:113:ARG:HD3	1:E:134:SER:OG	1.90	0.72
1:I:395:THR:HG23	1:I:413:LEU:HD22	1.70	0.71
1:J:357:GLY:C	3:J:503:HOH:O	2.24	0.71
1:H:180:GLU:O	3:H:506:HOH:O	2.06	0.71
1:F:54:ARG:NH2	1:F:246:GLY:O	2.22	0.71
1:D:233:GLU:O	3:D:503:HOH:O	2.07	0.71
1:J:54:ARG:NH2	1:J:246:GLY:O	2.23	0.71
1:D:160:ASP:CG	3:J:504:HOH:O	2.29	0.71
1:H:15:ARG:CZ	1:H:294:LEU:CD1	2.65	0.71
1:I:54:ARG:NH2	1:I:246:GLY:O	2.22	0.70
1:A:54:ARG:NH2	1:A:246:GLY:O	2.23	0.70
2:L:2:FRU:H11	2:L:3:FRU:O1	1.90	0.70
1:F:181:ARG:HD3	3:F:503:HOH:O	1.81	0.70
1:E:54:ARG:NH2	1:E:246:GLY:O	2.23	0.70
1:F:215:ALA:CB	3:F:504:HOH:O	2.35	0.70
1:D:54:ARG:NH1	1:D:246:GLY:O	2.24	0.70
1:G:360:LEU:CD2	2:Q:1:GLC:H5	2.22	0.69
1:B:64:TRP:CZ2	1:B:93:ARG:HD3	2.28	0.69
1:D:317:GLY:HA2	3:D:504:HOH:O	1.91	0.69
1:F:30:PRO:CB	3:F:502:HOH:O	2.40	0.69
1:F:170:ALA:CA	3:F:506:HOH:O	2.37	0.69
1:D:54:ARG:HH11	1:D:209:THR:HG21	1.57	0.69
1:J:224:GLY:O	1:J:232:GLU:OE2	2.11	0.69
1:F:363:VAL:HA	1:F:366:LEU:CD1	2.23	0.68
1:J:83:ASP:O	3:J:502:HOH:O	2.09	0.68

*Continued on next page...*

*Continued from previous page...*

Atom-1	Atom-2	Interatomic distance (Å)	Clash overlap (Å)
1:G:47:ASP:O	1:G:70:LEU:HD13	1.92	0.68
1:B:373:ALA:HA	1:D:36:ARG:HH21	1.57	0.68
1:E:275:ARG:HD3	1:E:387:LEU:HD12	1.75	0.68
1:G:139:GLU:OE1	1:G:143:THR:HG22	1.93	0.68
1:H:15:ARG:NH2	1:H:294:LEU:CD1	2.56	0.68
1:I:363:VAL:HA	1:I:366:LEU:CD1	2.24	0.68
1:J:113:ARG:CG	3:J:502:HOH:O	2.41	0.68
1:C:363:VAL:HA	1:C:366:LEU:CD1	2.24	0.67
1:E:136:ARG:CZ	3:E:501:HOH:O	2.33	0.67
1:I:322:LEU:CD2	1:I:346:VAL:HG11	2.24	0.67
1:B:159:ASP:O	3:B:505:HOH:O	2.10	0.67
1:B:115:TRP:HB2	1:B:132:THR:HB	1.76	0.67
1:H:140:ALA:C	3:H:505:HOH:O	2.33	0.67
1:G:363:VAL:HA	1:G:366:LEU:CD1	2.24	0.67
1:D:275:ARG:HD3	1:D:387:LEU:HD12	1.77	0.67
1:E:217:THR:HG21	1:E:259:GLU:OE2	1.95	0.67
1:G:275:ARG:HD3	1:G:387:LEU:HD12	1.75	0.67
1:C:115:TRP:HB2	1:C:132:THR:HB	1.77	0.67
1:J:113:ARG:HG3	3:J:502:HOH:O	1.94	0.67
1:D:317:GLY:O	3:D:504:HOH:O	2.14	0.66
1:G:115:TRP:HB2	1:G:132:THR:HB	1.77	0.66
2:O:1:GLC:H2	2:O:2:FRU:H11	1.77	0.66
1:E:235:ASN:OD1	3:E:502:HOH:O	2.12	0.66
1:I:115:TRP:HB2	1:I:132:THR:HB	1.78	0.66
1:H:294:LEU:N	1:H:294:LEU:HD12	2.11	0.66
1:I:144:TYR:CD1	3:I:504:HOH:O	2.49	0.66
1:J:191:MET:CB	3:J:505:HOH:O	2.36	0.66
1:E:115:TRP:HB2	1:E:132:THR:HB	1.77	0.66
1:A:115:TRP:HB2	1:A:132:THR:HB	1.78	0.66
1:B:322:LEU:CD2	1:B:346:VAL:HG11	2.25	0.66
1:J:115:TRP:HB2	1:J:132:THR:HB	1.78	0.66
1:F:215:ALA:HA	3:F:504:HOH:O	1.87	0.66
1:F:175:LEU:HD22	1:F:253:LEU:HD11	1.75	0.65
1:B:136:ARG:HG2	1:B:145:GLU:OE2	1.95	0.65
1:F:275:ARG:HD3	1:F:387:LEU:HD12	1.77	0.65
1:B:139:GLU:OE1	1:B:143:THR:HG22	1.97	0.65
1:H:115:TRP:HB2	1:H:132:THR:HB	1.77	0.65
1:I:103:PRO:C	3:I:503:HOH:O	2.30	0.65
1:J:395:THR:HG21	1:J:413:LEU:HD13	1.78	0.65
1:D:115:TRP:HB2	1:D:132:THR:HB	1.79	0.65
1:F:115:TRP:HB2	1:F:132:THR:HB	1.78	0.65

*Continued on next page...*

*Continued from previous page...*

Atom-1	Atom-2	Interatomic distance (Å)	Clash overlap (Å)
1:I:194:THR:O	3:I:502:HOH:O	2.15	0.65
1:F:30:PRO:N	3:F:502:HOH:O	2.29	0.65
1:I:215:ALA:CA	3:I:502:HOH:O	2.45	0.64
1:H:270:PRO:N	3:H:508:HOH:O	2.29	0.64
1:I:322:LEU:HD12	1:I:322:LEU:O	1.97	0.64
1:F:352:TYR:O	3:F:507:HOH:O	2.14	0.64
2:Q:1:GLC:H2	2:Q:2:FRU:H11	1.79	0.64
1:H:146:GLN:O	3:H:507:HOH:O	2.15	0.64
1:B:136:ARG:CG	1:B:145:GLU:OE2	2.45	0.63
1:B:148:LEU:HD13	1:B:195:PHE:CE2	2.34	0.63
1:F:363:VAL:HA	1:F:366:LEU:HD13	1.80	0.63
1:A:275:ARG:HD3	1:A:387:LEU:HD12	1.79	0.63
1:A:189:ARG:HA	3:A:501:HOH:O	1.98	0.63
1:I:139:GLU:OE1	1:I:143:THR:HG22	1.98	0.63
1:H:270:PRO:O	3:H:508:HOH:O	2.15	0.63
1:J:110:ARG:NH2	3:J:504:HOH:O	2.30	0.63
1:D:142:ILE:HD12	1:D:142:ILE:O	1.99	0.62
1:B:127:LEU:CD2	1:B:129:VAL:HG23	2.29	0.62
1:G:148:LEU:HD13	1:G:195:PHE:CE2	2.35	0.62
1:C:363:VAL:HA	1:C:366:LEU:HD13	1.81	0.62
1:E:54:ARG:HH12	1:E:209:THR:CG2	2.12	0.62
1:F:148:LEU:HD13	1:F:195:PHE:CE2	2.34	0.62
1:B:187:GLN:CB	3:B:507:HOH:O	2.30	0.62
1:E:395:THR:HG21	1:E:413:LEU:HD13	1.81	0.62
1:H:148:LEU:HD13	1:H:195:PHE:CE2	2.34	0.62
1:B:322:LEU:O	1:B:322:LEU:HD12	1.99	0.61
1:F:210:TYR:CZ	3:F:501:HOH:O	2.46	0.61
1:C:47:ASP:OD1	2:M:3:FRU:H11	2.00	0.61
1:B:14:THR:CG2	3:B:503:HOH:O	1.99	0.61
1:I:380:ALA:N	3:I:501:HOH:O	1.84	0.61
1:H:37:GLU:HA	3:H:510:HOH:O	2.00	0.61
1:I:322:LEU:HD12	1:I:322:LEU:C	2.20	0.61
1:G:70:LEU:N	1:G:70:LEU:CD1	2.63	0.61
1:G:363:VAL:HA	1:G:366:LEU:HD13	1.82	0.60
1:E:88:ARG:NH1	1:E:102:GLY:HA2	2.16	0.60
1:I:88:ARG:NH1	1:I:102:GLY:HA2	2.17	0.60
1:I:363:VAL:HA	1:I:366:LEU:HD13	1.81	0.60
1:B:83:ASP:HA	3:B:501:HOH:O	2.01	0.60
1:B:161:ASP:N	3:B:505:HOH:O	2.35	0.60
1:B:127:LEU:HD21	1:B:129:VAL:CG2	2.30	0.60
1:B:322:LEU:HD12	1:B:322:LEU:C	2.22	0.60

*Continued on next page...*

*Continued from previous page...*

Atom-1	Atom-2	Interatomic distance (Å)	Clash overlap (Å)
1:E:9:ALA:CA	3:E:503:HOH:O	2.45	0.60
1:E:113:ARG:CD	1:E:134:SER:OG	2.50	0.60
1:H:127:LEU:CD2	1:H:129:VAL:HG23	2.31	0.60
1:I:127:LEU:CD2	1:I:129:VAL:HG23	2.30	0.60
1:F:54:ARG:HH12	1:F:209:THR:CG2	2.14	0.59
1:G:355:LEU:O	1:G:358:LEU:HD13	2.03	0.59
1:C:157:VAL:HG23	1:C:164:ARG:HG2	1.84	0.59
1:I:115:TRP:CD2	2:T:3:FRU:H61	2.36	0.59
1:E:395:THR:HG22	1:E:413:LEU:HD22	1.85	0.59
1:D:88:ARG:NH1	1:D:102:GLY:HA2	2.17	0.59
1:I:286:HIS:CE1	2:T:2:FRU:O3	2.55	0.59
1:C:115:TRP:CD1	2:M:3:FRU:H62	2.38	0.58
1:C:110:ARG:HD3	1:C:171:HIS:HB3	1.84	0.58
1:I:215:ALA:HB1	3:I:502:HOH:O	2.03	0.58
1:H:174:LEU:O	1:H:175:LEU:HD13	2.02	0.58
1:J:275:ARG:HD3	1:J:387:LEU:HD12	1.84	0.58
1:H:48:THR:HG21	1:H:379:LEU:HD21	1.86	0.58
1:F:175:LEU:HD22	1:F:253:LEU:CD1	2.33	0.58
1:I:115:TRP:CD1	2:T:3:FRU:H61	2.39	0.58
1:H:240:ILE:CG2	1:H:257:LEU:HD11	2.34	0.57
1:I:344:LEU:HB3	1:I:385:VAL:HG23	1.86	0.57
1:I:355:LEU:O	1:I:358:LEU:HD13	2.03	0.57
1:F:115:TRP:CG	2:P:3:FRU:H62	2.39	0.57
2:Q:1:GLC:H2	2:Q:2:FRU:C1	2.34	0.57
1:I:395:THR:CG2	1:I:413:LEU:HD22	2.34	0.57
1:C:48:THR:HG21	1:C:379:LEU:HD21	1.86	0.57
1:D:344:LEU:HB3	1:D:385:VAL:HG23	1.87	0.57
1:J:191:MET:CA	3:J:505:HOH:O	2.53	0.57
1:F:48:THR:HG21	1:F:379:LEU:HD21	1.87	0.57
1:E:48:THR:HG21	1:E:379:LEU:HD21	1.87	0.57
1:C:115:TRP:CG	2:M:3:FRU:H62	2.39	0.57
1:H:164:ARG:HD2	1:H:166:GLU:OE2	2.03	0.57
1:I:48:THR:HG21	1:I:379:LEU:HD21	1.86	0.57
1:I:174:LEU:N	1:I:174:LEU:HD12	2.20	0.57
1:F:344:LEU:HB3	1:F:385:VAL:HG23	1.87	0.57
2:M:1:GLC:H62	2:M:1:GLC:O3	2.05	0.57
1:G:64:TRP:CZ2	1:G:93:ARG:HD3	2.40	0.56
1:G:298:ASP:CB	3:G:504:HOH:O	2.53	0.56
2:M:2:FRU:H11	2:M:3:FRU:O1	2.05	0.56
2:N:2:FRU:H11	2:N:3:FRU:O3	2.05	0.56
1:A:344:LEU:HB3	1:A:385:VAL:HG23	1.88	0.56

*Continued on next page...*

*Continued from previous page...*

Atom-1	Atom-2	Interatomic distance (Å)	Clash overlap (Å)
2:R:2:FRU:H11	2:R:3:FRU:O1	2.04	0.56
1:G:174:LEU:HD12	1:G:174:LEU:N	2.21	0.56
1:G:344:LEU:HB3	1:G:385:VAL:HG23	1.86	0.56
1:H:127:LEU:HD21	1:H:129:VAL:CG2	2.36	0.56
1:J:177:PRO:HG2	1:J:184:ARG:HG2	1.88	0.56
1:G:135:GLY:N	3:G:506:HOH:O	2.28	0.56
1:I:103:PRO:CB	3:I:503:HOH:O	2.52	0.56
1:C:344:LEU:HB3	1:C:385:VAL:HG23	1.87	0.56
1:H:275:ARG:HD3	1:H:387:LEU:HD12	1.86	0.56
1:A:48:THR:HG21	1:A:379:LEU:HD21	1.86	0.56
1:D:48:THR:HG21	1:D:379:LEU:HD21	1.87	0.56
1:E:344:LEU:HB3	1:E:385:VAL:HG23	1.86	0.56
2:L:1:GLC:O2	2:L:2:FRU:H11	2.06	0.56
2:T:2:FRU:H11	2:T:3:FRU:O1	2.04	0.56
1:J:344:LEU:HB3	1:J:385:VAL:HG23	1.87	0.56
1:B:344:LEU:HB3	1:B:385:VAL:HG23	1.87	0.56
1:G:49:TRP:HZ3	1:G:70:LEU:CD1	2.18	0.56
1:H:344:LEU:HB3	1:H:385:VAL:HG23	1.87	0.56
1:J:110:ARG:CZ	3:J:504:HOH:O	2.54	0.55
1:E:355:LEU:O	1:E:358:LEU:HD13	2.06	0.55
1:H:15:ARG:NH1	1:H:294:LEU:CD1	2.69	0.55
1:H:157:VAL:HG13	1:H:164:ARG:HG2	1.88	0.55
1:I:144:TYR:HA	3:I:504:HOH:O	2.06	0.55
1:B:54:ARG:NH2	1:B:202:GLU:OE1	2.40	0.55
1:F:30:PRO:HB2	3:F:502:HOH:O	2.06	0.55
1:H:139:GLU:HG3	3:H:505:HOH:O	2.06	0.55
1:I:127:LEU:HD21	1:I:129:VAL:CG2	2.35	0.55
1:F:164:ARG:HD2	1:F:166:GLU:OE1	2.06	0.55
2:O:2:FRU:H11	2:O:3:FRU:O1	2.06	0.55
1:A:389:GLY:HA2	1:H:278:PHE:CE2	2.42	0.55
1:J:395:THR:HG22	1:J:413:LEU:HD22	1.88	0.54
1:F:210:TYR:HE1	3:F:501:HOH:O	1.87	0.54
1:I:275:ARG:HD3	1:I:387:LEU:HD12	1.89	0.54
1:I:93:ARG:NH2	3:I:506:HOH:O	2.12	0.54
1:J:48:THR:HG21	1:J:379:LEU:HD21	1.89	0.54
1:C:269:ARG:HG2	1:C:269:ARG:HH11	1.73	0.54
1:A:269:ARG:HH11	1:A:269:ARG:HG2	1.73	0.54
1:G:70:LEU:CD1	1:G:70:LEU:H	2.20	0.53
1:H:257:LEU:HD12	1:H:257:LEU:N	2.21	0.53
1:A:115:TRP:CD2	2:K:3:FRU:H61	2.44	0.53
1:C:344:LEU:HD22	1:C:387:LEU:HD11	1.90	0.53

*Continued on next page...*

*Continued from previous page...*

Atom-1	Atom-2	Interatomic distance (Å)	Clash overlap (Å)
1:G:48:THR:HG21	1:G:379:LEU:HD21	1.89	0.53
2:L:1:GLC:HO2	2:L:2:FRU:H11	1.74	0.53
1:B:48:THR:HG21	1:B:379:LEU:HD21	1.91	0.53
1:I:103:PRO:CA	3:I:503:HOH:O	2.56	0.53
1:F:330:TYR:HB2	3:F:507:HOH:O	2.07	0.53
1:F:115:TRP:CD2	2:P:3:FRU:H62	2.43	0.53
1:D:136:ARG:NH1	1:D:145:GLU:OE2	2.42	0.53
1:E:286:HIS:NE2	2:O:1:GLC:O2	2.36	0.53
1:H:213:PHE:CD1	3:H:504:HOH:O	2.53	0.53
1:B:355:LEU:O	1:B:358:LEU:HD13	2.09	0.53
1:E:269:ARG:HG2	1:E:269:ARG:HH11	1.74	0.53
2:Q:1:GLC:C2	2:Q:2:FRU:H11	2.38	0.53
1:C:341:ARG:HH12	1:C:409:GLU:HG2	1.74	0.52
1:G:115:TRP:CD2	2:Q:3:FRU:H62	2.44	0.52
1:I:15:ARG:NH2	3:I:507:HOH:O	2.42	0.52
1:H:64:TRP:CZ2	1:H:93:ARG:HD3	2.44	0.52
1:H:240:ILE:CG2	1:H:257:LEU:CD1	2.86	0.52
2:M:1:GLC:C2	2:M:2:FRU:H11	2.35	0.52
1:H:269:ARG:HH11	1:H:269:ARG:HG2	1.74	0.52
1:C:269:ARG:HA	3:C:502:HOH:O	2.09	0.52
1:J:47:ASP:OD2	2:U:3:FRU:H11	2.10	0.52
1:F:269:ARG:HH11	1:F:269:ARG:HG2	1.74	0.52
1:J:121:LEU:CD1	1:J:156:VAL:HG11	2.39	0.52
1:D:269:ARG:HG2	1:D:269:ARG:HH11	1.75	0.52
1:G:47:ASP:OD2	2:Q:3:FRU:H11	2.10	0.52
1:B:402:ARG:CZ	3:B:504:HOH:O	2.31	0.51
1:G:380:ALA:N	3:G:503:HOH:O	2.08	0.51
1:I:269:ARG:HG2	1:I:269:ARG:HH11	1.75	0.51
1:C:330:TYR:O	1:C:351:ASN:HB3	2.11	0.51
3:D:506:HOH:O	2:N:3:FRU:H3	2.09	0.51
1:H:206:SER:HB2	1:H:208:LYS:HG3	1.92	0.51
1:I:47:ASP:OD2	2:T:3:FRU:H11	2.10	0.51
1:I:389:GLY:HA2	1:J:278:PHE:CE2	2.46	0.51
1:H:148:LEU:HD13	1:H:195:PHE:CD2	2.46	0.51
1:H:175:LEU:HD21	1:H:251:TRP:HB2	1.92	0.51
1:J:269:ARG:HG2	1:J:269:ARG:HH11	1.75	0.51
1:A:42:GLU:HG3	1:A:43:ILE:HG12	1.93	0.51
1:C:280:TYR:CE2	1:C:387:LEU:HD22	2.46	0.51
1:D:330:TYR:O	1:D:351:ASN:HB3	2.11	0.51
1:D:382:THR:HG21	1:D:402:ARG:O	2.11	0.51
1:F:330:TYR:CA	3:F:507:HOH:O	2.59	0.51

*Continued on next page...*

*Continued from previous page...*

Atom-1	Atom-2	Interatomic distance (Å)	Clash overlap (Å)
1:B:330:TYR:O	1:B:351:ASN:HB3	2.11	0.51
1:G:269:ARG:HG2	1:G:269:ARG:HH11	1.75	0.51
1:G:330:TYR:O	1:G:351:ASN:HB3	2.10	0.51
1:J:330:TYR:O	1:J:351:ASN:HB3	2.11	0.51
1:B:36:ARG:NH2	1:D:373:ALA:HA	2.25	0.50
1:C:157:VAL:CG2	1:C:164:ARG:HG2	2.41	0.50
3:G:505:HOH:O	2:Q:3:FRU:O6	2.17	0.50
1:A:161:ASP:OD1	1:C:147:ARG:NH2	2.45	0.50
1:B:269:ARG:HG2	1:B:269:ARG:HH11	1.77	0.50
1:B:83:ASP:CA	3:B:501:HOH:O	2.59	0.50
1:F:382:THR:HG21	1:F:402:ARG:O	2.12	0.50
1:H:36:ARG:HD2	1:H:36:ARG:N	2.26	0.50
1:A:330:TYR:O	1:A:351:ASN:HB3	2.11	0.50
1:F:330:TYR:O	1:F:351:ASN:HB3	2.12	0.50
1:I:330:TYR:O	1:I:351:ASN:HB3	2.11	0.50
1:B:286:HIS:HE1	2:L:1:GLC:H3	1.75	0.50
1:E:330:TYR:O	1:E:351:ASN:HB3	2.11	0.50
1:H:330:TYR:O	1:H:351:ASN:HB3	2.12	0.50
1:B:148:LEU:HD13	1:B:195:PHE:CD2	2.46	0.49
1:E:115:TRP:CG	2:O:3:FRU:H62	2.47	0.49
1:G:206:SER:HB2	1:G:208:LYS:HG3	1.92	0.49
1:H:174:LEU:C	1:H:175:LEU:HD22	2.33	0.49
1:J:357:GLY:HA2	3:J:503:HOH:O	1.96	0.49
1:B:382:THR:HG21	1:B:402:ARG:O	2.13	0.49
1:C:286:HIS:NE2	2:M:1:GLC:O2	2.33	0.49
1:I:348:GLY:C	3:I:501:HOH:O	2.36	0.49
1:C:282:PHE:HB3	1:C:300:LEU:HD11	1.94	0.49
3:D:506:HOH:O	2:N:3:FRU:O4	2.20	0.49
1:E:115:TRP:CD1	2:O:3:FRU:H62	2.47	0.49
1:H:64:TRP:CD2	1:H:93:ARG:HD2	2.47	0.49
1:H:115:TRP:CG	2:R:3:FRU:H61	2.48	0.49
1:I:93:ARG:NH1	3:I:506:HOH:O	2.41	0.49
1:E:282:PHE:HB3	1:E:300:LEU:HD11	1.95	0.49
1:F:42:GLU:HG3	1:F:43:ILE:HG12	1.95	0.49
1:H:83:ASP:O	1:H:113:ARG:HG2	2.12	0.49
1:H:113:ARG:CD	1:H:134:SER:HB3	2.42	0.49
1:J:82:HIS:HD2	2:U:3:FRU:H62	1.77	0.49
1:F:148:LEU:HD13	1:F:195:PHE:CD2	2.48	0.49
1:G:64:TRP:CD2	1:G:93:ARG:HD2	2.47	0.49
1:G:282:PHE:HB3	1:G:300:LEU:HD11	1.95	0.49
1:G:382:THR:HG21	1:G:402:ARG:O	2.13	0.49

*Continued on next page...*



*Continued from previous page...*

Atom-1	Atom-2	Interatomic distance (Å)	Clash overlap (Å)
1:H:282:PHE:HB3	1:H:300:LEU:HD11	1.95	0.49
1:J:382:THR:HG21	1:J:402:ARG:O	2.12	0.49
1:F:330:TYR:N	3:F:507:HOH:O	2.41	0.49
1:J:282:PHE:HB3	1:J:300:LEU:HD11	1.95	0.49
1:D:368:PRO:HB3	1:D:372:ARG:HH12	1.78	0.48
1:G:150:VAL:CG1	1:G:174:LEU:HD11	2.40	0.48
1:I:215:ALA:HA	3:I:502:HOH:O	2.10	0.48
1:B:50:PHE:CD2	1:B:58:ILE:HD11	2.47	0.48
1:C:164:ARG:HG3	1:C:166:GLU:HG3	1.95	0.48
1:F:344:LEU:HD22	1:F:387:LEU:HD11	1.95	0.48
1:G:148:LEU:HD13	1:G:195:PHE:CD2	2.49	0.48
1:A:382:THR:HG21	1:A:402:ARG:O	2.12	0.48
1:A:282:PHE:HB3	1:A:300:LEU:HD11	1.95	0.48
1:G:380:ALA:CB	3:G:503:HOH:O	2.60	0.48
1:F:282:PHE:HB3	1:F:300:LEU:HD11	1.95	0.48
2:P:1:GLC:O2	2:P:2:FRU:H11	2.14	0.48
1:C:382:THR:HG21	1:C:402:ARG:O	2.13	0.48
1:G:344:LEU:HD22	1:G:387:LEU:HD11	1.95	0.48
1:C:387:LEU:HD23	1:C:392:THR:HG22	1.96	0.48
1:G:157:VAL:CG2	1:G:164:ARG:HG2	2.43	0.48
1:A:344:LEU:HD22	1:A:387:LEU:HD11	1.95	0.48
1:D:282:PHE:HB3	1:D:300:LEU:HD11	1.95	0.48
1:E:147:ARG:NH2	3:E:504:HOH:O	2.46	0.48
1:E:344:LEU:HD22	1:E:387:LEU:HD11	1.96	0.48
1:E:382:THR:HG21	1:E:402:ARG:O	2.14	0.48
1:H:155:SER:CA	3:H:503:HOH:O	2.01	0.48
1:I:382:THR:HG21	1:I:402:ARG:O	2.14	0.48
1:A:47:ASP:OD2	2:K:3:FRU:H11	2.14	0.47
1:H:322:LEU:C	1:H:322:LEU:HD23	2.35	0.47
2:T:1:GLC:O2	2:T:2:FRU:H11	2.13	0.47
1:B:282:PHE:HB3	1:B:300:LEU:HD11	1.95	0.47
2:K:1:GLC:O2	2:K:2:FRU:H11	2.14	0.47
1:F:209:THR:OG1	1:F:243:SER:HB3	2.15	0.47
1:F:181:ARG:NH1	3:F:503:HOH:O	2.36	0.47
1:I:215:ALA:CB	3:I:502:HOH:O	2.62	0.47
1:B:64:TRP:CH2	1:B:93:ARG:HD3	2.50	0.47
1:B:268:GLU:OE1	2:L:3:FRU:H12	2.15	0.47
1:H:382:THR:HG21	1:H:402:ARG:O	2.15	0.47
1:D:344:LEU:HD22	1:D:387:LEU:HD11	1.97	0.47
1:I:282:PHE:HB3	1:I:300:LEU:HD11	1.95	0.47
1:B:265:GLN:NE2	3:B:506:HOH:O	2.00	0.47

*Continued on next page...*



*Continued from previous page...*

Atom-1	Atom-2	Interatomic distance (Å)	Clash overlap (Å)
1:G:127:LEU:CD2	1:G:129:VAL:HG23	2.45	0.47
1:F:330:TYR:C	3:F:507:HOH:O	2.53	0.46
1:I:150:VAL:CG1	1:I:174:LEU:HD11	2.40	0.46
1:I:344:LEU:HD22	1:I:387:LEU:HD11	1.98	0.46
1:B:372:ARG:NH2	1:J:221:GLU:OE1	2.48	0.46
1:B:185:GLU:HB2	1:B:193:TYR:CE1	2.51	0.46
1:F:65:ARG:NE	1:F:405:LEU:HD13	2.30	0.46
1:J:65:ARG:NE	1:J:405:LEU:HD13	2.31	0.46
1:B:226:CYS:SG	1:B:231:TRP:HB2	2.56	0.46
1:E:209:THR:OG1	1:E:243:SER:HB3	2.16	0.46
1:C:414:PRO:C	3:C:503:HOH:O	2.54	0.46
1:D:209:THR:OG1	1:D:243:SER:HB3	2.16	0.46
1:J:344:LEU:HD22	1:J:387:LEU:HD11	1.98	0.46
1:D:65:ARG:NE	1:D:405:LEU:HD13	2.31	0.45
1:H:115:TRP:CD2	2:R:3:FRU:H61	2.51	0.45
1:A:65:ARG:NE	1:A:405:LEU:HD13	2.31	0.45
1:G:286:HIS:NE2	2:Q:1:GLC:O2	2.42	0.45
1:H:174:LEU:HB3	1:H:175:LEU:HD22	1.98	0.45
1:C:150:VAL:HB	1:C:174:LEU:HD11	1.98	0.45
1:H:43:ILE:CG2	1:H:71:THR:HB	2.47	0.45
1:I:15:ARG:NE	3:I:505:HOH:O	2.03	0.45
1:B:48:THR:HG22	1:B:69:SER:OG	2.17	0.45
1:C:48:THR:HG22	1:C:69:SER:OG	2.17	0.45
1:F:47:ASP:OD2	2:P:3:FRU:H11	2.17	0.45
1:G:115:TRP:CE2	2:Q:3:FRU:H62	2.51	0.45
1:J:48:THR:HG22	1:J:69:SER:OG	2.17	0.45
1:A:90:PHE:CD1	1:A:100:ASP:HA	2.52	0.45
1:H:344:LEU:HD22	1:H:387:LEU:HD11	1.98	0.45
1:B:159:ASP:C	3:B:505:HOH:O	2.54	0.45
1:D:183:GLU:OE1	1:D:235:ASN:ND2	2.50	0.45
1:G:48:THR:HG22	1:G:69:SER:OG	2.17	0.45
1:F:48:THR:HG22	1:F:69:SER:OG	2.17	0.45
1:F:194:THR:O	3:F:504:HOH:O	2.21	0.45
1:H:294:LEU:CD1	1:H:294:LEU:N	2.77	0.45
1:B:120:LEU:HD23	1:B:121:LEU:N	2.33	0.44
1:A:206:SER:HB2	1:A:208:LYS:HG2	1.98	0.44
1:J:192:ILE:N	3:J:505:HOH:O	2.12	0.44
1:C:48:THR:O	1:C:269:ARG:NH2	2.51	0.44
1:H:120:LEU:HD23	1:H:122:ASP:N	2.32	0.44
1:I:183:GLU:OE1	1:I:235:ASN:ND2	2.51	0.44
1:J:150:VAL:HB	1:J:174:LEU:HD11	1.99	0.44

*Continued on next page...*

*Continued from previous page...*

Atom-1	Atom-2	Interatomic distance (Å)	Clash overlap (Å)
1:J:91:TYR:CB	3:J:501:HOH:O	2.60	0.44
1:A:183:GLU:OE1	1:A:235:ASN:ND2	2.51	0.44
1:A:389:GLY:HA2	1:H:278:PHE:HE2	1.82	0.44
1:B:175:LEU:CD2	1:B:253:LEU:CD1	2.88	0.44
1:A:150:VAL:HB	1:A:174:LEU:HD11	1.99	0.44
1:I:48:THR:HG22	1:I:69:SER:OG	2.18	0.44
1:J:356:GLY:C	3:J:503:HOH:O	2.47	0.44
1:E:48:THR:HG22	1:E:69:SER:OG	2.18	0.44
1:G:183:GLU:OE1	1:G:235:ASN:ND2	2.51	0.44
1:D:71:THR:HG21	1:D:88:ARG:HD2	2.00	0.44
1:G:174:LEU:HD23	1:G:251:TRP:CD1	2.53	0.44
1:A:71:THR:HG21	1:A:88:ARG:HD3	2.00	0.43
1:B:150:VAL:HB	1:B:174:LEU:HD11	2.00	0.43
1:E:150:VAL:HB	1:E:174:LEU:HD11	2.00	0.43
1:G:298:ASP:HB3	3:G:504:HOH:O	2.14	0.43
1:I:300:LEU:HB3	1:I:322:LEU:CG	2.35	0.43
1:J:48:THR:O	1:J:269:ARG:NH2	2.51	0.43
1:E:71:THR:HG21	1:E:88:ARG:HD2	2.00	0.43
1:A:48:THR:O	1:A:269:ARG:NH2	2.51	0.43
1:B:183:GLU:OE1	1:B:235:ASN:ND2	2.52	0.43
1:H:202:GLU:OE2	1:H:207:GLY:O	2.37	0.43
1:I:48:THR:O	1:I:269:ARG:NH2	2.51	0.43
1:C:183:GLU:OE1	1:C:235:ASN:ND2	2.51	0.43
1:D:50:PHE:CD2	1:D:58:ILE:HD11	2.52	0.43
1:F:170:ALA:N	3:F:506:HOH:O	2.50	0.43
1:H:48:THR:O	1:H:269:ARG:NH2	2.51	0.43
1:H:183:GLU:OE1	1:H:235:ASN:ND2	2.51	0.43
2:Q:2:FRU:H11	2:Q:3:FRU:O1	2.19	0.43
1:E:183:GLU:OE1	1:E:235:ASN:ND2	2.51	0.43
1:H:48:THR:HG22	1:H:69:SER:OG	2.18	0.43
1:I:286:HIS:HE1	2:T:2:FRU:O3	2.00	0.43
1:J:82:HIS:HD2	2:U:3:FRU:C6	2.32	0.43
1:A:115:TRP:CG	2:K:3:FRU:H61	2.54	0.43
1:D:317:GLY:CA	3:D:504:HOH:O	2.59	0.43
1:J:183:GLU:OE1	1:J:235:ASN:ND2	2.51	0.43
1:E:48:THR:O	1:E:269:ARG:NH2	2.51	0.43
1:G:148:LEU:N	1:G:148:LEU:HD12	2.33	0.43
1:H:293:GLY:C	1:H:294:LEU:HD12	2.39	0.43
1:B:120:LEU:HD23	1:B:121:LEU:C	2.39	0.43
1:B:148:LEU:N	1:B:148:LEU:HD12	2.34	0.43
1:D:267:LEU:HD12	1:D:267:LEU:N	2.34	0.43

*Continued on next page...*

*Continued from previous page...*

Atom-1	Atom-2	Interatomic distance (Å)	Clash overlap (Å)
1:H:36:ARG:HD2	1:H:36:ARG:H	1.82	0.43
1:B:286:HIS:NE2	2:L:2:FRU:O3	2.49	0.43
1:G:48:THR:O	1:G:269:ARG:NH2	2.51	0.43
1:B:71:THR:HG21	1:B:88:ARG:HD3	2.01	0.42
1:D:12:ARG:NH1	1:D:261:ILE:HD11	2.34	0.42
1:F:71:THR:HG21	1:F:88:ARG:HD3	2.01	0.42
1:H:257:LEU:N	1:H:257:LEU:CD1	2.81	0.42
1:A:48:THR:HG22	1:A:69:SER:OG	2.18	0.42
1:D:48:THR:O	1:D:269:ARG:NH2	2.51	0.42
1:F:48:THR:O	1:F:269:ARG:NH2	2.52	0.42
1:G:71:THR:HG21	1:G:88:ARG:HD3	2.02	0.42
1:B:403:ILE:HD12	1:B:403:ILE:N	2.34	0.42
1:D:150:VAL:HB	1:D:174:LEU:HD11	2.01	0.42
1:F:253:LEU:HD12	1:F:253:LEU:N	2.35	0.42
1:D:48:THR:HG22	1:D:69:SER:OG	2.20	0.42
1:D:147:ARG:HE	1:D:173:VAL:HG21	1.84	0.42
1:F:148:LEU:HD12	1:F:148:LEU:N	2.34	0.42
1:G:157:VAL:HG23	1:G:164:ARG:HG2	2.00	0.42
2:O:1:GLC:H62	2:O:1:GLC:O3	2.18	0.42
1:E:75:ASP:O	1:E:372:ARG:NE	2.53	0.42
1:G:15:ARG:NH2	1:G:291:ALA:CB	2.82	0.42
1:G:148:LEU:HD23	1:G:211:LEU:HD21	2.01	0.42
1:G:135:GLY:HA2	1:G:143:THR:HG23	2.02	0.42
1:H:240:ILE:HG21	1:H:257:LEU:CD1	2.43	0.42
1:D:286:HIS:CE1	2:N:1:GLC:H3	2.54	0.42
1:H:71:THR:HG21	1:H:88:ARG:HD3	2.02	0.42
1:B:48:THR:O	1:B:269:ARG:NH2	2.52	0.42
1:C:358:LEU:HD13	1:C:366:LEU:HD11	2.02	0.42
1:D:136:ARG:NH1	1:D:145:GLU:OE1	2.50	0.42
1:D:161:ASP:OD1	1:J:147:ARG:NH2	2.53	0.42
1:H:15:ARG:NH2	1:H:294:LEU:HD12	2.35	0.42
1:H:120:LEU:HD23	1:H:120:LEU:C	2.39	0.42
1:H:150:VAL:HB	1:H:174:LEU:HD11	2.01	0.42
1:J:61:VAL:HG23	1:J:61:VAL:O	2.20	0.42
1:F:150:VAL:HB	1:F:174:LEU:HD11	2.02	0.41
1:G:15:ARG:NH2	1:G:291:ALA:HB1	2.35	0.41
1:B:189:ARG:NH2	1:B:221:GLU:HA	2.34	0.41
1:C:54:ARG:HH12	1:C:209:THR:HG1	1.58	0.41
1:E:403:ILE:N	1:E:403:ILE:HD12	2.35	0.41
1:E:88:ARG:HH12	1:E:102:GLY:HA2	1.85	0.41
1:I:395:THR:CG2	1:I:413:LEU:CD2	2.99	0.41

*Continued on next page...*

Continued from previous page...

Atom-1	Atom-2	Interatomic distance (Å)	Clash overlap (Å)
1:I:358:LEU:HD23	1:I:366:LEU:HD11	2.02	0.41
1:J:403:ILE:N	1:J:403:ILE:HD12	2.34	0.41
1:C:71:THR:HG21	1:C:88:ARG:HD3	2.02	0.41
1:F:182:TYR:HD2	1:F:253:LEU:HD23	1.85	0.41
1:I:71:THR:HG21	1:I:88:ARG:HD2	2.03	0.41
1:I:135:GLY:HA2	1:I:143:THR:HG23	2.03	0.41
1:G:403:ILE:N	1:G:403:ILE:HD12	2.36	0.41
1:J:71:THR:HG21	1:J:88:ARG:HD3	2.02	0.41
1:J:114:GLN:OE1	1:J:114:GLN:N	2.54	0.41
1:H:175:LEU:HD12	1:H:253:LEU:CD1	2.51	0.41
1:I:70:LEU:CD1	2:T:3:FRU:H5	2.50	0.41
1:F:275:ARG:NH1	1:F:339:SER:OG	2.54	0.40
1:I:182:TYR:HD2	1:I:253:LEU:HD23	1.87	0.40
1:D:136:ARG:NH1	1:D:145:GLU:CD	2.75	0.40
1:F:115:TRP:CD1	2:P:3:FRU:H62	2.56	0.40
1:I:403:ILE:HD12	1:I:403:ILE:N	2.36	0.40
2:Q:1:GLC:C2	2:Q:2:FRU:C1	2.98	0.40
1:A:403:ILE:HD12	1:A:403:ILE:N	2.35	0.40
1:I:379:LEU:HA	3:I:501:HOH:O	2.20	0.40
2:R:1:GLC:O2	2:R:2:FRU:H11	2.21	0.40

There are no symmetry-related clashes.

## 5.3 Torsion angles [i](#)

### 5.3.1 Protein backbone [i](#)

In the following table, the Percentiles column shows the percent Ramachandran outliers of the chain as a percentile score with respect to all X-ray entries followed by that with respect to entries of similar resolution.

The Analysed column shows the number of residues for which the backbone conformation was analysed, and the total number of residues.

Mol	Chain	Analysed	Favoured	Allowed	Outliers	Percentiles
1	A	404/428 (94%)	383 (95%)	21 (5%)	0	100   100
1	B	404/428 (94%)	385 (95%)	19 (5%)	0	100   100
1	C	404/428 (94%)	384 (95%)	20 (5%)	0	100   100
1	D	404/428 (94%)	384 (95%)	20 (5%)	0	100   100

Continued on next page...

Continued from previous page...

Mol	Chain	Analysed	Favoured	Allowed	Outliers	Percentiles	
1	E	404/428 (94%)	383 (95%)	21 (5%)	0	100	100
1	F	404/428 (94%)	383 (95%)	21 (5%)	0	100	100
1	G	404/428 (94%)	385 (95%)	19 (5%)	0	100	100
1	H	404/428 (94%)	383 (95%)	21 (5%)	0	100	100
1	I	404/428 (94%)	384 (95%)	20 (5%)	0	100	100
1	J	404/428 (94%)	380 (94%)	24 (6%)	0	100	100
All	All	4040/4280 (94%)	3834 (95%)	206 (5%)	0	100	100

There are no Ramachandran outliers to report.

### 5.3.2 Protein sidechains [i](#)

In the following table, the Percentiles column shows the percent sidechain outliers of the chain as a percentile score with respect to all X-ray entries followed by that with respect to entries of similar resolution.

The Analysed column shows the number of residues for which the sidechain conformation was analysed, and the total number of residues.

Mol	Chain	Analysed	Rotameric	Outliers	Percentiles	
1	A	329/348 (94%)	327 (99%)	2 (1%)	86	94
1	B	329/348 (94%)	326 (99%)	3 (1%)	78	91
1	C	329/348 (94%)	327 (99%)	2 (1%)	86	94
1	D	329/348 (94%)	325 (99%)	4 (1%)	71	88
1	E	329/348 (94%)	324 (98%)	5 (2%)	65	85
1	F	329/348 (94%)	326 (99%)	3 (1%)	78	91
1	G	329/348 (94%)	325 (99%)	4 (1%)	71	88
1	H	329/348 (94%)	325 (99%)	4 (1%)	71	88
1	I	329/348 (94%)	324 (98%)	5 (2%)	65	85
1	J	329/348 (94%)	326 (99%)	3 (1%)	78	91
All	All	3290/3480 (94%)	3255 (99%)	35 (1%)	73	89

All (35) residues with a non-rotameric sidechain are listed below:

Mol	Chain	Res	Type
1	A	113	ARG

Continued on next page...

*Continued from previous page...*

<b>Mol</b>	<b>Chain</b>	<b>Res</b>	<b>Type</b>
1	A	193	TYR
1	B	113	ARG
1	B	226	CYS
1	B	322	LEU
1	C	113	ARG
1	C	193	TYR
1	D	113	ARG
1	D	193	TYR
1	D	206	SER
1	D	378	THR
1	E	113	ARG
1	E	147	ARG
1	E	193	TYR
1	E	206	SER
1	E	378	THR
1	F	113	ARG
1	F	147	ARG
1	F	193	TYR
1	G	113	ARG
1	G	193	TYR
1	G	226	CYS
1	G	258	LEU
1	H	113	ARG
1	H	193	TYR
1	H	226	CYS
1	H	372	ARG
1	I	113	ARG
1	I	193	TYR
1	I	226	CYS
1	I	322	LEU
1	I	395	THR
1	J	113	ARG
1	J	193	TYR
1	J	206	SER

Sometimes sidechains can be flipped to improve hydrogen bonding and reduce clashes. All (11) such sidechains are listed below:

<b>Mol</b>	<b>Chain</b>	<b>Res</b>	<b>Type</b>
1	A	286	HIS
1	B	351	ASN
1	D	286	HIS
1	F	286	HIS

*Continued on next page...*

Continued from previous page...

Mol	Chain	Res	Type
1	G	242	HIS
1	H	242	HIS
1	I	242	HIS
1	I	276	ASN
1	I	286	HIS
1	J	82	HIS
1	J	114	GLN

### 5.3.3 RNA [i](#)

There are no RNA molecules in this entry.

### 5.4 Non-standard residues in protein, DNA, RNA chains [i](#)

There are no non-standard protein/DNA/RNA residues in this entry.

### 5.5 Carbohydrates [i](#)

30 monosaccharides are modelled in this entry.

In the following table, the Counts columns list the number of bonds (or angles) for which Mogul statistics could be retrieved, the number of bonds (or angles) that are observed in the model and the number of bonds (or angles) that are defined in the Chemical Component Dictionary. The Link column lists molecule types, if any, to which the group is linked. The Z score for a bond length (or angle) is the number of standard deviations the observed value is removed from the expected value. A bond length (or angle) with  $|Z| > 2$  is considered an outlier worth inspection. RMSZ is the root-mean-square of all Z scores of the bond lengths (or angles).

Mol	Type	Chain	Res	Link	Bond lengths			Bond angles		
					Counts	RMSZ	$\# Z  > 2$	Counts	RMSZ	$\# Z  > 2$
2	GLC	K	1	2	11,11,12	0.27	0	15,15,17	0.65	0
2	FRU	K	2	2	11,12,12	0.54	0	10,18,18	0.93	0
2	FRU	K	3	2	11,11,12	0.39	0	15,15,18	1.16	1 (6%)
2	GLC	L	1	2	11,11,12	0.27	0	15,15,17	0.64	0
2	FRU	L	2	2	11,12,12	0.55	0	10,18,18	0.88	0
2	FRU	L	3	2	11,11,12	0.40	0	15,15,18	1.14	0
2	GLC	M	1	2	11,11,12	0.26	0	15,15,17	0.61	0
2	FRU	M	2	2	11,12,12	0.59	0	10,18,18	0.87	0
2	FRU	M	3	2	11,11,12	0.39	0	15,15,18	1.17	1 (6%)
2	GLC	N	1	2	11,11,12	0.27	0	15,15,17	0.67	0
2	FRU	N	2	2	11,12,12	0.56	0	10,18,18	0.90	0

Mol	Type	Chain	Res	Link	Bond lengths			Bond angles		
					Counts	RMSZ	# Z  > 2	Counts	RMSZ	# Z  > 2
2	FRU	N	3	2	11,11,12	0.40	0	15,15,18	1.16	0
2	GLC	O	1	2	11,11,12	0.26	0	15,15,17	0.63	0
2	FRU	O	2	2	11,12,12	0.60	0	10,18,18	0.88	0
2	FRU	O	3	2	11,11,12	0.39	0	15,15,18	1.15	0
2	GLC	P	1	2	11,11,12	0.26	0	15,15,17	0.64	0
2	FRU	P	2	2	11,12,12	0.54	0	10,18,18	0.92	0
2	FRU	P	3	2	11,11,12	0.40	0	15,15,18	1.16	0
2	GLC	Q	1	2	11,11,12	0.26	0	15,15,17	0.64	0
2	FRU	Q	2	2	11,12,12	0.61	0	10,18,18	0.87	0
2	FRU	Q	3	2	11,11,12	0.39	0	15,15,18	1.13	0
2	GLC	R	1	2	11,11,12	0.26	0	15,15,17	0.67	0
2	FRU	R	2	2	11,12,12	0.58	0	10,18,18	0.91	0
2	FRU	R	3	2	11,11,12	0.40	0	15,15,18	1.12	0
2	GLC	T	1	2	11,11,12	0.26	0	15,15,17	0.65	0
2	FRU	T	2	2	11,12,12	0.55	0	10,18,18	0.91	0
2	FRU	T	3	2	11,11,12	0.39	0	15,15,18	1.13	0
2	GLC	U	1	2	11,11,12	0.26	0	15,15,17	0.67	0
2	FRU	U	2	2	11,12,12	0.58	0	10,18,18	0.92	0
2	FRU	U	3	2	11,11,12	0.40	0	15,15,18	1.13	0

In the following table, the Chirals column lists the number of chiral outliers, the number of chiral centers analysed, the number of these observed in the model and the number defined in the Chemical Component Dictionary. Similar counts are reported in the Torsion and Rings columns. '-' means no outliers of that kind were identified.

Mol	Type	Chain	Res	Link	Chirals	Torsions	Rings
2	GLC	K	1	2	-	0/2/19/22	0/1/1/1
2	FRU	K	2	2	-	3/5/24/24	0/1/1/1
2	FRU	K	3	2	-	3/4/20/24	0/1/1/1
2	GLC	L	1	2	-	0/2/19/22	0/1/1/1
2	FRU	L	2	2	-	5/5/24/24	0/1/1/1
2	FRU	L	3	2	-	3/4/20/24	0/1/1/1
2	GLC	M	1	2	-	1/2/19/22	0/1/1/1
2	FRU	M	2	2	-	4/5/24/24	0/1/1/1
2	FRU	M	3	2	-	0/4/20/24	0/1/1/1
2	GLC	N	1	2	-	2/2/19/22	0/1/1/1
2	FRU	N	2	2	-	5/5/24/24	0/1/1/1
2	FRU	N	3	2	-	4/4/20/24	0/1/1/1
2	GLC	O	1	2	-	2/2/19/22	0/1/1/1
2	FRU	O	2	2	-	3/5/24/24	0/1/1/1

Continued on next page...



Continued from previous page...

Mol	Type	Chain	Res	Link	Chirals	Torsions	Rings
2	FRU	O	3	2	-	0/4/20/24	0/1/1/1
2	GLC	P	1	2	-	2/2/19/22	0/1/1/1
2	FRU	P	2	2	-	3/5/24/24	0/1/1/1
2	FRU	P	3	2	-	2/4/20/24	0/1/1/1
2	GLC	Q	1	2	-	2/2/19/22	0/1/1/1
2	FRU	Q	2	2	-	3/5/24/24	0/1/1/1
2	FRU	Q	3	2	-	3/4/20/24	0/1/1/1
2	GLC	R	1	2	-	2/2/19/22	0/1/1/1
2	FRU	R	2	2	-	3/5/24/24	0/1/1/1
2	FRU	R	3	2	-	2/4/20/24	0/1/1/1
2	GLC	T	1	2	-	0/2/19/22	0/1/1/1
2	FRU	T	2	2	-	5/5/24/24	0/1/1/1
2	FRU	T	3	2	-	3/4/20/24	0/1/1/1
2	GLC	U	1	2	-	2/2/19/22	0/1/1/1
2	FRU	U	2	2	-	4/5/24/24	0/1/1/1
2	FRU	U	3	2	-	2/4/20/24	0/1/1/1

There are no bond length outliers.

All (2) bond angle outliers are listed below:

Mol	Chain	Res	Type	Atoms	Z	Observed(°)	Ideal(°)
2	M	3	FRU	C1-C2-C3	-2.04	110.18	115.09
2	K	3	FRU	C1-C2-C3	-2.02	110.22	115.09

There are no chirality outliers.

All (73) torsion outliers are listed below:

Mol	Chain	Res	Type	Atoms
2	K	2	FRU	O1-C1-C2-C3
2	K	2	FRU	O1-C1-C2-O2
2	L	2	FRU	O1-C1-C2-C3
2	L	2	FRU	O1-C1-C2-O2
2	M	2	FRU	O1-C1-C2-C3
2	M	2	FRU	O1-C1-C2-O2
2	M	2	FRU	O1-C1-C2-O5
2	O	2	FRU	O1-C1-C2-C3
2	O	2	FRU	O1-C1-C2-O2
2	P	2	FRU	O1-C1-C2-C3

Continued on next page...

*Continued from previous page...*

Mol	Chain	Res	Type	Atoms
2	P	2	FRU	O1-C1-C2-O2
2	Q	2	FRU	O1-C1-C2-C3
2	Q	2	FRU	O1-C1-C2-O2
2	Q	2	FRU	O1-C1-C2-O5
2	R	2	FRU	O1-C1-C2-C3
2	R	2	FRU	O1-C1-C2-O2
2	T	2	FRU	O1-C1-C2-C3
2	T	2	FRU	O1-C1-C2-O2
2	U	2	FRU	O1-C1-C2-C3
2	U	2	FRU	O1-C1-C2-O2
2	T	2	FRU	O5-C5-C6-O6
2	T	2	FRU	C4-C5-C6-O6
2	N	2	FRU	O5-C5-C6-O6
2	L	2	FRU	O5-C5-C6-O6
2	L	2	FRU	C4-C5-C6-O6
2	O	1	GLC	O5-C5-C6-O6
2	O	1	GLC	C4-C5-C6-O6
2	P	1	GLC	O5-C5-C6-O6
2	N	2	FRU	C4-C5-C6-O6
2	N	1	GLC	O5-C5-C6-O6
2	Q	1	GLC	O5-C5-C6-O6
2	R	1	GLC	C4-C5-C6-O6
2	R	1	GLC	O5-C5-C6-O6
2	N	1	GLC	C4-C5-C6-O6
2	K	2	FRU	O1-C1-C2-O5
2	L	2	FRU	O1-C1-C2-O5
2	O	2	FRU	O1-C1-C2-O5
2	P	2	FRU	O1-C1-C2-O5
2	R	2	FRU	O1-C1-C2-O5
2	T	2	FRU	O1-C1-C2-O5
2	U	2	FRU	O1-C1-C2-O5
2	P	1	GLC	C4-C5-C6-O6
2	Q	3	FRU	C4-C5-C6-O6
2	M	1	GLC	O5-C5-C6-O6
2	T	3	FRU	O1-C1-C2-C3
2	T	3	FRU	O1-C1-C2-O5
2	N	3	FRU	O5-C5-C6-O6
2	K	3	FRU	O5-C5-C6-O6
2	L	3	FRU	O1-C1-C2-O5
2	L	3	FRU	O5-C5-C6-O6
2	P	3	FRU	O1-C1-C2-O5
2	K	3	FRU	O1-C1-C2-O5

*Continued on next page...*

*Continued from previous page...*

Mol	Chain	Res	Type	Atoms
2	R	3	FRU	O1-C1-C2-O5
2	U	3	FRU	O1-C1-C2-O5
2	K	3	FRU	O1-C1-C2-C3
2	L	3	FRU	O1-C1-C2-C3
2	R	3	FRU	O1-C1-C2-C3
2	U	3	FRU	O1-C1-C2-C3
2	N	2	FRU	O1-C1-C2-C3
2	Q	1	GLC	C4-C5-C6-O6
2	P	3	FRU	O1-C1-C2-C3
2	U	1	GLC	C4-C5-C6-O6
2	Q	3	FRU	O5-C5-C6-O6
2	N	3	FRU	C4-C5-C6-O6
2	U	1	GLC	O5-C5-C6-O6
2	N	2	FRU	O1-C1-C2-O2
2	N	3	FRU	O1-C1-C2-O5
2	T	3	FRU	O5-C5-C6-O6
2	N	3	FRU	O1-C1-C2-C3
2	Q	3	FRU	O1-C1-C2-O5
2	U	2	FRU	O5-C5-C6-O6
2	N	2	FRU	O1-C1-C2-O5
2	M	2	FRU	O5-C5-C6-O6

There are no ring outliers.

28 monomers are involved in 65 short contacts:

Mol	Chain	Res	Type	Clashes	Symm-Clashes
2	P	2	FRU	1	0
2	K	2	FRU	1	0
2	U	3	FRU	3	0
2	T	3	FRU	6	0
2	T	1	GLC	1	0
2	R	1	GLC	1	0
2	M	3	FRU	6	0
2	Q	2	FRU	5	0
2	O	2	FRU	2	0
2	P	3	FRU	4	0
2	K	3	FRU	3	0
2	N	1	GLC	1	0
2	M	2	FRU	3	0
2	O	3	FRU	3	0
2	R	3	FRU	3	0
2	P	1	GLC	1	0

*Continued on next page...*

*Continued from previous page...*

Mol	Chain	Res	Type	Clashes	Symm-Clashes
2	K	1	GLC	1	0
2	L	3	FRU	2	0
2	N	2	FRU	1	0
2	O	1	GLC	3	0
2	R	2	FRU	2	0
2	Q	3	FRU	7	0
2	L	1	GLC	3	0
2	Q	1	GLC	7	0
2	T	2	FRU	4	0
2	L	2	FRU	4	0
2	M	1	GLC	4	0
2	N	3	FRU	3	0

The following is a two-dimensional graphical depiction of Mogul quality analysis of bond lengths, bond angles, torsion angles, and ring geometry for oligosaccharide.

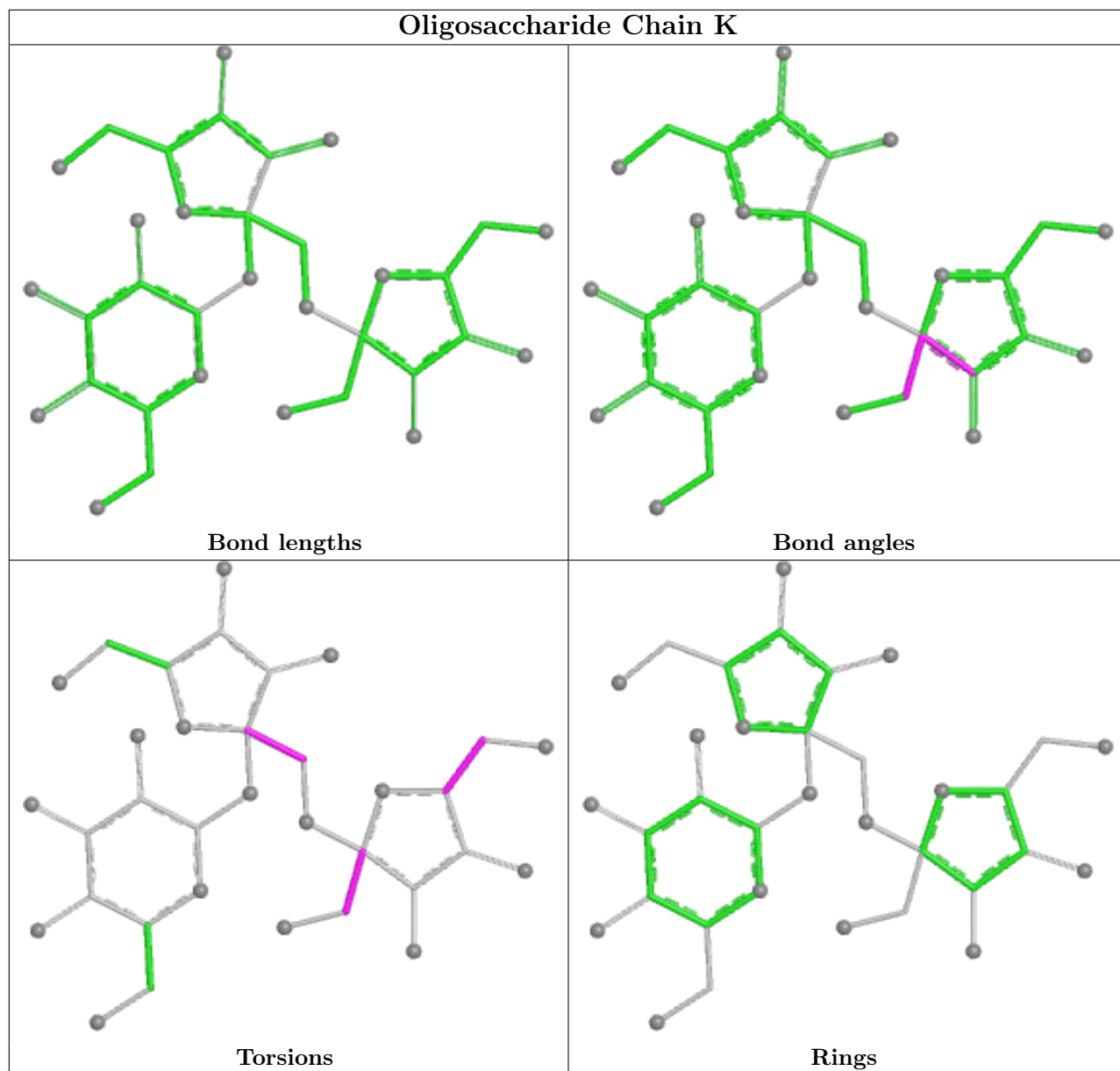

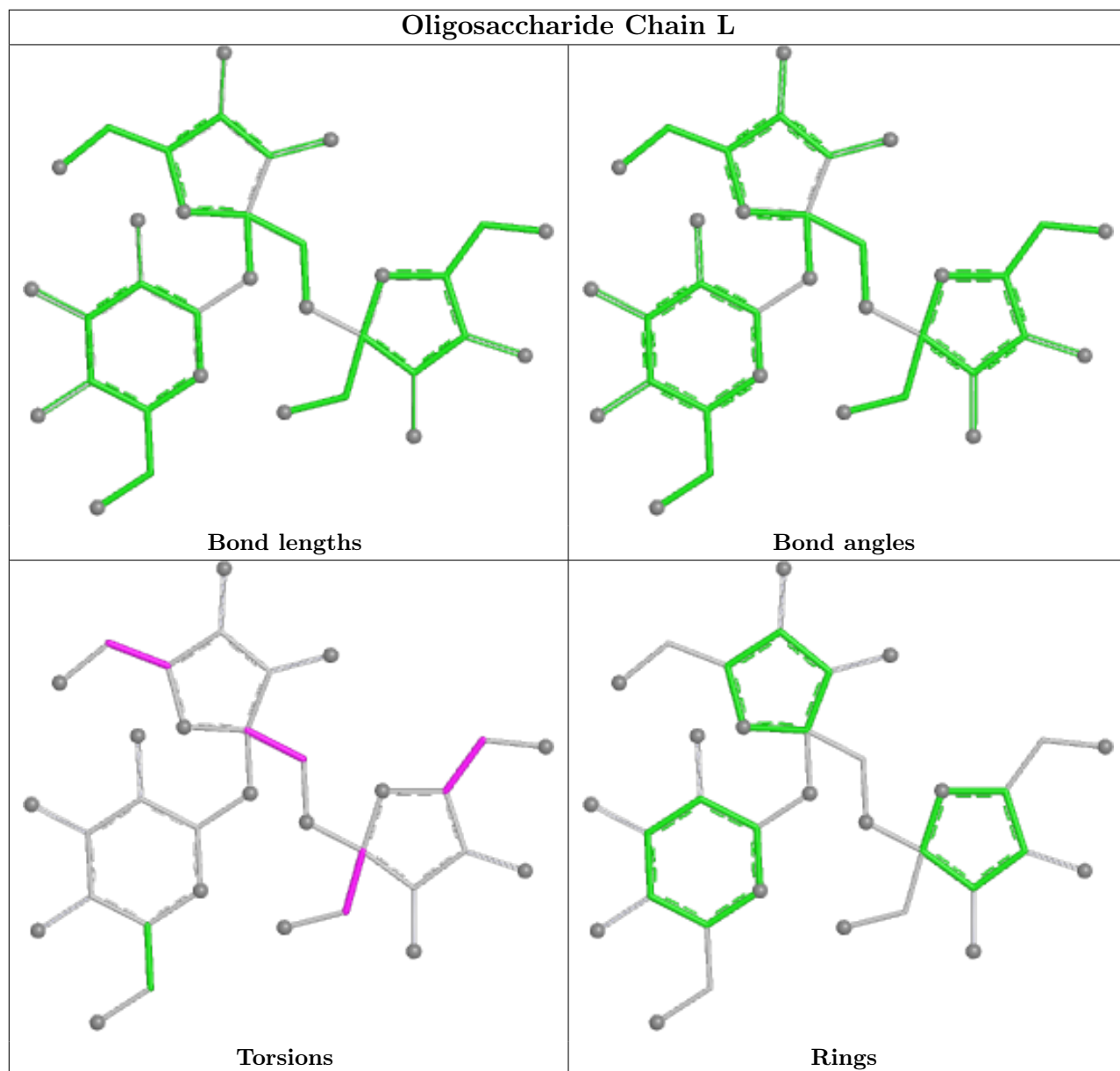

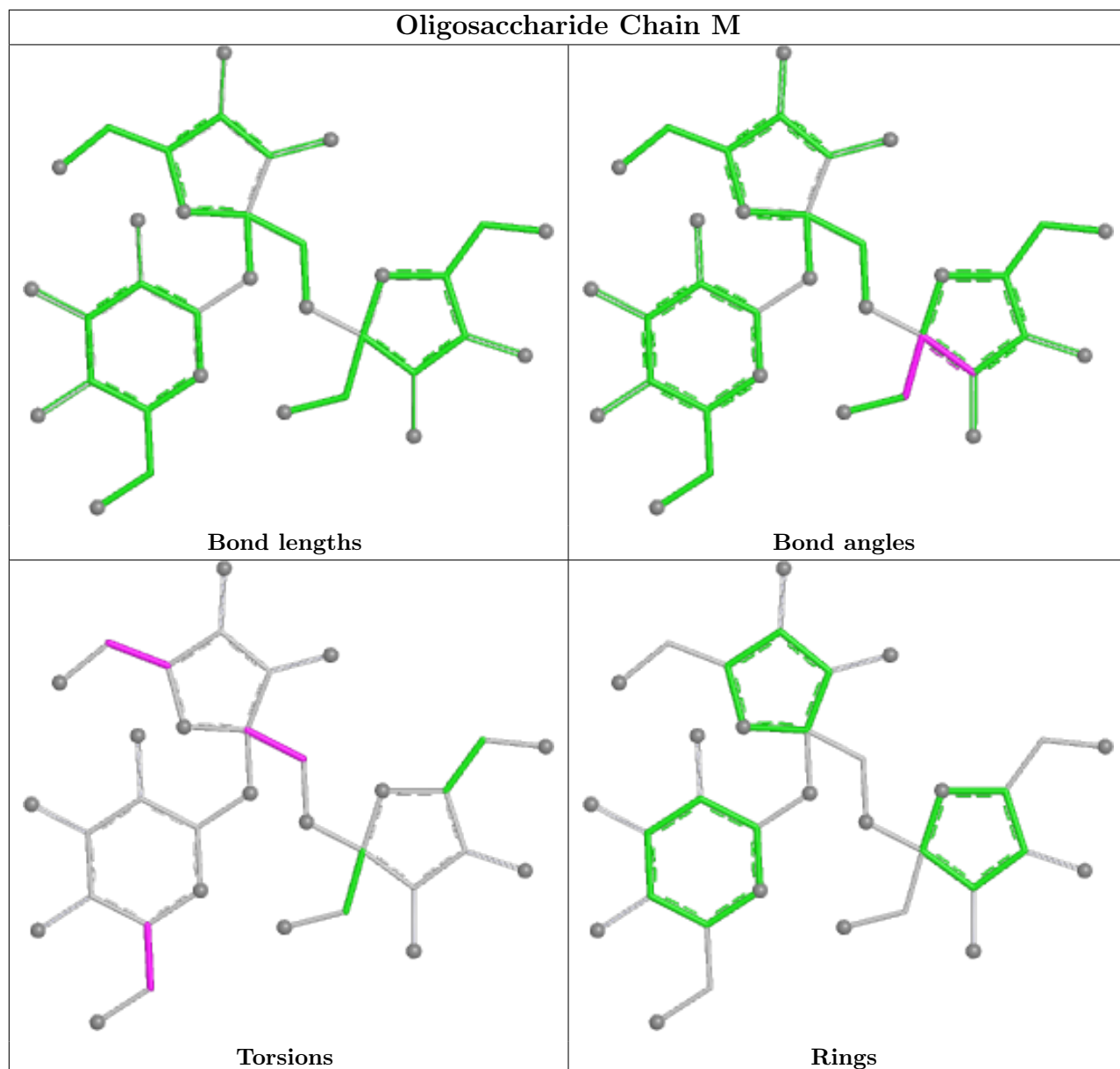

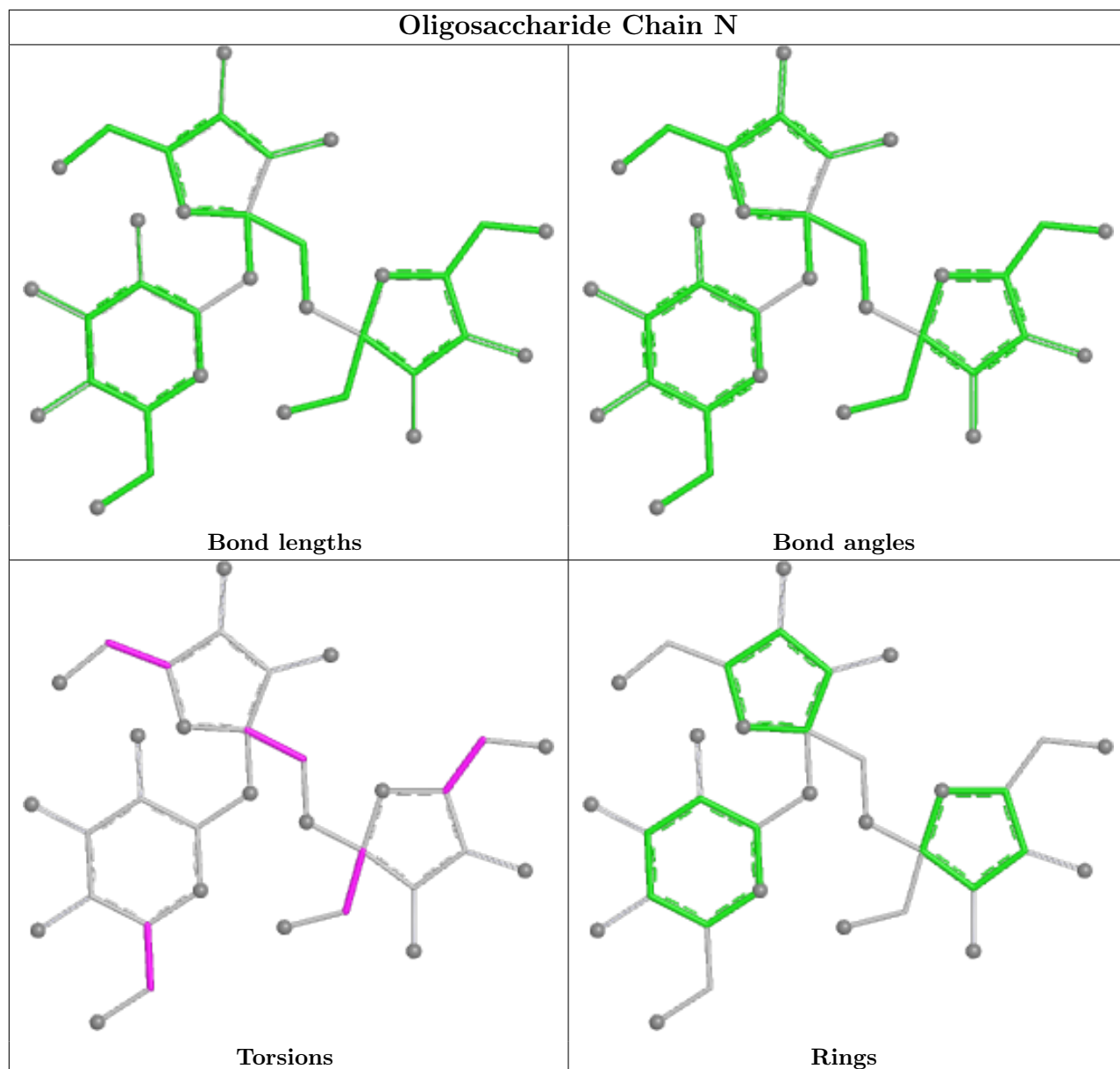



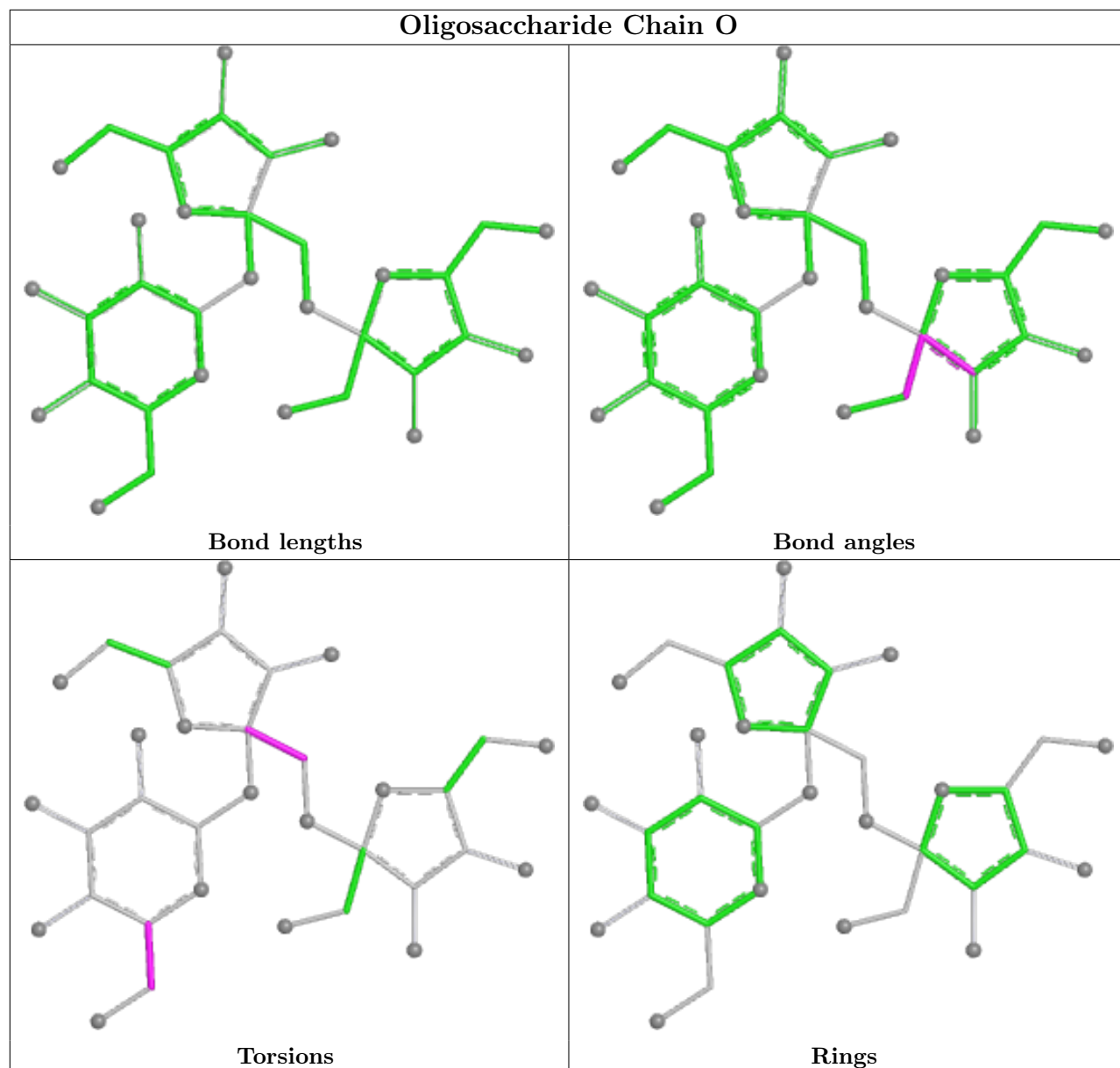

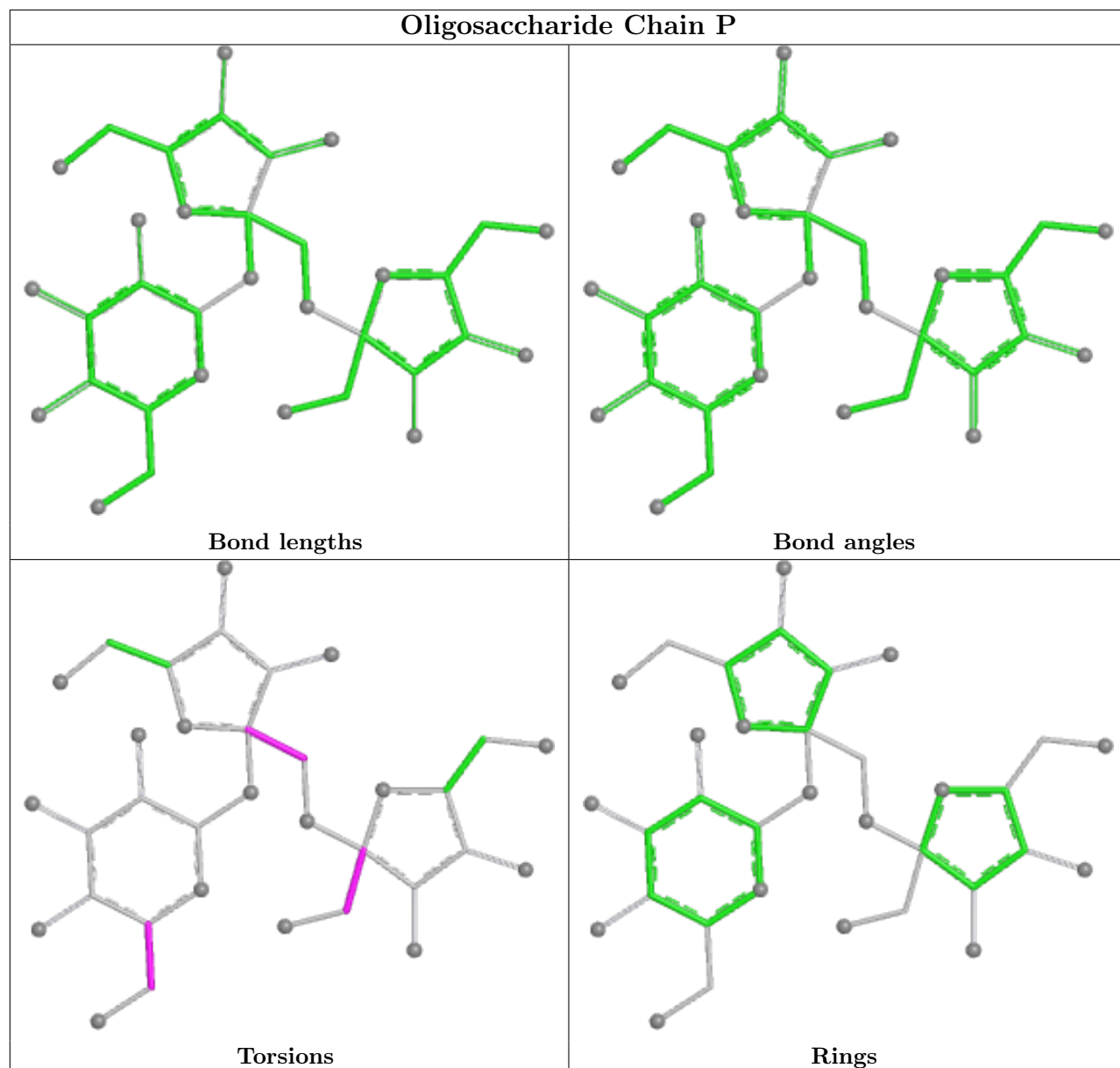

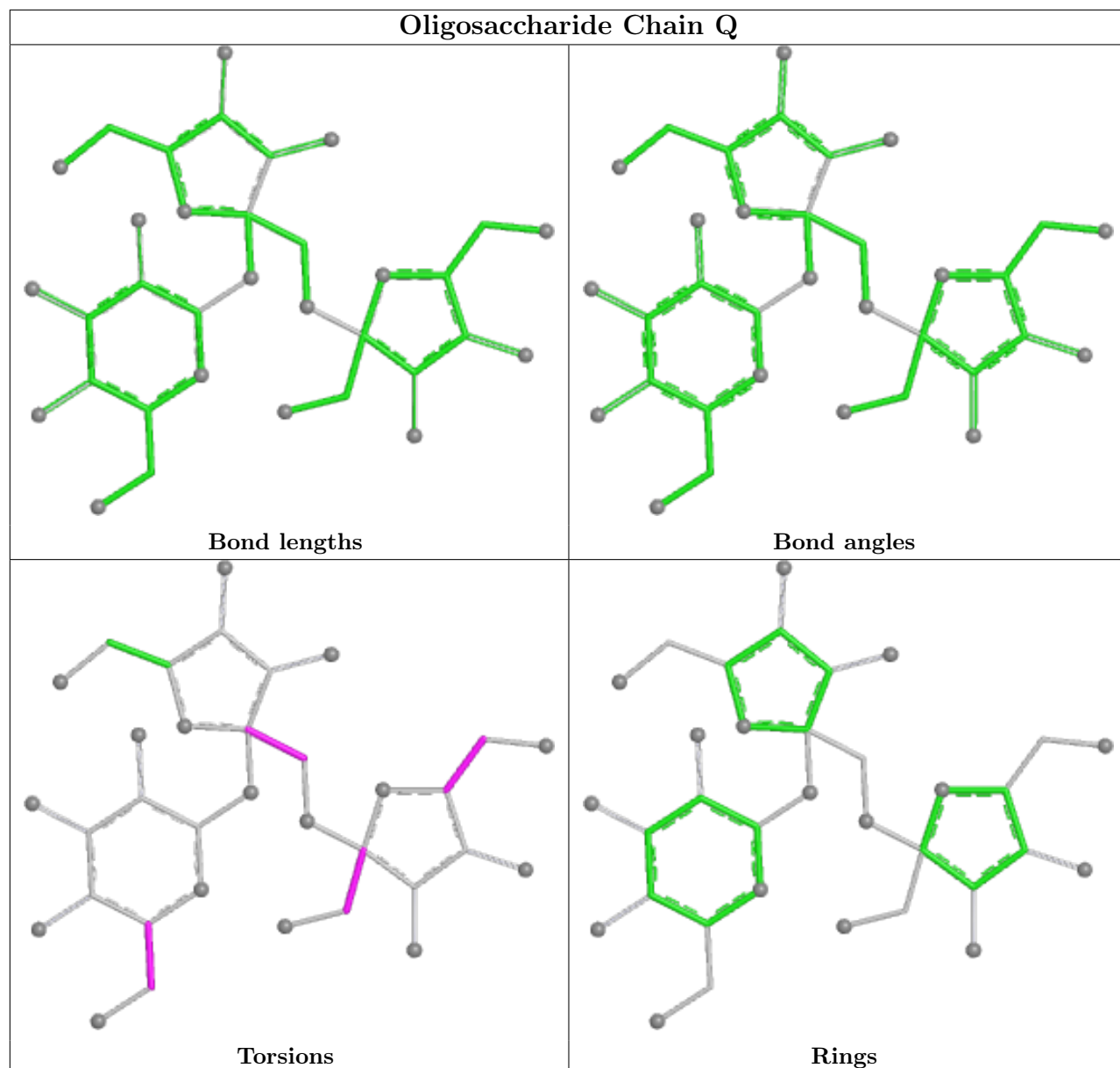

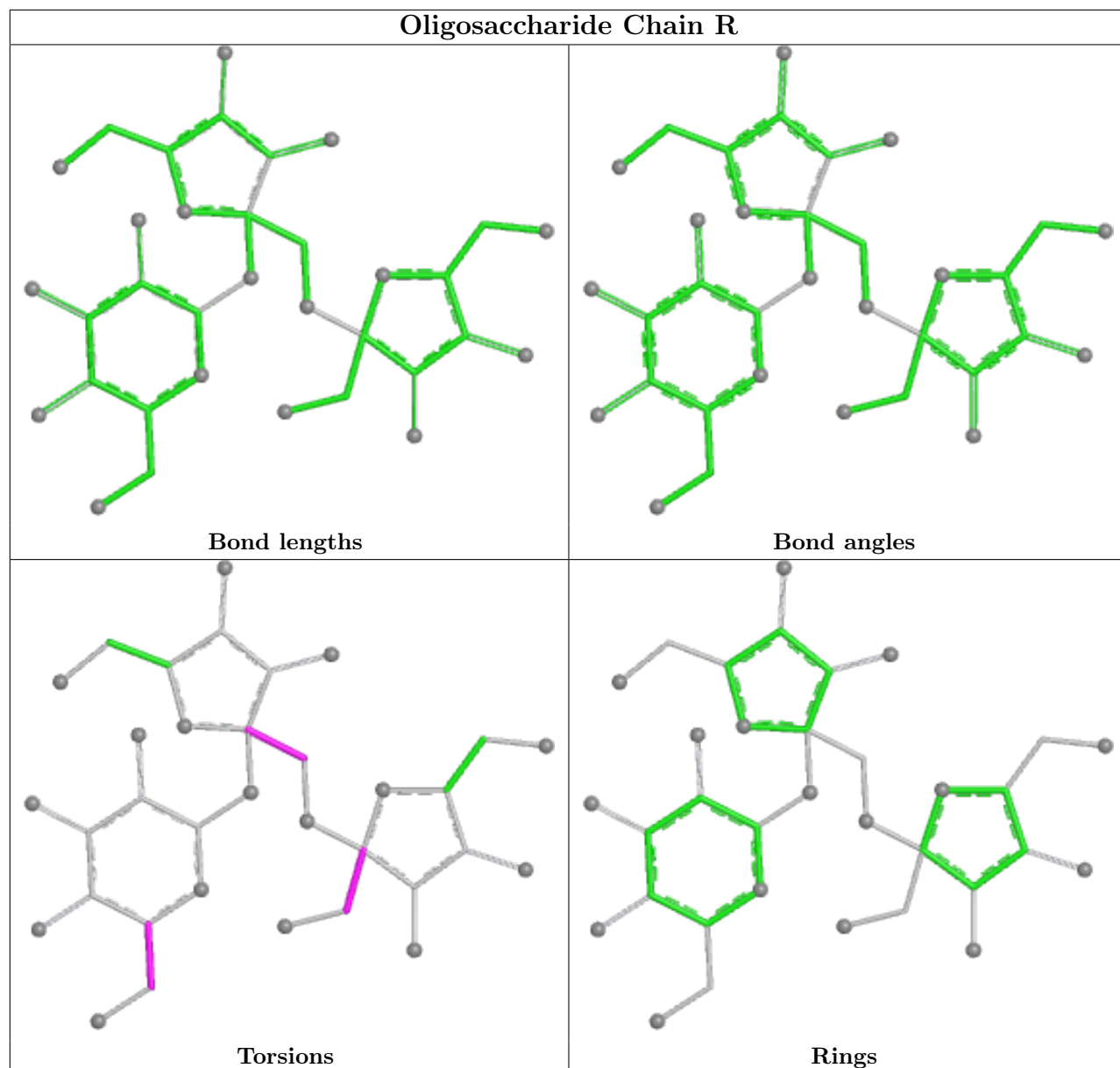

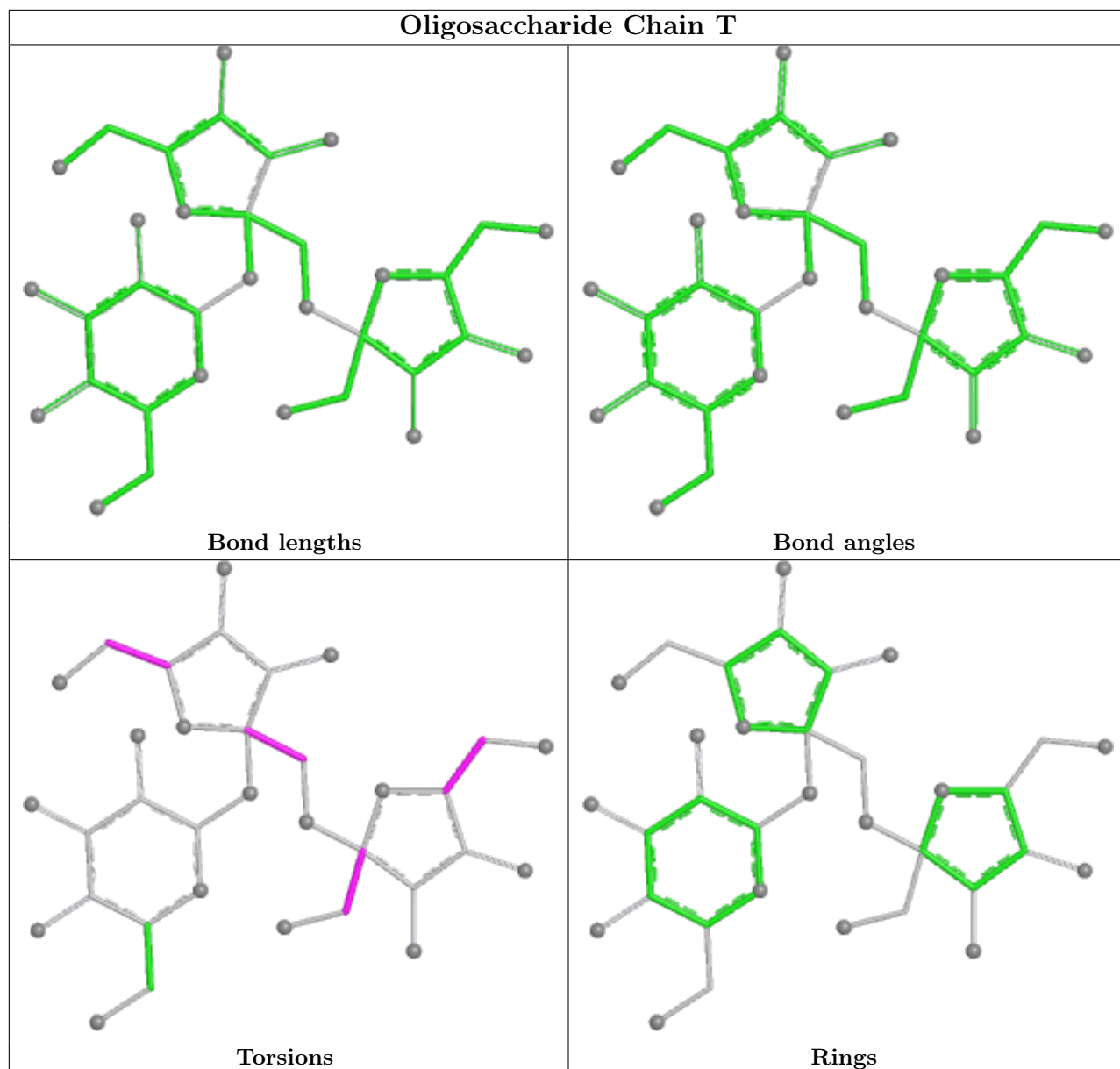

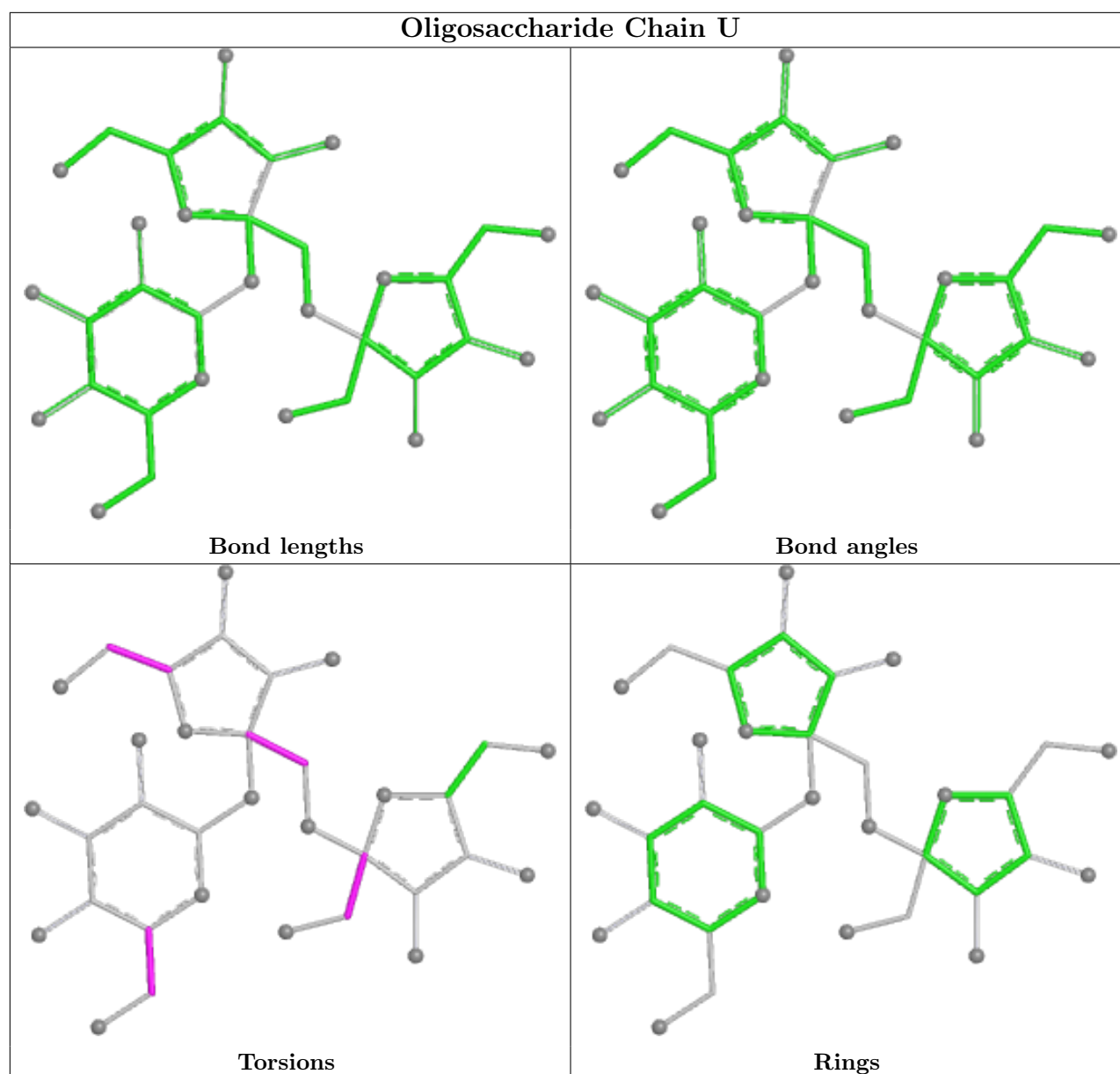

## 5.6 Ligand geometry [i](#)

There are no ligands in this entry.

## 5.7 Other polymers [i](#)

There are no such residues in this entry.

## 5.8 Polymer linkage issues [i](#)

There are no chain breaks in this entry.

## 6 Fit of model and data [i](#)

### 6.1 Protein, DNA and RNA chains [i](#)

In the following table, the column labelled ‘#RSRZ > 2’ contains the number (and percentage) of RSRZ outliers, followed by percent RSRZ outliers for the chain as percentile scores relative to all X-ray entries and entries of similar resolution. The OWAB column contains the minimum, median, 95<sup>th</sup> percentile and maximum values of the occupancy-weighted average B-factor per residue. The column labelled ‘Q < 0.9’ lists the number of (and percentage) of residues with an average occupancy less than 0.9.

Mol	Chain	Analysed	<RSRZ>	#RSRZ>2	OWAB(Å <sup>2</sup> )	Q<0.9
1	A	406/428 (94%)	0.54	3 (0%) 87 89	34, 51, 77, 94	0
1	B	406/428 (94%)	0.87	46 (11%) 5 4	43, 77, 118, 135	0
1	C	406/428 (94%)	0.50	7 (1%) 70 72	37, 56, 81, 93	0
1	D	406/428 (94%)	0.55	3 (0%) 87 89	28, 47, 70, 89	0
1	E	406/428 (94%)	0.56	9 (2%) 62 63	28, 50, 81, 104	0
1	F	406/428 (94%)	0.56	13 (3%) 47 48	37, 57, 83, 106	0
1	G	406/428 (94%)	0.89	46 (11%) 5 4	43, 73, 109, 128	0
1	H	406/428 (94%)	0.85	39 (9%) 8 6	37, 72, 113, 136	0
1	I	406/428 (94%)	0.80	34 (8%) 11 9	44, 72, 103, 121	0
1	J	406/428 (94%)	0.54	7 (1%) 70 72	37, 54, 77, 94	0
All	All	4060/4280 (94%)	0.67	207 (5%) 28 27	28, 58, 102, 136	0

All (207) RSRZ outliers are listed below:

Mol	Chain	Res	Type	RSRZ
1	H	222	GLY	5.5
1	G	174	LEU	5.1
1	I	130	PHE	5.0
1	I	144	TYR	5.0
1	G	223	ALA	5.0
1	B	221	GLU	4.8
1	I	142	ILE	4.6
1	B	169	PHE	4.5
1	G	144	TYR	4.5
1	G	226	CYS	4.5
1	B	220	PRO	4.5
1	I	221	GLU	4.4
1	B	229	PRO	4.3

*Continued on next page...*

*Continued from previous page...*

<b>Mol</b>	<b>Chain</b>	<b>Res</b>	<b>Type</b>	<b>RSRZ</b>
1	B	230	VAL	4.2
1	B	219	ILE	4.2
1	G	225	ALA	4.2
1	H	174	LEU	4.1
1	B	104	VAL	4.0
1	H	148	LEU	4.0
1	H	140	ALA	4.0
1	I	360	LEU	3.9
1	H	223	ALA	3.9
1	C	174	LEU	3.9
1	B	225	ALA	3.9
1	B	182	TYR	3.9
1	I	219	ILE	3.9
1	G	165	ILE	3.8
1	I	220	PRO	3.8
1	G	156	VAL	3.8
1	H	221	GLU	3.7
1	I	166	GLU	3.7
1	E	220	PRO	3.6
1	G	229	PRO	3.6
1	G	140	ALA	3.6
1	I	175	LEU	3.6
1	G	224	GLY	3.5
1	E	219	ILE	3.5
1	B	148	LEU	3.5
1	G	127	LEU	3.5
1	I	127	LEU	3.5
1	G	106	GLU	3.4
1	B	105	PHE	3.4
1	B	61	VAL	3.4
1	C	165	ILE	3.4
1	H	129	VAL	3.4
1	F	142	ILE	3.4
1	G	220	PRO	3.4
1	I	156	VAL	3.4
1	B	128	TYR	3.3
1	I	106	GLU	3.3
1	G	227	GLY	3.3
1	H	68	PHE	3.3
1	G	246	GLY	3.3
1	B	175	LEU	3.2
1	G	219	ILE	3.2

*Continued on next page...*



*Continued from previous page...*

<b>Mol</b>	<b>Chain</b>	<b>Res</b>	<b>Type</b>	<b>RSRZ</b>
1	H	104	VAL	3.2
1	G	141	GLU	3.2
1	B	174	LEU	3.2
1	B	58	ILE	3.2
1	B	251	TRP	3.1
1	B	166	GLU	3.1
1	B	249	THR	3.1
1	B	127	LEU	3.1
1	B	142	ILE	3.1
1	B	156	VAL	3.1
1	G	130	PHE	3.1
1	I	129	VAL	3.1
1	G	175	LEU	3.1
1	H	360	LEU	3.1
1	H	38	ASP	3.0
1	G	105	PHE	3.0
1	F	230	VAL	3.0
1	B	144	TYR	3.0
1	F	175	LEU	3.0
1	B	200	PHE	3.0
1	I	174	LEU	2.9
1	B	250	ASP	2.9
1	G	292	PRO	2.9
1	G	76	LEU	2.8
1	G	222	GLY	2.8
1	G	148	LEU	2.8
1	B	72	ALA	2.8
1	E	144	TYR	2.8
1	H	144	TYR	2.8
1	H	194	THR	2.8
1	F	219	ILE	2.8
1	G	358	LEU	2.8
1	G	178	ASP	2.7
1	G	201	PHE	2.7
1	H	84	VAL	2.7
1	B	165	ILE	2.7
1	E	225	ALA	2.7
1	B	130	PHE	2.7
1	B	64	TRP	2.7
1	H	131	TYR	2.7
1	G	129	VAL	2.6
1	I	134	SER	2.6

*Continued on next page...*

*Continued from previous page...*

<b>Mol</b>	<b>Chain</b>	<b>Res</b>	<b>Type</b>	<b>RSRZ</b>
1	H	201	PHE	2.6
1	I	141	GLU	2.6
1	B	185	GLU	2.6
1	G	36	ARG	2.6
1	H	225	ALA	2.6
1	H	130	PHE	2.6
1	I	147	ARG	2.6
1	H	165	ILE	2.6
1	B	211	LEU	2.6
1	I	165	ILE	2.5
1	G	173	VAL	2.5
1	H	61	VAL	2.5
1	I	68	PHE	2.5
1	H	261	ILE	2.5
1	I	211	LEU	2.5
1	H	220	PRO	2.5
1	F	36	ARG	2.5
1	G	58	ILE	2.5
1	B	213	PHE	2.5
1	H	182	TYR	2.5
1	B	54	ARG	2.5
1	D	166	GLU	2.4
1	G	194	THR	2.4
1	H	175	LEU	2.4
1	J	61	VAL	2.4
1	G	128	TYR	2.4
1	B	173	VAL	2.4
1	A	189	ARG	2.4
1	B	370	GLU	2.4
1	I	322	LEU	2.4
1	H	93	ARG	2.4
1	J	229	PRO	2.4
1	B	155	SER	2.4
1	G	147	ARG	2.4
1	H	156	VAL	2.4
1	J	129	VAL	2.4
1	F	127	LEU	2.4
1	I	148	LEU	2.4
1	H	75	ASP	2.4
1	E	174	LEU	2.3
1	H	139	GLU	2.3
1	I	77	LEU	2.3

*Continued on next page...*

*Continued from previous page...*

<b>Mol</b>	<b>Chain</b>	<b>Res</b>	<b>Type</b>	<b>RSRZ</b>
1	H	259	GLU	2.3
1	G	248	PRO	2.3
1	G	401	GLY	2.3
1	H	39	ALA	2.3
1	J	225	ALA	2.3
1	H	43	ILE	2.3
1	G	190	GLY	2.3
1	I	128	TYR	2.3
1	G	252	GLU	2.3
1	G	131	TYR	2.3
1	G	37	GLU	2.3
1	B	403	ILE	2.3
1	G	157	VAL	2.3
1	I	189	ARG	2.3
1	G	267	LEU	2.2
1	F	39	ALA	2.2
1	A	200	PHE	2.2
1	C	175	LEU	2.2
1	I	36	ARG	2.2
1	H	192	ILE	2.2
1	C	156	VAL	2.2
1	F	144	TYR	2.2
1	B	238	VAL	2.2
1	A	76	LEU	2.2
1	H	200	PHE	2.2
1	F	58	ILE	2.2
1	G	363	VAL	2.2
1	G	70	LEU	2.2
1	G	166	GLU	2.2
1	I	91	TYR	2.1
1	H	267	LEU	2.1
1	J	76	LEU	2.1
1	H	121	LEU	2.1
1	H	127	LEU	2.1
1	I	75	ASP	2.1
1	C	106	GLU	2.1
1	I	104	VAL	2.1
1	I	263	VAL	2.1
1	J	175	LEU	2.1
1	D	36	ARG	2.1
1	H	153	GLY	2.1
1	J	75	ASP	2.1

*Continued on next page...*

*Continued from previous page...*

Mol	Chain	Res	Type	RSRZ
1	C	277	GLY	2.1
1	G	126	ARG	2.1
1	E	129	VAL	2.1
1	F	37	GLU	2.1
1	B	195	PHE	2.1
1	I	200	PHE	2.1
1	E	190	GLY	2.1
1	B	405	LEU	2.1
1	E	141	GLU	2.1
1	E	221	GLU	2.1
1	H	106	GLU	2.1
1	I	51	LEU	2.1
1	I	173	VAL	2.1
1	F	41	PRO	2.1
1	F	225	ALA	2.1
1	H	98	TRP	2.1
1	I	180	GLU	2.1
1	B	223	ALA	2.1
1	B	138	GLY	2.1
1	B	31	ILE	2.0
1	B	158	ALA	2.0
1	C	225	ALA	2.0
1	B	100	ASP	2.0
1	D	229	PRO	2.0
1	B	50	PHE	2.0
1	F	115	TRP	2.0

## 6.2 Non-standard residues in protein, DNA, RNA chains [\(i\)](#)

There are no non-standard protein/DNA/RNA residues in this entry.

## 6.3 Carbohydrates [\(i\)](#)

In the following table, the Atoms column lists the number of modelled atoms in the group and the number defined in the chemical component dictionary. The B-factors column lists the minimum, median, 95<sup>th</sup> percentile and maximum values of B factors of atoms in the group. The column labelled 'Q<0.9' lists the number of atoms with occupancy less than 0.9.

Mol	Type	Chain	Res	Atoms	RSCC	RSR	B-factors(Å <sup>2</sup> )	Q<0.9
2	GLC	O	1	11/12	0.52	0.42	45,45,66,70	11
2	GLC	N	1	11/12	0.60	0.40	45,58,75,83	11

*Continued on next page...*

Continued from previous page...

Mol	Type	Chain	Res	Atoms	RSCC	RSR	B-factors( $\text{\AA}^2$ )	Q<0.9
2	FRU	Q	3	11/12	0.67	0.49	45,54,69,72	11
2	GLC	T	1	11/12	0.67	0.58	45,49,63,70	11
2	GLC	M	1	11/12	0.68	0.28	45,53,63,69	11
2	GLC	Q	1	11/12	0.68	0.38	45,52,65,66	11
2	GLC	U	1	11/12	0.70	0.42	45,46,66,68	11
2	GLC	L	1	11/12	0.71	0.37	45,47,62,63	11
2	GLC	R	1	11/12	0.71	0.37	45,45,56,61	11
2	GLC	K	1	11/12	0.73	0.26	45,46,65,78	11
2	FRU	R	2	12/12	0.73	0.32	45,49,62,63	12
2	FRU	O	2	12/12	0.74	0.28	45,54,66,70	12
2	FRU	U	2	12/12	0.74	0.33	45,54,58,60	12
2	GLC	P	1	11/12	0.75	0.27	45,51,63,73	11
2	FRU	K	3	11/12	0.75	0.39	45,48,62,64	11
2	FRU	L	2	12/12	0.76	0.32	45,56,62,65	12
2	FRU	T	2	12/12	0.78	0.54	45,53,62,66	12
2	FRU	K	2	12/12	0.78	0.20	45,50,63,64	12
2	FRU	Q	2	12/12	0.78	0.29	47,57,67,70	12
2	FRU	U	3	11/12	0.78	0.46	45,51,57,60	11
2	FRU	O	3	11/12	0.79	0.43	45,45,60,63	11
2	FRU	M	3	11/12	0.80	0.43	45,47,57,58	11
2	FRU	P	2	12/12	0.81	0.37	45,54,60,64	12
2	FRU	L	3	11/12	0.84	0.60	45,54,70,75	11
2	FRU	N	2	12/12	0.84	0.30	45,47,57,61	12
2	FRU	N	3	11/12	0.84	0.36	45,45,52,54	11
2	FRU	R	3	11/12	0.85	0.42	45,49,54,55	11
2	FRU	P	3	11/12	0.85	0.41	45,50,63,73	11
2	FRU	M	2	12/12	0.85	0.26	45,50,60,61	12
2	FRU	T	3	11/12	0.90	0.48	45,49,58,60	11

The following is a graphical depiction of the model fit to experimental electron density for oligosaccharide. Each fit is shown from different orientation to approximate a three-dimensional view.

**Electron density around Chain K:**

$2mF_o-DF_c$  (at 0.7 rmsd) in gray  
 $mF_o-DF_c$  (at 3 rmsd) in purple (negative)  
and green (positive)

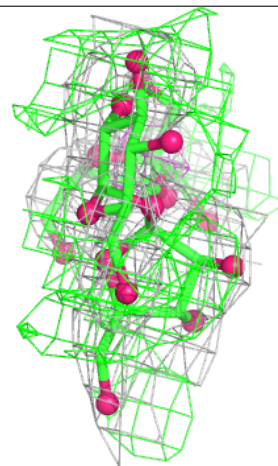
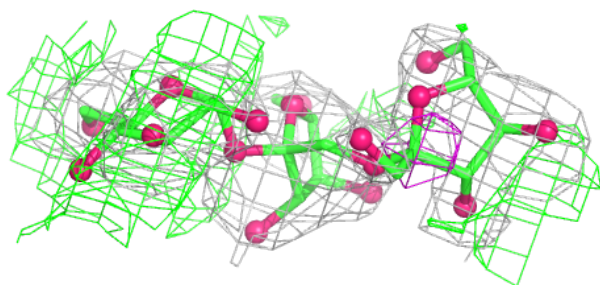
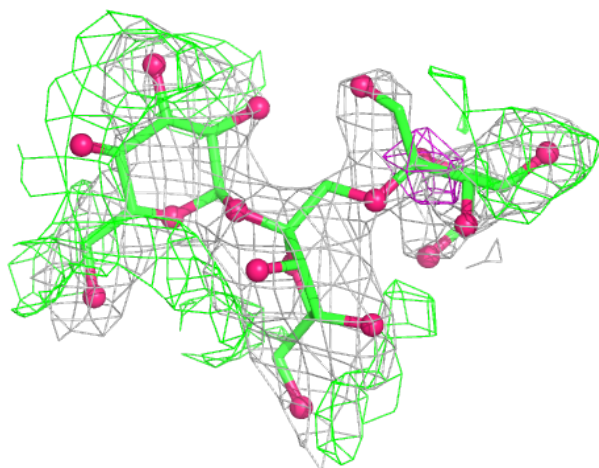

**Electron density around Chain L:**

$2mF_o-DF_c$  (at 0.7 rmsd) in gray  
 $mF_o-DF_c$  (at 3 rmsd) in purple (negative)  
and green (positive)

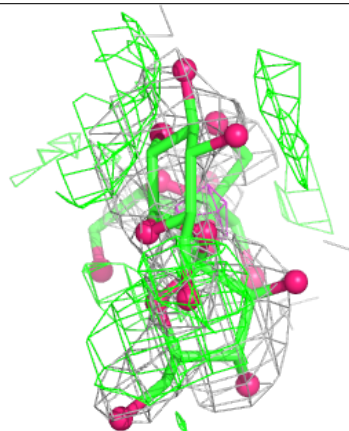
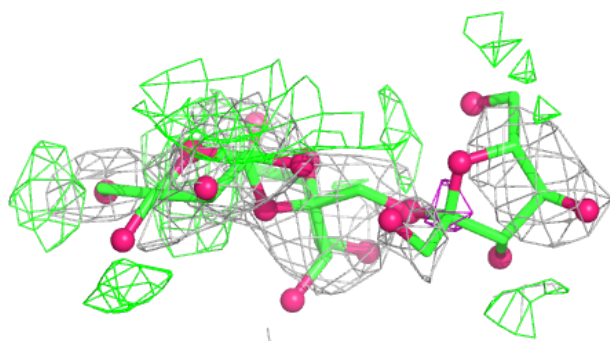
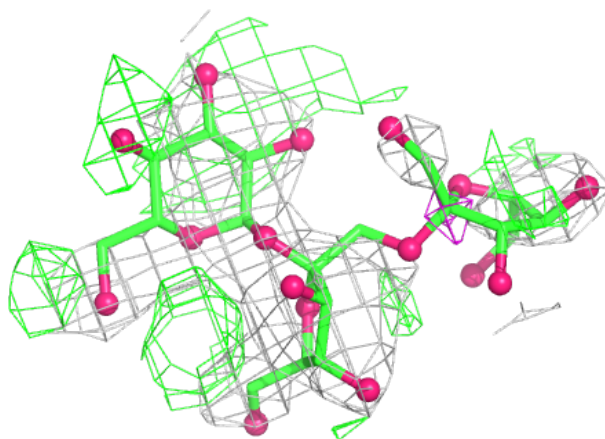

**Electron density around Chain M:**

$2mF_o-DF_c$  (at 0.7 rmsd) in gray  
 $mF_o-DF_c$  (at 3 rmsd) in purple (negative)  
and green (positive)

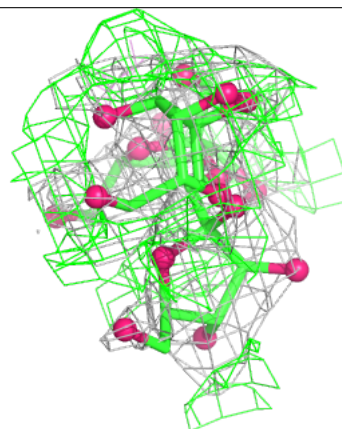
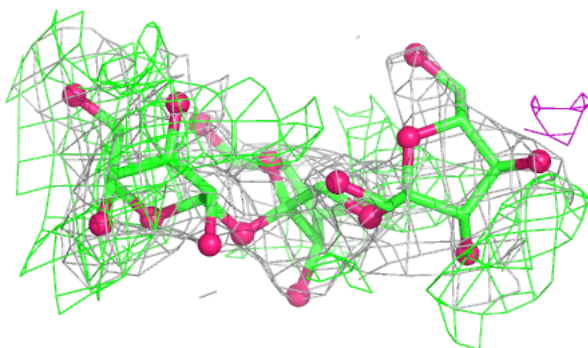
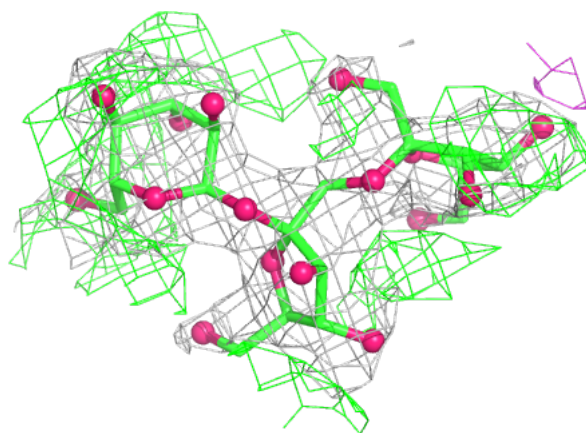



**Electron density around Chain N:**

$2mF_o-DF_c$  (at 0.7 rmsd) in gray  
 $mF_o-DF_c$  (at 3 rmsd) in purple (negative)  
and green (positive)

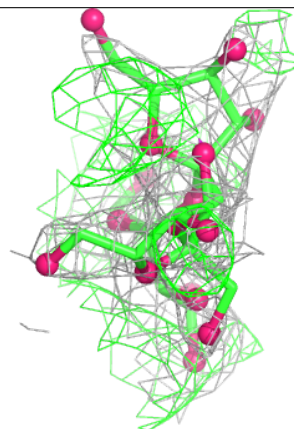
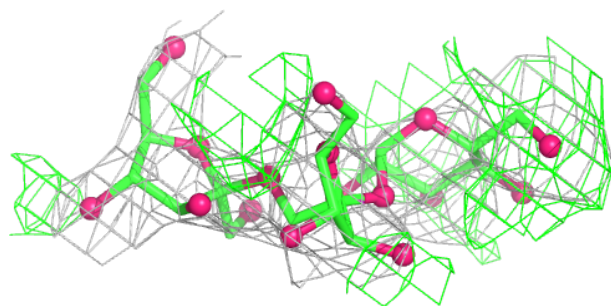
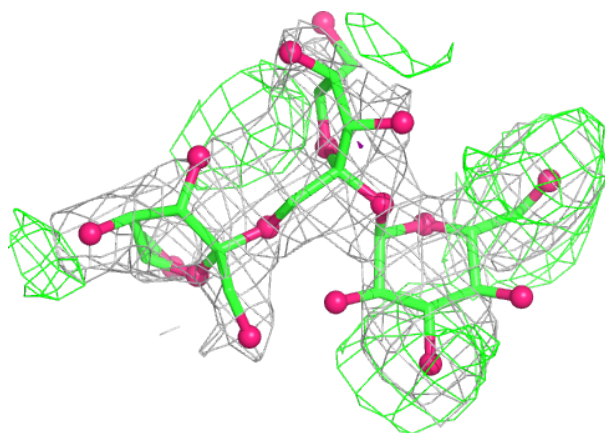

**Electron density around Chain O:**

$2mF_o-DF_c$  (at 0.7 rmsd) in gray  
 $mF_o-DF_c$  (at 3 rmsd) in purple (negative)  
and green (positive)

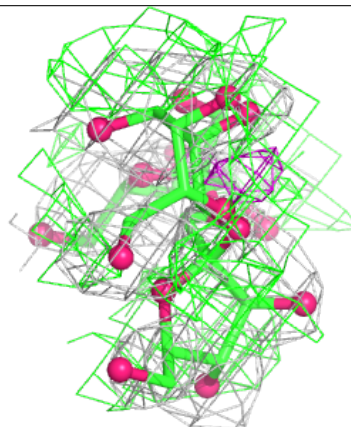
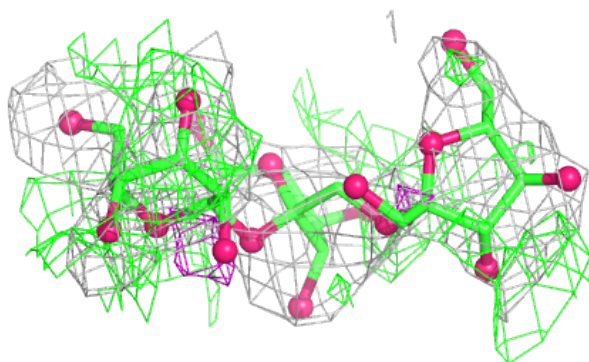
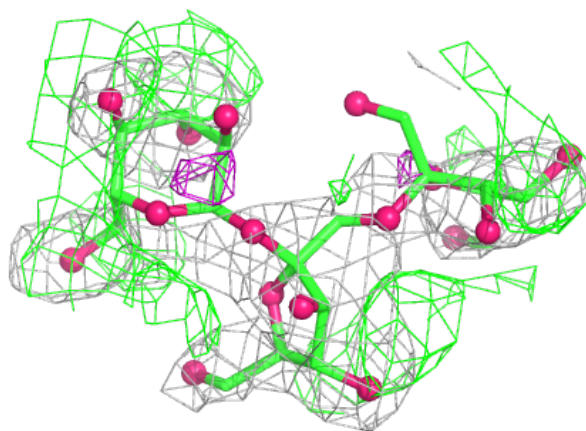

**Electron density around Chain P:**

$2mF_o-DF_c$  (at 0.7 rmsd) in gray  
 $mF_o-DF_c$  (at 3 rmsd) in purple (negative)  
and green (positive)

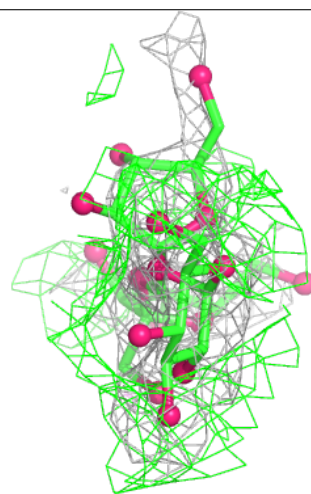
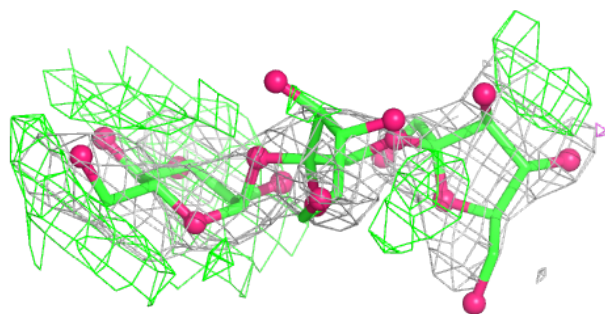
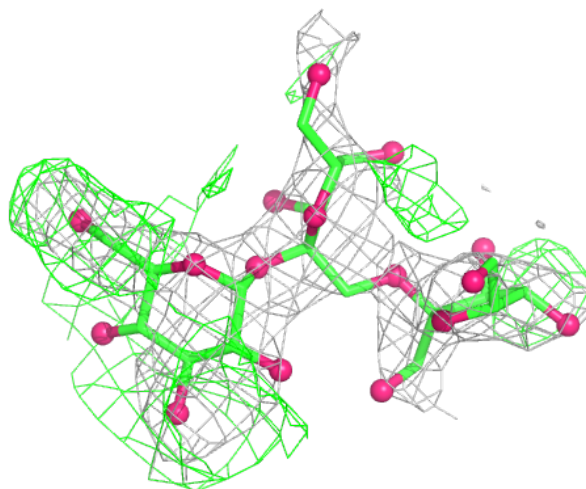

**Electron density around Chain Q:**

$2mF_o-DF_c$  (at 0.7 rmsd) in gray  
 $mF_o-DF_c$  (at 3 rmsd) in purple (negative)  
and green (positive)

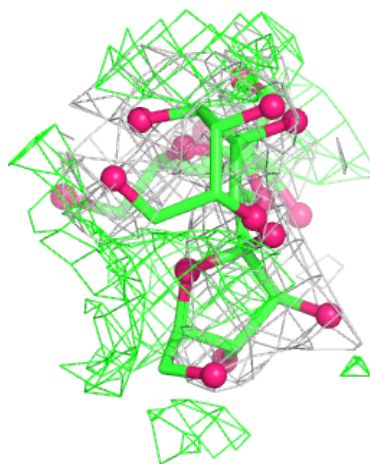
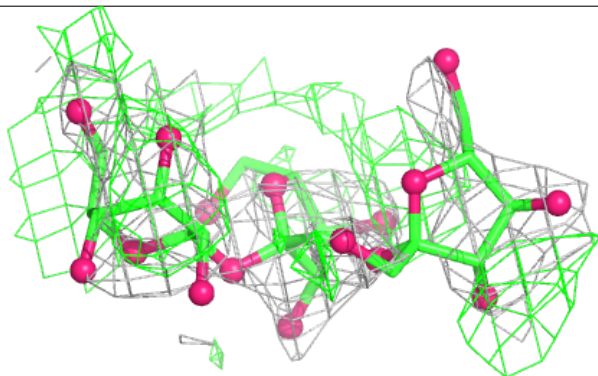
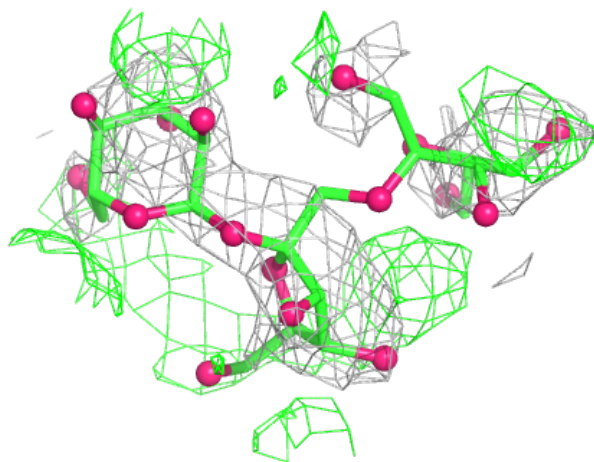

**Electron density around Chain R:**

$2mF_o-DF_c$  (at 0.7 rmsd) in gray  
 $mF_o-DF_c$  (at 3 rmsd) in purple (negative)  
and green (positive)

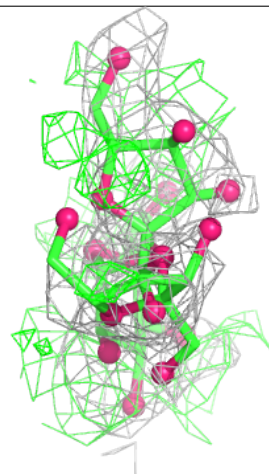
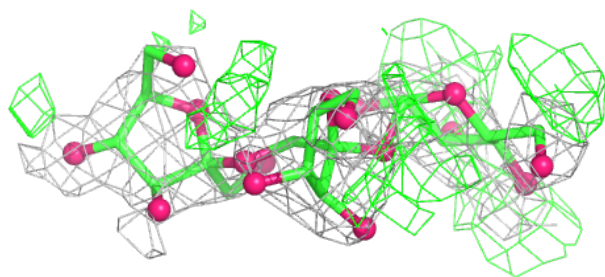
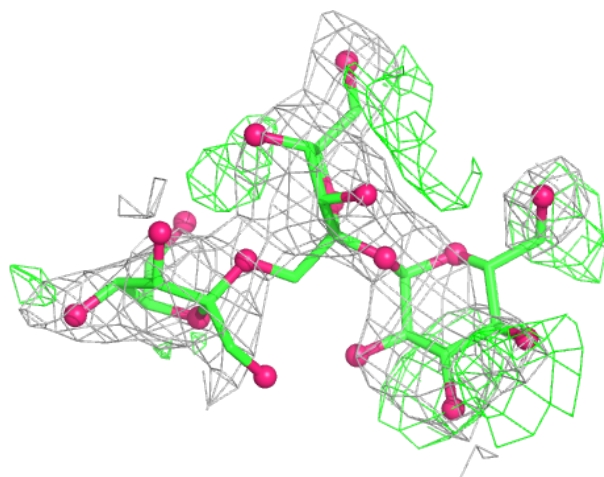

**Electron density around Chain T:**

$2mF_o-DF_c$  (at 0.7 rmsd) in gray  
 $mF_o-DF_c$  (at 3 rmsd) in purple (negative)  
and green (positive)

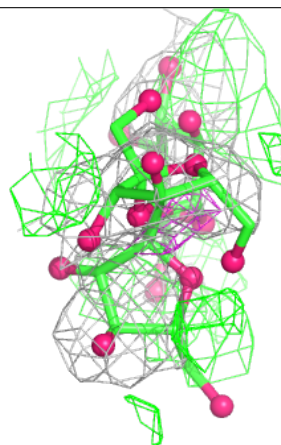
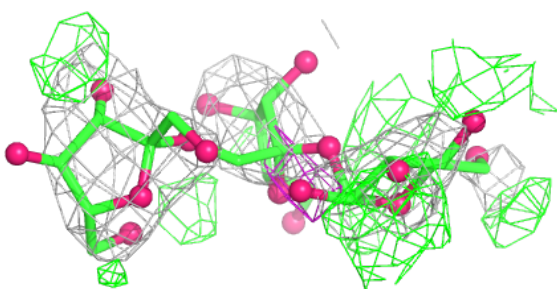
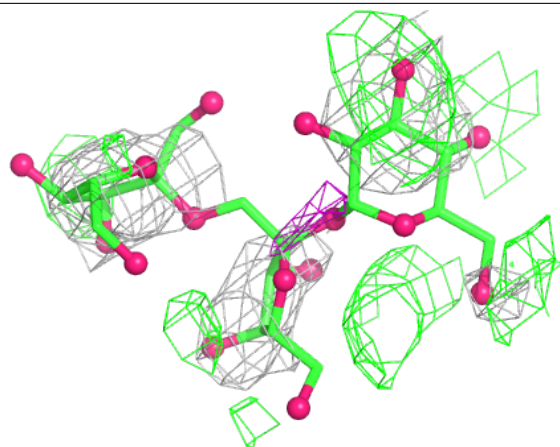



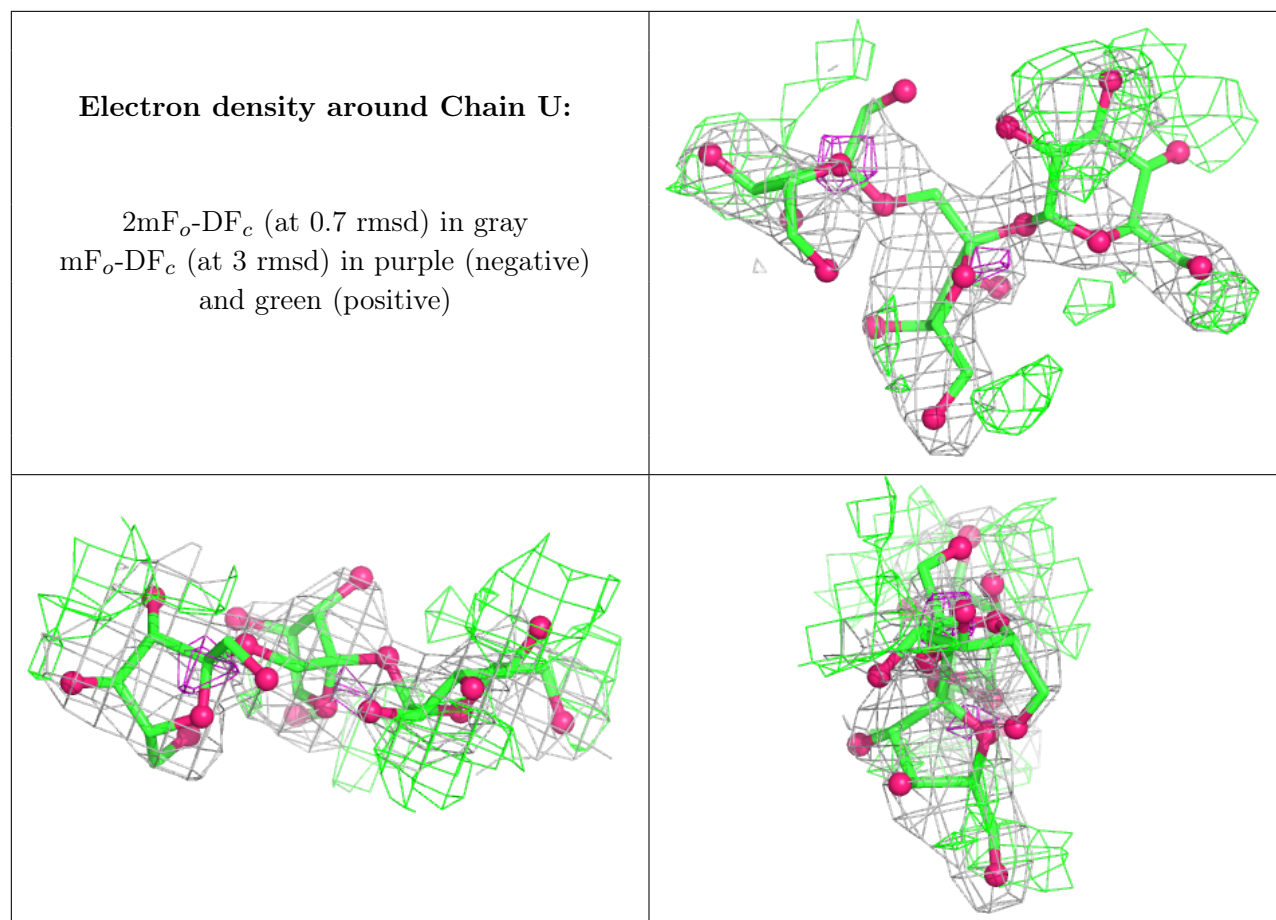

## 6.4 Ligands [i](#)

There are no ligands in this entry.

## 6.5 Other polymers [i](#)

There are no such residues in this entry.