



wwPDB X-ray Structure Validation Summary Report ⓘ

Jan 10, 2023 – 03:18 pm GMT

PDB ID : 8BVL
Title : Crystal structure of the IBR-RING2 domain of HOIL-1
Authors : Stieglitz, B.; Koliopoulos, M.G.; Rittinger, K.
Deposited on : 2022-12-04
Resolution : 2.24 Å(reported)

This is a wwPDB X-ray Structure Validation Summary Report for a publicly released PDB entry.

We welcome your comments at validation@mail.wwpdb.org

A user guide is available at

<https://www.wwpdb.org/validation/2017/XrayValidationReportHelp>

with specific help available everywhere you see the ⓘ symbol.

The types of validation reports are described at

<http://www.wwpdb.org/validation/2017/FAQs#types>.

The following versions of software and data (see [references ⓘ](#)) were used in the production of this report:

MolProbity : 4.02b-467
Xtriage (Phenix) : 1.13
EDS : 2.31.3
buster-report : 1.1.7 (2018)
Percentile statistics : 20191225.v01 (using entries in the PDB archive December 25th 2019)
Refmac : 5.8.0158
CCP4 : 7.0.044 (Gargrove)
Ideal geometry (proteins) : Engh & Huber (2001)
Ideal geometry (DNA, RNA) : Parkinson et al. (1996)
Validation Pipeline (wwPDB-VP) : 2.31.3

1 Overall quality at a glance

The following experimental techniques were used to determine the structure:

X-RAY DIFFRACTION

The reported resolution of this entry is 2.24 Å.

Percentile scores (ranging between 0-100) for global validation metrics of the entry are shown in the following graphic. The table shows the number of entries on which the scores are based.

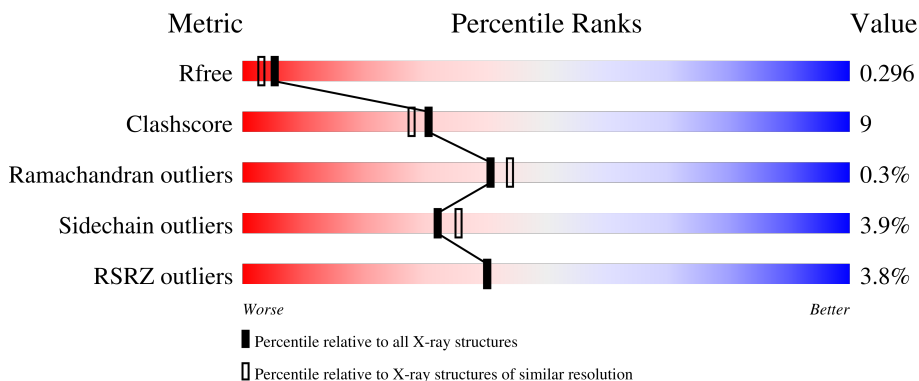

Metric	Whole archive (#Entries)	Similar resolution (#Entries, resolution range(Å))
R_{free}	130704	2391 (2.26-2.22)
Clashscore	141614	2539 (2.26-2.22)
Ramachandran outliers	138981	2489 (2.26-2.22)
Sidechain outliers	138945	2490 (2.26-2.22)
RSRZ outliers	127900	2353 (2.26-2.22)

The table below summarises the geometric issues observed across the polymeric chains and their fit to the electron density. The red, orange, yellow and green segments of the lower bar indicate the fraction of residues that contain outliers for ≥ 3 , 2, 1 and 0 types of geometric quality criteria respectively. A grey segment represents the fraction of residues that are not modelled. The numeric value for each fraction is indicated below the corresponding segment, with a dot representing fractions $\leq 5\%$. The upper red bar (where present) indicates the fraction of residues that have poor fit to the electron density. The numeric value is given above the bar.

Mol	Chain	Length	Quality of chain
1	A	145	 5% 77% 23%
1	B	145	 3% 77% 21% ..

2 Entry composition

There are 3 unique types of molecules in this entry. The entry contains 2340 atoms, of which 0 are hydrogens and 0 are deuteriums.

In the tables below, the ZeroOcc column contains the number of atoms modelled with zero occupancy, the AltConf column contains the number of residues with at least one atom in alternate conformation and the Trace column contains the number of residues modelled with at most 2 atoms.

- Molecule 1 is a protein called RanBP-type and C3HC4-type zinc finger-containing protein 1.

Mol	Chain	Residues	Atoms					ZeroOcc	AltConf	Trace
			Total	C	N	O	S			
1	A	145	1127	691	206	207	23	0	0	0
1	B	145	1127	691	206	207	23	0	0	0

There are 4 discrepancies between the modelled and reference sequences:

Chain	Residue	Modelled	Actual	Comment	Reference
A	366	GLY	-	expression tag	UNP Q9BYM8
A	367	PRO	-	expression tag	UNP Q9BYM8
B	366	GLY	-	expression tag	UNP Q9BYM8
B	367	PRO	-	expression tag	UNP Q9BYM8

- Molecule 2 is ZINC ION (three-letter code: ZN) (formula: Zn) (labeled as "Ligand of Interest" by depositor).

Mol	Chain	Residues	Atoms		ZeroOcc	AltConf
2	A	5	Total	Zn	0	0
			5	5		
2	B	5	Total	Zn	0	0
			5	5		

- Molecule 3 is water.

Mol	Chain	Residues	Atoms		ZeroOcc	AltConf
3	A	39	Total	O	0	0
			39	39		
3	B	37	Total	O	0	0
			37	37		

4 Data and refinement statistics

Property	Value	Source
Space group	P 1 21 1	Depositor
Cell constants a, b, c, α , β , γ	53.91Å 59.26Å 57.21Å 90.00° 90.31° 90.00°	Depositor
Resolution (Å)	41.16 – 2.24 41.16 – 2.24	Depositor EDS
% Data completeness (in resolution range)	95.6 (41.16-2.24) 95.8 (41.16-2.24)	Depositor EDS
R_{merge}	0.08	Depositor
R_{sym}	(Not available)	Depositor
$\langle I/\sigma(I) \rangle$ ¹	5.83 (at 2.24Å)	Xtrriage
Refinement program	PHENIX (1.20.1_4487: ???)	Depositor
R, R_{free}	0.234 , 0.296 0.234 , 0.296	Depositor DCC
R_{free} test set	850 reflections (5.07%)	wwPDB-VP
Wilson B-factor (Å ²)	24.9	Xtrriage
Anisotropy	0.912	Xtrriage
Bulk solvent k_{sol} (e/Å ³), B_{sol} (Å ²)	0.31 , 17.5	EDS
L-test for twinning ²	$\langle L \rangle = 0.50$, $\langle L^2 \rangle = 0.33$	Xtrriage
Estimated twinning fraction	0.014 for -h,-l,-k 0.000 for -h,l,k 0.029 for h,-k,-l	Xtrriage
F_o, F_c correlation	0.92	EDS
Total number of atoms	2340	wwPDB-VP
Average B, all atoms (Å ²)	39.0	wwPDB-VP

Xtrriage's analysis on translational NCS is as follows: *The largest off-origin peak in the Patterson function is 7.39% of the height of the origin peak. No significant pseudotranslation is detected.*

¹Intensities estimated from amplitudes.

²Theoretical values of $\langle |L| \rangle$, $\langle L^2 \rangle$ for acentric reflections are 0.5, 0.333 respectively for untwinned datasets, and 0.375, 0.2 for perfectly twinned datasets.

5 Model quality

5.1 Standard geometry

Bond lengths and bond angles in the following residue types are not validated in this section:
ZN

The Z score for a bond length (or angle) is the number of standard deviations the observed value is removed from the expected value. A bond length (or angle) with $|Z| > 5$ is considered an outlier worth inspection. RMSZ is the root-mean-square of all Z scores of the bond lengths (or angles).

Mol	Chain	Bond lengths		Bond angles	
		RMSZ	# Z >5	RMSZ	# Z >5
1	A	0.46	0/1155	0.64	0/1562
1	B	0.47	0/1155	0.64	0/1562
All	All	0.46	0/2310	0.64	0/3124

There are no bond length outliers.

There are no bond angle outliers.

There are no chirality outliers.

There are no planarity outliers.

5.2 Too-close contacts

In the following table, the Non-H and H(model) columns list the number of non-hydrogen atoms and hydrogen atoms in the chain respectively. The H(added) column lists the number of hydrogen atoms added and optimized by MolProbity. The Clashes column lists the number of clashes within the asymmetric unit, whereas Symm-Clashes lists symmetry-related clashes.

Mol	Chain	Non-H	H(model)	H(added)	Clashes	Symm-Clashes
1	A	1127	0	1051	19	0
1	B	1127	0	1051	22	0
2	A	5	0	0	0	0
2	B	5	0	0	0	0
3	A	39	0	0	1	0
3	B	37	0	0	1	0
All	All	2340	0	2102	40	0

The all-atom clashscore is defined as the number of clashes found per 1000 atoms (including hydrogen atoms). The all-atom clashscore for this structure is 9.

The worst 5 of 40 close contacts within the same asymmetric unit are listed below, sorted by their

clash magnitude.

Atom-1	Atom-2	Interatomic distance (Å)	Clash overlap (Å)
1:B:435:LEU:HD23	1:B:438:MET:HE3	1.71	0.71
1:B:401:LEU:HD21	1:B:466:THR:HG23	1.72	0.71
1:A:464:ARG:NH1	3:A:702:HOH:O	2.26	0.69
1:B:463:ILE:HG23	1:B:472:ILE:HB	1.79	0.64
1:A:438:MET:HE2	1:A:444:ALA:HB2	1.81	0.62

There are no symmetry-related clashes.

5.3 Torsion angles [i](#)

5.3.1 Protein backbone [i](#)

In the following table, the Percentiles column shows the percent Ramachandran outliers of the chain as a percentile score with respect to all X-ray entries followed by that with respect to entries of similar resolution.

The Analysed column shows the number of residues for which the backbone conformation was analysed, and the total number of residues.

Mol	Chain	Analysed	Favoured	Allowed	Outliers	Percentiles	
1	A	143/145 (99%)	136 (95%)	7 (5%)	0	100	100
1	B	143/145 (99%)	133 (93%)	9 (6%)	1 (1%)	22	20
All	All	286/290 (99%)	269 (94%)	16 (6%)	1 (0%)	41	44

All (1) Ramachandran outliers are listed below:

Mol	Chain	Res	Type
1	B	424	ASN

5.3.2 Protein sidechains [i](#)

In the following table, the Percentiles column shows the percent sidechain outliers of the chain as a percentile score with respect to all X-ray entries followed by that with respect to entries of similar resolution.

The Analysed column shows the number of residues for which the sidechain conformation was analysed, and the total number of residues.

Mol	Chain	Analysed	Rotameric	Outliers	Percentiles	
1	A	127/127 (100%)	123 (97%)	4 (3%)	40	46
1	B	127/127 (100%)	121 (95%)	6 (5%)	26	27
All	All	254/254 (100%)	244 (96%)	10 (4%)	32	35

5 of 10 residues with a non-rotameric sidechain are listed below:

Mol	Chain	Res	Type
1	B	421	ARG
1	B	424	ASN
1	B	431	THR
1	A	494	ARG
1	B	401	LEU

Sometimes sidechains can be flipped to improve hydrogen bonding and reduce clashes. All (2) such sidechains are listed below:

Mol	Chain	Res	Type
1	A	507	GLN
1	B	441	GLN

5.3.3 RNA [i](#)

There are no RNA molecules in this entry.

5.4 Non-standard residues in protein, DNA, RNA chains [i](#)

There are no non-standard protein/DNA/RNA residues in this entry.

5.5 Carbohydrates [i](#)

There are no monosaccharides in this entry.

5.6 Ligand geometry [i](#)

Of 10 ligands modelled in this entry, 10 are monoatomic - leaving 0 for Mogul analysis.

There are no bond length outliers.

There are no bond angle outliers.

There are no chirality outliers.

There are no torsion outliers.

There are no ring outliers.

No monomer is involved in short contacts.

5.7 Other polymers [i](#)

There are no such residues in this entry.

5.8 Polymer linkage issues [i](#)

There are no chain breaks in this entry.

6 Fit of model and data [i](#)

6.1 Protein, DNA and RNA chains [i](#)

In the following table, the column labelled ‘#RSRZ> 2’ contains the number (and percentage) of RSRZ outliers, followed by percent RSRZ outliers for the chain as percentile scores relative to all X-ray entries and entries of similar resolution. The OWAB column contains the minimum, median, 95th percentile and maximum values of the occupancy-weighted average B-factor per residue. The column labelled ‘Q< 0.9’ lists the number of (and percentage) of residues with an average occupancy less than 0.9.

Mol	Chain	Analysed	<RSRZ>	#RSRZ>2	OWAB(Å ²)	Q<0.9
1	A	145/145 (100%)	0.09	7 (4%) 30 30	22, 32, 79, 104	0
1	B	145/145 (100%)	0.05	4 (2%) 53 53	19, 32, 82, 116	0
All	All	290/290 (100%)	0.07	11 (3%) 40 40	19, 32, 82, 116	0

The worst 5 of 11 RSRZ outliers are listed below:

Mol	Chain	Res	Type	RSRZ
1	A	367	PRO	3.1
1	A	424	ASN	2.6
1	B	434	MET	2.5
1	B	424	ASN	2.5
1	B	441	GLN	2.4

6.2 Non-standard residues in protein, DNA, RNA chains [i](#)

There are no non-standard protein/DNA/RNA residues in this entry.

6.3 Carbohydrates [i](#)

There are no monosaccharides in this entry.

6.4 Ligands [i](#)

In the following table, the Atoms column lists the number of modelled atoms in the group and the number defined in the chemical component dictionary. The B-factors column lists the minimum, median, 95th percentile and maximum values of B factors of atoms in the group. The column labelled ‘Q< 0.9’ lists the number of atoms with occupancy less than 0.9.

Mol	Type	Chain	Res	Atoms	RSCC	RSR	B-factors(\AA^2)	Q<0.9
2	ZN	A	603	1/1	0.97	0.04	33,33,33,33	0
2	ZN	A	604	1/1	0.99	0.03	24,24,24,24	0
2	ZN	A	605	1/1	0.99	0.04	28,28,28,28	0
2	ZN	B	601	1/1	0.99	0.03	29,29,29,29	0
2	ZN	B	603	1/1	0.99	0.05	33,33,33,33	0
2	ZN	B	605	1/1	0.99	0.04	28,28,28,28	0
2	ZN	B	602	1/1	1.00	0.04	29,29,29,29	0
2	ZN	A	601	1/1	1.00	0.03	27,27,27,27	0
2	ZN	B	604	1/1	1.00	0.04	27,27,27,27	0
2	ZN	A	602	1/1	1.00	0.03	29,29,29,29	0

The following is a graphical depiction of the model fit to experimental electron density of all instances of the Ligand of Interest. In addition, ligands with molecular weight > 250 and outliers as shown on the geometry validation Tables will also be included. Each fit is shown from different orientation to approximate a three-dimensional view.

Electron density around ZN A 603:

$2mF_o-DF_c$ (at 0.7 rmsd) in gray
 mF_o-DF_c (at 3 rmsd) in purple (negative)
and green (positive)

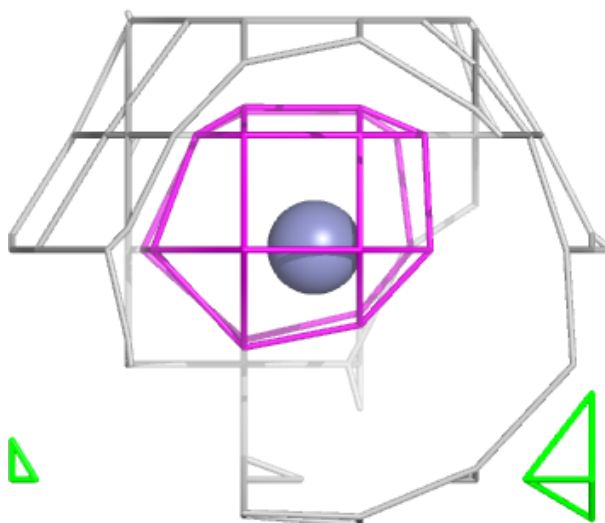
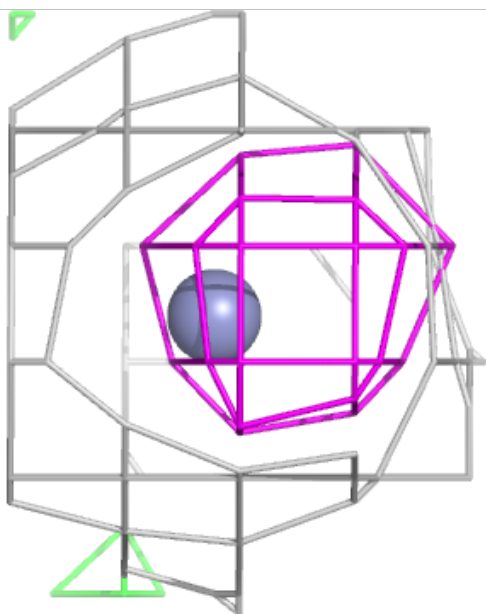
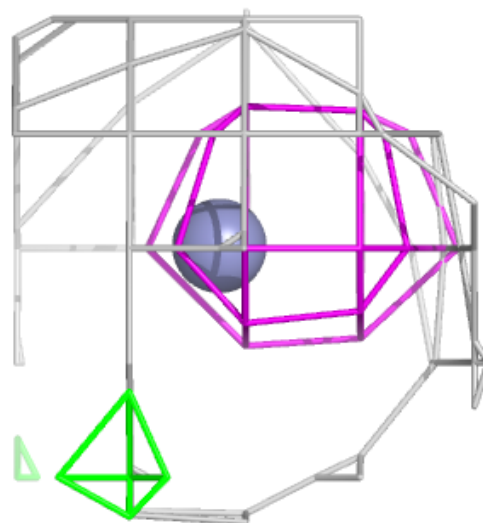

Electron density around ZN A 604:

$2mF_o-DF_c$ (at 0.7 rmsd) in gray
 mF_o-DF_c (at 3 rmsd) in purple (negative)
and green (positive)

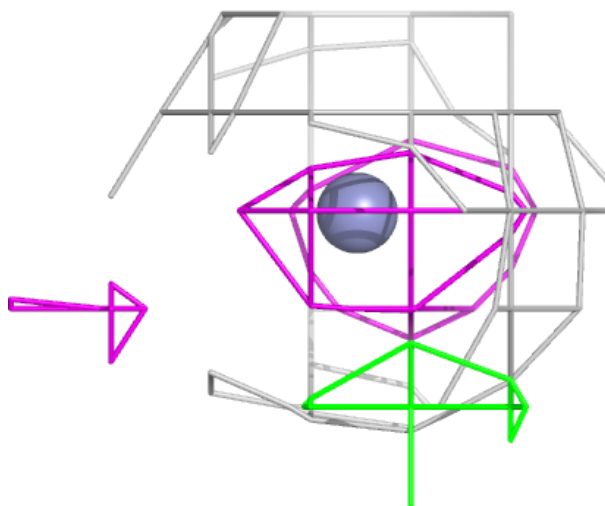
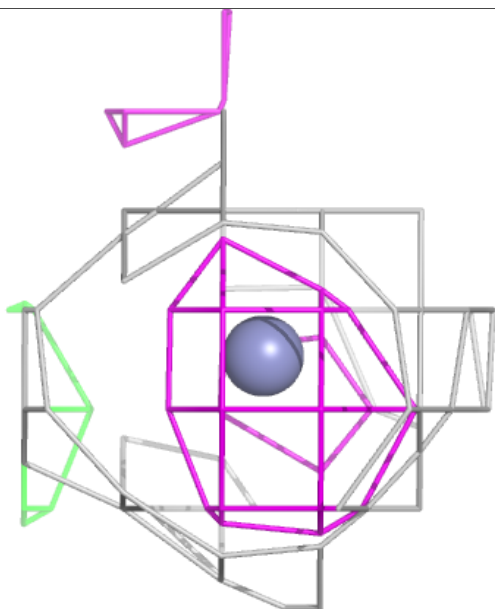
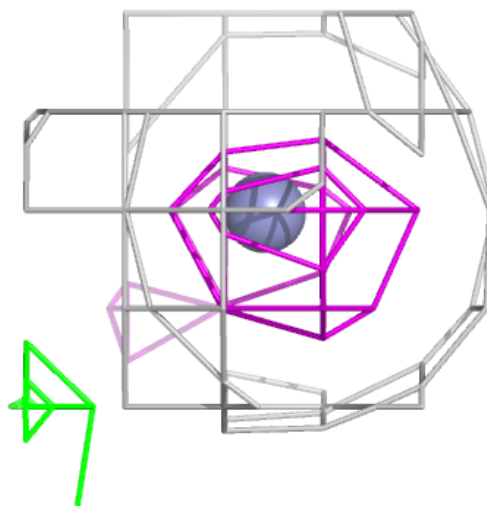

Electron density around ZN A 605:

$2mF_o-DF_c$ (at 0.7 rmsd) in gray
 mF_o-DF_c (at 3 rmsd) in purple (negative)
and green (positive)

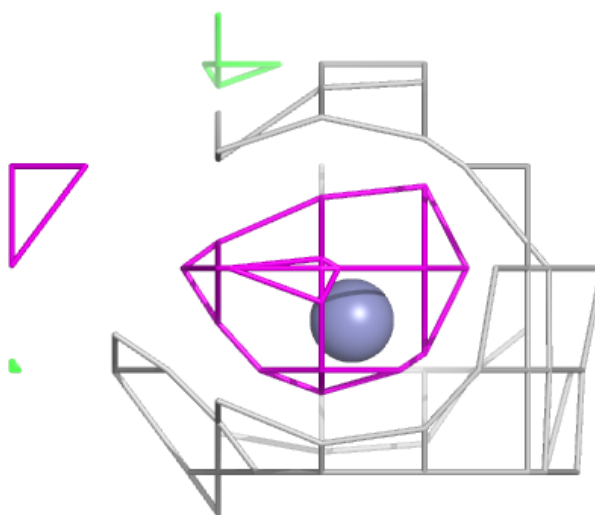
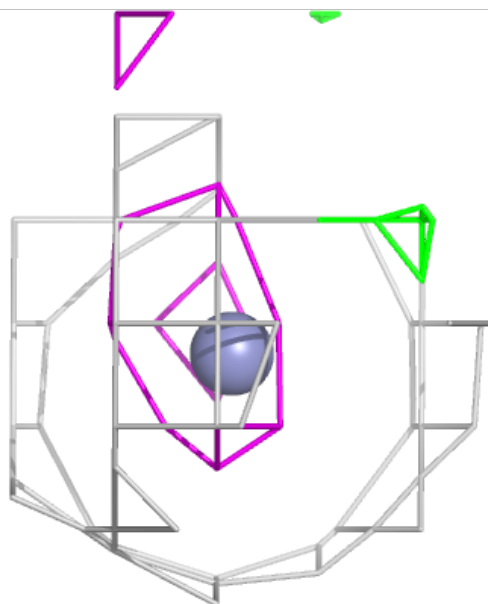
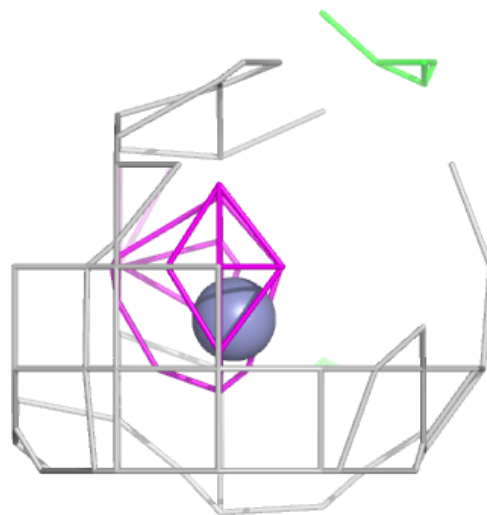

Electron density around ZN B 601:

$2mF_o-DF_c$ (at 0.7 rmsd) in gray
 mF_o-DF_c (at 3 rmsd) in purple (negative)
and green (positive)

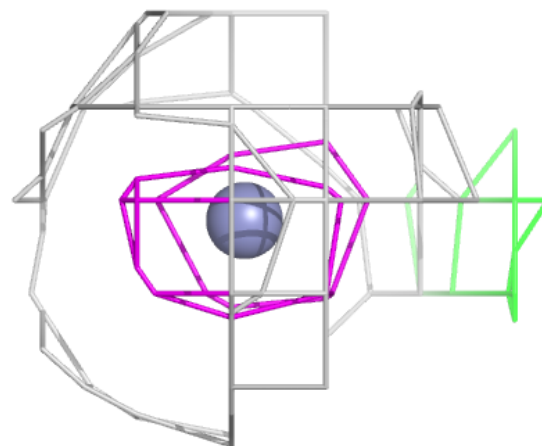
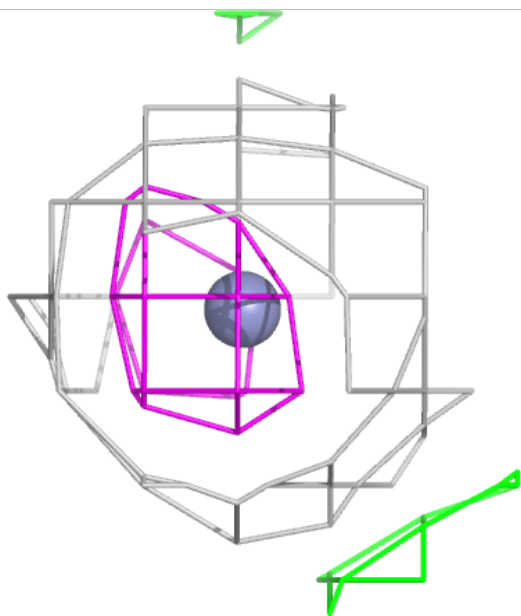
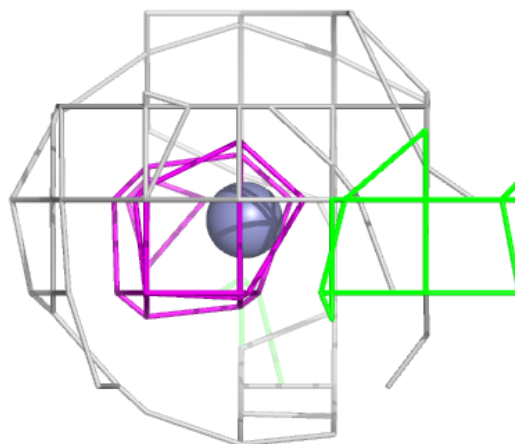

Electron density around ZN B 603:

$2mF_o-DF_c$ (at 0.7 rmsd) in gray
 mF_o-DF_c (at 3 rmsd) in purple (negative)
and green (positive)

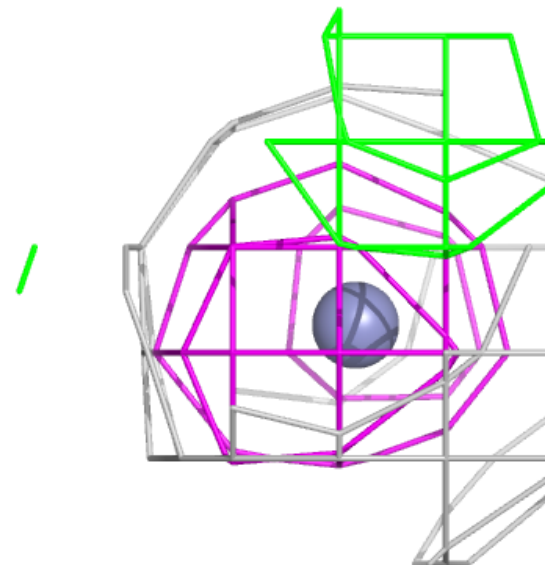
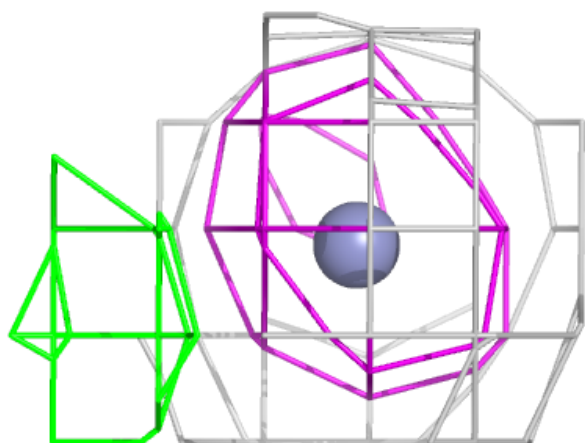
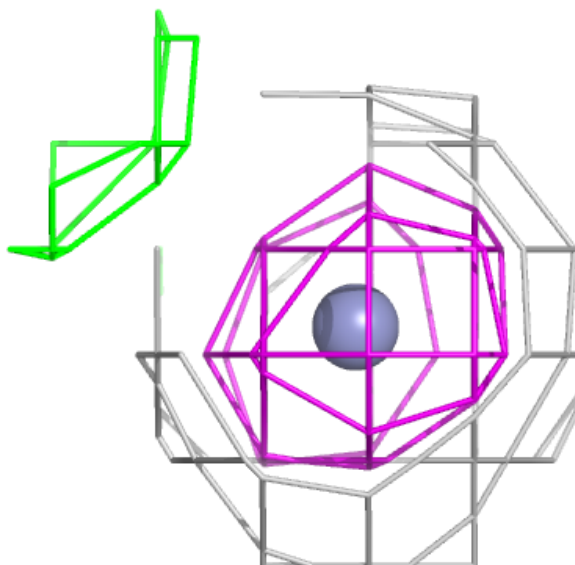

Electron density around ZN B 605:

$2mF_o-DF_c$ (at 0.7 rmsd) in gray
 mF_o-DF_c (at 3 rmsd) in purple (negative)
and green (positive)

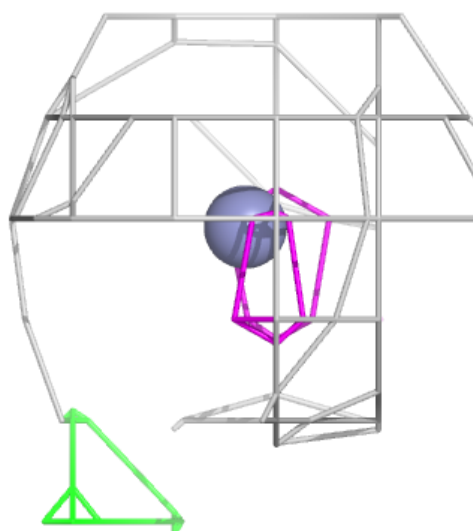
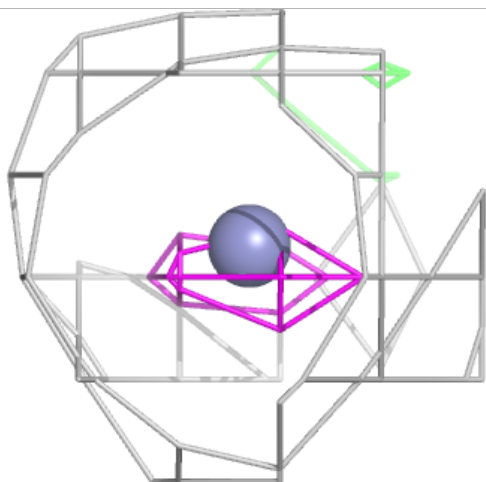
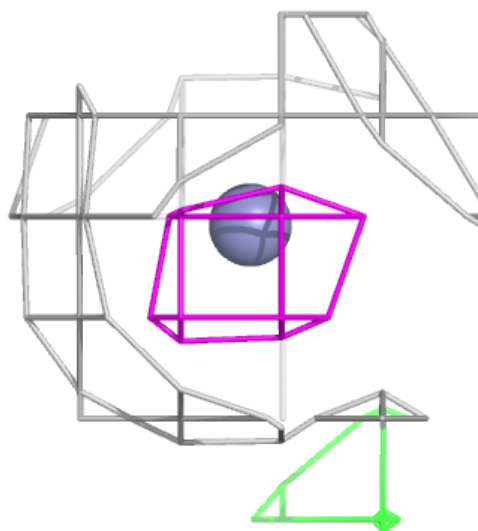

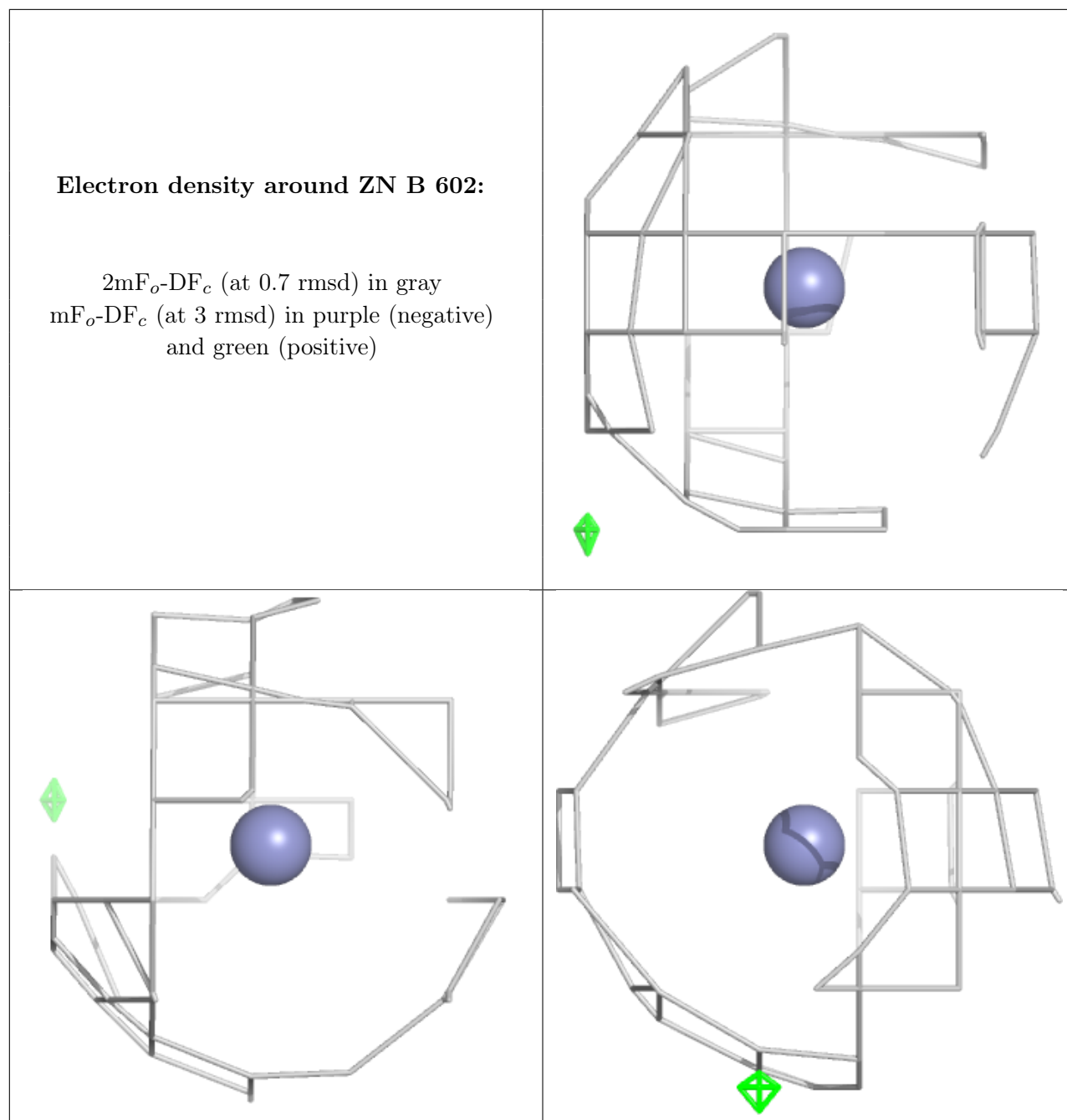

Electron density around ZN A 601:

$2mF_o-DF_c$ (at 0.7 rmsd) in gray
 mF_o-DF_c (at 3 rmsd) in purple (negative)
and green (positive)

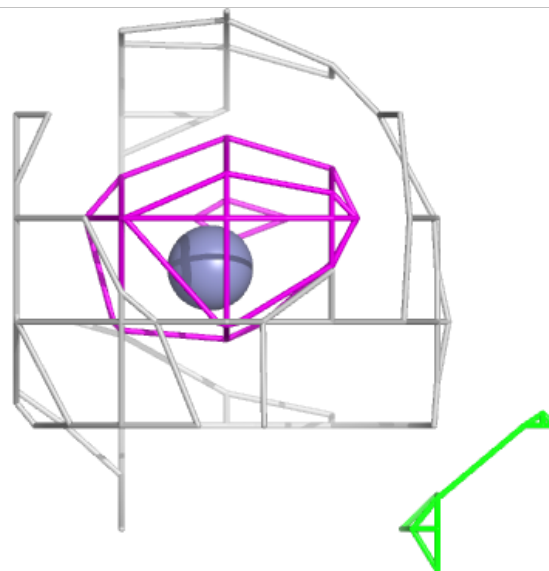
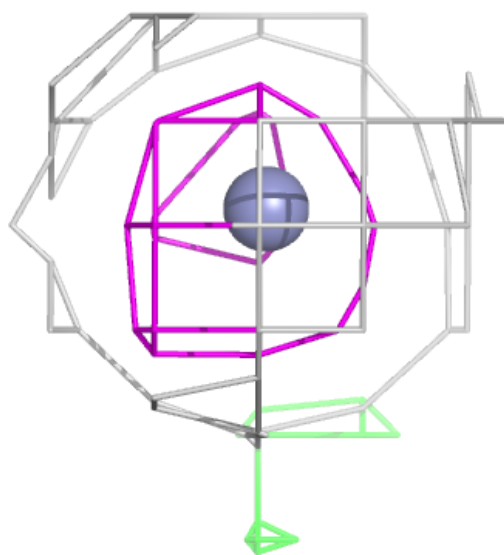
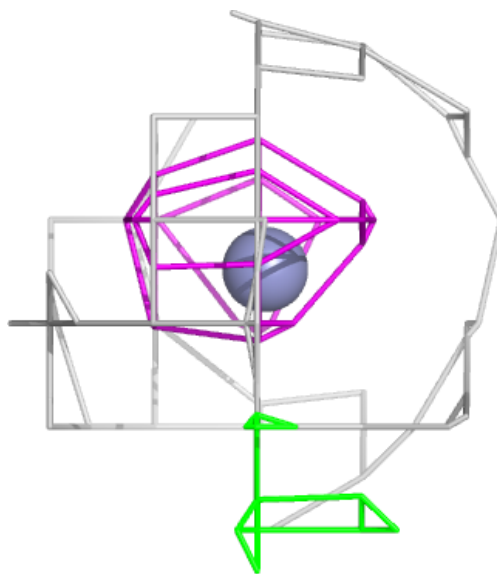

Electron density around ZN B 604:

$2mF_o-DF_c$ (at 0.7 rmsd) in gray
 mF_o-DF_c (at 3 rmsd) in purple (negative)
and green (positive)

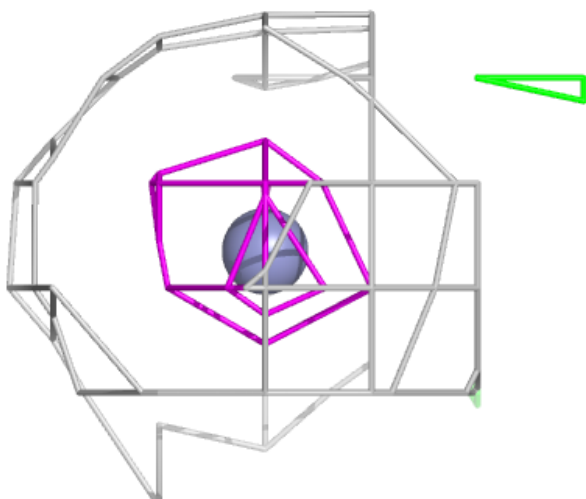
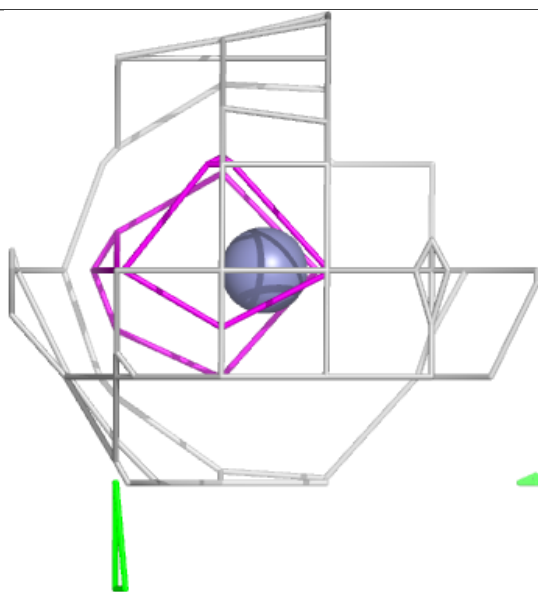
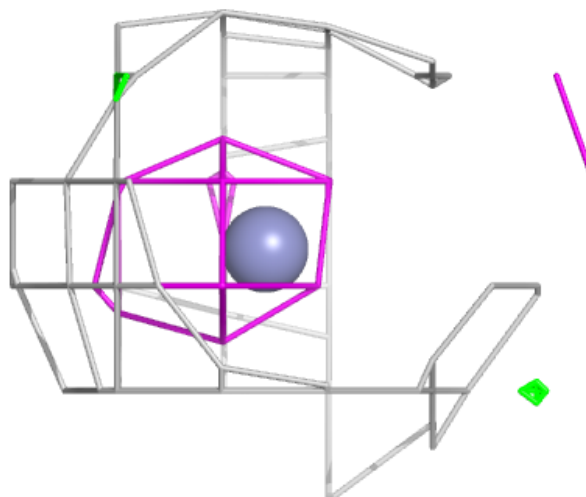

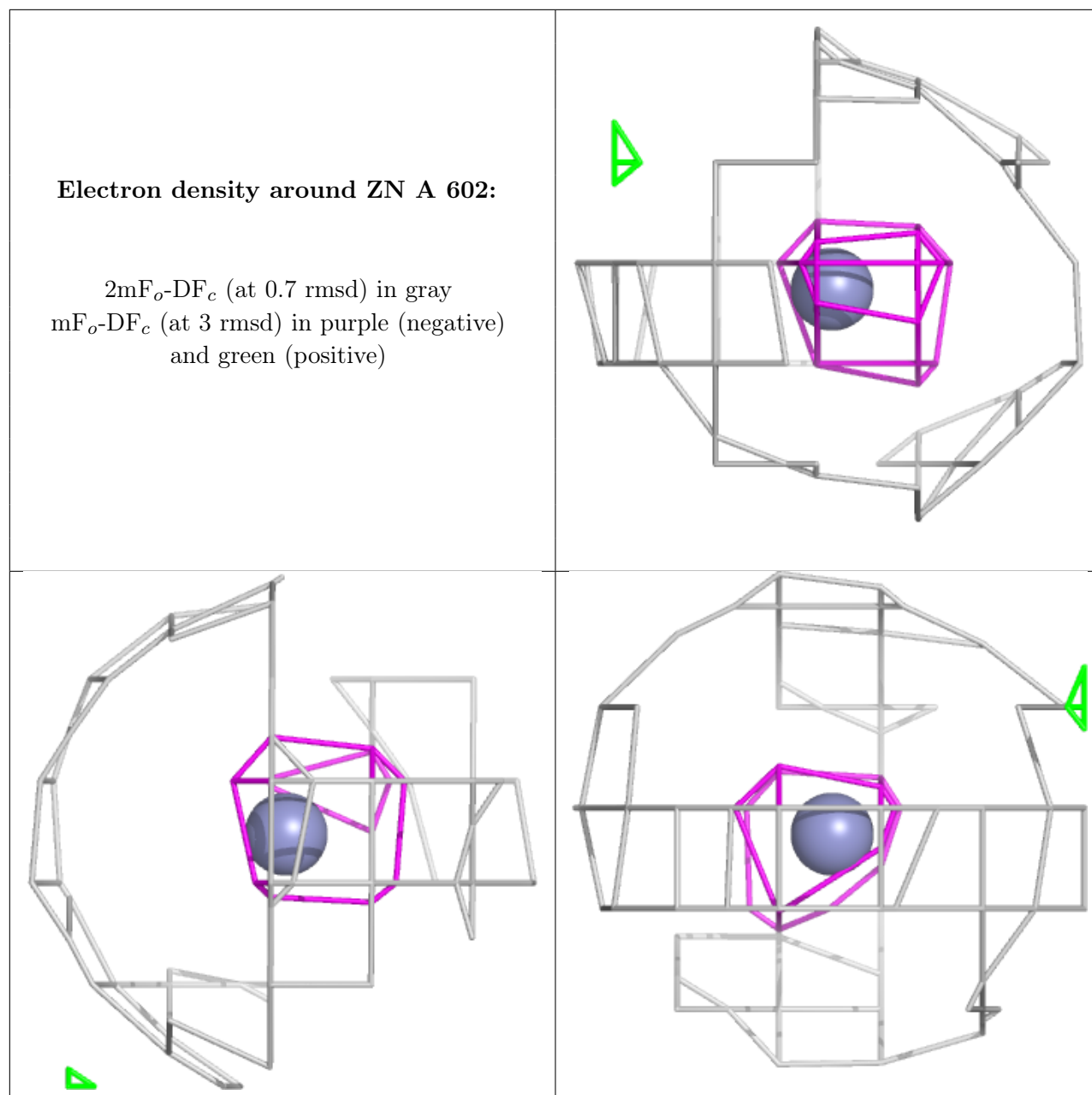

6.5 Other polymers [i](#)

There are no such residues in this entry.