



# Full wwPDB X-ray Structure Validation Report ⓘ

Apr 18, 2021 – 01:01 AM JST

PDB ID : 7BYF  
Title : The crystal structure of mouse ORF10-Rae1-Nup98 complex  
Authors : Gao, P.; Feng, H.  
Deposited on : 2020-04-22  
Resolution : 2.50 Å(reported)

This is a Full wwPDB X-ray Structure Validation Report for a publicly released PDB entry.

We welcome your comments at [validation@mail.wwpdb.org](mailto:validation@mail.wwpdb.org)

A user guide is available at

<https://www.wwpdb.org/validation/2017/XrayValidationReportHelp>

with specific help available everywhere you see the ⓘ symbol.

---

The following versions of software and data (see [references ⓘ](#)) were used in the production of this report:

MolProbity : 4.02b-467  
Xtriage (Phenix) : 1.13  
EDS : 2.18  
buster-report : 1.1.7 (2018)  
Percentile statistics : 20191225.v01 (using entries in the PDB archive December 25th 2019)  
Refmac : 5.8.0158  
CCP4 : 7.0.044 (Gargrove)  
Ideal geometry (proteins) : Engh & Huber (2001)  
Ideal geometry (DNA, RNA) : Parkinson et al. (1996)  
Validation Pipeline (wwPDB-VP) : 2.18

# 1 Overall quality at a glance

The following experimental techniques were used to determine the structure:

*X-RAY DIFFRACTION*

The reported resolution of this entry is 2.50 Å.

Percentile scores (ranging between 0-100) for global validation metrics of the entry are shown in the following graphic. The table shows the number of entries on which the scores are based.

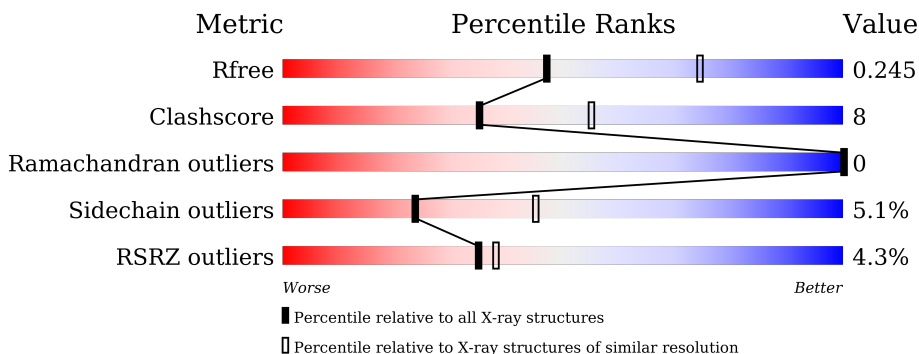

Metric	Whole archive (#Entries)	Similar resolution (#Entries, resolution range(Å))
$R_{free}$	130704	4661 (2.50-2.50)
Clashscore	141614	5346 (2.50-2.50)
Ramachandran outliers	138981	5231 (2.50-2.50)
Sidechain outliers	138945	5233 (2.50-2.50)
RSRZ outliers	127900	4559 (2.50-2.50)

The table below summarises the geometric issues observed across the polymeric chains and their fit to the electron density. The red, orange, yellow and green segments of the lower bar indicate the fraction of residues that contain outliers for  $\geq 3$ , 2, 1 and 0 types of geometric quality criteria respectively. A grey segment represents the fraction of residues that are not modelled. The numeric value for each fraction is indicated below the corresponding segment, with a dot representing fractions  $\leq 5\%$ . The upper red bar (where present) indicates the fraction of residues that have poor fit to the electron density. The numeric value is given above the bar.

Mol	Chain	Length	Quality of chain
1	A	347	
1	D	347	
2	B	57	
2	E	57	
3	C	418	
3	F	418	

The following table lists non-polymeric compounds, carbohydrate monomers and non-standard residues in protein, DNA, RNA chains that are outliers for geometric or electron-density-fit criteria:

<b>Mol</b>	<b>Type</b>	<b>Chain</b>	<b>Res</b>	<b>Chirality</b>	<b>Geometry</b>	<b>Clashes</b>	<b>Electron density</b>
5	NA	C	501	-	-	-	X

## 2 Entry composition i

There are 6 unique types of molecules in this entry. The entry contains 12838 atoms, of which 0 are hydrogens and 0 are deuteriums.

In the tables below, the ZeroOcc column contains the number of atoms modelled with zero occupancy, the AltConf column contains the number of residues with at least one atom in alternate conformation and the Trace column contains the number of residues modelled with at most 2 atoms.

- Molecule 1 is a protein called mRNA export factor.

Mol	Chain	Residues	Atoms					ZeroOcc	AltConf	Trace
			Total	C	N	O	S			
1	A	337	2673	1689	468	498	18	0	0	0
1	D	339	2683	1695	469	501	18	0	0	0

There are 4 discrepancies between the modelled and reference sequences:

Chain	Residue	Modelled	Actual	Comment	Reference
A	22	LEU	-	expression tag	UNP Q8C570
A	23	GLU	-	expression tag	UNP Q8C570
D	22	LEU	-	expression tag	UNP Q8C570
D	23	GLU	-	expression tag	UNP Q8C570

- Molecule 2 is a protein called Peptidase S59 domain-containing protein.

Mol	Chain	Residues	Atoms					ZeroOcc	AltConf	Trace
			Total	C	N	O	S			
2	B	52	412	254	70	85	3	0	0	0
2	E	57	443	273	76	91	3	0	0	0

- Molecule 3 is a protein called 10 protein.

Mol	Chain	Residues	Atoms					ZeroOcc	AltConf	Trace
			Total	C	N	O	S			
3	F	393	3065	1979	517	552	17	0	0	0
3	C	399	3113	2007	526	562	18	0	0	0

- Molecule 4 is MERCURY (II) ION (three-letter code: HG) (formula: Hg) (labeled as "Ligand of Interest" by depositor).

Mol	Chain	Residues	Atoms	ZeroOcc	AltConf
4	A	4	Total Hg 4 4	0	0
4	F	8	Total Hg 8 8	0	0
4	C	8	Total Hg 8 8	0	0
4	D	4	Total Hg 4 4	0	0

- Molecule 5 is SODIUM ION (three-letter code: NA) (formula: Na) (labeled as "Ligand of Interest" by depositor).

Mol	Chain	Residues	Atoms	ZeroOcc	AltConf
5	F	2	Total Na 2 2	0	0
5	C	1	Total Na 1 1	0	0
5	D	1	Total Na 1 1	0	0

- Molecule 6 is water.

Mol	Chain	Residues	Atoms	ZeroOcc	AltConf
6	A	113	Total O 113 113	0	0
6	B	16	Total O 16 16	0	0
6	F	75	Total O 75 75	0	0
6	C	64	Total O 64 64	0	0
6	D	138	Total O 138 138	0	0
6	E	15	Total O 15 15	0	0

### 3 Residue-property plots [i](#)

These plots are drawn for all protein, RNA, DNA and oligosaccharide chains in the entry. The first graphic for a chain summarises the proportions of the various outlier classes displayed in the second graphic. The second graphic shows the sequence view annotated by issues in geometry and electron density. Residues are color-coded according to the number of geometric quality criteria for which they contain at least one outlier: green = 0, yellow = 1, orange = 2 and red = 3 or more. A red dot above a residue indicates a poor fit to the electron density ( $RSRZ > 2$ ). Stretches of 2 or more consecutive residues without any outlier are shown as a green connector. Residues present in the sample, but not in the model, are shown in grey.

- Molecule 1: mRNA export factor

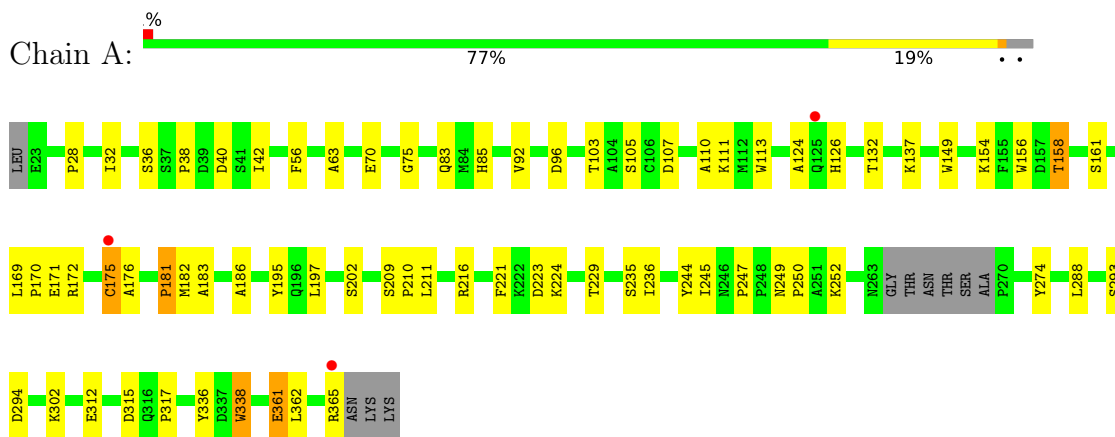

- Molecule 1: mRNA export factor

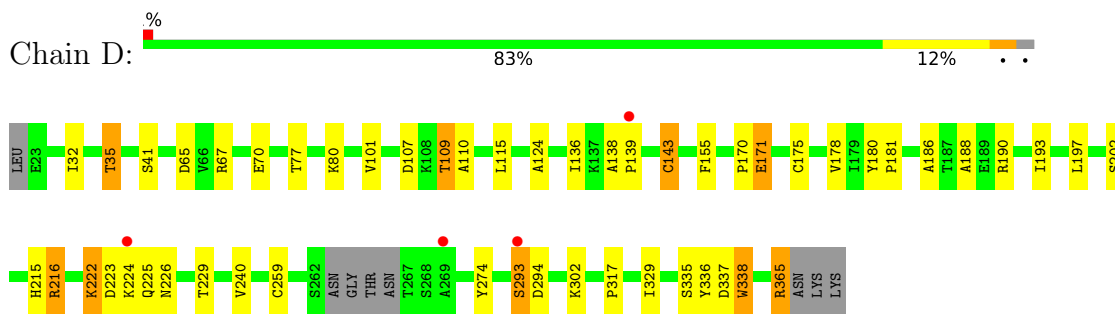

- Molecule 2: Peptidase S59 domain-containing protein

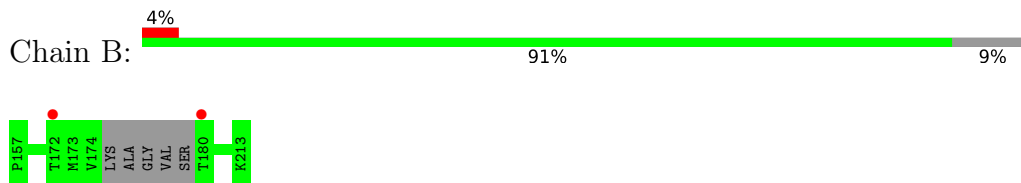

- Molecule 2: Peptidase S59 domain-containing protein





• Molecule 3: 10 protein

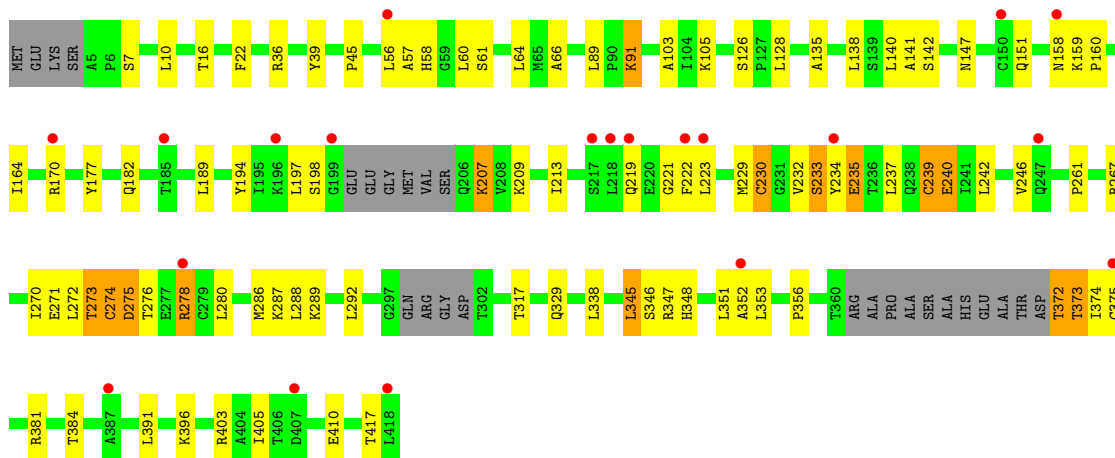

• Molecule 3: 10 protein

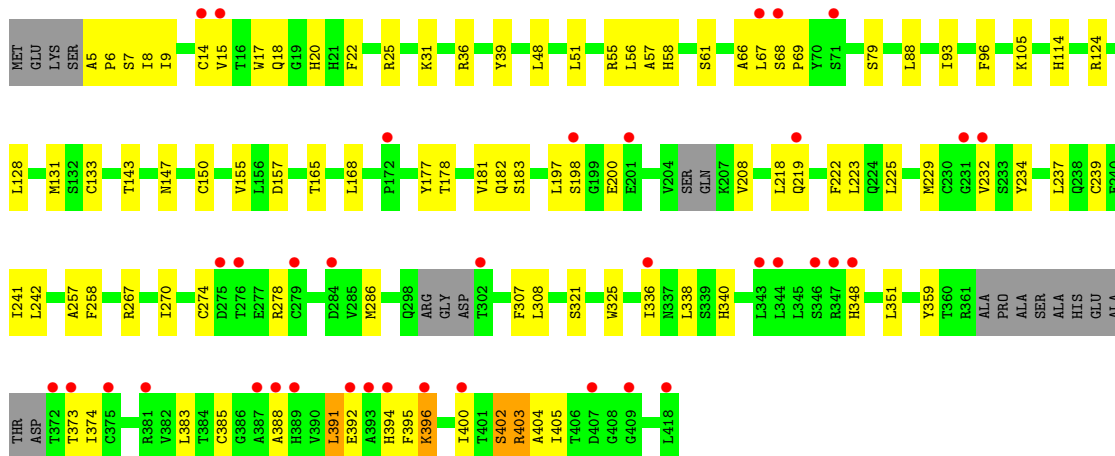

## 4 Data and refinement statistics

Property	Value	Source
Space group	C 1 2 1	Depositor
Cell constants a, b, c, $\alpha$ , $\beta$ , $\gamma$	135.40Å 150.63Å 101.62Å 90.00° 111.03° 90.00°	Depositor
Resolution (Å)	48.90 – 2.50 48.90 – 2.50	Depositor EDS
% Data completeness (in resolution range)	97.5 (48.90-2.50) 97.2 (48.90-2.50)	Depositor EDS
$R_{merge}$	0.15	Depositor
$R_{sym}$	(Not available)	Depositor
$\langle I/\sigma(I) \rangle$ <sup>1</sup>	2.57 (at 2.51Å)	Xtrriage
Refinement program	PHENIX 1.11.1_2575	Depositor
R, $R_{free}$	0.184 , 0.233 0.204 , 0.245	Depositor DCC
$R_{free}$ test set	2000 reflections (3.06%)	wwPDB-VP
Wilson B-factor (Å <sup>2</sup> )	31.6	Xtrriage
Anisotropy	0.571	Xtrriage
Bulk solvent $k_{sol}$ (e/Å <sup>3</sup> ), $B_{sol}$ (Å <sup>2</sup> )	0.32 , 34.1	EDS
L-test for twinning <sup>2</sup>	$\langle  L  \rangle = 0.49$ , $\langle L^2 \rangle = 0.32$	Xtrriage
Estimated twinning fraction	No twinning to report.	Xtrriage
$F_o, F_c$ correlation	0.93	EDS
Total number of atoms	12838	wwPDB-VP
Average B, all atoms (Å <sup>2</sup> )	41.0	wwPDB-VP

Xtrriage's analysis on translational NCS is as follows: *The largest off-origin peak in the Patterson function is 3.13% of the height of the origin peak. No significant pseudotranslation is detected.*

<sup>1</sup>Intensities estimated from amplitudes.

<sup>2</sup>Theoretical values of  $\langle |L| \rangle$ ,  $\langle L^2 \rangle$  for acentric reflections are 0.5, 0.333 respectively for untwinned datasets, and 0.375, 0.2 for perfectly twinned datasets.



## 5 Model quality [i](#)

### 5.1 Standard geometry [i](#)

Bond lengths and bond angles in the following residue types are not validated in this section: HG, NA

The Z score for a bond length (or angle) is the number of standard deviations the observed value is removed from the expected value. A bond length (or angle) with  $|Z| > 5$  is considered an outlier worth inspection. RMSZ is the root-mean-square of all Z scores of the bond lengths (or angles).

Mol	Chain	Bond lengths		Bond angles	
		RMSZ	# Z  >5	RMSZ	# Z  >5
1	A	0.71	0/2750	0.71	0/3737
1	D	0.52	0/2760	0.64	0/3752
2	B	0.45	0/417	0.57	0/560
2	E	0.53	0/449	0.74	0/604
3	C	0.63	0/3195	0.67	0/4364
3	F	0.57	0/3147	0.66	0/4301
All	All	0.61	0/12718	0.67	0/17318

There are no bond length outliers.

There are no bond angle outliers.

There are no chirality outliers.

There are no planarity outliers.

### 5.2 Too-close contacts [i](#)

In the following table, the Non-H and H(model) columns list the number of non-hydrogen atoms and hydrogen atoms in the chain respectively. The H(added) column lists the number of hydrogen atoms added and optimized by MolProbity. The Clashes column lists the number of clashes within the asymmetric unit, whereas Symm-Clashes lists symmetry-related clashes.

Mol	Chain	Non-H	H(model)	H(added)	Clashes	Symm-Clashes
1	A	2673	0	2561	45	0
1	D	2683	0	2572	33	0
2	B	412	0	409	0	0
2	E	443	0	445	1	0
3	C	3113	0	3161	68	0
3	F	3065	0	3114	63	0
4	A	4	0	0	0	0

*Continued on next page...*

Continued from previous page...

Mol	Chain	Non-H	H(model)	H(added)	Clashes	Symm-Clashes
4	C	8	0	0	0	0
4	D	4	0	0	0	0
4	F	8	0	0	0	0
5	C	1	0	0	0	0
5	D	1	0	0	0	0
5	F	2	0	0	0	0
6	A	113	0	0	4	0
6	B	16	0	0	0	0
6	C	64	0	0	0	0
6	D	138	0	0	0	0
6	E	15	0	0	0	0
6	F	75	0	0	1	0
All	All	12838	0	12262	203	0

The all-atom clashscore is defined as the number of clashes found per 1000 atoms (including hydrogen atoms). The all-atom clashscore for this structure is 8.

All (203) close contacts within the same asymmetric unit are listed below, sorted by their clash magnitude.

Atom-1	Atom-2	Interatomic distance (Å)	Clash overlap (Å)
3:F:410:GLU:HB2	1:D:365:ARG:HH21	1.26	0.97
3:F:375:CYS:SG	6:F:655:HOH:O	2.29	0.90
3:C:143:THR:HG21	3:C:147:ASN:HD21	1.39	0.86
1:D:293:SER:HA	1:D:317:PRO:HB3	1.59	0.83
1:A:183:ALA:HB3	1:A:195:TYR:HB2	1.60	0.81
3:F:140:LEU:HD11	3:F:222:PHE:HB3	1.61	0.81
3:C:8:ILE:O	3:C:14:CYS:HA	1.79	0.81
3:C:321:SER:HB2	3:C:336:ILE:HD11	1.65	0.78
3:C:321:SER:HB2	3:C:336:ILE:CD1	2.13	0.78
1:A:38:PRO:HG2	1:A:42:ILE:HG12	1.64	0.78
3:F:209:LYS:HD2	3:F:230:CYS:SG	2.24	0.77
3:F:410:GLU:HB2	1:D:365:ARG:NH2	2.01	0.76
3:C:403:ARG:HH22	3:C:405:ILE:HG12	1.49	0.75
3:C:6:PRO:HB2	3:C:56:LEU:HD22	1.68	0.75
1:D:138:ALA:HB1	1:D:139:PRO:HD2	1.69	0.74
3:F:198:SER:O	3:F:237:LEU:HD23	1.88	0.73
1:D:216:ARG:HH11	1:D:216:ARG:HG3	1.56	0.71
1:A:216:ARG:HG2	1:A:216:ARG:HH11	1.54	0.71
1:A:182:MET:CE	1:A:245:ILE:HG13	2.21	0.70
3:C:6:PRO:HG2	3:C:17:TRP:HB3	1.73	0.69
3:F:410:GLU:CB	1:D:365:ARG:HH21	2.03	0.69

Continued on next page...

*Continued from previous page...*

Atom-1	Atom-2	Interatomic distance (Å)	Clash overlap (Å)
1:D:293:SER:HB3	1:D:337:ASP:OD2	1.92	0.69
1:A:40:ASP:HB2	1:A:63:ALA:HB2	1.76	0.67
3:F:141:ALA:HB2	3:C:9:ILE:HG12	1.77	0.67
3:C:197:LEU:HD13	3:C:237:LEU:HD13	1.77	0.66
3:F:140:LEU:HD11	3:F:222:PHE:CB	2.27	0.64
1:D:136:ILE:HD13	1:D:197:LEU:HD13	1.78	0.64
3:F:57:ALA:HB2	3:F:405:ILE:HD11	1.79	0.64
3:C:143:THR:HG21	3:C:147:ASN:ND2	2.11	0.64
1:A:182:MET:HE2	1:A:245:ILE:HG13	1.79	0.63
3:F:278:ARG:O	3:F:345:LEU:HB2	1.98	0.63
3:C:67:LEU:HD11	3:C:400:ILE:HG21	1.81	0.63
1:A:216:ARG:HG2	1:A:216:ARG:NH1	2.14	0.63
3:C:9:ILE:HG13	3:C:14:CYS:SG	2.38	0.63
3:C:15:VAL:HG11	3:C:51:LEU:HG	1.79	0.63
3:C:56:LEU:HD23	3:C:404:ALA:HA	1.80	0.62
1:A:175:CYS:SG	1:A:186:ALA:HB3	2.40	0.62
3:C:133:CYS:SG	3:C:257:ALA:HB2	2.40	0.62
3:C:278:ARG:HD2	3:C:286:MET:CE	2.30	0.61
3:C:392:GLU:HA	3:C:395:PHE:CZ	2.34	0.61
3:C:68:SER:HB3	3:C:69:PRO:HD3	1.81	0.61
1:D:138:ALA:HB1	1:D:139:PRO:CD	2.30	0.60
3:F:126:SER:HB2	3:F:356:PRO:HB2	1.83	0.60
1:D:101:VAL:HG23	1:D:115:LEU:HD21	1.83	0.60
1:D:222:LYS:HD2	1:D:226:ASN:OD1	2.01	0.60
3:F:235:GLU:H	3:F:235:GLU:CD	2.06	0.59
3:F:275:ASP:HB3	3:F:276:THR:HG23	1.82	0.59
1:D:216:ARG:HH11	1:D:216:ARG:CG	2.14	0.59
1:A:110:ALA:HB3	1:A:124:ALA:HB3	1.85	0.59
3:C:58:HIS:HA	3:C:402:SER:HB3	1.85	0.59
3:C:68:SER:CB	3:C:69:PRO:HD3	2.33	0.59
3:C:182:GLN:HG2	3:C:222:PHE:CD1	2.38	0.59
1:A:132:THR:HG21	1:A:176:ALA:CB	2.33	0.59
3:C:182:GLN:HG2	3:C:222:PHE:HD1	1.68	0.59
3:F:142:SER:HB3	3:F:222:PHE:CZ	2.39	0.58
3:F:159:LYS:HB3	3:F:160:PRO:HD2	1.85	0.58
3:F:272:LEU:HB2	3:F:352:ALA:HB3	1.85	0.58
1:D:274:TYR:CD1	1:D:294:ASP:HB3	2.39	0.58
1:A:132:THR:HG21	1:A:176:ALA:HB3	1.86	0.57
3:C:36:ARG:HH12	3:C:340:HIS:HB3	1.70	0.57
1:A:158:THR:HG23	1:A:158:THR:O	2.03	0.57
3:C:61:SER:OG	3:C:66:ALA:HB3	2.05	0.57

*Continued on next page...*

*Continued from previous page...*

Atom-1	Atom-2	Interatomic distance (Å)	Clash overlap (Å)
1:A:96:ASP:OD2	1:A:137:LYS:HD3	2.05	0.56
3:C:58:HIS:HA	3:C:402:SER:CB	2.35	0.56
1:A:182:MET:HE1	1:A:245:ILE:HG13	1.88	0.56
3:C:39:TYR:CE2	3:C:105:LYS:HB2	2.41	0.56
3:F:89:LEU:HB2	3:F:103:ALA:HB3	1.88	0.55
3:F:280:LEU:HD21	3:F:286:MET:HB2	1.89	0.55
3:C:258:PHE:CE1	3:C:270:ILE:HG12	2.41	0.55
1:A:216:ARG:HD2	1:A:236:ILE:HG22	1.90	0.54
3:F:274:CYS:HB2	3:F:351:LEU:HD11	1.89	0.54
3:F:372:THR:HG23	3:F:373:THR:HG22	1.88	0.54
3:F:189:LEU:HB2	3:F:246:VAL:HG22	1.88	0.54
3:F:275:ASP:O	3:F:347:ARG:HG3	2.07	0.54
3:F:177:TYR:OH	3:F:232:VAL:HG12	2.07	0.54
1:A:92:VAL:HG12	1:A:103:THR:HG22	1.89	0.54
1:A:36:SER:HB3	6:A:564:HOH:O	2.08	0.53
3:F:207:LYS:O	3:F:229:MET:HE3	2.08	0.53
3:C:232:VAL:HG13	3:C:234:TYR:CD2	2.43	0.53
1:D:110:ALA:HB3	1:D:124:ALA:HB3	1.91	0.53
3:F:274:CYS:SG	3:F:347:ARG:HA	2.49	0.53
3:C:321:SER:HB2	3:C:336:ILE:HD12	1.87	0.53
3:C:403:ARG:NH2	3:C:405:ILE:HG12	2.20	0.52
3:C:168:LEU:HB3	3:C:177:TYR:HB3	1.91	0.52
3:F:39:TYR:HB2	3:F:338:LEU:HD22	1.90	0.52
1:D:293:SER:O	1:D:317:PRO:HA	2.10	0.52
3:C:39:TYR:HB2	3:C:338:LEU:HD22	1.91	0.51
1:A:158:THR:HG21	6:A:608:HOH:O	2.09	0.51
3:F:58:HIS:CD2	3:F:64:LEU:HB2	2.45	0.51
3:F:374:ILE:HA	3:F:384:THR:O	2.10	0.51
3:C:15:VAL:HG11	3:C:51:LEU:CG	2.40	0.51
1:A:28:PRO:HB2	1:A:312:GLU:HB2	1.93	0.51
1:A:105:SER:HB3	1:A:107:ASP:OD1	2.11	0.50
3:F:197:LEU:HD23	3:F:239:CYS:HB2	1.93	0.50
1:A:293:SER:HA	1:A:317:PRO:HB3	1.94	0.50
3:C:239:CYS:SG	3:C:241:ILE:HG13	2.52	0.50
1:A:247:PRO:HG2	1:A:250:PRO:HG3	1.94	0.50
3:F:381:ARG:HG2	3:F:396:LYS:HD3	1.93	0.50
1:A:83:GLN:HG2	1:A:113:TRP:CE2	2.46	0.50
1:D:180:TYR:CD1	1:D:181:PRO:HA	2.46	0.49
1:D:274:TYR:CG	1:D:294:ASP:HB3	2.47	0.49
1:D:65:ASP:OD2	1:D:67:ARG:HD2	2.13	0.49
3:C:278:ARG:HD2	3:C:286:MET:HE1	1.94	0.49

*Continued on next page...*

*Continued from previous page...*

Atom-1	Atom-2	Interatomic distance (Å)	Clash overlap (Å)
1:D:41:SER:HB3	1:D:335:SER:HB3	1.95	0.49
3:C:57:ALA:O	3:C:402:SER:HB3	2.12	0.49
3:F:61:SER:OG	3:F:66:ALA:HB3	2.11	0.49
1:D:216:ARG:CG	1:D:216:ARG:NH1	2.73	0.49
3:F:39:TYR:CE1	3:F:105:LYS:HB2	2.47	0.49
3:C:359:TYR:CD2	3:C:388:ALA:HB1	2.47	0.49
3:C:373:THR:HG22	3:C:373:THR:O	2.13	0.49
3:F:170:ARG:HH11	3:F:233:SER:HA	1.76	0.49
3:F:22:PHE:HE1	3:F:56:LEU:HD12	1.78	0.49
3:C:5:ALA:HB3	3:C:6:PRO:HD3	1.94	0.48
3:F:60:LEU:HB3	1:D:329:ILE:HG12	1.94	0.48
3:C:307:PHE:HB2	3:C:325:TRP:HB3	1.95	0.48
3:F:22:PHE:HE1	3:F:56:LEU:CD1	2.27	0.48
3:F:261:PRO:HB3	3:F:271:GLU:HG3	1.95	0.48
3:F:194:TYR:CE2	3:F:242:LEU:HB2	2.48	0.48
3:C:25:ARG:HH11	3:C:114:HIS:HD2	1.62	0.48
1:A:315:ASP:HB2	3:F:289:LYS:NZ	2.29	0.48
3:F:272:LEU:HD12	3:F:352:ALA:CB	2.44	0.48
3:C:48:LEU:HD22	3:C:93:ILE:CG2	2.43	0.47
3:C:67:LEU:HD13	3:C:400:ILE:HD12	1.96	0.47
1:A:56:PHE:CE2	1:A:70:GLU:HG3	2.49	0.47
3:C:36:ARG:NH1	3:C:340:HIS:HB3	2.29	0.47
1:A:169:LEU:HB3	1:A:170:PRO:HD2	1.96	0.47
3:F:39:TYR:CZ	3:F:89:LEU:HD13	2.50	0.46
1:A:221:PHE:CE1	1:A:302:LYS:HE3	2.51	0.46
1:D:336:TYR:CE2	1:D:338:TRP:HA	2.50	0.46
1:A:211:LEU:HD13	1:A:235:SER:HB3	1.97	0.46
3:F:164:ILE:O	3:F:240:GLU:HA	2.15	0.46
1:A:223:ASP:HB3	1:A:229:THR:HG21	1.97	0.46
1:A:274:TYR:CD1	1:A:294:ASP:HB3	2.51	0.45
3:C:15:VAL:HG21	3:C:51:LEU:HD11	1.99	0.45
1:A:361:GLU:HG2	6:A:545:HOH:O	2.17	0.45
3:F:7:SER:OG	3:F:16:THR:HG22	2.17	0.45
3:C:218:LEU:HD23	3:C:218:LEU:HA	1.76	0.45
3:F:138:LEU:HD13	3:F:138:LEU:HA	1.84	0.45
3:C:79:SER:HB3	3:C:88:LEU:HB2	1.99	0.45
1:D:175:CYS:SG	1:D:186:ALA:HB3	2.57	0.45
3:F:135:ALA:HA	3:F:213:ILE:O	2.17	0.45
3:C:5:ALA:N	3:C:6:PRO:HD2	2.32	0.44
3:C:308:LEU:HD21	3:C:385:CYS:SG	2.57	0.44
1:A:85:HIS:CE1	1:A:111:LYS:HG3	2.52	0.44

*Continued on next page...*

*Continued from previous page...*

Atom-1	Atom-2	Interatomic distance (Å)	Clash overlap (Å)
1:A:132:THR:CG2	1:A:176:ALA:HB3	2.48	0.44
1:D:143:CYS:SG	1:D:155:PHE:HB3	2.57	0.44
1:D:190:ARG:HA	1:D:215:HIS:CE1	2.52	0.44
1:A:182:MET:HE1	1:A:245:ILE:CG1	2.48	0.44
3:F:292:LEU:HD23	3:F:292:LEU:HA	1.72	0.44
1:A:361:GLU:CG	6:A:545:HOH:O	2.65	0.44
3:F:229:MET:HE2	3:F:229:MET:HB3	1.84	0.44
3:C:178:THR:HA	3:C:225:LEU:O	2.17	0.44
3:F:209:LYS:HB3	3:F:209:LYS:HE3	1.81	0.44
1:A:244:TYR:HB2	1:A:247:PRO:HB3	2.00	0.44
1:A:249:ASN:ND2	1:A:252:LYS:HD3	2.32	0.43
3:F:207:LYS:H	3:F:207:LYS:HG2	1.55	0.43
3:C:155:VAL:HG11	3:C:242:LEU:HD11	2.00	0.43
3:F:182:GLN:HE22	3:F:221:GLY:HA3	1.82	0.43
1:D:223:ASP:HB3	1:D:229:THR:HG21	1.99	0.43
3:F:182:GLN:HG2	3:F:222:PHE:CD1	2.54	0.43
3:C:48:LEU:HD22	3:C:93:ILE:HG22	2.00	0.43
3:F:273:THR:OG1	3:F:348:HIS:HA	2.18	0.43
1:A:149:TRP:O	1:A:172:ARG:HG2	2.17	0.43
1:A:181:PRO:O	1:A:197:LEU:HB2	2.19	0.43
3:F:170:ARG:NH1	3:F:233:SER:HA	2.34	0.43
3:C:48:LEU:HB3	3:C:96:PHE:HA	2.01	0.43
3:C:208:VAL:HG22	3:C:229:MET:SD	2.58	0.43
3:C:6:PRO:HB2	3:C:56:LEU:CD2	2.43	0.43
3:C:383:LEU:HB3	3:C:395:PHE:CE1	2.54	0.43
3:C:396:LYS:HA	3:C:396:LYS:HD2	1.70	0.43
3:F:232:VAL:HG11	3:F:237:LEU:HD11	2.01	0.42
3:C:392:GLU:HA	3:C:395:PHE:CE2	2.53	0.42
3:C:403:ARG:HH21	3:C:403:ARG:CG	2.32	0.42
1:D:35:THR:HG23	1:D:77:THR:OG1	2.19	0.42
1:D:240:VAL:HG23	1:D:259:CYS:SG	2.59	0.42
3:F:60:LEU:HD21	1:D:32:ILE:HD12	2.01	0.42
3:F:10:LEU:HD13	3:F:45:PRO:HG2	2.00	0.42
3:F:270:ILE:O	3:F:353:LEU:HD23	2.19	0.42
3:F:329:GLN:HE21	3:F:329:GLN:HA	1.84	0.42
3:C:150:CYS:SG	3:C:181:VAL:HB	2.60	0.42
3:F:36:ARG:NE	3:F:36:ARG:HA	2.35	0.41
3:C:183:SER:HB2	3:C:223:LEU:CD1	2.49	0.41
1:A:156:TRP:CD1	1:A:156:TRP:N	2.88	0.41
3:C:274:CYS:HB2	3:C:351:LEU:HD11	2.02	0.41
1:A:32:ILE:HG21	1:A:75:GLY:O	2.20	0.41

*Continued on next page...*

Continued from previous page...

Atom-1	Atom-2	Interatomic distance (Å)	Clash overlap (Å)
1:A:209:SER:HA	1:A:210:PRO:HD3	1.81	0.41
3:F:91:LYS:HE3	3:F:317:THR:HG21	2.02	0.41
3:C:67:LEU:HD13	3:C:400:ILE:CD1	2.51	0.41
3:F:232:VAL:HG13	3:F:234:TYR:HD2	1.86	0.41
1:D:107:ASP:OD1	1:D:109:THR:HB	2.21	0.41
1:D:170:PRO:HD3	1:D:193:ILE:HD11	2.03	0.41
3:C:15:VAL:HG12	3:C:22:PHE:CD1	2.56	0.41
3:C:61:SER:HG	3:C:66:ALA:HB3	1.83	0.41
1:D:70:GLU:HB2	1:D:80:LYS:HD2	2.02	0.41
1:A:336:TYR:CE2	1:A:338:TRP:HA	2.56	0.40
1:A:224:LYS:HA	1:A:224:LYS:HD3	1.86	0.40
1:D:171:GLU:HB3	1:D:188:ALA:HB3	2.04	0.40
2:E:203:LEU:HD23	2:E:203:LEU:HA	1.94	0.40
3:F:39:TYR:CE1	3:F:89:LEU:HD13	2.57	0.40
3:C:39:TYR:CD2	3:C:105:LYS:HB2	2.57	0.40
3:C:374:ILE:HG12	3:C:385:CYS:SG	2.62	0.40
3:C:391:LEU:HB2	3:C:394:HIS:CD2	2.56	0.40
1:A:126:HIS:CE1	1:A:154:LYS:HG3	2.57	0.40

There are no symmetry-related clashes.

## 5.3 Torsion angles

### 5.3.1 Protein backbone

In the following table, the Percentiles column shows the percent Ramachandran outliers of the chain as a percentile score with respect to all X-ray entries followed by that with respect to entries of similar resolution.

The Analysed column shows the number of residues for which the backbone conformation was analysed, and the total number of residues.

Mol	Chain	Analysed	Favoured	Allowed	Outliers	Percentiles	
1	A	333/347 (96%)	323 (97%)	10 (3%)	0	100	100
1	D	335/347 (96%)	317 (95%)	18 (5%)	0	100	100
2	B	48/57 (84%)	46 (96%)	2 (4%)	0	100	100
2	E	55/57 (96%)	49 (89%)	6 (11%)	0	100	100
3	C	391/418 (94%)	379 (97%)	12 (3%)	0	100	100
3	F	385/418 (92%)	369 (96%)	16 (4%)	0	100	100

Continued on next page...

*Continued from previous page...*

Mol	Chain	Analysed	Favoured	Allowed	Outliers	Percentiles	
All	All	1547/1644 (94%)	1483 (96%)	64 (4%)	0	100	100

There are no Ramachandran outliers to report.

### 5.3.2 Protein sidechains [i](#)

In the following table, the Percentiles column shows the percent sidechain outliers of the chain as a percentile score with respect to all X-ray entries followed by that with respect to entries of similar resolution.

The Analysed column shows the number of residues for which the sidechain conformation was analysed, and the total number of residues.

Mol	Chain	Analysed	Rotameric	Outliers	Percentiles	
1	A	293/301 (97%)	282 (96%)	11 (4%)	33	58
1	D	294/301 (98%)	280 (95%)	14 (5%)	25	48
2	B	48/51 (94%)	48 (100%)	0	100	100
2	E	51/51 (100%)	50 (98%)	1 (2%)	55	79
3	C	359/373 (96%)	340 (95%)	19 (5%)	22	43
3	F	354/373 (95%)	327 (92%)	27 (8%)	13	25
All	All	1399/1450 (96%)	1327 (95%)	72 (5%)	24	45

All (72) residues with a non-rotameric sidechain are listed below:

Mol	Chain	Res	Type
1	A	158	THR
1	A	161	SER
1	A	171	GLU
1	A	175	CYS
1	A	181	PRO
1	A	202	SER
1	A	288	LEU
1	A	338	TRP
1	A	361	GLU
1	A	362	LEU
1	A	365	ARG
3	F	91	LYS
3	F	128	LEU
3	F	147	ASN

*Continued on next page...*



*Continued from previous page...*

<b>Mol</b>	<b>Chain</b>	<b>Res</b>	<b>Type</b>
3	F	151	GLN
3	F	158	ASN
3	F	207	LYS
3	F	219	GLN
3	F	223	LEU
3	F	230	CYS
3	F	233	SER
3	F	235	GLU
3	F	239	CYS
3	F	240	GLU
3	F	267	ARG
3	F	273	THR
3	F	274	CYS
3	F	275	ASP
3	F	278	ARG
3	F	287	LYS
3	F	288	LEU
3	F	345	LEU
3	F	346	SER
3	F	372	THR
3	F	373	THR
3	F	391	LEU
3	F	403	ARG
3	F	417	THR
3	C	7	SER
3	C	18	GLN
3	C	20	HIS
3	C	31	LYS
3	C	55	ARG
3	C	124	ARG
3	C	128	LEU
3	C	131	MET
3	C	157	ASP
3	C	165	THR
3	C	198	SER
3	C	200	GLU
3	C	219	GLN
3	C	267	ARG
3	C	348	HIS
3	C	391	LEU
3	C	396	LYS
3	C	402	SER

*Continued on next page...*

*Continued from previous page...*

Mol	Chain	Res	Type
3	C	403	ARG
1	D	35	THR
1	D	109	THR
1	D	143	CYS
1	D	171	GLU
1	D	178	VAL
1	D	202	SER
1	D	216	ARG
1	D	222	LYS
1	D	224	LYS
1	D	225	GLN
1	D	293	SER
1	D	302	LYS
1	D	338	TRP
1	D	365	ARG
2	E	184	THR

Sometimes sidechains can be flipped to improve hydrogen bonding and reduce clashes. All (8) such sidechains are listed below:

Mol	Chain	Res	Type
1	A	76	GLN
3	F	18	GLN
3	F	182	GLN
3	F	348	HIS
3	C	20	HIS
3	C	21	HIS
3	C	34	ASN
3	C	147	ASN

### 5.3.3 RNA [i](#)

There are no RNA molecules in this entry.

## 5.4 Non-standard residues in protein, DNA, RNA chains [i](#)

There are no non-standard protein/DNA/RNA residues in this entry.

## 5.5 Carbohydrates [i](#)

There are no monosaccharides in this entry.

## 5.6 Ligand geometry

Of 28 ligands modelled in this entry, 28 are monoatomic - leaving 0 for Mogul analysis.

There are no bond length outliers.

There are no bond angle outliers.

There are no chirality outliers.

There are no torsion outliers.

There are no ring outliers.

No monomer is involved in short contacts.

## 5.7 Other polymers

There are no such residues in this entry.

## 5.8 Polymer linkage issues

There are no chain breaks in this entry.

## 6 Fit of model and data [i](#)

### 6.1 Protein, DNA and RNA chains [i](#)

In the following table, the column labelled ‘#RSRZ > 2’ contains the number (and percentage) of RSRZ outliers, followed by percent RSRZ outliers for the chain as percentile scores relative to all X-ray entries and entries of similar resolution. The OWAB column contains the minimum, median, 95<sup>th</sup> percentile and maximum values of the occupancy-weighted average B-factor per residue. The column labelled ‘Q < 0.9’ lists the number of (and percentage) of residues with an average occupancy less than 0.9.

Mol	Chain	Analysed	<RSRZ>	#RSRZ>2	OWAB(Å <sup>2</sup> )	Q<0.9
1	A	337/347 (97%)	-0.20	3 (0%) 84 86	24, 35, 52, 71	0
1	D	339/347 (97%)	-0.20	4 (1%) 79 80	22, 30, 47, 80	0
2	B	52/57 (91%)	0.01	2 (3%) 40 43	25, 38, 78, 90	0
2	E	57/57 (100%)	0.16	2 (3%) 44 47	24, 36, 92, 101	0
3	C	399/418 (95%)	0.47	37 (9%) 8 8	26, 42, 78, 89	0
3	F	393/418 (94%)	0.34	20 (5%) 28 29	25, 46, 76, 92	0
All	All	1577/1644 (95%)	0.12	68 (4%) 35 38	22, 37, 72, 101	0

All (68) RSRZ outliers are listed below:

Mol	Chain	Res	Type	RSRZ
3	C	68	SER	7.2
3	C	348	HIS	6.9
3	F	418	LEU	5.9
3	C	14	CYS	5.7
3	C	418	LEU	4.9
3	C	201	GLU	4.6
3	C	375	CYS	4.5
2	B	180	THR	4.3
3	C	344	LEU	3.9
3	F	223	LEU	3.8
3	F	375	CYS	3.7
3	F	158	ASN	3.7
2	E	179	SER	3.4
3	C	347	ARG	3.3
3	F	407	ASP	3.3
3	F	387	ALA	3.3
1	A	365	ARG	3.3
3	C	15	VAL	3.3
3	C	407	ASP	3.2

*Continued on next page...*

*Continued from previous page...*

<b>Mol</b>	<b>Chain</b>	<b>Res</b>	<b>Type</b>	<b>RSRZ</b>
3	C	279	CYS	3.1
3	C	387	ALA	3.0
3	F	218	LEU	3.0
3	F	199	GLY	3.0
3	C	393	ALA	2.9
1	D	293	SER	2.9
1	A	175	CYS	2.9
3	C	394	HIS	2.9
1	D	139	PRO	2.9
3	C	400	ILE	2.8
3	C	231	GLY	2.7
1	D	269	ALA	2.7
3	F	150	CYS	2.7
3	C	302	THR	2.7
3	C	373	THR	2.7
3	F	222	PHE	2.6
3	C	381	ARG	2.6
3	C	388	ALA	2.6
3	F	278	ARG	2.6
3	C	232	VAL	2.6
3	F	185	THR	2.5
3	F	56	LEU	2.5
3	F	219	GLN	2.5
3	C	275	ASP	2.5
2	E	176	ALA	2.5
3	C	346	SER	2.5
3	F	234	TYR	2.4
2	B	172	THR	2.4
3	C	372	THR	2.4
3	C	71	SER	2.4
3	C	336	ILE	2.4
3	C	396	LYS	2.4
3	F	247	GLN	2.4
3	C	67	LEU	2.3
3	C	343	LEU	2.3
3	C	284	ASP	2.3
3	F	170	ARG	2.2
3	C	389	HIS	2.2
3	C	172	PRO	2.2
3	F	196	LYS	2.1
3	C	392	GLU	2.1
3	C	198	SER	2.1

*Continued on next page...*

*Continued from previous page...*

Mol	Chain	Res	Type	RSRZ
3	C	409	GLY	2.1
1	D	224	LYS	2.1
1	A	125	GLN	2.1
3	C	276	THR	2.0
3	C	219	GLN	2.0
3	F	217	SER	2.0
3	F	352	ALA	2.0

## 6.2 Non-standard residues in protein, DNA, RNA chains [i](#)

There are no non-standard protein/DNA/RNA residues in this entry.

## 6.3 Carbohydrates [i](#)

There are no monosaccharides in this entry.

## 6.4 Ligands [i](#)

In the following table, the Atoms column lists the number of modelled atoms in the group and the number defined in the chemical component dictionary. The B-factors column lists the minimum, median, 95<sup>th</sup> percentile and maximum values of B factors of atoms in the group. The column labelled 'Q< 0.9' lists the number of atoms with occupancy less than 0.9.

Mol	Type	Chain	Res	Atoms	RSCC	RSR	B-factors(Å <sup>2</sup> )	Q<0.9
5	NA	C	501	1/1	0.24	0.49	76,76,76,76	0
5	NA	F	501	1/1	0.41	0.35	70,70,70,70	0
5	NA	F	502	1/1	0.68	0.30	54,54,54,54	0
4	HG	C	505	1/1	0.71	0.14	57,57,57,57	1
5	NA	D	401	1/1	0.73	0.25	67,67,67,67	0
4	HG	F	509	1/1	0.80	0.13	55,55,55,55	1
4	HG	F	506	1/1	0.95	0.04	51,51,51,51	1
4	HG	C	503	1/1	0.96	0.08	35,35,35,35	1
4	HG	D	403	1/1	0.96	0.10	48,48,48,48	1
4	HG	C	507	1/1	0.97	0.07	54,54,54,54	1
4	HG	A	403	1/1	0.97	0.06	44,44,44,44	1
4	HG	C	502	1/1	0.97	0.05	35,35,35,35	1
4	HG	C	509	1/1	0.98	0.06	32,32,32,32	1
4	HG	A	402	1/1	0.98	0.05	40,40,40,40	1
4	HG	F	507	1/1	0.98	0.06	30,30,30,30	1
4	HG	F	508	1/1	0.98	0.05	37,37,37,37	1

*Continued on next page...*

*Continued from previous page...*

Mol	Type	Chain	Res	Atoms	RSCC	RSR	B-factors( $\text{\AA}^2$ )	Q<0.9
4	HG	F	504	1/1	0.98	0.09	39,39,39,39	1
4	HG	C	508	1/1	0.98	0.05	33,33,33,33	1
4	HG	F	505	1/1	0.99	0.05	29,29,29,29	1
4	HG	D	402	1/1	0.99	0.06	32,32,32,32	1
4	HG	C	504	1/1	0.99	0.06	31,31,31,31	1
4	HG	F	503	1/1	0.99	0.06	41,41,41,41	1
4	HG	C	506	1/1	0.99	0.05	33,33,33,33	1
4	HG	F	510	1/1	0.99	0.09	33,33,33,33	1
4	HG	A	401	1/1	0.99	0.07	35,35,35,35	1
4	HG	D	404	1/1	1.00	0.06	25,25,25,25	1
4	HG	D	405	1/1	1.00	0.10	20,20,20,20	1
4	HG	A	404	1/1	1.00	0.05	25,25,25,25	1

The following is a graphical depiction of the model fit to experimental electron density of all instances of the Ligand of Interest. In addition, ligands with molecular weight > 250 and outliers as shown on the geometry validation Tables will also be included. Each fit is shown from different orientation to approximate a three-dimensional view.

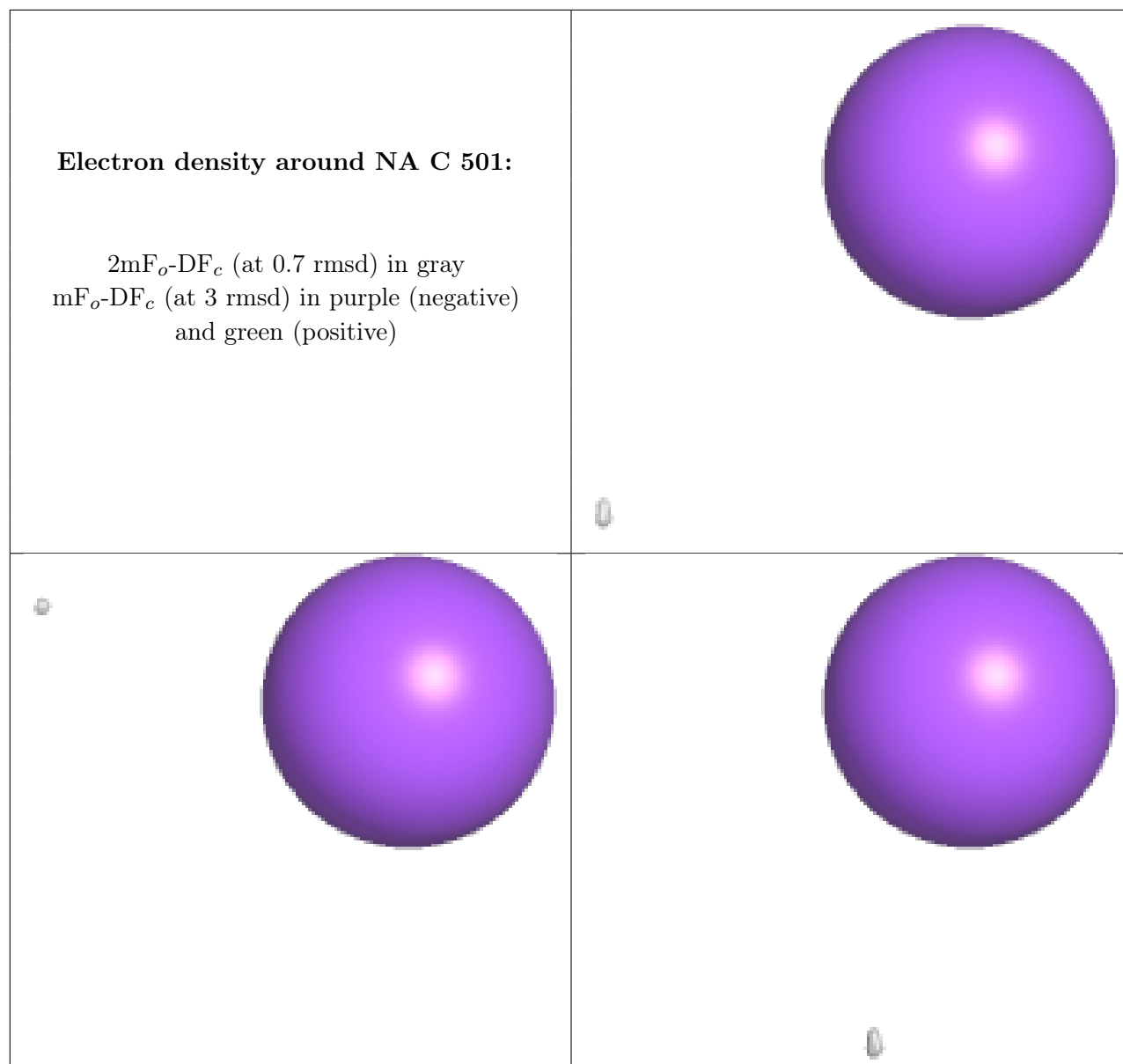



**Electron density around NA F 501:**

$2mF_o-DF_c$  (at 0.7 rmsd) in gray  
 $mF_o-DF_c$  (at 3 rmsd) in purple (negative)  
and green (positive)

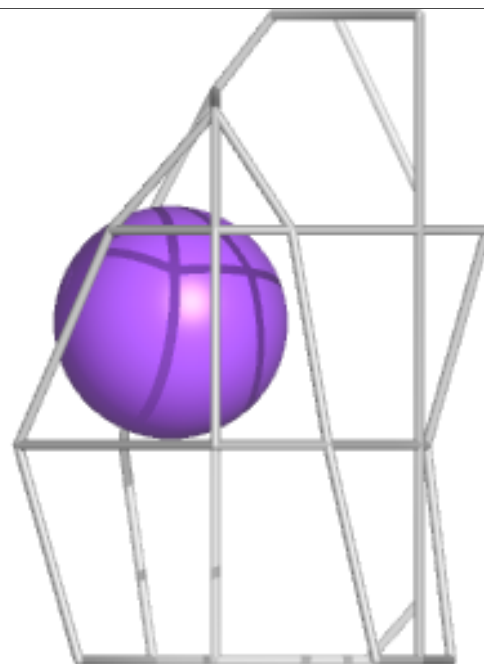
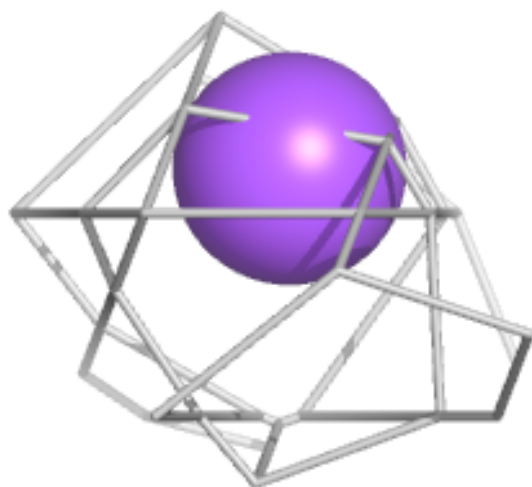
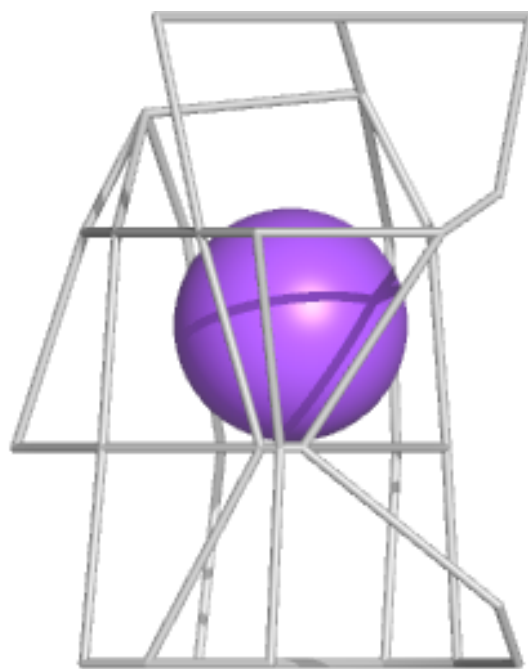

**Electron density around NA F 502:**

$2mF_o-DF_c$  (at 0.7 rmsd) in gray  
 $mF_o-DF_c$  (at 3 rmsd) in purple (negative)  
and green (positive)

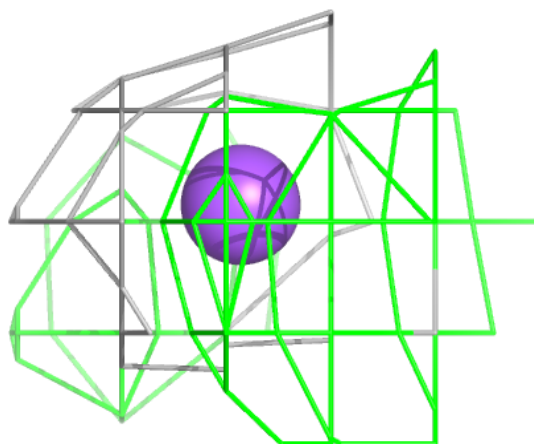
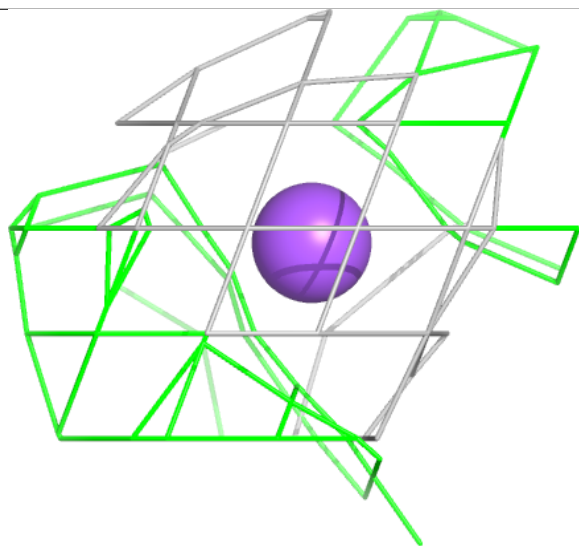
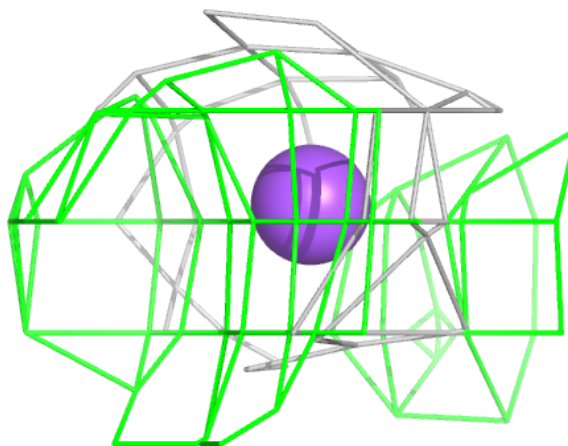

**Electron density around HG C 505:**

$2mF_o-DF_c$  (at 0.7 rmsd) in gray  
 $mF_o-DF_c$  (at 3 rmsd) in purple (negative)  
and green (positive)

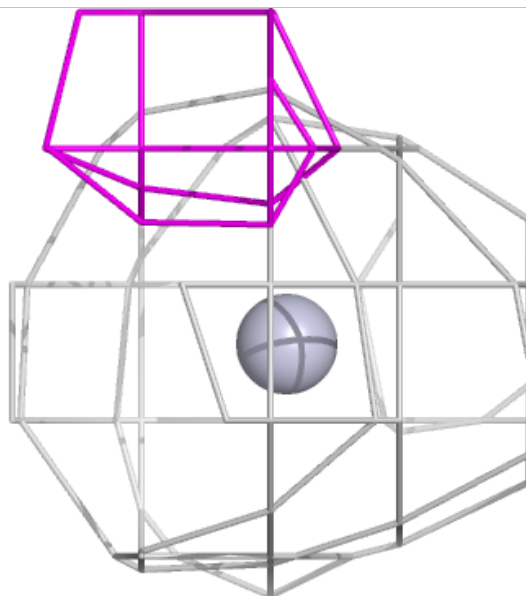
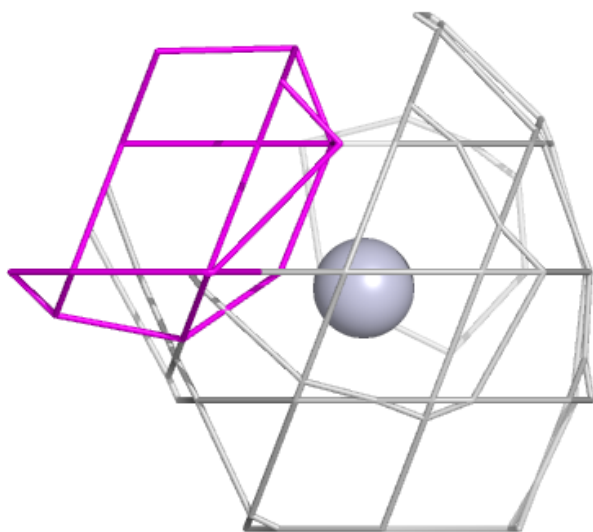
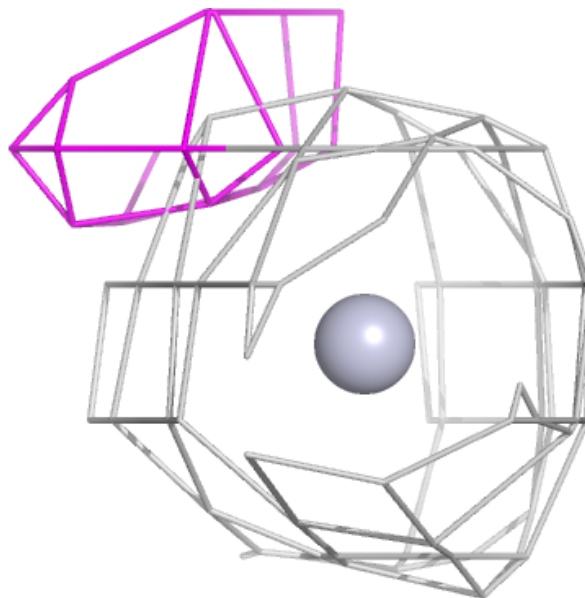

**Electron density around NA D 401:**

$2mF_o-DF_c$  (at 0.7 rmsd) in gray  
 $mF_o-DF_c$  (at 3 rmsd) in purple (negative)  
and green (positive)

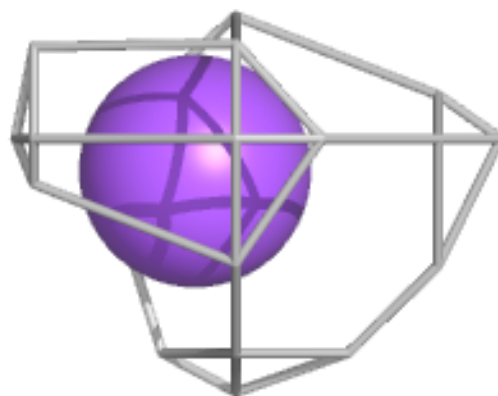
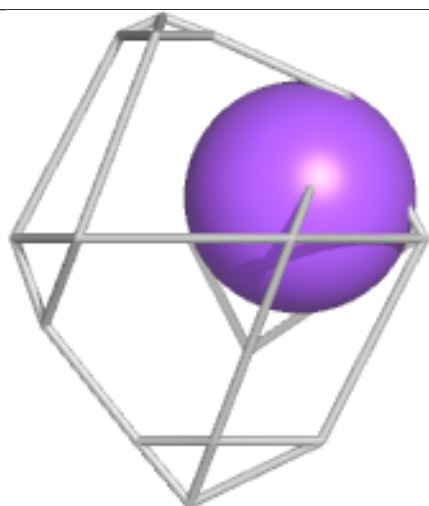
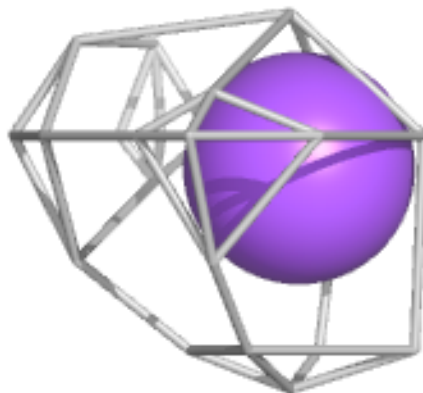

**Electron density around HG F 509:**

$2mF_o-DF_c$  (at 0.7 rmsd) in gray  
 $mF_o-DF_c$  (at 3 rmsd) in purple (negative)  
and green (positive)

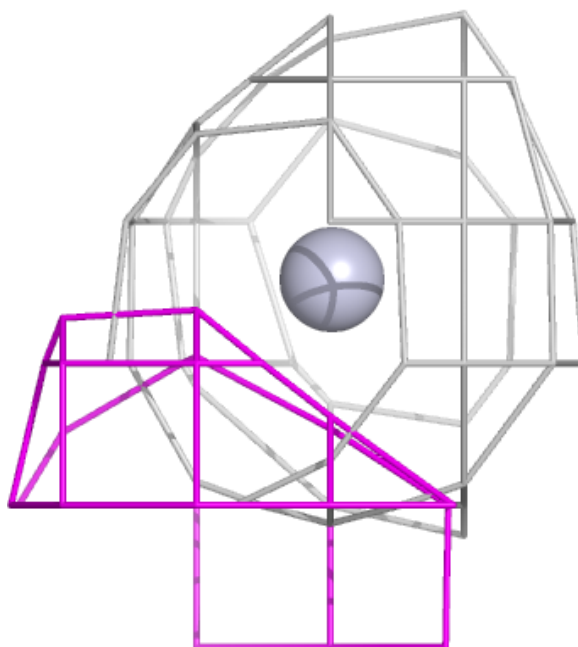
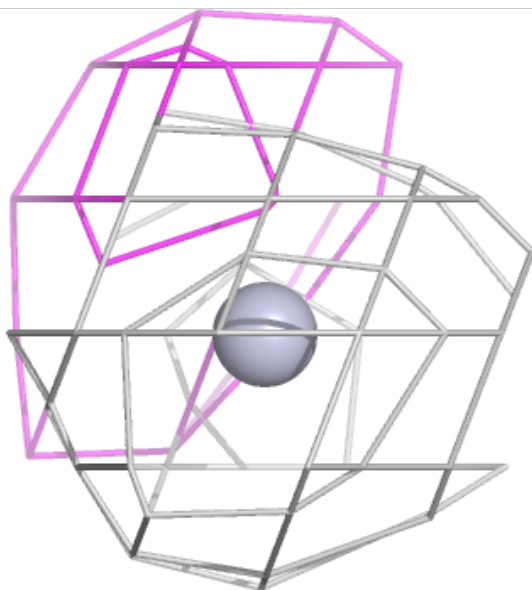
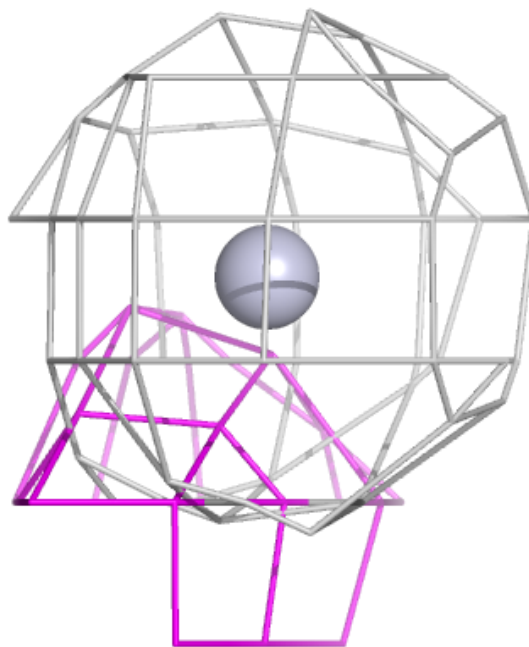

**Electron density around HG F 506:**

$2mF_o-DF_c$  (at 0.7 rmsd) in gray  
 $mF_o-DF_c$  (at 3 rmsd) in purple (negative)  
and green (positive)

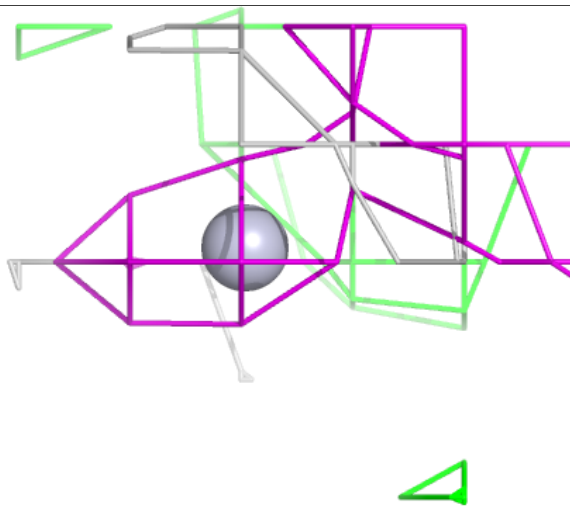
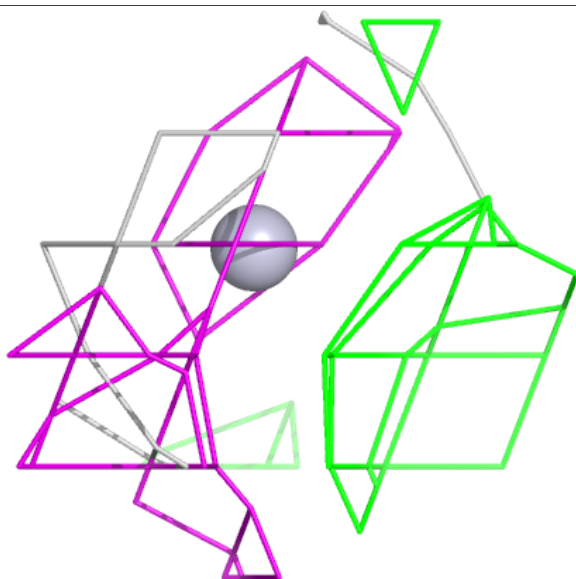
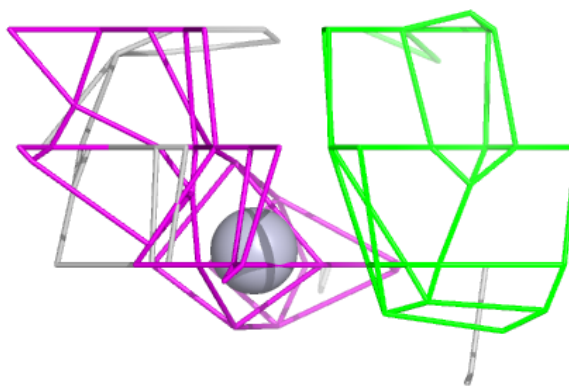

**Electron density around HG C 503:**

$2mF_o-DF_c$  (at 0.7 rmsd) in gray  
 $mF_o-DF_c$  (at 3 rmsd) in purple (negative)  
and green (positive)

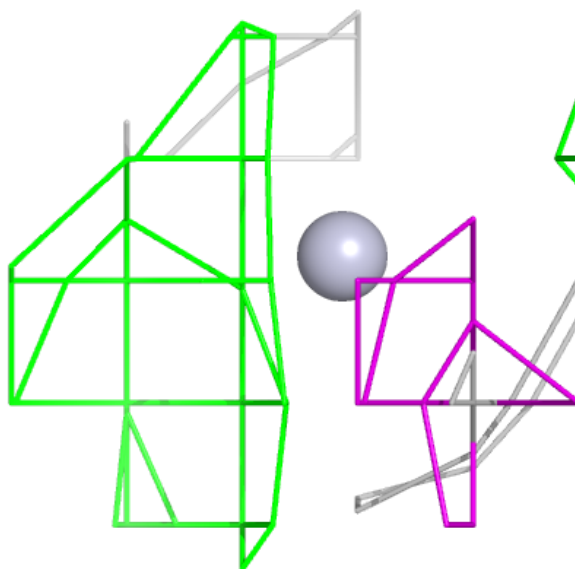
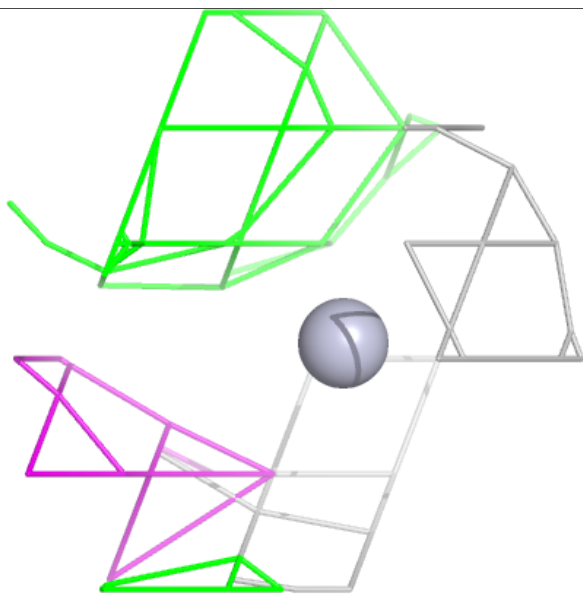
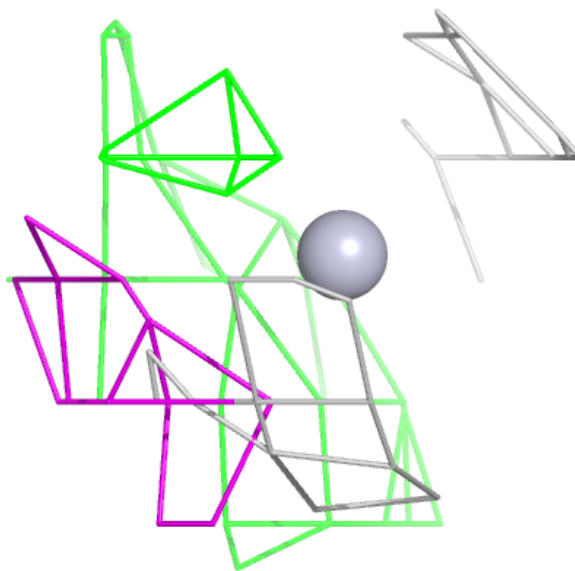

**Electron density around HG D 403:**

$2mF_o-DF_c$  (at 0.7 rmsd) in gray  
 $mF_o-DF_c$  (at 3 rmsd) in purple (negative)  
and green (positive)

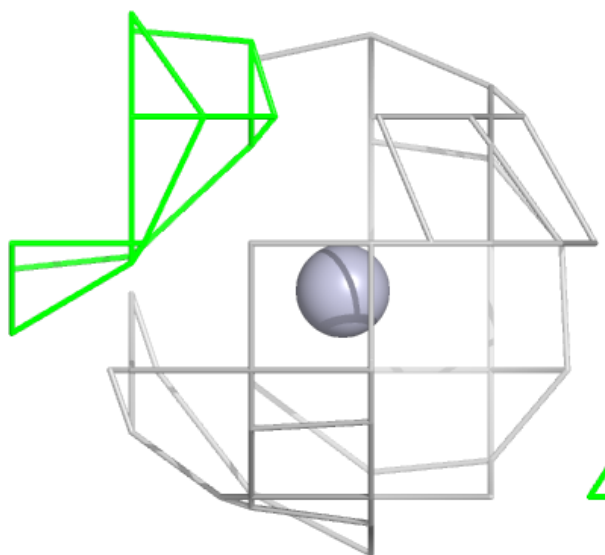
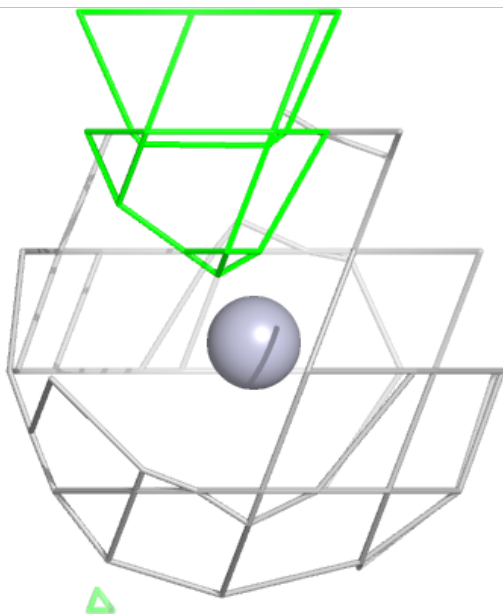
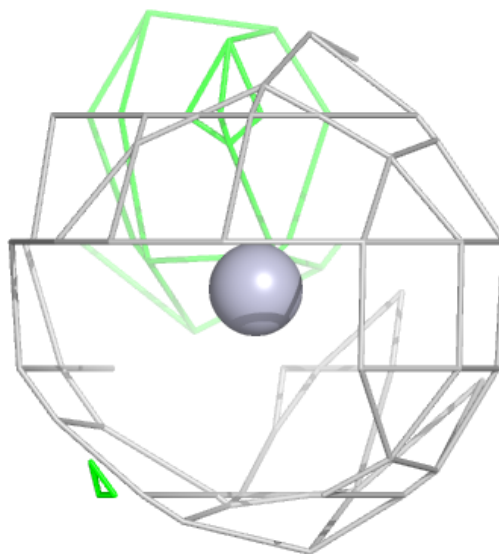



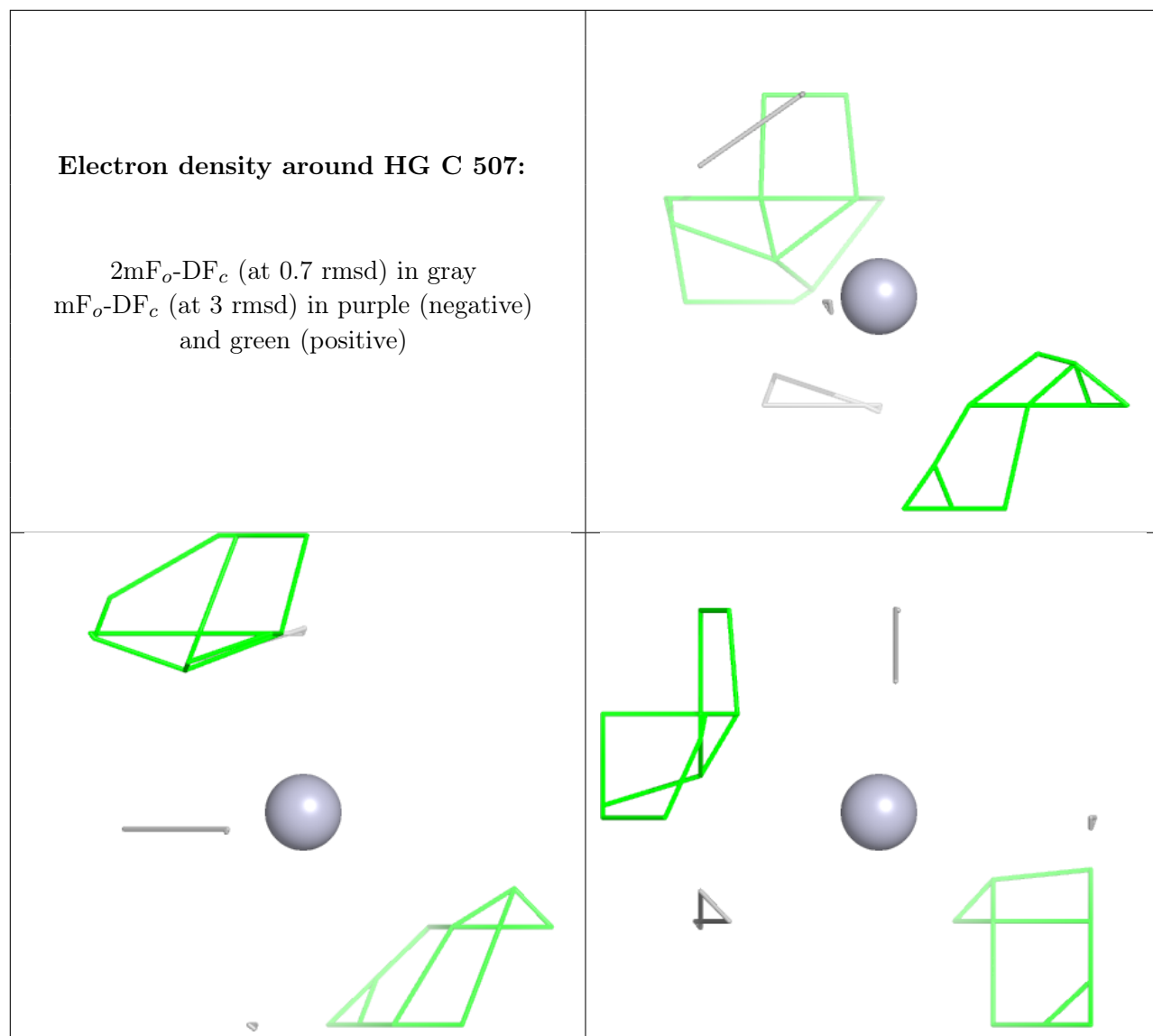

**Electron density around HG A 403:**

$2mF_o-DF_c$  (at 0.7 rmsd) in gray  
 $mF_o-DF_c$  (at 3 rmsd) in purple (negative)  
and green (positive)

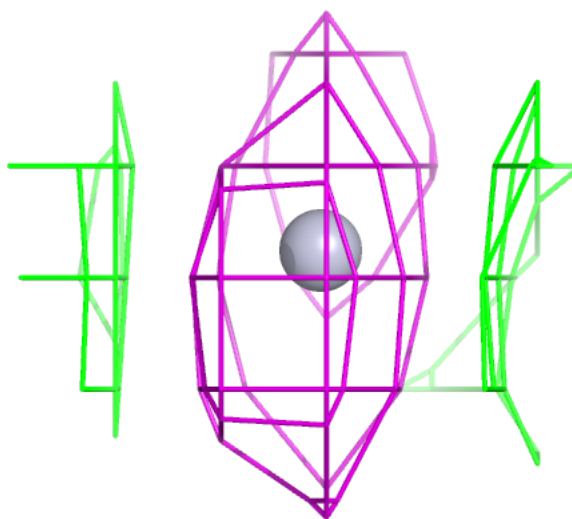
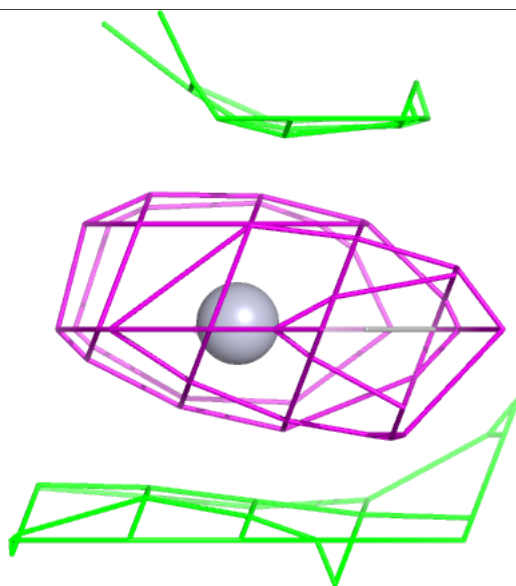
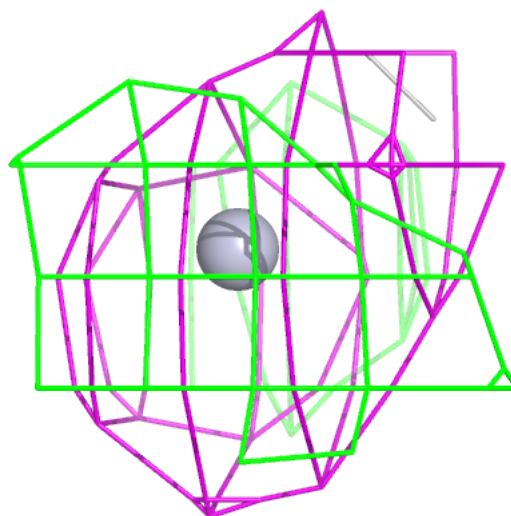

**Electron density around HG C 502:**

$2mF_o-DF_c$  (at 0.7 rmsd) in gray  
 $mF_o-DF_c$  (at 3 rmsd) in purple (negative)  
and green (positive)

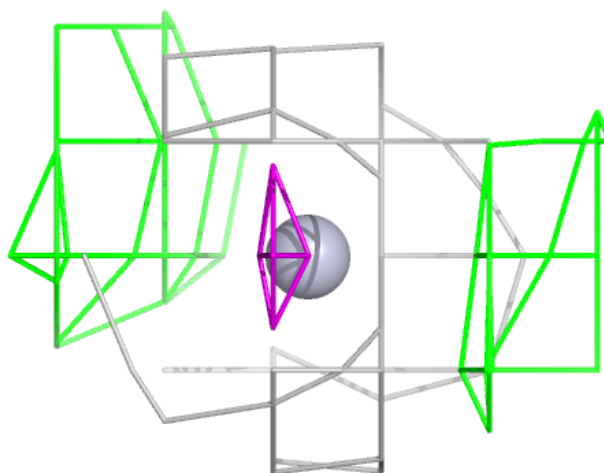
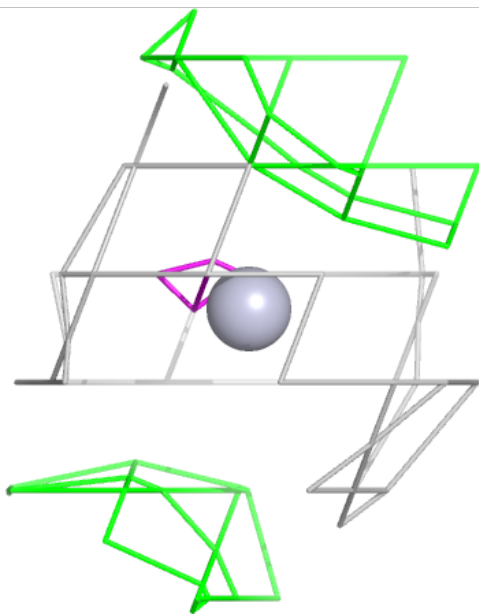
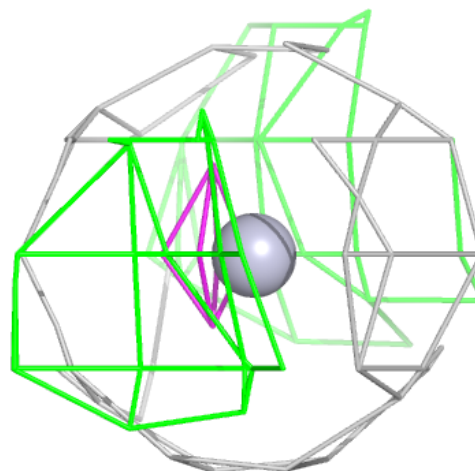

**Electron density around HG C 509:**

$2mF_o-DF_c$  (at 0.7 rmsd) in gray  
 $mF_o-DF_c$  (at 3 rmsd) in purple (negative)  
and green (positive)

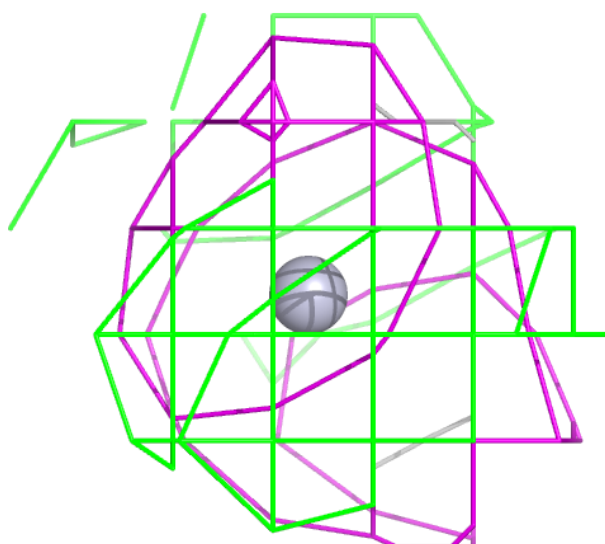
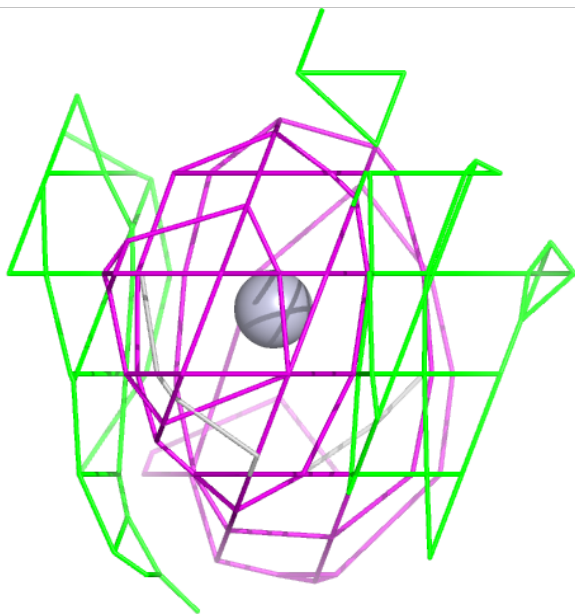
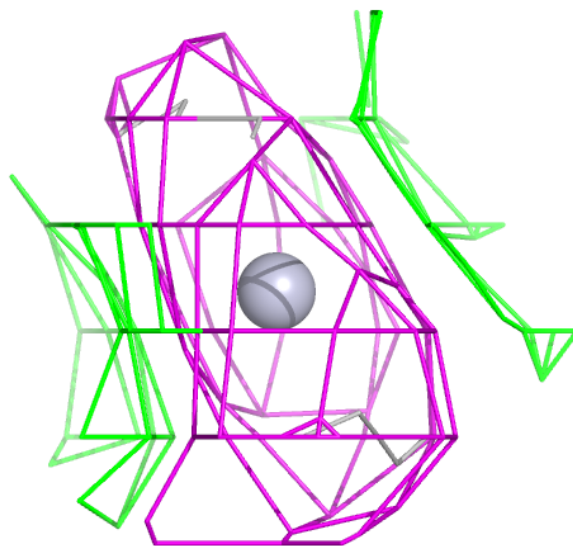

**Electron density around HG A 402:**

$2mF_o-DF_c$  (at 0.7 rmsd) in gray  
 $mF_o-DF_c$  (at 3 rmsd) in purple (negative)  
and green (positive)

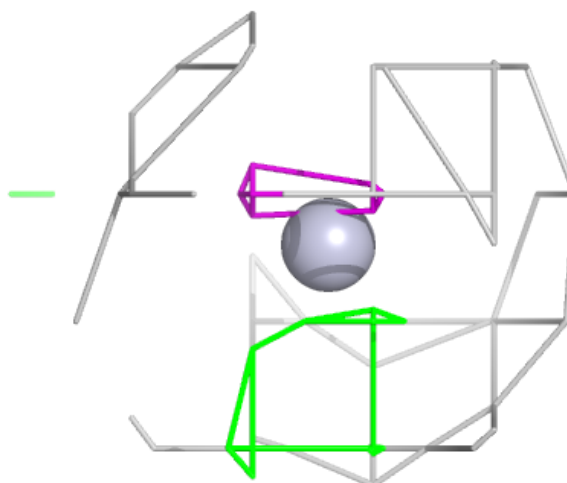
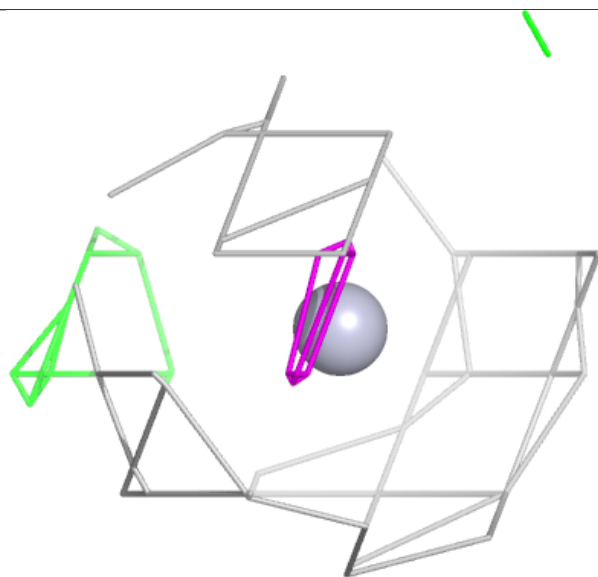
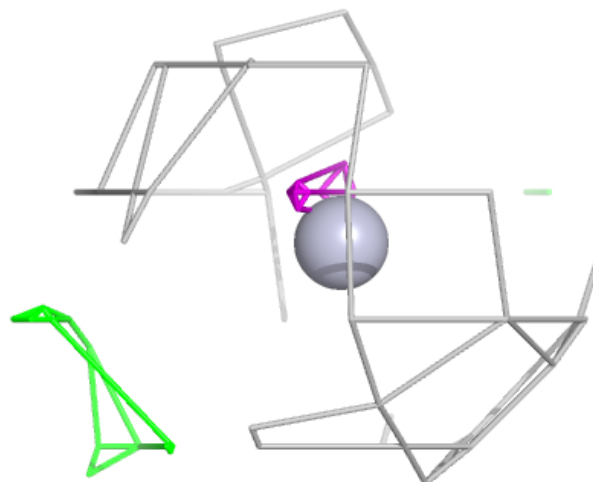

**Electron density around HG F 507:**

$2mF_o-DF_c$  (at 0.7 rmsd) in gray  
 $mF_o-DF_c$  (at 3 rmsd) in purple (negative)  
and green (positive)

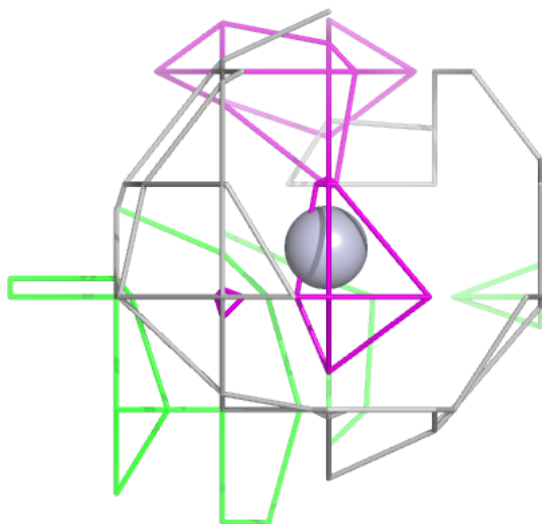
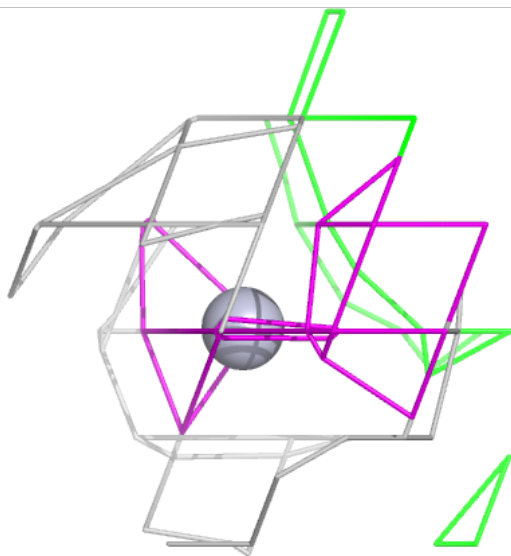
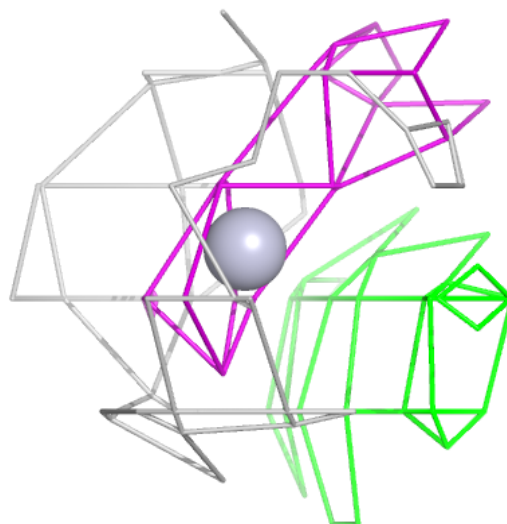

**Electron density around HG F 508:**

$2mF_o-DF_c$  (at 0.7 rmsd) in gray  
 $mF_o-DF_c$  (at 3 rmsd) in purple (negative)  
and green (positive)

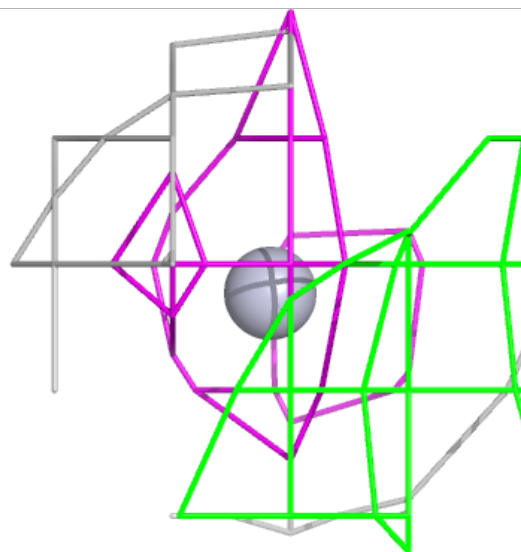
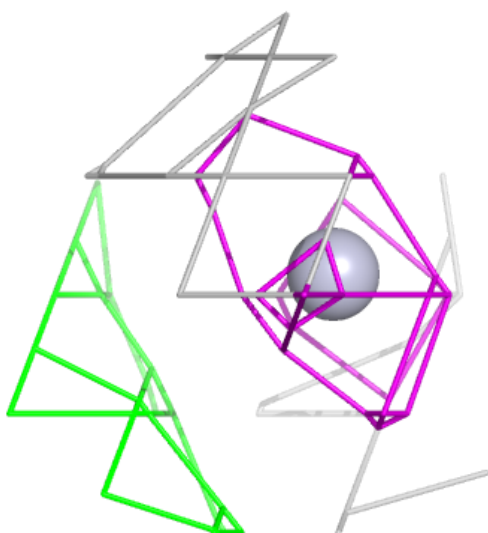
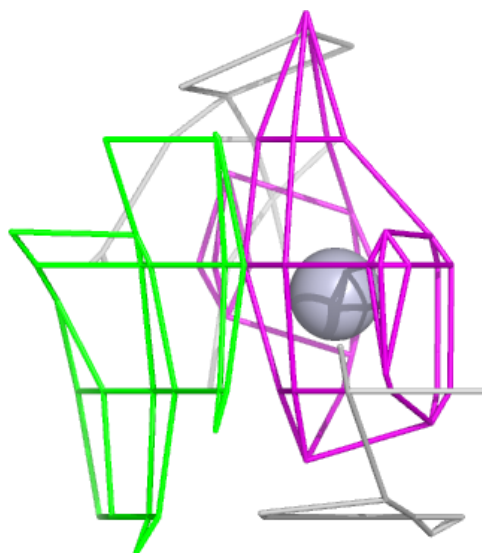

**Electron density around HG F 504:**

$2mF_o-DF_c$  (at 0.7 rmsd) in gray  
 $mF_o-DF_c$  (at 3 rmsd) in purple (negative)  
and green (positive)

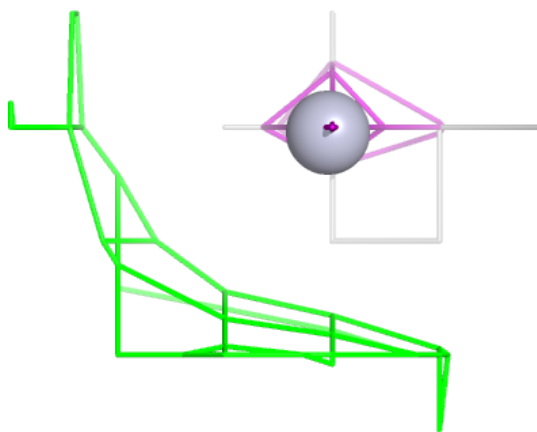
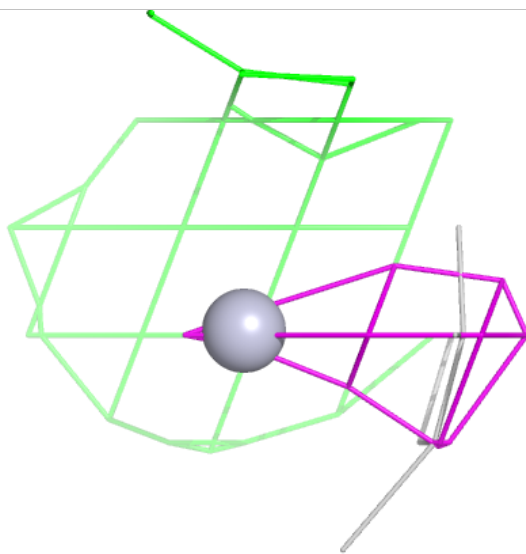
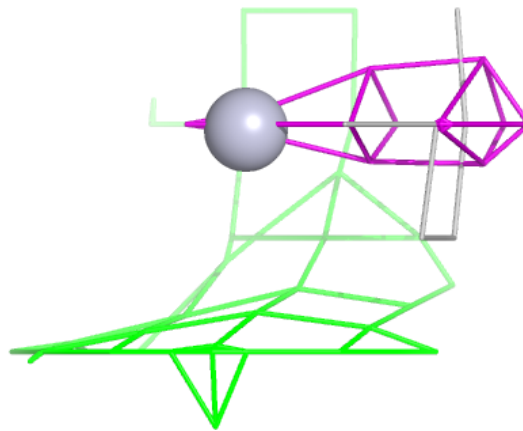



**Electron density around HG C 508:**

$2mF_o-DF_c$  (at 0.7 rmsd) in gray  
 $mF_o-DF_c$  (at 3 rmsd) in purple (negative)  
and green (positive)

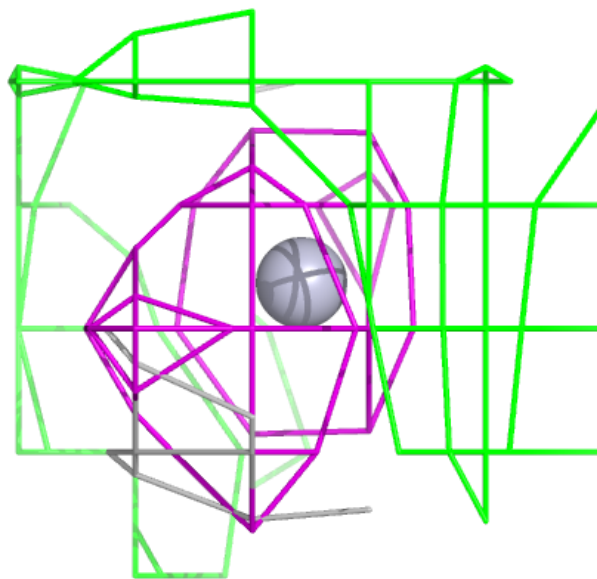
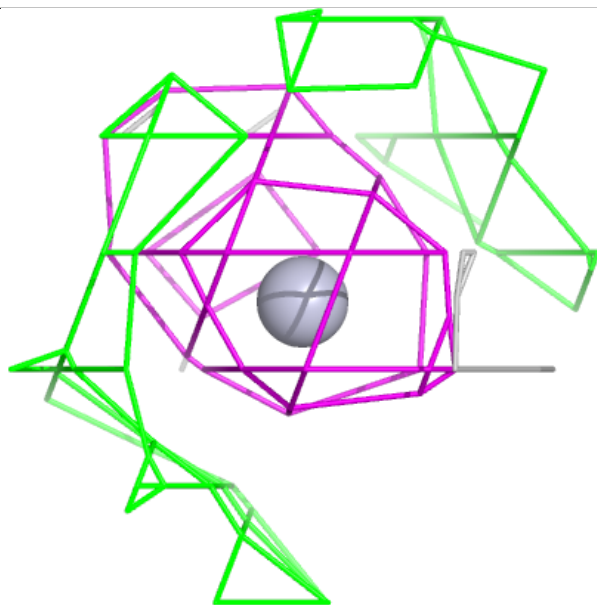
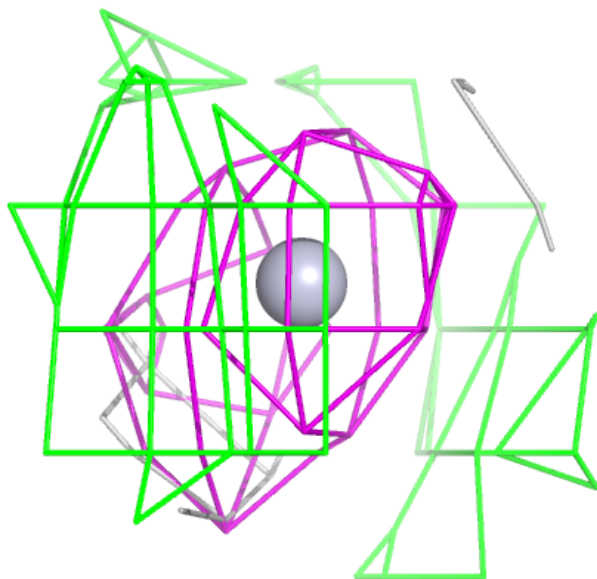

**Electron density around HG F 505:**

$2mF_o-DF_c$  (at 0.7 rmsd) in gray  
 $mF_o-DF_c$  (at 3 rmsd) in purple (negative)  
and green (positive)

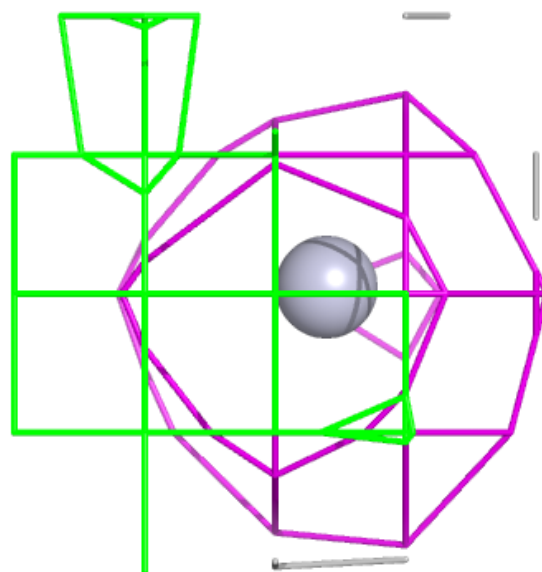
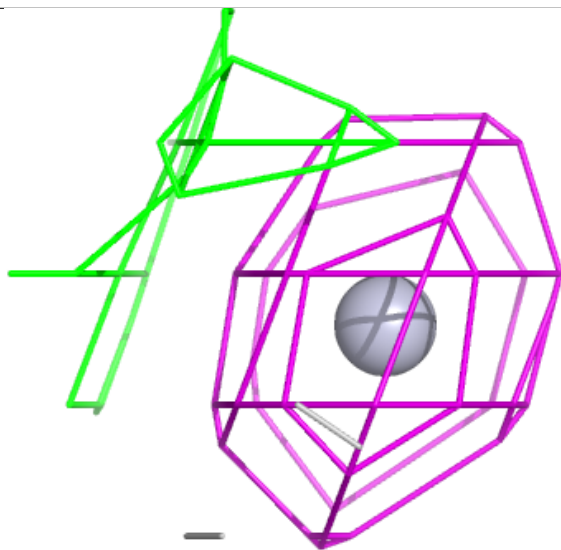
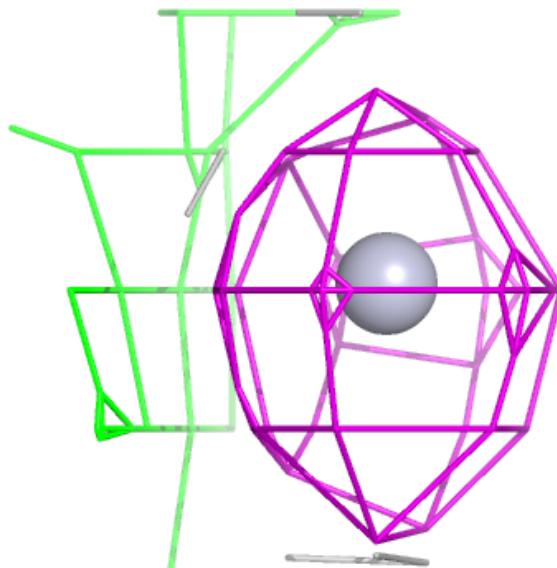

**Electron density around HG D 402:**

$2mF_o-DF_c$  (at 0.7 rmsd) in gray  
 $mF_o-DF_c$  (at 3 rmsd) in purple (negative)  
and green (positive)

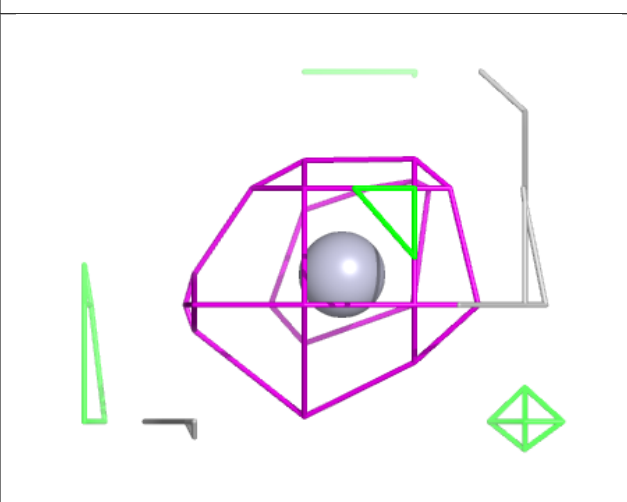
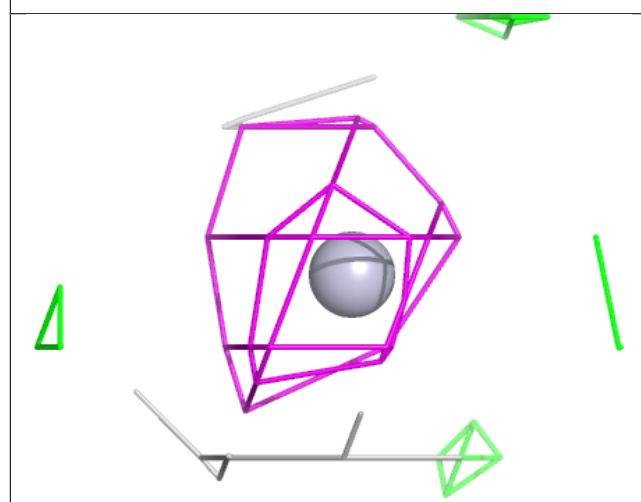
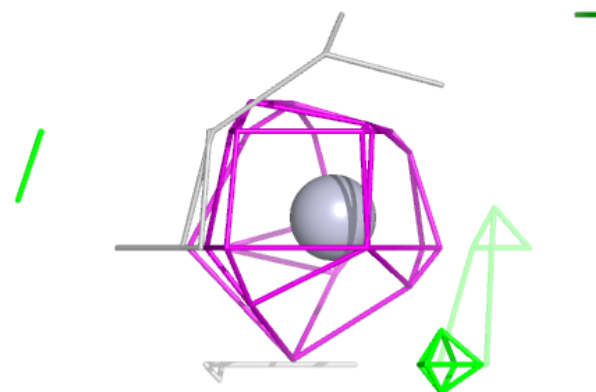

**Electron density around HG C 504:**

$2mF_o-DF_c$  (at 0.7 rmsd) in gray  
 $mF_o-DF_c$  (at 3 rmsd) in purple (negative)  
and green (positive)

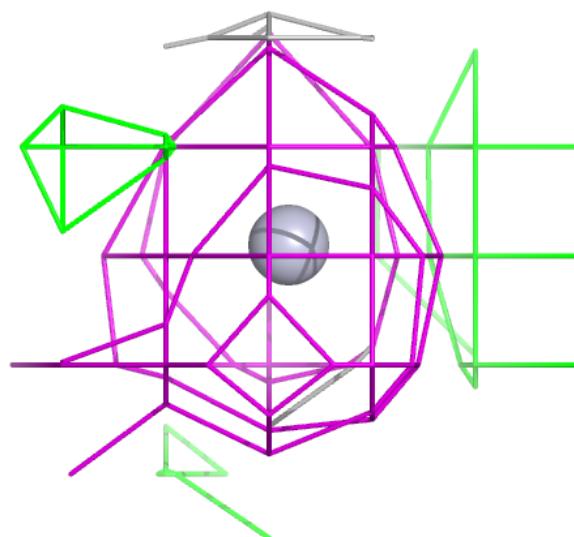
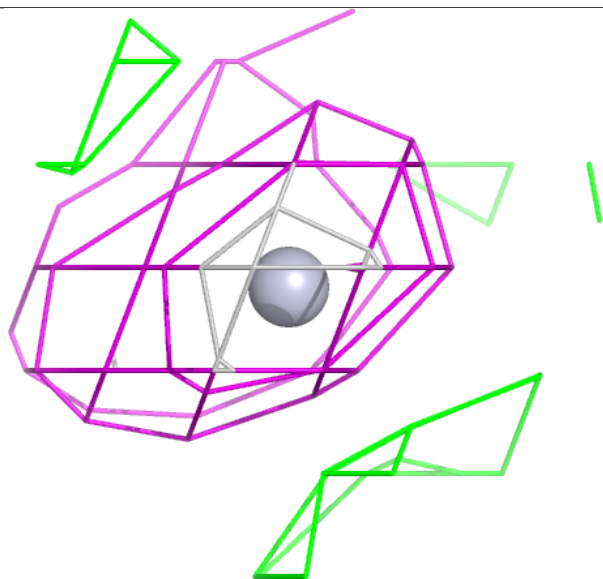
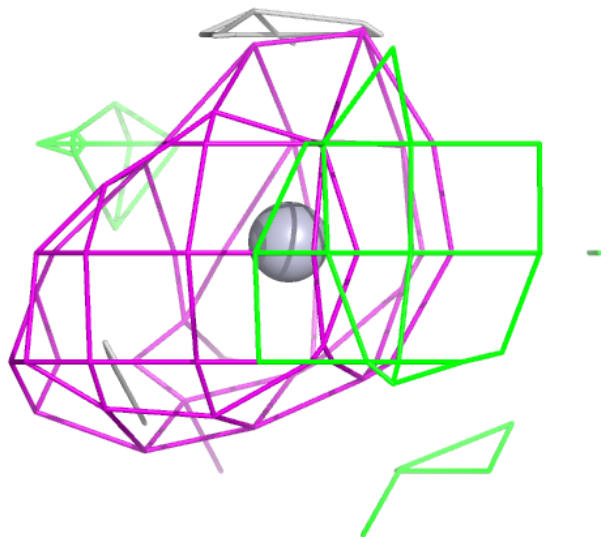

**Electron density around HG F 503:**

$2mF_o-DF_c$  (at 0.7 rmsd) in gray  
 $mF_o-DF_c$  (at 3 rmsd) in purple (negative)  
and green (positive)

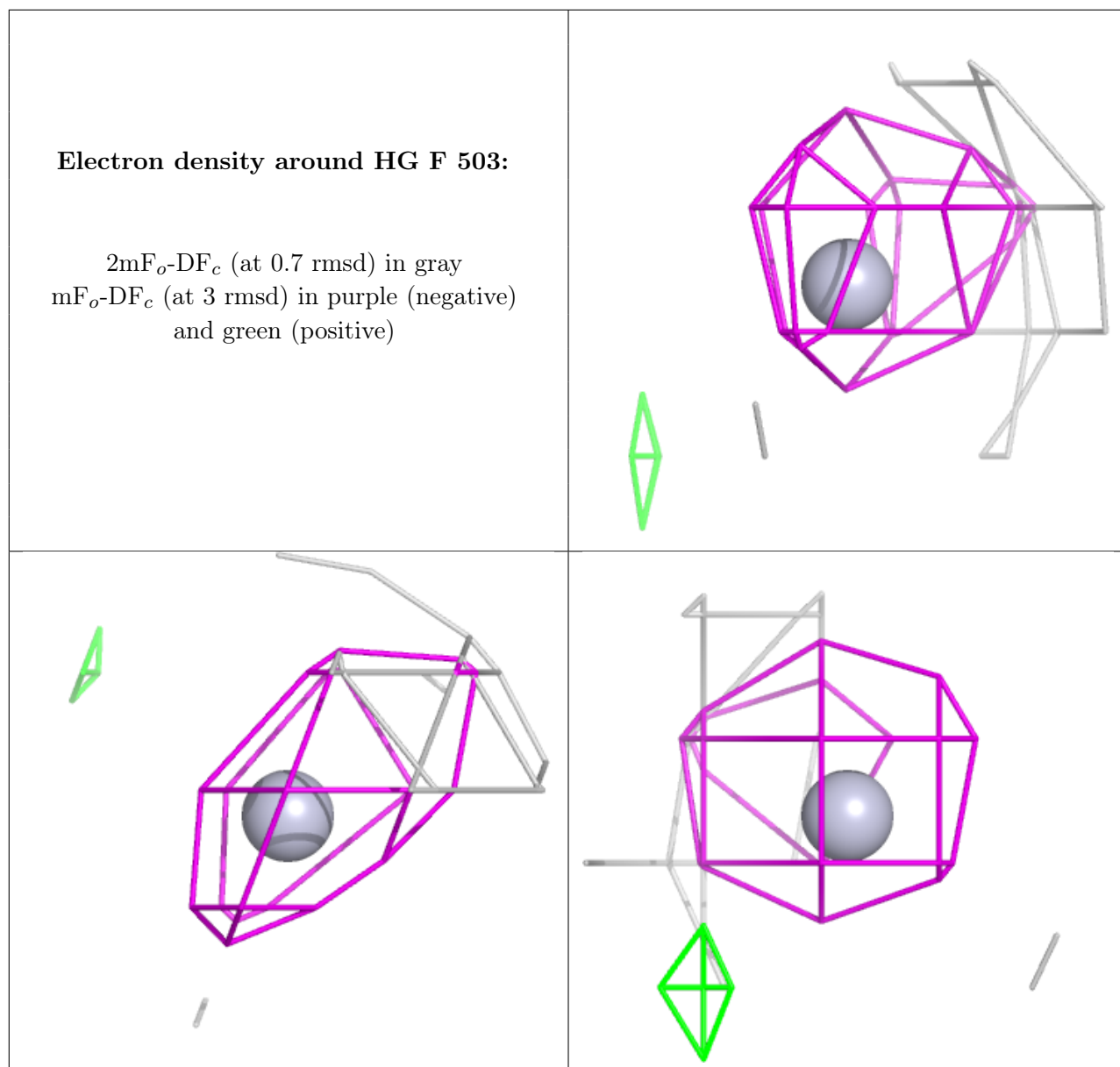

**Electron density around HG C 506:**

$2mF_o-DF_c$  (at 0.7 rmsd) in gray  
 $mF_o-DF_c$  (at 3 rmsd) in purple (negative)  
and green (positive)

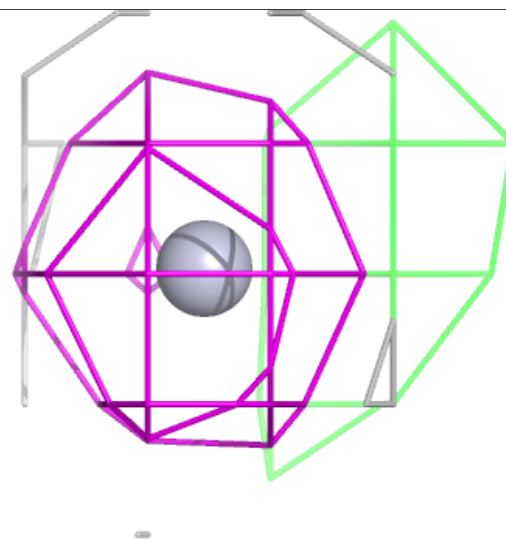
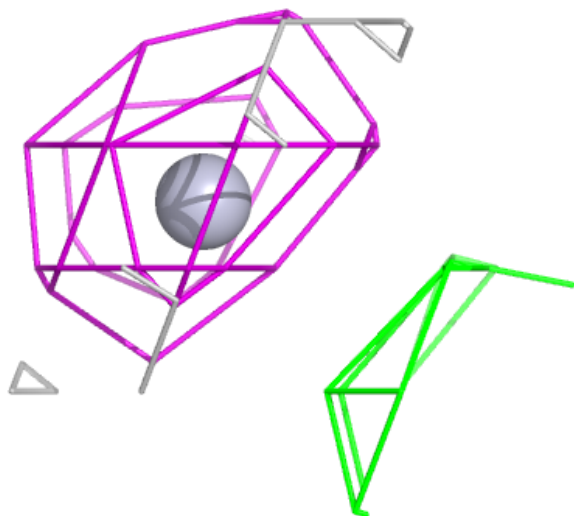
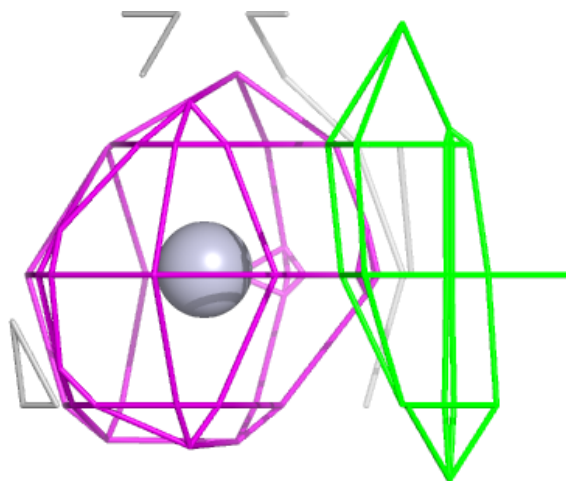

**Electron density around HG F 510:**

$2mF_o-DF_c$  (at 0.7 rmsd) in gray  
 $mF_o-DF_c$  (at 3 rmsd) in purple (negative)  
and green (positive)

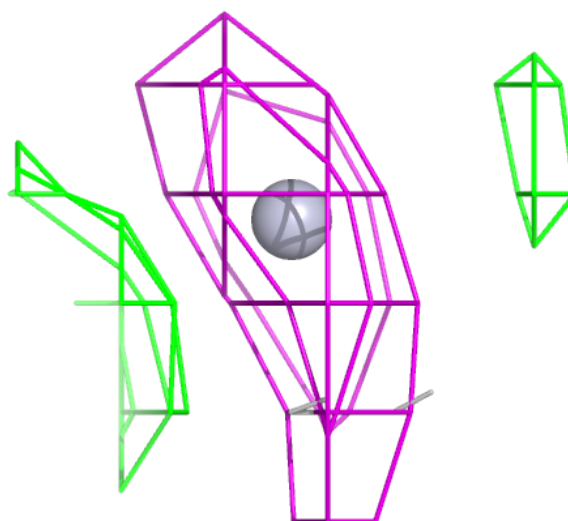
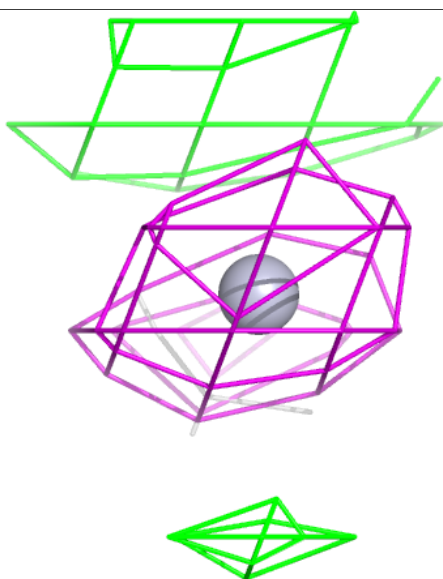
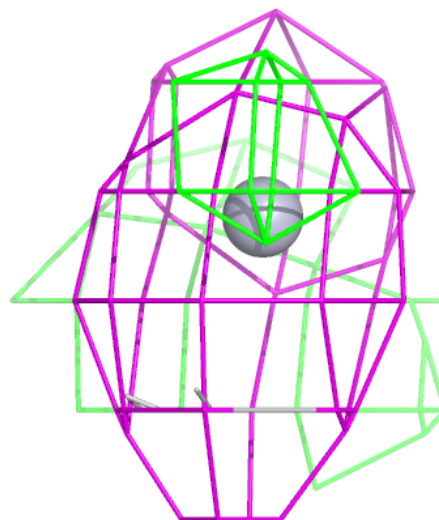

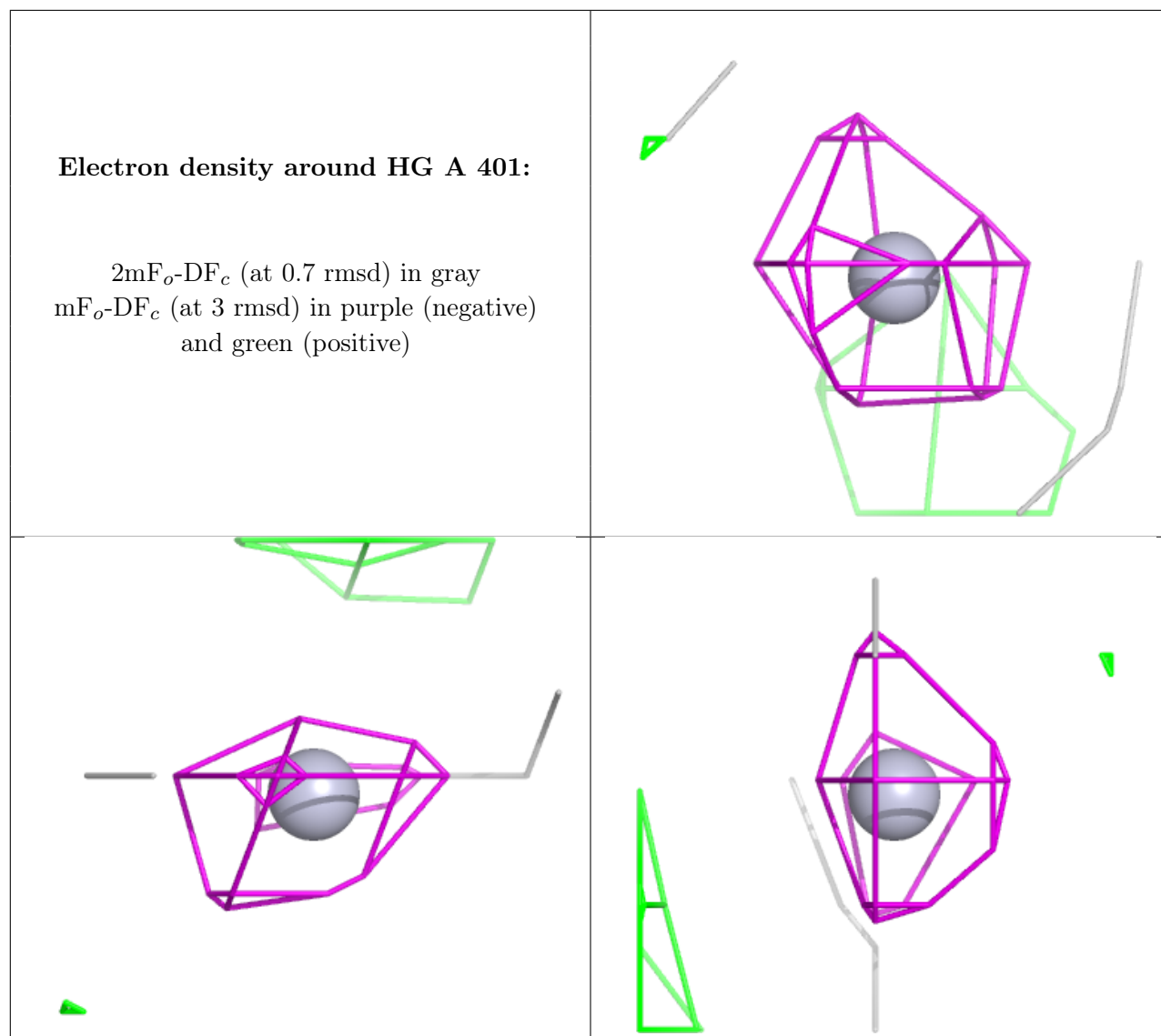



**Electron density around HG D 404:**

$2mF_o-DF_c$  (at 0.7 rmsd) in gray  
 $mF_o-DF_c$  (at 3 rmsd) in purple (negative)  
and green (positive)

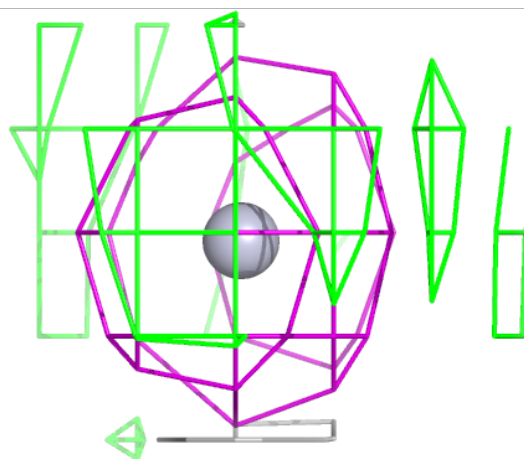
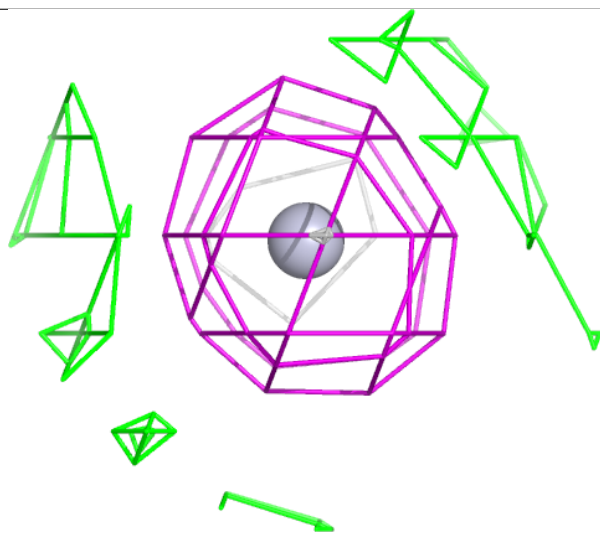
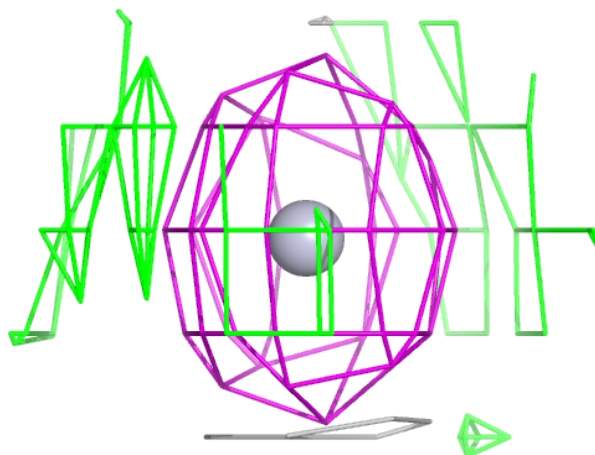

**Electron density around HG D 405:**

$2mF_o-DF_c$  (at 0.7 rmsd) in gray  
 $mF_o-DF_c$  (at 3 rmsd) in purple (negative)  
and green (positive)

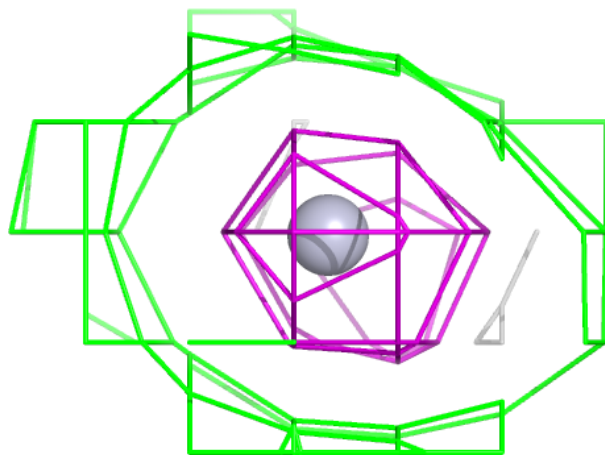
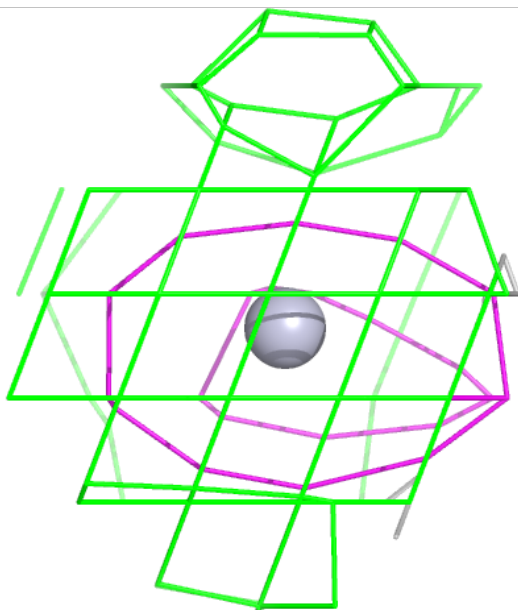
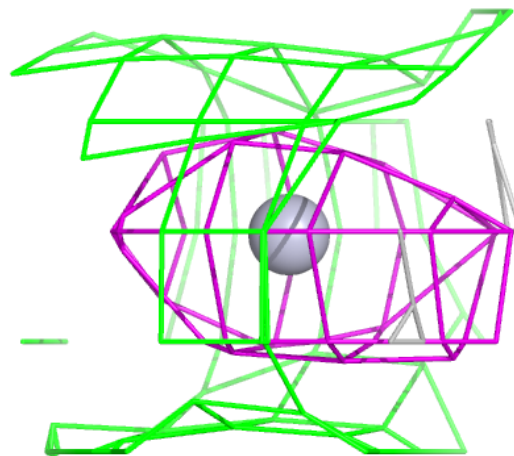

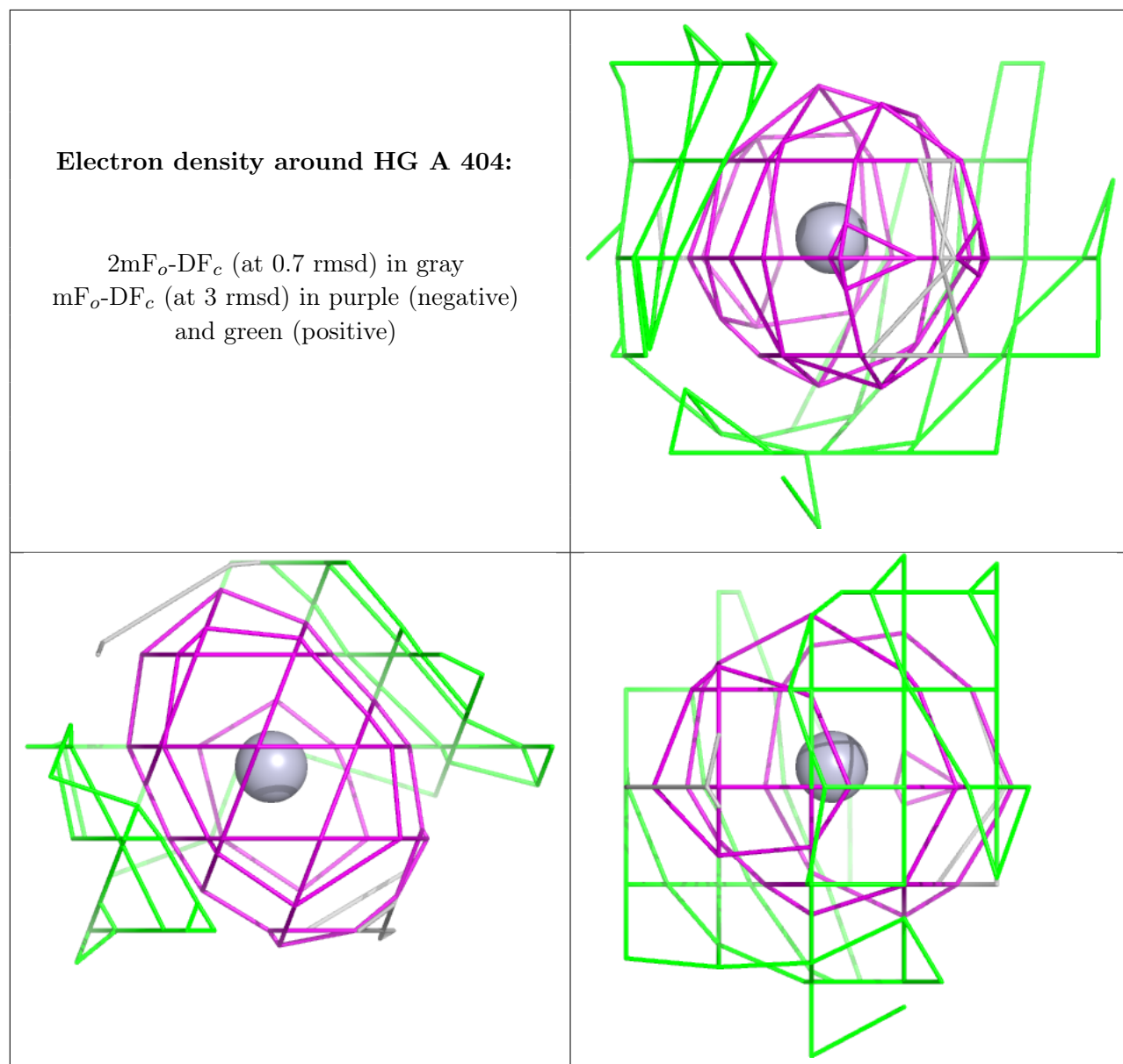

## 6.5 Other polymers [i](#)

There are no such residues in this entry.