



# Full wwPDB X-ray Structure Validation Report ⓘ

Nov 20, 2023 – 11:23 AM JST

PDB ID : 7CF8  
Title : PfkB(Mycobacterium marinum)  
Authors : Li, J.; Gao, B.; Ji, R.  
Deposited on : 2020-06-24  
Resolution : 2.21 Å(reported)

This is a Full wwPDB X-ray Structure Validation Report for a publicly released PDB entry.

We welcome your comments at [validation@mail.wwpdb.org](mailto:validation@mail.wwpdb.org)

A user guide is available at

<https://www.wwpdb.org/validation/2017/XrayValidationReportHelp>

with specific help available everywhere you see the ⓘ symbol.

The types of validation reports are described at

<http://www.wwpdb.org/validation/2017/FAQs#types>.

---

The following versions of software and data (see [references ⓘ](#)) were used in the production of this report:

MolProbity : 4.02b-467  
Mogul : 1.8.5 (274361), CSD as541be (2020)  
Xtriage (Phenix) : 1.13  
EDS : 2.36  
buster-report : 1.1.7 (2018)  
Percentile statistics : 20191225.v01 (using entries in the PDB archive December 25th 2019)  
Refmac : 5.8.0158  
CCP4 : 7.0.044 (Gargrove)  
Ideal geometry (proteins) : Engh & Huber (2001)  
Ideal geometry (DNA, RNA) : Parkinson et al. (1996)  
Validation Pipeline (wwPDB-VP) : 2.36

# 1 Overall quality at a glance

The following experimental techniques were used to determine the structure:

*X-RAY DIFFRACTION*

The reported resolution of this entry is 2.21 Å.

Percentile scores (ranging between 0-100) for global validation metrics of the entry are shown in the following graphic. The table shows the number of entries on which the scores are based.

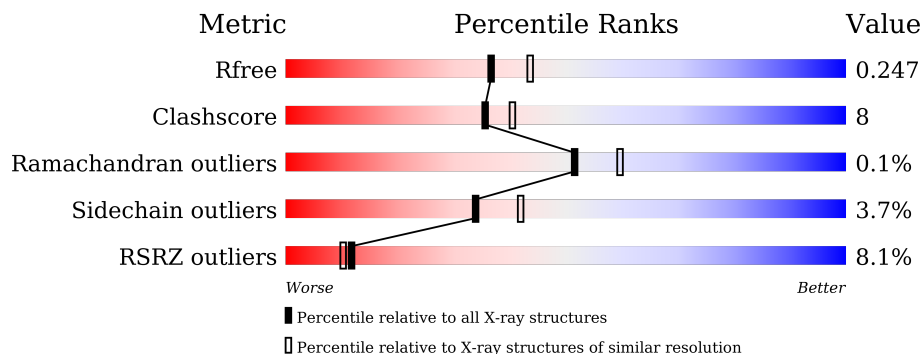

Metric	Whole archive (#Entries)	Similar resolution (#Entries, resolution range(Å))
$R_{free}$	130704	5912 (2.24-2.20)
Clashscore	141614	6646 (2.24-2.20)
Ramachandran outliers	138981	6543 (2.24-2.20)
Sidechain outliers	138945	6544 (2.24-2.20)
RSRZ outliers	127900	5797 (2.24-2.20)

The table below summarises the geometric issues observed across the polymeric chains and their fit to the electron density. The red, orange, yellow and green segments of the lower bar indicate the fraction of residues that contain outliers for  $\geq 3$ , 2, 1 and 0 types of geometric quality criteria respectively. A grey segment represents the fraction of residues that are not modelled. The numeric value for each fraction is indicated below the corresponding segment, with a dot representing fractions  $\leq 5\%$ . The upper red bar (where present) indicates the fraction of residues that have poor fit to the electron density. The numeric value is given above the bar.

Mol	Chain	Length	Quality of chain
1	A	303	
1	B	303	
1	C	303	
1	D	303	
1	E	303	
1	F	303	

The following table lists non-polymeric compounds, carbohydrate monomers and non-standard residues in protein, DNA, RNA chains that are outliers for geometric or electron-density-fit criteria:

Mol	Type	Chain	Res	Chirality	Geometry	Clashes	Electron density
3	PO4	A	402	-	X	-	-

## 2 Entry composition [i](#)

There are 4 unique types of molecules in this entry. The entry contains 11872 atoms, of which 0 are hydrogens and 0 are deuteriums.

In the tables below, the ZeroOcc column contains the number of atoms modelled with zero occupancy, the AltConf column contains the number of residues with at least one atom in alternate conformation and the Trace column contains the number of residues modelled with at most 2 atoms.

- Molecule 1 is a protein called Fructokinase, PfkB.

Mol	Chain	Residues	Atoms					ZeroOcc	AltConf	Trace
			Total	C	N	O	S			
1	A	279	Total 1967	C 1238	N 353	O 371	S 5	0	0	0
1	B	272	Total 1924	C 1209	N 340	O 371	S 4	0	0	0
1	C	273	Total 1918	C 1207	N 341	O 366	S 4	0	0	0
1	D	282	Total 1990	C 1249	N 354	O 383	S 4	0	0	0
1	E	278	Total 1960	C 1233	N 349	O 374	S 4	0	0	0
1	F	271	Total 1914	C 1207	N 342	O 362	S 3	0	0	0

- Molecule 2 is GLYCEROL (three-letter code: GOL) (formula: C<sub>3</sub>H<sub>8</sub>O<sub>3</sub>) (labeled as "Ligand of Interest" by depositor).

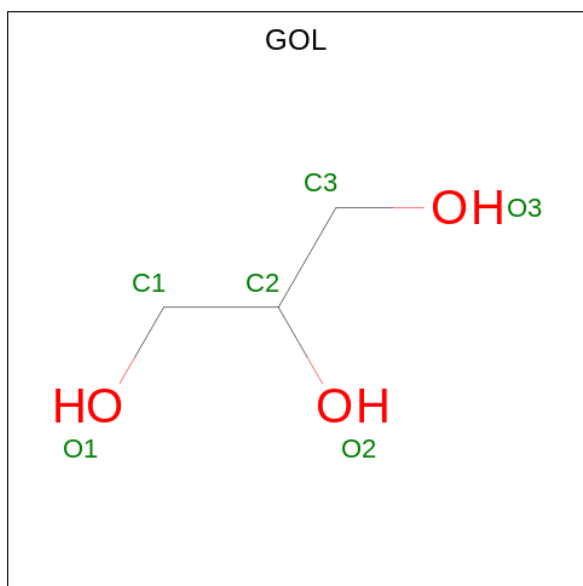

Mol	Chain	Residues	Atoms			ZeroOcc	AltConf
2	A	1	Total	C	O	0	0
			6	3	3		
2	D	1	Total	C	O	0	0
			6	3	3		
2	E	1	Total	C	O	0	0
			6	3	3		

- Molecule 3 is PHOSPHATE ION (three-letter code: PO4) (formula: O<sub>4</sub>P) (labeled as "Ligand of Interest" by depositor).

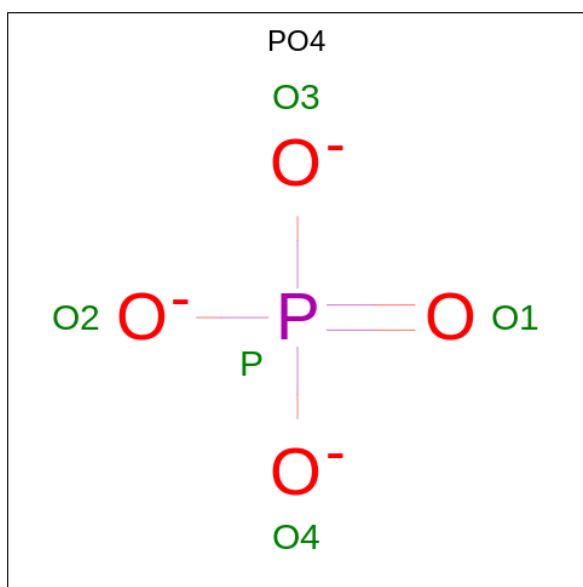

Mol	Chain	Residues	Atoms			ZeroOcc	AltConf
3	A	1	Total	O	P	0	0
			5	4	1		
3	B	1	Total	O	P	0	0
			5	4	1		
3	D	1	Total	O	P	0	0
			5	4	1		
3	E	1	Total	O	P	0	0
			5	4	1		
3	F	1	Total	O	P	0	0
			5	4	1		

- Molecule 4 is water.

Mol	Chain	Residues	Atoms		ZeroOcc	AltConf
4	A	46	Total	O	0	0
			46	46		

*Continued on next page...*

*Continued from previous page...*

<b>Mol</b>	<b>Chain</b>	<b>Residues</b>	<b>Atoms</b>	<b>ZeroOcc</b>	<b>AltConf</b>
4	B	22	Total O 22 22	0	0
4	C	19	Total O 19 19	0	0
4	D	41	Total O 41 41	0	0
4	E	15	Total O 15 15	0	0
4	F	13	Total O 13 13	0	0

### 3 Residue-property plots [i](#)

These plots are drawn for all protein, RNA, DNA and oligosaccharide chains in the entry. The first graphic for a chain summarises the proportions of the various outlier classes displayed in the second graphic. The second graphic shows the sequence view annotated by issues in geometry and electron density. Residues are color-coded according to the number of geometric quality criteria for which they contain at least one outlier: green = 0, yellow = 1, orange = 2 and red = 3 or more. A red dot above a residue indicates a poor fit to the electron density ( $RSRZ > 2$ ). Stretches of 2 or more consecutive residues without any outlier are shown as a green connector. Residues present in the sample, but not in the model, are shown in grey.

- Molecule 1: Fructokinase, PfkB

Chain A: 

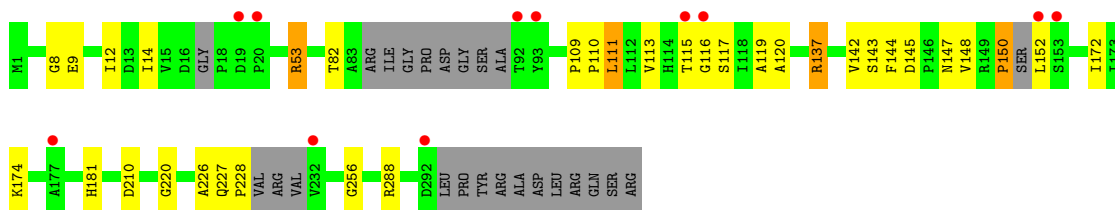

- Molecule 1: Fructokinase, PfkB

Chain B: 

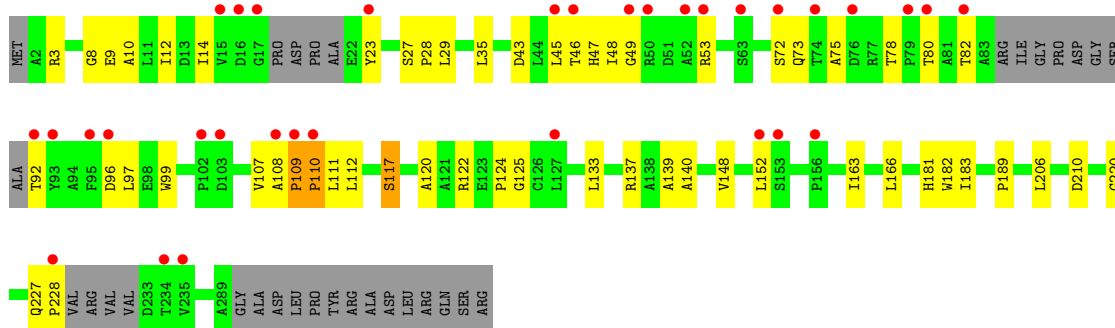

- Molecule 1: Fructokinase, PfkB

Chain C: 

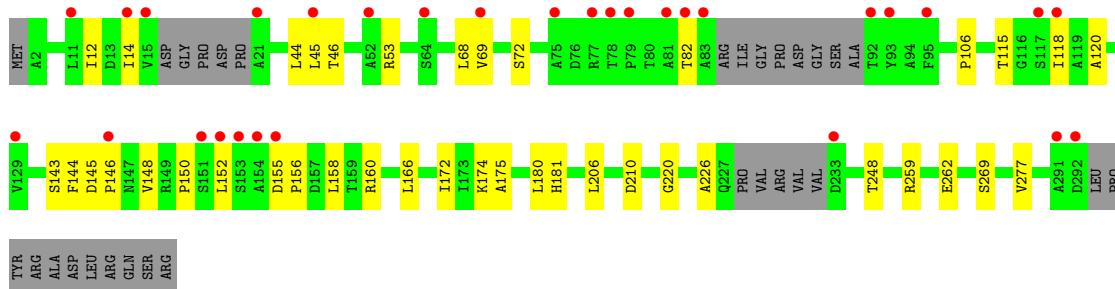

• Molecule 1: Fructokinase, PfkB

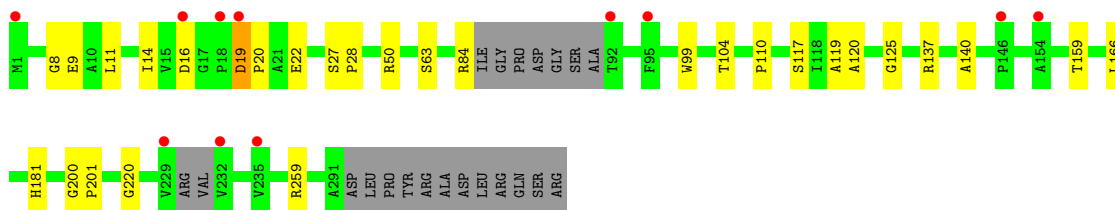
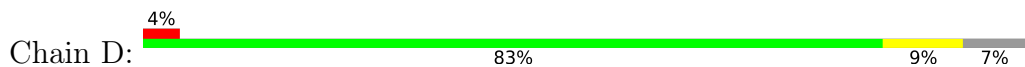

• Molecule 1: Fructokinase, PfkB

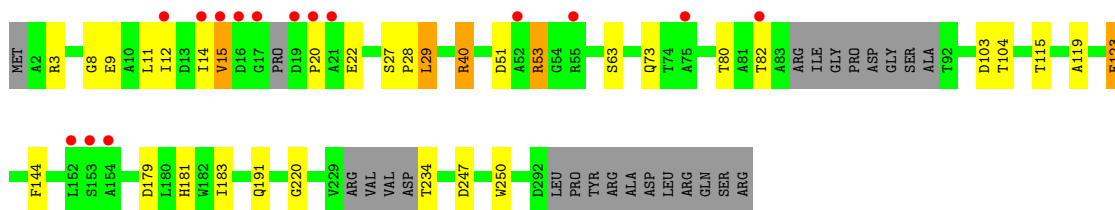
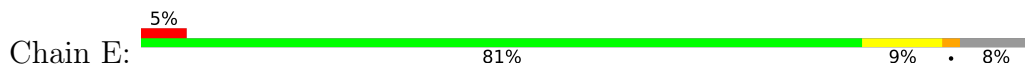

• Molecule 1: Fructokinase, PfkB

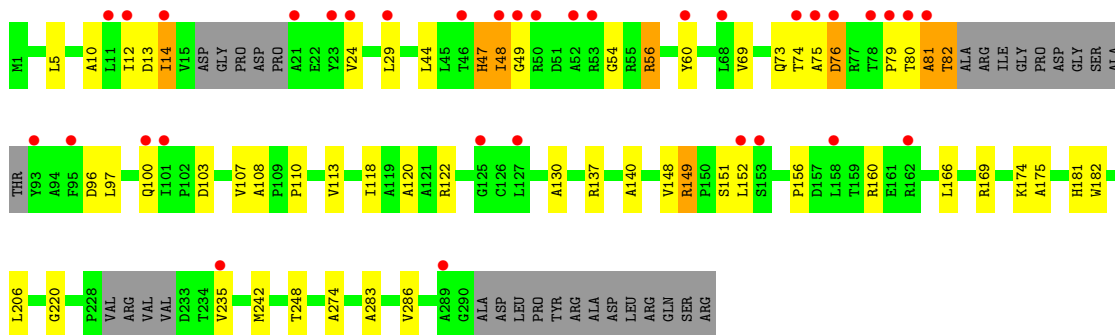



## 4 Data and refinement statistics

Property	Value	Source
Space group	C 1 2 1	Depositor
Cell constants a, b, c, $\alpha$ , $\beta$ , $\gamma$	128.41Å 125.41Å 137.52Å 90.00° 106.83° 90.00°	Depositor
Resolution (Å)	66.92 – 2.21 66.92 – 2.21	Depositor EDS
% Data completeness (in resolution range)	99.8 (66.92-2.21) 99.8 (66.92-2.21)	Depositor EDS
$R_{merge}$	0.05	Depositor
$R_{sym}$	(Not available)	Depositor
$\langle I/\sigma(I) \rangle$ <sup>1</sup>	2.27 (at 2.20Å)	Xtriage
Refinement program	PHENIX 1.13_2998, PHENIX 1.13_2998	Depositor
R, $R_{free}$	0.218 , 0.247 0.218 , 0.247	Depositor DCC
$R_{free}$ test set	5124 reflections (4.91%)	wwPDB-VP
Wilson B-factor (Å <sup>2</sup> )	55.0	Xtriage
Anisotropy	0.140	Xtriage
Bulk solvent $k_{sol}$ (e/Å <sup>3</sup> ), $B_{sol}$ (Å <sup>2</sup> )	0.34 , 49.8	EDS
L-test for twinning <sup>2</sup>	$\langle  L  \rangle = 0.50$ , $\langle L^2 \rangle = 0.34$	Xtriage
Estimated twinning fraction	No twinning to report.	Xtriage
$F_o, F_c$ correlation	0.96	EDS
Total number of atoms	11872	wwPDB-VP
Average B, all atoms (Å <sup>2</sup> )	63.0	wwPDB-VP

Xtriage's analysis on translational NCS is as follows: *The analyses of the Patterson function reveals a significant off-origin peak that is 39.62 % of the origin peak, indicating pseudo-translational symmetry. The chance of finding a peak of this or larger height randomly in a structure without pseudo-translational symmetry is equal to 3.0880e-04. The detected translational NCS is most likely also responsible for the elevated intensity ratio.*

<sup>1</sup>Intensities estimated from amplitudes.

<sup>2</sup>Theoretical values of  $\langle |L| \rangle$ ,  $\langle L^2 \rangle$  for acentric reflections are 0.5, 0.333 respectively for untwinned datasets, and 0.375, 0.2 for perfectly twinned datasets.

## 5 Model quality i

### 5.1 Standard geometry i

Bond lengths and bond angles in the following residue types are not validated in this section: PO4, GOL

The Z score for a bond length (or angle) is the number of standard deviations the observed value is removed from the expected value. A bond length (or angle) with  $|Z| > 5$  is considered an outlier worth inspection. RMSZ is the root-mean-square of all Z scores of the bond lengths (or angles).

Mol	Chain	Bond lengths		Bond angles	
		RMSZ	# $ Z  > 5$	RMSZ	# $ Z  > 5$
1	A	0.78	0/1999	0.89	1/2738 (0.0%)
1	B	0.74	0/1954	0.87	4/2677 (0.1%)
1	C	0.76	1/1948 (0.1%)	0.86	2/2671 (0.1%)
1	D	0.77	1/2024 (0.0%)	0.84	1/2777 (0.0%)
1	E	0.71	0/1992	0.82	0/2732
1	F	0.77	0/1946	0.90	3/2669 (0.1%)
All	All	0.76	2/11863 (0.0%)	0.86	11/16264 (0.1%)

All (2) bond length outliers are listed below:

Mol	Chain	Res	Type	Atoms	Z	Observed(Å)	Ideal(Å)
1	C	155	ASP	C-N	8.63	1.50	1.34
1	D	19	ASP	C-N	8.53	1.50	1.34

All (11) bond angle outliers are listed below:

Mol	Chain	Res	Type	Atoms	Z	Observed(°)	Ideal(°)
1	F	81	ALA	N-CA-C	-9.25	86.03	111.00
1	B	110	PRO	N-CA-CB	8.20	113.14	103.30
1	F	81	ALA	CB-CA-C	-6.90	99.75	110.10
1	F	82	THR	N-CA-C	-6.33	93.90	111.00
1	B	109	PRO	N-CA-C	-5.79	97.03	112.10
1	A	150	PRO	N-CD-CG	-5.71	94.64	103.20
1	C	146	PRO	N-CA-CB	5.50	109.91	103.30
1	B	110	PRO	N-CA-C	-5.26	98.43	112.10
1	D	19	ASP	C-N-CD	-5.18	109.19	120.60
1	C	155	ASP	C-N-CD	-5.18	109.21	120.60
1	B	228	PRO	N-CA-CB	5.10	109.42	103.30

There are no chirality outliers.

There are no planarity outliers.

## 5.2 Too-close contacts [i](#)

In the following table, the Non-H and H(model) columns list the number of non-hydrogen atoms and hydrogen atoms in the chain respectively. The H(added) column lists the number of hydrogen atoms added and optimized by MolProbity. The Clashes column lists the number of clashes within the asymmetric unit, whereas Symm-Clashes lists symmetry-related clashes.

Mol	Chain	Non-H	H(model)	H(added)	Clashes	Symm-Clashes
1	A	1967	0	1939	28	0
1	B	1924	0	1864	41	0
1	C	1918	0	1885	28	0
1	D	1990	0	1943	19	0
1	E	1960	0	1927	23	0
1	F	1914	0	1887	55	0
2	A	6	0	8	0	0
2	D	6	0	8	0	0
2	E	6	0	8	0	0
3	A	5	0	0	0	0
3	B	5	0	0	0	0
3	D	5	0	0	0	0
3	E	5	0	0	0	0
3	F	5	0	0	0	0
4	A	46	0	0	1	0
4	B	22	0	0	0	0
4	C	19	0	0	0	0
4	D	41	0	0	0	0
4	E	15	0	0	0	0
4	F	13	0	0	0	0
All	All	11872	0	11469	188	0

The all-atom clashscore is defined as the number of clashes found per 1000 atoms (including hydrogen atoms). The all-atom clashscore for this structure is 8.

All (188) close contacts within the same asymmetric unit are listed below, sorted by their clash magnitude.

Atom-1	Atom-2	Interatomic distance (Å)	Clash overlap (Å)
1:F:79:PRO:HB3	1:F:97:LEU:CB	1.62	1.25
1:F:79:PRO:HB3	1:F:97:LEU:HB3	1.29	1.10
1:B:110:PRO:O	1:B:140:ALA:HB2	1.53	1.06
1:F:79:PRO:HB3	1:F:97:LEU:HB2	1.38	1.05

*Continued on next page...*

*Continued from previous page...*

Atom-1	Atom-2	Interatomic distance (Å)	Clash overlap (Å)
1:F:122:ARG:HG3	1:F:122:ARG:HH21	1.31	0.96
1:F:149:ARG:HG2	1:F:149:ARG:HH11	1.42	0.85
1:F:13:ASP:HA	1:F:81:ALA:HB3	1.58	0.84
1:F:14:ILE:O	1:F:82:THR:HA	1.79	0.82
1:B:47:HIS:NE2	1:B:75:ALA:HA	1.96	0.79
1:B:80:THR:HG22	1:B:96:ASP:HB3	1.63	0.79
1:F:79:PRO:CB	1:F:97:LEU:HB2	2.13	0.77
1:C:145:ASP:OD2	1:C:174:LYS:HE2	1.87	0.74
1:C:46:THR:O	1:C:72:SER:HA	1.89	0.72
1:D:16:ASP:HB3	1:D:84:ARG:HA	1.70	0.72
1:F:130:ALA:HB1	1:F:169:ARG:NH2	2.04	0.72
1:E:27:SER:HB3	1:E:28:PRO:HD3	1.71	0.71
1:B:80:THR:CG2	1:B:96:ASP:HB3	2.21	0.71
1:B:110:PRO:O	1:B:140:ALA:CB	2.36	0.70
1:C:12:ILE:HG13	1:C:53:ARG:HG2	1.71	0.70
1:B:97:LEU:O	1:B:122:ARG:NH1	2.25	0.70
1:A:210:ASP:O	1:A:226:ALA:HB2	1.92	0.69
1:C:45:LEU:HD12	1:C:69:VAL:HG11	1.73	0.69
1:F:137:ARG:HG2	1:F:137:ARG:NH1	2.06	0.69
1:A:116:GLY:HA2	1:A:120:ALA:HB2	1.74	0.69
1:C:45:LEU:HD12	1:C:106:PRO:HG3	1.75	0.69
1:C:148:VAL:HG12	1:C:150:PRO:HG3	1.75	0.68
1:B:148:VAL:HG21	1:B:182:TRP:CE3	2.28	0.68
1:B:99:TRP:CD1	1:B:125:GLY:HA3	2.28	0.68
1:E:14:ILE:HB	1:E:82:THR:HG22	1.77	0.67
1:B:49:GLY:HA2	1:B:75:ALA:HB3	1.77	0.67
1:F:149:ARG:NH2	1:F:235:VAL:HG11	2.10	0.67
1:A:181:HIS:CD2	1:C:220:GLY:HA2	2.31	0.66
1:F:79:PRO:CB	1:F:97:LEU:HB3	2.19	0.65
1:B:3:ARG:NH1	1:B:43:ASP:OD1	2.29	0.65
1:A:210:ASP:O	1:A:226:ALA:CB	2.45	0.65
1:C:118:ILE:HG12	1:C:152:LEU:HD22	1.79	0.64
1:B:45:LEU:HG	1:B:45:LEU:O	1.98	0.63
1:E:40:ARG:HD2	1:E:247:ASP:OD1	1.99	0.63
1:E:40:ARG:HD3	1:E:250:TRP:CE3	2.34	0.63
1:F:122:ARG:HH21	1:F:122:ARG:CG	2.09	0.62
1:E:179:ASP:O	1:E:183:ILE:HG12	1.99	0.62
1:F:79:PRO:CB	1:F:97:LEU:CB	2.57	0.62
1:E:12:ILE:HG13	1:E:53:ARG:HB3	1.80	0.62
1:D:27:SER:HB3	1:D:28:PRO:HD3	1.81	0.61
1:F:122:ARG:HD2	1:F:152:LEU:HD11	1.82	0.61

*Continued on next page...*

*Continued from previous page...*

Atom-1	Atom-2	Interatomic distance (Å)	Clash overlap (Å)
1:D:120:ALA:HB1	1:D:166:LEU:HD12	1.83	0.60
1:B:109:PRO:HB3	1:B:139:ALA:HB3	1.82	0.60
1:A:150:PRO:HB2	1:A:152:LEU:HA	1.82	0.60
1:B:120:ALA:HB1	1:B:166:LEU:HD12	1.84	0.59
1:B:46:THR:O	1:B:72:SER:HB2	2.02	0.59
1:F:122:ARG:HG3	1:F:122:ARG:NH2	2.08	0.59
1:F:56:ARG:CG	1:F:56:ARG:HH11	2.15	0.59
1:B:9:GLU:OE1	1:B:117:SER:HB3	2.03	0.58
1:F:149:ARG:HH11	1:F:149:ARG:CG	2.14	0.58
1:C:180:LEU:HD22	1:C:206:LEU:HD13	1.86	0.58
1:D:11:LEU:C	1:D:11:LEU:HD12	2.23	0.58
1:A:113:VAL:CG1	1:A:142:VAL:HG22	2.34	0.58
1:F:49:GLY:HA2	1:F:75:ALA:O	2.03	0.58
1:B:12:ILE:HD12	1:B:12:ILE:O	2.03	0.58
1:E:11:LEU:C	1:E:11:LEU:HD12	2.25	0.58
1:E:123:GLU:H	1:E:123:GLU:CD	2.06	0.57
1:E:104:THR:O	1:E:104:THR:HG23	2.04	0.57
1:F:120:ALA:HB1	1:F:166:LEU:HD12	1.87	0.57
1:B:14:ILE:O	1:B:82:THR:HA	2.05	0.56
1:A:14:ILE:HB	1:A:82:THR:HG22	1.87	0.56
1:F:149:ARG:HH22	1:F:235:VAL:HG11	1.70	0.56
1:E:8:GLY:HA2	1:E:119:ALA:HB2	1.88	0.55
1:F:156:PRO:HB2	1:F:160:ARG:HH12	1.72	0.55
1:F:149:ARG:HG2	1:F:149:ARG:NH1	2.18	0.55
1:D:120:ALA:HB1	1:D:166:LEU:CD1	2.38	0.54
1:B:108:ALA:O	1:B:109:PRO:C	2.45	0.54
1:F:283:ALA:O	1:F:286:VAL:HG22	2.07	0.54
1:A:137:ARG:HG3	1:A:137:ARG:NH1	2.21	0.54
1:F:10:ALA:HB1	1:F:29:LEU:HD13	1.90	0.53
1:D:104:THR:O	1:D:104:THR:OG1	2.23	0.53
1:B:49:GLY:CA	1:B:75:ALA:HB3	2.39	0.53
1:C:14:ILE:O	1:C:82:THR:HA	2.08	0.53
1:F:76:ASP:OD1	1:F:76:ASP:N	2.30	0.53
1:A:137:ARG:HG3	1:A:137:ARG:HH11	1.75	0.52
1:A:148:VAL:HG23	1:A:148:VAL:O	2.09	0.52
1:C:120:ALA:HB1	1:C:166:LEU:HD12	1.92	0.51
1:C:45:LEU:CD1	1:C:69:VAL:HG11	2.41	0.51
1:E:181:HIS:CE1	1:F:220:GLY:HA2	2.44	0.51
1:C:210:ASP:O	1:C:226:ALA:CB	2.58	0.51
1:E:29:LEU:HD13	1:E:29:LEU:C	2.31	0.51
1:A:227:GLN:HB3	1:A:228:PRO:HD2	1.92	0.51

*Continued on next page...*

*Continued from previous page...*

Atom-1	Atom-2	Interatomic distance (Å)	Clash overlap (Å)
1:B:8:GLY:O	1:B:46:THR:HB	2.11	0.51
1:D:99:TRP:CD1	1:D:125:GLY:HA3	2.46	0.51
1:C:248:THR:OG1	1:C:277:VAL:HG11	2.12	0.50
1:E:8:GLY:HA2	1:E:119:ALA:CB	2.42	0.50
1:B:48:ILE:O	1:B:73:GLN:HA	2.11	0.50
1:F:137:ARG:HG2	1:F:137:ARG:HH11	1.76	0.50
1:E:14:ILE:HD12	1:E:82:THR:HG22	1.92	0.50
1:A:111:LEU:HD22	1:A:256:GLY:CA	2.43	0.49
1:A:143:SER:HA	1:A:172:ILE:O	2.13	0.49
1:B:47:HIS:NE2	1:B:75:ALA:CA	2.71	0.49
1:F:80:THR:OG1	1:F:96:ASP:HB3	2.12	0.49
1:A:53:ARG:HG3	4:A:532:HOH:O	2.13	0.49
1:E:51:ASP:OD1	1:E:51:ASP:N	2.43	0.49
1:D:181:HIS:CD2	1:E:220:GLY:HA2	2.48	0.49
1:B:12:ILE:HA	1:B:23:TYR:O	2.13	0.49
1:C:259:ARG:HA	1:C:262:GLU:OE1	2.13	0.49
1:B:48:ILE:C	1:B:75:ALA:HB3	2.33	0.48
1:F:107:VAL:HG12	1:F:108:ALA:O	2.13	0.48
1:F:47:HIS:HD2	1:F:100:GLN:H	1.61	0.48
1:F:149:ARG:CG	1:F:149:ARG:NH1	2.73	0.48
1:D:14:ILE:HG12	1:D:22:GLU:HG2	1.96	0.48
1:C:44:LEU:O	1:C:68:LEU:HD12	2.14	0.47
1:C:45:LEU:CD1	1:C:106:PRO:HG3	2.42	0.47
1:F:47:HIS:ND1	1:F:75:ALA:HB2	2.29	0.47
1:B:122:ARG:HD3	1:B:152:LEU:HD21	1.96	0.47
1:A:109:PRO:HA	1:A:110:PRO:HD3	1.80	0.47
1:F:56:ARG:HH11	1:F:56:ARG:HG3	1.79	0.47
1:B:163:ILE:HD13	1:B:183:ILE:HD11	1.97	0.47
1:E:29:LEU:C	1:E:29:LEU:CD1	2.84	0.47
1:B:47:HIS:CE1	1:B:75:ALA:HA	2.51	0.46
1:C:156:PRO:HB2	1:C:160:ARG:HH12	1.80	0.46
1:C:45:LEU:HG	1:C:69:VAL:HB	1.98	0.46
1:B:120:ALA:HB1	1:B:166:LEU:CD1	2.45	0.46
1:B:53:ARG:CB	1:B:78:THR:HG21	2.47	0.46
1:E:8:GLY:HA3	1:E:28:PRO:HG2	1.98	0.45
1:B:47:HIS:CD2	1:B:75:ALA:HB2	2.52	0.45
1:E:15:VAL:HG12	1:E:20:PRO:HB2	1.97	0.45
1:B:27:SER:HB3	1:B:28:PRO:HD3	1.99	0.45
1:D:220:GLY:HA2	1:F:181:HIS:CD2	2.51	0.45
1:D:19:ASP:HA	1:D:20:PRO:HD2	1.86	0.44
1:D:99:TRP:CZ2	1:D:119:ALA:HB1	2.53	0.44

*Continued on next page...*

*Continued from previous page...*

Atom-1	Atom-2	Interatomic distance (Å)	Clash overlap (Å)
1:F:120:ALA:HB1	1:F:166:LEU:CD1	2.47	0.44
1:F:130:ALA:HB1	1:F:169:ARG:HH22	1.81	0.44
1:D:50:ARG:HH11	1:D:50:ARG:HG2	1.82	0.44
1:C:145:ASP:HA	1:C:174:LYS:O	2.18	0.44
1:B:99:TRP:O	1:B:124:PRO:HD2	2.18	0.44
1:F:118:ILE:HG12	1:F:152:LEU:HD13	1.99	0.44
1:B:8:GLY:O	1:B:46:THR:CB	2.66	0.44
1:D:8:GLY:HA3	1:D:28:PRO:CB	2.48	0.44
1:B:133:LEU:HD12	1:B:166:LEU:HD22	2.00	0.43
1:A:137:ARG:HH11	1:A:137:ARG:CG	2.31	0.43
1:F:122:ARG:CG	1:F:122:ARG:NH2	2.72	0.43
1:A:8:GLY:HA2	1:A:119:ALA:CB	2.49	0.43
1:F:48:ILE:HG22	1:F:73:GLN:HG2	2.00	0.43
1:F:156:PRO:HB2	1:F:160:ARG:NH1	2.33	0.43
1:A:220:GLY:HA2	1:B:181:HIS:CD2	2.53	0.43
1:D:9:GLU:O	1:D:9:GLU:HG2	2.18	0.43
1:E:9:GLU:O	1:E:9:GLU:HG2	2.19	0.43
1:A:8:GLY:HA2	1:A:119:ALA:HB2	2.01	0.43
1:C:143:SER:HA	1:C:172:ILE:O	2.19	0.42
1:E:12:ILE:CG2	1:E:22:GLU:HB3	2.49	0.42
1:B:10:ALA:HB1	1:B:29:LEU:HD12	2.02	0.42
1:A:12:ILE:HG13	1:A:53:ARG:HB3	2.00	0.42
1:A:150:PRO:HB2	1:A:152:LEU:CA	2.48	0.42
1:C:115:THR:O	1:C:144:PHE:HA	2.19	0.42
1:F:47:HIS:CD2	1:F:100:GLN:HB3	2.55	0.42
1:B:49:GLY:N	1:B:75:ALA:HB3	2.34	0.42
1:F:44:LEU:O	1:F:69:VAL:N	2.52	0.42
1:D:200:GLY:N	1:D:201:PRO:CD	2.82	0.42
1:F:148:VAL:HG11	1:F:182:TRP:HB3	2.01	0.42
1:A:113:VAL:HG13	1:A:113:VAL:O	2.20	0.42
1:F:175:ALA:O	1:F:206:LEU:HA	2.20	0.42
1:E:8:GLY:HA3	1:E:28:PRO:CB	2.50	0.42
1:F:24:VAL:HG11	1:F:60:TYR:CD1	2.55	0.42
1:F:49:GLY:O	1:F:54:GLY:HA3	2.20	0.42
1:F:137:ARG:HH11	1:F:137:ARG:CG	2.31	0.42
1:D:110:PRO:O	1:D:140:ALA:HB2	2.20	0.42
1:F:248:THR:HG21	1:F:274:ALA:HA	2.02	0.41
1:A:116:GLY:CA	1:A:120:ALA:HB2	2.48	0.41
1:F:5:LEU:O	1:F:113:VAL:HA	2.20	0.41
1:F:12:ILE:O	1:F:81:ALA:N	2.50	0.41
1:B:189:PRO:HB2	1:B:206:LEU:HD21	2.01	0.41

*Continued on next page...*

Continued from previous page...

Atom-1	Atom-2	Interatomic distance (Å)	Clash overlap (Å)
1:E:115:THR:O	1:E:144:PHE:HA	2.20	0.41
1:A:145:ASP:OD2	1:A:174:LYS:HE2	2.21	0.41
1:B:10:ALA:CB	1:B:29:LEU:HD12	2.51	0.41
1:F:110:PRO:O	1:F:140:ALA:HB2	2.21	0.41
1:D:8:GLY:HA2	1:D:119:ALA:CB	2.50	0.41
1:B:35:LEU:HD23	1:B:35:LEU:HA	1.93	0.41
1:A:9:GLU:OE1	1:A:117:SER:OG	2.34	0.41
1:A:115:THR:O	1:A:144:PHE:HA	2.21	0.41
1:A:111:LEU:HD22	1:A:256:GLY:HA2	2.03	0.40
1:F:10:ALA:HB1	1:F:29:LEU:CD1	2.51	0.40
1:C:118:ILE:HG12	1:C:152:LEU:CD2	2.47	0.40
1:C:158:LEU:HD12	1:C:158:LEU:HA	1.92	0.40
1:C:175:ALA:HB1	1:C:180:LEU:HD13	2.03	0.40
1:F:47:HIS:HD2	1:F:100:GLN:N	2.19	0.40
1:C:210:ASP:O	1:C:226:ALA:HB2	2.20	0.40
1:C:210:ASP:O	1:C:226:ALA:HB1	2.22	0.40
1:F:47:HIS:CE1	1:F:75:ALA:HB2	2.56	0.40
1:B:220:GLY:HA2	1:C:181:HIS:CE1	2.56	0.40
1:D:19:ASP:N	1:D:20:PRO:CD	2.84	0.40
1:A:14:ILE:O	1:A:82:THR:HA	2.22	0.40

There are no symmetry-related clashes.

## 5.3 Torsion angles [i](#)

### 5.3.1 Protein backbone [i](#)

In the following table, the Percentiles column shows the percent Ramachandran outliers of the chain as a percentile score with respect to all X-ray entries followed by that with respect to entries of similar resolution.

The Analysed column shows the number of residues for which the backbone conformation was analysed, and the total number of residues.

Mol	Chain	Analysed	Favoured	Allowed	Outliers	Percentiles
1	A	269/303 (89%)	260 (97%)	9 (3%)	0	100 100
1	B	264/303 (87%)	252 (96%)	11 (4%)	1 (0%)	34 37
1	C	265/303 (88%)	253 (96%)	12 (4%)	0	100 100
1	D	276/303 (91%)	268 (97%)	8 (3%)	0	100 100

Continued on next page...



Continued from previous page...

Mol	Chain	Analysed	Favoured	Allowed	Outliers	Percentiles	
1	E	270/303 (89%)	264 (98%)	6 (2%)	0	100	100
1	F	263/303 (87%)	254 (97%)	9 (3%)	0	100	100
All	All	1607/1818 (88%)	1551 (96%)	55 (3%)	1 (0%)	51	60

All (1) Ramachandran outliers are listed below:

Mol	Chain	Res	Type
1	B	227	GLN

### 5.3.2 Protein sidechains [i](#)

In the following table, the Percentiles column shows the percent sidechain outliers of the chain as a percentile score with respect to all X-ray entries followed by that with respect to entries of similar resolution.

The Analysed column shows the number of residues for which the sidechain conformation was analysed, and the total number of residues.

Mol	Chain	Analysed	Rotameric	Outliers	Percentiles	
1	A	187/227 (82%)	182 (97%)	5 (3%)	44	55
1	B	181/227 (80%)	174 (96%)	7 (4%)	32	40
1	C	182/227 (80%)	181 (100%)	1 (0%)	88	94
1	D	190/227 (84%)	185 (97%)	5 (3%)	46	57
1	E	187/227 (82%)	175 (94%)	12 (6%)	17	18
1	F	182/227 (80%)	171 (94%)	11 (6%)	19	21
All	All	1109/1362 (81%)	1068 (96%)	41 (4%)	34	42

All (41) residues with a non-rotameric sidechain are listed below:

Mol	Chain	Res	Type
1	A	53	ARG
1	A	111	LEU
1	A	137	ARG
1	A	147	ASN
1	A	288	ARG
1	B	92	THR
1	B	107	VAL
1	B	111	LEU
1	B	112	LEU

Continued on next page...

*Continued from previous page...*

<b>Mol</b>	<b>Chain</b>	<b>Res</b>	<b>Type</b>
1	B	117	SER
1	B	137	ARG
1	B	210	ASP
1	C	269	SER
1	D	63	SER
1	D	117	SER
1	D	137	ARG
1	D	159	THR
1	D	259	ARG
1	E	3	ARG
1	E	15	VAL
1	E	29	LEU
1	E	40	ARG
1	E	53	ARG
1	E	63	SER
1	E	73	GLN
1	E	80	THR
1	E	103	ASP
1	E	123	GLU
1	E	191	GLN
1	E	234	THR
1	F	14	ILE
1	F	47	HIS
1	F	48	ILE
1	F	56	ARG
1	F	74	THR
1	F	76	ASP
1	F	103	ASP
1	F	149	ARG
1	F	151	SER
1	F	174	LYS
1	F	242	MET

Sometimes sidechains can be flipped to improve hydrogen bonding and reduce clashes. All (4) such sidechains are listed below:

<b>Mol</b>	<b>Chain</b>	<b>Res</b>	<b>Type</b>
1	B	191	GLN
1	C	191	GLN
1	E	191	GLN
1	F	47	HIS

### 5.3.3 RNA [i](#)

There are no RNA molecules in this entry.

## 5.4 Non-standard residues in protein, DNA, RNA chains [i](#)

There are no non-standard protein/DNA/RNA residues in this entry.

## 5.5 Carbohydrates [i](#)

There are no monosaccharides in this entry.

## 5.6 Ligand geometry [i](#)

8 ligands are modelled in this entry.

In the following table, the Counts columns list the number of bonds (or angles) for which Mogul statistics could be retrieved, the number of bonds (or angles) that are observed in the model and the number of bonds (or angles) that are defined in the Chemical Component Dictionary. The Link column lists molecule types, if any, to which the group is linked. The Z score for a bond length (or angle) is the number of standard deviations the observed value is removed from the expected value. A bond length (or angle) with  $|Z| > 2$  is considered an outlier worth inspection. RMSZ is the root-mean-square of all Z scores of the bond lengths (or angles).

Mol	Type	Chain	Res	Link	Bond lengths			Bond angles		
					Counts	RMSZ	# Z  > 2	Counts	RMSZ	# Z  > 2
2	GOL	D	401	-	5,5,5	0.12	0	5,5,5	0.46	0
3	PO4	B	401	-	4,4,4	1.35	0	6,6,6	0.44	0
3	PO4	A	402	-	4,4,4	2.63	4 (100%)	6,6,6	0.60	0
3	PO4	D	402	-	4,4,4	1.39	0	6,6,6	0.45	0
3	PO4	F	401	-	4,4,4	1.51	0	6,6,6	0.46	0
2	GOL	E	401	-	5,5,5	0.18	0	5,5,5	0.36	0
2	GOL	A	401	-	5,5,5	0.19	0	5,5,5	0.41	0
3	PO4	E	402	-	4,4,4	1.28	0	6,6,6	0.41	0

In the following table, the Chirals column lists the number of chiral outliers, the number of chiral centers analysed, the number of these observed in the model and the number defined in the Chemical Component Dictionary. Similar counts are reported in the Torsion and Rings columns. '-' means no outliers of that kind were identified.

Mol	Type	Chain	Res	Link	Chirals	Torsions	Rings
2	GOL	A	401	-	-	2/4/4/4	-
2	GOL	E	401	-	-	2/4/4/4	-

*Continued on next page...*

*Continued from previous page...*

Mol	Type	Chain	Res	Link	Chirals	Torsions	Rings
2	GOL	D	401	-	-	1/4/4/4	-

All (4) bond length outliers are listed below:

Mol	Chain	Res	Type	Atoms	Z	Observed(Å)	Ideal(Å)
3	A	402	PO4	P-O4	-2.98	1.45	1.54
3	A	402	PO4	P-O3	-2.76	1.46	1.54
3	A	402	PO4	P-O2	-2.63	1.46	1.54
3	A	402	PO4	P-O1	-2.09	1.45	1.50

There are no bond angle outliers.

There are no chirality outliers.

All (5) torsion outliers are listed below:

Mol	Chain	Res	Type	Atoms
2	A	401	GOL	C1-C2-C3-O3
2	A	401	GOL	O2-C2-C3-O3
2	E	401	GOL	O1-C1-C2-C3
2	E	401	GOL	O1-C1-C2-O2
2	D	401	GOL	O1-C1-C2-C3

There are no ring outliers.

No monomer is involved in short contacts.

The following is a two-dimensional graphical depiction of Mogul quality analysis of bond lengths, bond angles, torsion angles, and ring geometry for all instances of the Ligand of Interest. In addition, ligands with molecular weight > 250 and outliers as shown on the validation Tables will also be included. For torsion angles, if less than 5% of the Mogul distribution of torsion angles is within 10 degrees of the torsion angle in question, then that torsion angle is considered an outlier. Any bond that is central to one or more torsion angles identified as an outlier by Mogul will be highlighted in the graph. For rings, the root-mean-square deviation (RMSD) between the ring in question and similar rings identified by Mogul is calculated over all ring torsion angles. If the average RMSD is greater than 60 degrees and the minimal RMSD between the ring in question and any Mogul-identified rings is also greater than 60 degrees, then that ring is considered an outlier. The outliers are highlighted in purple. The color gray indicates Mogul did not find sufficient equivalents in the CSD to analyse the geometry.

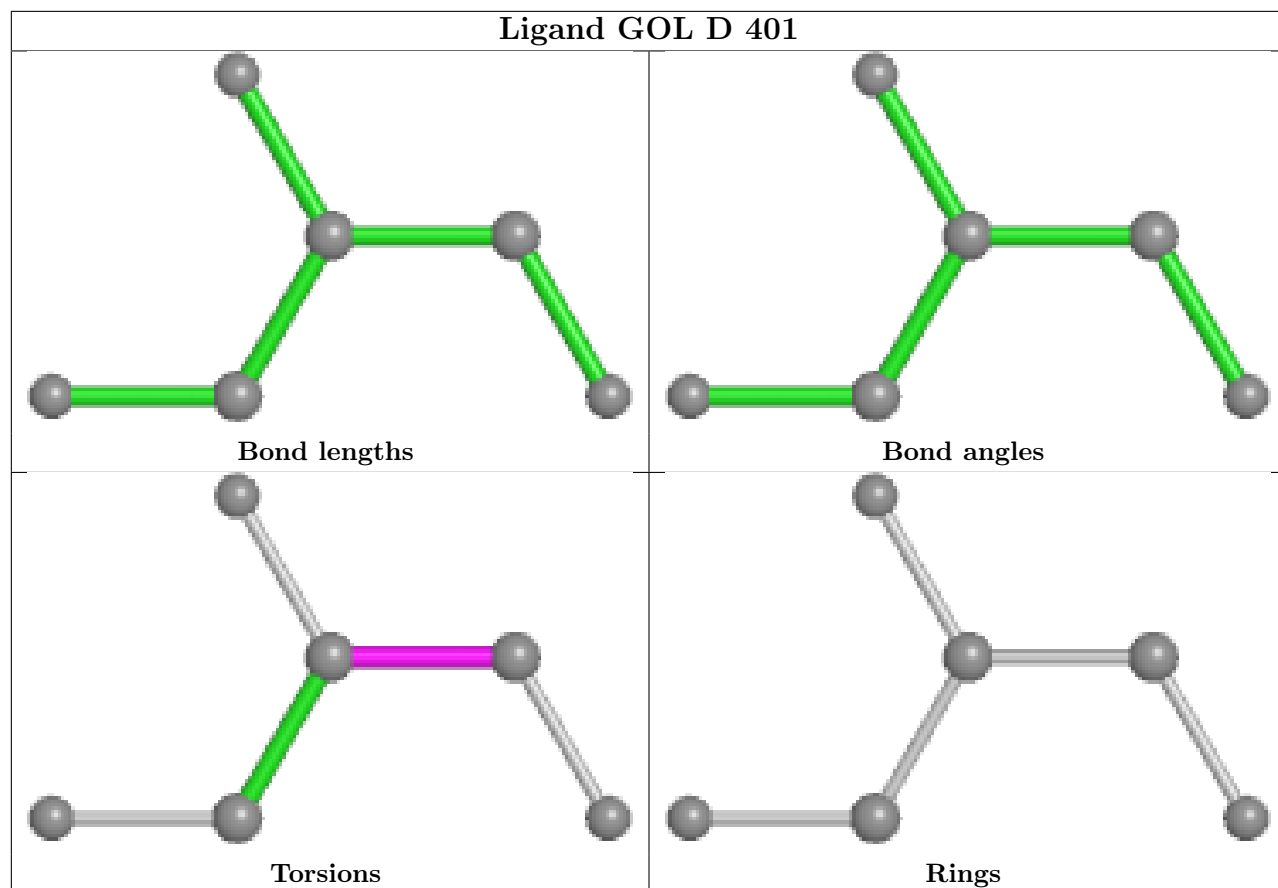

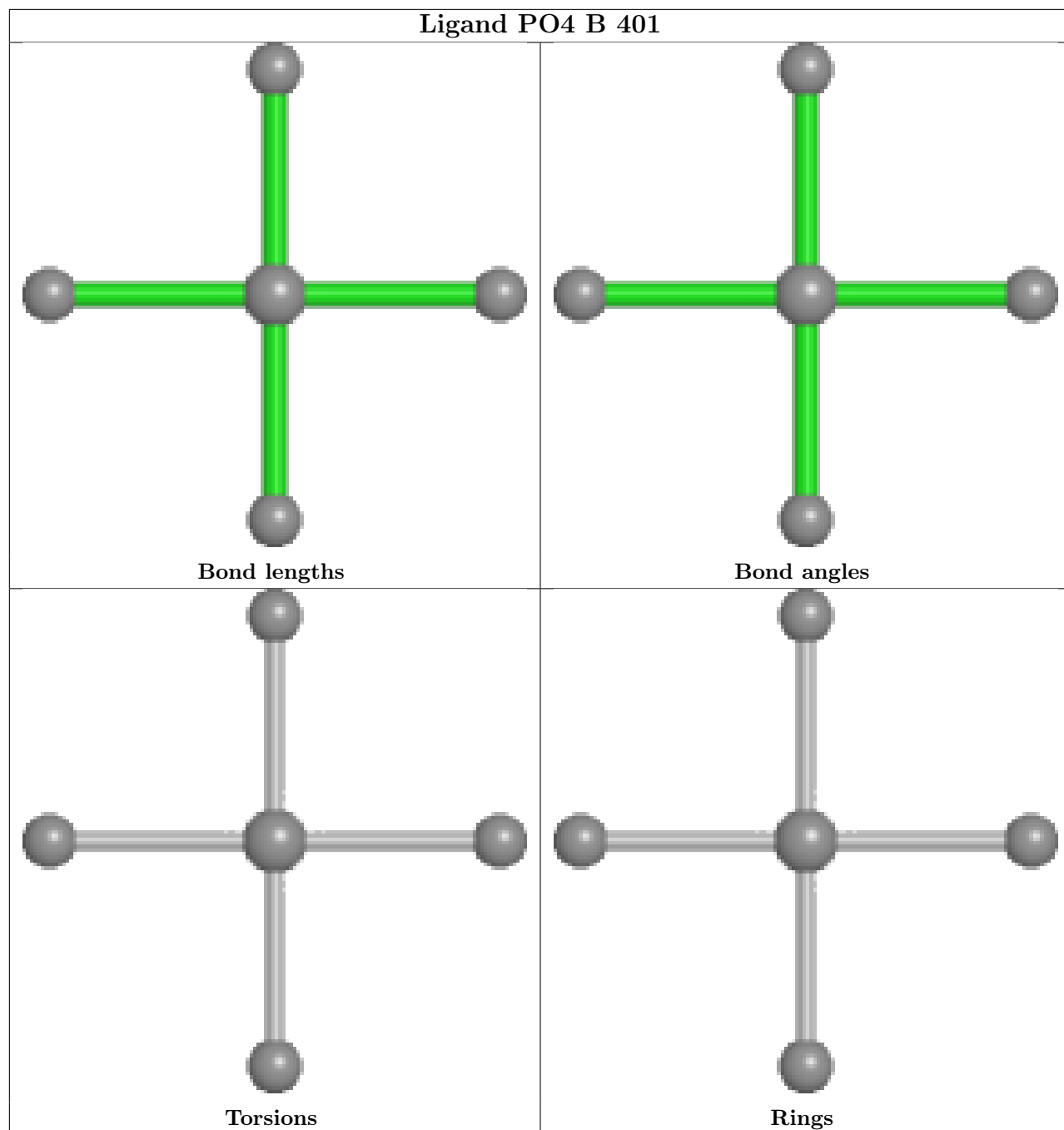

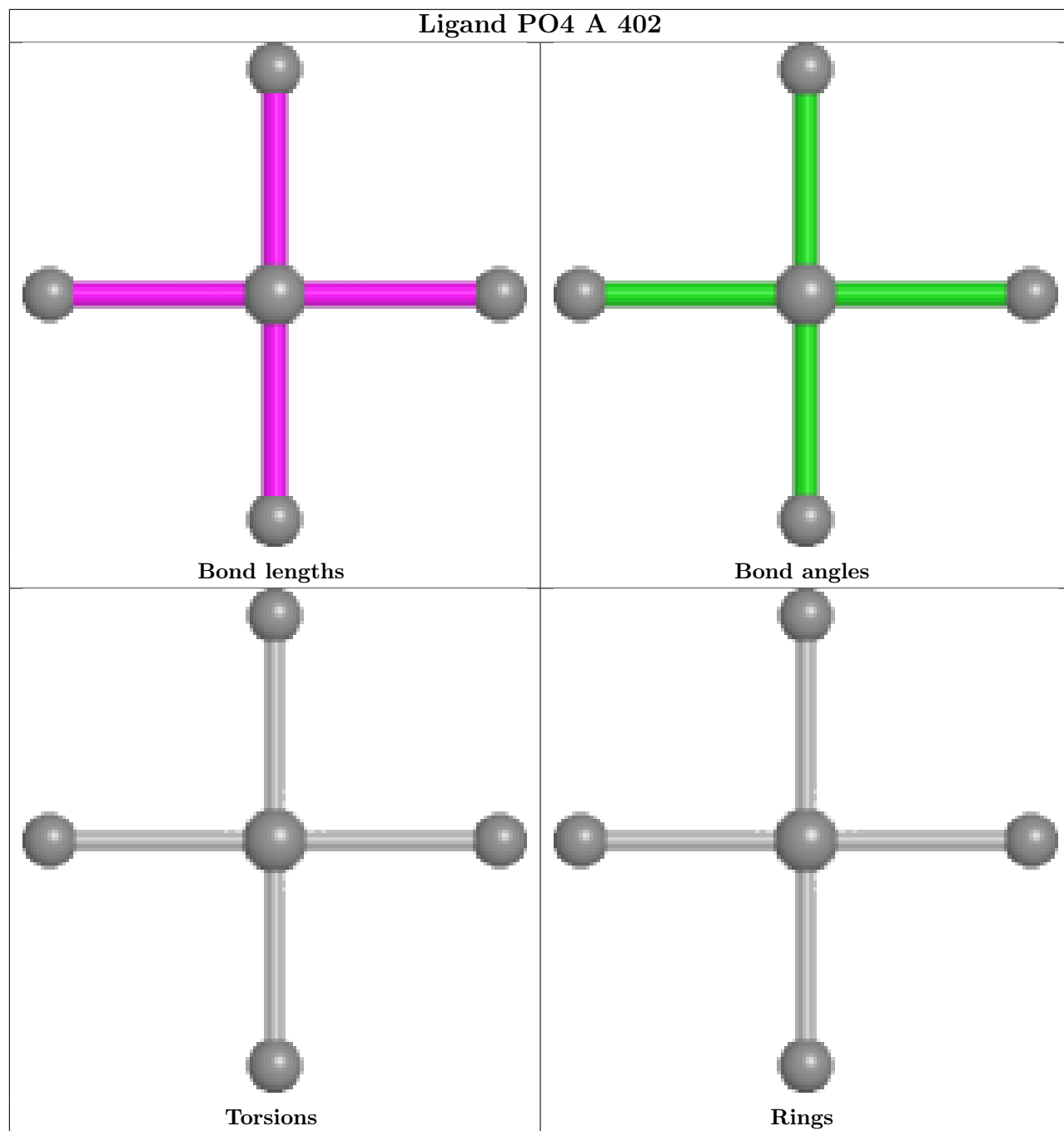

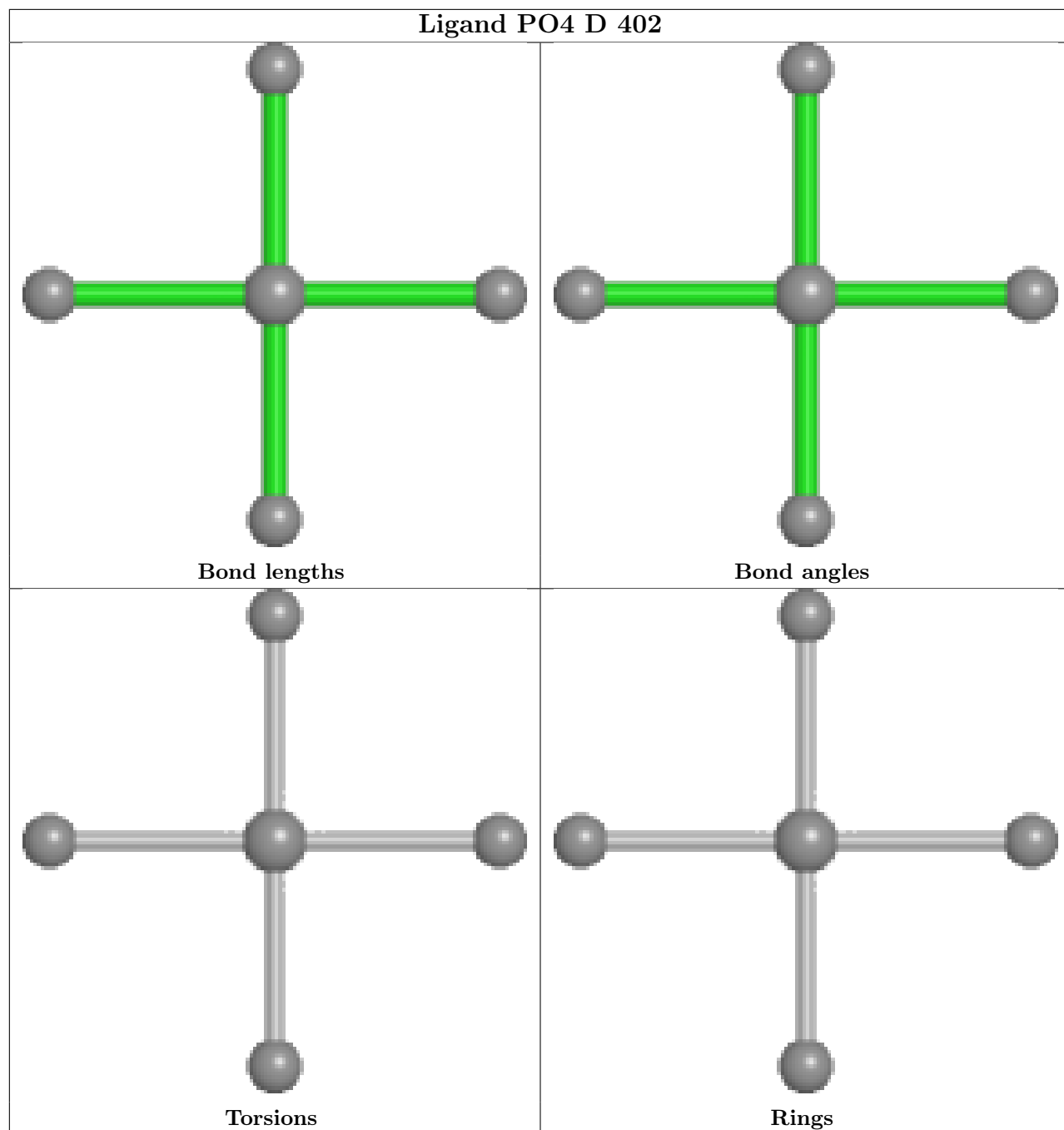



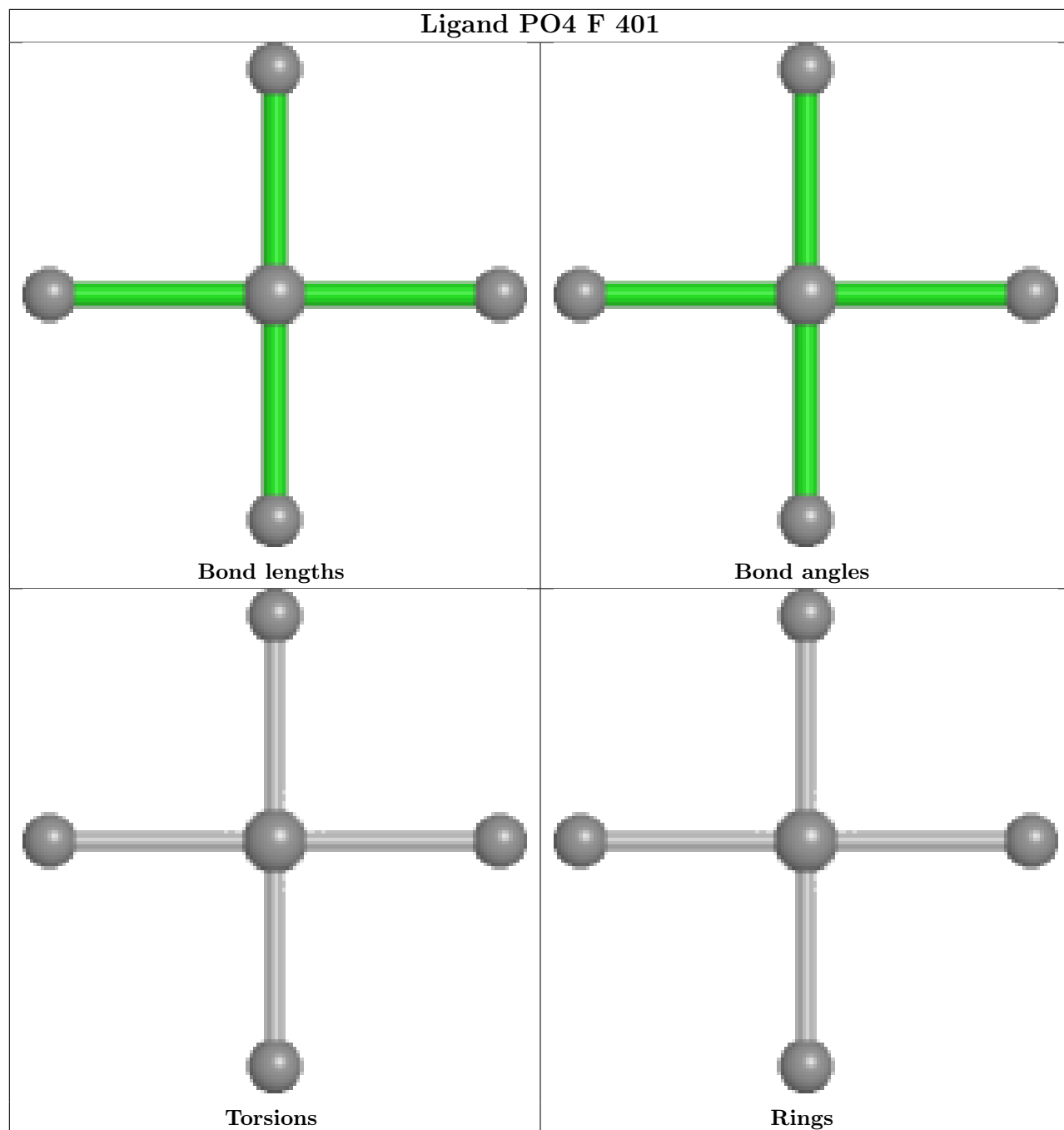

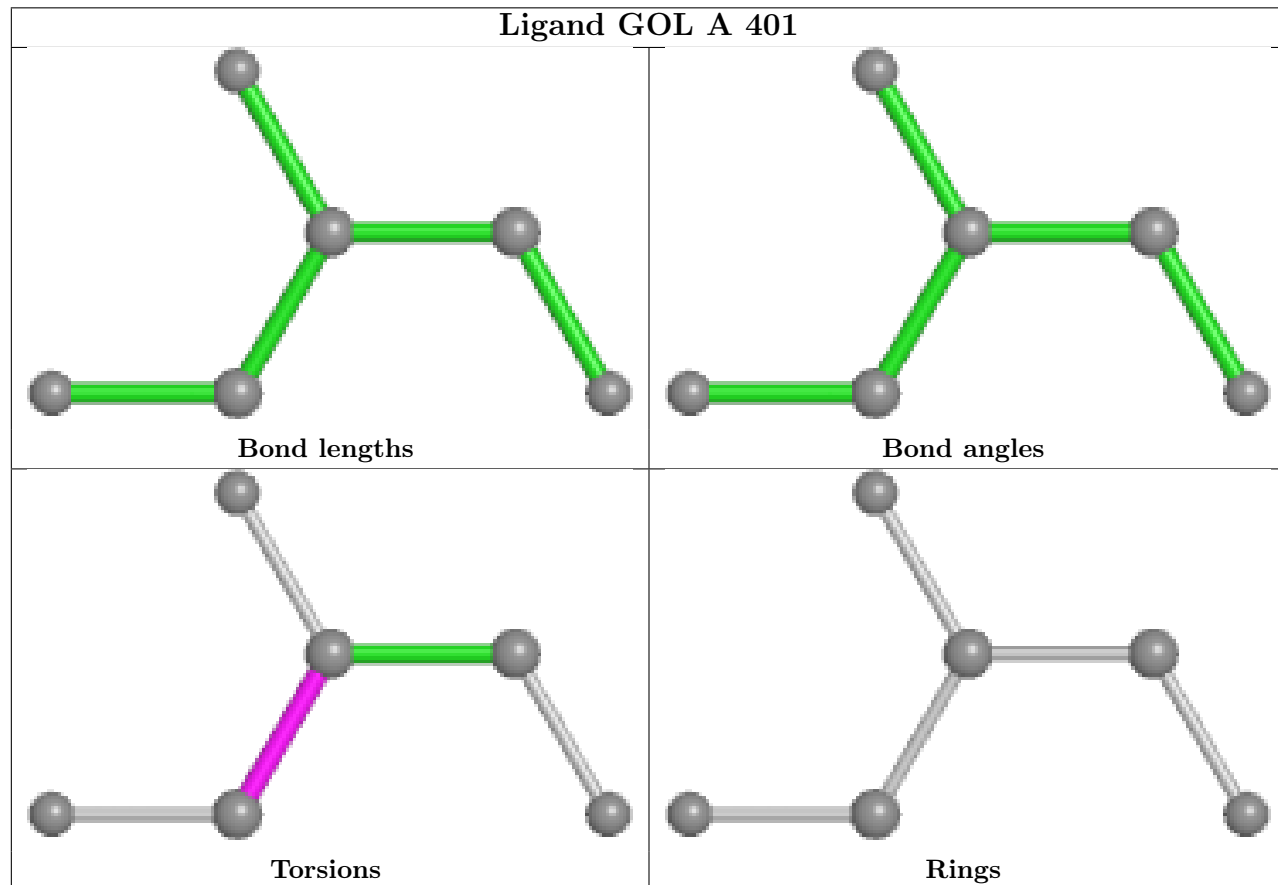
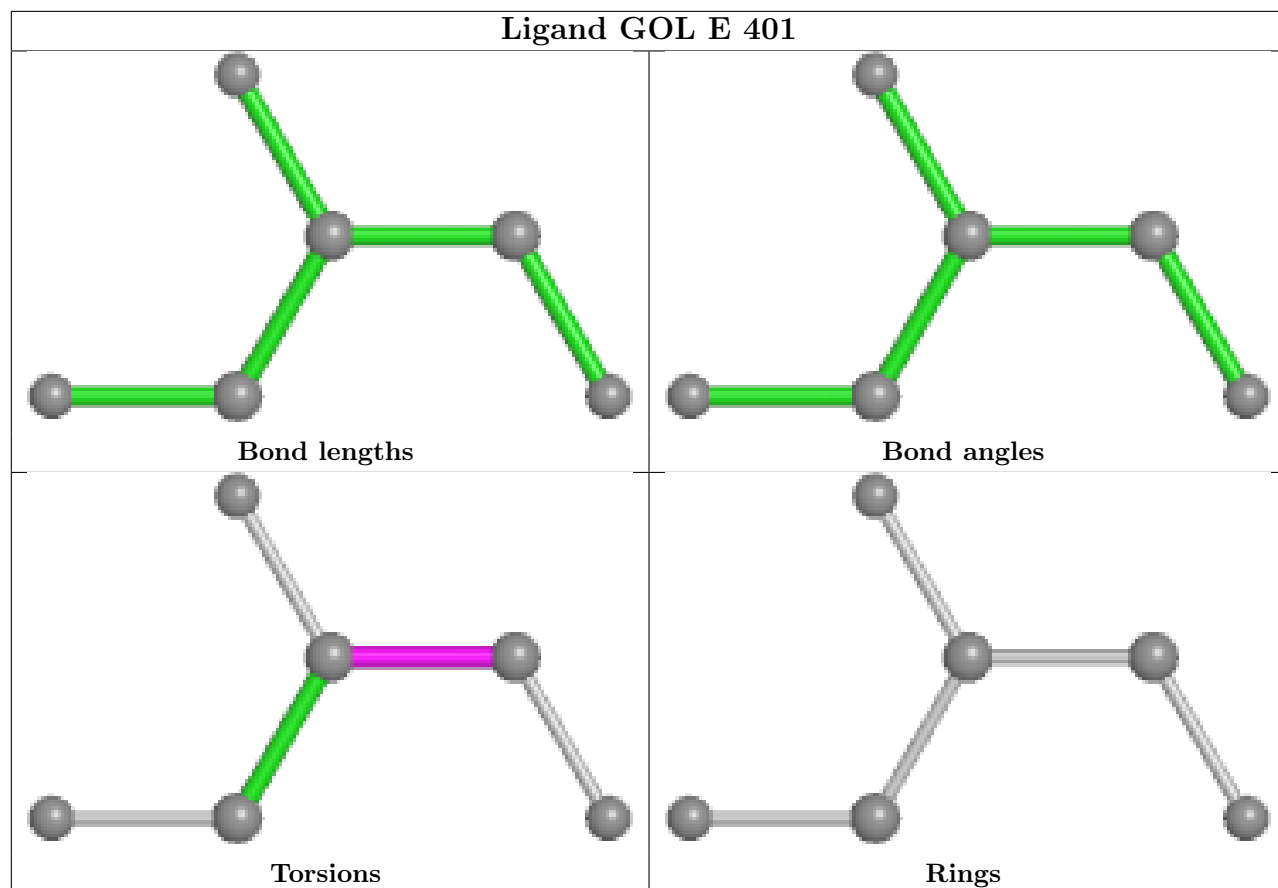

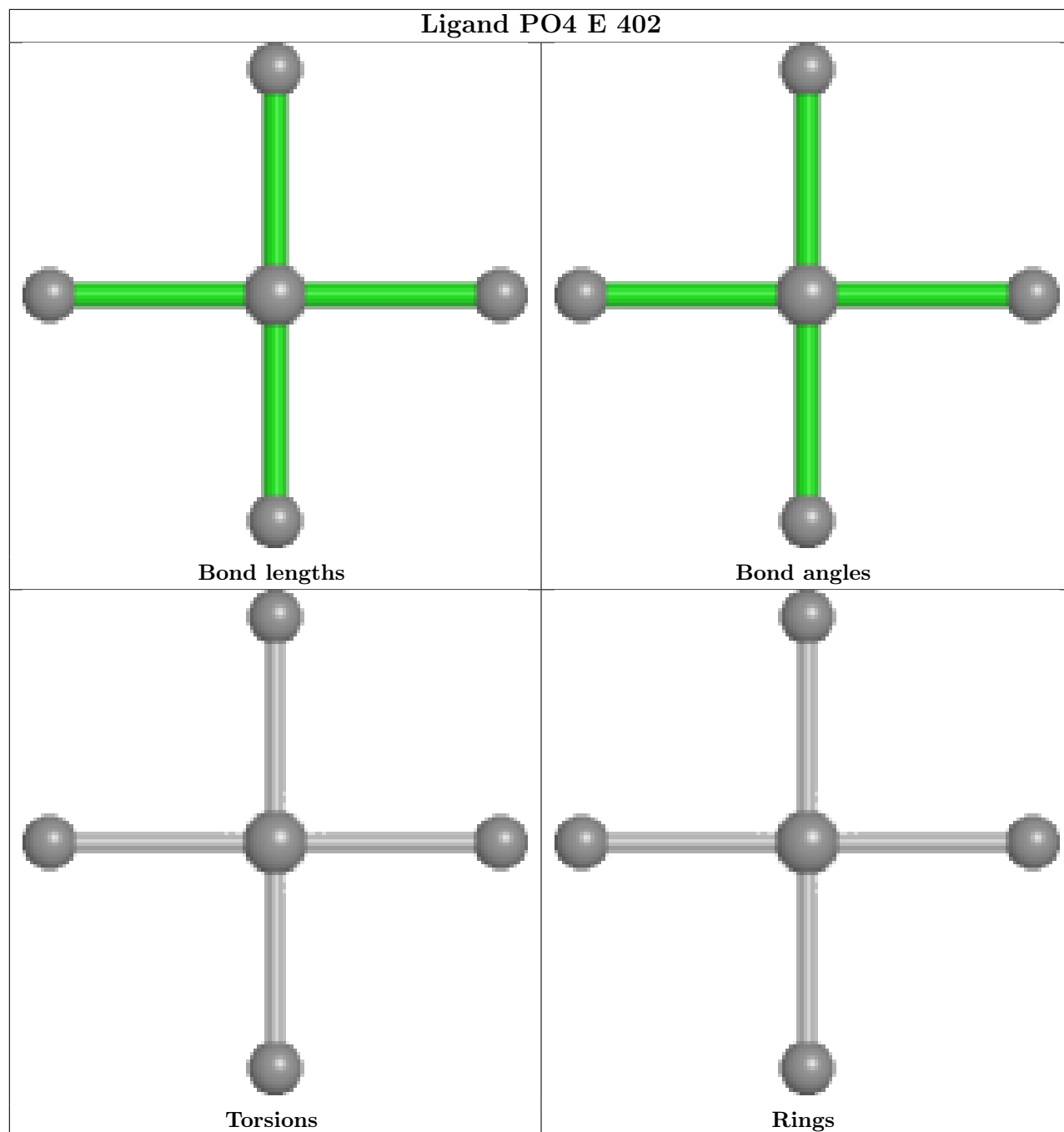

## 5.7 Other polymers [i](#)

There are no such residues in this entry.

## 5.8 Polymer linkage issues [i](#)

There are no chain breaks in this entry.

## 6 Fit of model and data

### 6.1 Protein, DNA and RNA chains

In the following table, the column labelled ‘#RSRZ> 2’ contains the number (and percentage) of RSRZ outliers, followed by percent RSRZ outliers for the chain as percentile scores relative to all X-ray entries and entries of similar resolution. The OWAB column contains the minimum, median, 95<sup>th</sup> percentile and maximum values of the occupancy-weighted average B-factor per residue. The column labelled ‘Q< 0.9’ lists the number of (and percentage) of residues with an average occupancy less than 0.9.

Mol	Chain	Analysed	<RSRZ>	#RSRZ>2	OWAB(Å <sup>2</sup> )	Q<0.9
1	A	279/303 (92%)	0.58	11 (3%) 39 37	30, 50, 85, 107	0
1	B	272/303 (89%)	0.69	33 (12%) 4 3	43, 62, 94, 107	0
1	C	273/303 (90%)	0.66	30 (10%) 5 4	30, 67, 96, 117	0
1	D	282/303 (93%)	0.55	11 (3%) 39 37	38, 54, 87, 122	0
1	E	278/303 (91%)	0.49	15 (5%) 25 24	46, 63, 92, 115	0
1	F	271/303 (89%)	0.72	34 (12%) 3 3	30, 65, 103, 110	0
All	All	1655/1818 (91%)	0.62	134 (8%) 12 10	30, 60, 96, 122	0

All (134) RSRZ outliers are listed below:

Mol	Chain	Res	Type	RSRZ
1	C	153	SER	8.1
1	E	19	ASP	7.1
1	B	52	ALA	5.9
1	F	75	ALA	5.4
1	D	18	PRO	5.1
1	C	154	ALA	5.0
1	E	52	ALA	5.0
1	D	232	VAL	4.8
1	C	93	TYR	4.8
1	F	11	LEU	4.6
1	E	152	LEU	4.6
1	F	95	PHE	4.5
1	C	45	LEU	4.5
1	F	49	GLY	4.5
1	F	50	ARG	4.4
1	F	21	ALA	4.4
1	F	81	ALA	4.3
1	F	76	ASP	4.1
1	B	235	VAL	4.0

*Continued on next page...*

*Continued from previous page...*

<b>Mol</b>	<b>Chain</b>	<b>Res</b>	<b>Type</b>	<b>RSRZ</b>
1	C	14	ILE	4.0
1	B	93	TYR	4.0
1	F	24	VAL	3.9
1	C	95	PHE	3.8
1	C	15	VAL	3.8
1	B	17	GLY	3.7
1	F	46	THR	3.7
1	C	233	ASP	3.7
1	E	153	SER	3.7
1	F	12	ILE	3.7
1	F	235	VAL	3.6
1	B	152	LEU	3.6
1	F	53	ARG	3.5
1	E	20	PRO	3.5
1	B	109	PRO	3.4
1	C	79	PRO	3.4
1	E	75	ALA	3.4
1	F	48	ILE	3.4
1	F	158	LEU	3.4
1	C	152	LEU	3.3
1	B	23	TYR	3.2
1	D	154	ALA	3.2
1	B	82	THR	3.2
1	B	92	THR	3.2
1	C	82	THR	3.2
1	C	291	ALA	3.2
1	D	16	ASP	3.1
1	A	152	LEU	3.1
1	A	92	THR	3.1
1	A	153	SER	3.0
1	B	95	PHE	3.0
1	C	92	THR	3.0
1	C	81	ALA	3.0
1	C	64	SER	3.0
1	A	115	THR	3.0
1	F	78	THR	3.0
1	C	75	ALA	3.0
1	A	116	GLY	2.9
1	B	76	ASP	2.9
1	D	1	MET	2.9
1	E	21	ALA	2.9
1	F	153	SER	2.9

*Continued on next page...*

*Continued from previous page...*

<b>Mol</b>	<b>Chain</b>	<b>Res</b>	<b>Type</b>	<b>RSRZ</b>
1	E	154	ALA	2.9
1	D	19	ASP	2.9
1	C	78	THR	2.9
1	C	69	VAL	2.8
1	F	68	LEU	2.8
1	A	292	ASP	2.8
1	B	228	PRO	2.8
1	B	45	LEU	2.8
1	B	16	ASP	2.7
1	B	96	ASP	2.7
1	B	15	VAL	2.7
1	C	83	ALA	2.7
1	E	12	ILE	2.7
1	D	229	VAL	2.7
1	B	46	THR	2.7
1	C	151	SER	2.7
1	F	162	ARG	2.6
1	B	102	PRO	2.6
1	C	21	ALA	2.6
1	E	82	THR	2.6
1	B	110	PRO	2.6
1	C	292	ASP	2.6
1	C	146	PRO	2.6
1	B	49	GLY	2.6
1	E	16	ASP	2.6
1	E	17	GLY	2.6
1	E	14	ILE	2.6
1	F	125	GLY	2.5
1	F	14	ILE	2.5
1	B	234	THR	2.4
1	E	15	VAL	2.4
1	B	74	THR	2.4
1	F	100	GLN	2.4
1	B	108	ALA	2.4
1	C	117	SER	2.4
1	F	79	PRO	2.4
1	B	103	ASP	2.4
1	F	289	ALA	2.4
1	B	80	THR	2.4
1	B	156	PRO	2.3
1	B	72	SER	2.3
1	C	77	ARG	2.3

*Continued on next page...*

*Continued from previous page...*

Mol	Chain	Res	Type	RSRZ
1	A	93	TYR	2.3
1	F	127	LEU	2.3
1	A	20	PRO	2.3
1	E	55	ARG	2.3
1	F	80	THR	2.3
1	F	93	TYR	2.3
1	A	232	VAL	2.3
1	D	146	PRO	2.3
1	C	155	ASP	2.3
1	F	52	ALA	2.3
1	B	153	SER	2.2
1	B	53	ARG	2.2
1	B	79	PRO	2.2
1	C	52	ALA	2.2
1	A	177	ALA	2.2
1	F	74	THR	2.2
1	D	92	THR	2.1
1	F	101	ILE	2.1
1	C	129	VAL	2.1
1	A	19	ASP	2.1
1	C	11	LEU	2.1
1	D	235	VAL	2.1
1	F	23	TYR	2.1
1	D	95	PHE	2.1
1	B	50	ARG	2.0
1	F	29	LEU	2.0
1	B	127	LEU	2.0
1	F	60	TYR	2.0
1	C	118	ILE	2.0
1	F	152	LEU	2.0
1	B	63	SER	2.0

## 6.2 Non-standard residues in protein, DNA, RNA chains [i](#)

There are no non-standard protein/DNA/RNA residues in this entry.

## 6.3 Carbohydrates [i](#)

There are no monosaccharides in this entry.

## 6.4 Ligands

In the following table, the Atoms column lists the number of modelled atoms in the group and the number defined in the chemical component dictionary. The B-factors column lists the minimum, median, 95<sup>th</sup> percentile and maximum values of B factors of atoms in the group. The column labelled 'Q< 0.9' lists the number of atoms with occupancy less than 0.9.

Mol	Type	Chain	Res	Atoms	RSCC	RSR	B-factors(Å <sup>2</sup> )	Q<0.9
2	GOL	A	401	6/6	0.67	0.28	52,70,75,78	0
2	GOL	E	401	6/6	0.84	0.15	74,76,80,87	0
2	GOL	D	401	6/6	0.86	0.17	50,68,74,77	0
3	PO4	D	402	5/5	0.91	0.14	80,81,88,96	0
3	PO4	F	401	5/5	0.91	0.16	107,110,112,122	0
3	PO4	A	402	5/5	0.92	0.21	73,75,84,84	0
3	PO4	B	401	5/5	0.94	0.13	88,99,104,105	0
3	PO4	E	402	5/5	0.96	0.08	84,87,93,96	0

The following is a graphical depiction of the model fit to experimental electron density of all instances of the Ligand of Interest. In addition, ligands with molecular weight > 250 and outliers as shown on the geometry validation Tables will also be included. Each fit is shown from different orientation to approximate a three-dimensional view.



**Electron density around GOL A 401:**

$2mF_o-DF_c$  (at 0.7 rmsd) in gray  
 $mF_o-DF_c$  (at 3 rmsd) in purple (negative)  
and green (positive)

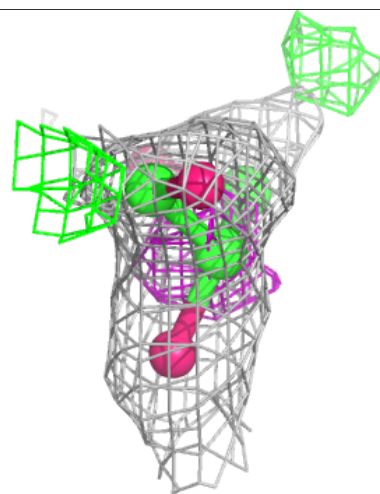
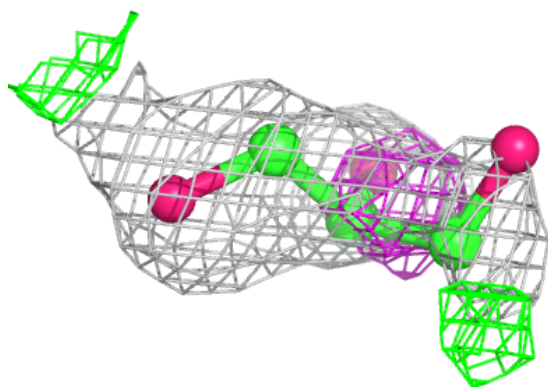
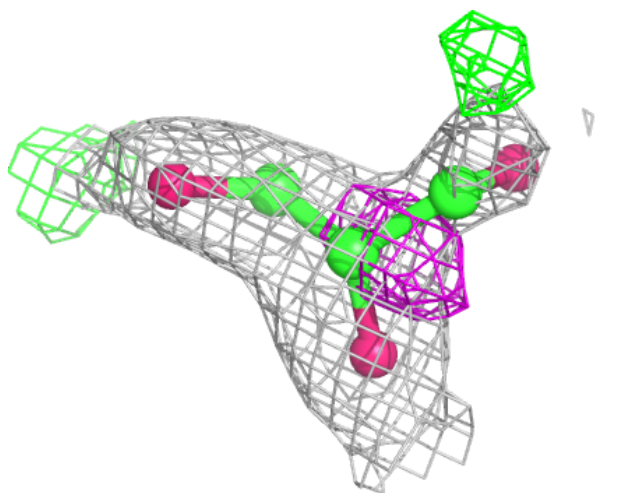

**Electron density around GOL E 401:**

$2mF_o-DF_c$  (at 0.7 rmsd) in gray  
 $mF_o-DF_c$  (at 3 rmsd) in purple (negative)  
and green (positive)

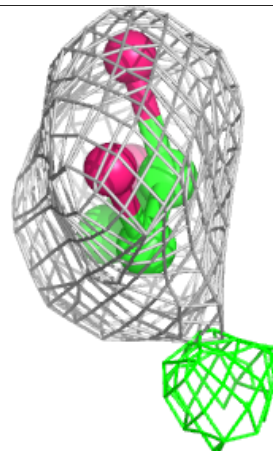
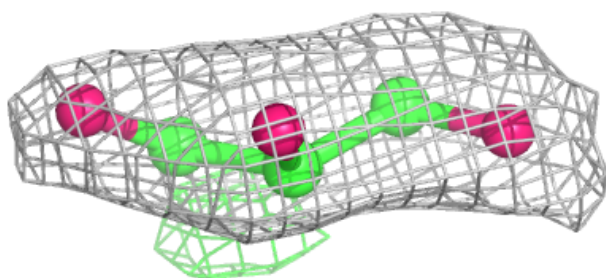
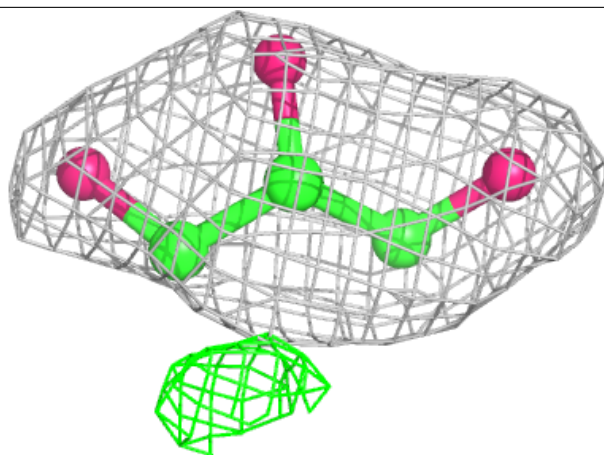

**Electron density around GOL D 401:**

$2mF_o-DF_c$  (at 0.7 rmsd) in gray  
 $mF_o-DF_c$  (at 3 rmsd) in purple (negative)  
and green (positive)

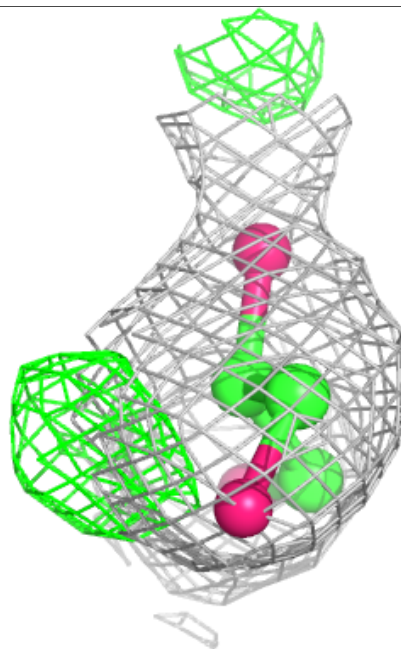
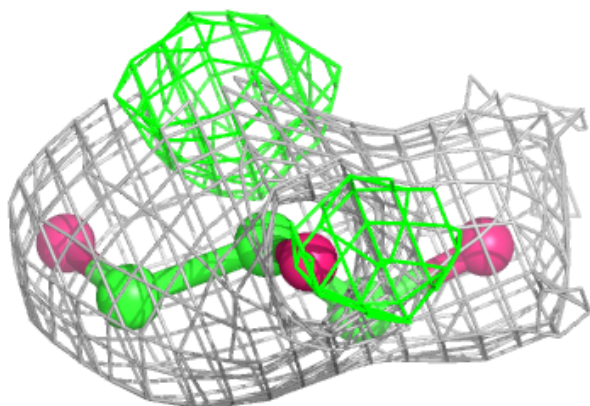
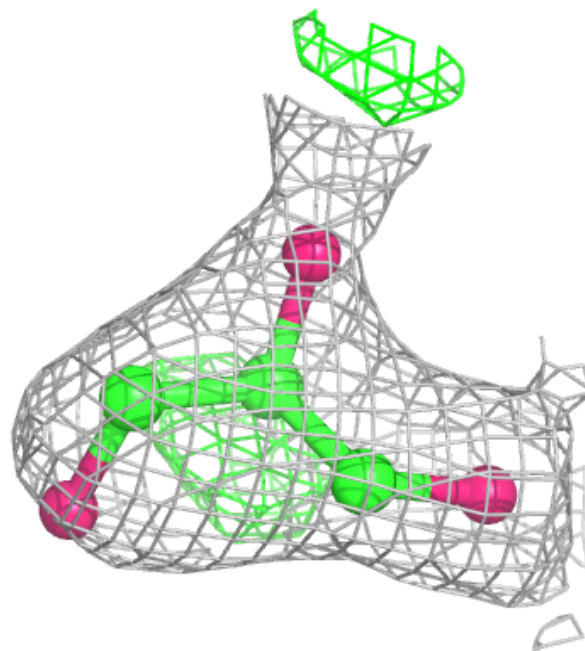

**Electron density around PO4 D 402:**

$2mF_o-DF_c$  (at 0.7 rmsd) in gray  
 $mF_o-DF_c$  (at 3 rmsd) in purple (negative)  
and green (positive)

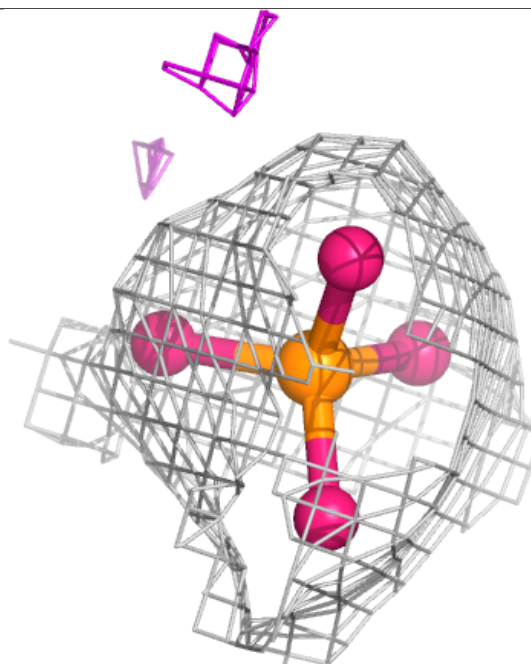
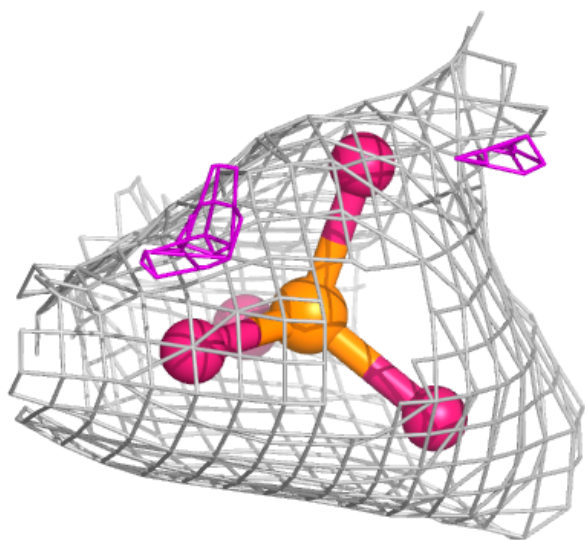
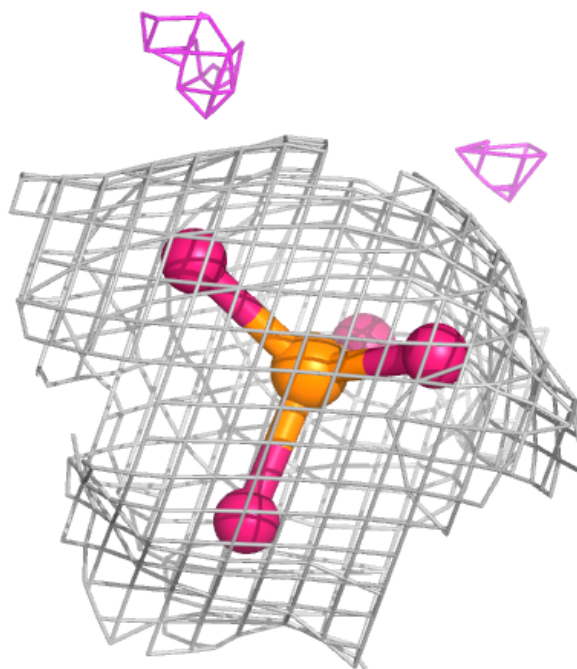

**Electron density around PO4 F 401:**

$2mF_o-DF_c$  (at 0.7 rmsd) in gray  
 $mF_o-DF_c$  (at 3 rmsd) in purple (negative)  
and green (positive)

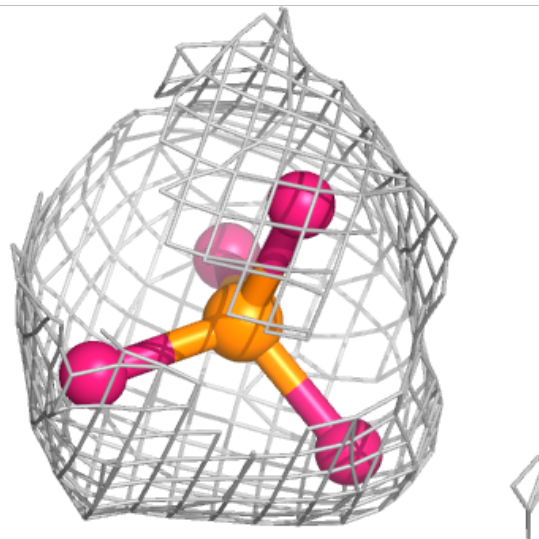
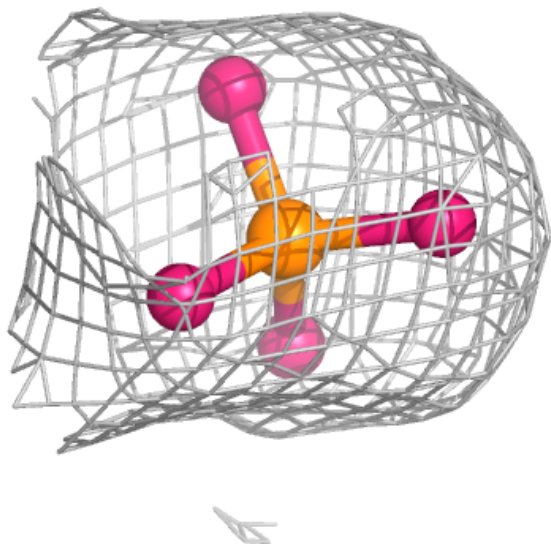
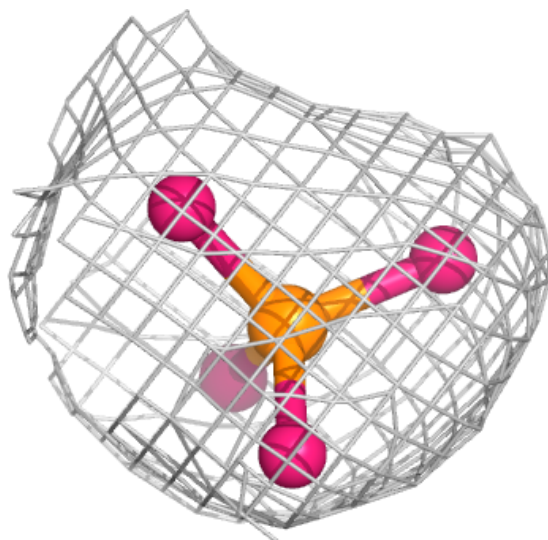

**Electron density around PO4 A 402:**

$2mF_o-DF_c$  (at 0.7 rmsd) in gray  
 $mF_o-DF_c$  (at 3 rmsd) in purple (negative)  
and green (positive)

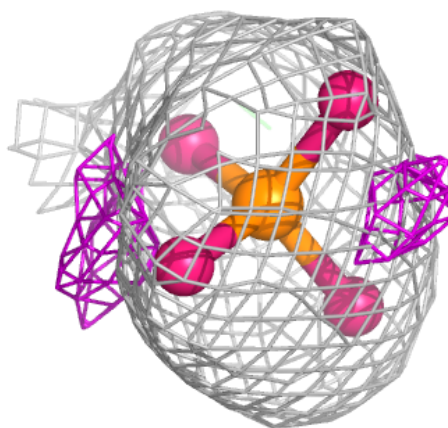
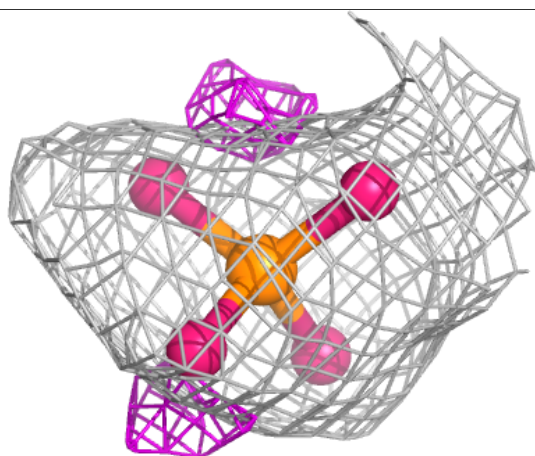
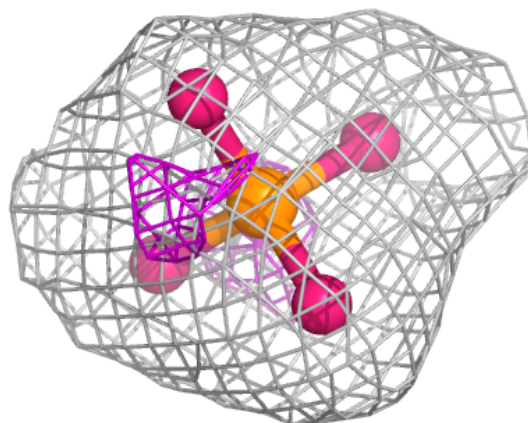

**Electron density around PO4 B 401:**

$2mF_o-DF_c$  (at 0.7 rmsd) in gray  
 $mF_o-DF_c$  (at 3 rmsd) in purple (negative)  
and green (positive)

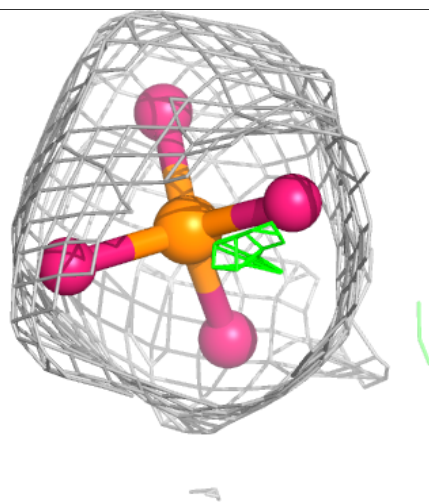
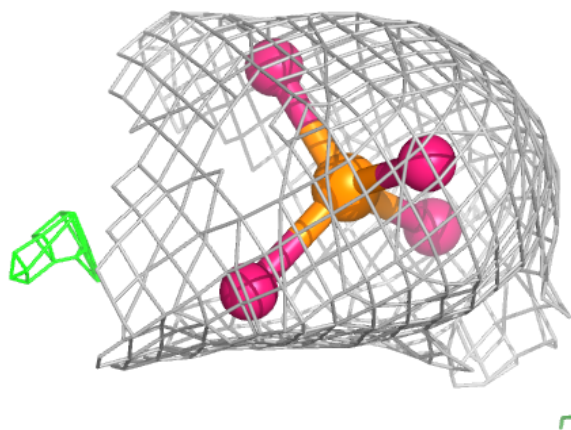
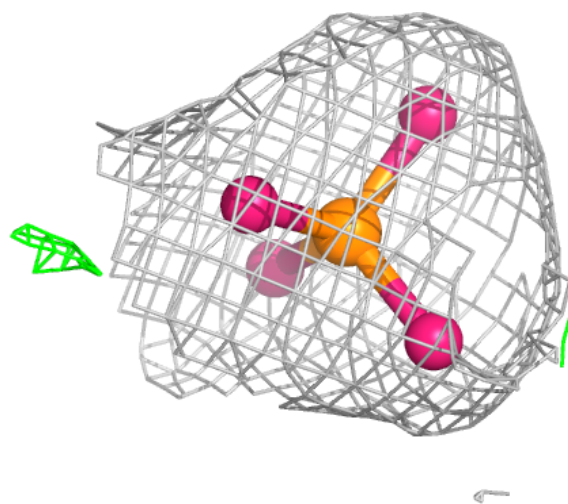

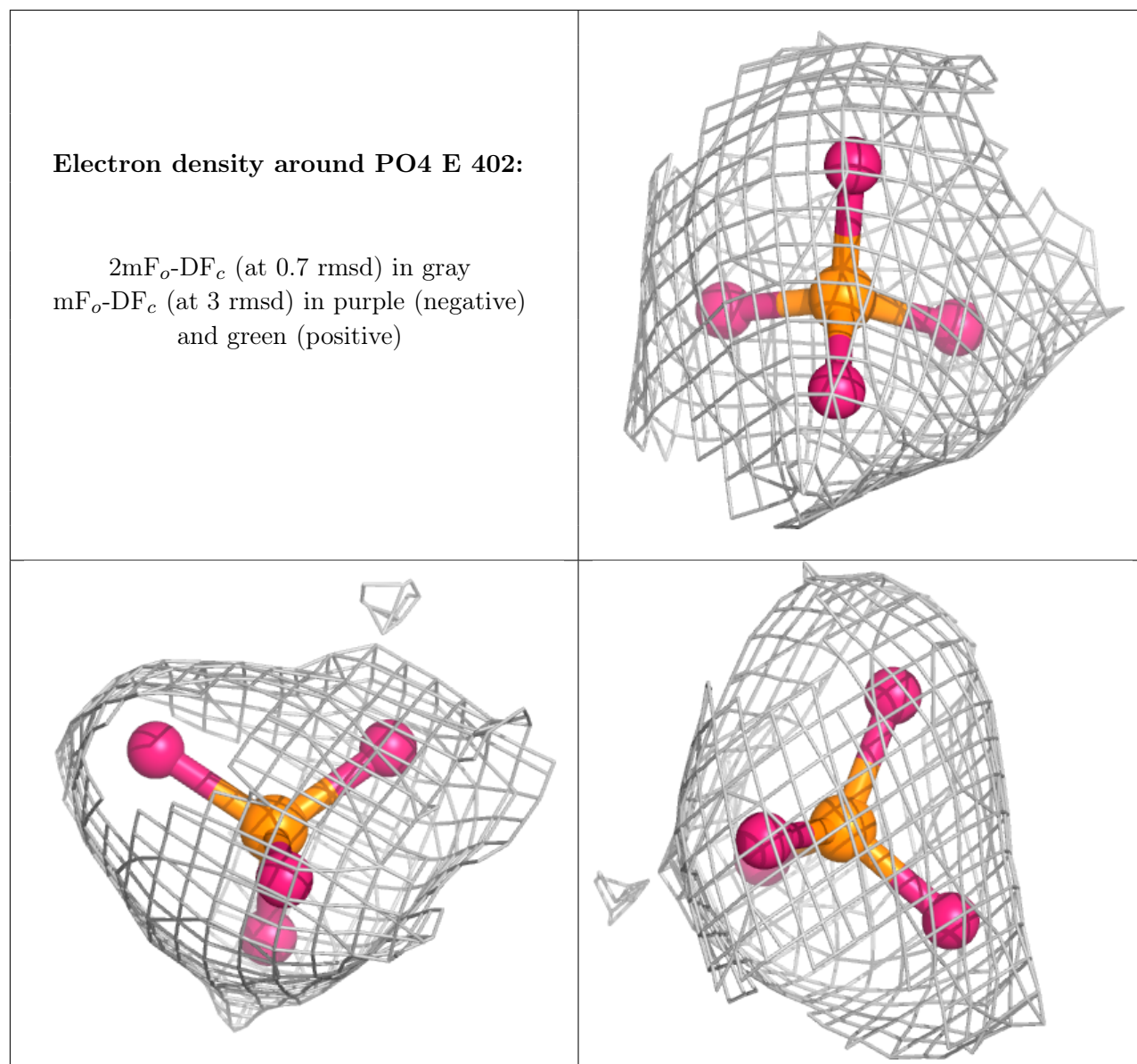

## 6.5 Other polymers [i](#)

There are no such residues in this entry.