



Full wwPDB X-ray Structure Validation Report ⓘ

Oct 15, 2023 – 06:27 PM EDT

PDB ID : 2D69
Title : Crystal structure of the complex of sulfate ion and octameric ribulose-1,5-bisphosphate carboxylase/oxygenase (Rubisco) from *Pyrococcus horikoshii* OT3 (form-2 crystal)
Authors : Mizohata, E.; Mishima, C.; Akasaka, R.; Uda, H.; Terada, T.; Shirouzu, M.; Yokoyama, S.; RIKEN Structural Genomics/Proteomics Initiative (RSGI)
Deposited on : 2005-11-10
Resolution : 1.90 Å(reported)

This is a Full wwPDB X-ray Structure Validation Report for a publicly released PDB entry.

We welcome your comments at validation@mail.wwpdb.org

A user guide is available at

<https://www.wwpdb.org/validation/2017/XrayValidationReportHelp>

with specific help available everywhere you see the ⓘ symbol.

The types of validation reports are described at

<http://www.wwpdb.org/validation/2017/FAQs#types>.

The following versions of software and data (see [references ⓘ](#)) were used in the production of this report:

MolProbity : 4.02b-467
Mogul : 1.8.5 (274361), CSD as541be (2020)
Xtrriage (Phenix) : 1.13
EDS : 2.36
Percentile statistics : 20191225.v01 (using entries in the PDB archive December 25th 2019)
Refmac : 5.8.0158
CCP4 : 7.0.044 (Gargrove)
Ideal geometry (proteins) : Engh & Huber (2001)
Ideal geometry (DNA, RNA) : Parkinson et al. (1996)
Validation Pipeline (wwPDB-VP) : 2.36

1 Overall quality at a glance

The following experimental techniques were used to determine the structure:

X-RAY DIFFRACTION

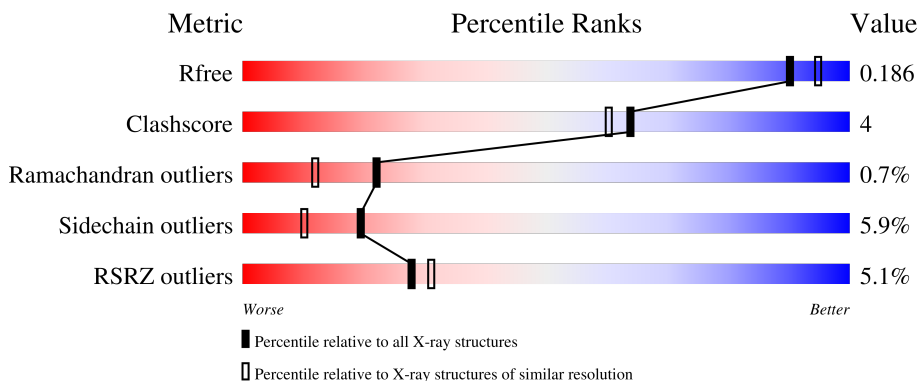

The reported resolution of this entry is 1.90 Å.

Percentile scores (ranging between 0-100) for global validation metrics of the entry are shown in the following graphic. The table shows the number of entries on which the scores are based.

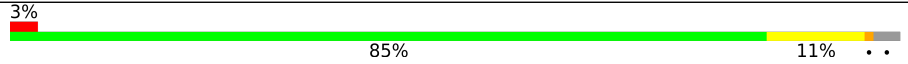
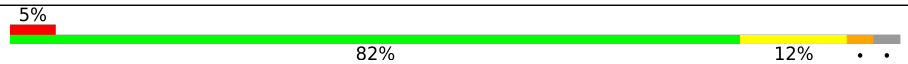

Metric	Whole archive (#Entries)	Similar resolution (#Entries, resolution range(Å))
R_{free}	130704	6207 (1.90-1.90)
Clashscore	141614	6847 (1.90-1.90)
Ramachandran outliers	138981	6760 (1.90-1.90)
Sidechain outliers	138945	6760 (1.90-1.90)
RSRZ outliers	127900	6082 (1.90-1.90)

The table below summarises the geometric issues observed across the polymeric chains and their fit to the electron density. The red, orange, yellow and green segments of the lower bar indicate the fraction of residues that contain outliers for ≥ 3 , 2, 1 and 0 types of geometric quality criteria respectively. A grey segment represents the fraction of residues that are not modelled. The numeric value for each fraction is indicated below the corresponding segment, with a dot representing fractions $\leq 5\%$. The upper red bar (where present) indicates the fraction of residues that have poor fit to the electron density. The numeric value is given above the bar.

Mol	Chain	Length	Quality of chain
1	A	430	 3% 85% 12% ..
1	B	430	 3% 85% 11% ..
1	D	430	 5% 82% 12% ..
1	E	430	 8% 80% 13% • 5%

2 Entry composition [i](#)

There are 3 unique types of molecules in this entry. The entry contains 14062 atoms, of which 0 are hydrogens and 0 are deuteriums.

In the tables below, the ZeroOcc column contains the number of atoms modelled with zero occupancy, the AltConf column contains the number of residues with at least one atom in alternate conformation and the Trace column contains the number of residues modelled with at most 2 atoms.

- Molecule 1 is a protein called Ribulose biphosphate carboxylase.

Mol	Chain	Residues	Atoms					ZeroOcc	AltConf	Trace
			Total	C	N	O	S			
1	A	424	Total 3351	C 2150	N 577	O 606	S 18	0	0	0
1	B	418	Total 3301	C 2118	N 568	O 600	S 15	0	0	0
1	D	419	Total 3319	C 2130	N 571	O 600	S 18	0	0	0
1	E	410	Total 3246	C 2082	N 558	O 591	S 15	0	0	0

- Molecule 2 is SULFATE ION (three-letter code: SO4) (formula: O₄S).



Mol	Chain	Residues	Atoms			ZeroOcc	AltConf
			Total	O	S		
2	A	1	Total 5	O 4	S 1	0	0
2	A	1	Total 5	O 4	S 1	0	0

Continued on next page...

Continued from previous page...

Mol	Chain	Residues	Atoms			ZeroOcc	AltConf
2	A	1	Total	O	S	0	0
			5	4	1		
2	A	1	Total	O	S	0	0
			5	4	1		
2	A	1	Total	O	S	0	0
			5	4	1		
2	B	1	Total	O	S	0	0
			5	4	1		
2	B	1	Total	O	S	0	0
			5	4	1		
2	B	1	Total	O	S	0	0
			5	4	1		
2	B	1	Total	O	S	0	0
			5	4	1		
2	B	1	Total	O	S	0	0
			5	4	1		
2	D	1	Total	O	S	0	0
			5	4	1		
2	D	1	Total	O	S	0	0
			5	4	1		
2	D	1	Total	O	S	0	0
			5	4	1		
2	D	1	Total	O	S	0	0
			5	4	1		
2	E	1	Total	O	S	0	0
			5	4	1		
2	E	1	Total	O	S	0	0
			5	4	1		
2	E	1	Total	O	S	0	0
			5	4	1		
2	E	1	Total	O	S	0	0
			5	4	1		

- Molecule 3 is water.

Mol	Chain	Residues	Atoms		ZeroOcc	AltConf
3	A	225	Total	O	0	0
			225	225		
3	B	181	Total	O	0	0
			181	181		

Continued on next page...

Continued from previous page...

Mol	Chain	Residues	Atoms		ZeroOcc	AltConf
3	D	173	Total	O	0	0
			173	173		
3	E	171	Total	O	0	0
			171	171		

3 Residue-property plots [i](#)

These plots are drawn for all protein, RNA, DNA and oligosaccharide chains in the entry. The first graphic for a chain summarises the proportions of the various outlier classes displayed in the second graphic. The second graphic shows the sequence view annotated by issues in geometry and electron density. Residues are color-coded according to the number of geometric quality criteria for which they contain at least one outlier: green = 0, yellow = 1, orange = 2 and red = 3 or more. A red dot above a residue indicates a poor fit to the electron density ($RSRZ > 2$). Stretches of 2 or more consecutive residues without any outlier are shown as a green connector. Residues present in the sample, but not in the model, are shown in grey.

- Molecule 1: Ribulose biphosphate carboxylase

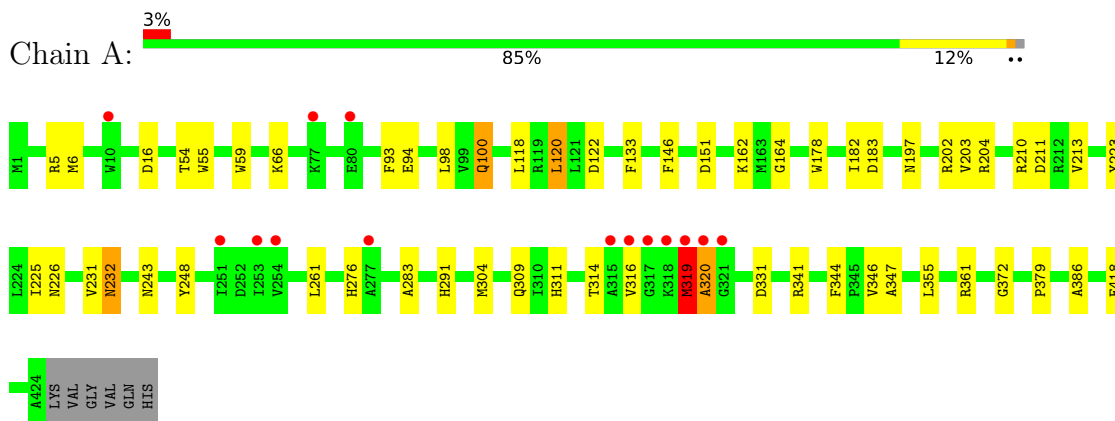

- Molecule 1: Ribulose biphosphate carboxylase

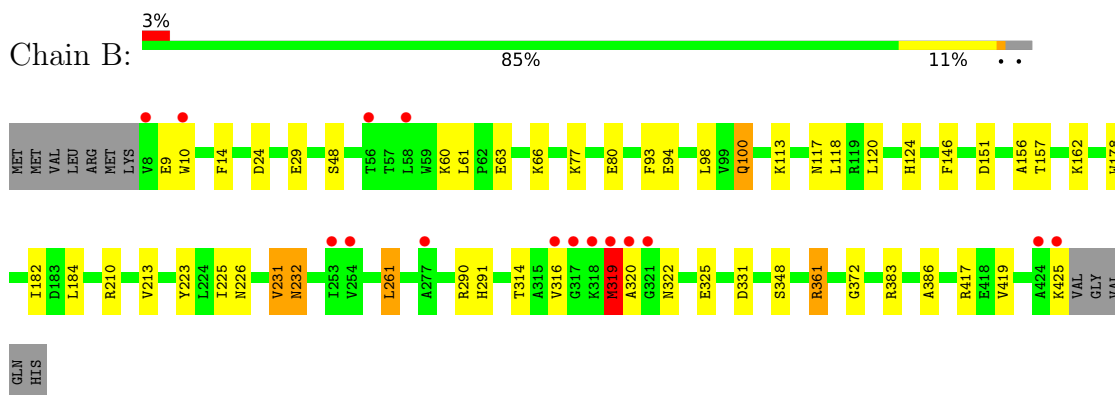

- Molecule 1: Ribulose biphosphate carboxylase

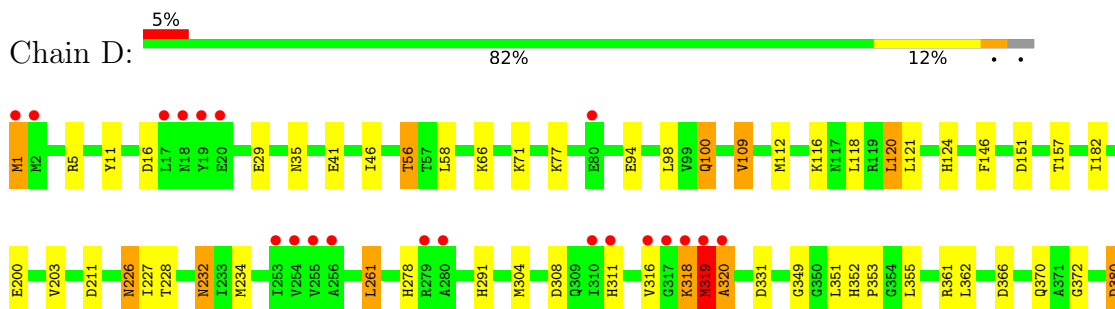

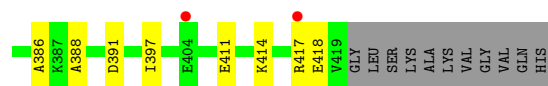

- Molecule 1: Ribulose biphosphate carboxylase

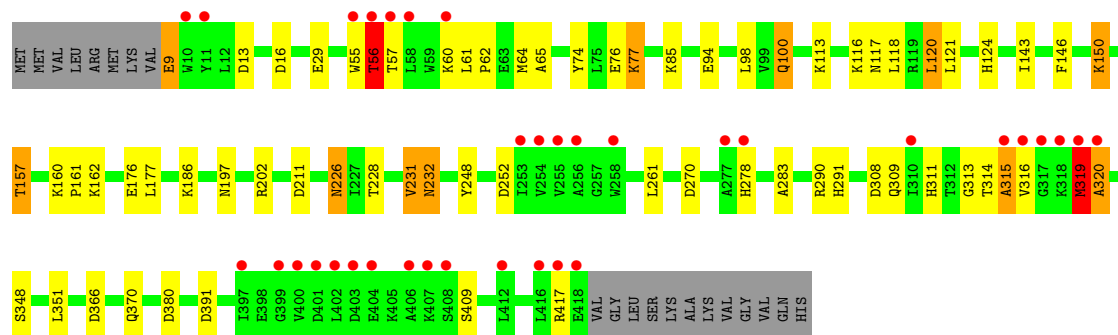
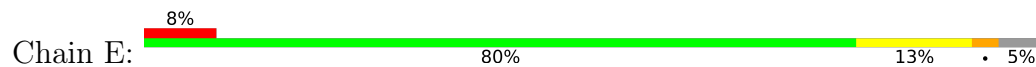

4 Data and refinement statistics i

Property	Value	Source
Space group	C 1 2 1	Depositor
Cell constants a, b, c, α , β , γ	172.59Å 148.77Å 108.45Å 90.00° 126.49° 90.00°	Depositor
Resolution (Å)	50.00 – 1.90 46.70 – 1.90	Depositor EDS
% Data completeness (in resolution range)	94.3 (50.00-1.90) 94.2 (46.70-1.90)	Depositor EDS
R_{merge}	(Not available)	Depositor
R_{sym}	(Not available)	Depositor
$\langle I/\sigma(I) \rangle$ ¹	2.19 (at 1.90Å)	Xtrriage
Refinement program	REFMAC 5.1.24	Depositor
R, R_{free}	0.180 , 0.209 0.186 , 0.186	Depositor DCC
R_{free} test set	7994 reflections (4.91%)	wwPDB-VP
Wilson B-factor (Å ²)	29.1	Xtrriage
Anisotropy	0.318	Xtrriage
Bulk solvent k_{sol} (e/Å ³), B_{sol} (Å ²)	0.35 , 41.8	EDS
L-test for twinning ²	$\langle L \rangle = 0.49$, $\langle L^2 \rangle = 0.32$	Xtrriage
Estimated twinning fraction	0.008 for -h-2*1,-k,l	Xtrriage
F_o, F_c correlation	0.96	EDS
Total number of atoms	14062	wwPDB-VP
Average B, all atoms (Å ²)	21.0	wwPDB-VP

Xtrriage's analysis on translational NCS is as follows: *The largest off-origin peak in the Patterson function is 3.25% of the height of the origin peak. No significant pseudotranslation is detected.*

¹Intensities estimated from amplitudes.

²Theoretical values of $\langle |L| \rangle$, $\langle L^2 \rangle$ for acentric reflections are 0.5, 0.333 respectively for untwinned datasets, and 0.375, 0.2 for perfectly twinned datasets.

5 Model quality [i](#)

5.1 Standard geometry [i](#)

Bond lengths and bond angles in the following residue types are not validated in this section: SO4

The Z score for a bond length (or angle) is the number of standard deviations the observed value is removed from the expected value. A bond length (or angle) with $|Z| > 5$ is considered an outlier worth inspection. RMSZ is the root-mean-square of all Z scores of the bond lengths (or angles).

Mol	Chain	Bond lengths		Bond angles	
		RMSZ	# Z >5	RMSZ	# Z >5
1	A	0.89	0/3430	0.90	11/4631 (0.2%)
1	B	0.88	1/3380 (0.0%)	0.90	8/4566 (0.2%)
1	D	0.85	0/3398	0.93	12/4589 (0.3%)
1	E	0.90	1/3325 (0.0%)	0.93	9/4493 (0.2%)
All	All	0.88	2/13533 (0.0%)	0.91	40/18279 (0.2%)

Chiral center outliers are detected by calculating the chiral volume of a chiral center and verifying if the center is modelled as a planar moiety or with the opposite hand. A planarity outlier is detected by checking planarity of atoms in a peptide group, atoms in a mainchain group or atoms of a sidechain that are expected to be planar.

Mol	Chain	#Chirality outliers	#Planarity outliers
1	E	0	2

All (2) bond length outliers are listed below:

Mol	Chain	Res	Type	Atoms	Z	Observed(Å)	Ideal(Å)
1	E	231	VAL	CB-CG2	-6.44	1.39	1.52
1	B	231	VAL	CB-CG2	-5.36	1.41	1.52

All (40) bond angle outliers are listed below:

Mol	Chain	Res	Type	Atoms	Z	Observed(°)	Ideal(°)
1	B	331	ASP	CB-CG-OD2	7.60	125.14	118.30
1	D	380	ASP	CB-CG-OD2	7.54	125.08	118.30
1	E	380	ASP	CB-CG-OD2	7.42	124.97	118.30
1	B	261	LEU	CB-CG-CD2	7.29	123.39	111.00
1	D	151	ASP	CB-CG-OD2	6.91	124.52	118.30
1	D	211	ASP	CB-CG-OD2	6.73	124.36	118.30
1	D	331	ASP	CB-CG-OD2	6.49	124.14	118.30

Continued on next page...

Continued from previous page...

Mol	Chain	Res	Type	Atoms	Z	Observed(°)	Ideal(°)
1	A	331	ASP	CB-CG-OD2	6.47	124.12	118.30
1	E	211	ASP	CB-CG-OD2	6.33	124.00	118.30
1	D	261	LEU	CB-CG-CD2	6.31	121.73	111.00
1	D	391	ASP	CB-CG-OD2	6.30	123.97	118.30
1	D	16	ASP	CB-CG-OD2	6.24	123.92	118.30
1	D	308	ASP	CB-CG-OD2	6.22	123.90	118.30
1	D	366	ASP	CB-CG-OD2	6.17	123.85	118.30
1	E	16	ASP	CB-CG-OD2	6.14	123.83	118.30
1	E	308	ASP	CB-CG-OD2	6.09	123.78	118.30
1	E	13	ASP	CB-CG-OD2	6.00	123.70	118.30
1	A	211	ASP	CB-CG-OD2	5.99	123.69	118.30
1	B	361	ARG	NE-CZ-NH2	5.95	123.27	120.30
1	B	383	ARG	NE-CZ-NH2	-5.93	117.33	120.30
1	A	120	LEU	CA-CB-CG	5.87	128.79	115.30
1	E	120	LEU	CA-CB-CG	5.72	128.45	115.30
1	B	361	ARG	NE-CZ-NH1	-5.70	117.45	120.30
1	B	151	ASP	CB-CG-OD2	5.69	123.42	118.30
1	A	16	ASP	CB-CG-OD2	5.69	123.42	118.30
1	A	151	ASP	CB-CG-OD2	5.66	123.39	118.30
1	D	1	MET	CG-SD-CE	5.66	109.25	100.20
1	A	361	ARG	NE-CZ-NH2	5.61	123.11	120.30
1	A	341	ARG	NE-CZ-NH1	5.57	123.08	120.30
1	B	24	ASP	CB-CG-OD2	5.52	123.27	118.30
1	E	366	ASP	CB-CG-OD2	5.45	123.21	118.30
1	E	231	VAL	CB-CA-C	-5.41	101.13	111.40
1	D	120	LEU	CA-CB-CG	5.36	127.62	115.30
1	A	248	TYR	CA-CB-CG	5.34	123.55	113.40
1	A	204	ARG	NE-CZ-NH2	-5.26	117.67	120.30
1	D	304	MET	CG-SD-CE	-5.26	91.79	100.20
1	A	122	ASP	CB-CG-OD2	5.23	123.01	118.30
1	A	183	ASP	CB-CG-OD2	5.19	122.97	118.30
1	E	252	ASP	CB-CG-OD2	5.16	122.94	118.30
1	B	383	ARG	NE-CZ-NH1	5.01	122.81	120.30

There are no chirality outliers.

All (2) planarity outliers are listed below:

Mol	Chain	Res	Type	Group
1	E	315	ALA	Peptide
1	E	56	THR	Peptide

5.2 Too-close contacts [i](#)

In the following table, the Non-H and H(model) columns list the number of non-hydrogen atoms and hydrogen atoms in the chain respectively. The H(added) column lists the number of hydrogen atoms added and optimized by MolProbity. The Clashes column lists the number of clashes within the asymmetric unit, whereas Symm-Clashes lists symmetry-related clashes.

Mol	Chain	Non-H	H(model)	H(added)	Clashes	Symm-Clashes
1	A	3351	0	3356	28	0
1	B	3301	0	3293	21	0
1	D	3319	0	3319	31	0
1	E	3246	0	3225	34	0
2	A	25	0	0	0	0
2	B	25	0	0	0	0
2	D	20	0	0	0	0
2	E	25	0	0	1	0
3	A	225	0	0	1	0
3	B	181	0	0	1	0
3	D	173	0	0	1	0
3	E	171	0	0	2	0
All	All	14062	0	13193	110	0

The all-atom clashscore is defined as the number of clashes found per 1000 atoms (including hydrogen atoms). The all-atom clashscore for this structure is 4.

All (110) close contacts within the same asymmetric unit are listed below, sorted by their clash magnitude.

Atom-1	Atom-2	Interatomic distance (Å)	Clash overlap (Å)
1:E:248:TYR:OH	1:E:309:GLN:NE2	2.14	0.80
1:E:118:LEU:H	1:E:291:HIS:HD2	1.29	0.79
1:A:316:VAL:O	1:A:320:ALA:HB2	1.83	0.79
1:E:270:ASP:OD1	3:E:4105:HOH:O	2.05	0.73
1:B:232:ASN:HD22	1:B:232:ASN:H	1.36	0.72
1:D:227:ILE:O	1:D:234:MET:HG2	1.89	0.72
1:A:118:LEU:H	1:A:291:HIS:HD2	1.35	0.72
1:E:313:GLY:O	3:E:4128:HOH:O	2.07	0.72
1:E:391:ASP:OD2	1:E:409:SER:OG	2.02	0.72
1:B:29:GLU:OE1	1:B:124:HIS:HE1	1.73	0.71
1:D:316:VAL:HG13	1:D:355:LEU:CD1	2.24	0.68
1:B:157:THR:HG23	1:B:372:GLY:HA2	1.75	0.67
1:E:143:ILE:HD13	1:E:309:GLN:HE21	1.57	0.67
1:D:29:GLU:OE1	1:D:124:HIS:HE1	1.77	0.66
1:D:109:VAL:HG13	1:D:118:LEU:HD21	1.77	0.66

Continued on next page...

Continued from previous page...

Atom-1	Atom-2	Interatomic distance (Å)	Clash overlap (Å)
1:D:232:ASN:H	1:D:232:ASN:HD22	1.44	0.66
1:E:9:GLU:N	1:E:56:THR:HG1	1.94	0.66
1:E:150:LYS:NZ	2:E:4004:SO4:O3	2.24	0.65
1:D:56:THR:HG22	3:D:3113:HOH:O	1.97	0.65
1:E:74:TYR:CZ	1:E:76:GLU:HG3	2.33	0.64
1:D:109:VAL:HG13	1:D:118:LEU:CD2	2.28	0.63
1:A:316:VAL:HG13	1:A:355:LEU:CD1	2.28	0.62
1:A:118:LEU:H	1:A:291:HIS:CD2	2.17	0.61
1:D:316:VAL:HG13	1:D:355:LEU:HD13	1.84	0.60
1:D:109:VAL:HG22	1:D:112:MET:HE2	1.84	0.60
1:D:361:ARG:NH1	1:D:362:LEU:HD21	2.17	0.60
1:E:29:GLU:OE1	1:E:124:HIS:HE1	1.85	0.60
1:B:118:LEU:H	1:B:291:HIS:HD2	1.51	0.59
1:E:55:TRP:O	1:E:56:THR:HB	2.03	0.59
1:A:232:ASN:HD22	1:A:232:ASN:H	1.50	0.58
1:A:223:TYR:CE2	1:A:225:ILE:HD12	2.39	0.57
1:E:118:LEU:H	1:E:291:HIS:CD2	2.16	0.57
1:E:157:THR:CG2	1:E:177:LEU:HD13	2.35	0.57
1:D:380:ASP:OD1	1:D:414:LYS:HE3	2.05	0.57
1:E:232:ASN:HD22	1:E:232:ASN:H	1.54	0.56
1:A:283:ALA:O	1:E:291:HIS:HE1	1.89	0.56
1:D:316:VAL:HG13	1:D:355:LEU:HD11	1.88	0.56
1:B:232:ASN:HD22	1:B:232:ASN:N	2.01	0.55
1:A:379:PRO:CG	1:A:418:GLU:HG3	2.37	0.54
1:D:157:THR:HG23	1:D:372:GLY:HA2	1.90	0.53
1:B:63:GLU:O	3:B:2084:HOH:O	2.18	0.53
1:D:118:LEU:H	1:D:291:HIS:HD2	1.57	0.53
1:D:232:ASN:HD22	1:D:232:ASN:N	2.07	0.53
1:B:94:GLU:H	1:B:100:GLN:NE2	2.07	0.53
1:A:118:LEU:N	1:A:291:HIS:HD2	2.07	0.52
1:B:118:LEU:H	1:B:291:HIS:CD2	2.29	0.51
1:E:157:THR:O	1:E:157:THR:HG22	2.10	0.51
1:B:182:ILE:HG12	1:B:386:ALA:HB1	1.93	0.50
1:B:223:TYR:CE2	1:B:225:ILE:HD12	2.46	0.50
1:A:316:VAL:HG13	1:A:355:LEU:HD13	1.92	0.50
1:E:315:ALA:C	1:E:316:VAL:HG23	2.32	0.50
1:E:157:THR:CG2	1:E:157:THR:O	2.60	0.49
1:B:210:ARG:HD2	1:B:210:ARG:C	2.33	0.49
1:A:94:GLU:H	1:A:100:GLN:NE2	2.10	0.49
1:E:226:ASN:ND2	1:E:228:THR:H	2.12	0.48
1:E:29:GLU:HG2	1:E:85:LYS:HG2	1.95	0.48

Continued on next page...

Continued from previous page...

Atom-1	Atom-2	Interatomic distance (Å)	Clash overlap (Å)
1:A:314:THR:HG22	1:A:347:ALA:HB1	1.94	0.47
1:B:93:PHE:HA	1:B:100:GLN:HE22	1.79	0.47
1:A:291:HIS:HE1	1:E:283:ALA:O	1.96	0.47
1:A:311:HIS:CD2	3:A:1217:HOH:O	2.67	0.47
1:B:314:THR:HG23	1:B:348:SER:O	2.15	0.47
1:A:182:ILE:HG12	1:A:386:ALA:HB1	1.96	0.46
1:D:35:ASN:HD22	1:D:116:LYS:NZ	2.14	0.46
1:E:319:MET:O	1:E:320:ALA:HB3	2.16	0.45
1:B:182:ILE:HG12	1:B:386:ALA:CB	2.47	0.45
1:D:94:GLU:H	1:D:100:GLN:NE2	2.14	0.45
1:D:316:VAL:HG12	1:D:318:LYS:H	1.80	0.45
1:B:178:TRP:HB3	1:B:213:VAL:HG11	1.99	0.45
1:A:164:GLY:O	1:E:64:MET:HB2	2.17	0.45
1:E:160:LYS:HA	1:E:161:PRO:C	2.37	0.45
1:A:197:ASN:OD1	1:A:202:ARG:HD3	2.17	0.44
1:B:322:ASN:HD22	1:B:325:GLU:HB2	1.82	0.44
1:D:46:ILE:HG12	1:D:112:MET:HE1	1.99	0.44
1:D:319:MET:O	1:D:320:ALA:HB3	2.17	0.44
1:E:197:ASN:OD1	1:E:202:ARG:HD3	2.17	0.44
1:E:278:HIS:HA	1:E:311:HIS:HD2	1.82	0.44
1:E:232:ASN:HD22	1:E:232:ASN:N	2.15	0.44
1:E:94:GLU:H	1:E:100:GLN:NE2	2.15	0.43
1:A:311:HIS:HA	1:A:346:VAL:HB	1.99	0.43
1:E:77:LYS:HA	1:E:77:LYS:HD2	1.68	0.43
1:E:157:THR:HG21	1:E:177:LEU:HD22	2.01	0.43
1:A:276:HIS:CE1	1:A:346:VAL:HG21	2.53	0.43
1:D:388:ALA:HB2	1:D:411:GLU:C	2.39	0.43
1:E:117:ASN:HB3	1:E:290:ARG:O	2.19	0.43
1:B:319:MET:SD	1:B:320:ALA:N	2.92	0.43
1:E:62:PRO:HG2	1:E:65:ALA:HB2	2.01	0.42
1:D:118:LEU:H	1:D:291:HIS:CD2	2.36	0.42
1:D:352:HIS:HB2	1:D:353:PRO:CD	2.48	0.42
1:A:93:PHE:HA	1:A:100:GLN:HE22	1.83	0.42
1:A:210:ARG:HD2	1:A:210:ARG:C	2.40	0.42
1:A:178:TRP:HB3	1:A:213:VAL:HG11	2.00	0.42
1:D:11:TYR:CD1	1:D:41:GLU:HA	2.55	0.42
1:D:1:MET:CE	1:D:1:MET:N	2.84	0.41
1:D:352:HIS:HB2	1:D:353:PRO:HD2	2.01	0.41
1:D:316:VAL:HG22	1:D:351:LEU:HD23	2.02	0.41
1:B:14:PHE:CE2	1:B:48:SER:HB3	2.56	0.41
1:A:59:TRP:CH2	1:E:176:GLU:HG3	2.56	0.41

Continued on next page...

Continued from previous page...

Atom-1	Atom-2	Interatomic distance (Å)	Clash overlap (Å)
1:A:133:PHE:CG	1:A:304:MET:HG2	2.56	0.41
1:A:54:THR:C	1:A:55:TRP:CD1	2.94	0.41
1:A:182:ILE:HG12	1:A:386:ALA:CB	2.51	0.41
1:A:309:GLN:HB3	1:A:344:PHE:HB2	2.02	0.41
1:B:156:ALA:HA	1:B:184:LEU:O	2.21	0.41
1:B:316:VAL:H	1:B:320:ALA:HB2	1.86	0.41
1:D:226:ASN:ND2	1:D:228:THR:H	2.19	0.41
1:D:278:HIS:HA	1:D:311:HIS:HD2	1.86	0.41
1:D:182:ILE:HG12	1:D:386:ALA:CB	2.51	0.41
1:A:319:MET:O	1:A:320:ALA:C	2.60	0.40
1:D:200:GLU:O	1:D:203:VAL:HG22	2.22	0.40
1:E:314:THR:HG23	1:E:348:SER:O	2.21	0.40
1:B:117:ASN:HB3	1:B:290:ARG:O	2.21	0.40

There are no symmetry-related clashes.

5.3 Torsion angles [i](#)

5.3.1 Protein backbone [i](#)

In the following table, the Percentiles column shows the percent Ramachandran outliers of the chain as a percentile score with respect to all X-ray entries followed by that with respect to entries of similar resolution.

The Analysed column shows the number of residues for which the backbone conformation was analysed, and the total number of residues.

Mol	Chain	Analysed	Favoured	Allowed	Outliers	Percentiles
1	A	422/430 (98%)	407 (96%)	12 (3%)	3 (1%)	22 12
1	B	416/430 (97%)	401 (96%)	14 (3%)	1 (0%)	47 38
1	D	417/430 (97%)	401 (96%)	13 (3%)	3 (1%)	22 12
1	E	408/430 (95%)	389 (95%)	15 (4%)	4 (1%)	15 6
All	All	1663/1720 (97%)	1598 (96%)	54 (3%)	11 (1%)	22 12

All (11) Ramachandran outliers are listed below:

Mol	Chain	Res	Type
1	D	319	MET
1	E	57	THR

Continued on next page...

Continued from previous page...

Mol	Chain	Res	Type
1	B	319	MET
1	E	56	THR
1	E	319	MET
1	A	319	MET
1	A	320	ALA
1	A	372	GLY
1	E	320	ALA
1	D	320	ALA
1	D	349	GLY

5.3.2 Protein sidechains [i](#)

In the following table, the Percentiles column shows the percent sidechain outliers of the chain as a percentile score with respect to all X-ray entries followed by that with respect to entries of similar resolution.

The Analysed column shows the number of residues for which the sidechain conformation was analysed, and the total number of residues.

Mol	Chain	Analysed	Rotameric	Outliers	Percentiles	
1	A	346/351 (99%)	331 (96%)	15 (4%)	29	19
1	B	340/351 (97%)	318 (94%)	22 (6%)	17	8
1	D	343/351 (98%)	322 (94%)	21 (6%)	18	9
1	E	334/351 (95%)	311 (93%)	23 (7%)	15	7
All	All	1363/1404 (97%)	1282 (94%)	81 (6%)	19	10

All (81) residues with a non-rotameric sidechain are listed below:

Mol	Chain	Res	Type
1	A	5	ARG
1	A	6	MET
1	A	66	LYS
1	A	98	LEU
1	A	100	GLN
1	A	120	LEU
1	A	146	PHE
1	A	162	LYS
1	A	203	VAL
1	A	226	ASN
1	A	231	VAL
1	A	232	ASN

Continued on next page...

Continued from previous page...

Mol	Chain	Res	Type
1	A	243	ASN
1	A	261	LEU
1	A	319	MET
1	B	9	GLU
1	B	10	TRP
1	B	60	LYS
1	B	61	LEU
1	B	66	LYS
1	B	77	LYS
1	B	80	GLU
1	B	98	LEU
1	B	100	GLN
1	B	113	LYS
1	B	120	LEU
1	B	146	PHE
1	B	162	LYS
1	B	226	ASN
1	B	231	VAL
1	B	232	ASN
1	B	261	LEU
1	B	319	MET
1	B	361	ARG
1	B	417	ARG
1	B	419	VAL
1	B	425	LYS
1	D	5	ARG
1	D	56	THR
1	D	58	LEU
1	D	66	LYS
1	D	71	LYS
1	D	77	LYS
1	D	98	LEU
1	D	100	GLN
1	D	109	VAL
1	D	120	LEU
1	D	121	LEU
1	D	146	PHE
1	D	226	ASN
1	D	232	ASN
1	D	261	LEU
1	D	318	LYS
1	D	319	MET

Continued on next page...

Continued from previous page...

Mol	Chain	Res	Type
1	D	370	GLN
1	D	397	ILE
1	D	417	ARG
1	D	418	GLU
1	E	9	GLU
1	E	60	LYS
1	E	61	LEU
1	E	77	LYS
1	E	98	LEU
1	E	100	GLN
1	E	113	LYS
1	E	116	LYS
1	E	120	LEU
1	E	121	LEU
1	E	146	PHE
1	E	150	LYS
1	E	157	THR
1	E	162	LYS
1	E	186	LYS
1	E	226	ASN
1	E	231	VAL
1	E	232	ASN
1	E	261	LEU
1	E	319	MET
1	E	351	LEU
1	E	370	GLN
1	E	417	ARG

Sometimes sidechains can be flipped to improve hydrogen bonding and reduce clashes. All (33) such sidechains are listed below:

Mol	Chain	Res	Type
1	A	100	GLN
1	A	226	ASN
1	A	232	ASN
1	A	291	HIS
1	A	309	GLN
1	A	322	ASN
1	A	330	ASN
1	B	100	GLN
1	B	124	HIS
1	B	226	ASN
1	B	232	ASN

Continued on next page...

Continued from previous page...

Mol	Chain	Res	Type
1	B	291	HIS
1	B	309	GLN
1	B	322	ASN
1	B	330	ASN
1	D	35	ASN
1	D	100	GLN
1	D	124	HIS
1	D	226	ASN
1	D	232	ASN
1	D	291	HIS
1	D	309	GLN
1	D	330	ASN
1	E	35	ASN
1	E	100	GLN
1	E	124	HIS
1	E	137	GLN
1	E	226	ASN
1	E	232	ASN
1	E	291	HIS
1	E	309	GLN
1	E	322	ASN
1	E	330	ASN

5.3.3 RNA [i](#)

There are no RNA molecules in this entry.

5.4 Non-standard residues in protein, DNA, RNA chains [i](#)

There are no non-standard protein/DNA/RNA residues in this entry.

5.5 Carbohydrates [i](#)

There are no monosaccharides in this entry.

5.6 Ligand geometry [i](#)

19 ligands are modelled in this entry.

In the following table, the Counts columns list the number of bonds (or angles) for which Mogul statistics could be retrieved, the number of bonds (or angles) that are observed in the model and

the number of bonds (or angles) that are defined in the Chemical Component Dictionary. The Link column lists molecule types, if any, to which the group is linked. The Z score for a bond length (or angle) is the number of standard deviations the observed value is removed from the expected value. A bond length (or angle) with $|Z| > 2$ is considered an outlier worth inspection. RMSZ is the root-mean-square of all Z scores of the bond lengths (or angles).

Mol	Type	Chain	Res	Link	Bond lengths			Bond angles		
					Counts	RMSZ	# Z > 2	Counts	RMSZ	# Z > 2
2	SO4	D	3004	-	4,4,4	0.17	0	6,6,6	0.41	0
2	SO4	B	2002	-	4,4,4	0.19	0	6,6,6	0.40	0
2	SO4	B	2004	-	4,4,4	0.15	0	6,6,6	0.36	0
2	SO4	A	1004	-	4,4,4	0.19	0	6,6,6	0.32	0
2	SO4	E	4001	-	4,4,4	0.23	0	6,6,6	0.57	0
2	SO4	B	2003	-	4,4,4	0.12	0	6,6,6	0.27	0
2	SO4	B	2001	-	4,4,4	0.26	0	6,6,6	0.70	0
2	SO4	A	1005	-	4,4,4	0.15	0	6,6,6	0.16	0
2	SO4	E	4003	-	4,4,4	0.10	0	6,6,6	0.14	0
2	SO4	A	1003	-	4,4,4	0.11	0	6,6,6	0.34	0
2	SO4	E	4005	-	4,4,4	0.13	0	6,6,6	0.23	0
2	SO4	D	3003	-	4,4,4	0.15	0	6,6,6	0.18	0
2	SO4	E	4002	-	4,4,4	0.21	0	6,6,6	0.36	0
2	SO4	A	1002	-	4,4,4	0.11	0	6,6,6	0.34	0
2	SO4	D	3001	-	4,4,4	0.33	0	6,6,6	0.47	0
2	SO4	A	1001	-	4,4,4	0.24	0	6,6,6	0.31	0
2	SO4	B	2005	-	4,4,4	0.20	0	6,6,6	0.38	0
2	SO4	D	3002	-	4,4,4	0.11	0	6,6,6	0.31	0
2	SO4	E	4004	-	4,4,4	0.26	0	6,6,6	0.33	0

There are no bond length outliers.

There are no bond angle outliers.

There are no chirality outliers.

There are no torsion outliers.

There are no ring outliers.

1 monomer is involved in 1 short contact:

Mol	Chain	Res	Type	Clashes	Symm-Clashes
2	E	4004	SO4	1	0

5.7 Other polymers [i](#)

There are no such residues in this entry.

5.8 Polymer linkage issues

There are no chain breaks in this entry.

6 Fit of model and data

6.1 Protein, DNA and RNA chains

In the following table, the column labelled ‘#RSRZ > 2’ contains the number (and percentage) of RSRZ outliers, followed by percent RSRZ outliers for the chain as percentile scores relative to all X-ray entries and entries of similar resolution. The OWAB column contains the minimum, median, 95th percentile and maximum values of the occupancy-weighted average B-factor per residue. The column labelled ‘Q < 0.9’ lists the number of (and percentage) of residues with an average occupancy less than 0.9.

Mol	Chain	Analysed	<RSRZ>	#RSRZ>2	OWAB(Å ²)	Q<0.9
1	A	424/430 (98%)	0.03	14 (3%) 46 49	11, 17, 29, 68	0
1	B	418/430 (97%)	0.01	15 (3%) 42 45	10, 16, 36, 64	0
1	D	419/430 (97%)	0.09	22 (5%) 26 29	11, 19, 33, 63	0
1	E	410/430 (95%)	0.28	35 (8%) 10 12	11, 18, 38, 65	0
All	All	1671/1720 (97%)	0.10	86 (5%) 28 31	10, 18, 35, 68	0

All (86) RSRZ outliers are listed below:

Mol	Chain	Res	Type	RSRZ
1	E	317	GLY	18.7
1	B	317	GLY	14.6
1	D	317	GLY	14.1
1	A	316	VAL	9.1
1	E	316	VAL	8.3
1	E	55	TRP	7.7
1	D	318	LYS	7.7
1	B	316	VAL	7.6
1	E	318	LYS	6.0
1	A	319	MET	6.0
1	E	58	LEU	5.8
1	B	56	THR	5.5
1	E	417	ARG	5.5
1	A	320	ALA	5.4
1	E	400	VAL	5.4
1	B	320	ALA	5.2
1	A	317	GLY	5.2
1	B	319	MET	5.0
1	E	418	GLU	4.8
1	A	318	LYS	4.6
1	E	254	VAL	4.4

Continued on next page...

Continued from previous page...

Mol	Chain	Res	Type	RSRZ
1	E	416	LEU	4.2
1	D	254	VAL	4.0
1	D	1	MET	4.0
1	E	56	THR	3.9
1	B	318	LYS	3.7
1	B	58	LEU	3.6
1	A	254	VAL	3.5
1	E	406	ALA	3.4
1	D	316	VAL	3.4
1	E	408	SER	3.4
1	B	10	TRP	3.4
1	E	57	THR	3.3
1	E	407	LYS	3.3
1	E	412	LEU	3.3
1	E	319	MET	3.2
1	B	8	VAL	3.2
1	E	253	ILE	3.2
1	D	417	ARG	3.2
1	D	19	TYR	3.1
1	E	399	GLY	3.1
1	D	255	VAL	3.0
1	E	403	ASP	3.0
1	E	401	ASP	3.0
1	D	319	MET	2.9
1	D	253	ILE	2.9
1	D	2	MET	2.8
1	A	315	ALA	2.8
1	D	280	ALA	2.8
1	B	321	GLY	2.7
1	E	404	GLU	2.7
1	E	315	ALA	2.7
1	B	254	VAL	2.7
1	A	77	LYS	2.7
1	D	80	GLU	2.7
1	A	10	TRP	2.7
1	E	255	VAL	2.6
1	E	402	LEU	2.6
1	E	278	HIS	2.6
1	D	256	ALA	2.6
1	E	277	ALA	2.6
1	E	10	TRP	2.5
1	B	424	ALA	2.5

Continued on next page...

Continued from previous page...

Mol	Chain	Res	Type	RSRZ
1	E	320	ALA	2.5
1	A	253	ILE	2.5
1	E	258	TRP	2.5
1	A	321	GLY	2.5
1	A	80	GLU	2.5
1	E	11	TYR	2.4
1	D	310	ILE	2.3
1	E	397	ILE	2.3
1	D	311	HIS	2.3
1	E	256	ALA	2.3
1	D	279	ARG	2.3
1	E	310	ILE	2.3
1	B	425	LYS	2.2
1	D	404	GLU	2.2
1	B	253	ILE	2.2
1	D	20	GLU	2.1
1	A	251	ILE	2.1
1	B	277	ALA	2.1
1	D	17	LEU	2.1
1	A	277	ALA	2.0
1	D	320	ALA	2.0
1	E	60	LYS	2.0
1	D	18	ASN	2.0

6.2 Non-standard residues in protein, DNA, RNA chains [i](#)

There are no non-standard protein/DNA/RNA residues in this entry.

6.3 Carbohydrates [i](#)

There are no monosaccharides in this entry.

6.4 Ligands [i](#)

In the following table, the Atoms column lists the number of modelled atoms in the group and the number defined in the chemical component dictionary. The B-factors column lists the minimum, median, 95th percentile and maximum values of B factors of atoms in the group. The column labelled 'Q< 0.9' lists the number of atoms with occupancy less than 0.9.

Continued on next page...

Continued from previous page...

Mol	Type	Chain	Res	Atoms	RSCC	RSR	B-factors(\AA^2)	Q<0.9
2	SO4	A	1004	5/5	0.22	0.29	115,116,117,118	0
2	SO4	E	4004	5/5	0.40	0.23	97,98,100,100	0
2	SO4	A	1003	5/5	0.57	0.34	113,115,115,115	0
2	SO4	D	3004	5/5	0.65	0.28	103,103,104,105	0
2	SO4	D	3003	5/5	0.66	0.24	122,123,123,123	0
2	SO4	E	4003	5/5	0.77	0.31	111,111,112,112	0
2	SO4	B	2004	5/5	0.78	0.30	110,112,112,113	0
2	SO4	E	4005	5/5	0.80	0.26	124,125,125,125	0
2	SO4	B	2005	5/5	0.83	0.30	99,100,101,101	0
2	SO4	A	1005	5/5	0.86	0.29	131,131,132,132	0
2	SO4	B	2003	5/5	0.87	0.18	113,114,114,115	0
2	SO4	A	1002	5/5	0.93	0.13	77,79,80,80	0
2	SO4	B	2002	5/5	0.95	0.13	60,65,66,66	0
2	SO4	E	4002	5/5	0.96	0.10	68,71,72,72	0
2	SO4	D	3002	5/5	0.97	0.12	69,71,72,73	0
2	SO4	E	4001	5/5	0.98	0.11	53,56,56,58	0
2	SO4	D	3001	5/5	0.99	0.10	52,55,56,58	0
2	SO4	A	1001	5/5	0.99	0.07	50,53,55,57	0
2	SO4	B	2001	5/5	0.99	0.09	46,48,49,50	0

6.5 Other polymers [i](#)

There are no such residues in this entry.