



Full wwPDB X-ray Structure Validation Report ⓘ

Nov 20, 2023 – 06:56 PM JST

PDB ID : 7DAD
Title : EPD in complex with tubulin
Authors : Wang, Y.; Wu, C.
Deposited on : 2020-10-16
Resolution : 2.85 Å(reported)

This is a Full wwPDB X-ray Structure Validation Report for a publicly released PDB entry.

We welcome your comments at validation@mail.wwpdb.org

A user guide is available at

<https://www.wwpdb.org/validation/2017/XrayValidationReportHelp>

with specific help available everywhere you see the ⓘ symbol.

The types of validation reports are described at

<http://www.wwpdb.org/validation/2017/FAQs#types>.

The following versions of software and data (see [references ⓘ](#)) were used in the production of this report:

MolProbity : 4.02b-467
Mogul : 1.8.5 (274361), CSD as541be (2020)
Xtriage (Phenix) : 1.13
EDS : 2.36
buster-report : 1.1.7 (2018)
Percentile statistics : 20191225.v01 (using entries in the PDB archive December 25th 2019)
Refmac : 5.8.0158
CCP4 : 7.0.044 (Gargrove)
Ideal geometry (proteins) : Engh & Huber (2001)
Ideal geometry (DNA, RNA) : Parkinson et al. (1996)
Validation Pipeline (wwPDB-VP) : 2.36

1 Overall quality at a glance

The following experimental techniques were used to determine the structure:

X-RAY DIFFRACTION

The reported resolution of this entry is 2.85 Å.

Percentile scores (ranging between 0-100) for global validation metrics of the entry are shown in the following graphic. The table shows the number of entries on which the scores are based.

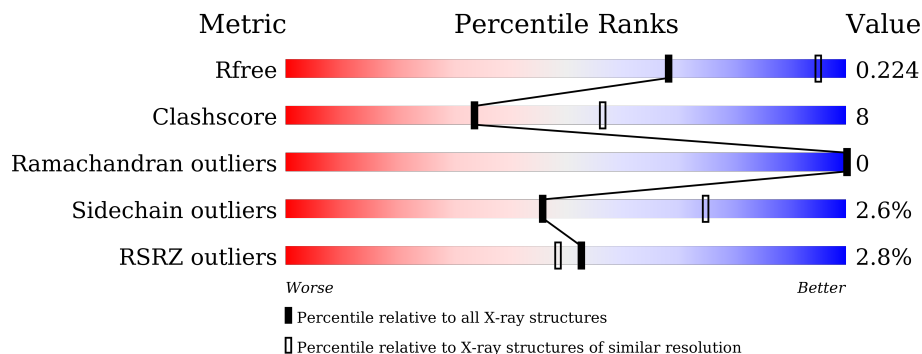

Metric	Whole archive (#Entries)	Similar resolution (#Entries, resolution range(Å))
R_{free}	130704	3168 (2.90-2.82)
Clashscore	141614	3438 (2.90-2.82)
Ramachandran outliers	138981	3348 (2.90-2.82)
Sidechain outliers	138945	3351 (2.90-2.82)
RSRZ outliers	127900	3103 (2.90-2.82)

The table below summarises the geometric issues observed across the polymeric chains and their fit to the electron density. The red, orange, yellow and green segments of the lower bar indicate the fraction of residues that contain outliers for ≥ 3 , 2, 1 and 0 types of geometric quality criteria respectively. A grey segment represents the fraction of residues that are not modelled. The numeric value for each fraction is indicated below the corresponding segment, with a dot representing fractions $\leq 5\%$. The upper red bar (where present) indicates the fraction of residues that have poor fit to the electron density. The numeric value is given above the bar.

Mol	Chain	Length	Quality of chain
1	A	451	78% 19% .
1	C	451	83% 14% .
2	B	445	76% 20% .
2	D	445	72% 25% .
3	E	143	67% 17% . 15%
4	F	384	12% 69% 20% . 9%

2 Entry composition [i](#)

There are 12 unique types of molecules in this entry. The entry contains 17890 atoms, of which 0 are hydrogens and 0 are deuteriums.

In the tables below, the ZeroOcc column contains the number of atoms modelled with zero occupancy, the AltConf column contains the number of residues with at least one atom in alternate conformation and the Trace column contains the number of residues modelled with at most 2 atoms.

- Molecule 1 is a protein called Tubulin alpha-1B chain.

Mol	Chain	Residues	Atoms					ZeroOcc	AltConf	Trace
			Total	C	N	O	S			
1	A	438	Total	C	N	O	S	0	7	0
			3458	2189	587	658	24			
1	C	440	Total	C	N	O	S	0	11	0
			3479	2203	586	664	26			

- Molecule 2 is a protein called Tubulin beta chain.

Mol	Chain	Residues	Atoms					ZeroOcc	AltConf	Trace
			Total	C	N	O	S			
2	B	428	Total	C	N	O	S	0	7	0
			3397	2135	577	658	27			
2	D	431	Total	C	N	O	S	0	5	0
			3403	2135	580	660	28			

- Molecule 3 is a protein called Stathmin-4.

Mol	Chain	Residues	Atoms					ZeroOcc	AltConf	Trace
			Total	C	N	O	S			
3	E	121	Total	C	N	O	S	0	4	0
			1022	632	185	199	6			

There are 2 discrepancies between the modelled and reference sequences:

Chain	Residue	Modelled	Actual	Comment	Reference
E	3	MET	-	initiating methionine	UNP P63042
E	4	ALA	-	expression tag	UNP P63042

- Molecule 4 is a protein called Tubulin tyrosine ligase.

Mol	Chain	Residues	Atoms					ZeroOcc	AltConf	Trace
			Total	C	N	O	S			
4	F	351	Total	C	N	O	S	0	5	0
			2908	1867	502	524	15			

There are 6 discrepancies between the modelled and reference sequences:

Chain	Residue	Modelled	Actual	Comment	Reference
F	379	HIS	-	expression tag	UNP E1BQ43
F	380	HIS	-	expression tag	UNP E1BQ43
F	381	HIS	-	expression tag	UNP E1BQ43
F	382	HIS	-	expression tag	UNP E1BQ43
F	383	HIS	-	expression tag	UNP E1BQ43
F	384	HIS	-	expression tag	UNP E1BQ43

- Molecule 5 is GUANOSINE-5'-TRIPHOSPHATE (three-letter code: GTP) (formula: $C_{10}H_{16}N_5O_{14}P_3$).

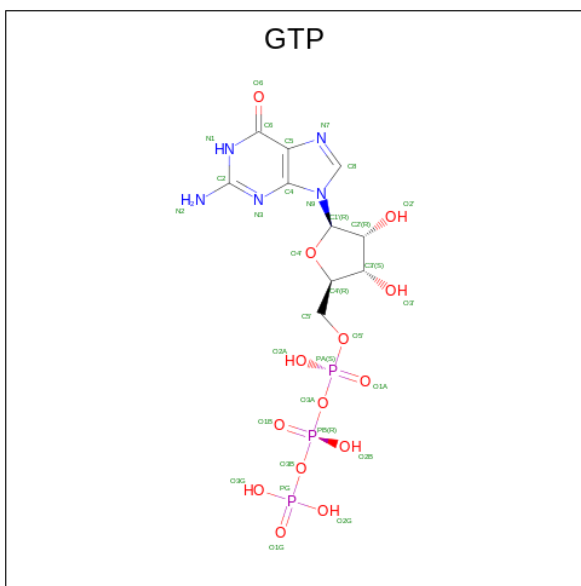

Mol	Chain	Residues	Atoms					ZeroOcc	AltConf
			Total	C	N	O	P		
5	A	1	Total	C	N	O	P	0	0
			32	10	5	14	3		
5	C	1	Total	C	N	O	P	0	0
			32	10	5	14	3		
5	D	1	Total	C	N	O	P	0	0
			32	10	5	14	3		

- Molecule 6 is MAGNESIUM ION (three-letter code: MG) (formula: Mg).

Mol	Chain	Residues	Atoms		ZeroOcc	AltConf
			Total	Mg		
6	A	1	Total	Mg	0	0
			1	1		
6	B	2	Total	Mg	0	0
			2	2		
6	C	1	Total	Mg	0	0
			1	1		

Continued on next page...

Continued from previous page...

Mol	Chain	Residues	Atoms		ZeroOcc	AltConf
6	F	1	Total	Mg	0	0
			1	1		

- Molecule 7 is CALCIUM ION (three-letter code: CA) (formula: Ca).

Mol	Chain	Residues	Atoms		ZeroOcc	AltConf
7	A	2	Total	Ca	0	0
			2	2		
7	B	1	Total	Ca	0	0
			1	1		
7	C	1	Total	Ca	0	0
			1	1		

- Molecule 8 is CHLORIDE ION (three-letter code: CL) (formula: Cl).

Mol	Chain	Residues	Atoms		ZeroOcc	AltConf
8	A	1	Total	Cl	0	0
			1	1		

- Molecule 9 is GUANOSINE-5'-DIPHOSPHATE (three-letter code: GDP) (formula: C₁₀H₁₅N₅O₁₁P₂).

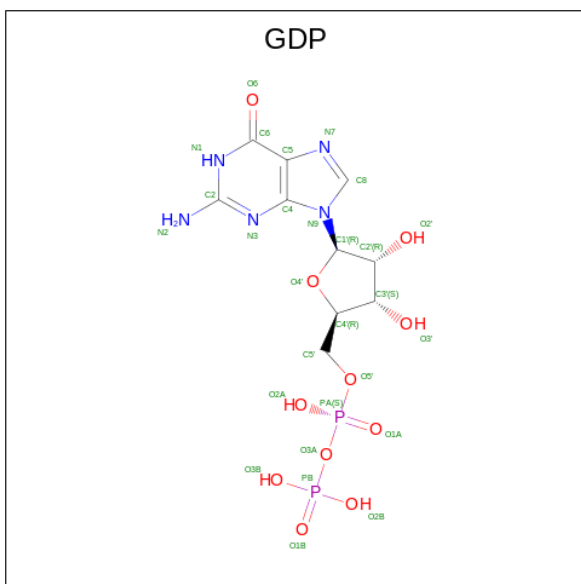

Mol	Chain	Residues	Atoms				ZeroOcc	AltConf	
9	B	1	Total	C	N	O	P	0	0
			28	10	5	11	2		

- Molecule 10 is 2-(N-MORPHOLINO)-ETHANESULFONIC ACID (three-letter code: MES) (formula: $C_6H_{13}NO_4S$).

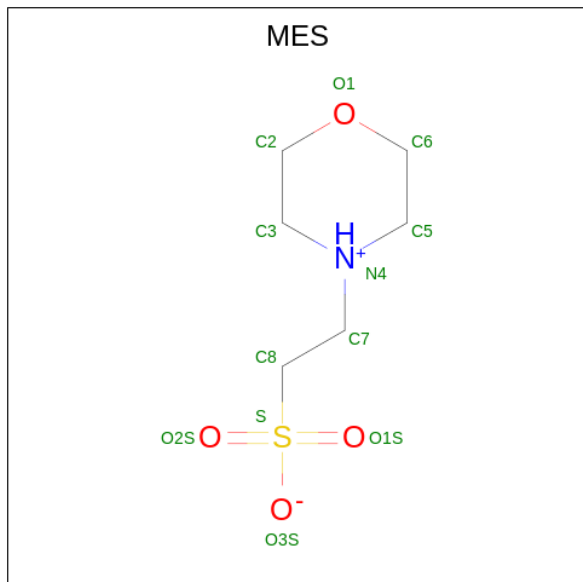

Mol	Chain	Residues	Atoms					ZeroOcc	AltConf	
			Total	C	N	O	S			
10	B	1	Total	12	6	1	4	1	0	0
10	B	1	Total	12	6	1	4	1	0	0

- Molecule 11 is EPOTHILONE D (three-letter code: EPD) (formula: $C_{27}H_{41}NO_5S$) (labeled as "Ligand of Interest" by depositor).

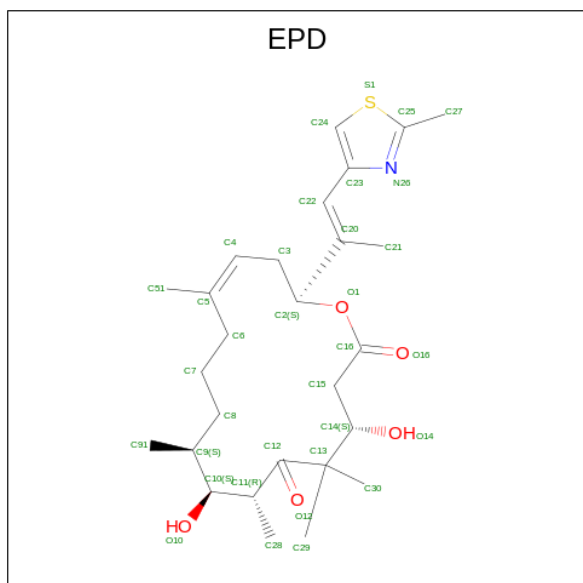

Mol	Chain	Residues	Atoms					ZeroOcc	AltConf
			Total	C	N	O	S		
11	D	1	34	27	1	5	1	0	0

- Molecule 12 is PHOSPHOMETHYLPHOSPHONIC ACID ADENYLATE ESTER (three-letter code: ACP) (formula: $C_{11}H_{18}N_5O_{12}P_3$).

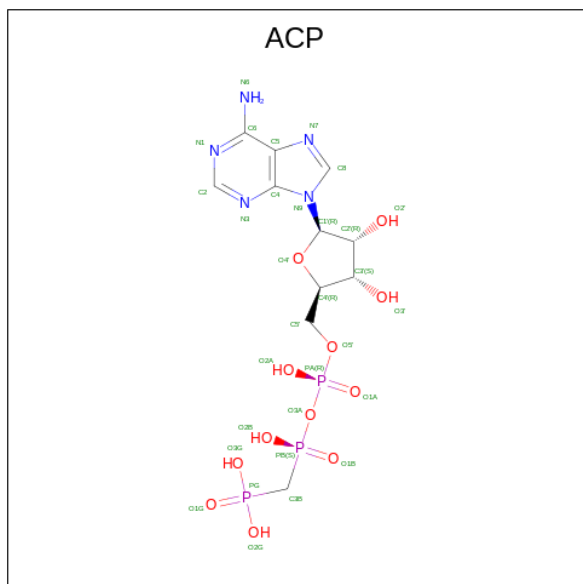

Mol	Chain	Residues	Atoms					ZeroOcc	AltConf
			Total	C	N	O	P		
12	F	1	31	11	5	12	3	0	0

3 Residue-property plots [i](#)

These plots are drawn for all protein, RNA, DNA and oligosaccharide chains in the entry. The first graphic for a chain summarises the proportions of the various outlier classes displayed in the second graphic. The second graphic shows the sequence view annotated by issues in geometry and electron density. Residues are color-coded according to the number of geometric quality criteria for which they contain at least one outlier: green = 0, yellow = 1, orange = 2 and red = 3 or more. A red dot above a residue indicates a poor fit to the electron density ($RSRZ > 2$). Stretches of 2 or more consecutive residues without any outlier are shown as a green connector. Residues present in the sample, but not in the model, are shown in grey.

- Molecule 1: Tubulin alpha-1B chain

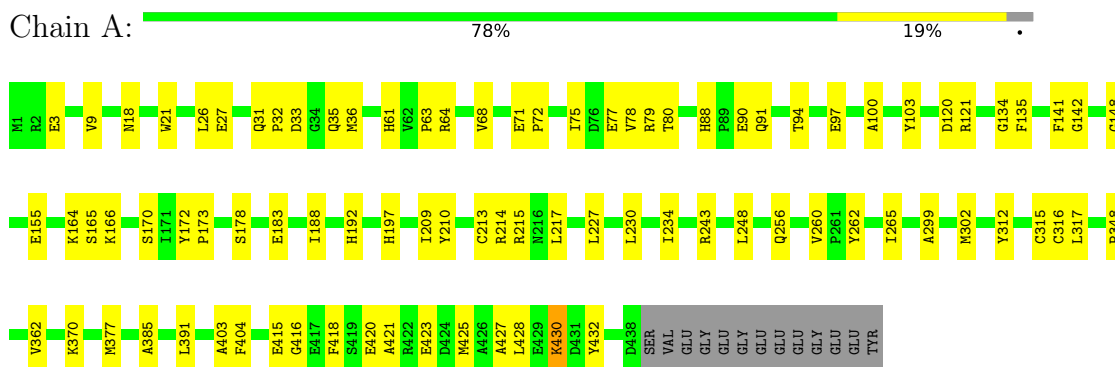

- Molecule 1: Tubulin alpha-1B chain

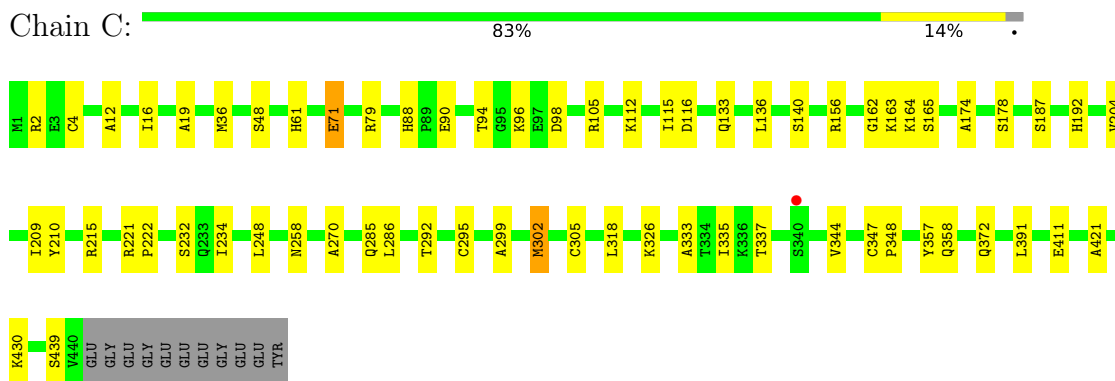

- Molecule 2: Tubulin beta chain

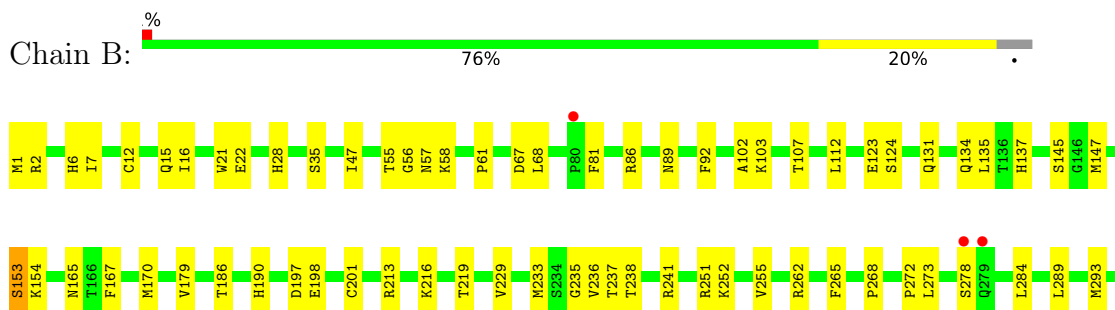

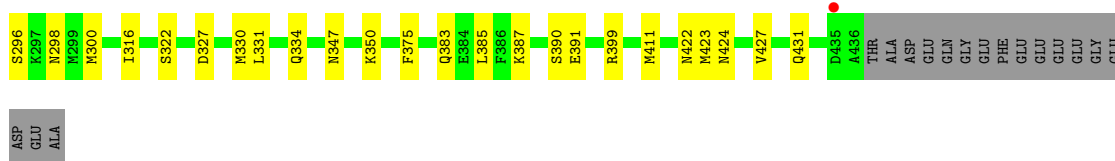

● Molecule 2: Tubulin beta chain

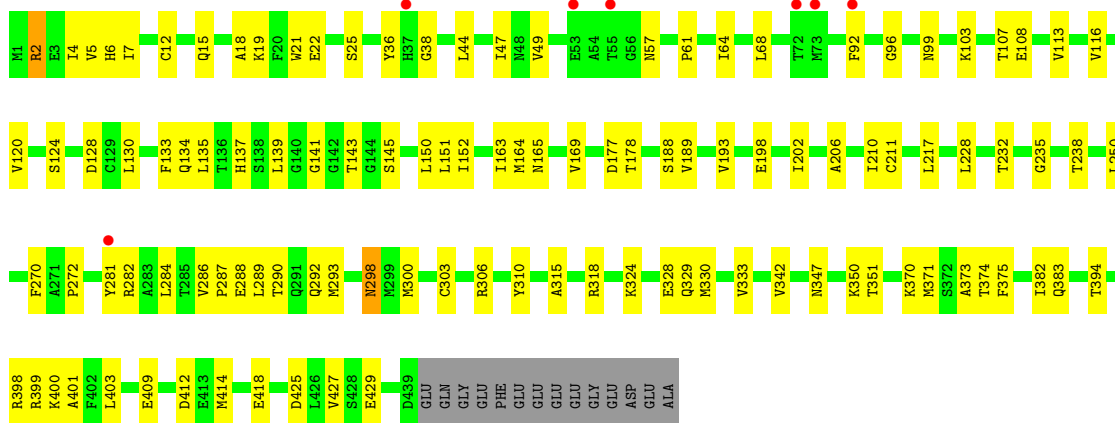

● Molecule 3: Stathmin-4

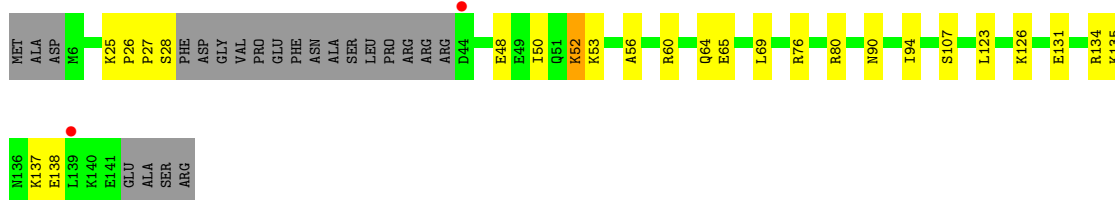

● Molecule 4: Tubulin tyrosine ligase

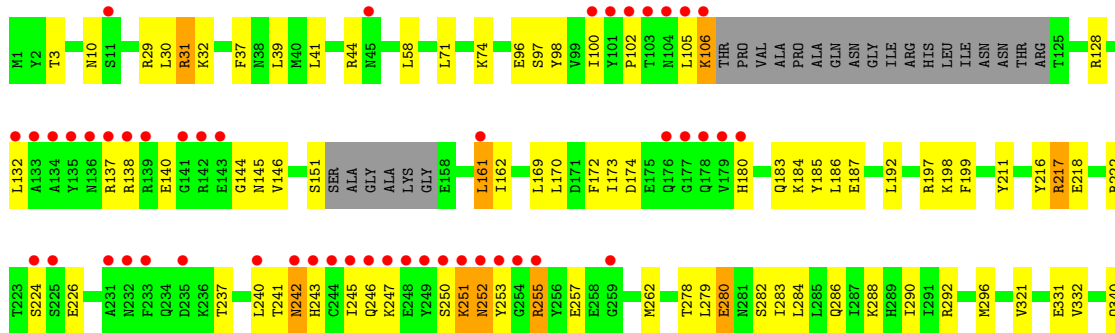

Q348	D352	A362	ASP	THR	GLY	GLN	LYS	THR	SER	GLN	PRO	T372	S373	I374	H384
------	------	------	-----	-----	-----	-----	-----	-----	-----	-----	-----	------	------	------	------

4 Data and refinement statistics

Property	Value	Source
Space group	P 21 21 21	Depositor
Cell constants a, b, c, α , β , γ	105.16Å 158.51Å 181.60Å 90.00° 90.00° 90.00°	Depositor
Resolution (Å)	49.91 – 2.85 49.91 – 2.85	Depositor EDS
% Data completeness (in resolution range)	99.0 (49.91-2.85) 99.0 (49.91-2.85)	Depositor EDS
R_{merge}	0.21	Depositor
R_{sym}	(Not available)	Depositor
$\langle I/\sigma(I) \rangle$ ¹	2.48 (at 2.86Å)	Xtrriage
Refinement program	PHENIX 1.14_3260	Depositor
R, R_{free}	0.179 , 0.226 0.178 , 0.224	Depositor DCC
R_{free} test set	2000 reflections (2.82%)	wwPDB-VP
Wilson B-factor (Å ²)	51.1	Xtrriage
Anisotropy	0.089	Xtrriage
Bulk solvent k_{sol} (e/Å ³), B_{sol} (Å ²)	0.33 , 54.0	EDS
L-test for twinning ²	$\langle L \rangle = 0.50$, $\langle L^2 \rangle = 0.33$	Xtrriage
Estimated twinning fraction	No twinning to report.	Xtrriage
F_o, F_c correlation	0.94	EDS
Total number of atoms	17890	wwPDB-VP
Average B, all atoms (Å ²)	49.0	wwPDB-VP

Xtrriage's analysis on translational NCS is as follows: *The largest off-origin peak in the Patterson function is 2.38% of the height of the origin peak. No significant pseudotranslation is detected.*

¹Intensities estimated from amplitudes.

²Theoretical values of $\langle |L| \rangle$, $\langle L^2 \rangle$ for acentric reflections are 0.5, 0.333 respectively for untwinned datasets, and 0.375, 0.2 for perfectly twinned datasets.

5 Model quality [i](#)

5.1 Standard geometry [i](#)

Bond lengths and bond angles in the following residue types are not validated in this section: MES, GTP, CA, CL, MG, GDP, ACP, EPD

The Z score for a bond length (or angle) is the number of standard deviations the observed value is removed from the expected value. A bond length (or angle) with $|Z| > 5$ is considered an outlier worth inspection. RMSZ is the root-mean-square of all Z scores of the bond lengths (or angles).

Mol	Chain	Bond lengths		Bond angles	
		RMSZ	# Z >5	RMSZ	# Z >5
1	A	0.49	0/3557	0.65	0/4828
1	C	0.55	1/3587 (0.0%)	0.68	1/4870 (0.0%)
2	B	0.53	0/3490	0.67	0/4728
2	D	0.50	1/3492 (0.0%)	0.67	4/4730 (0.1%)
3	E	0.59	0/1043	0.69	0/1384
4	F	0.44	0/2990	0.64	1/4038 (0.0%)
All	All	0.51	2/18159 (0.0%)	0.66	6/24578 (0.0%)

All (2) bond length outliers are listed below:

Mol	Chain	Res	Type	Atoms	Z	Observed(Å)	Ideal(Å)
2	D	281	TYR	CD2-CE2	8.39	1.51	1.39
1	C	295	CYS	CB-SG	-5.54	1.72	1.81

All (6) bond angle outliers are listed below:

Mol	Chain	Res	Type	Atoms	Z	Observed(°)	Ideal(°)
4	F	161	LEU	CA-CB-CG	6.82	130.98	115.30
2	D	2	ARG	NE-CZ-NH1	6.27	123.44	120.30
2	D	281	TYR	CD1-CE1-CZ	5.58	124.83	119.80
2	D	281	TYR	CZ-CE2-CD2	-5.46	114.88	119.80
2	D	281	TYR	CG-CD2-CE2	5.13	125.41	121.30
1	C	305	CYS	CA-CB-SG	-5.06	104.89	114.00

There are no chirality outliers.

There are no planarity outliers.

5.2 Too-close contacts [i](#)

In the following table, the Non-H and H(model) columns list the number of non-hydrogen atoms and hydrogen atoms in the chain respectively. The H(added) column lists the number of hydrogen atoms added and optimized by MolProbity. The Clashes column lists the number of clashes within the asymmetric unit, whereas Symm-Clashes lists symmetry-related clashes.

Mol	Chain	Non-H	H(model)	H(added)	Clashes	Symm-Clashes
1	A	3458	0	3382	52	0
1	C	3479	0	3405	36	0
2	B	3397	0	3278	65	0
2	D	3403	0	3285	75	0
3	E	1022	0	1046	18	0
4	F	2908	0	2892	65	0
5	A	32	0	12	0	0
5	C	32	0	12	0	0
5	D	32	0	12	2	0
6	A	1	0	0	0	0
6	B	2	0	0	0	0
6	C	1	0	0	0	0
6	F	1	0	0	0	0
7	A	2	0	0	0	0
7	B	1	0	0	0	0
7	C	1	0	0	0	0
8	A	1	0	0	0	0
9	B	28	0	12	1	0
10	B	24	0	24	1	0
11	D	34	0	41	3	0
12	F	31	0	13	3	0
All	All	17890	0	17414	299	0

The all-atom clashscore is defined as the number of clashes found per 1000 atoms (including hydrogen atoms). The all-atom clashscore for this structure is 8.

All (299) close contacts within the same asymmetric unit are listed below, sorted by their clash magnitude.

Atom-1	Atom-2	Interatomic distance (Å)	Clash overlap (Å)
4:F:251:LYS:H	4:F:251:LYS:HD2	1.35	0.91
2:D:99:ASN:HD22	2:D:178:THR:HG21	1.44	0.83
2:D:306:ARG:HG3	2:D:306:ARG:HH11	1.45	0.82
3:E:25:LYS:HD3	3:E:26:PRO:O	1.82	0.80
2:B:383:GLN:HB2	2:B:427:VAL:HG23	1.64	0.78
1:C:4[A]:CYS:SG	1:C:136:LEU:HG	2.24	0.77

Continued on next page...

Continued from previous page...

Atom-1	Atom-2	Interatomic distance (Å)	Clash overlap (Å)
2:B:1:MET:CE	2:B:251:ARG:HE	1.99	0.76
4:F:246:GLN:HA	4:F:250:SER:OG	1.86	0.76
2:B:1:MET:HE1	2:B:251:ARG:HE	1.51	0.75
1:C:270:ALA:HB3	1:C:302[B]:MET:SD	2.26	0.75
2:D:232:THR:HG22	2:D:270:PHE:HB2	1.68	0.75
2:D:330:MET:HG3	2:D:351:THR:HG21	1.68	0.75
2:D:383:GLN:HB2	2:D:427:VAL:HG13	1.70	0.73
1:C:285:GLN:HE22	1:C:372:GLN:HB2	1.54	0.73
2:B:262:ARG:HH12	2:B:422[A]:ASN:HD21	1.33	0.73
2:D:211:CYS:HB3	2:D:217:LEU:HD12	1.72	0.72
4:F:74:LYS:NZ	4:F:331:GLU:OE1	2.22	0.72
2:D:394:THR:O	2:D:398:ARG:HB2	1.90	0.72
2:B:35:SER:OG	2:B:58:LYS:NZ	2.23	0.71
2:D:315:ALA:HB3	2:D:351:THR:HG22	1.73	0.69
2:D:124:SER:HB3	2:D:130:LEU:HD22	1.74	0.69
3:E:65:GLU:O	3:E:69:LEU:HD12	1.93	0.69
2:D:64:ILE:HD13	2:D:120:VAL:HG12	1.73	0.69
1:A:31:GLN:HE21	1:A:35:GLN:HB2	1.57	0.68
2:D:228:LEU:HB3	2:D:300:MET:HE3	1.73	0.68
2:B:235:GLY:O	2:B:238:THR:HG22	1.92	0.67
1:C:162:GLY:HA2	3:E:94:ILE:HD11	1.75	0.67
1:C:204:VAL:HG22	1:C:302[B]:MET:CE	2.25	0.67
2:D:145[A]:SER:HB2	2:D:188:SER:OG	1.94	0.67
2:D:329:GLN:O	2:D:333:VAL:HG23	1.94	0.66
4:F:252:ASN:ND2	4:F:255[A]:ARG:HH21	1.93	0.66
3:E:131:GLU:HG2	3:E:134:ARG:HH21	1.61	0.66
2:D:21:TRP:O	2:D:25:SER:HB2	1.96	0.66
2:D:44:LEU:HD23	2:D:47:ILE:HD13	1.78	0.66
4:F:224:SER:HB2	4:F:246:GLN:HE22	1.60	0.65
2:B:16[B]:ILE:HG12	2:B:229:VAL:HG11	1.77	0.65
4:F:251:LYS:HD2	4:F:251:LYS:N	2.10	0.65
2:D:134:GLN:HA	2:D:165:ASN:O	1.97	0.64
4:F:226:GLU:OE2	4:F:251:LYS:HD3	1.96	0.64
1:A:3:GLU:HG2	1:A:64:ARG:CZ	2.28	0.63
2:B:6:HIS:CD2	2:B:21:TRP:HE1	2.16	0.63
1:C:105:ARG:NH1	1:C:411:GLU:OE1	2.31	0.63
2:D:238[B]:THR:HG21	2:D:318:ARG:HD2	1.80	0.63
1:C:163:LYS:HG3	3:E:90[A]:ASN:OD1	1.99	0.63
4:F:192:LEU:HD13	4:F:262:MET:CE	2.29	0.62
4:F:10:ASN:HB2	4:F:44:ARG:HH22	1.64	0.62
1:A:27:GLU:OE2	1:A:243:ARG:NH2	2.32	0.61

Continued on next page...

Continued from previous page...

Atom-1	Atom-2	Interatomic distance (Å)	Clash overlap (Å)
4:F:162:ILE:HD11	4:F:240:LEU:HD21	1.83	0.61
4:F:251:LYS:H	4:F:251:LYS:CD	2.10	0.61
2:B:237:THR:O	2:B:241:ARG:HG3	2.01	0.60
4:F:97:SER:OG	4:F:183:GLN:HG3	2.02	0.60
4:F:192:LEU:HD13	4:F:262:MET:HE1	1.84	0.60
1:C:71:GLU:HG2	1:C:98:ASP:HB3	1.83	0.60
2:D:6:HIS:CD2	2:D:21:TRP:HE1	2.19	0.60
4:F:243:HIS:HE1	4:F:247:LYS:HD2	1.67	0.60
2:B:165:ASN:OD1	2:B:198:GLU:HG3	2.02	0.60
4:F:280:GLU:HA	4:F:284:LEU:HB2	1.84	0.59
4:F:252:ASN:HD22	4:F:255[A]:ARG:HH21	1.48	0.59
2:D:103:LYS:HG2	2:D:108:GLU:HG3	1.85	0.59
3:E:50:ILE:O	3:E:53:LYS:HG2	2.02	0.59
11:D:502:EPD:H24	11:D:502:EPD:H211	1.85	0.59
3:E:56:ALA:HB1	3:E:60:ARG:HH12	1.66	0.59
1:A:141:PHE:CE1	1:A:170:SER:HB3	2.39	0.58
2:B:86:ARG:HD3	2:B:89:ASN:OD1	2.04	0.58
4:F:198:LYS:HG2	4:F:199:PHE:H	1.68	0.58
4:F:243:HIS:CE1	4:F:247:LYS:HD2	2.38	0.58
2:B:28:HIS:HB3	2:B:47:ILE:HD12	1.86	0.57
4:F:278:THR:O	4:F:282:SER:OG	2.21	0.57
1:C:333:ALA:O	1:C:337:THR:HG23	2.04	0.57
1:A:209:ILE:HD11	1:A:302:MET:SD	2.44	0.57
2:B:179:VAL:HG12	1:C:348:PRO:HG2	1.87	0.57
2:D:425:ASP:O	2:D:429:GLU:HG3	2.04	0.57
4:F:31:ARG:HE	4:F:32:LYS:H	1.52	0.57
4:F:105:LEU:O	4:F:106:LYS:HB2	2.05	0.57
1:A:155:GLU:HA	1:A:197:HIS:CE1	2.40	0.56
2:B:134:GLN:HA	2:B:165:ASN:O	2.04	0.56
4:F:286:GLN:O	4:F:290:ILE:HG13	2.06	0.56
2:D:290:THR:HG22	2:D:333:VAL:HG21	1.88	0.56
2:D:177:ASP:OD1	2:D:177:ASP:N	2.39	0.56
1:A:348:PRO:HD3	3:E:27:PRO:HG3	1.88	0.56
2:D:206:ALA:O	2:D:210:ILE:HG13	2.05	0.56
2:D:414:MET:O	2:D:418:GLU:HG3	2.07	0.55
4:F:146:VAL:HG12	4:F:187:GLU:OE2	2.06	0.55
1:A:416:GLY:O	1:A:420:GLU:HG3	2.06	0.55
1:A:18:ASN:HD21	1:A:78:VAL:HG22	1.71	0.54
1:C:174:ALA:O	1:C:178:SER:HB3	2.08	0.54
1:A:265:ILE:HG23	1:A:432:TYR:CZ	2.44	0.54
1:A:256:GLN:NE2	1:A:260:VAL:O	2.41	0.53

Continued on next page...

Continued from previous page...

Atom-1	Atom-2	Interatomic distance (Å)	Clash overlap (Å)
2:B:167:PHE:HE2	2:B:236:VAL:HG21	1.74	0.53
2:D:293:MET:HG2	2:D:375:PHE:HB2	1.90	0.53
4:F:146:VAL:HG13	4:F:185:TYR:HB3	1.88	0.53
4:F:39:LEU:HD21	4:F:41:LEU:HD21	1.91	0.53
4:F:138:ARG:NH1	4:F:144:GLY:O	2.42	0.53
1:A:142:GLY:CA	1:A:183:GLU:HG2	2.39	0.53
1:C:88:HIS:HE1	1:C:90:GLU:HG3	1.74	0.53
4:F:151:SER:HB3	4:F:180:HIS:CG	2.45	0.52
4:F:242:ASN:HB2	4:F:245:ILE:HG13	1.90	0.52
2:B:22:GLU:HG2	2:B:81:PHE:CD1	2.44	0.52
2:B:387:LYS:O	2:B:391:GLU:HG3	2.10	0.52
2:D:306:ARG:HG3	2:D:306:ARG:NH1	2.20	0.52
1:A:31:GLN:NE2	1:A:35:GLN:HB2	2.23	0.52
2:B:330:MET:O	2:B:334:GLN:HG3	2.09	0.52
2:B:2:ARG:O	2:B:131:GLN:NE2	2.43	0.52
2:B:134:GLN:HB3	2:B:165:ASN:HD22	1.75	0.52
2:D:272:PRO:HG3	2:D:284:LEU:HD11	1.91	0.52
2:D:169:VAL:HA	2:D:202:ILE:O	2.10	0.51
2:B:112:LEU:HD23	2:B:147:MET:HE1	1.93	0.51
2:D:12:CYS:HB2	5:D:501:GTP:C8	2.45	0.51
2:B:293:MET:HE2	2:B:375:PHE:HB2	1.92	0.51
2:B:219:THR:HG21	1:C:326:LYS:HA	1.92	0.51
3:E:60:ARG:O	3:E:64:GLN:HG3	2.11	0.51
4:F:251:LYS:HB2	4:F:252:ASN:OD1	2.10	0.51
11:D:502:EPD:H211	11:D:502:EPD:C24	2.41	0.51
1:A:31:GLN:HG3	1:A:33:ASP:OD1	2.11	0.50
2:D:293:MET:SD	2:D:373:ALA:HB1	2.51	0.50
1:A:142:GLY:HA3	1:A:183:GLU:HG2	1.93	0.50
4:F:241:THR:OG1	12:F:401:ACP:O3'	2.29	0.50
2:D:68:LEU:H	2:D:143:THR:HG21	1.76	0.50
2:D:400:LYS:HB3	2:D:403:LEU:HD12	1.94	0.50
1:C:215:ARG:NH2	1:C:299:ALA:HB1	2.27	0.50
4:F:217:ARG:NH2	4:F:374:ILE:HG22	2.26	0.50
12:F:401:ACP:H8	12:F:401:ACP:H5'2	1.94	0.50
1:C:96:LYS:HE2	2:D:128:ASP:OD1	2.11	0.49
2:D:44:LEU:HA	2:D:47:ILE:HB	1.94	0.49
1:C:204:VAL:HG22	1:C:302[B]:MET:HE2	1.95	0.49
4:F:137:ARG:NH1	4:F:140:GLU:OE1	2.46	0.49
1:A:100:ALA:HA	2:B:252:LYS:HG3	1.94	0.49
4:F:197:ARG:NH2	4:F:257:GLU:OE2	2.44	0.49
1:A:265:ILE:HG23	1:A:432:TYR:CE1	2.48	0.49

Continued on next page...

Continued from previous page...

Atom-1	Atom-2	Interatomic distance (Å)	Clash overlap (Å)
2:B:424:ASN:HA	2:B:427:VAL:HG12	1.95	0.49
2:B:56:GLY:O	2:B:57:ASN:C	2.50	0.49
2:D:288:GLU:OE1	2:D:288:GLU:HA	2.12	0.49
2:D:4:ILE:HD13	2:D:250:LEU:HD11	1.94	0.48
1:A:188:ILE:HG23	1:A:425:MET:HG3	1.93	0.48
2:B:112:LEU:HB3	2:B:147:MET:HE3	1.95	0.48
2:B:251:ARG:O	2:B:255:VAL:HG23	2.14	0.48
2:D:306:ARG:HH11	2:D:306:ARG:CG	2.21	0.48
1:A:230:LEU:O	1:A:234:ILE:HD12	2.13	0.48
4:F:197:ARG:HD2	4:F:224:SER:O	2.13	0.48
2:B:153:SER:HB3	3:E:76:ARG:HH22	1.77	0.48
2:B:154:LYS:HZ1	3:E:76:ARG:HD3	1.78	0.48
4:F:216:TYR:CE1	4:F:374:ILE:HD12	2.49	0.48
4:F:252:ASN:O	4:F:253:TYR:C	2.52	0.48
2:B:327:ASP:O	2:B:331:LEU:HG	2.14	0.48
2:B:347:ASN:O	2:B:350:LYS:NZ	2.47	0.48
4:F:198:LYS:HG2	4:F:199:PHE:N	2.28	0.47
2:D:286:VAL:HB	2:D:287:PRO:HD3	1.95	0.47
2:D:165:ASN:HA	2:D:198:GLU:O	2.15	0.47
2:D:310:TYR:O	2:D:342:VAL:HG22	2.14	0.47
2:B:170:MET:HG3	2:B:385:LEU:HD11	1.95	0.47
2:D:399:ARG:NH1	2:D:401:ALA:HB2	2.29	0.47
1:A:209:ILE:HG22	1:A:227:LEU:HD22	1.97	0.47
1:A:134:GLY:HA3	1:A:165:SER:O	2.14	0.47
2:B:213:ARG:O	2:B:216:LYS:HD3	2.14	0.47
2:B:431:GLN:HG3	2:B:431:GLN:O	2.13	0.47
2:D:4:ILE:HG13	2:D:49:VAL:HG13	1.97	0.47
2:D:36:TYR:CZ	2:D:38:GLY:HA3	2.49	0.47
2:D:139:LEU:HA	2:D:145[A]:SER:HB3	1.96	0.47
2:D:292:GLN:HG2	2:D:298:ASN:OD1	2.15	0.47
1:A:248:LEU:HD21	1:A:316[B]:CYS:SG	2.55	0.47
2:D:306:ARG:NH1	2:D:306:ARG:CG	2.78	0.46
4:F:279:LEU:HD12	4:F:283:ILE:HB	1.97	0.46
2:B:16[B]:ILE:HG12	2:B:229:VAL:CG1	2.45	0.46
2:B:390:SER:HB2	2:B:423:MET:HE3	1.96	0.46
4:F:138:ARG:HH12	4:F:145:ASN:HA	1.79	0.46
1:A:215:ARG:NH1	1:A:299:ALA:HB1	2.31	0.46
2:D:272:PRO:HA	2:D:292:GLN:HE22	1.80	0.46
4:F:100:ILE:HD11	4:F:128:ARG:HA	1.97	0.46
1:A:75:ILE:O	1:A:79:ARG:HG3	2.16	0.46
2:D:68:LEU:HA	2:D:68:LEU:HD23	1.66	0.46

Continued on next page...

Continued from previous page...

Atom-1	Atom-2	Interatomic distance (Å)	Clash overlap (Å)
2:D:290:THR:CG2	2:D:333:VAL:HG21	2.45	0.46
1:A:385:ALA:HB2	1:A:432:TYR:CG	2.51	0.46
3:E:123:LEU:O	3:E:126:LYS:HB2	2.16	0.46
2:B:284:LEU:HD13	2:B:289:LEU:HD23	1.98	0.46
1:C:234:ILE:HG21	1:C:302[B]:MET:SD	2.56	0.46
2:D:324:LYS:O	2:D:328:GLU:HG3	2.16	0.46
4:F:132:LEU:HD21	4:F:170:LEU:HD11	1.98	0.45
2:B:67:ASP:O	2:B:92:PHE:HA	2.16	0.45
1:C:12:ALA:O	1:C:16:ILE:HD12	2.16	0.45
1:A:135:PHE:HB2	1:A:166:LYS:HG2	1.97	0.45
2:B:190:HIS:NE2	2:B:422[B]:ASN:OD1	2.49	0.45
1:C:248:LEU:HD12	1:C:357:TYR:OH	2.16	0.45
2:D:21:TRP:CZ3	2:D:61:PRO:HB3	2.51	0.45
2:D:282:ARG:HD3	11:D:502:EPD:H271	1.99	0.45
4:F:58:LEU:HD23	4:F:58:LEU:HA	1.78	0.45
2:B:153:SER:CB	3:E:76:ARG:HH22	2.29	0.45
1:C:36:MET:HB3	1:C:61:HIS:CE1	2.51	0.45
2:D:7:ILE:O	2:D:135:LEU:HD12	2.16	0.45
2:B:273:LEU:HD11	2:B:298:ASN:HA	1.98	0.45
1:A:213:CYS:O	1:A:217:LEU:HB2	2.17	0.45
2:B:201:CYS:SG	2:B:265:PHE:HB3	2.56	0.45
4:F:242:ASN:OD1	4:F:242:ASN:N	2.49	0.45
1:A:88:HIS:N	1:A:91:GLN:OE1	2.38	0.45
1:A:391:LEU:HD12	1:A:391:LEU:HA	1.67	0.45
2:B:399:ARG:HD3	1:C:439:SER:OG	2.17	0.45
1:C:2:ARG:HB3	1:C:133:GLN:HB2	1.99	0.45
1:C:209:ILE:HD11	1:C:302[A]:MET:HG3	1.99	0.45
2:B:102:ALA:HB2	2:B:411:MET:SD	2.56	0.44
2:B:197:ASP:OD1	10:B:504:MES:H32	2.17	0.44
1:C:187:SER:HB3	1:C:391:LEU:HD21	1.98	0.44
1:A:210:TYR:CE2	1:A:214:ARG:HD2	2.52	0.44
2:B:272:PRO:HB3	2:B:284:LEU:HD11	1.99	0.44
2:D:232:THR:HG21	2:D:300:MET:HE2	1.99	0.44
2:D:303:CYS:SG	2:D:382:ILE:HA	2.58	0.44
4:F:292:ARG:O	4:F:296[B]:MET:HB2	2.16	0.44
2:B:238:THR:CG2	2:B:316:ILE:HG21	2.47	0.44
4:F:3:THR:OG1	4:F:37:PHE:HA	2.17	0.44
2:B:123:GLU:HA	2:B:123:GLU:OE1	2.17	0.44
3:E:48:GLU:O	3:E:48:GLU:HG2	2.17	0.44
2:B:284:LEU:HD23	2:B:284:LEU:HA	1.76	0.44
2:B:179:VAL:HG22	1:C:258:ASN:OD1	2.18	0.44

Continued on next page...

Continued from previous page...

Atom-1	Atom-2	Interatomic distance (Å)	Clash overlap (Å)
2:D:152:ILE:HG12	2:D:164:MET:SD	2.58	0.44
4:F:3:THR:HB	4:F:30:LEU:HD11	2.00	0.44
1:A:103:TYR:CE2	1:A:148:GLY:HA2	2.53	0.43
2:D:228:LEU:O	2:D:232:THR:HG23	2.17	0.43
4:F:31:ARG:NE	4:F:32:LYS:H	2.15	0.43
1:C:79:ARG:NH2	1:C:94:THR:HG23	2.32	0.43
1:C:164:LYS:HB2	1:C:164:LYS:HE3	1.79	0.43
2:D:189:VAL:O	2:D:193:VAL:HG23	2.18	0.43
4:F:284:LEU:O	4:F:288:LYS:HG3	2.18	0.43
2:B:1:MET:HE3	2:B:251:ARG:HE	1.77	0.43
2:D:232:THR:HG21	2:D:300:MET:CE	2.49	0.43
2:B:186:THR:HG23	2:B:423:MET:HE2	2.00	0.43
2:B:262:ARG:NH1	2:B:422[A]:ASN:HD21	2.10	0.43
1:A:415:GLU:O	1:A:418:PHE:HB2	2.18	0.43
2:D:409:GLU:HA	3:E:137:LYS:HG3	2.00	0.43
1:A:31:GLN:HB2	1:A:32:PRO:CD	2.48	0.43
2:D:141:GLY:HA3	5:D:501:GTP:O3A	2.19	0.43
2:D:163:ILE:HG21	2:D:250:LEU:HB3	2.01	0.43
4:F:100:ILE:CD1	4:F:128:ARG:HA	2.47	0.43
1:A:403:ALA:O	1:A:404:PHE:HB2	2.19	0.42
2:B:7:ILE:O	2:B:135:LEU:HA	2.19	0.42
2:B:272:PRO:HB3	2:B:284:LEU:CD1	2.49	0.42
1:C:210:TYR:CZ	1:C:222:PRO:HD2	2.54	0.42
1:C:292:THR:HG22	1:C:335:ILE:CD1	2.49	0.42
4:F:29:ARG:HH21	4:F:31:ARG:NH2	2.16	0.42
1:A:21:TRP:CZ3	1:A:63:PRO:HB3	2.55	0.42
1:A:9:VAL:HG22	1:A:68:VAL:CG1	2.50	0.42
1:A:90:GLU:O	1:A:121:ARG:HD2	2.18	0.42
2:D:68:LEU:O	2:D:96:GLY:N	2.51	0.42
4:F:283:ILE:HD13	4:F:321:VAL:HG21	2.01	0.42
2:D:36:TYR:CE2	2:D:44:LEU:HD11	2.54	0.42
1:A:317:LEU:HD23	1:A:377:MET:HB2	2.00	0.42
2:B:68:LEU:HD23	2:B:68:LEU:HA	1.92	0.42
4:F:138:ARG:HH22	4:F:184:LYS:HE3	1.83	0.42
4:F:161:LEU:HD23	4:F:172:PHE:CG	2.53	0.42
1:A:77:GLU:HA	1:A:80:THR:HG22	2.01	0.42
1:A:362:VAL:HG22	1:A:370:LYS:HG2	2.01	0.42
2:B:233:MET:HA	2:B:236:VAL:HG22	2.02	0.42
4:F:96:GLU:OE1	4:F:98:TYR:OH	2.37	0.42
2:B:154:LYS:HZ2	3:E:76:ARG:NE	2.18	0.42
1:C:115:ILE:HG23	1:C:116:ASP:N	2.35	0.42

Continued on next page...

Continued from previous page...

Atom-1	Atom-2	Interatomic distance (Å)	Clash overlap (Å)
2:D:18:ALA:O	2:D:22:GLU:HG3	2.20	0.42
4:F:284:LEU:HD12	4:F:284:LEU:HA	1.84	0.42
4:F:169:LEU:O	4:F:173:ILE:HG12	2.19	0.42
4:F:237:THR:O	4:F:246:GLN:NE2	2.53	0.42
1:A:312:TYR:CD2	1:A:315[B]:CYS:SG	3.13	0.41
1:C:192:HIS:CG	1:C:421:ALA:HA	2.55	0.41
2:B:134:GLN:CB	2:B:165:ASN:HD22	2.33	0.41
2:D:107:THR:OG1	2:D:108:GLU:N	2.52	0.41
1:C:344:VAL:HG23	1:C:347[B]:CYS:HB2	2.02	0.41
2:D:5:VAL:HB	2:D:133:PHE:CD1	2.55	0.41
2:D:116:VAL:HG11	2:D:151:LEU:HD11	2.03	0.41
3:E:48:GLU:O	3:E:52:LYS:HB2	2.21	0.41
1:C:12:ALA:HB3	1:C:140:SER:HB3	2.01	0.41
1:C:156:ARG:HA	1:C:156:ARG:HD2	1.74	0.41
1:A:166:LYS:HE2	1:A:197:HIS:O	2.20	0.41
1:A:427:ALA:O	1:A:430:LYS:HG3	2.19	0.41
1:A:428:LEU:HD12	1:A:428:LEU:HA	1.85	0.41
2:B:103:LYS:HA	2:B:107:THR:OG1	2.20	0.41
2:D:235:GLY:HA3	2:D:374:THR:HG21	2.02	0.41
1:A:79:ARG:NH2	1:A:94:THR:OG1	2.53	0.41
1:A:36:MET:HB3	1:A:61:HIS:CE1	2.55	0.41
1:A:172:TYR:CG	1:A:173:PRO:HD2	2.56	0.41
2:D:2:ARG:NH1	2:D:2:ARG:HG3	2.36	0.41
2:D:289:LEU:HD12	2:D:371:MET:HE3	2.03	0.41
4:F:161:LEU:CD2	4:F:172:PHE:CG	3.04	0.41
4:F:216:TYR:CE2	4:F:218:GLU:HB2	2.55	0.41
1:A:21:TRP:CH2	1:A:63:PRO:HB3	2.56	0.41
1:A:97:GLU:OE2	2:B:1:MET:HE2	2.21	0.41
2:B:268:PRO:HG2	2:B:300:MET:HB2	2.03	0.41
2:D:284:LEU:HD12	2:D:284:LEU:HA	1.90	0.41
3:E:135:LYS:O	3:E:138:GLU:HB2	2.21	0.41
4:F:71:LEU:HD23	4:F:332:VAL:HG11	2.03	0.41
1:A:26:LEU:HD23	1:A:26:LEU:HA	1.85	0.41
2:B:21:TRP:CZ3	2:B:61:PRO:HB3	2.56	0.41
2:D:228:LEU:HB3	2:D:300:MET:CE	2.47	0.41
2:D:347:ASN:O	2:D:350:LYS:HE2	2.21	0.41
4:F:102:PRO:HB3	4:F:174:ASP:HA	2.03	0.41
1:A:72:PRO:HA	1:A:94:THR:HG21	2.02	0.40
2:D:113:VAL:HG21	2:D:150:LEU:HD23	2.03	0.40
4:F:247:LYS:HG3	4:F:253:TYR:CZ	2.56	0.40
2:B:12:CYS:HB2	9:B:501:GDP:C8	2.56	0.40

Continued on next page...

Continued from previous page...

Atom-1	Atom-2	Interatomic distance (Å)	Clash overlap (Å)
1:C:19:ALA:HB1	1:C:232:SER:HB3	2.04	0.40
4:F:252:ASN:HD22	4:F:255[A]:ARG:HE	1.68	0.40
1:C:210:TYR:CE2	1:C:222:PRO:HD2	2.56	0.40
1:A:192:HIS:CG	1:A:421:ALA:HA	2.56	0.40
4:F:186:LEU:H	12:F:401:ACP:C2	2.35	0.40
4:F:348:GLN:NE2	4:F:352:ASP:OD1	2.53	0.40

There are no symmetry-related clashes.

5.3 Torsion angles [i](#)

5.3.1 Protein backbone [i](#)

In the following table, the Percentiles column shows the percent Ramachandran outliers of the chain as a percentile score with respect to all X-ray entries followed by that with respect to entries of similar resolution.

The Analysed column shows the number of residues for which the backbone conformation was analysed, and the total number of residues.

Mol	Chain	Analysed	Favoured	Allowed	Outliers	Percentiles	
1	A	443/451 (98%)	428 (97%)	15 (3%)	0	100	100
1	C	448/451 (99%)	436 (97%)	12 (3%)	0	100	100
2	B	433/445 (97%)	419 (97%)	14 (3%)	0	100	100
2	D	433/445 (97%)	416 (96%)	17 (4%)	0	100	100
3	E	121/143 (85%)	120 (99%)	1 (1%)	0	100	100
4	F	348/384 (91%)	328 (94%)	20 (6%)	0	100	100
All	All	2226/2319 (96%)	2147 (96%)	79 (4%)	0	100	100

There are no Ramachandran outliers to report.

5.3.2 Protein sidechains [i](#)

In the following table, the Percentiles column shows the percent sidechain outliers of the chain as a percentile score with respect to all X-ray entries followed by that with respect to entries of similar resolution.

The Analysed column shows the number of residues for which the sidechain conformation was analysed, and the total number of residues.

Mol	Chain	Analysed	Rotameric	Outliers	Percentiles	
1	A	376/379 (99%)	368 (98%)	8 (2%)	53	79
1	C	381/379 (100%)	368 (97%)	13 (3%)	37	67
2	B	375/383 (98%)	366 (98%)	9 (2%)	49	77
2	D	376/383 (98%)	368 (98%)	8 (2%)	53	79
3	E	113/127 (89%)	109 (96%)	4 (4%)	36	67
4	F	321/342 (94%)	309 (96%)	12 (4%)	34	65
All	All	1942/1993 (97%)	1888 (97%)	54 (3%)	46	73

All (54) residues with a non-rotameric sidechain are listed below:

Mol	Chain	Res	Type
1	A	71	GLU
1	A	120[A]	ASP
1	A	120[B]	ASP
1	A	164	LYS
1	A	178	SER
1	A	262	TYR
1	A	423	GLU
1	A	430	LYS
2	B	15	GLN
2	B	55	THR
2	B	124	SER
2	B	137	HIS
2	B	145	SER
2	B	153	SER
2	B	278	SER
2	B	296	SER
2	B	322	SER
1	C	48	SER
1	C	71	GLU
1	C	112	LYS
1	C	165[A]	SER
1	C	165[B]	SER
1	C	221	ARG
1	C	286	LEU
1	C	302[A]	MET
1	C	302[B]	MET
1	C	318	LEU
1	C	358[A]	GLN
1	C	358[B]	GLN
1	C	430	LYS

Continued on next page...

Continued from previous page...

Mol	Chain	Res	Type
2	D	15	GLN
2	D	19	LYS
2	D	57	ASN
2	D	92	PHE
2	D	137	HIS
2	D	298	ASN
2	D	370	LYS
2	D	412	ASP
3	E	28	SER
3	E	52	LYS
3	E	80	ARG
3	E	107	SER
4	F	31	ARG
4	F	106	LYS
4	F	211	TYR
4	F	217	ARG
4	F	222	ARG
4	F	242	ASN
4	F	251	LYS
4	F	252	ASN
4	F	255[A]	ARG
4	F	255[B]	ARG
4	F	280	GLU
4	F	340	GLN

Sometimes sidechains can be flipped to improve hydrogen bonding and reduce clashes. All (11) such sidechains are listed below:

Mol	Chain	Res	Type
1	A	18	ASN
1	A	35	GLN
1	A	301	GLN
2	B	11	GLN
1	C	285	GLN
2	D	99	ASN
2	D	424	ASN
3	E	18	GLN
3	E	51	GLN
4	F	183	GLN
4	F	252	ASN

5.3.3 RNA [i](#)

There are no RNA molecules in this entry.

5.4 Non-standard residues in protein, DNA, RNA chains [i](#)

There are no non-standard protein/DNA/RNA residues in this entry.

5.5 Carbohydrates [i](#)

There are no monosaccharides in this entry.

5.6 Ligand geometry [i](#)

Of 18 ligands modelled in this entry, 10 are monoatomic - leaving 8 for Mogul analysis.

In the following table, the Counts columns list the number of bonds (or angles) for which Mogul statistics could be retrieved, the number of bonds (or angles) that are observed in the model and the number of bonds (or angles) that are defined in the Chemical Component Dictionary. The Link column lists molecule types, if any, to which the group is linked. The Z score for a bond length (or angle) is the number of standard deviations the observed value is removed from the expected value. A bond length (or angle) with $|Z| > 2$ is considered an outlier worth inspection. RMSZ is the root-mean-square of all Z scores of the bond lengths (or angles).

Mol	Type	Chain	Res	Link	Bond lengths			Bond angles		
					Counts	RMSZ	# Z > 2	Counts	RMSZ	# Z > 2
5	GTP	A	501	6	26,34,34	1.14	1 (3%)	32,54,54	1.50	7 (21%)
12	ACP	F	401	6	27,33,33	4.80	9 (33%)	32,52,52	2.22	7 (21%)
5	GTP	D	501	-	26,34,34	1.16	1 (3%)	32,54,54	1.55	6 (18%)
9	GDP	B	501	6	24,30,30	1.00	1 (4%)	30,47,47	1.22	3 (10%)
10	MES	B	505	-	12,12,12	4.50	7 (58%)	14,16,16	2.01	4 (28%)
10	MES	B	504	-	12,12,12	4.50	7 (58%)	14,16,16	2.31	4 (28%)
5	GTP	C	501	6	26,34,34	1.20	1 (3%)	32,54,54	1.55	7 (21%)
11	EPD	D	502	-	31,35,35	3.24	6 (19%)	36,50,50	1.95	7 (19%)

In the following table, the Chirals column lists the number of chiral outliers, the number of chiral centers analysed, the number of these observed in the model and the number defined in the Chemical Component Dictionary. Similar counts are reported in the Torsion and Rings columns. '-' means no outliers of that kind were identified.

Mol	Type	Chain	Res	Link	Chirals	Torsions	Rings
5	GTP	A	501	6	-	5/18/38/38	0/3/3/3
12	ACP	F	401	6	-	1/15/38/38	0/3/3/3
5	GTP	D	501	-	-	5/18/38/38	0/3/3/3
9	GDP	B	501	6	-	4/12/32/32	0/3/3/3
10	MES	B	505	-	-	1/6/14/14	0/1/1/1
10	MES	B	504	-	-	1/6/14/14	0/1/1/1
5	GTP	C	501	6	-	4/18/38/38	0/3/3/3
11	EPD	D	502	-	-	16/50/51/51	0/1/2/2

All (33) bond length outliers are listed below:

Mol	Chain	Res	Type	Atoms	Z	Observed(Å)	Ideal(Å)
12	F	401	ACP	O4'-C1'	15.19	1.62	1.41
12	F	401	ACP	C2'-C1'	-15.01	1.31	1.53
11	D	502	EPD	C24-S1	-10.61	1.53	1.70
11	D	502	EPD	C4-C5	9.93	1.56	1.33
10	B	505	MES	C7-N4	-8.75	1.27	1.47
10	B	504	MES	C7-N4	-8.10	1.28	1.47
12	F	401	ACP	PB-O3A	7.81	1.67	1.58
10	B	504	MES	O1S-S	7.66	1.67	1.45
10	B	504	MES	O2S-S	7.37	1.66	1.45
10	B	505	MES	O2S-S	7.30	1.66	1.45
10	B	505	MES	O1S-S	6.90	1.65	1.45
11	D	502	EPD	C25-S1	-6.73	1.52	1.73
12	F	401	ACP	O4'-C4'	-6.35	1.30	1.45
11	D	502	EPD	C23-N26	5.95	1.55	1.37
10	B	505	MES	O3S-S	5.43	1.66	1.47
10	B	504	MES	O3S-S	5.20	1.66	1.47
10	B	504	MES	C8-S	4.48	1.83	1.77
10	B	505	MES	C8-S	3.99	1.83	1.77
5	A	501	GTP	C5-C6	-3.90	1.39	1.47
5	D	501	GTP	C5-C6	-3.76	1.39	1.47
5	C	501	GTP	C5-C6	-3.52	1.40	1.47
11	D	502	EPD	O1-C16	3.17	1.43	1.34
12	F	401	ACP	C6-N6	3.10	1.45	1.34
12	F	401	ACP	O3'-C3'	-3.06	1.35	1.43
12	F	401	ACP	O2'-C2'	3.01	1.50	1.43
10	B	505	MES	C5-N4	-2.87	1.39	1.46
11	D	502	EPD	O1-C2	-2.84	1.40	1.45
10	B	505	MES	C3-N4	-2.82	1.39	1.46
10	B	504	MES	C5-N4	-2.82	1.39	1.46
9	B	501	GDP	C2'-C1'	-2.74	1.49	1.53

Continued on next page...

Continued from previous page...

Mol	Chain	Res	Type	Atoms	Z	Observed(Å)	Ideal(Å)
12	F	401	ACP	C2-N3	2.69	1.36	1.32
10	B	504	MES	C3-N4	-2.49	1.40	1.46
12	F	401	ACP	C5-C4	-2.47	1.34	1.40

All (45) bond angle outliers are listed below:

Mol	Chain	Res	Type	Atoms	Z	Observed(°)	Ideal(°)
12	F	401	ACP	C5-C6-N6	7.07	131.09	120.35
11	D	502	EPD	C3-C4-C5	-6.61	116.23	127.25
10	B	504	MES	C5-N4-C3	5.39	120.97	108.83
12	F	401	ACP	N3-C2-N1	-5.25	120.47	128.68
10	B	505	MES	C5-N4-C3	4.63	119.25	108.83
12	F	401	ACP	N6-C6-N1	-4.54	109.15	118.57
10	B	504	MES	C2-C3-N4	4.09	116.31	110.10
11	D	502	EPD	C28-C11-C10	-4.06	105.60	112.37
12	F	401	ACP	C3'-C2'-C1'	4.02	107.03	100.98
5	C	501	GTP	C8-N7-C5	3.76	110.16	102.99
5	D	501	GTP	PA-O3A-PB	-3.75	119.96	132.83
11	D	502	EPD	C51-C5-C6	3.62	121.36	115.27
11	D	502	EPD	C27-C25-S1	3.58	124.92	120.12
10	B	505	MES	C2-C3-N4	3.57	115.51	110.10
10	B	504	MES	O3S-S-C8	3.30	111.11	105.77
5	A	501	GTP	C5-C6-N1	3.28	119.74	113.95
12	F	401	ACP	C5'-C4'-C3'	-3.19	103.21	115.18
5	C	501	GTP	PB-O3B-PG	-3.16	122.00	132.83
5	A	501	GTP	C2-N1-C6	-3.10	119.39	125.10
5	D	501	GTP	C8-N7-C5	3.03	108.77	102.99
9	B	501	GDP	PA-O3A-PB	-3.03	122.42	132.83
5	D	501	GTP	PB-O3B-PG	-2.95	122.71	132.83
10	B	504	MES	C6-C5-N4	2.92	114.53	110.10
10	B	505	MES	O1S-S-C8	2.90	110.41	106.92
5	C	501	GTP	PA-O3A-PB	-2.86	123.01	132.83
12	F	401	ACP	PB-O3A-PA	-2.86	123.50	132.56
11	D	502	EPD	C3-C2-C20	-2.84	106.35	112.68
5	A	501	GTP	PB-O3B-PG	-2.83	123.12	132.83
5	D	501	GTP	C2-N1-C6	-2.81	119.92	125.10
5	C	501	GTP	C2-N1-C6	-2.81	119.93	125.10
5	A	501	GTP	C8-N7-C5	2.80	108.32	102.99
5	D	501	GTP	C5-C6-N1	2.77	118.84	113.95
9	B	501	GDP	C5-C6-N1	2.64	118.61	113.95
5	C	501	GTP	O3'-C3'-C4'	-2.60	103.53	111.05
5	C	501	GTP	C5-C6-N1	2.60	118.54	113.95

Continued on next page...

Continued from previous page...

Mol	Chain	Res	Type	Atoms	Z	Observed(°)	Ideal(°)
9	B	501	GDP	C8-N7-C5	2.56	107.87	102.99
5	A	501	GTP	O6-C6-C5	-2.50	119.50	124.37
5	A	501	GTP	PA-O3A-PB	-2.48	124.33	132.83
5	C	501	GTP	N2-C2-N1	2.47	121.97	116.71
11	D	502	EPD	C8-C7-C6	-2.24	107.28	113.36
11	D	502	EPD	O1-C2-C3	2.22	111.25	106.71
5	D	501	GTP	O3G-PG-O3B	2.20	112.01	104.64
10	B	505	MES	C6-C5-N4	2.14	113.35	110.10
12	F	401	ACP	C2'-C3'-C4'	2.02	106.56	102.64
5	A	501	GTP	N2-C2-N1	2.00	120.98	116.71

There are no chirality outliers.

All (37) torsion outliers are listed below:

Mol	Chain	Res	Type	Atoms
5	A	501	GTP	PB-O3B-PG-O3G
5	A	501	GTP	C5'-O5'-PA-O1A
5	C	501	GTP	PB-O3B-PG-O3G
5	C	501	GTP	C5'-O5'-PA-O1A
5	D	501	GTP	PB-O3B-PG-O3G
9	B	501	GDP	C5'-O5'-PA-O1A
10	B	504	MES	C8-C7-N4-C5
11	D	502	EPD	C20-C2-C3-C4
11	D	502	EPD	O1-C2-C3-C4
11	D	502	EPD	C20-C22-C23-N26
11	D	502	EPD	C12-C13-C14-O14
11	D	502	EPD	C30-C13-C14-O14
11	D	502	EPD	C29-C13-C14-O14
12	F	401	ACP	PB-O3A-PA-O1A
5	D	501	GTP	O4'-C4'-C5'-O5'
5	D	501	GTP	C3'-C4'-C5'-O5'
5	A	501	GTP	C5'-O5'-PA-O3A
5	C	501	GTP	C5'-O5'-PA-O3A
9	B	501	GDP	PB-O3A-PA-O2A
11	D	502	EPD	C30-C13-C14-C15
11	D	502	EPD	C29-C13-C14-C15
11	D	502	EPD	C12-C13-C14-C15
5	A	501	GTP	C5'-O5'-PA-O2A
5	C	501	GTP	C5'-O5'-PA-O2A
9	B	501	GDP	C5'-O5'-PA-O2A
11	D	502	EPD	C14-C15-C16-O1
11	D	502	EPD	C3-C2-C20-C21

Continued on next page...

Continued from previous page...

Mol	Chain	Res	Type	Atoms
11	D	502	EPD	C3-C2-C20-C22
11	D	502	EPD	C9-C10-C11-C12
5	D	501	GTP	C4'-C5'-O5'-PA
11	D	502	EPD	C14-C15-C16-O16
10	B	505	MES	C8-C7-N4-C5
5	D	501	GTP	PB-O3B-PG-O1G
11	D	502	EPD	O10-C10-C9-C8
9	B	501	GDP	C5'-O5'-PA-O3A
5	A	501	GTP	PB-O3A-PA-O2A
11	D	502	EPD	C11-C10-C9-C8

There are no ring outliers.

5 monomers are involved in 10 short contacts:

Mol	Chain	Res	Type	Clashes	Symm-Clashes
12	F	401	ACP	3	0
5	D	501	GTP	2	0
9	B	501	GDP	1	0
10	B	504	MES	1	0
11	D	502	EPD	3	0

The following is a two-dimensional graphical depiction of Mogul quality analysis of bond lengths, bond angles, torsion angles, and ring geometry for all instances of the Ligand of Interest. In addition, ligands with molecular weight > 250 and outliers as shown on the validation Tables will also be included. For torsion angles, if less than 5% of the Mogul distribution of torsion angles is within 10 degrees of the torsion angle in question, then that torsion angle is considered an outlier. Any bond that is central to one or more torsion angles identified as an outlier by Mogul will be highlighted in the graph. For rings, the root-mean-square deviation (RMSD) between the ring in question and similar rings identified by Mogul is calculated over all ring torsion angles. If the average RMSD is greater than 60 degrees and the minimal RMSD between the ring in question and any Mogul-identified rings is also greater than 60 degrees, then that ring is considered an outlier. The outliers are highlighted in purple. The color gray indicates Mogul did not find sufficient equivalents in the CSD to analyse the geometry.

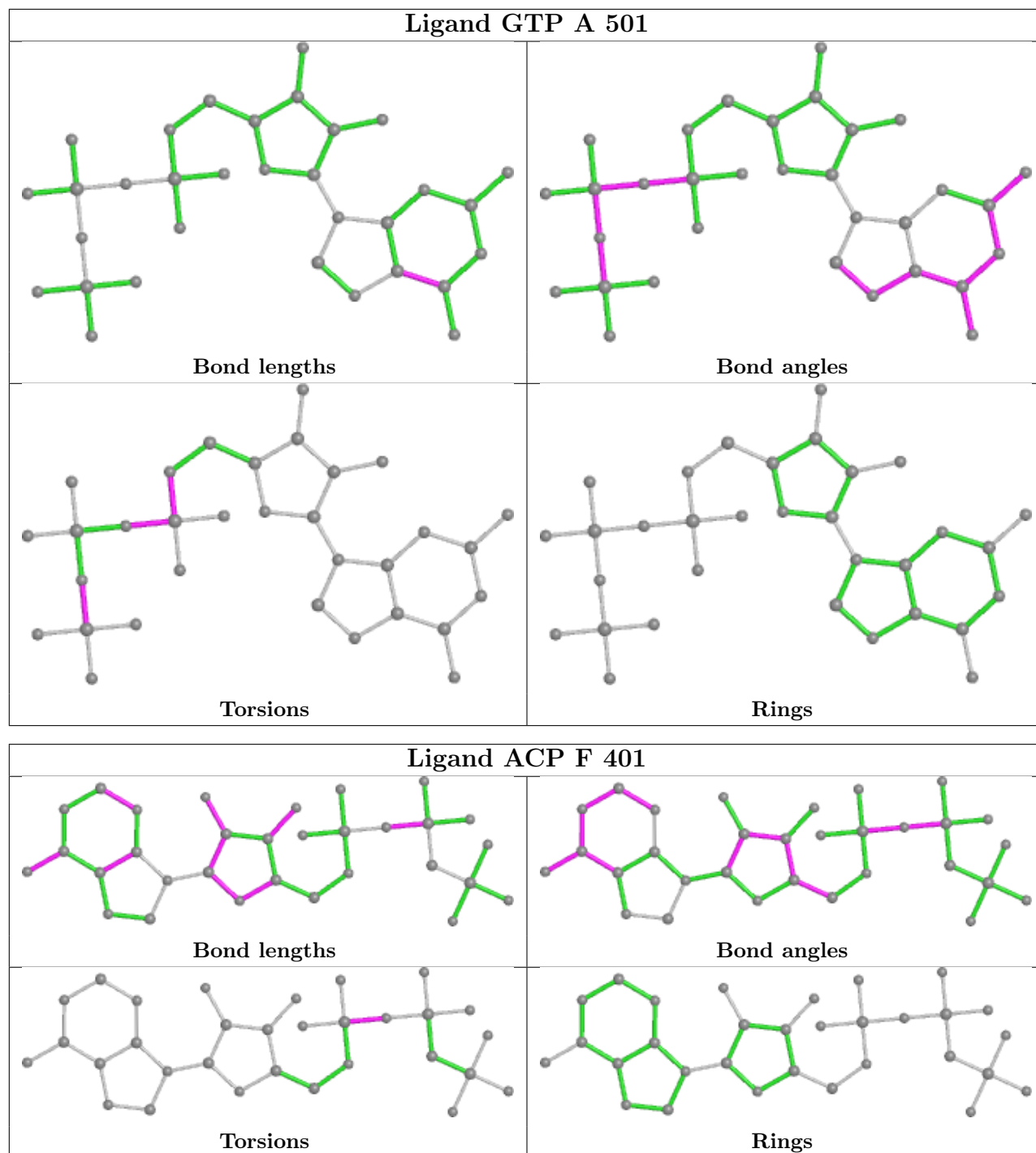

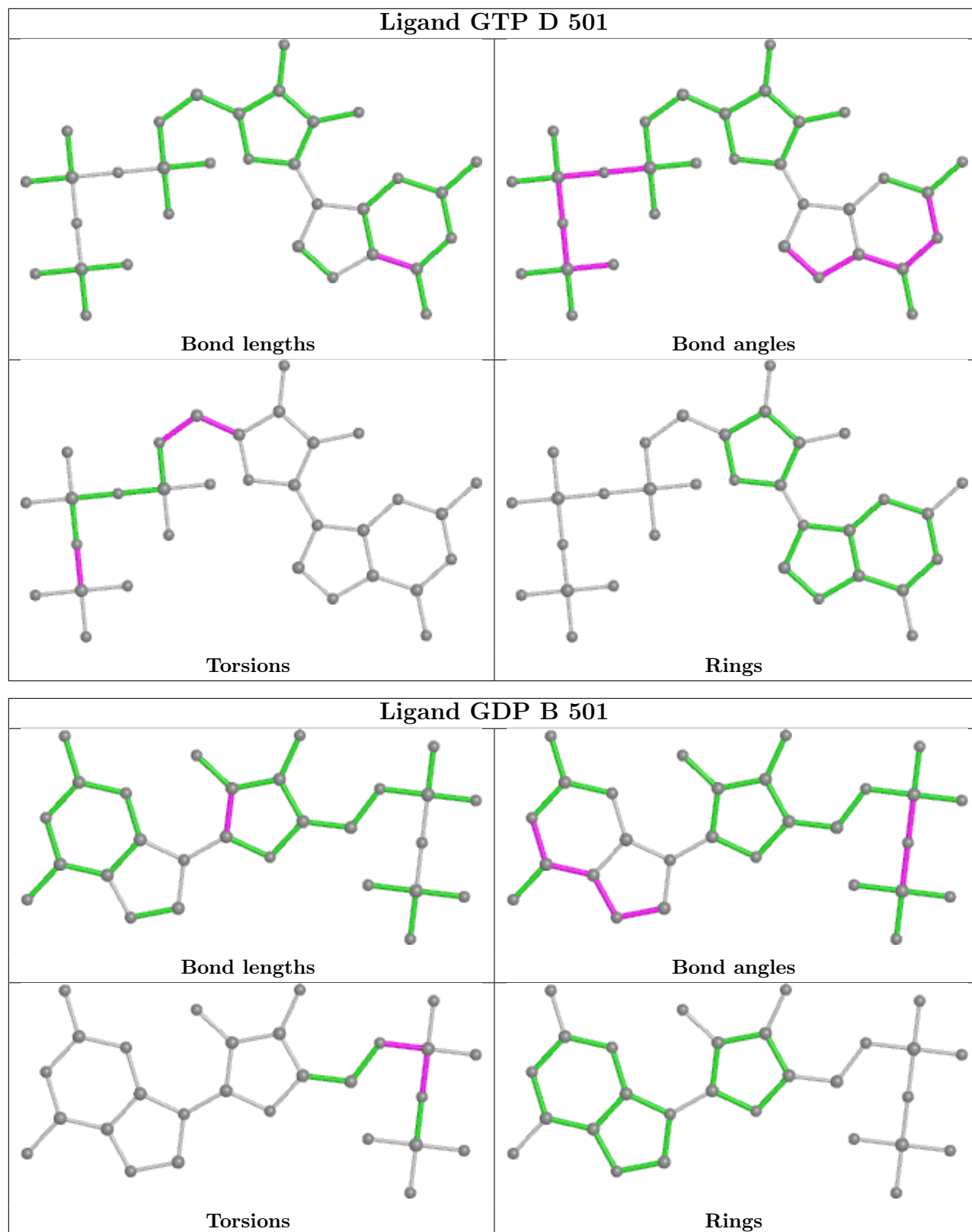

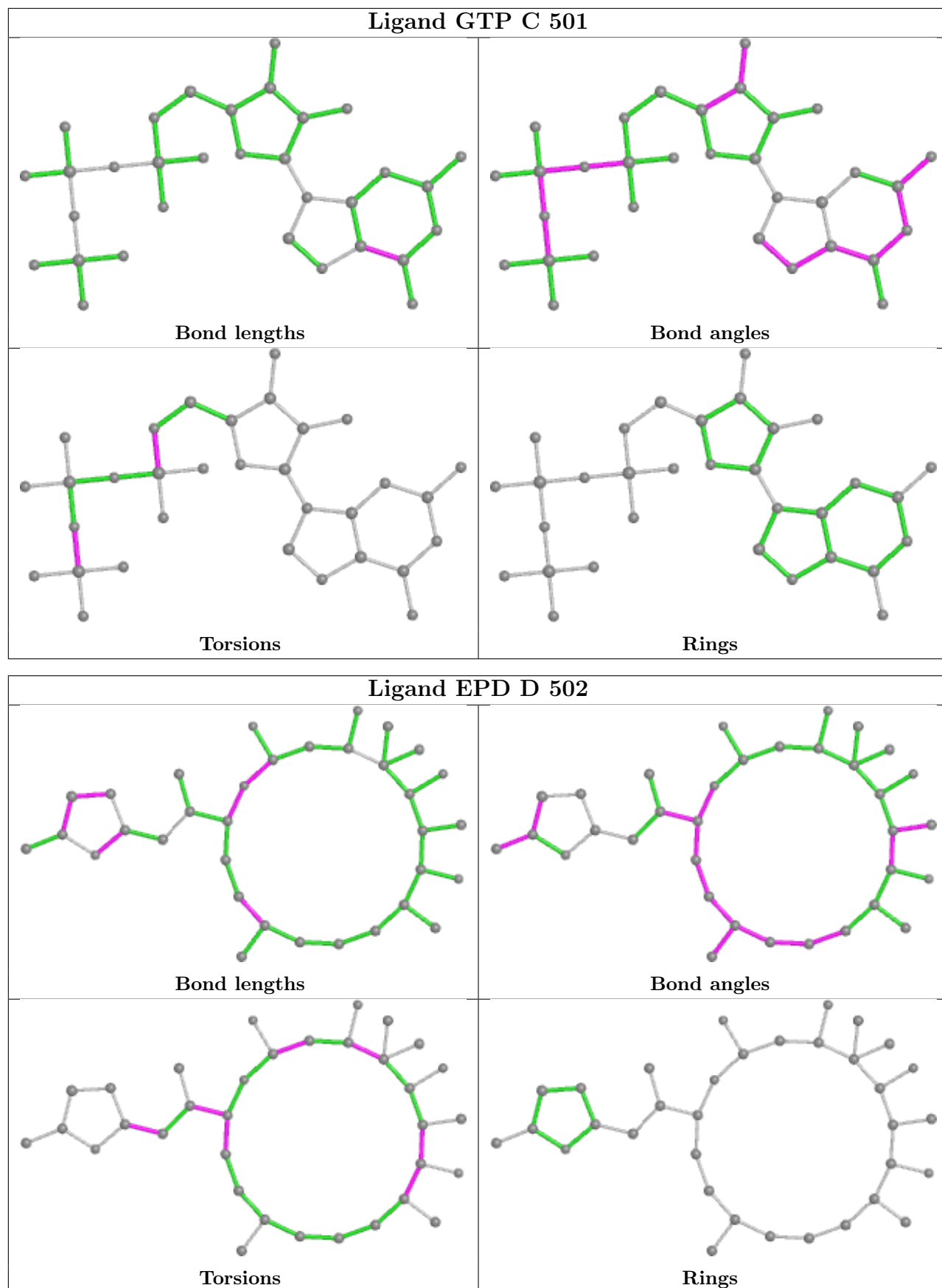

5.7 Other polymers [i](#)

There are no such residues in this entry.

5.8 Polymer linkage issues [i](#)

There are no chain breaks in this entry.

6 Fit of model and data

6.1 Protein, DNA and RNA chains

In the following table, the column labelled ‘#RSRZ > 2’ contains the number (and percentage) of RSRZ outliers, followed by percent RSRZ outliers for the chain as percentile scores relative to all X-ray entries and entries of similar resolution. The OWAB column contains the minimum, median, 95th percentile and maximum values of the occupancy-weighted average B-factor per residue. The column labelled ‘Q < 0.9’ lists the number of (and percentage) of residues with an average occupancy less than 0.9.

Mol	Chain	Analysed	<RSRZ>	#RSRZ>2	OWAB(Å ²)	Q<0.9
1	A	438/451 (97%)	-0.48	0 100 100	25, 40, 64, 96	0
1	C	440/451 (97%)	-0.58	1 (0%) 95 95	15, 31, 56, 81	0
2	B	428/445 (96%)	-0.38	4 (0%) 84 84	21, 41, 71, 121	1 (0%)
2	D	431/445 (96%)	-0.19	7 (1%) 72 70	28, 53, 85, 113	3 (0%)
3	E	121/143 (84%)	-0.27	2 (1%) 70 68	25, 53, 83, 92	0
4	F	351/384 (91%)	0.36	48 (13%) 3 2	33, 67, 111, 130	0
All	All	2209/2319 (95%)	-0.28	62 (2%) 53 48	15, 46, 88, 130	4 (0%)

All (62) RSRZ outliers are listed below:

Mol	Chain	Res	Type	RSRZ
4	F	105	LEU	8.0
4	F	177	GLY	6.2
4	F	244	CYS	5.5
4	F	232	ASN	4.6
2	D	281	TYR	4.6
4	F	142	ARG	4.4
4	F	253	TYR	4.3
4	F	249	TYR	4.2
4	F	251	LYS	4.0
4	F	250	SER	3.8
2	D	55	THR	3.7
4	F	248	GLU	3.6
4	F	176	GLN	3.5
4	F	137	ARG	3.5
4	F	246	GLN	3.3
4	F	231	ALA	3.2
4	F	243	HIS	3.1
4	F	178	GLN	3.0
4	F	161	LEU	3.0

Continued on next page...

Continued from previous page...

Mol	Chain	Res	Type	RSRZ
4	F	104	ASN	3.0
4	F	134	ALA	3.0
4	F	103	THR	2.9
4	F	252	ASN	2.9
4	F	132	LEU	2.9
4	F	242	ASN	2.9
4	F	139	ARG	2.8
4	F	133	ALA	2.8
4	F	259	GLY	2.7
4	F	240	LEU	2.7
3	E	44	ASP	2.7
2	B	278	SER	2.6
4	F	247	LYS	2.6
2	B	435	ASP	2.6
2	D	72	THR	2.6
2	B	279	GLN	2.6
4	F	245	ILE	2.6
2	B	80	PRO	2.5
4	F	225	SER	2.5
4	F	101	TYR	2.5
4	F	235	ASP	2.4
4	F	106	LYS	2.4
4	F	255[A]	ARG	2.4
3	E	139	LEU	2.4
2	D	92	PHE	2.4
2	D	37	HIS	2.3
4	F	135	TYR	2.3
4	F	224	SER	2.3
4	F	100	ILE	2.3
4	F	143	GLU	2.2
4	F	102	PRO	2.2
2	D	73	MET	2.2
4	F	136	ASN	2.2
4	F	45	ASN	2.1
4	F	11	SER	2.1
4	F	180	HIS	2.1
4	F	233	PHE	2.1
4	F	254	GLY	2.1
1	C	340	SER	2.1
4	F	138	ARG	2.0
4	F	179	VAL	2.0
2	D	53	GLU	2.0

Continued on next page...

Continued from previous page...

Mol	Chain	Res	Type	RSRZ
4	F	141	GLY	2.0

6.2 Non-standard residues in protein, DNA, RNA chains [i](#)

There are no non-standard protein/DNA/RNA residues in this entry.

6.3 Carbohydrates [i](#)

There are no monosaccharides in this entry.

6.4 Ligands [i](#)

In the following table, the Atoms column lists the number of modelled atoms in the group and the number defined in the chemical component dictionary. The B-factors column lists the minimum, median, 95th percentile and maximum values of B factors of atoms in the group. The column labelled 'Q< 0.9' lists the number of atoms with occupancy less than 0.9.

Mol	Type	Chain	Res	Atoms	RSCC	RSR	B-factors(Å ²)	Q<0.9
6	MG	B	506	1/1	0.81	0.51	68,68,68,68	0
8	CL	A	504	1/1	0.82	0.16	75,75,75,75	0
7	CA	A	505	1/1	0.90	0.18	88,88,88,88	0
6	MG	F	402	1/1	0.91	0.11	75,75,75,75	0
11	EPD	D	502	34/34	0.91	0.23	67,83,88,103	0
12	ACP	F	401	31/31	0.93	0.19	73,88,124,128	0
6	MG	B	502	1/1	0.94	0.36	37,37,37,37	0
7	CA	A	503	1/1	0.94	0.03	71,71,71,71	0
6	MG	C	502	1/1	0.95	0.32	28,28,28,28	0
10	MES	B	504	12/12	0.96	0.14	34,46,60,69	0
7	CA	C	503	1/1	0.97	0.04	47,47,47,47	0
5	GTP	D	501	32/32	0.98	0.12	40,49,76,165	0
6	MG	A	502	1/1	0.98	0.48	31,31,31,31	0
5	GTP	A	501	32/32	0.98	0.14	25,31,46,50	0
10	MES	B	505	12/12	0.98	0.11	54,62,75,86	0
5	GTP	C	501	32/32	0.98	0.14	18,29,39,47	0
7	CA	B	503	1/1	0.98	0.19	82,82,82,82	0
9	GDP	B	501	28/28	0.99	0.14	17,34,41,45	0

The following is a graphical depiction of the model fit to experimental electron density of all instances of the Ligand of Interest. In addition, ligands with molecular weight > 250 and outliers as shown on the geometry validation Tables will also be included. Each fit is shown from different orientation to approximate a three-dimensional view.

Electron density around EPD D 502:

$2mF_o-DF_c$ (at 0.7 rmsd) in gray
 mF_o-DF_c (at 3 rmsd) in purple (negative)
and green (positive)

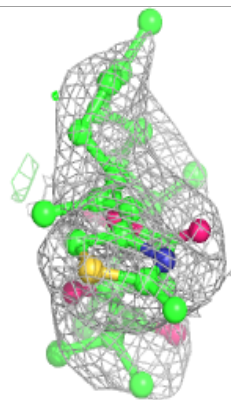
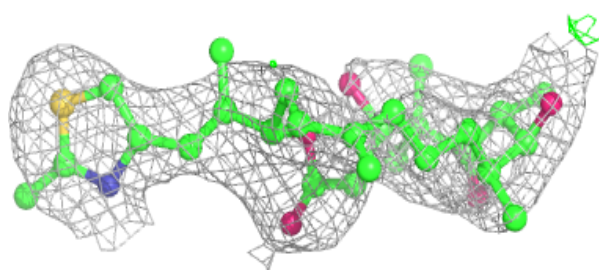
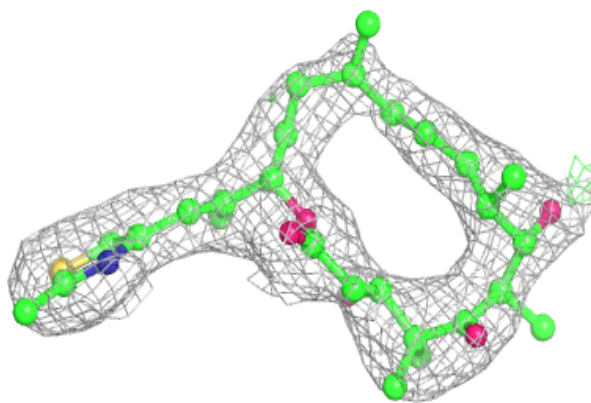
**Electron density around ACP F 401:**

$2mF_o-DF_c$ (at 0.7 rmsd) in gray
 mF_o-DF_c (at 3 rmsd) in purple (negative)
and green (positive)

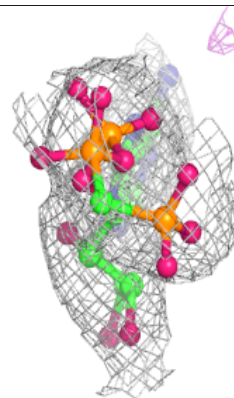
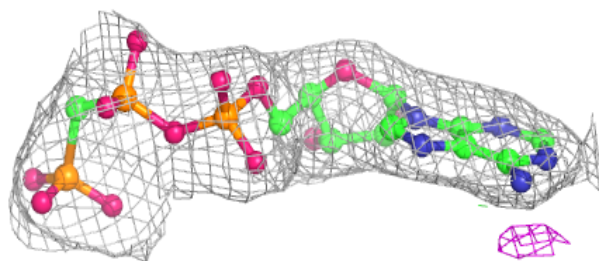
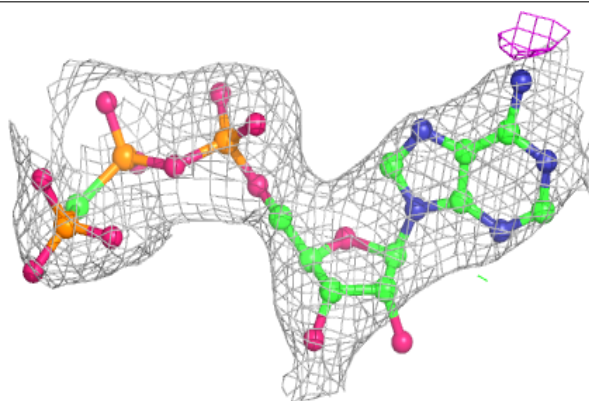

Electron density around GTP D 501:

$2mF_o-DF_c$ (at 0.7 rmsd) in gray
 mF_o-DF_c (at 3 rmsd) in purple (negative)
and green (positive)

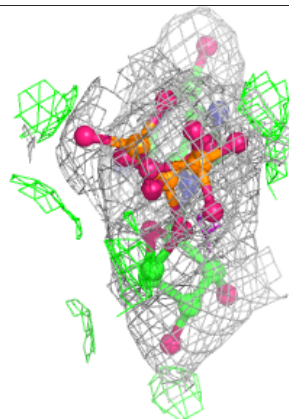
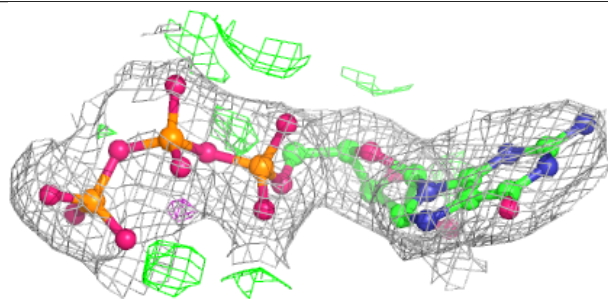
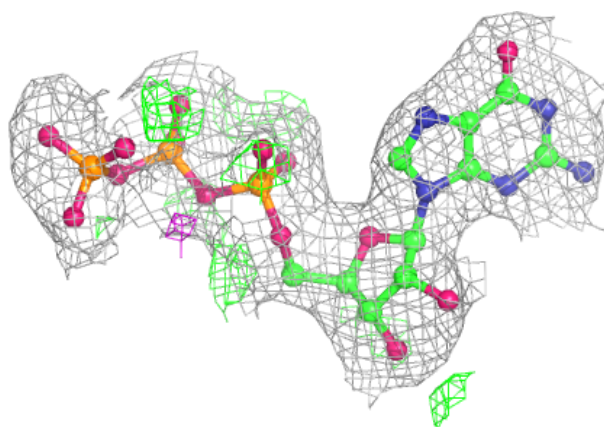
**Electron density around GTP A 501:**

$2mF_o-DF_c$ (at 0.7 rmsd) in gray
 mF_o-DF_c (at 3 rmsd) in purple (negative)
and green (positive)

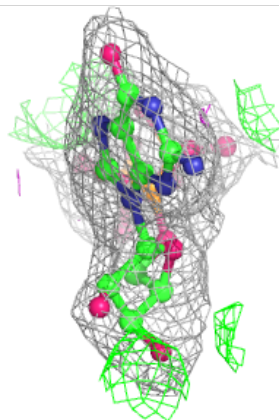
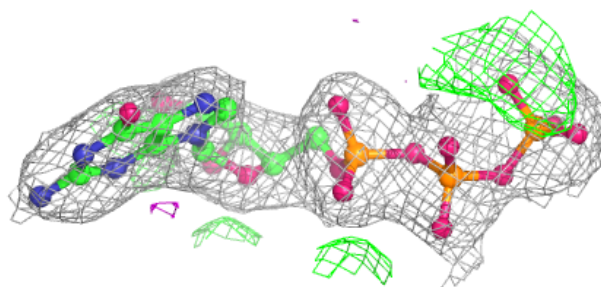
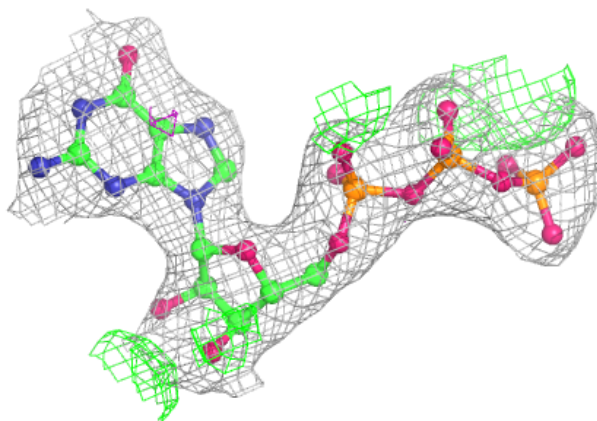

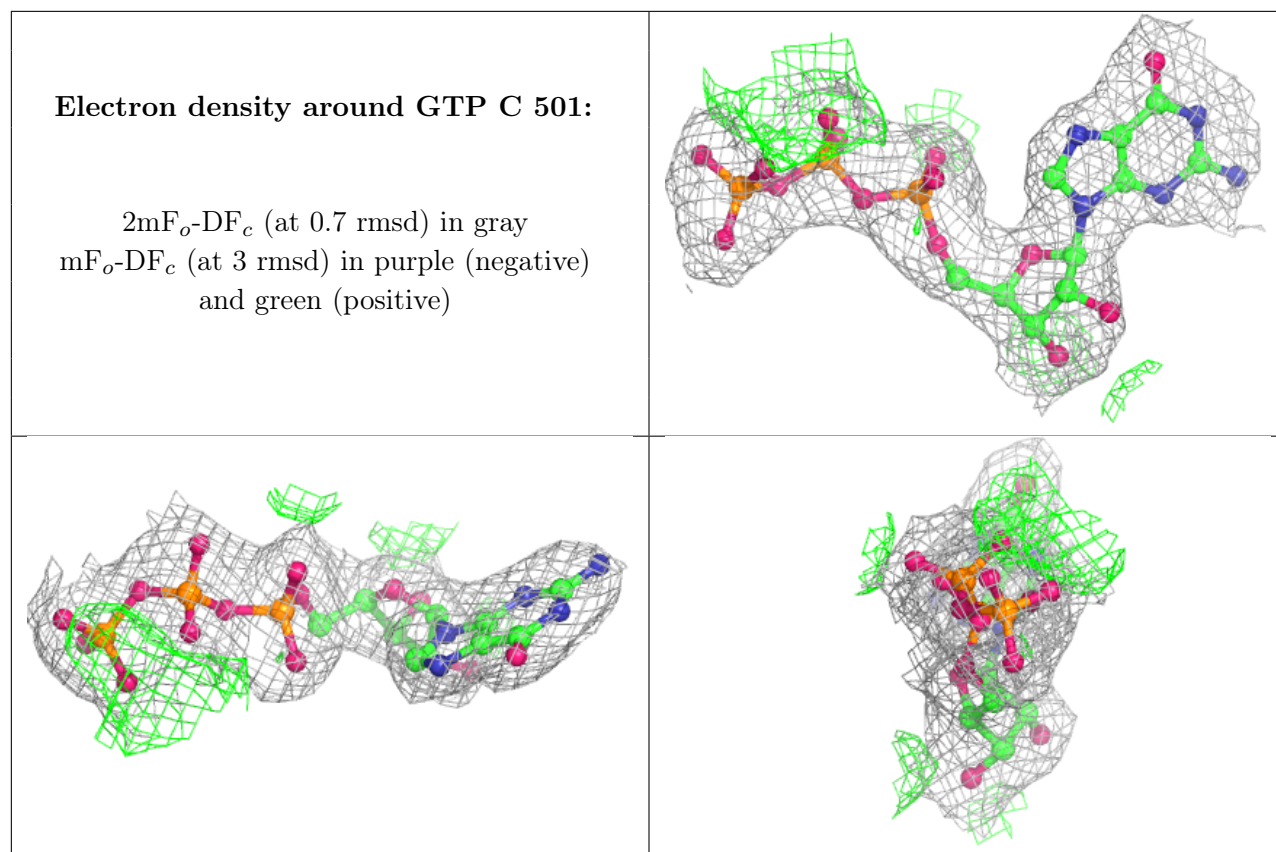

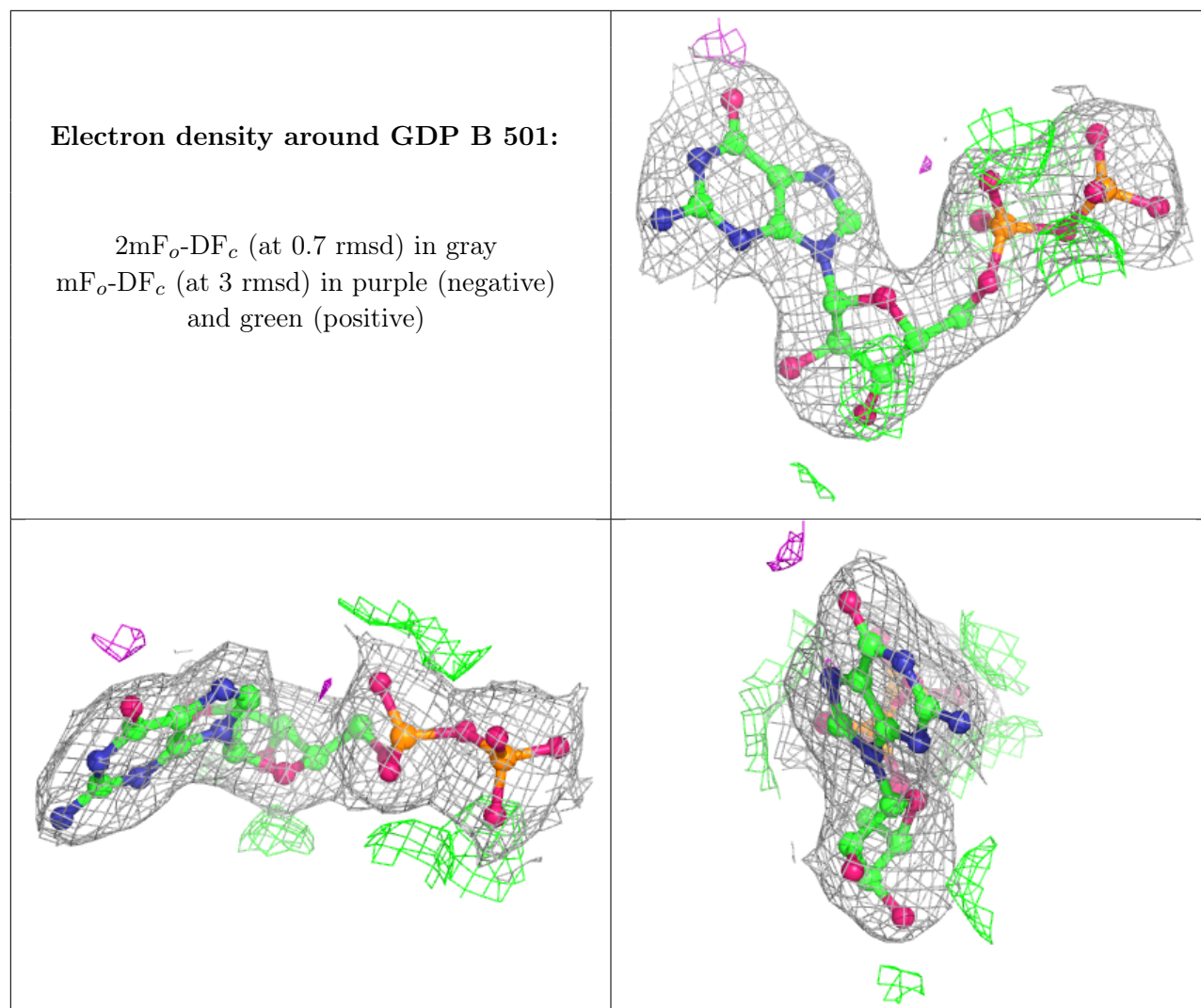

6.5 Other polymers [i](#)

There are no such residues in this entry.