



Full wwPDB X-ray Structure Validation Report ⓘ

May 22, 2024 – 02:54 pm BST

PDB ID : 5DGF
Title : Complex of yeast 80S ribosome with hypusine-containing/non-modified eIF5A and/or a peptidyl-tRNA analog
Authors : Melnikov, S.; Mailliot, J.; Shin, B.-S.; Rigger, L.; Yusupova, G.; Micura, R.; Dever, T.E.; Yusupov, M.
Deposited on : 2015-08-27
Resolution : 3.30 Å(reported)

This is a Full wwPDB X-ray Structure Validation Report for a publicly released PDB entry.

We welcome your comments at validation@mail.wwpdb.org

A user guide is available at

<https://www.wwpdb.org/validation/2017/XrayValidationReportHelp>

with specific help available everywhere you see the ⓘ symbol.

The types of validation reports are described at

<http://www.wwpdb.org/validation/2017/FAQs#types>.

The following versions of software and data (see [references ⓘ](#)) were used in the production of this report:

MolProbity : 4.02b-467
Mogul : 1.8.4, CSD as541be (2020)
Xtriage (Phenix) : 1.13
EDS : 2.36.2
buster-report : 1.1.7 (2018)
Percentile statistics : 20191225.v01 (using entries in the PDB archive December 25th 2019)
Refmac : 5.8.0158
CCP4 : 7.0.044 (Gargrove)
Ideal geometry (proteins) : Engh & Huber (2001)
Ideal geometry (DNA, RNA) : Parkinson et al. (1996)
Validation Pipeline (wwPDB-VP) : 2.36.2

1 Overall quality at a glance

The following experimental techniques were used to determine the structure:

X-RAY DIFFRACTION

The reported resolution of this entry is 3.30 Å.

Percentile scores (ranging between 0-100) for global validation metrics of the entry are shown in the following graphic. The table shows the number of entries on which the scores are based.

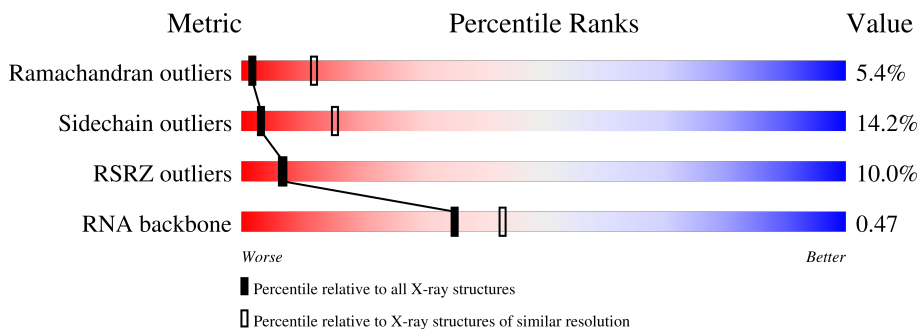

Metric	Whole archive (#Entries)	Similar resolution (#Entries, resolution range(Å))
Ramachandran outliers	138981	1183 (3.34-3.26)
Sidechain outliers	138945	1182 (3.34-3.26)
RSRZ outliers	127900	1115 (3.34-3.26)
RNA backbone	3102	1117 (3.70-2.90)

The table below summarises the geometric issues observed across the polymeric chains and their fit to the electron density. The red, orange, yellow and green segments of the lower bar indicate the fraction of residues that contain outliers for ≥ 3 , 2, 1 and 0 types of geometric quality criteria respectively. A grey segment represents the fraction of residues that are not modelled. The numeric value for each fraction is indicated below the corresponding segment, with a dot representing fractions $\leq 5\%$. The upper red bar (where present) indicates the fraction of residues that have poor fit to the electron density. The numeric value is given above the bar.

Mol	Chain	Length	Quality of chain
1	2	1800	5% (poor fit), 72% (0-1 outliers), 26% (2-3 outliers), .. (not modelled)
1	6	1800	3% (poor fit), 74% (0-1 outliers), 25% (2-3 outliers), . (not modelled)
2	S0	251	20% (poor fit), 65% (0-1 outliers), 16% (2-3 outliers), . (not modelled), 18% (not modelled)
2	s0	251	20% (poor fit), 67% (0-1 outliers), 15% (2-3 outliers), 18% (not modelled)
3	S1	254	30% (poor fit), 68% (0-1 outliers), 16% (2-3 outliers), . (not modelled), 16% (not modelled)
3	s1	254	17% (poor fit), 69% (0-1 outliers), 15% (2-3 outliers), 15% (not modelled)

Continued on next page...

Continued from previous page...

Mol	Chain	Length	Quality of chain
4	S2	253	12% 73% 12% 14%
4	s2	253	4% 66% 20% 14%
5	S3	239	10% 80% 13% 7%
5	s3	239	30% 81% 13% 7%
6	S4	260	25% 86% 13% .
6	s4	260	23% 83% 14% .
7	S5	224	17% 81% 10% 8%
7	s5	224	9% 74% 18% 8%
8	S6	236	17% 83% 13% .
8	s6	236	9% 78% 14% 8%
9	S7	189	16% 77% 19% ..
9	s7	189	12% 85% 12% ..
10	S8	200	10% 82% 12% 6%
10	s8	200	14% 81% 13% 6%
11	S9	196	36% 77% 16% 6%
11	s9	196	22% 77% 17% 6%
12	C0	96	54% 91% 9%
12	c0	96	42% 82% 17% .
13	C1	155	14% 87% 12% .
13	c1	155	6% 80% 14% 6%
14	C2	142	10% 71% 15% 13%
14	c2	142	11% 76% 10% 13%
15	C3	150	11% 87% 12% .
15	c3	150	3% 83% 16% .
16	C4	136	26% 77% 14% 7%

Continued on next page...

Continued from previous page...

Mol	Chain	Length	Quality of chain
16	c4	136	32% 71% 21% 6%
17	C5	141	15% 74% 10% 12%
17	c5	141	11% 80% 13% ..
18	C6	142	32% 85% 13% ..
18	c6	142	18% 82% 18%
19	C7	136	24% 71% 15% 12%
19	c7	136	7% 74% 11% 14%
20	C8	145	17% 78% 21% .
20	c8	145	16% 83% 15% .
21	C9	143	26% 84% 15% .
21	c9	143	36% 85% 15% .
22	D0	120	17% 76% 13% 11%
22	d0	120	48% 78% 14% 8%
23	D1	87	18% 80% 20%
23	d1	87	10% 85% 15%
24	D2	129	9% 86% 12% .
24	d2	129	8% 84% 15% .
25	D3	144	12% 83% 17% .
25	d3	144	5% 90% 10%
26	D4	134	25% 87% 13% .
26	d4	134	7% 84% 15% .
27	D5	107	22% 47% 18% 35%
27	d5	107	18% 55% 8% 36%
28	D6	97	45% 72% 27% .
28	d6	97	27% 79% 19% .













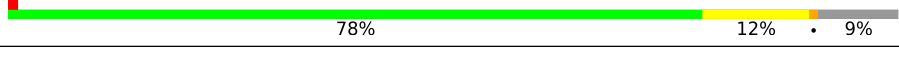

Continued on next page...

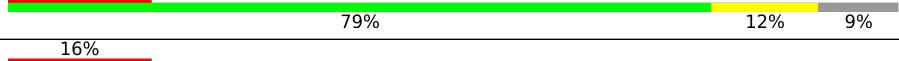
Continued from previous page...

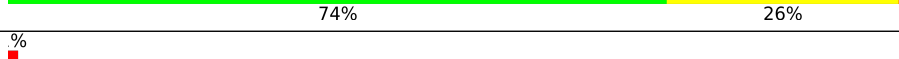
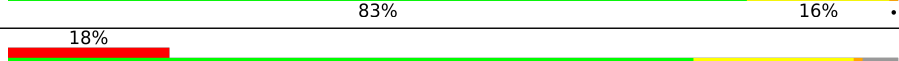
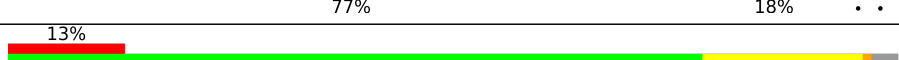
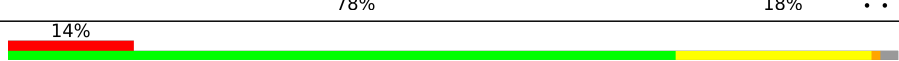
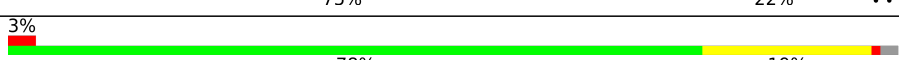
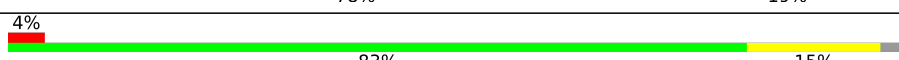
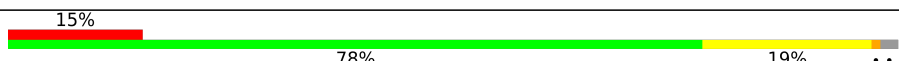
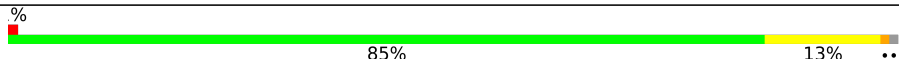
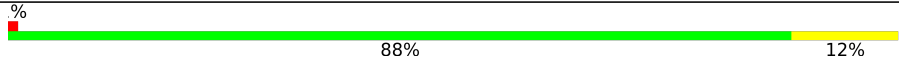
Mol	Chain	Length	Quality of chain
29	D7	81	21% 86% 14%
29	d7	81	16% 85% 15%
30	D8	66	20% 80% 15% 5%
30	d8	66	15% 77% 17% 5%
31	D9	55	22% 78% 15% • •
31	d9	55	47% 75% 22% •
32	E0	62	34% 87% 10% •
32	e0	62	18% 66% 32% •
33	E1	76	12% 63% 24% 7% 7%
33	e1	76	26% 67% 29% •
34	SR	318	32% 85% 14% •
34	sR	318	33% 91% 9%
35	SM	273	8% 48% 10% • 42%
35	sM	273	8% 33% • • 62%
36	1	3396	% 71% 20% • 7%
36	5	3396	% 72% 21% • 7%
37	3	121	91% 9%
37	7	121	88% 11% •
38	4	158	% 79% 20% •
38	8	158	% 78% 21% •
39	L2	253	4% 85% 15%
39	l2	253	4% 82% 17% •
40	L3	386	5% 82% 18%
40	l3	386	2% 82% 16% •
41	L4	361	84% 16%

Continued on next page...

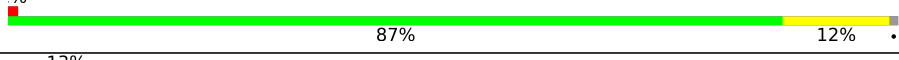
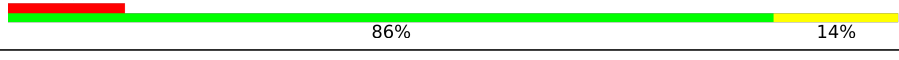
Continued from previous page...

Mol	Chain	Length	Quality of chain
41	l4	361	 84% 15%
42	L5	296	 23% 83% 16%
42	l5	296	 7% 83% 15%
43	L6	175	 6% 78% 11% 11%
43	l6	175	 3% 77% 13% 10%
44	L7	243	 78% 12% 9%
44	l7	243	 80% 11% 8%
45	L8	255	 16% 79% 12% 9%
45	l8	255	 16% 76% 15% 9%
46	L9	191	 5% 74% 26%
46	l9	191	 83% 16%
47	M0	220	 18% 77% 18%
47	m0	220	 13% 78% 18%
48	M1	173	 14% 75% 22%
48	m1	173	 3% 78% 19%
49	M3	198	 4% 83% 15%
49	m3	198	 15% 78% 19%
50	M4	137	 85% 13%
50	m4	137	 88% 12%
51	M5	203	 86% 13%
51	m5	203	 5% 88% 12%
52	M6	198	 2% 83% 15%
52	m6	198	 87% 12%
53	M7	183	 13% 86% 14%
53	m7	183	 73% 11% 15%

Continued on next page...

Continued from previous page...

Mol	Chain	Length	Quality of chain
54	M8	185	2% 86% 14%
54	m8	185	83% 16%
55	M9	188	10% 88% 12%
55	m9	188	6% 88% 12%
56	N0	172	2% 84% 16%
56	n0	172	% 85% 15%
57	N1	159	3% 80% 18%
57	n1	159	7% 84% 16%
58	N2	120	21% 73% 9% 17%
58	n2	120	18% 69% 12% 18%
59	N3	136	8% 87% 12%
59	n3	136	2% 85% 14%
60	N4	155	19% 54% 9% 37%
60	n4	155	12% 79% 8% 13%
61	N5	141	10% 69% 16% 14%
61	n5	141	% 70% 13% 15%
62	N6	126	15% 84% 14%
62	n6	126	3% 84% 15%
63	N7	135	36% 84% 13%
63	n7	135	32% 84% 14%
64	N8	148	% 82% 18%
64	n8	148	2% 82% 17%
65	N9	58	7% 84% 16%
65	n9	58	9% 83% 14%
66	O0	104	9% 81% 12% 7%

Continued on next page...

Continued from previous page...

Mol	Chain	Length	Quality of chain
66	o0	104	2% 83% 13% .
67	O1	112	12% 83% 13% ..
67	o1	112	4% 77% 19% ..
68	O2	129	2% 84% 15% .
68	o2	129	5% 80% 17% ..
69	O3	106	% 85% 14% .
69	o3	106	85% 15%
70	O4	120	6% 82% 12% 7%
70	o4	120	7% 82% 11% 7%
71	O5	119	5% 84% 16%
71	o5	119	7% 87% 13%
72	O6	99	5% 80% 15% 5%
72	o6	99	4% 72% 25% .
73	O7	87	% 86% 13% .
73	o7	87	2% 91% 8% .
74	O8	77	10% 82% 18%
74	o8	77	32% 81% 19%
75	O9	50	2% 82% 16% .
75	o9	50	2% 94% 6%
76	Q0	52	13% 81% 17% .
76	q0	52	2% 83% 17%
77	Q1	25	24% 88% 12%
77	q1	25	8% 72% 28%
78	Q2	105	2% 80% 19% .
78	q2	105	% 77% 22% .

Continued on next page...

Continued from previous page...

Mol	Chain	Length	Quality of chain
79	Q3	91	<p>2% 84% 14%</p>
79	q3	91	<p>3% 88% 12%</p>
80	m2	165	<p>91% 9%</p>
81	p0	311	<p>10% 41% 5% 54%</p>
82	p1	47	<p>100%</p>
82	p2	47	<p>98%</p>
83	f	157	<p>59% 73% 19% 6%</p>

2 Entry composition

There are 89 unique types of molecules in this entry. The entry contains 404292 atoms, of which 0 are hydrogens and 0 are deuteriums.

In the tables below, the ZeroOcc column contains the number of atoms modelled with zero occupancy, the AltConf column contains the number of residues with at least one atom in alternate conformation and the Trace column contains the number of residues modelled with at most 2 atoms.

- Molecule 1 is a RNA chain called 18S ribosomal RNA.

Mol	Chain	Residues	Atoms					ZeroOcc	AltConf	Trace
			Total	C	N	O	P			
1	2	1781	Total	C	N	O	P	0	1	0
			37970	16975	6720	12493	1782			
1	6	1795	Total	C	N	O	P	0	1	0
			38260	17105	6763	12596	1796			

- Molecule 2 is a protein called 40S ribosomal protein S0-A.

Mol	Chain	Residues	Atoms					ZeroOcc	AltConf	Trace
			Total	C	N	O	S			
2	S0	206	Total	C	N	O	S	0	0	0
			1577	1014	278	283	2			
2	s0	206	Total	C	N	O	S	0	0	0
			1583	1017	281	283	2			

- Molecule 3 is a protein called 40S ribosomal protein S1-A.

Mol	Chain	Residues	Atoms					ZeroOcc	AltConf	Trace
			Total	C	N	O	S			
3	S1	214	Total	C	N	O	S	0	0	0
			1709	1084	310	311	4			
3	s1	216	Total	C	N	O	S	0	0	0
			1722	1091	312	315	4			

- Molecule 4 is a protein called 40S ribosomal protein S2.

Mol	Chain	Residues	Atoms					ZeroOcc	AltConf	Trace
			Total	C	N	O	S			
4	S2	217	Total	C	N	O	S	0	0	0
			1635	1047	289	297	2			
4	s2	217	Total	C	N	O	S	0	0	0
			1635	1047	289	297	2			

- Molecule 5 is a protein called 40S ribosomal protein S3.

Mol	Chain	Residues	Atoms					ZeroOcc	AltConf	Trace
			Total	C	N	O	S			
5	S3	223	Total 1734	C 1101	N 313	O 314	S 6	0	0	0
5	s3	223	Total 1734	C 1101	N 313	O 314	S 6	0	0	0

- Molecule 6 is a protein called 40S ribosomal protein S4-A.

Mol	Chain	Residues	Atoms					ZeroOcc	AltConf	Trace
			Total	C	N	O	S			
6	S4	260	Total 2068	C 1316	N 389	O 360	S 3	0	0	0
6	s4	260	Total 2068	C 1316	N 389	O 360	S 3	0	0	0

- Molecule 7 is a protein called 40S ribosomal protein S5.

Mol	Chain	Residues	Atoms					ZeroOcc	AltConf	Trace
			Total	C	N	O	S			
7	S5	206	Total 1609	C 1007	N 300	O 299	S 3	0	0	0
7	s5	206	Total 1609	C 1007	N 300	O 299	S 3	0	0	0

- Molecule 8 is a protein called 40S ribosomal protein S6-A.

Mol	Chain	Residues	Atoms					ZeroOcc	AltConf	Trace
			Total	C	N	O	S			
8	S6	226	Total 1799	C 1129	N 346	O 321	S 3	0	0	0
8	s6	218	Total 1755	C 1102	N 337	O 313	S 3	0	0	0

- Molecule 9 is a protein called 40S ribosomal protein S7-A.

Mol	Chain	Residues	Atoms					ZeroOcc	AltConf	Trace
			Total	C	N	O	S			
9	S7	184	Total 1481	C 951	N 265	O 265		0	0	0
9	s7	186	Total 1491	C 957	N 267	O 267		0	0	0

- Molecule 10 is a protein called 40S ribosomal protein S8-A.

Mol	Chain	Residues	Atoms					ZeroOcc	AltConf	Trace
			Total	C	N	O	S			
10	S8	188	Total 1489	C 925	N 298	O 264	S 2	0	0	0

Continued on next page...

Continued from previous page...

Mol	Chain	Residues	Atoms					ZeroOcc	AltConf	Trace
10	s8	188	Total	C	N	O	S	0	0	0
			1489	925	298	264	2			

- Molecule 11 is a protein called 40S ribosomal protein S9-A.

Mol	Chain	Residues	Atoms					ZeroOcc	AltConf	Trace
11	S9	185	Total	C	N	O	S	0	0	0
			1494	943	289	261	1			
11	s9	185	Total	C	N	O	S	0	0	0
			1494	943	289	261	1			

- Molecule 12 is a protein called 40S ribosomal protein S10-A.

Mol	Chain	Residues	Atoms					ZeroOcc	AltConf	Trace
12	C0	96	Total	C	N	O	S	0	0	0
			773	500	126	145	2			
12	c0	96	Total	C	N	O	S	0	0	0
			762	491	125	144	2			

- Molecule 13 is a protein called 40S ribosomal protein S11-A.

Mol	Chain	Residues	Atoms					ZeroOcc	AltConf	Trace
13	C1	155	Total	C	N	O	S	0	0	0
			1214	775	230	206	3			
13	c1	146	Total	C	N	O	S	0	0	0
			1168	747	221	197	3			

- Molecule 14 is a protein called 40S ribosomal protein S12.

Mol	Chain	Residues	Atoms					ZeroOcc	AltConf	Trace
14	C2	124	Total	C	N	O	S	0	0	0
			892	562	156	172	2			
14	c2	124	Total	C	N	O	S	0	0	0
			892	562	156	172	2			

- Molecule 15 is a protein called 40S ribosomal protein S13.

Mol	Chain	Residues	Atoms					ZeroOcc	AltConf	Trace
15	C3	150	Total	C	N	O	S	0	0	0
			1192	759	224	207	2			
15	c3	150	Total	C	N	O	S	0	0	0
			1192	759	224	207	2			

- Molecule 16 is a protein called 40S ribosomal protein S14-A.

Mol	Chain	Residues	Atoms					ZeroOcc	AltConf	Trace
			Total	C	N	O	S			
16	C4	127	Total 891	C 545	N 182	O 163	S 1	0	0	0
16	c4	128	Total 949	C 582	N 188	O 176	S 3	0	0	0

- Molecule 17 is a protein called 40S ribosomal protein S15 (uS19).

Mol	Chain	Residues	Atoms					ZeroOcc	AltConf	Trace
			Total	C	N	O	S			
17	C5	124	Total 977	C 622	N 182	O 166	S 7	0	0	0
17	c5	135	Total 1039	C 658	N 196	O 178	S 7	0	0	0

- Molecule 18 is a protein called 40S ribosomal protein S16-A.

Mol	Chain	Residues	Atoms				ZeroOcc	AltConf	Trace
			Total	C	N	O			
18	C6	141	Total 1105	C 708	N 203	O 194	0	0	0
18	c6	142	Total 1111	C 711	N 204	O 196	0	0	0

- Molecule 19 is a protein called 40S ribosomal protein S17-A.

Mol	Chain	Residues	Atoms					ZeroOcc	AltConf	Trace
			Total	C	N	O	S			
19	C7	120	Total 926	C 577	N 177	O 170	S 2	0	0	0
19	c7	117	Total 906	C 563	N 174	O 167	S 2	0	0	0

- Molecule 20 is a protein called 40S ribosomal protein S18-A.

Mol	Chain	Residues	Atoms					ZeroOcc	AltConf	Trace
			Total	C	N	O	S			
20	C8	145	Total 1192	C 743	N 237	O 210	S 2	0	0	0
20	c8	145	Total 1192	C 743	N 237	O 210	S 2	0	0	0

- Molecule 21 is a protein called 40S ribosomal protein S19-A.

Mol	Chain	Residues	Atoms					ZeroOcc	AltConf	Trace
21	C9	143	Total	C	N	O	S	0	0	0
			1112	694	208	208	2			
21	c9	143	Total	C	N	O	S	0	0	0
			1112	694	208	208	2			

- Molecule 22 is a protein called 40S ribosomal protein S20.

Mol	Chain	Residues	Atoms					ZeroOcc	AltConf	Trace
22	D0	107	Total	C	N	O	S	0	0	0
			855	539	156	159	1			
22	d0	110	Total	C	N	O	S	0	0	0
			882	554	161	166	1			

- Molecule 23 is a protein called 40S ribosomal protein S21-A.

Mol	Chain	Residues	Atoms					ZeroOcc	AltConf	Trace
23	D1	87	Total	C	N	O	S	0	0	0
			684	420	125	137	2			
23	d1	87	Total	C	N	O	S	0	0	0
			684	420	125	137	2			

- Molecule 24 is a protein called 40S ribosomal protein S22-A.

Mol	Chain	Residues	Atoms					ZeroOcc	AltConf	Trace
24	D2	129	Total	C	N	O	S	0	0	0
			1021	650	188	180	3			
24	d2	129	Total	C	N	O	S	0	0	0
			1021	650	188	180	3			

- Molecule 25 is a protein called 40S ribosomal protein S23-A.

Mol	Chain	Residues	Atoms					ZeroOcc	AltConf	Trace
25	D3	144	Total	C	N	O	S	0	0	0
			1121	708	220	191	2			
25	d3	144	Total	C	N	O	S	0	0	0
			1121	708	220	191	2			

- Molecule 26 is a protein called 40S ribosomal protein S24-A.

Mol	Chain	Residues	Atoms				ZeroOcc	AltConf	Trace
26	D4	134	Total	C	N	O	0	0	0
			1073	676	208	189			

Continued on next page...

Continued from previous page...

Mol	Chain	Residues	Atoms				ZeroOcc	AltConf	Trace
			Total	C	N	O			
26	d4	134	1073	676	208	189	0	0	0

- Molecule 27 is a protein called 40S ribosomal protein S25-A.

Mol	Chain	Residues	Atoms				ZeroOcc	AltConf	Trace
			Total	C	N	O			
27	D5	70	563	360	104	99	0	0	0
27	d5	69	558	357	103	98	0	0	0

- Molecule 28 is a protein called 40S ribosomal protein S26-B.

Mol	Chain	Residues	Atoms					ZeroOcc	AltConf	Trace
			Total	C	N	O	S			
28	D6	97	769	475	160	129	5	0	0	0
28	d6	97	769	475	160	129	5	0	0	0

- Molecule 29 is a protein called 40S ribosomal protein S27-A.

Mol	Chain	Residues	Atoms					ZeroOcc	AltConf	Trace
			Total	C	N	O	S			
29	D7	81	610	382	110	113	5	0	0	0
29	d7	81	610	382	110	113	5	0	0	0

- Molecule 30 is a protein called 40S ribosomal protein S28-A.

Mol	Chain	Residues	Atoms					ZeroOcc	AltConf	Trace
			Total	C	N	O	S			
30	D8	63	497	306	99	91	1	0	0	0
30	d8	63	497	306	99	91	1	0	0	0

- Molecule 31 is a protein called 40S ribosomal protein S29-A.

Mol	Chain	Residues	Atoms					ZeroOcc	AltConf	Trace
			Total	C	N	O	S			
31	D9	53	442	274	92	72	4	0	0	0
31	d9	53	442	274	92	72	4	0	0	0

- Molecule 32 is a protein called 40S ribosomal protein S30-A.

Mol	Chain	Residues	Atoms					ZeroOcc	AltConf	Trace
			Total	C	N	O	S			
32	E0	60	Total 475	C 299	N 98	O 77	S 1	0	0	0
32	e0	62	Total 491	C 309	N 101	O 80	S 1	0	0	0

- Molecule 33 is a protein called Ubiquitin-40S ribosomal protein S31.

Mol	Chain	Residues	Atoms					ZeroOcc	AltConf	Trace
			Total	C	N	O	S			
33	E1	71	Total 566	C 362	N 106	O 94	S 4	0	0	0
33	e1	76	Total 608	C 388	N 117	O 99	S 4	0	0	0

- Molecule 34 is a protein called Guanine nucleotide-binding protein subunit beta-like protein.

Mol	Chain	Residues	Atoms					ZeroOcc	AltConf	Trace
			Total	C	N	O	S			
34	SR	318	Total 2437	C 1541	N 418	O 470	S 8	0	0	0
34	sR	318	Total 2442	C 1544	N 418	O 472	S 8	0	0	0

- Molecule 35 is a protein called Suppressor protein STM1.

Mol	Chain	Residues	Atoms				ZeroOcc	AltConf	Trace
			Total	C	N	O			
35	SM	159	Total 1105	C 653	N 221	O 231	0	0	0
35	sM	104	Total 680	C 403	N 140	O 137	0	0	0

- Molecule 36 is a RNA chain called 25S ribosomal RNA.

Mol	Chain	Residues	Atoms					ZeroOcc	AltConf	Trace
			Total	C	N	O	P			
36	1	3149	Total 67355	C 30086	N 12142	O 21978	P 3149	0	0	0
36	5	3169	Total 67780	C 30276	N 12216	O 22120	P 3168	0	0	0

- Molecule 37 is a RNA chain called 5S ribosomal RNA.

Mol	Chain	Residues	Atoms					ZeroOcc	AltConf	Trace
37	3	121	Total	C	N	O	P	0	0	0
			2579	1152	461	845	121			
37	7	121	Total	C	N	O	P	0	0	0
			2579	1152	461	845	121			

- Molecule 38 is a RNA chain called 5.8S ribosomal RNA.

Mol	Chain	Residues	Atoms					ZeroOcc	AltConf	Trace
38	4	158	Total	C	N	O	P	0	0	0
			3353	1500	586	1109	158			
38	8	158	Total	C	N	O	P	0	0	0
			3353	1500	586	1109	158			

- Molecule 39 is a protein called 60S ribosomal protein L2-A.

Mol	Chain	Residues	Atoms					ZeroOcc	AltConf	Trace
39	L2	252	Total	C	N	O	S	0	0	0
			1914	1191	388	334	1			
39	l2	252	Total	C	N	O	S	0	0	0
			1912	1190	388	333	1			

- Molecule 40 is a protein called 60S ribosomal protein L3.

Mol	Chain	Residues	Atoms					ZeroOcc	AltConf	Trace
40	L3	386	Total	C	N	O	S	0	0	0
			3075	1950	584	533	8			
40	l3	386	Total	C	N	O	S	0	0	0
			3075	1950	584	533	8			

- Molecule 41 is a protein called 60S ribosomal protein L4-A.

Mol	Chain	Residues	Atoms					ZeroOcc	AltConf	Trace
41	L4	361	Total	C	N	O	S	0	0	0
			2748	1729	522	494	3			
41	l4	361	Total	C	N	O	S	0	0	0
			2748	1729	522	494	3			

- Molecule 42 is a protein called 60S ribosomal protein L5.

Mol	Chain	Residues	Atoms					ZeroOcc	AltConf	Trace
42	L5	296	Total	C	N	O	S	0	0	0
			2375	1501	414	458	2			

Continued on next page...

Continued from previous page...

Mol	Chain	Residues	Atoms					ZeroOcc	AltConf	Trace
			Total	C	N	O	S			
42	15	294	Total	C	N	O	S	0	0	0
			2359	1489	412	456	2			

- Molecule 43 is a protein called 60S ribosomal protein L6-A.

Mol	Chain	Residues	Atoms					ZeroOcc	AltConf	Trace
			Total	C	N	O	S			
43	L6	156	Total	C	N	O	S	0	0	0
			1239	800	222	216	1			
43	16	157	Total	C	N	O	S	0	0	0
			1248	806	224	217	1			

- Molecule 44 is a protein called 60S ribosomal protein L7-A.

Mol	Chain	Residues	Atoms					ZeroOcc	AltConf	Trace
			Total	C	N	O	S			
44	L7	222	Total	C	N	O	S	0	0	0
			1784	1151	324	308	1			
44	17	223	Total	C	N	O	S	0	0	0
			1791	1155	325	310	1			

- Molecule 45 is a protein called 60S ribosomal protein L8-A.

Mol	Chain	Residues	Atoms					ZeroOcc	AltConf	Trace
			Total	C	N	O	S			
45	L8	233	Total	C	N	O	S	0	0	0
			1804	1151	323	327	3			
45	18	231	Total	C	N	O	S	0	0	0
			1764	1131	316	314	3			

There are 2 discrepancies between the modelled and reference sequences:

Chain	Residue	Modelled	Actual	Comment	Reference
L8	119	ALA	GLY	conflict	UNP P17076
18	119	ALA	GLY	conflict	UNP P17076

- Molecule 46 is a protein called 60S ribosomal protein L9-A.

Mol	Chain	Residues	Atoms					ZeroOcc	AltConf	Trace
			Total	C	N	O	S			
46	L9	191	Total	C	N	O	S	0	0	0
			1518	963	274	277	4			
46	19	191	Total	C	N	O	S	0	0	0
			1518	963	274	277	4			

- Molecule 47 is a protein called 60S ribosomal protein L10.

Mol	Chain	Residues	Atoms					ZeroOcc	AltConf	Trace
47	M0	211	Total	C	N	O	S	0	0	0
			1705	1083	322	294	6			
47	m0	213	Total	C	N	O	S	0	0	0
			1722	1094	325	297	6			

- Molecule 48 is a protein called 60S ribosomal protein L11-B.

Mol	Chain	Residues	Atoms					ZeroOcc	AltConf	Trace
48	M1	169	Total	C	N	O	S	0	0	0
			1353	847	253	249	4			
48	m1	169	Total	C	N	O	S	0	0	0
			1353	847	253	249	4			

- Molecule 49 is a protein called 60S ribosomal protein L13-A.

Mol	Chain	Residues	Atoms				ZeroOcc	AltConf	Trace
49	M3	193	Total	C	N	O	0	0	0
			1543	962	315	266			
49	m3	194	Total	C	N	O	0	0	0
			1548	965	316	267			

- Molecule 50 is a protein called 60S ribosomal protein L14-A.

Mol	Chain	Residues	Atoms					ZeroOcc	AltConf	Trace
50	M4	136	Total	C	N	O	S	0	0	0
			1053	675	199	177	2			
50	m4	137	Total	C	N	O	S	0	0	0
			1059	678	200	179	2			

- Molecule 51 is a protein called 60S ribosomal protein L15-A.

Mol	Chain	Residues	Atoms					ZeroOcc	AltConf	Trace
51	M5	203	Total	C	N	O	S	0	0	0
			1720	1077	361	281	1			
51	m5	203	Total	C	N	O	S	0	0	0
			1720	1077	361	281	1			

- Molecule 52 is a protein called 60S ribosomal protein L16-A.

Mol	Chain	Residues	Atoms					ZeroOcc	AltConf	Trace
52	M6	197	Total	C	N	O	S	0	0	0
			1555	1003	289	262	1			

Continued on next page...

Continued from previous page...

Mol	Chain	Residues	Atoms					ZeroOcc	AltConf	Trace
			Total	C	N	O	S			
52	m6	197	Total	C	N	O	S	0	0	0
			1555	1003	289	262	1			

- Molecule 53 is a protein called 60S ribosomal protein L17-A.

Mol	Chain	Residues	Atoms				ZeroOcc	AltConf	Trace
			Total	C	N	O			
53	M7	183	Total	C	N	O	0	0	0
			1420	882	281	257			
53	m7	155	Total	C	N	O	0	0	0
			1227	764	238	225			

- Molecule 54 is a protein called 60S ribosomal protein L18-A.

Mol	Chain	Residues	Atoms					ZeroOcc	AltConf	Trace
			Total	C	N	O	S			
54	M8	185	Total	C	N	O	S	0	0	0
			1441	908	290	241	2			
54	m8	185	Total	C	N	O	S	0	0	0
			1441	908	290	241	2			

- Molecule 55 is a protein called 60S ribosomal protein L19-A.

Mol	Chain	Residues	Atoms				ZeroOcc	AltConf	Trace
			Total	C	N	O			
55	M9	188	Total	C	N	O	0	0	0
			1521	935	326	260			
55	m9	188	Total	C	N	O	0	0	0
			1521	935	326	260			

- Molecule 56 is a protein called 60S ribosomal protein L20-A.

Mol	Chain	Residues	Atoms					ZeroOcc	AltConf	Trace
			Total	C	N	O	S			
56	N0	172	Total	C	N	O	S	0	0	0
			1445	930	267	244	4			
56	n0	172	Total	C	N	O	S	0	0	0
			1445	930	267	244	4			

- Molecule 57 is a protein called 60S ribosomal protein L21-A.

Mol	Chain	Residues	Atoms				ZeroOcc	AltConf	Trace	
			Total	C	N	O				
57	N1	159	Total	C	N	O	S	0	0	0
			1276	805	246	221	4			
57	n1	159	Total	C	N	O	S	0	0	0
			1276	805	246	221	4			

- Molecule 58 is a protein called 60S ribosomal protein L22-A.

Mol	Chain	Residues	Atoms				ZeroOcc	AltConf	Trace
			Total	C	N	O			
58	N2	100	796	516	131	149	0	0	0
58	n2	98	778	505	127	146	0	0	0

- Molecule 59 is a protein called 60S ribosomal protein L23-A.

Mol	Chain	Residues	Atoms					ZeroOcc	AltConf	Trace
			Total	C	N	O	S			
59	N3	136	1003	628	189	179	7	0	0	0
59	n3	136	1003	628	189	179	7	0	0	0

- Molecule 60 is a protein called 60S ribosomal protein L24-A.

Mol	Chain	Residues	Atoms					ZeroOcc	AltConf	Trace
			Total	C	N	O	S			
60	N4	98	699	443	137	118	1	0	0	0
60	n4	135	1038	651	206	180	1	0	0	0

- Molecule 61 is a protein called 60S ribosomal protein L25.

Mol	Chain	Residues	Atoms					ZeroOcc	AltConf	Trace
			Total	C	N	O	S			
61	N5	121	964	620	169	173	2	0	0	0
61	n5	120	959	617	168	172	2	0	0	0

- Molecule 62 is a protein called 60S ribosomal protein L26-A.

Mol	Chain	Residues	Atoms				ZeroOcc	AltConf	Trace
			Total	C	N	O			
62	N6	126	993	625	192	176	0	0	0
62	n6	126	993	625	192	176	0	0	0

- Molecule 63 is a protein called 60S ribosomal protein L27-A.

Mol	Chain	Residues	Atoms				ZeroOcc	AltConf	Trace
63	N7	135	Total	C	N	O	0	0	0
			1092	710	202	180			
63	n7	135	Total	C	N	O	0	0	0
			1092	710	202	180			

- Molecule 64 is a protein called 60S ribosomal protein L28.

Mol	Chain	Residues	Atoms					ZeroOcc	AltConf	Trace
64	N8	148	Total	C	N	O	S	0	0	0
			1173	749	231	190	3			
64	n8	148	Total	C	N	O	S	0	0	0
			1173	749	231	190	3			

- Molecule 65 is a protein called 60S ribosomal protein L29.

Mol	Chain	Residues	Atoms				ZeroOcc	AltConf	Trace
65	N9	58	Total	C	N	O	0	0	0
			462	289	100	73			
65	n9	58	Total	C	N	O	0	0	0
			462	289	100	73			

- Molecule 66 is a protein called 60S ribosomal protein L30.

Mol	Chain	Residues	Atoms					ZeroOcc	AltConf	Trace
66	O0	97	Total	C	N	O	S	0	0	0
			743	479	124	139	1			
66	o0	100	Total	C	N	O	S	0	0	0
			767	492	128	146	1			

- Molecule 67 is a protein called 60S ribosomal protein L31-A.

Mol	Chain	Residues	Atoms					ZeroOcc	AltConf	Trace
67	O1	109	Total	C	N	O	S	0	0	0
			876	556	167	152	1			
67	o1	109	Total	C	N	O	S	0	0	0
			883	559	167	156	1			

- Molecule 68 is a protein called 60S ribosomal protein L32.

Mol	Chain	Residues	Atoms					ZeroOcc	AltConf	Trace
68	O2	127	Total	C	N	O	S	0	0	0
			1020	647	205	167	1			

Continued on next page...

Continued from previous page...

Mol	Chain	Residues	Atoms					ZeroOcc	AltConf	Trace
68	o2	127	Total	C	N	O	S	0	0	0
			1020	647	205	167	1			

- Molecule 69 is a protein called 60S ribosomal protein L33-A.

Mol	Chain	Residues	Atoms					ZeroOcc	AltConf	Trace
69	O3	106	Total	C	N	O	S	0	0	0
			850	540	165	144	1			
69	o3	106	Total	C	N	O	S	0	0	0
			850	540	165	144	1			

- Molecule 70 is a protein called 60S ribosomal protein L34-A.

Mol	Chain	Residues	Atoms					ZeroOcc	AltConf	Trace
70	O4	112	Total	C	N	O	S	0	0	0
			880	545	179	152	4			
70	o4	112	Total	C	N	O	S	0	0	0
			880	545	179	152	4			

- Molecule 71 is a protein called 60S ribosomal protein L35-A.

Mol	Chain	Residues	Atoms					ZeroOcc	AltConf	Trace
71	O5	119	Total	C	N	O	S	0	0	0
			969	615	186	167	1			
71	o5	119	Total	C	N	O	S	0	0	0
			965	612	185	167	1			

- Molecule 72 is a protein called 60S ribosomal protein L36-A.

Mol	Chain	Residues	Atoms					ZeroOcc	AltConf	Trace
72	O6	99	Total	C	N	O	S	0	0	0
			771	481	156	132	2			
72	o6	99	Total	C	N	O	S	0	0	0
			770	481	156	131	2			

- Molecule 73 is a protein called 60S ribosomal protein L37-A.

Mol	Chain	Residues	Atoms					ZeroOcc	AltConf	Trace
73	O7	87	Total	C	N	O	S	0	0	0
			681	414	148	114	5			
73	o7	87	Total	C	N	O	S	0	0	0
			681	414	148	114	5			

- Molecule 74 is a protein called 60S ribosomal protein L38.

Mol	Chain	Residues	Atoms				ZeroOcc	AltConf	Trace
74	O8	77	Total	C	N	O	0	0	0
			612	391	115	106			
74	o8	77	Total	C	N	O	0	0	0
			608	388	114	106			

- Molecule 75 is a protein called 60S ribosomal protein L39.

Mol	Chain	Residues	Atoms					ZeroOcc	AltConf	Trace
75	O9	50	Total	C	N	O	S	0	0	0
			436	272	97	65	2			
75	o9	50	Total	C	N	O	S	0	0	0
			436	272	97	65	2			

- Molecule 76 is a protein called Ubiquitin-60S ribosomal protein L40.

Mol	Chain	Residues	Atoms					ZeroOcc	AltConf	Trace
76	Q0	52	Total	C	N	O	S	0	0	0
			417	259	86	67	5			
76	q0	52	Total	C	N	O	S	0	0	0
			417	259	86	67	5			

- Molecule 77 is a protein called 60S ribosomal protein L41-A.

Mol	Chain	Residues	Atoms					ZeroOcc	AltConf	Trace
77	Q1	25	Total	C	N	O	S	0	0	0
			233	142	63	27	1			
77	q1	25	Total	C	N	O	S	0	0	0
			233	142	63	27	1			

- Molecule 78 is a protein called 60S ribosomal protein L42-A.

Mol	Chain	Residues	Atoms					ZeroOcc	AltConf	Trace
78	Q2	105	Total	C	N	O	S	0	0	0
			847	534	170	138	5			
78	q2	105	Total	C	N	O	S	0	0	0
			847	534	170	138	5			

- Molecule 79 is a protein called 60S ribosomal protein L43-A.

Mol	Chain	Residues	Atoms					ZeroOcc	AltConf	Trace
79	Q3	91	Total	C	N	O	S	0	0	0
			694	429	138	121	6			
79	q3	91	Total	C	N	O	S	0	0	0
			694	429	138	121	6			

- Molecule 80 is a protein called 60S ribosomal protein L12-A (uL11).

Mol	Chain	Residues	Atoms				ZeroOcc	AltConf	Trace
80	m2	150	Total	C	N	O	0	0	0
			750	450	150	150			

- Molecule 81 is a protein called 60S acidic ribosomal protein P0.

Mol	Chain	Residues	Atoms					ZeroOcc	AltConf	Trace
81	p0	143	Total	C	N	O	S	0	0	0
			1077	687	192	195	3			

- Molecule 82 is a protein called 60S ribosomal protein P1 alpha/P2 beta.

Mol	Chain	Residues	Atoms				ZeroOcc	AltConf	Trace
82	p1	47	Total	C	N	O	0	0	0
			235	141	47	47			
82	p2	46	Total	C	N	O	0	0	0
			230	138	46	46			

- Molecule 83 is a protein called Eukaryotic translation initiation factor 5A-1.

Mol	Chain	Residues	Atoms					ZeroOcc	AltConf	Trace
83	f	148	Total	C	N	O	S	0	0	0
			1116	692	188	227	9			

- Molecule 84 is an unknown type called CH-CH-8AN-PRO-PRO.

Mol	Chain	Residues	Atoms					ZeroOcc	AltConf
84	B	5	Total	C	N	O	P	0	0
			76	38	14	21	3		
84	C	5	Total	C	N	O	P	0	0
			73	38	14	19	2		

- Molecule 85 is ZINC ION (three-letter code: ZN) (formula: Zn).

Mol	Chain	Residues	Atoms	ZeroOcc	AltConf
85	D6	1	Total Zn 1 1	0	0
85	D7	1	Total Zn 1 1	0	0
85	D9	1	Total Zn 1 1	0	0
85	E1	1	Total Zn 1 1	0	0
85	O7	1	Total Zn 1 1	0	0
85	Q0	1	Total Zn 1 1	0	0
85	Q2	1	Total Zn 1 1	0	0
85	Q3	1	Total Zn 1 1	0	0
85	d6	1	Total Zn 1 1	0	0
85	d7	1	Total Zn 1 1	0	0
85	d9	1	Total Zn 1 1	0	0
85	e1	1	Total Zn 1 1	0	0
85	o7	1	Total Zn 1 1	0	0
85	q0	1	Total Zn 1 1	0	0
85	q2	1	Total Zn 1 1	0	0
85	q3	1	Total Zn 1 1	0	0

- Molecule 86 is SPARSOMYCIN (three-letter code: SPS) (formula: $C_{13}H_{19}N_3O_5S_2$).

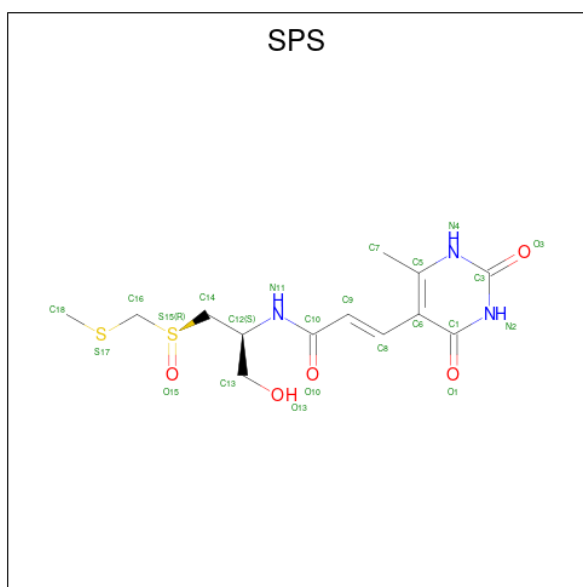

Mol	Chain	Residues	Atoms					ZeroOcc	AltConf
86	1	1	Total	C	N	O	S	0	0
			23	13	3	5	2		
86	B	1	Total	C	N	O	S	0	0
			23	13	3	5	2		

- Molecule 87 is MAGNESIUM ION (three-letter code: MG) (formula: Mg).

Mol	Chain	Residues	Atoms		ZeroOcc	AltConf
87	1	3	Total	Mg	0	0
			3	3		
87	5	5	Total	Mg	0	0
			5	5		
87	f	2	Total	Mg	0	0
			2	2		
87	B	1	Total	Mg	0	0
			1	1		
87	C	1	Total	Mg	0	0
			1	1		

- Molecule 88 is osmium (III) hexammine (three-letter code: OHX) (formula: H₁₂N₆Os).

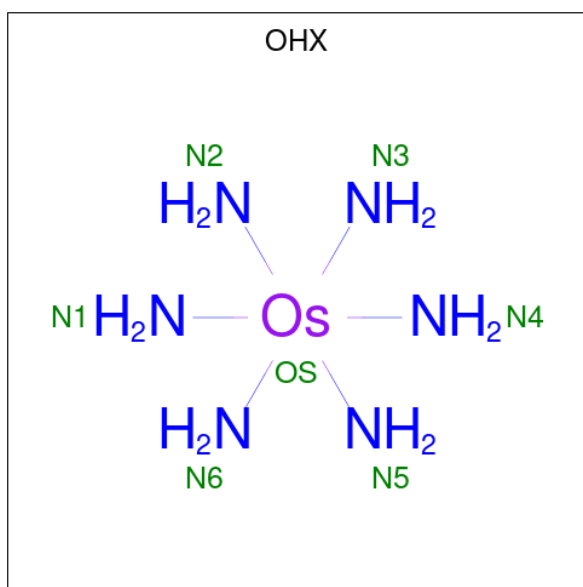

Mol	Chain	Residues	Atoms	ZeroOcc	AltConf
88	1	1	Total N Os 7 6 1	0	0
88	1	1	Total N Os 7 6 1	0	0
88	5	1	Total N Os 7 6 1	0	0

- Molecule 89 is water.

Mol	Chain	Residues	Atoms	ZeroOcc	AltConf
89	5	2	Total O 2 2	0	0
89	f	10	Total O 10 10	0	0

3 Residue-property plots

These plots are drawn for all protein, RNA, DNA and oligosaccharide chains in the entry. The first graphic for a chain summarises the proportions of the various outlier classes displayed in the second graphic. The second graphic shows the sequence view annotated by issues in geometry and electron density. Residues are color-coded according to the number of geometric quality criteria for which they contain at least one outlier: green = 0, yellow = 1, orange = 2 and red = 3 or more. A red dot above a residue indicates a poor fit to the electron density ($RSRZ > 2$). Stretches of 2 or more consecutive residues without any outlier are shown as a green connector. Residues present in the sample, but not in the model, are shown in grey.

- Molecule 1: 18S ribosomal RNA

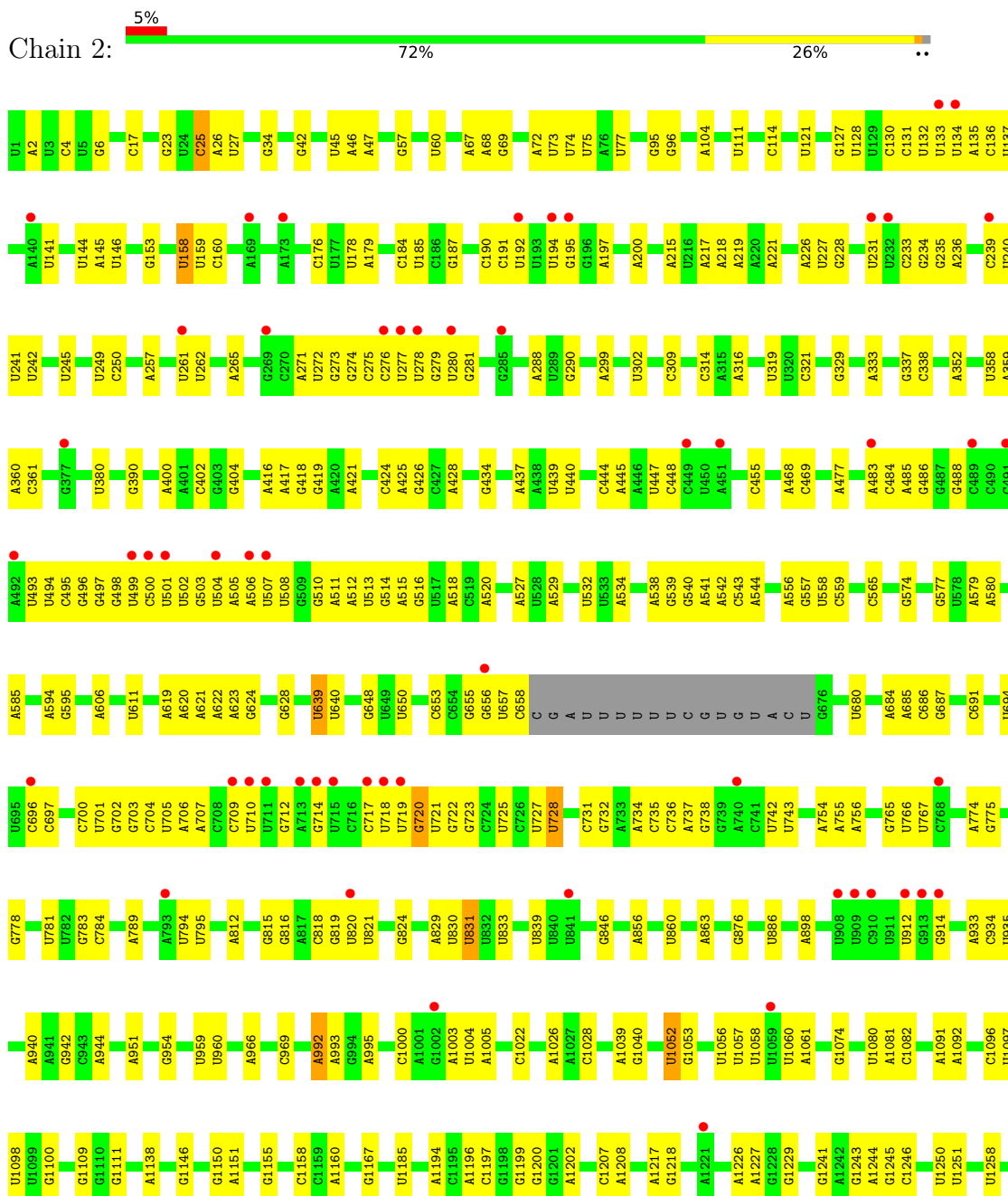

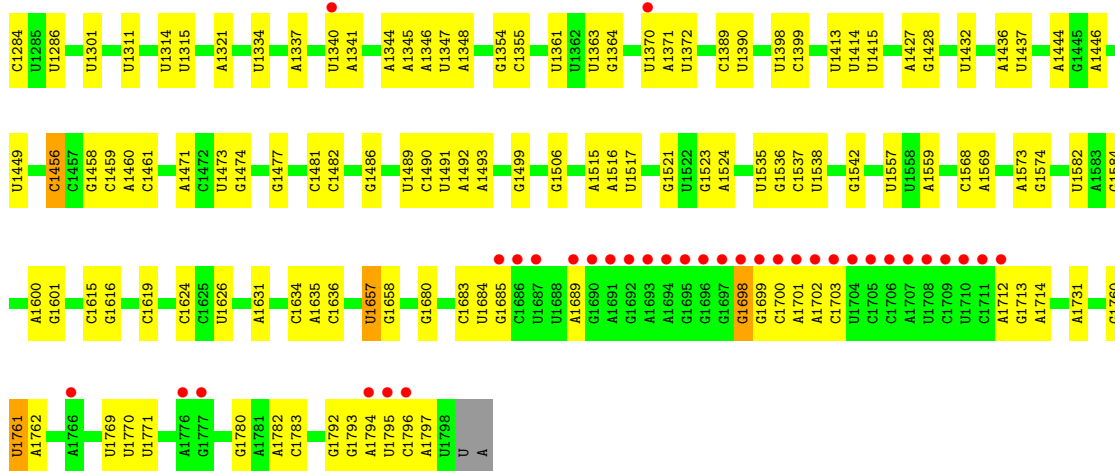

• Molecule 1: 18S ribosomal RNA

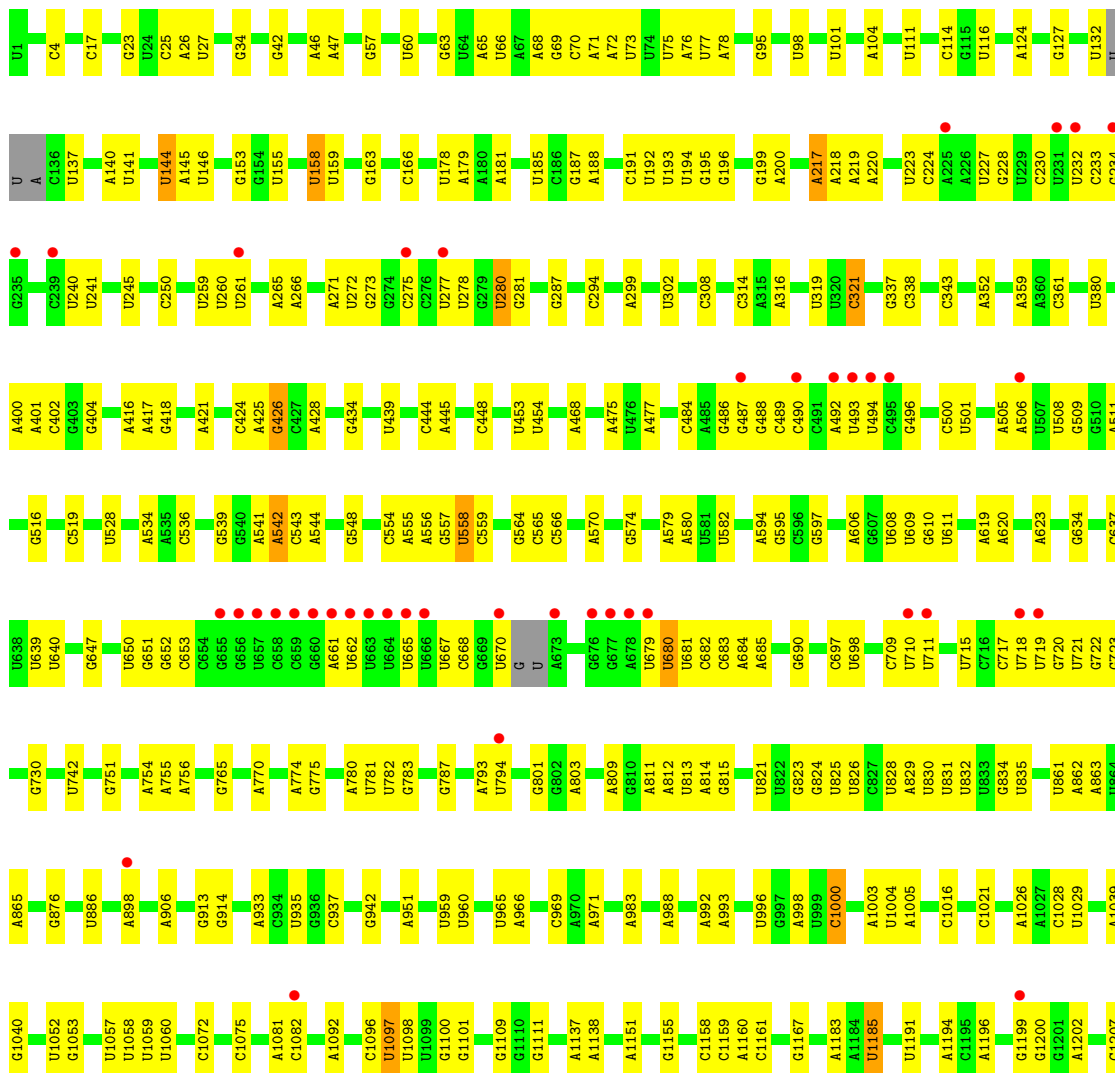
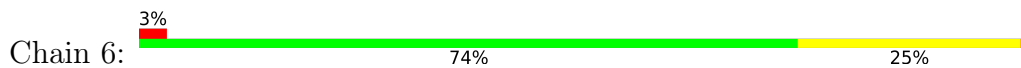

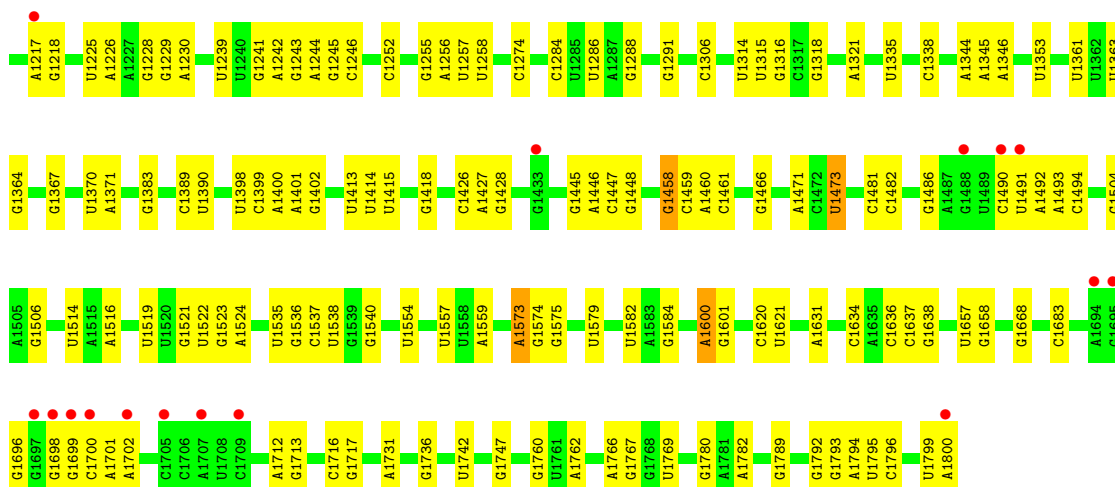

• Molecule 2: 40S ribosomal protein S0-A

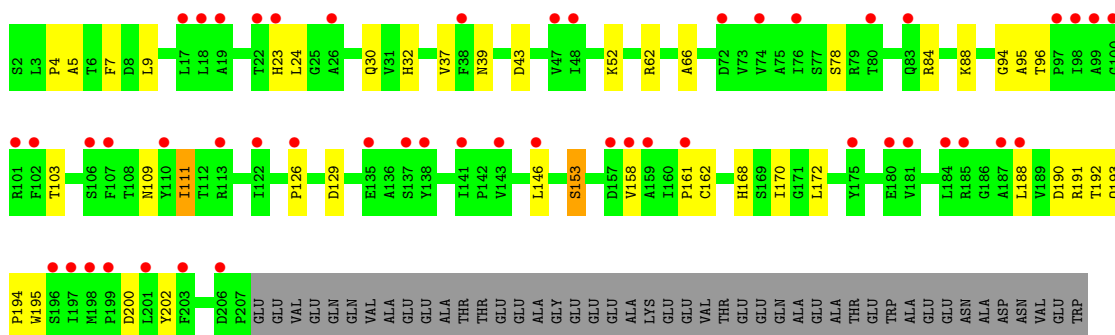

• Molecule 2: 40S ribosomal protein S0-A

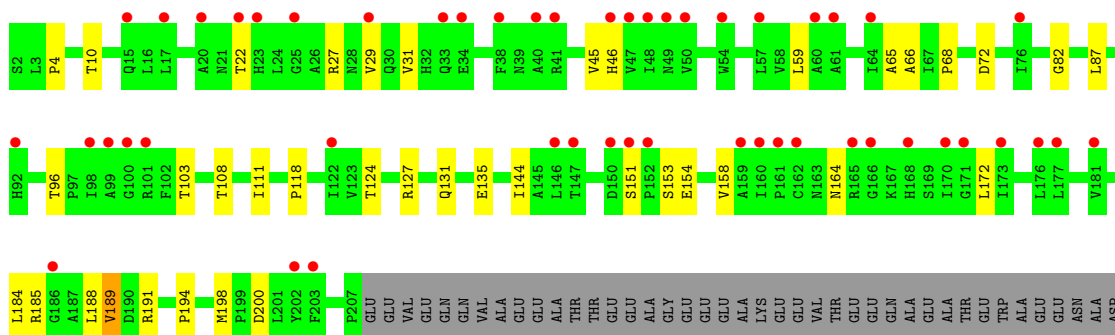

• Molecule 3: 40S ribosomal protein S1-A



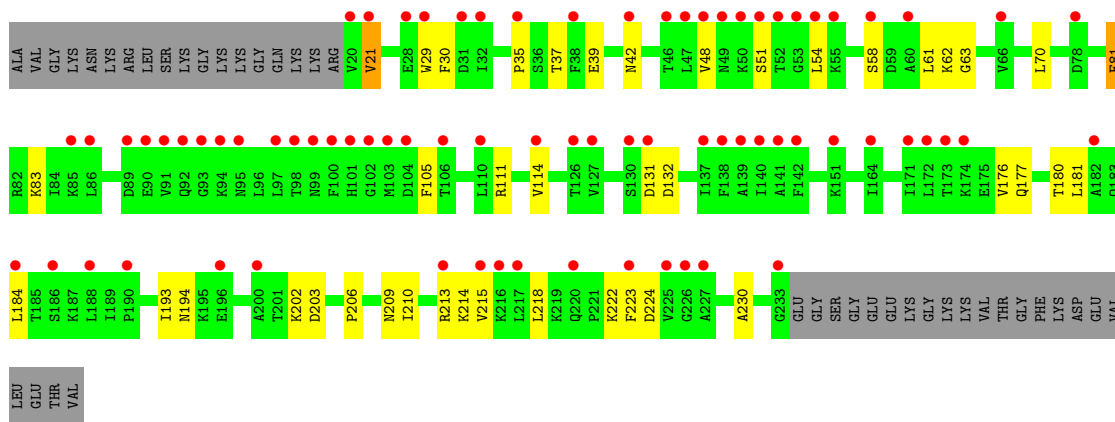

• Molecule 3: 40S ribosomal protein S1-A

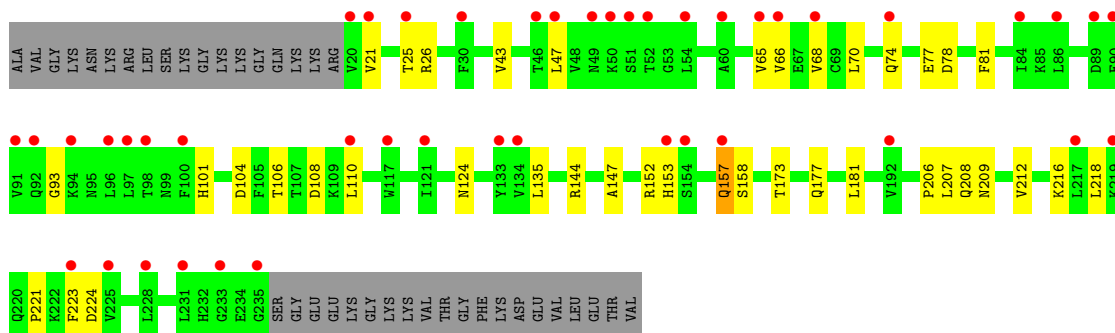

• Molecule 4: 40S ribosomal protein S2

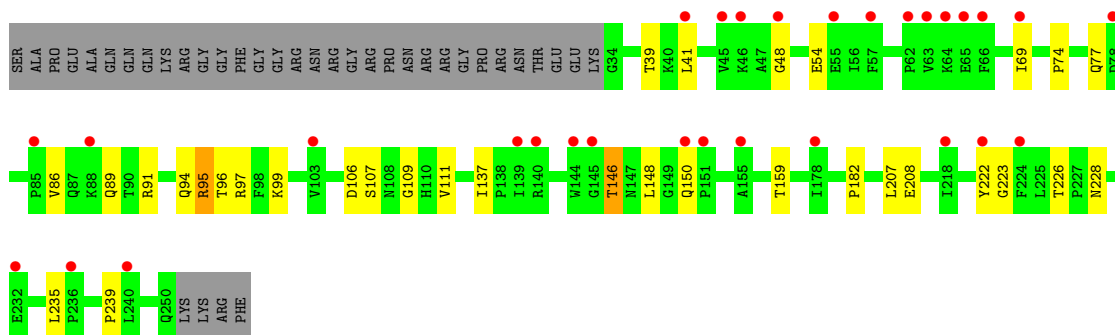
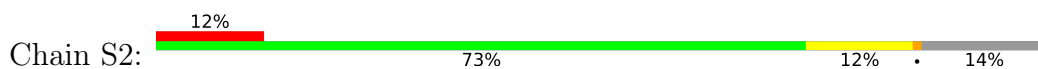

• Molecule 4: 40S ribosomal protein S2

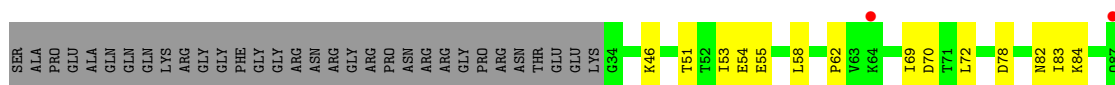

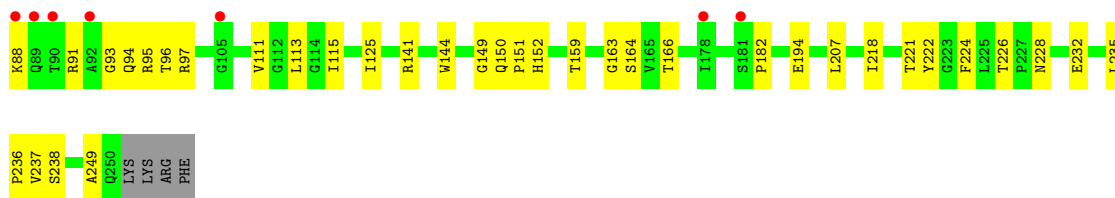

• Molecule 5: 40S ribosomal protein S3

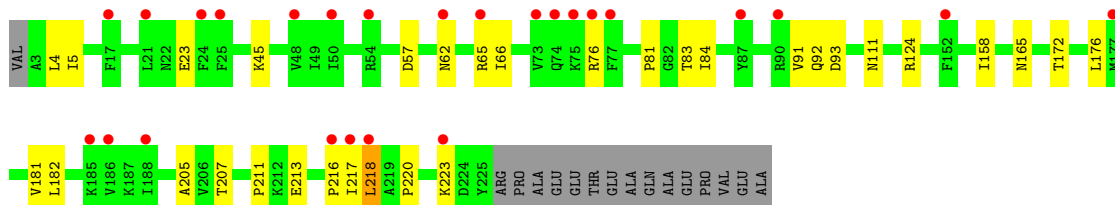
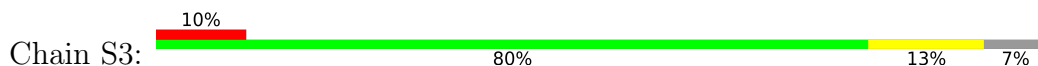

• Molecule 5: 40S ribosomal protein S3

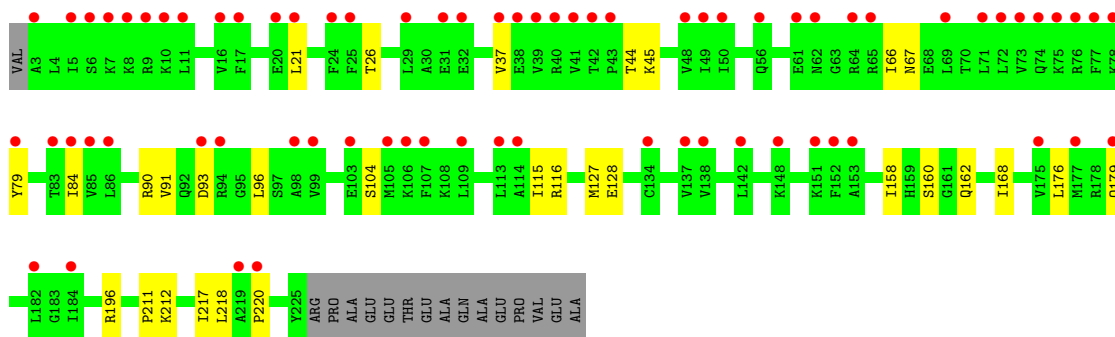
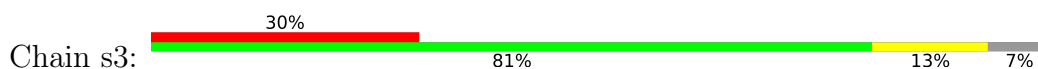

• Molecule 6: 40S ribosomal protein S4-A

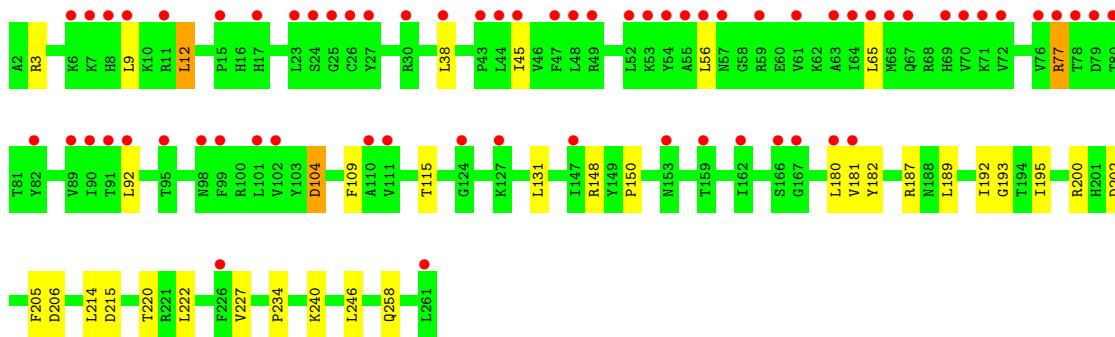
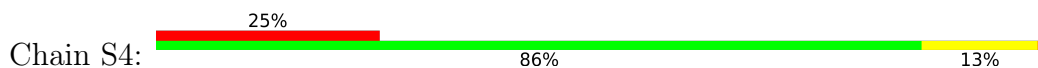

• Molecule 6: 40S ribosomal protein S4-A

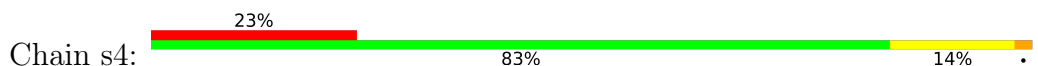

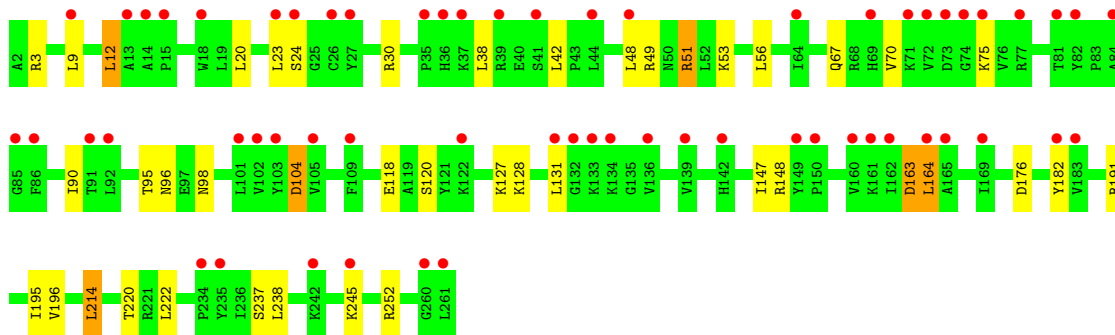

• Molecule 7: 40S ribosomal protein S5

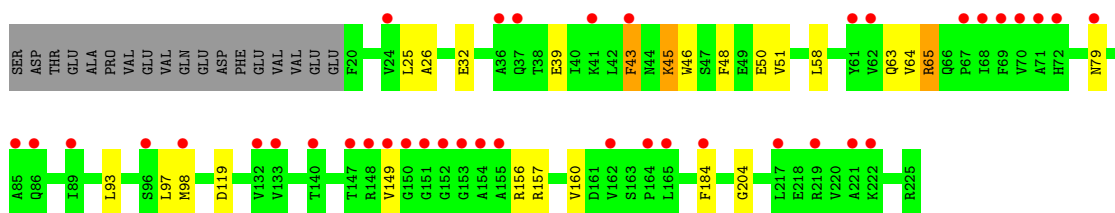
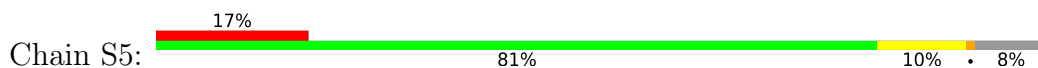

• Molecule 7: 40S ribosomal protein S5

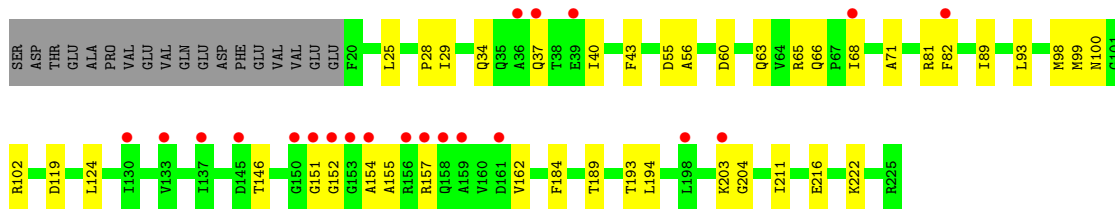
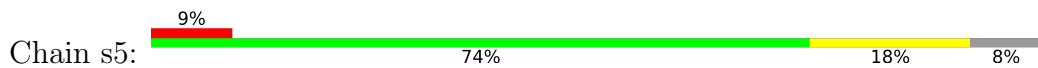

• Molecule 8: 40S ribosomal protein S6-A

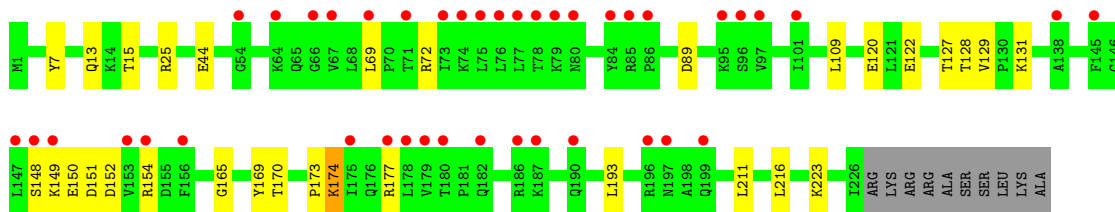
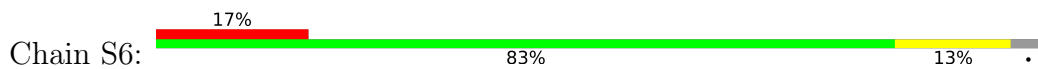

• Molecule 8: 40S ribosomal protein S6-A

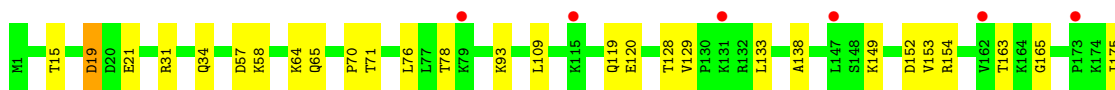
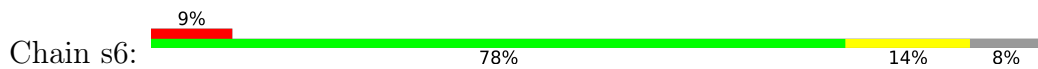

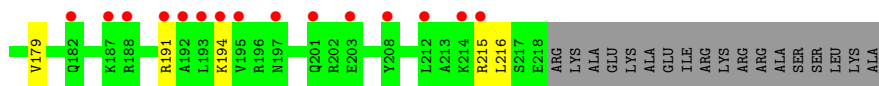

• Molecule 9: 40S ribosomal protein S7-A

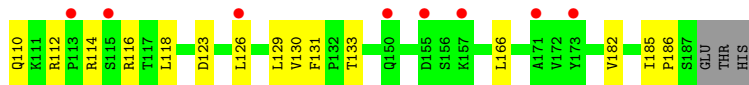
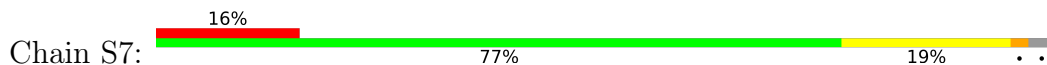

• Molecule 9: 40S ribosomal protein S7-A

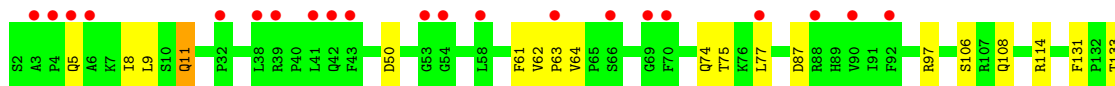
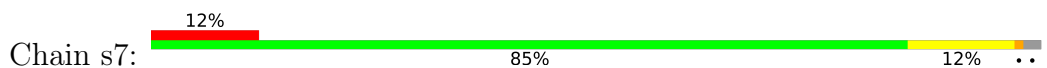

• Molecule 10: 40S ribosomal protein S8-A

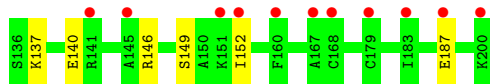
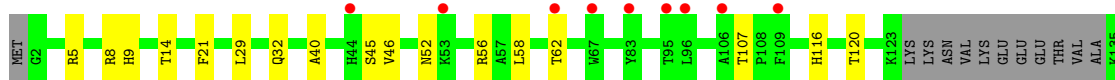
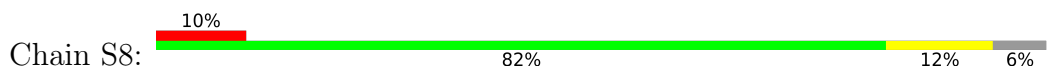

• Molecule 10: 40S ribosomal protein S8-A

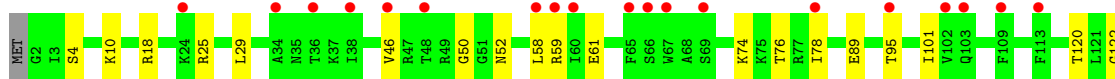
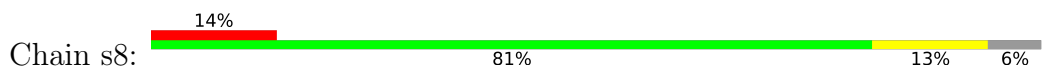

• Molecule 11: 40S ribosomal protein S9-A

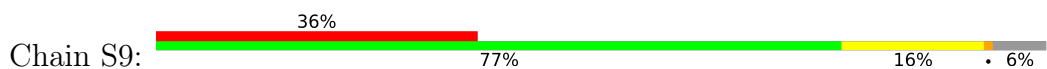

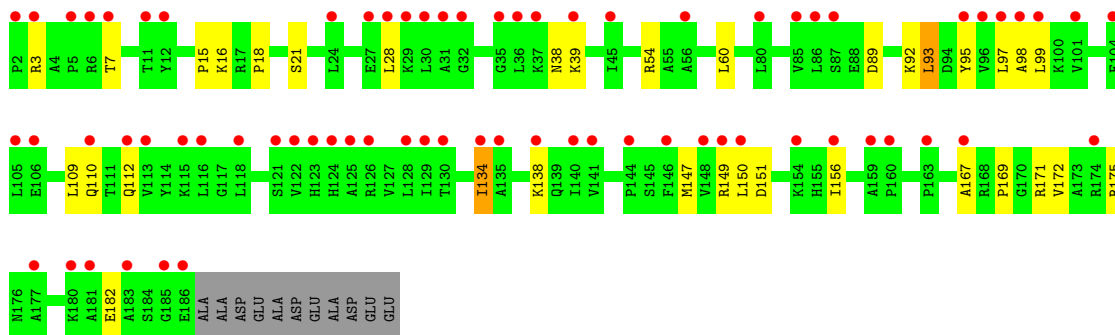

• Molecule 11: 40S ribosomal protein S9-A

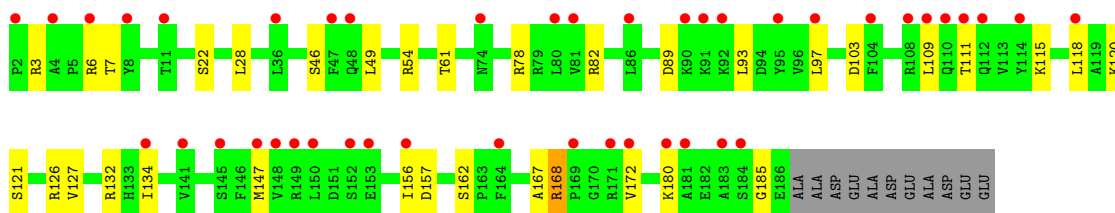
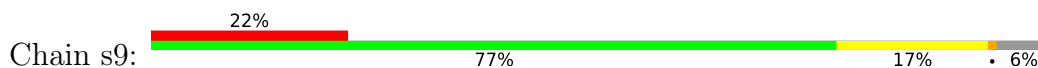

• Molecule 12: 40S ribosomal protein S10-A

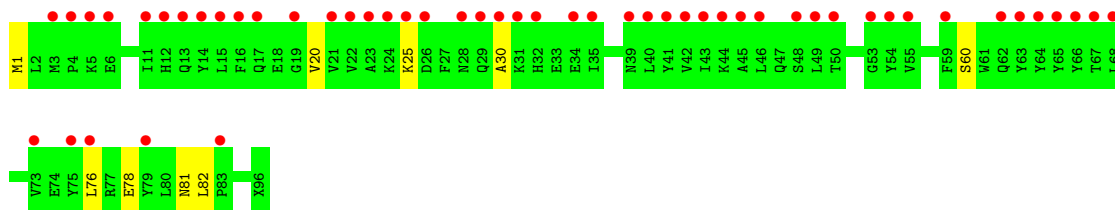
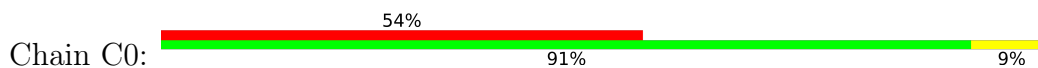

• Molecule 12: 40S ribosomal protein S10-A

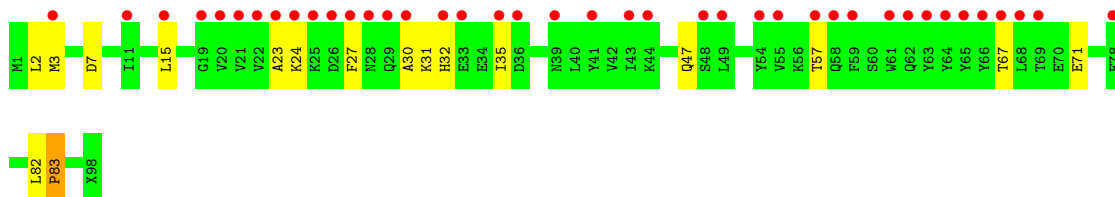
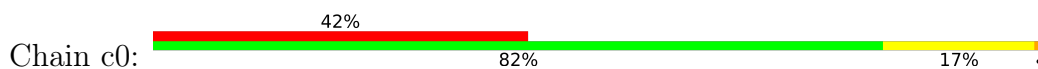

• Molecule 13: 40S ribosomal protein S11-A

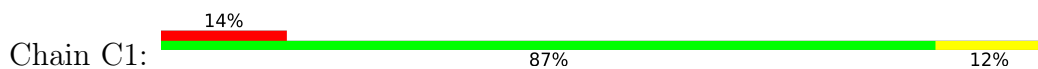



• Molecule 13: 40S ribosomal protein S11-A

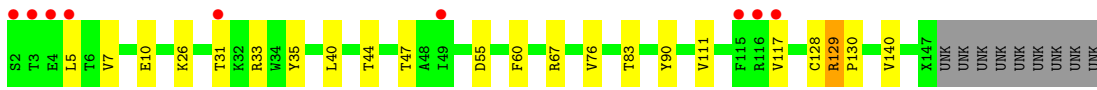
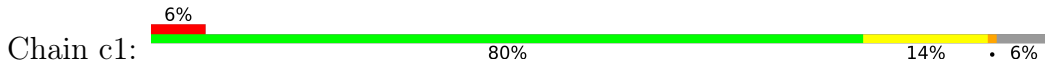

• Molecule 14: 40S ribosomal protein S12

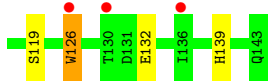
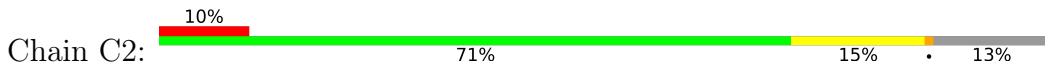

• Molecule 14: 40S ribosomal protein S12

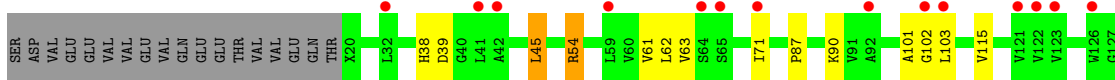
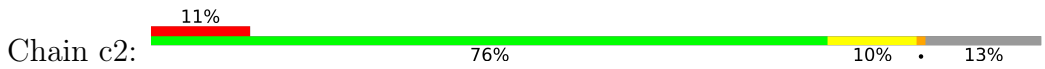

• Molecule 15: 40S ribosomal protein S13

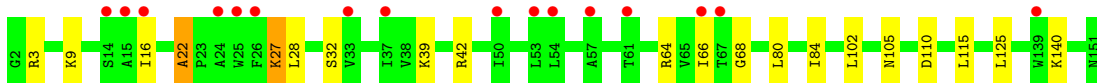
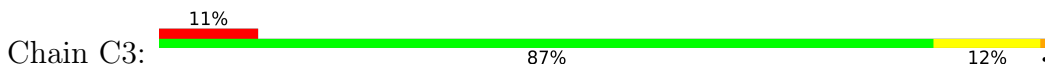

• Molecule 15: 40S ribosomal protein S13

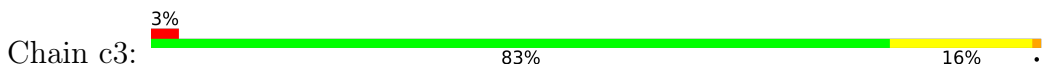

• Molecule 16: 40S ribosomal protein S14-A

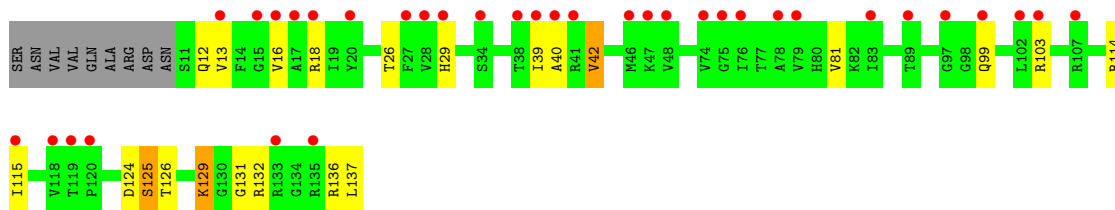
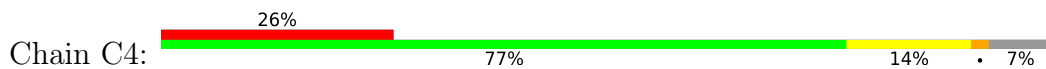

- Molecule 16: 40S ribosomal protein S14-A

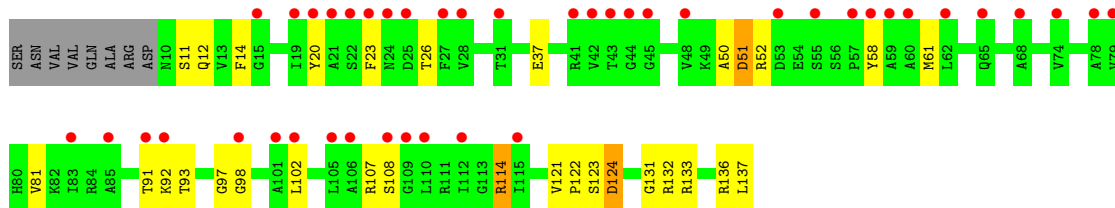

- Molecule 17: 40S ribosomal protein S15 (uS19)

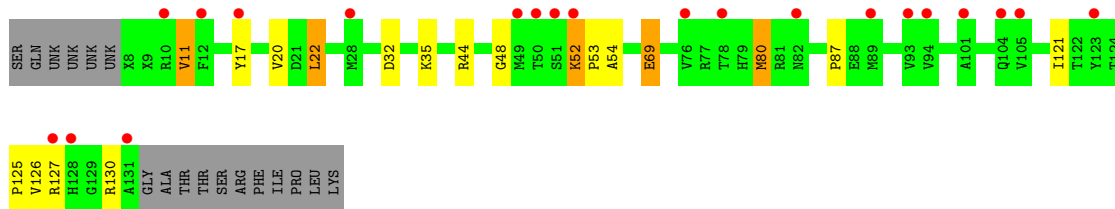
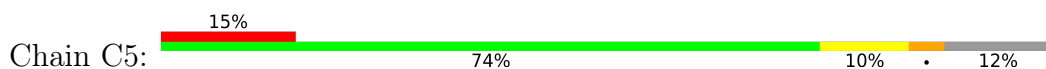

- Molecule 17: 40S ribosomal protein S15 (uS19)

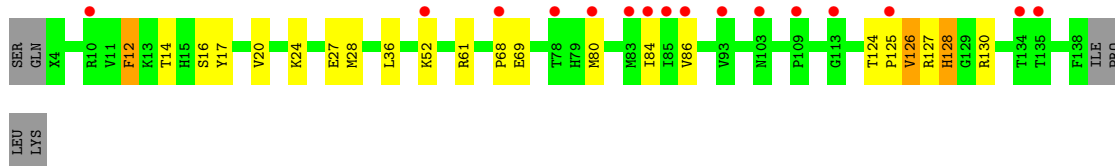
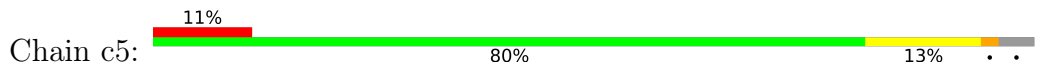

- Molecule 18: 40S ribosomal protein S16-A

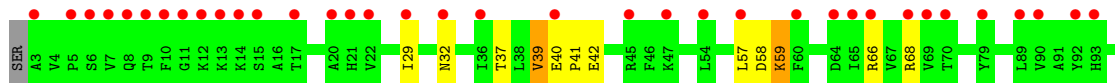
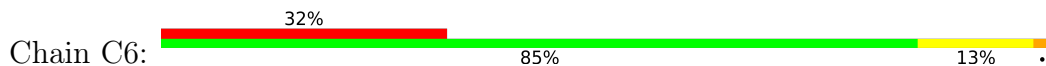



- Molecule 18: 40S ribosomal protein S16-A

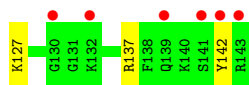
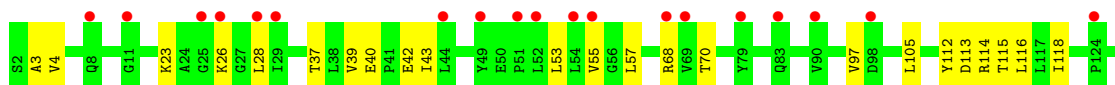
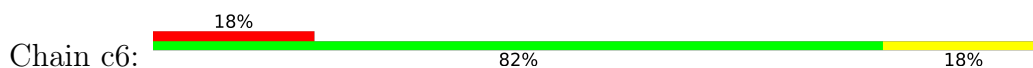

- Molecule 19: 40S ribosomal protein S17-A

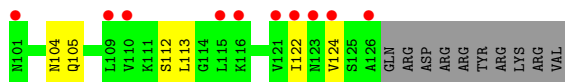
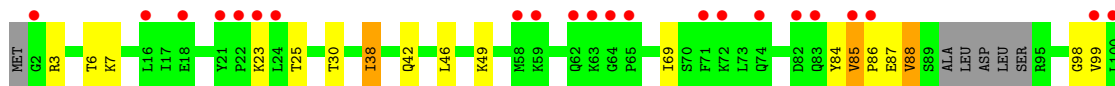
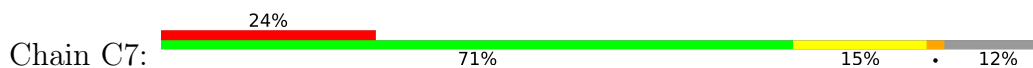

- Molecule 19: 40S ribosomal protein S17-A

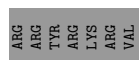
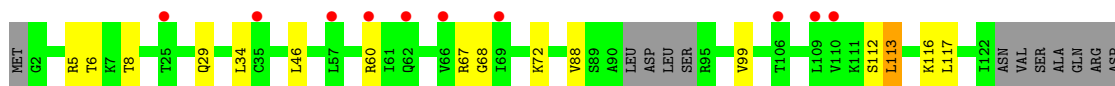
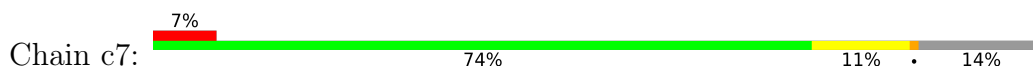

- Molecule 20: 40S ribosomal protein S18-A

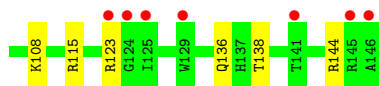
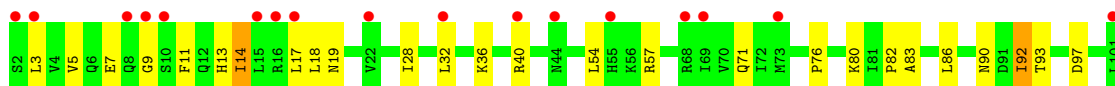
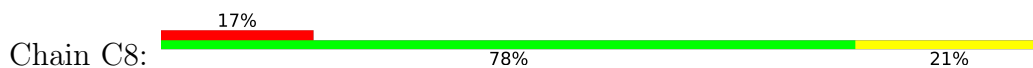

- Molecule 20: 40S ribosomal protein S18-A

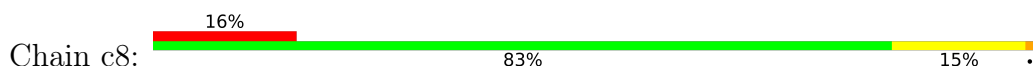

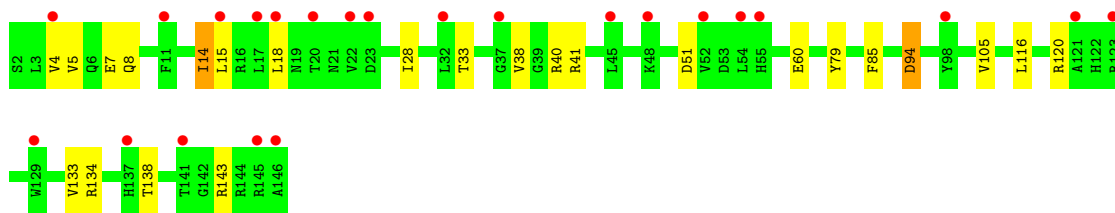

- Molecule 21: 40S ribosomal protein S19-A

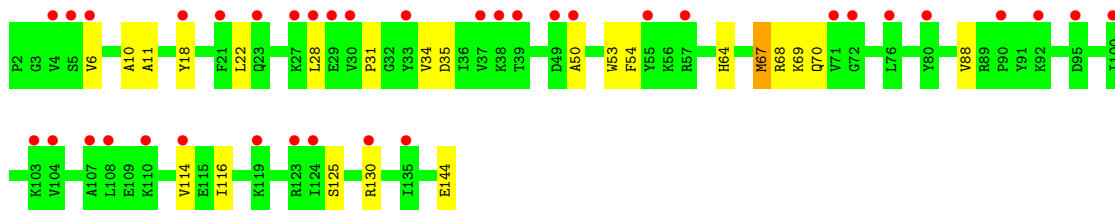
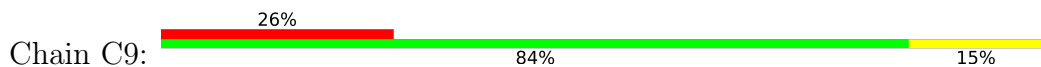

- Molecule 21: 40S ribosomal protein S19-A

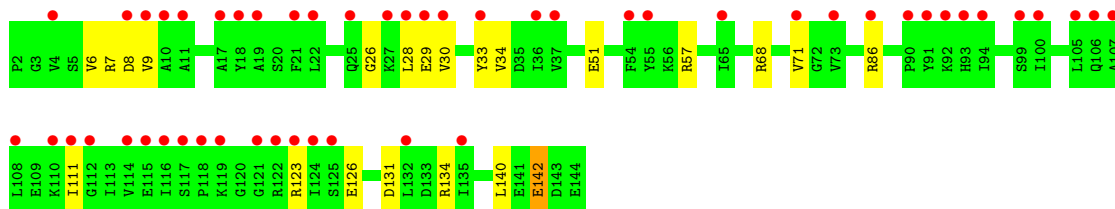
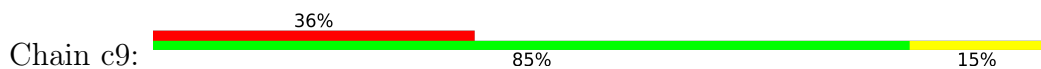

- Molecule 22: 40S ribosomal protein S20

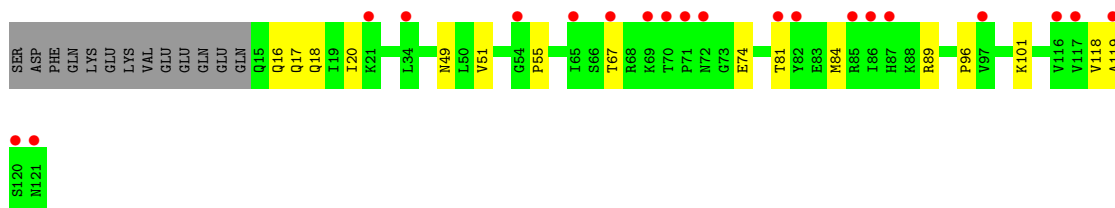
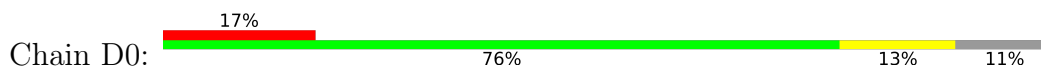

- Molecule 22: 40S ribosomal protein S20

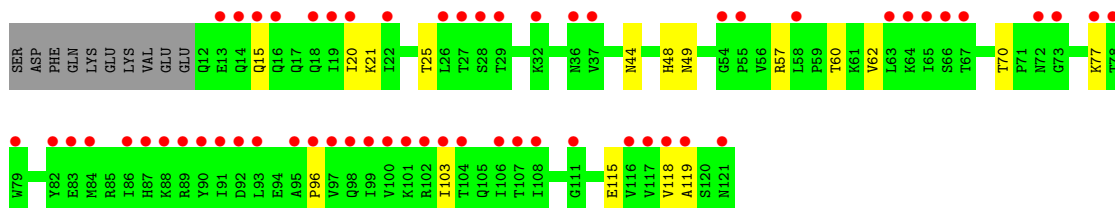
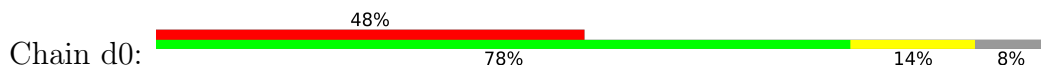

- Molecule 23: 40S ribosomal protein S21-A

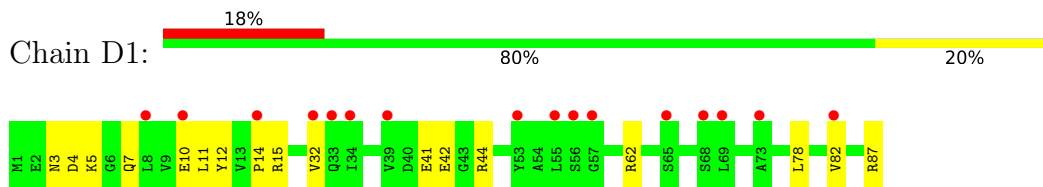

- Molecule 23: 40S ribosomal protein S21-A

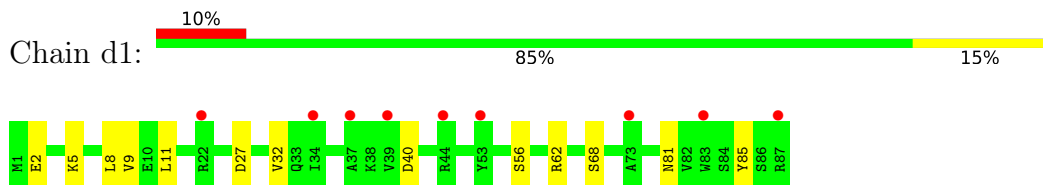

- Molecule 24: 40S ribosomal protein S22-A

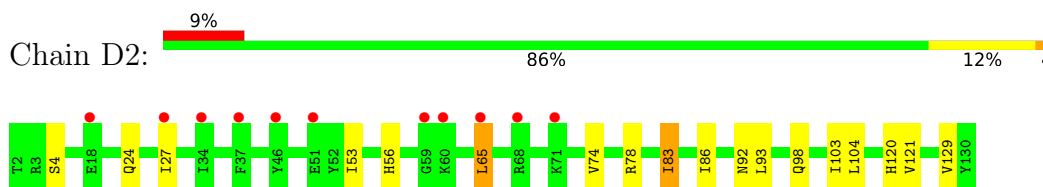

- Molecule 24: 40S ribosomal protein S22-A

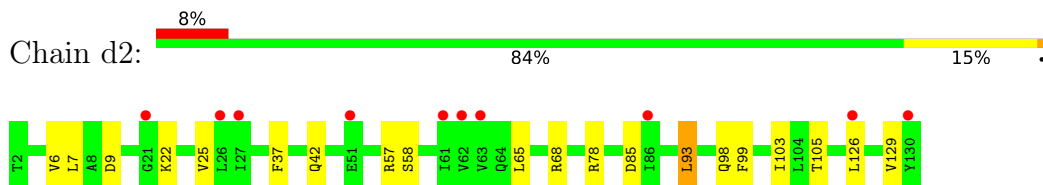

- Molecule 25: 40S ribosomal protein S23-A

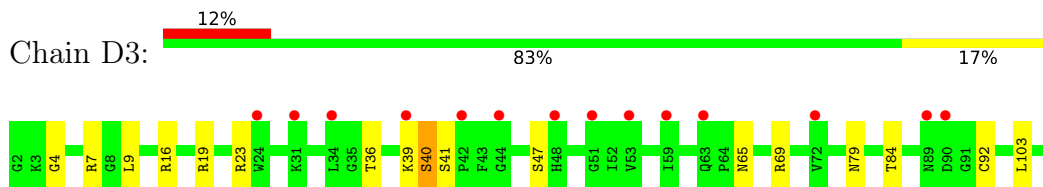

- Molecule 25: 40S ribosomal protein S23-A

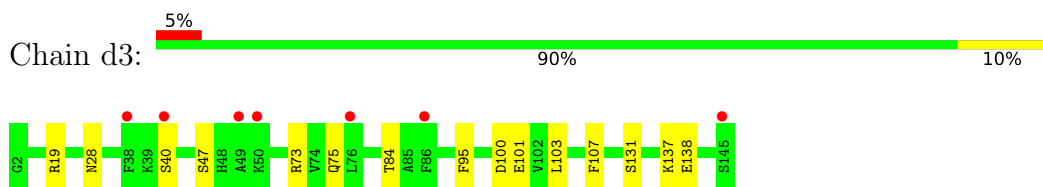

- Molecule 26: 40S ribosomal protein S24-A

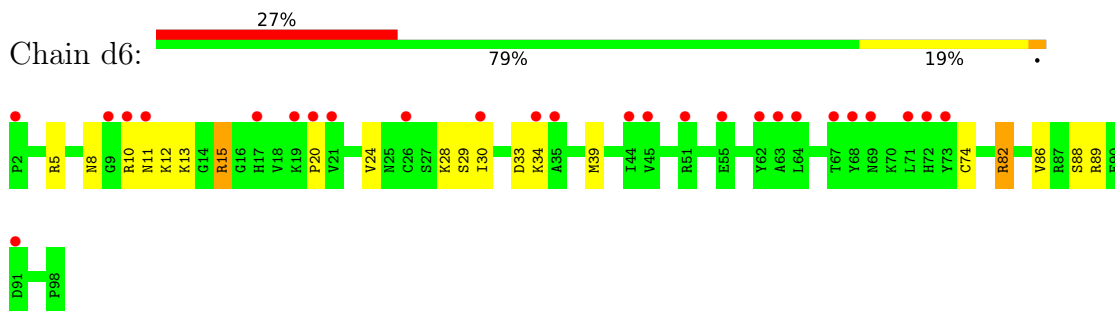

- Molecule 29: 40S ribosomal protein S27-A

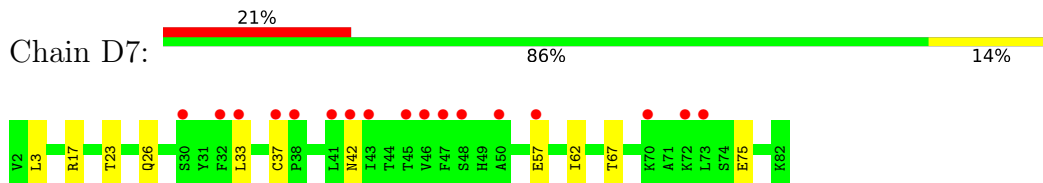

- Molecule 29: 40S ribosomal protein S27-A

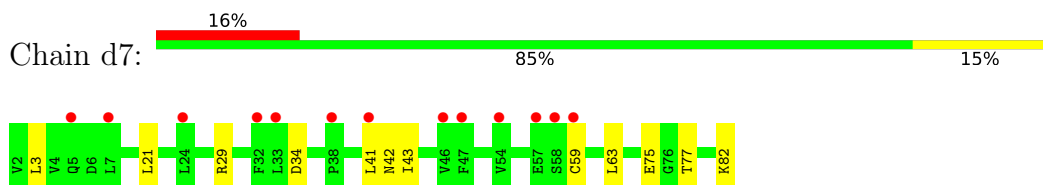

- Molecule 30: 40S ribosomal protein S28-A

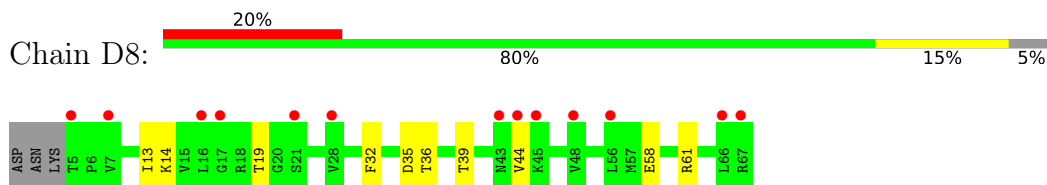

- Molecule 30: 40S ribosomal protein S28-A

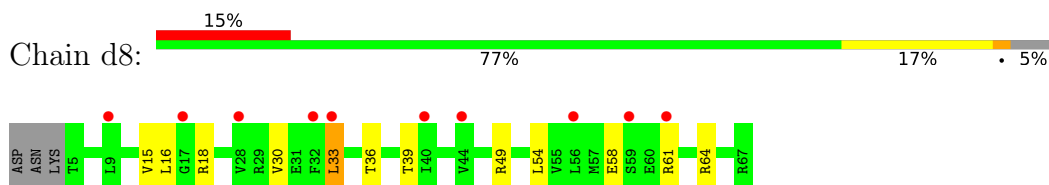

- Molecule 31: 40S ribosomal protein S29-A

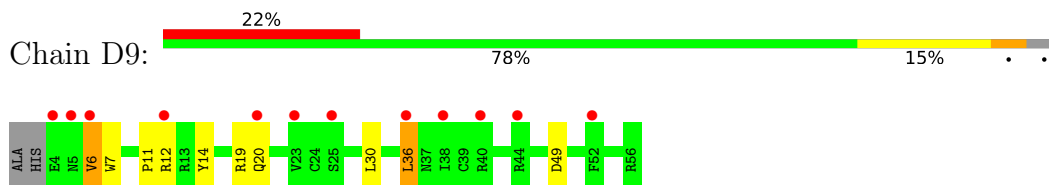

- Molecule 31: 40S ribosomal protein S29-A

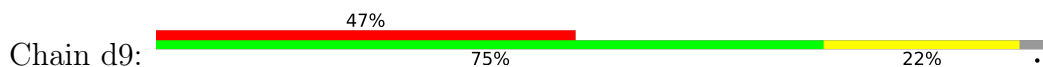



• Molecule 32: 40S ribosomal protein S30-A

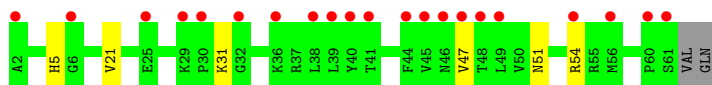
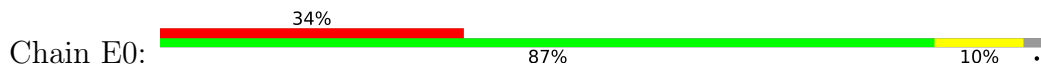

• Molecule 32: 40S ribosomal protein S30-A

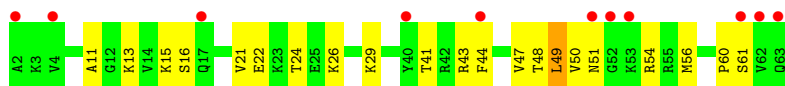

• Molecule 33: Ubiquitin-40S ribosomal protein S31



• Molecule 33: Ubiquitin-40S ribosomal protein S31

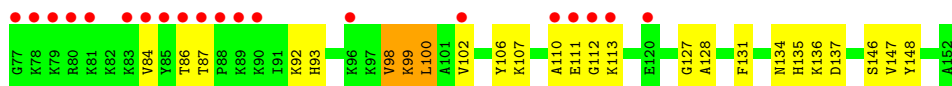

• Molecule 34: Guanine nucleotide-binding protein subunit beta-like protein

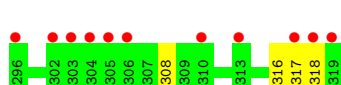
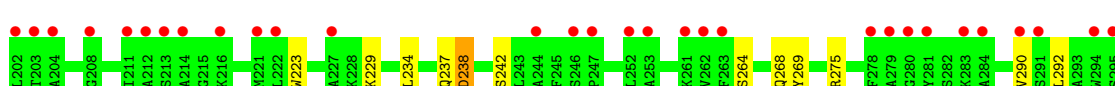
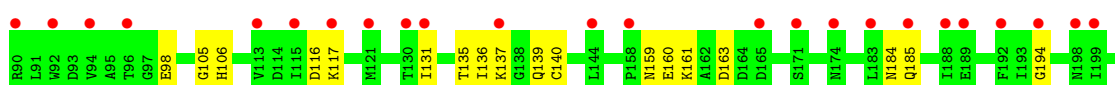
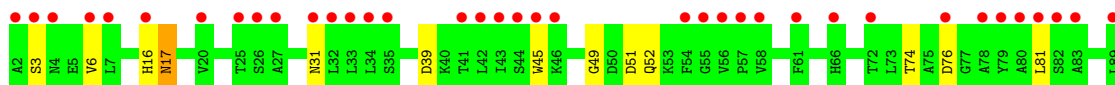
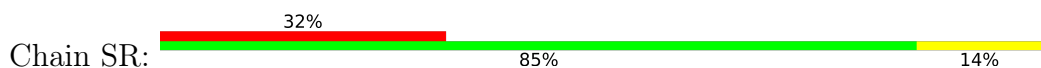

- Molecule 34: Guanine nucleotide-binding protein subunit beta-like protein

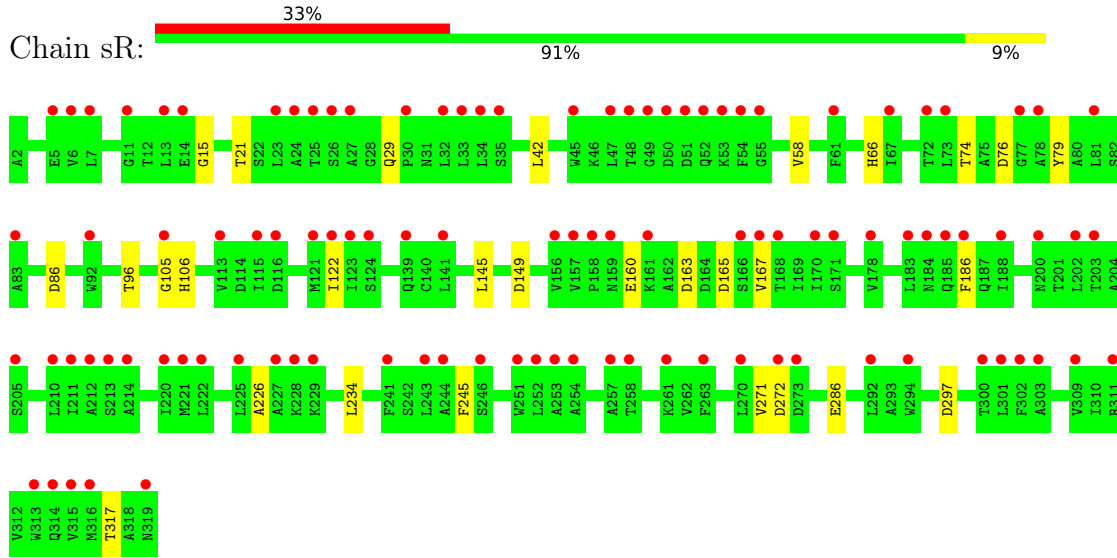

- Molecule 35: Suppressor protein STM1

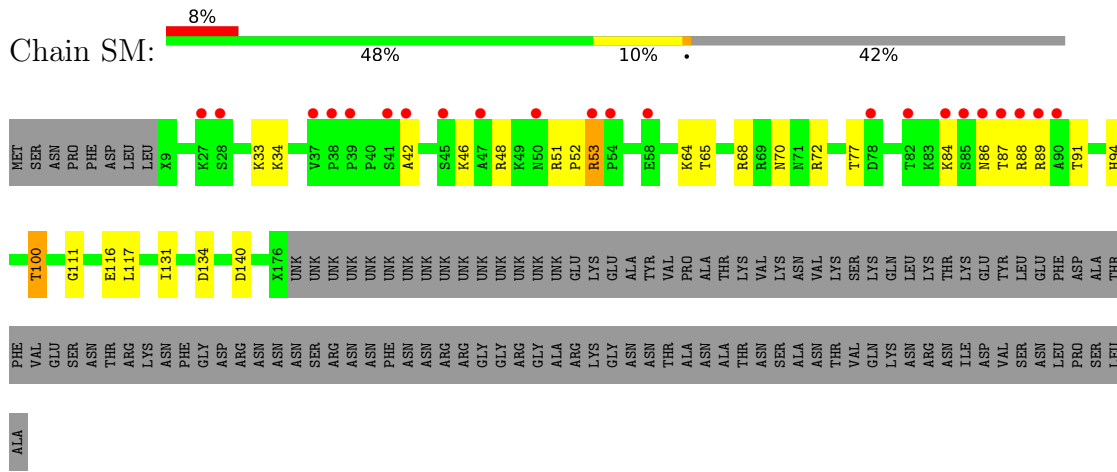

- Molecule 35: Suppressor protein STM1

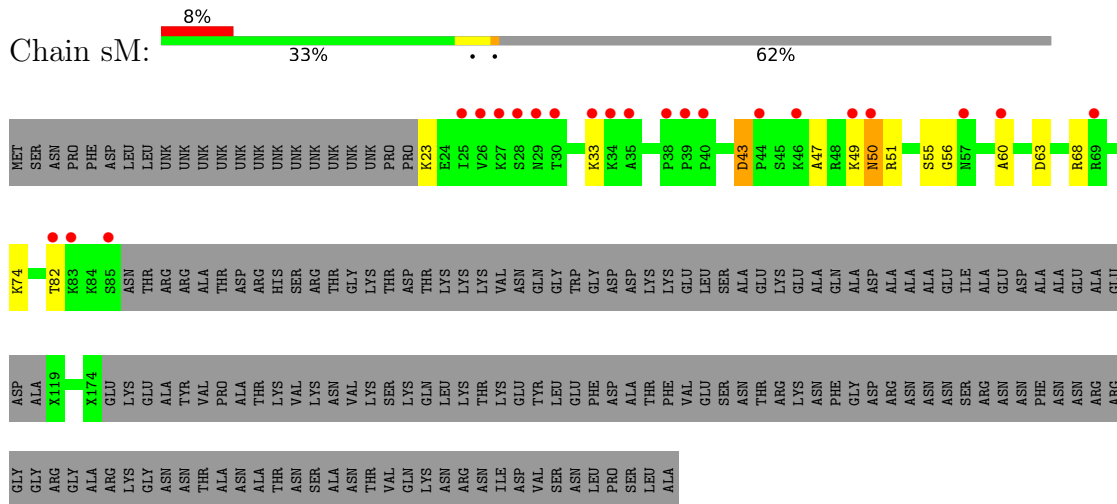

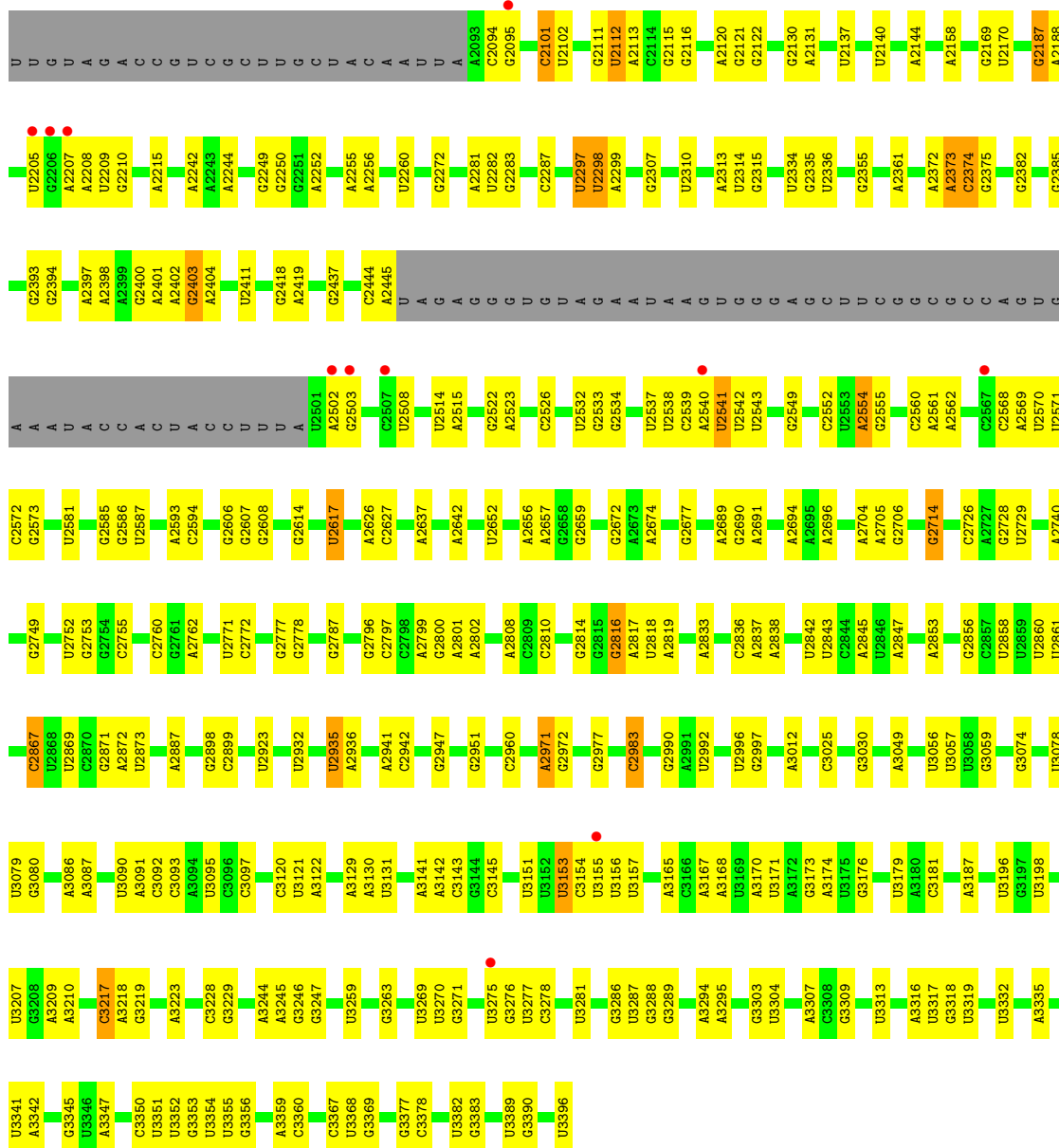

- Molecule 36: 25S ribosomal RNA

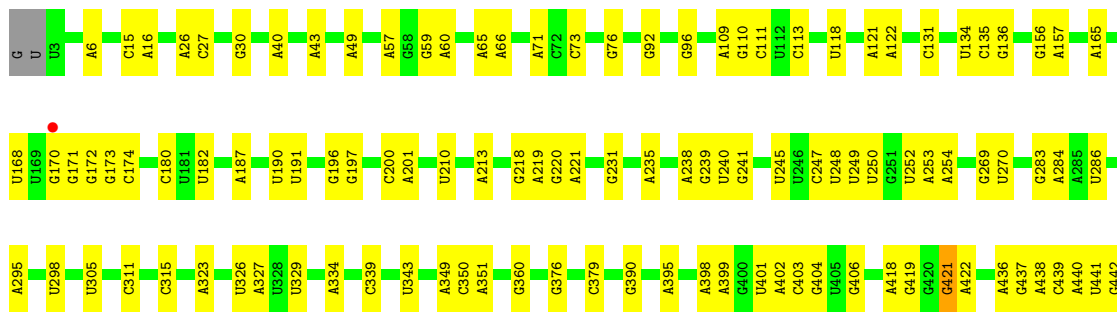

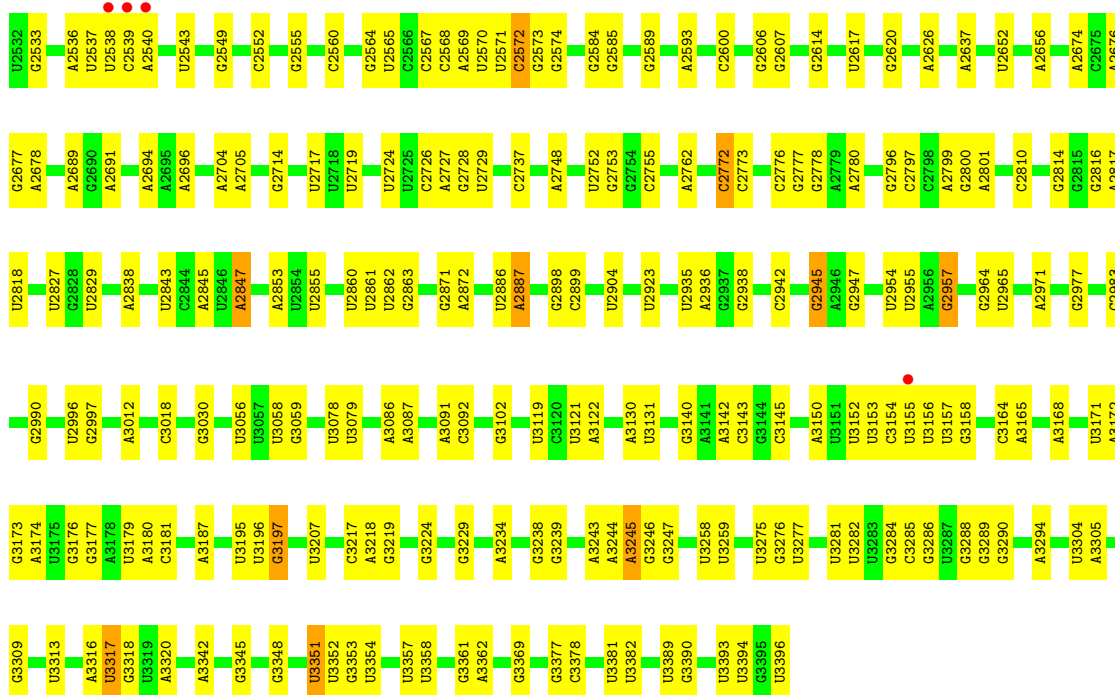

• Molecule 37: 5S ribosomal RNA

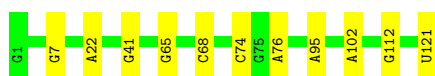
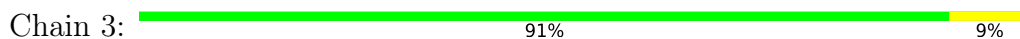

• Molecule 37: 5S ribosomal RNA

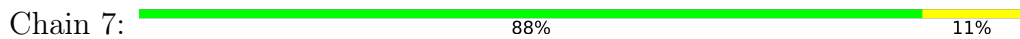

• Molecule 38: 5.8S ribosomal RNA

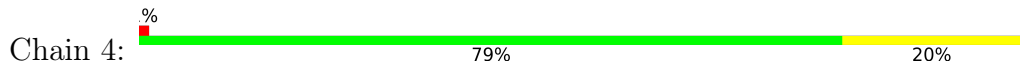

• Molecule 38: 5.8S ribosomal RNA

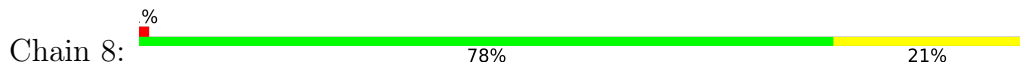

• Molecule 39: 60S ribosomal protein L2-A

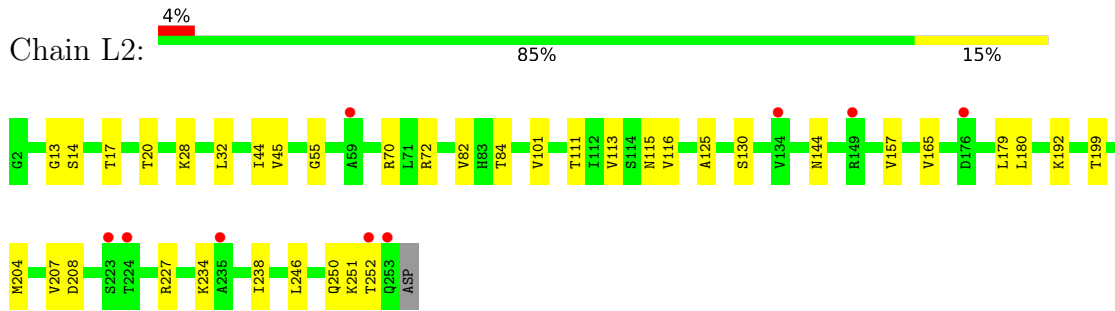

- Molecule 39: 60S ribosomal protein L2-A

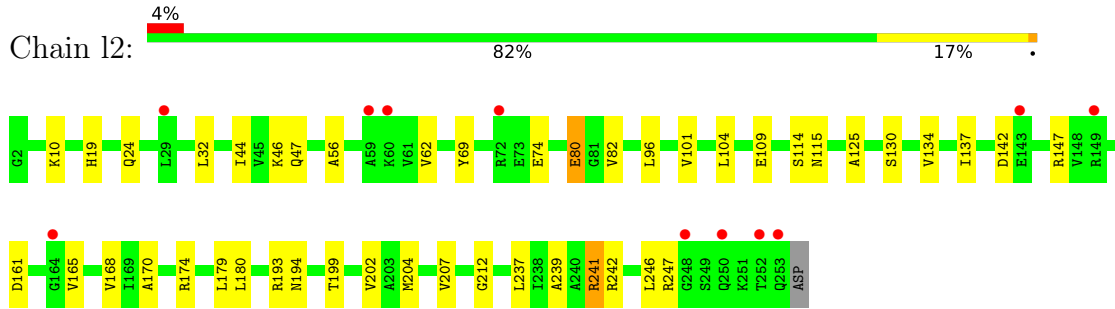

- Molecule 40: 60S ribosomal protein L3

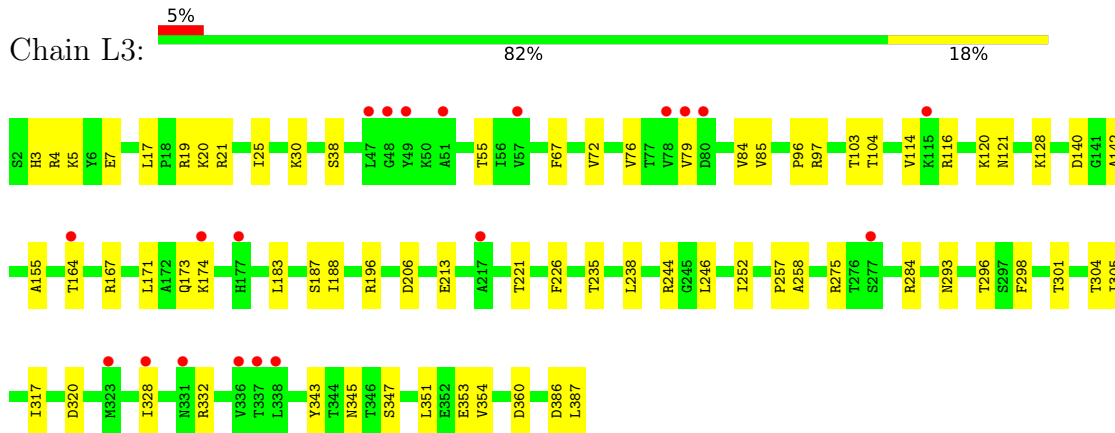

- Molecule 40: 60S ribosomal protein L3

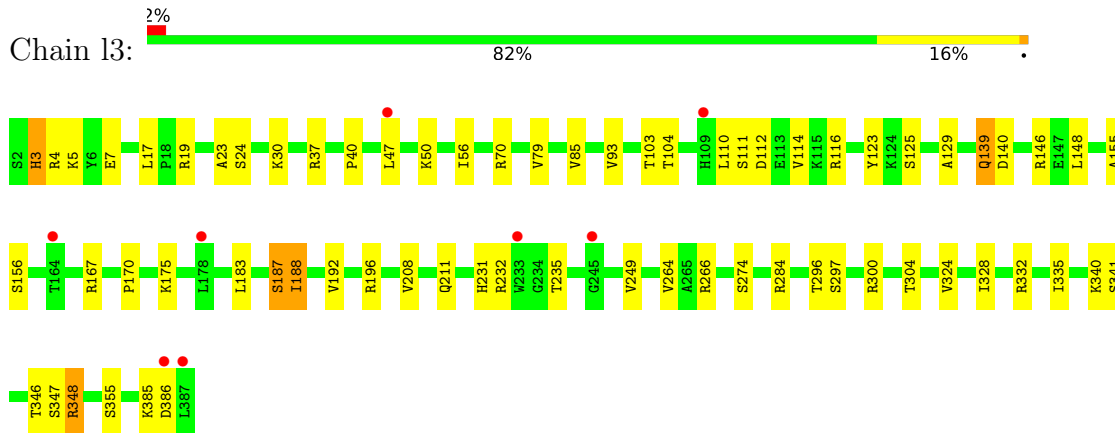

- Molecule 41: 60S ribosomal protein L4-A

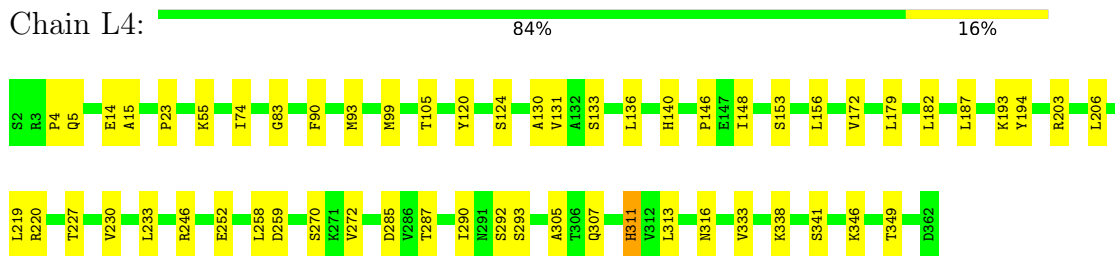

- Molecule 41: 60S ribosomal protein L4-A

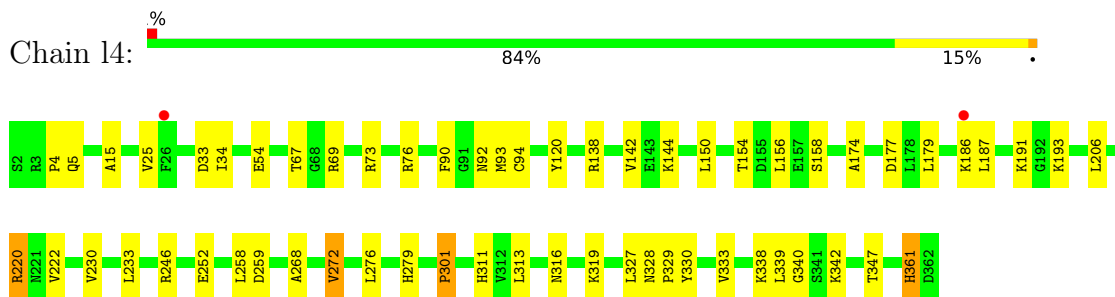

- Molecule 42: 60S ribosomal protein L5

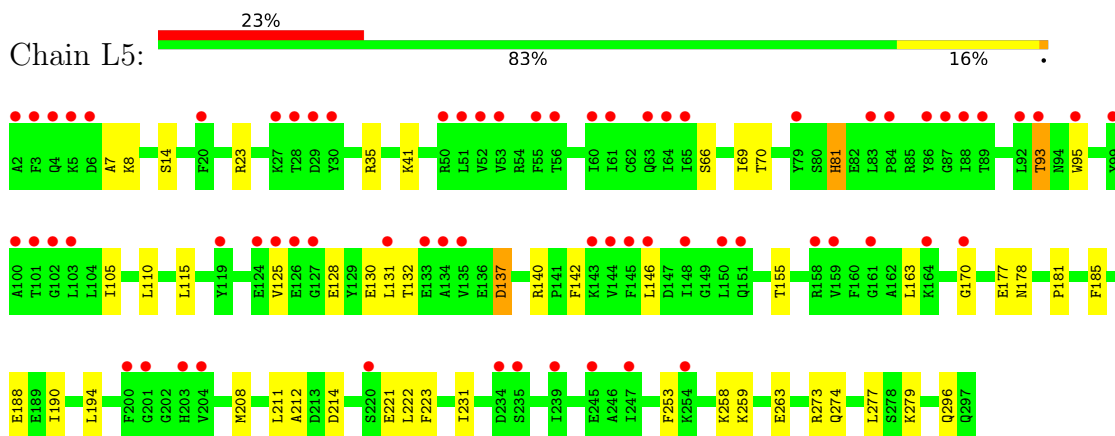

- Molecule 42: 60S ribosomal protein L5

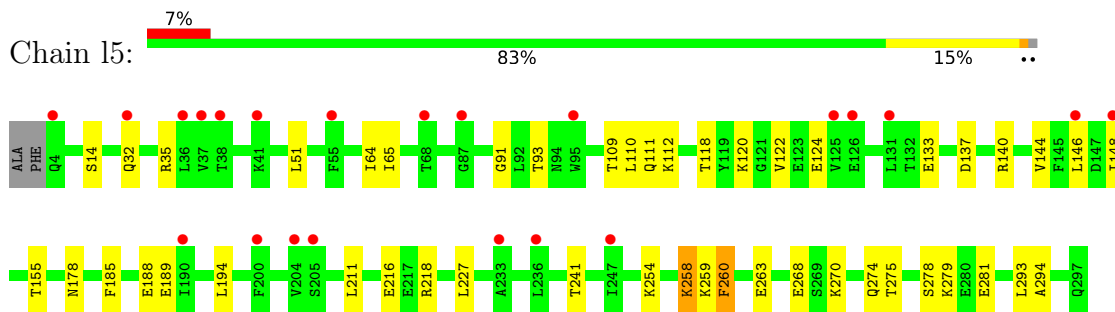

- Molecule 43: 60S ribosomal protein L6-A

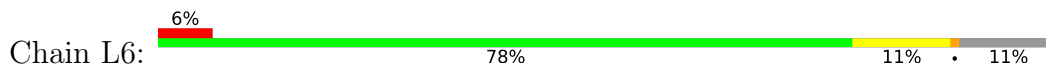

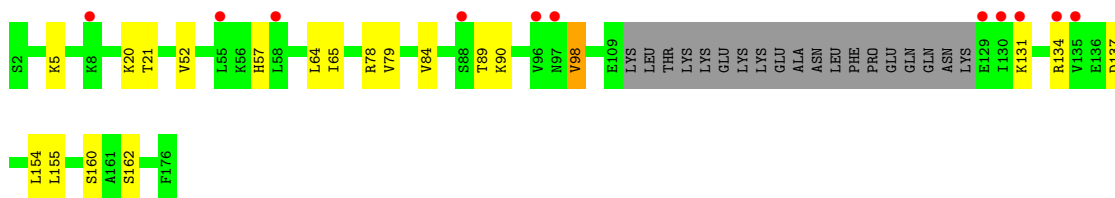

• Molecule 43: 60S ribosomal protein L6-A

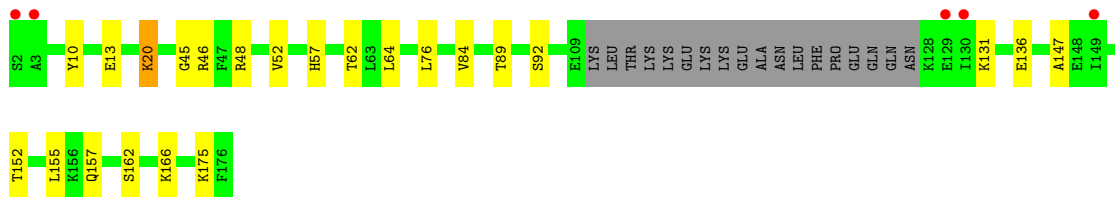
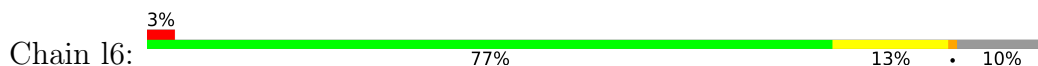

• Molecule 44: 60S ribosomal protein L7-A

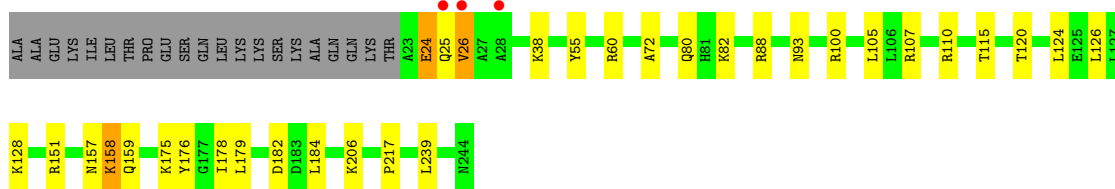
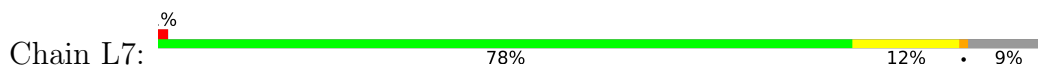

• Molecule 44: 60S ribosomal protein L7-A

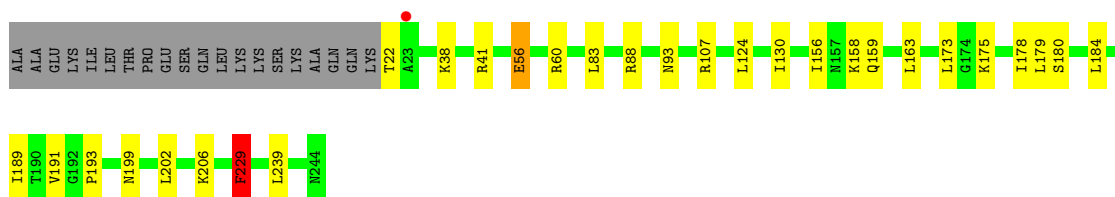
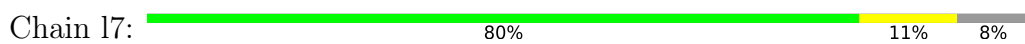

• Molecule 45: 60S ribosomal protein L8-A

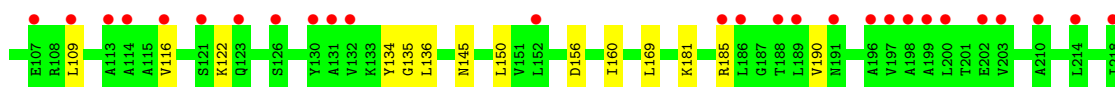
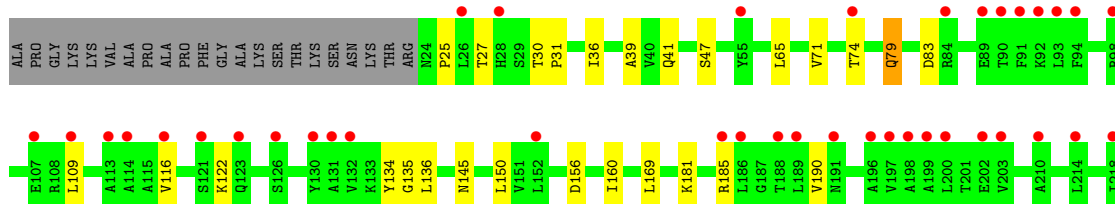
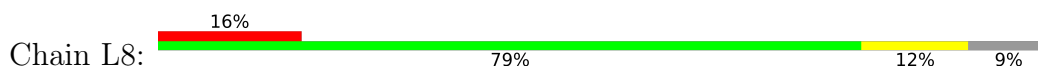

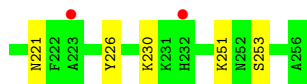

- Molecule 45: 60S ribosomal protein L8-A

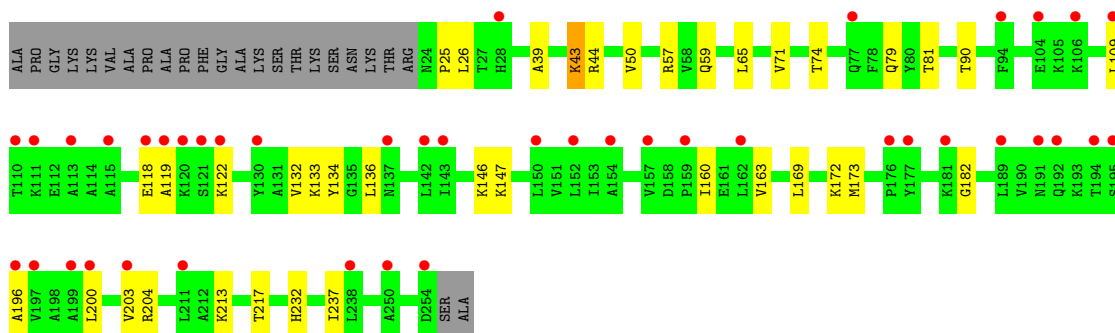
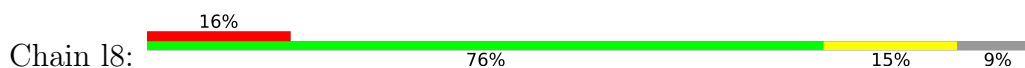

- Molecule 46: 60S ribosomal protein L9-A

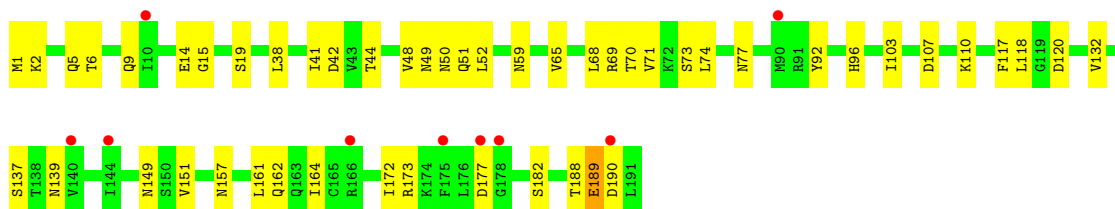
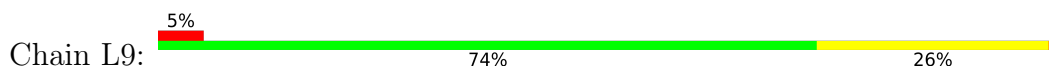

- Molecule 46: 60S ribosomal protein L9-A

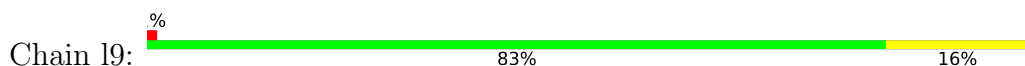

- Molecule 47: 60S ribosomal protein L10

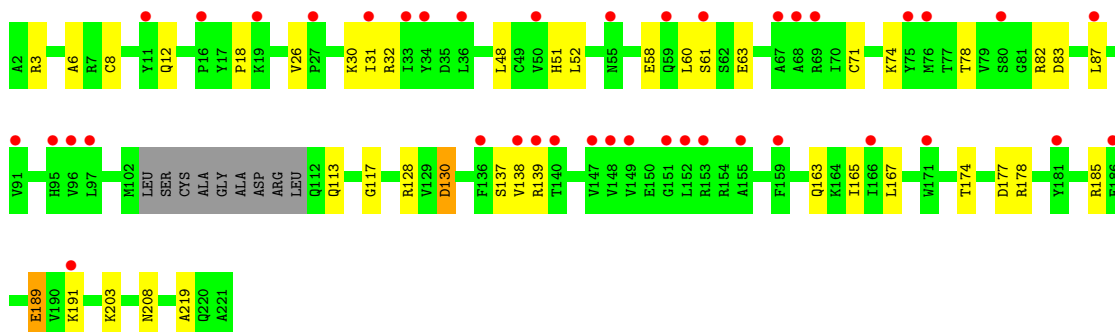
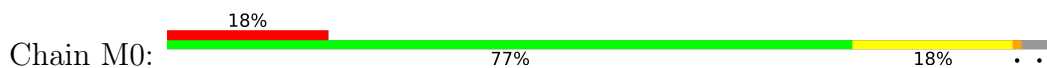

- Molecule 47: 60S ribosomal protein L10

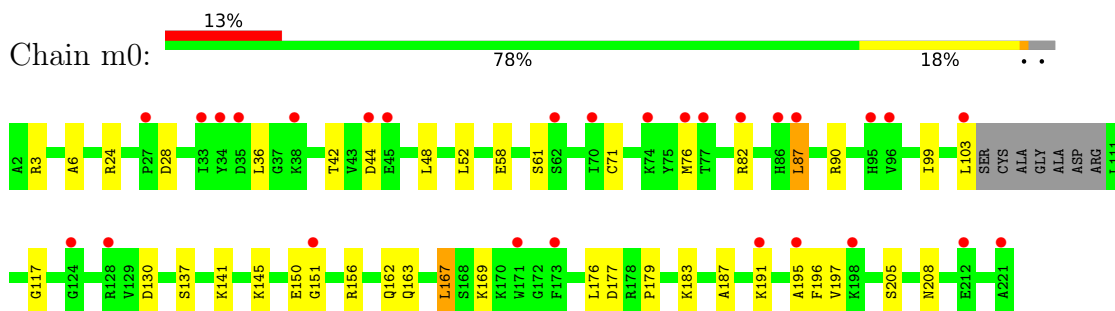

- Molecule 48: 60S ribosomal protein L11-B

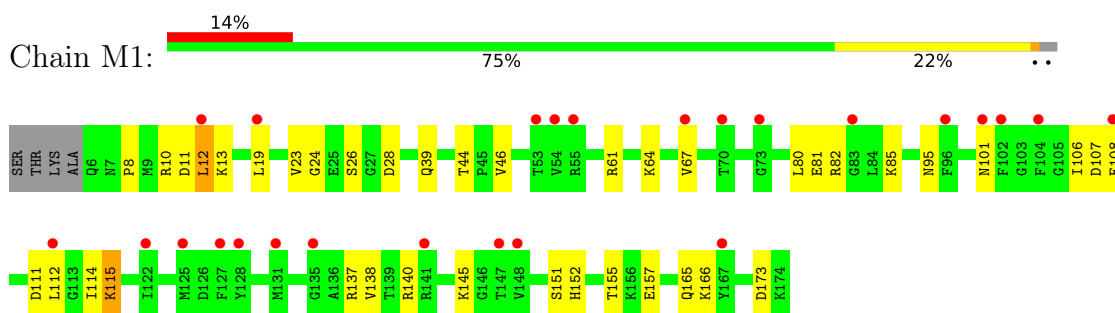

- Molecule 48: 60S ribosomal protein L11-B

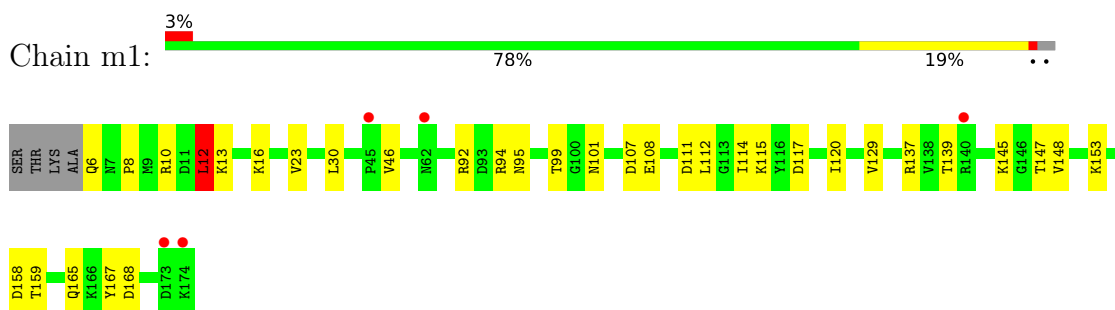

- Molecule 49: 60S ribosomal protein L13-A

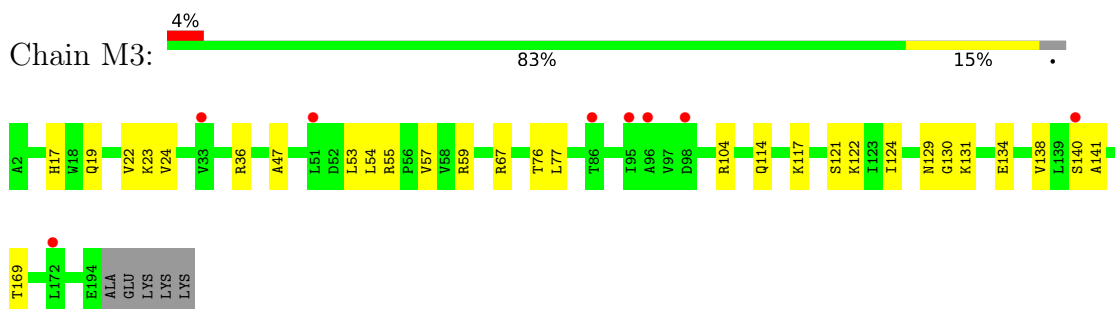

- Molecule 49: 60S ribosomal protein L13-A

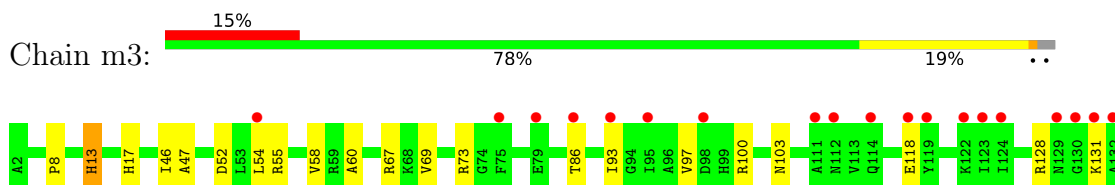

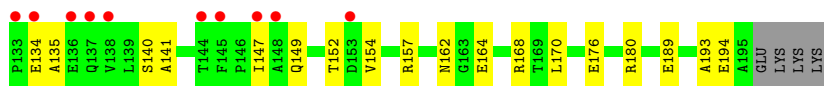

- Molecule 50: 60S ribosomal protein L14-A

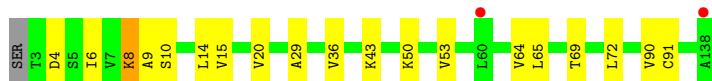
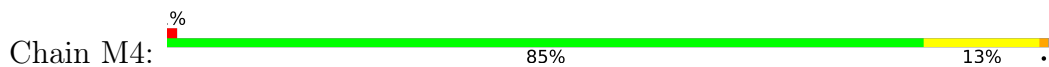

- Molecule 50: 60S ribosomal protein L14-A

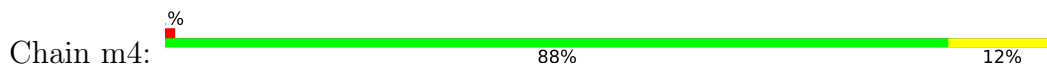

- Molecule 51: 60S ribosomal protein L15-A

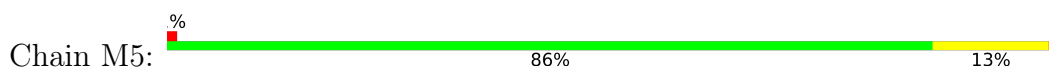

- Molecule 51: 60S ribosomal protein L15-A

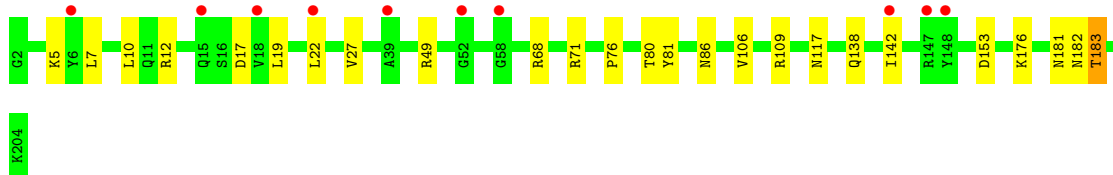
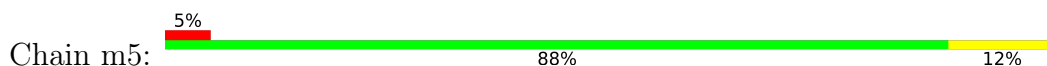

- Molecule 52: 60S ribosomal protein L16-A

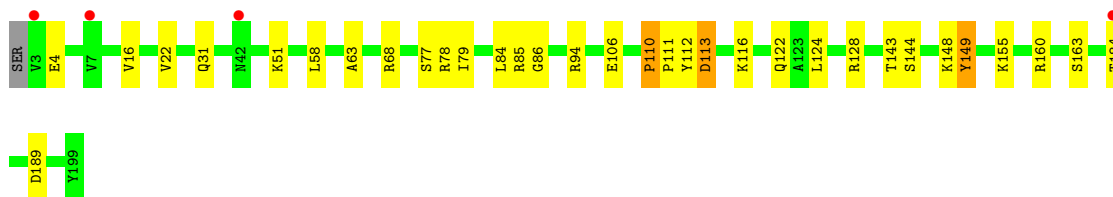
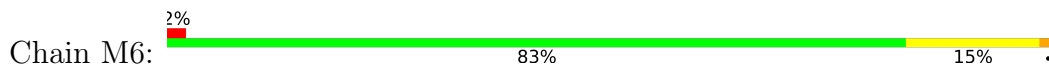

- Molecule 52: 60S ribosomal protein L16-A

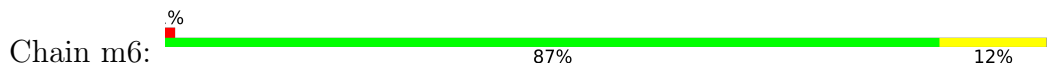



• Molecule 53: 60S ribosomal protein L17-A

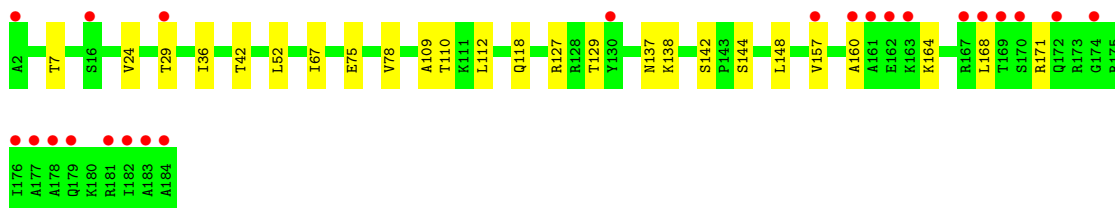
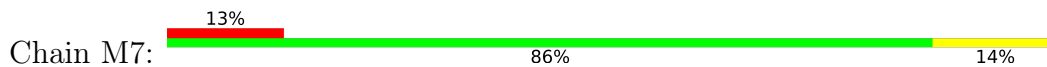

• Molecule 53: 60S ribosomal protein L17-A

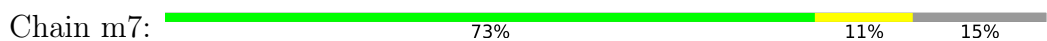

• Molecule 54: 60S ribosomal protein L18-A

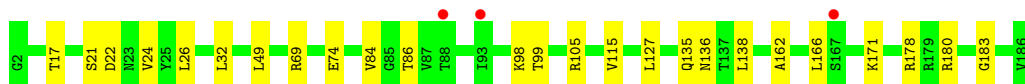
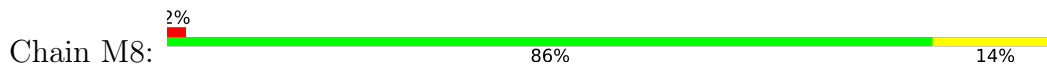

• Molecule 54: 60S ribosomal protein L18-A

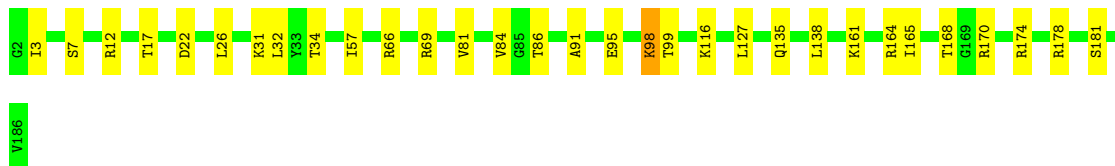
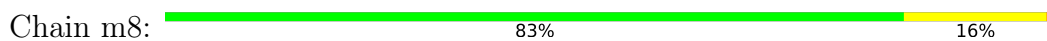

• Molecule 55: 60S ribosomal protein L19-A

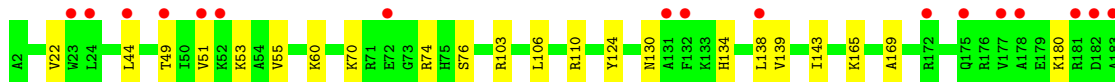
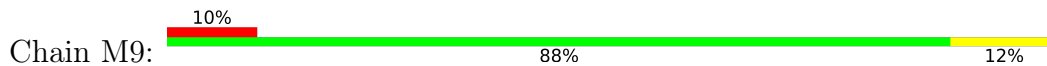

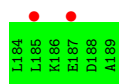

• Molecule 55: 60S ribosomal protein L19-A

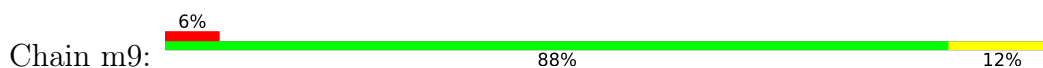

• Molecule 56: 60S ribosomal protein L20-A

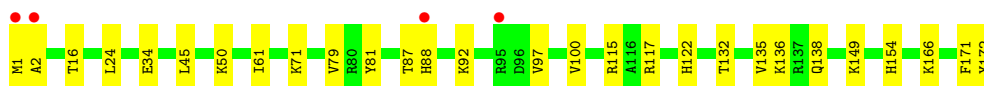
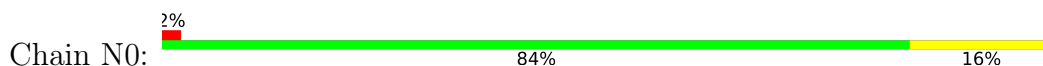

• Molecule 56: 60S ribosomal protein L20-A

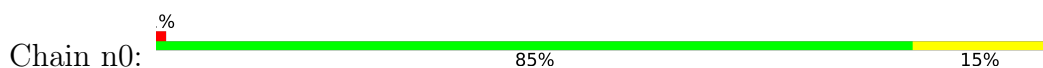

• Molecule 57: 60S ribosomal protein L21-A

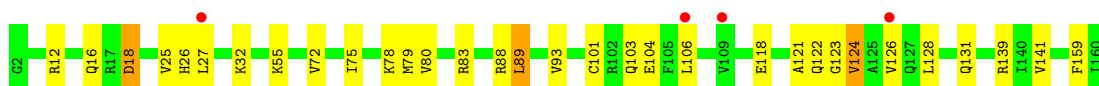
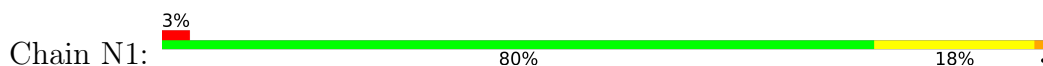

• Molecule 57: 60S ribosomal protein L21-A

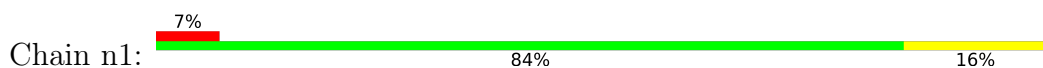

• Molecule 58: 60S ribosomal protein L22-A

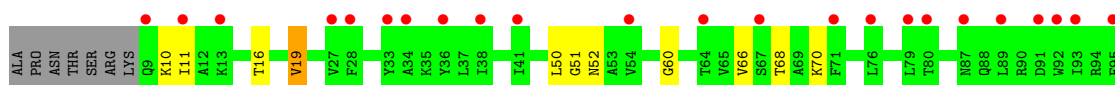
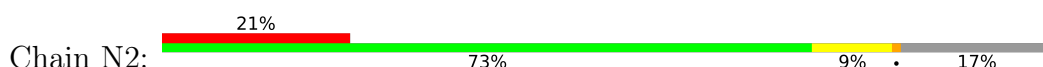

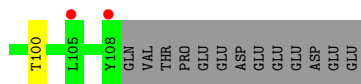

• Molecule 58: 60S ribosomal protein L22-A

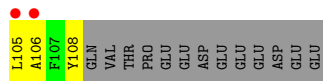

• Molecule 59: 60S ribosomal protein L23-A

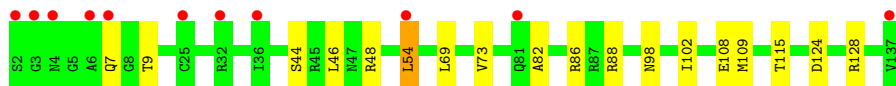
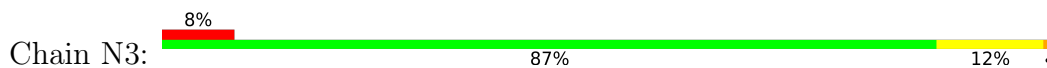

• Molecule 59: 60S ribosomal protein L23-A

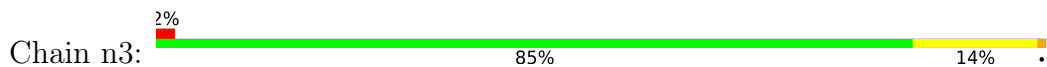

• Molecule 60: 60S ribosomal protein L24-A

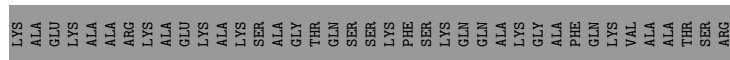
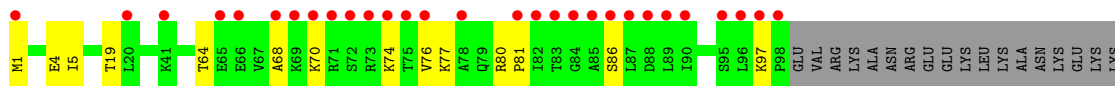

• Molecule 60: 60S ribosomal protein L24-A

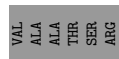
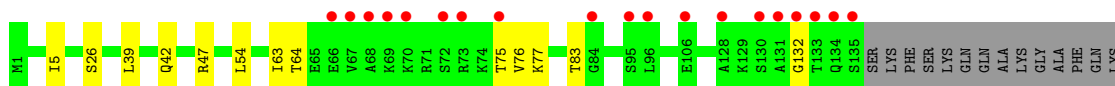
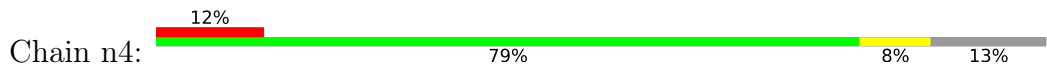

• Molecule 61: 60S ribosomal protein L25

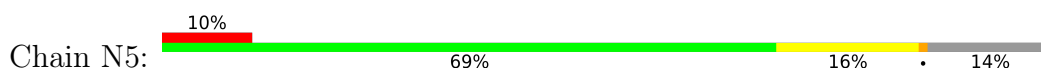

- Molecule 61: 60S ribosomal protein L25

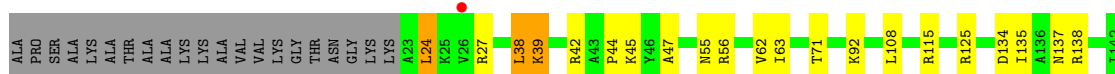

- Molecule 62: 60S ribosomal protein L26-A

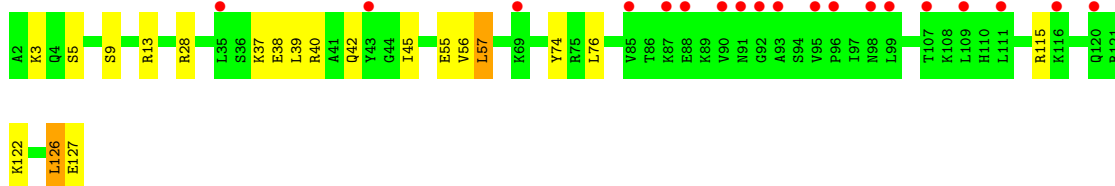
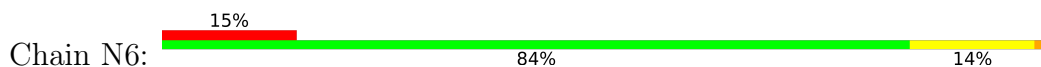

- Molecule 62: 60S ribosomal protein L26-A

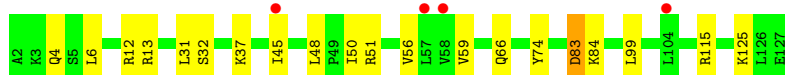
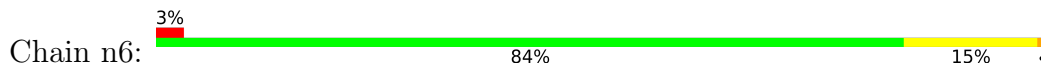

- Molecule 63: 60S ribosomal protein L27-A

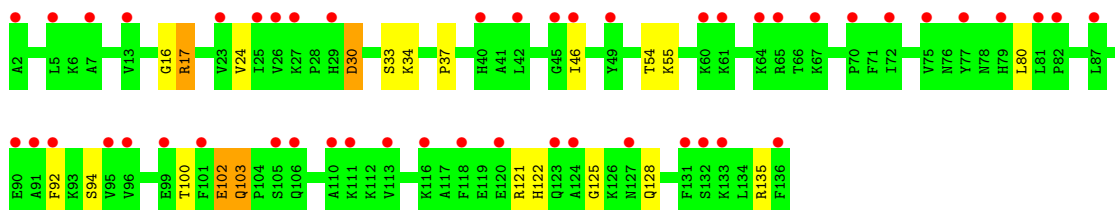
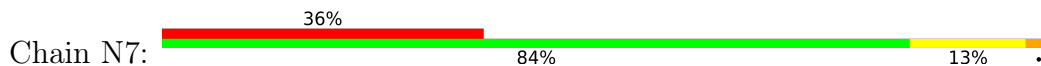

- Molecule 63: 60S ribosomal protein L27-A

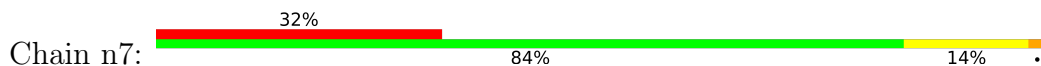

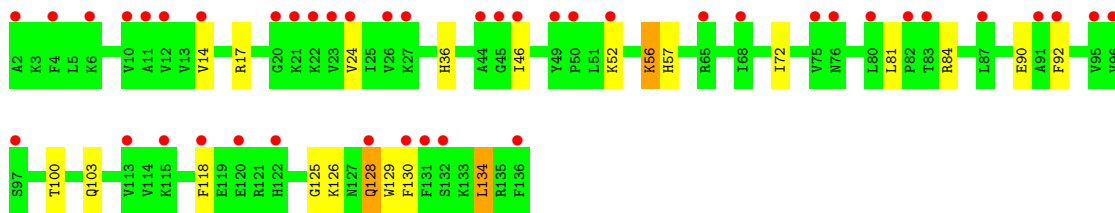

● Molecule 64: 60S ribosomal protein L28

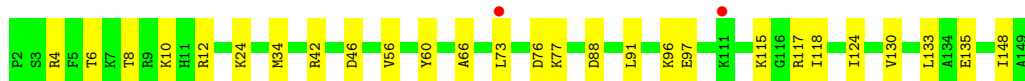
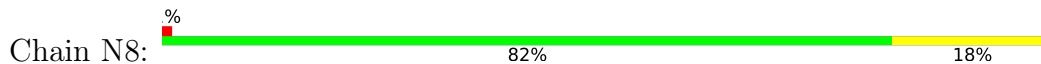

● Molecule 64: 60S ribosomal protein L28

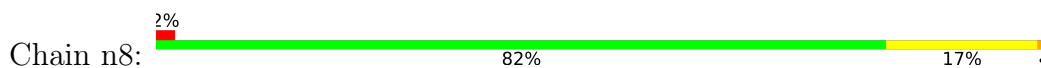

● Molecule 65: 60S ribosomal protein L29

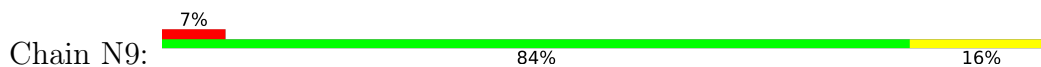

● Molecule 65: 60S ribosomal protein L29

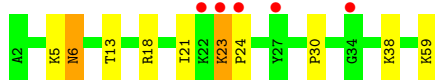
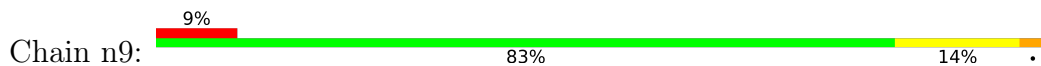

● Molecule 66: 60S ribosomal protein L30

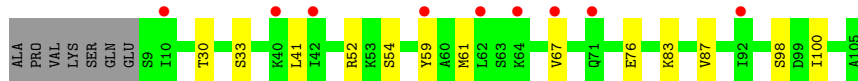
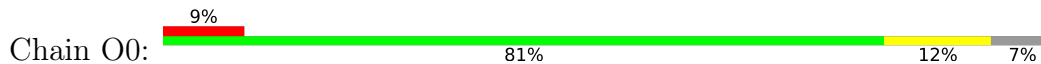

● Molecule 66: 60S ribosomal protein L30

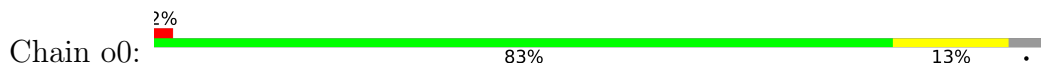

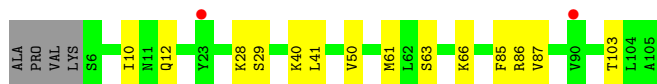

- Molecule 67: 60S ribosomal protein L31-A

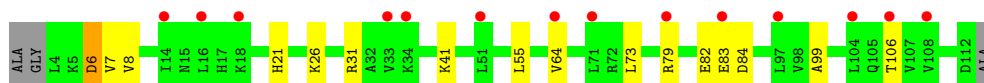
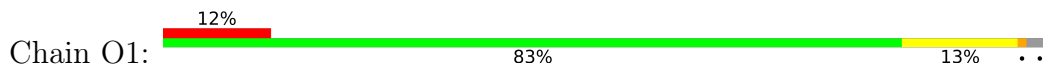

- Molecule 67: 60S ribosomal protein L31-A

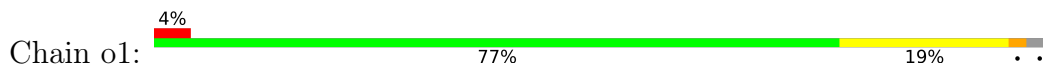

- Molecule 68: 60S ribosomal protein L32

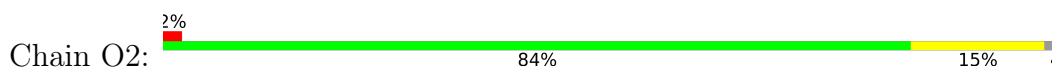

- Molecule 68: 60S ribosomal protein L32

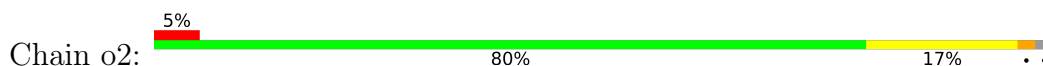

- Molecule 69: 60S ribosomal protein L33-A

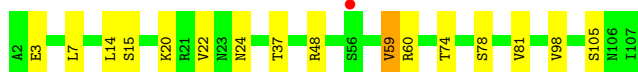
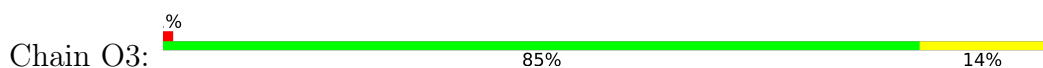

- Molecule 69: 60S ribosomal protein L33-A

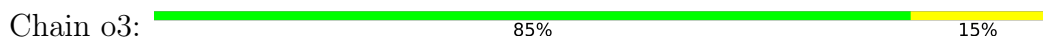

- Molecule 70: 60S ribosomal protein L34-A

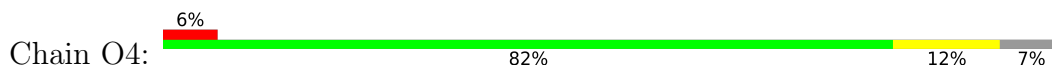

- Molecule 70: 60S ribosomal protein L34-A

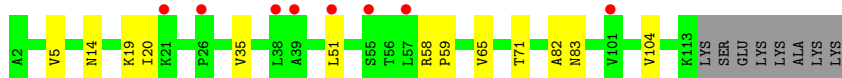
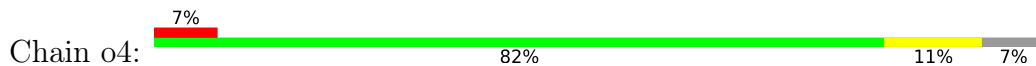

- Molecule 71: 60S ribosomal protein L35-A

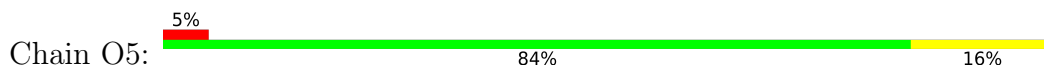

- Molecule 71: 60S ribosomal protein L35-A

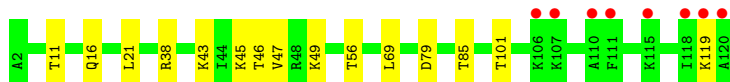
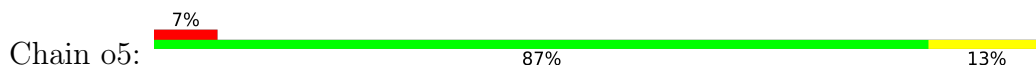

- Molecule 72: 60S ribosomal protein L36-A

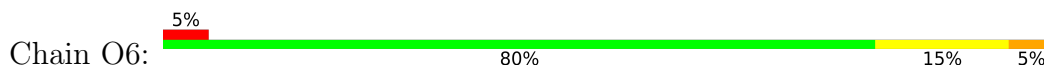

- Molecule 72: 60S ribosomal protein L36-A

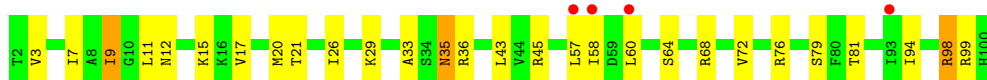
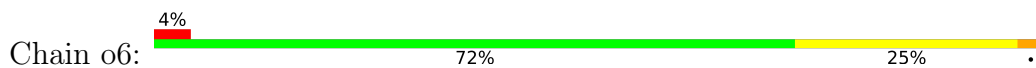

- Molecule 73: 60S ribosomal protein L37-A

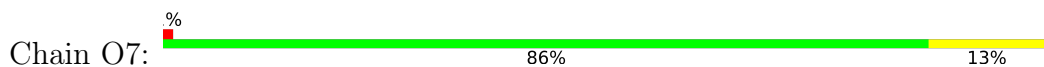

- Molecule 73: 60S ribosomal protein L37-A

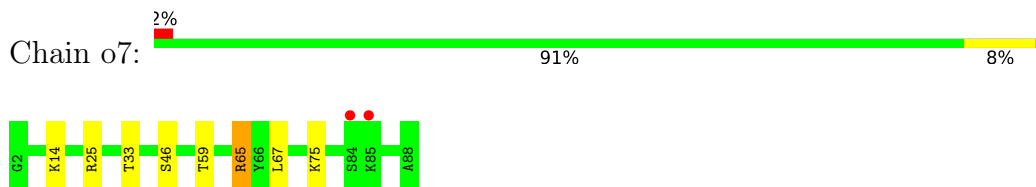

- Molecule 74: 60S ribosomal protein L38

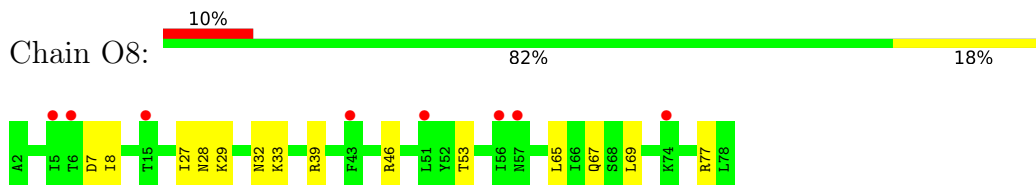

- Molecule 74: 60S ribosomal protein L38

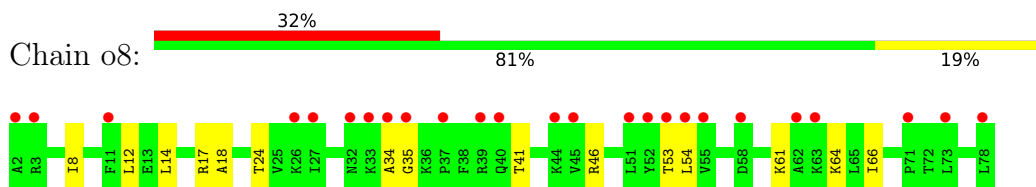

- Molecule 75: 60S ribosomal protein L39

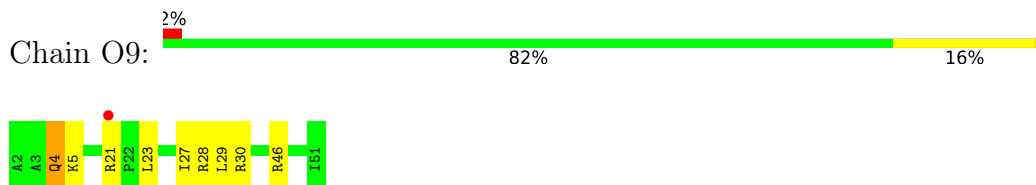

- Molecule 75: 60S ribosomal protein L39

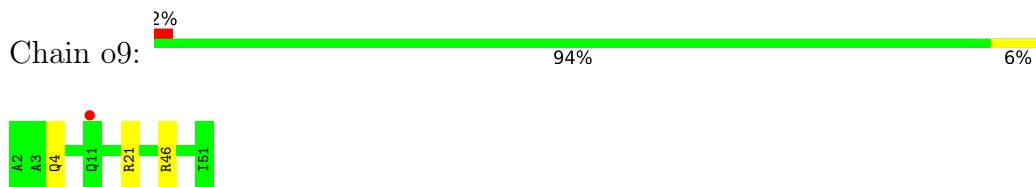

- Molecule 76: Ubiquitin-60S ribosomal protein L40

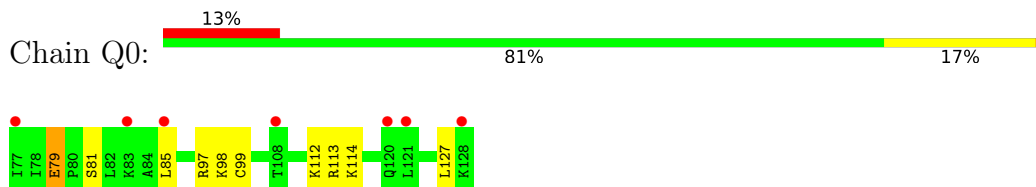

- Molecule 76: Ubiquitin-60S ribosomal protein L40

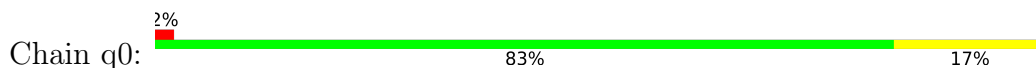

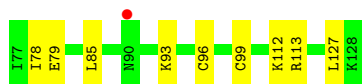

- Molecule 77: 60S ribosomal protein L41-A

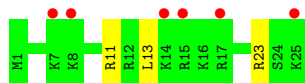
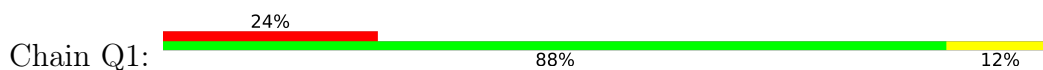

- Molecule 77: 60S ribosomal protein L41-A

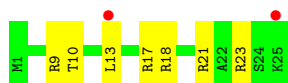
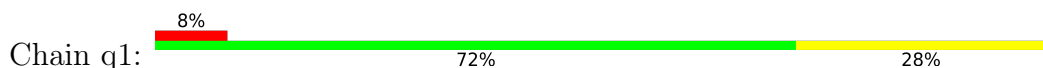

- Molecule 78: 60S ribosomal protein L42-A

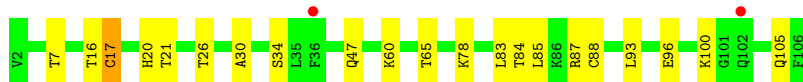
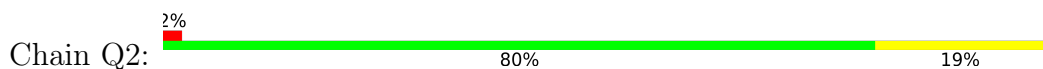

- Molecule 78: 60S ribosomal protein L42-A

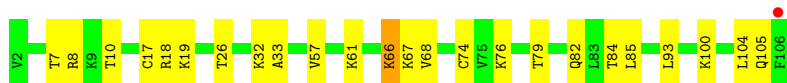
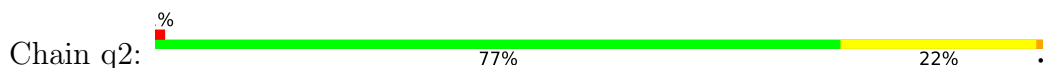

- Molecule 79: 60S ribosomal protein L43-A

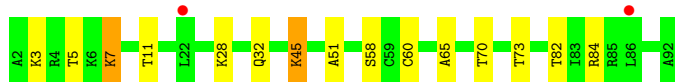
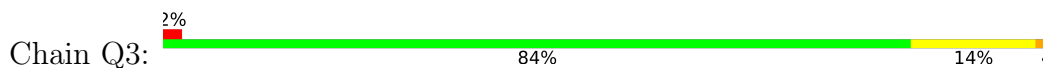

- Molecule 79: 60S ribosomal protein L43-A

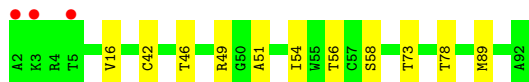
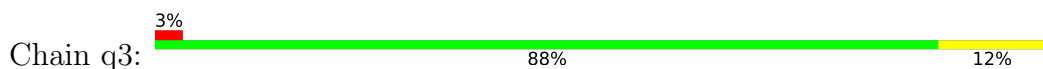

- Molecule 80: 60S ribosomal protein L12-A (uL11)

4 Data and refinement statistics

Property	Value	Source
Space group	P 1 21 1	Depositor
Cell constants a, b, c, α , β , γ	435.58Å 287.33Å 303.82Å 90.00° 98.95° 90.00°	Depositor
Resolution (Å)	99.53 – 3.30 99.53 – 3.30	Depositor EDS
% Data completeness (in resolution range)	100.0 (99.53-3.30) 99.9 (99.53-3.30)	Depositor EDS
R_{merge}	0.59	Depositor
R_{sym}	(Not available)	Depositor
$\langle I/\sigma(I) \rangle$ ¹	1.34 (at 3.33Å)	Xtrriage
Refinement program	PHENIX	Depositor
R, R_{free}	0.251 , 0.310 0.255 , (Not available)	Depositor DCC
R_{free} test set	No test flags present.	wwPDB-VP
Wilson B-factor (Å ²)	85.9	Xtrriage
Anisotropy	0.176	Xtrriage
Bulk solvent k_{sol} (e/Å ³), B_{sol} (Å ²)	0.32 , 74.2	EDS
L-test for twinning ²	$\langle L \rangle = 0.46$, $\langle L^2 \rangle = 0.28$	Xtrriage
Estimated twinning fraction	No twinning to report.	Xtrriage
F_o, F_c correlation	0.88	EDS
Total number of atoms	404292	wwPDB-VP
Average B, all atoms (Å ²)	79.0	wwPDB-VP

Xtrriage's analysis on translational NCS is as follows: *The largest off-origin peak in the Patterson function is 1.50% of the height of the origin peak. No significant pseudotranslation is detected.*

¹Intensities estimated from amplitudes.

²Theoretical values of $\langle |L| \rangle$, $\langle L^2 \rangle$ for acentric reflections are 0.5, 0.333 respectively for untwinned datasets, and 0.375, 0.2 for perfectly twinned datasets.

5 Model quality i

5.1 Standard geometry i

Bond lengths and bond angles in the following residue types are not validated in this section: CH, 8AN, SPS, MG, OHX, ZN

The Z score for a bond length (or angle) is the number of standard deviations the observed value is removed from the expected value. A bond length (or angle) with $|Z| > 5$ is considered an outlier worth inspection. RMSZ is the root-mean-square of all Z scores of the bond lengths (or angles).

Mol	Chain	Bond lengths		Bond angles	
		RMSZ	# Z >5	RMSZ	# Z >5
1	2	0.36	0/42467	0.89	42/66169 (0.1%)
1	6	0.43	0/42790	0.93	50/66673 (0.1%)
2	S0	0.28	0/1617	0.50	0/2215
2	s0	0.29	0/1623	0.51	0/2222
3	S1	0.26	0/1735	0.50	0/2335
3	s1	0.32	0/1748	0.53	0/2352
4	S2	0.30	0/1665	0.52	0/2263
4	s2	0.33	0/1665	0.55	1/2263 (0.0%)
5	S3	0.29	0/1759	0.47	0/2368
5	s3	0.27	0/1759	0.47	0/2368
6	S4	0.29	0/2109	0.53	0/2839
6	s4	0.34	0/2109	0.55	0/2839
7	S5	0.27	0/1629	0.50	0/2202
7	s5	0.28	0/1629	0.48	0/2202
8	S6	0.29	0/1823	0.47	0/2439
8	s6	0.33	0/1779	0.53	0/2379
9	S7	0.28	0/1506	0.53	1/2028 (0.0%)
9	s7	0.29	0/1516	0.52	0/2043
10	S8	0.30	0/1514	0.51	0/2021
10	s8	0.34	0/1514	0.52	0/2021
11	S9	0.29	0/1519	0.48	0/2035
11	s9	0.31	0/1519	0.50	0/2035
12	C0	0.28	0/725	0.44	0/978
12	c0	0.27	0/713	0.51	1/961 (0.1%)
13	C1	0.31	0/1185	0.50	0/1598
13	c1	0.36	0/1185	0.55	0/1598
14	C2	0.26	0/819	0.49	0/1109
14	c2	0.22	0/819	0.47	0/1109
15	C3	0.31	0/1215	0.52	1/1638 (0.1%)
15	c3	0.33	0/1215	0.51	0/1638
16	C4	0.26	0/901	0.51	0/1217
16	c4	0.30	0/960	0.54	0/1290

Mol	Chain	Bond lengths		Bond angles	
		RMSZ	# Z >5	RMSZ	# Z >5
17	C5	0.31	0/988	0.54	0/1327
17	c5	0.29	0/1030	0.52	0/1384
18	C6	0.29	0/1125	0.54	2/1510 (0.1%)
18	c6	0.29	0/1131	0.51	0/1518
19	C7	0.30	0/935	0.52	0/1254
19	c7	0.27	0/914	0.50	0/1224
20	C8	0.30	0/1211	0.51	0/1628
20	c8	0.28	0/1211	0.49	0/1628
21	C9	0.29	0/1130	0.48	0/1517
21	c9	0.29	0/1130	0.47	0/1517
22	D0	0.30	0/865	0.52	0/1169
22	d0	0.29	0/892	0.49	0/1205
23	D1	0.29	0/693	0.49	0/935
23	d1	0.31	0/693	0.50	0/935
24	D2	0.30	0/1038	0.55	1/1395 (0.1%)
24	d2	0.35	0/1038	0.56	1/1395 (0.1%)
25	D3	0.35	0/1139	0.55	0/1518
25	d3	0.38	0/1139	0.57	0/1518
26	D4	0.29	0/1087	0.47	0/1449
26	d4	0.31	0/1087	0.51	0/1449
27	D5	0.26	0/571	0.55	0/768
27	d5	0.26	0/566	0.47	0/761
28	D6	0.29	0/782	0.53	0/1047
28	d6	0.34	0/782	0.53	0/1047
29	D7	0.29	0/620	0.51	0/838
29	d7	0.28	0/620	0.49	0/838
30	D8	0.27	0/499	0.47	0/670
30	d8	0.28	0/499	0.49	0/670
31	D9	0.32	0/452	0.55	1/600 (0.2%)
31	d9	0.33	0/452	0.50	0/600
32	E0	0.28	0/483	0.48	0/643
32	e0	0.32	0/499	0.54	0/665
33	E1	0.29	0/577	0.56	0/770
33	e1	0.29	0/619	0.58	0/822
34	SR	0.26	0/2490	0.49	0/3389
34	sR	0.25	0/2495	0.44	0/3395
35	SM	0.31	0/925	0.54	1/1240 (0.1%)
35	sM	0.31	0/480	0.53	0/642
36	1	0.56	0/75394	1.03	115/117545 (0.1%)
36	5	0.59	2/75865 (0.0%)	1.05	143/118275 (0.1%)
37	3	0.46	0/2883	0.91	0/4491
37	7	0.55	0/2883	1.00	2/4491 (0.0%)
38	4	0.53	0/3746	1.00	5/5832 (0.1%)

Mol	Chain	Bond lengths		Bond angles	
		RMSZ	# Z >5	RMSZ	# Z >5
38	8	0.52	0/3746	0.97	2/5832 (0.0%)
39	L2	0.37	0/1948	0.57	0/2617
39	l2	0.40	0/1946	0.62	0/2614
40	L3	0.39	0/3146	0.56	0/4228
40	l3	0.45	0/3146	0.58	0/4228
41	L4	0.41	0/2800	0.61	0/3790
41	l4	0.41	1/2800 (0.0%)	0.63	2/3790 (0.1%)
42	L5	0.35	0/2425	0.53	0/3271
42	l5	0.42	0/2408	0.55	0/3248
43	L6	0.39	0/1260	0.55	0/1694
43	l6	0.41	0/1269	0.57	0/1705
44	L7	0.42	0/1821	0.59	0/2451
44	l7	0.43	0/1828	0.62	2/2461 (0.1%)
45	L8	0.31	0/1836	0.53	0/2481
45	l8	0.32	0/1796	0.51	0/2431
46	L9	0.36	0/1539	0.56	0/2073
46	l9	0.40	0/1539	0.57	0/2073
47	M0	0.40	1/1741 (0.1%)	0.55	0/2335
47	m0	0.43	0/1758	0.61	2/2358 (0.1%)
48	M1	0.31	0/1374	0.50	0/1842
48	m1	0.38	0/1374	0.59	1/1842 (0.1%)
49	M3	0.40	0/1568	0.59	0/2106
49	m3	0.37	0/1573	0.57	0/2113
50	M4	0.40	0/1068	0.54	0/1438
50	m4	0.41	0/1074	0.57	0/1446
51	M5	0.38	0/1757	0.56	0/2354
51	m5	0.36	0/1757	0.55	0/2354
52	M6	0.44	0/1585	0.59	0/2128
52	m6	0.50	0/1585	0.61	0/2128
53	M7	0.41	0/1443	0.58	0/1944
53	m7	0.44	0/1250	0.59	0/1683
54	M8	0.39	0/1465	0.60	0/1965
54	m8	0.39	0/1465	0.60	0/1965
55	M9	0.31	0/1538	0.49	0/2050
55	m9	0.34	0/1538	0.51	0/2050
56	N0	0.39	0/1481	0.56	0/1990
56	n0	0.44	0/1481	0.59	0/1990
57	N1	0.40	0/1300	0.56	1/1743 (0.1%)
57	n1	0.43	0/1300	0.55	0/1743
58	N2	0.30	0/812	0.48	0/1099
58	n2	0.32	0/794	0.52	0/1076
59	N3	0.39	0/1018	0.57	0/1369
59	n3	0.45	0/1018	0.61	0/1369

Mol	Chain	Bond lengths		Bond angles	
		RMSZ	# Z >5	RMSZ	# Z >5
60	N4	0.31	0/712	0.50	0/958
60	n4	0.35	0/1052	0.51	0/1398
61	N5	0.33	0/979	0.55	0/1321
61	n5	0.36	0/974	0.57	0/1314
62	N6	0.35	0/1004	0.62	2/1341 (0.1%)
62	n6	0.35	0/1004	0.57	0/1341
63	N7	0.30	0/1118	0.50	0/1497
63	n7	0.31	0/1118	0.51	0/1497
64	N8	0.41	0/1204	0.62	0/1612
64	n8	0.40	0/1204	0.61	0/1612
65	N9	0.38	0/473	0.60	0/629
65	n9	0.43	0/473	0.67	0/629
66	O0	0.30	0/751	0.47	0/1008
66	o0	0.31	0/775	0.52	0/1040
67	O1	0.34	0/890	0.52	0/1196
67	o1	0.41	0/897	0.60	0/1205
68	O2	0.43	0/1041	0.63	0/1394
68	o2	0.44	0/1041	0.62	0/1394
69	O3	0.48	0/868	0.56	0/1168
69	o3	0.48	0/868	0.58	0/1168
70	O4	0.34	0/890	0.54	0/1189
70	o4	0.34	0/890	0.58	0/1189
71	O5	0.37	0/978	0.57	0/1301
71	o5	0.34	0/974	0.53	0/1297
72	O6	0.37	0/778	0.60	0/1034
72	o6	0.34	0/777	0.54	0/1033
73	O7	0.42	0/696	0.61	0/923
73	o7	0.40	0/696	0.59	0/923
74	O8	0.30	0/618	0.47	0/826
74	o8	0.31	0/614	0.54	0/822
75	O9	0.39	0/443	0.58	0/588
75	o9	0.39	0/443	0.53	0/588
76	Q0	0.43	0/423	0.60	0/562
76	q0	0.45	0/423	0.55	0/562
77	Q1	0.36	0/234	0.59	0/300
77	q1	0.43	0/234	0.62	0/300
78	Q2	0.53	1/860 (0.1%)	0.63	0/1136
78	q2	0.52	1/860 (0.1%)	0.63	1/1136 (0.1%)
79	Q3	0.37	0/701	0.59	0/934
79	q3	0.43	0/701	0.56	0/934
81	p0	0.27	0/977	0.48	0/1313
83	f	0.34	0/1131	0.58	0/1522
84	B	0.31	0/15	0.54	0/20

Mol	Chain	Bond lengths		Bond angles	
		RMSZ	# Z >5	RMSZ	# Z >5
84	C	0.41	0/15	0.80	0/20
All	All	0.46	6/431576 (0.0%)	0.85	380/633602 (0.1%)

Chiral center outliers are detected by calculating the chiral volume of a chiral center and verifying if the center is modelled as a planar moiety or with the opposite hand. A planarity outlier is detected by checking planarity of atoms in a peptide group, atoms in a mainchain group or atoms of a sidechain that are expected to be planar.

Mol	Chain	#Chirality outliers	#Planarity outliers
18	c6	0	1
19	C7	0	1
27	D5	0	1
39	l2	0	1
44	L7	0	1
52	M6	0	1
64	n8	0	1
65	N9	0	1
65	n9	0	1
83	f	0	1
All	All	0	10

All (6) bond length outliers are listed below:

Mol	Chain	Res	Type	Atoms	Z	Observed(Å)	Ideal(Å)
78	q2	17	CYS	CB-SG	8.77	1.97	1.82
78	Q2	17	CYS	CB-SG	7.99	1.95	1.82
36	5	1152	G	N9-C4	-5.86	1.33	1.38
36	5	942	U	C4-O4	5.25	1.27	1.23
47	M0	8	CYS	CB-SG	-5.03	1.73	1.81
41	14	94	CYS	CB-SG	-5.00	1.73	1.81

All (380) bond angle outliers are listed below:

Mol	Chain	Res	Type	Atoms	Z	Observed(°)	Ideal(°)
36	5	1152	G	N3-C4-N9	-11.60	119.04	126.00
36	5	1152	G	N3-C4-C5	11.31	134.25	128.60
36	5	2726	C	C6-N1-C2	-9.68	116.43	120.30
36	5	1152	G	C2-N3-C4	-9.61	107.10	111.90
36	1	406	G	O4'-C1'-N9	9.54	115.83	108.20
36	1	1308	A	C8-N9-C4	-9.32	102.07	105.80
36	1	2617	U	C5-C4-O4	8.97	131.28	125.90
36	5	2278	C	N1-C2-O2	8.83	124.20	118.90

Continued on next page...

Continued from previous page...

Mol	Chain	Res	Type	Atoms	Z	Observed(°)	Ideal(°)
38	4	125	U	C2-N1-C1'	8.67	128.11	117.70
36	1	1308	A	N7-C8-N9	8.59	118.09	113.80
36	5	2169	G	C5-C6-O6	8.39	133.64	128.60
36	1	3217	C	C2-N1-C1'	8.35	127.98	118.80
1	6	453	U	C2-N1-C1'	8.21	127.56	117.70
36	5	1028	U	C2-N1-C1'	8.14	127.46	117.70
36	1	3217	C	N1-C2-O2	8.13	123.78	118.90
36	1	439	C	N1-C2-O2	8.12	123.77	118.90
36	1	2617	U	N1-C2-N3	8.03	119.72	114.90
36	5	2726	C	N3-C2-O2	-7.94	116.34	121.90
36	1	2355	G	N1-C6-O6	7.70	124.52	119.90
36	5	942	U	N3-C4-C5	-7.70	109.98	114.60
36	5	2524	A	O4'-C1'-N9	7.62	114.30	108.20
1	6	163	G	N3-C4-N9	-7.59	121.45	126.00
36	1	1115	G	C6-C5-N7	-7.56	125.86	130.40
36	5	1200	A	N1-C6-N6	7.56	123.13	118.60
36	5	1192	C	C5-C6-N1	7.53	124.76	121.00
36	1	2403	G	N1-C6-O6	7.51	124.41	119.90
36	1	2617	U	C4-C5-C6	7.38	124.13	119.70
36	1	3217	C	N3-C2-O2	-7.38	116.74	121.90
36	5	1152	G	C8-N9-C1'	7.37	136.58	127.00
1	6	1473	U	C2-N1-C1'	7.35	126.52	117.70
36	5	2169	G	C8-N9-C4	-7.33	103.47	106.40
36	5	2169	G	C4-C5-N7	-7.32	107.87	110.80
36	1	439	C	C2-N1-C1'	7.32	126.85	118.80
1	6	453	U	N1-C2-O2	7.29	127.90	122.80
36	5	3351	U	C2-N1-C1'	7.28	126.44	117.70
1	6	1473	U	N1-C2-O2	7.28	127.90	122.80
36	1	1367	G	N1-C6-O6	7.27	124.26	119.90
1	2	934	C	C2-N1-C1'	7.27	126.79	118.80
36	1	2714	G	N3-C4-C5	7.24	132.22	128.60
62	N6	57	LEU	CA-CB-CG	7.23	131.93	115.30
36	5	2726	C	C2-N1-C1'	7.23	126.75	118.80
36	5	1028	U	N1-C2-O2	7.21	127.84	122.80
36	5	1495	U	C2-N1-C1'	7.18	126.32	117.70
36	1	3278	C	N1-C2-O2	7.16	123.20	118.90
36	1	1115	G	N3-C4-N9	7.16	130.29	126.00
36	1	2869	U	C5-C4-O4	-7.14	121.62	125.90
36	5	406	G	N1-C6-O6	-7.14	115.62	119.90
1	2	831	U	C2-N1-C1'	7.14	126.27	117.70
36	5	1152	G	C4-N9-C1'	-7.08	117.30	126.50
1	6	1000	C	C2-N1-C1'	7.04	126.55	118.80

Continued on next page...

Continued from previous page...

Mol	Chain	Res	Type	Atoms	Z	Observed(°)	Ideal(°)
44	17	229	PHE	CB-CG-CD1	7.03	125.72	120.80
36	5	2272	G	O4'-C1'-N9	7.03	113.82	108.20
36	1	1556	C	N1-C2-O2	6.97	123.08	118.90
36	5	568	G	N1-C6-O6	6.96	124.08	119.90
36	5	2827	U	N1-C2-O2	6.95	127.67	122.80
1	2	1698	G	P-O3'-C3'	6.91	127.99	119.70
1	6	1274	C	N1-C2-O2	6.91	123.05	118.90
36	1	3278	C	N3-C2-O2	-6.91	117.06	121.90
1	6	680	U	C2-N1-C1'	6.91	125.99	117.70
36	5	2283	G	N1-C6-O6	6.88	124.03	119.90
36	1	3057	U	N3-C2-O2	-6.84	117.41	122.20
36	1	656	A	N1-C6-N6	6.83	122.70	118.60
1	2	728	U	N1-C2-O2	6.83	127.58	122.80
36	5	419	G	N1-C6-O6	-6.80	115.82	119.90
1	6	1473	U	N3-C2-O2	-6.76	117.47	122.20
1	2	1389	C	N1-C2-O2	6.76	122.96	118.90
36	5	1308	A	O5'-P-OP1	-6.71	99.66	105.70
38	4	125	U	N1-C2-O2	6.68	127.48	122.80
36	1	2819	A	O5'-P-OP2	-6.68	99.69	105.70
36	5	343	U	O5'-P-OP2	-6.65	99.71	105.70
1	6	680	U	N1-C2-O2	6.63	127.44	122.80
1	6	813	U	C2-N1-C1'	6.59	125.61	117.70
1	2	934	C	N1-C2-O2	6.57	122.84	118.90
36	5	2938	G	N1-C6-O6	-6.54	115.97	119.90
1	2	959	U	C2-N1-C1'	6.52	125.52	117.70
1	6	813	U	N1-C2-O2	6.47	127.33	122.80
36	5	2211	U	N3-C2-O2	-6.46	117.68	122.20
36	5	880	G	C4-N9-C1'	-6.45	118.12	126.50
36	5	568	G	C5-C6-N1	-6.45	108.28	111.50
1	2	728	U	C2-N1-C1'	6.44	125.42	117.70
36	1	1367	G	C5-C6-N1	-6.44	108.28	111.50
36	1	835	G	O4'-C1'-N9	6.42	113.34	108.20
36	5	3154	C	N1-C2-O2	6.42	122.75	118.90
1	2	728	U	N3-C2-O2	-6.42	117.71	122.20
1	2	831	U	C5-C6-N1	6.40	125.90	122.70
1	6	1274	C	C2-N1-C1'	6.40	125.84	118.80
36	1	1556	C	N3-C2-O2	-6.39	117.43	121.90
36	5	2372	A	P-O3'-C3'	6.37	127.34	119.70
36	1	650	C	N3-C2-O2	6.37	126.36	121.90
36	5	1367	G	N1-C6-O6	6.36	123.72	119.90
36	5	1307	G	P-O3'-C3'	6.35	127.32	119.70
36	5	1200	A	N9-C4-C5	-6.34	103.26	105.80

Continued on next page...

Continued from previous page...

Mol	Chain	Res	Type	Atoms	Z	Observed(°)	Ideal(°)
36	5	2572	C	C2-N1-C1'	6.33	125.77	118.80
36	5	2957	G	O5'-P-OP1	-6.32	100.01	105.70
36	1	1115	G	C4-N9-C1'	6.32	134.71	126.50
36	5	2169	G	N9-C4-C5	6.31	107.92	105.40
1	2	1389	C	C2-N1-C1'	6.30	125.73	118.80
1	6	1097	U	P-O3'-C3'	6.30	127.26	119.70
1	6	453	U	N3-C2-O2	-6.28	117.81	122.20
36	5	2847	A	C8-N9-C4	6.27	108.31	105.80
18	C6	40	GLU	C-N-CD	-6.26	106.83	120.60
38	4	125	U	C6-N1-C1'	-6.25	112.44	121.20
36	5	2860	U	O4'-C1'-N1	6.25	113.20	108.20
36	5	645	A	N1-C6-N6	-6.25	114.85	118.60
1	6	813	U	N3-C2-O2	-6.24	117.83	122.20
36	5	406	G	C8-N9-C1'	6.23	135.10	127.00
1	2	1052	U	C2-N1-C1'	6.22	125.16	117.70
36	5	1028	U	N3-C2-O2	-6.22	117.85	122.20
12	c0	83	PRO	N-CA-CB	6.21	110.75	103.30
36	1	2808	A	N1-C6-N6	6.17	122.31	118.60
36	1	1367	G	C6-C5-N7	-6.16	126.70	130.40
36	5	2572	C	N1-C2-O2	6.15	122.59	118.90
36	5	1352	A	OP1-P-O3'	6.14	118.71	105.20
36	1	2403	G	C6-C5-N7	-6.14	126.72	130.40
1	6	647	G	N3-C4-N9	-6.13	122.32	126.00
36	5	2234	G	N1-C6-O6	6.12	123.58	119.90
36	5	641	C	C2-N1-C1'	-6.12	112.07	118.80
36	1	583	G	O5'-P-OP1	-6.09	100.22	105.70
36	1	1115	G	C8-N9-C1'	-6.08	119.10	127.00
36	1	922	U	C2-N1-C1'	6.06	124.97	117.70
1	2	959	U	N3-C2-O2	-6.05	117.96	122.20
36	1	2374	C	C2-N1-C1'	6.01	125.41	118.80
1	6	275	C	C2-N1-C1'	6.00	125.40	118.80
1	2	959	U	N1-C2-O2	5.99	126.99	122.80
37	7	73	C	C6-N1-C2	-5.98	117.91	120.30
36	1	98	G	C6-C5-N7	-5.98	126.81	130.40
1	6	680	U	N3-C2-O2	-5.97	118.02	122.20
36	5	1302	A	O5'-P-OP1	-5.97	100.33	105.70
36	1	650	C	N1-C2-O2	-5.96	115.32	118.90
1	2	158	U	P-O3'-C3'	5.96	126.85	119.70
36	1	406	G	C4-N9-C1'	-5.96	118.75	126.50
36	5	2860	U	C5-C4-O4	5.96	129.47	125.90
36	5	1113	G	C8-N9-C4	-5.96	104.02	106.40
1	6	937	C	C6-N1-C2	-5.95	117.92	120.30

Continued on next page...

Continued from previous page...

Mol	Chain	Res	Type	Atoms	Z	Observed(°)	Ideal(°)
36	5	1115	G	N3-C4-N9	5.95	129.57	126.00
36	1	3095	U	C5-C6-N1	5.94	125.67	122.70
36	1	282	G	C8-N9-C4	-5.93	104.03	106.40
36	5	1208	U	N3-C2-O2	-5.92	118.05	122.20
36	1	2836	C	N3-C2-O2	-5.91	117.76	121.90
36	1	3217	C	C6-N1-C1'	-5.90	113.72	120.80
36	1	2627	C	N1-C2-O2	-5.90	115.36	118.90
1	2	1456	C	C2-N1-C1'	5.90	125.29	118.80
1	6	542	A	P-O3'-C3'	5.90	126.78	119.70
1	6	280	U	C2-N1-C1'	5.89	124.77	117.70
36	5	1177	G	N1-C6-O6	5.89	123.44	119.90
36	5	3245	A	N1-C6-N6	5.88	122.13	118.60
36	5	880	G	C8-N9-C1'	5.87	134.63	127.00
36	5	406	G	C4-N9-C1'	-5.87	118.87	126.50
36	1	2608	G	N1-C6-O6	5.86	123.42	119.90
36	5	1481	A	P-O3'-C3'	5.86	126.73	119.70
1	6	1185	U	N1-C2-O2	5.84	126.89	122.80
36	1	3275	U	C2-N1-C1'	5.83	124.70	117.70
36	5	1166	G	N7-C8-N9	-5.83	110.19	113.10
36	5	2620	G	N3-C4-N9	-5.83	122.50	126.00
37	7	92	A	C8-N9-C4	5.83	108.13	105.80
36	5	1433	A	C8-N9-C4	-5.83	103.47	105.80
36	5	3245	A	N7-C8-N9	5.82	116.71	113.80
36	5	3154	C	C2-N1-C1'	5.82	125.20	118.80
36	5	835	G	O4'-C1'-N9	5.81	112.85	108.20
41	14	339	LEU	CA-CB-CG	5.80	128.64	115.30
36	5	3245	A	C6-C5-N7	-5.79	128.25	132.30
1	2	1389	C	N3-C2-O2	-5.78	117.85	121.90
36	1	2187	G	C5-C6-O6	5.78	132.07	128.60
38	8	80	A	N7-C8-N9	5.78	116.69	113.80
1	6	1389	C	C2-N1-C1'	5.77	125.15	118.80
36	1	2983	C	O4'-C1'-N1	5.77	112.82	108.20
38	4	39	G	N1-C6-O6	-5.77	116.44	119.90
1	6	1306	C	C2-N1-C1'	5.76	125.14	118.80
36	1	1115	G	C4-C5-N7	5.76	113.10	110.80
36	1	2873	U	C5-C4-O4	5.76	129.36	125.90
36	1	439	C	N3-C2-O2	-5.75	117.87	121.90
38	8	80	A	C8-N9-C4	-5.75	103.50	105.80
1	2	1202	A	C8-N9-C4	-5.75	103.50	105.80
36	5	2142	A	C8-N9-C4	5.74	108.10	105.80
36	5	406	G	C6-C5-N7	5.74	133.84	130.40
36	5	1887	A	O5'-P-OP2	-5.73	100.54	105.70

Continued on next page...

Continued from previous page...

Mol	Chain	Res	Type	Atoms	Z	Observed(°)	Ideal(°)
36	5	2231	C	C2-N1-C1'	5.73	125.10	118.80
36	5	1367	G	C5-C6-N1	-5.73	108.64	111.50
36	5	2526	C	N1-C2-O2	5.72	122.33	118.90
36	1	2403	G	C4-C5-C6	5.70	122.22	118.80
36	1	2617	U	N3-C4-C5	-5.69	111.19	114.60
36	1	637	C	C6-N1-C2	5.68	122.57	120.30
24	d2	93	LEU	CA-CB-CG	5.67	128.35	115.30
1	6	321	C	C2-N1-C1'	5.66	125.03	118.80
36	1	644	G	C5-C6-O6	5.66	132.00	128.60
36	5	1166	G	C8-N9-C4	5.65	108.66	106.40
36	5	3351	U	N1-C2-O2	5.65	126.76	122.80
1	2	1456	C	N1-C2-O2	5.65	122.29	118.90
36	1	3095	U	C6-N1-C2	-5.65	117.61	121.00
36	1	2373	A	O5'-P-OP1	-5.64	100.62	105.70
36	5	2938	G	O5'-P-OP1	-5.63	100.64	105.70
1	2	720	G	P-O3'-C3'	5.62	126.45	119.70
36	5	3197	G	N3-C4-N9	-5.62	122.63	126.00
36	1	3277	U	N3-C2-O2	-5.61	118.27	122.20
36	5	1222	G	P-O3'-C3'	5.61	126.43	119.70
36	5	2169	G	N3-C4-C5	-5.61	125.80	128.60
36	5	806	A	O5'-P-OP1	-5.60	100.66	105.70
36	1	1269	U	C2-N1-C1'	5.60	124.42	117.70
36	1	1604	G	C4-N9-C1'	5.59	133.77	126.50
44	17	229	PHE	CB-CG-CD2	-5.59	116.89	120.80
36	5	3309	G	N3-C4-C5	-5.59	125.81	128.60
1	2	639	U	N3-C2-O2	-5.57	118.30	122.20
36	5	2938	G	C6-C5-N7	5.57	133.74	130.40
1	2	720	G	OP1-P-O3'	5.57	117.45	105.20
1	2	1600	A	O4'-C1'-N9	5.56	112.65	108.20
78	q2	17	CYS	CA-CB-SG	5.55	124.00	114.00
36	5	942	U	N3-C4-O4	5.55	123.28	119.40
36	1	1151	U	C6-N1-C2	-5.53	117.68	121.00
36	5	1028	U	C6-N1-C1'	-5.53	113.46	121.20
1	6	321	C	N1-C2-O2	5.53	122.22	118.90
36	1	2714	G	N3-C4-N9	-5.52	122.69	126.00
36	5	1152	G	N3-C2-N2	-5.52	116.03	119.90
36	1	439	C	C6-N1-C1'	-5.52	114.18	120.80
36	1	2935	U	N1-C2-O2	5.52	126.66	122.80
36	1	2833	A	C8-N9-C4	5.51	108.00	105.80
36	1	2867	C	N3-C4-C5	5.50	124.10	121.90
36	1	2971	A	P-O3'-C3'	5.50	126.30	119.70
36	1	1434	G	C4-C5-N7	5.49	113.00	110.80

Continued on next page...

Continued from previous page...

Mol	Chain	Res	Type	Atoms	Z	Observed(°)	Ideal(°)
36	1	644	G	C5-C6-N1	-5.48	108.76	111.50
1	2	1052	U	N1-C2-O2	5.47	126.63	122.80
48	m1	12	LEU	CA-CB-CG	5.47	127.87	115.30
36	1	2726	C	N3-C2-O2	-5.46	118.08	121.90
36	1	1484	U	P-O3'-C3'	5.46	126.26	119.70
1	2	1052	U	N3-C2-O2	-5.46	118.38	122.20
36	5	942	U	C6-N1-C2	-5.45	117.73	121.00
36	5	1495	U	C5-C6-N1	5.45	125.43	122.70
36	5	421	G	C6-C5-N7	-5.44	127.14	130.40
36	1	2726	C	C6-N1-C2	-5.43	118.13	120.30
36	5	2887	A	N1-C6-N6	5.43	121.86	118.60
36	5	1483	G	O4'-C1'-N9	5.43	112.54	108.20
36	5	1604	G	C4-N9-C1'	5.43	133.56	126.50
24	D2	65	LEU	CA-CB-CG	5.43	127.78	115.30
36	1	1113	G	C5-C6-O6	-5.42	125.35	128.60
1	2	577	G	N1-C6-O6	5.42	123.15	119.90
36	1	2983	C	C2-N1-C1'	5.42	124.76	118.80
36	1	2873	U	N3-C2-O2	-5.41	118.41	122.20
36	1	344	A	N1-C6-N6	-5.41	115.35	118.60
36	1	1419	A	O5'-P-OP1	5.41	117.19	110.70
36	1	1115	G	N9-C4-C5	-5.40	103.24	105.40
36	5	2724	U	C5-C4-O4	5.40	129.14	125.90
1	6	965	U	N1-C2-O2	5.40	126.58	122.80
36	1	2836	C	N1-C2-O2	5.39	122.14	118.90
1	2	1241	G	O4'-C1'-N9	5.39	112.51	108.20
36	1	2298	U	O4'-C1'-N1	5.39	112.51	108.20
36	1	3217	C	C6-N1-C2	-5.39	118.15	120.30
41	14	340	GLY	N-CA-C	-5.38	99.64	113.10
36	1	1820	U	OP2-P-O3'	5.38	117.04	105.20
36	1	2355	G	C5-C6-O6	-5.38	125.37	128.60
31	D9	36	LEU	CA-CB-CG	5.38	127.67	115.30
1	6	144	U	N3-C2-O2	-5.38	118.44	122.20
36	5	419	G	C5-C6-O6	5.37	131.82	128.60
36	1	24	G	O5'-P-OP2	-5.37	100.87	105.70
36	1	503	C	C6-N1-C2	5.36	122.44	120.30
1	2	1456	C	N3-C2-O2	-5.36	118.15	121.90
36	1	65	A	C8-N9-C4	-5.36	103.66	105.80
1	2	992	A	O4'-C1'-N9	5.35	112.48	108.20
1	6	1274	C	N3-C2-O2	-5.35	118.15	121.90
1	6	965	U	C2-N1-C1'	5.34	124.11	117.70
36	5	1208	U	C5-C4-O4	5.34	129.10	125.90
36	5	1368	U	C5-C6-N1	5.33	125.37	122.70

Continued on next page...

Continued from previous page...

Mol	Chain	Res	Type	Atoms	Z	Observed(°)	Ideal(°)
36	5	581	U	C5-C4-O4	-5.33	122.70	125.90
1	6	453	U	C5-C6-N1	5.33	125.36	122.70
36	5	406	G	N3-C4-N9	-5.33	122.81	126.00
36	1	2659	G	C8-N9-C4	5.32	108.53	106.40
36	5	2955	U	OP2-P-O3'	5.32	116.90	105.20
36	1	2112	U	P-O3'-C3'	5.31	126.08	119.70
36	1	2541	U	P-O3'-C3'	5.31	126.07	119.70
36	5	2531	C	C2-N1-C1'	5.31	124.64	118.80
1	2	1761	U	N3-C2-O2	-5.30	118.49	122.20
36	1	1879	A	O4'-C1'-N9	5.30	112.44	108.20
36	5	2273	G	C8-N9-C4	5.30	108.52	106.40
36	5	2964	G	N1-C6-O6	-5.30	116.72	119.90
36	5	2719	U	C2-N1-C1'	-5.28	111.36	117.70
36	1	2297	U	P-O3'-C3'	5.28	126.04	119.70
36	5	3058	U	C2-N1-C1'	5.28	124.03	117.70
36	5	2371	G	C4-N9-C1'	-5.28	119.64	126.50
36	5	3362	A	O4'-C1'-N9	5.28	112.42	108.20
1	2	831	U	N1-C2-O2	5.27	126.49	122.80
36	5	2572	C	C6-N1-C1'	-5.27	114.48	120.80
15	C3	22	ALA	C-N-CD	-5.27	109.02	120.60
1	6	98	U	N3-C2-O2	-5.26	118.52	122.20
36	5	1189	C	N1-C2-O2	-5.26	115.74	118.90
36	5	2827	U	C2-N1-C1'	5.26	124.01	117.70
1	6	275	C	N1-C2-O2	5.26	122.06	118.90
1	6	426	G	C4-N9-C1'	5.26	133.33	126.50
1	2	1657	U	P-O3'-C3'	5.25	126.00	119.70
1	2	934	C	N3-C2-O2	-5.24	118.23	121.90
36	5	1496	C	C2-N1-C1'	5.23	124.55	118.80
36	5	817	A	O5'-P-OP1	-5.22	101.00	105.70
1	2	1000	C	C2-N1-C1'	5.22	124.55	118.80
1	6	558	U	P-O3'-C3'	5.22	125.96	119.70
1	2	639	U	N1-C2-O2	5.22	126.45	122.80
1	6	158	U	P-O3'-C3'	5.22	125.96	119.70
36	5	2205	U	O4'-C1'-N1	5.22	112.37	108.20
36	5	2957	G	OP1-P-OP2	5.21	127.42	119.60
57	N1	89	LEU	CA-CB-CG	5.20	127.25	115.30
36	1	65	A	N7-C8-N9	5.19	116.40	113.80
1	2	1246	C	C2-N1-C1'	5.19	124.51	118.80
1	2	25	C	P-O3'-C3'	5.19	125.93	119.70
36	5	2600	C	C6-N1-C2	-5.19	118.22	120.30
36	5	638	C	C6-N1-C2	-5.19	118.23	120.30
36	1	1269	U	N3-C2-O2	-5.18	118.57	122.20

Continued on next page...

Continued from previous page...

Mol	Chain	Res	Type	Atoms	Z	Observed(°)	Ideal(°)
36	5	3145	C	C2-N1-C1'	5.18	124.50	118.80
1	6	453	U	C6-N1-C1'	-5.18	113.95	121.20
36	1	1115	G	C5-C6-O6	-5.18	125.49	128.60
36	5	283	G	C4-C5-N7	5.18	112.87	110.80
36	5	3245	A	C5-N7-C8	-5.18	101.31	103.90
36	5	3140	G	C6-C5-N7	-5.17	127.30	130.40
36	1	1365	G	N3-C4-C5	-5.17	126.02	128.60
36	1	1556	C	C2-N1-C1'	5.17	124.49	118.80
36	5	1166	G	C5-N7-C8	5.17	106.88	104.30
1	2	1389	C	C6-N1-C2	-5.16	118.23	120.30
36	5	663	C	C6-N1-C2	-5.16	118.23	120.30
36	5	2945	G	C5-C6-O6	-5.16	125.50	128.60
1	6	965	U	N3-C2-O2	-5.16	118.59	122.20
47	m0	167	LEU	CA-CB-CG	5.16	127.16	115.30
36	5	3351	U	C5-C6-N1	5.16	125.28	122.70
9	S7	31	SER	C-N-CD	5.15	139.22	128.40
62	N6	126	LEU	CA-CB-CG	5.15	127.15	115.30
36	1	2554	A	P-O3'-C3'	5.15	125.88	119.70
35	SM	134	ASP	CB-CG-OD2	5.15	122.94	118.30
36	1	2690	G	C4-N9-C1'	5.15	133.19	126.50
36	5	661	G	N3-C4-N9	5.15	129.09	126.00
36	1	917	A	N1-C6-N6	-5.15	115.51	118.60
36	5	2772	C	P-O3'-C3'	5.15	125.88	119.70
1	6	1458	G	C4-N9-C1'	5.14	133.19	126.50
36	5	1017	C	N1-C2-O2	5.14	121.99	118.90
36	5	2234	G	C5-C6-N1	-5.14	108.93	111.50
36	1	1349	G	O4'-C1'-N9	5.14	112.31	108.20
36	5	2347	U	N3-C4-O4	-5.14	115.80	119.40
36	5	3317	U	P-O3'-C3'	5.14	125.87	119.70
36	1	1903	U	N3-C4-O4	5.14	123.00	119.40
36	1	3275	U	C5-C6-N1	5.14	125.27	122.70
36	5	1208	U	N3-C4-O4	-5.14	115.80	119.40
36	1	2816	G	O5'-P-OP2	-5.13	101.08	105.70
36	5	1379	G	N3-C2-N2	5.13	123.49	119.90
1	2	1634	C	C2-N1-C1'	5.12	124.43	118.80
36	1	1434	G	C5-N7-C8	-5.11	101.75	104.30
36	5	2945	G	O5'-P-OP2	-5.11	101.10	105.70
1	6	1573	A	OP2-P-O3'	5.10	116.42	105.20
36	5	922	U	C5-C6-N1	-5.10	120.15	122.70
36	5	953	G	C5-C6-O6	-5.10	125.54	128.60
1	2	934	C	C6-N1-C1'	-5.10	114.69	120.80
1	6	1747	G	C8-N9-C4	5.10	108.44	106.40

Continued on next page...

Continued from previous page...

Mol	Chain	Res	Type	Atoms	Z	Observed(°)	Ideal(°)
1	6	163	G	N3-C4-C5	5.09	131.15	128.60
1	6	1600	A	OP1-P-O3'	5.09	116.41	105.20
36	1	2101	C	P-O3'-C3'	5.09	125.81	119.70
36	1	1716	U	P-O3'-C3'	5.09	125.81	119.70
36	1	880	G	C4-N9-C1'	-5.09	119.88	126.50
1	6	1389	C	N1-C2-O2	5.09	121.95	118.90
36	1	2617	U	C5-C6-N1	-5.08	120.16	122.70
36	5	968	G	O5'-P-OP1	-5.08	101.13	105.70
36	5	1352	A	P-O3'-C3'	5.08	125.80	119.70
36	5	1604	G	N3-C4-C5	-5.08	126.06	128.60
36	5	2169	G	N1-C6-O6	-5.08	116.86	119.90
1	6	163	G	N3-C2-N2	-5.07	116.35	119.90
1	6	1000	C	C6-N1-C1'	-5.07	114.71	120.80
1	6	217	A	P-O3'-C3'	5.07	125.78	119.70
1	2	577	G	C5-C6-O6	-5.07	125.56	128.60
36	5	1604	G	N3-C4-N9	5.06	129.04	126.00
36	5	27	C	C6-N1-C2	-5.05	118.28	120.30
4	s2	113	LEU	CA-CB-CG	5.04	126.90	115.30
36	1	915	A	C8-N9-C4	-5.04	103.78	105.80
36	1	343	U	O5'-P-OP2	-5.04	101.17	105.70
36	5	1433	A	N9-C4-C5	5.04	107.81	105.80
1	6	144	U	N1-C2-O2	5.03	126.32	122.80
36	5	2156	C	C6-N1-C2	5.03	122.31	120.30
36	1	656	A	C6-C5-N7	-5.02	128.78	132.30
36	5	1116	G	OP2-P-O3'	5.02	116.25	105.20
36	1	2617	U	N3-C2-O2	-5.02	118.69	122.20
36	5	2776	C	N1-C2-O2	5.02	121.91	118.90
47	m0	87	LEU	CA-CB-CG	5.02	126.84	115.30
38	4	125	U	C5-C6-N1	5.02	125.21	122.70
18	C6	40	GLU	C-N-CA	5.01	143.06	122.00
36	5	963	G	O5'-P-OP2	-5.01	101.19	105.70
1	2	767	U	N1-C2-O2	5.01	126.31	122.80
36	1	1269	U	N1-C2-O2	5.01	126.31	122.80
36	1	2971	A	C6-C5-N7	-5.01	128.80	132.30
1	6	163	G	N9-C4-C5	5.00	107.40	105.40
36	1	2137	U	C2-N1-C1'	5.00	123.70	117.70

There are no chirality outliers.

All (10) planarity outliers are listed below:

Mol	Chain	Res	Type	Group
19	C7	85	VAL	Peptide

Continued on next page...

Continued from previous page...

Mol	Chain	Res	Type	Group
27	D5	94	LYS	Peptide
44	L7	157	ASN	Peptide
52	M6	110	PRO	Peptide
65	N9	20	GLY	Peptide
18	c6	40	GLU	Peptide
83	f	108	ASP	Peptide
39	l2	237	LEU	Peptide
64	n8	46	ASP	Peptide
65	n9	23	LYS	Peptide

5.2 Too-close contacts [i](#)

Due to software issues we are unable to calculate clashes - this section is therefore empty.

5.3 Torsion angles [i](#)

5.3.1 Protein backbone [i](#)

In the following table, the Percentiles column shows the percent Ramachandran outliers of the chain as a percentile score with respect to all X-ray entries followed by that with respect to entries of similar resolution.

The Analysed column shows the number of residues for which the backbone conformation was analysed, and the total number of residues.

Mol	Chain	Analysed	Favoured	Allowed	Outliers	Percentiles	
2	S0	204/251 (81%)	151 (74%)	30 (15%)	23 (11%)	0	2
2	s0	204/251 (81%)	164 (80%)	25 (12%)	15 (7%)	1	7
3	S1	212/254 (84%)	152 (72%)	38 (18%)	22 (10%)	0	3
3	s1	214/254 (84%)	168 (78%)	33 (15%)	13 (6%)	1	10
4	S2	215/253 (85%)	168 (78%)	33 (15%)	14 (6%)	1	9
4	s2	215/253 (85%)	168 (78%)	33 (15%)	14 (6%)	1	9
5	S3	221/239 (92%)	187 (85%)	26 (12%)	8 (4%)	3	20
5	s3	221/239 (92%)	176 (80%)	35 (16%)	10 (4%)	2	15
6	S4	258/260 (99%)	202 (78%)	46 (18%)	10 (4%)	3	18
6	s4	258/260 (99%)	189 (73%)	53 (20%)	16 (6%)	1	10
7	S5	204/224 (91%)	155 (76%)	37 (18%)	12 (6%)	1	10

Continued on next page...

Continued from previous page...

Mol	Chain	Analysed	Favoured	Allowed	Outliers	Percentiles	
7	s5	204/224 (91%)	160 (78%)	29 (14%)	15 (7%)	1	7
8	S6	224/236 (95%)	193 (86%)	22 (10%)	9 (4%)	3	18
8	s6	216/236 (92%)	182 (84%)	22 (10%)	12 (6%)	2	11
9	S7	182/189 (96%)	134 (74%)	27 (15%)	21 (12%)	0	2
9	s7	184/189 (97%)	152 (83%)	20 (11%)	12 (6%)	1	9
10	S8	184/200 (92%)	151 (82%)	24 (13%)	9 (5%)	2	14
10	s8	184/200 (92%)	157 (85%)	20 (11%)	7 (4%)	3	19
11	S9	183/196 (93%)	149 (81%)	23 (13%)	11 (6%)	1	10
11	s9	183/196 (93%)	147 (80%)	27 (15%)	9 (5%)	2	14
12	C0	82/96 (85%)	71 (87%)	8 (10%)	3 (4%)	3	20
12	c0	82/96 (85%)	56 (68%)	16 (20%)	10 (12%)	0	1
13	C1	143/155 (92%)	116 (81%)	18 (13%)	9 (6%)	1	9
13	c1	143/155 (92%)	115 (80%)	21 (15%)	7 (5%)	2	14
14	C2	107/142 (75%)	70 (65%)	27 (25%)	10 (9%)	0	4
14	c2	107/142 (75%)	75 (70%)	22 (21%)	10 (9%)	0	4
15	C3	148/150 (99%)	124 (84%)	20 (14%)	4 (3%)	5	26
15	c3	148/150 (99%)	116 (78%)	23 (16%)	9 (6%)	1	10
16	C4	125/136 (92%)	81 (65%)	33 (26%)	11 (9%)	1	5
16	c4	126/136 (93%)	96 (76%)	15 (12%)	15 (12%)	0	2
17	C5	121/141 (86%)	95 (78%)	12 (10%)	14 (12%)	0	2
17	c5	128/141 (91%)	98 (77%)	19 (15%)	11 (9%)	1	5
18	C6	139/142 (98%)	116 (84%)	14 (10%)	9 (6%)	1	9
18	c6	140/142 (99%)	118 (84%)	13 (9%)	9 (6%)	1	9
19	C7	116/136 (85%)	82 (71%)	23 (20%)	11 (10%)	0	4
19	c7	113/136 (83%)	93 (82%)	13 (12%)	7 (6%)	1	10
20	C8	143/145 (99%)	116 (81%)	17 (12%)	10 (7%)	1	7
20	c8	143/145 (99%)	120 (84%)	16 (11%)	7 (5%)	2	14
21	C9	141/143 (99%)	115 (82%)	18 (13%)	8 (6%)	1	11
21	c9	141/143 (99%)	120 (85%)	15 (11%)	6 (4%)	2	16
22	D0	105/120 (88%)	89 (85%)	9 (9%)	7 (7%)	1	8
22	d0	108/120 (90%)	89 (82%)	14 (13%)	5 (5%)	2	15

Continued on next page...

Continued from previous page...

Mol	Chain	Analysed	Favoured	Allowed	Outliers	Percentiles	
23	D1	85/87 (98%)	66 (78%)	11 (13%)	8 (9%)	0	4
23	d1	85/87 (98%)	63 (74%)	17 (20%)	5 (6%)	1	10
24	D2	127/129 (98%)	116 (91%)	8 (6%)	3 (2%)	6	28
24	d2	127/129 (98%)	107 (84%)	17 (13%)	3 (2%)	6	28
25	D3	142/144 (99%)	109 (77%)	21 (15%)	12 (8%)	1	5
25	d3	142/144 (99%)	117 (82%)	20 (14%)	5 (4%)	3	21
26	D4	132/134 (98%)	109 (83%)	13 (10%)	10 (8%)	1	6
26	d4	132/134 (98%)	110 (83%)	15 (11%)	7 (5%)	2	12
27	D5	68/107 (64%)	48 (71%)	13 (19%)	7 (10%)	0	3
27	d5	67/107 (63%)	51 (76%)	15 (22%)	1 (2%)	10	38
28	D6	95/97 (98%)	56 (59%)	21 (22%)	18 (19%)	0	1
28	d6	95/97 (98%)	66 (70%)	20 (21%)	9 (10%)	0	4
29	D7	79/81 (98%)	61 (77%)	15 (19%)	3 (4%)	3	19
29	d7	79/81 (98%)	61 (77%)	14 (18%)	4 (5%)	2	13
30	D8	61/66 (92%)	50 (82%)	9 (15%)	2 (3%)	4	22
30	d8	61/66 (92%)	47 (77%)	11 (18%)	3 (5%)	2	14
31	D9	51/55 (93%)	39 (76%)	9 (18%)	3 (6%)	1	10
31	d9	51/55 (93%)	41 (80%)	8 (16%)	2 (4%)	3	18
32	E0	58/62 (94%)	46 (79%)	10 (17%)	2 (3%)	3	22
32	e0	60/62 (97%)	40 (67%)	12 (20%)	8 (13%)	0	1
33	E1	69/76 (91%)	35 (51%)	17 (25%)	17 (25%)	0	0
33	e1	74/76 (97%)	36 (49%)	21 (28%)	17 (23%)	0	0
34	SR	316/318 (99%)	263 (83%)	36 (11%)	17 (5%)	2	12
34	sR	316/318 (99%)	252 (80%)	53 (17%)	11 (4%)	3	21
35	SM	120/273 (44%)	91 (76%)	18 (15%)	11 (9%)	1	4
35	sM	61/273 (22%)	42 (69%)	11 (18%)	8 (13%)	0	1
39	L2	250/253 (99%)	213 (85%)	27 (11%)	10 (4%)	3	18
39	l2	250/253 (99%)	205 (82%)	30 (12%)	15 (6%)	1	10
40	L3	384/386 (100%)	316 (82%)	49 (13%)	19 (5%)	2	14
40	l3	384/386 (100%)	330 (86%)	39 (10%)	15 (4%)	3	18
41	L4	359/361 (99%)	291 (81%)	46 (13%)	22 (6%)	1	10

Continued on next page...

Continued from previous page...

Mol	Chain	Analysed	Favoured	Allowed	Outliers	Percentiles	
41	l4	359/361 (99%)	296 (82%)	43 (12%)	20 (6%)	2	11
42	L5	294/296 (99%)	232 (79%)	44 (15%)	18 (6%)	1	10
42	l5	292/296 (99%)	248 (85%)	38 (13%)	6 (2%)	7	31
43	L6	152/175 (87%)	122 (80%)	27 (18%)	3 (2%)	7	32
43	l6	153/175 (87%)	125 (82%)	24 (16%)	4 (3%)	5	27
44	L7	220/243 (90%)	185 (84%)	24 (11%)	11 (5%)	2	14
44	l7	221/243 (91%)	192 (87%)	21 (10%)	8 (4%)	3	20
45	L8	231/255 (91%)	190 (82%)	30 (13%)	11 (5%)	2	14
45	l8	229/255 (90%)	174 (76%)	40 (18%)	15 (7%)	1	8
46	L9	189/191 (99%)	145 (77%)	29 (15%)	15 (8%)	1	6
46	l9	189/191 (99%)	158 (84%)	24 (13%)	7 (4%)	3	20
47	M0	207/220 (94%)	161 (78%)	37 (18%)	9 (4%)	2	16
47	m0	209/220 (95%)	169 (81%)	29 (14%)	11 (5%)	2	12
48	M1	167/173 (96%)	128 (77%)	27 (16%)	12 (7%)	1	7
48	m1	167/173 (96%)	145 (87%)	9 (5%)	13 (8%)	1	6
49	M3	191/198 (96%)	153 (80%)	30 (16%)	8 (4%)	3	17
49	m3	192/198 (97%)	152 (79%)	27 (14%)	13 (7%)	1	8
50	M4	134/137 (98%)	116 (87%)	12 (9%)	6 (4%)	2	15
50	m4	135/137 (98%)	117 (87%)	15 (11%)	3 (2%)	6	30
51	M5	201/203 (99%)	175 (87%)	20 (10%)	6 (3%)	4	24
51	m5	201/203 (99%)	178 (89%)	18 (9%)	5 (2%)	5	27
52	M6	195/198 (98%)	174 (89%)	12 (6%)	9 (5%)	2	15
52	m6	195/198 (98%)	172 (88%)	20 (10%)	3 (2%)	10	38
53	M7	181/183 (99%)	151 (83%)	25 (14%)	5 (3%)	5	25
53	m7	153/183 (84%)	137 (90%)	14 (9%)	2 (1%)	12	40
54	M8	183/185 (99%)	156 (85%)	20 (11%)	7 (4%)	3	19
54	m8	183/185 (99%)	154 (84%)	21 (12%)	8 (4%)	2	16
55	M9	186/188 (99%)	164 (88%)	17 (9%)	5 (3%)	5	26
55	m9	186/188 (99%)	164 (88%)	20 (11%)	2 (1%)	14	45
56	N0	170/172 (99%)	151 (89%)	15 (9%)	4 (2%)	6	28
56	n0	170/172 (99%)	159 (94%)	9 (5%)	2 (1%)	13	42

Continued on next page...

Continued from previous page...

Mol	Chain	Analysed	Favoured	Allowed	Outliers	Percentiles	
57	N1	157/159 (99%)	131 (83%)	20 (13%)	6 (4%)	3	19
57	n1	157/159 (99%)	138 (88%)	16 (10%)	3 (2%)	8	34
58	N2	98/120 (82%)	73 (74%)	20 (20%)	5 (5%)	2	13
58	n2	96/120 (80%)	80 (83%)	13 (14%)	3 (3%)	4	23
59	N3	134/136 (98%)	117 (87%)	12 (9%)	5 (4%)	3	20
59	n3	134/136 (98%)	122 (91%)	4 (3%)	8 (6%)	1	10
60	N4	96/155 (62%)	66 (69%)	21 (22%)	9 (9%)	0	4
60	n4	133/155 (86%)	102 (77%)	23 (17%)	8 (6%)	1	10
61	N5	119/141 (84%)	103 (87%)	12 (10%)	4 (3%)	3	22
61	n5	118/141 (84%)	91 (77%)	17 (14%)	10 (8%)	1	5
62	N6	124/126 (98%)	104 (84%)	19 (15%)	1 (1%)	19	51
62	n6	124/126 (98%)	102 (82%)	17 (14%)	5 (4%)	3	18
63	N7	133/135 (98%)	112 (84%)	12 (9%)	9 (7%)	1	8
63	n7	133/135 (98%)	100 (75%)	26 (20%)	7 (5%)	2	12
64	N8	146/148 (99%)	113 (77%)	26 (18%)	7 (5%)	2	14
64	n8	146/148 (99%)	110 (75%)	25 (17%)	11 (8%)	1	7
65	N9	56/58 (97%)	46 (82%)	8 (14%)	2 (4%)	3	20
65	n9	56/58 (97%)	41 (73%)	9 (16%)	6 (11%)	0	3
66	O0	95/104 (91%)	83 (87%)	11 (12%)	1 (1%)	14	45
66	o0	98/104 (94%)	86 (88%)	10 (10%)	2 (2%)	7	32
67	O1	107/112 (96%)	96 (90%)	6 (6%)	5 (5%)	2	14
67	o1	107/112 (96%)	85 (79%)	15 (14%)	7 (6%)	1	9
68	O2	125/129 (97%)	110 (88%)	11 (9%)	4 (3%)	4	22
68	o2	125/129 (97%)	105 (84%)	16 (13%)	4 (3%)	4	22
69	O3	104/106 (98%)	96 (92%)	6 (6%)	2 (2%)	8	34
69	o3	104/106 (98%)	93 (89%)	9 (9%)	2 (2%)	8	34
70	O4	110/120 (92%)	96 (87%)	11 (10%)	3 (3%)	5	26
70	o4	110/120 (92%)	88 (80%)	18 (16%)	4 (4%)	3	20
71	O5	117/119 (98%)	95 (81%)	12 (10%)	10 (8%)	1	5
71	o5	117/119 (98%)	94 (80%)	21 (18%)	2 (2%)	9	35
72	O6	97/99 (98%)	76 (78%)	12 (12%)	9 (9%)	0	4

Continued on next page...

Continued from previous page...

Mol	Chain	Analysed	Favoured	Allowed	Outliers	Percentiles	
72	o6	97/99 (98%)	76 (78%)	11 (11%)	10 (10%)	0	3
73	O7	85/87 (98%)	69 (81%)	14 (16%)	2 (2%)	6	28
73	o7	85/87 (98%)	70 (82%)	14 (16%)	1 (1%)	13	42
74	O8	75/77 (97%)	66 (88%)	7 (9%)	2 (3%)	5	26
74	o8	75/77 (97%)	61 (81%)	9 (12%)	5 (7%)	1	8
75	O9	48/50 (96%)	35 (73%)	10 (21%)	3 (6%)	1	9
75	o9	48/50 (96%)	39 (81%)	9 (19%)	0	100	100
76	Q0	50/52 (96%)	43 (86%)	6 (12%)	1 (2%)	7	32
76	q0	50/52 (96%)	48 (96%)	1 (2%)	1 (2%)	7	32
77	Q1	23/25 (92%)	21 (91%)	2 (9%)	0	100	100
77	q1	23/25 (92%)	20 (87%)	2 (9%)	1 (4%)	2	16
78	Q2	103/105 (98%)	85 (82%)	13 (13%)	5 (5%)	2	14
78	q2	103/105 (98%)	88 (85%)	9 (9%)	6 (6%)	1	11
79	Q3	89/91 (98%)	70 (79%)	13 (15%)	6 (7%)	1	8
79	q3	89/91 (98%)	79 (89%)	9 (10%)	1 (1%)	14	45
81	p0	117/311 (38%)	97 (83%)	14 (12%)	6 (5%)	2	13
83	f	146/157 (93%)	91 (62%)	35 (24%)	20 (14%)	0	1
All	All	22316/24284 (92%)	18108 (81%)	2992 (13%)	1216 (5%)	2	12

All (1216) Ramachandran outliers are listed below:

Mol	Chain	Res	Type
2	S0	95	ALA
2	S0	158	VAL
2	S0	190	ASP
2	S0	192	THR
3	S1	35	PRO
3	S1	37	THR
3	S1	132	ASP
3	S1	206	PRO
3	S1	213	ARG
4	S2	48	GLY
4	S2	106	ASP
5	S3	217	ILE
5	S3	220	PRO
6	S4	12	LEU

Continued on next page...

Continued from previous page...

Mol	Chain	Res	Type
7	S5	63	GLN
7	S5	98	MET
8	S6	122	GLU
8	S6	173	PRO
9	S7	31	SER
9	S7	32	PRO
9	S7	64	VAL
9	S7	116	ARG
9	S7	186	PRO
11	S9	93	LEU
11	S9	98	ALA
11	S9	134	ILE
13	C1	7	VAL
13	C1	55	ASP
16	C4	42	VAL
17	C5	54	ALA
17	C5	69	GLU
17	C5	80	MET
17	C5	87	PRO
17	C5	125	PRO
18	C6	41	PRO
18	C6	58	ASP
18	C6	97	VAL
18	C6	114	ARG
19	C7	85	VAL
19	C7	86	PRO
19	C7	88	VAL
19	C7	99	VAL
19	C7	124	VAL
20	C8	76	PRO
20	C8	92	ILE
21	C9	11	ALA
21	C9	31	PRO
21	C9	53	TRP
21	C9	67	MET
21	C9	69	LYS
23	D1	4	ASP
24	D2	83	ILE
25	D3	36	THR
25	D3	114	LYS
25	D3	144	ARG
27	D5	44	GLN

Continued on next page...

Continued from previous page...

Mol	Chain	Res	Type
27	D5	71	ILE
27	D5	86	GLU
28	D6	45	VAL
28	D6	84	VAL
29	D7	57	GLU
31	D9	11	PRO
32	E0	47	VAL
33	E1	84	VAL
33	E1	98	VAL
33	E1	102	VAL
33	E1	103	LEU
34	SR	238	ASP
34	SR	318	ALA
35	SM	64	LYS
39	L2	144	ASN
40	L3	3	HIS
40	L3	5	LYS
41	L4	4	PRO
41	L4	130	ALA
41	L4	131	VAL
41	L4	220	ARG
41	L4	293	SER
41	L4	341	SER
42	L5	178	ASN
42	L5	223	PHE
42	L5	258	LYS
43	L6	98	VAL
44	L7	24	GLU
44	L7	72	ALA
45	L8	25	PRO
45	L8	31	PRO
45	L8	122	LYS
45	L8	226	TYR
46	L9	50	ASN
46	L9	107	ASP
47	M0	6	ALA
47	M0	113	GLN
47	M0	130	ASP
47	M0	219	ALA
48	M1	11	ASP
49	M3	129	ASN
50	M4	10	SER

Continued on next page...

Continued from previous page...

Mol	Chain	Res	Type
51	M5	74	PRO
51	M5	75	VAL
52	M6	110	PRO
52	M6	111	PRO
52	M6	149	TYR
53	M7	157	VAL
57	N1	159	PHE
58	N2	51	GLY
59	N3	54	LEU
60	N4	81	PRO
61	N5	48	SER
63	N7	17	ARG
63	N7	30	ASP
63	N7	125	GLY
63	N7	128	GLN
64	N8	66	ALA
64	N8	96	LYS
64	N8	97	GLU
67	O1	21	HIS
72	O6	28	TYR
72	O6	33	ALA
74	O8	33	LYS
75	O9	4	GLN
78	Q2	96	GLU
78	Q2	100	LYS
2	s0	29	VAL
2	s0	66	ALA
2	s0	68	PRO
2	s0	164	ASN
2	s0	189	VAL
2	s0	194	PRO
3	s1	158	SER
3	s1	218	LEU
4	s2	164	SER
5	s3	217	ILE
5	s3	220	PRO
6	s4	53	LYS
6	s4	163	ASP
6	s4	196	VAL
7	s5	43	PHE
7	s5	184	PHE
7	s5	204	GLY

Continued on next page...

Continued from previous page...

Mol	Chain	Res	Type
8	s6	152	ASP
8	s6	153	VAL
9	s7	5	GLN
9	s7	74	GLN
9	s7	106	SER
9	s7	131	PHE
12	c0	2	LEU
12	c0	32	HIS
12	c0	83	PRO
15	c3	66	ILE
16	c4	51	ASP
16	c4	91	THR
16	c4	98	GLY
17	c5	80	MET
17	c5	125	PRO
18	c6	39	VAL
18	c6	42	GLU
18	c6	97	VAL
18	c6	112	TYR
18	c6	113	ASP
18	c6	116	LEU
19	c7	67	ARG
19	c7	88	VAL
19	c7	99	VAL
20	c8	8	GLN
21	c9	33	TYR
24	d2	68	ARG
25	d3	47	SER
25	d3	138	GLU
26	d4	33	ALA
26	d4	35	VAL
26	d4	53	ASP
28	d6	28	LYS
28	d6	29	SER
31	d9	6	VAL
32	e0	60	PRO
33	e1	87	THR
33	e1	92	LYS
33	e1	98	VAL
33	e1	107	LYS
33	e1	110	ALA
34	sR	160	GLU

Continued on next page...

Continued from previous page...

Mol	Chain	Res	Type
34	sR	165	ASP
34	sR	226	ALA
35	sM	50	ASN
39	l2	24	GLN
39	l2	142	ASP
39	l2	194	ASN
40	l3	139	GLN
40	l3	170	PRO
40	l3	300	ARG
40	l3	347	SER
41	l4	142	VAL
41	l4	174	ALA
41	l4	252	GLU
41	l4	272	VAL
41	l4	301	PRO
41	l4	329	PRO
41	l4	342	LYS
41	l4	361	HIS
42	l5	178	ASN
44	l7	193	PRO
45	l8	25	PRO
45	l8	81	THR
46	l9	62	ARG
46	l9	167	VAL
47	m0	82	ARG
47	m0	145	LYS
48	m1	8	PRO
48	m1	108	GLU
49	m3	17	HIS
49	m3	134	GLU
50	m4	63	VAL
51	m5	76	PRO
52	m6	5	PRO
52	m6	110	PRO
54	m8	95	GLU
54	m8	99	THR
57	n1	135	PRO
58	n2	49	ASN
58	n2	105	LEU
59	n3	42	SER
60	n4	26	SER
60	n4	63	ILE

Continued on next page...

Continued from previous page...

Mol	Chain	Res	Type
60	n4	75	THR
60	n4	76	VAL
61	n5	42	ARG
61	n5	92	LYS
63	n7	56	LYS
64	n8	30	GLY
64	n8	47	LYS
64	n8	48	TYR
65	n9	21	ILE
65	n9	23	LYS
65	n9	24	PRO
67	o1	5	LYS
67	o1	45	GLY
67	o1	84	ASP
68	o2	6	HIS
69	o3	60	ARG
69	o3	94	PHE
72	o6	64	SER
72	o6	98	ARG
76	q0	78	ILE
78	q2	32	LYS
78	q2	33	ALA
83	f	52	HIS
83	f	54	HIS
83	f	64	ILE
83	f	109	THR
83	f	111	ASP
2	S0	4	PRO
2	S0	5	ALA
2	S0	39	ASN
2	S0	111	ILE
2	S0	191	ARG
2	S0	202	TYR
3	S1	21	VAL
3	S1	62	LYS
3	S1	63	GLY
3	S1	177	GLN
4	S2	91	ARG
4	S2	107	SER
5	S3	81	PRO
5	S3	216	PRO
6	S4	104	ASP

Continued on next page...

Continued from previous page...

Mol	Chain	Res	Type
6	S4	150	PRO
6	S4	195	ILE
7	S5	39	GLU
7	S5	43	PHE
7	S5	204	GLY
8	S6	149	LYS
8	S6	150	GLU
8	S6	174	LYS
9	S7	36	ALA
9	S7	74	GLN
9	S7	129	LEU
10	S8	52	ASN
10	S8	149	SER
11	S9	167	ALA
11	S9	169	PRO
13	C1	4	GLU
13	C1	19	ILE
13	C1	144	ALA
14	C2	69	ALA
14	C2	91	VAL
14	C2	93	ASP
14	C2	119	SER
14	C2	126	TRP
15	C3	22	ALA
16	C4	12	GLN
16	C4	124	ASP
16	C4	125	SER
16	C4	126	THR
17	C5	11	VAL
17	C5	22	LEU
17	C5	48	GLY
19	C7	98	GLY
19	C7	122	ILE
20	C8	14	ILE
21	C9	10	ALA
21	C9	116	ILE
22	D0	16	GLN
22	D0	17	GLN
22	D0	49	ASN
22	D0	96	PRO
22	D0	119	ALA
25	D3	39	LYS

Continued on next page...

Continued from previous page...

Mol	Chain	Res	Type
25	D3	112	LYS
25	D3	137	LYS
25	D3	138	GLU
26	D4	33	ALA
26	D4	54	ALA
26	D4	100	VAL
27	D5	41	ILE
28	D6	4	LYS
28	D6	16	GLY
28	D6	18	VAL
28	D6	36	ILE
28	D6	82	ARG
28	D6	86	VAL
29	D7	62	ILE
30	D8	36	THR
31	D9	20	GLN
32	E0	51	ASN
33	E1	87	THR
33	E1	118	ARG
33	E1	127	GLY
33	E1	144	CYS
33	E1	145	HIS
34	SR	51	ASP
34	SR	98	GLU
34	SR	135	THR
34	SR	160	GLU
34	SR	161	LYS
35	SM	52	PRO
35	SM	87	THR
35	SM	89	ARG
39	L2	13	GLY
39	L2	250	GLN
40	L3	4	ARG
40	L3	120	LYS
40	L3	121	ASN
40	L3	142	ALA
40	L3	155	ALA
40	L3	171	LEU
40	L3	174	LYS
40	L3	221	THR
40	L3	347	SER
40	L3	360	ASP

Continued on next page...

Continued from previous page...

Mol	Chain	Res	Type
41	L4	15	ALA
41	L4	83	GLY
41	L4	305	ALA
41	L4	311	HIS
42	L5	7	ALA
42	L5	212	ALA
42	L5	221	GLU
42	L5	253	PHE
44	L7	55	TYR
44	L7	80	GLN
44	L7	158	LYS
44	L7	159	GLN
45	L8	39	ALA
46	L9	38	LEU
46	L9	59	ASN
47	M0	78	THR
47	M0	117	GLY
48	M1	8	PRO
48	M1	114	ILE
48	M1	152	HIS
49	M3	47	ALA
49	M3	141	ALA
50	M4	8	LYS
50	M4	36	VAL
51	M5	81	TYR
51	M5	110	ALA
51	M5	184	LYS
52	M6	86	GLY
52	M6	112	TYR
52	M6	113	ASP
53	M7	109	ALA
54	M8	74	GLU
54	M8	98	LYS
54	M8	166	LEU
55	M9	53	LYS
56	N0	24	LEU
56	N0	154	HIS
57	N1	122	GLN
59	N3	46	LEU
61	N5	24	LEU
61	N5	77	GLU
61	N5	117	ASN

Continued on next page...

Continued from previous page...

Mol	Chain	Res	Type
63	N7	16	GLY
64	N8	117	ARG
67	O1	6	ASP
67	O1	99	ALA
69	O3	59	VAL
69	O3	60	ARG
70	O4	18	ASN
71	O5	35	LYS
71	O5	71	LYS
71	O5	118	ILE
72	O6	3	VAL
72	O6	78	GLY
72	O6	99	ARG
78	Q2	30	ALA
78	Q2	34	SER
78	Q2	60	LYS
79	Q3	3	LYS
79	Q3	58	SER
2	s0	4	PRO
2	s0	27	ARG
2	s0	65	ALA
3	s1	43	VAL
3	s1	206	PRO
3	s1	224	ASP
4	s2	93	GLY
4	s2	144	TRP
4	s2	149	GLY
4	s2	249	ALA
5	s3	115	ILE
5	s3	211	PRO
6	s4	3	ARG
6	s4	104	ASP
6	s4	118	GLU
6	s4	195	ILE
7	s5	28	PRO
7	s5	81	ARG
7	s5	155	ALA
8	s6	19	ASP
8	s6	58	LYS
9	s7	63	PRO
9	s7	144	VAL
10	s8	52	ASN

Continued on next page...

Continued from previous page...

Mol	Chain	Res	Type
10	s8	101	ILE
11	s9	115	LYS
11	s9	121	SER
12	c0	23	ALA
12	c0	82	LEU
13	c1	55	ASP
14	c2	131	ASP
15	c3	43	LYS
15	c3	137	PRO
15	c3	140	LYS
16	c4	14	PHE
17	c5	17	TYR
19	c7	116	LYS
20	c8	14	ILE
20	c8	60	GLU
21	c9	29	GLU
22	d0	15	GLN
22	d0	119	ALA
23	d1	11	LEU
23	d1	85	TYR
24	d2	78	ARG
25	d3	137	LYS
26	d4	52	LYS
26	d4	54	ALA
28	d6	5	ARG
28	d6	13	LYS
28	d6	34	LYS
29	d7	59	CYS
30	d8	33	LEU
32	e0	47	VAL
32	e0	49	LEU
32	e0	50	VAL
33	e1	84	VAL
33	e1	102	VAL
34	sR	163	ASP
35	sM	47	ALA
35	sM	55	SER
39	l2	170	ALA
40	l3	129	ALA
40	l3	187	SER
40	l3	385	LYS
40	l3	386	ASP

Continued on next page...

Continued from previous page...

Mol	Chain	Res	Type
41	l4	15	ALA
41	l4	90	PHE
41	l4	154	THR
41	l4	233	LEU
41	l4	268	ALA
41	l4	338	LYS
42	l5	260	PHE
44	l7	206	LYS
45	l8	26	LEU
45	l8	203	VAL
45	l8	237	ILE
46	l9	144	ILE
46	l9	175	PHE
47	m0	117	GLY
47	m0	151	GLY
47	m0	196	PHE
48	m1	94	ARG
48	m1	95	ASN
48	m1	114	ILE
48	m1	115	LYS
48	m1	145	LYS
48	m1	167	TYR
49	m3	13	HIS
49	m3	47	ALA
49	m3	141	ALA
49	m3	193	ALA
50	m4	74	ARG
54	m8	84	VAL
54	m8	98	LYS
54	m8	116	LYS
54	m8	168	THR
55	m9	36	ASN
56	n0	17	GLU
57	n1	136	ARG
59	n3	28	ASN
59	n3	134	GLY
60	n4	83	THR
61	n5	24	LEU
61	n5	44	PRO
61	n5	55	ASN
62	n6	83	ASP
62	n6	84	LYS

Continued on next page...

Continued from previous page...

Mol	Chain	Res	Type
63	n7	128	GLN
63	n7	129	TRP
63	n7	130	PHE
64	n8	76	ASP
64	n8	129	PHE
65	n9	5	LYS
66	o0	10	ILE
66	o0	85	PHE
67	o1	91	SER
68	o2	27	ARG
71	o5	43	LYS
71	o5	119	LYS
72	o6	12	ASN
72	o6	20	MET
72	o6	33	ALA
72	o6	35	ASN
72	o6	79	SER
73	o7	65	ARG
74	o8	18	ALA
74	o8	46	ARG
79	q3	51	ALA
81	p0	68	SER
81	p0	93	LEU
83	f	51	LYS
83	f	148	ILE
2	S0	30	GLN
2	S0	66	ALA
2	S0	78	SER
2	S0	161	PRO
3	S1	48	VAL
3	S1	51	SER
3	S1	58	SER
3	S1	81	PHE
3	S1	209	ASN
4	S2	95	ARG
5	S3	62	ASN
5	S3	205	ALA
5	S3	218	LEU
6	S4	205	PHE
6	S4	214	LEU
6	S4	234	PRO
7	S5	26	ALA

Continued on next page...

Continued from previous page...

Mol	Chain	Res	Type
7	S5	58	LEU
7	S5	64	VAL
7	S5	97	LEU
8	S6	148	SER
8	S6	152	ASP
9	S7	11	GLN
9	S7	12	ALA
9	S7	30	SER
10	S8	40	ALA
10	S8	116	HIS
10	S8	120	THR
10	S8	146	ARG
10	S8	152	ILE
11	S9	147	MET
11	S9	150	LEU
12	C0	30	ALA
12	C0	60	SER
13	C1	145	ALA
16	C4	18	ARG
16	C4	40	ALA
16	C4	129	LYS
16	C4	132	ARG
17	C5	127	ARG
17	C5	130	ARG
18	C6	32	ASN
18	C6	142	TYR
19	C7	42	GLN
19	C7	87	GLU
20	C8	7	GLU
20	C8	90	ASN
21	C9	50	ALA
22	D0	55	PRO
22	D0	118	VAL
23	D1	7	GLN
23	D1	10	GLU
23	D1	42	GLU
23	D1	82	VAL
24	D2	92	ASN
25	D3	40	SER
25	D3	41	SER
25	D3	110	LYS
26	D4	4	ALA

Continued on next page...

Continued from previous page...

Mol	Chain	Res	Type
26	D4	5	VAL
26	D4	6	THR
26	D4	34	ASN
26	D4	134	ALA
28	D6	63	ALA
28	D6	85	ARG
29	D7	75	GLU
33	E1	83	LYS
33	E1	93	HIS
33	E1	100	LEU
33	E1	111	GLU
34	SR	16	HIS
34	SR	185	GLN
34	SR	237	GLN
35	SM	65	THR
35	SM	100	THR
39	L2	17	THR
39	L2	115	ASN
39	L2	125	ALA
40	L3	298	PHE
40	L3	351	LEU
41	L4	146	PRO
41	L4	270	SER
41	L4	272	VAL
42	L5	132	THR
43	L6	20	LYS
44	L7	206	LYS
45	L8	253	SER
46	L9	2	LYS
46	L9	15	GLY
46	L9	96	HIS
46	L9	137	SER
46	L9	190	ASP
48	M1	12	LEU
48	M1	24	GLY
48	M1	151	SER
49	M3	76	THR
50	M4	9	ALA
50	M4	29	ALA
52	M6	148	LYS
53	M7	160	ALA
53	M7	164	LYS

Continued on next page...

Continued from previous page...

Mol	Chain	Res	Type
55	M9	169	ALA
56	N0	2	ALA
57	N1	124	VAL
60	N4	70	LYS
60	N4	76	VAL
60	N4	77	LYS
60	N4	80	ARG
60	N4	97	LYS
62	N6	126	LEU
63	N7	102	GLU
64	N8	24	LYS
70	O4	14	ASN
72	O6	80	PHE
75	O9	30	ARG
75	O9	46	ARG
2	s0	127	ARG
3	s1	93	GLY
3	s1	106	THR
3	s1	207	LEU
3	s1	223	PHE
4	s2	151	PRO
4	s2	182	PRO
5	s3	45	LYS
5	s3	179	GLN
5	s3	196	ARG
6	s4	20	LEU
6	s4	96	ASN
6	s4	164	LEU
6	s4	245	LYS
7	s5	56	ALA
7	s5	154	ALA
9	s7	11	GLN
10	s8	122	GLY
10	s8	136	SER
10	s8	149	SER
11	s9	156	ILE
11	s9	167	ALA
12	c0	30	ALA
14	c2	39	ASP
14	c2	54	ARG
14	c2	63	VAL
14	c2	90	LYS

Continued on next page...

Continued from previous page...

Mol	Chain	Res	Type
15	c3	108	ASP
15	c3	139	TRP
16	c4	12	GLN
16	c4	58	TYR
16	c4	97	GLY
16	c4	114	ARG
16	c4	124	ASP
16	c4	132	ARG
17	c5	12	PHE
17	c5	14	THR
18	c6	142	TYR
20	c8	7	GLU
20	c8	94	ASP
21	c9	142	GLU
23	d1	40	ASP
25	d3	131	SER
27	d5	53	GLU
29	d7	63	LEU
29	d7	75	GLU
31	d9	11	PRO
32	e0	11	ALA
32	e0	61	SER
33	e1	99	LYS
33	e1	100	LEU
33	e1	111	GLU
33	e1	128	ALA
33	e1	136	LYS
33	e1	146	SER
34	sR	96	THR
39	l2	56	ALA
39	l2	69	TYR
39	l2	130	SER
39	l2	239	ALA
40	l3	155	ALA
41	l4	4	PRO
41	l4	220	ARG
41	l4	311	HIS
41	l4	330	TYR
42	l5	258	LYS
42	l5	294	ALA
43	l6	10	TYR
44	l7	163	LEU

Continued on next page...

Continued from previous page...

Mol	Chain	Res	Type
44	l7	191	VAL
45	l8	39	ALA
45	l8	43	LYS
45	l8	119	ALA
45	l8	133	LYS
45	l8	147	LYS
45	l8	196	ALA
47	m0	187	ALA
48	m1	153	LYS
49	m3	135	ALA
49	m3	140	SER
49	m3	162	ASN
50	m4	136	ALA
51	m5	81	TYR
51	m5	183	THR
54	m8	164	ARG
56	n0	2	ALA
59	n3	107	GLY
60	n4	64	THR
60	n4	77	LYS
61	n5	47	ALA
62	n6	6	LEU
62	n6	31	LEU
62	n6	125	LYS
63	n7	103	GLN
63	n7	125	GLY
63	n7	134	LEU
64	n8	110	GLY
68	o2	5	PRO
70	o4	51	LEU
70	o4	82	ALA
77	q1	23	ARG
81	p0	33	VAL
81	p0	47	GLY
83	f	17	ALA
83	f	49	THR
83	f	63	ASP
83	f	121	GLY
83	f	152	GLU
2	S0	24	LEU
2	S0	162	CYS
2	S0	193	GLN

Continued on next page...

Continued from previous page...

Mol	Chain	Res	Type
2	S0	194	PRO
2	S0	195	TRP
3	S1	42	ASN
3	S1	54	LEU
3	S1	131	ASP
3	S1	176	VAL
3	S1	230	ALA
4	S2	109	GLY
4	S2	146	THR
5	S3	211	PRO
6	S4	200	ARG
7	S5	45	LYS
7	S5	65	ARG
8	S6	69	LEU
9	S7	29	ASN
9	S7	75	THR
9	S7	98	ILE
9	S7	133	THR
10	S8	9	HIS
13	C1	30	ARG
14	C2	85	LYS
14	C2	115	VAL
15	C3	28	LEU
16	C4	114	ARG
17	C5	17	TYR
17	C5	53	PRO
18	C6	39	VAL
18	C6	59	LYS
18	C6	136	SER
20	C8	9	GLY
20	C8	83	ALA
20	C8	144	ARG
23	D1	15	ARG
24	D2	78	ARG
25	D3	92	CYS
26	D4	53	ASP
27	D5	88	ILE
28	D6	3	LYS
28	D6	46	GLU
28	D6	47	ALA
28	D6	53	LEU
30	D8	35	ASP

Continued on next page...

Continued from previous page...

Mol	Chain	Res	Type
33	E1	85	TYR
33	E1	97	LYS
33	E1	148	TYR
34	SR	17	ASN
34	SR	163	ASP
34	SR	194	GLY
35	SM	42	ALA
35	SM	53	ARG
35	SM	86	ASN
39	L2	55	GLY
39	L2	246	LEU
39	L2	251	LYS
40	L3	258	ALA
41	L4	5	GLN
41	L4	14	GLU
41	L4	90	PHE
41	L4	219	LEU
41	L4	233	LEU
41	L4	292	SER
42	L5	214	ASP
42	L5	259	LYS
42	L5	274	GLN
43	L6	131	LYS
46	L9	110	LYS
46	L9	117	PHE
46	L9	188	THR
46	L9	189	GLU
47	M0	71	CYS
47	M0	189	GLU
48	M1	23	VAL
48	M1	64	LYS
48	M1	115	LYS
49	M3	19	GLN
49	M3	140	SER
51	M5	94	TYR
52	M6	63	ALA
54	M8	99	THR
54	M8	162	ALA
54	M8	183	GLY
55	M9	130	ASN
57	N1	18	ASP
58	N2	11	ILE

Continued on next page...

Continued from previous page...

Mol	Chain	Res	Type
58	N2	60	GLY
59	N3	82	ALA
60	N4	68	ALA
60	N4	86	SER
63	N7	33	SER
63	N7	37	PRO
64	N8	77	LYS
67	O1	83	GLU
68	O2	70	GLY
71	O5	10	ARG
71	O5	14	LYS
71	O5	80	LEU
71	O5	119	LYS
72	O6	21	THR
72	O6	98	ARG
73	O7	18	LEU
73	O7	85	LYS
74	O8	7	ASP
79	Q3	65	ALA
3	s1	157	GLN
4	s2	88	LYS
4	s2	235	LEU
4	s2	238	SER
5	s3	44	THR
5	s3	93	ASP
6	s4	12	LEU
6	s4	51	ARG
7	s5	29	ILE
7	s5	55	ASP
7	s5	71	ALA
7	s5	100	ASN
8	s6	149	LYS
8	s6	154	ARG
8	s6	216	LEU
9	s7	64	VAL
9	s7	133	THR
10	s8	78	ILE
11	s9	118	LEU
11	s9	147	MET
12	c0	3	MET
12	c0	31	LYS
13	c1	128	CYS

Continued on next page...

Continued from previous page...

Mol	Chain	Res	Type
14	c2	87	PRO
14	c2	101	ALA
16	c4	11	SER
16	c4	37	GLU
16	c4	50	ALA
17	c5	126	VAL
17	c5	128	HIS
19	c7	68	GLY
19	c7	117	LEU
20	c8	143	ARG
21	c9	51	GLU
23	d1	2	GLU
23	d1	9	VAL
28	d6	15	ARG
28	d6	82	ARG
29	d7	29	ARG
30	d8	16	LEU
32	e0	13	LYS
33	e1	131	PHE
33	e1	137	ASP
34	sR	149	ASP
34	sR	186	PHE
34	sR	271	VAL
35	sM	43	ASP
35	sM	60	ALA
35	sM	63	ASP
39	l2	80	GLU
39	l2	247	ARG
40	l3	3	HIS
40	l3	175	LYS
40	l3	348	ARG
42	l5	274	GLN
43	l6	20	LYS
44	l7	202	LEU
44	l7	229	PHE
45	l8	118	GLU
46	l9	2	LYS
46	l9	38	LEU
47	m0	195	ALA
48	m1	12	LEU
49	m3	60	ALA
49	m3	93	ILE

Continued on next page...

Continued from previous page...

Mol	Chain	Res	Type
49	m3	152	THR
51	m5	68	ARG
59	n3	106	LYS
59	n3	109	MET
60	n4	132	GLY
61	n5	38	LEU
61	n5	45	LYS
61	n5	62	VAL
64	n8	24	LYS
65	n9	6	ASN
67	o1	90	PHE
72	o6	99	ARG
74	o8	34	ALA
78	q2	104	LEU
81	p0	102	SER
83	f	13	ALA
83	f	113	VAL
83	f	132	LYS
2	S0	109	ASN
2	S0	126	PRO
3	S1	210	ILE
3	S1	224	ASP
4	S2	39	THR
4	S2	150	GLN
4	S2	223	GLY
4	S2	235	LEU
4	S2	239	PRO
9	S7	38	LEU
9	S7	166	LEU
10	S8	107	THR
11	S9	16	LYS
12	C0	25	LYS
13	C1	3	THR
15	C3	27	LYS
15	C3	68	GLY
17	C5	52	LYS
17	C5	126	VAL
19	C7	23	LYS
20	C8	36	LYS
23	D1	12	TYR
26	D4	95	GLY
27	D5	94	LYS

Continued on next page...

Continued from previous page...

Mol	Chain	Res	Type
28	D6	64	LEU
28	D6	80	HIS
34	SR	3	SER
34	SR	139	GLN
39	L2	234	LYS
41	L4	140	HIS
41	L4	182	LEU
42	L5	81	HIS
42	L5	93	THR
42	L5	125	VAL
42	L5	181	PRO
42	L5	273	ARG
44	L7	176	TYR
44	L7	178	ILE
45	L8	36	ILE
45	L8	79	GLN
46	L9	14	GLU
46	L9	74	LEU
47	M0	18	PRO
48	M1	108	GLU
48	M1	173	ASP
49	M3	77	LEU
52	M6	16	VAL
55	M9	55	VAL
57	N1	121	ALA
57	N1	123	GLY
59	N3	109	MET
63	N7	103	GLN
65	N9	25	LYS
66	O0	98	SER
67	O1	7	VAL
68	O2	68	PRO
70	O4	82	ALA
71	O5	98	SER
71	O5	99	GLN
76	Q0	79	GLU
79	Q3	7	LYS
79	Q3	45	LYS
79	Q3	51	ALA
2	s0	10	THR
2	s0	103	THR
2	s0	185	ARG

Continued on next page...

Continued from previous page...

Mol	Chain	Res	Type
3	s1	221	PRO
4	s2	62	PRO
4	s2	150	GLN
4	s2	163	GLY
5	s3	160	SER
6	s4	30	ARG
6	s4	90	ILE
6	s4	214	LEU
7	s5	37	GLN
8	s6	65	GLN
8	s6	70	PRO
8	s6	138	ALA
11	s9	168	ARG
12	c0	24	LYS
12	c0	35	ILE
14	c2	45	LEU
14	c2	115	VAL
15	c3	29	SER
17	c5	130	ARG
18	c6	3	ALA
19	c7	113	LEU
22	d0	49	ASN
25	d3	101	GLU
26	d4	58	PHE
28	d6	8	ASN
34	sR	234	LEU
39	l2	115	ASN
39	l2	125	ALA
39	l2	241	ARG
40	l3	23	ALA
41	l4	328	ASN
43	l6	147	ALA
45	l8	122	LYS
45	l8	146	LYS
45	l8	182	GLY
46	l9	189	GLU
47	m0	6	ALA
47	m0	176	LEU
48	m1	168	ASP
49	m3	46	ILE
51	m5	181	ASN
53	m7	23	ARG

Continued on next page...

Continued from previous page...

Mol	Chain	Res	Type
54	m8	91	ALA
55	m9	130	ASN
57	n1	127	GLN
58	n2	106	ALA
61	n5	39	LYS
64	n8	78	LEU
67	o1	82	GLU
67	o1	83	GLU
74	o8	17	ARG
78	q2	66	LYS
78	q2	76	LYS
81	p0	30	VAL
83	f	15	SER
83	f	16	SER
83	f	98	GLY
83	f	127	ALA
2	S0	94	GLY
2	S0	153	SER
4	S2	182	PRO
4	S2	228	ASN
6	S4	77	ARG
11	S9	156	ILE
14	C2	66	VAL
14	C2	82	PRO
31	D9	6	VAL
33	E1	109	ASP
35	SM	88	ARG
40	L3	345	ASN
42	L5	137	ASP
44	L7	26	VAL
45	L8	116	VAL
49	M3	130	GLY
50	M4	6	ILE
55	M9	124	TYR
58	N2	68	THR
59	N3	7	GLN
60	N4	74	LYS
68	O2	62	LYS
68	O2	69	SER
72	O6	34	SER
2	s0	118	PRO
3	s1	147	ALA

Continued on next page...

Continued from previous page...

Mol	Chain	Res	Type
3	s1	177	GLN
7	s5	151	GLY
9	s7	61	PHE
9	s7	145	GLY
11	s9	185	GLY
13	c1	7	VAL
15	c3	22	ALA
16	c4	131	GLY
17	c5	52	LYS
17	c5	68	PRO
20	c8	79	TYR
21	c9	34	VAL
22	d0	96	PRO
22	d0	118	VAL
32	e0	51	ASN
34	sR	15	GLY
34	sR	105	GLY
39	l2	174	ARG
40	l3	188	ILE
41	l4	5	GLN
44	l7	56	GLU
44	l7	178	ILE
47	m0	150	GLU
64	n8	15	VAL
70	o4	14	ASN
70	o4	59	PRO
78	q2	18	ARG
83	f	97	ASP
8	S6	165	GLY
9	S7	73	VAL
11	S9	15	PRO
14	C2	87	PRO
16	C4	131	GLY
25	D3	4	GLY
44	L7	217	PRO
45	L8	135	GLY
54	M8	84	VAL
58	N2	19	VAL
71	O5	77	PRO
7	s5	152	GLY
13	c1	130	PRO
24	d2	6	VAL

Continued on next page...

Continued from previous page...

Mol	Chain	Res	Type
33	e1	112	GLY
39	l2	212	GLY
40	l3	40	PRO
47	m0	179	PRO
48	m1	120	ILE
68	o2	124	GLY
74	o8	35	GLY
3	S1	114	VAL
9	S7	109	VAL
9	S7	131	PHE
23	D1	14	PRO
40	L3	317	ILE
8	s6	165	GLY
8	s6	175	ILE
10	s8	50	GLY
11	s9	162	SER
16	c4	122	PRO
17	c5	20	VAL
35	sM	51	ARG
42	l5	91	GLY
43	l6	45	GLY
53	m7	67	ILE
59	n3	3	GLY
59	n3	41	GLY
72	o6	9	ILE
6	S4	193	GLY
9	S7	112	ARG
20	C8	82	PRO
27	D5	87	GLY
28	D6	58	VAL
28	D6	59	TYR
34	SR	49	GLY
34	SR	105	GLY
35	SM	111	GLY
45	L8	30	THR
53	M7	67	ILE
56	N0	135	VAL
65	N9	21	ILE
4	s2	236	PRO
13	c1	140	VAL
26	d4	30	PRO
30	d8	30	VAL

Continued on next page...

Continued from previous page...

Mol	Chain	Res	Type
33	e1	127	GLY
35	sM	56	GLY
52	m6	16	VAL
64	n8	28	HIS
65	n9	30	PRO
72	o6	3	VAL
7	S5	51	VAL
11	S9	18	PRO
13	C1	113	PRO
40	L3	96	PRO
41	L4	23	PRO
42	L5	170	GLY
2	s0	82	GLY
9	s7	8	ILE
13	c1	76	VAL
48	m1	117	ASP
19	C7	38	ILE
64	N8	148	ILE
13	c1	129	ARG
14	c2	102	GLY
15	c3	71	ILE
18	c6	4	VAL
21	c9	26	GLY
28	d6	20	PRO
64	n8	148	ILE
40	L3	257	PRO

5.3.2 Protein sidechains [i](#)

In the following table, the Percentiles column shows the percent sidechain outliers of the chain as a percentile score with respect to all X-ray entries followed by that with respect to entries of similar resolution.

The Analysed column shows the number of residues for which the sidechain conformation was analysed, and the total number of residues.

Mol	Chain	Analysed	Rotameric	Outliers	Percentiles	
2	S0	164/209 (78%)	143 (87%)	21 (13%)	4	18
2	s0	165/209 (79%)	140 (85%)	25 (15%)	3	13
3	S1	191/223 (86%)	169 (88%)	22 (12%)	5	22
3	s1	192/223 (86%)	164 (85%)	28 (15%)	3	14

Continued on next page...

Continued from previous page...

Mol	Chain	Analysed	Rotameric	Outliers	Percentiles	
4	S2	176/204 (86%)	155 (88%)	21 (12%)	5	21
4	s2	176/204 (86%)	141 (80%)	35 (20%)	1	5
5	S3	182/194 (94%)	157 (86%)	25 (14%)	3	16
5	s3	182/194 (94%)	162 (89%)	20 (11%)	6	24
6	S4	221/221 (100%)	192 (87%)	29 (13%)	4	17
6	s4	221/221 (100%)	188 (85%)	33 (15%)	3	13
7	S5	173/190 (91%)	157 (91%)	16 (9%)	9	31
7	s5	173/190 (91%)	147 (85%)	26 (15%)	3	13
8	S6	188/201 (94%)	165 (88%)	23 (12%)	5	20
8	s6	187/201 (93%)	165 (88%)	22 (12%)	5	21
9	S7	165/169 (98%)	145 (88%)	20 (12%)	5	20
9	s7	165/169 (98%)	150 (91%)	15 (9%)	9	31
10	S8	150/161 (93%)	136 (91%)	14 (9%)	9	30
10	s8	150/161 (93%)	131 (87%)	19 (13%)	4	19
11	S9	158/165 (96%)	133 (84%)	25 (16%)	2	11
11	s9	158/165 (96%)	132 (84%)	26 (16%)	2	10
12	C0	77/77 (100%)	71 (92%)	6 (8%)	12	38
12	c0	73/77 (95%)	66 (90%)	7 (10%)	8	29
13	C1	129/129 (100%)	117 (91%)	12 (9%)	9	30
13	c1	129/129 (100%)	113 (88%)	16 (12%)	4	19
14	C2	88/106 (83%)	73 (83%)	15 (17%)	2	9
14	c2	88/106 (83%)	80 (91%)	8 (9%)	9	31
15	C3	127/127 (100%)	110 (87%)	17 (13%)	4	16
15	c3	127/127 (100%)	110 (87%)	17 (13%)	4	16
16	C4	81/104 (78%)	67 (83%)	14 (17%)	2	8
16	c4	97/104 (93%)	78 (80%)	19 (20%)	1	5
17	C5	101/113 (89%)	91 (90%)	10 (10%)	8	28
17	c5	103/113 (91%)	89 (86%)	14 (14%)	3	16
18	C6	117/118 (99%)	103 (88%)	14 (12%)	5	20
18	c6	118/118 (100%)	102 (86%)	16 (14%)	3	16
19	C7	94/124 (76%)	79 (84%)	15 (16%)	2	11

Continued on next page...

Continued from previous page...

Mol	Chain	Analysed	Rotameric	Outliers	Percentiles	
19	c7	92/124 (74%)	82 (89%)	10 (11%)	6	24
20	C8	128/128 (100%)	104 (81%)	24 (19%)	1	6
20	c8	128/128 (100%)	109 (85%)	19 (15%)	3	13
21	C9	115/115 (100%)	99 (86%)	16 (14%)	3	16
21	c9	115/115 (100%)	98 (85%)	17 (15%)	3	13
22	D0	100/113 (88%)	91 (91%)	9 (9%)	9	32
22	d0	103/113 (91%)	91 (88%)	12 (12%)	5	21
23	D1	74/74 (100%)	65 (88%)	9 (12%)	5	20
23	d1	74/74 (100%)	66 (89%)	8 (11%)	6	24
24	D2	110/110 (100%)	94 (86%)	16 (14%)	3	14
24	d2	110/110 (100%)	93 (84%)	17 (16%)	2	12
25	D3	119/119 (100%)	105 (88%)	14 (12%)	5	21
25	d3	119/119 (100%)	109 (92%)	10 (8%)	11	35
26	D4	112/112 (100%)	103 (92%)	9 (8%)	12	37
26	d4	112/112 (100%)	97 (87%)	15 (13%)	4	16
27	D5	61/88 (69%)	48 (79%)	13 (21%)	1	4
27	d5	61/88 (69%)	51 (84%)	10 (16%)	2	10
28	D6	83/83 (100%)	73 (88%)	10 (12%)	5	20
28	d6	83/83 (100%)	70 (84%)	13 (16%)	2	12
29	D7	70/70 (100%)	62 (89%)	8 (11%)	5	22
29	d7	70/70 (100%)	62 (89%)	8 (11%)	5	22
30	D8	56/59 (95%)	48 (86%)	8 (14%)	3	15
30	d8	56/59 (95%)	46 (82%)	10 (18%)	2	8
31	D9	47/48 (98%)	39 (83%)	8 (17%)	2	9
31	d9	47/48 (98%)	37 (79%)	10 (21%)	1	4
32	E0	51/53 (96%)	47 (92%)	4 (8%)	12	38
32	e0	53/53 (100%)	39 (74%)	14 (26%)	0	1
33	E1	62/66 (94%)	51 (82%)	11 (18%)	2	8
33	e1	66/66 (100%)	55 (83%)	11 (17%)	2	10
34	SR	259/261 (99%)	227 (88%)	32 (12%)	4	19
34	sR	260/261 (100%)	243 (94%)	17 (6%)	17	46

Continued on next page...

Continued from previous page...

Mol	Chain	Analysed	Rotameric	Outliers	Percentiles	
35	SM	97/183 (53%)	79 (81%)	18 (19%)	1	7
35	sM	54/183 (30%)	46 (85%)	8 (15%)	3	13
39	L2	193/195 (99%)	166 (86%)	27 (14%)	3	16
39	l2	192/195 (98%)	161 (84%)	31 (16%)	2	10
40	L3	319/322 (99%)	267 (84%)	52 (16%)	2	10
40	l3	319/322 (99%)	261 (82%)	58 (18%)	1	7
41	L4	288/288 (100%)	252 (88%)	36 (12%)	4	19
41	l4	288/288 (100%)	248 (86%)	40 (14%)	3	16
42	L5	244/244 (100%)	208 (85%)	36 (15%)	3	13
42	l5	243/244 (100%)	200 (82%)	43 (18%)	2	8
43	L6	134/152 (88%)	116 (87%)	18 (13%)	4	16
43	l6	135/152 (89%)	115 (85%)	20 (15%)	3	13
44	L7	186/204 (91%)	162 (87%)	24 (13%)	4	18
44	l7	187/204 (92%)	164 (88%)	23 (12%)	4	20
45	L8	187/207 (90%)	165 (88%)	22 (12%)	5	21
45	l8	177/207 (86%)	153 (86%)	24 (14%)	3	16
46	L9	171/171 (100%)	135 (79%)	36 (21%)	1	4
46	l9	171/171 (100%)	143 (84%)	28 (16%)	2	10
47	M0	177/186 (95%)	144 (81%)	33 (19%)	1	7
47	m0	179/186 (96%)	149 (83%)	30 (17%)	2	9
48	M1	147/150 (98%)	117 (80%)	30 (20%)	1	4
48	m1	147/150 (98%)	125 (85%)	22 (15%)	3	13
49	M3	154/158 (98%)	133 (86%)	21 (14%)	3	16
49	m3	154/158 (98%)	127 (82%)	27 (18%)	2	8
50	M4	107/108 (99%)	93 (87%)	14 (13%)	4	17
50	m4	108/108 (100%)	94 (87%)	14 (13%)	4	17
51	M5	175/175 (100%)	151 (86%)	24 (14%)	3	16
51	m5	175/175 (100%)	154 (88%)	21 (12%)	5	20
52	M6	160/161 (99%)	134 (84%)	26 (16%)	2	10
52	m6	160/161 (99%)	139 (87%)	21 (13%)	4	17
53	M7	140/145 (97%)	120 (86%)	20 (14%)	3	15

Continued on next page...

Continued from previous page...

Mol	Chain	Analysed	Rotameric	Outliers	Percentiles	
53	m7	125/145 (86%)	106 (85%)	19 (15%)	3	13
54	M8	150/150 (100%)	132 (88%)	18 (12%)	5	20
54	m8	150/150 (100%)	126 (84%)	24 (16%)	2	11
55	M9	153/153 (100%)	136 (89%)	17 (11%)	6	23
55	m9	153/153 (100%)	133 (87%)	20 (13%)	4	17
56	N0	156/156 (100%)	132 (85%)	24 (15%)	2	12
56	n0	156/156 (100%)	133 (85%)	23 (15%)	3	14
57	N1	136/136 (100%)	108 (79%)	28 (21%)	1	4
57	n1	136/136 (100%)	113 (83%)	23 (17%)	2	9
58	N2	87/106 (82%)	79 (91%)	8 (9%)	9	31
58	n2	85/106 (80%)	73 (86%)	12 (14%)	3	16
59	N3	104/104 (100%)	90 (86%)	14 (14%)	4	16
59	n3	104/104 (100%)	91 (88%)	13 (12%)	4	19
60	N4	57/129 (44%)	52 (91%)	5 (9%)	10	33
60	n4	100/129 (78%)	95 (95%)	5 (5%)	24	55
61	N5	104/117 (89%)	83 (80%)	21 (20%)	1	5
61	n5	104/117 (89%)	90 (86%)	14 (14%)	4	16
62	N6	109/109 (100%)	90 (83%)	19 (17%)	2	8
62	n6	109/109 (100%)	93 (85%)	16 (15%)	3	14
63	N7	115/115 (100%)	99 (86%)	16 (14%)	3	16
63	n7	115/115 (100%)	97 (84%)	18 (16%)	2	12
64	N8	118/118 (100%)	98 (83%)	20 (17%)	2	9
64	n8	118/118 (100%)	101 (86%)	17 (14%)	3	15
65	N9	46/46 (100%)	40 (87%)	6 (13%)	4	17
65	n9	46/46 (100%)	41 (89%)	5 (11%)	6	24
66	O0	81/87 (93%)	69 (85%)	12 (15%)	3	13
66	o0	84/87 (97%)	72 (86%)	12 (14%)	3	15
67	O1	92/96 (96%)	80 (87%)	12 (13%)	4	17
67	o1	94/96 (98%)	76 (81%)	18 (19%)	1	6
68	O2	109/110 (99%)	94 (86%)	15 (14%)	3	16
68	o2	109/110 (99%)	87 (80%)	22 (20%)	1	5

Continued on next page...

Continued from previous page...

Mol	Chain	Analysed	Rotameric	Outliers	Percentiles	
69	O3	90/90 (100%)	75 (83%)	15 (17%)	2	10
69	o3	90/90 (100%)	76 (84%)	14 (16%)	2	12
70	O4	95/102 (93%)	84 (88%)	11 (12%)	5	22
70	o4	95/102 (93%)	86 (90%)	9 (10%)	8	29
71	O5	104/104 (100%)	95 (91%)	9 (9%)	10	34
71	o5	103/104 (99%)	90 (87%)	13 (13%)	4	19
72	O6	81/81 (100%)	65 (80%)	16 (20%)	1	5
72	o6	80/81 (99%)	59 (74%)	21 (26%)	0	2
73	O7	70/70 (100%)	59 (84%)	11 (16%)	2	12
73	o7	70/70 (100%)	62 (89%)	8 (11%)	5	22
74	O8	68/68 (100%)	56 (82%)	12 (18%)	2	8
74	o8	67/68 (98%)	57 (85%)	10 (15%)	3	13
75	O9	45/45 (100%)	38 (84%)	7 (16%)	2	12
75	o9	45/45 (100%)	42 (93%)	3 (7%)	16	45
76	Q0	47/47 (100%)	37 (79%)	10 (21%)	1	4
76	q0	47/47 (100%)	39 (83%)	8 (17%)	2	9
77	Q1	23/23 (100%)	20 (87%)	3 (13%)	4	17
77	q1	23/23 (100%)	17 (74%)	6 (26%)	0	2
78	Q2	90/90 (100%)	74 (82%)	16 (18%)	2	8
78	q2	90/90 (100%)	72 (80%)	18 (20%)	1	5
79	Q3	71/71 (100%)	60 (84%)	11 (16%)	2	12
79	q3	71/71 (100%)	61 (86%)	10 (14%)	3	16
81	p0	105/232 (45%)	93 (89%)	12 (11%)	5	22
83	f	124/133 (93%)	107 (86%)	17 (14%)	3	16
All	All	18849/20177 (93%)	16179 (86%)	2670 (14%)	3	15

All (2670) residues with a non-rotameric sidechain are listed below:

Mol	Chain	Res	Type
2	S0	7	PHE
2	S0	9	LEU
2	S0	23	HIS
2	S0	32	HIS
2	S0	37	VAL

Continued on next page...

Continued from previous page...

Mol	Chain	Res	Type
2	S0	43	ASP
2	S0	52	LYS
2	S0	62	ARG
2	S0	84	ARG
2	S0	88	LYS
2	S0	96	THR
2	S0	103	THR
2	S0	111	ILE
2	S0	129	ASP
2	S0	146	LEU
2	S0	153	SER
2	S0	168	HIS
2	S0	170	ILE
2	S0	172	LEU
2	S0	188	LEU
2	S0	200	ASP
3	S1	21	VAL
3	S1	29	TRP
3	S1	30	PHE
3	S1	39	GLU
3	S1	61	LEU
3	S1	70	LEU
3	S1	81	PHE
3	S1	83	LYS
3	S1	105	PHE
3	S1	111	ARG
3	S1	180	THR
3	S1	181	LEU
3	S1	184	LEU
3	S1	193	ILE
3	S1	194	ASN
3	S1	202	LYS
3	S1	203	ASP
3	S1	214	LYS
3	S1	215	VAL
3	S1	218	LEU
3	S1	222	LYS
3	S1	223	PHE
4	S2	41	LEU
4	S2	54	GLU
4	S2	69	ILE
4	S2	74	PRO

Continued on next page...

Continued from previous page...

Mol	Chain	Res	Type
4	S2	77	GLN
4	S2	86	VAL
4	S2	89	GLN
4	S2	94	GLN
4	S2	95	ARG
4	S2	96	THR
4	S2	97	ARG
4	S2	99	LYS
4	S2	111	VAL
4	S2	137	ILE
4	S2	146	THR
4	S2	148	LEU
4	S2	159	THR
4	S2	207	LEU
4	S2	208	GLU
4	S2	222	TYR
4	S2	226	THR
5	S3	4	LEU
5	S3	5	ILE
5	S3	23	GLU
5	S3	45	LYS
5	S3	57	ASP
5	S3	65	ARG
5	S3	66	ILE
5	S3	76	ARG
5	S3	83	THR
5	S3	84	ILE
5	S3	91	VAL
5	S3	92	GLN
5	S3	93	ASP
5	S3	111	ASN
5	S3	124	ARG
5	S3	158	ILE
5	S3	165	ASN
5	S3	172	THR
5	S3	176	LEU
5	S3	181	VAL
5	S3	182	LEU
5	S3	207	THR
5	S3	213	GLU
5	S3	218	LEU
5	S3	223	LYS

Continued on next page...

Continued from previous page...

Mol	Chain	Res	Type
6	S4	3	ARG
6	S4	9	LEU
6	S4	12	LEU
6	S4	38	LEU
6	S4	45	ILE
6	S4	56	LEU
6	S4	65	LEU
6	S4	77	ARG
6	S4	92	LEU
6	S4	104	ASP
6	S4	109	PHE
6	S4	115	THR
6	S4	131	LEU
6	S4	148	ARG
6	S4	180	LEU
6	S4	181	VAL
6	S4	182	TYR
6	S4	187	ARG
6	S4	189	LEU
6	S4	192	ILE
6	S4	202	ASP
6	S4	206	ASP
6	S4	215	ASP
6	S4	220	THR
6	S4	222	LEU
6	S4	227	VAL
6	S4	240	LYS
6	S4	246	LEU
6	S4	258	GLN
7	S5	25	LEU
7	S5	32	GLU
7	S5	43	PHE
7	S5	45	LYS
7	S5	46	TRP
7	S5	48	PHE
7	S5	50	GLU
7	S5	65	ARG
7	S5	79	ASN
7	S5	93	LEU
7	S5	119	ASP
7	S5	149	VAL
7	S5	156	ARG

Continued on next page...

Continued from previous page...

Mol	Chain	Res	Type
7	S5	157	ARG
7	S5	160	VAL
7	S5	184	PHE
8	S6	7	TYR
8	S6	13	GLN
8	S6	15	THR
8	S6	25	ARG
8	S6	44	GLU
8	S6	72	ARG
8	S6	89	ASP
8	S6	109	LEU
8	S6	120	GLU
8	S6	127	THR
8	S6	128	THR
8	S6	129	VAL
8	S6	131	LYS
8	S6	151	ASP
8	S6	154	ARG
8	S6	169	TYR
8	S6	170	THR
8	S6	174	LYS
8	S6	177	ARG
8	S6	193	LEU
8	S6	211	LEU
8	S6	216	LEU
8	S6	223	LYS
9	S7	9	LEU
9	S7	15	GLU
9	S7	24	PHE
9	S7	28	GLU
9	S7	38	LEU
9	S7	42	GLN
9	S7	46	ILE
9	S7	67	LEU
9	S7	77	LEU
9	S7	85	PHE
9	S7	97	ARG
9	S7	109	VAL
9	S7	110	GLN
9	S7	114	ARG
9	S7	118	LEU
9	S7	123	ASP

Continued on next page...

Continued from previous page...

Mol	Chain	Res	Type
9	S7	126	LEU
9	S7	130	VAL
9	S7	182	VAL
9	S7	185	ILE
10	S8	5	ARG
10	S8	8	ARG
10	S8	14	THR
10	S8	21	PHE
10	S8	29	LEU
10	S8	32	GLN
10	S8	45	SER
10	S8	46	VAL
10	S8	56	ARG
10	S8	58	LEU
10	S8	62	THR
10	S8	137	LYS
10	S8	140	GLU
10	S8	187	GLU
11	S9	3	ARG
11	S9	7	THR
11	S9	21	SER
11	S9	28	LEU
11	S9	38	ASN
11	S9	39	LYS
11	S9	54	ARG
11	S9	60	LEU
11	S9	89	ASP
11	S9	92	LYS
11	S9	93	LEU
11	S9	95	TYR
11	S9	97	LEU
11	S9	99	LEU
11	S9	109	LEU
11	S9	110	GLN
11	S9	112	GLN
11	S9	134	ILE
11	S9	138	LYS
11	S9	149	ARG
11	S9	151	ASP
11	S9	171	ARG
11	S9	172	VAL
11	S9	175	ARG

Continued on next page...

Continued from previous page...

Mol	Chain	Res	Type
11	S9	182	GLU
12	C0	1	MET
12	C0	20	VAL
12	C0	76	LEU
12	C0	78	GLU
12	C0	81	ASN
12	C0	82	LEU
13	C1	9	SER
13	C1	21	ASN
13	C1	30	ARG
13	C1	40	LEU
13	C1	44	THR
13	C1	67	ARG
13	C1	69	LYS
13	C1	74	THR
13	C1	87	ARG
13	C1	123	VAL
13	C1	131	ILE
13	C1	136	ARG
14	C2	28	LEU
14	C2	33	ARG
14	C2	36	LEU
14	C2	37	VAL
14	C2	38	HIS
14	C2	43	ARG
14	C2	45	LEU
14	C2	71	ILE
14	C2	74	LEU
14	C2	86	VAL
14	C2	93	ASP
14	C2	103	LEU
14	C2	126	TRP
14	C2	132	GLU
14	C2	139	HIS
15	C3	3	ARG
15	C3	9	LYS
15	C3	16	ILE
15	C3	27	LYS
15	C3	32	SER
15	C3	39	LYS
15	C3	42	ARG
15	C3	64	ARG

Continued on next page...

Continued from previous page...

Mol	Chain	Res	Type
15	C3	66	ILE
15	C3	80	LEU
15	C3	84	ILE
15	C3	102	LEU
15	C3	105	ASN
15	C3	110	ASP
15	C3	115	LEU
15	C3	125	LEU
15	C3	140	LYS
16	C4	13	VAL
16	C4	16	VAL
16	C4	26	THR
16	C4	29	HIS
16	C4	39	ILE
16	C4	42	VAL
16	C4	81	VAL
16	C4	99	GLN
16	C4	103	ARG
16	C4	115	ILE
16	C4	125	SER
16	C4	129	LYS
16	C4	136	ARG
16	C4	137	LEU
17	C5	11	VAL
17	C5	20	VAL
17	C5	22	LEU
17	C5	32	ASP
17	C5	35	LYS
17	C5	44	ARG
17	C5	52	LYS
17	C5	69	GLU
17	C5	80	MET
17	C5	121	ILE
18	C6	29	ILE
18	C6	37	THR
18	C6	39	VAL
18	C6	42	GLU
18	C6	57	LEU
18	C6	59	LYS
18	C6	66	ARG
18	C6	68	ARG
18	C6	114	ARG

Continued on next page...

Continued from previous page...

Mol	Chain	Res	Type
18	C6	117	LEU
18	C6	123	ARG
18	C6	128	LYS
18	C6	137	ARG
18	C6	143	ARG
19	C7	3	ARG
19	C7	6	THR
19	C7	7	LYS
19	C7	25	THR
19	C7	30	THR
19	C7	38	ILE
19	C7	46	LEU
19	C7	49	LYS
19	C7	69	ILE
19	C7	84	TYR
19	C7	88	VAL
19	C7	104	ASN
19	C7	105	GLN
19	C7	112	SER
19	C7	113	LEU
20	C8	3	LEU
20	C8	5	VAL
20	C8	11	PHE
20	C8	13	HIS
20	C8	14	ILE
20	C8	17	LEU
20	C8	18	LEU
20	C8	19	ASN
20	C8	28	ILE
20	C8	32	LEU
20	C8	40	ARG
20	C8	54	LEU
20	C8	57	ARG
20	C8	71	GLN
20	C8	80	LYS
20	C8	86	LEU
20	C8	92	ILE
20	C8	93	THR
20	C8	97	ASP
20	C8	108	LYS
20	C8	115	ARG
20	C8	123	ARG

Continued on next page...

Continued from previous page...

Mol	Chain	Res	Type
20	C8	136	GLN
20	C8	138	THR
21	C9	6	VAL
21	C9	18	TYR
21	C9	22	LEU
21	C9	28	LEU
21	C9	34	VAL
21	C9	35	ASP
21	C9	54	PHE
21	C9	64	HIS
21	C9	67	MET
21	C9	68	ARG
21	C9	70	GLN
21	C9	88	VAL
21	C9	114	VAL
21	C9	125	SER
21	C9	130	ARG
21	C9	144	GLU
22	D0	18	GLN
22	D0	20	ILE
22	D0	51	VAL
22	D0	67	THR
22	D0	74	GLU
22	D0	81	THR
22	D0	84	MET
22	D0	89	ARG
22	D0	101	LYS
23	D1	3	ASN
23	D1	5	LYS
23	D1	11	LEU
23	D1	32	VAL
23	D1	41	GLU
23	D1	44	ARG
23	D1	62	ARG
23	D1	78	LEU
23	D1	87	ARG
24	D2	4	SER
24	D2	24	GLN
24	D2	27	ILE
24	D2	53	ILE
24	D2	56	HIS
24	D2	65	LEU

Continued on next page...

Continued from previous page...

Mol	Chain	Res	Type
24	D2	74	VAL
24	D2	83	ILE
24	D2	86	ILE
24	D2	93	LEU
24	D2	98	GLN
24	D2	103	ILE
24	D2	104	LEU
24	D2	120	HIS
24	D2	121	VAL
24	D2	129	VAL
25	D3	7	ARG
25	D3	9	LEU
25	D3	16	ARG
25	D3	19	ARG
25	D3	23	ARG
25	D3	40	SER
25	D3	47	SER
25	D3	65	ASN
25	D3	69	ARG
25	D3	79	ASN
25	D3	84	THR
25	D3	103	LEU
25	D3	107	PHE
25	D3	127	VAL
26	D4	34	ASN
26	D4	51	GLU
26	D4	57	VAL
26	D4	62	THR
26	D4	84	LYS
26	D4	102	LYS
26	D4	123	LYS
26	D4	124	ARG
26	D4	132	ARG
27	D5	37	GLN
27	D5	40	VAL
27	D5	42	LEU
27	D5	60	VAL
27	D5	62	VAL
27	D5	67	ASP
27	D5	75	LEU
27	D5	78	ILE
27	D5	95	HIS

Continued on next page...

Continued from previous page...

Mol	Chain	Res	Type
27	D5	96	SER
27	D5	97	LYS
27	D5	98	GLN
27	D5	102	THR
28	D6	12	LYS
28	D6	37	LYS
28	D6	38	ARG
28	D6	39	MET
28	D6	61	GLU
28	D6	64	LEU
28	D6	68	TYR
28	D6	69	ASN
28	D6	71	LEU
28	D6	91	ASP
29	D7	3	LEU
29	D7	17	ARG
29	D7	23	THR
29	D7	26	GLN
29	D7	33	LEU
29	D7	37	CYS
29	D7	42	ASN
29	D7	67	THR
30	D8	13	ILE
30	D8	14	LYS
30	D8	19	THR
30	D8	32	PHE
30	D8	39	THR
30	D8	44	VAL
30	D8	58	GLU
30	D8	61	ARG
31	D9	6	VAL
31	D9	7	TRP
31	D9	12	ARG
31	D9	14	TYR
31	D9	19	ARG
31	D9	30	LEU
31	D9	36	LEU
31	D9	49	ASP
32	E0	5	HIS
32	E0	21	VAL
32	E0	31	LYS
32	E0	54	ARG

Continued on next page...

Continued from previous page...

Mol	Chain	Res	Type
33	E1	85	TYR
33	E1	89	LYS
33	E1	98	VAL
33	E1	100	LEU
33	E1	102	VAL
33	E1	103	LEU
33	E1	108	VAL
33	E1	130	VAL
33	E1	135	HIS
33	E1	147	VAL
33	E1	151	ASN
34	SR	6	VAL
34	SR	17	ASN
34	SR	31	ASN
34	SR	39	ASP
34	SR	45	TRP
34	SR	52	GLN
34	SR	74	THR
34	SR	76	ASP
34	SR	81	LEU
34	SR	106	HIS
34	SR	116	ASP
34	SR	117	LYS
34	SR	131	ILE
34	SR	136	ILE
34	SR	137	LYS
34	SR	140	CYS
34	SR	159	ASN
34	SR	184	ASN
34	SR	223	TRP
34	SR	229	LYS
34	SR	234	LEU
34	SR	238	ASP
34	SR	242	SER
34	SR	264	SER
34	SR	268	GLN
34	SR	269	TYR
34	SR	275	ARG
34	SR	290	VAL
34	SR	292	LEU
34	SR	308	ASN
34	SR	316	MET

Continued on next page...

Continued from previous page...

Mol	Chain	Res	Type
34	SR	317	THR
35	SM	33	LYS
35	SM	34	LYS
35	SM	46	LYS
35	SM	48	ARG
35	SM	51	ARG
35	SM	53	ARG
35	SM	68	ARG
35	SM	70	ASN
35	SM	72	ARG
35	SM	77	THR
35	SM	84	LYS
35	SM	91	THR
35	SM	94	HIS
35	SM	100	THR
35	SM	116	GLU
35	SM	117	LEU
35	SM	131	ILE
35	SM	140	ASP
39	L2	14	SER
39	L2	20	THR
39	L2	28	LYS
39	L2	32	LEU
39	L2	44	ILE
39	L2	45	VAL
39	L2	70	ARG
39	L2	72	ARG
39	L2	82	VAL
39	L2	84	THR
39	L2	101	VAL
39	L2	111	THR
39	L2	113	VAL
39	L2	116	VAL
39	L2	130	SER
39	L2	157	VAL
39	L2	165	VAL
39	L2	179	LEU
39	L2	180	LEU
39	L2	192	LYS
39	L2	199	THR
39	L2	204	MET
39	L2	207	VAL

Continued on next page...

Continued from previous page...

Mol	Chain	Res	Type
39	L2	208	ASP
39	L2	227	ARG
39	L2	238	ILE
39	L2	252	THR
40	L3	7	GLU
40	L3	17	LEU
40	L3	19	ARG
40	L3	20	LYS
40	L3	21	ARG
40	L3	25	ILE
40	L3	30	LYS
40	L3	38	SER
40	L3	55	THR
40	L3	67	PHE
40	L3	72	VAL
40	L3	76	VAL
40	L3	79	VAL
40	L3	84	VAL
40	L3	85	VAL
40	L3	97	ARG
40	L3	103	THR
40	L3	104	THR
40	L3	114	VAL
40	L3	116	ARG
40	L3	128	LYS
40	L3	140	ASP
40	L3	164	THR
40	L3	167	ARG
40	L3	173	GLN
40	L3	183	LEU
40	L3	187	SER
40	L3	188	ILE
40	L3	196	ARG
40	L3	206	ASP
40	L3	213	GLU
40	L3	226	PHE
40	L3	235	THR
40	L3	238	LEU
40	L3	244	ARG
40	L3	246	LEU
40	L3	252	ILE
40	L3	275	ARG

Continued on next page...

Continued from previous page...

Mol	Chain	Res	Type
40	L3	284	ARG
40	L3	293	ASN
40	L3	296	THR
40	L3	301	THR
40	L3	304	THR
40	L3	305	ILE
40	L3	320	ASP
40	L3	328	ILE
40	L3	332	ARG
40	L3	343	TYR
40	L3	353	GLU
40	L3	354	VAL
40	L3	386	ASP
40	L3	387	LEU
41	L4	55	LYS
41	L4	74	ILE
41	L4	93	MET
41	L4	99	MET
41	L4	105	THR
41	L4	120	TYR
41	L4	124	SER
41	L4	133	SER
41	L4	136	LEU
41	L4	148	ILE
41	L4	153	SER
41	L4	156	LEU
41	L4	172	VAL
41	L4	179	LEU
41	L4	187	LEU
41	L4	193	LYS
41	L4	194	TYR
41	L4	203	ARG
41	L4	206	LEU
41	L4	227	THR
41	L4	230	VAL
41	L4	246	ARG
41	L4	252	GLU
41	L4	258	LEU
41	L4	259	ASP
41	L4	285	ASP
41	L4	287	THR
41	L4	290	ILE

Continued on next page...

Continued from previous page...

Mol	Chain	Res	Type
41	L4	307	GLN
41	L4	311	HIS
41	L4	313	LEU
41	L4	316	ASN
41	L4	333	VAL
41	L4	338	LYS
41	L4	346	LYS
41	L4	349	THR
42	L5	8	LYS
42	L5	14	SER
42	L5	23	ARG
42	L5	35	ARG
42	L5	41	LYS
42	L5	66	SER
42	L5	69	ILE
42	L5	70	THR
42	L5	81	HIS
42	L5	93	THR
42	L5	95	TRP
42	L5	105	ILE
42	L5	110	LEU
42	L5	115	LEU
42	L5	128	GLU
42	L5	130	GLU
42	L5	131	LEU
42	L5	137	ASP
42	L5	140	ARG
42	L5	142	PHE
42	L5	146	LEU
42	L5	155	THR
42	L5	163	LEU
42	L5	177	GLU
42	L5	185	PHE
42	L5	188	GLU
42	L5	190	ILE
42	L5	194	LEU
42	L5	208	MET
42	L5	211	LEU
42	L5	222	LEU
42	L5	231	ILE
42	L5	263	GLU
42	L5	277	LEU

Continued on next page...

Continued from previous page...

Mol	Chain	Res	Type
42	L5	279	LYS
42	L5	296	GLN
43	L6	5	LYS
43	L6	21	THR
43	L6	52	VAL
43	L6	57	HIS
43	L6	64	LEU
43	L6	65	ILE
43	L6	78	ARG
43	L6	79	VAL
43	L6	84	VAL
43	L6	89	THR
43	L6	90	LYS
43	L6	98	VAL
43	L6	134	ARG
43	L6	137	ASP
43	L6	154	LEU
43	L6	155	LEU
43	L6	160	SER
43	L6	162	SER
44	L7	24	GLU
44	L7	25	GLN
44	L7	26	VAL
44	L7	38	LYS
44	L7	60	ARG
44	L7	82	LYS
44	L7	88	ARG
44	L7	93	ASN
44	L7	100	ARG
44	L7	105	LEU
44	L7	107	ARG
44	L7	110	ARG
44	L7	115	THR
44	L7	120	THR
44	L7	124	LEU
44	L7	126	LEU
44	L7	128	LYS
44	L7	151	ARG
44	L7	158	LYS
44	L7	175	LYS
44	L7	179	LEU
44	L7	182	ASP

Continued on next page...

Continued from previous page...

Mol	Chain	Res	Type
44	L7	184	LEU
44	L7	239	LEU
45	L8	27	THR
45	L8	41	GLN
45	L8	47	SER
45	L8	65	LEU
45	L8	71	VAL
45	L8	74	THR
45	L8	79	GLN
45	L8	83	ASP
45	L8	109	LEU
45	L8	134	TYR
45	L8	136	LEU
45	L8	145	ASN
45	L8	150	LEU
45	L8	156	ASP
45	L8	160	ILE
45	L8	169	LEU
45	L8	181	LYS
45	L8	185	ARG
45	L8	190	VAL
45	L8	221	ASN
45	L8	230	LYS
45	L8	251	LYS
46	L9	1	MET
46	L9	5	GLN
46	L9	6	THR
46	L9	9	GLN
46	L9	19	SER
46	L9	41	ILE
46	L9	42	ASP
46	L9	44	THR
46	L9	48	VAL
46	L9	49	ASN
46	L9	51	GLN
46	L9	52	LEU
46	L9	65	VAL
46	L9	68	LEU
46	L9	69	ARG
46	L9	70	THR
46	L9	71	VAL
46	L9	73	SER

Continued on next page...

Continued from previous page...

Mol	Chain	Res	Type
46	L9	77	ASN
46	L9	92	TYR
46	L9	103	ILE
46	L9	118	LEU
46	L9	120	ASP
46	L9	132	VAL
46	L9	139	ASN
46	L9	149	ASN
46	L9	151	VAL
46	L9	157	ASN
46	L9	161	LEU
46	L9	162	GLN
46	L9	164	ILE
46	L9	172	ILE
46	L9	173	ARG
46	L9	177	ASP
46	L9	182	SER
46	L9	189	GLU
47	M0	3	ARG
47	M0	12	GLN
47	M0	26	VAL
47	M0	30	LYS
47	M0	31	ILE
47	M0	32	ARG
47	M0	48	LEU
47	M0	51	HIS
47	M0	52	LEU
47	M0	58	GLU
47	M0	60	LEU
47	M0	61	SER
47	M0	63	GLU
47	M0	74	LYS
47	M0	82	ARG
47	M0	83	ASP
47	M0	87	LEU
47	M0	128	ARG
47	M0	130	ASP
47	M0	137	SER
47	M0	138	VAL
47	M0	139	ARG
47	M0	163	GLN
47	M0	165	ILE

Continued on next page...

Continued from previous page...

Mol	Chain	Res	Type
47	M0	167	LEU
47	M0	174	THR
47	M0	177	ASP
47	M0	178	ARG
47	M0	185	ARG
47	M0	189	GLU
47	M0	191	LYS
47	M0	203	LYS
47	M0	208	ASN
48	M1	10	ARG
48	M1	12	LEU
48	M1	13	LYS
48	M1	19	LEU
48	M1	26	SER
48	M1	28	ASP
48	M1	39	GLN
48	M1	44	THR
48	M1	46	VAL
48	M1	61	ARG
48	M1	67	VAL
48	M1	80	LEU
48	M1	81	GLU
48	M1	82	ARG
48	M1	85	LYS
48	M1	95	ASN
48	M1	101	ASN
48	M1	106	ILE
48	M1	107	ASP
48	M1	111	ASP
48	M1	112	LEU
48	M1	115	LYS
48	M1	137	ARG
48	M1	138	VAL
48	M1	140	ARG
48	M1	145	LYS
48	M1	155	THR
48	M1	157	GLU
48	M1	165	GLN
48	M1	166	LYS
49	M3	17	HIS
49	M3	22	VAL
49	M3	23	LYS

Continued on next page...

Continued from previous page...

Mol	Chain	Res	Type
49	M3	24	VAL
49	M3	36	ARG
49	M3	53	LEU
49	M3	54	LEU
49	M3	55	ARG
49	M3	57	VAL
49	M3	59	ARG
49	M3	67	ARG
49	M3	104	ARG
49	M3	114	GLN
49	M3	117	LYS
49	M3	121	SER
49	M3	122	LYS
49	M3	124	ILE
49	M3	131	LYS
49	M3	134	GLU
49	M3	138	VAL
49	M3	169	THR
50	M4	4	ASP
50	M4	8	LYS
50	M4	14	LEU
50	M4	15	VAL
50	M4	20	VAL
50	M4	43	LYS
50	M4	50	LYS
50	M4	53	VAL
50	M4	64	VAL
50	M4	65	LEU
50	M4	69	THR
50	M4	72	LEU
50	M4	90	VAL
50	M4	91	CYS
51	M5	7	LEU
51	M5	17	ASP
51	M5	18	VAL
51	M5	22	LEU
51	M5	46	ASP
51	M5	80	THR
51	M5	85	THR
51	M5	94	TYR
51	M5	99	ARG
51	M5	106	VAL

Continued on next page...

Continued from previous page...

Mol	Chain	Res	Type
51	M5	117	ASN
51	M5	133	ILE
51	M5	134	LEU
51	M5	138	GLN
51	M5	151	ILE
51	M5	153	ASP
51	M5	157	LYS
51	M5	167	THR
51	M5	183	THR
51	M5	184	LYS
51	M5	188	ARG
51	M5	190	THR
51	M5	196	THR
51	M5	198	SER
52	M6	4	GLU
52	M6	22	VAL
52	M6	31	GLN
52	M6	51	LYS
52	M6	58	LEU
52	M6	68	ARG
52	M6	77	SER
52	M6	78	ARG
52	M6	79	ILE
52	M6	84	LEU
52	M6	85	ARG
52	M6	94	ARG
52	M6	106	GLU
52	M6	113	ASP
52	M6	116	LYS
52	M6	122	GLN
52	M6	124	LEU
52	M6	128	ARG
52	M6	143	THR
52	M6	144	SER
52	M6	149	TYR
52	M6	155	LYS
52	M6	160	ARG
52	M6	163	SER
52	M6	184	THR
52	M6	189	ASP
53	M7	7	THR
53	M7	24	VAL

Continued on next page...

Continued from previous page...

Mol	Chain	Res	Type
53	M7	29	THR
53	M7	36	ILE
53	M7	42	THR
53	M7	52	LEU
53	M7	75	GLU
53	M7	78	VAL
53	M7	110	THR
53	M7	112	LEU
53	M7	118	GLN
53	M7	127	ARG
53	M7	129	THR
53	M7	137	ASN
53	M7	138	LYS
53	M7	142	SER
53	M7	144	SER
53	M7	148	LEU
53	M7	168	LEU
53	M7	171	ARG
54	M8	17	THR
54	M8	21	SER
54	M8	22	ASP
54	M8	24	VAL
54	M8	26	LEU
54	M8	32	LEU
54	M8	49	LEU
54	M8	69	ARG
54	M8	86	THR
54	M8	105	ARG
54	M8	115	VAL
54	M8	127	LEU
54	M8	135	GLN
54	M8	136	ASN
54	M8	138	LEU
54	M8	171	LYS
54	M8	178	ARG
54	M8	180	ARG
55	M9	22	VAL
55	M9	44	LEU
55	M9	49	THR
55	M9	51	VAL
55	M9	60	LYS
55	M9	70	LYS

Continued on next page...

Continued from previous page...

Mol	Chain	Res	Type
55	M9	74	ARG
55	M9	76	SER
55	M9	103	ARG
55	M9	106	LEU
55	M9	110	ARG
55	M9	134	HIS
55	M9	138	LEU
55	M9	139	VAL
55	M9	143	ILE
55	M9	165	LYS
55	M9	180	LYS
56	N0	1	MET
56	N0	16	THR
56	N0	34	GLU
56	N0	45	LEU
56	N0	50	LYS
56	N0	61	ILE
56	N0	71	LYS
56	N0	79	VAL
56	N0	81	TYR
56	N0	87	THR
56	N0	88	HIS
56	N0	92	LYS
56	N0	97	VAL
56	N0	100	VAL
56	N0	115	ARG
56	N0	117	ARG
56	N0	122	HIS
56	N0	132	THR
56	N0	136	LYS
56	N0	138	GLN
56	N0	149	LYS
56	N0	166	LYS
56	N0	171	PHE
56	N0	172	TYR
57	N1	12	ARG
57	N1	16	GLN
57	N1	18	ASP
57	N1	25	VAL
57	N1	26	HIS
57	N1	27	LEU
57	N1	32	LYS

Continued on next page...

Continued from previous page...

Mol	Chain	Res	Type
57	N1	55	LYS
57	N1	72	VAL
57	N1	75	ILE
57	N1	78	LYS
57	N1	79	MET
57	N1	80	VAL
57	N1	83	ARG
57	N1	88	ARG
57	N1	89	LEU
57	N1	93	VAL
57	N1	101	CYS
57	N1	103	GLN
57	N1	104	GLU
57	N1	106	LEU
57	N1	118	GLU
57	N1	124	VAL
57	N1	126	VAL
57	N1	128	LEU
57	N1	131	GLN
57	N1	139	ARG
57	N1	141	VAL
58	N2	10	LYS
58	N2	16	THR
58	N2	19	VAL
58	N2	50	LEU
58	N2	52	ASN
58	N2	66	VAL
58	N2	70	LYS
58	N2	100	THR
59	N3	9	THR
59	N3	44	SER
59	N3	48	ARG
59	N3	54	LEU
59	N3	69	LEU
59	N3	73	VAL
59	N3	86	ARG
59	N3	88	ARG
59	N3	98	ASN
59	N3	102	ILE
59	N3	108	GLU
59	N3	115	THR
59	N3	124	ASP

Continued on next page...

Continued from previous page...

Mol	Chain	Res	Type
59	N3	128	ARG
60	N4	1	MET
60	N4	4	GLU
60	N4	5	ILE
60	N4	19	THR
60	N4	64	THR
61	N5	25	LYS
61	N5	27	ARG
61	N5	29	SER
61	N5	36	LYS
61	N5	37	THR
61	N5	38	LEU
61	N5	39	LYS
61	N5	63	ILE
61	N5	69	SER
61	N5	70	GLU
61	N5	77	GLU
61	N5	78	ASP
61	N5	86	VAL
61	N5	108	LEU
61	N5	113	LEU
61	N5	115	ARG
61	N5	119	THR
61	N5	125	ARG
61	N5	133	LEU
61	N5	135	ILE
61	N5	137	ASN
62	N6	3	LYS
62	N6	5	SER
62	N6	9	SER
62	N6	13	ARG
62	N6	28	ARG
62	N6	37	LYS
62	N6	38	GLU
62	N6	39	LEU
62	N6	40	ARG
62	N6	42	GLN
62	N6	45	ILE
62	N6	55	GLU
62	N6	56	VAL
62	N6	57	LEU
62	N6	74	TYR

Continued on next page...

Continued from previous page...

Mol	Chain	Res	Type
62	N6	76	LEU
62	N6	115	ARG
62	N6	122	LYS
62	N6	127	GLU
63	N7	17	ARG
63	N7	24	VAL
63	N7	30	ASP
63	N7	34	LYS
63	N7	46	ILE
63	N7	54	THR
63	N7	55	LYS
63	N7	80	LEU
63	N7	92	PHE
63	N7	94	SER
63	N7	100	THR
63	N7	102	GLU
63	N7	103	GLN
63	N7	121	ARG
63	N7	122	HIS
63	N7	135	ARG
64	N8	4	ARG
64	N8	6	THR
64	N8	8	THR
64	N8	10	LYS
64	N8	12	ARG
64	N8	34	MET
64	N8	42	ARG
64	N8	46	ASP
64	N8	56	VAL
64	N8	60	TYR
64	N8	73	LEU
64	N8	76	ASP
64	N8	88	ASP
64	N8	91	LEU
64	N8	115	LYS
64	N8	118	ILE
64	N8	124	ILE
64	N8	130	VAL
64	N8	133	LEU
64	N8	135	GLU
65	N9	3	LYS
65	N9	8	THR

Continued on next page...

Continued from previous page...

Mol	Chain	Res	Type
65	N9	13	THR
65	N9	18	ARG
65	N9	22	LYS
65	N9	59	LYS
66	O0	30	THR
66	O0	33	SER
66	O0	41	LEU
66	O0	52	ARG
66	O0	54	SER
66	O0	59	TYR
66	O0	61	MET
66	O0	67	VAL
66	O0	76	GLU
66	O0	83	LYS
66	O0	87	VAL
66	O0	100	ILE
67	O1	6	ASP
67	O1	8	VAL
67	O1	26	LYS
67	O1	31	ARG
67	O1	41	LYS
67	O1	55	LEU
67	O1	64	VAL
67	O1	73	LEU
67	O1	79	ARG
67	O1	82	GLU
67	O1	84	ASP
67	O1	106	THR
68	O2	3	SER
68	O2	9	ILE
68	O2	19	ARG
68	O2	31	ASN
68	O2	33	ARG
68	O2	35	GLN
68	O2	41	VAL
68	O2	54	LYS
68	O2	61	LYS
68	O2	73	THR
68	O2	95	GLU
68	O2	104	ASN
68	O2	106	VAL
68	O2	109	LEU

Continued on next page...

Continued from previous page...

Mol	Chain	Res	Type
68	O2	126	LEU
69	O3	3	GLU
69	O3	7	LEU
69	O3	14	LEU
69	O3	15	SER
69	O3	20	LYS
69	O3	22	VAL
69	O3	24	ASN
69	O3	37	THR
69	O3	48	ARG
69	O3	59	VAL
69	O3	74	THR
69	O3	78	SER
69	O3	81	VAL
69	O3	98	VAL
69	O3	105	SER
70	O4	6	THR
70	O4	8	ARG
70	O4	23	VAL
70	O4	24	LYS
70	O4	29	ILE
70	O4	38	LEU
70	O4	58	ARG
70	O4	65	VAL
70	O4	71	THR
70	O4	102	LYS
70	O4	104	VAL
71	O5	13	SER
71	O5	20	GLN
71	O5	47	VAL
71	O5	48	ARG
71	O5	49	LYS
71	O5	89	ARG
71	O5	101	THR
71	O5	102	GLU
71	O5	105	ARG
72	O6	11	LEU
72	O6	13	LYS
72	O6	21	THR
72	O6	25	LYS
72	O6	26	ILE
72	O6	28	TYR

Continued on next page...

Continued from previous page...

Mol	Chain	Res	Type
72	O6	36	ARG
72	O6	42	SER
72	O6	57	LEU
72	O6	60	LEU
72	O6	68	ARG
72	O6	76	ARG
72	O6	80	PHE
72	O6	90	MET
72	O6	98	ARG
72	O6	99	ARG
73	O7	14	LYS
73	O7	24	ARG
73	O7	25	ARG
73	O7	31	LYS
73	O7	33	THR
73	O7	36	SER
73	O7	44	THR
73	O7	59	THR
73	O7	67	LEU
73	O7	75	LYS
73	O7	85	LYS
74	O8	8	ILE
74	O8	27	ILE
74	O8	28	ASN
74	O8	29	LYS
74	O8	32	ASN
74	O8	39	ARG
74	O8	46	ARG
74	O8	53	THR
74	O8	65	LEU
74	O8	67	GLN
74	O8	69	LEU
74	O8	77	ARG
75	O9	4	GLN
75	O9	5	LYS
75	O9	21	ARG
75	O9	23	LEU
75	O9	27	ILE
75	O9	28	ARG
75	O9	29	LEU
76	Q0	79	GLU
76	Q0	81	SER

Continued on next page...

Continued from previous page...

Mol	Chain	Res	Type
76	Q0	85	LEU
76	Q0	97	ARG
76	Q0	98	LYS
76	Q0	99	CYS
76	Q0	112	LYS
76	Q0	113	ARG
76	Q0	114	LYS
76	Q0	127	LEU
77	Q1	11	ARG
77	Q1	13	LEU
77	Q1	23	ARG
78	Q2	7	THR
78	Q2	16	THR
78	Q2	17	CYS
78	Q2	20	HIS
78	Q2	21	THR
78	Q2	26	THR
78	Q2	47	GLN
78	Q2	65	THR
78	Q2	78	LYS
78	Q2	83	LEU
78	Q2	84	THR
78	Q2	85	LEU
78	Q2	87	ARG
78	Q2	88	CYS
78	Q2	93	LEU
78	Q2	105	GLN
79	Q3	5	THR
79	Q3	7	LYS
79	Q3	11	THR
79	Q3	28	LYS
79	Q3	32	GLN
79	Q3	45	LYS
79	Q3	60	CYS
79	Q3	70	THR
79	Q3	73	THR
79	Q3	82	THR
79	Q3	84	ARG
2	s0	22	THR
2	s0	31	VAL
2	s0	45	VAL
2	s0	46	HIS

Continued on next page...

Continued from previous page...

Mol	Chain	Res	Type
2	s0	59	LEU
2	s0	72	ASP
2	s0	87	LEU
2	s0	96	THR
2	s0	108	THR
2	s0	111	ILE
2	s0	124	THR
2	s0	131	GLN
2	s0	135	GLU
2	s0	144	ILE
2	s0	151	SER
2	s0	153	SER
2	s0	154	GLU
2	s0	158	VAL
2	s0	172	LEU
2	s0	184	LEU
2	s0	188	LEU
2	s0	189	VAL
2	s0	191	ARG
2	s0	198	MET
2	s0	200	ASP
3	s1	21	VAL
3	s1	25	THR
3	s1	26	ARG
3	s1	47	LEU
3	s1	65	VAL
3	s1	66	VAL
3	s1	68	VAL
3	s1	70	LEU
3	s1	74	GLN
3	s1	77	GLU
3	s1	78	ASP
3	s1	81	PHE
3	s1	101	HIS
3	s1	104	ASP
3	s1	108	ASP
3	s1	110	LEU
3	s1	124	ASN
3	s1	135	LEU
3	s1	144	ARG
3	s1	152	ARG
3	s1	153	HIS

Continued on next page...

Continued from previous page...

Mol	Chain	Res	Type
3	s1	157	GLN
3	s1	173	THR
3	s1	181	LEU
3	s1	208	GLN
3	s1	209	ASN
3	s1	212	VAL
3	s1	216	LYS
4	s2	46	LYS
4	s2	51	THR
4	s2	53	ILE
4	s2	54	GLU
4	s2	55	GLU
4	s2	58	LEU
4	s2	69	ILE
4	s2	70	ASP
4	s2	72	LEU
4	s2	78	ASP
4	s2	82	ASN
4	s2	83	ILE
4	s2	84	LYS
4	s2	91	ARG
4	s2	94	GLN
4	s2	95	ARG
4	s2	96	THR
4	s2	97	ARG
4	s2	111	VAL
4	s2	115	ILE
4	s2	125	ILE
4	s2	141	ARG
4	s2	152	HIS
4	s2	159	THR
4	s2	166	THR
4	s2	194	GLU
4	s2	207	LEU
4	s2	218	ILE
4	s2	221	THR
4	s2	222	TYR
4	s2	224	PHE
4	s2	226	THR
4	s2	228	ASN
4	s2	232	GLU
4	s2	237	VAL

Continued on next page...

Continued from previous page...

Mol	Chain	Res	Type
5	s3	21	LEU
5	s3	26	THR
5	s3	37	VAL
5	s3	66	ILE
5	s3	67	ASN
5	s3	79	TYR
5	s3	84	ILE
5	s3	90	ARG
5	s3	91	VAL
5	s3	96	LEU
5	s3	104	SER
5	s3	116	ARG
5	s3	127	MET
5	s3	128	GLU
5	s3	158	ILE
5	s3	162	GLN
5	s3	168	ILE
5	s3	176	LEU
5	s3	212	LYS
5	s3	218	LEU
6	s4	9	LEU
6	s4	12	LEU
6	s4	23	LEU
6	s4	24	SER
6	s4	38	LEU
6	s4	42	LEU
6	s4	48	LEU
6	s4	49	ARG
6	s4	51	ARG
6	s4	56	LEU
6	s4	67	GLN
6	s4	70	VAL
6	s4	75	LYS
6	s4	95	THR
6	s4	98	ASN
6	s4	104	ASP
6	s4	120	SER
6	s4	127	LYS
6	s4	128	LYS
6	s4	131	LEU
6	s4	147	ILE
6	s4	148	ARG

Continued on next page...

Continued from previous page...

Mol	Chain	Res	Type
6	s4	163	ASP
6	s4	164	LEU
6	s4	176	ASP
6	s4	182	TYR
6	s4	191	ARG
6	s4	214	LEU
6	s4	220	THR
6	s4	222	LEU
6	s4	237	SER
6	s4	238	LEU
6	s4	252	ARG
7	s5	25	LEU
7	s5	34	GLN
7	s5	40	ILE
7	s5	60	ASP
7	s5	63	GLN
7	s5	65	ARG
7	s5	66	GLN
7	s5	68	ILE
7	s5	82	PHE
7	s5	89	ILE
7	s5	93	LEU
7	s5	98	MET
7	s5	99	MET
7	s5	102	ARG
7	s5	119	ASP
7	s5	124	LEU
7	s5	146	THR
7	s5	157	ARG
7	s5	162	VAL
7	s5	189	THR
7	s5	193	THR
7	s5	194	LEU
7	s5	203	LYS
7	s5	211	ILE
7	s5	216	GLU
7	s5	222	LYS
8	s6	15	THR
8	s6	19	ASP
8	s6	21	GLU
8	s6	31	ARG
8	s6	34	GLN

Continued on next page...

Continued from previous page...

Mol	Chain	Res	Type
8	s6	57	ASP
8	s6	64	LYS
8	s6	71	THR
8	s6	76	LEU
8	s6	78	THR
8	s6	93	LYS
8	s6	109	LEU
8	s6	119	GLN
8	s6	120	GLU
8	s6	128	THR
8	s6	129	VAL
8	s6	133	LEU
8	s6	163	THR
8	s6	179	VAL
8	s6	191	ARG
8	s6	194	LYS
8	s6	215	ARG
9	s7	9	LEU
9	s7	11	GLN
9	s7	50	ASP
9	s7	62	VAL
9	s7	75	THR
9	s7	77	LEU
9	s7	87	ASP
9	s7	97	ARG
9	s7	108	GLN
9	s7	114	ARG
9	s7	143	LEU
9	s7	144	VAL
9	s7	160	GLN
9	s7	163	ASP
9	s7	176	LEU
10	s8	4	SER
10	s8	10	LYS
10	s8	18	ARG
10	s8	25	ARG
10	s8	29	LEU
10	s8	46	VAL
10	s8	58	LEU
10	s8	59	ARG
10	s8	61	GLU
10	s8	74	LYS

Continued on next page...

Continued from previous page...

Mol	Chain	Res	Type
10	s8	76	THR
10	s8	89	GLU
10	s8	95	THR
10	s8	120	THR
10	s8	151	LYS
10	s8	152	ILE
10	s8	155	SER
10	s8	176	SER
10	s8	183	ILE
11	s9	3	ARG
11	s9	6	ARG
11	s9	7	THR
11	s9	22	SER
11	s9	28	LEU
11	s9	46	SER
11	s9	49	LEU
11	s9	54	ARG
11	s9	61	THR
11	s9	78	ARG
11	s9	82	ARG
11	s9	89	ASP
11	s9	93	LEU
11	s9	97	LEU
11	s9	103	ASP
11	s9	109	LEU
11	s9	111	THR
11	s9	120	LYS
11	s9	126	ARG
11	s9	127	VAL
11	s9	132	ARG
11	s9	134	ILE
11	s9	157	ASP
11	s9	168	ARG
11	s9	172	VAL
11	s9	180	LYS
12	c0	7	ASP
12	c0	15	LEU
12	c0	27	PHE
12	c0	47	GLN
12	c0	57	THR
12	c0	67	THR
12	c0	71	GLU

Continued on next page...

Continued from previous page...

Mol	Chain	Res	Type
13	c1	5	LEU
13	c1	10	GLU
13	c1	26	LYS
13	c1	31	THR
13	c1	33	ARG
13	c1	35	TYR
13	c1	40	LEU
13	c1	44	THR
13	c1	47	THR
13	c1	60	PHE
13	c1	67	ARG
13	c1	83	THR
13	c1	90	TYR
13	c1	111	VAL
13	c1	117	VAL
13	c1	129	ARG
14	c2	38	HIS
14	c2	45	LEU
14	c2	54	ARG
14	c2	61	VAL
14	c2	62	LEU
14	c2	71	ILE
14	c2	103	LEU
14	c2	136	ILE
15	c3	6	SER
15	c3	21	ASN
15	c3	30	SER
15	c3	46	THR
15	c3	60	VAL
15	c3	66	ILE
15	c3	67	THR
15	c3	70	LYS
15	c3	74	ILE
15	c3	75	LEU
15	c3	78	ASN
15	c3	84	ILE
15	c3	101	HIS
15	c3	115	LEU
15	c3	125	LEU
15	c3	128	TYR
15	c3	149	LEU
16	c4	20	TYR

Continued on next page...

Continued from previous page...

Mol	Chain	Res	Type
16	c4	23	PHE
16	c4	26	THR
16	c4	51	ASP
16	c4	52	ARG
16	c4	61	MET
16	c4	81	VAL
16	c4	92	LYS
16	c4	93	THR
16	c4	102	LEU
16	c4	107	ARG
16	c4	108	SER
16	c4	114	ARG
16	c4	121	VAL
16	c4	123	SER
16	c4	124	ASP
16	c4	133	ARG
16	c4	136	ARG
16	c4	137	LEU
17	c5	12	PHE
17	c5	16	SER
17	c5	24	LYS
17	c5	27	GLU
17	c5	28	MET
17	c5	36	LEU
17	c5	61	ARG
17	c5	69	GLU
17	c5	84	ILE
17	c5	86	VAL
17	c5	124	THR
17	c5	126	VAL
17	c5	127	ARG
17	c5	128	HIS
18	c6	23	LYS
18	c6	26	LYS
18	c6	28	LEU
18	c6	37	THR
18	c6	43	ILE
18	c6	53	LEU
18	c6	55	VAL
18	c6	57	LEU
18	c6	68	ARG
18	c6	70	THR

Continued on next page...

Continued from previous page...

Mol	Chain	Res	Type
18	c6	105	LEU
18	c6	114	ARG
18	c6	115	THR
18	c6	118	ILE
18	c6	127	LYS
18	c6	137	ARG
19	c7	5	ARG
19	c7	6	THR
19	c7	8	THR
19	c7	29	GLN
19	c7	34	LEU
19	c7	46	LEU
19	c7	60	ARG
19	c7	72	LYS
19	c7	112	SER
19	c7	113	LEU
20	c8	4	VAL
20	c8	5	VAL
20	c8	14	ILE
20	c8	15	LEU
20	c8	18	LEU
20	c8	28	ILE
20	c8	33	THR
20	c8	38	VAL
20	c8	40	ARG
20	c8	41	ARG
20	c8	51	ASP
20	c8	85	PHE
20	c8	94	ASP
20	c8	105	VAL
20	c8	116	LEU
20	c8	120	ARG
20	c8	133	VAL
20	c8	134	ARG
20	c8	138	THR
21	c9	6	VAL
21	c9	7	ARG
21	c9	8	ASP
21	c9	9	VAL
21	c9	28	LEU
21	c9	30	VAL
21	c9	57	ARG

Continued on next page...

Continued from previous page...

Mol	Chain	Res	Type
21	c9	68	ARG
21	c9	71	VAL
21	c9	86	ARG
21	c9	111	ILE
21	c9	123	ARG
21	c9	126	GLU
21	c9	131	ASP
21	c9	134	ARG
21	c9	140	LEU
21	c9	142	GLU
22	d0	20	ILE
22	d0	21	LYS
22	d0	25	THR
22	d0	44	ASN
22	d0	48	HIS
22	d0	57	ARG
22	d0	60	THR
22	d0	62	VAL
22	d0	70	THR
22	d0	77	LYS
22	d0	103	ILE
22	d0	115	GLU
23	d1	5	LYS
23	d1	8	LEU
23	d1	27	ASP
23	d1	32	VAL
23	d1	56	SER
23	d1	62	ARG
23	d1	68	SER
23	d1	81	ASN
24	d2	7	LEU
24	d2	9	ASP
24	d2	22	LYS
24	d2	25	VAL
24	d2	37	PHE
24	d2	42	GLN
24	d2	57	ARG
24	d2	58	SER
24	d2	65	LEU
24	d2	85	ASP
24	d2	93	LEU
24	d2	98	GLN

Continued on next page...

Continued from previous page...

Mol	Chain	Res	Type
24	d2	99	PHE
24	d2	103	ILE
24	d2	105	THR
24	d2	126	LEU
24	d2	129	VAL
25	d3	19	ARG
25	d3	28	ASN
25	d3	40	SER
25	d3	73	ARG
25	d3	75	GLN
25	d3	84	THR
25	d3	95	PHE
25	d3	100	ASP
25	d3	103	LEU
25	d3	107	PHE
26	d4	6	THR
26	d4	26	ASP
26	d4	34	ASN
26	d4	36	SER
26	d4	40	LEU
26	d4	49	LYS
26	d4	51	GLU
26	d4	58	PHE
26	d4	61	ARG
26	d4	62	THR
26	d4	74	LEU
26	d4	78	SER
26	d4	83	LYS
26	d4	125	LEU
26	d4	133	ASN
27	d5	41	ILE
27	d5	52	LYS
27	d5	53	GLU
27	d5	57	TYR
27	d5	60	VAL
27	d5	77	ARG
27	d5	81	ARG
27	d5	88	ILE
27	d5	92	ILE
27	d5	103	ARG
28	d6	10	ARG
28	d6	11	ASN

Continued on next page...

Continued from previous page...

Mol	Chain	Res	Type
28	d6	12	LYS
28	d6	15	ARG
28	d6	24	VAL
28	d6	30	ILE
28	d6	33	ASP
28	d6	39	MET
28	d6	74	CYS
28	d6	82	ARG
28	d6	86	VAL
28	d6	88	SER
28	d6	89	ARG
29	d7	3	LEU
29	d7	21	LEU
29	d7	34	ASP
29	d7	41	LEU
29	d7	42	ASN
29	d7	43	ILE
29	d7	77	THR
29	d7	82	LYS
30	d8	15	VAL
30	d8	18	ARG
30	d8	33	LEU
30	d8	36	THR
30	d8	39	THR
30	d8	49	ARG
30	d8	54	LEU
30	d8	58	GLU
30	d8	61	ARG
30	d8	64	ARG
31	d9	10	HIS
31	d9	12	ARG
31	d9	19	ARG
31	d9	21	CYS
31	d9	28	THR
31	d9	30	LEU
31	d9	32	ARG
31	d9	36	LEU
31	d9	54	LYS
31	d9	56	ARG
32	e0	15	LYS
32	e0	16	SER
32	e0	21	VAL

Continued on next page...

Continued from previous page...

Mol	Chain	Res	Type
32	e0	22	GLU
32	e0	24	THR
32	e0	26	LYS
32	e0	29	LYS
32	e0	41	THR
32	e0	43	ARG
32	e0	44	PHE
32	e0	48	THR
32	e0	49	LEU
32	e0	54	ARG
32	e0	56	MET
33	e1	86	THR
33	e1	93	HIS
33	e1	98	VAL
33	e1	99	LYS
33	e1	100	LEU
33	e1	106	TYR
33	e1	113	LYS
33	e1	134	ASN
33	e1	135	HIS
33	e1	147	VAL
33	e1	148	TYR
34	sR	21	THR
34	sR	29	GLN
34	sR	42	LEU
34	sR	58	VAL
34	sR	66	HIS
34	sR	74	THR
34	sR	76	ASP
34	sR	86	ASP
34	sR	106	HIS
34	sR	122	ILE
34	sR	145	LEU
34	sR	167	VAL
34	sR	245	PHE
34	sR	272	ASP
34	sR	286	GLU
34	sR	297	ASP
34	sR	317	THR
35	sM	23	LYS
35	sM	33	LYS
35	sM	43	ASP

Continued on next page...

Continued from previous page...

Mol	Chain	Res	Type
35	sM	49	LYS
35	sM	50	ASN
35	sM	68	ARG
35	sM	74	LYS
35	sM	82	THR
39	l2	10	LYS
39	l2	19	HIS
39	l2	32	LEU
39	l2	44	ILE
39	l2	46	LYS
39	l2	47	GLN
39	l2	62	VAL
39	l2	74	GLU
39	l2	80	GLU
39	l2	82	VAL
39	l2	96	LEU
39	l2	101	VAL
39	l2	104	LEU
39	l2	109	GLU
39	l2	114	SER
39	l2	134	VAL
39	l2	137	ILE
39	l2	147	ARG
39	l2	161	ASP
39	l2	165	VAL
39	l2	168	VAL
39	l2	179	LEU
39	l2	180	LEU
39	l2	193	ARG
39	l2	199	THR
39	l2	202	VAL
39	l2	204	MET
39	l2	207	VAL
39	l2	241	ARG
39	l2	242	ARG
39	l2	246	LEU
40	l3	3	HIS
40	l3	4	ARG
40	l3	5	LYS
40	l3	7	GLU
40	l3	17	LEU
40	l3	19	ARG

Continued on next page...

Continued from previous page...

Mol	Chain	Res	Type
40	l3	24	SER
40	l3	30	LYS
40	l3	37	ARG
40	l3	47	LEU
40	l3	50	LYS
40	l3	56	ILE
40	l3	70	ARG
40	l3	79	VAL
40	l3	85	VAL
40	l3	93	VAL
40	l3	103	THR
40	l3	104	THR
40	l3	110	LEU
40	l3	111	SER
40	l3	112	ASP
40	l3	114	VAL
40	l3	116	ARG
40	l3	123	TYR
40	l3	125	SER
40	l3	139	GLN
40	l3	140	ASP
40	l3	146	ARG
40	l3	148	LEU
40	l3	156	SER
40	l3	167	ARG
40	l3	183	LEU
40	l3	187	SER
40	l3	188	ILE
40	l3	192	VAL
40	l3	196	ARG
40	l3	208	VAL
40	l3	211	GLN
40	l3	231	HIS
40	l3	232	ARG
40	l3	235	THR
40	l3	249	VAL
40	l3	264	VAL
40	l3	266	ARG
40	l3	274	SER
40	l3	284	ARG
40	l3	296	THR
40	l3	297	SER

Continued on next page...

Continued from previous page...

Mol	Chain	Res	Type
40	13	304	THR
40	13	324	VAL
40	13	328	ILE
40	13	332	ARG
40	13	335	ILE
40	13	340	LYS
40	13	341	SER
40	13	346	THR
40	13	348	ARG
40	13	355	SER
41	14	25	VAL
41	14	33	ASP
41	14	34	ILE
41	14	54	GLU
41	14	67	THR
41	14	69	ARG
41	14	73	ARG
41	14	76	ARG
41	14	92	ASN
41	14	93	MET
41	14	120	TYR
41	14	138	ARG
41	14	144	LYS
41	14	150	LEU
41	14	156	LEU
41	14	158	SER
41	14	177	ASP
41	14	179	LEU
41	14	186	LYS
41	14	187	LEU
41	14	191	LYS
41	14	193	LYS
41	14	206	LEU
41	14	220	ARG
41	14	222	VAL
41	14	230	VAL
41	14	246	ARG
41	14	258	LEU
41	14	259	ASP
41	14	272	VAL
41	14	276	LEU
41	14	279	HIS

Continued on next page...

Continued from previous page...

Mol	Chain	Res	Type
41	14	301	PRO
41	14	313	LEU
41	14	316	ASN
41	14	319	LYS
41	14	327	LEU
41	14	333	VAL
41	14	347	THR
41	14	361	HIS
42	15	14	SER
42	15	32	GLN
42	15	35	ARG
42	15	51	LEU
42	15	64	ILE
42	15	65	ILE
42	15	93	THR
42	15	109	THR
42	15	110	LEU
42	15	111	GLN
42	15	112	LYS
42	15	118	THR
42	15	120	LYS
42	15	122	VAL
42	15	124	GLU
42	15	133	GLU
42	15	137	ASP
42	15	140	ARG
42	15	144	VAL
42	15	146	LEU
42	15	148	ILE
42	15	155	THR
42	15	185	PHE
42	15	188	GLU
42	15	189	GLU
42	15	194	LEU
42	15	211	LEU
42	15	216	GLU
42	15	218	ARG
42	15	227	LEU
42	15	241	THR
42	15	254	LYS
42	15	258	LYS
42	15	259	LYS

Continued on next page...

Continued from previous page...

Mol	Chain	Res	Type
42	15	260	PHE
42	15	263	GLU
42	15	268	GLU
42	15	270	LYS
42	15	275	THR
42	15	278	SER
42	15	279	LYS
42	15	281	GLU
42	15	293	LEU
43	16	13	GLU
43	16	20	LYS
43	16	46	ARG
43	16	48	ARG
43	16	52	VAL
43	16	57	HIS
43	16	62	THR
43	16	64	LEU
43	16	76	LEU
43	16	84	VAL
43	16	89	THR
43	16	92	SER
43	16	131	LYS
43	16	136	GLU
43	16	152	THR
43	16	155	LEU
43	16	157	GLN
43	16	162	SER
43	16	166	LYS
43	16	175	LYS
44	17	22	THR
44	17	38	LYS
44	17	41	ARG
44	17	56	GLU
44	17	60	ARG
44	17	83	LEU
44	17	88	ARG
44	17	93	ASN
44	17	107	ARG
44	17	124	LEU
44	17	130	ILE
44	17	156	ILE
44	17	158	LYS

Continued on next page...

Continued from previous page...

Mol	Chain	Res	Type
44	17	159	GLN
44	17	173	LEU
44	17	175	LYS
44	17	179	LEU
44	17	180	SER
44	17	184	LEU
44	17	189	ILE
44	17	199	ASN
44	17	229	PHE
44	17	239	LEU
45	18	43	LYS
45	18	44	ARG
45	18	50	VAL
45	18	57	ARG
45	18	59	GLN
45	18	65	LEU
45	18	71	VAL
45	18	74	THR
45	18	79	GLN
45	18	90	THR
45	18	109	LEU
45	18	132	VAL
45	18	134	TYR
45	18	136	LEU
45	18	160	ILE
45	18	163	VAL
45	18	169	LEU
45	18	172	LYS
45	18	173	MET
45	18	200	LEU
45	18	204	ARG
45	18	213	LYS
45	18	217	THR
45	18	232	HIS
46	19	1	MET
46	19	6	THR
46	19	16	VAL
46	19	17	THR
46	19	18	VAL
46	19	44	THR
46	19	46	THR
46	19	55	VAL

Continued on next page...

Continued from previous page...

Mol	Chain	Res	Type
46	19	68	LEU
46	19	70	THR
46	19	80	THR
46	19	118	LEU
46	19	120	ASP
46	19	123	ILE
46	19	130	ASP
46	19	132	VAL
46	19	133	THR
46	19	134	ILE
46	19	144	ILE
46	19	151	VAL
46	19	157	ASN
46	19	162	GLN
46	19	166	ARG
46	19	167	VAL
46	19	173	ARG
46	19	187	ILE
46	19	190	ASP
46	19	191	LEU
47	m0	3	ARG
47	m0	24	ARG
47	m0	28	ASP
47	m0	36	LEU
47	m0	42	THR
47	m0	44	ASP
47	m0	48	LEU
47	m0	52	LEU
47	m0	58	GLU
47	m0	61	SER
47	m0	71	CYS
47	m0	76	MET
47	m0	87	LEU
47	m0	90	ARG
47	m0	99	ILE
47	m0	103	LEU
47	m0	130	ASP
47	m0	137	SER
47	m0	141	LYS
47	m0	156	ARG
47	m0	162	GLN
47	m0	163	GLN

Continued on next page...

Continued from previous page...

Mol	Chain	Res	Type
47	m0	167	LEU
47	m0	169	LYS
47	m0	177	ASP
47	m0	183	LYS
47	m0	191	LYS
47	m0	197	VAL
47	m0	205	SER
47	m0	208	ASN
48	m1	6	GLN
48	m1	10	ARG
48	m1	12	LEU
48	m1	13	LYS
48	m1	16	LYS
48	m1	23	VAL
48	m1	30	LEU
48	m1	46	VAL
48	m1	92	ARG
48	m1	99	THR
48	m1	101	ASN
48	m1	107	ASP
48	m1	111	ASP
48	m1	112	LEU
48	m1	129	VAL
48	m1	137	ARG
48	m1	139	THR
48	m1	147	THR
48	m1	148	VAL
48	m1	158	ASP
48	m1	159	THR
48	m1	165	GLN
49	m3	8	PRO
49	m3	13	HIS
49	m3	52	ASP
49	m3	54	LEU
49	m3	55	ARG
49	m3	58	VAL
49	m3	67	ARG
49	m3	69	VAL
49	m3	73	ARG
49	m3	86	THR
49	m3	97	VAL
49	m3	100	ARG

Continued on next page...

Continued from previous page...

Mol	Chain	Res	Type
49	m3	103	ASN
49	m3	118	GLU
49	m3	128	ARG
49	m3	131	LYS
49	m3	147	ILE
49	m3	149	GLN
49	m3	154	VAL
49	m3	157	ARG
49	m3	164	GLU
49	m3	168	ARG
49	m3	170	LEU
49	m3	176	GLU
49	m3	180	ARG
49	m3	189	GLU
49	m3	194	GLU
50	m4	4	ASP
50	m4	8	LYS
50	m4	11	ASN
50	m4	15	VAL
50	m4	28	SER
50	m4	42	LYS
50	m4	53	VAL
50	m4	69	THR
50	m4	72	LEU
50	m4	80	THR
50	m4	106	ARG
50	m4	107	GLU
50	m4	108	ARG
50	m4	113	THR
51	m5	5	LYS
51	m5	7	LEU
51	m5	10	LEU
51	m5	12	ARG
51	m5	17	ASP
51	m5	19	LEU
51	m5	22	LEU
51	m5	27	VAL
51	m5	49	ARG
51	m5	71	ARG
51	m5	80	THR
51	m5	86	ASN
51	m5	106	VAL

Continued on next page...

Continued from previous page...

Mol	Chain	Res	Type
51	m5	109	ARG
51	m5	117	ASN
51	m5	138	GLN
51	m5	142	ILE
51	m5	153	ASP
51	m5	176	LYS
51	m5	182	ASN
51	m5	183	THR
52	m6	4	GLU
52	m6	22	VAL
52	m6	34	VAL
52	m6	46	GLU
52	m6	60	LYS
52	m6	74	ARG
52	m6	85	ARG
52	m6	106	GLU
52	m6	116	LYS
52	m6	118	VAL
52	m6	124	LEU
52	m6	126	VAL
52	m6	129	LEU
52	m6	134	LYS
52	m6	143	THR
52	m6	151	ASP
52	m6	160	ARG
52	m6	162	VAL
52	m6	175	THR
52	m6	178	VAL
52	m6	197	LEU
53	m7	7	THR
53	m7	9	THR
53	m7	24	VAL
53	m7	32	THR
53	m7	41	LEU
53	m7	47	TYR
53	m7	52	LEU
53	m7	79	THR
53	m7	80	LYS
53	m7	89	LYS
53	m7	107	LEU
53	m7	112	LEU
53	m7	119	VAL

Continued on next page...

Continued from previous page...

Mol	Chain	Res	Type
53	m7	126	ARG
53	m7	135	ARG
53	m7	136	ILE
53	m7	147	GLU
53	m7	148	LEU
53	m7	150	VAL
54	m8	3	ILE
54	m8	7	SER
54	m8	12	ARG
54	m8	17	THR
54	m8	22	ASP
54	m8	26	LEU
54	m8	31	LYS
54	m8	32	LEU
54	m8	34	THR
54	m8	57	ILE
54	m8	66	ARG
54	m8	69	ARG
54	m8	81	VAL
54	m8	86	THR
54	m8	98	LYS
54	m8	127	LEU
54	m8	135	GLN
54	m8	138	LEU
54	m8	161	LYS
54	m8	165	ILE
54	m8	170	ARG
54	m8	174	ARG
54	m8	178	ARG
54	m8	181	SER
55	m9	7	GLN
55	m9	10	LEU
55	m9	21	LYS
55	m9	29	THR
55	m9	30	SER
55	m9	34	GLN
55	m9	43	LYS
55	m9	49	THR
55	m9	55	VAL
55	m9	63	THR
55	m9	74	ARG
55	m9	88	ARG

Continued on next page...

Continued from previous page...

Mol	Chain	Res	Type
55	m9	138	LEU
55	m9	152	GLU
55	m9	164	LEU
55	m9	166	ASN
55	m9	173	ARG
55	m9	180	LYS
55	m9	182	ASP
55	m9	186	LYS
56	n0	1	MET
56	n0	3	HIS
56	n0	8	GLN
56	n0	21	GLU
56	n0	73	LYS
56	n0	80	ARG
56	n0	87	THR
56	n0	96	ASP
56	n0	97	VAL
56	n0	100	VAL
56	n0	105	THR
56	n0	107	TYR
56	n0	130	GLU
56	n0	132	THR
56	n0	136	LYS
56	n0	137	ARG
56	n0	145	THR
56	n0	148	LEU
56	n0	155	ARG
56	n0	160	THR
56	n0	161	LYS
56	n0	162	THR
56	n0	172	TYR
57	n1	25	VAL
57	n1	27	LEU
57	n1	33	VAL
57	n1	47	SER
57	n1	71	SER
57	n1	78	LYS
57	n1	80	VAL
57	n1	83	ARG
57	n1	89	LEU
57	n1	96	ILE
57	n1	103	GLN

Continued on next page...

Continued from previous page...

Mol	Chain	Res	Type
57	n1	126	VAL
57	n1	128	LEU
57	n1	130	ARG
57	n1	131	GLN
57	n1	138	SER
57	n1	139	ARG
57	n1	141	VAL
57	n1	143	THR
57	n1	150	THR
57	n1	157	GLU
57	n1	158	THR
57	n1	159	PHE
58	n2	27	VAL
58	n2	29	ASP
58	n2	43	VAL
58	n2	57	THR
58	n2	58	GLU
58	n2	68	THR
58	n2	74	LYS
58	n2	75	TYR
58	n2	90	ARG
58	n2	94	ARG
58	n2	100	THR
58	n2	108	TYR
59	n3	4	ASN
59	n3	7	GLN
59	n3	12	ARG
59	n3	13	ILE
59	n3	14	SER
59	n3	48	ARG
59	n3	68	GLU
59	n3	73	VAL
59	n3	74	MET
59	n3	84	SER
59	n3	93	LEU
59	n3	96	GLU
59	n3	109	MET
60	n4	5	ILE
60	n4	39	LEU
60	n4	42	GLN
60	n4	47	ARG
60	n4	54	LEU

Continued on next page...

Continued from previous page...

Mol	Chain	Res	Type
61	n5	24	LEU
61	n5	27	ARG
61	n5	38	LEU
61	n5	39	LYS
61	n5	56	ARG
61	n5	63	ILE
61	n5	71	THR
61	n5	108	LEU
61	n5	115	ARG
61	n5	125	ARG
61	n5	134	ASP
61	n5	135	ILE
61	n5	137	ASN
61	n5	138	ARG
62	n6	4	GLN
62	n6	12	ARG
62	n6	13	ARG
62	n6	32	SER
62	n6	37	LYS
62	n6	45	ILE
62	n6	48	LEU
62	n6	50	ILE
62	n6	51	ARG
62	n6	56	VAL
62	n6	59	VAL
62	n6	66	GLN
62	n6	74	TYR
62	n6	83	ASP
62	n6	99	LEU
62	n6	115	ARG
63	n7	14	VAL
63	n7	17	ARG
63	n7	24	VAL
63	n7	36	HIS
63	n7	46	ILE
63	n7	52	LYS
63	n7	56	LYS
63	n7	57	HIS
63	n7	72	ILE
63	n7	81	LEU
63	n7	84	ARG
63	n7	90	GLU

Continued on next page...

Continued from previous page...

Mol	Chain	Res	Type
63	n7	92	PHE
63	n7	100	THR
63	n7	118	PHE
63	n7	126	LYS
63	n7	128	GLN
63	n7	134	LEU
64	n8	4	ARG
64	n8	6	THR
64	n8	8	THR
64	n8	10	LYS
64	n8	15	VAL
64	n8	19	LYS
64	n8	24	LYS
64	n8	26	ARG
64	n8	27	LYS
64	n8	42	ARG
64	n8	56	VAL
64	n8	60	TYR
64	n8	65	GLN
64	n8	91	LEU
64	n8	123	VAL
64	n8	132	LYS
64	n8	139	ARG
65	n9	6	ASN
65	n9	13	THR
65	n9	18	ARG
65	n9	38	LYS
65	n9	59	LYS
66	o0	12	GLN
66	o0	28	LYS
66	o0	29	SER
66	o0	40	LYS
66	o0	41	LEU
66	o0	50	VAL
66	o0	61	MET
66	o0	63	SER
66	o0	66	LYS
66	o0	86	ARG
66	o0	87	VAL
66	o0	103	THR
67	o1	13	THR
67	o1	16	LEU

Continued on next page...

Continued from previous page...

Mol	Chain	Res	Type
67	o1	24	SER
67	o1	26	LYS
67	o1	31	ARG
67	o1	41	LYS
67	o1	42	LEU
67	o1	44	MET
67	o1	50	ARG
67	o1	62	ARG
67	o1	68	GLU
67	o1	83	GLU
67	o1	91	SER
67	o1	93	VAL
67	o1	96	VAL
67	o1	102	LYS
67	o1	106	THR
67	o1	110	GLU
68	o2	3	SER
68	o2	6	HIS
68	o2	19	ARG
68	o2	24	ARG
68	o2	27	ARG
68	o2	33	ARG
68	o2	38	ILE
68	o2	49	ASN
68	o2	51	SER
68	o2	59	SER
68	o2	61	LYS
68	o2	73	THR
68	o2	75	LEU
68	o2	81	ASP
68	o2	82	LEU
68	o2	84	THR
68	o2	91	THR
68	o2	95	GLU
68	o2	103	LYS
68	o2	109	LEU
68	o2	125	ARG
68	o2	126	LEU
69	o3	3	GLU
69	o3	15	SER
69	o3	20	LYS
69	o3	21	ARG

Continued on next page...

Continued from previous page...

Mol	Chain	Res	Type
69	o3	28	SER
69	o3	31	LYS
69	o3	37	THR
69	o3	45	LEU
69	o3	74	THR
69	o3	80	VAL
69	o3	81	VAL
69	o3	87	ASN
69	o3	98	VAL
69	o3	105	SER
70	o4	5	VAL
70	o4	19	LYS
70	o4	20	ILE
70	o4	35	VAL
70	o4	58	ARG
70	o4	65	VAL
70	o4	71	THR
70	o4	83	ASN
70	o4	104	VAL
71	o5	11	THR
71	o5	16	GLN
71	o5	21	LEU
71	o5	38	ARG
71	o5	45	LYS
71	o5	46	THR
71	o5	47	VAL
71	o5	49	LYS
71	o5	56	THR
71	o5	69	LEU
71	o5	79	ASP
71	o5	85	THR
71	o5	101	THR
72	o6	7	ILE
72	o6	9	ILE
72	o6	11	LEU
72	o6	15	LYS
72	o6	17	VAL
72	o6	21	THR
72	o6	26	ILE
72	o6	29	LYS
72	o6	35	ASN
72	o6	36	ARG

Continued on next page...

Continued from previous page...

Mol	Chain	Res	Type
72	o6	43	LEU
72	o6	45	ARG
72	o6	57	LEU
72	o6	58	ILE
72	o6	60	LEU
72	o6	68	ARG
72	o6	72	VAL
72	o6	76	ARG
72	o6	81	THR
72	o6	94	ILE
72	o6	98	ARG
73	o7	14	LYS
73	o7	25	ARG
73	o7	33	THR
73	o7	46	SER
73	o7	59	THR
73	o7	65	ARG
73	o7	67	LEU
73	o7	75	LYS
74	o8	8	ILE
74	o8	12	LEU
74	o8	14	LEU
74	o8	24	THR
74	o8	41	THR
74	o8	53	THR
74	o8	54	LEU
74	o8	61	LYS
74	o8	64	LYS
74	o8	66	ILE
75	o9	4	GLN
75	o9	21	ARG
75	o9	46	ARG
76	q0	79	GLU
76	q0	85	LEU
76	q0	93	LYS
76	q0	96	CYS
76	q0	99	CYS
76	q0	112	LYS
76	q0	113	ARG
76	q0	127	LEU
77	q1	9	ARG
77	q1	10	THR

Continued on next page...

Continued from previous page...

Mol	Chain	Res	Type
77	q1	13	LEU
77	q1	17	ARG
77	q1	18	ARG
77	q1	21	ARG
78	q2	7	THR
78	q2	8	ARG
78	q2	10	THR
78	q2	19	LYS
78	q2	26	THR
78	q2	57	VAL
78	q2	61	LYS
78	q2	66	LYS
78	q2	67	LYS
78	q2	68	VAL
78	q2	74	CYS
78	q2	79	THR
78	q2	82	GLN
78	q2	84	THR
78	q2	85	LEU
78	q2	93	LEU
78	q2	100	LYS
78	q2	105	GLN
79	q3	16	VAL
79	q3	42	CYS
79	q3	46	THR
79	q3	49	ARG
79	q3	54	ILE
79	q3	56	THR
79	q3	58	SER
79	q3	73	THR
79	q3	78	THR
79	q3	89	MET
81	p0	4	ILE
81	p0	5	ARG
81	p0	15	LEU
81	p0	39	HIS
81	p0	48	ARG
81	p0	52	LEU
81	p0	67	LEU
81	p0	70	LEU
81	p0	81	LYS
81	p0	93	LEU

Continued on next page...

Continued from previous page...

Mol	Chain	Res	Type
81	p0	97	LYS
81	p0	105	VAL
83	f	37	ARG
83	f	51	LYS
83	f	52	HIS
83	f	54	HIS
83	f	58	HIS
83	f	78	HIS
83	f	79	ASN
83	f	80	MET
83	f	87	ARG
83	f	102	LEU
83	f	103	MET
83	f	105	MET
83	f	106	ASP
83	f	109	THR
83	f	112	ASP
83	f	120	LEU
83	f	138	ILE

Sometimes sidechains can be flipped to improve hydrogen bonding and reduce clashes. All (40) such sidechains are listed below:

Mol	Chain	Res	Type
2	S0	163	ASN
3	S1	209	ASN
4	S2	77	GLN
20	C8	99	HIS
23	D1	3	ASN
25	D3	65	ASN
25	D3	79	ASN
26	D4	106	GLN
34	SR	248	ASN
41	L4	311	HIS
42	L5	40	HIS
46	L9	49	ASN
46	L9	116	ASN
47	M0	144	ASN
48	M1	95	ASN
51	M5	178	HIS
51	M5	194	GLN
54	M8	73	GLN
57	N1	26	HIS

Continued on next page...

Continued from previous page...

Mol	Chain	Res	Type
3	s1	157	GLN
4	s2	94	GLN
7	s5	34	GLN
9	s7	71	HIS
9	s7	74	GLN
12	c0	32	HIS
15	c3	69	ASN
18	c6	139	GLN
24	d2	15	ASN
26	d4	34	ASN
32	e0	17	GLN
33	e1	93	HIS
34	sR	268	GLN
45	l8	59	GLN
51	m5	87	GLN
52	m6	72	HIS
53	m7	137	ASN
64	n8	25	HIS
65	n9	12	GLN
75	o9	25	GLN
78	q2	82	GLN

5.3.3 RNA [i](#)

Mol	Chain	Analysed	Backbone Outliers	Pucker Outliers
1	2	1776/1800 (98%)	455 (25%)	40 (2%)
1	6	1791/1800 (99%)	447 (24%)	29 (1%)
36	1	3145/3396 (92%)	672 (21%)	53 (1%)
36	5	3163/3396 (93%)	649 (20%)	52 (1%)
37	3	120/121 (99%)	11 (9%)	0
37	7	120/121 (99%)	13 (10%)	0
38	4	157/158 (99%)	32 (20%)	3 (1%)
38	8	157/158 (99%)	34 (21%)	0
All	All	10429/10950 (95%)	2313 (22%)	177 (1%)

All (2313) RNA backbone outliers are listed below:

Mol	Chain	Res	Type
1	2	2	A
1	2	4	C
1	2	6	G

Continued on next page...

Continued from previous page...

Mol	Chain	Res	Type
1	2	17	C
1	2	23	G
1	2	25	C
1	2	26	A
1	2	27	U
1	2	34	G
1	2	42	G
1	2	45	U
1	2	46	A
1	2	47	A
1	2	57	G
1	2	60	U
1	2	67	A
1	2	68	A
1	2	69	G
1	2	72	A
1	2	73	U
1	2	74	U
1	2	75	U
1	2	77	U
1	2	95	G
1	2	96	G
1	2	104	A
1	2	111	U
1	2	114	C
1	2	121	U
1	2	127	G
1	2	128	U
1	2	131	C
1	2	132	U
1	2	133	U
1	2	134	U
1	2	135	A
1	2	136	C
1	2	137	U
1	2	141	U
1	2	144	U
1	2	145	A
1	2	146	U
1	2	153	G
1	2	159	U
1	2	160	C

Continued on next page...

Continued from previous page...

Mol	Chain	Res	Type
1	2	176	C
1	2	178	U
1	2	179	A
1	2	184	C
1	2	185	U
1	2	187	G
1	2	190	C
1	2	191	C
1	2	192	U
1	2	194	U
1	2	195	G
1	2	197	A
1	2	200	A
1	2	215	A
1	2	217	A
1	2	218	A
1	2	219	A
1	2	221	A
1	2	226	A
1	2	227	U
1	2	228	G
1	2	231	U
1	2	233	C
1	2	234	G
1	2	235	G
1	2	236	A
1	2	239	C
1	2	240	U
1	2	241	U
1	2	242	U
1	2	245	U
1	2	249	U
1	2	250	C
1	2	257	A
1	2	261	U
1	2	262	U
1	2	265	A
1	2	271	A
1	2	272	U
1	2	273	G
1	2	274	G
1	2	275	C

Continued on next page...

Continued from previous page...

Mol	Chain	Res	Type
1	2	276	C
1	2	277	U
1	2	278	U
1	2	279	G
1	2	280	U
1	2	281	G
1	2	288	A
1	2	290	G
1	2	299	A
1	2	302	U
1	2	309	C
1	2	314	C
1	2	316	A
1	2	319	U
1	2	321	C
1	2	329	G
1	2	333	A
1	2	337	G
1	2	338	C
1	2	352	A
1	2	358	U
1	2	359	A
1	2	360	A
1	2	361	C
1	2	380	U
1	2	390	G
1	2	400	A
1	2	402	C
1	2	404	G
1	2	416	A
1	2	418	G
1	2	419	G
1	2	421	A
1	2	424	C
1	2	425	A
1	2	426	G
1	2	428	A
1	2	434	G
1	2	437	A
1	2	439	U
1	2	440	U
1	2	444	C

Continued on next page...

Continued from previous page...

Mol	Chain	Res	Type
1	2	445	A
1	2	447	U
1	2	448	C
1	2	455	C
1	2	468	A
1	2	469	C
1	2	477	A
1	2	483	A
1	2	484	C
1	2	485	A
1	2	486	G
1	2	488	G
1	2	493	U
1	2	494	U
1	2	495	C
1	2	496	G
1	2	497	G
1	2	498	G
1	2	499	U
1	2	500	C
1	2	502	U
1	2	503	G
1	2	504	U
1	2	505	A
1	2	506	A
1	2	507	U
1	2	508	U
1	2	510	G
1	2	511	A
1	2	513	U
1	2	514	G
1	2	515	A
1	2	516	G
1	2	518	A
1	2	520	A
1	2	527	A
1	2	529	A
1	2	532	U
1	2	534	A
1	2	538	A
1	2	539	G
1	2	540	G

Continued on next page...

Continued from previous page...

Mol	Chain	Res	Type
1	2	541	A
1	2	542	A
1	2	543	C
1	2	544	A
1	2	556	A
1	2	557	G
1	2	558	U
1	2	559	C
1	2	565	C
1	2	574	G
1	2	579	A
1	2	580	A
1	2	585	A
1	2	594	A
1	2	595	G
1	2	606	A
1	2	611	U
1	2	619	A
1	2	620	A
1	2	621	A
1	2	622	A
1	2	623	A
1	2	624	G
1	2	628	G
1	2	639	U
1	2	640	U
1	2	648	G
1	2	650	U
1	2	653	C
1	2	655	G
1	2	656	G
1	2	657	U
1	2	658	C
1	2	680	U
1	2	684	A
1	2	686	C
1	2	687	G
1	2	691	C
1	2	694	U
1	2	696	C
1	2	697	C
1	2	700	C

Continued on next page...

Continued from previous page...

Mol	Chain	Res	Type
1	2	701	U
1	2	702	G
1	2	703	G
1	2	704	C
1	2	705	U
1	2	706	A
1	2	707	A
1	2	709	C
1	2	710	U
1	2	712	G
1	2	714	G
1	2	717	C
1	2	718	U
1	2	719	U
1	2	721	U
1	2	722	G
1	2	723	G
1	2	725	U
1	2	727	U
1	2	728	U
1	2	731	C
1	2	732	G
1	2	734	A
1	2	735	C
1	2	736	C
1	2	737	A
1	2	738	G
1	2	742	U
1	2	743	U
1	2	754	A
1	2	755	A
1	2	756	A
1	2	765	G
1	2	766	U
1	2	774	A
1	2	775	G
1	2	778	G
1	2	781	U
1	2	783	G
1	2	784	C
1	2	789	A
1	2	794	U

Continued on next page...

Continued from previous page...

Mol	Chain	Res	Type
1	2	795	U
1	2	812	A
1	2	815	G
1	2	816	G
1	2	818	C
1	2	819	G
1	2	820	U
1	2	821	U
1	2	824	G
1	2	829	A
1	2	830	U
1	2	831	U
1	2	833	U
1	2	839	U
1	2	846	G
1	2	856	A
1	2	860	U
1	2	863	A
1	2	876	G
1	2	886	U
1	2	898	A
1	2	912	U
1	2	914	G
1	2	933	A
1	2	935	U
1	2	940	A
1	2	942	G
1	2	944	A
1	2	951	A
1	2	954	G
1	2	960	U
1	2	966	A
1	2	969	C
1	2	992	A
1	2	993	A
1	2	995	A
1	2	1003	A
1	2	1004	U
1	2	1005	A
1	2	1022	C
1	2	1026	A
1	2	1028	C

Continued on next page...

Continued from previous page...

Mol	Chain	Res	Type
1	2	1039	A
1	2	1040	G
1	2	1052	U
1	2	1053	G
1	2	1056	U
1	2	1057	U
1	2	1058	U
1	2	1060	U
1	2	1061	A
1	2	1074	G
1	2	1080	U
1	2	1082	C
1	2	1091	A
1	2	1092	A
1	2	1096	C
1	2	1097	U
1	2	1098	U
1	2	1100	G
1	2	1109	G
1	2	1111	G
1	2	1138	A
1	2	1146	G
1	2	1150	G
1	2	1151	A
1	2	1155	G
1	2	1158	C
1	2	1160	A
1	2	1167	G
1	2	1185	U
1	2	1194	A
1	2	1196	A
1	2	1197	C
1	2	1199	G
1	2	1200	G
1	2	1208	A
1	2	1217	A
1	2	1218	G
1	2	1227	A
1	2	1229	G
1	2	1243	G
1	2	1244	A
1	2	1245	G

Continued on next page...

Continued from previous page...

Mol	Chain	Res	Type
1	2	1250	U
1	2	1251	U
1	2	1258	U
1	2	1284	C
1	2	1286	U
1	2	1301	U
1	2	1311	U
1	2	1314	U
1	2	1315	U
1	2	1321	A
1	2	1334	U
1	2	1337	A
1	2	1340	U
1	2	1341	A
1	2	1344	A
1	2	1345	A
1	2	1346	A
1	2	1347	U
1	2	1348	A
1	2	1354	G
1	2	1355	C
1	2	1361	U
1	2	1363	U
1	2	1364	G
1	2	1370	U
1	2	1371	A
1	2	1372	U
1	2	1390	U
1	2	1398	U
1	2	1399	C
1	2	1413	U
1	2	1414	U
1	2	1415	U
1	2	1427	A
1	2	1428	G
1	2	1432	U
1	2	1436	A
1	2	1437	U
1	2	1444	A
1	2	1446	A
1	2	1449	U
1	2	1456	C

Continued on next page...

Continued from previous page...

Mol	Chain	Res	Type
1	2	1458	G
1	2	1459	C
1	2	1460	A
1	2	1461	C
1	2	1471	A
1	2	1473	U
1	2	1474	G
1	2	1477	G
1	2	1481	C
1	2	1482	C
1	2	1486	G
1	2	1489	U
1	2	1490	C
1	2	1491	U
1	2	1492	A
1	2	1493	A
1	2	1499	G
1	2	1506	G
1	2	1515	A
1	2	1516	A
1	2	1517	U
1	2	1521	G
1	2	1523	G
1	2	1524	A
1	2	1535	U
1	2	1536	G
1	2	1537	C
1	2	1538	U
1	2	1542	G
1	2	1557	U
1	2	1559	A
1	2	1569	A
1	2	1574	G
1	2	1582	U
1	2	1584	G
1	2	1601	G
1	2	1616	G
1	2	1619	C
1	2	1624	C
1	2	1626	U
1	2	1631	A
1	2	1635	A

Continued on next page...

Continued from previous page...

Mol	Chain	Res	Type
1	2	1636	C
1	2	1657	U
1	2	1658	G
1	2	1680	G
1	2	1683	C
1	2	1684	U
1	2	1685	G
1	2	1689	A
1	2	1698	G
1	2	1699	G
1	2	1700	C
1	2	1701	A
1	2	1702	A
1	2	1703	C
1	2	1712	A
1	2	1713	G
1	2	1714	A
1	2	1731	A
1	2	1760	G
1	2	1762	A
1	2	1769	U
1	2	1770	U
1	2	1771	U
1	2	1780	G
1	2	1782	A
1	2	1783	C
1	2	1792	G
1	2	1793	G
1	2	1794	A
1	2	1795	U
1	2	1796	C
1	2	1797	A
36	1	15	C
36	1	16	A
36	1	21	G
36	1	24	G
36	1	26	A
36	1	40	A
36	1	43	A
36	1	49	A
36	1	59	G
36	1	60	A

Continued on next page...

Continued from previous page...

Mol	Chain	Res	Type
36	1	65	A
36	1	66	A
36	1	67	A
36	1	68	C
36	1	74	G
36	1	83	U
36	1	92	G
36	1	93	C
36	1	99	A
36	1	108	A
36	1	109	A
36	1	110	G
36	1	111	C
36	1	113	C
36	1	116	A
36	1	117	U
36	1	121	A
36	1	122	A
36	1	131	C
36	1	133	U
36	1	136	G
36	1	140	C
36	1	154	U
36	1	155	G
36	1	156	G
36	1	157	A
36	1	173	G
36	1	175	C
36	1	187	A
36	1	190	U
36	1	191	U
36	1	201	A
36	1	206	G
36	1	210	U
36	1	213	A
36	1	218	G
36	1	219	A
36	1	220	G
36	1	239	G
36	1	240	U
36	1	241	G
36	1	243	G

Continued on next page...

Continued from previous page...

Mol	Chain	Res	Type
36	1	245	U
36	1	249	U
36	1	250	U
36	1	252	U
36	1	253	A
36	1	256	G
36	1	269	G
36	1	282	G
36	1	283	G
36	1	286	U
36	1	287	G
36	1	288	C
36	1	295	A
36	1	298	U
36	1	299	G
36	1	305	U
36	1	315	C
36	1	323	A
36	1	329	U
36	1	330	G
36	1	338	A
36	1	339	C
36	1	349	A
36	1	350	C
36	1	366	A
36	1	376	G
36	1	380	U
36	1	398	A
36	1	399	A
36	1	401	U
36	1	402	A
36	1	403	C
36	1	414	U
36	1	421	G
36	1	422	A
36	1	439	C
36	1	440	A
36	1	495	G
36	1	498	A
36	1	520	U
36	1	521	A
36	1	523	A

Continued on next page...

Continued from previous page...

Mol	Chain	Res	Type
36	1	535	G
36	1	543	C
36	1	544	C
36	1	546	C
36	1	547	G
36	1	548	G
36	1	550	A
36	1	552	G
36	1	555	U
36	1	556	U
36	1	557	A
36	1	559	A
36	1	568	G
36	1	578	A
36	1	579	G
36	1	588	G
36	1	592	A
36	1	602	A
36	1	604	G
36	1	609	G
36	1	611	A
36	1	619	A
36	1	620	U
36	1	621	A
36	1	636	C
36	1	649	A
36	1	660	A
36	1	677	A
36	1	681	U
36	1	682	U
36	1	689	U
36	1	690	A
36	1	691	A
36	1	705	A
36	1	708	G
36	1	709	A
36	1	712	G
36	1	715	A
36	1	716	A
36	1	718	G
36	1	764	U
36	1	765	C

Continued on next page...

Continued from previous page...

Mol	Chain	Res	Type
36	1	766	U
36	1	767	U
36	1	768	C
36	1	776	U
36	1	777	U
36	1	781	G
36	1	785	G
36	1	792	G
36	1	806	A
36	1	817	A
36	1	830	A
36	1	837	A
36	1	849	C
36	1	861	C
36	1	873	C
36	1	874	U
36	1	879	U
36	1	890	C
36	1	896	A
36	1	907	G
36	1	908	G
36	1	914	A
36	1	916	G
36	1	917	A
36	1	921	A
36	1	923	C
36	1	924	G
36	1	937	G
36	1	943	U
36	1	944	C
36	1	953	G
36	1	959	C
36	1	960	U
36	1	962	A
36	1	963	G
36	1	964	G
36	1	974	G
36	1	979	U
36	1	980	A
36	1	981	U
36	1	982	C
36	1	993	G

Continued on next page...

Continued from previous page...

Mol	Chain	Res	Type
36	1	994	G
36	1	1001	G
36	1	1002	A
36	1	1010	G
36	1	1013	G
36	1	1016	C
36	1	1017	C
36	1	1018	G
36	1	1020	G
36	1	1024	G
36	1	1025	A
36	1	1029	G
36	1	1037	C
36	1	1038	C
36	1	1047	A
36	1	1049	C
36	1	1063	G
36	1	1064	A
36	1	1065	A
36	1	1071	U
36	1	1072	G
36	1	1081	U
36	1	1082	U
36	1	1093	A
36	1	1094	U
36	1	1095	U
36	1	1097	G
36	1	1098	A
36	1	1103	A
36	1	1104	G
36	1	1117	G
36	1	1128	U
36	1	1131	G
36	1	1144	U
36	1	1153	A
36	1	1156	C
36	1	1159	A
36	1	1178	G
36	1	1179	A
36	1	1180	A
36	1	1181	U
36	1	1182	A

Continued on next page...

Continued from previous page...

Mol	Chain	Res	Type
36	1	1190	A
36	1	1191	U
36	1	1192	C
36	1	1201	C
36	1	1206	G
36	1	1209	G
36	1	1212	A
36	1	1217	A
36	1	1222	G
36	1	1227	C
36	1	1232	C
36	1	1235	U
36	1	1236	G
36	1	1237	G
36	1	1240	A
36	1	1241	U
36	1	1243	G
36	1	1245	A
36	1	1246	G
36	1	1248	C
36	1	1249	G
36	1	1253	U
36	1	1254	C
36	1	1258	U
36	1	1262	G
36	1	1263	A
36	1	1264	G
36	1	1266	G
36	1	1270	A
36	1	1271	A
36	1	1274	A
36	1	1278	A
36	1	1279	C
36	1	1285	G
36	1	1287	A
36	1	1305	U
36	1	1308	A
36	1	1309	U
36	1	1318	A
36	1	1330	A
36	1	1331	U
36	1	1332	A

Continued on next page...

Continued from previous page...

Mol	Chain	Res	Type
36	1	1345	G
36	1	1348	U
36	1	1349	G
36	1	1350	A
36	1	1351	U
36	1	1352	A
36	1	1353	U
36	1	1354	G
36	1	1355	A
36	1	1356	U
36	1	1357	G
36	1	1386	A
36	1	1387	G
36	1	1392	G
36	1	1398	U
36	1	1399	A
36	1	1400	G
36	1	1408	G
36	1	1417	G
36	1	1418	A
36	1	1419	A
36	1	1421	G
36	1	1429	G
36	1	1431	G
36	1	1433	A
36	1	1434	G
36	1	1437	C
36	1	1446	A
36	1	1481	A
36	1	1482	A
36	1	1483	G
36	1	1485	G
36	1	1502	C
36	1	1508	C
36	1	1525	G
36	1	1527	C
36	1	1535	A
36	1	1556	C
36	1	1560	G
36	1	1562	C
36	1	1563	C
36	1	1567	U

Continued on next page...

Continued from previous page...

Mol	Chain	Res	Type
36	1	1568	U
36	1	1569	U
36	1	1570	U
36	1	1571	A
36	1	1576	G
36	1	1579	C
36	1	1580	A
36	1	1582	C
36	1	1583	A
36	1	1587	A
36	1	1589	A
36	1	1592	G
36	1	1605	A
36	1	1620	U
36	1	1621	A
36	1	1629	U
36	1	1633	C
36	1	1639	C
36	1	1641	U
36	1	1642	A
36	1	1643	A
36	1	1644	C
36	1	1645	U
36	1	1655	G
36	1	1657	C
36	1	1658	G
36	1	1675	G
36	1	1683	A
36	1	1688	U
36	1	1702	U
36	1	1713	G
36	1	1715	A
36	1	1716	U
36	1	1717	U
36	1	1724	U
36	1	1729	A
36	1	1736	G
36	1	1740	U
36	1	1742	U
36	1	1750	A
36	1	1751	G
36	1	1753	G

Continued on next page...

Continued from previous page...

Mol	Chain	Res	Type
36	1	1761	C
36	1	1762	C
36	1	1763	U
36	1	1764	U
36	1	1765	U
36	1	1766	G
36	1	1767	C
36	1	1770	G
36	1	1775	G
36	1	1778	G
36	1	1780	G
36	1	1781	C
36	1	1797	A
36	1	1798	A
36	1	1810	A
36	1	1814	A
36	1	1816	A
36	1	1819	U
36	1	1820	U
36	1	1821	U
36	1	1834	U
36	1	1839	A
36	1	1841	A
36	1	1842	A
36	1	1846	C
36	1	1849	C
36	1	1850	A
36	1	1871	U
36	1	1879	A
36	1	1880	U
36	1	1881	A
36	1	1906	G
36	1	1937	U
36	1	1948	G
36	1	1952	G
36	1	1953	G
36	1	1954	G
36	1	2094	C
36	1	2095	G
36	1	2101	C
36	1	2102	U
36	1	2111	G

Continued on next page...

Continued from previous page...

Mol	Chain	Res	Type
36	1	2113	A
36	1	2115	G
36	1	2116	G
36	1	2120	A
36	1	2121	G
36	1	2122	G
36	1	2130	G
36	1	2131	A
36	1	2140	U
36	1	2144	A
36	1	2158	A
36	1	2169	G
36	1	2170	U
36	1	2187	G
36	1	2188	A
36	1	2205	U
36	1	2207	A
36	1	2208	A
36	1	2209	U
36	1	2210	G
36	1	2215	A
36	1	2242	A
36	1	2244	A
36	1	2249	G
36	1	2250	G
36	1	2252	A
36	1	2255	A
36	1	2256	A
36	1	2260	U
36	1	2272	G
36	1	2281	A
36	1	2282	U
36	1	2283	G
36	1	2287	C
36	1	2298	U
36	1	2299	A
36	1	2307	G
36	1	2310	U
36	1	2313	A
36	1	2314	U
36	1	2315	G
36	1	2334	U

Continued on next page...

Continued from previous page...

Mol	Chain	Res	Type
36	1	2335	G
36	1	2336	U
36	1	2361	A
36	1	2372	A
36	1	2373	A
36	1	2374	C
36	1	2375	G
36	1	2382	G
36	1	2385	G
36	1	2393	G
36	1	2394	G
36	1	2397	A
36	1	2398	A
36	1	2401	A
36	1	2402	A
36	1	2403	G
36	1	2404	A
36	1	2411	U
36	1	2418	G
36	1	2419	A
36	1	2437	G
36	1	2444	C
36	1	2445	A
36	1	2502	A
36	1	2503	G
36	1	2508	U
36	1	2514	U
36	1	2515	A
36	1	2522	G
36	1	2523	A
36	1	2526	C
36	1	2532	U
36	1	2533	G
36	1	2534	G
36	1	2537	U
36	1	2538	U
36	1	2539	C
36	1	2540	A
36	1	2541	U
36	1	2542	U
36	1	2543	U
36	1	2549	G

Continued on next page...

Continued from previous page...

Mol	Chain	Res	Type
36	1	2552	C
36	1	2554	A
36	1	2555	G
36	1	2560	C
36	1	2561	A
36	1	2562	A
36	1	2568	C
36	1	2569	A
36	1	2570	U
36	1	2571	U
36	1	2572	C
36	1	2573	G
36	1	2581	U
36	1	2585	G
36	1	2586	G
36	1	2587	U
36	1	2593	A
36	1	2594	C
36	1	2606	G
36	1	2607	G
36	1	2614	G
36	1	2617	U
36	1	2626	A
36	1	2637	A
36	1	2642	A
36	1	2652	U
36	1	2656	A
36	1	2657	A
36	1	2672	G
36	1	2674	A
36	1	2677	G
36	1	2689	A
36	1	2691	A
36	1	2694	A
36	1	2696	A
36	1	2704	A
36	1	2705	A
36	1	2706	G
36	1	2714	G
36	1	2728	G
36	1	2729	U
36	1	2740	A

Continued on next page...

Continued from previous page...

Mol	Chain	Res	Type
36	1	2749	G
36	1	2752	U
36	1	2753	G
36	1	2755	C
36	1	2760	C
36	1	2762	A
36	1	2771	U
36	1	2772	C
36	1	2777	G
36	1	2778	G
36	1	2787	G
36	1	2796	G
36	1	2797	C
36	1	2799	A
36	1	2800	G
36	1	2801	A
36	1	2802	A
36	1	2810	C
36	1	2814	G
36	1	2816	G
36	1	2817	A
36	1	2818	U
36	1	2837	A
36	1	2838	A
36	1	2842	U
36	1	2843	U
36	1	2845	A
36	1	2847	A
36	1	2853	A
36	1	2856	G
36	1	2858	U
36	1	2860	U
36	1	2861	U
36	1	2867	C
36	1	2871	G
36	1	2872	A
36	1	2887	A
36	1	2898	G
36	1	2899	C
36	1	2923	U
36	1	2932	U
36	1	2935	U

Continued on next page...

Continued from previous page...

Mol	Chain	Res	Type
36	1	2936	A
36	1	2941	A
36	1	2942	C
36	1	2947	G
36	1	2951	G
36	1	2960	C
36	1	2971	A
36	1	2972	G
36	1	2977	G
36	1	2983	C
36	1	2990	G
36	1	2992	U
36	1	2996	U
36	1	2997	G
36	1	3012	A
36	1	3025	C
36	1	3030	G
36	1	3049	A
36	1	3056	U
36	1	3059	G
36	1	3074	G
36	1	3078	U
36	1	3079	U
36	1	3080	G
36	1	3086	A
36	1	3087	A
36	1	3090	U
36	1	3091	A
36	1	3092	C
36	1	3093	C
36	1	3097	C
36	1	3120	C
36	1	3122	A
36	1	3129	A
36	1	3130	A
36	1	3131	U
36	1	3141	A
36	1	3142	A
36	1	3143	C
36	1	3145	C
36	1	3151	U
36	1	3153	U

Continued on next page...

Continued from previous page...

Mol	Chain	Res	Type
36	1	3154	C
36	1	3155	U
36	1	3156	U
36	1	3157	U
36	1	3165	A
36	1	3167	A
36	1	3168	A
36	1	3170	A
36	1	3171	U
36	1	3173	G
36	1	3174	A
36	1	3176	G
36	1	3179	U
36	1	3181	C
36	1	3187	A
36	1	3196	U
36	1	3198	U
36	1	3207	U
36	1	3209	A
36	1	3210	A
36	1	3217	C
36	1	3218	A
36	1	3219	G
36	1	3223	A
36	1	3228	C
36	1	3229	G
36	1	3244	A
36	1	3245	A
36	1	3246	G
36	1	3247	G
36	1	3259	U
36	1	3263	G
36	1	3269	U
36	1	3270	U
36	1	3271	G
36	1	3276	G
36	1	3281	U
36	1	3286	G
36	1	3287	U
36	1	3288	G
36	1	3289	G
36	1	3294	A

Continued on next page...

Continued from previous page...

Mol	Chain	Res	Type
36	1	3295	A
36	1	3303	G
36	1	3304	U
36	1	3307	A
36	1	3309	G
36	1	3313	U
36	1	3316	A
36	1	3317	U
36	1	3318	G
36	1	3319	U
36	1	3332	U
36	1	3335	A
36	1	3341	U
36	1	3342	A
36	1	3345	G
36	1	3347	A
36	1	3351	U
36	1	3352	U
36	1	3354	U
36	1	3355	U
36	1	3356	G
36	1	3359	A
36	1	3360	C
36	1	3367	C
36	1	3368	U
36	1	3369	G
36	1	3378	C
36	1	3382	U
36	1	3383	G
36	1	3389	U
36	1	3390	G
36	1	3396	U
37	3	7	G
37	3	22	A
37	3	41	G
37	3	65	G
37	3	68	C
37	3	74	C
37	3	76	A
37	3	95	A
37	3	102	A
37	3	112	G

Continued on next page...

Continued from previous page...

Mol	Chain	Res	Type
37	3	121	U
38	4	34	U
38	4	35	C
38	4	48	A
38	4	53	A
38	4	59	A
38	4	60	U
38	4	62	C
38	4	63	G
38	4	75	G
38	4	80	A
38	4	81	U
38	4	83	C
38	4	85	G
38	4	86	U
38	4	87	G
38	4	90	U
38	4	95	G
38	4	104	A
38	4	105	A
38	4	106	C
38	4	107	G
38	4	111	A
38	4	112	U
38	4	113	U
38	4	125	U
38	4	126	A
38	4	128	U
38	4	149	A
38	4	152	G
38	4	155	A
38	4	157	U
38	4	158	U
1	6	4	C
1	6	17	C
1	6	23	G
1	6	25	C
1	6	26	A
1	6	27	U
1	6	34	G
1	6	42	G
1	6	46	A

Continued on next page...

Continued from previous page...

Mol	Chain	Res	Type
1	6	47	A
1	6	57	G
1	6	60	U
1	6	63	G
1	6	65	A
1	6	66	U
1	6	68	A
1	6	69	G
1	6	70	C
1	6	71	A
1	6	72	A
1	6	73	U
1	6	75	U
1	6	76	A
1	6	77	U
1	6	78	A
1	6	95	G
1	6	101	U
1	6	104	A
1	6	111	U
1	6	114	C
1	6	116	U
1	6	124	A
1	6	127	G
1	6	132	U
1	6	137	U
1	6	140	A
1	6	141	U
1	6	144	U
1	6	145	A
1	6	146	U
1	6	153	G
1	6	155	U
1	6	158	U
1	6	159	U
1	6	166	C
1	6	178	U
1	6	179	A
1	6	181	A
1	6	185	U
1	6	188	A
1	6	191	C

Continued on next page...

Continued from previous page...

Mol	Chain	Res	Type
1	6	192	U
1	6	193	U
1	6	194	U
1	6	195	G
1	6	196	G
1	6	199	G
1	6	200	A
1	6	217	A
1	6	218	A
1	6	219	A
1	6	220	A
1	6	223	U
1	6	224	C
1	6	227	U
1	6	228	G
1	6	230	C
1	6	232	U
1	6	233	C
1	6	234	G
1	6	240	U
1	6	241	U
1	6	245	U
1	6	250	C
1	6	260	U
1	6	261	U
1	6	265	A
1	6	266	A
1	6	271	A
1	6	272	U
1	6	273	G
1	6	277	U
1	6	278	U
1	6	280	U
1	6	281	G
1	6	287	G
1	6	294	C
1	6	299	A
1	6	302	U
1	6	308	C
1	6	314	C
1	6	316	A
1	6	319	U

Continued on next page...

Continued from previous page...

Mol	Chain	Res	Type
1	6	321	C
1	6	337	G
1	6	338	C
1	6	343	C
1	6	352	A
1	6	359	A
1	6	361	C
1	6	380	U
1	6	400	A
1	6	401	A
1	6	402	C
1	6	404	G
1	6	416	A
1	6	418	G
1	6	421	A
1	6	424	C
1	6	425	A
1	6	426	G
1	6	428	A
1	6	434	G
1	6	439	U
1	6	444	C
1	6	445	A
1	6	448	C
1	6	468	A
1	6	475	A
1	6	477	A
1	6	484	C
1	6	486	G
1	6	487	G
1	6	488	G
1	6	489	C
1	6	490	C
1	6	492	A
1	6	493	U
1	6	494	U
1	6	496	G
1	6	500	C
1	6	501	U
1	6	505	A
1	6	506	A
1	6	508	U

Continued on next page...

Continued from previous page...

Mol	Chain	Res	Type
1	6	509	G
1	6	511	A
1	6	516	G
1	6	519	C
1	6	528	U
1	6	534	A
1	6	536	C
1	6	539	G
1	6	541	A
1	6	542	A
1	6	543	C
1	6	544	A
1	6	548	G
1	6	554	C
1	6	555	A
1	6	556	A
1	6	557	G
1	6	558	U
1	6	559	C
1	6	564	G
1	6	565	C
1	6	566	C
1	6	570	A
1	6	574	G
1	6	579	A
1	6	580	A
1	6	582	U
1	6	594	A
1	6	595	G
1	6	597	G
1	6	606	A
1	6	608	U
1	6	609	U
1	6	610	G
1	6	611	U
1	6	619	A
1	6	620	A
1	6	623	A
1	6	634	G
1	6	637	C
1	6	639	U
1	6	640	U

Continued on next page...

Continued from previous page...

Mol	Chain	Res	Type
1	6	650	U
1	6	651	G
1	6	652	G
1	6	653	C
1	6	661	A
1	6	662	U
1	6	665	U
1	6	667	U
1	6	668	C
1	6	670	U
1	6	679	U
1	6	680	U
1	6	681	U
1	6	682	C
1	6	683	C
1	6	684	A
1	6	685	A
1	6	690	G
1	6	698	U
1	6	709	C
1	6	710	U
1	6	711	U
1	6	715	U
1	6	718	U
1	6	719	U
1	6	720	G
1	6	721	U
1	6	722	G
1	6	723	G
1	6	730	G
1	6	742	U
1	6	751	G
1	6	754	A
1	6	755	A
1	6	756	A
1	6	765	G
1	6	770	A
1	6	774	A
1	6	775	G
1	6	780	A
1	6	781	U
1	6	782	U

Continued on next page...

Continued from previous page...

Mol	Chain	Res	Type
1	6	783	G
1	6	787	G
1	6	793	A
1	6	794	U
1	6	801	G
1	6	803	A
1	6	809	A
1	6	811	A
1	6	812	A
1	6	814	A
1	6	815	G
1	6	821	U
1	6	823	G
1	6	824	G
1	6	825	U
1	6	826	U
1	6	829	A
1	6	830	U
1	6	831	U
1	6	832	U
1	6	834	G
1	6	835	U
1	6	861	U
1	6	862	A
1	6	863	A
1	6	865	A
1	6	876	G
1	6	886	U
1	6	898	A
1	6	906	A
1	6	913	G
1	6	914	G
1	6	933	A
1	6	935	U
1	6	942	G
1	6	951	A
1	6	959	U
1	6	960	U
1	6	966	A
1	6	969	C
1	6	971	A
1	6	983	A

Continued on next page...

Continued from previous page...

Mol	Chain	Res	Type
1	6	988	A
1	6	992	A
1	6	993	A
1	6	996	U
1	6	998	A
1	6	1000	C
1	6	1003	A
1	6	1004	U
1	6	1005	A
1	6	1016	C
1	6	1021	C
1	6	1026	A
1	6	1028	C
1	6	1029	U
1	6	1039	A
1	6	1040	G
1	6	1052	U
1	6	1053	G
1	6	1057	U
1	6	1058	U
1	6	1059	U
1	6	1060	U
1	6	1072	C
1	6	1075	C
1	6	1081	A
1	6	1082	C
1	6	1092	A
1	6	1096	C
1	6	1097	U
1	6	1098	U
1	6	1100	G
1	6	1101	G
1	6	1109	G
1	6	1111	G
1	6	1137	A
1	6	1138	A
1	6	1151	A
1	6	1155	G
1	6	1158	C
1	6	1159	C
1	6	1160	A
1	6	1161	C

Continued on next page...

Continued from previous page...

Mol	Chain	Res	Type
1	6	1167	G
1	6	1183	A
1	6	1185	U
1	6	1191	U
1	6	1194	A
1	6	1196	A
1	6	1199	G
1	6	1200	G
1	6	1202	A
1	6	1207	C
1	6	1217	A
1	6	1218	G
1	6	1225	U
1	6	1226	A
1	6	1228	G
1	6	1229	G
1	6	1230	A
1	6	1239	U
1	6	1241	G
1	6	1242	A
1	6	1243	G
1	6	1245	G
1	6	1246	C
1	6	1252	C
1	6	1256	A
1	6	1257	U
1	6	1258	U
1	6	1284	C
1	6	1286	U
1	6	1288	G
1	6	1291	G
1	6	1314	U
1	6	1315	U
1	6	1316	G
1	6	1318	G
1	6	1321	A
1	6	1335	U
1	6	1338	C
1	6	1344	A
1	6	1345	A
1	6	1346	A
1	6	1353	U

Continued on next page...

Continued from previous page...

Mol	Chain	Res	Type
1	6	1361	U
1	6	1363	U
1	6	1364	G
1	6	1367	G
1	6	1370	U
1	6	1371	A
1	6	1383	G
1	6	1390	U
1	6	1398	U
1	6	1399	C
1	6	1400	A
1	6	1401	A
1	6	1402	G
1	6	1413	U
1	6	1414	U
1	6	1415	U
1	6	1418	G
1	6	1426	C
1	6	1427	A
1	6	1428	G
1	6	1445	G
1	6	1446	A
1	6	1447	C
1	6	1448	G
1	6	1458	G
1	6	1459	C
1	6	1460	A
1	6	1461	C
1	6	1466	G
1	6	1471	A
1	6	1473	U
1	6	1481	C
1	6	1482	C
1	6	1486	G
1	6	1490	C
1	6	1491	U
1	6	1492	A
1	6	1493	A
1	6	1494	C
1	6	1504	G
1	6	1506	G
1	6	1514	U

Continued on next page...

Continued from previous page...

Mol	Chain	Res	Type
1	6	1516	A
1	6	1519	U
1	6	1521	G
1	6	1522	U
1	6	1523	G
1	6	1524	A
1	6	1535	U
1	6	1536	G
1	6	1537	C
1	6	1538	U
1	6	1540	G
1	6	1554	U
1	6	1557	U
1	6	1559	A
1	6	1573	A
1	6	1574	G
1	6	1575	G
1	6	1579	U
1	6	1582	U
1	6	1584	G
1	6	1600	A
1	6	1601	G
1	6	1621	U
1	6	1631	A
1	6	1634	C
1	6	1636	C
1	6	1637	C
1	6	1638	G
1	6	1657	U
1	6	1658	G
1	6	1668	G
1	6	1683	C
1	6	1696	G
1	6	1698	G
1	6	1699	G
1	6	1700	C
1	6	1701	A
1	6	1702	A
1	6	1712	A
1	6	1713	G
1	6	1716	C
1	6	1717	G

Continued on next page...

Continued from previous page...

Mol	Chain	Res	Type
1	6	1731	A
1	6	1736	G
1	6	1742	U
1	6	1760	G
1	6	1762	A
1	6	1766	A
1	6	1767	G
1	6	1769	U
1	6	1780	G
1	6	1782	A
1	6	1789	G
1	6	1792	G
1	6	1793	G
1	6	1794	A
1	6	1795	U
1	6	1796	C
1	6	1799	U
1	6	1800	A
36	5	6	A
36	5	15	C
36	5	16	A
36	5	26	A
36	5	30	G
36	5	40	A
36	5	43	A
36	5	49	A
36	5	57	A
36	5	59	G
36	5	60	A
36	5	65	A
36	5	66	A
36	5	71	A
36	5	73	C
36	5	76	G
36	5	92	G
36	5	96	G
36	5	109	A
36	5	110	G
36	5	111	C
36	5	113	C
36	5	118	U
36	5	121	A

Continued on next page...

Continued from previous page...

Mol	Chain	Res	Type
36	5	122	A
36	5	131	C
36	5	134	U
36	5	135	C
36	5	136	G
36	5	156	G
36	5	157	A
36	5	165	A
36	5	168	U
36	5	170	G
36	5	171	G
36	5	172	G
36	5	173	G
36	5	174	C
36	5	180	C
36	5	182	U
36	5	187	A
36	5	190	U
36	5	191	U
36	5	196	G
36	5	197	G
36	5	200	C
36	5	201	A
36	5	210	U
36	5	213	A
36	5	218	G
36	5	219	A
36	5	220	G
36	5	221	A
36	5	231	G
36	5	235	A
36	5	239	G
36	5	240	U
36	5	241	G
36	5	245	U
36	5	247	C
36	5	248	U
36	5	249	U
36	5	250	U
36	5	252	U
36	5	253	A
36	5	254	A

Continued on next page...

Continued from previous page...

Mol	Chain	Res	Type
36	5	269	G
36	5	270	U
36	5	284	A
36	5	286	U
36	5	295	A
36	5	298	U
36	5	305	U
36	5	311	C
36	5	315	C
36	5	323	A
36	5	326	U
36	5	327	A
36	5	329	U
36	5	334	A
36	5	339	C
36	5	349	A
36	5	350	C
36	5	351	A
36	5	360	G
36	5	376	G
36	5	379	C
36	5	390	G
36	5	395	A
36	5	398	A
36	5	399	A
36	5	401	U
36	5	402	A
36	5	403	C
36	5	404	G
36	5	418	A
36	5	421	G
36	5	422	A
36	5	436	A
36	5	437	G
36	5	439	C
36	5	440	A
36	5	441	U
36	5	442	G
36	5	492	U
36	5	496	C
36	5	521	A
36	5	542	G

Continued on next page...

Continued from previous page...

Mol	Chain	Res	Type
36	5	546	C
36	5	547	G
36	5	548	G
36	5	550	A
36	5	551	A
36	5	554	A
36	5	557	A
36	5	559	A
36	5	578	A
36	5	579	G
36	5	581	U
36	5	592	A
36	5	600	G
36	5	609	G
36	5	611	A
36	5	619	A
36	5	621	A
36	5	636	C
36	5	647	A
36	5	649	A
36	5	651	G
36	5	660	A
36	5	662	U
36	5	677	A
36	5	681	U
36	5	691	A
36	5	692	A
36	5	700	C
36	5	705	A
36	5	712	G
36	5	715	A
36	5	716	A
36	5	725	G
36	5	736	A
36	5	766	U
36	5	767	U
36	5	776	U
36	5	777	U
36	5	781	G
36	5	785	G
36	5	786	A
36	5	806	A

Continued on next page...

Continued from previous page...

Mol	Chain	Res	Type
36	5	811	U
36	5	817	A
36	5	826	G
36	5	830	A
36	5	847	A
36	5	861	C
36	5	874	U
36	5	879	U
36	5	881	C
36	5	890	C
36	5	907	G
36	5	908	G
36	5	914	A
36	5	916	G
36	5	917	A
36	5	921	A
36	5	923	C
36	5	924	G
36	5	925	A
36	5	937	G
36	5	944	C
36	5	959	C
36	5	960	U
36	5	962	A
36	5	963	G
36	5	964	G
36	5	974	G
36	5	979	U
36	5	994	G
36	5	1000	C
36	5	1001	G
36	5	1002	A
36	5	1010	G
36	5	1015	U
36	5	1016	C
36	5	1017	C
36	5	1018	G
36	5	1021	G
36	5	1024	G
36	5	1025	A
36	5	1026	A
36	5	1028	U

Continued on next page...

Continued from previous page...

Mol	Chain	Res	Type
36	5	1029	G
36	5	1035	G
36	5	1047	A
36	5	1049	C
36	5	1063	G
36	5	1064	A
36	5	1065	A
36	5	1072	G
36	5	1081	U
36	5	1082	U
36	5	1085	A
36	5	1087	G
36	5	1093	A
36	5	1095	U
36	5	1097	G
36	5	1098	A
36	5	1103	A
36	5	1104	G
36	5	1117	G
36	5	1131	G
36	5	1143	A
36	5	1144	U
36	5	1152	G
36	5	1153	A
36	5	1159	A
36	5	1160	C
36	5	1169	A
36	5	1175	C
36	5	1177	G
36	5	1178	G
36	5	1179	A
36	5	1180	A
36	5	1181	U
36	5	1191	U
36	5	1196	C
36	5	1201	C
36	5	1202	A
36	5	1206	G
36	5	1209	G
36	5	1222	G
36	5	1223	A
36	5	1235	U

Continued on next page...

Continued from previous page...

Mol	Chain	Res	Type
36	5	1236	G
36	5	1239	C
36	5	1241	U
36	5	1242	G
36	5	1243	G
36	5	1245	A
36	5	1246	G
36	5	1252	A
36	5	1253	U
36	5	1258	U
36	5	1262	G
36	5	1263	A
36	5	1264	G
36	5	1265	U
36	5	1266	G
36	5	1277	C
36	5	1307	G
36	5	1308	A
36	5	1309	U
36	5	1313	G
36	5	1316	C
36	5	1330	A
36	5	1331	U
36	5	1332	A
36	5	1348	U
36	5	1349	G
36	5	1351	U
36	5	1353	U
36	5	1354	G
36	5	1355	A
36	5	1356	U
36	5	1357	G
36	5	1386	A
36	5	1387	G
36	5	1391	C
36	5	1398	U
36	5	1399	A
36	5	1400	G
36	5	1408	G
36	5	1417	G
36	5	1418	A
36	5	1419	A

Continued on next page...

Continued from previous page...

Mol	Chain	Res	Type
36	5	1421	G
36	5	1428	A
36	5	1431	G
36	5	1433	A
36	5	1434	G
36	5	1437	C
36	5	1438	U
36	5	1446	A
36	5	1450	G
36	5	1471	U
36	5	1481	A
36	5	1482	A
36	5	1490	A
36	5	1503	A
36	5	1508	C
36	5	1523	U
36	5	1527	C
36	5	1536	G
36	5	1554	U
36	5	1555	U
36	5	1556	C
36	5	1557	A
36	5	1560	G
36	5	1561	G
36	5	1562	C
36	5	1567	U
36	5	1569	U
36	5	1570	U
36	5	1571	A
36	5	1574	C
36	5	1575	A
36	5	1576	G
36	5	1577	G
36	5	1578	C
36	5	1579	C
36	5	1581	C
36	5	1582	C
36	5	1583	A
36	5	1587	A
36	5	1589	A
36	5	1593	A
36	5	1605	A

Continued on next page...

Continued from previous page...

Mol	Chain	Res	Type
36	5	1620	U
36	5	1621	A
36	5	1629	U
36	5	1632	A
36	5	1639	C
36	5	1643	A
36	5	1644	C
36	5	1645	U
36	5	1657	C
36	5	1677	G
36	5	1683	A
36	5	1687	U
36	5	1694	U
36	5	1702	U
36	5	1714	A
36	5	1716	U
36	5	1717	U
36	5	1724	U
36	5	1725	C
36	5	1730	G
36	5	1750	A
36	5	1751	G
36	5	1760	A
36	5	1762	C
36	5	1764	U
36	5	1765	U
36	5	1766	G
36	5	1769	G
36	5	1770	G
36	5	1775	G
36	5	1780	G
36	5	1797	A
36	5	1812	G
36	5	1814	A
36	5	1815	U
36	5	1816	A
36	5	1817	G
36	5	1818	U
36	5	1821	U
36	5	1829	G
36	5	1839	A
36	5	1841	A

Continued on next page...

Continued from previous page...

Mol	Chain	Res	Type
36	5	1842	A
36	5	1846	C
36	5	1847	A
36	5	1849	C
36	5	1850	A
36	5	1878	G
36	5	1879	A
36	5	1880	U
36	5	1895	A
36	5	1901	A
36	5	1906	G
36	5	1935	G
36	5	2101	C
36	5	2102	U
36	5	2111	G
36	5	2112	U
36	5	2113	A
36	5	2115	G
36	5	2121	G
36	5	2122	G
36	5	2131	A
36	5	2144	A
36	5	2149	A
36	5	2157	G
36	5	2158	A
36	5	2168	A
36	5	2169	G
36	5	2187	G
36	5	2188	A
36	5	2205	U
36	5	2206	G
36	5	2210	G
36	5	2215	A
36	5	2223	A
36	5	2225	U
36	5	2231	C
36	5	2244	A
36	5	2246	G
36	5	2250	G
36	5	2253	G
36	5	2255	A
36	5	2256	A

Continued on next page...

Continued from previous page...

Mol	Chain	Res	Type
36	5	2258	U
36	5	2267	C
36	5	2269	U
36	5	2270	A
36	5	2272	G
36	5	2273	G
36	5	2276	G
36	5	2279	A
36	5	2281	A
36	5	2288	G
36	5	2298	U
36	5	2303	A
36	5	2307	G
36	5	2308	C
36	5	2310	U
36	5	2313	A
36	5	2315	G
36	5	2318	U
36	5	2335	G
36	5	2336	U
36	5	2364	G
36	5	2367	A
36	5	2372	A
36	5	2373	A
36	5	2374	C
36	5	2375	G
36	5	2385	G
36	5	2393	G
36	5	2397	A
36	5	2401	A
36	5	2403	G
36	5	2404	A
36	5	2411	U
36	5	2418	G
36	5	2419	A
36	5	2435	G
36	5	2439	A
36	5	2446	U
36	5	2447	A
36	5	2452	G
36	5	2494	A
36	5	2497	U

Continued on next page...

Continued from previous page...

Mol	Chain	Res	Type
36	5	2501	U
36	5	2502	A
36	5	2503	G
36	5	2504	U
36	5	2505	U
36	5	2514	U
36	5	2515	A
36	5	2518	C
36	5	2523	A
36	5	2529	A
36	5	2533	G
36	5	2536	A
36	5	2537	U
36	5	2538	U
36	5	2539	C
36	5	2540	A
36	5	2543	U
36	5	2549	G
36	5	2552	C
36	5	2555	G
36	5	2560	C
36	5	2564	G
36	5	2565	U
36	5	2567	C
36	5	2568	C
36	5	2569	A
36	5	2570	U
36	5	2571	U
36	5	2572	C
36	5	2573	G
36	5	2574	G
36	5	2584	G
36	5	2585	G
36	5	2589	G
36	5	2593	A
36	5	2606	G
36	5	2607	G
36	5	2614	G
36	5	2617	U
36	5	2626	A
36	5	2637	A
36	5	2652	U

Continued on next page...

Continued from previous page...

Mol	Chain	Res	Type
36	5	2656	A
36	5	2674	A
36	5	2676	A
36	5	2677	G
36	5	2678	A
36	5	2689	A
36	5	2691	A
36	5	2694	A
36	5	2696	A
36	5	2704	A
36	5	2705	A
36	5	2714	G
36	5	2717	U
36	5	2727	A
36	5	2728	G
36	5	2729	U
36	5	2737	C
36	5	2748	A
36	5	2752	U
36	5	2753	G
36	5	2755	C
36	5	2762	A
36	5	2772	C
36	5	2773	C
36	5	2777	G
36	5	2778	G
36	5	2780	A
36	5	2796	G
36	5	2797	C
36	5	2799	A
36	5	2800	G
36	5	2801	A
36	5	2810	C
36	5	2814	G
36	5	2816	G
36	5	2817	A
36	5	2818	U
36	5	2829	U
36	5	2838	A
36	5	2843	U
36	5	2845	A
36	5	2847	A

Continued on next page...

Continued from previous page...

Mol	Chain	Res	Type
36	5	2853	A
36	5	2855	U
36	5	2861	U
36	5	2862	U
36	5	2863	G
36	5	2871	G
36	5	2886	U
36	5	2887	A
36	5	2898	G
36	5	2899	C
36	5	2904	U
36	5	2923	U
36	5	2935	U
36	5	2936	A
36	5	2942	C
36	5	2945	G
36	5	2947	G
36	5	2954	U
36	5	2957	G
36	5	2965	U
36	5	2971	A
36	5	2977	G
36	5	2983	C
36	5	2990	G
36	5	2996	U
36	5	2997	G
36	5	3012	A
36	5	3018	C
36	5	3030	G
36	5	3056	U
36	5	3059	G
36	5	3078	U
36	5	3079	U
36	5	3086	A
36	5	3087	A
36	5	3091	A
36	5	3092	C
36	5	3102	G
36	5	3119	U
36	5	3122	A
36	5	3130	A
36	5	3131	U

Continued on next page...

Continued from previous page...

Mol	Chain	Res	Type
36	5	3142	A
36	5	3143	C
36	5	3150	A
36	5	3152	U
36	5	3153	U
36	5	3155	U
36	5	3156	U
36	5	3157	U
36	5	3158	G
36	5	3164	C
36	5	3165	A
36	5	3168	A
36	5	3171	U
36	5	3172	A
36	5	3173	G
36	5	3174	A
36	5	3176	G
36	5	3177	G
36	5	3179	U
36	5	3180	A
36	5	3181	C
36	5	3187	A
36	5	3195	U
36	5	3196	U
36	5	3197	G
36	5	3207	U
36	5	3217	C
36	5	3218	A
36	5	3219	G
36	5	3224	G
36	5	3229	G
36	5	3234	A
36	5	3238	G
36	5	3239	G
36	5	3243	A
36	5	3244	A
36	5	3245	A
36	5	3246	G
36	5	3247	G
36	5	3258	U
36	5	3259	U
36	5	3275	U

Continued on next page...

Continued from previous page...

Mol	Chain	Res	Type
36	5	3276	G
36	5	3277	U
36	5	3281	U
36	5	3282	U
36	5	3284	G
36	5	3285	C
36	5	3286	G
36	5	3288	G
36	5	3289	G
36	5	3290	G
36	5	3294	A
36	5	3304	U
36	5	3305	A
36	5	3313	U
36	5	3316	A
36	5	3317	U
36	5	3318	G
36	5	3320	A
36	5	3342	A
36	5	3345	G
36	5	3348	G
36	5	3351	U
36	5	3352	U
36	5	3353	G
36	5	3354	U
36	5	3358	U
36	5	3361	G
36	5	3369	G
36	5	3377	G
36	5	3378	C
36	5	3381	U
36	5	3382	U
36	5	3389	U
36	5	3390	G
36	5	3393	U
36	5	3394	U
36	5	3396	U
37	7	7	G
37	7	22	A
37	7	41	G
37	7	47	C
37	7	54	U

Continued on next page...

Continued from previous page...

Mol	Chain	Res	Type
37	7	55	A
37	7	60	G
37	7	65	G
37	7	73	C
37	7	76	A
37	7	99	G
37	7	102	A
37	7	112	G
38	8	34	U
38	8	35	C
38	8	48	A
38	8	53	A
38	8	57	C
38	8	58	G
38	8	59	A
38	8	60	U
38	8	62	C
38	8	63	G
38	8	75	G
38	8	79	A
38	8	80	A
38	8	81	U
38	8	82	U
38	8	83	C
38	8	84	C
38	8	86	U
38	8	87	G
38	8	95	G
38	8	96	A
38	8	97	A
38	8	99	C
38	8	104	A
38	8	106	C
38	8	111	A
38	8	113	U
38	8	125	U
38	8	126	A
38	8	127	U
38	8	129	C
38	8	152	G
38	8	157	U
38	8	158	U

All (177) RNA pucker outliers are listed below:

Mol	Chain	Res	Type
1	2	25	C
1	2	114	C
1	2	130	C
1	2	131	C
1	2	158	U
1	2	218	A
1	2	240	U
1	2	278	U
1	2	280	U
1	2	417	A
1	2	497	G
1	2	499	U
1	2	501	U
1	2	503	G
1	2	512	A
1	2	558	U
1	2	622	A
1	2	685	A
1	2	704	C
1	2	720	G
1	2	721	U
1	2	755	A
1	2	829	A
1	2	1081	A
1	2	1150	G
1	2	1196	A
1	2	1207	C
1	2	1226	A
1	2	1244	A
1	2	1250	U
1	2	1344	A
1	2	1370	U
1	2	1481	C
1	2	1489	U
1	2	1568	C
1	2	1573	A
1	2	1615	C
1	2	1657	U
1	2	1698	G
1	2	1761	U
36	1	65	A
36	1	210	U

Continued on next page...

Continued from previous page...

Mol	Chain	Res	Type
36	1	239	G
36	1	282	G
36	1	547	G
36	1	659	G
36	1	715	A
36	1	763	G
36	1	873	C
36	1	916	G
36	1	981	U
36	1	993	G
36	1	1064	A
36	1	1094	U
36	1	1097	G
36	1	1103	A
36	1	1181	U
36	1	1196	C
36	1	1307	G
36	1	1329	U
36	1	1331	U
36	1	1352	A
36	1	1355	A
36	1	1484	U
36	1	1507	G
36	1	1562	C
36	1	1582	C
36	1	1716	U
36	1	1820	U
36	1	2101	C
36	1	2112	U
36	1	2209	U
36	1	2249	G
36	1	2297	U
36	1	2372	A
36	1	2400	G
36	1	2418	G
36	1	2537	U
36	1	2541	U
36	1	2554	A
36	1	2585	G
36	1	2593	A
36	1	2817	A
36	1	2818	U

Continued on next page...

Continued from previous page...

Mol	Chain	Res	Type
36	1	2971	A
36	1	3078	U
36	1	3121	U
36	1	3228	C
36	1	3269	U
36	1	3350	C
36	1	3351	U
36	1	3353	G
36	1	3377	G
38	4	80	A
38	4	85	G
38	4	125	U
1	6	25	C
1	6	114	C
1	6	158	U
1	6	187	G
1	6	192	U
1	6	217	A
1	6	259	U
1	6	400	A
1	6	417	A
1	6	454	U
1	6	542	A
1	6	555	A
1	6	558	U
1	6	697	C
1	6	717	C
1	6	720	G
1	6	755	A
1	6	828	U
1	6	1058	U
1	6	1097	U
1	6	1244	A
1	6	1255	G
1	6	1344	A
1	6	1481	C
1	6	1491	U
1	6	1535	U
1	6	1573	A
1	6	1600	A
1	6	1620	C
36	5	210	U

Continued on next page...

Continued from previous page...

Mol	Chain	Res	Type
36	5	238	A
36	5	438	A
36	5	594	U
36	5	873	C
36	5	916	G
36	5	978	G
36	5	993	G
36	5	1027	A
36	5	1064	A
36	5	1081	U
36	5	1152	G
36	5	1190	A
36	5	1222	G
36	5	1238	C
36	5	1241	U
36	5	1307	G
36	5	1329	U
36	5	1331	U
36	5	1352	A
36	5	1355	A
36	5	1481	A
36	5	1560	G
36	5	1580	A
36	5	1716	U
36	5	1816	A
36	5	1841	A
36	5	1842	A
36	5	2101	C
36	5	2112	U
36	5	2209	U
36	5	2249	G
36	5	2255	A
36	5	2257	C
36	5	2372	A
36	5	2400	G
36	5	2418	G
36	5	2500	A
36	5	2513	U
36	5	2539	C
36	5	2772	C
36	5	2818	U
36	5	2872	A

Continued on next page...

Continued from previous page...

Mol	Chain	Res	Type
36	5	3078	U
36	5	3121	U
36	5	3195	U
36	5	3207	U
36	5	3218	A
36	5	3275	U
36	5	3289	G
36	5	3317	U
36	5	3357	U

5.4 Non-standard residues in protein, DNA, RNA chains [i](#)

There are no non-standard protein/DNA/RNA residues in this entry.

5.5 Carbohydrates [i](#)

There are no monosaccharides in this entry.

5.6 Ligand geometry [i](#)

Of 33 ligands modelled in this entry, 28 are monoatomic - leaving 5 for Mogul analysis.

In the following table, the Counts columns list the number of bonds (or angles) for which Mogul statistics could be retrieved, the number of bonds (or angles) that are observed in the model and the number of bonds (or angles) that are defined in the Chemical Component Dictionary. The Link column lists molecule types, if any, to which the group is linked. The Z score for a bond length (or angle) is the number of standard deviations the observed value is removed from the expected value. A bond length (or angle) with $|Z| > 2$ is considered an outlier worth inspection. RMSZ is the root-mean-square of all Z scores of the bond lengths (or angles).

Mol	Type	Chain	Res	Link	Bond lengths			Bond angles		
					Counts	RMSZ	# Z > 2	Counts	RMSZ	# Z > 2
88	OHX	1	3406	-	0,6,6	-	-	-		
88	OHX	5	3406	-	0,6,6	-	-	-		
86	SPS	1	3401	-	20,23,23	3.43	10 (50%)	18,30,30	2.96	6 (33%)
88	OHX	1	3405	-	0,6,6	-	-	-		
86	SPS	B	3401	87	20,23,23	3.42	11 (55%)	18,30,30	3.02	7 (38%)

In the following table, the Chirals column lists the number of chiral outliers, the number of chiral centers analysed, the number of these observed in the model and the number defined in the Chemical Component Dictionary. Similar counts are reported in the Torsion and Rings columns.

'-' means no outliers of that kind were identified.

Mol	Type	Chain	Res	Link	Chirals	Torsions	Rings
86	SPS	B	3401	87	-	3/15/18/18	0/1/1/1
86	SPS	1	3401	-	-	3/15/18/18	0/1/1/1

All (21) bond length outliers are listed below:

Mol	Chain	Res	Type	Atoms	Z	Observed(Å)	Ideal(Å)
86	1	3401	SPS	C9-C10	-8.24	1.31	1.48
86	B	3401	SPS	C9-C10	-7.97	1.31	1.48
86	B	3401	SPS	C9-C8	7.78	1.53	1.33
86	1	3401	SPS	C9-C8	7.48	1.52	1.33
86	B	3401	SPS	O13-C13	-5.45	1.19	1.42
86	1	3401	SPS	O13-C13	-5.34	1.19	1.42
86	1	3401	SPS	C10-N11	4.61	1.45	1.34
86	1	3401	SPS	O15-S15	4.19	1.65	1.50
86	B	3401	SPS	C10-N11	4.11	1.44	1.34
86	B	3401	SPS	O15-S15	3.95	1.64	1.50
86	1	3401	SPS	C6-C8	3.26	1.54	1.47
86	B	3401	SPS	O10-C10	-3.02	1.18	1.24
86	B	3401	SPS	C6-C8	2.92	1.53	1.47
86	1	3401	SPS	O10-C10	-2.78	1.19	1.24
86	B	3401	SPS	C3-N4	-2.44	1.33	1.38
86	B	3401	SPS	C3-N2	-2.37	1.33	1.38
86	1	3401	SPS	O1-C1	-2.14	1.19	1.24
86	1	3401	SPS	C3-N4	-2.13	1.33	1.38
86	B	3401	SPS	C6-C1	-2.05	1.38	1.43
86	B	3401	SPS	O1-C1	-2.04	1.19	1.24
86	1	3401	SPS	C3-N2	-2.04	1.34	1.38

All (13) bond angle outliers are listed below:

Mol	Chain	Res	Type	Atoms	Z	Observed(°)	Ideal(°)
86	B	3401	SPS	C3-N2-C1	8.31	122.15	115.14
86	1	3401	SPS	C3-N2-C1	7.60	121.56	115.14
86	1	3401	SPS	C6-C1-N2	-7.07	119.47	124.40
86	B	3401	SPS	C6-C1-N2	-6.31	120.00	124.40
86	B	3401	SPS	C18-S17-C16	3.98	111.12	100.10
86	1	3401	SPS	O13-C13-C12	3.15	120.08	111.95
86	1	3401	SPS	C18-S17-C16	2.86	108.02	100.10
86	B	3401	SPS	O13-C13-C12	2.81	119.20	111.95
86	1	3401	SPS	C7-C5-N4	2.77	120.77	116.49
86	B	3401	SPS	C9-C10-N11	2.76	119.86	114.56

Continued on next page...

Continued from previous page...

Mol	Chain	Res	Type	Atoms	Z	Observed(°)	Ideal(°)
86	B	3401	SPS	C12-N11-C10	-2.63	118.86	122.57
86	1	3401	SPS	O15-S15-C16	2.34	109.25	106.47
86	B	3401	SPS	O10-C10-N11	-2.20	119.45	122.35

There are no chirality outliers.

All (6) torsion outliers are listed below:

Mol	Chain	Res	Type	Atoms
86	B	3401	SPS	N11-C12-C13-O13
86	1	3401	SPS	C14-C12-C13-O13
86	B	3401	SPS	C14-C12-C13-O13
86	1	3401	SPS	N11-C12-C13-O13
86	1	3401	SPS	C5-C6-C8-C9
86	B	3401	SPS	C5-C6-C8-C9

There are no ring outliers.

No monomer is involved in short contacts.

The following is a two-dimensional graphical depiction of Mogul quality analysis of bond lengths, bond angles, torsion angles, and ring geometry for all instances of the Ligand of Interest. In addition, ligands with molecular weight > 250 and outliers as shown on the validation Tables will also be included. For torsion angles, if less than 5% of the Mogul distribution of torsion angles is within 10 degrees of the torsion angle in question, then that torsion angle is considered an outlier. Any bond that is central to one or more torsion angles identified as an outlier by Mogul will be highlighted in the graph. For rings, the root-mean-square deviation (RMSD) between the ring in question and similar rings identified by Mogul is calculated over all ring torsion angles. If the average RMSD is greater than 60 degrees and the minimal RMSD between the ring in question and any Mogul-identified rings is also greater than 60 degrees, then that ring is considered an outlier. The outliers are highlighted in purple. The color gray indicates Mogul did not find sufficient equivalents in the CSD to analyse the geometry.

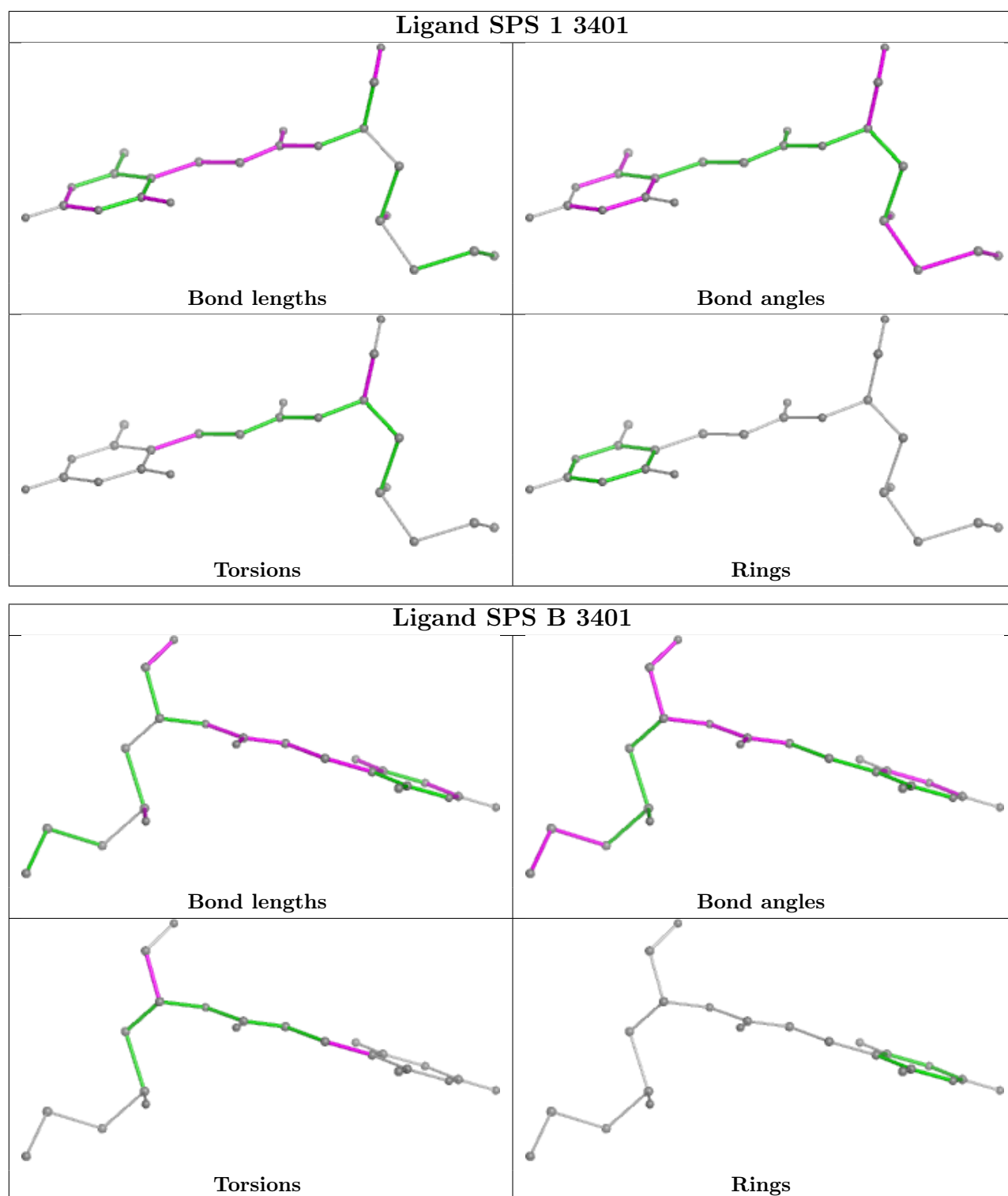

5.7 Other polymers [i](#)

10 such residues are modelled in this entry.

In the following table, the Counts columns list the number of bonds (or angles) for which Mogul statistics could be retrieved, the number of bonds (or angles) that are observed in the model and

the number of bonds (or angles) that are defined in the Chemical Component Dictionary. The Link column lists molecule types, if any, to which the group is linked. The Z score for a bond length (or angle) is the number of standard deviations the observed value is removed from the expected value. A bond length (or angle) with $|Z| > 2$ is considered an outlier worth inspection. RMSZ is the root-mean-square of all Z scores of the bond lengths (or angles).

Mol	Type	Chain	Res	Link	Bond lengths			Bond angles		
					Counts	RMSZ	# Z > 2	Counts	RMSZ	# Z > 2
84	CH	C	75	84,87	16,21,22	0.96	2 (12%)	20,30,33	1.91	2 (10%)
84	CH	B	75	84,87	16,21,22	0.73	0	20,30,33	1.91	2 (10%)
84	8AN	B	76	84,87	19,24,25	1.06	1 (5%)	13,35,38	1.55	3 (23%)
84	CH	C	74	84	16,18,22	0.92	1 (6%)	20,26,33	1.75	2 (10%)
84	8AN	C	76	84,87	19,24,25	1.11	1 (5%)	13,35,38	1.52	2 (15%)
84	CH	B	74	84	16,21,22	1.02	1 (6%)	20,30,33	1.81	2 (10%)

In the following table, the Chirals column lists the number of chiral outliers, the number of chiral centers analysed, the number of these observed in the model and the number defined in the Chemical Component Dictionary. Similar counts are reported in the Torsion and Rings columns. '-' means no outliers of that kind were identified.

Mol	Type	Chain	Res	Link	Chirals	Torsions	Rings
84	CH	C	75	84,87	-	1/5/25/26	0/2/2/2
84	CH	B	75	84,87	-	0/5/25/26	0/2/2/2
84	8AN	B	76	84,87	-	3/3/25/26	0/3/3/3
84	CH	C	74	84	-	2/4/22/26	0/2/2/2
84	8AN	C	76	84,87	-	3/3/25/26	0/3/3/3
84	CH	B	74	84	-	0/5/25/26	0/2/2/2

All (6) bond length outliers are listed below:

Mol	Chain	Res	Type	Atoms	Z	Observed(Å)	Ideal(Å)
84	B	74	CH	C4-N3	-2.99	1.33	1.37
84	C	74	CH	C4-N3	-2.79	1.33	1.37
84	B	76	8AN	C5-C4	2.61	1.47	1.40
84	C	75	CH	C5-C4	2.46	1.43	1.39
84	C	76	8AN	C5-C4	2.34	1.47	1.40
84	C	75	CH	C4-N3	-2.26	1.34	1.37

All (13) bond angle outliers are listed below:

Mol	Chain	Res	Type	Atoms	Z	Observed(°)	Ideal(°)
84	B	74	CH	C5-C4-N3	7.27	122.18	118.04

Continued on next page...

Continued from previous page...

Mol	Chain	Res	Type	Atoms	Z	Observed(°)	Ideal(°)
84	C	75	CH	C5-C4-N3	7.25	122.17	118.04
84	B	75	CH	C5-C4-N3	6.07	121.50	118.04
84	C	74	CH	C5-C4-N3	5.87	121.38	118.04
84	B	75	CH	C5-C4-N4	-5.28	118.74	123.88
84	C	74	CH	C5-C4-N4	-4.50	119.50	123.88
84	C	75	CH	C5-C4-N4	-3.63	120.35	123.88
84	C	76	8AN	C4-C5-N7	-3.26	106.00	109.40
84	B	74	CH	C5-C4-N4	-2.93	121.03	123.88
84	C	76	8AN	N3-C2-N1	-2.80	124.30	128.68
84	B	76	8AN	N3-C2-N1	-2.75	124.39	128.68
84	B	76	8AN	C4-C5-N7	-2.45	106.84	109.40
84	B	76	8AN	C2'-C3'-C4'	2.06	105.55	102.68

There are no chirality outliers.

All (9) torsion outliers are listed below:

Mol	Chain	Res	Type	Atoms
84	C	74	CH	C3'-C4'-C5'-O5'
84	C	74	CH	O4'-C4'-C5'-O5'
84	C	76	8AN	C3'-C4'-C5'-O5'
84	B	76	8AN	C3'-C4'-C5'-O5'
84	C	76	8AN	O4'-C4'-C5'-O5'
84	B	76	8AN	O4'-C4'-C5'-O5'
84	B	76	8AN	C4'-C5'-O5'-P
84	C	76	8AN	C4'-C5'-O5'-P
84	C	75	CH	O4'-C4'-C5'-O5'

There are no ring outliers.

No monomer is involved in short contacts.

5.8 Polymer linkage issues

The following chains have linkage breaks:

Mol	Chain	Number of breaks
1	2	2
80	m2	2
35	sM	1
35	SM	1
12	c0	1
36	5	1

All chain breaks are listed below:

Model	Chain	Residue-1	Atom-1	Residue-2	Atom-2	Distance (Å)
1	sM	139:UNK	C	155:UNK	N	38.68
1	SM	141:ALA	C	151:UNK	N	26.53
1	c0	84:UNK	C	87:UNK	N	8.84
1	2	1716:C	O3'	1717:G	P	5.83
1	5	2437:G	O3'	2438:A	P	4.00
1	m2	23:UNK	C	28:UNK	N	3.70
1	m2	52:UNK	C	54:UNK	N	3.66
1	2	1685:G	O3'	1686:C	P	3.03

6 Fit of model and data i

6.1 Protein, DNA and RNA chains i

In the following table, the column labelled ‘#RSRZ> 2’ contains the number (and percentage) of RSRZ outliers, followed by percent RSRZ outliers for the chain as percentile scores relative to all X-ray entries and entries of similar resolution. The OWAB column contains the minimum, median, 95th percentile and maximum values of the occupancy-weighted average B-factor per residue. The column labelled ‘Q< 0.9’ lists the number of (and percentage) of residues with an average occupancy less than 0.9.

Mol	Chain	Analysed	<RSRZ>	#RSRZ>2	OWAB(Å ²)	Q<0.9
1	2	1781/1800 (98%)	0.48	91 (5%) 28 26	60, 98, 170, 210	0
1	6	1795/1800 (99%)	0.27	58 (3%) 47 46	44, 86, 157, 204	0
2	S0	206/251 (82%)	1.22	50 (24%) 0 0	100, 112, 123, 128	0
2	s0	206/251 (82%)	1.16	50 (24%) 0 0	80, 97, 111, 117	0
3	S1	214/254 (84%)	1.60	76 (35%) 0 0	110, 145, 169, 175	0
3	s1	216/254 (85%)	1.03	44 (20%) 1 1	80, 96, 114, 123	0
4	S2	217/253 (85%)	0.73	30 (13%) 2 2	83, 96, 109, 113	0
4	s2	217/253 (85%)	0.45	9 (4%) 37 35	68, 79, 93, 108	0
5	S3	223/239 (93%)	0.67	25 (11%) 5 5	91, 100, 123, 128	0
5	s3	223/239 (93%)	1.46	72 (32%) 0 0	86, 112, 131, 137	0
6	S4	260/260 (100%)	1.31	66 (25%) 0 0	77, 99, 107, 124	0
6	s4	260/260 (100%)	1.20	60 (23%) 0 1	60, 82, 92, 119	0
7	S5	206/224 (91%)	1.21	39 (18%) 1 1	104, 124, 131, 134	0
7	s5	206/224 (91%)	0.62	21 (10%) 6 6	87, 108, 123, 130	0
8	S6	226/236 (95%)	0.85	41 (18%) 1 1	77, 105, 126, 132	0
8	s6	218/236 (92%)	0.49	21 (9%) 8 8	60, 89, 106, 114	0
9	S7	184/189 (97%)	0.90	30 (16%) 1 2	102, 121, 136, 142	0
9	s7	186/189 (98%)	0.67	23 (12%) 4 3	77, 104, 130, 134	0
10	S8	188/200 (94%)	0.78	20 (10%) 6 6	70, 86, 119, 129	0
10	s8	188/200 (94%)	1.01	28 (14%) 2 2	56, 73, 113, 130	0
11	S9	185/196 (94%)	1.69	71 (38%) 0 0	89, 106, 130, 141	0
11	s9	185/196 (94%)	1.21	43 (23%) 0 1	71, 88, 115, 126	0
12	C0	83/96 (86%)	2.34	52 (62%) 0 0	94, 112, 122, 126	0
12	c0	83/96 (86%)	2.04	40 (48%) 0 0	103, 131, 145, 149	0

Continued on next page...

Continued from previous page...

Mol	Chain	Analysed	<RSRZ>	#RSRZ>2	OWAB(Å ²)	Q<0.9
13	C1	144/155 (92%)	1.04	21 (14%) 2 2	73, 83, 101, 113	0
13	c1	144/155 (92%)	0.84	9 (6%) 20 20	59, 70, 91, 113	0
14	C2	108/142 (76%)	0.53	14 (12%) 3 3	137, 145, 150, 152	0
14	c2	108/142 (76%)	0.82	15 (13%) 2 2	167, 183, 196, 199	0
15	C3	150/150 (100%)	0.59	16 (10%) 6 5	82, 95, 111, 115	0
15	c3	150/150 (100%)	0.14	5 (3%) 46 44	66, 79, 95, 100	0
16	C4	127/136 (93%)	1.42	35 (27%) 0 0	84, 142, 156, 161	0
16	c4	128/136 (94%)	1.53	43 (33%) 0 0	67, 101, 113, 116	0
17	C5	122/141 (86%)	0.94	21 (17%) 1 1	88, 99, 111, 117	0
17	c5	129/141 (91%)	0.67	16 (12%) 4 3	86, 103, 113, 119	0
18	C6	141/142 (99%)	1.70	46 (32%) 0 0	91, 112, 117, 120	0
18	c6	142/142 (100%)	0.81	25 (17%) 1 1	83, 102, 115, 126	0
19	C7	120/136 (88%)	1.44	32 (26%) 0 0	97, 109, 125, 129	0
19	c7	117/136 (86%)	0.37	10 (8%) 10 10	88, 101, 115, 119	0
20	C8	145/145 (100%)	0.95	24 (16%) 1 2	85, 110, 131, 138	0
20	c8	145/145 (100%)	0.81	23 (15%) 1 2	86, 101, 116, 126	0
21	C9	143/143 (100%)	1.40	37 (25%) 0 0	96, 112, 122, 126	0
21	c9	143/143 (100%)	1.63	51 (35%) 0 0	85, 97, 112, 118	0
22	D0	107/120 (89%)	0.98	20 (18%) 1 1	86, 112, 123, 125	0
22	d0	110/120 (91%)	2.37	58 (52%) 0 0	84, 114, 138, 147	0
23	D1	87/87 (100%)	0.91	16 (18%) 1 1	96, 104, 119, 127	0
23	d1	87/87 (100%)	0.70	9 (10%) 6 6	76, 88, 104, 112	0
24	D2	129/129 (100%)	0.64	11 (8%) 10 10	83, 95, 101, 109	0
24	d2	129/129 (100%)	0.47	10 (7%) 13 12	64, 74, 81, 87	0
25	D3	144/144 (100%)	0.81	18 (12%) 3 3	69, 77, 86, 96	0
25	d3	144/144 (100%)	0.60	7 (4%) 29 27	56, 61, 71, 79	0
26	D4	134/134 (100%)	1.30	34 (25%) 0 0	86, 107, 118, 129	0
26	d4	134/134 (100%)	0.36	10 (7%) 14 13	68, 90, 105, 110	0
27	D5	70/107 (65%)	1.51	24 (34%) 0 0	119, 130, 139, 140	0
27	d5	69/107 (64%)	1.51	19 (27%) 0 0	99, 113, 123, 125	0
28	D6	97/97 (100%)	2.00	44 (45%) 0 0	88, 106, 154, 159	0

Continued on next page...

Continued from previous page...

Mol	Chain	Analysed	<RSRZ>	#RSRZ>2	OWAB(Å ²)	Q<0.9
28	d6	97/97 (100%)	1.37	26 (26%) 0 0	70, 87, 116, 123	0
29	D7	81/81 (100%)	1.23	17 (20%) 1 1	98, 110, 135, 141	0
29	d7	81/81 (100%)	0.94	13 (16%) 1 2	80, 93, 121, 128	0
30	D8	63/66 (95%)	1.20	13 (20%) 1 1	111, 127, 139, 143	0
30	d8	63/66 (95%)	1.06	10 (15%) 1 2	104, 116, 127, 129	0
31	D9	53/55 (96%)	1.26	12 (22%) 0 1	84, 91, 107, 112	0
31	d9	53/55 (96%)	2.26	26 (49%) 0 0	82, 92, 128, 139	0
32	E0	60/62 (96%)	1.83	21 (35%) 0 0	78, 107, 129, 134	0
32	e0	62/62 (100%)	0.84	11 (17%) 1 1	63, 88, 109, 122	0
33	E1	71/76 (93%)	0.66	9 (12%) 3 3	107, 133, 145, 148	0
33	e1	76/76 (100%)	1.08	20 (26%) 0 0	112, 158, 170, 175	0
34	SR	318/318 (100%)	1.49	102 (32%) 0 0	109, 120, 132, 146	0
34	sR	318/318 (100%)	1.56	105 (33%) 0 0	110, 126, 140, 150	0
35	SM	121/273 (44%)	0.86	22 (18%) 1 1	59, 94, 111, 116	0
35	sM	63/273 (23%)	1.59	22 (34%) 0 0	55, 105, 111, 112	0
36	1	3149/3396 (92%)	0.19	48 (1%) 73 72	35, 59, 123, 212	0
36	5	3169/3396 (93%)	0.21	48 (1%) 73 72	35, 54, 124, 188	0
37	3	121/121 (100%)	0.00	0 100 100	43, 76, 90, 96	0
37	7	121/121 (100%)	-0.09	0 100 100	39, 59, 70, 75	0
38	4	158/158 (100%)	0.12	2 (1%) 77 77	43, 61, 91, 130	0
38	8	158/158 (100%)	0.11	1 (0%) 89 90	43, 63, 96, 120	0
39	L2	252/253 (99%)	0.36	9 (3%) 42 40	42, 61, 77, 82	0
39	l2	252/253 (99%)	0.41	11 (4%) 34 33	43, 59, 74, 83	0
40	L3	386/386 (100%)	0.45	20 (5%) 27 25	42, 63, 77, 85	0
40	l3	386/386 (100%)	0.33	8 (2%) 63 62	34, 49, 62, 77	0
41	L4	361/361 (100%)	-0.03	0 100 100	40, 54, 70, 71	0
41	l4	361/361 (100%)	0.14	2 (0%) 89 90	40, 57, 73, 88	0
42	L5	296/296 (100%)	1.15	68 (22%) 0 1	58, 81, 97, 111	0
42	l5	294/296 (99%)	0.61	22 (7%) 14 13	49, 60, 84, 93	0
43	L6	156/175 (89%)	0.59	11 (7%) 16 16	49, 57, 72, 79	0
43	l6	157/175 (89%)	0.19	5 (3%) 47 46	49, 57, 75, 85	0

Continued on next page...

Continued from previous page...

Mol	Chain	Analysed	<RSRZ>	#RSRZ>2	OWAB(Å ²)	Q<0.9
44	L7	222/243 (91%)	0.19	3 (1%) 75 75	40, 49, 73, 106	0
44	l7	223/243 (91%)	-0.05	1 (0%) 92 93	39, 49, 80, 107	0
45	L8	233/255 (91%)	0.94	41 (17%) 1 1	67, 81, 104, 112	0
45	l8	231/255 (90%)	1.04	42 (18%) 1 1	73, 84, 106, 114	0
46	L9	191/191 (100%)	0.21	9 (4%) 31 29	60, 70, 82, 93	0
46	l9	191/191 (100%)	0.08	1 (0%) 91 91	44, 55, 71, 81	0
47	M0	211/220 (95%)	1.08	40 (18%) 1 1	45, 63, 92, 106	0
47	m0	213/220 (96%)	0.96	28 (13%) 3 3	40, 55, 80, 90	0
48	M1	169/173 (97%)	1.03	25 (14%) 2 2	68, 84, 94, 98	0
48	m1	169/173 (97%)	0.38	5 (2%) 50 49	52, 67, 77, 82	0
49	M3	193/198 (97%)	0.40	8 (4%) 37 35	39, 64, 92, 113	0
49	m3	194/198 (97%)	0.77	29 (14%) 2 2	41, 69, 100, 111	0
50	M4	136/137 (99%)	-0.04	2 (1%) 73 72	54, 61, 73, 83	0
50	m4	137/137 (100%)	-0.04	1 (0%) 87 88	48, 54, 69, 82	0
51	M5	203/203 (100%)	0.27	3 (1%) 73 72	41, 56, 66, 69	0
51	m5	203/203 (100%)	0.47	10 (4%) 29 27	44, 60, 71, 76	0
52	M6	197/198 (99%)	0.27	4 (2%) 65 64	42, 49, 65, 68	0
52	m6	197/198 (99%)	0.08	2 (1%) 82 82	34, 42, 64, 66	0
53	M7	183/183 (100%)	0.87	23 (12%) 3 3	47, 55, 98, 116	0
53	m7	155/183 (84%)	0.17	0 100 100	39, 46, 59, 77	0
54	M8	185/185 (100%)	0.22	3 (1%) 72 70	43, 55, 69, 88	0
54	m8	185/185 (100%)	0.11	0 100 100	42, 57, 66, 70	0
55	M9	188/188 (100%)	0.55	19 (10%) 7 6	65, 77, 135, 140	0
55	m9	188/188 (100%)	0.49	12 (6%) 19 19	51, 65, 121, 134	0
56	N0	172/172 (100%)	0.18	4 (2%) 60 59	49, 57, 69, 74	0
56	n0	172/172 (100%)	0.02	1 (0%) 89 90	43, 49, 59, 66	0
57	N1	159/159 (100%)	0.44	4 (2%) 57 54	42, 56, 93, 101	0
57	n1	159/159 (100%)	0.57	11 (6%) 16 16	40, 49, 83, 87	0
58	N2	100/120 (83%)	1.06	25 (25%) 0 0	93, 104, 120, 122	0
58	n2	98/120 (81%)	1.04	21 (21%) 0 1	75, 88, 94, 97	0
59	N3	136/136 (100%)	0.67	11 (8%) 12 11	51, 60, 70, 74	0

Continued on next page...

Continued from previous page...

Mol	Chain	Analysed	<RSRZ>	#RSRZ>2	OWAB(Å ²)	Q<0.9
59	n3	136/136 (100%)	0.41	3 (2%) 62 60	36, 45, 55, 58	0
60	N4	98/155 (63%)	1.83	29 (29%) 0 0	62, 72, 134, 147	0
60	n4	135/155 (87%)	0.74	19 (14%) 2 2	46, 91, 115, 116	0
61	N5	121/141 (85%)	0.80	14 (11%) 4 4	58, 69, 84, 95	0
61	n5	120/141 (85%)	0.27	1 (0%) 86 86	56, 68, 85, 93	0
62	N6	126/126 (100%)	0.84	19 (15%) 2 2	50, 62, 74, 79	0
62	n6	126/126 (100%)	0.42	4 (3%) 47 46	51, 64, 77, 83	0
63	N7	135/135 (100%)	1.78	49 (36%) 0 0	82, 94, 103, 109	0
63	n7	135/135 (100%)	1.44	43 (31%) 0 0	76, 91, 102, 105	0
64	N8	148/148 (100%)	0.36	2 (1%) 75 75	35, 56, 74, 82	0
64	n8	148/148 (100%)	0.16	3 (2%) 65 64	34, 59, 74, 77	0
65	N9	58/58 (100%)	0.54	4 (6%) 16 16	38, 61, 95, 106	0
65	n9	58/58 (100%)	0.36	5 (8%) 10 10	38, 58, 78, 85	0
66	O0	97/104 (93%)	0.64	9 (9%) 8 9	81, 89, 101, 102	0
66	o0	100/104 (96%)	0.44	2 (2%) 65 64	75, 82, 102, 108	0
67	O1	109/112 (97%)	0.97	14 (12%) 3 3	61, 72, 91, 103	0
67	o1	109/112 (97%)	0.45	4 (3%) 41 38	47, 58, 81, 90	0
68	O2	127/129 (98%)	0.16	2 (1%) 72 70	36, 49, 62, 68	0
68	o2	127/129 (98%)	0.54	7 (5%) 25 23	35, 52, 63, 71	0
69	O3	106/106 (100%)	0.31	1 (0%) 84 84	42, 47, 71, 78	0
69	o3	106/106 (100%)	0.14	0 100 100	40, 46, 69, 75	0
70	O4	112/120 (93%)	0.60	7 (6%) 20 20	57, 75, 101, 107	0
70	o4	112/120 (93%)	0.66	8 (7%) 16 16	50, 68, 99, 103	0
71	O5	119/119 (100%)	0.32	6 (5%) 28 27	55, 70, 78, 82	0
71	o5	119/119 (100%)	0.59	8 (6%) 17 17	59, 71, 87, 96	0
72	O6	99/99 (100%)	0.63	5 (5%) 28 26	60, 68, 91, 102	0
72	o6	99/99 (100%)	0.39	4 (4%) 38 36	64, 72, 88, 103	0
73	O7	87/87 (100%)	0.13	1 (1%) 80 81	43, 50, 65, 71	0
73	o7	87/87 (100%)	0.21	2 (2%) 60 59	41, 50, 73, 84	0
74	O8	77/77 (100%)	0.86	8 (10%) 6 6	83, 93, 108, 113	0
74	o8	77/77 (100%)	1.51	25 (32%) 0 0	77, 86, 94, 98	0

Continued on next page...

Continued from previous page...

Mol	Chain	Analysed	<RSRZ>	#RSRZ>2	OWAB(Å ²)	Q<0.9
75	O9	50/50 (100%)	0.49	1 (2%) 65 64	52, 57, 59, 60	0
75	o9	50/50 (100%)	0.27	1 (2%) 65 64	50, 55, 63, 63	0
76	Q0	52/52 (100%)	0.86	7 (13%) 3 3	53, 59, 74, 79	0
76	q0	52/52 (100%)	0.37	1 (1%) 66 65	41, 45, 55, 58	0
77	Q1	25/25 (100%)	1.26	6 (24%) 0 0	62, 66, 73, 74	0
77	q1	25/25 (100%)	0.99	2 (8%) 12 11	50, 56, 58, 58	0
78	Q2	105/105 (100%)	0.12	2 (1%) 66 65	41, 56, 76, 91	0
78	q2	105/105 (100%)	0.26	1 (0%) 82 82	44, 56, 70, 93	0
79	Q3	91/91 (100%)	0.21	2 (2%) 62 60	54, 65, 80, 85	0
79	q3	91/91 (100%)	0.38	3 (3%) 46 44	46, 59, 72, 84	0
80	m2	0/165	-	-	-	-
81	p0	120/311 (38%)	1.27	32 (26%) 0 0	101, 124, 144, 152	0
82	p1	0/47	-	-	-	-
82	p2	0/47	-	-	-	-
83	f	148/157 (94%)	2.86	92 (62%) 0 0	55, 96, 150, 153	75 (50%)
All	All	33080/35493 (93%)	0.60	3313 (10%) 7 7	34, 74, 132, 212	75 (0%)

All (3313) RSRZ outliers are listed below:

Mol	Chain	Res	Type	RSRZ
60	N4	75	THR	13.9
1	2	1699	G	13.8
53	M7	161	ALA	12.0
1	2	1696	G	12.0
1	2	1697	G	11.7
60	N4	86	SER	11.4
53	M7	160	ALA	11.3
60	N4	88	ASP	11.0
1	2	1709	C	10.9
32	E0	61	SER	10.8
71	o5	120	ALA	10.8
36	1	1570	U	10.4
1	2	1698	G	10.4
12	c0	23	ALA	10.2
34	sR	213	SER	9.8
60	N4	89	LEU	9.7
1	2	1708	U	9.6
36	5	2443	A	9.6

Continued on next page...

Continued from previous page...

Mol	Chain	Res	Type	RSRZ
36	5	2442	G	9.5
33	e1	77	GLY	9.5
7	S5	152	GLY	9.4
53	M7	184	ALA	9.3
1	2	1694	A	9.2
16	C4	75	GLY	9.2
32	e0	63	GLN	9.0
13	c1	3	THR	9.0
83	f	120	LEU	9.0
34	SR	32	LEU	8.9
7	S5	36	ALA	8.6
13	c1	4	GLU	8.6
18	C6	20	ALA	8.4
53	M7	162	GLU	8.3
1	2	1702	A	8.2
34	SR	25	THR	8.2
31	d9	29	GLY	8.2
1	6	662	U	8.2
36	1	1568	U	8.1
34	sR	314	GLN	7.9
18	C6	21	HIS	7.9
60	N4	83	THR	7.9
7	S5	153	GLY	7.8
83	f	134	LEU	7.7
34	SR	44	SER	7.7
3	s1	89	ASP	7.7
1	2	1695	G	7.6
21	c9	55	TYR	7.6
60	N4	87	LEU	7.5
60	N4	85	ALA	7.4
13	c1	2	SER	7.3
27	d5	50	ILE	7.3
3	S1	20	VAL	7.2
12	c0	22	VAL	7.2
22	d0	67	THR	7.2
28	D6	20	PRO	7.1
34	SR	262	VAL	7.1
1	6	678	A	7.1
28	d6	63	ALA	7.1
36	5	2494	A	6.9
22	d0	14	GLN	6.9
34	sR	24	ALA	6.9

Continued on next page...

Continued from previous page...

Mol	Chain	Res	Type	RSRZ
21	c9	18	TYR	6.8
1	6	659	C	6.8
42	L5	6	ASP	6.8
7	S5	71	ALA	6.8
1	2	1700	C	6.8
6	S4	54	TYR	6.7
12	c0	65	TYR	6.7
19	C7	99	VAL	6.7
22	D0	120	SER	6.7
17	c5	134	THR	6.6
83	f	31	PHE	6.6
11	S9	87	SER	6.6
60	N4	97	LYS	6.6
83	f	121	GLY	6.6
60	N4	81	PRO	6.5
28	D6	76	SER	6.5
22	d0	98	GLN	6.5
22	d0	18	GLN	6.4
34	SR	131	ILE	6.4
22	d0	100	VAL	6.3
7	s5	152	GLY	6.3
35	sM	85	SER	6.3
32	E0	47	VAL	6.3
32	E0	60	PRO	6.3
29	d7	59	CYS	6.2
60	N4	76	VAL	6.2
45	l8	192	GLN	6.2
22	d0	101	LYS	6.2
34	sR	303	ALA	6.2
1	2	913	G	6.2
83	f	71	GLU	6.2
7	S5	151	GLY	6.2
36	5	2444	C	6.2
29	D7	38	PRO	6.2
60	N4	72	SER	6.2
1	2	1701	A	6.1
7	S5	37	GLN	6.1
83	f	86	LYS	6.1
36	5	2496	C	6.1
83	f	38	PRO	6.1
36	5	2495	C	6.1
83	f	30	GLY	6.1

Continued on next page...

Continued from previous page...

Mol	Chain	Res	Type	RSRZ
60	N4	74	LYS	6.1
29	d7	58	SER	6.0
6	S4	111	VAL	6.0
1	6	663	U	6.0
36	1	1569	U	6.0
13	C1	2	SER	6.0
22	d0	95	ALA	6.0
3	s1	54	LEU	6.0
1	2	506	A	6.0
17	C5	50	THR	6.0
34	sR	302	PHE	6.0
4	S2	62	PRO	6.0
6	S4	77	ARG	6.0
83	f	83	PRO	5.9
36	5	2441	A	5.9
18	C6	8	GLN	5.9
83	f	22	GLN	5.9
45	l8	120	LYS	5.9
39	L2	253	GLN	5.9
1	2	1703	C	5.9
60	N4	82	ILE	5.9
6	S4	66	MET	5.9
16	C4	15	GLY	5.9
22	d0	93	LEU	5.9
16	c4	55	SER	5.8
35	sM	40	PRO	5.8
6	S4	71	LYS	5.8
83	f	64	ILE	5.8
3	S1	94	LYS	5.8
32	E0	46	ASN	5.8
22	d0	64	LYS	5.8
48	M1	127	PHE	5.8
12	c0	25	LYS	5.8
12	c0	20	VAL	5.8
63	n7	2	ALA	5.8
81	p0	69	ASP	5.8
16	C4	16	VAL	5.8
42	L5	51	LEU	5.8
83	f	157	ASP	5.7
31	d9	30	LEU	5.7
6	s4	15	PRO	5.7
23	d1	87	ARG	5.7

Continued on next page...

Continued from previous page...

Mol	Chain	Res	Type	RSRZ
4	s2	105	GLY	5.7
83	f	135	MET	5.7
1	2	1705	C	5.6
34	sR	214	ALA	5.6
1	2	1707	A	5.6
1	6	1491	U	5.6
83	f	149	SER	5.6
19	C7	121	VAL	5.6
1	2	1706	C	5.6
29	D7	37	CYS	5.6
19	C7	62	GLN	5.5
81	p0	88	PHE	5.5
83	f	90	TYR	5.5
5	s3	37	VAL	5.5
5	s3	69	LEU	5.5
36	1	1567	U	5.5
16	C4	74	VAL	5.5
16	c4	28	VAL	5.5
34	sR	158	PRO	5.5
36	5	2447	A	5.5
11	s9	148	VAL	5.5
8	S6	175	ILE	5.5
45	L8	116	VAL	5.5
81	p0	68	SER	5.5
6	S4	65	LEU	5.5
33	e1	112	GLY	5.4
22	d0	19	ILE	5.4
1	6	493	U	5.4
6	s4	261	LEU	5.4
11	S9	128	LEU	5.4
9	s7	43	PHE	5.4
2	S0	26	ALA	5.4
34	sR	170	ILE	5.4
19	C7	2	GLY	5.3
11	S9	85	VAL	5.3
36	5	2451	G	5.3
53	M7	168	LEU	5.3
12	c0	57	THR	5.3
1	2	1690	G	5.3
8	S6	149	LYS	5.3
3	S1	217	LEU	5.3
2	S0	98	ILE	5.3

Continued on next page...

Continued from previous page...

Mol	Chain	Res	Type	RSRZ
20	C8	2	SER	5.3
3	S1	50	LYS	5.3
18	C6	143	ARG	5.3
9	s7	70	PHE	5.3
6	s4	131	LEU	5.3
7	S5	96	SER	5.3
28	D6	49	ALA	5.3
3	S1	140	ILE	5.3
1	2	1693	A	5.3
83	f	87	ARG	5.3
22	D0	121	ASN	5.3
2	s0	20	ALA	5.3
1	6	658	C	5.2
7	s5	150	GLY	5.2
60	n4	69	LYS	5.2
12	c0	67	THR	5.2
44	L7	28	ALA	5.2
35	SM	86	ASN	5.2
63	N7	26	VAL	5.2
56	N0	1	MET	5.2
18	C6	22	VAL	5.2
31	d9	20	GLN	5.2
28	D6	31	PRO	5.2
34	SR	33	LEU	5.2
34	sR	244	ALA	5.2
83	f	136	VAL	5.2
83	f	18	THR	5.2
83	f	142	MET	5.2
10	S8	168	CYS	5.2
45	l8	109	LEU	5.2
6	S4	102	VAL	5.2
8	S6	77	LEU	5.2
7	S5	70	VAL	5.2
27	d5	89	ILE	5.1
1	6	495	C	5.1
34	sR	202	LEU	5.1
1	2	1711	C	5.1
14	c2	65	SER	5.1
11	S9	86	LEU	5.1
35	sM	39	PRO	5.1
5	s3	175	VAL	5.1
83	f	81	GLU	5.1

Continued on next page...

Continued from previous page...

Mol	Chain	Res	Type	RSRZ
10	s8	176	SER	5.1
13	c1	5	LEU	5.1
29	d7	46	VAL	5.1
4	S2	63	VAL	5.1
30	D8	67	ARG	5.1
83	f	41	ILE	5.0
1	2	1692	G	5.0
81	p0	20	GLU	5.0
20	C8	146	ALA	5.0
83	f	36	SER	5.0
34	sR	72	THR	5.0
27	d5	51	LEU	5.0
34	sR	252	LEU	5.0
3	S1	55	LYS	5.0
12	C0	22	VAL	5.0
36	5	2452	G	5.0
2	S0	100	GLY	5.0
12	c0	68	LEU	5.0
35	SM	89	ARG	5.0
45	l8	121	SER	5.0
8	S6	73	ILE	5.0
22	D0	82	TYR	5.0
36	5	2440	G	5.0
83	f	23	CYS	5.0
4	S2	232	GLU	5.0
22	d0	97	VAL	5.0
6	S4	261	LEU	5.0
20	C8	15	LEU	5.0
22	d0	96	PRO	5.0
10	s8	200	LYS	5.0
18	C6	15	SER	5.0
6	S4	69	HIS	5.0
23	D1	56	SER	4.9
36	5	1569	U	4.9
32	E0	56	MET	4.9
22	d0	54	GLY	4.9
34	SR	61	PHE	4.9
83	f	42	VAL	4.9
2	s0	98	ILE	4.9
9	s7	69	GLY	4.9
5	s3	6	SER	4.9
34	sR	166	SER	4.9

Continued on next page...

Continued from previous page...

Mol	Chain	Res	Type	RSRZ
27	d5	42	LEU	4.9
42	L5	3	PHE	4.9
12	C0	24	LYS	4.9
10	s8	143	TRP	4.9
60	n4	67	VAL	4.9
83	f	153	ALA	4.9
1	2	1710	U	4.9
63	N7	2	ALA	4.9
18	C6	68	ARG	4.9
21	c9	28	LEU	4.9
42	L5	146	LEU	4.9
49	m3	131	LYS	4.9
74	O8	43	PHE	4.9
2	s0	170	ILE	4.9
8	S6	75	LEU	4.9
34	sR	313	TRP	4.9
11	S9	96	VAL	4.8
83	f	72	ASP	4.8
2	s0	46	HIS	4.8
11	S9	186	GLU	4.8
31	d9	27	HIS	4.8
11	S9	2	PRO	4.8
31	D9	4	GLU	4.8
3	S1	86	LEU	4.8
35	SM	85	SER	4.8
34	sR	212	ALA	4.8
1	2	277	U	4.8
6	S4	101	LEU	4.8
12	C0	64	TYR	4.8
34	sR	157	VAL	4.8
3	S1	220	GLN	4.8
22	d0	121	ASN	4.8
33	e1	79	LYS	4.8
45	L8	202	GLU	4.8
30	d8	9	LEU	4.8
81	p0	70	LEU	4.8
3	S1	233	GLY	4.8
17	C5	28	MET	4.8
21	c9	118	PRO	4.8
36	5	1567	U	4.8
22	d0	102	ARG	4.7
6	S4	47	PHE	4.7

Continued on next page...

Continued from previous page...

Mol	Chain	Res	Type	RSRZ
58	n2	14	THR	4.7
10	s8	177	GLY	4.7
28	d6	69	ASN	4.7
45	L8	93	LEU	4.7
71	o5	119	LYS	4.7
53	M7	183	ALA	4.7
21	c9	25	GLN	4.7
26	D4	26	ASP	4.7
17	c5	135	THR	4.7
30	d8	44	VAL	4.7
34	sR	301	LEU	4.7
34	SR	253	ALA	4.7
23	D1	55	LEU	4.7
26	D4	18	LEU	4.7
6	s4	14	ALA	4.7
8	S6	148	SER	4.7
34	SR	115	ILE	4.7
34	SR	79	TYR	4.7
14	c2	123	VAL	4.7
83	f	85	VAL	4.7
16	c4	105	LEU	4.7
45	l8	111	LYS	4.7
5	s3	38	GLU	4.7
5	s3	184	ILE	4.6
28	d6	44	ILE	4.6
29	D7	48	SER	4.6
47	m0	173	PHE	4.6
83	f	32	VAL	4.6
16	C4	34	SER	4.6
7	S5	154	ALA	4.6
74	o8	2	ALA	4.6
83	f	105	MET	4.6
34	SR	55	GLY	4.6
2	S0	97	PRO	4.6
34	sR	26	SER	4.6
11	S9	156	ILE	4.6
28	D6	9	GLY	4.6
49	m3	130	GLY	4.6
10	S8	152	ILE	4.6
45	L8	26	LEU	4.6
22	d0	78	THR	4.6
34	sR	11	GLY	4.6

Continued on next page...

Continued from previous page...

Mol	Chain	Res	Type	RSRZ
5	s3	11	LEU	4.6
3	S1	138	PHE	4.6
1	2	715	U	4.6
5	s3	43	PRO	4.6
22	D0	86	ILE	4.6
16	C4	29	HIS	4.6
3	S1	92	GLN	4.5
49	m3	133	PRO	4.5
42	L5	148	ILE	4.5
6	s4	183	VAL	4.5
81	p0	19	LEU	4.5
83	f	65	PHE	4.5
12	c0	64	TYR	4.5
2	S0	18	LEU	4.5
28	D6	17	HIS	4.5
63	N7	124	ALA	4.5
1	2	820	U	4.5
3	S1	151	LYS	4.5
22	d0	27	THR	4.5
63	n7	118	PHE	4.5
21	C9	28	LEU	4.5
28	D6	21	VAL	4.5
60	N4	70	LYS	4.5
18	c6	44	LEU	4.5
26	D4	25	VAL	4.5
34	sR	210	LEU	4.5
1	2	709	C	4.5
12	C0	6	GLU	4.5
2	S0	201	LEU	4.5
5	s3	42	THR	4.5
71	o5	118	ILE	4.5
21	C9	108	LEU	4.5
43	L6	131	LYS	4.4
23	D1	53	TYR	4.4
5	s3	113	LEU	4.4
8	S6	78	THR	4.4
83	f	43	ASP	4.4
81	p0	86	PHE	4.4
63	n7	75	VAL	4.4
9	S7	150	GLN	4.4
36	1	1566	A	4.4
45	L8	94	PHE	4.4

Continued on next page...

Continued from previous page...

Mol	Chain	Res	Type	RSRZ
47	m0	195	ALA	4.4
2	s0	22	THR	4.4
10	s8	67	TRP	4.4
60	N4	90	ILE	4.4
34	sR	13	LEU	4.4
36	1	1573	G	4.4
47	M0	33	ILE	4.4
3	S1	110	LEU	4.4
10	s8	69	SER	4.4
22	d0	28	SER	4.4
83	f	115	ALA	4.4
53	M7	176	ILE	4.4
36	1	1565	G	4.4
36	5	2446	U	4.4
63	N7	46	ILE	4.4
5	S3	21	LEU	4.4
83	f	147	ALA	4.4
8	S6	74	LYS	4.4
60	N4	96	LEU	4.3
11	S9	106	GLU	4.3
36	5	2539	C	4.3
18	C6	7	VAL	4.3
83	f	70	LEU	4.3
9	s7	54	GLY	4.3
16	C4	115	ILE	4.3
4	s2	88	LYS	4.3
5	s3	134	CYS	4.3
14	c2	128	ALA	4.3
83	f	39	CYS	4.3
7	s5	37	GLN	4.3
63	n7	68	ILE	4.3
31	d9	14	TYR	4.3
5	s3	8	LYS	4.3
31	d9	16	LYS	4.3
34	SR	278	PHE	4.3
53	M7	167	ARG	4.3
11	s9	156	ILE	4.3
45	l8	203	VAL	4.3
76	Q0	77	ILE	4.3
78	Q2	36	PHE	4.3
4	S2	145	GLY	4.3
7	S5	41	LYS	4.3

Continued on next page...

Continued from previous page...

Mol	Chain	Res	Type	RSRZ
30	D8	16	LEU	4.3
63	N7	91	ALA	4.3
81	p0	81	LYS	4.3
22	d0	20	ILE	4.3
29	D7	43	ILE	4.3
1	2	1794	A	4.3
1	2	134	U	4.3
6	S4	78	THR	4.3
1	2	1691	A	4.3
19	C7	123	ASN	4.3
1	2	276	C	4.3
12	c0	26	ASP	4.3
28	D6	69	ASN	4.3
83	f	156	THR	4.3
3	S1	28	GLU	4.3
12	C0	66	TYR	4.3
6	S4	52	LEU	4.3
18	C6	57	LEU	4.3
35	SM	87	THR	4.2
8	s6	215	ARG	4.2
36	5	2445	A	4.2
63	N7	113	VAL	4.2
5	s3	98	ALA	4.2
83	f	11	ALA	4.2
31	d9	40	ARG	4.2
32	E0	45	VAL	4.2
22	d0	87	HIS	4.2
36	5	1350	A	4.2
48	M1	96	PHE	4.2
61	N5	107	VAL	4.2
63	n7	96	VAL	4.2
63	N7	99	GLU	4.2
21	c9	22	LEU	4.2
40	l3	387	LEU	4.2
36	5	2493	U	4.2
60	N4	98	PRO	4.2
3	s1	51	SER	4.2
76	Q0	128	LYS	4.2
31	d9	36	LEU	4.2
34	SR	78	ALA	4.2
74	O8	6	THR	4.2
59	N3	2	SER	4.2

Continued on next page...

Continued from previous page...

Mol	Chain	Res	Type	RSRZ
83	f	138	ILE	4.2
45	l8	200	LEU	4.2
67	O1	71	LEU	4.2
16	C4	18	ARG	4.2
63	N7	65	ARG	4.2
2	S0	198	MET	4.2
33	e1	88	PRO	4.2
36	5	1352	A	4.2
11	S9	148	VAL	4.2
36	5	2498	U	4.2
39	l2	164	GLY	4.2
63	N7	92	PHE	4.2
34	SR	198	ASN	4.2
34	SR	45	TRP	4.2
12	C0	5	LYS	4.2
34	SR	46	LYS	4.2
42	L5	101	THR	4.2
12	C0	16	PHE	4.2
28	D6	18	VAL	4.2
11	S9	99	LEU	4.2
18	C6	92	TYR	4.2
34	SR	94	VAL	4.2
34	sR	272	ASP	4.1
3	S1	47	LEU	4.1
6	S4	63	ALA	4.1
6	S4	67	GLN	4.1
9	S7	108	GLN	4.1
42	L5	92	LEU	4.1
2	s0	165	ARG	4.1
1	6	718	U	4.1
33	E1	91	ILE	4.1
63	n7	92	PHE	4.1
4	S2	45	VAL	4.1
43	L6	130	ILE	4.1
31	d9	52	PHE	4.1
44	L7	25	GLN	4.1
32	E0	48	THR	4.1
45	l8	94	PHE	4.1
63	N7	120	GLU	4.1
36	5	1568	U	4.1
3	S1	114	VAL	4.1
12	c0	62	GLN	4.1

Continued on next page...

Continued from previous page...

Mol	Chain	Res	Type	RSRZ
21	C9	6	VAL	4.1
21	c9	122	ARG	4.1
3	S1	89	ASP	4.1
6	S4	79	ASP	4.1
35	sM	46	LYS	4.1
6	S4	49	ARG	4.1
49	m3	95	ILE	4.1
83	f	28	LYS	4.1
26	D4	16	PRO	4.1
63	N7	7	ALA	4.1
79	q3	2	ALA	4.1
63	N7	5	LEU	4.1
3	S1	52	THR	4.1
48	M1	104	PHE	4.1
83	f	46	THR	4.1
83	f	45	SER	4.1
5	S3	186	VAL	4.1
21	c9	37	VAL	4.1
55	m9	184	LEU	4.1
13	C1	4	GLU	4.0
71	O5	120	ALA	4.0
27	D5	89	ILE	4.0
52	m6	182	ASN	4.0
58	N2	89	LEU	4.0
36	5	1016	C	4.0
8	S6	186	ARG	4.0
27	D5	58	ARG	4.0
7	S5	150	GLY	4.0
50	M4	138	ALA	4.0
63	N7	132	SER	4.0
9	S7	98	ILE	4.0
29	d7	24	LEU	4.0
10	s8	179	CYS	4.0
16	c4	27	PHE	4.0
1	2	910	C	4.0
1	2	914	G	4.0
3	s1	84	ILE	4.0
12	C0	62	GLN	4.0
83	f	16	SER	4.0
20	C8	145	ARG	4.0
11	S9	144	PRO	4.0
14	C2	32	LEU	4.0

Continued on next page...

Continued from previous page...

Mol	Chain	Res	Type	RSRZ
20	C8	22	VAL	4.0
45	l8	104	GLU	4.0
14	c2	103	LEU	4.0
11	s9	111	THR	4.0
42	L5	95	TRP	4.0
5	s3	9	ARG	4.0
32	E0	32	GLY	4.0
35	SM	84	LYS	4.0
2	s0	48	ILE	4.0
45	l8	142	LEU	4.0
11	S9	138	LYS	4.0
18	C6	114	ARG	4.0
3	S1	139	ALA	4.0
6	S4	44	LEU	4.0
74	o8	34	ALA	4.0
6	S4	26	CYS	4.0
5	s3	79	TYR	4.0
55	M9	51	VAL	4.0
3	s1	217	LEU	4.0
5	S3	24	PHE	4.0
42	L5	60	ILE	4.0
11	S9	29	LYS	4.0
63	n7	49	TYR	4.0
74	o8	33	LYS	4.0
83	f	119	GLU	4.0
19	C7	65	PRO	4.0
3	S1	101	HIS	4.0
3	S1	141	ALA	4.0
18	c6	141	SER	4.0
21	c9	111	ILE	4.0
25	D3	48	HIS	4.0
45	L8	131	ALA	4.0
18	c6	142	TYR	4.0
20	c8	22	VAL	4.0
81	p0	192	ASP	4.0
74	o8	54	LEU	3.9
83	f	73	LEU	3.9
5	s3	65	ARG	3.9
1	6	1694	A	3.9
11	S9	141	VAL	3.9
5	s3	86	LEU	3.9
16	c4	53	ASP	3.9

Continued on next page...

Continued from previous page...

Mol	Chain	Res	Type	RSRZ
8	S6	199	GLN	3.9
1	6	664	U	3.9
36	5	1566	A	3.9
36	5	2540	A	3.9
3	S1	100	PHE	3.9
3	S1	103	MET	3.9
11	S9	135	ALA	3.9
21	c9	21	PHE	3.9
35	sM	38	PRO	3.9
16	C4	119	THR	3.9
33	E1	82	LYS	3.9
34	SR	72	THR	3.9
9	S7	115	SER	3.9
18	C6	79	TYR	3.9
26	D4	35	VAL	3.9
31	d9	28	THR	3.9
40	L3	337	THR	3.9
2	S0	99	ALA	3.9
2	S0	158	VAL	3.9
11	S9	28	LEU	3.9
16	C4	97	GLY	3.9
26	D4	7	ILE	3.9
9	s7	41	LEU	3.9
2	s0	162	CYS	3.9
19	C7	71	PHE	3.9
17	c5	85	ILE	3.9
22	d0	103	ILE	3.9
34	SR	263	PHE	3.9
39	l2	253	GLN	3.9
53	M7	182	ILE	3.9
13	C1	145	ALA	3.9
21	c9	4	VAL	3.9
83	f	84	VAL	3.9
11	S9	180	LYS	3.9
6	S4	45	ILE	3.9
32	E0	25	GLU	3.9
3	s1	47	LEU	3.9
11	S9	97	LEU	3.9
83	f	20	PRO	3.9
55	M9	178	ALA	3.9
22	D0	54	GLY	3.9
83	f	19	TYR	3.9

Continued on next page...

Continued from previous page...

Mol	Chain	Res	Type	RSRZ
28	D6	2	PRO	3.9
36	1	1571	A	3.9
36	1	2502	A	3.9
60	n4	134	GLN	3.9
29	D7	41	LEU	3.8
34	SR	284	ALA	3.9
42	L5	144	VAL	3.8
6	s4	162	ILE	3.8
28	D6	80	HIS	3.8
52	M6	184	THR	3.8
7	S5	149	VAL	3.8
21	C9	27	LYS	3.8
53	M7	181	ARG	3.8
1	6	1199	G	3.8
8	s6	201	GLN	3.8
3	S1	91	VAL	3.8
7	S5	155	ALA	3.8
34	SR	214	ALA	3.8
40	L3	217	ALA	3.8
28	D6	8	ASN	3.8
32	E0	44	PHE	3.8
35	sM	33	LYS	3.8
15	C3	15	ALA	3.8
83	f	35	LYS	3.8
36	1	1349	G	3.8
26	D4	31	ASN	3.8
13	C1	3	THR	3.8
16	C4	46	MET	3.8
20	c8	18	LEU	3.8
1	2	1059	U	3.8
45	L8	126	SER	3.8
83	f	97	ASP	3.8
27	D5	88	ILE	3.8
30	D8	66	LEU	3.8
47	M0	87	LEU	3.8
16	c4	42	VAL	3.8
3	S1	142	PHE	3.8
6	S4	55	ALA	3.8
22	d0	107	THR	3.8
26	D4	72	PHE	3.8
45	l8	110	THR	3.8
65	N9	55	ALA	3.8

Continued on next page...

Continued from previous page...

Mol	Chain	Res	Type	RSRZ
35	sM	28	SER	3.8
2	S0	122	ILE	3.8
63	N7	42	LEU	3.8
5	s3	85	VAL	3.8
28	D6	89	ARG	3.8
34	SR	313	TRP	3.8
60	n4	68	ALA	3.8
28	D6	67	THR	3.8
40	L3	164	THR	3.8
5	s3	75	LYS	3.8
11	S9	115	LYS	3.8
18	C6	65	ILE	3.8
21	C9	95	ASP	3.8
28	d6	64	LEU	3.8
1	6	1700	C	3.8
3	s1	30	PHE	3.8
34	sR	253	ALA	3.8
71	O5	20	GLN	3.8
27	d5	102	THR	3.8
70	O4	73	SER	3.8
36	1	1572	U	3.8
34	sR	229	LYS	3.8
34	sR	315	VAL	3.8
34	sR	55	GLY	3.7
12	C0	13	GLN	3.7
7	S5	222	LYS	3.7
42	L5	89	THR	3.7
45	L8	91	PHE	3.7
63	n7	130	PHE	3.7
12	C0	76	LEU	3.7
66	O0	62	LEU	3.7
47	M0	148	VAL	3.7
6	S4	80	THR	3.7
5	s3	179	GLN	3.7
34	sR	211	ILE	3.7
45	L8	130	TYR	3.7
58	n2	13	LYS	3.7
83	f	139	ILE	3.7
6	S4	25	GLY	3.7
21	c9	93	HIS	3.7
60	n4	132	GLY	3.7
7	s5	159	ALA	3.7

Continued on next page...

Continued from previous page...

Mol	Chain	Res	Type	RSRZ
26	D4	69	SER	3.7
6	S4	64	ILE	3.7
18	C6	36	ILE	3.7
49	m3	54	LEU	3.7
6	s4	139	VAL	3.7
48	M1	148	VAL	3.7
83	f	57	VAL	3.7
3	S1	95	ASN	3.7
22	d0	13	GLU	3.7
5	s3	151	LYS	3.7
74	o8	53	THR	3.7
7	s5	158	GLN	3.7
12	c0	66	TYR	3.7
70	o4	38	LEU	3.7
53	M7	157	VAL	3.7
83	f	63	ASP	3.7
36	1	1252	A	3.7
1	2	719	U	3.7
45	L8	191	ASN	3.7
33	E1	87	THR	3.7
5	s3	138	VAL	3.7
7	S5	69	PHE	3.7
18	C6	9	THR	3.7
19	c7	25	THR	3.7
7	s5	151	GLY	3.7
22	D0	71	PRO	3.7
34	SR	92	TRP	3.7
34	SR	121	MET	3.7
83	f	44	MET	3.7
5	s3	182	LEU	3.7
11	S9	167	ALA	3.7
15	C3	57	ALA	3.7
31	D9	5	ASN	3.7
11	s9	112	GLN	3.7
18	c6	90	VAL	3.7
83	f	33	VAL	3.7
43	l6	129	GLU	3.7
2	S0	17	LEU	3.7
5	s3	114	ALA	3.7
67	O1	14	ILE	3.7
26	D4	70	VAL	3.7
58	n2	17	VAL	3.7

Continued on next page...

Continued from previous page...

Mol	Chain	Res	Type	RSRZ
6	S4	180	LEU	3.7
18	c6	52	LEU	3.7
34	SR	7	LEU	3.7
10	s8	60	ILE	3.7
22	d0	22	ILE	3.7
22	d0	99	ILE	3.7
8	S6	67	VAL	3.7
48	M1	167	TYR	3.7
2	s0	101	ARG	3.7
6	s4	132	GLY	3.7
3	S1	98	THR	3.7
32	E0	30	PRO	3.7
26	D4	57	VAL	3.7
45	L8	197	VAL	3.7
34	sR	81	LEU	3.6
26	D4	82	ALA	3.6
83	f	141	ALA	3.6
10	s8	103	GLN	3.6
42	L5	151	GLN	3.6
11	s9	91	LYS	3.6
9	S7	31	SER	3.6
28	D6	83	ILE	3.6
83	f	17	ALA	3.6
83	f	148	ILE	3.6
8	S6	95	LYS	3.6
12	c0	28	ASN	3.6
49	m3	129	ASN	3.6
19	C7	22	PRO	3.6
21	C9	21	PHE	3.6
34	sR	115	ILE	3.6
43	l6	130	ILE	3.6
81	p0	26	PHE	3.6
21	C9	71	VAL	3.6
17	C5	52	LYS	3.6
34	SR	291	SER	3.6
34	sR	32	LEU	3.6
27	D5	50	ILE	3.6
58	n2	106	ALA	3.6
63	n7	95	VAL	3.6
7	S5	147	THR	3.6
22	D0	81	THR	3.6
28	D6	73	TYR	3.6

Continued on next page...

Continued from previous page...

Mol	Chain	Res	Type	RSRZ
34	SR	246	SER	3.6
11	S9	112	GLN	3.6
12	C0	29	GLN	3.6
4	S2	66	PHE	3.6
63	N7	133	LYS	3.6
3	s1	91	VAL	3.6
34	sR	294	TRP	3.6
34	SR	26	SER	3.6
34	SR	211	ILE	3.6
55	m9	178	ALA	3.6
10	S8	179	CYS	3.6
1	2	714	G	3.6
21	C9	39	THR	3.6
42	L5	83	LEU	3.6
42	L5	103	LEU	3.6
8	s6	162	VAL	3.6
28	D6	82	ARG	3.6
28	D6	70	LYS	3.6
29	D7	45	THR	3.6
1	6	660	G	3.6
6	S4	162	ILE	3.6
36	1	1243	G	3.6
2	S0	188	LEU	3.6
12	c0	24	LYS	3.6
42	L5	86	TYR	3.6
17	c5	125	PRO	3.6
19	C7	83	GLN	3.6
22	D0	70	THR	3.6
23	d1	39	VAL	3.6
27	D5	102	THR	3.6
27	D5	103	ARG	3.6
57	n1	33	VAL	3.6
6	s4	13	ALA	3.6
11	S9	181	ALA	3.6
15	c3	59	GLY	3.6
6	S4	76	VAL	3.6
6	S4	91	THR	3.6
23	D1	34	ILE	3.6
39	l2	252	THR	3.6
61	N5	124	VAL	3.6
83	f	59	LEU	3.6
1	6	661	A	3.6

Continued on next page...

Continued from previous page...

Mol	Chain	Res	Type	RSRZ
21	C9	100	ILE	3.6
3	S1	53	GLY	3.6
3	S1	58	SER	3.6
3	S1	223	PHE	3.5
36	5	2506	U	3.5
49	m3	145	PHE	3.5
59	N3	81	GLN	3.5
6	S4	166	SER	3.5
28	D6	92	ARG	3.5
33	e1	86	THR	3.5
49	m3	119	TYR	3.5
3	s1	100	PHE	3.5
5	s3	77	PHE	3.5
5	s3	84	ILE	3.5
12	C0	67	THR	3.5
17	C5	131	ALA	3.5
45	l8	150	LEU	3.5
21	C9	38	LYS	3.5
81	p0	24	SER	3.5
5	S3	74	GLN	3.5
48	M1	55	ARG	3.5
6	S4	48	LEU	3.5
29	d7	33	LEU	3.5
35	SM	90	ALA	3.5
49	m3	132	ALA	3.5
5	s3	62	ASN	3.5
11	S9	146	PHE	3.5
36	1	1239	C	3.5
34	sR	141	LEU	3.5
34	sR	243	LEU	3.5
6	S4	167	GLY	3.5
63	n7	45	GLY	3.5
42	l5	125	VAL	3.5
8	s6	193	LEU	3.5
19	C7	74	GLN	3.5
12	C0	79	TYR	3.5
34	SR	305	TYR	3.5
36	1	1270	A	3.5
31	d9	4	GLU	3.5
1	2	718	U	3.5
70	O4	23	VAL	3.5
2	s0	146	LEU	3.5

Continued on next page...

Continued from previous page...

Mol	Chain	Res	Type	RSRZ
7	S5	165	LEU	3.5
16	C4	89	THR	3.5
34	sR	52	GLN	3.5
20	C8	40	ARG	3.5
13	c1	117	VAL	3.5
34	SR	42	LEU	3.5
5	s3	152	PHE	3.5
34	sR	185	GLN	3.5
58	n2	98	THR	3.5
6	s4	133	LYS	3.5
16	c4	79	VAL	3.5
20	c8	52	VAL	3.5
22	d0	116	VAL	3.5
47	M0	97	LEU	3.5
63	n7	76	ASN	3.5
19	C7	63	LYS	3.5
4	S2	144	TRP	3.5
34	sR	25	THR	3.5
47	M0	36	LEU	3.5
63	n7	46	ILE	3.5
13	C1	30	ARG	3.5
12	c0	59	PHE	3.5
83	f	40	LYS	3.5
14	C2	27	ALA	3.5
36	5	2499	U	3.5
70	o4	39	ALA	3.5
83	f	13	ALA	3.5
6	S4	15	PRO	3.5
58	N2	27	VAL	3.5
61	N5	108	LEU	3.5
83	f	92	LEU	3.5
21	c9	92	LYS	3.5
63	N7	45	GLY	3.5
4	s2	87	GLN	3.4
1	6	232	U	3.4
38	4	158	U	3.4
11	S9	3	ARG	3.4
33	E1	145	HIS	3.4
3	S1	42	ASN	3.4
12	C0	75	TYR	3.4
11	s9	90	LYS	3.4
14	c2	121	VAL	3.4

Continued on next page...

Continued from previous page...

Mol	Chain	Res	Type	RSRZ
14	c2	59	LEU	3.4
36	5	2098	C	3.4
3	S1	46	THR	3.4
21	C9	124	ILE	3.4
33	E1	86	THR	3.4
45	L8	90	THR	3.4
1	6	1699	G	3.4
34	SR	296	ALA	3.4
9	S7	62	VAL	3.4
2	s0	160	ILE	3.4
47	M0	152	LEU	3.4
70	O4	64	THR	3.4
9	S7	48	GLU	3.4
55	m9	189	ALA	3.4
3	s1	133	TYR	3.4
51	m5	148	TYR	3.4
63	n7	131	PHE	3.4
1	2	1704	U	3.4
35	SM	88	ARG	3.4
58	n2	70	LYS	3.4
83	f	66	THR	3.4
32	e0	2	ALA	3.4
6	S4	8	HIS	3.4
18	c6	79	TYR	3.4
20	C8	17	LEU	3.4
26	D4	22	GLN	3.4
34	SR	34	LEU	3.4
81	p0	187	VAL	3.4
16	C4	83	ILE	3.4
55	M9	52	LYS	3.4
18	C6	6	SER	3.4
28	D6	27	SER	3.4
1	2	1370	U	3.4
47	M0	96	VAL	3.4
11	S9	104	PHE	3.4
27	d5	41	ILE	3.4
28	D6	41	ILE	3.4
8	S6	66	GLY	3.4
15	C3	14	SER	3.4
31	d9	23	VAL	3.4
34	SR	20	VAL	3.4
81	p0	87	VAL	3.4

Continued on next page...

Continued from previous page...

Mol	Chain	Res	Type	RSRZ
12	c0	58	GLN	3.4
17	c5	84	ILE	3.4
28	D6	90	GLU	3.4
60	n4	66	GLU	3.4
6	s4	101	LEU	3.4
11	S9	36	LEU	3.4
11	s9	80	LEU	3.4
16	c4	48	VAL	3.4
20	c8	17	LEU	3.4
12	C0	65	TYR	3.4
21	c9	100	ILE	3.4
32	e0	17	GLN	3.4
42	l5	247	ILE	3.4
36	5	2497	U	3.4
16	C4	47	LYS	3.4
16	c4	78	ALA	3.4
17	c5	103	ASN	3.4
21	c9	108	LEU	3.4
34	sR	159	ASN	3.4
60	N4	84	GLY	3.4
36	1	1351	U	3.4
34	sR	6	VAL	3.4
58	N2	92	TRP	3.4
71	o5	110	ALA	3.4
12	C0	35	ILE	3.4
27	d5	59	TYR	3.4
34	sR	122	ILE	3.4
58	n2	11	ILE	3.4
61	N5	82	LEU	3.4
74	O8	51	LEU	3.4
28	D6	78	ALA	3.4
10	s8	78	ILE	3.4
27	d5	88	ILE	3.4
63	N7	72	ILE	3.4
2	S0	22	THR	3.4
48	m1	174	LYS	3.4
22	d0	84	MET	3.4
63	N7	96	VAL	3.3
6	s4	18	TRP	3.3
36	5	2500	A	3.3
7	s5	68	ILE	3.3
28	D6	68	TYR	3.3

Continued on next page...

Continued from previous page...

Mol	Chain	Res	Type	RSRZ
40	L3	49	TYR	3.3
72	o6	58	ILE	3.3
81	p0	73	PHE	3.3
4	s2	89	GLN	3.3
19	C7	64	GLY	3.3
19	C7	101	ASN	3.3
28	D6	19	LYS	3.3
7	S5	217	LEU	3.3
9	s7	58	LEU	3.3
16	C4	48	VAL	3.3
1	2	656	G	3.3
58	N2	95	PHE	3.3
1	6	494	U	3.3
63	n7	6	LYS	3.3
59	N3	4	ASN	3.3
53	M7	169	THR	3.3
34	SR	117	LYS	3.3
42	L5	2	ALA	3.3
6	s4	26	CYS	3.3
66	o0	23	TYR	3.3
7	s5	161	ASP	3.3
11	S9	110	GLN	3.3
6	S4	57	ASN	3.3
12	C0	25	LYS	3.3
33	e1	83	LYS	3.3
74	o8	63	LYS	3.3
1	6	679	U	3.3
11	S9	80	LEU	3.3
34	SR	221	MET	3.3
47	M0	91	VAL	3.3
13	c1	116	ARG	3.3
7	s5	36	ALA	3.3
2	S0	126	PRO	3.3
6	s4	149	TYR	3.3
63	N7	90	GLU	3.3
3	s1	86	LEU	3.3
45	l8	152	LEU	3.3
58	N2	9	GLN	3.3
22	D0	117	VAL	3.3
36	1	1564	U	3.3
59	n3	2	SER	3.3
11	S9	39	LYS	3.3

Continued on next page...

Continued from previous page...

Mol	Chain	Res	Type	RSRZ
22	d0	37	VAL	3.3
16	C4	27	PHE	3.3
16	c4	25	ASP	3.3
30	d8	61	ARG	3.3
67	O1	33	VAL	3.3
71	o5	111	PHE	3.3
1	2	231	U	3.3
34	SR	27	ALA	3.3
35	sM	57	ASN	3.3
42	L5	88	ILE	3.3
3	s1	25	THR	3.3
10	S8	151	LYS	3.3
63	N7	111	LYS	3.3
1	2	1712	A	3.3
16	c4	20	TYR	3.3
48	M1	135	GLY	3.3
6	S4	92	LEU	3.3
6	s4	23	LEU	3.3
13	C1	25	VAL	3.3
17	C5	49	MET	3.3
22	d0	86	ILE	3.3
26	D4	19	ALA	3.3
27	d5	52	LYS	3.3
28	d6	55	GLU	3.3
45	L8	196	ALA	3.3
12	c0	32	HIS	3.3
21	c9	33	TYR	3.3
11	s9	104	PHE	3.3
21	c9	117	SER	3.3
26	D4	58	PHE	3.3
7	S5	85	ALA	3.3
16	c4	41	ARG	3.3
59	N3	32	ARG	3.3
3	s1	49	ASN	3.3
21	c9	30	VAL	3.3
34	sR	241	PHE	3.3
36	5	1565	G	3.3
3	s1	52	THR	3.3
23	D1	10	GLU	3.3
47	M0	140	THR	3.3
18	c6	28	LEU	3.3
81	p0	25	LEU	3.3

Continued on next page...

Continued from previous page...

Mol	Chain	Res	Type	RSRZ
83	f	122	ASP	3.3
21	c9	73	VAL	3.3
63	N7	61	LYS	3.3
31	D9	25	SER	3.2
34	SR	222	LEU	3.2
29	d7	32	PHE	3.2
32	E0	29	LYS	3.2
47	M0	149	VAL	3.2
34	sR	67	ILE	3.2
28	D6	28	LYS	3.2
28	d6	73	TYR	3.2
11	s9	149	ARG	3.2
36	1	1016	C	3.2
63	N7	118	PHE	3.2
18	c6	51	PRO	3.2
15	c3	40	TYR	3.2
3	S1	48	VAL	3.2
63	N7	95	VAL	3.2
6	s4	69	HIS	3.2
36	1	1238	C	3.2
5	s3	50	ILE	3.2
1	2	195	G	3.2
3	S1	190	PRO	3.2
35	sM	34	LYS	3.2
16	c4	85	ALA	3.2
47	m0	82	ARG	3.2
57	n1	121	ALA	3.2
2	S0	203	PHE	3.2
8	S6	84	TYR	3.2
25	D3	130	VAL	3.2
58	n2	97	SER	3.2
34	sR	48	THR	3.2
15	c3	83	GLU	3.2
34	sR	121	MET	3.2
63	n7	21	LYS	3.2
7	S5	86	GLN	3.2
34	sR	270	LEU	3.2
45	l8	189	LEU	3.2
74	o8	51	LEU	3.2
12	C0	39	ASN	3.2
21	C9	104	VAL	3.2
30	D8	17	GLY	3.2

Continued on next page...

Continued from previous page...

Mol	Chain	Res	Type	RSRZ
2	S0	199	PRO	3.2
58	N2	28	PHE	3.2
58	N2	34	ALA	3.2
35	SM	28	SER	3.2
1	2	194	U	3.2
45	L8	214	LEU	3.2
83	f	12	ASP	3.2
36	5	2448	G	3.2
34	SR	212	ALA	3.2
63	N7	110	ALA	3.2
26	d4	24	VAL	3.2
45	l8	197	VAL	3.2
74	o8	45	VAL	3.2
5	s3	56	GLN	3.2
20	c8	137	HIS	3.2
60	N4	73	ARG	3.2
40	L3	47	LEU	3.2
62	N6	92	GLY	3.2
12	C0	50	THR	3.2
6	S4	110	ALA	3.2
8	S6	97	VAL	3.2
12	c0	55	VAL	3.2
58	n2	62	VAL	3.2
83	f	58	HIS	3.2
2	s0	34	GLU	3.2
9	s7	32	PRO	3.2
63	N7	70	PRO	3.2
4	S2	41	LEU	3.2
15	C3	54	LEU	3.2
16	C4	39	ILE	3.2
2	S0	196	SER	3.2
3	S1	85	LYS	3.2
34	sR	53	LYS	3.2
5	S3	77	PHE	3.2
9	S7	61	PHE	3.2
10	s8	109	PHE	3.2
16	c4	101	ALA	3.2
34	sR	30	PRO	3.2
14	C2	41	LEU	3.2
21	C9	119	LYS	3.2
29	D7	70	LYS	3.2
42	l5	131	LEU	3.2

Continued on next page...

Continued from previous page...

Mol	Chain	Res	Type	RSRZ
7	S5	148	ARG	3.2
48	M1	102	PHE	3.2
2	S0	187	ALA	3.2
27	d5	76	ALA	3.2
83	f	152	GLU	3.2
31	d9	11	PRO	3.1
2	s0	64	ILE	3.1
15	C3	53	LEU	3.1
18	C6	89	LEU	3.1
20	C8	124	GLY	3.1
27	D5	51	LEU	3.1
2	s0	99	ALA	3.1
5	s3	74	GLN	3.1
16	c4	24	ASN	3.1
21	C9	80	TYR	3.1
2	S0	206	ASP	3.1
4	S2	151	PRO	3.1
34	sR	34	LEU	3.1
40	l3	47	LEU	3.1
40	L3	51	ALA	3.1
45	l8	122	LYS	3.1
70	O4	110	GLU	3.1
3	S1	130	SER	3.1
11	s9	184	SER	3.1
18	C6	54	LEU	3.1
27	D5	69	LEU	3.1
57	N1	27	LEU	3.1
58	n2	16	THR	3.1
7	S5	164	PRO	3.1
40	L3	328	ILE	3.1
11	s9	110	GLN	3.1
12	C0	17	GLN	3.1
12	C0	45	ALA	3.1
42	L5	5	LYS	3.1
16	c4	62	LEU	3.1
42	L5	131	LEU	3.1
6	S4	95	THR	3.1
22	d0	29	THR	3.1
47	M0	95	HIS	3.1
2	S0	110	TYR	3.1
5	s3	64	ARG	3.1
17	C5	127	ARG	3.1

Continued on next page...

Continued from previous page...

Mol	Chain	Res	Type	RSRZ
34	sR	227	ALA	3.1
48	M1	12	LEU	3.1
1	6	656	G	3.1
14	c2	64	SER	3.1
8	S6	79	LYS	3.1
34	SR	317	THR	3.1
34	sR	50	ASP	3.1
39	L2	252	THR	3.1
42	l5	55	PHE	3.1
8	S6	179	VAL	3.1
20	C8	129	TRP	3.1
28	D6	85	ARG	3.1
68	o2	93	ALA	3.1
9	S7	93	LEU	3.1
11	S9	105	LEU	3.1
6	S4	90	ILE	3.1
8	S6	187	LYS	3.1
34	sR	263	PHE	3.1
63	n7	22	LYS	3.1
60	N4	95	SER	3.1
5	s3	48	VAL	3.1
22	D0	116	VAL	3.1
58	n2	66	VAL	3.1
8	S6	138	ALA	3.1
26	D4	74	LEU	3.1
55	M9	44	LEU	3.1
22	d0	88	LYS	3.1
2	S0	197	ILE	3.1
60	n4	95	SER	3.1
81	p0	16	ARG	3.1
25	D3	42	PRO	3.1
14	C2	28	LEU	3.1
20	c8	32	LEU	3.1
42	L5	99	TYR	3.1
36	1	1268	G	3.1
42	L5	127	GLY	3.1
5	S3	65	ARG	3.1
51	M5	60	VAL	3.1
26	D4	68	LYS	3.1
81	p0	18	TYR	3.1
83	f	49	THR	3.1
4	S2	224	PHE	3.1

Continued on next page...

Continued from previous page...

Mol	Chain	Res	Type	RSRZ
5	s3	76	ARG	3.1
42	L5	247	ILE	3.1
47	m0	124	GLY	3.1
28	d6	45	VAL	3.1
22	D0	87	HIS	3.1
11	s9	183	ALA	3.1
20	C8	3	LEU	3.1
27	d5	104	ALA	3.1
29	D7	33	LEU	3.1
26	d4	72	PHE	3.1
42	L5	63	GLN	3.1
18	C6	5	PRO	3.1
22	D0	119	ALA	3.1
1	2	280	U	3.1
9	S7	155	ASP	3.1
2	s0	166	GLY	3.1
15	C3	139	TRP	3.1
35	sM	25	ILE	3.1
36	1	2205	U	3.1
63	n7	4	PHE	3.1
13	C1	16	GLN	3.1
42	L5	126	GLU	3.1
47	M0	153	ARG	3.1
6	s4	165	ALA	3.1
8	S6	96	SER	3.0
1	6	231	U	3.0
36	1	3275	U	3.0
42	L5	159	VAL	3.0
83	f	82	VAL	3.0
76	Q0	121	LEU	3.0
3	S1	200	ALA	3.0
1	2	1766	A	3.0
12	C0	4	PRO	3.0
13	C1	137	PHE	3.0
36	5	2508	U	3.0
81	p0	80	VAL	3.0
6	s4	134	LYS	3.0
21	c9	19	ALA	3.0
60	n4	70	LYS	3.0
5	s3	103	GLU	3.0
11	S9	163	PRO	3.0
5	s3	41	VAL	3.0

Continued on next page...

Continued from previous page...

Mol	Chain	Res	Type	RSRZ
9	s7	66	SER	3.0
36	1	1762	C	3.0
18	C6	117	LEU	3.0
25	d3	86	PHE	3.0
11	S9	5	PRO	3.0
7	S5	24	VAL	3.0
21	c9	71	VAL	3.0
8	s6	214	LYS	3.0
10	s8	66	SER	3.0
42	L5	55	PHE	3.0
60	n4	75	THR	3.0
33	e1	85	TYR	3.0
34	sR	27	ALA	3.0
57	n1	24	ALA	3.0
74	o8	11	PHE	3.0
12	C0	32	HIS	3.0
18	c6	143	ARG	3.0
40	L3	48	GLY	3.0
21	C9	114	VAL	3.0
11	S9	150	LEU	3.0
19	C7	100	LEU	3.0
8	S6	180	THR	3.0
34	sR	300	THR	3.0
7	S5	67	PRO	3.0
10	S8	96	LEU	3.0
12	C0	83	PRO	3.0
19	c7	110	VAL	3.0
3	s1	223	PHE	3.0
12	c0	36	ASP	3.0
3	S1	216	LYS	3.0
5	s3	7	LYS	3.0
8	s6	203	GLU	3.0
10	S8	95	THR	3.0
18	C6	118	ILE	3.0
18	C6	142	TYR	3.0
21	C9	50	ALA	3.0
22	d0	82	TYR	3.0
68	o2	2	ALA	3.0
1	6	676	G	3.0
8	S6	177	ARG	3.0
22	D0	85	ARG	3.0
11	S9	35	GLY	3.0

Continued on next page...

Continued from previous page...

Mol	Chain	Res	Type	RSRZ
12	C0	31	LYS	3.0
19	C7	126	ALA	3.0
42	L5	64	ILE	3.0
16	c4	91	THR	3.0
5	s3	21	LEU	3.0
11	S9	118	LEU	3.0
62	N6	120	GLN	3.0
5	s3	20	GLU	3.0
12	c0	33	GLU	3.0
49	M3	95	ILE	3.0
60	n4	130	SER	3.0
66	O0	10	ILE	3.0
34	SR	58	VAL	3.0
74	O8	57	ASN	3.0
12	C0	46	LEU	3.0
2	S0	23	HIS	3.0
9	s7	42	GLN	3.0
10	S8	200	LYS	3.0
36	1	1269	U	3.0
3	s1	90	GLU	3.0
6	S4	27	TYR	3.0
65	N9	56	ALA	3.0
2	s0	177	LEU	3.0
34	SR	252	LEU	3.0
1	6	655	G	3.0
6	s4	81	THR	3.0
22	D0	67	THR	3.0
58	N2	80	THR	3.0
16	C4	120	PRO	3.0
7	S5	68	ILE	3.0
14	c2	126	TRP	3.0
18	c6	11	GLY	3.0
11	S9	95	TYR	3.0
31	d9	34	TYR	3.0
32	E0	54	ARG	3.0
60	n4	131	ALA	3.0
3	S1	184	LEU	3.0
12	c0	49	LEU	3.0
22	D0	21	LYS	3.0
28	d6	19	LYS	3.0
36	1	1813	A	3.0
40	L3	331	ASN	3.0

Continued on next page...

Continued from previous page...

Mol	Chain	Res	Type	RSRZ
71	o5	115	LYS	3.0
9	S7	92	PHE	3.0
3	s1	157	GLN	3.0
4	S2	48	GLY	2.9
22	D0	65	ILE	2.9
51	m5	147	ARG	2.9
53	M7	178	ALA	2.9
35	SM	27	LYS	2.9
6	s4	86	PHE	2.9
35	SM	50	ASN	2.9
9	S7	74	GLN	2.9
9	S7	63	PRO	2.9
11	S9	185	GLY	2.9
12	c0	69	THR	2.9
19	C7	86	PRO	2.9
31	d9	19	ARG	2.9
60	n4	73	ARG	2.9
54	M8	93	ILE	2.9
55	M9	177	VAL	2.9
11	s9	147	MET	2.9
34	SR	174	ASN	2.9
5	S3	75	LYS	2.9
6	s4	37	LYS	2.9
13	C1	78	THR	2.9
21	C9	92	LYS	2.9
4	s2	92	ALA	2.9
9	S7	109	VAL	2.9
30	D8	5	THR	2.9
42	l5	38	THR	2.9
34	SR	202	LEU	2.9
34	SR	244	ALA	2.9
63	n7	23	VAL	2.9
68	O2	127	ALA	2.9
9	S7	43	PHE	2.9
11	S9	27	GLU	2.9
48	M1	108	GLU	2.9
12	c0	39	ASN	2.9
83	f	24	SER	2.9
14	C2	136	ILE	2.9
11	S9	183	ALA	2.9
20	c8	45	LEU	2.9
26	d4	35	VAL	2.9

Continued on next page...

Continued from previous page...

Mol	Chain	Res	Type	RSRZ
36	1	1605	A	2.9
5	s3	31	GLU	2.9
62	N6	116	LYS	2.9
71	O5	32	LYS	2.9
7	s5	153	GLY	2.9
59	n3	3	GLY	2.9
18	C6	29	ILE	2.9
18	C6	90	VAL	2.9
19	C7	85	VAL	2.9
2	S0	161	PRO	2.9
8	S6	80	ASN	2.9
44	L7	26	VAL	2.9
9	s7	4	PRO	2.9
16	c4	57	PRO	2.9
28	d6	20	PRO	2.9
16	C4	38	THR	2.9
26	D4	9	THR	2.9
1	2	717	C	2.9
4	S2	55	GLU	2.9
17	c5	83	MET	2.9
18	C6	64	ASP	2.9
2	s0	33	GLN	2.9
6	S4	70	VAL	2.9
66	O0	67	VAL	2.9
28	d6	2	PRO	2.9
42	L5	119	TYR	2.9
83	f	155	ARG	2.9
18	c6	25	GLY	2.9
20	C8	73	MET	2.9
42	L5	52	VAL	2.9
45	L8	152	LEU	2.9
79	Q3	86	LEU	2.9
1	6	506	A	2.9
1	6	719	U	2.9
19	C7	116	LYS	2.9
28	d6	62	TYR	2.9
31	d9	25	SER	2.9
18	C6	70	THR	2.9
14	c2	102	GLY	2.9
34	sR	49	GLY	2.9
3	s1	96	LEU	2.9
48	M1	54	VAL	2.9

Continued on next page...

Continued from previous page...

Mol	Chain	Res	Type	RSRZ
33	E1	85	TYR	2.9
63	N7	29	HIS	2.9
22	d0	79	TRP	2.9
42	L5	28	THR	2.9
16	c4	110	LEU	2.9
35	sM	27	LYS	2.9
55	m9	21	LYS	2.9
30	d8	59	SER	2.9
45	L8	28	HIS	2.9
45	L8	89	GLU	2.9
3	s1	50	LYS	2.9
6	S4	153	ASN	2.9
19	C7	16	LEU	2.9
20	c8	20	THR	2.9
22	d0	77	LYS	2.9
22	d0	65	ILE	2.9
22	d0	118	VAL	2.9
34	sR	33	LEU	2.9
63	N7	25	ILE	2.9
63	n7	83	THR	2.9
81	p0	185	LEU	2.9
83	f	34	ILE	2.9
49	m3	111	ALA	2.9
28	D6	72	HIS	2.9
6	S4	56	LEU	2.9
21	c9	116	ILE	2.9
47	M0	171	TRP	2.9
55	M9	138	LEU	2.9
36	5	2505	U	2.9
60	N4	78	ALA	2.9
47	M0	151	GLY	2.9
62	N6	109	LEU	2.9
65	n9	34	GLY	2.9
83	f	116	PRO	2.9
34	sR	92	TRP	2.8
64	n8	121	VAL	2.8
25	D3	89	ASN	2.8
5	s3	219	ALA	2.8
28	d6	35	ALA	2.8
34	SR	83	ALA	2.8
36	1	1955	U	2.8
60	N4	68	ALA	2.8

Continued on next page...

Continued from previous page...

Mol	Chain	Res	Type	RSRZ
2	s0	152	PRO	2.8
8	S6	76	LEU	2.8
34	SR	188	ILE	2.8
35	SM	37	VAL	2.8
25	d3	40	SER	2.8
63	n7	136	PHE	2.8
13	C1	46	LYS	2.8
63	n7	27	LYS	2.8
1	2	500	C	2.8
1	2	507	U	2.8
12	C0	19	GLY	2.8
22	d0	63	LEU	2.8
29	D7	73	LEU	2.8
20	c8	4	VAL	2.8
22	d0	91	ILE	2.8
34	SR	247	PRO	2.8
63	N7	40	HIS	2.8
63	n7	14	VAL	2.8
34	sR	316	MET	2.8
45	L8	114	ALA	2.8
45	l8	119	ALA	2.8
70	O4	66	SER	2.8
12	c0	29	GLN	2.8
83	f	61	ALA	2.8
3	S1	106	THR	2.8
40	l3	178	LEU	2.8
1	2	696	C	2.8
6	s4	161	LYS	2.8
34	sR	113	VAL	2.8
45	L8	232	HIS	2.8
11	S9	159	ALA	2.8
58	N2	33	TYR	2.8
62	N6	43	TYR	2.8
1	2	1777	G	2.8
11	s9	11	THR	2.8
12	C0	15	LEU	2.8
3	S1	215	VAL	2.8
6	S4	6	LYS	2.8
20	C8	16	ARG	2.8
25	D3	133	LEU	2.8
45	l8	238	LEU	2.8
6	s4	109	PHE	2.8

Continued on next page...

Continued from previous page...

Mol	Chain	Res	Type	RSRZ
7	S5	43	PHE	2.8
11	S9	134	ILE	2.8
22	d0	106	ILE	2.8
36	5	2538	U	2.8
42	l5	41	LYS	2.8
63	N7	131	PHE	2.8
27	d5	47	TYR	2.8
34	SR	279	ALA	2.8
55	M9	183	ALA	2.8
45	l8	195	SER	2.8
5	S3	223	LYS	2.8
47	M0	19	LYS	2.8
55	m9	180	LYS	2.8
72	O6	99	ARG	2.8
77	Q1	14	LYS	2.8
7	S5	140	THR	2.8
11	S9	11	THR	2.8
22	D0	97	VAL	2.8
26	D4	13	ILE	2.8
28	d6	21	VAL	2.8
32	E0	41	THR	2.8
36	5	2450	G	2.8
42	L5	234	ASP	2.8
26	D4	20	ARG	2.8
36	1	2507	C	2.8
9	S7	126	LEU	2.8
3	s1	68	VAL	2.8
26	d4	57	VAL	2.8
34	SR	54	PHE	2.8
21	c9	29	GLU	2.8
1	2	232	U	2.8
11	S9	31	ALA	2.8
63	n7	52	LYS	2.8
11	s9	86	LEU	2.8
45	l8	162	LEU	2.8
2	s0	173	ILE	2.8
3	S1	137	ILE	2.8
21	c9	99	SER	2.8
30	D8	7	VAL	2.8
42	L5	53	VAL	2.8
2	S0	80	THR	2.8
10	s8	36	THR	2.8

Continued on next page...

Continued from previous page...

Mol	Chain	Res	Type	RSRZ
34	sR	14	GLU	2.8
6	s4	36	HIS	2.8
8	s6	147	LEU	2.8
21	C9	18	TYR	2.8
27	D5	65	LEU	2.8
45	L8	109	LEU	2.8
42	L5	4	GLN	2.8
30	d8	32	PHE	2.8
34	SR	56	VAL	2.8
49	m3	136	GLU	2.8
57	n1	66	ASN	2.8
62	N6	69	LYS	2.8
34	SR	130	THR	2.8
3	S1	78	ASP	2.8
40	l3	386	ASP	2.8
45	L8	223	ALA	2.8
1	2	133	U	2.8
1	2	278	U	2.8
2	S0	102	PHE	2.8
12	c0	27	PHE	2.8
28	D6	45	VAL	2.8
58	n2	54	VAL	2.8
33	e1	89	LYS	2.8
34	SR	216	LYS	2.8
83	f	47	SER	2.8
3	S1	49	ASN	2.8
22	d0	58	LEU	2.8
29	d7	41	LEU	2.8
22	d0	111	GLY	2.8
15	C3	33	VAL	2.8
28	d6	91	ASP	2.8
28	D6	66	LYS	2.8
49	m3	137	GLN	2.8
49	m3	147	ILE	2.8
1	2	793	A	2.8
28	d6	71	LEU	2.8
27	d5	101	TYR	2.8
30	d8	17	GLY	2.8
63	n7	91	ALA	2.8
3	s1	65	VAL	2.8
14	c2	122	VAL	2.8
23	d1	22	ARG	2.8

Continued on next page...

Continued from previous page...

Mol	Chain	Res	Type	RSRZ
39	L2	224	THR	2.8
18	c6	139	GLN	2.7
31	D9	38	ILE	2.7
6	S4	23	LEU	2.7
22	D0	34	LEU	2.7
22	d0	26	LEU	2.7
3	s1	60	ALA	2.7
36	1	1814	A	2.7
36	5	2449	A	2.7
3	s1	20	VAL	2.7
4	S2	57	PHE	2.7
19	C7	122	ILE	2.7
34	SR	43	ILE	2.7
34	sR	220	ILE	2.7
63	N7	106	GLN	2.7
83	f	89	GLU	2.7
53	M7	163	LYS	2.7
63	n7	115	LYS	2.7
65	n9	23	LYS	2.7
83	f	93	LEU	2.7
2	s0	159	ALA	2.7
28	D6	29	SER	2.7
30	D8	28	VAL	2.7
35	SM	42	ALA	2.7
49	M3	140	SER	2.7
55	M9	132	PHE	2.7
59	N3	6	ALA	2.7
63	n7	11	ALA	2.7
65	n9	27	TYR	2.7
1	6	1217	A	2.7
5	s3	61	GLU	2.7
21	c9	90	PRO	2.7
2	S0	72	ASP	2.7
3	S1	126	THR	2.7
10	s8	95	THR	2.7
51	m5	15	GLN	2.7
8	S6	154	ARG	2.7
18	C6	12	LYS	2.7
18	C6	47	LYS	2.7
34	SR	283	LYS	2.7
45	L8	189	LEU	2.7
72	o6	60	LEU	2.7

Continued on next page...

Continued from previous page...

Mol	Chain	Res	Type	RSRZ
2	s0	100	GLY	2.7
1	6	657	U	2.7
11	S9	98	ALA	2.7
11	S9	101	VAL	2.7
34	sR	54	PHE	2.7
43	l6	3	ALA	2.7
2	S0	135	GLU	2.7
4	S2	178	ILE	2.7
12	c0	43	ILE	2.7
11	s9	74	ASN	2.7
47	M0	55	ASN	2.7
55	M9	72	GLU	2.7
8	S6	71	THR	2.7
42	L5	56	THR	2.7
55	M9	181	ARG	2.7
10	S8	67	TRP	2.7
8	s6	192	ALA	2.7
11	S9	122	VAL	2.7
15	C3	24	ALA	2.7
16	c4	59	ALA	2.7
42	L5	134	ALA	2.7
49	M3	96	ALA	2.7
1	6	239	C	2.7
4	S2	65	GLU	2.7
6	s4	64	ILE	2.7
16	c4	19	ILE	2.7
21	c9	94	ILE	2.7
58	n2	41	ILE	2.7
8	s6	194	LYS	2.7
31	d9	12	ARG	2.7
34	SR	144	LEU	2.7
63	n7	122	HIS	2.7
5	S3	25	PHE	2.7
5	s3	17	PHE	2.7
5	s3	24	PHE	2.7
16	c4	23	PHE	2.7
34	SR	280	GLY	2.7
16	C4	17	ALA	2.7
20	c8	98	TYR	2.7
43	L6	135	VAL	2.7
45	l8	154	ALA	2.7
10	s8	58	LEU	2.7

Continued on next page...

Continued from previous page...

Mol	Chain	Res	Type	RSRZ
17	C5	51	SER	2.7
23	D1	69	LEU	2.7
36	5	3155	U	2.7
45	L8	121	SER	2.7
58	n2	105	LEU	2.7
16	c4	109	GLY	2.7
34	sR	116	ASP	2.7
2	s0	50	VAL	2.7
5	s3	148	LYS	2.7
6	s4	245	LYS	2.7
12	c0	21	VAL	2.7
2	s0	122	ILE	2.7
20	c8	145	ARG	2.7
28	d6	30	ILE	2.7
42	L5	158	ARG	2.7
79	q3	3	LYS	2.7
1	2	140	A	2.7
3	S1	54	LEU	2.7
11	S9	116	LEU	2.7
11	s9	109	LEU	2.7
72	o6	57	LEU	2.7
22	D0	72	ASN	2.7
34	sR	186	PHE	2.7
74	o8	32	ASN	2.7
2	S0	175	TYR	2.7
16	C4	107	ARG	2.7
28	D6	81	ALA	2.7
28	d6	51	ARG	2.7
42	L5	100	ALA	2.7
74	o8	55	VAL	2.7
34	sR	123	ILE	2.7
49	m3	79	GLU	2.7
5	s3	72	LEU	2.7
32	E0	38	LEU	2.7
53	M7	179	GLN	2.7
8	S6	145	PHE	2.7
12	c0	48	SER	2.7
10	s8	102	VAL	2.7
21	c9	123	ARG	2.7
43	l6	2	SER	2.7
42	L5	135	VAL	2.7
3	S1	164	ILE	2.7

Continued on next page...

Continued from previous page...

Mol	Chain	Res	Type	RSRZ
21	C9	107	ALA	2.7
34	SR	310	ILE	2.7
47	m0	221	ALA	2.7
6	s4	39	ARG	2.7
20	C8	8	GLN	2.7
21	c9	106	GLN	2.7
29	d7	47	PHE	2.7
42	L5	200	PHE	2.7
16	C4	13	VAL	2.7
47	m0	96	VAL	2.7
4	S2	69	ILE	2.7
16	c4	21	ALA	2.7
49	m3	118	GLU	2.7
73	O7	88	ALA	2.7
6	S4	159	THR	2.7
8	s6	79	LYS	2.7
9	S7	99	LEU	2.7
14	c2	41	LEU	2.7
25	D3	34	LEU	2.7
34	sR	23	LEU	2.7
9	s7	5	GLN	2.7
39	L2	149	ARG	2.7
81	p0	64	ARG	2.7
16	C4	28	VAL	2.7
27	D5	73	GLY	2.7
28	D6	65	PRO	2.7
32	E0	6	GLY	2.7
47	m0	45	GLU	2.7
81	p0	50	VAL	2.7
6	s4	84	ALA	2.7
6	s4	169	ILE	2.7
11	s9	8	TYR	2.7
12	C0	54	TYR	2.7
20	C8	69	ILE	2.7
47	m0	34	TYR	2.7
53	M7	170	SER	2.7
58	n2	33	TYR	2.7
83	f	15	SER	2.7
3	s1	98	THR	2.7
6	s4	73	ASP	2.7
7	s5	198	LEU	2.7
10	s8	24	LYS	2.7

Continued on next page...

Continued from previous page...

Mol	Chain	Res	Type	RSRZ
32	E0	49	LEU	2.7
35	sM	29	ASN	2.7
42	L5	150	LEU	2.7
9	s7	92	PHE	2.7
13	c1	115	PHE	2.7
12	C0	34	GLU	2.7
62	N6	90	VAL	2.7
2	S0	141	ILE	2.7
5	s3	78	LYS	2.6
15	C3	66	ILE	2.7
26	D4	4	ALA	2.7
72	O6	100	HIS	2.7
34	SR	3	SER	2.6
64	n8	120	ASN	2.6
1	2	261	U	2.6
1	2	711	U	2.6
3	s1	66	VAL	2.6
5	s3	105	MET	2.6
40	L3	79	VAL	2.6
6	s4	71	LYS	2.6
39	l2	60	LYS	2.6
3	s1	97	LEU	2.6
39	l2	72	ARG	2.6
35	SM	41	SER	2.6
48	M1	19	LEU	2.6
55	M9	182	ASP	2.6
22	d0	117	VAL	2.6
28	d6	9	GLY	2.6
31	d9	33	LYS	2.6
33	e1	120	GLU	2.6
77	q1	25	LYS	2.6
13	c1	49	ILE	2.6
21	c9	65	ILE	2.6
33	e1	80	ARG	2.6
29	D7	50	ALA	2.6
34	SR	318	ALA	2.6
34	sR	7	LEU	2.6
57	n1	30	TYR	2.6
58	N2	108	TYR	2.6
36	1	2567	C	2.6
2	s0	151	SER	2.6
16	c4	22	SER	2.6

Continued on next page...

Continued from previous page...

Mol	Chain	Res	Type	RSRZ
72	O6	64	SER	2.6
4	S2	64	LYS	2.6
5	s3	10	LYS	2.6
5	s3	16	VAL	2.6
11	s9	81	VAL	2.6
21	C9	29	GLU	2.6
34	SR	6	VAL	2.6
2	S0	19	ALA	2.6
16	C4	76	ILE	2.6
16	c4	102	LEU	2.6
34	sR	257	ALA	2.6
35	sM	35	ALA	2.6
61	N5	128	ALA	2.6
31	d9	55	PHE	2.6
45	l8	28	HIS	2.6
3	S1	226	GLY	2.6
6	s4	75	LYS	2.6
21	C9	72	GLY	2.6
21	c9	119	LYS	2.6
45	L8	92	LYS	2.6
60	n4	135	SER	2.6
66	O0	40	LYS	2.6
67	o1	76	SER	2.6
33	E1	147	VAL	2.6
10	s8	48	THR	2.6
11	S9	140	ILE	2.6
16	c4	60	ALA	2.6
34	sR	292	LEU	2.6
35	SM	38	PRO	2.6
36	1	1765	U	2.6
42	L5	79	TYR	2.6
48	m1	45	PRO	2.6
18	C6	13	LYS	2.6
21	C9	103	LYS	2.6
3	S1	213	ARG	2.6
1	6	898	A	2.6
16	c4	108	SER	2.6
42	L5	245	GLU	2.6
8	S6	182	GLN	2.6
18	c6	8	GLN	2.6
53	M7	172	GLN	2.6
3	s1	110	LEU	2.6

Continued on next page...

Continued from previous page...

Mol	Chain	Res	Type	RSRZ
47	M0	166	ILE	2.6
7	s5	154	ALA	2.6
9	S7	157	LYS	2.6
11	S9	37	LYS	2.6
12	c0	41	TYR	2.6
61	N5	122	ALA	2.6
74	o8	52	TYR	2.6
11	S9	6	ARG	2.6
14	C2	33	ARG	2.6
70	O4	34	HIS	2.6
2	S0	74	VAL	2.6
2	s0	181	VAL	2.6
62	N6	95	VAL	2.6
81	p0	188	VAL	2.6
3	S1	186	SER	2.6
1	2	740	A	2.6
9	s7	38	LEU	2.6
5	S3	87	TYR	2.6
7	S5	61	TYR	2.6
11	S9	56	ALA	2.6
12	C0	63	TYR	2.6
21	c9	110	LYS	2.6
23	d1	37	ALA	2.6
34	sR	261	LYS	2.6
58	n2	104	ARG	2.6
9	S7	32	PRO	2.6
1	6	277	U	2.6
6	s4	74	GLY	2.6
83	f	60	VAL	2.6
11	s9	92	LYS	2.6
33	e1	96	LYS	2.6
49	m3	124	ILE	2.6
58	N2	13	LYS	2.6
61	N5	135	ILE	2.6
63	N7	123	GLN	2.6
67	O1	51	LEU	2.6
4	S2	140	ARG	2.6
34	sR	254	ALA	2.6
42	L5	30	TYR	2.6
66	O0	59	TYR	2.6
11	s9	2	PRO	2.6
19	C7	110	VAL	2.6

Continued on next page...

Continued from previous page...

Mol	Chain	Res	Type	RSRZ
27	D5	40	VAL	2.6
34	SR	208	GLY	2.6
47	M0	50	VAL	2.6
83	f	145	GLU	2.6
42	L5	254	LYS	2.6
12	C0	49	LEU	2.6
3	S1	31	ASP	2.6
12	C0	14	TYR	2.6
26	D4	56	SER	2.6
28	d6	68	TYR	2.6
69	O3	56	SER	2.6
81	p0	197	PHE	2.6
83	f	74	SER	2.6
26	D4	67	GLY	2.6
48	m1	62	ASN	2.6
49	m3	134	GLU	2.6
67	O1	83	GLU	2.6
5	s3	220	PRO	2.6
10	s8	137	LYS	2.6
20	c8	141	THR	2.6
41	l4	186	LYS	2.6
76	Q0	83	LYS	2.6
2	s0	23	HIS	2.6
8	S6	196	ARG	2.6
17	C5	89	MET	2.6
19	C7	109	LEU	2.6
1	2	710	U	2.6
6	s4	41	SER	2.6
16	c4	68	ALA	2.6
31	D9	52	PHE	2.6
21	c9	125	SER	2.6
34	sR	171	SER	2.6
45	l8	177	TYR	2.6
3	s1	94	LYS	2.6
8	S6	197	ASN	2.6
21	c9	112	GLY	2.6
70	o4	101	VAL	2.6
5	S3	54	ARG	2.6
18	C6	123	ARG	2.6
24	d2	126	LEU	2.6
33	e1	87	THR	2.6
60	N4	71	ARG	2.6

Continued on next page...

Continued from previous page...

Mol	Chain	Res	Type	RSRZ
63	n7	65	ARG	2.6
74	o8	73	LEU	2.6
79	q3	5	THR	2.6
47	m0	33	ILE	2.6
47	m0	86	HIS	2.6
1	2	713	A	2.6
1	2	1685	G	2.6
21	c9	107	ALA	2.6
27	d5	90	LYS	2.6
33	e1	90	LYS	2.6
38	8	81	U	2.6
39	l2	59	ALA	2.6
55	M9	131	ALA	2.6
12	c0	44	LYS	2.6
2	s0	171	GLY	2.6
17	c5	113	GLY	2.6
6	S4	59	ARG	2.6
21	C9	37	VAL	2.6
21	C9	123	ARG	2.6
63	N7	13	VAL	2.6
63	n7	26	VAL	2.6
20	C8	44	ASN	2.6
42	L5	84	PRO	2.6
62	n6	57	LEU	2.6
21	c9	135	ILE	2.6
47	M0	159	PHE	2.5
2	S0	83	GLN	2.5
8	s6	131	LYS	2.5
26	D4	107	GLN	2.5
35	sM	83	LYS	2.5
1	2	269	G	2.5
7	S5	162	VAL	2.5
21	C9	5	SER	2.5
34	SR	213	SER	2.5
40	L3	277	SER	2.5
59	N3	137	VAL	2.5
70	o4	55	SER	2.5
3	s1	228	LEU	2.5
4	S2	240	LEU	2.5
34	sR	225	LEU	2.5
63	N7	81	LEU	2.5
62	n6	45	ILE	2.5

Continued on next page...

Continued from previous page...

Mol	Chain	Res	Type	RSRZ
20	C8	55	HIS	2.5
20	c8	55	HIS	2.5
3	S1	182	ALA	2.5
3	S1	196	GLU	2.5
14	c2	42	ALA	2.5
16	C4	20	TYR	2.5
45	l8	118	GLU	2.5
3	s1	233	GLY	2.5
25	D3	51	GLY	2.5
62	N6	85	VAL	2.5
1	6	1707	A	2.5
34	sR	35	SER	2.5
34	sR	124	SER	2.5
5	s3	5	ILE	2.5
20	C8	125	ILE	2.5
36	1	1242	G	2.5
13	C1	136	ARG	2.5
15	c3	25	TRP	2.5
21	c9	17	ALA	2.5
34	sR	203	THR	2.5
45	L8	123	GLN	2.5
67	O1	106	THR	2.5
17	c5	93	VAL	2.5
12	C0	43	ILE	2.5
34	SR	302	PHE	2.5
34	sR	273	ASP	2.5
74	O8	56	ILE	2.5
9	S7	113	PRO	2.5
2	s0	49	ASN	2.5
30	D8	43	ASN	2.5
34	SR	31	ASN	2.5
34	sR	200	ASN	2.5
35	SM	58	GLU	2.5
36	5	1025	A	2.5
3	s1	92	GLN	2.5
13	C1	38	ALA	2.5
21	C9	55	TYR	2.5
1	6	235	G	2.5
21	C9	4	VAL	2.5
27	d5	40	VAL	2.5
31	D9	20	GLN	2.5
63	N7	75	VAL	2.5

Continued on next page...

Continued from previous page...

Mol	Chain	Res	Type	RSRZ
63	n7	10	VAL	2.5
20	c8	54	LEU	2.5
61	N5	126	LEU	2.5
83	f	26	LEU	2.5
5	S3	76	ARG	2.5
6	s4	24	SER	2.5
2	s0	186	GLY	2.5
5	s3	137	VAL	2.5
11	S9	125	ALA	2.5
12	C0	53	GLY	2.5
12	c0	54	TYR	2.5
17	C5	93	VAL	2.5
45	l8	157	VAL	2.5
63	N7	87	LEU	2.5
76	Q0	85	LEU	2.5
9	S7	49	ILE	2.5
9	S7	91	ILE	2.5
45	L8	218	ILE	2.5
20	C8	10	SER	2.5
53	M7	16	SER	2.5
3	S1	97	LEU	2.5
16	C4	99	GLN	2.5
21	C9	33	TYR	2.5
29	d7	54	VAL	2.5
35	sM	49	LYS	2.5
45	l8	130	TYR	2.5
21	c9	105	LEU	2.5
76	q0	90	ASN	2.5
5	s3	94	ARG	2.5
18	C6	17	THR	2.5
19	c7	60	ARG	2.5
28	d6	67	THR	2.5
3	s1	121	ILE	2.5
34	SR	192	PHE	2.5
19	C7	18	GLU	2.5
21	c9	115	GLU	2.5
34	sR	5	GLU	2.5
5	S3	73	VAL	2.5
20	c8	146	ALA	2.5
27	D5	60	VAL	2.5
45	L8	198	ALA	2.5
49	M3	33	VAL	2.5

Continued on next page...

Continued from previous page...

Mol	Chain	Res	Type	RSRZ
51	m5	6	TYR	2.5
52	m6	61	ALA	2.5
12	C0	68	LEU	2.5
34	SR	183	LEU	2.5
17	C5	82	ASN	2.5
23	d1	83	TRP	2.5
31	d9	5	ASN	2.5
3	s1	46	THR	2.5
15	C3	50	ILE	2.5
24	d2	61	ILE	2.5
8	s6	187	LYS	2.5
24	D2	60	LYS	2.5
48	M1	131	MET	2.5
55	M9	187	GLU	2.5
65	n9	22	LYS	2.5
1	6	225	A	2.5
6	S4	181	VAL	2.5
31	d9	41	GLN	2.5
34	sR	47	LEU	2.5
43	L6	134	ARG	2.5
49	m3	98	ASP	2.5
59	N3	3	GLY	2.5
63	N7	82	PRO	2.5
63	n7	24	VAL	2.5
22	d0	66	SER	2.5
72	O6	27	SER	2.5
1	6	1695	G	2.5
5	s3	49	ILE	2.5
19	C7	72	LYS	2.5
20	c8	129	TRP	2.5
21	C9	110	LYS	2.5
47	m0	38	LYS	2.5
77	Q1	7	LYS	2.5
2	s0	176	LEU	2.5
10	S8	145	ALA	2.5
11	s9	141	VAL	2.5
12	c0	19	GLY	2.5
16	C4	79	VAL	2.5
47	m0	128	ARG	2.5
58	N2	54	VAL	2.5
62	n6	104	LEU	2.5
1	2	173	A	2.5

Continued on next page...

Continued from previous page...

Mol	Chain	Res	Type	RSRZ
1	2	492	A	2.5
11	s9	152	SER	2.5
20	c8	48	LYS	2.5
27	D5	70	LYS	2.5
34	sR	61	PHE	2.5
46	L9	10	ILE	2.5
42	L5	124	GLU	2.5
77	Q1	17	ARG	2.5
5	S3	218	LEU	2.5
6	s4	182	TYR	2.5
9	S7	38	LEU	2.5
12	c0	15	LEU	2.5
16	C4	102	LEU	2.5
35	sM	60	ALA	2.5
39	L2	59	ALA	2.5
45	L8	55	TYR	2.5
45	l8	115	ALA	2.5
16	c4	65	GLN	2.5
29	D7	47	PHE	2.5
42	L5	145	PHE	2.5
42	l5	4	GLN	2.5
46	L9	177	ASP	2.5
46	L9	190	ASP	2.5
58	N2	91	ASP	2.5
59	N3	7	GLN	2.5
13	C1	77	SER	2.5
27	D5	71	ILE	2.5
33	E1	93	HIS	2.5
24	D2	68	ARG	2.5
2	s0	147	THR	2.5
3	S1	127	VAL	2.5
4	s2	90	THR	2.5
10	S8	62	THR	2.5
12	C0	42	VAL	2.5
12	C0	55	VAL	2.5
32	e0	62	VAL	2.5
34	sR	167	VAL	2.5
4	S2	222	TYR	2.5
9	S7	173	TYR	2.5
34	SR	137	LYS	2.5
34	sR	78	ALA	2.5
45	L8	210	ALA	2.5

Continued on next page...

Continued from previous page...

Mol	Chain	Res	Type	RSRZ
58	n2	37	LEU	2.5
11	s9	48	GLN	2.5
16	C4	135	ARG	2.5
28	D6	52	ASP	2.5
18	C6	93	HIS	2.5
34	sR	246	SER	2.5
35	SM	45	SER	2.5
36	5	1349	G	2.5
43	L6	88	SER	2.5
55	m9	179	GLU	2.5
14	C2	126	TRP	2.4
17	c5	80	MET	2.4
1	2	1776	A	2.4
2	s0	25	GLY	2.4
6	s4	44	LEU	2.4
18	C6	32	ASN	2.4
18	c6	26	LYS	2.4
19	C7	115	LEU	2.4
43	L6	58	LEU	2.4
47	M0	181	TYR	2.4
49	m3	112	ASN	2.4
62	N6	35	LEU	2.4
64	N8	73	LEU	2.4
65	N9	54	LEU	2.4
16	c4	106	ALA	2.4
36	1	3155	U	2.4
36	5	2501	U	2.4
42	L5	93	THR	2.4
45	l8	199	ALA	2.4
3	S1	171	ILE	2.4
5	S3	90	ARG	2.4
7	s5	157	ARG	2.4
11	S9	126	ARG	2.4
14	c2	71	ILE	2.4
22	d0	89	ARG	2.4
29	d7	38	PRO	2.4
39	l2	250	GLN	2.4
60	N4	66	GLU	2.4
11	S9	121	SER	2.4
26	D4	117	LYS	2.4
34	SR	295	SER	2.4
31	D9	6	VAL	2.4

Continued on next page...

Continued from previous page...

Mol	Chain	Res	Type	RSRZ
34	sR	45	TRP	2.4
42	l5	87	GLY	2.4
49	M3	172	LEU	2.4
1	2	239	C	2.4
1	2	489	C	2.4
7	s5	82	PHE	2.4
10	S8	109	PHE	2.4
11	s9	164	PHE	2.4
20	C8	141	THR	2.4
21	C9	57	ARG	2.4
35	SM	82	THR	2.4
42	L5	20	PHE	2.4
2	s0	161	PRO	2.4
11	S9	160	PRO	2.4
19	C7	23	LYS	2.4
27	d5	46	LYS	2.4
42	L5	143	LYS	2.4
45	l8	181	LYS	2.4
49	m3	153	ASP	2.4
2	S0	146	LEU	2.4
21	c9	9	VAL	2.4
26	D4	120	GLY	2.4
30	D8	21	SER	2.4
63	n7	12	VAL	2.4
73	o7	84	SER	2.4
5	s3	25	PHE	2.4
34	SR	281	TYR	2.4
1	2	491	C	2.4
52	M6	42	ASN	2.4
2	s0	15	GLN	2.4
8	S6	190	GLN	2.4
36	5	1353	U	2.4
74	o8	40	GLN	2.4
3	S1	225	VAL	2.4
5	S3	48	VAL	2.4
6	S4	17	HIS	2.4
11	s9	36	LEU	2.4
11	s9	172	VAL	2.4
39	l2	29	LEU	2.4
66	o0	90	VAL	2.4
12	C0	48	SER	2.4
47	M0	80	SER	2.4

Continued on next page...

Continued from previous page...

Mol	Chain	Res	Type	RSRZ
47	M0	68	ALA	2.4
4	S2	139	ILE	2.4
7	S5	89	ILE	2.4
12	c0	11	ILE	2.4
34	sR	184	ASN	2.4
47	m0	212	GLU	2.4
58	N2	38	ILE	2.4
63	N7	64	LYS	2.4
1	6	665	U	2.4
1	6	1709	C	2.4
6	s4	150	PRO	2.4
2	s0	47	VAL	2.4
6	s4	9	LEU	2.4
19	C7	58	MET	2.4
24	d2	63	VAL	2.4
1	6	487	G	2.4
4	S2	78	ASP	2.4
2	S0	106	SER	2.4
2	s0	202	TYR	2.4
10	S8	83	TYR	2.4
34	SR	35	SER	2.4
53	M7	130	TYR	2.4
74	o8	26	LYS	2.4
2	S0	180	GLU	2.4
24	D2	51	GLU	2.4
3	s1	192	VAL	2.4
13	C1	116	ARG	2.4
34	SR	319	ASN	2.4
47	M0	69	ARG	2.4
75	o9	11	GLN	2.4
76	Q0	120	GLN	2.4
13	c1	31	THR	2.4
30	D8	56	LEU	2.4
18	C6	11	GLY	2.4
63	n7	50	PRO	2.4
1	6	670	U	2.4
1	6	794	U	2.4
11	s9	47	PHE	2.4
42	L5	29	ASP	2.4
42	L5	164	LYS	2.4
58	n2	15	PHE	2.4
6	s4	103	TYR	2.4

Continued on next page...

Continued from previous page...

Mol	Chain	Res	Type	RSRZ
56	N0	2	ALA	2.4
1	2	1002	G	2.4
34	SR	199	ILE	2.4
42	L5	220	SER	2.4
49	m3	123	ILE	2.4
58	N2	11	ILE	2.4
74	o8	3	ARG	2.4
2	s0	57	LEU	2.4
3	s1	134	VAL	2.4
5	s3	99	VAL	2.4
6	S4	61	VAL	2.4
60	n4	96	LEU	2.4
81	p0	27	VAL	2.4
3	S1	174	LYS	2.4
68	o2	62	LYS	2.4
11	s9	4	ALA	2.4
14	c2	92	ALA	2.4
2	S0	113	ARG	2.4
18	C6	66	ARG	2.4
26	d4	2	SER	2.4
5	s3	142	LEU	2.4
6	S4	89	VAL	2.4
8	S6	54	GLY	2.4
8	S6	64	LYS	2.4
13	C1	26	LYS	2.4
17	C5	105	VAL	2.4
18	C6	107	LYS	2.4
22	d0	15	GLN	2.4
29	D7	72	LYS	2.4
34	sR	228	LYS	2.4
40	L3	57	VAL	2.4
57	N1	106	LEU	2.4
32	e0	51	ASN	2.4
48	M1	83	GLY	2.4
7	S5	184	PHE	2.4
9	s7	39	ARG	2.4
16	c4	58	TYR	2.4
21	c9	124	ILE	2.4
8	s6	212	LEU	2.4
10	S8	53	LYS	2.4
28	d6	26	CYS	2.4
32	E0	36	LYS	2.4

Continued on next page...

Continued from previous page...

Mol	Chain	Res	Type	RSRZ
47	m0	87	LEU	2.4
47	m0	103	LEU	2.4
47	m0	191	LYS	2.4
58	n2	76	LEU	2.4
68	o2	4	LEU	2.4
18	C6	60	PHE	2.4
40	L3	323	MET	2.4
42	L5	201	GLY	2.4
46	L9	178	GLY	2.4
5	S3	62	ASN	2.4
6	s4	77	ARG	2.4
7	S5	79	ASN	2.4
12	C0	28	ASN	2.4
12	c0	63	TYR	2.4
18	C6	3	ALA	2.4
32	E0	40	TYR	2.4
67	o1	82	GLU	2.4
6	S4	7	LYS	2.4
43	L6	8	LYS	2.4
45	L8	200	LEU	2.4
55	M9	24	LEU	2.4
3	S1	93	GLY	2.4
16	c4	44	GLY	2.4
21	c9	114	VAL	2.4
22	d0	16	GLN	2.4
25	D3	63	GLN	2.4
27	D5	72	GLY	2.4
42	L5	125	VAL	2.4
8	s6	188	ARG	2.4
6	s4	82	TYR	2.4
16	C4	40	ALA	2.4
24	d2	51	GLU	2.4
2	s0	92	HIS	2.4
19	c7	69	ILE	2.4
21	C9	135	ILE	2.4
45	L8	74	THR	2.4
45	l8	211	LEU	2.4
48	M1	112	LEU	2.4
77	q1	13	LEU	2.4
6	S4	72	VAL	2.4
1	2	1340	U	2.4
1	6	234	G	2.4

Continued on next page...

Continued from previous page...

Mol	Chain	Res	Type	RSRZ
5	s3	107	PHE	2.4
28	d6	10	ARG	2.4
47	M0	136	PHE	2.4
63	n7	132	SER	2.4
3	S1	90	GLU	2.4
4	S2	88	LYS	2.4
12	C0	44	LYS	2.4
33	e1	111	GLU	2.4
10	S8	183	ILE	2.4
15	C3	37	ILE	2.4
17	C5	101	ALA	2.4
64	N8	111	LYS	2.4
28	D6	25	ASN	2.4
49	m3	93	ILE	2.4
2	s0	168	HIS	2.4
51	m5	22	LEU	2.4
1	2	483	A	2.3
2	S0	47	VAL	2.3
14	C2	31	VAL	2.3
17	C5	10	ARG	2.3
26	d4	23	PHE	2.3
47	m0	35	ASP	2.3
49	M3	98	ASP	2.3
2	s0	40	ALA	2.3
9	S7	58	LEU	2.3
3	s1	153	HIS	2.3
8	S6	153	VAL	2.3
8	s6	195	VAL	2.3
10	s8	46	VAL	2.3
14	C2	130	THR	2.3
48	M1	101	ASN	2.3
68	o2	6	HIS	2.3
12	c0	61	TRP	2.3
16	c4	15	GLY	2.3
17	C5	12	PHE	2.3
21	c9	121	GLY	2.3
34	SR	304	GLY	2.3
71	O5	3	GLY	2.3
11	s9	153	GLU	2.3
21	C9	23	GLN	2.3
28	D6	3	LYS	2.3
47	M0	191	LYS	2.3

Continued on next page...

Continued from previous page...

Mol	Chain	Res	Type	RSRZ
57	n1	35	LYS	2.3
14	C2	42	ALA	2.3
23	d1	73	ALA	2.3
26	D4	125	LEU	2.3
32	E0	39	LEU	2.3
35	SM	47	ALA	2.3
45	l8	113	ALA	2.3
58	N2	105	LEU	2.3
74	o8	71	PRO	2.3
83	f	37	ARG	2.3
1	6	1698	G	2.3
4	S2	46	LYS	2.3
6	S4	99	PHE	2.3
6	s4	122	LYS	2.3
10	s8	113	PHE	2.3
28	d6	11	ASN	2.3
42	l5	204	VAL	2.3
63	n7	20	GLY	2.3
5	s3	93	ASP	2.3
27	D5	48	ASP	2.3
29	D7	57	GLU	2.3
46	L9	90	MET	2.3
3	S1	60	ALA	2.3
9	s7	154	LEU	2.3
11	s9	145	SER	2.3
15	C3	16	ILE	2.3
24	D2	65	LEU	2.3
27	D5	80	LEU	2.3
28	D6	35	ALA	2.3
45	L8	84	ARG	2.3
45	L8	113	ALA	2.3
58	N2	76	LEU	2.3
63	N7	77	TYR	2.3
63	n7	80	LEU	2.3
34	sR	77	GLY	2.3
53	M7	174	GLY	2.3
62	n6	58	VAL	2.3
77	Q1	25	LYS	2.3
35	sM	30	THR	2.3
40	l3	233	TRP	2.3
47	m0	77	THR	2.3
48	M1	53	THR	2.3

Continued on next page...

Continued from previous page...

Mol	Chain	Res	Type	RSRZ
48	M1	70	THR	2.3
58	N2	87	ASN	2.3
58	n2	61	THR	2.3
1	6	1490	C	2.3
11	s9	6	ARG	2.3
6	S4	53	LYS	2.3
22	d0	119	ALA	2.3
34	sR	73	LEU	2.3
36	1	1954	G	2.3
55	M9	185	LEU	2.3
2	S0	107	PHE	2.3
2	S0	181	VAL	2.3
31	d9	18	SER	2.3
34	SR	113	VAL	2.3
47	m0	27	PRO	2.3
57	N1	126	VAL	2.3
67	O1	34	LYS	2.3
1	6	666	U	2.3
24	d2	21	GLY	2.3
63	N7	101	PHE	2.3
78	q2	106	PHE	2.3
56	N0	88	HIS	2.3
19	c7	106	THR	2.3
22	d0	104	THR	2.3
74	o8	39	ARG	2.3
83	f	137	THR	2.3
21	c9	27	LYS	2.3
22	d0	32	LYS	2.3
23	D1	73	ALA	2.3
23	d1	53	TYR	2.3
34	SR	81	LEU	2.3
34	sR	83	ALA	2.3
45	l8	106	LYS	2.3
57	n1	34	TYR	2.3
67	O1	18	LYS	2.3
3	S1	38	PHE	2.3
12	C0	21	VAL	2.3
34	SR	57	PRO	2.3
34	sR	309	VAL	2.3
47	M0	147	VAL	2.3
42	L5	87	GLY	2.3
10	s8	185	GLU	2.3

Continued on next page...

Continued from previous page...

Mol	Chain	Res	Type	RSRZ
11	S9	123	HIS	2.3
11	S9	149	ARG	2.3
16	C4	133	ARG	2.3
42	L5	50	ARG	2.3
46	L9	166	ARG	2.3
55	m9	170	ARG	2.3
3	s1	231	LEU	2.3
11	S9	154	LYS	2.3
17	c5	52	LYS	2.3
34	SR	4	ASN	2.3
34	sR	251	TRP	2.3
36	5	2099	A	2.3
4	S2	155	ALA	2.3
6	S4	82	TYR	2.3
9	s7	153	LEU	2.3
11	S9	45	ILE	2.3
17	c5	78	THR	2.3
47	m0	74	LYS	2.3
83	f	114	LYS	2.3
25	D3	59	ILE	2.3
25	D3	90	ASP	2.3
34	SR	2	ALA	2.3
51	m5	39	ALA	2.3
21	c9	54	PHE	2.3
28	D6	84	VAL	2.3
52	M6	7	VAL	2.3
42	L5	170	GLY	2.3
3	s1	154	SER	2.3
31	d9	13	ARG	2.3
34	SR	90	ARG	2.3
62	N6	87	LYS	2.3
1	6	1697	G	2.3
3	S1	188	LEU	2.3
7	s5	130	ILE	2.3
18	C6	116	LEU	2.3
21	C9	76	LEU	2.3
1	2	1689	A	2.3
12	C0	41	TYR	2.3
9	S7	85	PHE	2.3
9	s7	3	ALA	2.3
9	s7	6	ALA	2.3
13	C1	48	ALA	2.3

Continued on next page...

Continued from previous page...

Mol	Chain	Res	Type	RSRZ
18	C6	96	TYR	2.3
24	D2	27	ILE	2.3
25	d3	76	LEU	2.3
27	D5	83	LEU	2.3
36	1	2095	G	2.3
47	m0	70	ILE	2.3
21	C9	49	ASP	2.3
60	n4	133	THR	2.3
62	N6	107	THR	2.3
9	s7	53	GLY	2.3
39	l2	149	ARG	2.3
74	o8	35	GLY	2.3
59	N3	25	CYS	2.3
71	O5	45	LYS	2.3
6	s4	142	HIS	2.3
28	d6	17	HIS	2.3
34	SR	16	HIS	2.3
34	sR	183	LEU	2.3
74	o8	78	LEU	2.3
42	L5	61	ILE	2.3
7	s5	133	VAL	2.3
6	s4	85	GLY	2.3
11	S9	130	THR	2.3
15	C3	26	PHE	2.3
39	L2	235	ALA	2.3
61	N5	60	TYR	2.3
68	o2	120	THR	2.3
22	d0	83	GLU	2.3
34	sR	222	LEU	2.3
8	S6	101	ILE	2.3
24	d2	86	ILE	2.3
27	d5	68	ARG	2.3
40	l3	109	HIS	2.3
42	L5	239	ILE	2.3
66	O0	42	ILE	2.3
6	s4	27	TYR	2.3
11	s9	114	TYR	2.3
1	2	1686	C	2.3
6	s4	72	VAL	2.3
7	S5	62	VAL	2.3
7	S5	221	ALA	2.3
23	D1	32	VAL	2.3

Continued on next page...

Continued from previous page...

Mol	Chain	Res	Type	RSRZ
33	e1	84	VAL	2.3
34	SR	80	ALA	2.3
18	C6	40	GLU	2.3
29	D7	42	ASN	2.3
34	SR	96	THR	2.3
35	sM	82	THR	2.3
55	M9	49	THR	2.3
8	s6	173	PRO	2.3
12	c0	3	MET	2.3
1	2	169	A	2.3
23	D1	8	LEU	2.3
30	d8	56	LEU	2.3
45	l8	176	PRO	2.3
70	o4	51	LEU	2.3
4	S2	218	ILE	2.3
12	C0	12	HIS	2.3
18	C6	10	PHE	2.3
21	c9	11	ALA	2.3
25	d3	38	PHE	2.3
26	D4	110	GLN	2.3
25	d3	49	ALA	2.3
31	d9	43	PHE	2.3
7	s5	39	GLU	2.3
51	m5	52	GLY	2.3
36	1	1764	U	2.3
36	5	2509	U	2.3
54	M8	88	THR	2.3
74	O8	15	THR	2.3
12	C0	40	LEU	2.3
16	C4	103	ARG	2.3
17	c5	68	PRO	2.3
17	c5	109	PRO	2.3
21	C9	130	ARG	2.3
21	c9	132	LEU	2.3
43	L6	55	LEU	2.3
4	s2	178	ILE	2.3
5	S3	217	ILE	2.3
27	D5	41	ILE	2.3
34	sR	205	SER	2.3
41	l4	26	PHE	2.3
46	L9	175	PHE	2.3
58	N2	71	PHE	2.3

Continued on next page...

Continued from previous page...

Mol	Chain	Res	Type	RSRZ
36	5	1580	A	2.3
63	N7	49	TYR	2.3
47	m0	151	GLY	2.2
81	p0	47	GLY	2.2
8	S6	85	ARG	2.2
10	S8	141	ARG	2.2
34	sR	258	THR	2.2
45	l8	194	THR	2.2
63	n7	87	LEU	2.2
67	O1	97	LEU	2.2
75	O9	21	ARG	2.2
21	c9	36	ILE	2.2
25	d3	50	LYS	2.2
33	E1	83	LYS	2.2
29	D7	32	PHE	2.2
42	l5	190	ILE	2.2
81	p0	71	PRO	2.2
6	s4	136	VAL	2.2
32	e0	40	TYR	2.2
45	L8	132	VAL	2.2
3	s1	235	GLY	2.2
45	l8	250	ALA	2.2
47	M0	75	TYR	2.2
60	n4	128	ALA	2.2
81	p0	191	TYR	2.2
34	SR	82	SER	2.2
42	l5	205	SER	2.2
2	S0	185	ARG	2.2
9	s7	88	ARG	2.2
6	s4	92	LEU	2.2
10	s8	196	LEU	2.2
81	p0	67	LEU	2.2
19	C7	82	ASP	2.2
20	c8	23	ASP	2.2
1	2	908	U	2.2
2	s0	38	PHE	2.2
2	s0	76	ILE	2.2
5	S3	50	ILE	2.2
3	S1	66	VAL	2.2
7	S5	133	VAL	2.2
10	s8	65	PHE	2.2
11	S9	7	THR	2.2

Continued on next page...

Continued from previous page...

Mol	Chain	Res	Type	RSRZ
16	c4	112	ILE	2.2
22	d0	108	ILE	2.2
34	sR	168	THR	2.2
49	M3	86	THR	2.2
36	1	1241	U	2.2
45	L8	203	VAL	2.2
6	S4	124	GLY	2.2
16	C4	78	ALA	2.2
19	c7	62	GLN	2.2
24	D2	59	GLY	2.2
6	S4	24	SER	2.2
13	C1	82	ARG	2.2
60	n4	72	SER	2.2
6	s4	164	LEU	2.2
18	c6	132	LYS	2.2
22	D0	69	LYS	2.2
1	6	1800	A	2.2
3	S1	32	ILE	2.2
3	S1	173	THR	2.2
5	S3	17	PHE	2.2
7	s5	145	ASP	2.2
10	S8	160	PHE	2.2
39	L2	176	ASP	2.2
47	M0	31	ILE	2.2
61	N5	84	PHE	2.2
11	S9	113	VAL	2.2
30	D8	48	VAL	2.2
81	p0	94	THR	2.2
83	f	88	ASN	2.2
1	2	841	U	2.2
1	6	1433	G	2.2
1	6	1488	G	2.2
11	S9	12	TYR	2.2
22	d0	73	GLY	2.2
32	e0	52	GLY	2.2
62	N6	93	ALA	2.2
25	D3	31	LYS	2.2
2	s0	54	TRP	2.2
7	S5	72	HIS	2.2
28	d6	72	HIS	2.2
63	N7	116	LYS	2.2
6	S4	38	LEU	2.2

Continued on next page...

Continued from previous page...

Mol	Chain	Res	Type	RSRZ
11	S9	30	LEU	2.2
31	D9	36	LEU	2.2
50	M4	60	LEU	2.2
58	N2	67	SER	2.2
2	S0	48	ILE	2.2
11	S9	129	ILE	2.2
12	C0	59	PHE	2.2
2	S0	101	ARG	2.2
21	c9	8	ASP	2.2
42	l5	37	VAL	2.2
3	S1	102	GLY	2.2
14	C2	82	PRO	2.2
18	C6	128	LYS	2.2
20	c8	121	ALA	2.2
28	D6	32	LYS	2.2
42	L5	27	LYS	2.2
45	L8	107	GLU	2.2
46	l9	3	TYR	2.2
47	M0	186	GLU	2.2
48	M1	73	GLY	2.2
53	M7	177	ALA	2.2
67	o1	111	GLU	2.2
76	Q0	108	THR	2.2
70	o4	57	LEU	2.2
1	6	1705	C	2.2
6	S4	147	ILE	2.2
7	s5	156	ARG	2.2
12	C0	73	VAL	2.2
18	C6	69	VAL	2.2
24	D2	34	ILE	2.2
47	M0	138	VAL	2.2
48	M1	67	VAL	2.2
49	m3	138	VAL	2.2
52	M6	3	VAL	2.2
72	o6	93	ILE	2.2
11	s9	180	LYS	2.2
9	S7	171	ALA	2.2
9	s7	63	PRO	2.2
17	C5	17	TYR	2.2
34	SR	165	ASP	2.2
62	N6	88	GLU	2.2
63	N7	60	LYS	2.2

Continued on next page...

Continued from previous page...

Mol	Chain	Res	Type	RSRZ
22	d0	72	ASN	2.2
33	e1	110	ALA	2.2
45	L8	199	ALA	2.2
49	m3	144	THR	2.2
11	s9	118	LEU	2.2
28	D6	77	CYS	2.2
45	L8	186	LEU	2.2
1	2	909	U	2.2
7	S5	98	MET	2.2
8	S6	156	PHE	2.2
15	C3	25	TRP	2.2
36	1	252	U	2.2
42	L5	203	HIS	2.2
4	S2	103	VAL	2.2
10	s8	59	ARG	2.2
20	C8	123	ARG	2.2
58	N2	93	ILE	2.2
63	N7	136	PHE	2.2
31	D9	23	VAL	2.2
40	L3	336	VAL	2.2
83	f	76	SER	2.2
1	6	490	C	2.2
34	SR	227	ALA	2.2
36	1	1017	C	2.2
36	1	1574	C	2.2
57	n1	23	GLY	2.2
57	n1	73	GLY	2.2
3	S1	35	PRO	2.2
23	D1	14	PRO	2.2
3	S1	172	LEU	2.2
4	S2	150	GLN	2.2
6	S4	98	ASN	2.2
8	S6	86	PRO	2.2
10	S8	167	ALA	2.2
35	SM	54	PRO	2.2
3	S1	29	TRP	2.2
16	c4	92	LYS	2.2
20	C8	68	ARG	2.2
25	D3	137	LYS	2.2
27	D5	49	ARG	2.2
45	L8	98	ARG	2.2
55	m9	181	ARG	2.2

Continued on next page...

Continued from previous page...

Mol	Chain	Res	Type	RSRZ
16	C4	118	VAL	2.2
18	c6	69	VAL	2.2
30	D8	44	VAL	2.2
42	l5	126	GLU	2.2
54	M8	167	SER	2.2
3	S1	227	ALA	2.2
8	s6	208	TYR	2.2
65	N9	2	ALA	2.2
42	l5	32	GLN	2.2
63	n7	128	GLN	2.2
70	o4	26	PRO	2.2
6	S4	11	ARG	2.2
16	c4	83	ILE	2.2
16	c4	115	ILE	2.2
83	f	21	MET	2.2
34	sR	105	GLY	2.2
17	C5	123	TYR	2.2
47	M0	34	TYR	2.2
63	N7	105	SER	2.2
32	E0	2	ALA	2.2
55	m9	183	ALA	2.2
68	o2	92	TYR	2.2
5	s3	29	LEU	2.2
5	s3	109	LEU	2.2
3	S1	104	ASP	2.2
8	s6	191	ARG	2.2
31	D9	40	ARG	2.2
33	e1	78	LYS	2.2
71	o5	106	LYS	2.2
6	S4	226	PHE	2.2
26	D4	77	ASN	2.2
43	L6	97	ASN	2.2
61	N5	111	ASN	2.2
63	N7	127	ASN	2.2
23	D1	82	VAL	2.2
34	sR	221	MET	2.2
35	sM	26	VAL	2.2
43	L6	96	VAL	2.2
74	O8	5	ILE	2.2
81	p0	190	VAL	2.2
16	c4	98	GLY	2.2
20	c8	37	GLY	2.2

Continued on next page...

Continued from previous page...

Mol	Chain	Res	Type	RSRZ
36	1	2503	G	2.2
60	n4	84	GLY	2.2
3	S1	51	SER	2.2
4	s2	181	SER	2.2
5	s3	3	ALA	2.2
11	s9	150	LEU	2.2
59	N3	54	LEU	2.2
63	n7	97	SER	2.2
3	s1	74	GLN	2.2
34	sR	51	ASP	2.2
55	m9	188	ASP	2.2
22	d0	36	ASN	2.2
34	SR	290	VAL	2.2
34	sR	178	VAL	2.2
45	l8	191	ASN	2.2
46	L9	140	VAL	2.2
47	M0	76	MET	2.2
48	M1	125	MET	2.2
57	n1	48	ILE	2.2
57	n1	76	ILE	2.2
67	O1	64	VAL	2.2
1	2	1796	C	2.2
23	D1	57	GLY	2.2
2	s0	41	ARG	2.2
2	s0	61	ALA	2.2
40	L3	338	LEU	2.2
1	2	504	U	2.2
1	2	1687	U	2.2
1	2	1795	U	2.2
1	6	710	U	2.2
68	O2	51	SER	2.2
2	s0	150	ASP	2.2
27	D5	64	VAL	2.2
32	e0	4	VAL	2.2
34	SR	76	ASP	2.2
34	SR	158	PRO	2.2
1	6	673	A	2.2
5	s3	177	MET	2.2
12	c0	78	GLU	2.2
34	sR	156	VAL	2.2
42	l5	148	ILE	2.2
9	S7	44	LYS	2.2

Continued on next page...

Continued from previous page...

Mol	Chain	Res	Type	RSRZ
11	S9	124	HIS	2.2
19	C7	59	LYS	2.2
21	c9	86	ARG	2.2
62	N6	91	ASN	2.2
63	N7	79	HIS	2.2
81	p0	14	LYS	2.2
8	S6	178	LEU	2.1
11	s9	97	LEU	2.1
20	c8	15	LEU	2.1
2	s0	60	ALA	2.1
11	s9	181	ALA	2.1
47	M0	155	ALA	2.1
58	n2	103	TYR	2.1
32	e0	44	PHE	2.1
66	O0	71	GLN	2.1
6	S4	43	PRO	2.1
10	s8	38	ILE	2.1
45	l8	143	ILE	2.1
65	n9	24	PRO	2.1
74	o8	37	PRO	2.1
34	SR	194	GLY	2.1
51	M5	58	GLY	2.1
60	N4	69	LYS	2.1
1	2	285	G	2.1
1	6	677	G	2.1
1	2	451	A	2.1
3	s1	117	TRP	2.1
13	C1	40	LEU	2.1
2	S0	159	ALA	2.1
24	d2	130	TYR	2.1
36	5	1813	A	2.1
47	m0	95	HIS	2.1
58	N2	79	LEU	2.1
71	O5	46	THR	2.1
49	m3	148	ALA	2.1
83	f	146	ALA	2.1
12	C0	11	ILE	2.1
20	c8	123	ARG	2.1
25	D3	39	LYS	2.1
25	D3	72	VAL	2.1
33	e1	113	LYS	2.1
42	L5	133	GLU	2.1

Continued on next page...

Continued from previous page...

Mol	Chain	Res	Type	RSRZ
45	L8	185	ARG	2.1
45	l8	159	PRO	2.1
61	n5	26	VAL	2.1
62	N6	96	PRO	2.1
77	Q1	15	ARG	2.1
1	2	912	U	2.1
12	C0	26	ASP	2.1
49	M3	51	LEU	2.1
62	N6	111	LEU	2.1
10	S8	44	HIS	2.1
12	C0	30	ALA	2.1
24	D2	46	TYR	2.1
26	d4	9	THR	2.1
26	d4	34	ASN	2.1
27	D5	101	TYR	2.1
42	l5	68	THR	2.1
45	l8	137	ASN	2.1
3	s1	219	LYS	2.1
9	S7	33	GLU	2.1
18	C6	45	ARG	2.1
29	d7	5	GLN	2.1
36	1	1036	A	2.1
36	1	1271	A	2.1
47	M0	59	GLN	2.1
55	M9	172	ARG	2.1
73	o7	85	LYS	2.1
14	C2	30	VAL	2.1
23	D1	39	VAL	2.1
25	D3	53	VAL	2.1
58	N2	41	ILE	2.1
18	c6	124	PRO	2.1
18	c6	130	GLY	2.1
47	M0	27	PRO	2.1
1	6	261	U	2.1
1	6	711	U	2.1
30	d8	33	LEU	2.1
36	5	2507	C	2.1
42	l5	236	LEU	2.1
48	m1	173	ASP	2.1
61	N5	24	LEU	2.1
74	o8	58	ASP	2.1
55	M9	23	TRP	2.1

Continued on next page...

Continued from previous page...

Mol	Chain	Res	Type	RSRZ
58	N2	36	TYR	2.1
11	S9	174	ARG	2.1
15	C3	67	THR	2.1
47	M0	139	ARG	2.1
48	M1	147	THR	2.1
5	s3	73	VAL	2.1
13	C1	64	VAL	2.1
16	c4	74	VAL	2.1
27	D5	54	VAL	2.1
34	SR	189	GLU	2.1
34	sR	139	GLN	2.1
64	n8	124	ILE	2.1
2	S0	184	LEU	2.1
6	s4	234	PRO	2.1
20	C8	101	LEU	2.1
28	D6	88	SER	2.1
29	D7	30	SER	2.1
42	L5	161	GLY	2.1
2	S0	138	TYR	2.1
19	C7	21	TYR	2.1
26	d4	26	ASP	2.1
45	l8	254	ASP	2.1
47	m0	44	ASP	2.1
47	m0	198	LYS	2.1
34	SR	294	TRP	2.1
40	L3	177	HIS	2.1
5	S3	188	ILE	2.1
7	S5	132	VAL	2.1
31	d9	37	ASN	2.1
15	c3	66	ILE	2.1
30	d8	40	ILE	2.1
34	SR	185	GLN	2.1
43	l6	149	ILE	2.1
5	s3	71	LEU	2.1
8	S6	69	LEU	2.1
14	C2	36	LEU	2.1
19	C7	24	LEU	2.1
19	c7	57	LEU	2.1
5	s3	106	LYS	2.1
6	s4	35	PRO	2.1
22	d0	55	PRO	2.1
24	d2	26	LEU	2.1

Continued on next page...

Continued from previous page...

Mol	Chain	Res	Type	RSRZ
67	O1	104	LEU	2.1
30	D8	45	LYS	2.1
49	m3	122	LYS	2.1
63	N7	27	LYS	2.1
3	S1	131	ASP	2.1
5	S3	152	PHE	2.1
21	c9	10	ALA	2.1
21	c9	91	TYR	2.1
22	d0	92	ASP	2.1
74	o8	62	ALA	2.1
1	2	192	U	2.1
1	2	768	C	2.1
1	6	275	C	2.1
6	s4	102	VAL	2.1
6	s4	160	VAL	2.1
29	d7	57	GLU	2.1
43	L6	129	GLU	2.1
63	n7	120	GLU	2.1
53	M7	29	THR	2.1
13	C1	62	GLY	2.1
5	S3	185	LYS	2.1
6	S4	9	LEU	2.1
9	s7	77	LEU	2.1
39	l2	248	GLY	2.1
42	L5	102	GLY	2.1
83	f	118	GLY	2.1
26	D4	41	ARG	2.1
74	O8	74	LYS	2.1
26	d4	30	PRO	2.1
5	s3	32	GLU	2.1
11	S9	177	ALA	2.1
11	s9	95	TYR	2.1
30	d8	28	VAL	2.1
39	l2	143	GLU	2.1
44	l7	23	ALA	2.1
56	n0	2	ALA	2.1
1	2	1221	A	2.1
13	C1	117	VAL	2.1
60	N4	65	GLU	2.1
23	d1	34	ILE	2.1
36	1	2540	A	2.1
63	n7	113	VAL	2.1

Continued on next page...

Continued from previous page...

Mol	Chain	Res	Type	RSRZ
6	s4	242	LYS	2.1
11	s9	108	ARG	2.1
14	C2	34	THR	2.1
16	c4	31	THR	2.1
20	C8	9	GLY	2.1
27	d5	105	THR	2.1
28	d6	34	LYS	2.1
31	D9	44	ARG	2.1
34	SR	89	LEU	2.1
34	sR	319	ASN	2.1
36	1	2206	G	2.1
48	m1	140	ARG	2.1
55	M9	175	GLN	2.1
56	N0	95	ARG	2.1
5	S3	216	PRO	2.1
11	s9	169	PRO	2.1
34	SR	171	SER	2.1
3	s1	21	VAL	2.1
5	s3	39	VAL	2.1
7	S5	219	ARG	2.1
10	s8	169	ILE	2.1
42	L5	65	ILE	2.1
51	m5	18	VAL	2.1
67	O1	108	VAL	2.1
70	O4	35	VAL	2.1
17	C5	128	HIS	2.1
20	C8	32	LEU	2.1
25	D3	24	TRP	2.1
25	D3	44	GLY	2.1
34	SR	203	THR	2.1
34	SR	306	THR	2.1
36	1	2207	A	2.1
49	m3	114	GLN	2.1
2	s0	203	PHE	2.1
49	m3	86	THR	2.1
1	2	449	C	2.1
4	S2	85	PRO	2.1
63	n7	82	PRO	2.1
6	S4	127	LYS	2.1
10	S8	106	ALA	2.1
19	c7	66	VAL	2.1
29	D7	46	VAL	2.1

Continued on next page...

Continued from previous page...

Mol	Chain	Res	Type	RSRZ
40	L3	115	LYS	2.1
55	m9	165	LYS	2.1
48	M1	122	ILE	2.1
66	O0	92	ILE	2.1
18	c6	83	GLN	2.1
45	l8	77	GLN	2.1
15	C3	61	THR	2.1
5	s3	153	ALA	2.1
6	S4	30	ARG	2.1
9	S7	4	PRO	2.1
26	D4	76	TYR	2.1
34	sR	161	LYS	2.1
47	M0	11	TYR	2.1
51	M5	6	TYR	2.1
36	1	1761	C	2.1
39	L2	134	VAL	2.1
53	M7	2	ALA	2.1
2	S0	76	ILE	2.1
12	c0	35	ILE	2.1
46	L9	144	ILE	2.1
2	s0	17	LEU	2.1
6	s4	260	GLY	2.1
16	c4	45	GLY	2.1
47	M0	61	SER	2.1
47	m0	62	SER	2.1
36	5	170	G	2.1
5	s3	83	THR	2.1
6	s4	91	THR	2.1
11	s9	171	ARG	2.1
24	D2	18	GLU	2.1
33	e1	81	LYS	2.1
62	N6	98	ASN	2.1
70	o4	21	LYS	2.1
34	SR	41	THR	2.1
34	SR	303	ALA	2.1
35	sM	44	PRO	2.1
38	4	125	U	2.1
40	l3	164	THR	2.1
17	C5	76	VAL	2.1
17	C5	94	VAL	2.1
17	c5	86	VAL	2.1
21	C9	90	PRO	2.1

Continued on next page...

Continued from previous page...

Mol	Chain	Res	Type	RSRZ
47	M0	16	PRO	2.1
57	N1	109	VAL	2.1
1	6	492	A	2.1
18	c6	29	ILE	2.1
36	5	1575	A	2.1
51	m5	142	ILE	2.1
11	S9	32	GLY	2.1
62	N6	99	LEU	2.1
1	6	1082	C	2.1
25	d3	145	SER	2.1
42	L5	235	SER	2.1
5	S3	177	MET	2.1
18	c6	98	ASP	2.1
27	D5	67	ASP	2.1
5	s3	40	ARG	2.0
8	s6	115	LYS	2.0
40	L3	174	LYS	2.0
42	l5	200	PHE	2.0
10	S8	187	GLU	2.0
23	d1	44	ARG	2.0
74	o8	44	LYS	2.0
1	2	501	U	2.0
2	s0	29	VAL	2.0
19	C7	124	VAL	2.0
22	d0	90	TYR	2.0
34	SR	204	ALA	2.0
61	N5	103	TYR	2.0
34	sR	188	ILE	2.0
36	1	1028	U	2.0
59	n3	4	ASN	2.0
11	s9	134	ILE	2.0
72	O6	22	PRO	2.0
40	l3	245	GLY	2.0
51	m5	58	GLY	2.0
23	D1	65	SER	2.0
25	D3	122	PHE	2.0
26	D4	61	ARG	2.0
31	D9	12	ARG	2.0
34	SR	66	HIS	2.0
39	L2	223	SER	2.0
66	O0	64	LYS	2.0
40	L3	80	ASP	2.0

Continued on next page...

Continued from previous page...

Mol	Chain	Res	Type	RSRZ
47	m0	171	TRP	2.0
60	n4	106	GLU	2.0
33	e1	102	VAL	2.0
42	L5	204	VAL	2.0
63	N7	23	VAL	2.0
4	S2	236	PRO	2.0
8	S6	147	LEU	2.0
11	S9	24	LEU	2.0
16	c4	43	THR	2.0
17	C5	78	THR	2.0
42	l5	36	LEU	2.0
42	l5	146	LEU	2.0
59	N3	36	ILE	2.0
67	O1	16	LEU	2.0
79	Q3	22	LEU	2.0
18	C6	14	LYS	2.0
24	D2	71	LYS	2.0
77	Q1	8	LYS	2.0
16	C4	41	ARG	2.0
35	SM	53	ARG	2.0
47	m0	76	MET	2.0
81	p0	48	ARG	2.0
17	C5	104	GLN	2.0
31	d9	45	GLU	2.0
78	Q2	102	GLN	2.0
6	s4	105	VAL	2.0
18	c6	49	TYR	2.0
28	D6	62	TYR	2.0
7	s5	137	ILE	2.0
14	c2	32	LEU	2.0
47	M0	67	ALA	2.0
83	f	25	ALA	2.0
34	SR	261	LYS	2.0
34	sR	311	ARG	2.0
35	SM	39	PRO	2.0
60	N4	41	LYS	2.0
67	o1	45	GLY	2.0
71	o5	107	LYS	2.0
83	f	151	LYS	2.0
3	S1	99	ASN	2.0
8	s6	197	ASN	2.0
17	c5	10	ARG	2.0

Continued on next page...

Continued from previous page...

Mol	Chain	Res	Type	RSRZ
35	sM	69	ARG	2.0
45	L8	188	THR	2.0
58	N2	64	THR	2.0
12	C0	3	MET	2.0
60	N4	1	MET	2.0
1	2	377	G	2.0
8	s6	182	GLN	2.0
23	D1	33	GLN	2.0
23	D1	68	SER	2.0
32	e0	61	SER	2.0
24	d2	62	VAL	2.0
28	D6	24	VAL	2.0
35	SM	78	ASP	2.0
55	m9	51	VAL	2.0
10	s8	34	ALA	2.0
12	c0	30	ALA	2.0
24	d2	27	ILE	2.0
26	D4	90	ARG	2.0
28	D6	64	LEU	2.0
2	S0	38	PHE	2.0
20	c8	11	PHE	2.0
24	D2	37	PHE	2.0
50	m4	92	GLU	2.0
1	2	499	U	2.0
2	S0	137	SER	2.0
2	S0	157	ASP	2.0
3	S1	21	VAL	2.0
3	s1	225	VAL	2.0
4	s2	64	LYS	2.0
6	s4	235	TYR	2.0
7	s5	203	LYS	2.0
9	s7	90	VAL	2.0
18	c6	55	VAL	2.0
21	C9	30	VAL	2.0
27	d5	60	VAL	2.0
42	l5	95	TRP	2.0
6	s4	48	LEU	2.0
12	C0	23	ALA	2.0
18	c6	54	LEU	2.0
42	l5	233	ALA	2.0
45	l8	196	ALA	2.0
48	M1	141	ARG	2.0

Continued on next page...

Continued from previous page...

Mol	Chain	Res	Type	RSRZ
63	n7	44	ALA	2.0
74	o8	27	ILE	2.0
26	D4	60	PHE	2.0
49	m3	75	PHE	2.0
61	N5	66	PRO	2.0
1	6	1702	A	2.0
32	e0	53	LYS	2.0
35	sM	50	ASN	2.0
83	f	144	GLU	2.0
63	N7	67	LYS	2.0
2	S0	143	VAL	2.0
18	c6	68	ARG	2.0
19	c7	35	CYS	2.0
19	c7	109	LEU	2.0
29	d7	7	LEU	2.0
40	L3	78	VAL	2.0
48	M1	128	TYR	2.0
60	N4	20	LEU	2.0
67	O1	79	ARG	2.0

6.2 Non-standard residues in protein, DNA, RNA chains [i](#)

There are no non-standard protein/DNA/RNA residues in this entry.

6.3 Carbohydrates [i](#)

There are no monosaccharides in this entry.

6.4 Ligands [i](#)

In the following table, the Atoms column lists the number of modelled atoms in the group and the number defined in the chemical component dictionary. The B-factors column lists the minimum, median, 95th percentile and maximum values of B factors of atoms in the group. The column labelled 'Q< 0.9' lists the number of atoms with occupancy less than 0.9.

Mol	Type	Chain	Res	Atoms	RSCC	RSR	B-factors(Å ²)	Q<0.9
85	ZN	e1	501	1/1	0.79	0.08	164,164,164,164	0
85	ZN	D7	101	1/1	0.81	0.21	141,141,141,141	0
85	ZN	d7	101	1/1	0.82	0.16	131,131,131,131	0
87	MG	5	3402	1/1	0.84	0.36	45,45,45,45	0

Continued on next page...

Continued from previous page...

Mol	Type	Chain	Res	Atoms	RSCC	RSR	B-factors(\AA^2)	Q<0.9
87	MG	1	3403	1/1	0.89	0.38	45,45,45,45	0
85	ZN	Q2	501	1/1	0.91	0.05	76,76,76,76	0
87	MG	1	3402	1/1	0.93	0.65	21,21,21,21	0
87	MG	f	1002	1/1	0.93	0.08	66,66,66,66	0
87	MG	1	3404	1/1	0.94	0.65	29,29,29,29	0
85	ZN	D6	500	1/1	0.94	0.07	105,105,105,105	0
86	SPS	1	3401	23/23	0.94	0.24	40,43,57,59	0
87	MG	C	101	1/1	0.94	0.31	49,49,49,49	0
87	MG	5	3405	1/1	0.95	0.74	42,42,42,42	0
87	MG	5	3401	1/1	0.95	0.38	41,41,41,41	0
87	MG	5	3404	1/1	0.95	0.48	36,36,36,36	0
87	MG	B	3402	1/1	0.96	0.32	40,40,40,40	0
86	SPS	B	3401	23/23	0.96	0.31	37,40,54,56	0
87	MG	f	1001	1/1	0.97	0.33	52,52,52,52	0
85	ZN	E1	501	1/1	0.97	0.05	136,136,136,136	0
85	ZN	d6	500	1/1	0.97	0.06	87,87,87,87	0
85	ZN	q2	501	1/1	0.97	0.05	77,77,77,77	0
85	ZN	D9	101	1/1	0.98	0.08	88,88,88,88	0
87	MG	5	3403	1/1	0.98	0.55	23,23,23,23	0
85	ZN	Q3	501	1/1	0.98	0.11	77,77,77,77	0
85	ZN	Q0	500	1/1	0.98	0.10	57,57,57,57	0
88	OHX	1	3405	7/7	0.98	0.09	91,91,91,91	0
88	OHX	5	3406	7/7	0.98	0.09	95,95,95,95	0
85	ZN	O7	100	1/1	0.99	0.14	52,52,52,52	0
85	ZN	o7	501	1/1	0.99	0.21	51,51,51,51	0
85	ZN	q0	500	1/1	0.99	0.13	42,42,42,42	0
88	OHX	1	3406	7/7	0.99	0.14	73,73,73,73	0
85	ZN	d9	101	1/1	0.99	0.09	94,94,94,94	0
85	ZN	q3	501	1/1	1.00	0.17	69,69,69,69	0

6.5 Other polymers [\(i\)](#)

There are no such residues in this entry.