



Full wwPDB X-ray Structure Validation Report ⓘ

Nov 6, 2023 – 01:26 AM EST

PDB ID : 8EQW
Title : Crystal structure of Fub7
Authors : Hai, Y.
Deposited on : 2022-10-10
Resolution : 1.76 Å(reported)

This is a Full wwPDB X-ray Structure Validation Report for a publicly released PDB entry.

We welcome your comments at validation@mail.wwpdb.org

A user guide is available at

<https://www.wwpdb.org/validation/2017/XrayValidationReportHelp>

with specific help available everywhere you see the ⓘ symbol.

The types of validation reports are described at

<http://www.wwpdb.org/validation/2017/FAQs#types>.

The following versions of software and data (see [references ⓘ](#)) were used in the production of this report:

MolProbity : 4.02b-467
Mogul : 1.8.5 (274361), CSD as541be (2020)
Xtrriage (Phenix) : 1.13
EDS : 2.36
Percentile statistics : 20191225.v01 (using entries in the PDB archive December 25th 2019)
Refmac : 5.8.0158
CCP4 : 7.0.044 (Gargrove)
Ideal geometry (proteins) : Engh & Huber (2001)
Ideal geometry (DNA, RNA) : Parkinson et al. (1996)
Validation Pipeline (wwPDB-VP) : 2.36

1 Overall quality at a glance

The following experimental techniques were used to determine the structure:

X-RAY DIFFRACTION

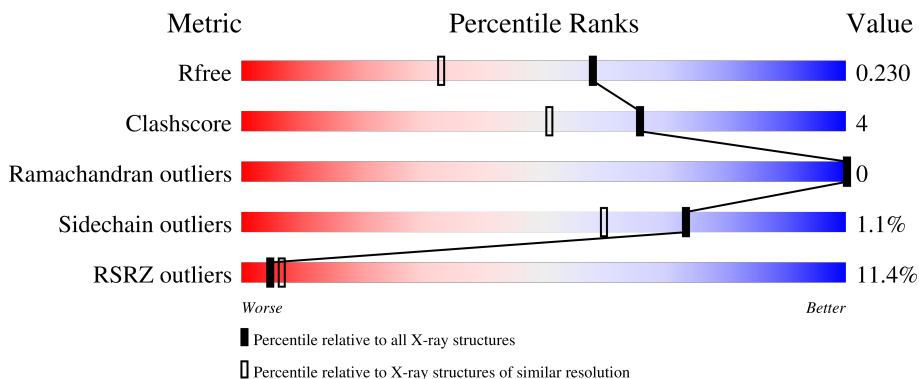

The reported resolution of this entry is 1.76 Å.

Percentile scores (ranging between 0-100) for global validation metrics of the entry are shown in the following graphic. The table shows the number of entries on which the scores are based.



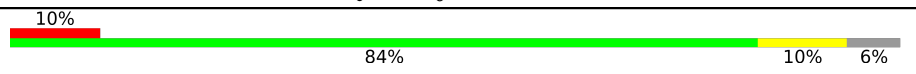
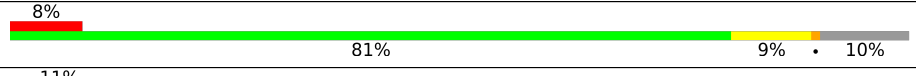

Metric	Whole archive (#Entries)	Similar resolution (#Entries, resolution range(Å))
R_{free}	130704	2340 (1.76-1.76)
Clashscore	141614	2466 (1.76-1.76)
Ramachandran outliers	138981	2437 (1.76-1.76)
Sidechain outliers	138945	2437 (1.76-1.76)
RSRZ outliers	127900	2298 (1.76-1.76)

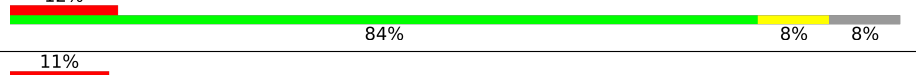
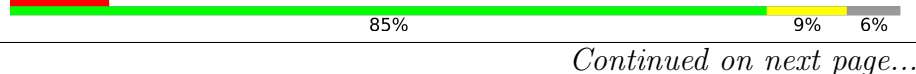
The table below summarises the geometric issues observed across the polymeric chains and their fit to the electron density. The red, orange, yellow and green segments of the lower bar indicate the fraction of residues that contain outliers for ≥ 3 , 2, 1 and 0 types of geometric quality criteria respectively. A grey segment represents the fraction of residues that are not modelled. The numeric value for each fraction is indicated below the corresponding segment, with a dot representing fractions $\leq 5\%$. The upper red bar (where present) indicates the fraction of residues that have poor fit to the electron density. The numeric value is given above the bar.

Mol	Chain	Length	Quality of chain
1	A	450	
1	B	450	
1	C	450	
1	D	450	
1	E	450	

Continued on next page...

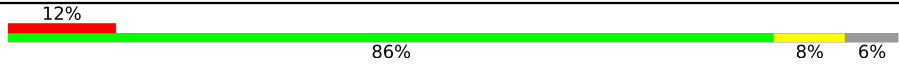
Continued from previous page...

Mol	Chain	Length	Quality of chain
1	F	450	
1	G	450	
1	H	450	

2 Entry composition [i](#)

There are 2 unique types of molecules in this entry. The entry contains 27419 atoms, of which 0 are hydrogens and 0 are deuteriums.

In the tables below, the ZeroOcc column contains the number of atoms modelled with zero occupancy, the AltConf column contains the number of residues with at least one atom in alternate conformation and the Trace column contains the number of residues modelled with at most 2 atoms.

- Molecule 1 is a protein called Sulphydrylase FUB7.

Mol	Chain	Residues	Atoms					ZeroOcc	AltConf	Trace	
			Total	C	N	O	P				S
1	A	422	3259	2070	561	620	1	7	0	0	0
1	B	407	3143	2000	538	597	1	7	0	0	0
1	C	418	3220	2046	554	612	1	7	0	0	0
1	D	414	3198	2035	548	607	1	7	0	0	0
1	E	424	3271	2075	563	625	1	7	0	0	0
1	F	424	3272	2074	563	627	1	7	0	0	0
1	G	415	3210	2042	552	608	1	7	0	1	0
1	H	426	3289	2085	566	630	1	7	0	0	0

There are 144 discrepancies between the modelled and reference sequences:

Chain	Residue	Modelled	Actual	Comment	Reference
A	-16	MET	-	initiating methionine	UNP S0DUX5
A	-15	GLY	-	expression tag	UNP S0DUX5
A	-14	SER	-	expression tag	UNP S0DUX5
A	-13	SER	-	expression tag	UNP S0DUX5
A	-12	HIS	-	expression tag	UNP S0DUX5
A	-11	HIS	-	expression tag	UNP S0DUX5
A	-10	HIS	-	expression tag	UNP S0DUX5
A	-9	HIS	-	expression tag	UNP S0DUX5
A	-8	HIS	-	expression tag	UNP S0DUX5
A	-7	HIS	-	expression tag	UNP S0DUX5
A	-6	GLU	-	expression tag	UNP S0DUX5
A	-5	ASN	-	expression tag	UNP S0DUX5
A	-4	LEU	-	expression tag	UNP S0DUX5

Continued on next page...

Continued from previous page...

Chain	Residue	Modelled	Actual	Comment	Reference
A	-3	TYR	-	expression tag	UNP S0DUX5
A	-2	PHE	-	expression tag	UNP S0DUX5
A	-1	GLN	-	expression tag	UNP S0DUX5
A	0	SER	-	expression tag	UNP S0DUX5
A	1	ASN	-	expression tag	UNP S0DUX5
B	-16	MET	-	initiating methionine	UNP S0DUX5
B	-15	GLY	-	expression tag	UNP S0DUX5
B	-14	SER	-	expression tag	UNP S0DUX5
B	-13	SER	-	expression tag	UNP S0DUX5
B	-12	HIS	-	expression tag	UNP S0DUX5
B	-11	HIS	-	expression tag	UNP S0DUX5
B	-10	HIS	-	expression tag	UNP S0DUX5
B	-9	HIS	-	expression tag	UNP S0DUX5
B	-8	HIS	-	expression tag	UNP S0DUX5
B	-7	HIS	-	expression tag	UNP S0DUX5
B	-6	GLU	-	expression tag	UNP S0DUX5
B	-5	ASN	-	expression tag	UNP S0DUX5
B	-4	LEU	-	expression tag	UNP S0DUX5
B	-3	TYR	-	expression tag	UNP S0DUX5
B	-2	PHE	-	expression tag	UNP S0DUX5
B	-1	GLN	-	expression tag	UNP S0DUX5
B	0	SER	-	expression tag	UNP S0DUX5
B	1	ASN	-	expression tag	UNP S0DUX5
C	-16	MET	-	initiating methionine	UNP S0DUX5
C	-15	GLY	-	expression tag	UNP S0DUX5
C	-14	SER	-	expression tag	UNP S0DUX5
C	-13	SER	-	expression tag	UNP S0DUX5
C	-12	HIS	-	expression tag	UNP S0DUX5
C	-11	HIS	-	expression tag	UNP S0DUX5
C	-10	HIS	-	expression tag	UNP S0DUX5
C	-9	HIS	-	expression tag	UNP S0DUX5
C	-8	HIS	-	expression tag	UNP S0DUX5
C	-7	HIS	-	expression tag	UNP S0DUX5
C	-6	GLU	-	expression tag	UNP S0DUX5
C	-5	ASN	-	expression tag	UNP S0DUX5
C	-4	LEU	-	expression tag	UNP S0DUX5
C	-3	TYR	-	expression tag	UNP S0DUX5
C	-2	PHE	-	expression tag	UNP S0DUX5
C	-1	GLN	-	expression tag	UNP S0DUX5
C	0	SER	-	expression tag	UNP S0DUX5
C	1	ASN	-	expression tag	UNP S0DUX5
D	-16	MET	-	initiating methionine	UNP S0DUX5

Continued on next page...

Continued from previous page...

Chain	Residue	Modelled	Actual	Comment	Reference
D	-15	GLY	-	expression tag	UNP S0DUX5
D	-14	SER	-	expression tag	UNP S0DUX5
D	-13	SER	-	expression tag	UNP S0DUX5
D	-12	HIS	-	expression tag	UNP S0DUX5
D	-11	HIS	-	expression tag	UNP S0DUX5
D	-10	HIS	-	expression tag	UNP S0DUX5
D	-9	HIS	-	expression tag	UNP S0DUX5
D	-8	HIS	-	expression tag	UNP S0DUX5
D	-7	HIS	-	expression tag	UNP S0DUX5
D	-6	GLU	-	expression tag	UNP S0DUX5
D	-5	ASN	-	expression tag	UNP S0DUX5
D	-4	LEU	-	expression tag	UNP S0DUX5
D	-3	TYR	-	expression tag	UNP S0DUX5
D	-2	PHE	-	expression tag	UNP S0DUX5
D	-1	GLN	-	expression tag	UNP S0DUX5
D	0	SER	-	expression tag	UNP S0DUX5
D	1	ASN	-	expression tag	UNP S0DUX5
E	-16	MET	-	initiating methionine	UNP S0DUX5
E	-15	GLY	-	expression tag	UNP S0DUX5
E	-14	SER	-	expression tag	UNP S0DUX5
E	-13	SER	-	expression tag	UNP S0DUX5
E	-12	HIS	-	expression tag	UNP S0DUX5
E	-11	HIS	-	expression tag	UNP S0DUX5
E	-10	HIS	-	expression tag	UNP S0DUX5
E	-9	HIS	-	expression tag	UNP S0DUX5
E	-8	HIS	-	expression tag	UNP S0DUX5
E	-7	HIS	-	expression tag	UNP S0DUX5
E	-6	GLU	-	expression tag	UNP S0DUX5
E	-5	ASN	-	expression tag	UNP S0DUX5
E	-4	LEU	-	expression tag	UNP S0DUX5
E	-3	TYR	-	expression tag	UNP S0DUX5
E	-2	PHE	-	expression tag	UNP S0DUX5
E	-1	GLN	-	expression tag	UNP S0DUX5
E	0	SER	-	expression tag	UNP S0DUX5
E	1	ASN	-	expression tag	UNP S0DUX5
F	-16	MET	-	initiating methionine	UNP S0DUX5
F	-15	GLY	-	expression tag	UNP S0DUX5
F	-14	SER	-	expression tag	UNP S0DUX5
F	-13	SER	-	expression tag	UNP S0DUX5
F	-12	HIS	-	expression tag	UNP S0DUX5
F	-11	HIS	-	expression tag	UNP S0DUX5
F	-10	HIS	-	expression tag	UNP S0DUX5

Continued on next page...

Continued from previous page...

Chain	Residue	Modelled	Actual	Comment	Reference
F	-9	HIS	-	expression tag	UNP S0DUX5
F	-8	HIS	-	expression tag	UNP S0DUX5
F	-7	HIS	-	expression tag	UNP S0DUX5
F	-6	GLU	-	expression tag	UNP S0DUX5
F	-5	ASN	-	expression tag	UNP S0DUX5
F	-4	LEU	-	expression tag	UNP S0DUX5
F	-3	TYR	-	expression tag	UNP S0DUX5
F	-2	PHE	-	expression tag	UNP S0DUX5
F	-1	GLN	-	expression tag	UNP S0DUX5
F	0	SER	-	expression tag	UNP S0DUX5
F	1	ASN	-	expression tag	UNP S0DUX5
G	-16	MET	-	initiating methionine	UNP S0DUX5
G	-15	GLY	-	expression tag	UNP S0DUX5
G	-14	SER	-	expression tag	UNP S0DUX5
G	-13	SER	-	expression tag	UNP S0DUX5
G	-12	HIS	-	expression tag	UNP S0DUX5
G	-11	HIS	-	expression tag	UNP S0DUX5
G	-10	HIS	-	expression tag	UNP S0DUX5
G	-9	HIS	-	expression tag	UNP S0DUX5
G	-8	HIS	-	expression tag	UNP S0DUX5
G	-7	HIS	-	expression tag	UNP S0DUX5
G	-6	GLU	-	expression tag	UNP S0DUX5
G	-5	ASN	-	expression tag	UNP S0DUX5
G	-4	LEU	-	expression tag	UNP S0DUX5
G	-3	TYR	-	expression tag	UNP S0DUX5
G	-2	PHE	-	expression tag	UNP S0DUX5
G	-1	GLN	-	expression tag	UNP S0DUX5
G	0	SER	-	expression tag	UNP S0DUX5
G	1	ASN	-	expression tag	UNP S0DUX5
H	-16	MET	-	initiating methionine	UNP S0DUX5
H	-15	GLY	-	expression tag	UNP S0DUX5
H	-14	SER	-	expression tag	UNP S0DUX5
H	-13	SER	-	expression tag	UNP S0DUX5
H	-12	HIS	-	expression tag	UNP S0DUX5
H	-11	HIS	-	expression tag	UNP S0DUX5
H	-10	HIS	-	expression tag	UNP S0DUX5
H	-9	HIS	-	expression tag	UNP S0DUX5
H	-8	HIS	-	expression tag	UNP S0DUX5
H	-7	HIS	-	expression tag	UNP S0DUX5
H	-6	GLU	-	expression tag	UNP S0DUX5
H	-5	ASN	-	expression tag	UNP S0DUX5
H	-4	LEU	-	expression tag	UNP S0DUX5

Continued on next page...

Continued from previous page...

Chain	Residue	Modelled	Actual	Comment	Reference
H	-3	TYR	-	expression tag	UNP S0DUX5
H	-2	PHE	-	expression tag	UNP S0DUX5
H	-1	GLN	-	expression tag	UNP S0DUX5
H	0	SER	-	expression tag	UNP S0DUX5
H	1	ASN	-	expression tag	UNP S0DUX5

- Molecule 2 is water.

Mol	Chain	Residues	Atoms	ZeroOcc	AltConf
2	A	187	Total O 187 187	0	0
2	B	161	Total O 161 161	0	0
2	C	216	Total O 216 216	0	0
2	D	215	Total O 215 215	0	0
2	E	200	Total O 200 200	0	0
2	F	219	Total O 220 220	0	1
2	G	168	Total O 168 168	0	0
2	H	190	Total O 190 190	0	0

3 Residue-property plots [i](#)

These plots are drawn for all protein, RNA, DNA and oligosaccharide chains in the entry. The first graphic for a chain summarises the proportions of the various outlier classes displayed in the second graphic. The second graphic shows the sequence view annotated by issues in geometry and electron density. Residues are color-coded according to the number of geometric quality criteria for which they contain at least one outlier: green = 0, yellow = 1, orange = 2 and red = 3 or more. A red dot above a residue indicates a poor fit to the electron density ($RSRZ > 2$). Stretches of 2 or more consecutive residues without any outlier are shown as a green connector. Residues present in the sample, but not in the model, are shown in grey.

- Molecule 1: Sulphydrylase FUB7

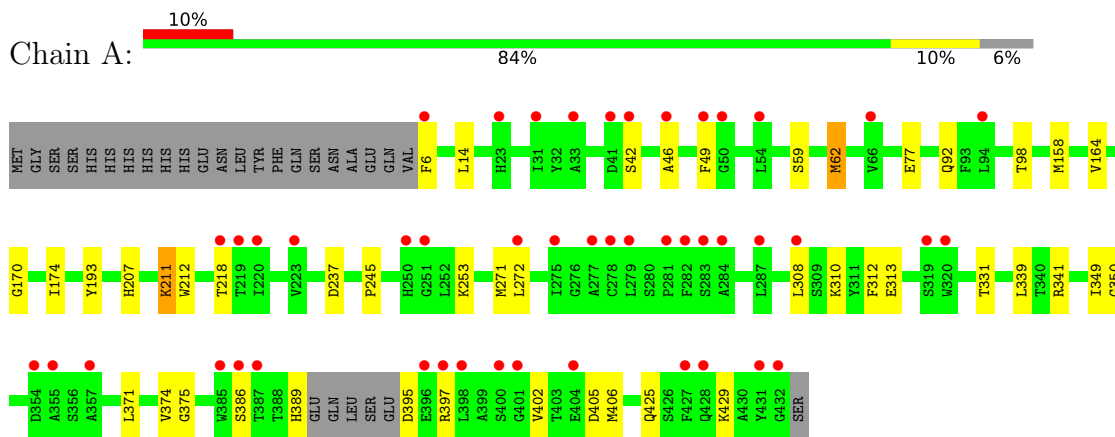

- Molecule 1: Sulphydrylase FUB7

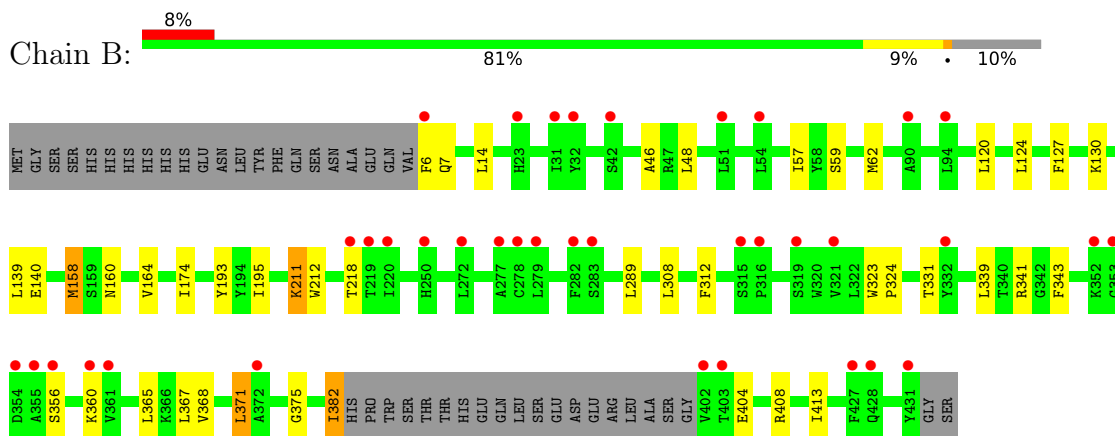

- Molecule 1: Sulphydrylase FUB7

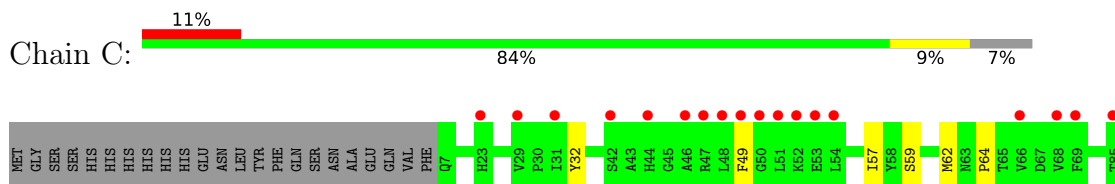

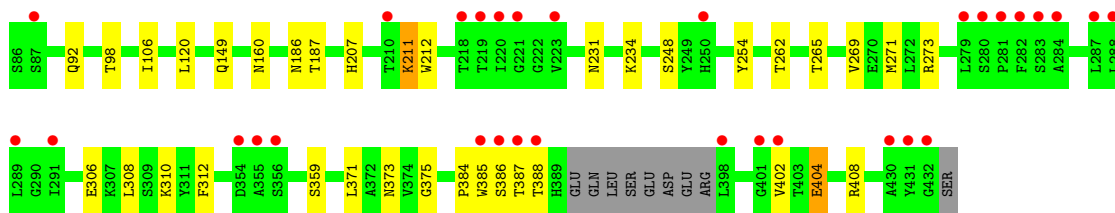

● Molecule 1: Sulphydrylase FUB7

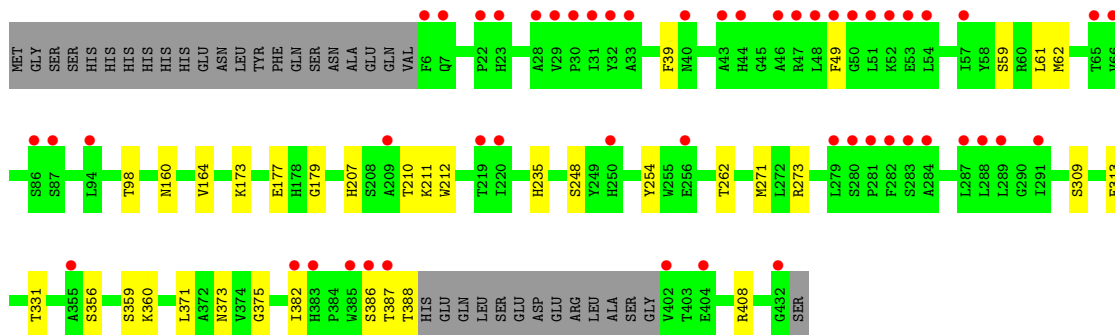
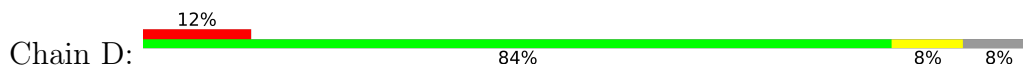

● Molecule 1: Sulphydrylase FUB7

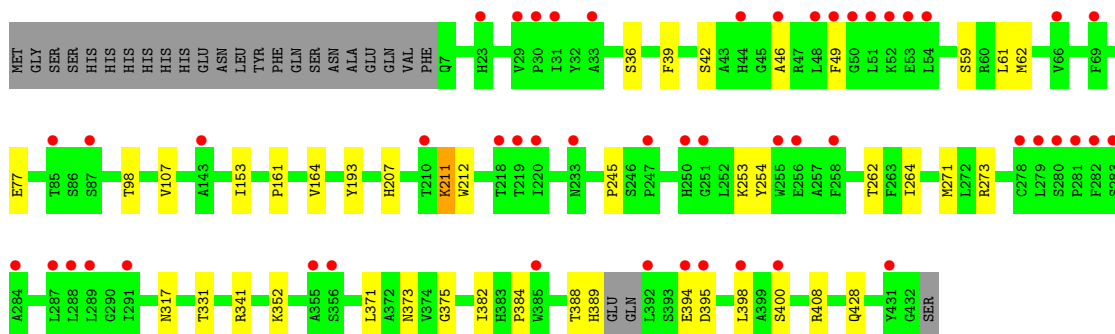
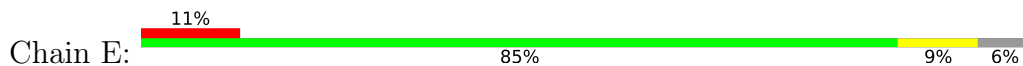

● Molecule 1: Sulphydrylase FUB7

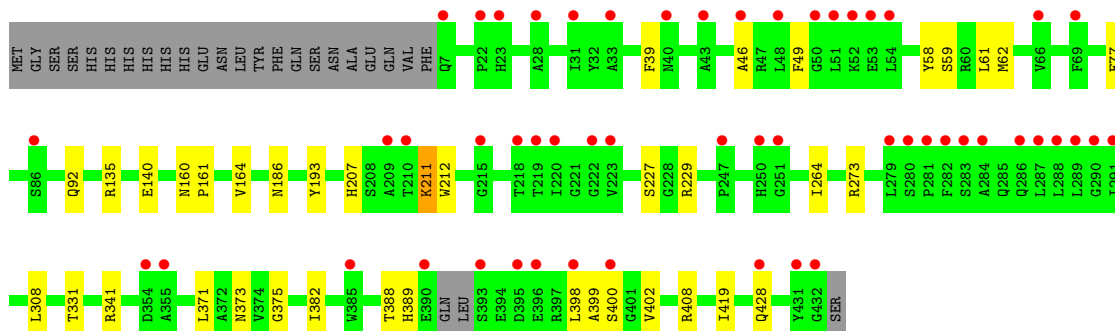
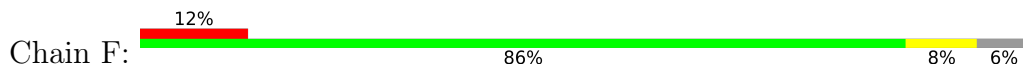

• Molecule 1: Sulfhydrylase FUB7

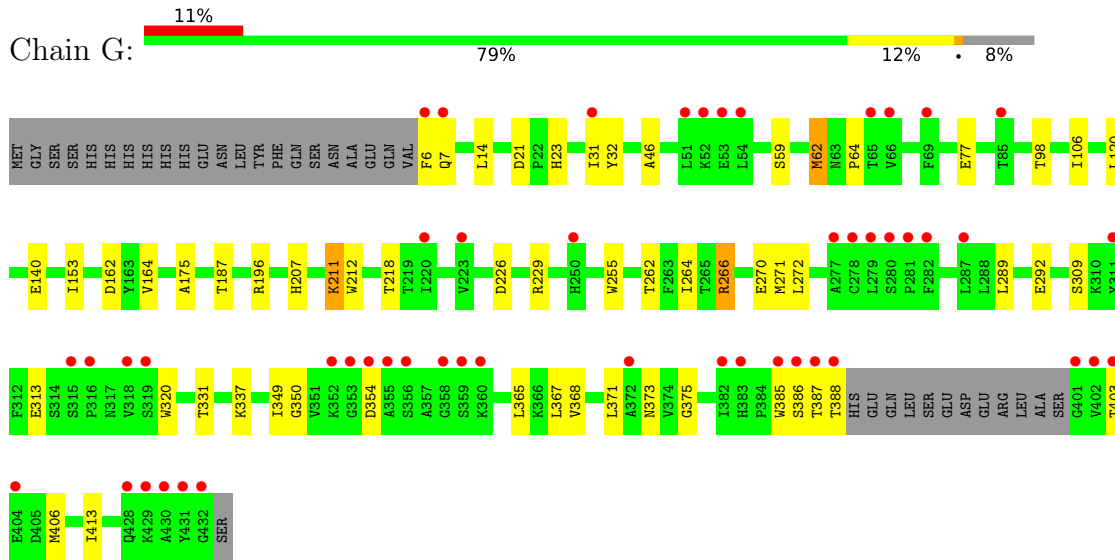

• Molecule 1: Sulfhydrylase FUB7

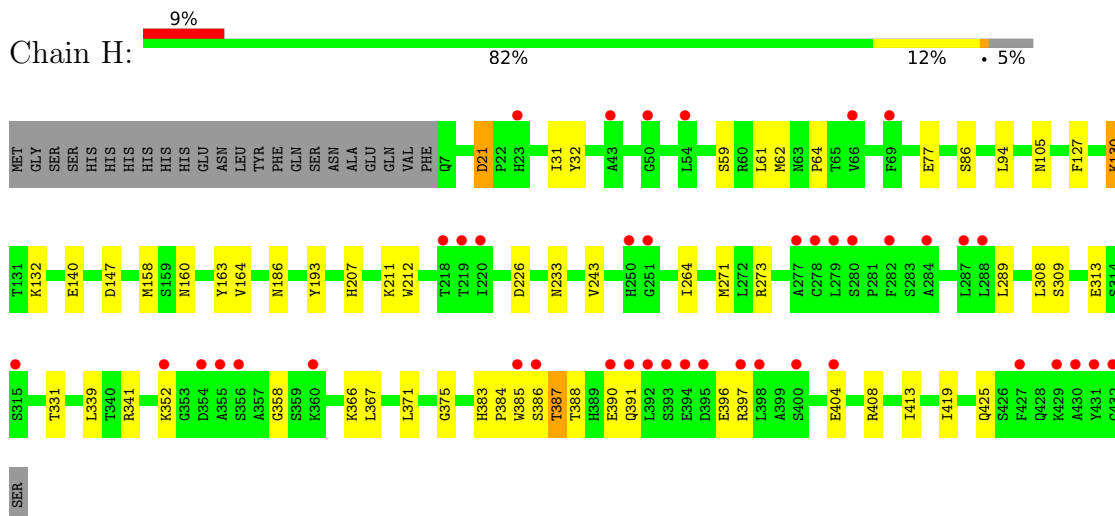

4 Data and refinement statistics i

Property	Value	Source
Space group	P 1 21 1	Depositor
Cell constants a, b, c, α , β , γ	93.93Å 195.29Å 112.42Å 90.00° 91.82° 90.00°	Depositor
Resolution (Å)	47.97 – 1.76 47.97 – 1.76	Depositor EDS
% Data completeness (in resolution range)	97.8 (47.97-1.76) 98.6 (47.97-1.76)	Depositor EDS
R_{merge}	(Not available)	Depositor
R_{sym}	(Not available)	Depositor
$\langle I/\sigma(I) \rangle$ ¹	1.80 (at 1.76Å)	Xtrriage
Refinement program	PHENIX 1.18.2_3874	Depositor
R, R_{free}	0.198 , 0.229 0.200 , 0.230	Depositor DCC
R_{free} test set	19975 reflections (5.07%)	wwPDB-VP
Wilson B-factor (Å ²)	29.4	Xtrriage
Anisotropy	0.336	Xtrriage
Bulk solvent k_{sol} (e/Å ³), B_{sol} (Å ²)	0.36 , 40.1	EDS
L-test for twinning ²	$\langle L \rangle = 0.50$, $\langle L^2 \rangle = 0.33$	Xtrriage
Estimated twinning fraction	0.017 for h,-k,-l	Xtrriage
F_o, F_c correlation	0.96	EDS
Total number of atoms	27419	wwPDB-VP
Average B, all atoms (Å ²)	36.0	wwPDB-VP

Xtrriage's analysis on translational NCS is as follows: *The analyses of the Patterson function reveals a significant off-origin peak that is 25.76 % of the origin peak, indicating pseudo-translational symmetry. The chance of finding a peak of this or larger height randomly in a structure without pseudo-translational symmetry is equal to 2.9858e-03. The detected translational NCS is most likely also responsible for the elevated intensity ratio.*

¹Intensities estimated from amplitudes.

²Theoretical values of $\langle |L| \rangle$, $\langle L^2 \rangle$ for acentric reflections are 0.5, 0.333 respectively for untwinned datasets, and 0.375, 0.2 for perfectly twinned datasets.

5 Model quality [i](#)

5.1 Standard geometry [i](#)

Bond lengths and bond angles in the following residue types are not validated in this section: LLP

The Z score for a bond length (or angle) is the number of standard deviations the observed value is removed from the expected value. A bond length (or angle) with $|Z| > 5$ is considered an outlier worth inspection. RMSZ is the root-mean-square of all Z scores of the bond lengths (or angles).

Mol	Chain	Bond lengths		Bond angles	
		RMSZ	# Z >5	RMSZ	# Z >5
1	A	0.47	0/3313	0.62	0/4498
1	B	0.48	0/3192	0.66	1/4332 (0.0%)
1	C	0.51	0/3273	0.66	0/4445
1	D	0.55	0/3251	0.69	1/4415 (0.0%)
1	E	0.46	0/3324	0.63	0/4513
1	F	0.48	0/3325	0.64	0/4514
1	G	0.46	0/3266	0.61	0/4435
1	H	0.45	0/3343	0.64	1/4540 (0.0%)
All	All	0.48	0/26287	0.64	3/35692 (0.0%)

Chiral center outliers are detected by calculating the chiral volume of a chiral center and verifying if the center is modelled as a planar moiety or with the opposite hand. A planarity outlier is detected by checking planarity of atoms in a peptide group, atoms in a mainchain group or atoms of a sidechain that are expected to be planar.

Mol	Chain	#Chirality outliers	#Planarity outliers
1	E	0	1

There are no bond length outliers.

All (3) bond angle outliers are listed below:

Mol	Chain	Res	Type	Atoms	Z	Observed(°)	Ideal(°)
1	B	371	LEU	CA-CB-CG	7.04	131.50	115.30
1	D	207	HIS	CB-CA-C	-5.53	99.35	110.40
1	H	130	LYS	CD-CE-NZ	5.24	123.74	111.70

There are no chirality outliers.

All (1) planarity outliers are listed below:

Mol	Chain	Res	Type	Group
1	E	211	LLP	Mainchain

5.2 Too-close contacts [i](#)

In the following table, the Non-H and H(model) columns list the number of non-hydrogen atoms and hydrogen atoms in the chain respectively. The H(added) column lists the number of hydrogen atoms added and optimized by MolProbity. The Clashes column lists the number of clashes within the asymmetric unit, whereas Symm-Clashes lists symmetry-related clashes.

Mol	Chain	Non-H	H(model)	H(added)	Clashes	Symm-Clashes
1	A	3259	0	3172	29	0
1	B	3143	0	3073	27	0
1	C	3220	0	3140	25	0
1	D	3198	0	3118	19	0
1	E	3271	0	3186	26	0
1	F	3272	0	3180	23	0
1	G	3210	0	3136	40	0
1	H	3289	0	3201	40	0
2	A	187	0	0	0	0
2	B	161	0	0	1	0
2	C	216	0	0	1	0
2	D	215	0	0	0	0
2	E	200	0	0	1	0
2	F	220	0	0	0	0
2	G	168	0	0	2	0
2	H	190	0	0	1	0
All	All	27419	0	25206	206	0

The all-atom clashscore is defined as the number of clashes found per 1000 atoms (including hydrogen atoms). The all-atom clashscore for this structure is 4.

All (206) close contacts within the same asymmetric unit are listed below, sorted by their clash magnitude.

Atom-1	Atom-2	Interatomic distance (Å)	Clash overlap (Å)
1:E:388:THR:HG23	1:E:389:HIS:HD2	1.28	0.98
1:E:388:THR:HG23	1:E:389:HIS:CD2	2.13	0.83
1:D:61:LEU:HD11	1:D:273:ARG:HB2	1.67	0.75
1:G:309:SER:O	1:G:313:GLU:HG2	1.89	0.73
1:C:248:SER:HB3	1:C:273:ARG:HH12	1.58	0.67
1:C:384:PRO:HB2	1:C:402:VAL:HG11	1.78	0.65
1:G:266:ARG:NH1	1:G:270:GLU:OE1	2.29	0.65

Continued on next page...

Continued from previous page...

Atom-1	Atom-2	Interatomic distance (Å)	Clash overlap (Å)
1:E:59:SER:HA	1:E:62:MET:O	1.97	0.65
1:B:158:MET:HE2	1:B:195:ILE:HD11	1.78	0.65
1:A:389:HIS:HB3	1:A:397:ARG:HG2	1.79	0.63
1:C:385:TRP:CE2	1:C:404:GLU:HB2	2.33	0.63
1:A:245:PRO:HG3	1:A:253:LYS:HE2	1.80	0.62
1:D:59:SER:HA	1:D:62:MET:O	2.00	0.62
1:H:384:PRO:HA	1:H:387:THR:HG23	1.81	0.62
1:F:39:PHE:HZ	1:F:49:PHE:HE2	1.47	0.61
1:G:164:VAL:HG13	1:G:331:THR:HG21	1.85	0.59
1:D:387:THR:O	1:D:388:THR:HB	2.03	0.58
1:F:59:SER:HA	1:F:62:MET:O	2.04	0.58
1:A:14:LEU:HD11	1:H:413:ILE:HG13	1.86	0.56
1:G:59:SER:HA	1:G:62:MET:O	2.05	0.56
1:G:212:TRP:CE2	1:G:375:GLY:HA2	2.41	0.56
1:H:308:LEU:HD11	1:H:419:ILE:HG21	1.86	0.55
1:B:367:LEU:HD13	1:G:6:PHE:CZ	2.41	0.55
1:B:382:ILE:HD11	1:B:408:ARG:NE	2.21	0.55
1:D:173:LYS:NZ	1:D:177:GLU:OE1	2.37	0.55
1:F:77:GLU:OE2	1:F:207:HIS:NE2	2.35	0.55
1:H:59:SER:HA	1:H:62:MET:O	2.07	0.54
1:H:212:TRP:CE2	1:H:375:GLY:HA2	2.43	0.54
1:D:386:SER:O	1:F:46:ALA:HB2	2.08	0.54
1:A:212:TRP:CE2	1:A:375:GLY:HA2	2.43	0.53
1:H:309:SER:O	1:H:313:GLU:HG2	2.08	0.53
1:H:387:THR:OG1	1:H:388:THR:N	2.41	0.53
1:B:139:LEU:HB3	1:B:174:ILE:HD11	1.91	0.53
1:A:158:MET:CE	1:A:339:LEU:HD21	2.38	0.53
1:F:389:HIS:CG	1:F:402:VAL:HG21	2.43	0.53
1:E:245:PRO:HD3	1:E:253:LYS:HE3	1.91	0.53
1:H:77:GLU:OE2	1:H:207:HIS:NE2	2.40	0.53
1:A:158:MET:HE1	1:A:339:LEU:HD21	1.91	0.53
1:E:77:GLU:OE2	1:E:207:HIS:NE2	2.38	0.53
1:F:227:SER:HB2	1:F:229:ARG:HD2	1.91	0.52
1:C:106:ILE:HD11	1:C:120:LEU:HD22	1.90	0.52
1:C:212:TRP:CE2	1:C:375:GLY:HA2	2.45	0.52
1:C:306:GLU:OE2	1:C:310:LYS:HE3	2.09	0.52
1:G:153:ILE:HD12	1:G:175:ALA:HB2	1.92	0.52
1:G:337:LYS:HE2	2:G:501:HOH:O	2.10	0.51
1:A:6:PHE:CZ	1:H:367:LEU:HD13	2.45	0.51
1:H:158:MET:HE1	1:H:339:LEU:HD21	1.93	0.51
1:D:212:TRP:CE2	1:D:375:GLY:HA2	2.45	0.51

Continued on next page...

Continued from previous page...

Atom-1	Atom-2	Interatomic distance (Å)	Clash overlap (Å)
1:E:254:TYR:HB3	1:E:262:THR:HG23	1.93	0.51
1:D:387:THR:OG1	1:D:388:THR:N	2.41	0.51
1:H:186:ASN:HB3	1:H:207:HIS:CE1	2.46	0.50
1:B:339:LEU:HD23	1:B:343:PHE:HA	1.93	0.50
1:H:390:GLU:O	1:H:397:ARG:NH1	2.45	0.50
1:H:132:LYS:NZ	1:H:147:ASP:OD2	2.32	0.50
1:C:386:SER:O	1:E:46:ALA:HB2	2.12	0.50
1:E:382:ILE:O	1:E:384:PRO:HD3	2.12	0.50
1:A:218:THR:HG21	1:H:289:LEU:HD21	1.94	0.50
1:G:365:LEU:HD13	1:G:368:VAL:HB	1.94	0.50
1:F:61:LEU:HD21	1:F:273:ARG:HB2	1.94	0.50
1:C:231:ASN:CG	1:C:234:LYS:HG2	2.33	0.49
1:E:382:ILE:HD11	1:E:408:ARG:CZ	2.42	0.49
1:H:383:HIS:O	1:H:387:THR:HG22	2.11	0.49
1:G:371:LEU:HD12	1:G:373:ASN:H	1.77	0.49
1:D:98:THR:OG1	1:D:271:MET:HG3	2.11	0.49
1:E:212:TRP:CE2	1:E:375:GLY:HA2	2.48	0.49
1:D:164:VAL:HG13	1:D:331:THR:HG21	1.95	0.49
1:H:130:LYS:HE2	2:H:680:HOH:O	2.12	0.49
1:A:164:VAL:HG13	1:A:331:THR:HG21	1.95	0.49
1:A:350:GLY:HA2	1:A:405:ASP:O	2.12	0.49
1:C:308:LEU:HG	1:C:312:PHE:CE2	2.48	0.49
1:F:186:ASN:HB3	1:F:207:HIS:CE1	2.48	0.49
1:B:382:ILE:HD11	1:B:408:ARG:CZ	2.43	0.48
1:C:371:LEU:HD12	1:C:373:ASN:H	1.79	0.48
1:G:349:ILE:O	1:G:406:MET:HA	2.13	0.48
1:H:226:ASP:HB2	1:H:264:ILE:HB	1.95	0.48
1:A:386:SER:O	1:G:46:ALA:HB2	2.13	0.48
1:A:98:THR:OG1	1:A:271:MET:HG3	2.13	0.48
1:F:161:PRO:HD2	1:F:400:SER:HB3	1.96	0.48
1:F:382:ILE:HD13	1:F:388:THR:HG23	1.96	0.48
1:B:193:TYR:CE2	1:B:341:ARG:HG2	2.48	0.48
1:B:413:ILE:HG13	1:G:14:LEU:HD11	1.96	0.48
1:H:140:GLU:H	1:H:140:GLU:CD	2.16	0.48
1:A:77:GLU:OE2	1:A:207:HIS:NE2	2.43	0.48
1:A:42:SER:O	1:G:387:THR:HG22	2.13	0.48
1:B:218:THR:HG21	1:G:289:LEU:HD21	1.95	0.48
1:E:193:TYR:CE2	1:E:341:ARG:HG2	2.48	0.48
1:B:46:ALA:HB2	1:H:386:SER:O	2.14	0.48
1:G:98:THR:OG1	1:G:271:MET:HG3	2.14	0.48
1:D:254:TYR:HB3	1:D:262:THR:HG23	1.95	0.47

Continued on next page...

Continued from previous page...

Atom-1	Atom-2	Interatomic distance (Å)	Clash overlap (Å)
1:G:162:ASP:OD1	1:G:162:ASP:N	2.47	0.47
1:A:310:LYS:HA	1:A:313:GLU:HG2	1.96	0.47
1:C:254:TYR:HB3	1:C:262:THR:HG23	1.96	0.47
1:H:352:LYS:HA	1:H:352:LYS:HD2	1.59	0.47
1:E:39:PHE:HZ	1:E:49:PHE:HE2	1.62	0.47
1:A:46:ALA:HB2	1:G:386:SER:O	2.14	0.47
1:B:212:TRP:CE2	1:B:375:GLY:HA2	2.49	0.47
1:F:212:TRP:CE2	1:F:375:GLY:HA2	2.50	0.47
1:C:92:GLN:OE1	1:C:211:LLP:H6	2.15	0.47
1:D:248:SER:HB3	1:D:273:ARG:HH22	1.79	0.47
1:C:57:ILE:HG22	1:C:62:MET:SD	2.55	0.46
1:B:308:LEU:HG	1:B:312:PHE:CE2	2.50	0.46
1:C:59:SER:HA	1:C:62:MET:O	2.15	0.46
1:F:308:LEU:HD11	1:F:419:ILE:HG21	1.97	0.46
1:E:371:LEU:HD12	1:E:373:ASN:H	1.81	0.46
1:H:193:TYR:CE2	1:H:341:ARG:HG2	2.51	0.46
1:B:59:SER:HA	1:B:62:MET:O	2.14	0.46
1:C:49:PHE:CE1	1:C:57:ILE:HD11	2.50	0.46
1:C:387:THR:OG1	1:C:388:THR:N	2.49	0.46
1:B:164:VAL:HG13	1:B:331:THR:HG21	1.97	0.46
1:H:158:MET:CE	1:H:339:LEU:HD21	2.46	0.46
1:F:371:LEU:HD12	1:F:373:ASN:H	1.81	0.46
1:H:32:TYR:CD2	1:H:64:PRO:HB2	2.51	0.46
1:H:383:HIS:CE1	1:H:385:TRP:HB3	2.51	0.46
1:G:226:ASP:HB2	1:G:264:ILE:HB	1.98	0.45
1:A:92:GLN:OE1	1:A:211:LLP:H6	2.16	0.45
1:B:14:LEU:HD11	1:G:413:ILE:HG13	1.97	0.45
1:B:289:LEU:HD21	1:G:218:THR:HG21	1.97	0.45
1:G:196[B]:ARG:NH2	2:G:506:HOH:O	2.49	0.45
1:B:120:LEU:HD23	1:B:124:LEU:HD12	1.98	0.45
1:B:356:SER:HB3	1:B:360:LYS:HE3	1.99	0.45
1:C:265:THR:O	1:C:269:VAL:HG22	2.17	0.45
1:H:21:ASP:OD1	1:H:21:ASP:N	2.38	0.45
1:H:366:LYS:HE3	1:H:366:LYS:HB2	1.78	0.45
1:F:140:GLU:H	1:F:140:GLU:CD	2.20	0.45
1:E:317:ASN:HA	1:E:352:LYS:HD3	1.99	0.45
1:H:358:GLY:HA3	1:H:383:HIS:CD2	2.52	0.44
1:E:61:LEU:HD11	1:E:273:ARG:CA	2.47	0.44
1:E:98:THR:OG1	1:E:271:MET:HG3	2.18	0.44
1:F:193:TYR:CE2	1:F:341:ARG:HG2	2.52	0.44
1:B:127:PHE:HB3	1:H:127:PHE:HB3	1.98	0.44

Continued on next page...

Continued from previous page...

Atom-1	Atom-2	Interatomic distance (Å)	Clash overlap (Å)
1:F:164:VAL:HG13	1:F:331:THR:HG21	1.98	0.44
1:B:48:LEU:HB3	1:B:57:ILE:HG12	2.00	0.44
1:G:106:ILE:HD11	1:G:120:LEU:HD22	1.99	0.44
1:A:49:PHE:CE1	1:G:388:THR:HG22	2.52	0.44
1:A:389:HIS:CD2	1:A:402:VAL:HG21	2.52	0.44
1:D:39:PHE:HZ	1:D:49:PHE:HE2	1.65	0.44
1:F:398:LEU:HD23	1:F:398:LEU:HA	1.88	0.44
1:G:272:LEU:HD23	1:G:272:LEU:HA	1.89	0.44
1:H:61:LEU:HD11	1:H:273:ARG:HB2	1.99	0.44
1:B:130:LYS:HB2	1:B:130:LYS:HE2	1.63	0.43
1:C:160:ASN:OD1	1:C:408:ARG:HD2	2.18	0.43
1:C:98:THR:OG1	1:C:271:MET:HG3	2.18	0.43
1:D:356:SER:O	1:D:360:LYS:HG3	2.17	0.43
1:B:323:TRP:CD1	1:B:324:PRO:HD2	2.53	0.43
1:G:23:HIS:ND1	1:H:21:ASP:HB3	2.34	0.43
1:H:160:ASN:OD1	1:H:408:ARG:HD2	2.19	0.43
1:E:61:LEU:HD11	1:E:273:ARG:HB2	1.99	0.43
1:D:371:LEU:HD12	1:D:373:ASN:H	1.84	0.43
1:G:212:TRP:NE1	1:G:375:GLY:HA2	2.33	0.43
1:F:135:ARG:HH21	1:F:399:ALA:HB2	1.84	0.43
1:G:140:GLU:CD	1:G:140:GLU:H	2.21	0.43
1:E:398:LEU:HD13	1:E:398:LEU:HA	1.91	0.42
1:G:354:ASP:OD1	1:G:354:ASP:N	2.46	0.42
1:C:186:ASN:HB3	1:C:207:HIS:CE1	2.54	0.42
1:D:179:GLY:HA2	1:D:235:HIS:CD2	2.54	0.42
1:A:59:SER:HA	1:A:62:MET:O	2.19	0.42
1:D:309:SER:O	1:D:313:GLU:HG2	2.19	0.42
1:G:14:LEU:HD23	1:G:292:GLU:HG2	2.00	0.42
1:H:158:MET:HG2	1:H:163:TYR:HA	2.01	0.42
1:H:366:LYS:HE2	1:H:425:GLN:CD	2.40	0.42
1:E:264:ILE:HD12	1:E:264:ILE:HA	1.95	0.42
1:G:6:PHE:CD1	1:G:6:PHE:N	2.83	0.42
1:G:21:ASP:OD1	1:G:21:ASP:N	2.52	0.42
1:B:6:PHE:CE1	1:G:367:LEU:HD13	2.54	0.42
1:G:32:TYR:CD2	1:G:64:PRO:HB2	2.54	0.42
1:G:320:TRP:CE2	1:G:350:GLY:HA3	2.55	0.42
1:H:385:TRP:CG	1:H:404:GLU:HA	2.54	0.42
1:D:212:TRP:NE1	1:D:375:GLY:HA2	2.35	0.42
1:E:164:VAL:HG13	1:E:331:THR:HG21	2.01	0.42
1:F:264:ILE:HD12	1:F:264:ILE:HA	1.98	0.42
1:A:46:ALA:HB2	1:G:387:THR:HA	2.02	0.41

Continued on next page...

Continued from previous page...

Atom-1	Atom-2	Interatomic distance (Å)	Clash overlap (Å)
1:B:365:LEU:HD13	1:B:368:VAL:HB	2.02	0.41
1:A:170:GLY:O	1:A:174:ILE:HG12	2.20	0.41
1:G:77:GLU:OE2	1:G:207:HIS:NE2	2.51	0.41
1:F:92:GLN:OE1	1:F:211:LLP:H6	2.21	0.41
1:C:32:TYR:CD2	1:C:64:PRO:HB2	2.56	0.41
1:C:160:ASN:ND2	2:C:502:HOH:O	2.42	0.41
1:F:39:PHE:CZ	1:F:49:PHE:HE2	2.33	0.41
1:C:373:ASN:HB2	1:E:36:SER:OG	2.20	0.41
1:E:107:VAL:O	1:E:153:ILE:HA	2.20	0.41
1:G:31:ILE:HB	1:H:31:ILE:HB	2.03	0.41
1:H:130:LYS:HE2	1:H:130:LYS:HB2	1.96	0.41
1:A:425:GLN:OE1	1:A:429:LYS:HE2	2.20	0.41
1:B:140:GLU:CD	1:B:140:GLU:H	2.24	0.41
1:B:211:LLP:H	1:B:211:LLP:HG3	1.69	0.41
1:C:387:THR:HG22	1:E:42:SER:O	2.21	0.41
1:D:210:THR:HG21	1:F:58:TYR:OH	2.21	0.41
1:E:212:TRP:NE1	1:E:375:GLY:HA2	2.36	0.41
1:G:187:THR:HB	1:G:211:LLP:H2'2	2.03	0.41
1:H:94:LEU:HG	1:H:271:MET:HB3	2.03	0.41
1:A:237:ASP:N	1:A:237:ASP:OD1	2.53	0.41
1:E:62:MET:HB2	2:E:671:HOH:O	2.20	0.41
1:F:160:ASN:OD1	1:F:408:ARG:HD2	2.21	0.41
1:G:255:TRP:HA	1:G:262:THR:OG1	2.21	0.41
1:H:164:VAL:HG13	1:H:331:THR:HG21	2.02	0.41
1:H:233:ASN:HA	1:H:243:VAL:HG11	2.03	0.41
1:A:272:LEU:HA	1:A:272:LEU:HD23	1.85	0.40
1:H:105:ASN:HA	1:H:130:LYS:O	2.21	0.40
1:A:349:ILE:O	1:A:406:MET:HA	2.20	0.40
1:C:187:THR:HB	1:C:211:LLP:H2'2	2.03	0.40
1:A:193:TYR:CZ	1:A:341:ARG:HD2	2.56	0.40
1:A:308:LEU:HG	1:A:312:PHE:CE2	2.56	0.40
1:A:211:LLP:HD3	1:A:374:VAL:O	2.21	0.40
1:B:62:MET:HA	2:B:594:HOH:O	2.21	0.40
1:D:382:ILE:HG22	1:D:408:ARG:HB3	2.03	0.40
1:E:161:PRO:HD2	1:E:400:SER:HB3	2.03	0.40

There are no symmetry-related clashes.

5.3 Torsion angles [i](#)

5.3.1 Protein backbone [i](#)

In the following table, the Percentiles column shows the percent Ramachandran outliers of the chain as a percentile score with respect to all X-ray entries followed by that with respect to entries of similar resolution.

The Analysed column shows the number of residues for which the backbone conformation was analysed, and the total number of residues.

Mol	Chain	Analysed	Favoured	Allowed	Outliers	Percentiles	
1	A	417/450 (93%)	406 (97%)	11 (3%)	0	100	100
1	B	402/450 (89%)	393 (98%)	9 (2%)	0	100	100
1	C	413/450 (92%)	405 (98%)	8 (2%)	0	100	100
1	D	409/450 (91%)	400 (98%)	9 (2%)	0	100	100
1	E	419/450 (93%)	405 (97%)	14 (3%)	0	100	100
1	F	419/450 (93%)	408 (97%)	11 (3%)	0	100	100
1	G	411/450 (91%)	405 (98%)	6 (2%)	0	100	100
1	H	423/450 (94%)	414 (98%)	9 (2%)	0	100	100
All	All	3313/3600 (92%)	3236 (98%)	77 (2%)	0	100	100

There are no Ramachandran outliers to report.

5.3.2 Protein sidechains [i](#)

In the following table, the Percentiles column shows the percent sidechain outliers of the chain as a percentile score with respect to all X-ray entries followed by that with respect to entries of similar resolution.

The Analysed column shows the number of residues for which the sidechain conformation was analysed, and the total number of residues.

Mol	Chain	Analysed	Rotameric	Outliers	Percentiles	
1	A	339/365 (93%)	336 (99%)	3 (1%)	78	67
1	B	327/365 (90%)	321 (98%)	6 (2%)	59	40
1	C	335/365 (92%)	332 (99%)	3 (1%)	78	67
1	D	333/365 (91%)	331 (99%)	2 (1%)	86	79
1	E	341/365 (93%)	338 (99%)	3 (1%)	78	67
1	F	341/365 (93%)	340 (100%)	1 (0%)	92	89

Continued on next page...

Continued from previous page...

Mol	Chain	Analysed	Rotameric	Outliers	Percentiles	
1	G	334/365 (92%)	328 (98%)	6 (2%)	59	40
1	H	343/365 (94%)	337 (98%)	6 (2%)	60	42
All	All	2693/2920 (92%)	2663 (99%)	30 (1%)	73	60

All (30) residues with a non-rotameric sidechain are listed below:

Mol	Chain	Res	Type
1	A	62	MET
1	A	371	LEU
1	A	395	ASP
1	B	7	GLN
1	B	158	MET
1	B	160	ASN
1	B	371	LEU
1	B	382	ILE
1	B	404	GLU
1	C	149	GLN
1	C	359	SER
1	C	404	GLU
1	D	160	ASN
1	D	359	SER
1	E	394	GLU
1	E	395	ASP
1	E	428	GLN
1	F	428	GLN
1	G	7	GLN
1	G	62	MET
1	G	229	ARG
1	G	266	ARG
1	G	385	TRP
1	G	403	THR
1	H	21	ASP
1	H	86	SER
1	H	371	LEU
1	H	387	THR
1	H	391	GLN
1	H	396	GLU

Sometimes sidechains can be flipped to improve hydrogen bonding and reduce clashes. All (1) such sidechains are listed below:

Mol	Chain	Res	Type
1	E	389	HIS

5.3.3 RNA [i](#)

There are no RNA molecules in this entry.

5.4 Non-standard residues in protein, DNA, RNA chains [i](#)

8 non-standard protein/DNA/RNA residues are modelled in this entry.

In the following table, the Counts columns list the number of bonds (or angles) for which Mogul statistics could be retrieved, the number of bonds (or angles) that are observed in the model and the number of bonds (or angles) that are defined in the Chemical Component Dictionary. The Link column lists molecule types, if any, to which the group is linked. The Z score for a bond length (or angle) is the number of standard deviations the observed value is removed from the expected value. A bond length (or angle) with $|Z| > 2$ is considered an outlier worth inspection. RMSZ is the root-mean-square of all Z scores of the bond lengths (or angles).

Mol	Type	Chain	Res	Link	Bond lengths			Bond angles		
					Counts	RMSZ	# Z > 2	Counts	RMSZ	# Z > 2
1	LLP	A	211	1	23,24,25	1.98	5 (21%)	25,32,34	1.39	5 (20%)
1	LLP	H	211	1	23,24,25	1.78	5 (21%)	25,32,34	1.56	6 (24%)
1	LLP	E	211	1	23,24,25	1.57	4 (17%)	25,32,34	1.57	5 (20%)
1	LLP	F	211	1	23,24,25	1.84	5 (21%)	25,32,34	1.45	4 (16%)
1	LLP	G	211	1	23,24,25	2.06	6 (26%)	25,32,34	1.41	4 (16%)
1	LLP	B	211	1	23,24,25	2.04	6 (26%)	25,32,34	1.42	5 (20%)
1	LLP	D	211	1	23,24,25	1.84	6 (26%)	25,32,34	1.39	4 (16%)
1	LLP	C	211	1	23,24,25	2.19	8 (34%)	25,32,34	1.46	5 (20%)

In the following table, the Chirals column lists the number of chiral outliers, the number of chiral centers analysed, the number of these observed in the model and the number defined in the Chemical Component Dictionary. Similar counts are reported in the Torsion and Rings columns. '-' means no outliers of that kind were identified.

Mol	Type	Chain	Res	Link	Chirals	Torsions	Rings
1	LLP	A	211	1	-	4/16/17/19	0/1/1/1
1	LLP	H	211	1	-	4/16/17/19	0/1/1/1
1	LLP	E	211	1	-	4/16/17/19	0/1/1/1
1	LLP	F	211	1	-	4/16/17/19	0/1/1/1
1	LLP	G	211	1	-	4/16/17/19	0/1/1/1

Continued on next page...

Continued from previous page...

Mol	Type	Chain	Res	Link	Chirals	Torsions	Rings
1	LLP	B	211	1	-	5/16/17/19	0/1/1/1
1	LLP	D	211	1	-	4/16/17/19	0/1/1/1
1	LLP	C	211	1	-	4/16/17/19	0/1/1/1

All (45) bond length outliers are listed below:

Mol	Chain	Res	Type	Atoms	Z	Observed(Å)	Ideal(Å)
1	G	211	LLP	P-OP4	6.08	1.79	1.60
1	A	211	LLP	P-OP4	5.91	1.79	1.60
1	B	211	LLP	P-OP4	5.55	1.78	1.60
1	C	211	LLP	CB-CA	5.21	1.60	1.53
1	H	211	LLP	P-OP4	4.95	1.76	1.60
1	D	211	LLP	P-OP4	4.83	1.75	1.60
1	C	211	LLP	P-OP4	4.50	1.74	1.60
1	F	211	LLP	CB-CA	4.20	1.59	1.53
1	C	211	LLP	C6-C5	4.17	1.46	1.37
1	F	211	LLP	P-OP4	4.14	1.73	1.60
1	E	211	LLP	P-OP4	3.78	1.72	1.60
1	B	211	LLP	C6-C5	3.62	1.45	1.37
1	F	211	LLP	C3-C2	3.51	1.44	1.40
1	G	211	LLP	OP4-C5'	-3.48	1.32	1.45
1	D	211	LLP	CB-CA	3.47	1.58	1.53
1	H	211	LLP	OP4-C5'	-3.39	1.32	1.45
1	G	211	LLP	CD-CE	3.33	1.63	1.51
1	E	211	LLP	CD-CE	3.29	1.62	1.51
1	A	211	LLP	CB-CA	3.29	1.57	1.53
1	A	211	LLP	OP4-C5'	-3.17	1.33	1.45
1	B	211	LLP	CB-CA	3.07	1.57	1.53
1	B	211	LLP	C4-C5	-3.06	1.38	1.42
1	D	211	LLP	CD-CE	3.03	1.62	1.51
1	F	211	LLP	OP4-C5'	-2.99	1.33	1.45
1	B	211	LLP	OP4-C5'	-2.98	1.33	1.45
1	E	211	LLP	OP4-C5'	-2.97	1.33	1.45
1	C	211	LLP	OP4-C5'	-2.93	1.34	1.45
1	C	211	LLP	CD-CE	2.90	1.61	1.51
1	G	211	LLP	CB-CA	2.76	1.57	1.53
1	G	211	LLP	C6-C5	2.75	1.43	1.37
1	A	211	LLP	CD-CE	2.69	1.60	1.51
1	H	211	LLP	C2-N1	2.67	1.38	1.33
1	C	211	LLP	C4-C5	-2.61	1.38	1.42
1	D	211	LLP	OP4-C5'	-2.60	1.35	1.45
1	D	211	LLP	CG-CB	2.48	1.62	1.52

Continued on next page...

Continued from previous page...

Mol	Chain	Res	Type	Atoms	Z	Observed(Å)	Ideal(Å)
1	A	211	LLP	C6-C5	2.46	1.42	1.37
1	B	211	LLP	C2-N1	2.38	1.38	1.33
1	D	211	LLP	C6-C5	2.33	1.42	1.37
1	H	211	LLP	CD-CE	2.27	1.59	1.51
1	C	211	LLP	CG-CB	2.14	1.61	1.52
1	F	211	LLP	C6-C5	2.10	1.42	1.37
1	G	211	LLP	C4-C4'	2.05	1.50	1.46
1	C	211	LLP	C4-C4'	2.03	1.50	1.46
1	E	211	LLP	C6-C5	2.01	1.41	1.37
1	H	211	LLP	C6-C5	2.01	1.41	1.37

All (38) bond angle outliers are listed below:

Mol	Chain	Res	Type	Atoms	Z	Observed(°)	Ideal(°)
1	E	211	LLP	OP4-P-OP1	-4.42	94.07	106.47
1	C	211	LLP	OP3-P-OP2	3.45	120.83	107.64
1	D	211	LLP	OP4-P-OP1	-3.32	97.16	106.47
1	F	211	LLP	OP4-P-OP1	-3.30	97.21	106.47
1	H	211	LLP	OP3-P-OP2	3.19	119.84	107.64
1	B	211	LLP	OP3-P-OP2	3.13	119.59	107.64
1	E	211	LLP	C5'-C5-C6	-3.10	114.28	119.37
1	A	211	LLP	OP3-P-OP2	3.04	119.26	107.64
1	G	211	LLP	C5'-C5-C6	-2.98	114.46	119.37
1	G	211	LLP	OP3-P-OP2	2.98	119.03	107.64
1	H	211	LLP	C5'-C5-C6	-2.97	114.49	119.37
1	F	211	LLP	C5'-C5-C6	-2.95	114.53	119.37
1	D	211	LLP	OP3-P-OP2	2.94	118.88	107.64
1	C	211	LLP	OP3-P-OP4	-2.94	98.91	106.73
1	H	211	LLP	OP4-P-OP1	-2.91	98.32	106.47
1	A	211	LLP	OP4-P-OP1	-2.85	98.49	106.47
1	D	211	LLP	C5'-C5-C6	-2.73	114.88	119.37
1	H	211	LLP	OP2-P-OP4	-2.64	99.71	106.73
1	C	211	LLP	OP2-P-OP4	-2.61	99.80	106.73
1	H	211	LLP	OP3-P-OP4	-2.61	99.80	106.73
1	B	211	LLP	C5'-C5-C6	-2.59	115.12	119.37
1	A	211	LLP	OP3-P-OP4	-2.57	99.91	106.73
1	E	211	LLP	OP3-P-OP2	2.54	117.36	107.64
1	A	211	LLP	C4-C4'-NZ	-2.42	113.22	124.31
1	B	211	LLP	C4-C4'-NZ	-2.39	113.34	124.31
1	F	211	LLP	C4-C4'-NZ	-2.38	113.39	124.31
1	E	211	LLP	C4-C4'-NZ	-2.37	113.40	124.31
1	C	211	LLP	C4-C4'-NZ	-2.36	113.47	124.31

Continued on next page...

Continued from previous page...

Mol	Chain	Res	Type	Atoms	Z	Observed(°)	Ideal(°)
1	D	211	LLP	C4-C4'-NZ	-2.36	113.49	124.31
1	G	211	LLP	C4-C4'-NZ	-2.33	113.63	124.31
1	B	211	LLP	OP3-P-OP4	-2.31	100.59	106.73
1	H	211	LLP	C4-C4'-NZ	-2.31	113.71	124.31
1	B	211	LLP	OP4-P-OP1	-2.28	100.07	106.47
1	G	211	LLP	OP4-P-OP1	-2.25	100.17	106.47
1	C	211	LLP	OP4-P-OP1	-2.23	100.21	106.47
1	A	211	LLP	C5'-C5-C6	-2.23	115.71	119.37
1	F	211	LLP	OP3-P-OP2	2.08	115.60	107.64
1	E	211	LLP	OP3-P-OP4	-2.02	101.37	106.73

There are no chirality outliers.

All (33) torsion outliers are listed below:

Mol	Chain	Res	Type	Atoms
1	A	211	LLP	O-C-CA-CB
1	B	211	LLP	O-C-CA-CB
1	C	211	LLP	O-C-CA-CB
1	D	211	LLP	O-C-CA-CB
1	E	211	LLP	O-C-CA-CB
1	F	211	LLP	O-C-CA-CB
1	G	211	LLP	O-C-CA-CB
1	H	211	LLP	O-C-CA-CB
1	A	211	LLP	CG-CD-CE-NZ
1	D	211	LLP	CG-CD-CE-NZ
1	E	211	LLP	CG-CD-CE-NZ
1	F	211	LLP	CG-CD-CE-NZ
1	G	211	LLP	CG-CD-CE-NZ
1	H	211	LLP	CG-CD-CE-NZ
1	B	211	LLP	CG-CD-CE-NZ
1	C	211	LLP	CG-CD-CE-NZ
1	C	211	LLP	CD-CE-NZ-C4'
1	D	211	LLP	CD-CE-NZ-C4'
1	A	211	LLP	CD-CE-NZ-C4'
1	B	211	LLP	CD-CE-NZ-C4'
1	A	211	LLP	C3-C4-C4'-NZ
1	B	211	LLP	C3-C4-C4'-NZ
1	C	211	LLP	C3-C4-C4'-NZ
1	D	211	LLP	C3-C4-C4'-NZ
1	G	211	LLP	CD-CE-NZ-C4'
1	F	211	LLP	CD-CE-NZ-C4'
1	H	211	LLP	CD-CE-NZ-C4'

Continued on next page...

Continued from previous page...

Mol	Chain	Res	Type	Atoms
1	F	211	LLP	C3-C4-C4'-NZ
1	G	211	LLP	C3-C4-C4'-NZ
1	H	211	LLP	C3-C4-C4'-NZ
1	E	211	LLP	CD-CE-NZ-C4'
1	E	211	LLP	C3-C4-C4'-NZ
1	B	211	LLP	N-CA-CB-CG

There are no ring outliers.

5 monomers are involved in 7 short contacts:

Mol	Chain	Res	Type	Clashes	Symm-Clashes
1	A	211	LLP	2	0
1	F	211	LLP	1	0
1	G	211	LLP	1	0
1	B	211	LLP	1	0
1	C	211	LLP	2	0

5.5 Carbohydrates [i](#)

There are no monosaccharides in this entry.

5.6 Ligand geometry [i](#)

There are no ligands in this entry.

5.7 Other polymers [i](#)

There are no such residues in this entry.

5.8 Polymer linkage issues [i](#)

There are no chain breaks in this entry.

6 Fit of model and data

6.1 Protein, DNA and RNA chains

In the following table, the column labelled ‘#RSRZ > 2’ contains the number (and percentage) of RSRZ outliers, followed by percent RSRZ outliers for the chain as percentile scores relative to all X-ray entries and entries of similar resolution. The OWAB column contains the minimum, median, 95th percentile and maximum values of the occupancy-weighted average B-factor per residue. The column labelled ‘Q < 0.9’ lists the number of (and percentage) of residues with an average occupancy less than 0.9.

Mol	Chain	Analysed	<RSRZ>	#RSRZ>2	OWAB(Å ²)	Q<0.9
1	A	421/450 (93%)	0.53	47 (11%) 5 7	23, 35, 59, 76	1 (0%)
1	B	406/450 (90%)	0.54	37 (9%) 9 11	23, 35, 59, 74	1 (0%)
1	C	417/450 (92%)	0.47	49 (11%) 4 6	20, 30, 57, 72	1 (0%)
1	D	413/450 (91%)	0.47	52 (12%) 3 5	20, 30, 53, 75	1 (0%)
1	E	423/450 (94%)	0.56	50 (11%) 4 6	20, 33, 56, 77	1 (0%)
1	F	423/450 (94%)	0.50	53 (12%) 3 5	21, 32, 54, 69	2 (0%)
1	G	414/450 (92%)	0.60	50 (12%) 4 6	23, 36, 61, 75	1 (0%)
1	H	425/450 (94%)	0.56	42 (9%) 7 10	23, 35, 60, 77	1 (0%)
All	All	3342/3600 (92%)	0.53	380 (11%) 5 7	20, 33, 58, 77	9 (0%)

All (380) RSRZ outliers are listed below:

Mol	Chain	Res	Type	RSRZ
1	G	385	TRP	9.5
1	E	54	LEU	7.3
1	A	385	TRP	6.5
1	C	385	TRP	6.5
1	D	6	PHE	6.1
1	G	432	GLY	5.9
1	A	355	ALA	5.8
1	E	250	HIS	5.8
1	H	355	ALA	5.7
1	G	431	TYR	5.6
1	H	385	TRP	5.6
1	C	355	ALA	5.4
1	D	54	LEU	5.4
1	A	432	GLY	5.3
1	D	282	PHE	5.3
1	H	431	TYR	5.2

Continued on next page...

Continued from previous page...

Mol	Chain	Res	Type	RSRZ
1	A	398	LEU	5.2
1	D	385	TRP	5.2
1	H	54	LEU	5.1
1	G	355	ALA	5.1
1	F	46	ALA	5.1
1	C	282	PHE	5.1
1	F	250	HIS	5.1
1	C	386	SER	5.0
1	G	6	PHE	5.0
1	D	432	GLY	5.0
1	B	372	ALA	4.9
1	E	385	TRP	4.8
1	F	282	PHE	4.8
1	B	355	ALA	4.8
1	H	432	GLY	4.7
1	C	52	LYS	4.7
1	E	49	PHE	4.7
1	F	400	SER	4.6
1	D	250	HIS	4.6
1	E	31	ILE	4.5
1	G	403	THR	4.5
1	H	390	GLU	4.5
1	G	250	HIS	4.4
1	E	220	ILE	4.4
1	F	51	LEU	4.4
1	B	54	LEU	4.4
1	B	23	HIS	4.3
1	H	250	HIS	4.3
1	D	52	LYS	4.3
1	E	400	SER	4.3
1	H	393	SER	4.3
1	F	52	LYS	4.2
1	H	251	GLY	4.2
1	B	428	GLN	4.1
1	C	279	LEU	4.1
1	C	50	GLY	4.1
1	F	54	LEU	4.0
1	H	279	LEU	4.0
1	F	31	ILE	4.0
1	C	31	ILE	4.0
1	D	31	ILE	4.0
1	E	52	LYS	4.0

Continued on next page...

Continued from previous page...

Mol	Chain	Res	Type	RSRZ
1	G	386	SER	4.0
1	G	383	HIS	4.0
1	H	391	GLN	4.0
1	B	403	THR	4.0
1	B	353	GLY	4.0
1	C	23	HIS	4.0
1	H	430	ALA	4.0
1	B	250	HIS	3.9
1	B	354	ASP	3.9
1	E	282	PHE	3.9
1	E	48	LEU	3.9
1	E	51	LEU	3.9
1	F	395	ASP	3.9
1	A	279	LEU	3.8
1	D	49	PHE	3.8
1	G	7	GLN	3.8
1	D	51	LEU	3.8
1	D	287	LEU	3.8
1	E	23	HIS	3.8
1	D	46	ALA	3.8
1	F	23	HIS	3.8
1	G	428	GLN	3.8
1	B	6	PHE	3.7
1	F	279	LEU	3.7
1	C	432	GLY	3.7
1	A	54	LEU	3.7
1	H	352	LYS	3.7
1	H	398	LEU	3.7
1	A	386	SER	3.6
1	E	398	LEU	3.6
1	G	279	LEU	3.6
1	F	50	GLY	3.6
1	D	7	GLN	3.6
1	C	289	LEU	3.6
1	C	398	LEU	3.6
1	G	54	LEU	3.6
1	E	251	GLY	3.6
1	D	23	HIS	3.6
1	G	282	PHE	3.6
1	B	431	TYR	3.6
1	A	250	HIS	3.5
1	C	250	HIS	3.5

Continued on next page...

Continued from previous page...

Mol	Chain	Res	Type	RSRZ
1	G	352	LYS	3.5
1	A	6	PHE	3.5
1	H	427	PHE	3.5
1	H	23	HIS	3.5
1	C	287	LEU	3.4
1	D	289	LEU	3.4
1	B	356	SER	3.4
1	F	218	THR	3.4
1	B	427	PHE	3.4
1	C	49	PHE	3.4
1	F	284	ALA	3.4
1	F	288	LEU	3.4
1	D	355	ALA	3.4
1	D	50	GLY	3.4
1	F	281	PRO	3.4
1	C	281	PRO	3.3
1	B	361	VAL	3.3
1	C	51	LEU	3.3
1	D	288	LEU	3.3
1	D	220	ILE	3.3
1	G	220	ILE	3.3
1	C	42	SER	3.3
1	G	358	GLY	3.3
1	H	220	ILE	3.3
1	G	372	ALA	3.3
1	B	282	PHE	3.3
1	F	289	LEU	3.3
1	F	385	TRP	3.2
1	A	23	HIS	3.2
1	E	283	SER	3.2
1	D	279	LEU	3.2
1	F	287	LEU	3.2
1	B	402	VAL	3.2
1	E	279	LEU	3.2
1	E	392	LEU	3.2
1	F	220	ILE	3.2
1	C	288	LEU	3.2
1	B	31	ILE	3.1
1	H	354	ASP	3.1
1	G	278	CYS	3.1
1	E	46	ALA	3.1
1	A	400	SER	3.1

Continued on next page...

Continued from previous page...

Mol	Chain	Res	Type	RSRZ
1	B	42	SER	3.1
1	G	388	THR	3.1
1	F	219	THR	3.1
1	C	54	LEU	3.1
1	C	284	ALA	3.1
1	E	284	ALA	3.0
1	G	354	ASP	3.0
1	A	427	PHE	3.0
1	E	50	GLY	3.0
1	H	282	PHE	3.0
1	H	397	ARG	3.0
1	D	44	HIS	3.0
1	B	279	LEU	3.0
1	E	218	THR	3.0
1	F	251	GLY	3.0
1	F	432	GLY	3.0
1	A	404	GLU	3.0
1	D	281	PRO	2.9
1	D	386	SER	2.9
1	D	47	ARG	2.9
1	E	431	TYR	2.9
1	H	277	ALA	2.9
1	D	48	LEU	2.9
1	D	66	VAL	2.9
1	E	288	LEU	2.9
1	G	316	PRO	2.9
1	C	219	THR	2.9
1	G	430	ALA	2.9
1	D	29	VAL	2.8
1	E	287	LEU	2.8
1	H	392	LEU	2.8
1	G	356	SER	2.8
1	C	46	ALA	2.8
1	B	278	CYS	2.8
1	A	220	ILE	2.8
1	B	220	ILE	2.8
1	F	291	ILE	2.8
1	F	22	PRO	2.8
1	G	387	THR	2.8
1	D	283	SER	2.8
1	A	281	PRO	2.8
1	A	431	TYR	2.8

Continued on next page...

Continued from previous page...

Mol	Chain	Res	Type	RSRZ
1	G	66	VAL	2.8
1	D	404	GLU	2.7
1	C	218	THR	2.7
1	C	66	VAL	2.7
1	A	31	ILE	2.7
1	G	382	ILE	2.7
1	C	431	TYR	2.7
1	D	284	ALA	2.7
1	A	277	ALA	2.7
1	G	359	SER	2.7
1	A	397	ARG	2.7
1	A	219	THR	2.7
1	B	352	LYS	2.7
1	E	280	SER	2.7
1	H	278	CYS	2.7
1	F	398	LEU	2.7
1	F	354	ASP	2.7
1	A	387	THR	2.7
1	E	210	THR	2.7
1	E	69	PHE	2.7
1	C	280	SER	2.7
1	A	284	ALA	2.6
1	G	353	GLY	2.6
1	C	291	ILE	2.6
1	E	255	TRP	2.6
1	A	49	PHE	2.6
1	G	69	PHE	2.6
1	H	404	GLU	2.6
1	B	277	ALA	2.6
1	D	22	PRO	2.6
1	G	401	GLY	2.6
1	A	428	GLN	2.6
1	D	387	THR	2.6
1	F	33	ALA	2.6
1	E	87	SER	2.6
1	E	356	SER	2.6
1	E	395	ASP	2.5
1	A	282	PHE	2.5
1	H	400	SER	2.5
1	E	29	VAL	2.5
1	F	66	VAL	2.5
1	C	387	THR	2.5

Continued on next page...

Continued from previous page...

Mol	Chain	Res	Type	RSRZ
1	E	256	GLU	2.5
1	C	401	GLY	2.5
1	D	382	ILE	2.5
1	E	291	ILE	2.5
1	G	31	ILE	2.5
1	A	41	ASP	2.5
1	H	395	ASP	2.5
1	F	40	ASN	2.5
1	A	218	THR	2.5
1	F	210	THR	2.5
1	D	402	VAL	2.5
1	G	319	SER	2.5
1	H	429	LYS	2.5
1	D	43	ALA	2.5
1	E	143	ALA	2.5
1	D	219	THR	2.5
1	C	283	SER	2.5
1	A	272	LEU	2.5
1	A	320	TRP	2.5
1	B	360	LYS	2.4
1	E	30	PRO	2.4
1	F	393	SER	2.4
1	F	428	GLN	2.4
1	A	42	SER	2.4
1	G	315	SER	2.4
1	E	53	GLU	2.4
1	A	66	VAL	2.4
1	A	94	LEU	2.4
1	C	44	HIS	2.4
1	C	47	ARG	2.4
1	C	53	GLU	2.4
1	F	396	GLU	2.4
1	F	86	SER	2.4
1	D	53	GLU	2.4
1	D	65	THR	2.4
1	D	256	GLU	2.4
1	E	289	LEU	2.3
1	C	356	SER	2.3
1	E	355	ALA	2.3
1	C	388	THR	2.3
1	G	65	THR	2.3
1	G	281	PRO	2.3

Continued on next page...

Continued from previous page...

Mol	Chain	Res	Type	RSRZ
1	A	319	SER	2.3
1	B	283	SER	2.3
1	F	223	VAL	2.3
1	D	291	ILE	2.3
1	G	429	LYS	2.3
1	D	33	ALA	2.3
1	F	431	TYR	2.3
1	C	210	THR	2.3
1	E	219	THR	2.3
1	A	251	GLY	2.3
1	F	48	LEU	2.3
1	G	404	GLU	2.3
1	E	394	GLU	2.3
1	B	94	LEU	2.3
1	B	316	PRO	2.3
1	H	218	THR	2.3
1	H	315	SER	2.3
1	F	7	GLN	2.2
1	H	394	GLU	2.2
1	C	87	SER	2.2
1	E	66	VAL	2.2
1	H	66	VAL	2.2
1	A	287	LEU	2.2
1	C	48	LEU	2.2
1	H	288	LEU	2.2
1	F	280	SER	2.2
1	A	354	ASP	2.2
1	C	29	VAL	2.2
1	D	383	HIS	2.2
1	G	360	LYS	2.2
1	E	233	ASN	2.2
1	F	290	GLY	2.2
1	D	87	SER	2.2
1	E	281	PRO	2.2
1	F	69	PHE	2.2
1	G	52	LYS	2.2
1	F	222	GLY	2.2
1	F	53	GLU	2.2
1	H	280	SER	2.2
1	D	57	ILE	2.2
1	C	85	THR	2.2
1	A	396	GLU	2.2

Continued on next page...

Continued from previous page...

Mol	Chain	Res	Type	RSRZ
1	B	32	TYR	2.2
1	A	223	VAL	2.2
1	G	223	VAL	2.2
1	D	94	LEU	2.2
1	G	51	LEU	2.2
1	C	220	ILE	2.2
1	C	221	GLY	2.2
1	H	219	THR	2.2
1	A	46	ALA	2.2
1	C	430	ALA	2.2
1	F	209	ALA	2.2
1	D	280	SER	2.1
1	G	311	TYR	2.1
1	C	402	VAL	2.1
1	B	272	LEU	2.1
1	H	287	LEU	2.1
1	E	85	THR	2.1
1	F	286	GLN	2.1
1	F	28	ALA	2.1
1	F	390	GLU	2.1
1	G	280	SER	2.1
1	H	43	ALA	2.1
1	F	247	PRO	2.1
1	B	51	LEU	2.1
1	G	287	LEU	2.1
1	A	283	SER	2.1
1	B	315	SER	2.1
1	H	356	SER	2.1
1	A	33	ALA	2.1
1	D	32	TYR	2.1
1	C	69	PHE	2.1
1	B	218	THR	2.1
1	C	68	VAL	2.1
1	G	402	VAL	2.1
1	A	308	LEU	2.1
1	B	90	ALA	2.1
1	E	33	ALA	2.1
1	E	278	CYS	2.1
1	F	355	ALA	2.1
1	G	277	ALA	2.1
1	H	360	LYS	2.1
1	D	40	ASN	2.1

Continued on next page...

Continued from previous page...

Mol	Chain	Res	Type	RSRZ
1	D	86	SER	2.1
1	H	386	SER	2.1
1	B	219	THR	2.1
1	C	223	VAL	2.1
1	G	318	VAL	2.1
1	A	50	GLY	2.1
1	H	50	GLY	2.1
1	A	275	ILE	2.1
1	B	319	SER	2.1
1	E	44	HIS	2.1
1	E	247	PRO	2.0
1	A	401	GLY	2.0
1	B	332	TYR	2.0
1	D	28	ALA	2.0
1	H	284	ALA	2.0
1	E	258	PHE	2.0
1	H	69	PHE	2.0
1	A	278	CYS	2.0
1	D	30	PRO	2.0
1	A	357	ALA	2.0
1	D	209	ALA	2.0
1	F	43	ALA	2.0
1	F	283	SER	2.0
1	G	53	GLU	2.0
1	B	321	VAL	2.0
1	C	354	ASP	2.0
1	G	85	THR	2.0
1	F	215	GLY	2.0

6.2 Non-standard residues in protein, DNA, RNA chains [i](#)

In the following table, the Atoms column lists the number of modelled atoms in the group and the number defined in the chemical component dictionary. The B-factors column lists the minimum, median, 95th percentile and maximum values of B factors of atoms in the group. The column labelled 'Q< 0.9' lists the number of atoms with occupancy less than 0.9.

Mol	Type	Chain	Res	Atoms	RSCC	RSR	B-factors(Å ²)	Q<0.9
1	LLP	A	211	24/25	0.97	0.11	25,29,34,36	0
1	LLP	B	211	24/25	0.97	0.10	24,29,33,37	0
1	LLP	C	211	24/25	0.97	0.12	19,25,31,33	0
1	LLP	D	211	24/25	0.97	0.13	19,24,30,32	0
1	LLP	E	211	24/25	0.97	0.13	23,27,31,34	0

Continued on next page...

Continued from previous page...

Mol	Type	Chain	Res	Atoms	RSCC	RSR	B-factors(\AA^2)	Q<0.9
1	LLP	G	211	24/25	0.97	0.12	23,32,34,38	0
1	LLP	F	211	24/25	0.98	0.15	23,27,31,34	0
1	LLP	H	211	24/25	0.98	0.12	23,31,36,37	0

6.3 Carbohydrates [i](#)

There are no monosaccharides in this entry.

6.4 Ligands [i](#)

There are no ligands in this entry.

6.5 Other polymers [i](#)

There are no such residues in this entry.