



## Full wwPDB EM Validation Report ⓘ

Mar 12, 2025 – 04:20 pm GMT

PDB ID : 9F3S  
EMDB ID : EMD-50178  
Title : 13pf mosaic 20%E254Q - 80% E254N microtubule from recombinant human tubulin decorated with EB3  
Authors : Estevez-Gallego, J.; Blum, T.B.; Steinmetz, M.O.; Surrey, T.  
Deposited on : 2024-04-25  
Resolution : 4.20 Å(reported)  
Based on initial model : 7sj7

This is a Full wwPDB EM Validation Report for a publicly released PDB entry.

We welcome your comments at [validation@mail.wwpdb.org](mailto:validation@mail.wwpdb.org)

A user guide is available at

<https://www.wwpdb.org/validation/2017/EMValidationReportHelp>

with specific help available everywhere you see the ⓘ symbol.

The types of validation reports are described at

<http://www.wwpdb.org/validation/2017/FAQs#types>.

---

The following versions of software and data (see [references ⓘ](#)) were used in the production of this report:

EMDB validation analysis : 0.0.1.dev117  
Mogul : 1.8.4, CSD as541be (2020)  
MolProbity : 4.02b-467  
buster-report : 1.1.7 (2018)  
Percentile statistics : 20231227.v01 (using entries in the PDB archive December 27th 2023)  
MapQ : 1.9.13  
Ideal geometry (proteins) : Engh & Huber (2001)  
Ideal geometry (DNA, RNA) : Parkinson et al. (1996)  
Validation Pipeline (wwPDB-VP) : 2.41

# 1 Overall quality at a glance i

The following experimental techniques were used to determine the structure:

*ELECTRON MICROSCOPY*

The reported resolution of this entry is 4.20 Å.

Percentile scores (ranging between 0-100) for global validation metrics of the entry are shown in the following graphic. The table shows the number of entries on which the scores are based.

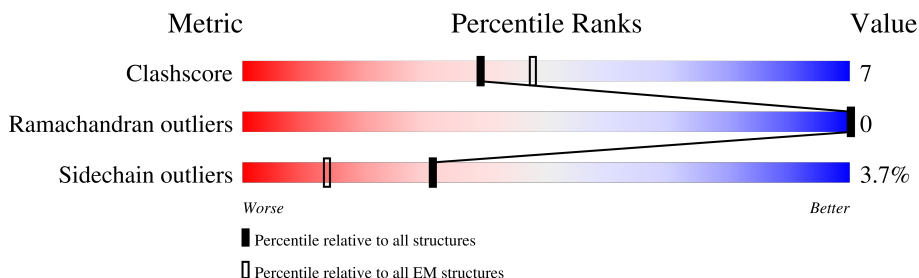







Metric	Whole archive (#Entries)	EM structures (#Entries)
Clashscore	210492	15764
Ramachandran outliers	207382	16835
Sidechain outliers	206894	16415

The table below summarises the geometric issues observed across the polymeric chains and their fit to the map. The red, orange, yellow and green segments of the bar indicate the fraction of residues that contain outliers for  $\geq 3$ , 2, 1 and 0 types of geometric quality criteria respectively. A grey segment represents the fraction of residues that are not modelled. The numeric value for each fraction is indicated below the corresponding segment, with a dot representing fractions  $\leq 5\%$ . The upper red bar (where present) indicates the fraction of residues that have poor fit to the EM map (all-atom inclusion  $< 40\%$ ). The numeric value is given above the bar.

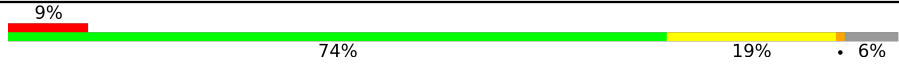
Mol	Chain	Length	Quality of chain
1	S	131	
1	T	131	
2	A	453	
2	C	453	
2	E	453	
2	G	453	
2	I	453	
2	K	453	

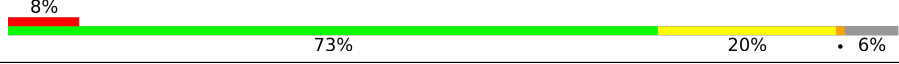
Continued on next page...

*Continued from previous page...*

Mol	Chain	Length	Quality of chain
3	B	456	 <p>9% 74% 19% • 6%</p>
3	D	456	 <p>9% 73% 20% • 6%</p>
3	F	456	 <p>8% 73% 20% • 6%</p>
3	N	456	 <p>15% 72% 21% • 6%</p>
3	P	456	 <p>15% 75% 18% • 6%</p>
3	R	456	 <p>13% 76% 17% • 6%</p>

## 2 Entry composition [i](#)

There are 5 unique types of molecules in this entry. The entry contains 43258 atoms, of which 0 are hydrogens and 0 are deuteriums.

In the tables below, the AltConf column contains the number of residues with at least one atom in alternate conformation and the Trace column contains the number of residues modelled with at most 2 atoms.

- Molecule 1 is a protein called Microtubule-associated protein RP/EB family member 3.

Mol	Chain	Residues	Atoms					AltConf	Trace
			Total	C	N	O	S		
1	S	131	1079	702	181	189	7	0	0
1	T	131	1079	702	181	189	7	0	0

- Molecule 2 is a protein called Detyrosinated tubulin alpha-1B chain.

Mol	Chain	Residues	Atoms					AltConf	Trace
			Total	C	N	O	S		
2	A	435	3417	2164	585	646	22	0	0
2	G	435	3417	2164	585	646	22	0	0
2	C	435	3417	2164	585	646	22	0	0
2	I	435	3417	2164	585	646	22	0	0
2	E	435	3417	2164	585	646	22	0	0
2	K	435	3417	2164	585	646	22	0	0

There are 102 discrepancies between the modelled and reference sequences:

Chain	Residue	Modelled	Actual	Comment	Reference
A	40	HIS	-	linker	UNP P68363
A	41	HIS	-	linker	UNP P68363
A	42	HIS	-	linker	UNP P68363
A	42A	HIS	-	linker	UNP P68363
A	42B	HIS	-	linker	UNP P68363
A	42C	HIS	-	linker	UNP P68363
A	42D	GLY	-	linker	UNP P68363
A	42E	GLY	-	linker	UNP P68363
A	42F	GLY	-	linker	UNP P68363

*Continued on next page...*

*Continued from previous page...*

Chain	Residue	Modelled	Actual	Comment	Reference
A	42G	HIS	-	linker	UNP P68363
A	42H	HIS	-	linker	UNP P68363
A	42I	HIS	-	linker	UNP P68363
A	42J	PHE	-	linker	UNP P68363
A	42K	ASN	-	linker	UNP P68363
A	42L	THR	-	linker	UNP P68363
A	42M	PHE	-	linker	UNP P68363
A	254	ASN	GLU	engineered mutation	UNP P68363
G	40	HIS	-	linker	UNP P68363
G	41	HIS	-	linker	UNP P68363
G	42	HIS	-	linker	UNP P68363
G	42A	HIS	-	linker	UNP P68363
G	42B	HIS	-	linker	UNP P68363
G	42C	HIS	-	linker	UNP P68363
G	42D	GLY	-	linker	UNP P68363
G	42E	GLY	-	linker	UNP P68363
G	42F	GLY	-	linker	UNP P68363
G	42G	HIS	-	linker	UNP P68363
G	42H	HIS	-	linker	UNP P68363
G	42I	HIS	-	linker	UNP P68363
G	42J	PHE	-	linker	UNP P68363
G	42K	ASN	-	linker	UNP P68363
G	42L	THR	-	linker	UNP P68363
G	42M	PHE	-	linker	UNP P68363
G	254	ASN	GLU	engineered mutation	UNP P68363
C	40	HIS	-	linker	UNP P68363
C	41	HIS	-	linker	UNP P68363
C	42	HIS	-	linker	UNP P68363
C	42A	HIS	-	linker	UNP P68363
C	42B	HIS	-	linker	UNP P68363
C	42C	HIS	-	linker	UNP P68363
C	42D	GLY	-	linker	UNP P68363
C	42E	GLY	-	linker	UNP P68363
C	42F	GLY	-	linker	UNP P68363
C	42G	HIS	-	linker	UNP P68363
C	42H	HIS	-	linker	UNP P68363
C	42I	HIS	-	linker	UNP P68363
C	42J	PHE	-	linker	UNP P68363
C	42K	ASN	-	linker	UNP P68363
C	42L	THR	-	linker	UNP P68363
C	42M	PHE	-	linker	UNP P68363
C	254	ASN	GLU	engineered mutation	UNP P68363

*Continued on next page...*

*Continued from previous page...*

Chain	Residue	Modelled	Actual	Comment	Reference
I	40	HIS	-	linker	UNP P68363
I	41	HIS	-	linker	UNP P68363
I	42	HIS	-	linker	UNP P68363
I	42A	HIS	-	linker	UNP P68363
I	42B	HIS	-	linker	UNP P68363
I	42C	HIS	-	linker	UNP P68363
I	42D	GLY	-	linker	UNP P68363
I	42E	GLY	-	linker	UNP P68363
I	42F	GLY	-	linker	UNP P68363
I	42G	HIS	-	linker	UNP P68363
I	42H	HIS	-	linker	UNP P68363
I	42I	HIS	-	linker	UNP P68363
I	42J	PHE	-	linker	UNP P68363
I	42K	ASN	-	linker	UNP P68363
I	42L	THR	-	linker	UNP P68363
I	42M	PHE	-	linker	UNP P68363
I	254	ASN	GLU	engineered mutation	UNP P68363
E	40	HIS	-	linker	UNP P68363
E	41	HIS	-	linker	UNP P68363
E	42	HIS	-	linker	UNP P68363
E	42A	HIS	-	linker	UNP P68363
E	42B	HIS	-	linker	UNP P68363
E	42C	HIS	-	linker	UNP P68363
E	42D	GLY	-	linker	UNP P68363
E	42E	GLY	-	linker	UNP P68363
E	42F	GLY	-	linker	UNP P68363
E	42G	HIS	-	linker	UNP P68363
E	42H	HIS	-	linker	UNP P68363
E	42I	HIS	-	linker	UNP P68363
E	42J	PHE	-	linker	UNP P68363
E	42K	ASN	-	linker	UNP P68363
E	42L	THR	-	linker	UNP P68363
E	42M	PHE	-	linker	UNP P68363
E	254	ASN	GLU	engineered mutation	UNP P68363
K	40	HIS	-	linker	UNP P68363
K	41	HIS	-	linker	UNP P68363
K	42	HIS	-	linker	UNP P68363
K	42A	HIS	-	linker	UNP P68363
K	42B	HIS	-	linker	UNP P68363
K	42C	HIS	-	linker	UNP P68363
K	42D	GLY	-	linker	UNP P68363
K	42E	GLY	-	linker	UNP P68363

*Continued on next page...*

*Continued from previous page...*

Chain	Residue	Modelled	Actual	Comment	Reference
K	42F	GLY	-	linker	UNP P68363
K	42G	HIS	-	linker	UNP P68363
K	42H	HIS	-	linker	UNP P68363
K	42I	HIS	-	linker	UNP P68363
K	42J	PHE	-	linker	UNP P68363
K	42K	ASN	-	linker	UNP P68363
K	42L	THR	-	linker	UNP P68363
K	42M	PHE	-	linker	UNP P68363
K	254	ASN	GLU	engineered mutation	UNP P68363

- Molecule 3 is a protein called Tubulin beta-3 chain.

Mol	Chain	Residues	Atoms					AltConf	Trace
3	B	429	Total	C	N	O	S	0	0
			3367	2117	577	648	25		
3	N	429	Total	C	N	O	S	0	0
			3367	2117	577	648	25		
3	D	429	Total	C	N	O	S	0	0
			3367	2117	577	648	25		
3	P	429	Total	C	N	O	S	0	0
			3367	2117	577	648	25		
3	F	429	Total	C	N	O	S	0	0
			3367	2117	577	648	25		
3	R	429	Total	C	N	O	S	0	0
			3367	2117	577	648	25		

There are 36 discrepancies between the modelled and reference sequences:

Chain	Residue	Modelled	Actual	Comment	Reference
B	451	GLU	-	expression tag	UNP Q13509
B	452	ASN	-	expression tag	UNP Q13509
B	453	LEU	-	expression tag	UNP Q13509
B	454	TYR	-	expression tag	UNP Q13509
B	455	PHE	-	expression tag	UNP Q13509
B	456	GLN	-	expression tag	UNP Q13509
N	451	GLU	-	expression tag	UNP Q13509
N	452	ASN	-	expression tag	UNP Q13509
N	453	LEU	-	expression tag	UNP Q13509
N	454	TYR	-	expression tag	UNP Q13509
N	455	PHE	-	expression tag	UNP Q13509
N	456	GLN	-	expression tag	UNP Q13509
D	451	GLU	-	expression tag	UNP Q13509

*Continued on next page...*

Continued from previous page...

Chain	Residue	Modelled	Actual	Comment	Reference
D	452	ASN	-	expression tag	UNP Q13509
D	453	LEU	-	expression tag	UNP Q13509
D	454	TYR	-	expression tag	UNP Q13509
D	455	PHE	-	expression tag	UNP Q13509
D	456	GLN	-	expression tag	UNP Q13509
P	451	GLU	-	expression tag	UNP Q13509
P	452	ASN	-	expression tag	UNP Q13509
P	453	LEU	-	expression tag	UNP Q13509
P	454	TYR	-	expression tag	UNP Q13509
P	455	PHE	-	expression tag	UNP Q13509
P	456	GLN	-	expression tag	UNP Q13509
F	451	GLU	-	expression tag	UNP Q13509
F	452	ASN	-	expression tag	UNP Q13509
F	453	LEU	-	expression tag	UNP Q13509
F	454	TYR	-	expression tag	UNP Q13509
F	455	PHE	-	expression tag	UNP Q13509
F	456	GLN	-	expression tag	UNP Q13509
R	451	GLU	-	expression tag	UNP Q13509
R	452	ASN	-	expression tag	UNP Q13509
R	453	LEU	-	expression tag	UNP Q13509
R	454	TYR	-	expression tag	UNP Q13509
R	455	PHE	-	expression tag	UNP Q13509
R	456	GLN	-	expression tag	UNP Q13509

- Molecule 4 is GUANOSINE-5'-TRIPHOSPHATE (three-letter code: GTP) (formula:  $C_{10}H_{16}N_5O_{14}P_3$ ) (labeled as "Ligand of Interest" by depositor).

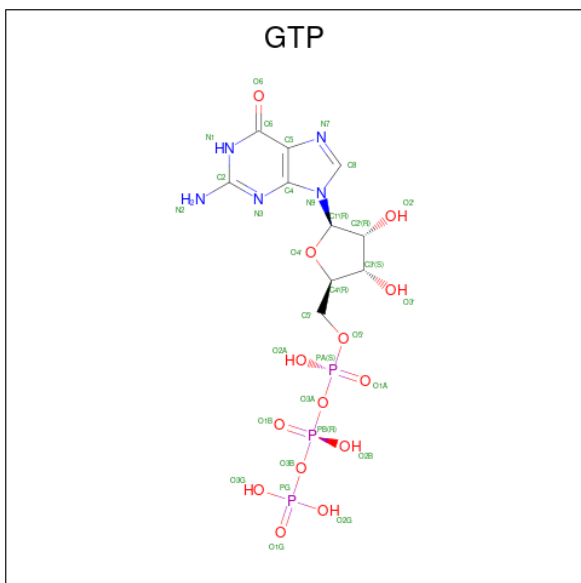



Mol	Chain	Residues	Atoms					AltConf
4	A	1	Total	C	N	O	P	0
			32	10	5	14	3	
4	B	1	Total	C	N	O	P	0
			32	10	5	14	3	
4	G	1	Total	C	N	O	P	0
			32	10	5	14	3	
4	N	1	Total	C	N	O	P	0
			32	10	5	14	3	
4	C	1	Total	C	N	O	P	0
			32	10	5	14	3	
4	D	1	Total	C	N	O	P	0
			32	10	5	14	3	
4	I	1	Total	C	N	O	P	0
			32	10	5	14	3	
4	P	1	Total	C	N	O	P	0
			32	10	5	14	3	
4	E	1	Total	C	N	O	P	0
			32	10	5	14	3	
4	F	1	Total	C	N	O	P	0
			32	10	5	14	3	
4	K	1	Total	C	N	O	P	0
			32	10	5	14	3	
4	R	1	Total	C	N	O	P	0
			32	10	5	14	3	

- Molecule 5 is MAGNESIUM ION (three-letter code: MG) (formula: Mg) (labeled as "Ligand of Interest" by depositor).

Mol	Chain	Residues	Atoms		AltConf
5	A	1	Total	Mg	0
			1	1	
5	B	1	Total	Mg	0
			1	1	
5	G	1	Total	Mg	0
			1	1	
5	N	1	Total	Mg	0
			1	1	
5	C	1	Total	Mg	0
			1	1	
5	D	1	Total	Mg	0
			1	1	
5	I	1	Total	Mg	0
			1	1	

*Continued on next page...*

*Continued from previous page...*

<b>Mol</b>	<b>Chain</b>	<b>Residues</b>	<b>Atoms</b>		<b>AltConf</b>
5	P	1	Total 1	Mg 1	0
5	E	1	Total 1	Mg 1	0
5	F	1	Total 1	Mg 1	0
5	K	1	Total 1	Mg 1	0
5	R	1	Total 1	Mg 1	0

### 3 Residue-property plots [i](#)

These plots are drawn for all protein, RNA, DNA and oligosaccharide chains in the entry. The first graphic for a chain summarises the proportions of the various outlier classes displayed in the second graphic. The second graphic shows the sequence view annotated by issues in geometry and atom inclusion in map density. Residues are color-coded according to the number of geometric quality criteria for which they contain at least one outlier: green = 0, yellow = 1, orange = 2 and red = 3 or more. A red diamond above a residue indicates a poor fit to the EM map for this residue (all-atom inclusion < 40%). Stretches of 2 or more consecutive residues without any outlier are shown as a green connector. Residues present in the sample, but not in the model, are shown in grey.

- Molecule 1: Microtubule-associated protein RP/EB family member 3

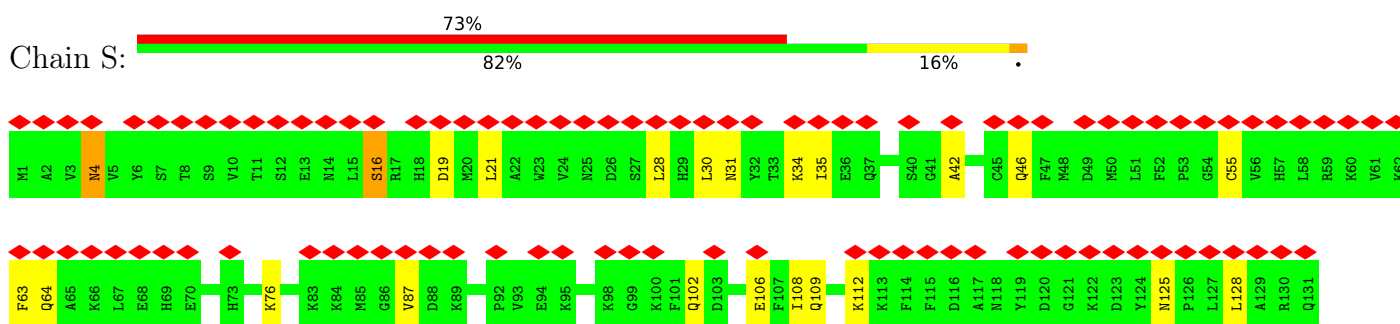

- Molecule 1: Microtubule-associated protein RP/EB family member 3

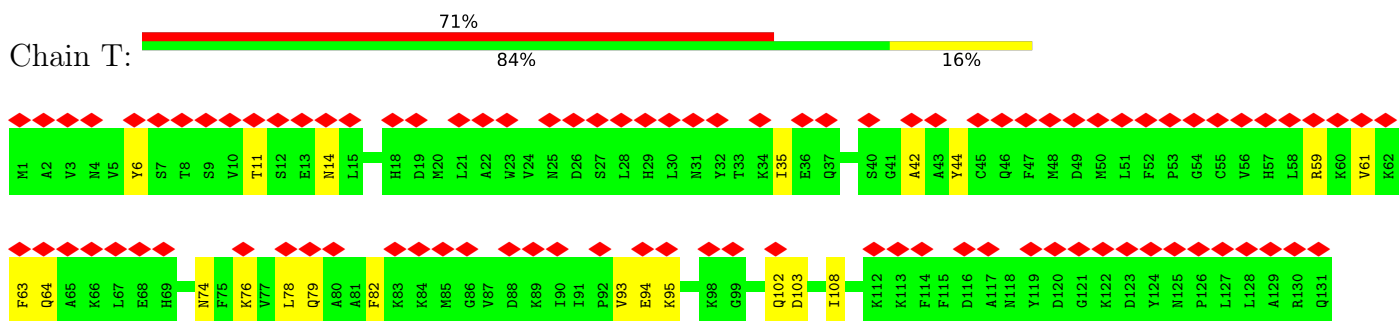

- Molecule 2: Detyrosinated tubulin alpha-1B chain

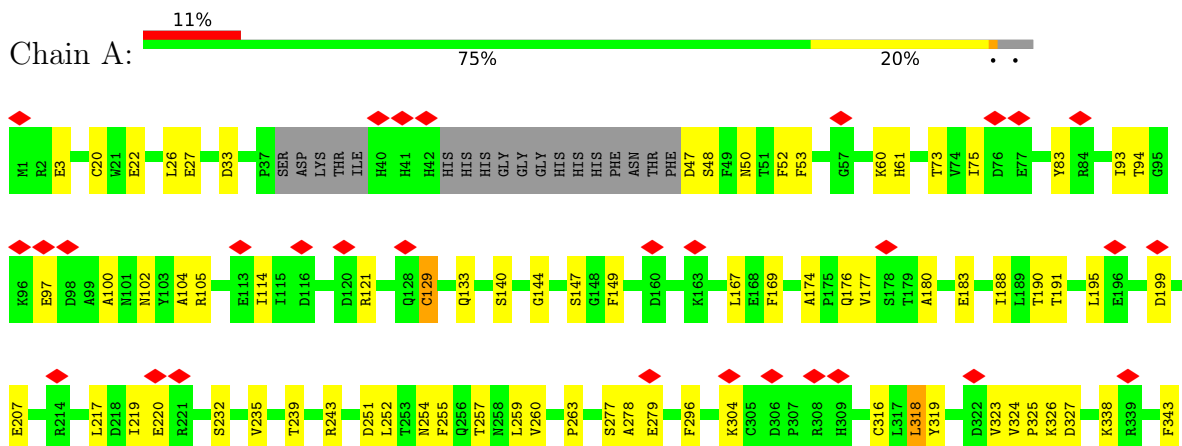

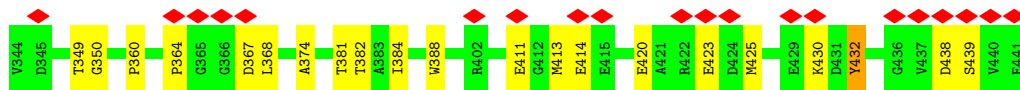

• Molecule 2: Detyrosinated tubulin alpha-1B chain

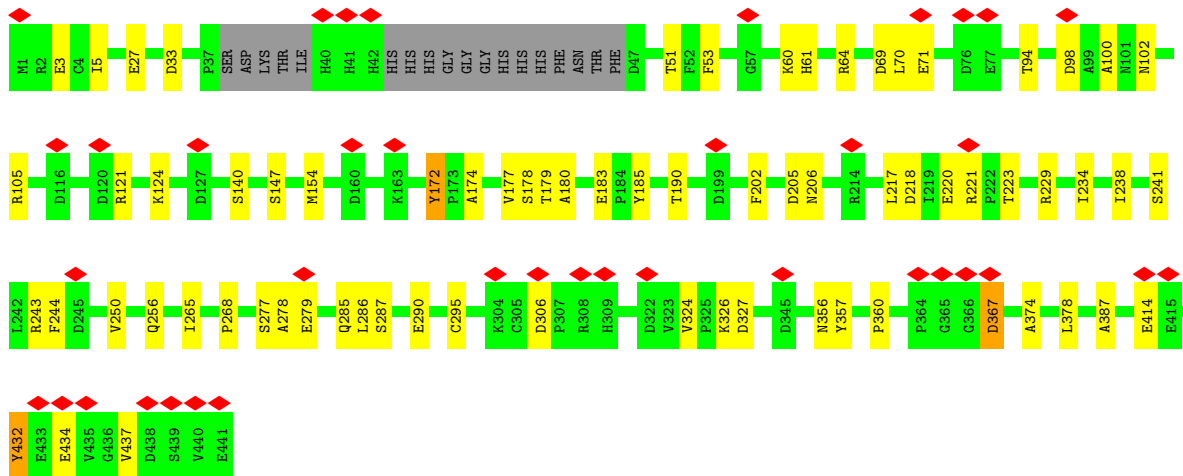
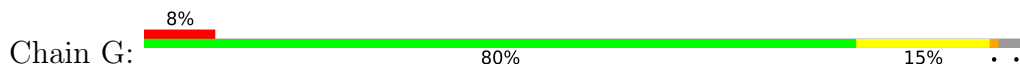

• Molecule 2: Detyrosinated tubulin alpha-1B chain

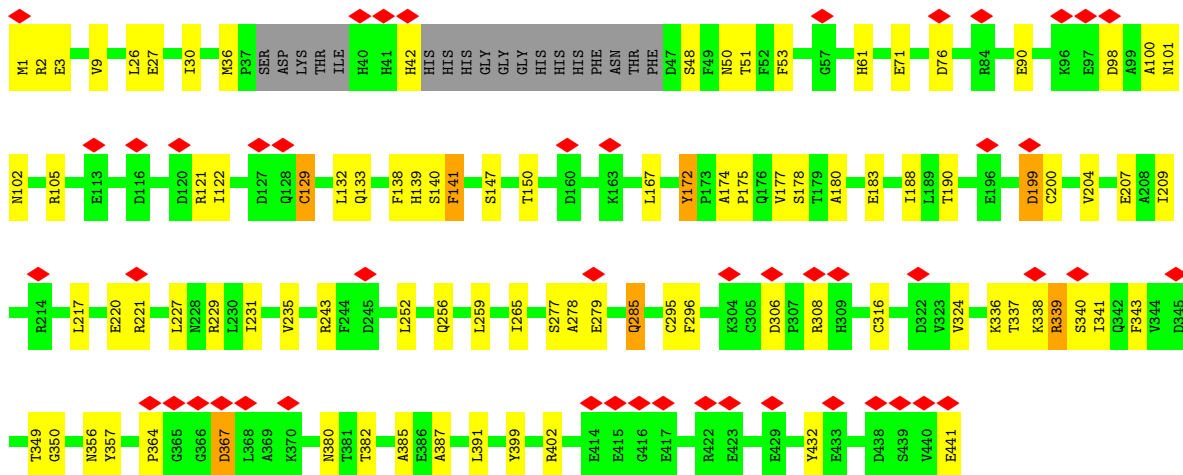
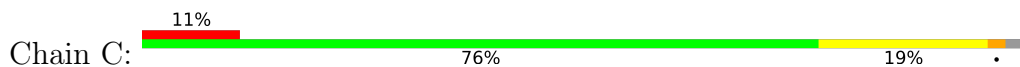

• Molecule 2: Detyrosinated tubulin alpha-1B chain

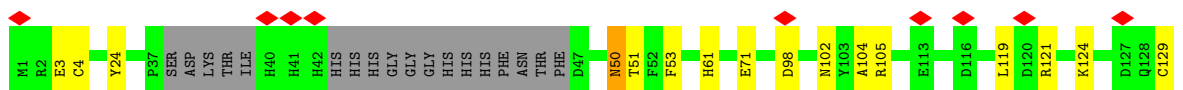

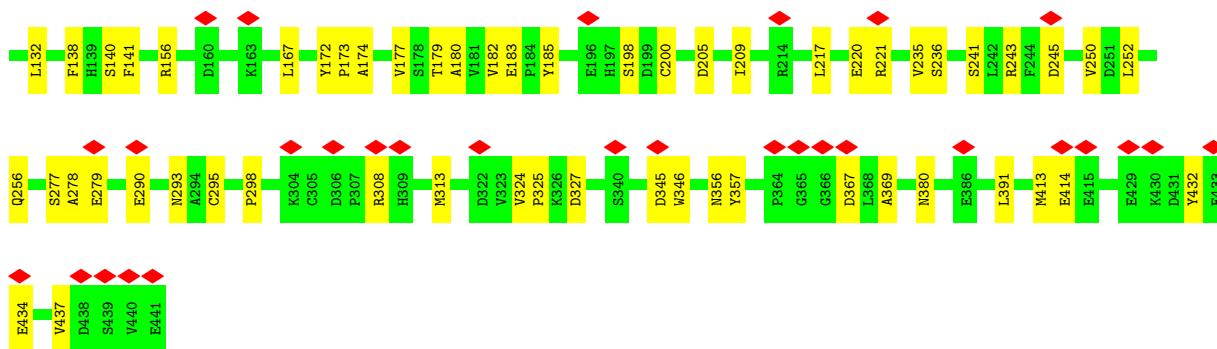

• Molecule 2: Detyrosinated tubulin alpha-1B chain

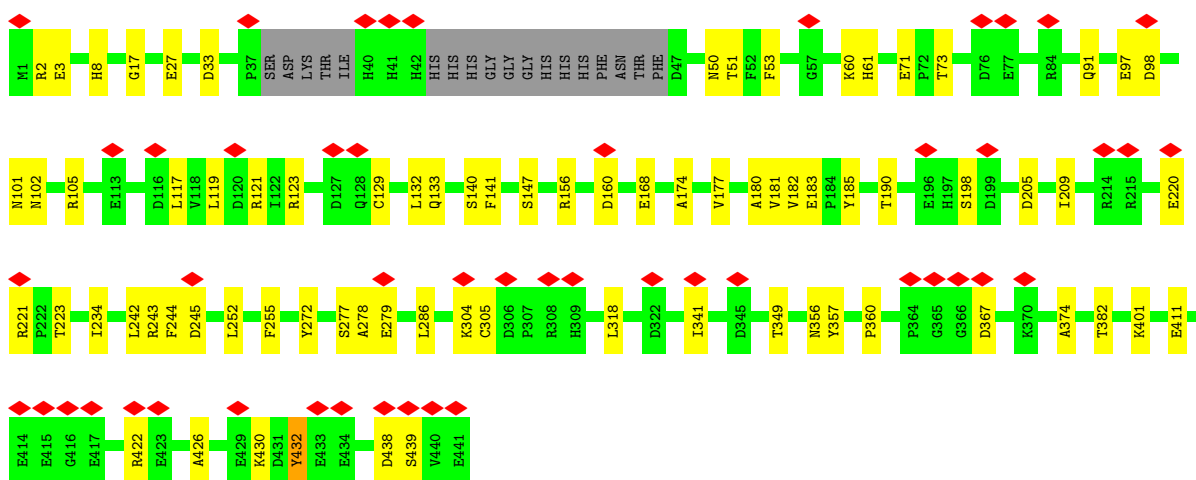
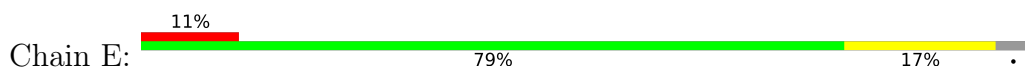

• Molecule 2: Detyrosinated tubulin alpha-1B chain

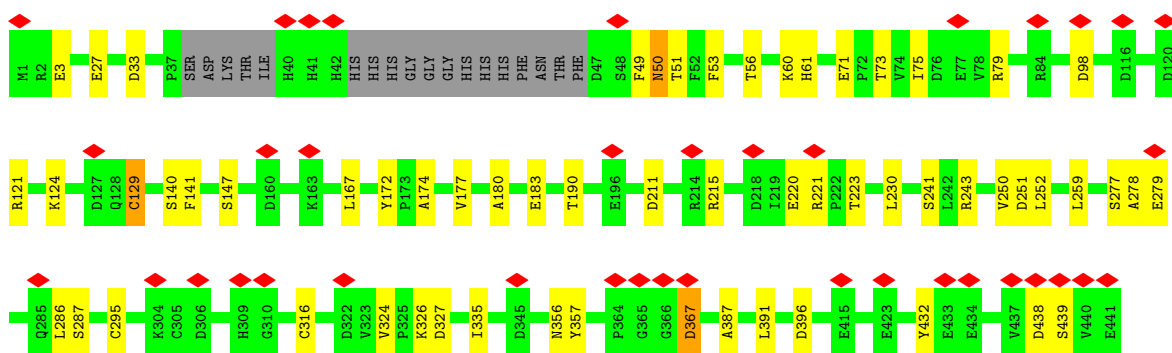
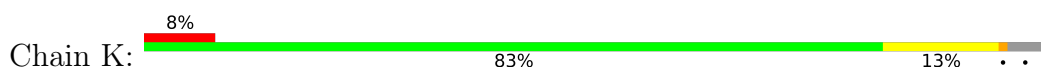

• Molecule 3: Tubulin beta-3 chain

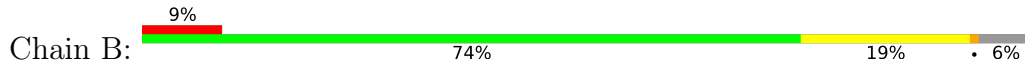

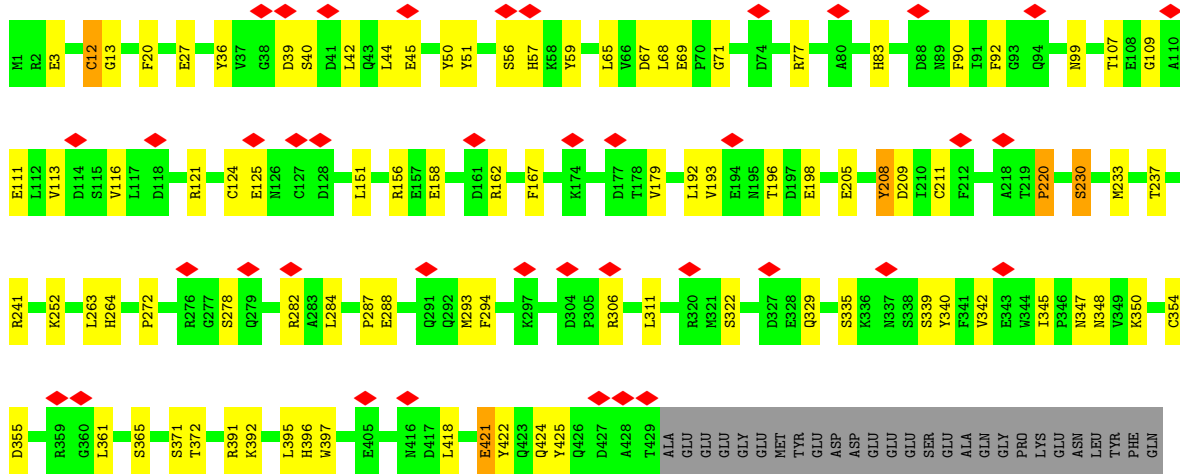

• Molecule 3: Tubulin beta-3 chain

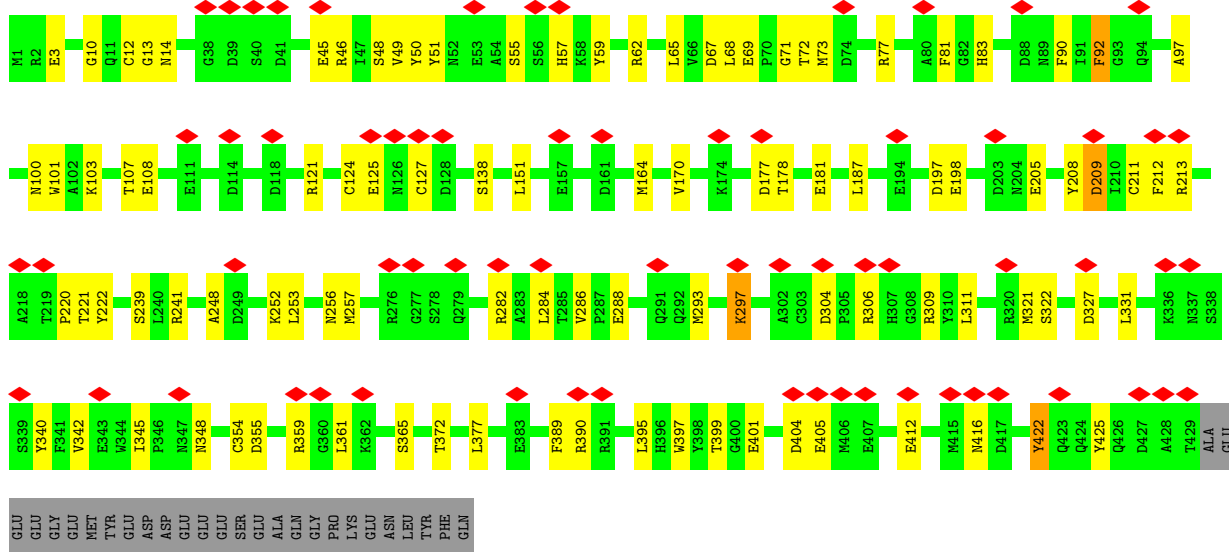
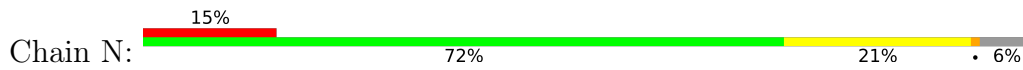

• Molecule 3: Tubulin beta-3 chain

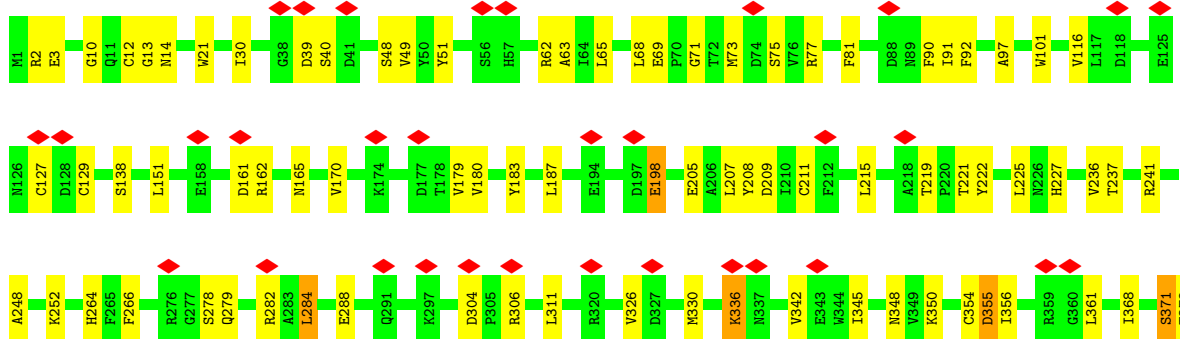
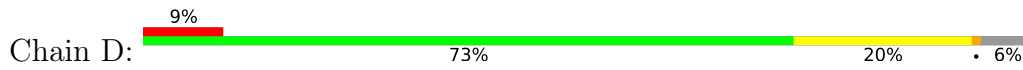

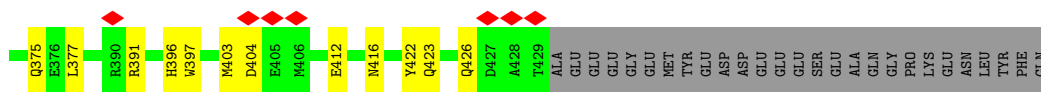

• Molecule 3: Tubulin beta-3 chain

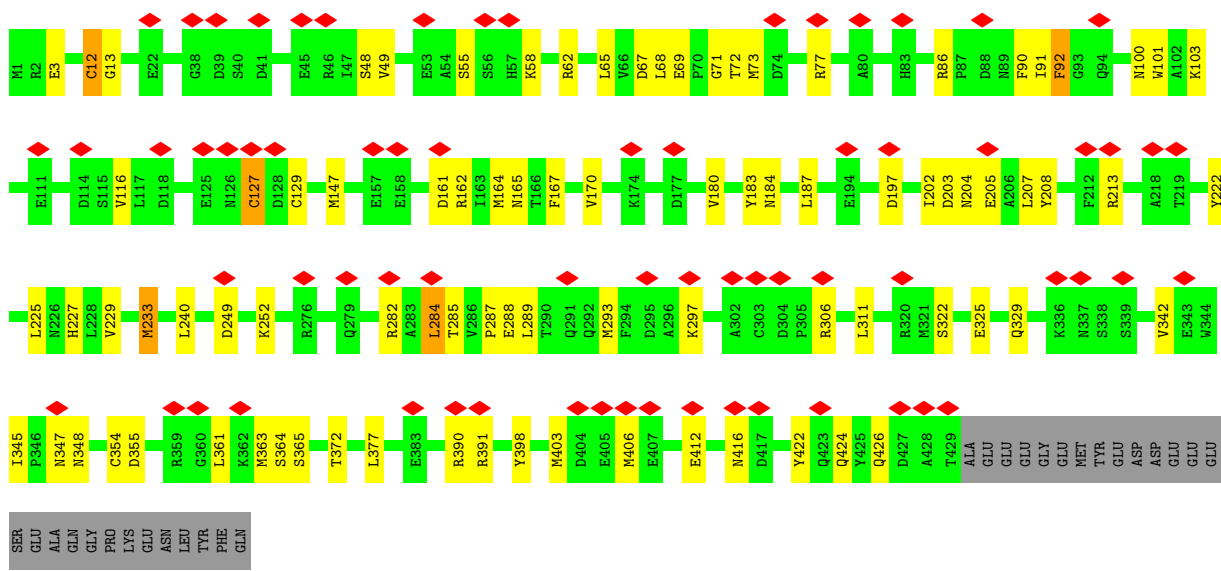
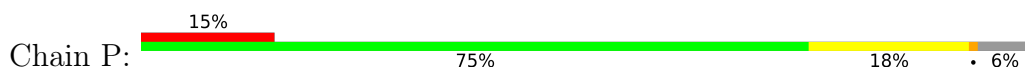

• Molecule 3: Tubulin beta-3 chain

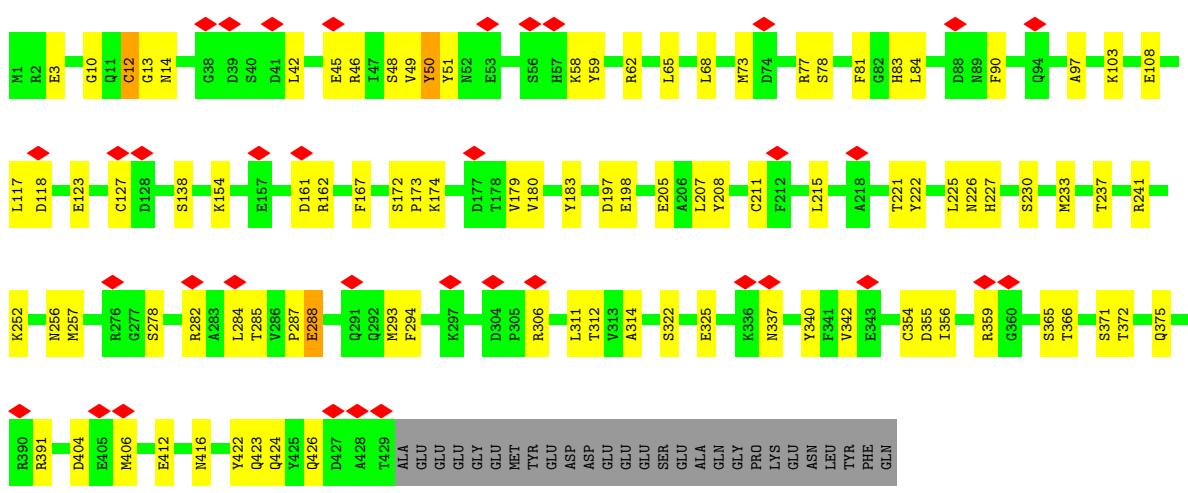

• Molecule 3: Tubulin beta-3 chain

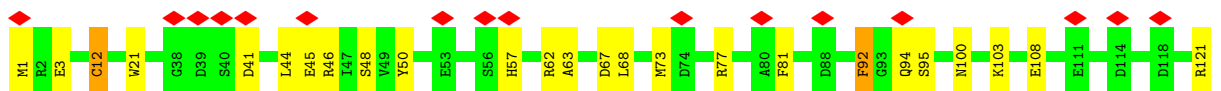
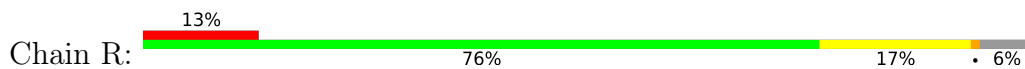

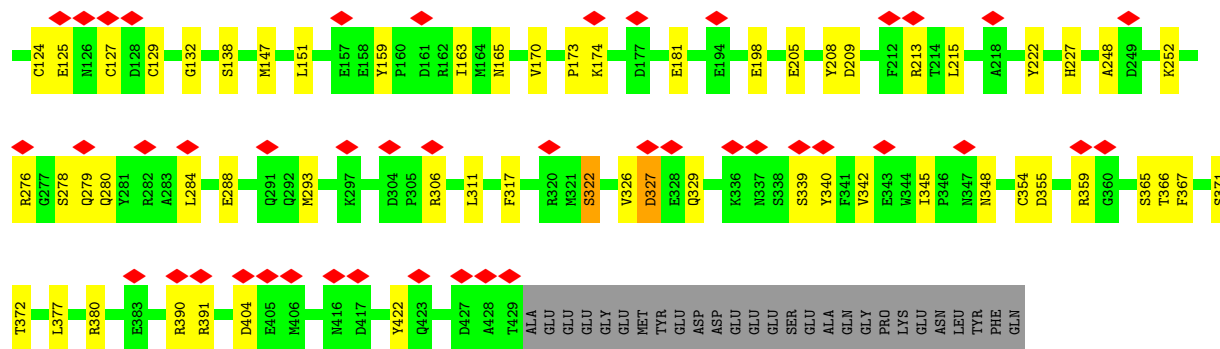



## 4 Experimental information

Property	Value	Source
EM reconstruction method	HELICAL	Depositor
Imposed symmetry	HELICAL, twist=-27.6855°, rise=9.58598 Å, axial sym=C13	Depositor
Number of segments used	30010	Depositor
Resolution determination method	FSC 0.143 CUT-OFF	Depositor
CTF correction method	PHASE FLIPPING AND AMPLITUDE CORRECTION	Depositor
Microscope	TFS GLACIOS	Depositor
Voltage (kV)	200	Depositor
Electron dose ( $e^-/\text{Å}^2$ )	7.27	Depositor
Minimum defocus (nm)	1000	Depositor
Maximum defocus (nm)	2500	Depositor
Magnification	Not provided	
Image detector	FEI FALCON IV (4k x 4k)	Depositor
Maximum map value	0.100	Depositor
Minimum map value	-0.050	Depositor
Average map value	0.000	Depositor
Map value standard deviation	0.004	Depositor
Recommended contour level	0.018	Depositor
Map size (Å)	573.0, 573.0, 573.0	wwPDB
Map dimensions	600, 600, 600	wwPDB
Map angles (°)	90.0, 90.0, 90.0	wwPDB
Pixel spacing (Å)	0.955, 0.955, 0.955	Depositor

## 5 Model quality i

### 5.1 Standard geometry i

Bond lengths and bond angles in the following residue types are not validated in this section: MG, GTP

The Z score for a bond length (or angle) is the number of standard deviations the observed value is removed from the expected value. A bond length (or angle) with  $|Z| > 5$  is considered an outlier worth inspection. RMSZ is the root-mean-square of all Z scores of the bond lengths (or angles).

Mol	Chain	Bond lengths		Bond angles	
		RMSZ	# Z  >5	RMSZ	# Z  >5
1	S	0.25	0/1107	0.44	0/1490
1	T	0.25	0/1107	0.43	0/1490
2	A	0.25	0/3496	0.49	0/4745
2	C	0.25	0/3496	0.47	0/4745
2	E	0.24	0/3496	0.48	0/4745
2	G	0.25	0/3496	0.47	0/4745
2	I	0.25	0/3496	0.48	0/4745
2	K	0.25	0/3496	0.47	0/4745
3	B	0.27	0/3442	0.51	1/4663 (0.0%)
3	D	0.25	0/3442	0.51	1/4663 (0.0%)
3	F	0.25	0/3442	0.50	0/4663
3	N	0.25	0/3442	0.51	2/4663 (0.0%)
3	P	0.25	0/3442	0.49	0/4663
3	R	0.25	0/3442	0.50	1/4663 (0.0%)
All	All	0.25	0/43842	0.49	5/59428 (0.0%)

Chiral center outliers are detected by calculating the chiral volume of a chiral center and verifying if the center is modelled as a planar moiety or with the opposite hand. A planarity outlier is detected by checking planarity of atoms in a peptide group, atoms in a mainchain group or atoms of a sidechain that are expected to be planar.

Mol	Chain	#Chirality outliers	#Planarity outliers
2	C	0	1

There are no bond length outliers.

All (5) bond angle outliers are listed below:

Mol	Chain	Res	Type	Atoms	Z	Observed(°)	Ideal(°)
3	N	197	ASP	CB-CG-OD1	6.17	123.85	118.30
3	B	209	ASP	CB-CG-OD1	5.53	123.27	118.30

*Continued on next page...*

*Continued from previous page...*

Mol	Chain	Res	Type	Atoms	Z	Observed(°)	Ideal(°)
3	R	327	ASP	CB-CG-OD1	5.24	123.02	118.30
3	N	209	ASP	CB-CG-OD1	5.14	122.93	118.30
3	D	209	ASP	CB-CG-OD2	5.14	122.93	118.30

There are no chirality outliers.

All (1) planarity outliers are listed below:

Mol	Chain	Res	Type	Group
2	C	339	ARG	Peptide

## 5.2 Too-close contacts [i](#)

In the following table, the Non-H and H(model) columns list the number of non-hydrogen atoms and hydrogen atoms in the chain respectively. The H(added) column lists the number of hydrogen atoms added and optimized by MolProbity. The Clashes column lists the number of clashes within the asymmetric unit, whereas Symm-Clashes lists symmetry-related clashes.

Mol	Chain	Non-H	H(model)	H(added)	Clashes	Symm-Clashes
1	S	1079	0	1065	13	0
1	T	1079	0	1065	17	0
2	A	3417	0	3321	60	0
2	C	3417	0	3321	60	0
2	E	3417	0	3321	49	0
2	G	3417	0	3321	44	0
2	I	3417	0	3321	44	0
2	K	3417	0	3321	37	0
3	B	3367	0	3251	54	0
3	D	3367	0	3251	58	0
3	F	3367	0	3251	49	0
3	N	3367	0	3251	55	0
3	P	3367	0	3251	48	0
3	R	3367	0	3251	45	0
4	A	32	0	12	2	0
4	B	32	0	12	1	0
4	C	32	0	12	1	0
4	D	32	0	12	0	0
4	E	32	0	12	1	0
4	F	32	0	12	1	0
4	G	32	0	12	1	0
4	I	32	0	12	1	0
4	K	32	0	12	0	0

*Continued on next page...*

Continued from previous page...

Mol	Chain	Non-H	H(model)	H(added)	Clashes	Symm-Clashes
4	N	32	0	12	0	0
4	P	32	0	12	0	0
4	R	32	0	12	0	0
5	A	1	0	0	0	0
5	B	1	0	0	0	0
5	C	1	0	0	0	0
5	D	1	0	0	0	0
5	E	1	0	0	0	0
5	F	1	0	0	0	0
5	G	1	0	0	0	0
5	I	1	0	0	0	0
5	K	1	0	0	0	0
5	N	1	0	0	0	0
5	P	1	0	0	0	0
5	R	1	0	0	0	0
All	All	43258	0	41706	595	0

The all-atom clashscore is defined as the number of clashes found per 1000 atoms (including hydrogen atoms). The all-atom clashscore for this structure is 7.

All (595) close contacts within the same asymmetric unit are listed below, sorted by their clash magnitude.

Atom-1	Atom-2	Interatomic distance (Å)	Clash overlap (Å)
3:P:203:ASP:OD1	3:P:204:ASN:N	2.12	0.82
2:K:180:ALA:HB3	2:K:183:GLU:HG3	1.68	0.76
2:C:204:VAL:HG11	2:C:231:ILE:HD11	1.69	0.73
2:A:102:ASN:HB3	2:A:105:ARG:HB2	1.70	0.73
3:N:354:CYS:SG	3:N:355:ASP:N	2.63	0.72
3:F:354:CYS:SG	3:F:355:ASP:N	2.63	0.71
2:K:71:GLU:HB3	2:K:98:ASP:HB3	1.70	0.71
2:C:3:GLU:HG3	2:C:129:CYS:HB2	1.72	0.71
3:F:12:CYS:HG	3:F:138:SER:HG	1.38	0.70
3:R:205:GLU:N	3:R:205:GLU:OE2	2.25	0.70
2:G:324:VAL:HG12	2:G:326:LYS:H	1.56	0.69
3:B:56:SER:O	3:B:57:HIS:ND1	2.23	0.69
2:I:180:ALA:HB3	2:I:183:GLU:HG3	1.75	0.69
3:F:372:THR:HG21	3:F:426:GLN:HB2	1.74	0.69
3:R:354:CYS:SG	3:R:355:ASP:N	2.66	0.69
2:K:3:GLU:HG3	2:K:129:CYS:HB2	1.74	0.69
3:B:354:CYS:SG	3:B:355:ASP:N	2.66	0.69
3:P:354:CYS:SG	3:P:355:ASP:N	2.64	0.68

Continued on next page...

*Continued from previous page...*

Atom-1	Atom-2	Interatomic distance (Å)	Clash overlap (Å)
3:R:77:ARG:HH22	3:R:92:PHE:HE2	1.41	0.68
3:N:100:ASN:HB3	3:N:103:LYS:HB2	1.75	0.68
2:G:180:ALA:HB3	2:G:183:GLU:HG3	1.74	0.68
2:C:221:ARG:NH1	3:P:325:GLU:OE2	2.26	0.68
2:C:220:GLU:OE2	2:C:220:GLU:N	2.26	0.68
2:I:51:THR:HG21	2:I:243:ARG:HG2	1.75	0.67
3:D:354:CYS:SG	3:D:355:ASP:N	2.68	0.67
2:G:71:GLU:HB2	2:G:98:ASP:HB3	1.76	0.67
3:P:293:MET:SD	3:P:365:SER:OG	2.51	0.67
3:D:48:SER:O	3:D:62:ARG:NH2	2.28	0.66
3:N:399:THR:HG23	3:N:404:ASP:HA	1.77	0.66
3:R:48:SER:O	3:R:62:ARG:NH2	2.29	0.66
3:P:207:LEU:HB3	3:P:225:LEU:HD11	1.78	0.66
2:K:324:VAL:HG12	2:K:326:LYS:H	1.60	0.66
3:D:372:THR:HG21	3:D:426:GLN:HB2	1.78	0.66
2:C:147:SER:OG	2:C:190:THR:OG1	2.14	0.65
3:B:282:ARG:NH2	3:B:288:GLU:OE1	2.29	0.65
3:N:48:SER:O	3:N:62:ARG:NH2	2.29	0.65
2:C:2:ARG:HB2	2:C:133:GLN:HE21	1.61	0.65
2:K:51:THR:HG21	2:K:243:ARG:HG2	1.77	0.65
3:P:48:SER:O	3:P:62:ARG:NH2	2.30	0.65
2:A:260:VAL:HB	3:B:397:TRP:CH2	2.32	0.64
3:N:248:ALA:HA	3:N:252:LYS:HD3	1.78	0.64
2:G:51:THR:HG21	2:G:243:ARG:HG2	1.78	0.64
2:I:50:ASN:HD22	2:I:50:ASN:C	1.99	0.64
2:E:234:ILE:HD11	2:E:272:TYR:HB2	1.79	0.64
2:C:199:ASP:OD2	2:C:256:GLN:NE2	2.30	0.63
1:T:35:ILE:HD11	1:T:108:ILE:HG21	1.78	0.63
2:A:53:PHE:HB3	2:A:61:HIS:HB3	1.80	0.63
2:E:147:SER:OG	2:E:190:THR:OG1	2.13	0.63
2:A:319:TYR:HB3	2:A:323:VAL:HG21	1.80	0.63
1:T:64:GLN:N	1:T:64:GLN:OE1	2.32	0.63
2:C:180:ALA:HB3	2:C:183:GLU:HG3	1.81	0.63
2:G:220:GLU:HG2	2:G:221:ARG:HG2	1.80	0.62
3:F:73:MET:HB3	3:F:77:ARG:HH21	1.65	0.62
3:R:100:ASN:HB3	3:R:103:LYS:HB2	1.80	0.62
3:B:27:GLU:OE1	3:B:241:ARG:NH1	2.31	0.62
2:C:100:ALA:HA	3:P:252:LYS:HG2	1.80	0.62
3:F:282:ARG:NH2	3:F:288:GLU:OE1	2.33	0.62
3:P:287:PRO:HA	3:P:329:GLN:HE22	1.64	0.62
2:K:241:SER:OG	2:K:250:VAL:O	2.17	0.62

*Continued on next page...*

*Continued from previous page...*

Atom-1	Atom-2	Interatomic distance (Å)	Clash overlap (Å)
2:E:181:VAL:HG23	3:R:348:ASN:HA	1.82	0.61
2:A:73:THR:HG22	3:N:46:ARG:HH12	1.66	0.61
3:B:252:LYS:HG3	2:G:100:ALA:HA	1.81	0.61
3:R:73:MET:HB3	3:R:77:ARG:HH21	1.65	0.61
1:S:64:GLN:OE1	1:S:64:GLN:N	2.34	0.61
3:R:345:ILE:HG22	3:R:348:ASN:HB3	1.83	0.61
2:K:367:ASP:OD1	2:K:367:ASP:N	2.34	0.60
3:R:12:CYS:HG	3:R:138:SER:HG	1.48	0.60
2:A:257:THR:HA	3:B:397:TRP:HZ3	1.66	0.60
2:A:220:GLU:OE2	2:A:220:GLU:N	2.31	0.60
3:N:297:LYS:HD3	3:N:297:LYS:N	2.16	0.60
3:B:205:GLU:OE1	3:B:205:GLU:N	2.26	0.60
3:D:170:VAL:HG21	3:D:377:LEU:HD21	1.84	0.60
3:F:10:GLY:O	3:F:14:ASN:ND2	2.31	0.60
3:F:322:SER:HA	2:K:223:THR:HG22	1.84	0.60
2:A:257:THR:HA	3:B:397:TRP:CZ3	2.37	0.60
3:D:77:ARG:HH22	3:D:92:PHE:HE2	1.47	0.59
1:T:93:VAL:HG13	2:C:337:THR:HG23	1.82	0.59
2:A:259:LEU:HD11	2:A:316:CYS:HB2	1.83	0.59
3:F:325:GLU:OE2	2:K:221:ARG:NH1	2.36	0.59
2:K:147:SER:OG	2:K:190:THR:OG1	2.20	0.59
3:D:248:ALA:HA	3:D:252:LYS:HD3	1.84	0.59
3:B:293:MET:SD	3:B:365:SER:OG	2.51	0.59
3:N:69:GLU:HG2	3:N:71:GLY:H	1.67	0.59
2:A:277:SER:OG	2:A:279:GLU:OE2	2.20	0.59
2:G:102:ASN:HB3	2:G:105:ARG:HB2	1.85	0.59
3:N:311:LEU:HD23	3:N:342:VAL:HG21	1.85	0.59
3:F:49:VAL:HG11	3:F:241:ARG:HG2	1.83	0.59
3:R:45:GLU:OE2	3:R:46:ARG:NH2	2.35	0.59
2:C:279:GLU:N	2:C:279:GLU:OE2	2.34	0.59
2:A:27:GLU:OE1	2:A:243:ARG:NH1	2.36	0.59
2:C:101:ASN:OD1	3:P:252:LYS:NZ	2.36	0.59
1:S:16:SER:HB2	3:F:404:ASP:HB3	1.85	0.58
1:T:76:LYS:NZ	2:C:336:LYS:O	2.30	0.58
2:K:327:ASP:OD1	2:K:327:ASP:N	2.37	0.58
2:A:93:ILE:HG22	2:A:114:ILE:HD11	1.85	0.58
2:G:414:GLU:N	2:G:414:GLU:OE1	2.36	0.58
3:D:10:GLY:O	3:D:14:ASN:ND2	2.35	0.58
2:E:349:THR:OG1	3:F:179:VAL:O	2.21	0.58
3:B:69:GLU:HG2	3:B:71:GLY:H	1.69	0.58
2:E:33:ASP:O	2:E:60:LYS:NZ	2.36	0.58

*Continued on next page...*

*Continued from previous page...*

Atom-1	Atom-2	Interatomic distance (Å)	Clash overlap (Å)
3:F:365:SER:OG	3:F:366:THR:N	2.36	0.58
2:I:241:SER:OG	2:I:250:VAL:O	2.19	0.58
1:T:79:GLN:HG3	2:C:339:ARG:NH2	2.19	0.58
3:D:91:ILE:HD12	3:D:116:VAL:HG23	1.86	0.58
3:P:345:ILE:HG22	3:P:348:ASN:HB3	1.86	0.58
3:N:372:THR:HA	3:N:422:TYR:HE1	1.69	0.57
2:C:217:LEU:HD21	2:C:367:ASP:HB2	1.86	0.57
2:I:298:PRO:HG2	2:I:308:ARG:HH11	1.68	0.57
2:A:180:ALA:HB3	2:A:183:GLU:HG3	1.86	0.57
2:C:27:GLU:OE1	2:C:243:ARG:NH1	2.34	0.57
2:G:241:SER:OG	2:G:250:VAL:O	2.19	0.57
2:C:349:THR:OG1	3:D:179:VAL:O	2.20	0.57
2:I:50:ASN:C	2:I:50:ASN:ND2	2.58	0.57
1:T:95:LYS:HG2	1:T:103:ASP:OD2	2.04	0.57
2:A:349:THR:OG1	3:B:179:VAL:O	2.21	0.56
2:G:217:LEU:HD21	2:G:367:ASP:HB2	1.87	0.56
2:C:26:LEU:HD21	2:C:364:PRO:HD3	1.88	0.56
2:C:367:ASP:OD1	2:C:367:ASP:N	2.36	0.56
2:A:251:ASP:H	2:A:254:ASN:HB2	1.70	0.56
2:E:51:THR:HG21	2:E:243:ARG:HG2	1.87	0.56
2:G:367:ASP:OD1	2:G:367:ASP:N	2.34	0.56
2:E:220:GLU:OE1	2:E:220:GLU:N	2.31	0.56
1:S:4:ASN:HD21	1:S:87:VAL:HA	1.70	0.56
2:E:168:GLU:OE2	2:E:198:SER:OG	2.24	0.56
2:K:140:SER:OG	2:K:141:PHE:N	2.39	0.56
3:R:248:ALA:HA	3:R:252:LYS:HD3	1.86	0.56
3:F:311:LEU:HD23	3:F:342:VAL:HG21	1.88	0.56
3:R:3:GLU:HB2	3:R:127:CYS:SG	2.46	0.56
3:N:252:LYS:O	3:N:256:ASN:ND2	2.38	0.55
2:I:217:LEU:HD21	2:I:367:ASP:HB3	1.87	0.55
3:P:65:LEU:HD13	3:P:90:PHE:HE1	1.71	0.55
3:D:227:HIS:O	3:D:227:HIS:ND1	2.33	0.55
2:K:33:ASP:O	2:K:60:LYS:NZ	2.40	0.55
2:G:327:ASP:OD1	2:G:327:ASP:N	2.37	0.55
1:T:103:ASP:OD1	1:T:103:ASP:N	2.38	0.55
3:D:3:GLU:N	3:D:3:GLU:OE1	2.40	0.55
2:I:102:ASN:HB3	2:I:105:ARG:HB2	1.89	0.55
3:B:121:ARG:NH1	3:B:158:GLU:OE2	2.39	0.55
3:N:198:GLU:N	3:N:198:GLU:OE1	2.40	0.54
3:P:322:SER:OG	3:P:325:GLU:OE1	2.25	0.54
3:D:12:CYS:SG	3:D:138:SER:OG	2.55	0.54

*Continued on next page...*

*Continued from previous page...*

Atom-1	Atom-2	Interatomic distance (Å)	Clash overlap (Å)
2:A:167:LEU:HD11	2:A:252:LEU:HG	1.88	0.54
3:D:237:THR:HG22	3:D:241:ARG:HE	1.72	0.54
3:R:371:SER:OG	3:R:372:THR:N	2.38	0.54
3:D:69:GLU:HG2	3:D:71:GLY:H	1.72	0.54
2:K:50:ASN:O	2:K:50:ASN:ND2	2.41	0.54
2:K:356:ASN:OD1	2:K:357:TYR:N	2.41	0.54
3:R:170:VAL:HG21	3:R:377:LEU:HD11	1.89	0.54
1:S:125:ASN:HD21	1:S:128:LEU:HD23	1.71	0.54
2:G:147:SER:OG	2:G:190:THR:OG1	2.11	0.54
2:C:399:TYR:O	2:C:402:ARG:NH1	2.41	0.54
1:S:42:ALA:HB1	1:S:63:PHE:HD1	1.72	0.54
1:T:42:ALA:HB1	1:T:63:PHE:HD1	1.72	0.54
3:R:132:GLY:HA3	3:R:163:ILE:HG22	1.89	0.54
2:I:277:SER:OG	2:I:278:ALA:N	2.42	0.53
2:A:217:LEU:HD21	2:A:367:ASP:HB2	1.89	0.53
2:C:53:PHE:HB3	2:C:61:HIS:HB3	1.90	0.53
3:F:68:LEU:HD12	3:F:97:ALA:HB2	1.89	0.53
3:N:170:VAL:HG21	3:N:377:LEU:HD11	1.90	0.53
3:P:100:ASN:HB3	3:P:103:LYS:HB2	1.91	0.53
2:A:279:GLU:OE2	2:A:279:GLU:N	2.30	0.53
3:B:77:ARG:HH22	3:B:92:PHE:HE2	1.56	0.53
3:D:282:ARG:NH2	3:D:288:GLU:OE1	2.41	0.53
3:F:375:GLN:OE1	3:F:423:GLN:HB2	2.09	0.53
2:G:3:GLU:N	2:G:3:GLU:OE1	2.41	0.53
2:G:140:SER:OG	4:G:501:GTP:O2A	2.20	0.53
3:N:68:LEU:HD13	3:N:108:GLU:HG3	1.90	0.53
3:P:73:MET:HB3	3:P:77:ARG:HH21	1.72	0.53
2:C:324:VAL:HG21	3:D:219:THR:HB	1.91	0.53
2:I:220:GLU:HG2	2:I:221:ARG:HG2	1.90	0.53
2:E:123:ARG:NH2	2:E:160:ASP:OD2	2.38	0.53
3:R:57:HIS:O	3:R:57:HIS:ND1	2.41	0.53
2:A:22:GLU:HB2	2:A:83:TYR:HE2	1.74	0.53
2:E:119:LEU:HD11	2:E:156:ARG:HB3	1.91	0.53
1:T:102:GLN:NE2	3:B:111:GLU:OE2	2.42	0.53
2:E:2:ARG:HB3	2:E:133:GLN:HE21	1.73	0.53
2:A:26:LEU:HD21	2:A:364:PRO:HD3	1.90	0.52
3:N:253:LEU:O	3:N:257:MET:HG2	2.09	0.52
3:R:173:PRO:HD2	3:R:205:GLU:OE1	2.09	0.52
2:C:167:LEU:HD11	2:C:252:LEU:HG	1.92	0.52
3:D:326:VAL:O	3:D:330:MET:HG2	2.08	0.52
3:D:396:HIS:CE1	3:D:397:TRP:HE1	2.27	0.52

*Continued on next page...*



*Continued from previous page...*

Atom-1	Atom-2	Interatomic distance (Å)	Clash overlap (Å)
2:A:360:PRO:HG3	2:A:374:ALA:HB2	1.91	0.52
2:C:71:GLU:HB2	2:C:98:ASP:HB3	1.91	0.52
3:P:311:LEU:HD23	3:P:342:VAL:HG21	1.91	0.52
2:A:105:ARG:HG3	2:A:411:GLU:HG2	1.91	0.52
2:A:3:GLU:O	2:A:133:GLN:N	2.35	0.52
3:P:249:ASP:HB3	3:P:252:LYS:HG3	1.92	0.52
3:F:252:LYS:O	3:F:256:ASN:ND2	2.43	0.52
3:P:170:VAL:HG21	3:P:377:LEU:HD11	1.92	0.52
3:B:278:SER:O	3:B:278:SER:OG	2.27	0.52
3:B:121:ARG:O	3:B:125:GLU:HG2	2.10	0.52
3:B:371:SER:OG	3:B:372:THR:N	2.41	0.52
1:T:94:GLU:HB2	2:C:337:THR:HG21	1.92	0.52
2:G:285:GLN:OE1	2:G:285:GLN:N	2.24	0.52
3:R:209:ASP:HB3	3:R:213:ARG:HH22	1.74	0.52
2:A:100:ALA:HA	3:N:252:LYS:HG2	1.91	0.51
2:G:244:PHE:HB2	2:G:356:ASN:HD21	1.75	0.51
2:E:27:GLU:OE1	2:E:243:ARG:NH1	2.37	0.51
2:C:220:GLU:H	2:C:220:GLU:CD	2.13	0.51
2:C:140:SER:OG	4:C:501:GTP:O2A	2.23	0.51
2:C:265:ILE:HG23	2:C:432:TYR:CE2	2.45	0.51
3:D:2:ARG:NH1	2:I:71:GLU:OE2	2.37	0.51
3:D:371:SER:OG	3:D:372:THR:N	2.43	0.51
3:P:282:ARG:NH2	3:P:288:GLU:OE1	2.43	0.51
3:D:345:ILE:HG22	3:D:348:ASN:HB3	1.91	0.51
3:D:412:GLU:OE2	3:D:416:ASN:ND2	2.43	0.51
2:E:182:VAL:HG22	2:E:185:TYR:HB2	1.93	0.51
3:B:99:ASN:ND2	4:B:501:GTP:O3G	2.43	0.51
3:N:3:GLU:HB2	3:N:127:CYS:SG	2.51	0.51
3:P:3:GLU:HB2	3:P:127:CYS:SG	2.50	0.51
3:F:3:GLU:HG3	3:F:127:CYS:SG	2.50	0.51
3:D:205:GLU:OE1	3:D:205:GLU:N	2.32	0.51
2:I:140:SER:OG	4:I:501:GTP:O2A	2.22	0.51
2:E:180:ALA:HB3	2:E:183:GLU:HG3	1.92	0.51
2:K:27:GLU:OE1	2:K:243:ARG:NH1	2.34	0.51
3:N:178:THR:HG23	3:N:181:GLU:HG3	1.91	0.51
3:B:350:LYS:HA	2:G:179:THR:O	2.11	0.51
2:C:42:HIS:NE2	2:C:48:SER:OG	2.40	0.51
2:I:50:ASN:ND2	2:I:50:ASN:O	2.37	0.51
2:I:53:PHE:HB3	2:I:61:HIS:HB3	1.93	0.51
2:E:382:THR:HA	2:E:432:TYR:HE1	1.75	0.51
3:D:404:ASP:OD1	3:D:404:ASP:N	2.42	0.50

*Continued on next page...*

*Continued from previous page...*

Atom-1	Atom-2	Interatomic distance (Å)	Clash overlap (Å)
3:B:3:GLU:OE2	3:B:3:GLU:N	2.45	0.50
3:P:91:ILE:HD12	3:P:116:VAL:HG23	1.93	0.50
2:E:367:ASP:N	2:E:367:ASP:OD1	2.43	0.50
2:I:3:GLU:HG2	2:I:129:CYS:HB2	1.94	0.50
3:N:286:VAL:HG22	3:N:321:MET:HE2	1.94	0.50
2:K:174:ALA:HB3	2:K:177:VAL:O	2.11	0.50
2:A:367:ASP:OD1	2:A:367:ASP:N	2.44	0.50
3:D:375:GLN:OE1	3:D:423:GLN:HB2	2.11	0.50
2:G:33:ASP:O	2:G:60:LYS:NZ	2.44	0.50
3:N:221:THR:OG1	3:N:222:TYR:N	2.45	0.50
3:D:161:ASP:O	3:D:162:ARG:NE	2.45	0.50
3:P:167:PHE:CE2	3:P:233:MET:HB2	2.46	0.50
3:D:51:TYR:O	3:D:62:ARG:NH2	2.45	0.50
3:D:180:VAL:HG23	3:D:183:TYR:HD2	1.76	0.50
3:F:167:PHE:CE2	3:F:233:MET:HG3	2.47	0.50
1:T:79:GLN:O	1:T:82:PHE:HB2	2.12	0.49
3:B:12:CYS:SG	3:B:13:GLY:N	2.85	0.49
2:G:174:ALA:HB3	2:G:177:VAL:O	2.12	0.49
2:C:172:TYR:HE2	2:C:387:ALA:HB1	1.76	0.49
2:I:345:ASP:OD1	2:I:346:TRP:N	2.45	0.49
3:D:49:VAL:HG11	3:D:241:ARG:HG2	1.94	0.49
3:P:77:ARG:HH22	3:P:92:PHE:HE2	1.60	0.49
3:P:180:VAL:HG23	3:P:183:TYR:HD2	1.78	0.49
3:F:51:TYR:HD2	3:F:59:TYR:HB3	1.77	0.49
3:D:311:LEU:HD23	3:D:342:VAL:HG21	1.95	0.49
3:P:49:VAL:HG21	3:P:240:LEU:HD11	1.95	0.49
3:P:184:ASN:OD1	3:P:398:TYR:OH	2.29	0.49
2:A:277:SER:OG	2:A:278:ALA:N	2.45	0.49
2:C:259:LEU:HD11	2:C:316:CYS:HB2	1.93	0.49
3:R:1:MET:N	3:R:3:GLU:OE2	2.40	0.49
2:A:438:ASP:OD1	2:A:439:SER:N	2.46	0.49
3:D:278:SER:O	3:D:278:SER:OG	2.29	0.49
2:I:414:GLU:N	2:I:414:GLU:OE2	2.46	0.49
3:B:51:TYR:HD1	3:B:59:TYR:HB3	1.78	0.49
3:D:68:LEU:HD12	3:D:97:ALA:HB2	1.94	0.49
3:F:45:GLU:OE2	3:F:46:ARG:NH2	2.46	0.49
3:F:173:PRO:HD2	3:F:205:GLU:OE2	2.13	0.49
2:A:217:LEU:HD22	2:A:219:ILE:HG13	1.94	0.48
3:N:12:CYS:HG	3:N:138:SER:HG	1.54	0.48
2:E:102:ASN:HB3	2:E:105:ARG:HB2	1.95	0.48
2:K:259:LEU:HD11	2:K:316:CYS:HB2	1.95	0.48

*Continued on next page...*

*Continued from previous page...*

Atom-1	Atom-2	Interatomic distance (Å)	Clash overlap (Å)
3:R:311:LEU:HD23	3:R:342:VAL:HG21	1.94	0.48
3:B:42:LEU:HA	3:B:45:GLU:HG3	1.95	0.48
3:B:192:LEU:O	3:B:196:THR:HG22	2.14	0.48
3:N:45:GLU:OE2	3:N:46:ARG:NH2	2.46	0.48
3:N:239:SER:HG	3:N:248:ALA:H	1.62	0.48
2:I:217:LEU:HD23	2:I:217:LEU:O	2.13	0.48
2:K:438:ASP:OD2	2:K:439:SER:N	2.47	0.48
3:P:164:MET:N	3:P:197:ASP:OD2	2.40	0.48
1:T:79:GLN:HB2	1:T:82:PHE:CG	2.49	0.48
3:N:101:TRP:CD1	3:N:187:LEU:HD13	2.48	0.48
2:E:223:THR:HG22	3:R:322:SER:HA	1.95	0.48
3:F:285:THR:HG23	3:F:287:PRO:HD2	1.96	0.48
3:B:67:ASP:OD1	3:B:68:LEU:N	2.46	0.48
2:E:73:THR:HG22	3:R:46:ARG:HH12	1.79	0.48
2:G:27:GLU:OE1	2:G:243:ARG:NH1	2.32	0.48
2:G:205:ASP:OD1	2:G:206:ASN:N	2.47	0.48
2:E:277:SER:OG	2:E:278:ALA:N	2.46	0.48
3:B:392:LYS:HD2	3:B:395:LEU:HD22	1.96	0.47
3:D:211:CYS:HA	3:D:215:LEU:HB2	1.95	0.47
2:E:255:PHE:CZ	2:E:318:LEU:HD21	2.49	0.47
1:S:28:LEU:HB2	1:S:30:LEU:HD22	1.96	0.47
2:C:1:MET:N	2:C:50:ASN:OD1	2.33	0.47
2:A:97:GLU:N	2:A:97:GLU:OE1	2.47	0.47
3:P:289:LEU:HD21	3:P:363:MET:HG3	1.94	0.47
3:D:30:ILE:HG21	3:D:51:TYR:HE2	1.79	0.47
3:D:3:GLU:HB2	3:D:127:CYS:SG	2.55	0.47
2:I:174:ALA:HB3	2:I:177:VAL:O	2.13	0.47
2:K:277:SER:OG	2:K:278:ALA:N	2.47	0.47
1:T:102:GLN:NE2	3:B:107:THR:O	2.47	0.47
2:A:3:GLU:HG3	2:A:129:CYS:HB2	1.96	0.47
3:B:396:HIS:CD2	3:B:397:TRP:CD1	3.02	0.47
3:P:67:ASP:OD2	3:P:72:THR:OG1	2.32	0.47
3:R:365:SER:OG	3:R:366:THR:N	2.48	0.47
3:D:221:THR:OG1	3:D:222:TYR:N	2.48	0.47
2:I:356:ASN:OD1	2:I:357:TYR:N	2.48	0.47
3:F:48:SER:O	3:F:62:ARG:NH2	2.48	0.47
3:B:156:ARG:NH1	3:B:162:ARG:O	2.47	0.47
3:N:68:LEU:HD12	3:N:97:ALA:HB2	1.97	0.47
2:C:9:VAL:HG21	2:C:150:THR:HB	1.96	0.47
3:D:116:VAL:HG11	3:D:151:LEU:HD11	1.97	0.47
2:I:104:ALA:HB2	2:I:413:MET:HE3	1.96	0.47

*Continued on next page...*

*Continued from previous page...*

Atom-1	Atom-2	Interatomic distance (Å)	Clash overlap (Å)
3:B:20:PHE:HA	3:B:230:SER:HB2	1.97	0.46
3:P:213:ARG:CZ	3:P:297:LYS:HE2	2.46	0.46
3:P:412:GLU:OE2	3:P:416:ASN:ND2	2.48	0.46
2:A:33:ASP:O	2:A:60:LYS:NZ	2.44	0.46
2:A:75:ILE:HD12	2:A:94:THR:HG22	1.97	0.46
3:F:221:THR:OG1	3:F:222:TYR:N	2.48	0.46
3:F:278:SER:O	3:F:278:SER:OG	2.29	0.46
2:A:207:GLU:HG2	2:A:304:LYS:HE3	1.97	0.46
1:S:21:LEU:HD12	1:S:21:LEU:HA	1.83	0.46
2:G:172:TYR:HE2	2:G:387:ALA:HB1	1.81	0.46
2:G:279:GLU:N	2:G:279:GLU:OE2	2.49	0.46
3:F:226:ASN:OD1	4:F:501:GTP:N1	2.44	0.46
1:T:59:ARG:HH22	2:C:441:GLU:HA	1.80	0.46
2:A:47:ASP:OD1	2:A:48:SER:N	2.46	0.46
3:B:116:VAL:HG11	3:B:151:LEU:HD21	1.98	0.46
2:C:129:CYS:SG	2:C:132:LEU:HB2	2.56	0.46
2:A:420:GLU:O	2:A:423:GLU:HG3	2.16	0.46
3:D:207:LEU:HB3	3:D:225:LEU:HD22	1.96	0.46
2:E:101:ASN:OD1	3:R:252:LYS:NZ	2.48	0.46
2:I:129:CYS:SG	2:I:132:LEU:HB2	2.56	0.46
3:F:198:GLU:OE1	3:F:198:GLU:N	2.49	0.46
3:R:12:CYS:SG	3:R:138:SER:OG	2.63	0.46
3:D:101:TRP:CD1	3:D:187:LEU:HD13	2.51	0.46
3:P:205:GLU:HA	3:P:208:TYR:CD2	2.51	0.46
2:G:306:ASP:OD1	2:G:306:ASP:N	2.40	0.45
2:I:24:TYR:HE1	2:I:236:SER:HB2	1.81	0.45
3:P:285:THR:HG23	3:P:287:PRO:HD2	1.97	0.45
2:C:356:ASN:OD1	2:C:357:TYR:N	2.49	0.45
3:R:174:LYS:HA	3:R:174:LYS:HD3	1.74	0.45
2:G:217:LEU:HD23	2:G:217:LEU:O	2.17	0.45
2:C:277:SER:OG	2:C:278:ALA:N	2.48	0.45
2:K:53:PHE:HB3	2:K:61:HIS:HB3	1.99	0.45
3:B:193:VAL:HG21	3:B:418:LEU:HD22	1.99	0.45
2:G:202:PHE:HD1	2:G:268:PRO:HG2	1.81	0.45
3:N:10:GLY:O	3:N:14:ASN:ND2	2.46	0.45
3:B:237:THR:HG22	3:B:241:ARG:HE	1.81	0.45
2:I:138:PHE:HE2	2:I:235:VAL:HG21	1.82	0.45
3:N:77:ARG:HH22	3:N:92:PHE:HE2	1.64	0.45
3:D:236:VAL:HG22	3:D:368:ILE:HD11	1.99	0.45
2:E:356:ASN:OD1	2:E:357:TYR:N	2.50	0.45
3:R:67:ASP:OD1	3:R:68:LEU:N	2.47	0.45

*Continued on next page...*

*Continued from previous page...*

Atom-1	Atom-2	Interatomic distance (Å)	Clash overlap (Å)
3:N:3:GLU:HA	3:N:49:VAL:HA	1.98	0.45
2:E:91:GLN:HE21	2:E:121:ARG:HH21	1.63	0.45
2:A:174:ALA:HB3	2:A:177:VAL:O	2.17	0.45
3:B:272:PRO:HG3	3:B:284:LEU:HD21	1.99	0.45
2:I:182:VAL:HG22	2:I:185:TYR:HB2	1.99	0.45
2:E:242:LEU:HD11	2:E:252:LEU:HD13	1.97	0.45
3:R:44:LEU:HD23	3:R:44:LEU:HA	1.83	0.45
3:D:350:LYS:HA	2:I:179:THR:O	2.16	0.45
3:P:101:TRP:HD1	3:P:403:MET:SD	2.40	0.45
3:N:151:LEU:HD12	3:N:151:LEU:HA	1.87	0.45
3:P:205:GLU:HA	3:P:208:TYR:HD2	1.81	0.45
2:A:217:LEU:O	2:A:217:LEU:HD23	2.17	0.44
2:A:326:LYS:HB2	3:B:208:TYR:CE1	2.53	0.44
2:E:97:GLU:N	2:E:97:GLU:OE1	2.50	0.44
3:F:103:LYS:O	3:F:108:GLU:HB3	2.17	0.44
3:R:95:SER:OG	3:R:108:GLU:OE2	2.27	0.44
3:P:391:ARG:HD3	3:P:391:ARG:HA	1.82	0.44
2:E:3:GLU:HG3	2:E:129:CYS:HB2	1.99	0.44
1:S:76:LYS:HD2	1:S:76:LYS:HA	1.74	0.44
2:A:147:SER:OG	2:A:190:THR:HB	2.17	0.44
3:N:51:TYR:HD2	3:N:59:TYR:HB3	1.82	0.44
3:D:73:MET:HB3	3:D:77:ARG:HH21	1.82	0.44
2:I:167:LEU:HD11	2:I:252:LEU:HG	2.00	0.44
2:K:56:THR:OG1	2:K:60:LYS:O	2.33	0.44
2:K:172:TYR:HE2	2:K:387:ALA:HB1	1.81	0.44
3:D:198:GLU:HB2	3:D:266:PHE:CE2	2.52	0.44
3:F:237:THR:HG22	3:F:241:ARG:HE	1.82	0.44
2:G:277:SER:OG	2:G:278:ALA:N	2.51	0.44
3:N:361:LEU:HD23	3:N:361:LEU:HA	1.80	0.44
3:F:257:MET:SD	3:F:314:ALA:HB2	2.58	0.44
3:F:284:LEU:HD23	3:F:284:LEU:HA	1.85	0.44
3:B:311:LEU:HD23	3:B:342:VAL:HG21	1.99	0.44
3:N:345:ILE:HG22	3:N:348:ASN:HB3	1.98	0.44
2:C:51:THR:HG21	2:C:243:ARG:HG2	2.00	0.44
3:D:65:LEU:HD13	3:D:90:PHE:CE1	2.52	0.44
3:P:58:LYS:HE2	3:P:58:LYS:HB3	1.81	0.44
2:E:140:SER:OG	4:E:501:GTP:O2A	2.22	0.44
3:F:58:LYS:HE2	3:F:58:LYS:HB3	1.93	0.44
3:F:174:LYS:HD3	3:F:174:LYS:HA	1.82	0.44
3:B:345:ILE:HG22	3:B:348:ASN:HB3	1.99	0.44
3:B:361:LEU:HD23	3:B:361:LEU:HA	1.78	0.44

*Continued on next page...*

*Continued from previous page...*

Atom-1	Atom-2	Interatomic distance (Å)	Clash overlap (Å)
2:K:172:TYR:CE2	2:K:387:ALA:HB1	2.53	0.44
1:S:102:GLN:O	1:S:106:GLU:HG2	2.17	0.44
2:A:121:ARG:HD2	2:A:121:ARG:HA	1.63	0.44
3:B:211:CYS:SG	3:B:220:PRO:HB3	2.58	0.44
3:B:263:LEU:HD11	3:B:421:GLU:OE2	2.18	0.44
3:N:12:CYS:SG	3:N:138:SER:OG	2.65	0.44
3:D:21:TRP:CZ2	3:D:63:ALA:HB2	2.53	0.44
2:A:104:ALA:HB2	2:A:413:MET:HE3	2.00	0.43
3:B:167:PHE:CE2	3:B:233:MET:HG2	2.53	0.43
3:N:67:ASP:OD2	3:N:72:THR:OG1	2.36	0.43
2:C:343:PHE:CE2	2:C:350:GLY:HA3	2.53	0.43
3:R:151:LEU:HD23	3:R:151:LEU:HA	1.90	0.43
2:A:52:PHE:CE2	2:A:239:THR:HG21	2.52	0.43
3:N:121:ARG:O	3:N:125:GLU:HG2	2.18	0.43
2:C:285:GLN:O	2:C:285:GLN:NE2	2.39	0.43
2:E:220:GLU:HG2	2:E:221:ARG:HD3	2.00	0.43
2:E:279:GLU:N	2:E:279:GLU:OE2	2.51	0.43
3:F:412:GLU:OE2	3:F:416:ASN:ND2	2.50	0.43
3:B:65:LEU:HD13	3:B:90:PHE:CE1	2.54	0.43
3:N:65:LEU:HD13	3:N:90:PHE:CE1	2.53	0.43
3:N:205:GLU:HA	3:N:208:TYR:CD2	2.53	0.43
3:N:284:LEU:HA	3:N:284:LEU:HD12	1.79	0.43
2:I:3:GLU:N	2:I:3:GLU:OE1	2.51	0.43
3:P:69:GLU:HG3	3:P:71:GLY:H	1.82	0.43
3:F:359:ARG:HD3	3:F:359:ARG:HA	1.92	0.43
2:K:335:ILE:HD13	2:K:335:ILE:HA	1.87	0.43
3:B:36:TYR:CE2	3:B:44:LEU:HG	2.53	0.43
3:B:347:ASN:HD21	2:G:178:SER:HB2	1.82	0.43
3:N:209:ASP:OD1	3:N:213:ARG:NH2	2.52	0.43
2:E:129:CYS:SG	2:E:132:LEU:HB2	2.58	0.43
3:F:211:CYS:HA	3:F:215:LEU:HB2	2.00	0.43
1:T:61:VAL:HG23	1:T:74:ASN:OD1	2.18	0.43
2:G:121:ARG:HA	2:G:121:ARG:HD2	1.57	0.43
1:S:35:ILE:HD11	1:S:108:ILE:HG21	2.00	0.43
3:N:359:ARG:HD3	3:N:359:ARG:HA	1.82	0.43
2:C:385:ALA:HB2	2:C:432:TYR:CD1	2.53	0.43
3:D:219:THR:O	3:D:219:THR:OG1	2.34	0.43
2:I:121:ARG:HD2	2:I:121:ARG:HA	1.70	0.43
3:F:180:VAL:HG23	3:F:183:TYR:HD2	1.82	0.43
2:A:188:ILE:HD12	2:A:425:MET:HG2	2.01	0.43
3:B:322:SER:HA	2:G:223:THR:HG22	2.01	0.43

*Continued on next page...*

*Continued from previous page...*

Atom-1	Atom-2	Interatomic distance (Å)	Clash overlap (Å)
3:B:397:TRP:CD1	3:B:397:TRP:N	2.85	0.43
3:N:389:PHE:HZ	3:N:405:GLU:HG2	1.84	0.43
3:D:198:GLU:HA	3:D:264:HIS:HB2	2.00	0.43
2:I:172:TYR:CD1	2:I:173:PRO:HD2	2.53	0.43
2:A:381:THR:OG1	2:A:382:THR:N	2.52	0.43
3:N:12:CYS:SG	3:N:13:GLY:N	2.91	0.43
2:C:138:PHE:HE1	2:C:235:VAL:HG21	1.83	0.43
3:R:359:ARG:HA	3:R:359:ARG:HD3	1.74	0.43
2:A:176:GLN:HB3	3:N:331:LEU:HD13	2.01	0.43
2:G:5:ILE:HG22	2:G:64:ARG:HD3	2.00	0.43
3:N:390:ARG:NH1	3:N:390:ARG:HB3	2.34	0.43
2:C:382:THR:HA	2:C:432:TYR:HE1	1.84	0.43
3:P:77:ARG:HE	3:P:77:ARG:HB2	1.56	0.43
2:A:325:PRO:HB2	3:B:208:TYR:OH	2.19	0.43
3:B:39:ASP:OD1	3:B:40:SER:N	2.52	0.43
3:N:252:LYS:HE3	3:N:252:LYS:HB3	1.84	0.43
3:N:390:ARG:HB3	3:N:390:ARG:HH11	1.84	0.43
2:C:30:ILE:HD13	2:C:36:MET:HG3	2.01	0.43
3:P:161:ASP:O	3:P:162:ARG:NE	2.51	0.43
2:E:121:ARG:HA	2:E:121:ARG:HD2	1.74	0.43
3:F:205:GLU:HA	3:F:208:TYR:CD2	2.54	0.43
2:A:20:CYS:HA	2:A:232:SER:HB2	2.01	0.42
2:C:90:GLU:OE1	2:C:121:ARG:NE	2.52	0.42
2:C:102:ASN:HB3	2:C:105:ARG:HB2	2.01	0.42
2:A:144:GLY:N	4:A:501:GTP:O1G	2.52	0.42
2:I:434:GLU:O	2:I:437:VAL:HG12	2.19	0.42
2:A:140:SER:OG	4:A:501:GTP:O2A	2.31	0.42
2:G:434:GLU:O	2:G:437:VAL:HG12	2.19	0.42
2:I:71:GLU:HB2	2:I:98:ASP:HB3	2.01	0.42
2:E:245:ASP:OD1	2:E:245:ASP:N	2.53	0.42
2:K:211:ASP:O	2:K:215:ARG:HG3	2.19	0.42
3:R:391:ARG:HD3	3:R:391:ARG:HA	1.83	0.42
2:A:414:GLU:OE1	2:A:414:GLU:N	2.53	0.42
3:B:287:PRO:HA	3:B:329:GLN:NE2	2.34	0.42
3:P:361:LEU:HD12	3:P:361:LEU:HA	1.81	0.42
3:F:117:LEU:HD11	3:F:154:LYS:HB3	2.01	0.42
2:K:124:LYS:HE2	2:K:124:LYS:HB2	1.84	0.42
2:C:259:LEU:O	2:C:380:ASN:ND2	2.52	0.42
2:C:285:GLN:HE21	2:C:285:GLN:C	2.18	0.42
2:C:340:SER:C	2:C:341:ILE:HD13	2.39	0.42
3:P:202:ILE:HD13	3:P:229:VAL:HG13	2.02	0.42

*Continued on next page...*



*Continued from previous page...*

Atom-1	Atom-2	Interatomic distance (Å)	Clash overlap (Å)
3:R:121:ARG:O	3:R:125:GLU:HG2	2.19	0.42
3:R:276:ARG:HA	3:R:276:ARG:HD3	1.87	0.42
2:A:338:LYS:HE2	2:A:338:LYS:HB2	1.89	0.42
3:B:391:ARG:HA	3:B:391:ARG:HD2	1.70	0.42
2:G:69:ASP:OD1	2:G:70:LEU:N	2.52	0.42
2:I:245:ASP:OD1	2:I:245:ASP:N	2.53	0.42
2:I:313:MET:HB2	2:I:380:ASN:O	2.20	0.42
1:S:4:ASN:OD1	1:S:4:ASN:N	2.51	0.42
1:T:44:TYR:HB3	1:T:78:LEU:HD13	2.01	0.42
3:N:73:MET:HB3	3:N:77:ARG:HH21	1.85	0.42
2:E:53:PHE:HB3	2:E:61:HIS:HB3	2.00	0.42
3:F:391:ARG:HD3	3:F:391:ARG:HA	1.84	0.42
3:R:21:TRP:CZ2	3:R:63:ALA:HB2	2.54	0.42
3:B:109:GLY:O	3:B:113:VAL:HG13	2.20	0.42
2:C:175:PRO:HD2	2:C:207:GLU:OE2	2.19	0.42
3:D:215:LEU:HD23	3:D:215:LEU:HA	1.89	0.42
2:K:49:PHE:HB2	2:K:53:PHE:HB2	2.01	0.42
2:A:191:THR:O	2:A:195:LEU:HB2	2.20	0.42
2:G:360:PRO:HG3	2:G:374:ALA:HB2	2.02	0.42
3:D:101:TRP:HD1	3:D:403:MET:SD	2.43	0.42
3:D:356:ILE:HD13	3:D:356:ILE:HA	1.84	0.42
3:F:12:CYS:SG	3:F:138:SER:OG	2.56	0.42
3:N:211:CYS:SG	3:N:220:PRO:HB3	2.59	0.42
3:P:284:LEU:HD23	3:P:284:LEU:HA	1.85	0.42
2:K:71:GLU:HG3	2:K:73:THR:HG22	2.01	0.42
3:R:215:LEU:O	3:R:215:LEU:HD23	2.20	0.42
2:G:286:LEU:HA	2:G:290:GLU:OE2	2.20	0.41
3:F:12:CYS:SG	3:F:13:GLY:N	2.92	0.41
2:C:391:LEU:HD12	2:C:391:LEU:HA	1.91	0.41
2:I:327:ASP:OD1	2:I:327:ASP:N	2.54	0.41
2:K:279:GLU:N	2:K:279:GLU:OE1	2.53	0.41
3:R:205:GLU:HA	3:R:208:TYR:CD2	2.55	0.41
2:A:343:PHE:CE2	2:A:350:GLY:HA3	2.55	0.41
3:N:49:VAL:HG11	3:N:241:ARG:HG2	2.02	0.41
3:N:107:THR:OG1	3:N:401:GLU:OE2	2.27	0.41
2:C:122:ILE:HD13	2:C:122:ILE:HA	1.89	0.41
2:I:391:LEU:HD12	2:I:391:LEU:HA	1.85	0.41
2:E:105:ARG:HG3	2:E:411:GLU:HG2	2.02	0.41
2:E:360:PRO:HG3	2:E:374:ALA:HB2	2.02	0.41
3:R:94:GLN:OE1	3:R:94:GLN:HA	2.20	0.41
2:A:382:THR:HA	2:A:432:TYR:HE1	1.84	0.41

*Continued on next page...*



*Continued from previous page...*

Atom-1	Atom-2	Interatomic distance (Å)	Clash overlap (Å)
2:G:234:ILE:O	2:G:238:ILE:HG12	2.20	0.41
2:I:98:ASP:OD1	2:I:98:ASP:N	2.53	0.41
2:E:304:LYS:HA	2:E:304:LYS:HD3	1.90	0.41
2:E:422:ARG:HH12	2:E:426:ALA:HB2	1.85	0.41
3:B:50:TYR:CZ	3:B:237:THR:HG21	2.55	0.41
2:C:385:ALA:HB2	2:C:432:TYR:HD1	1.85	0.41
2:E:71:GLU:HB2	2:E:98:ASP:HB3	2.01	0.41
2:E:341:ILE:HD12	2:E:341:ILE:N	2.35	0.41
3:R:390:ARG:HB3	3:R:390:ARG:NH1	2.35	0.41
2:G:124:LYS:HB2	2:G:124:LYS:HE2	1.83	0.41
3:N:282:ARG:NH2	3:N:288:GLU:OE1	2.54	0.41
3:N:293:MET:SD	3:N:365:SER:OG	2.65	0.41
3:N:412:GLU:OE2	3:N:416:ASN:ND2	2.53	0.41
3:D:397:TRP:N	3:D:397:TRP:CD1	2.88	0.41
3:P:372:THR:HG21	3:P:426:GLN:HB2	2.03	0.41
2:E:286:LEU:HD23	2:E:286:LEU:HA	1.83	0.41
2:K:391:LEU:HD12	2:K:391:LEU:HA	1.82	0.41
2:A:324:VAL:HG12	2:A:327:ASP:H	1.85	0.41
2:G:53:PHE:HB3	2:G:61:HIS:HB3	2.03	0.41
3:D:12:CYS:SG	3:D:13:GLY:N	2.94	0.41
3:D:361:LEU:HD12	3:D:361:LEU:HA	1.87	0.41
2:I:124:LYS:HE2	2:I:124:LYS:HB2	1.86	0.41
3:P:101:TRP:CD1	3:P:187:LEU:HD13	2.55	0.41
3:F:257:MET:HA	3:F:312:THR:OG1	2.21	0.41
2:K:167:LEU:HD11	2:K:252:LEU:HD22	2.02	0.41
3:R:173:PRO:HB3	3:R:380:ARG:NE	2.36	0.41
1:T:11:THR:HG21	2:A:263:PRO:HG3	2.03	0.41
2:A:104:ALA:HB1	2:A:411:GLU:O	2.20	0.41
3:N:425:TYR:HD1	3:N:425:TYR:HA	1.74	0.41
2:C:209:ILE:HG13	2:C:227:LEU:HD21	2.02	0.41
2:C:217:LEU:O	2:C:217:LEU:HD23	2.20	0.41
2:E:205:ASP:O	2:E:209:ILE:HG13	2.20	0.41
2:A:169:PHE:CE2	2:A:235:VAL:HG22	2.56	0.41
2:A:255:PHE:CZ	2:A:318:LEU:HD21	2.55	0.41
3:B:198:GLU:HA	3:B:264:HIS:HB2	2.02	0.41
2:C:178:SER:OG	3:P:347:ASN:HB2	2.20	0.41
3:D:391:ARG:HA	3:D:391:ARG:HD3	1.80	0.41
2:I:119:LEU:HD11	2:I:156:ARG:HB3	2.03	0.41
2:I:205:ASP:O	2:I:209:ILE:HG13	2.21	0.41
2:I:278:ALA:HA	2:I:369:ALA:HB2	2.03	0.41
3:P:68:LEU:HD23	3:P:68:LEU:HA	1.88	0.41

*Continued on next page...*

*Continued from previous page...*

Atom-1	Atom-2	Interatomic distance (Å)	Clash overlap (Å)
2:E:117:LEU:HD12	2:E:117:LEU:O	2.21	0.41
2:E:401:LYS:HB3	2:E:401:LYS:HE3	1.90	0.41
2:E:438:ASP:OD1	2:E:439:SER:N	2.54	0.41
3:F:42:LEU:HD23	3:F:356:ILE:HD11	2.03	0.41
3:F:207:LEU:HB3	3:F:225:LEU:HD11	2.03	0.41
2:K:121:ARG:HD2	2:K:121:ARG:HA	1.89	0.41
2:K:220:GLU:O	2:K:221:ARG:HD3	2.21	0.41
2:C:139:HIS:HE1	2:C:141:PHE:HE1	1.69	0.41
3:D:208:TYR:CE1	3:D:225:LEU:HD11	2.56	0.41
3:F:65:LEU:HD13	3:F:90:PHE:CE1	2.56	0.41
3:F:293:MET:HE3	3:F:293:MET:HB3	1.92	0.41
2:C:382:THR:HA	2:C:432:TYR:CE1	2.56	0.40
2:I:324:VAL:HA	2:I:325:PRO:HD3	1.94	0.40
3:P:12:CYS:SG	3:P:13:GLY:N	2.93	0.40
2:E:177:VAL:HG22	3:R:327:ASP:OD1	2.22	0.40
3:F:50:TYR:CE2	3:F:237:THR:HG21	2.56	0.40
1:S:112:LYS:HA	1:S:112:LYS:HD2	1.88	0.40
2:G:265:ILE:HG23	2:G:432:TYR:CZ	2.56	0.40
3:N:309:ARG:H	3:N:372:THR:HB	1.86	0.40
3:D:336:LYS:C	3:D:336:LYS:HD2	2.41	0.40
2:I:279:GLU:OE1	2:I:279:GLU:N	2.52	0.40
2:I:290:GLU:HA	2:I:293:ASN:HB2	2.03	0.40
2:E:174:ALA:HB3	2:E:177:VAL:HB	2.02	0.40
2:K:75:ILE:HG22	2:K:79:ARG:HD2	2.03	0.40
3:R:284:LEU:HD23	3:R:284:LEU:HA	1.80	0.40
2:G:356:ASN:OD1	2:G:357:TYR:N	2.54	0.40
3:F:161:ASP:O	3:F:162:ARG:NE	2.54	0.40
3:R:278:SER:O	3:R:278:SER:OG	2.36	0.40
1:S:34:LYS:HB2	1:S:34:LYS:HE3	1.77	0.40
2:G:121:ARG:NH1	2:G:124:LYS:HD2	2.35	0.40
2:G:154:MET:H	2:G:154:MET:HG2	1.69	0.40
2:C:188:ILE:HD13	2:C:188:ILE:HA	1.97	0.40
3:D:39:ASP:OD1	3:D:40:SER:N	2.54	0.40
3:D:284:LEU:HD23	3:D:284:LEU:HA	1.83	0.40
2:E:244:PHE:HB2	2:E:356:ASN:HD21	1.87	0.40
2:K:286:LEU:HD23	2:K:286:LEU:HA	1.88	0.40
3:R:293:MET:HE3	3:R:367:PHE:HB2	2.03	0.40
3:R:317:PHE:CE2	3:R:326:VAL:HG13	2.57	0.40
2:A:384:ILE:HG23	2:A:388:TRP:CD1	2.56	0.40
2:G:238:ILE:HD12	2:G:378:LEU:HD11	2.04	0.40
2:C:174:ALA:HB3	2:C:177:VAL:O	2.20	0.40

*Continued on next page...*

Continued from previous page...

Atom-1	Atom-2	Interatomic distance (Å)	Clash overlap (Å)
3:P:390:ARG:HH11	3:P:390:ARG:HB3	1.86	0.40
2:E:8:HIS:CD2	2:E:17:GLY:HA3	2.56	0.40
2:K:230:LEU:O	2:K:230:LEU:HD12	2.21	0.40

There are no symmetry-related clashes.

## 5.3 Torsion angles [i](#)

### 5.3.1 Protein backbone [i](#)

In the following table, the Percentiles column shows the percent Ramachandran outliers of the chain as a percentile score with respect to all PDB entries followed by that with respect to all EM entries.

The Analysed column shows the number of residues for which the backbone conformation was analysed, and the total number of residues.

Mol	Chain	Analysed	Favoured	Allowed	Outliers	Percentiles	
1	S	129/131 (98%)	124 (96%)	5 (4%)	0	100	100
1	T	129/131 (98%)	124 (96%)	5 (4%)	0	100	100
2	A	429/453 (95%)	413 (96%)	16 (4%)	0	100	100
2	C	429/453 (95%)	419 (98%)	10 (2%)	0	100	100
2	E	429/453 (95%)	420 (98%)	9 (2%)	0	100	100
2	G	429/453 (95%)	418 (97%)	11 (3%)	0	100	100
2	I	429/453 (95%)	418 (97%)	11 (3%)	0	100	100
2	K	429/453 (95%)	420 (98%)	9 (2%)	0	100	100
3	B	427/456 (94%)	411 (96%)	16 (4%)	0	100	100
3	D	427/456 (94%)	414 (97%)	13 (3%)	0	100	100
3	F	427/456 (94%)	413 (97%)	14 (3%)	0	100	100
3	N	427/456 (94%)	417 (98%)	10 (2%)	0	100	100
3	P	427/456 (94%)	419 (98%)	8 (2%)	0	100	100
3	R	427/456 (94%)	415 (97%)	12 (3%)	0	100	100
All	All	5394/5716 (94%)	5245 (97%)	149 (3%)	0	100	100

There are no Ramachandran outliers to report.

### 5.3.2 Protein sidechains [i](#)

In the following table, the Percentiles column shows the percent sidechain outliers of the chain as a percentile score with respect to all PDB entries followed by that with respect to all EM entries.

The Analysed column shows the number of residues for which the sidechain conformation was analysed, and the total number of residues.

Mol	Chain	Analysed	Rotameric	Outliers	Percentiles	
1	S	116/117 (99%)	109 (94%)	7 (6%)	16	40
1	T	116/117 (99%)	114 (98%)	2 (2%)	56	72
2	A	369/384 (96%)	360 (98%)	9 (2%)	44	63
2	C	369/384 (96%)	355 (96%)	14 (4%)	28	50
2	E	369/384 (96%)	364 (99%)	5 (1%)	62	75
2	G	369/384 (96%)	359 (97%)	10 (3%)	40	60
2	I	369/384 (96%)	361 (98%)	8 (2%)	47	65
2	K	369/384 (96%)	361 (98%)	8 (2%)	47	65
3	B	368/392 (94%)	353 (96%)	15 (4%)	26	49
3	D	368/392 (94%)	355 (96%)	13 (4%)	31	53
3	F	368/392 (94%)	347 (94%)	21 (6%)	17	41
3	N	368/392 (94%)	349 (95%)	19 (5%)	19	43
3	P	368/392 (94%)	351 (95%)	17 (5%)	23	46
3	R	368/392 (94%)	344 (94%)	24 (6%)	14	37
All	All	4654/4890 (95%)	4482 (96%)	172 (4%)	31	51

All (172) residues with a non-rotameric sidechain are listed below:

Mol	Chain	Res	Type
1	S	4	ASN
1	S	16	SER
1	S	19	ASP
1	S	31	ASN
1	S	46	GLN
1	S	55	CYS
1	S	109	GLN
1	T	6	TYR
1	T	14	ASN
2	A	50	ASN
2	A	129	CYS

*Continued on next page...*

*Continued from previous page...*

<b>Mol</b>	<b>Chain</b>	<b>Res</b>	<b>Type</b>
2	A	149	PHE
2	A	199	ASP
2	A	296	PHE
2	A	318	LEU
2	A	368	LEU
2	A	430	LYS
2	A	432	TYR
3	B	12	CYS
3	B	83	HIS
3	B	124	CYS
3	B	208	TYR
3	B	220	PRO
3	B	230	SER
3	B	294	PHE
3	B	306	ARG
3	B	335	SER
3	B	339	SER
3	B	340	TYR
3	B	421	GLU
3	B	422	TYR
3	B	424	GLN
3	B	425	TYR
2	G	94	THR
2	G	172	TYR
2	G	185	TYR
2	G	218	ASP
2	G	229	ARG
2	G	256	GLN
2	G	287	SER
2	G	295	CYS
2	G	367	ASP
2	G	432	TYR
3	N	50	TYR
3	N	55	SER
3	N	57	HIS
3	N	81	PHE
3	N	83	HIS
3	N	92	PHE
3	N	124	CYS
3	N	164	MET
3	N	177	ASP
3	N	212	PHE

*Continued on next page...*

*Continued from previous page...*

<b>Mol</b>	<b>Chain</b>	<b>Res</b>	<b>Type</b>
3	N	297	LYS
3	N	304	ASP
3	N	306	ARG
3	N	322	SER
3	N	327	ASP
3	N	340	TYR
3	N	395	LEU
3	N	397	TRP
3	N	422	TYR
2	C	76	ASP
2	C	129	CYS
2	C	141	PHE
2	C	172	TYR
2	C	199	ASP
2	C	200	CYS
2	C	229	ARG
2	C	285	GLN
2	C	295	CYS
2	C	296	PHE
2	C	306	ASP
2	C	308	ARG
2	C	338	LYS
2	C	367	ASP
3	D	75	SER
3	D	81	PHE
3	D	129	CYS
3	D	165	ASN
3	D	198	GLU
3	D	279	GLN
3	D	284	LEU
3	D	304	ASP
3	D	306	ARG
3	D	336	LYS
3	D	355	ASP
3	D	371	SER
3	D	422	TYR
2	I	4	CYS
2	I	50	ASN
2	I	141	PHE
2	I	198	SER
2	I	200	CYS
2	I	256	GLN

*Continued on next page...*

*Continued from previous page...*

<b>Mol</b>	<b>Chain</b>	<b>Res</b>	<b>Type</b>
2	I	295	CYS
2	I	432	TYR
3	P	12	CYS
3	P	55	SER
3	P	86	ARG
3	P	92	PHE
3	P	127	CYS
3	P	129	CYS
3	P	147	MET
3	P	165	ASN
3	P	222	TYR
3	P	227	HIS
3	P	233	MET
3	P	284	LEU
3	P	306	ARG
3	P	364	SER
3	P	406	MET
3	P	422	TYR
3	P	424	GLN
2	E	50	ASN
2	E	141	PHE
2	E	305	CYS
2	E	430	LYS
2	E	432	TYR
3	F	12	CYS
3	F	50	TYR
3	F	78	SER
3	F	81	PHE
3	F	83	HIS
3	F	84	LEU
3	F	118	ASP
3	F	123	GLU
3	F	172	SER
3	F	197	ASP
3	F	227	HIS
3	F	230	SER
3	F	288	GLU
3	F	294	PHE
3	F	306	ARG
3	F	337	ASN
3	F	340	TYR
3	F	371	SER

*Continued on next page...*

*Continued from previous page...*

<b>Mol</b>	<b>Chain</b>	<b>Res</b>	<b>Type</b>
3	F	406	MET
3	F	422	TYR
3	F	424	GLN
2	K	50	ASN
2	K	129	CYS
2	K	251	ASP
2	K	287	SER
2	K	295	CYS
2	K	367	ASP
2	K	396	ASP
2	K	432	TYR
3	R	12	CYS
3	R	41	ASP
3	R	50	TYR
3	R	81	PHE
3	R	92	PHE
3	R	124	CYS
3	R	129	CYS
3	R	147	MET
3	R	159	TYR
3	R	165	ASN
3	R	181	GLU
3	R	198	GLU
3	R	222	TYR
3	R	227	HIS
3	R	279	GLN
3	R	280	GLN
3	R	288	GLU
3	R	306	ARG
3	R	322	SER
3	R	329	GLN
3	R	339	SER
3	R	340	TYR
3	R	404	ASP
3	R	422	TYR

Sometimes sidechains can be flipped to improve hydrogen bonding and reduce clashes. All (4) such sidechains are listed below:

<b>Mol</b>	<b>Chain</b>	<b>Res</b>	<b>Type</b>
1	T	102	GLN
2	C	133	GLN
2	C	256	GLN

*Continued on next page...*



*Continued from previous page...*

Mol	Chain	Res	Type
3	P	14	ASN

### 5.3.3 RNA [i](#)

There are no RNA molecules in this entry.

## 5.4 Non-standard residues in protein, DNA, RNA chains [i](#)

There are no non-standard protein/DNA/RNA residues in this entry.

### 5.5 Carbohydrates [i](#)

There are no oligosaccharides in this entry.

### 5.6 Ligand geometry [i](#)

Of 24 ligands modelled in this entry, 12 are monoatomic - leaving 12 for Mogul analysis.

In the following table, the Counts columns list the number of bonds (or angles) for which Mogul statistics could be retrieved, the number of bonds (or angles) that are observed in the model and the number of bonds (or angles) that are defined in the Chemical Component Dictionary. The Link column lists molecule types, if any, to which the group is linked. The Z score for a bond length (or angle) is the number of standard deviations the observed value is removed from the expected value. A bond length (or angle) with  $|Z| > 2$  is considered an outlier worth inspection. RMSZ is the root-mean-square of all Z scores of the bond lengths (or angles).

Mol	Type	Chain	Res	Link	Bond lengths			Bond angles		
					Counts	RMSZ	# Z  > 2	Counts	RMSZ	# Z  > 2
4	GTP	A	501	5	26,34,34	1.14	2 (7%)	32,54,54	1.57	7 (21%)
4	GTP	F	501	5	26,34,34	1.14	2 (7%)	32,54,54	1.60	7 (21%)
4	GTP	I	501	5	26,34,34	1.14	2 (7%)	32,54,54	1.61	7 (21%)
4	GTP	G	501	5	26,34,34	1.14	2 (7%)	32,54,54	1.61	7 (21%)
4	GTP	N	501	5	26,34,34	1.14	2 (7%)	32,54,54	1.57	7 (21%)
4	GTP	R	501	5	26,34,34	1.14	2 (7%)	32,54,54	1.57	7 (21%)
4	GTP	E	501	5	26,34,34	1.14	2 (7%)	32,54,54	1.61	7 (21%)
4	GTP	D	501	5	26,34,34	1.14	2 (7%)	32,54,54	1.60	7 (21%)
4	GTP	C	501	5	26,34,34	1.14	2 (7%)	32,54,54	1.61	7 (21%)
4	GTP	P	501	5	26,34,34	1.14	2 (7%)	32,54,54	1.55	7 (21%)

Mol	Type	Chain	Res	Link	Bond lengths			Bond angles		
					Counts	RMSZ	# Z  > 2	Counts	RMSZ	# Z  > 2
4	GTP	B	501	5	26,34,34	1.14	2 (7%)	32,54,54	1.59	7 (21%)
4	GTP	K	501	5	26,34,34	1.14	2 (7%)	32,54,54	1.60	7 (21%)

In the following table, the Chirals column lists the number of chiral outliers, the number of chiral centers analysed, the number of these observed in the model and the number defined in the Chemical Component Dictionary. Similar counts are reported in the Torsion and Rings columns. '-' means no outliers of that kind were identified.

Mol	Type	Chain	Res	Link	Chirals	Torsions	Rings
4	GTP	A	501	5	-	5/18/38/38	0/3/3/3
4	GTP	F	501	5	-	6/18/38/38	0/3/3/3
4	GTP	I	501	5	-	5/18/38/38	0/3/3/3
4	GTP	G	501	5	-	6/18/38/38	0/3/3/3
4	GTP	N	501	5	-	6/18/38/38	0/3/3/3
4	GTP	R	501	5	-	7/18/38/38	0/3/3/3
4	GTP	E	501	5	-	6/18/38/38	0/3/3/3
4	GTP	D	501	5	-	7/18/38/38	0/3/3/3
4	GTP	C	501	5	-	6/18/38/38	0/3/3/3
4	GTP	P	501	5	-	6/18/38/38	0/3/3/3
4	GTP	B	501	5	-	6/18/38/38	0/3/3/3
4	GTP	K	501	5	-	5/18/38/38	0/3/3/3

All (24) bond length outliers are listed below:

Mol	Chain	Res	Type	Atoms	Z	Observed(Å)	Ideal(Å)
4	B	501	GTP	C5-C6	-4.09	1.39	1.47
4	F	501	GTP	C5-C6	-4.09	1.39	1.47
4	D	501	GTP	C5-C6	-4.08	1.39	1.47
4	N	501	GTP	C5-C6	-4.07	1.39	1.47
4	P	501	GTP	C5-C6	-4.06	1.39	1.47
4	K	501	GTP	C5-C6	-4.06	1.39	1.47
4	R	501	GTP	C5-C6	-4.06	1.39	1.47
4	G	501	GTP	C5-C6	-4.05	1.39	1.47
4	I	501	GTP	C5-C6	-4.05	1.39	1.47
4	A	501	GTP	C5-C6	-4.05	1.39	1.47
4	E	501	GTP	C5-C6	-4.05	1.39	1.47
4	C	501	GTP	C5-C6	-4.05	1.39	1.47
4	P	501	GTP	C2-N3	2.19	1.38	1.33
4	R	501	GTP	C2-N3	2.18	1.38	1.33

*Continued on next page...*

*Continued from previous page...*

Mol	Chain	Res	Type	Atoms	Z	Observed(Å)	Ideal(Å)
4	N	501	GTP	C2-N3	2.17	1.38	1.33
4	C	501	GTP	C2-N3	2.17	1.38	1.33
4	E	501	GTP	C2-N3	2.17	1.38	1.33
4	D	501	GTP	C2-N3	2.16	1.38	1.33
4	A	501	GTP	C2-N3	2.16	1.38	1.33
4	I	501	GTP	C2-N3	2.16	1.38	1.33
4	F	501	GTP	C2-N3	2.16	1.38	1.33
4	B	501	GTP	C2-N3	2.15	1.38	1.33
4	G	501	GTP	C2-N3	2.15	1.38	1.33
4	K	501	GTP	C2-N3	2.15	1.38	1.33

All (84) bond angle outliers are listed below:

Mol	Chain	Res	Type	Atoms	Z	Observed(°)	Ideal(°)
4	F	501	GTP	PB-O3B-PG	-3.76	119.93	132.83
4	G	501	GTP	PB-O3B-PG	-3.72	120.06	132.83
4	C	501	GTP	PB-O3B-PG	-3.71	120.09	132.83
4	E	501	GTP	PB-O3B-PG	-3.68	120.18	132.83
4	I	501	GTP	PB-O3B-PG	-3.68	120.21	132.83
4	N	501	GTP	PB-O3B-PG	-3.66	120.27	132.83
4	K	501	GTP	PA-O3A-PB	-3.65	120.31	132.83
4	D	501	GTP	PB-O3B-PG	-3.62	120.41	132.83
4	I	501	GTP	PA-O3A-PB	-3.61	120.43	132.83
4	G	501	GTP	PA-O3A-PB	-3.60	120.47	132.83
4	B	501	GTP	PB-O3B-PG	-3.60	120.48	132.83
4	E	501	GTP	PA-O3A-PB	-3.58	120.54	132.83
4	K	501	GTP	PB-O3B-PG	-3.57	120.56	132.83
4	C	501	GTP	PA-O3A-PB	-3.55	120.63	132.83
4	A	501	GTP	PA-O3A-PB	-3.55	120.65	132.83
4	R	501	GTP	PB-O3B-PG	-3.51	120.79	132.83
4	P	501	GTP	PB-O3B-PG	-3.44	121.01	132.83
4	A	501	GTP	PB-O3B-PG	-3.30	121.49	132.83
4	A	501	GTP	C5-C6-N1	3.20	119.61	113.95
4	P	501	GTP	C5-C6-N1	3.20	119.60	113.95
4	I	501	GTP	C5-C6-N1	3.20	119.60	113.95
4	B	501	GTP	C5-C6-N1	3.20	119.60	113.95
4	K	501	GTP	C5-C6-N1	3.19	119.59	113.95
4	R	501	GTP	C5-C6-N1	3.19	119.59	113.95
4	F	501	GTP	C5-C6-N1	3.19	119.59	113.95
4	N	501	GTP	C5-C6-N1	3.19	119.58	113.95
4	D	501	GTP	C5-C6-N1	3.19	119.58	113.95
4	G	501	GTP	C5-C6-N1	3.18	119.58	113.95

*Continued on next page...*

*Continued from previous page...*

Mol	Chain	Res	Type	Atoms	Z	Observed(°)	Ideal(°)
4	C	501	GTP	C5-C6-N1	3.18	119.57	113.95
4	E	501	GTP	C5-C6-N1	3.18	119.56	113.95
4	I	501	GTP	C3'-C2'-C1'	3.13	105.69	100.98
4	F	501	GTP	C3'-C2'-C1'	3.13	105.69	100.98
4	E	501	GTP	C3'-C2'-C1'	3.13	105.69	100.98
4	B	501	GTP	C3'-C2'-C1'	3.13	105.69	100.98
4	D	501	GTP	C3'-C2'-C1'	3.13	105.69	100.98
4	C	501	GTP	C3'-C2'-C1'	3.12	105.68	100.98
4	R	501	GTP	C3'-C2'-C1'	3.11	105.65	100.98
4	G	501	GTP	C3'-C2'-C1'	3.10	105.65	100.98
4	N	501	GTP	C3'-C2'-C1'	3.09	105.64	100.98
4	A	501	GTP	C3'-C2'-C1'	3.09	105.63	100.98
4	K	501	GTP	C3'-C2'-C1'	3.08	105.62	100.98
4	F	501	GTP	PA-O3A-PB	-3.08	122.26	132.83
4	P	501	GTP	C3'-C2'-C1'	3.07	105.60	100.98
4	D	501	GTP	PA-O3A-PB	-3.04	122.38	132.83
4	G	501	GTP	C8-N7-C5	3.01	108.73	102.99
4	E	501	GTP	C8-N7-C5	3.00	108.71	102.99
4	K	501	GTP	C8-N7-C5	3.00	108.71	102.99
4	C	501	GTP	C8-N7-C5	3.00	108.70	102.99
4	A	501	GTP	C8-N7-C5	3.00	108.70	102.99
4	I	501	GTP	C8-N7-C5	3.00	108.70	102.99
4	R	501	GTP	C8-N7-C5	2.98	108.66	102.99
4	P	501	GTP	C8-N7-C5	2.97	108.65	102.99
4	B	501	GTP	C8-N7-C5	2.96	108.63	102.99
4	F	501	GTP	C8-N7-C5	2.96	108.63	102.99
4	D	501	GTP	C8-N7-C5	2.96	108.63	102.99
4	N	501	GTP	C8-N7-C5	2.96	108.62	102.99
4	R	501	GTP	PA-O3A-PB	-2.92	122.80	132.83
4	I	501	GTP	C2-N1-C6	-2.84	119.87	125.10
4	P	501	GTP	C2-N1-C6	-2.84	119.88	125.10
4	N	501	GTP	C2-N1-C6	-2.83	119.88	125.10
4	R	501	GTP	C2-N1-C6	-2.83	119.89	125.10
4	K	501	GTP	C2-N1-C6	-2.83	119.89	125.10
4	A	501	GTP	C2-N1-C6	-2.83	119.89	125.10
4	D	501	GTP	C2-N1-C6	-2.83	119.89	125.10
4	C	501	GTP	C2-N1-C6	-2.83	119.89	125.10
4	E	501	GTP	C2-N1-C6	-2.83	119.89	125.10
4	F	501	GTP	C2-N1-C6	-2.83	119.89	125.10
4	B	501	GTP	C2-N1-C6	-2.82	119.90	125.10
4	G	501	GTP	C2-N1-C6	-2.82	119.90	125.10
4	B	501	GTP	PA-O3A-PB	-2.82	123.16	132.83

*Continued on next page...*

*Continued from previous page...*

Mol	Chain	Res	Type	Atoms	Z	Observed(°)	Ideal(°)
4	P	501	GTP	PA-O3A-PB	-2.78	123.28	132.83
4	N	501	GTP	PA-O3A-PB	-2.60	123.91	132.83
4	B	501	GTP	O6-C6-C5	-2.13	120.22	124.37
4	N	501	GTP	O6-C6-C5	-2.13	120.22	124.37
4	P	501	GTP	O6-C6-C5	-2.13	120.22	124.37
4	F	501	GTP	O6-C6-C5	-2.12	120.23	124.37
4	R	501	GTP	O6-C6-C5	-2.12	120.23	124.37
4	K	501	GTP	O6-C6-C5	-2.12	120.24	124.37
4	D	501	GTP	O6-C6-C5	-2.11	120.25	124.37
4	I	501	GTP	O6-C6-C5	-2.11	120.25	124.37
4	G	501	GTP	O6-C6-C5	-2.10	120.27	124.37
4	E	501	GTP	O6-C6-C5	-2.09	120.28	124.37
4	C	501	GTP	O6-C6-C5	-2.09	120.28	124.37
4	A	501	GTP	O6-C6-C5	-2.09	120.29	124.37

There are no chirality outliers.

All (71) torsion outliers are listed below:

Mol	Chain	Res	Type	Atoms
4	A	501	GTP	C5'-O5'-PA-O1A
4	A	501	GTP	C5'-O5'-PA-O2A
4	B	501	GTP	C5'-O5'-PA-O1A
4	B	501	GTP	C5'-O5'-PA-O2A
4	B	501	GTP	O4'-C4'-C5'-O5'
4	B	501	GTP	C3'-C4'-C5'-O5'
4	G	501	GTP	C5'-O5'-PA-O1A
4	G	501	GTP	C5'-O5'-PA-O2A
4	N	501	GTP	C5'-O5'-PA-O1A
4	N	501	GTP	C5'-O5'-PA-O2A
4	N	501	GTP	C3'-C4'-C5'-O5'
4	C	501	GTP	C5'-O5'-PA-O1A
4	C	501	GTP	C5'-O5'-PA-O2A
4	D	501	GTP	C5'-O5'-PA-O1A
4	D	501	GTP	C5'-O5'-PA-O2A
4	D	501	GTP	O4'-C4'-C5'-O5'
4	D	501	GTP	C3'-C4'-C5'-O5'
4	I	501	GTP	C5'-O5'-PA-O1A
4	I	501	GTP	C5'-O5'-PA-O2A
4	P	501	GTP	C5'-O5'-PA-O1A
4	P	501	GTP	C5'-O5'-PA-O2A
4	P	501	GTP	O4'-C4'-C5'-O5'
4	P	501	GTP	C3'-C4'-C5'-O5'

*Continued on next page...*

*Continued from previous page...*

Mol	Chain	Res	Type	Atoms
4	E	501	GTP	C5'-O5'-PA-O1A
4	E	501	GTP	C5'-O5'-PA-O2A
4	F	501	GTP	C5'-O5'-PA-O1A
4	F	501	GTP	C5'-O5'-PA-O2A
4	F	501	GTP	C3'-C4'-C5'-O5'
4	R	501	GTP	C5'-O5'-PA-O1A
4	R	501	GTP	C5'-O5'-PA-O2A
4	R	501	GTP	C3'-C4'-C5'-O5'
4	N	501	GTP	O4'-C4'-C5'-O5'
4	C	501	GTP	C3'-C4'-C5'-O5'
4	F	501	GTP	O4'-C4'-C5'-O5'
4	R	501	GTP	O4'-C4'-C5'-O5'
4	G	501	GTP	C3'-C4'-C5'-O5'
4	E	501	GTP	C3'-C4'-C5'-O5'
4	A	501	GTP	C3'-C4'-C5'-O5'
4	C	501	GTP	O4'-C4'-C5'-O5'
4	C	501	GTP	C4'-C5'-O5'-PA
4	E	501	GTP	C4'-C5'-O5'-PA
4	G	501	GTP	C4'-C5'-O5'-PA
4	K	501	GTP	C4'-C5'-O5'-PA
4	C	501	GTP	C5'-O5'-PA-O3A
4	P	501	GTP	C5'-O5'-PA-O3A
4	E	501	GTP	C5'-O5'-PA-O3A
4	B	501	GTP	PB-O3A-PA-O1A
4	P	501	GTP	PB-O3A-PA-O1A
4	K	501	GTP	PA-O3A-PB-O2B
4	R	501	GTP	PB-O3A-PA-O1A
4	A	501	GTP	C4'-C5'-O5'-PA
4	I	501	GTP	C4'-C5'-O5'-PA
4	K	501	GTP	C5'-O5'-PA-O2A
4	I	501	GTP	C3'-C4'-C5'-O5'
4	R	501	GTP	C4'-C5'-O5'-PA
4	E	501	GTP	O4'-C4'-C5'-O5'
4	K	501	GTP	C3'-C4'-C5'-O5'
4	G	501	GTP	O4'-C4'-C5'-O5'
4	A	501	GTP	C5'-O5'-PA-O3A
4	B	501	GTP	C5'-O5'-PA-O3A
4	G	501	GTP	C5'-O5'-PA-O3A
4	N	501	GTP	C5'-O5'-PA-O3A
4	D	501	GTP	C5'-O5'-PA-O3A
4	I	501	GTP	C5'-O5'-PA-O3A
4	F	501	GTP	C5'-O5'-PA-O3A

*Continued on next page...*

*Continued from previous page...*

Mol	Chain	Res	Type	Atoms
4	K	501	GTP	C5'-O5'-PA-O3A
4	R	501	GTP	C5'-O5'-PA-O3A
4	N	501	GTP	C4'-C5'-O5'-PA
4	D	501	GTP	C4'-C5'-O5'-PA
4	F	501	GTP	C4'-C5'-O5'-PA
4	D	501	GTP	PB-O3A-PA-O1A

There are no ring outliers.

7 monomers are involved in 8 short contacts:

Mol	Chain	Res	Type	Clashes	Symm-Clashes
4	A	501	GTP	2	0
4	F	501	GTP	1	0
4	I	501	GTP	1	0
4	G	501	GTP	1	0
4	E	501	GTP	1	0
4	C	501	GTP	1	0
4	B	501	GTP	1	0

The following is a two-dimensional graphical depiction of Mogul quality analysis of bond lengths, bond angles, torsion angles, and ring geometry for all instances of the Ligand of Interest. In addition, ligands with molecular weight > 250 and outliers as shown on the validation Tables will also be included. For torsion angles, if less than 5% of the Mogul distribution of torsion angles is within 10 degrees of the torsion angle in question, then that torsion angle is considered an outlier. Any bond that is central to one or more torsion angles identified as an outlier by Mogul will be highlighted in the graph. For rings, the root-mean-square deviation (RMSD) between the ring in question and similar rings identified by Mogul is calculated over all ring torsion angles. If the average RMSD is greater than 60 degrees and the minimal RMSD between the ring in question and any Mogul-identified rings is also greater than 60 degrees, then that ring is considered an outlier. The outliers are highlighted in purple. The color gray indicates Mogul did not find sufficient equivalents in the CSD to analyse the geometry.

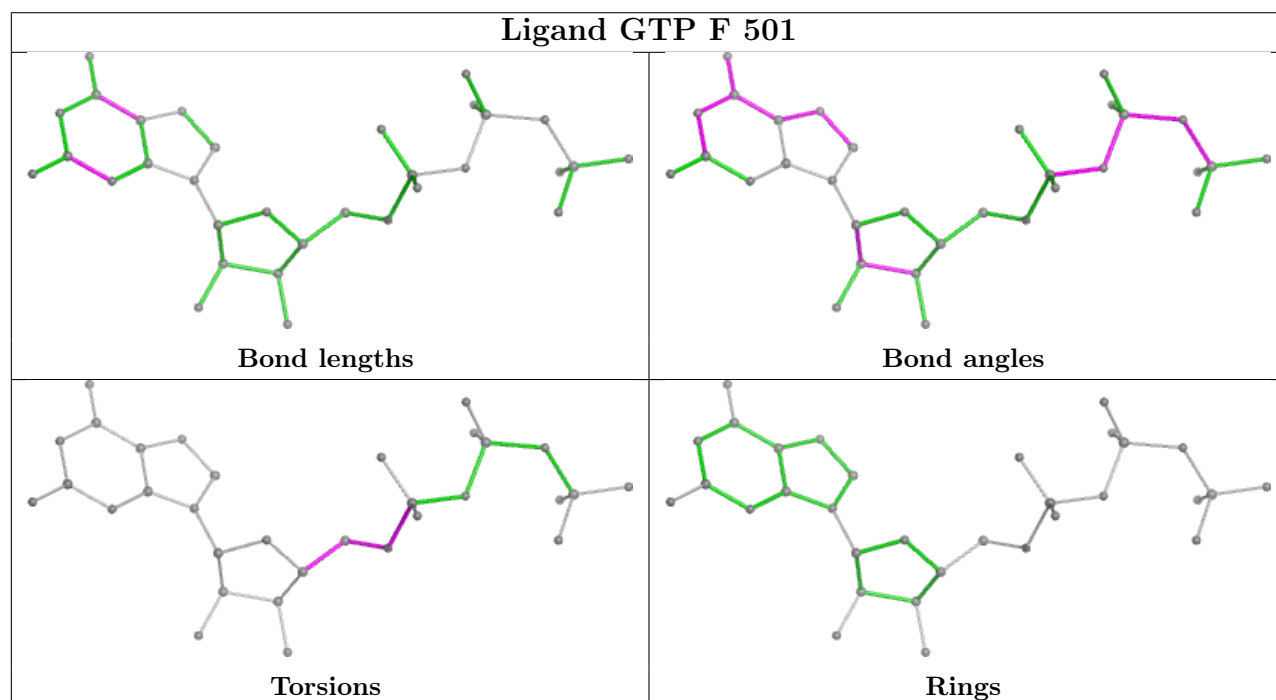
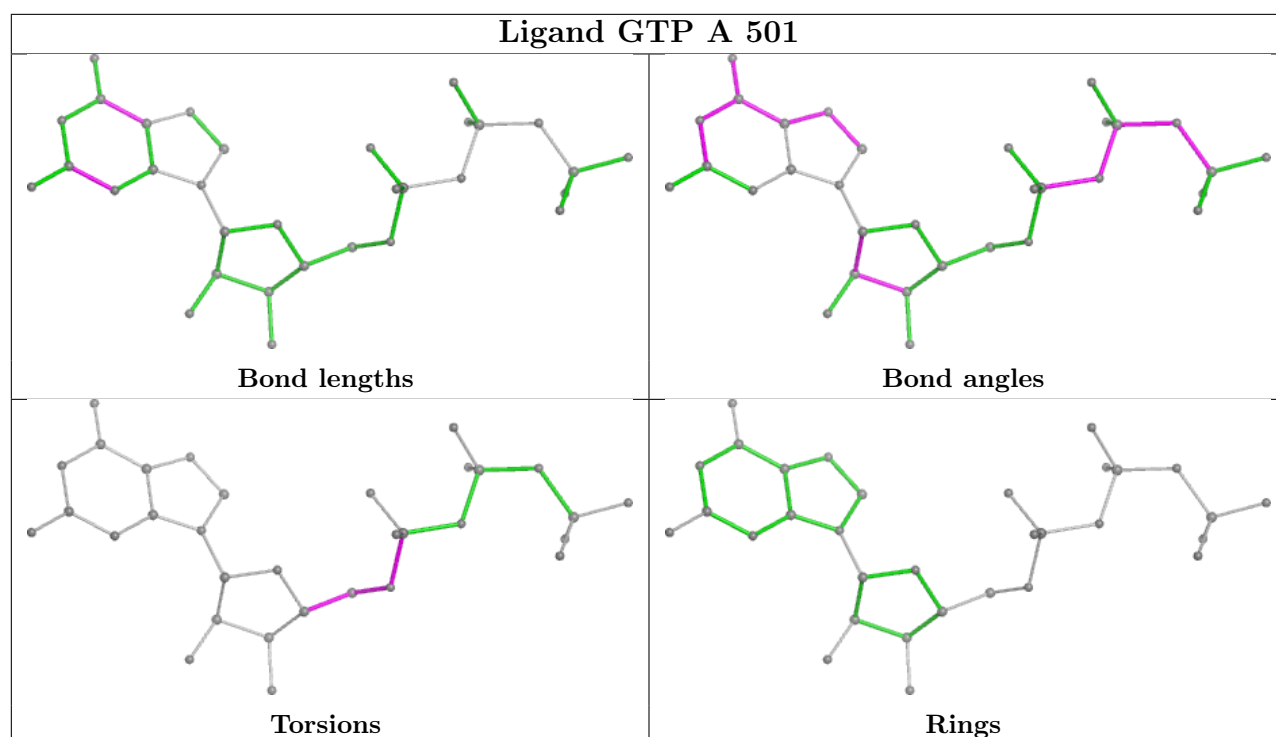



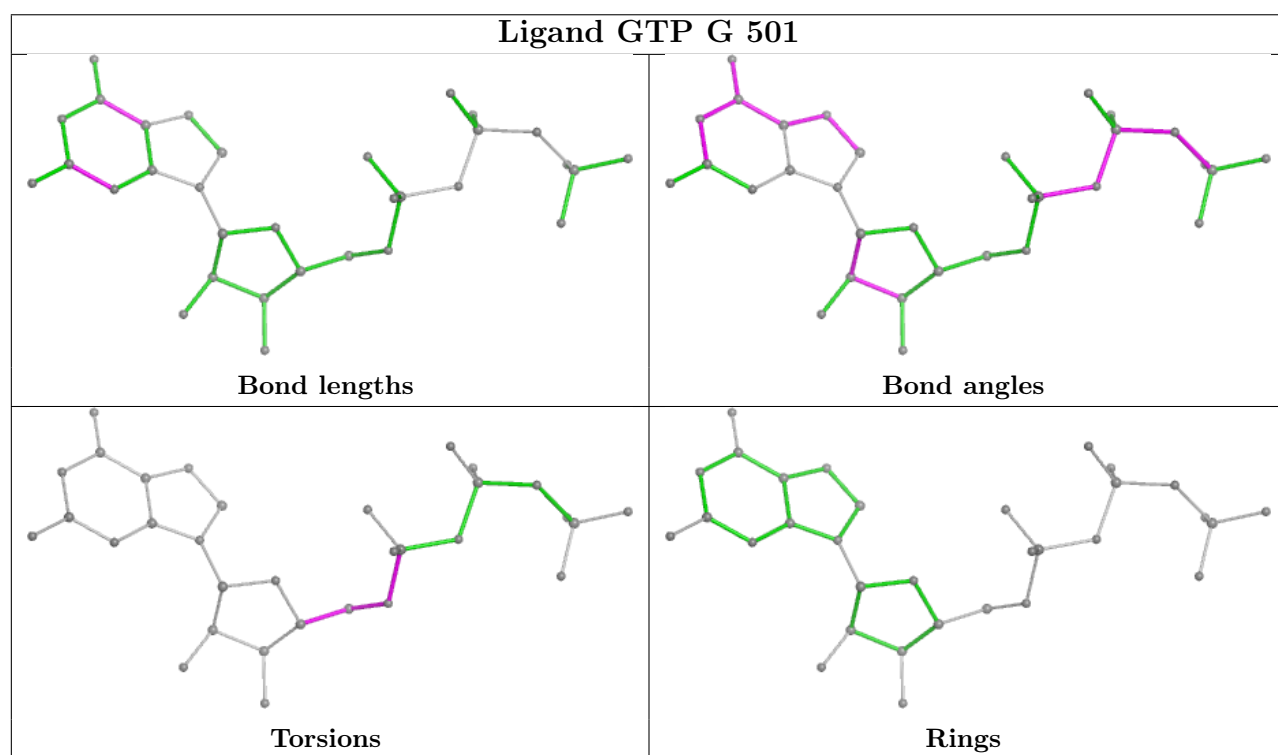
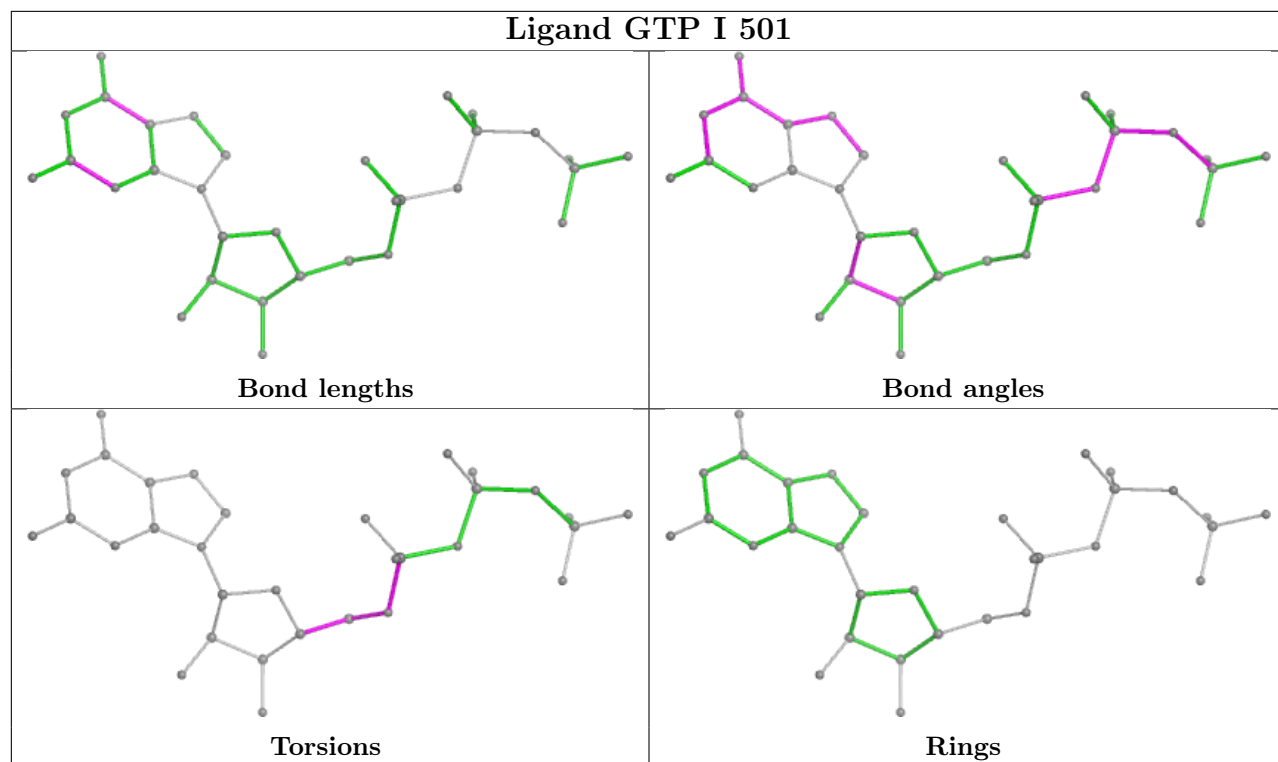

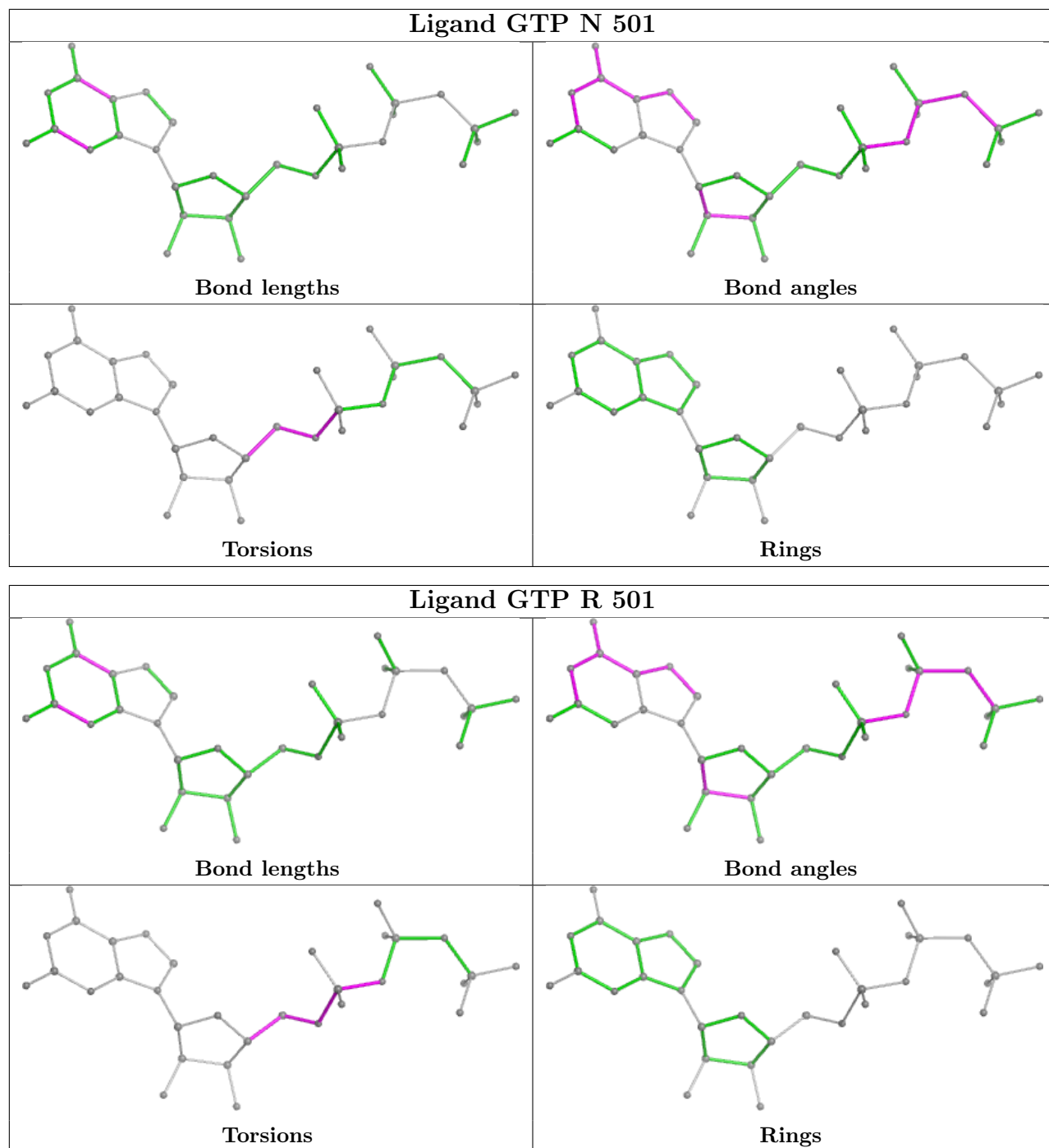

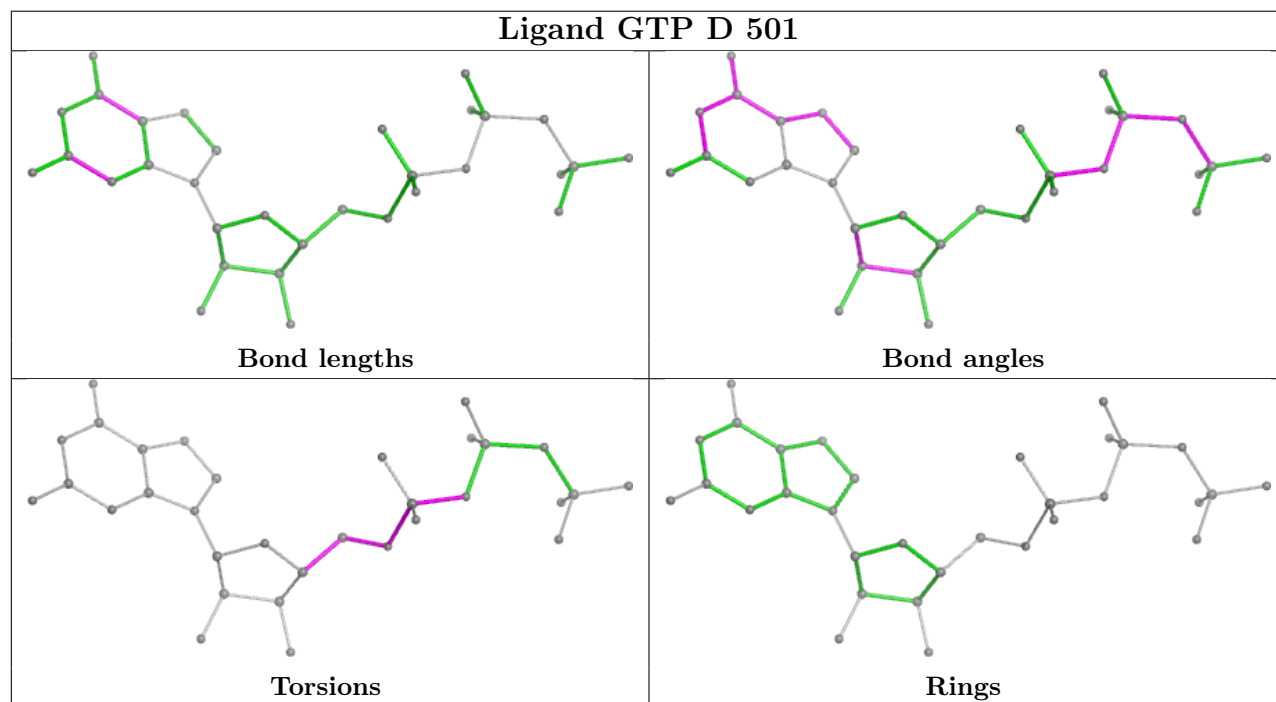
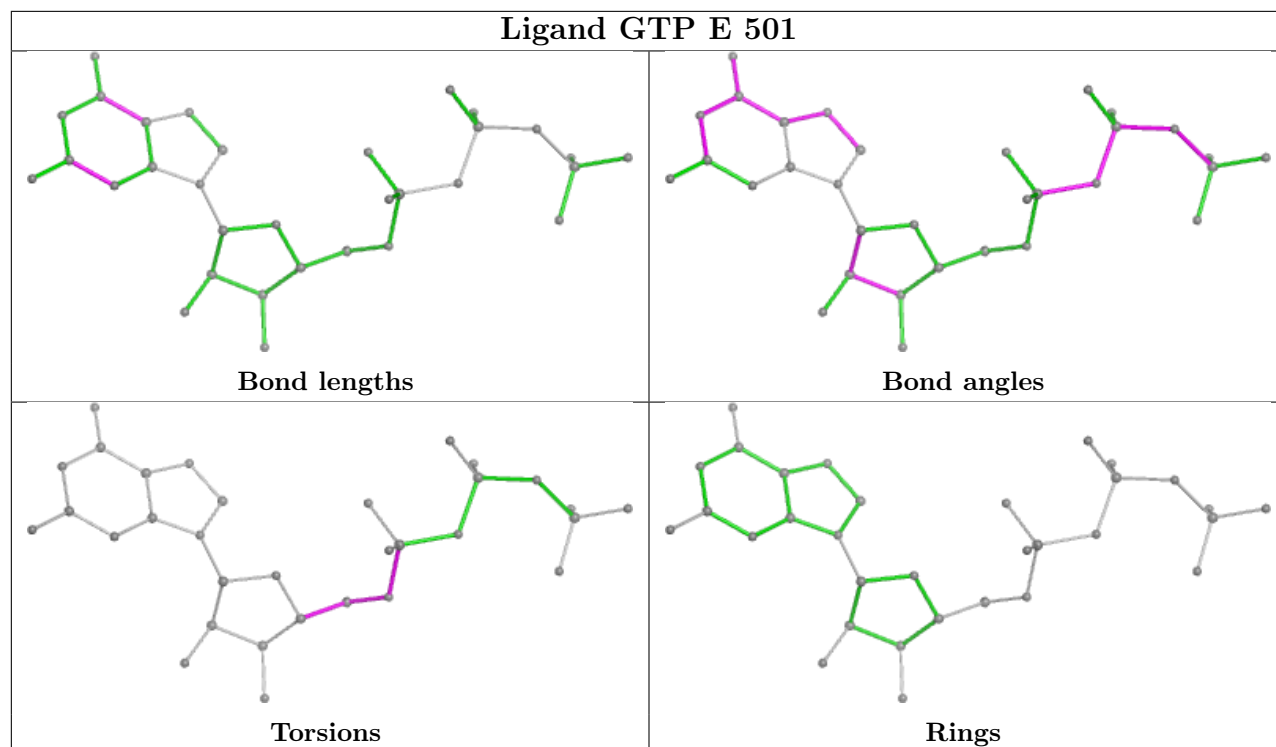

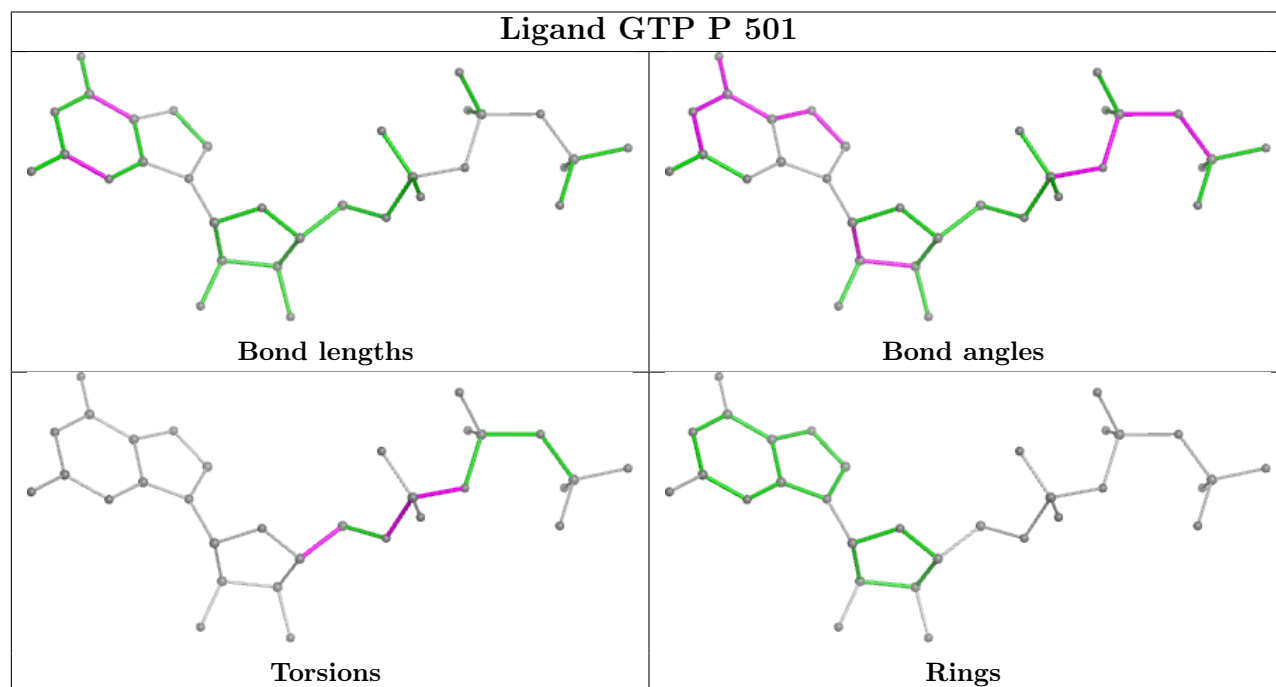
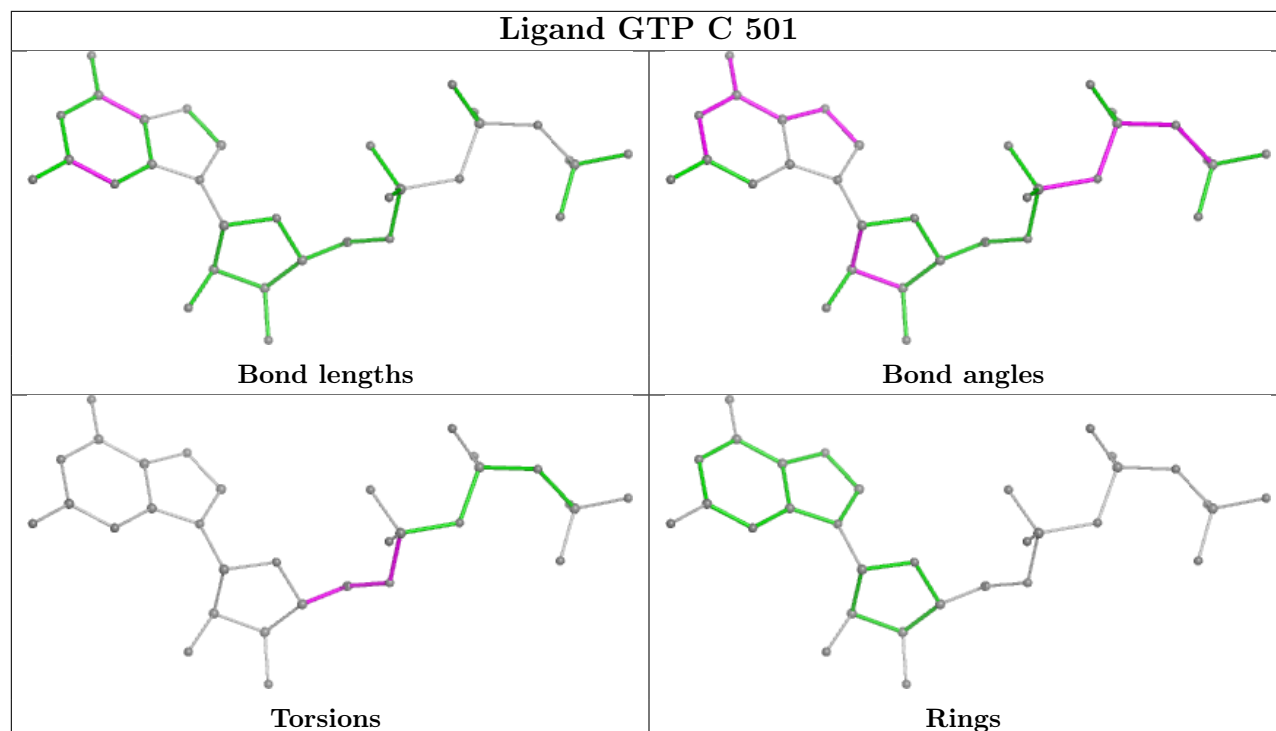

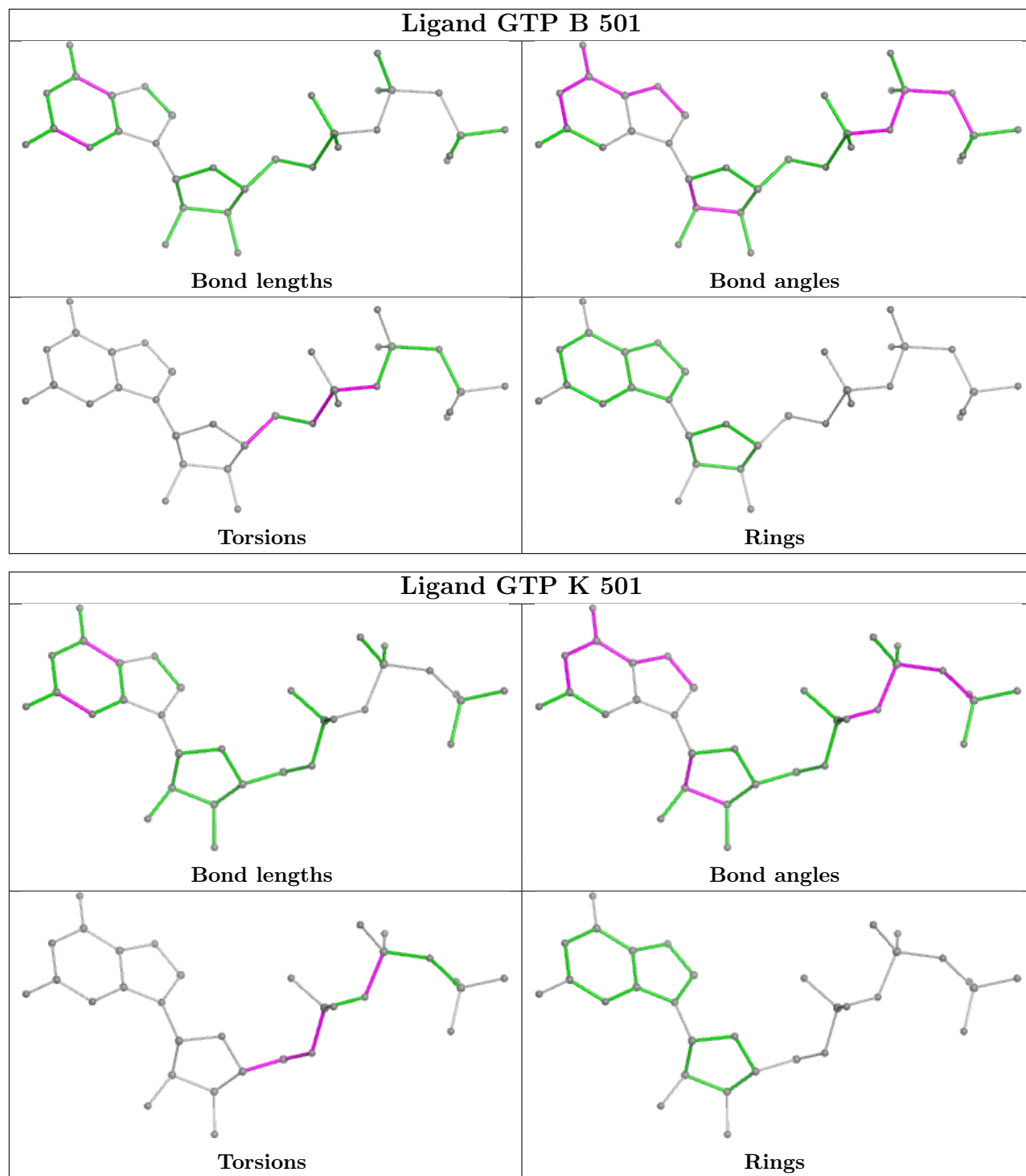

## 5.7 Other polymers [\(i\)](#)

There are no such residues in this entry.

## 5.8 Polymer linkage issues

There are no chain breaks in this entry.

## 6 Map visualisation [i](#)

This section contains visualisations of the EMDB entry EMD-50178. These allow visual inspection of the internal detail of the map and identification of artifacts.

Images derived from a raw map, generated by summing the deposited half-maps, are presented below the corresponding image components of the primary map to allow further visual inspection and comparison with those of the primary map.

### 6.1 Orthogonal projections [i](#)

#### 6.1.1 Primary map

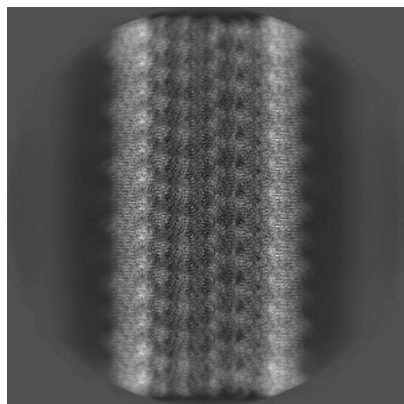

X

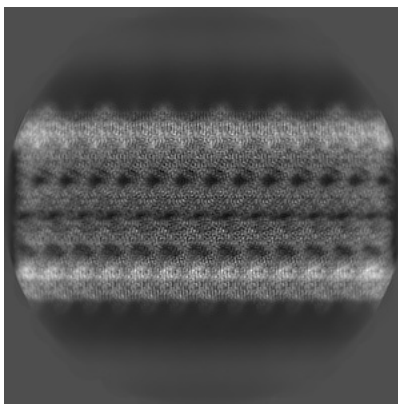

Y

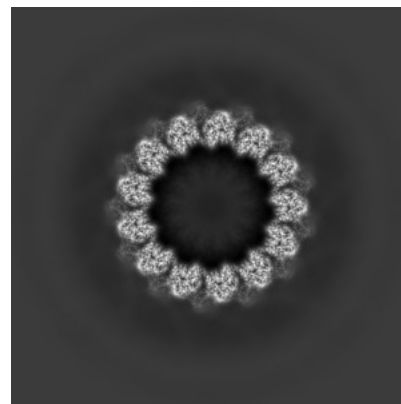

Z

#### 6.1.2 Raw map

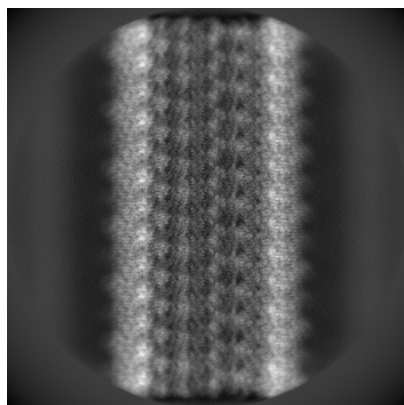

X

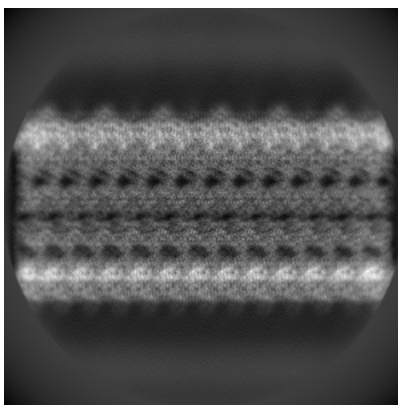

Y

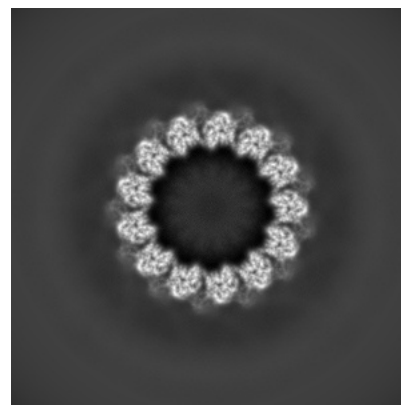

Z

The images above show the map projected in three orthogonal directions.

## 6.2 Central slices [i](#)

### 6.2.1 Primary map

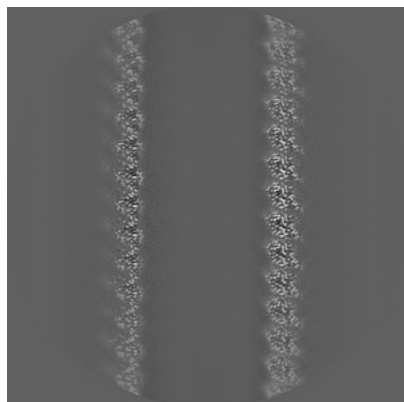

X Index: 300

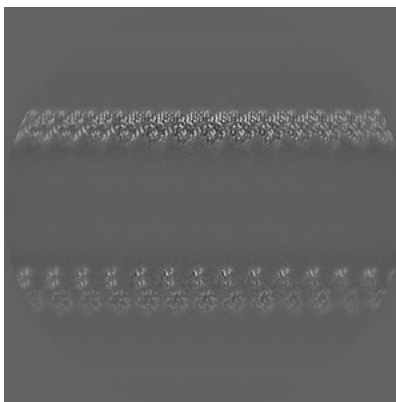

Y Index: 300

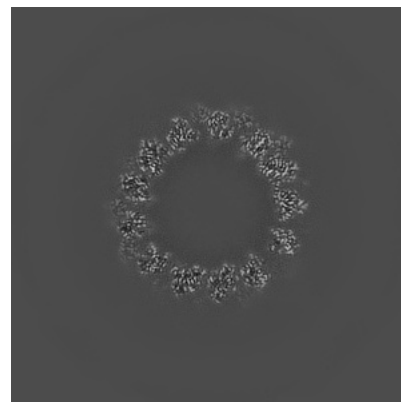

Z Index: 300

### 6.2.2 Raw map

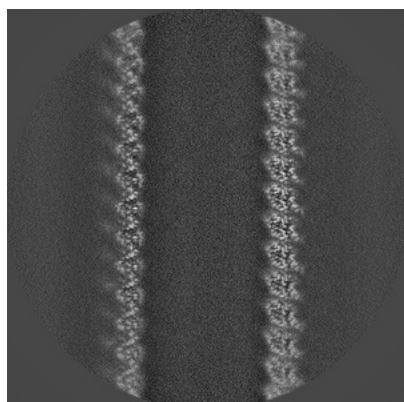

X Index: 300

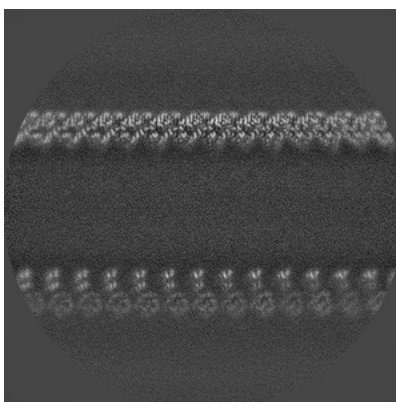

Y Index: 300

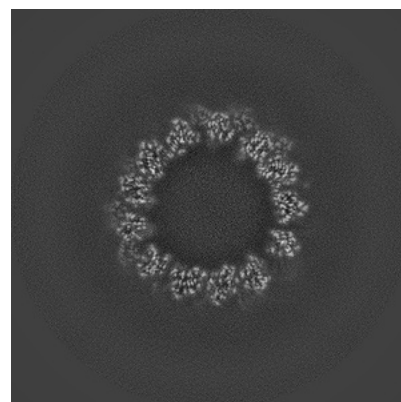

Z Index: 300

The images above show central slices of the map in three orthogonal directions.



## 6.3 Largest variance slices [i](#)

### 6.3.1 Primary map

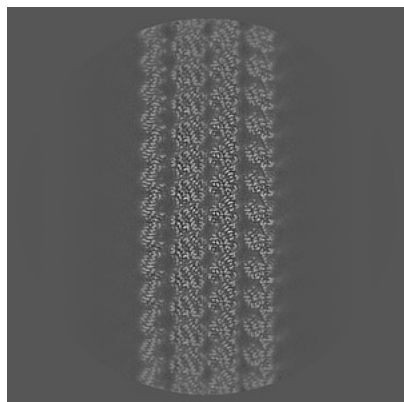

X Index: 195

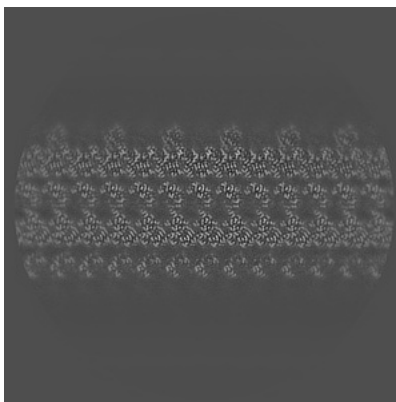

Y Index: 200

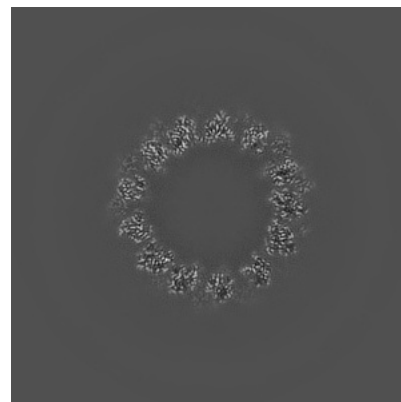

Z Index: 313

### 6.3.2 Raw map

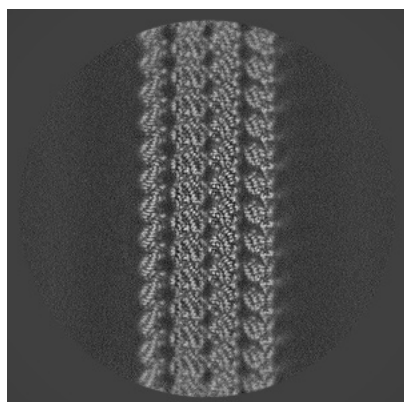

X Index: 195

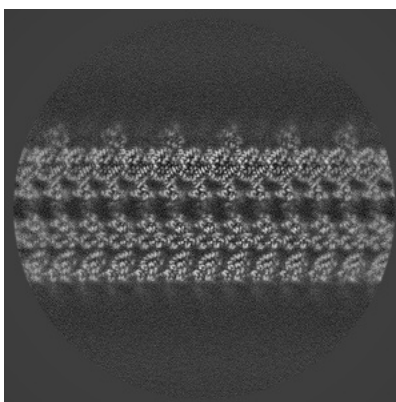

Y Index: 205

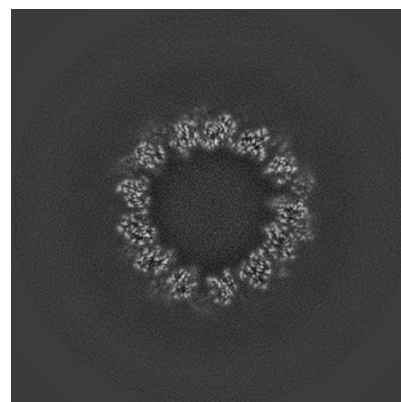

Z Index: 323

The images above show the largest variance slices of the map in three orthogonal directions.

## 6.4 Orthogonal standard-deviation projections (False-color) [i](#)

### 6.4.1 Primary map

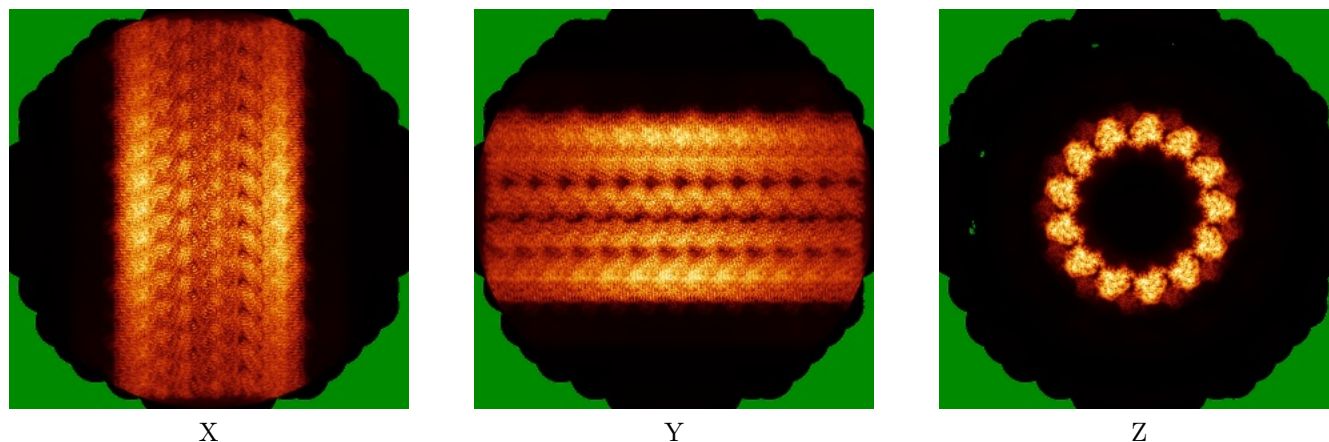

### 6.4.2 Raw map

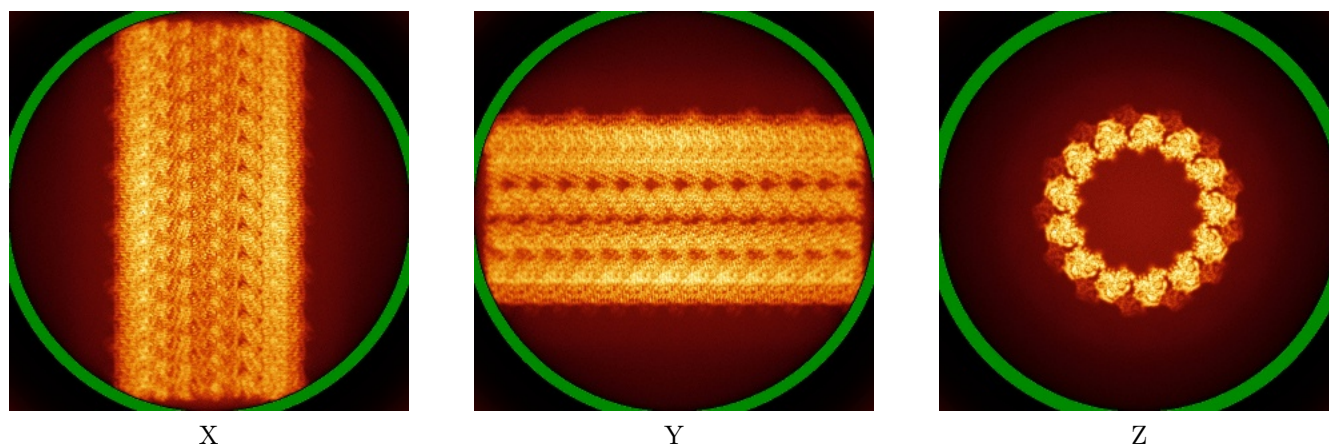

The images above show the map standard deviation projections with false color in three orthogonal directions. Minimum values are shown in green, max in blue, and dark to light orange shades represent small to large values respectively.

## 6.5 Orthogonal surface views [i](#)

### 6.5.1 Primary map

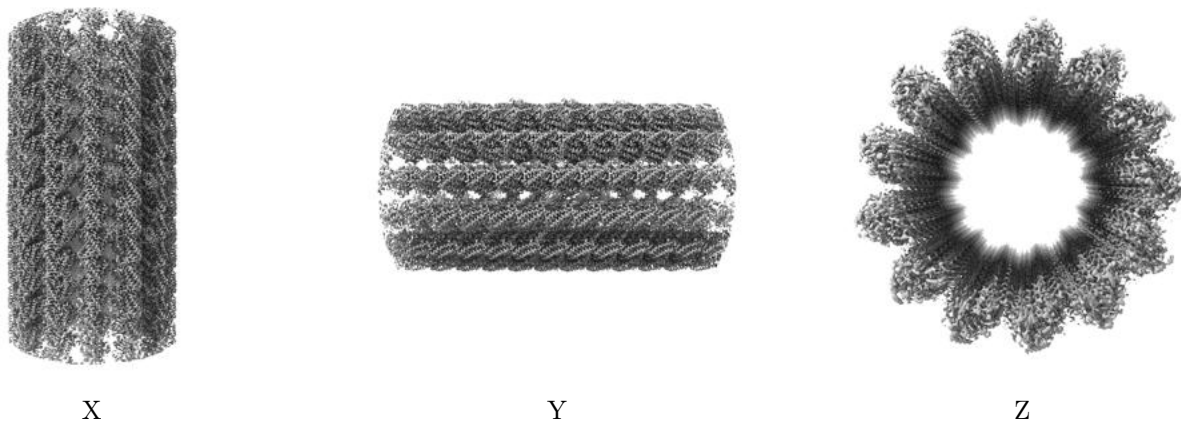

The images above show the 3D surface view of the map at the recommended contour level 0.018. These images, in conjunction with the slice images, may facilitate assessment of whether an appropriate contour level has been provided.

### 6.5.2 Raw map

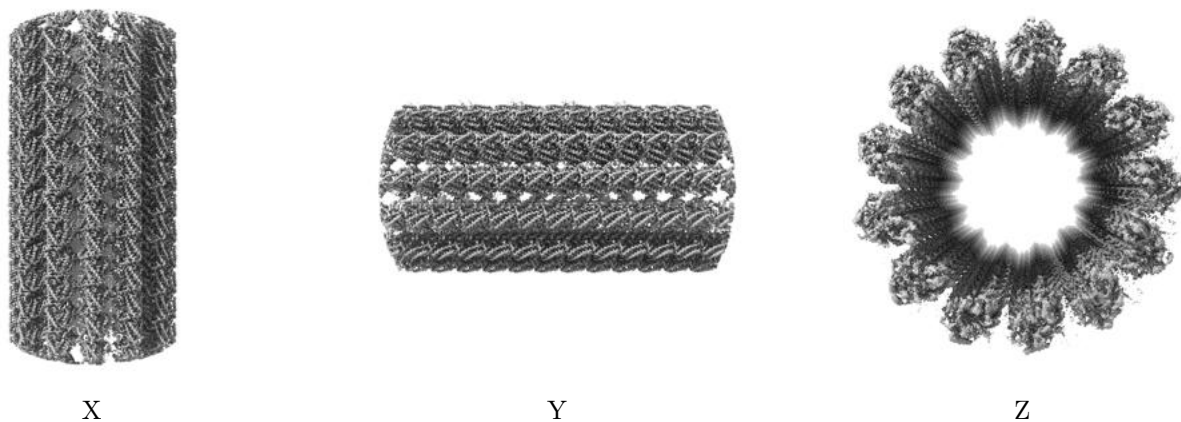

These images show the 3D surface of the raw map. The raw map's contour level was selected so that its surface encloses the same volume as the primary map does at its recommended contour level.

## 6.6 Mask visualisation [i](#)

This section was not generated. No masks/segmentation were deposited.

## 7 Map analysis [i](#)

This section contains the results of statistical analysis of the map.

### 7.1 Map-value distribution [i](#)

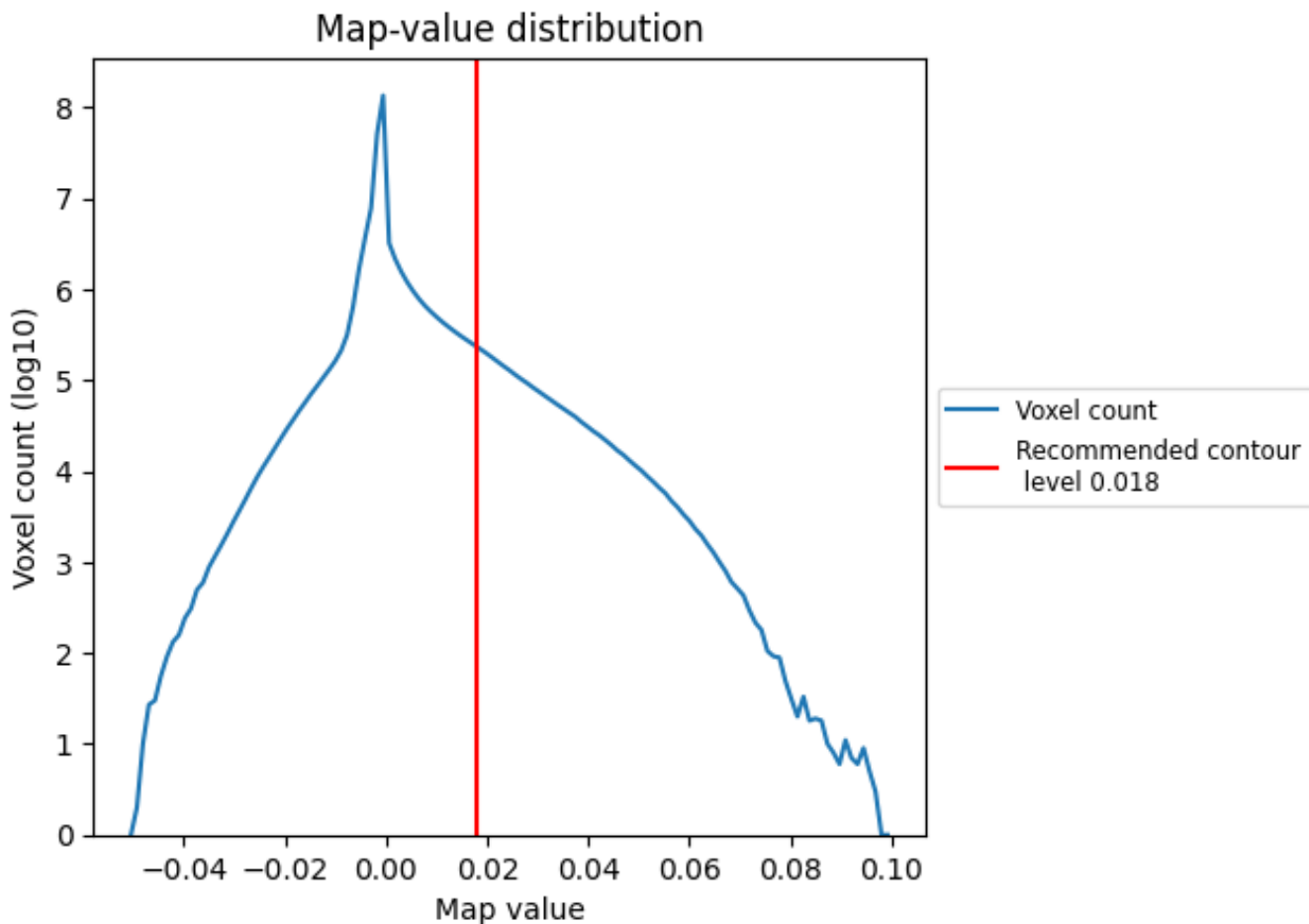

The map-value distribution is plotted in 128 intervals along the x-axis. The y-axis is logarithmic. A spike in this graph at zero usually indicates that the volume has been masked.

## 7.2 Volume estimate [i](#)

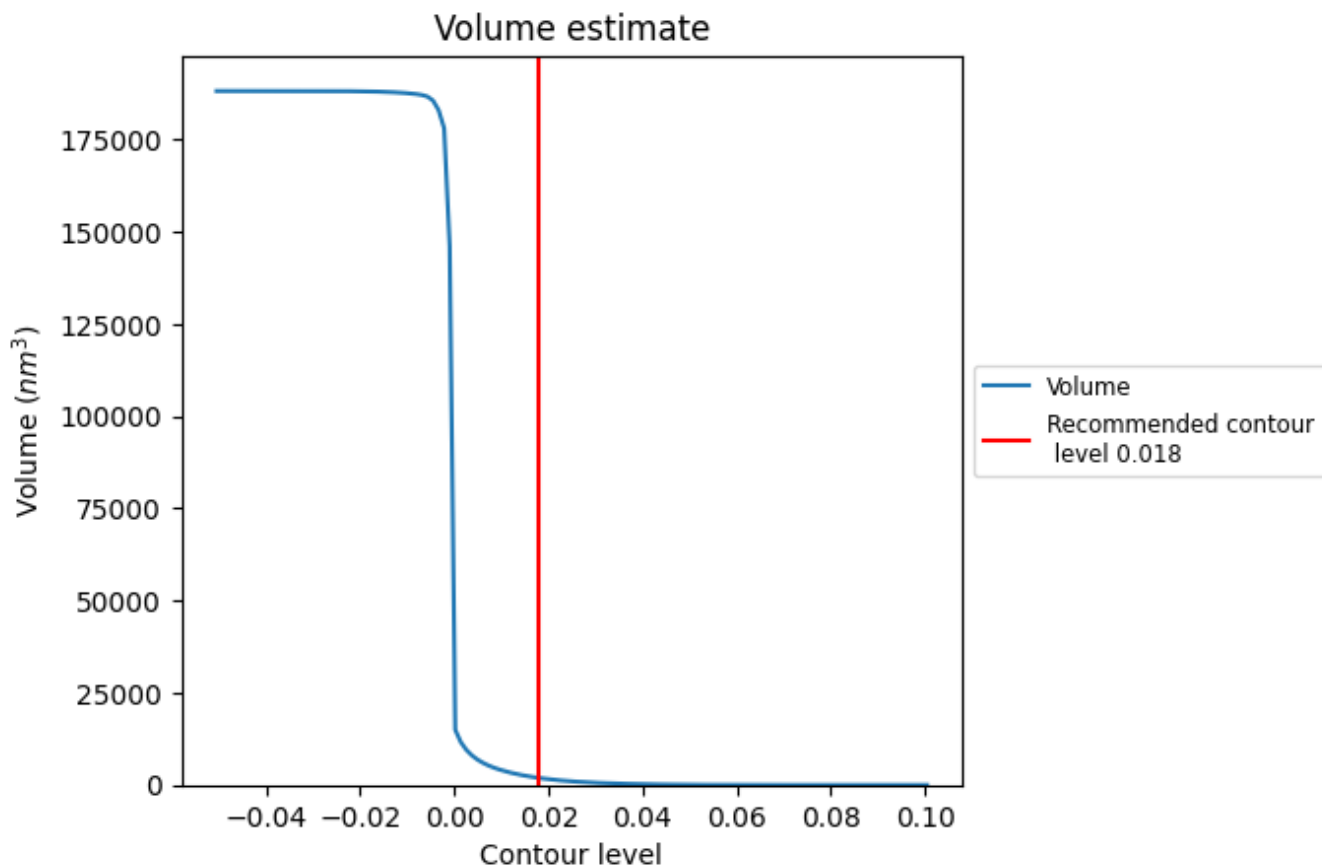

The volume at the recommended contour level is 1904  $\text{nm}^3$ ; this corresponds to an approximate mass of 1720 kDa.

The volume estimate graph shows how the enclosed volume varies with the contour level. The recommended contour level is shown as a vertical line and the intersection between the line and the curve gives the volume of the enclosed surface at the given level.

### 7.3 Rotationally averaged power spectrum [i](#)

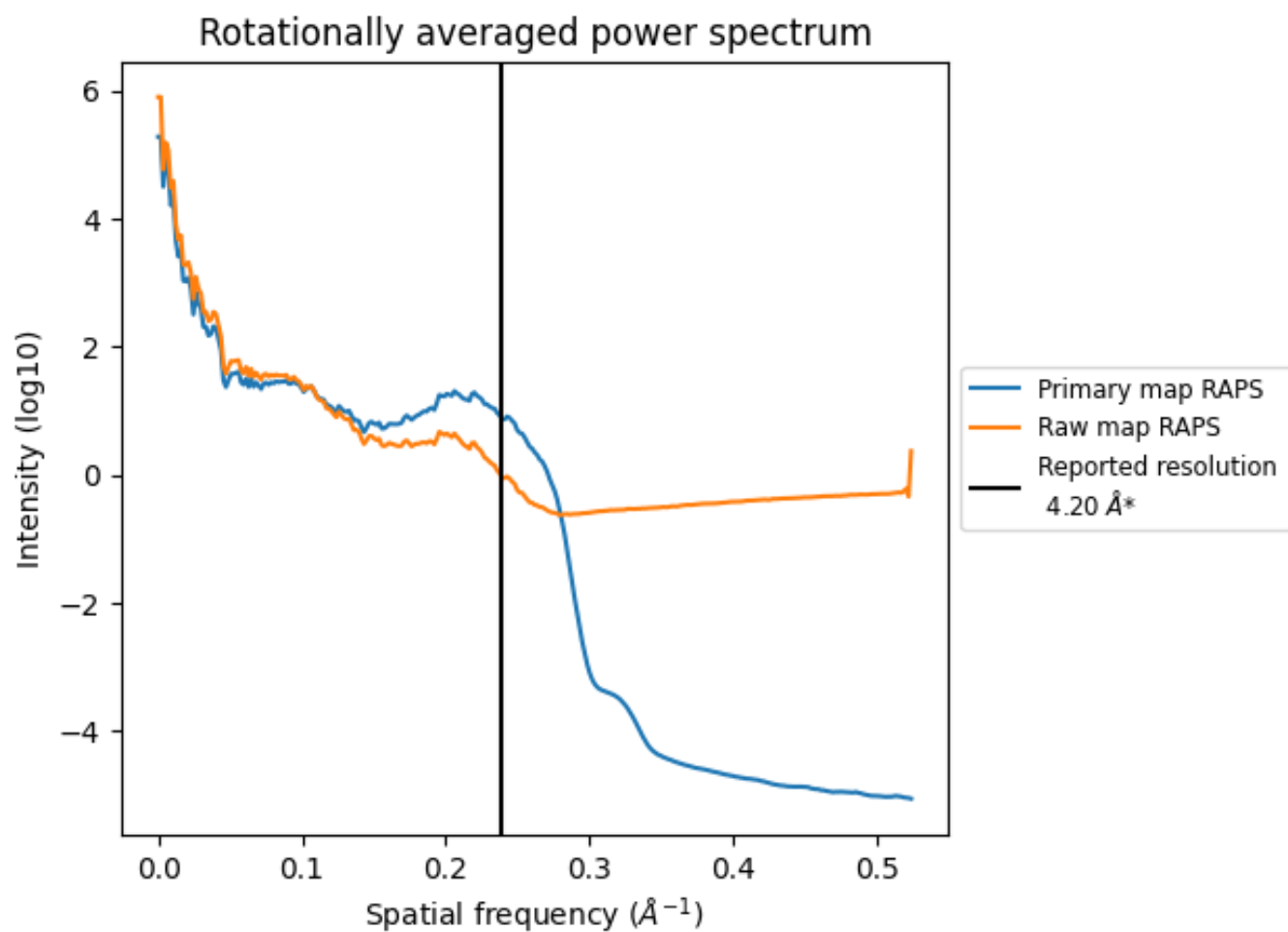

\*Reported resolution corresponds to spatial frequency of 0.238 Å<sup>-1</sup>

## 8 Fourier-Shell correlation [i](#)

Fourier-Shell Correlation (FSC) is the most commonly used method to estimate the resolution of single-particle and subtomogram-averaged maps. The shape of the curve depends on the imposed symmetry, mask and whether or not the two 3D reconstructions used were processed from a common reference. The reported resolution is shown as a black line. A curve is displayed for the half-bit criterion in addition to lines showing the 0.143 gold standard cut-off and 0.5 cut-off.

### 8.1 FSC [i](#)

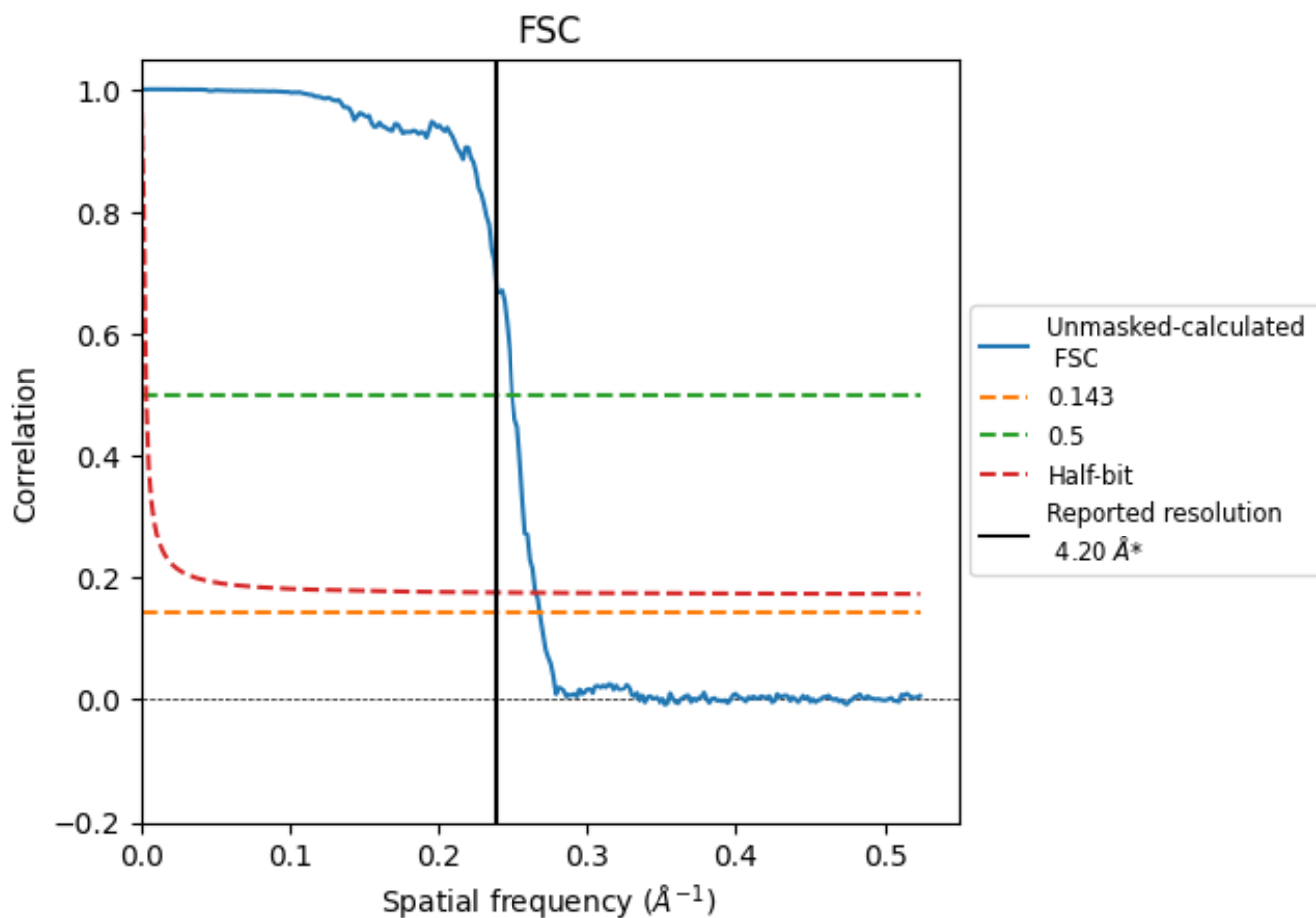

\*Reported resolution corresponds to spatial frequency of 0.238 Å<sup>-1</sup>

## 8.2 Resolution estimates

Resolution estimate (Å)	Estimation criterion (FSC cut-off)		
	0.143	0.5	Half-bit
Reported by author	4.20	-	-
Author-provided FSC curve	-	-	-
Unmasked-calculated*	3.73	4.01	3.77

\*Resolution estimate based on FSC curve calculated by comparison of deposited half-maps. The value from deposited half-maps intersecting FSC 0.143 CUT-OFF 3.73 differs from the reported value 4.2 by more than 10 %



## 9 Map-model fit [i](#)

This section contains information regarding the fit between EMDB map EMD-50178 and PDB model 9F3S. Per-residue inclusion information can be found in section 3 on page 11.

### 9.1 Map-model overlay [i](#)

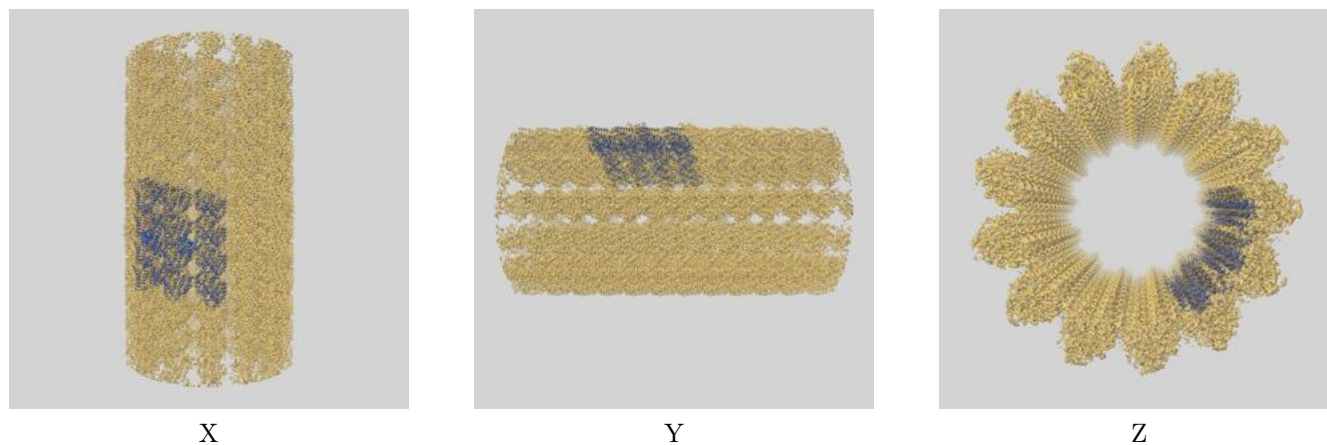

The images above show the 3D surface view of the map at the recommended contour level 0.018 at 50% transparency in yellow overlaid with a ribbon representation of the model coloured in blue. These images allow for the visual assessment of the quality of fit between the atomic model and the map.

## 9.2 Q-score mapped to coordinate model [i](#)

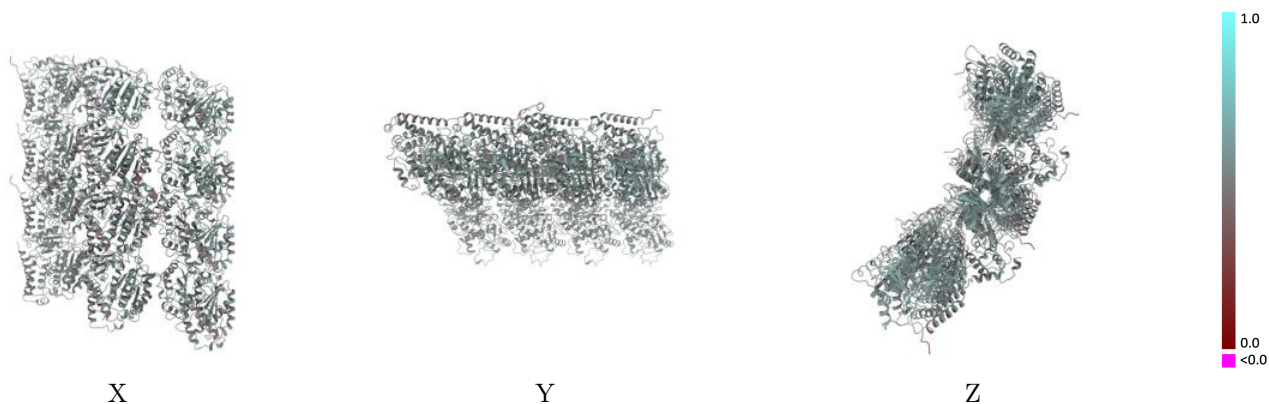

The images above show the model with each residue coloured according to its Q-score. This shows their resolvability in the map with higher Q-score values reflecting better resolvability. Please note: Q-score is calculating the resolvability of atoms, and thus high values are only expected at resolutions at which atoms can be resolved. Low Q-score values may therefore be expected for many entries.

## 9.3 Atom inclusion mapped to coordinate model [i](#)

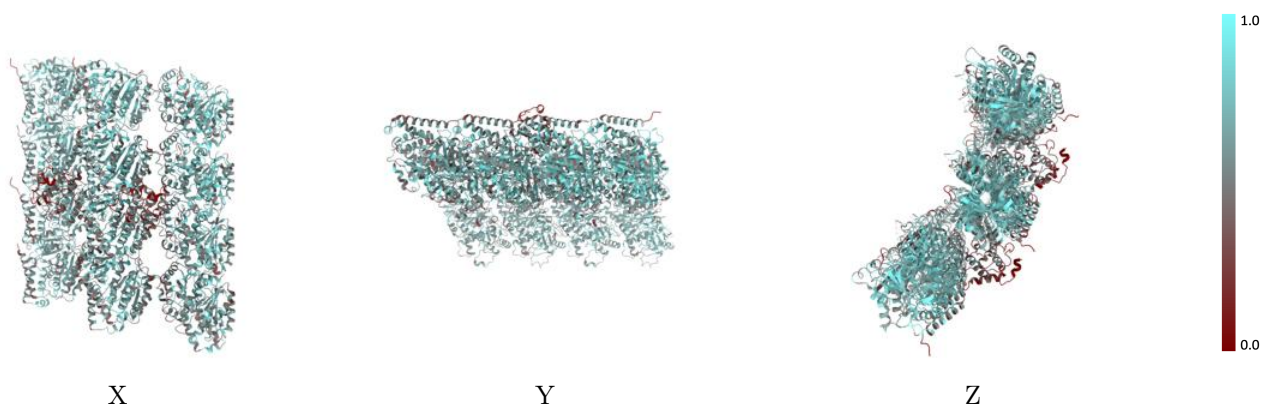

The images above show the model with each residue coloured according to its atom inclusion. This shows to what extent they are inside the map at the recommended contour level (0.018).



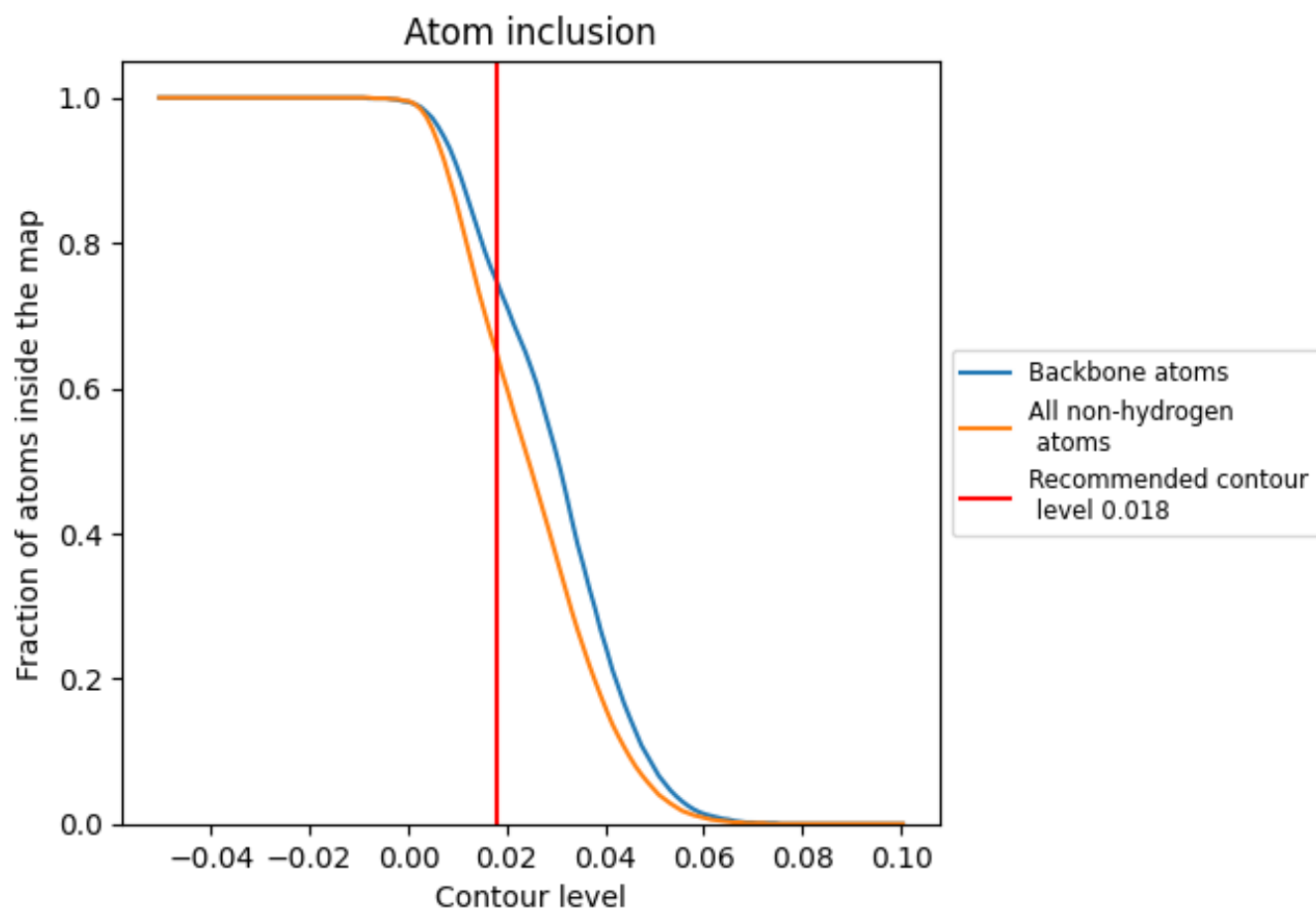



























## 9.4 Atom inclusion [i](#)



At the recommended contour level, 75% of all backbone atoms, 65% of all non-hydrogen atoms, are inside the map.

## 9.5 Map-model fit summary

The table lists the average atom inclusion at the recommended contour level (0.018) and Q-score for the entire model and for each chain.

Chain	Atom inclusion	Q-score
All	 0.6480	 0.5210
A	 0.6590	 0.5150
B	 0.6900	 0.5130
C	 0.6540	 0.5250
D	 0.6980	 0.5270
E	 0.6620	 0.5250
F	 0.7010	 0.5270
G	 0.6880	 0.5290
I	 0.6860	 0.5300
K	 0.6860	 0.5290
N	 0.6240	 0.5180
P	 0.6170	 0.5150
R	 0.6350	 0.5190
S	 0.2780	 0.5060
T	 0.2910	 0.4910

