



Full wwPDB EM Validation Report ⓘ

Jul 10, 2023 – 01:00 PM EDT

PDB ID : 8FKX
EMDB ID : EMD-29260
Title : Human nucleolar pre-60S ribosomal subunit (State E)
Authors : Vanden Broeck, A.; Klinge, S.
Deposited on : 2022-12-21
Resolution : 2.59 Å (reported)

This is a Full wwPDB EM Validation Report for a publicly released PDB entry.

We welcome your comments at validation@mail.wwpdb.org

A user guide is available at

<https://www.wwpdb.org/validation/2017/EMValidationReportHelp>

with specific help available everywhere you see the ⓘ symbol.

The types of validation reports are described at

<http://www.wwpdb.org/validation/2017/FAQs#types>.

The following versions of software and data (see [references ⓘ](#)) were used in the production of this report:

EMDB validation analysis : 0.0.1.dev50
Mogul : 1.8.5 (274361), CSD as541be (2020)
MolProbity : 4.02b-467
buster-report : 1.1.7 (2018)
Percentile statistics : 20191225.v01 (using entries in the PDB archive December 25th 2019)
MapQ : 1.9.9
Ideal geometry (proteins) : Engh & Huber (2001)
Ideal geometry (DNA, RNA) : Parkinson et al. (1996)
Validation Pipeline (wwPDB-VP) : 2.34

1 Overall quality at a glance

The following experimental techniques were used to determine the structure:
ELECTRON MICROSCOPY

The reported resolution of this entry is 2.59 Å.

Percentile scores (ranging between 0-100) for global validation metrics of the entry are shown in the following graphic. The table shows the number of entries on which the scores are based.

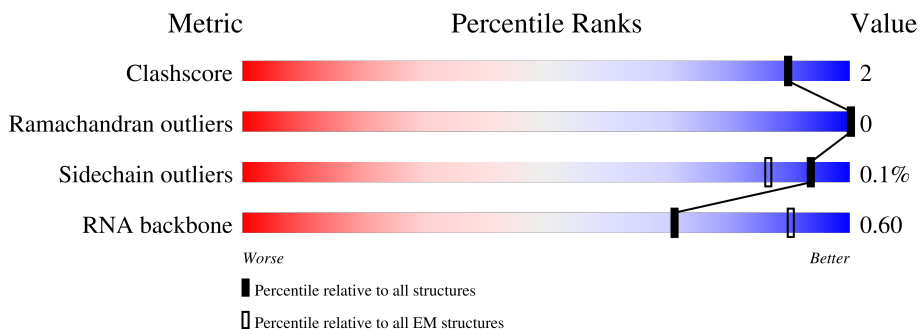

















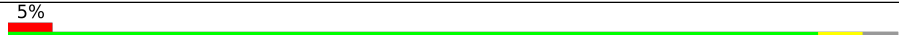

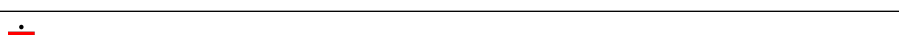
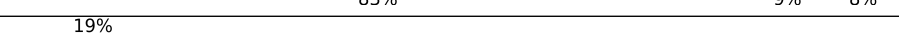
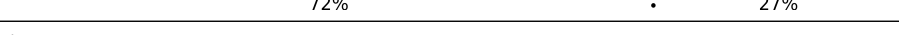
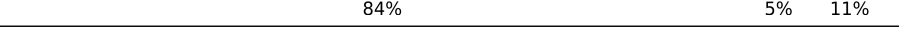

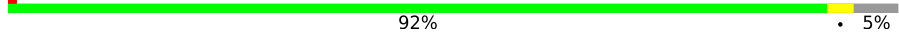
Metric	Whole archive (#Entries)	EM structures (#Entries)
Clashscore	158937	4297
Ramachandran outliers	154571	4023
Sidechain outliers	154315	3826
RNA backbone	4643	859

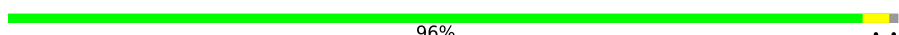
The table below summarises the geometric issues observed across the polymeric chains and their fit to the map. The red, orange, yellow and green segments of the bar indicate the fraction of residues that contain outliers for ≥ 3 , 2, 1 and 0 types of geometric quality criteria respectively. A grey segment represents the fraction of residues that are not modelled. The numeric value for each fraction is indicated below the corresponding segment, with a dot representing fractions $\leq 5\%$. The upper red bar (where present) indicates the fraction of residues that have poor fit to the EM map (all-atom inclusion $< 40\%$). The numeric value is given above the bar.

Mol	Chain	Length	Quality of chain
1	BA	165	
2	BB	217	
3	L1	157	
4	L2	1167	
5	L3	5070	
6	L6	211	
7	L7	203	

Continued on next page...

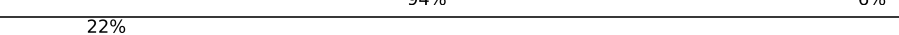
Continued from previous page...

Mol	Chain	Length	Quality of chain
8	L8	215	
9	L9	204	
10	LA	184	
11	LB	188	
12	LC	176	
13	LE	160	
14	LG	140	
15	LH	156	
16	LI	145	
17	LK	148	
18	LL	137	
19	LN	403	
20	LP	125	
21	LQ	135	
22	LS	123	
23	LT	110	
24	LU	105	
25	LW	97	
26	NA	749	
27	NB	549	
28	NF	260	
29	NH	180	
30	NI	881	
31	NK	129	
32	SA	427	

Continued on next page...

Continued from previous page...

Mol	Chain	Length	Quality of chain
33	SC	288	
34	SD	248	
35	SE	266	
36	SG	192	
37	SH	293	
38	SI	255	
39	SJ	847	
40	SK	245	
41	SL	490	
42	SM	588	
43	SN	306	
44	SO	353	
45	SQ	239	
46	SR	634	
47	SS	746	
48	ST	365	
49	SU	800	
50	SV	163	
51	SW	670	
52	SY	812	
53	SZ	178	

2 Entry composition [i](#)

There are 58 unique types of molecules in this entry. The entry contains 138643 atoms, of which 0 are hydrogens and 0 are deuteriums.

In the tables below, the AltConf column contains the number of residues with at least one atom in alternate conformation and the Trace column contains the number of residues modelled with at most 2 atoms.

- Molecule 1 is a protein called 60S ribosomal protein L12.

Mol	Chain	Residues	Atoms					AltConf	Trace
			Total	C	N	O	S		
1	BA	160	1208	749	226	229	4	0	0

- Molecule 2 is a protein called 60S ribosomal protein L10a.

Mol	Chain	Residues	Atoms				AltConf	Trace
			Total	C	N	O		
2	BB	213	1057	631	213	213	0	0

- Molecule 3 is a RNA chain called 5.8S rRNA.

Mol	Chain	Residues	Atoms					AltConf	Trace
			Total	C	N	O	P		
3	L1	152	3234	1443	571	1068	152	0	0

- Molecule 4 is a RNA chain called ITS2 rRNA.

Mol	Chain	Residues	Atoms					AltConf	Trace
			Total	C	N	O	P		
4	L2	69	1468	653	263	483	69	0	0

- Molecule 5 is a RNA chain called 28S rRNA.

Mol	Chain	Residues	Atoms					AltConf	Trace
			Total	C	N	O	P		
5	L3	2250	48236	21483	8831	15672	2250	0	0

- Molecule 6 is a protein called 60S ribosomal protein L13.

Mol	Chain	Residues	Atoms					AltConf	Trace
			Total	C	N	O	S		
6	L6	120	998	625	218	154	1	0	0

- Molecule 7 is a protein called 60S ribosomal protein L13a.

Mol	Chain	Residues	Atoms					AltConf	Trace
			Total	C	N	O	S		
7	L7	201	1650	1063	321	261	5	0	0

- Molecule 8 is a protein called 60S ribosomal protein L14.

Mol	Chain	Residues	Atoms					AltConf	Trace
			Total	C	N	O	S		
8	L8	135	1111	713	213	178	7	0	0

- Molecule 9 is a protein called 60S ribosomal protein L15.

Mol	Chain	Residues	Atoms					AltConf	Trace
			Total	C	N	O	S		
9	L9	183	1546	974	325	243	4	0	0

- Molecule 10 is a protein called 60S ribosomal protein L17.

Mol	Chain	Residues	Atoms					AltConf	Trace
			Total	C	N	O	S		
10	LA	138	1106	693	208	197	8	0	0

- Molecule 11 is a protein called 60S ribosomal protein L18.

Mol	Chain	Residues	Atoms					AltConf	Trace
			Total	C	N	O	S		
11	LB	151	1223	768	247	203	5	0	0

- Molecule 12 is a protein called 60S ribosomal protein L18a.

Mol	Chain	Residues	Atoms					AltConf	Trace
			Total	C	N	O	S		
12	LC	176	1461	930	284	236	11	0	0

- Molecule 13 is a protein called 60S ribosomal protein L21.

Mol	Chain	Residues	Atoms					AltConf	Trace
			Total	C	N	O	S		
13	LE	113	926	589	176	159	2	0	0

- Molecule 14 is a protein called 60S ribosomal protein L23.

Mol	Chain	Residues	Atoms					AltConf	Trace
14	LG	134	Total	C	N	O	S	0	0
			993	625	187	176	5		

- Molecule 15 is a protein called 60S ribosomal protein L23a.

Mol	Chain	Residues	Atoms					AltConf	Trace
15	LH	133	Total	C	N	O	S	0	0
			1071	686	201	183	1		

- Molecule 16 is a protein called 60S ribosomal protein L26.

Mol	Chain	Residues	Atoms					AltConf	Trace
16	LI	134	Total	C	N	O	S	0	0
			1115	700	226	186	3		

- Molecule 17 is a protein called 60S ribosomal protein L27a.

Mol	Chain	Residues	Atoms					AltConf	Trace
17	LK	108	Total	C	N	O	S	0	0
			642	388	137	115	2		

- Molecule 18 is a protein called 60S ribosomal protein L28.

Mol	Chain	Residues	Atoms					AltConf	Trace
18	LL	122	Total	C	N	O	S	0	0
			980	607	204	165	4		

- Molecule 19 is a protein called 60S ribosomal protein L3.

Mol	Chain	Residues	Atoms					AltConf	Trace
19	LN	358	Total	C	N	O	S	0	0
			2884	1834	531	506	13		

- Molecule 20 is a protein called 60S ribosomal protein L31.

Mol	Chain	Residues	Atoms				AltConf	Trace
20	LP	106	Total	C	N	O	0	0
			526	314	106	106		

- Molecule 21 is a protein called 60S ribosomal protein L32.

Mol	Chain	Residues	Atoms					AltConf	Trace
			Total	C	N	O	S		
21	LQ	128	1053	667	216	165	5	0	0

- Molecule 22 is a protein called 60S ribosomal protein L35.

Mol	Chain	Residues	Atoms					AltConf	Trace
			Total	C	N	O	S		
22	LS	122	1015	641	205	168	1	0	0

- Molecule 23 is a protein called 60S ribosomal protein L35a.

Mol	Chain	Residues	Atoms					AltConf	Trace
			Total	C	N	O	S		
23	LT	109	876	555	174	144	3	0	0

- Molecule 24 is a protein called 60S ribosomal protein L36.

Mol	Chain	Residues	Atoms					AltConf	Trace
			Total	C	N	O	S		
24	LU	102	840	526	180	129	5	1	0

- Molecule 25 is a protein called 60S ribosomal protein L37.

Mol	Chain	Residues	Atoms					AltConf	Trace
			Total	C	N	O	S		
25	LW	74	612	379	134	94	5	0	0

- Molecule 26 is a protein called Nucleolar complex protein 2 homolog.

Mol	Chain	Residues	Atoms					AltConf	Trace
			Total	C	N	O	S		
26	NA	484	3389	2157	608	609	15	0	0

- Molecule 27 is a protein called Guanine nucleotide-binding protein-like 3.

Mol	Chain	Residues	Atoms					AltConf	Trace
			Total	C	N	O	S		
27	NB	71	603	376	125	99	3	0	0

- Molecule 28 is a protein called Ribosome biogenesis protein NSA2 homolog.

Mol	Chain	Residues	Atoms					AltConf	Trace
28	NF	209	Total	C	N	O	S	0	0
			1696	1078	322	287	9		

- Molecule 29 is a protein called 60S ribosome subunit biogenesis protein NIP7 homolog.

Mol	Chain	Residues	Atoms					AltConf	Trace
29	NH	180	Total	C	N	O	S	0	0
			1441	925	245	263	8		

- Molecule 30 is a protein called ATP-dependent RNA helicase DDX54.

Mol	Chain	Residues	Atoms					AltConf	Trace
30	NI	612	Total	C	N	O	S	0	0
			4832	3067	866	884	15		

- Molecule 31 is a protein called Protein LLP homolog.

Mol	Chain	Residues	Atoms					AltConf	Trace
31	NK	67	Total	C	N	O	S	0	0
			581	363	128	88	2		

- Molecule 32 is a protein called 60S ribosomal protein L4.

Mol	Chain	Residues	Atoms					AltConf	Trace
32	SA	358	Total	C	N	O	S	0	0
			2853	1797	570	473	13		

- Molecule 33 is a protein called 60S ribosomal protein L6.

Mol	Chain	Residues	Atoms					AltConf	Trace
33	SC	214	Total	C	N	O	S	0	0
			1721	1107	327	283	4		

- Molecule 34 is a protein called 60S ribosomal protein L7.

Mol	Chain	Residues	Atoms					AltConf	Trace
34	SD	225	Total	C	N	O	S	0	0
			1870	1202	358	301	9		

- Molecule 35 is a protein called 60S ribosomal protein L7a.

Mol	Chain	Residues	Atoms					AltConf	Trace
			Total	C	N	O	S		
35	SE	186	1498	951	290	253	4	0	0

- Molecule 36 is a protein called 60S ribosomal protein L9.

Mol	Chain	Residues	Atoms					AltConf	Trace
			Total	C	N	O	S		
36	SG	190	1526	961	287	272	6	1	0

- Molecule 37 is a protein called MKI67 FHA domain-interacting nucleolar phosphoprotein.

Mol	Chain	Residues	Atoms					AltConf	Trace
			Total	C	N	O	S		
37	SH	150	1267	819	224	220	4	0	0

- Molecule 38 is a protein called 60S ribosomal protein L7-like 1.

Mol	Chain	Residues	Atoms					AltConf	Trace
			Total	C	N	O	S		
38	SI	223	1850	1197	347	302	4	1	0

- Molecule 39 is a protein called pre-rRNA 2'-O-ribose RNA methyltransferase FTSJ3.

Mol	Chain	Residues	Atoms					AltConf	Trace
			Total	C	N	O	S		
39	SJ	219	1803	1127	352	322	2	0	0

- Molecule 40 is a protein called Eukaryotic translation initiation factor 6.

Mol	Chain	Residues	Atoms					AltConf	Trace
			Total	C	N	O	S		
40	SK	244	1852	1149	318	372	13	0	0

- Molecule 41 is a protein called Ribosomal L1 domain-containing protein 1.

Mol	Chain	Residues	Atoms					AltConf	Trace
			Total	C	N	O	S		
41	SL	243	1960	1254	344	356	6	0	0

- Molecule 42 is a protein called Pescadillo homolog.

Mol	Chain	Residues	Atoms					AltConf	Trace
			Total	C	N	O	S		
42	SM	441	3646	2354	647	633	12	0	0

- Molecule 43 is a protein called Probable rRNA-processing protein EBP2.

Mol	Chain	Residues	Atoms					AltConf	Trace
			Total	C	N	O	S		
43	SN	173	1350	849	251	243	7	0	0

- Molecule 44 is a protein called Ribosome biogenesis protein BRX1 homolog.

Mol	Chain	Residues	Atoms					AltConf	Trace
			Total	C	N	O	S		
44	SO	296	2460	1583	446	416	15	0	0

- Molecule 45 is a protein called mRNA turnover protein 4 homolog.

Mol	Chain	Residues	Atoms					AltConf	Trace
			Total	C	N	O	S		
45	SQ	217	1778	1134	313	320	11	1	0

- Molecule 46 is a protein called GTP-binding protein 4.

Mol	Chain	Residues	Atoms					AltConf	Trace
			Total	C	N	O	S		
46	SR	493	4073	2584	723	747	19	0	0

- Molecule 47 is a protein called Ribosome biogenesis protein BOP1.

Mol	Chain	Residues	Atoms						AltConf	Trace
			Total	C	N	O	P	S		
47	SS	259	2150	1355	381	404	2	8	0	0

- Molecule 48 is a protein called Ribosome biogenesis regulatory protein homolog.

Mol	Chain	Residues	Atoms					AltConf	Trace
			Total	C	N	O	S		
48	ST	148	1091	675	207	206	3	0	0

- Molecule 49 is a protein called Nucleolar complex protein 3 homolog.

Mol	Chain	Residues	Atoms					AltConf	Trace
			Total	C	N	O	S		
49	SU	552	4360	2795	748	796	21	0	0

- Molecule 50 is a protein called Probable ribosome biogenesis protein RLP24.

Mol	Chain	Residues	Atoms					AltConf	Trace
			Total	C	N	O	S		
50	SV	137	1171	745	227	189	10	0	0

- Molecule 51 is a protein called ATP-dependent RNA helicase DDX18.

Mol	Chain	Residues	Atoms					AltConf	Trace
			Total	C	N	O	S		
51	SW	444	3549	2282	605	645	17	0	0

- Molecule 52 is a protein called Probable 28S rRNA (cytosine(4447)-C(5))-methyltransferase.

Mol	Chain	Residues	Atoms					AltConf	Trace
			Total	C	N	O	S		
52	SY	378	2985	1887	533	550	15	0	0

- Molecule 53 is a protein called Nucleolar protein 16.

Mol	Chain	Residues	Atoms					AltConf	Trace
			Total	C	N	O	S		
53	SZ	160	1338	835	260	238	5	0	0

- Molecule 54 is MAGNESIUM ION (three-letter code: MG) (formula: Mg).

Mol	Chain	Residues	Atoms		AltConf
54	L1	4	Total	Mg	0
			4	4	
54	L2	1	Total	Mg	0
			1	1	
54	L3	46	Total	Mg	0
			46	46	
54	L9	1	Total	Mg	0
			1	1	
54	LB	1	Total	Mg	0
			1	1	
54	LQ	1	Total	Mg	0
			1	1	

Continued on next page...

Continued from previous page...

Mol	Chain	Residues	Atoms	AltConf
54	LT	1	Total Mg 1 1	0
54	NI	1	Total Mg 1 1	0
54	SA	2	Total Mg 2 2	0
54	SO	1	Total Mg 1 1	0
54	SR	1	Total Mg 1 1	0
54	SU	1	Total Mg 1 1	0

- Molecule 55 is ZINC ION (three-letter code: ZN) (formula: Zn).

Mol	Chain	Residues	Atoms	AltConf
55	LW	1	Total Zn 1 1	0
55	SV	1	Total Zn 1 1	0

- Molecule 56 is ADENOSINE-5'-DIPHOSPHATE (three-letter code: ADP) (formula: C₁₀H₁₅N₅O₁₀P₂).

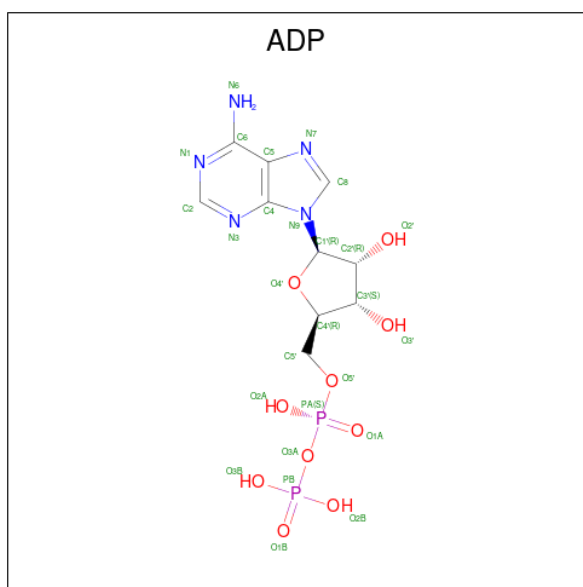

Mol	Chain	Residues	Atoms	AltConf
56	NI	1	Total C N O P 27 10 5 10 2	0

- Molecule 57 is GUANOSINE-5'-DIPHOSPHATE (three-letter code: GDP) (formula: $C_{10}H_{15}N_5O_{11}P_2$).

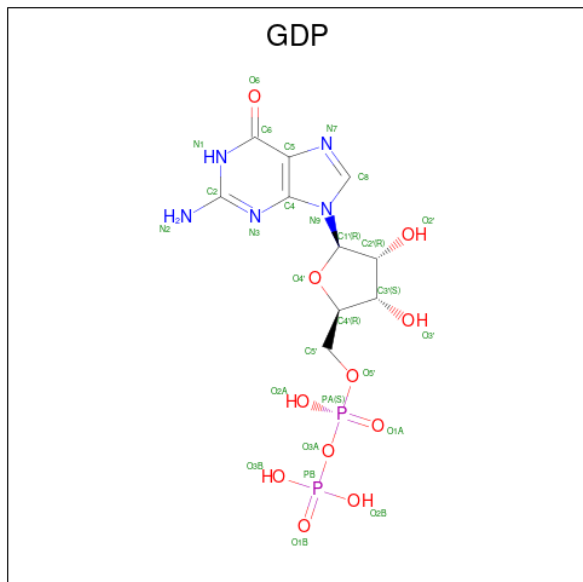

Mol	Chain	Residues	Atoms					AltConf
			Total	C	N	O	P	
57	SR	1	28	10	5	11	2	0

- Molecule 58 is POTASSIUM ION (three-letter code: K) (formula: K).

Mol	Chain	Residues	Atoms		AltConf
			Total	K	
58	SR	1	1	1	0

3 Residue-property plots i

These plots are drawn for all protein, RNA, DNA and oligosaccharide chains in the entry. The first graphic for a chain summarises the proportions of the various outlier classes displayed in the second graphic. The second graphic shows the sequence view annotated by issues in geometry and atom inclusion in map density. Residues are color-coded according to the number of geometric quality criteria for which they contain at least one outlier: green = 0, yellow = 1, orange = 2 and red = 3 or more. A red diamond above a residue indicates a poor fit to the EM map for this residue (all-atom inclusion < 40%). Stretches of 2 or more consecutive residues without any outlier are shown as a green connector. Residues present in the sample, but not in the model, are shown in grey.

- Molecule 1: 60S ribosomal protein L12

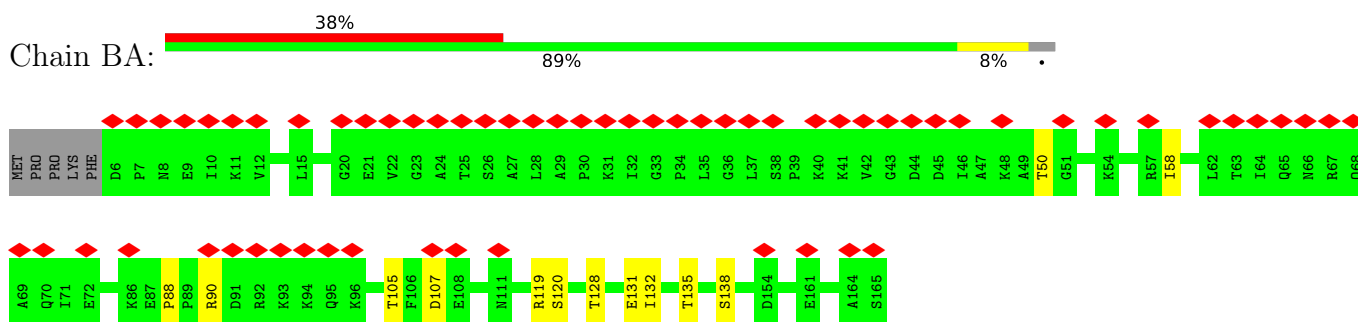

- Molecule 2: 60S ribosomal protein L10a

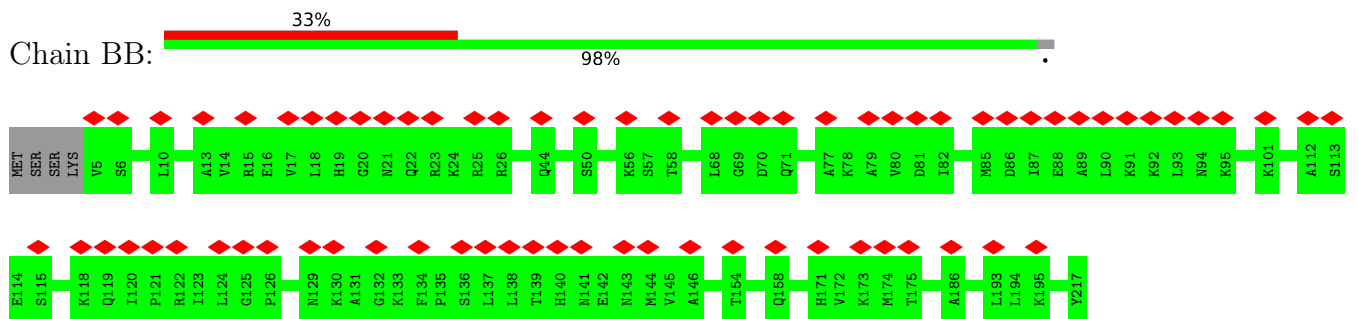

- Molecule 3: 5.8S rRNA

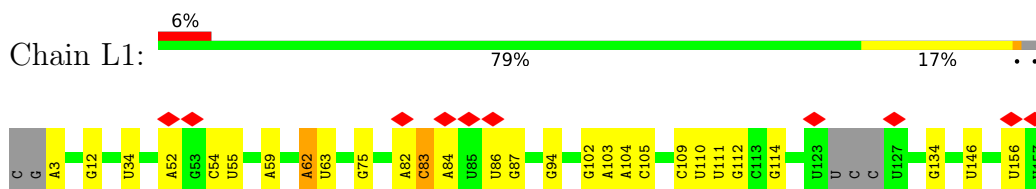

- Molecule 4: ITS2 rRNA

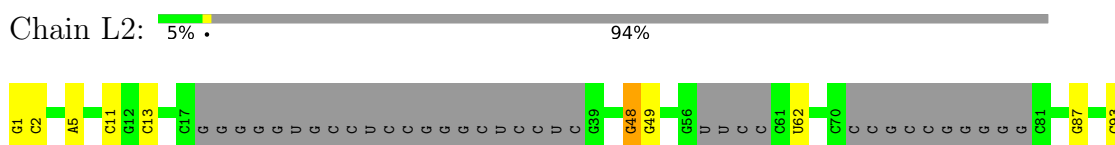

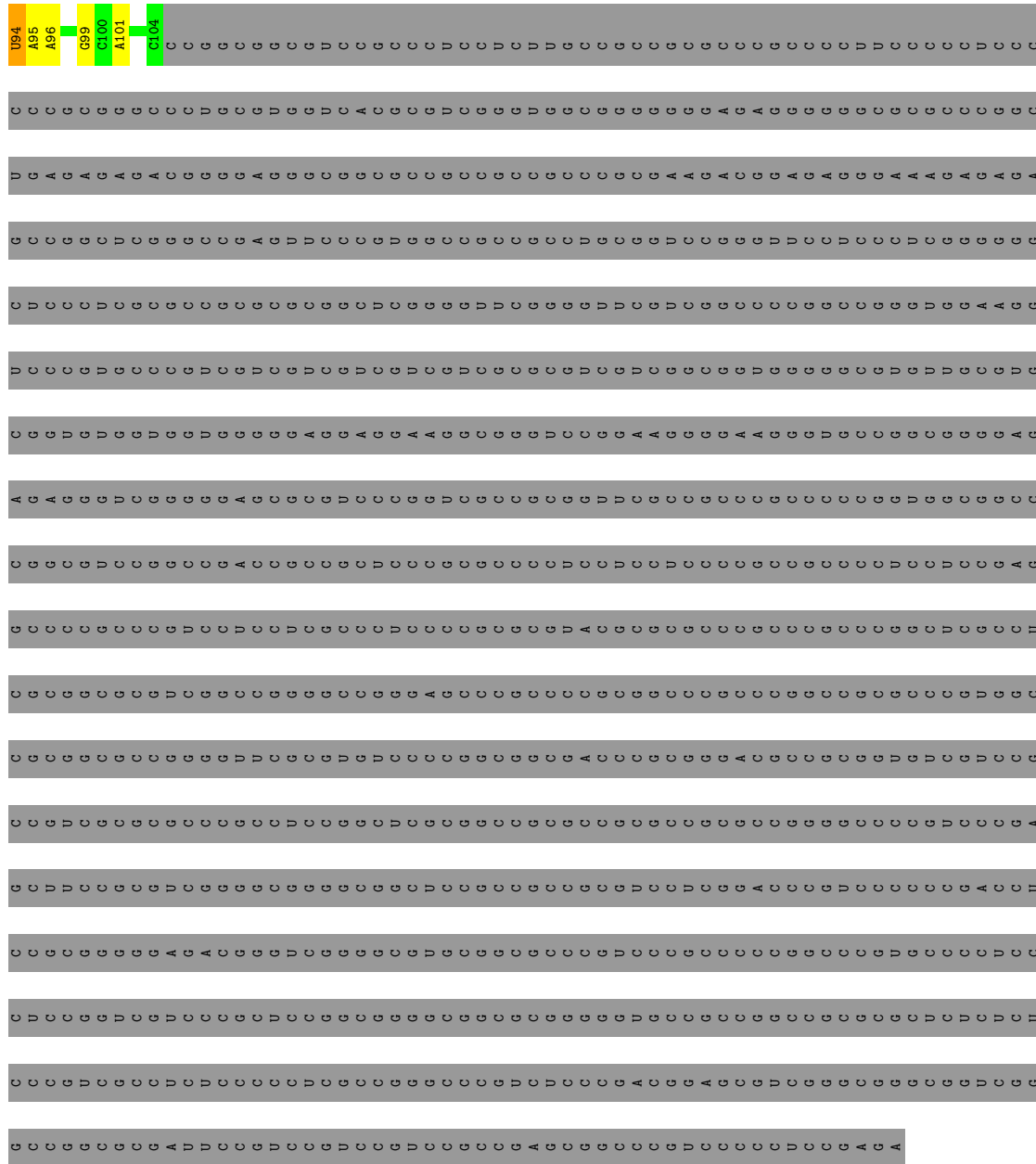

● Molecule 5: 28S rRNA

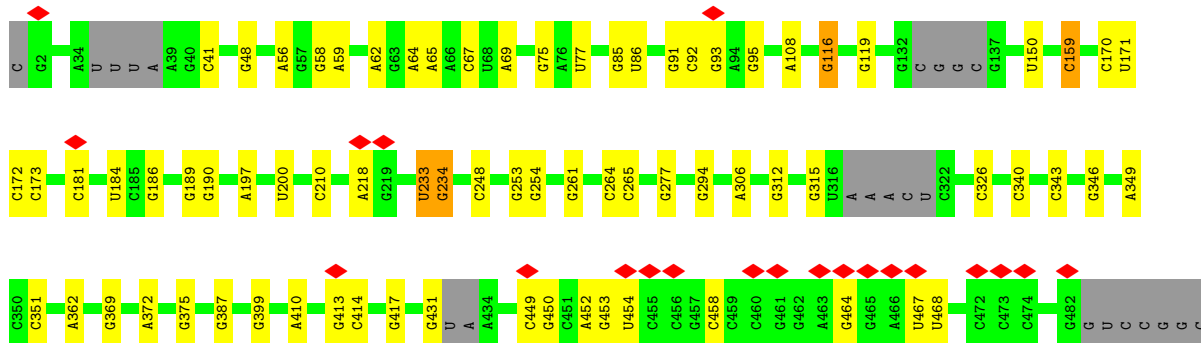
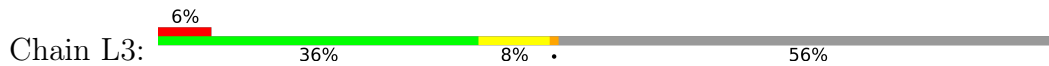

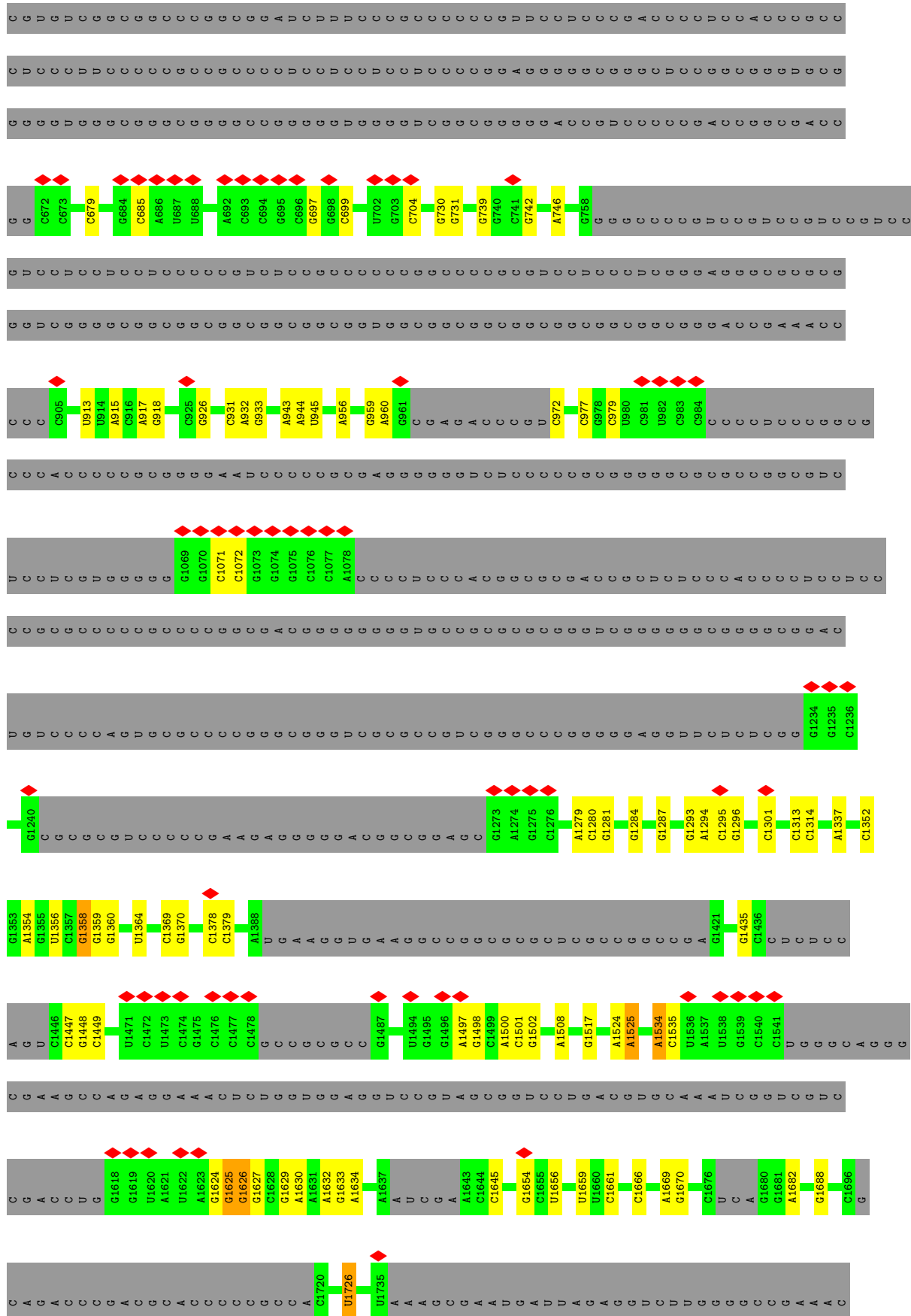

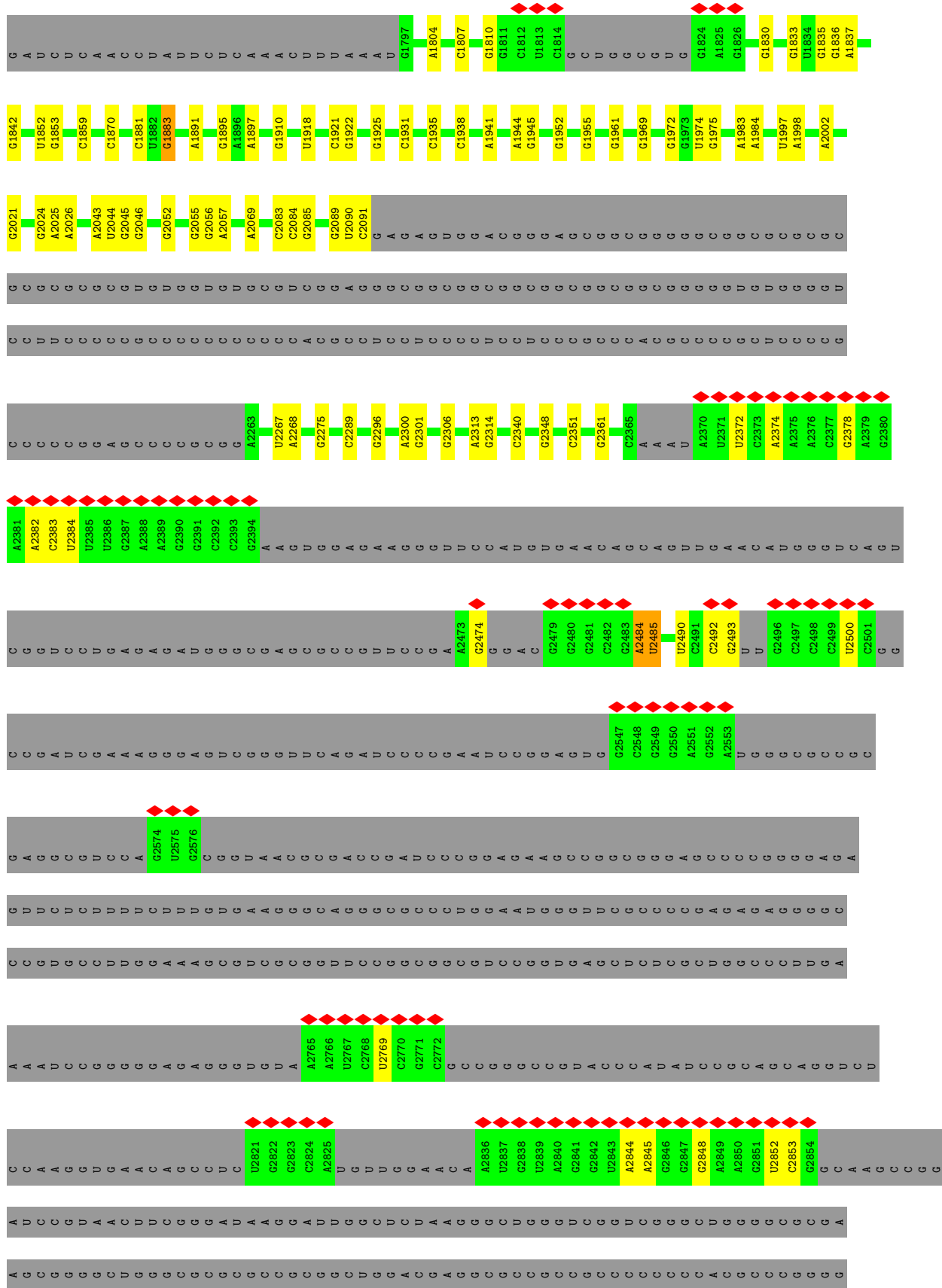

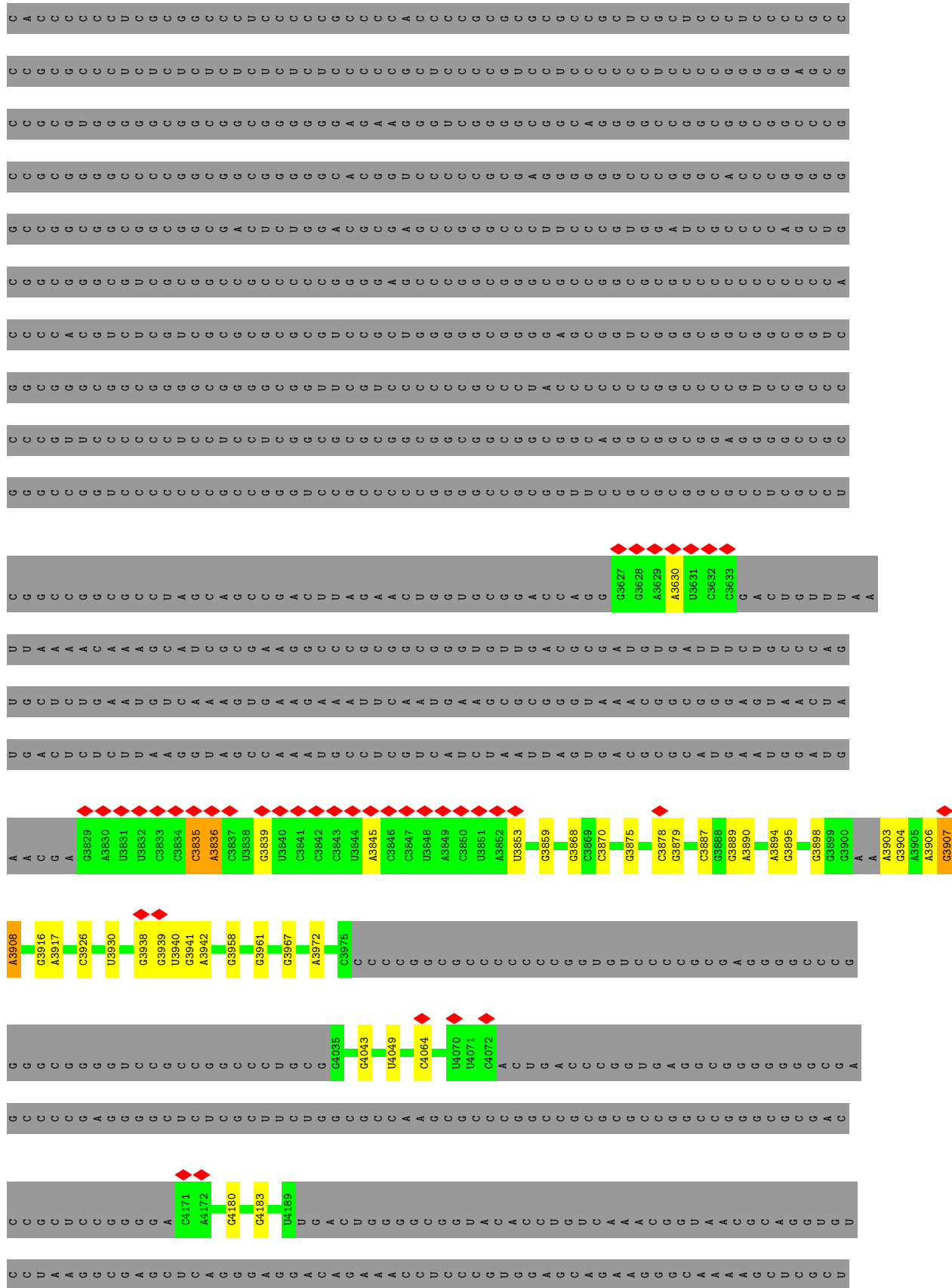

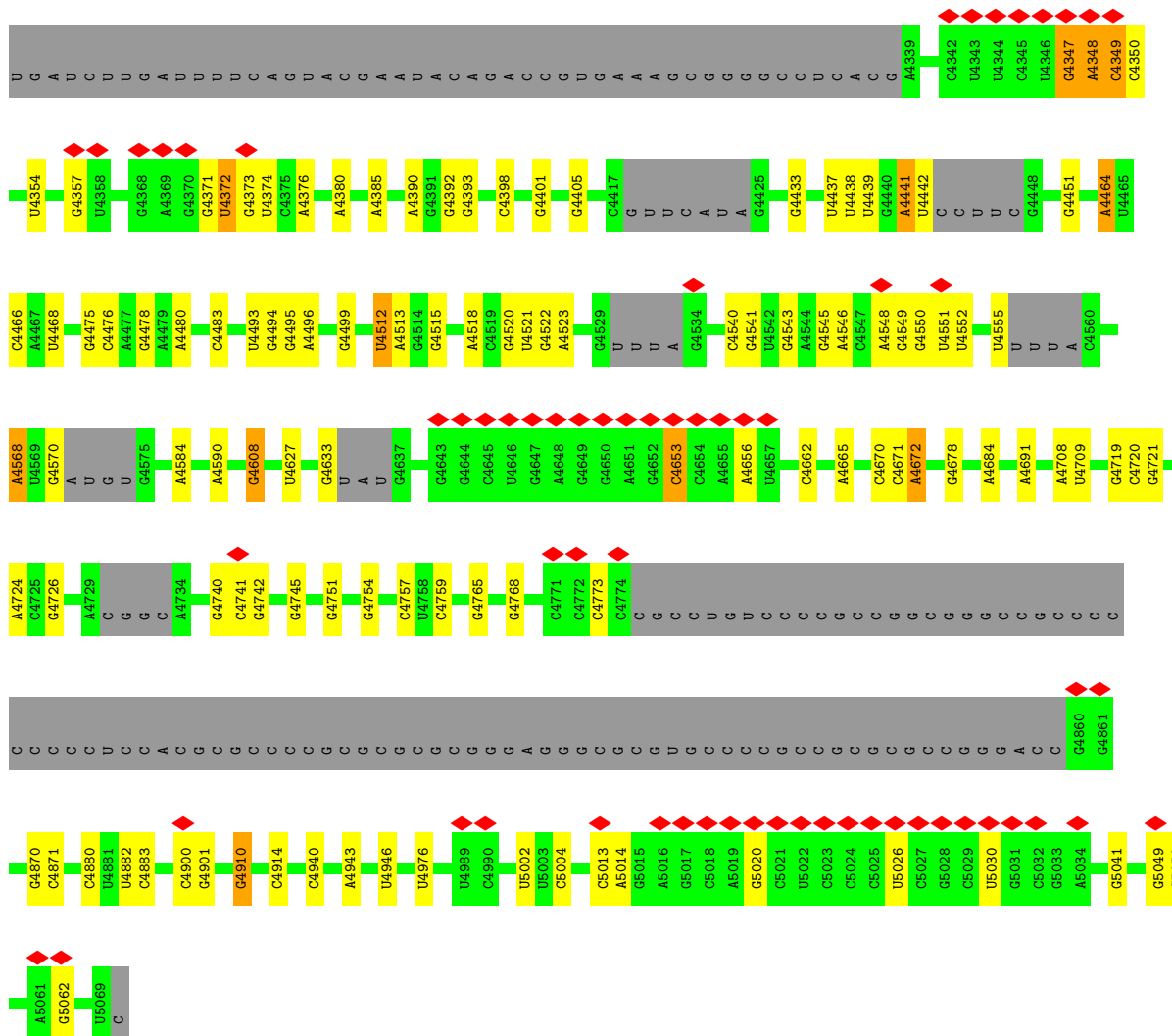

● Molecule 6: 60S ribosomal protein L13

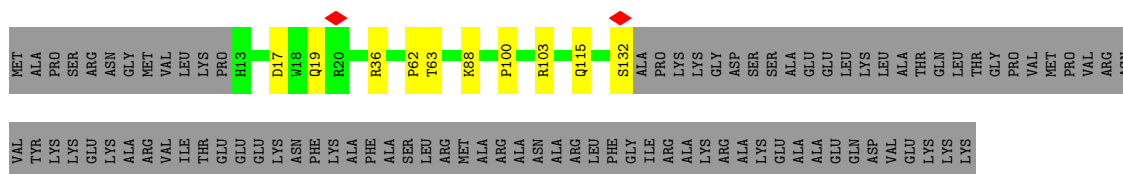

● Molecule 7: 60S ribosomal protein L13a



● Molecule 8: 60S ribosomal protein L14

• Molecule 14: 60S ribosomal protein L23

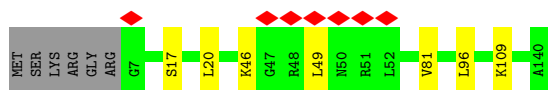
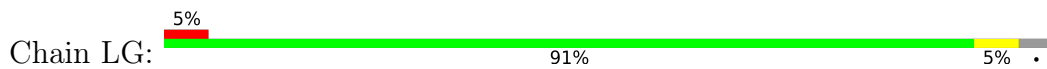

• Molecule 15: 60S ribosomal protein L23a

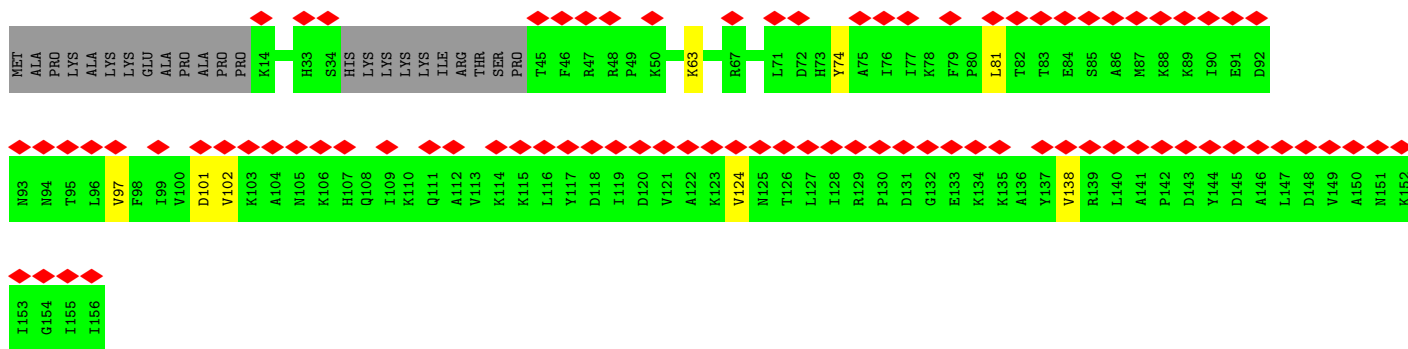
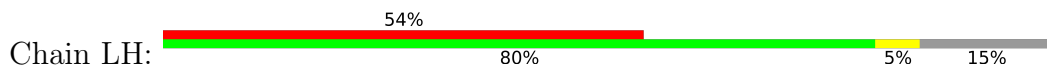

• Molecule 16: 60S ribosomal protein L26

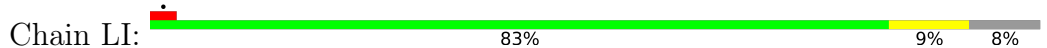

• Molecule 17: 60S ribosomal protein L27a

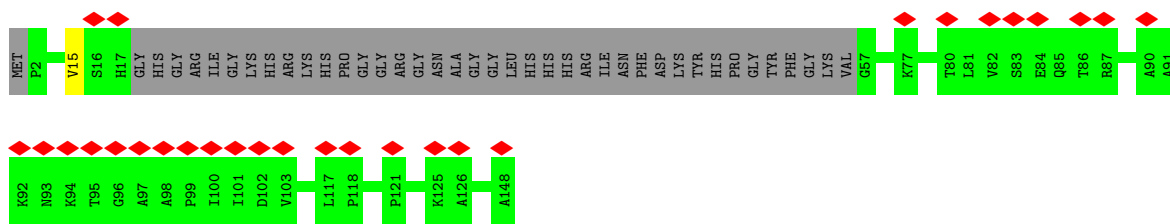
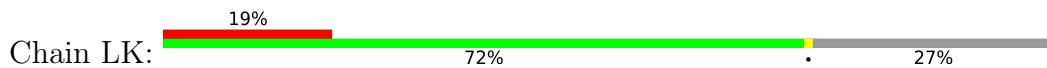

• Molecule 18: 60S ribosomal protein L28

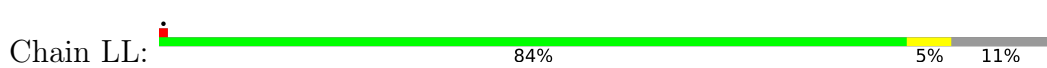

• Molecule 19: 60S ribosomal protein L3

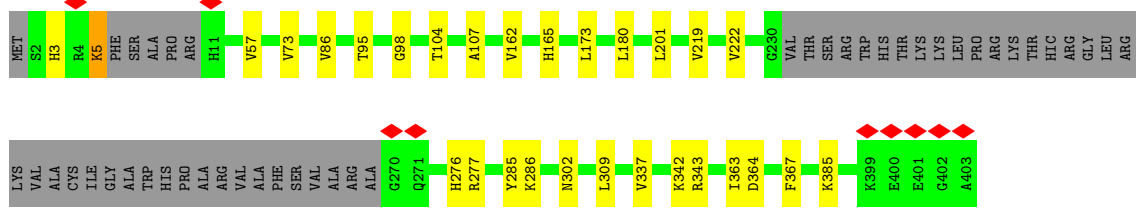
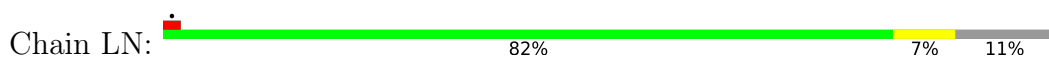

• Molecule 20: 60S ribosomal protein L31

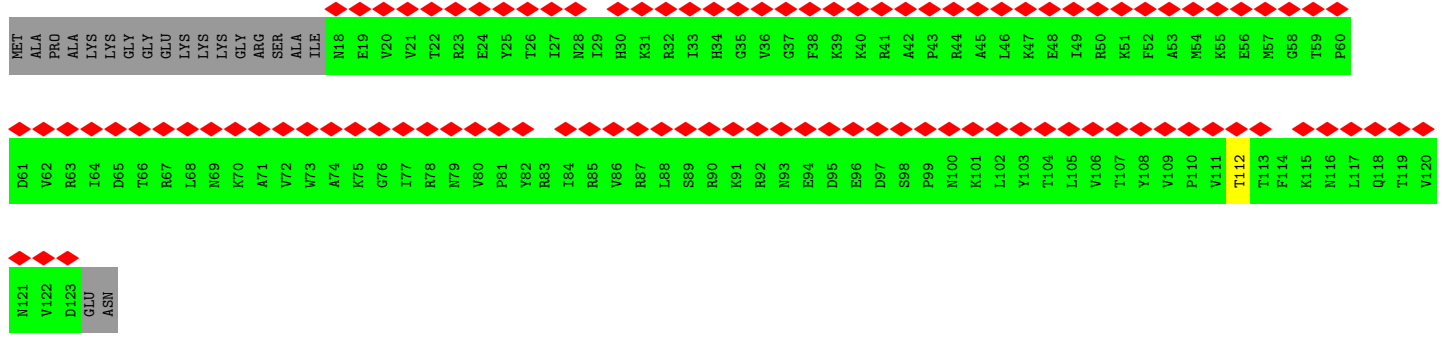
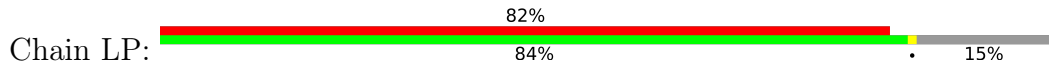

• Molecule 21: 60S ribosomal protein L32

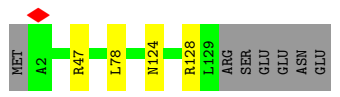

• Molecule 22: 60S ribosomal protein L35

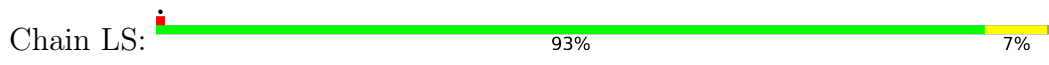

• Molecule 23: 60S ribosomal protein L35a

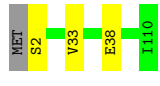

• Molecule 24: 60S ribosomal protein L36



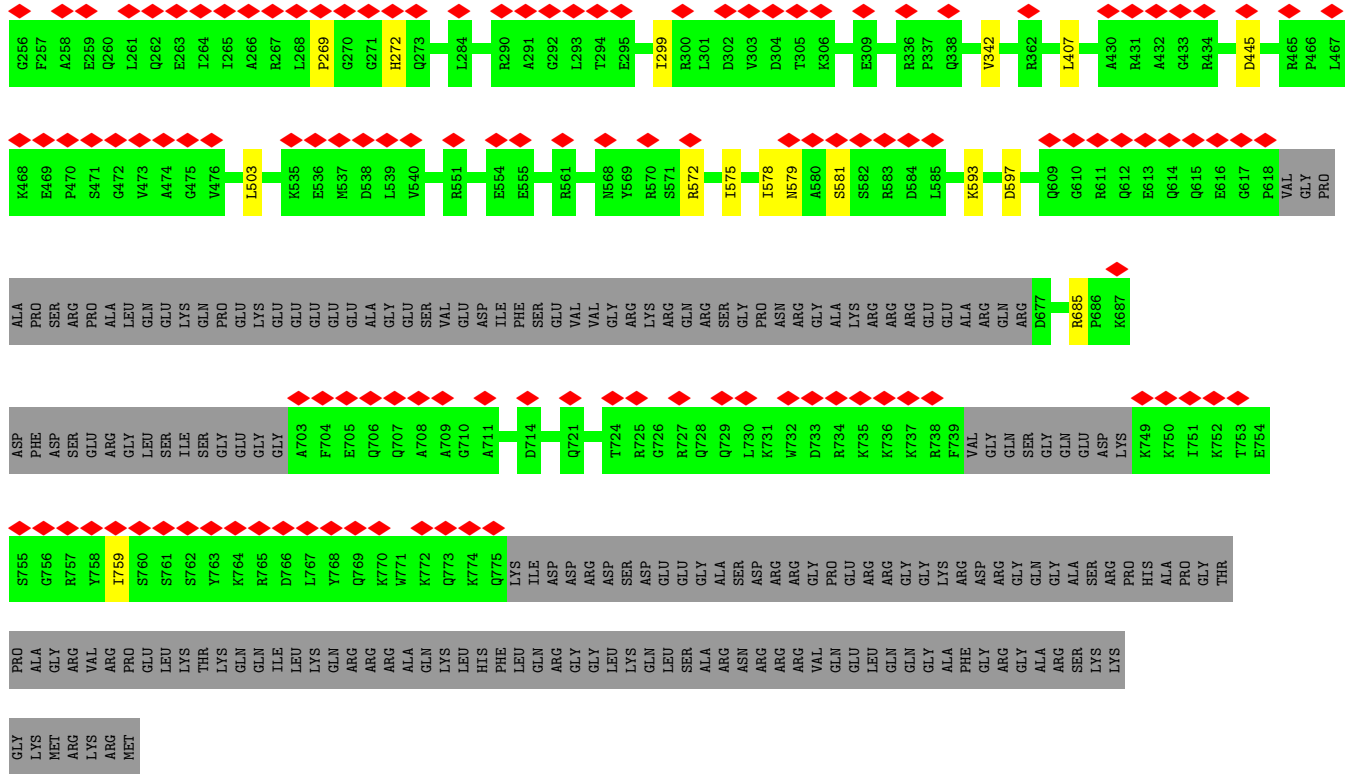

- Molecule 31: Protein LLP homolog

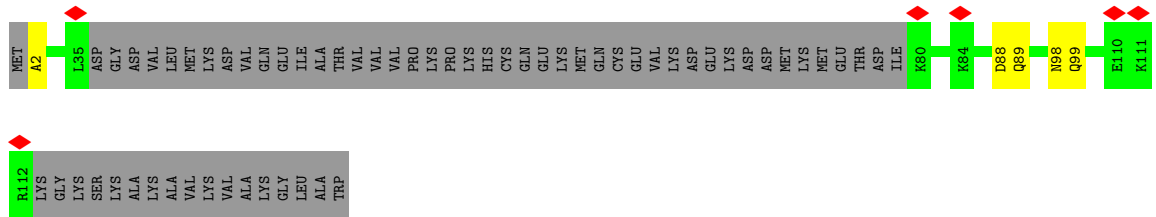

- Molecule 32: 60S ribosomal protein L4

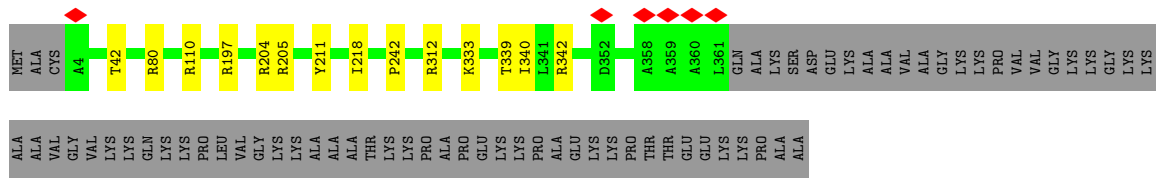
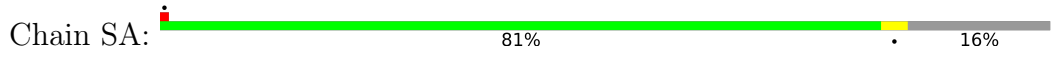

- Molecule 33: 60S ribosomal protein L6



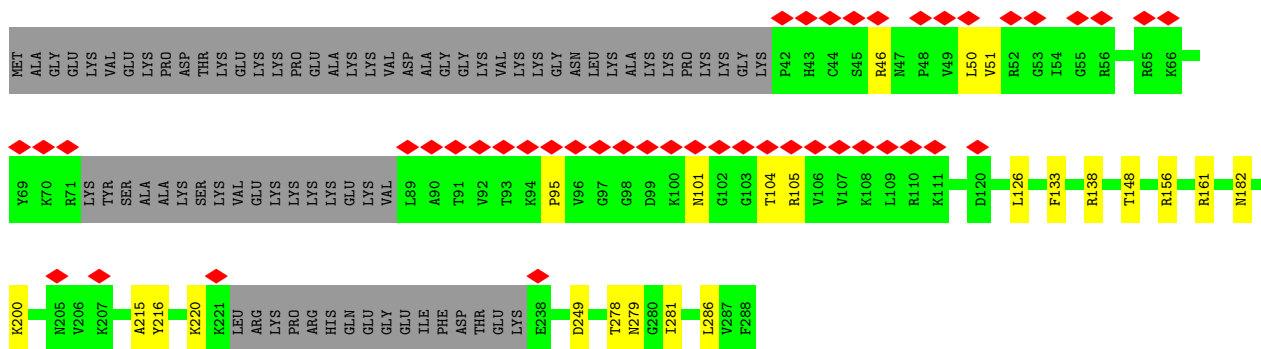

• Molecule 34: 60S ribosomal protein L7

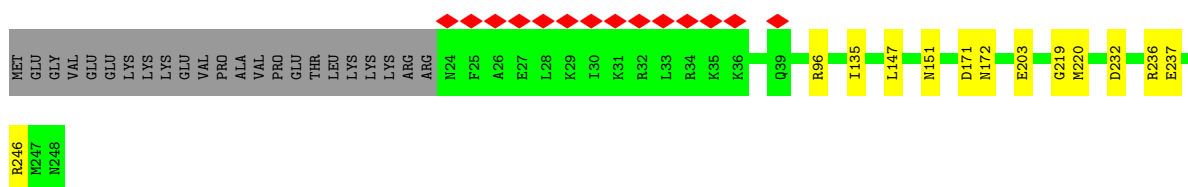
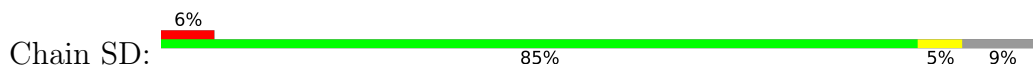

• Molecule 35: 60S ribosomal protein L7a

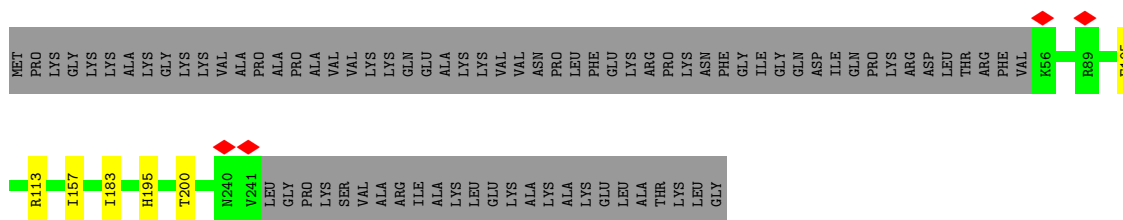

• Molecule 36: 60S ribosomal protein L9

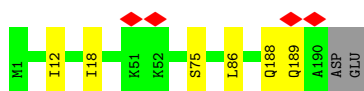

• Molecule 37: MKI67 FHA domain-interacting nucleolar phosphoprotein

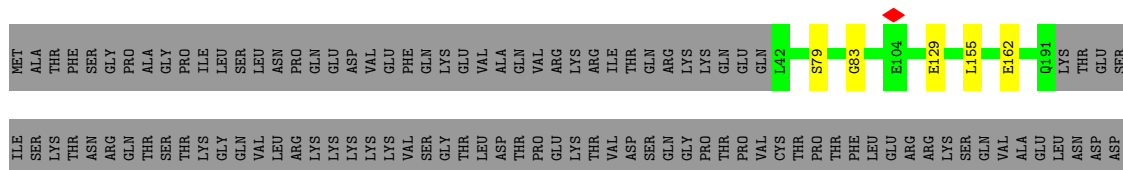

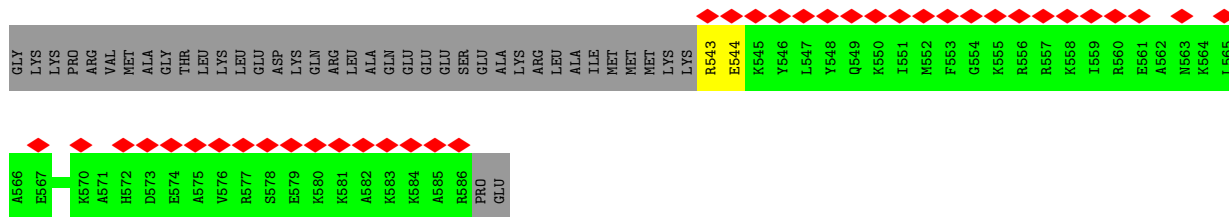

• Molecule 43: Probable rRNA-processing protein EBP2

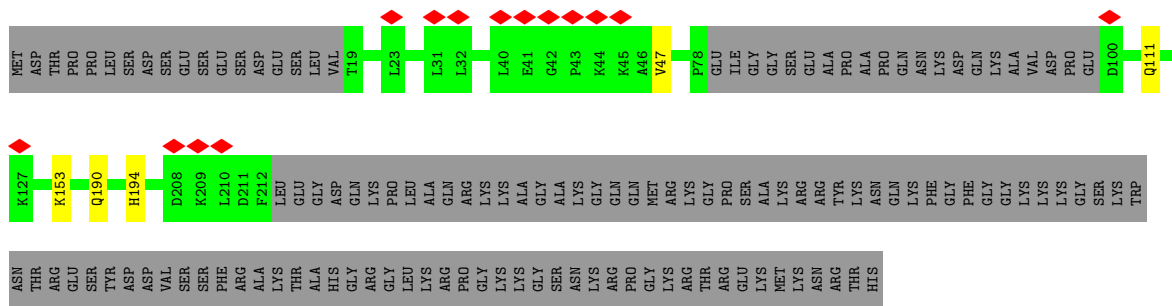

• Molecule 44: Ribosome biogenesis protein BRX1 homolog

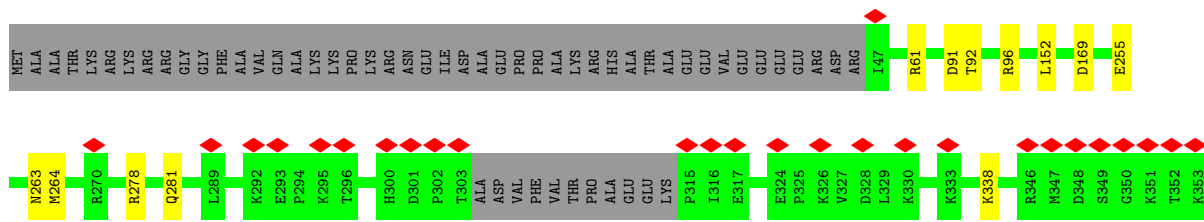
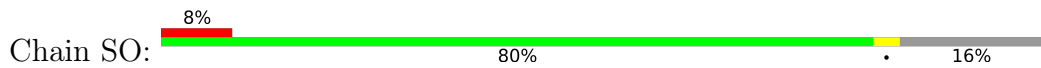

• Molecule 45: mRNA turnover protein 4 homolog

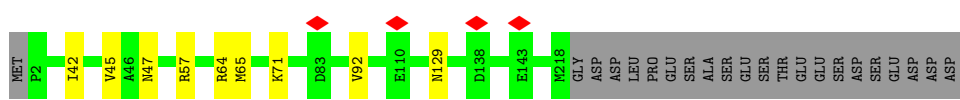
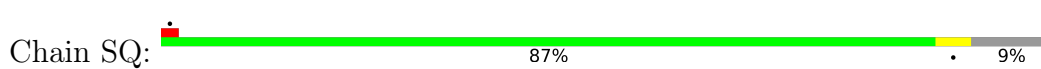

• Molecule 46: GTP-binding protein 4

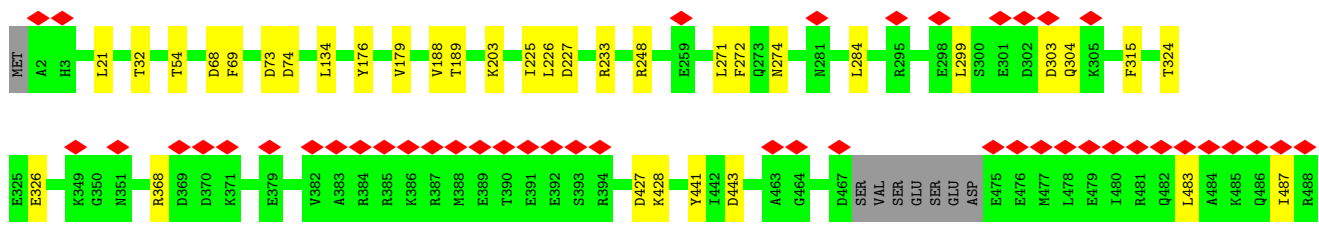
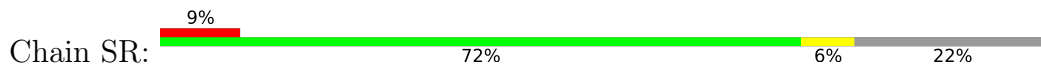

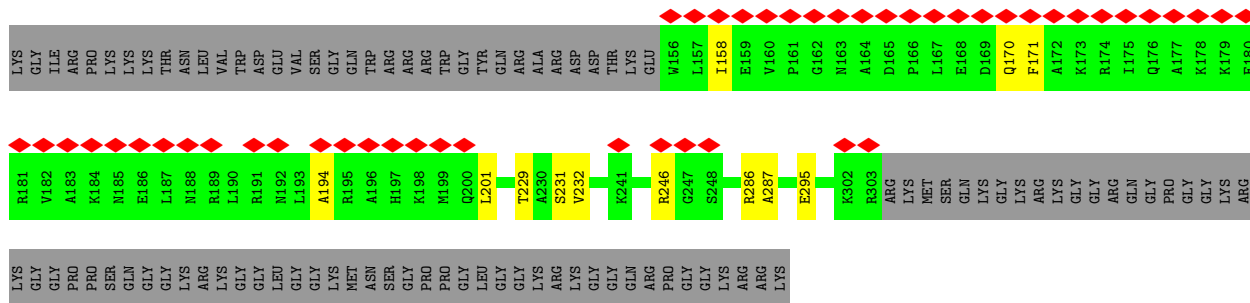

• Molecule 49: Nucleolar complex protein 3 homolog

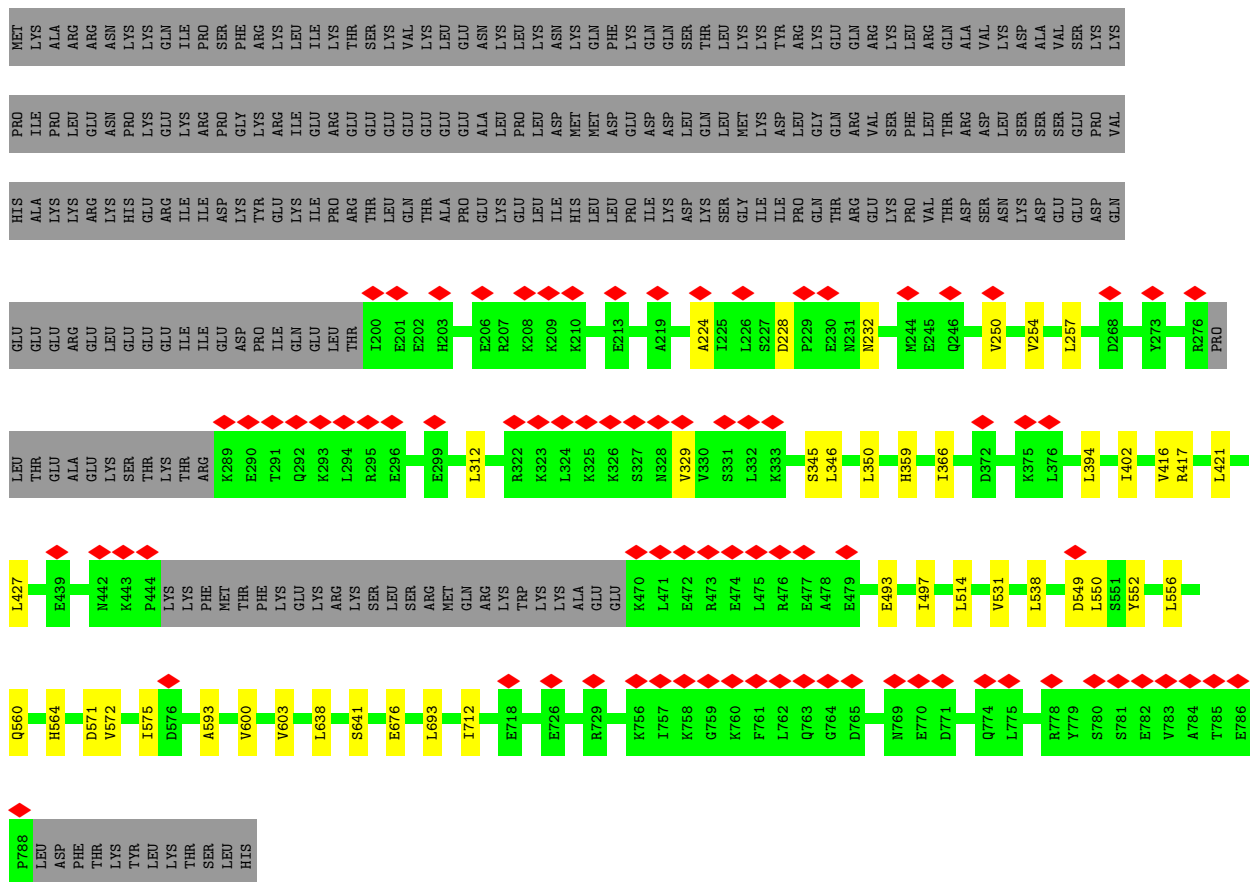

• Molecule 50: Probable ribosome biogenesis protein RLP24

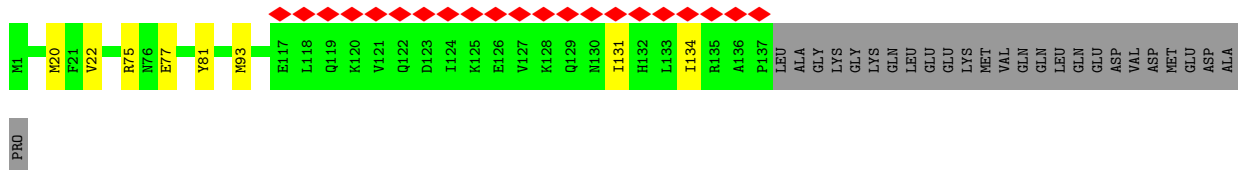
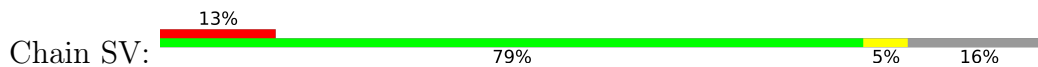

• Molecule 51: ATP-dependent RNA helicase DDX18

ASN
SER
GLN
LEU
LEU
LEU
SER

- Molecule 53: Nucleolar protein 16

Chain SZ:

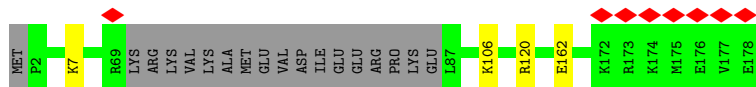

4 Experimental information

Property	Value	Source
EM reconstruction method	SINGLE PARTICLE	Depositor
Imposed symmetry	POINT, C1	Depositor
Number of particles used	126301	Depositor
Resolution determination method	FSC 0.143 CUT-OFF	Depositor
CTF correction method	PHASE FLIPPING AND AMPLITUDE CORRECTION	Depositor
Microscope	FEI TITAN KRIOS	Depositor
Voltage (kV)	300	Depositor
Electron dose ($e^-/\text{\AA}^2$)	60	Depositor
Minimum defocus (nm)	500	Depositor
Maximum defocus (nm)	2500	Depositor
Magnification	64000	Depositor
Image detector	GATAN K3 (6k x 4k)	Depositor
Maximum map value	9.181	Depositor
Minimum map value	-0.008	Depositor
Average map value	0.045	Depositor
Map value standard deviation	0.178	Depositor
Recommended contour level	0.85	Depositor
Map size (Å)	514.56, 514.56, 514.56	wwPDB
Map dimensions	480, 480, 480	wwPDB
Map angles (°)	90.0, 90.0, 90.0	wwPDB
Pixel spacing (Å)	1.072, 1.072, 1.072	Depositor

5 Model quality i

5.1 Standard geometry i

Bond lengths and bond angles in the following residue types are not validated in this section: GDP, MG, ZN, K, ADP, SEP

The Z score for a bond length (or angle) is the number of standard deviations the observed value is removed from the expected value. A bond length (or angle) with $|Z| > 5$ is considered an outlier worth inspection. RMSZ is the root-mean-square of all Z scores of the bond lengths (or angles).

Mol	Chain	Bond lengths		Bond angles	
		RMSZ	# Z >5	RMSZ	# Z >5
1	BA	0.24	0/1224	0.50	0/1651
2	BB	0.24	0/1056	0.46	0/1472
3	L1	0.33	0/3611	0.75	0/5623
4	L2	0.38	0/1634	0.79	0/2538
5	L3	0.34	0/53925	0.78	2/84029 (0.0%)
6	L6	0.27	0/1020	0.66	0/1367
7	L7	0.28	0/1682	0.56	0/2250
8	L8	0.27	0/1133	0.53	0/1516
9	L9	0.27	0/1584	0.63	0/2117
10	LA	0.24	0/1127	0.50	0/1511
11	LB	0.26	0/1239	0.64	0/1658
12	LC	0.28	0/1501	0.57	0/2013
13	LE	0.25	0/941	0.51	0/1254
14	LG	0.26	0/1007	0.54	0/1350
15	LH	0.25	0/1087	0.51	0/1455
16	LI	0.28	0/1132	0.61	1/1504 (0.1%)
17	LK	0.24	0/648	0.52	0/880
18	LL	0.25	0/995	0.61	0/1334
19	LN	0.28	0/2938	0.54	0/3923
20	LP	0.23	0/525	0.42	0/731
21	LQ	0.25	0/1071	0.56	0/1429
22	LS	0.26	0/1023	0.57	0/1351
23	LT	0.28	0/895	0.60	0/1198
24	LU	0.27	0/854	0.63	0/1129
25	LW	0.28	0/626	0.64	0/829
26	NA	0.25	0/3451	0.45	0/4714
27	NB	0.27	0/610	0.57	0/802
28	NF	0.26	0/1724	0.52	0/2295
29	NH	0.29	0/1473	0.52	0/1988
30	NI	0.25	0/4914	0.50	0/6619
31	NK	0.24	0/587	0.61	0/767
32	SA	0.26	0/2907	0.57	0/3905

Mol	Chain	Bond lengths		Bond angles	
		RMSZ	# Z >5	RMSZ	# Z >5
33	SC	0.25	0/1754	0.57	0/2353
34	SD	0.27	0/1905	0.55	0/2539
35	SE	0.26	0/1524	0.55	0/2056
36	SG	0.25	0/1548	0.53	0/2081
37	SH	0.30	0/1298	0.52	0/1742
38	SI	0.26	0/1891	0.53	0/2539
39	SJ	0.25	0/1827	0.53	0/2429
40	SK	0.25	0/1877	0.53	0/2554
41	SL	0.26	0/1994	0.51	0/2684
42	SM	0.27	0/3729	0.49	0/5020
43	SN	0.25	0/1368	0.48	0/1830
44	SO	0.25	0/2521	0.51	0/3384
45	SQ	0.25	0/1817	0.51	0/2435
46	SR	0.25	0/4147	0.50	0/5583
47	SS	0.27	0/2193	0.54	0/2977
48	ST	0.25	0/1107	0.49	0/1491
49	SU	0.26	0/4433	0.47	0/5976
50	SV	0.29	0/1194	0.57	0/1582
51	SW	0.26	0/3620	0.48	0/4886
52	SY	0.27	0/3046	0.53	0/4117
53	SZ	0.25	0/1364	0.53	0/1826
All	All	0.29	0/146301	0.65	3/209286 (0.0%)

There are no bond length outliers.

All (3) bond angle outliers are listed below:

Mol	Chain	Res	Type	Atoms	Z	Observed(°)	Ideal(°)
5	L3	4653	C	C2-N1-C1'	5.87	125.25	118.80
5	L3	417	G	O4'-C1'-N9	5.13	112.30	108.20
16	LI	53	ASP	CB-CG-OD1	5.07	122.86	118.30

There are no chirality outliers.

There are no planarity outliers.

5.2 Too-close contacts

In the following table, the Non-H and H(model) columns list the number of non-hydrogen atoms and hydrogen atoms in the chain respectively. The H(added) column lists the number of hydrogen atoms added and optimized by MolProbity. The Clashes column lists the number of clashes within the asymmetric unit, whereas Symm-Clashes lists symmetry-related clashes.

Mol	Chain	Non-H	H(model)	H(added)	Clashes	Symm-Clashes
1	BA	1208	0	1257	10	0
2	BB	1057	0	464	0	0
3	L1	3234	0	1639	11	0
4	L2	1468	0	755	8	0
5	L3	48236	0	24409	112	0
6	L6	998	0	1067	8	0
7	L7	1650	0	1794	6	0
8	L8	1111	0	1174	5	0
9	L9	1546	0	1585	6	0
10	LA	1106	0	1130	11	0
11	LB	1223	0	1330	5	0
12	LC	1461	0	1502	8	0
13	LE	926	0	979	5	0
14	LG	993	0	1050	9	0
15	LH	1071	0	1165	6	0
16	LI	1115	0	1205	9	0
17	LK	642	0	455	2	0
18	LL	980	0	1041	5	0
19	LN	2884	0	3000	19	0
20	LP	526	0	225	1	0
21	LQ	1053	0	1147	4	0
22	LS	1015	0	1148	6	0
23	LT	876	0	912	2	0
24	LU	840	0	930	5	0
25	LW	612	0	640	3	0
26	NA	3389	0	2971	9	0
27	NB	603	0	661	3	0
28	NF	1696	0	1812	3	0
29	NH	1441	0	1448	9	0
30	NI	4832	0	4965	17	0
31	NK	581	0	656	4	0
32	SA	2853	0	3028	12	0
33	SC	1721	0	1871	17	0
34	SD	1870	0	1996	9	0
35	SE	1498	0	1601	5	0
36	SG	1526	0	1614	4	0
37	SH	1267	0	1291	4	0
38	SI	1850	0	1966	13	0
39	SJ	1803	0	1871	12	0
40	SK	1852	0	1828	18	0
41	SL	1960	0	2052	4	0
42	SM	3646	0	3724	12	0
43	SN	1350	0	1345	4	0

Continued on next page...

Continued from previous page...

Mol	Chain	Non-H	H(model)	H(added)	Clashes	Symm-Clashes
44	SO	2460	0	2551	9	0
45	SQ	1778	0	1817	6	0
46	SR	4073	0	4159	31	0
47	SS	2150	0	2050	16	0
48	ST	1091	0	1036	8	0
49	SU	4360	0	4474	29	0
50	SV	1171	0	1232	11	0
51	SW	3549	0	3628	11	0
52	SY	2985	0	3004	12	0
53	SZ	1338	0	1352	3	0
54	L1	4	0	0	0	0
54	L2	1	0	0	0	0
54	L3	46	0	0	0	0
54	L9	1	0	0	0	0
54	LB	1	0	0	0	0
54	LQ	1	0	0	0	0
54	LT	1	0	0	0	0
54	NI	1	0	0	0	0
54	SA	2	0	0	0	0
54	SO	1	0	0	0	0
54	SR	1	0	0	0	0
54	SU	1	0	0	0	0
55	LW	1	0	0	0	0
55	SV	1	0	0	0	0
56	NI	27	0	12	0	0
57	SR	28	0	12	0	0
58	SR	1	0	0	0	0
All	All	138643	0	114030	411	0

The all-atom clashscore is defined as the number of clashes found per 1000 atoms (including hydrogen atoms). The all-atom clashscore for this structure is 2.

All (411) close contacts within the same asymmetric unit are listed below, sorted by their clash magnitude.

Atom-1	Atom-2	Interatomic distance (Å)	Clash overlap (Å)
1:BA:50:THR:HG22	1:BA:58:ILE:HD11	1.53	0.88
32:SA:340:ILE:HG21	33:SC:50:LEU:HD13	1.58	0.83
3:L1:83:C:H42	16:LI:50:ARG:HE	1.23	0.82
3:L1:75:G:OP2	16:LI:74:TYR:OH	1.96	0.81
5:L3:4493:U:O2	14:LG:46:LYS:NZ	2.11	0.80
48:ST:229:THR:OG1	48:ST:231:SER:O	1.99	0.80

Continued on next page...

Continued from previous page...

Atom-1	Atom-2	Interatomic distance (Å)	Clash overlap (Å)
40:SK:53:ILE:HG23	40:SK:76:THR:HG22	1.64	0.79
40:SK:93:GLN:NE2	50:SV:77:GLU:OE2	2.16	0.79
19:LN:364:ASP:OD2	46:SR:428:LYS:NZ	2.15	0.78
5:L3:979:C:OP1	33:SC:46:ARG:NH1	2.17	0.78
30:NI:572:ARG:NH2	46:SR:233:ARG:O	2.17	0.78
46:SR:227:ASP:OD1	46:SR:274:ASN:ND2	2.17	0.77
5:L3:1625:G:O2'	5:L3:1626:G:OP1	2.02	0.77
5:L3:375:G:OP2	25:LW:52:LYS:NZ	2.18	0.77
26:NA:341:VAL:HG21	30:NI:48:ILE:HD13	1.66	0.77
40:SK:99:GLU:OE1	40:SK:125:THR:OG1	2.01	0.76
37:SH:162:GLU:OE2	41:SL:269:SER:OG	2.02	0.76
40:SK:119:PRO:O	40:SK:139:ARG:NH1	2.18	0.76
28:NF:8:GLU:OE2	30:NI:581:SER:OG	2.05	0.75
5:L3:3890:A:OP2	5:L3:4570:G:N2	2.19	0.75
7:L7:3:GLU:OE1	7:L7:5:GLN:NE2	2.19	0.75
29:NH:81:LEU:HD21	29:NH:89:LEU:HD11	1.68	0.75
5:L3:254:G:OP2	44:SO:338:LYS:NZ	2.19	0.74
8:L8:106:ASP:OD1	33:SC:161:ARG:NH2	2.20	0.74
44:SO:61:ARG:NH1	47:SS:128:ASP:OD2	2.20	0.74
5:L3:1645:C:OP1	32:SA:80:ARG:NH2	2.21	0.74
5:L3:3839:G:OP1	5:L3:3839:G:N2	2.16	0.73
35:SE:195:HIS:ND1	42:SM:100:GLU:OE1	2.20	0.73
26:NA:487:ASP:O	26:NA:519:ARG:NH1	2.20	0.73
3:L1:111:U:O4	25:LW:20:ARG:NH1	2.21	0.73
30:NI:269:PRO:O	30:NI:272:HIS:ND1	2.22	0.72
3:L1:134:G:OP1	15:LH:63:LYS:NZ	2.23	0.72
5:L3:4441:A:N6	30:NI:445:ASP:O	2.23	0.71
5:L3:3961:G:O2'	5:L3:4043:G:N2	2.24	0.71
3:L1:87:G:OP2	22:LS:7:ARG:NH2	2.23	0.71
5:L3:184:U:O2'	5:L3:189:G:OP2	2.06	0.71
5:L3:306:A:OP1	24:LU:53:TYR:OH	2.08	0.71
5:L3:4672:A:OP1	14:LG:17:SER:OG	2.03	0.71
26:NA:520:ASP:OD1	26:NA:566:TYR:OH	2.05	0.71
19:LN:286:LYS:NZ	19:LN:302:ASN:O	2.22	0.70
4:L2:1:G:N2	38:SI:106:ASP:OD2	2.23	0.70
13:LE:68:THR:OG1	13:LE:71:ALA:O	2.07	0.70
4:L2:48:G:OP2	41:SL:162:ARG:NH1	2.24	0.70
5:L3:3835:C:O2'	5:L3:3836:A:OP1	2.06	0.70
5:L3:62:A:N3	5:L3:77:U:O2'	2.24	0.70
5:L3:2275:G:OP2	32:SA:312:ARG:NH1	2.25	0.70
1:BA:135:THR:O	1:BA:138:SER:OG	2.09	0.69

Continued on next page...

Continued from previous page...

Atom-1	Atom-2	Interatomic distance (Å)	Clash overlap (Å)
38:SI:177:THR:HG23	47:SS:355:ALA:HB3	1.74	0.69
49:SU:402:ILE:HD11	49:SU:427:LEU:HD21	1.74	0.69
19:LN:309:LEU:HD23	19:LN:309:LEU:O	1.93	0.69
1:BA:105:THR:OG1	1:BA:107:ASP:OD2	2.06	0.68
5:L3:4768:G:OP1	7:L7:168:TYR:OH	2.10	0.68
9:L9:103:GLU:OE2	9:L9:118:SER:OG	2.08	0.68
5:L3:4940:C:OP1	33:SC:156:ARG:NH1	2.27	0.68
29:NH:69:CYS:O	29:NH:84:THR:OG1	2.11	0.68
5:L3:1669:A:N3	5:L3:1852:U:O2'	2.28	0.67
5:L3:4354:U:OP1	52:SY:530:TYR:OH	2.10	0.66
5:L3:1859:C:OP1	27:NB:26:ARG:NH1	2.29	0.66
40:SK:136:GLU:OE1	46:SR:368:ARG:NH2	2.29	0.66
5:L3:1524:A:O2'	5:L3:1525:A:O5'	2.13	0.66
46:SR:487:ILE:HD11	50:SV:134:ILE:HG12	1.77	0.66
10:LA:42:ARG:NH2	10:LA:110:ASP:OD1	2.29	0.65
19:LN:57:VAL:HG12	19:LN:73:VAL:HG22	1.78	0.65
38:SI:92:ASP:OD1	38:SI:93:LYS:N	2.29	0.65
38:SI:177:THR:CG2	47:SS:355:ALA:HB3	2.27	0.65
5:L3:4910:G:N2	7:L7:106:ASP:O	2.29	0.65
1:BA:88:PRO:O	1:BA:90:ARG:NH1	2.30	0.64
5:L3:1895:G:OP1	34:SD:96:ARG:NH2	2.30	0.64
18:LL:20:ARG:NH1	21:LQ:78:LEU:O	2.30	0.64
5:L3:4347:G:O2'	5:L3:4348:A:O5'	2.13	0.64
46:SR:176:TYR:CE1	46:SR:271:LEU:HD22	2.34	0.64
5:L3:4880:C:OP1	8:L8:124:LYS:NZ	2.24	0.63
26:NA:384:LEU:O	26:NA:408:TYR:OH	2.10	0.63
5:L3:2043:A:N1	5:L3:4515:G:O2'	2.26	0.63
13:LE:79:GLN:NE2	13:LE:80:VAL:O	2.32	0.63
16:LI:50:ARG:NH1	16:LI:51:LYS:O	2.31	0.63
15:LH:124:VAL:HG12	15:LH:138:VAL:HG12	1.79	0.62
5:L3:1508:A:OP1	32:SA:110:ARG:NH2	2.31	0.62
40:SK:72:VAL:HB	40:SK:76:THR:HG21	1.82	0.62
5:L3:3907:G:O2'	5:L3:3908:A:OP1	2.14	0.62
46:SR:427:ASP:OD2	50:SV:81:TYR:OH	2.16	0.62
9:L9:126:THR:HG21	39:SJ:712:HIS:HD2	1.64	0.61
45:SQ:64:ARG:NH1	45:SQ:65:MET:O	2.33	0.61
19:LN:86:VAL:HG13	19:LN:162:VAL:HG13	1.83	0.61
5:L3:2484:A:N6	42:SM:214:ASP:O	2.34	0.61
5:L3:3835:C:HO2'	5:L3:3836:A:P	2.23	0.61
5:L3:1961:G:N7	45:SQ:71:LYS:NZ	2.38	0.60
39:SJ:761:ARG:NE	39:SJ:789:ALA:O	2.34	0.60

Continued on next page...

Continued from previous page...

Atom-1	Atom-2	Interatomic distance (Å)	Clash overlap (Å)
4:L2:5:A:N6	4:L2:95:A:O2'	2.35	0.60
5:L3:3958:G:OP1	52:SY:553:ARG:NH1	2.35	0.60
5:L3:343:C:OP2	53:SZ:7:LYS:NZ	2.34	0.60
1:BA:128:THR:O	1:BA:132:ILE:HD12	2.02	0.60
5:L3:369:G:N2	5:L3:372:A:OP2	2.28	0.60
43:SN:190:GLN:O	43:SN:194:HIS:ND1	2.33	0.59
5:L3:1807:C:O2'	13:LE:113:ASP:OD2	2.16	0.59
5:L3:2306:G:OP1	21:LQ:128:ARG:NH1	2.35	0.59
3:L1:62:A:OP1	22:LS:52:LYS:NZ	2.36	0.59
49:SU:250:VAL:O	49:SU:254:VAL:HG23	2.02	0.59
20:LP:112:THR:HA	46:SR:496:LEU:HD21	1.85	0.58
49:SU:228:ASP:O	49:SU:232:ASN:ND2	2.36	0.58
5:L3:1955:G:OP2	27:NB:52:ASN:ND2	2.36	0.58
53:SZ:120:ARG:NH2	53:SZ:162:GLU:OE2	2.36	0.58
52:SY:331:ARG:NH1	52:SY:360:GLU:OE2	2.36	0.58
29:NH:135:SER:OG	29:NH:137:ALA:O	2.18	0.58
14:LG:49:LEU:HD11	19:LN:5:LYS:HA	1.86	0.58
38:SI:143:VAL:O	38:SI:147:VAL:HG12	2.03	0.58
38:SI:101:ARG:NH1	38:SI:122:LYS:O	2.37	0.57
48:ST:158:ILE:HD11	48:ST:170:GLN:HB2	1.86	0.57
47:SS:180:ASP:O	47:SS:184:THR:HG23	2.04	0.57
30:NI:129:VAL:HG11	30:NI:299:ILE:HD11	1.87	0.57
39:SJ:530:PHE:HZ	49:SU:257:LEU:HD21	1.68	0.57
1:BA:50:THR:CG2	1:BA:58:ILE:HD11	2.29	0.57
3:L1:12:G:OP1	10:LA:3:ARG:NH1	2.38	0.57
22:LS:36:VAL:HG13	22:LS:37:THR:HG23	1.85	0.57
30:NI:593:LYS:NZ	30:NI:597:ASP:OD2	2.24	0.57
29:NH:81:LEU:HD21	29:NH:89:LEU:CD1	2.35	0.57
33:SC:161:ARG:O	33:SC:182:ASN:ND2	2.38	0.57
5:L3:1501:C:O2'	11:LB:68:ARG:NH2	2.38	0.56
5:L3:2485:U:O2'	42:SM:216:ASP:OD2	2.20	0.56
12:LC:24:THR:HG23	12:LC:24:THR:O	2.05	0.56
42:SM:207:PHE:CD2	47:SS:355:ALA:HB2	2.40	0.56
35:SE:105:GLU:OE1	35:SE:113:ARG:NH1	2.37	0.56
12:LC:38:VAL:HG13	34:SD:237:GLU:OE1	2.04	0.56
10:LA:40:HIS:NE2	10:LA:110:ASP:O	2.35	0.56
5:L3:1883:G:OP1	21:LQ:47:ARG:NH1	2.37	0.56
11:LB:88:ASP:OD1	11:LB:89:ASP:N	2.39	0.56
5:L3:1659:U:H2'	17:LK:15:VAL:HG13	1.88	0.56
38:SI:29:ARG:HH12	47:SS:368:LEU:HD13	1.71	0.56
48:ST:232:VAL:HG23	48:ST:232:VAL:O	2.05	0.56

Continued on next page...

Continued from previous page...

Atom-1	Atom-2	Interatomic distance (Å)	Clash overlap (Å)
5:L3:4724:A:O2'	19:LN:104:THR:HG22	2.06	0.56
3:L1:102:G:OP2	3:L1:104:A:O2'	2.24	0.55
9:L9:126:THR:HG21	39:SJ:712:HIS:CD2	2.41	0.55
5:L3:1629:G:N2	5:L3:1632:A:OP2	2.38	0.55
19:LN:95:THR:OG1	19:LN:98:GLY:O	2.15	0.55
18:LL:28:GLU:OE2	18:LL:42:GLY:N	2.38	0.55
33:SC:216:TYR:OH	33:SC:249:ASP:OD2	2.20	0.55
34:SD:232:ASP:OD1	34:SD:236:ARG:NH2	2.40	0.55
5:L3:150:U:OP2	35:SE:200:THR:OG1	2.21	0.55
42:SM:265:TYR:OH	42:SM:358:LYS:O	2.18	0.55
46:SR:284:LEU:HD23	46:SR:315:PHE:CD1	2.41	0.54
5:L3:1534:A:O2'	5:L3:1535:C:O4'	2.24	0.54
46:SR:68:ASP:OD1	46:SR:69:PHE:N	2.40	0.54
49:SU:600:VAL:HG11	49:SU:641:SER:OG	2.08	0.54
52:SY:480:ASP:OD2	52:SY:481:GLU:N	2.37	0.54
5:L3:1833:G:N2	5:L3:1835:G:O4'	2.41	0.54
40:SK:2:ALA:HB3	40:SK:215:LEU:HD11	1.90	0.54
5:L3:4568:A:O2'	10:LA:69:ARG:NH2	2.40	0.54
1:BA:131:GLU:OE1	5:L3:1972:G:N2	2.33	0.54
28:NF:174:MET:SD	28:NF:177:ARG:NH1	2.81	0.53
44:SO:263:ASN:OD1	44:SO:264:MET:N	2.42	0.53
4:L2:93:C:HO2'	4:L2:94:U:P	2.31	0.53
38:SI:135:GLN:N	38:SI:135:GLN:OE1	2.41	0.53
31:NK:98:ASN:OD1	31:NK:99:GLN:N	2.41	0.53
33:SC:95:PRO:HA	33:SC:104:THR:HG22	1.89	0.53
40:SK:166:SER:OG	40:SK:168:GLU:OE2	2.25	0.53
5:L3:4726:G:OP2	31:NK:98:ASN:ND2	2.42	0.53
46:SR:225:ILE:HG13	46:SR:271:LEU:HD21	1.91	0.53
46:SR:299:LEU:HD13	46:SR:303:ASP:HB2	1.90	0.53
13:LE:103:ASP:OD2	13:LE:104:SER:N	2.42	0.53
30:NI:68:PHE:O	30:NI:70:THR:HG23	2.08	0.52
38:SI:29:ARG:NH1	47:SS:368:LEU:HD13	2.23	0.52
46:SR:54:THR:HG21	46:SR:134:LEU:HD22	1.91	0.52
1:BA:120:SER:OG	1:BA:128:THR:HG22	2.09	0.52
31:NK:88:ASP:OD1	31:NK:89:GLN:N	2.41	0.52
49:SU:224:ALA:O	49:SU:232:ASN:ND2	2.43	0.52
5:L3:1502:G:OP1	11:LB:65:ARG:NH1	2.42	0.52
24:LU:46:GLU:OE1	47:SS:227:PHE:N	2.40	0.52
40:SK:176:LEU:O	46:SR:368:ARG:NH1	2.43	0.52
10:LA:41:ILE:HD13	10:LA:150:LEU:HD21	1.91	0.51
14:LG:96:LEU:HD13	50:SV:20:MET:CE	2.40	0.51

Continued on next page...

Continued from previous page...

Atom-1	Atom-2	Interatomic distance (Å)	Clash overlap (Å)
52:SY:314:THR:HG22	52:SY:324:LEU:HD23	1.91	0.51
5:L3:4478:G:N2	5:L3:4608:G:O2'	2.43	0.51
48:ST:194:ALA:HB1	48:ST:201:LEU:HD23	1.92	0.51
5:L3:1517:G:OP1	6:L6:19:GLN:NE2	2.44	0.51
14:LG:96:LEU:HD11	50:SV:22:VAL:HG23	1.92	0.51
34:SD:203:GLU:OE2	34:SD:203:GLU:N	2.43	0.51
46:SR:176:TYR:CD1	46:SR:271:LEU:HD22	2.46	0.51
5:L3:4347:G:HO2'	5:L3:4348:A:P	2.33	0.51
26:NA:362:LEU:HD12	26:NA:414:LEU:HD11	1.93	0.51
39:SJ:530:PHE:CZ	49:SU:257:LEU:HD21	2.46	0.51
15:LH:124:VAL:CG1	15:LH:138:VAL:HG12	2.39	0.51
5:L3:1998:A:OP1	45:SQ:57:ARG:NH2	2.44	0.51
22:LS:43:LYS:HE3	22:LS:43:LYS:HA	1.93	0.51
39:SJ:685:ILE:O	39:SJ:688:SER:OG	2.20	0.51
5:L3:233:U:HO2'	5:L3:234:G:H8	1.57	0.50
5:L3:1369:C:OP2	5:L3:1370:G:O2'	2.12	0.50
52:SY:311:THR:OG1	52:SY:369:GLN:O	2.26	0.50
4:L2:93:C:O2'	4:L2:94:U:O5'	2.19	0.50
5:L3:4543:G:N7	29:NH:15:LYS:NZ	2.56	0.50
5:L3:4468:U:HO2'	31:NK:2:ALA:N	2.09	0.50
26:NA:555:LYS:NZ	49:SU:676:GLU:OE1	2.44	0.50
4:L2:13:C:OP1	38:SI:86:HIS:NE2	2.31	0.50
34:SD:219:GLY:O	34:SD:246:ARG:NH2	2.45	0.50
49:SU:538:LEU:HD12	49:SU:575:ILE:HG21	1.93	0.50
10:LA:41:ILE:HG23	10:LA:42:ARG:HD2	1.93	0.50
33:SC:50:LEU:HD12	33:SC:51:VAL:N	2.26	0.50
5:L3:458:C:OP1	18:LL:87:ARG:NH2	2.44	0.50
33:SC:133:PHE:O	33:SC:138:ARG:NH2	2.45	0.50
49:SU:560:GLN:O	49:SU:564:HIS:ND1	2.38	0.50
40:SK:107:VAL:HG13	40:SK:118:HIS:HB2	1.94	0.50
43:SN:47:VAL:N	44:SO:255:GLU:OE1	2.41	0.50
5:L3:4946:U:HO2'	23:LT:2:SER:N	2.10	0.49
39:SJ:530:PHE:CZ	49:SU:257:LEU:HD11	2.47	0.49
5:L3:972:C:C6	33:SC:126:LEU:HD13	2.47	0.49
44:SO:278:ARG:NH1	44:SO:281:GLN:OE1	2.46	0.49
5:L3:1279:A:O2'	5:L3:1281:G:N7	2.34	0.49
9:L9:103:GLU:OE1	9:L9:165:THR:HG21	2.12	0.49
46:SR:188:VAL:HG23	46:SR:189:THR:HG23	1.95	0.49
47:SS:150:VAL:HG23	47:SS:150:VAL:O	2.13	0.49
19:LN:276:HIS:O	19:LN:277:ARG:NH1	2.45	0.49
19:LN:222:VAL:O	19:LN:343:ARG:NH1	2.46	0.49

Continued on next page...

Continued from previous page...

Atom-1	Atom-2	Interatomic distance (Å)	Clash overlap (Å)
50:SV:131:ILE:H	50:SV:131:ILE:HD12	1.78	0.49
19:LN:285:TYR:HA	19:LN:363:ILE:HD11	1.94	0.49
48:ST:286:ARG:NH2	49:SU:571:ASP:O	2.46	0.49
40:SK:93:GLN:OE1	40:SK:132:VAL:HG13	2.13	0.48
48:ST:158:ILE:HD12	48:ST:171:PHE:CD2	2.49	0.48
5:L3:4180:G:N2	29:NH:57:ASN:OD1	2.47	0.48
5:L3:4691:A:OP1	36:SG:75:SER:OG	2.26	0.48
35:SE:157:ILE:HB	35:SE:183:ILE:HD13	1.96	0.48
41:SL:53:ASN:ND2	41:SL:56:LEU:HD22	2.29	0.48
5:L3:4633:G:H21	5:L3:4665:A:H62	1.62	0.48
46:SR:299:LEU:HD12	46:SR:304:GLN:HG3	1.94	0.48
6:L6:132:SER:O	53:SZ:106:LYS:N	2.47	0.48
15:LH:101:ASP:OD1	15:LH:102:VAL:N	2.46	0.48
5:L3:4512:U:O4	19:LN:3:HIS:NE2	2.43	0.48
9:L9:126:THR:HG23	9:L9:127:TYR:CD2	2.48	0.48
5:L3:75:G:O6	6:L6:103:ARG:NH1	2.46	0.47
5:L3:1358:G:O2'	5:L3:1360:G:O6	2.24	0.47
5:L3:1952:G:OP1	12:LC:139:ARG:NE	2.47	0.47
4:L2:99:G:N2	37:SH:129:GLU:OE1	2.47	0.47
5:L3:4483:C:H5''	46:SR:21:LEU:HD13	1.96	0.47
5:L3:4662:C:O2'	5:L3:5004:C:OP1	2.28	0.47
10:LA:12:THR:HG23	10:LA:13:LYS:HG3	1.96	0.47
14:LG:96:LEU:HD13	50:SV:20:MET:HE3	1.95	0.47
5:L3:2340:C:H4'	32:SA:42:THR:HG23	1.97	0.47
40:SK:101:LEU:HB3	40:SK:107:VAL:HG21	1.96	0.47
51:SW:351:ILE:HG21	51:SW:377:ILE:HG13	1.96	0.47
5:L3:4910:G:H4'	19:LN:95:THR:HG22	1.96	0.47
30:NI:575:ILE:HD12	30:NI:578:ILE:HD11	1.97	0.47
1:BA:135:THR:HG22	5:L3:1974:U:O4	2.14	0.47
5:L3:3839:G:O2'	30:NI:759:ILE:HD13	2.15	0.47
16:LI:89:LYS:HE2	16:LI:95:VAL:HG11	1.97	0.47
19:LN:57:VAL:HG22	19:LN:367:PHE:HB3	1.96	0.47
24:LU:46:GLU:OE1	47:SS:228:SER:N	2.43	0.47
49:SU:549:ASP:OD1	49:SU:550:LEU:N	2.47	0.47
3:L1:3:A:O2'	10:LA:61:ARG:NH1	2.44	0.47
45:SQ:42:ILE:HD11	45:SQ:92:VAL:HG13	1.96	0.47
5:L3:116:G:O2'	47:SS:239:ARG:NH1	2.48	0.47
26:NA:341:VAL:CG2	30:NI:48:ILE:HD13	2.42	0.47
4:L2:1:G:O2'	38:SI:104:ARG:NH2	2.48	0.47
5:L3:315:G:N7	44:SO:96:ARG:NH2	2.63	0.46
49:SU:693:LEU:HB3	49:SU:712:ILE:HD13	1.97	0.46

Continued on next page...

Continued from previous page...

Atom-1	Atom-2	Interatomic distance (Å)	Clash overlap (Å)
8:L8:12:VAL:O	8:L8:58:THR:OG1	2.21	0.46
17:LK:15:VAL:HG22	17:LK:15:VAL:O	2.15	0.46
30:NI:579:ASN:O	46:SR:203:LYS:NZ	2.26	0.46
5:L3:2083:C:OP2	11:LB:14:ARG:NH2	2.45	0.46
30:NI:685:ARG:NH1	52:SY:350:ASP:OD2	2.47	0.46
40:SK:2:ALA:CB	40:SK:215:LEU:HD11	2.45	0.46
52:SY:314:THR:HG22	52:SY:324:LEU:CD2	2.45	0.46
5:L3:1524:A:O2'	5:L3:1525:A:O4'	2.30	0.46
33:SC:281:ILE:CG2	33:SC:286:LEU:HD11	2.44	0.46
46:SR:73:ASP:OD1	46:SR:74:ASP:N	2.49	0.46
46:SR:483:LEU:HD21	50:SV:134:ILE:HG21	1.96	0.46
5:L3:159:C:O2	6:L6:88:LYS:NZ	2.32	0.46
5:L3:977:C:O5'	32:SA:333:LYS:NZ	2.49	0.46
34:SD:171:ASP:OD1	34:SD:172:ASN:N	2.48	0.46
43:SN:111:GLN:NE2	44:SO:169:ASP:OD1	2.49	0.46
51:SW:211:ARG:HB3	51:SW:212:PRO:HD3	1.98	0.46
1:BA:119:ARG:NH1	5:L3:1974:U:OP2	2.49	0.46
12:LC:83:ARG:NE	12:LC:92:ASN:OD1	2.49	0.46
36:SG:12:ILE:HG12	36:SG:18:ILE:HD12	1.98	0.46
46:SR:487:ILE:HD11	50:SV:134:ILE:CG1	2.43	0.46
5:L3:1627:G:H22	5:L3:1634:A:H2	1.64	0.46
49:SU:346:LEU:HB3	49:SU:366:ILE:HD11	1.98	0.46
5:L3:3917:A:OP1	29:NH:74:THR:HG21	2.16	0.46
5:L3:346:G:OP1	16:LI:8:THR:HG23	2.15	0.46
5:L3:1449:C:OP1	11:LB:132:LYS:NZ	2.48	0.45
5:L3:5002:U:OP2	19:LN:385:LYS:NZ	2.43	0.45
3:L1:146:U:OP2	42:SM:90:ARG:NH2	2.49	0.45
30:NI:201:LEU:HD22	30:NI:223:THR:HG23	1.97	0.45
45:SQ:47:ASN:ND2	45:SQ:129:ASN:OD1	2.49	0.45
33:SC:278:THR:HG22	33:SC:279:ASN:H	1.80	0.45
6:L6:62:PRO:O	6:L6:63:THR:OG1	2.28	0.45
34:SD:147:LEU:O	34:SD:151:ASN:ND2	2.50	0.45
49:SU:556:LEU:HD21	49:SU:603:VAL:CG1	2.46	0.45
5:L3:85:G:O2'	5:L3:86:U:OP2	2.34	0.45
5:L3:4371:G:H1'	5:L3:4372:U:O4'	2.17	0.45
36:SG:86:LEU:HD22	36:SG:188:GLN:O	2.16	0.45
5:L3:351:C:OP2	32:SA:197:ARG:NH1	2.49	0.45
42:SM:337:GLU:OE2	42:SM:380:ARG:N	2.50	0.45
46:SR:226:LEU:O	46:SR:233:ARG:NH1	2.47	0.45
8:L8:80:ALA:O	8:L8:85:LYS:NZ	2.46	0.45
46:SR:324:THR:O	46:SR:326:GLU:N	2.49	0.45

Continued on next page...

Continued from previous page...

Atom-1	Atom-2	Interatomic distance (Å)	Clash overlap (Å)
51:SW:397:VAL:HG22	51:SW:398:ASP:H	1.81	0.45
47:SS:197:THR:HG22	47:SS:198:ASP:N	2.33	0.44
5:L3:1666:C:O2'	5:L3:1688:G:OP1	2.31	0.44
6:L6:17:ASP:O	6:L6:17:ASP:OD1	2.36	0.44
26:NA:477:PRO:HB2	49:SU:593:ALA:HB3	1.97	0.44
41:SL:149:LEU:HD21	41:SL:176:ARG:HG3	2.00	0.44
12:LC:99:ASP:OD2	12:LC:100:LEU:N	2.49	0.44
37:SH:79:SER:O	37:SH:83:GLY:N	2.46	0.44
49:SU:556:LEU:HD21	49:SU:603:VAL:HG13	2.00	0.44
19:LN:165:HIS:HB3	19:LN:180:LEU:HD23	2.00	0.44
46:SR:284:LEU:HD23	46:SR:315:PHE:CE1	2.53	0.44
5:L3:1656:U:O2'	39:SJ:831:ASP:OD2	2.24	0.44
26:NA:369:GLU:OE1	26:NA:372:VAL:N	2.40	0.44
24:LU:21:VAL:HG11	51:SW:321:GLY:HA2	1.99	0.44
32:SA:339:THR:HG22	32:SA:342:ARG:HH22	1.81	0.44
38:SI:98:PHE:HB2	38:SI:152:PRO:HG3	2.00	0.44
51:SW:338:ILE:HG21	51:SW:347:LEU:HD11	1.98	0.44
5:L3:1975:G:N2	5:L3:1983:A:OP1	2.49	0.44
42:SM:16:ASN:O	42:SM:67:ILE:N	2.46	0.44
42:SM:268:ASP:OD2	42:SM:269:SER:N	2.51	0.44
47:SS:361:GLN:OE1	47:SS:361:GLN:N	2.51	0.44
52:SY:324:LEU:HD11	52:SY:366:TYR:CD1	2.53	0.44
49:SU:350:LEU:HD12	49:SU:359:HIS:CE1	2.53	0.43
5:L3:2361:G:O2'	5:L3:3859:G:O6	2.28	0.43
15:LH:81:LEU:HD12	15:LH:97:VAL:HG12	1.99	0.43
29:NH:99:ILE:HD11	29:NH:141:LEU:HD12	2.00	0.43
33:SC:148:THR:HG22	33:SC:200:LYS:HG2	1.99	0.43
38:SI:155:LYS:NZ	38:SI:159:GLU:OE2	2.44	0.43
5:L3:248:C:O2	16:LI:121:ARG:NH2	2.51	0.43
48:ST:287:ALA:HB2	49:SU:572:VAL:HG11	2.00	0.43
32:SA:204:ARG:NH1	32:SA:205:ARG:O	2.51	0.43
29:NH:57:ASN:HD22	52:SY:451:VAL:HG12	1.83	0.43
5:L3:67:C:OP2	5:L3:312:G:N2	2.47	0.43
19:LN:219:VAL:HG11	19:LN:337:VAL:CG2	2.48	0.43
16:LI:34:LEU:HD12	16:LI:44:VAL:HG13	2.01	0.43
42:SM:543:ARG:NH2	42:SM:544:GLU:OE2	2.51	0.43
46:SR:272:PHE:CE1	46:SR:284:LEU:HD21	2.54	0.43
49:SU:593:ALA:HB1	49:SU:638:LEU:HD12	2.01	0.43
33:SC:215:ALA:O	33:SC:220:LYS:NZ	2.52	0.43
37:SH:155:LEU:HD23	37:SH:155:LEU:O	2.18	0.43
49:SU:493:GLU:O	49:SU:497:ILE:HD12	2.18	0.43

Continued on next page...

Continued from previous page...

Atom-1	Atom-2	Interatomic distance (Å)	Clash overlap (Å)
10:LA:2:VAL:HG12	10:LA:3:ARG:H	1.84	0.43
42:SM:185:ILE:HD11	47:SS:342:PHE:CD2	2.54	0.43
44:SO:91:ASP:OD1	44:SO:92:THR:N	2.49	0.43
5:L3:4464:A:N7	46:SR:32:THR:OG1	2.45	0.42
40:SK:199:VAL:HG23	40:SK:204:ALA:HB2	2.01	0.42
51:SW:499:GLN:NE2	51:SW:501:ASP:O	2.51	0.42
5:L3:1364:U:OP2	6:L6:36:ARG:NH2	2.45	0.42
10:LA:6:LEU:HD12	10:LA:116:HIS:CD2	2.55	0.42
16:LI:54:GLU:OE2	16:LI:108:ARG:HB3	2.19	0.42
51:SW:285:ILE:CD1	51:SW:298:LEU:HD21	2.48	0.42
5:L3:372:A:O3'	25:LW:45:ARG:NH2	2.46	0.42
49:SU:421:LEU:HD13	49:SU:514:LEU:HD22	2.01	0.42
52:SY:313:ARG:HD2	52:SY:401:TYR:CD1	2.54	0.42
23:LT:33:VAL:HG23	23:LT:38:GLU:HB2	2.01	0.42
52:SY:221:LEU:HD23	52:SY:261:ARG:HD3	2.02	0.42
5:L3:679:C:OP1	18:LL:84:LYS:NZ	2.45	0.42
5:L3:3903:A:H2'	5:L3:3904:G:O4'	2.19	0.42
15:LH:74:TYR:OH	22:LS:22:ASP:OD1	2.36	0.42
33:SC:278:THR:HG22	33:SC:279:ASN:N	2.34	0.42
45:SQ:45:VAL:HG23	45:SQ:45:VAL:O	2.20	0.42
7:L7:190:ASP:OD1	7:L7:191:LYS:N	2.52	0.42
12:LC:93:MET:SD	12:LC:95:ARG:NH1	2.88	0.42
32:SA:211:TYR:OH	32:SA:218:ILE:HD11	2.19	0.42
39:SJ:751:ARG:NH2	48:ST:295:GLU:OE1	2.52	0.42
40:SK:116:LEU:HD11	40:SK:173:LEU:HD11	2.01	0.42
12:LC:68:PHE:O	12:LC:70:LYS:NZ	2.47	0.42
34:SD:220:MET:O	34:SD:220:MET:HG2	2.20	0.42
42:SM:171:TYR:CE1	42:SM:242:LEU:HD12	2.55	0.42
14:LG:109:LYS:HE3	30:NI:503:LEU:HD22	2.02	0.42
39:SJ:739:ILE:HG12	49:SU:531:VAL:HG22	2.02	0.42
14:LG:20:LEU:CD1	14:LG:81:VAL:HG21	2.50	0.41
51:SW:285:ILE:HD11	51:SW:298:LEU:HD21	2.02	0.41
5:L3:1630:A:OP1	39:SJ:737:ARG:NH1	2.49	0.41
5:L3:1726:U:H5'	34:SD:135:ILE:HD11	2.02	0.41
6:L6:100:PRO:O	24:LU:25[A]:ARG:NH2	2.45	0.41
7:L7:185:VAL:HG13	8:L8:126:GLU:HG3	2.03	0.41
9:L9:114:ARG:NH1	9:L9:151:ILE:O	2.53	0.41
40:SK:103:ALA:O	40:SK:107:VAL:HG23	2.20	0.41
49:SU:394:LEU:HD12	49:SU:394:LEU:H	1.85	0.41
5:L3:2296:G:O2'	32:SA:242:PRO:O	2.34	0.41
7:L7:84:VAL:HG11	7:L7:102:LEU:HD22	2.01	0.41

Continued on next page...

Continued from previous page...

Atom-1	Atom-2	Interatomic distance (Å)	Clash overlap (Å)
14:LG:109:LYS:HG3	30:NI:503:LEU:HD22	2.01	0.41
19:LN:107:ALA:HB2	19:LN:201:LEU:HG	2.02	0.41
39:SJ:550:GLN:HG2	49:SU:329:VAL:HG12	2.02	0.41
46:SR:299:LEU:HD13	46:SR:303:ASP:CB	2.50	0.41
46:SR:443:ASP:OD1	50:SV:75:ARG:NH1	2.53	0.41
5:L3:1952:G:H4'	12:LC:93:MET:HB2	2.03	0.41
30:NI:342:VAL:HG23	30:NI:407:LEU:HD22	2.02	0.41
40:SK:155:SER:OG	40:SK:156:ASN:N	2.54	0.41
40:SK:159:GLY:O	40:SK:221:VAL:HG21	2.21	0.41
46:SR:441:TYR:CD2	50:SV:93:MET:HE3	2.55	0.41
13:LE:66:ASN:O	13:LE:73:GLY:N	2.49	0.41
47:SS:239:ARG:NH2	47:SS:242:ASP:OD2	2.53	0.41
5:L3:1352:C:O2'	5:L3:1356:U:OP1	2.35	0.41
5:L3:2361:G:O6	10:LA:25:HIS:ND1	2.54	0.41
5:L3:4493:U:C5	5:L3:4512:U:H2'	2.55	0.41
19:LN:173:LEU:HD22	19:LN:342:LYS:HE3	2.02	0.41
5:L3:2045:G:O6	5:L3:3870:C:O2'	2.34	0.41
18:LL:57:GLY:O	18:LL:121:GLN:NE2	2.53	0.41
43:SN:153:LYS:HG3	44:SO:152:LEU:HD13	2.03	0.41
49:SU:552:TYR:O	49:SU:556:LEU:HD13	2.21	0.41
51:SW:336:ASP:OD1	51:SW:336:ASP:N	2.54	0.41
51:SW:434:SER:O	51:SW:437:SER:OG	2.38	0.41
5:L3:4348:A:OP1	5:L3:4349:C:O2'	2.27	0.40
22:LS:82:ASP:OD1	22:LS:83:LEU:N	2.54	0.40
36:SG:189:GLN:OE1	36:SG:189:GLN:N	2.53	0.40
51:SW:555:TRP:CE3	51:SW:558:ILE:HD12	2.57	0.40
3:L1:83:C:H42	16:LI:50:ARG:NE	2.03	0.40
5:L3:2052:G:O2'	5:L3:2057:A:N1	2.41	0.40
27:NB:1:MET:CE	28:NF:43:ILE:HD12	2.51	0.40
33:SC:101:ASN:OD1	33:SC:105:ARG:NH2	2.54	0.40
32:SA:340:ILE:CG2	33:SC:50:LEU:HD13	2.40	0.40
49:SU:312:LEU:HD21	49:SU:345:SER:OG	2.22	0.40
21:LQ:124:ASN:OD1	21:LQ:124:ASN:N	2.54	0.40
35:SE:113:ARG:NH2	47:SS:252:GLU:OE2	2.54	0.40
46:SR:176:TYR:O	46:SR:179:VAL:HG12	2.21	0.40
49:SU:416:VAL:HG12	49:SU:417:ARG:N	2.37	0.40

There are no symmetry-related clashes.

5.3 Torsion angles

5.3.1 Protein backbone

In the following table, the Percentiles column shows the percent Ramachandran outliers of the chain as a percentile score with respect to all PDB entries followed by that with respect to all EM entries.

The Analysed column shows the number of residues for which the backbone conformation was analysed, and the total number of residues.

Mol	Chain	Analysed	Favoured	Allowed	Outliers	Percentiles	
1	BA	158/165 (96%)	157 (99%)	1 (1%)	0	100	100
2	BB	211/217 (97%)	208 (99%)	3 (1%)	0	100	100
6	L6	118/211 (56%)	116 (98%)	2 (2%)	0	100	100
7	L7	199/203 (98%)	197 (99%)	2 (1%)	0	100	100
8	L8	133/215 (62%)	128 (96%)	5 (4%)	0	100	100
9	L9	179/204 (88%)	178 (99%)	1 (1%)	0	100	100
10	LA	134/184 (73%)	132 (98%)	2 (2%)	0	100	100
11	LB	149/188 (79%)	149 (100%)	0	0	100	100
12	LC	174/176 (99%)	174 (100%)	0	0	100	100
13	LE	107/160 (67%)	104 (97%)	3 (3%)	0	100	100
14	LG	132/140 (94%)	128 (97%)	4 (3%)	0	100	100
15	LH	129/156 (83%)	128 (99%)	1 (1%)	0	100	100
16	LI	132/145 (91%)	132 (100%)	0	0	100	100
17	LK	104/148 (70%)	101 (97%)	3 (3%)	0	100	100
18	LL	120/137 (88%)	119 (99%)	1 (1%)	0	100	100
19	LN	352/403 (87%)	349 (99%)	3 (1%)	0	100	100
20	LP	104/125 (83%)	103 (99%)	1 (1%)	0	100	100
21	LQ	126/135 (93%)	126 (100%)	0	0	100	100
22	LS	120/123 (98%)	119 (99%)	1 (1%)	0	100	100
23	LT	107/110 (97%)	106 (99%)	1 (1%)	0	100	100
24	LU	101/105 (96%)	99 (98%)	2 (2%)	0	100	100
25	LW	72/97 (74%)	72 (100%)	0	0	100	100
26	NA	480/749 (64%)	478 (100%)	2 (0%)	0	100	100
27	NB	67/549 (12%)	66 (98%)	1 (2%)	0	100	100
28	NF	201/260 (77%)	200 (100%)	1 (0%)	0	100	100

Continued on next page...

Continued from previous page...

Mol	Chain	Analysed	Favoured	Allowed	Outliers	Percentiles	
29	NH	178/180 (99%)	177 (99%)	1 (1%)	0	100	100
30	NI	600/881 (68%)	593 (99%)	7 (1%)	0	100	100
31	NK	63/129 (49%)	63 (100%)	0	0	100	100
32	SA	356/427 (83%)	353 (99%)	3 (1%)	0	100	100
33	SC	208/288 (72%)	206 (99%)	2 (1%)	0	100	100
34	SD	223/248 (90%)	218 (98%)	5 (2%)	0	100	100
35	SE	184/266 (69%)	182 (99%)	2 (1%)	0	100	100
36	SG	189/192 (98%)	187 (99%)	2 (1%)	0	100	100
37	SH	148/293 (50%)	146 (99%)	2 (1%)	0	100	100
38	SI	220/255 (86%)	218 (99%)	2 (1%)	0	100	100
39	SJ	213/847 (25%)	211 (99%)	2 (1%)	0	100	100
40	SK	242/245 (99%)	236 (98%)	6 (2%)	0	100	100
41	SL	241/490 (49%)	233 (97%)	8 (3%)	0	100	100
42	SM	431/588 (73%)	431 (100%)	0	0	100	100
43	SN	169/306 (55%)	169 (100%)	0	0	100	100
44	SO	292/353 (83%)	287 (98%)	5 (2%)	0	100	100
45	SQ	216/239 (90%)	214 (99%)	2 (1%)	0	100	100
46	SR	489/634 (77%)	484 (99%)	5 (1%)	0	100	100
47	SS	255/746 (34%)	252 (99%)	3 (1%)	0	100	100
48	ST	146/365 (40%)	144 (99%)	2 (1%)	0	100	100
49	SU	546/800 (68%)	535 (98%)	11 (2%)	0	100	100
50	SV	135/163 (83%)	134 (99%)	1 (1%)	0	100	100
51	SW	440/670 (66%)	431 (98%)	9 (2%)	0	100	100
52	SY	376/812 (46%)	371 (99%)	5 (1%)	0	100	100
53	SZ	156/178 (88%)	156 (100%)	0	0	100	100
All	All	10625/15900 (67%)	10500 (99%)	125 (1%)	0	100	100

There are no Ramachandran outliers to report.

5.3.2 Protein sidechains [i](#)

In the following table, the Percentiles column shows the percent sidechain outliers of the chain as a percentile score with respect to all PDB entries followed by that with respect to all EM

entries.

The Analysed column shows the number of residues for which the sidechain conformation was analysed, and the total number of residues.

Mol	Chain	Analysed	Rotameric	Outliers	Percentiles	
1	BA	132/137 (96%)	132 (100%)	0	100	100
6	L6	104/177 (59%)	103 (99%)	1 (1%)	76	90
7	L7	173/174 (99%)	173 (100%)	0	100	100
8	L8	115/161 (71%)	115 (100%)	0	100	100
9	L9	155/172 (90%)	155 (100%)	0	100	100
10	LA	121/163 (74%)	121 (100%)	0	100	100
11	LB	136/165 (82%)	136 (100%)	0	100	100
12	LC	157/157 (100%)	157 (100%)	0	100	100
13	LE	101/140 (72%)	101 (100%)	0	100	100
14	LG	102/107 (95%)	102 (100%)	0	100	100
15	LH	114/133 (86%)	114 (100%)	0	100	100
16	LI	124/135 (92%)	123 (99%)	1 (1%)	81	92
17	LK	29/121 (24%)	29 (100%)	0	100	100
18	LL	106/121 (88%)	106 (100%)	0	100	100
19	LN	313/348 (90%)	312 (100%)	1 (0%)	92	98
21	LQ	114/121 (94%)	114 (100%)	0	100	100
22	LS	109/110 (99%)	109 (100%)	0	100	100
23	LT	88/89 (99%)	88 (100%)	0	100	100
24	LU	87/89 (98%)	87 (100%)	0	100	100
25	LW	63/80 (79%)	63 (100%)	0	100	100
26	NA	277/656 (42%)	277 (100%)	0	100	100
27	NB	65/485 (13%)	65 (100%)	0	100	100
28	NF	184/228 (81%)	184 (100%)	0	100	100
29	NH	155/155 (100%)	155 (100%)	0	100	100
30	NI	520/730 (71%)	520 (100%)	0	100	100
31	NK	61/115 (53%)	61 (100%)	0	100	100
32	SA	298/348 (86%)	298 (100%)	0	100	100
33	SC	190/252 (75%)	190 (100%)	0	100	100
34	SD	194/215 (90%)	194 (100%)	0	100	100

Continued on next page...

Continued from previous page...

Mol	Chain	Analysed	Rotameric	Outliers	Percentiles	
35	SE	159/223 (71%)	159 (100%)	0	100	100
36	SG	170/171 (99%)	170 (100%)	0	100	100
37	SH	140/274 (51%)	140 (100%)	0	100	100
38	SI	200/228 (88%)	200 (100%)	0	100	100
39	SJ	187/733 (26%)	186 (100%)	1 (0%)	88	96
40	SK	212/213 (100%)	212 (100%)	0	100	100
41	SL	226/437 (52%)	226 (100%)	0	100	100
42	SM	392/509 (77%)	392 (100%)	0	100	100
43	SN	133/260 (51%)	133 (100%)	0	100	100
44	SO	274/319 (86%)	274 (100%)	0	100	100
45	SQ	195/214 (91%)	195 (100%)	0	100	100
46	SR	451/574 (79%)	450 (100%)	1 (0%)	93	98
47	SS	230/648 (36%)	230 (100%)	0	100	100
48	ST	101/300 (34%)	100 (99%)	1 (1%)	76	90
49	SU	478/733 (65%)	478 (100%)	0	100	100
50	SV	127/149 (85%)	127 (100%)	0	100	100
51	SW	393/591 (66%)	392 (100%)	1 (0%)	92	98
52	SY	325/685 (47%)	325 (100%)	0	100	100
53	SZ	141/158 (89%)	141 (100%)	0	100	100
All	All	8921/13503 (66%)	8914 (100%)	7 (0%)	93	98

All (7) residues with a non-rotameric sidechain are listed below:

Mol	Chain	Res	Type
6	L6	115	GLN
16	LI	2	LYS
19	LN	5	LYS
39	SJ	769	ASN
46	SR	248	ARG
48	ST	246	ARG
51	SW	402	GLN

Sometimes sidechains can be flipped to improve hydrogen bonding and reduce clashes. All (21) such sidechains are listed below:

Mol	Chain	Res	Type
8	L8	69	HIS
16	LI	14	ASN
19	LN	42	HIS
24	LU	26	HIS
26	NA	376	HIS
26	NA	457	HIS
33	SC	136	HIS
33	SC	190	HIS
38	SI	94	HIS
39	SJ	712	HIS
40	SK	68	HIS
42	SM	154	HIS
42	SM	211	HIS
45	SQ	47	ASN
46	SR	157	HIS
46	SR	209	HIS
47	SS	310	HIS
49	SU	359	HIS
49	SU	592	HIS
49	SU	636	HIS
49	SU	654	HIS

5.3.3 RNA [i](#)

Mol	Chain	Analysed	Backbone Outliers	Pucker Outliers
3	L1	150/157 (95%)	19 (12%)	0
4	L2	65/1167 (5%)	9 (13%)	0
5	L3	2206/5070 (43%)	303 (13%)	6 (0%)
All	All	2421/6394 (37%)	331 (13%)	6 (0%)

All (331) RNA backbone outliers are listed below:

Mol	Chain	Res	Type
3	L1	34	U
3	L1	52	A
3	L1	54	C
3	L1	55	U
3	L1	59	A
3	L1	62	A
3	L1	63	U
3	L1	82	A
3	L1	83	C

Continued on next page...

Continued from previous page...

Mol	Chain	Res	Type
3	L1	84	A
3	L1	86	U
3	L1	94	G
3	L1	103	A
3	L1	105	C
3	L1	109	C
3	L1	110	U
3	L1	112	G
3	L1	114	G
3	L1	156	U
4	L2	2	C
4	L2	11	C
4	L2	48	G
4	L2	49	G
4	L2	62	U
4	L2	87	G
4	L2	94	U
4	L2	96	A
4	L2	101	A
5	L3	41	C
5	L3	48	G
5	L3	56	A
5	L3	58	G
5	L3	59	A
5	L3	64	A
5	L3	65	A
5	L3	69	A
5	L3	91	G
5	L3	92	C
5	L3	93	G
5	L3	95	G
5	L3	108	A
5	L3	116	G
5	L3	119	G
5	L3	159	C
5	L3	170	C
5	L3	171	U
5	L3	172	C
5	L3	173	C
5	L3	181	C
5	L3	186	G
5	L3	190	G

Continued on next page...

Continued from previous page...

Mol	Chain	Res	Type
5	L3	197	A
5	L3	200	U
5	L3	210	C
5	L3	218	A
5	L3	233	U
5	L3	234	G
5	L3	253	G
5	L3	261	G
5	L3	264	C
5	L3	265	C
5	L3	277	G
5	L3	294	G
5	L3	326	C
5	L3	340	C
5	L3	349	A
5	L3	362	A
5	L3	387	G
5	L3	399	G
5	L3	410	A
5	L3	413	G
5	L3	414	C
5	L3	431	G
5	L3	449	C
5	L3	450	G
5	L3	452	A
5	L3	453	G
5	L3	454	U
5	L3	464	G
5	L3	467	U
5	L3	468	U
5	L3	685	C
5	L3	697	G
5	L3	699	C
5	L3	704	C
5	L3	730	G
5	L3	731	G
5	L3	739	G
5	L3	742	G
5	L3	746	A
5	L3	913	U
5	L3	915	A
5	L3	917	A

Continued on next page...

Continued from previous page...

Mol	Chain	Res	Type
5	L3	918	G
5	L3	926	G
5	L3	931	C
5	L3	932	A
5	L3	933	G
5	L3	943	A
5	L3	944	A
5	L3	945	U
5	L3	956	A
5	L3	959	G
5	L3	960	A
5	L3	1071	C
5	L3	1072	C
5	L3	1280	C
5	L3	1284	G
5	L3	1287	G
5	L3	1293	G
5	L3	1294	A
5	L3	1295	C
5	L3	1296	G
5	L3	1301	C
5	L3	1313	C
5	L3	1314	C
5	L3	1337	A
5	L3	1354	A
5	L3	1358	G
5	L3	1359	G
5	L3	1378	C
5	L3	1379	C
5	L3	1435	G
5	L3	1447	C
5	L3	1448	G
5	L3	1497	A
5	L3	1498	G
5	L3	1500	A
5	L3	1525	A
5	L3	1534	A
5	L3	1624	G
5	L3	1625	G
5	L3	1626	G
5	L3	1633	G
5	L3	1654	G

Continued on next page...

Continued from previous page...

Mol	Chain	Res	Type
5	L3	1661	C
5	L3	1670	G
5	L3	1682	A
5	L3	1726	U
5	L3	1804	A
5	L3	1810	G
5	L3	1830	G
5	L3	1836	G
5	L3	1837	A
5	L3	1842	G
5	L3	1853	G
5	L3	1870	C
5	L3	1881	C
5	L3	1883	G
5	L3	1891	A
5	L3	1897	A
5	L3	1910	G
5	L3	1918	U
5	L3	1921	C
5	L3	1922	G
5	L3	1925	G
5	L3	1931	C
5	L3	1935	C
5	L3	1938	C
5	L3	1941	A
5	L3	1944	A
5	L3	1945	G
5	L3	1969	G
5	L3	1984	A
5	L3	1997	U
5	L3	2002	A
5	L3	2021	G
5	L3	2024	G
5	L3	2025	A
5	L3	2026	A
5	L3	2044	U
5	L3	2046	G
5	L3	2055	G
5	L3	2056	G
5	L3	2069	A
5	L3	2084	C
5	L3	2085	G

Continued on next page...

Continued from previous page...

Mol	Chain	Res	Type
5	L3	2089	G
5	L3	2090	U
5	L3	2091	C
5	L3	2268	A
5	L3	2289	C
5	L3	2300	A
5	L3	2301	G
5	L3	2313	A
5	L3	2314	G
5	L3	2348	G
5	L3	2351	C
5	L3	2372	U
5	L3	2374	A
5	L3	2378	G
5	L3	2382	A
5	L3	2383	C
5	L3	2384	U
5	L3	2474	G
5	L3	2484	A
5	L3	2485	U
5	L3	2490	U
5	L3	2492	C
5	L3	2493	G
5	L3	2500	U
5	L3	2769	U
5	L3	2844	A
5	L3	2845	A
5	L3	2848	G
5	L3	2852	U
5	L3	2853	C
5	L3	3630	A
5	L3	3835	C
5	L3	3836	A
5	L3	3845	A
5	L3	3853	U
5	L3	3868	G
5	L3	3875	G
5	L3	3878	C
5	L3	3879	G
5	L3	3887	C
5	L3	3889	G
5	L3	3894	A

Continued on next page...

Continued from previous page...

Mol	Chain	Res	Type
5	L3	3895	G
5	L3	3898	G
5	L3	3906	A
5	L3	3907	G
5	L3	3908	A
5	L3	3916	G
5	L3	3926	C
5	L3	3930	U
5	L3	3938	G
5	L3	3939	G
5	L3	3940	U
5	L3	3941	G
5	L3	3942	A
5	L3	3967	G
5	L3	3972	A
5	L3	4049	U
5	L3	4064	C
5	L3	4183	G
5	L3	4348	A
5	L3	4349	C
5	L3	4350	C
5	L3	4357	G
5	L3	4372	U
5	L3	4373	G
5	L3	4374	U
5	L3	4376	A
5	L3	4380	A
5	L3	4385	A
5	L3	4390	A
5	L3	4392	G
5	L3	4393	G
5	L3	4398	C
5	L3	4401	G
5	L3	4405	G
5	L3	4433	G
5	L3	4437	U
5	L3	4438	U
5	L3	4439	U
5	L3	4441	A
5	L3	4442	U
5	L3	4451	G
5	L3	4464	A

Continued on next page...

Continued from previous page...

Mol	Chain	Res	Type
5	L3	4466	C
5	L3	4475	G
5	L3	4476	C
5	L3	4480	A
5	L3	4494	G
5	L3	4495	G
5	L3	4496	A
5	L3	4499	G
5	L3	4512	U
5	L3	4513	A
5	L3	4518	A
5	L3	4521	U
5	L3	4522	G
5	L3	4523	A
5	L3	4540	C
5	L3	4541	G
5	L3	4545	G
5	L3	4546	A
5	L3	4548	A
5	L3	4549	G
5	L3	4550	G
5	L3	4551	U
5	L3	4552	U
5	L3	4555	U
5	L3	4568	A
5	L3	4584	A
5	L3	4590	A
5	L3	4608	G
5	L3	4627	U
5	L3	4653	C
5	L3	4656	A
5	L3	4670	C
5	L3	4671	C
5	L3	4672	A
5	L3	4678	G
5	L3	4684	A
5	L3	4708	A
5	L3	4709	U
5	L3	4719	G
5	L3	4720	C
5	L3	4721	G
5	L3	4740	G

Continued on next page...

Continued from previous page...

Mol	Chain	Res	Type
5	L3	4741	C
5	L3	4742	G
5	L3	4745	G
5	L3	4751	G
5	L3	4754	G
5	L3	4757	C
5	L3	4759	C
5	L3	4765	G
5	L3	4773	C
5	L3	4870	G
5	L3	4871	C
5	L3	4882	U
5	L3	4883	C
5	L3	4900	C
5	L3	4901	G
5	L3	4910	G
5	L3	4914	C
5	L3	4943	A
5	L3	4976	U
5	L3	5013	C
5	L3	5014	A
5	L3	5020	G
5	L3	5026	U
5	L3	5030	U
5	L3	5041	G
5	L3	5049	G
5	L3	5050	C
5	L3	5062	G

All (6) RNA pucker outliers are listed below:

Mol	Chain	Res	Type
5	L3	1625	G
5	L3	2267	U
5	L3	3835	C
5	L3	4347	G
5	L3	4520	G
5	L3	5013	C

5.4 Non-standard residues in protein, DNA, RNA chains [\(i\)](#)

2 non-standard protein/DNA/RNA residues are modelled in this entry.

In the following table, the Counts columns list the number of bonds (or angles) for which Mogul statistics could be retrieved, the number of bonds (or angles) that are observed in the model and the number of bonds (or angles) that are defined in the Chemical Component Dictionary. The Link column lists molecule types, if any, to which the group is linked. The Z score for a bond length (or angle) is the number of standard deviations the observed value is removed from the expected value. A bond length (or angle) with $|Z| > 2$ is considered an outlier worth inspection. RMSZ is the root-mean-square of all Z scores of the bond lengths (or angles).

Mol	Type	Chain	Res	Link	Bond lengths			Bond angles		
					Counts	RMSZ	# Z > 2	Counts	RMSZ	# Z > 2
47	SEP	SS	127	47	8,9,10	1.52	1 (12%)	8,12,14	1.58	2 (25%)
47	SEP	SS	126	47	8,9,10	1.54	1 (12%)	8,12,14	1.53	2 (25%)

In the following table, the Chirals column lists the number of chiral outliers, the number of chiral centers analysed, the number of these observed in the model and the number defined in the Chemical Component Dictionary. Similar counts are reported in the Torsion and Rings columns. '-' means no outliers of that kind were identified.

Mol	Type	Chain	Res	Link	Chirals	Torsions	Rings
47	SEP	SS	127	47	-	1/5/8/10	-
47	SEP	SS	126	47	-	0/5/8/10	-

All (2) bond length outliers are listed below:

Mol	Chain	Res	Type	Atoms	Z	Observed(Å)	Ideal(Å)
47	SS	126	SEP	P-O1P	3.36	1.61	1.50
47	SS	127	SEP	P-O1P	3.32	1.61	1.50

All (4) bond angle outliers are listed below:

Mol	Chain	Res	Type	Atoms	Z	Observed(°)	Ideal(°)
47	SS	127	SEP	P-OG-CB	-2.95	110.17	118.30
47	SS	126	SEP	P-OG-CB	-2.80	110.57	118.30
47	SS	127	SEP	OG-CB-CA	2.73	110.80	108.14
47	SS	126	SEP	OG-CB-CA	2.63	110.70	108.14

There are no chirality outliers.

All (1) torsion outliers are listed below:

Mol	Chain	Res	Type	Atoms
47	SS	127	SEP	N-CA-CB-OG

There are no ring outliers.

No monomer is involved in short contacts.

5.5 Carbohydrates [i](#)

There are no monosaccharides in this entry.

5.6 Ligand geometry [i](#)

Of 66 ligands modelled in this entry, 64 are monoatomic - leaving 2 for Mogul analysis.

In the following table, the Counts columns list the number of bonds (or angles) for which Mogul statistics could be retrieved, the number of bonds (or angles) that are observed in the model and the number of bonds (or angles) that are defined in the Chemical Component Dictionary. The Link column lists molecule types, if any, to which the group is linked. The Z score for a bond length (or angle) is the number of standard deviations the observed value is removed from the expected value. A bond length (or angle) with $|Z| > 2$ is considered an outlier worth inspection. RMSZ is the root-mean-square of all Z scores of the bond lengths (or angles).

Mol	Type	Chain	Res	Link	Bond lengths			Bond angles		
					Counts	RMSZ	# Z > 2	Counts	RMSZ	# Z > 2
56	ADP	NI	901	54	24,29,29	0.94	1 (4%)	29,45,45	1.46	4 (13%)
57	GDP	SR	1001	58,54	24,30,30	2.54	8 (33%)	30,47,47	1.73	9 (30%)

In the following table, the Chirals column lists the number of chiral outliers, the number of chiral centers analysed, the number of these observed in the model and the number defined in the Chemical Component Dictionary. Similar counts are reported in the Torsion and Rings columns. '-' means no outliers of that kind were identified.

Mol	Type	Chain	Res	Link	Chirals	Torsions	Rings
56	ADP	NI	901	54	-	3/12/32/32	0/3/3/3
57	GDP	SR	1001	58,54	-	0/12/32/32	0/3/3/3

All (9) bond length outliers are listed below:

Mol	Chain	Res	Type	Atoms	Z	Observed(Å)	Ideal(Å)
57	SR	1001	GDP	O6-C6	8.32	1.40	1.23
57	SR	1001	GDP	C2-N2	4.68	1.45	1.34
57	SR	1001	GDP	O4'-C1'	4.28	1.47	1.41
57	SR	1001	GDP	C5-C4	2.31	1.49	1.43
57	SR	1001	GDP	PB-O2B	-2.29	1.46	1.54
57	SR	1001	GDP	PB-O3B	-2.29	1.46	1.54
56	NI	901	ADP	C5-C4	2.27	1.46	1.40
57	SR	1001	GDP	C2'-C1'	-2.23	1.50	1.53

Continued on next page...

Continued from previous page...

Mol	Chain	Res	Type	Atoms	Z	Observed(Å)	Ideal(Å)
57	SR	1001	GDP	C2'-C3'	-2.10	1.47	1.53

All (13) bond angle outliers are listed below:

Mol	Chain	Res	Type	Atoms	Z	Observed(°)	Ideal(°)
57	SR	1001	GDP	C3'-C2'-C1'	3.93	106.89	100.98
56	NI	901	ADP	N3-C2-N1	-3.67	122.94	128.68
56	NI	901	ADP	PA-O3A-PB	-3.44	121.03	132.83
57	SR	1001	GDP	C5-C6-N1	3.36	119.88	113.95
56	NI	901	ADP	C3'-C2'-C1'	3.08	105.61	100.98
57	SR	1001	GDP	O2B-PB-O3A	2.91	114.40	104.64
57	SR	1001	GDP	C2-N1-C6	-2.90	119.76	125.10
57	SR	1001	GDP	O3B-PB-O3A	2.83	114.14	104.64
57	SR	1001	GDP	PA-O3A-PB	-2.71	123.53	132.83
56	NI	901	ADP	C4-C5-N7	-2.66	106.63	109.40
57	SR	1001	GDP	C2'-C3'-C4'	2.60	107.70	102.64
57	SR	1001	GDP	O6-C6-C5	-2.21	120.06	124.37
57	SR	1001	GDP	O2A-PA-O1A	-2.17	101.51	112.24

There are no chirality outliers.

All (3) torsion outliers are listed below:

Mol	Chain	Res	Type	Atoms
56	NI	901	ADP	O4'-C4'-C5'-O5'
56	NI	901	ADP	C3'-C4'-C5'-O5'
56	NI	901	ADP	PA-O3A-PB-O3B

There are no ring outliers.

No monomer is involved in short contacts.

The following is a two-dimensional graphical depiction of Mogul quality analysis of bond lengths, bond angles, torsion angles, and ring geometry for all instances of the Ligand of Interest. In addition, ligands with molecular weight > 250 and outliers as shown on the validation Tables will also be included. For torsion angles, if less than 5% of the Mogul distribution of torsion angles is within 10 degrees of the torsion angle in question, then that torsion angle is considered an outlier. Any bond that is central to one or more torsion angles identified as an outlier by Mogul will be highlighted in the graph. For rings, the root-mean-square deviation (RMSD) between the ring in question and similar rings identified by Mogul is calculated over all ring torsion angles. If the average RMSD is greater than 60 degrees and the minimal RMSD between the ring in question and any Mogul-identified rings is also greater than 60 degrees, then that ring is considered an outlier. The outliers are highlighted in purple. The color gray indicates Mogul did not find sufficient equivalents in the CSD to analyse the geometry.

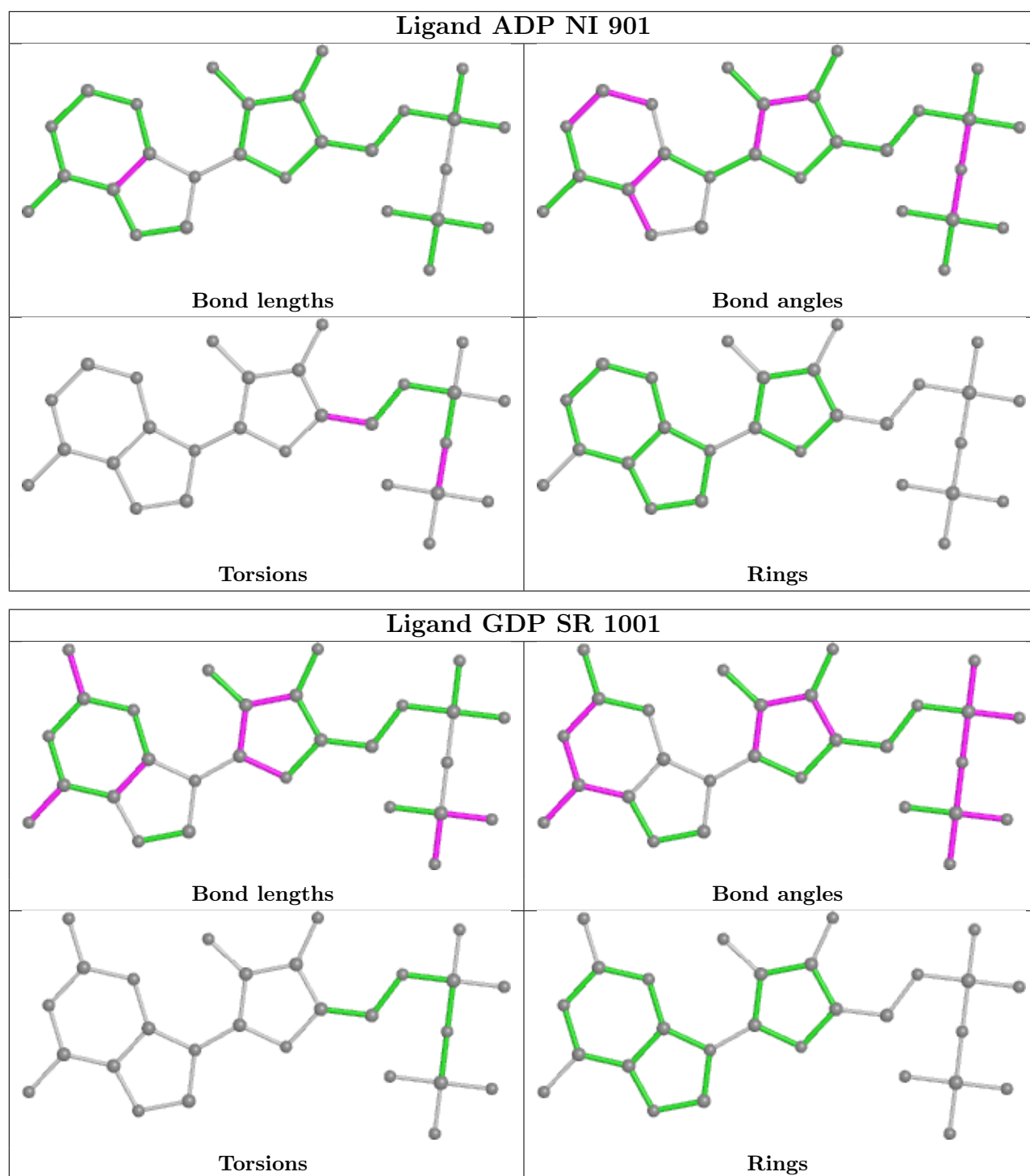

5.7 Other polymers [\(i\)](#)

There are no such residues in this entry.

5.8 Polymer linkage issues

There are no chain breaks in this entry.

6 Map visualisation [i](#)

This section contains visualisations of the EMDB entry EMD-29260. These allow visual inspection of the internal detail of the map and identification of artifacts.

Images derived from a raw map, generated by summing the deposited half-maps, are presented below the corresponding image components of the primary map to allow further visual inspection and comparison with those of the primary map.

6.1 Orthogonal projections [i](#)

6.1.1 Primary map

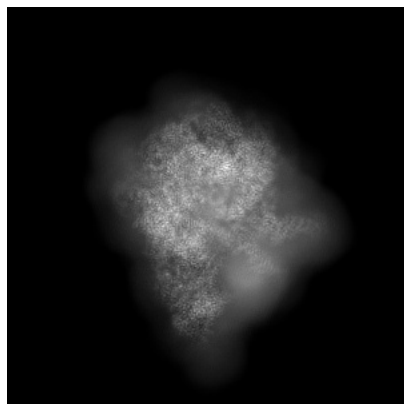

X

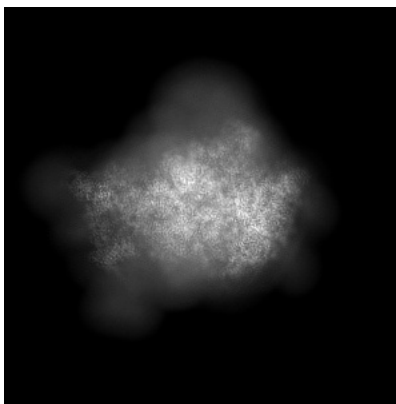

Y

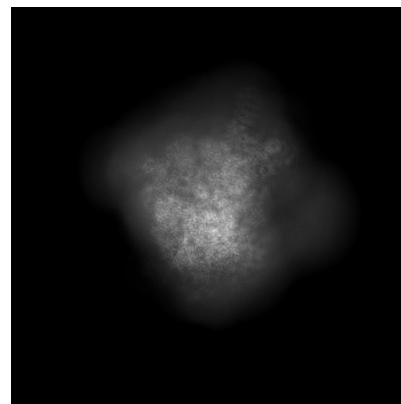

Z

6.1.2 Raw map

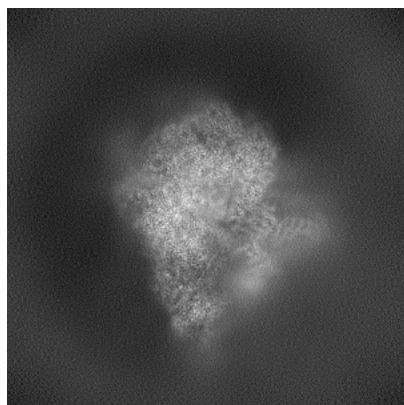

X

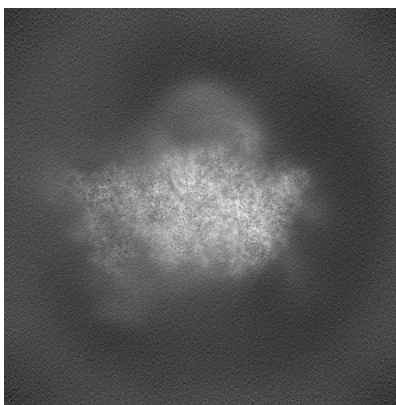

Y

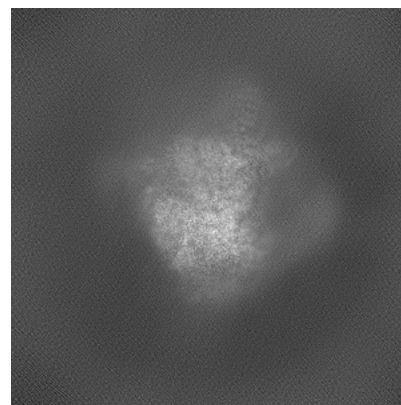

Z

The images above show the map projected in three orthogonal directions.

6.2 Central slices [i](#)

6.2.1 Primary map

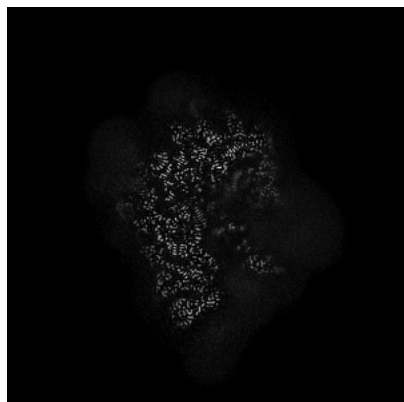

X Index: 240

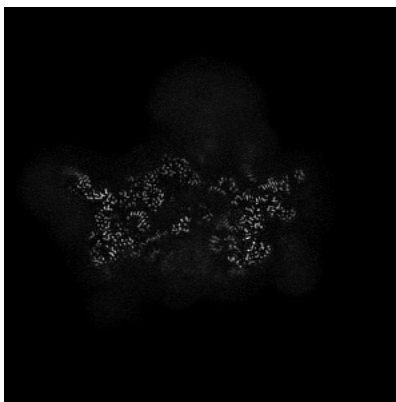

Y Index: 240

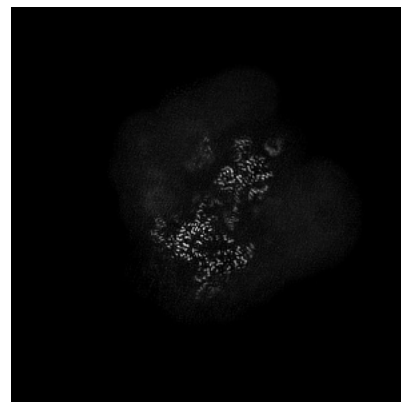

Z Index: 240

6.2.2 Raw map

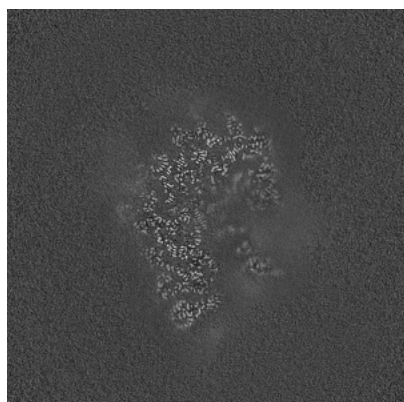

X Index: 240

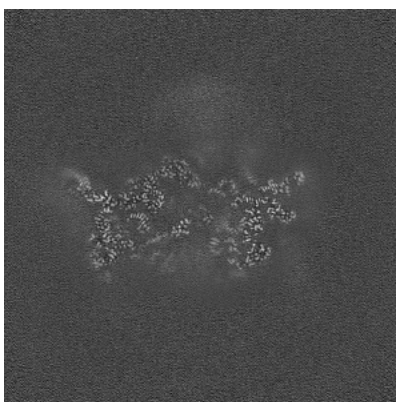

Y Index: 240

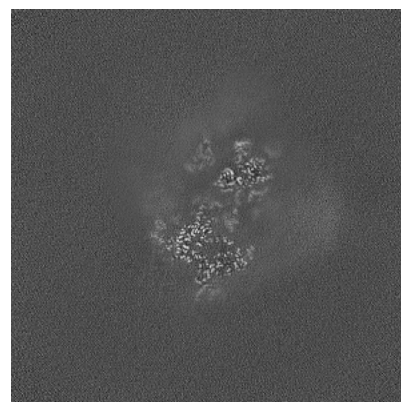

Z Index: 240

The images above show central slices of the map in three orthogonal directions.

6.3 Largest variance slices [i](#)

6.3.1 Primary map

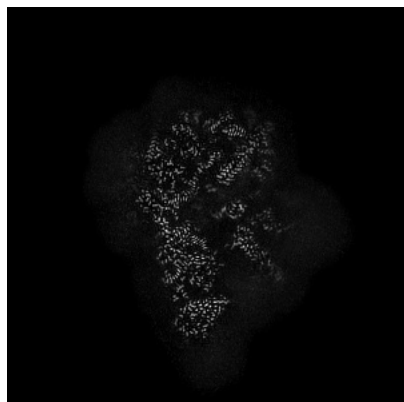

X Index: 256

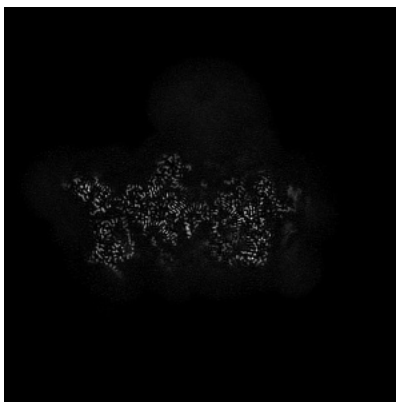

Y Index: 228

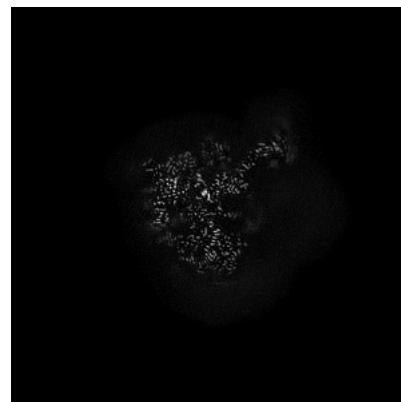

Z Index: 285

6.3.2 Raw map

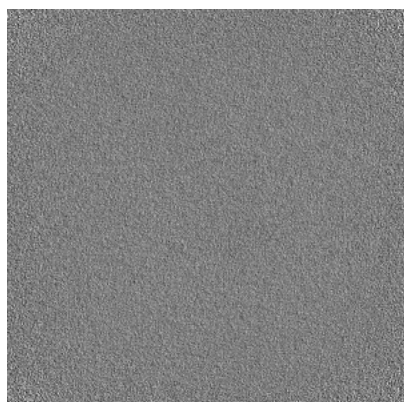

X Index: 0

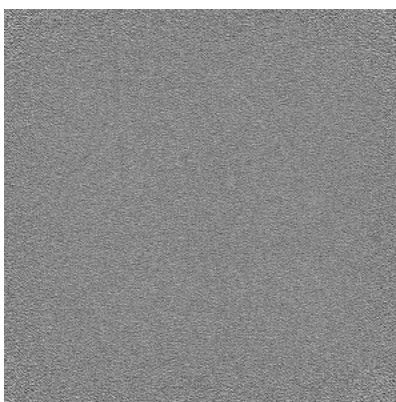

Y Index: 0

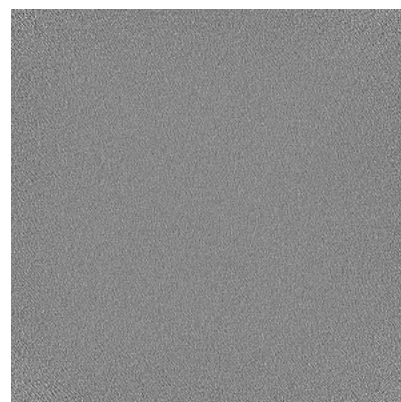

Z Index: 0

The images above show the largest variance slices of the map in three orthogonal directions.

6.4 Orthogonal standard-deviation projections (False-color) [i](#)

6.4.1 Primary map

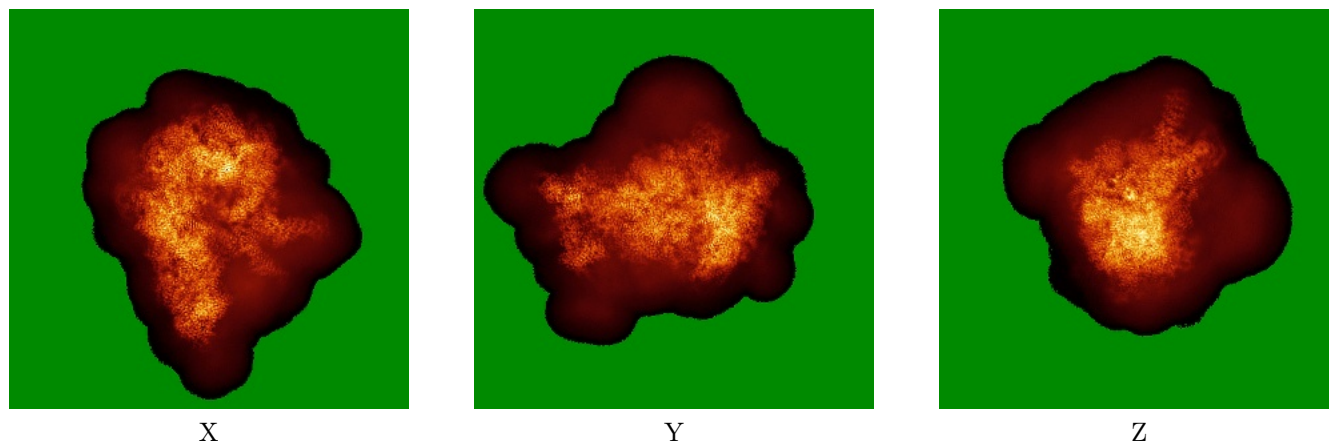

6.4.2 Raw map

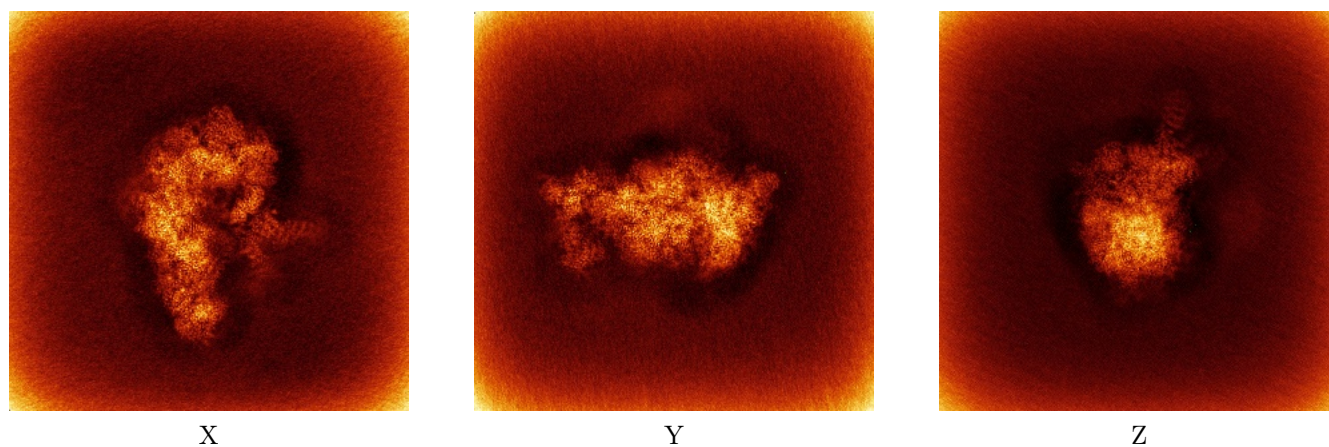

The images above show the map standard deviation projections with false color in three orthogonal directions. Minimum values are shown in green, max in blue, and dark to light orange shades represent small to large values respectively.

6.5 Orthogonal surface views [i](#)

6.5.1 Primary map

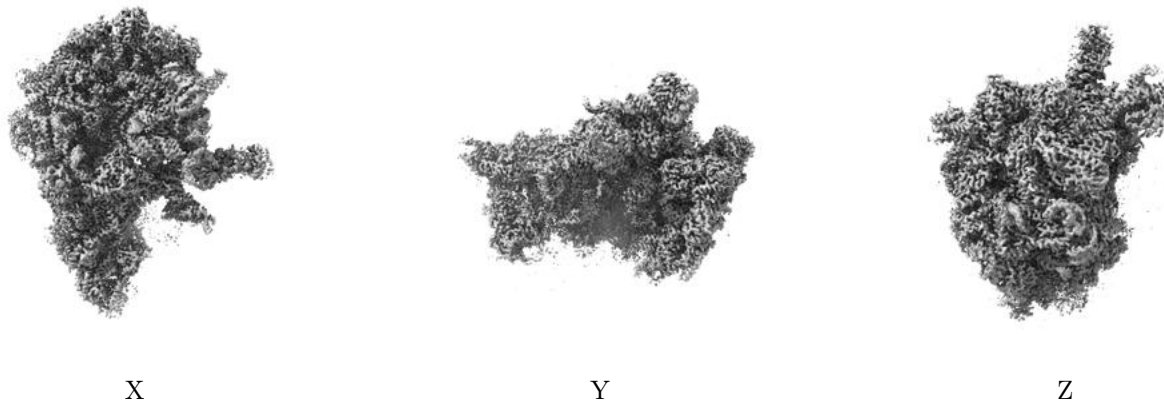

The images above show the 3D surface view of the map at the recommended contour level 0.85. These images, in conjunction with the slice images, may facilitate assessment of whether an appropriate contour level has been provided.

6.5.2 Raw map

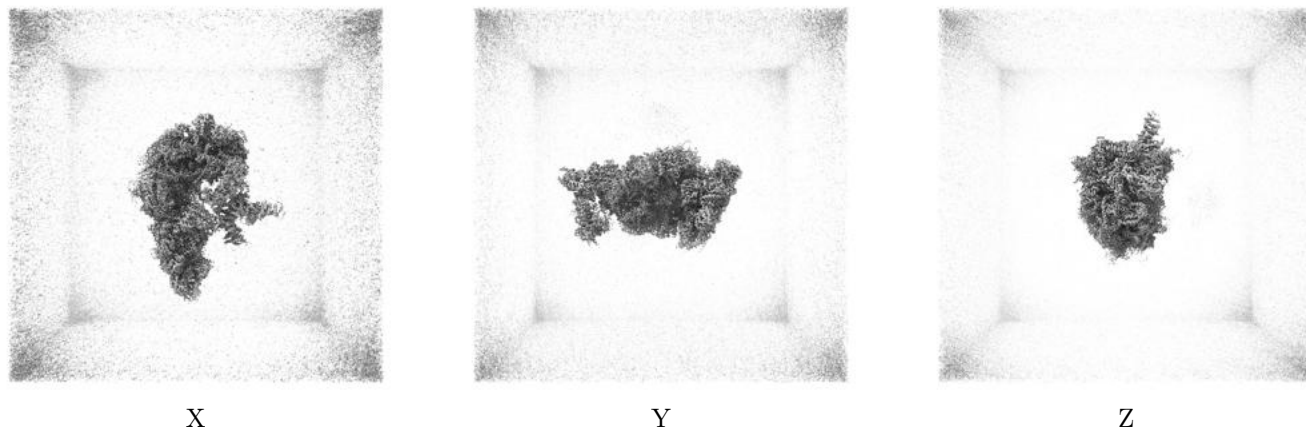

These images show the 3D surface of the raw map. The raw map's contour level was selected so that its surface encloses the same volume as the primary map does at its recommended contour level.

6.6 Mask visualisation [i](#)

This section shows the 3D surface view of the primary map at 50% transparency overlaid with the specified mask at 0% transparency

A mask typically either:

- Encompasses the whole structure
- Separates out a domain, a functional unit, a monomer or an area of interest from a larger structure

6.6.1 emd_29260_msk_1.map [i](#)

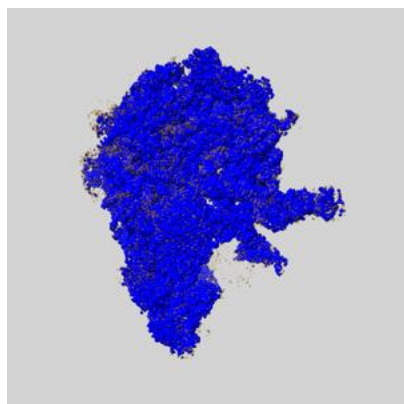

X

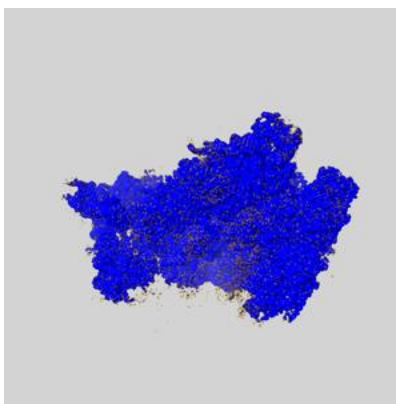

Y

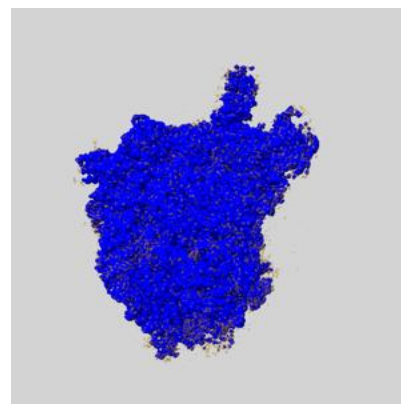

Z

7 Map analysis [i](#)

This section contains the results of statistical analysis of the map.

7.1 Map-value distribution [i](#)

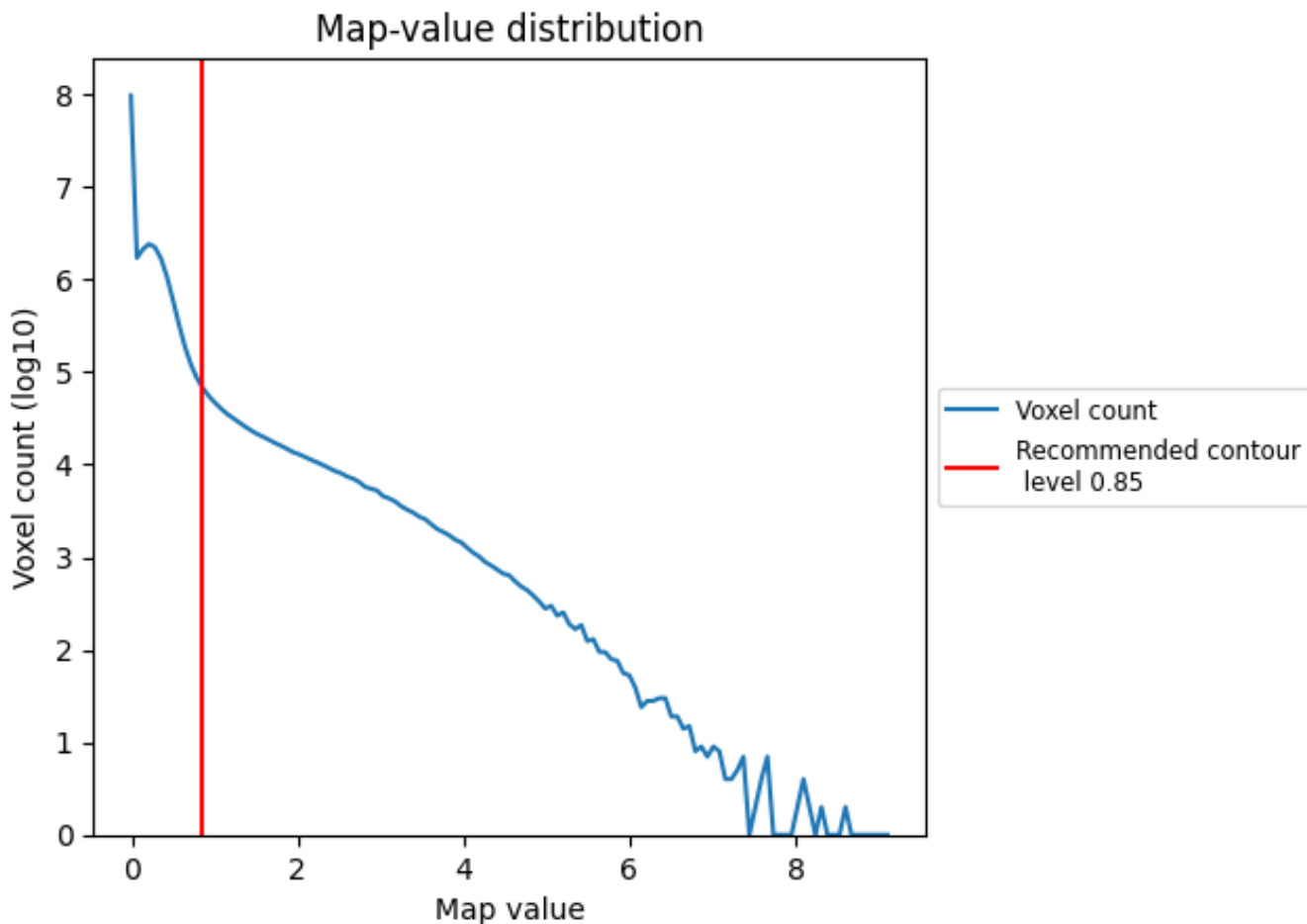

The map-value distribution is plotted in 128 intervals along the x-axis. The y-axis is logarithmic. A spike in this graph at zero usually indicates that the volume has been masked.

7.2 Volume estimate [i](#)

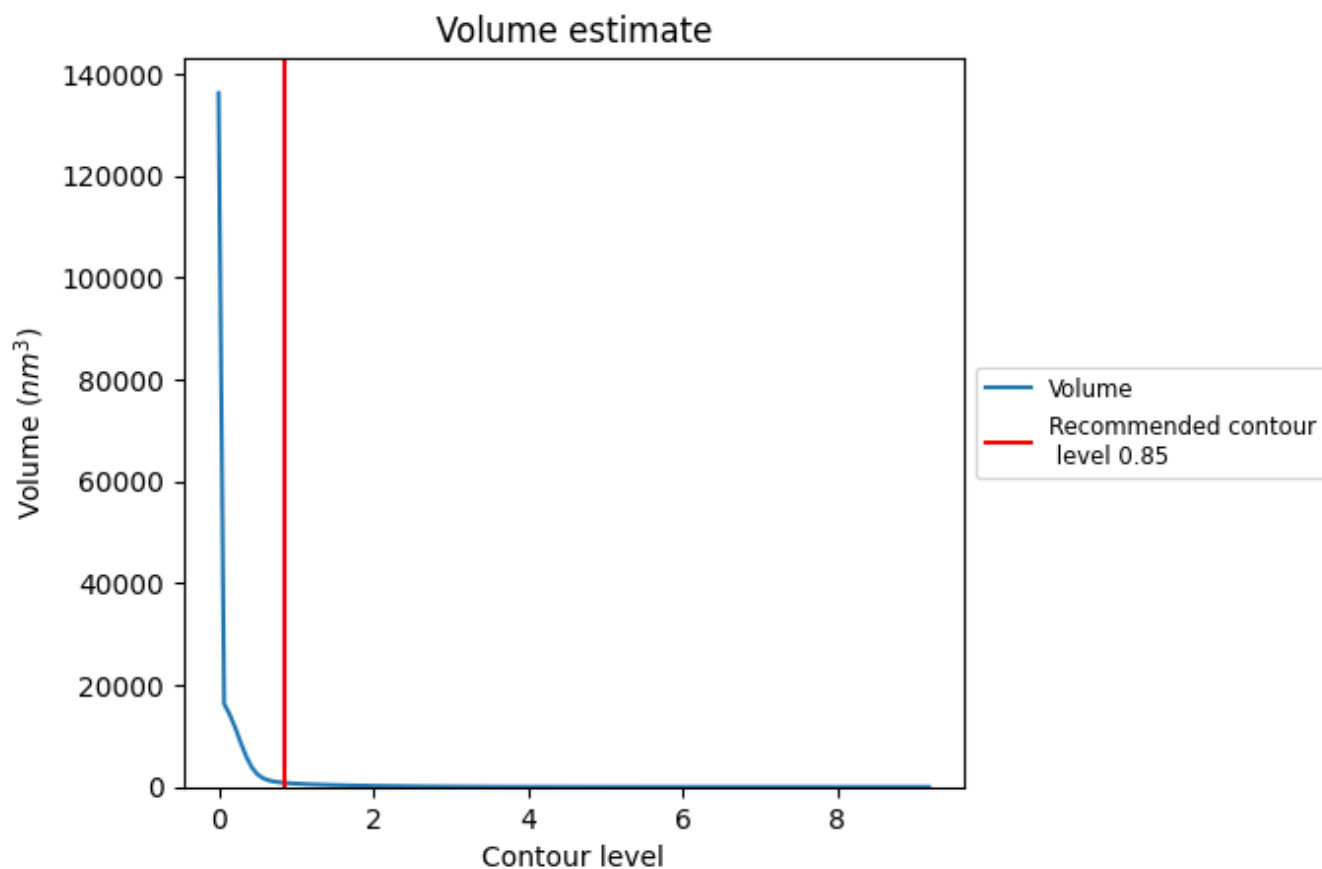

The volume at the recommended contour level is 810 nm³; this corresponds to an approximate mass of 732 kDa.

The volume estimate graph shows how the enclosed volume varies with the contour level. The recommended contour level is shown as a vertical line and the intersection between the line and the curve gives the volume of the enclosed surface at the given level.

7.3 Rotationally averaged power spectrum i

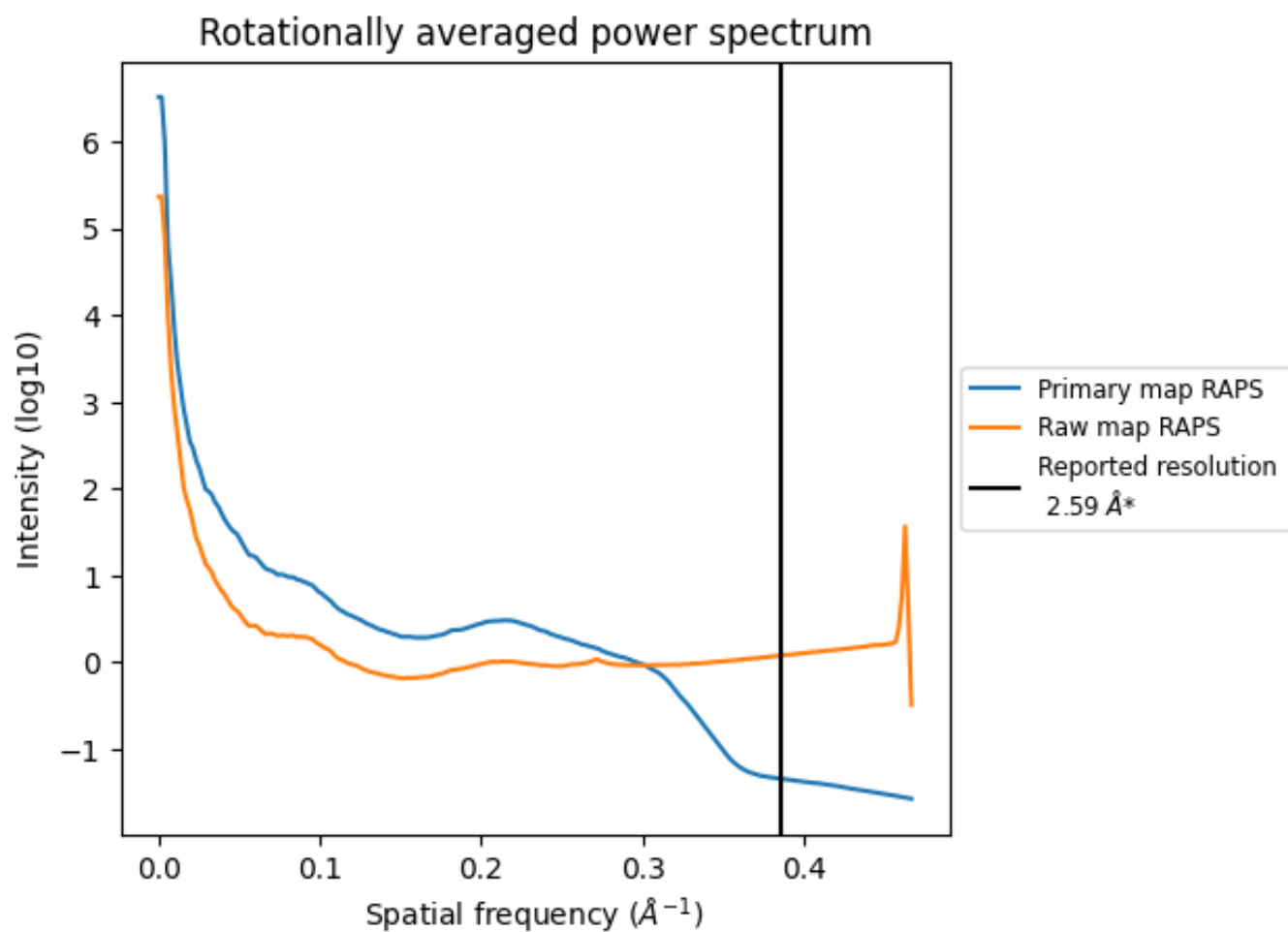

*Reported resolution corresponds to spatial frequency of 0.386 Å⁻¹

8 Fourier-Shell correlation [i](#)

Fourier-Shell Correlation (FSC) is the most commonly used method to estimate the resolution of single-particle and subtomogram-averaged maps. The shape of the curve depends on the imposed symmetry, mask and whether or not the two 3D reconstructions used were processed from a common reference. The reported resolution is shown as a black line. A curve is displayed for the half-bit criterion in addition to lines showing the 0.143 gold standard cut-off and 0.5 cut-off.

8.1 FSC [i](#)

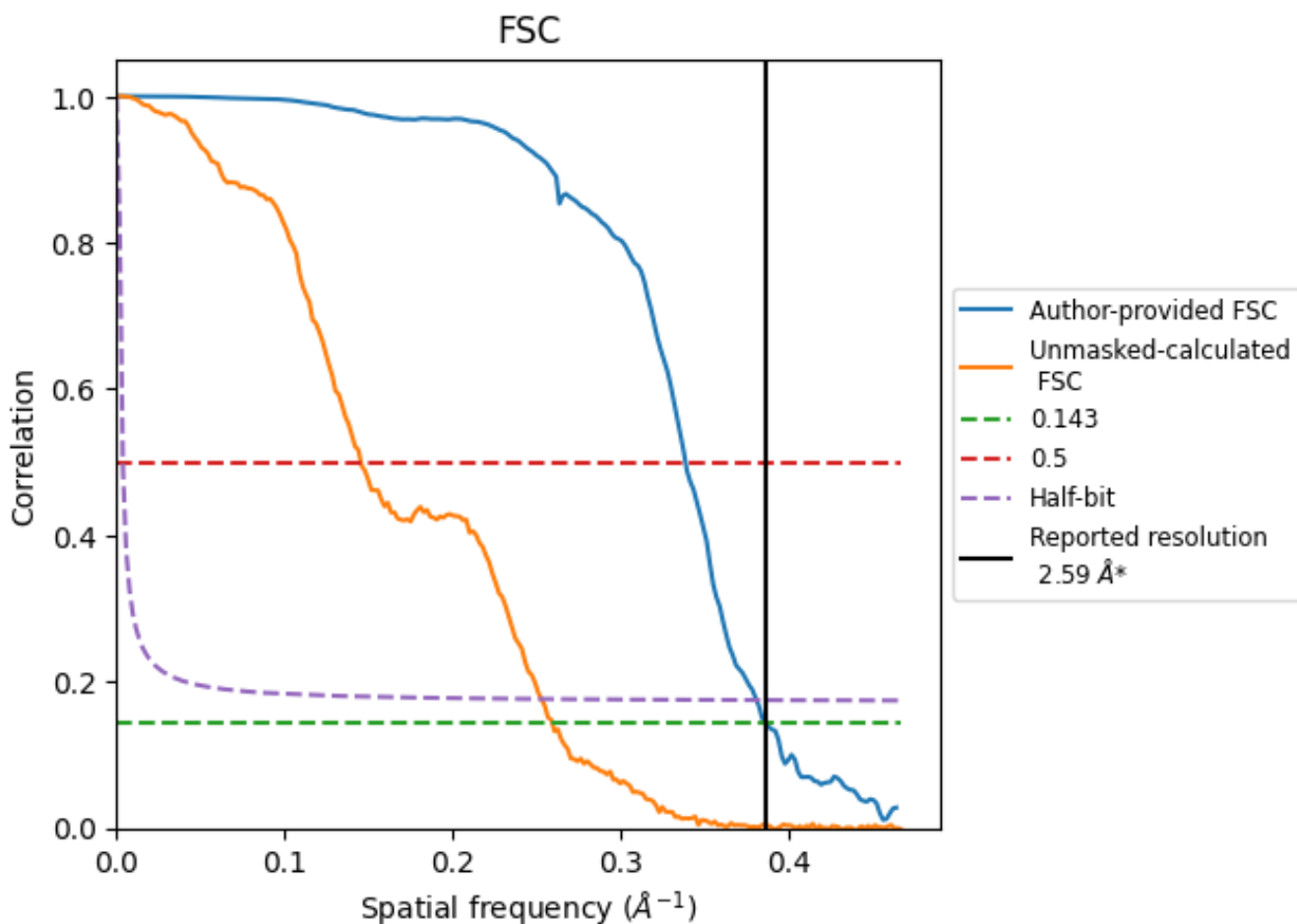

*Reported resolution corresponds to spatial frequency of 0.386 Å⁻¹

8.2 Resolution estimates [i](#)

Resolution estimate (Å)	Estimation criterion (FSC cut-off)		
	0.143	0.5	Half-bit
Reported by author	2.59	-	-
Author-provided FSC curve	2.59	2.96	2.63
Unmasked-calculated*	3.86	6.88	3.96

*Resolution estimate based on FSC curve calculated by comparison of deposited half-maps. The value from deposited half-maps intersecting FSC 0.143 CUT-OFF 3.86 differs from the reported value 2.59 by more than 10 %

9 Map-model fit [i](#)

This section contains information regarding the fit between EMDB map EMD-29260 and PDB model 8FKX. Per-residue inclusion information can be found in section 3 on page 15.

9.1 Map-model overlay [i](#)

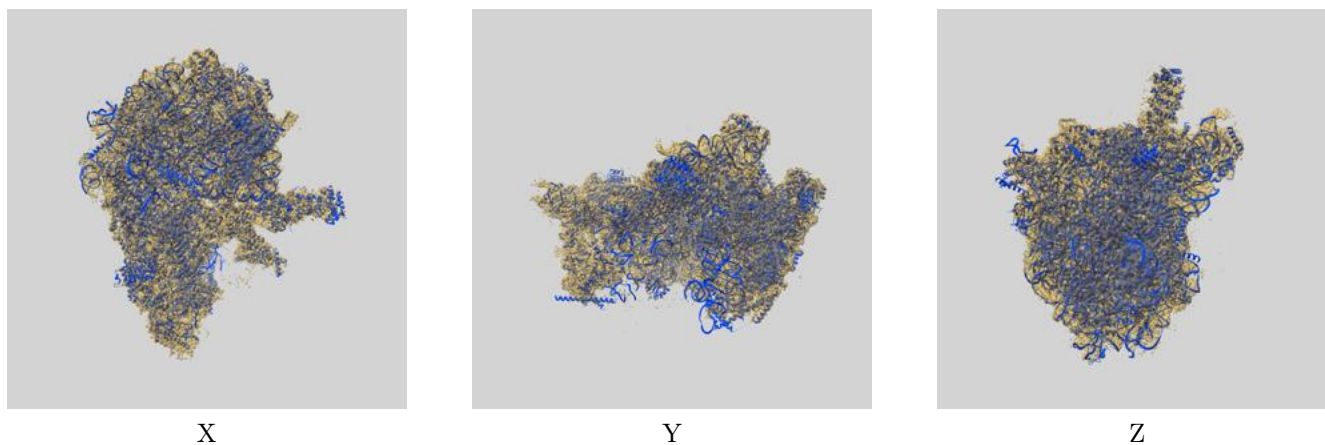

The images above show the 3D surface view of the map at the recommended contour level 0.85 at 50% transparency in yellow overlaid with a ribbon representation of the model coloured in blue. These images allow for the visual assessment of the quality of fit between the atomic model and the map.

9.2 Q-score mapped to coordinate model [i](#)

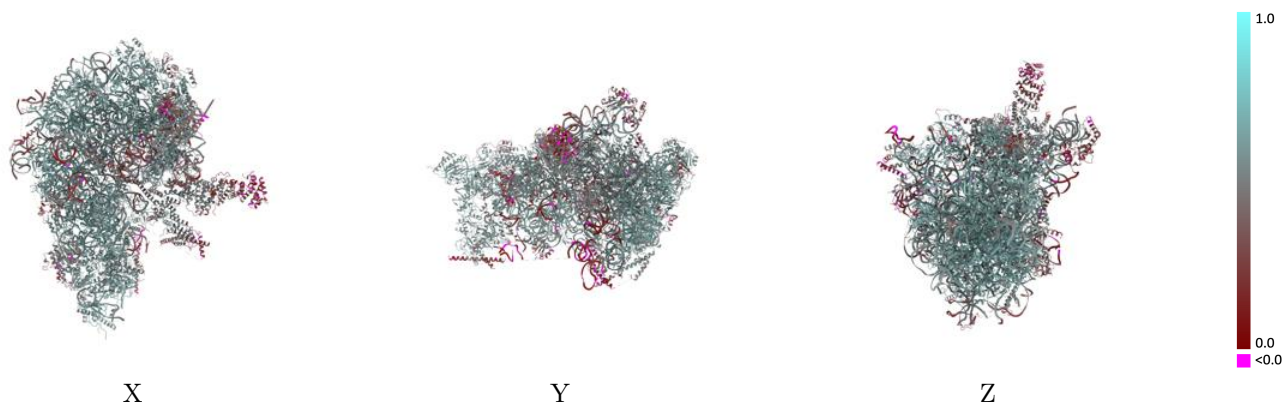

The images above show the model with each residue coloured according to its Q-score. This shows their resolvability in the map with higher Q-score values reflecting better resolvability. Please note: Q-score is calculating the resolvability of atoms, and thus high values are only expected at resolutions at which atoms can be resolved. Low Q-score values may therefore be expected for many entries.

9.3 Atom inclusion mapped to coordinate model [i](#)

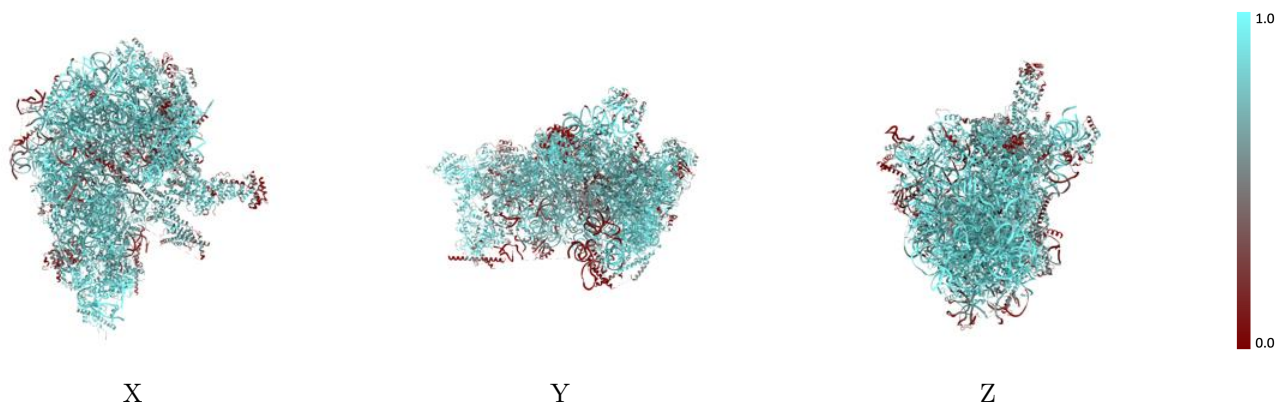

The images above show the model with each residue coloured according to its atom inclusion. This shows to what extent they are inside the map at the recommended contour level (0.85).



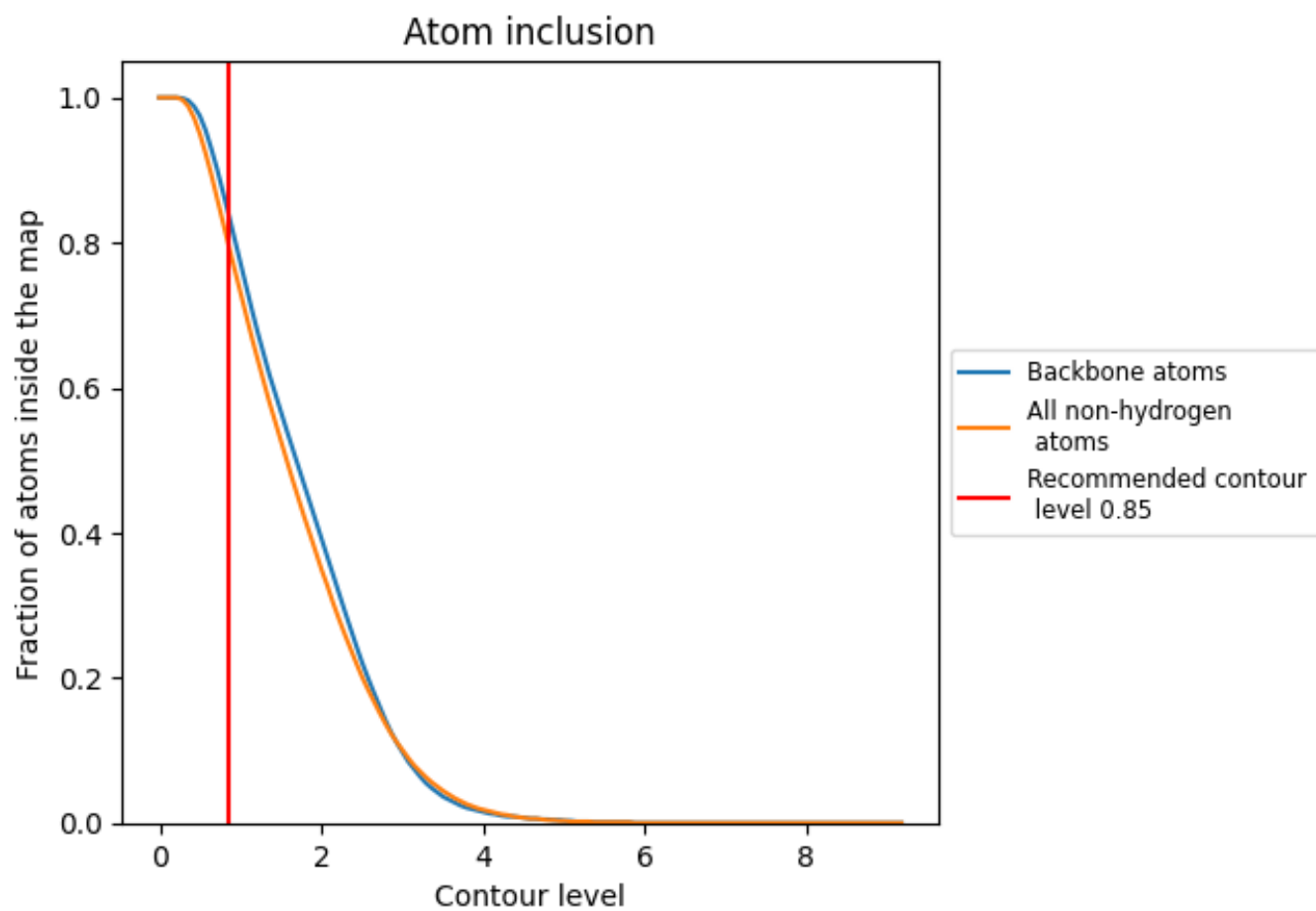



































































9.4 Atom inclusion [i](#)



At the recommended contour level, 84% of all backbone atoms, 80% of all non-hydrogen atoms, are inside the map.

9.5 Map-model fit summary







































The table lists the average atom inclusion at the recommended contour level (0.85) and Q-score for the entire model and for each chain.

Chain	Atom inclusion	Q-score
All	 0.7960	 0.5350
BA	 0.4440	 0.4530
BB	 0.5930	 0.3080
L1	 0.8830	 0.5730
L2	 0.9310	 0.5710
L3	 0.8310	 0.5330
L6	 0.9220	 0.6150
L7	 0.9250	 0.6160
L8	 0.9260	 0.6160
L9	 0.9570	 0.6400
LA	 0.7680	 0.5340
LB	 0.9230	 0.6210
LC	 0.9280	 0.6280
LE	 0.4720	 0.4540
LG	 0.8350	 0.5580
LH	 0.3600	 0.4150
LI	 0.8790	 0.6050
LK	 0.6620	 0.4310
LL	 0.9160	 0.6080
LN	 0.9110	 0.6120
LP	 0.1030	 0.2170
LQ	 0.9290	 0.6330
LS	 0.8170	 0.5870
LT	 0.9610	 0.6410
LU	 0.8150	 0.5890
LW	 0.9490	 0.6320
NA	 0.7180	 0.3890
NB	 0.6920	 0.5360
NF	 0.8530	 0.5840
NH	 0.8940	 0.5520
NI	 0.5480	 0.4450
NK	 0.8060	 0.5590
SA	 0.9230	 0.6230
SC	 0.6880	 0.5330
SD	 0.8640	 0.5970



Continued on next page...

Continued from previous page...

Chain	Atom inclusion	Q-score
SE	 0.8860	 0.6000
SG	 0.8970	 0.6080
SH	 0.8680	 0.5750
SI	 0.8120	 0.5520
SJ	 0.5820	 0.4290
SK	 0.8580	 0.5670
SL	 0.8660	 0.5650
SM	 0.7310	 0.5050
SN	 0.7040	 0.5060
SO	 0.7660	 0.5600
SQ	 0.7790	 0.5760
SR	 0.7660	 0.5320
SS	 0.7750	 0.5350
ST	 0.5620	 0.4220
SU	 0.7140	 0.4460
SV	 0.7530	 0.5210
SW	 0.6420	 0.5060
SY	 0.8630	 0.5520
SZ	 0.8290	 0.5710