



wwPDB X-ray Structure Validation Summary Report ⓘ

Jun 25, 2024 – 01:11 PM EDT

PDB ID : 6FL5
Title : Structure of human SHMT1-H135N-R137A-E168N mutant at 3.6 Ang. resolution
Authors : Giardina, G.; Cutruzzola, F.; Lucchi, R.
Deposited on : 2018-01-25
Resolution : 3.60 Å (reported)

This is a wwPDB X-ray Structure Validation Summary Report for a publicly released PDB entry.

We welcome your comments at validation@mail.wwpdb.org

A user guide is available at

<https://www.wwpdb.org/validation/2017/XrayValidationReportHelp>

with specific help available everywhere you see the ⓘ symbol.

The types of validation reports are described at

<http://www.wwpdb.org/validation/2017/FAQs#types>.

The following versions of software and data (see [references ⓘ](#)) were used in the production of this report:

MolProbity : 4.02b-467
Mogul : 1.8.5 (274361), CSD as541be (2020)
Xtriage (Phenix) : 1.13
EDS : 2.37.1
Percentile statistics : 20191225.v01 (using entries in the PDB archive December 25th 2019)
Refmac : 5.8.0158
CCP4 : 7.0.044 (Gargrove)
Ideal geometry (proteins) : Engh & Huber (2001)
Ideal geometry (DNA, RNA) : Parkinson et al. (1996)
Validation Pipeline (wwPDB-VP) : 2.37.1

1 Overall quality at a glance

The following experimental techniques were used to determine the structure:

X-RAY DIFFRACTION

The reported resolution of this entry is 3.60 Å.

Percentile scores (ranging between 0-100) for global validation metrics of the entry are shown in the following graphic. The table shows the number of entries on which the scores are based.

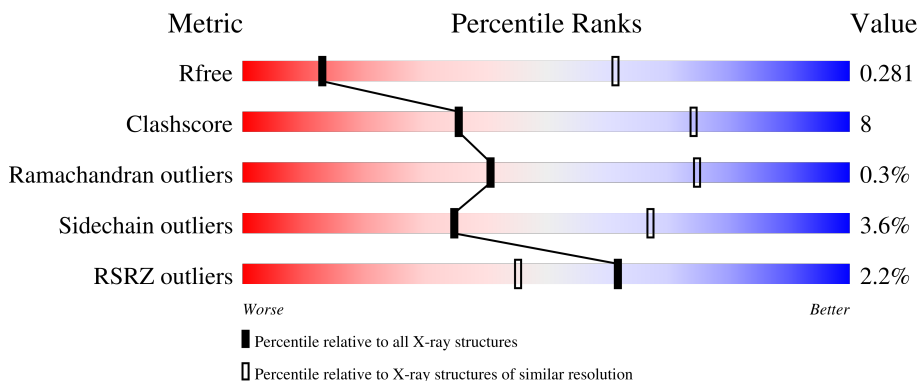

Metric	Whole archive (#Entries)	Similar resolution (#Entries, resolution range(Å))
R_{free}	130704	1257 (3.70-3.50)
Clashscore	141614	1353 (3.70-3.50)
Ramachandran outliers	138981	1307 (3.70-3.50)
Sidechain outliers	138945	1307 (3.70-3.50)
RSRZ outliers	127900	1161 (3.70-3.50)

The table below summarises the geometric issues observed across the polymeric chains and their fit to the electron density. The red, orange, yellow and green segments of the lower bar indicate the fraction of residues that contain outliers for ≥ 3 , 2, 1 and 0 types of geometric quality criteria respectively. A grey segment represents the fraction of residues that are not modelled. The numeric value for each fraction is indicated below the corresponding segment, with a dot representing fractions $\leq 5\%$. The upper red bar (where present) indicates the fraction of residues that have poor fit to the electron density. The numeric value is given above the bar.

Mol	Chain	Length	Quality of chain
1	A	471	 2% (red), 82% (green), 16% (yellow), . (orange)
1	D	471	 % (red), 83% (green), 16% (yellow), . (orange)
1	G	471	 % (red), 81% (green), 17% (yellow), .. (orange)
1	J	471	 4% (red), 81% (green), 14% (yellow), .. (orange)

2 Entry composition [i](#)

There are 3 unique types of molecules in this entry. The entry contains 14389 atoms, of which 0 are hydrogens and 0 are deuteriums.

In the tables below, the ZeroOcc column contains the number of atoms modelled with zero occupancy, the AltConf column contains the number of residues with at least one atom in alternate conformation and the Trace column contains the number of residues modelled with at most 2 atoms.

- Molecule 1 is a protein called Serine hydroxymethyltransferase, cytosolic.

Mol	Chain	Residues	Atoms					ZeroOcc	AltConf	Trace
			Total	C	N	O	S			
1	A	471	3614	2282	632	682	18	0	0	0
1	D	470	3603	2275	631	679	18	0	0	0
1	G	467	3590	2266	628	678	18	0	0	0
1	J	458	3518	2222	615	663	18	0	0	0

There are 12 discrepancies between the modelled and reference sequences:

Chain	Residue	Modelled	Actual	Comment	Reference
A	135	ASN	HIS	engineered mutation	UNP P34896
A	137	ALA	ARG	engineered mutation	UNP P34896
A	168	ASN	GLU	engineered mutation	UNP P34896
D	135	ASN	HIS	engineered mutation	UNP P34896
D	137	ALA	ARG	engineered mutation	UNP P34896
D	168	ASN	GLU	engineered mutation	UNP P34896
G	135	ASN	HIS	engineered mutation	UNP P34896
G	137	ALA	ARG	engineered mutation	UNP P34896
G	168	ASN	GLU	engineered mutation	UNP P34896
J	135	ASN	HIS	engineered mutation	UNP P34896
J	137	ALA	ARG	engineered mutation	UNP P34896
J	168	ASN	GLU	engineered mutation	UNP P34896

- Molecule 2 is PYRIDOXAL-5'-PHOSPHATE (three-letter code: PLP) (formula: C₈H₁₀NO₆P).



Mol	Chain	Residues	Atoms					ZeroOcc	AltConf
2	A	1	Total	C	N	O	P	0	0
			15	8	1	5	1		
2	D	1	Total	C	N	O	P	0	0
			15	8	1	5	1		
2	G	1	Total	C	N	O	P	0	0
			15	8	1	5	1		
2	J	1	Total	C	N	O	P	0	0
			15	8	1	5	1		

- Molecule 3 is CHLORIDE ION (three-letter code: CL) (formula: Cl).

Mol	Chain	Residues	Atoms		ZeroOcc	AltConf
3	A	2	Total	Cl	0	0
			2	2		
3	G	1	Total	Cl	0	0
			1	1		
3	J	1	Total	Cl	0	0
			1	1		

3 Residue-property plots [i](#)

These plots are drawn for all protein, RNA, DNA and oligosaccharide chains in the entry. The first graphic for a chain summarises the proportions of the various outlier classes displayed in the second graphic. The second graphic shows the sequence view annotated by issues in geometry and electron density. Residues are color-coded according to the number of geometric quality criteria for which they contain at least one outlier: green = 0, yellow = 1, orange = 2 and red = 3 or more. A red dot above a residue indicates a poor fit to the electron density ($RSRZ > 2$). Stretches of 2 or more consecutive residues without any outlier are shown as a green connector. Residues present in the sample, but not in the model, are shown in grey.

- Molecule 1: Serine hydroxymethyltransferase, cytosolic

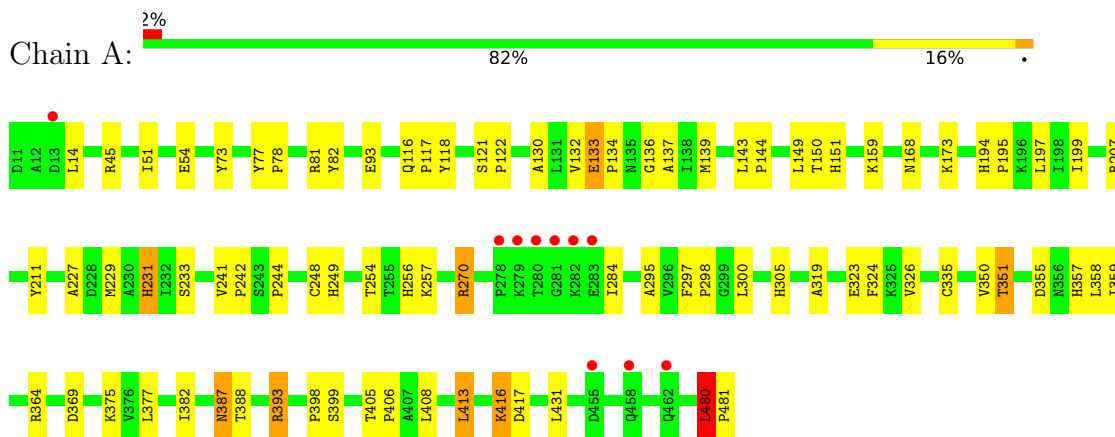

- Molecule 1: Serine hydroxymethyltransferase, cytosolic

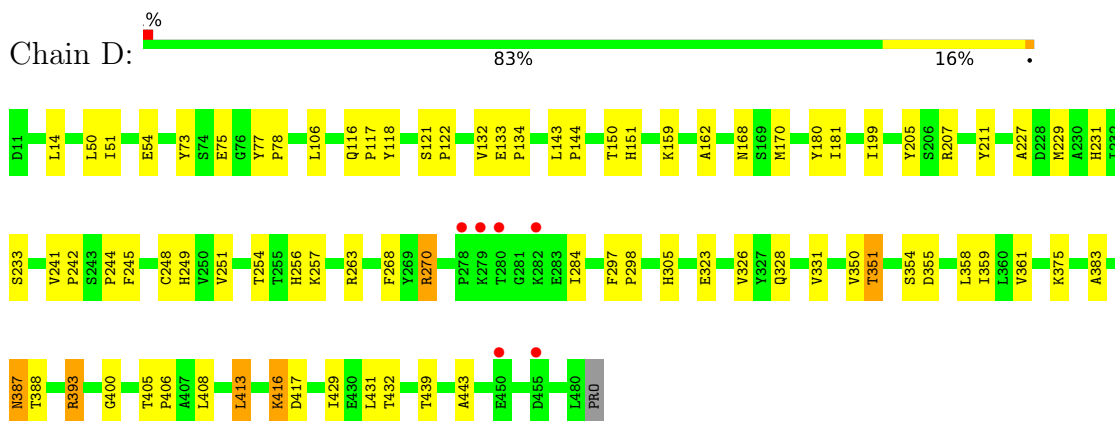

- Molecule 1: Serine hydroxymethyltransferase, cytosolic

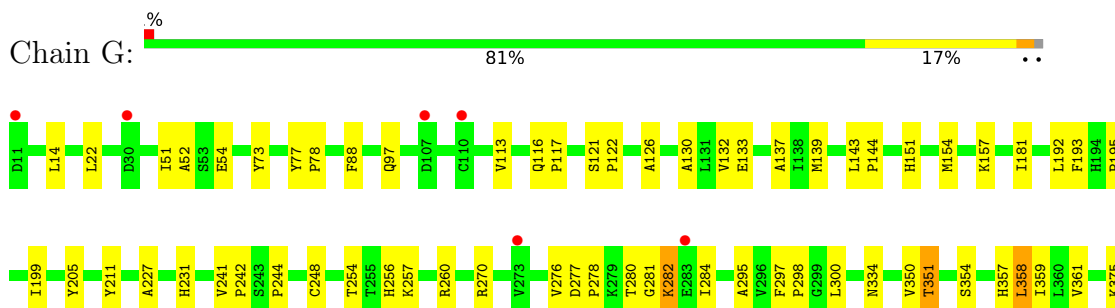

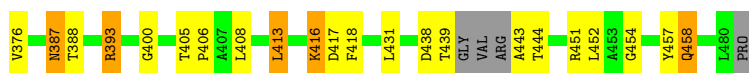

● Molecule 1: Serine hydroxymethyltransferase, cytosolic

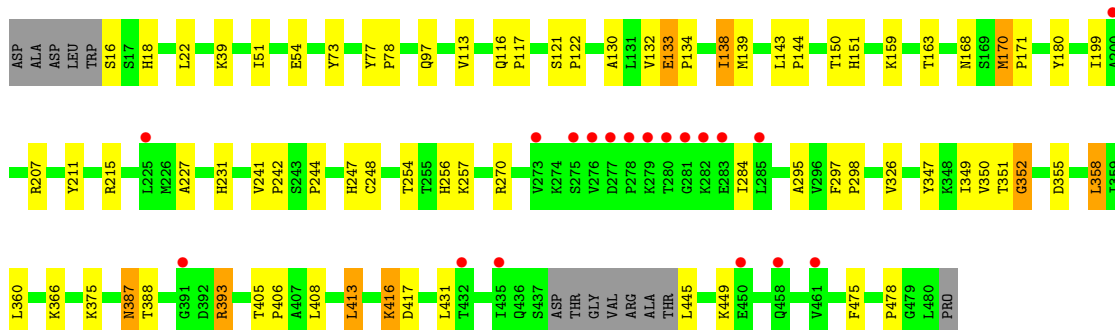
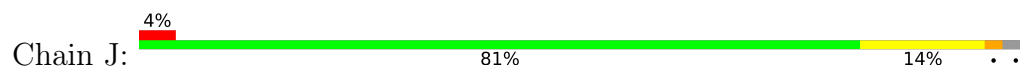

4 Data and refinement statistics

Property	Value	Source
Space group	P 43 21 2	Depositor
Cell constants a, b, c, α , β , γ	139.72Å 139.72Å 267.38Å 90.00° 90.00° 90.00°	Depositor
Resolution (Å)	50.01 – 3.60 56.61 – 3.60	Depositor EDS
% Data completeness (in resolution range)	98.0 (50.01-3.60) 98.1 (56.61-3.60)	Depositor EDS
R_{merge}	0.31	Depositor
R_{sym}	(Not available)	Depositor
$\langle I/\sigma(I) \rangle$ ¹	1.98 (at 3.57Å)	Xtrriage
Refinement program	REFMAC	Depositor
R, R_{free}	0.262 , 0.277 0.262 , 0.281	Depositor DCC
R_{free} test set	1545 reflections (5.01%)	wwPDB-VP
Wilson B-factor (Å ²)	72.1	Xtrriage
Anisotropy	0.460	Xtrriage
Bulk solvent k_{sol} (e/Å ³), B_{sol} (Å ²)	0.34 , 64.7	EDS
L-test for twinning ²	$\langle L \rangle = 0.43$, $\langle L^2 \rangle = 0.26$	Xtrriage
Estimated twinning fraction	No twinning to report.	Xtrriage
F_o, F_c correlation	0.86	EDS
Total number of atoms	14389	wwPDB-VP
Average B, all atoms (Å ²)	76.0	wwPDB-VP

Xtrriage's analysis on translational NCS is as follows: *The largest off-origin peak in the Patterson function is 2.53% of the height of the origin peak. No significant pseudotranslation is detected.*

¹Intensities estimated from amplitudes.

²Theoretical values of $\langle |L| \rangle$, $\langle L^2 \rangle$ for acentric reflections are 0.5, 0.333 respectively for untwinned datasets, and 0.375, 0.2 for perfectly twinned datasets.

5 Model quality [i](#)

5.1 Standard geometry [i](#)

Bond lengths and bond angles in the following residue types are not validated in this section: CL, PLP

The Z score for a bond length (or angle) is the number of standard deviations the observed value is removed from the expected value. A bond length (or angle) with $|Z| > 5$ is considered an outlier worth inspection. RMSZ is the root-mean-square of all Z scores of the bond lengths (or angles).

Mol	Chain	Bond lengths		Bond angles	
		RMSZ	# Z >5	RMSZ	# Z >5
1	A	0.23	0/3687	0.38	0/4992
1	D	0.23	0/3675	0.38	0/4975
1	G	0.22	0/3661	0.39	0/4954
1	J	0.22	0/3587	0.38	0/4851
All	All	0.23	0/14610	0.38	0/19772

There are no bond length outliers.

There are no bond angle outliers.

There are no chirality outliers.

There are no planarity outliers.

5.2 Too-close contacts [i](#)

In the following table, the Non-H and H(model) columns list the number of non-hydrogen atoms and hydrogen atoms in the chain respectively. The H(added) column lists the number of hydrogen atoms added and optimized by MolProbity. The Clashes column lists the number of clashes within the asymmetric unit, whereas Symm-Clashes lists symmetry-related clashes.

Mol	Chain	Non-H	H(model)	H(added)	Clashes	Symm-Clashes
1	A	3614	0	3587	68	0
1	D	3603	0	3576	56	0
1	G	3590	0	3563	63	0
1	J	3518	0	3499	61	0
2	A	15	0	6	0	0
2	D	15	0	6	0	0
2	G	15	0	6	0	0
2	J	15	0	6	0	0
3	A	2	0	0	0	0

Continued on next page...

Continued from previous page...

Mol	Chain	Non-H	H(model)	H(added)	Clashes	Symm-Clashes
3	G	1	0	0	0	0
3	J	1	0	0	0	0
All	All	14389	0	14249	233	0

The all-atom clashscore is defined as the number of clashes found per 1000 atoms (including hydrogen atoms). The all-atom clashscore for this structure is 8.

The worst 5 of 233 close contacts within the same asymmetric unit are listed below, sorted by their clash magnitude.

Atom-1	Atom-2	Interatomic distance (Å)	Clash overlap (Å)
1:A:480:LEU:HB2	1:A:481:PRO:CD	1.71	1.20
1:A:480:LEU:CD1	1:A:481:PRO:HD2	1.75	1.14
1:A:480:LEU:HB2	1:A:481:PRO:HD3	1.34	1.09
1:A:480:LEU:HD12	1:A:481:PRO:HD2	1.11	1.07
1:G:438:ASP:OD2	1:G:457:TYR:OH	1.86	0.92

There are no symmetry-related clashes.

5.3 Torsion angles [i](#)

5.3.1 Protein backbone [i](#)

In the following table, the Percentiles column shows the percent Ramachandran outliers of the chain as a percentile score with respect to all X-ray entries followed by that with respect to entries of similar resolution.

The Analysed column shows the number of residues for which the backbone conformation was analysed, and the total number of residues.

Mol	Chain	Analysed	Favoured	Allowed	Outliers	Percentiles
1	A	469/471 (100%)	451 (96%)	15 (3%)	3 (1%)	25 64
1	D	468/471 (99%)	449 (96%)	19 (4%)	0	100 100
1	G	463/471 (98%)	443 (96%)	20 (4%)	0	100 100
1	J	454/471 (96%)	437 (96%)	14 (3%)	3 (1%)	22 61
All	All	1854/1884 (98%)	1780 (96%)	68 (4%)	6 (0%)	41 75

5 of 6 Ramachandran outliers are listed below:

Mol	Chain	Res	Type
1	A	480	LEU
1	J	352	GLY
1	J	134	PRO
1	A	134	PRO
1	J	133	GLU

5.3.2 Protein sidechains [i](#)

In the following table, the Percentiles column shows the percent sidechain outliers of the chain as a percentile score with respect to all X-ray entries followed by that with respect to entries of similar resolution.

The Analysed column shows the number of residues for which the sidechain conformation was analysed, and the total number of residues.

Mol	Chain	Analysed	Rotameric	Outliers	Percentiles	
1	A	383/387 (99%)	371 (97%)	12 (3%)	40	71
1	D	381/387 (98%)	369 (97%)	12 (3%)	40	71
1	G	381/387 (98%)	366 (96%)	15 (4%)	32	65
1	J	374/387 (97%)	359 (96%)	15 (4%)	31	65
All	All	1519/1548 (98%)	1465 (96%)	54 (4%)	35	67

5 of 54 residues with a non-rotameric sidechain are listed below:

Mol	Chain	Res	Type
1	G	282	LYS
1	G	416	LYS
1	J	387	ASN
1	G	351	THR
1	G	387	ASN

Sometimes sidechains can be flipped to improve hydrogen bonding and reduce clashes. 5 of 45 such sidechains are listed below:

Mol	Chain	Res	Type
1	G	231	HIS
1	J	97	GLN
1	G	256	HIS
1	G	387	ASN
1	J	109	GLN

5.3.3 RNA [i](#)

There are no RNA molecules in this entry.

5.4 Non-standard residues in protein, DNA, RNA chains [i](#)

There are no non-standard protein/DNA/RNA residues in this entry.

5.5 Carbohydrates [i](#)

There are no monosaccharides in this entry.

5.6 Ligand geometry [i](#)

Of 8 ligands modelled in this entry, 4 are monoatomic - leaving 4 for Mogul analysis.

In the following table, the Counts columns list the number of bonds (or angles) for which Mogul statistics could be retrieved, the number of bonds (or angles) that are observed in the model and the number of bonds (or angles) that are defined in the Chemical Component Dictionary. The Link column lists molecule types, if any, to which the group is linked. The Z score for a bond length (or angle) is the number of standard deviations the observed value is removed from the expected value. A bond length (or angle) with $|Z| > 2$ is considered an outlier worth inspection. RMSZ is the root-mean-square of all Z scores of the bond lengths (or angles).

Mol	Type	Chain	Res	Link	Bond lengths			Bond angles		
					Counts	RMSZ	# Z > 2	Counts	RMSZ	# Z > 2
2	PLP	G	501	1	15,15,16	3.11	3 (20%)	20,22,23	1.30	2 (10%)
2	PLP	A	501	1	15,15,16	3.09	3 (20%)	20,22,23	1.33	2 (10%)
2	PLP	J	501	1	15,15,16	3.15	3 (20%)	20,22,23	1.27	2 (10%)
2	PLP	D	500	1	15,15,16	3.18	3 (20%)	20,22,23	1.34	3 (15%)

In the following table, the Chirals column lists the number of chiral outliers, the number of chiral centers analysed, the number of these observed in the model and the number defined in the Chemical Component Dictionary. Similar counts are reported in the Torsion and Rings columns. '-' means no outliers of that kind were identified.

Mol	Type	Chain	Res	Link	Chirals	Torsions	Rings
2	PLP	G	501	1	-	2/6/6/8	0/1/1/1
2	PLP	A	501	1	-	2/6/6/8	0/1/1/1
2	PLP	J	501	1	-	2/6/6/8	0/1/1/1
2	PLP	D	500	1	-	3/6/6/8	0/1/1/1

The worst 5 of 12 bond length outliers are listed below:

Mol	Chain	Res	Type	Atoms	Z	Observed(Å)	Ideal(Å)
2	D	500	PLP	C5-C4	8.08	1.49	1.40
2	D	500	PLP	C3-C2	7.98	1.48	1.40
2	J	501	PLP	C5-C4	7.95	1.49	1.40
2	J	501	PLP	C3-C2	7.84	1.48	1.40
2	G	501	PLP	C5-C4	7.83	1.49	1.40

The worst 5 of 9 bond angle outliers are listed below:

Mol	Chain	Res	Type	Atoms	Z	Observed(°)	Ideal(°)
2	G	501	PLP	O4P-C5A-C5	2.70	114.49	109.35
2	J	501	PLP	C6-N1-C2	2.45	123.70	119.17
2	A	501	PLP	O4P-C5A-C5	2.41	113.95	109.35
2	A	501	PLP	C6-N1-C2	2.41	123.63	119.17
2	J	501	PLP	O4P-C5A-C5	2.40	113.93	109.35

There are no chirality outliers.

5 of 9 torsion outliers are listed below:

Mol	Chain	Res	Type	Atoms
2	A	501	PLP	C5A-O4P-P-O2P
2	D	500	PLP	C4-C5-C5A-O4P
2	D	500	PLP	C6-C5-C5A-O4P
2	G	501	PLP	C4-C5-C5A-O4P
2	G	501	PLP	C6-C5-C5A-O4P

There are no ring outliers.

No monomer is involved in short contacts.

5.7 Other polymers [i](#)

There are no such residues in this entry.

5.8 Polymer linkage issues [i](#)

There are no chain breaks in this entry.

6 Fit of model and data [i](#)

6.1 Protein, DNA and RNA chains [i](#)

In the following table, the column labelled ‘#RSRZ > 2’ contains the number (and percentage) of RSRZ outliers, followed by percent RSRZ outliers for the chain as percentile scores relative to all X-ray entries and entries of similar resolution. The OWAB column contains the minimum, median, 95th percentile and maximum values of the occupancy-weighted average B-factor per residue. The column labelled ‘Q < 0.9’ lists the number of (and percentage) of residues with an average occupancy less than 0.9.

Mol	Chain	Analysed	<RSRZ>	#RSRZ>2	OWAB(Å ²)	Q<0.9
1	A	471/471 (100%)	-0.10	10 (2%) 63 48	46, 64, 102, 151	0
1	D	470/471 (99%)	-0.12	6 (1%) 77 63	47, 66, 108, 150	0
1	G	467/471 (99%)	-0.05	6 (1%) 77 63	56, 74, 105, 128	0
1	J	458/471 (97%)	0.27	19 (4%) 37 24	54, 83, 137, 159	0
All	All	1866/1884 (99%)	-0.00	41 (2%) 62 45	46, 71, 117, 159	0

The worst 5 of 41 RSRZ outliers are listed below:

Mol	Chain	Res	Type	RSRZ
1	J	461	VAL	5.0
1	J	278	PRO	4.6
1	J	432	THR	4.3
1	D	278	PRO	3.9
1	A	278	PRO	3.8

6.2 Non-standard residues in protein, DNA, RNA chains [i](#)

There are no non-standard protein/DNA/RNA residues in this entry.

6.3 Carbohydrates [i](#)

There are no monosaccharides in this entry.

6.4 Ligands [i](#)

In the following table, the Atoms column lists the number of modelled atoms in the group and the number defined in the chemical component dictionary. The B-factors column lists the minimum, median, 95th percentile and maximum values of B factors of atoms in the group. The column labelled ‘Q < 0.9’ lists the number of atoms with occupancy less than 0.9.

Mol	Type	Chain	Res	Atoms	RSCC	RSR	B-factors(\AA^2)	Q<0.9
2	PLP	G	501	15/16	0.92	0.21	67,69,73,73	0
3	CL	A	503	1/1	0.92	0.31	32,32,32,32	0
2	PLP	D	500	15/16	0.93	0.21	62,65,65,66	0
2	PLP	J	501	15/16	0.94	0.21	69,71,72,72	0
3	CL	G	502	1/1	0.95	0.24	42,42,42,42	0
3	CL	J	502	1/1	0.95	0.18	20,20,20,20	0
2	PLP	A	501	15/16	0.96	0.18	59,60,61,61	0
3	CL	A	502	1/1	0.98	0.11	19,19,19,19	0

6.5 Other polymers [i](#)

There are no such residues in this entry.