



wwPDB EM Validation Summary Report ⓘ

Jul 10, 2023 – 04:58 PM EDT

PDB ID : 8FL4
EMDB ID : EMD-29267
Title : Human nuclear pre-60S ribosomal subunit (State I3)
Authors : Vanden Broeck, A.; Klinge, S.
Deposited on : 2022-12-21
Resolution : 2.89 Å (reported)

This is a wwPDB EM Validation Summary Report for a publicly released PDB entry.

We welcome your comments at validation@mail.wwpdb.org

A user guide is available at

<https://www.wwpdb.org/validation/2017/EMValidationReportHelp>

with specific help available everywhere you see the ⓘ symbol.

The types of validation reports are described at

<http://www.wwpdb.org/validation/2017/FAQs#types>.

The following versions of software and data (see [references ⓘ](#)) were used in the production of this report:

EMDB validation analysis : 0.0.1.dev50
Mogul : 1.8.5 (274361), CSD as541be (2020)
MolProbity : 4.02b-467
buster-report : 1.1.7 (2018)
Percentile statistics : 20191225.v01 (using entries in the PDB archive December 25th 2019)
MapQ : 1.9.9
Ideal geometry (proteins) : Engh & Huber (2001)
Ideal geometry (DNA, RNA) : Parkinson et al. (1996)
Validation Pipeline (wwPDB-VP) : 2.34

1 Overall quality at a glance

The following experimental techniques were used to determine the structure:
ELECTRON MICROSCOPY

The reported resolution of this entry is 2.89 Å.

Percentile scores (ranging between 0-100) for global validation metrics of the entry are shown in the following graphic. The table shows the number of entries on which the scores are based.

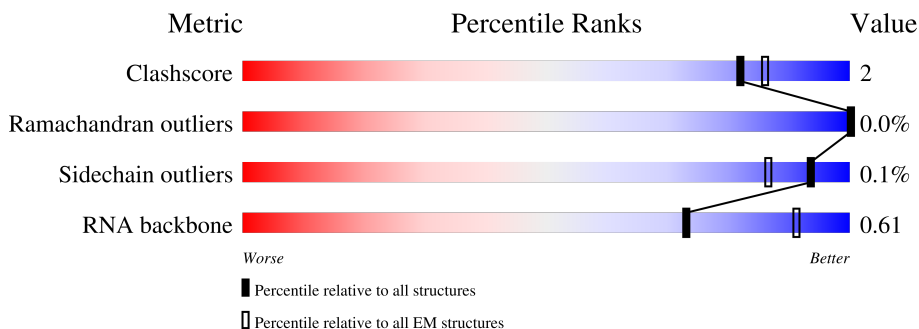











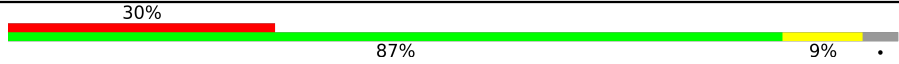
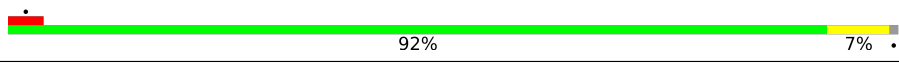
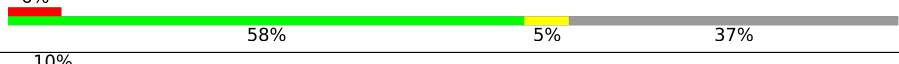

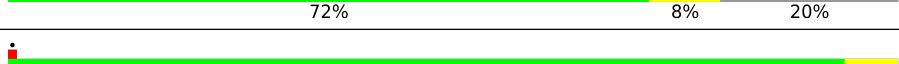
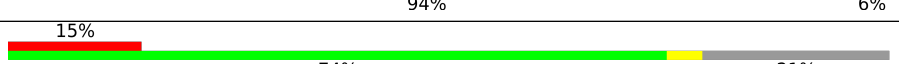
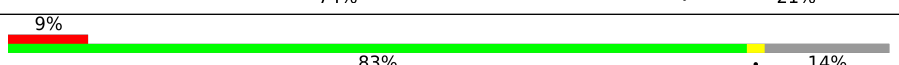
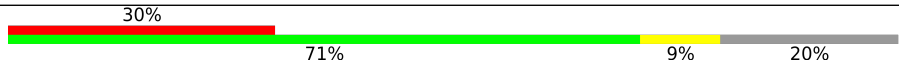
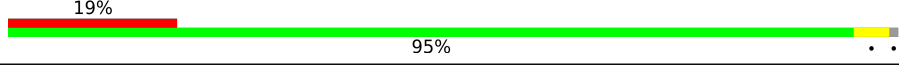
Metric	Whole archive (#Entries)	EM structures (#Entries)
Clashscore	158937	4297
Ramachandran outliers	154571	4023
Sidechain outliers	154315	3826
RNA backbone	4643	859

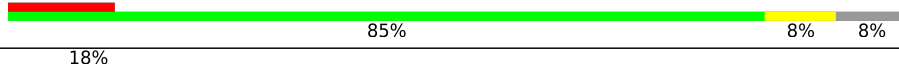
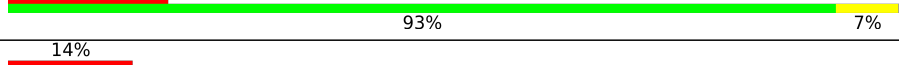
The table below summarises the geometric issues observed across the polymeric chains and their fit to the map. The red, orange, yellow and green segments of the bar indicate the fraction of residues that contain outliers for ≥ 3 , 2, 1 and 0 types of geometric quality criteria respectively. A grey segment represents the fraction of residues that are not modelled. The numeric value for each fraction is indicated below the corresponding segment, with a dot representing fractions $\leq 5\%$. The upper red bar (where present) indicates the fraction of residues that have poor fit to the EM map (all-atom inclusion $< 40\%$). The numeric value is given above the bar.

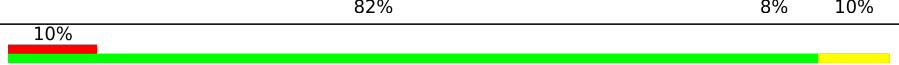
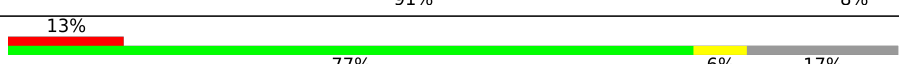
Mol	Chain	Length	Quality of chain
1	BA	165	
2	BB	217	
3	BD	734	
4	L1	157	
5	L3	5070	
6	L4	121	
7	L5	178	

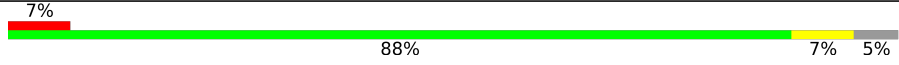
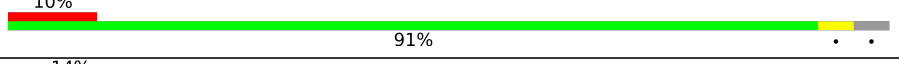
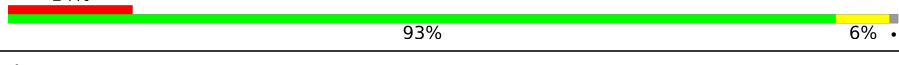
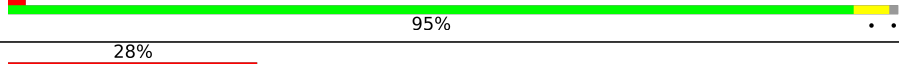
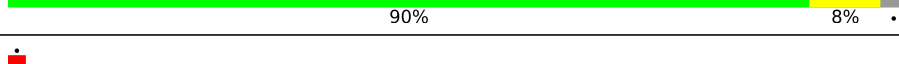
Continued on next page...

Continued from previous page...

Mol	Chain	Length	Quality of chain
8	L6	211	
9	L7	203	
10	L8	215	
11	L9	204	
12	LA	184	
13	LB	188	
14	LC	176	
15	LD	196	
16	LE	160	
17	LF	128	
18	LG	140	
19	LH	156	
20	LI	145	
21	LJ	136	
22	LK	148	
23	LL	137	
24	LN	403	
25	LO	115	
26	LP	125	
27	LQ	135	
28	LR	117	
29	LS	123	
30	LT	110	
31	LU	105	
32	LW	97	

Continued on next page...

Continued from previous page...

Mol	Chain	Length	Quality of chain
33	LX	92	95%
34	LY	70	46% 89% 10%
35	LZ	51	6% 92% 6%
36	NB	549	14% 85%
37	NC	731	12% 66% 30%
38	NF	260	88% 10%
39	NJ	485	71% 7% 22%
40	NK	129	22% 47% 5% 48%
41	NL	478	46% 49% 47%
42	NP	134	34% 69% 8% 22%
43	NT	687	70% 27%
44	NU	929	14% 83% 6% 10%
45	NV	432	5% 82% 6% 12%
45	NW	432	78% 6% 15%
46	NX	1130	44% 54%
46	NY	1130	45% 53%
47	NZ	360	5% 30% 68%
48	SA	427	7% 77% 7% 16%
49	SB	297	83% 14%
50	SC	288	18% 67% 8% 25%
51	SD	248	8% 88% 9%
52	SE	266	31% 82% 6% 12%
53	SF	257	88% 7% 5%
54	SG	192	19% 97%
55	SI	255	12% 88%

Continued on next page...

Continued from previous page...

Mol	Chain	Length	Quality of chain
56	SK	245	
57	SM	588	
58	SQ	239	
59	SR	634	
60	SV	163	

2 Entry composition [i](#)

There are 65 unique types of molecules in this entry. The entry contains 180494 atoms, of which 0 are hydrogens and 0 are deuteriums.

In the tables below, the AltConf column contains the number of residues with at least one atom in alternate conformation and the Trace column contains the number of residues modelled with at most 2 atoms.

- Molecule 1 is a protein called 60S ribosomal protein L12.

Mol	Chain	Residues	Atoms					AltConf	Trace
			Total	C	N	O	S		
1	BA	160	1208	749	226	229	4	0	0

- Molecule 2 is a protein called 60S ribosomal protein L10a.

Mol	Chain	Residues	Atoms					AltConf	Trace
			Total	C	N	O	S		
2	BB	216	1736	1109	313	306	8	0	0

- Molecule 3 is a protein called Ribosomal biogenesis protein LAS1L.

Mol	Chain	Residues	Atoms				AltConf	Trace
			Total	C	N	O		
3	BD	19	149	98	26	25	0	0

- Molecule 4 is a RNA chain called 5.8S rRNA.

Mol	Chain	Residues	Atoms					AltConf	Trace
			Total	C	N	O	P		
4	L1	154	3278	1463	581	1080	154	0	0

- Molecule 5 is a RNA chain called 28S rRNA.

Mol	Chain	Residues	Atoms					AltConf	Trace
			Total	C	N	O	P		
5	L3	3486	74838	33364	13702	24286	3486	0	0

- Molecule 6 is a RNA chain called 5S rRNA.

Mol	Chain	Residues	Atoms					AltConf	Trace
			Total	C	N	O	P		
6	L4	117	2494	1111	441	825	117	0	0

- Molecule 7 is a protein called 60S ribosomal protein L11.

Mol	Chain	Residues	Atoms					AltConf	Trace
			Total	C	N	O	S		
7	L5	168	1349	853	251	239	6	0	0

- Molecule 8 is a protein called 60S ribosomal protein L13.

Mol	Chain	Residues	Atoms					AltConf	Trace
			Total	C	N	O	S		
8	L6	203	1652	1036	341	272	3	0	0

- Molecule 9 is a protein called 60S ribosomal protein L13a.

Mol	Chain	Residues	Atoms					AltConf	Trace
			Total	C	N	O	S		
9	L7	201	1650	1063	321	261	5	0	0

- Molecule 10 is a protein called 60S ribosomal protein L14.

Mol	Chain	Residues	Atoms					AltConf	Trace
			Total	C	N	O	S		
10	L8	135	1111	713	213	178	7	0	0

- Molecule 11 is a protein called 60S ribosomal protein L15.

Mol	Chain	Residues	Atoms					AltConf	Trace
			Total	C	N	O	S		
11	L9	194	1635	1030	345	256	4	0	0

- Molecule 12 is a protein called 60S ribosomal protein L17.

Mol	Chain	Residues	Atoms					AltConf	Trace
			Total	C	N	O	S		
12	LA	153	1249	781	243	216	9	1	0

- Molecule 13 is a protein called 60S ribosomal protein L18.

Mol	Chain	Residues	Atoms					AltConf	Trace
			Total	C	N	O	S		
13	LB	151	1223	768	247	203	5	0	0

- Molecule 14 is a protein called 60S ribosomal protein L18a.

Mol	Chain	Residues	Atoms					AltConf	Trace
			Total	C	N	O	S		
14	LC	176	1461	930	284	236	11	0	0

- Molecule 15 is a protein called 60S ribosomal protein L19.

Mol	Chain	Residues	Atoms					AltConf	Trace
			Total	C	N	O	S		
15	LD	154	1289	805	277	198	9	0	0

- Molecule 16 is a protein called 60S ribosomal protein L21.

Mol	Chain	Residues	Atoms					AltConf	Trace
			Total	C	N	O	S		
16	LE	137	1119	714	213	187	5	1	0

- Molecule 17 is a protein called 60S ribosomal protein L22.

Mol	Chain	Residues	Atoms					AltConf	Trace
			Total	C	N	O	S		
17	LF	103	842	538	148	154	2	0	0

- Molecule 18 is a protein called 60S ribosomal protein L23.

Mol	Chain	Residues	Atoms					AltConf	Trace
			Total	C	N	O	S		
18	LG	139	1034	648	199	182	5	0	0

- Molecule 19 is a protein called 60S ribosomal protein L23a.

Mol	Chain	Residues	Atoms					AltConf	Trace
			Total	C	N	O	S		
19	LH	122	1004	642	190	171	1	0	0

- Molecule 20 is a protein called 60S ribosomal protein L26.

Mol	Chain	Residues	Atoms					AltConf	Trace
			Total	C	N	O	S		
20	LI	134	1115	700	226	186	3	0	0

- Molecule 21 is a protein called 60S ribosomal protein L27.

Mol	Chain	Residues	Atoms					AltConf	Trace
21	LJ	135	Total	C	N	O	S	0	0
			1107	714	208	182	3		

- Molecule 22 is a protein called 60S ribosomal protein L27a.

Mol	Chain	Residues	Atoms					AltConf	Trace
22	LK	117	Total	C	N	O	S	0	0
			918	583	183	149	3		

- Molecule 23 is a protein called 60S ribosomal protein L28.

Mol	Chain	Residues	Atoms					AltConf	Trace
23	LL	123	Total	C	N	O	S	0	0
			987	612	205	166	4		

- Molecule 24 is a protein called 60S ribosomal protein L3.

Mol	Chain	Residues	Atoms					AltConf	Trace
24	LN	402	Total	C	N	O	S	0	0
			3239	2061	608	556	14		

- Molecule 25 is a protein called 60S ribosomal protein L30.

Mol	Chain	Residues	Atoms					AltConf	Trace
25	LO	95	Total	C	N	O	S	0	0
			738	468	131	133	6		

- Molecule 26 is a protein called 60S ribosomal protein L31.

Mol	Chain	Residues	Atoms					AltConf	Trace
26	LP	106	Total	C	N	O	S	0	0
			879	555	170	152	2		

- Molecule 27 is a protein called 60S ribosomal protein L32.

Mol	Chain	Residues	Atoms					AltConf	Trace
27	LQ	128	Total	C	N	O	S	0	0
			1053	667	216	165	5		

- Molecule 28 is a protein called 60S ribosomal protein L34.

Mol	Chain	Residues	Atoms					AltConf	Trace
			Total	C	N	O	S		
28	LR	112	888	555	183	144	6	0	0

- Molecule 29 is a protein called 60S ribosomal protein L35.

Mol	Chain	Residues	Atoms					AltConf	Trace
			Total	C	N	O	S		
29	LS	122	1015	641	205	168	1	0	0

- Molecule 30 is a protein called 60S ribosomal protein L35a.

Mol	Chain	Residues	Atoms					AltConf	Trace
			Total	C	N	O	S		
30	LT	109	876	555	174	144	3	0	0

- Molecule 31 is a protein called 60S ribosomal protein L36.

Mol	Chain	Residues	Atoms					AltConf	Trace
			Total	C	N	O	S		
31	LU	102	832	521	177	129	5	0	0

- Molecule 32 is a protein called 60S ribosomal protein L37.

Mol	Chain	Residues	Atoms					AltConf	Trace
			Total	C	N	O	S		
32	LW	86	705	434	155	111	5	0	0

- Molecule 33 is a protein called 60S ribosomal protein L37a.

Mol	Chain	Residues	Atoms					AltConf	Trace
			Total	C	N	O	S		
33	LX	91	708	445	136	120	7	0	0

- Molecule 34 is a protein called 60S ribosomal protein L38.

Mol	Chain	Residues	Atoms					AltConf	Trace
			Total	C	N	O	S		
34	LY	69	569	366	103	99	1	0	0

- Molecule 35 is a protein called 60S ribosomal protein L39.

Mol	Chain	Residues	Atoms					AltConf	Trace
35	LZ	50	Total	C	N	O	S	0	0
			444	281	98	64	1		

- Molecule 36 is a protein called Guanine nucleotide-binding protein-like 3.

Mol	Chain	Residues	Atoms					AltConf	Trace
36	NB	81	Total	C	N	O	S	0	0
			691	431	148	109	3		

- Molecule 37 is a protein called Nucleolar GTP-binding protein 2.

Mol	Chain	Residues	Atoms					AltConf	Trace
37	NC	511	Total	C	N	O	S	0	0
			4097	2595	729	757	16		

- Molecule 38 is a protein called Ribosome biogenesis protein NSA2 homolog.

Mol	Chain	Residues	Atoms					AltConf	Trace
38	NF	233	Total	C	N	O	S	0	0
			1891	1210	355	318	8		

- Molecule 39 is a protein called Notchless protein homolog 1.

Mol	Chain	Residues	Atoms					AltConf	Trace
39	NJ	379	Total	C	N	O	S	0	0
			2951	1849	544	547	11		

- Molecule 40 is a protein called Protein LLP homolog.

Mol	Chain	Residues	Atoms					AltConf	Trace
40	NK	67	Total	C	N	O	S	0	0
			581	363	128	88	2		

- Molecule 41 is a protein called Ribosome biogenesis protein NOP53.

Mol	Chain	Residues	Atoms					AltConf	Trace
41	NL	254	Total	C	N	O	S	0	0
			2091	1295	413	381	2		

- Molecule 42 is a protein called Zinc finger protein 593.

Mol	Chain	Residues	Atoms					AltConf	Trace
			Total	C	N	O	S		
42	NP	104	847	520	178	145	4	0	0

- Molecule 43 is a protein called Protein SDA1 homolog.

Mol	Chain	Residues	Atoms					AltConf	Trace
			Total	C	N	O	S		
43	NT	501	4072	2610	706	727	29	0	0

- Molecule 44 is a protein called Testis-expressed protein 10.

Mol	Chain	Residues	Atoms					AltConf	Trace
			Total	C	N	O	S		
44	NU	833	6469	4154	1128	1165	22	0	0

- Molecule 45 is a protein called WD repeat-containing protein 18.

Mol	Chain	Residues	Atoms					AltConf	Trace
			Total	C	N	O	S		
45	NV	381	2915	1849	506	540	20	1	0
45	NW	367	2789	1771	482	516	20	0	0

- Molecule 46 is a protein called Proline-, glutamic acid- and leucine-rich protein 1.

Mol	Chain	Residues	Atoms					AltConf	Trace
			Total	C	N	O	S		
46	NX	518	3926	2491	698	708	29	0	0
46	NY	526	3983	2528	708	718	29	0	0

- Molecule 47 is a protein called Coiled-coil domain-containing protein 86.

Mol	Chain	Residues	Atoms					AltConf	Trace
			Total	C	N	O	S		
47	NZ	117	1010	624	216	168	2	0	0

- Molecule 48 is a protein called 60S ribosomal protein L4.

Mol	Chain	Residues	Atoms					AltConf	Trace
			Total	C	N	O	S		
48	SA	358	2853	1797	570	473	13	0	0

- Molecule 49 is a protein called 60S ribosomal protein L5.

Mol	Chain	Residues	Atoms					AltConf	Trace
			Total	C	N	O	S		
49	SB	254	2057	1303	365	376	13	0	0

- Molecule 50 is a protein called 60S ribosomal protein L6.

Mol	Chain	Residues	Atoms					AltConf	Trace
			Total	C	N	O	S		
50	SC	217	1743	1121	332	286	4	0	0

- Molecule 51 is a protein called 60S ribosomal protein L7.

Mol	Chain	Residues	Atoms					AltConf	Trace
			Total	C	N	O	S		
51	SD	225	1870	1202	358	301	9	0	0

- Molecule 52 is a protein called 60S ribosomal protein L7a.

Mol	Chain	Residues	Atoms					AltConf	Trace
			Total	C	N	O	S		
52	SE	233	1885	1202	364	315	4	1	0

- Molecule 53 is a protein called 60S ribosomal protein L8.

Mol	Chain	Residues	Atoms					AltConf	Trace
			Total	C	N	O	S		
53	SF	245	1876	1177	383	310	6	0	0

- Molecule 54 is a protein called 60S ribosomal protein L9.

Mol	Chain	Residues	Atoms					AltConf	Trace
			Total	C	N	O	S		
54	SG	190	1518	956	284	272	6	0	0

- Molecule 55 is a protein called 60S ribosomal protein L7-like 1.

Mol	Chain	Residues	Atoms				AltConf	Trace
			Total	C	N	O		
55	SI	31	154	92	31	31	0	0

- Molecule 56 is a protein called Eukaryotic translation initiation factor 6.

Mol	Chain	Residues	Atoms					AltConf	Trace
			Total	C	N	O	S		
56	SK	244	1852	1149	318	372	13	0	0

- Molecule 57 is a protein called Pescadillo homolog.

Mol	Chain	Residues	Atoms				AltConf	Trace
			Total	C	N	O		
57	SM	399	1976	1178	399	399	0	0

- Molecule 58 is a protein called mRNA turnover protein 4 homolog.

Mol	Chain	Residues	Atoms					AltConf	Trace
			Total	C	N	O	S		
58	SQ	217	1778	1134	313	320	11	1	0

- Molecule 59 is a protein called GTP-binding protein 4.

Mol	Chain	Residues	Atoms					AltConf	Trace
			Total	C	N	O	S		
59	SR	593	4875	3066	891	892	26	1	0

- Molecule 60 is a protein called Probable ribosome biogenesis protein RLP24.

Mol	Chain	Residues	Atoms					AltConf	Trace
			Total	C	N	O	S		
60	SV	139	1184	754	229	191	10	0	0

- Molecule 61 is MAGNESIUM ION (three-letter code: MG) (formula: Mg).

Mol	Chain	Residues	Atoms		AltConf
61	L1	4	Total	Mg	0
			4	4	
61	L3	87	Total	Mg	0
			87	87	
61	L4	1	Total	Mg	0
			1	1	
61	L9	1	Total	Mg	0
			1	1	
61	LQ	1	Total	Mg	0
			1	1	
61	LT	1	Total	Mg	0
			1	1	

Continued on next page...

Continued from previous page...

Mol	Chain	Residues	Atoms		AltConf
61	LW	1	Total	Mg	0
			1	1	
61	NC	1	Total	Mg	0
			1	1	
61	SA	1	Total	Mg	0
			1	1	
61	SF	1	Total	Mg	0
			1	1	

- Molecule 62 is ZINC ION (three-letter code: ZN) (formula: Zn).

Mol	Chain	Residues	Atoms		AltConf
62	LR	1	Total	Zn	0
			1	1	
62	LW	1	Total	Zn	0
			1	1	
62	LX	1	Total	Zn	0
			1	1	
62	NP	1	Total	Zn	0
			1	1	
62	SV	1	Total	Zn	0
			1	1	

- Molecule 63 is GUANOSINE-5'-TRIPHOSPHATE (three-letter code: GTP) (formula: $C_{10}H_{16}N_5O_{14}P_3$).

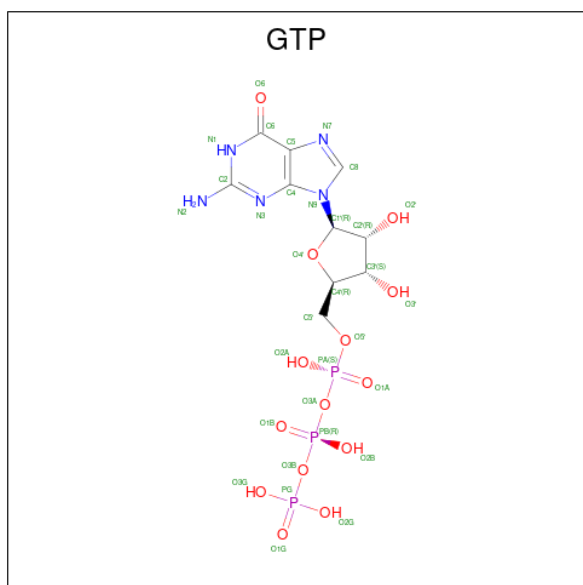

Mol	Chain	Residues	Atoms				AltConf	
			Total	C	N	O		P
63	NC	1	32	10	5	14	3	0

- Molecule 64 is POTASSIUM ION (three-letter code: K) (formula: K).

Mol	Chain	Residues	Atoms		AltConf
			Total	K	
64	NC	1	1	1	0
64	SR	1	1	1	0

- Molecule 65 is GUANOSINE-5'-DIPHOSPHATE (three-letter code: GDP) (formula: C₁₀H₁₅N₅O₁₁P₂).

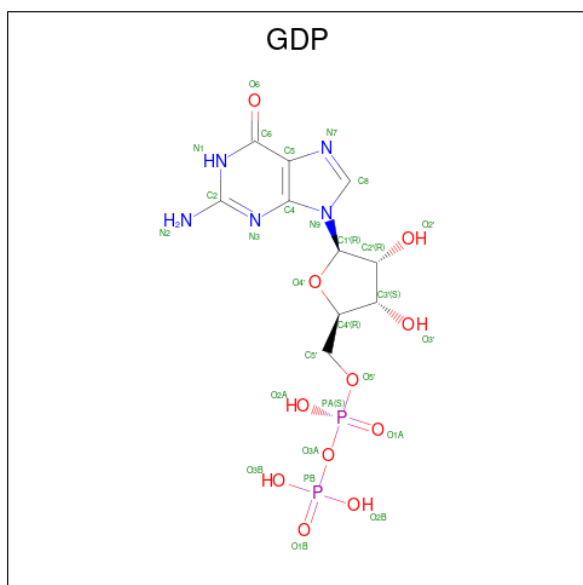

Mol	Chain	Residues	Atoms				AltConf	
			Total	C	N	O		P
65	SR	1	28	10	5	11	2	0

3 Residue-property plots i

These plots are drawn for all protein, RNA, DNA and oligosaccharide chains in the entry. The first graphic for a chain summarises the proportions of the various outlier classes displayed in the second graphic. The second graphic shows the sequence view annotated by issues in geometry and atom inclusion in map density. Residues are color-coded according to the number of geometric quality criteria for which they contain at least one outlier: green = 0, yellow = 1, orange = 2 and red = 3 or more. A red diamond above a residue indicates a poor fit to the EM map for this residue (all-atom inclusion < 40%). Stretches of 2 or more consecutive residues without any outlier are shown as a green connector. Residues present in the sample, but not in the model, are shown in grey.

- Molecule 1: 60S ribosomal protein L12

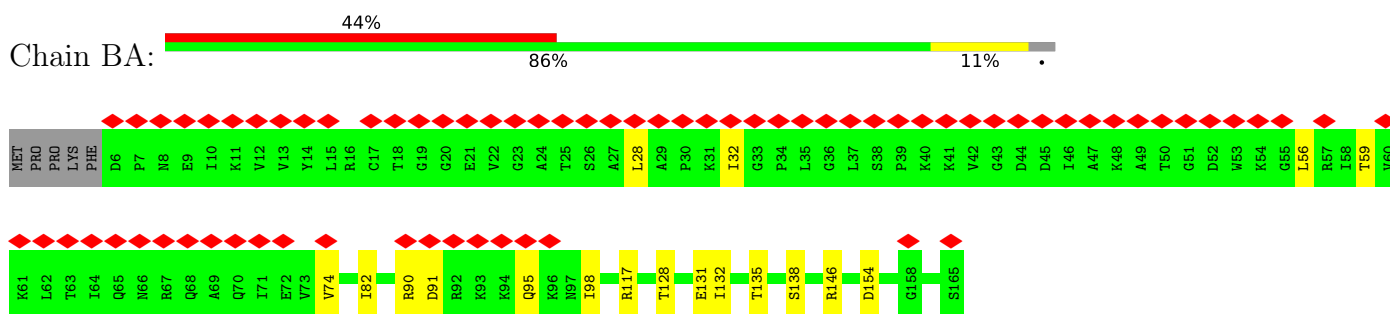

- Molecule 2: 60S ribosomal protein L10a

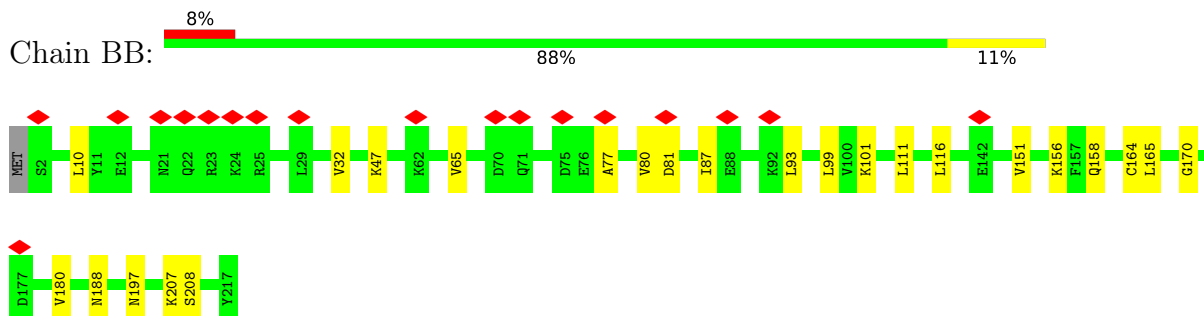

- Molecule 3: Ribosomal biogenesis protein LAS1L

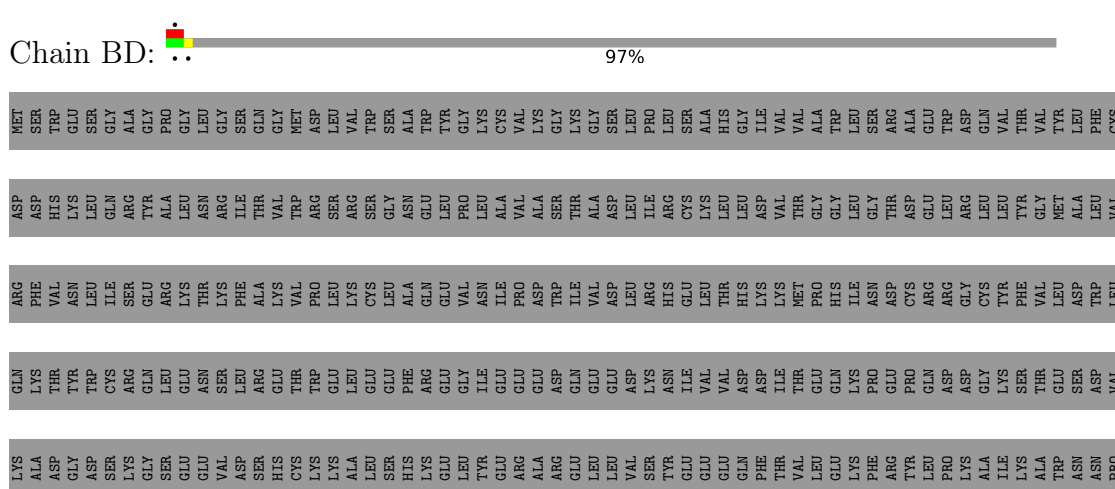

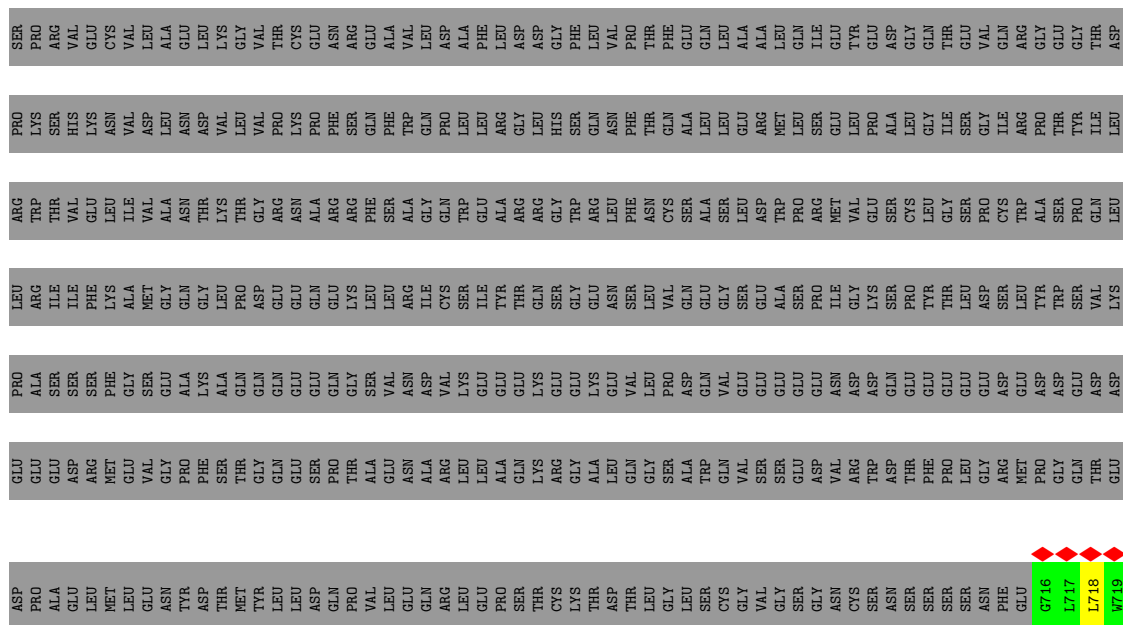

• Molecule 4: 5.8S rRNA

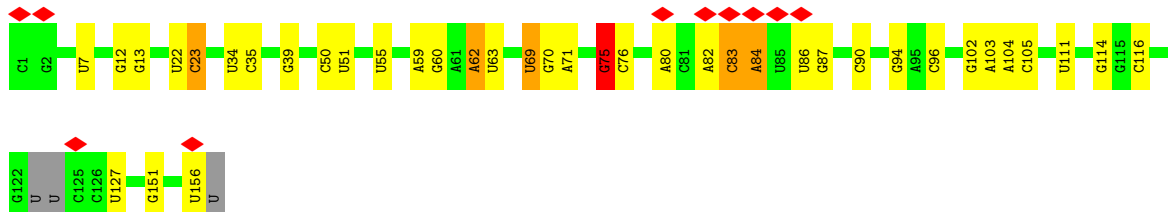
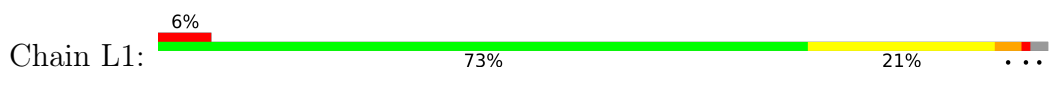

• Molecule 5: 28S rRNA

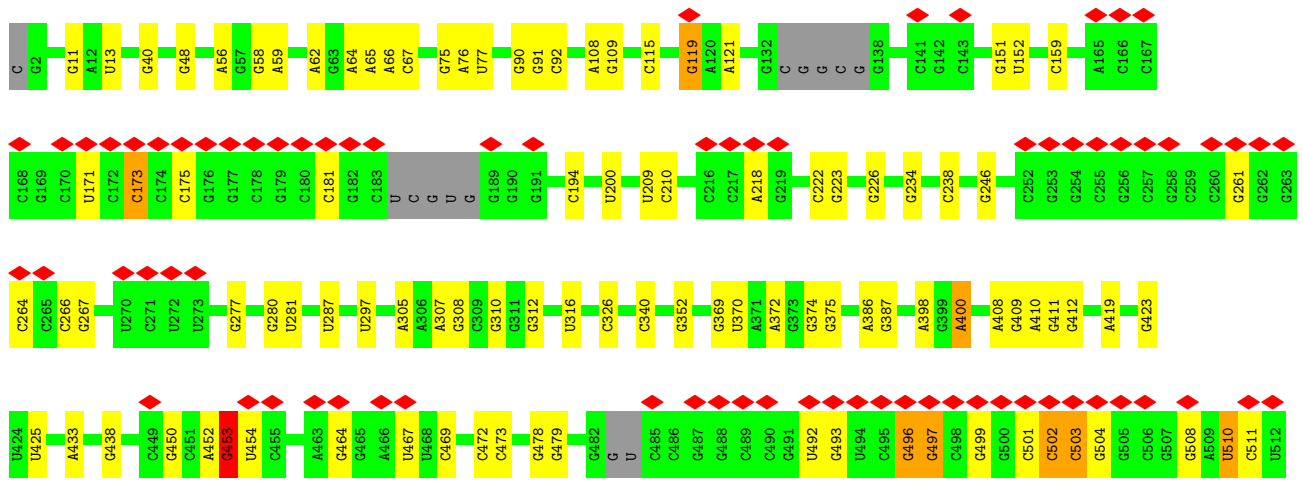

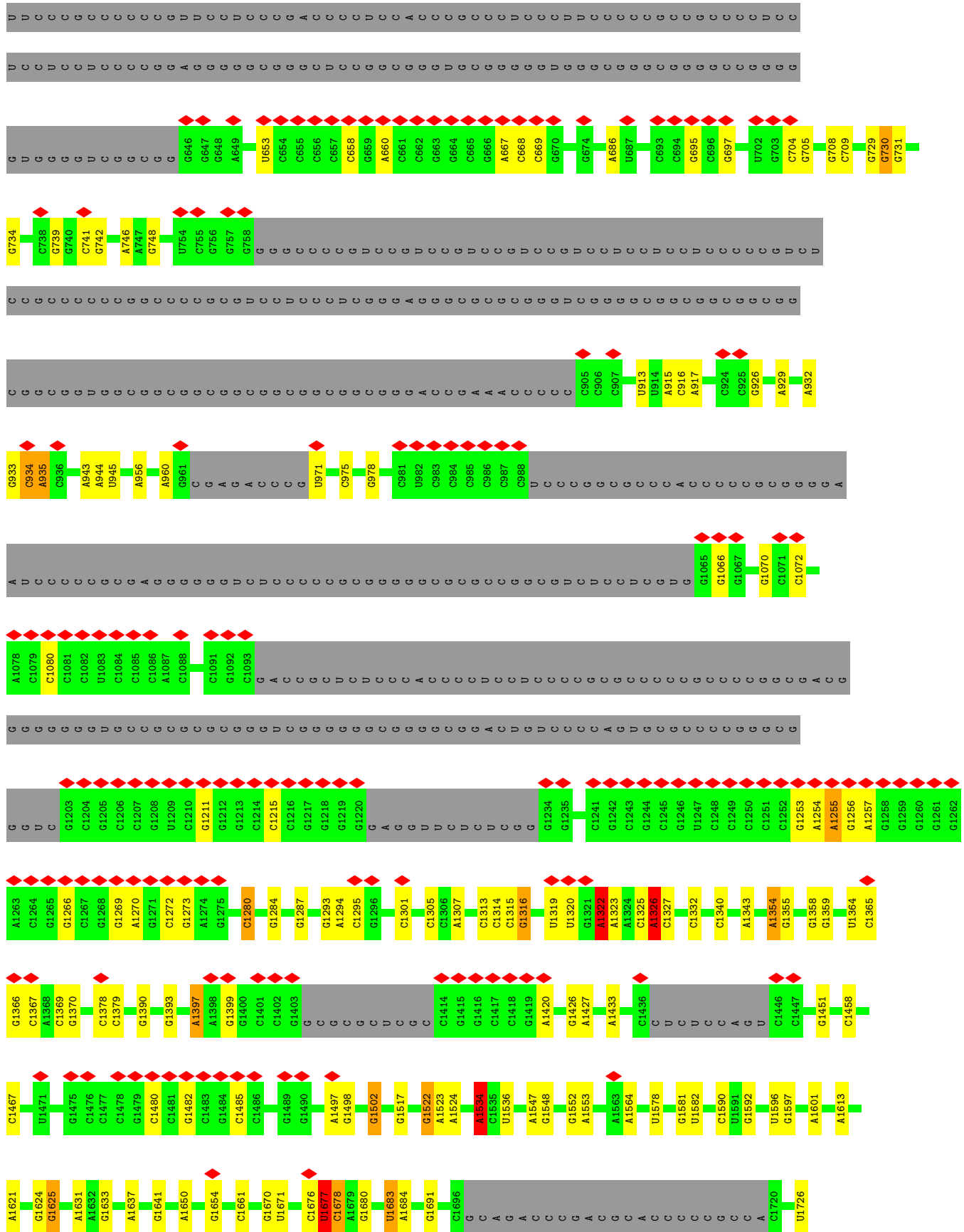

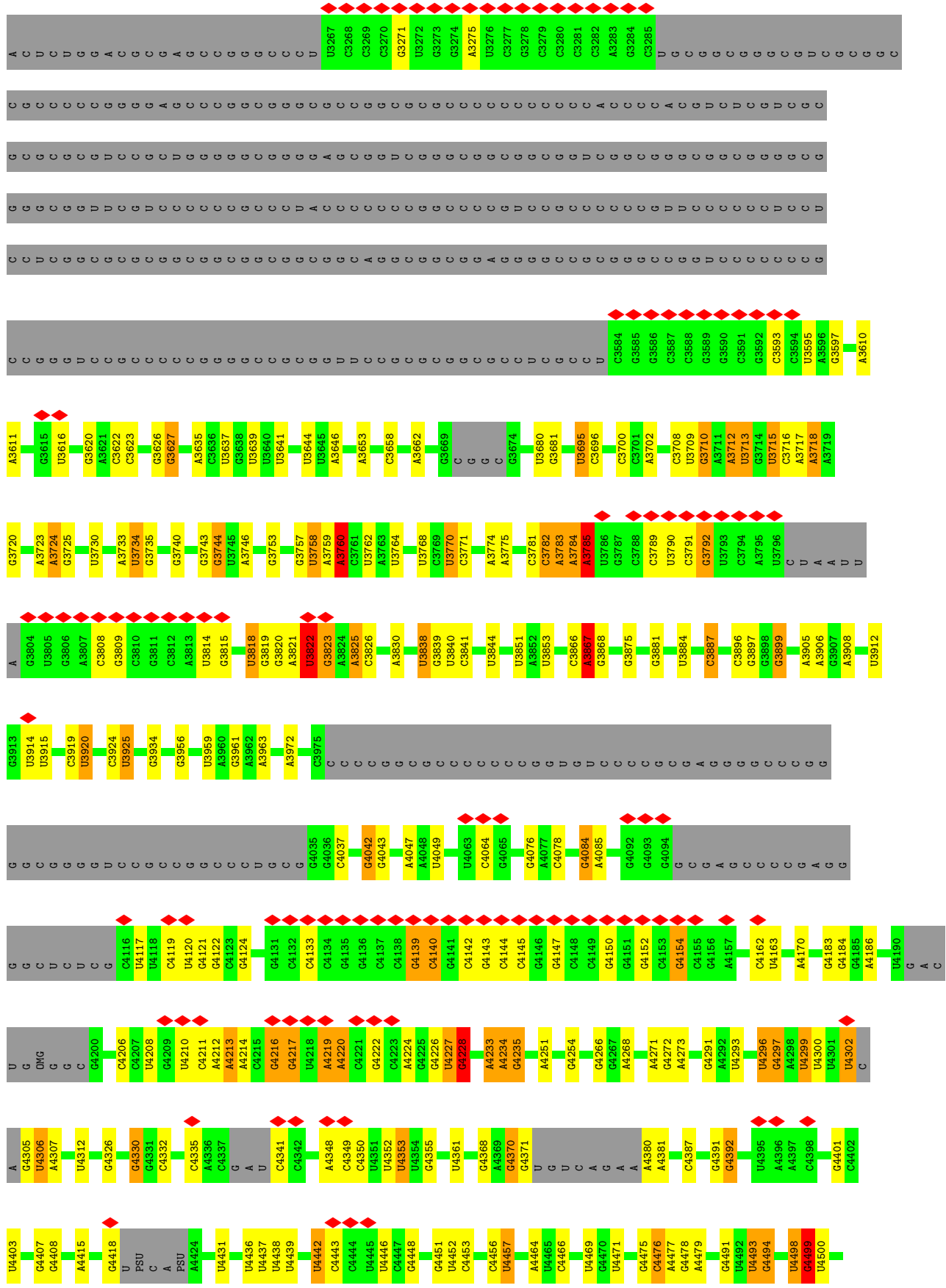

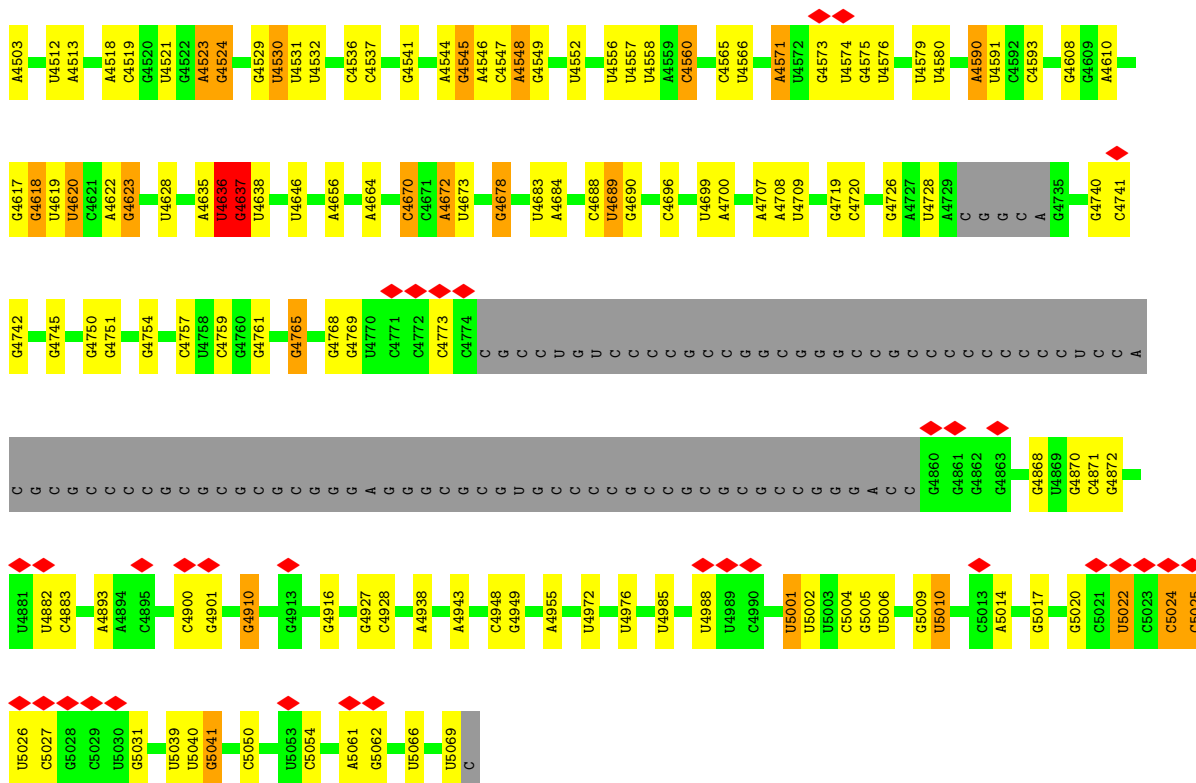

• Molecule 6: 5S rRNA

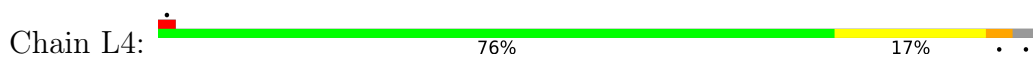

• Molecule 7: 60S ribosomal protein L11

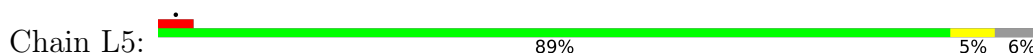

• Molecule 8: 60S ribosomal protein L13

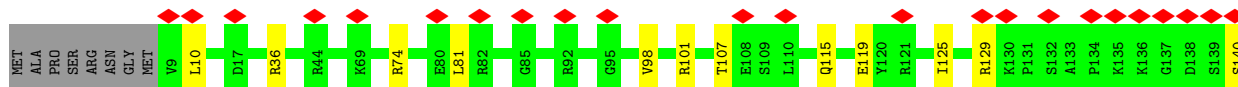
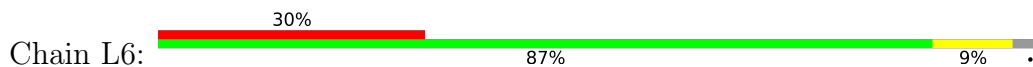

• Molecule 9: 60S ribosomal protein L13a

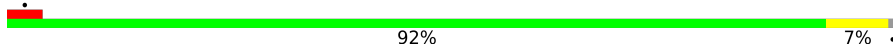
Chain L7:  92% 7%

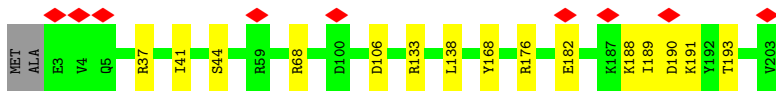

- Molecule 10: 60S ribosomal protein L14

Chain L8:  6% 58% 5% 37%

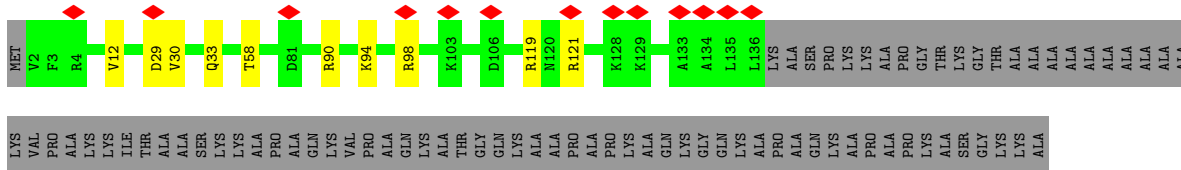

- Molecule 11: 60S ribosomal protein L15

Chain L9:  10% 87% 8% 5%

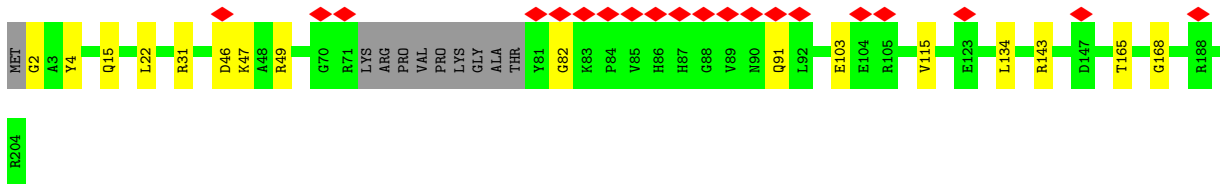

- Molecule 12: 60S ribosomal protein L17

Chain LA:  5% 77% 6% 17%

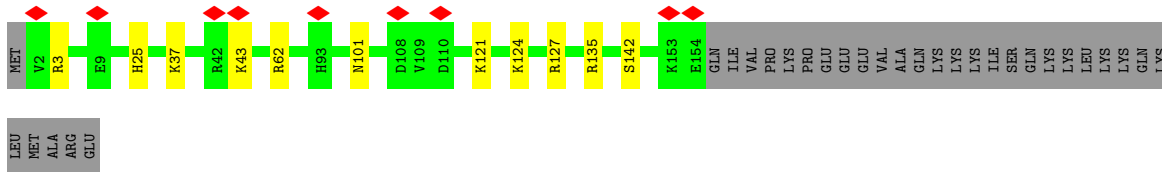

- Molecule 13: 60S ribosomal protein L18

Chain LB:  10% 72% 8% 20%

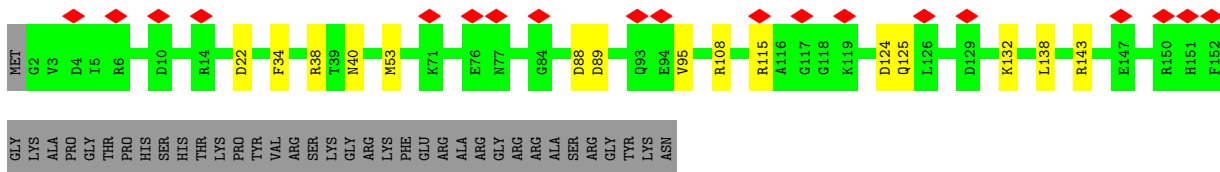

- Molecule 14: 60S ribosomal protein L18a

Chain LC:  94% 6%



- Molecule 15: 60S ribosomal protein L19

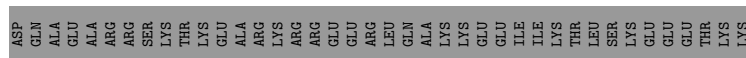
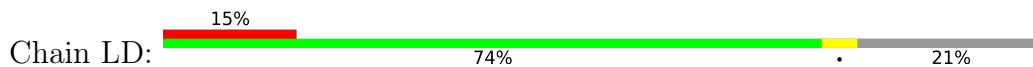

- Molecule 16: 60S ribosomal protein L21

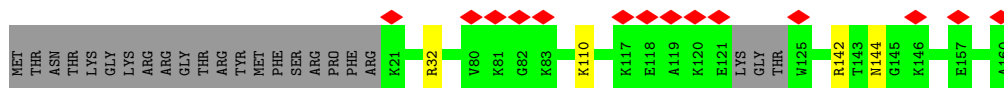
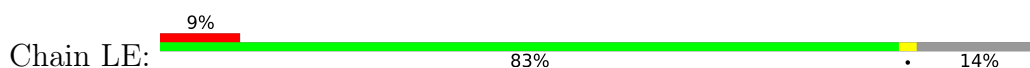

- Molecule 17: 60S ribosomal protein L22

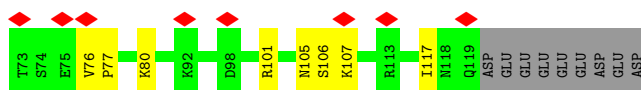
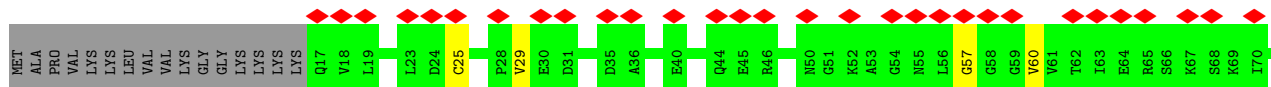
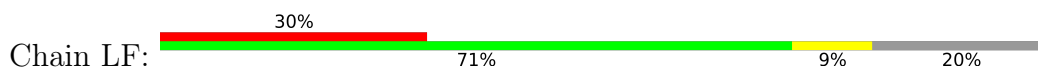

- Molecule 18: 60S ribosomal protein L23

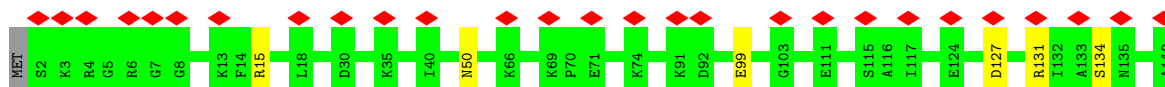

- Molecule 19: 60S ribosomal protein L23a

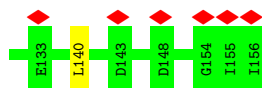
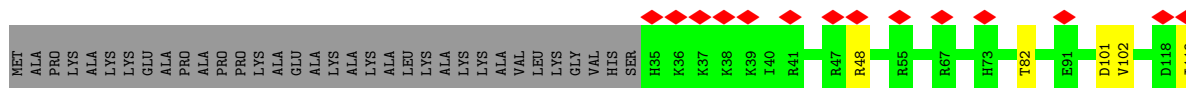
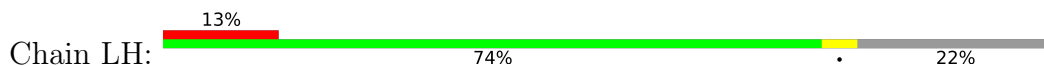

• Molecule 20: 60S ribosomal protein L26

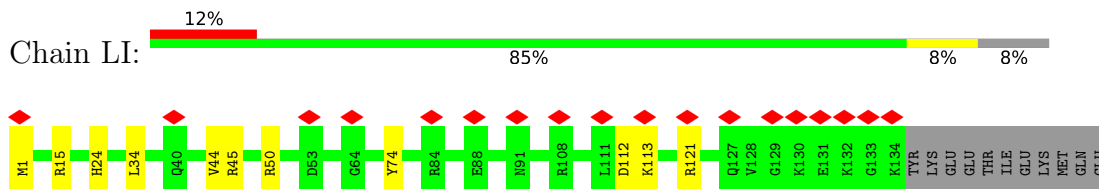

• Molecule 21: 60S ribosomal protein L27

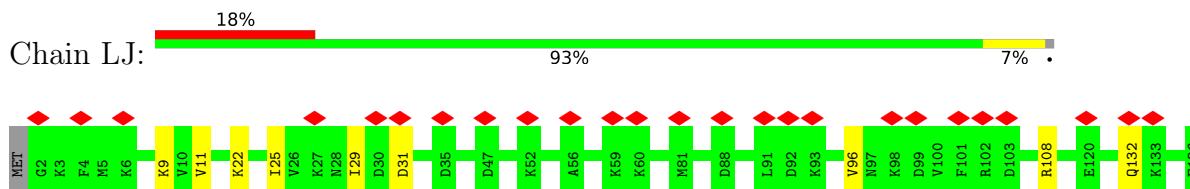

• Molecule 22: 60S ribosomal protein L27a

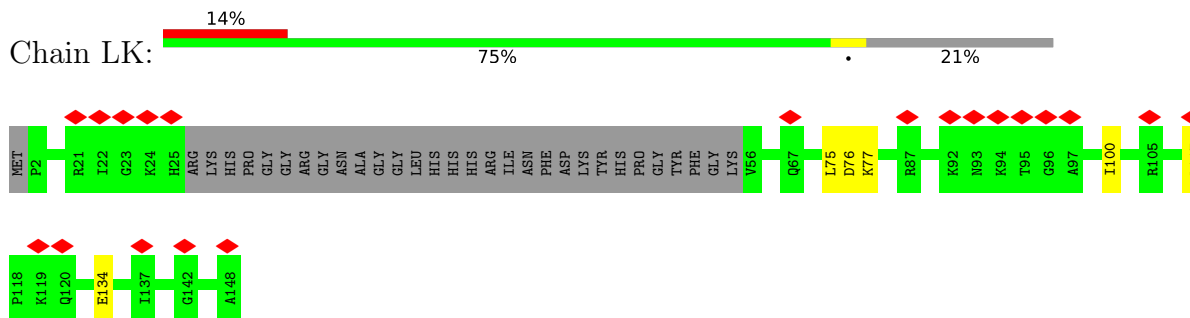

• Molecule 23: 60S ribosomal protein L28

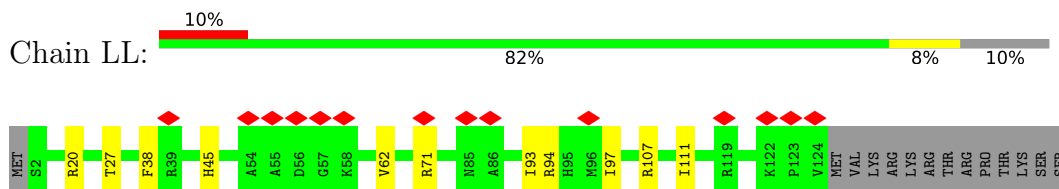

• Molecule 24: 60S ribosomal protein L3

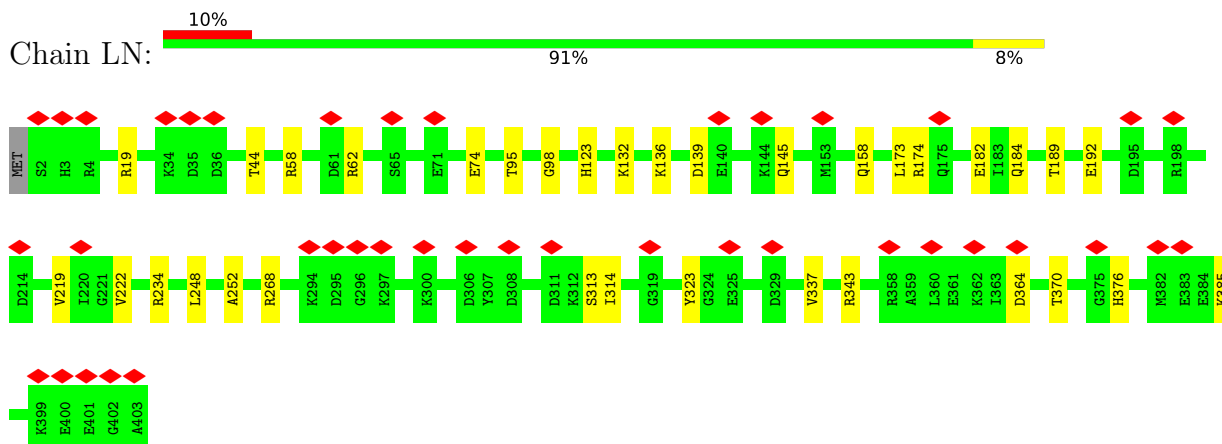

• Molecule 25: 60S ribosomal protein L30

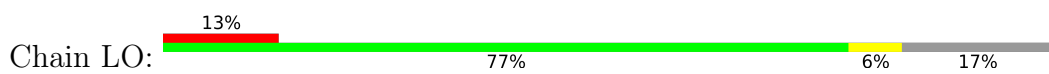

• Molecule 26: 60S ribosomal protein L31

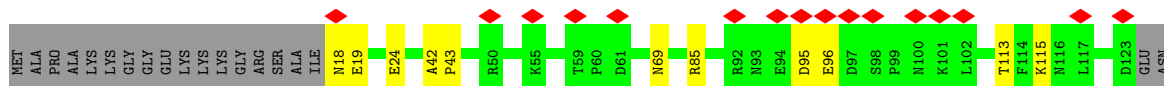
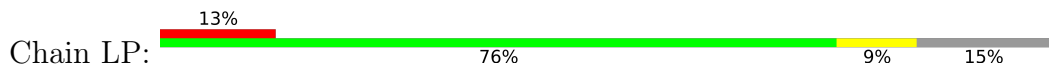

• Molecule 27: 60S ribosomal protein L32

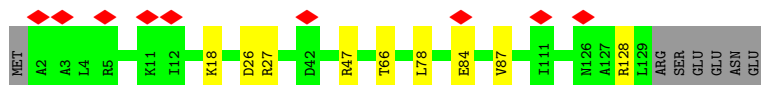
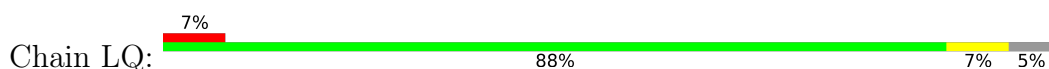

• Molecule 28: 60S ribosomal protein L34

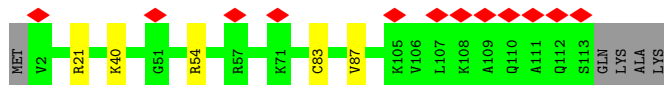

• Molecule 29: 60S ribosomal protein L35

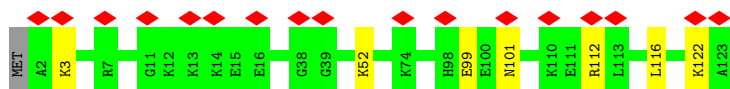
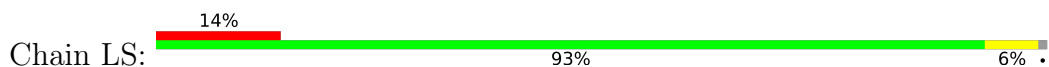

• Molecule 30: 60S ribosomal protein L35a

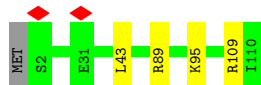

• Molecule 31: 60S ribosomal protein L36

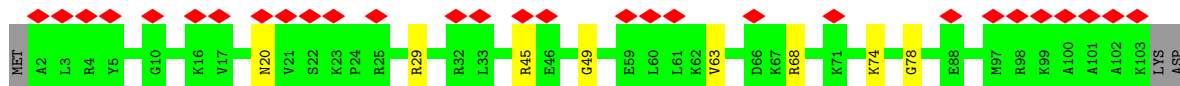
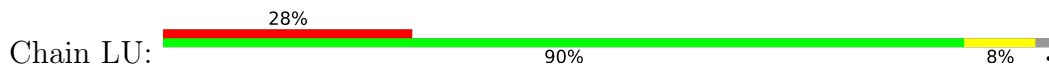

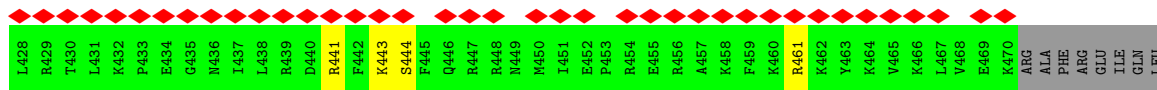

• Molecule 42: Zinc finger protein 593

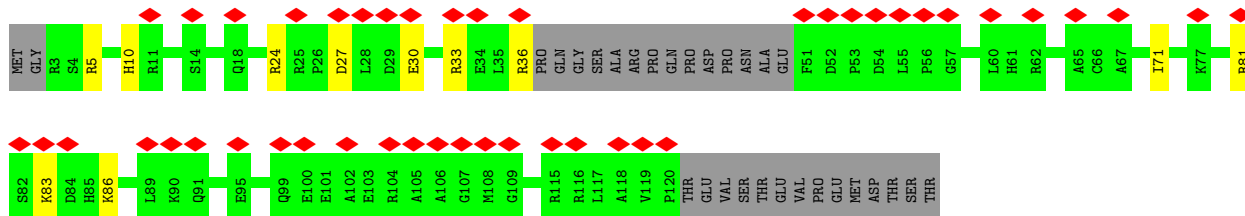
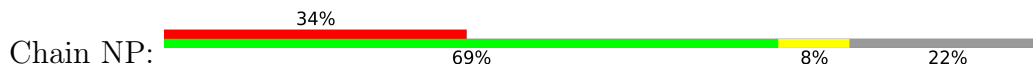

• Molecule 43: Protein SDA1 homolog

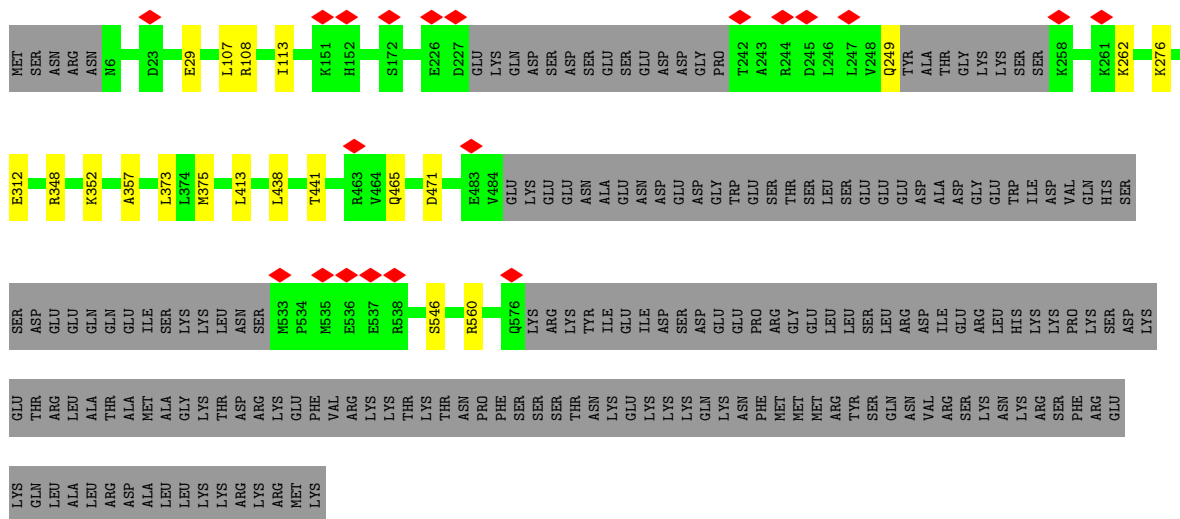

• Molecule 44: Testis-expressed protein 10

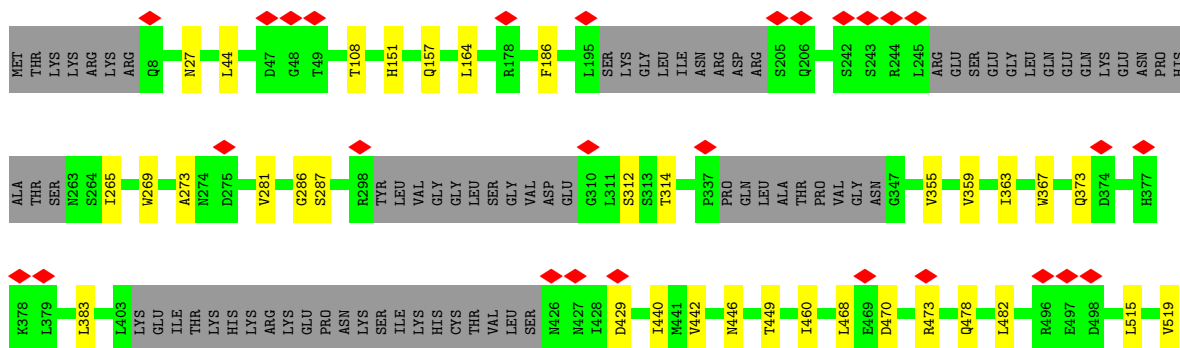
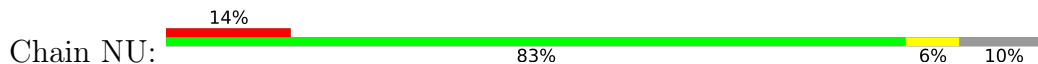

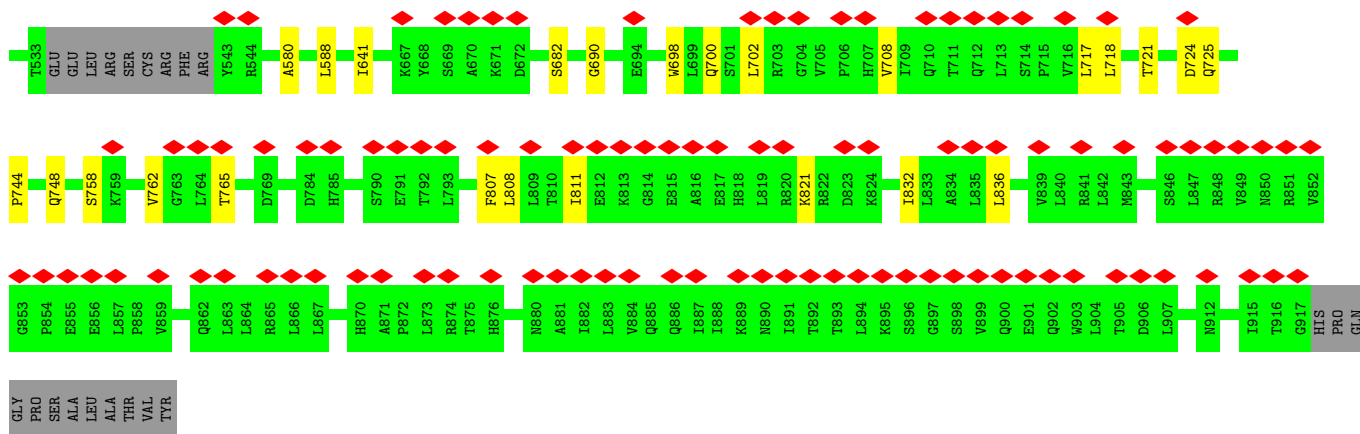

• Molecule 45: WD repeat-containing protein 18

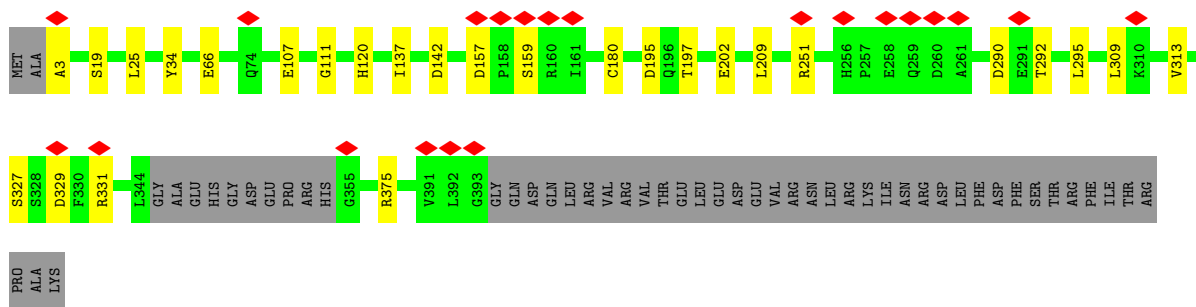
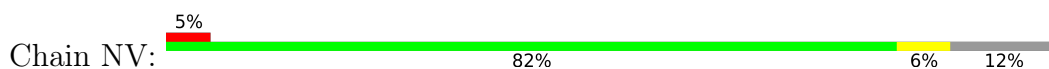

• Molecule 45: WD repeat-containing protein 18

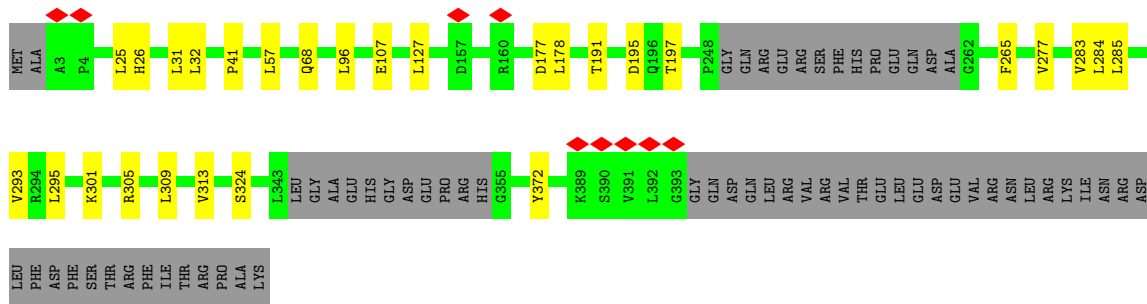
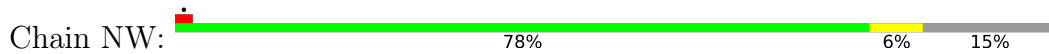

• Molecule 46: Proline-, glutamic acid- and leucine-rich protein 1

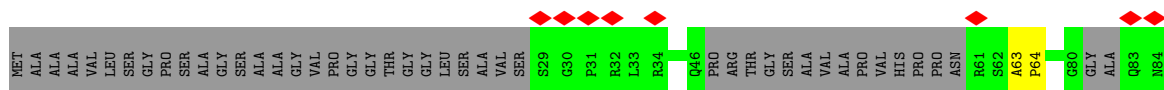

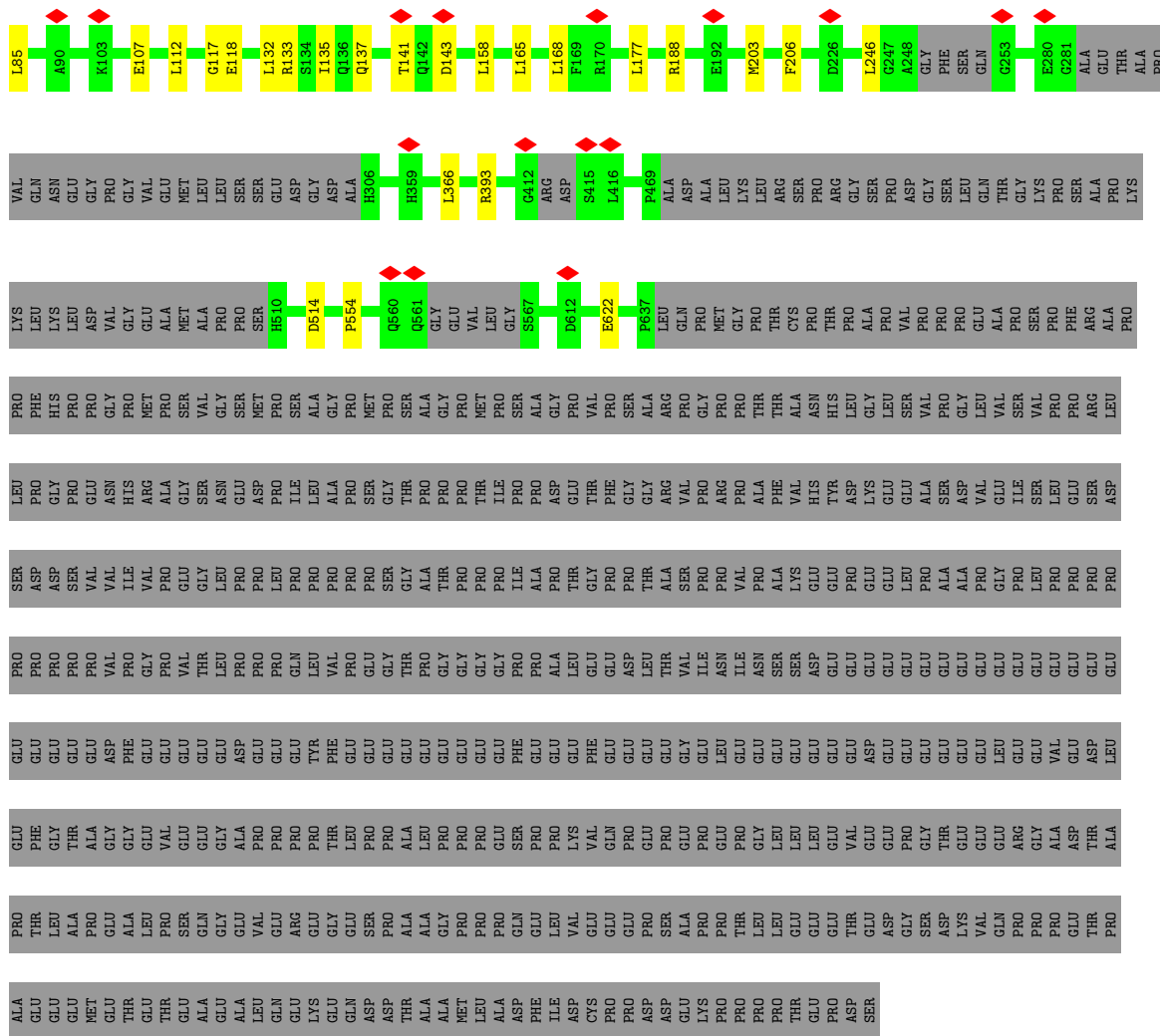

● Molecule 46: Proline-, glutamic acid- and leucine-rich protein 1

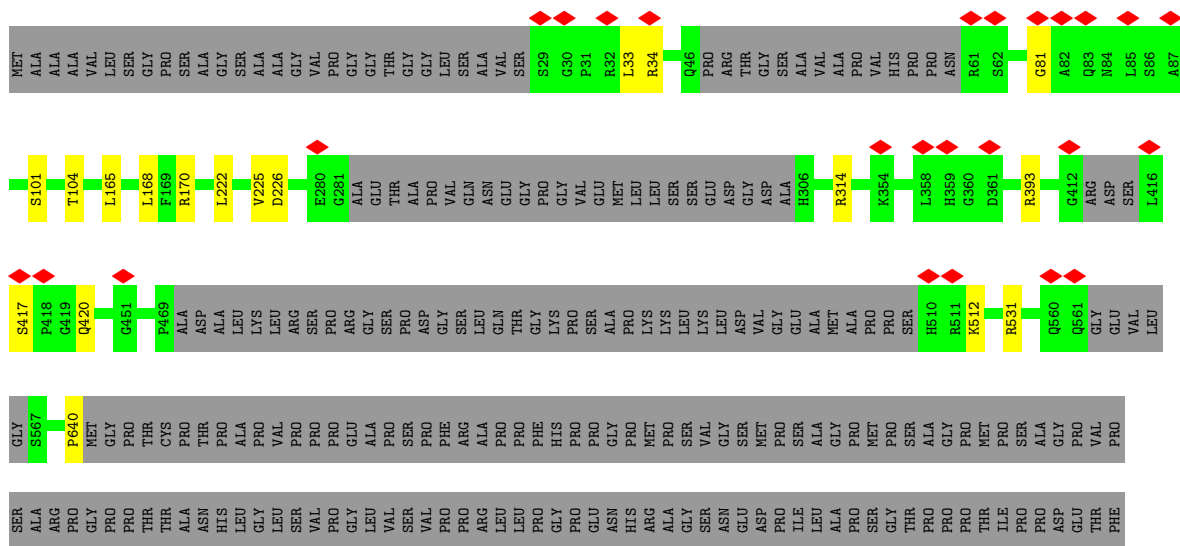

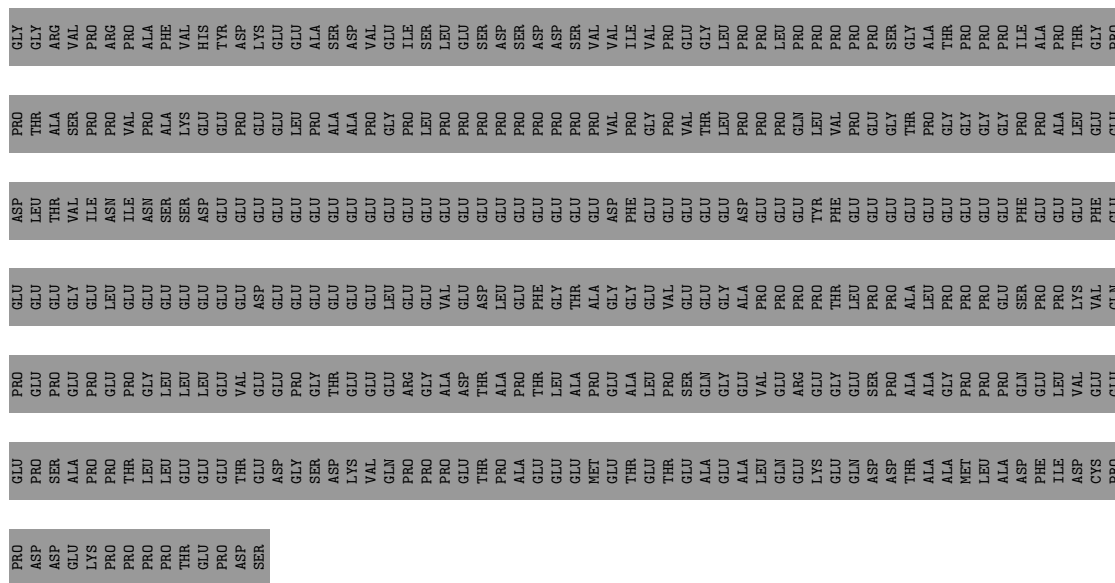

● Molecule 47: Coiled-coil domain-containing protein 86

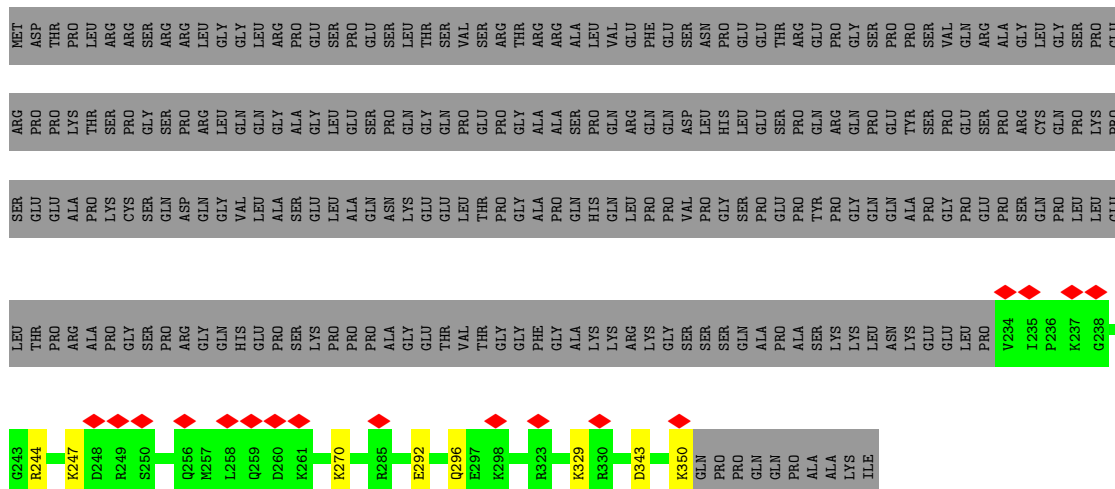

● Molecule 48: 60S ribosomal protein L4

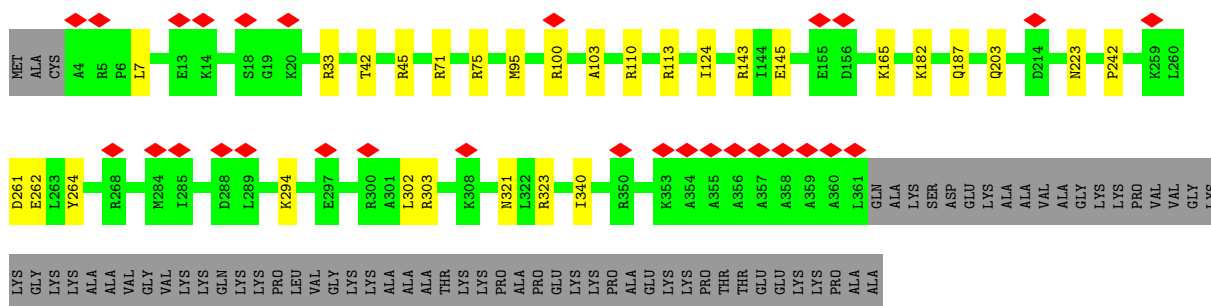
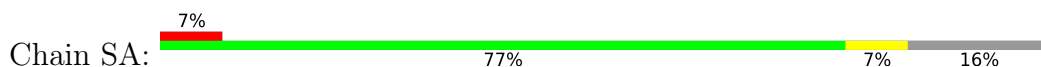

● Molecule 49: 60S ribosomal protein L5

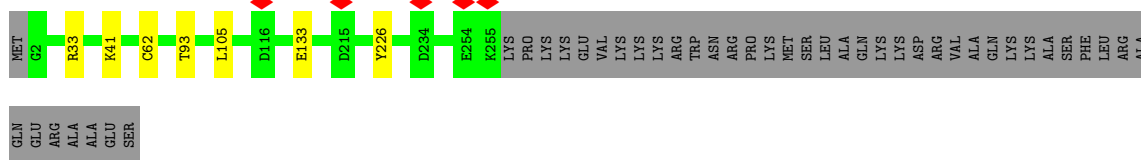
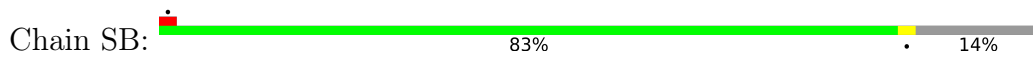

• Molecule 50: 60S ribosomal protein L6

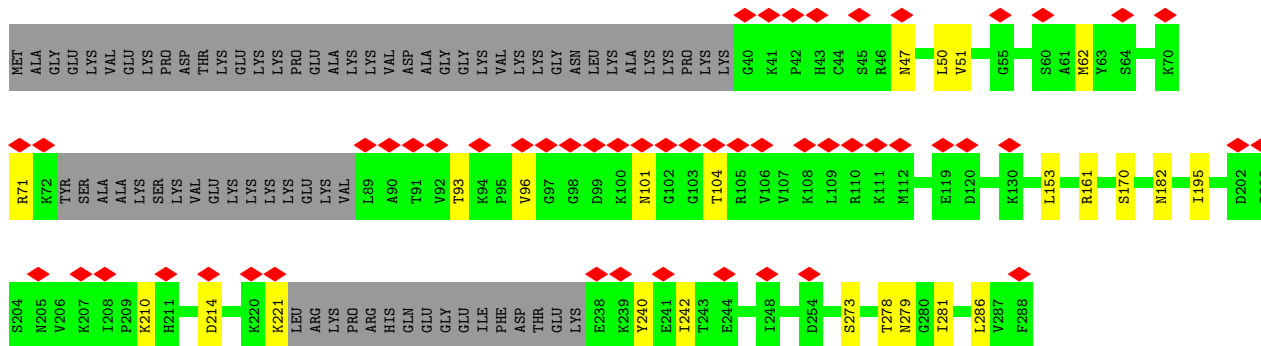

• Molecule 51: 60S ribosomal protein L7

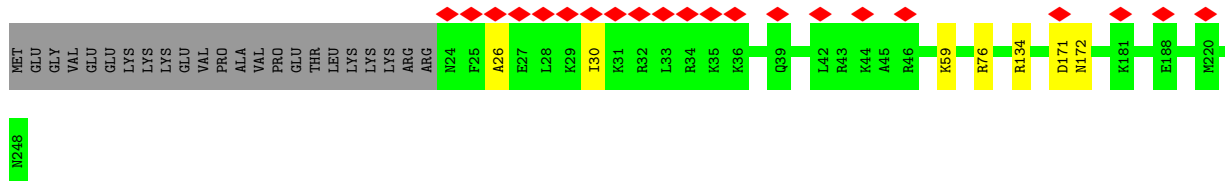
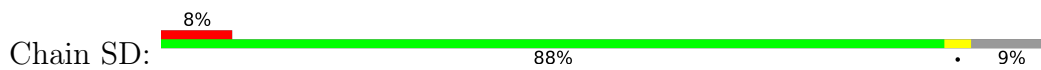

• Molecule 52: 60S ribosomal protein L7a

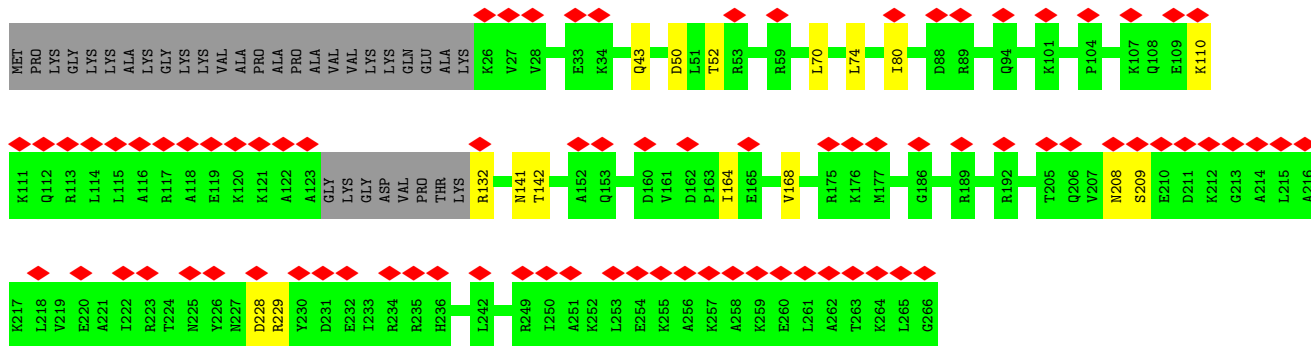
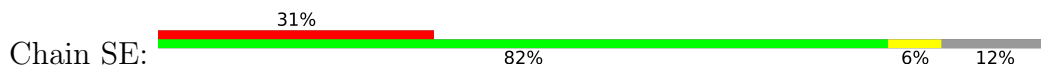

• Molecule 53: 60S ribosomal protein L8

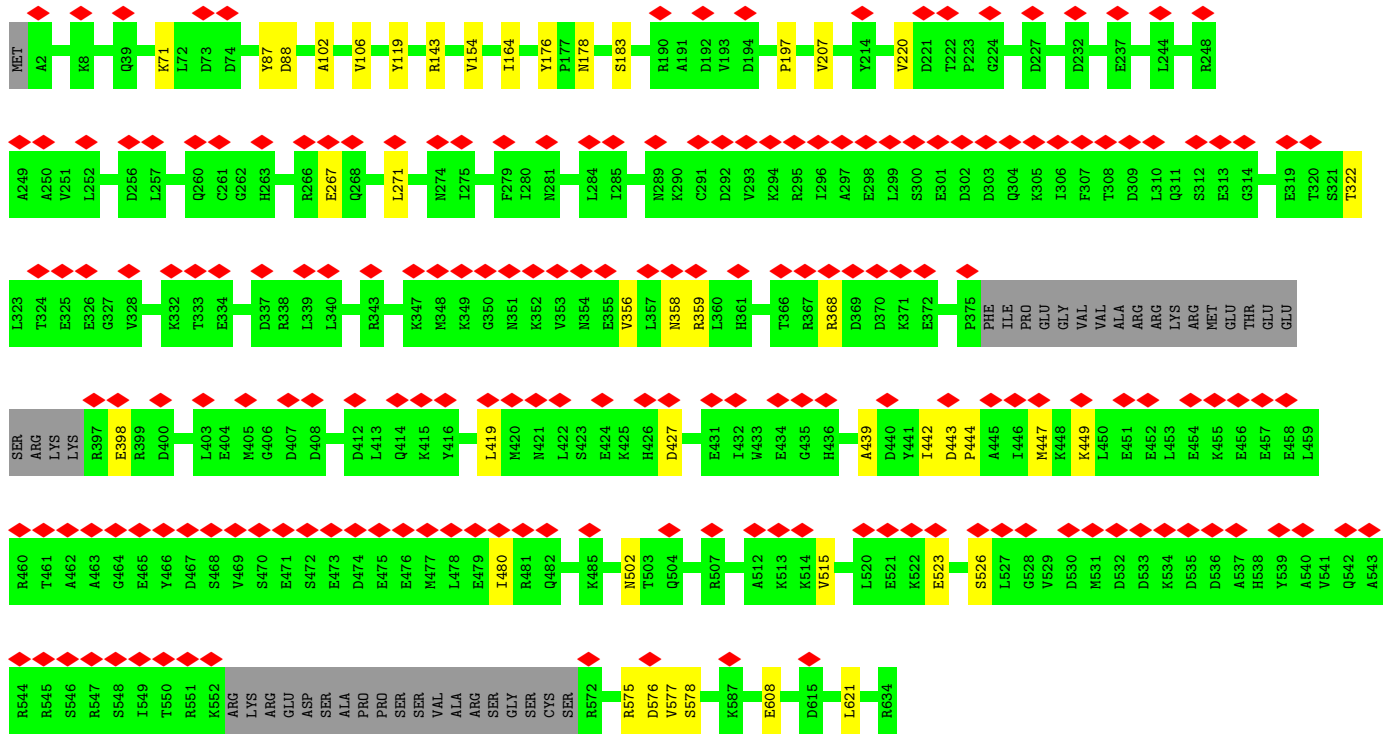

• Molecule 60: Probable ribosome biogenesis protein RLP24

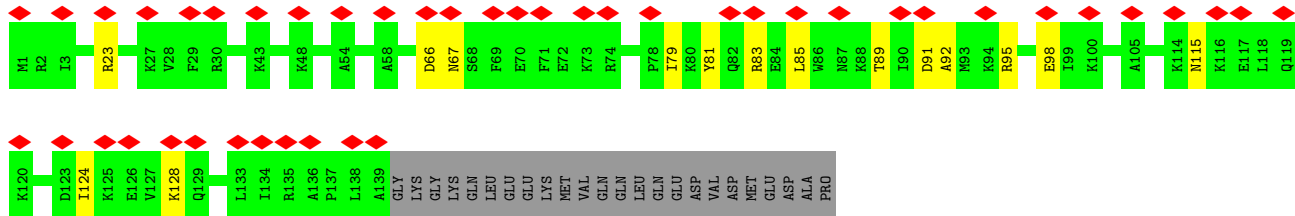
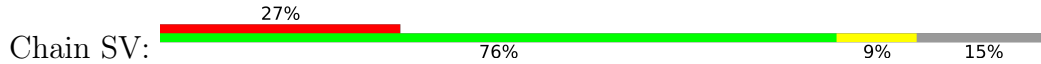

4 Experimental information

Property	Value	Source
EM reconstruction method	SINGLE PARTICLE	Depositor
Imposed symmetry	POINT, C1	Depositor
Number of particles used	22406	Depositor
Resolution determination method	FSC 0.143 CUT-OFF	Depositor
CTF correction method	PHASE FLIPPING AND AMPLITUDE CORRECTION	Depositor
Microscope	FEI TITAN KRIOS	Depositor
Voltage (kV)	300	Depositor
Electron dose ($e^-/\text{\AA}^2$)	60	Depositor
Minimum defocus (nm)	500	Depositor
Maximum defocus (nm)	2500	Depositor
Magnification	64000	Depositor
Image detector	GATAN K3 (6k x 4k)	Depositor
Maximum map value	7.513	Depositor
Minimum map value	-0.842	Depositor
Average map value	0.054	Depositor
Map value standard deviation	0.170	Depositor
Recommended contour level	0.95	Depositor
Map size (Å)	514.56, 514.56, 514.56	wwPDB
Map dimensions	480, 480, 480	wwPDB
Map angles (°)	90.0, 90.0, 90.0	wwPDB
Pixel spacing (Å)	1.072, 1.072, 1.072	Depositor

5 Model quality i

5.1 Standard geometry i

Bond lengths and bond angles in the following residue types are not validated in this section: HIC, 1MA, PSU, OMG, UR3, 6MZ, GTP, K, OMU, MG, ZN, GDP, A2M, 5MC, OMC

The Z score for a bond length (or angle) is the number of standard deviations the observed value is removed from the expected value. A bond length (or angle) with $|Z| > 5$ is considered an outlier worth inspection. RMSZ is the root-mean-square of all Z scores of the bond lengths (or angles).

Mol	Chain	Bond lengths		Bond angles	
		RMSZ	# Z >5	RMSZ	# Z >5
1	BA	0.24	0/1224	0.51	0/1651
2	BB	0.25	0/1764	0.51	0/2365
3	BD	0.25	0/152	0.47	0/202
4	L1	0.25	0/3589	0.72	1/5589 (0.0%)
5	L3	0.25	0/80734	0.76	5/125915 (0.0%)
6	L4	0.30	0/2784	0.77	0/4336
7	L5	0.26	0/1372	0.57	0/1836
8	L6	0.25	0/1682	0.58	0/2248
9	L7	0.25	0/1682	0.54	0/2250
10	L8	0.25	0/1133	0.52	0/1516
11	L9	0.25	0/1677	0.61	0/2243
12	LA	0.25	0/1279	0.53	0/1716
13	LB	0.24	0/1239	0.61	0/1658
14	LC	0.27	0/1501	0.56	0/2013
15	LD	0.23	0/1305	0.60	0/1727
16	LE	0.27	0/1146	0.52	0/1533
17	LF	0.26	0/856	0.51	0/1149
18	LG	0.26	0/1048	0.55	0/1402
19	LH	0.24	0/1022	0.52	0/1371
20	LI	0.25	0/1132	0.57	0/1504
21	LJ	0.26	0/1130	0.53	0/1507
22	LK	0.24	0/935	0.54	0/1249
23	LL	0.24	0/1002	0.58	0/1344
24	LN	0.25	0/3294	0.53	0/4406
25	LO	0.26	0/748	0.50	0/1004
26	LP	0.25	0/894	0.58	0/1204
27	LQ	0.24	0/1071	0.56	0/1429
28	LR	0.25	0/898	0.60	0/1197
29	LS	0.27	0/1023	0.57	0/1351
30	LT	0.26	0/895	0.61	0/1198
31	LU	0.25	0/843	0.59	0/1115
32	LW	0.25	0/720	0.64	0/952

Mol	Chain	Bond lengths		Bond angles	
		RMSZ	# Z >5	RMSZ	# Z >5
33	LX	0.25	0/718	0.54	0/953
34	LY	0.25	0/575	0.51	0/761
35	LZ	0.24	0/454	0.61	0/599
36	NB	0.26	0/701	0.55	0/920
37	NC	0.24	0/4175	0.49	0/5621
38	NF	0.26	0/1929	0.52	0/2579
39	NJ	0.27	0/3024	0.57	0/4099
40	NK	0.24	0/587	0.59	0/767
41	NL	0.25	0/2122	0.57	0/2842
42	NP	0.25	0/864	0.60	0/1154
43	NT	0.26	0/4144	0.46	0/5575
44	NU	0.25	0/6590	0.46	0/8941
45	NV	0.25	0/2987	0.51	0/4065
45	NW	0.27	0/2853	0.51	0/3883
46	NX	0.24	0/3993	0.49	0/5410
46	NY	0.25	0/4054	0.48	0/5496
47	NZ	0.24	0/1020	0.61	0/1343
48	SA	0.24	0/2907	0.56	0/3905
49	SB	0.27	0/2098	0.54	0/2817
50	SC	0.25	0/1776	0.55	0/2381
51	SD	0.26	0/1905	0.54	0/2539
52	SE	0.25	0/1919	0.55	0/2580
53	SF	0.26	0/1914	0.60	0/2567
54	SG	0.24	0/1537	0.53	0/2066
55	SI	0.22	0/153	0.29	0/212
56	SK	0.24	0/1877	0.51	0/2554
57	SM	0.23	0/1973	0.41	0/2746
58	SQ	0.25	0/1817	0.51	0/2435
59	SR	0.25	0/4959	0.52	0/6654
60	SV	0.26	0/1207	0.55	0/1600
All	All	0.25	0/188606	0.65	6/272244 (0.0%)

There are no bond length outliers.

The worst 5 of 6 bond angle outliers are listed below:

Mol	Chain	Res	Type	Atoms	Z	Observed(°)	Ideal(°)
5	L3	2469	C	C2-N1-C1'	8.09	127.70	118.80
5	L3	971	U	C2-N1-C1'	6.07	124.98	117.70
5	L3	1854	G	O4'-C1'-N9	6.04	113.03	108.20
5	L3	453	G	C4-N9-C1'	5.79	134.03	126.50
5	L3	2469	C	C6-N1-C1'	-5.75	113.90	120.80

There are no chirality outliers.

There are no planarity outliers.

5.2 Too-close contacts

In the following table, the Non-H and H(model) columns list the number of non-hydrogen atoms and hydrogen atoms in the chain respectively. The H(added) column lists the number of hydrogen atoms added and optimized by MolProbity. The Clashes column lists the number of clashes within the asymmetric unit, whereas Symm-Clashes lists symmetry-related clashes.

Mol	Chain	Non-H	H(model)	H(added)	Clashes	Symm-Clashes
1	BA	1208	0	1257	13	0
2	BB	1736	0	1847	15	0
3	BD	149	0	152	4	0
4	L1	3278	0	1665	21	0
5	L3	74838	0	37916	380	0
6	L4	2494	0	1263	14	0
7	L5	1349	0	1383	7	0
8	L6	1652	0	1770	18	0
9	L7	1650	0	1794	13	0
10	L8	1111	0	1174	8	0
11	L9	1635	0	1671	15	0
12	LA	1249	0	1276	10	0
13	LB	1223	0	1330	14	0
14	LC	1461	0	1502	8	0
15	LD	1289	0	1429	8	0
16	LE	1119	0	1177	2	0
17	LF	842	0	864	9	0
18	LG	1034	0	1097	7	0
19	LH	1004	0	1086	5	0
20	LI	1115	0	1205	9	0
21	LJ	1107	0	1182	8	0
22	LK	918	0	985	5	0
23	LL	987	0	1050	8	0
24	LN	3239	0	3377	30	0
25	LO	738	0	774	4	0
26	LP	879	0	924	6	0
27	LQ	1053	0	1147	8	0
28	LR	888	0	977	3	0
29	LS	1015	0	1148	8	0
30	LT	876	0	912	3	0
31	LU	832	0	917	6	0
32	LW	705	0	737	7	0
33	LX	708	0	756	3	0

Continued on next page...

Continued from previous page...

Mol	Chain	Non-H	H(model)	H(added)	Clashes	Symm-Clashes
34	LY	569	0	637	7	0
35	LZ	444	0	483	3	0
36	NB	691	0	770	3	0
37	NC	4097	0	4176	19	0
38	NF	1891	0	2015	4	0
39	NJ	2951	0	2895	20	0
40	NK	581	0	656	6	0
41	NL	2091	0	2145	14	0
42	NP	847	0	854	12	0
43	NT	4072	0	4225	13	0
44	NU	6469	0	6478	41	0
45	NV	2915	0	2896	16	0
45	NW	2789	0	2781	18	0
46	NX	3926	0	4073	17	0
46	NY	3983	0	4129	12	0
47	NZ	1010	0	1106	7	0
48	SA	2853	0	3028	25	0
49	SB	2057	0	2050	6	0
50	SC	1743	0	1899	17	0
51	SD	1870	0	1996	6	0
52	SE	1885	0	2036	12	0
53	SF	1876	0	1970	14	0
54	SG	1518	0	1601	3	0
55	SI	154	0	80	0	0
56	SK	1852	0	1828	17	0
57	SM	1976	0	874	1	0
58	SQ	1778	0	1817	8	0
59	SR	4875	0	5008	33	0
60	SV	1184	0	1248	12	0
61	L1	4	0	0	0	0
61	L3	87	0	0	0	0
61	L4	1	0	0	0	0
61	L9	1	0	0	0	0
61	LQ	1	0	0	0	0
61	LT	1	0	0	0	0
61	LW	1	0	0	0	0
61	NC	1	0	0	0	0
61	SA	1	0	0	0	0
61	SF	1	0	0	0	0
62	LR	1	0	0	0	0
62	LW	1	0	0	0	0
62	LX	1	0	0	0	0

Continued on next page...

Continued from previous page...

Mol	Chain	Non-H	H(model)	H(added)	Clashes	Symm-Clashes
62	NP	1	0	0	0	0
62	SV	1	0	0	0	0
63	NC	32	0	12	0	0
64	NC	1	0	0	0	0
64	SR	1	0	0	0	0
65	SR	28	0	12	0	0
All	All	180494	0	143522	791	0

The all-atom clashscore is defined as the number of clashes found per 1000 atoms (including hydrogen atoms). The all-atom clashscore for this structure is 2.

The worst 5 of 791 close contacts within the same asymmetric unit are listed below, sorted by their clash magnitude.

Atom-1	Atom-2	Interatomic distance (Å)	Clash overlap (Å)
5:L3:3713:U:O4	5:L3:3740:G:N2	2.06	0.89
6:L4:40:U:O2	7:L5:75:ARG:NH1	2.05	0.88
5:L3:67:C:OP2	5:L3:312:G:N2	2.11	0.83
5:L3:3912:U:OP1	37:NC:49:ARG:NH2	2.12	0.83
5:L3:4620:OMU:OP2	5:L3:4670:C:N4	2.12	0.83

There are no symmetry-related clashes.

5.3 Torsion angles [i](#)

5.3.1 Protein backbone [i](#)

In the following table, the Percentiles column shows the percent Ramachandran outliers of the chain as a percentile score with respect to all PDB entries followed by that with respect to all EM entries.

The Analysed column shows the number of residues for which the backbone conformation was analysed, and the total number of residues.

Mol	Chain	Analysed	Favoured	Allowed	Outliers	Percentiles	
1	BA	158/165 (96%)	156 (99%)	2 (1%)	0	100	100
2	BB	214/217 (99%)	209 (98%)	5 (2%)	0	100	100
3	BD	17/734 (2%)	17 (100%)	0	0	100	100
7	L5	166/178 (93%)	163 (98%)	3 (2%)	0	100	100
8	L6	201/211 (95%)	197 (98%)	4 (2%)	0	100	100

Continued on next page...

Continued from previous page...

Mol	Chain	Analysed	Favoured	Allowed	Outliers	Percentiles	
9	L7	199/203 (98%)	198 (100%)	1 (0%)	0	100	100
10	L8	133/215 (62%)	132 (99%)	1 (1%)	0	100	100
11	L9	190/204 (93%)	186 (98%)	4 (2%)	0	100	100
12	LA	152/184 (83%)	148 (97%)	4 (3%)	0	100	100
13	LB	149/188 (79%)	149 (100%)	0	0	100	100
14	LC	174/176 (99%)	171 (98%)	3 (2%)	0	100	100
15	LD	152/196 (78%)	151 (99%)	1 (1%)	0	100	100
16	LE	134/160 (84%)	130 (97%)	4 (3%)	0	100	100
17	LF	101/128 (79%)	98 (97%)	3 (3%)	0	100	100
18	LG	137/140 (98%)	136 (99%)	1 (1%)	0	100	100
19	LH	120/156 (77%)	119 (99%)	1 (1%)	0	100	100
20	LI	132/145 (91%)	130 (98%)	2 (2%)	0	100	100
21	LJ	133/136 (98%)	131 (98%)	2 (2%)	0	100	100
22	LK	113/148 (76%)	112 (99%)	1 (1%)	0	100	100
23	LL	121/137 (88%)	120 (99%)	1 (1%)	0	100	100
24	LN	399/403 (99%)	388 (97%)	11 (3%)	0	100	100
25	LO	93/115 (81%)	92 (99%)	1 (1%)	0	100	100
26	LP	104/125 (83%)	100 (96%)	4 (4%)	0	100	100
27	LQ	126/135 (93%)	125 (99%)	1 (1%)	0	100	100
28	LR	110/117 (94%)	109 (99%)	1 (1%)	0	100	100
29	LS	120/123 (98%)	119 (99%)	1 (1%)	0	100	100
30	LT	107/110 (97%)	107 (100%)	0	0	100	100
31	LU	100/105 (95%)	100 (100%)	0	0	100	100
32	LW	84/97 (87%)	83 (99%)	1 (1%)	0	100	100
33	LX	89/92 (97%)	88 (99%)	1 (1%)	0	100	100
34	LY	67/70 (96%)	67 (100%)	0	0	100	100
35	LZ	48/51 (94%)	48 (100%)	0	0	100	100
36	NB	79/549 (14%)	78 (99%)	1 (1%)	0	100	100
37	NC	501/731 (68%)	499 (100%)	2 (0%)	0	100	100
38	NF	227/260 (87%)	222 (98%)	5 (2%)	0	100	100
39	NJ	375/485 (77%)	362 (96%)	13 (4%)	0	100	100

Continued on next page...

Continued from previous page...

Mol	Chain	Analysed	Favoured	Allowed	Outliers	Percentiles	
40	NK	63/129 (49%)	63 (100%)	0	0	100	100
41	NL	250/478 (52%)	250 (100%)	0	0	100	100
42	NP	100/134 (75%)	100 (100%)	0	0	100	100
43	NT	493/687 (72%)	487 (99%)	6 (1%)	0	100	100
44	NU	819/929 (88%)	808 (99%)	11 (1%)	0	100	100
45	NV	378/432 (88%)	373 (99%)	5 (1%)	0	100	100
45	NW	361/432 (84%)	352 (98%)	9 (2%)	0	100	100
46	NX	502/1130 (44%)	499 (99%)	3 (1%)	0	100	100
46	NY	514/1130 (46%)	508 (99%)	6 (1%)	0	100	100
47	NZ	115/360 (32%)	114 (99%)	1 (1%)	0	100	100
48	SA	356/427 (83%)	351 (99%)	5 (1%)	0	100	100
49	SB	252/297 (85%)	247 (98%)	5 (2%)	0	100	100
50	SC	211/288 (73%)	206 (98%)	5 (2%)	0	100	100
51	SD	223/248 (90%)	217 (97%)	6 (3%)	0	100	100
52	SE	230/266 (86%)	223 (97%)	7 (3%)	0	100	100
53	SF	243/257 (95%)	236 (97%)	7 (3%)	0	100	100
54	SG	188/192 (98%)	187 (100%)	1 (0%)	0	100	100
55	SI	29/255 (11%)	29 (100%)	0	0	100	100
56	SK	242/245 (99%)	236 (98%)	6 (2%)	0	100	100
57	SM	393/588 (67%)	388 (99%)	5 (1%)	0	100	100
58	SQ	216/239 (90%)	213 (99%)	3 (1%)	0	100	100
59	SR	588/634 (93%)	577 (98%)	10 (2%)	1 (0%)	47	78
60	SV	137/163 (84%)	136 (99%)	1 (1%)	0	100	100
All	All	12428/17529 (71%)	12240 (98%)	187 (2%)	1 (0%)	100	100

All (1) Ramachandran outliers are listed below:

Mol	Chain	Res	Type
59	SR	88	ASP

5.3.2 Protein sidechains [i](#)

In the following table, the Percentiles column shows the percent sidechain outliers of the chain as a percentile score with respect to all PDB entries followed by that with respect to all EM

entries.

The Analysed column shows the number of residues for which the sidechain conformation was analysed, and the total number of residues.

Mol	Chain	Analysed	Rotameric	Outliers	Percentiles	
1	BA	132/137 (96%)	132 (100%)	0	100	100
2	BB	195/196 (100%)	195 (100%)	0	100	100
3	BD	15/641 (2%)	15 (100%)	0	100	100
7	L5	142/149 (95%)	142 (100%)	0	100	100
8	L6	171/177 (97%)	171 (100%)	0	100	100
9	L7	173/174 (99%)	173 (100%)	0	100	100
10	L8	115/161 (71%)	115 (100%)	0	100	100
11	L9	164/172 (95%)	164 (100%)	0	100	100
12	LA	135/163 (83%)	135 (100%)	0	100	100
13	LB	136/165 (82%)	136 (100%)	0	100	100
14	LC	157/157 (100%)	157 (100%)	0	100	100
15	LD	138/175 (79%)	138 (100%)	0	100	100
16	LE	121/140 (86%)	120 (99%)	1 (1%)	81	94
17	LF	93/115 (81%)	93 (100%)	0	100	100
18	LG	106/107 (99%)	106 (100%)	0	100	100
19	LH	110/133 (83%)	110 (100%)	0	100	100
20	LI	124/135 (92%)	124 (100%)	0	100	100
21	LJ	117/118 (99%)	117 (100%)	0	100	100
22	LK	98/121 (81%)	98 (100%)	0	100	100
23	LL	107/121 (88%)	107 (100%)	0	100	100
24	LN	347/348 (100%)	347 (100%)	0	100	100
25	LO	80/97 (82%)	80 (100%)	0	100	100
26	LP	97/110 (88%)	97 (100%)	0	100	100
27	LQ	114/121 (94%)	114 (100%)	0	100	100
28	LR	96/100 (96%)	95 (99%)	1 (1%)	76	92
29	LS	109/110 (99%)	109 (100%)	0	100	100
30	LT	88/89 (99%)	88 (100%)	0	100	100
31	LU	86/89 (97%)	86 (100%)	0	100	100
32	LW	73/80 (91%)	73 (100%)	0	100	100

Continued on next page...

Continued from previous page...

Mol	Chain	Analysed	Rotameric	Outliers	Percentiles	
33	LX	74/75 (99%)	74 (100%)	0	100	100
34	LY	64/65 (98%)	64 (100%)	0	100	100
35	LZ	47/48 (98%)	47 (100%)	0	100	100
36	NB	74/485 (15%)	74 (100%)	0	100	100
37	NC	455/654 (70%)	455 (100%)	0	100	100
38	NF	203/228 (89%)	203 (100%)	0	100	100
39	NJ	314/404 (78%)	314 (100%)	0	100	100
40	NK	61/115 (53%)	61 (100%)	0	100	100
41	NL	219/402 (54%)	219 (100%)	0	100	100
42	NP	88/114 (77%)	88 (100%)	0	100	100
43	NT	457/629 (73%)	456 (100%)	1 (0%)	93	98
44	NU	694/843 (82%)	693 (100%)	1 (0%)	93	98
45	NV	324/368 (88%)	324 (100%)	0	100	100
45	NW	311/368 (84%)	311 (100%)	0	100	100
46	NX	440/944 (47%)	439 (100%)	1 (0%)	93	98
46	NY	445/944 (47%)	445 (100%)	0	100	100
47	NZ	108/312 (35%)	107 (99%)	1 (1%)	78	93
48	SA	298/348 (86%)	297 (100%)	1 (0%)	92	98
49	SB	213/250 (85%)	213 (100%)	0	100	100
50	SC	192/252 (76%)	189 (98%)	3 (2%)	62	86
51	SD	194/215 (90%)	194 (100%)	0	100	100
52	SE	200/223 (90%)	200 (100%)	0	100	100
53	SF	188/199 (94%)	188 (100%)	0	100	100
54	SG	169/171 (99%)	169 (100%)	0	100	100
56	SK	212/213 (100%)	212 (100%)	0	100	100
58	SQ	195/214 (91%)	195 (100%)	0	100	100
59	SR	539/574 (94%)	539 (100%)	0	100	100
60	SV	128/149 (86%)	128 (100%)	0	100	100
All	All	10545/14407 (73%)	10535 (100%)	10 (0%)	93	98

5 of 10 residues with a non-rotameric sidechain are listed below:

Mol	Chain	Res	Type
50	SC	71	ARG
50	SC	210	LYS
50	SC	221	LYS
44	NU	473	ARG
46	NX	133	ARG

Sometimes sidechains can be flipped to improve hydrogen bonding and reduce clashes. 5 of 20 such sidechains are listed below:

Mol	Chain	Res	Type
46	NY	560	GLN
53	SF	139	HIS
59	SR	91	HIS
56	SK	50	HIS
37	NC	25	GLN

5.3.3 RNA [i](#)

Mol	Chain	Analysed	Backbone Outliers	Pucker Outliers
4	L1	152/157 (96%)	19 (12%)	0
5	L3	3454/5070 (68%)	461 (13%)	14 (0%)
6	L4	115/121 (95%)	11 (9%)	1 (0%)
All	All	3721/5348 (69%)	491 (13%)	15 (0%)

5 of 491 RNA backbone outliers are listed below:

Mol	Chain	Res	Type
4	L1	23	C
4	L1	34	U
4	L1	35	C
4	L1	59	A
4	L1	62	A

5 of 15 RNA pucker outliers are listed below:

Mol	Chain	Res	Type
5	L3	2469	C
5	L3	4699	U
5	L3	3712	A
6	L4	109	U
5	L3	4213	A

5.4 Non-standard residues in protein, DNA, RNA chains [i](#)

129 non-standard protein/DNA/RNA residues are modelled in this entry.

In the following table, the Counts columns list the number of bonds (or angles) for which Mogul statistics could be retrieved, the number of bonds (or angles) that are observed in the model and the number of bonds (or angles) that are defined in the Chemical Component Dictionary. The Link column lists molecule types, if any, to which the group is linked. The Z score for a bond length (or angle) is the number of standard deviations the observed value is removed from the expected value. A bond length (or angle) with $|Z| > 2$ is considered an outlier worth inspection. RMSZ is the root-mean-square of all Z scores of the bond lengths (or angles).

Mol	Type	Chain	Res	Link	Bond lengths			Bond angles		
					Counts	RMSZ	# Z > 2	Counts	RMSZ	# Z > 2
5	OMC	L3	3869	5	19,22,23	0.54	0	26,31,34	0.67	0
5	6MZ	L3	4220	5	18,25,26	1.04	2 (11%)	16,36,39	1.96	4 (25%)
5	OMG	L3	4499	5	18,26,27	1.14	2 (11%)	19,38,41	0.84	1 (5%)
5	UR3	L3	4530	5	19,22,23	1.05	3 (15%)	26,32,35	1.23	1 (3%)
5	OMU	L3	4498	5	19,22,23	2.05	7 (36%)	26,31,34	1.70	5 (19%)
5	PSU	L3	1862	5	18,21,22	1.03	1 (5%)	22,30,33	1.81	5 (22%)
5	A2M	L3	4571	5	18,25,26	1.19	2 (11%)	18,36,39	1.23	2 (11%)
5	A2M	L3	3718	5	18,25,26	1.22	2 (11%)	18,36,39	1.23	2 (11%)
5	PSU	L3	4689	5	18,21,22	1.06	1 (5%)	22,30,33	1.81	5 (22%)
5	A2M	L3	3825	5	18,25,26	1.20	2 (11%)	18,36,39	1.26	2 (11%)
5	PSU	L3	4628	5	18,21,22	1.01	1 (5%)	22,30,33	1.72	4 (18%)
5	OMC	L3	3841	5	19,22,23	0.53	0	26,31,34	0.68	0
5	OMC	L3	2824	5	19,22,23	0.53	0	26,31,34	0.66	0
5	PSU	L3	3920	5,61	18,21,22	1.05	1 (5%)	22,30,33	1.79	4 (18%)
5	PSU	L3	3851	5	18,21,22	1.09	1 (5%)	22,30,33	1.81	6 (27%)
5	A2M	L3	3785	5	18,25,26	1.19	2 (11%)	18,36,39	1.27	2 (11%)
5	A2M	L3	2363	5,61	18,25,26	1.20	2 (11%)	18,36,39	1.24	2 (11%)
5	OMC	L3	2422	5,61	19,22,23	0.53	0	26,31,34	0.74	0
5	PSU	L3	3637	5	18,21,22	1.05	1 (5%)	22,30,33	1.89	4 (18%)
5	OMU	L3	4306	5	19,22,23	2.06	7 (36%)	26,31,34	1.76	5 (19%)
5	OMC	L3	2365	5	19,22,23	0.54	0	26,31,34	0.68	0
5	PSU	L3	4471	5	18,21,22	1.07	1 (5%)	22,30,33	1.81	5 (22%)
5	A2M	L3	2401	5	18,25,26	1.16	2 (11%)	18,36,39	1.26	2 (11%)
5	PSU	L3	4493	5	18,21,22	1.07	1 (5%)	22,30,33	1.84	5 (22%)
5	OMC	L3	1340	5	19,22,23	0.55	0	26,31,34	0.71	0
5	OMC	L3	2351	5,61	19,22,23	0.54	0	26,31,34	0.77	1 (3%)
5	A2M	L3	2787	5	18,25,26	1.14	2 (11%)	18,36,39	1.31	2 (11%)

Mol	Type	Chain	Res	Link	Bond lengths			Bond angles		
					Counts	RMSZ	# Z > 2	Counts	RMSZ	# Z > 2
5	PSU	L3	3884	5	18,21,22	1.05	1 (5%)	22,30,33	1.81	5 (22%)
5	OMG	L3	4637	5	18,26,27	1.14	2 (11%)	19,38,41	0.83	1 (5%)
5	PSU	L3	4457	5	18,21,22	1.08	1 (5%)	22,30,33	1.79	6 (27%)
5	OMU	L3	3925	5	19,22,23	2.01	7 (36%)	26,31,34	1.69	5 (19%)
5	PSU	L3	1781	5	18,21,22	1.14	1 (5%)	22,30,33	1.82	5 (22%)
5	PSU	L3	4532	5	18,21,22	1.04	1 (5%)	22,30,33	1.81	5 (22%)
5	PSU	L3	4293	5	18,21,22	1.06	1 (5%)	22,30,33	1.82	4 (18%)
5	OMG	L3	3899	5	18,26,27	1.13	2 (11%)	19,38,41	0.90	1 (5%)
5	PSU	L3	3730	5	18,21,22	1.06	1 (5%)	22,30,33	1.83	5 (22%)
5	PSU	L3	1582	5	18,21,22	1.04	1 (5%)	22,30,33	1.81	3 (13%)
5	OMG	L3	4370	5	18,26,27	1.12	2 (11%)	19,38,41	0.85	1 (5%)
5	A2M	L3	398	5	18,25,26	1.19	2 (11%)	18,36,39	1.32	2 (11%)
5	PSU	L3	2632	5	18,21,22	1.06	1 (5%)	22,30,33	1.69	3 (13%)
5	PSU	L3	3959	5	18,21,22	1.05	1 (5%)	22,30,33	1.87	5 (22%)
5	OMC	L3	3701	5	19,22,23	0.55	0	26,31,34	0.57	0
5	PSU	L3	2508	5	18,21,22	1.06	1 (5%)	22,30,33	1.80	5 (22%)
5	OMG	L3	1625	5	18,26,27	1.14	2 (11%)	19,38,41	0.86	1 (5%)
5	PSU	L3	5001	5	18,21,22	1.07	1 (5%)	22,30,33	1.84	5 (22%)
5	A2M	L3	3867	5	18,25,26	1.20	2 (11%)	18,36,39	1.25	1 (5%)
5	PSU	L3	3768	5	18,21,22	1.03	1 (5%)	22,30,33	1.79	5 (22%)
5	PSU	L3	1860	5	18,21,22	1.04	1 (5%)	22,30,33	1.79	5 (22%)
5	OMG	L3	4623	5	18,26,27	1.15	2 (11%)	19,38,41	0.90	1 (5%)
5	5MC	L3	4447	5	18,22,23	0.54	0	26,32,35	0.62	0
5	OMU	L3	2837	5	19,22,23	2.03	7 (36%)	26,31,34	1.75	5 (19%)
5	PSU	L3	4296	5	18,21,22	1.07	1 (5%)	22,30,33	1.80	5 (22%)
24	HIC	LN	245	24	8,11,12	0.86	0	6,14,16	0.79	0
5	OMU	L3	4227	5	19,22,23	2.08	7 (36%)	26,31,34	1.70	5 (19%)
5	OMU	L3	4620	5	19,22,23	1.99	7 (36%)	26,31,34	1.69	5 (19%)
5	PSU	L3	4576	5	18,21,22	1.06	1 (5%)	22,30,33	1.81	5 (22%)
5	A2M	L3	400	5	18,25,26	1.18	2 (11%)	18,36,39	1.28	2 (11%)
5	OMG	L3	2424	5	18,26,27	1.13	2 (11%)	19,38,41	0.86	1 (5%)
5	1MA	L3	1322	5	16,25,26	0.86	2 (12%)	18,37,40	1.04	2 (11%)
5	PSU	L3	1677	5	18,21,22	1.08	1 (5%)	22,30,33	1.81	6 (27%)
5	OMG	L3	1760	5	18,26,27	1.11	2 (11%)	19,38,41	0.89	1 (5%)
5	A2M	L3	1534	5,61	18,25,26	1.18	2 (11%)	18,36,39	1.41	3 (16%)

Mol	Type	Chain	Res	Link	Bond lengths			Bond angles		
					Counts	RMSZ	# Z > 2	Counts	RMSZ	# Z > 2
5	A2M	L3	4590	5	18,25,26	1.16	2 (11%)	18,36,39	1.31	2 (11%)
5	PSU	L3	4500	5	18,21,22	1.07	1 (5%)	22,30,33	1.75	5 (22%)
5	OMG	L3	4494	5	18,26,27	1.13	2 (11%)	19,38,41	0.86	1 (5%)
5	PSU	L3	4403	5	18,21,22	1.05	1 (5%)	22,30,33	1.82	5 (22%)
5	OMC	L3	4536	5	19,22,23	0.54	0	26,31,34	0.70	0
5	PSU	L3	3770	5	18,21,22	1.06	1 (5%)	22,30,33	1.76	4 (18%)
5	PSU	L3	3853	5	18,21,22	1.05	1 (5%)	22,30,33	1.75	4 (18%)
5	PSU	L3	4361	5	18,21,22	1.06	1 (5%)	22,30,33	1.83	5 (22%)
4	PSU	L1	55	4	18,21,22	1.06	1 (5%)	22,30,33	1.82	5 (22%)
5	A2M	L3	3760	5	18,25,26	1.19	2 (11%)	18,36,39	1.23	1 (5%)
5	PSU	L3	4521	5	18,21,22	1.09	1 (5%)	22,30,33	1.81	5 (22%)
5	PSU	L3	3734	5	18,21,22	1.07	1 (5%)	22,30,33	1.81	6 (27%)
5	OMC	L3	4054	5	19,22,23	0.55	0	26,31,34	0.76	0
5	OMC	L3	3808	5	19,22,23	0.50	0	26,31,34	0.71	0
4	PSU	L1	69	4	18,21,22	1.09	1 (5%)	22,30,33	1.84	6 (27%)
5	OMC	L3	3887	5	19,22,23	0.52	0	26,31,34	0.67	0
4	OMG	L1	75	4	18,26,27	1.15	2 (11%)	19,38,41	0.87	1 (5%)
5	A2M	L3	3724	5	18,25,26	1.21	2 (11%)	18,36,39	1.24	2 (11%)
5	A2M	L3	1326	5	18,25,26	1.16	2 (11%)	18,36,39	1.26	2 (11%)
5	PSU	L3	4972	5	18,21,22	1.06	1 (5%)	22,30,33	1.80	5 (22%)
5	A2M	L3	3830	5	18,25,26	1.18	2 (11%)	18,36,39	1.28	2 (11%)
5	PSU	L3	4353	5	18,21,22	1.05	1 (5%)	22,30,33	1.80	5 (22%)
5	PSU	L3	4636	5	18,21,22	1.05	1 (5%)	22,30,33	1.84	4 (18%)
5	A2M	L3	1871	5	18,25,26	1.25	3 (16%)	18,36,39	1.39	2 (11%)
5	OMG	L3	3627	5	18,26,27	1.13	2 (11%)	19,38,41	0.93	1 (5%)
5	PSU	L3	4552	5	18,21,22	1.05	1 (5%)	22,30,33	1.80	5 (22%)
5	OMU	L3	3818	5	19,22,23	2.06	7 (36%)	26,31,34	1.70	5 (19%)
5	OMC	L3	2804	5	19,22,23	0.54	0	26,31,34	0.70	0
5	OMG	L3	2364	5	18,26,27	1.13	2 (11%)	19,38,41	0.85	1 (5%)
5	PSU	L3	2839	5	18,21,22	1.05	1 (5%)	22,30,33	1.81	5 (22%)
5	OMG	L3	3792	5	18,26,27	1.12	2 (11%)	19,38,41	0.84	1 (5%)
5	PSU	L3	1536	5	18,21,22	1.06	1 (5%)	22,30,33	1.80	4 (18%)
5	PSU	L3	3715	5	18,21,22	1.07	1 (5%)	22,30,33	1.79	5 (22%)
5	PSU	L3	3844	5	18,21,22	1.09	1 (5%)	22,30,33	1.79	5 (22%)
5	5MC	L3	3782	5	18,22,23	0.54	0	26,32,35	0.62	0
5	PSU	L3	4299	5	18,21,22	1.07	1 (5%)	22,30,33	1.84	5 (22%)

Mol	Type	Chain	Res	Link	Bond lengths			Bond angles		
					Counts	RMSZ	# Z > 2	Counts	RMSZ	# Z > 2
5	PSU	L3	4431	5	18,21,22	1.07	1 (5%)	22,30,33	1.82	4 (18%)
5	A2M	L3	1524	5	18,25,26	1.21	2 (11%)	18,36,39	1.24	2 (11%)
5	OMG	L3	2876	5	18,26,27	1.14	2 (11%)	19,38,41	0.84	1 (5%)
5	PSU	L3	3762	5	18,21,22	1.02	1 (5%)	22,30,33	1.76	5 (22%)
5	PSU	L3	3758	5	18,21,22	1.05	1 (5%)	22,30,33	1.81	5 (22%)
5	OMG	L3	4042	5	18,26,27	1.16	2 (11%)	19,38,41	0.86	1 (5%)
5	OMG	L3	4392	5	18,26,27	1.14	2 (11%)	19,38,41	0.88	1 (5%)
5	OMG	L3	1316	5	18,26,27	1.15	2 (11%)	19,38,41	0.89	1 (5%)
5	PSU	L3	3822	5	18,21,22	1.02	1 (5%)	22,30,33	1.65	4 (18%)
5	PSU	L3	5010	5	18,21,22	1.06	1 (5%)	22,30,33	1.80	5 (22%)
5	PSU	L3	1744	5	18,21,22	1.07	1 (5%)	22,30,33	1.80	5 (22%)
5	OMC	L3	2861	5	19,22,23	0.53	0	26,31,34	0.71	0
5	PSU	L3	3695	5	18,21,22	1.08	1 (5%)	22,30,33	1.80	5 (22%)
5	PSU	L3	1683	5	18,21,22	1.06	1 (5%)	22,30,33	1.84	5 (22%)
5	A2M	L3	2815	5	18,25,26	1.17	2 (11%)	18,36,39	1.23	2 (11%)
5	A2M	L3	4523	5	18,25,26	1.18	2 (11%)	18,36,39	1.24	2 (11%)
5	OMC	L3	4456	5	19,22,23	0.55	0	26,31,34	0.69	0
5	PSU	L3	1779	5	18,21,22	1.09	1 (5%)	22,30,33	1.74	4 (18%)
5	OMG	L3	4228	5	18,26,27	1.10	2 (11%)	19,38,41	0.86	1 (5%)
5	PSU	L3	4579	5	18,21,22	1.03	1 (5%)	22,30,33	1.76	4 (18%)
5	OMG	L3	1522	5	18,26,27	1.13	2 (11%)	19,38,41	0.85	1 (5%)
5	OMG	L3	4618	5	18,26,27	1.15	2 (11%)	19,38,41	0.87	1 (5%)
5	PSU	L3	3764	5	18,21,22	1.06	1 (5%)	22,30,33	1.76	4 (18%)
5	PSU	L3	4312	5	18,21,22	1.03	1 (5%)	22,30,33	1.81	4 (18%)
5	PSU	L3	4673	5	18,21,22	1.03	1 (5%)	22,30,33	1.77	3 (13%)
5	PSU	L3	1782	5	18,21,22	1.05	1 (5%)	22,30,33	1.82	5 (22%)
5	PSU	L3	4442	5	18,21,22	1.10	1 (5%)	22,30,33	1.76	4 (18%)
5	PSU	L3	3639	5	18,21,22	1.06	1 (5%)	22,30,33	1.79	5 (22%)
5	OMU	L3	1773	5	19,22,23	2.08	7 (36%)	26,31,34	1.70	5 (19%)
5	OMU	L3	2415	5	19,22,23	2.05	7 (36%)	26,31,34	1.72	5 (19%)
5	OMG	L3	3744	5	18,26,27	1.15	2 (11%)	19,38,41	0.87	1 (5%)

In the following table, the Chirals column lists the number of chiral outliers, the number of chiral centers analysed, the number of these observed in the model and the number defined in the Chemical Component Dictionary. Similar counts are reported in the Torsion and Rings columns. '-' means no outliers of that kind were identified.

Mol	Type	Chain	Res	Link	Chirals	Torsions	Rings
5	OMC	L3	3869	5	-	0/9/27/28	0/2/2/2
5	6MZ	L3	4220	5	-	4/5/27/28	0/3/3/3
5	OMG	L3	4499	5	-	1/5/27/28	0/3/3/3
5	UR3	L3	4530	5	-	0/7/25/26	0/2/2/2
5	OMU	L3	4498	5	-	6/9/27/28	0/2/2/2
5	PSU	L3	1862	5	-	0/7/25/26	0/2/2/2
5	A2M	L3	4571	5	-	1/5/27/28	0/3/3/3
5	A2M	L3	3718	5	-	1/5/27/28	0/3/3/3
5	PSU	L3	4689	5	-	0/7/25/26	0/2/2/2
5	A2M	L3	3825	5	-	1/5/27/28	0/3/3/3
5	PSU	L3	4628	5	-	0/7/25/26	0/2/2/2
5	OMC	L3	3841	5	-	1/9/27/28	0/2/2/2
5	OMC	L3	2824	5	-	1/9/27/28	0/2/2/2
5	PSU	L3	3920	5,61	-	0/7/25/26	0/2/2/2
5	PSU	L3	3851	5	-	0/7/25/26	0/2/2/2
5	A2M	L3	3785	5	-	3/5/27/28	0/3/3/3
5	A2M	L3	2363	5,61	-	1/5/27/28	0/3/3/3
5	OMC	L3	2422	5,61	-	2/9/27/28	0/2/2/2
5	PSU	L3	3637	5	-	0/7/25/26	0/2/2/2
5	OMU	L3	4306	5	-	1/9/27/28	0/2/2/2
5	OMC	L3	2365	5	-	1/9/27/28	0/2/2/2
5	PSU	L3	4471	5	-	0/7/25/26	0/2/2/2
5	A2M	L3	2401	5	-	2/5/27/28	0/3/3/3
5	PSU	L3	4493	5	-	0/7/25/26	0/2/2/2
5	OMC	L3	1340	5	-	1/9/27/28	0/2/2/2
5	OMC	L3	2351	5,61	-	4/9/27/28	0/2/2/2
5	A2M	L3	2787	5	-	2/5/27/28	0/3/3/3
5	PSU	L3	3884	5	-	0/7/25/26	0/2/2/2
5	OMG	L3	4637	5	-	1/5/27/28	0/3/3/3
5	PSU	L3	4457	5	-	0/7/25/26	0/2/2/2
5	OMU	L3	3925	5	-	1/9/27/28	0/2/2/2
5	PSU	L3	1781	5	-	2/7/25/26	0/2/2/2
5	PSU	L3	4532	5	-	0/7/25/26	0/2/2/2
5	PSU	L3	4293	5	-	0/7/25/26	0/2/2/2
5	OMG	L3	3899	5	-	1/5/27/28	0/3/3/3
5	PSU	L3	3730	5	-	0/7/25/26	0/2/2/2
5	PSU	L3	1582	5	-	0/7/25/26	0/2/2/2
5	OMG	L3	4370	5	-	3/5/27/28	0/3/3/3
5	A2M	L3	398	5	-	1/5/27/28	0/3/3/3
5	PSU	L3	2632	5	-	0/7/25/26	0/2/2/2
5	PSU	L3	3959	5	-	0/7/25/26	0/2/2/2

Continued on next page...

Continued from previous page...

Mol	Type	Chain	Res	Link	Chirals	Torsions	Rings
5	OMC	L3	3701	5	-	4/9/27/28	0/2/2/2
5	PSU	L3	2508	5	-	0/7/25/26	0/2/2/2
5	OMG	L3	1625	5	-	1/5/27/28	0/3/3/3
5	PSU	L3	5001	5	-	0/7/25/26	0/2/2/2
5	A2M	L3	3867	5	-	4/5/27/28	0/3/3/3
5	PSU	L3	3768	5	-	0/7/25/26	0/2/2/2
5	PSU	L3	1860	5	-	0/7/25/26	0/2/2/2
5	OMG	L3	4623	5	-	1/5/27/28	0/3/3/3
5	5MC	L3	4447	5	-	0/7/25/26	0/2/2/2
5	OMU	L3	2837	5	-	1/9/27/28	0/2/2/2
5	PSU	L3	4296	5	-	0/7/25/26	0/2/2/2
24	HIC	LN	245	24	-	2/5/6/8	0/1/1/1
5	OMU	L3	4227	5	-	1/9/27/28	0/2/2/2
5	OMU	L3	4620	5	-	1/9/27/28	0/2/2/2
5	PSU	L3	4576	5	-	0/7/25/26	0/2/2/2
5	A2M	L3	400	5	-	1/5/27/28	0/3/3/3
5	OMG	L3	2424	5	-	3/5/27/28	0/3/3/3
5	1MA	L3	1322	5	-	2/3/25/26	0/3/3/3
5	PSU	L3	1677	5	-	0/7/25/26	0/2/2/2
5	OMG	L3	1760	5	-	1/5/27/28	0/3/3/3
5	A2M	L3	1534	5,61	-	3/5/27/28	0/3/3/3
5	A2M	L3	4590	5	-	4/5/27/28	0/3/3/3
5	PSU	L3	4500	5	-	1/7/25/26	0/2/2/2
5	OMG	L3	4494	5	-	0/5/27/28	0/3/3/3
5	PSU	L3	4403	5	-	0/7/25/26	0/2/2/2
5	OMC	L3	4536	5	-	1/9/27/28	0/2/2/2
5	PSU	L3	3770	5	-	0/7/25/26	0/2/2/2
5	PSU	L3	3853	5	-	0/7/25/26	0/2/2/2
5	PSU	L3	4361	5	-	0/7/25/26	0/2/2/2
4	PSU	L1	55	4	-	0/7/25/26	0/2/2/2
5	A2M	L3	3760	5	-	2/5/27/28	0/3/3/3
5	PSU	L3	4521	5	-	0/7/25/26	0/2/2/2
5	PSU	L3	3734	5	-	0/7/25/26	0/2/2/2
5	OMC	L3	4054	5	-	1/9/27/28	0/2/2/2
5	OMC	L3	3808	5	-	1/9/27/28	0/2/2/2
4	PSU	L1	69	4	-	0/7/25/26	0/2/2/2
5	OMC	L3	3887	5	-	3/9/27/28	0/2/2/2
4	OMG	L1	75	4	-	1/5/27/28	0/3/3/3
5	A2M	L3	3724	5	-	2/5/27/28	0/3/3/3
5	A2M	L3	1326	5	-	3/5/27/28	0/3/3/3

Continued on next page...

Continued from previous page...

Mol	Type	Chain	Res	Link	Chirals	Torsions	Rings
5	PSU	L3	4972	5	-	0/7/25/26	0/2/2/2
5	A2M	L3	3830	5	-	0/5/27/28	0/3/3/3
5	PSU	L3	4353	5	-	0/7/25/26	0/2/2/2
5	PSU	L3	4636	5	-	3/7/25/26	0/2/2/2
5	A2M	L3	1871	5	-	0/5/27/28	0/3/3/3
5	OMG	L3	3627	5	-	1/5/27/28	0/3/3/3
5	PSU	L3	4552	5	-	0/7/25/26	0/2/2/2
5	OMU	L3	3818	5	-	0/9/27/28	0/2/2/2
5	OMC	L3	2804	5	-	1/9/27/28	0/2/2/2
5	OMG	L3	2364	5	-	1/5/27/28	0/3/3/3
5	PSU	L3	2839	5	-	0/7/25/26	0/2/2/2
5	OMG	L3	3792	5	-	1/5/27/28	0/3/3/3
5	PSU	L3	1536	5	-	0/7/25/26	0/2/2/2
5	PSU	L3	3715	5	-	0/7/25/26	0/2/2/2
5	PSU	L3	3844	5	-	1/7/25/26	0/2/2/2
5	5MC	L3	3782	5	-	2/7/25/26	0/2/2/2
5	PSU	L3	4299	5	-	0/7/25/26	0/2/2/2
5	PSU	L3	4431	5	-	0/7/25/26	0/2/2/2
5	A2M	L3	1524	5	-	0/5/27/28	0/3/3/3
5	OMG	L3	2876	5	-	3/5/27/28	0/3/3/3
5	PSU	L3	3762	5	-	0/7/25/26	0/2/2/2
5	PSU	L3	3758	5	-	0/7/25/26	0/2/2/2
5	OMG	L3	4042	5	-	0/5/27/28	0/3/3/3
5	OMG	L3	4392	5	-	3/5/27/28	0/3/3/3
5	OMG	L3	1316	5	-	1/5/27/28	0/3/3/3
5	PSU	L3	3822	5	-	0/7/25/26	0/2/2/2
5	PSU	L3	5010	5	-	0/7/25/26	0/2/2/2
5	PSU	L3	1744	5	-	2/7/25/26	0/2/2/2
5	OMC	L3	2861	5	-	1/9/27/28	0/2/2/2
5	PSU	L3	3695	5	-	0/7/25/26	0/2/2/2
5	PSU	L3	1683	5	-	0/7/25/26	0/2/2/2
5	A2M	L3	2815	5	-	0/5/27/28	0/3/3/3
5	A2M	L3	4523	5	-	2/5/27/28	0/3/3/3
5	OMC	L3	4456	5	-	1/9/27/28	0/2/2/2
5	PSU	L3	1779	5	-	1/7/25/26	0/2/2/2
5	OMG	L3	4228	5	-	4/5/27/28	0/3/3/3
5	PSU	L3	4579	5	-	0/7/25/26	0/2/2/2
5	OMG	L3	1522	5	-	0/5/27/28	0/3/3/3
5	OMG	L3	4618	5	-	2/5/27/28	0/3/3/3
5	PSU	L3	3764	5	-	0/7/25/26	0/2/2/2

Continued on next page...

Continued from previous page...

Mol	Type	Chain	Res	Link	Chirals	Torsions	Rings
5	PSU	L3	4312	5	-	0/7/25/26	0/2/2/2
5	PSU	L3	4673	5	-	0/7/25/26	0/2/2/2
5	PSU	L3	1782	5	-	0/7/25/26	0/2/2/2
5	PSU	L3	4442	5	-	0/7/25/26	0/2/2/2
5	PSU	L3	3639	5	-	0/7/25/26	0/2/2/2
5	OMU	L3	1773	5	-	1/9/27/28	0/2/2/2
5	OMU	L3	2415	5	-	3/9/27/28	0/2/2/2
5	OMG	L3	3744	5	-	1/5/27/28	0/3/3/3

The worst 5 of 211 bond length outliers are listed below:

Mol	Chain	Res	Type	Atoms	Z	Observed(Å)	Ideal(Å)
5	L3	4227	OMU	C6-N1	4.80	1.49	1.38
5	L3	1773	OMU	C6-N1	4.79	1.49	1.38
5	L3	4498	OMU	C6-N1	4.78	1.49	1.38
5	L3	3818	OMU	C6-N1	4.77	1.49	1.38
5	L3	2415	OMU	C6-N1	4.75	1.49	1.38

The worst 5 of 387 bond angle outliers are listed below:

Mol	Chain	Res	Type	Atoms	Z	Observed(°)	Ideal(°)
5	L3	4306	OMU	C4-N3-C2	-5.23	119.68	126.58
5	L3	4220	6MZ	C2-N1-C6	5.19	121.04	116.59
5	L3	2837	OMU	C4-N3-C2	-5.13	119.81	126.58
5	L3	4498	OMU	C4-N3-C2	-5.10	119.85	126.58
5	L3	4227	OMU	C4-N3-C2	-5.09	119.86	126.58

There are no chirality outliers.

5 of 121 torsion outliers are listed below:

Mol	Chain	Res	Type	Atoms
4	L1	75	OMG	C1'-C2'-O2'-CM2
5	L3	398	A2M	C1'-C2'-O2'-CM'
5	L3	400	A2M	C1'-C2'-O2'-CM'
5	L3	1316	OMG	C1'-C2'-O2'-CM2
5	L3	1322	1MA	O4'-C4'-C5'-O5'

There are no ring outliers.

78 monomers are involved in 131 short contacts:

Mol	Chain	Res	Type	Clashes	Symm-Clashes
5	L3	4220	6MZ	3	0
5	L3	4499	OMG	1	0
5	L3	4530	UR3	2	0
5	L3	4571	A2M	2	0
5	L3	3718	A2M	3	0
5	L3	4689	PSU	1	0
5	L3	3825	A2M	2	0
5	L3	3841	OMC	1	0
5	L3	2824	OMC	1	0
5	L3	3920	PSU	1	0
5	L3	3785	A2M	3	0
5	L3	2363	A2M	4	0
5	L3	2422	OMC	2	0
5	L3	4306	OMU	4	0
5	L3	2365	OMC	2	0
5	L3	4493	PSU	1	0
5	L3	1340	OMC	1	0
5	L3	2351	OMC	1	0
5	L3	4637	OMG	2	0
5	L3	4457	PSU	4	0
5	L3	3925	OMU	3	0
5	L3	1781	PSU	2	0
5	L3	3899	OMG	1	0
5	L3	4370	OMG	3	0
5	L3	2632	PSU	2	0
5	L3	2508	PSU	1	0
5	L3	5001	PSU	2	0
5	L3	3867	A2M	1	0
5	L3	4623	OMG	3	0
5	L3	2837	OMU	1	0
5	L3	4296	PSU	1	0
5	L3	4227	OMU	3	0
5	L3	4620	OMU	2	0
5	L3	400	A2M	2	0
5	L3	2424	OMG	1	0
5	L3	1322	1MA	3	0
5	L3	1677	PSU	2	0
5	L3	1760	OMG	1	0
5	L3	1534	A2M	1	0
5	L3	4494	OMG	1	0
5	L3	4536	OMC	3	0
5	L3	3770	PSU	2	0
5	L3	3760	A2M	1	0

Continued on next page...

Continued from previous page...

Mol	Chain	Res	Type	Clashes	Symm-Clashes
5	L3	3734	PSU	1	0
5	L3	3808	OMC	3	0
4	L1	69	PSU	1	0
5	L3	3887	OMC	1	0
4	L1	75	OMG	2	0
5	L3	3724	A2M	2	0
5	L3	1326	A2M	4	0
5	L3	4353	PSU	1	0
5	L3	4636	PSU	1	0
5	L3	3627	OMG	1	0
5	L3	3818	OMU	1	0
5	L3	2804	OMC	1	0
5	L3	2364	OMG	2	0
5	L3	3792	OMG	1	0
5	L3	3715	PSU	1	0
5	L3	3782	5MC	1	0
5	L3	4299	PSU	2	0
5	L3	2876	OMG	1	0
5	L3	3758	PSU	1	0
5	L3	4042	OMG	1	0
5	L3	4392	OMG	1	0
5	L3	1316	OMG	1	0
5	L3	3822	PSU	2	0
5	L3	5010	PSU	1	0
5	L3	2861	OMC	3	0
5	L3	3695	PSU	1	0
5	L3	1683	PSU	1	0
5	L3	4456	OMC	2	0
5	L3	4228	OMG	1	0
5	L3	1522	OMG	1	0
5	L3	4618	OMG	3	0
5	L3	4442	PSU	1	0
5	L3	1773	OMU	3	0
5	L3	2415	OMU	1	0
5	L3	3744	OMG	1	0

5.5 Carbohydrates

There are no monosaccharides in this entry.

5.6 Ligand geometry

Of 108 ligands modelled in this entry, 106 are monoatomic - leaving 2 for Mogul analysis.

In the following table, the Counts columns list the number of bonds (or angles) for which Mogul statistics could be retrieved, the number of bonds (or angles) that are observed in the model and the number of bonds (or angles) that are defined in the Chemical Component Dictionary. The Link column lists molecule types, if any, to which the group is linked. The Z score for a bond length (or angle) is the number of standard deviations the observed value is removed from the expected value. A bond length (or angle) with $|Z| > 2$ is considered an outlier worth inspection. RMSZ is the root-mean-square of all Z scores of the bond lengths (or angles).

Mol	Type	Chain	Res	Link	Bond lengths			Bond angles		
					Counts	RMSZ	# Z > 2	Counts	RMSZ	# Z > 2
65	GDP	SR	1001	64	24,30,30	2.57	8 (33%)	30,47,47	1.79	9 (30%)
63	GTP	NC	1000	64,61	26,34,34	2.81	10 (38%)	32,54,54	1.75	10 (31%)

In the following table, the Chirals column lists the number of chiral outliers, the number of chiral centers analysed, the number of these observed in the model and the number defined in the Chemical Component Dictionary. Similar counts are reported in the Torsion and Rings columns. '-' means no outliers of that kind were identified.

Mol	Type	Chain	Res	Link	Chirals	Torsions	Rings
65	GDP	SR	1001	64	-	3/12/32/32	0/3/3/3
63	GTP	NC	1000	64,61	-	2/18/38/38	0/3/3/3

The worst 5 of 18 bond length outliers are listed below:

Mol	Chain	Res	Type	Atoms	Z	Observed(Å)	Ideal(Å)
65	SR	1001	GDP	O6-C6	8.36	1.40	1.23
63	NC	1000	GTP	O6-C6	8.33	1.40	1.23
63	NC	1000	GTP	O4'-C1'	4.93	1.48	1.41
63	NC	1000	GTP	C2-N2	4.75	1.45	1.34
65	SR	1001	GDP	C2-N2	4.74	1.45	1.34

The worst 5 of 19 bond angle outliers are listed below:

Mol	Chain	Res	Type	Atoms	Z	Observed(°)	Ideal(°)
65	SR	1001	GDP	C3'-C2'-C1'	4.39	107.59	100.98
63	NC	1000	GTP	C3'-C2'-C1'	3.39	106.08	100.98
65	SR	1001	GDP	C5-C6-N1	3.32	119.81	113.95
63	NC	1000	GTP	C2-N1-C6	-3.31	119.00	125.10
63	NC	1000	GTP	C5-C6-N1	3.25	119.69	113.95

There are no chirality outliers.

All (5) torsion outliers are listed below:

Mol	Chain	Res	Type	Atoms
65	SR	1001	GDP	C5'-O5'-PA-O3A
65	SR	1001	GDP	C5'-O5'-PA-O1A
63	NC	1000	GTP	PB-O3A-PA-O1A
63	NC	1000	GTP	O4'-C4'-C5'-O5'
65	SR	1001	GDP	C5'-O5'-PA-O2A

There are no ring outliers.

No monomer is involved in short contacts.

The following is a two-dimensional graphical depiction of Mogul quality analysis of bond lengths, bond angles, torsion angles, and ring geometry for all instances of the Ligand of Interest. In addition, ligands with molecular weight > 250 and outliers as shown on the validation Tables will also be included. For torsion angles, if less than 5% of the Mogul distribution of torsion angles is within 10 degrees of the torsion angle in question, then that torsion angle is considered an outlier. Any bond that is central to one or more torsion angles identified as an outlier by Mogul will be highlighted in the graph. For rings, the root-mean-square deviation (RMSD) between the ring in question and similar rings identified by Mogul is calculated over all ring torsion angles. If the average RMSD is greater than 60 degrees and the minimal RMSD between the ring in question and any Mogul-identified rings is also greater than 60 degrees, then that ring is considered an outlier. The outliers are highlighted in purple. The color gray indicates Mogul did not find sufficient equivalents in the CSD to analyse the geometry.

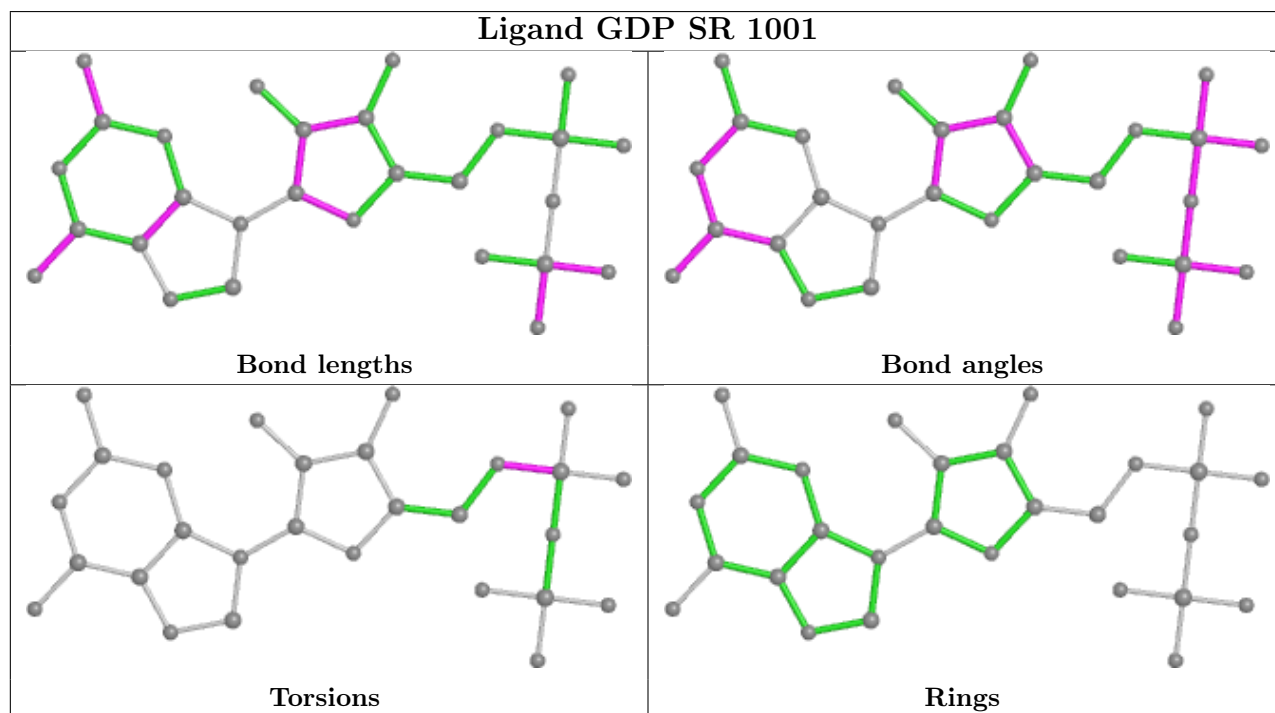

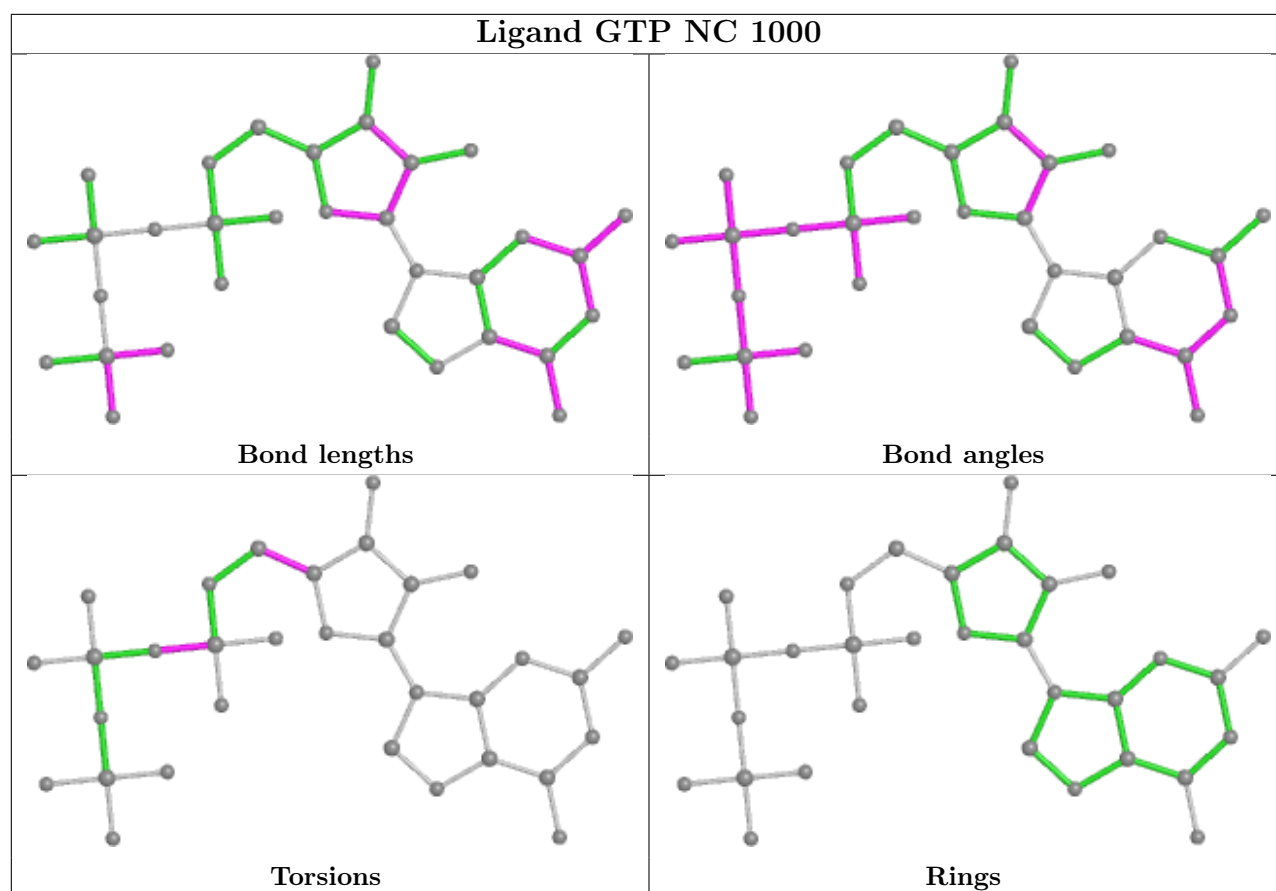

5.7 Other polymers [i](#)

There are no such residues in this entry.

5.8 Polymer linkage issues [i](#)

There are no chain breaks in this entry.

6 Map visualisation [i](#)

This section contains visualisations of the EMDB entry EMD-29267. These allow visual inspection of the internal detail of the map and identification of artifacts.

Images derived from a raw map, generated by summing the deposited half-maps, are presented below the corresponding image components of the primary map to allow further visual inspection and comparison with those of the primary map.

6.1 Orthogonal projections [i](#)

6.1.1 Primary map

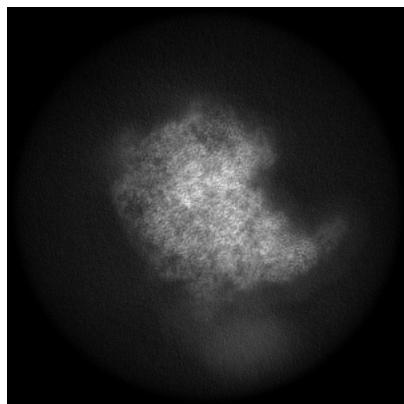

X

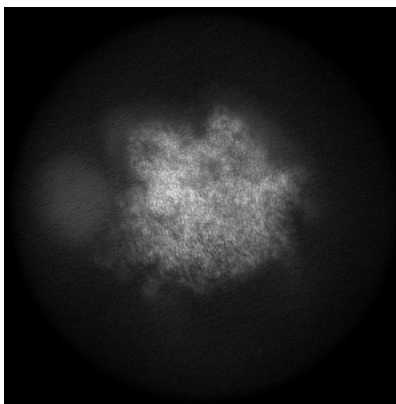

Y

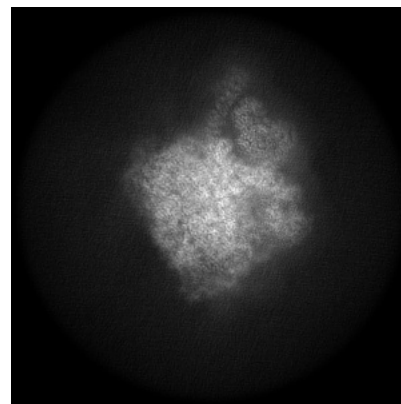

Z

6.1.2 Raw map

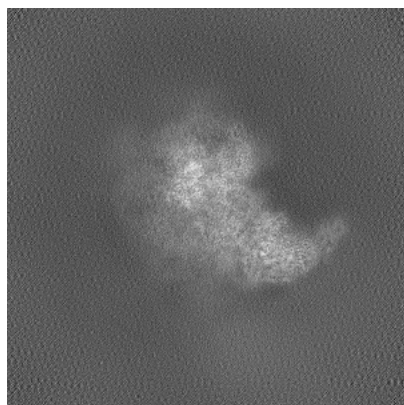

X

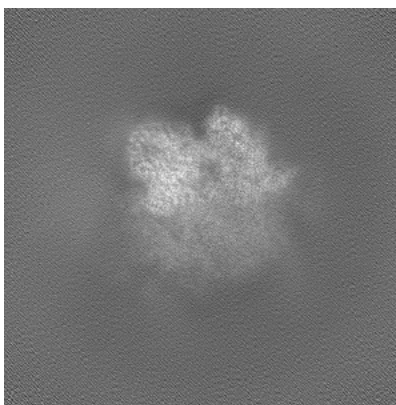

Y

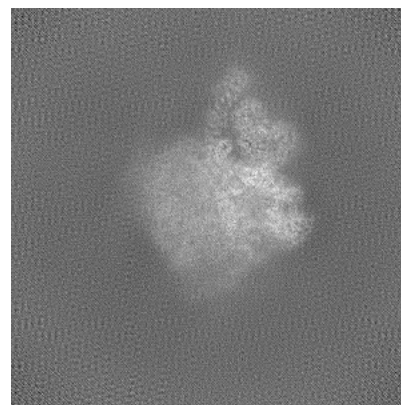

Z

The images above show the map projected in three orthogonal directions.

6.2 Central slices [i](#)

6.2.1 Primary map

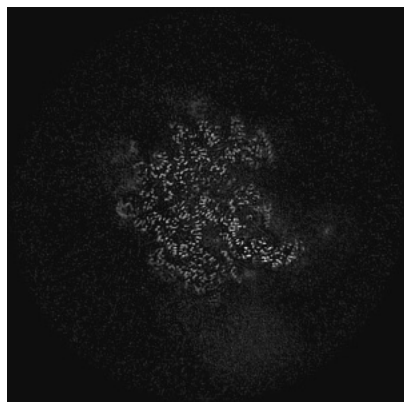

X Index: 240

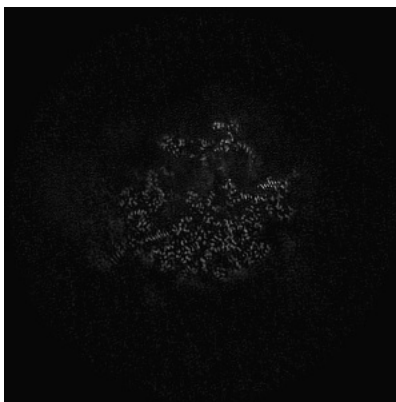

Y Index: 240

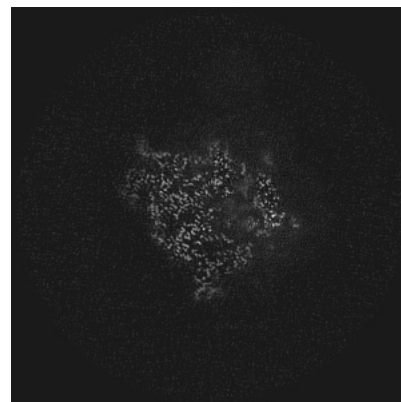

Z Index: 240

6.2.2 Raw map

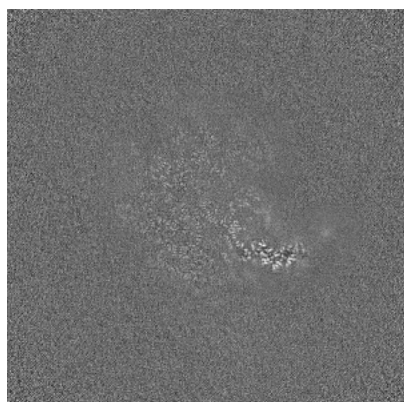

X Index: 240

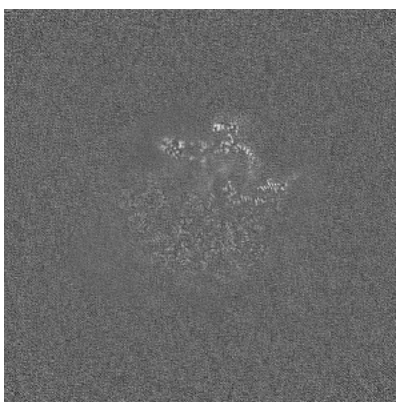

Y Index: 240

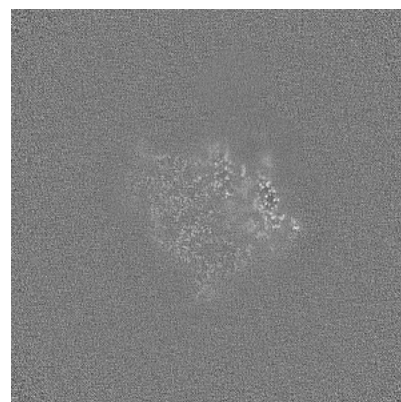

Z Index: 240

The images above show central slices of the map in three orthogonal directions.

6.3 Largest variance slices [i](#)

6.3.1 Primary map

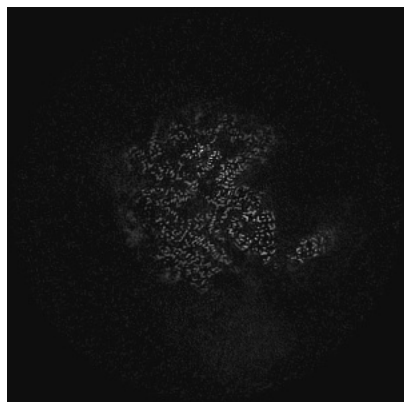

X Index: 254

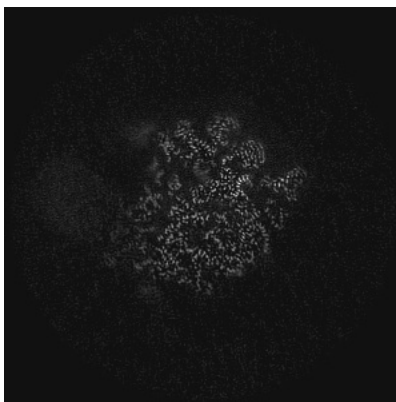

Y Index: 260

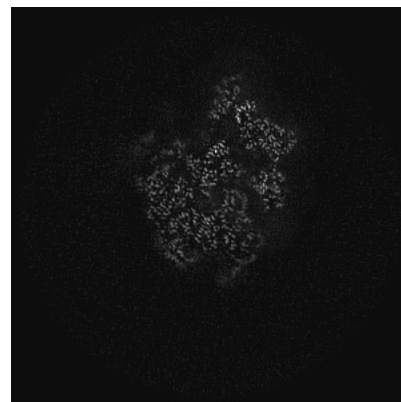

Z Index: 197

6.3.2 Raw map

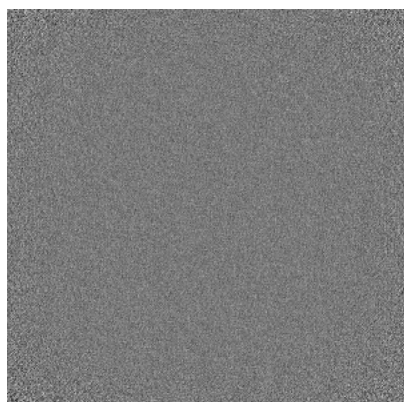

X Index: 0

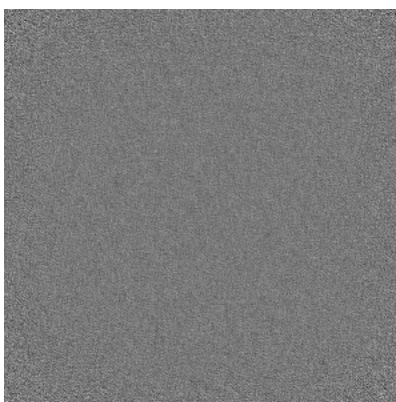

Y Index: 0

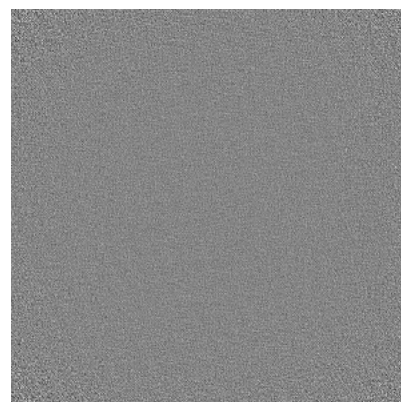

Z Index: 0

The images above show the largest variance slices of the map in three orthogonal directions.

6.4 Orthogonal standard-deviation projections (False-color) [i](#)

6.4.1 Primary map

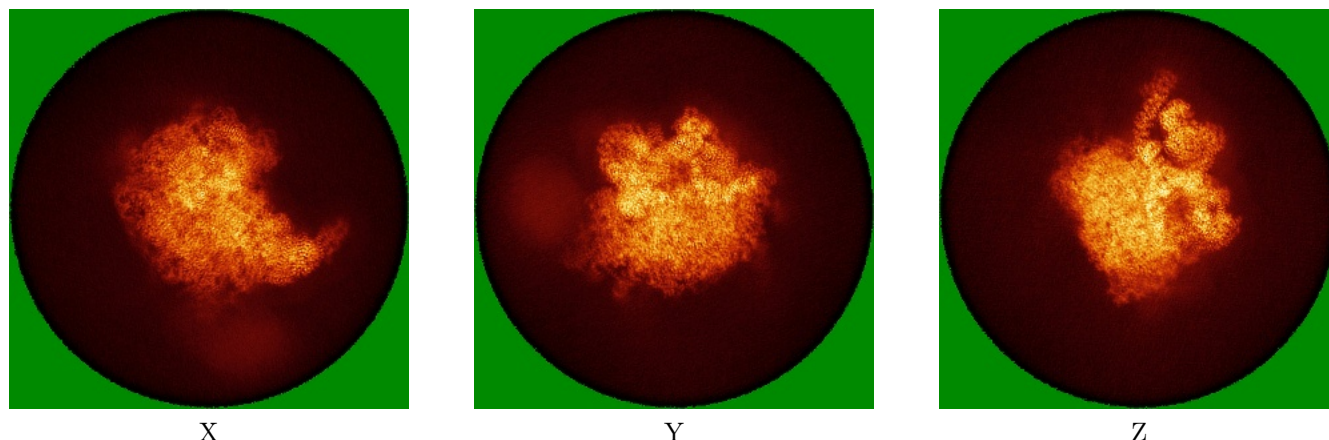

6.4.2 Raw map

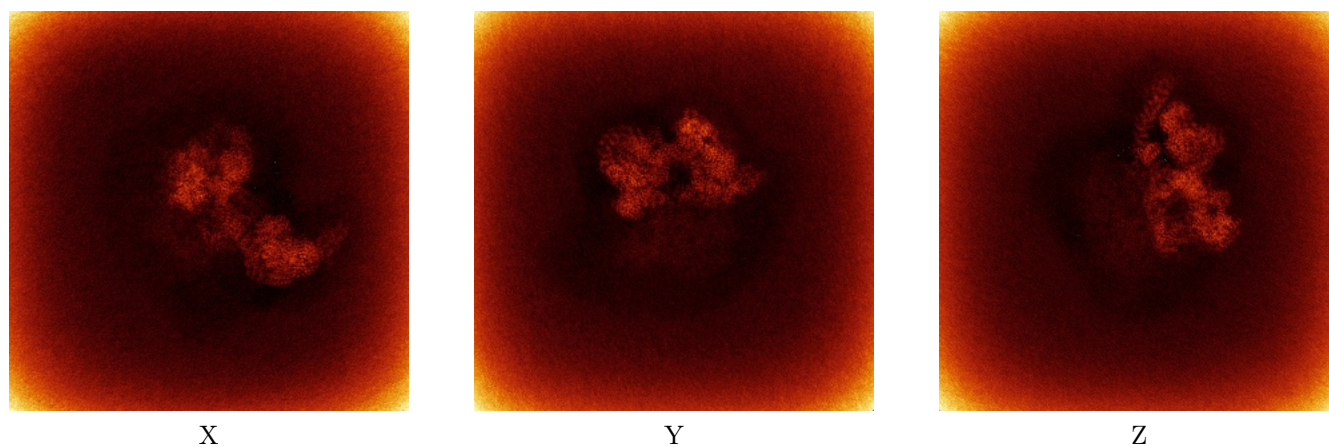

The images above show the map standard deviation projections with false color in three orthogonal directions. Minimum values are shown in green, max in blue, and dark to light orange shades represent small to large values respectively.

6.5 Orthogonal surface views [i](#)

6.5.1 Primary map



X

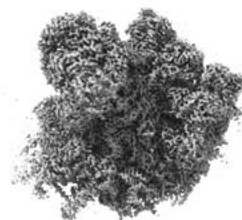

Y

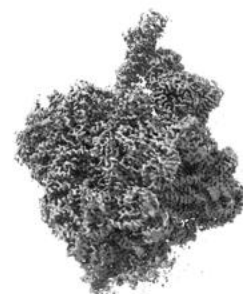

Z

The images above show the 3D surface view of the map at the recommended contour level 0.95. These images, in conjunction with the slice images, may facilitate assessment of whether an appropriate contour level has been provided.

6.5.2 Raw map



X

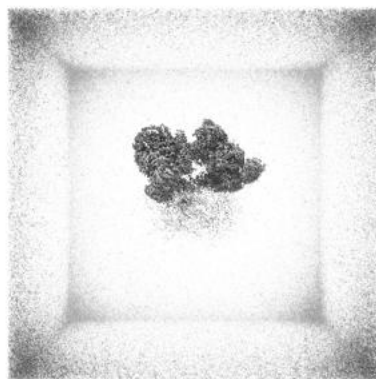

Y

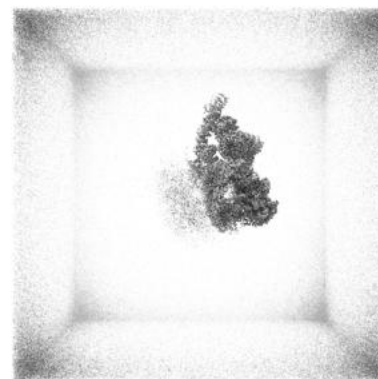

Z

These images show the 3D surface of the raw map. The raw map's contour level was selected so that its surface encloses the same volume as the primary map does at its recommended contour level.

6.6 Mask visualisation [i](#)

This section shows the 3D surface view of the primary map at 50% transparency overlaid with the specified mask at 0% transparency

A mask typically either:

- Encompasses the whole structure
- Separates out a domain, a functional unit, a monomer or an area of interest from a larger structure

6.6.1 emd_29267_msk_1.map [i](#)

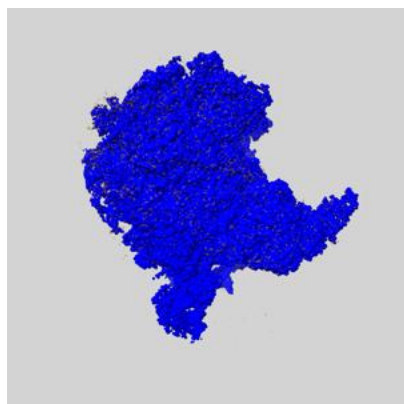

X

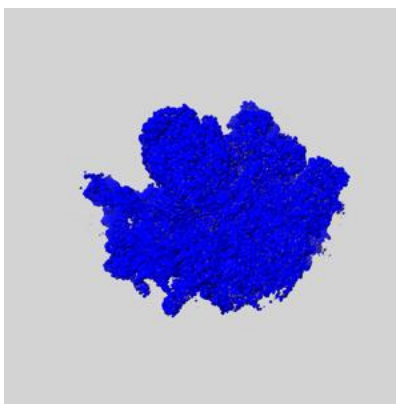

Y

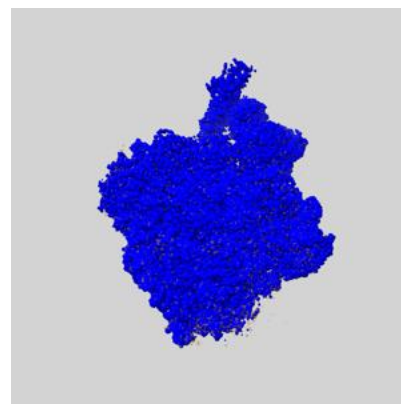

Z

7 Map analysis [i](#)

This section contains the results of statistical analysis of the map.

7.1 Map-value distribution [i](#)

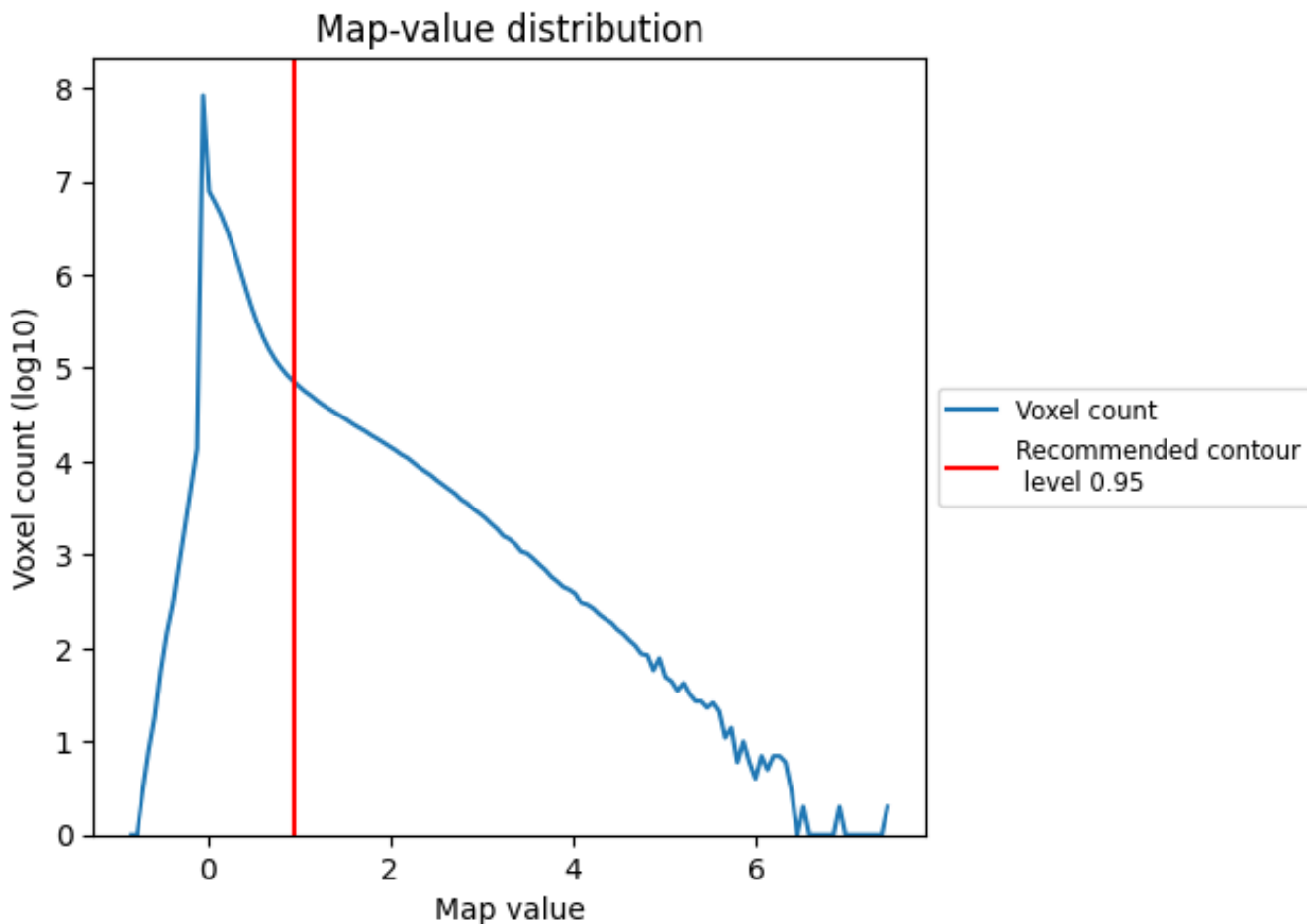

The map-value distribution is plotted in 128 intervals along the x-axis. The y-axis is logarithmic. A spike in this graph at zero usually indicates that the volume has been masked.

7.2 Volume estimate [i](#)

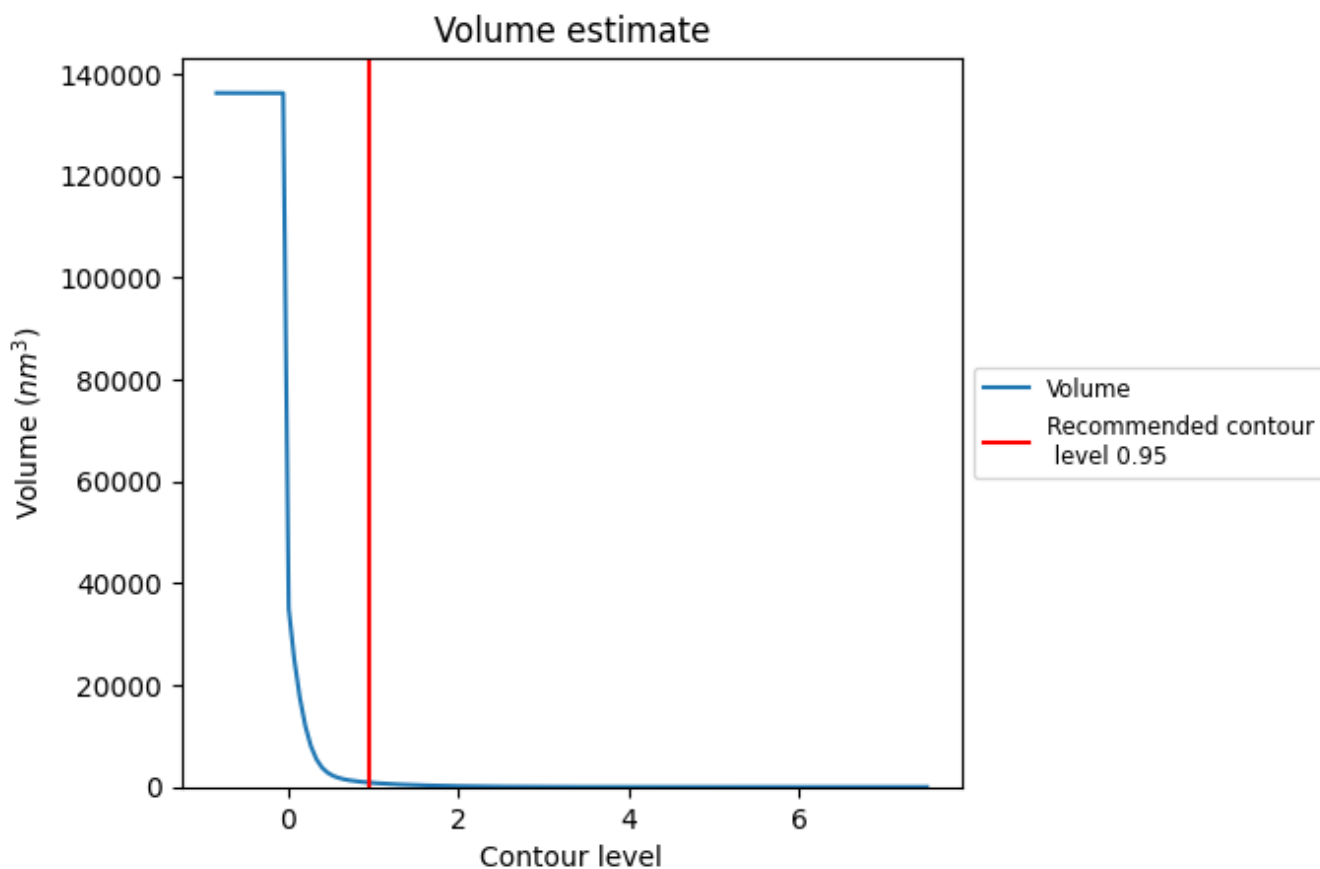

The volume at the recommended contour level is 863 nm^3 ; this corresponds to an approximate mass of 779 kDa.

The volume estimate graph shows how the enclosed volume varies with the contour level. The recommended contour level is shown as a vertical line and the intersection between the line and the curve gives the volume of the enclosed surface at the given level.

7.3 Rotationally averaged power spectrum i

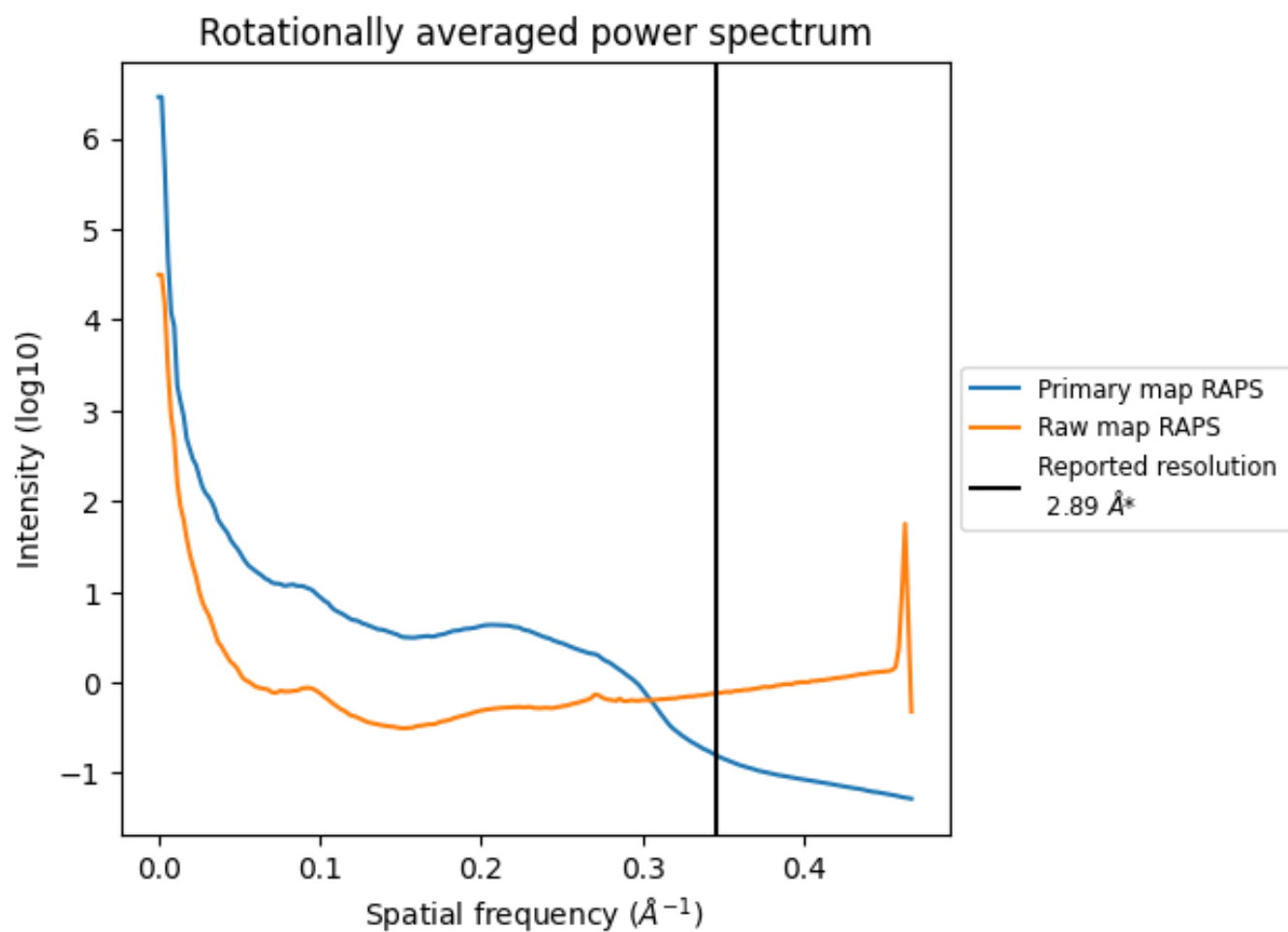

*Reported resolution corresponds to spatial frequency of 0.346 Å⁻¹

8 Fourier-Shell correlation [i](#)

Fourier-Shell Correlation (FSC) is the most commonly used method to estimate the resolution of single-particle and subtomogram-averaged maps. The shape of the curve depends on the imposed symmetry, mask and whether or not the two 3D reconstructions used were processed from a common reference. The reported resolution is shown as a black line. A curve is displayed for the half-bit criterion in addition to lines showing the 0.143 gold standard cut-off and 0.5 cut-off.

8.1 FSC [i](#)

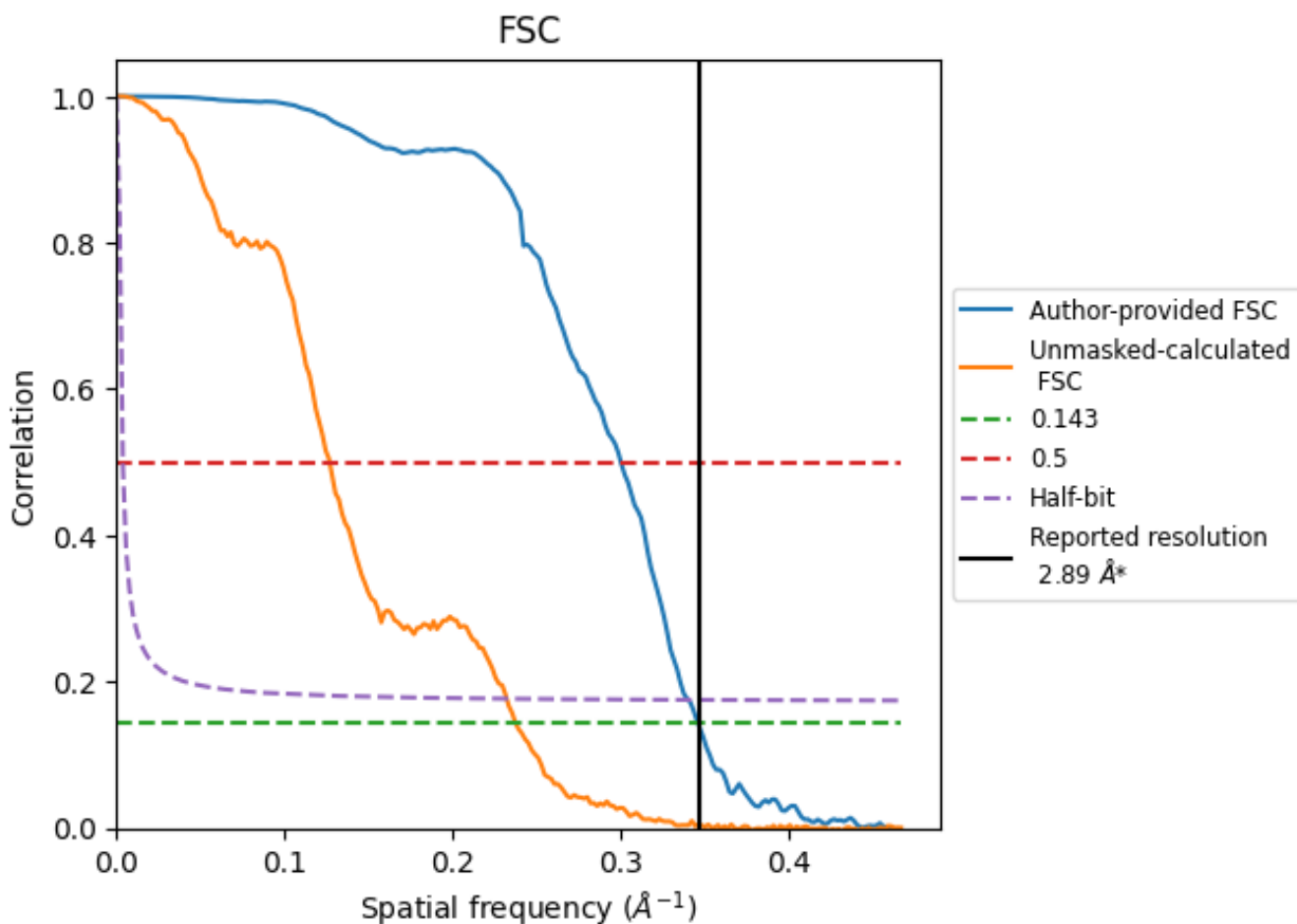

*Reported resolution corresponds to spatial frequency of 0.346 \AA^{-1}

8.2 Resolution estimates [i](#)

Resolution estimate (Å)	Estimation criterion (FSC cut-off)		
	0.143	0.5	Half-bit
Reported by author	2.89	-	-
Author-provided FSC curve	2.89	3.34	2.94
Unmasked-calculated*	4.21	7.89	4.31

*Resolution estimate based on FSC curve calculated by comparison of deposited half-maps. The value from deposited half-maps intersecting FSC 0.143 CUT-OFF 4.21 differs from the reported value 2.89 by more than 10 %

9 Map-model fit [i](#)

This section contains information regarding the fit between EMDB map EMD-29267 and PDB model 8FL4. Per-residue inclusion information can be found in section 3 on page 17.

9.1 Map-model overlay [i](#)

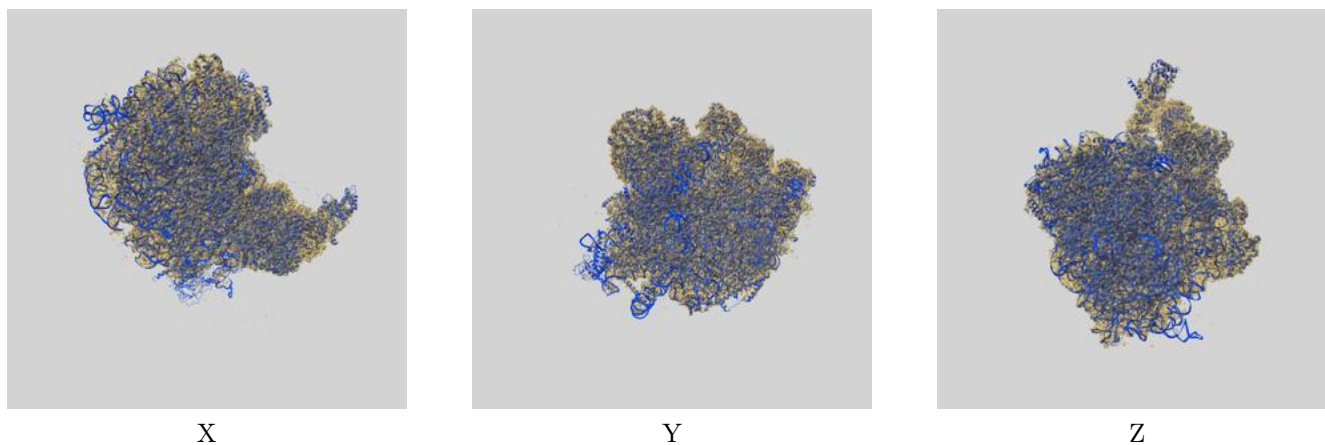

The images above show the 3D surface view of the map at the recommended contour level 0.95 at 50% transparency in yellow overlaid with a ribbon representation of the model coloured in blue. These images allow for the visual assessment of the quality of fit between the atomic model and the map.

9.2 Q-score mapped to coordinate model [i](#)

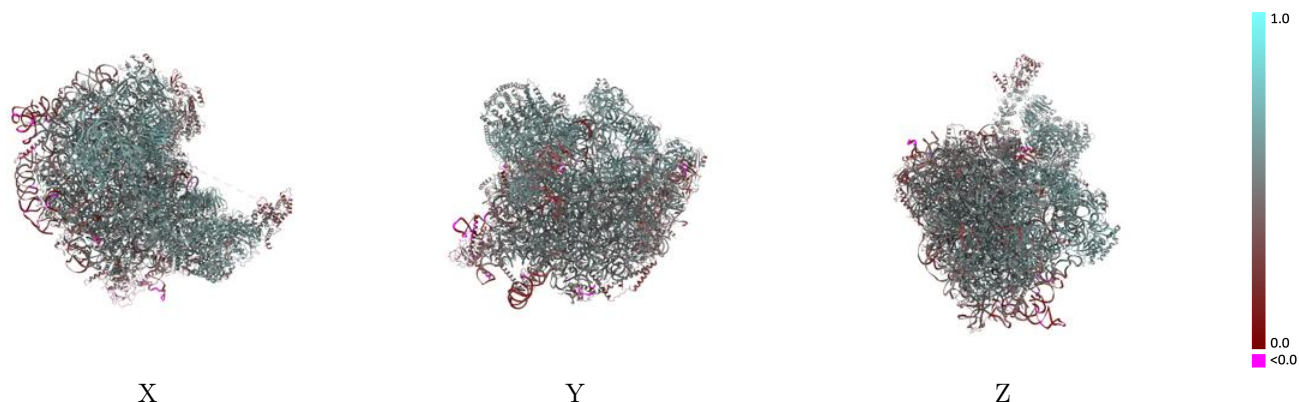

The images above show the model with each residue coloured according to its Q-score. This shows their resolvability in the map with higher Q-score values reflecting better resolvability. Please note: Q-score is calculating the resolvability of atoms, and thus high values are only expected at resolutions at which atoms can be resolved. Low Q-score values may therefore be expected for many entries.

9.3 Atom inclusion mapped to coordinate model [i](#)

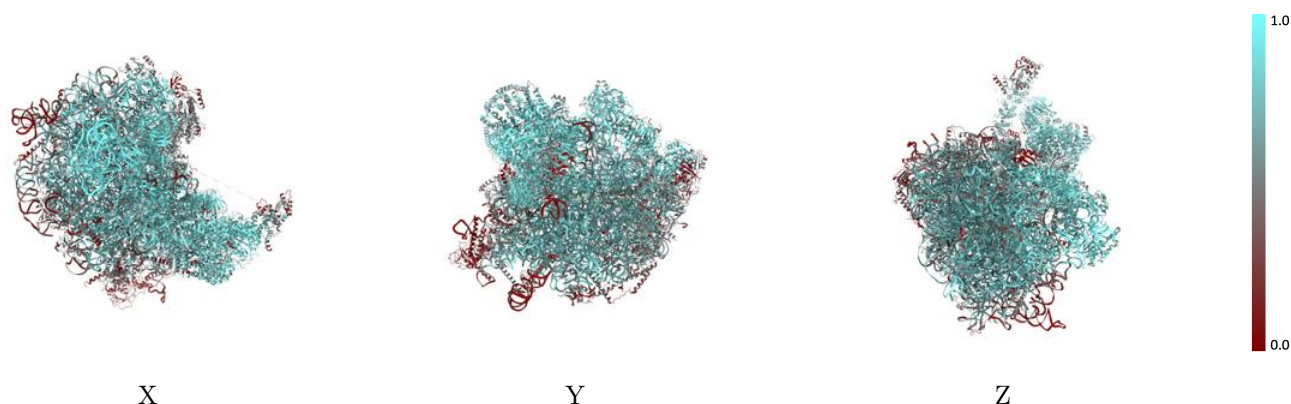

The images above show the model with each residue coloured according to its atom inclusion. This shows to what extent they are inside the map at the recommended contour level (0.95).



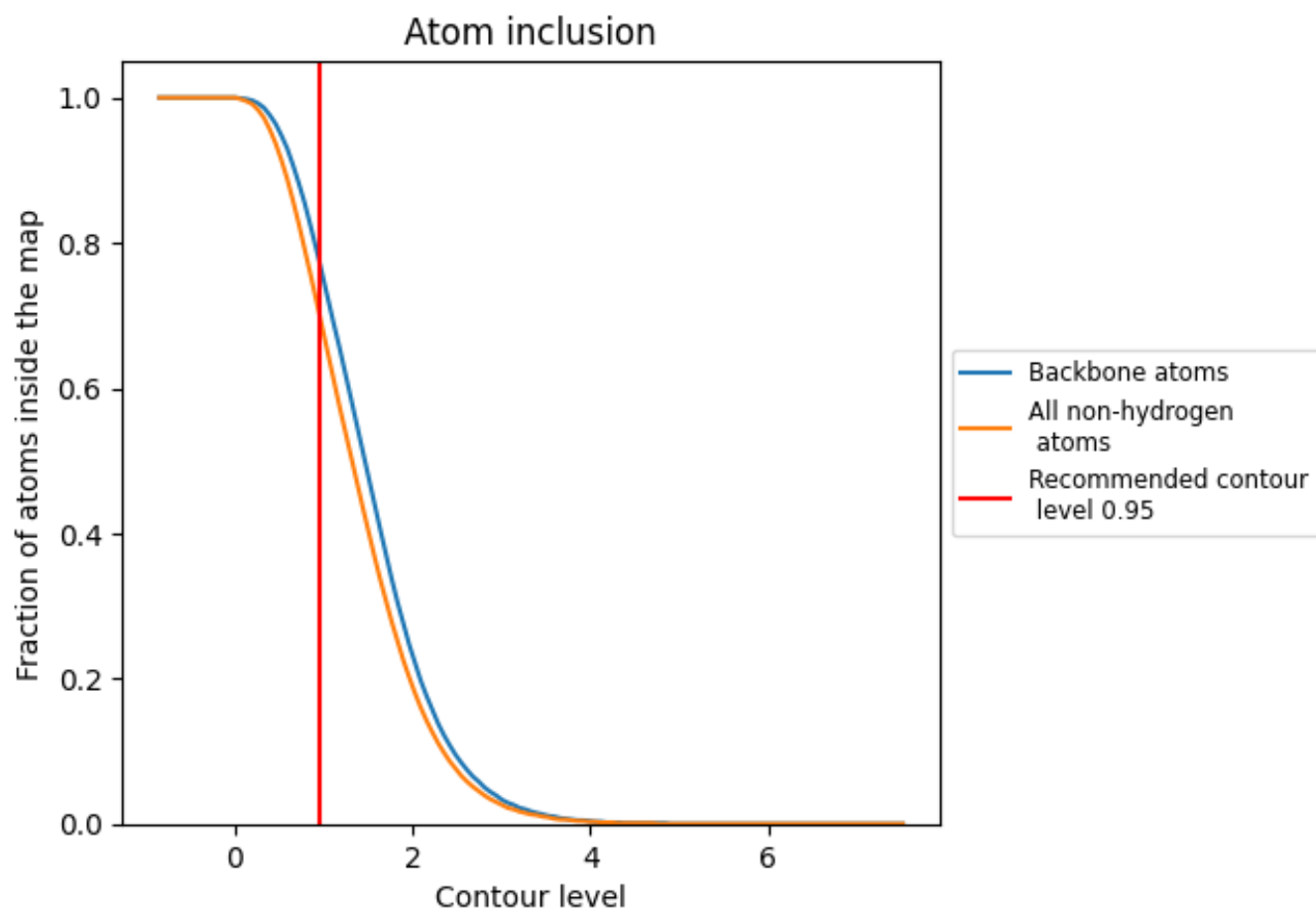



































































9.4 Atom inclusion [i](#)



At the recommended contour level, 78% of all backbone atoms, 70% of all non-hydrogen atoms, are inside the map.

9.5 Map-model fit summary

























































The table lists the average atom inclusion at the recommended contour level (0.95) and Q-score for the entire model and for each chain.

Chain	Atom inclusion	Q-score
All	 0.7050	 0.4940
BA	 0.4550	 0.3940
BB	 0.7120	 0.5260
BD	 0.2770	 0.3860
L1	 0.8200	 0.5130
L3	 0.7450	 0.4770
L4	 0.9400	 0.5910
L5	 0.8020	 0.5640
L6	 0.5370	 0.4410
L7	 0.6830	 0.5220
L8	 0.6540	 0.5130
L9	 0.6870	 0.5270
LA	 0.7000	 0.5240
LB	 0.6310	 0.4950
LC	 0.8600	 0.6210
LD	 0.6220	 0.4870
LE	 0.7570	 0.5670
LF	 0.4720	 0.4260
LG	 0.6020	 0.4890
LH	 0.6170	 0.4890
LI	 0.6450	 0.4930
LJ	 0.5890	 0.4670
LK	 0.5660	 0.4730
LL	 0.6490	 0.4950
LN	 0.6580	 0.4980
LO	 0.5710	 0.4530
LP	 0.6030	 0.4670
LQ	 0.6980	 0.5400
LR	 0.6440	 0.5060
LS	 0.5960	 0.4750
LT	 0.7560	 0.5560
LU	 0.4990	 0.4380
LW	 0.7550	 0.5370
LX	 0.7390	 0.5230
LY	 0.4630	 0.4350



Continued on next page...

Continued from previous page...

Chain	Atom inclusion	Q-score
LZ	 0.7490	 0.5520
NB	 0.5940	 0.5040
NC	 0.6750	 0.5100
NF	 0.8560	 0.6070
NJ	 0.8630	 0.5960
NK	 0.4570	 0.3990
NL	 0.1690	 0.3480
NP	 0.4640	 0.4390
NT	 0.8080	 0.5560
NU	 0.7210	 0.4920
NV	 0.7890	 0.5590
NW	 0.8720	 0.5610
NX	 0.7920	 0.5500
NY	 0.7960	 0.5540
NZ	 0.6300	 0.5260
SA	 0.6760	 0.5080
SB	 0.8500	 0.5940
SC	 0.5470	 0.4590
SD	 0.7360	 0.5360
SE	 0.4740	 0.4220
SF	 0.7940	 0.5620
SG	 0.5710	 0.4890
SI	 0.0060	 0.2160
SK	 0.4830	 0.4030
SM	 0.2440	 0.3380
SQ	 0.5570	 0.4810
SR	 0.5590	 0.4470
SV	 0.5450	 0.4350