



Full wwPDB X-ray Structure Validation Report ⓘ

Jan 4, 2024 – 05:15 pm GMT

PDB ID : 5G2Q
Title : The crystal structure of a S-selective transaminase from *Arthrobacter* sp. with alanine bound
Authors : van Oosterwijk, N.; Willies, S.; Hekelaar, J.; Terwisscha van Scheltinga, A.C.; Turner, N.J.; Dijkstra, B.W.
Deposited on : 2016-04-12
Resolution : 2.30 Å(reported)

This is a Full wwPDB X-ray Structure Validation Report for a publicly released PDB entry.

We welcome your comments at validation@mail.wwpdb.org

A user guide is available at

<https://www.wwpdb.org/validation/2017/XrayValidationReportHelp>

with specific help available everywhere you see the ⓘ symbol.

The types of validation reports are described at

<http://www.wwpdb.org/validation/2017/FAQs#types>.

The following versions of software and data (see [references ⓘ](#)) were used in the production of this report:

MolProbity : 4.02b-467
Mogul : 1.8.4, CSD as541be (2020)
Xtriage (Phenix) : 1.13
EDS : 2.36
buster-report : 1.1.7 (2018)
Percentile statistics : 20191225.v01 (using entries in the PDB archive December 25th 2019)
Refmac : 5.8.0158
CCP4 : 7.0.044 (Gargrove)
Ideal geometry (proteins) : Engh & Huber (2001)
Ideal geometry (DNA, RNA) : Parkinson et al. (1996)
Validation Pipeline (wwPDB-VP) : 2.36

1 Overall quality at a glance

The following experimental techniques were used to determine the structure:

X-RAY DIFFRACTION

The reported resolution of this entry is 2.30 Å.

Percentile scores (ranging between 0-100) for global validation metrics of the entry are shown in the following graphic. The table shows the number of entries on which the scores are based.

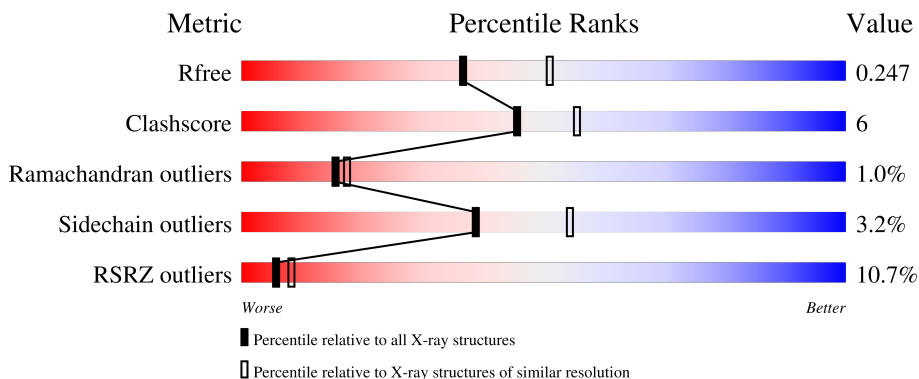

Metric	Whole archive (#Entries)	Similar resolution (#Entries, resolution range(Å))
R_{free}	130704	5042 (2.30-2.30)
Clashscore	141614	5643 (2.30-2.30)
Ramachandran outliers	138981	5575 (2.30-2.30)
Sidechain outliers	138945	5575 (2.30-2.30)
RSRZ outliers	127900	4938 (2.30-2.30)

The table below summarises the geometric issues observed across the polymeric chains and their fit to the electron density. The red, orange, yellow and green segments of the lower bar indicate the fraction of residues that contain outliers for ≥ 3 , 2, 1 and 0 types of geometric quality criteria respectively. A grey segment represents the fraction of residues that are not modelled. The numeric value for each fraction is indicated below the corresponding segment, with a dot representing fractions $\leq 5\%$. The upper red bar (where present) indicates the fraction of residues that have poor fit to the electron density. The numeric value is given above the bar.

Mol	Chain	Length	Quality of chain
1	A	485	 2% 81% 13% 5%
1	B	485	 3% 84% 9% 5%
1	C	485	 3% 80% 14% 5%
1	D	485	 7% 83% 11% 5%

Continued on next page...

Continued from previous page...

Mol	Chain	Length	Quality of chain
1	E	485	<p>7% 80% 14% • 5%</p>
1	F	485	<p>3% 78% 16% • •</p>
1	G	485	<p>7% 82% 12% • 5%</p>
1	H	485	<p>% 81% 13% • 5%</p>
1	I	485	<p>10% 79% 15% • 5%</p>
1	J	485	<p>24% 78% 16% • 5%</p>
1	K	485	<p>25% 72% 21% • 5%</p>
1	L	485	<p>31% 73% 20% • 5%</p>

2 Entry composition [i](#)

There are 3 unique types of molecules in this entry. The entry contains 44561 atoms, of which 0 are hydrogens and 0 are deuteriums.

In the tables below, the ZeroOcc column contains the number of atoms modelled with zero occupancy, the AltConf column contains the number of residues with at least one atom in alternate conformation and the Trace column contains the number of residues modelled with at most 2 atoms.

- Molecule 1 is a protein called TRANSAMINASE.

Mol	Chain	Residues	Atoms					ZeroOcc	AltConf	Trace
			Total	C	N	O	S			
1	A	461	3624	2297	617	692	18	0	0	0
1	B	461	3624	2297	617	692	18	0	0	0
1	C	461	3624	2297	617	692	18	0	0	0
1	D	465	3650	2310	622	700	18	0	0	0
1	E	461	3624	2297	617	692	18	0	0	0
1	F	465	3650	2310	622	700	18	0	0	0
1	G	459	3607	2288	613	688	18	0	0	0
1	H	462	3629	2300	618	693	18	0	0	0
1	I	461	3624	2297	617	692	18	0	0	0
1	J	461	3624	2297	617	692	18	0	0	0
1	K	461	3624	2297	617	692	18	0	0	0
1	L	460	3615	2291	615	691	18	0	0	0

- Molecule 2 is 2-[(3-HYDROXY-2-METHYL-5-PHOSPHONOXYMETHYL-PYRIDIN-4-YLMETHYL)-AMINO]-PROPIONIC ACID (three-letter code: PDA) (formula: C₁₁H₁₇N₂O₇P).

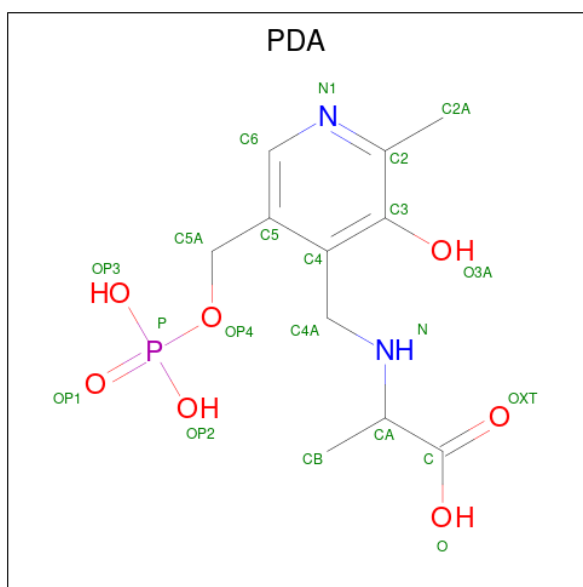

Mol	Chain	Residues	Atoms					ZeroOcc	AltConf
			Total	C	N	O	P		
2	A	1	Total	C	N	O	P	0	0
			21	11	2	7	1		
2	B	1	Total	C	N	O	P	0	0
			21	11	2	7	1		
2	C	1	Total	C	N	O	P	0	0
			21	11	2	7	1		
2	D	1	Total	C	N	O	P	0	0
			21	11	2	7	1		
2	E	1	Total	C	N	O	P	0	0
			21	11	2	7	1		
2	F	1	Total	C	N	O	P	0	0
			21	11	2	7	1		
2	G	1	Total	C	N	O	P	0	0
			21	11	2	7	1		
2	H	1	Total	C	N	O	P	0	0
			21	11	2	7	1		
2	I	1	Total	C	N	O	P	0	0
			21	11	2	7	1		
2	J	1	Total	C	N	O	P	0	0
			21	11	2	7	1		
2	K	1	Total	C	N	O	P	0	0
			21	11	2	7	1		
2	L	1	Total	C	N	O	P	0	0
			21	11	2	7	1		

- Molecule 3 is water.

Mol	Chain	Residues	Atoms	ZeroOcc	AltConf
3	A	162	Total O 162 162	0	0
3	B	110	Total O 110 110	0	0
3	C	80	Total O 80 80	0	0
3	D	66	Total O 66 66	0	0
3	E	63	Total O 63 63	0	0
3	F	64	Total O 64 64	0	0
3	G	90	Total O 90 90	0	0
3	H	74	Total O 74 74	0	0
3	I	38	Total O 38 38	0	0
3	J	17	Total O 17 17	0	0
3	K	12	Total O 12 12	0	0
3	L	14	Total O 14 14	0	0

3 Residue-property plots

These plots are drawn for all protein, RNA, DNA and oligosaccharide chains in the entry. The first graphic for a chain summarises the proportions of the various outlier classes displayed in the second graphic. The second graphic shows the sequence view annotated by issues in geometry and electron density. Residues are color-coded according to the number of geometric quality criteria for which they contain at least one outlier: green = 0, yellow = 1, orange = 2 and red = 3 or more. A red dot above a residue indicates a poor fit to the electron density ($RSRZ > 2$). Stretches of 2 or more consecutive residues without any outlier are shown as a green connector. Residues present in the sample, but not in the model, are shown in grey.

- Molecule 1: TRANSAMINASE

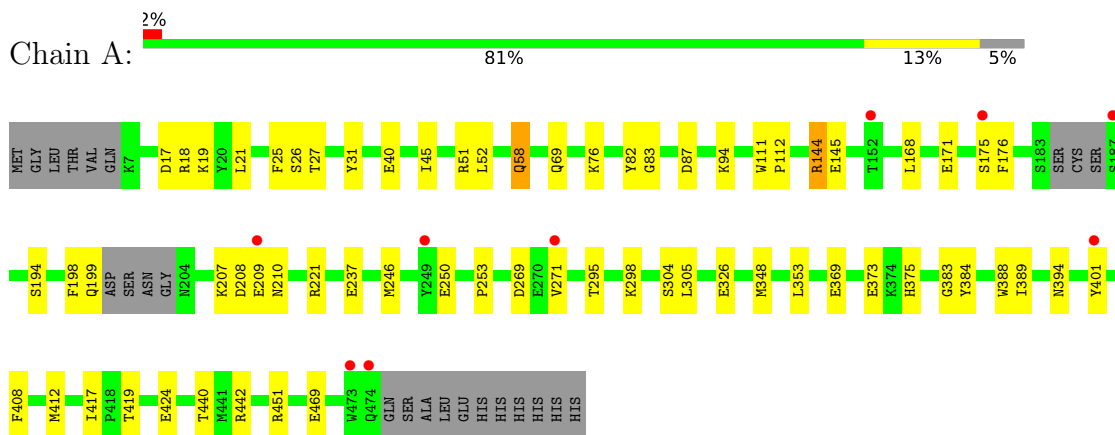

- Molecule 1: TRANSAMINASE

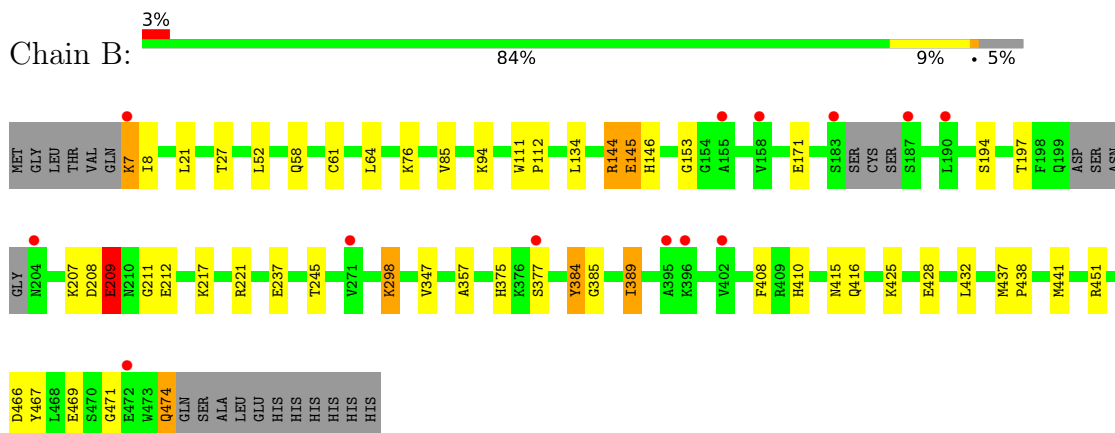

- Molecule 1: TRANSAMINASE

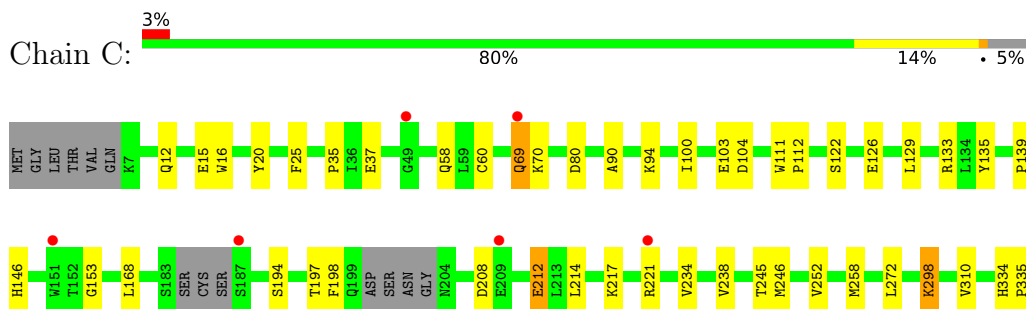

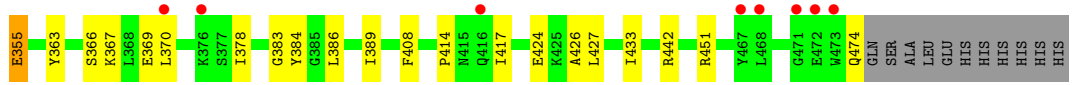

• Molecule 1: TRANSAMINASE

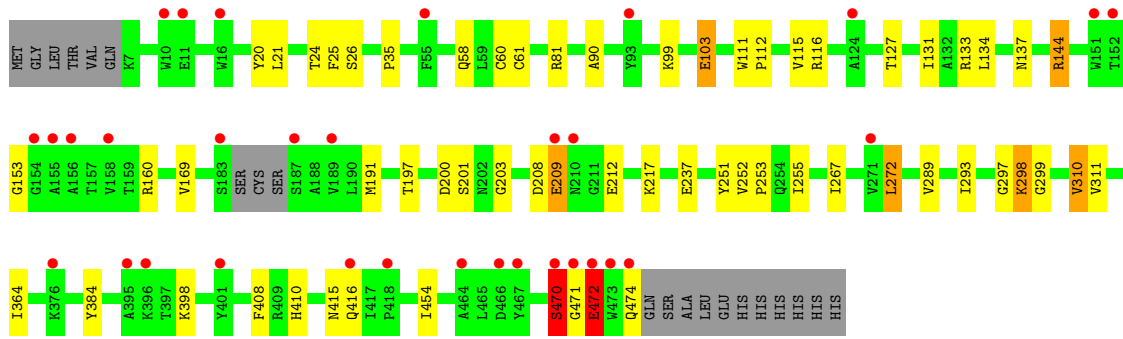
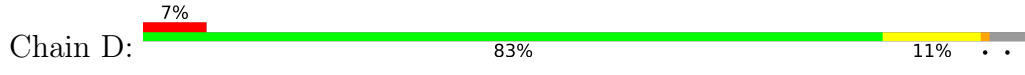

• Molecule 1: TRANSAMINASE

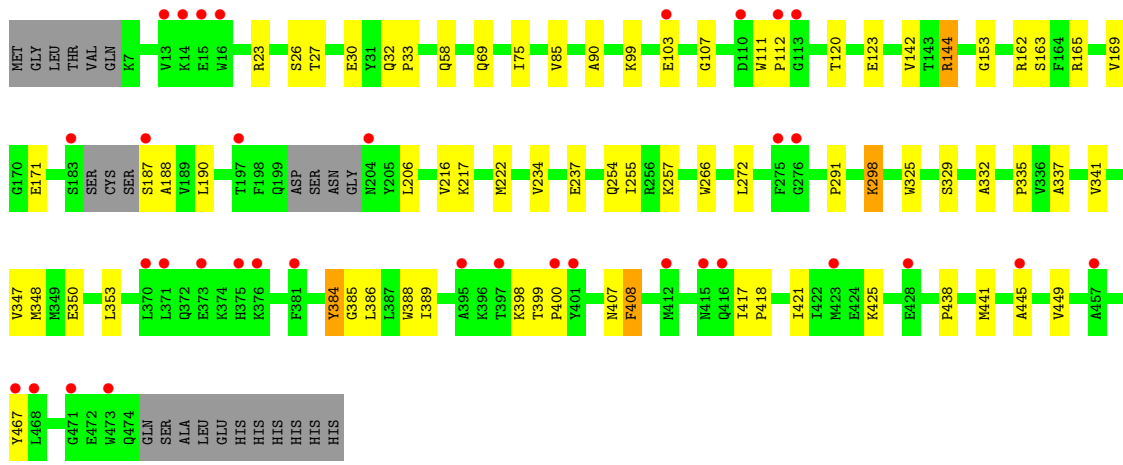
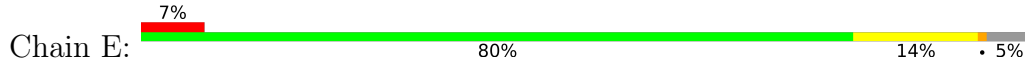

• Molecule 1: TRANSAMINASE

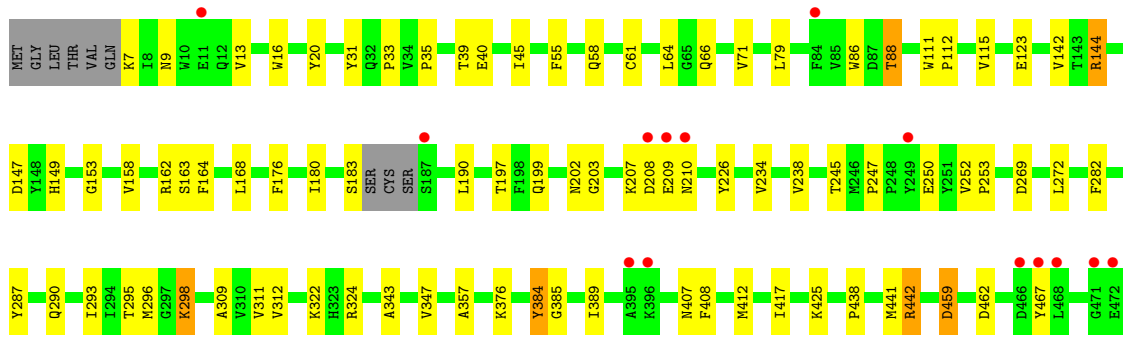
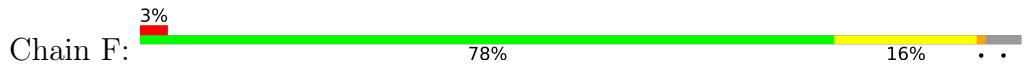

W473
Q474
GLN
SER
SER
ALA
LEU
LEU
GLU
HIS
HIS
HIS
HIS
HIS
HIS

● Molecule 1: TRANSAMINASE

Chain G: 7% 82% 12% 5%

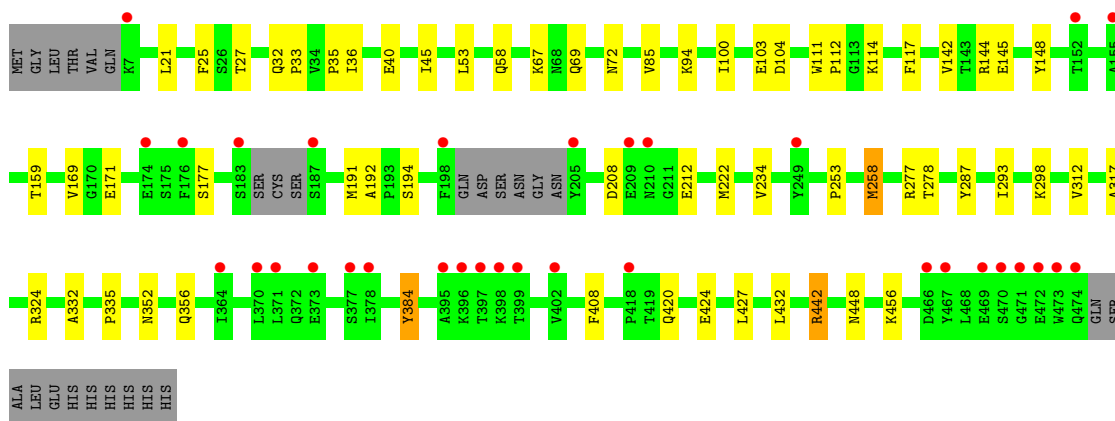

● Molecule 1: TRANSAMINASE

Chain H: 81% 13% 5%

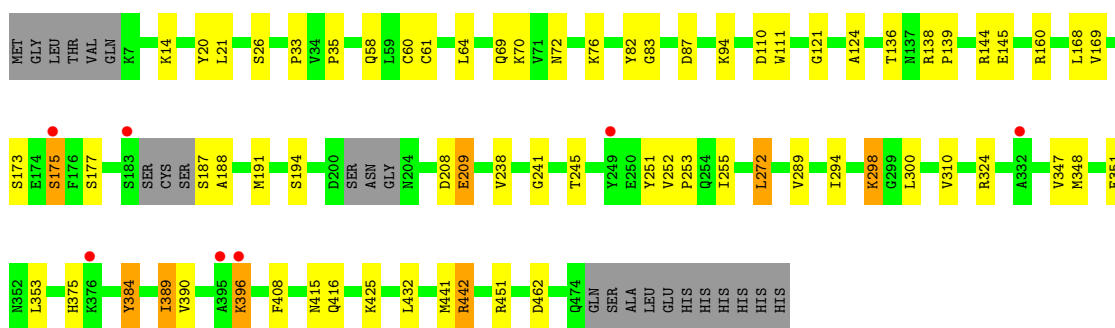

● Molecule 1: TRANSAMINASE

Chain I: 10% 79% 15% 5%

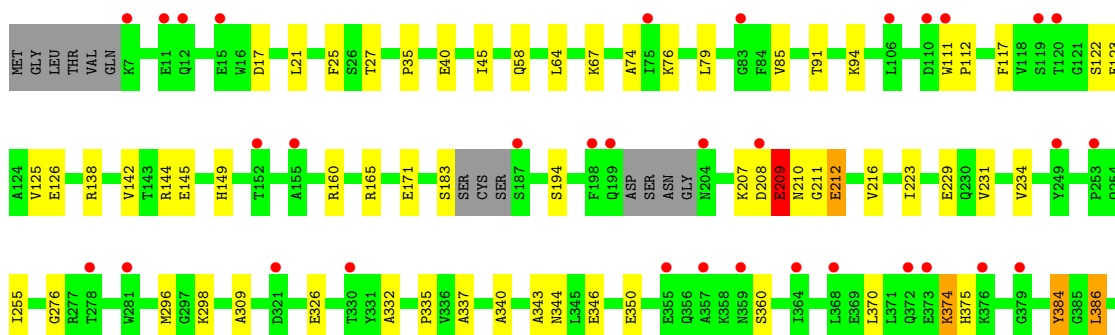



- Molecule 1: TRANSAMINASE

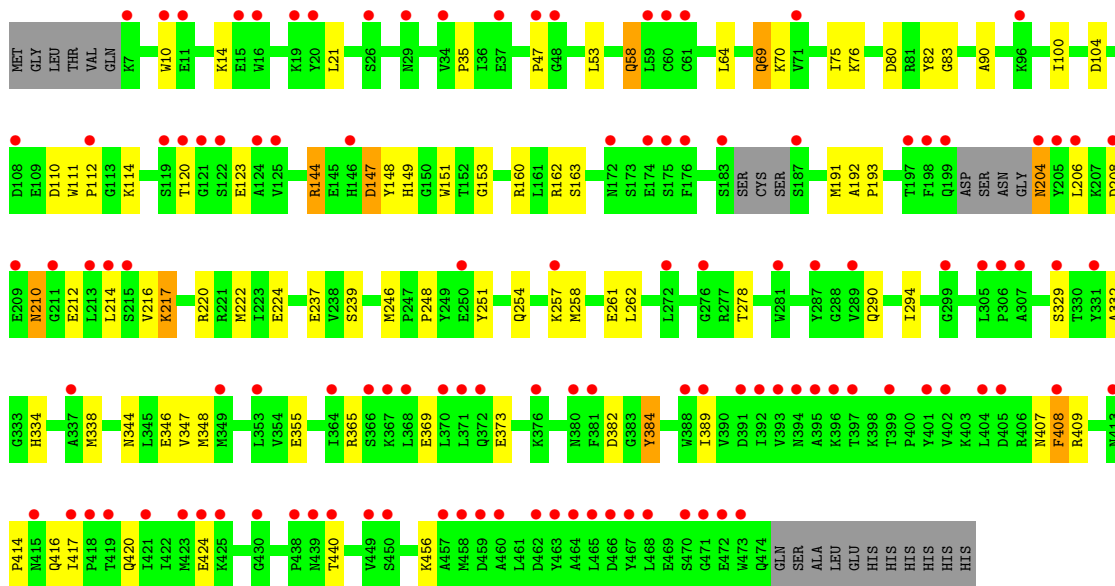
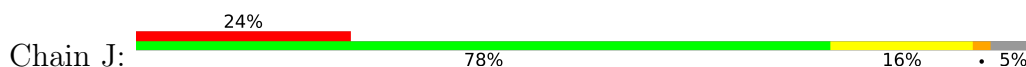

- Molecule 1: TRANSAMINASE

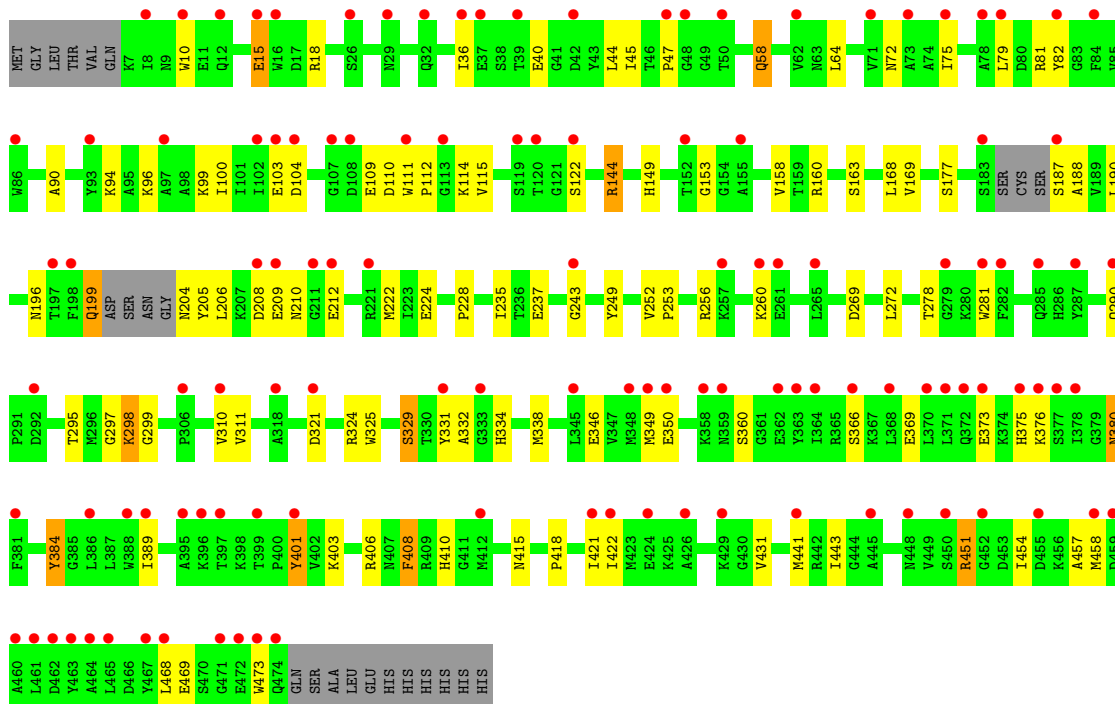

- Molecule 1: TRANSAMINASE

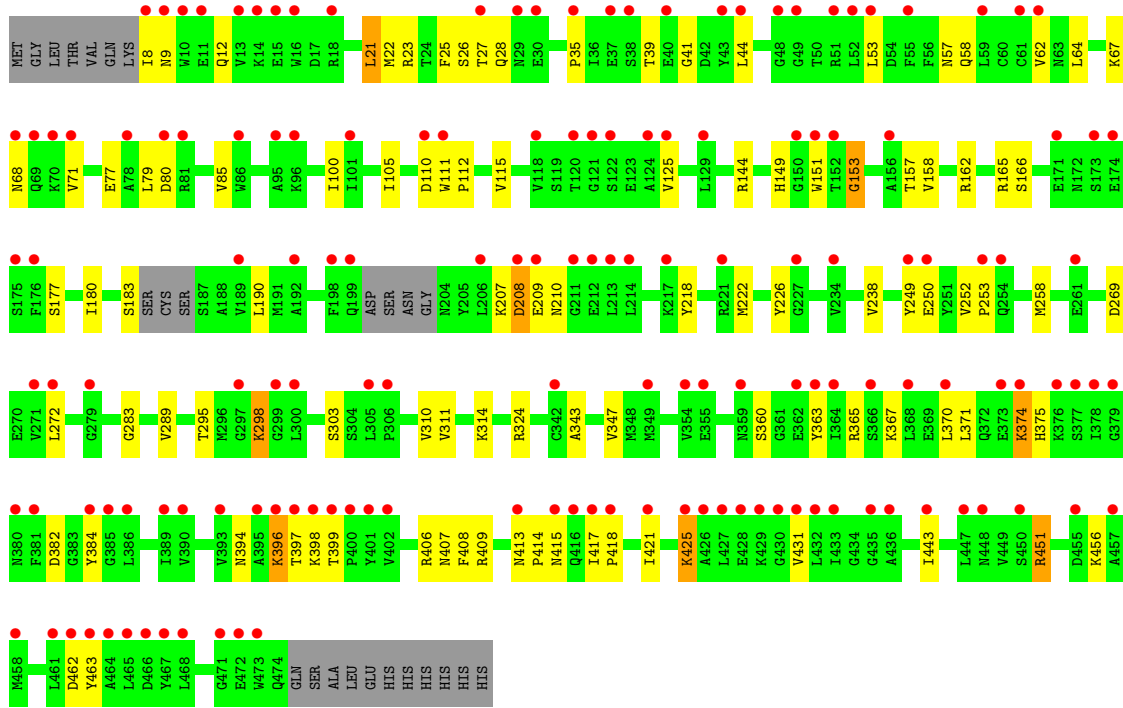
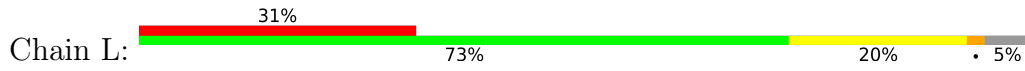

4 Data and refinement statistics

Property	Value	Source
Space group	P 1	Depositor
Cell constants a, b, c, α , β , γ	64.28Å 99.81Å 217.34Å 81.58° 89.12° 74.49°	Depositor
Resolution (Å)	47.96 – 2.30 46.51 – 2.30	Depositor EDS
% Data completeness (in resolution range)	93.7 (47.96-2.30) 93.8 (46.51-2.30)	Depositor EDS
R_{merge}	0.07	Depositor
R_{sym}	(Not available)	Depositor
$\langle I/\sigma(I) \rangle$ ¹	1.87 (at 2.29Å)	Xtrriage
Refinement program	REFMAC 5.8.0073	Depositor
R, R_{free}	0.192 , 0.249 0.184 , 0.247	Depositor DCC
R_{free} test set	10758 reflections (5.02%)	wwPDB-VP
Wilson B-factor (Å ²)	29.6	Xtrriage
Anisotropy	0.900	Xtrriage
Bulk solvent k_{sol} (e/Å ³), B_{sol} (Å ²)	0.34 , 56.7	EDS
L-test for twinning ²	$\langle L \rangle = 0.44$, $\langle L^2 \rangle = 0.26$	Xtrriage
Estimated twinning fraction	No twinning to report.	Xtrriage
F_o, F_c correlation	0.96	EDS
Total number of atoms	44561	wwPDB-VP
Average B, all atoms (Å ²)	74.0	wwPDB-VP

Xtrriage's analysis on translational NCS is as follows: *The largest off-origin peak in the Patterson function is 3.46% of the height of the origin peak. No significant pseudotranslation is detected.*

¹Intensities estimated from amplitudes.

²Theoretical values of $\langle |L| \rangle$, $\langle L^2 \rangle$ for acentric reflections are 0.5, 0.333 respectively for untwinned datasets, and 0.375, 0.2 for perfectly twinned datasets.

5 Model quality i

5.1 Standard geometry i

Bond lengths and bond angles in the following residue types are not validated in this section: PDA

The Z score for a bond length (or angle) is the number of standard deviations the observed value is removed from the expected value. A bond length (or angle) with $|Z| > 5$ is considered an outlier worth inspection. RMSZ is the root-mean-square of all Z scores of the bond lengths (or angles).

Mol	Chain	Bond lengths		Bond angles	
		RMSZ	# $ Z > 5$	RMSZ	# $ Z > 5$
1	A	0.68	0/3700	0.81	1/5009 (0.0%)
1	B	0.69	0/3700	0.83	0/5009
1	C	0.62	0/3700	0.78	2/5009 (0.0%)
1	D	0.60	0/3727	0.77	1/5047 (0.0%)
1	E	0.59	0/3700	0.74	0/5009
1	F	0.59	0/3727	0.74	0/5047
1	G	0.61	0/3683	0.75	2/4986 (0.0%)
1	H	0.65	0/3705	0.78	1/5016 (0.0%)
1	I	0.53	0/3700	0.71	2/5009 (0.0%)
1	J	0.50	0/3700	0.67	0/5009
1	K	0.48	1/3700 (0.0%)	0.66	0/5009
1	L	0.55	5/3691 (0.1%)	0.71	2/4998 (0.0%)
All	All	0.59	6/44433 (0.0%)	0.75	11/60157 (0.0%)

Chiral center outliers are detected by calculating the chiral volume of a chiral center and verifying if the center is modelled as a planar moiety or with the opposite hand. A planarity outlier is detected by checking planarity of atoms in a peptide group, atoms in a mainchain group or atoms of a sidechain that are expected to be planar.

Mol	Chain	#Chirality outliers	#Planarity outliers
1	B	0	1
1	F	0	1
All	All	0	2

All (6) bond length outliers are listed below:

Mol	Chain	Res	Type	Atoms	Z	Observed(Å)	Ideal(Å)
1	L	443	ILE	C-N	7.92	1.47	1.33
1	L	374	LYS	CB-CG	7.53	1.72	1.52
1	L	425	LYS	CG-CD	6.73	1.75	1.52
1	L	456	LYS	CE-NZ	5.98	1.64	1.49

Continued on next page...

Continued from previous page...

Mol	Chain	Res	Type	Atoms	Z	Observed(Å)	Ideal(Å)
1	L	374	LYS	CD-CE	-5.46	1.37	1.51
1	K	81	ARG	NE-CZ	5.07	1.39	1.33

All (11) bond angle outliers are listed below:

Mol	Chain	Res	Type	Atoms	Z	Observed(°)	Ideal(°)
1	L	443	ILE	CB-CA-C	-6.57	98.45	111.60
1	L	443	ILE	CA-C-N	-6.07	104.05	116.20
1	D	472	GLU	N-CA-C	-5.84	95.24	111.00
1	C	370	LEU	CA-CB-CG	5.65	128.30	115.30
1	A	18	ARG	NE-CZ-NH2	-5.62	117.49	120.30
1	I	386	LEU	CA-CB-CG	-5.56	102.51	115.30
1	I	160	ARG	NE-CZ-NH2	-5.34	117.63	120.30
1	G	277	ARG	NE-CZ-NH1	5.26	122.93	120.30
1	H	110	ASP	CB-CG-OD1	-5.13	113.68	118.30
1	C	80	ASP	CB-CG-OD1	5.06	122.85	118.30
1	G	277	ARG	NE-CZ-NH2	-5.02	117.79	120.30

There are no chirality outliers.

All (2) planarity outliers are listed below:

Mol	Chain	Res	Type	Group
1	B	207	LYS	Peptide
1	F	176	PHE	Peptide

5.2 Too-close contacts [i](#)

In the following table, the Non-H and H(model) columns list the number of non-hydrogen atoms and hydrogen atoms in the chain respectively. The H(added) column lists the number of hydrogen atoms added and optimized by MolProbity. The Clashes column lists the number of clashes within the asymmetric unit, whereas Symm-Clashes lists symmetry-related clashes.

Mol	Chain	Non-H	H(model)	H(added)	Clashes	Symm-Clashes
1	A	3624	0	3573	41	0
1	B	3624	0	3573	38	0
1	C	3624	0	3573	45	0
1	D	3650	0	3592	43	0
1	E	3624	0	3573	42	0
1	F	3650	0	3592	62	0
1	G	3607	0	3559	38	0
1	H	3629	0	3575	46	0

Continued on next page...

Continued from previous page...

Mol	Chain	Non-H	H(model)	H(added)	Clashes	Symm-Clashes
1	I	3624	0	3573	54	0
1	J	3624	0	3573	52	0
1	K	3624	0	3573	75	0
1	L	3615	0	3560	69	0
2	A	21	0	13	2	0
2	B	21	0	13	3	0
2	C	21	0	13	3	0
2	D	21	0	14	3	0
2	E	21	0	13	0	0
2	F	21	0	14	4	0
2	G	21	0	14	0	0
2	H	21	0	14	0	0
2	I	21	0	14	2	0
2	J	21	0	13	1	0
2	K	21	0	12	2	0
2	L	21	0	12	1	0
3	A	162	0	0	2	0
3	B	110	0	0	2	0
3	C	80	0	0	2	0
3	D	66	0	0	0	0
3	E	63	0	0	0	0
3	F	64	0	0	0	0
3	G	90	0	0	2	0
3	H	74	0	0	2	0
3	I	38	0	0	1	0
3	J	17	0	0	0	0
3	K	12	0	0	0	0
3	L	14	0	0	2	0
All	All	44561	0	43048	552	0

The all-atom clashscore is defined as the number of clashes found per 1000 atoms (including hydrogen atoms). The all-atom clashscore for this structure is 6.

All (552) close contacts within the same asymmetric unit are listed below, sorted by their clash magnitude.

Atom-1	Atom-2	Interatomic distance (Å)	Clash overlap (Å)
1:L:425:LYS:CD	1:L:425:LYS:CG	1.75	1.58
1:H:208:ASP:O	1:H:209:GLU:HG2	1.41	1.19
1:L:8:ILE:HG22	1:L:9:ASN:H	1.12	1.11
3:A:2078:HOH:O	1:C:221:ARG:HD3	1.64	0.95
1:G:192:ALA:HA	1:G:222:MET:HE1	1.53	0.91

Continued on next page...

Continued from previous page...

Atom-1	Atom-2	Interatomic distance (Å)	Clash overlap (Å)
1:J:414:PRO:HA	1:J:417:ILE:HD12	1.59	0.84
1:L:64:LEU:HD11	1:L:347:VAL:HG11	1.60	0.81
1:L:8:ILE:HG22	1:L:9:ASN:N	1.95	0.80
1:A:221:ARG:HH21	1:C:145:GLU:CD	1.86	0.78
1:C:60:CYS:HB2	1:C:272:LEU:HD11	1.65	0.78
1:I:208:ASP:HB3	1:I:211:GLY:H	1.50	0.77
1:A:111:TRP:N	1:A:112:PRO:HD3	2.00	0.77
1:F:208:ASP:O	1:F:209:GLU:HB2	1.84	0.75
1:J:220:ARG:O	1:J:224:GLU:HG3	1.86	0.74
1:I:138:ARG:HD3	1:I:229:GLU:O	1.88	0.74
3:C:2006:HOH:O	1:D:116:ARG:HG3	1.87	0.74
1:F:40:GLU:HG2	1:F:45:ILE:HD11	1.70	0.73
1:F:298:LYS:NZ	2:F:1000:PDA:HA	2.04	0.73
1:D:61:CYS:HB3	1:D:298:LYS:HD3	1.71	0.73
1:H:241:GLY:HA3	1:H:272:LEU:HD23	1.72	0.72
1:L:8:ILE:CG2	1:L:9:ASN:H	1.93	0.72
1:F:199:GLN:HE21	1:F:203:GLY:HA2	1.54	0.71
1:I:207:LYS:HE2	1:I:211:GLY:O	1.91	0.71
1:I:142:VAL:HB	1:I:234:VAL:HG22	1.73	0.71
1:L:425:LYS:CD	1:L:425:LYS:CB	2.69	0.71
1:L:272:LEU:HA	1:L:298:LYS:HD2	1.73	0.71
1:G:192:ALA:HA	1:G:222:MET:CE	2.20	0.70
1:L:238:VAL:HG21	1:L:283:GLY:HA3	1.74	0.70
1:B:375:HIS:HE1	1:B:466:ASP:OD1	1.74	0.70
1:B:208:ASP:O	1:B:209:GLU:HB3	1.92	0.69
1:D:115:VAL:HG22	1:D:311:VAL:HG22	1.73	0.69
1:A:111:TRP:N	1:A:112:PRO:CD	2.56	0.68
1:C:94:LYS:HE3	1:D:21:LEU:HD13	1.75	0.68
1:I:165:ARG:HH21	1:I:183:SER:HB2	1.59	0.68
1:C:298:LYS:HE2	2:C:1000:PDA:H4A1	1.76	0.68
1:D:111:TRP:N	1:D:112:PRO:HD3	2.09	0.67
1:J:53:LEU:HD22	1:J:456:LYS:HD3	1.76	0.67
1:I:145:GLU:HG2	1:I:194:SER:HB2	1.77	0.67
1:F:115:VAL:HG22	1:F:311:VAL:HG22	1.76	0.67
1:K:376:LYS:H	1:K:376:LYS:HD2	1.59	0.66
1:L:23:ARG:HB3	1:L:26:SER:O	1.95	0.66
1:D:208:ASP:O	1:D:209:GLU:HB2	1.94	0.66
1:A:375:HIS:HB3	1:A:469:GLU:OE2	1.96	0.66
1:J:208:ASP:HB2	1:J:212:GLU:O	1.96	0.66
1:F:207:LYS:NZ	1:F:250:GLU:OE2	2.30	0.65
1:C:298:LYS:CE	2:C:1000:PDA:H4A1	2.26	0.65

Continued on next page...

Continued from previous page...

Atom-1	Atom-2	Interatomic distance (Å)	Clash overlap (Å)
1:F:199:GLN:NE2	1:F:203:GLY:HA2	2.11	0.65
1:K:115:VAL:HG22	1:K:311:VAL:HG22	1.77	0.65
1:B:245:THR:HA	1:B:389:ILE:HD13	1.78	0.65
1:H:375:HIS:NE2	1:H:462:ASP:OD1	2.26	0.64
1:I:17:ASP:HA	1:I:21:LEU:HD12	1.79	0.64
1:F:298:LYS:HZ1	2:F:1000:PDA:HA	1.62	0.64
1:I:429:LYS:HD3	1:I:463:TYR:CD2	2.33	0.64
1:C:12:GLN:HA	1:C:15:GLU:OE1	1.99	0.63
1:I:276:GLY:HA3	1:I:447:LEU:HD11	1.80	0.63
1:C:246:MET:HE3	1:C:383:GLY:HA2	1.79	0.63
1:K:329:SER:HB2	1:L:151:TRP:NE1	2.14	0.62
1:F:384:TYR:N	1:F:384:TYR:CD1	2.66	0.62
1:L:365:ARG:NH1	3:L:2010:HOH:O	2.30	0.62
1:E:144:ARG:NH2	1:E:237:GLU:H	1.98	0.62
1:H:145:GLU:HG2	1:H:194:SER:HB2	1.80	0.62
1:L:394:ASN:OD1	1:L:396:LYS:HB2	1.99	0.62
1:K:208:ASP:N	1:K:212:GLU:O	2.32	0.62
1:C:111:TRP:N	1:C:112:PRO:HD3	2.15	0.62
1:E:348:MET:HG2	1:E:353:LEU:HD12	1.81	0.62
1:L:425:LYS:CG	1:L:425:LYS:CE	2.73	0.61
1:K:15:GLU:OE1	1:K:18:ARG:NH1	2.33	0.61
1:H:160:ARG:HG3	1:H:191:MET:HG3	1.82	0.61
1:H:384:TYR:N	1:H:384:TYR:CD1	2.67	0.61
1:H:272:LEU:HD12	1:H:272:LEU:O	2.01	0.61
1:I:208:ASP:HB3	1:I:211:GLY:N	2.16	0.61
1:E:190:LEU:HB3	1:E:222:MET:HE1	1.81	0.61
1:J:144:ARG:O	1:J:147:ASP:HB2	2.01	0.61
1:E:120:THR:HG21	1:F:123:GLU:OE2	2.01	0.60
1:L:53:LEU:HD23	1:L:431:VAL:HG22	1.84	0.60
1:L:68:ASN:HB3	1:L:71:VAL:HB	1.83	0.60
1:I:296:MET:HB2	1:I:309:ALA:HB3	1.83	0.60
1:L:153:GLY:O	1:L:157:THR:HG23	2.01	0.60
1:G:145:GLU:HG2	1:G:194:SER:HB2	1.84	0.60
1:J:144:ARG:HG3	1:J:192:ALA:HB3	1.84	0.59
1:I:165:ARG:NH2	1:I:183:SER:HB2	2.16	0.59
1:K:196:ASN:HA	1:K:205:TYR:HE2	1.68	0.59
1:C:20:TYR:OH	1:D:103:GLU:HG3	2.03	0.59
1:A:111:TRP:H	1:A:112:PRO:HD3	1.65	0.59
1:E:389:ILE:O	1:E:389:ILE:HG13	2.01	0.59
1:H:208:ASP:C	1:H:209:GLU:HG2	2.22	0.59
1:K:72:ASN:ND2	1:L:79:LEU:O	2.36	0.59

Continued on next page...

Continued from previous page...

Atom-1	Atom-2	Interatomic distance (Å)	Clash overlap (Å)
1:D:471:GLY:H	1:D:472:GLU:HB2	1.68	0.59
1:H:208:ASP:O	1:H:209:GLU:CG	2.34	0.59
1:G:53:LEU:HD22	1:G:456:LYS:HD3	1.85	0.58
1:K:111:TRP:N	1:K:112:PRO:HD3	2.17	0.58
1:D:144:ARG:HH21	1:D:237:GLU:H	1.51	0.58
1:I:216:VAL:HG13	1:I:255:ILE:HD13	1.86	0.58
1:E:90:ALA:O	1:F:35:PRO:HA	2.03	0.58
1:J:248:PRO:HG2	1:J:251:TYR:HB2	1.84	0.58
1:D:160:ARG:HG3	1:D:191:MET:HG3	1.86	0.58
1:K:40:GLU:HG2	1:K:45:ILE:HD11	1.86	0.58
1:F:111:TRP:HD1	1:F:290:GLN:NE2	2.00	0.58
1:H:389:ILE:HG13	1:H:389:ILE:O	2.04	0.58
1:B:425:LYS:HD2	1:B:428:GLU:OE2	2.03	0.58
1:K:334:HIS:O	1:K:338:MET:HG2	2.04	0.58
1:L:425:LYS:HD2	1:L:463:TYR:CE2	2.39	0.58
1:F:39:THR:OG1	1:F:66:GLN:HB3	2.04	0.57
1:H:70:LYS:HD3	1:H:347:VAL:HG22	1.85	0.57
1:E:386:LEU:HD12	1:E:445:ALA:HB3	1.86	0.57
1:K:256:ARG:NH1	1:K:290:GLN:O	2.31	0.57
1:I:21:LEU:O	1:J:114:LYS:NZ	2.30	0.57
1:I:298:LYS:HE2	2:I:1000:PDA:H4A1	1.86	0.57
1:L:413:ASN:ND2	1:L:415:ASN:OD1	2.37	0.57
1:B:298:LYS:HZ1	2:B:1000:PDA:HA	1.69	0.57
1:H:442:ARG:HH11	1:H:442:ARG:HB3	1.70	0.57
1:B:432:LEU:HA	3:B:2106:HOH:O	2.05	0.57
1:K:346:GLU:O	1:K:350:GLU:HG2	2.04	0.57
1:B:389:ILE:O	1:B:389:ILE:HG13	2.03	0.57
1:K:208:ASP:C	1:K:210:ASN:H	2.06	0.57
1:G:103:GLU:OE2	1:H:20:TYR:OH	2.18	0.56
1:L:451:ARG:HD2	3:L:2009:HOH:O	2.05	0.56
1:F:343:ALA:O	1:F:347:VAL:HG23	2.05	0.56
1:K:376:LYS:HD2	1:K:376:LYS:N	2.21	0.56
1:I:74:ALA:CB	1:I:343:ALA:HB2	2.35	0.56
1:B:111:TRP:N	1:B:112:PRO:HD3	2.21	0.56
1:L:252:VAL:HG12	1:L:289:VAL:HG21	1.88	0.56
1:B:145:GLU:OE2	1:B:197:THR:OG1	2.24	0.56
1:F:9:ASN:O	1:F:13:VAL:HG23	2.05	0.56
1:J:162:ARG:HD3	1:J:407:ASN:O	2.05	0.55
1:B:208:ASP:O	1:B:209:GLU:CB	2.54	0.55
1:C:135:TYR:OH	3:C:2035:HOH:O	2.17	0.55
1:E:266:TRP:CE3	1:E:291:PRO:HA	2.42	0.55

Continued on next page...

Continued from previous page...

Atom-1	Atom-2	Interatomic distance (Å)	Clash overlap (Å)
1:D:200:ASP:OD1	1:D:203:GLY:O	2.25	0.55
1:I:111:TRP:N	1:I:112:PRO:HD3	2.21	0.55
1:K:190:LEU:HB3	1:K:222:MET:CE	2.36	0.55
1:I:122:SER:O	1:I:126:GLU:HG2	2.07	0.55
1:K:94:LYS:HG2	1:L:21:LEU:HD11	1.88	0.55
1:K:149:HIS:CE1	1:K:235:ILE:HG12	2.42	0.55
1:H:61:CYS:HB3	1:H:298:LYS:HG2	1.87	0.55
1:J:365:ARG:HG2	1:J:369:GLU:OE2	2.06	0.55
1:L:374:LYS:HE2	1:L:375:HIS:NE2	2.22	0.55
1:B:384:TYR:CD1	1:B:384:TYR:N	2.74	0.55
1:D:111:TRP:N	1:D:112:PRO:CD	2.70	0.55
1:G:94:LYS:HE3	1:H:21:LEU:HD13	1.89	0.55
1:K:281:TRP:HZ2	1:K:349:MET:HG2	1.72	0.55
1:L:9:ASN:ND2	1:L:12:GLN:HB2	2.22	0.55
1:L:208:ASP:C	1:L:210:ASN:H	2.10	0.54
1:F:61:CYS:HB3	1:F:298:LYS:HG2	1.89	0.54
1:H:14:LYS:HG2	1:H:33:PRO:HB2	1.89	0.54
1:A:45:ILE:N	1:A:45:ILE:HD12	2.22	0.54
1:A:298:LYS:NZ	2:A:1000:PDA:HA	2.22	0.54
1:C:245:THR:HA	1:C:389:ILE:HD13	1.88	0.54
1:A:94:LYS:HE3	1:B:21:LEU:HD13	1.88	0.54
1:E:347:VAL:HA	1:E:350:GLU:HG2	1.89	0.54
1:F:142:VAL:HB	1:F:234:VAL:HG22	1.89	0.54
1:I:138:ARG:HD3	1:I:229:GLU:C	2.28	0.54
1:I:91:THR:HG21	1:I:335:PRO:HB3	1.89	0.54
1:H:390:VAL:HB	1:H:441:MET:HB2	1.90	0.54
1:I:111:TRP:N	1:I:112:PRO:CD	2.71	0.54
1:E:399:THR:HB	1:E:400:PRO:CD	2.38	0.54
1:G:111:TRP:N	1:G:112:PRO:HD3	2.22	0.54
1:K:454:ILE:O	1:K:458:MET:HG2	2.08	0.54
1:E:272:LEU:HA	1:E:298:LYS:HD2	1.90	0.53
1:I:27:THR:HG21	1:I:171:GLU:HB2	1.89	0.53
1:E:27:THR:HG21	1:E:171:GLU:HB2	1.90	0.53
1:C:111:TRP:N	1:C:112:PRO:CD	2.71	0.53
1:F:425:LYS:HG3	1:F:467:TYR:CD2	2.43	0.53
1:F:376:LYS:N	1:F:376:LYS:HD2	2.22	0.53
1:C:142:VAL:HB	1:C:234:VAL:HG22	1.90	0.53
1:K:208:ASP:HB2	1:K:212:GLU:O	2.08	0.53
1:K:109:GLU:HB3	1:K:290:GLN:HE21	1.74	0.53
1:L:374:LYS:NZ	1:L:462:ASP:OD1	2.34	0.53
1:B:144:ARG:NH2	1:B:237:GLU:H	2.06	0.53

Continued on next page...

Continued from previous page...

Atom-1	Atom-2	Interatomic distance (Å)	Clash overlap (Å)
1:B:437:MET:HB3	1:B:438:PRO:HD2	1.90	0.53
1:K:94:LYS:HE3	1:L:21:LEU:HD13	1.90	0.53
1:I:360:SER:HA	1:I:451:ARG:NH1	2.24	0.53
1:I:298:LYS:CE	2:I:1000:PDA:H4A1	2.39	0.53
1:A:326:GLU:OE2	1:B:410:HIS:ND1	2.35	0.52
1:E:103:GLU:OE2	1:F:20:TYR:OH	2.26	0.52
1:B:7:LYS:HD3	1:B:8:ILE:N	2.24	0.52
1:J:420:GLN:O	1:J:424:GLU:HG2	2.09	0.52
1:K:36:ILE:HD12	1:K:44:LEU:HB3	1.92	0.52
1:G:191:MET:O	1:G:222:MET:HE1	2.09	0.52
1:D:272:LEU:HD12	1:D:272:LEU:O	2.09	0.52
1:F:111:TRP:N	1:F:112:PRO:HD3	2.25	0.52
1:F:252:VAL:HB	1:F:253:PRO:HD3	1.90	0.52
1:B:145:GLU:HG3	1:B:194:SER:H	1.74	0.52
1:E:111:TRP:N	1:E:112:PRO:HD3	2.25	0.52
1:J:246:MET:HG3	1:J:382:ASP:HB3	1.91	0.52
1:B:211:GLY:HA2	1:F:202:ASN:HD21	1.74	0.52
1:A:144:ARG:NH2	1:A:237:GLU:H	2.06	0.52
1:D:60:CYS:CB	1:D:272:LEU:HD11	2.40	0.52
1:D:208:ASP:O	1:D:209:GLU:CB	2.58	0.52
1:E:386:LEU:HD11	1:E:449:VAL:HG11	1.91	0.52
1:K:321:ASP:HB3	1:L:28:GLN:HB2	1.91	0.52
1:L:208:ASP:OD1	1:L:210:ASN:HB2	2.10	0.52
1:F:149:HIS:HB2	1:F:158:VAL:HG23	1.92	0.51
1:H:111:TRP:HZ2	1:H:294:ILE:HD11	1.75	0.51
1:K:10:TRP:CD1	1:K:47:PRO:HB3	2.45	0.51
1:D:415:ASN:OD1	1:D:416:GLN:NE2	2.43	0.51
1:E:27:THR:OG1	1:E:30:GLU:HG2	2.10	0.51
1:J:365:ARG:O	1:J:369:GLU:HG3	2.11	0.51
1:E:329:SER:HB3	1:E:332:ALA:HB2	1.93	0.51
1:I:326:GLU:HB3	1:J:163:SER:O	2.11	0.51
1:J:257:LYS:O	1:J:261:GLU:HG3	2.10	0.51
1:A:394:ASN:ND2	1:A:401:TYR:CE1	2.78	0.51
1:C:129:LEU:O	1:C:133:ARG:HG3	2.10	0.51
1:G:424:GLU:HA	1:G:424:GLU:OE1	2.11	0.51
1:H:60:CYS:CB	1:H:272:LEU:HD11	2.40	0.51
1:I:76:LYS:HG2	1:J:76:LYS:HG2	1.93	0.51
1:F:163:SER:HG	1:F:164:PHE:HD1	1.58	0.51
1:C:414:PRO:HA	1:C:417:ILE:HD12	1.93	0.51
1:E:190:LEU:HB3	1:E:222:MET:CE	2.41	0.51
1:A:76:LYS:HG2	1:B:76:LYS:HG2	1.92	0.51

Continued on next page...

Continued from previous page...

Atom-1	Atom-2	Interatomic distance (Å)	Clash overlap (Å)
1:H:64:LEU:HD12	1:H:353:LEU:CD1	2.41	0.51
1:A:94:LYS:NZ	3:A:2040:HOH:O	2.44	0.50
1:A:419:THR:HG21	1:A:440:THR:O	2.11	0.50
1:G:94:LYS:NZ	3:G:2030:HOH:O	2.37	0.50
1:I:223:ILE:HG23	1:I:231:VAL:HG21	1.93	0.50
1:A:304:SER:O	1:A:305:LEU:HD23	2.11	0.50
1:I:394:ASN:OD1	1:I:396:LYS:HB2	2.11	0.50
1:I:442:ARG:HD2	3:I:2009:HOH:O	2.12	0.50
1:G:324:ARG:HB2	1:H:169:VAL:HG23	1.94	0.50
1:H:168:LEU:O	1:H:177:SER:HA	2.12	0.50
1:G:117:PHE:O	1:G:332:ALA:HB1	2.12	0.50
1:H:35:PRO:HD2	3:H:2005:HOH:O	2.12	0.50
1:B:471:GLY:O	1:B:474:GLN:HG3	2.12	0.50
1:E:337:ALA:O	1:E:341:VAL:HG23	2.12	0.49
1:F:293:ILE:HG12	1:F:312:VAL:HG12	1.92	0.49
1:G:356:GLN:HE21	1:G:448:ASN:HA	1.77	0.49
1:I:384:TYR:CD1	1:I:384:TYR:N	2.79	0.49
1:J:111:TRP:N	1:J:112:PRO:CD	2.75	0.49
1:A:58:GLN:OE1	1:B:85:VAL:HA	2.13	0.49
1:C:424:GLU:OE1	1:C:424:GLU:HA	2.12	0.49
1:G:111:TRP:N	1:G:112:PRO:CD	2.75	0.49
1:K:451:ARG:HD2	1:K:451:ARG:N	2.28	0.49
1:E:111:TRP:N	1:E:112:PRO:CD	2.75	0.49
1:K:187:SER:O	1:K:188:ALA:HB3	2.13	0.49
1:C:69:GLN:HG3	1:C:70:LYS:N	2.27	0.49
1:F:111:TRP:N	1:F:112:PRO:CD	2.76	0.49
1:H:136:THR:HB	1:H:138:ARG:HD2	1.95	0.49
1:D:267:ILE:HG12	1:D:293:ILE:HB	1.95	0.49
1:L:367:LYS:O	1:L:371:LEU:HG	2.13	0.49
1:L:394:ASN:OD1	1:L:396:LYS:HD2	2.13	0.49
1:L:64:LEU:HD11	1:L:347:VAL:CG1	2.38	0.49
1:B:298:LYS:HZ3	2:B:1000:PDA:H4A1	1.78	0.48
1:J:100:ILE:O	1:J:104:ASP:HB2	2.13	0.48
1:K:208:ASP:C	1:K:210:ASN:N	2.67	0.48
1:I:360:SER:HA	1:I:451:ARG:HH12	1.77	0.48
1:I:386:LEU:HD13	1:I:447:LEU:HA	1.95	0.48
1:K:100:ILE:HA	1:K:104:ASP:HB2	1.95	0.48
1:L:208:ASP:O	1:L:209:GLU:HB2	2.13	0.48
1:I:276:GLY:HA3	1:I:447:LEU:CD1	2.43	0.48
1:J:258:MET:HG2	1:J:262:LEU:HD12	1.93	0.48
1:J:334:HIS:O	1:J:338:MET:HG2	2.14	0.48

Continued on next page...

Continued from previous page...

Atom-1	Atom-2	Interatomic distance (Å)	Clash overlap (Å)
1:A:221:ARG:NH2	1:C:145:GLU:CD	2.62	0.48
1:G:420:GLN:O	1:G:424:GLU:HG2	2.12	0.48
1:A:424:GLU:OE1	1:A:424:GLU:HA	2.14	0.48
1:G:40:GLU:HG2	1:G:45:ILE:HD11	1.95	0.48
1:G:169:VAL:HG23	1:H:324:ARG:HB2	1.95	0.48
1:I:337:ALA:O	1:I:340:ALA:HB3	2.14	0.48
1:K:415:ASN:O	1:K:421:ILE:HD11	2.13	0.48
1:L:222:MET:O	1:L:226:TYR:HD1	1.96	0.48
1:D:252:VAL:HB	1:D:253:PRO:HD3	1.95	0.48
1:D:470:SER:HB3	1:D:472:GLU:HB2	1.96	0.48
1:E:23:ARG:HB3	1:E:26:SER:O	2.14	0.48
1:F:180:ILE:HB	1:F:183:SER:OG	2.13	0.48
1:K:111:TRP:N	1:K:112:PRO:CD	2.77	0.48
1:B:425:LYS:HG3	1:B:467:TYR:CD2	2.48	0.48
1:E:425:LYS:HG3	1:E:467:TYR:CD2	2.49	0.48
1:L:207:LYS:C	1:L:209:GLU:H	2.17	0.48
1:L:269:ASP:HA	1:L:295:THR:OG1	2.14	0.48
1:F:144:ARG:NH2	1:F:147:ASP:OD1	2.46	0.47
1:E:142:VAL:HB	1:E:234:VAL:HG22	1.96	0.47
1:J:120:THR:OG1	1:J:123:GLU:HG3	2.14	0.47
1:D:127:THR:O	1:D:131:ILE:HG13	2.13	0.47
1:F:298:LYS:HE2	2:F:1000:PDA:H4A1	1.96	0.47
1:K:190:LEU:HB3	1:K:222:MET:HE2	1.95	0.47
1:L:343:ALA:O	1:L:347:VAL:HG23	2.14	0.47
1:F:384:TYR:N	1:F:384:TYR:HD1	2.11	0.47
1:J:216:VAL:HG11	1:J:254:GLN:HB3	1.95	0.47
1:F:412:MET:HG3	1:F:417:ILE:HD11	1.95	0.47
1:I:208:ASP:HB2	1:I:212:GLU:O	2.14	0.47
1:E:325:TRP:HA	1:F:168:LEU:HD23	1.97	0.47
1:F:357:ALA:O	1:F:385:GLY:HA2	2.15	0.47
1:G:148:TYR:HA	1:G:159:THR:HG23	1.97	0.47
1:J:162:ARG:NH1	1:J:409:ARG:HG3	2.30	0.47
1:J:208:ASP:C	1:J:210:ASN:H	2.18	0.47
1:A:348:MET:HA	1:A:353:LEU:HD12	1.97	0.47
1:C:103:GLU:OE2	1:D:20:TYR:OH	2.25	0.47
1:G:27:THR:HG21	1:G:171:GLU:HB2	1.97	0.47
1:J:69:GLN:HG3	1:J:70:LYS:N	2.30	0.47
2:L:1000:PDA:O3A	2:L:1000:PDA:N	2.46	0.47
1:A:27:THR:HG21	1:A:171:GLU:HB2	1.95	0.47
1:A:246:MET:HG2	1:A:389:ILE:HG12	1.97	0.47
1:A:40:GLU:HG2	1:A:45:ILE:HD11	1.97	0.46

Continued on next page...

Continued from previous page...

Atom-1	Atom-2	Interatomic distance (Å)	Clash overlap (Å)
1:E:417:ILE:O	1:E:421:ILE:HG12	2.15	0.46
1:H:187:SER:O	1:H:188:ALA:HB3	2.15	0.46
1:C:37:GLU:O	1:D:81:ARG:HD2	2.15	0.46
1:G:427:LEU:HD13	1:G:432:LEU:HD23	1.97	0.46
1:I:375:HIS:HB3	1:I:469:GLU:OE2	2.14	0.46
1:K:90:ALA:O	1:L:35:PRO:HA	2.15	0.46
1:C:378:ILE:O	1:C:378:ILE:HG22	2.15	0.46
1:F:298:LYS:HZ3	2:F:1000:PDA:HA	1.76	0.46
1:E:190:LEU:CB	1:E:222:MET:HE1	2.45	0.46
1:F:282:PHE:HZ	1:F:296:MET:HE1	1.80	0.46
1:K:473:TRP:O	1:K:473:TRP:CE3	2.68	0.46
1:C:272:LEU:HA	1:C:298:LYS:HD2	1.96	0.46
1:C:366:SER:HA	1:C:369:GLU:HB2	1.98	0.46
1:H:238:VAL:HG13	1:H:252:VAL:HG21	1.97	0.46
1:F:111:TRP:CD1	1:F:290:GLN:NE2	2.83	0.46
1:J:163:SER:HB3	1:J:408:PHE:O	2.15	0.46
1:A:269:ASP:OD1	1:A:271:VAL:HG23	2.16	0.46
1:D:251:TYR:CZ	1:D:255:ILE:HG13	2.50	0.46
1:J:278:THR:HB	1:J:384:TYR:CD1	2.51	0.46
1:K:144:ARG:NH2	1:K:237:GLU:H	2.14	0.46
1:L:115:VAL:HG22	1:L:311:VAL:HG22	1.97	0.46
1:L:162:ARG:HD3	1:L:407:ASN:O	2.16	0.46
1:A:21:LEU:HD13	1:B:94:LYS:HE3	1.98	0.46
1:E:99:LYS:HG3	1:F:16:TRP:CE2	2.50	0.46
1:G:208:ASP:HB2	1:G:212:GLU:O	2.16	0.46
1:L:111:TRP:N	1:L:112:PRO:CD	2.79	0.46
1:E:169:VAL:HG23	1:F:324:ARG:HB2	1.98	0.46
1:G:21:LEU:HD13	1:H:94:LYS:HE3	1.98	0.46
1:K:79:LEU:HA	1:K:82:TYR:O	2.16	0.46
1:K:111:TRP:H	1:K:112:PRO:HD3	1.81	0.46
1:B:111:TRP:N	1:B:112:PRO:CD	2.78	0.45
1:B:208:ASP:HB2	1:B:212:GLU:O	2.14	0.45
1:J:111:TRP:HZ2	1:J:294:ILE:HD11	1.80	0.45
1:J:278:THR:HB	1:J:384:TYR:CE1	2.51	0.45
1:G:432:LEU:HA	3:G:2087:HOH:O	2.16	0.45
1:H:64:LEU:HD12	1:H:353:LEU:HD11	1.97	0.45
1:J:344:ASN:O	1:J:348:MET:HG3	2.16	0.45
1:B:145:GLU:O	1:B:146:HIS:HB2	2.16	0.45
1:C:212:GLU:OE2	1:C:217:LYS:HA	2.17	0.45
1:D:298:LYS:HZ1	2:D:1000:PDA:C	2.29	0.45
1:J:14:LYS:HD3	1:J:35:PRO:HG3	1.98	0.45

Continued on next page...

Continued from previous page...

Atom-1	Atom-2	Interatomic distance (Å)	Clash overlap (Å)
1:K:144:ARG:HH21	1:K:237:GLU:H	1.63	0.45
1:F:208:ASP:HB3	1:F:210:ASN:H	1.81	0.45
1:L:397:THR:C	1:L:399:THR:H	2.19	0.45
1:C:334:HIS:HA	1:C:335:PRO:HD2	1.74	0.45
1:C:347:VAL:HA	1:C:350:GLU:HG2	1.98	0.45
1:D:470:SER:HB3	1:D:471:GLY:H	1.47	0.45
1:K:269:ASP:HA	1:K:295:THR:OG1	2.16	0.45
1:K:360:SER:OG	1:K:451:ARG:NH2	2.49	0.45
1:A:82:TYR:HA	1:A:83:GLY:HA3	1.83	0.45
1:C:122:SER:O	1:C:126:GLU:HG2	2.17	0.45
1:G:442:ARG:HE	1:G:442:ARG:HB3	1.56	0.45
1:L:165:ARG:HH21	1:L:183:SER:HB2	1.82	0.45
1:A:208:ASP:C	1:A:210:ASN:H	2.20	0.45
1:C:145:GLU:HG2	1:C:194:SER:HB3	1.97	0.45
1:F:31:TYR:CE2	1:F:33:PRO:HG3	2.52	0.45
1:F:190:LEU:HD11	1:F:226:TYR:CD1	2.52	0.45
1:H:396:LYS:HB2	1:H:396:LYS:NZ	2.32	0.45
1:B:298:LYS:NZ	2:B:1000:PDA:H4A1	2.32	0.45
1:F:149:HIS:HD2	1:F:158:VAL:O	1.99	0.45
1:J:329:SER:HB3	1:J:332:ALA:HB2	1.98	0.45
1:K:451:ARG:HD2	1:K:451:ARG:H	1.82	0.45
1:F:147:ASP:OD2	1:F:149:HIS:NE2	2.42	0.45
1:H:390:VAL:HB	1:H:441:MET:HG3	1.98	0.45
1:J:160:ARG:HG3	1:J:191:MET:HG3	1.99	0.45
1:K:473:TRP:O	1:K:473:TRP:HE3	2.00	0.45
1:F:272:LEU:HD11	1:F:442:ARG:NH1	2.32	0.45
1:I:85:VAL:HA	1:J:58:GLN:OE1	2.17	0.45
1:K:169:VAL:CG2	1:L:324:ARG:HB2	2.47	0.45
1:L:249:TYR:CD1	1:L:249:TYR:C	2.89	0.45
1:H:415:ASN:O	1:H:416:GLN:NE2	2.50	0.44
1:I:40:GLU:HG2	1:I:45:ILE:HD11	1.99	0.44
1:F:86:TRP:CZ2	1:F:88:THR:HB	2.53	0.44
1:F:111:TRP:CD1	1:F:112:PRO:HD3	2.51	0.44
1:F:269:ASP:HA	1:F:295:THR:OG1	2.16	0.44
1:H:72:ASN:O	1:H:76:LYS:HG3	2.17	0.44
1:H:208:ASP:C	1:H:208:ASP:OD1	2.56	0.44
1:K:252:VAL:HB	1:K:253:PRO:HD3	1.98	0.44
1:K:331:TYR:HE1	1:L:303:SER:HA	1.83	0.44
1:L:190:LEU:HD21	1:L:226:TYR:CZ	2.53	0.44
1:C:168:LEU:HG	1:D:134:LEU:HD13	2.00	0.44
1:G:100:ILE:O	1:G:104:ASP:HB2	2.18	0.44

Continued on next page...

Continued from previous page...

Atom-1	Atom-2	Interatomic distance (Å)	Clash overlap (Å)
1:H:173:SER:OG	1:H:175:SER:HB2	2.17	0.44
1:I:79:LEU:HD11	1:J:75:ILE:HG21	1.99	0.44
1:I:111:TRP:H	1:I:112:PRO:HD3	1.81	0.44
1:J:64:LEU:HD11	1:J:347:VAL:HG11	1.98	0.44
1:L:252:VAL:HB	1:L:253:PRO:HD3	1.99	0.44
1:L:417:ILE:O	1:L:421:ILE:HG12	2.17	0.44
1:E:449:VAL:O	1:E:449:VAL:HG13	2.17	0.44
1:G:94:LYS:CE	1:H:21:LEU:HD13	2.48	0.44
1:I:64:LEU:HD13	1:I:344:ASN:OD1	2.17	0.44
1:K:58:GLN:OE1	1:L:85:VAL:HA	2.17	0.44
1:K:163:SER:HB3	1:K:408:PHE:O	2.18	0.44
1:C:60:CYS:CB	1:C:272:LEU:HD11	2.41	0.44
1:C:100:ILE:O	1:C:104:ASP:HB2	2.17	0.44
1:C:212:GLU:HG2	1:C:217:LYS:HG2	1.99	0.44
1:D:298:LYS:CE	2:D:1000:PDA:H4A1	2.48	0.44
1:L:360:SER:O	1:L:363:TYR:HB3	2.17	0.44
1:A:207:LYS:NZ	1:A:250:GLU:OE2	2.44	0.44
1:H:253:PRO:HA	1:H:289:VAL:HG11	1.99	0.44
1:K:72:ASN:HA	1:K:75:ILE:HD12	2.00	0.44
1:A:221:ARG:NH2	1:C:145:GLU:OE1	2.47	0.44
1:B:27:THR:HG21	1:B:171:GLU:HB2	1.98	0.44
1:B:245:THR:CA	1:B:389:ILE:HD13	2.48	0.44
1:F:238:VAL:O	1:F:247:PRO:HG3	2.18	0.44
1:K:325:TRP:NE1	1:L:166:SER:O	2.51	0.44
1:L:77:GLU:O	1:L:80:ASP:HB2	2.18	0.44
1:A:412:MET:HG3	1:A:417:ILE:HD11	2.00	0.43
1:J:111:TRP:N	1:J:112:PRO:HD3	2.32	0.43
1:H:251:TYR:CZ	1:H:255:ILE:HG13	2.53	0.43
1:I:94:LYS:HG2	1:J:21:LEU:HD11	2.00	0.43
1:L:39:THR:O	1:L:67:LYS:NZ	2.42	0.43
1:L:57:ASN:HD21	1:L:62:VAL:HB	1.82	0.43
1:C:426:ALA:CB	1:C:433:ILE:HG22	2.48	0.43
1:I:117:PHE:O	1:I:332:ALA:HB1	2.18	0.43
1:K:96:LYS:HE2	1:K:100:ILE:HD11	2.00	0.43
1:K:380:ASN:HD22	1:K:380:ASN:HA	1.54	0.43
1:J:214:LEU:HA	1:J:217:LYS:HB2	1.99	0.43
1:K:431:VAL:HG11	1:K:457:ALA:HA	1.99	0.43
1:D:298:LYS:NZ	2:D:1000:PDA:H4A1	2.34	0.43
1:F:162:ARG:HD3	1:F:407:ASN:O	2.17	0.43
1:L:100:ILE:HG22	1:L:105:ILE:HD12	2.01	0.43
1:G:253:PRO:HD3	1:G:287:TYR:HB3	2.00	0.43

Continued on next page...

Continued from previous page...

Atom-1	Atom-2	Interatomic distance (Å)	Clash overlap (Å)
1:H:60:CYS:HB3	1:H:272:LEU:HD11	2.01	0.43
1:J:144:ARG:HH21	1:J:237:GLU:H	1.65	0.43
1:C:197:THR:HG22	1:C:198:PHE:N	2.33	0.43
1:H:145:GLU:HG2	1:H:194:SER:CB	2.48	0.43
1:B:217:LYS:O	1:B:221:ARG:HG2	2.18	0.43
1:G:258:MET:HE2	1:G:258:MET:HB3	1.97	0.43
1:F:296:MET:HB2	1:F:309:ALA:HB3	2.00	0.43
1:H:82:TYR:HA	1:H:83:GLY:HA3	1.69	0.43
1:K:297:GLY:O	1:K:299:GLY:N	2.52	0.42
1:K:298:LYS:HZ1	2:K:1000:PDA:HA	1.83	0.42
1:A:369:GLU:O	1:A:373:GLU:HG3	2.18	0.42
1:F:459:ASP:O	1:F:462:ASP:HB3	2.19	0.42
1:G:85:VAL:HG22	1:G:335:PRO:HG3	2.01	0.42
1:I:346:GLU:O	1:I:350:GLU:HG2	2.19	0.42
1:K:149:HIS:HB2	1:K:158:VAL:HG23	2.01	0.42
1:A:17:ASP:OD2	1:A:31:TYR:OH	2.33	0.42
1:F:64:LEU:HD23	1:F:71:VAL:HG21	2.00	0.42
1:F:322:LYS:HB3	1:F:322:LYS:HE2	1.85	0.42
1:H:121:GLY:O	1:H:124:ALA:HB3	2.19	0.42
1:A:250:GLU:C	1:A:253:PRO:HD2	2.40	0.42
1:E:187:SER:O	1:E:188:ALA:HB3	2.19	0.42
1:C:298:LYS:NZ	2:C:1000:PDA:H4A1	2.34	0.42
1:D:61:CYS:HB3	1:D:298:LYS:CD	2.46	0.42
1:G:208:ASP:N	1:G:212:GLU:O	2.53	0.42
1:K:243:GLY:O	1:K:406:ARG:NE	2.49	0.42
1:A:298:LYS:HZ1	2:A:1000:PDA:HA	1.83	0.42
1:E:32:GLN:HA	1:E:33:PRO:HD3	1.93	0.42
1:F:238:VAL:CG1	1:F:287:TYR:HE2	2.32	0.42
1:J:148:TYR:HE2	2:J:1000:PDA:H4A2	1.83	0.42
1:A:383:GLY:HA3	1:A:388:TRP:CE3	2.54	0.42
1:G:278:THR:HB	1:G:384:TYR:CD1	2.54	0.42
1:D:127:THR:CG2	1:D:310:VAL:HG11	2.50	0.42
1:E:385:GLY:O	1:E:388:TRP:NE1	2.50	0.42
1:H:390:VAL:HB	1:H:441:MET:CG	2.50	0.42
1:K:366:SER:HA	1:K:369:GLU:HG3	2.02	0.42
1:K:401:TYR:HB2	1:K:418:PRO:HG3	2.01	0.42
1:L:208:ASP:C	1:L:210:ASN:N	2.72	0.42
1:D:169:VAL:HG21	1:D:410:HIS:C	2.40	0.42
1:D:208:ASP:N	1:D:212:GLU:O	2.52	0.42
1:I:429:LYS:HD3	1:I:463:TYR:CE2	2.54	0.42
1:L:57:ASN:ND2	1:L:62:VAL:HB	2.35	0.42

Continued on next page...

Continued from previous page...

Atom-1	Atom-2	Interatomic distance (Å)	Clash overlap (Å)
1:C:355:GLU:OE1	1:C:355:GLU:HA	2.20	0.42
1:F:417:ILE:HG23	1:F:438:PRO:HA	2.01	0.42
1:L:177:SER:HB2	1:L:409:ARG:NH1	2.35	0.42
1:C:363:TYR:CE2	1:C:367:LYS:HD2	2.55	0.41
1:D:252:VAL:HG12	1:D:289:VAL:HG21	2.01	0.41
1:H:432:LEU:HA	3:H:2073:HOH:O	2.19	0.41
1:L:111:TRP:N	1:L:112:PRO:HD3	2.34	0.41
1:A:198:PHE:HD1	1:C:214:LEU:HD13	1.85	0.41
1:C:35:PRO:HA	1:D:90:ALA:O	2.20	0.41
1:D:364:ILE:HG13	1:D:454:ILE:HD13	2.01	0.41
1:E:120:THR:OG1	1:E:123:GLU:HG3	2.20	0.41
1:G:145:GLU:CG	1:G:194:SER:HB2	2.49	0.41
1:K:169:VAL:HG21	1:K:410:HIS:C	2.41	0.41
1:B:64:LEU:HD11	1:B:347:VAL:HG12	2.01	0.41
1:I:405:ASP:CG	1:I:406:ARG:H	2.24	0.41
1:D:133:ARG:O	1:D:137:ASN:N	2.53	0.41
1:E:85:VAL:HG22	1:E:335:PRO:HG3	2.03	0.41
1:F:208:ASP:C	1:F:210:ASN:H	2.24	0.41
1:F:245:THR:HA	1:F:389:ILE:HD13	2.01	0.41
1:J:193:PRO:HB3	1:L:218:TYR:CE1	2.55	0.41
1:J:204:ASN:OD1	1:J:204:ASN:N	2.54	0.41
1:B:377:SER:HB3	1:B:469:GLU:HG3	2.02	0.41
1:F:272:LEU:HD12	1:F:298:LYS:HE3	2.03	0.41
1:A:412:MET:HE2	1:A:412:MET:HB2	1.87	0.41
1:C:90:ALA:O	1:D:35:PRO:HA	2.20	0.41
1:E:103:GLU:O	1:E:107:GLY:HA3	2.20	0.41
1:G:32:GLN:HA	1:G:33:PRO:HD3	1.88	0.41
1:G:142:VAL:HB	1:G:234:VAL:HG22	2.02	0.41
1:I:370:LEU:O	1:I:374:LYS:HB2	2.20	0.41
1:K:114:LYS:HD3	1:L:22:MET:HA	2.01	0.41
1:K:324:ARG:HG3	1:L:27:THR:HG23	2.02	0.41
1:B:52:LEU:HD13	1:B:432:LEU:HD21	2.03	0.41
1:C:145:GLU:O	1:C:146:HIS:HB2	2.21	0.41
1:D:144:ARG:NH2	1:D:237:GLU:H	2.14	0.41
1:E:162:ARG:HD3	1:E:407:ASN:O	2.20	0.41
1:E:165:ARG:HA	1:E:165:ARG:HD2	1.85	0.41
1:G:293:ILE:HG12	1:G:312:VAL:HG12	2.02	0.41
1:I:420:GLN:O	1:I:424:GLU:HG2	2.21	0.41
1:L:252:VAL:N	1:L:253:PRO:HD2	2.35	0.41
1:A:144:ARG:HH21	1:A:237:GLU:H	1.67	0.41
1:D:60:CYS:HB3	1:D:272:LEU:HD11	2.02	0.41

Continued on next page...

Continued from previous page...

Atom-1	Atom-2	Interatomic distance (Å)	Clash overlap (Å)
1:I:123:GLU:HB3	1:J:151:TRP:HZ2	1.85	0.41
1:I:125:VAL:HG21	1:I:149:HIS:O	2.20	0.41
1:J:147:ASP:OD2	1:J:149:HIS:NE2	2.41	0.41
1:K:99:LYS:HE2	1:K:103:GLU:OE1	2.21	0.41
1:L:149:HIS:HB2	1:L:158:VAL:HG23	2.03	0.41
1:L:413:ASN:HA	1:L:414:PRO:HD2	1.83	0.41
1:B:357:ALA:O	1:B:385:GLY:HA2	2.20	0.41
1:D:99:LYS:C	1:D:99:LYS:HD3	2.41	0.41
1:E:75:ILE:HG21	1:F:79:LEU:HD11	2.02	0.41
1:E:216:VAL:HG11	1:E:254:GLN:HB3	2.03	0.41
1:G:114:LYS:HD2	1:G:317:ALA:HB1	2.02	0.41
1:H:348:MET:HG2	1:H:353:LEU:HD12	2.02	0.41
1:I:35:PRO:HA	1:J:90:ALA:O	2.21	0.41
1:J:10:TRP:CD1	1:J:47:PRO:HB3	2.56	0.41
1:J:82:TYR:HA	1:J:83:GLY:HA3	1.83	0.41
1:B:415:ASN:OD1	1:B:416:GLN:HG2	2.21	0.41
1:C:238:VAL:HG22	1:C:252:VAL:HG21	2.03	0.41
1:F:282:PHE:CZ	1:F:296:MET:CE	3.04	0.41
1:J:206:LEU:HB3	1:J:214:LEU:CD1	2.51	0.41
1:K:79:LEU:HD23	1:K:82:TYR:O	2.21	0.41
1:K:422:ILE:HD11	1:K:468:LEU:HD22	2.03	0.41
1:L:125:VAL:HG21	1:L:149:HIS:O	2.21	0.41
1:L:166:SER:HB2	1:L:180:ILE:HD11	2.02	0.41
1:I:208:ASP:O	1:I:209:GLU:CB	2.68	0.40
1:I:208:ASP:CG	1:I:210:ASN:HB2	2.42	0.40
1:A:269:ASP:HA	1:A:295:THR:OG1	2.20	0.40
1:C:16:TRP:CE2	1:D:99:LYS:HG3	2.57	0.40
1:D:297:GLY:O	1:D:299:GLY:N	2.54	0.40
1:E:163:SER:HB3	1:E:408:PHE:O	2.21	0.40
1:E:347:VAL:O	1:E:350:GLU:HG2	2.22	0.40
1:K:122:SER:N	2:K:1000:PDA:OP1	2.49	0.40
1:K:249:TYR:CD1	1:K:249:TYR:C	2.94	0.40
1:K:278:THR:O	1:K:384:TYR:HB2	2.21	0.40
1:G:35:PRO:O	1:G:36:ILE:HD13	2.21	0.40
1:G:67:LYS:HG3	1:G:72:ASN:HD21	1.86	0.40
1:H:245:THR:HA	1:H:389:ILE:HD13	2.03	0.40
1:I:67:LYS:HE2	1:J:80:ASP:O	2.20	0.40
1:J:384:TYR:CD1	1:J:384:TYR:N	2.89	0.40
1:K:441:MET:CE	1:K:443:ILE:HD11	2.51	0.40
1:L:110:ASP:O	1:L:314:LYS:HD2	2.22	0.40
1:A:40:GLU:OE2	1:A:51:ARG:NH1	2.49	0.40

Continued on next page...

Continued from previous page...

Atom-1	Atom-2	Interatomic distance (Å)	Clash overlap (Å)
1:B:61:CYS:HB3	1:B:298:LYS:HD3	2.03	0.40
1:E:418:PRO:HD2	1:E:438:PRO:O	2.22	0.40
1:F:272:LEU:HA	1:F:298:LYS:HD2	2.03	0.40
1:J:160:ARG:NE	1:J:160:ARG:HA	2.37	0.40
1:K:160:ARG:NE	1:K:160:ARG:HA	2.36	0.40
1:K:168:LEU:O	1:K:177:SER:HA	2.22	0.40
1:K:199:GLN:HA	1:K:204:ASN:O	2.22	0.40
1:K:224:GLU:HA	1:K:228:PRO:HD3	2.03	0.40
1:K:375:HIS:ND1	1:K:469:GLU:OE1	2.54	0.40
1:A:168:LEU:HG	1:B:134:LEU:HD22	2.04	0.40
1:A:176:PHE:HB3	3:B:2088:HOH:O	2.21	0.40
1:D:24:THR:C	1:D:26:SER:H	2.25	0.40
1:K:111:TRP:CE2	1:K:112:PRO:HG3	2.56	0.40
1:K:272:LEU:HD12	1:K:298:LYS:HE3	2.03	0.40

There are no symmetry-related clashes.

5.3 Torsion angles [i](#)

5.3.1 Protein backbone [i](#)

In the following table, the Percentiles column shows the percent Ramachandran outliers of the chain as a percentile score with respect to all X-ray entries followed by that with respect to entries of similar resolution.

The Analysed column shows the number of residues for which the backbone conformation was analysed, and the total number of residues.

Mol	Chain	Analysed	Favoured	Allowed	Outliers	Percentiles	
1	A	455/485 (94%)	429 (94%)	22 (5%)	4 (1%)	17	20
1	B	455/485 (94%)	429 (94%)	22 (5%)	4 (1%)	17	20
1	C	455/485 (94%)	428 (94%)	22 (5%)	5 (1%)	14	15
1	D	461/485 (95%)	429 (93%)	26 (6%)	6 (1%)	12	12
1	E	455/485 (94%)	430 (94%)	21 (5%)	4 (1%)	17	20
1	F	461/485 (95%)	435 (94%)	23 (5%)	3 (1%)	22	26
1	G	453/485 (93%)	430 (95%)	20 (4%)	3 (1%)	22	26
1	H	456/485 (94%)	434 (95%)	18 (4%)	4 (1%)	17	20
1	I	455/485 (94%)	421 (92%)	30 (7%)	4 (1%)	17	20

Continued on next page...

Continued from previous page...

Mol	Chain	Analysed	Favoured	Allowed	Outliers	Percentiles	
1	J	455/485 (94%)	422 (93%)	31 (7%)	2 (0%)	34	42
1	K	455/485 (94%)	420 (92%)	30 (7%)	5 (1%)	14	15
1	L	454/485 (94%)	419 (92%)	27 (6%)	8 (2%)	8	7
All	All	5470/5820 (94%)	5126 (94%)	292 (5%)	52 (1%)	15	17

All (52) Ramachandran outliers are listed below:

Mol	Chain	Res	Type
1	K	153	GLY
1	K	209	GLU
1	A	87	ASP
1	B	209	GLU
1	D	153	GLY
1	D	298	LYS
1	E	153	GLY
1	G	25	PHE
1	G	58	GLN
1	J	153	GLY
1	K	58	GLN
1	L	153	GLY
1	L	208	ASP
1	L	298	LYS
1	A	58	GLN
1	B	298	LYS
1	C	298	LYS
1	D	470	SER
1	E	58	GLN
1	F	153	GLY
1	F	298	LYS
1	G	298	LYS
1	H	298	LYS
1	I	25	PHE
1	I	472	GLU
1	J	58	GLN
1	L	58	GLN
1	B	58	GLN
1	C	58	GLN
1	C	153	GLY
1	D	58	GLN
1	E	298	LYS
1	F	58	GLN

Continued on next page...

Continued from previous page...

Mol	Chain	Res	Type
1	H	58	GLN
1	H	87	ASP
1	K	298	LYS
1	K	332	ALA
1	L	398	LYS
1	A	25	PHE
1	A	209	GLU
1	D	25	PHE
1	D	209	GLU
1	I	58	GLN
1	I	209	GLU
1	C	25	PHE
1	E	384	TYR
1	L	25	PHE
1	L	41	GLY
1	L	406	ARG
1	B	153	GLY
1	C	139	PRO
1	H	139	PRO

5.3.2 Protein sidechains [i](#)

In the following table, the Percentiles column shows the percent sidechain outliers of the chain as a percentile score with respect to all X-ray entries followed by that with respect to entries of similar resolution.

The Analysed column shows the number of residues for which the sidechain conformation was analysed, and the total number of residues.

Mol	Chain	Analysed	Rotameric	Outliers	Percentiles	
1	A	388/409 (95%)	375 (97%)	13 (3%)	37	51
1	B	388/409 (95%)	378 (97%)	10 (3%)	46	63
1	C	388/409 (95%)	374 (96%)	14 (4%)	35	49
1	D	391/409 (96%)	378 (97%)	13 (3%)	38	53
1	E	388/409 (95%)	378 (97%)	10 (3%)	46	63
1	F	391/409 (96%)	381 (97%)	10 (3%)	46	63
1	G	386/409 (94%)	378 (98%)	8 (2%)	53	70
1	H	388/409 (95%)	372 (96%)	16 (4%)	30	43
1	I	388/409 (95%)	379 (98%)	9 (2%)	50	67

Continued on next page...

Continued from previous page...

Mol	Chain	Analysed	Rotameric	Outliers	Percentiles	
1	J	388/409 (95%)	370 (95%)	18 (5%)	27	38
1	K	388/409 (95%)	371 (96%)	17 (4%)	28	39
1	L	387/409 (95%)	374 (97%)	13 (3%)	37	51
All	All	4659/4908 (95%)	4508 (97%)	151 (3%)	39	54

All (151) residues with a non-rotameric sidechain are listed below:

Mol	Chain	Res	Type
1	A	19	LYS
1	A	26	SER
1	A	52	LEU
1	A	69	GLN
1	A	144	ARG
1	A	145	GLU
1	A	175	SER
1	A	194	SER
1	A	199	GLN
1	A	384	TYR
1	A	408	PHE
1	A	442	ARG
1	A	451	ARG
1	B	7	LYS
1	B	144	ARG
1	B	145	GLU
1	B	209	GLU
1	B	384	TYR
1	B	389	ILE
1	B	408	PHE
1	B	441	MET
1	B	451	ARG
1	B	474	GLN
1	C	69	GLN
1	C	144	ARG
1	C	208	ASP
1	C	212	GLU
1	C	258	MET
1	C	310	VAL
1	C	355	GLU
1	C	384	TYR
1	C	386	LEU
1	C	408	PHE

Continued on next page...

Continued from previous page...

Mol	Chain	Res	Type
1	C	427	LEU
1	C	442	ARG
1	C	451	ARG
1	C	474	GLN
1	D	103	GLU
1	D	144	ARG
1	D	197	THR
1	D	201	SER
1	D	217	LYS
1	D	272	LEU
1	D	310	VAL
1	D	384	TYR
1	D	398	LYS
1	D	408	PHE
1	D	470	SER
1	D	472	GLU
1	D	474	GLN
1	E	69	GLN
1	E	144	ARG
1	E	206	LEU
1	E	217	LYS
1	E	255	ILE
1	E	257	LYS
1	E	384	TYR
1	E	398	LYS
1	E	408	PHE
1	E	441	MET
1	F	7	LYS
1	F	55	PHE
1	F	88	THR
1	F	144	ARG
1	F	197	THR
1	F	384	TYR
1	F	408	PHE
1	F	441	MET
1	F	442	ARG
1	F	459	ASP
1	G	69	GLN
1	G	144	ARG
1	G	177	SER
1	G	258	MET
1	G	352	ASN

Continued on next page...

Continued from previous page...

Mol	Chain	Res	Type
1	G	384	TYR
1	G	408	PHE
1	G	442	ARG
1	H	26	SER
1	H	69	GLN
1	H	144	ARG
1	H	175	SER
1	H	209	GLU
1	H	272	LEU
1	H	300	LEU
1	H	310	VAL
1	H	351	GLU
1	H	384	TYR
1	H	389	ILE
1	H	396	LYS
1	H	408	PHE
1	H	425	LYS
1	H	442	ARG
1	H	451	ARG
1	I	144	ARG
1	I	209	GLU
1	I	212	GLU
1	I	374	LYS
1	I	384	TYR
1	I	398	LYS
1	I	408	PHE
1	I	440	THR
1	I	451	ARG
1	J	69	GLN
1	J	110	ASP
1	J	144	ARG
1	J	147	ASP
1	J	204	ASN
1	J	210	ASN
1	J	217	LYS
1	J	222	MET
1	J	239	SER
1	J	290	GLN
1	J	346	GLU
1	J	355	GLU
1	J	373	GLU
1	J	384	TYR

Continued on next page...

Continued from previous page...

Mol	Chain	Res	Type
1	J	389	ILE
1	J	408	PHE
1	J	416	GLN
1	J	440	THR
1	K	15	GLU
1	K	64	LEU
1	K	110	ASP
1	K	144	ARG
1	K	199	GLN
1	K	206	LEU
1	K	260	LYS
1	K	310	VAL
1	K	329	SER
1	K	373	GLU
1	K	380	ASN
1	K	384	TYR
1	K	389	ILE
1	K	401	TYR
1	K	403	LYS
1	K	408	PHE
1	K	451	ARG
1	L	21	LEU
1	L	44	LEU
1	L	144	ARG
1	L	250	GLU
1	L	258	MET
1	L	310	VAL
1	L	370	LEU
1	L	382	ASP
1	L	384	TYR
1	L	396	LYS
1	L	408	PHE
1	L	418	PRO
1	L	451	ARG

Sometimes sidechains can be flipped to improve hydrogen bonding and reduce clashes. All (30) such sidechains are listed below:

Mol	Chain	Res	Type
1	A	199	GLN
1	B	416	GLN
1	C	196	ASN
1	C	474	GLN

Continued on next page...

Continued from previous page...

Mol	Chain	Res	Type
1	D	72	ASN
1	D	199	GLN
1	D	202	ASN
1	D	372	GLN
1	D	416	GLN
1	E	69	GLN
1	E	372	GLN
1	E	474	GLN
1	F	196	ASN
1	F	199	GLN
1	F	202	ASN
1	F	290	GLN
1	F	372	GLN
1	G	69	GLN
1	G	356	GLN
1	G	372	GLN
1	G	474	GLN
1	H	29	ASN
1	H	204	ASN
1	H	372	GLN
1	I	196	ASN
1	J	199	GLN
1	J	359	ASN
1	K	380	ASN
1	L	196	ASN
1	L	372	GLN

5.3.3 RNA [i](#)

There are no RNA molecules in this entry.

5.4 Non-standard residues in protein, DNA, RNA chains [i](#)

There are no non-standard protein/DNA/RNA residues in this entry.

5.5 Carbohydrates [i](#)

There are no monosaccharides in this entry.

5.6 Ligand geometry

12 ligands are modelled in this entry.

In the following table, the Counts columns list the number of bonds (or angles) for which Mogul statistics could be retrieved, the number of bonds (or angles) that are observed in the model and the number of bonds (or angles) that are defined in the Chemical Component Dictionary. The Link column lists molecule types, if any, to which the group is linked. The Z score for a bond length (or angle) is the number of standard deviations the observed value is removed from the expected value. A bond length (or angle) with $|Z| > 2$ is considered an outlier worth inspection. RMSZ is the root-mean-square of all Z scores of the bond lengths (or angles).

Mol	Type	Chain	Res	Link	Bond lengths			Bond angles		
					Counts	RMSZ	# Z > 2	Counts	RMSZ	# Z > 2
2	PDA	E	1000	-	20,21,21	2.47	2 (10%)	26,30,30	1.43	3 (11%)
2	PDA	I	1000	-	20,21,21	2.40	2 (10%)	26,30,30	1.64	6 (23%)
2	PDA	A	1000	-	20,21,21	2.34	2 (10%)	26,30,30	1.32	3 (11%)
2	PDA	L	1000	-	20,21,21	2.63	3 (15%)	26,30,30	1.53	4 (15%)
2	PDA	G	1000	-	20,21,21	2.27	3 (15%)	26,30,30	1.51	5 (19%)
2	PDA	D	1000	-	20,21,21	2.21	3 (15%)	26,30,30	1.69	6 (23%)
2	PDA	J	1000	-	20,21,21	2.30	2 (10%)	26,30,30	1.27	1 (3%)
2	PDA	H	1000	-	20,21,21	2.56	2 (10%)	26,30,30	1.68	4 (15%)
2	PDA	B	1000	-	20,21,21	2.22	3 (15%)	26,30,30	1.59	7 (26%)
2	PDA	C	1000	-	20,21,21	2.38	3 (15%)	26,30,30	1.43	4 (15%)
2	PDA	K	1000	-	20,21,21	2.29	2 (10%)	26,30,30	1.43	4 (15%)
2	PDA	F	1000	-	20,21,21	2.60	2 (10%)	26,30,30	1.44	2 (7%)

In the following table, the Chirals column lists the number of chiral outliers, the number of chiral centers analysed, the number of these observed in the model and the number defined in the Chemical Component Dictionary. Similar counts are reported in the Torsion and Rings columns. '-' means no outliers of that kind were identified.

Mol	Type	Chain	Res	Link	Chirals	Torsions	Rings
2	PDA	E	1000	-	-	8/15/15/15	0/1/1/1
2	PDA	I	1000	-	-	7/15/15/15	0/1/1/1
2	PDA	A	1000	-	-	5/15/15/15	0/1/1/1
2	PDA	L	1000	-	-	6/15/15/15	0/1/1/1
2	PDA	G	1000	-	-	7/15/15/15	0/1/1/1
2	PDA	D	1000	-	-	3/15/15/15	0/1/1/1
2	PDA	J	1000	-	-	6/15/15/15	0/1/1/1
2	PDA	H	1000	-	-	6/15/15/15	0/1/1/1

Continued on next page...

Continued from previous page...

Mol	Type	Chain	Res	Link	Chirals	Torsions	Rings
2	PDA	B	1000	-	-	6/15/15/15	0/1/1/1
2	PDA	C	1000	-	-	6/15/15/15	0/1/1/1
2	PDA	K	1000	-	-	6/15/15/15	0/1/1/1
2	PDA	F	1000	-	-	7/15/15/15	0/1/1/1

All (29) bond length outliers are listed below:

Mol	Chain	Res	Type	Atoms	Z	Observed(Å)	Ideal(Å)
2	F	1000	PDA	C3-C2	9.12	1.50	1.40
2	H	1000	PDA	C3-C2	8.66	1.49	1.40
2	E	1000	PDA	C3-C2	8.30	1.49	1.40
2	I	1000	PDA	C3-C2	7.77	1.48	1.40
2	L	1000	PDA	C3-C2	7.71	1.48	1.40
2	J	1000	PDA	C3-C2	7.58	1.48	1.40
2	C	1000	PDA	C3-C2	7.55	1.48	1.40
2	A	1000	PDA	C3-C2	7.36	1.48	1.40
2	L	1000	PDA	C4A-N	-7.29	1.25	1.46
2	K	1000	PDA	C4A-N	-6.78	1.26	1.46
2	K	1000	PDA	C3-C2	6.77	1.47	1.40
2	B	1000	PDA	C3-C2	6.74	1.47	1.40
2	G	1000	PDA	C4A-N	-6.72	1.26	1.46
2	I	1000	PDA	C4A-N	-6.65	1.27	1.46
2	C	1000	PDA	C4A-N	-6.56	1.27	1.46
2	D	1000	PDA	C4A-N	-6.51	1.27	1.46
2	G	1000	PDA	C3-C2	6.46	1.47	1.40
2	E	1000	PDA	C4A-N	-6.32	1.28	1.46
2	H	1000	PDA	C4A-N	-6.21	1.28	1.46
2	D	1000	PDA	C3-C2	6.19	1.47	1.40
2	A	1000	PDA	C4A-N	-6.19	1.28	1.46
2	J	1000	PDA	C4A-N	-6.13	1.28	1.46
2	F	1000	PDA	C4A-N	-6.12	1.28	1.46
2	B	1000	PDA	C4A-N	-5.92	1.29	1.46
2	L	1000	PDA	C4A-C4	-3.51	1.47	1.51
2	D	1000	PDA	C4A-C4	-2.70	1.48	1.51
2	G	1000	PDA	C4A-C4	-2.61	1.48	1.51
2	B	1000	PDA	C4A-C4	-2.54	1.48	1.51
2	C	1000	PDA	OXT-C	2.01	1.28	1.22

All (49) bond angle outliers are listed below:

Mol	Chain	Res	Type	Atoms	Z	Observed(°)	Ideal(°)
2	H	1000	PDA	C6-C5-C4	5.02	121.67	118.12
2	I	1000	PDA	C4-C4A-N	4.23	123.42	111.78
2	L	1000	PDA	OP4-C5A-C5	3.98	116.93	109.35
2	F	1000	PDA	C4-C4A-N	3.67	121.88	111.78
2	G	1000	PDA	C4-C4A-N	3.62	121.76	111.78
2	A	1000	PDA	C4-C4A-N	3.58	121.64	111.78
2	D	1000	PDA	C4A-C4-C5	3.51	123.62	119.71
2	B	1000	PDA	C4A-C4-C5	3.50	123.60	119.71
2	J	1000	PDA	C4-C4A-N	3.40	121.14	111.78
2	E	1000	PDA	C4A-C4-C5	3.18	123.24	119.71
2	G	1000	PDA	C6-C5-C4	3.15	120.35	118.12
2	K	1000	PDA	C4A-C4-C3	3.10	123.36	120.04
2	H	1000	PDA	C4-C4A-N	3.09	120.29	111.78
2	D	1000	PDA	C4-C4A-N	3.04	120.16	111.78
2	C	1000	PDA	C6-C5-C4	3.01	120.25	118.12
2	F	1000	PDA	C6-C5-C4	2.97	120.22	118.12
2	D	1000	PDA	C2A-C2-N1	2.83	123.19	117.67
2	D	1000	PDA	C4A-C4-C3	-2.79	117.06	120.04
2	B	1000	PDA	C4A-C4-C3	-2.74	117.11	120.04
2	B	1000	PDA	C2A-C2-N1	2.73	123.01	117.67
2	K	1000	PDA	C4-C4A-N	2.69	119.19	111.78
2	H	1000	PDA	C5A-C5-C6	-2.69	114.95	119.37
2	C	1000	PDA	C4A-C4-C5	2.65	122.66	119.71
2	D	1000	PDA	C2A-C2-C3	-2.62	117.65	120.89
2	A	1000	PDA	C6-C5-C4	2.58	119.95	118.12
2	C	1000	PDA	OP3-P-OP2	2.58	117.48	107.64
2	A	1000	PDA	C4A-C4-C5	2.57	122.57	119.71
2	E	1000	PDA	C6-C5-C4	2.56	119.93	118.12
2	B	1000	PDA	O-C-CA	2.53	122.80	114.13
2	L	1000	PDA	C2A-C2-N1	2.51	122.57	117.67
2	E	1000	PDA	C4-C4A-N	2.49	118.65	111.78
2	B	1000	PDA	OXT-C-CA	-2.49	113.74	121.83
2	I	1000	PDA	CB-CA-C	2.47	115.79	110.20
2	I	1000	PDA	OP4-C5A-C5	2.44	114.00	109.35
2	L	1000	PDA	OP2-P-OP4	2.43	113.19	106.73
2	I	1000	PDA	O-C-CA	2.41	122.40	114.13
2	H	1000	PDA	OP3-P-OP2	2.39	116.77	107.64
2	D	1000	PDA	C6-C5-C4	2.35	119.78	118.12
2	B	1000	PDA	C4-C4A-N	2.31	118.14	111.78
2	C	1000	PDA	C4-C4A-N	2.26	118.02	111.78
2	I	1000	PDA	C2A-C2-N1	2.24	122.05	117.67
2	K	1000	PDA	C2A-C2-N1	2.23	122.03	117.67
2	I	1000	PDA	C6-C5-C4	2.22	119.69	118.12

Continued on next page...

Continued from previous page...

Mol	Chain	Res	Type	Atoms	Z	Observed(°)	Ideal(°)
2	B	1000	PDA	OP3-P-OP4	2.22	112.64	106.73
2	L	1000	PDA	C3-C2-N1	-2.20	117.92	120.77
2	G	1000	PDA	O3A-C3-C4	2.14	124.40	118.13
2	G	1000	PDA	C6-N1-C2	2.06	122.98	119.17
2	G	1000	PDA	C5-C6-N1	-2.04	120.42	123.82
2	K	1000	PDA	OP2-P-OP4	2.02	112.12	106.73

There are no chirality outliers.

All (73) torsion outliers are listed below:

Mol	Chain	Res	Type	Atoms
2	A	1000	PDA	C5-C4-C4A-N
2	B	1000	PDA	C-CA-N-C4A
2	C	1000	PDA	CB-CA-N-C4A
2	C	1000	PDA	C-CA-N-C4A
2	D	1000	PDA	CB-CA-N-C4A
2	E	1000	PDA	C-CA-N-C4A
2	E	1000	PDA	O-C-CA-N
2	E	1000	PDA	OXT-C-CA-N
2	E	1000	PDA	O-C-CA-CB
2	F	1000	PDA	C-CA-N-C4A
2	F	1000	PDA	O-C-CA-CB
2	F	1000	PDA	OXT-C-CA-CB
2	G	1000	PDA	C-CA-N-C4A
2	H	1000	PDA	C-CA-N-C4A
2	H	1000	PDA	C3-C4-C4A-N
2	H	1000	PDA	C5-C4-C4A-N
2	I	1000	PDA	CB-CA-N-C4A
2	I	1000	PDA	C5-C4-C4A-N
2	I	1000	PDA	O-C-CA-N
2	I	1000	PDA	OXT-C-CA-N
2	J	1000	PDA	CB-CA-N-C4A
2	J	1000	PDA	C3-C4-C4A-N
2	J	1000	PDA	C5-C4-C4A-N
2	J	1000	PDA	C5A-OP4-P-OP2
2	K	1000	PDA	C-CA-N-C4A
2	K	1000	PDA	C3-C4-C4A-N
2	K	1000	PDA	C5-C4-C4A-N
2	L	1000	PDA	C-CA-N-C4A
2	L	1000	PDA	C3-C4-C4A-N
2	L	1000	PDA	C5-C4-C4A-N
2	B	1000	PDA	C5-C4-C4A-N

Continued on next page...

Continued from previous page...

Mol	Chain	Res	Type	Atoms
2	C	1000	PDA	C5-C4-C4A-N
2	E	1000	PDA	C5-C4-C4A-N
2	F	1000	PDA	C5-C4-C4A-N
2	G	1000	PDA	C5-C4-C4A-N
2	E	1000	PDA	OXT-C-CA-CB
2	A	1000	PDA	C3-C4-C4A-N
2	C	1000	PDA	C3-C4-C4A-N
2	G	1000	PDA	C3-C4-C4A-N
2	I	1000	PDA	C3-C4-C4A-N
2	B	1000	PDA	O-C-CA-CB
2	A	1000	PDA	C-CA-N-C4A
2	J	1000	PDA	C-CA-N-C4A
2	E	1000	PDA	CB-CA-N-C4A
2	B	1000	PDA	C3-C4-C4A-N
2	E	1000	PDA	C3-C4-C4A-N
2	F	1000	PDA	C3-C4-C4A-N
2	G	1000	PDA	C4-C5-C5A-OP4
2	B	1000	PDA	OXT-C-CA-CB
2	G	1000	PDA	O-C-CA-CB
2	G	1000	PDA	OXT-C-CA-CB
2	H	1000	PDA	O-C-CA-CB
2	L	1000	PDA	O-C-CA-CB
2	A	1000	PDA	CB-CA-N-C4A
2	B	1000	PDA	CB-CA-N-C4A
2	C	1000	PDA	C5A-OP4-P-OP2
2	F	1000	PDA	CB-CA-N-C4A
2	G	1000	PDA	CB-CA-N-C4A
2	H	1000	PDA	CB-CA-N-C4A
2	K	1000	PDA	CB-CA-N-C4A
2	L	1000	PDA	CB-CA-N-C4A
2	A	1000	PDA	OXT-C-CA-CB
2	D	1000	PDA	O-C-CA-CB
2	D	1000	PDA	OXT-C-CA-CB
2	H	1000	PDA	OXT-C-CA-CB
2	I	1000	PDA	O-C-CA-CB
2	I	1000	PDA	OXT-C-CA-CB
2	J	1000	PDA	OXT-C-CA-CB
2	K	1000	PDA	OXT-C-CA-CB
2	L	1000	PDA	OXT-C-CA-CB
2	C	1000	PDA	OXT-C-CA-CB
2	K	1000	PDA	O-C-CA-CB
2	F	1000	PDA	O-C-CA-N

There are no ring outliers.

9 monomers are involved in 21 short contacts:

Mol	Chain	Res	Type	Clashes	Symm-Clashes
2	I	1000	PDA	2	0
2	A	1000	PDA	2	0
2	L	1000	PDA	1	0
2	D	1000	PDA	3	0
2	J	1000	PDA	1	0
2	B	1000	PDA	3	0
2	C	1000	PDA	3	0
2	K	1000	PDA	2	0
2	F	1000	PDA	4	0

The following is a two-dimensional graphical depiction of Mogul quality analysis of bond lengths, bond angles, torsion angles, and ring geometry for all instances of the Ligand of Interest. In addition, ligands with molecular weight > 250 and outliers as shown on the validation Tables will also be included. For torsion angles, if less than 5% of the Mogul distribution of torsion angles is within 10 degrees of the torsion angle in question, then that torsion angle is considered an outlier. Any bond that is central to one or more torsion angles identified as an outlier by Mogul will be highlighted in the graph. For rings, the root-mean-square deviation (RMSD) between the ring in question and similar rings identified by Mogul is calculated over all ring torsion angles. If the average RMSD is greater than 60 degrees and the minimal RMSD between the ring in question and any Mogul-identified rings is also greater than 60 degrees, then that ring is considered an outlier. The outliers are highlighted in purple. The color gray indicates Mogul did not find sufficient equivalents in the CSD to analyse the geometry.

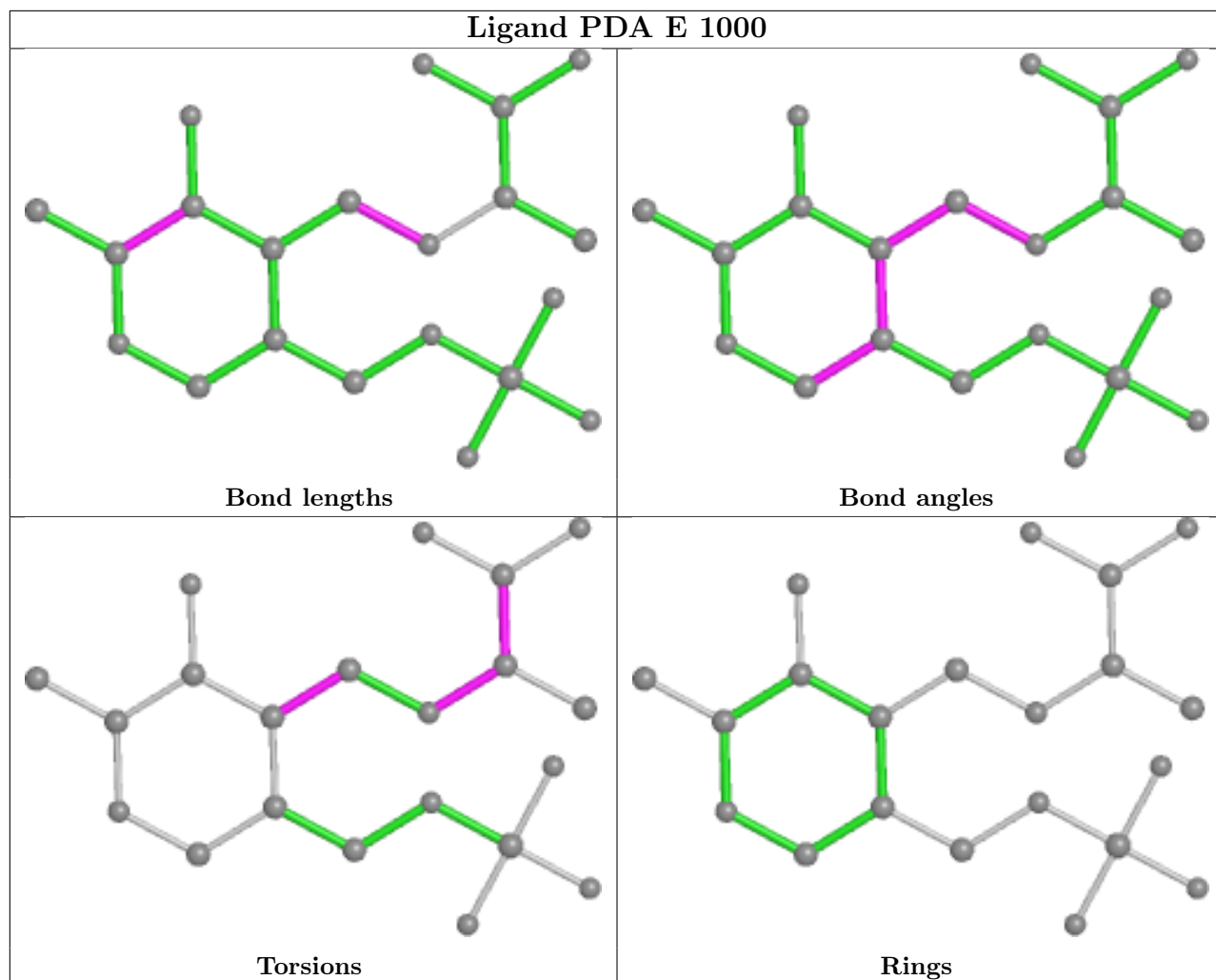

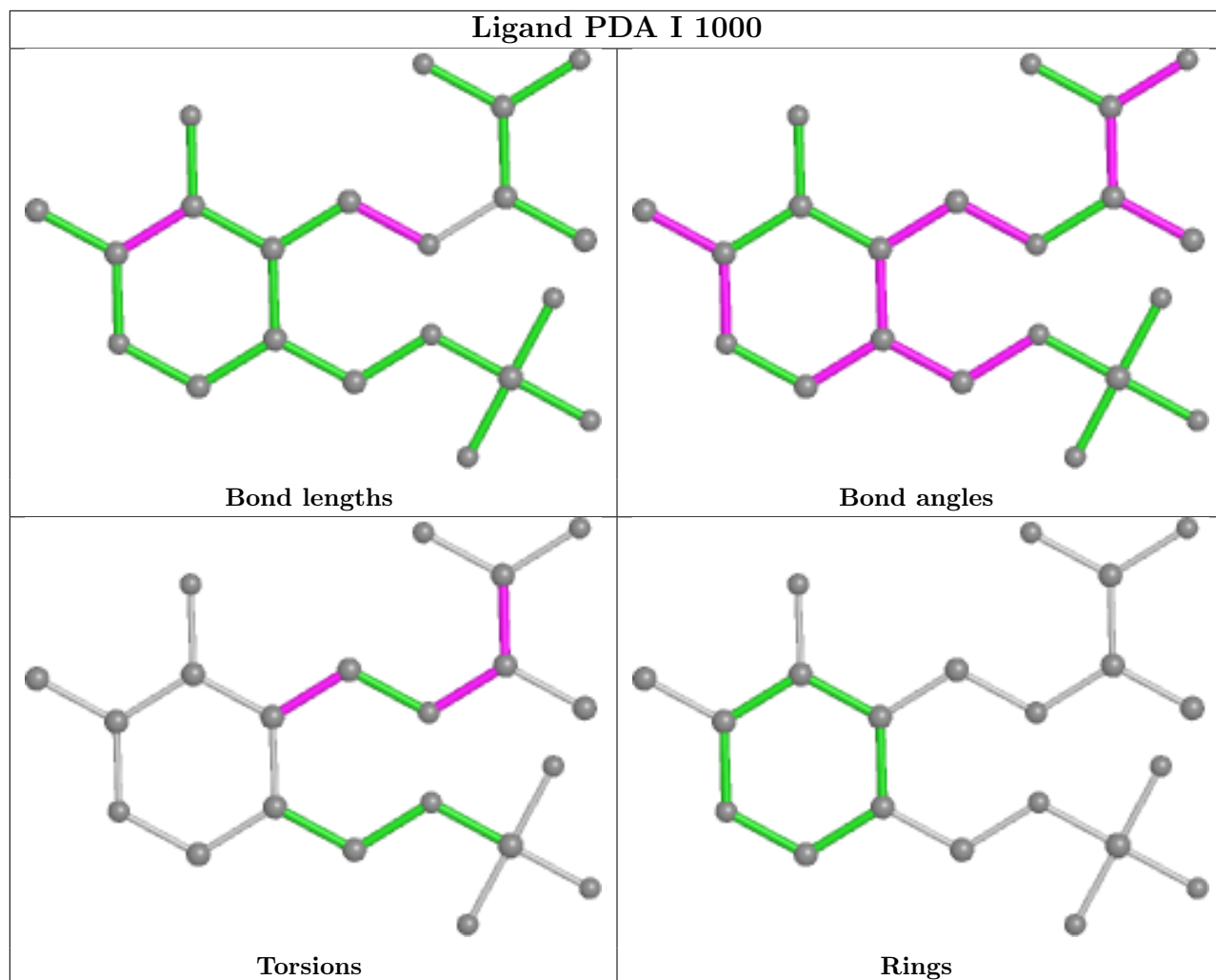

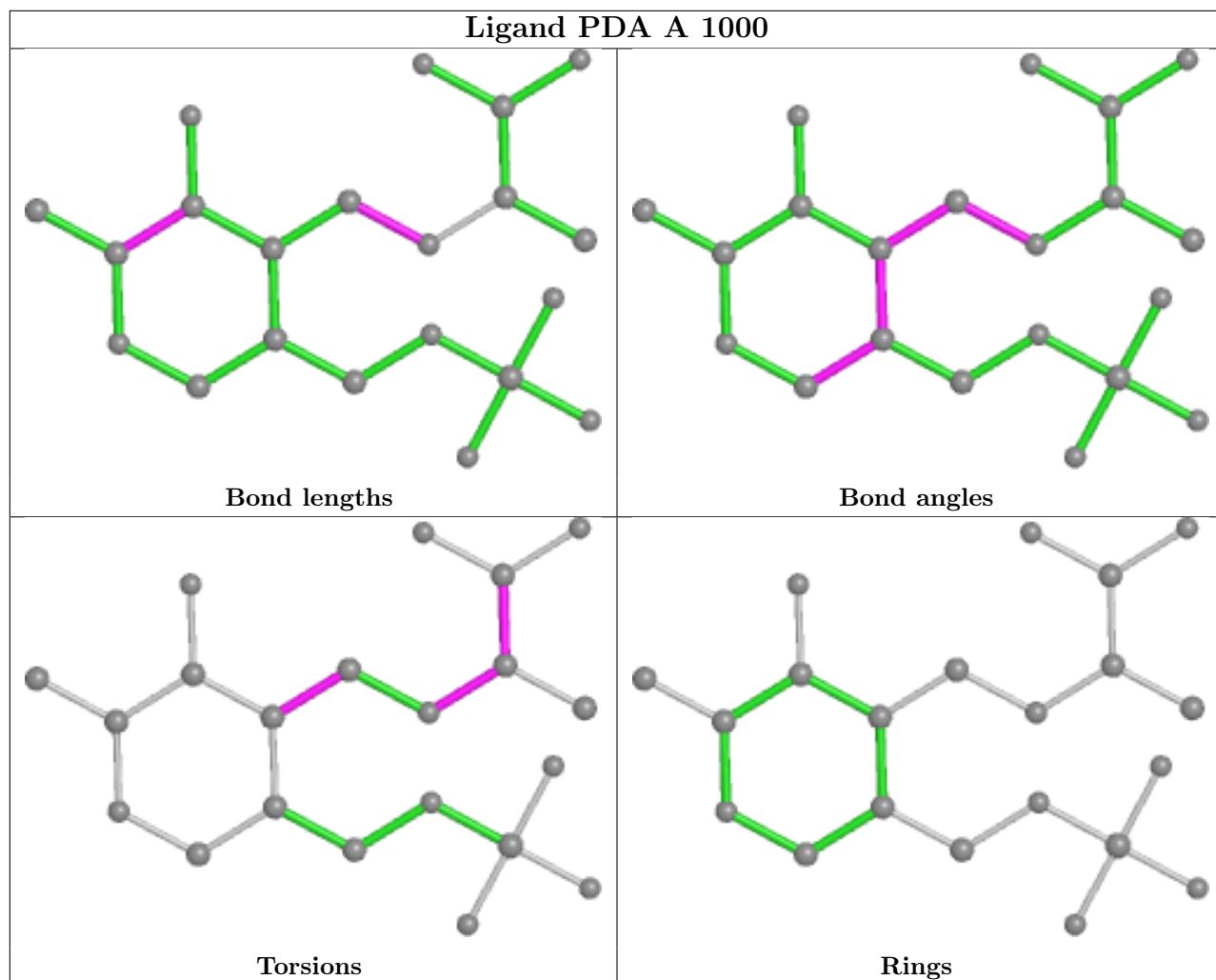

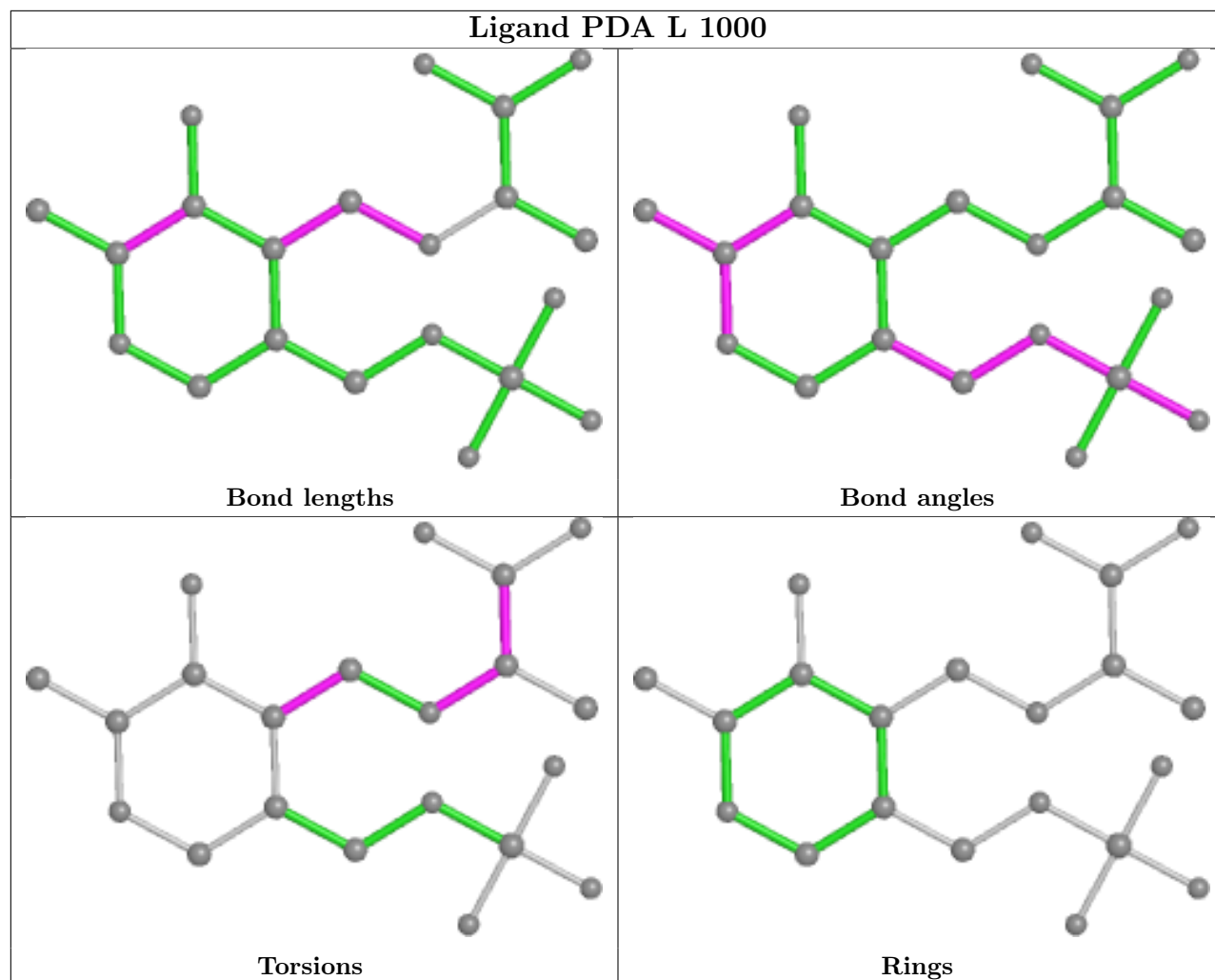

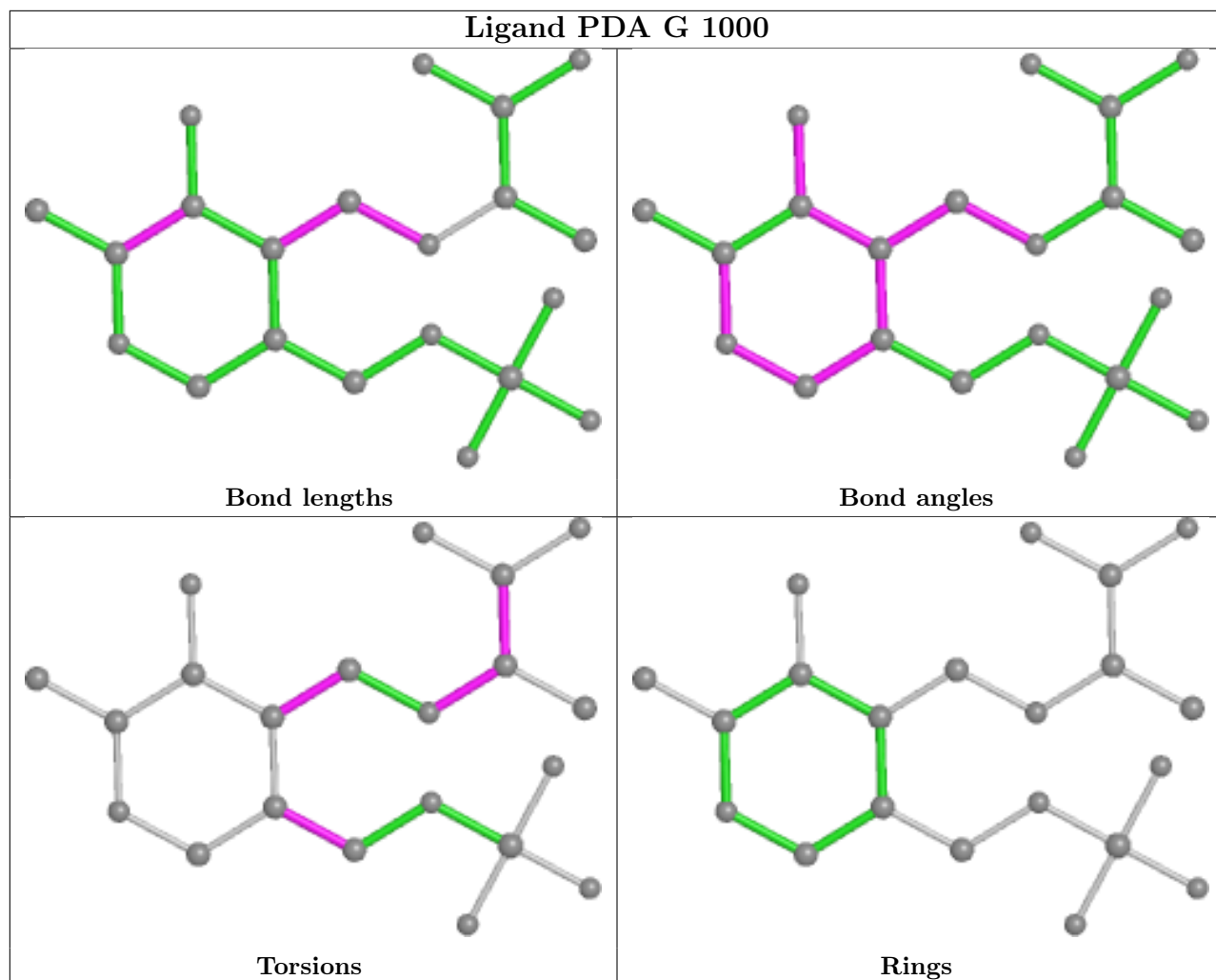

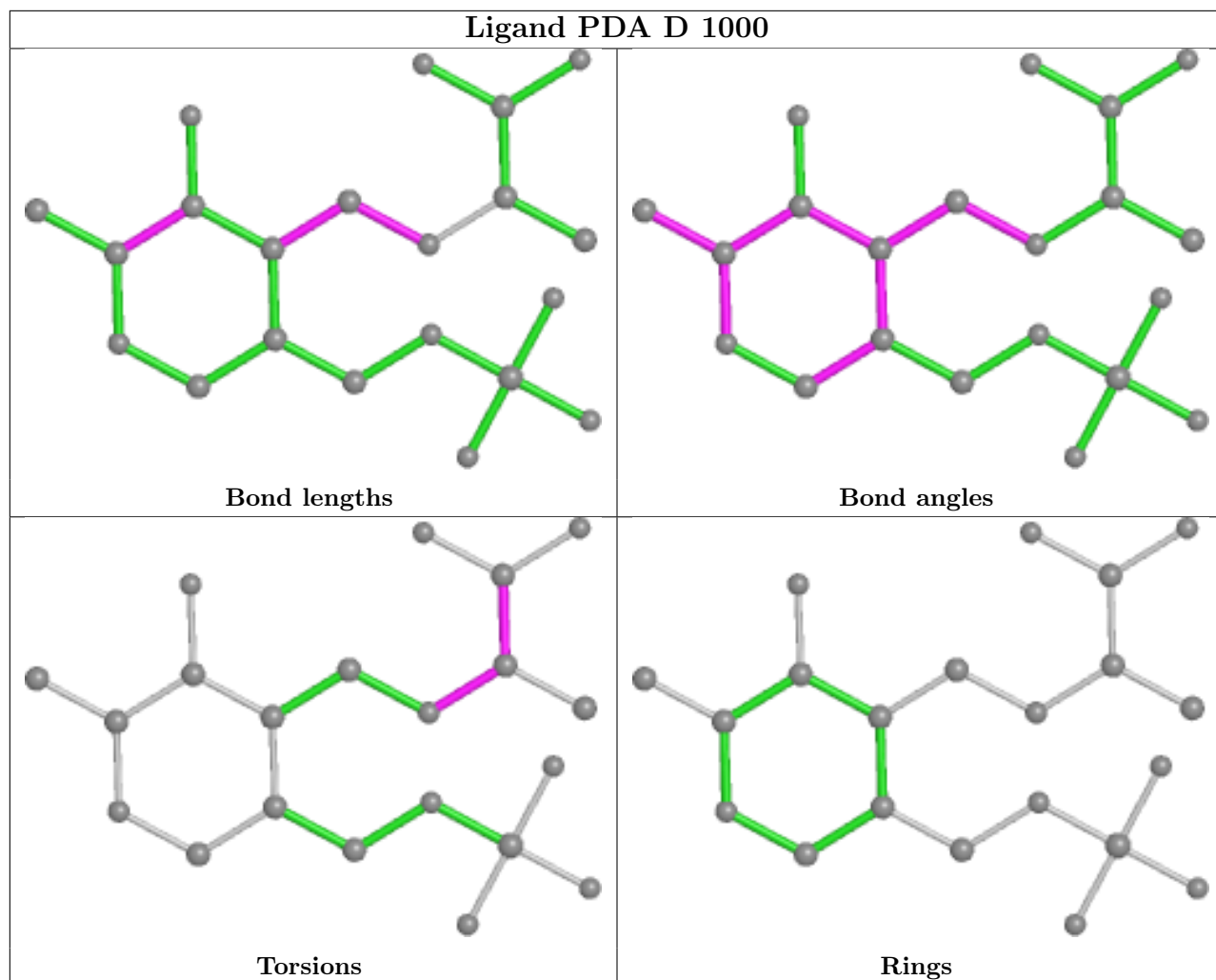

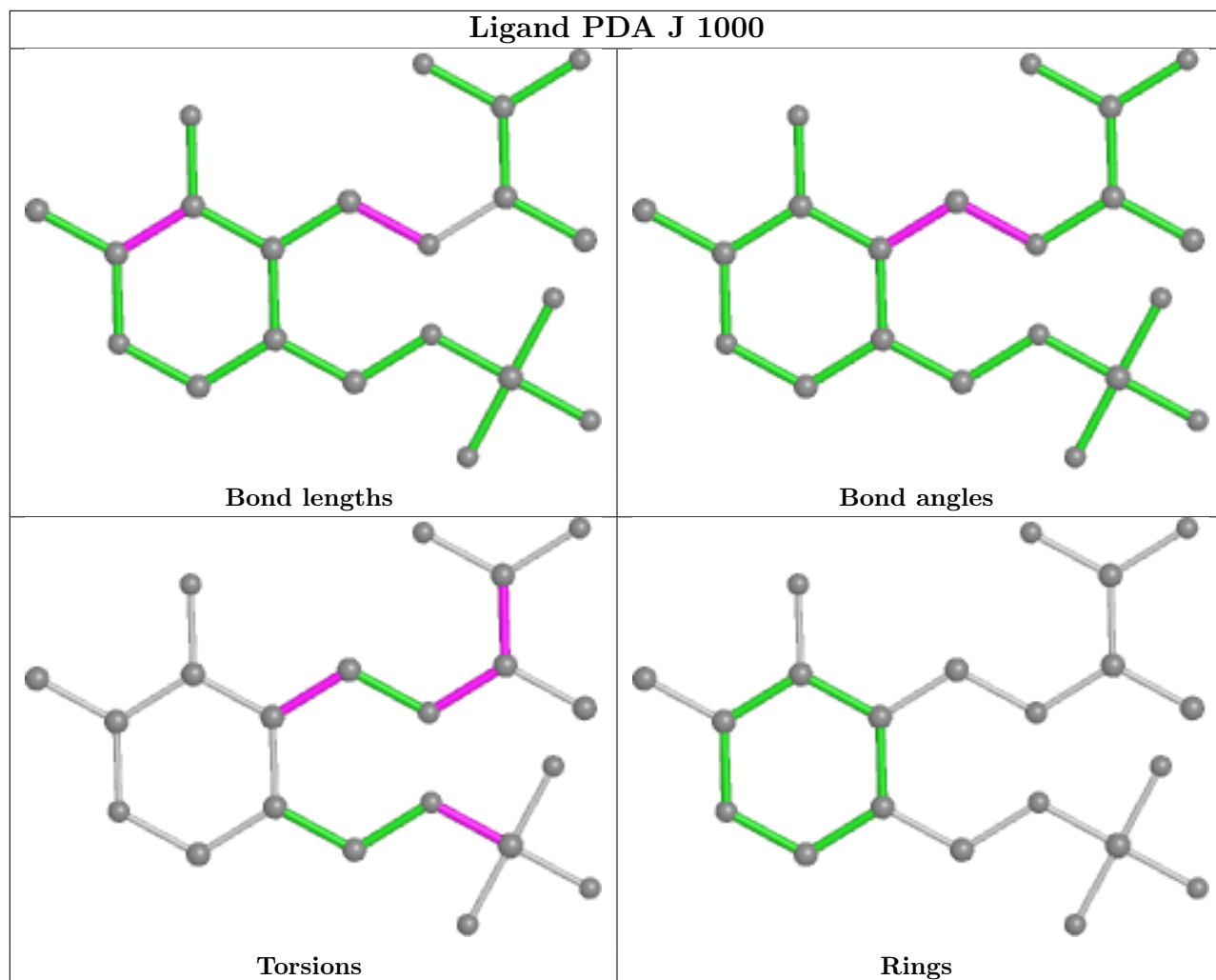

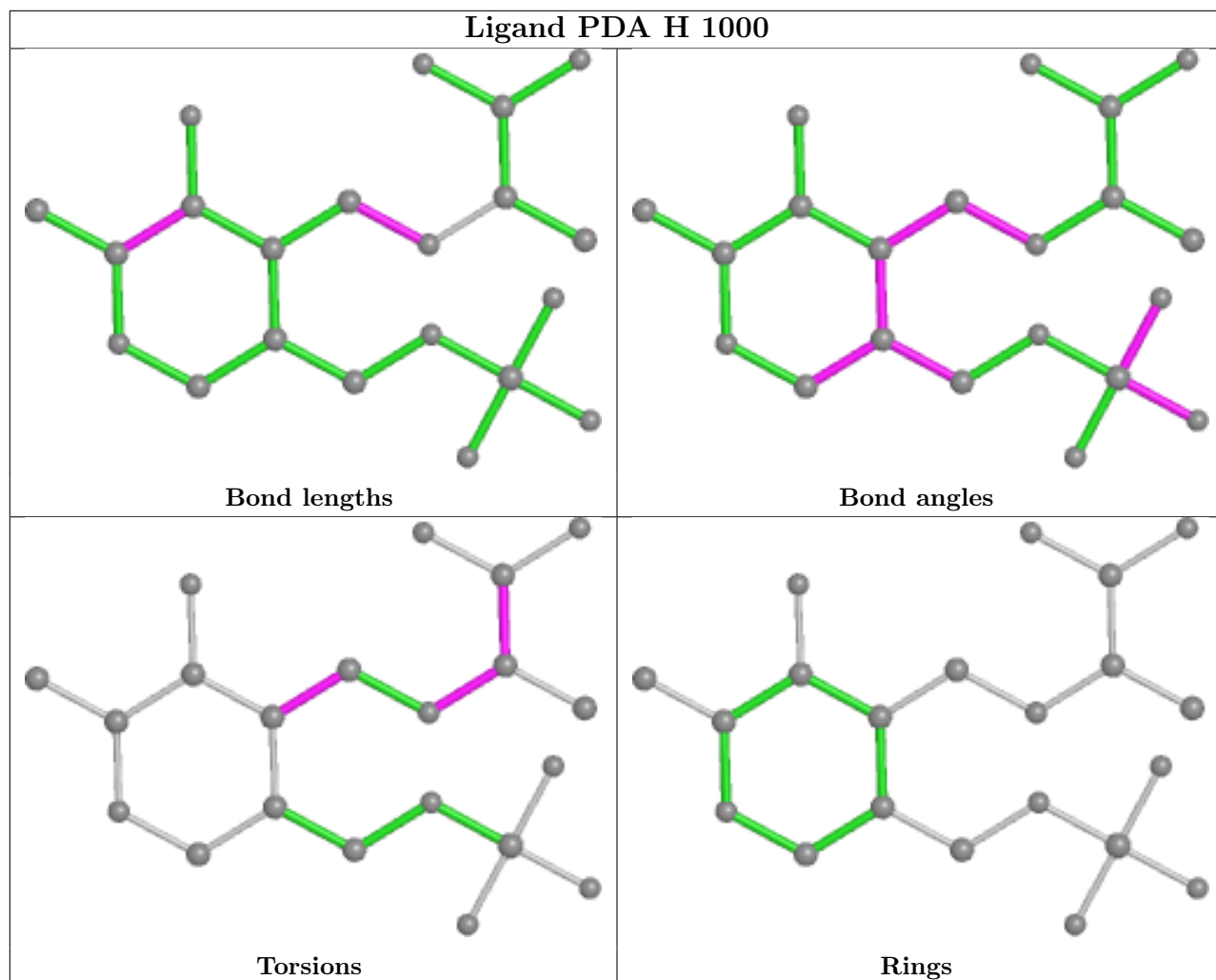

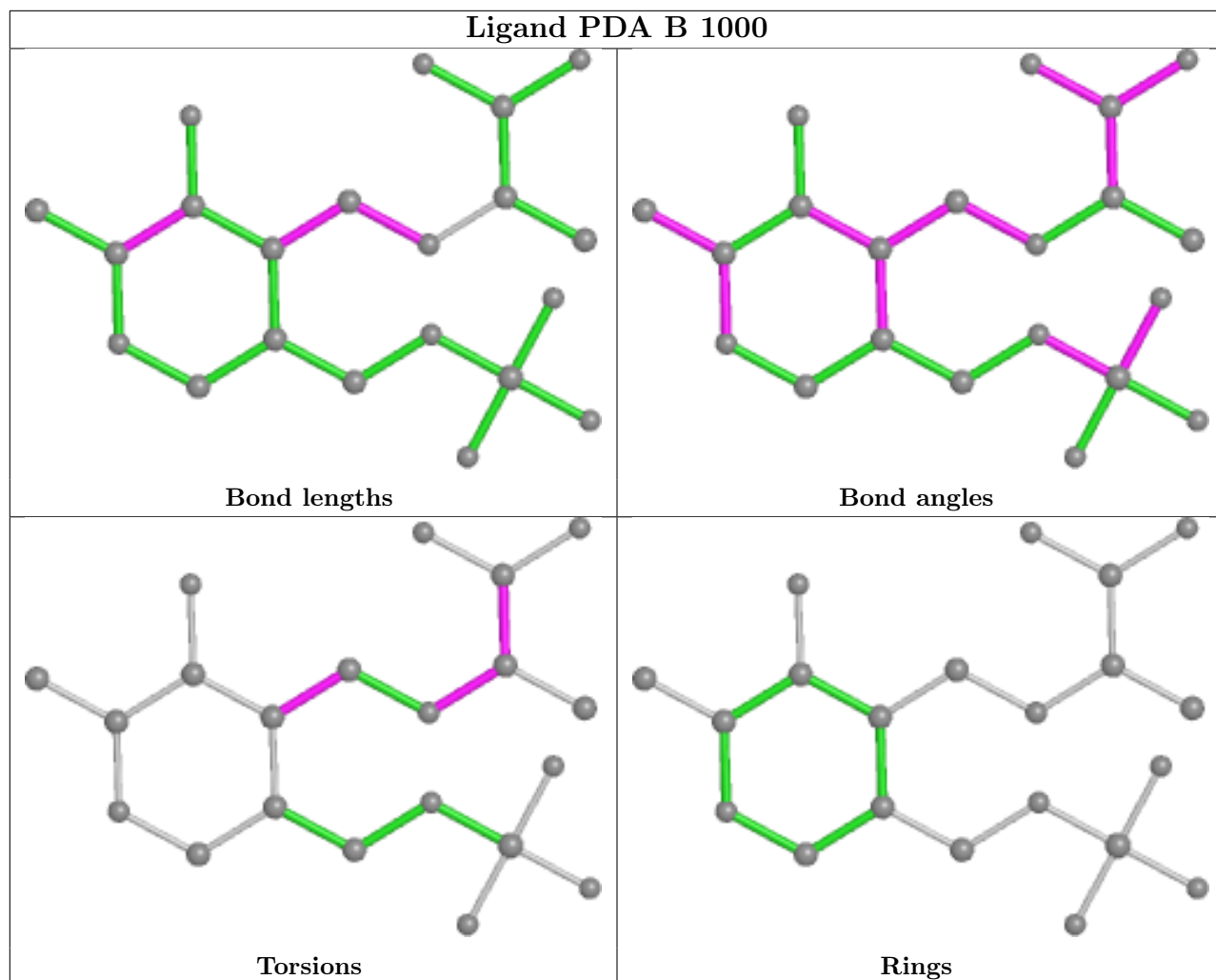

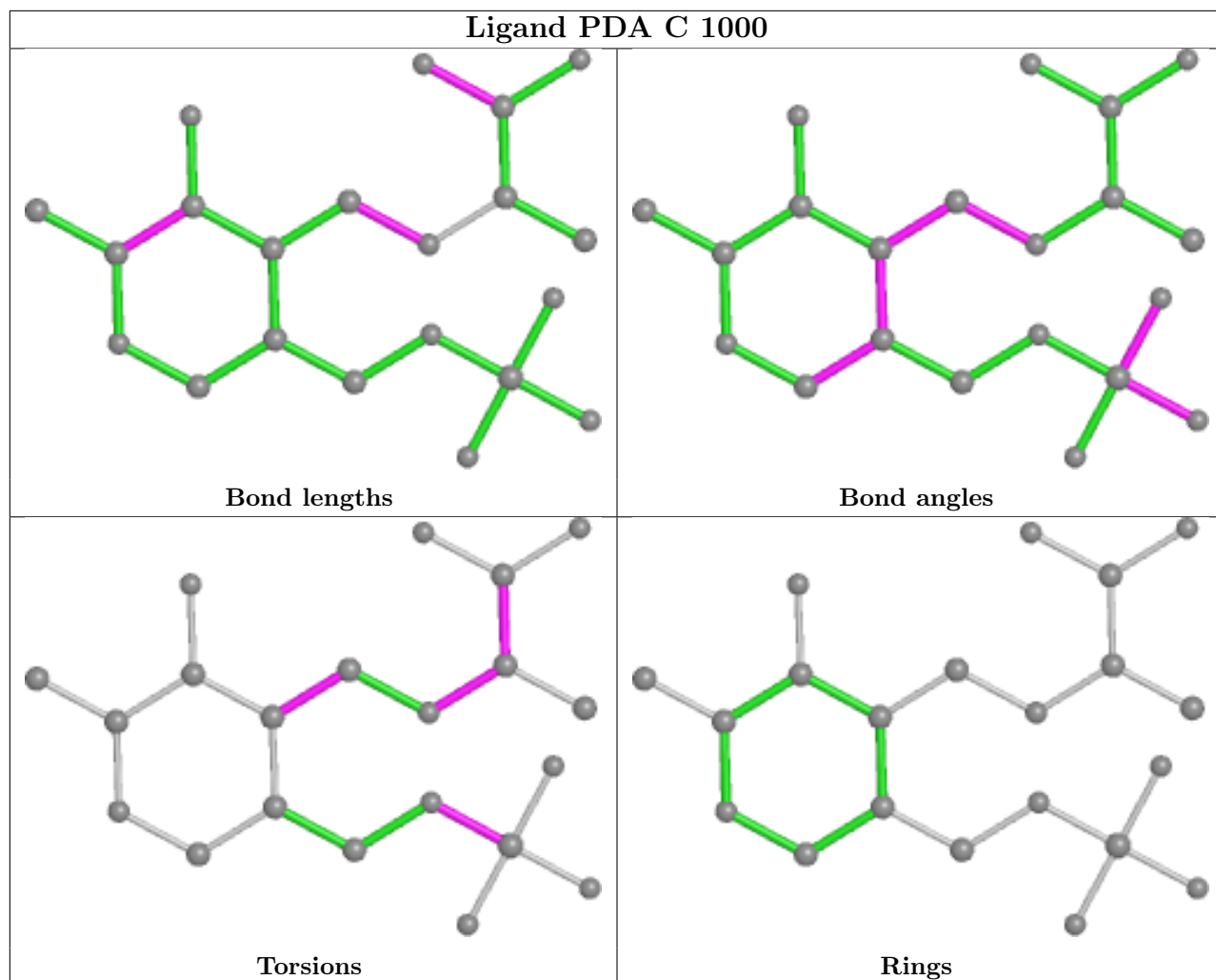

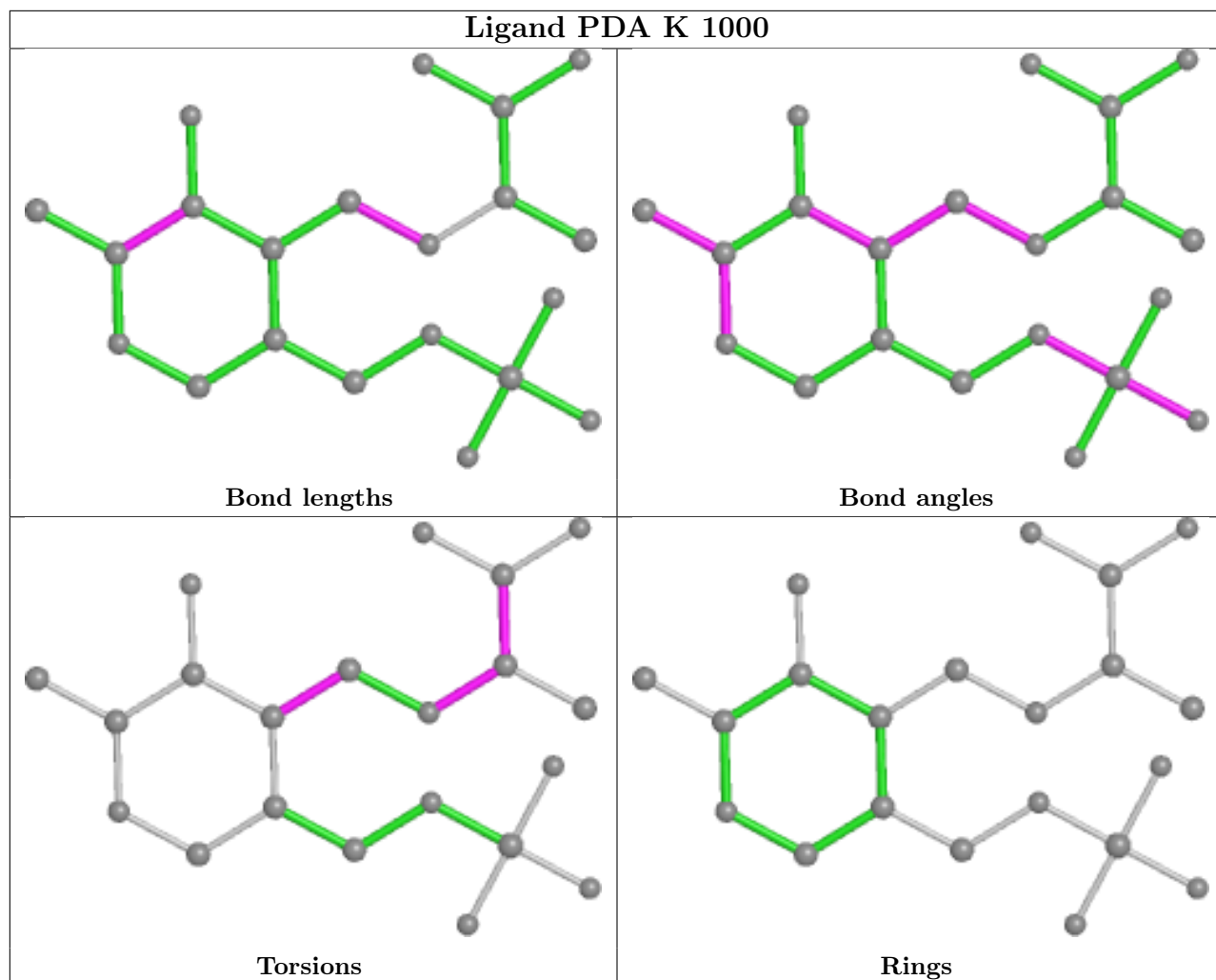

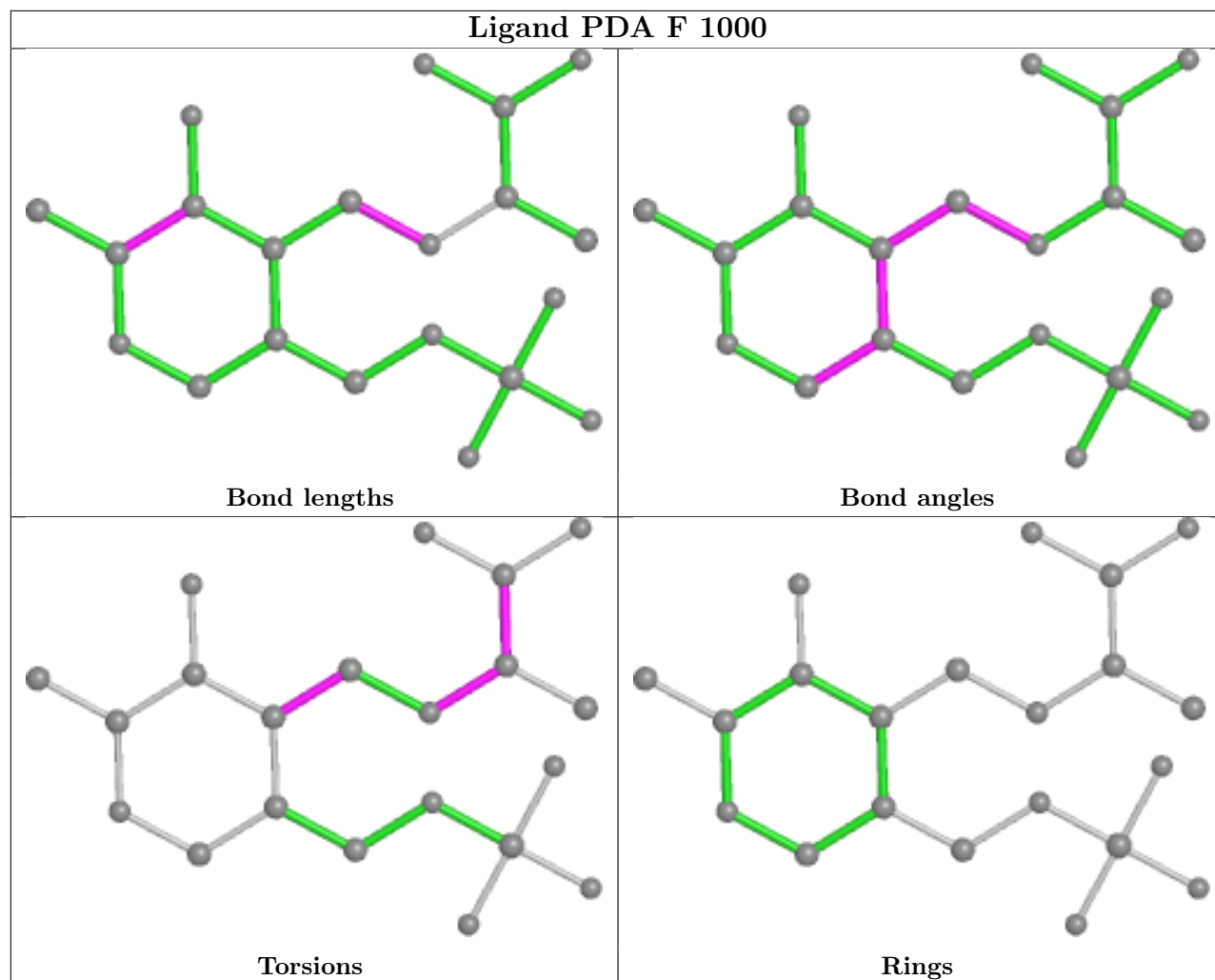

5.7 Other polymers [i](#)

There are no such residues in this entry.

5.8 Polymer linkage issues [i](#)

There are no chain breaks in this entry.

6 Fit of model and data [i](#)

6.1 Protein, DNA and RNA chains [i](#)

In the following table, the column labelled ‘#RSRZ > 2’ contains the number (and percentage) of RSRZ outliers, followed by percent RSRZ outliers for the chain as percentile scores relative to all X-ray entries and entries of similar resolution. The OWAB column contains the minimum, median, 95th percentile and maximum values of the occupancy-weighted average B-factor per residue. The column labelled ‘Q < 0.9’ lists the number of (and percentage) of residues with an average occupancy less than 0.9.

Mol	Chain	Analysed	<RSRZ>	#RSRZ>2	OWAB(Å ²)	Q<0.9
1	A	461/485 (95%)	0.24	9 (1%) 65 71	45, 55, 75, 94	0
1	B	461/485 (95%)	0.39	13 (2%) 53 60	43, 56, 74, 97	0
1	C	461/485 (95%)	0.38	14 (3%) 50 57	49, 63, 81, 96	0
1	D	465/485 (95%)	0.55	32 (6%) 16 22	48, 63, 84, 116	0
1	E	461/485 (95%)	0.63	35 (7%) 13 18	53, 72, 91, 107	0
1	F	465/485 (95%)	0.40	15 (3%) 47 54	51, 68, 88, 114	0
1	G	459/485 (94%)	0.54	33 (7%) 15 20	49, 64, 87, 118	0
1	H	462/485 (95%)	0.32	7 (1%) 73 79	47, 61, 81, 98	0
1	I	461/485 (95%)	0.74	47 (10%) 6 9	52, 77, 101, 127	0
1	J	461/485 (95%)	1.36	116 (25%) 0 0	59, 86, 114, 133	0
1	K	461/485 (95%)	1.35	119 (25%) 0 0	57, 96, 136, 163	0
1	L	460/485 (94%)	1.81	152 (33%) 0 0	63, 110, 164, 185	0
All	All	5538/5820 (95%)	0.73	592 (10%) 6 8	43, 69, 119, 185	0

All (592) RSRZ outliers are listed below:

Mol	Chain	Res	Type	RSRZ
1	L	473	TRP	14.7
1	L	399	THR	10.6
1	L	8	ILE	10.4
1	L	48	GLY	10.4
1	L	366	SER	8.6
1	L	468	LEU	7.9
1	L	11	GLU	7.3
1	J	366	SER	7.2
1	J	473	TRP	7.2
1	J	399	THR	7.2
1	L	10	TRP	7.0

Continued on next page...

Continued from previous page...

Mol	Chain	Res	Type	RSRZ
1	L	214	LEU	6.9
1	J	209	GLU	6.8
1	K	370	LEU	6.8
1	J	467	TYR	6.6
1	E	395	ALA	6.5
1	J	199	GLN	6.2
1	J	204	ASN	6.1
1	L	14	LYS	6.1
1	L	363	TYR	5.9
1	J	370	LEU	5.9
1	L	35	PRO	5.9
1	L	206	LEU	5.9
1	I	281	TRP	5.9
1	J	393	VAL	5.8
1	L	384	TYR	5.8
1	J	381	PHE	5.7
1	K	279	GLY	5.7
1	E	370	LEU	5.6
1	J	368	LEU	5.6
1	L	198	PHE	5.6
1	J	371	LEU	5.6
1	J	402	VAL	5.5
1	L	174	GLU	5.5
1	L	175	SER	5.5
1	I	249	TYR	5.4
1	J	470	SER	5.4
1	D	467	TYR	5.4
1	I	401	TYR	5.4
1	L	221	ARG	5.4
1	L	465	LEU	5.4
1	L	427	LEU	5.4
1	E	473	TRP	5.3
1	G	395	ALA	5.3
1	J	457	ALA	5.3
1	K	366	SER	5.3
1	D	471	GLY	5.2
1	K	396	LYS	5.2
1	K	395	ALA	5.2
1	L	52	LEU	5.2
1	C	187	SER	5.2
1	J	206	LEU	5.2
1	L	249	TYR	5.1

Continued on next page...

Continued from previous page...

Mol	Chain	Res	Type	RSRZ
1	D	473	TRP	5.1
1	L	209	GLU	5.1
1	K	197	THR	5.1
1	H	395	ALA	5.0
1	L	397	THR	5.0
1	L	429	LYS	5.0
1	J	364	ILE	5.0
1	L	173	SER	5.0
1	J	367	LYS	5.0
1	K	401	TYR	5.0
1	K	10	TRP	4.9
1	J	20	TYR	4.9
1	K	93	TYR	4.9
1	L	395	ALA	4.9
1	K	281	TRP	4.9
1	L	428	GLU	4.9
1	J	395	ALA	4.8
1	L	455	ASP	4.7
1	J	7	LYS	4.7
1	K	187	SER	4.7
1	L	431	VAL	4.6
1	J	205	TYR	4.6
1	D	474	GLN	4.6
1	L	430	GLY	4.6
1	J	415	ASN	4.5
1	L	472	GLU	4.5
1	G	187	SER	4.5
1	J	401	TYR	4.5
1	L	13	VAL	4.5
1	L	447	LEU	4.5
1	C	473	TRP	4.5
1	L	464	ALA	4.4
1	L	29	ASN	4.4
1	L	425	LYS	4.4
1	L	462	ASP	4.4
1	J	394	ASN	4.3
1	L	400	PRO	4.3
1	L	208	ASP	4.3
1	L	416	GLN	4.3
1	J	176	PHE	4.3
1	L	368	LEU	4.3
1	L	466	ASP	4.2

Continued on next page...

Continued from previous page...

Mol	Chain	Res	Type	RSRZ
1	L	467	TYR	4.2
1	G	471	GLY	4.2
1	K	458	MET	4.2
1	J	197	THR	4.2
1	J	71	VAL	4.2
1	J	464	ALA	4.1
1	I	198	PHE	4.1
1	L	471	GLY	4.1
1	J	16	TRP	4.1
1	K	381	PHE	4.1
1	L	110	ASP	4.1
1	L	417	ILE	4.1
1	D	418	PRO	4.1
1	F	473	TRP	4.1
1	I	399	THR	4.1
1	J	187	SER	4.1
1	L	433	ILE	4.0
1	H	183	SER	4.0
1	L	359	ASN	4.0
1	K	364	ILE	4.0
1	K	290	GLN	4.0
1	I	106	LEU	4.0
1	K	198	PHE	4.0
1	K	389	ILE	4.0
1	C	467	TYR	4.0
1	J	423	MET	4.0
1	L	461	LEU	4.0
1	G	183	SER	4.0
1	L	377	SER	4.0
1	F	209	GLU	3.9
1	L	68	ASN	3.9
1	D	187	SER	3.9
1	J	174	GLU	3.9
1	J	468	LEU	3.9
1	D	466	ASP	3.9
1	K	111	TRP	3.9
1	L	393	VAL	3.9
1	K	464	ALA	3.9
1	K	282	PHE	3.8
1	K	473	TRP	3.8
1	E	468	LEU	3.8
1	F	472	GLU	3.8

Continued on next page...

Continued from previous page...

Mol	Chain	Res	Type	RSRZ
1	L	418	PRO	3.8
1	L	51	ARG	3.8
1	E	445	ALA	3.8
1	K	71	VAL	3.8
1	K	452	GLY	3.8
1	K	97	ALA	3.8
1	I	394	ASN	3.8
1	L	250	GLU	3.7
1	L	18	ARG	3.7
1	K	426	ALA	3.7
1	K	348	MET	3.7
1	L	415	ASN	3.6
1	K	376	LYS	3.6
1	L	364	ILE	3.6
1	L	370	LEU	3.6
1	J	376	LYS	3.6
1	K	468	LEU	3.6
1	J	281	TRP	3.6
1	F	471	GLY	3.6
1	G	473	TRP	3.6
1	I	395	ALA	3.5
1	L	381	PHE	3.5
1	J	471	GLY	3.5
1	I	397	THR	3.5
1	K	459	ASP	3.5
1	J	211	GLY	3.5
1	K	377	SER	3.5
1	K	152	THR	3.5
1	K	373	GLU	3.5
1	K	208	ASP	3.5
1	L	426	ALA	3.5
1	A	473	TRP	3.5
1	L	349	MET	3.5
1	K	363	TYR	3.5
1	L	80	ASP	3.5
1	K	47	PRO	3.4
1	L	30	GLU	3.4
1	G	209	GLU	3.4
1	K	412	MET	3.4
1	K	183	SER	3.4
1	K	388	TRP	3.4
1	L	53	LEU	3.4

Continued on next page...

Continued from previous page...

Mol	Chain	Res	Type	RSRZ
1	D	472	GLU	3.4
1	I	392	ILE	3.4
1	E	376	LYS	3.4
1	L	385	GLY	3.4
1	E	416	GLN	3.3
1	K	119	SER	3.3
1	L	373	GLU	3.3
1	L	49	GLY	3.3
1	K	16	TRP	3.3
1	L	297	GLY	3.3
1	I	15	GLU	3.3
1	J	353	LEU	3.3
1	L	213	LEU	3.3
1	L	306	PRO	3.3
1	E	457	ALA	3.3
1	J	48	GLY	3.3
1	L	254	GLN	3.3
1	D	155	ALA	3.3
1	G	371	LEU	3.3
1	J	15	GLU	3.3
1	K	265	LEU	3.2
1	J	391	ASP	3.2
1	J	424	GLU	3.2
1	K	349	MET	3.2
1	J	392	ILE	3.2
1	L	398	LYS	3.2
1	K	368	LEU	3.2
1	F	395	ALA	3.2
1	I	472	GLU	3.2
1	C	49	GLY	3.2
1	J	29	ASN	3.2
1	L	271	VAL	3.2
1	L	40	GLU	3.2
1	J	462	ASP	3.2
1	F	187	SER	3.1
1	K	463	TYR	3.1
1	K	37	GLU	3.1
1	L	355	GLU	3.1
1	J	438	PRO	3.1
1	J	34	VAL	3.1
1	E	412	MET	3.1
1	E	397	THR	3.1

Continued on next page...

Continued from previous page...

Mol	Chain	Res	Type	RSRZ
1	J	121	GLY	3.1
1	K	467	TYR	3.1
1	L	69	GLN	3.1
1	L	199	GLN	3.1
1	L	402	VAL	3.1
1	J	388	TRP	3.1
1	J	404	LEU	3.1
1	L	111	TRP	3.1
1	J	198	PHE	3.0
1	K	429	LYS	3.0
1	J	439	ASN	3.0
1	K	78	ALA	3.0
1	L	401	TYR	3.0
1	K	371	LEU	3.0
1	K	103	GLU	3.0
1	K	362	GLU	3.0
1	J	389	ILE	3.0
1	K	84	PHE	3.0
1	I	396	LYS	3.0
1	F	249	TYR	3.0
1	I	372	GLN	3.0
1	L	124	ALA	3.0
1	L	176	PHE	3.0
1	I	204	ASN	3.0
1	B	183	SER	3.0
1	G	377	SER	3.0
1	J	26	SER	3.0
1	K	8	ILE	3.0
1	L	55	PHE	3.0
1	L	413	ASN	3.0
1	J	460	ALA	2.9
1	J	108	ASP	2.9
1	K	350	GLU	2.9
1	J	466	ASP	2.9
1	K	285	GLN	2.9
1	G	472	GLU	2.9
1	L	16	TRP	2.9
1	K	359	ASN	2.9
1	B	377	SER	2.9
1	E	187	SER	2.9
1	K	221	ARG	2.9
1	F	468	LEU	2.9

Continued on next page...

Continued from previous page...

Mol	Chain	Res	Type	RSRZ
1	J	307	ALA	2.9
1	E	467	TYR	2.9
1	L	43	TYR	2.9
1	G	397	THR	2.9
1	I	120	THR	2.9
1	I	187	SER	2.9
1	C	69	GLN	2.9
1	E	14	LYS	2.9
1	B	155	ALA	2.9
1	J	463	TYR	2.9
1	K	397	THR	2.8
1	L	156	ALA	2.8
1	K	424	GLU	2.8
1	K	32	GLN	2.8
1	J	450	SER	2.8
1	D	396	LYS	2.8
1	L	457	ALA	2.8
1	K	104	ASP	2.8
1	L	421	ILE	2.8
1	G	155	ALA	2.8
1	L	78	ALA	2.8
1	K	333	GLY	2.8
1	L	96	LYS	2.8
1	F	210	ASN	2.8
1	I	83	GLY	2.8
1	K	386	LEU	2.8
1	G	249	TYR	2.8
1	L	125	VAL	2.7
1	D	470	SER	2.7
1	B	190	LEU	2.7
1	D	16	TRP	2.7
1	K	48	GLY	2.7
1	K	445	ALA	2.7
1	K	465	LEU	2.7
1	L	27	THR	2.7
1	L	37	GLU	2.7
1	A	401	TYR	2.7
1	J	183	SER	2.7
1	J	372	GLN	2.7
1	K	82	TYR	2.7
1	L	279	GLY	2.7
1	K	450	SER	2.7

Continued on next page...

Continued from previous page...

Mol	Chain	Res	Type	RSRZ
1	K	209	GLU	2.7
1	L	354	VAL	2.7
1	K	321	ASP	2.7
1	J	11	GLU	2.7
1	E	371	LEU	2.7
1	E	15	GLU	2.7
1	B	187	SER	2.7
1	L	378	ILE	2.7
1	G	205	TYR	2.7
1	K	287	TYR	2.7
1	D	11	GLU	2.7
1	K	372	GLN	2.7
1	K	86	TRP	2.7
1	J	122	SER	2.7
1	J	472	GLU	2.7
1	L	152	THR	2.7
1	L	189	VAL	2.7
1	J	276	GLY	2.7
1	G	210	ASN	2.6
1	K	421	ILE	2.6
1	L	70	LYS	2.6
1	G	467	TYR	2.6
1	G	7	LYS	2.6
1	K	306	PRO	2.6
1	L	396	LYS	2.6
1	D	395	ALA	2.6
1	L	101	ILE	2.6
1	L	211	GLY	2.6
1	K	62	VAL	2.6
1	L	374	LYS	2.6
1	E	471	GLY	2.6
1	K	12	GLN	2.6
1	B	204	ASN	2.6
1	E	275	PHE	2.6
1	L	261	GLU	2.6
1	L	122	SER	2.6
1	D	93	TYR	2.6
1	I	355	GLU	2.6
1	J	289	VAL	2.6
1	J	425	LYS	2.6
1	K	474	GLN	2.6
1	L	150	GLY	2.6

Continued on next page...

Continued from previous page...

Mol	Chain	Res	Type	RSRZ
1	E	204	ASN	2.6
1	J	172	ASN	2.6
1	I	11	GLU	2.6
1	G	198	PHE	2.6
1	J	430	GLY	2.6
1	J	250	GLU	2.6
1	B	7	LYS	2.6
1	K	448	ASN	2.6
1	L	151	TRP	2.5
1	K	79	LEU	2.5
1	K	345	LEU	2.5
1	L	300	LEU	2.5
1	G	469	GLU	2.5
1	K	107	GLY	2.5
1	I	330	THR	2.5
1	L	129	LEU	2.5
1	L	386	LEU	2.5
1	I	379	GLY	2.5
1	L	71	VAL	2.5
1	J	60	CYS	2.5
1	J	215	SER	2.5
1	A	474	GLN	2.5
1	D	401	TYR	2.5
1	K	331	TYR	2.5
1	J	96	LYS	2.5
1	L	217	LYS	2.5
1	C	221	ARG	2.5
1	E	401	TYR	2.5
1	G	466	ASP	2.5
1	G	373	GLU	2.5
1	G	470	SER	2.5
1	K	462	ASP	2.5
1	C	472	GLU	2.5
1	K	422	ILE	2.5
1	I	321	ASP	2.5
1	B	395	ALA	2.4
1	D	158	VAL	2.4
1	F	84	PHE	2.4
1	J	299	GLY	2.4
1	C	416	GLN	2.4
1	D	183	SER	2.4
1	B	271	VAL	2.4

Continued on next page...

Continued from previous page...

Mol	Chain	Res	Type	RSRZ
1	K	211	GLY	2.4
1	L	120	THR	2.4
1	L	362	GLU	2.4
1	J	19	LYS	2.4
1	L	450	SER	2.4
1	C	370	LEU	2.4
1	I	357	ALA	2.4
1	C	471	GLY	2.4
1	E	428	GLU	2.4
1	K	108	ASP	2.4
1	J	421	ILE	2.4
1	C	468	LEU	2.4
1	D	210	ASN	2.4
1	I	199	GLN	2.4
1	J	305	LEU	2.4
1	A	209	GLU	2.4
1	G	418	PRO	2.4
1	L	118	VAL	2.4
1	G	396	LYS	2.4
1	I	470	SER	2.4
1	I	75	ILE	2.4
1	L	15	GLU	2.4
1	E	375	HIS	2.4
1	L	435	GLY	2.4
1	G	399	THR	2.4
1	K	399	THR	2.4
1	G	474	GLN	2.4
1	K	455	ASP	2.4
1	E	423	MET	2.4
1	I	155	ALA	2.4
1	K	73	ALA	2.4
1	K	261	GLU	2.4
1	J	175	SER	2.4
1	L	342	CYS	2.4
1	K	75	ILE	2.3
1	L	389	ILE	2.3
1	K	471	GLY	2.3
1	C	209	GLU	2.3
1	J	124	ALA	2.3
1	E	381	PHE	2.3
1	G	364	ILE	2.3
1	D	416	GLN	2.3

Continued on next page...

Continued from previous page...

Mol	Chain	Res	Type	RSRZ
1	H	249	TYR	2.3
1	J	112	PRO	2.3
1	L	44	LEU	2.3
1	D	152	THR	2.3
1	E	415	ASN	2.3
1	I	111	TRP	2.3
1	J	10	TRP	2.3
1	J	413	ASN	2.3
1	I	119	SER	2.3
1	J	329	SER	2.3
1	G	176	PHE	2.3
1	J	125	VAL	2.3
1	K	15	GLU	2.3
1	D	154	GLY	2.3
1	L	61	CYS	2.3
1	J	380	ASN	2.3
1	K	460	ALA	2.3
1	L	380	ASN	2.3
1	H	175	SER	2.3
1	H	396	LYS	2.3
1	L	390	VAL	2.3
1	I	12	GLN	2.3
1	K	378	ILE	2.3
1	K	155	ALA	2.3
1	J	440	THR	2.3
1	J	465	LEU	2.3
1	L	463	TYR	2.3
1	H	376	LYS	2.3
1	I	376	LYS	2.3
1	I	473	TRP	2.3
1	A	271	VAL	2.3
1	K	310	VAL	2.3
1	L	9	ASN	2.3
1	L	171	GLU	2.3
1	F	466	ASP	2.3
1	I	208	ASP	2.3
1	J	405	ASP	2.3
1	J	417	ILE	2.3
1	K	318	ALA	2.3
1	L	436	ALA	2.3
1	I	278	THR	2.3
1	A	249	TYR	2.3

Continued on next page...

Continued from previous page...

Mol	Chain	Res	Type	RSRZ
1	L	458	MET	2.3
1	L	212	GLU	2.3
1	I	402	VAL	2.3
1	D	376	LYS	2.3
1	I	368	LEU	2.2
1	K	120	THR	2.2
1	K	113	GLY	2.2
1	K	472	GLU	2.2
1	J	331	TYR	2.2
1	J	459	ASP	2.2
1	L	234	VAL	2.2
1	E	183	SER	2.2
1	E	276	GLY	2.2
1	I	7	LYS	2.2
1	J	213	LEU	2.2
1	K	461	LEU	2.2
1	J	146	HIS	2.2
1	I	359	ASN	2.2
1	J	61	CYS	2.2
1	K	39	THR	2.2
1	K	212	GLU	2.2
1	L	253	PRO	2.2
1	J	449	VAL	2.2
1	D	151	TRP	2.2
1	E	197	THR	2.2
1	G	152	THR	2.2
1	I	110	ASP	2.2
1	G	378	ILE	2.2
1	K	102	ILE	2.2
1	J	59	LEU	2.2
1	L	81	ARG	2.2
1	B	402	VAL	2.2
1	L	62	VAL	2.2
1	L	121	GLY	2.2
1	E	373	GLU	2.2
1	J	337	ALA	2.2
1	K	50	THR	2.2
1	K	375	HIS	2.2
1	L	192	ALA	2.2
1	J	396	LYS	2.2
1	B	472	GLU	2.2
1	G	174	GLU	2.2

Continued on next page...

Continued from previous page...

Mol	Chain	Res	Type	RSRZ
1	B	158	VAL	2.2
1	K	243	GLY	2.2
1	K	29	ASN	2.2
1	F	396	LYS	2.2
1	J	120	THR	2.2
1	L	305	LEU	2.2
1	J	37	GLU	2.2
1	E	110	ASP	2.2
1	K	260	LYS	2.1
1	I	467	TYR	2.1
1	D	271	VAL	2.1
1	A	152	THR	2.1
1	L	432	LEU	2.1
1	A	175	SER	2.1
1	D	10	TRP	2.1
1	E	400	PRO	2.1
1	I	253	PRO	2.1
1	E	113	GLY	2.1
1	E	13	VAL	2.1
1	I	373	GLU	2.1
1	F	208	ASP	2.1
1	K	42	ASP	2.1
1	K	358	LYS	2.1
1	E	16	TRP	2.1
1	H	332	ALA	2.1
1	J	208	ASP	2.1
1	D	209	GLU	2.1
1	J	119	SER	2.1
1	K	26	SER	2.1
1	L	38	SER	2.1
1	L	59	LEU	2.1
1	L	299	GLY	2.1
1	K	441	MET	2.1
1	C	376	LYS	2.1
1	J	257	LYS	2.1
1	C	151	TRP	2.1
1	G	402	VAL	2.1
1	J	408	PHE	2.1
1	L	448	ASN	2.1
1	L	379	GLY	2.1
1	I	364	ILE	2.1
1	G	398	LYS	2.1

Continued on next page...

Continued from previous page...

Mol	Chain	Res	Type	RSRZ
1	L	376	LYS	2.1
1	E	103	GLU	2.1
1	D	156	ALA	2.1
1	D	189	VAL	2.1
1	D	55	PHE	2.1
1	I	398	LYS	2.1
1	J	287	TYR	2.1
1	L	227	GLY	2.1
1	G	370	LEU	2.1
1	L	272	LEU	2.1
1	L	443	ILE	2.1
1	J	349	MET	2.1
1	J	397	THR	2.1
1	J	419	THR	2.1
1	K	257	LYS	2.1
1	F	11	GLU	2.0
1	K	122	SER	2.0
1	E	112	PRO	2.0
1	J	47	PRO	2.0
1	J	306	PRO	2.0
1	J	418	PRO	2.0
1	K	292	ASP	2.0
1	F	467	TYR	2.0
1	B	396	LYS	2.0
1	J	272	LEU	2.0
1	K	36	ILE	2.0
1	J	458	MET	2.0
1	I	152	THR	2.0
1	D	464	ALA	2.0
1	L	95	ALA	2.0
1	I	400	PRO	2.0
1	L	86	TRP	2.0
1	J	214	LEU	2.0
1	A	187	SER	2.0
1	D	124	ALA	2.0

6.2 Non-standard residues in protein, DNA, RNA chains

There are no non-standard protein/DNA/RNA residues in this entry.

6.3 Carbohydrates [i](#)

There are no monosaccharides in this entry.

6.4 Ligands [i](#)

In the following table, the Atoms column lists the number of modelled atoms in the group and the number defined in the chemical component dictionary. The B-factors column lists the minimum, median, 95th percentile and maximum values of B factors of atoms in the group. The column labelled 'Q< 0.9' lists the number of atoms with occupancy less than 0.9.

Mol	Type	Chain	Res	Atoms	RSCC	RSR	B-factors(\AA^2)	Q<0.9
2	PDA	J	1000	21/21	0.91	0.22	68,74,89,92	0
2	PDA	K	1000	21/21	0.93	0.22	76,83,87,88	0
2	PDA	L	1000	21/21	0.93	0.24	90,94,117,121	0
2	PDA	I	1000	21/21	0.95	0.17	60,62,85,91	0
2	PDA	E	1000	21/21	0.95	0.17	65,69,81,84	0
2	PDA	C	1000	21/21	0.96	0.16	49,57,74,76	0
2	PDA	F	1000	21/21	0.96	0.16	60,63,89,92	0
2	PDA	D	1000	21/21	0.96	0.20	55,60,71,75	0
2	PDA	G	1000	21/21	0.97	0.19	53,60,77,79	0
2	PDA	H	1000	21/21	0.97	0.14	48,55,72,76	0
2	PDA	A	1000	21/21	0.97	0.18	48,52,66,69	0
2	PDA	B	1000	21/21	0.98	0.18	47,55,65,69	0

The following is a graphical depiction of the model fit to experimental electron density of all instances of the Ligand of Interest. In addition, ligands with molecular weight > 250 and outliers as shown on the geometry validation Tables will also be included. Each fit is shown from different orientation to approximate a three-dimensional view.

Electron density around PDA J 1000:

$2mF_o-DF_c$ (at 0.7 rmsd) in gray
 mF_o-DF_c (at 3 rmsd) in purple (negative)
and green (positive)

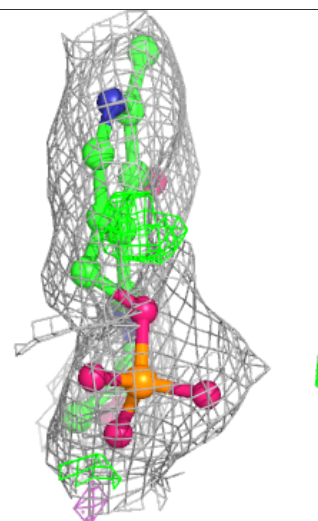
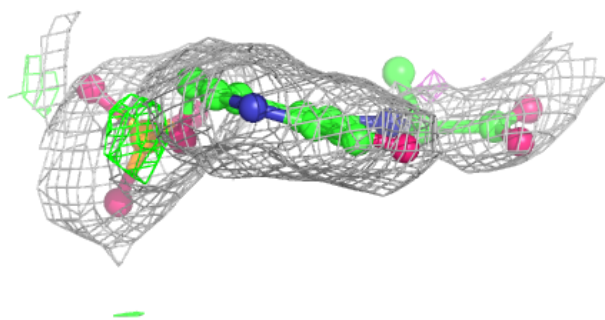
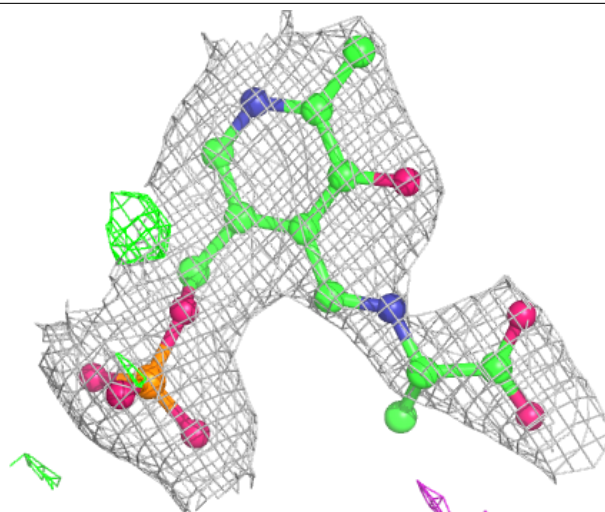

Electron density around PDA K 1000:

$2mF_o-DF_c$ (at 0.7 rmsd) in gray
 mF_o-DF_c (at 3 rmsd) in purple (negative)
and green (positive)

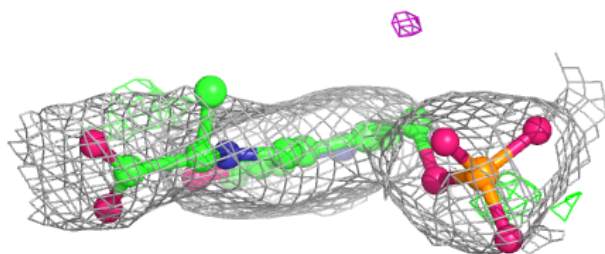
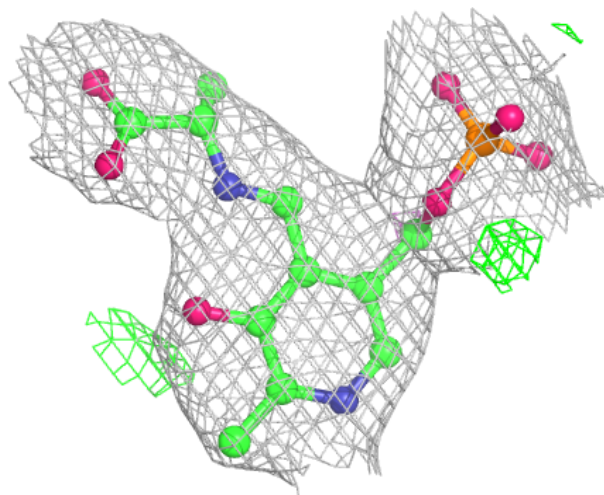

Electron density around PDA L 1000:

$2mF_o-DF_c$ (at 0.7 rmsd) in gray
 mF_o-DF_c (at 3 rmsd) in purple (negative)
and green (positive)

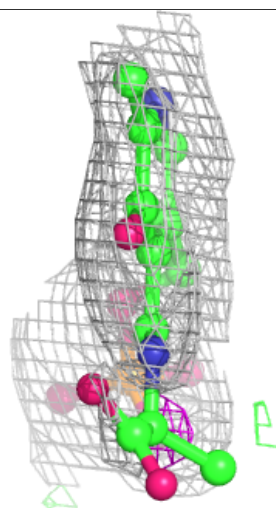
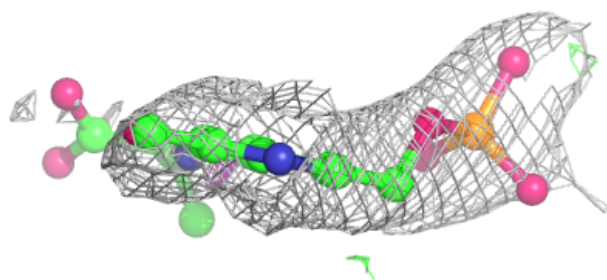
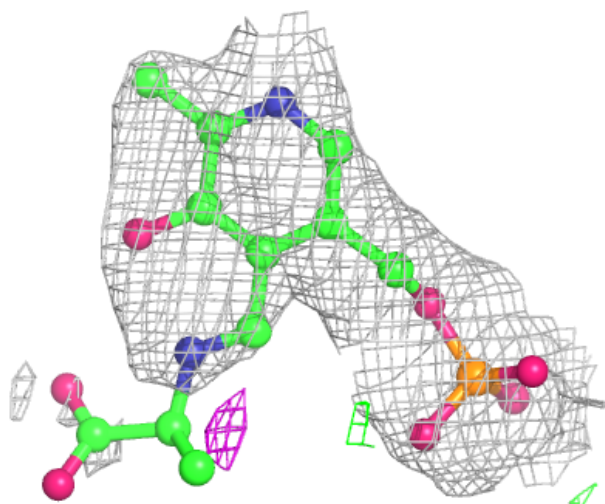

Electron density around PDA I 1000:

$2mF_o-DF_c$ (at 0.7 rmsd) in gray
 mF_o-DF_c (at 3 rmsd) in purple (negative)
and green (positive)

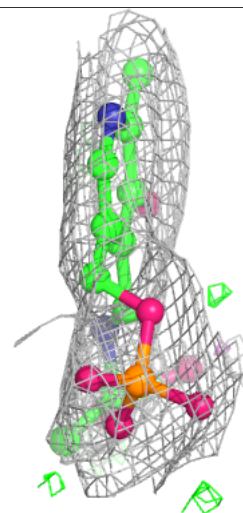
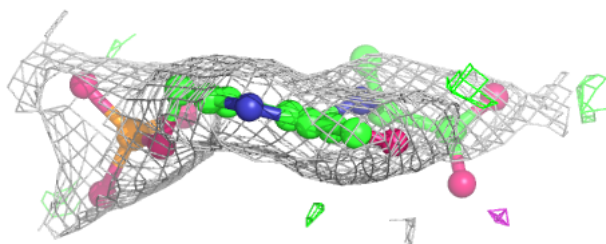
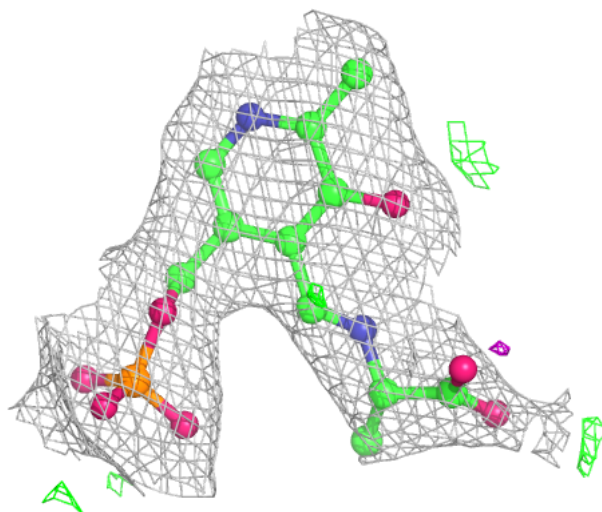

Electron density around PDA E 1000:

$2mF_o-DF_c$ (at 0.7 rmsd) in gray
 mF_o-DF_c (at 3 rmsd) in purple (negative)
and green (positive)

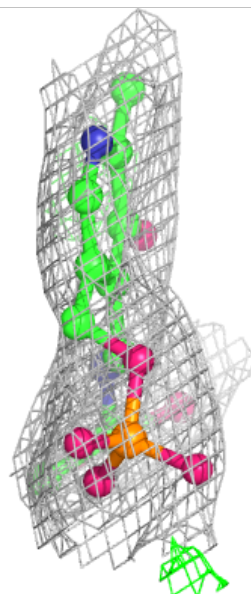
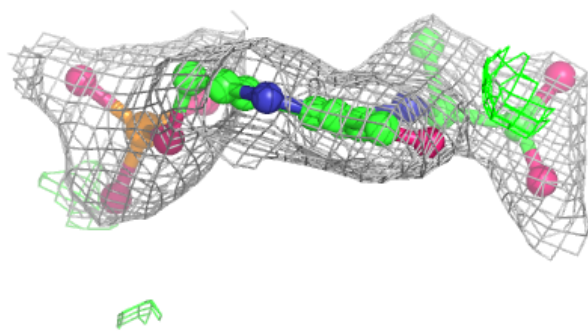
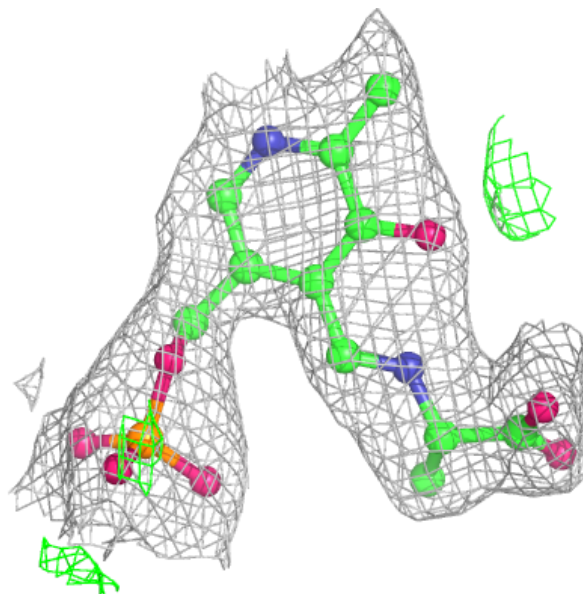

Electron density around PDA C 1000:

$2mF_o-DF_c$ (at 0.7 rmsd) in gray
 mF_o-DF_c (at 3 rmsd) in purple (negative)
and green (positive)

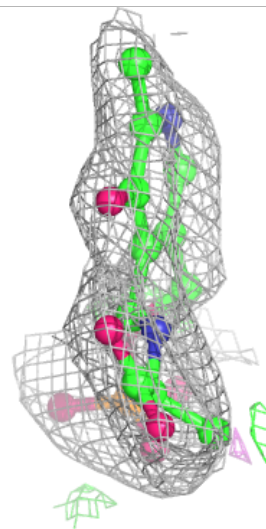
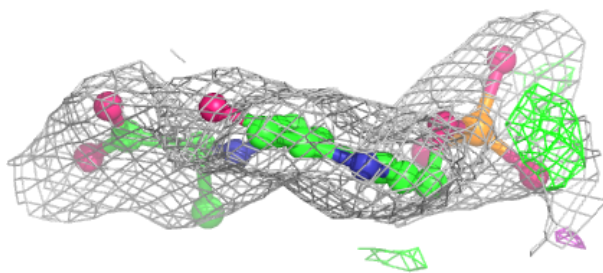
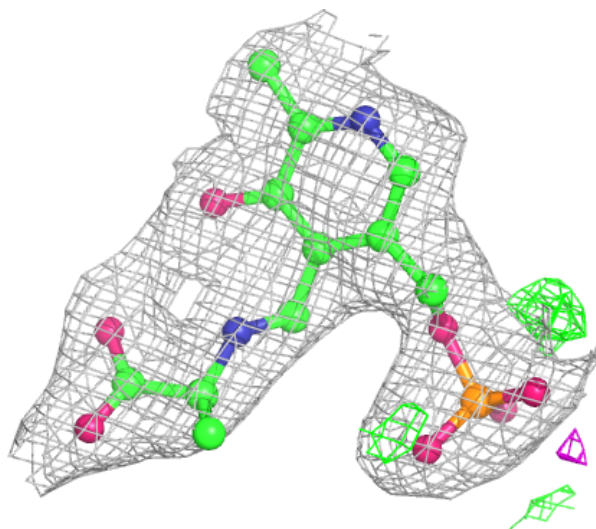

Electron density around PDA F 1000:

$2mF_o-DF_c$ (at 0.7 rmsd) in gray
 mF_o-DF_c (at 3 rmsd) in purple (negative)
and green (positive)

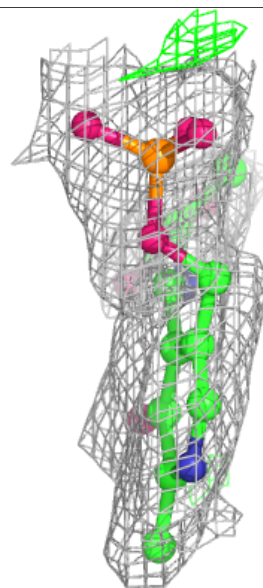
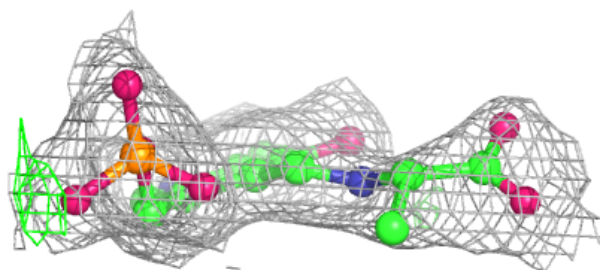
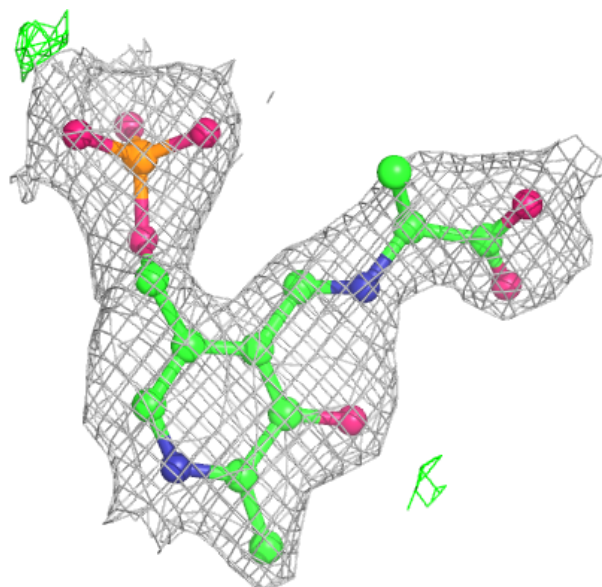

Electron density around PDA D 1000:

$2mF_o-DF_c$ (at 0.7 rmsd) in gray
 mF_o-DF_c (at 3 rmsd) in purple (negative)
and green (positive)

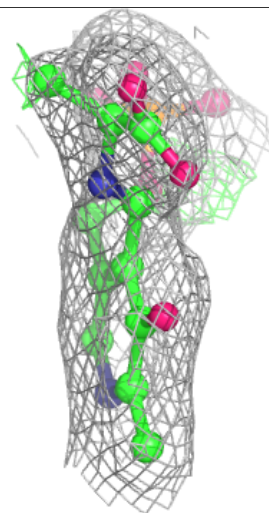
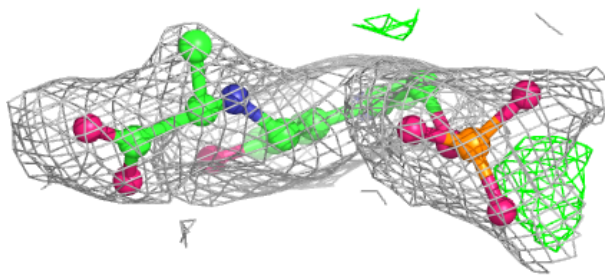
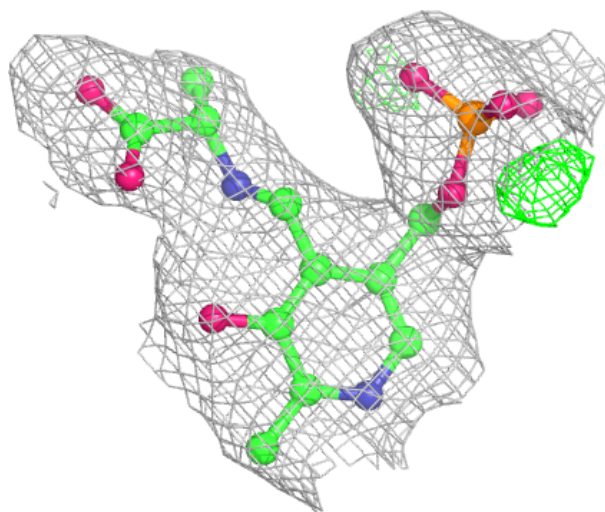

Electron density around PDA G 1000:

$2mF_o-DF_c$ (at 0.7 rmsd) in gray
 mF_o-DF_c (at 3 rmsd) in purple (negative)
and green (positive)

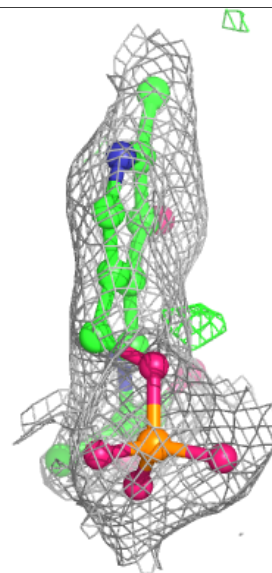
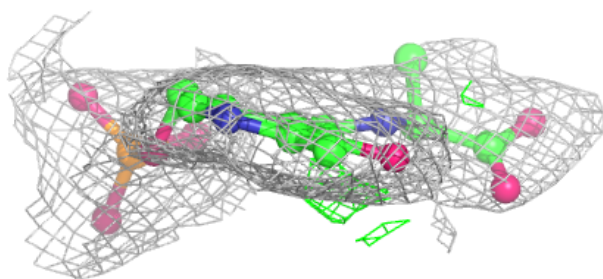
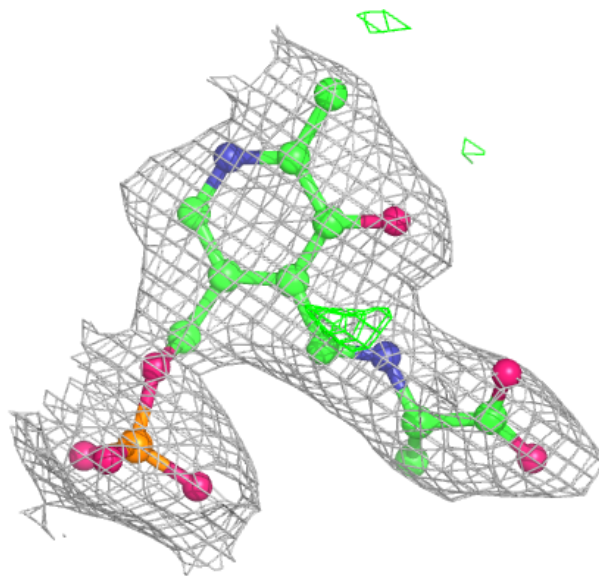

Electron density around PDA H 1000:

$2mF_o-DF_c$ (at 0.7 rmsd) in gray
 mF_o-DF_c (at 3 rmsd) in purple (negative)
and green (positive)

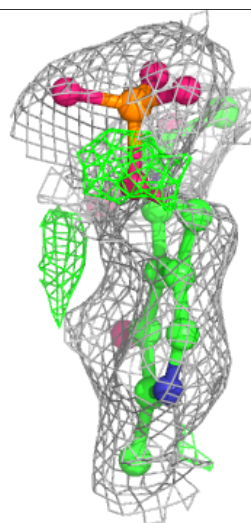
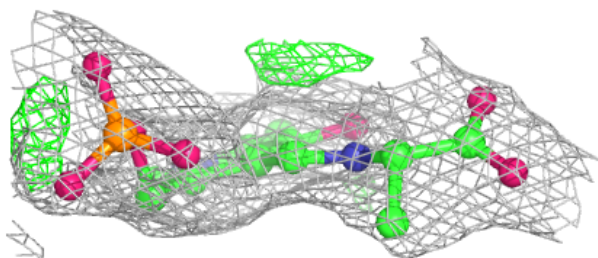
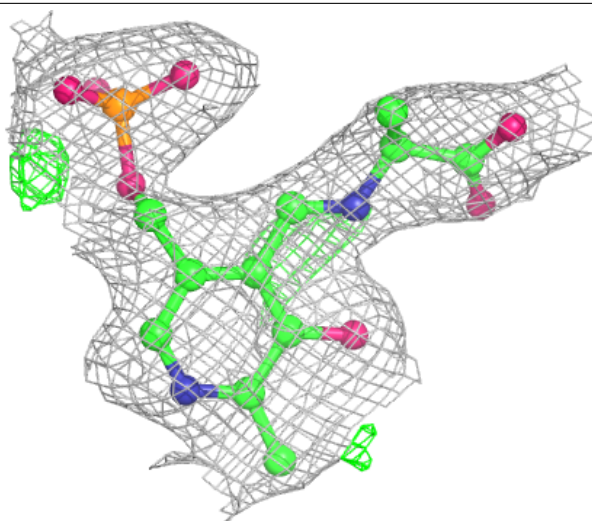

Electron density around PDA A 1000:

$2mF_o-DF_c$ (at 0.7 rmsd) in gray
 mF_o-DF_c (at 3 rmsd) in purple (negative)
and green (positive)

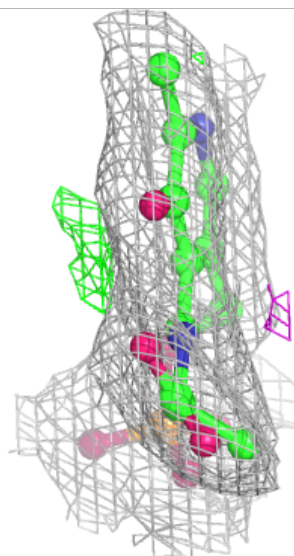
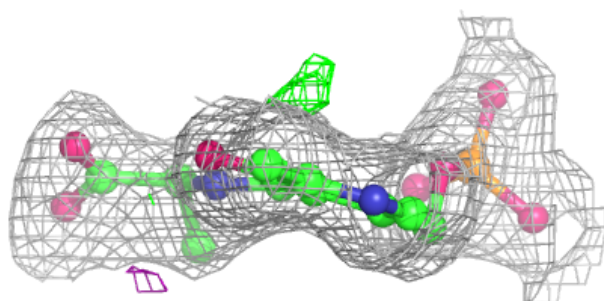
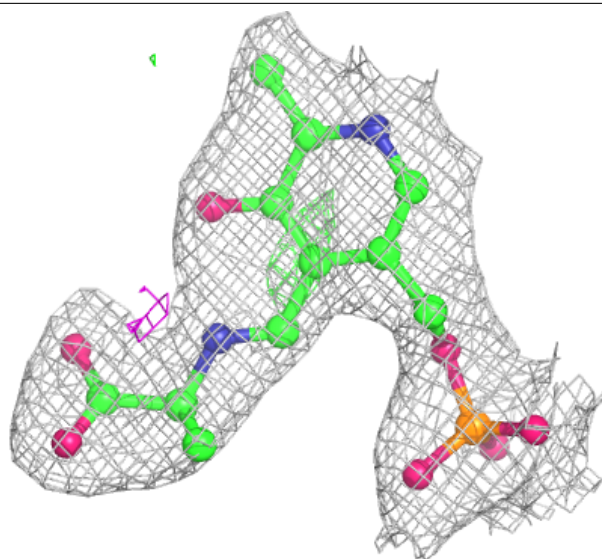

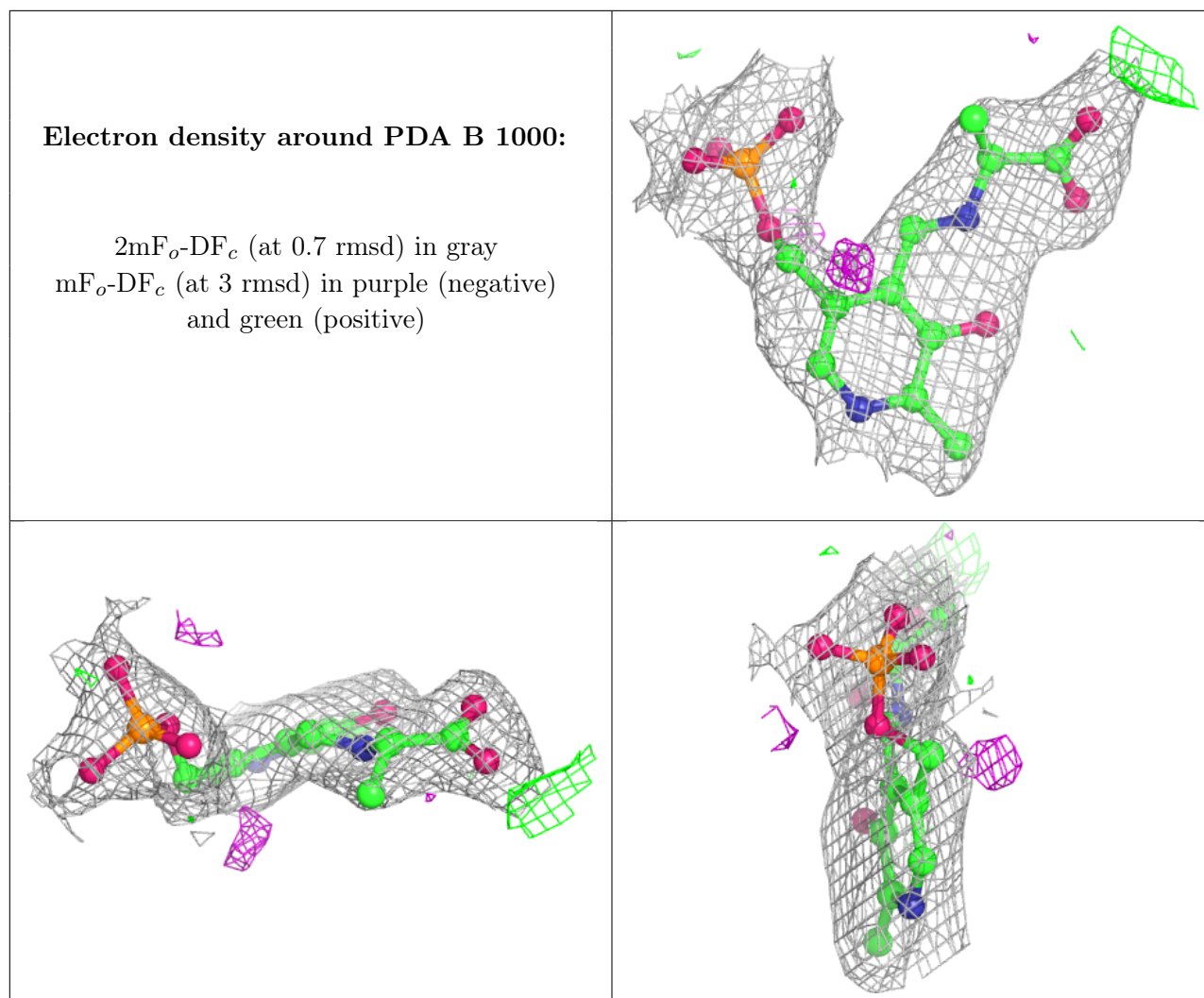

6.5 Other polymers [i](#)

There are no such residues in this entry.