



# wwPDB EM Validation Summary Report ⓘ

Jun 12, 2023 – 06:23 PM EDT

PDB ID : 8G2Z  
EMDB ID : EMD-29685  
Title : 48-nm doublet microtubule from Tetrahymena thermophila strain CU428  
Authors : Black, C.S.; Kubo, S.; Yang, S.K.; Bui, K.H.  
Deposited on : 2023-02-06  
Resolution : 4.10 Å (reported)

This is a wwPDB EM Validation Summary Report for a publicly released PDB entry.

We welcome your comments at [validation@mail.wwpdb.org](mailto:validation@mail.wwpdb.org)

A user guide is available at

<https://www.wwpdb.org/validation/2017/EMValidationReportHelp>

with specific help available everywhere you see the ⓘ symbol.

The types of validation reports are described at

<http://www.wwpdb.org/validation/2017/FAQs#types>.

---

The following versions of software and data (see [references ⓘ](#)) were used in the production of this report:

EMDB validation analysis : 0.0.1.dev50  
Mogul : 1.8.5 (274361), CSD as541be (2020)  
MolProbity : 4.02b-467  
buster-report : 1.1.7 (2018)  
Percentile statistics : 20191225.v01 (using entries in the PDB archive December 25th 2019)  
MapQ : 1.9.9  
Ideal geometry (proteins) : Engh & Huber (2001)  
Ideal geometry (DNA, RNA) : Parkinson et al. (1996)  
Validation Pipeline (wwPDB-VP) : 2.33

# 1 Overall quality at a glance i

The following experimental techniques were used to determine the structure:

*ELECTRON MICROSCOPY*

The reported resolution of this entry is 4.10 Å.

Percentile scores (ranging between 0-100) for global validation metrics of the entry are shown in the following graphic. The table shows the number of entries on which the scores are based.

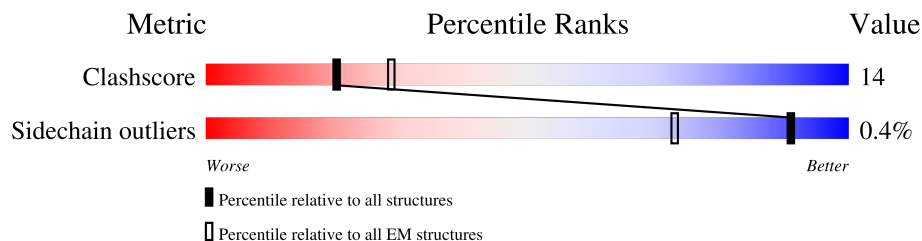

Metric	Whole archive (#Entries)	EM structures (#Entries)
Clashscore	158937	4297
Sidechain outliers	154315	3826

The table below summarises the geometric issues observed across the polymeric chains and their fit to the map. The red, orange, yellow and green segments of the bar indicate the fraction of residues that contain outliers for  $\geq 3$ , 2, 1 and 0 types of geometric quality criteria respectively. A grey segment represents the fraction of residues that are not modelled. The numeric value for each fraction is indicated below the corresponding segment, with a dot representing fractions  $\leq 5\%$ . The upper red bar (where present) indicates the fraction of residues that have poor fit to the EM map (all-atom inclusion  $< 40\%$ ). The numeric value is given above the bar.

Mol	Chain	Length	Quality of chain
1	0A	236	
1	1A	236	
1	2A	236	
1	3A	236	
2	0B	329	
3	0C	156	
3	1C	156	
4	0D	225	
4	1D	225	

*Continued on next page...*

Continued from previous page...

Mol	Chain	Length	Quality of chain
4	2D	225	
5	0E	191	
5	1E	191	
5	2E	191	
5	3E	191	
6	0F	219	
7	0G	183	
7	1G	183	
8	0H	447	
8	1H	447	
9	0N	492	
9	1N	492	
9	2N	492	
10	0Q	195	
10	1Q	195	
10	2Q	195	
10	3Q	195	
10	4Q	195	
10	5Q	195	
10	6Q	195	
11	0S	319	
11	1S	319	
11	2S	319	
11	3S	319	
12	0T	298	

Continued on next page...

Continued from previous page...

Mol	Chain	Length	Quality of chain	
12	1T	298	6%	92%
12	2T	298	5%	91%
12	3T	298	7%	93%
13	0U	656	14%	91%
13	1U	656	6%	91%
13	2U	656	5%	91%
13	3U	656	14%	91%
14	0V	269	45%	74%
14	1V	269	24%	88%
14	2V	269	24%	88%
14	3V	269	29%	92%
15	0X	142	11%	71%
15	1X	142	•	92%
15	2X	142	•	90%
15	3X	142	13%	94%
15	4X	142	10%	54%
16	1B	498	12%	99%
16	2B	498	9%	58%
16	3B	498	12%	58%
17	1F	173	12%	66%
18	1I	263	6%	63%
19	1J	422	16%	76%
20	1K	489	18%	53%
20	2K	489	22%	54%
21	1L	940	20%	82%

Continued on next page...



Continued from previous page...

Mol	Chain	Length	Quality of chain
21	2L	940	
21	3L	940	
22	1M	372	
22	2M	372	
23	1O	494	
23	2O	494	
23	3O	494	
24	1P	507	
24	2P	507	
25	1R	516	
25	2R	516	
25	3R	516	
26	1W	280	
26	2W	280	
27	2C	300	
27	3C	300	
27	4C	300	
28	2F	96	
29	2G	99	
30	2H	229	
30	3H	229	
30	4H	229	
31	2I	293	
31	3I	293	
32	3D	237	











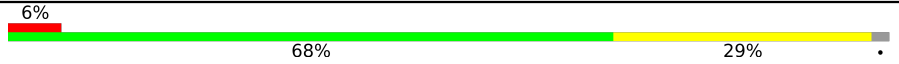
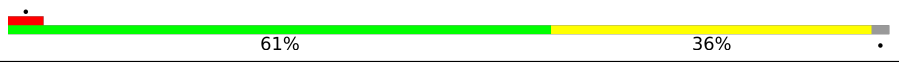
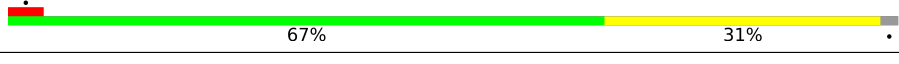

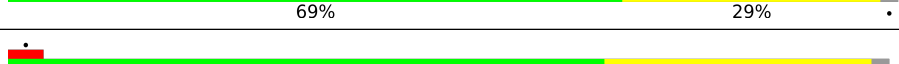
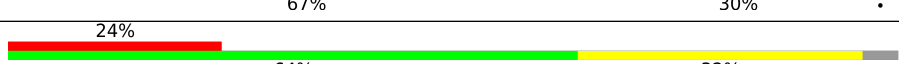
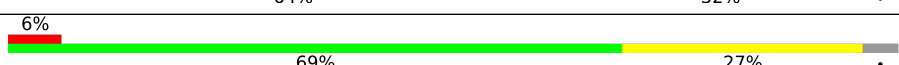
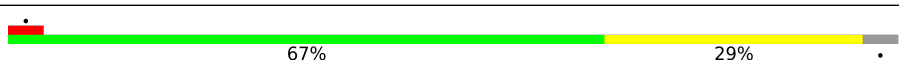

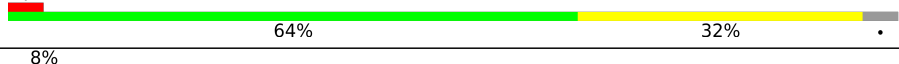

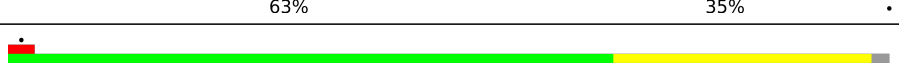
Continued on next page...

Continued from previous page...

Mol	Chain	Length	Quality of chain
33	4F	276	13% 66% 7% 28%
34	4R	613	9% 80% 19%
34	5R	613	7% 68% 31%
34	6R	613	30% 71% 28%
34	7R	613	30% 70% 29%
35	4S	249	8% 40% 35% 24%
35	5S	249	8% 45% 30% 24%
36	5A	175	30% 60% 29% 10%
36	5B	175	12% 58% 31% 10%
36	5C	175	12% 58% 32% 10%
36	5D	175	25% 46% 18% 35%
37	5E	247	45% 45% 30% 24%
37	5F	247	36% 50% 35% 15%
37	5G	247	32% 53% 31% 15%
37	5H	247	28% 33% 26% 41%
38	5I	168	45% 61% 39%
38	5J	168	42% 64% 35%
38	5K	168	40% 48% 52%
39	6F	145	6% 57% 34% 9%
40	6G	364	16% 31% 28% 41%
41	6H	518	7% 20% 11% 68%
42	8L	507	20% 75% 24%
42	8N	507	23% 71% 29%
43	8P	529	17% 68% 31%
44	8R	361	26% 94% 6%













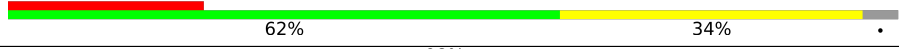



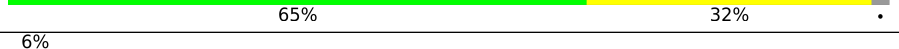
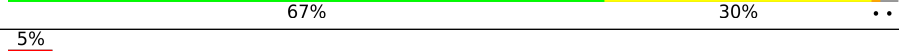
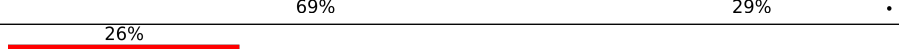
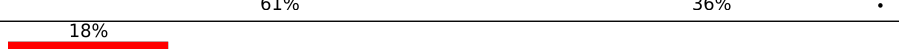
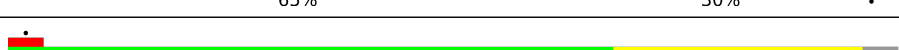

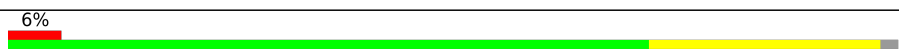
Continued on next page...

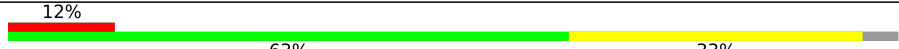
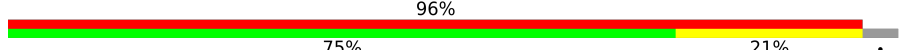
Continued from previous page...

Mol	Chain	Length	Quality of chain
45	AA	449	
45	AC	449	
45	AE	449	
45	AG	449	
45	AI	449	
45	AK	449	
45	AM	449	
45	BA	449	
45	BC	449	
45	BE	449	
45	BG	449	
45	BI	449	
45	BK	449	
45	BM	449	
45	CA	449	
45	CC	449	
45	CE	449	
45	CG	449	
45	CI	449	
45	CK	449	
45	CM	449	
45	DA	449	
45	DC	449	
45	DE	449	
45	DG	449	

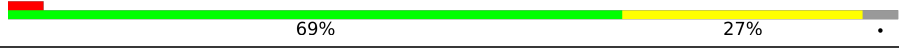
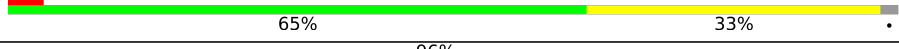
Continued on next page...

Continued from previous page...

Mol	Chain	Length	Quality of chain
45	DI	449	 65% 31%
45	DK	449	 65% 32%
45	DM	449	 22% 62% 34%
45	EA	449	 98% 79% 19%
45	EC	449	 17% 59% 38%
45	EE	449	 5% 64% 34%
45	EG	449	 5% 65% 32%
45	EI	449	 6% 67% 30%
45	EK	449	 5% 69% 29%
45	EM	449	 26% 61% 36%
45	FA	449	 18% 65% 30%
45	FC	449	 68% 28%
45	FE	449	 70% 26%
45	FG	449	 6% 72% 26%
45	FI	449	 68% 28%
45	FK	449	 12% 63% 33%
45	FM	449	 96% 75% 21%
45	GA	449	 21% 61% 34%
45	GC	449	 70% 26%
45	GE	449	 64% 32%
45	GG	449	 6% 68% 28%
45	GI	449	 69% 27%
45	GK	449	 65% 33%
45	GM	449	 96% 75% 20%
45	HA	449	 19% 67% 28%













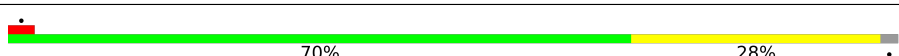
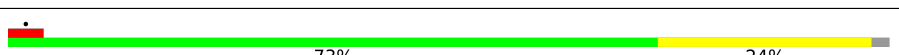
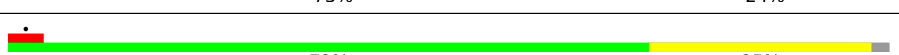

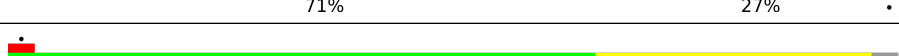
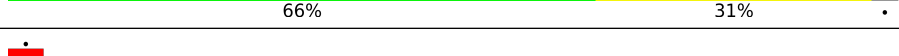

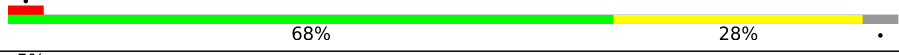

Continued on next page...

Continued from previous page...

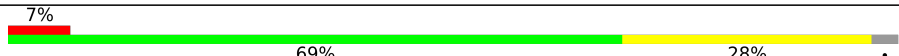
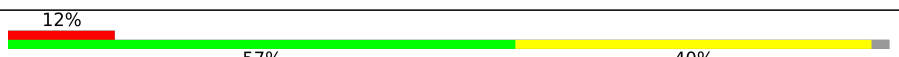
Mol	Chain	Length	Quality of chain
45	HC	449	67% 29%
45	HE	449	66% 29%
45	HG	449	71% 25%
45	HI	449	67% 29%
45	HK	449	64% 31%
45	HM	449	89% 72% 24%
45	IA	449	10% 64% 32%
45	IC	449	63% 34%
45	IE	449	64% 32%
45	IG	449	5% 63% 34%
45	II	449	69% 29%
45	IK	449	64% 32%
45	IM	449	31% 60% 36%
45	JA	449	65% 31%
45	JC	449	67% 30%
45	JE	449	71% 27%
45	JG	449	65% 33%
45	JI	449	67% 31%
45	JK	449	64% 34%
45	JM	449	69% 65% 31%
45	KA	449	64% 32%
45	KC	449	68% 28%
45	KE	449	66% 31%
45	KG	449	67% 31%
45	KI	449	70% 27%

Continued on next page...

Continued from previous page...

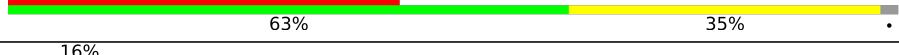
Mol	Chain	Length	Quality of chain
45	KK	449	 65% 32%
45	KM	449	 17% 64% 32%
45	LA	449	 70% 28%
45	LC	449	 73% 24%
45	LE	449	 72% 25%
45	LG	449	 71% 27%
45	LI	449	 66% 31%
45	LK	449	 68% 30%
45	LM	449	 67% 30%
45	MA	449	 6% 66% 31%
45	MC	449	 64% 32%
45	ME	449	 68% 28%
45	MG	449	 5% 67% 30%
45	MI	449	 6% 71% 27%
45	MK	449	 5% 68% 29%
45	MM	449	 7% 69% 28%
45	NA	449	 12% 57% 40%
45	NC	449	 6% 64% 32%
45	NE	449	 6% 68% 30%
45	NG	449	 5% 62% 34%
45	NI	449	 7% 64% 33%
45	NK	449	 5% 61% 35%
45	NM	449	 44% 63% 35%
45	OA	449	 16% 54% 42%
45	OC	449	 61% 35%

Continued on next page...

Continued from previous page...

Mol	Chain	Length	Quality of chain
45	OE	449	5% 62% 34%
45	OG	449	6% 64% 33%
45	OI	449	6% 65% 31%
45	OK	449	6% 62% 34%
45	OM	449	47% 68% 29%
45	PA	449	40% 56% 39%
45	PC	449	7% 62% 34%
45	PE	449	5% 60% 35%
45	PG	449	5% 59% 37%
45	PI	449	6% 65% 31%
45	PK	449	6% 64% 31%
45	PM	449	59% 67% 28%
45	QA	449	72% 66% 29%
45	QC	449	10% 60% 36%
45	QE	449	6% 61% 34%
45	QG	449	7% 55% 41%
45	QI	449	7% 61% 35%
45	QK	449	6% 61% 35%
45	QM	449	73% 66% 29%
45	RA	449	88% 72% 24%
45	RC	449	12% 60% 35%
45	RE	449	9% 61% 35%
45	RG	449	9% 62% 34%
45	RI	449	7% 66% 30%
45	RK	449	8% 63% 32%

Continued on next page...

Continued from previous page...

Mol	Chain	Length	Quality of chain
45	RM	449	67% 66% 29%
45	SA	449	95% 77% 19%
45	SC	449	11% 59% 37%
45	SE	449	7% 60% 35%
45	SG	449	6% 60% 36%
45	SI	449	8% 63% 32%
45	SK	449	6% 58% 38%
45	SM	449	50% 65% 30%
45	TA	449	96% 73% 22%
45	TC	449	17% 56% 39%
45	TE	449	9% 61% 35%
45	TG	449	10% 63% 33%
45	TI	449	10% 67% 29%
45	TK	449	9% 64% 32%
45	TM	449	36% 59% 37%
45	UA	449	94% 76% 19%
45	UC	449	16% 58% 38%
45	UE	449	8% 62% 34%
45	UG	449	10% 67% 29%
45	UI	449	12% 71% 25%
45	UK	449	10% 64% 32%
45	UM	449	20% 58% 37%
45	VA	449	7% 56% 40%
45	VC	449	7% 67% 31%
45	VE	449	61% 36%

Continued on next page...











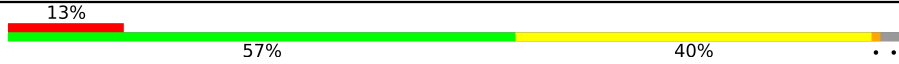
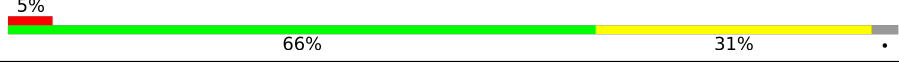
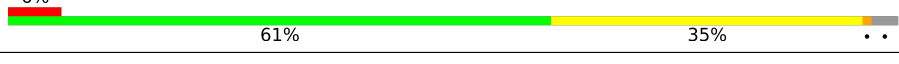

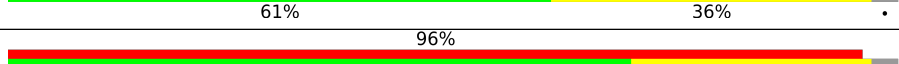
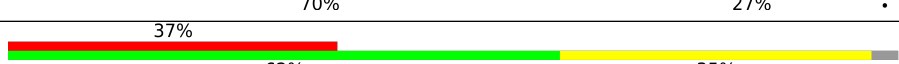
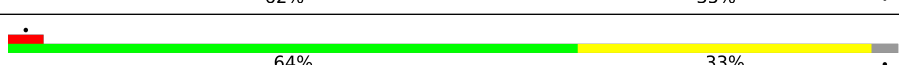
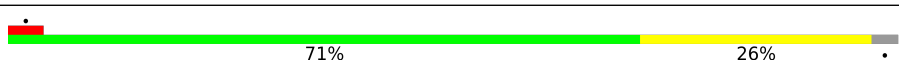

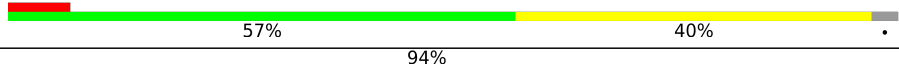

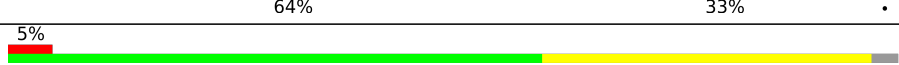

Continued from previous page...

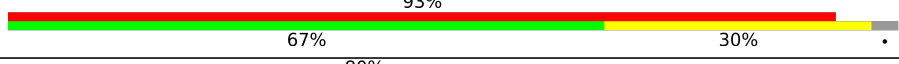
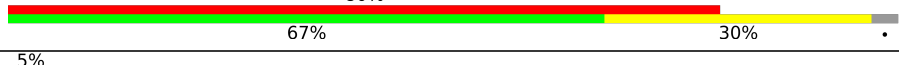
Mol	Chain	Length	Quality of chain
45	VG	449	6% 59% 38%
45	VI	449	5% 63% 33%
45	VK	449	7% 59% 38%
45	VM	449	96% 76% 20%
45	WA	449	5% 61% 35%
45	WC	449	5% 61% 36%
45	WE	449	63% 33%
45	WG	449	5% 63% 34%
45	WI	449	66% 30%
45	WK	449	6% 61% 37%
45	WM	449	70% 71% 25%
46	AB	443	32% 64% 33%
46	AD	443	64% 33%
46	AF	443	64% 33%
46	AH	443	65% 32%
46	AJ	443	71% 26%
46	AL	443	65% 33%
46	AN	443	63% 34%
46	BB	443	89% 72% 25%
46	BD	443	7% 62% 35%
46	BF	443	5% 65% 32%
46	BH	443	6% 62% 35%
46	BJ	443	69% 28%
46	BL	443	5% 62% 35%
46	BN	443	6% 60% 37%













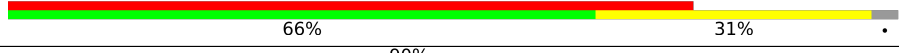



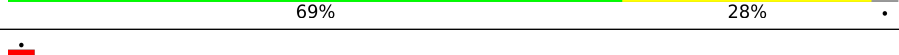
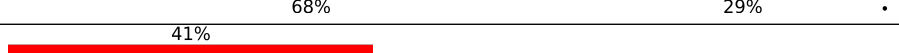

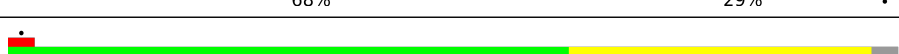

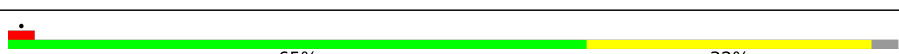
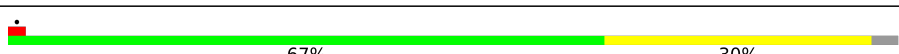
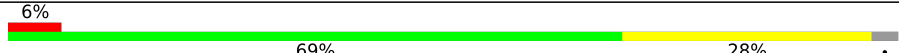
Continued on next page...

Continued from previous page...

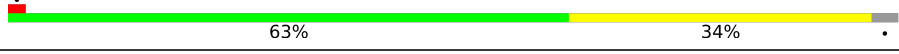
Mol	Chain	Length	Quality of chain
46	CB	443	
46	CD	443	
46	CF	443	
46	CH	443	
46	CJ	443	
46	CL	443	
46	CN	443	
46	DB	443	
46	DD	443	
46	DF	443	
46	DH	443	
46	DJ	443	
46	DL	443	
46	DN	443	
46	EB	443	
46	ED	443	
46	EF	443	
46	EH	443	
46	EJ	443	
46	EL	443	
46	EN	443	
46	FB	443	
46	FD	443	
46	FF	443	
46	FH	443	



















Continued on next page...

Continued from previous page...

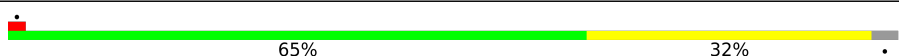
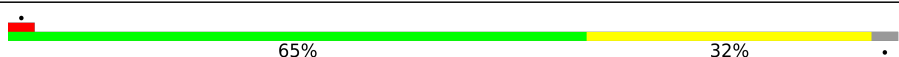
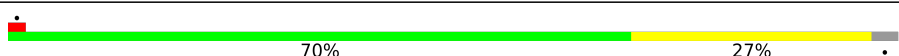
Mol	Chain	Length	Quality of chain
46	FJ	443	 67% 30%
46	FL	443	 64% 33%
46	FN	443	 77% 66% 31%
46	GB	443	 90% 71% 26%
46	GD	443	 6% 62% 35%
46	GF	443	 5% 66% 31%
46	GH	443	 68% 29%
46	GJ	443	 69% 28%
46	GL	443	 68% 29%
46	GN	443	 41% 63% 34%
46	HB	443	 83% 68% 29%
46	HD	443	 63% 34%
46	HF	443	 66% 30%
46	HH	443	 65% 32%
46	HJ	443	 67% 30%
46	HL	443	 6% 69% 28%
46	HN	443	 17% 59% 38%
46	IB	443	 67% 66% 31%
46	ID	443	 65% 32%
46	IF	443	 73% 24%
46	IH	443	 63% 34%
46	IJ	443	 66% 31%
46	IL	443	 63% 34%
46	IN	443	 5% 59% 38%
46	JB	443	 6% 64% 33%

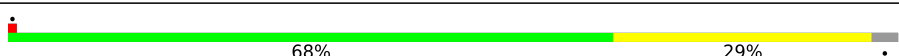
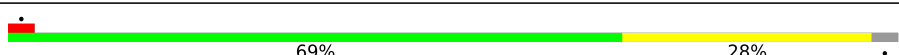
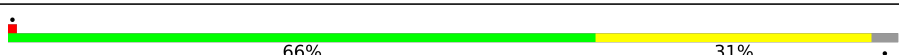
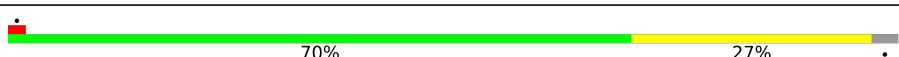
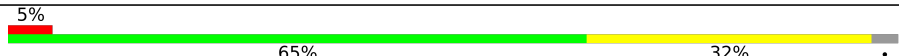



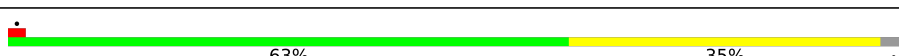













Continued on next page...

Continued from previous page...

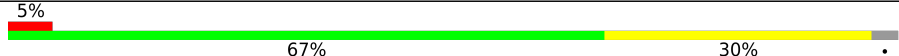
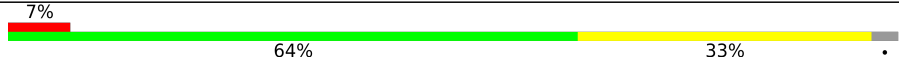
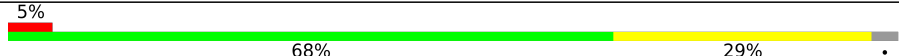
Mol	Chain	Length	Quality of chain
46	JD	443	 73% 24%
46	JF	443	 69% 28%
46	JH	443	 68% 29%
46	JJ	443	 67% 30%
46	JL	443	 66% 31%
46	JN	443	 61% 36% 6%
46	KB	443	 66% 31% 5%
46	KD	443	 67% 29%
46	KF	443	 67% 30%
46	KH	443	 72% 25%
46	KJ	443	 68% 29%
46	KL	443	 67% 30%
46	KN	443	 65% 32%
46	LB	443	 65% 32%
46	LD	443	 70% 27%
46	LF	443	 71% 26%
46	LH	443	 68% 29%
46	LJ	443	 69% 28%
46	LL	443	 66% 31%
46	LN	443	 70% 27%
46	MB	443	 65% 32% 5%
46	MD	443	 67% 29%
46	MF	443	 70% 27%
46	MH	443	 70% 27%
46	MJ	443	 63% 35%

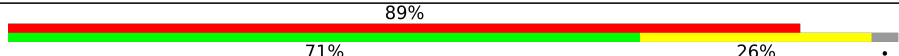
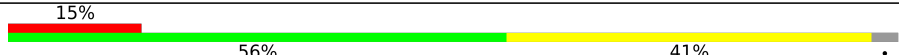
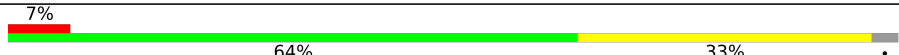
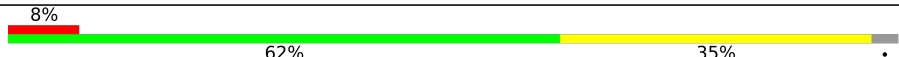
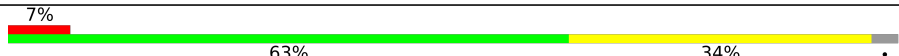
Continued on next page...

Continued from previous page...

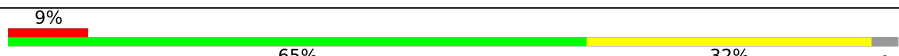
Mol	Chain	Length	Quality of chain
46	ML	443	
46	MN	443	
46	NB	443	
46	ND	443	
46	NF	443	
46	NH	443	
46	NJ	443	
46	NL	443	
46	NN	443	
46	OB	443	
46	OD	443	
46	OF	443	
46	OH	443	
46	OJ	443	
46	OL	443	
46	ON	443	
46	PB	443	
46	PD	443	
46	PF	443	
46	PH	443	
46	PJ	443	
46	PL	443	
46	PN	443	
46	QB	443	
46	QD	443	

Continued on next page...

Continued from previous page...

Mol	Chain	Length	Quality of chain
46	QF	443	7% 63% 35%
46	QH	443	7% 58% 39%
46	QJ	443	7% 63% 33%
46	QL	443	13% 56% 42%
46	QN	443	97% 77% 20%
46	RB	443	29% 57% 40%
46	RD	443	9% 60% 37%
46	RF	443	8% 59% 38%
46	RH	443	7% 60% 37%
46	RJ	443	8% 62% 35%
46	RL	443	14% 55% 42%
46	RN	443	97% 77% 20%
46	SB	443	41% 57% 40%
46	SD	443	7% 59% 38%
46	SF	443	7% 60% 37%
46	SH	443	8% 62% 35%
46	SJ	443	8% 62% 35%
46	SL	443	11% 57% 40%
46	SN	443	97% 75% 22%
46	TB	443	62% 60% 37%
46	TD	443	10% 64% 32%
46	TF	443	8% 57% 40%
46	TH	443	12% 60% 37%
46	TJ	443	10% 60% 37%
46	TL	443	12% 54% 42%

Continued on next page...

Continued from previous page...

Mol	Chain	Length	Quality of chain
46	TN	443	94% 73% 24%
46	UB	443	54% 57% 40%
46	UD	443	11% 63% 34%
46	UF	443	9% 60% 37%
46	UH	443	12% 60% 37%
46	UJ	443	10% 58% 39%
46	UL	443	12% 52% 45%
46	UN	443	76% 60% 37%
46	VB	443	37% 56% 41%
46	VD	443	5% 61% 36%
46	VF	443	• 62% 35%
46	VH	443	5% 56% 41%
46	VJ	443	5% 60% 37%
46	VL	443	5% 58% 39%
46	VN	443	40% 56% 41%
46	WB	443	31% 61% 36%
46	WD	443	5% 59% 38%
46	WF	443	5% 60% 37%
46	WH	443	6% 63% 34%
46	WJ	443	5% 61% 36%
46	WL	443	7% 62% 35%
46	WN	443	14% 58% 39%

## 2 Entry composition i

There are 49 unique types of molecules in this entry. The entry contains 1325153 atoms, of which 0 are hydrogens and 0 are deuteriums.

In the tables below, the AltConf column contains the number of residues with at least one atom in alternate conformation and the Trace column contains the number of residues modelled with at most 2 atoms.

- Molecule 1 is a protein called RIB27A.

Mol	Chain	Residues	Atoms					AltConf	Trace
			Total	C	N	O	S		
1	0A	152	1229	776	224	228	1	0	0
1	1A	152	1229	776	224	228	1	0	0
1	2A	152	1229	776	224	228	1	0	0
1	3A	152	1229	776	224	228	1	0	0

- Molecule 2 is a protein called RIB38.

Mol	Chain	Residues	Atoms					AltConf	Trace
			Total	C	N	O	S		
2	0B	321	2615	1634	472	502	7	0	0

There are 5 discrepancies between the modelled and reference sequences:

Chain	Residue	Modelled	Actual	Comment	Reference
0B	10	THR	SER	conflict	UNP Q23JL9
0B	11	ALA	THR	conflict	UNP Q23JL9
0B	12	LEU	ALA	conflict	UNP Q23JL9
0B	13	MET	LEU	conflict	UNP Q23JL9
0B	36	SER	THR	conflict	UNP Q23JL9

- Molecule 3 is a protein called CFAM166B.

Mol	Chain	Residues	Atoms					AltConf	Trace
			Total	C	N	O	S		
3	0C	95	747	471	131	143	2	0	0
3	1C	95	747	471	131	143	2	0	0

- Molecule 4 is a protein called CFAM166A.



Mol	Chain	Residues	Atoms					AltConf	Trace
			Total	C	N	O	S		
4	0D	202	1619	1018	292	307	2	1	0
4	1D	202	1619	1018	292	307	2	1	0
4	2D	202	1619	1018	292	307	2	1	0

There are 6 discrepancies between the modelled and reference sequences:

Chain	Residue	Modelled	Actual	Comment	Reference
0D	86	ALA	THR	conflict	UNP Q238X3
0D	87	GLU	GLN	conflict	UNP Q238X3
1D	86	ALA	THR	conflict	UNP Q238X3
1D	87	GLU	GLN	conflict	UNP Q238X3
2D	86	ALA	THR	conflict	UNP Q238X3
2D	87	GLU	GLN	conflict	UNP Q238X3

- Molecule 5 is a protein called RIB22.

Mol	Chain	Residues	Atoms					AltConf	Trace
			Total	C	N	O	S		
5	0E	189	1557	978	280	294	5	0	0
5	1E	189	1557	978	280	294	5	0	0
5	2E	189	1557	978	280	294	5	0	0
5	3E	189	1557	978	280	294	5	0	0

- Molecule 6 is a protein called CFAM166C.

Mol	Chain	Residues	Atoms					AltConf	Trace
			Total	C	N	O	S		
6	0F	206	1665	1048	300	314	3	0	0

- Molecule 7 is a protein called CFAP107.

Mol	Chain	Residues	Atoms					AltConf	Trace
			Total	C	N	O	S		
7	0G	168	1378	871	237	265	5	0	0
7	1G	135	1109	702	190	214	3	0	0

There are 12 discrepancies between the modelled and reference sequences:

Chain	Residue	Modelled	Actual	Comment	Reference
0G	127	ALA	LEU	conflict	UNP Q237T1
0G	128	LEU	SER	conflict	UNP Q237T1
0G	129	SER	ALA	conflict	UNP Q237T1
0G	130	ALA	SER	conflict	UNP Q237T1
0G	131	SER	ALA	conflict	UNP Q237T1
0G	140	PHE	TYR	conflict	UNP Q237T1
1G	127	ALA	LEU	conflict	UNP Q237T1
1G	128	LEU	SER	conflict	UNP Q237T1
1G	129	SER	ALA	conflict	UNP Q237T1
1G	130	ALA	SER	conflict	UNP Q237T1
1G	131	SER	ALA	conflict	UNP Q237T1
1G	140	PHE	TYR	conflict	UNP Q237T1

- Molecule 8 is a protein called CFAP127.

Mol	Chain	Residues	Atoms					AltConf	Trace
			Total	C	N	O	S		
8	0H	120	Total	C	N	O	S	0	0
			1046	654	189	198	5		
8	1H	425	Total	C	N	O	S	0	0
			3706	2281	691	720	14		

- Molecule 9 is a protein called CFAP161A.

Mol	Chain	Residues	Atoms					AltConf	Trace
			Total	C	N	O	S		
9	0N	280	Total	C	N	O	S	0	0
			2305	1455	396	441	13		
9	1N	463	Total	C	N	O	S	0	0
			3805	2414	653	723	15		
9	2N	280	Total	C	N	O	S	0	0
			2305	1455	396	441	13		

- Molecule 10 is a protein called CFAP20.

Mol	Chain	Residues	Atoms					AltConf	Trace
			Total	C	N	O	S		
10	0Q	186	Total	C	N	O	S	0	0
			1548	997	268	276	7		
10	1Q	186	Total	C	N	O	S	0	0
			1548	997	268	276	7		
10	2Q	186	Total	C	N	O	S	0	0
			1548	997	268	276	7		

*Continued on next page...*

*Continued from previous page...*

Mol	Chain	Residues	Atoms					AltConf	Trace
10	3Q	186	Total	C	N	O	S	0	0
			1548	997	268	276	7		
10	4Q	186	Total	C	N	O	S	0	0
			1548	997	268	276	7		
10	5Q	186	Total	C	N	O	S	0	0
			1548	997	268	276	7		
10	6Q	186	Total	C	N	O	S	0	0
			1548	997	268	276	7		

- Molecule 11 is a protein called Parkin co-regulated protein PACRGA.

Mol	Chain	Residues	Atoms					AltConf	Trace
11	0S	288	Total	C	N	O	S	0	0
			2310	1485	397	422	6		
11	1S	288	Total	C	N	O	S	0	0
			2310	1485	397	422	6		
11	2S	288	Total	C	N	O	S	0	0
			2310	1485	397	422	6		
11	3S	288	Total	C	N	O	S	0	0
			2310	1485	397	422	6		

- Molecule 12 is a protein called IJ34.

Mol	Chain	Residues	Atoms					AltConf	Trace
12	0T	261	Total	C	N	O	S	0	0
			2124	1351	373	391	9		
12	1T	285	Total	C	N	O	S	0	0
			2321	1471	411	430	9		
12	2T	285	Total	C	N	O	S	0	0
			2321	1471	411	430	9		
12	3T	285	Total	C	N	O	S	0	0
			2321	1471	411	430	9		

- Molecule 13 is a protein called CFAP52A.

Mol	Chain	Residues	Atoms					AltConf	Trace
13	0U	607	Total	C	N	O	S	0	0
			4774	3025	819	906	24		
13	1U	607	Total	C	N	O	S	0	0
			4774	3025	819	906	24		
13	2U	607	Total	C	N	O	S	0	0
			4774	3025	819	906	24		

*Continued on next page...*

*Continued from previous page...*

Mol	Chain	Residues	Atoms					AltConf	Trace
			Total	C	N	O	S		
13	3U	607	4774	3025	819	906	24	0	0

- Molecule 14 is a protein called DNA polymerase delta C4-type zinc-finger protein.

Mol	Chain	Residues	Atoms					AltConf	Trace
			Total	C	N	O	S		
14	0V	212	1750	1095	317	332	6	0	0
14	1V	263	2168	1359	388	412	9	0	0
14	2V	263	2168	1359	388	412	9	0	0
14	3V	263	2168	1359	388	412	9	0	0

- Molecule 15 is a protein called RIB43A protein.

Mol	Chain	Residues	Atoms					AltConf	Trace
			Total	C	N	O	S		
15	0X	110	935	570	175	185	5	0	0
15	1X	141	1202	732	227	237	6	0	0
15	2X	141	1202	732	227	237	6	0	0
15	3X	141	1202	732	227	237	6	0	0
15	4X	141	1202	732	227	237	6	0	0

There are 10 discrepancies between the modelled and reference sequences:

Chain	Residue	Modelled	Actual	Comment	Reference
0X	13	SER	PRO	conflict	UNP A4VDZ5
0X	14	ASP	HIS	conflict	UNP A4VDZ5
1X	13	SER	PRO	conflict	UNP A4VDZ5
1X	14	ASP	HIS	conflict	UNP A4VDZ5
2X	13	SER	PRO	conflict	UNP A4VDZ5
2X	14	ASP	HIS	conflict	UNP A4VDZ5
3X	13	SER	PRO	conflict	UNP A4VDZ5
3X	14	ASP	HIS	conflict	UNP A4VDZ5
4X	13	SER	PRO	conflict	UNP A4VDZ5
4X	14	ASP	HIS	conflict	UNP A4VDZ5

- Molecule 16 is a protein called RIB57.

Mol	Chain	Residues	Atoms					AltConf	Trace
16	1B	498	Total	C	N	O	S	0	0
			4066	2598	692	768	8		
16	2B	295	Total	C	N	O	S	0	0
			2439	1553	416	464	6		
16	3B	295	Total	C	N	O	S	0	0
			2437	1552	416	463	6		

- Molecule 17 is a protein called CFAP182A.

Mol	Chain	Residues	Atoms					AltConf	Trace
17	1F	136	Total	C	N	O	S	0	0
			1093	696	184	208	5		

- Molecule 18 is a protein called CFAP143.

Mol	Chain	Residues	Atoms					AltConf	Trace
18	1I	188	Total	C	N	O	S	0	0
			1546	951	285	306	4		

- Molecule 19 is a protein called CFAP21A.

Mol	Chain	Residues	Atoms					AltConf	Trace
19	1J	370	Total	C	N	O	S	0	0
			3025	1901	533	580	11		

There is a discrepancy between the modelled and reference sequences:

Chain	Residue	Modelled	Actual	Comment	Reference
1J	322	ASP	ASN	conflict	UNP I7MLS4

- Molecule 20 is a protein called CFAP53.

Mol	Chain	Residues	Atoms					AltConf	Trace
20	1K	277	Total	C	N	O	S	0	0
			2425	1500	452	466	7		
20	2K	288	Total	C	N	O	S	0	0
			2506	1547	460	492	7		

- Molecule 21 is a protein called CFAP115.

Mol	Chain	Residues	Atoms					AltConf	Trace
			Total	C	N	O	S		
21	1L	820	6842	4358	1186	1280	18	0	0
21	2L	616	5151	3286	896	957	12	0	0
21	3L	200	1660	1053	284	317	6	0	0

There are 6 discrepancies between the modelled and reference sequences:

Chain	Residue	Modelled	Actual	Comment	Reference
1L	863	GLU	GLY	conflict	UNP Q23KF9
1L	864	ALA	GLU	conflict	UNP Q23KF9
2L	863	GLU	GLY	conflict	UNP Q23KF9
2L	864	ALA	GLU	conflict	UNP Q23KF9
3L	863	GLU	GLY	conflict	UNP Q23KF9
3L	864	ALA	GLU	conflict	UNP Q23KF9

- Molecule 22 is a protein called Nucleoside diphosphate kinase.

Mol	Chain	Residues	Atoms					AltConf	Trace
			Total	C	N	O	S		
22	1M	369	2978	1910	501	552	15	0	0
22	2M	369	2978	1910	501	552	15	0	0

- Molecule 23 is a protein called Cilia- and flagella-associated protein 45.

Mol	Chain	Residues	Atoms					AltConf	Trace
			Total	C	N	O	S		
23	1O	241	2032	1266	359	395	12	0	0
23	2O	370	3173	1948	595	617	13	0	0
23	3O	279	2397	1471	456	466	4	0	0

- Molecule 24 is a protein called CFAP210.

Mol	Chain	Residues	Atoms					AltConf	Trace
			Total	C	N	O	S		
24	1P	355	3060	1889	575	588	8	0	0
24	2P	190	1633	1005	309	313	6	0	0

- Molecule 25 is a protein called RIB72B.

Mol	Chain	Residues	Atoms					AltConf	Trace
25	1R	508	Total	C	N	O	S	0	0
			4244	2744	711	777	12		
25	2R	508	Total	C	N	O	S	0	0
			4244	2744	711	777	12		
25	3R	508	Total	C	N	O	S	0	0
			4244	2744	711	777	12		

- Molecule 26 is a protein called Protofilament ribbon protein.

Mol	Chain	Residues	Atoms					AltConf	Trace
26	1W	224	Total	C	N	O	S	0	0
			1924	1167	380	368	9		
26	2W	116	Total	C	N	O	S	0	0
			990	611	189	184	6		

- Molecule 27 is a protein called RIB35.

Mol	Chain	Residues	Atoms					AltConf	Trace
27	2C	300	Total	C	N	O	S	0	0
			2467	1581	417	464	5		
27	3C	300	Total	C	N	O	S	0	0
			2467	1581	417	464	5		
27	4C	300	Total	C	N	O	S	0	0
			2467	1581	417	464	5		

- Molecule 28 is a protein called CFAP182B.

Mol	Chain	Residues	Atoms					AltConf	Trace
28	2F	87	Total	C	N	O	S	0	0
			746	469	136	137	4		

- Molecule 29 is a protein called Flagellar FliJ protein.

Mol	Chain	Residues	Atoms					AltConf	Trace
29	2G	99	Total	C	N	O	S	0	0
			848	536	153	155	4		

- Molecule 30 is a protein called RIB27B.

Mol	Chain	Residues	Atoms					AltConf	Trace
30	2H	61	Total	C	N	O	S	0	0
			501	313	92	94	2		
30	3H	61	Total	C	N	O	S	0	0
			501	313	92	94	2		
30	4H	61	Total	C	N	O	S	0	0
			501	313	92	94	2		

- Molecule 31 is a protein called STPG2.

Mol	Chain	Residues	Atoms					AltConf	Trace
31	2I	142	Total	C	N	O	S	0	0
			1150	736	204	209	1		
31	3I	87	Total	C	N	O	S	0	0
			712	451	130	127	4		

- Molecule 32 is a protein called RIB26.

Mol	Chain	Residues	Atoms					AltConf	Trace
32	3D	237	Total	C	N	O	S	0	0
			1835	1174	310	340	11		

- Molecule 33 is a protein called CFAP129.

Mol	Chain	Residues	Atoms					AltConf	Trace
33	4F	200	Total	C	N	O	S	0	0
			1618	1022	286	308	2		

There is a discrepancy between the modelled and reference sequences:

Chain	Residue	Modelled	Actual	Comment	Reference
4F	70	VAL	ASP	conflict	UNP I7M9I4

- Molecule 34 is a protein called Flagellar microtubule protofilament ribbon protein.

Mol	Chain	Residues	Atoms					AltConf	Trace
34	4R	609	Total	C	N	O	S	0	0
			5070	3267	847	932	24		
34	5R	609	Total	C	N	O	S	0	0
			5070	3267	847	932	24		
34	6R	609	Total	C	N	O	S	0	0
			5070	3267	847	932	24		
34	7R	609	Total	C	N	O	S	0	0
			5070	3267	847	932	24		



- Molecule 35 is a protein called Parkin co-regulated protein PACRGB.

Mol	Chain	Residues	Atoms					AltConf	Trace
			Total	C	N	O	S		
35	4S	188	Total	C	N	O	S	0	0
			1537	999	251	279	8		
35	5S	188	Total	C	N	O	S	0	0
			1537	999	251	279	8		

- Molecule 36 is a protein called OJ2.

Mol	Chain	Residues	Atoms					AltConf	Trace
			Total	C	N	O	S		
36	5A	157	Total	C	N	O	S	0	0
			1261	795	234	229	3		
36	5B	157	Total	C	N	O	S	0	0
			1261	795	234	229	3		
36	5C	157	Total	C	N	O	S	0	0
			1261	795	234	229	3		
36	5D	114	Total	C	N	O	S	0	0
			908	571	165	169	3		

- Molecule 37 is a protein called CFAP77A.

Mol	Chain	Residues	Atoms					AltConf	Trace
			Total	C	N	O	S		
37	5E	188	Total	C	N	O	S	0	0
			1566	992	281	288	5		
37	5F	210	Total	C	N	O	S	0	0
			1750	1107	316	322	5		
37	5G	210	Total	C	N	O	S	0	0
			1750	1107	316	322	5		
37	5H	146	Total	C	N	O	S	0	0
			1210	764	217	225	4		

- Molecule 38 is a protein called OJ3.

Mol	Chain	Residues	Atoms				AltConf	Trace
			Total	C	N	O		
38	5I	103	Total	C	N	O	0	0
			515	309	103	103		
38	5J	109	Total	C	N	O	0	0
			545	327	109	109		
38	5K	80	Total	C	N	O	0	0
			400	240	80	80		

- Molecule 39 is a protein called SB1.

Mol	Chain	Residues	Atoms					AltConf	Trace
			Total	C	N	O	S		
39	6F	132	1140	718	197	221	4	0	0

- Molecule 40 is a protein called STPG1A.

Mol	Chain	Residues	Atoms					AltConf	Trace
			Total	C	N	O	S		
40	6G	216	1769	1128	303	333	5	0	0

- Molecule 41 is a protein called Nebulin.

Mol	Chain	Residues	Atoms					AltConf	Trace
			Total	C	N	O	S		
41	6H	165	1362	857	234	266	5	0	0

There are 2 discrepancies between the modelled and reference sequences:

Chain	Residue	Modelled	Actual	Comment	Reference
6H	186	HIS	GLN	conflict	UNP Q231B6
6H	198	HIS	MET	conflict	UNP Q231B6

- Molecule 42 is a protein called B5B6\_fMIP.

Mol	Chain	Residues	Atoms				AltConf	Trace
			Total	C	N	O		
42	8L	385	1925	1155	385	385	0	0
42	8N	358	1790	1074	358	358	0	0

- Molecule 43 is a protein called CFAP112A.

Mol	Chain	Residues	Atoms				AltConf	Trace
			Total	C	N	O		
43	8P	363	1815	1089	363	363	0	0

- Molecule 44 is a protein called B2B3\_fMIP.

Mol	Chain	Residues	Atoms				AltConf	Trace
			Total	C	N	O		
44	8R	361	2020	1269	361	390	0	0

- Molecule 45 is a protein called Tubulin alpha chain.

Mol	Chain	Residues	Atoms					AltConf	Trace
			Total	C	N	O	S		
45	AA	439	3408	2155	579	652	22	0	0
45	AC	439	3408	2155	579	652	22	0	0
45	AE	439	3408	2155	579	652	22	0	0
45	AG	439	3408	2155	579	652	22	0	0
45	AI	439	3408	2155	579	652	22	0	0
45	AK	439	3408	2155	579	652	22	0	0
45	AM	439	3408	2155	579	652	22	0	0
45	BA	432	3364	2129	571	642	22	0	0
45	BC	432	3364	2129	571	642	22	0	0
45	BE	432	3364	2129	571	642	22	0	0
45	BG	432	3364	2129	571	642	22	0	0
45	BI	432	3364	2129	571	642	22	0	0
45	BK	432	3364	2129	571	642	22	0	0
45	BM	432	3364	2129	571	642	22	0	0
45	CA	439	3408	2155	579	652	22	0	0
45	CC	439	3408	2155	579	652	22	0	0
45	CG	439	3408	2155	579	652	22	0	0
45	CI	439	3408	2155	579	652	22	0	0
45	CK	439	3408	2155	579	652	22	0	0
45	CM	439	3408	2155	579	652	22	0	0
45	DA	433	3372	2133	572	645	22	0	0
45	DE	433	3372	2133	572	645	22	0	0

*Continued on next page...*

*Continued from previous page...*

Mol	Chain	Residues	Atoms					AltConf	Trace
			Total	C	N	O	S		
45	DG	436	Total 3389	C 2143	N 576	O 648	S 22	0	0
45	DI	433	Total 3372	C 2133	N 572	O 645	S 22	0	0
45	DK	436	Total 3389	C 2143	N 576	O 648	S 22	0	0
45	DM	433	Total 3372	C 2133	N 572	O 645	S 22	0	0
45	EA	439	Total 3408	C 2155	N 579	O 652	S 22	0	0
45	EC	439	Total 3408	C 2155	N 579	O 652	S 22	0	0
45	EE	439	Total 3408	C 2155	N 579	O 652	S 22	0	0
45	EG	439	Total 3408	C 2155	N 579	O 652	S 22	0	0
45	EI	439	Total 3408	C 2155	N 579	O 652	S 22	0	0
45	EK	439	Total 3408	C 2155	N 579	O 652	S 22	0	0
45	EM	439	Total 3408	C 2155	N 579	O 652	S 22	0	0
45	FA	429	Total 3342	C 2118	N 568	O 634	S 22	0	0
45	FC	432	Total 3364	C 2129	N 571	O 642	S 22	0	0
45	FE	434	Total 3376	C 2135	N 573	O 646	S 22	0	0
45	FG	439	Total 3408	C 2155	N 579	O 652	S 22	0	0
45	FI	433	Total 3372	C 2133	N 572	O 645	S 22	0	0
45	FK	432	Total 3364	C 2129	N 571	O 642	S 22	0	0
45	FM	429	Total 3342	C 2118	N 568	O 634	S 22	0	0
45	GA	429	Total 3342	C 2118	N 568	O 634	S 22	0	0
45	GC	431	Total 3358	C 2126	N 570	O 640	S 22	0	0
45	GE	431	Total 3358	C 2126	N 570	O 640	S 22	0	0

*Continued on next page...*

*Continued from previous page...*

Mol	Chain	Residues	Atoms					AltConf	Trace
			Total	C	N	O	S		
45	GG	431	Total 3358	C 2126	N 570	O 640	S 22	0	0
45	GI	431	Total 3358	C 2126	N 570	O 640	S 22	0	0
45	GK	439	Total 3408	C 2155	N 579	O 652	S 22	0	0
45	GM	429	Total 3342	C 2118	N 568	O 634	S 22	0	0
45	HA	431	Total 3356	C 2125	N 570	O 639	S 22	0	0
45	HC	431	Total 3356	C 2125	N 570	O 639	S 22	0	0
45	HE	431	Total 3356	C 2125	N 570	O 639	S 22	0	0
45	HG	431	Total 3356	C 2125	N 570	O 639	S 22	0	0
45	HI	431	Total 3356	C 2125	N 570	O 639	S 22	0	0
45	HK	431	Total 3356	C 2125	N 570	O 639	S 22	0	0
45	HM	431	Total 3356	C 2125	N 570	O 639	S 22	0	0
45	IA	432	Total 3364	C 2129	N 571	O 642	S 22	0	0
45	IC	439	Total 3408	C 2155	N 579	O 652	S 22	0	0
45	IE	432	Total 3364	C 2129	N 571	O 642	S 22	0	0
45	IG	439	Total 3408	C 2155	N 579	O 652	S 22	0	0
45	II	439	Total 3408	C 2155	N 579	O 652	S 22	0	0
45	IK	432	Total 3364	C 2129	N 571	O 642	S 22	0	0
45	IM	432	Total 3364	C 2129	N 571	O 642	S 22	0	0
45	JA	432	Total 3364	C 2129	N 571	O 642	S 22	0	0
45	JC	434	Total 3376	C 2135	N 573	O 646	S 22	0	0
45	JE	439	Total 3408	C 2155	N 579	O 652	S 22	0	0

*Continued on next page...*

*Continued from previous page...*

Mol	Chain	Residues	Atoms					AltConf	Trace
			Total	C	N	O	S		
45	JG	439	Total 3408	C 2155	N 579	O 652	S 22	0	0
45	JI	439	Total 3404	C 2151	N 579	O 652	S 22	0	0
45	JK	439	Total 3408	C 2155	N 579	O 652	S 22	0	0
45	JM	432	Total 3364	C 2129	N 571	O 642	S 22	0	0
45	KA	434	Total 3376	C 2135	N 573	O 646	S 22	0	0
45	KC	433	Total 3372	C 2133	N 572	O 645	S 22	0	0
45	KE	435	Total 3385	C 2141	N 575	O 647	S 22	0	0
45	KG	439	Total 3408	C 2155	N 579	O 652	S 22	0	0
45	KI	439	Total 3408	C 2155	N 579	O 652	S 22	0	0
45	KK	439	Total 3408	C 2155	N 579	O 652	S 22	0	0
45	KM	434	Total 3376	C 2135	N 573	O 646	S 22	0	0
45	LA	439	Total 3408	C 2155	N 579	O 652	S 22	0	0
45	LC	439	Total 3408	C 2155	N 579	O 652	S 22	0	0
45	LE	438	Total 3400	C 2149	N 578	O 651	S 22	0	0
45	LG	439	Total 3408	C 2155	N 579	O 652	S 22	0	0
45	LI	434	Total 3381	C 2139	N 574	O 646	S 22	0	0
45	LK	439	Total 3408	C 2155	N 579	O 652	S 22	0	0
45	LM	439	Total 3408	C 2155	N 579	O 652	S 22	0	0
45	MA	436	Total 3392	C 2145	N 576	O 649	S 22	0	0
45	MC	433	Total 3368	C 2131	N 572	O 643	S 22	0	0
45	ME	433	Total 3372	C 2133	N 572	O 645	S 22	0	0

*Continued on next page...*

*Continued from previous page...*

Mol	Chain	Residues	Atoms					AltConf	Trace
			Total	C	N	O	S		
45	MG	437	Total 3400	C 2151	N 577	O 650	S 22	0	0
45	MI	439	Total 3408	C 2155	N 579	O 652	S 22	0	0
45	MK	436	Total 3384	C 2139	N 575	O 648	S 22	0	0
45	MM	436	Total 3392	C 2145	N 576	O 649	S 22	0	0
45	NA	439	Total 3408	C 2155	N 579	O 652	S 22	0	0
45	NC	432	Total 3364	C 2129	N 571	O 642	S 22	0	0
45	NE	439	Total 3408	C 2155	N 579	O 652	S 22	0	0
45	NG	432	Total 3364	C 2129	N 571	O 642	S 22	0	0
45	NI	439	Total 3408	C 2155	N 579	O 652	S 22	0	0
45	NK	432	Total 3364	C 2129	N 571	O 642	S 22	0	0
45	NM	439	Total 3408	C 2155	N 579	O 652	S 22	0	0
45	OA	433	Total 3368	C 2131	N 572	O 643	S 22	0	0
45	OC	433	Total 3368	C 2131	N 572	O 643	S 22	0	0
45	OE	433	Total 3368	C 2131	N 572	O 643	S 22	0	0
45	OG	433	Total 3368	C 2131	N 572	O 643	S 22	0	0
45	OI	433	Total 3368	C 2131	N 572	O 643	S 22	0	0
45	OK	433	Total 3368	C 2131	N 572	O 643	S 22	0	0
45	OM	433	Total 3368	C 2131	N 572	O 643	S 22	0	0
45	PA	429	Total 3342	C 2118	N 568	O 634	S 22	0	0
45	PC	429	Total 3342	C 2118	N 568	O 634	S 22	0	0
45	PE	429	Total 3342	C 2118	N 568	O 634	S 22	0	0

*Continued on next page...*

*Continued from previous page...*

Mol	Chain	Residues	Atoms					AltConf	Trace
			Total	C	N	O	S		
45	PG	429	Total 3342	C 2118	N 568	O 634	S 22	0	0
45	PI	429	Total 3342	C 2118	N 568	O 634	S 22	0	0
45	PK	429	Total 3342	C 2118	N 568	O 634	S 22	0	0
45	PM	429	Total 3342	C 2118	N 568	O 634	S 22	0	0
45	QA	431	Total 3356	C 2125	N 570	O 639	S 22	0	0
45	QC	431	Total 3356	C 2125	N 570	O 639	S 22	0	0
45	QE	431	Total 3356	C 2125	N 570	O 639	S 22	0	0
45	QG	431	Total 3356	C 2125	N 570	O 639	S 22	0	0
45	QI	431	Total 3356	C 2125	N 570	O 639	S 22	0	0
45	QK	431	Total 3356	C 2125	N 570	O 639	S 22	0	0
45	QM	431	Total 3356	C 2125	N 570	O 639	S 22	0	0
45	RA	431	Total 3356	C 2125	N 570	O 639	S 22	0	0
45	RC	431	Total 3356	C 2125	N 570	O 639	S 22	0	0
45	RE	431	Total 3356	C 2125	N 570	O 639	S 22	0	0
45	RG	431	Total 3356	C 2125	N 570	O 639	S 22	0	0
45	RI	431	Total 3356	C 2125	N 570	O 639	S 22	0	0
45	RK	431	Total 3356	C 2125	N 570	O 639	S 22	0	0
45	RM	431	Total 3356	C 2125	N 570	O 639	S 22	0	0
45	SA	430	Total 3350	C 2122	N 569	O 637	S 22	0	0
45	SC	430	Total 3350	C 2122	N 569	O 637	S 22	0	0
45	SE	430	Total 3350	C 2122	N 569	O 637	S 22	0	0

*Continued on next page...*



*Continued from previous page...*

Mol	Chain	Residues	Atoms					AltConf	Trace
			Total	C	N	O	S		
45	SG	430	Total 3350	C 2122	N 569	O 637	S 22	0	0
45	SI	430	Total 3350	C 2122	N 569	O 637	S 22	0	0
45	SK	430	Total 3350	C 2122	N 569	O 637	S 22	0	0
45	SM	430	Total 3350	C 2122	N 569	O 637	S 22	0	0
45	TA	430	Total 3350	C 2122	N 569	O 637	S 22	0	0
45	TC	430	Total 3350	C 2122	N 569	O 637	S 22	0	0
45	TE	430	Total 3350	C 2122	N 569	O 637	S 22	0	0
45	TG	430	Total 3350	C 2122	N 569	O 637	S 22	0	0
45	TI	430	Total 3350	C 2122	N 569	O 637	S 22	0	0
45	TK	430	Total 3350	C 2122	N 569	O 637	S 22	0	0
45	TM	430	Total 3350	C 2122	N 569	O 637	S 22	0	0
45	UA	431	Total 3356	C 2125	N 570	O 639	S 22	0	0
45	UC	431	Total 3356	C 2125	N 570	O 639	S 22	0	0
45	UE	431	Total 3356	C 2125	N 570	O 639	S 22	0	0
45	UG	431	Total 3356	C 2125	N 570	O 639	S 22	0	0
45	UI	431	Total 3356	C 2125	N 570	O 639	S 22	0	0
45	UK	431	Total 3356	C 2125	N 570	O 639	S 22	0	0
45	UM	431	Total 3356	C 2125	N 570	O 639	S 22	0	0
45	VA	433	Total 3372	C 2133	N 572	O 645	S 22	0	0
45	VC	439	Total 3408	C 2155	N 579	O 652	S 22	0	0
45	VE	433	Total 3372	C 2133	N 572	O 645	S 22	0	0

*Continued on next page...*

*Continued from previous page...*

Mol	Chain	Residues	Atoms					AltConf	Trace
			Total	C	N	O	S		
45	VG	439	Total 3408	C 2155	N 579	O 652	S 22	0	0
45	VI	433	Total 3372	C 2133	N 572	O 645	S 22	0	0
45	VK	439	Total 3408	C 2155	N 579	O 652	S 22	0	0
45	VM	433	Total 3372	C 2133	N 572	O 645	S 22	0	0
45	WA	431	Total 3356	C 2125	N 570	O 639	S 22	0	0
45	WC	439	Total 3408	C 2155	N 579	O 652	S 22	0	0
45	WE	431	Total 3356	C 2125	N 570	O 639	S 22	0	0
45	WG	439	Total 3408	C 2155	N 579	O 652	S 22	0	0
45	WI	431	Total 3356	C 2125	N 570	O 639	S 22	0	0
45	WK	439	Total 3408	C 2155	N 579	O 652	S 22	0	0
45	WM	431	Total 3356	C 2125	N 570	O 639	S 22	0	0
45	CE	439	Total 3408	C 2155	N 579	O 652	S 22	0	0
45	DC	436	Total 3389	C 2143	N 576	O 648	S 22	0	0

- Molecule 46 is a protein called Tubulin beta chain.

Mol	Chain	Residues	Atoms					AltConf	Trace
			Total	C	N	O	S		
46	AB	430	Total 3366	C 2115	N 577	O 646	S 28	0	0
46	AD	430	Total 3366	C 2115	N 577	O 646	S 28	0	0
46	AF	430	Total 3366	C 2115	N 577	O 646	S 28	0	0
46	AH	430	Total 3366	C 2115	N 577	O 646	S 28	0	0
46	AJ	430	Total 3366	C 2115	N 577	O 646	S 28	0	0
46	AL	430	Total 3366	C 2115	N 577	O 646	S 28	0	0

*Continued on next page...*

*Continued from previous page...*

Mol	Chain	Residues	Atoms					AltConf	Trace
			Total	C	N	O	S		
46	AN	430	3366	2115	577	646	28	0	0
46	BB	430	3366	2115	577	646	28	0	0
46	BD	430	3366	2115	577	646	28	0	0
46	BF	430	3366	2115	577	646	28	0	0
46	BH	430	3366	2115	577	646	28	0	0
46	BJ	430	3366	2115	577	646	28	0	0
46	BL	430	3366	2115	577	646	28	0	0
46	BN	430	3366	2115	577	646	28	0	0
46	CB	430	3366	2115	577	646	28	0	0
46	CD	430	3366	2115	577	646	28	0	0
46	CF	430	3366	2115	577	646	28	0	0
46	CH	430	3366	2115	577	646	28	0	0
46	CJ	430	3366	2115	577	646	28	0	0
46	CL	430	3366	2115	577	646	28	0	0
46	CN	430	3366	2115	577	646	28	0	0
46	DB	430	3366	2115	577	646	28	0	0
46	DD	430	3366	2115	577	646	28	0	0
46	DF	430	3366	2115	577	646	28	0	0
46	DH	430	3366	2115	577	646	28	0	0
46	DJ	430	3366	2115	577	646	28	0	0
46	DL	430	3366	2115	577	646	28	0	0

*Continued on next page...*

*Continued from previous page...*

Mol	Chain	Residues	Atoms					AltConf	Trace
			Total	C	N	O	S		
46	DN	430	3366	2115	577	646	28	0	0
46	EB	430	3366	2115	577	646	28	0	0
46	ED	430	3366	2115	577	646	28	0	0
46	EF	430	3366	2115	577	646	28	0	0
46	EH	430	3366	2115	577	646	28	0	0
46	EJ	430	3366	2115	577	646	28	0	0
46	EL	430	3366	2115	577	646	28	0	0
46	EN	430	3366	2115	577	646	28	0	0
46	FB	430	3366	2115	577	646	28	0	0
46	FD	430	3366	2115	577	646	28	0	0
46	FF	430	3366	2115	577	646	28	0	0
46	FH	430	3366	2115	577	646	28	0	0
46	FJ	430	3366	2115	577	646	28	0	0
46	FL	430	3366	2115	577	646	28	0	0
46	FN	430	3366	2115	577	646	28	0	0
46	GB	430	3366	2115	577	646	28	0	0
46	GD	430	3366	2115	577	646	28	0	0
46	GF	430	3366	2115	577	646	28	0	0
46	GH	430	3366	2115	577	646	28	0	0
46	GJ	430	3366	2115	577	646	28	0	0
46	GL	430	3366	2115	577	646	28	0	0

*Continued on next page...*

*Continued from previous page...*

Mol	Chain	Residues	Atoms					AltConf	Trace
			Total	C	N	O	S		
46	GN	430	Total 3366	C 2115	N 577	O 646	S 28	0	0
46	HB	430	Total 3366	C 2115	N 577	O 646	S 28	0	0
46	HD	430	Total 3366	C 2115	N 577	O 646	S 28	0	0
46	HF	430	Total 3366	C 2115	N 577	O 646	S 28	0	0
46	HH	430	Total 3366	C 2115	N 577	O 646	S 28	0	0
46	HJ	430	Total 3366	C 2115	N 577	O 646	S 28	0	0
46	HL	430	Total 3366	C 2115	N 577	O 646	S 28	0	0
46	HN	430	Total 3366	C 2115	N 577	O 646	S 28	0	0
46	IB	430	Total 3366	C 2115	N 577	O 646	S 28	0	0
46	ID	430	Total 3366	C 2115	N 577	O 646	S 28	0	0
46	IF	430	Total 3366	C 2115	N 577	O 646	S 28	0	0
46	IH	430	Total 3366	C 2115	N 577	O 646	S 28	0	0
46	IJ	430	Total 3366	C 2115	N 577	O 646	S 28	0	0
46	IL	430	Total 3366	C 2115	N 577	O 646	S 28	0	0
46	IN	430	Total 3366	C 2115	N 577	O 646	S 28	0	0
46	JB	430	Total 3366	C 2115	N 577	O 646	S 28	0	0
46	JD	430	Total 3366	C 2115	N 577	O 646	S 28	0	0
46	JF	430	Total 3366	C 2115	N 577	O 646	S 28	0	0
46	JH	430	Total 3366	C 2115	N 577	O 646	S 28	0	0
46	JJ	430	Total 3366	C 2115	N 577	O 646	S 28	0	0
46	JL	430	Total 3366	C 2115	N 577	O 646	S 28	0	0

*Continued on next page...*

*Continued from previous page...*

Mol	Chain	Residues	Atoms					AltConf	Trace
			Total	C	N	O	S		
46	JN	430	3366	2115	577	646	28	0	0
46	KB	430	3366	2115	577	646	28	0	0
46	KD	430	3366	2115	577	646	28	0	0
46	KF	430	3366	2115	577	646	28	0	0
46	KH	430	3366	2115	577	646	28	0	0
46	KJ	430	3366	2115	577	646	28	0	0
46	KL	430	3366	2115	577	646	28	0	0
46	KN	430	3366	2115	577	646	28	0	0
46	LB	430	3366	2115	577	646	28	0	0
46	LD	430	3366	2115	577	646	28	0	0
46	LF	430	3366	2115	577	646	28	0	0
46	LH	430	3366	2115	577	646	28	0	0
46	LJ	430	3366	2115	577	646	28	0	0
46	LL	430	3366	2115	577	646	28	0	0
46	LN	430	3366	2115	577	646	28	0	0
46	MB	430	3366	2115	577	646	28	0	0
46	MD	430	3366	2115	577	646	28	0	0
46	MF	430	3366	2115	577	646	28	0	0
46	MH	430	3366	2115	577	646	28	0	0
46	MJ	430	3366	2115	577	646	28	0	0
46	ML	430	3366	2115	577	646	28	0	0

*Continued on next page...*

*Continued from previous page...*

Mol	Chain	Residues	Atoms					AltConf	Trace
			Total	C	N	O	S		
46	MN	430	Total 3366	C 2115	N 577	O 646	S 28	0	0
46	NB	423	Total 3304	C 2079	N 562	O 635	S 28	0	0
46	ND	430	Total 3366	C 2115	N 577	O 646	S 28	0	0
46	NF	423	Total 3304	C 2079	N 562	O 635	S 28	0	0
46	NH	430	Total 3366	C 2115	N 577	O 646	S 28	0	0
46	NJ	423	Total 3304	C 2079	N 562	O 635	S 28	0	0
46	NL	430	Total 3366	C 2115	N 577	O 646	S 28	0	0
46	NN	423	Total 3304	C 2079	N 562	O 635	S 28	0	0
46	OB	430	Total 3366	C 2115	N 577	O 646	S 28	0	0
46	OD	430	Total 3366	C 2115	N 577	O 646	S 28	0	0
46	OF	430	Total 3366	C 2115	N 577	O 646	S 28	0	0
46	OH	430	Total 3366	C 2115	N 577	O 646	S 28	0	0
46	OJ	430	Total 3366	C 2115	N 577	O 646	S 28	0	0
46	OL	430	Total 3366	C 2115	N 577	O 646	S 28	0	0
46	ON	430	Total 3366	C 2115	N 577	O 646	S 28	0	0
46	PB	430	Total 3366	C 2115	N 577	O 646	S 28	0	0
46	PD	430	Total 3366	C 2115	N 577	O 646	S 28	0	0
46	PF	430	Total 3366	C 2115	N 577	O 646	S 28	0	0
46	PH	430	Total 3366	C 2115	N 577	O 646	S 28	0	0
46	PJ	430	Total 3366	C 2115	N 577	O 646	S 28	0	0
46	PL	430	Total 3366	C 2115	N 577	O 646	S 28	0	0

*Continued on next page...*

*Continued from previous page...*

Mol	Chain	Residues	Atoms					AltConf	Trace
			Total	C	N	O	S		
46	PN	430	3366	2115	577	646	28	0	0
46	QB	430	3366	2115	577	646	28	0	0
46	QD	430	3366	2115	577	646	28	0	0
46	QF	430	3366	2115	577	646	28	0	0
46	QH	430	3366	2115	577	646	28	0	0
46	QJ	430	3366	2115	577	646	28	0	0
46	QL	430	3366	2115	577	646	28	0	0
46	QN	430	3366	2115	577	646	28	0	0
46	RB	430	3366	2115	577	646	28	0	0
46	RD	430	3366	2115	577	646	28	0	0
46	RF	430	3366	2115	577	646	28	0	0
46	RH	430	3366	2115	577	646	28	0	0
46	RJ	430	3366	2115	577	646	28	0	0
46	RL	430	3366	2115	577	646	28	0	0
46	RN	430	3366	2115	577	646	28	0	0
46	SB	430	3366	2115	577	646	28	0	0
46	SD	430	3366	2115	577	646	28	0	0
46	SF	430	3366	2115	577	646	28	0	0
46	SH	430	3366	2115	577	646	28	0	0
46	SJ	430	3366	2115	577	646	28	0	0
46	SL	430	3366	2115	577	646	28	0	0

*Continued on next page...*



*Continued from previous page...*

Mol	Chain	Residues	Atoms					AltConf	Trace
			Total	C	N	O	S		
46	SN	430	3366	2115	577	646	28	0	0
46	TB	430	3366	2115	577	646	28	0	0
46	TD	430	3366	2115	577	646	28	0	0
46	TF	430	3366	2115	577	646	28	0	0
46	TH	430	3366	2115	577	646	28	0	0
46	TJ	430	3366	2115	577	646	28	0	0
46	TL	430	3366	2115	577	646	28	0	0
46	TN	430	3366	2115	577	646	28	0	0
46	UB	430	3366	2115	577	646	28	0	0
46	UD	430	3366	2115	577	646	28	0	0
46	UF	430	3366	2115	577	646	28	0	0
46	UH	430	3366	2115	577	646	28	0	0
46	UJ	430	3366	2115	577	646	28	0	0
46	UL	430	3366	2115	577	646	28	0	0
46	UN	430	3366	2115	577	646	28	0	0
46	VB	430	3366	2115	577	646	28	0	0
46	VD	430	3366	2115	577	646	28	0	0
46	VF	430	3366	2115	577	646	28	0	0
46	VH	430	3366	2115	577	646	28	0	0
46	VJ	430	3366	2115	577	646	28	0	0
46	VL	430	3366	2115	577	646	28	0	0

*Continued on next page...*

Continued from previous page...

Mol	Chain	Residues	Atoms					AltConf	Trace
			Total	C	N	O	S		
46	VN	430	Total 3366	C 2115	N 577	O 646	S 28	0	0
46	WB	430	Total 3366	C 2115	N 577	O 646	S 28	0	0
46	WD	430	Total 3366	C 2115	N 577	O 646	S 28	0	0
46	WF	430	Total 3366	C 2115	N 577	O 646	S 28	0	0
46	WH	430	Total 3366	C 2115	N 577	O 646	S 28	0	0
46	WJ	430	Total 3366	C 2115	N 577	O 646	S 28	0	0
46	WL	430	Total 3366	C 2115	N 577	O 646	S 28	0	0
46	WN	430	Total 3366	C 2115	N 577	O 646	S 28	0	0

- Molecule 47 is GUANOSINE-5'-TRIPHOSPHATE (three-letter code: GTP) (formula:  $C_{10}H_{16}N_5O_{14}P_3$ ) (labeled as "Ligand of Interest" by depositor).

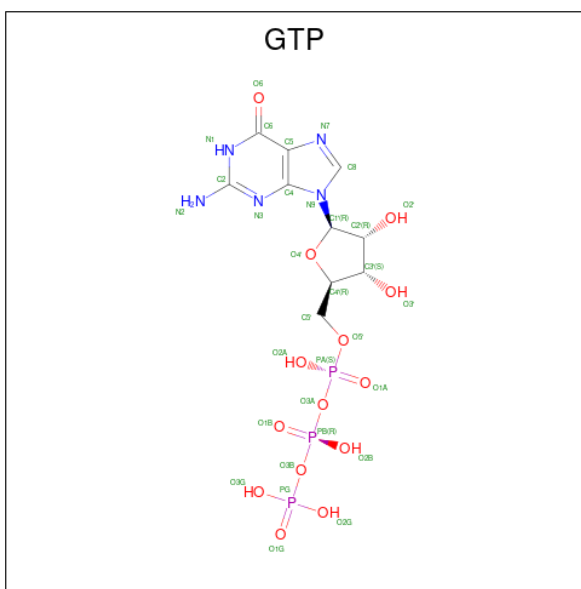

Mol	Chain	Residues	Atoms					AltConf
			Total	C	N	O	P	
47	AA	1	Total 32	C 10	N 5	O 14	P 3	0
47	AC	1	Total 32	C 10	N 5	O 14	P 3	0
47	AE	1	Total 32	C 10	N 5	O 14	P 3	0

Continued on next page...

*Continued from previous page...*

Mol	Chain	Residues	Atoms					AltConf
			Total	C	N	O	P	
47	AG	1	Total 32	C 10	N 5	O 14	P 3	0
47	AI	1	Total 32	C 10	N 5	O 14	P 3	0
47	AK	1	Total 32	C 10	N 5	O 14	P 3	0
47	AM	1	Total 32	C 10	N 5	O 14	P 3	0
47	BA	1	Total 32	C 10	N 5	O 14	P 3	0
47	BC	1	Total 32	C 10	N 5	O 14	P 3	0
47	BE	1	Total 32	C 10	N 5	O 14	P 3	0
47	BG	1	Total 32	C 10	N 5	O 14	P 3	0
47	BI	1	Total 32	C 10	N 5	O 14	P 3	0
47	BK	1	Total 32	C 10	N 5	O 14	P 3	0
47	BM	1	Total 32	C 10	N 5	O 14	P 3	0
47	CA	1	Total 32	C 10	N 5	O 14	P 3	0
47	CC	1	Total 32	C 10	N 5	O 14	P 3	0
47	CG	1	Total 32	C 10	N 5	O 14	P 3	0
47	CI	1	Total 32	C 10	N 5	O 14	P 3	0
47	CK	1	Total 32	C 10	N 5	O 14	P 3	0
47	CM	1	Total 32	C 10	N 5	O 14	P 3	0
47	DA	1	Total 32	C 10	N 5	O 14	P 3	0
47	DE	1	Total 32	C 10	N 5	O 14	P 3	0
47	DG	1	Total 32	C 10	N 5	O 14	P 3	0
47	DI	1	Total 32	C 10	N 5	O 14	P 3	0

*Continued on next page...*

*Continued from previous page...*

Mol	Chain	Residues	Atoms					AltConf
			Total	C	N	O	P	
47	DK	1	Total 32	10	5	14	3	0
47	DM	1	Total 32	10	5	14	3	0
47	EA	1	Total 32	10	5	14	3	0
47	EC	1	Total 32	10	5	14	3	0
47	EE	1	Total 32	10	5	14	3	0
47	EG	1	Total 32	10	5	14	3	0
47	EI	1	Total 32	10	5	14	3	0
47	EK	1	Total 32	10	5	14	3	0
47	EM	1	Total 32	10	5	14	3	0
47	FA	1	Total 32	10	5	14	3	0
47	FC	1	Total 32	10	5	14	3	0
47	FE	1	Total 32	10	5	14	3	0
47	FG	1	Total 32	10	5	14	3	0
47	FI	1	Total 32	10	5	14	3	0
47	FK	1	Total 32	10	5	14	3	0
47	FM	1	Total 32	10	5	14	3	0
47	GA	1	Total 32	10	5	14	3	0
47	GC	1	Total 32	10	5	14	3	0
47	GE	1	Total 32	10	5	14	3	0
47	GG	1	Total 32	10	5	14	3	0
47	GI	1	Total 32	10	5	14	3	0

*Continued on next page...*

*Continued from previous page...*

Mol	Chain	Residues	Atoms					AltConf
			Total	C	N	O	P	
47	GK	1	Total 32	C 10	N 5	O 14	P 3	0
47	GM	1	Total 32	C 10	N 5	O 14	P 3	0
47	HA	1	Total 32	C 10	N 5	O 14	P 3	0
47	HC	1	Total 32	C 10	N 5	O 14	P 3	0
47	HE	1	Total 32	C 10	N 5	O 14	P 3	0
47	HG	1	Total 32	C 10	N 5	O 14	P 3	0
47	HI	1	Total 32	C 10	N 5	O 14	P 3	0
47	HK	1	Total 32	C 10	N 5	O 14	P 3	0
47	HM	1	Total 32	C 10	N 5	O 14	P 3	0
47	IA	1	Total 32	C 10	N 5	O 14	P 3	0
47	IC	1	Total 32	C 10	N 5	O 14	P 3	0
47	IE	1	Total 32	C 10	N 5	O 14	P 3	0
47	IG	1	Total 32	C 10	N 5	O 14	P 3	0
47	II	1	Total 32	C 10	N 5	O 14	P 3	0
47	IK	1	Total 32	C 10	N 5	O 14	P 3	0
47	IM	1	Total 32	C 10	N 5	O 14	P 3	0
47	JA	1	Total 32	C 10	N 5	O 14	P 3	0
47	JC	1	Total 32	C 10	N 5	O 14	P 3	0
47	JE	1	Total 32	C 10	N 5	O 14	P 3	0
47	JG	1	Total 32	C 10	N 5	O 14	P 3	0
47	JI	1	Total 32	C 10	N 5	O 14	P 3	0

*Continued on next page...*

*Continued from previous page...*

Mol	Chain	Residues	Atoms					AltConf
			Total	C	N	O	P	
47	JK	1	Total 32	C 10	N 5	O 14	P 3	0
47	JM	1	Total 32	C 10	N 5	O 14	P 3	0
47	KA	1	Total 32	C 10	N 5	O 14	P 3	0
47	KC	1	Total 32	C 10	N 5	O 14	P 3	0
47	KE	1	Total 32	C 10	N 5	O 14	P 3	0
47	KG	1	Total 32	C 10	N 5	O 14	P 3	0
47	KI	1	Total 32	C 10	N 5	O 14	P 3	0
47	KK	1	Total 32	C 10	N 5	O 14	P 3	0
47	KM	1	Total 32	C 10	N 5	O 14	P 3	0
47	LA	1	Total 32	C 10	N 5	O 14	P 3	0
47	LC	1	Total 32	C 10	N 5	O 14	P 3	0
47	LE	1	Total 32	C 10	N 5	O 14	P 3	0
47	LG	1	Total 32	C 10	N 5	O 14	P 3	0
47	LI	1	Total 32	C 10	N 5	O 14	P 3	0
47	LK	1	Total 32	C 10	N 5	O 14	P 3	0
47	LM	1	Total 32	C 10	N 5	O 14	P 3	0
47	MA	1	Total 32	C 10	N 5	O 14	P 3	0
47	MC	1	Total 32	C 10	N 5	O 14	P 3	0
47	ME	1	Total 32	C 10	N 5	O 14	P 3	0
47	MG	1	Total 32	C 10	N 5	O 14	P 3	0
47	MI	1	Total 32	C 10	N 5	O 14	P 3	0

*Continued on next page...*

*Continued from previous page...*

Mol	Chain	Residues	Atoms					AltConf
			Total	C	N	O	P	
47	MK	1	32	10	5	14	3	0
47	MM	1	32	10	5	14	3	0
47	NA	1	32	10	5	14	3	0
47	NC	1	32	10	5	14	3	0
47	NE	1	32	10	5	14	3	0
47	NG	1	32	10	5	14	3	0
47	NI	1	32	10	5	14	3	0
47	NK	1	32	10	5	14	3	0
47	NM	1	32	10	5	14	3	0
47	OA	1	32	10	5	14	3	0
47	OC	1	32	10	5	14	3	0
47	OF	1	32	10	5	14	3	0
47	OG	1	32	10	5	14	3	0
47	OI	1	32	10	5	14	3	0
47	OK	1	32	10	5	14	3	0
47	OM	1	32	10	5	14	3	0
47	PA	1	32	10	5	14	3	0
47	PD	1	32	10	5	14	3	0
47	PE	1	32	10	5	14	3	0
47	PG	1	32	10	5	14	3	0
47	PI	1	32	10	5	14	3	0

*Continued on next page...*

*Continued from previous page...*

Mol	Chain	Residues	Atoms					AltConf
			Total	C	N	O	P	
47	PK	1	Total 32	C 10	N 5	O 14	P 3	0
47	PM	1	Total 32	C 10	N 5	O 14	P 3	0
47	QA	1	Total 32	C 10	N 5	O 14	P 3	0
47	QC	1	Total 32	C 10	N 5	O 14	P 3	0
47	QE	1	Total 32	C 10	N 5	O 14	P 3	0
47	QG	1	Total 32	C 10	N 5	O 14	P 3	0
47	QI	1	Total 32	C 10	N 5	O 14	P 3	0
47	QK	1	Total 32	C 10	N 5	O 14	P 3	0
47	QM	1	Total 32	C 10	N 5	O 14	P 3	0
47	RA	1	Total 32	C 10	N 5	O 14	P 3	0
47	RC	1	Total 32	C 10	N 5	O 14	P 3	0
47	RE	1	Total 32	C 10	N 5	O 14	P 3	0
47	RG	1	Total 32	C 10	N 5	O 14	P 3	0
47	RI	1	Total 32	C 10	N 5	O 14	P 3	0
47	RK	1	Total 32	C 10	N 5	O 14	P 3	0
47	RM	1	Total 32	C 10	N 5	O 14	P 3	0
47	SA	1	Total 32	C 10	N 5	O 14	P 3	0
47	SC	1	Total 32	C 10	N 5	O 14	P 3	0
47	SE	1	Total 32	C 10	N 5	O 14	P 3	0
47	SG	1	Total 32	C 10	N 5	O 14	P 3	0
47	SI	1	Total 32	C 10	N 5	O 14	P 3	0

*Continued on next page...*



*Continued from previous page...*

Mol	Chain	Residues	Atoms					AltConf
			Total	C	N	O	P	
47	SK	1	Total 32	C 10	N 5	O 14	P 3	0
47	SM	1	Total 32	C 10	N 5	O 14	P 3	0
47	TA	1	Total 32	C 10	N 5	O 14	P 3	0
47	TC	1	Total 32	C 10	N 5	O 14	P 3	0
47	TE	1	Total 32	C 10	N 5	O 14	P 3	0
47	TG	1	Total 32	C 10	N 5	O 14	P 3	0
47	TI	1	Total 32	C 10	N 5	O 14	P 3	0
47	TK	1	Total 32	C 10	N 5	O 14	P 3	0
47	TM	1	Total 32	C 10	N 5	O 14	P 3	0
47	UA	1	Total 32	C 10	N 5	O 14	P 3	0
47	UC	1	Total 32	C 10	N 5	O 14	P 3	0
47	UE	1	Total 32	C 10	N 5	O 14	P 3	0
47	UG	1	Total 32	C 10	N 5	O 14	P 3	0
47	UI	1	Total 32	C 10	N 5	O 14	P 3	0
47	UK	1	Total 32	C 10	N 5	O 14	P 3	0
47	UM	1	Total 32	C 10	N 5	O 14	P 3	0
47	VA	1	Total 32	C 10	N 5	O 14	P 3	0
47	VC	1	Total 32	C 10	N 5	O 14	P 3	0
47	VE	1	Total 32	C 10	N 5	O 14	P 3	0
47	VG	1	Total 32	C 10	N 5	O 14	P 3	0
47	VI	1	Total 32	C 10	N 5	O 14	P 3	0

*Continued on next page...*

*Continued from previous page...*

Mol	Chain	Residues	Atoms					AltConf
			Total	C	N	O	P	
47	VK	1	32	10	5	14	3	0
47	VM	1	32	10	5	14	3	0
47	WA	1	32	10	5	14	3	0
47	WC	1	32	10	5	14	3	0
47	WE	1	32	10	5	14	3	0
47	WG	1	32	10	5	14	3	0
47	WI	1	32	10	5	14	3	0
47	WK	1	32	10	5	14	3	0
47	WM	1	32	10	5	14	3	0
47	CE	1	32	10	5	14	3	0
47	DC	1	32	10	5	14	3	0

- Molecule 48 is MAGNESIUM ION (three-letter code: MG) (formula: Mg) (labeled as "Ligand of Interest" by depositor).

Mol	Chain	Residues	Atoms		AltConf
			Total	Mg	
48	AA	1	1	1	0
48	AC	1	1	1	0
48	AE	1	1	1	0
48	AG	1	1	1	0
48	AI	1	1	1	0
48	AK	1	1	1	0
48	AM	1	1	1	0
48	BA	1	1	1	0

*Continued on next page...*

*Continued from previous page...*

Mol	Chain	Residues	Atoms		AltConf
			Total	Mg	
48	BC	1	1	1	0
48	BE	1	1	1	0
48	BG	1	1	1	0
48	BI	1	1	1	0
48	BK	1	1	1	0
48	BM	1	1	1	0
48	CA	1	1	1	0
48	CC	1	1	1	0
48	CG	1	1	1	0
48	CI	1	1	1	0
48	CK	1	1	1	0
48	CM	1	1	1	0
48	DA	1	1	1	0
48	DE	1	1	1	0
48	DG	1	1	1	0
48	DI	1	1	1	0
48	DK	1	1	1	0
48	DM	1	1	1	0
48	EA	1	1	1	0
48	EC	1	1	1	0
48	EE	1	1	1	0

*Continued on next page...*

*Continued from previous page...*

Mol	Chain	Residues	Atoms		AltConf
			Total	Mg	
48	EG	1	1	1	0
48	EI	1	1	1	0
48	EK	1	1	1	0
48	EM	1	1	1	0
48	FA	1	1	1	0
48	FC	1	1	1	0
48	FE	1	1	1	0
48	FG	1	1	1	0
48	FI	1	1	1	0
48	FL	1	1	1	0
48	FM	1	1	1	0
48	GB	1	1	1	0
48	GC	1	1	1	0
48	GE	1	1	1	0
48	GG	1	1	1	0
48	GI	1	1	1	0
48	GL	1	1	1	0
48	GN	1	1	1	0
48	HA	1	1	1	0
48	HC	1	1	1	0
48	HE	1	1	1	0

*Continued on next page...*

*Continued from previous page...*

Mol	Chain	Residues	Atoms		AltConf
			Total	Mg	
48	HG	1	1	1	0
48	HI	1	1	1	0
48	HK	1	1	1	0
48	HM	1	1	1	0
48	IA	1	1	1	0
48	IC	1	1	1	0
48	IE	1	1	1	0
48	IG	1	1	1	0
48	II	1	1	1	0
48	IK	1	1	1	0
48	IM	1	1	1	0
48	JA	1	1	1	0
48	JC	1	1	1	0
48	JE	1	1	1	0
48	JG	1	1	1	0
48	JI	1	1	1	0
48	JK	1	1	1	0
48	JM	1	1	1	0
48	KA	1	1	1	0
48	KC	1	1	1	0
48	KE	1	1	1	0

*Continued on next page...*

*Continued from previous page...*

Mol	Chain	Residues	Atoms		AltConf
			Total	Mg	
48	KG	1	1	1	0
48	KI	1	1	1	0
48	KK	1	1	1	0
48	KM	1	1	1	0
48	LA	1	1	1	0
48	LC	1	1	1	0
48	LE	1	1	1	0
48	LG	1	1	1	0
48	LI	1	1	1	0
48	LK	1	1	1	0
48	LM	1	1	1	0
48	MA	1	1	1	0
48	MC	1	1	1	0
48	ME	1	1	1	0
48	MG	1	1	1	0
48	MI	1	1	1	0
48	MK	1	1	1	0
48	MM	1	1	1	0
48	NA	1	1	1	0
48	ND	1	1	1	0
48	NE	1	1	1	0

*Continued on next page...*

*Continued from previous page...*

Mol	Chain	Residues	Atoms		AltConf
			Total	Mg	
48	NG	1	1	1	0
48	NI	1	1	1	0
48	NK	1	1	1	0
48	NM	1	1	1	0
48	OA	1	1	1	0
48	OC	1	1	1	0
48	OE	1	1	1	0
48	OG	1	1	1	0
48	OI	1	1	1	0
48	OK	1	1	1	0
48	OM	1	1	1	0
48	PA	1	1	1	0
48	PC	1	1	1	0
48	PE	1	1	1	0
48	PG	1	1	1	0
48	PI	1	1	1	0
48	PK	1	1	1	0
48	PN	1	1	1	0
48	QA	1	1	1	0
48	QC	1	1	1	0
48	QE	1	1	1	0

*Continued on next page...*

*Continued from previous page...*

Mol	Chain	Residues	Atoms		AltConf
			Total	Mg	
48	QG	1	1	1	0
48	QI	1	1	1	0
48	QK	1	1	1	0
48	QM	1	1	1	0
48	RA	1	1	1	0
48	RC	1	1	1	0
48	RD	1	1	1	0
48	RG	1	1	1	0
48	RI	1	1	1	0
48	RK	1	1	1	0
48	RM	1	1	1	0
48	SA	1	1	1	0
48	SC	1	1	1	0
48	SE	1	1	1	0
48	SG	1	1	1	0
48	SI	1	1	1	0
48	SK	1	1	1	0
48	SM	1	1	1	0
48	TA	1	1	1	0
48	TB	1	1	1	0
48	TE	1	1	1	0

*Continued on next page...*



*Continued from previous page...*

Mol	Chain	Residues	Atoms		AltConf
			Total	Mg	
48	TF	1	1	1	0
48	TI	1	1	1	0
48	TK	1	1	1	0
48	TL	1	1	1	0
48	UA	1	1	1	0
48	UC	1	1	1	0
48	UE	1	1	1	0
48	UG	1	1	1	0
48	UI	1	1	1	0
48	UK	1	1	1	0
48	UM	1	1	1	0
48	VA	1	1	1	0
48	VC	1	1	1	0
48	VE	1	1	1	0
48	VG	1	1	1	0
48	VI	1	1	1	0
48	VK	1	1	1	0
48	VM	1	1	1	0
48	WA	1	1	1	0
48	WC	1	1	1	0
48	WE	1	1	1	0

*Continued on next page...*

Continued from previous page...

Mol	Chain	Residues	Atoms		AltConf
48	WG	1	Total	Mg	0
			1	1	
48	WI	1	Total	Mg	0
			1	1	
48	WK	1	Total	Mg	0
			1	1	
48	WM	1	Total	Mg	0
			1	1	
48	CE	1	Total	Mg	0
			1	1	
48	DC	1	Total	Mg	0
			1	1	

- Molecule 49 is GUANOSINE-5'-DIPHOSPHATE (three-letter code: GDP) (formula:  $C_{10}H_{15}N_5O_{11}P_2$ ) (labeled as "Ligand of Interest" by depositor).

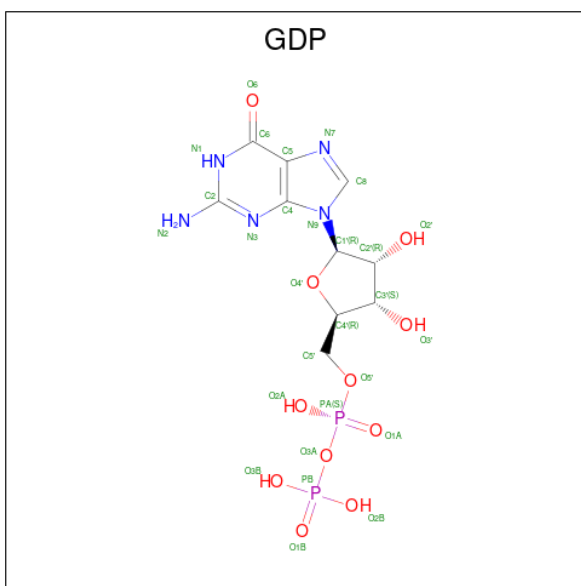

Mol	Chain	Residues	Atoms					AltConf
49	AB	1	Total	C	N	O	P	0
			28	10	5	11	2	
49	AD	1	Total	C	N	O	P	0
			28	10	5	11	2	
49	AF	1	Total	C	N	O	P	0
			28	10	5	11	2	
49	AH	1	Total	C	N	O	P	0
			28	10	5	11	2	
49	AJ	1	Total	C	N	O	P	0
			28	10	5	11	2	

Continued on next page...

*Continued from previous page...*

Mol	Chain	Residues	Atoms					AltConf
			Total	C	N	O	P	
49	AL	1	Total 28	C 10	N 5	O 11	P 2	0
49	AN	1	Total 28	C 10	N 5	O 11	P 2	0
49	BB	1	Total 28	C 10	N 5	O 11	P 2	0
49	BD	1	Total 28	C 10	N 5	O 11	P 2	0
49	BF	1	Total 28	C 10	N 5	O 11	P 2	0
49	BH	1	Total 28	C 10	N 5	O 11	P 2	0
49	BJ	1	Total 28	C 10	N 5	O 11	P 2	0
49	BL	1	Total 28	C 10	N 5	O 11	P 2	0
49	BN	1	Total 28	C 10	N 5	O 11	P 2	0
49	CB	1	Total 28	C 10	N 5	O 11	P 2	0
49	CD	1	Total 28	C 10	N 5	O 11	P 2	0
49	CF	1	Total 28	C 10	N 5	O 11	P 2	0
49	CH	1	Total 28	C 10	N 5	O 11	P 2	0
49	CJ	1	Total 28	C 10	N 5	O 11	P 2	0
49	CL	1	Total 28	C 10	N 5	O 11	P 2	0
49	CN	1	Total 28	C 10	N 5	O 11	P 2	0
49	DB	1	Total 28	C 10	N 5	O 11	P 2	0
49	DD	1	Total 28	C 10	N 5	O 11	P 2	0
49	DF	1	Total 28	C 10	N 5	O 11	P 2	0
49	DH	1	Total 28	C 10	N 5	O 11	P 2	0
49	DJ	1	Total 28	C 10	N 5	O 11	P 2	0

*Continued on next page...*

*Continued from previous page...*

Mol	Chain	Residues	Atoms					AltConf
			Total	C	N	O	P	
49	DL	1	28	10	5	11	2	0
49	DN	1	28	10	5	11	2	0
49	EB	1	28	10	5	11	2	0
49	ED	1	28	10	5	11	2	0
49	EF	1	28	10	5	11	2	0
49	EH	1	28	10	5	11	2	0
49	EJ	1	28	10	5	11	2	0
49	EL	1	28	10	5	11	2	0
49	EN	1	28	10	5	11	2	0
49	FB	1	28	10	5	11	2	0
49	FD	1	28	10	5	11	2	0
49	FF	1	28	10	5	11	2	0
49	FH	1	28	10	5	11	2	0
49	FJ	1	28	10	5	11	2	0
49	FL	1	28	10	5	11	2	0
49	FN	1	28	10	5	11	2	0
49	GB	1	28	10	5	11	2	0
49	GD	1	28	10	5	11	2	0
49	GF	1	28	10	5	11	2	0
49	GH	1	28	10	5	11	2	0
49	GJ	1	28	10	5	11	2	0

*Continued on next page...*

*Continued from previous page...*

Mol	Chain	Residues	Atoms					AltConf
			Total	C	N	O	P	
49	GL	1	Total 28	C 10	N 5	O 11	P 2	0
49	GN	1	Total 28	C 10	N 5	O 11	P 2	0
49	HB	1	Total 28	C 10	N 5	O 11	P 2	0
49	HD	1	Total 28	C 10	N 5	O 11	P 2	0
49	HF	1	Total 28	C 10	N 5	O 11	P 2	0
49	HH	1	Total 28	C 10	N 5	O 11	P 2	0
49	HJ	1	Total 28	C 10	N 5	O 11	P 2	0
49	HL	1	Total 28	C 10	N 5	O 11	P 2	0
49	HN	1	Total 28	C 10	N 5	O 11	P 2	0
49	IB	1	Total 28	C 10	N 5	O 11	P 2	0
49	ID	1	Total 28	C 10	N 5	O 11	P 2	0
49	IF	1	Total 28	C 10	N 5	O 11	P 2	0
49	IH	1	Total 28	C 10	N 5	O 11	P 2	0
49	IJ	1	Total 28	C 10	N 5	O 11	P 2	0
49	IL	1	Total 28	C 10	N 5	O 11	P 2	0
49	IN	1	Total 28	C 10	N 5	O 11	P 2	0
49	JB	1	Total 28	C 10	N 5	O 11	P 2	0
49	JD	1	Total 28	C 10	N 5	O 11	P 2	0
49	JF	1	Total 28	C 10	N 5	O 11	P 2	0
49	JH	1	Total 28	C 10	N 5	O 11	P 2	0
49	JJ	1	Total 28	C 10	N 5	O 11	P 2	0

*Continued on next page...*

*Continued from previous page...*

Mol	Chain	Residues	Atoms					AltConf
			Total	C	N	O	P	
49	JL	1	28	10	5	11	2	0
49	JN	1	28	10	5	11	2	0
49	KB	1	28	10	5	11	2	0
49	KD	1	28	10	5	11	2	0
49	KF	1	28	10	5	11	2	0
49	KH	1	28	10	5	11	2	0
49	KJ	1	28	10	5	11	2	0
49	KL	1	28	10	5	11	2	0
49	KN	1	28	10	5	11	2	0
49	LB	1	28	10	5	11	2	0
49	LD	1	28	10	5	11	2	0
49	LF	1	28	10	5	11	2	0
49	LH	1	28	10	5	11	2	0
49	LJ	1	28	10	5	11	2	0
49	LL	1	28	10	5	11	2	0
49	LN	1	28	10	5	11	2	0
49	MB	1	28	10	5	11	2	0
49	MD	1	28	10	5	11	2	0
49	MF	1	28	10	5	11	2	0
49	MH	1	28	10	5	11	2	0
49	MJ	1	28	10	5	11	2	0

*Continued on next page...*

*Continued from previous page...*

Mol	Chain	Residues	Atoms					AltConf
			Total	C	N	O	P	
49	ML	1	28	10	5	11	2	0
49	MN	1	28	10	5	11	2	0
49	NB	1	28	10	5	11	2	0
49	ND	1	28	10	5	11	2	0
49	NF	1	28	10	5	11	2	0
49	NH	1	28	10	5	11	2	0
49	NJ	1	28	10	5	11	2	0
49	NL	1	28	10	5	11	2	0
49	NN	1	28	10	5	11	2	0
49	OB	1	28	10	5	11	2	0
49	OD	1	28	10	5	11	2	0
49	OF	1	28	10	5	11	2	0
49	OH	1	28	10	5	11	2	0
49	OJ	1	28	10	5	11	2	0
49	OL	1	28	10	5	11	2	0
49	ON	1	28	10	5	11	2	0
49	PB	1	28	10	5	11	2	0
49	PD	1	28	10	5	11	2	0
49	PF	1	28	10	5	11	2	0
49	PH	1	28	10	5	11	2	0
49	PJ	1	28	10	5	11	2	0

*Continued on next page...*

*Continued from previous page...*

Mol	Chain	Residues	Atoms					AltConf
			Total	C	N	O	P	
49	PL	1	Total 28	C 10	N 5	O 11	P 2	0
49	PN	1	Total 28	C 10	N 5	O 11	P 2	0
49	QB	1	Total 28	C 10	N 5	O 11	P 2	0
49	QD	1	Total 28	C 10	N 5	O 11	P 2	0
49	QF	1	Total 28	C 10	N 5	O 11	P 2	0
49	QH	1	Total 28	C 10	N 5	O 11	P 2	0
49	QJ	1	Total 28	C 10	N 5	O 11	P 2	0
49	QL	1	Total 28	C 10	N 5	O 11	P 2	0
49	QN	1	Total 28	C 10	N 5	O 11	P 2	0
49	RB	1	Total 28	C 10	N 5	O 11	P 2	0
49	RD	1	Total 28	C 10	N 5	O 11	P 2	0
49	RF	1	Total 28	C 10	N 5	O 11	P 2	0
49	RH	1	Total 28	C 10	N 5	O 11	P 2	0
49	RJ	1	Total 28	C 10	N 5	O 11	P 2	0
49	RL	1	Total 28	C 10	N 5	O 11	P 2	0
49	RN	1	Total 28	C 10	N 5	O 11	P 2	0
49	SB	1	Total 28	C 10	N 5	O 11	P 2	0
49	SD	1	Total 28	C 10	N 5	O 11	P 2	0
49	SF	1	Total 28	C 10	N 5	O 11	P 2	0
49	SH	1	Total 28	C 10	N 5	O 11	P 2	0
49	SJ	1	Total 28	C 10	N 5	O 11	P 2	0

*Continued on next page...*



*Continued from previous page...*

Mol	Chain	Residues	Atoms					AltConf
			Total	C	N	O	P	
49	SL	1	28	10	5	11	2	0
49	SN	1	28	10	5	11	2	0
49	TB	1	28	10	5	11	2	0
49	TD	1	28	10	5	11	2	0
49	TF	1	28	10	5	11	2	0
49	TH	1	28	10	5	11	2	0
49	TJ	1	28	10	5	11	2	0
49	TL	1	28	10	5	11	2	0
49	TN	1	28	10	5	11	2	0
49	UB	1	28	10	5	11	2	0
49	UD	1	28	10	5	11	2	0
49	UF	1	28	10	5	11	2	0
49	UH	1	28	10	5	11	2	0
49	UJ	1	28	10	5	11	2	0
49	UL	1	28	10	5	11	2	0
49	UN	1	28	10	5	11	2	0
49	VB	1	28	10	5	11	2	0
49	VD	1	28	10	5	11	2	0
49	VF	1	28	10	5	11	2	0
49	VH	1	28	10	5	11	2	0
49	VJ	1	28	10	5	11	2	0

*Continued on next page...*

*Continued from previous page...*

Mol	Chain	Residues	Atoms					AltConf
			Total	C	N	O	P	
49	VL	1	Total 28	10	5	11	2	0
49	VN	1	Total 28	10	5	11	2	0
49	WB	1	Total 28	10	5	11	2	0
49	WD	1	Total 28	10	5	11	2	0
49	WF	1	Total 28	10	5	11	2	0
49	WH	1	Total 28	10	5	11	2	0
49	WJ	1	Total 28	10	5	11	2	0
49	WL	1	Total 28	10	5	11	2	0
49	WN	1	Total 28	10	5	11	2	0

### 3 Residue-property plots i

These plots are drawn for all protein, RNA, DNA and oligosaccharide chains in the entry. The first graphic for a chain summarises the proportions of the various outlier classes displayed in the second graphic. The second graphic shows the sequence view annotated by issues in geometry and atom inclusion in map density. Residues are color-coded according to the number of geometric quality criteria for which they contain at least one outlier: green = 0, yellow = 1, orange = 2 and red = 3 or more. A red diamond above a residue indicates a poor fit to the EM map for this residue (all-atom inclusion < 40%). Stretches of 2 or more consecutive residues without any outlier are shown as a green connector. Residues present in the sample, but not in the model, are shown in grey.

#### • Molecule 1: RIB27A

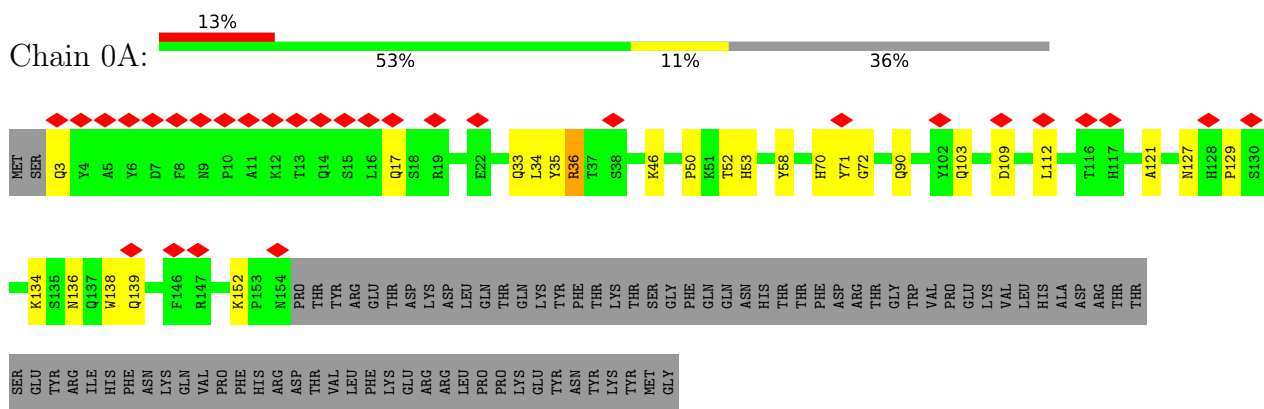

#### • Molecule 1: RIB27A

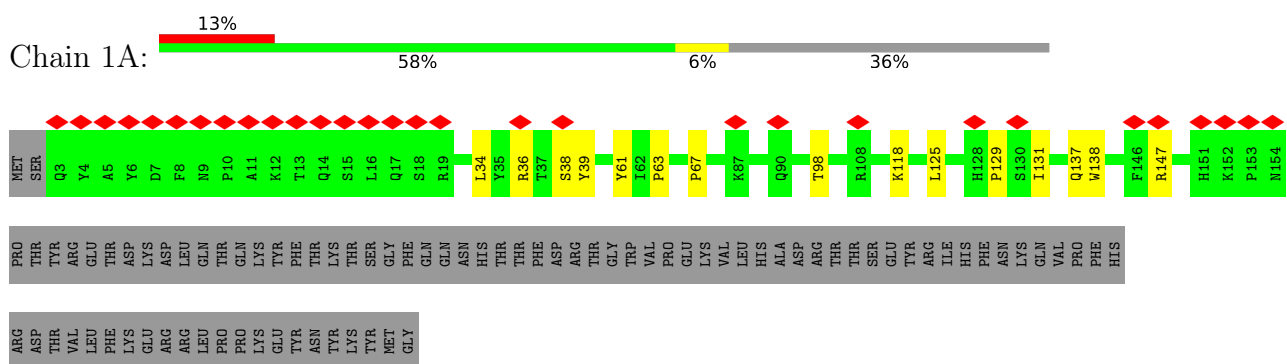

#### • Molecule 1: RIB27A

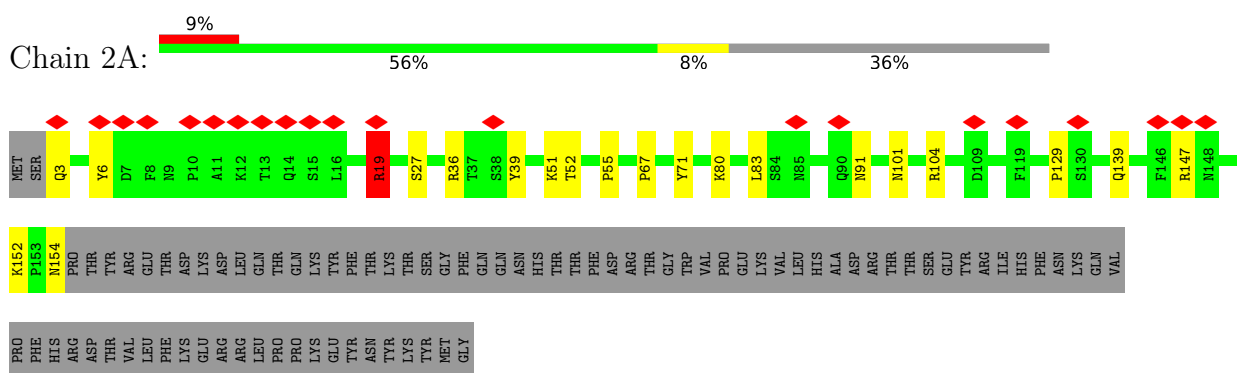

• Molecule 1: RIB27A

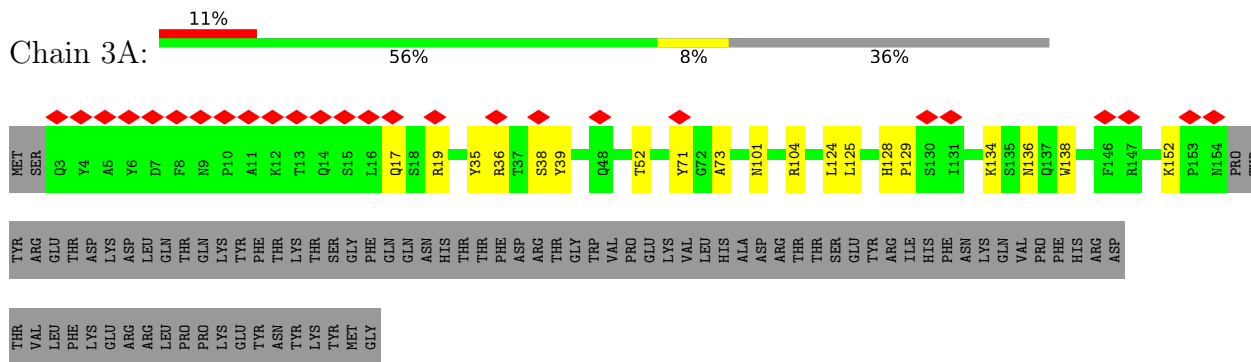

• Molecule 2: RIB38

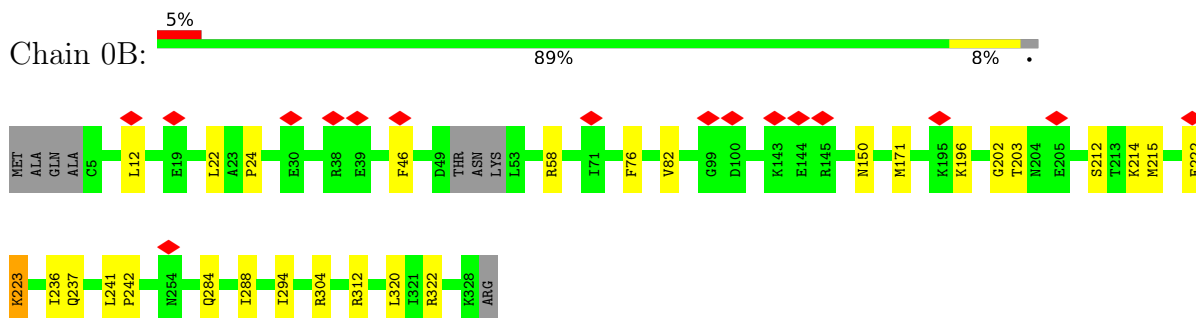

• Molecule 3: CFAM166B

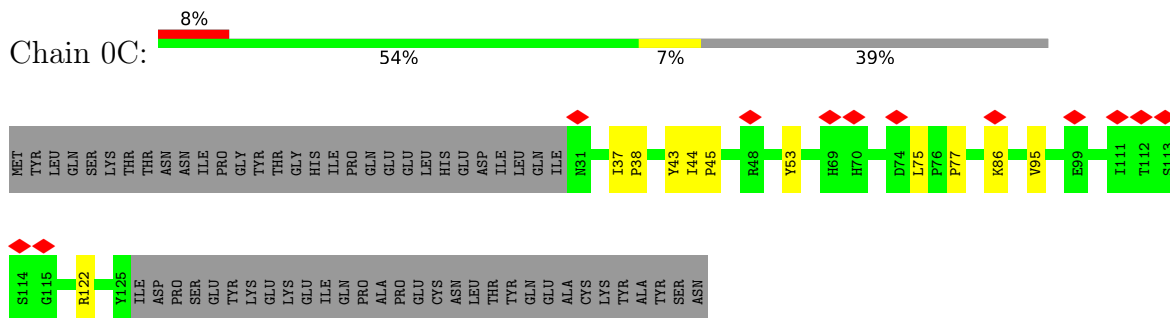

• Molecule 3: CFAM166B

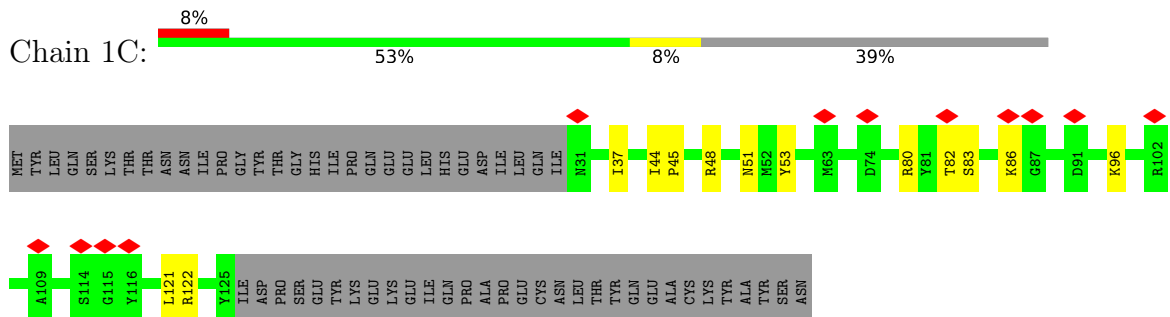

• Molecule 4: CFAM166A

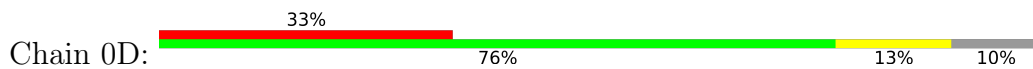

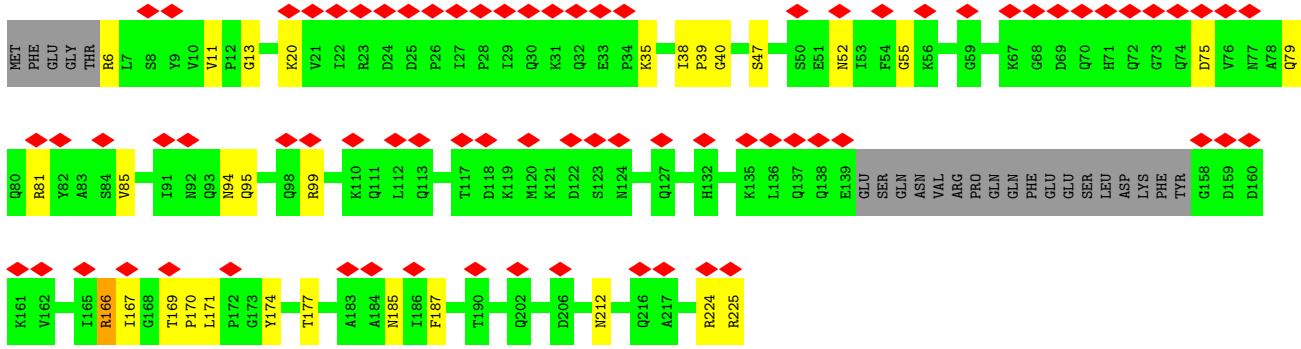

• Molecule 4: CFAM166A

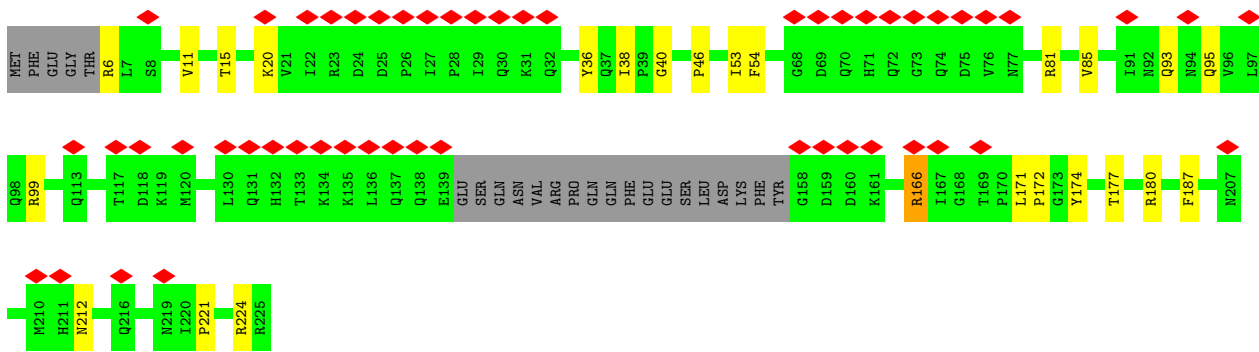
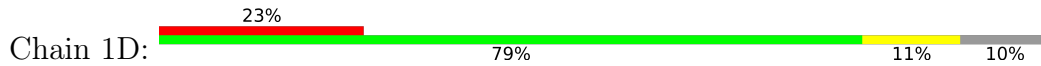

• Molecule 4: CFAM166A

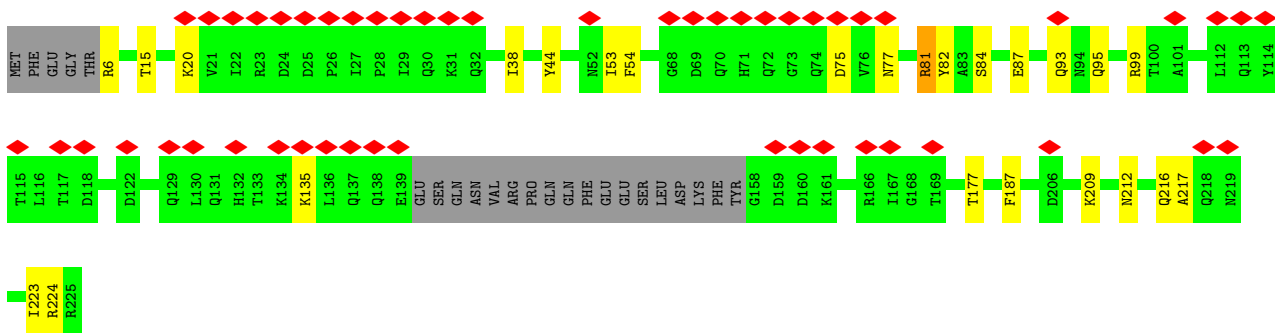
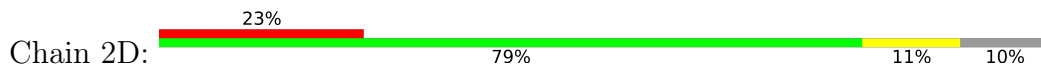

• Molecule 5: RIB22

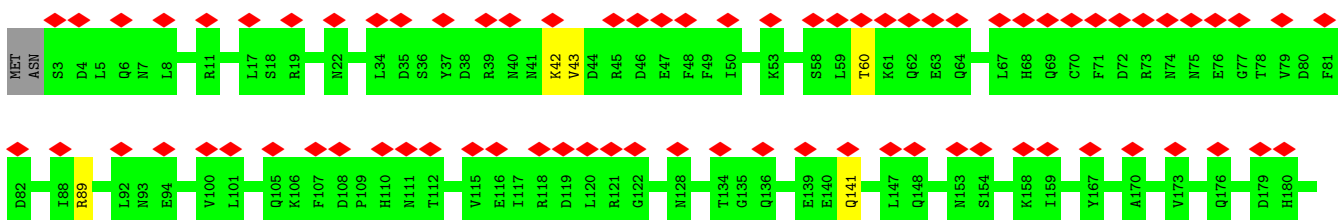
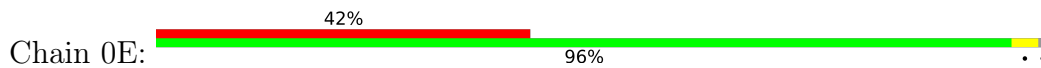

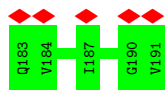

- Molecule 5: RIB22

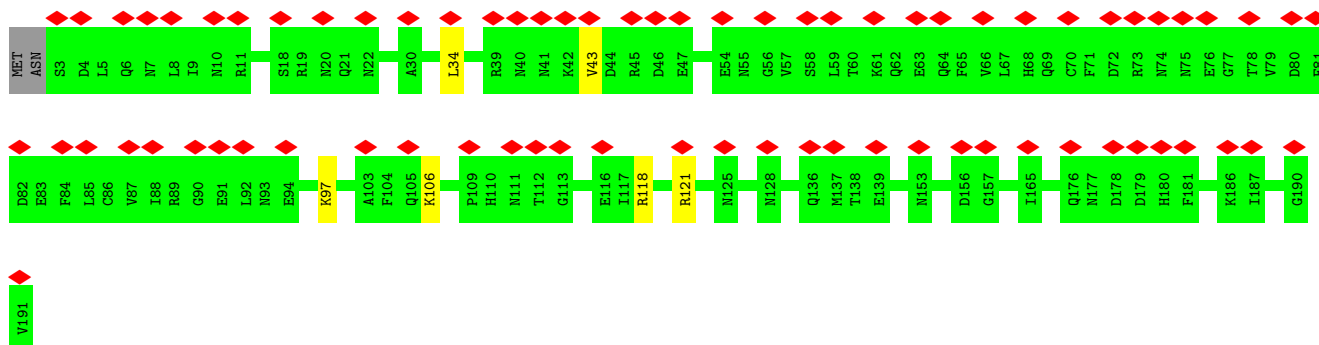
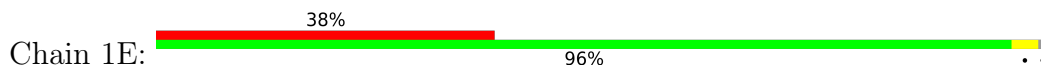

- Molecule 5: RIB22

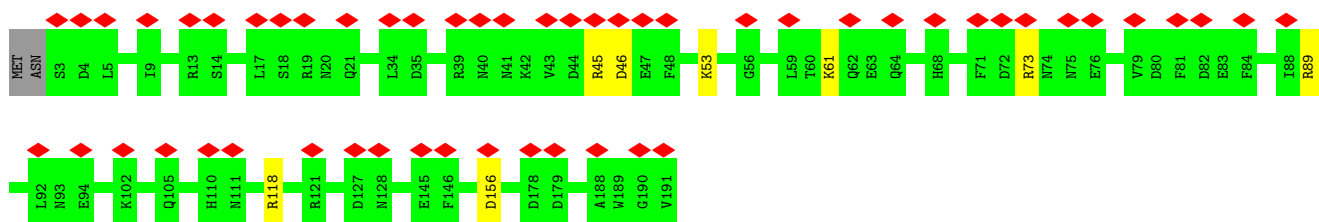

- Molecule 5: RIB22

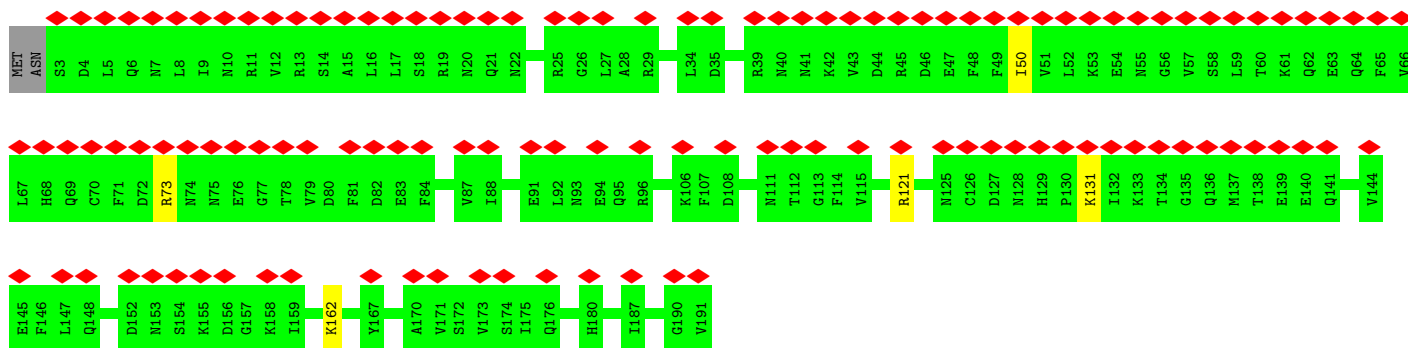

- Molecule 6: CFAM166C

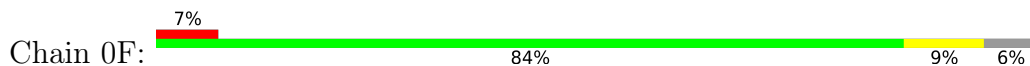

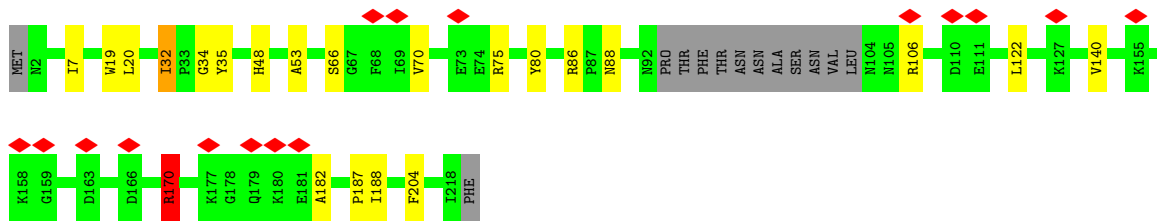

• Molecule 7: CFAP107

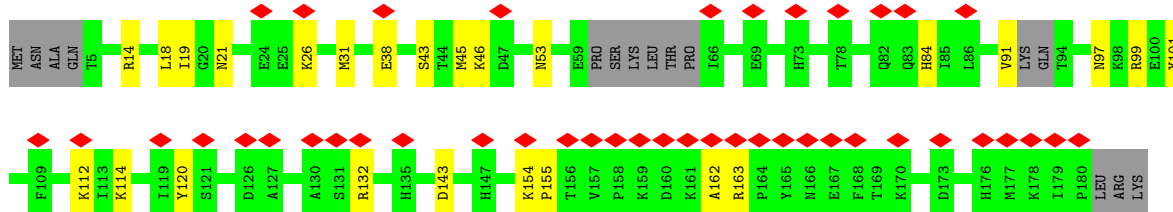
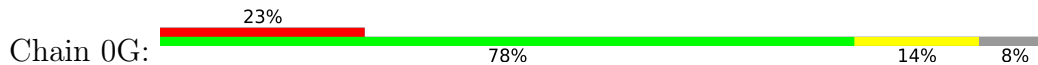

• Molecule 7: CFAP107

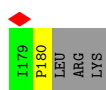
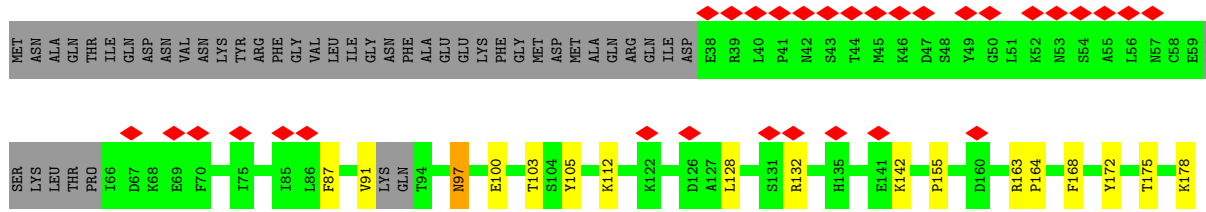

• Molecule 8: CFAP127

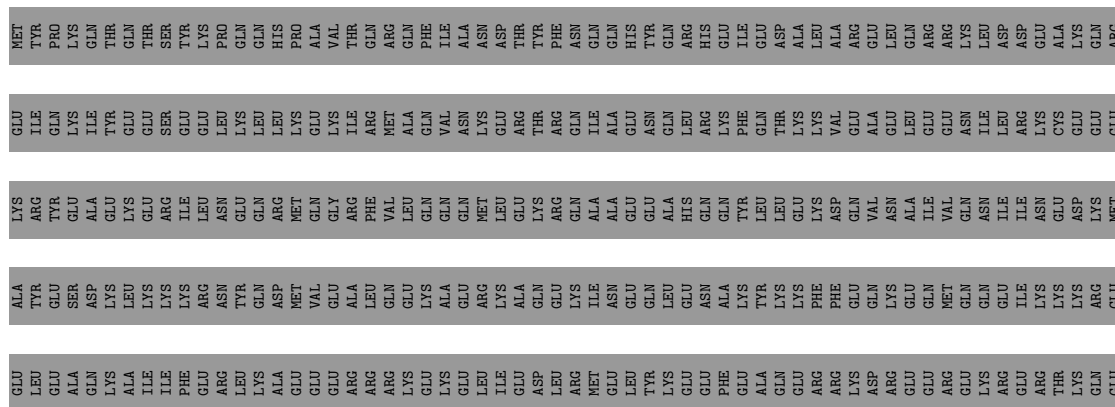

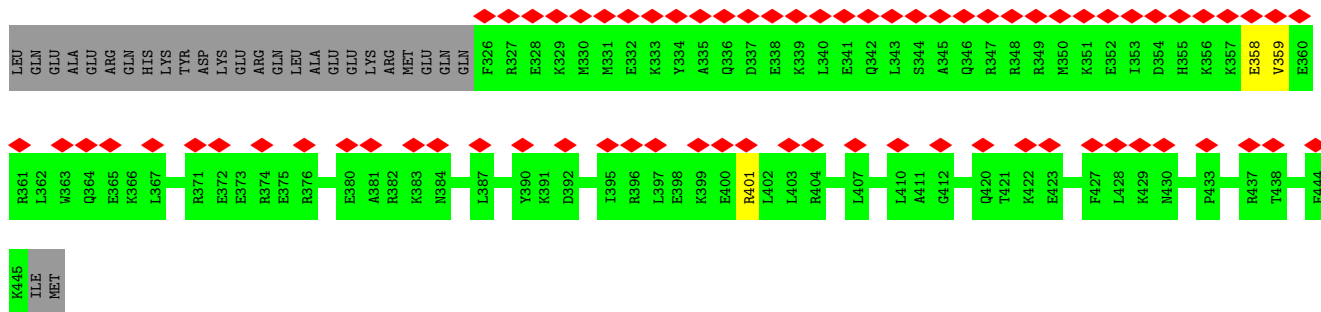

• Molecule 8: CFAP127

Chain 1H:

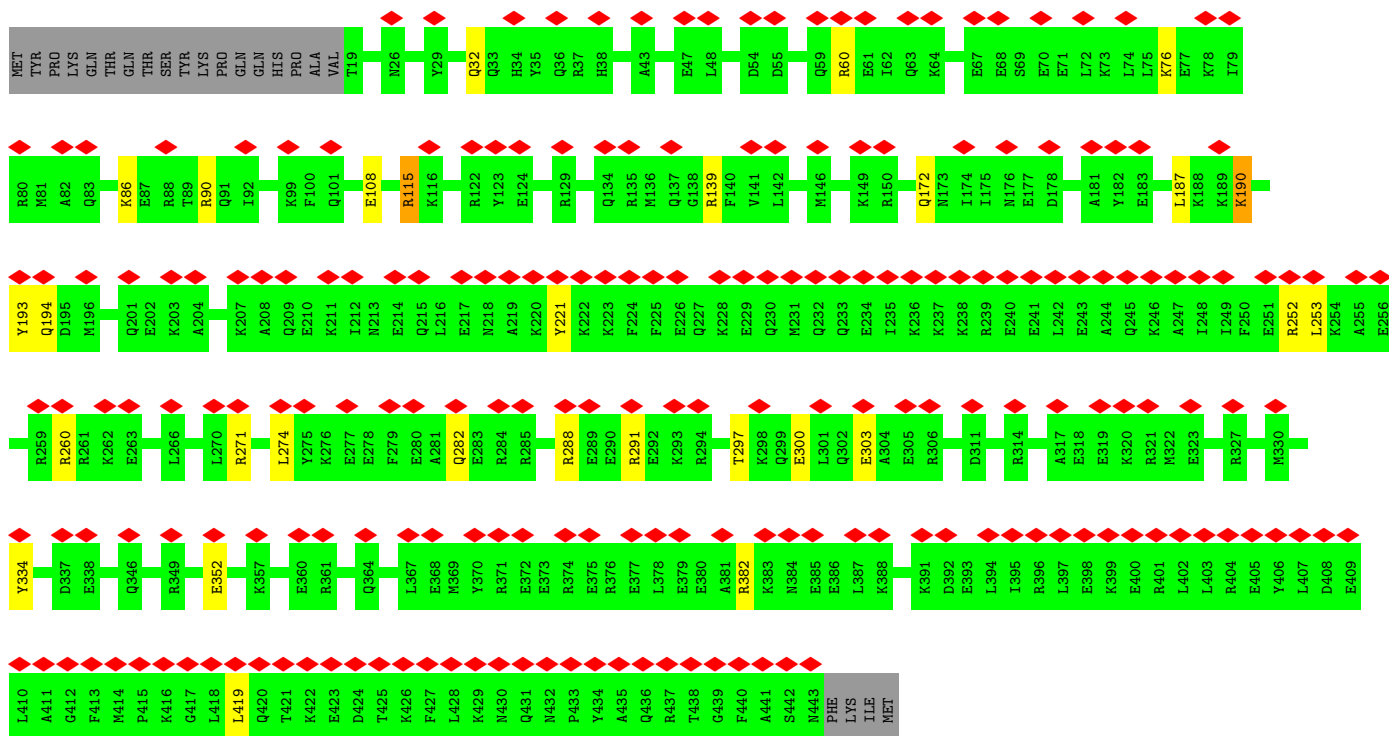

• Molecule 9: CFAP161A

Chain 0N:

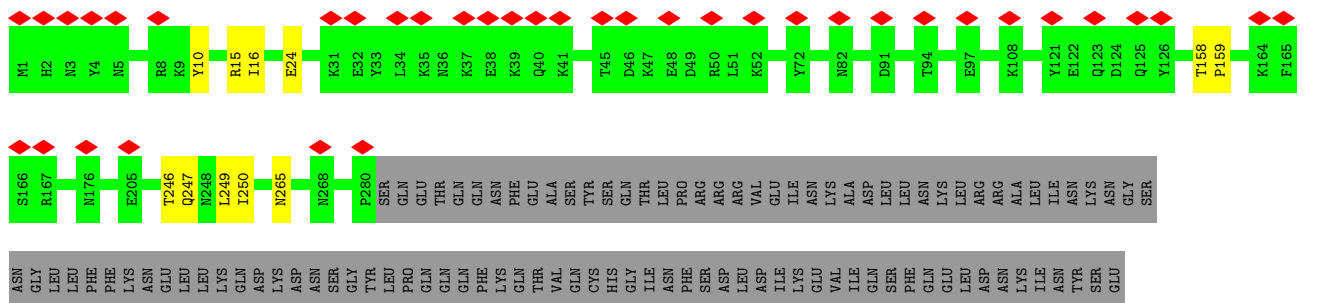



LEU LEU  
ILE ILE  
GLN VAL  
LEU LEU  
LYS LYS  
GLY THR  
THR THR  
LEU SER  
SER LEU  
GLU LEU  
LYS LYS  
ARG ARG  
ASN ASN  
ALA LEU  
LEU LEU  
ALA LEU  
TYR TYR  
PHE ASP  
GLU GLU  
SER VAL  
VAL VAL  
TYR LEU  
TYR ALA  
GLU GLU  
LYS LYS  
PHE LEU  
SER GLY  
GLN GLN  
ASN ASN  
VAL VAL  
THR THR  
SER SER  
LEU LEU  
GLY GLY  
ILE ILE  
PHE PHE  
SER SER  
ALA ALA  
VAL VAL  
PHE LEU  
LEU LEU  
LYS LYS  
ASN ASN  
SER SER  
THR THR  
ASP ASP  
PRO PRO  
ILE ILE  
VAL VAL  
VAL VAL  
LYS LYS

ASN ASN  
ASN PHE  
VAL VAL  
LEU LEU  
SER SER  
TRP TRP  
GLY GLY  
ASN ASN  
LEU LEU  
SER SER  
PRO PRO  
LYS LYS  
HIS HIS  
ILE ILE  
ALA ALA  
ASN ASN  
SER SER  
ILE ILE  
ARG ARG  
ASN ASN  
LEU LEU  
GLU GLU  
ALA ALA  
TYR TYR  
PHE PHE  
GLU GLU  
SER SER  
VAL VAL  
TYR TYR  
HIS HIS  
ASP ASP  
PHE PHE  
SER SER  
ALA ALA  
GLN GLN  
ASN ASN  
VAL VAL  
ASP ASP  
THR THR  
LYS LYS  
LEU LEU  
SER SER  
GLY GLY  
TYR TYR  
PHE PHE  
SER SER  
VAL VAL  
ALA ALA  
LYS LYS  
ASN ASN

• Molecule 9: CFAP161A

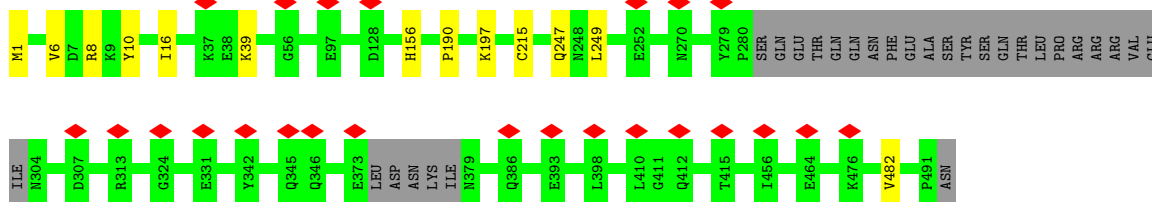
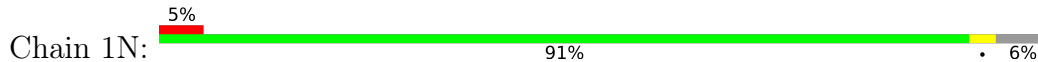

• Molecule 9: CFAP161A

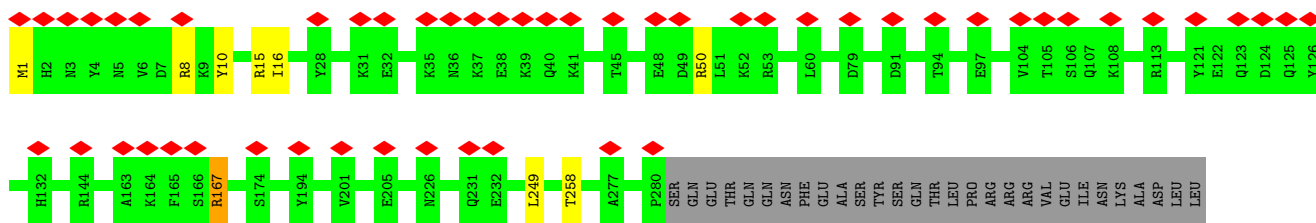

ASN LYS  
LYS LEU  
ARG ARG  
ARG ARG  
ALA ALA  
LEU LEU  
ILE ILE  
ASN ASN  
LYS LYS  
TYR TYR  
SER SER  
GLY GLY  
ASN ASN  
GLY GLY  
LEU LEU  
LEU LEU  
PHE PHE  
PHE PHE  
LYS LYS  
ASN ASN  
THR THR  
GLY GLY  
LEU LEU  
SER SER  
GLU GLU  
LEU LEU  
ILE ILE  
LEU LEU  
LEU LEU  
PHE PHE  
PHE PHE  
ASN ASN  
LYS LYS  
GLU GLU  
SER SER  
VAL VAL  
TYR TYR  
PHE PHE  
SER SER  
GLY GLY  
ILE ILE  
SER SER  
GLN GLN  
THR THR  
PHE PHE  
ALA ALA  
VAL VAL  
CYS CYS  
HIS HIS  
GLY GLY  
ILE ILE  
SER SER  
ASN ASN  
PHE PHE  
THR THR  
SER SER  
PRO PRO  
ARG ARG  
ARG ARG  
ILE ILE  
LYS LYS  
VAL VAL  
GLU GLU  
ILE ILE  
VAL VAL  
ASN ASN  
HIS HIS  
TRP TRP  
ASP ASP

SER PHE  
GLN GLN  
LEU LEU  
LEU LEU  
ASP ASP  
ASN ASN  
LYS LYS  
ILE ILE  
TYR TYR  
SER SER  
GLU GLU  
LEU LEU  
LEU LEU  
LEU LEU  
PHE PHE  
PHE PHE  
LYS LYS  
THR THR  
GLY GLY  
LEU LEU  
SER SER  
VAL VAL  
TYR TYR  
ALA ALA  
GLN GLN  
TYR TYR  
LEU LEU  
ASP ASP  
PRO PRO  
GLN GLN  
GLN GLN  
PHE PHE  
LYS LYS  
GLN GLN  
THR THR  
VAL VAL  
ASN ASN  
CYS CYS  
VAL VAL  
THR THR  
HIS HIS  
LYS LYS  
LEU LEU  
SER SER  
GLY GLY  
ILE ILE  
PHE PHE  
SER SER  
PRO PRO  
ARG ARG  
ARG ARG  
ILE ILE  
LYS LYS  
VAL VAL  
GLU GLU  
ILE ILE  
VAL VAL  
ASN ASN  
HIS HIS  
TRP TRP  
ASP ASP

ASP VAL  
VAL VAL  
LYS LYS  
LYS LYS  
TYR TYR  
GLY GLY  
THR THR  
ASP ASP  
GLU GLU  
GLU GLU  
ILE ILE  
PHE PHE  
ASN ASN  
ASN ASN  
PHE PHE  
VAL VAL  
LEU LEU  
SER SER  
TRP TRP  
GLY GLY  
ASN ASN  
LEU LEU  
SER SER  
GLU GLU  
SER SER  
VAL VAL  
TYR TYR  
HIS HIS  
ILE ILE  
ALA ALA  
ILE ILE  
SER SER  
ARG ARG  
GLU GLU  
LEU LEU  
GLN GLN  
TYR TYR  
PHE PHE  
GLU GLU  
SER SER  
VAL VAL  
TYR TYR  
HIS HIS  
ASP ASP  
PHE PHE  
SER SER  
ALA ALA  
CYS CYS  
VAL VAL  
THR THR  
LYS LYS  
LEU LEU  
SER SER  
GLY GLY  
ILE ILE  
PHE PHE  
THR THR  
SER SER  
ASN ASN  
VAL VAL

ILE PRO  
ASN ASN

• Molecule 10: CFAP20

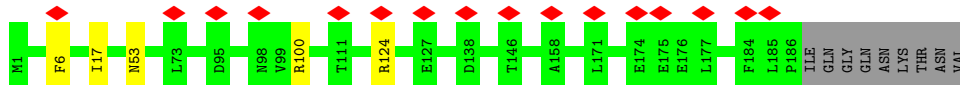

• Molecule 10: CFAP20

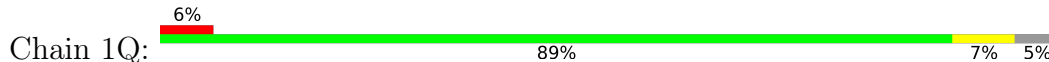

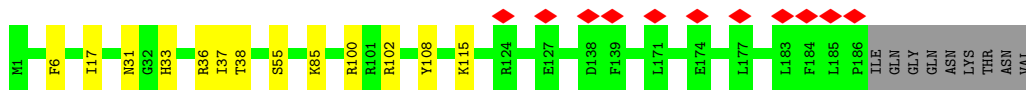

• Molecule 10: CFAP20

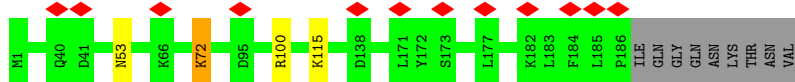
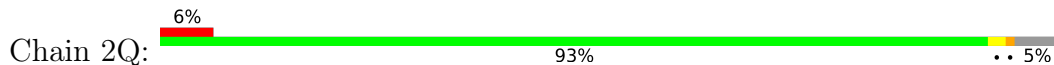

• Molecule 10: CFAP20

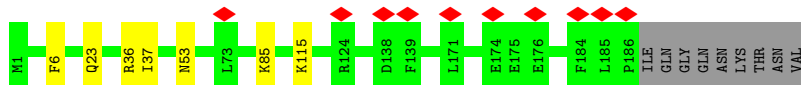

• Molecule 10: CFAP20

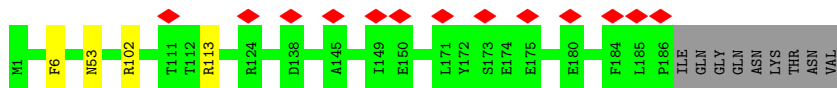

• Molecule 10: CFAP20

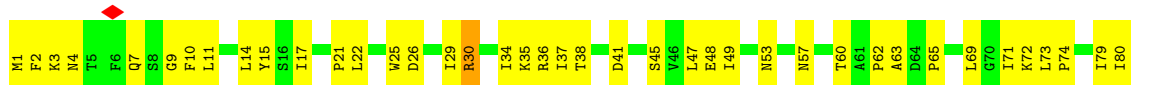

• Molecule 10: CFAP20

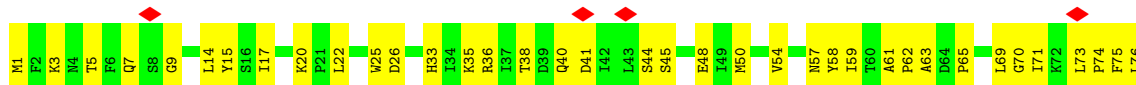

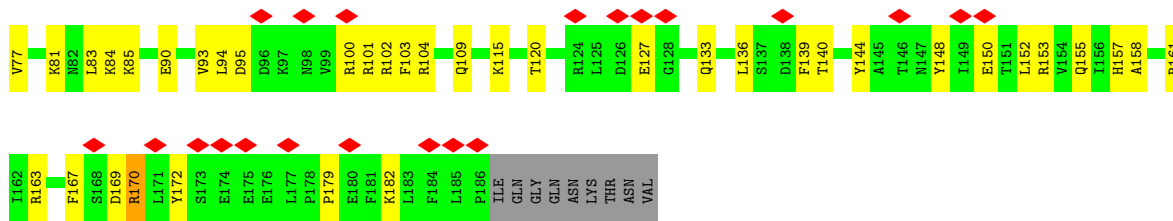

• Molecule 11: Parkin co-regulated protein PACRGA

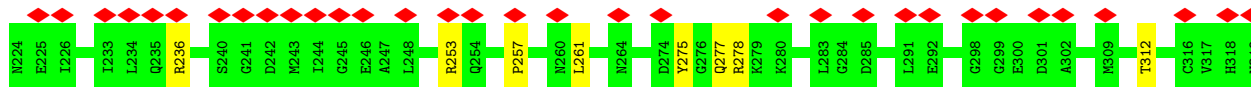
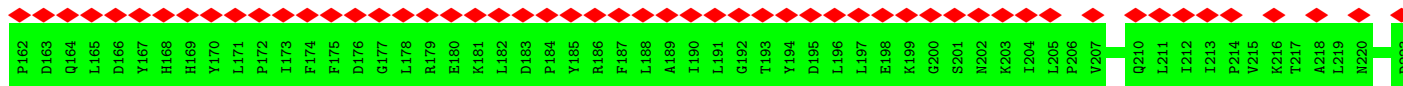
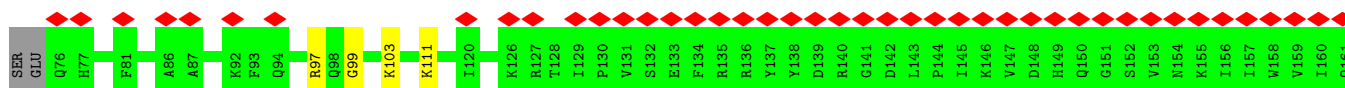
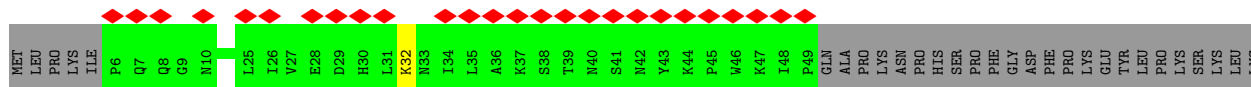
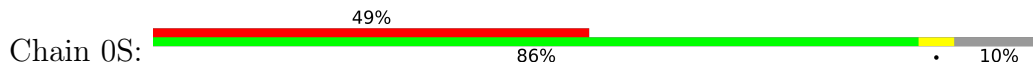

• Molecule 11: Parkin co-regulated protein PACRGA

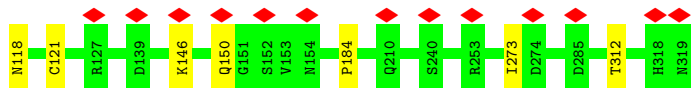
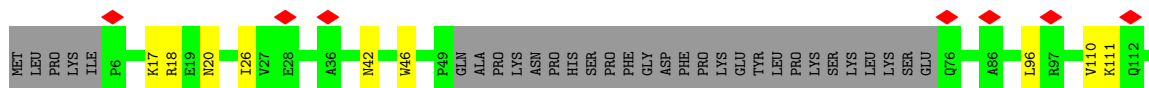
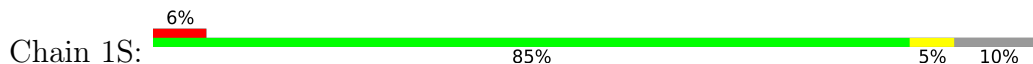

• Molecule 11: Parkin co-regulated protein PACRGA

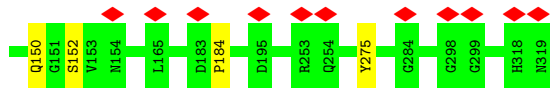
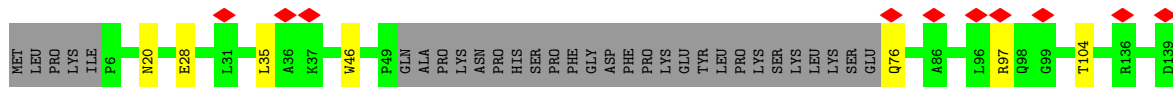
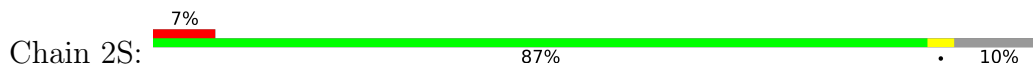

• Molecule 11: Parkin co-regulated protein PACRGA

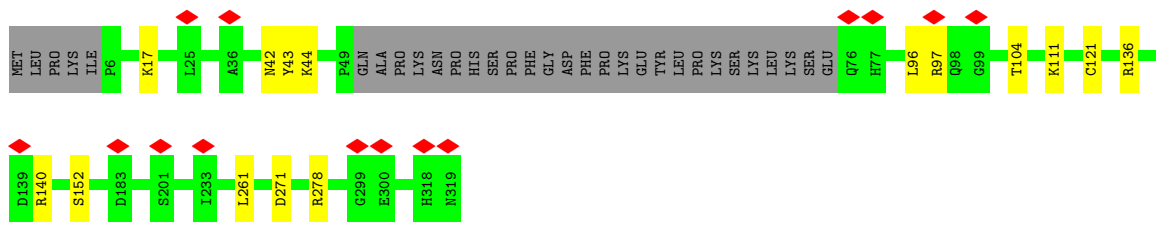
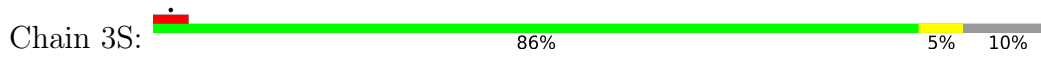

• Molecule 12: IJ34

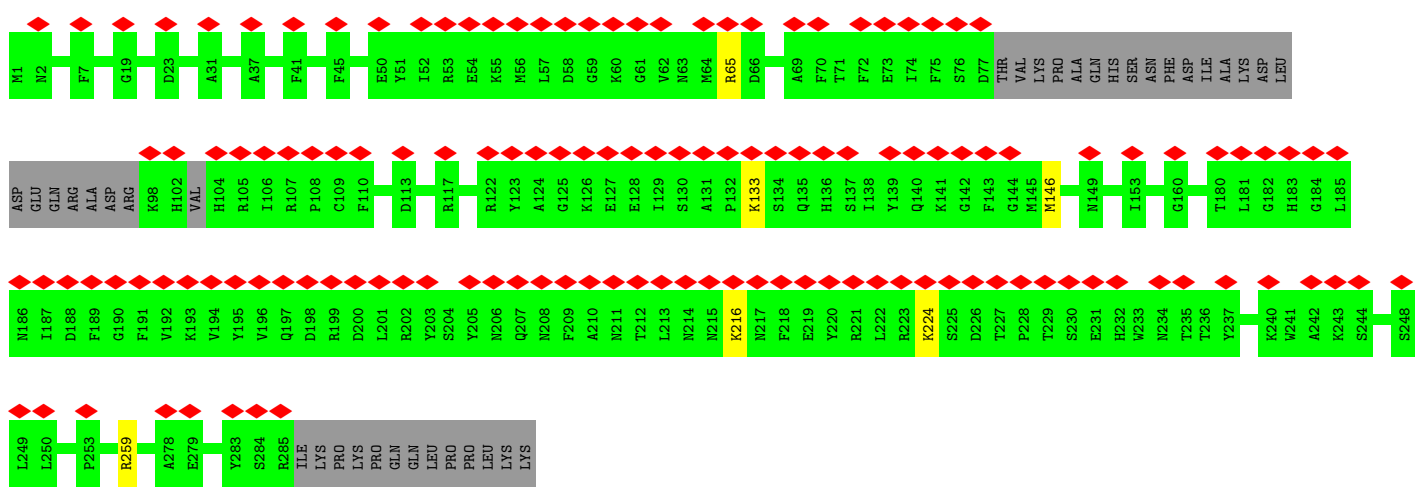
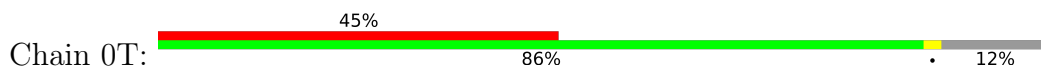

• Molecule 12: IJ34

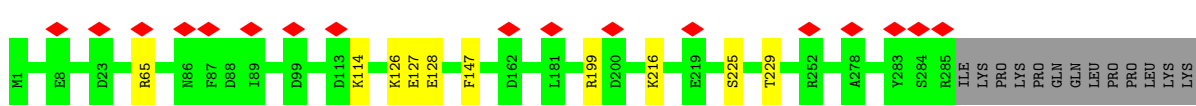
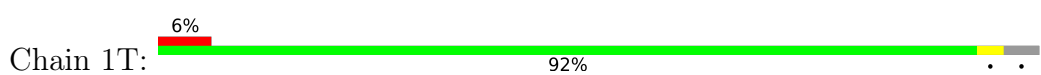

• Molecule 12: IJ34

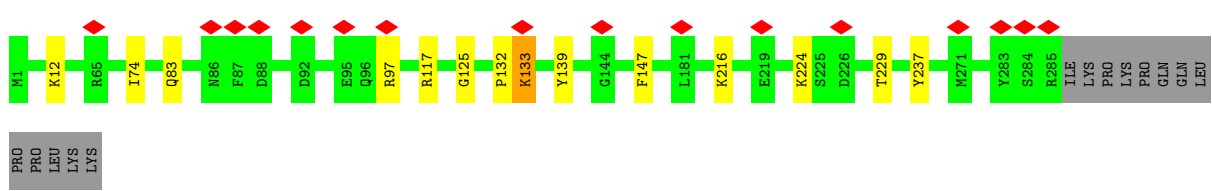
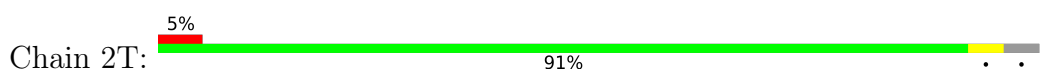

• Molecule 12: IJ34

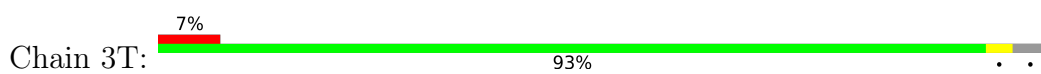

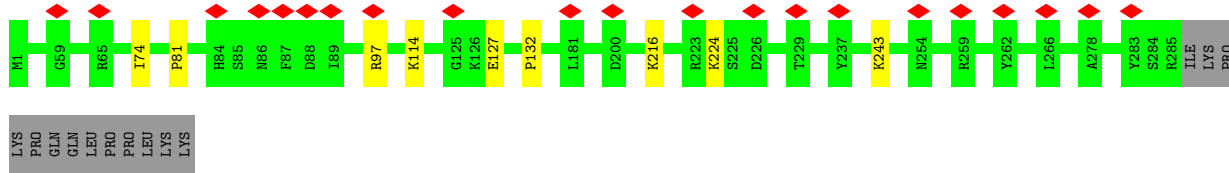

• Molecule 13: CFAP52A

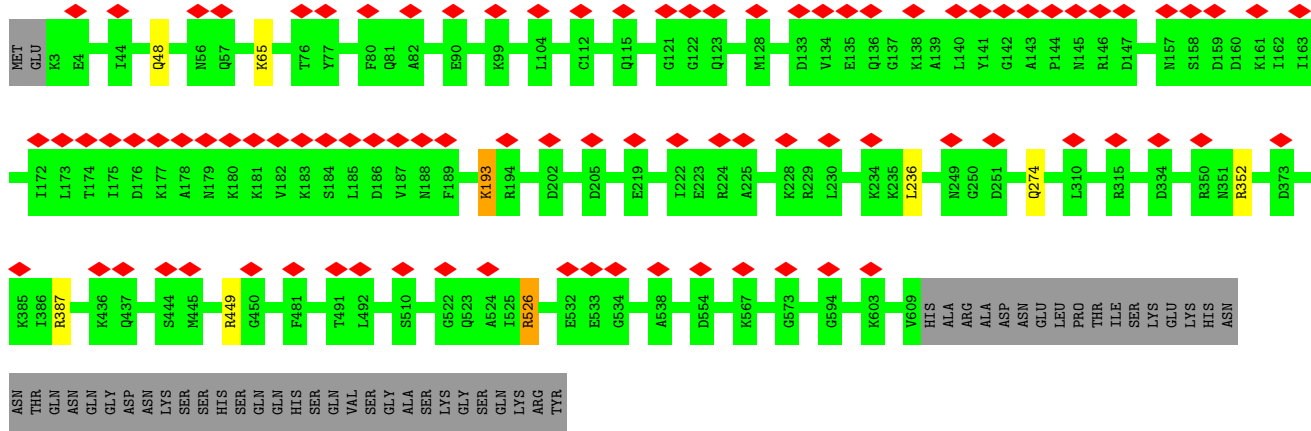

• Molecule 13: CFAP52A

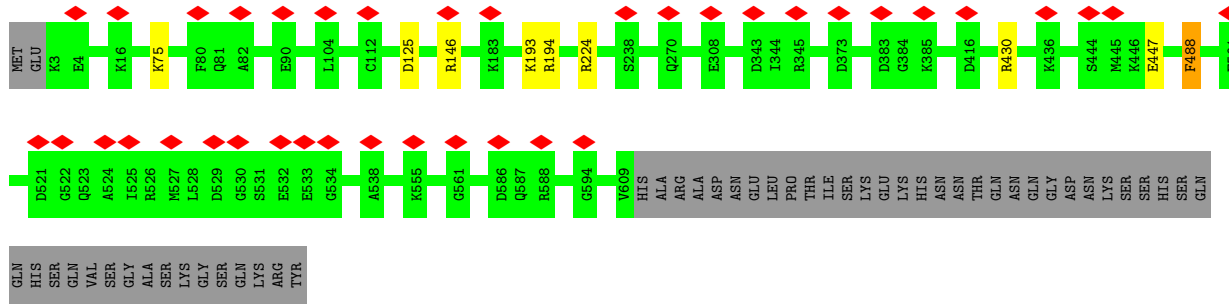

• Molecule 13: CFAP52A

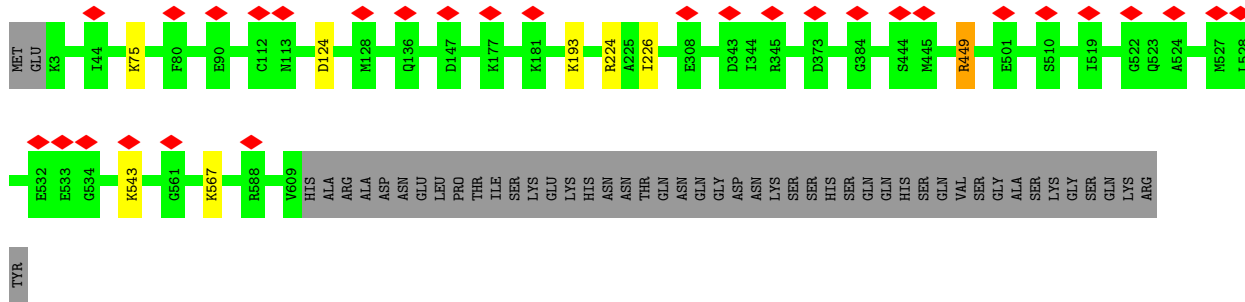
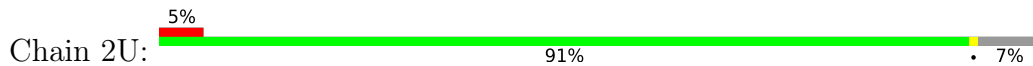

• Molecule 13: CFAP52A

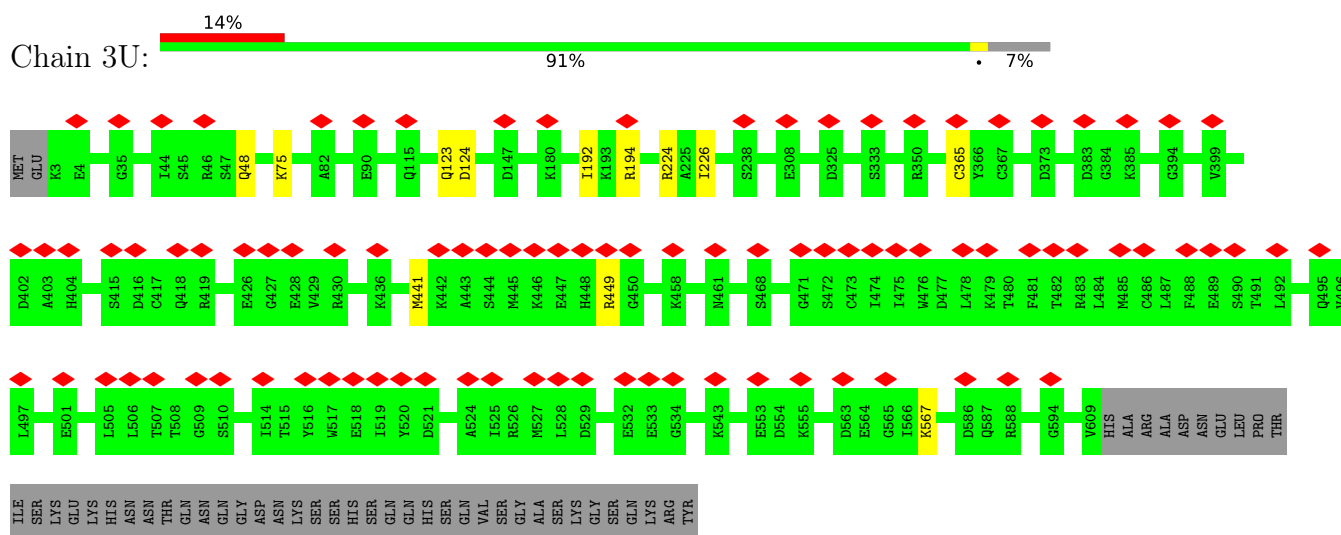

• Molecule 14: DNA polymerase delta C4-type zinc-finger protein

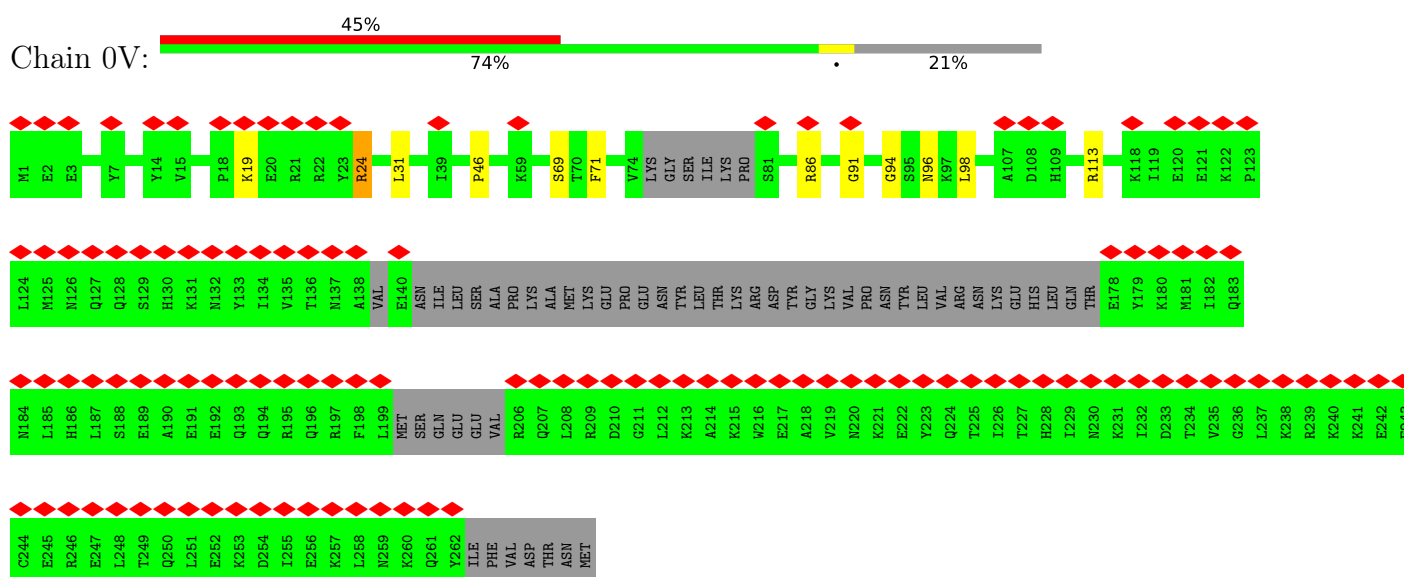

• Molecule 14: DNA polymerase delta C4-type zinc-finger protein

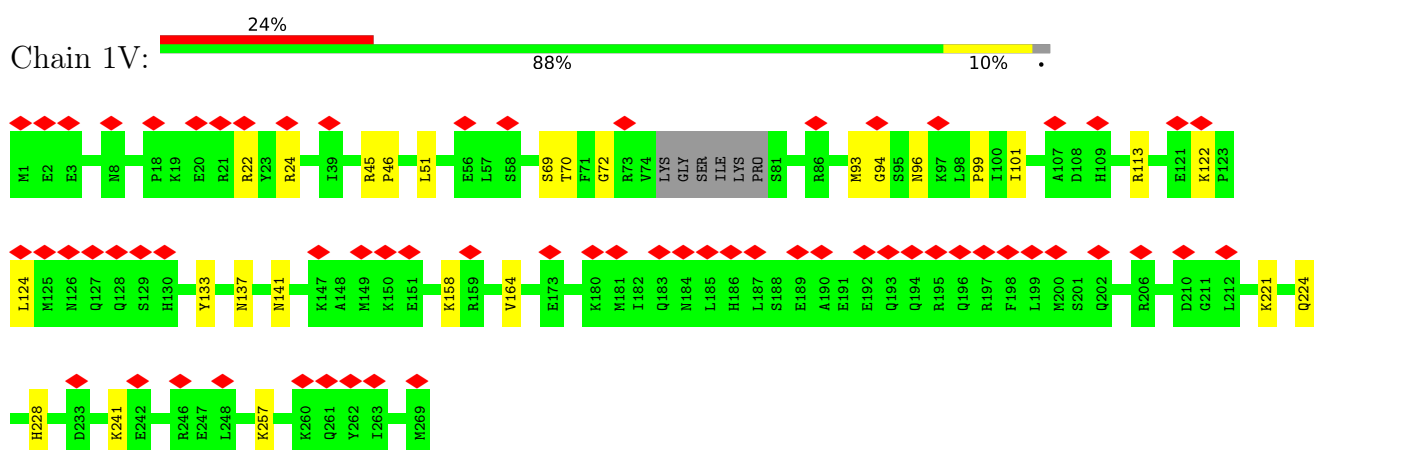

• Molecule 14: DNA polymerase delta C4-type zinc-finger protein

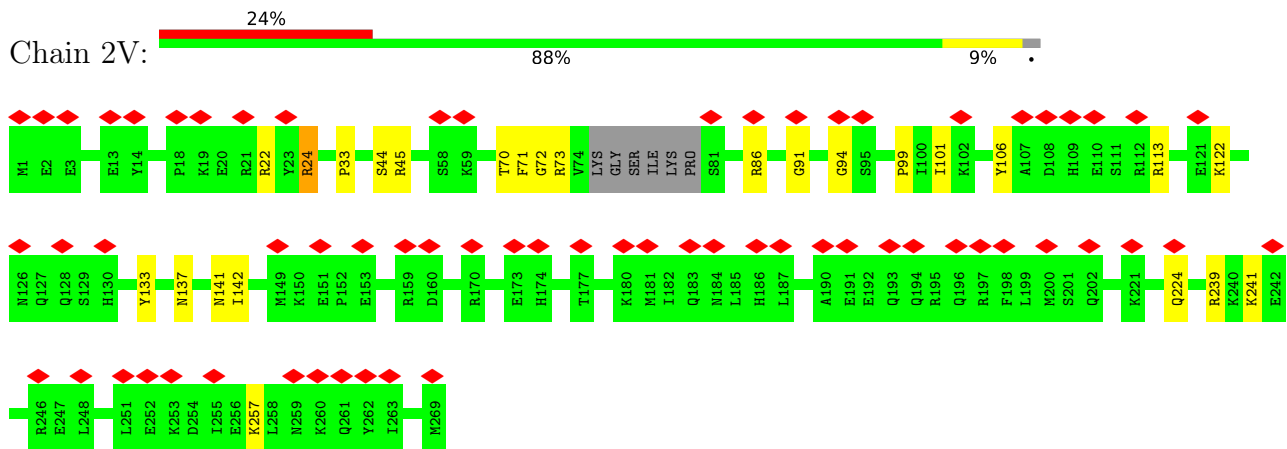

• Molecule 14: DNA polymerase delta C4-type zinc-finger protein

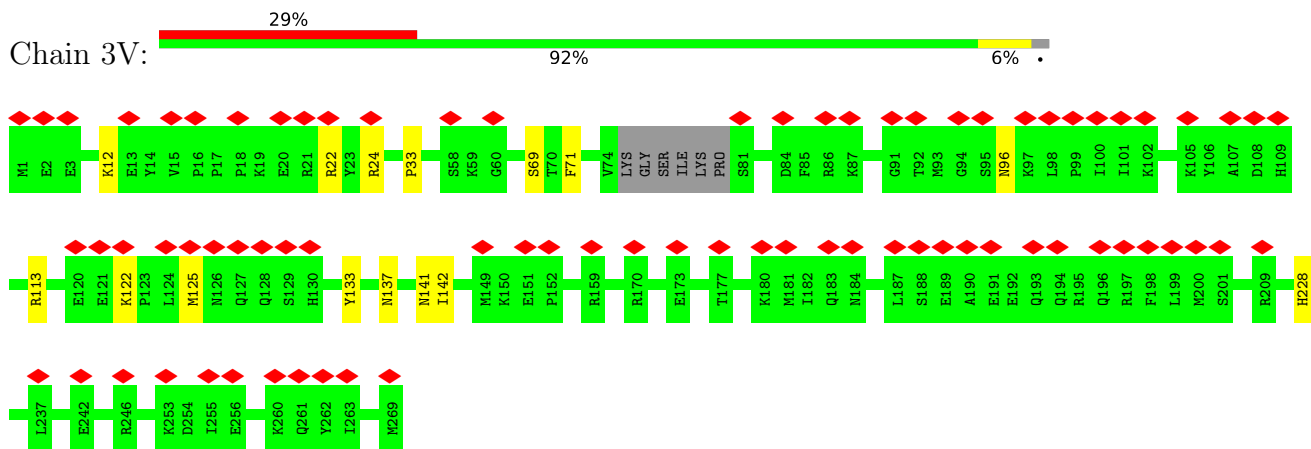

• Molecule 15: RIB43A protein

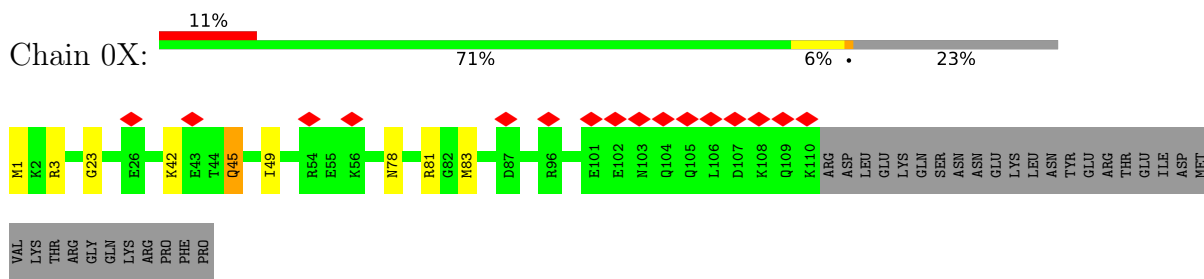

• Molecule 15: RIB43A protein

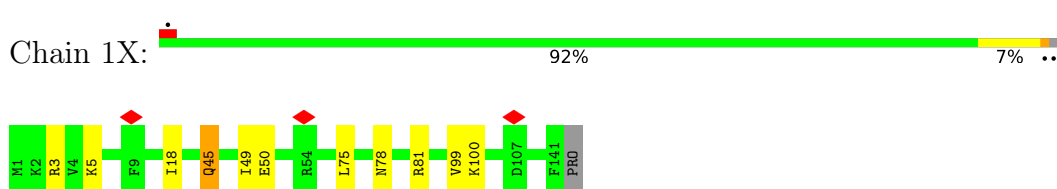

• Molecule 15: RIB43A protein

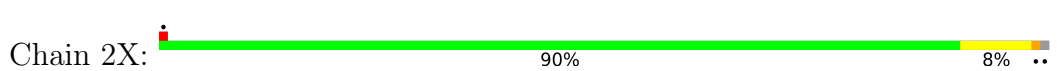

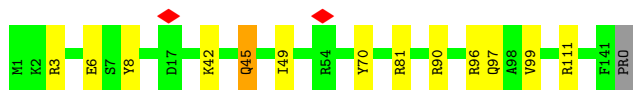

• Molecule 15: RIB43A protein

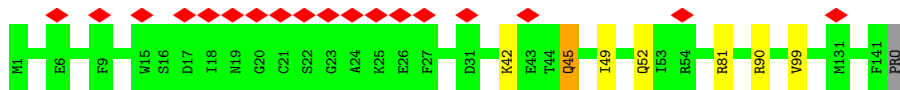

• Molecule 15: RIB43A protein

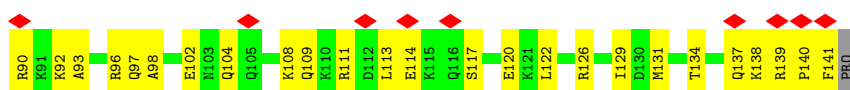

• Molecule 16: RIB57

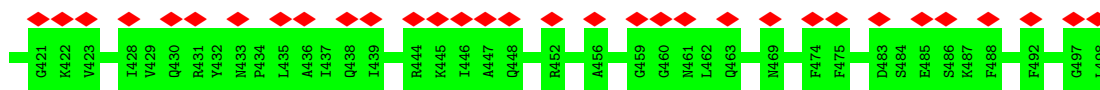

• Molecule 16: RIB57

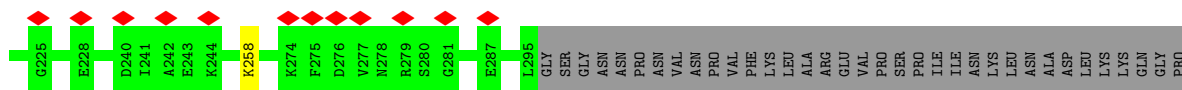
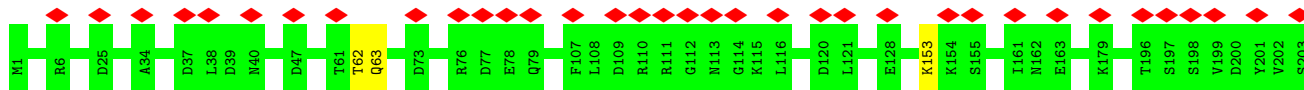

PHE  
ALA  
PHE  
ASP  
LEU  
SER  
SER  
LYS  
ALA  
ALA  
CYS  
GLN  
GLU  
GLU  
ILE  
THR  
GLN  
SER  
SER  
GLY  
SER  
LEU  
SER  
HIS  
ASP  
ALA  
GLU  
PHE  
LYS  
TRP  
ASN  
VAL  
ILE  
LYS  
GLU  
ILE  
VAL  
THR  
VAL  
GLU  
SER  
LEU  
THR  
VAL  
THR  
PHE  
GLU  
ASP  
ASN  
LEU  
ALA  
PHE  
LYS  
SER  
THR  
ILE  
TTR  
ARG  
LEU  
PRO  
LEU  
ALA  
ILE  
PHE  
PHE  
ASP  
LYS  
ASN  
TYR  
GLU  
GLY  
LYS  
VAL  
ALA  
GLN  
ILE  
LEU  
SER

VAL  
PHE  
ILE  
ASP  
VAL  
VAL  
ARG  
GLY  
GLN  
GLN  
SER  
SER  
GLU  
ILE  
THR  
GLN  
SER  
SER  
GLY  
SER  
HIS  
ASP  
ALA  
GLU  
PHE  
LYS  
TRP  
ASN  
VAL  
ILE  
LYS  
GLU  
ILE  
VAL  
THR  
VAL  
GLU  
SER  
LEU  
THR  
VAL  
THR  
PHE  
GLU  
ASP  
ASN  
LEU  
ALA  
PHE  
LYS  
SER  
THR  
ILE  
TTR  
ARG  
LEU  
PRO  
LEU  
ALA  
ILE  
PHE  
PHE  
ASP  
LYS  
ASN  
TYR  
GLU  
GLY  
LYS  
VAL  
ALA  
GLN  
ILE  
LEU  
SER



GLN	ARG	GLU	PHE	VAL	ALA	GLU	TRP	GLY	GLY	ASN	LEU	GLN	GLN	VAL	ASN	LYS	ASN	ALA	PHE	VAL	GLU	PHE	PHE	SER	ASP	VAL	ALA	PHE	CYS	ASP	GLU	SER	SER	LYS	PHE	HIS	TYR	PHE	SER	ASN	ALA	GLY	LEU
-----	-----	-----	-----	-----	-----	-----	-----	-----	-----	-----	-----	-----	-----	-----	-----	-----	-----	-----	-----	-----	-----	-----	-----	-----	-----	-----	-----	-----	-----	-----	-----	-----	-----	-----	-----	-----	-----	-----	-----	-----	-----	-----	-----

• Molecule 16: RIB57

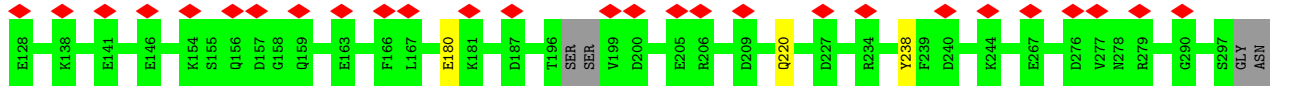
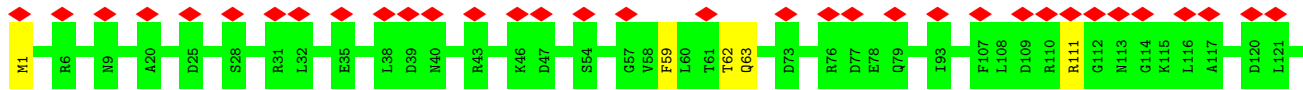

ASN	PRO	ASN	VAL	ASN	PRO	VAL	PHE	LEU	THR	LYS	VAL	ALA	ARG	GLU	VAL	PRO	SER	PRO	ILE	ASN	LYS	LEU	ASN	ASN	ALA	ASP	GLY	LEU	LYS	VAL	GLN	GLN	TYR	ARG	ASP	ASP	ASN	ASN	GLN	VAL	GLN	LEU	VAL	GLN	ASN
-----	-----	-----	-----	-----	-----	-----	-----	-----	-----	-----	-----	-----	-----	-----	-----	-----	-----	-----	-----	-----	-----	-----	-----	-----	-----	-----	-----	-----	-----	-----	-----	-----	-----	-----	-----	-----	-----	-----	-----	-----	-----	-----	-----	-----	-----

ILE	LYS	VAL	ILE	THR	PHE	SER	LEU	THR	THR	THR	THR	THR	THR	THR	THR	THR	THR	THR	THR	THR	THR	THR	THR	THR	THR	THR	THR	THR	THR	THR	THR	THR	THR	THR	THR	THR	THR	THR	THR	THR	THR	THR	THR	THR	THR	THR	THR	THR
-----	-----	-----	-----	-----	-----	-----	-----	-----	-----	-----	-----	-----	-----	-----	-----	-----	-----	-----	-----	-----	-----	-----	-----	-----	-----	-----	-----	-----	-----	-----	-----	-----	-----	-----	-----	-----	-----	-----	-----	-----	-----	-----	-----	-----	-----	-----	-----	-----

GLY	GLY	LYS	VAL	THR	THR	VAL	SER	GLU	SER	ILE	VAL	GLN	ARG	TYR	ASN	PRO	LEU	ALA	ILE	ILE	ILE	TYR	PRO	THR	THR	ARG	LYS	ILE	ALA	GLN	ASP	LEU	GLN	VAL	ALA	GLU	TRP	GLY	ASN	LEU	GLN	VAL	GLN	THR	VAL	ASN	ASN	ALA	ASN	PHE	VAL	GLU	ASP	PHE	PHE	SER	SER	ASP	VAL	VAL	ARG
-----	-----	-----	-----	-----	-----	-----	-----	-----	-----	-----	-----	-----	-----	-----	-----	-----	-----	-----	-----	-----	-----	-----	-----	-----	-----	-----	-----	-----	-----	-----	-----	-----	-----	-----	-----	-----	-----	-----	-----	-----	-----	-----	-----	-----	-----	-----	-----	-----	-----	-----	-----	-----	-----	-----	-----	-----	-----	-----	-----	-----	-----

ALA	PHE	CYS	ASP	SER	GLU	SER	LYS	PHE	HIS	GLN	TYR	PHE	SER	ASN	ALA	PHE	GLY	LEU
-----	-----	-----	-----	-----	-----	-----	-----	-----	-----	-----	-----	-----	-----	-----	-----	-----	-----	-----

• Molecule 17: CFAP182A

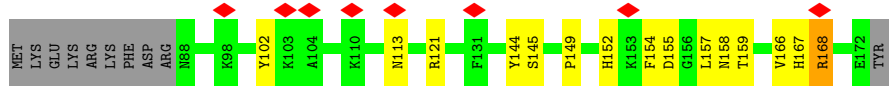
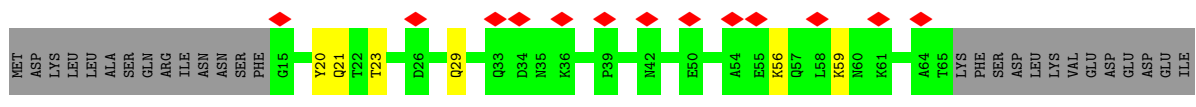

• Molecule 18: CFAP143

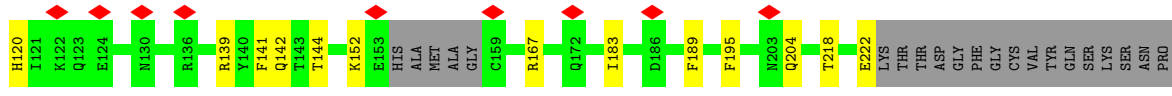
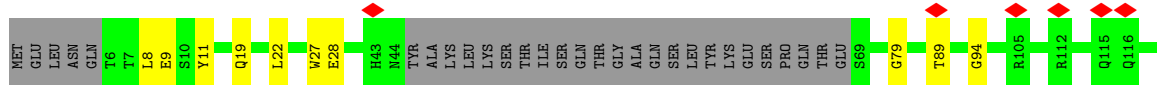

ASN	ASP	PRO	LYS	SER	THR	PHE	LYS	LEU	ASN	ASN	GLN	PHE	LEU	LYS	THR	THR	HIS	ASP	TYR	SER	HIS	HIS	VAL	ARG	LYS
-----	-----	-----	-----	-----	-----	-----	-----	-----	-----	-----	-----	-----	-----	-----	-----	-----	-----	-----	-----	-----	-----	-----	-----	-----	-----

• Molecule 19: CFAP21A



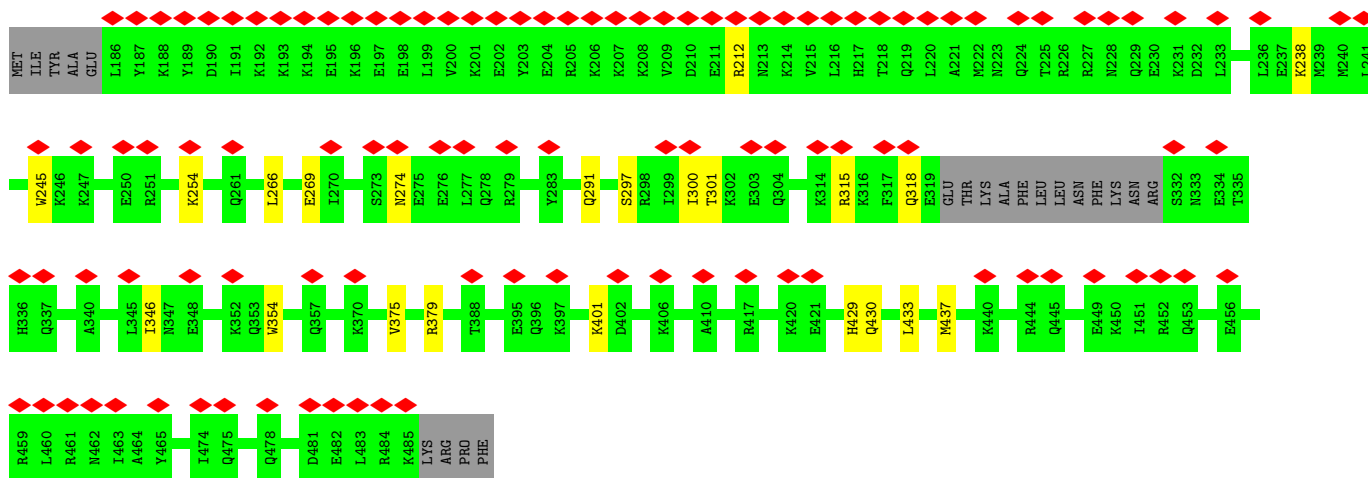

• Molecule 21: CFAP115

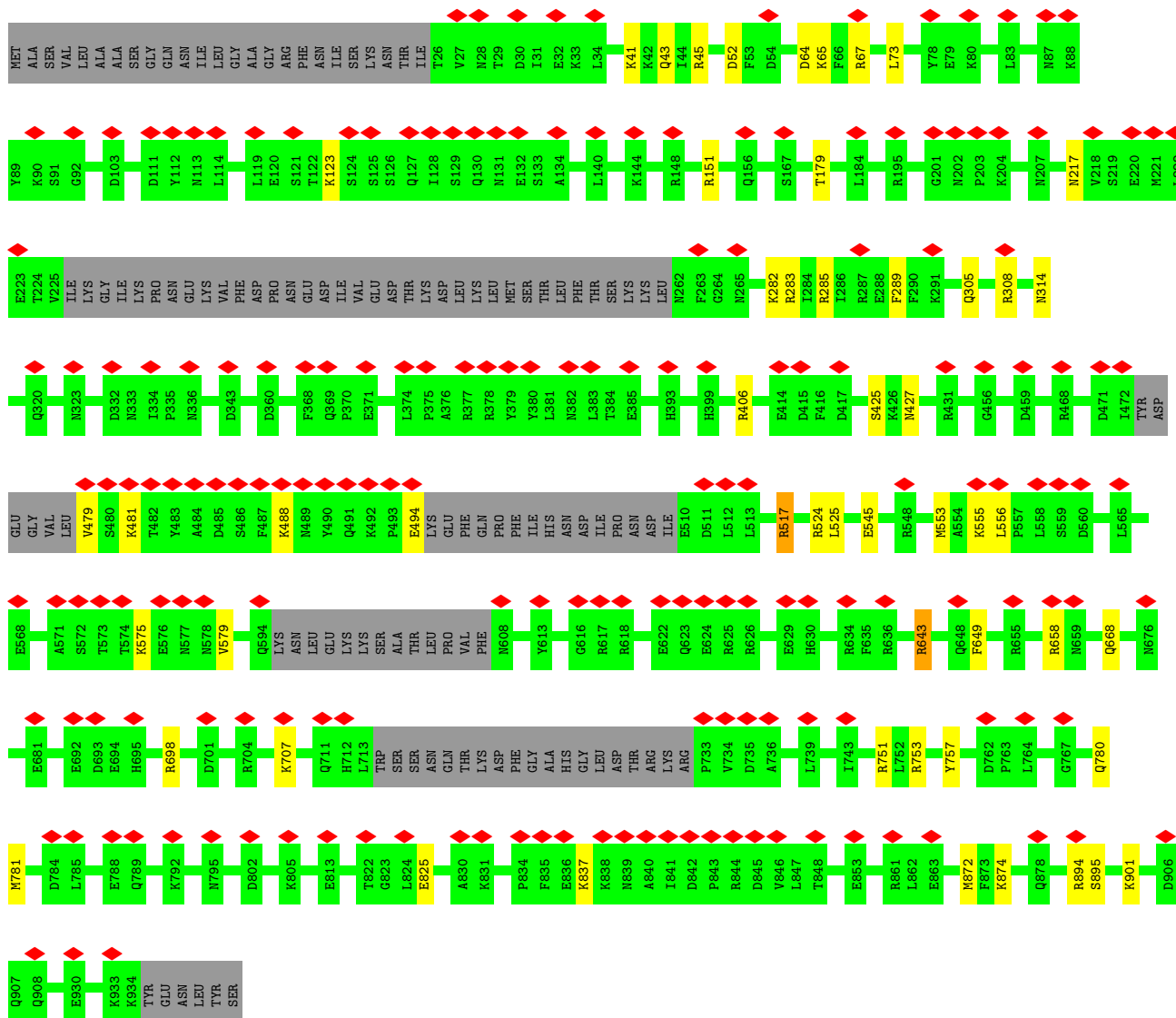
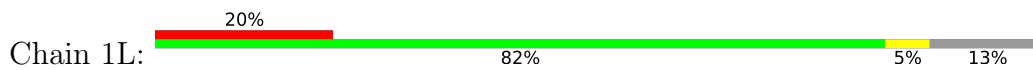







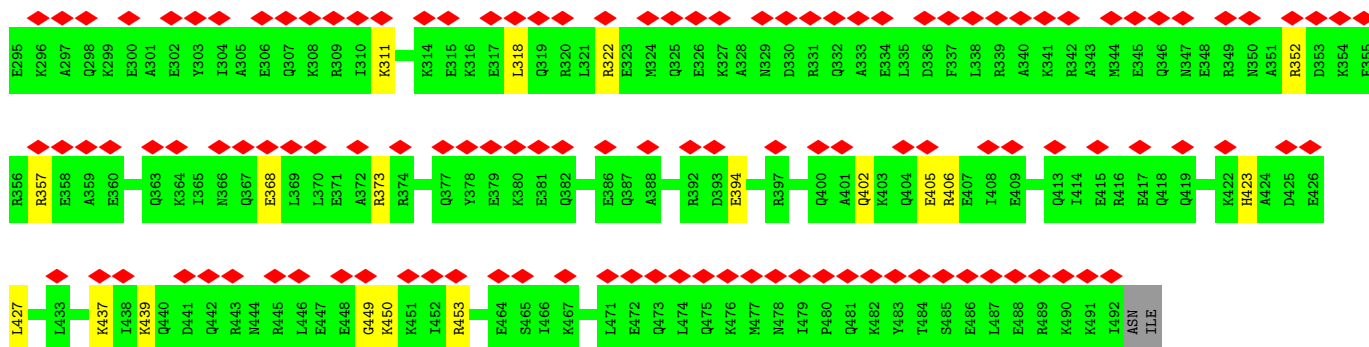

• Molecule 23: Cilia- and flagella-associated protein 45

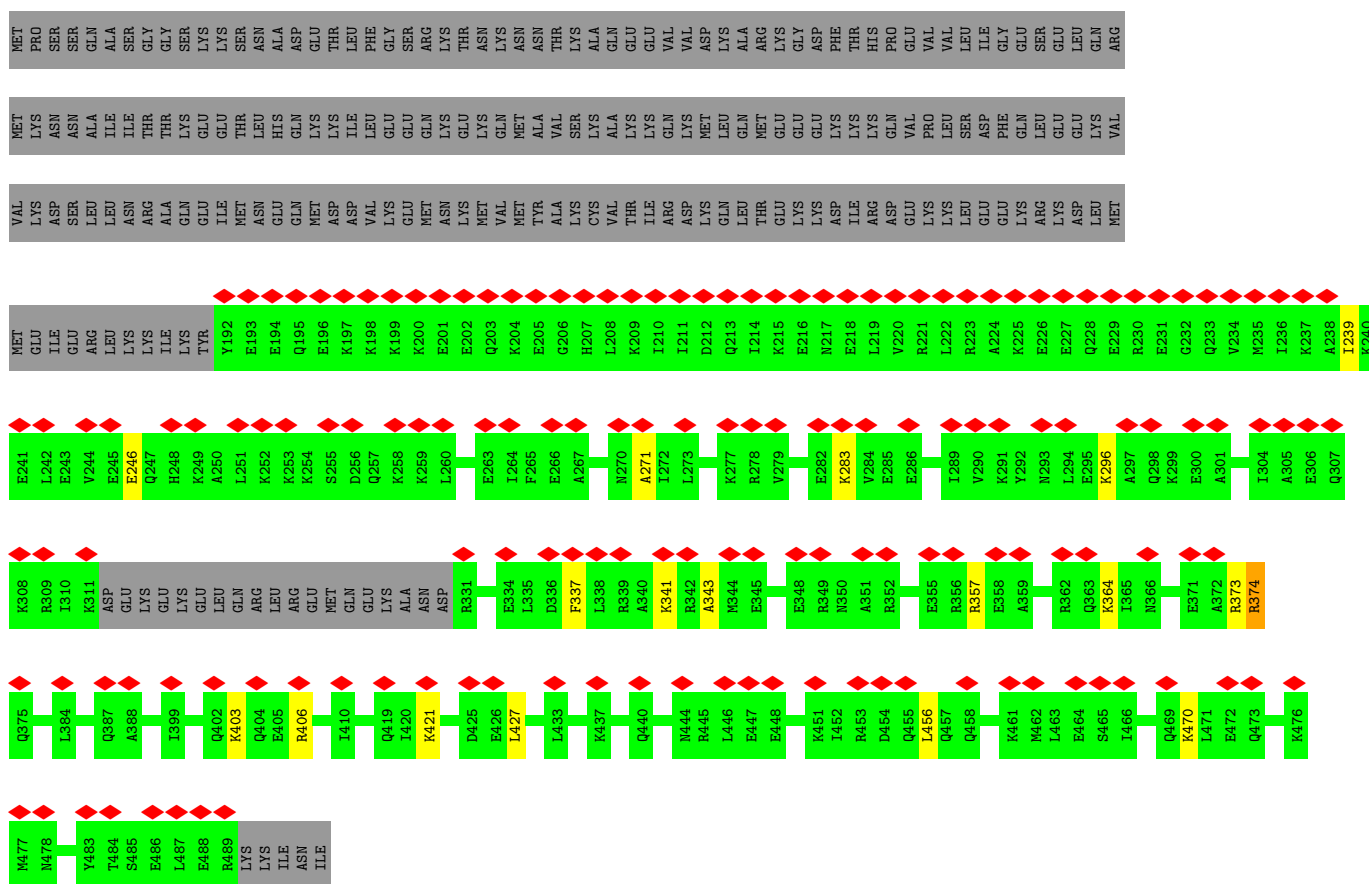

• Molecule 24: CFAP210

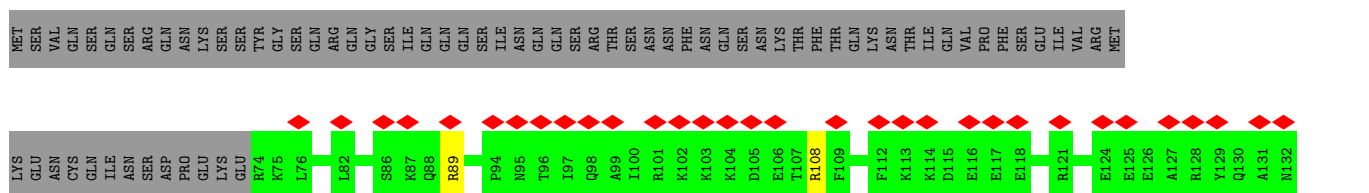

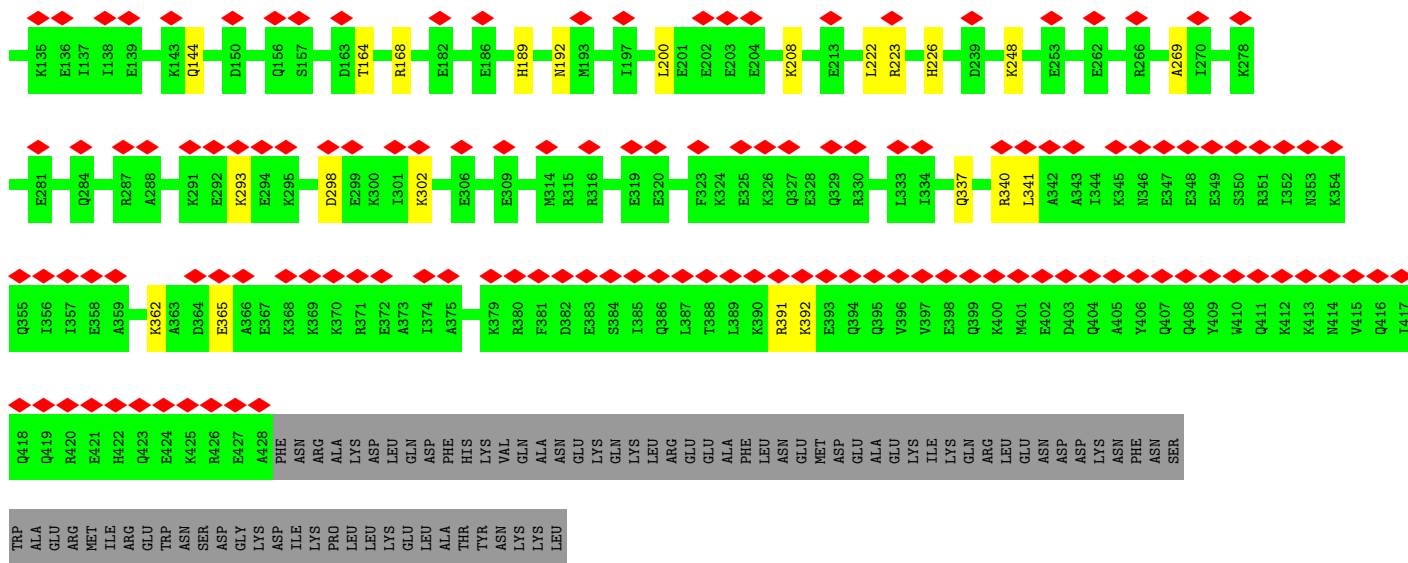

• Molecule 24: CFAP210

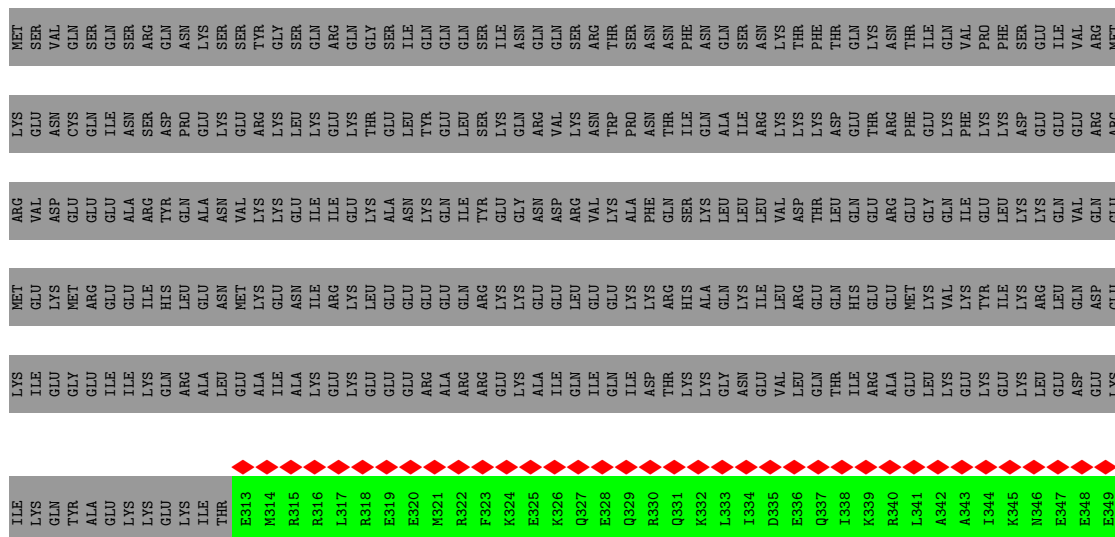

• Molecule 25: RIB72B

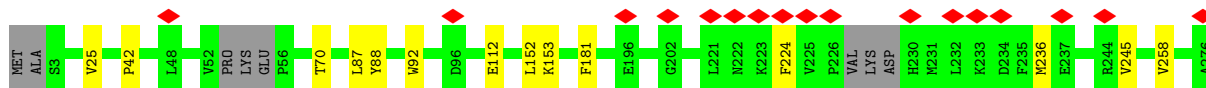



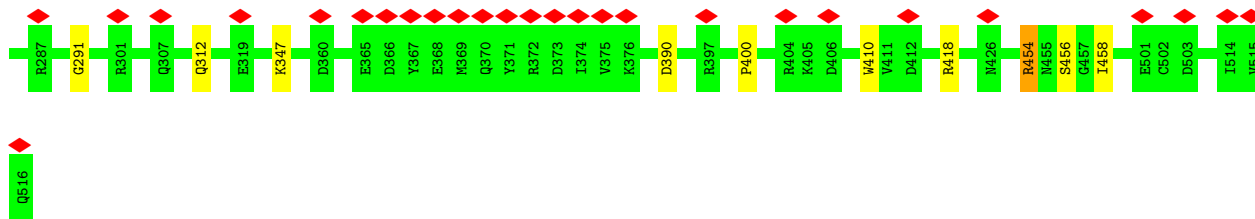

• Molecule 25: RIB72B

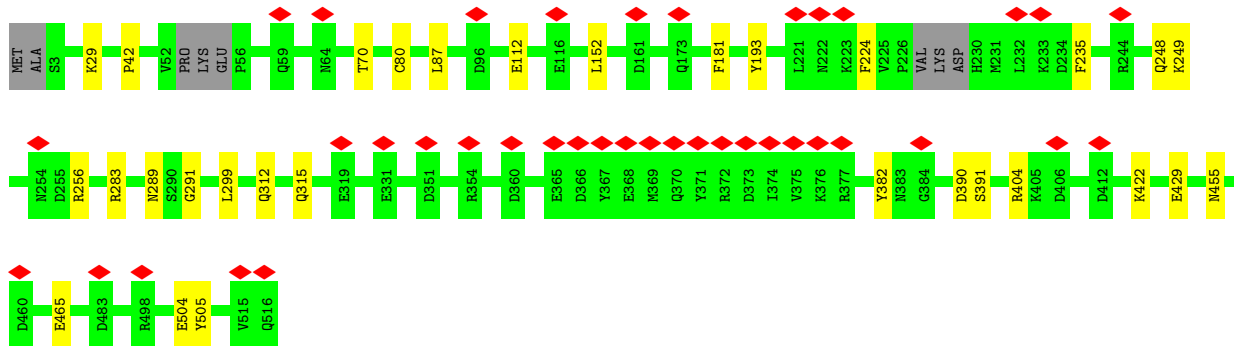

• Molecule 25: RIB72B

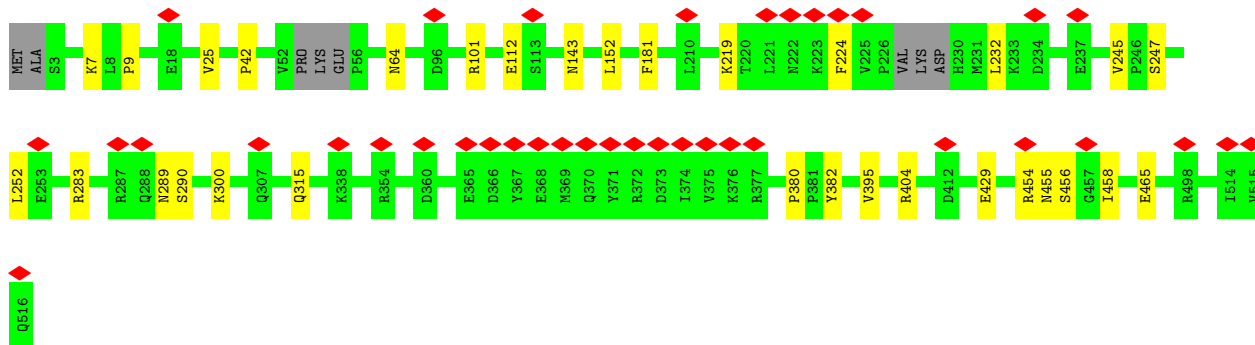

• Molecule 26: Protofilament ribbon protein

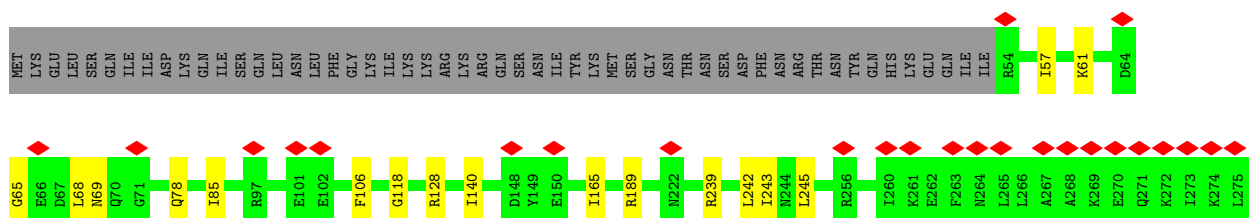
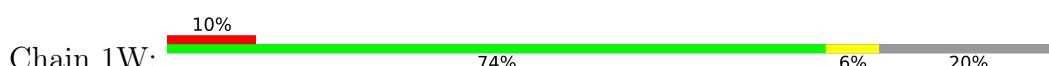

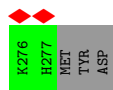

Molecule 26: Protofilament ribbon protein

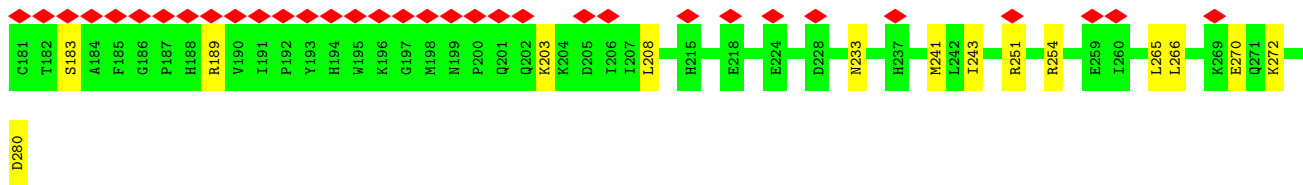
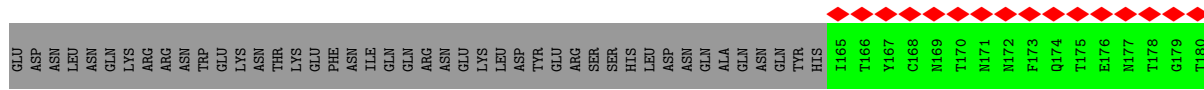
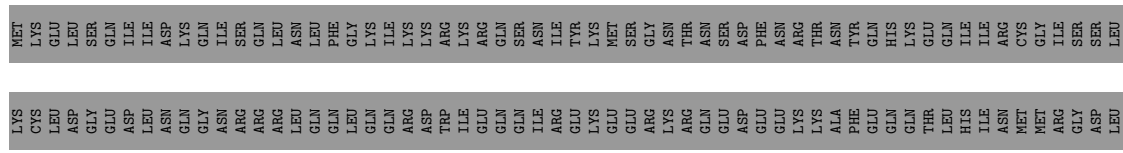
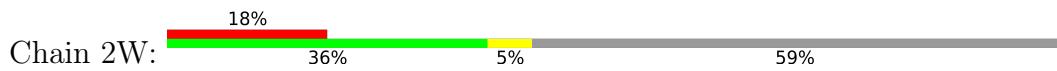

Molecule 27: RIB35

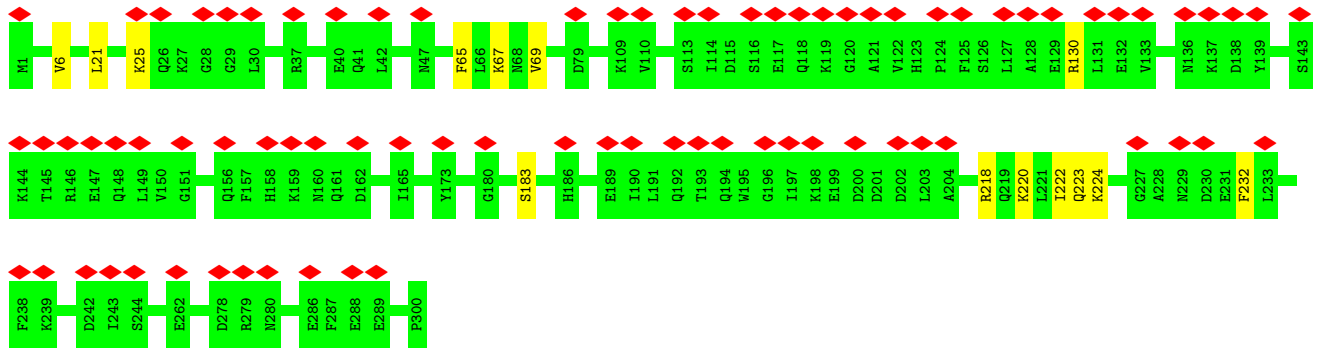

Molecule 27: RIB35

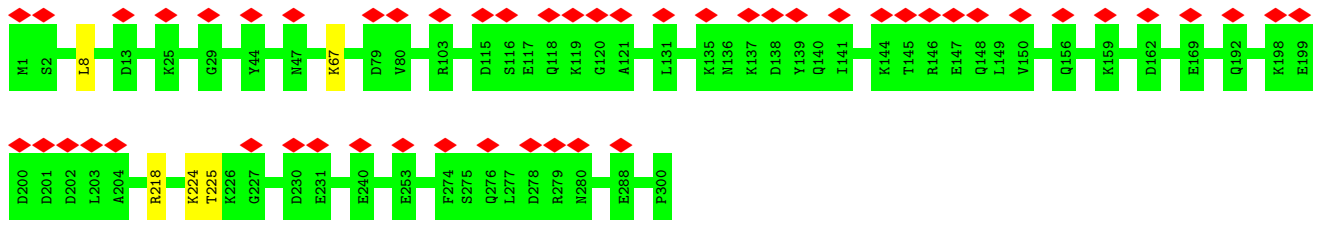

Molecule 27: RIB35





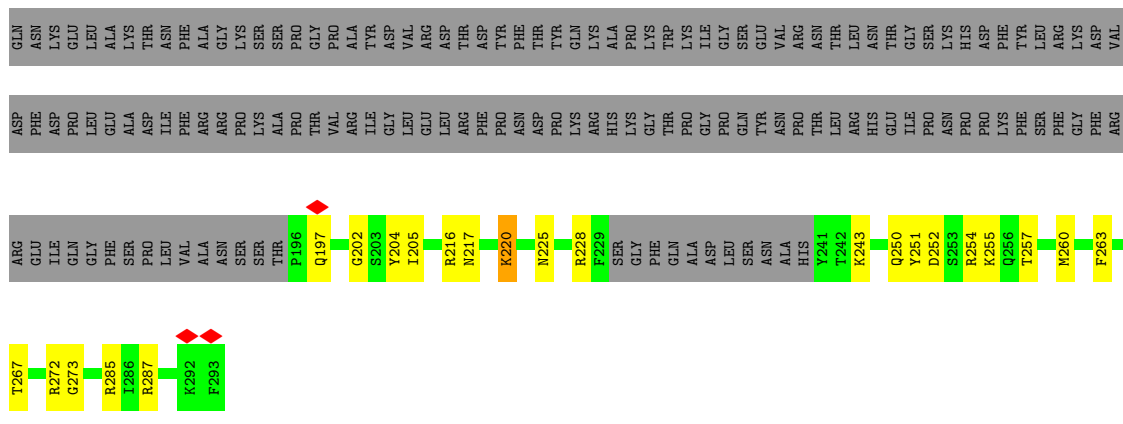

• Molecule 32: RIB26

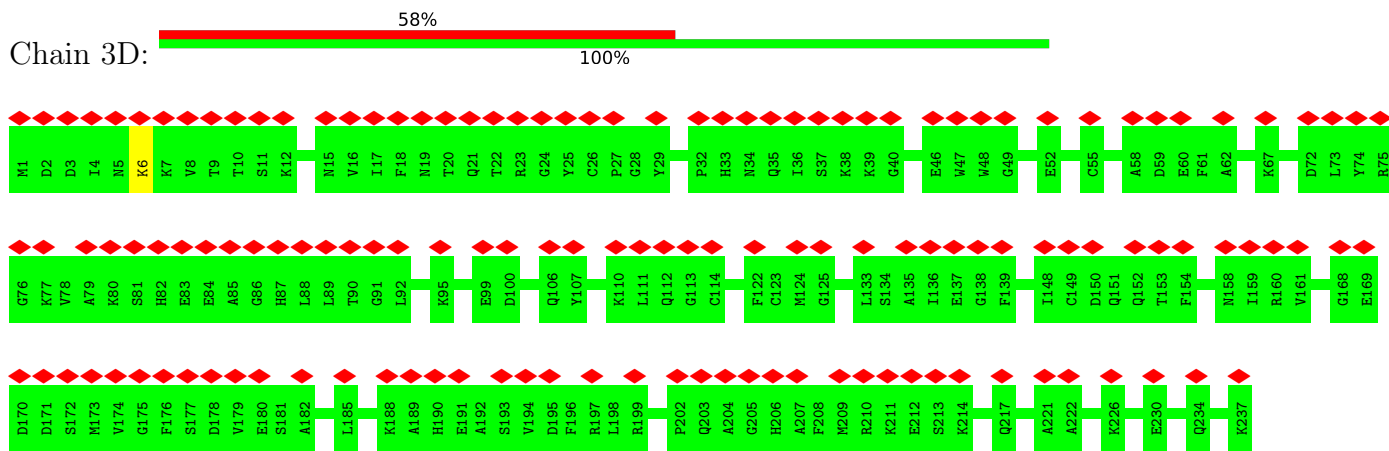

• Molecule 33: CFAP129

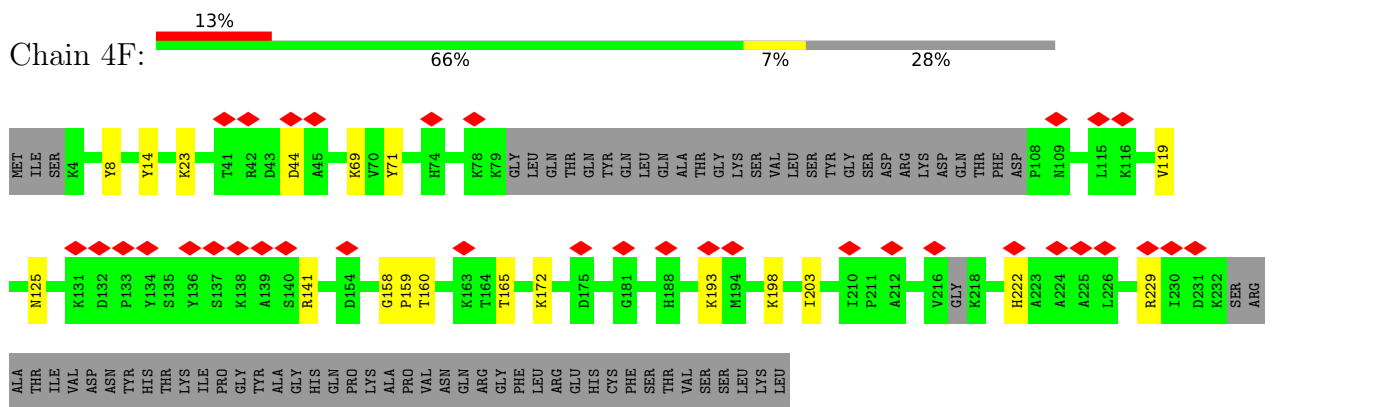

• Molecule 34: Flagellar microtubule protofilament ribbon protein

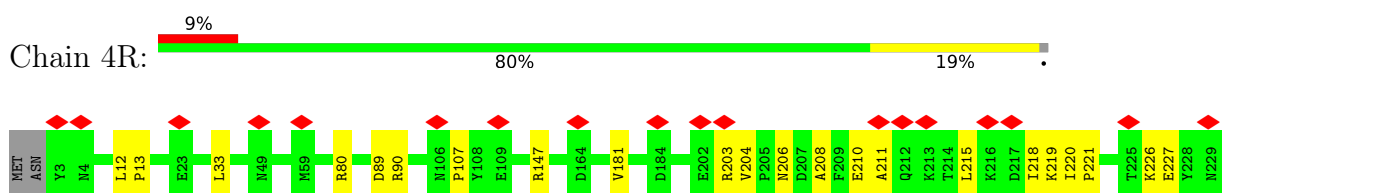

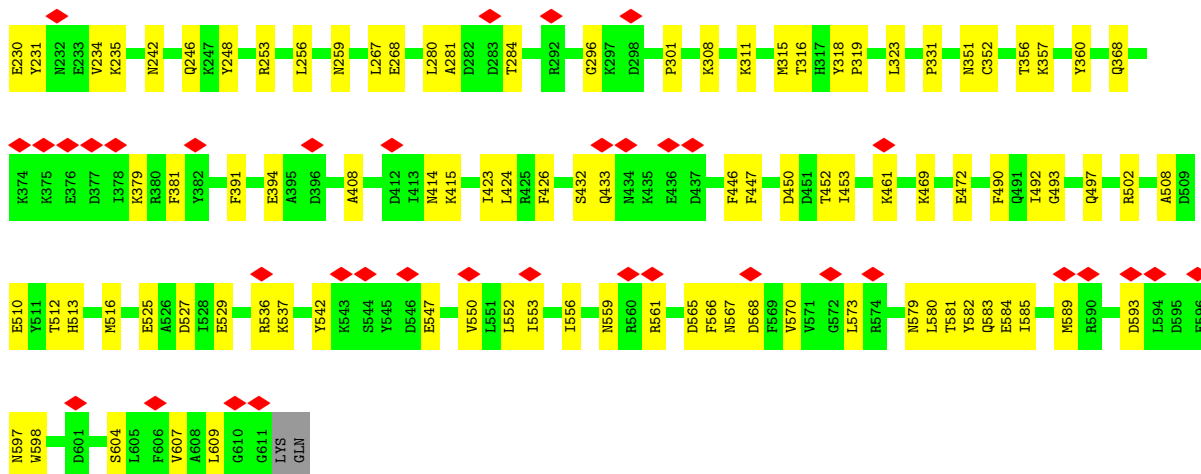

• Molecule 34: Flagellar microtubule protofilament ribbon protein

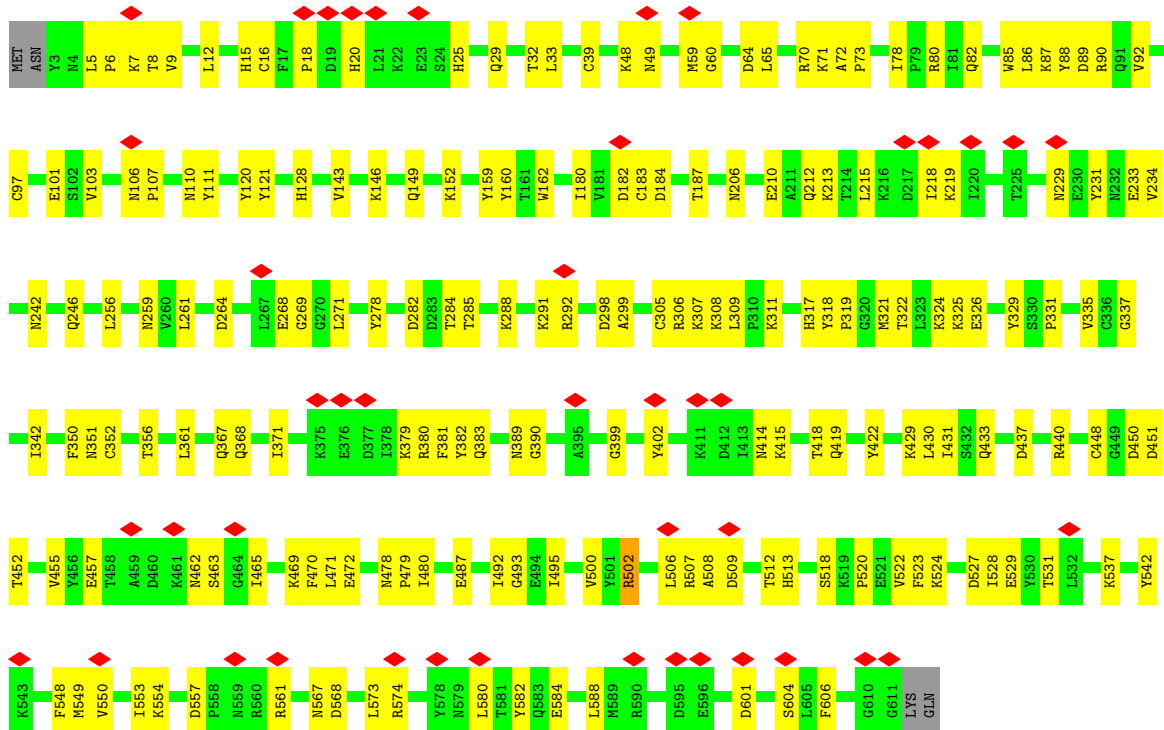

• Molecule 34: Flagellar microtubule protofilament ribbon protein

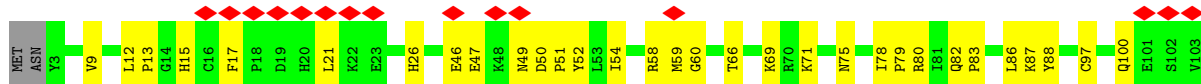
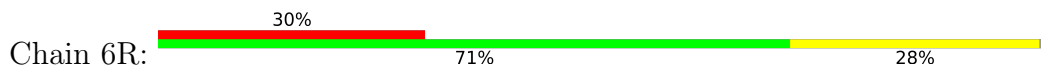

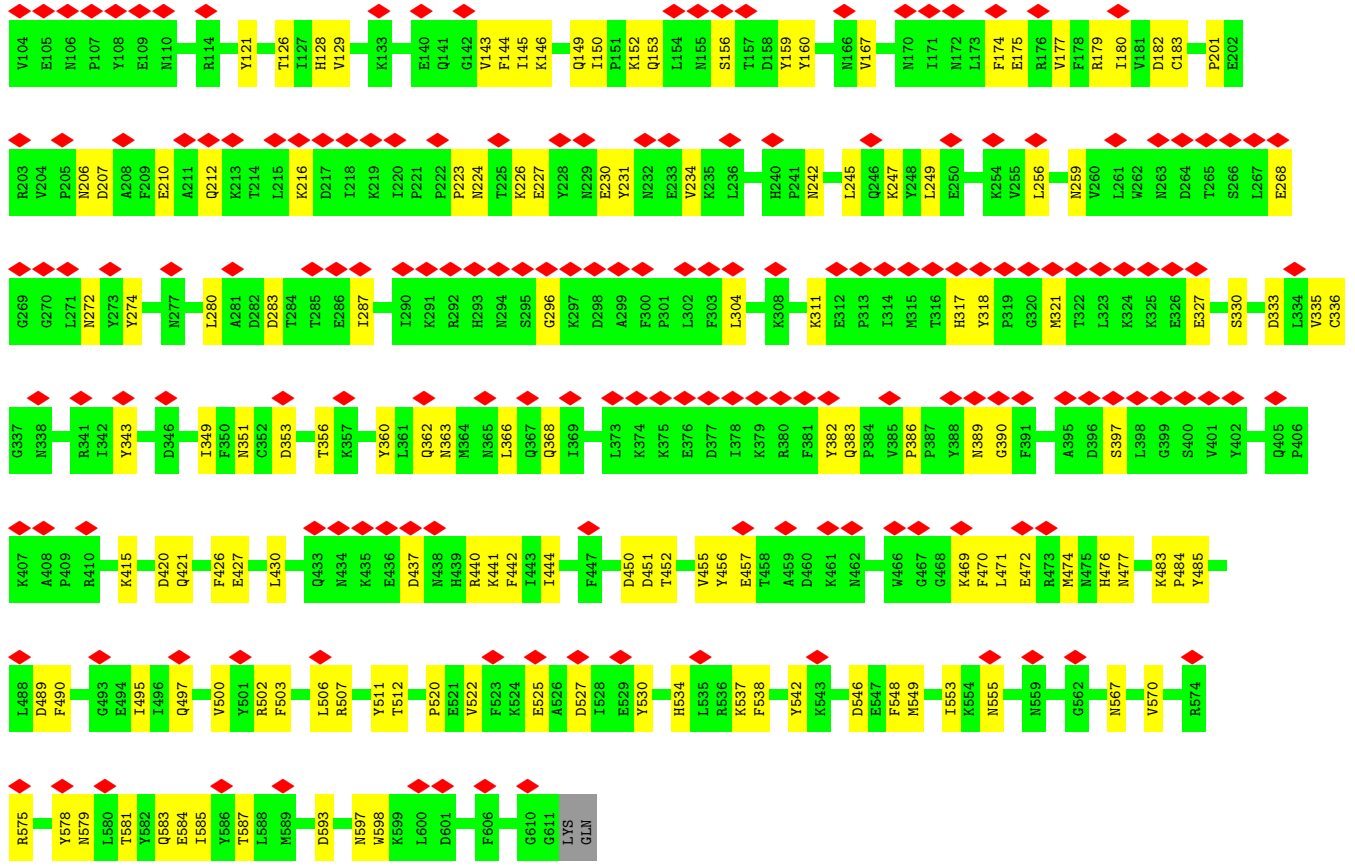

• Molecule 34: Flagellar microtubule protofilament ribbon protein

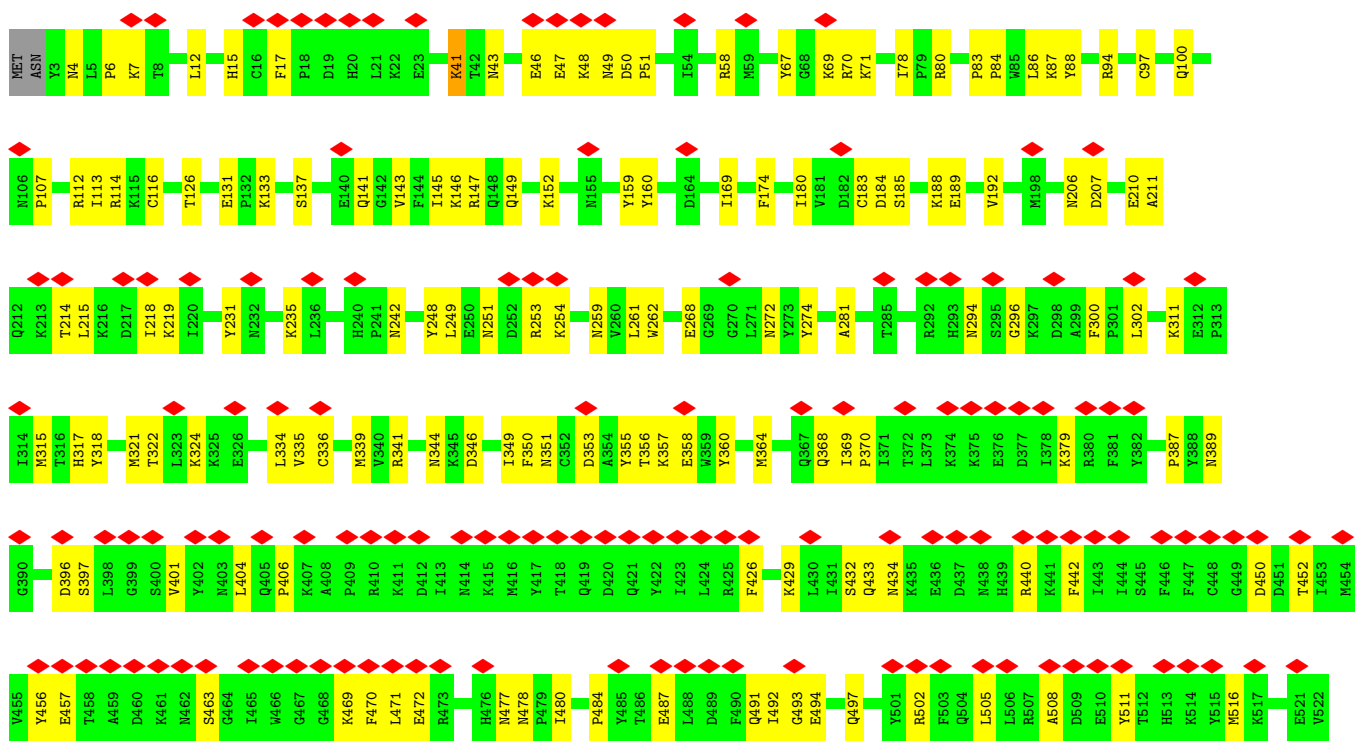

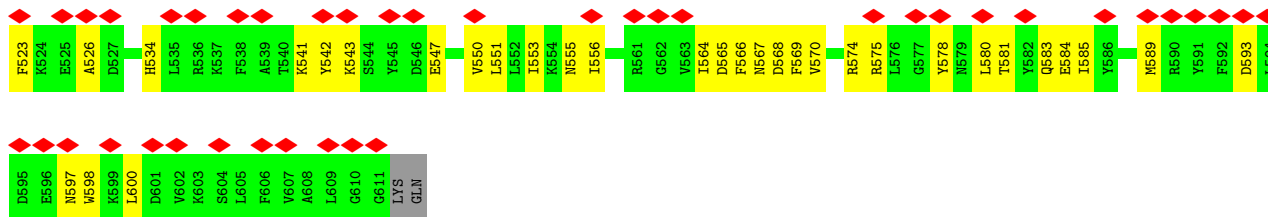

• Molecule 35: Parkin co-regulated protein PACRGB

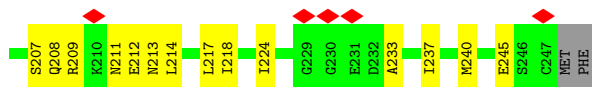
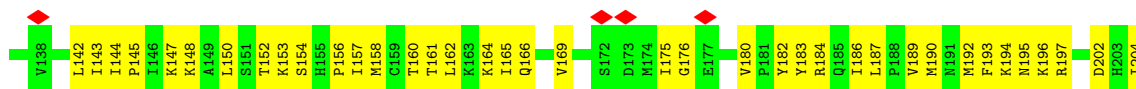
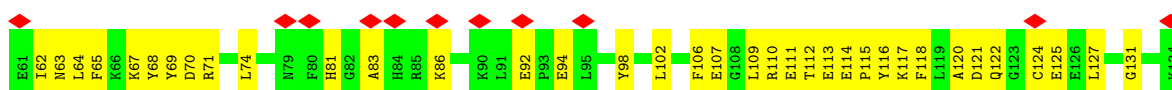

• Molecule 35: Parkin co-regulated protein PACRGB

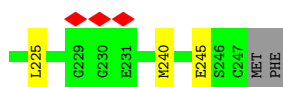
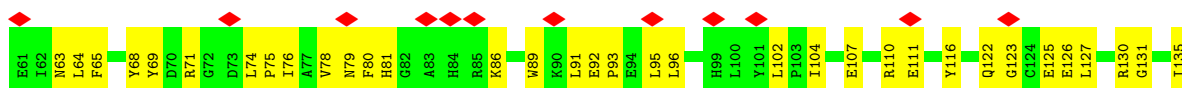
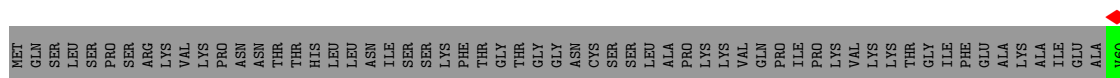

• Molecule 36: OJ2

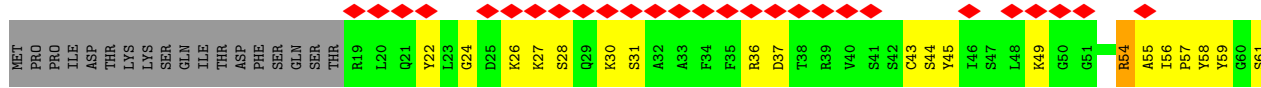



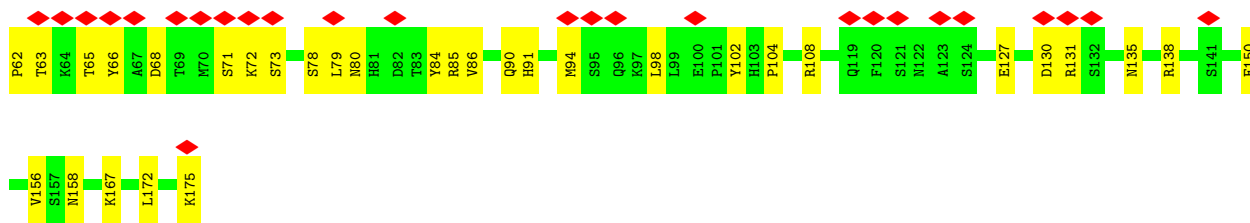

• Molecule 36: OJ2

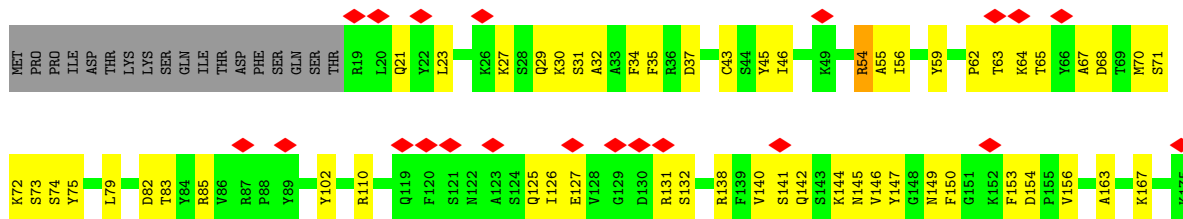

• Molecule 36: OJ2

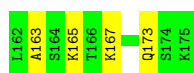
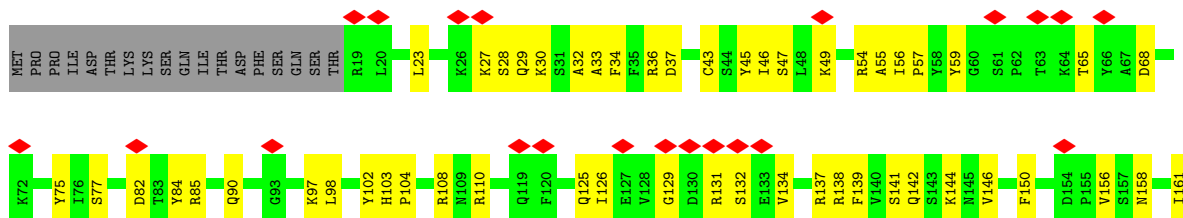

• Molecule 36: OJ2

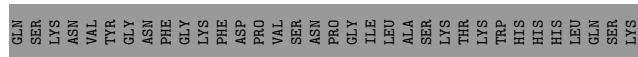
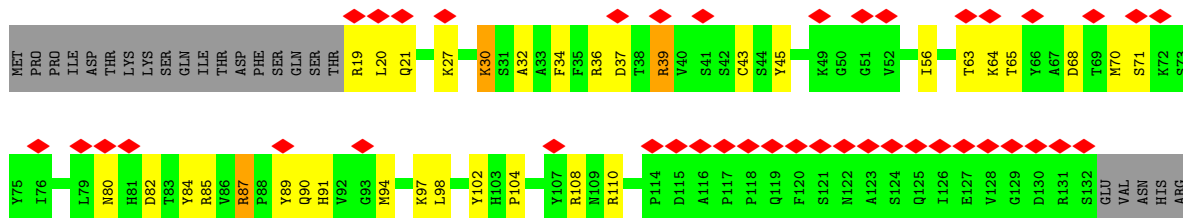

• Molecule 37: CFAP77A



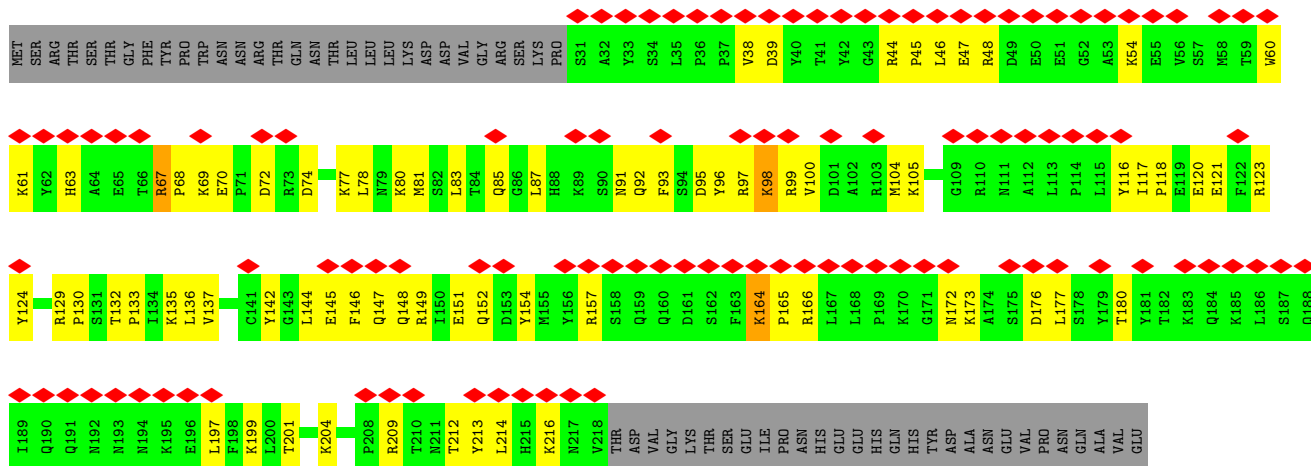

• Molecule 37: CFAP77A

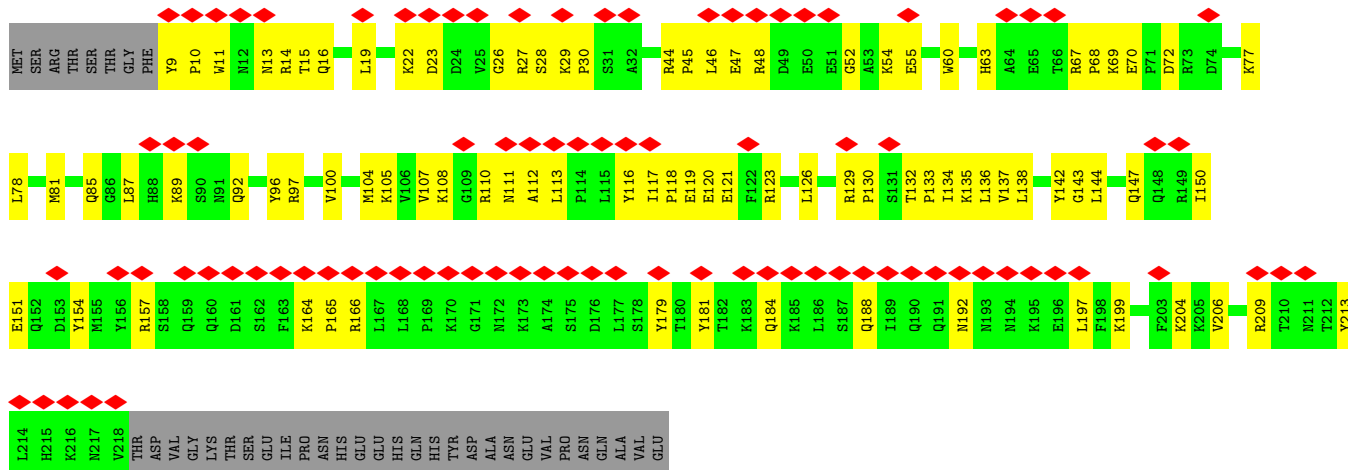

• Molecule 37: CFAP77A

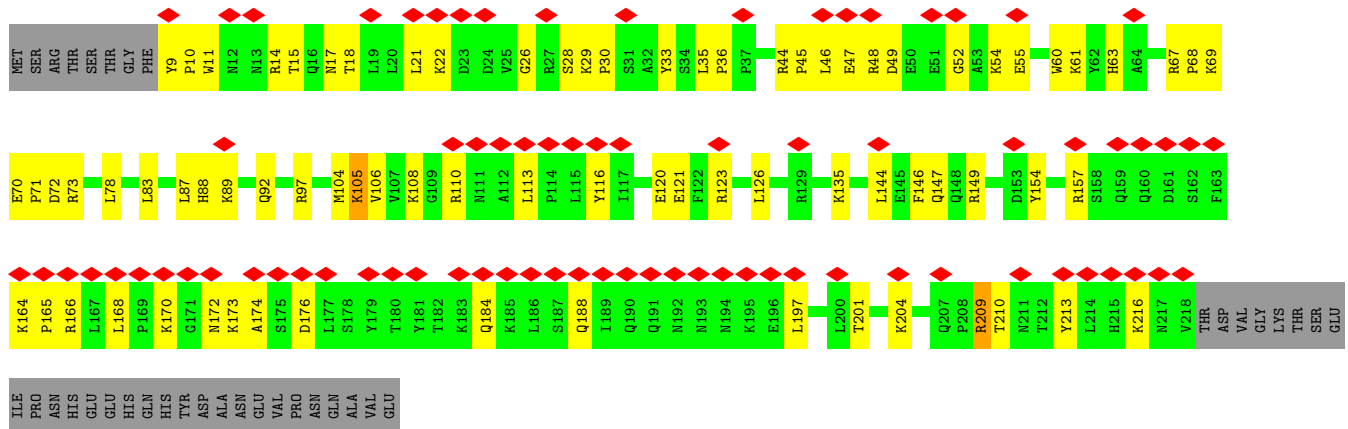



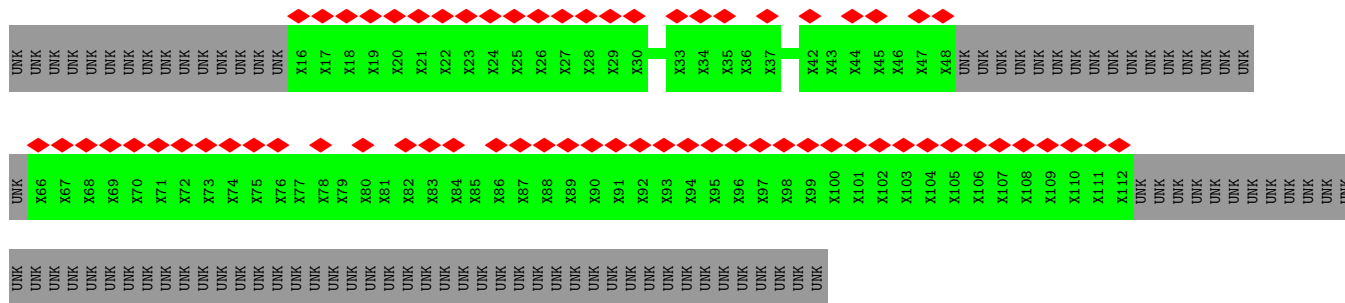

• Molecule 39: SB1

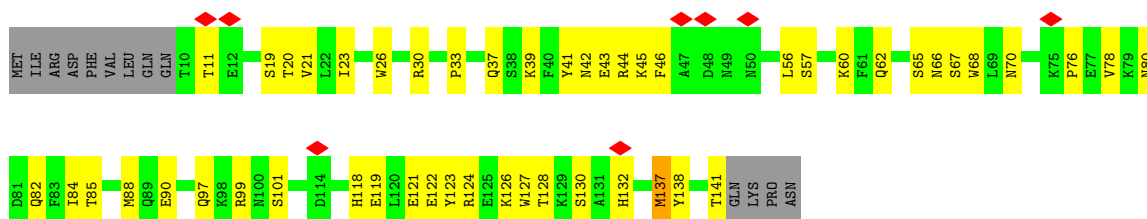

• Molecule 40: STPG1A

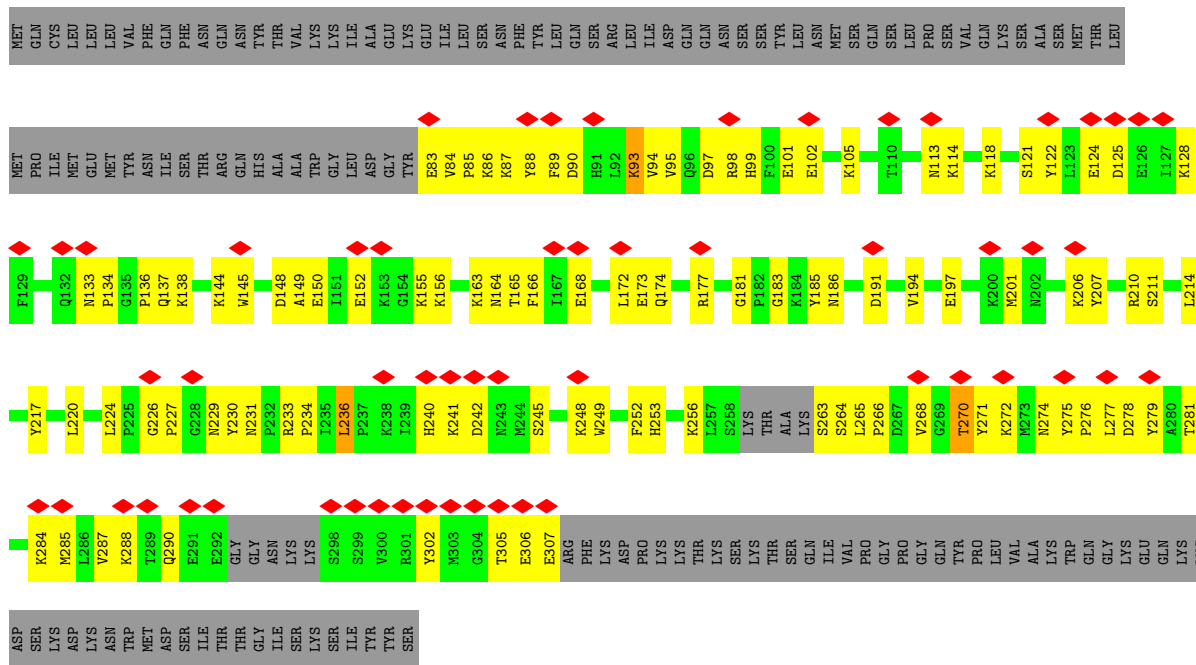
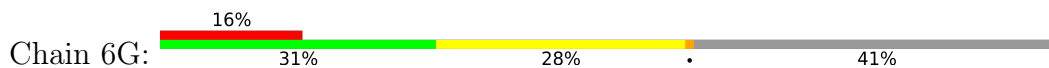

• Molecule 41: Nebulin

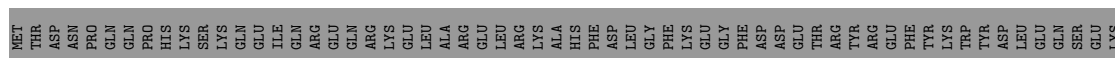

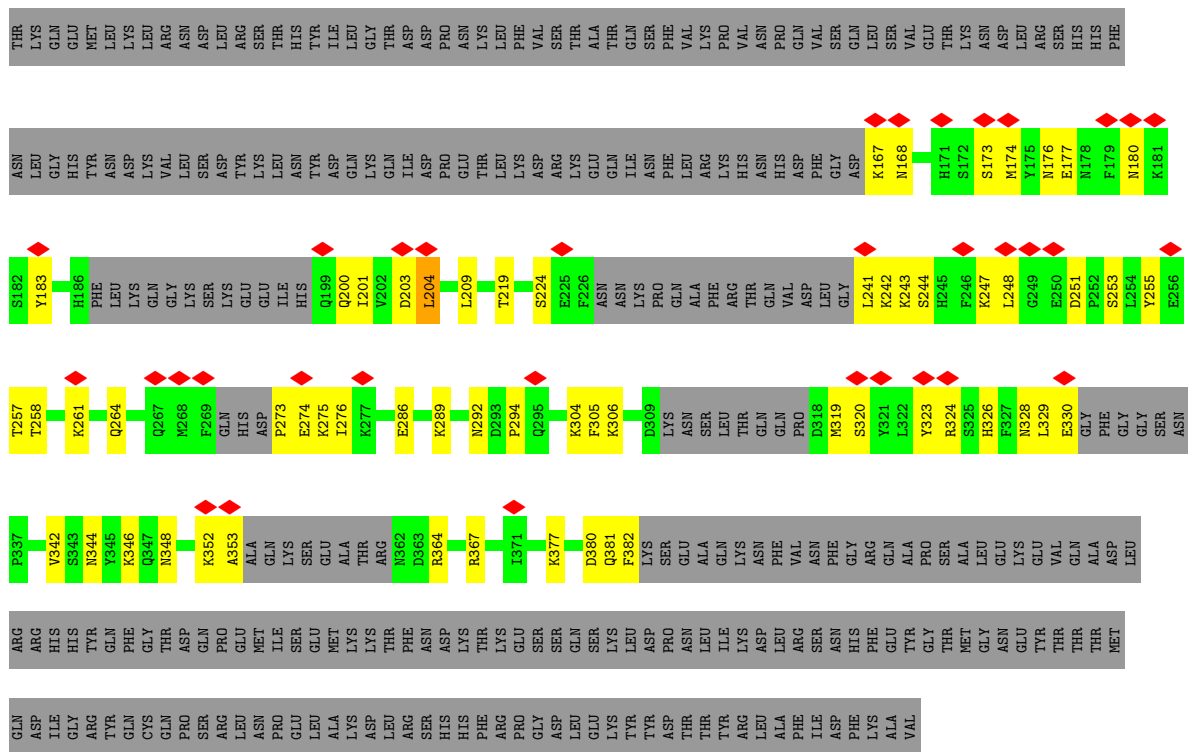

• Molecule 42: B5B6\_fMIP

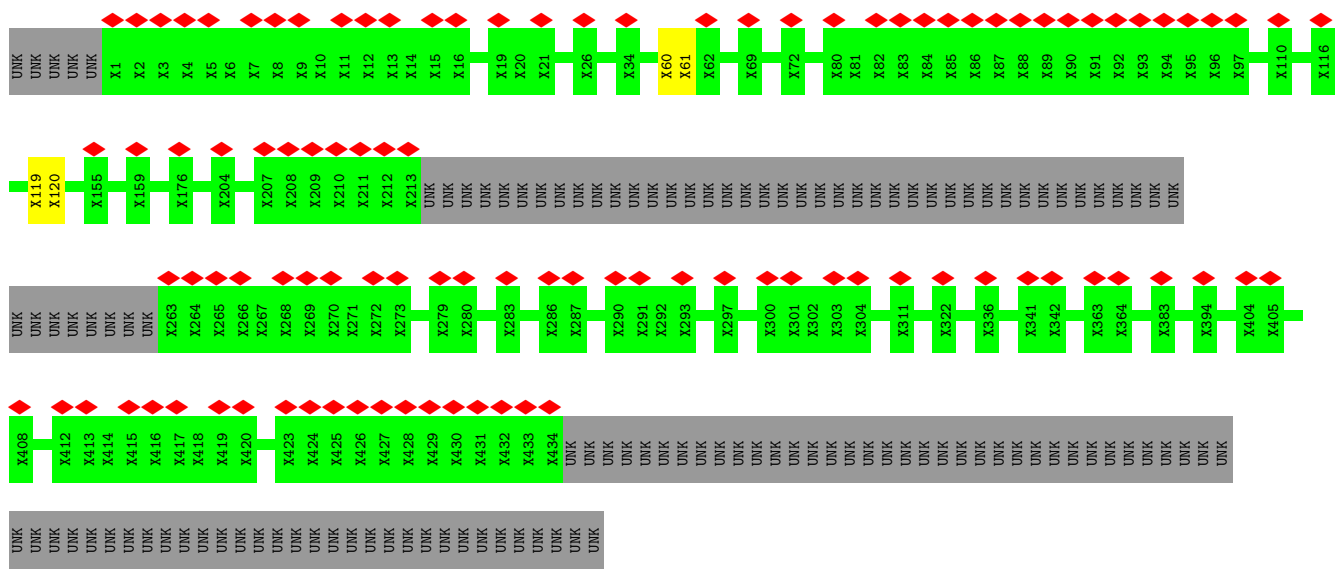
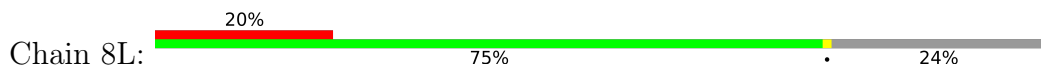

• Molecule 42: B5B6\_fMIP

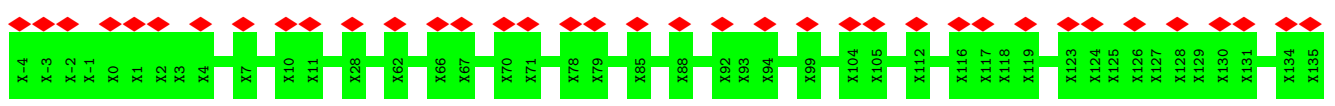
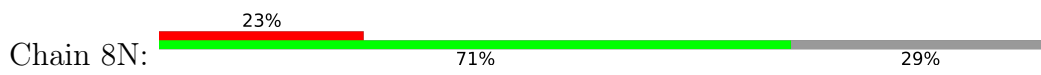

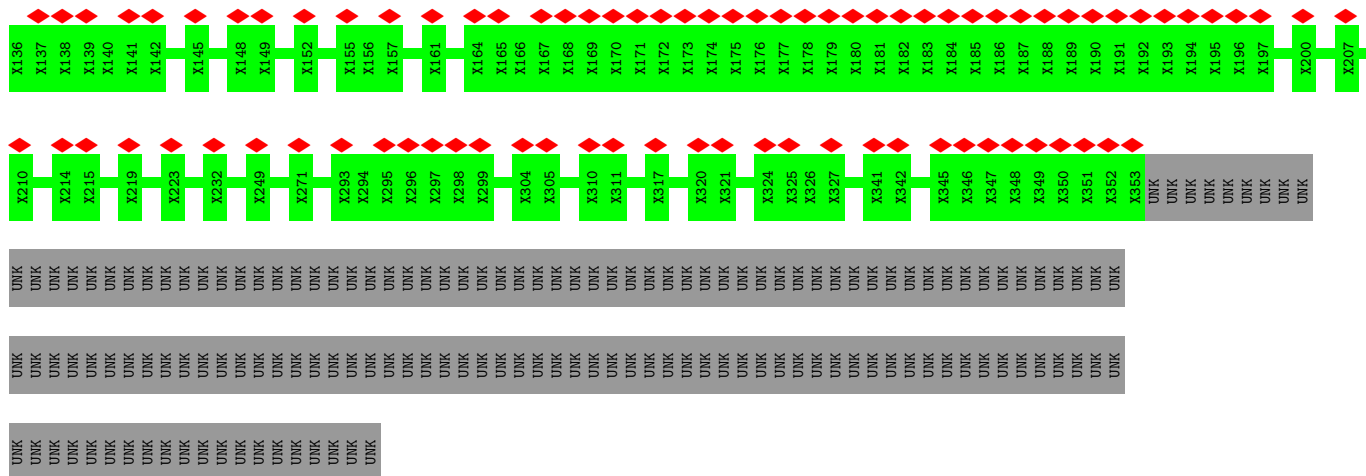

• Molecule 43: CFAP112A

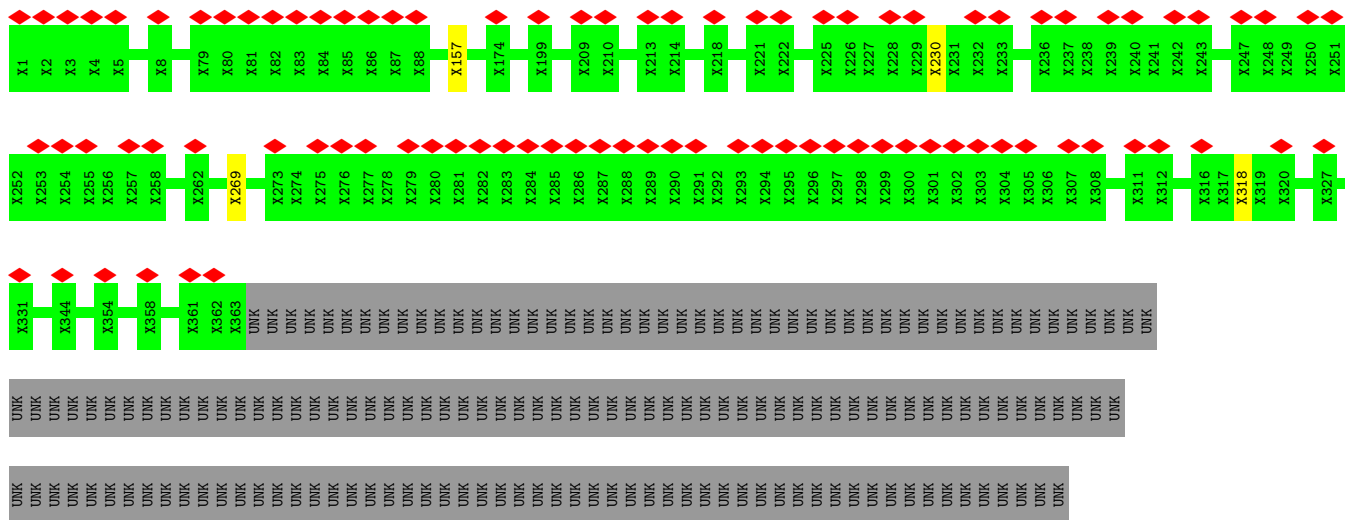

• Molecule 44: B2B3\_fmIP

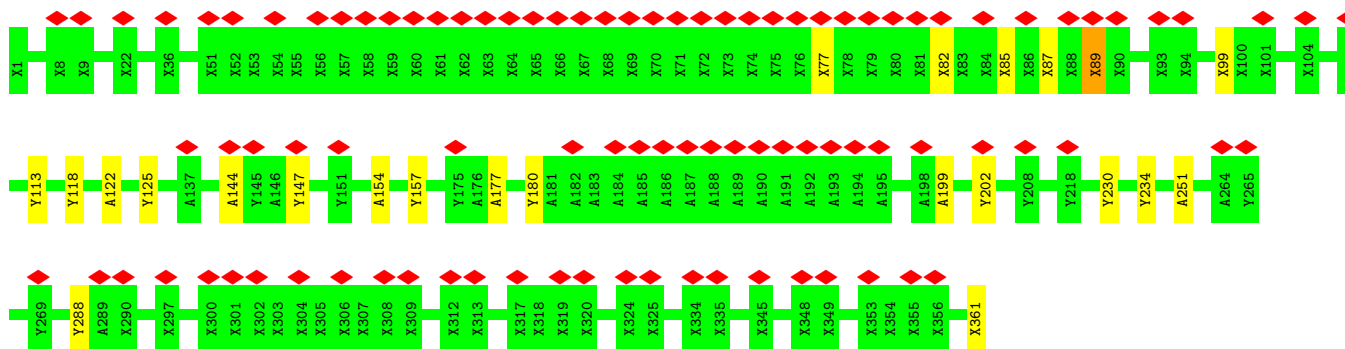

• Molecule 45: Tubulin alpha chain

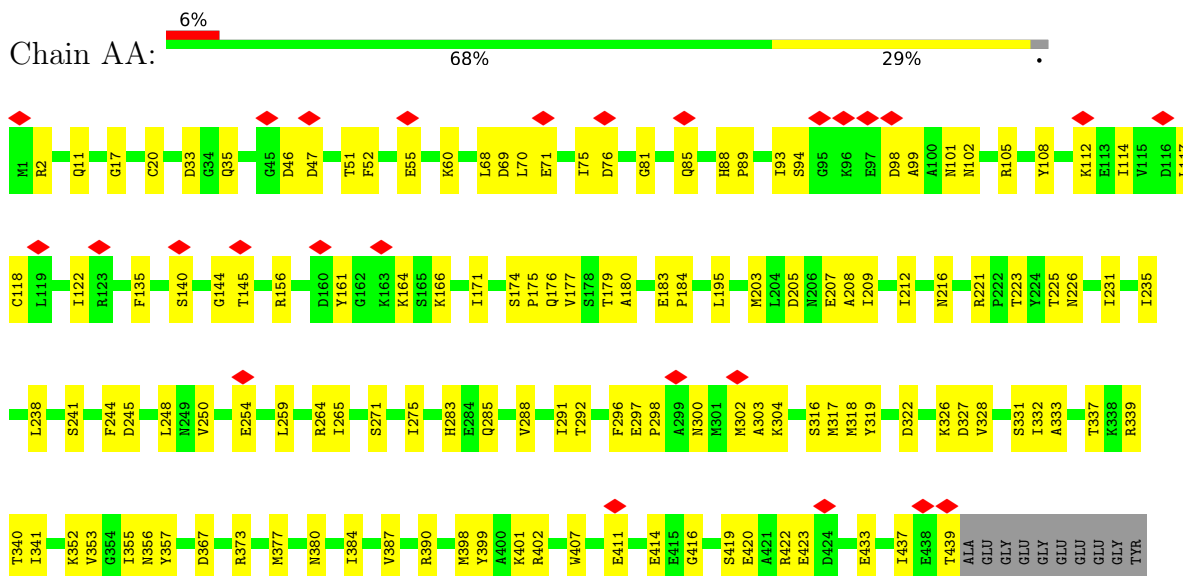

• Molecule 45: Tubulin alpha chain

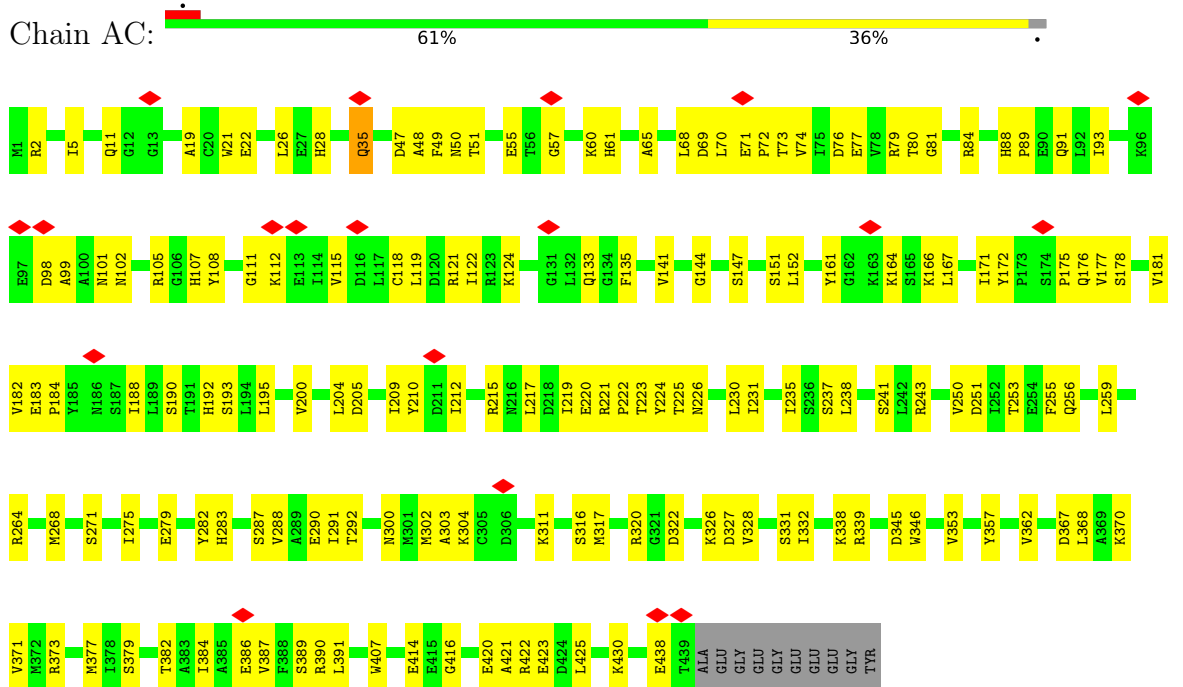

• Molecule 45: Tubulin alpha chain

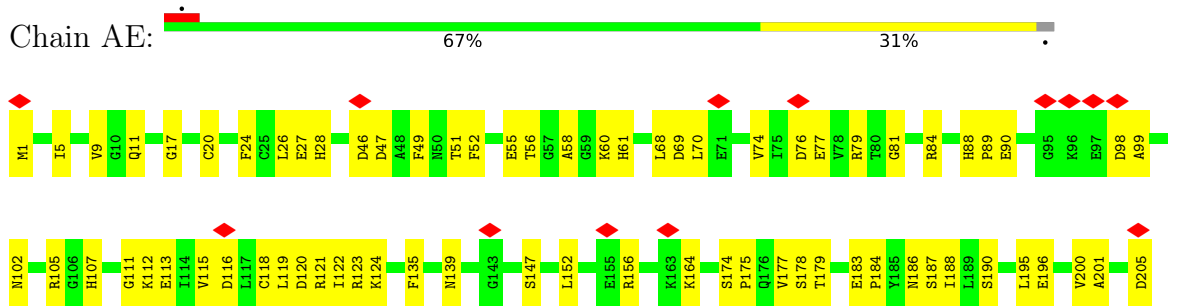

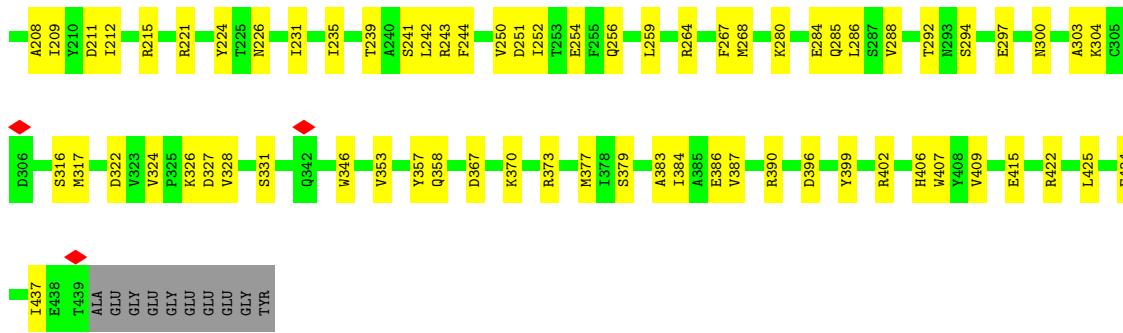

• Molecule 45: Tubulin alpha chain

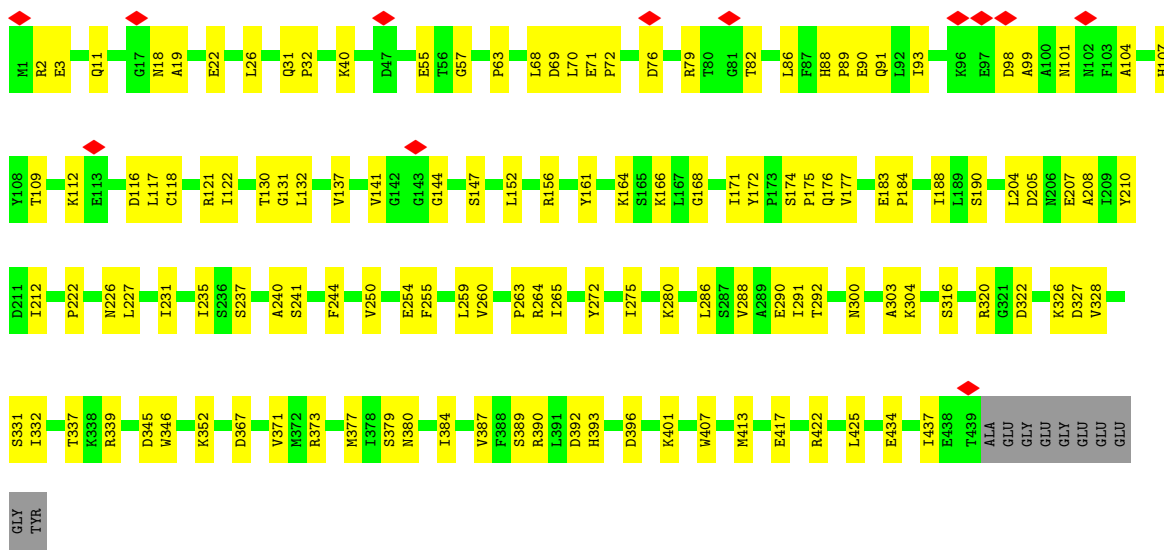

• Molecule 45: Tubulin alpha chain

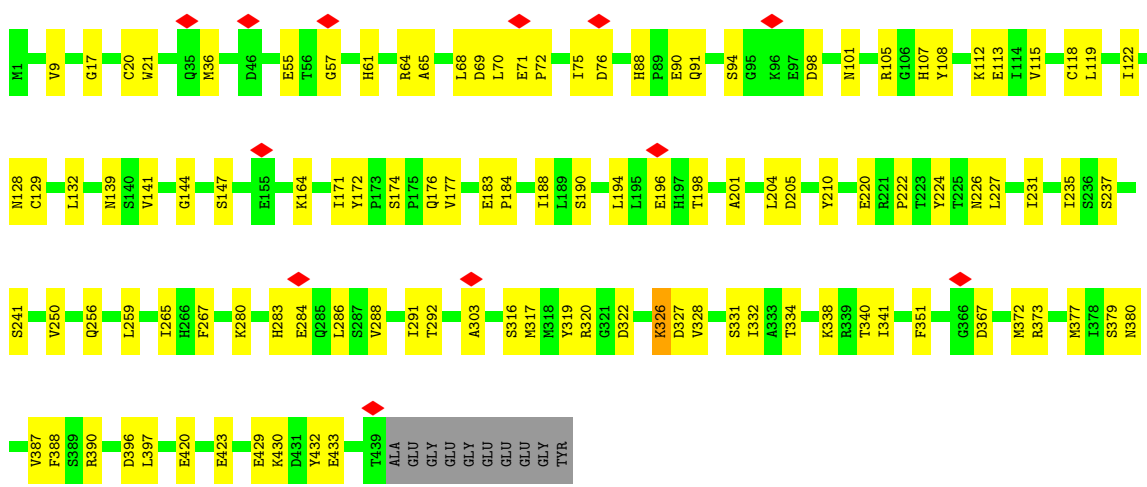
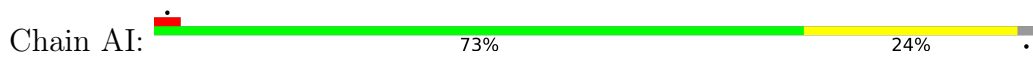

• Molecule 45: Tubulin alpha chain



Chain AK:

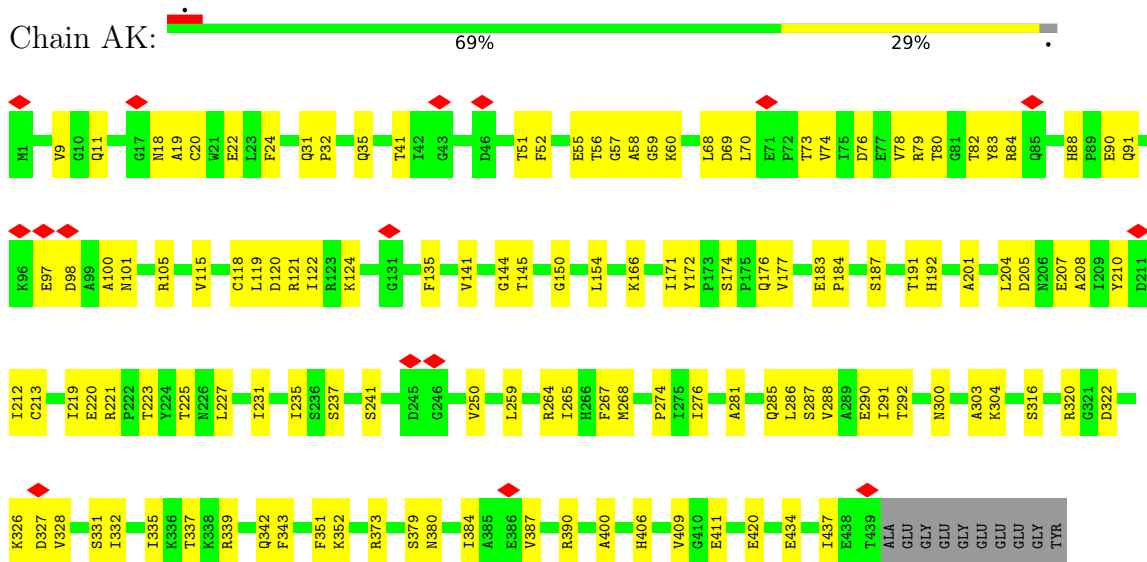

• Molecule 45: Tubulin alpha chain

Chain AM:

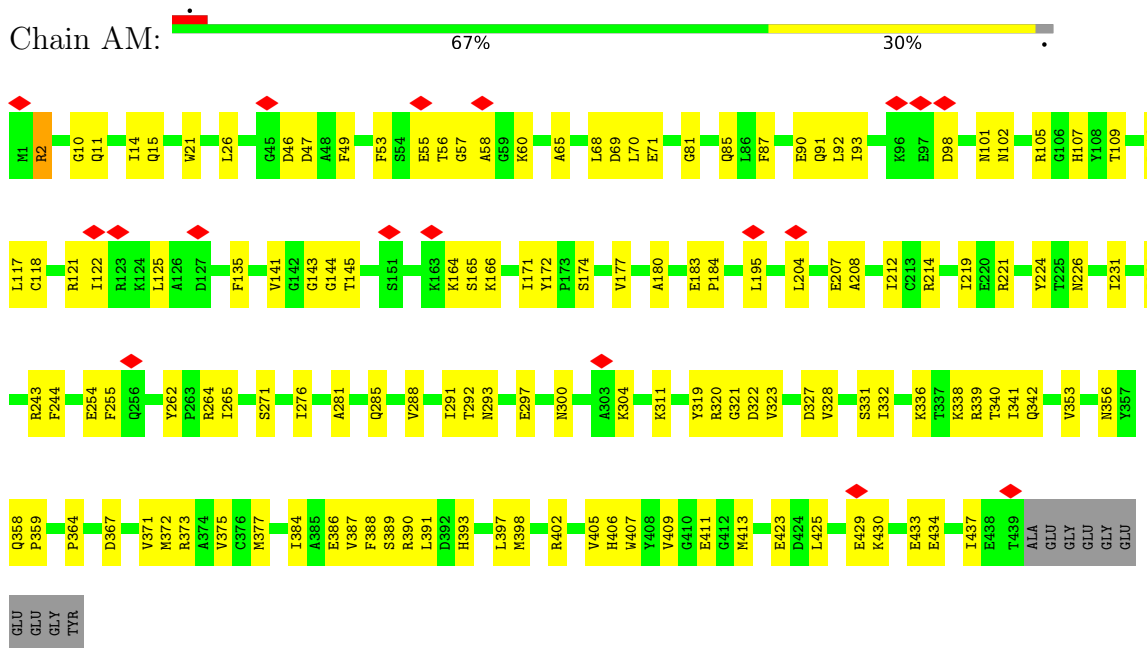

• Molecule 45: Tubulin alpha chain

Chain BA:

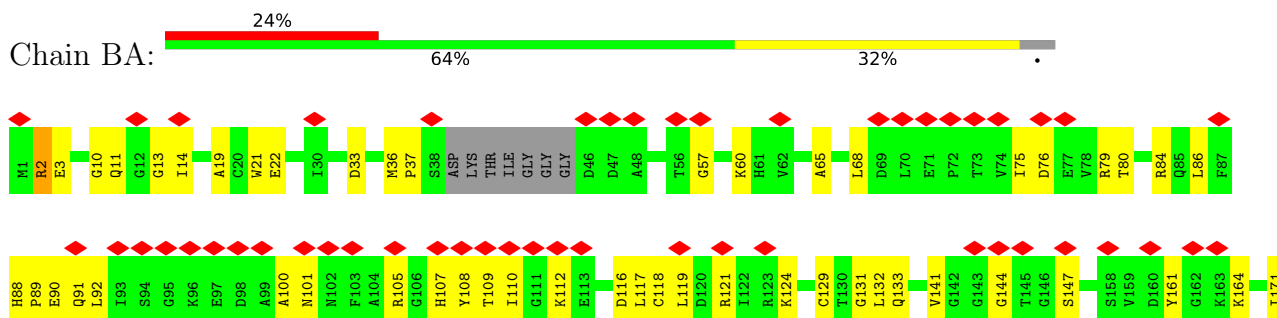

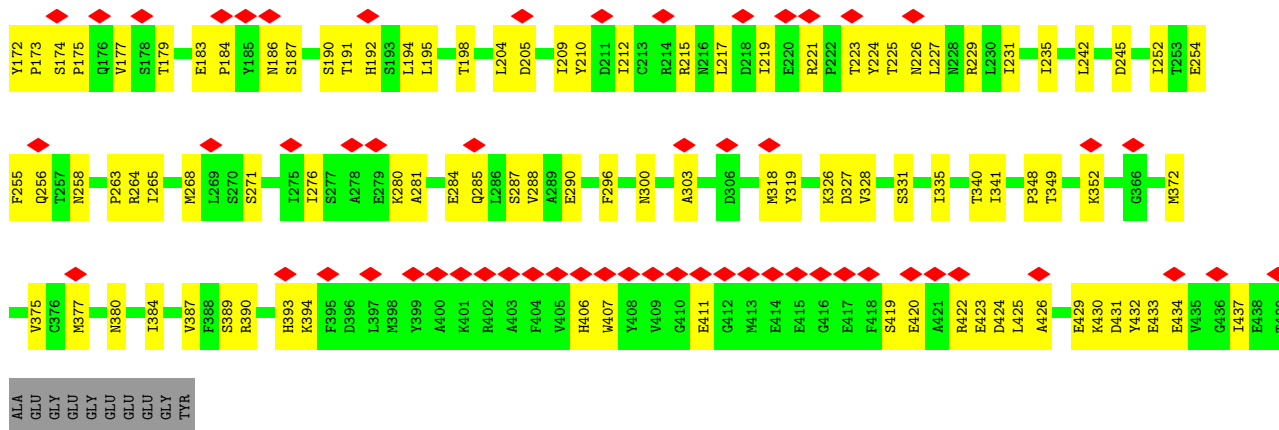

• Molecule 45: Tubulin alpha chain

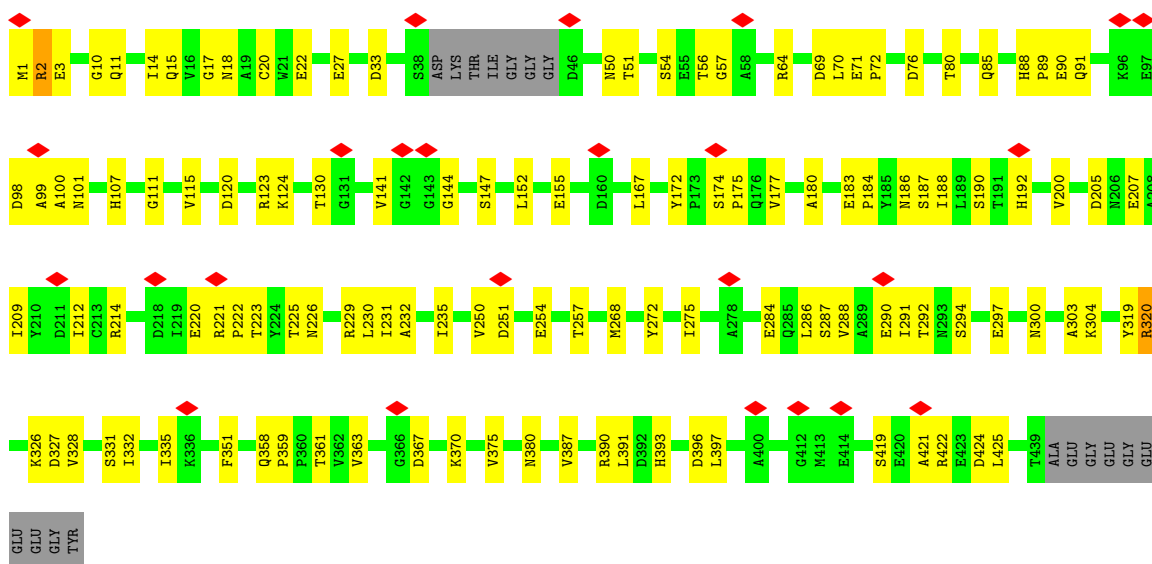

• Molecule 45: Tubulin alpha chain

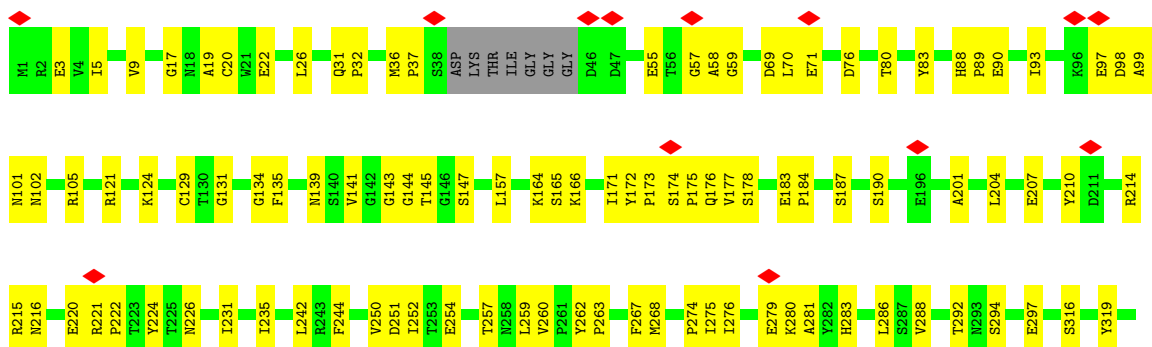

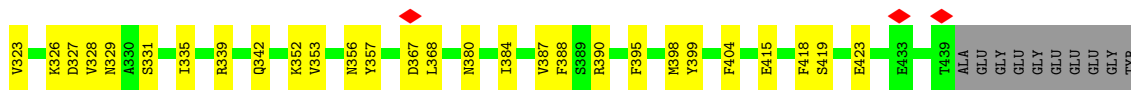

• Molecule 45: Tubulin alpha chain

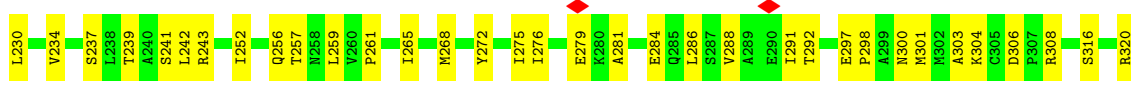

GLU  
GLY  
TYR

• Molecule 45: Tubulin alpha chain

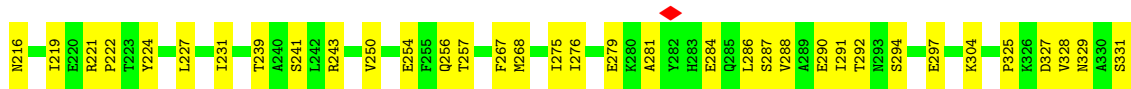
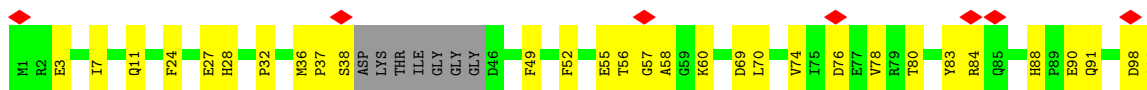

• Molecule 45: Tubulin alpha chain

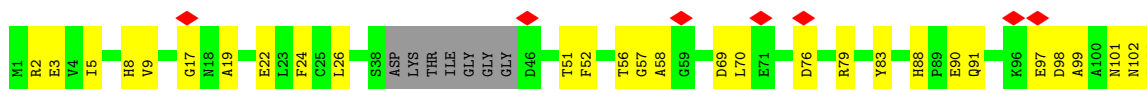

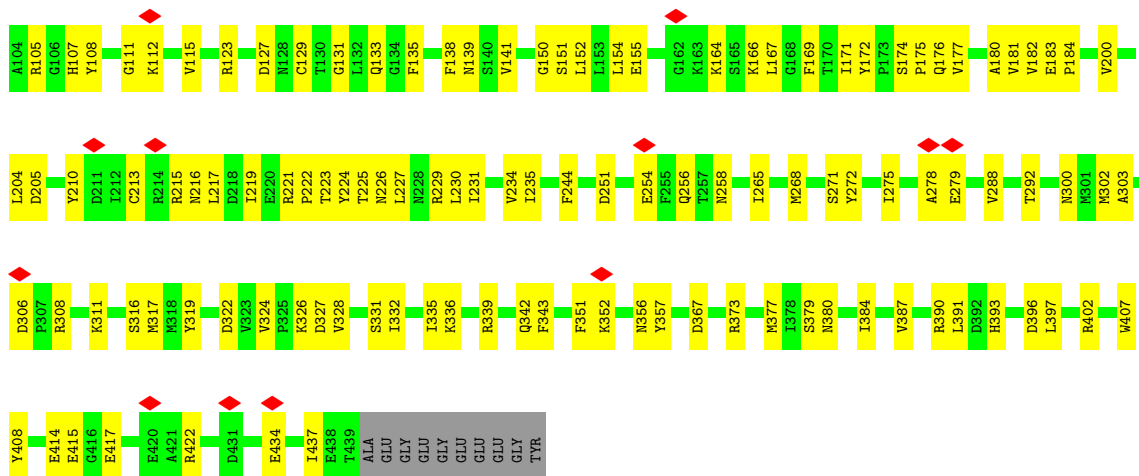

• Molecule 45: Tubulin alpha chain

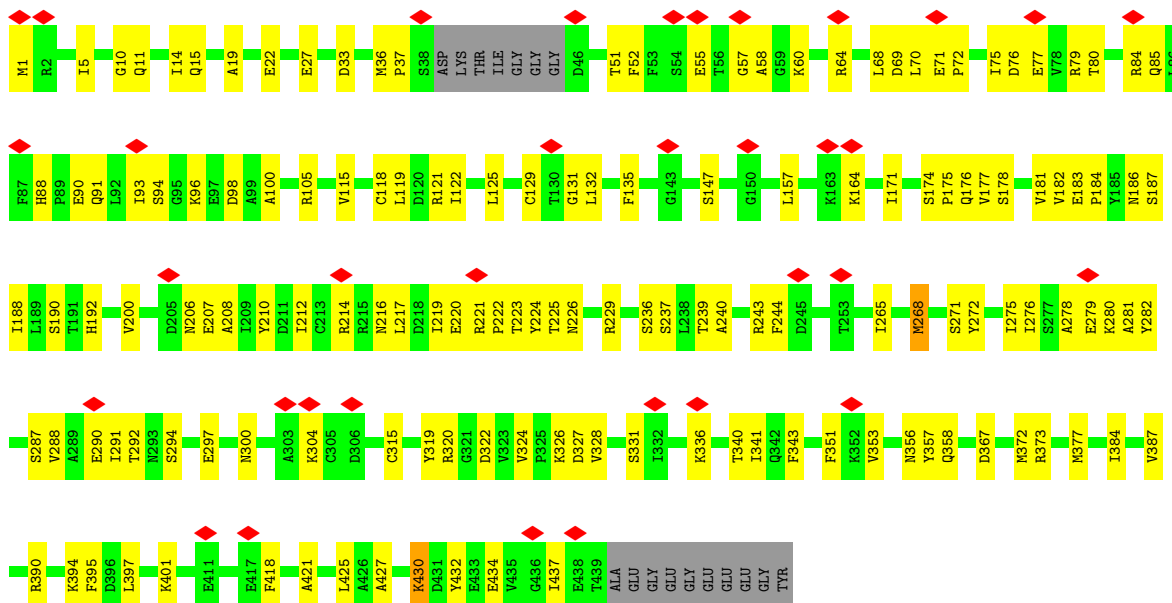

• Molecule 45: Tubulin alpha chain

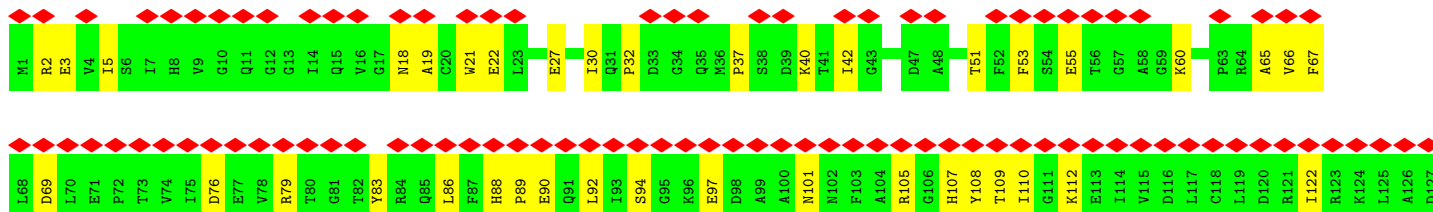

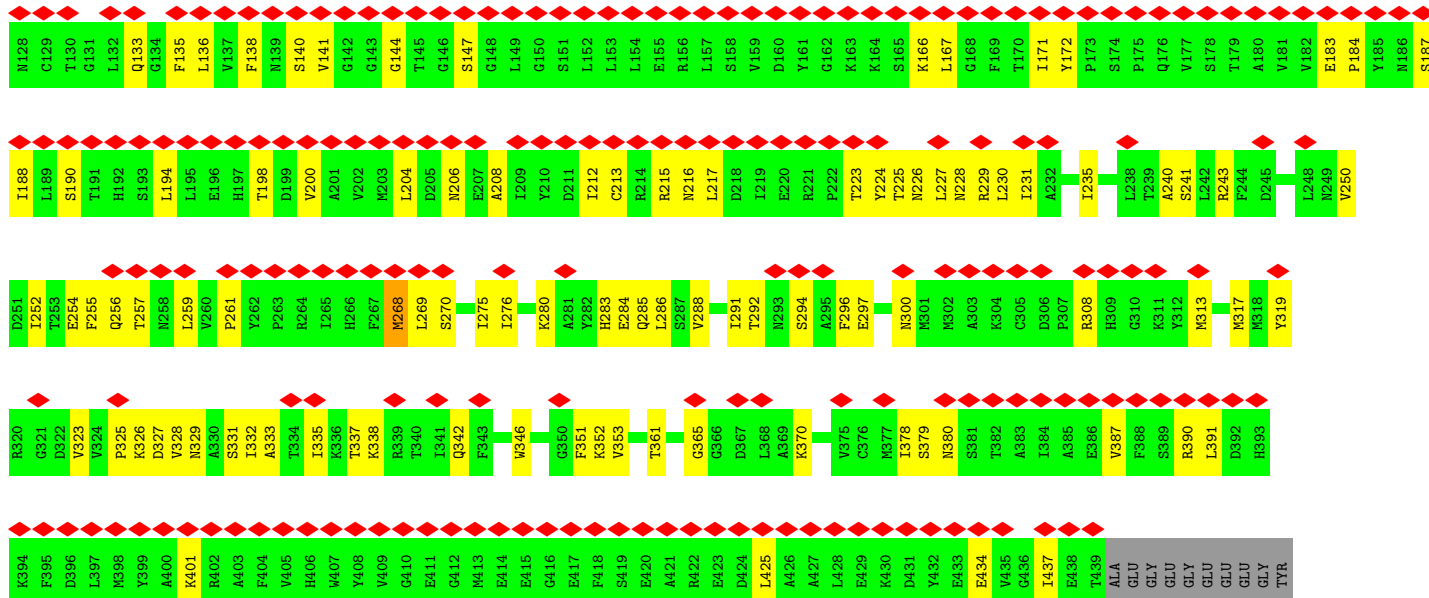

• Molecule 45: Tubulin alpha chain

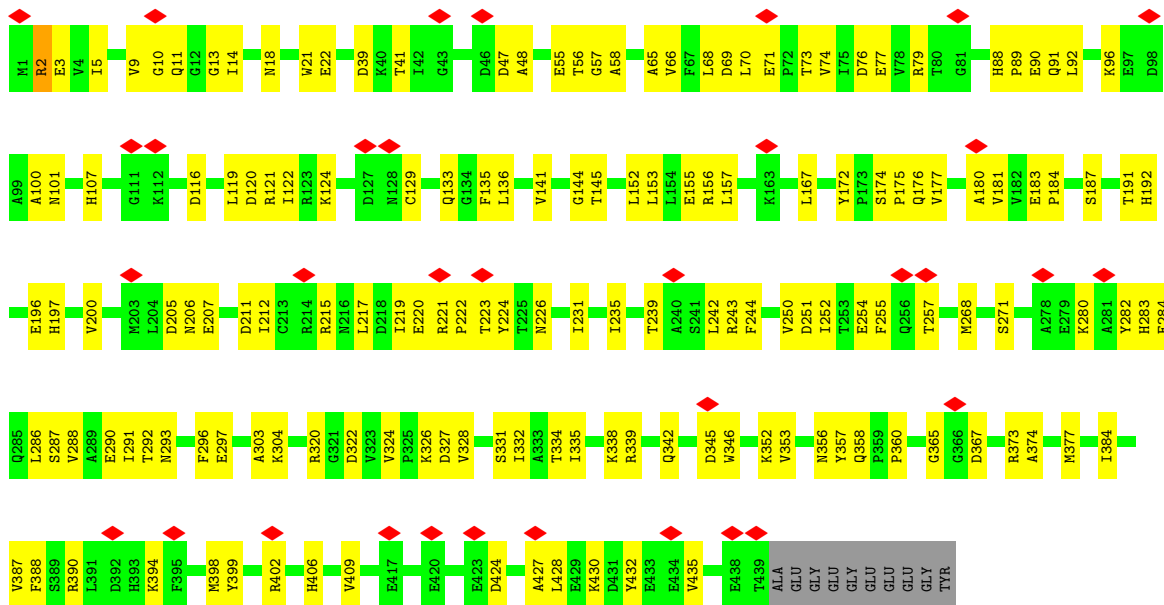

• Molecule 45: Tubulin alpha chain

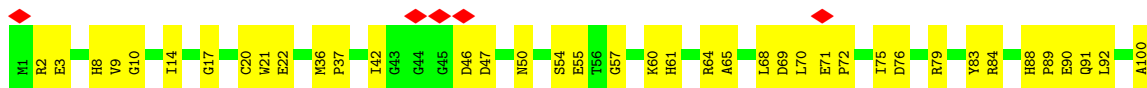

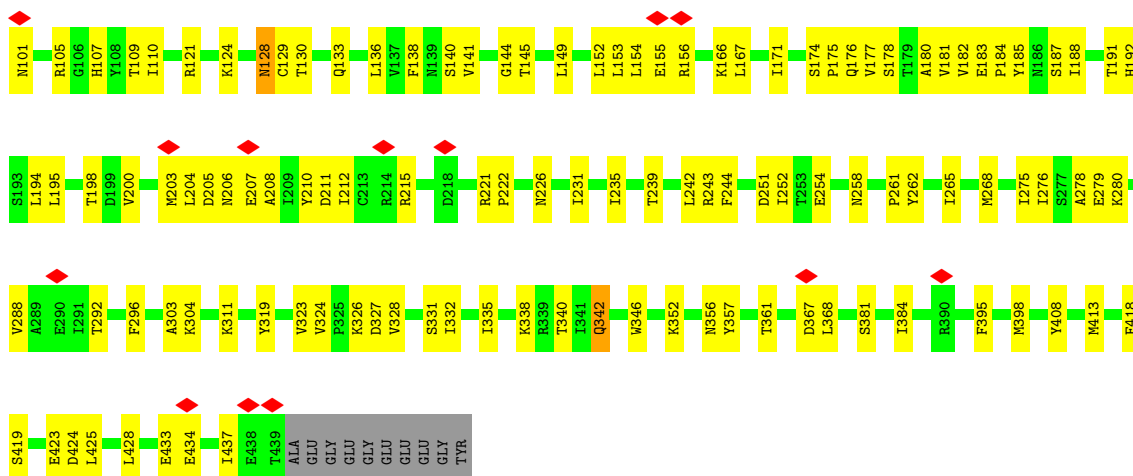

• Molecule 45: Tubulin alpha chain

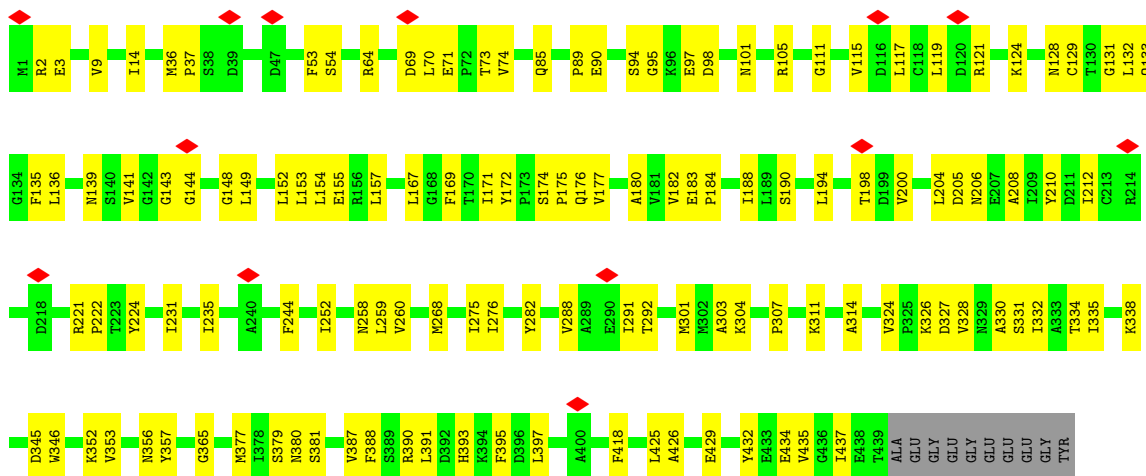

• Molecule 45: Tubulin alpha chain

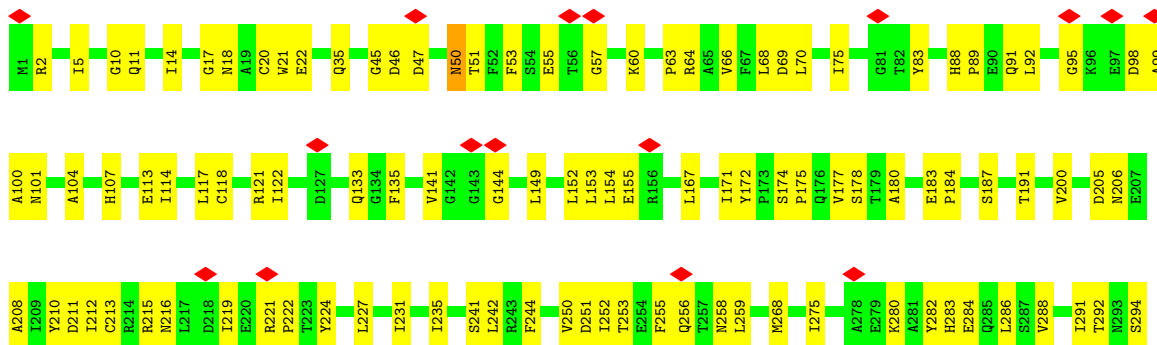

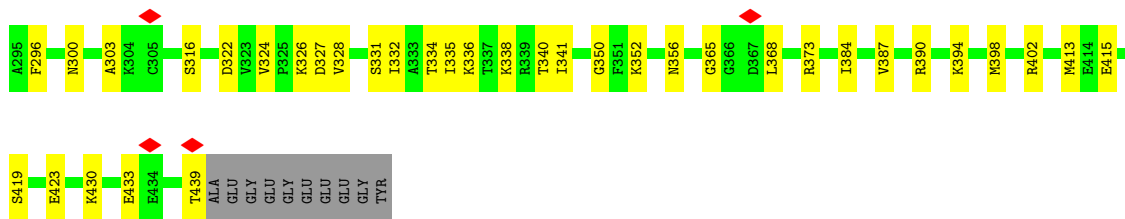

• Molecule 45: Tubulin alpha chain

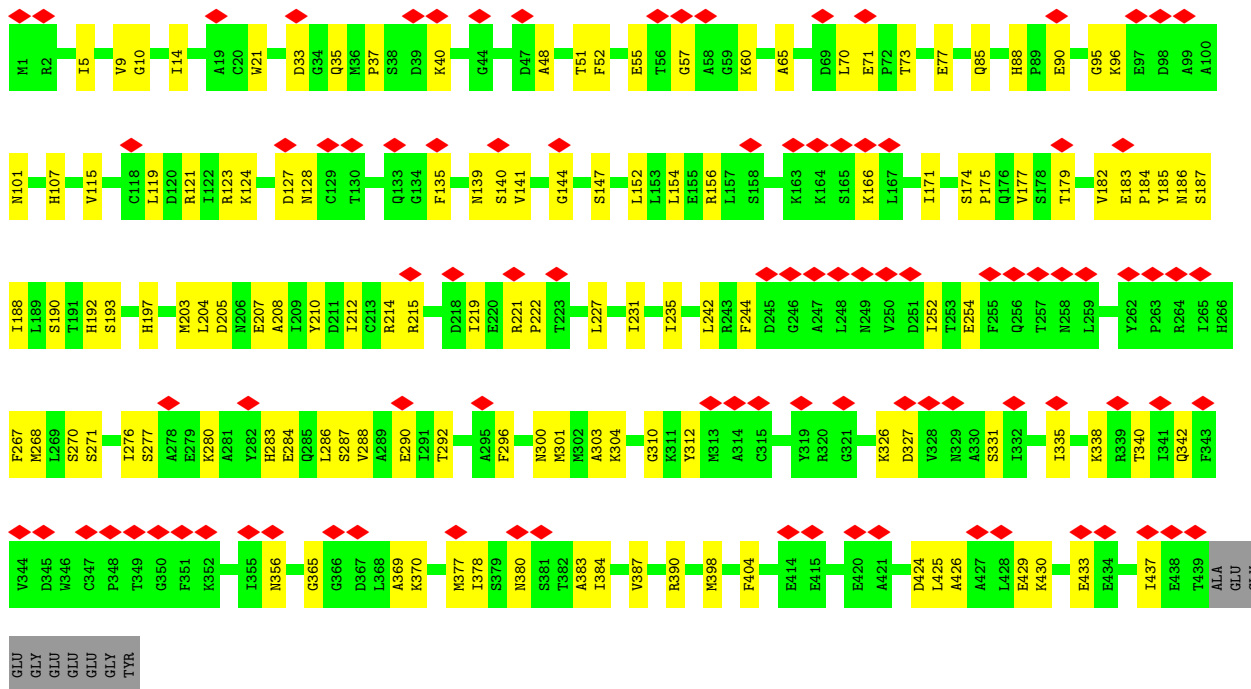
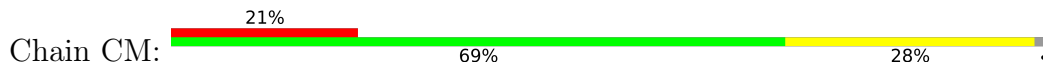

• Molecule 45: Tubulin alpha chain

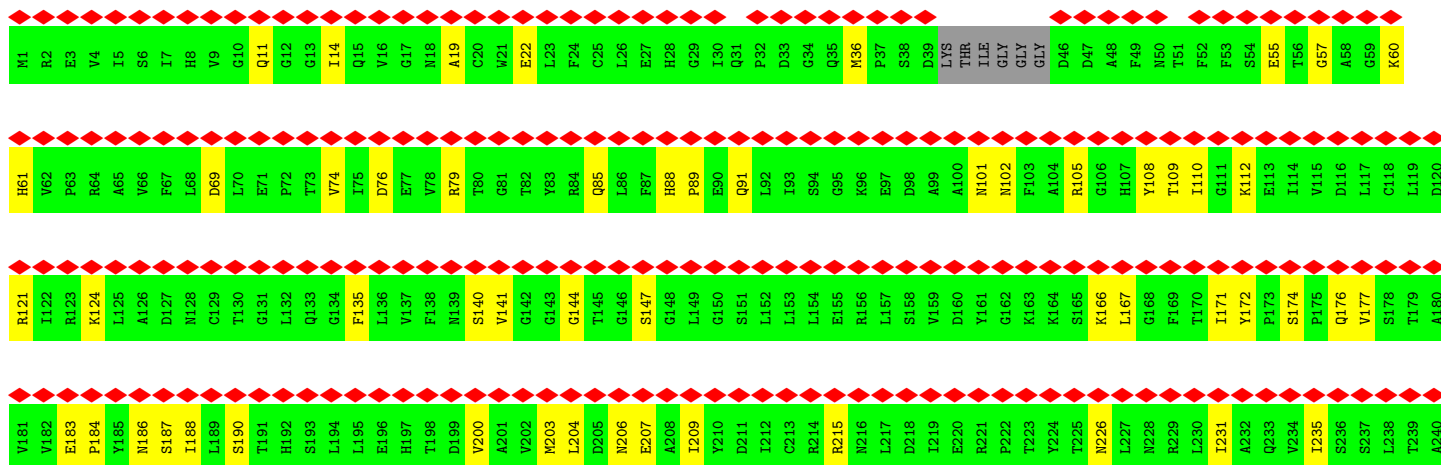
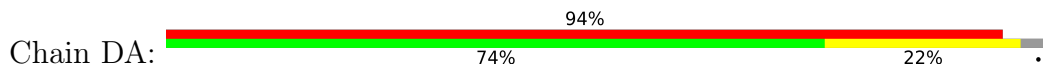



• Molecule 45: Tubulin alpha chain

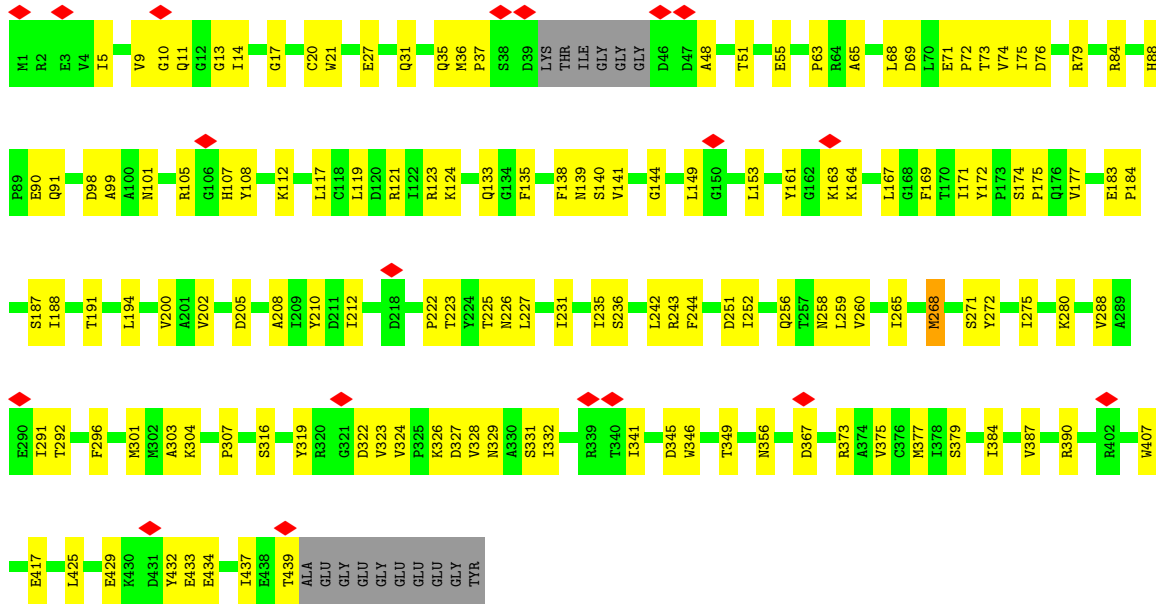

• Molecule 45: Tubulin alpha chain

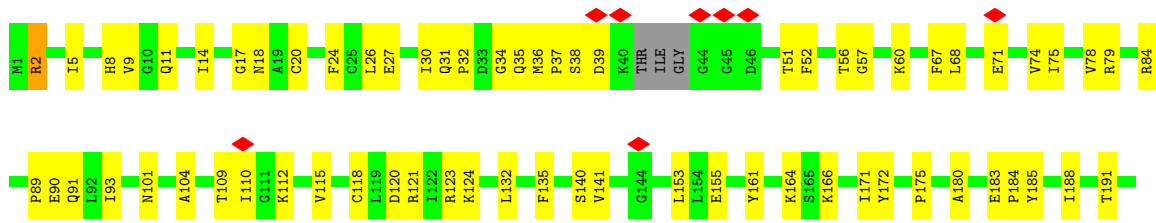



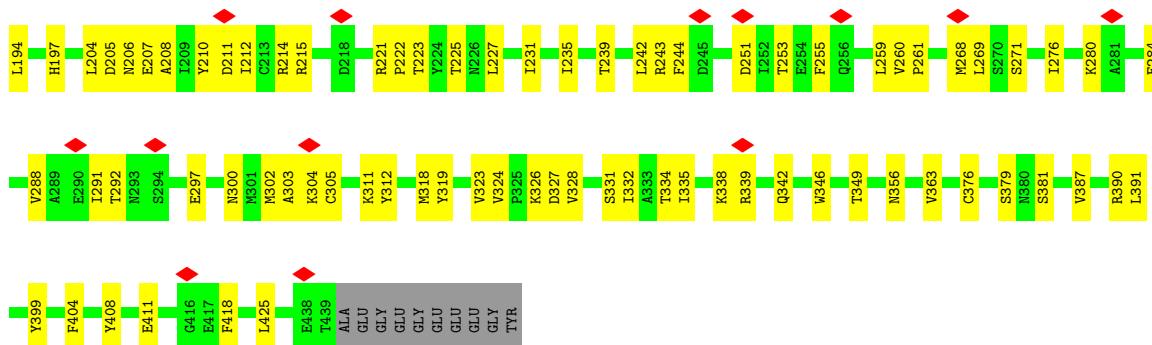

• Molecule 45: Tubulin alpha chain

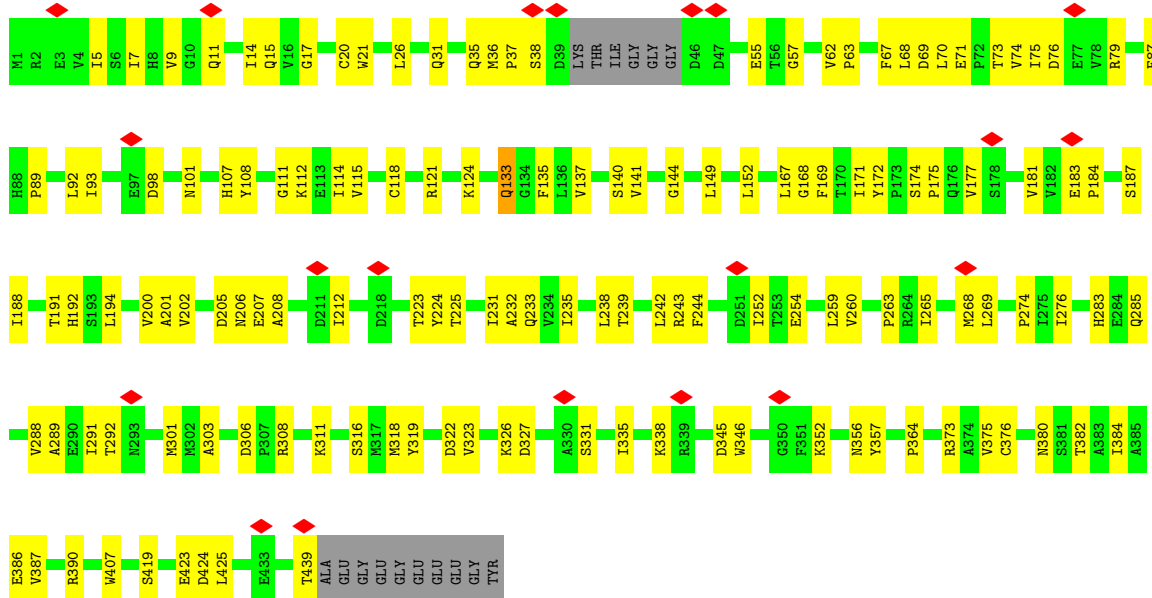

• Molecule 45: Tubulin alpha chain

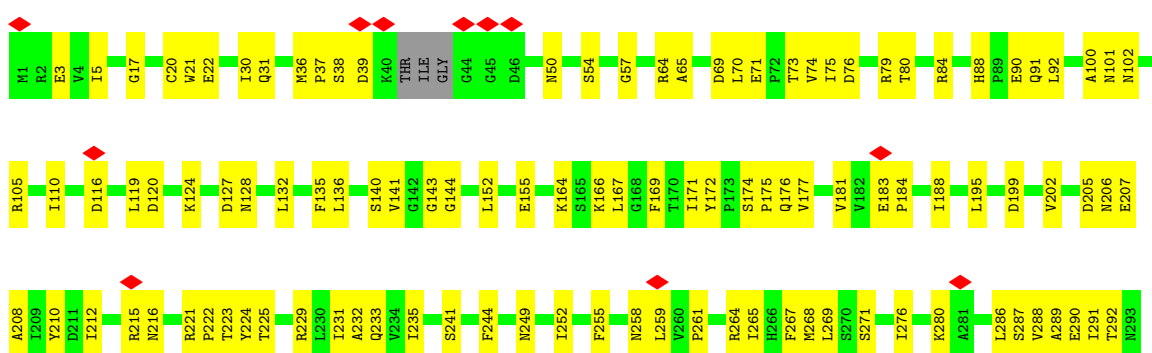

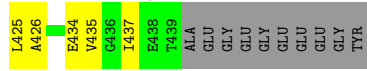
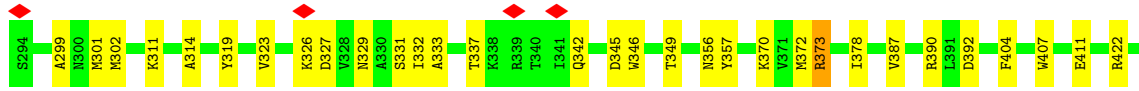

• Molecule 45: Tubulin alpha chain

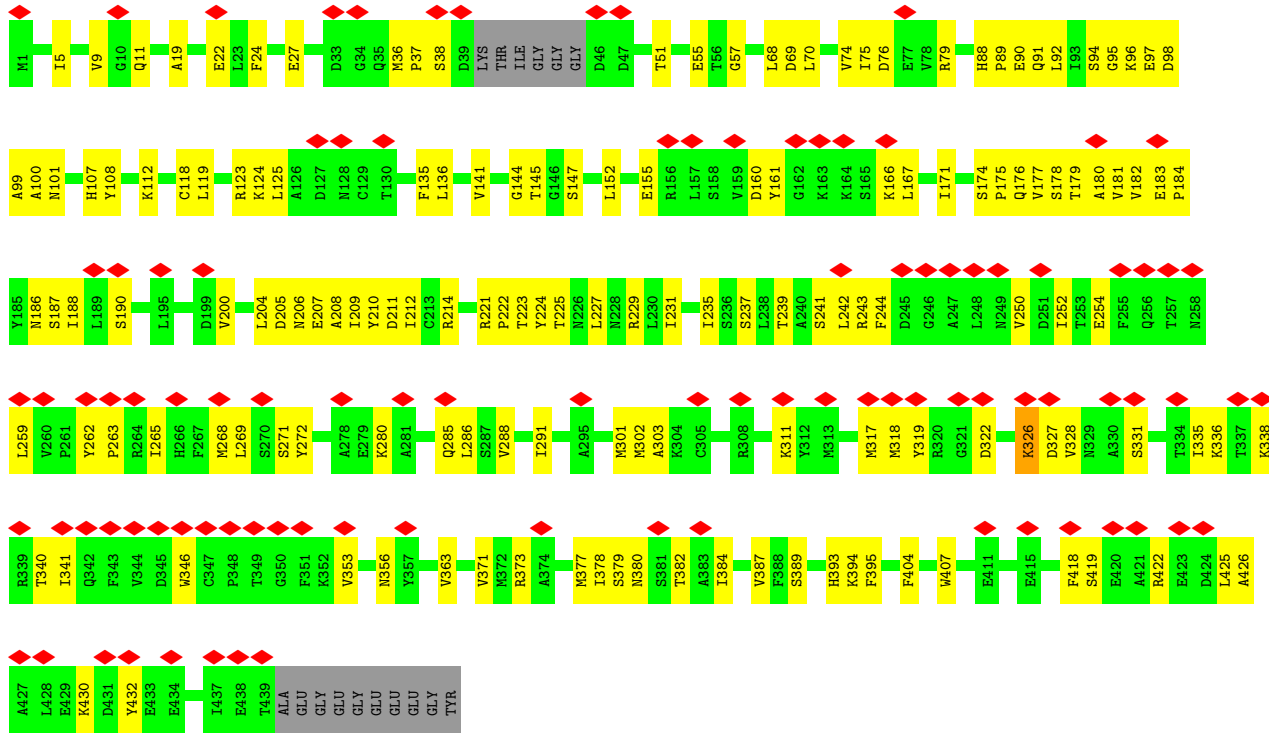

• Molecule 45: Tubulin alpha chain

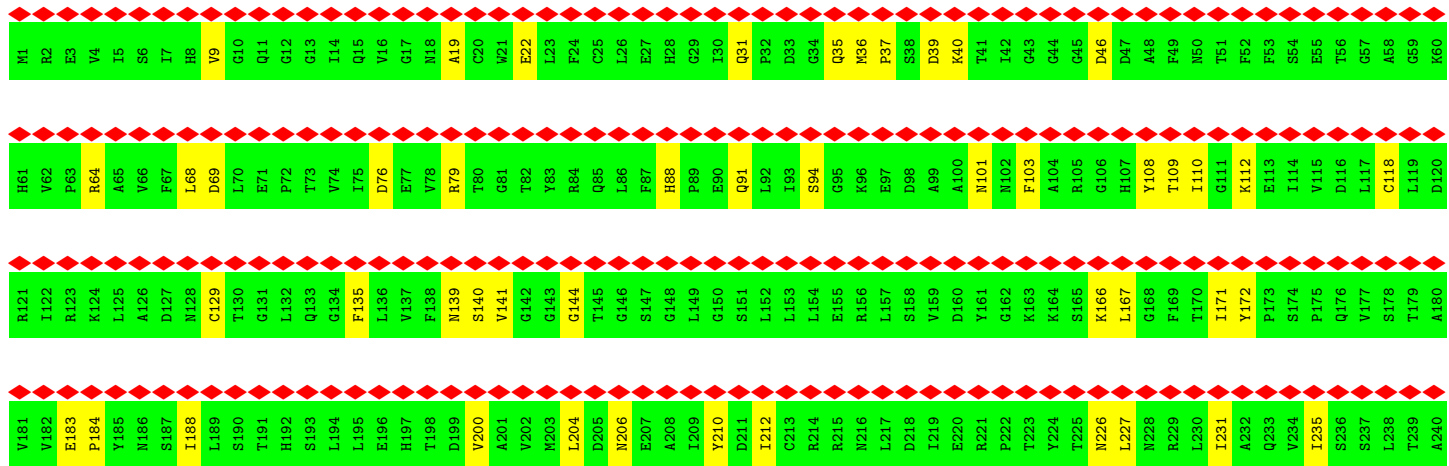
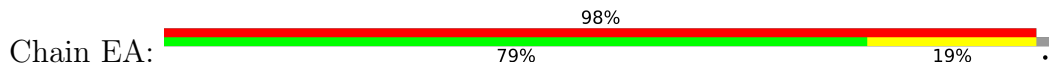



• Molecule 45: Tubulin alpha chain

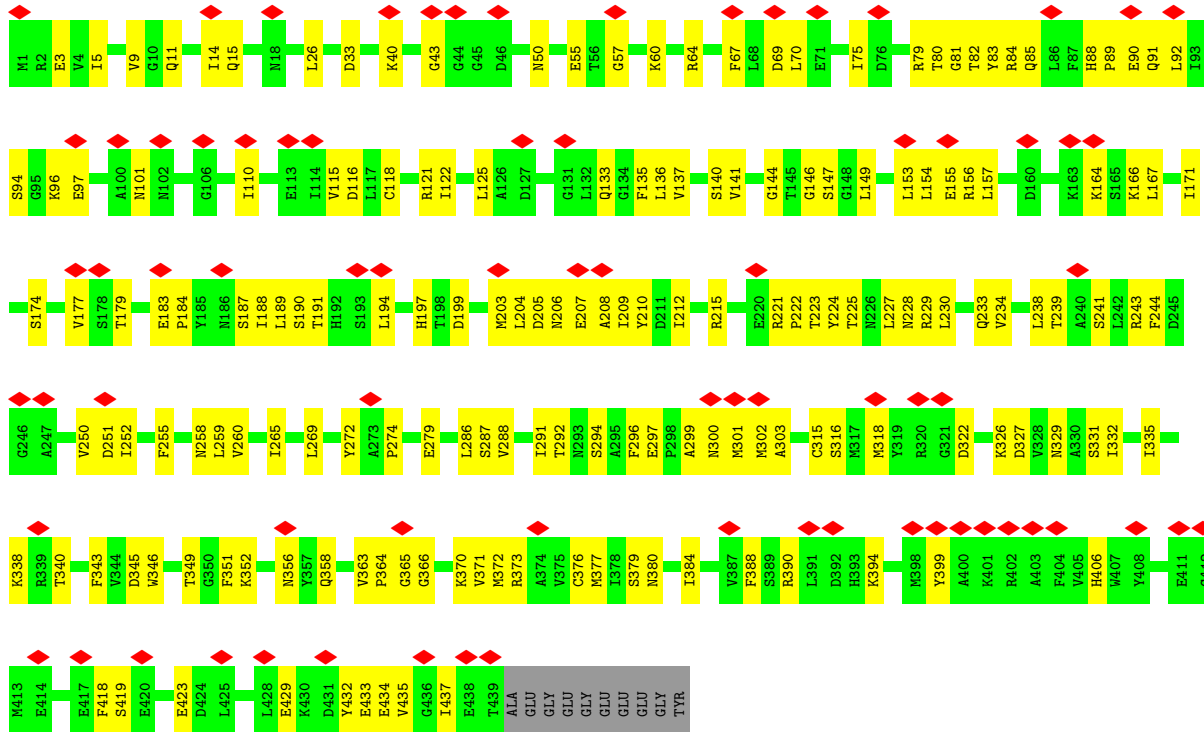

• Molecule 45: Tubulin alpha chain

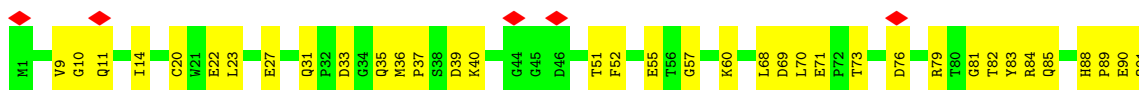

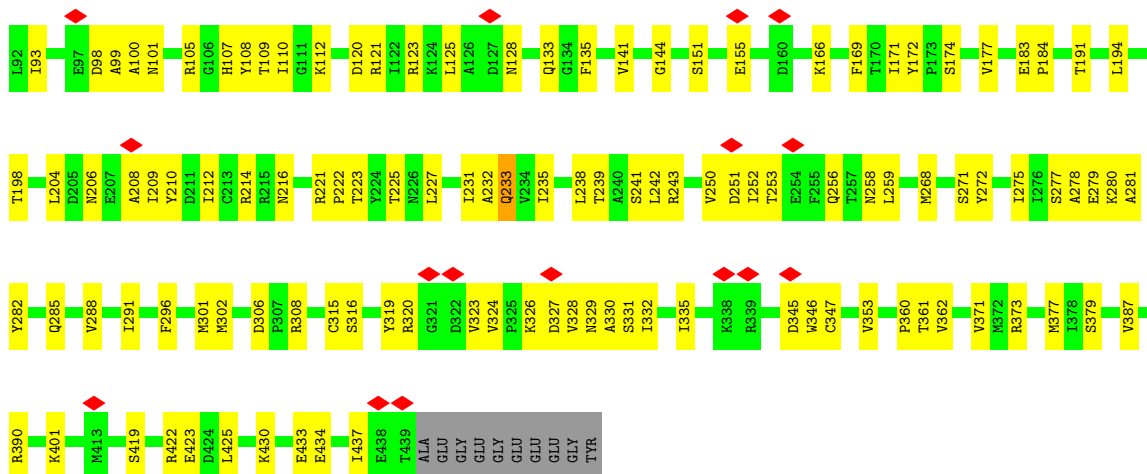

• Molecule 45: Tubulin alpha chain

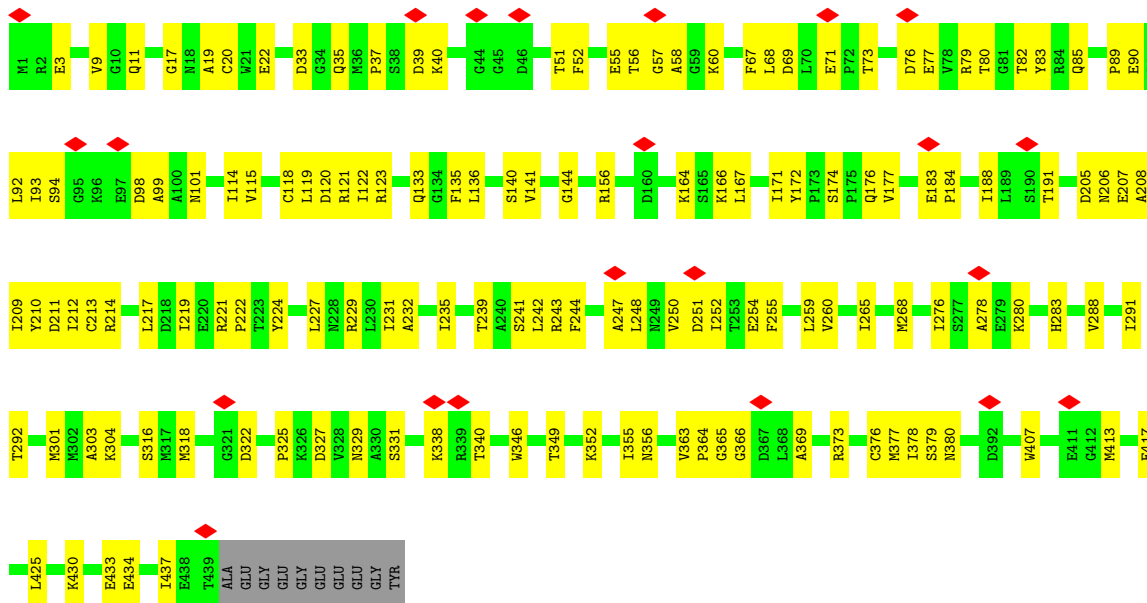

• Molecule 45: Tubulin alpha chain

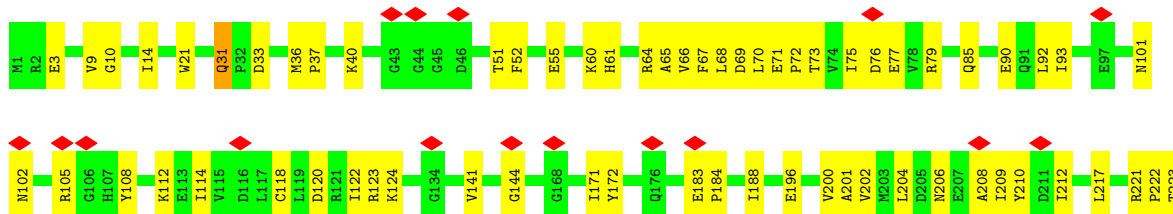

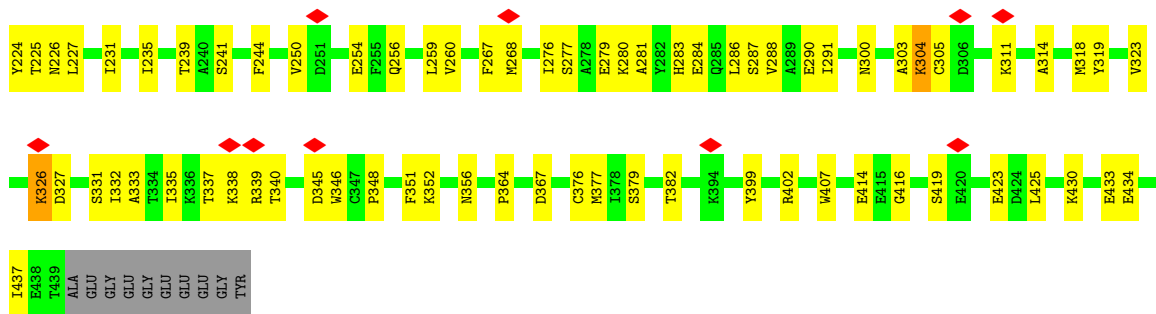

• Molecule 45: Tubulin alpha chain

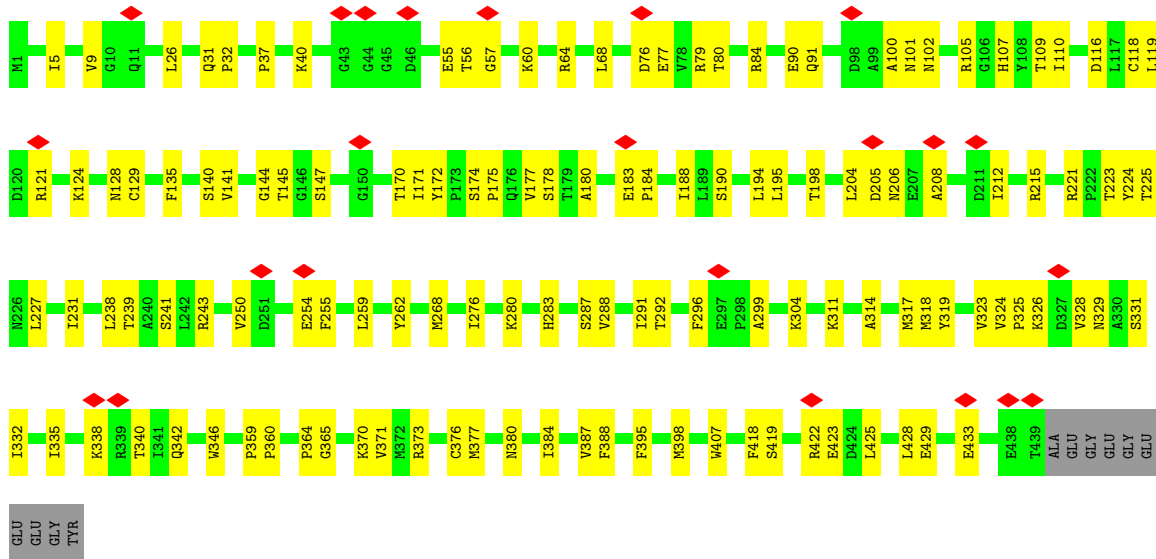

• Molecule 45: Tubulin alpha chain

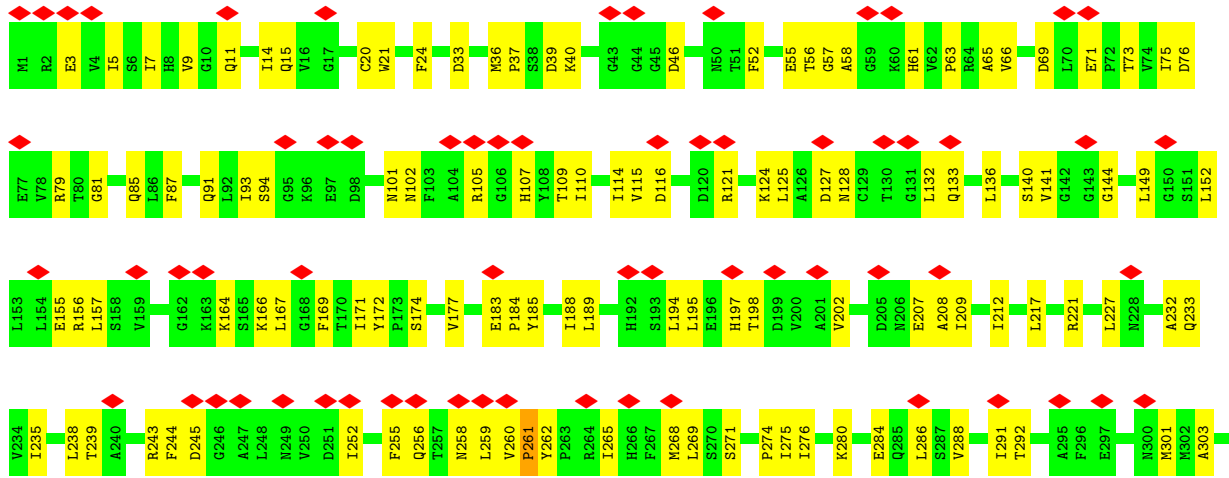

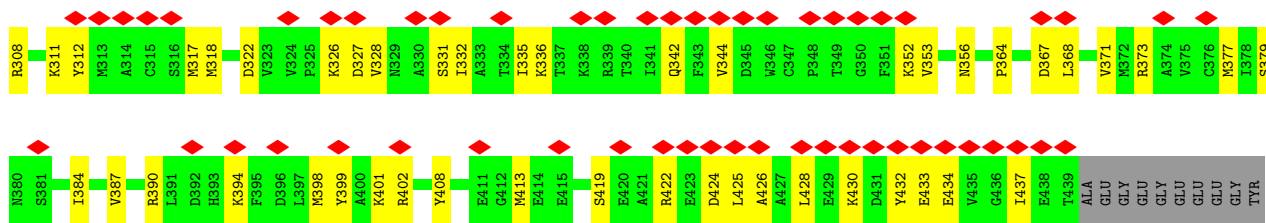

• Molecule 45: Tubulin alpha chain

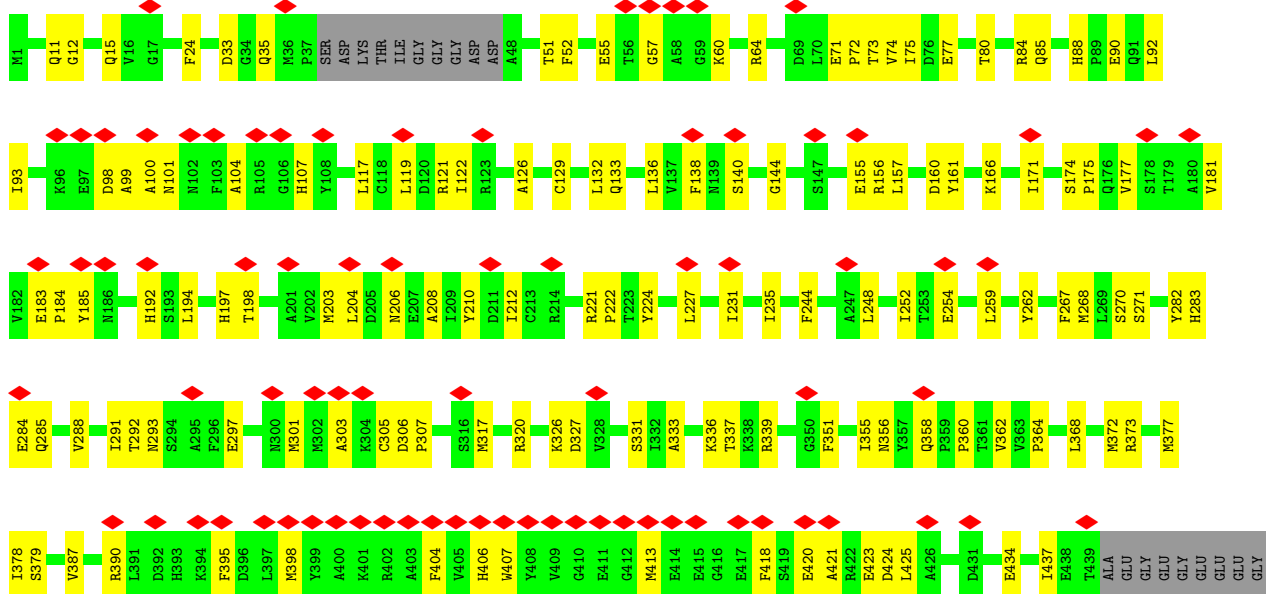

• Molecule 45: Tubulin alpha chain

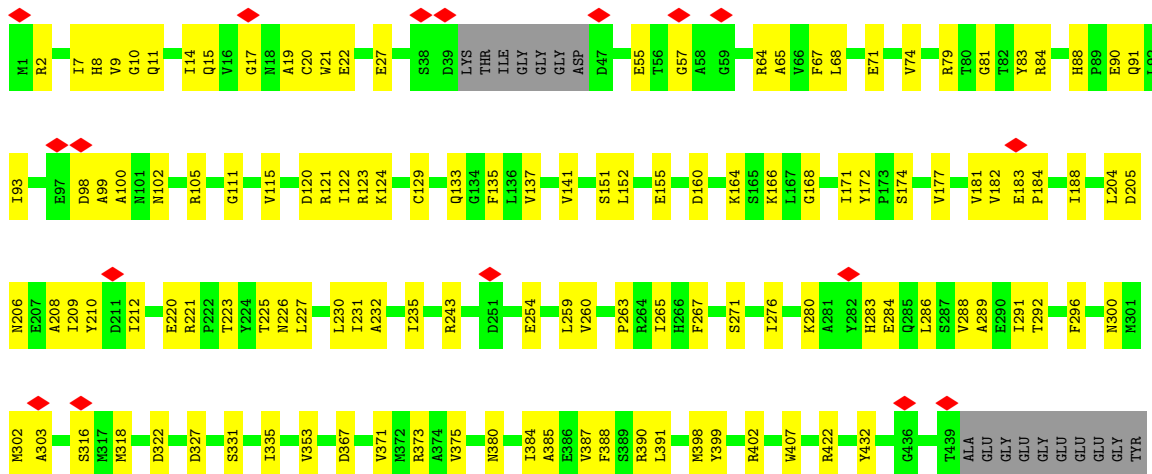

• Molecule 45: Tubulin alpha chain

Chain FE:

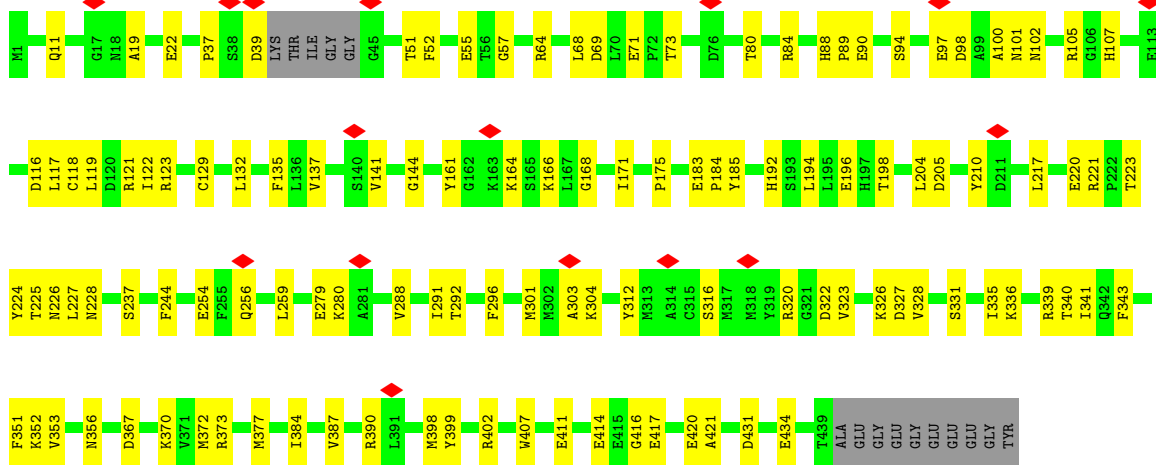

• Molecule 45: Tubulin alpha chain

Chain FG:

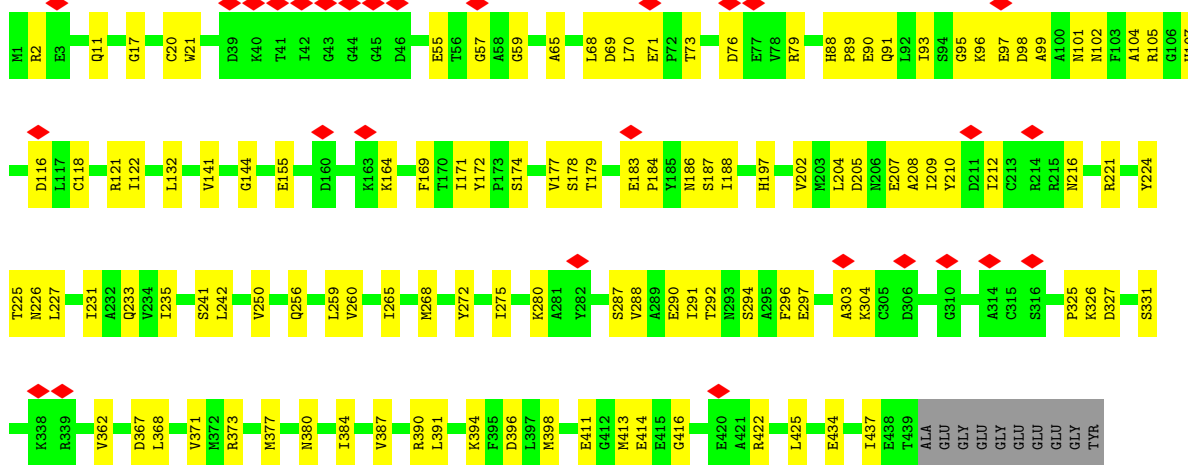

• Molecule 45: Tubulin alpha chain

Chain FI:

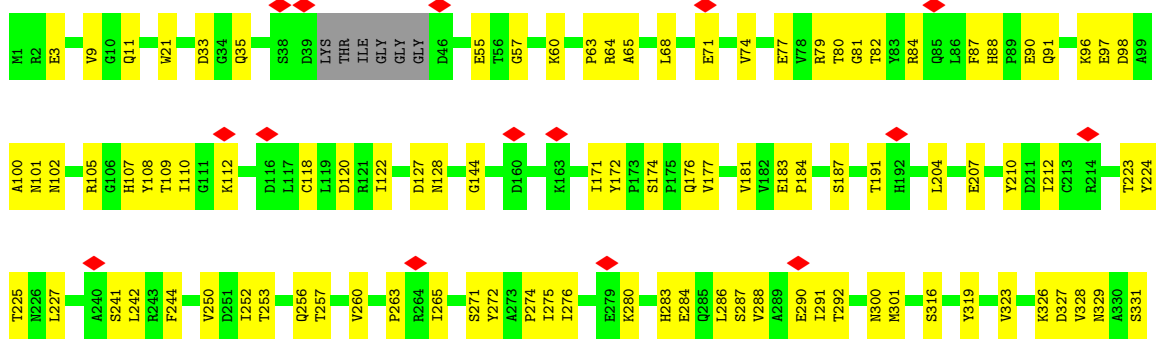

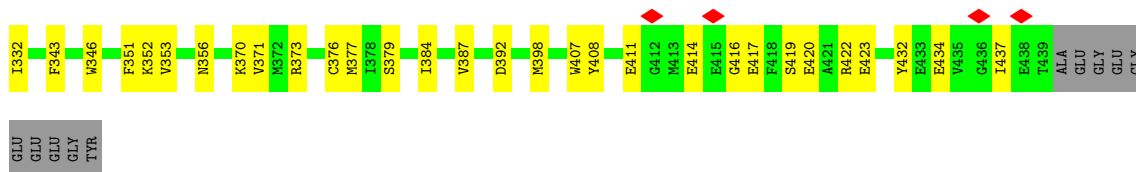

• Molecule 45: Tubulin alpha chain

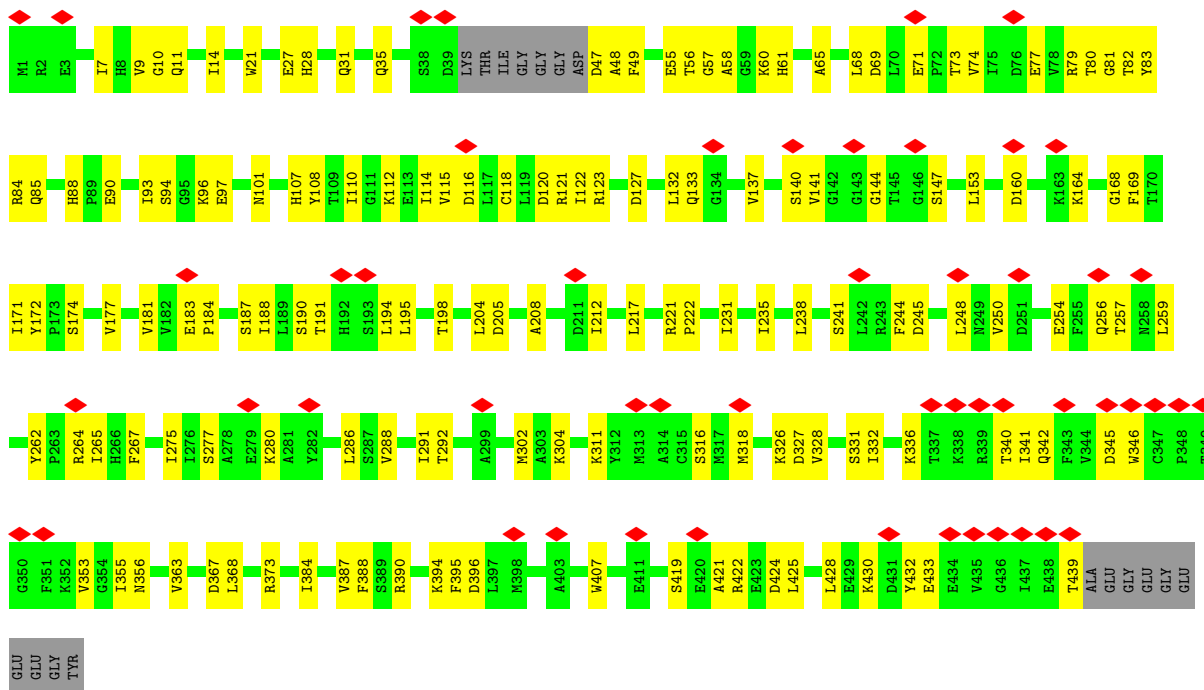

• Molecule 45: Tubulin alpha chain

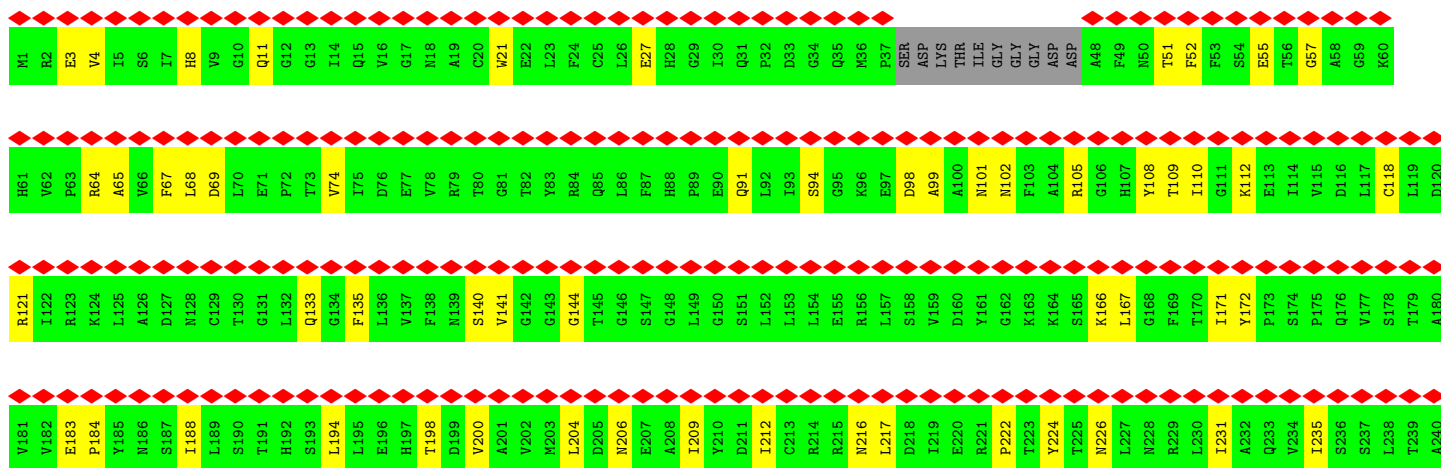
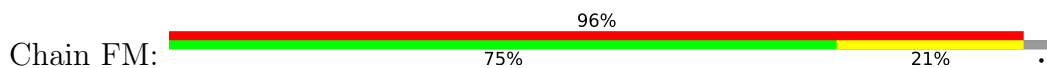



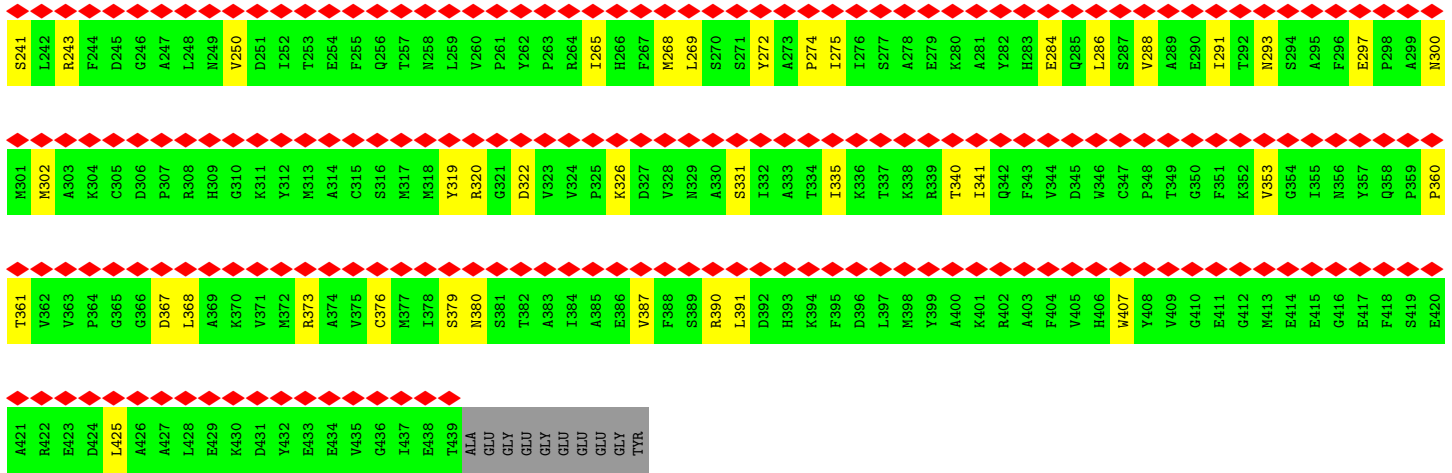

• Molecule 45: Tubulin alpha chain

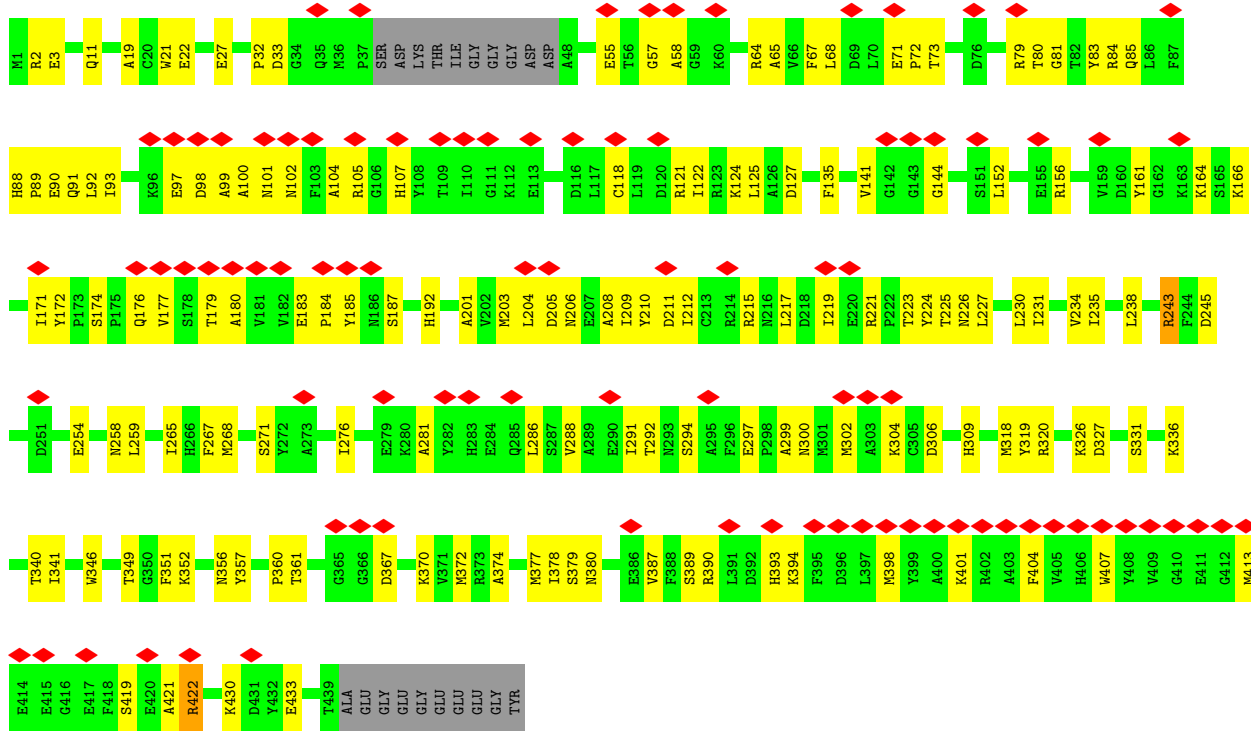

• Molecule 45: Tubulin alpha chain



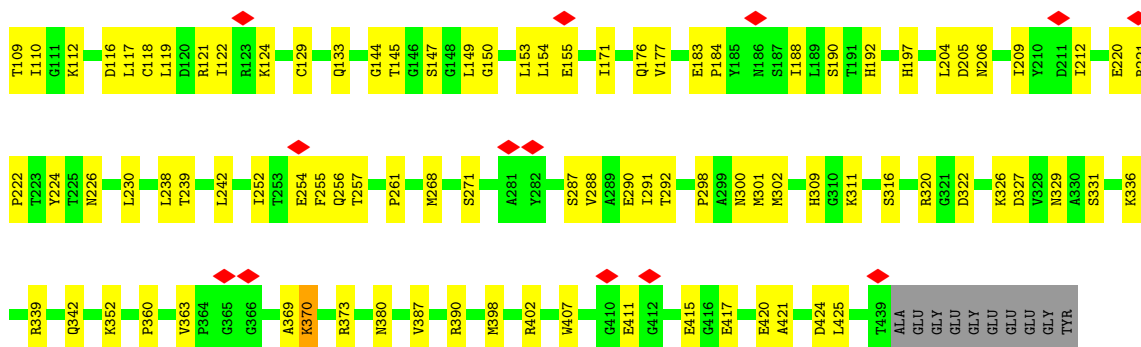

• Molecule 45: Tubulin alpha chain

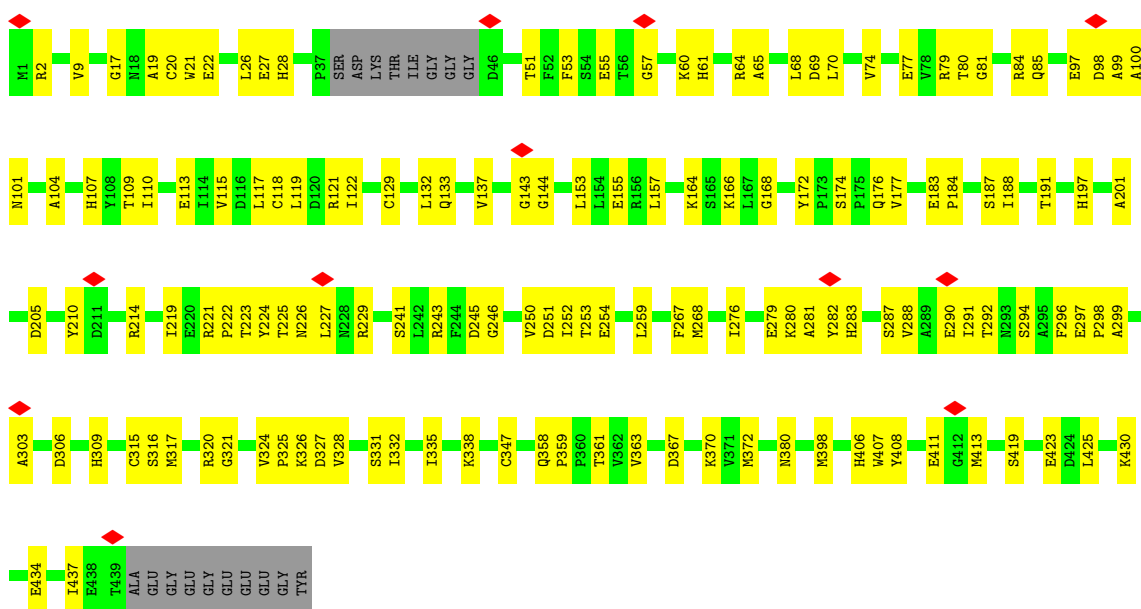

• Molecule 45: Tubulin alpha chain

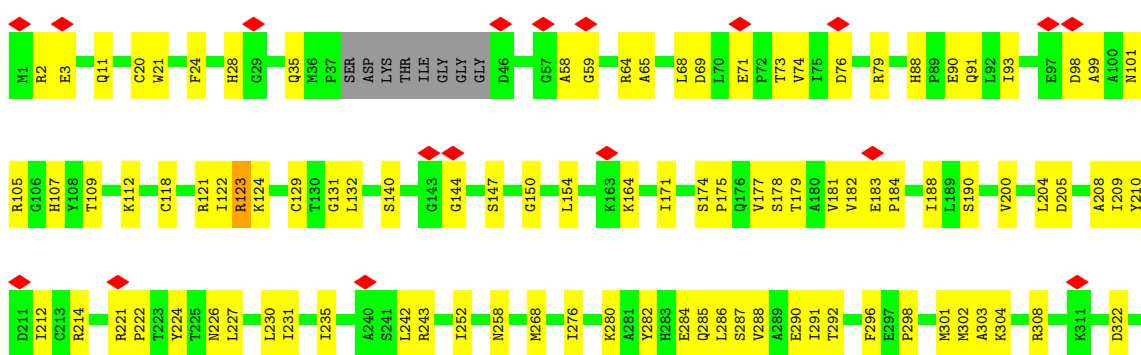

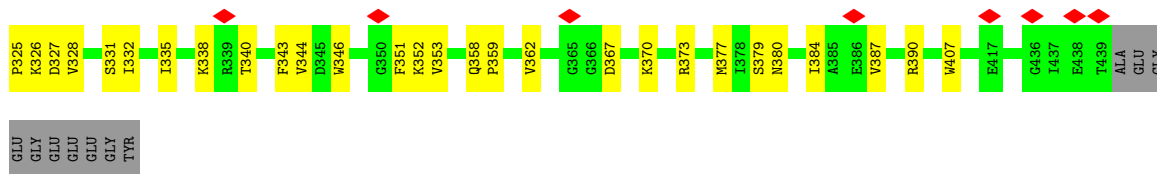

• Molecule 45: Tubulin alpha chain

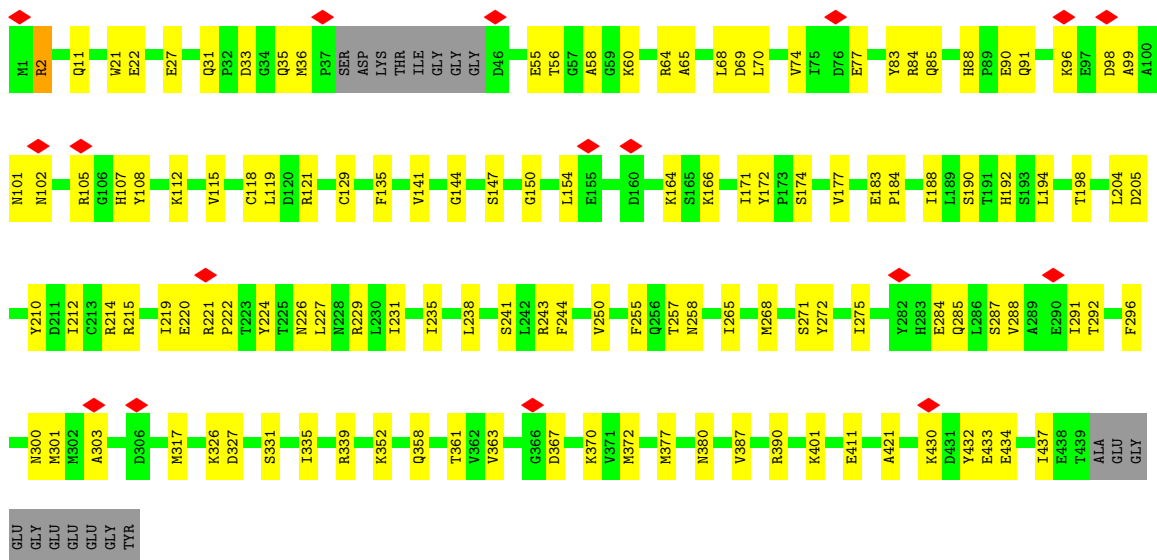

• Molecule 45: Tubulin alpha chain

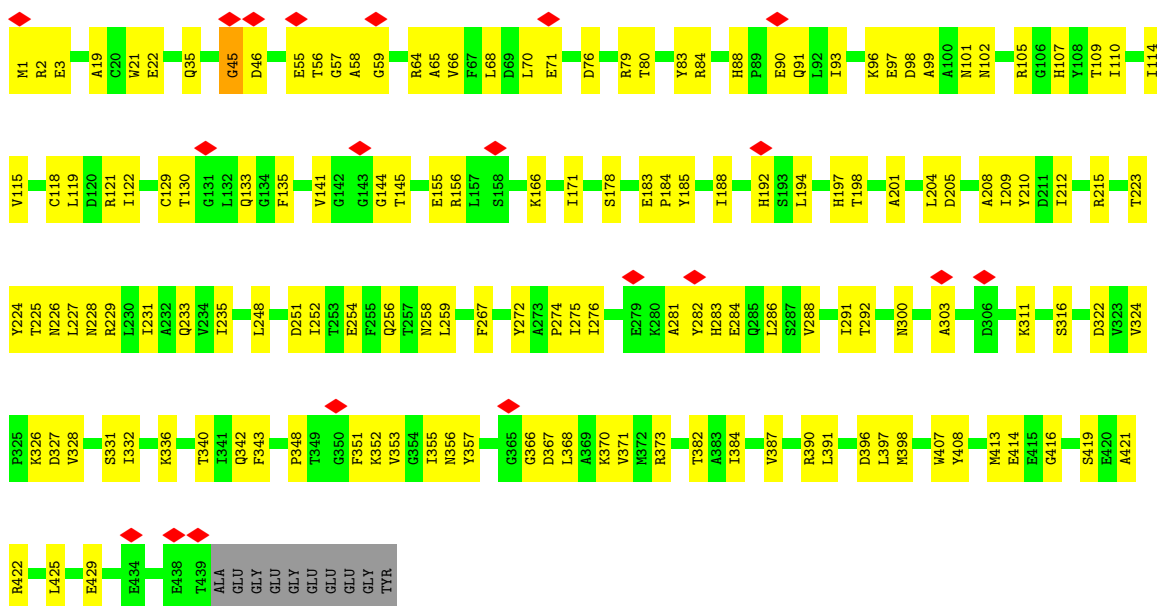

• Molecule 45: Tubulin alpha chain

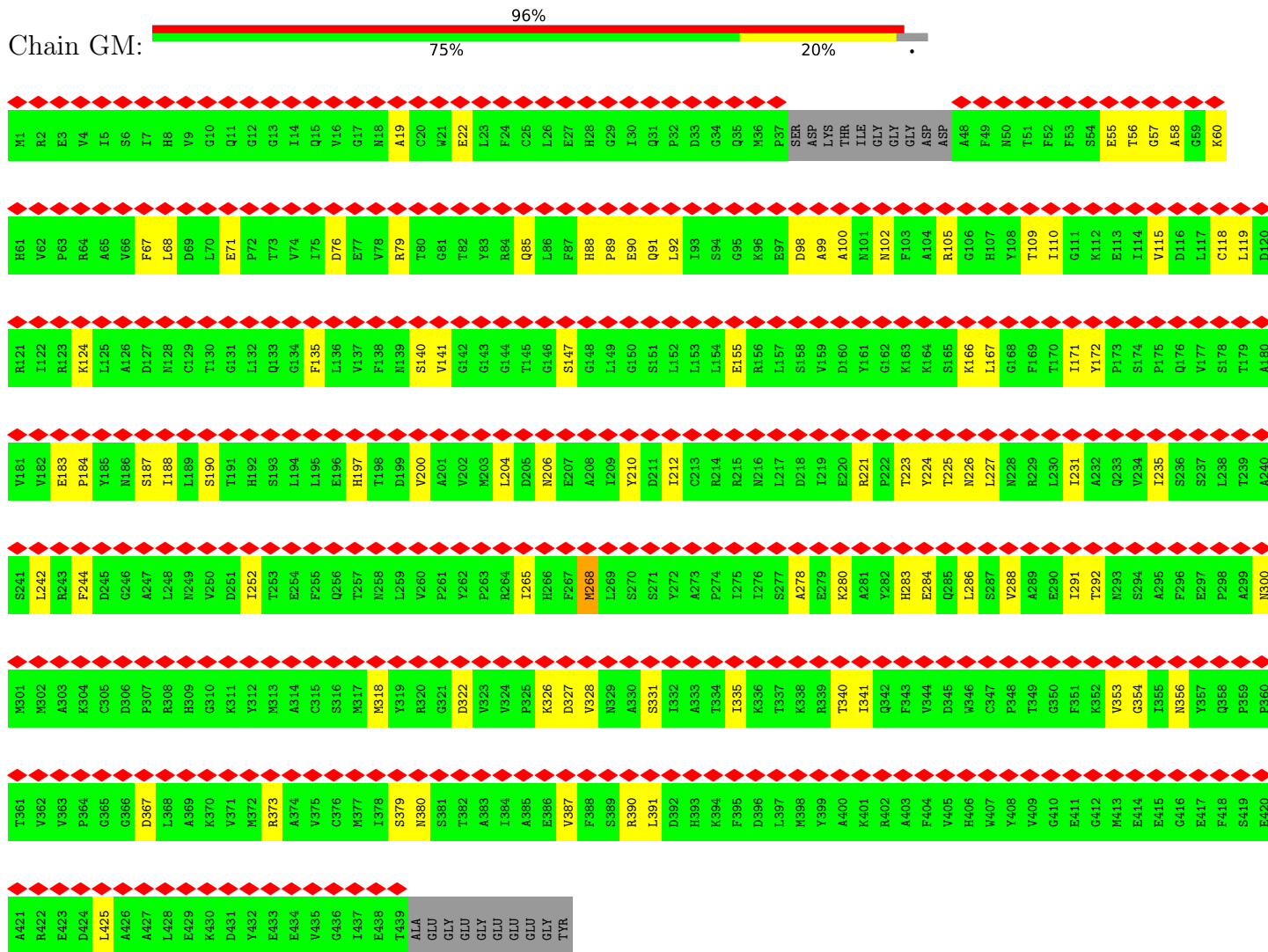

• Molecule 45: Tubulin alpha chain

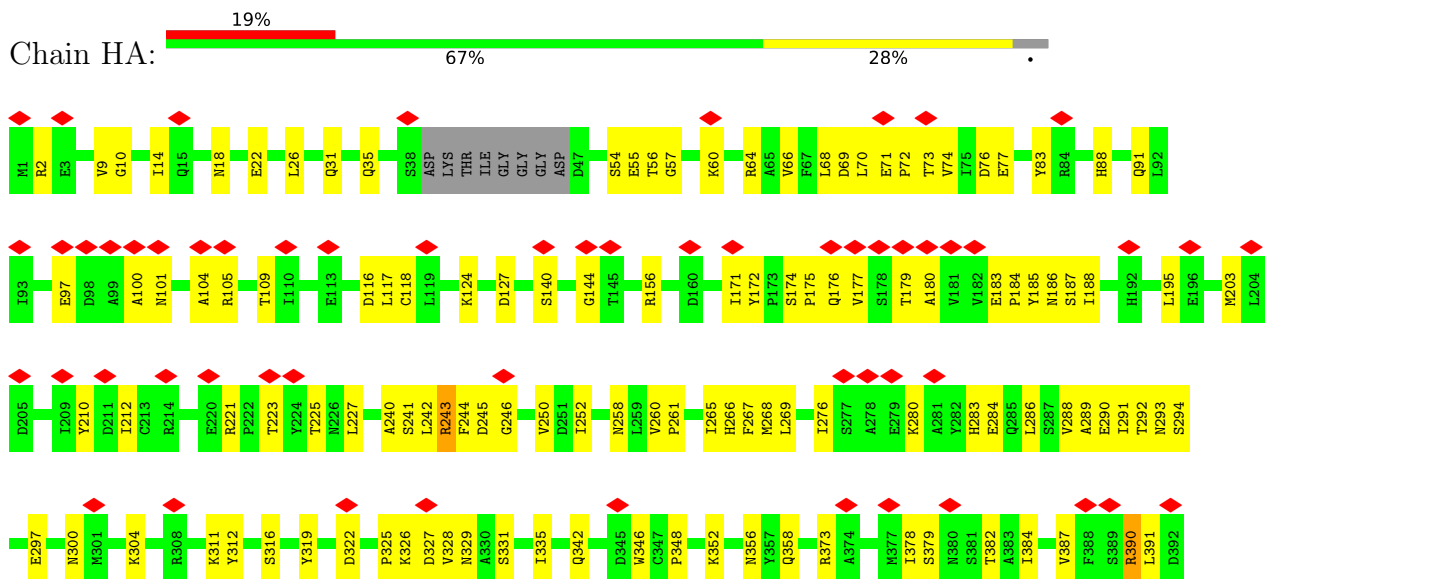

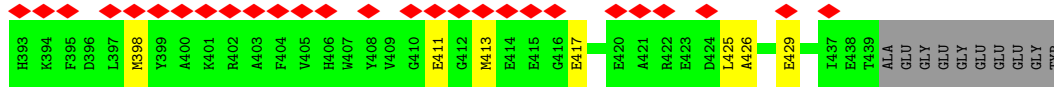

• Molecule 45: Tubulin alpha chain

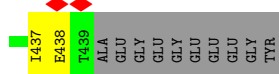
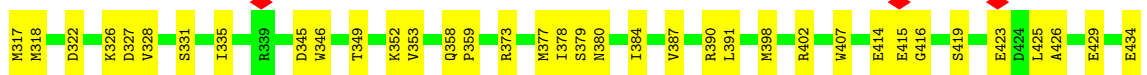
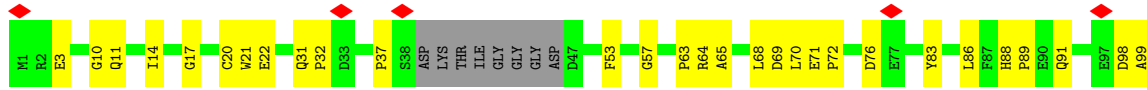

• Molecule 45: Tubulin alpha chain

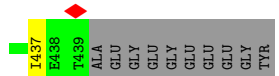
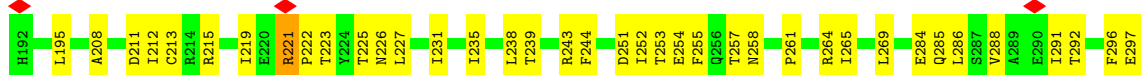
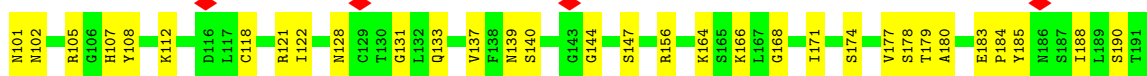

• Molecule 45: Tubulin alpha chain

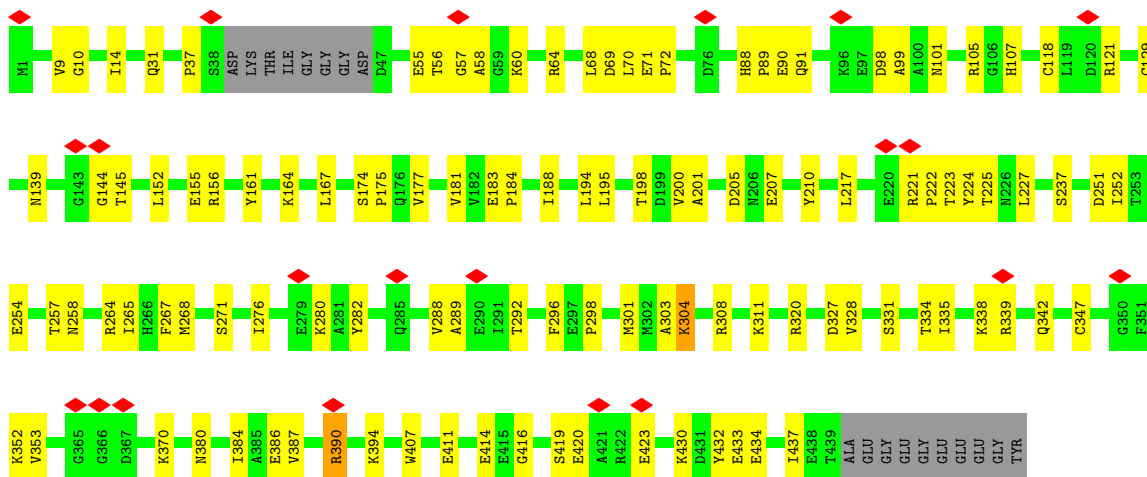
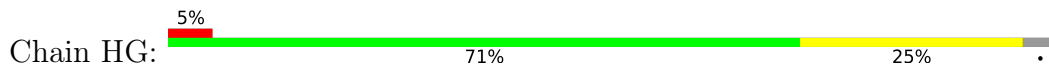

• Molecule 45: Tubulin alpha chain

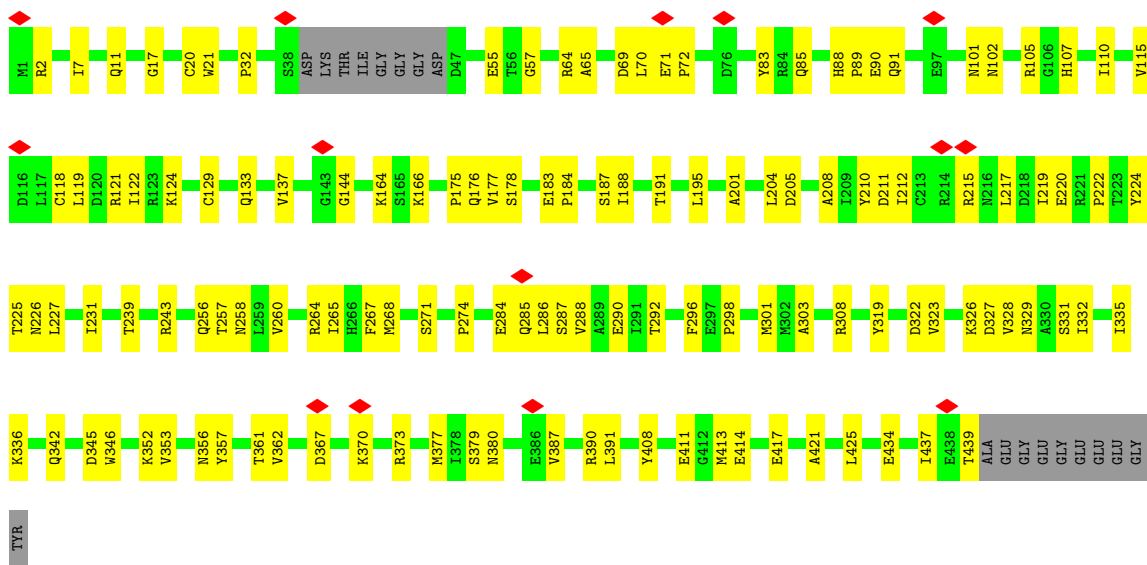

• Molecule 45: Tubulin alpha chain

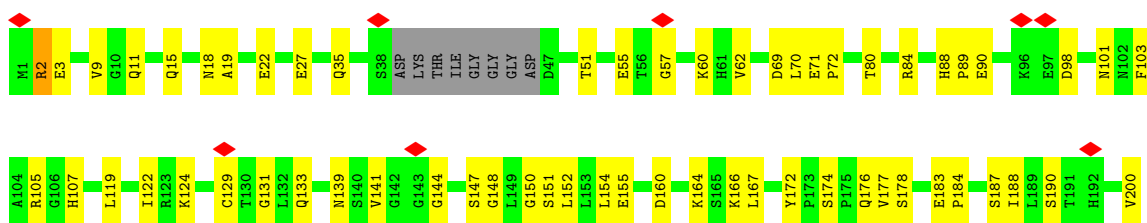

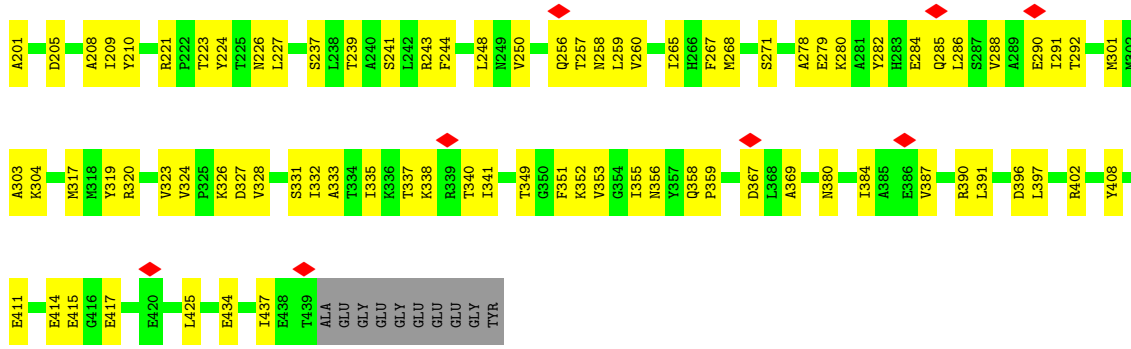

• Molecule 45: Tubulin alpha chain

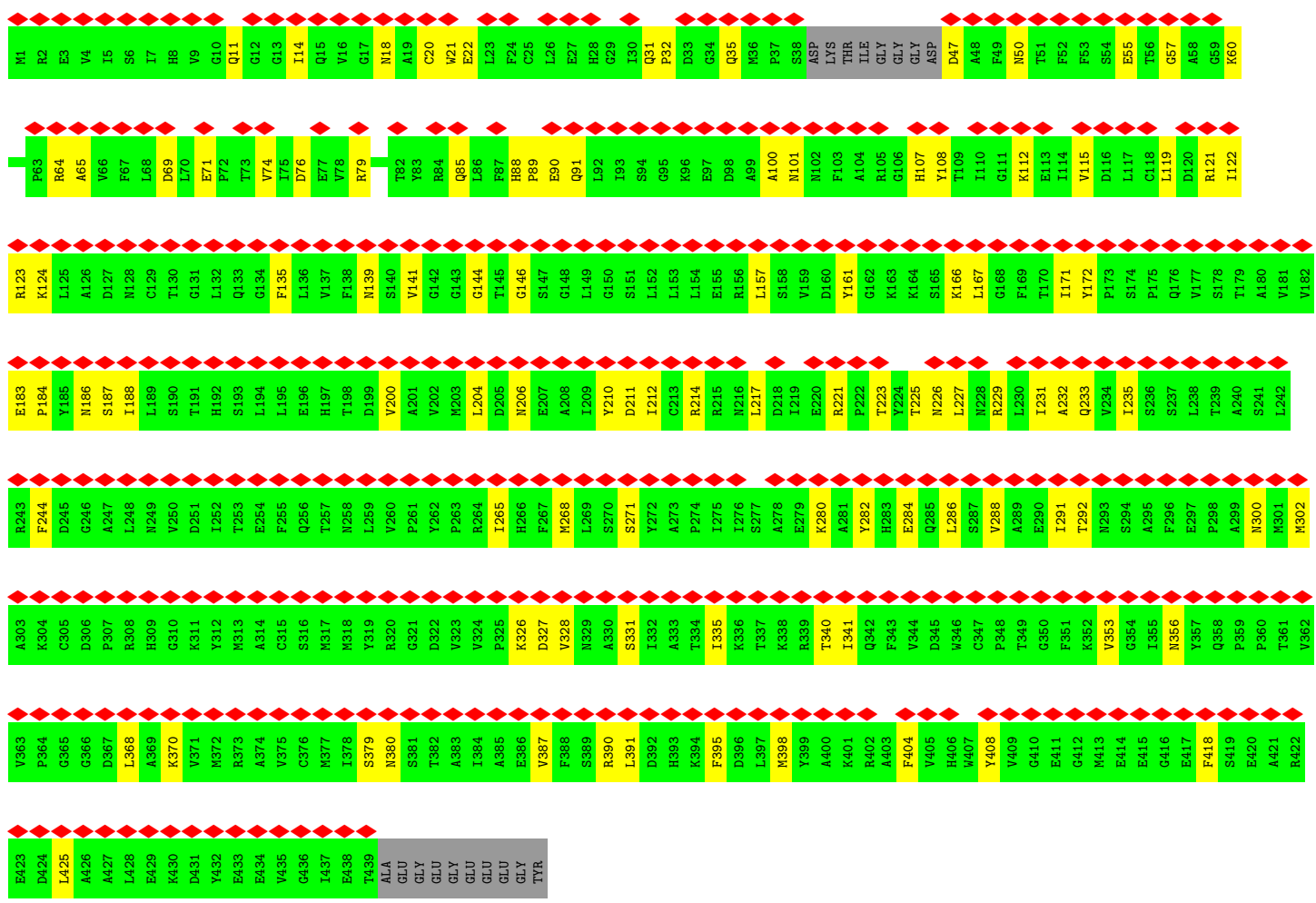
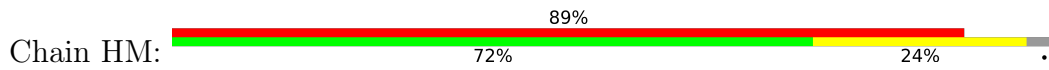

• Molecule 45: Tubulin alpha chain

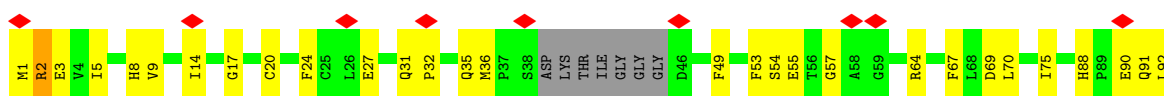

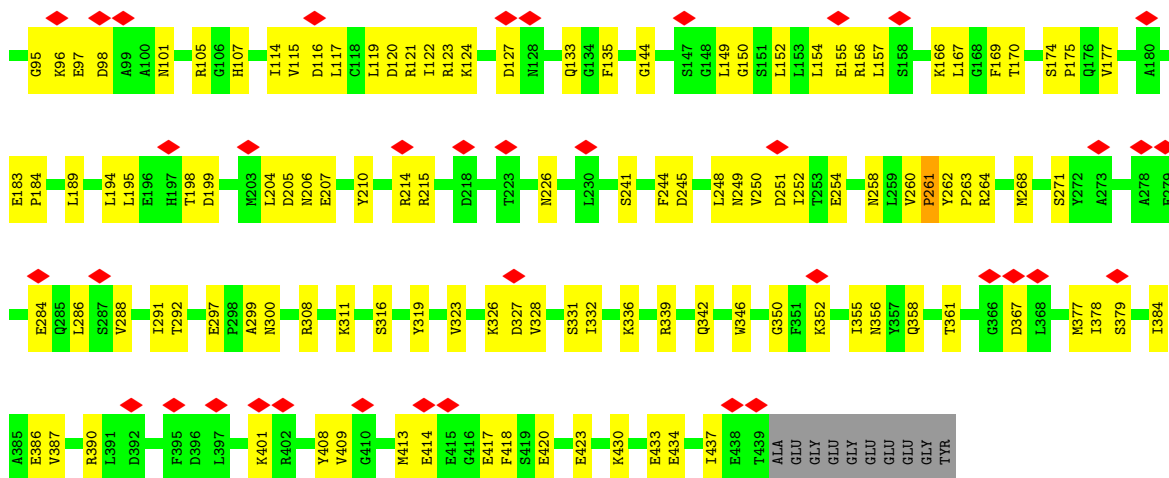

• Molecule 45: Tubulin alpha chain

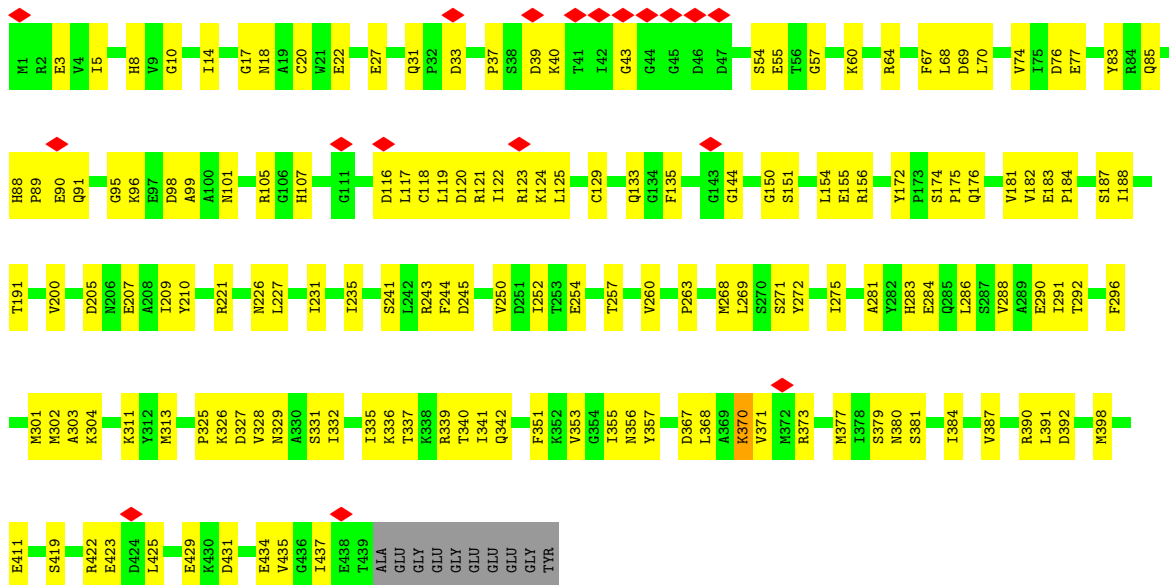

• Molecule 45: Tubulin alpha chain

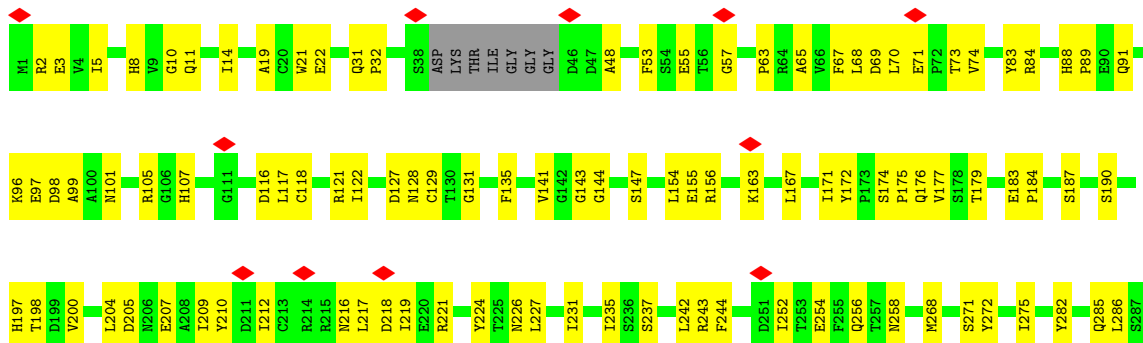



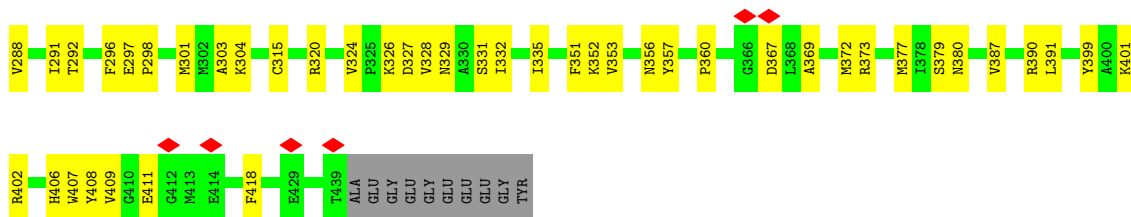

• Molecule 45: Tubulin alpha chain

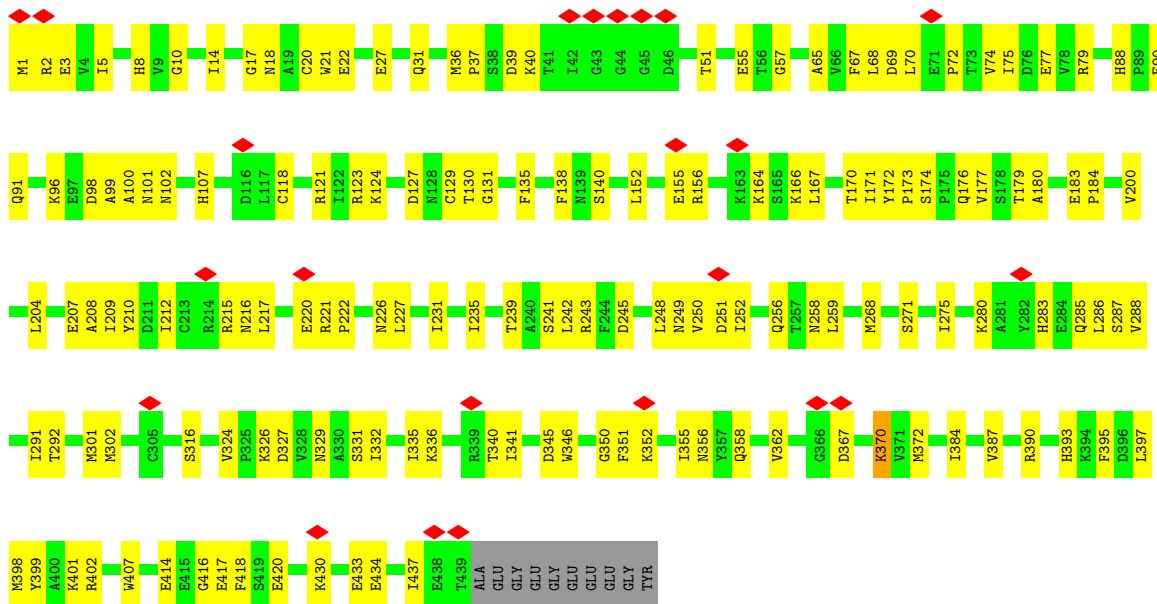

• Molecule 45: Tubulin alpha chain

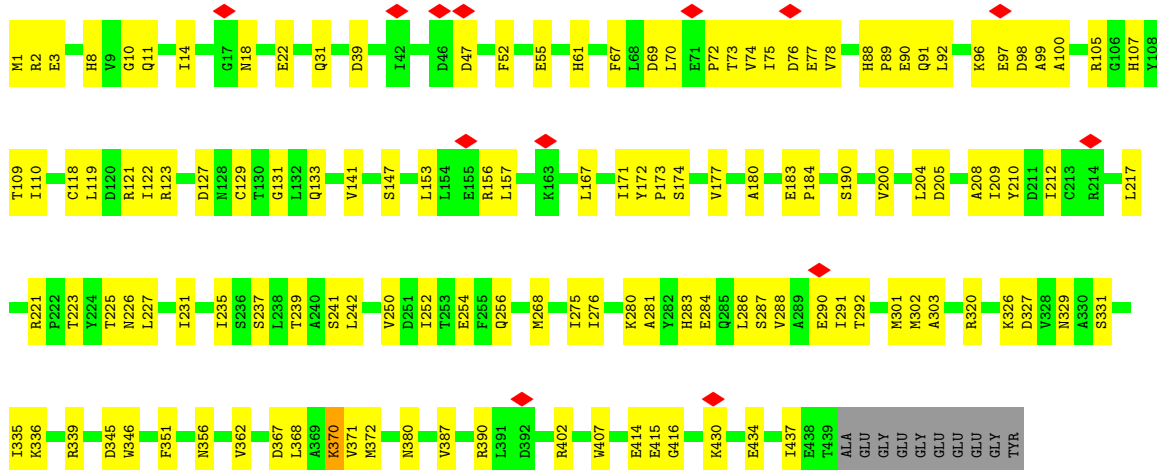

• Molecule 45: Tubulin alpha chain

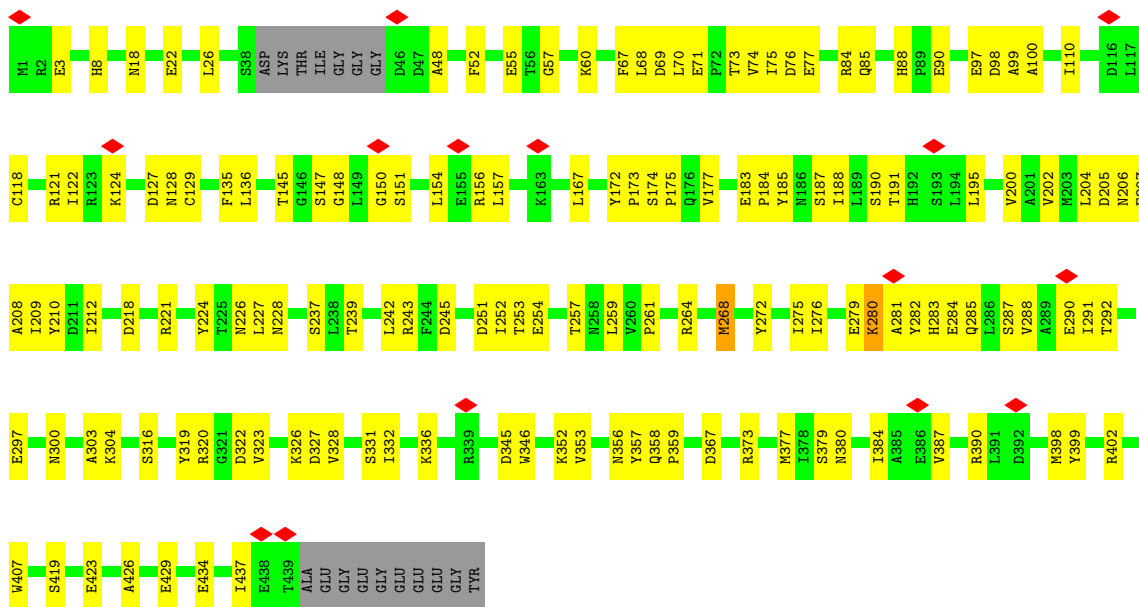

• Molecule 45: Tubulin alpha chain

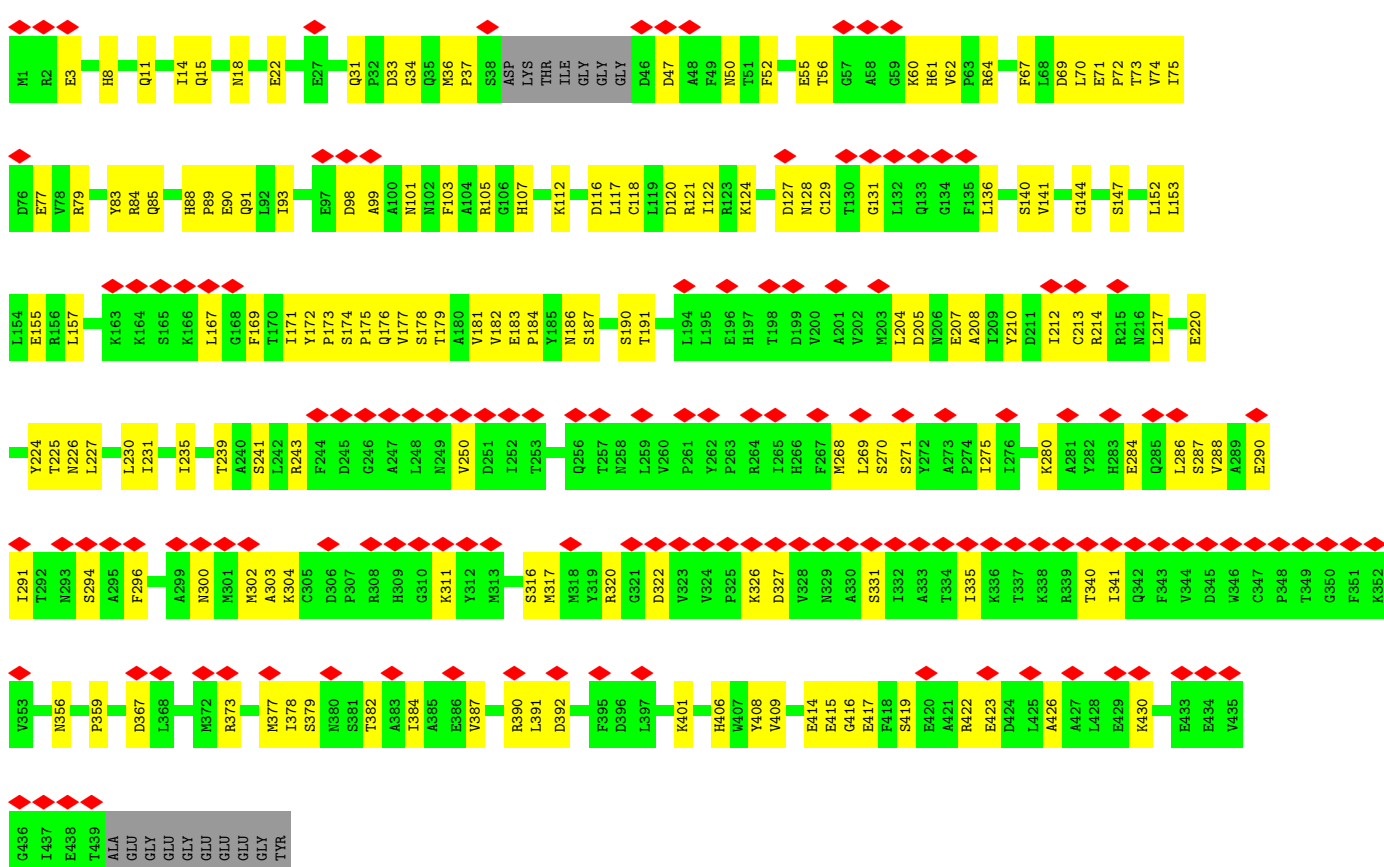

• Molecule 45: Tubulin alpha chain

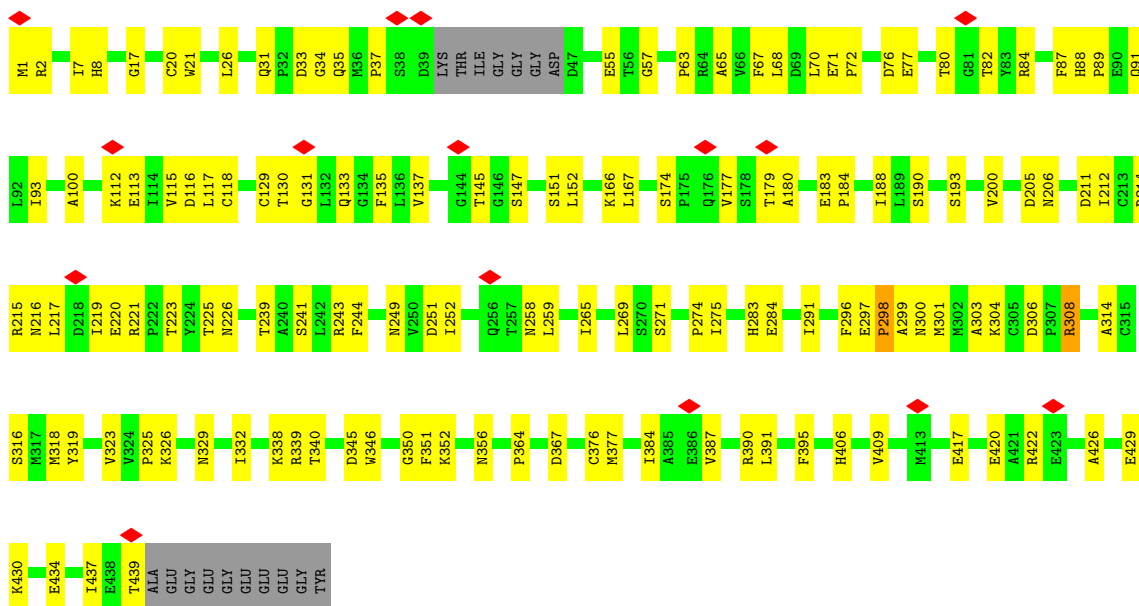

• Molecule 45: Tubulin alpha chain

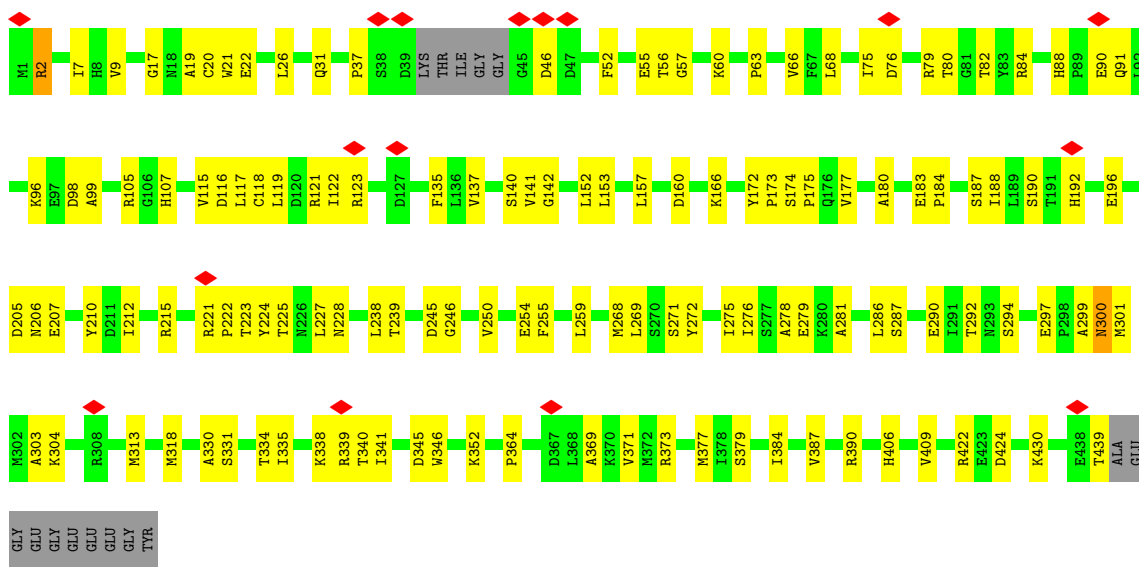

• Molecule 45: Tubulin alpha chain

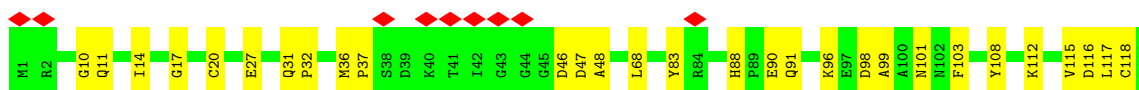

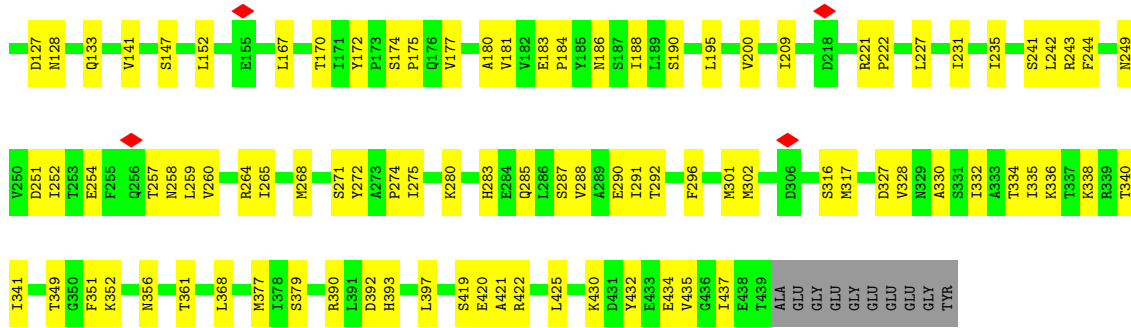

• Molecule 45: Tubulin alpha chain

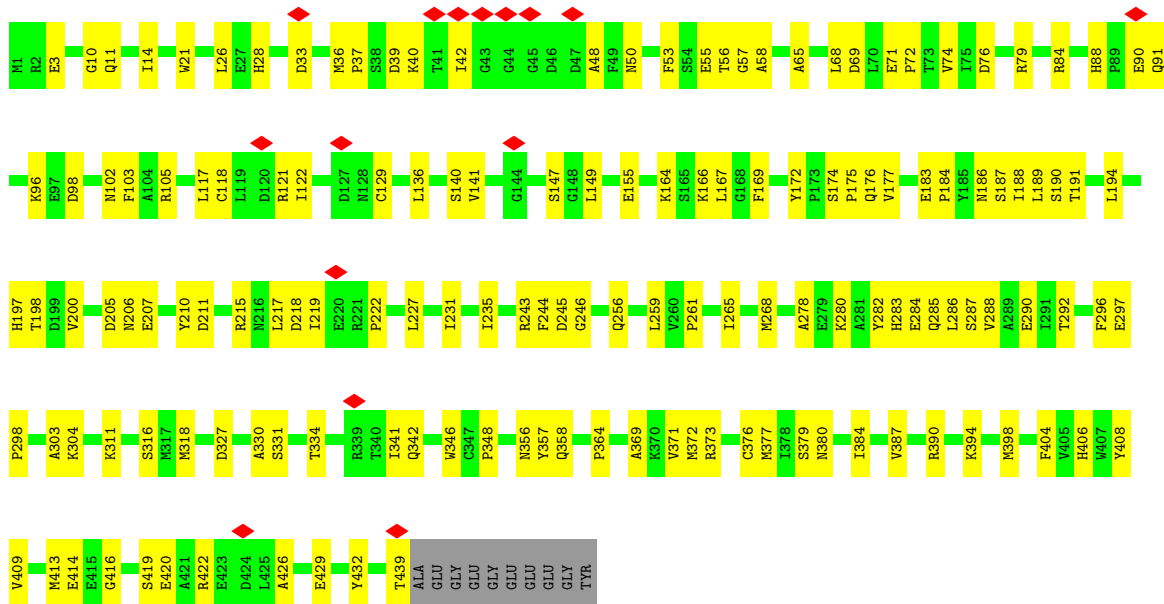

• Molecule 45: Tubulin alpha chain

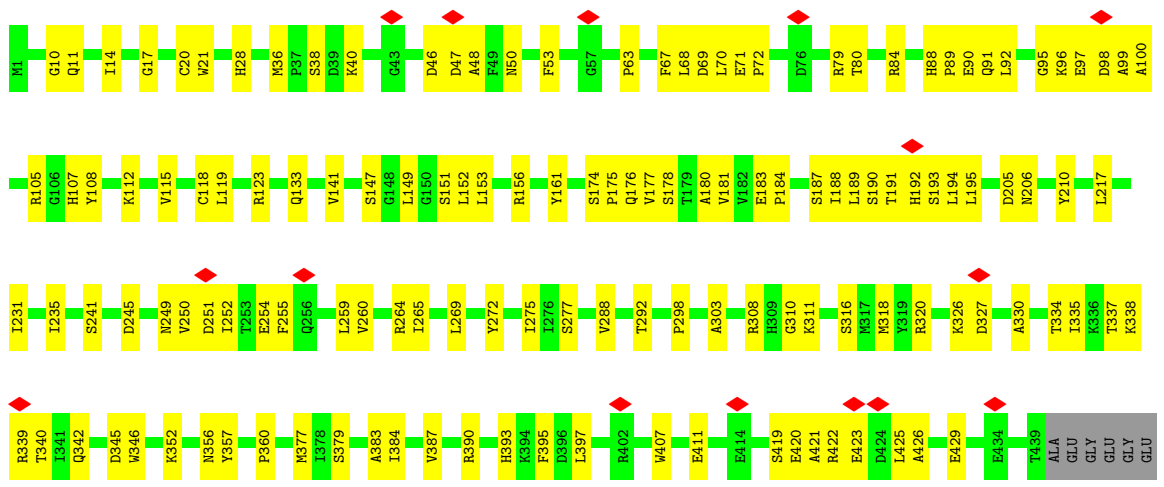

GLU  
GLU  
GLY  
TYR

• Molecule 45: Tubulin alpha chain

Chain JK:

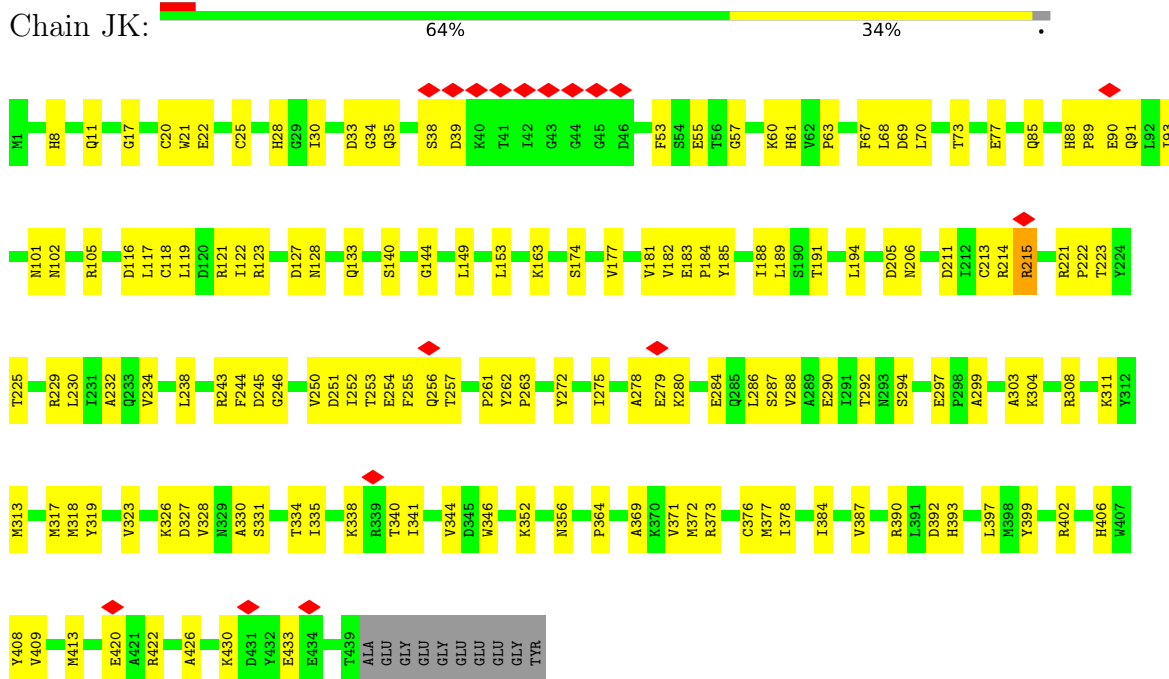

• Molecule 45: Tubulin alpha chain

Chain JM:

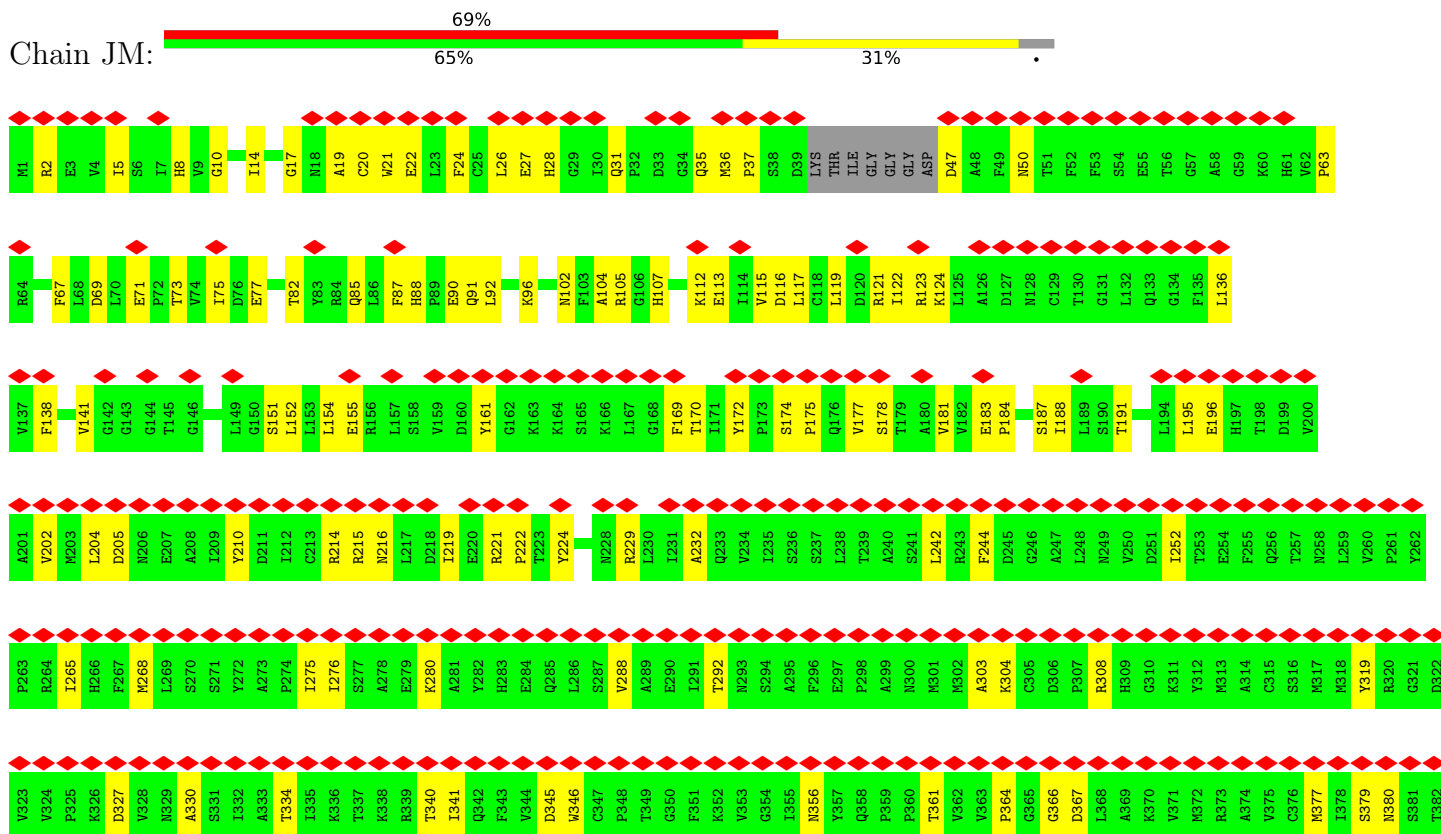

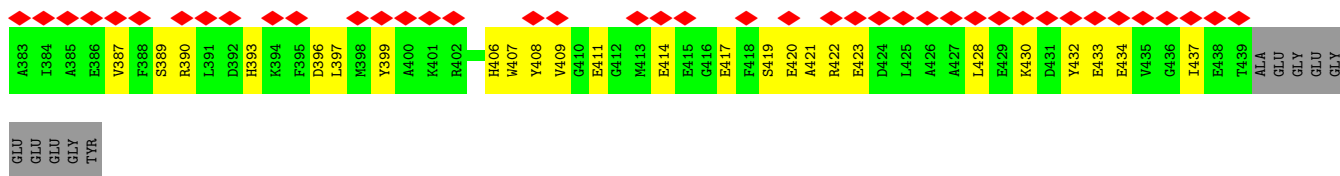

• Molecule 45: Tubulin alpha chain

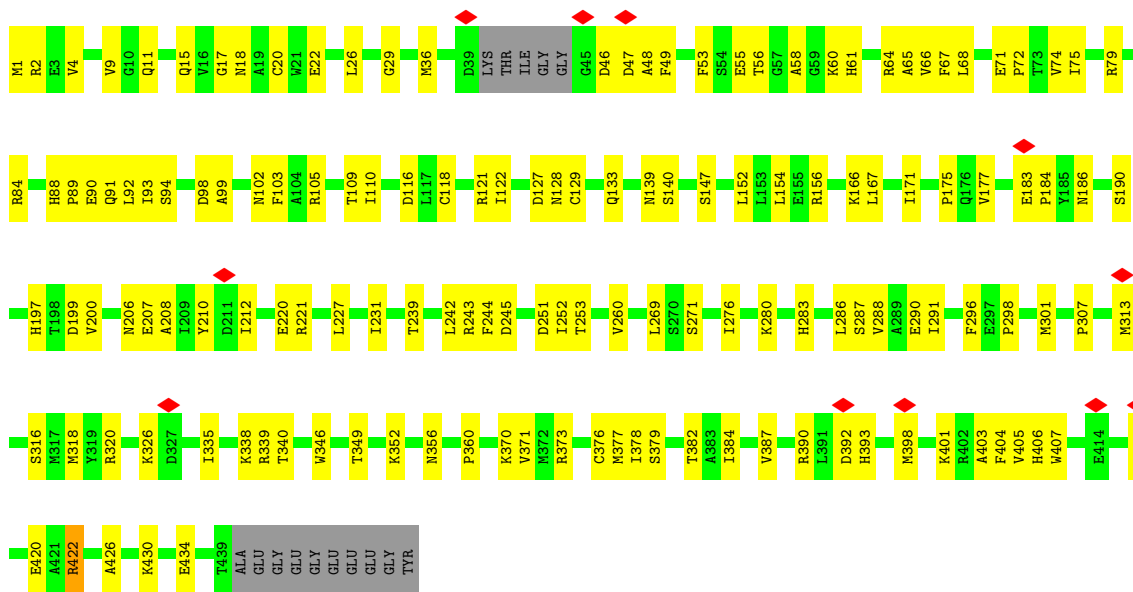

• Molecule 45: Tubulin alpha chain

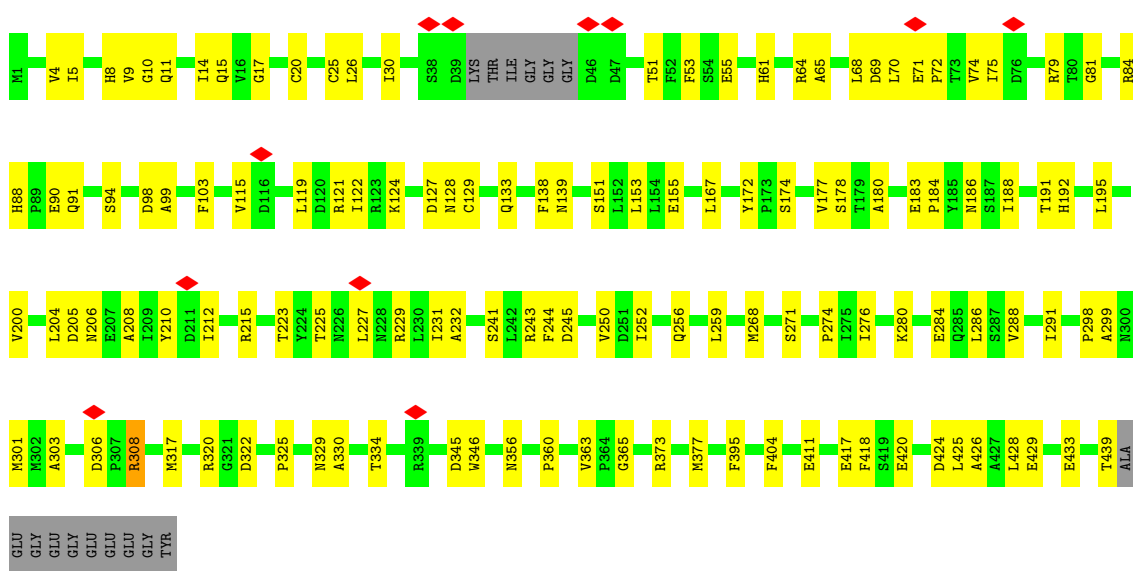

• Molecule 45: Tubulin alpha chain

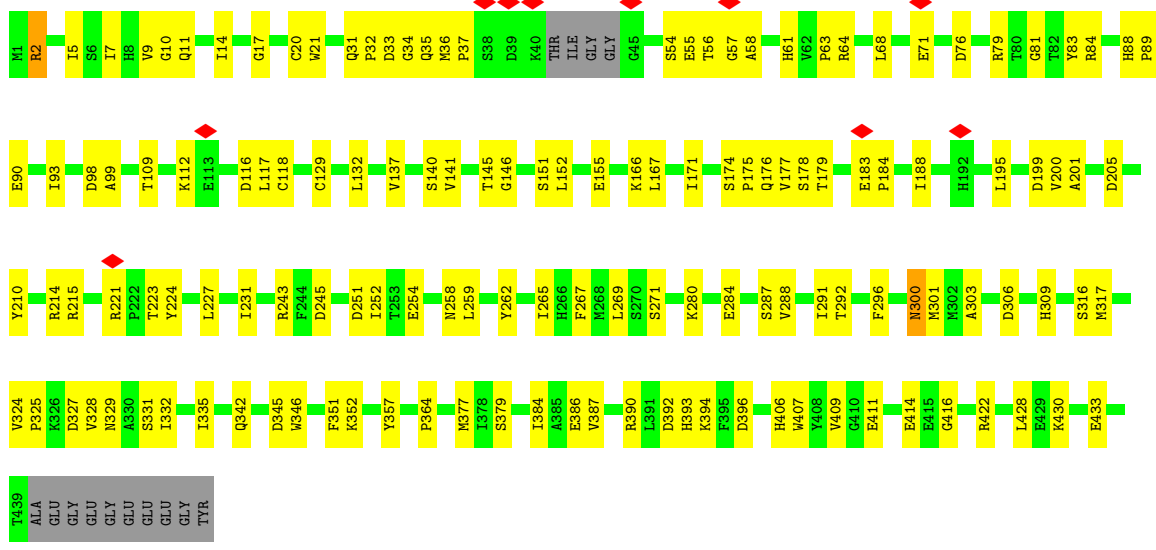

• Molecule 45: Tubulin alpha chain

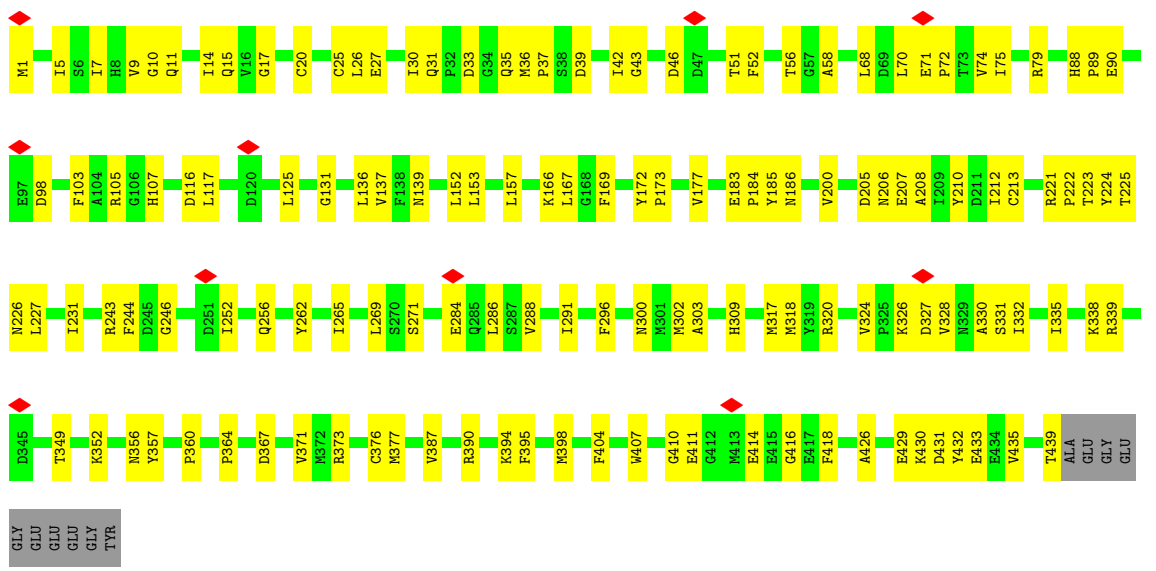

• Molecule 45: Tubulin alpha chain

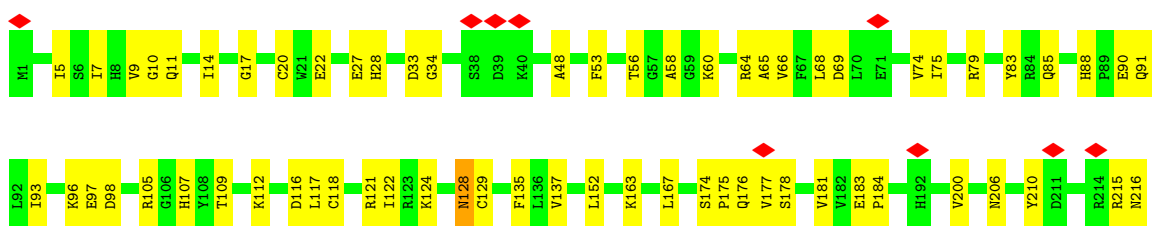



• Molecule 45: Tubulin alpha chain

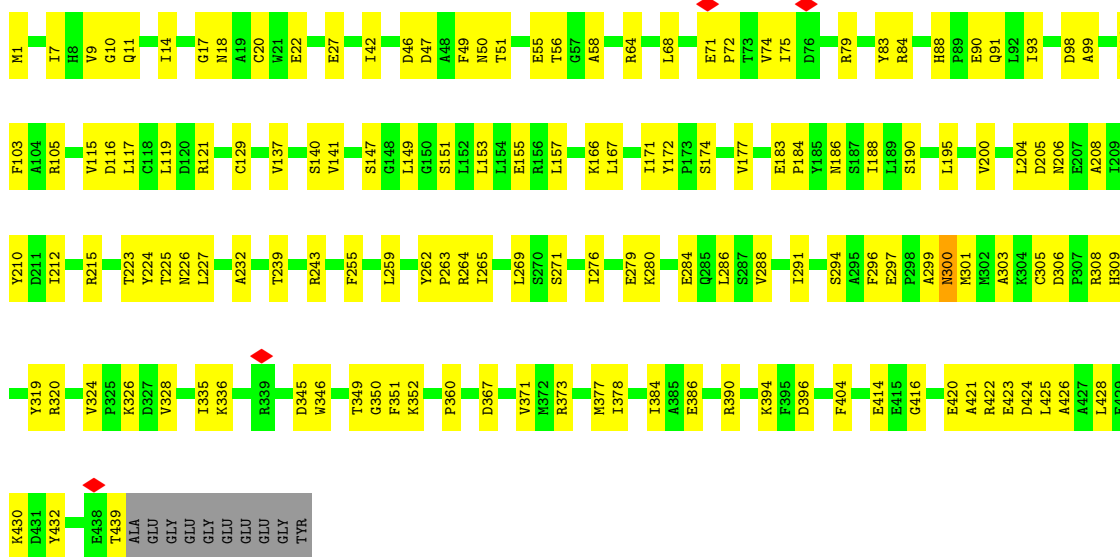

• Molecule 45: Tubulin alpha chain

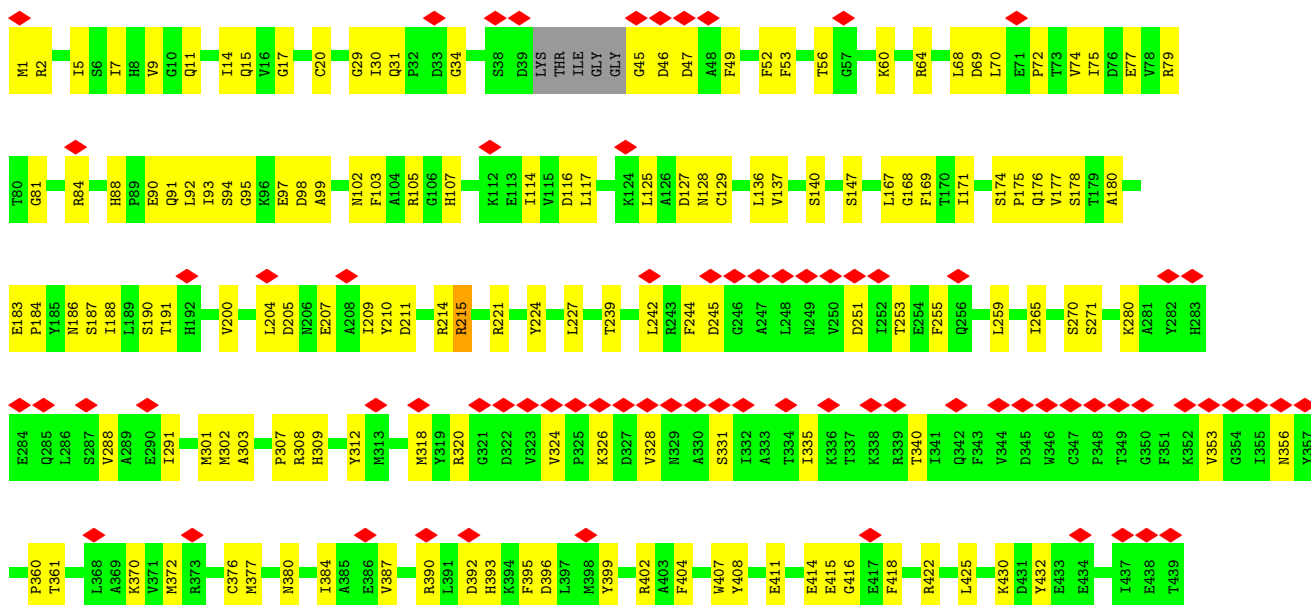



ALA  
GLU  
GLY  
GLY  
GLY  
GLY  
GLY  
GLY  
GLY  
TYR

• Molecule 45: Tubulin alpha chain

Chain LA:

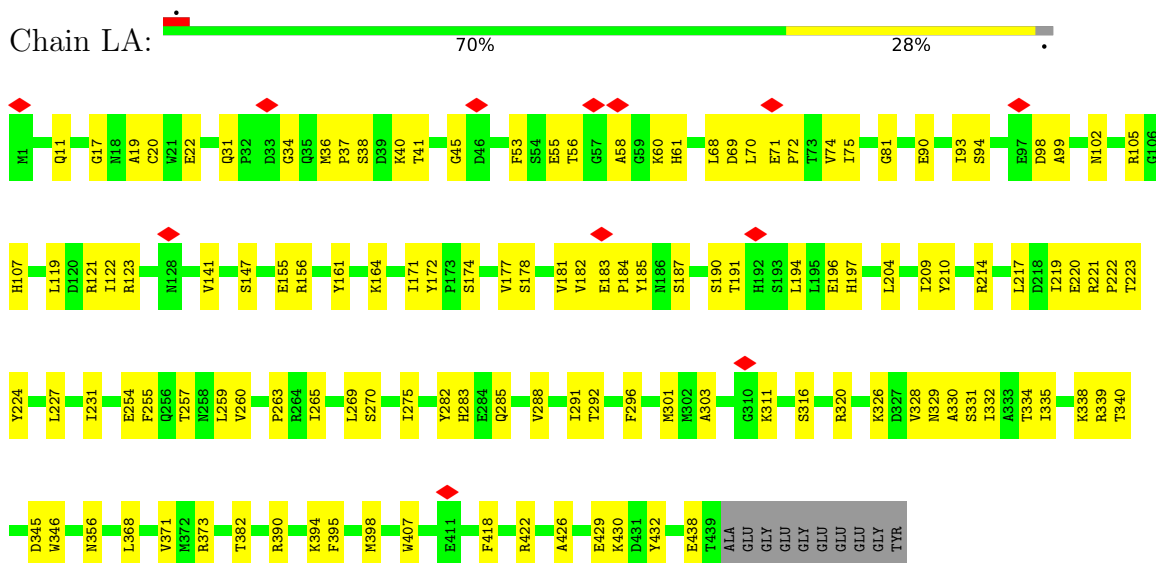

• Molecule 45: Tubulin alpha chain

Chain LC:

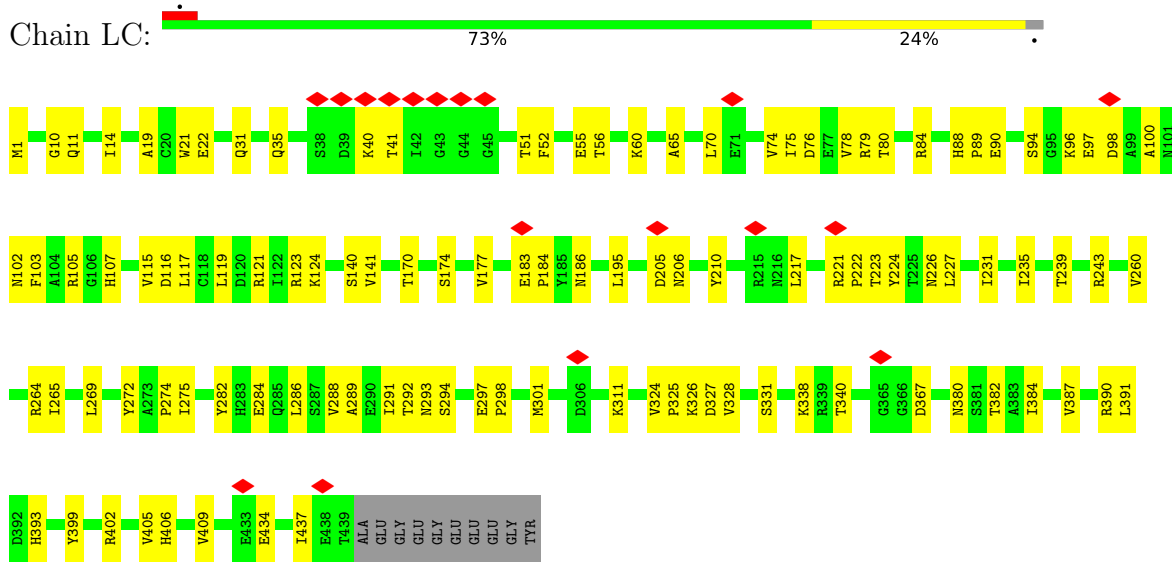

• Molecule 45: Tubulin alpha chain

Chain LE:

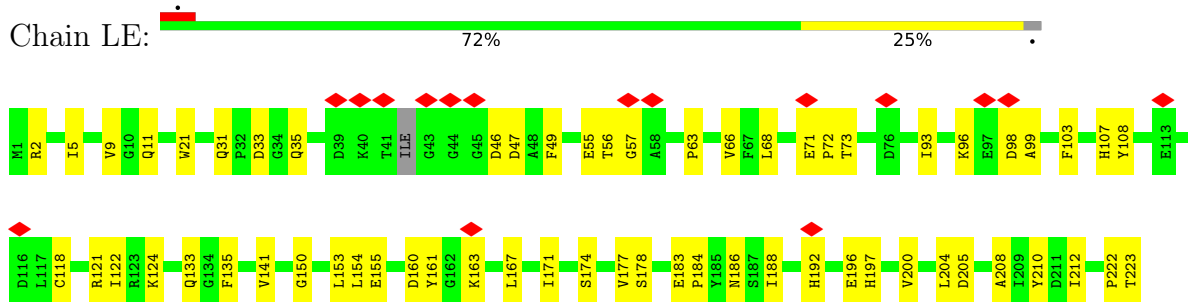

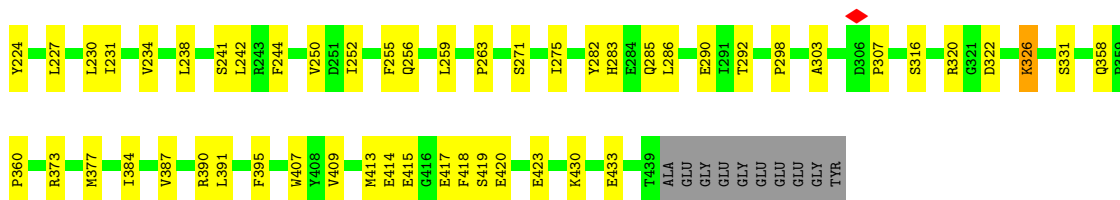

• Molecule 45: Tubulin alpha chain

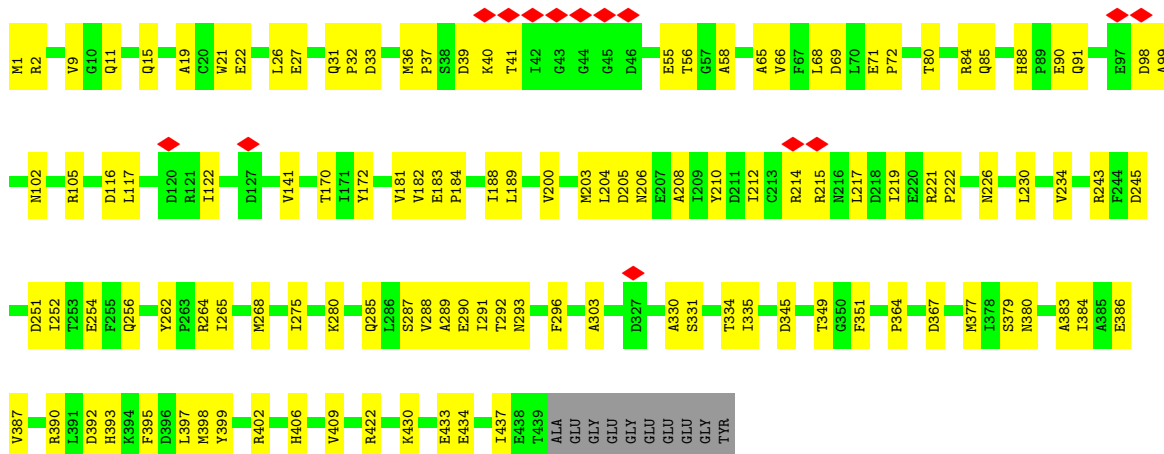

• Molecule 45: Tubulin alpha chain

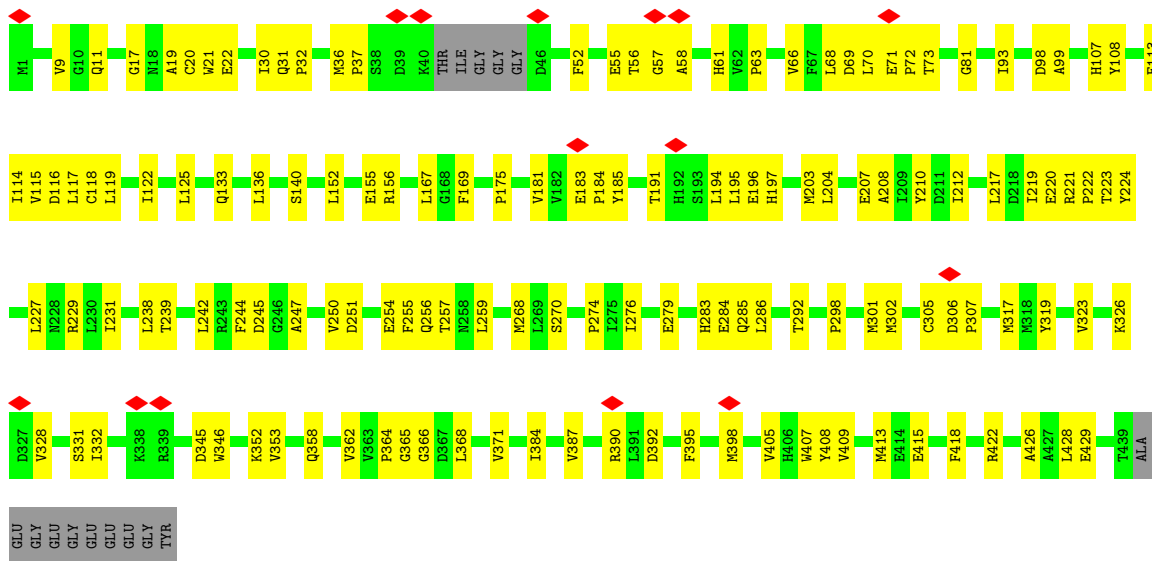

• Molecule 45: Tubulin alpha chain



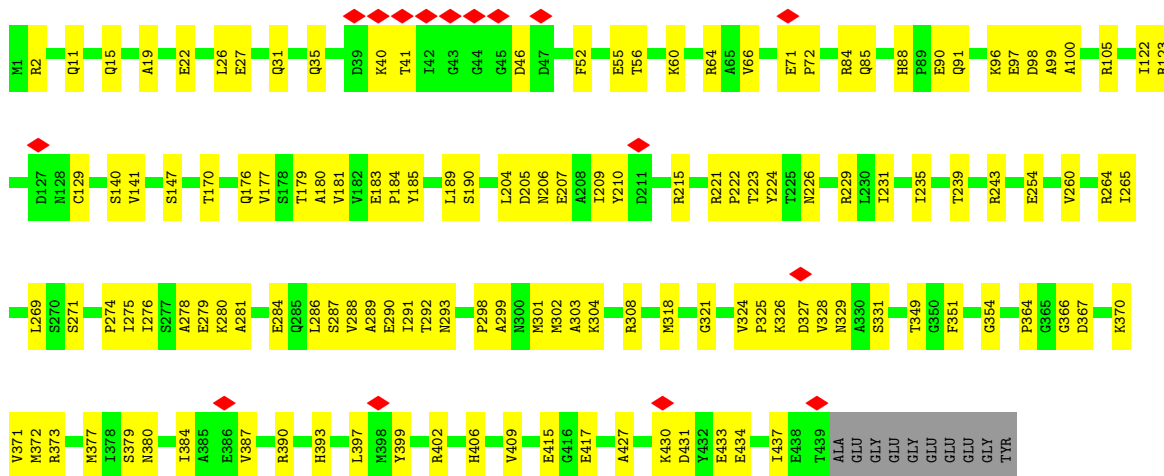

• Molecule 45: Tubulin alpha chain

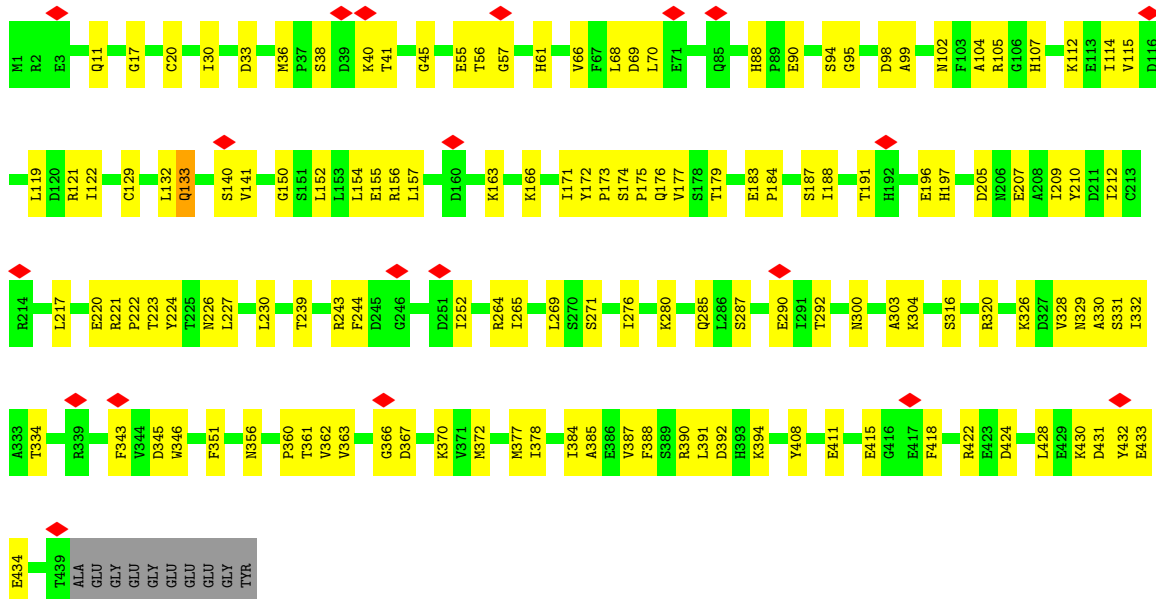

• Molecule 45: Tubulin alpha chain

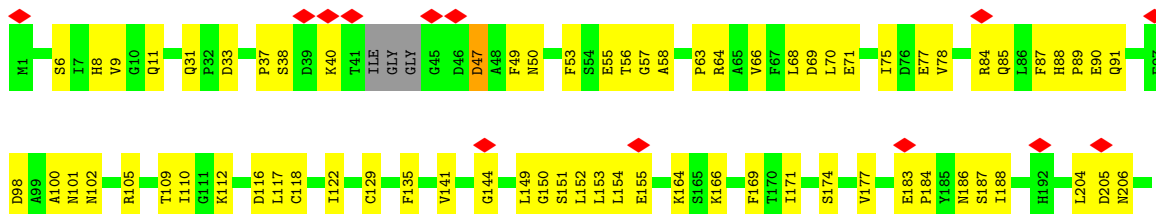

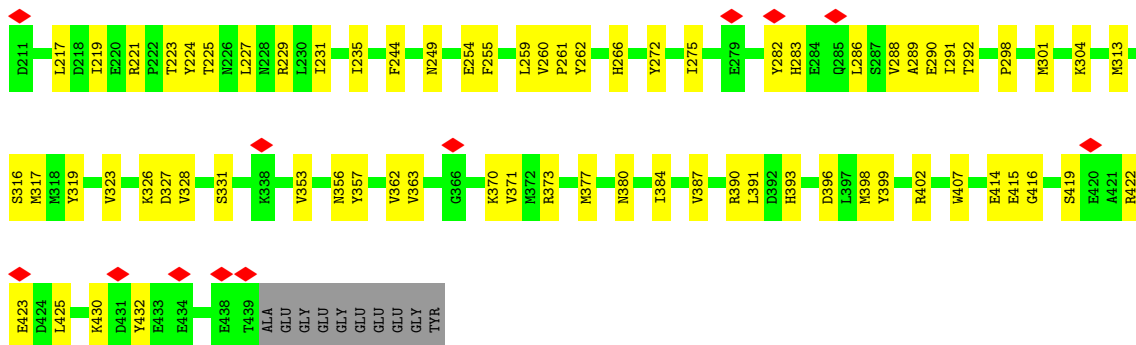

• Molecule 45: Tubulin alpha chain

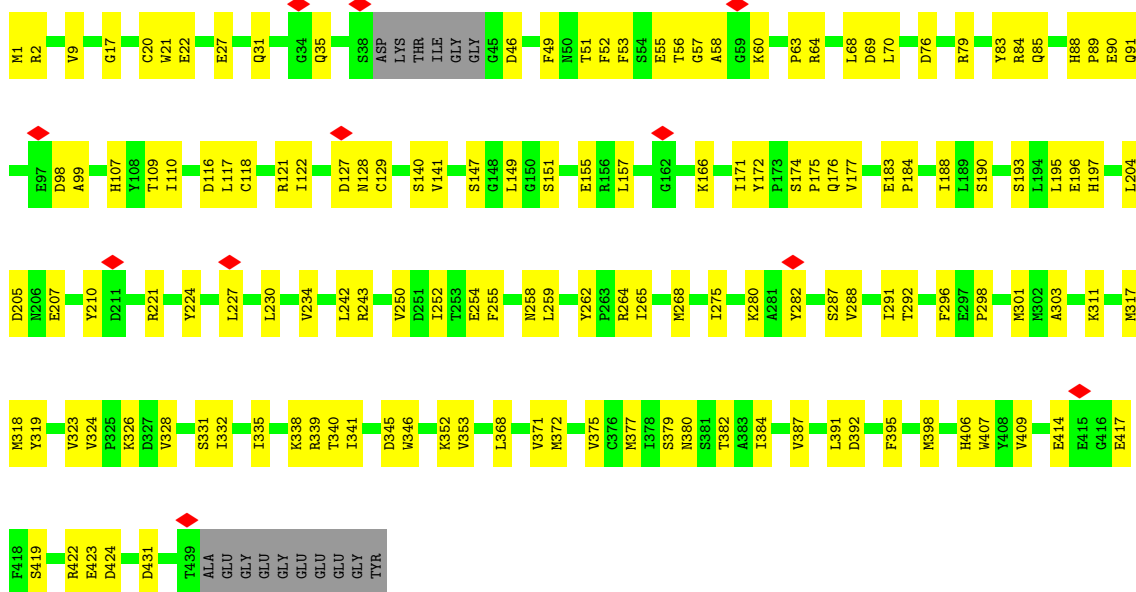

• Molecule 45: Tubulin alpha chain

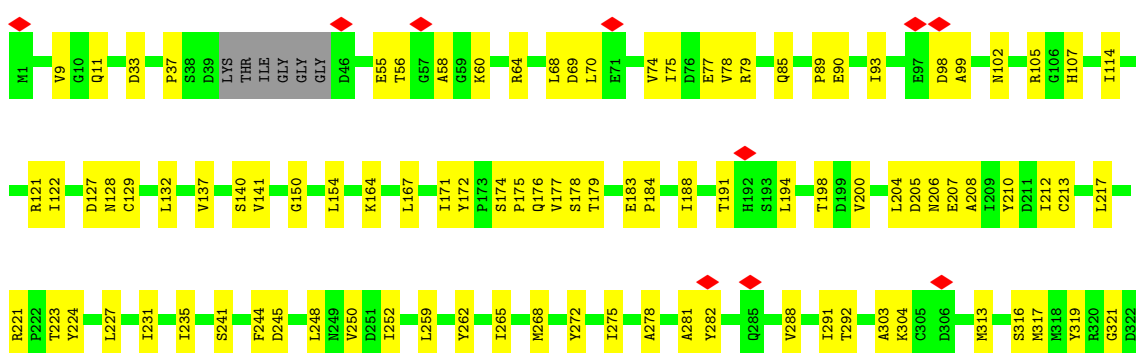

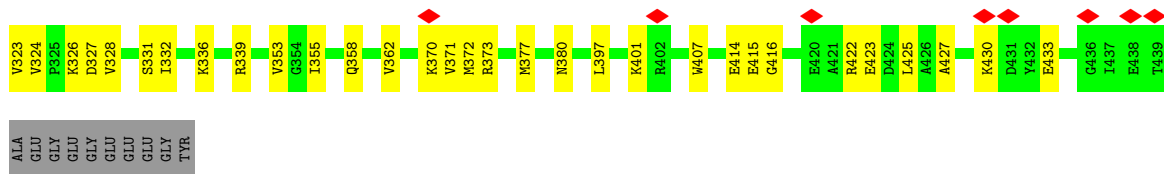

• Molecule 45: Tubulin alpha chain

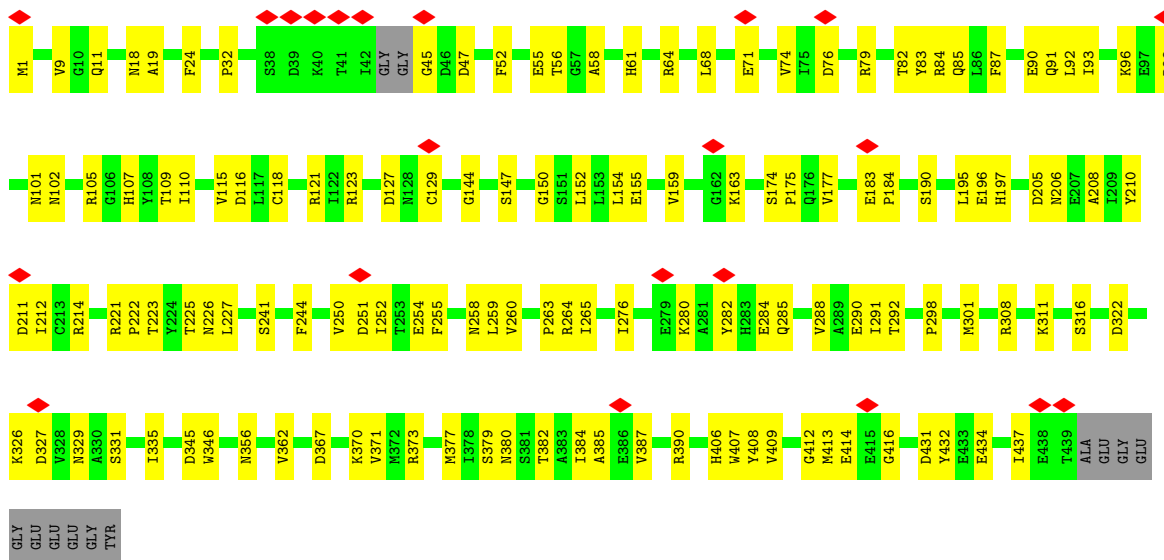

• Molecule 45: Tubulin alpha chain

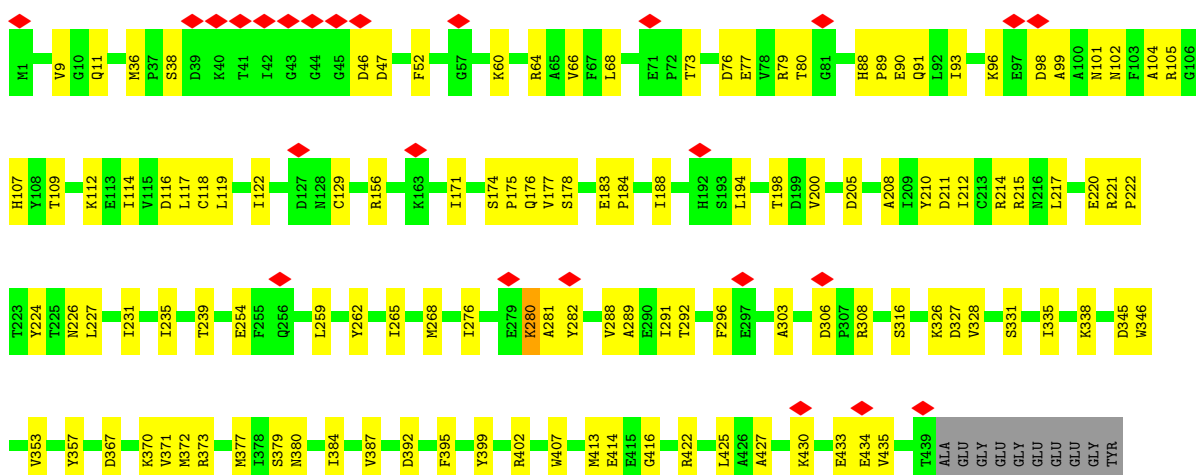

• Molecule 45: Tubulin alpha chain



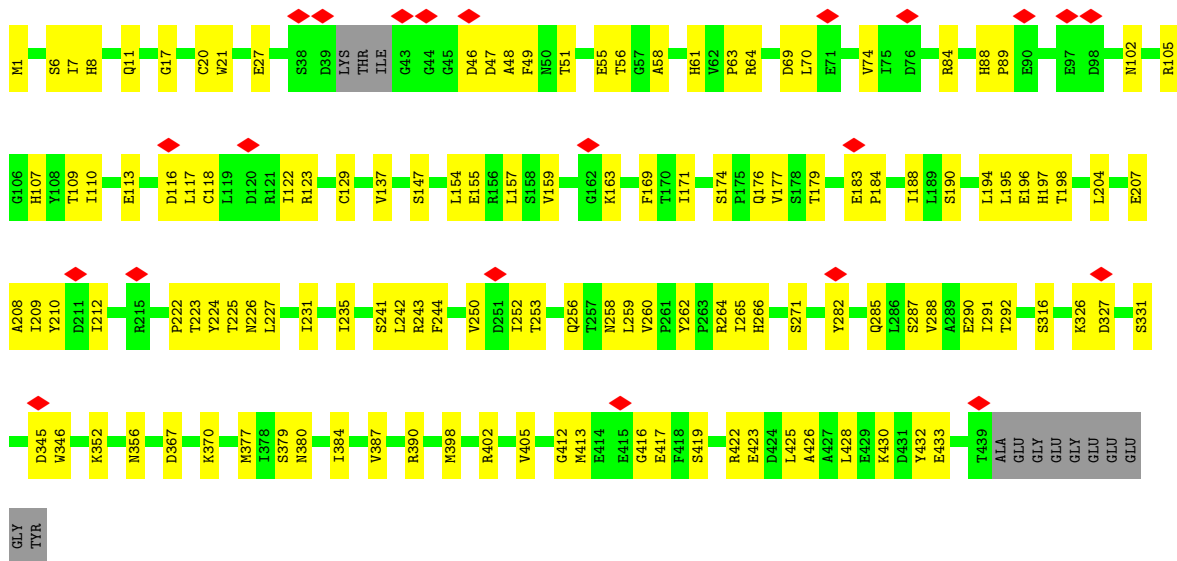

• Molecule 45: Tubulin alpha chain

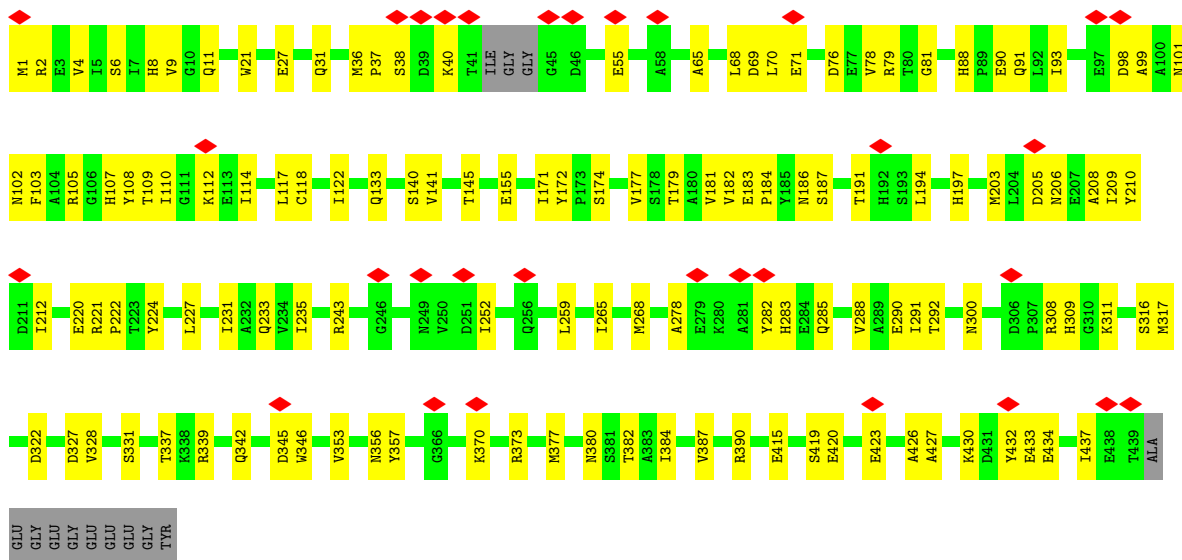
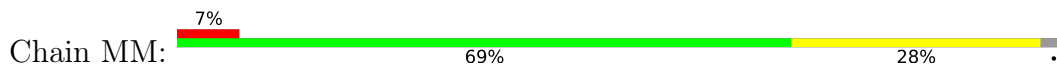

• Molecule 45: Tubulin alpha chain

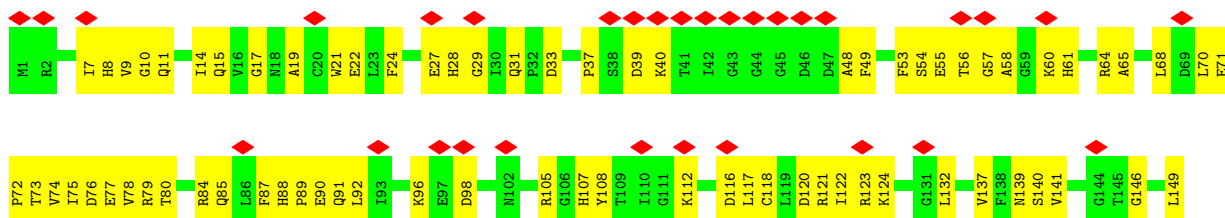

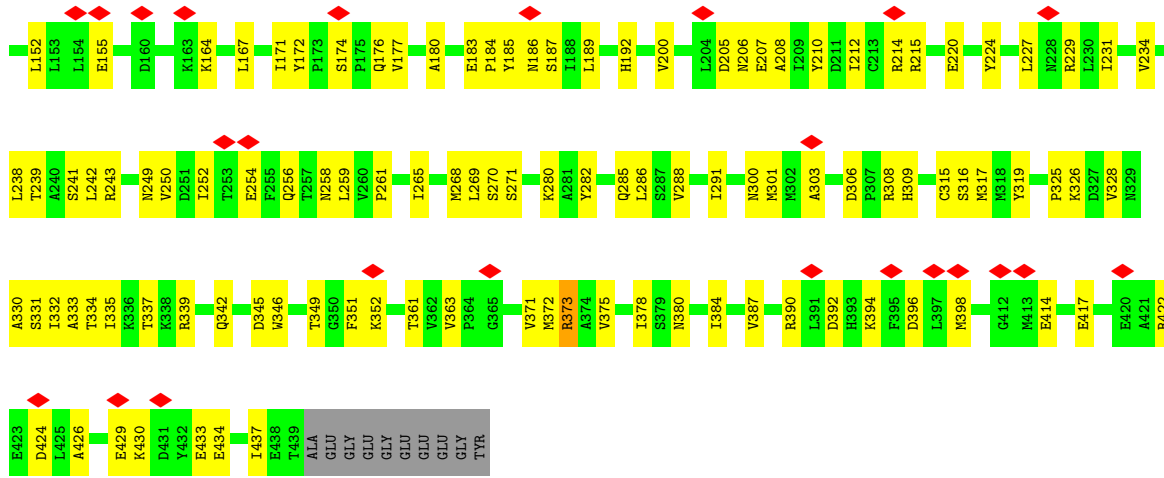

• Molecule 45: Tubulin alpha chain

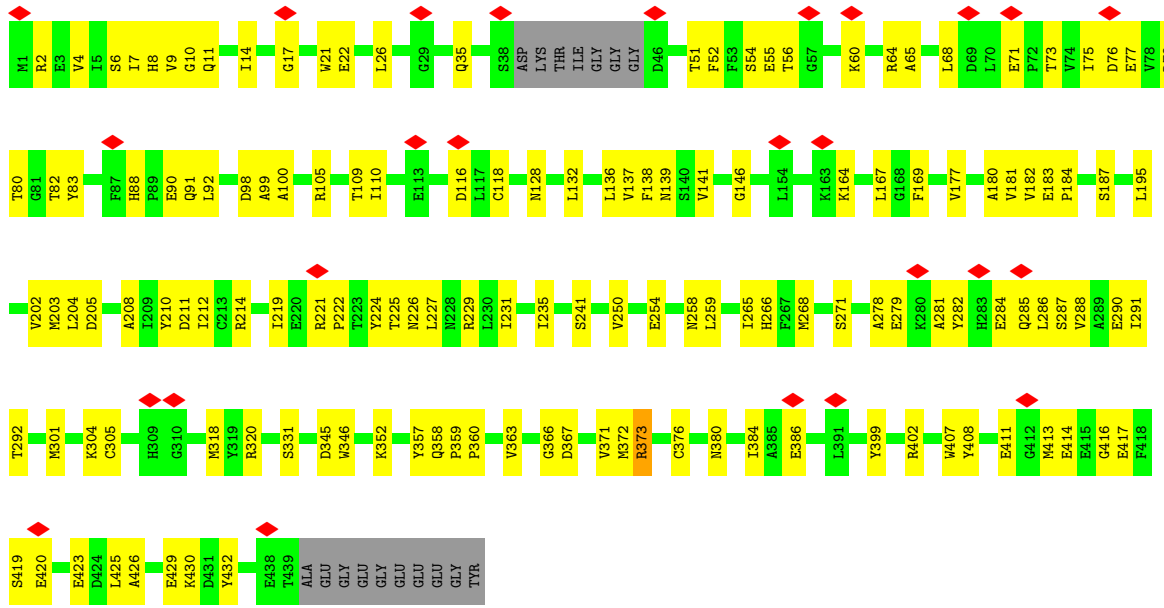

• Molecule 45: Tubulin alpha chain

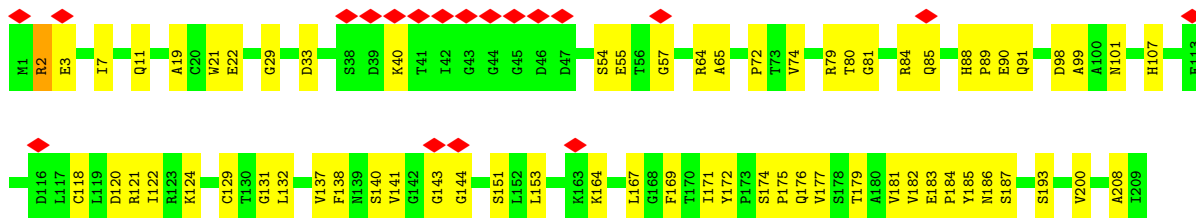

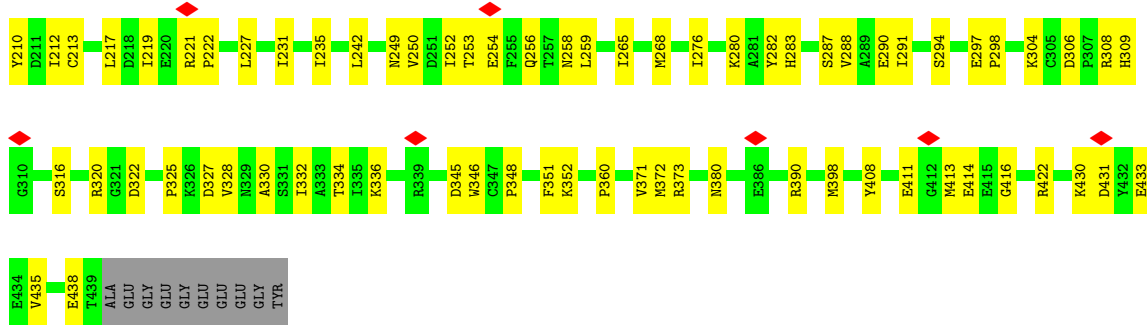

• Molecule 45: Tubulin alpha chain

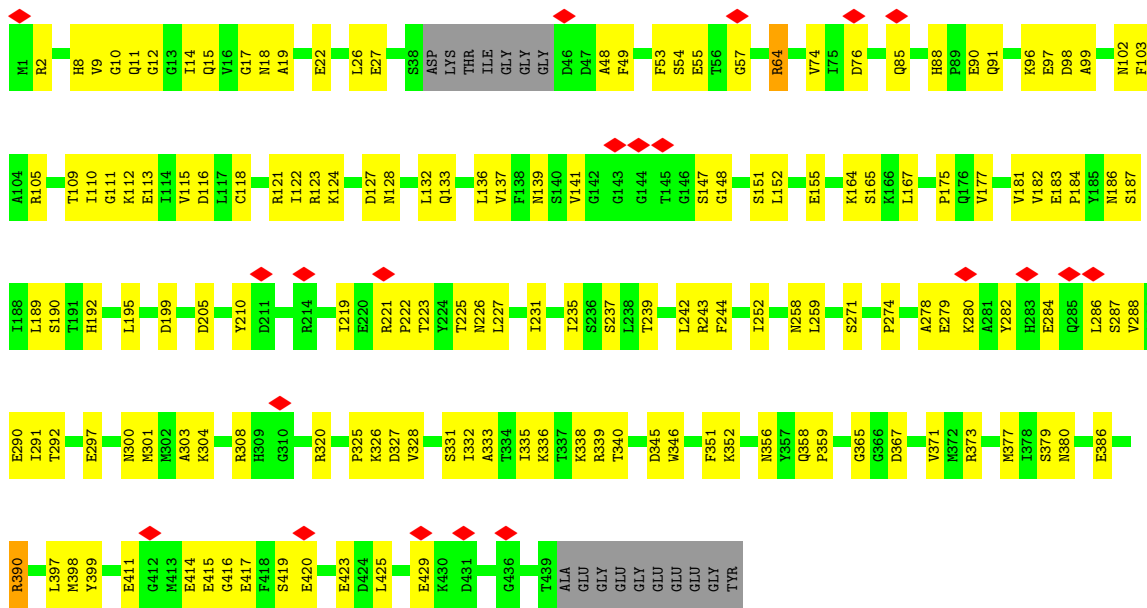

• Molecule 45: Tubulin alpha chain

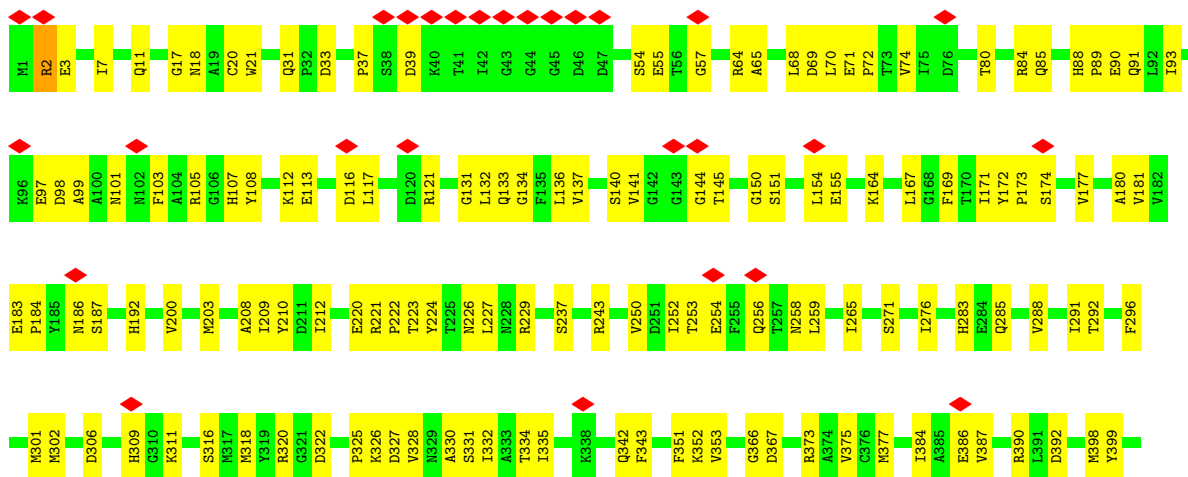





• Molecule 45: Tubulin alpha chain

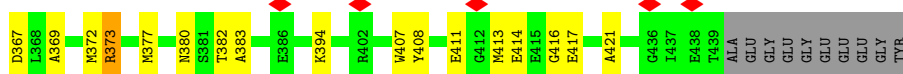
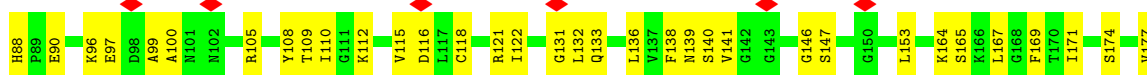
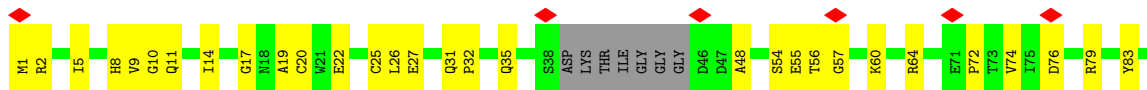

• Molecule 45: Tubulin alpha chain

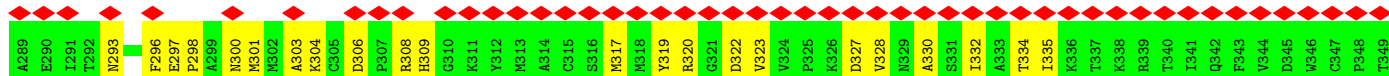
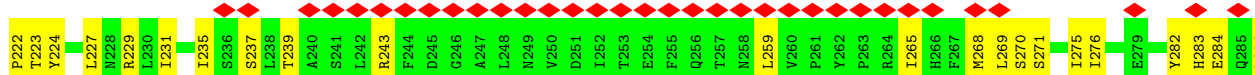
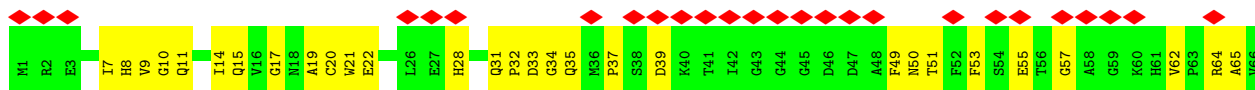

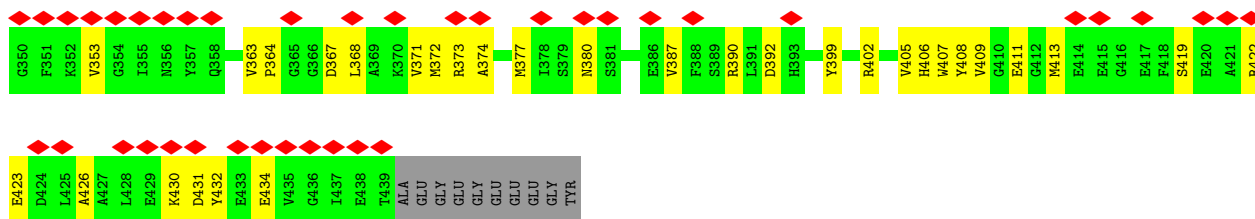

• Molecule 45: Tubulin alpha chain

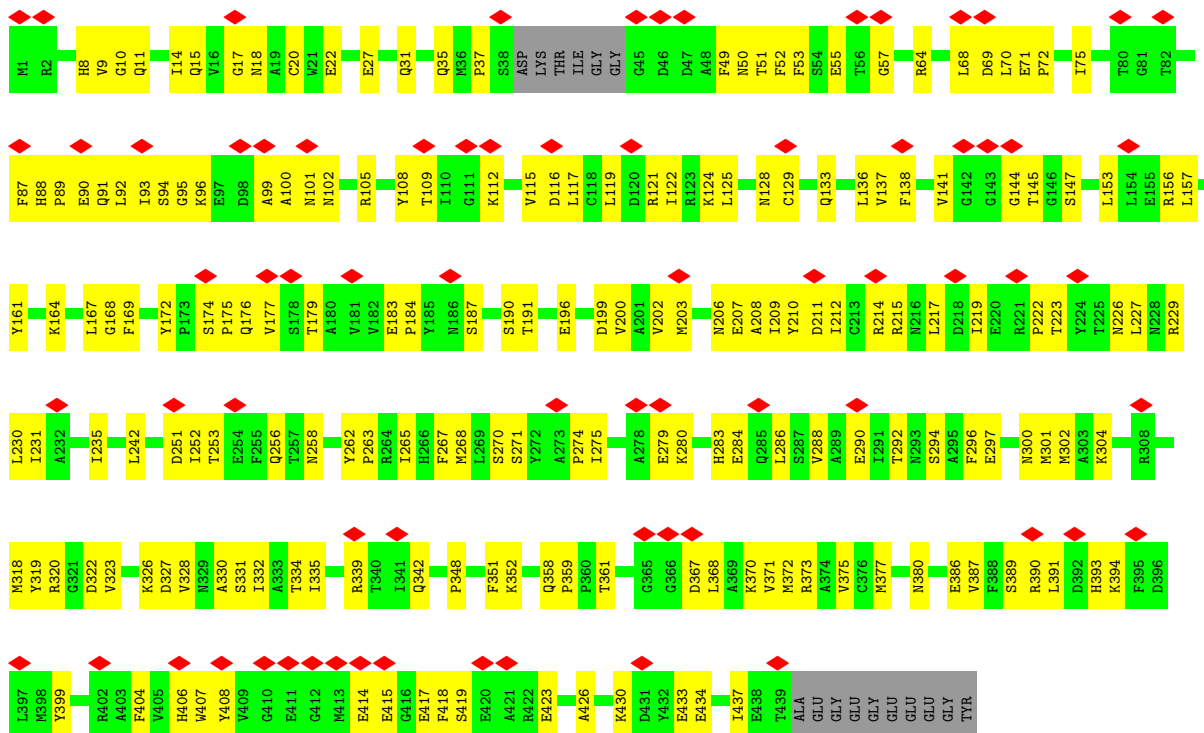

• Molecule 45: Tubulin alpha chain

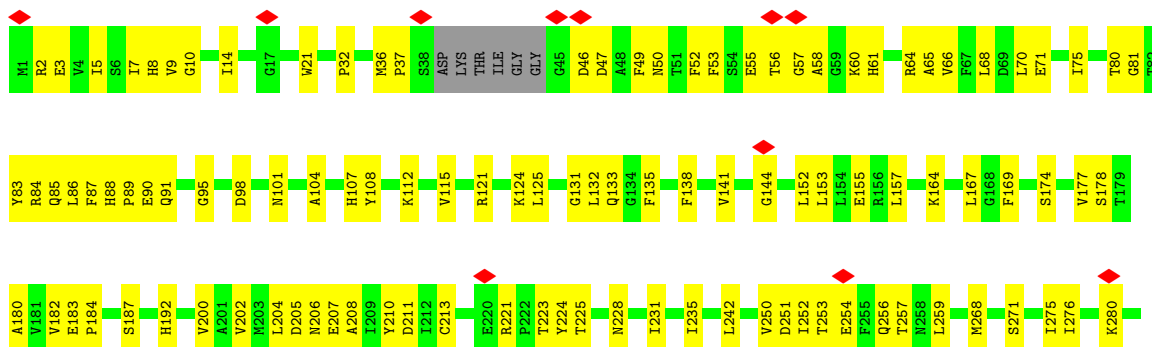

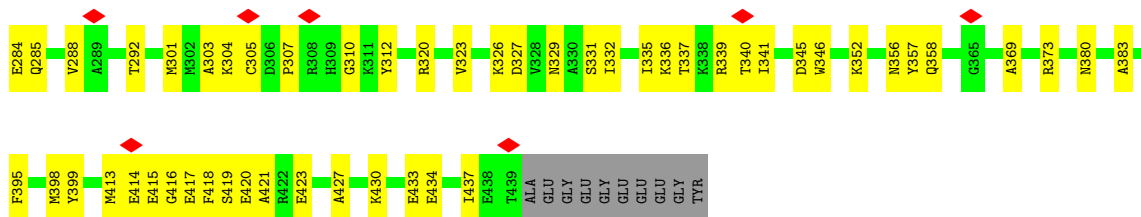

• Molecule 45: Tubulin alpha chain

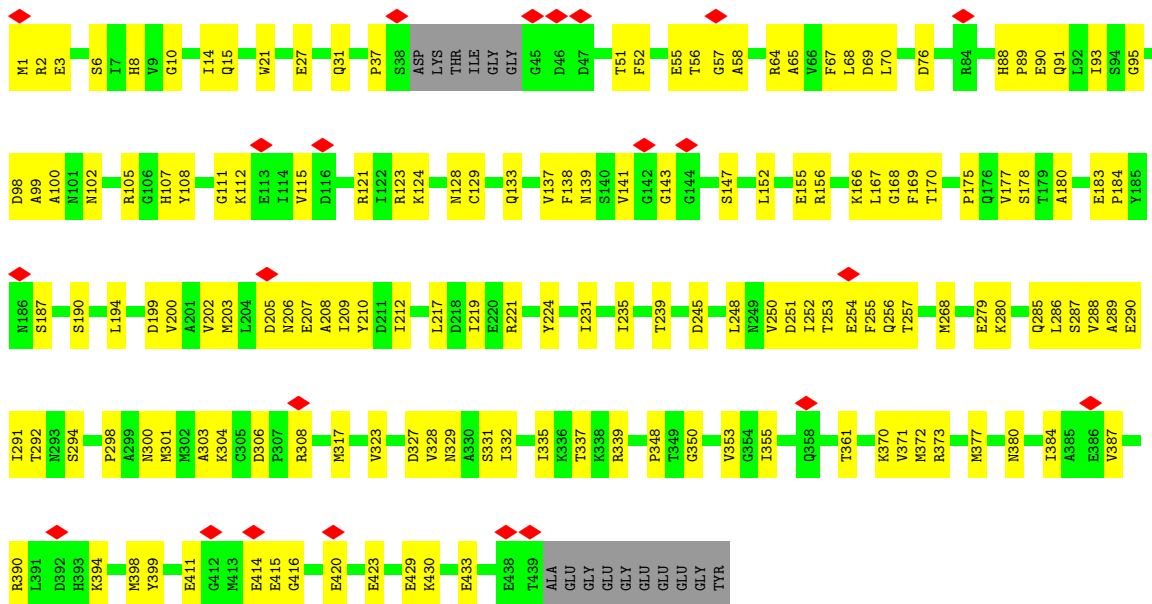

• Molecule 45: Tubulin alpha chain

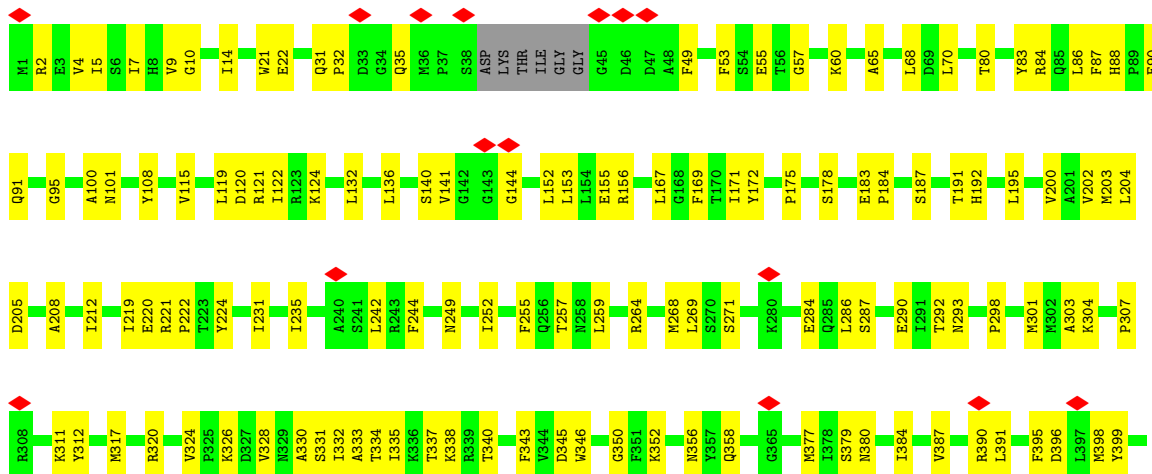



• Molecule 45: Tubulin alpha chain

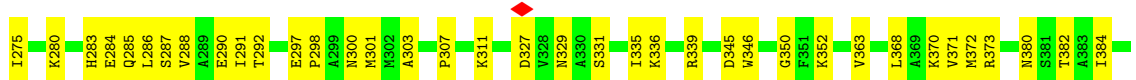
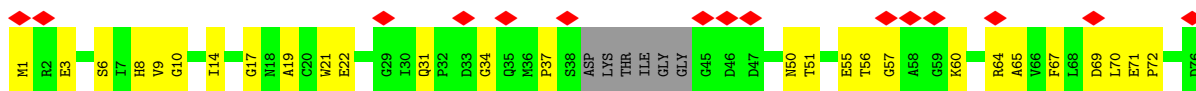

• Molecule 45: Tubulin alpha chain

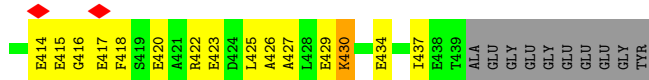
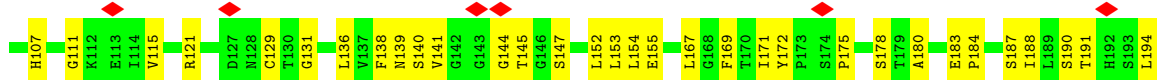
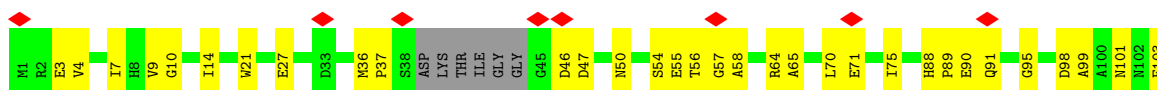

• Molecule 45: Tubulin alpha chain

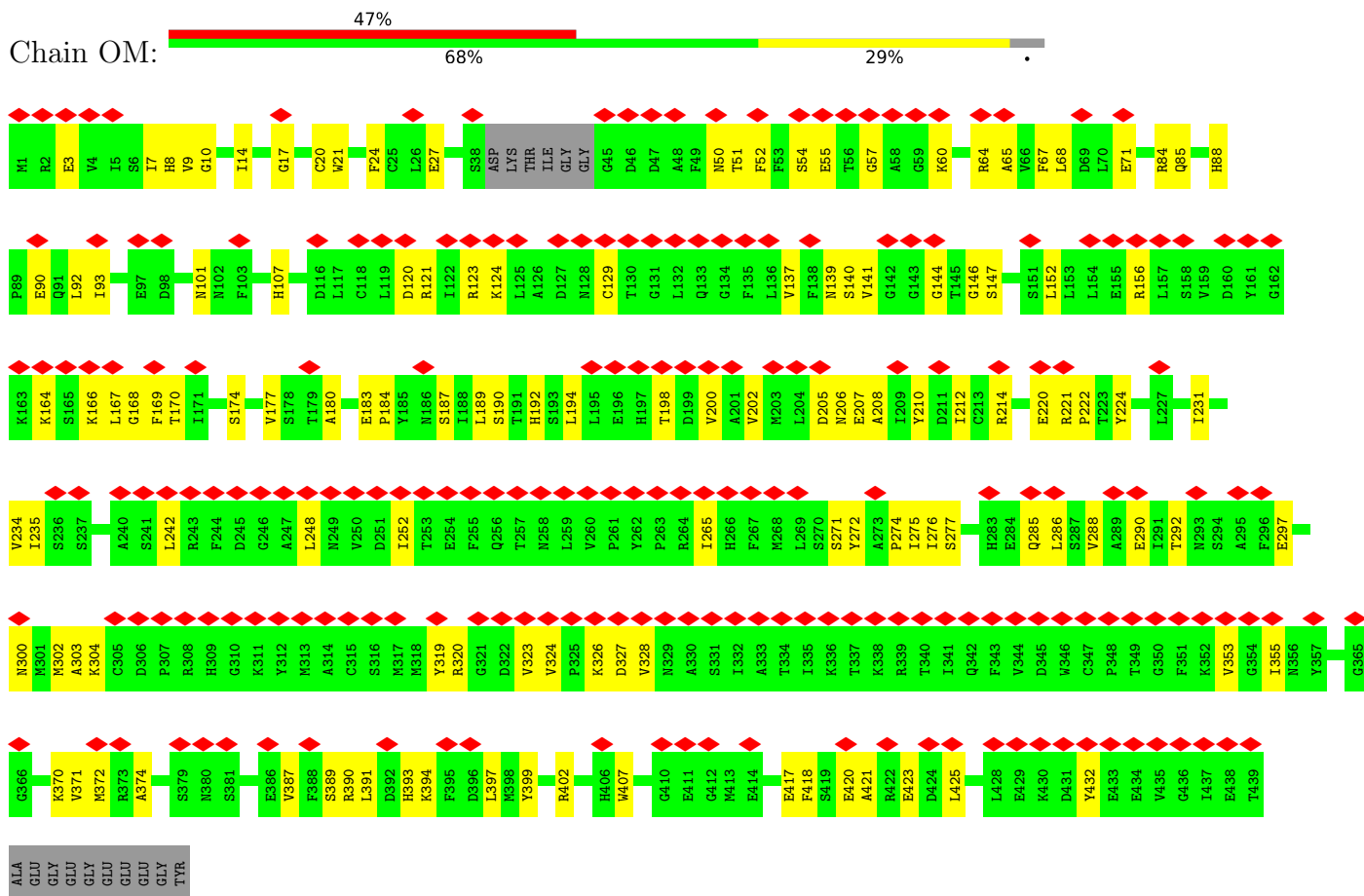

• Molecule 45: Tubulin alpha chain

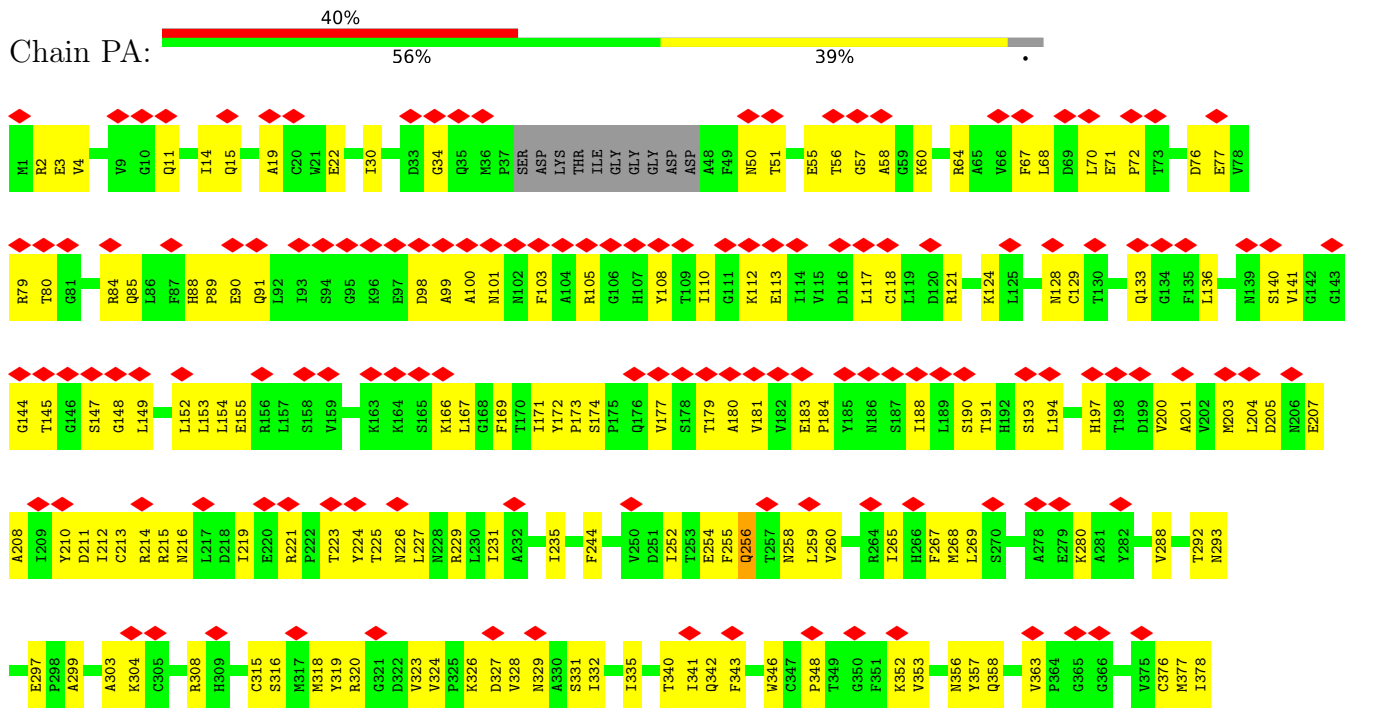

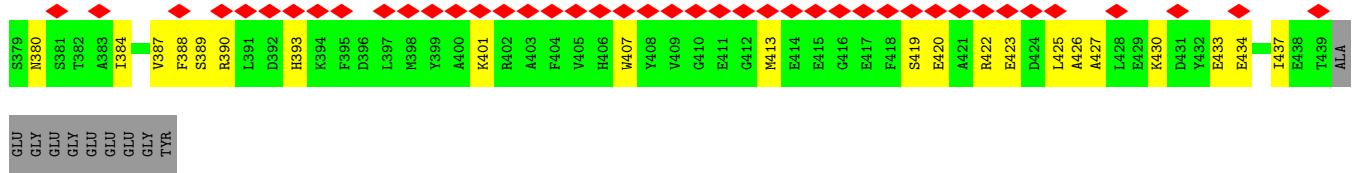

• Molecule 45: Tubulin alpha chain

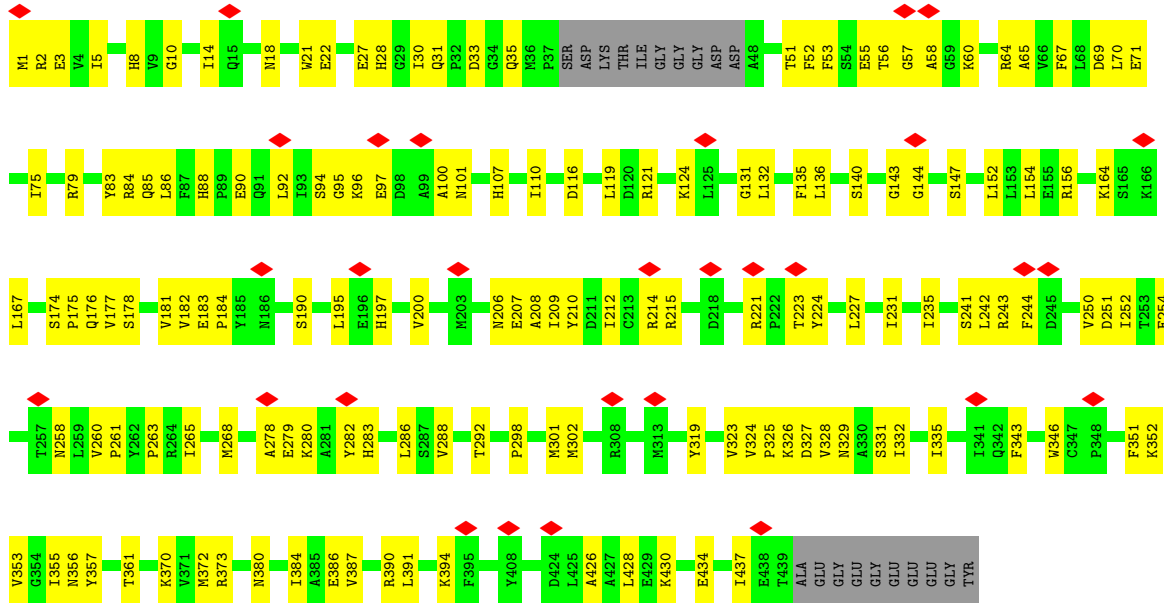

• Molecule 45: Tubulin alpha chain

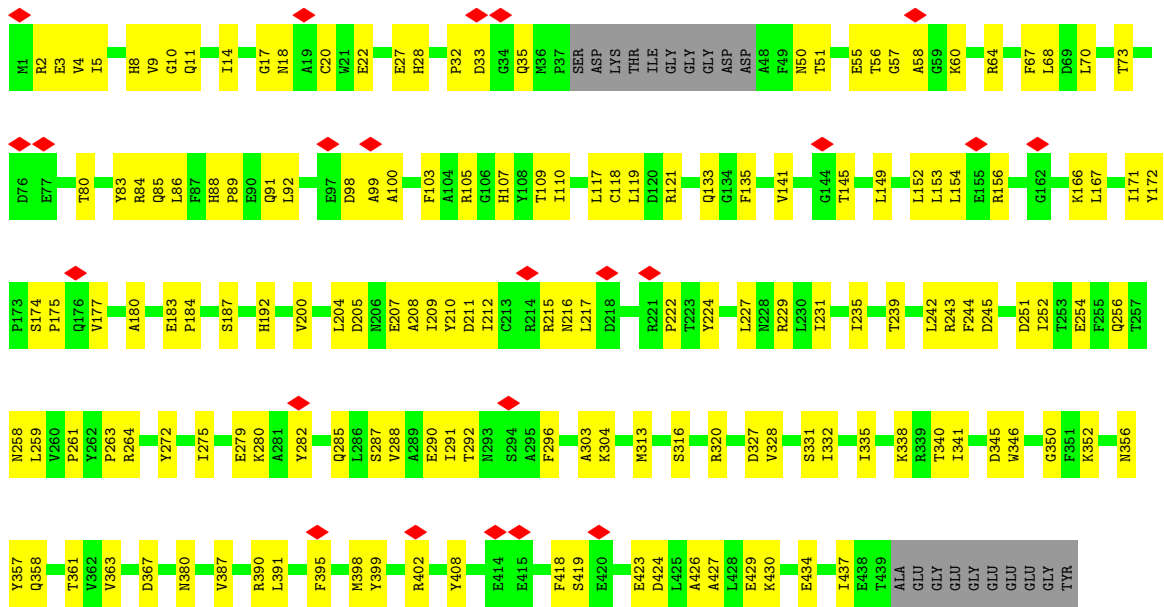



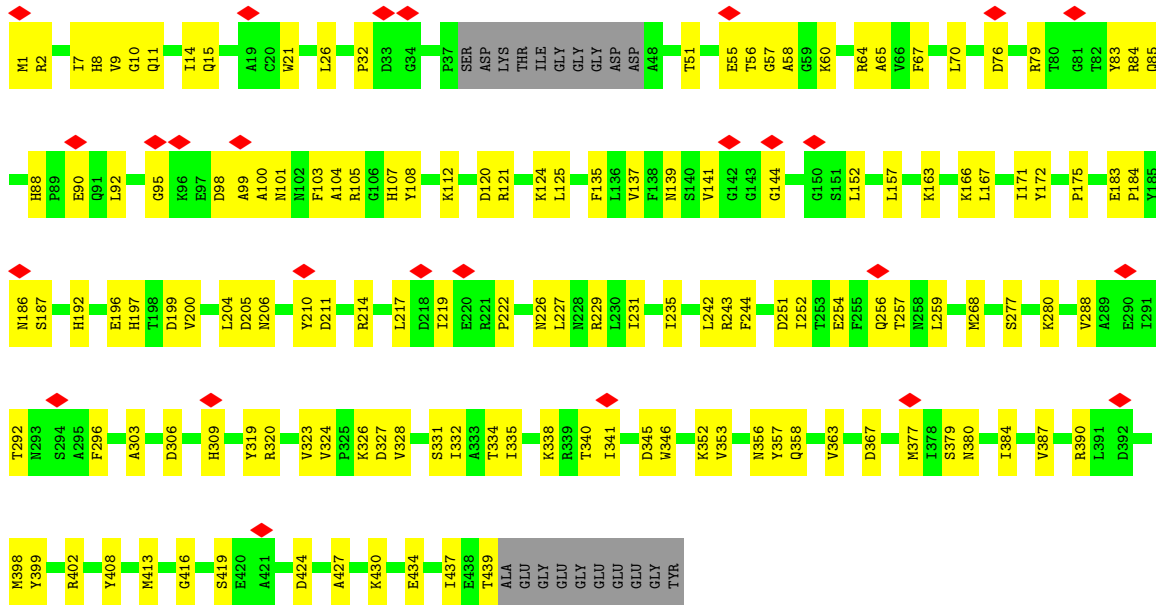

• Molecule 45: Tubulin alpha chain

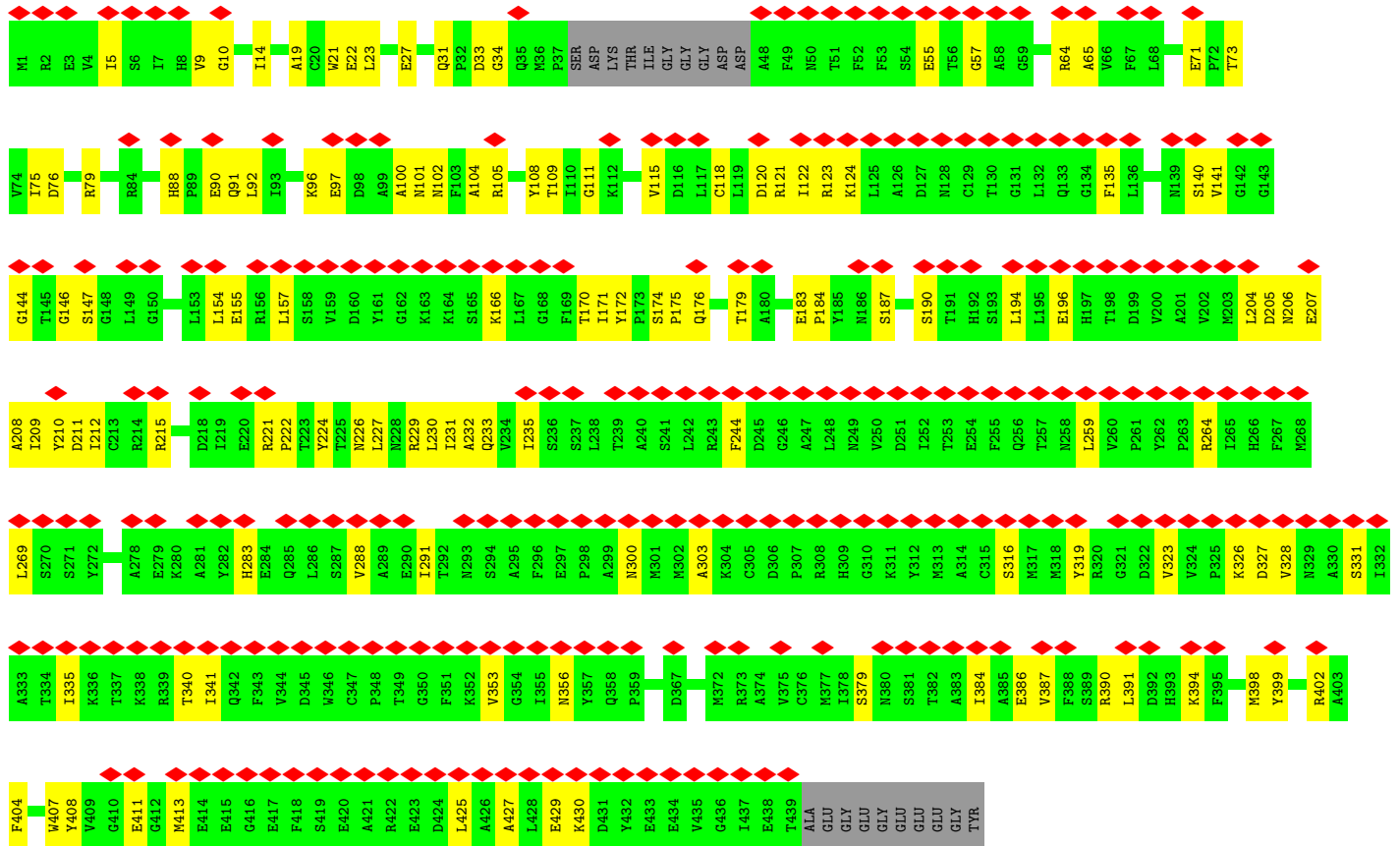
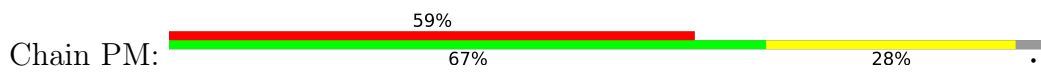

• Molecule 45: Tubulin alpha chain



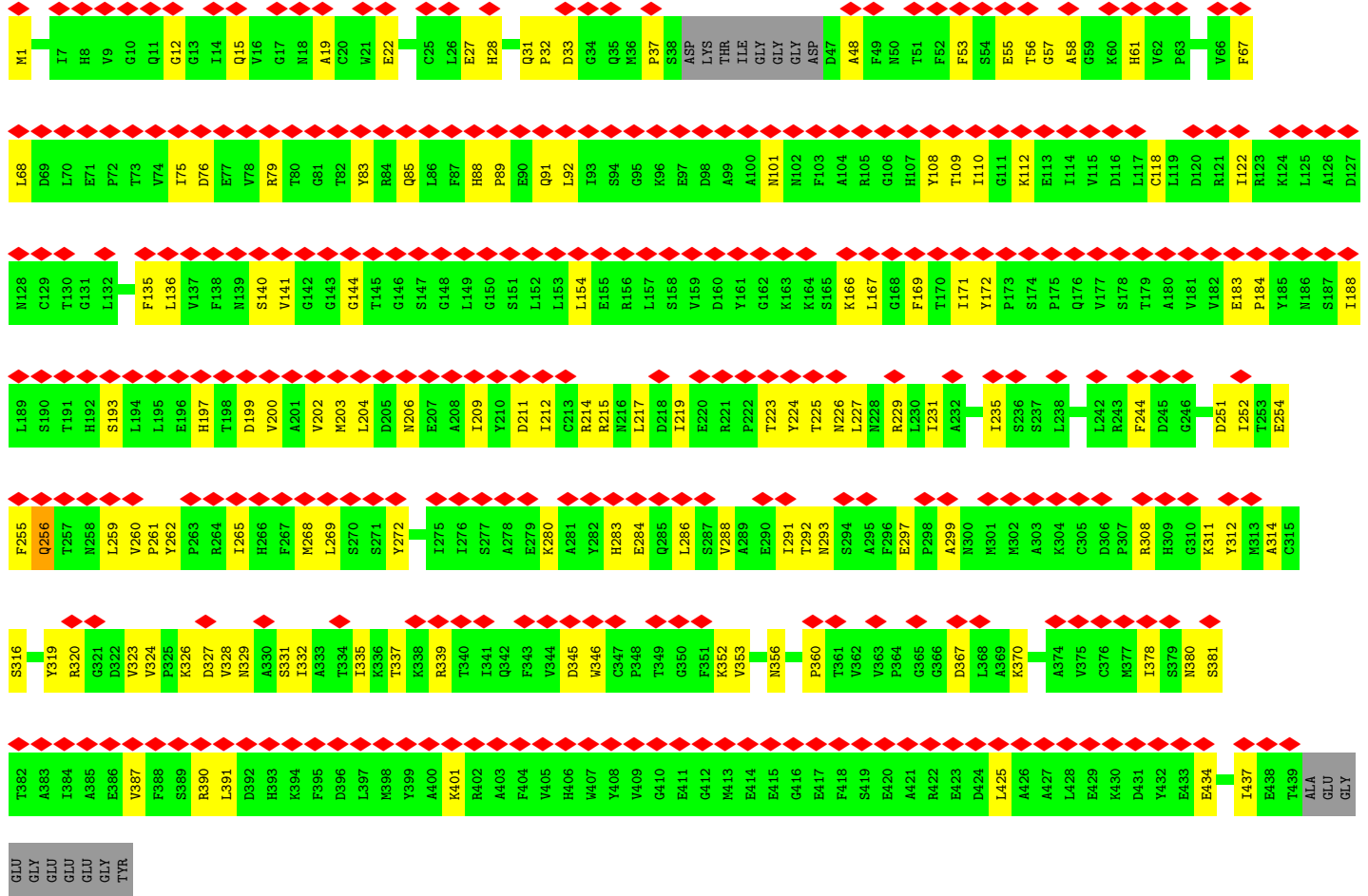
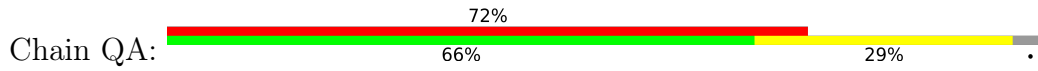

• Molecule 45: Tubulin alpha chain

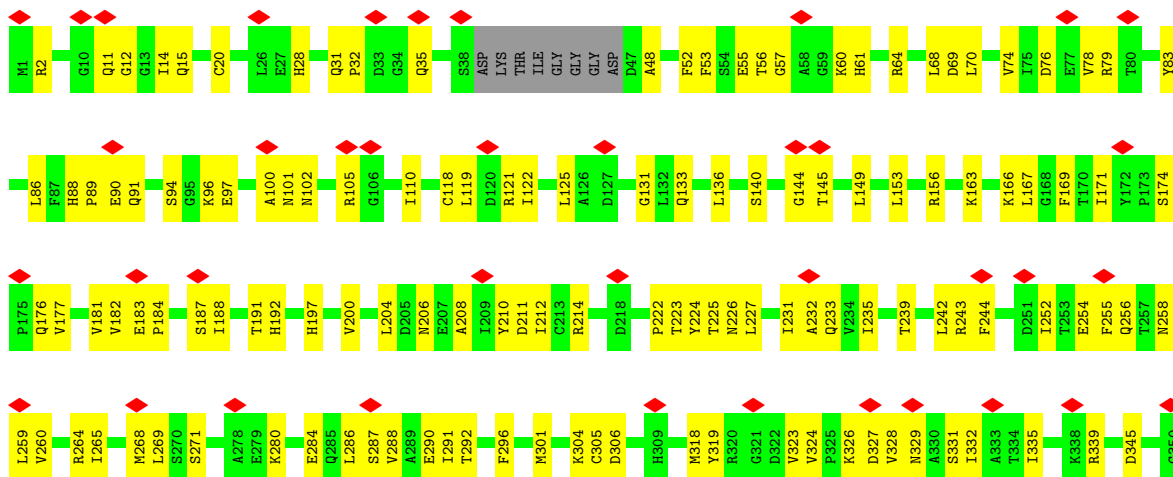

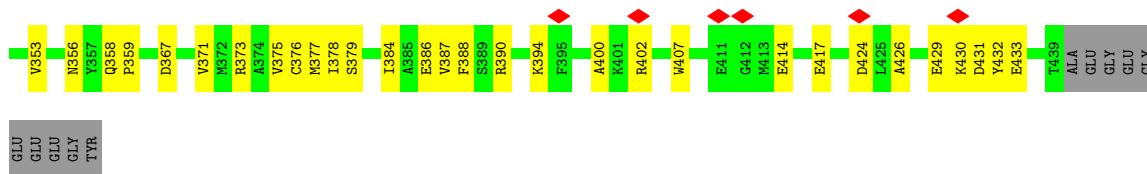

• Molecule 45: Tubulin alpha chain

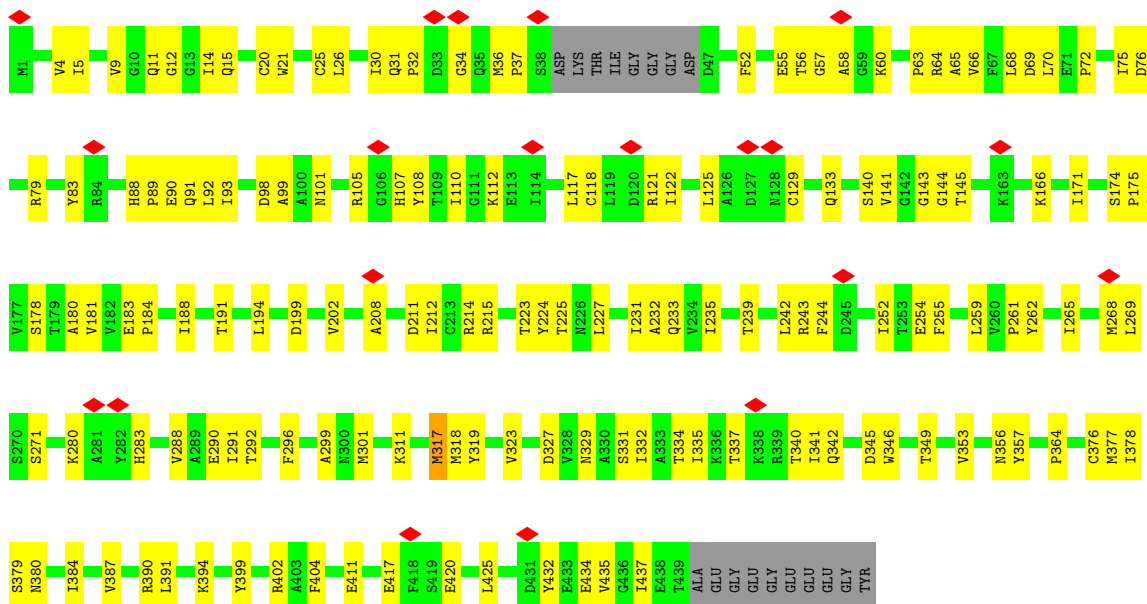

• Molecule 45: Tubulin alpha chain

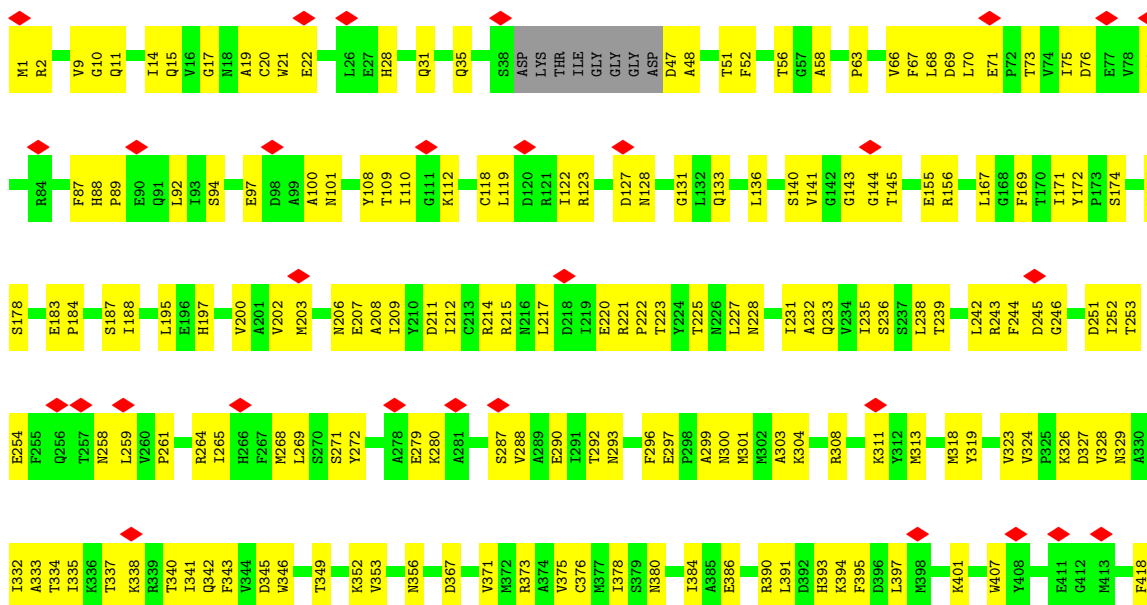

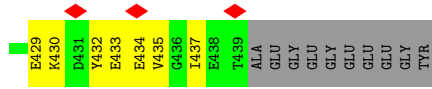

• Molecule 45: Tubulin alpha chain

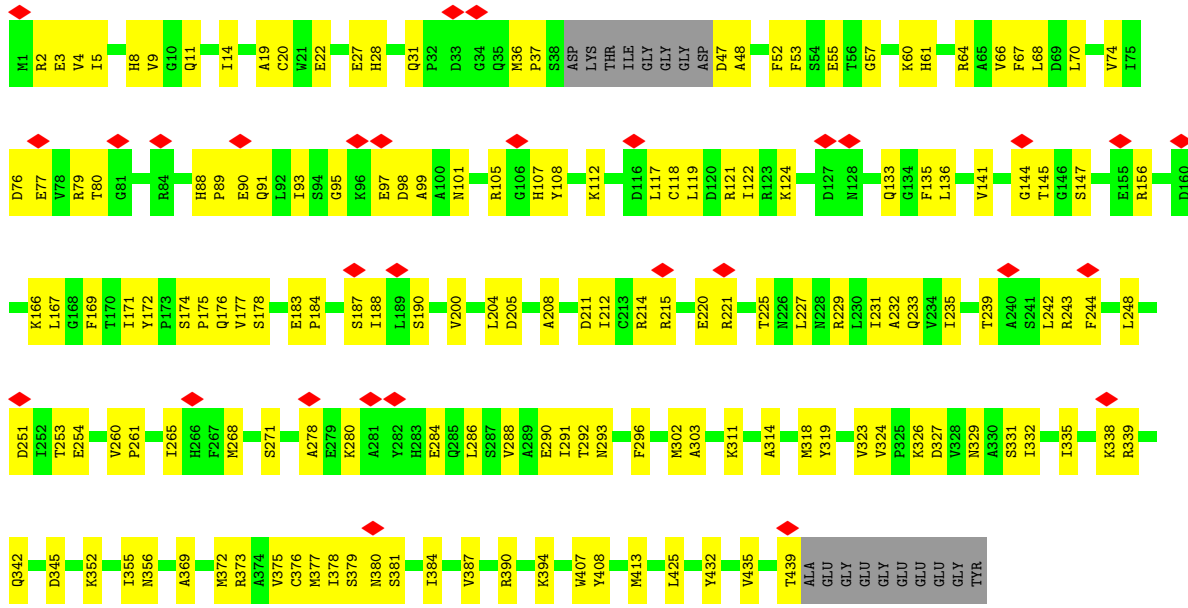

• Molecule 45: Tubulin alpha chain

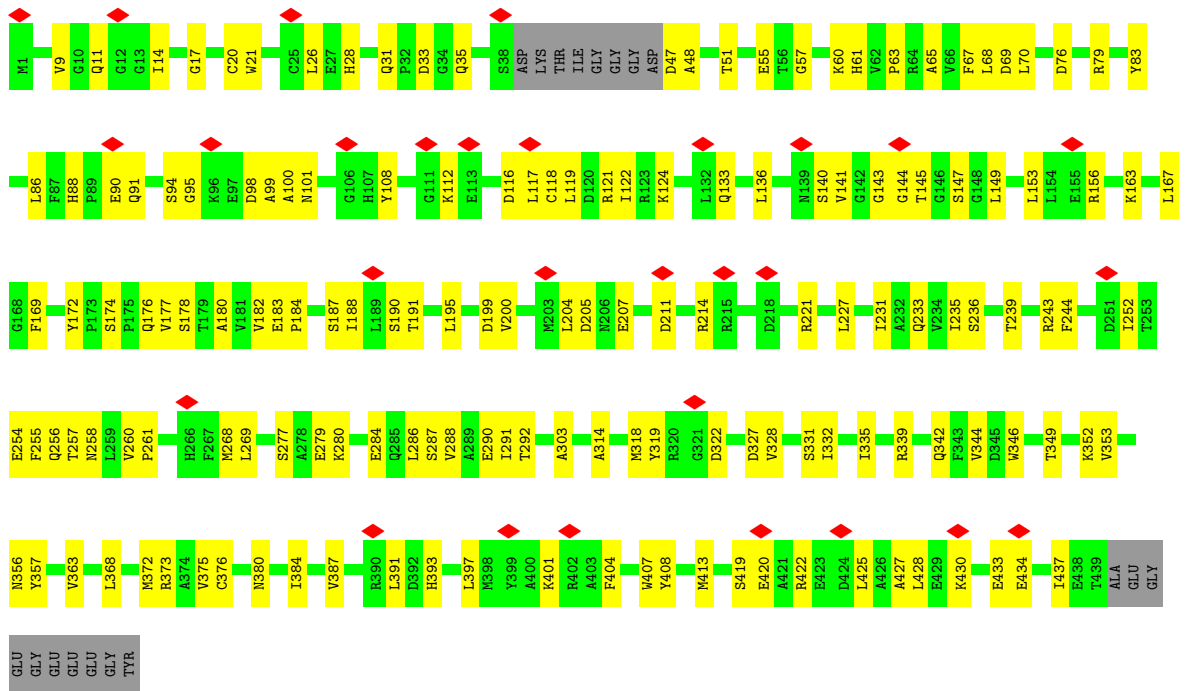

• Molecule 45: Tubulin alpha chain

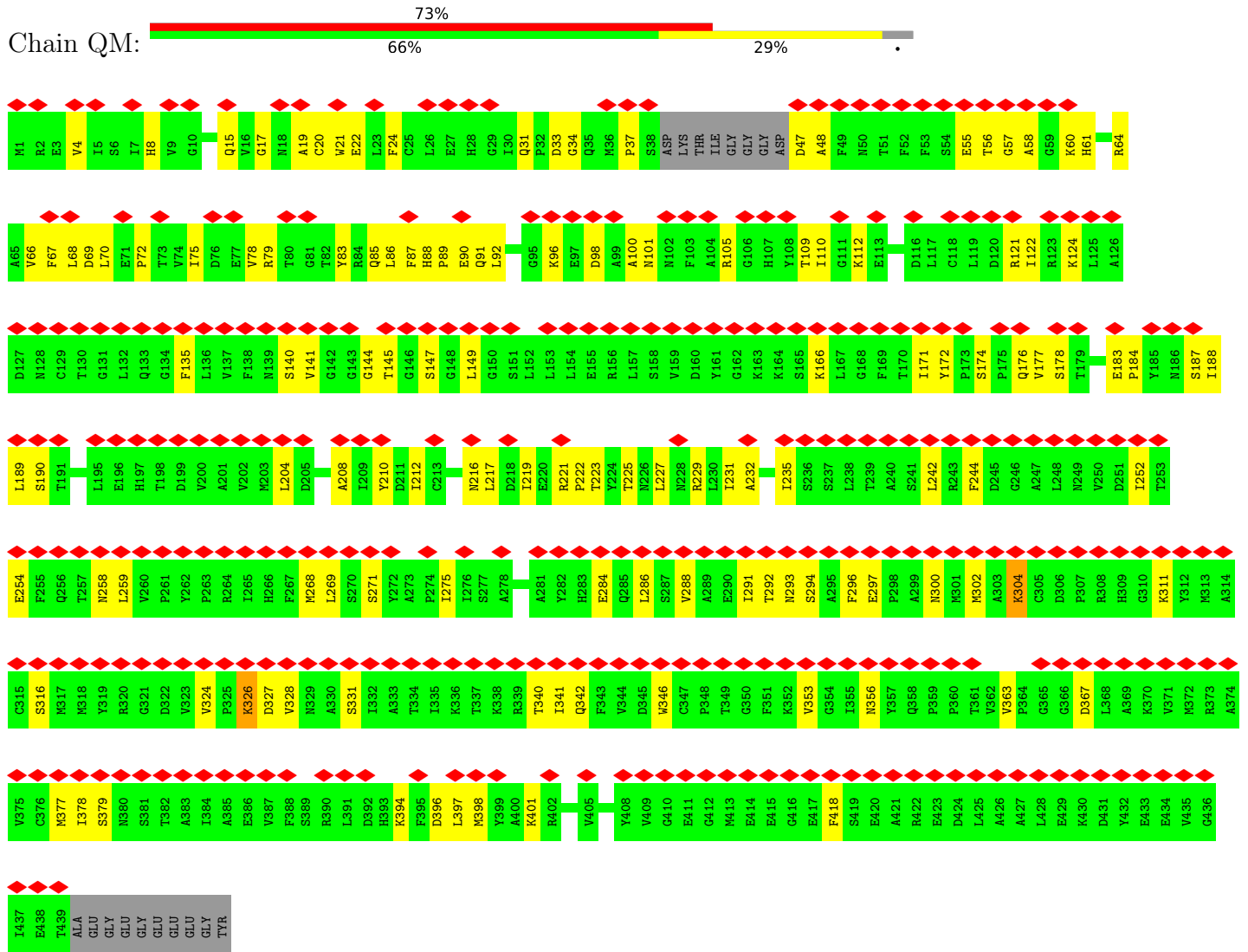

• Molecule 45: Tubulin alpha chain

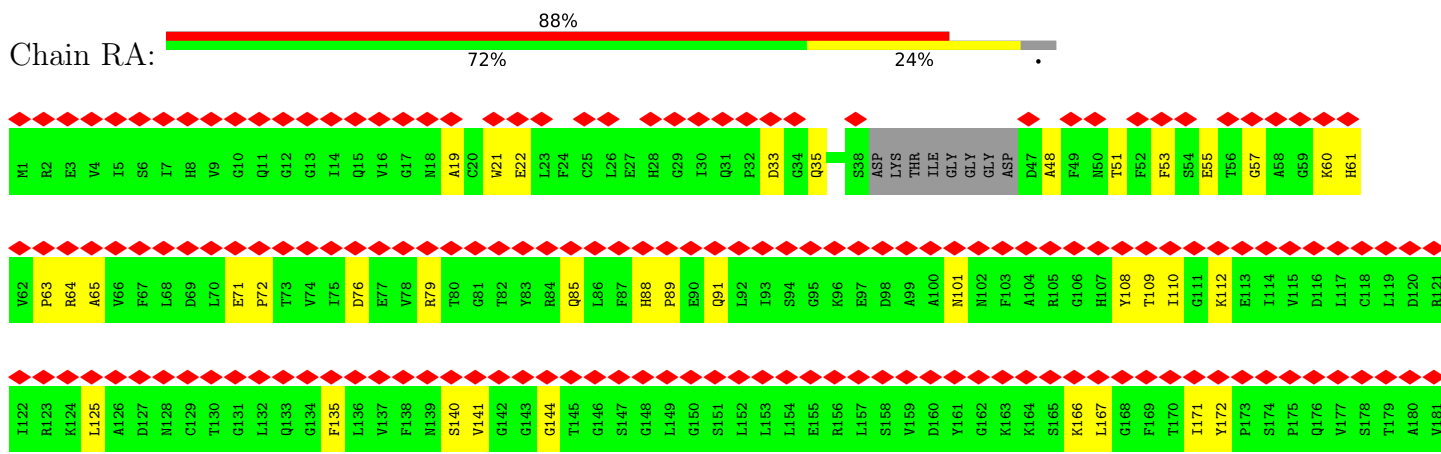

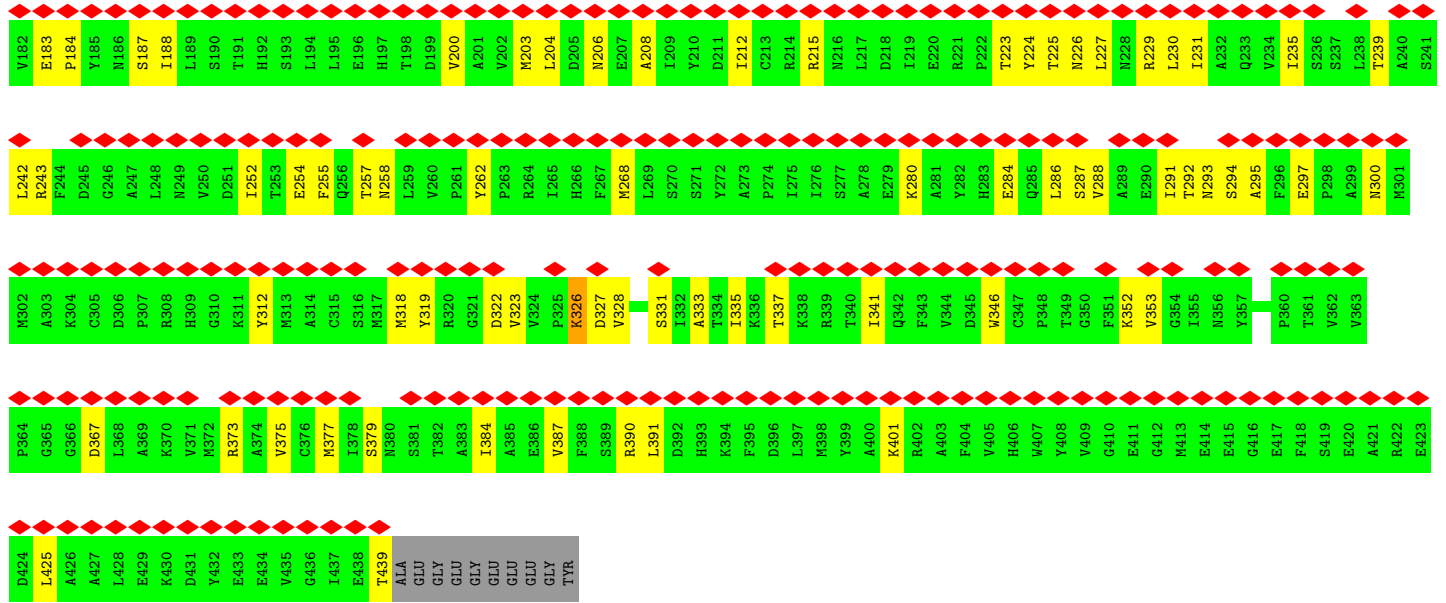

• Molecule 45: Tubulin alpha chain

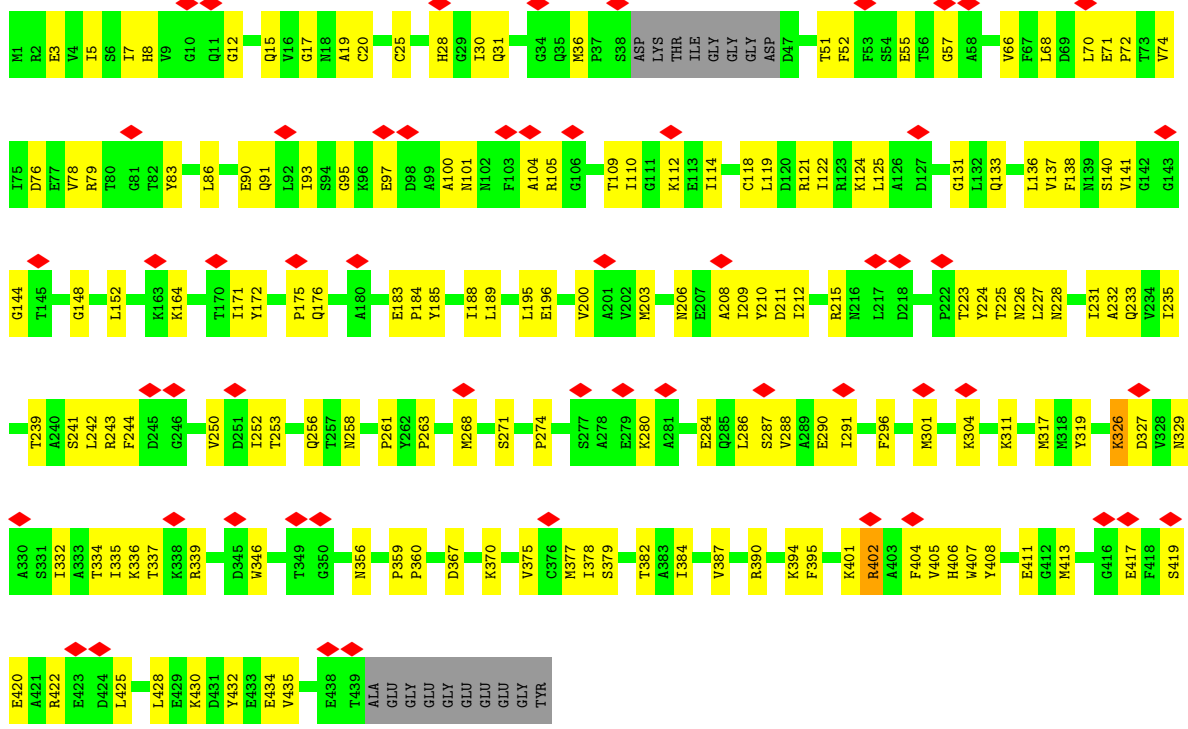

• Molecule 45: Tubulin alpha chain



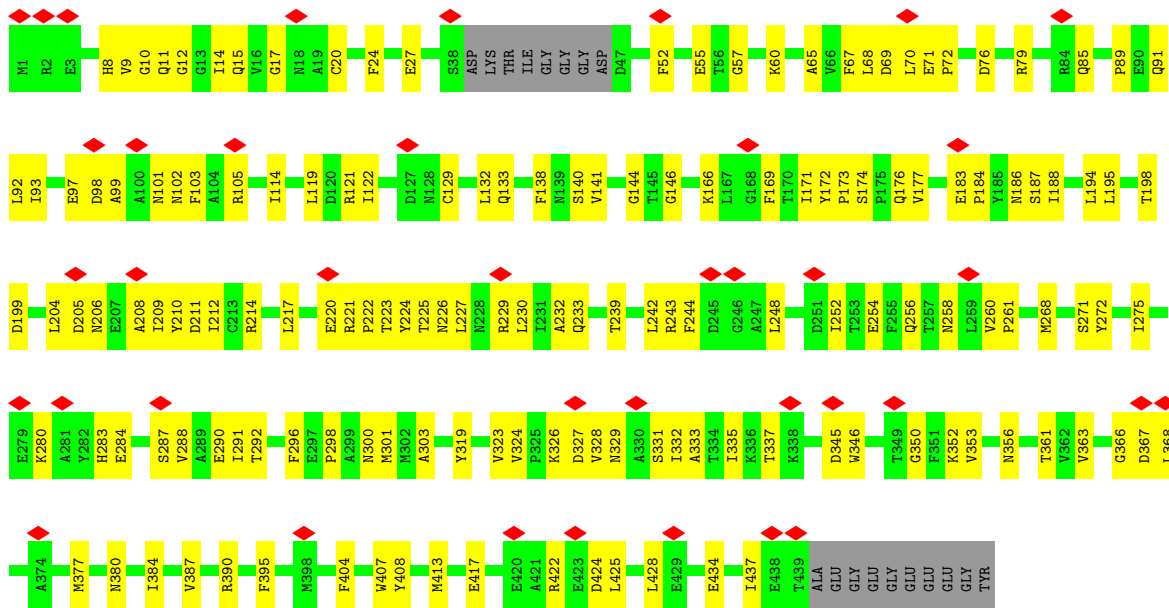

• Molecule 45: Tubulin alpha chain

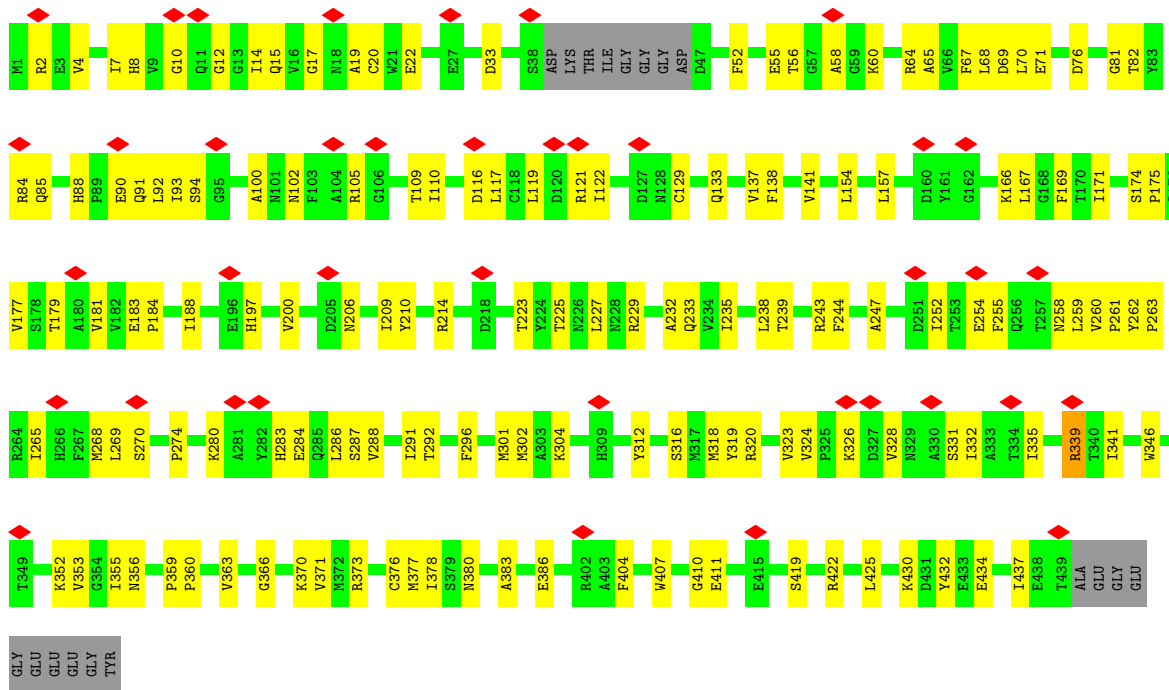

• Molecule 45: Tubulin alpha chain

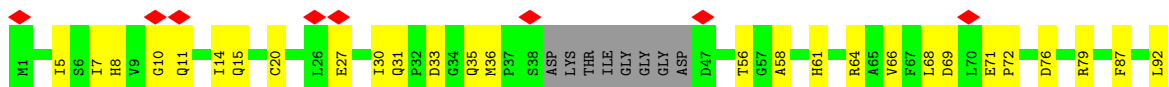

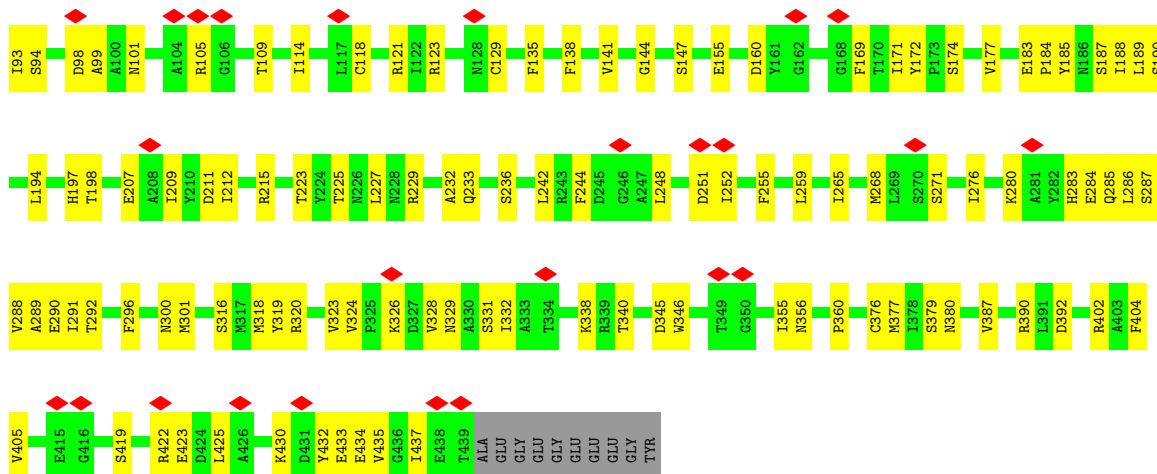

• Molecule 45: Tubulin alpha chain

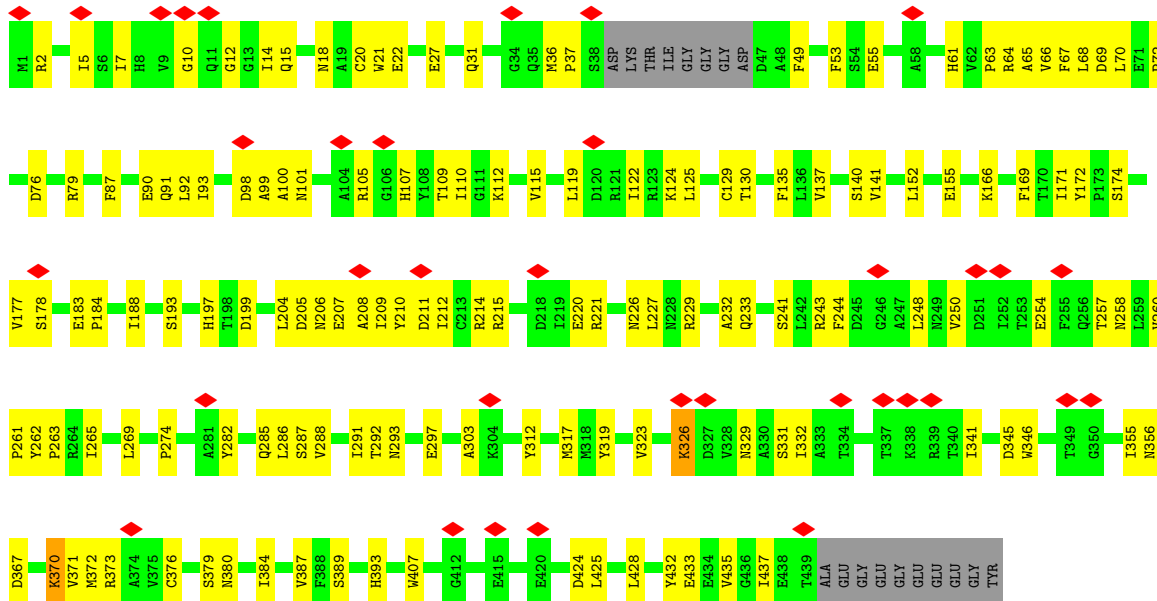

• Molecule 45: Tubulin alpha chain

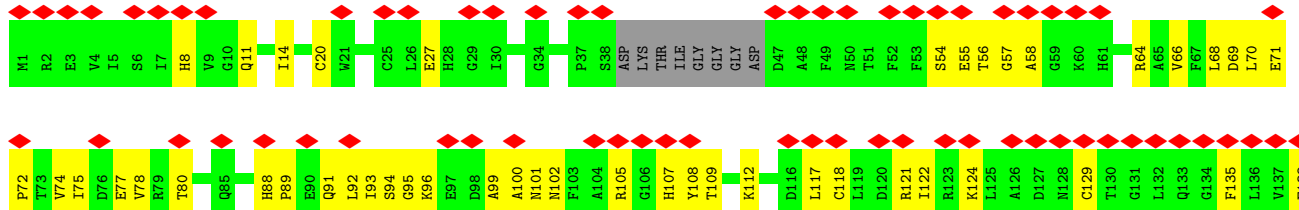

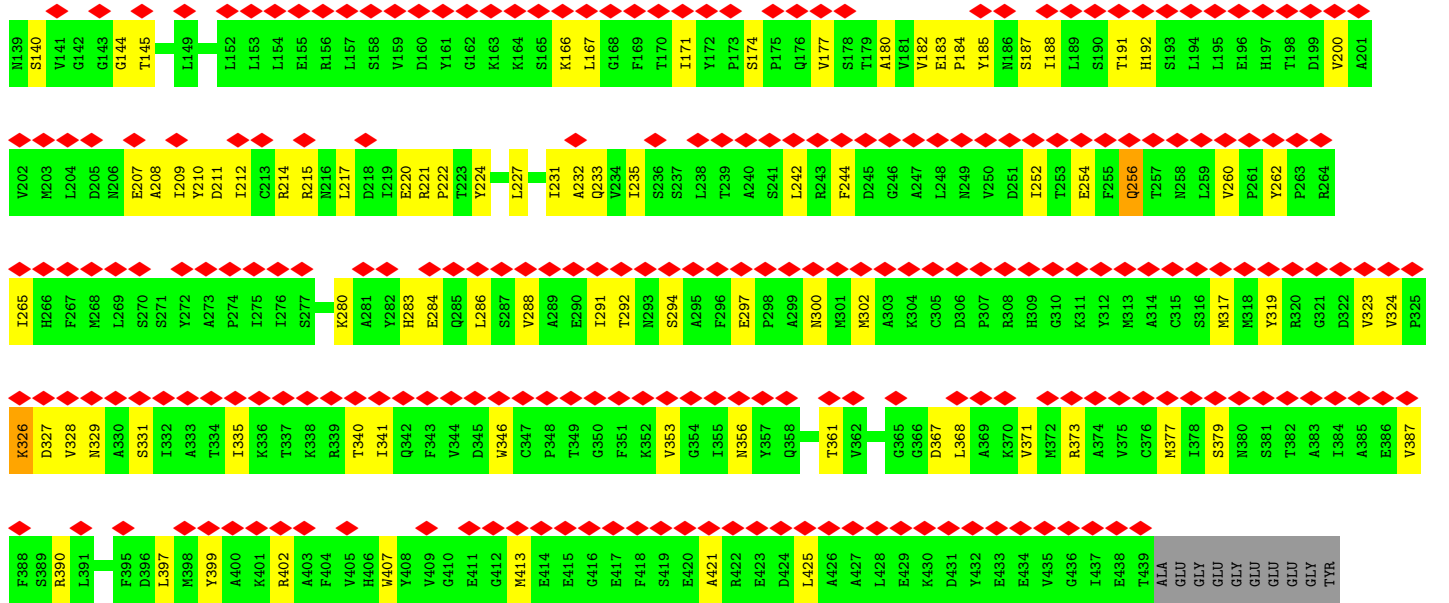

### Molecule 45: Tubulin alpha chain

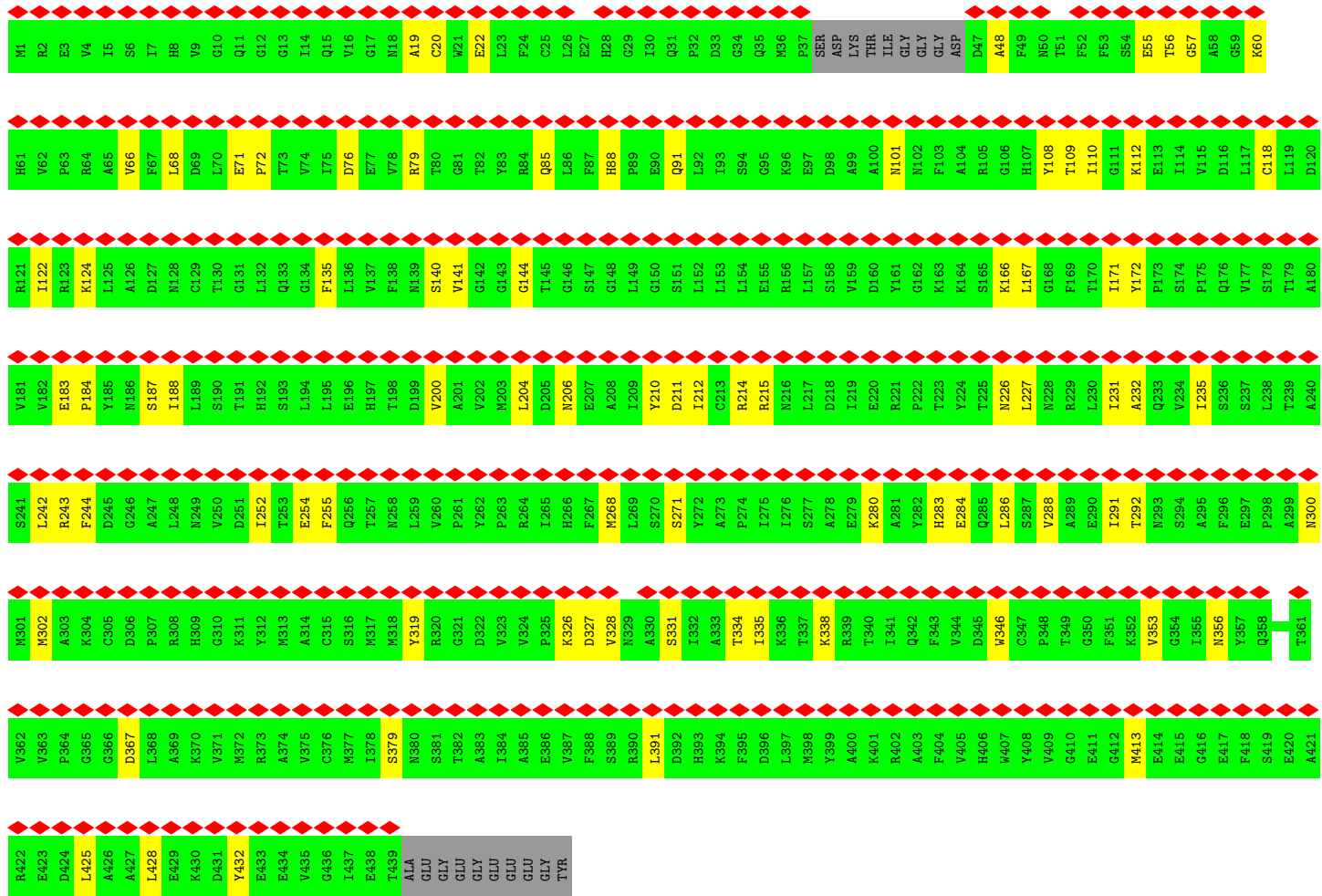
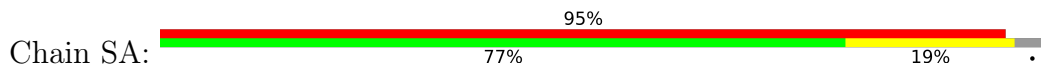



• Molecule 45: Tubulin alpha chain

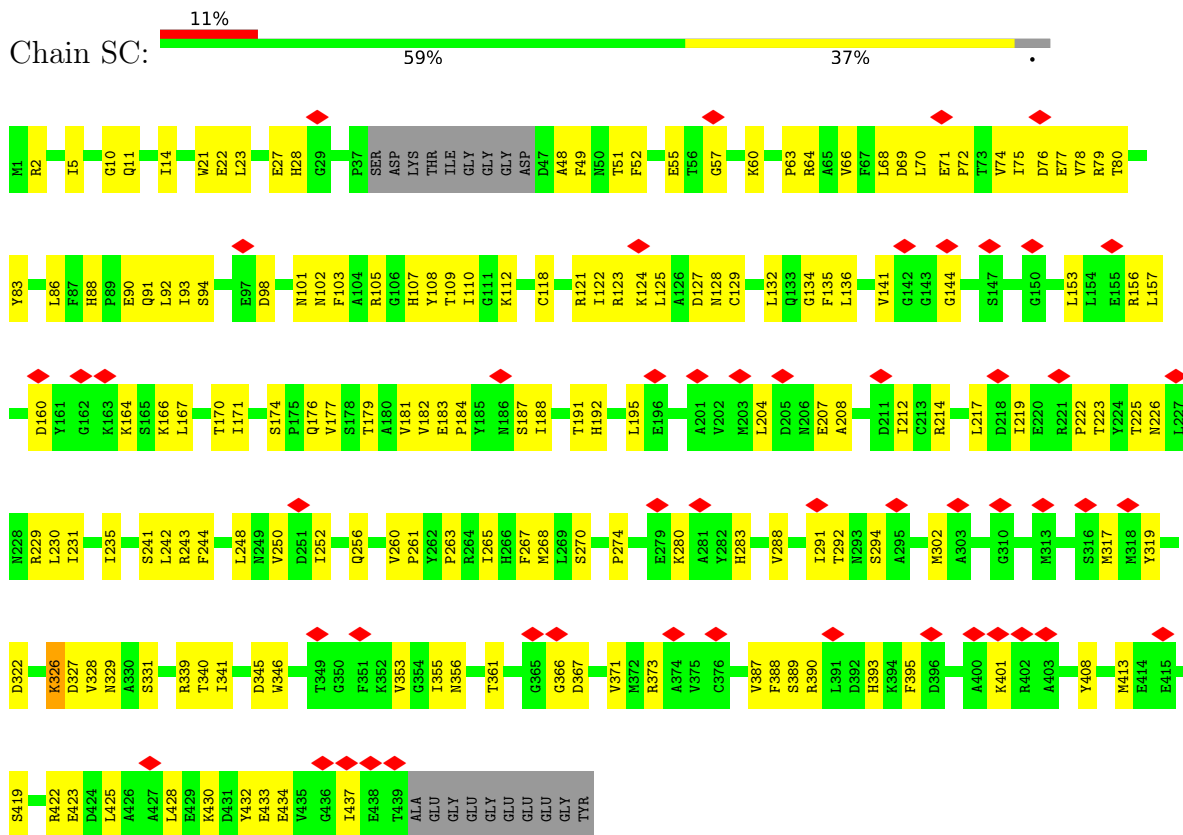

• Molecule 45: Tubulin alpha chain

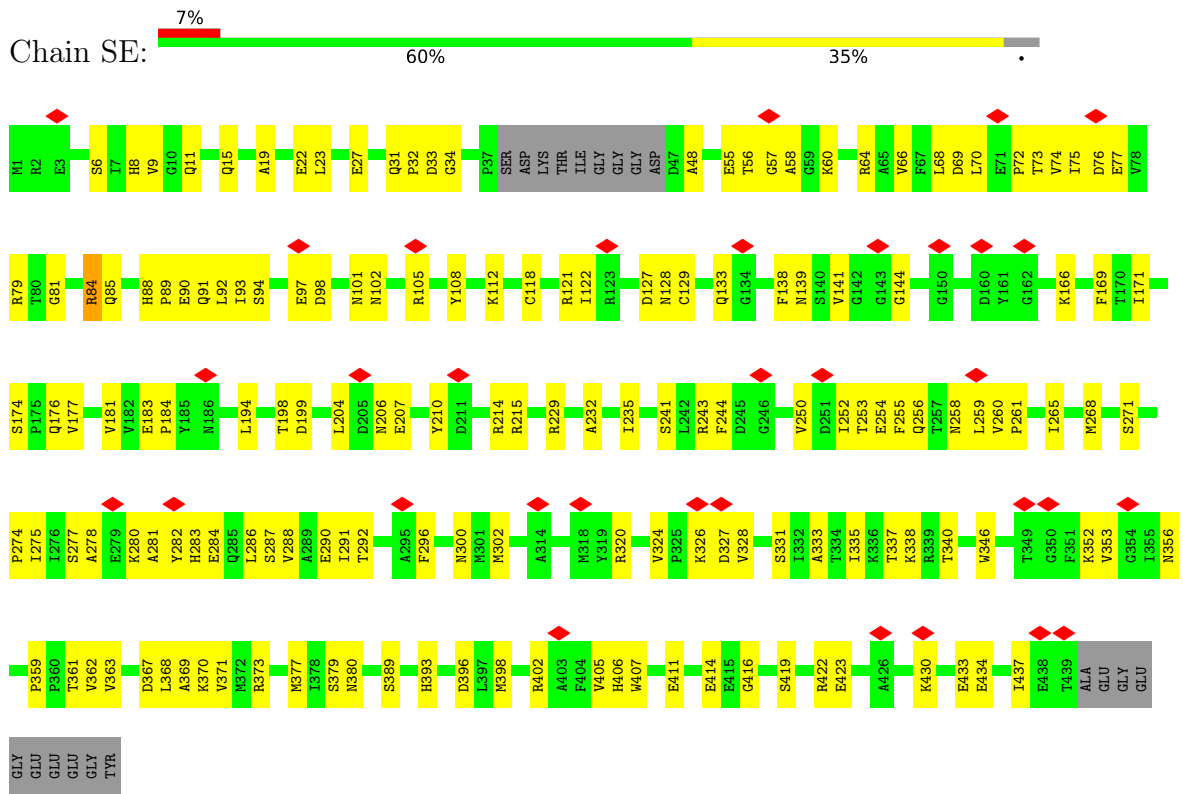

- Molecule 45: Tubulin alpha chain

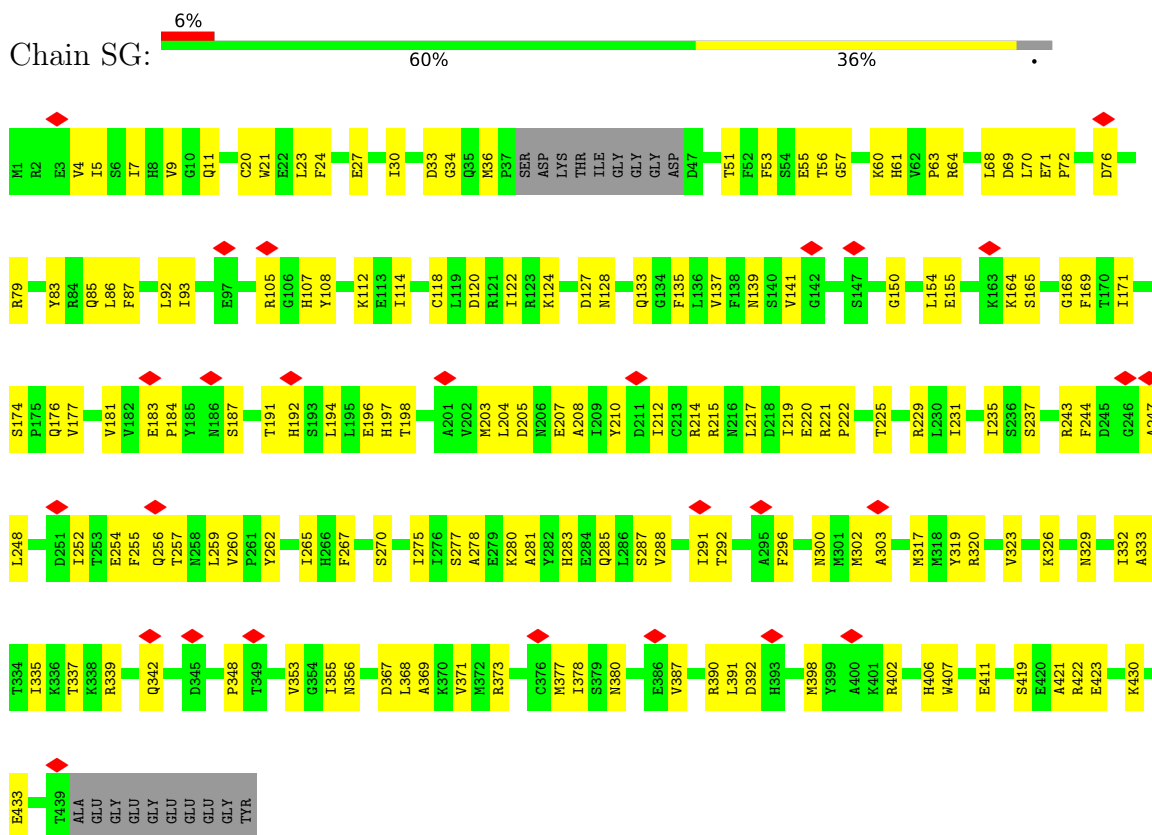

- Molecule 45: Tubulin alpha chain

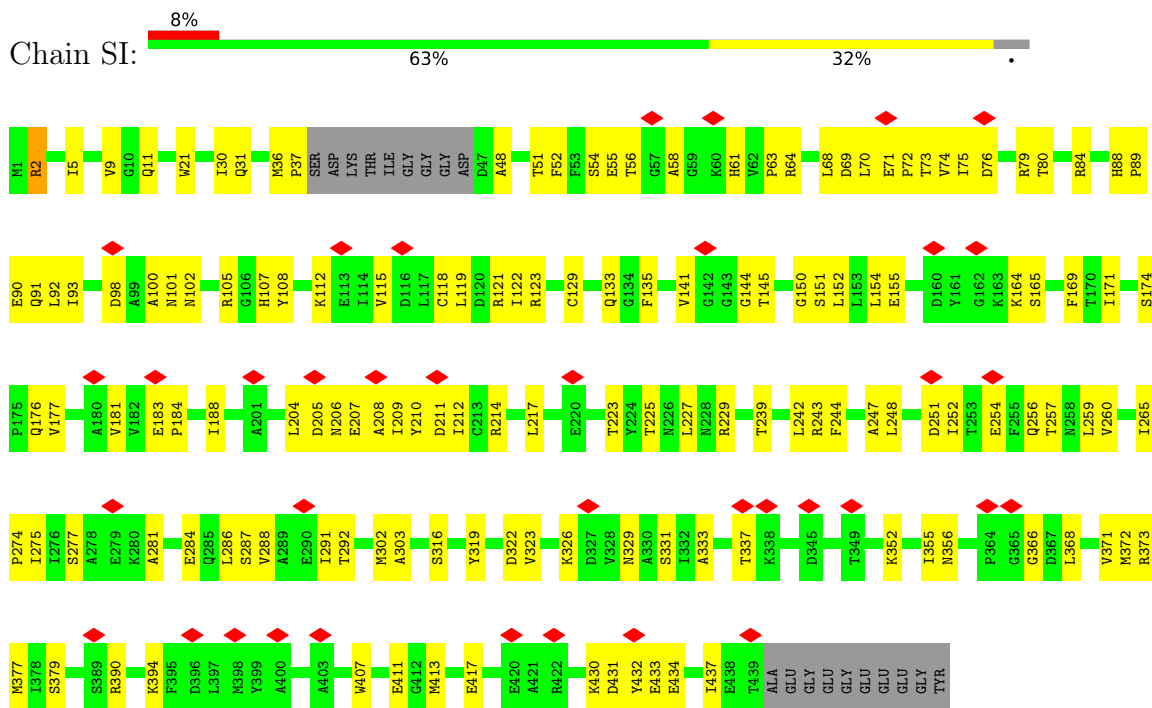

- Molecule 45: Tubulin alpha chain



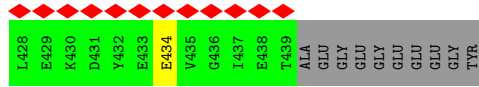

• Molecule 45: Tubulin alpha chain

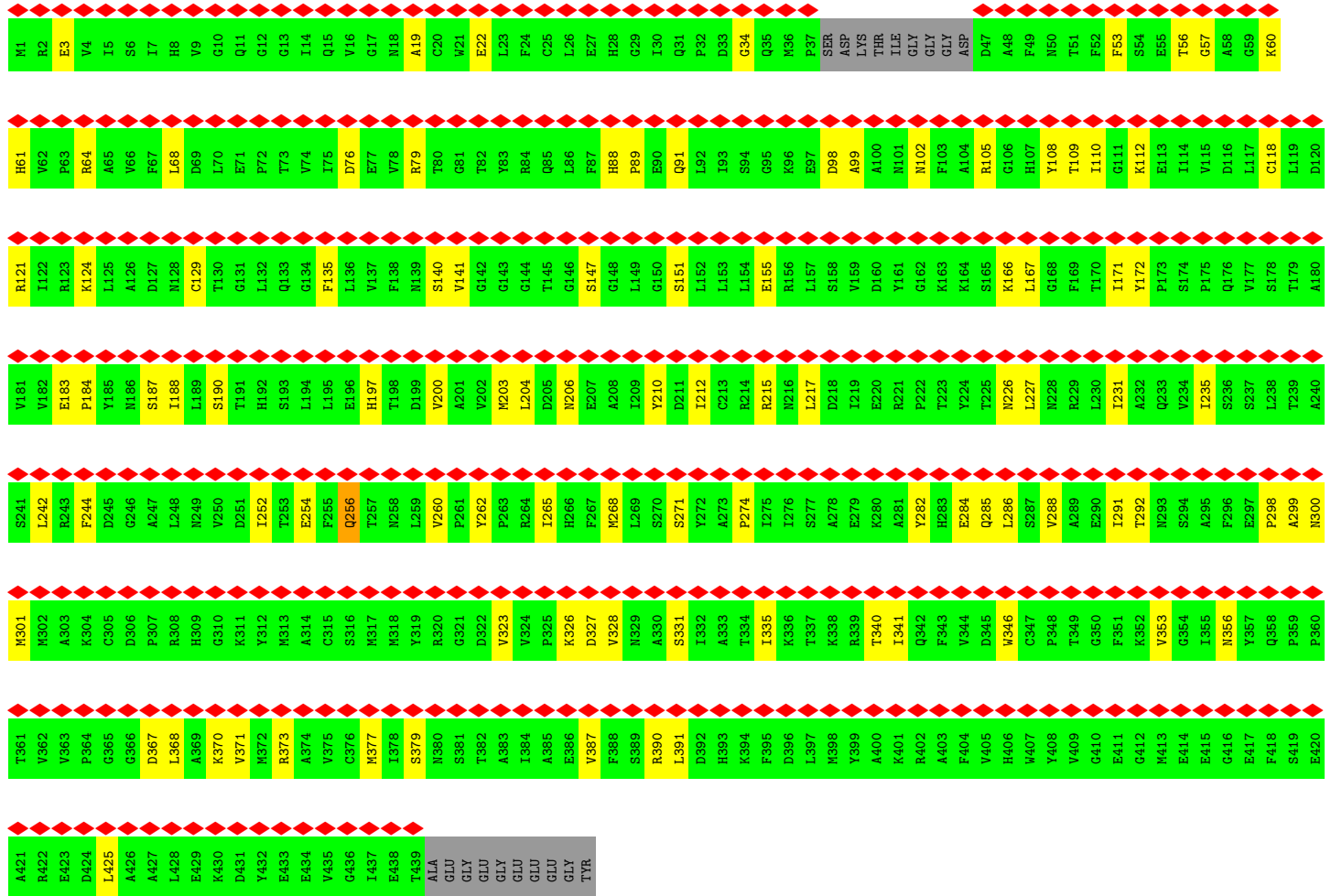
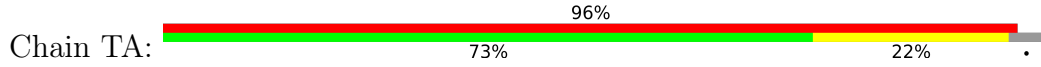

• Molecule 45: Tubulin alpha chain

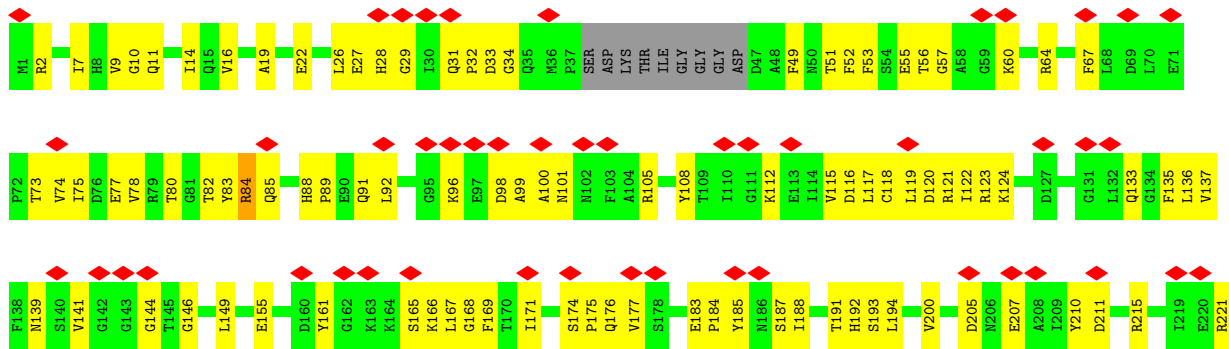

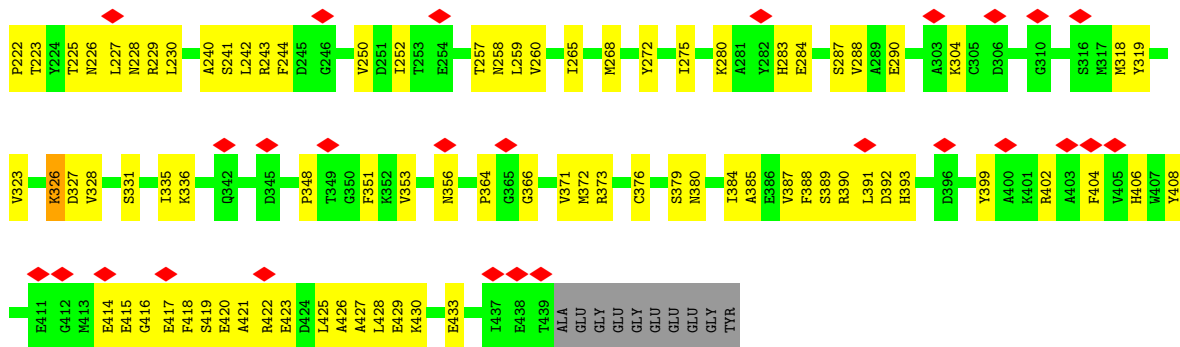

• Molecule 45: Tubulin alpha chain

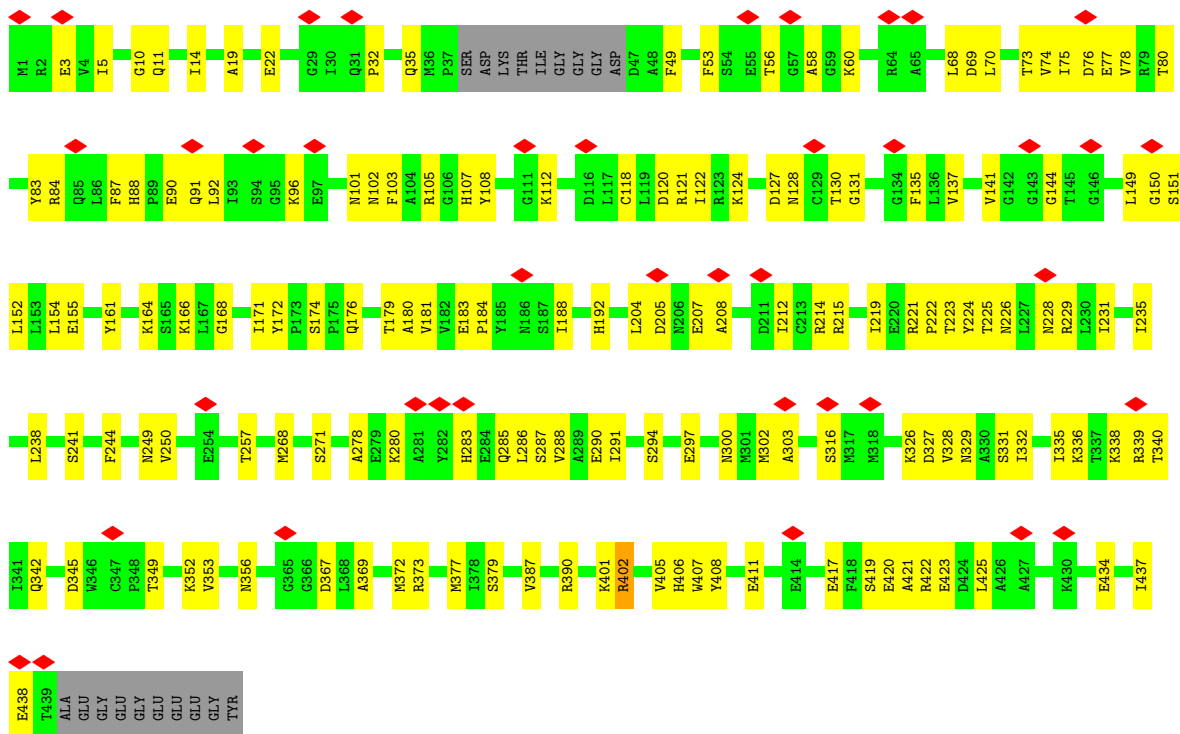

• Molecule 45: Tubulin alpha chain

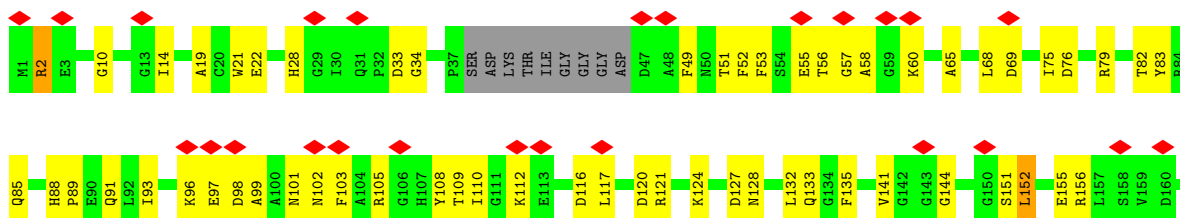

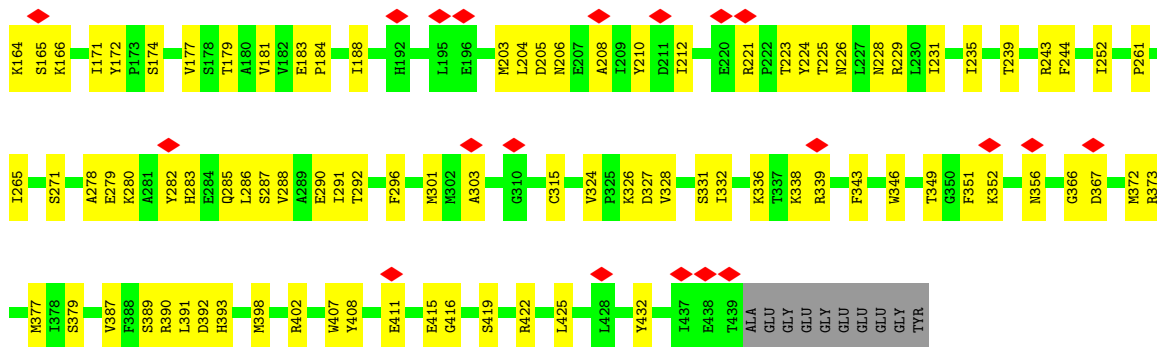

• Molecule 45: Tubulin alpha chain

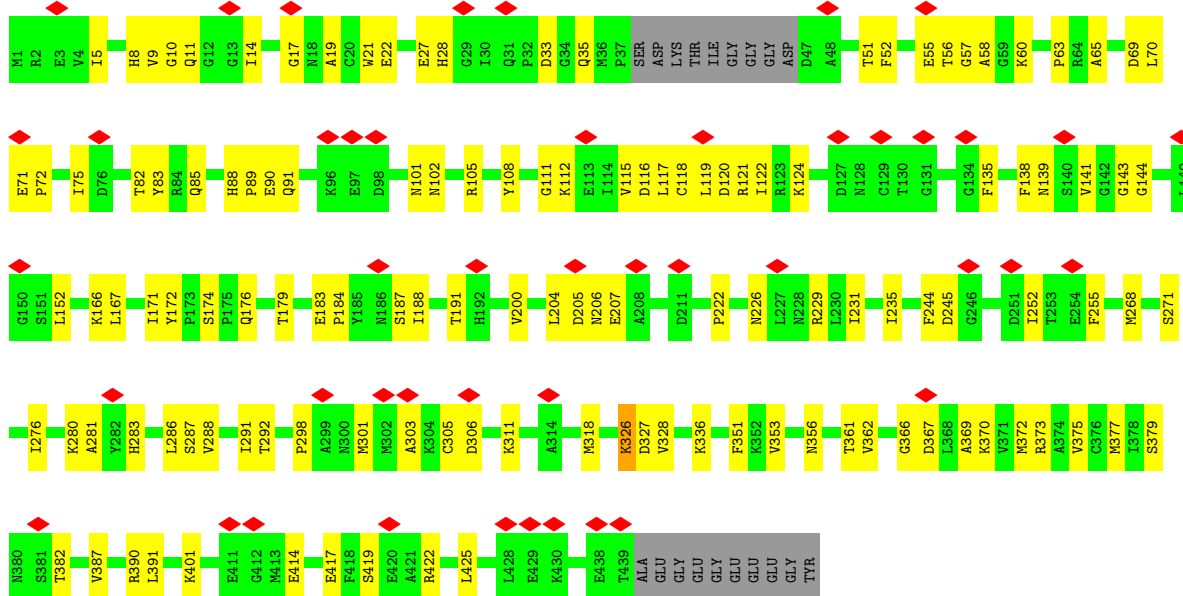

• Molecule 45: Tubulin alpha chain

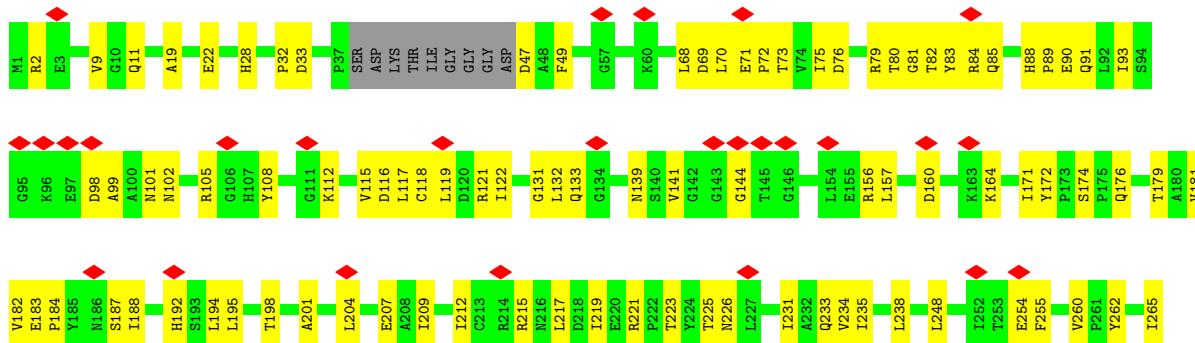

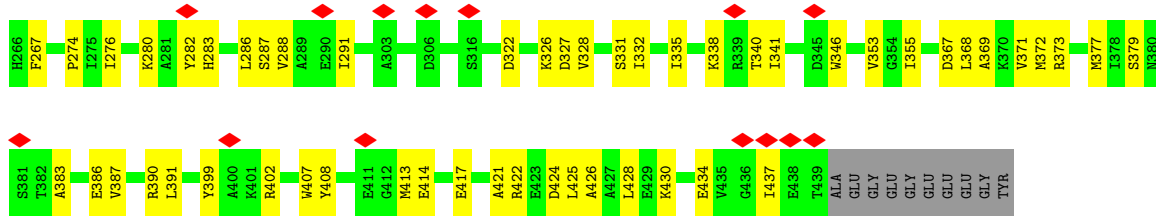

• Molecule 45: Tubulin alpha chain

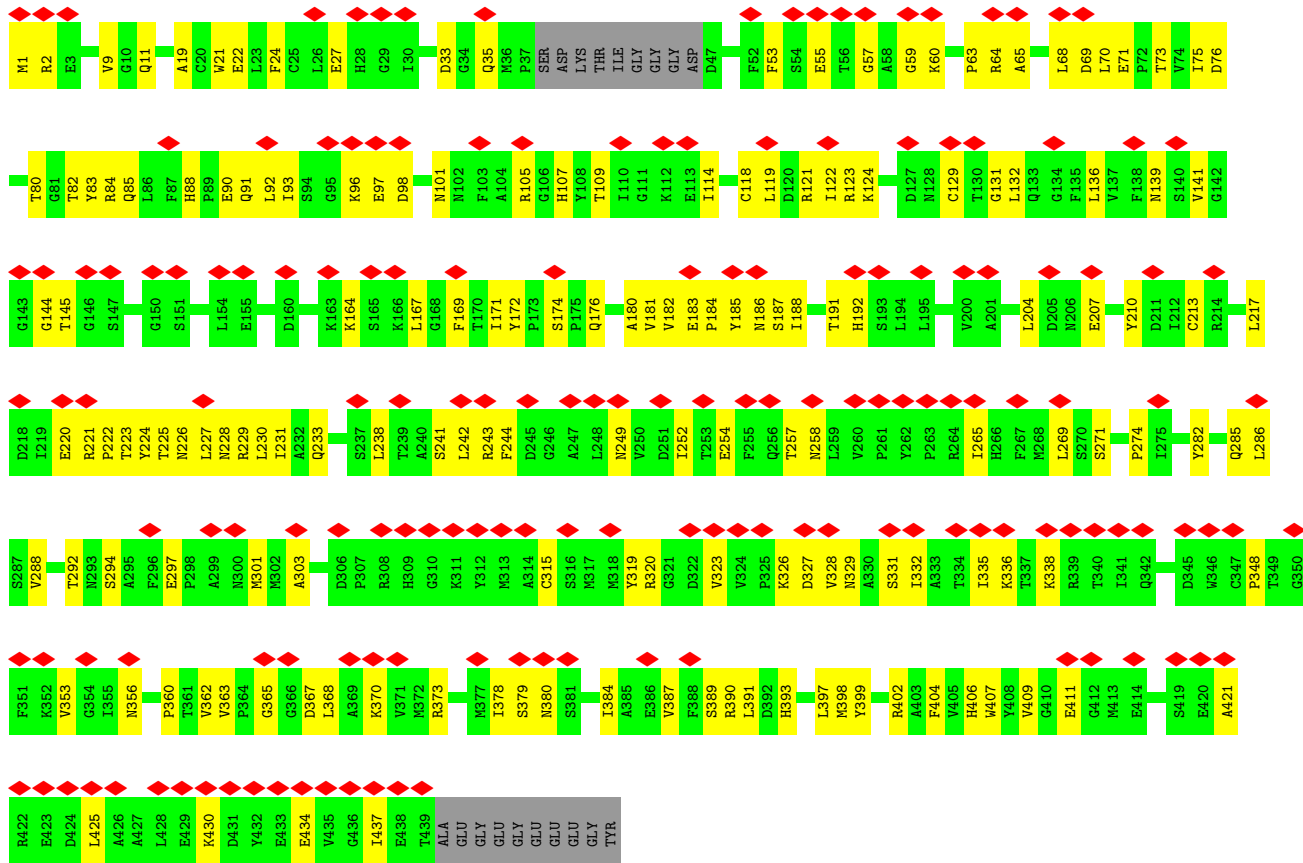

• Molecule 45: Tubulin alpha chain

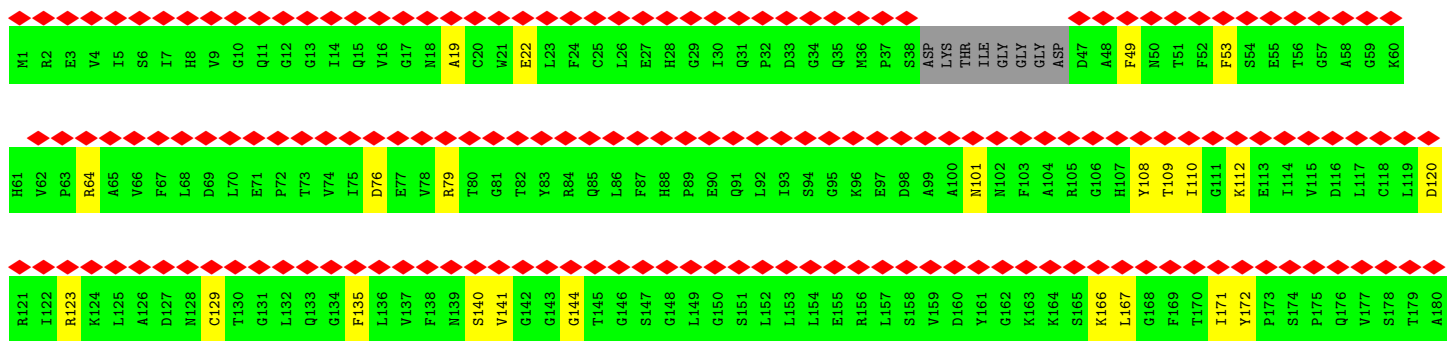
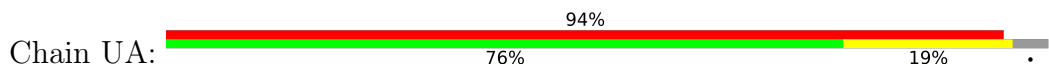

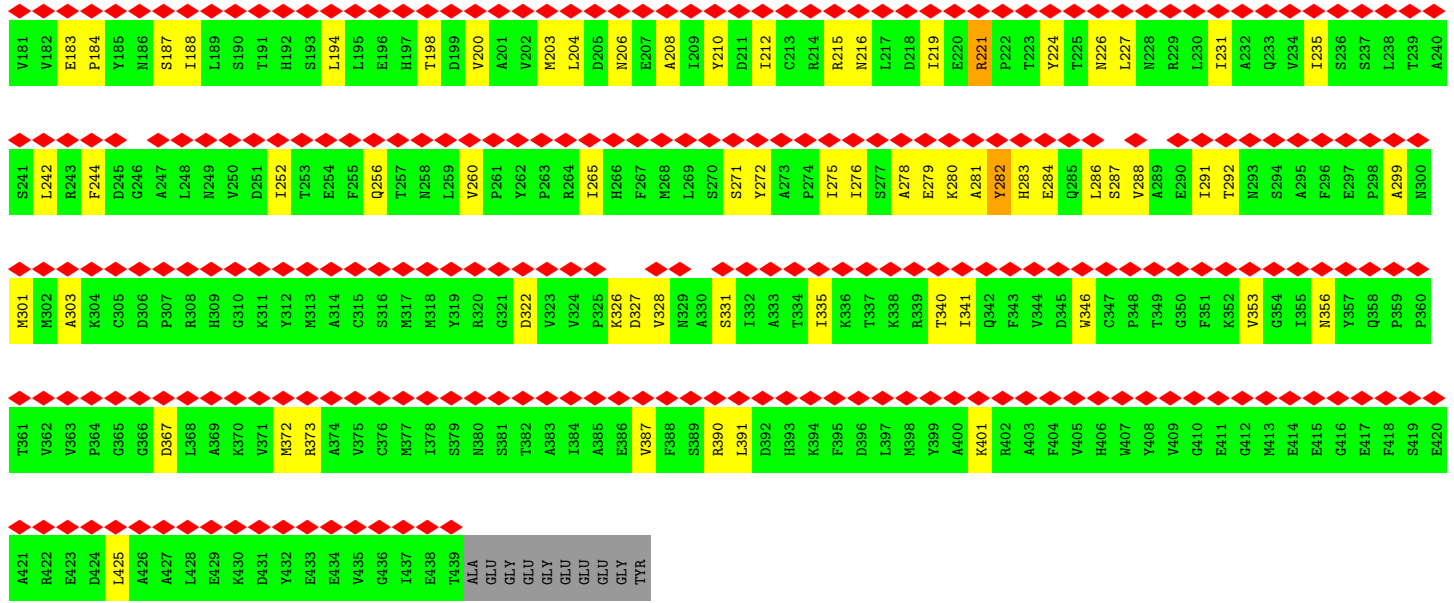

• Molecule 45: Tubulin alpha chain

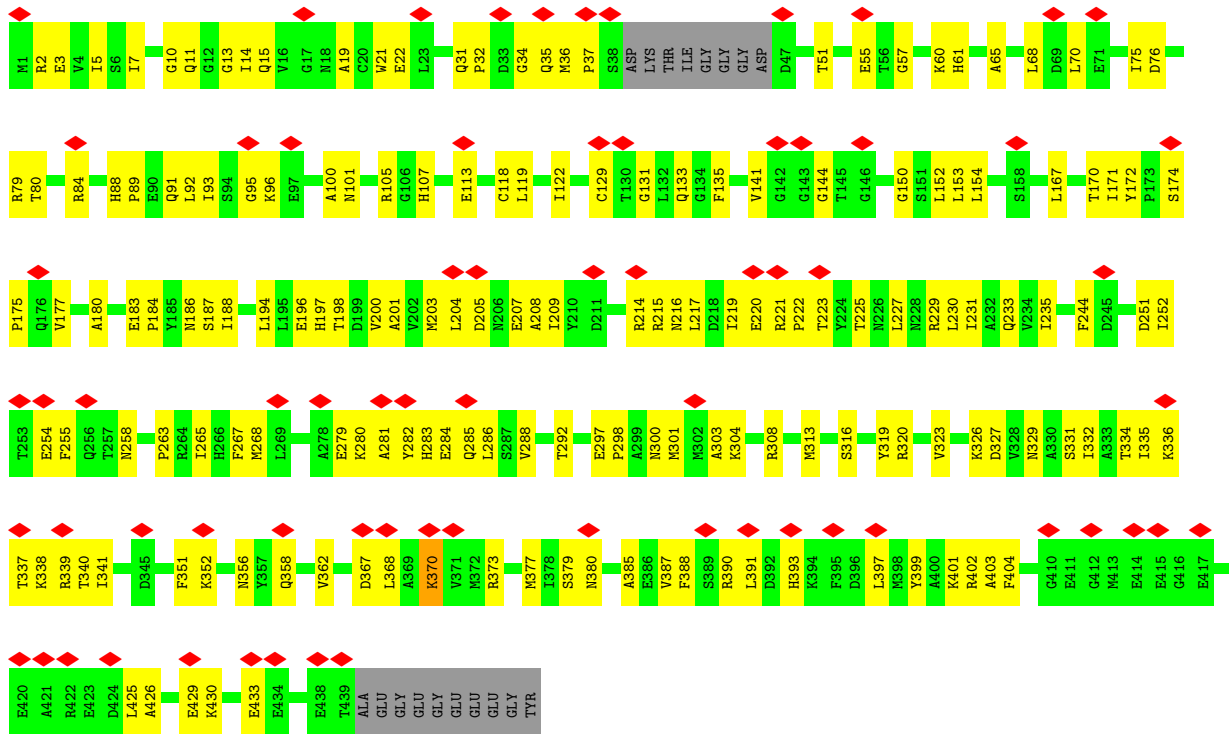

• Molecule 45: Tubulin alpha chain





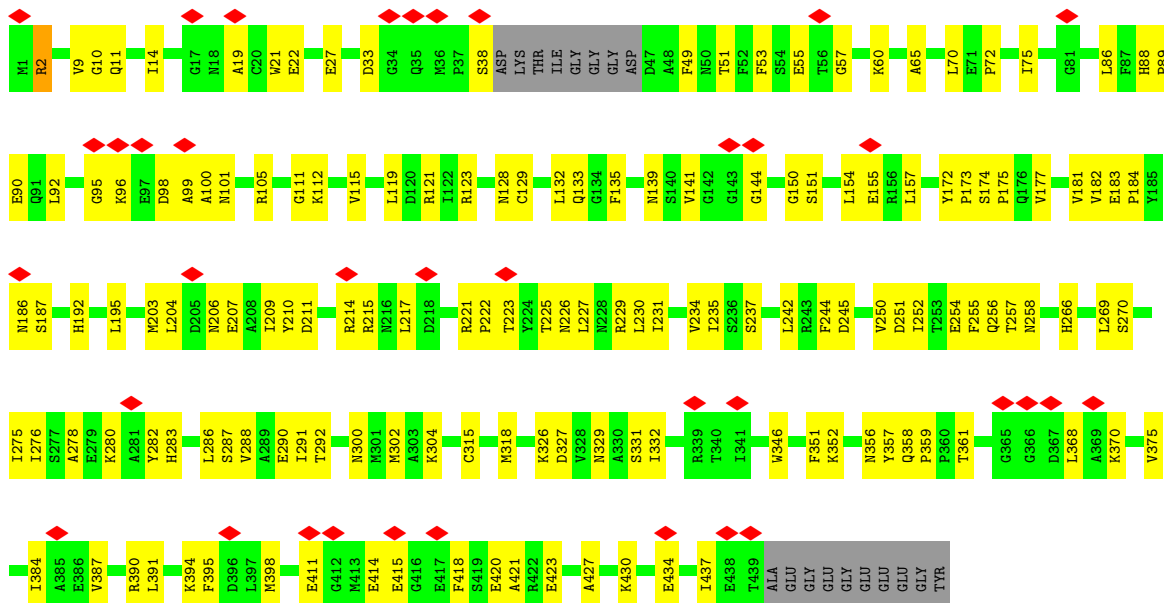

• Molecule 45: Tubulin alpha chain

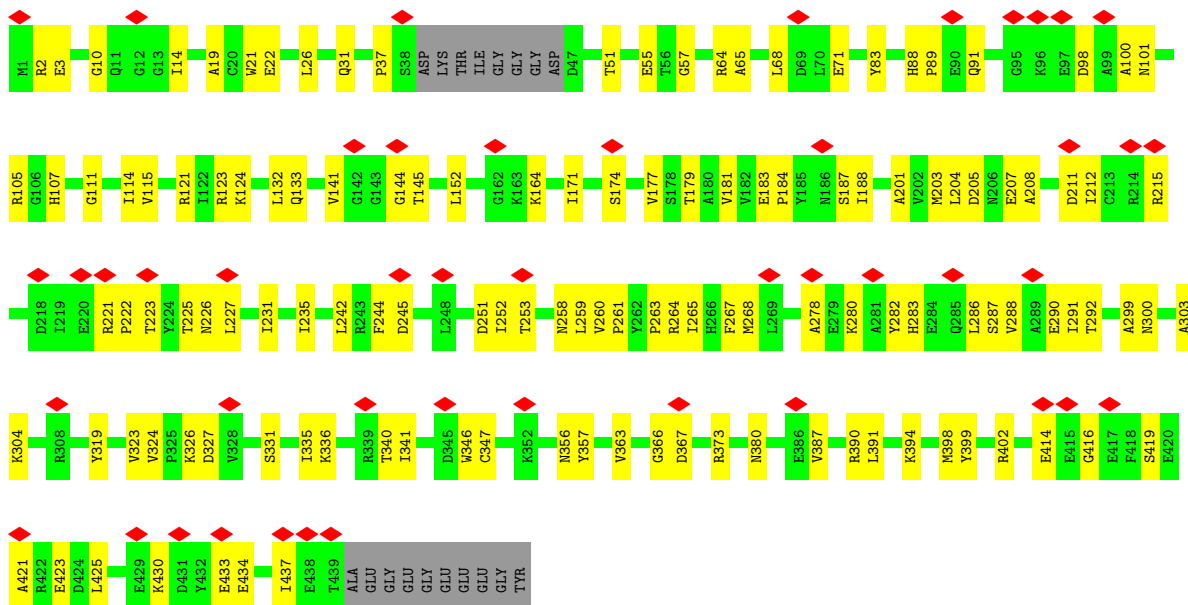

• Molecule 45: Tubulin alpha chain

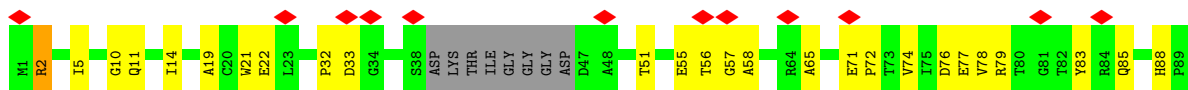

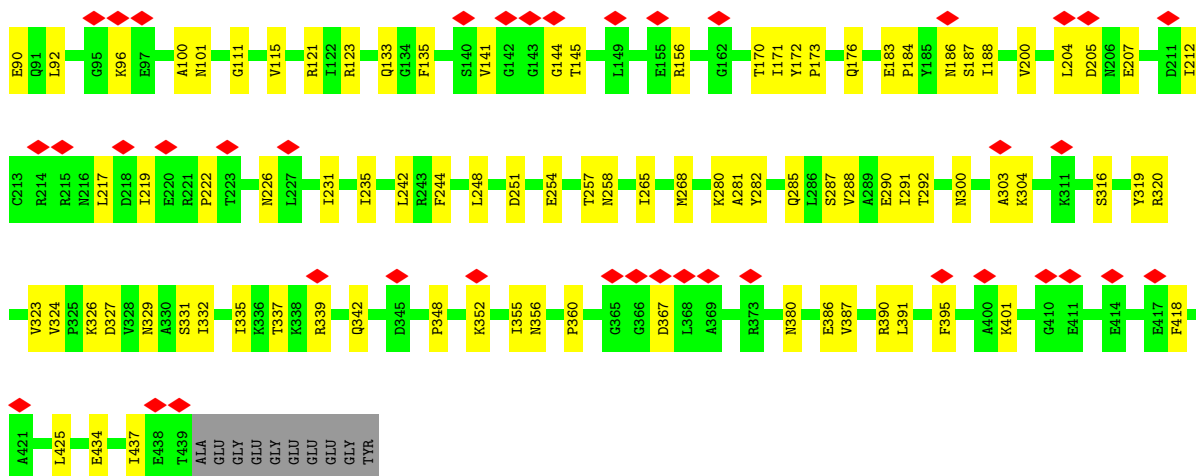

• Molecule 45: Tubulin alpha chain

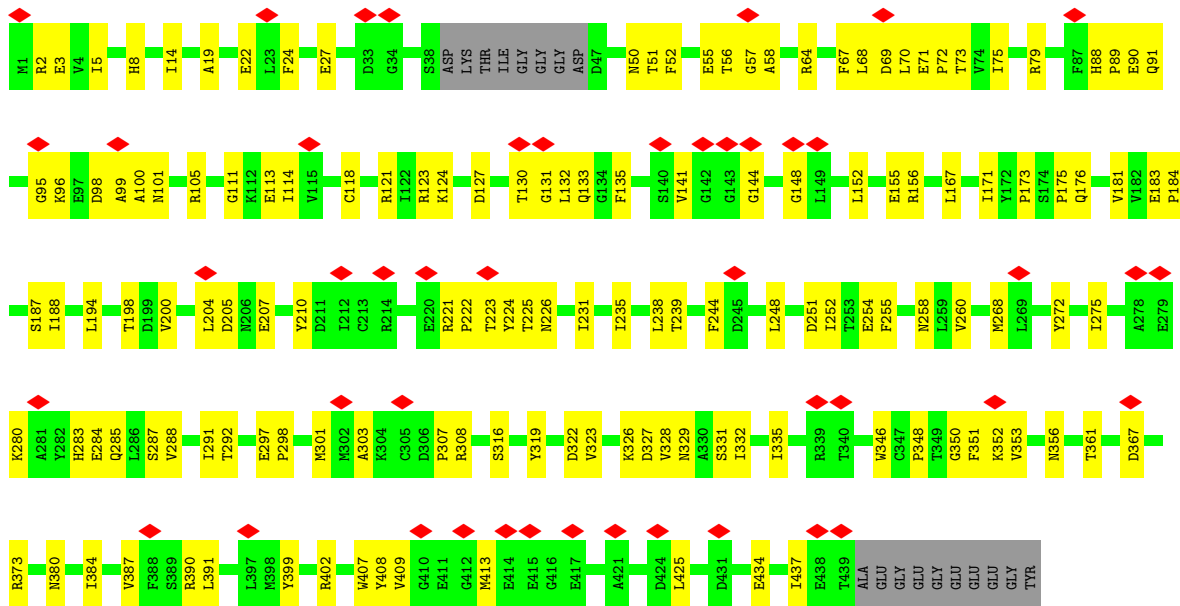

• Molecule 45: Tubulin alpha chain

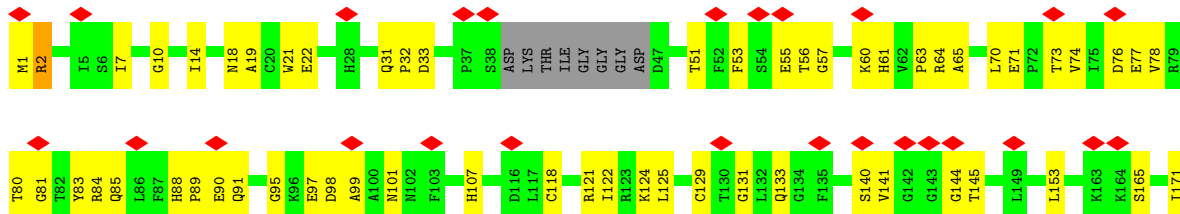

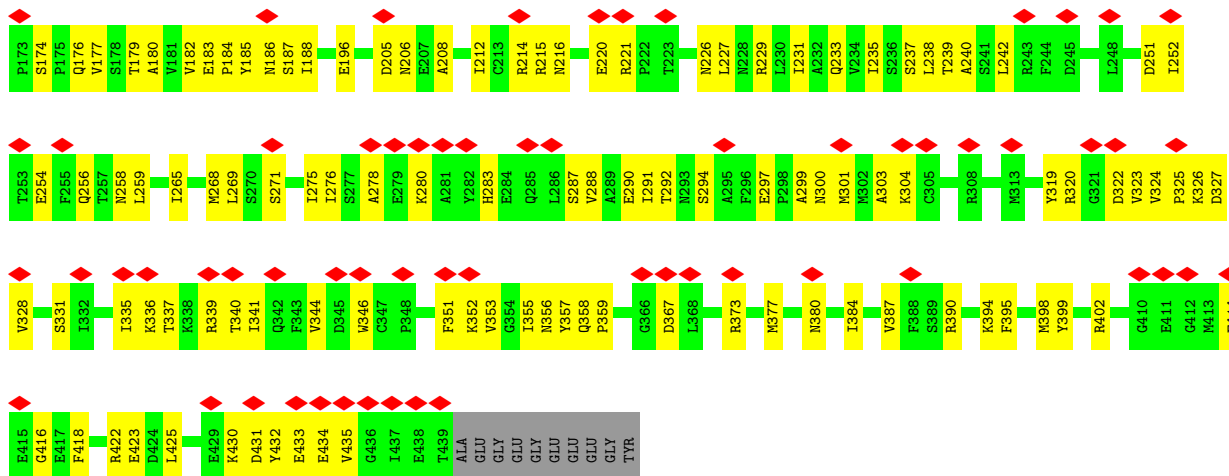

• Molecule 45: Tubulin alpha chain

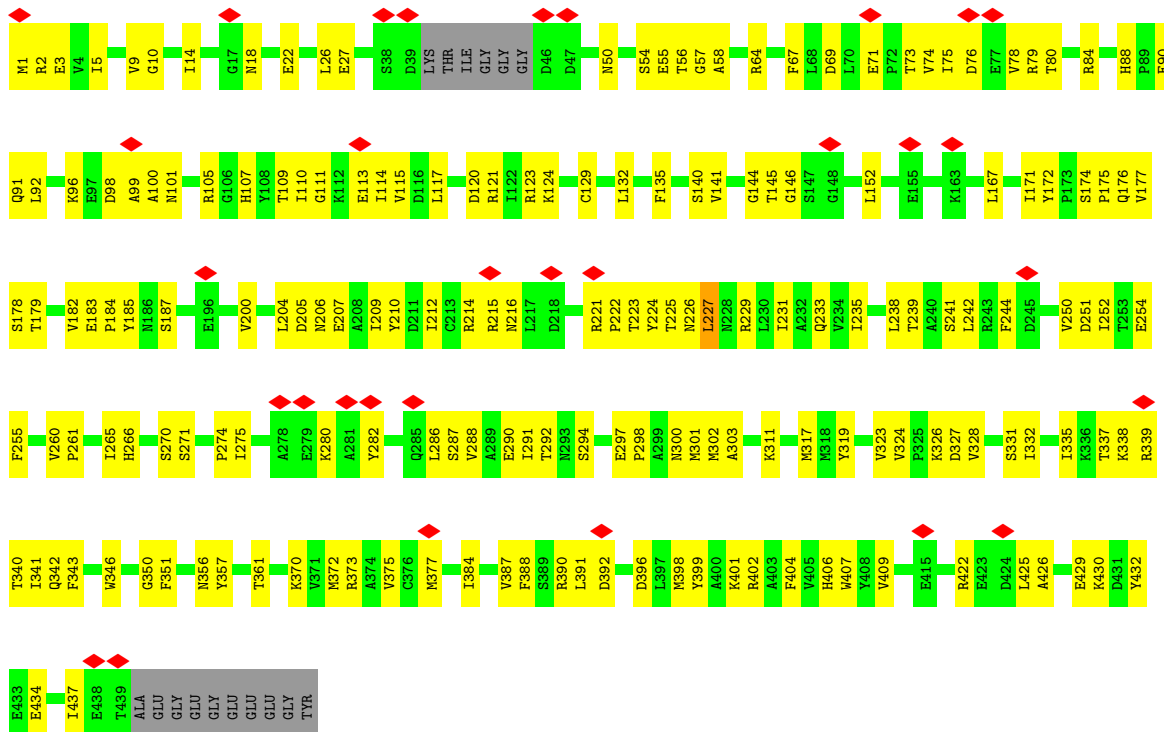

• Molecule 45: Tubulin alpha chain

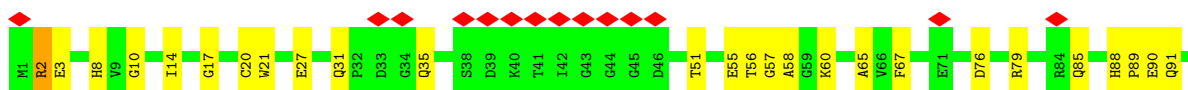

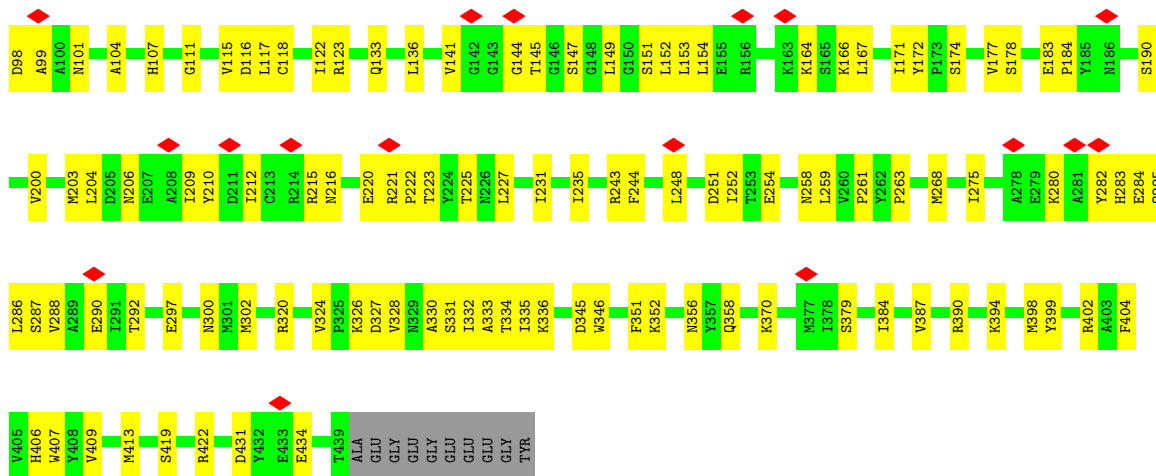

• Molecule 45: Tubulin alpha chain

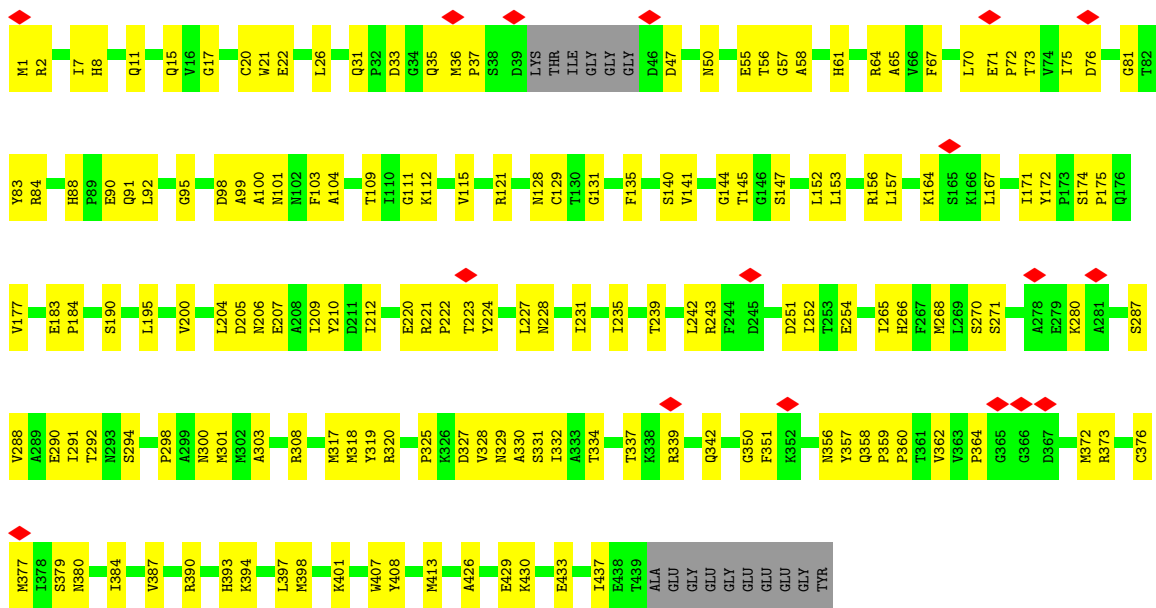

• Molecule 45: Tubulin alpha chain

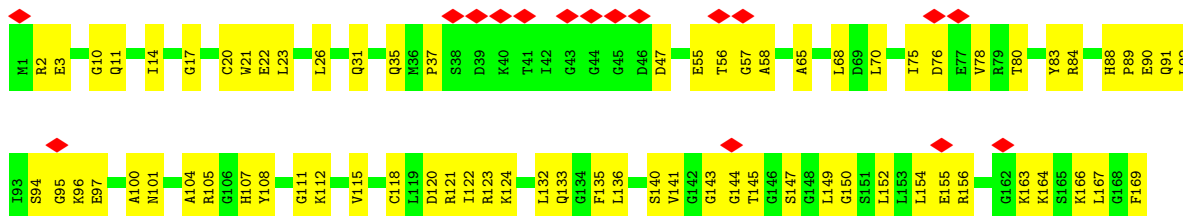

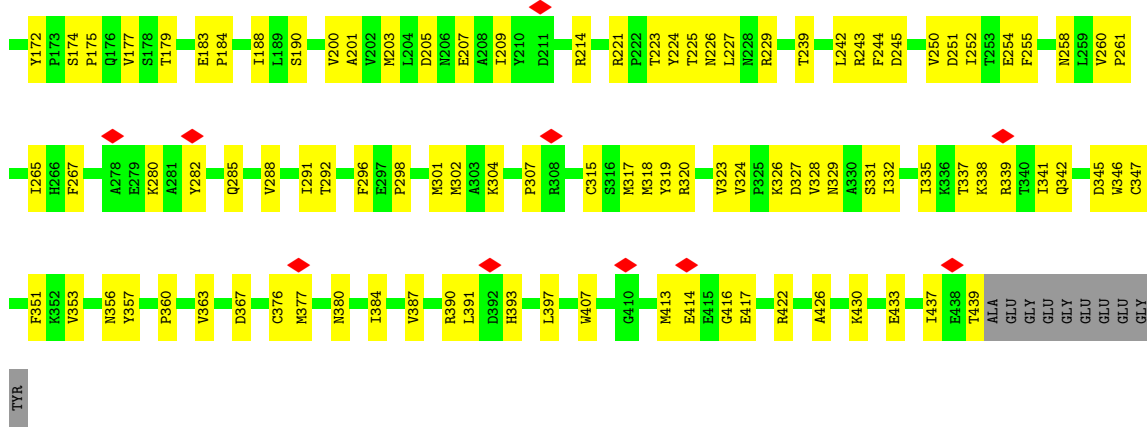

• Molecule 45: Tubulin alpha chain

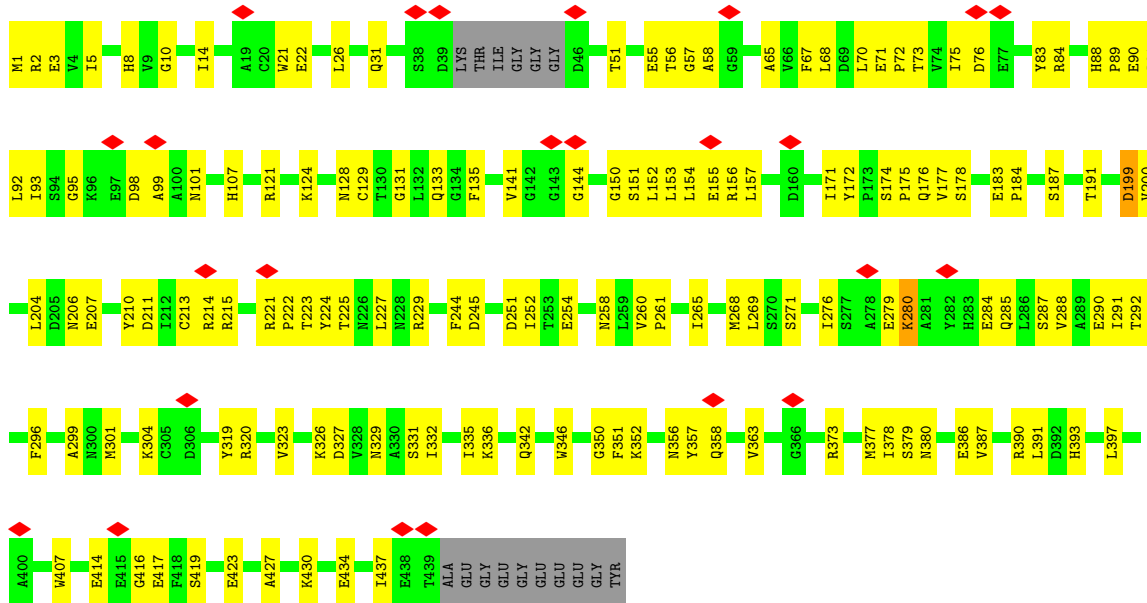

• Molecule 45: Tubulin alpha chain

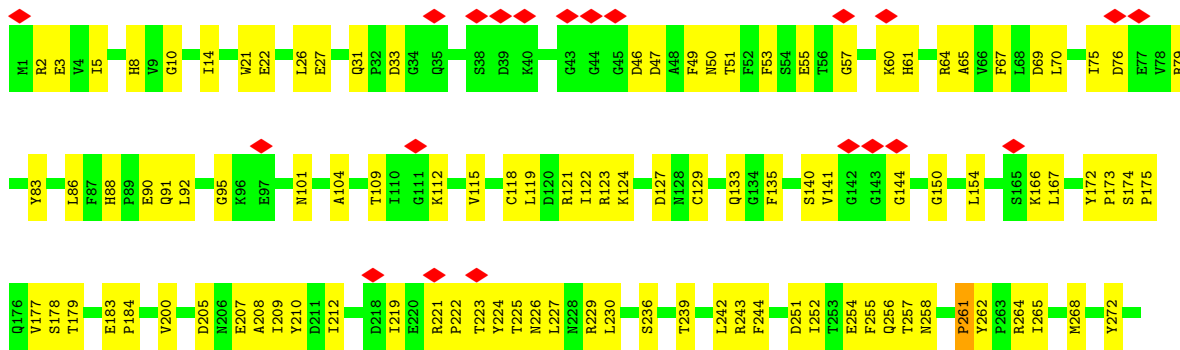

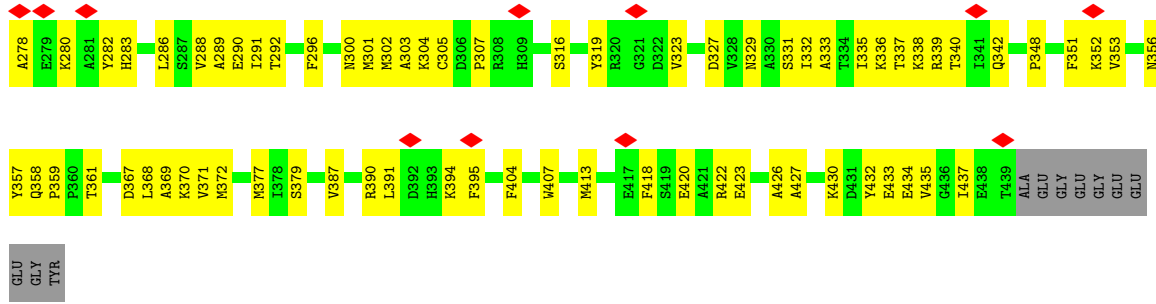

• Molecule 45: Tubulin alpha chain

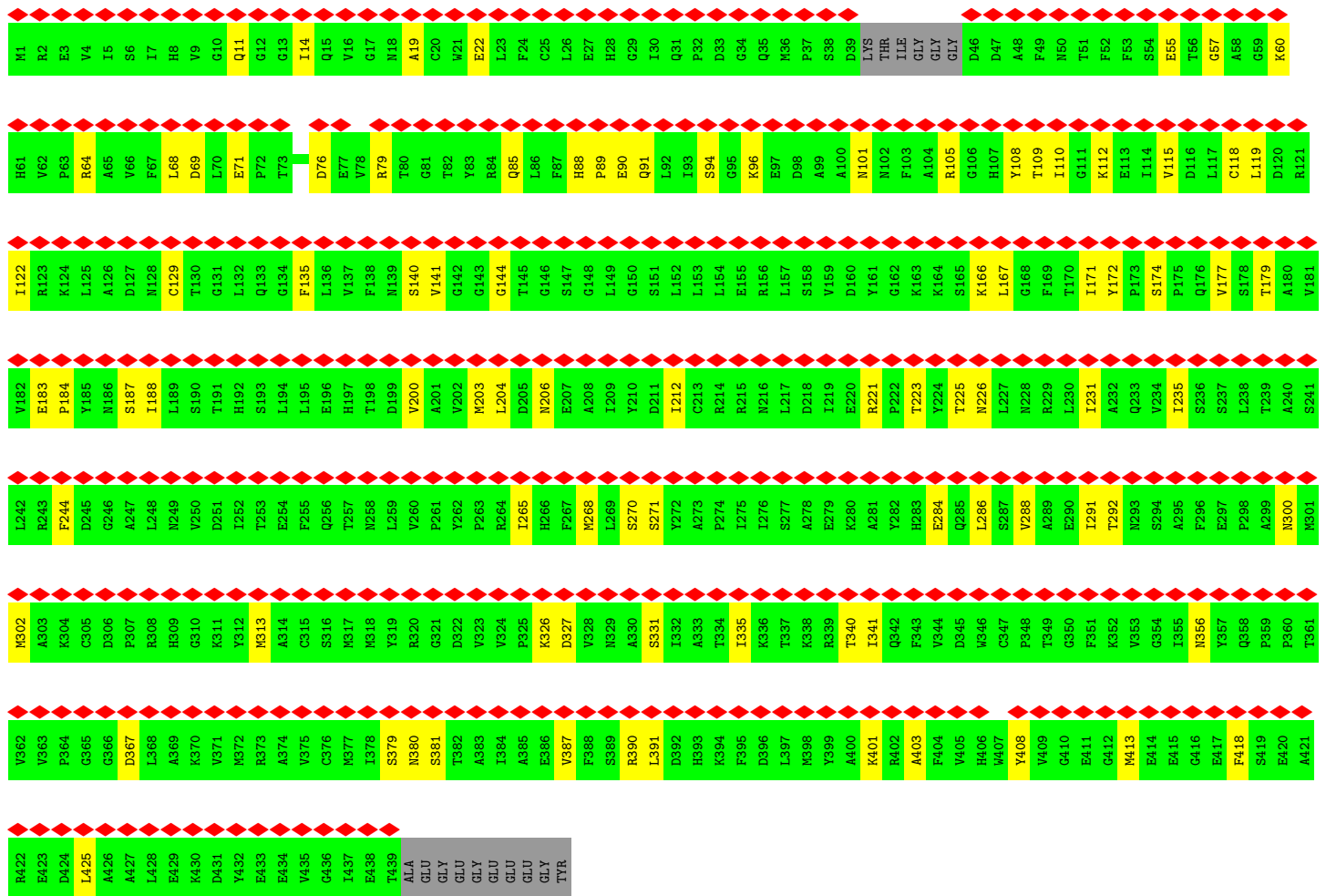
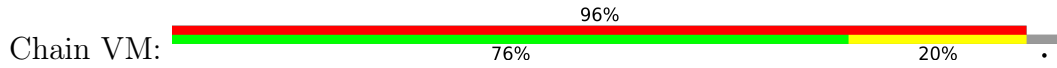

• Molecule 45: Tubulin alpha chain

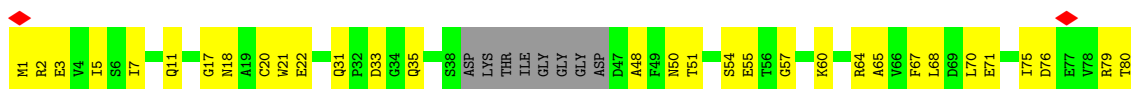

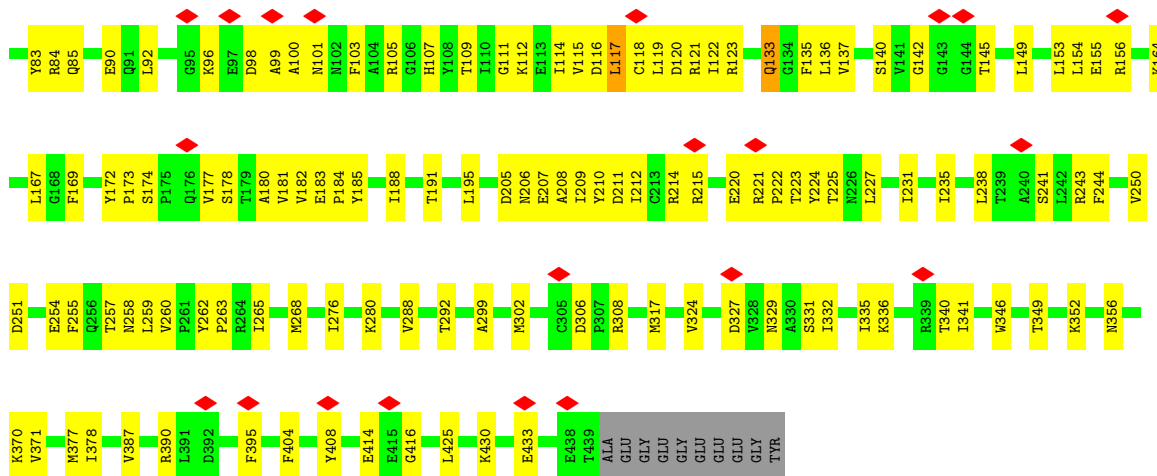

• Molecule 45: Tubulin alpha chain

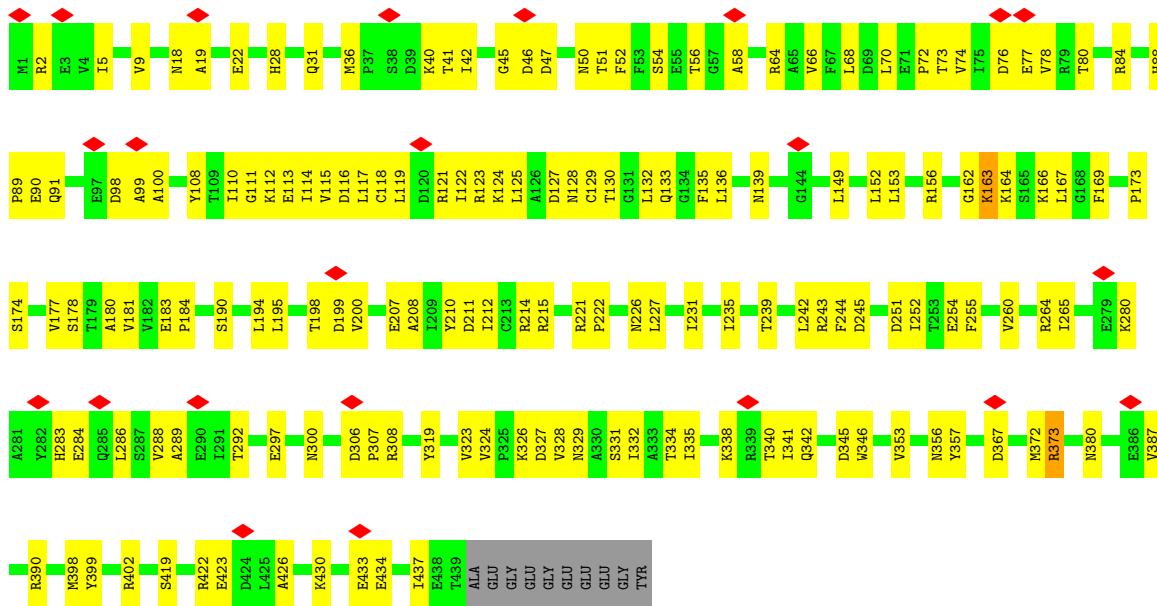

• Molecule 45: Tubulin alpha chain

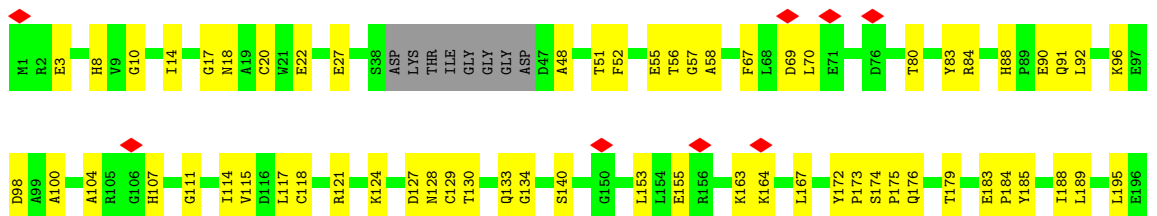

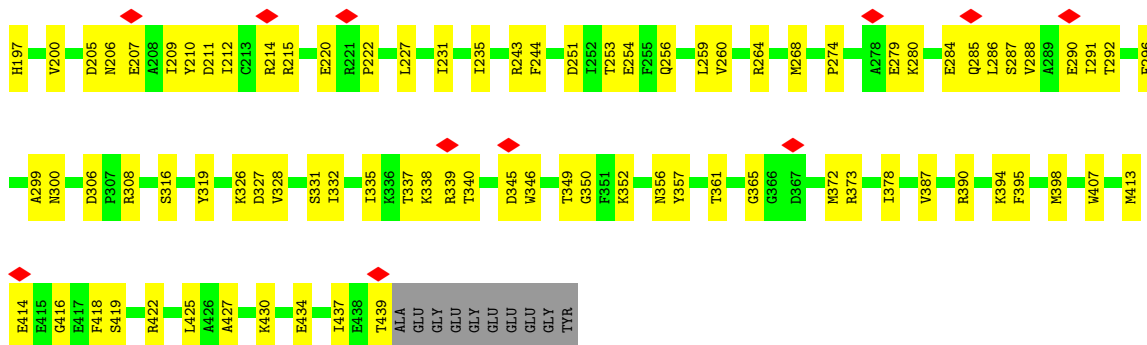

• Molecule 45: Tubulin alpha chain

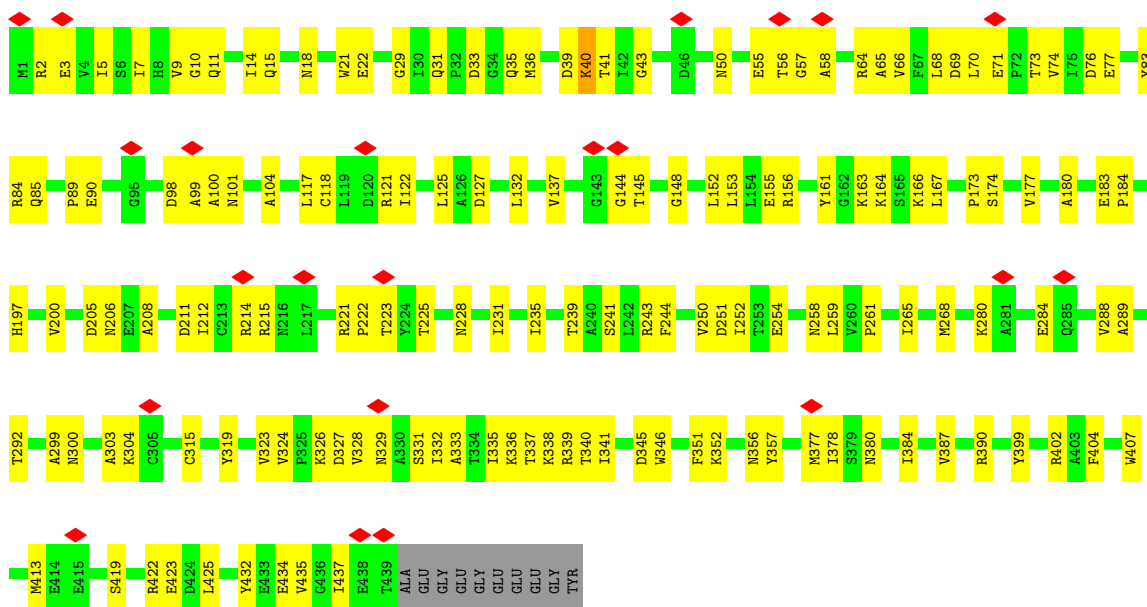

• Molecule 45: Tubulin alpha chain

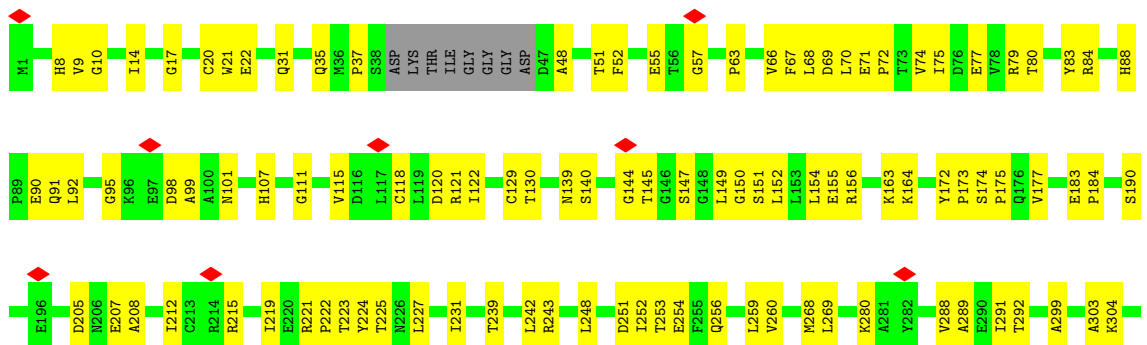



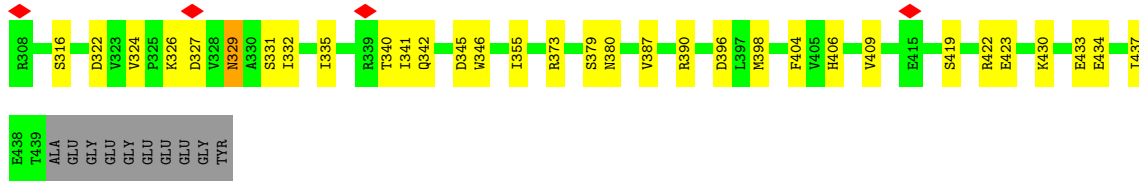

• Molecule 45: Tubulin alpha chain

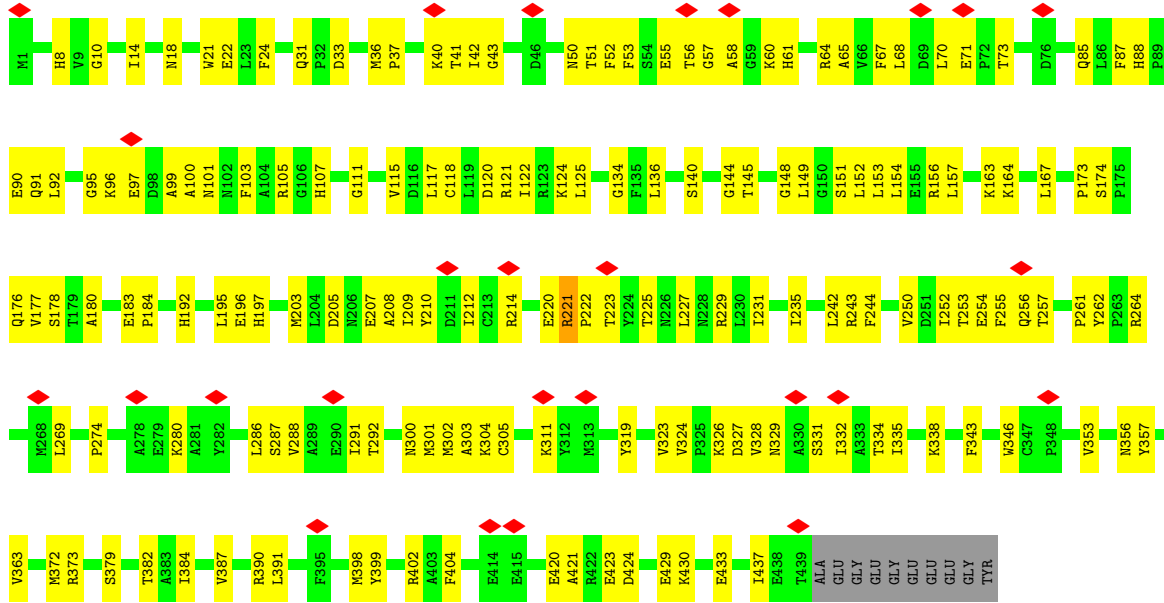

• Molecule 45: Tubulin alpha chain

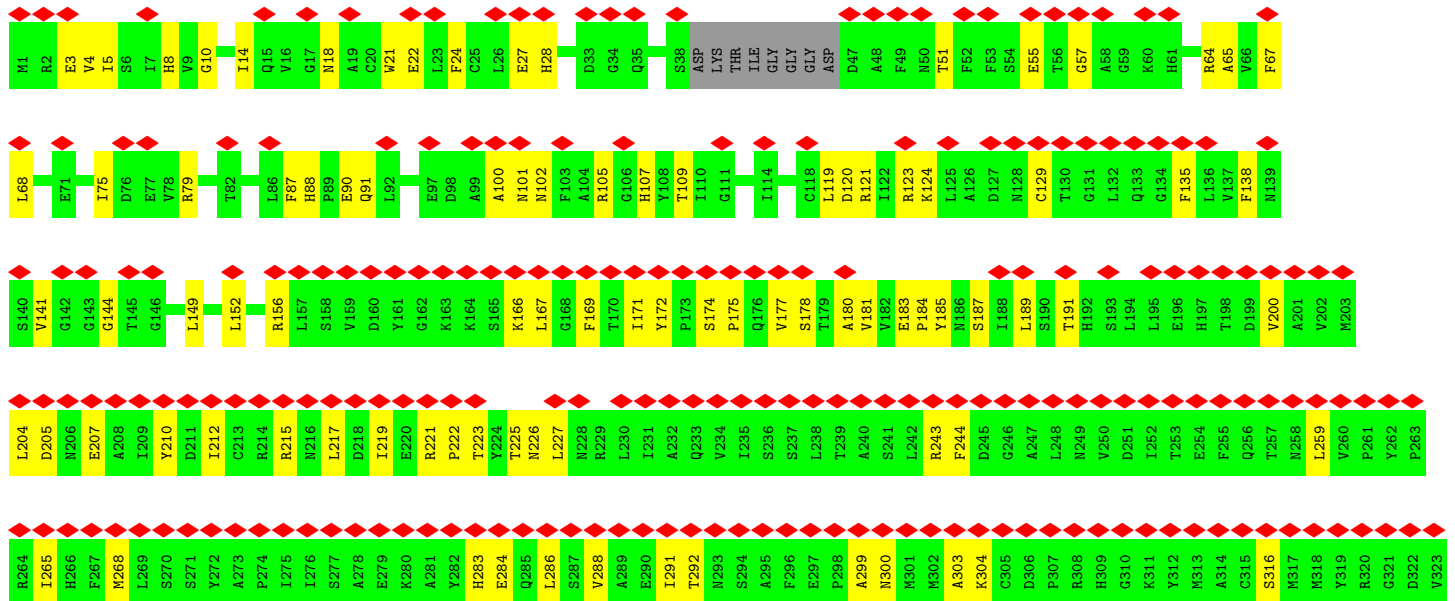
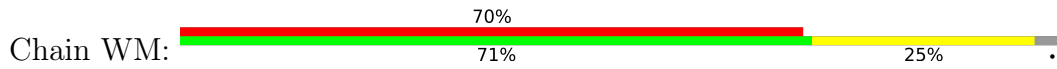

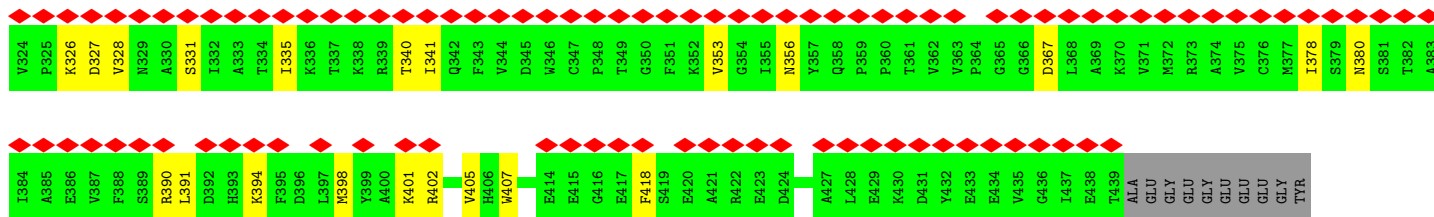

• Molecule 45: Tubulin alpha chain

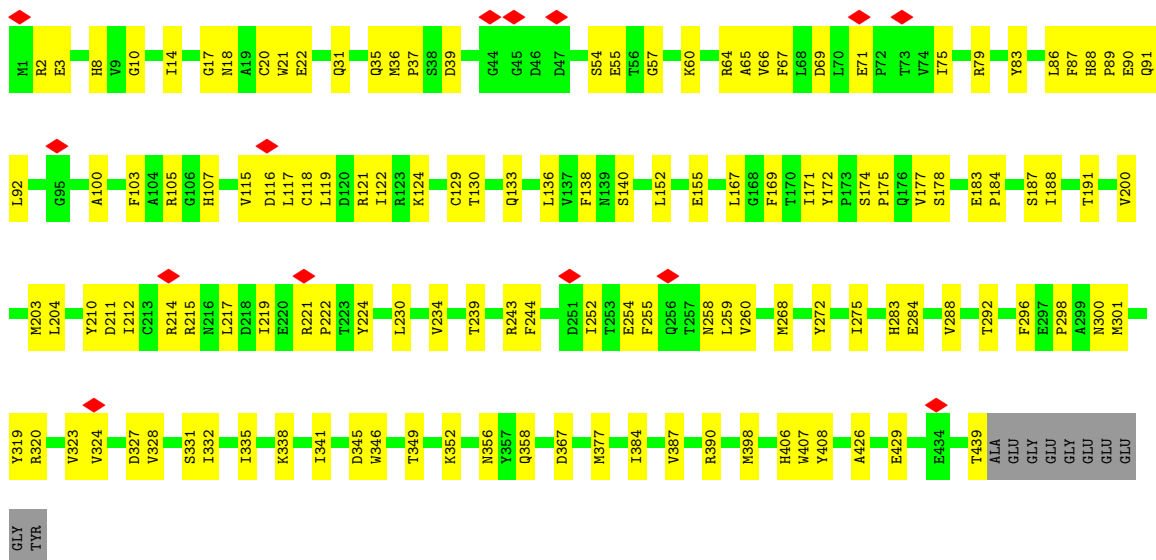

• Molecule 45: Tubulin alpha chain

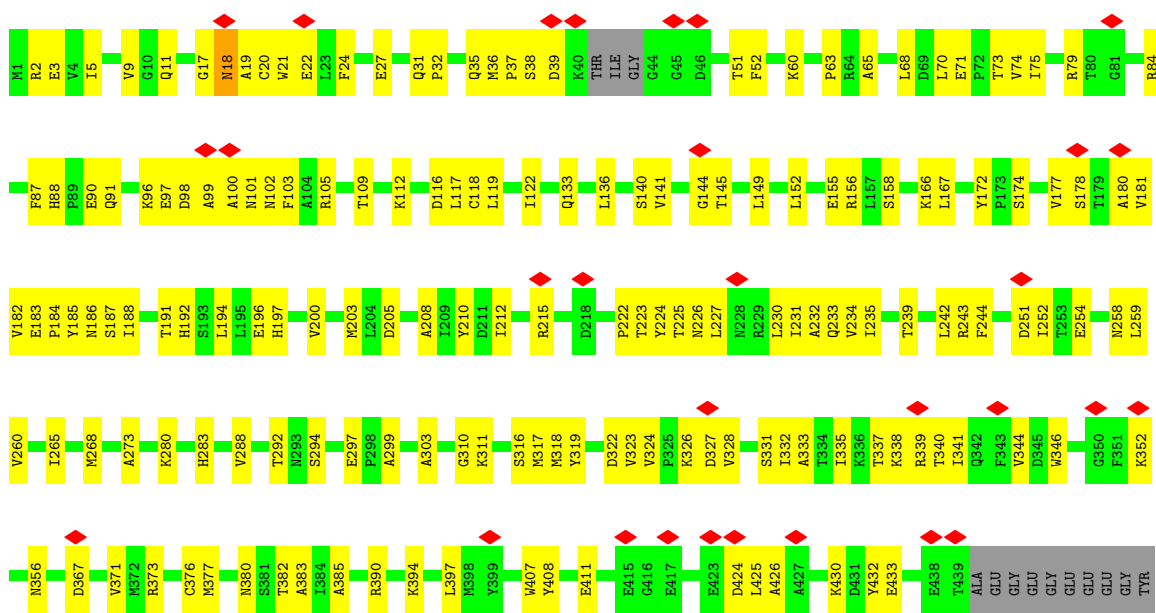

• Molecule 46: Tubulin beta chain

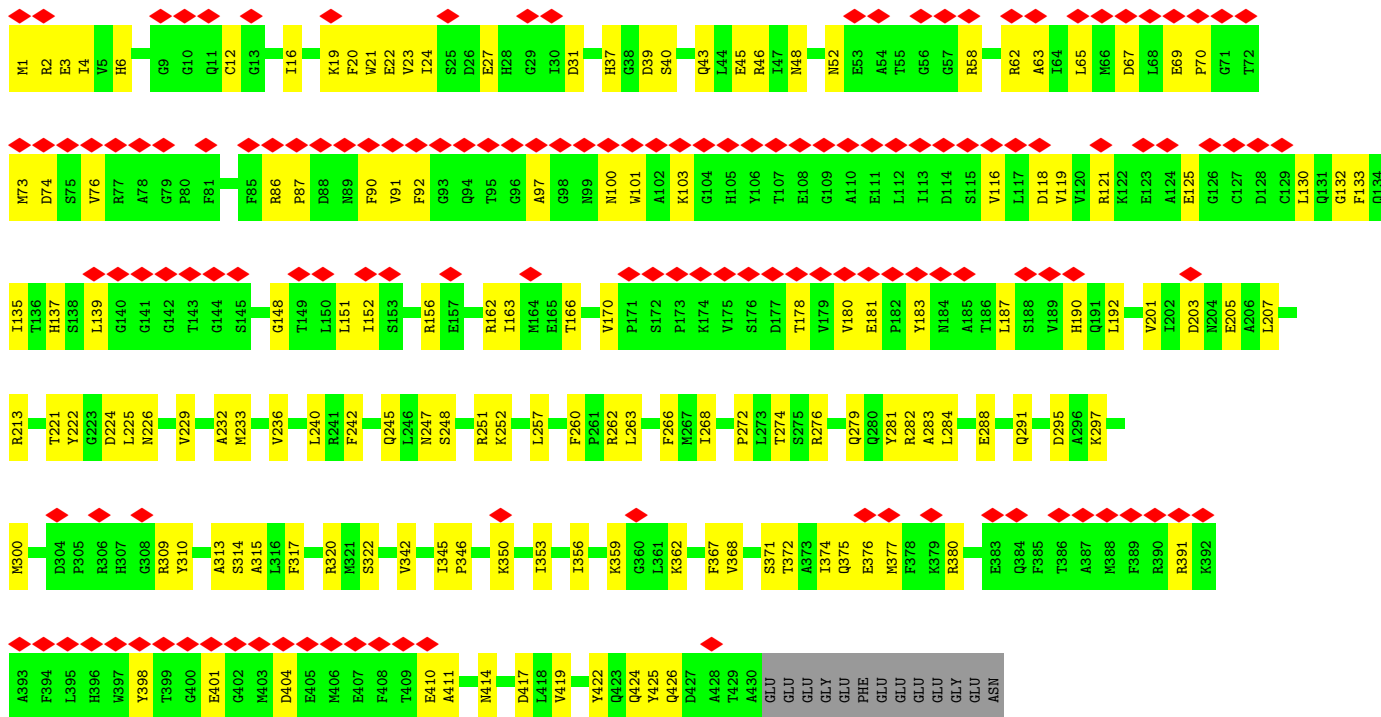

• Molecule 46: Tubulin beta chain

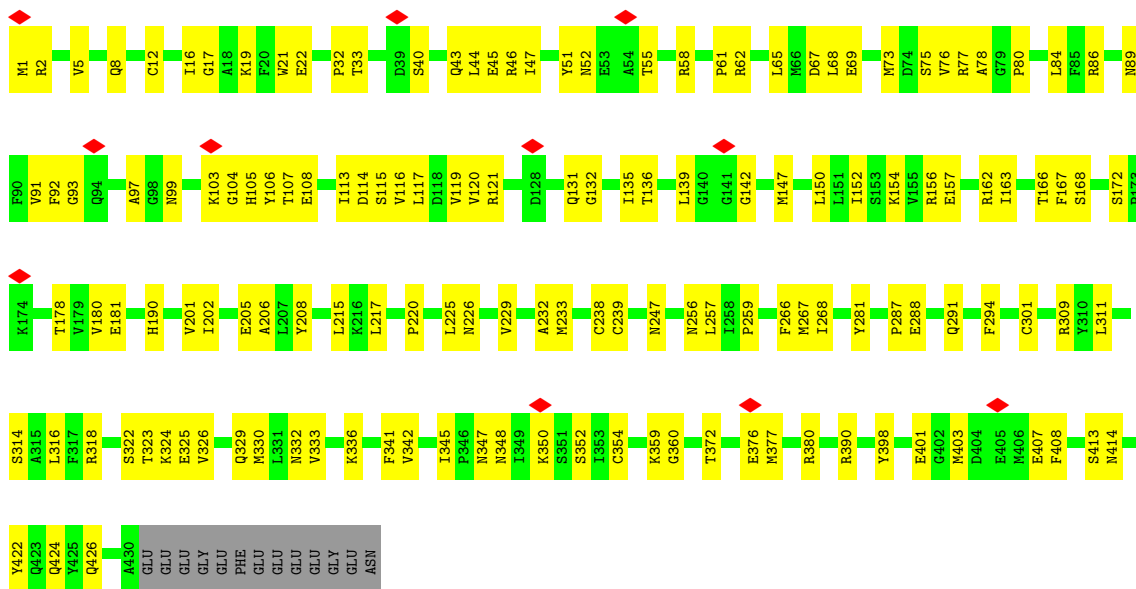

• Molecule 46: Tubulin beta chain



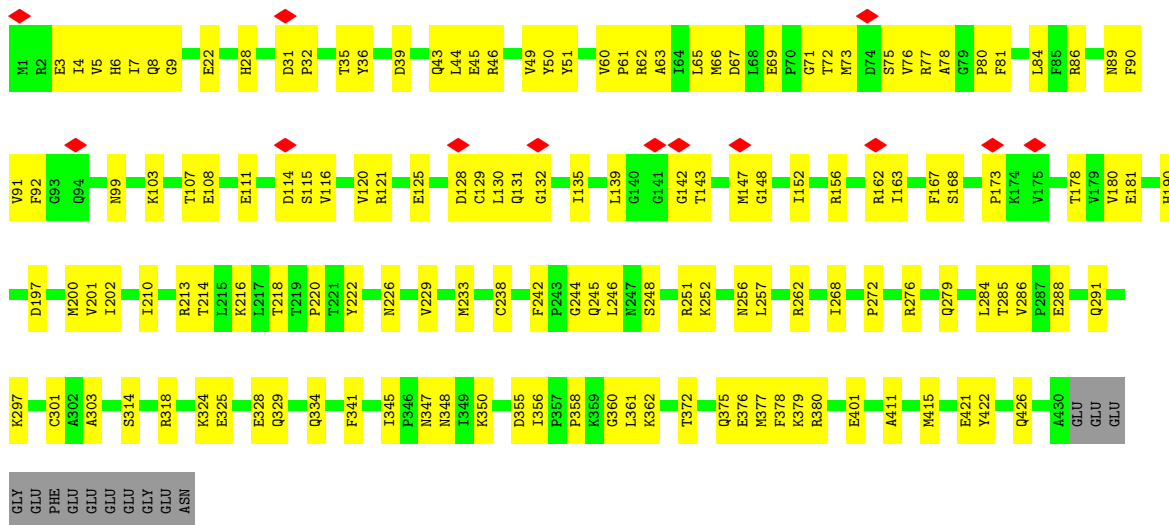

• Molecule 46: Tubulin beta chain

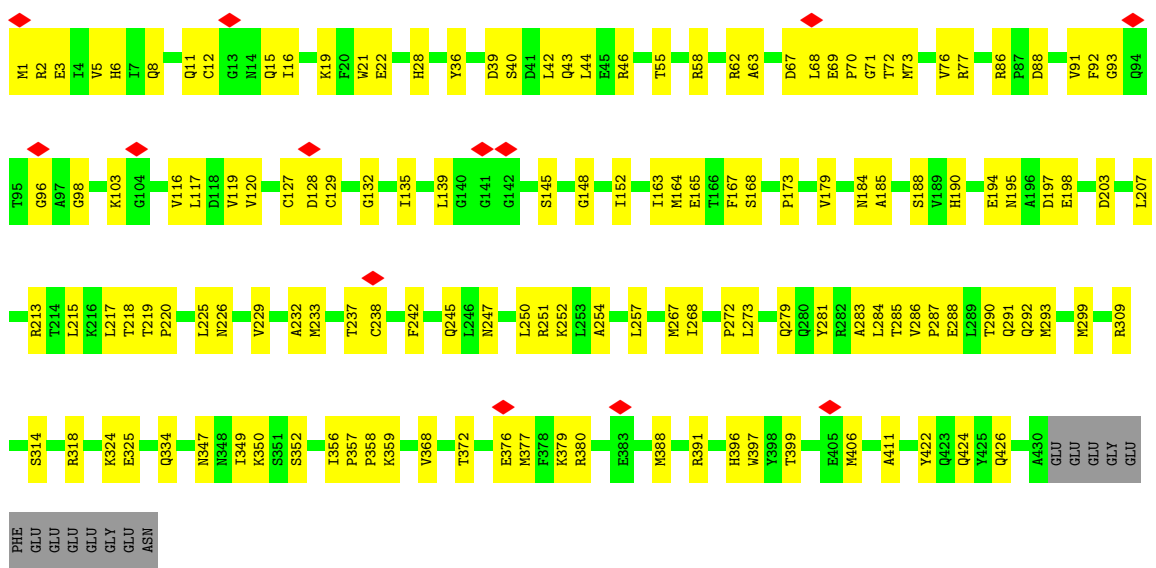

• Molecule 46: Tubulin beta chain

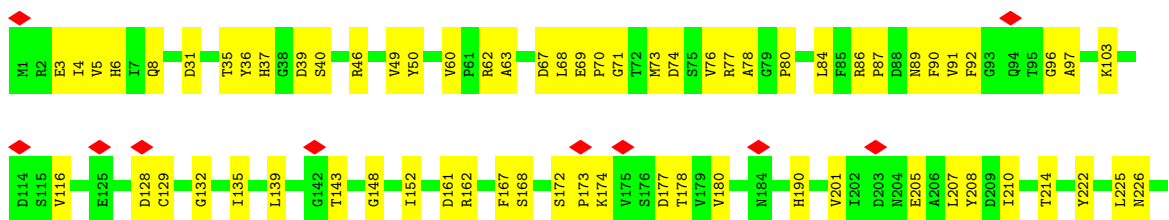

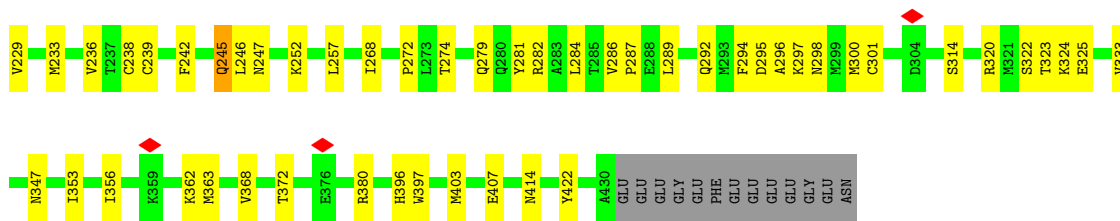

• Molecule 46: Tubulin beta chain

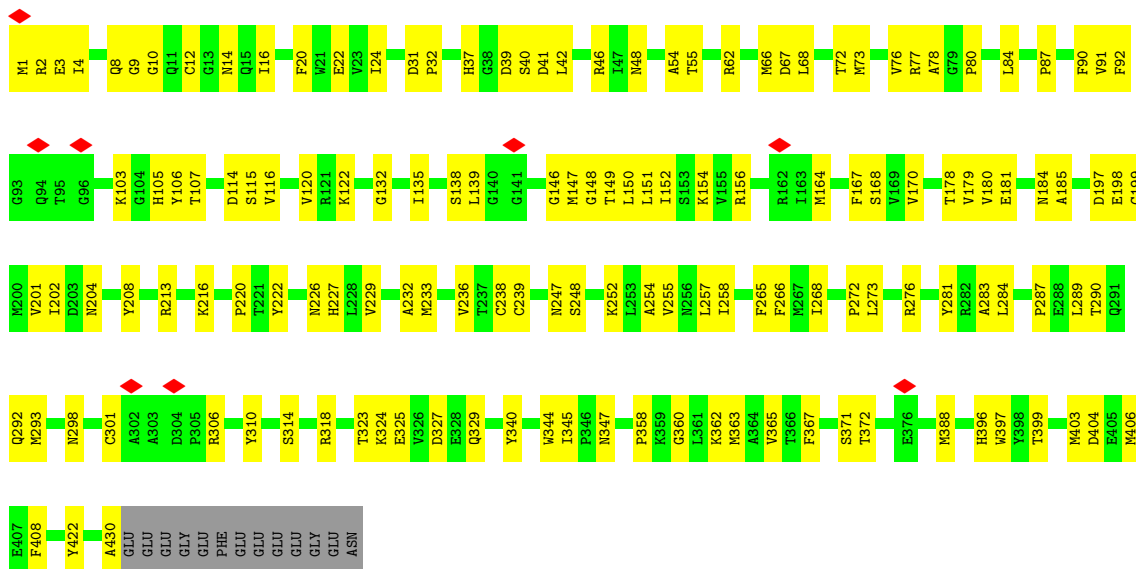

• Molecule 46: Tubulin beta chain

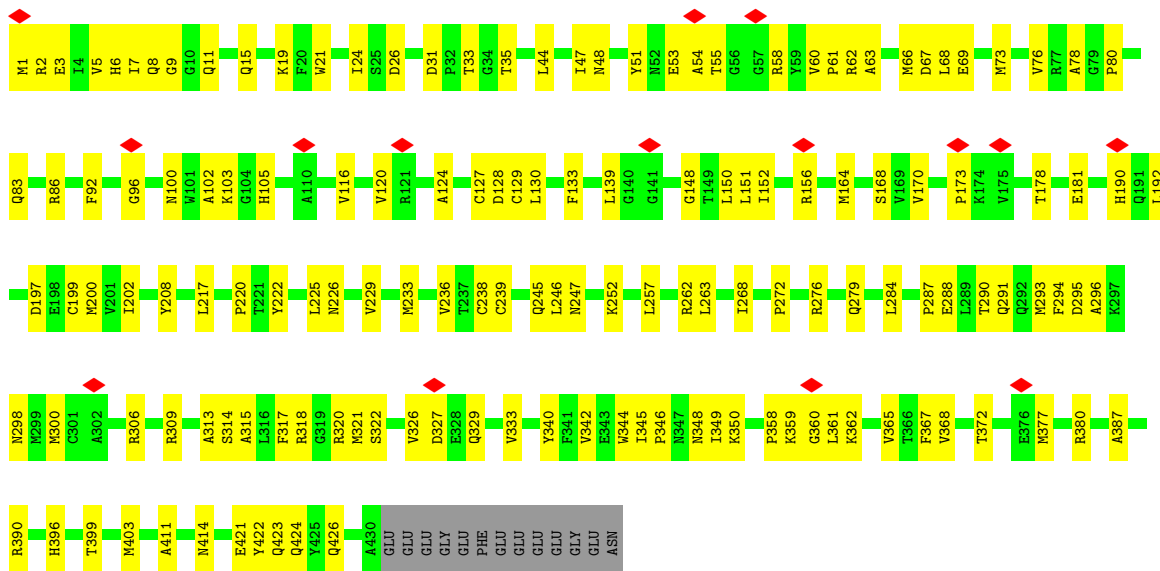

• Molecule 46: Tubulin beta chain

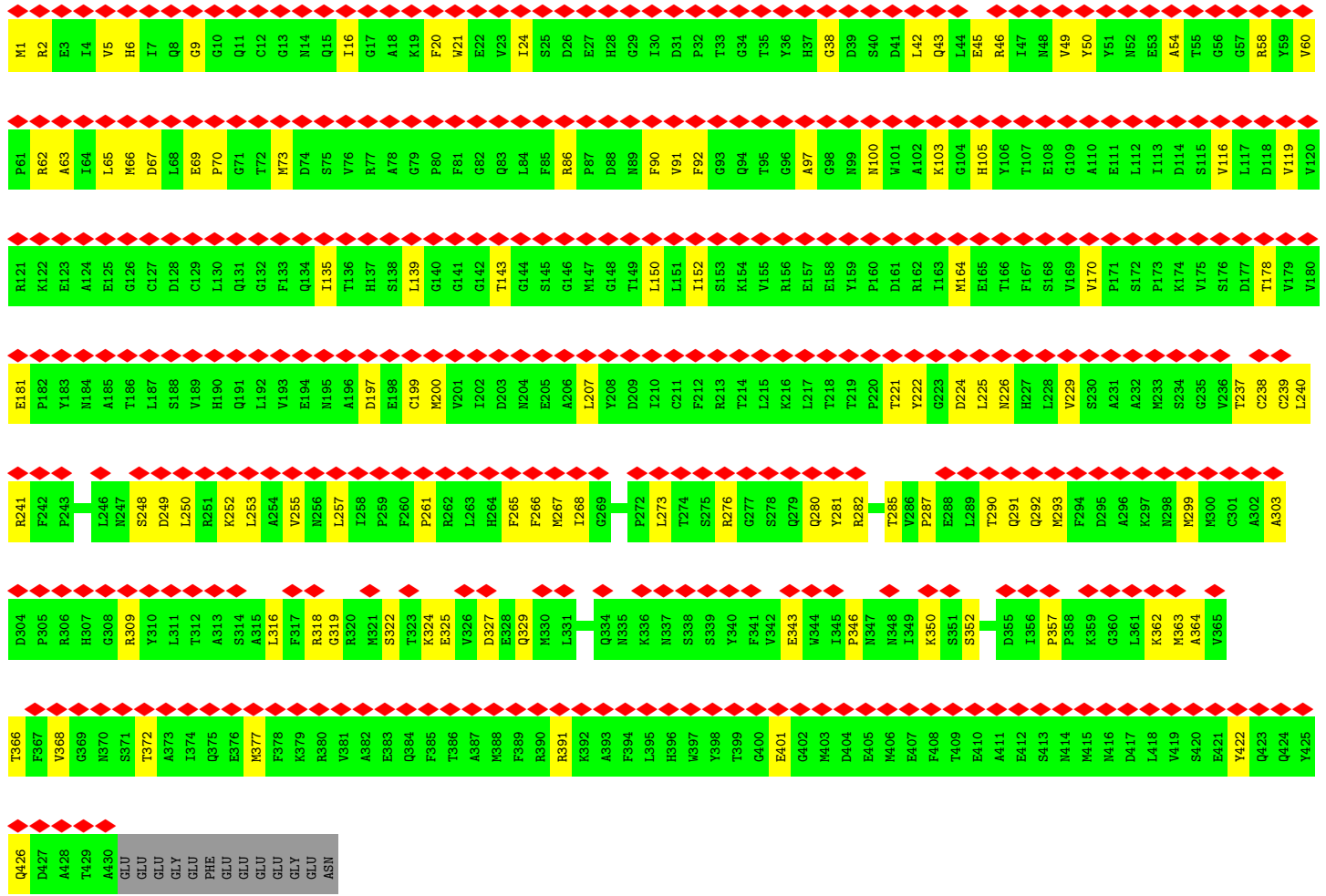

• Molecule 46: Tubulin beta chain

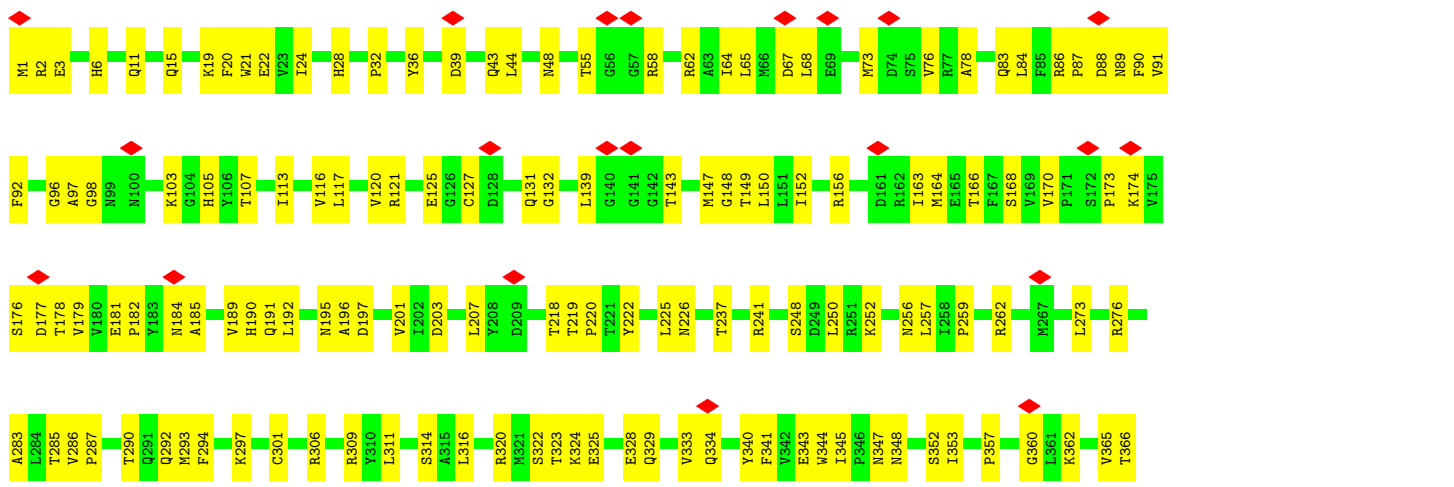

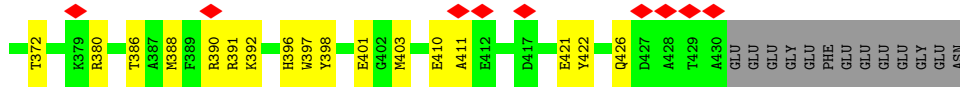

• Molecule 46: Tubulin beta chain

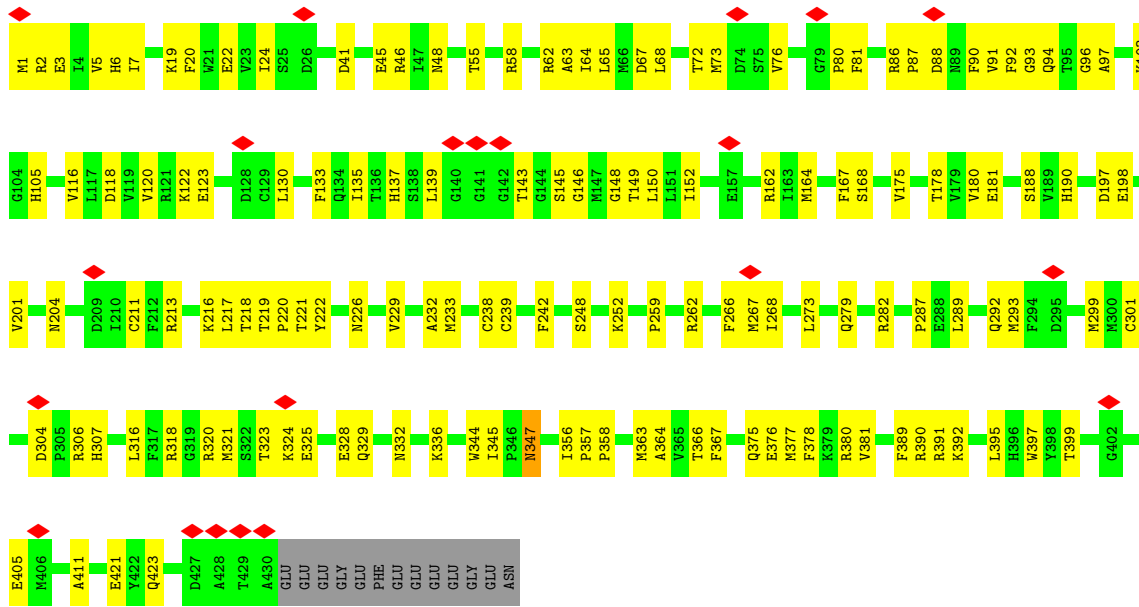

• Molecule 46: Tubulin beta chain

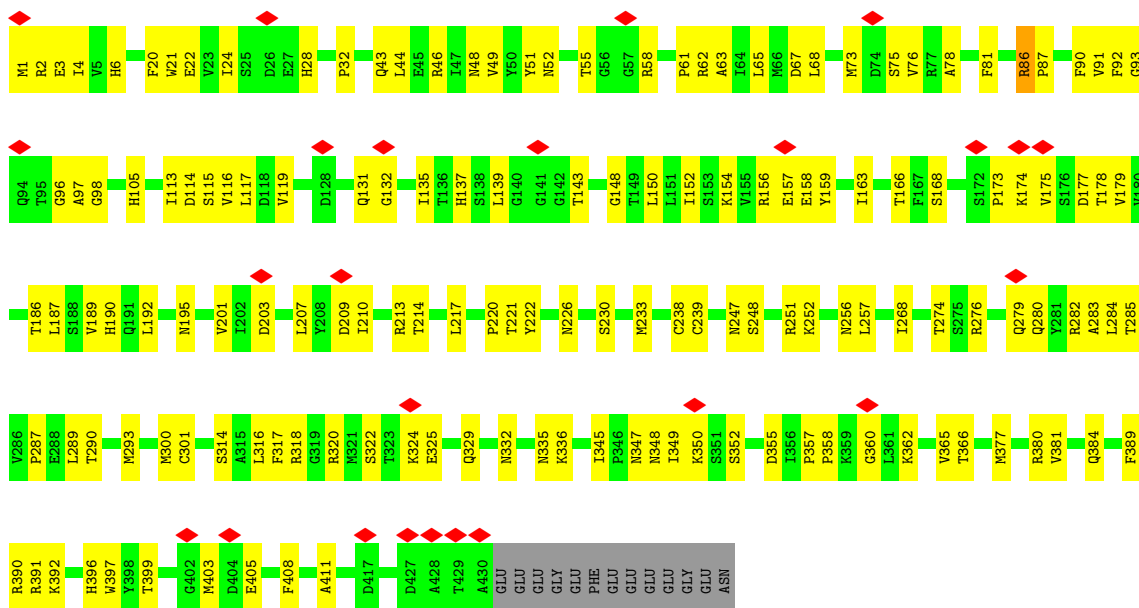

• Molecule 46: Tubulin beta chain



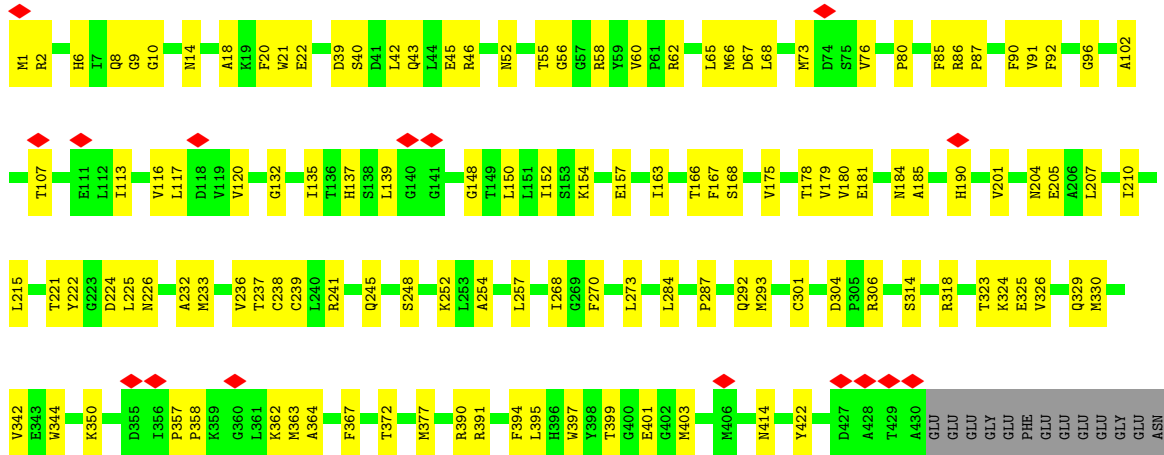

• Molecule 46: Tubulin beta chain

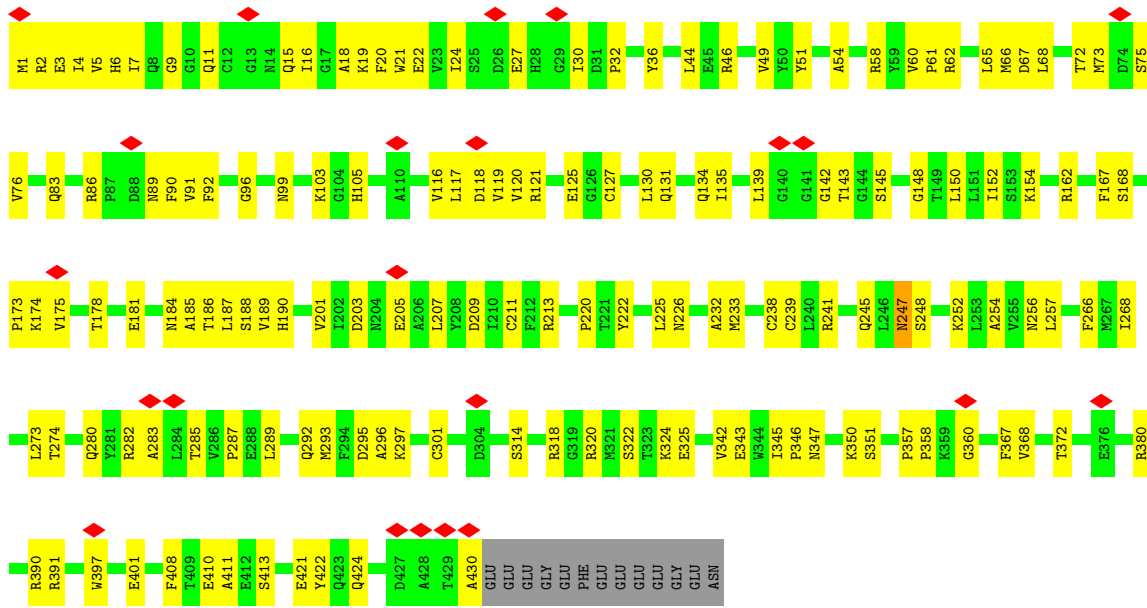

• Molecule 46: Tubulin beta chain

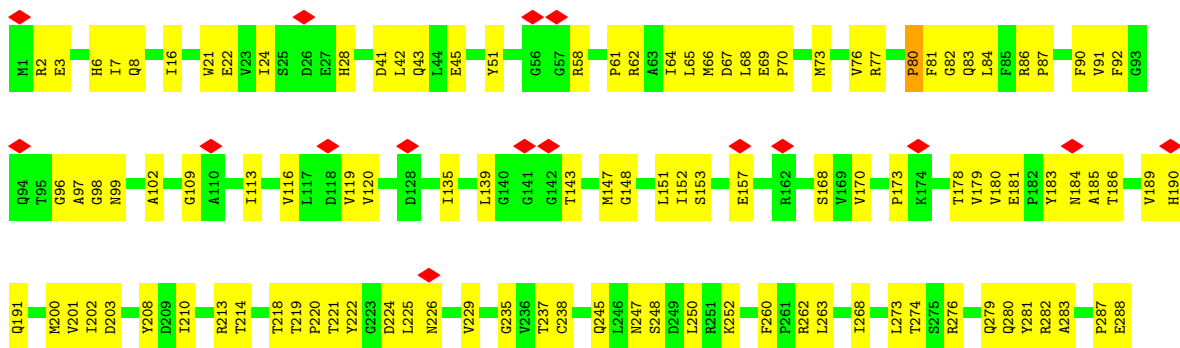



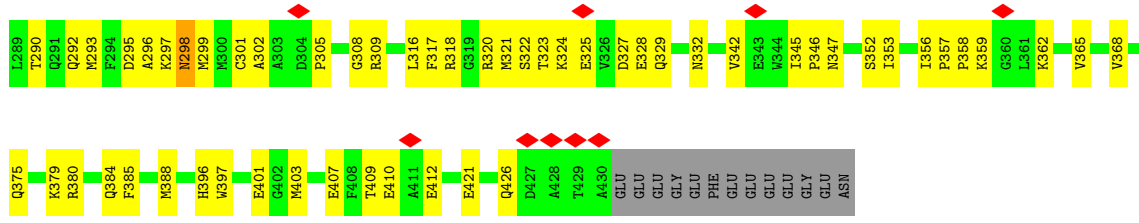

• Molecule 46: Tubulin beta chain

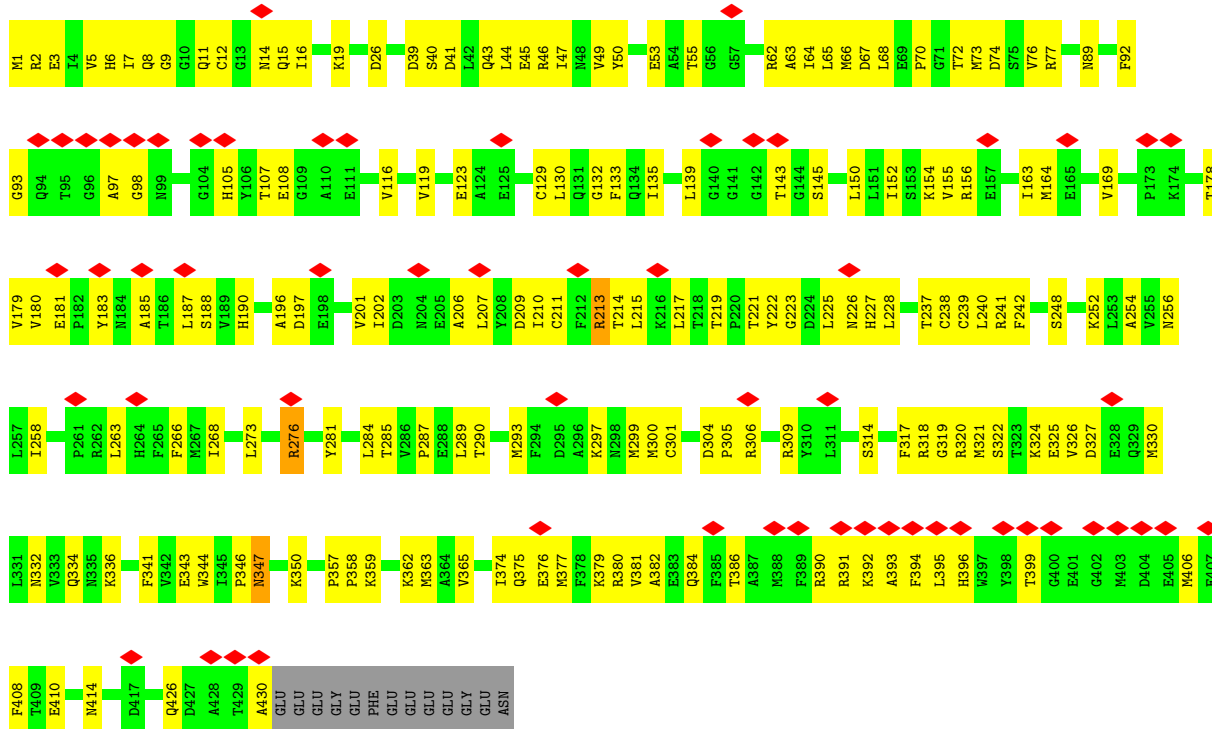

• Molecule 46: Tubulin beta chain

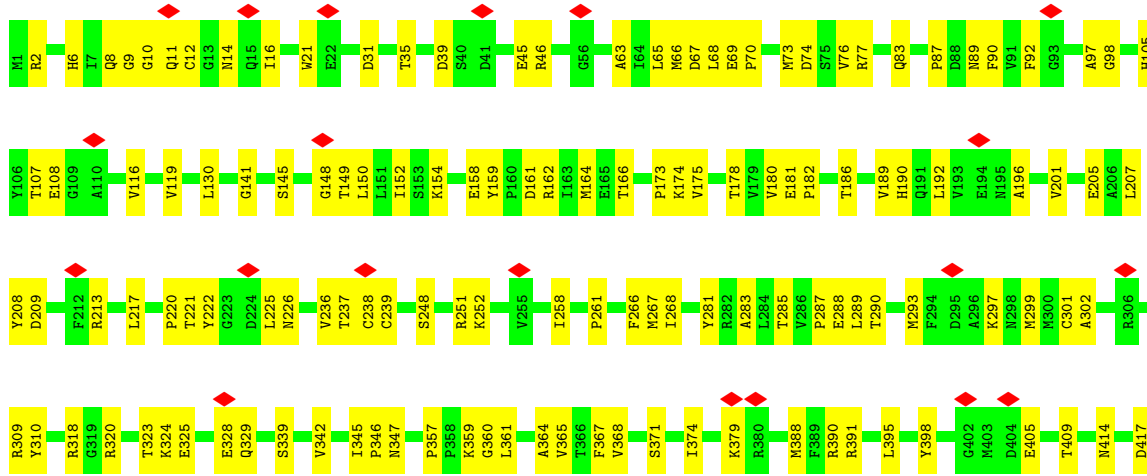

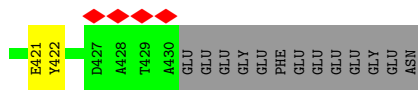

• Molecule 46: Tubulin beta chain

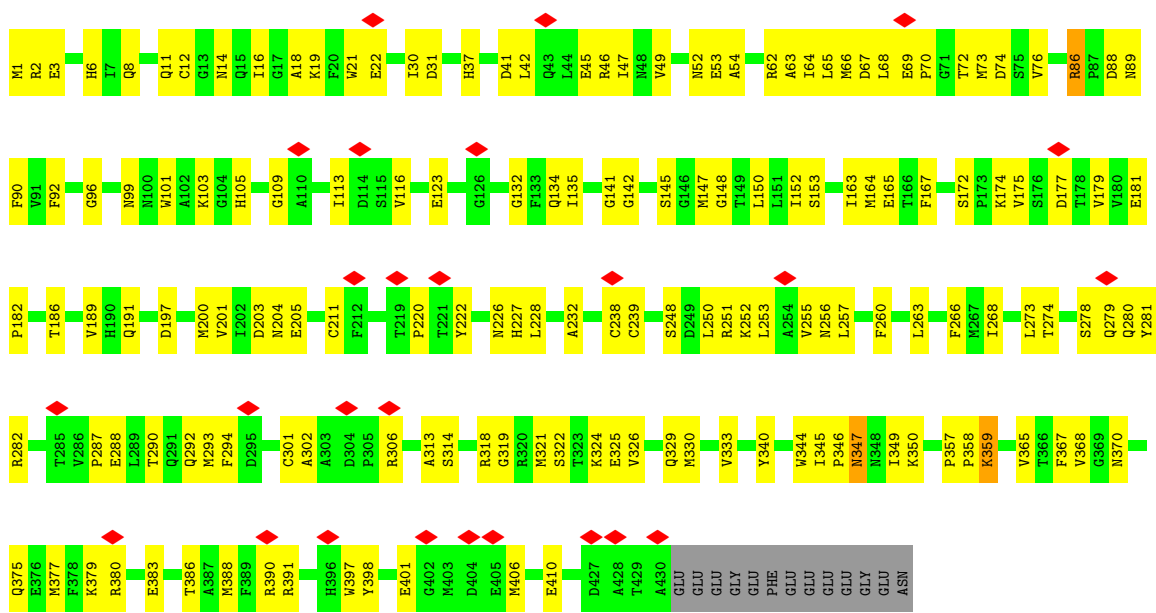

• Molecule 46: Tubulin beta chain

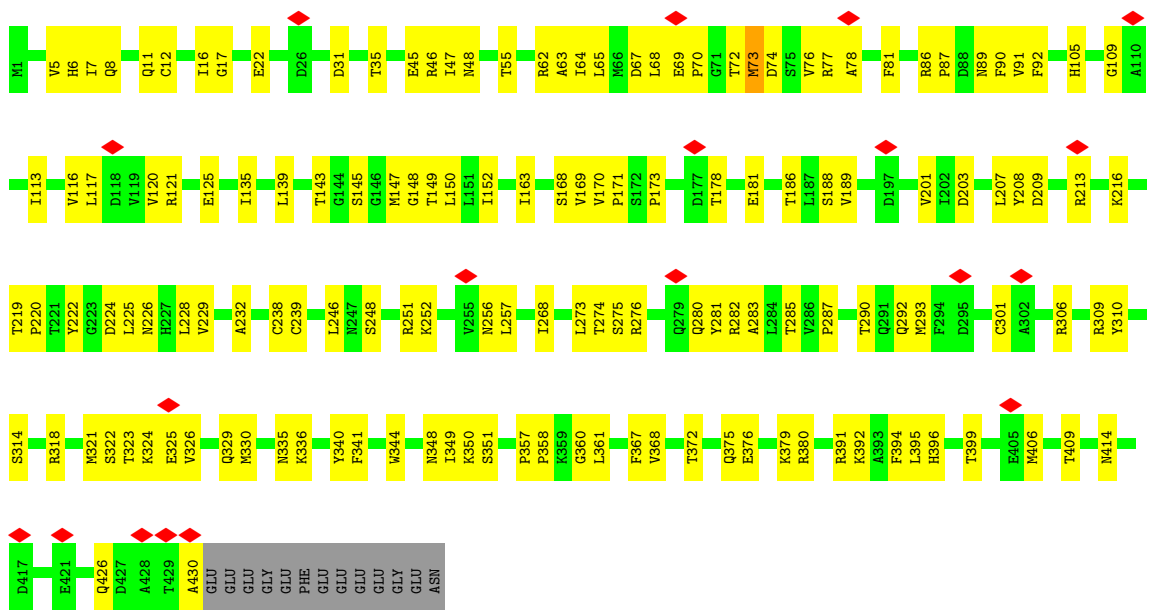

• Molecule 46: Tubulin beta chain



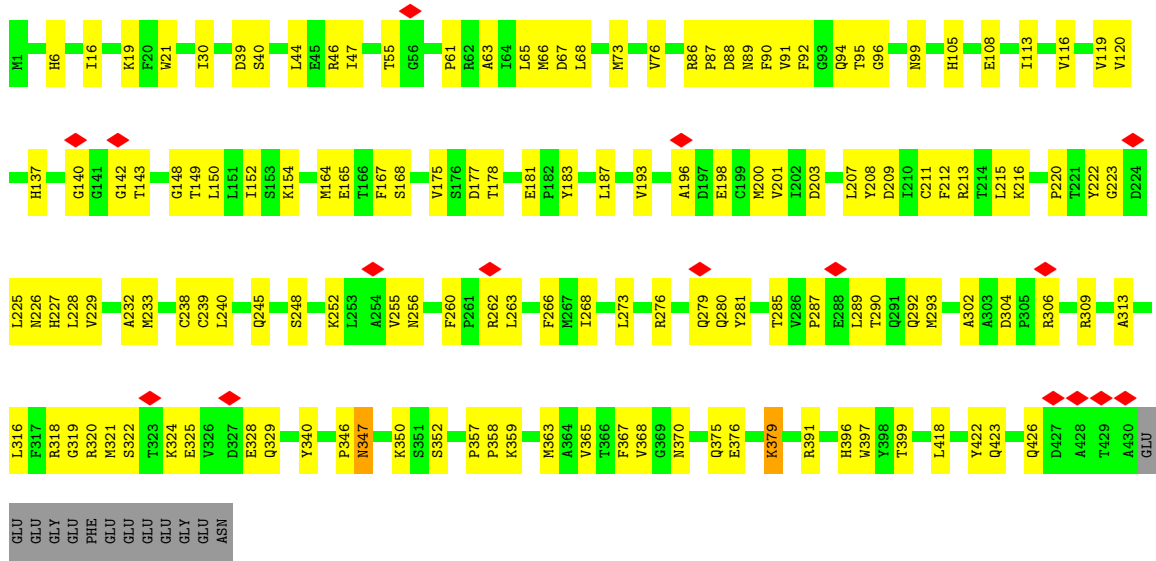

• Molecule 46: Tubulin beta chain

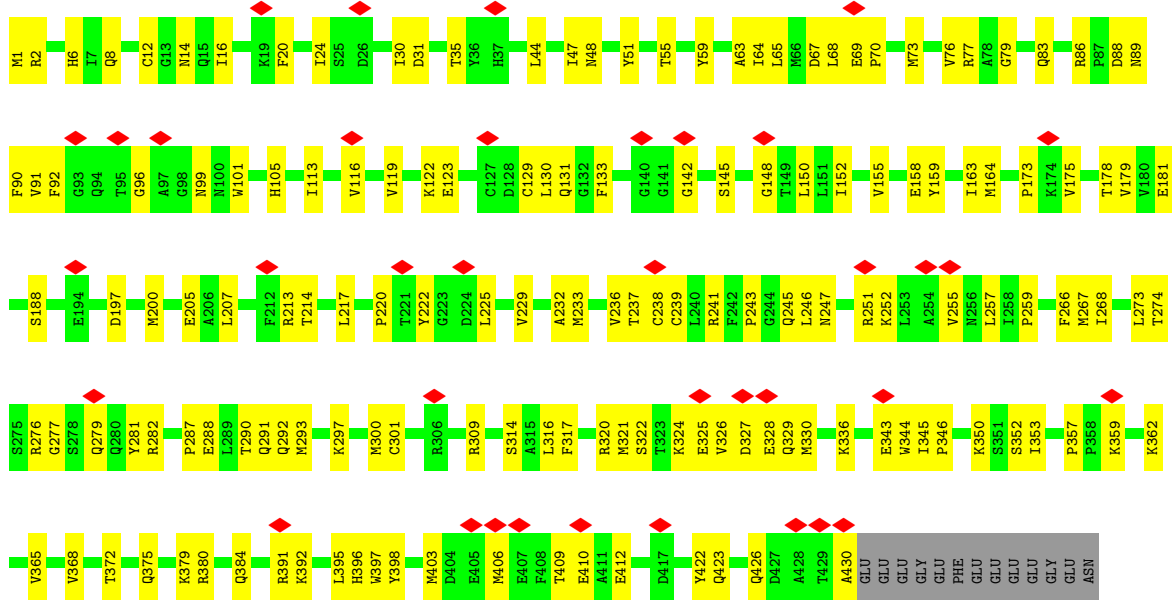

• Molecule 46: Tubulin beta chain

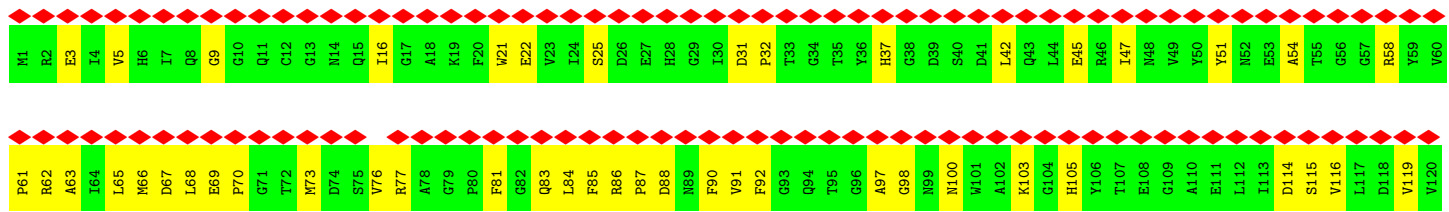
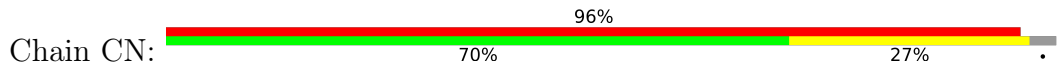

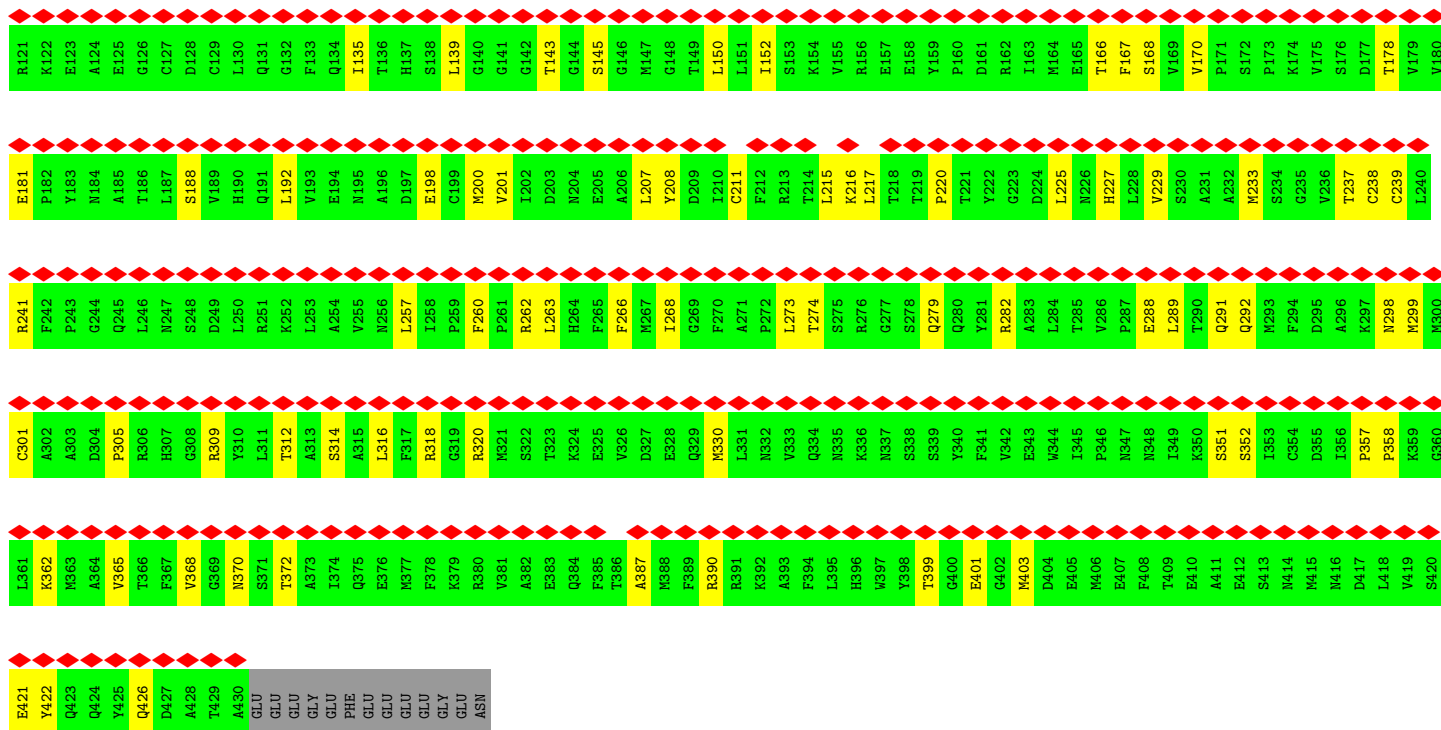

● Molecule 46: Tubulin beta chain

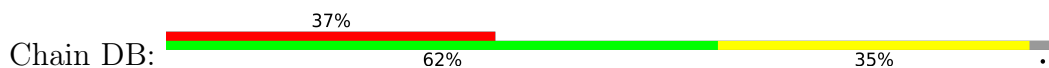

Chain DB:

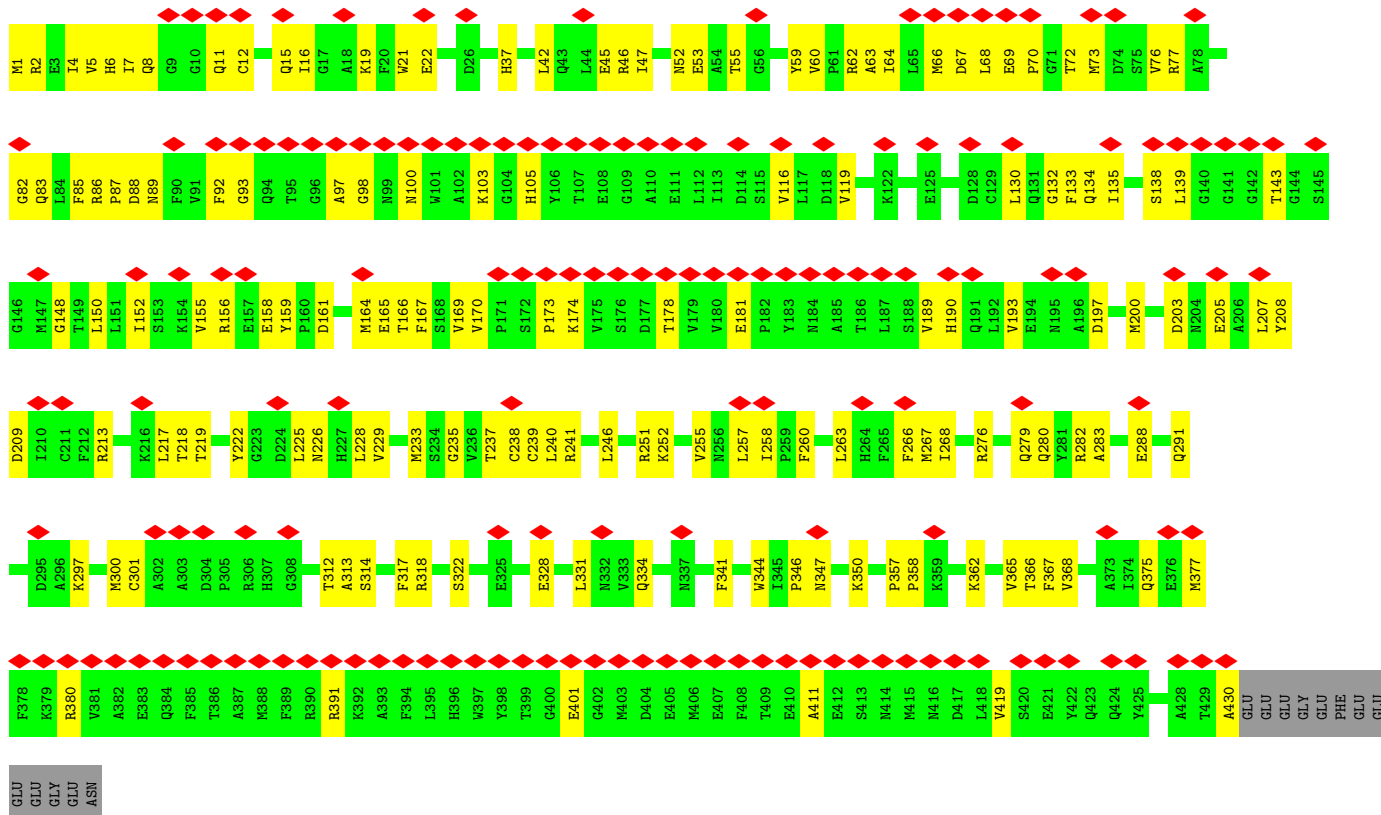

● Molecule 46: Tubulin beta chain

Chain DD:

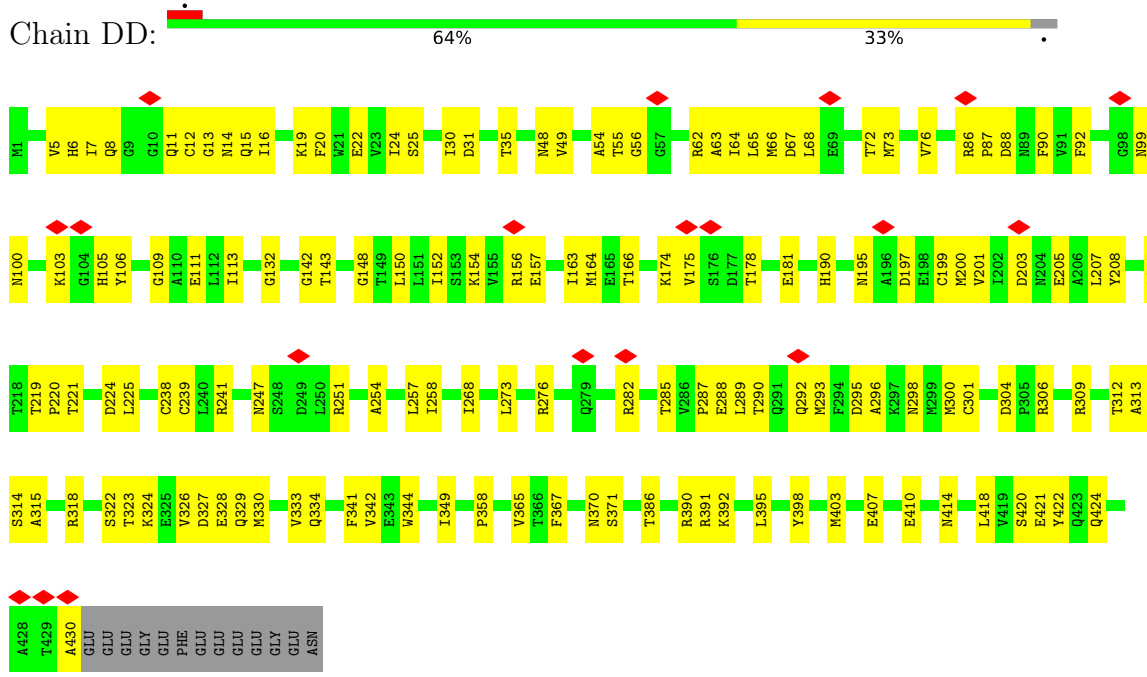

● Molecule 46: Tubulin beta chain

Chain DF:

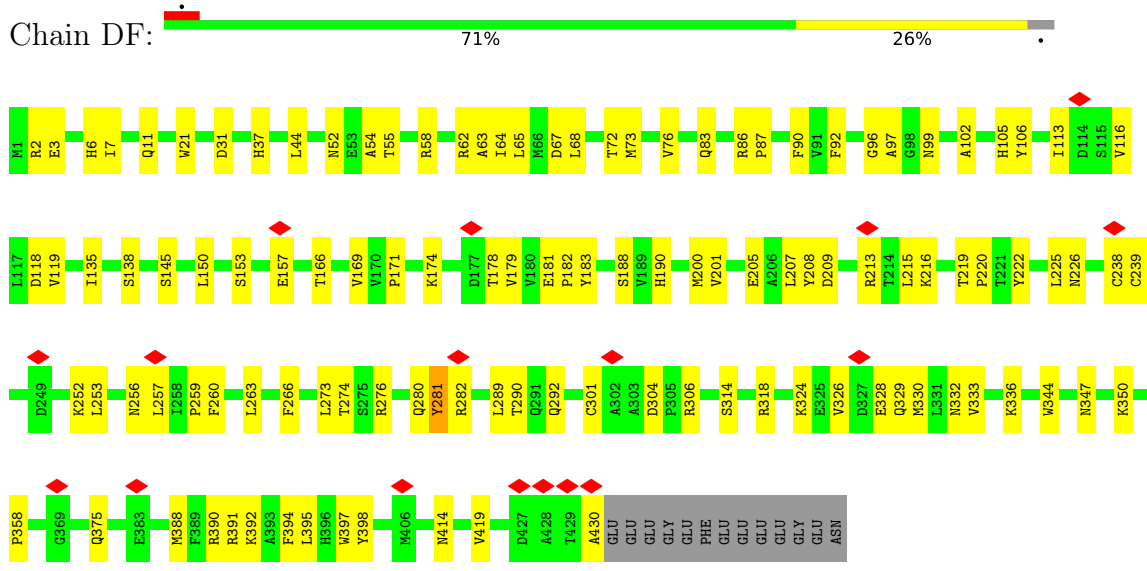

● Molecule 46: Tubulin beta chain

Chain DH:

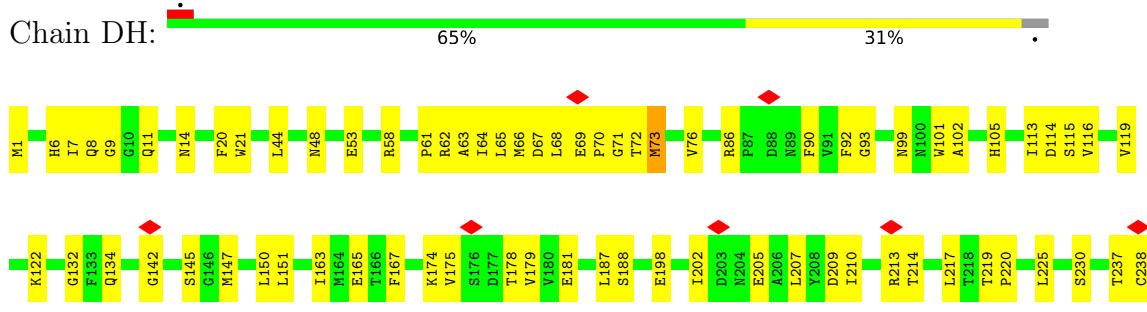

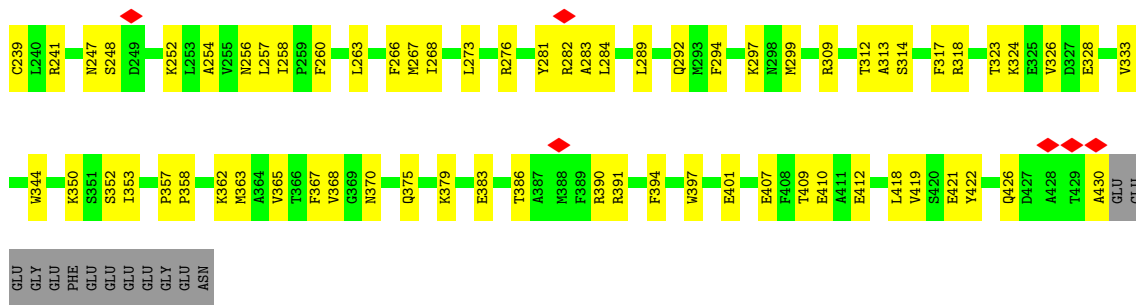

• Molecule 46: Tubulin beta chain

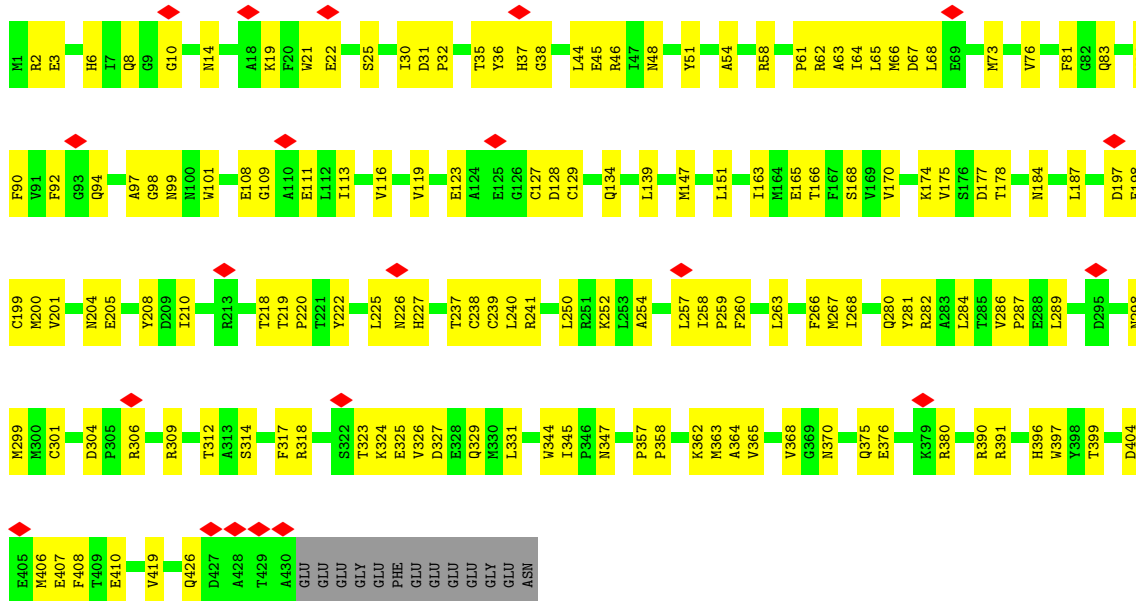

• Molecule 46: Tubulin beta chain

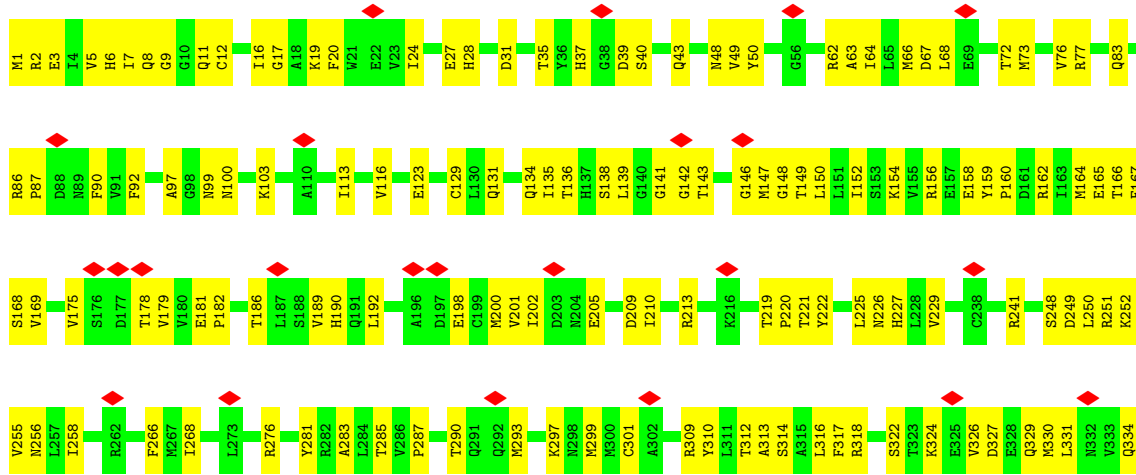

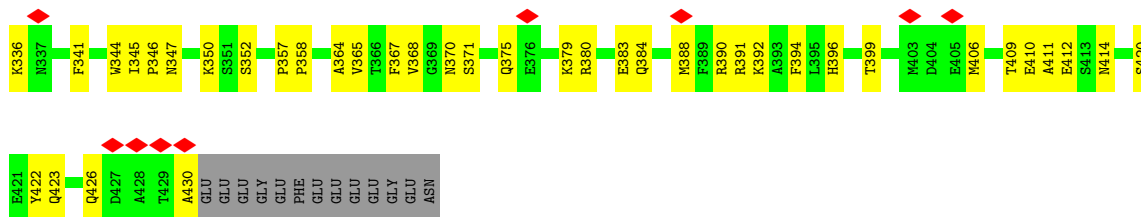

• Molecule 46: Tubulin beta chain

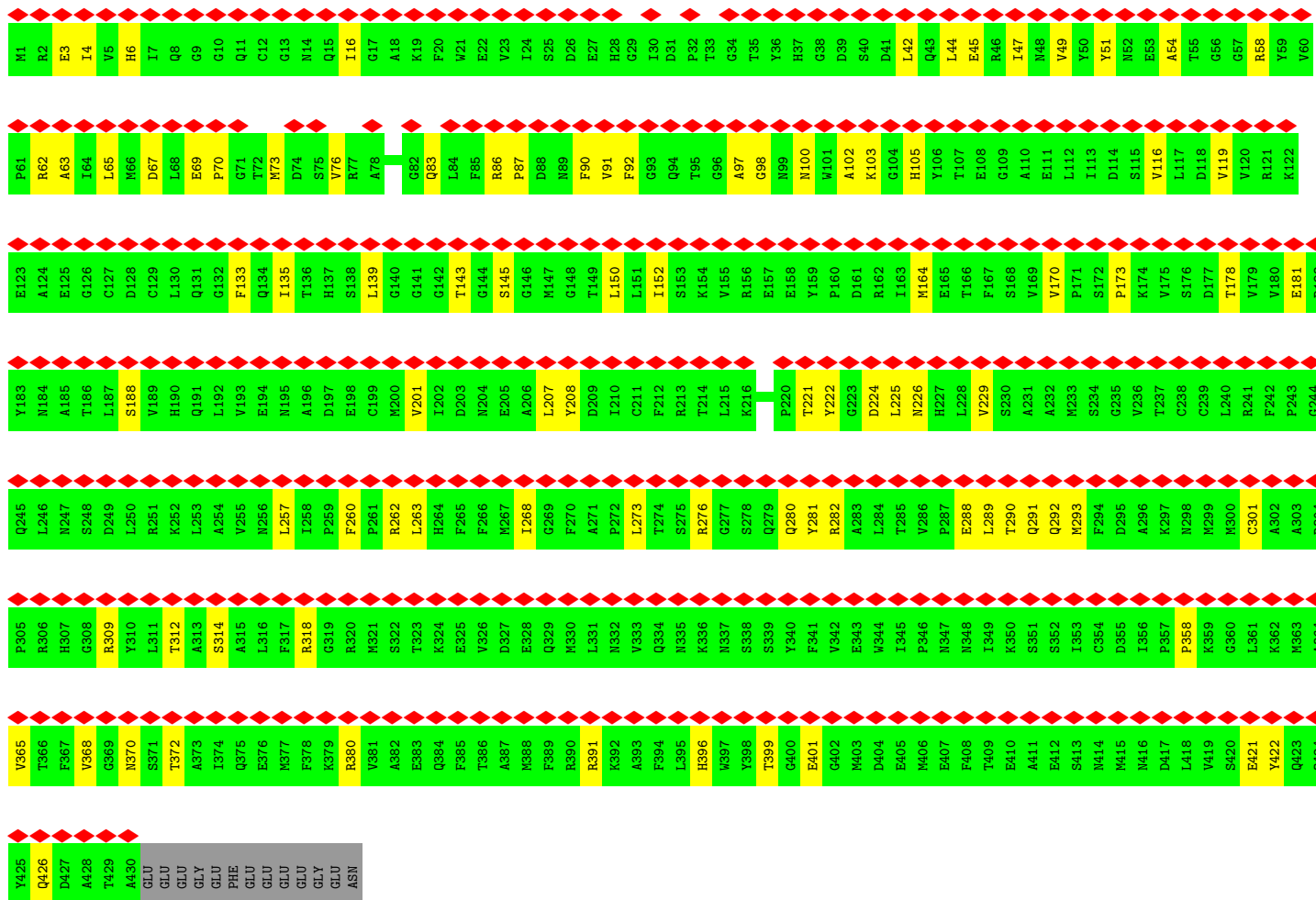
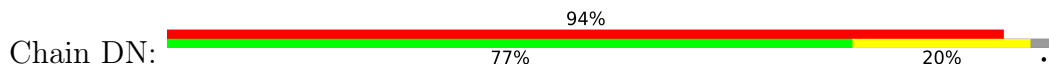

• Molecule 46: Tubulin beta chain

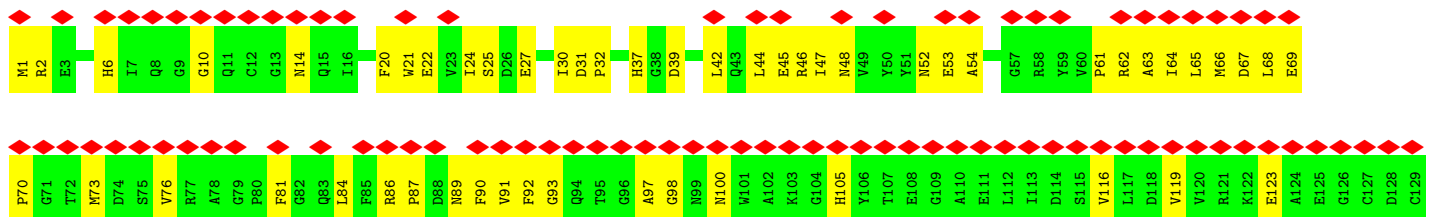

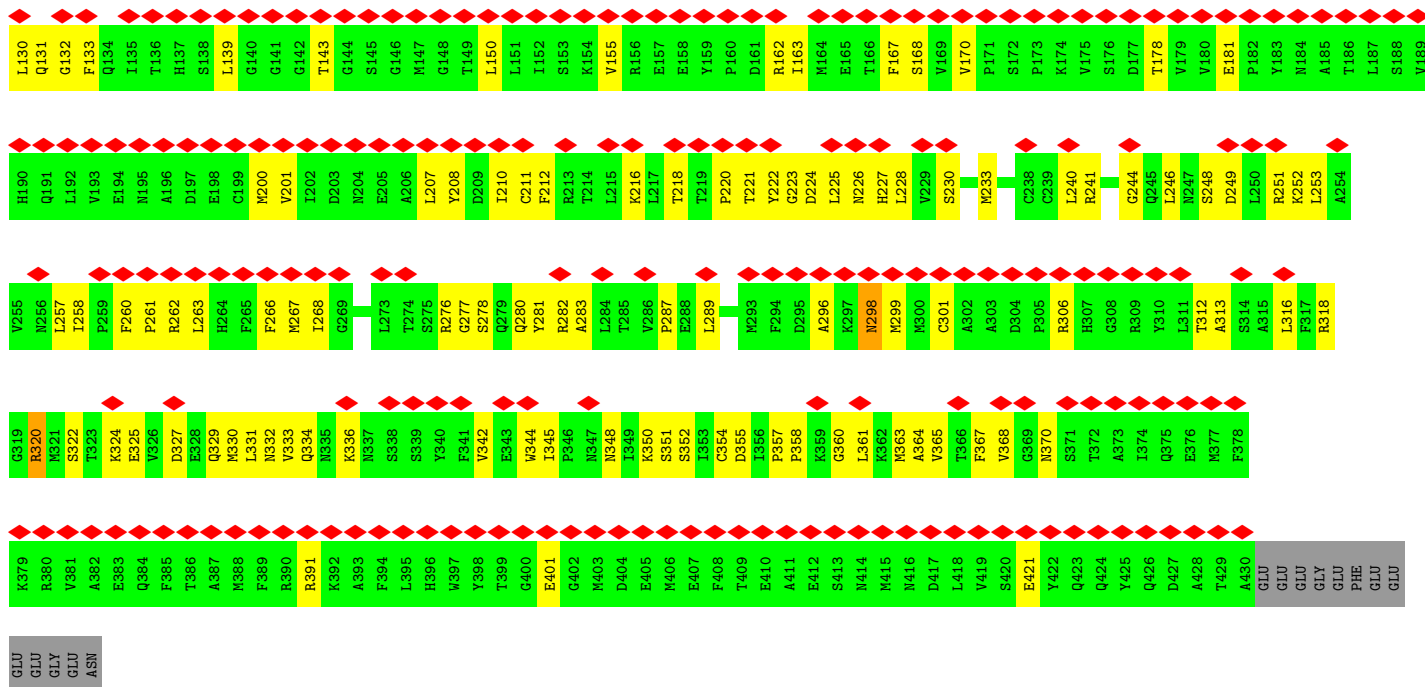

• Molecule 46: Tubulin beta chain

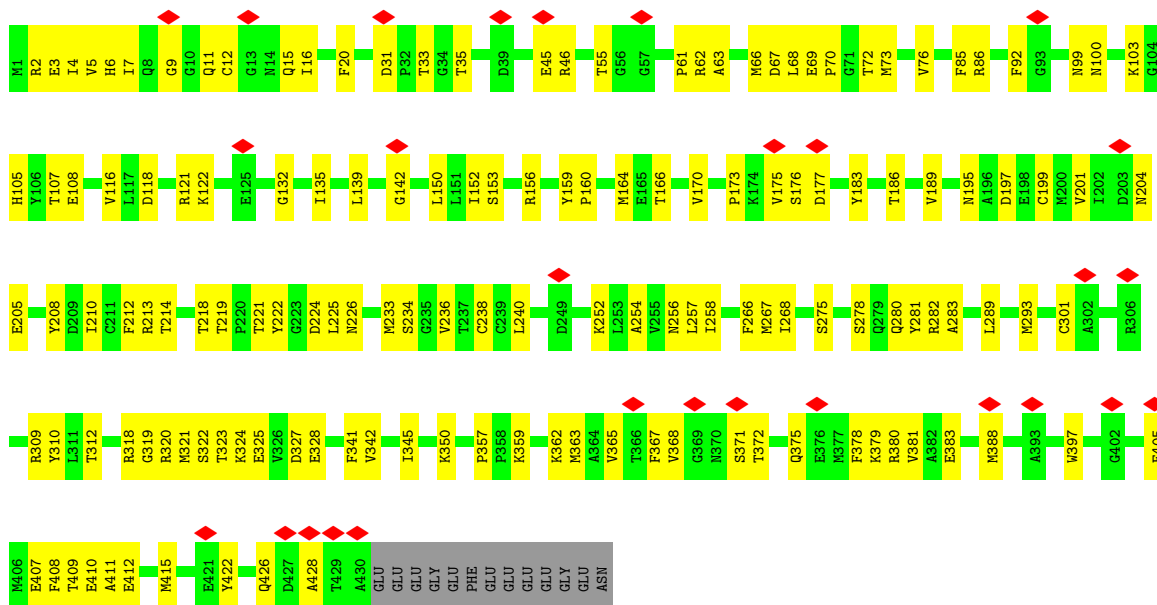

• Molecule 46: Tubulin beta chain

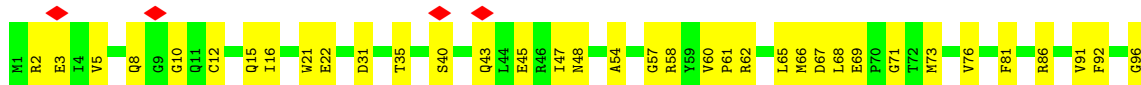



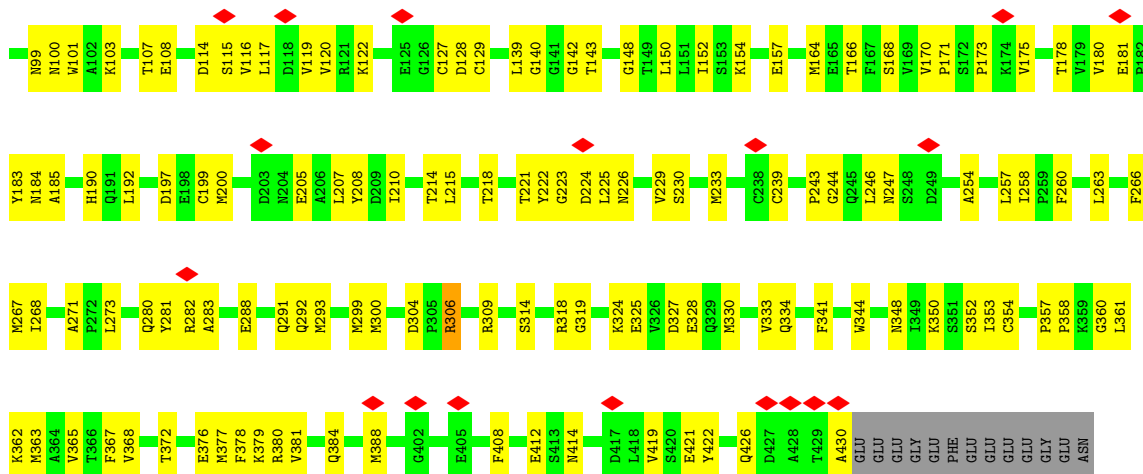

• Molecule 46: Tubulin beta chain

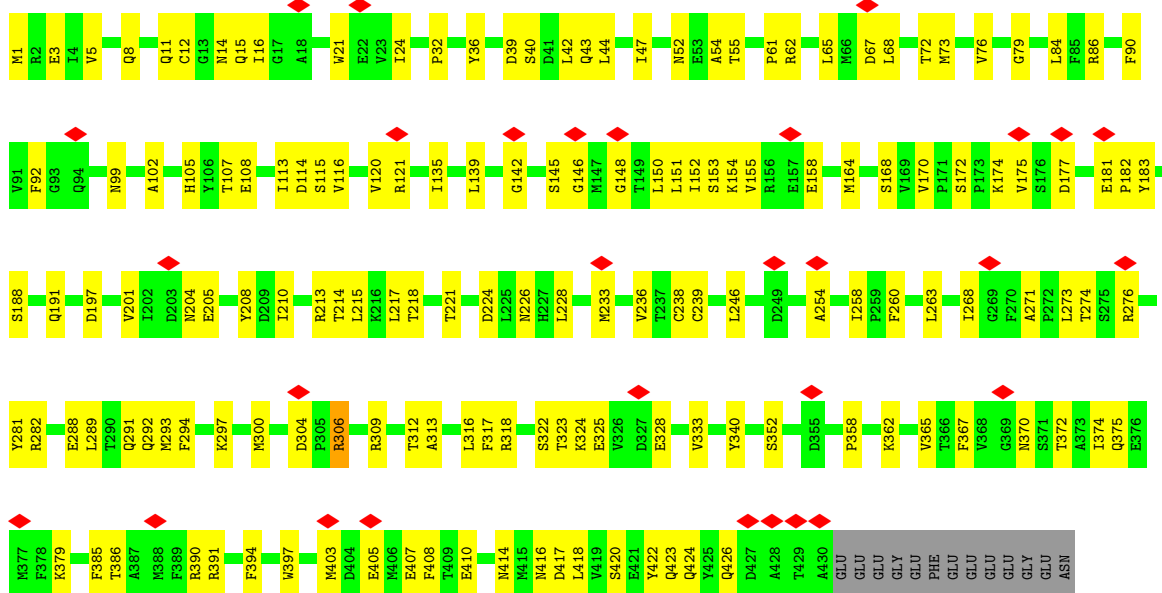

• Molecule 46: Tubulin beta chain

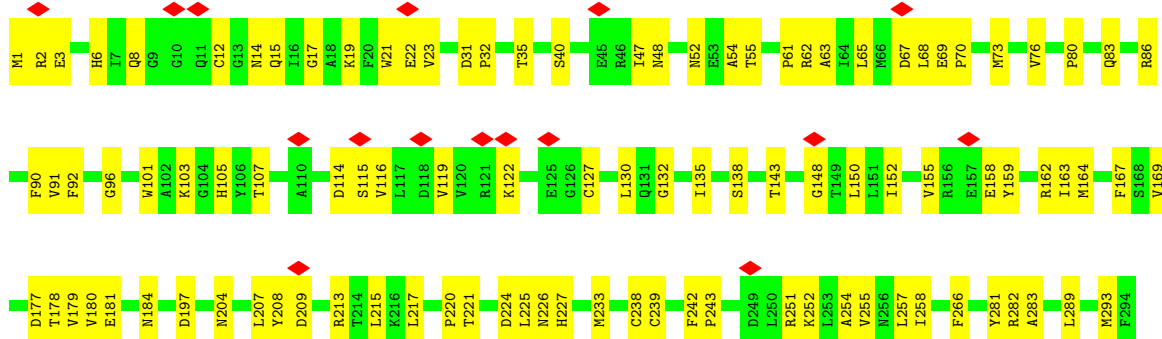

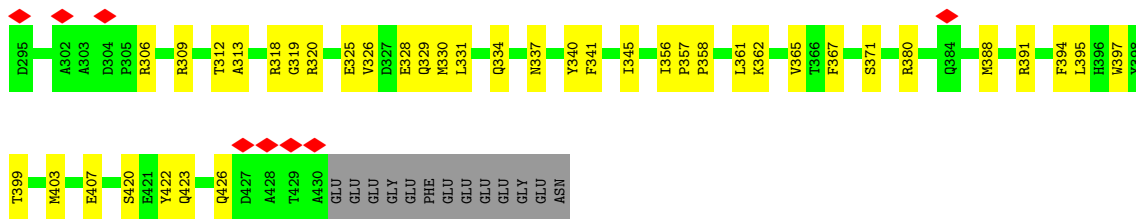

• Molecule 46: Tubulin beta chain

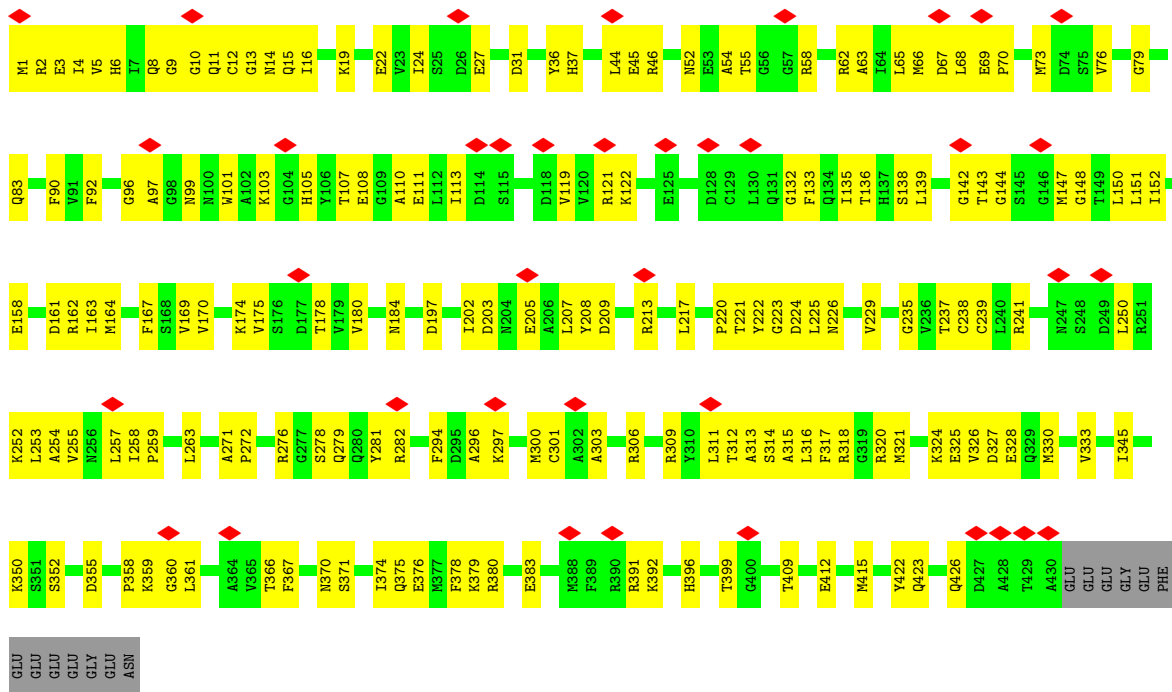

• Molecule 46: Tubulin beta chain

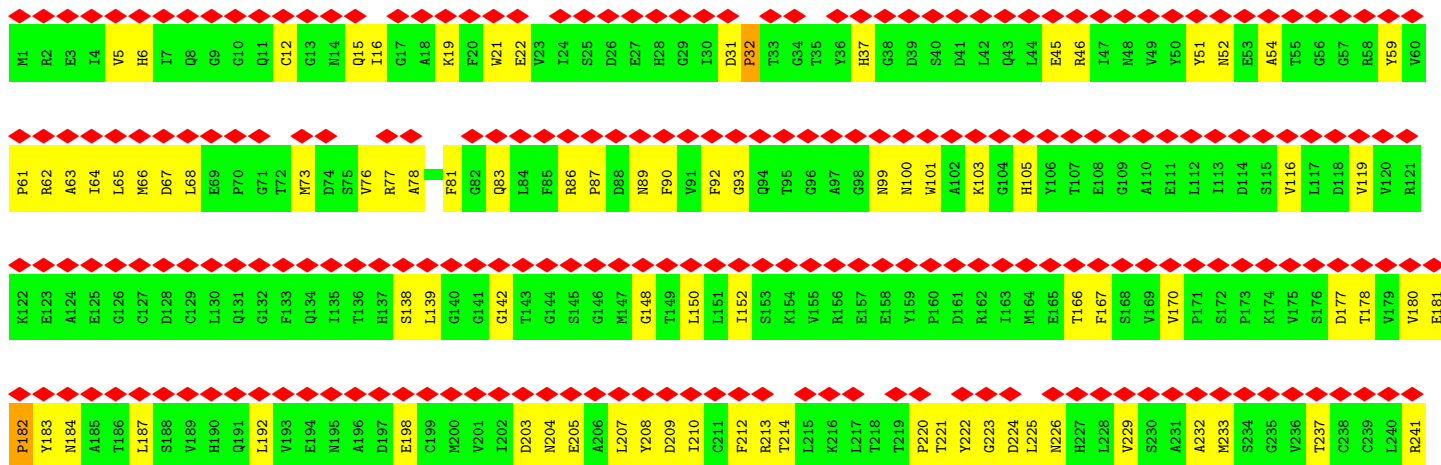



• Molecule 46: Tubulin beta chain

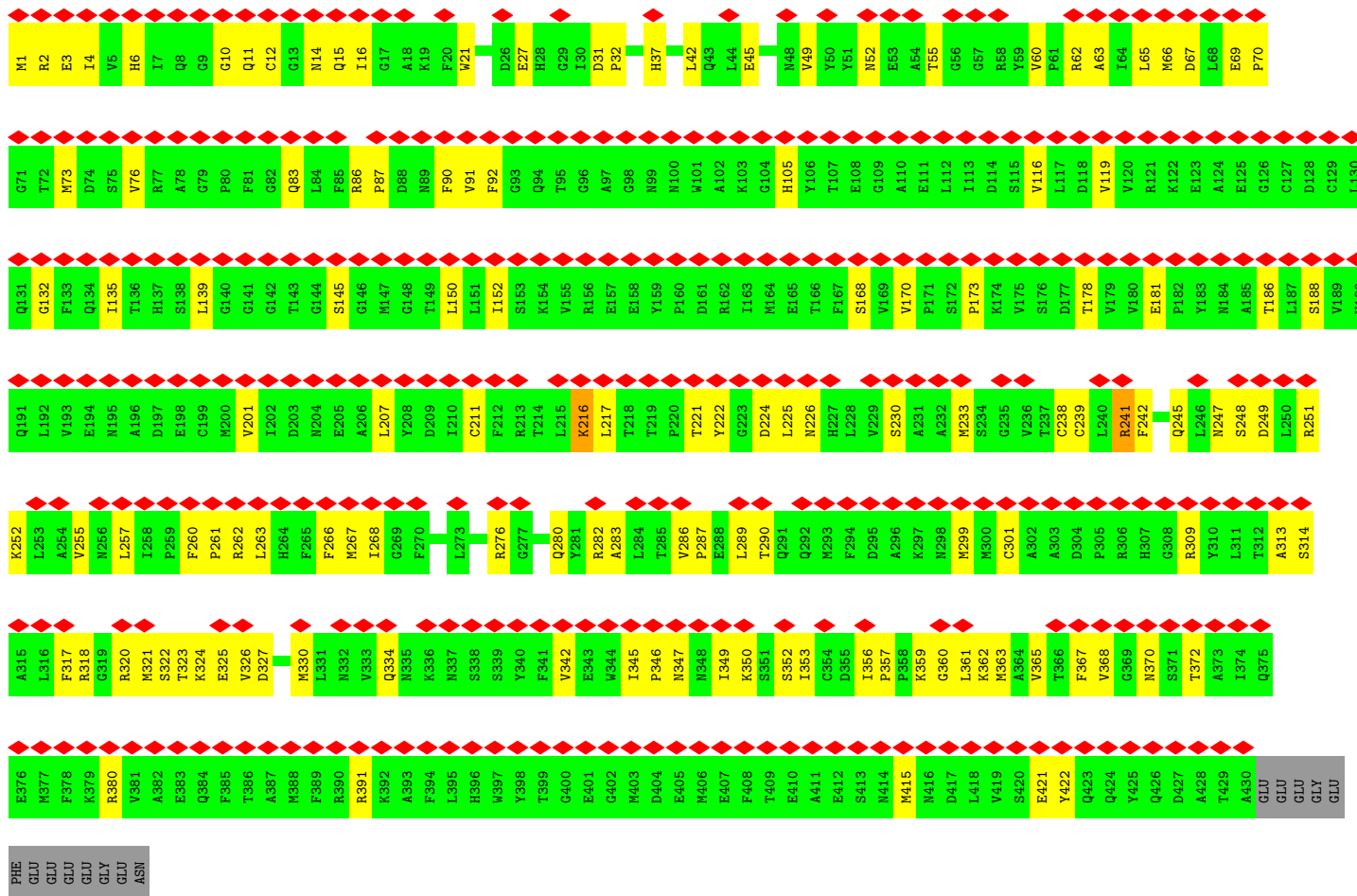
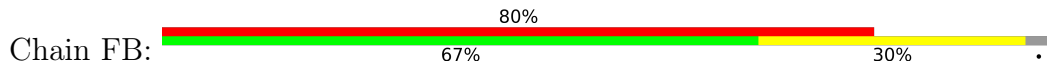

• Molecule 46: Tubulin beta chain



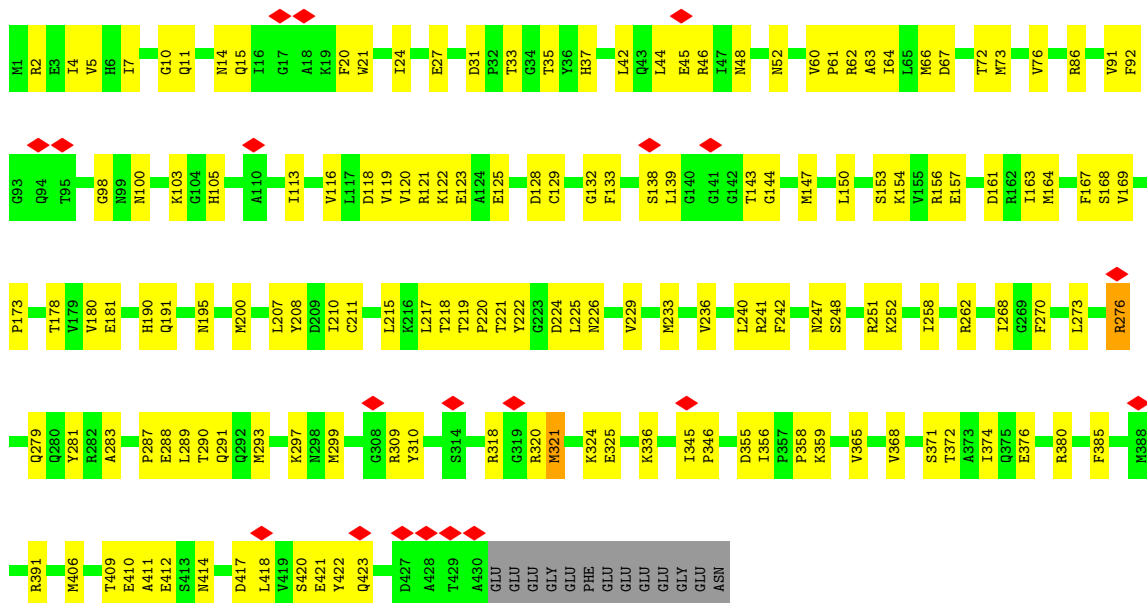

• Molecule 46: Tubulin beta chain

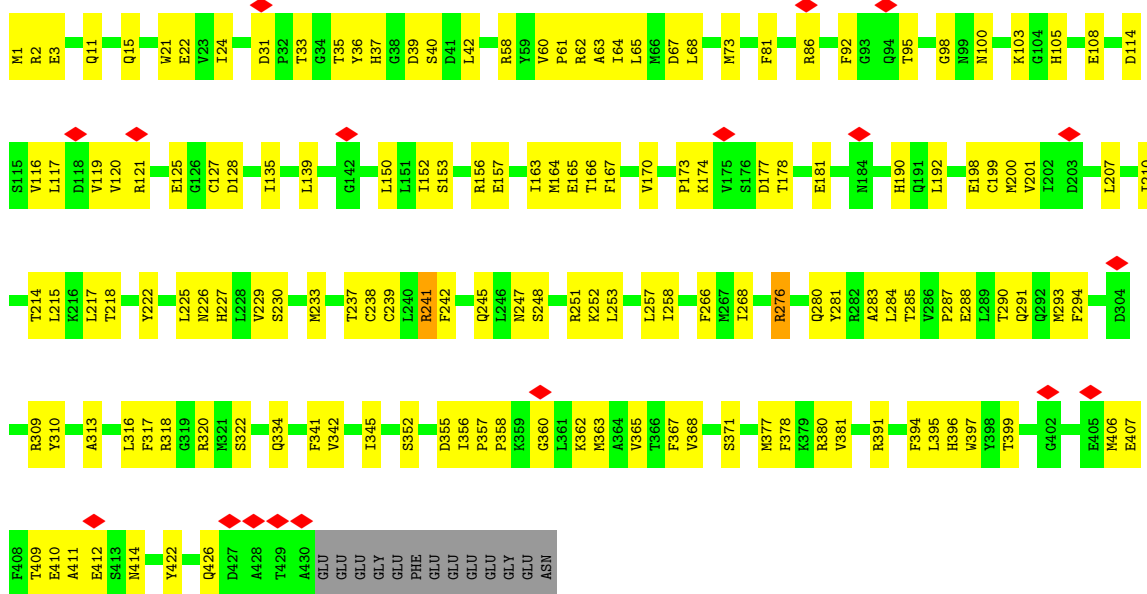

• Molecule 46: Tubulin beta chain

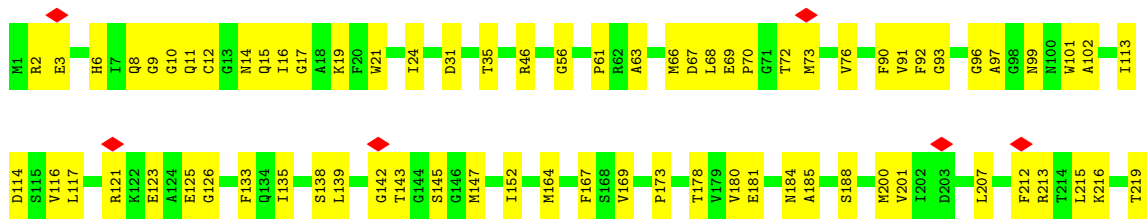

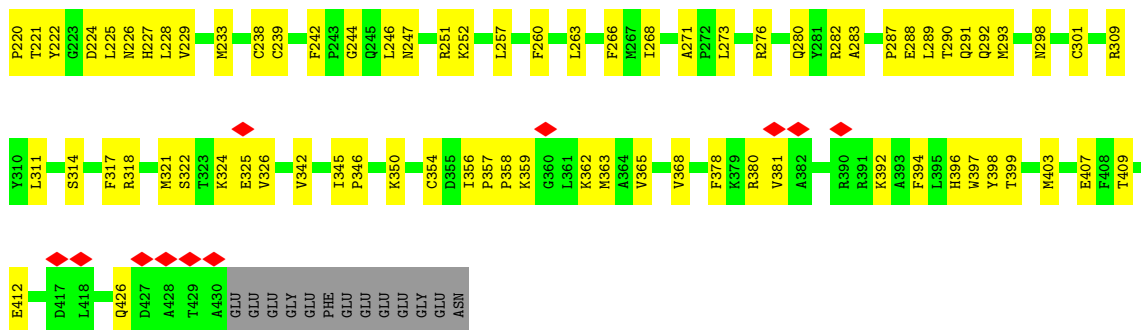

• Molecule 46: Tubulin beta chain

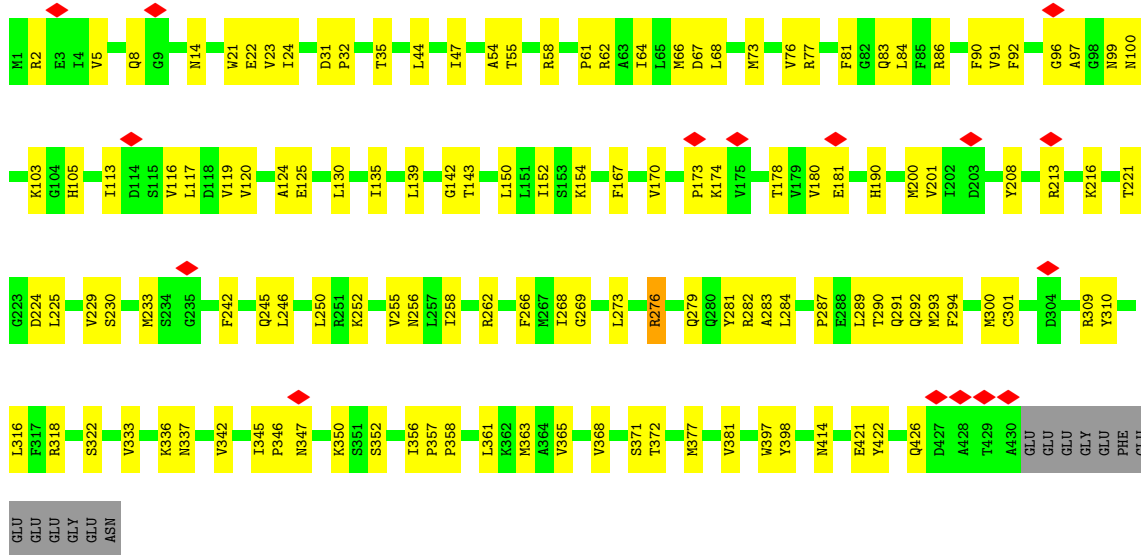

• Molecule 46: Tubulin beta chain

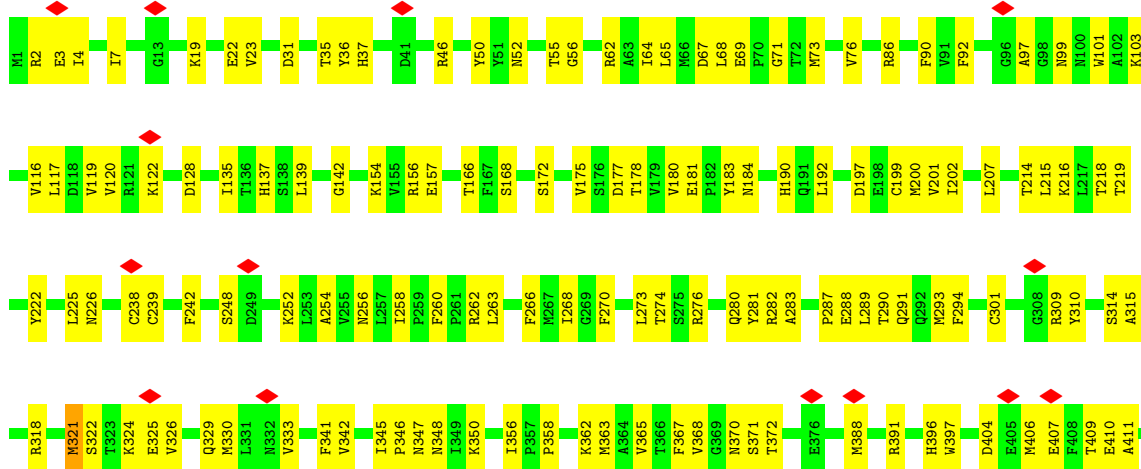

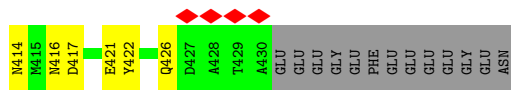

• Molecule 46: Tubulin beta chain

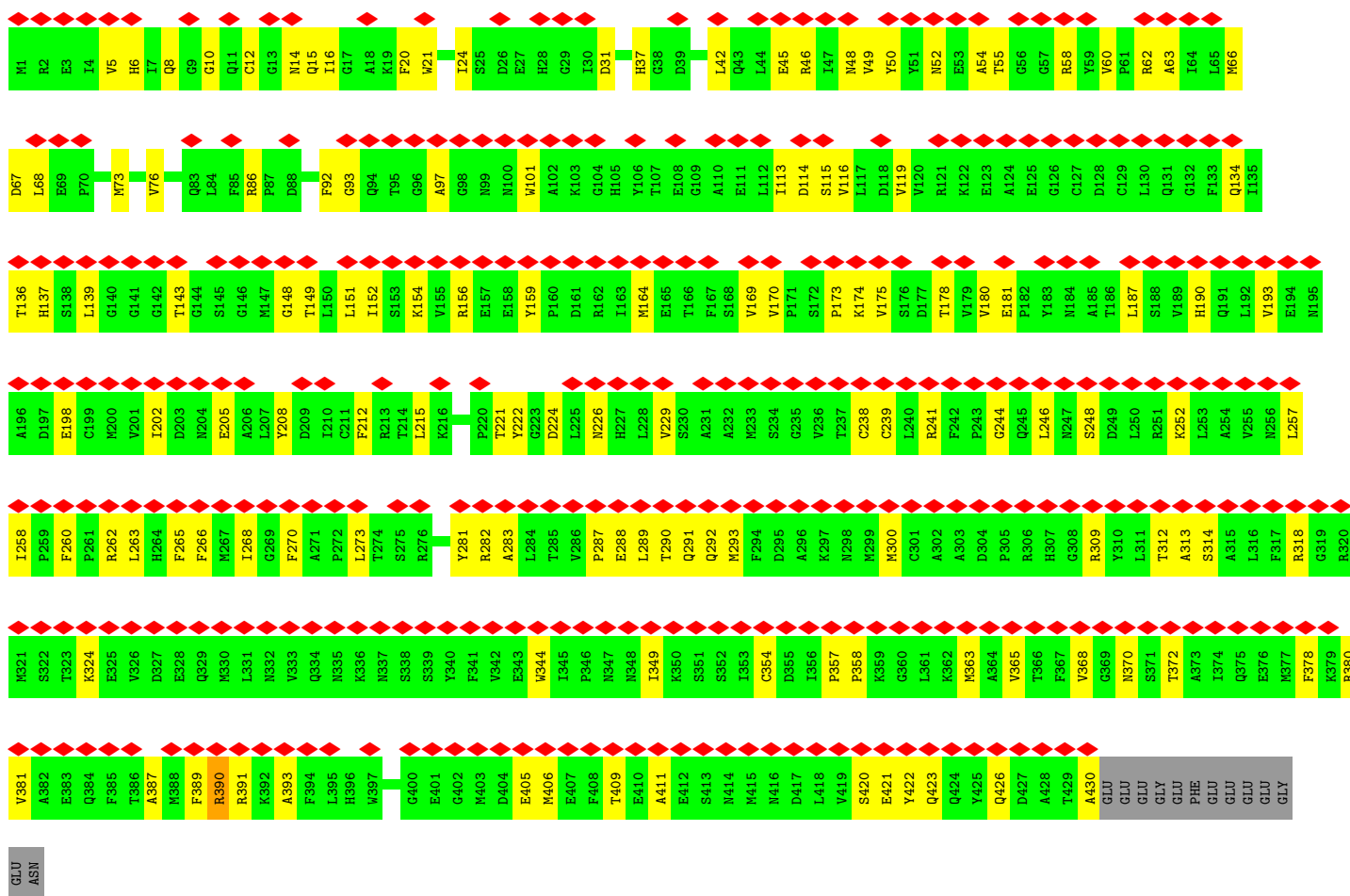
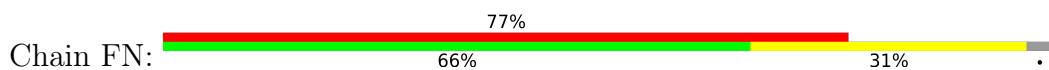

• Molecule 46: Tubulin beta chain

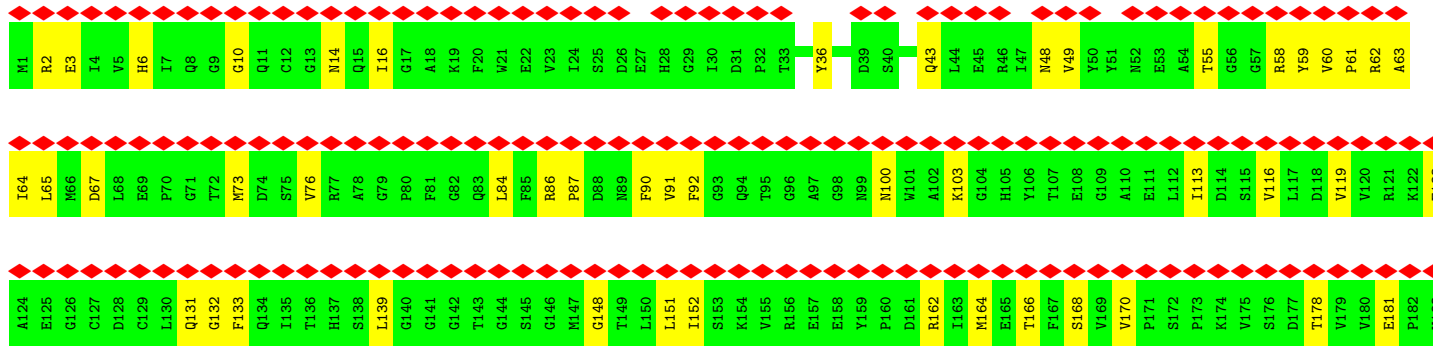
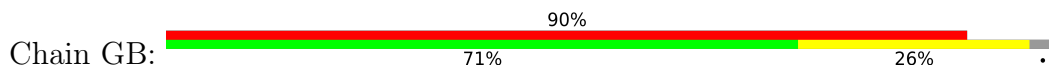

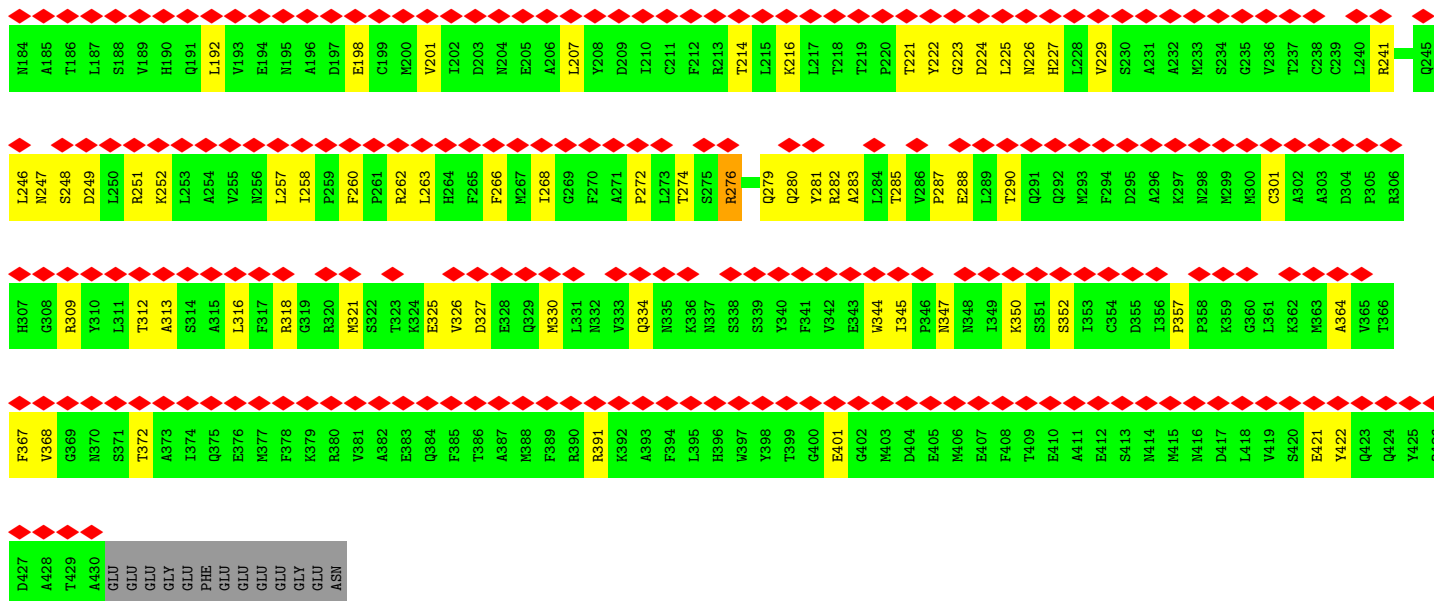

• Molecule 46: Tubulin beta chain

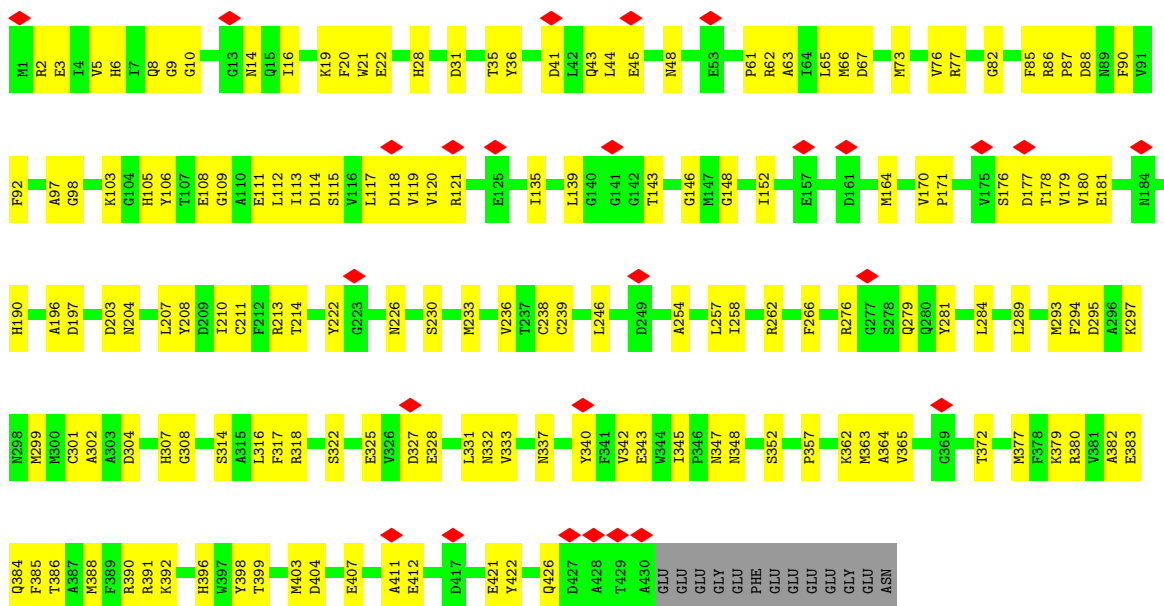

• Molecule 46: Tubulin beta chain

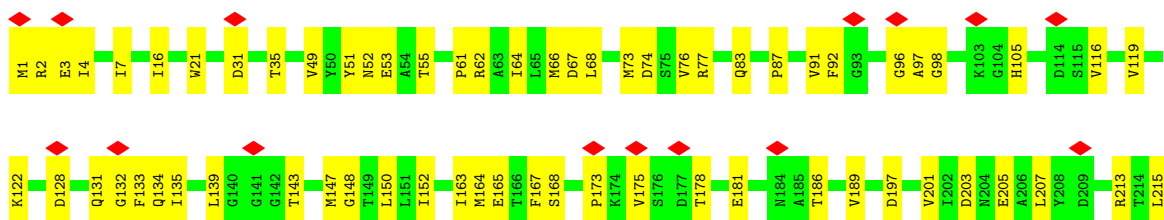

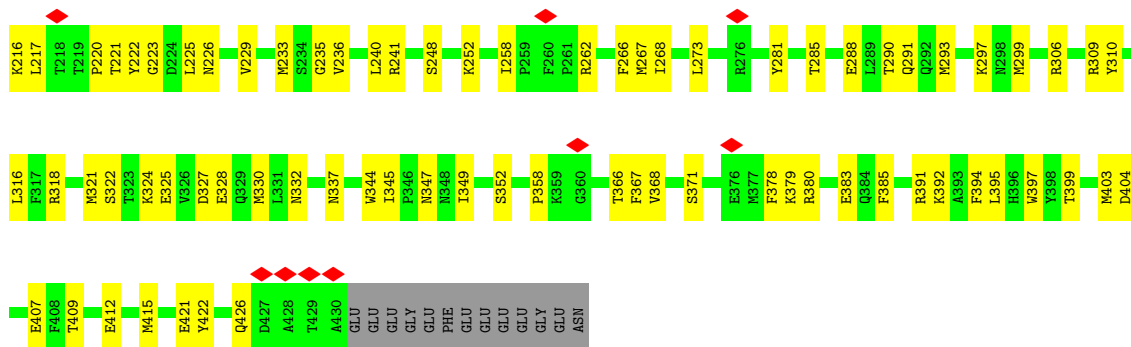

• Molecule 46: Tubulin beta chain

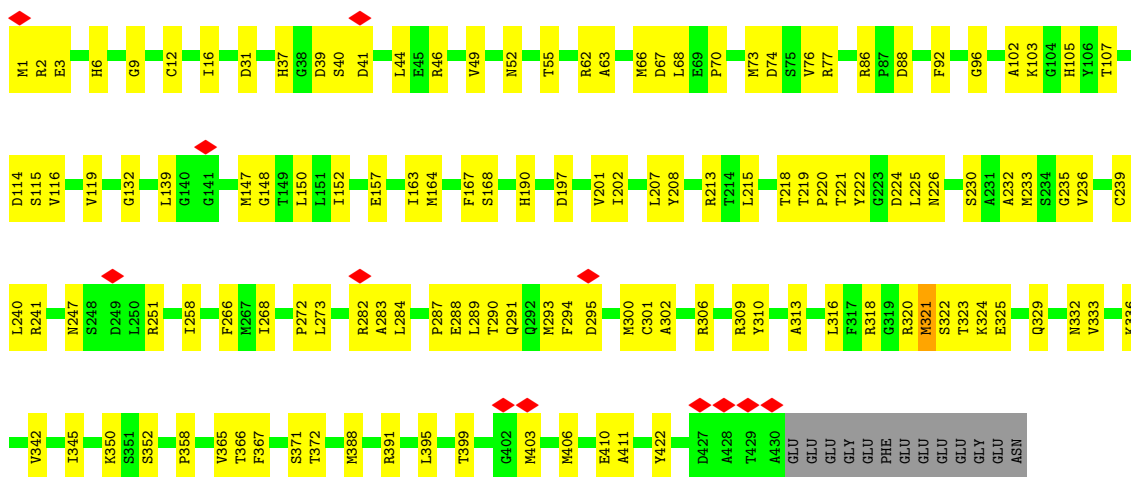

• Molecule 46: Tubulin beta chain

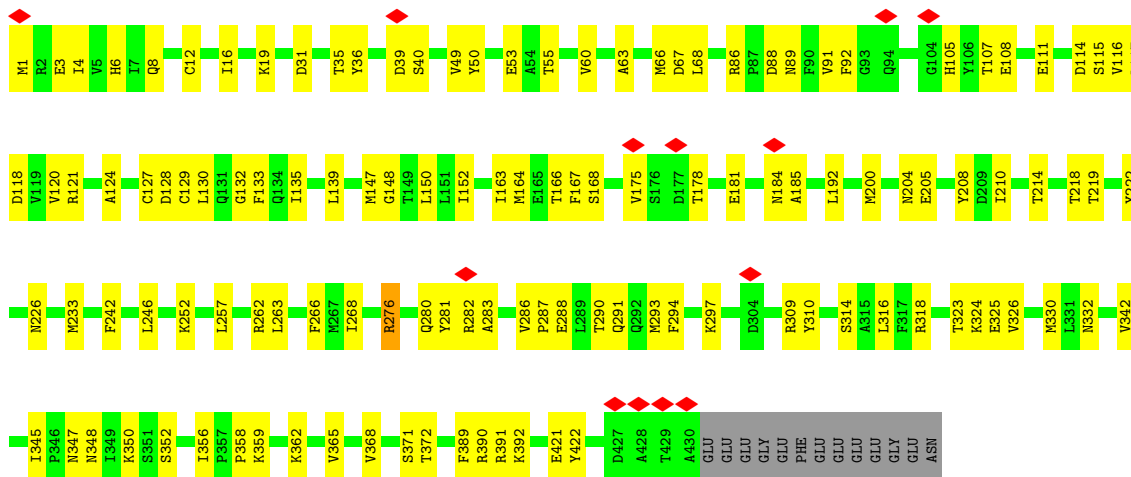

• Molecule 46: Tubulin beta chain





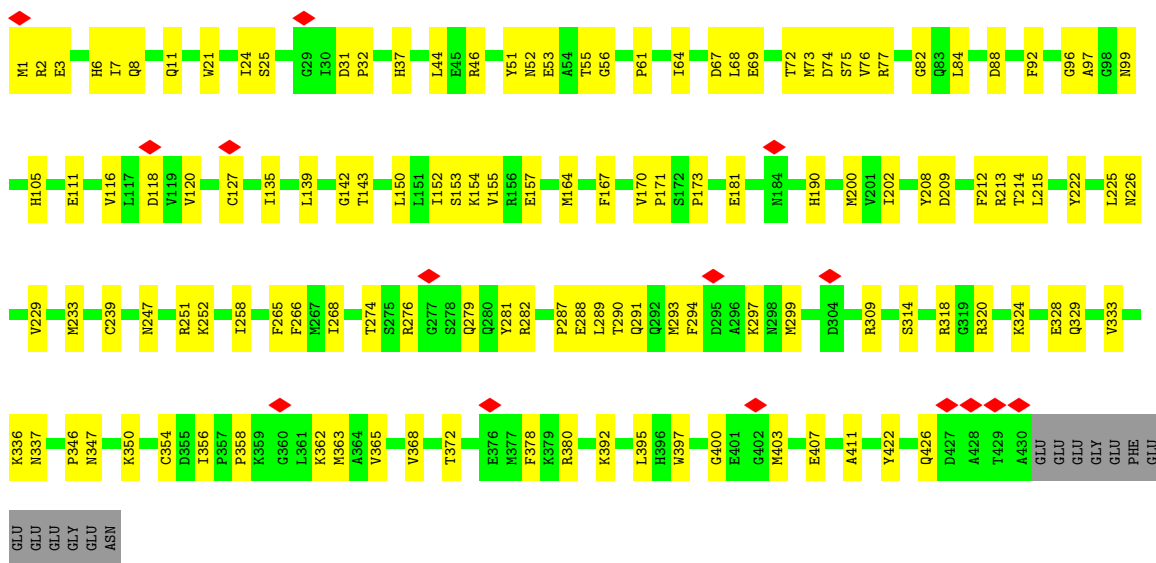

• Molecule 46: Tubulin beta chain

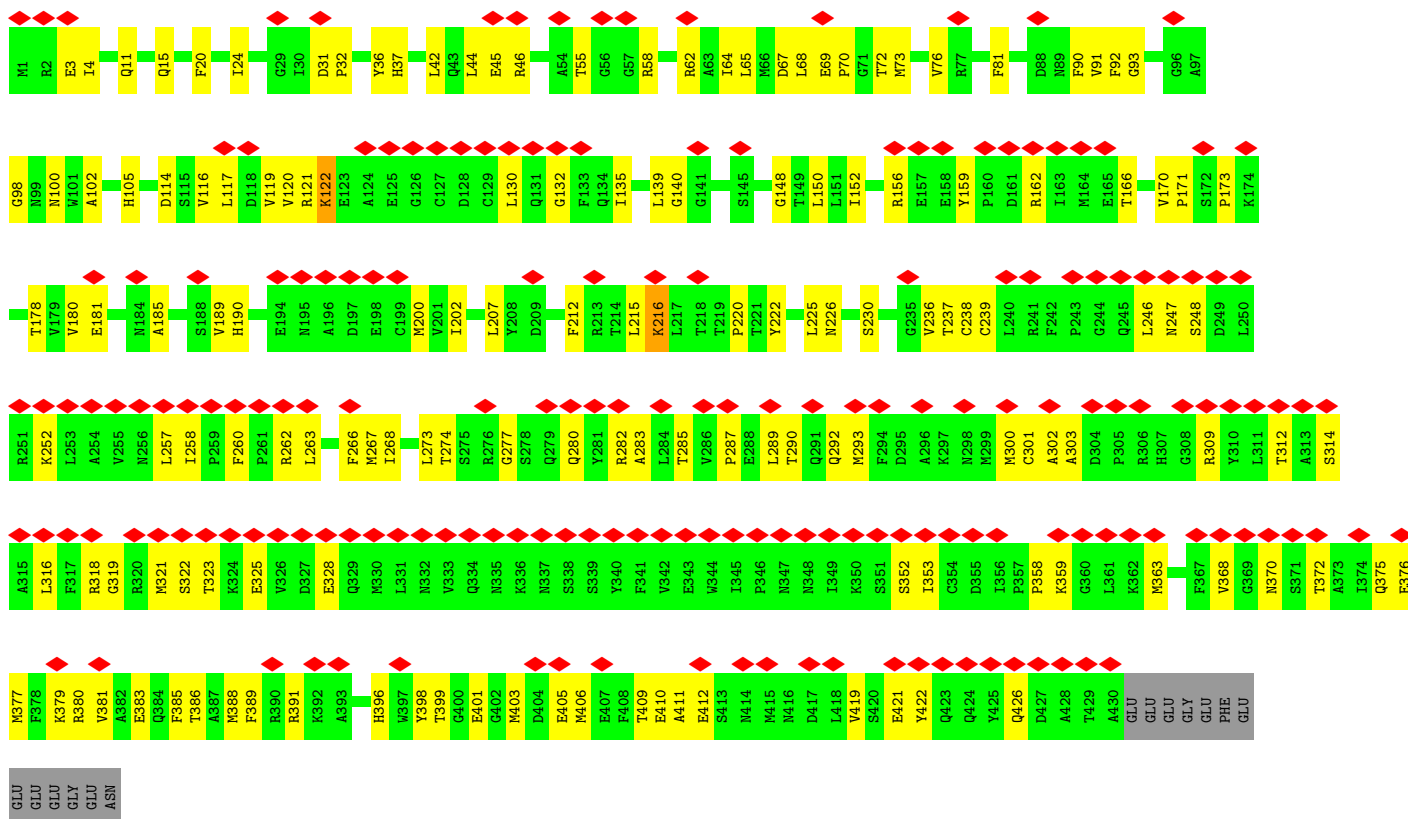
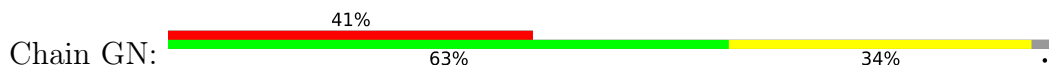

• Molecule 46: Tubulin beta chain

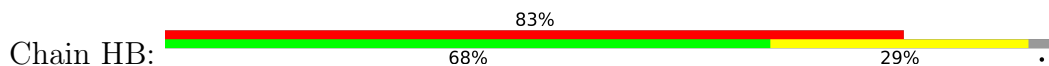

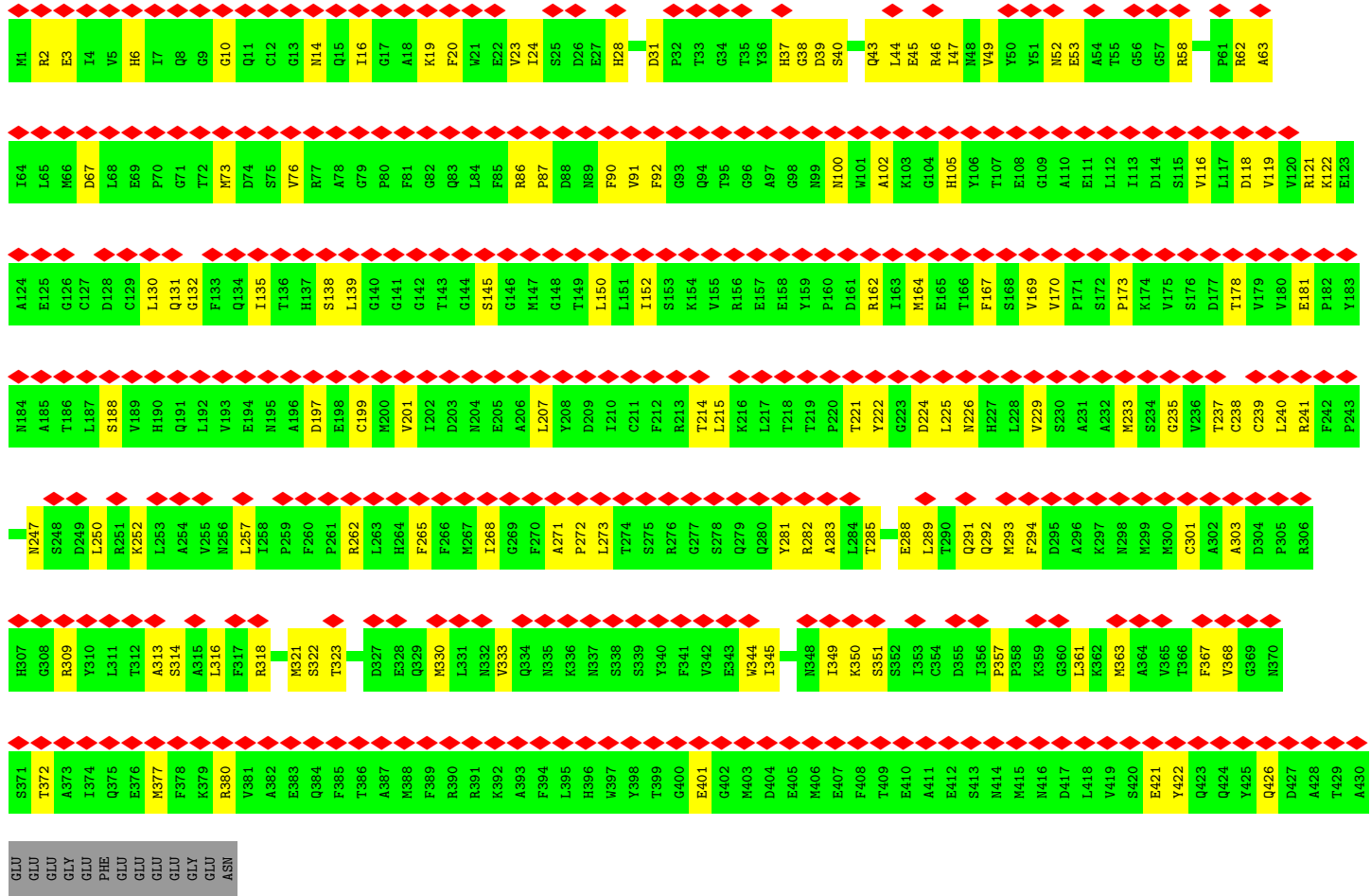

• Molecule 46: Tubulin beta chain

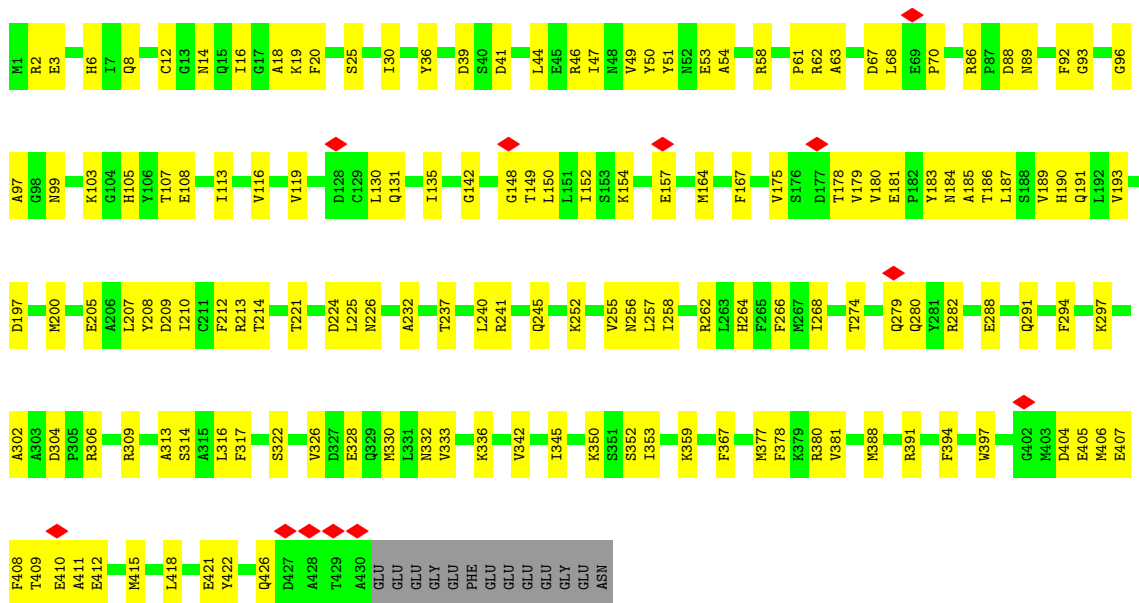

• Molecule 46: Tubulin beta chain

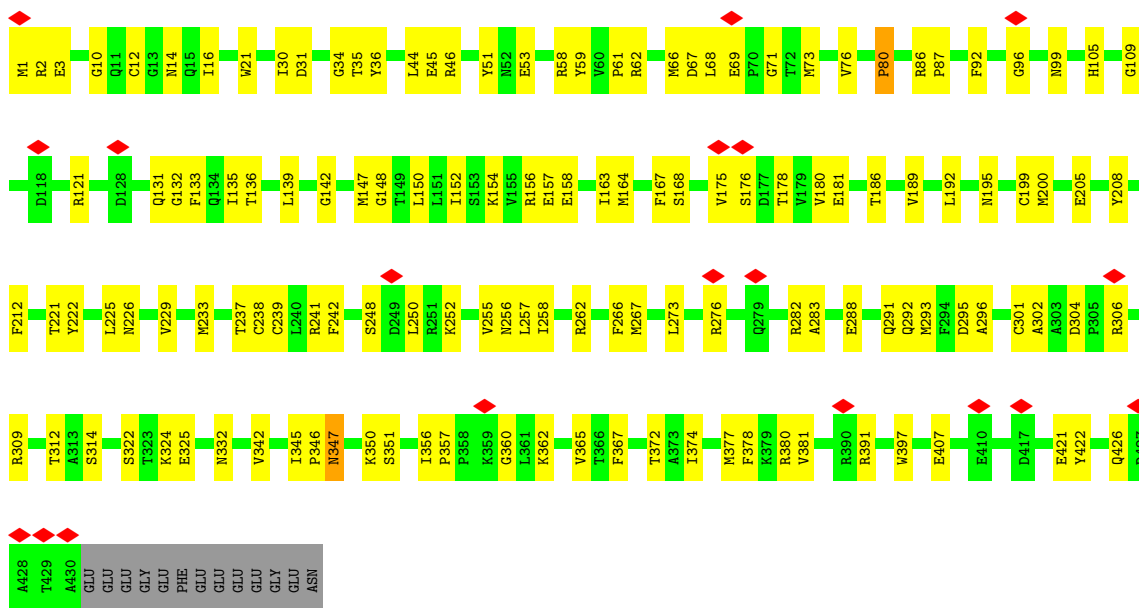

• Molecule 46: Tubulin beta chain

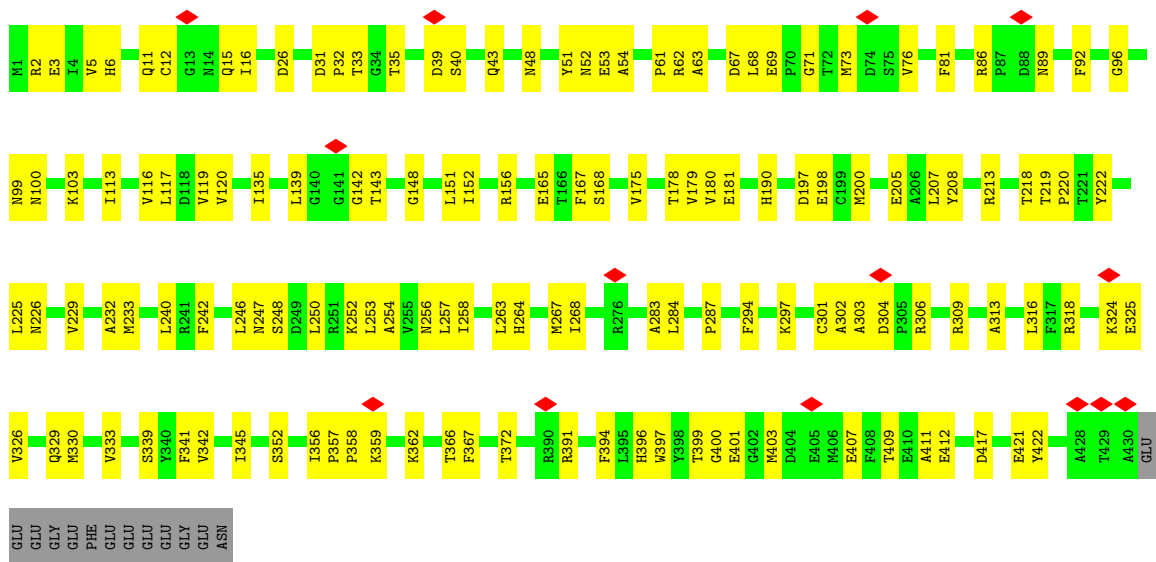

• Molecule 46: Tubulin beta chain

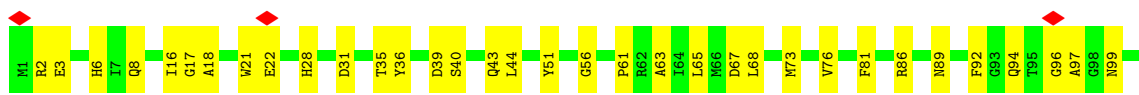



• Molecule 46: Tubulin beta chain

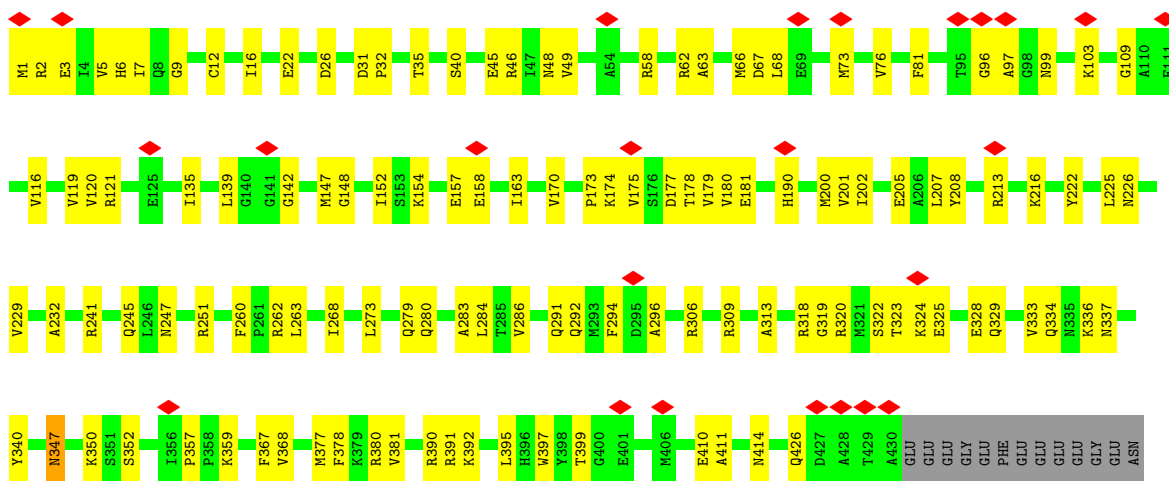

• Molecule 46: Tubulin beta chain

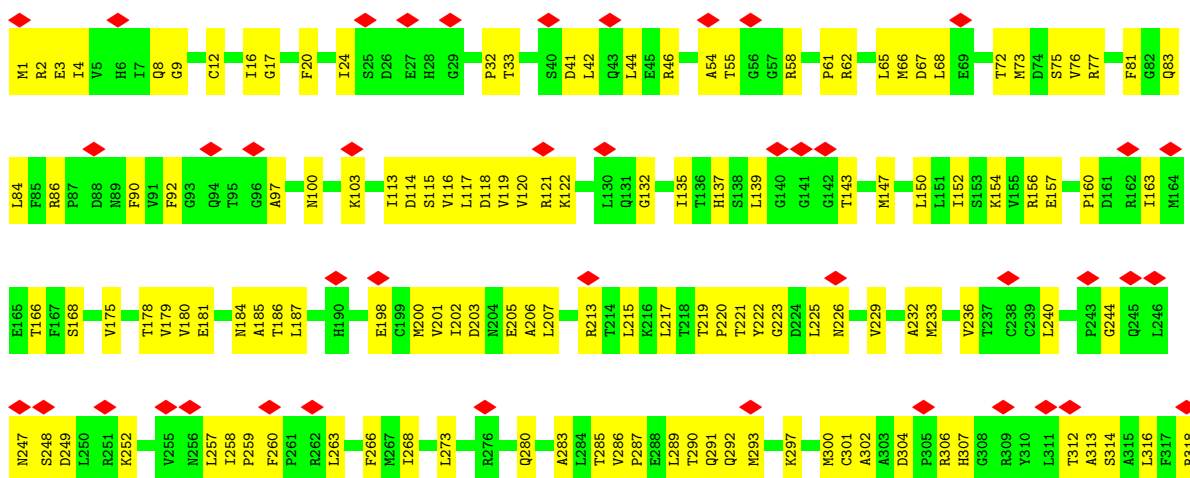

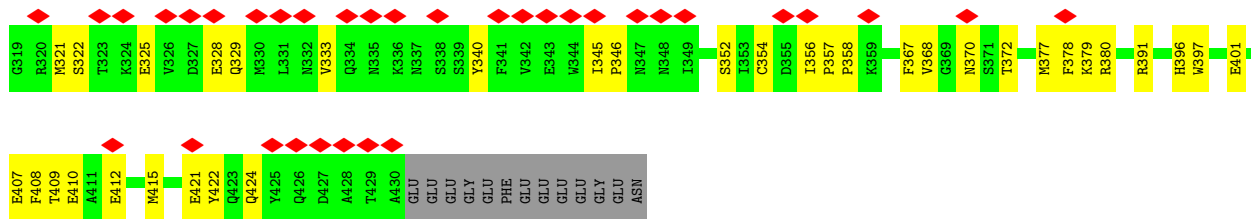

• Molecule 46: Tubulin beta chain

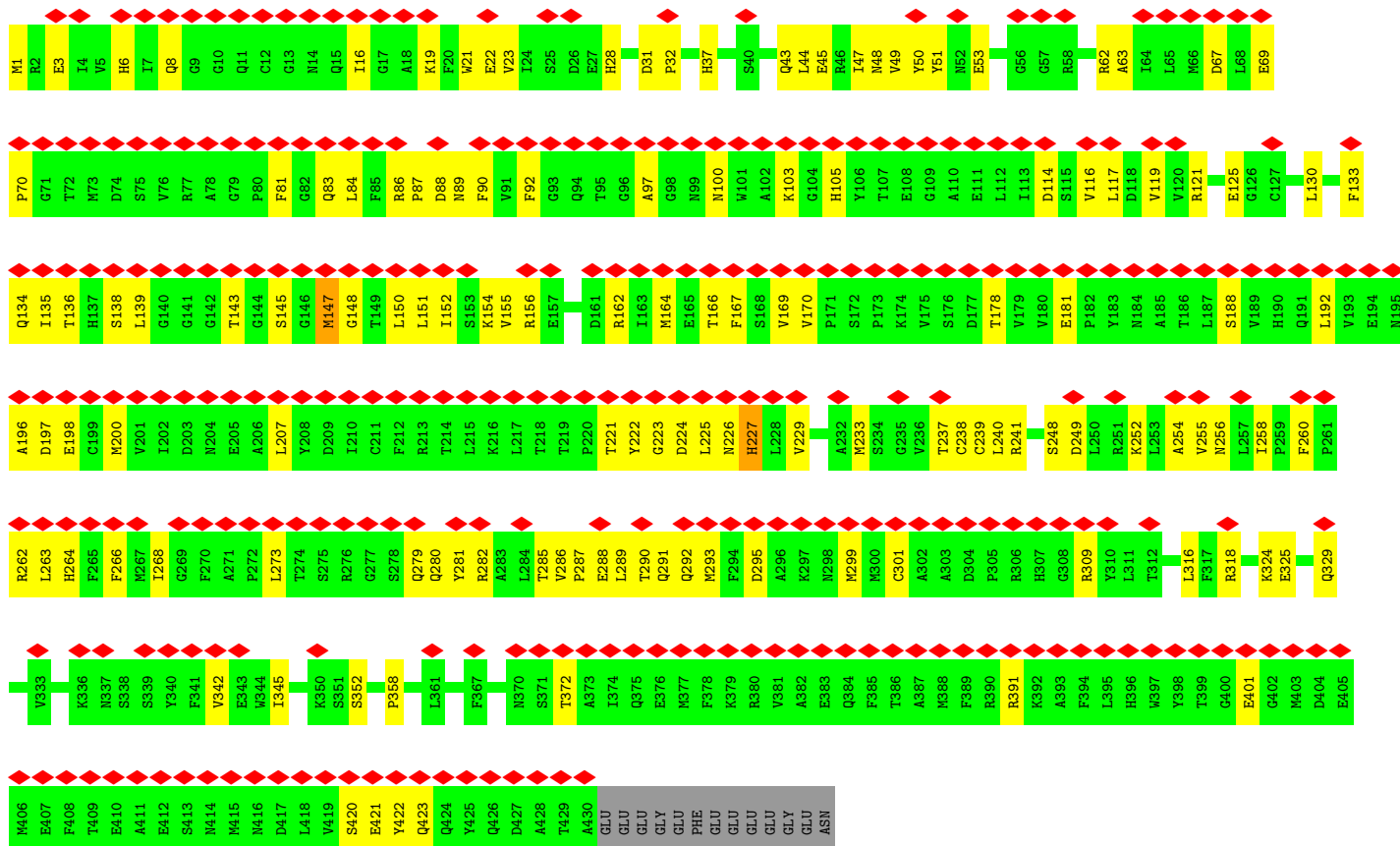

• Molecule 46: Tubulin beta chain

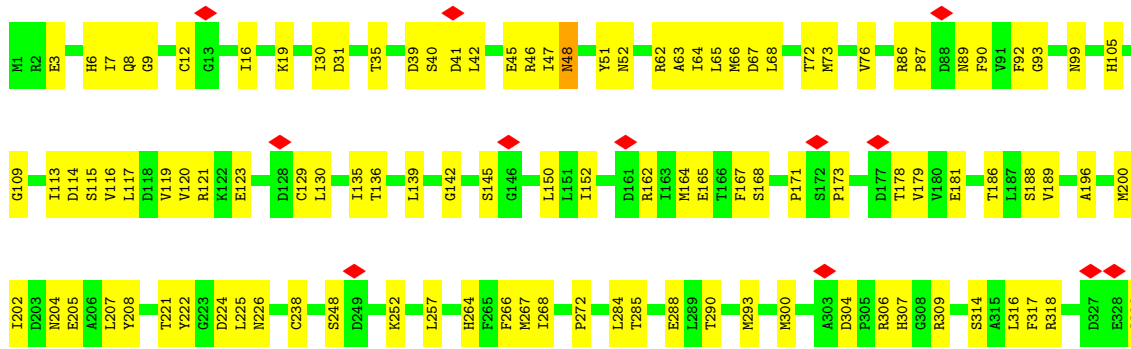

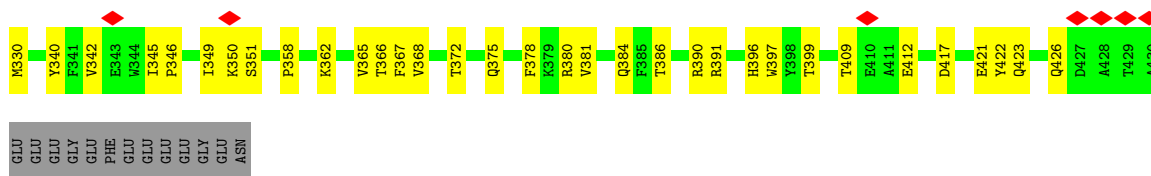

- Molecule 46: Tubulin beta chain

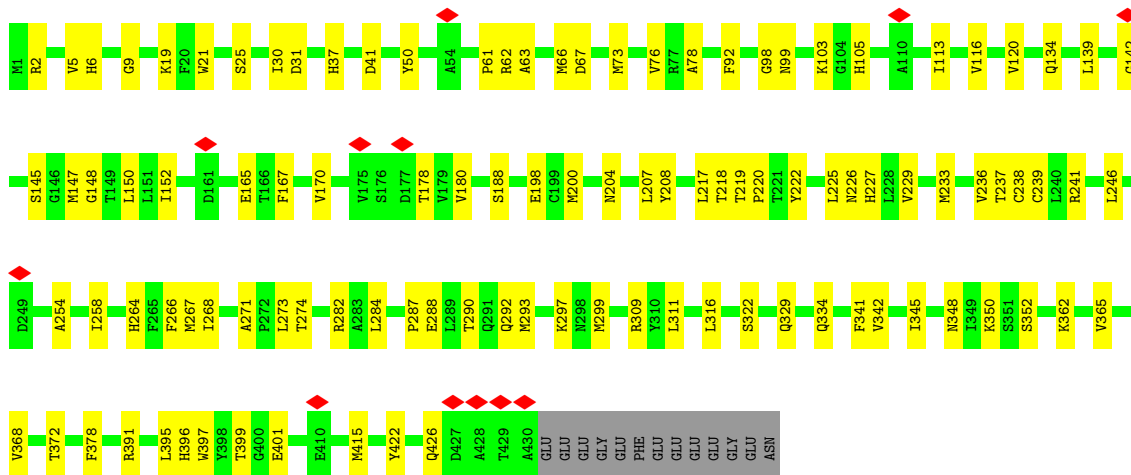

- Molecule 46: Tubulin beta chain

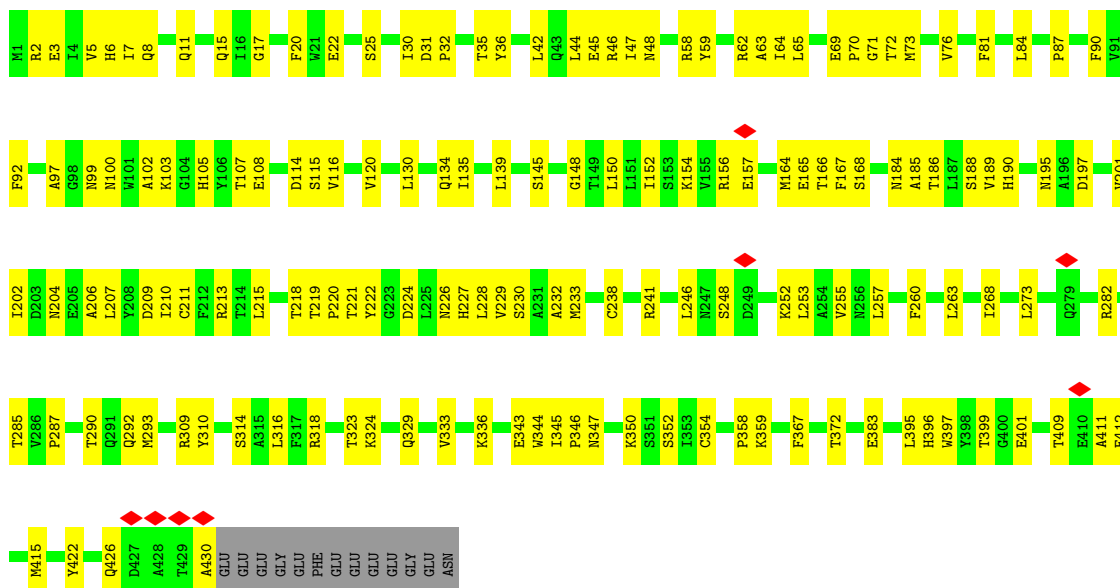

- Molecule 46: Tubulin beta chain



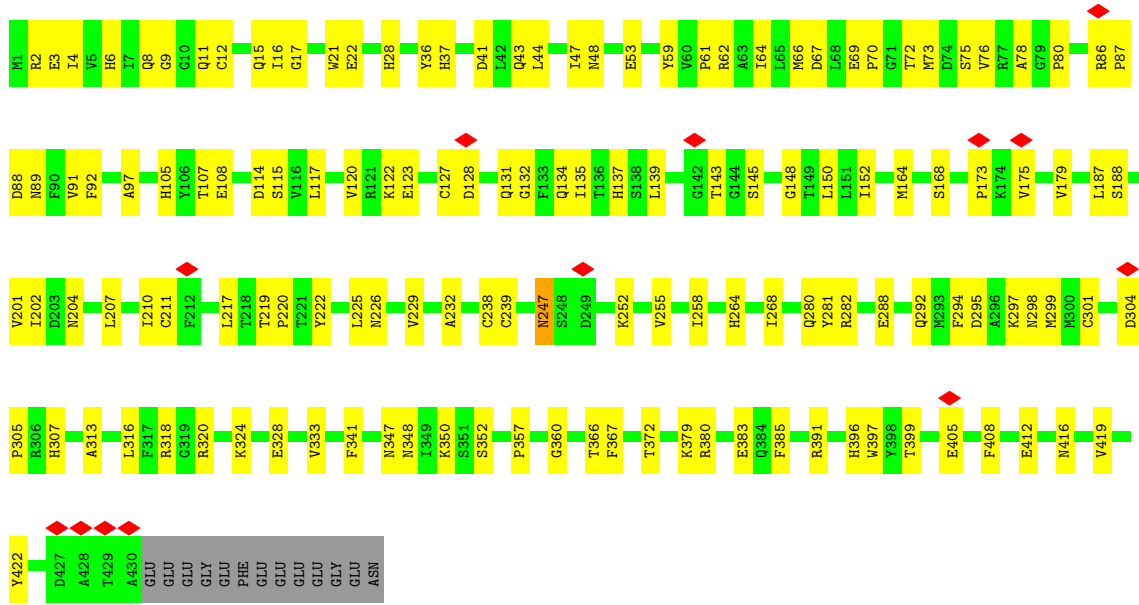

• Molecule 46: Tubulin beta chain

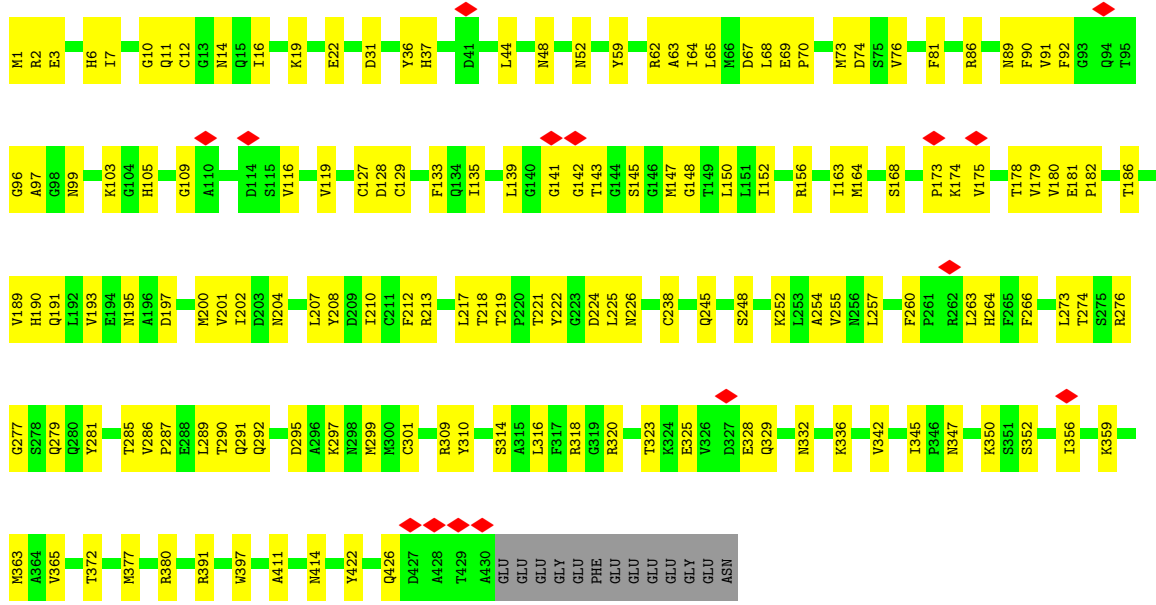

• Molecule 46: Tubulin beta chain

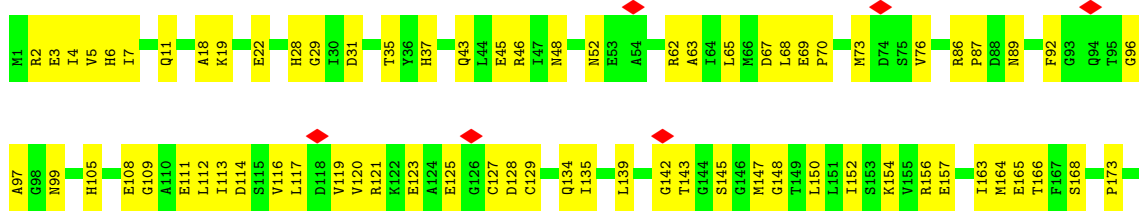

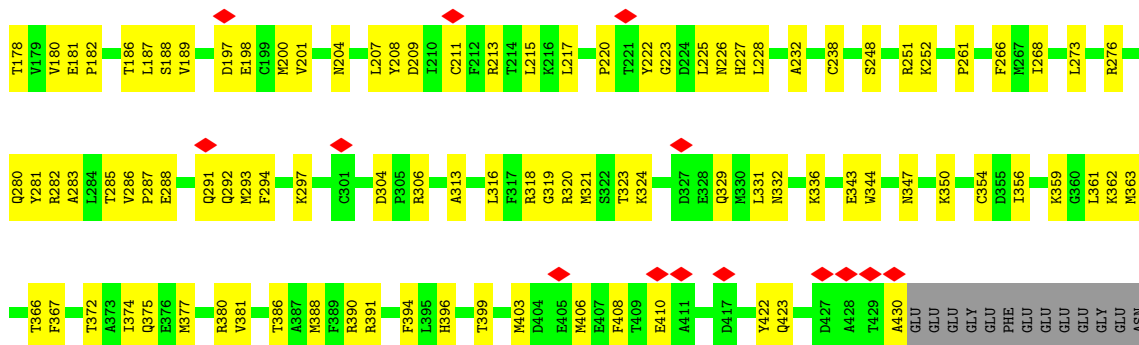

• Molecule 46: Tubulin beta chain

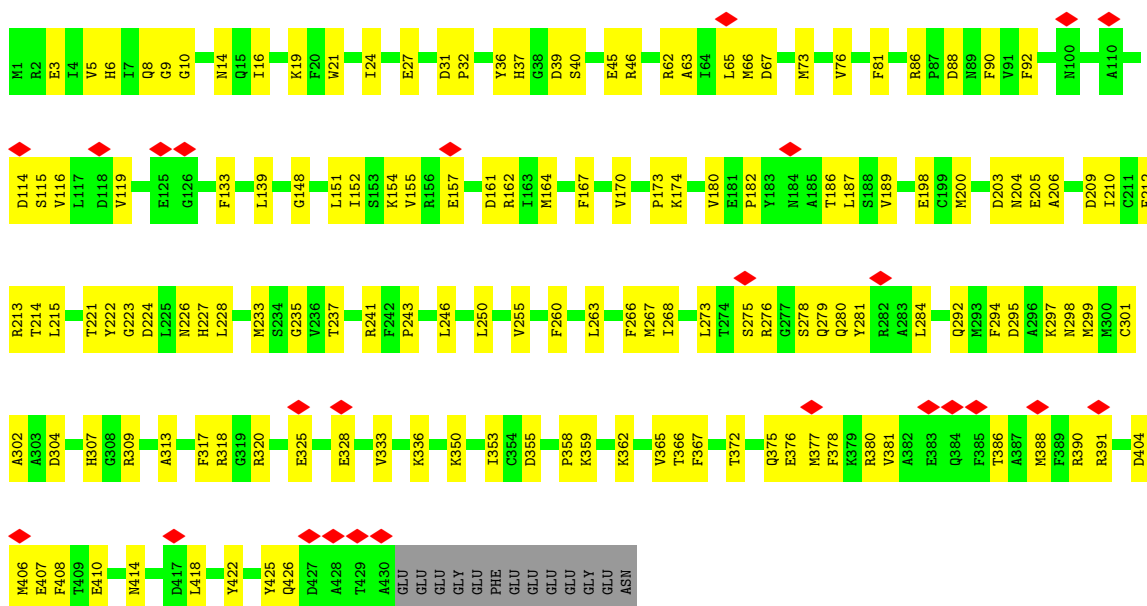

• Molecule 46: Tubulin beta chain

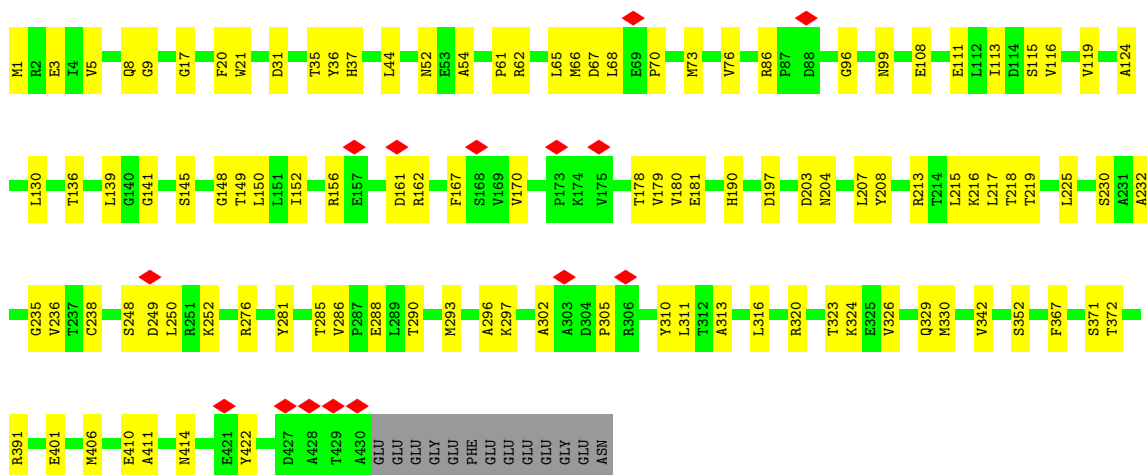
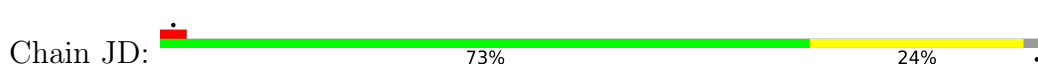



- Molecule 46: Tubulin beta chain

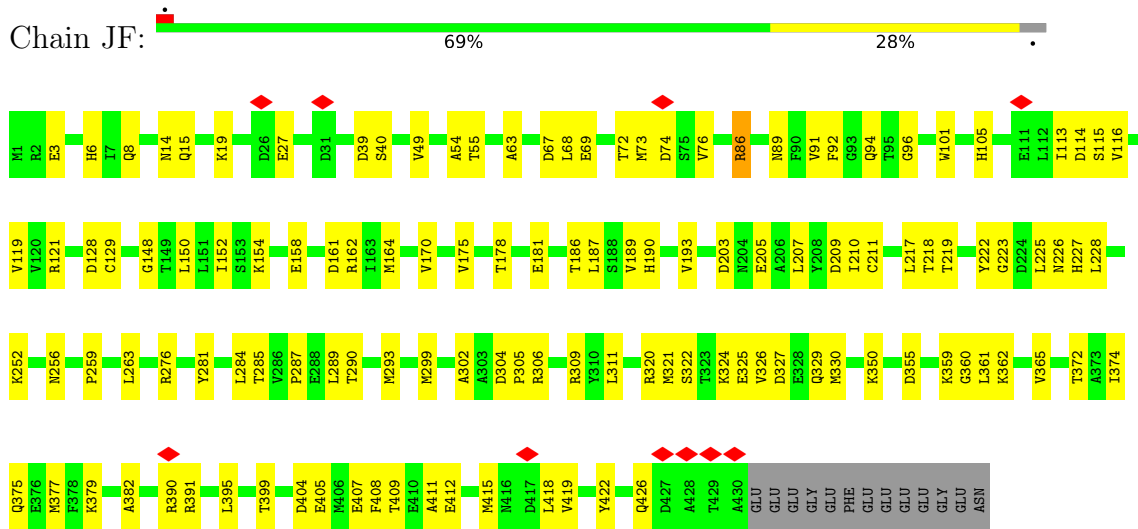

- Molecule 46: Tubulin beta chain

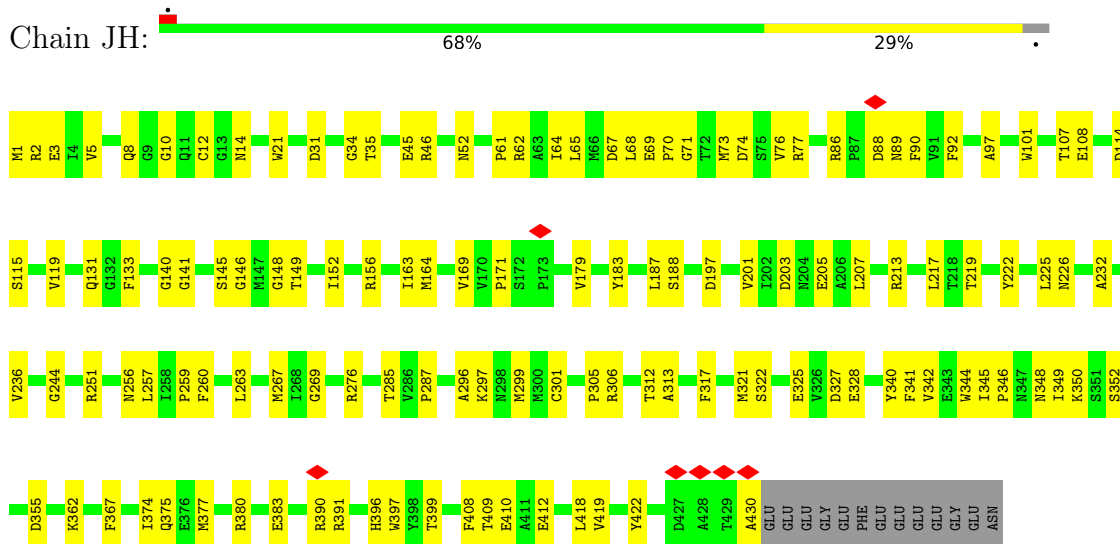

- Molecule 46: Tubulin beta chain

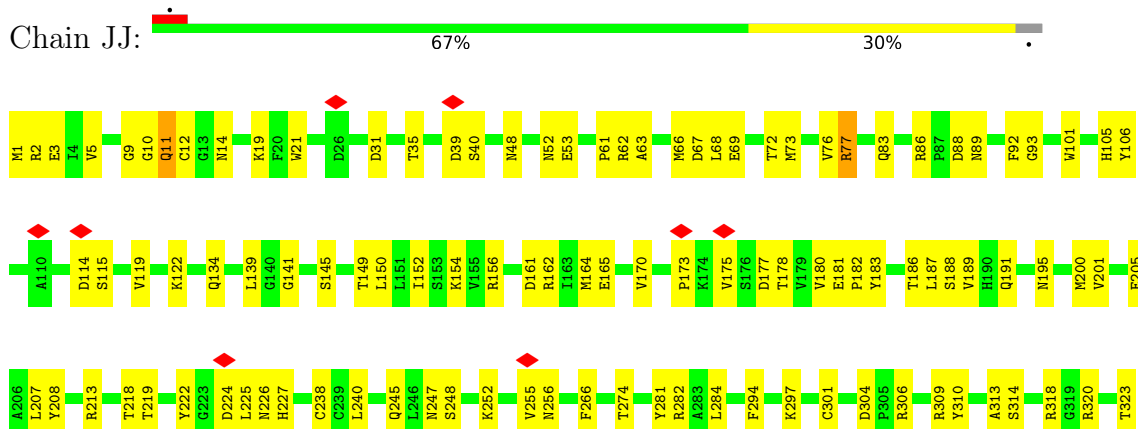

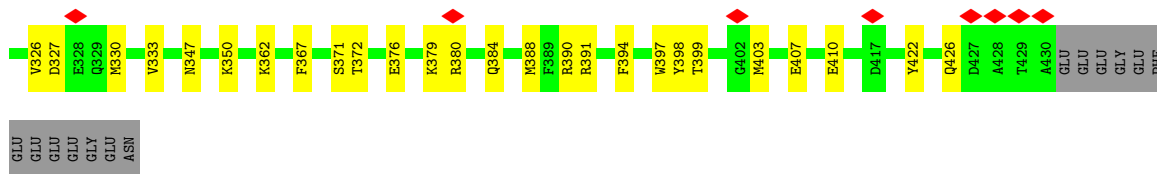

• Molecule 46: Tubulin beta chain

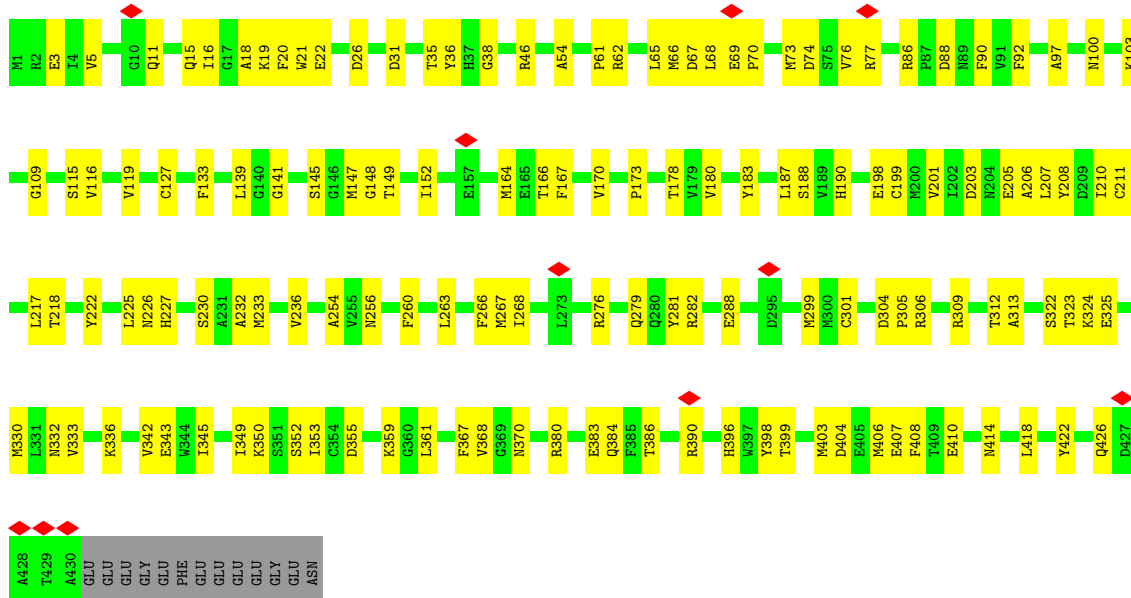

• Molecule 46: Tubulin beta chain

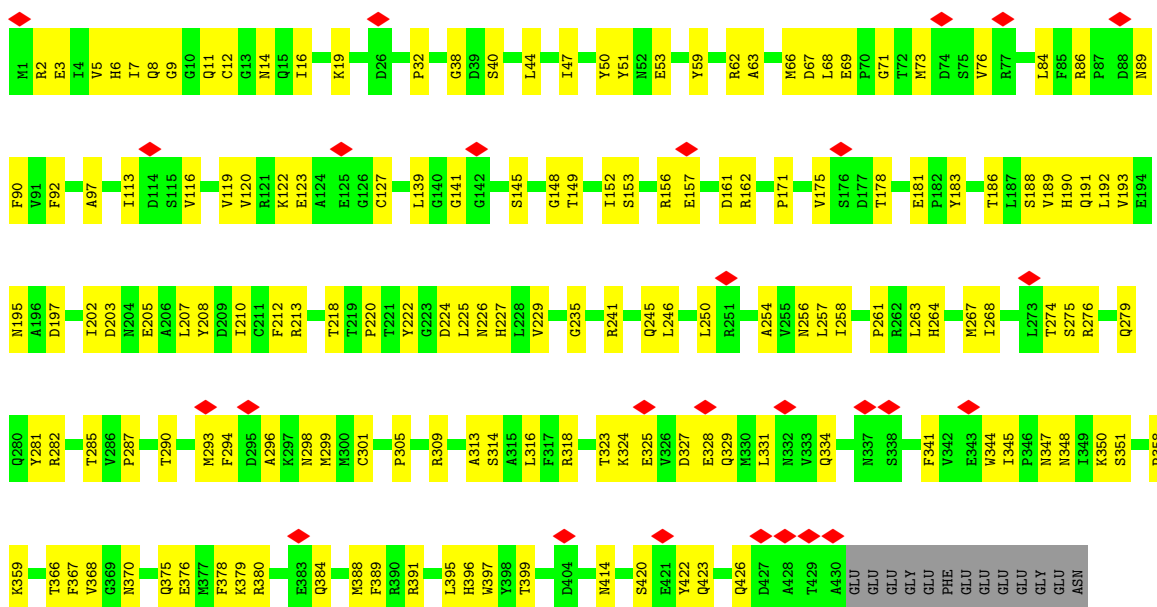

• Molecule 46: Tubulin beta chain

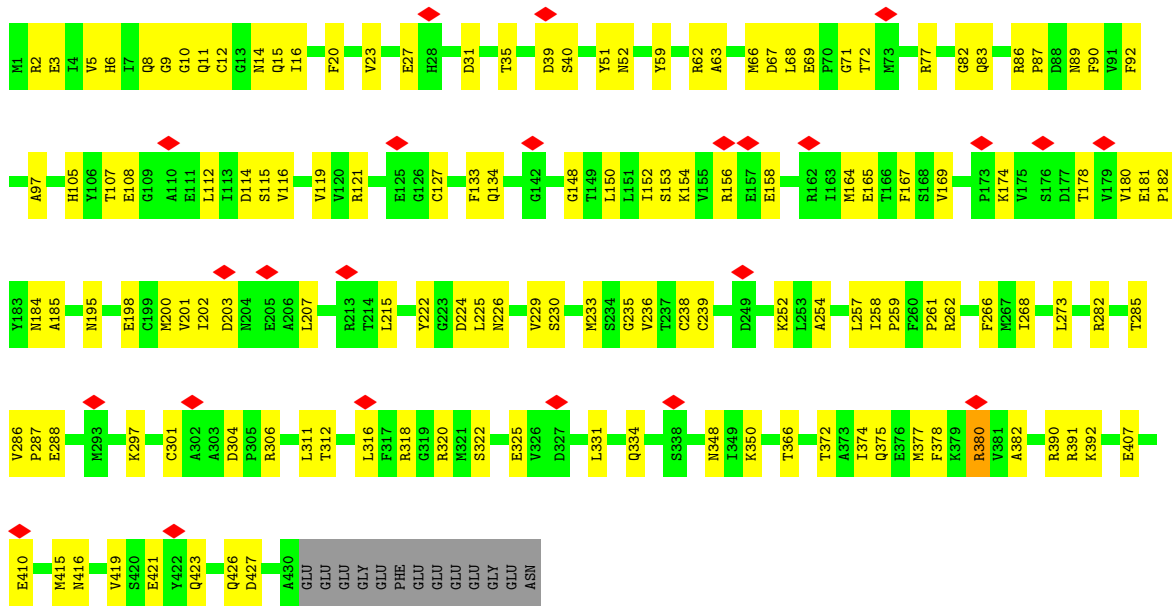

• Molecule 46: Tubulin beta chain

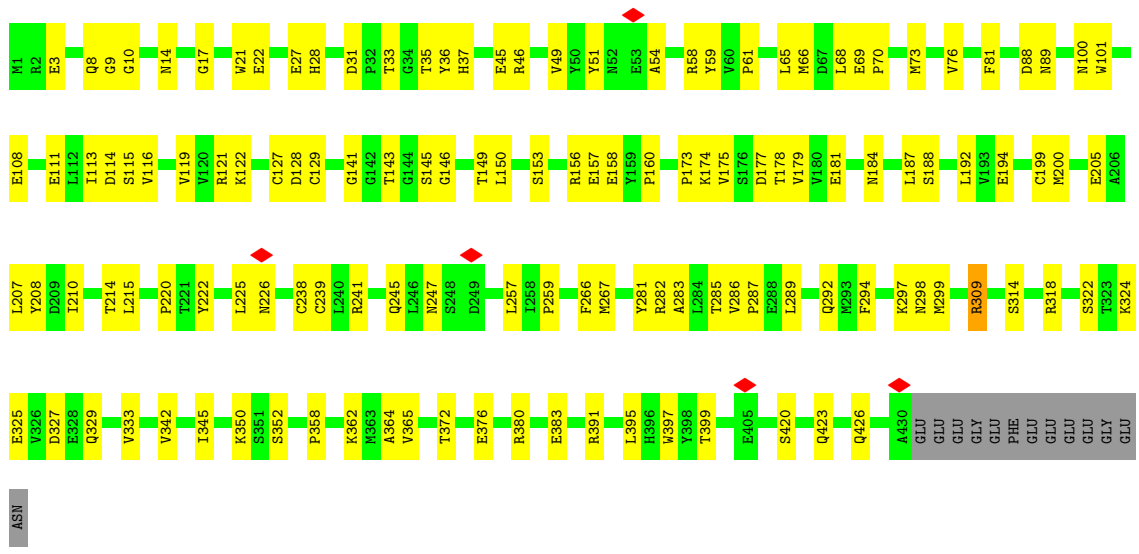

• Molecule 46: Tubulin beta chain

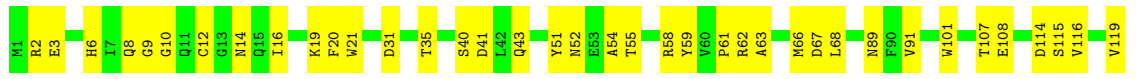

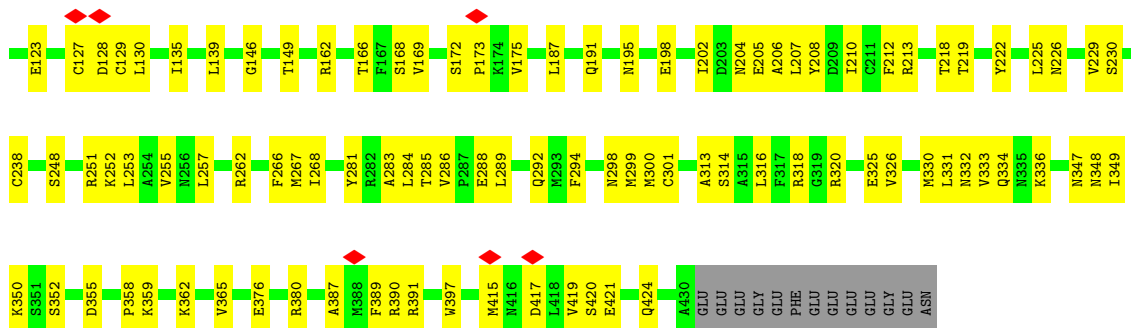

• Molecule 46: Tubulin beta chain

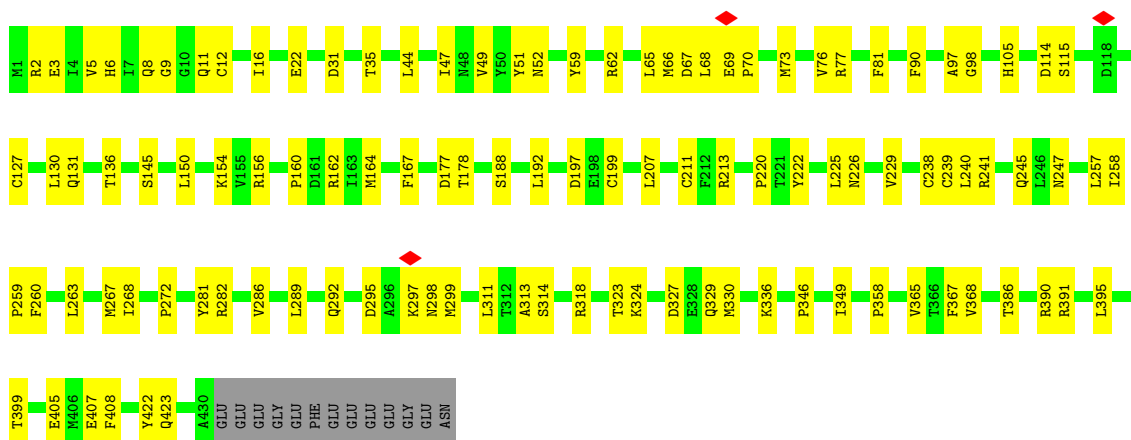
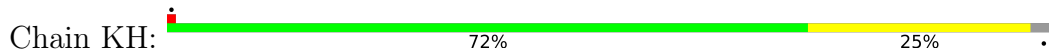

• Molecule 46: Tubulin beta chain

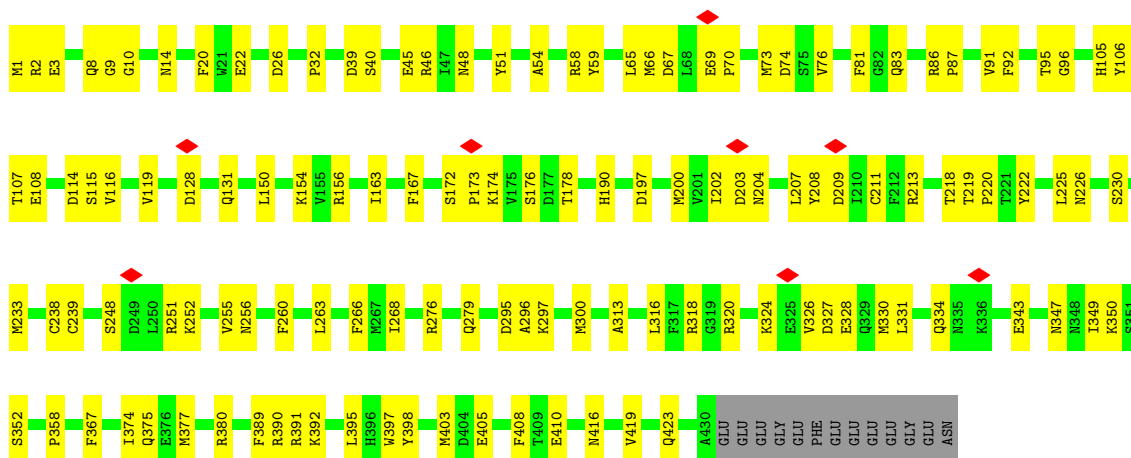

• Molecule 46: Tubulin beta chain



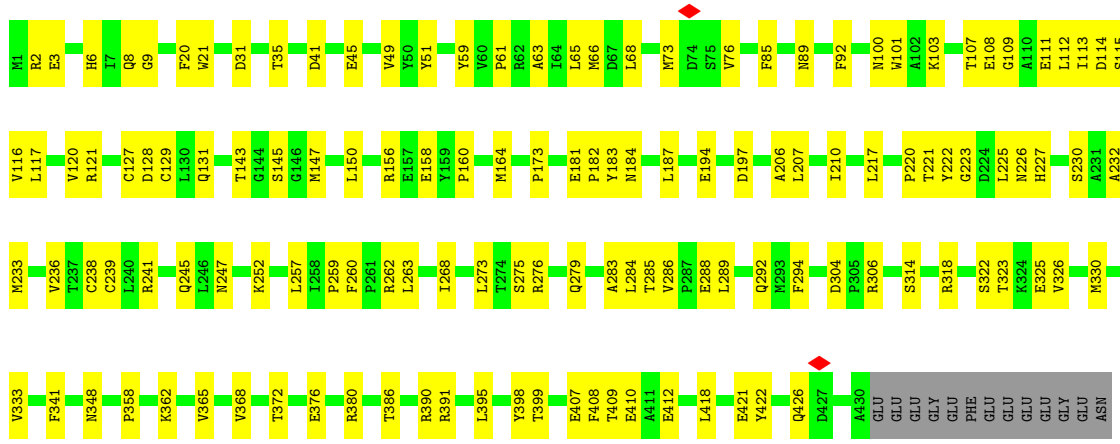

• Molecule 46: Tubulin beta chain

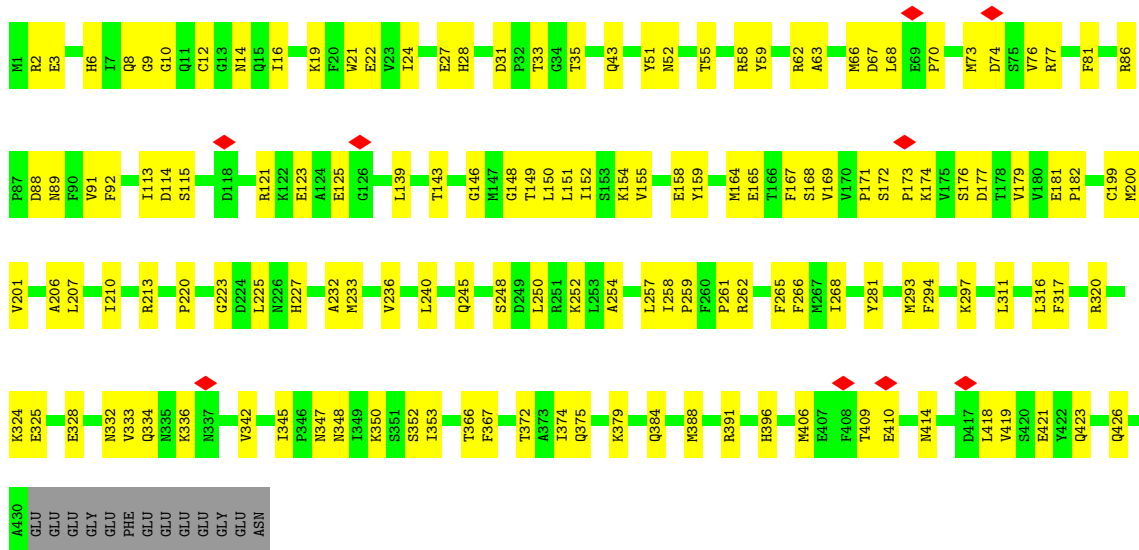

• Molecule 46: Tubulin beta chain

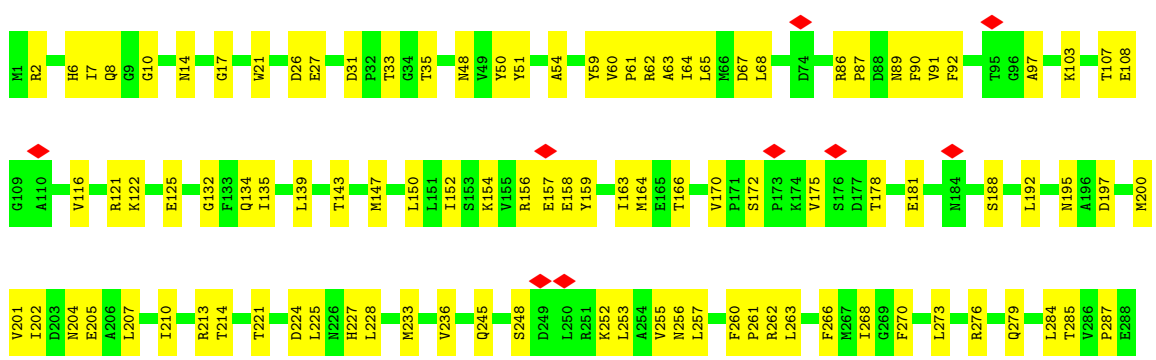

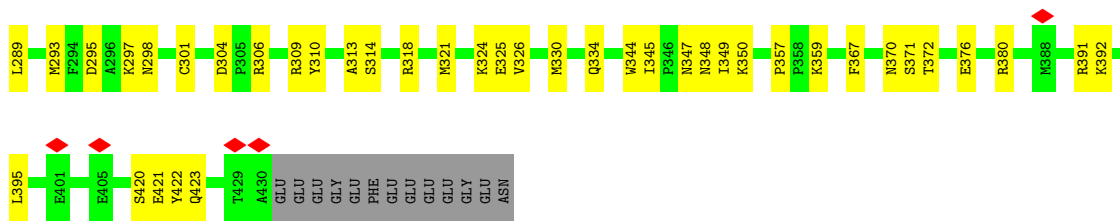

• Molecule 46: Tubulin beta chain

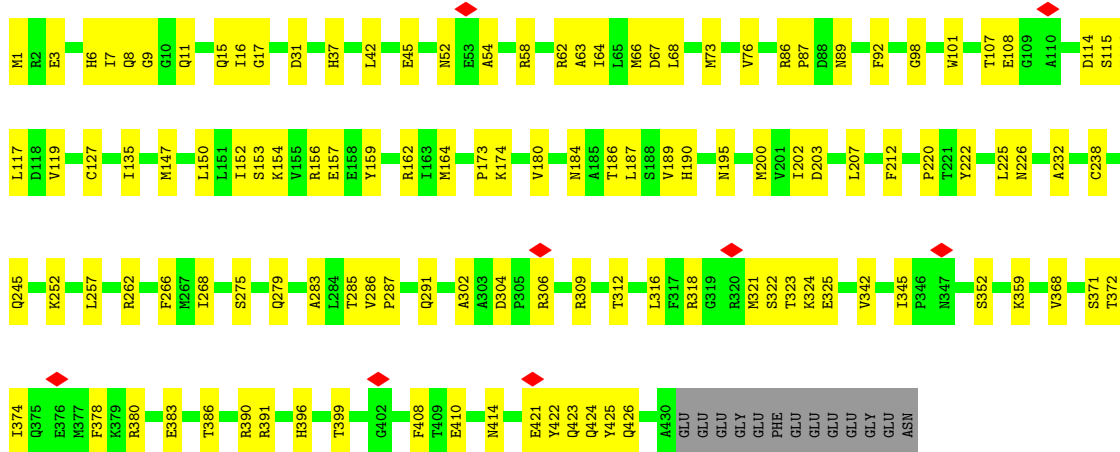

• Molecule 46: Tubulin beta chain

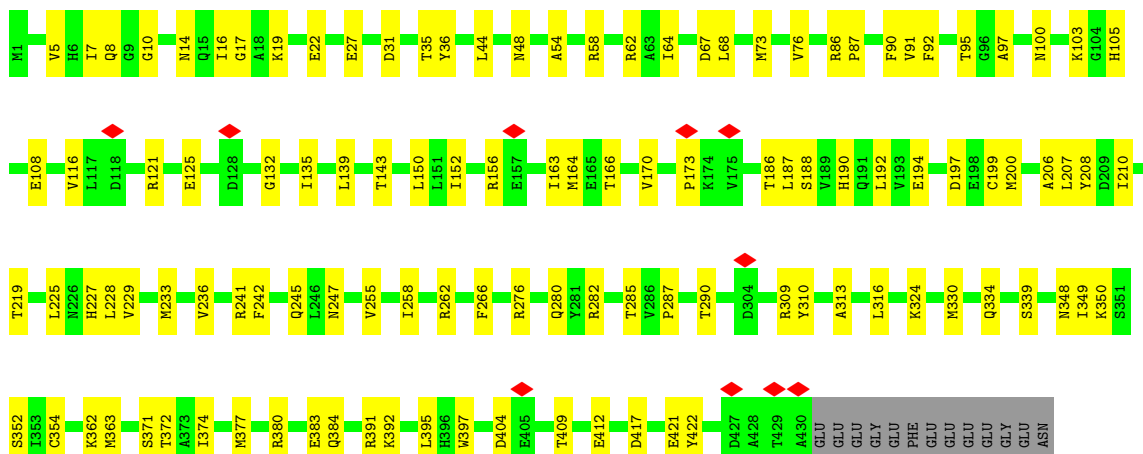

• Molecule 46: Tubulin beta chain

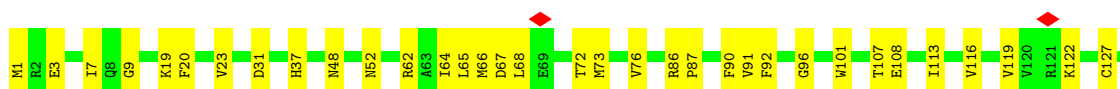

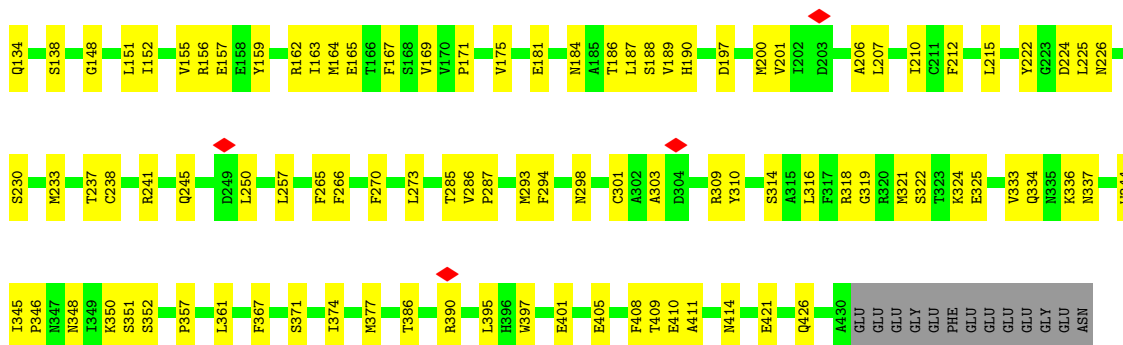

• Molecule 46: Tubulin beta chain

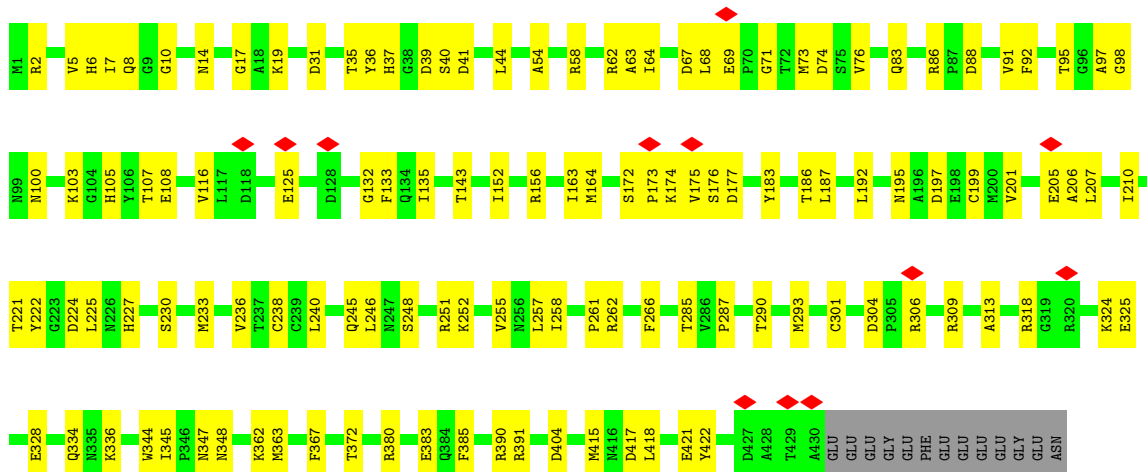

• Molecule 46: Tubulin beta chain

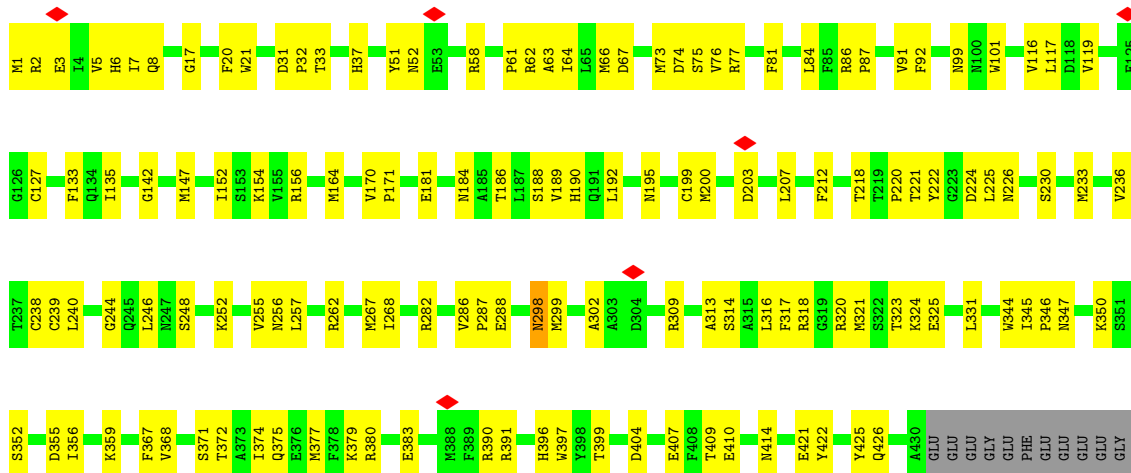

GLU ASN

• Molecule 46: Tubulin beta chain

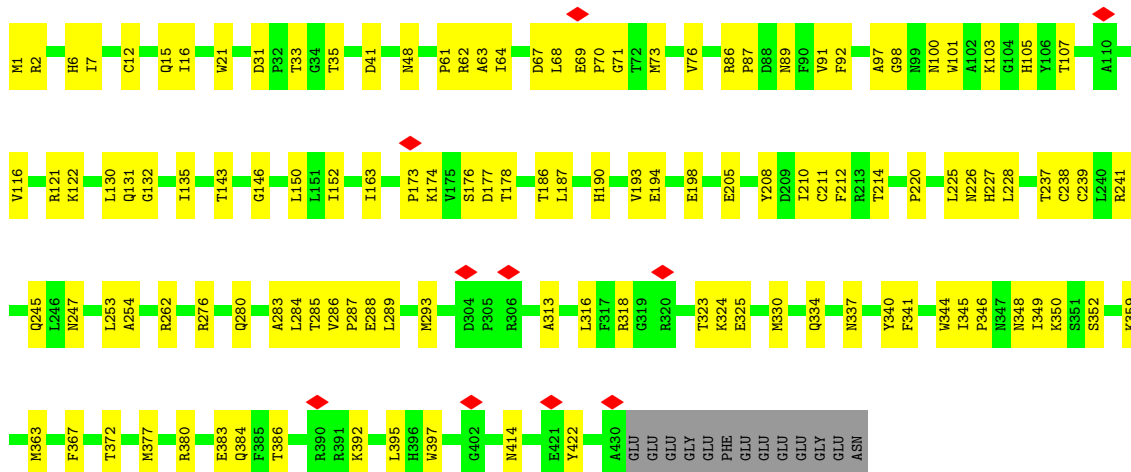

• Molecule 46: Tubulin beta chain

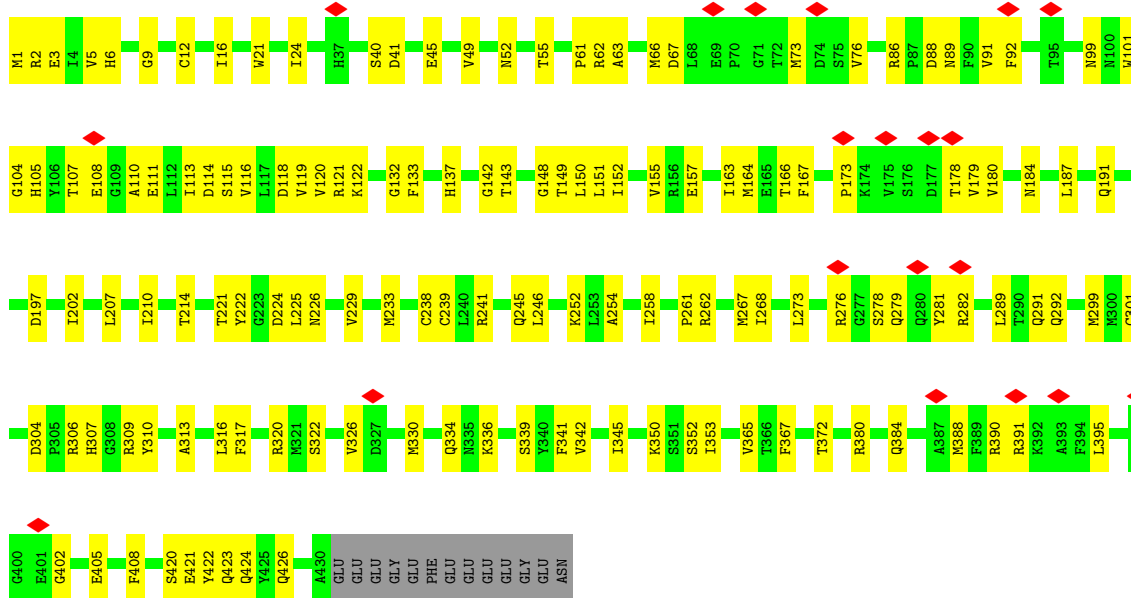

• Molecule 46: Tubulin beta chain

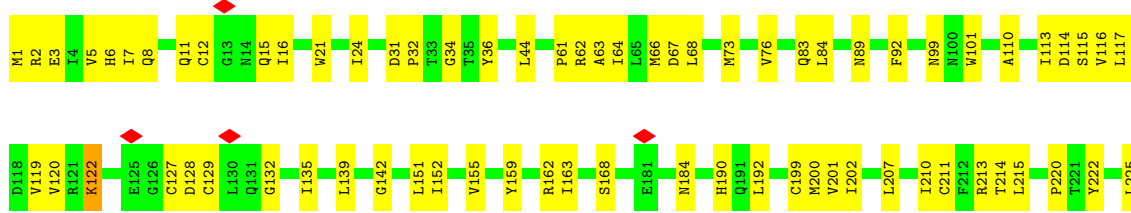



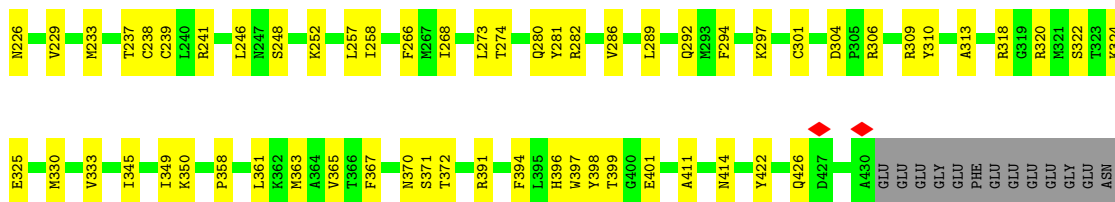

• Molecule 46: Tubulin beta chain

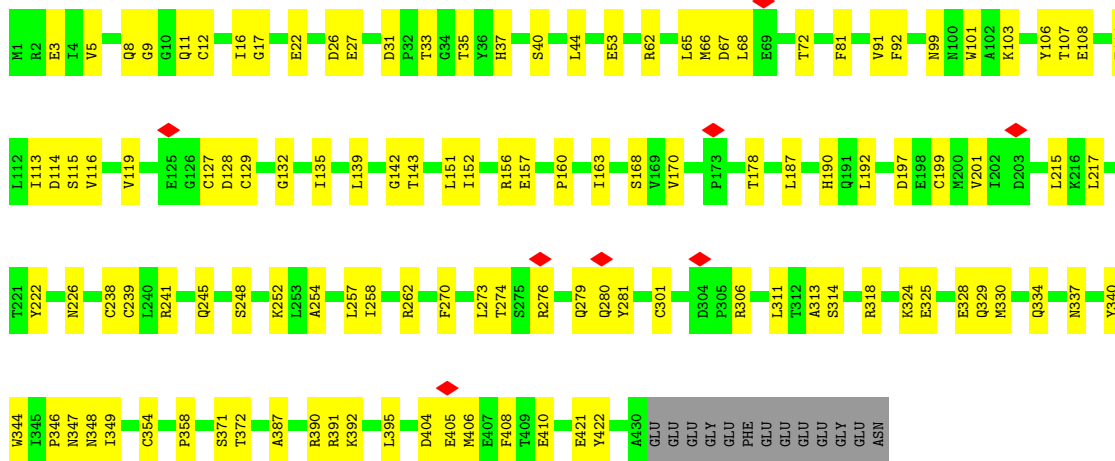

• Molecule 46: Tubulin beta chain

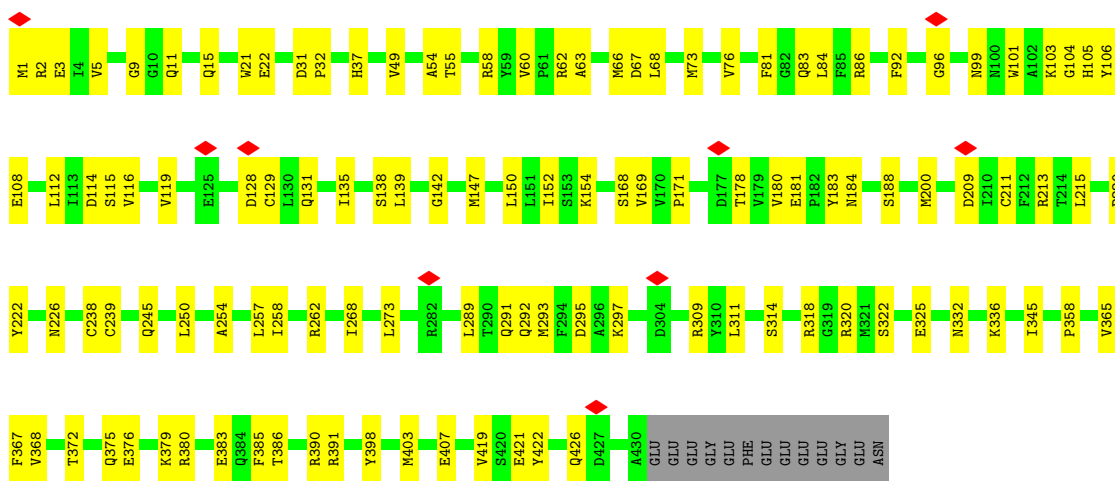

• Molecule 46: Tubulin beta chain



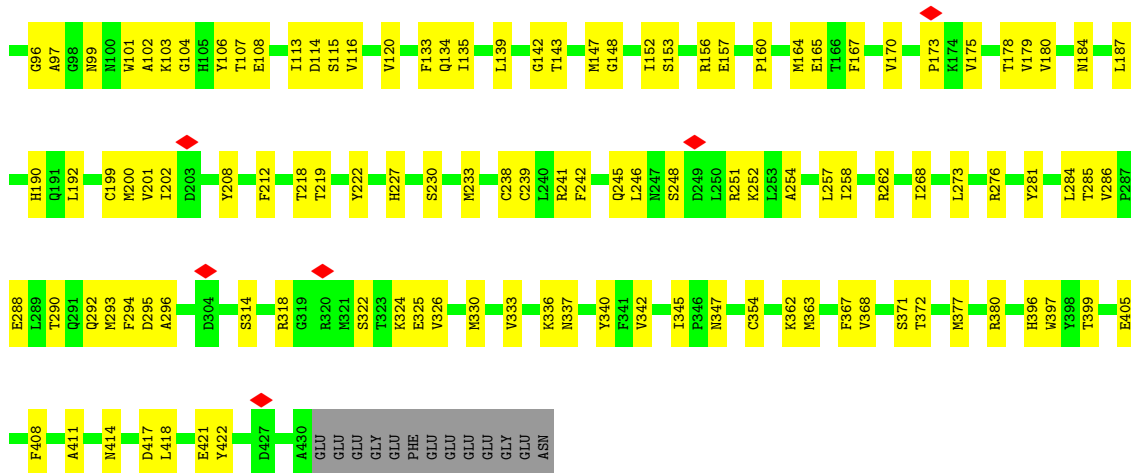

• Molecule 46: Tubulin beta chain

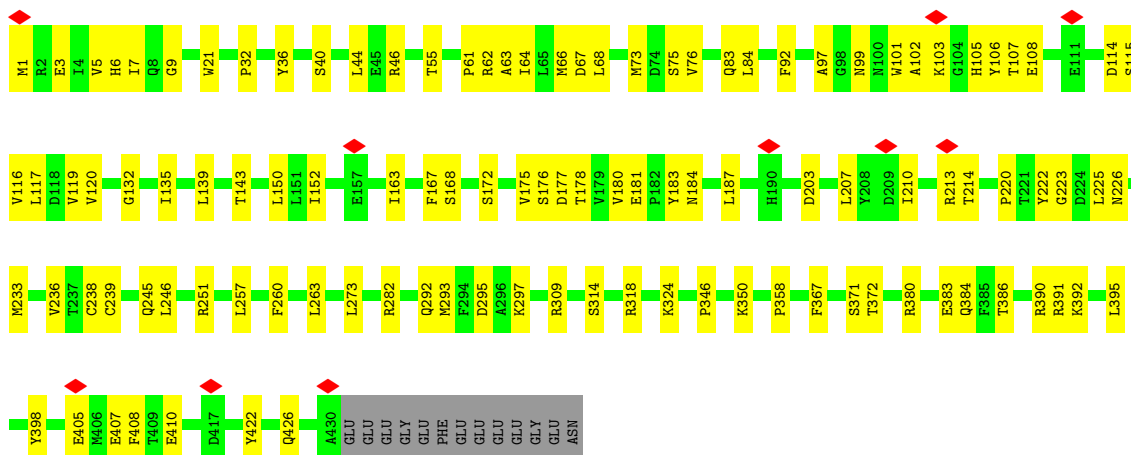

• Molecule 46: Tubulin beta chain

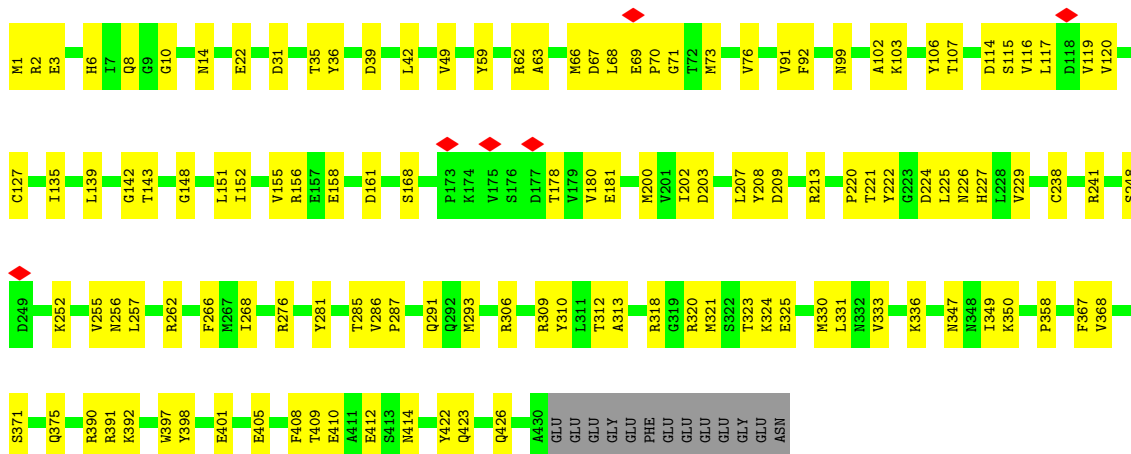

• Molecule 46: Tubulin beta chain

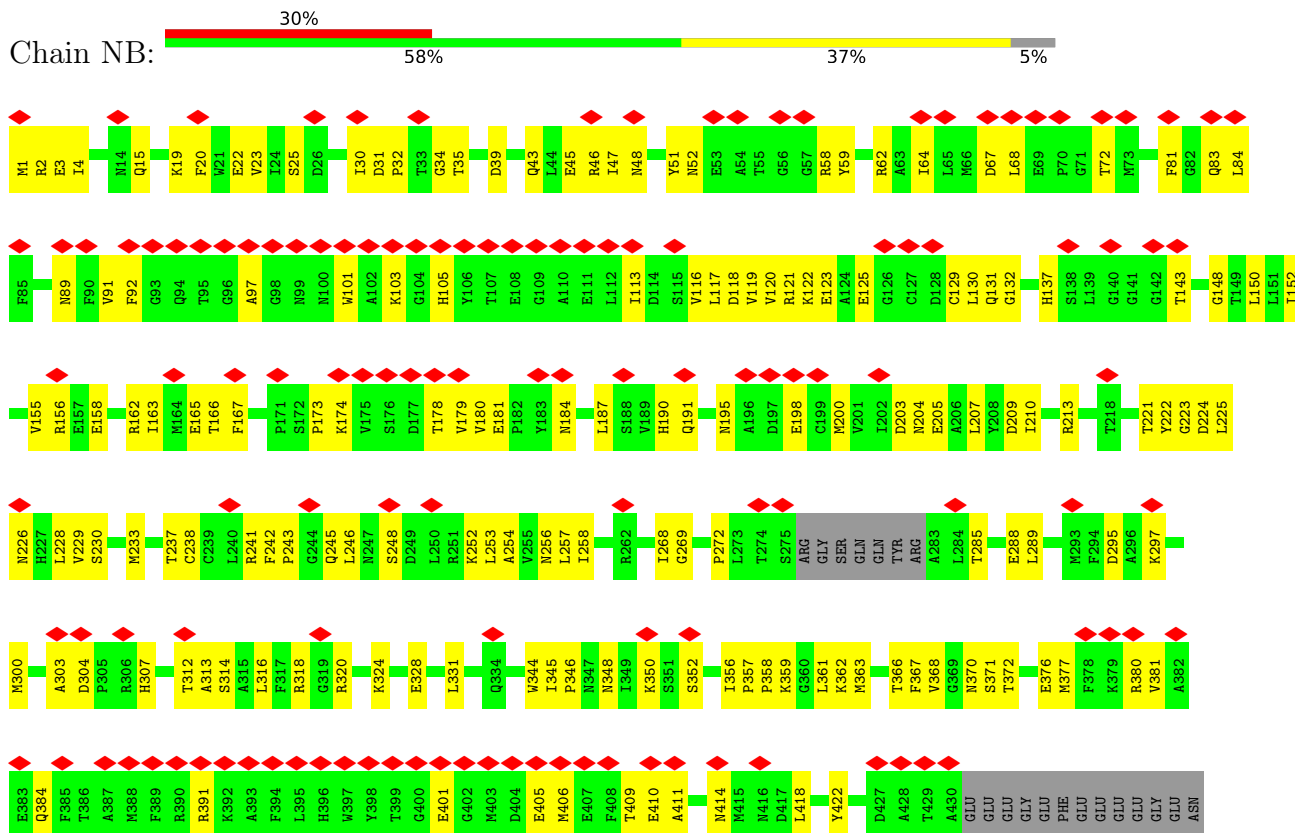

• Molecule 46: Tubulin beta chain

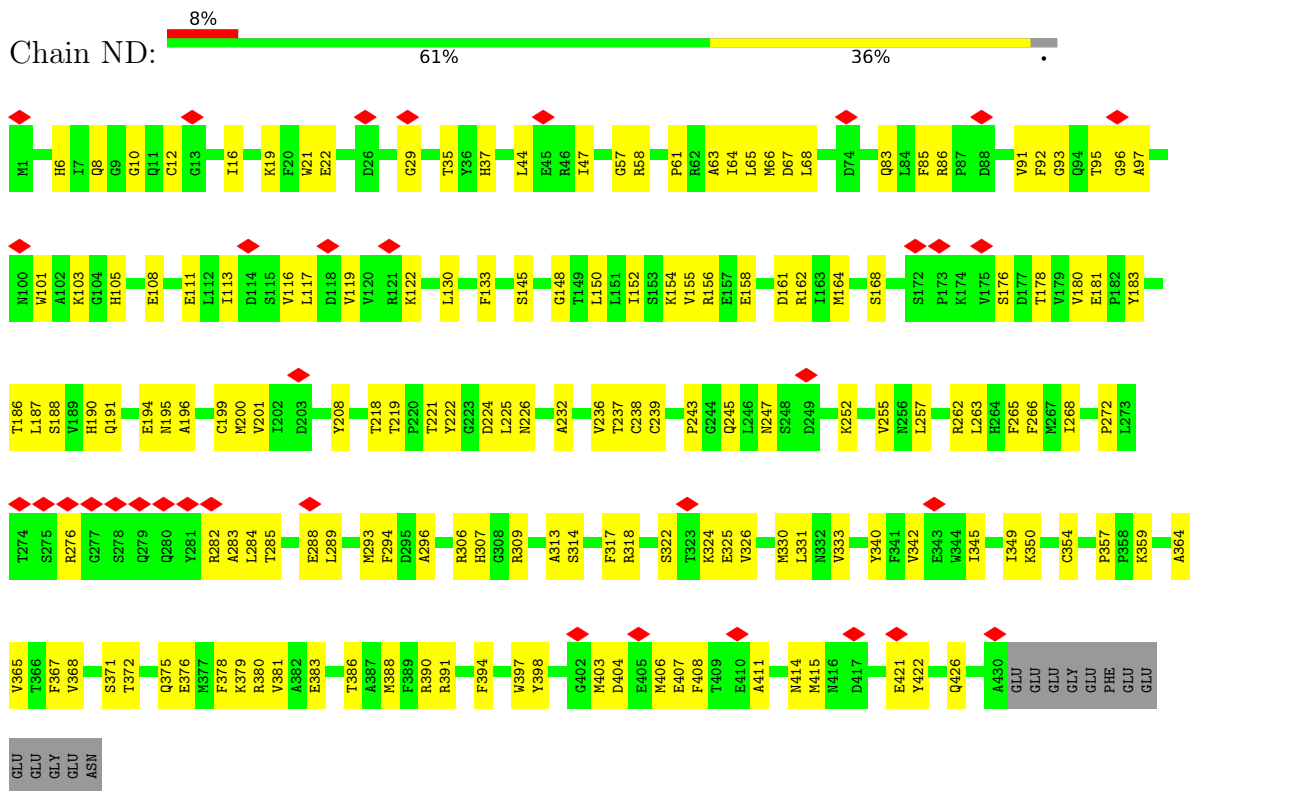

• Molecule 46: Tubulin beta chain

Chain NF: 

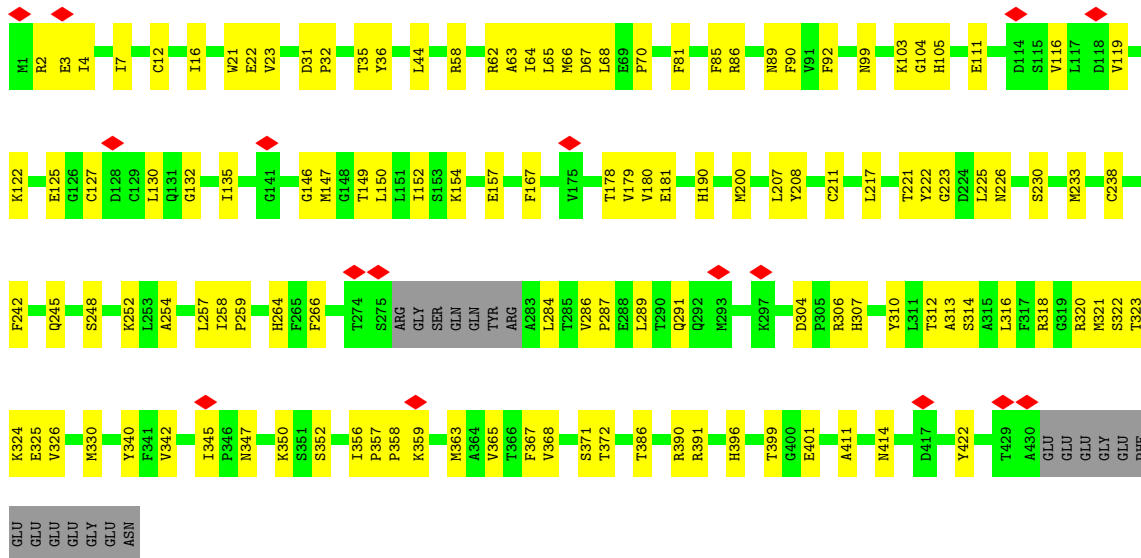

• Molecule 46: Tubulin beta chain

Chain NH: 

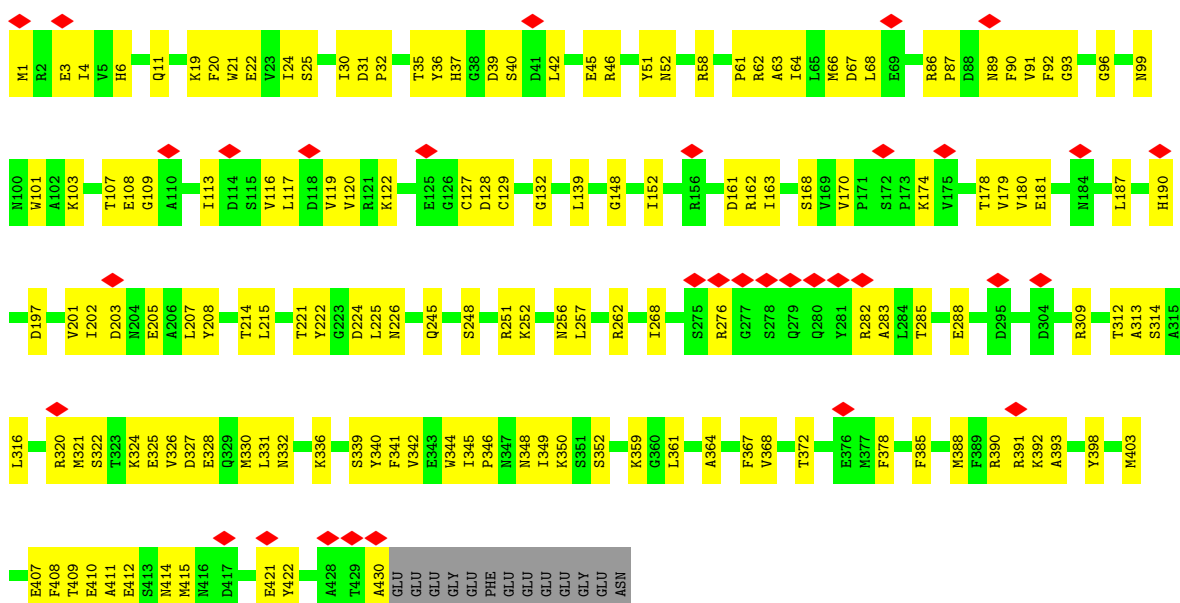

• Molecule 46: Tubulin beta chain

Chain NJ: 



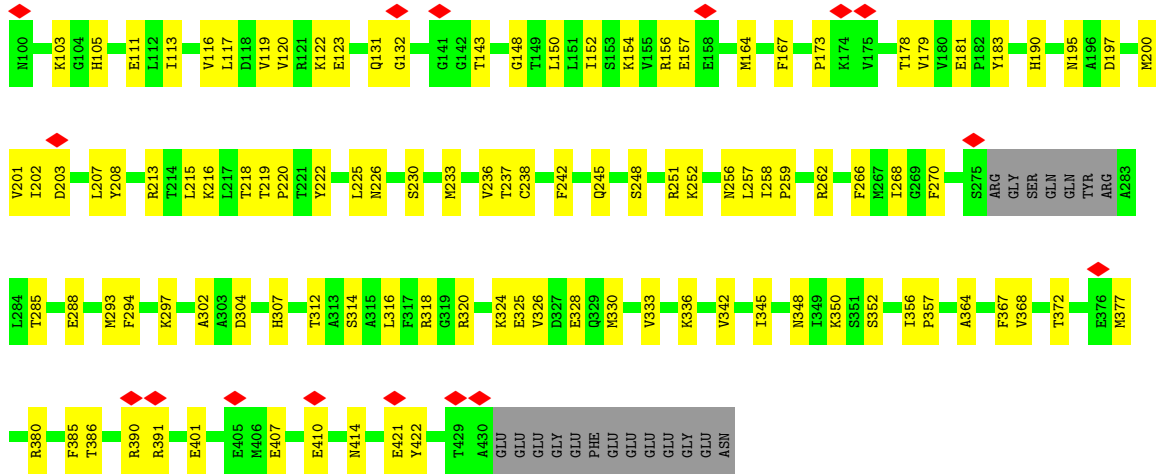

• Molecule 46: Tubulin beta chain

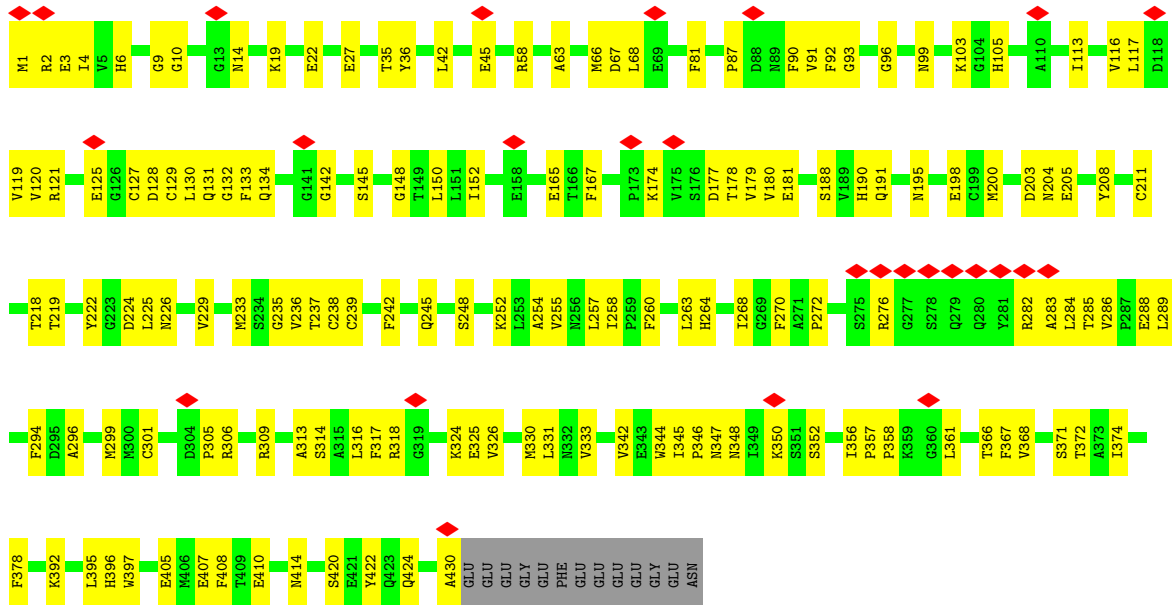

• Molecule 46: Tubulin beta chain

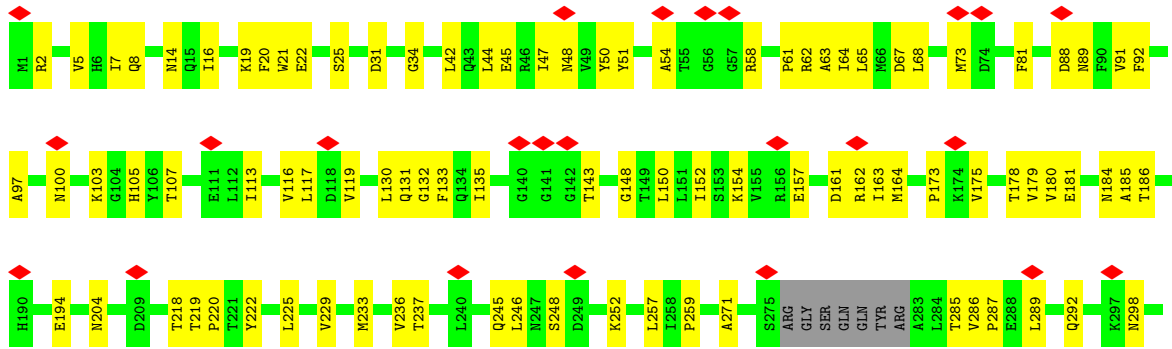

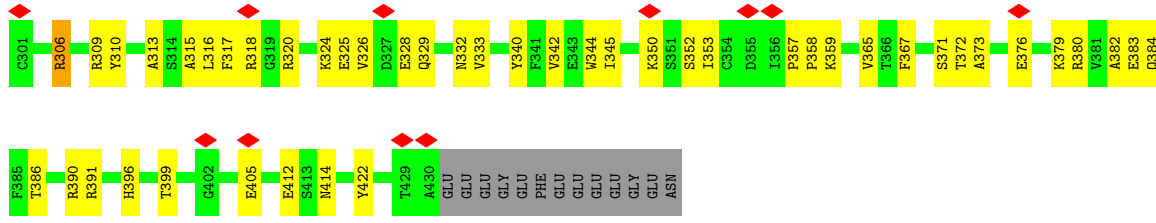

• Molecule 46: Tubulin beta chain

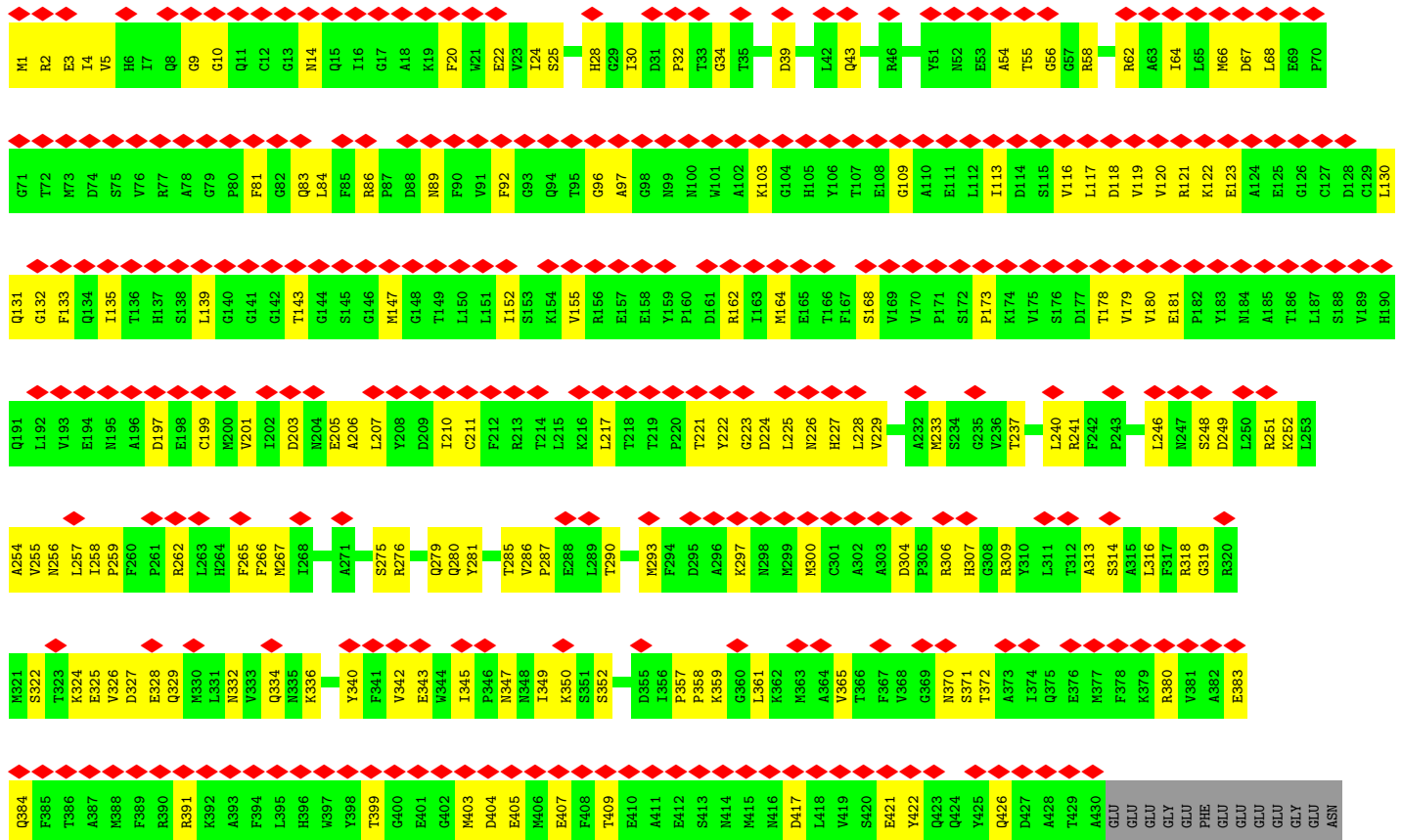

• Molecule 46: Tubulin beta chain

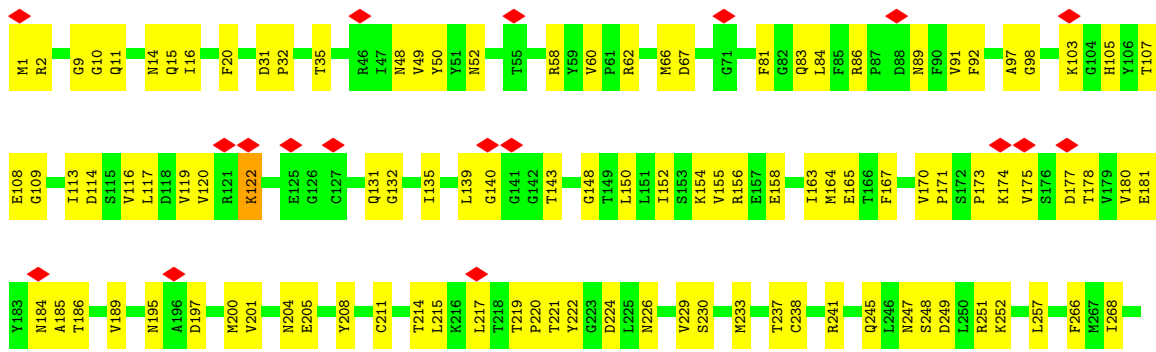

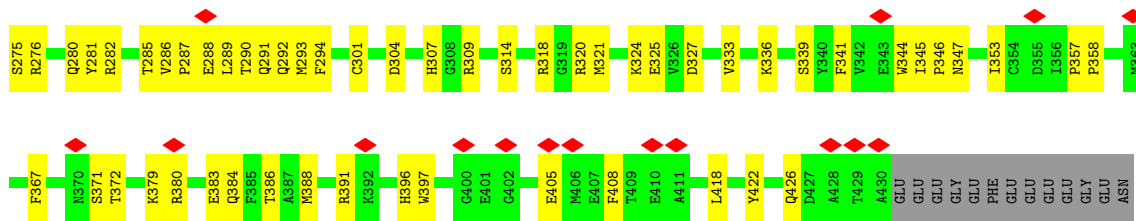

• Molecule 46: Tubulin beta chain

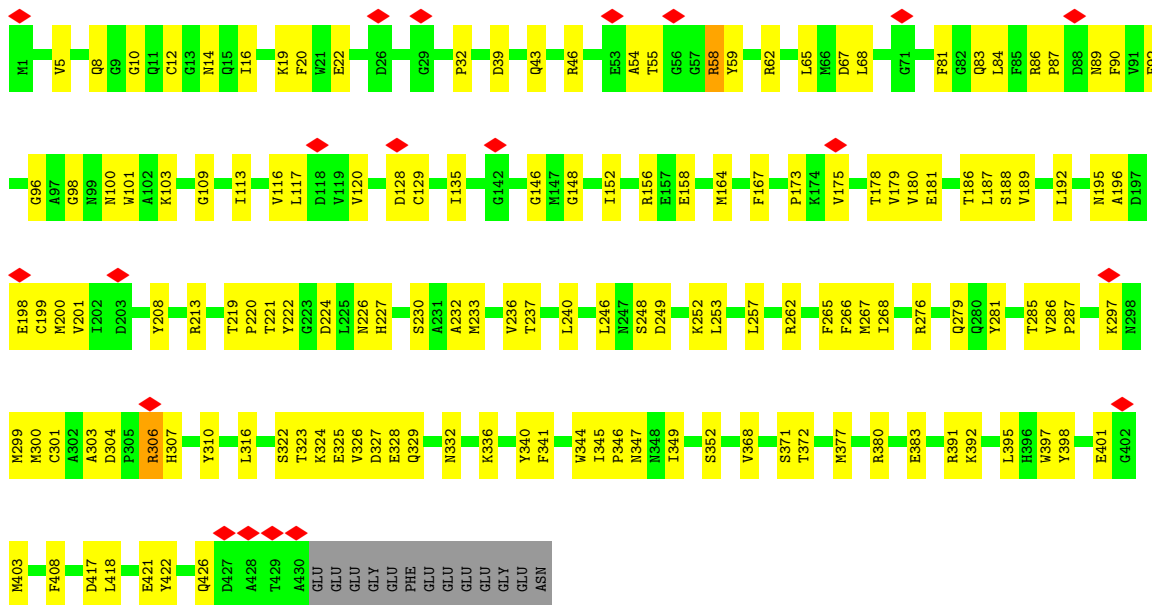

• Molecule 46: Tubulin beta chain

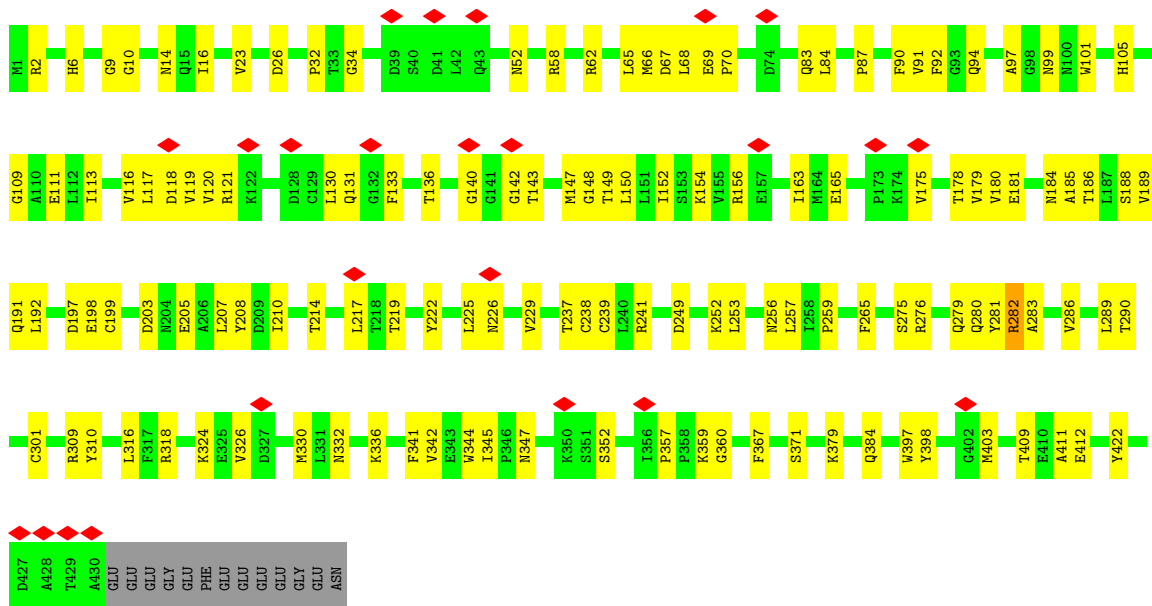

• Molecule 46: Tubulin beta chain

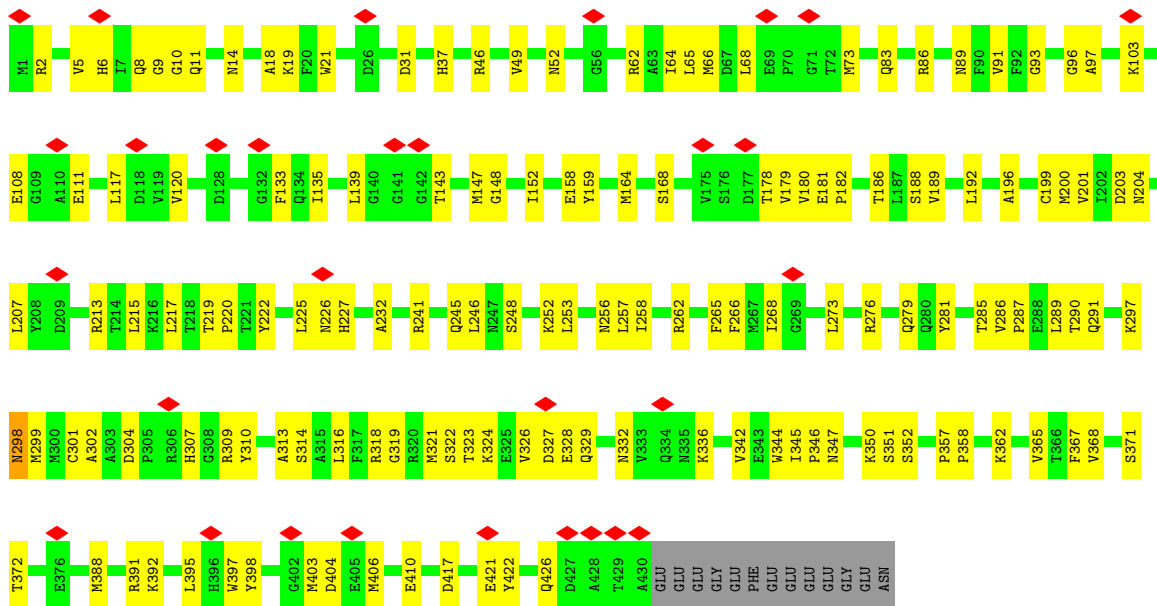

• Molecule 46: Tubulin beta chain

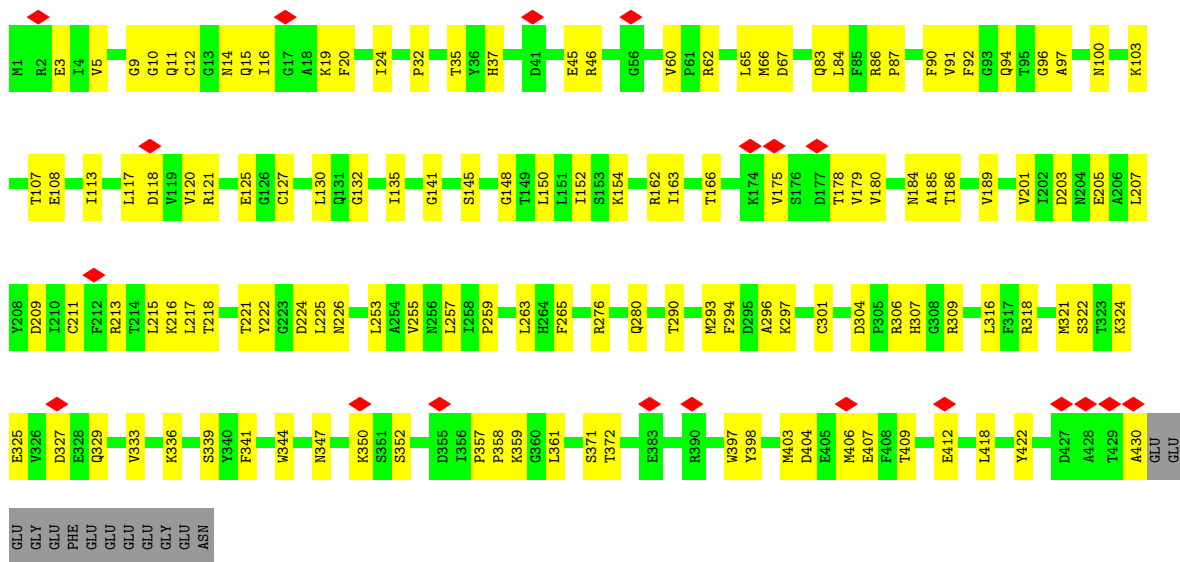

• Molecule 46: Tubulin beta chain

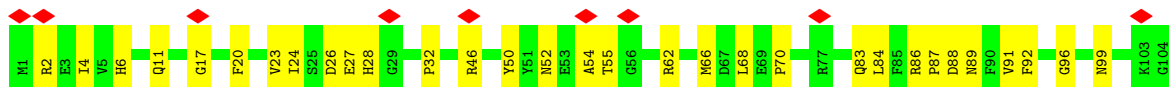



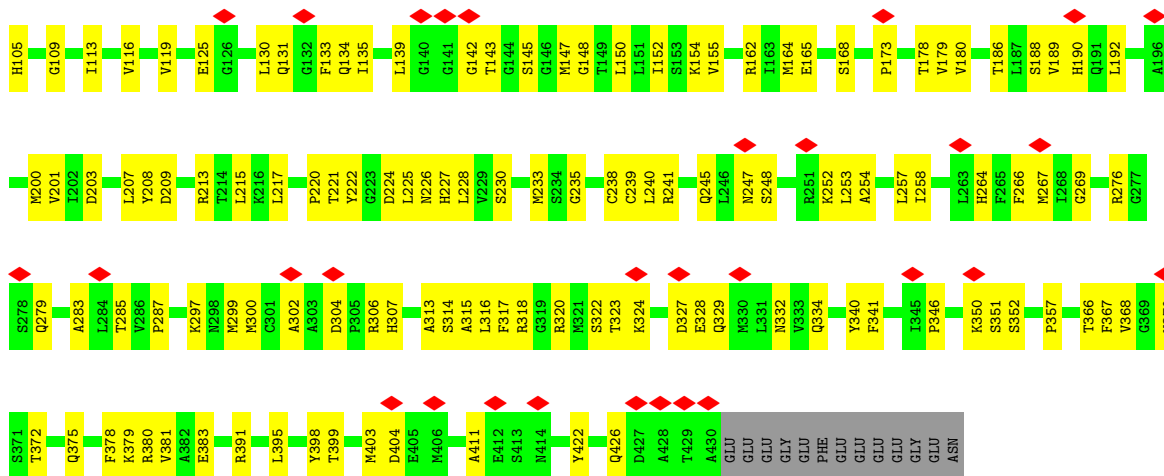

• Molecule 46: Tubulin beta chain

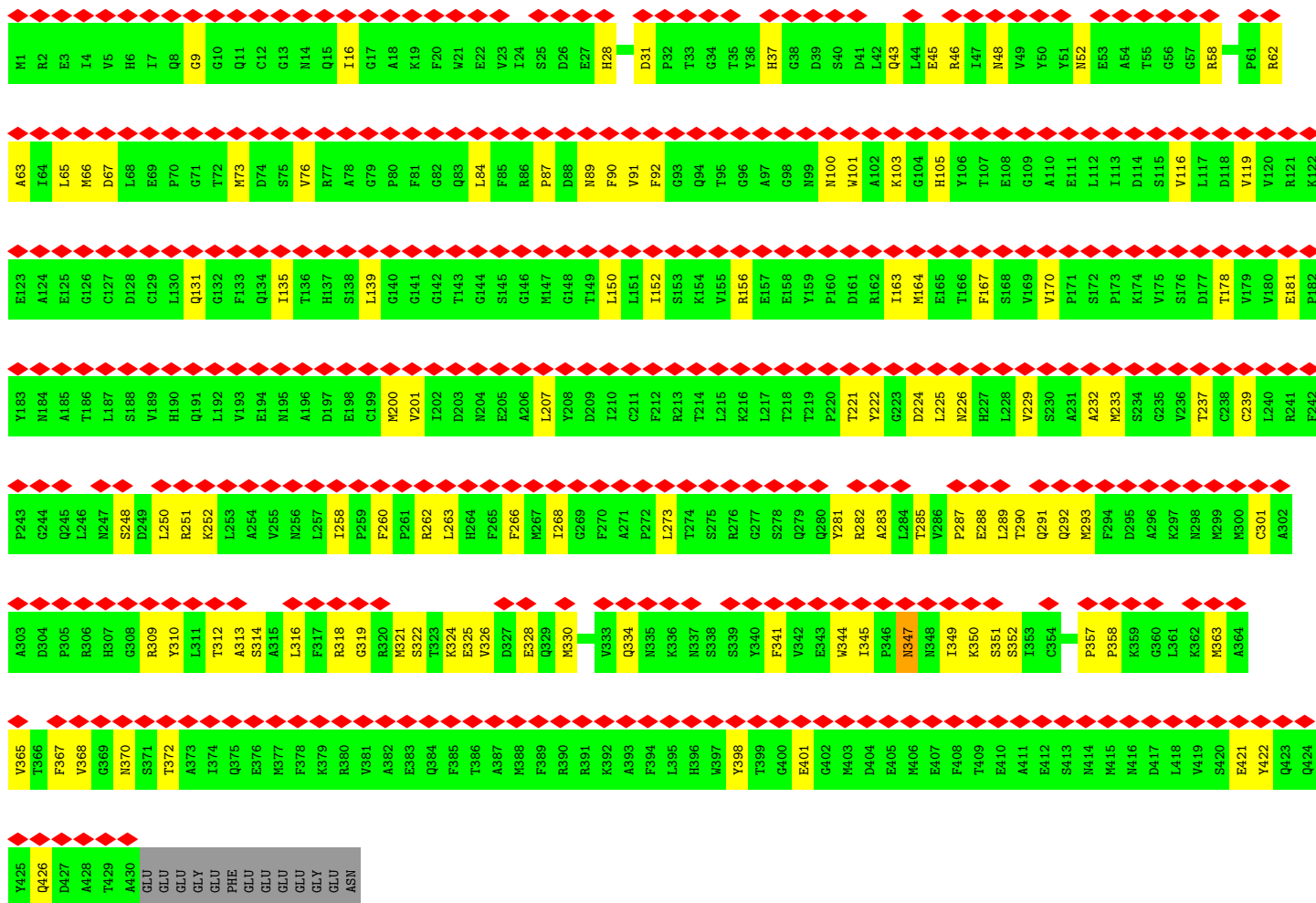
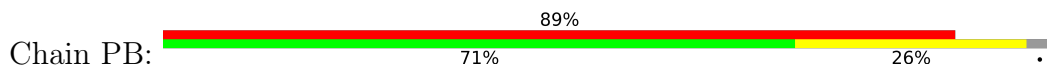

• Molecule 46: Tubulin beta chain



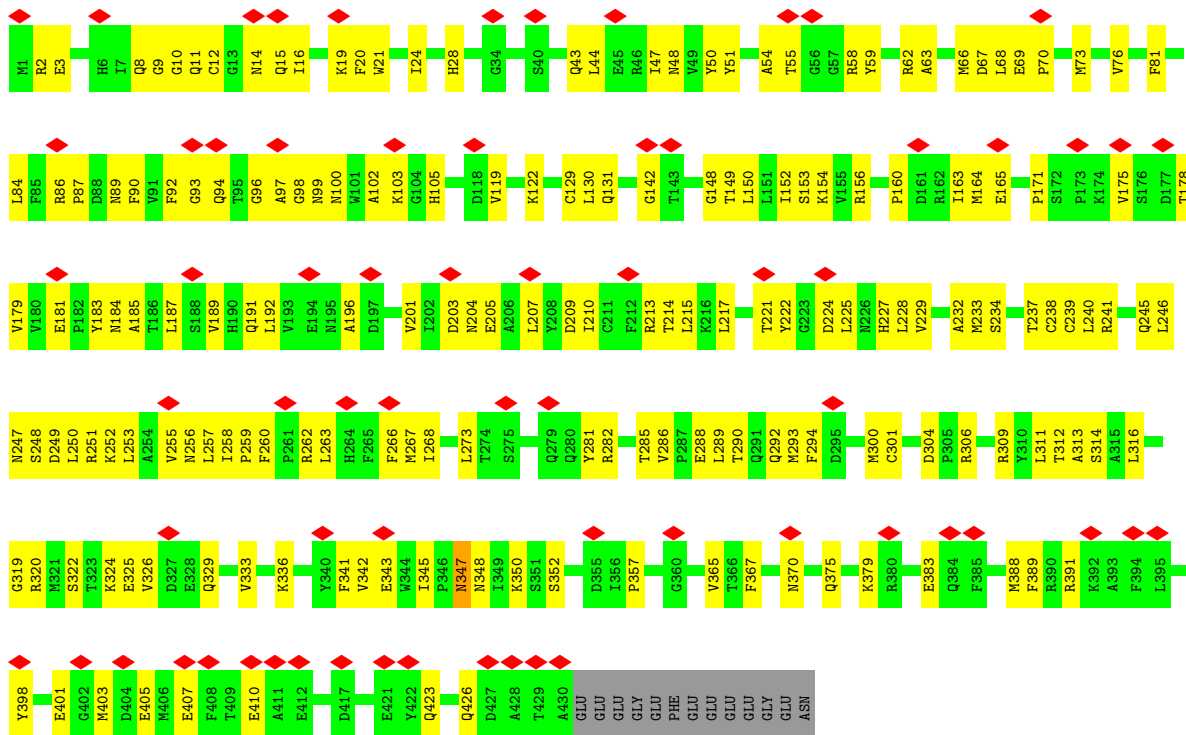

• Molecule 46: Tubulin beta chain

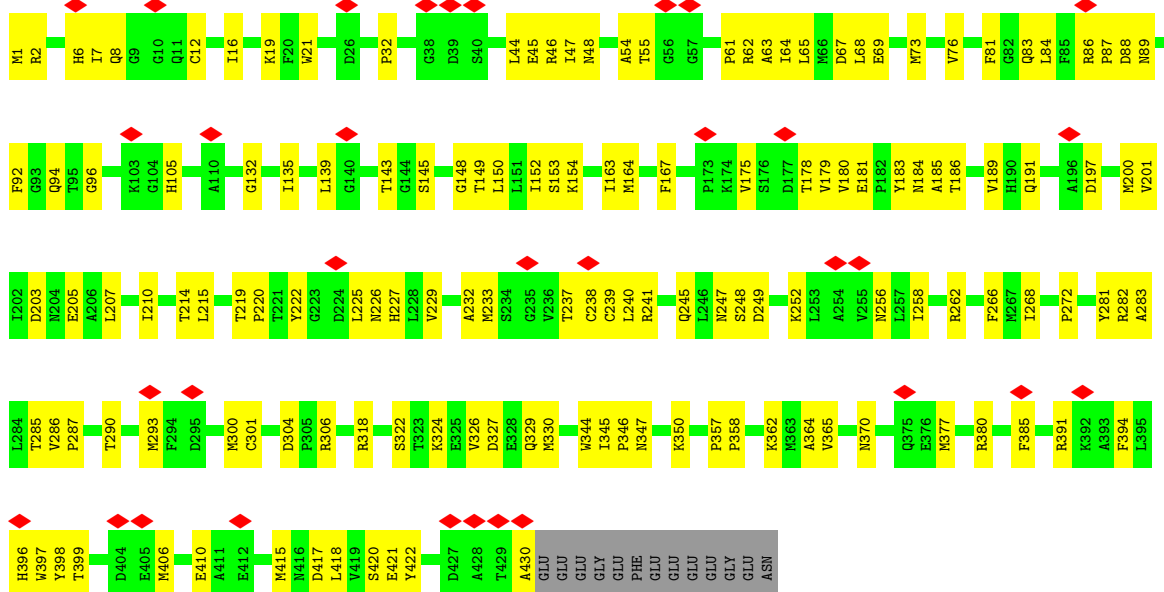

• Molecule 46: Tubulin beta chain

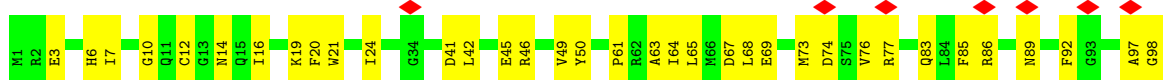

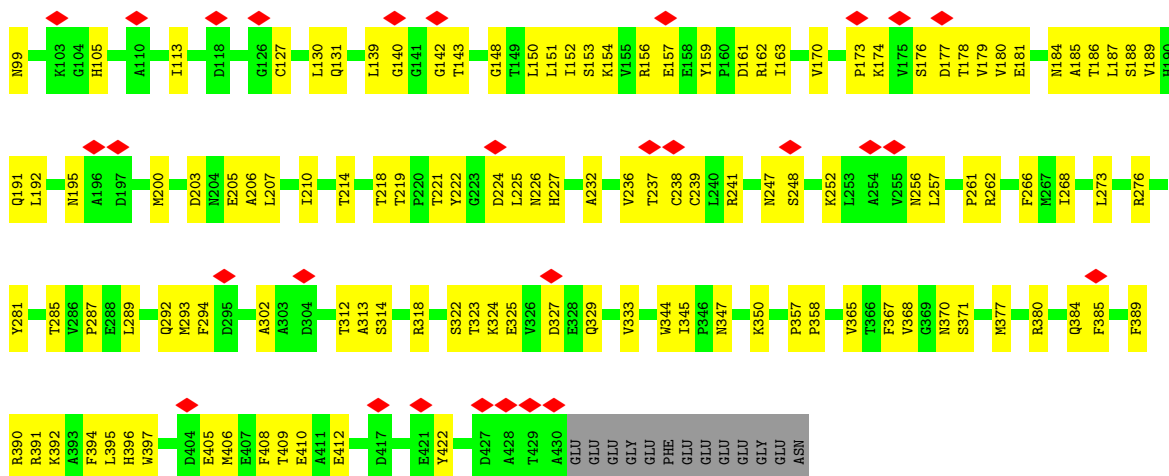

• Molecule 46: Tubulin beta chain

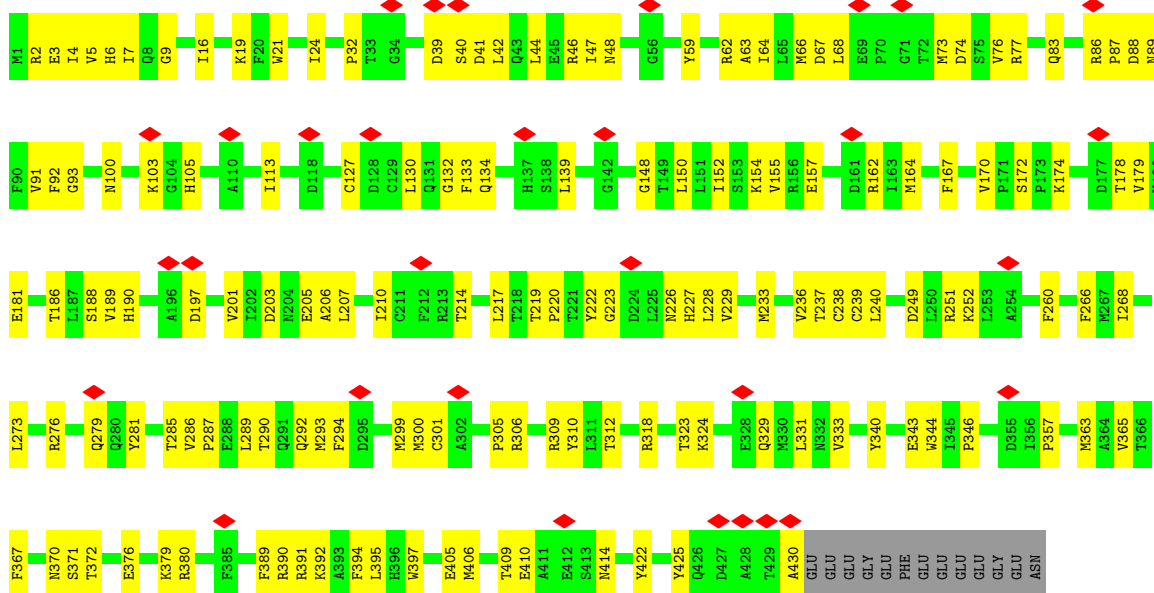

• Molecule 46: Tubulin beta chain

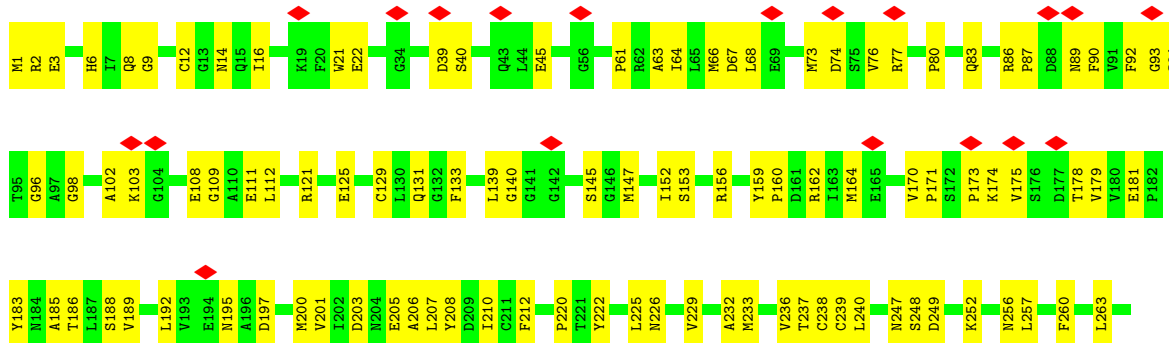

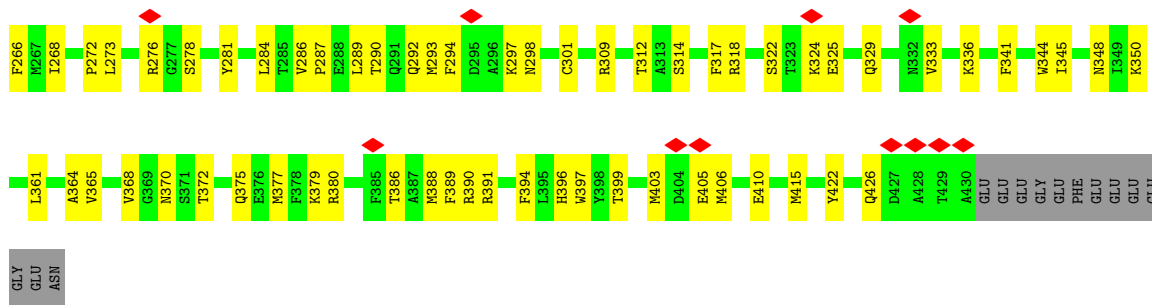

• Molecule 46: Tubulin beta chain

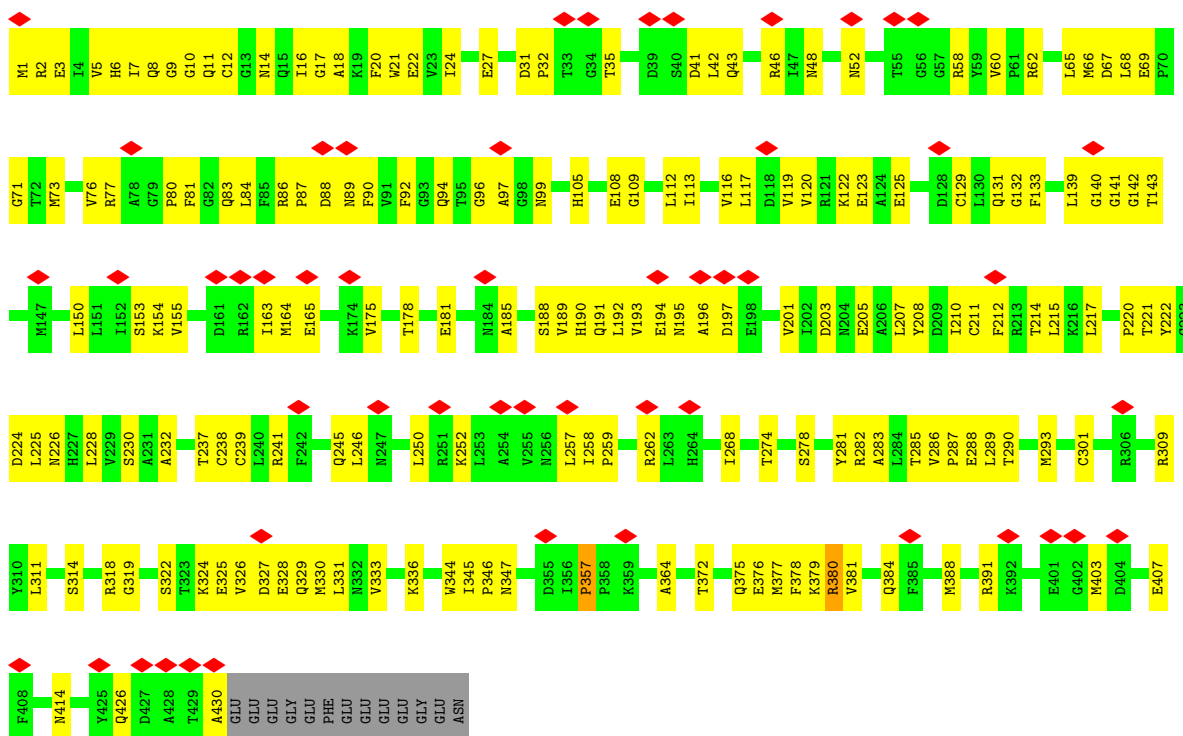

• Molecule 46: Tubulin beta chain

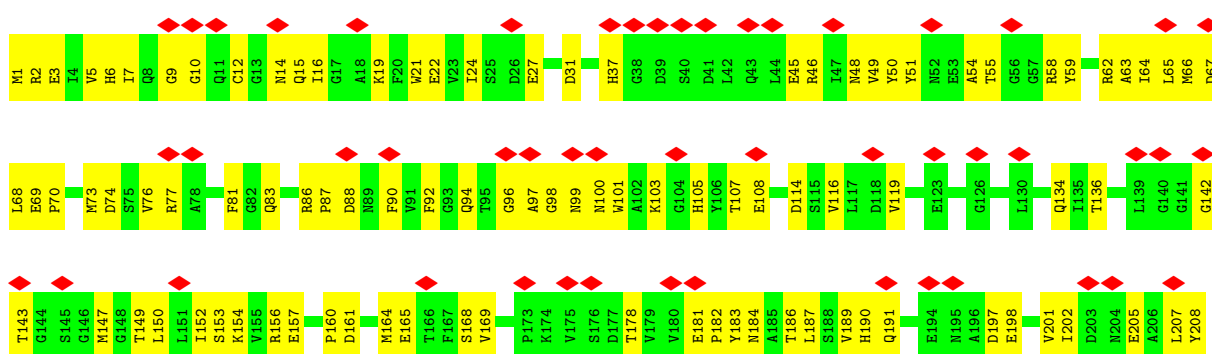

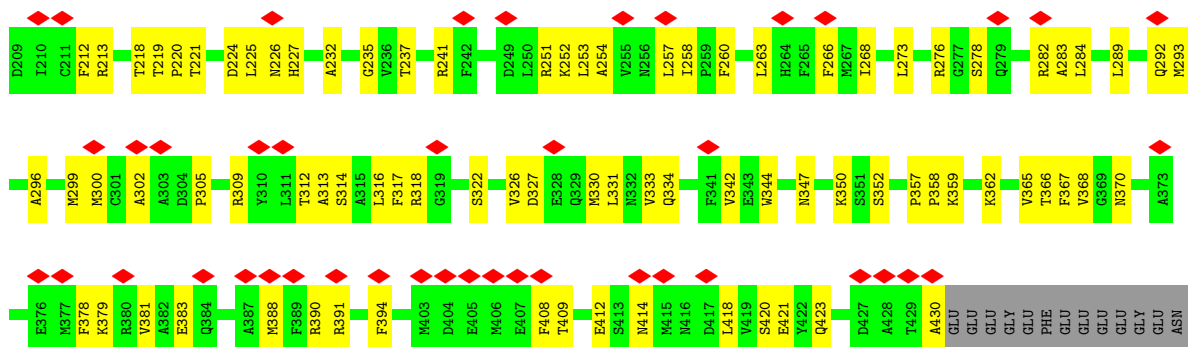

• Molecule 46: Tubulin beta chain

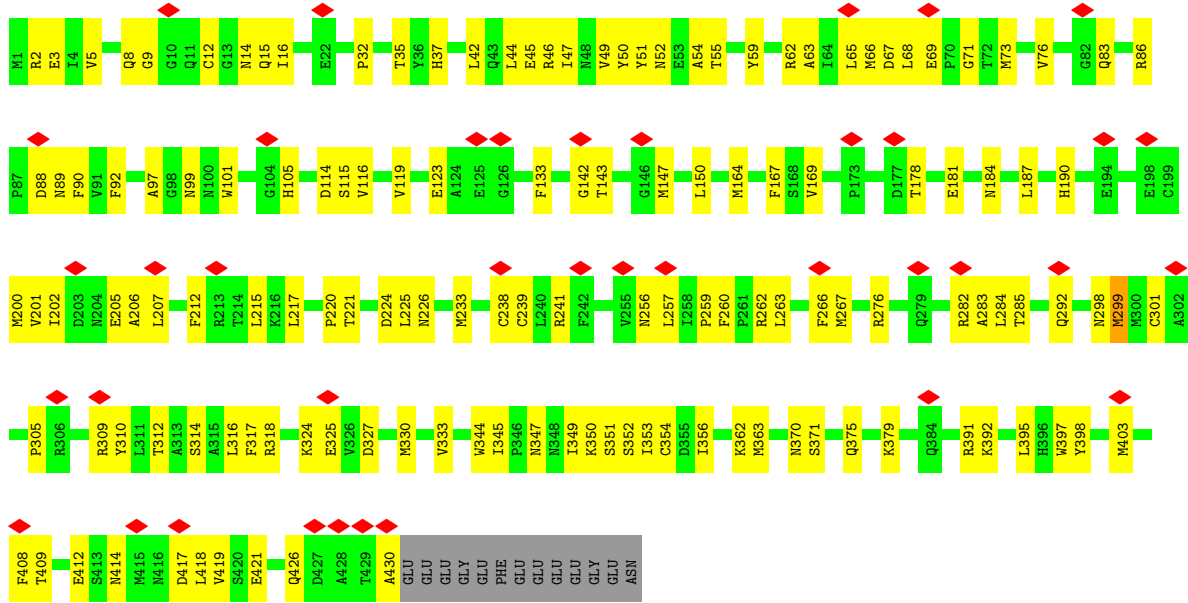

• Molecule 46: Tubulin beta chain

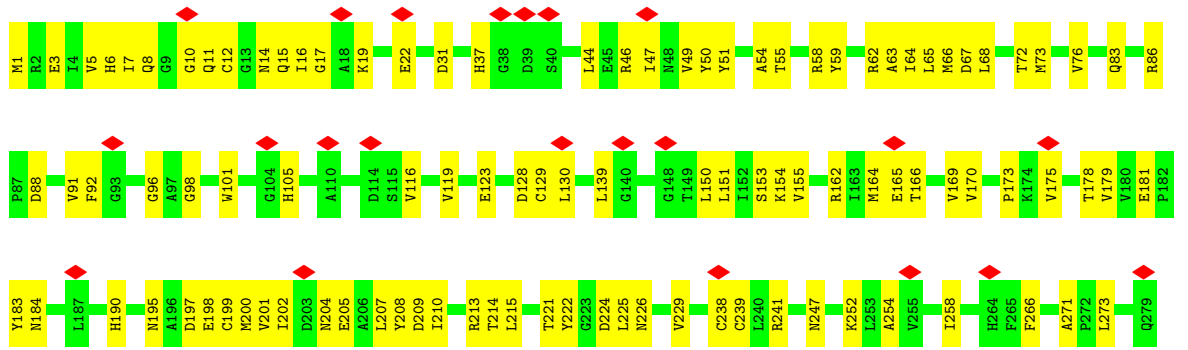

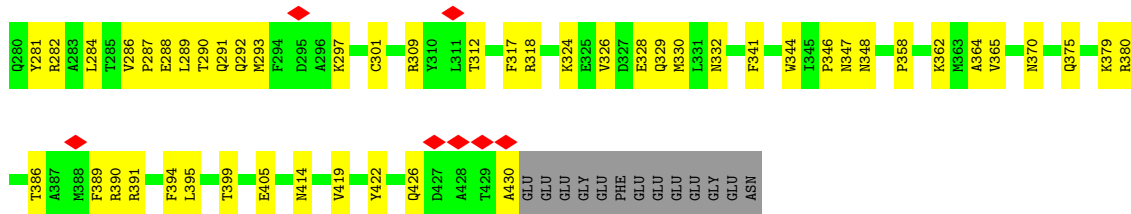

• Molecule 46: Tubulin beta chain

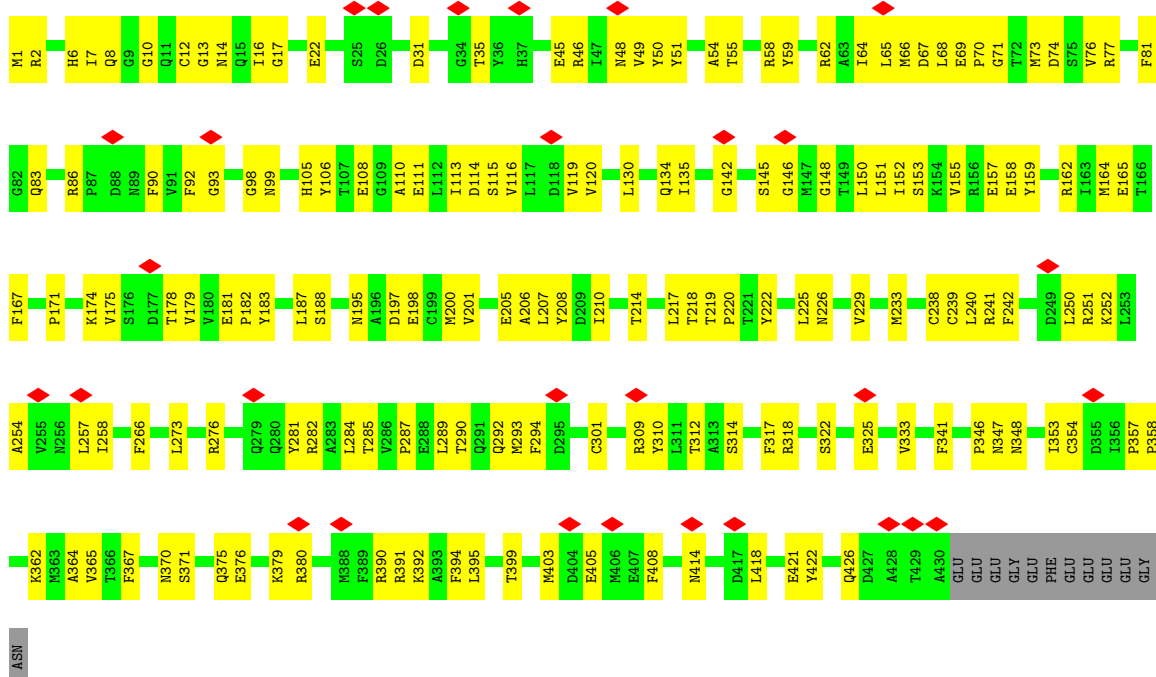

• Molecule 46: Tubulin beta chain

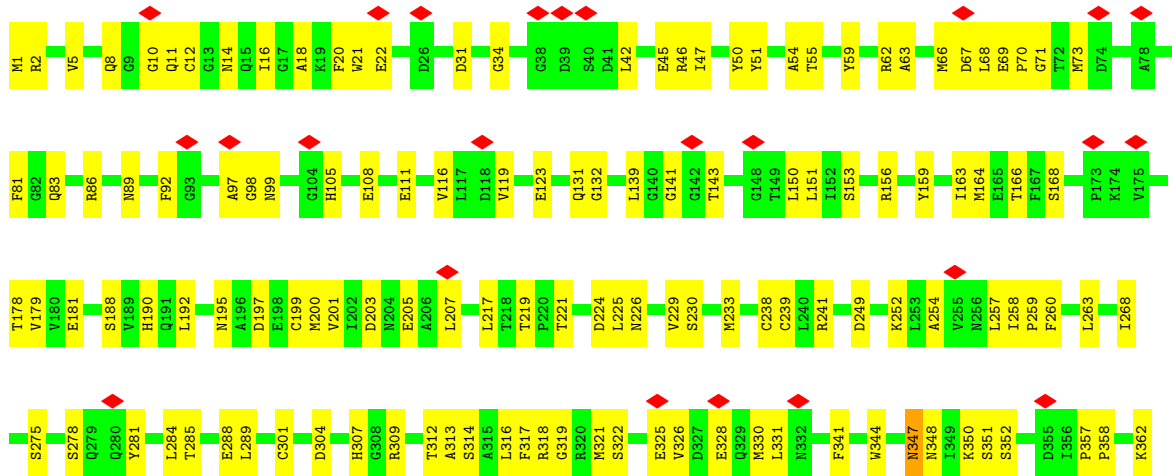

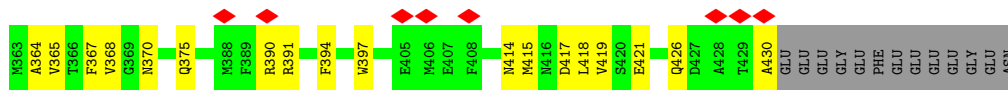

• Molecule 46: Tubulin beta chain

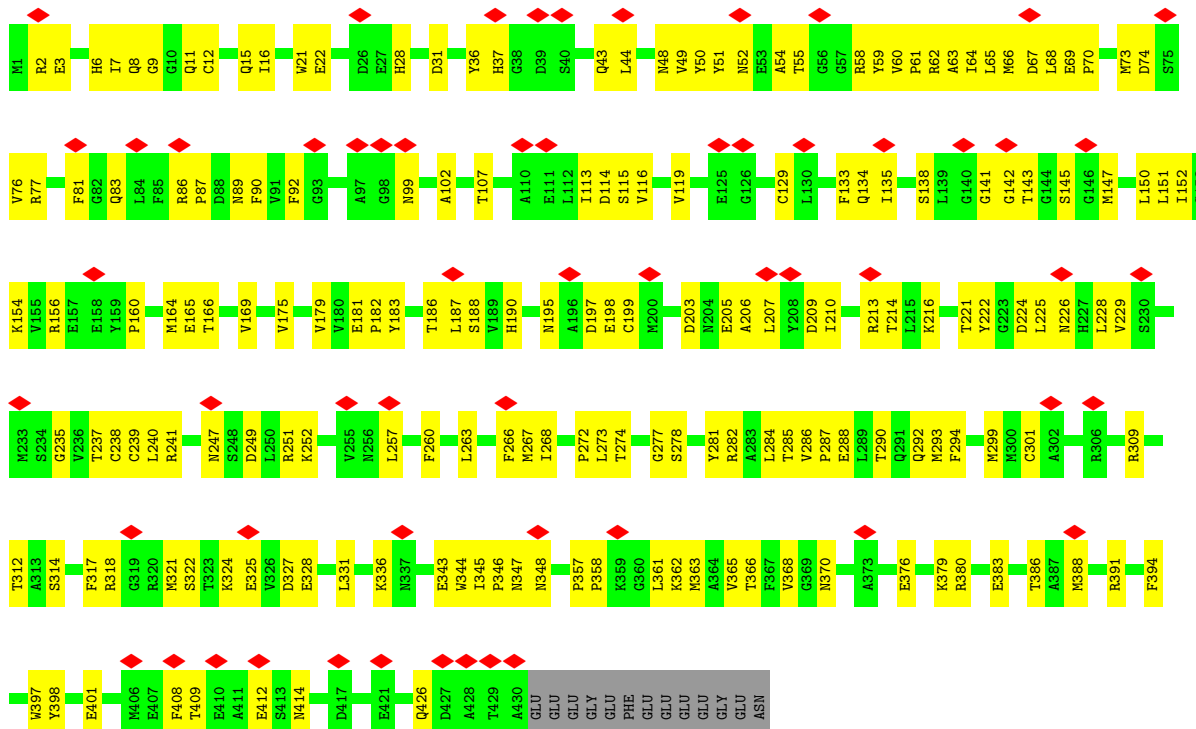

• Molecule 46: Tubulin beta chain

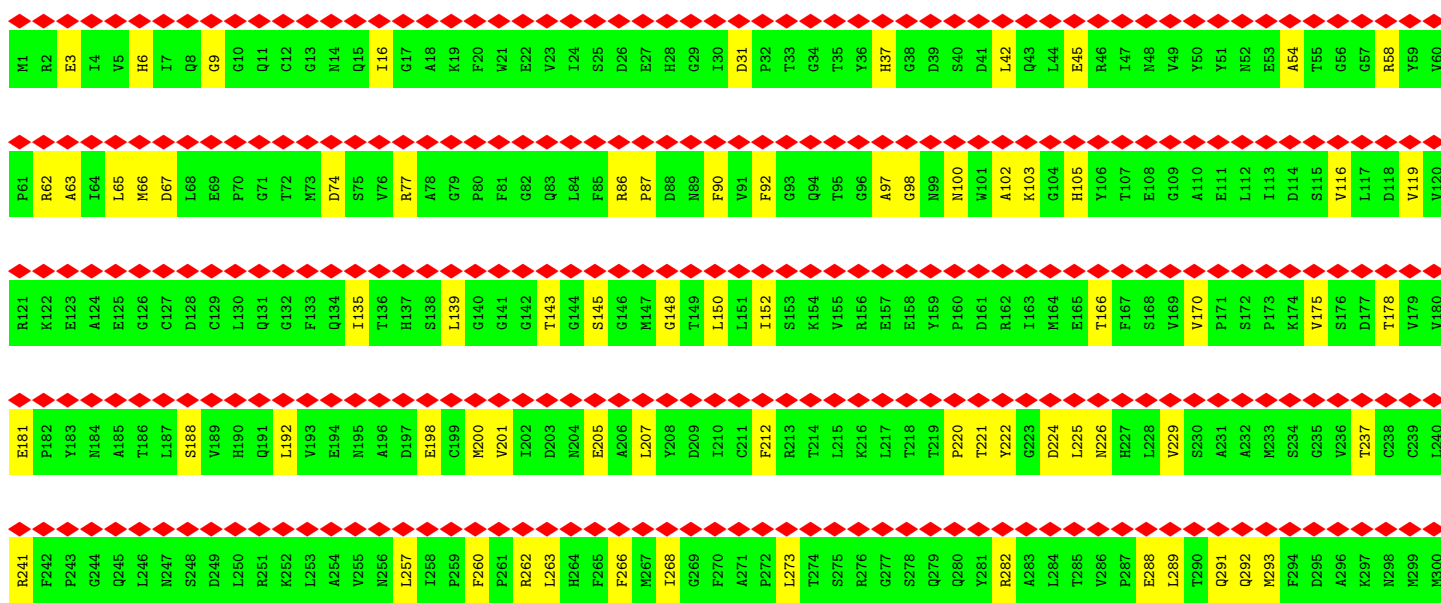
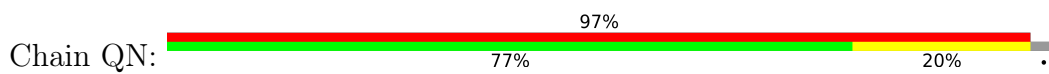

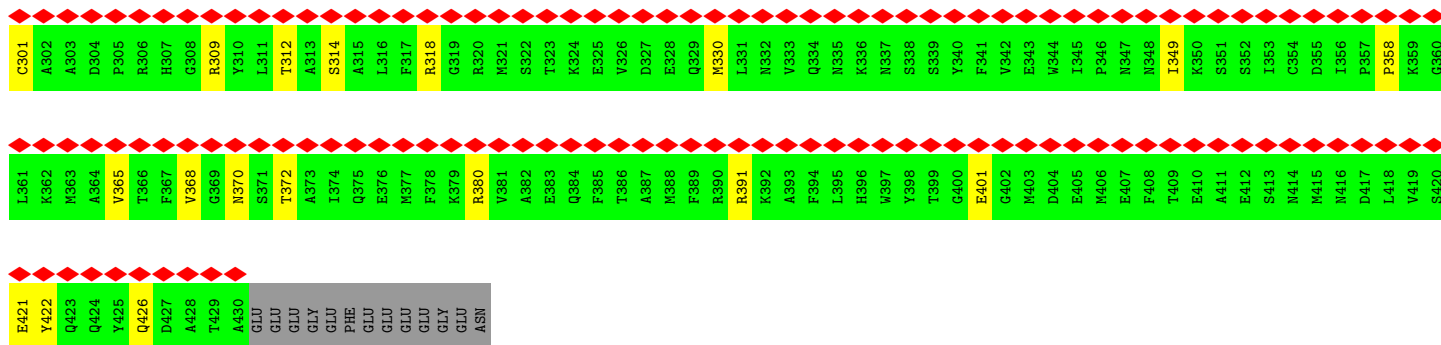

• Molecule 46: Tubulin beta chain

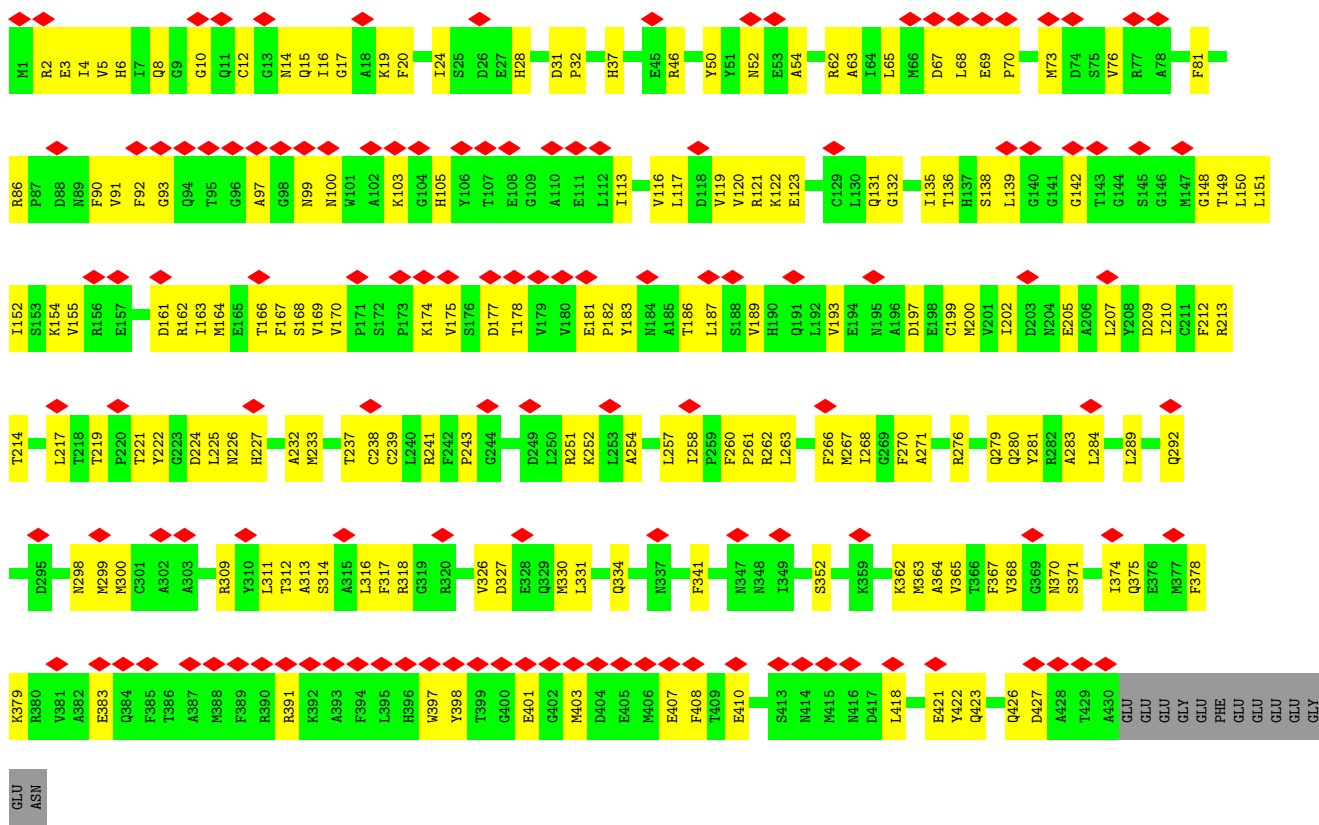

• Molecule 46: Tubulin beta chain

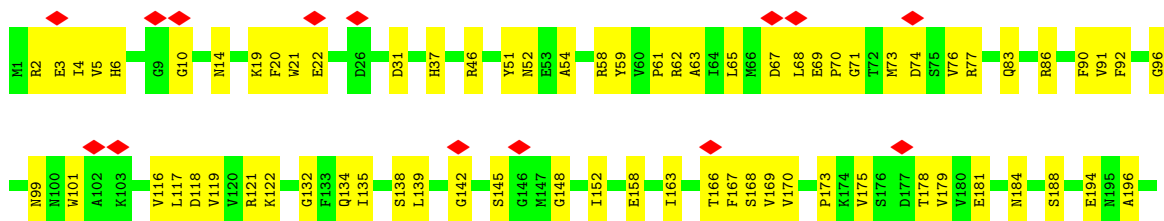



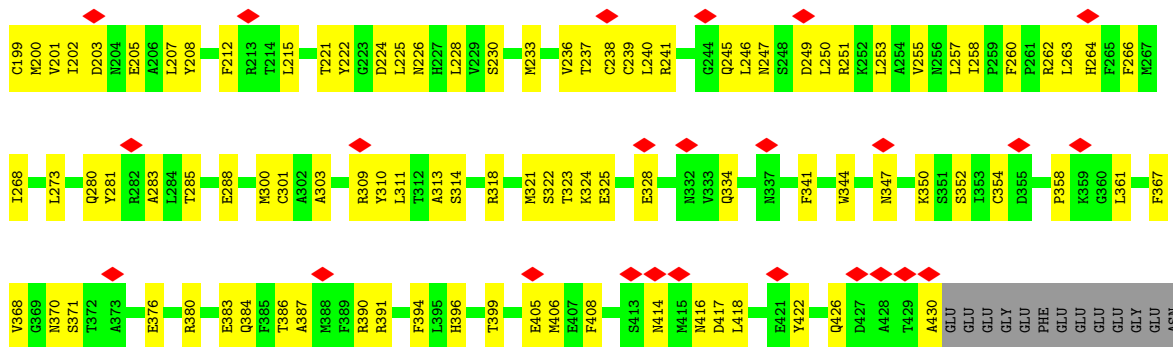

• Molecule 46: Tubulin beta chain

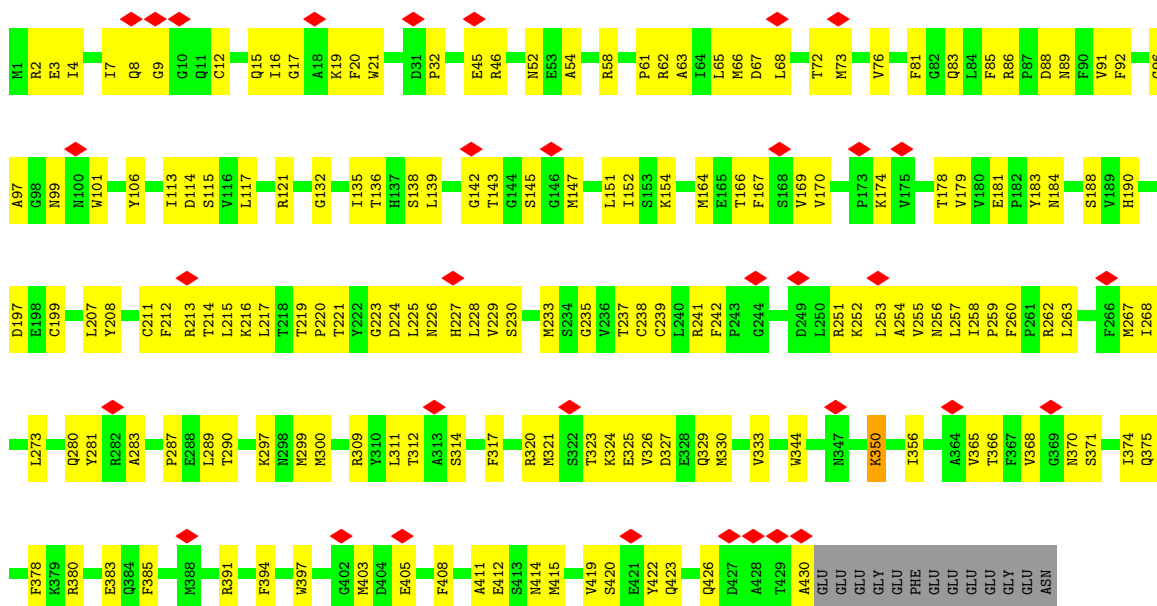

• Molecule 46: Tubulin beta chain

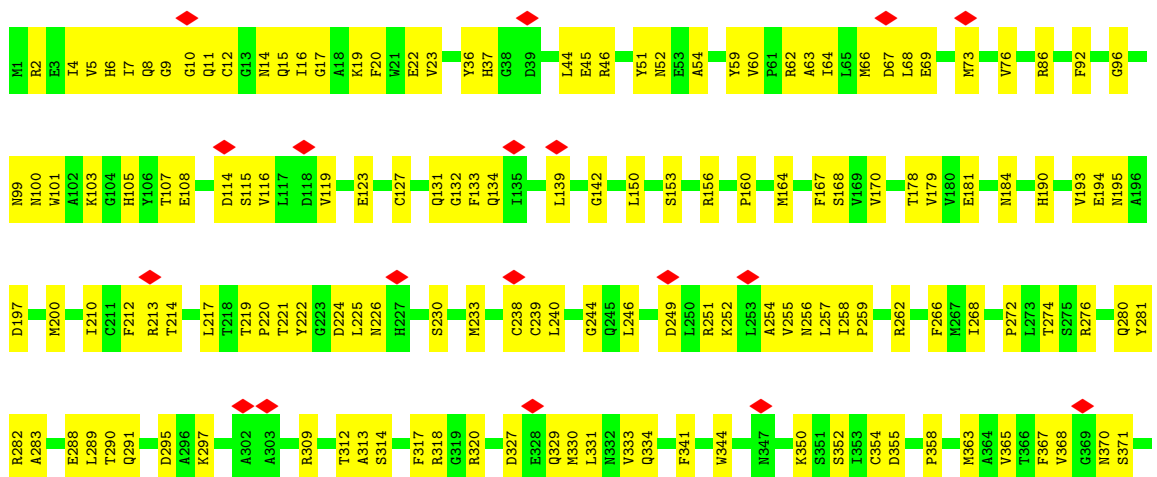

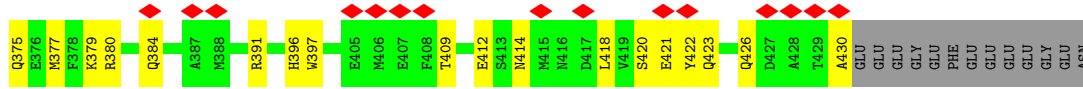

• Molecule 46: Tubulin beta chain

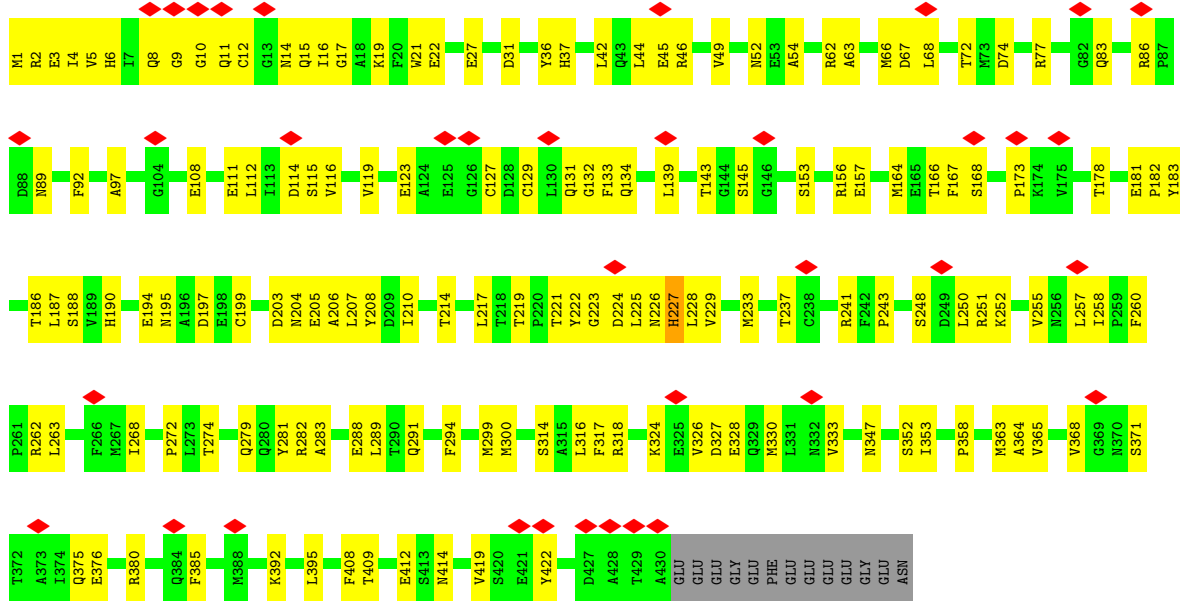

• Molecule 46: Tubulin beta chain

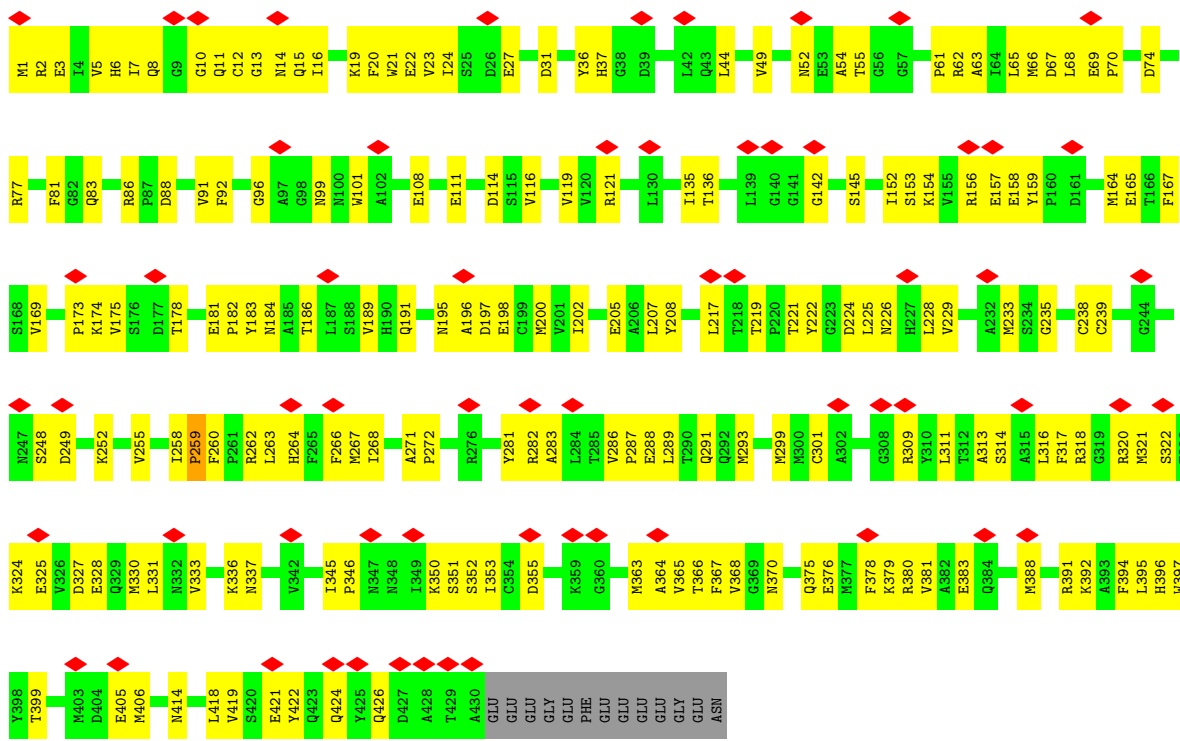



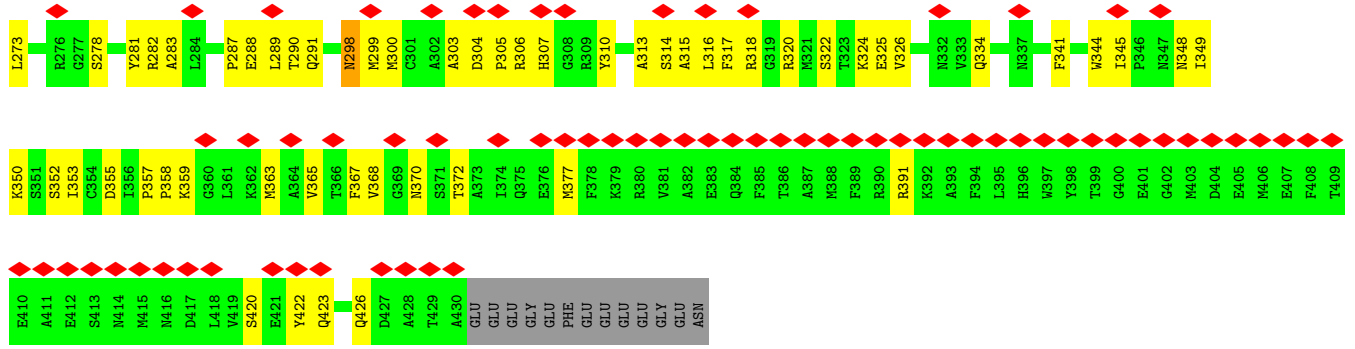

• Molecule 46: Tubulin beta chain

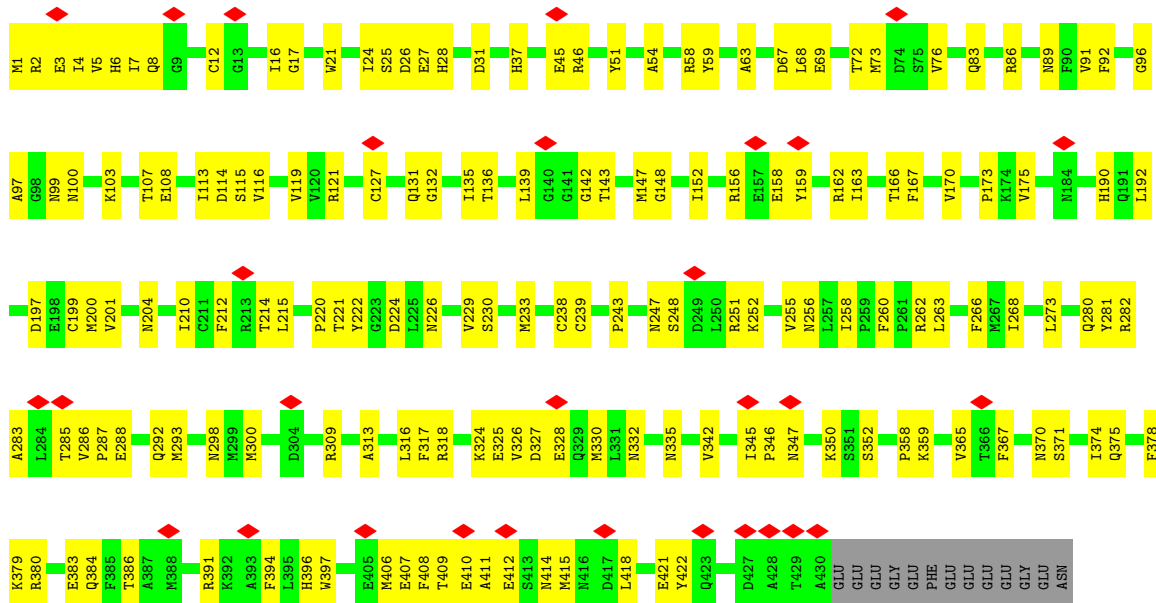

• Molecule 46: Tubulin beta chain

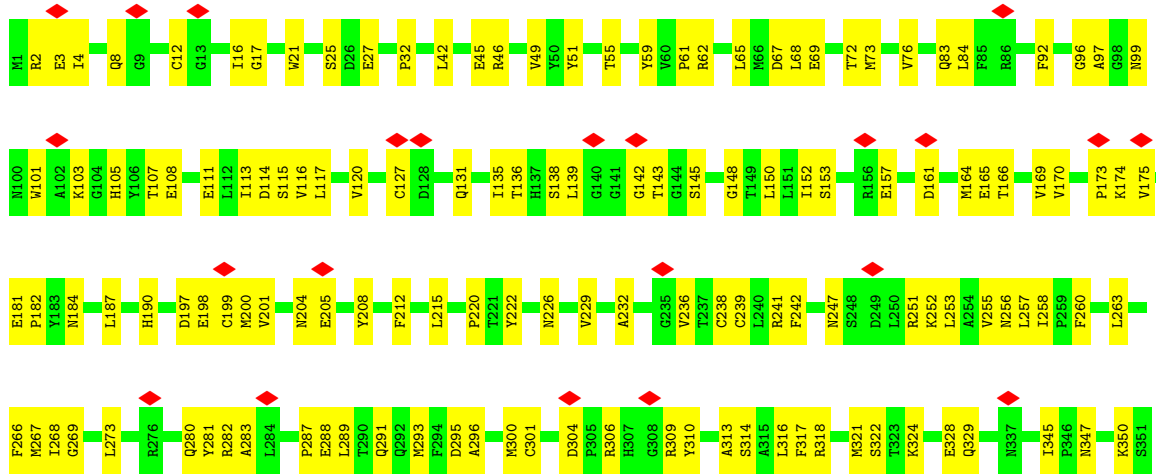

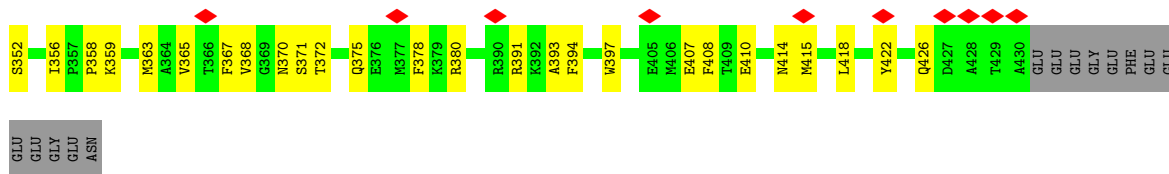

• Molecule 46: Tubulin beta chain

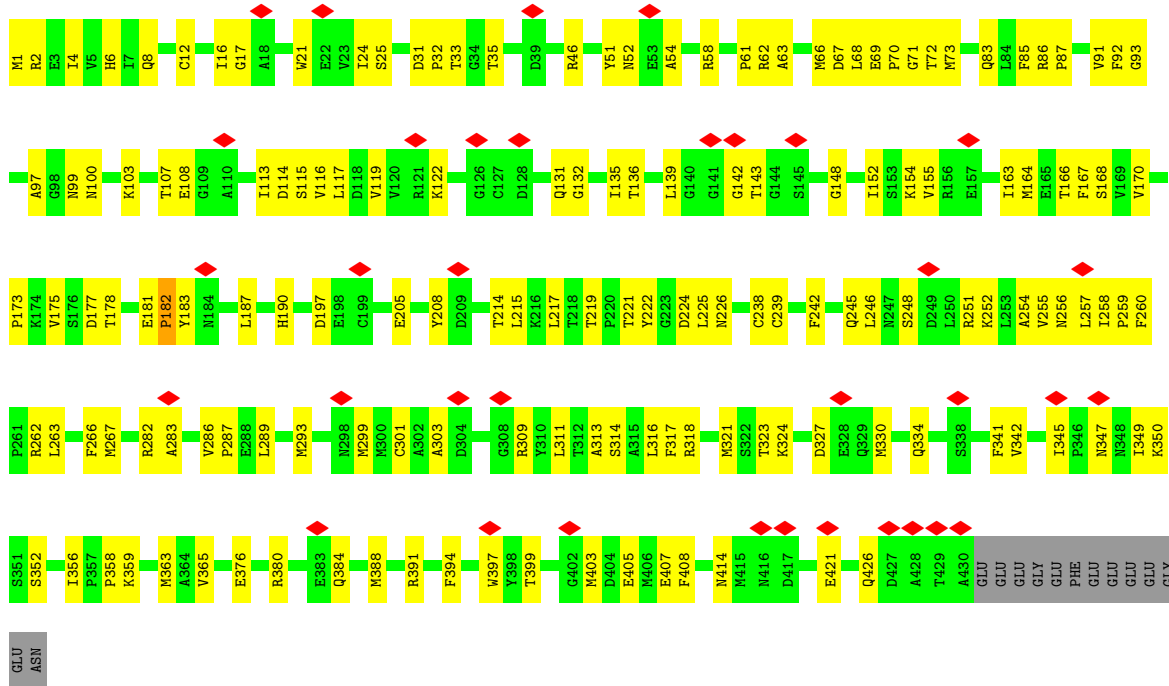

• Molecule 46: Tubulin beta chain

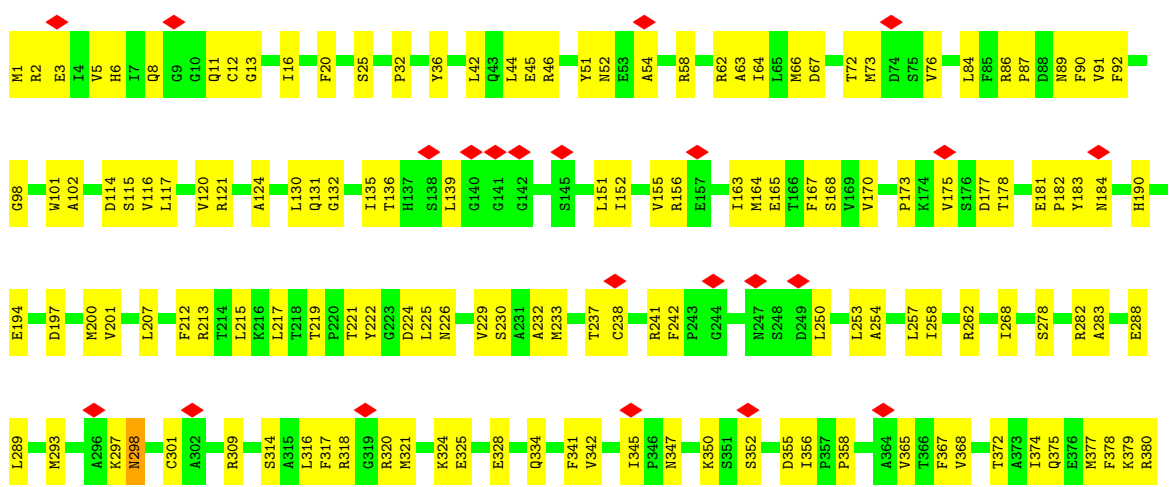

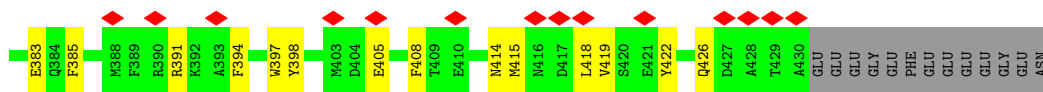

• Molecule 46: Tubulin beta chain

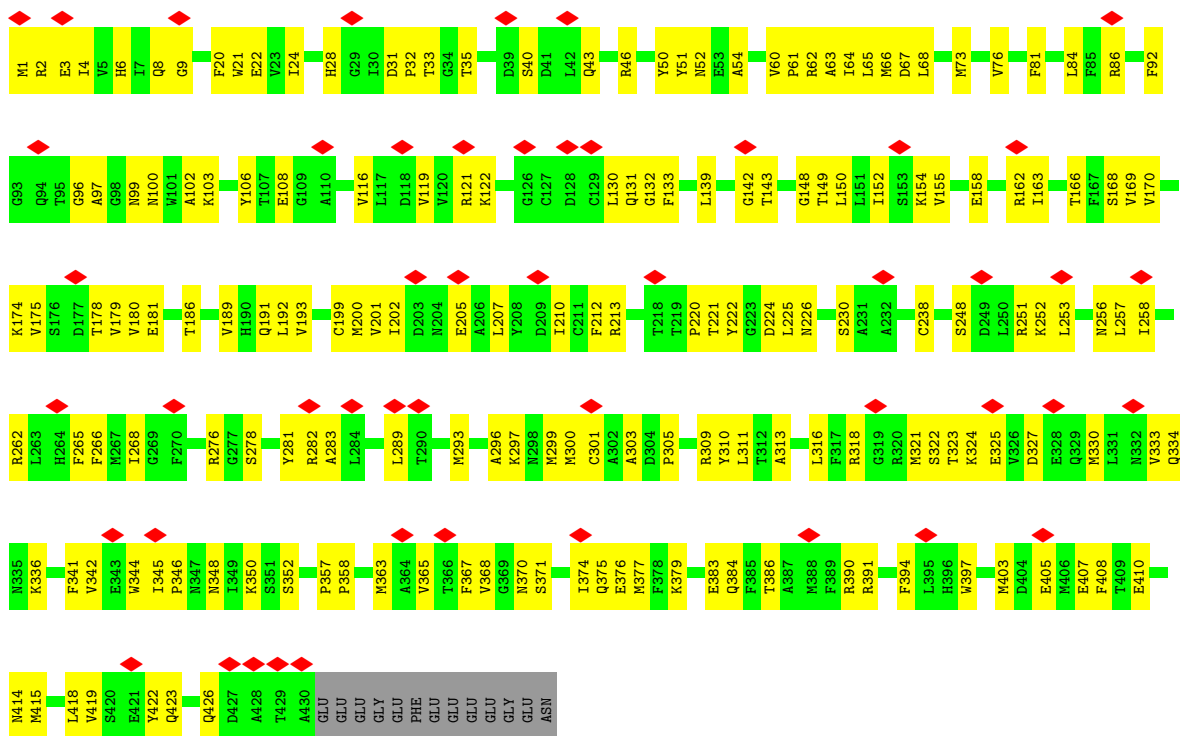

• Molecule 46: Tubulin beta chain

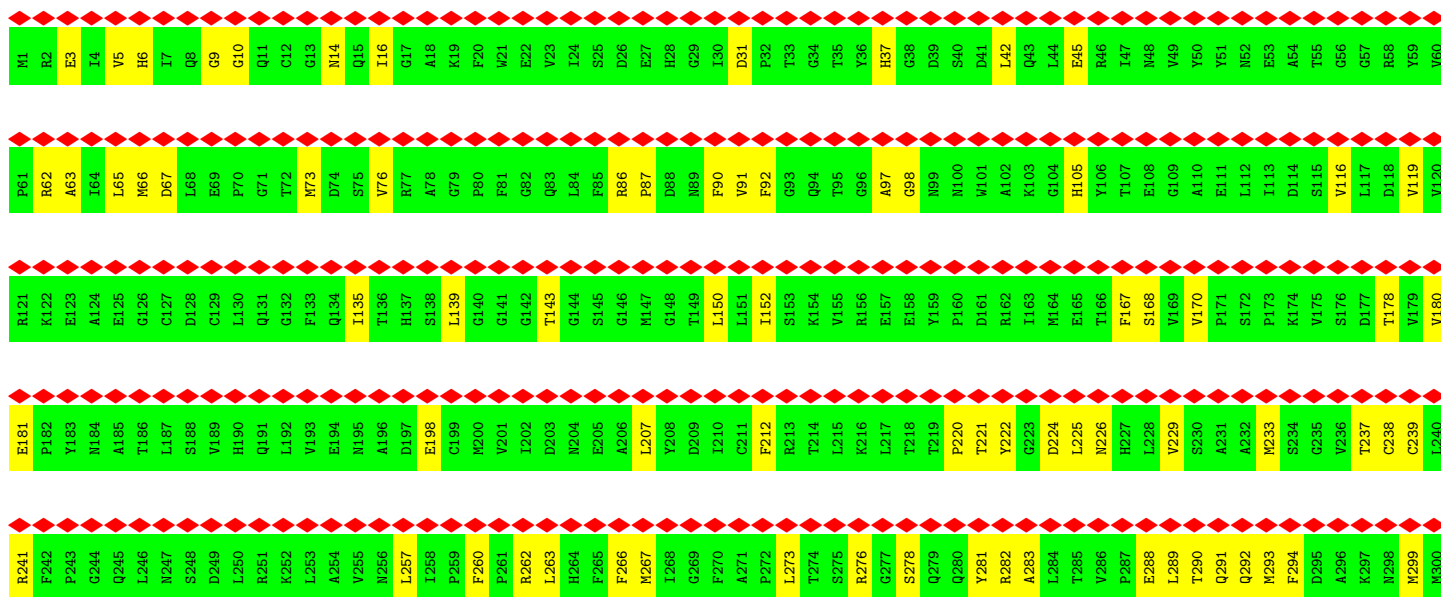
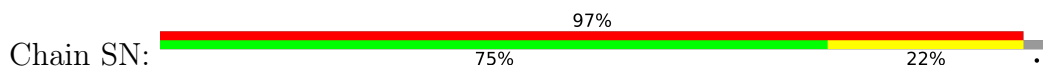



• Molecule 46: Tubulin beta chain

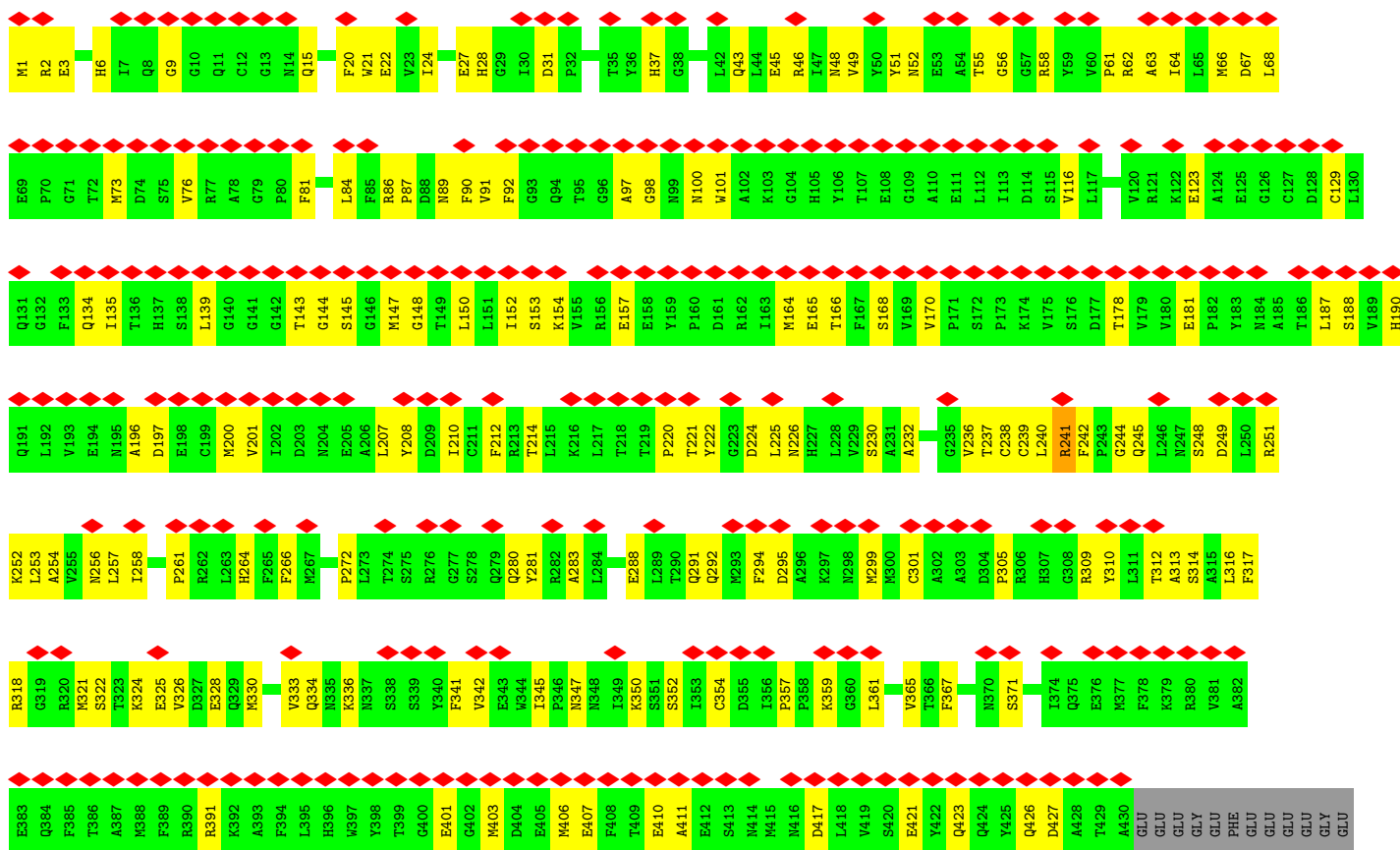

• Molecule 46: Tubulin beta chain

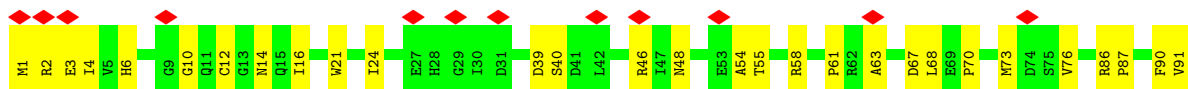

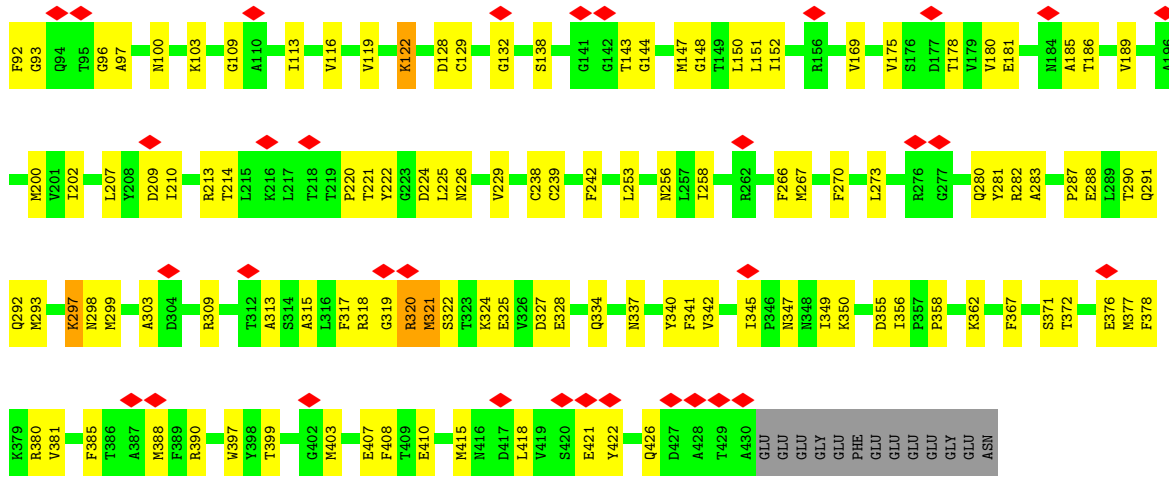

• Molecule 46: Tubulin beta chain

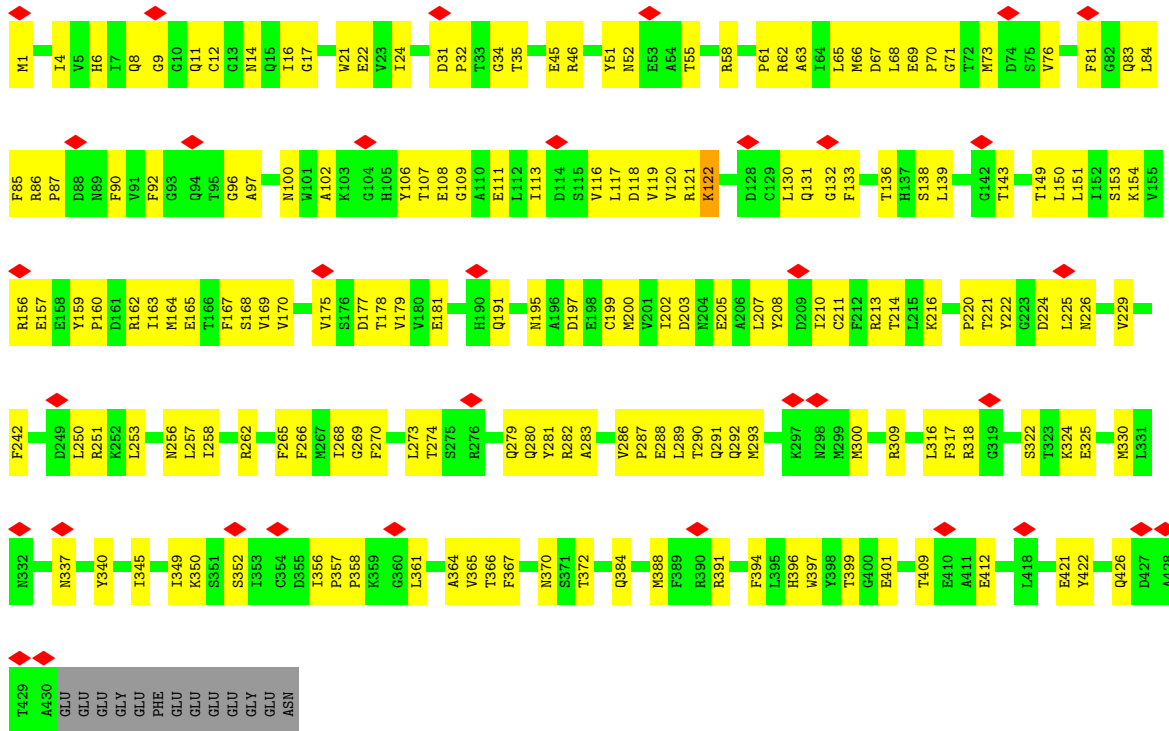

• Molecule 46: Tubulin beta chain

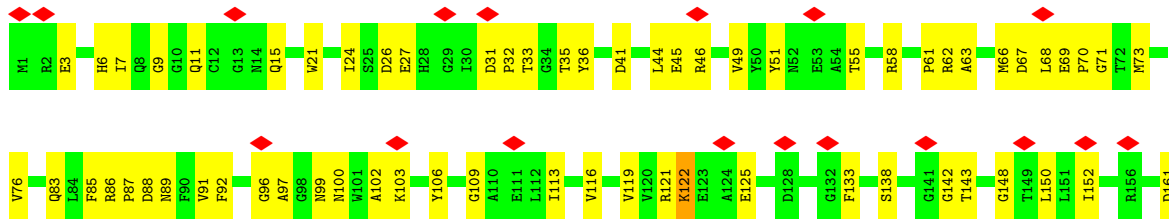



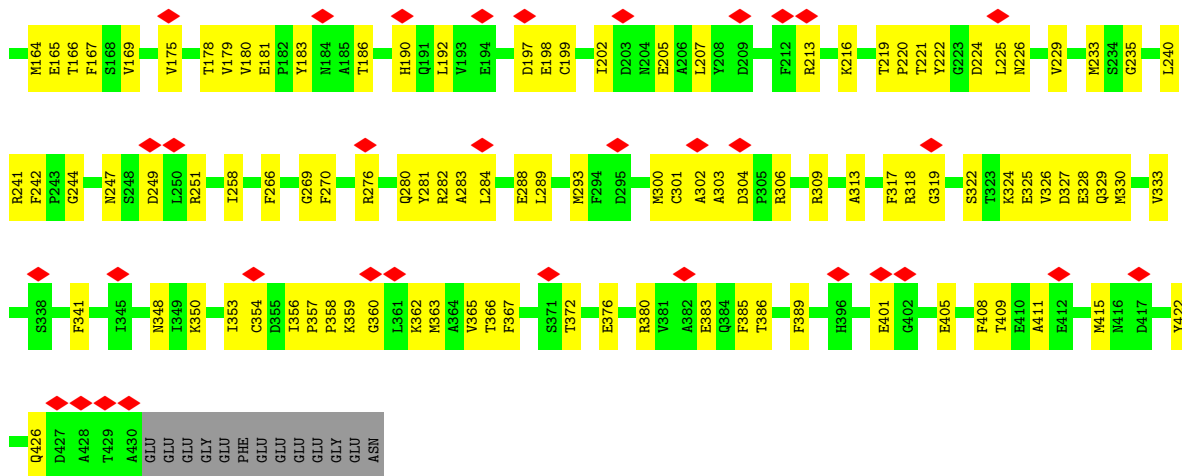

• Molecule 46: Tubulin beta chain

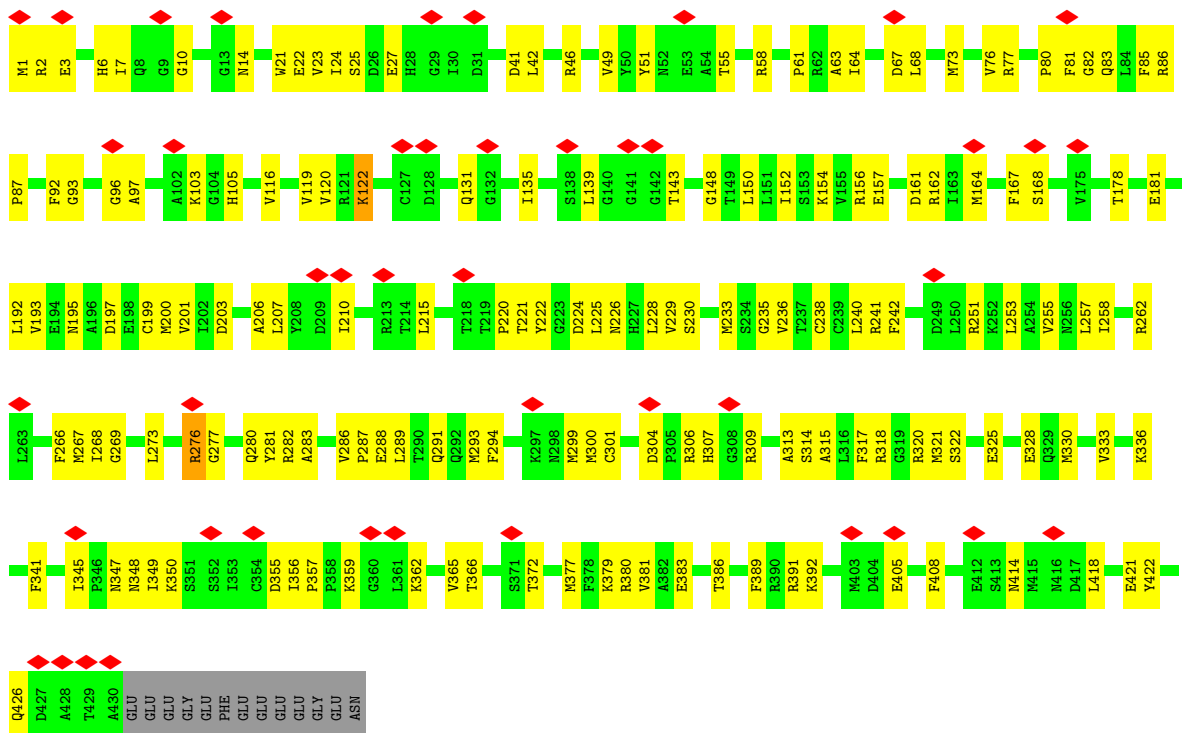

• Molecule 46: Tubulin beta chain

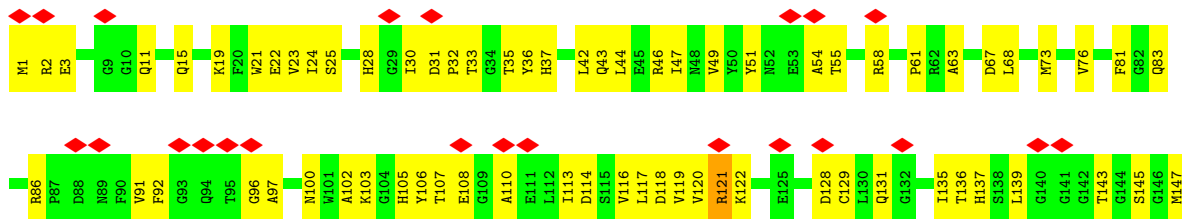

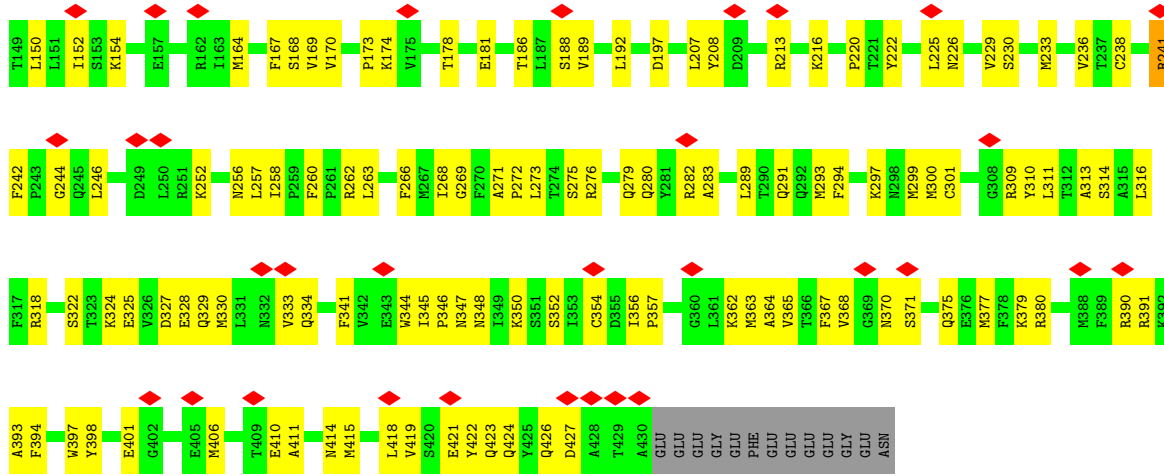

• Molecule 46: Tubulin beta chain

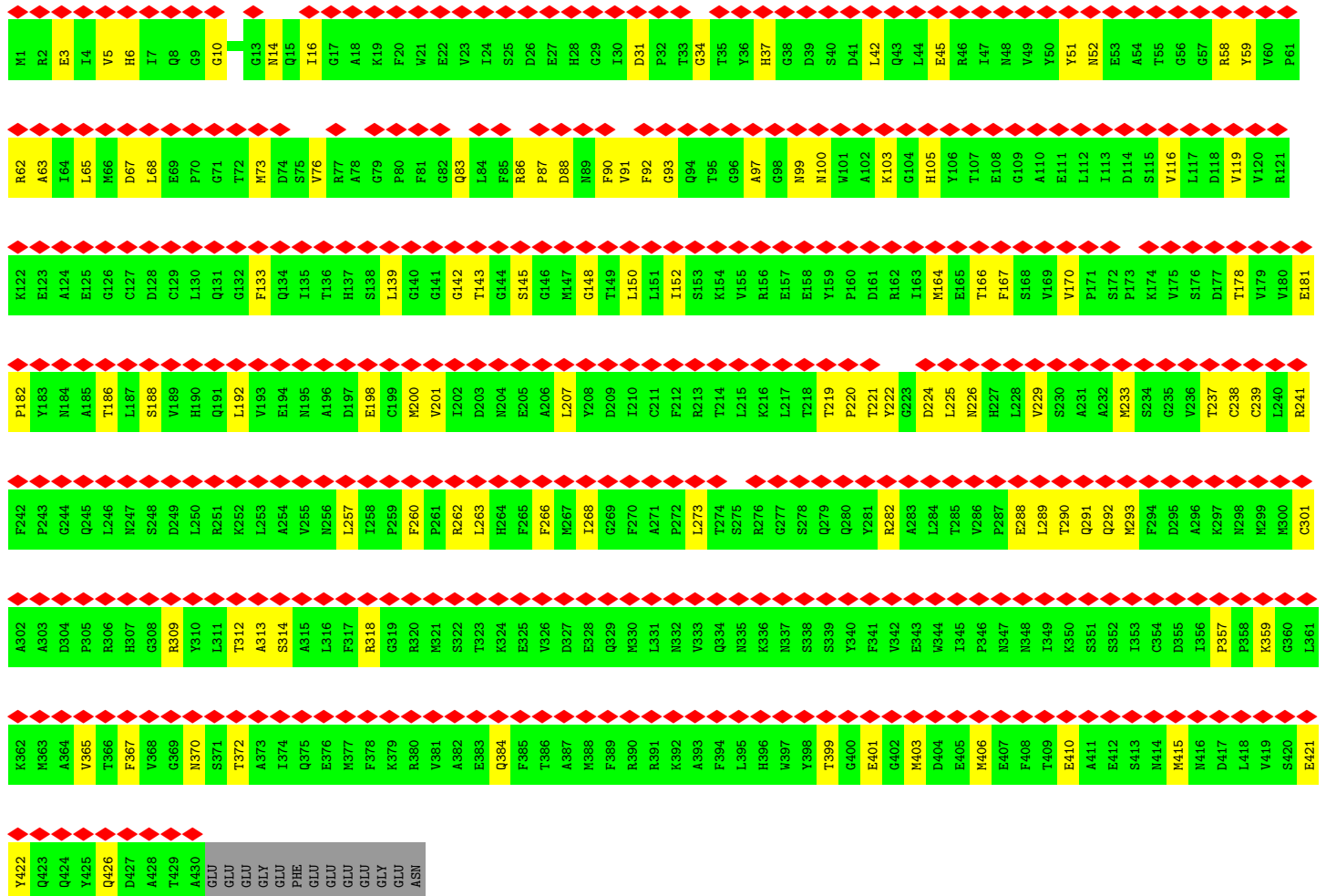
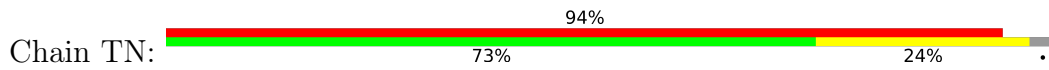

• Molecule 46: Tubulin beta chain



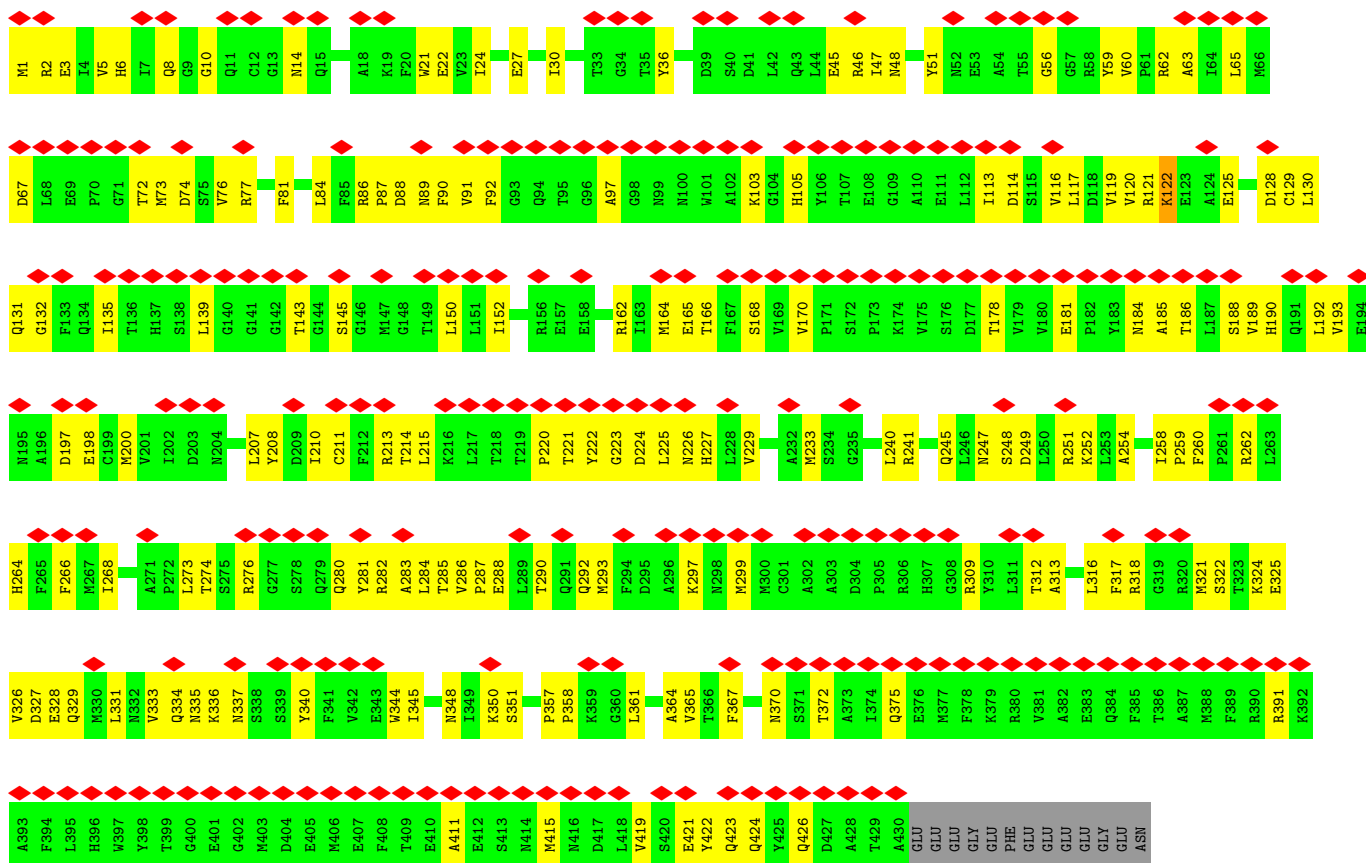

• Molecule 46: Tubulin beta chain

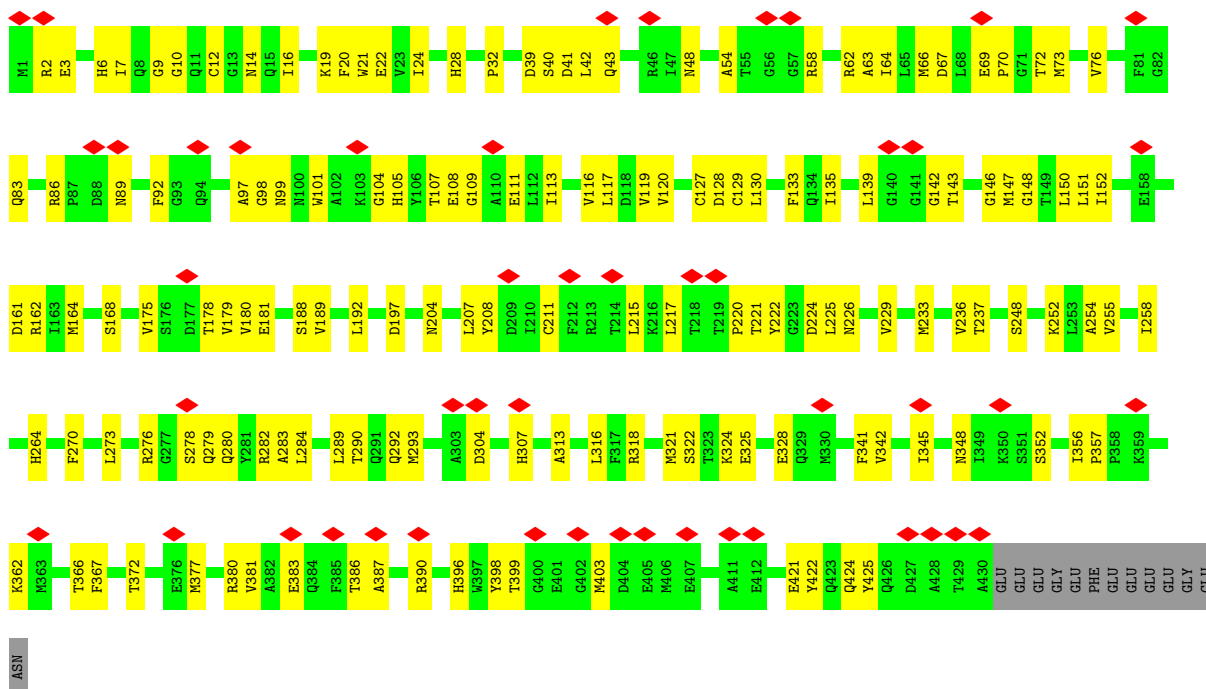

- Molecule 46: Tubulin beta chain

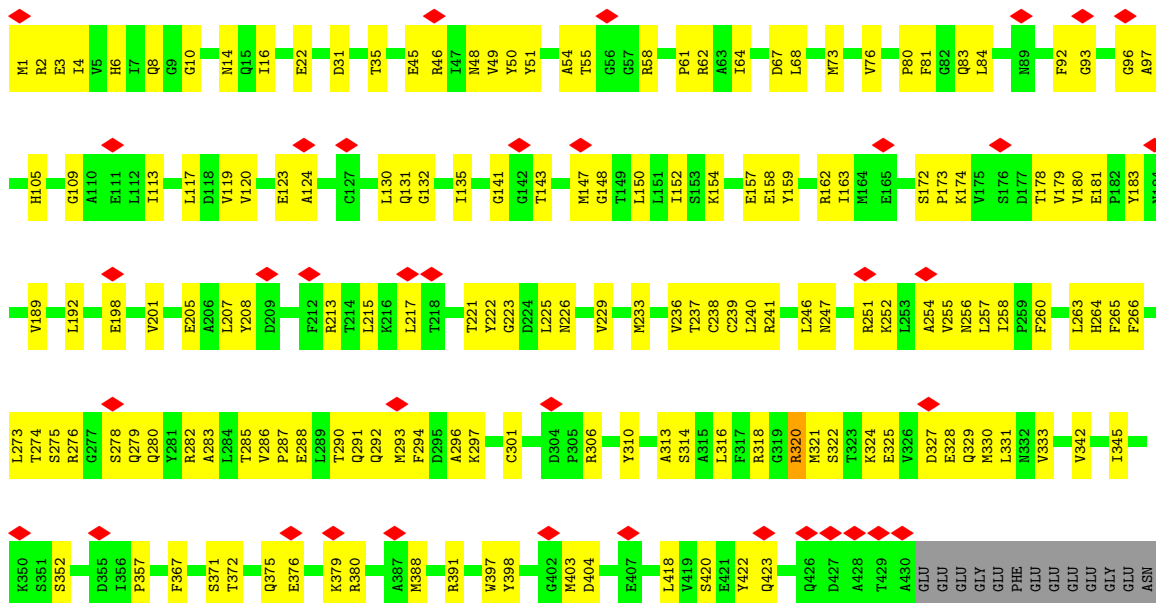

- Molecule 46: Tubulin beta chain

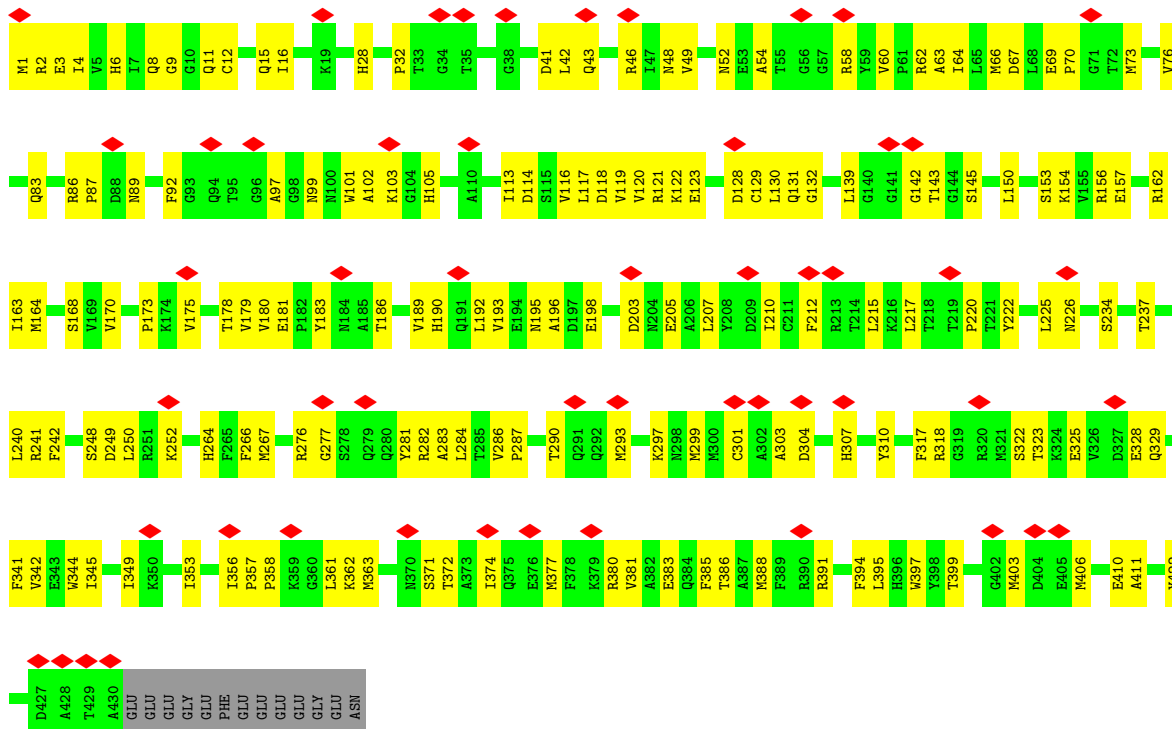

- Molecule 46: Tubulin beta chain



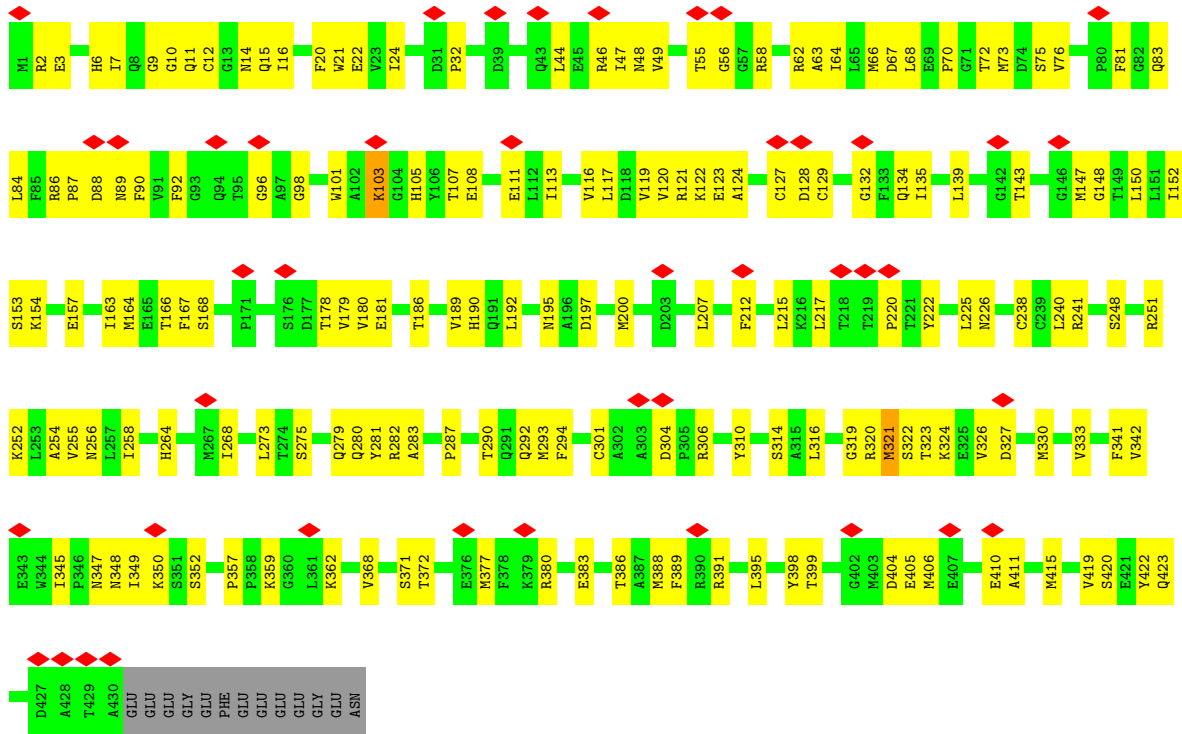

• Molecule 46: Tubulin beta chain

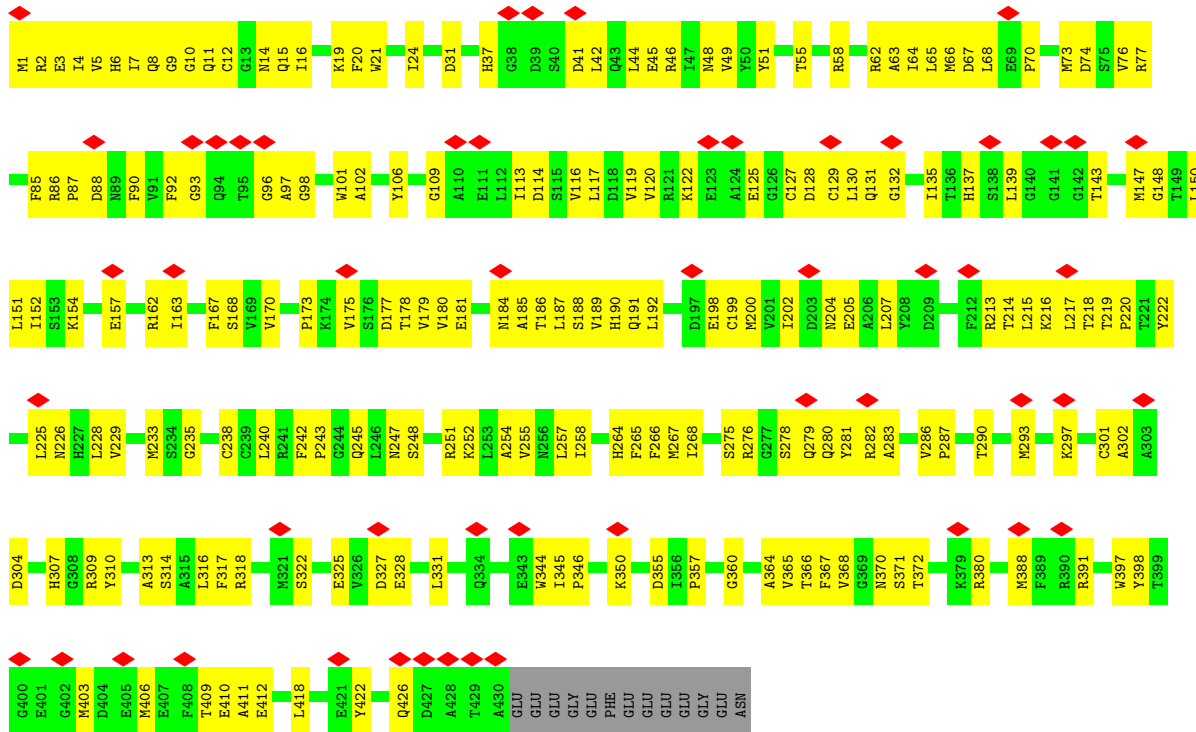

• Molecule 46: Tubulin beta chain

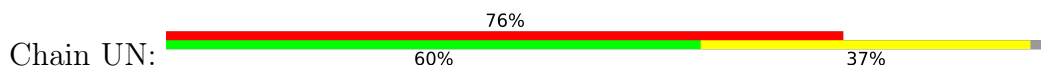

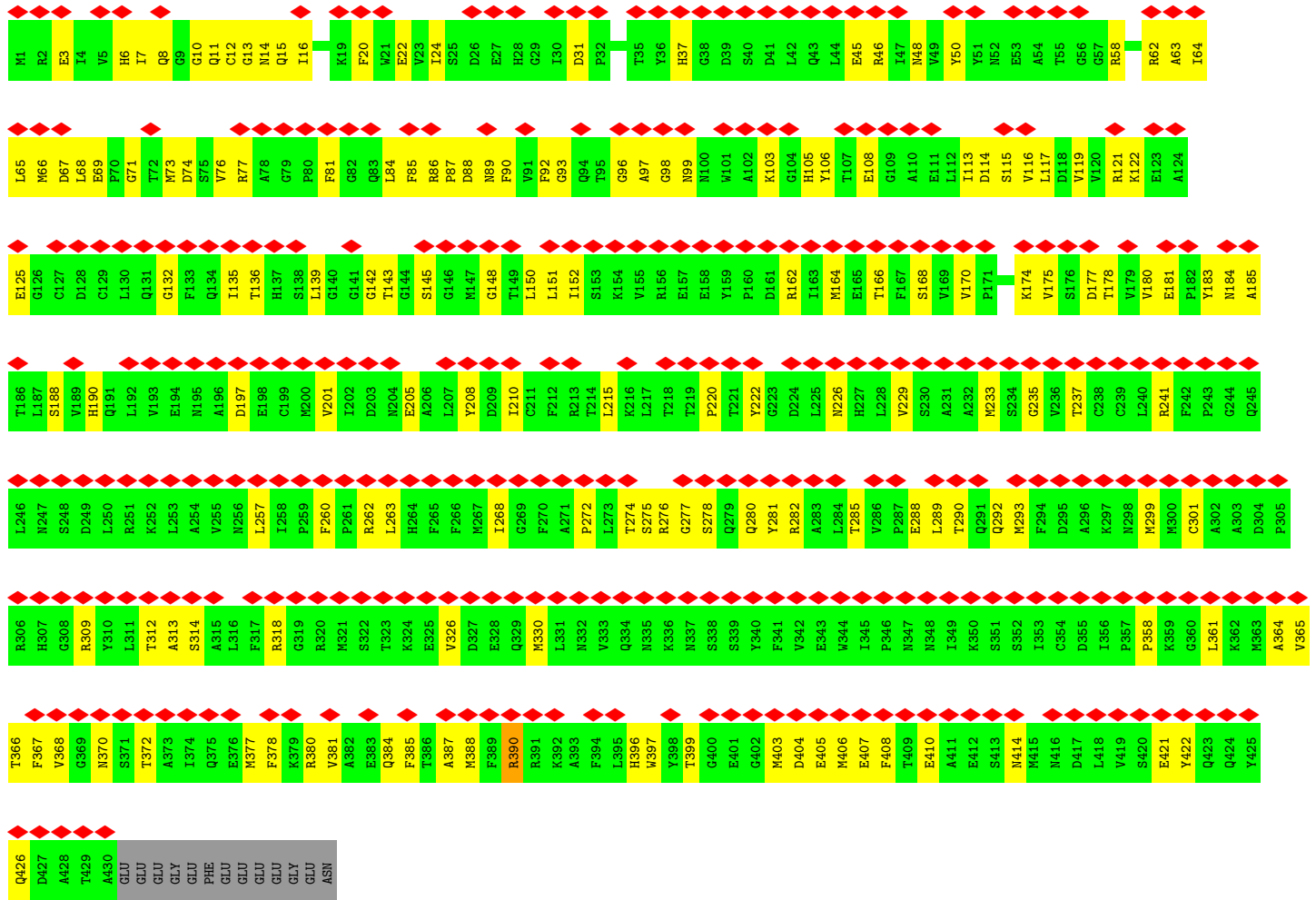

- Molecule 46: Tubulin beta chain

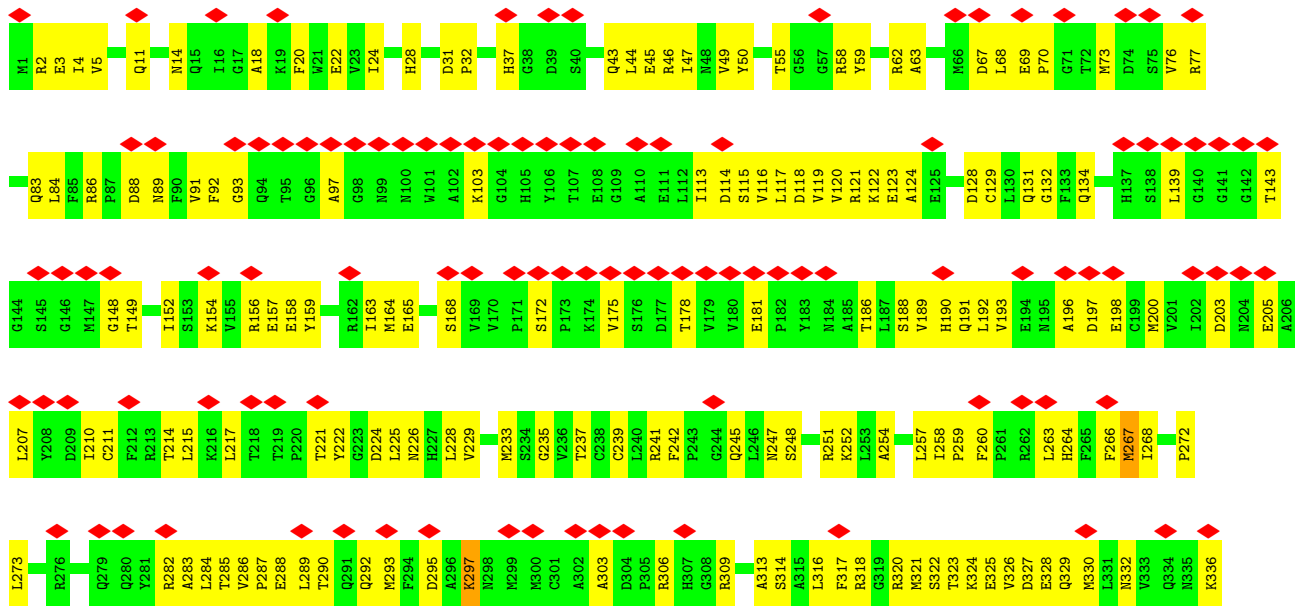

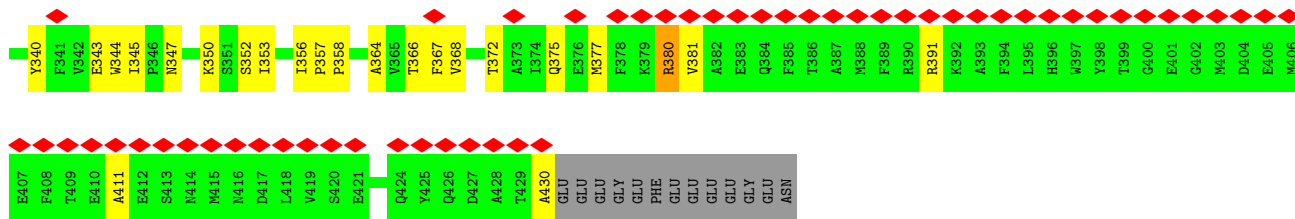

• Molecule 46: Tubulin beta chain

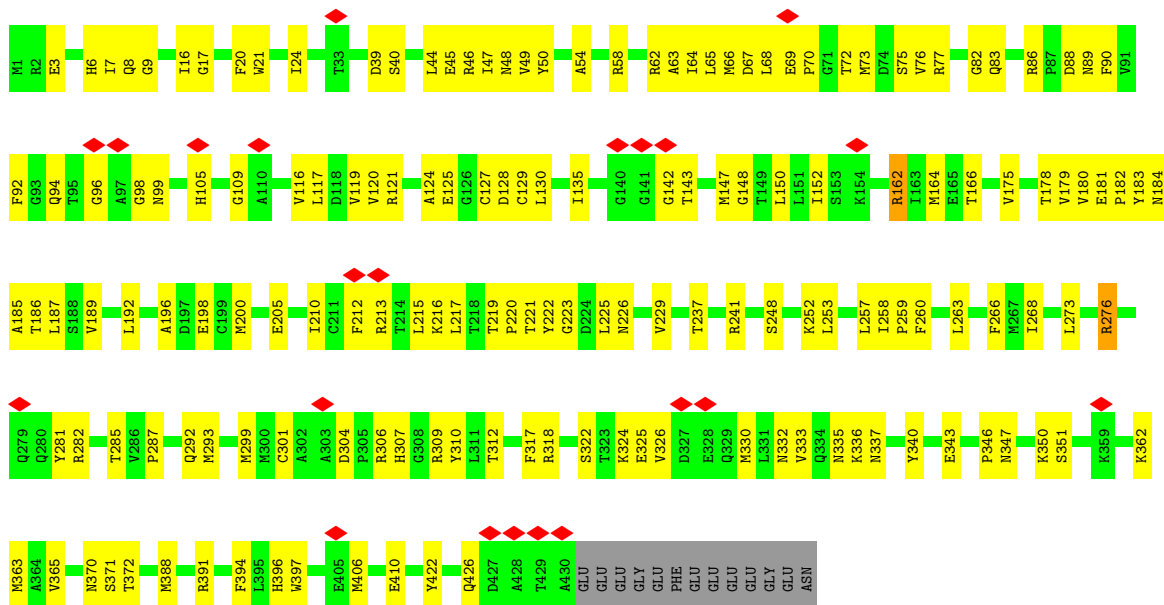

• Molecule 46: Tubulin beta chain

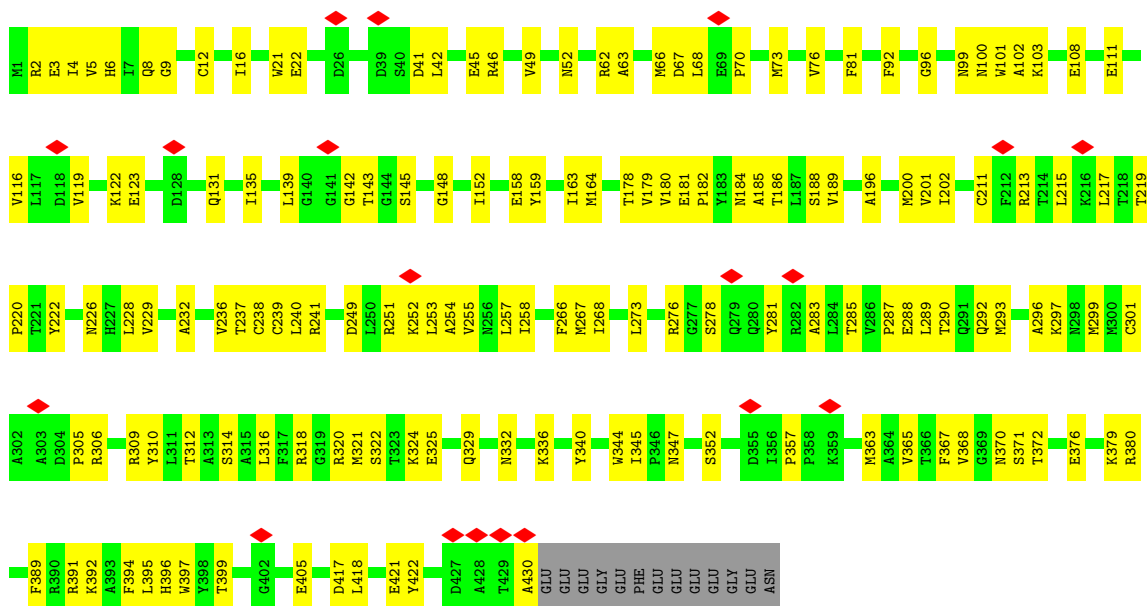

• Molecule 46: Tubulin beta chain

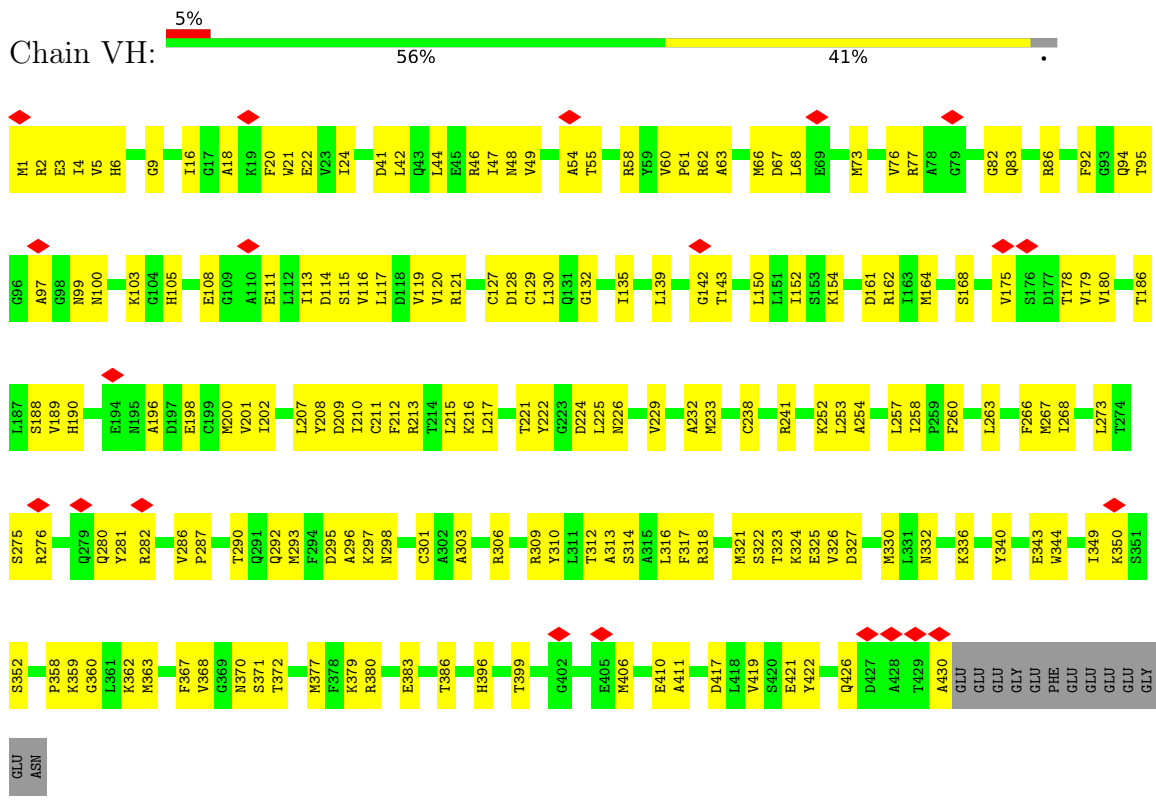

• Molecule 46: Tubulin beta chain

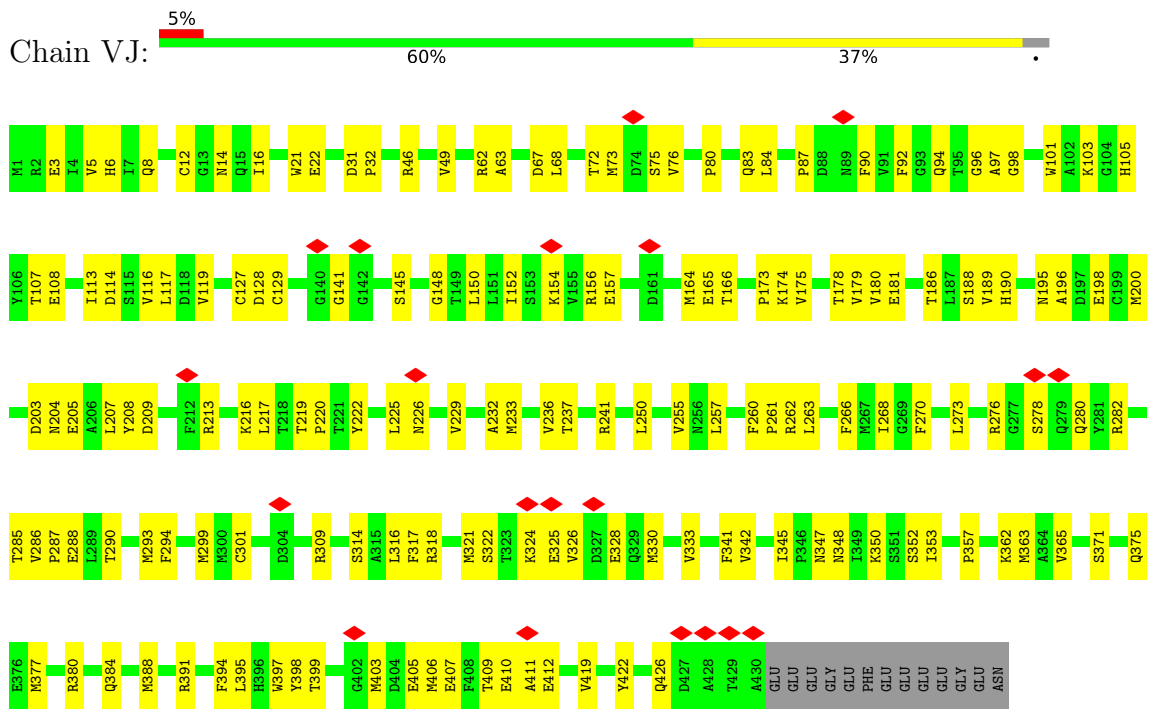

• Molecule 46: Tubulin beta chain





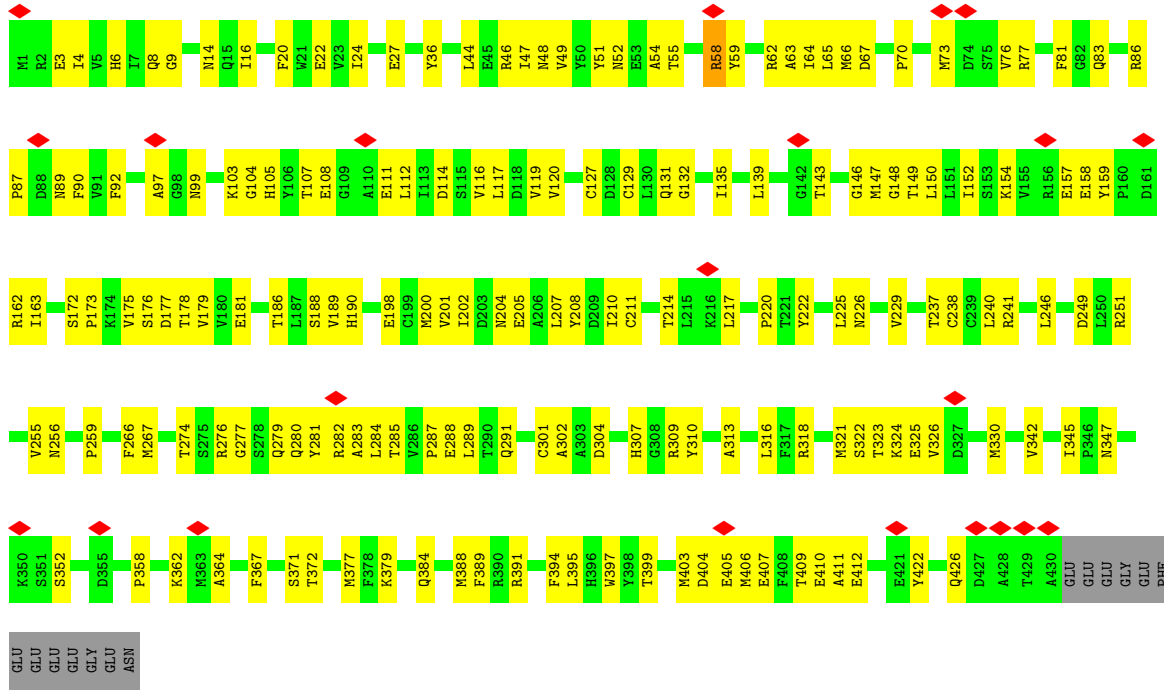

• Molecule 46: Tubulin beta chain

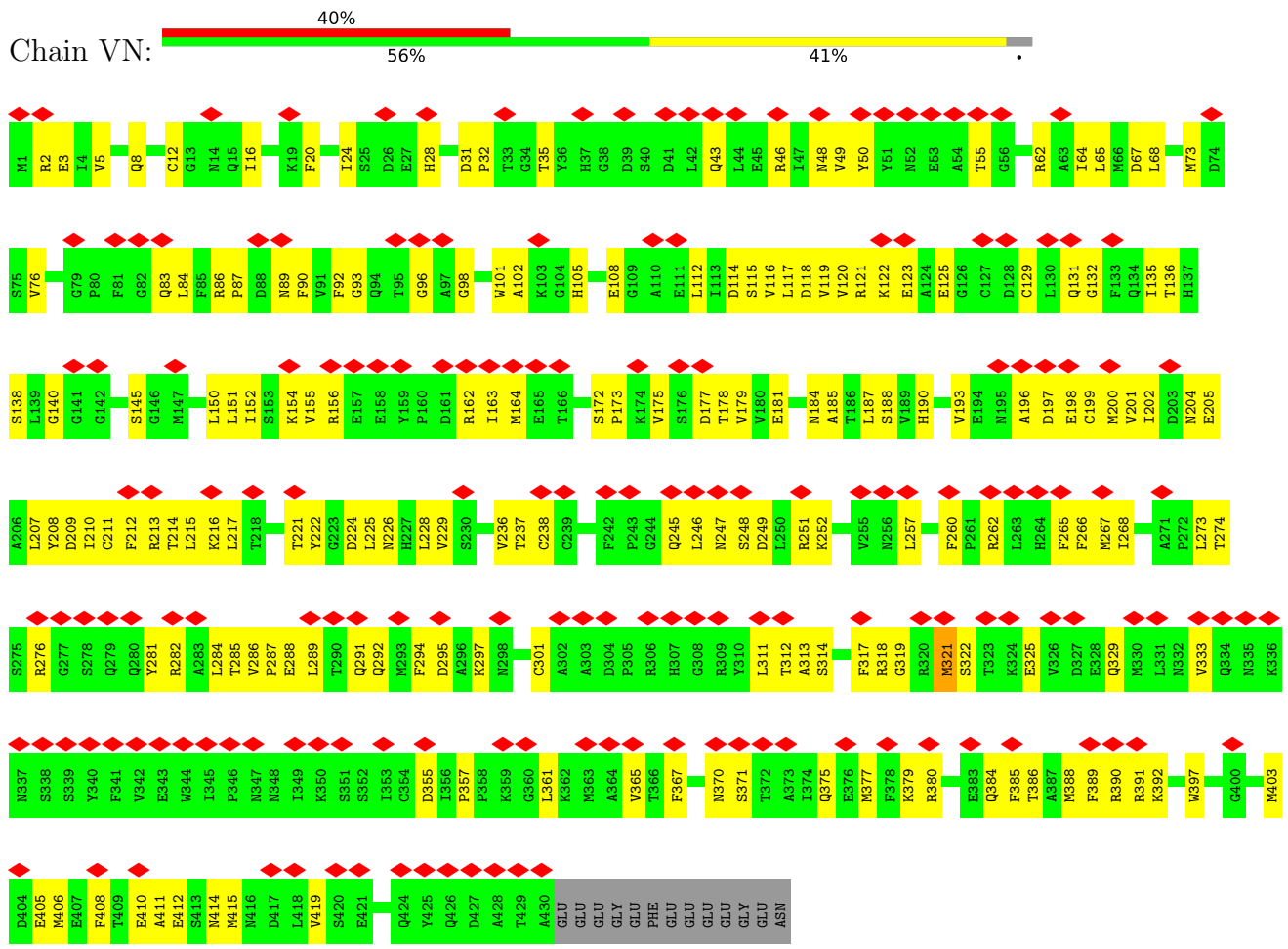

• Molecule 46: Tubulin beta chain

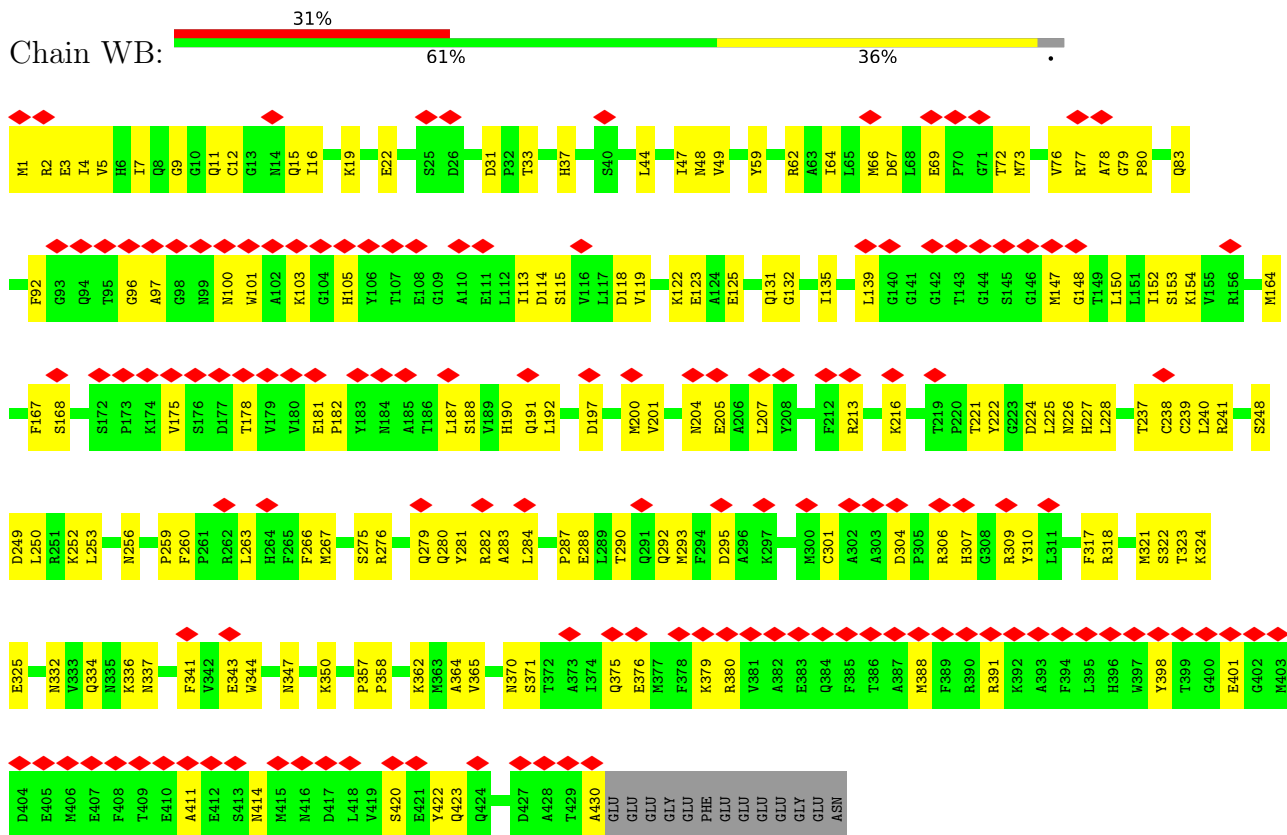

• Molecule 46: Tubulin beta chain

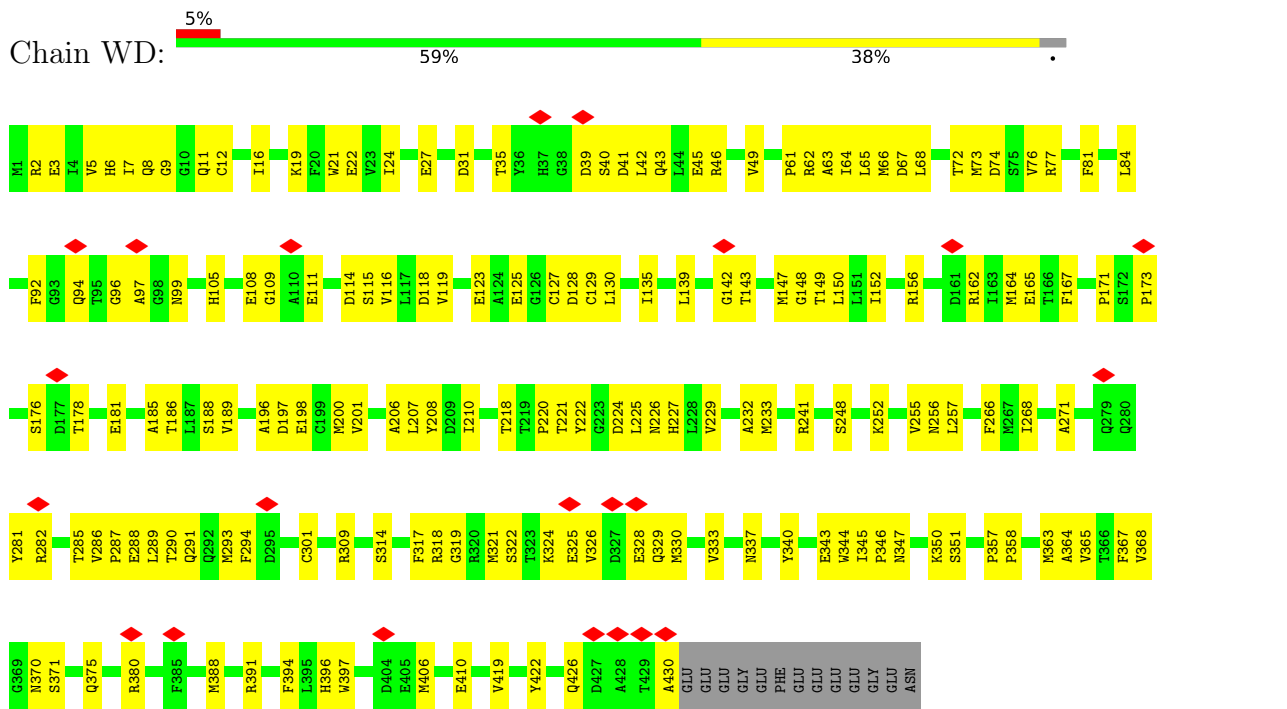

• Molecule 46: Tubulin beta chain



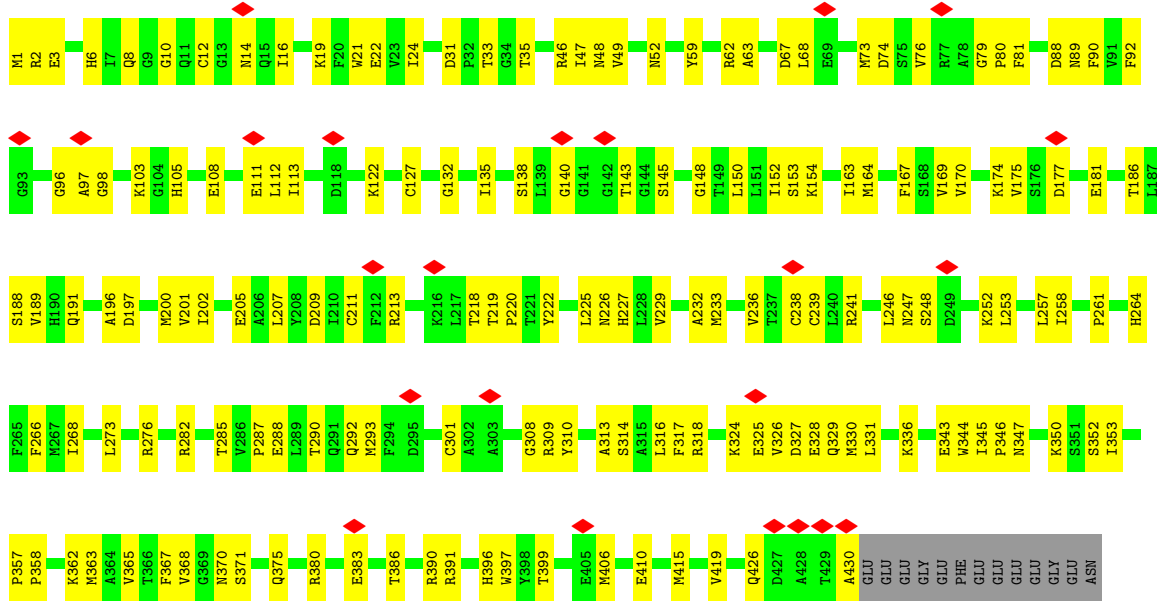

• Molecule 46: Tubulin beta chain

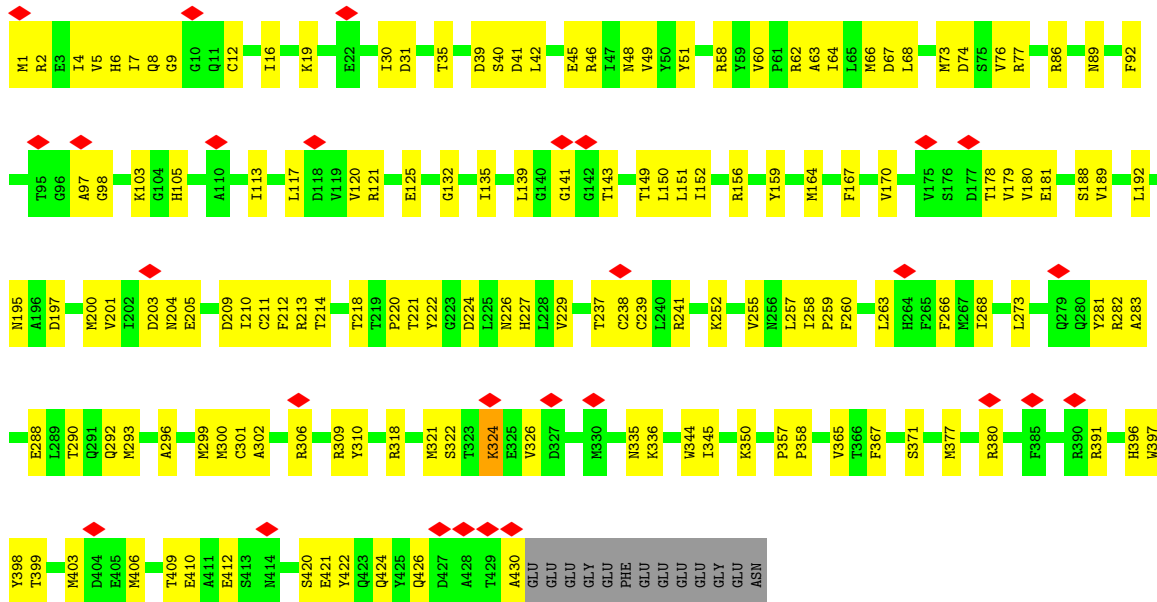

• Molecule 46: Tubulin beta chain

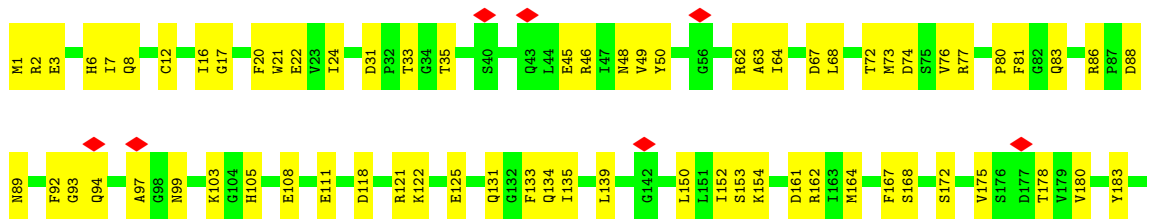

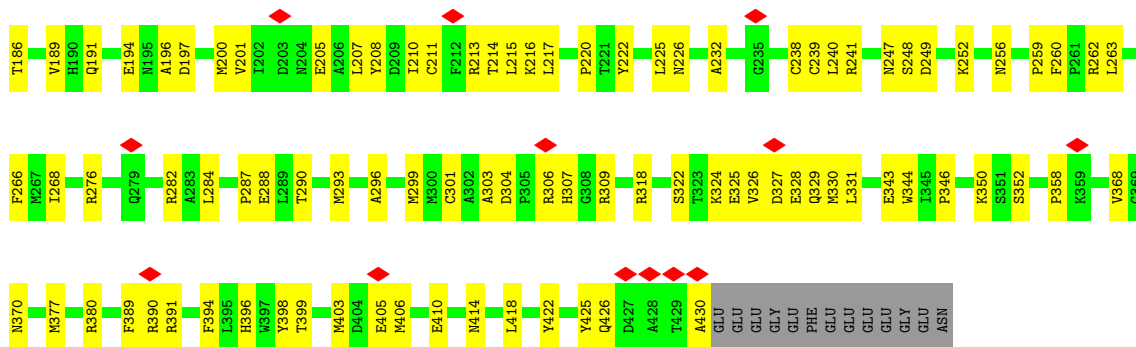

• Molecule 46: Tubulin beta chain

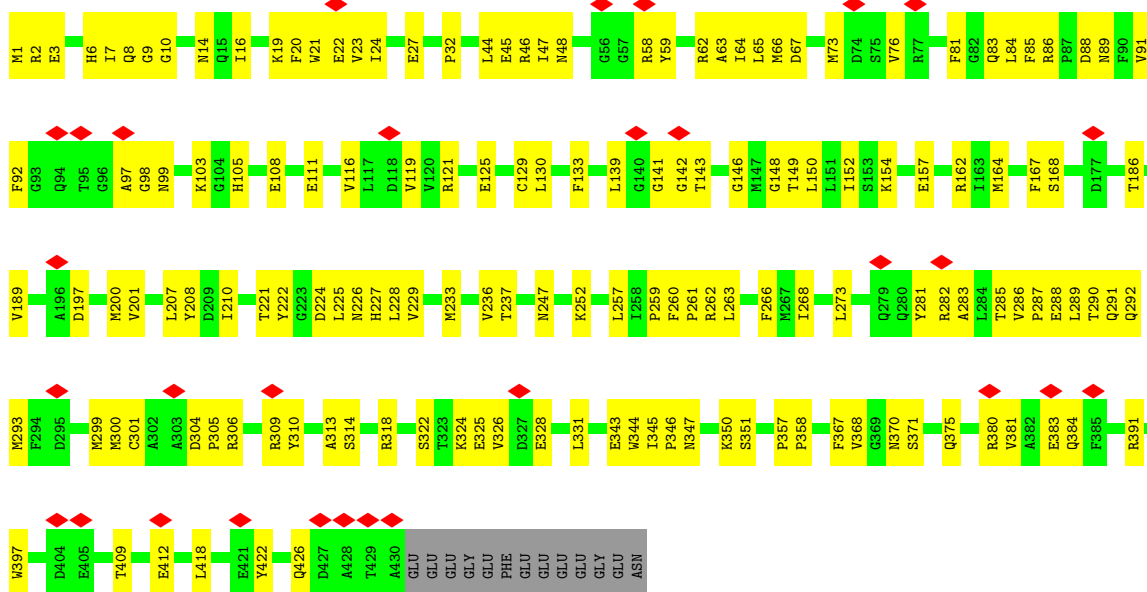

• Molecule 46: Tubulin beta chain

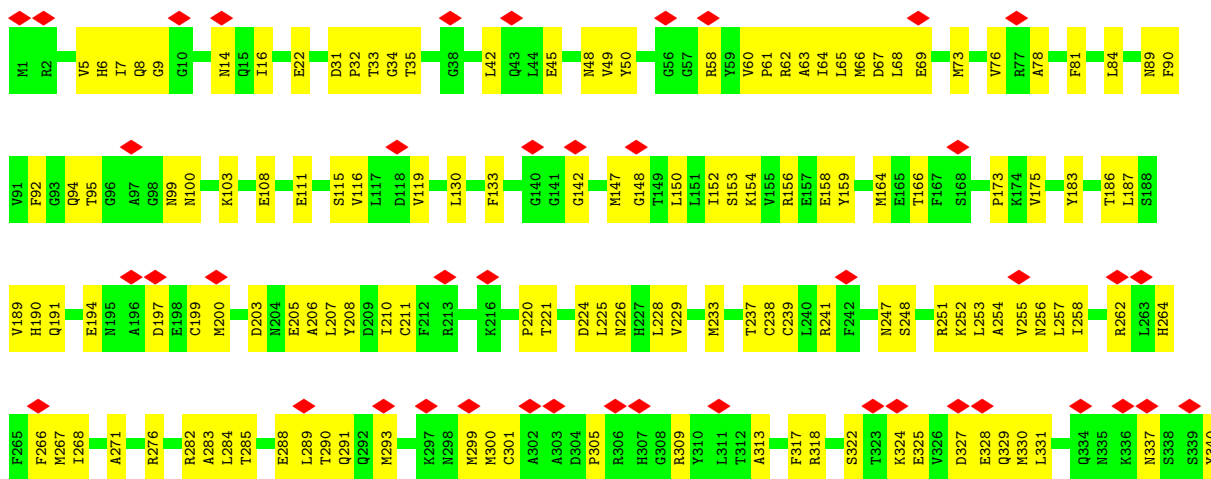

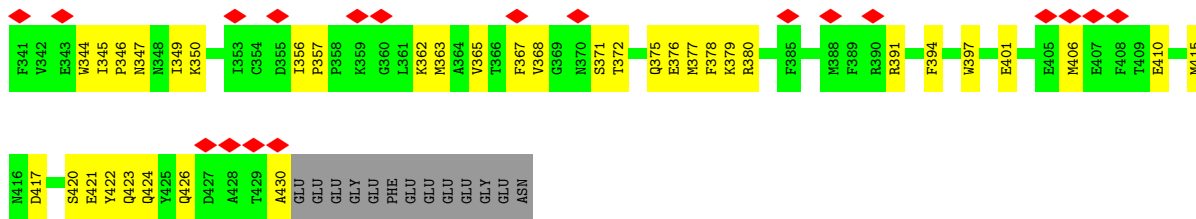

## 4 Experimental information

Property	Value	Source
EM reconstruction method	SINGLE PARTICLE	Depositor
Imposed symmetry	POINT, C1	Depositor
Number of particles used	148365	Depositor
Resolution determination method	FSC 0.143 CUT-OFF	Depositor
CTF correction method	NONE	Depositor
Microscope	TFS KRIOS	Depositor
Voltage (kV)	300	Depositor
Electron dose ( $e^-/\text{\AA}^2$ )	45	Depositor
Minimum defocus (nm)	1000	Depositor
Maximum defocus (nm)	3000	Depositor
Magnification	Not provided	
Image detector	GATAN K3 (6k x 4k)	Depositor
Maximum map value	2.356	Depositor
Minimum map value	-0.004	Depositor
Average map value	0.011	Depositor
Map value standard deviation	0.079	Depositor
Recommended contour level	0.15	Depositor
Map size ( $\text{\AA}$ )	701.44, 701.44, 701.44	wwPDB
Map dimensions	512, 512, 512	wwPDB
Map angles ( $^\circ$ )	90.0, 90.0, 90.0	wwPDB
Pixel spacing ( $\text{\AA}$ )	1.37, 1.37, 1.37	Depositor

## 5 Model quality [i](#)

### 5.1 Standard geometry [i](#)

Bond lengths and bond angles in the following residue types are not validated in this section: GDP, GTP, MG

The Z score for a bond length (or angle) is the number of standard deviations the observed value is removed from the expected value. A bond length (or angle) with  $|Z| > 5$  is considered an outlier worth inspection. RMSZ is the root-mean-square of all Z scores of the bond lengths (or angles).

Mol	Chain	Bond lengths		Bond angles	
		RMSZ	# Z  >5	RMSZ	# Z  >5
1	0A	0.29	0/1272	0.61	2/1730 (0.1%)
1	1A	0.29	0/1272	0.56	0/1730
1	2A	0.30	0/1272	0.62	1/1730 (0.1%)
1	3A	0.28	0/1272	0.56	0/1730
2	0B	0.28	0/2674	0.60	1/3619 (0.0%)
3	0C	0.29	0/764	0.69	1/1029 (0.1%)
3	1C	0.28	0/764	0.79	2/1029 (0.2%)
4	0D	0.28	0/1653	0.62	0/2238
4	1D	0.30	0/1653	0.64	1/2238 (0.0%)
4	2D	0.30	0/1653	0.67	0/2238
5	0E	0.29	0/1584	0.62	0/2133
5	1E	0.31	0/1584	0.64	1/2133 (0.0%)
5	2E	0.30	0/1584	0.63	1/2133 (0.0%)
5	3E	0.27	0/1584	0.57	0/2133
6	0F	0.31	0/1699	0.74	2/2294 (0.1%)
7	0G	0.28	0/1409	0.64	0/1895
7	1G	0.29	0/1136	0.65	0/1530
8	0H	0.35	0/1060	0.67	0/1404
8	1H	0.33	0/3741	0.68	2/4955 (0.0%)
9	0N	0.29	0/2355	0.53	0/3181
9	1N	0.28	0/3884	0.51	0/5240
9	2N	0.27	0/2355	0.52	0/3181
10	0Q	0.29	0/1583	0.63	0/2138
10	1Q	0.30	0/1583	0.63	0/2138
10	2Q	0.30	0/1583	0.61	0/2138
10	3Q	0.29	0/1583	0.61	0/2138
10	4Q	0.30	0/1583	0.62	0/2138
10	5Q	0.29	0/1583	0.61	0/2138
10	6Q	0.29	0/1583	0.63	0/2138
11	0S	0.26	0/2361	0.53	0/3199
11	1S	0.28	0/2361	0.56	0/3199
11	2S	0.29	0/2361	0.57	2/3199 (0.1%)

Mol	Chain	Bond lengths		Bond angles	
		RMSZ	# Z  >5	RMSZ	# Z  >5
11	3S	0.28	0/2361	0.54	0/3199
12	0T	0.28	0/2176	0.54	0/2931
12	1T	0.29	0/2379	0.55	0/3209
12	2T	0.30	0/2379	0.55	0/3209
12	3T	0.32	0/2379	0.55	0/3209
13	0U	0.27	0/4866	0.57	0/6583
13	1U	0.28	0/4866	0.57	1/6583 (0.0%)
13	2U	0.28	0/4866	0.58	0/6583
13	3U	0.27	0/4866	0.58	1/6583 (0.0%)
14	0V	0.25	0/1784	0.53	0/2393
14	1V	0.27	0/2213	0.59	2/2978 (0.1%)
14	2V	0.27	0/2213	0.58	1/2978 (0.0%)
14	3V	0.26	0/2213	0.55	0/2978
15	0X	0.35	0/946	0.70	1/1255 (0.1%)
15	1X	0.32	0/1216	0.66	2/1614 (0.1%)
15	2X	0.31	0/1216	0.63	1/1614 (0.1%)
15	3X	0.30	0/1216	0.60	1/1614 (0.1%)
15	4X	0.30	0/1216	0.61	0/1614
16	1B	0.29	0/4148	0.52	0/5587
16	2B	0.28	0/2483	0.54	0/3339
16	3B	0.28	0/2480	0.57	0/3333
17	1F	0.29	0/1119	0.71	1/1513 (0.1%)
18	1I	0.30	0/1574	0.63	0/2125
19	1J	0.29	0/3090	0.57	0/4148
20	1K	0.29	0/2454	0.56	0/3260
20	2K	0.30	0/2528	0.59	0/3351
21	1L	0.27	0/6961	0.59	2/9360 (0.0%)
21	2L	0.26	0/5243	0.57	2/7046 (0.0%)
21	3L	0.27	0/1685	0.61	0/2266
22	1M	0.29	0/3041	0.55	0/4100
22	2M	0.29	0/3041	0.54	0/4100
23	1O	0.46	1/2039 (0.0%)	0.66	4/2687 (0.1%)
23	2O	0.30	0/3185	0.62	0/4204
23	3O	0.29	0/2407	0.60	2/3180 (0.1%)
24	1P	0.31	0/3080	0.62	0/4069
24	2P	0.32	0/1649	0.65	0/2186
25	1R	0.28	0/4366	0.55	1/5904 (0.0%)
25	2R	0.28	0/4366	0.52	0/5904
25	3R	0.28	0/4366	0.54	0/5904
26	1W	0.29	0/1952	0.54	0/2606
26	2W	0.39	0/1008	0.74	1/1349 (0.1%)
27	2C	0.29	0/2511	0.56	0/3378
27	3C	0.27	0/2511	0.52	0/3378



Mol	Chain	Bond lengths		Bond angles	
		RMSZ	# Z  >5	RMSZ	# Z  >5
27	4C	0.27	0/2511	0.53	0/3378
28	2F	0.31	0/766	0.60	1/1025 (0.1%)
29	2G	0.30	0/861	0.57	1/1146 (0.1%)
30	2H	0.26	0/507	0.58	0/672
30	3H	4.16	6/507 (1.2%)	0.71	2/672 (0.3%)
30	4H	0.26	0/507	0.56	0/672
31	2I	0.30	0/1178	0.60	0/1583
31	3I	0.29	0/729	0.69	0/975
32	3D	0.27	0/1878	0.49	0/2538
33	4F	0.28	0/1664	0.57	0/2251
34	4R	0.37	2/5205 (0.0%)	0.61	3/7042 (0.0%)
34	5R	0.28	0/5205	0.53	0/7042
34	6R	0.26	0/5205	0.49	0/7042
34	7R	0.26	0/5205	0.50	0/7042
35	4S	0.29	0/1572	0.53	0/2122
35	5S	0.28	0/1572	0.54	0/2122
36	5A	0.28	0/1299	0.63	1/1757 (0.1%)
36	5B	0.27	0/1299	0.61	1/1757 (0.1%)
36	5C	0.28	0/1299	0.59	1/1757 (0.1%)
36	5D	0.27	0/934	0.68	0/1265
37	5E	0.28	0/1603	0.59	0/2157
37	5F	0.30	0/1792	0.62	0/2415
37	5G	0.27	0/1792	0.57	0/2415
37	5H	0.27	0/1241	0.64	0/1677
39	6F	0.29	0/1170	0.55	0/1571
40	6G	0.30	0/1809	0.61	2/2426 (0.1%)
41	6H	0.28	0/1391	0.60	1/1858 (0.1%)
44	8R	0.39	0/1135	0.48	0/1581
45	AA	0.29	0/3480	0.54	1/4716 (0.0%)
45	AC	0.30	0/3480	0.55	1/4716 (0.0%)
45	AE	0.30	0/3480	0.53	0/4716
45	AG	0.29	0/3480	0.54	1/4716 (0.0%)
45	AI	0.29	0/3480	0.54	0/4716
45	AK	0.29	0/3480	0.53	0/4716
45	AM	0.28	0/3480	0.54	0/4716
45	BA	0.27	0/3435	0.53	0/4655
45	BC	0.29	0/3435	0.54	0/4655
45	BE	0.29	0/3435	0.55	0/4655
45	BG	0.29	0/3435	0.53	0/4655
45	BI	0.29	0/3435	0.54	0/4655
45	BK	0.29	0/3435	0.54	0/4655
45	BM	0.28	0/3435	0.54	0/4655
45	CA	0.26	0/3480	0.52	1/4716 (0.0%)

Mol	Chain	Bond lengths		Bond angles	
		RMSZ	# Z  >5	RMSZ	# Z  >5
45	CC	0.28	0/3480	0.54	0/4716
45	CE	0.30	0/3480	0.55	1/4716 (0.0%)
45	CG	0.29	0/3480	0.53	0/4716
45	CI	0.28	0/3480	0.54	0/4716
45	CK	0.28	0/3480	0.54	0/4716
45	CM	0.27	0/3480	0.53	0/4716
45	DA	0.25	0/3443	0.49	0/4666
45	DC	0.28	0/3460	0.56	1/4687 (0.0%)
45	DE	0.29	0/3443	0.53	0/4666
45	DG	0.28	0/3460	0.53	0/4687
45	DI	0.27	0/3443	0.52	0/4666
45	DK	0.28	0/3460	0.54	0/4687
45	DM	0.27	0/3443	0.53	0/4666
45	EA	0.25	0/3480	0.49	0/4716
45	EC	0.27	0/3480	0.54	0/4716
45	EE	0.27	0/3480	0.53	0/4716
45	EG	0.27	0/3480	0.51	0/4716
45	EI	0.26	0/3480	0.52	0/4716
45	EK	0.28	0/3480	0.54	0/4716
45	EM	0.28	0/3480	0.55	1/4716 (0.0%)
45	FA	0.27	0/3413	0.53	1/4625 (0.0%)
45	FC	0.29	0/3435	0.52	0/4655
45	FE	0.29	0/3447	0.52	0/4671
45	FG	0.29	0/3480	0.51	0/4716
45	FI	0.29	0/3443	0.51	0/4666
45	FK	0.27	0/3435	0.54	0/4655
45	FM	0.25	0/3413	0.50	0/4625
45	GA	0.27	0/3413	0.52	0/4625
45	GC	0.30	0/3429	0.54	0/4647
45	GE	0.31	0/3429	0.54	0/4647
45	GG	0.29	0/3429	0.51	0/4647
45	GI	0.30	0/3429	0.52	0/4647
45	GK	0.29	0/3480	0.54	1/4716 (0.0%)
45	GM	0.24	0/3413	0.49	0/4625
45	HA	0.28	0/3427	0.55	0/4644
45	HC	0.29	0/3427	0.51	0/4644
45	HE	0.30	0/3427	0.53	0/4644
45	HG	0.30	0/3427	0.52	0/4644
45	HI	0.30	0/3427	0.52	0/4644
45	HK	0.30	0/3427	0.54	0/4644
45	HM	0.25	0/3427	0.48	0/4644
45	IA	0.29	0/3435	0.55	1/4655 (0.0%)
45	IC	0.30	0/3480	0.55	0/4716

Mol	Chain	Bond lengths		Bond angles	
		RMSZ	# Z  >5	RMSZ	# Z  >5
45	IE	0.30	0/3435	0.53	0/4655
45	IG	0.29	0/3480	0.54	0/4716
45	II	0.32	0/3480	0.54	0/4716
45	IK	0.30	0/3435	0.53	0/4655
45	IM	0.27	0/3435	0.53	0/4655
45	JA	0.29	0/3435	0.54	1/4655 (0.0%)
45	JC	0.29	0/3447	0.53	0/4671
45	JE	0.29	0/3480	0.52	0/4716
45	JG	0.29	0/3480	0.53	0/4716
45	JI	0.29	0/3476	0.53	0/4710
45	JK	0.30	0/3480	0.56	0/4716
45	JM	0.27	0/3435	0.54	0/4655
45	KA	0.27	0/3447	0.51	0/4671
45	KC	0.28	0/3443	0.53	0/4666
45	KE	0.29	0/3456	0.52	0/4682
45	KG	0.29	0/3480	0.53	0/4716
45	KI	0.30	0/3480	0.54	0/4716
45	KK	0.29	0/3480	0.54	0/4716
45	KM	0.27	0/3447	0.51	0/4671
45	LA	0.29	0/3480	0.54	0/4716
45	LC	0.28	0/3480	0.53	0/4716
45	LE	0.29	0/3471	0.53	0/4702
45	LG	0.28	0/3480	0.52	0/4716
45	LI	0.29	0/3452	0.52	0/4677
45	LK	0.29	0/3480	0.53	0/4716
45	LM	0.28	0/3480	0.52	0/4716
45	MA	0.29	0/3463	0.53	1/4692 (0.0%)
45	MC	0.30	0/3439	0.52	0/4660
45	ME	0.30	0/3443	0.53	0/4666
45	MG	0.29	0/3471	0.53	0/4703
45	MI	0.29	0/3480	0.53	0/4716
45	MK	0.30	0/3455	0.53	0/4681
45	MM	0.28	0/3463	0.52	0/4692
45	NA	0.28	0/3480	0.55	0/4716
45	NC	0.28	0/3435	0.53	0/4655
45	NE	0.28	0/3480	0.52	0/4716
45	NG	0.28	0/3435	0.51	0/4655
45	NI	0.28	0/3480	0.52	0/4716
45	NK	0.28	0/3435	0.54	0/4655
45	NM	0.27	0/3480	0.54	0/4716
45	OA	0.27	0/3439	0.54	0/4660
45	OC	0.29	0/3439	0.53	0/4660
45	OE	0.29	0/3439	0.54	0/4660

Mol	Chain	Bond lengths		Bond angles	
		RMSZ	# Z  >5	RMSZ	# Z  >5
45	OG	0.27	0/3439	0.51	0/4660
45	OI	0.28	0/3439	0.53	0/4660
45	OK	0.28	0/3439	0.53	0/4660
45	OM	0.27	0/3439	0.55	0/4660
45	PA	0.27	0/3413	0.53	0/4625
45	PC	0.27	0/3413	0.53	0/4625
45	PE	0.28	0/3413	0.53	0/4625
45	PG	0.28	0/3413	0.53	0/4625
45	PI	0.28	0/3413	0.53	0/4625
45	PK	0.27	0/3413	0.52	0/4625
45	PM	0.28	0/3413	0.55	0/4625
45	QA	0.26	0/3427	0.53	1/4644 (0.0%)
45	QC	0.27	0/3427	0.53	0/4644
45	QE	0.27	0/3427	0.52	0/4644
45	QG	0.28	0/3427	0.55	0/4644
45	QI	0.28	0/3427	0.52	0/4644
45	QK	0.28	0/3427	0.53	0/4644
45	QM	0.26	0/3427	0.53	0/4644
45	RA	0.25	0/3427	0.50	0/4644
45	RC	0.27	0/3427	0.52	0/4644
45	RE	0.34	1/3427 (0.0%)	0.59	5/4644 (0.1%)
45	RG	0.27	0/3427	0.52	0/4644
45	RI	0.28	0/3427	0.51	0/4644
45	RK	0.28	0/3427	0.53	0/4644
45	RM	0.26	0/3427	0.53	0/4644
45	SA	0.25	0/3421	0.49	0/4636
45	SC	0.27	0/3421	0.52	0/4636
45	SE	0.28	0/3421	0.52	0/4636
45	SG	0.28	0/3421	0.53	0/4636
45	SI	0.28	0/3421	0.52	0/4636
45	SK	0.28	0/3421	0.53	0/4636
45	SM	0.26	0/3421	0.53	0/4636
45	TA	0.25	0/3421	0.48	0/4636
45	TC	0.28	0/3421	0.54	0/4636
45	TE	0.30	0/3421	0.55	0/4636
45	TG	0.27	0/3421	0.53	1/4636 (0.0%)
45	TI	0.28	0/3421	0.52	0/4636
45	TK	0.28	0/3421	0.52	0/4636
45	TM	0.28	0/3421	0.54	0/4636
45	UA	2.24	6/3427 (0.2%)	0.52	1/4644 (0.0%)
45	UC	0.27	0/3427	0.52	0/4644
45	UE	0.28	0/3427	0.54	0/4644
45	UG	0.27	0/3427	0.53	0/4644

Mol	Chain	Bond lengths		Bond angles	
		RMSZ	# Z  >5	RMSZ	# Z  >5
45	UI	0.28	0/3427	0.55	0/4644
45	UK	0.28	0/3427	0.53	0/4644
45	UM	0.28	0/3427	0.54	0/4644
45	VA	0.28	0/3443	0.55	1/4666 (0.0%)
45	VC	0.28	0/3480	0.53	0/4716
45	VE	0.28	0/3443	0.52	0/4666
45	VG	0.29	0/3480	0.53	0/4716
45	VI	0.28	0/3443	0.55	1/4666 (0.0%)
45	VK	0.32	1/3480 (0.0%)	0.58	2/4716 (0.0%)
45	VM	0.25	0/3443	0.49	0/4666
45	WA	0.28	0/3427	0.57	1/4644 (0.0%)
45	WC	0.29	0/3480	0.54	0/4716
45	WE	0.28	0/3427	0.53	0/4644
45	WG	0.29	0/3480	0.54	0/4716
45	WI	0.29	0/3427	0.52	0/4644
45	WK	0.29	0/3480	0.56	0/4716
45	WM	0.26	0/3427	0.53	0/4644
46	AB	0.28	0/3439	0.53	0/4655
46	AD	0.30	0/3439	0.54	0/4655
46	AF	0.30	0/3439	0.53	0/4655
46	AH	0.30	0/3439	0.54	0/4655
46	AJ	0.30	0/3439	0.53	0/4655
46	AL	0.29	0/3439	0.52	0/4655
46	AN	0.29	0/3439	0.54	0/4655
46	BB	0.25	0/3439	0.50	0/4655
46	BD	0.29	0/3439	0.54	0/4655
46	BF	0.29	0/3439	0.53	0/4655
46	BH	0.31	0/3439	0.57	0/4655
46	BJ	0.30	0/3439	0.53	0/4655
46	BL	0.30	0/3439	0.56	0/4655
46	BN	0.29	0/3439	0.56	1/4655 (0.0%)
46	CB	0.29	0/3439	0.55	0/4655
46	CD	0.29	0/3439	0.55	0/4655
46	CF	0.42	2/3439 (0.1%)	0.66	3/4655 (0.1%)
46	CH	0.28	0/3439	0.54	0/4655
46	CJ	0.28	0/3439	0.52	0/4655
46	CL	0.29	0/3439	0.55	0/4655
46	CN	0.25	0/3439	0.48	0/4655
46	DB	0.27	0/3439	0.53	0/4655
46	DD	0.28	0/3439	0.56	0/4655
46	DF	1.98	6/3439 (0.2%)	0.56	0/4655
46	DH	0.27	0/3439	0.53	0/4655
46	DJ	0.28	0/3439	0.53	0/4655

Mol	Chain	Bond lengths		Bond angles	
		RMSZ	# Z  >5	RMSZ	# Z  >5
46	DL	0.28	0/3439	0.55	0/4655
46	DN	0.25	0/3439	0.48	0/4655
46	EB	0.26	0/3439	0.51	0/4655
46	ED	0.28	0/3439	0.55	0/4655
46	EF	0.28	0/3439	0.56	0/4655
46	EH	0.27	0/3439	0.54	0/4655
46	EJ	0.28	0/3439	0.53	0/4655
46	EL	0.29	0/3439	0.56	0/4655
46	EN	0.27	0/3439	0.54	3/4655 (0.1%)
46	FB	0.25	0/3439	0.51	0/4655
46	FD	0.30	0/3439	0.57	0/4655
46	FF	0.30	0/3439	0.54	0/4655
46	FH	0.29	0/3439	0.53	0/4655
46	FJ	0.30	0/3439	0.53	0/4655
46	FL	0.30	0/3439	0.55	0/4655
46	FN	0.26	0/3439	0.52	0/4655
46	GB	0.25	0/3439	0.51	0/4655
46	GD	0.29	0/3439	0.55	0/4655
46	GF	0.30	0/3439	0.53	0/4655
46	GH	0.33	0/3439	0.56	1/4655 (0.0%)
46	GJ	0.30	0/3439	0.53	0/4655
46	GL	0.30	0/3439	0.53	0/4655
46	GN	0.27	0/3439	0.54	0/4655
46	HB	0.25	0/3439	0.50	0/4655
46	HD	0.29	0/3439	0.53	0/4655
46	HF	0.32	0/3439	0.57	2/4655 (0.0%)
46	HH	0.30	0/3439	0.53	0/4655
46	HJ	0.31	0/3439	0.54	0/4655
46	HL	0.30	0/3439	0.53	0/4655
46	HN	0.27	0/3439	0.52	0/4655
46	IB	0.27	0/3439	0.54	1/4655 (0.0%)
46	ID	0.29	0/3439	0.53	0/4655
46	IF	0.29	0/3439	0.53	0/4655
46	IH	0.30	0/3439	0.53	0/4655
46	IJ	0.30	0/3439	0.53	0/4655
46	IL	0.29	0/3439	0.53	0/4655
46	IN	0.29	0/3439	0.56	0/4655
46	JB	0.28	0/3439	0.53	0/4655
46	JD	0.30	0/3439	0.53	0/4655
46	JF	0.30	0/3439	0.52	0/4655
46	JH	0.29	0/3439	0.53	0/4655
46	JJ	0.30	0/3439	0.54	0/4655
46	JL	0.29	0/3439	0.53	0/4655

Mol	Chain	Bond lengths		Bond angles	
		RMSZ	# Z  >5	RMSZ	# Z  >5
46	JN	0.29	0/3439	0.55	0/4655
46	KB	0.28	0/3439	0.54	0/4655
46	KD	0.28	0/3439	0.53	0/4655
46	KF	0.29	0/3439	0.53	0/4655
46	KH	0.30	0/3439	0.53	0/4655
46	KJ	0.29	0/3439	0.56	0/4655
46	KL	0.29	0/3439	0.54	0/4655
46	KN	0.29	0/3439	0.55	0/4655
46	LB	0.27	0/3439	0.51	0/4655
46	LD	0.28	0/3439	0.53	0/4655
46	LF	0.29	0/3439	0.55	0/4655
46	LH	0.28	0/3439	0.53	0/4655
46	LJ	0.30	0/3439	0.54	0/4655
46	LL	0.30	0/3439	0.54	0/4655
46	LN	0.29	0/3439	0.54	0/4655
46	MB	0.28	0/3439	0.53	0/4655
46	MD	0.30	0/3439	0.53	0/4655
46	MF	0.30	0/3439	0.54	0/4655
46	MH	0.29	0/3439	0.54	0/4655
46	MJ	0.31	0/3439	0.55	0/4655
46	ML	0.29	0/3439	0.52	0/4655
46	MN	0.29	0/3439	0.52	0/4655
46	NB	0.27	0/3375	0.56	0/4569
46	ND	0.29	0/3439	0.57	0/4655
46	NF	0.28	0/3375	0.53	0/4569
46	NH	0.28	0/3439	0.54	0/4655
46	NJ	0.28	0/3375	0.54	0/4569
46	NL	0.28	0/3439	0.55	0/4655
46	NN	0.28	0/3375	0.54	0/4569
46	OB	0.27	0/3439	0.53	0/4655
46	OD	0.29	0/3439	0.55	0/4655
46	OF	0.27	0/3439	0.54	0/4655
46	OH	0.28	0/3439	0.53	0/4655
46	OJ	0.28	0/3439	0.53	0/4655
46	OL	0.29	0/3439	0.54	0/4655
46	ON	0.27	0/3439	0.55	0/4655
46	PB	0.25	0/3439	0.49	0/4655
46	PD	0.27	0/3439	0.55	0/4655
46	PF	0.28	0/3439	0.53	0/4655
46	PH	0.29	0/3439	0.56	0/4655
46	PJ	0.27	0/3439	0.53	0/4655
46	PL	0.28	0/3439	0.54	0/4655
46	PN	0.29	0/3439	0.59	2/4655 (0.0%)

Mol	Chain	Bond lengths		Bond angles	
		RMSZ	# Z  >5	RMSZ	# Z  >5
46	QB	0.27	0/3439	0.53	0/4655
46	QD	0.27	0/3439	0.53	0/4655
46	QF	0.28	0/3439	0.54	0/4655
46	QH	0.28	0/3439	0.54	0/4655
46	QJ	0.28	0/3439	0.53	0/4655
46	QL	0.28	0/3439	0.55	0/4655
46	QN	0.24	0/3439	0.49	0/4655
46	RB	0.28	0/3439	0.54	0/4655
46	RD	0.28	0/3439	0.52	0/4655
46	RF	0.29	0/3439	0.54	0/4655
46	RH	0.28	0/3439	0.54	0/4655
46	RJ	0.28	0/3439	0.54	0/4655
46	RL	0.35	1/3439 (0.0%)	0.64	4/4655 (0.1%)
46	RN	0.25	0/3439	0.48	0/4655
46	SB	0.27	0/3439	0.55	0/4655
46	SD	0.31	0/3439	0.54	0/4655
46	SF	0.29	0/3439	0.53	0/4655
46	SH	0.29	0/3439	0.54	0/4655
46	SJ	0.29	0/3439	0.54	0/4655
46	SL	0.30	0/3439	0.56	0/4655
46	SN	0.25	0/3439	0.49	0/4655
46	TB	0.27	0/3439	0.55	0/4655
46	TD	0.28	0/3439	0.54	0/4655
46	TF	0.27	0/3439	0.53	0/4655
46	TH	0.27	0/3439	0.53	0/4655
46	TJ	0.28	0/3439	0.54	0/4655
46	TL	0.28	0/3439	0.55	0/4655
46	TN	0.25	0/3439	0.49	0/4655
46	UB	0.28	0/3439	0.54	0/4655
46	UD	0.28	0/3439	0.54	0/4655
46	UF	0.28	0/3439	0.53	0/4655
46	UH	0.29	0/3439	0.54	0/4655
46	UJ	0.29	0/3439	0.56	1/4655 (0.0%)
46	UL	0.28	0/3439	0.54	0/4655
46	UN	0.27	0/3439	0.54	0/4655
46	VB	0.28	0/3439	0.55	0/4655
46	VD	0.29	0/3439	0.55	0/4655
46	VF	0.29	0/3439	0.54	0/4655
46	VH	0.28	0/3439	0.55	0/4655
46	VJ	0.28	0/3439	0.54	0/4655
46	VL	0.28	0/3439	0.56	0/4655
46	VN	0.28	0/3439	0.54	0/4655
46	WB	0.27	0/3439	0.56	0/4655



Mol	Chain	Bond lengths		Bond angles	
		RMSZ	# Z  >5	RMSZ	# Z  >5
46	WD	0.29	0/3439	0.55	0/4655
46	WF	0.29	0/3439	0.53	0/4655
46	WH	0.28	0/3439	0.55	0/4655
46	WJ	0.29	0/3439	0.56	0/4655
46	WL	0.30	0/3439	0.55	0/4655
46	WN	0.28	0/3439	0.55	0/4655
All	All	0.33	26/1335252 (0.0%)	0.54	95/1806584 (0.0%)

Chiral center outliers are detected by calculating the chiral volume of a chiral center and verifying if the center is modelled as a planar moiety or with the opposite hand. A planarity outlier is detected by checking planarity of atoms in a peptide group, atoms in a mainchain group or atoms of a sidechain that are expected to be planar.

Mol	Chain	#Chirality outliers	#Planarity outliers
1	0A	0	1
1	1A	0	1
1	2A	0	1
1	3A	0	1
2	0B	0	3
4	1D	0	1
4	2D	0	1
5	0E	0	1
5	1E	0	1
6	0F	0	4
7	0G	0	2
7	1G	0	1
10	2Q	0	1
11	0S	0	1
13	0U	0	1
13	1U	0	1
13	3U	0	1
21	1L	0	2
21	2L	0	2
23	1O	0	1
25	1R	0	1
25	2R	0	1
25	3R	0	1
31	3I	0	1
33	4F	0	1
40	6G	0	2
44	8R	0	1
45	BI	0	1

*Continued on next page...*

Continued from previous page...

Mol	Chain	#Chirality outliers	#Planarity outliers
45	EA	0	1
45	EE	0	1
45	EI	0	1
45	EM	0	1
45	PA	0	1
45	QA	0	1
45	RM	0	1
45	TA	0	1
46	BH	0	1
46	QD	0	1
46	UF	0	1
All	All	0	48

The worst 5 of 26 bond length outliers are listed below:

Mol	Chain	Res	Type	Atoms	Z	Observed(Å)	Ideal(Å)
45	UA	282	TYR	CD2-CE2	82.47	2.63	1.39
46	DF	281	TYR	CD2-CE2	66.29	2.38	1.39
45	UA	282	TYR	CD1-CE1	61.55	2.31	1.39
46	DF	281	TYR	CD1-CE1	59.73	2.29	1.39
30	3H	174	PHE	CE1-CZ	46.67	2.26	1.37

The worst 5 of 95 bond angle outliers are listed below:

Mol	Chain	Res	Type	Atoms	Z	Observed(°)	Ideal(°)
34	4R	147	ARG	CD-NE-CZ	21.71	153.99	123.60
46	CF	86	ARG	CD-NE-CZ	21.01	153.02	123.60
17	1F	29	GLN	C-N-CD	-14.46	88.80	120.60
3	1C	44	ILE	C-N-CD	-14.05	89.69	120.60
34	4R	147	ARG	NE-CZ-NH1	12.17	126.39	120.30

There are no chirality outliers.

5 of 48 planarity outliers are listed below:

Mol	Chain	Res	Type	Group
1	0A	70	HIS	Peptide
2	0B	222	GLU	Peptide
2	0B	223	LYS	Peptide
2	0B	322	ARG	Peptide
5	0E	43	VAL	Peptide

## 5.2 Too-close contacts

In the following table, the Non-H and H(model) columns list the number of non-hydrogen atoms and hydrogen atoms in the chain respectively. The H(added) column lists the number of hydrogen atoms added and optimized by MolProbity. The Clashes column lists the number of clashes within the asymmetric unit, whereas Symm-Clashes lists symmetry-related clashes.

Mol	Chain	Non-H	H(model)	H(added)	Clashes	Symm-Clashes
1	0A	1229	0	1156	31	0
1	1A	1229	0	1156	17	0
1	2A	1229	0	1156	25	0
1	3A	1229	0	1156	25	0
2	0B	2615	0	2539	31	0
3	0C	747	0	746	11	0
3	1C	747	0	746	17	0
4	0D	1619	0	1606	49	0
4	1D	1619	0	1606	36	0
4	2D	1619	0	1606	42	0
5	0E	1557	0	1513	2	0
5	1E	1557	0	1513	2	0
5	2E	1557	0	1513	7	0
5	3E	1557	0	1513	2	0
6	0F	1665	0	1658	24	0
7	0G	1378	0	1332	23	0
7	1G	1109	0	1072	25	0
8	0H	1046	0	1051	2	0
8	1H	3706	0	3719	37	0
9	0N	2305	0	2251	12	0
9	1N	3805	0	3734	13	0
9	2N	2305	0	2251	11	0
10	0Q	1548	0	1575	4	0
10	1Q	1548	0	1575	15	0
10	2Q	1548	0	1575	4	0
10	3Q	1548	0	1575	7	0
10	4Q	1548	0	1575	7	0
10	5Q	1548	0	1575	56	0
10	6Q	1548	0	1575	62	0
11	0S	2310	0	2349	16	0
11	1S	2310	0	2349	20	0
11	2S	2310	0	2349	14	0
11	3S	2310	0	2349	17	0
12	0T	2124	0	2067	3	0
12	1T	2321	0	2267	8	0
12	2T	2321	0	2267	16	0
12	3T	2321	0	2267	8	0

*Continued on next page...*

*Continued from previous page...*

Mol	Chain	Non-H	H(model)	H(added)	Clashes	Symm-Clashes
13	0U	4774	0	4750	3	0
13	1U	4774	0	4750	7	0
13	2U	4774	0	4750	7	0
13	3U	4774	0	4750	6	0
14	0V	1750	0	1740	18	0
14	1V	2168	0	2164	31	0
14	2V	2168	0	2164	33	0
14	3V	2168	0	2164	21	0
15	0X	935	0	911	13	0
15	1X	1202	0	1179	21	0
15	2X	1202	0	1179	14	0
15	3X	1202	0	1179	11	0
15	4X	1202	0	1179	56	0
16	1B	4066	0	4014	5	0
16	2B	2439	0	2418	4	0
16	3B	2437	0	2415	10	0
17	1F	1093	0	1080	21	0
18	1I	1546	0	1485	31	0
19	1J	3025	0	2936	74	0
20	1K	2425	0	2432	28	0
20	2K	2506	0	2541	30	0
21	1L	6842	0	6888	70	0
21	2L	5151	0	5185	51	0
21	3L	1660	0	1672	5	0
22	1M	2978	0	2957	4	0
22	2M	2978	0	2957	7	0
23	1O	2032	0	2152	71	0
23	2O	3173	0	3302	48	0
23	3O	2397	0	2483	16	0
24	1P	3060	0	3181	39	0
24	2P	1633	0	1646	15	0
25	1R	4244	0	4119	30	0
25	2R	4244	0	4119	39	0
25	3R	4244	0	4119	33	0
26	1W	1924	0	1867	20	0
26	2W	990	0	967	19	0
27	2C	2467	0	2457	16	0
27	3C	2467	0	2457	7	0
27	4C	2467	0	2457	9	0
28	2F	746	0	702	12	0
29	2G	848	0	871	5	0
30	2H	501	0	513	14	0

*Continued on next page...*

*Continued from previous page...*

Mol	Chain	Non-H	H(model)	H(added)	Clashes	Symm-Clashes
30	3H	501	0	513	15	0
30	4H	501	0	513	7	0
31	2I	1150	0	1150	60	0
31	3I	712	0	722	30	0
32	3D	1835	0	1817	2	0
33	4F	1618	0	1562	23	0
34	4R	5070	0	4976	97	0
34	5R	5070	0	4976	160	0
34	6R	5070	0	4976	141	0
34	7R	5070	0	4976	159	0
35	4S	1537	0	1565	90	0
35	5S	1537	0	1565	72	0
36	5A	1261	0	1230	49	0
36	5B	1261	0	1230	55	0
36	5C	1261	0	1230	50	0
36	5D	908	0	886	35	0
37	5E	1566	0	1570	74	0
37	5F	1750	0	1753	104	0
37	5G	1750	0	1753	83	0
37	5H	1210	0	1191	69	0
38	5I	515	0	109	0	0
38	5J	545	0	115	1	0
38	5K	400	0	84	0	0
39	6F	1140	0	1077	47	0
40	6G	1769	0	1772	121	0
41	6H	1362	0	1278	57	0
42	8L	1925	0	391	4	0
42	8N	1790	0	362	0	0
43	8P	1815	0	369	4	0
44	8R	2020	0	1200	23	0
45	AA	3408	0	3347	97	0
45	AC	3408	0	3347	125	0
45	AE	3408	0	3347	115	0
45	AG	3408	0	3347	93	0
45	AI	3408	0	3347	81	0
45	AK	3408	0	3347	89	0
45	AM	3408	0	3347	104	0
45	BA	3364	0	3302	131	0
45	BC	3364	0	3302	104	0
45	BE	3364	0	3302	113	0
45	BG	3364	0	3302	102	0
45	BI	3364	0	3302	101	0

*Continued on next page...*

*Continued from previous page...*

Mol	Chain	Non-H	H(model)	H(added)	Clashes	Symm-Clashes
45	BK	3364	0	3302	115	0
45	BM	3364	0	3302	123	0
45	CA	3408	0	3347	108	0
45	CC	3408	0	3347	134	0
45	CE	3408	0	3347	104	0
45	CG	3408	0	3347	135	0
45	CI	3408	0	3347	104	0
45	CK	3408	0	3347	107	0
45	CM	3408	0	3347	100	0
45	DA	3372	0	3305	66	0
45	DC	3389	0	3325	135	0
45	DE	3372	0	3306	116	0
45	DG	3389	0	3325	114	0
45	DI	3372	0	3306	110	0
45	DK	3389	0	3325	121	0
45	DM	3372	0	3306	130	0
45	EA	3408	0	3347	53	0
45	EC	3408	0	3347	161	0
45	EE	3408	0	3347	112	0
45	EG	3408	0	3347	115	0
45	EI	3408	0	3346	99	0
45	EK	3408	0	3347	104	0
45	EM	3408	0	3347	129	0
45	FA	3342	0	3289	107	0
45	FC	3364	0	3302	101	0
45	FE	3376	0	3309	83	0
45	FG	3408	0	3347	93	0
45	FI	3372	0	3306	94	0
45	FK	3364	0	3302	117	0
45	FM	3342	0	3289	55	0
45	GA	3342	0	3289	121	0
45	GC	3358	0	3297	90	0
45	GE	3358	0	3297	132	0
45	GG	3358	0	3297	111	0
45	GI	3358	0	3297	93	0
45	GK	3408	0	3347	110	0
45	GM	3342	0	3289	60	0
45	HA	3356	0	3298	101	0
45	HC	3356	0	3298	100	0
45	HE	3356	0	3298	111	0
45	HG	3356	0	3298	92	0
45	HI	3356	0	3298	103	0

*Continued on next page...*

*Continued from previous page...*

Mol	Chain	Non-H	H(model)	H(added)	Clashes	Symm-Clashes
45	HK	3356	0	3298	112	0
45	HM	3356	0	3298	74	0
45	IA	3364	0	3302	114	0
45	IC	3408	0	3347	114	0
45	IE	3364	0	3302	122	0
45	IG	3408	0	3347	136	0
45	II	3408	0	3347	104	0
45	IK	3364	0	3302	112	0
45	IM	3364	0	3302	128	0
45	JA	3364	0	3302	108	0
45	JC	3376	0	3309	104	0
45	JE	3408	0	3347	87	0
45	JG	3408	0	3347	109	0
45	JI	3404	0	3337	105	0
45	JK	3408	0	3347	115	0
45	JM	3364	0	3302	104	0
45	KA	3376	0	3309	117	0
45	KC	3372	0	3306	84	0
45	KE	3385	0	3322	108	0
45	KG	3408	0	3347	125	0
45	KI	3408	0	3347	96	0
45	KK	3408	0	3347	107	0
45	KM	3376	0	3309	126	0
45	LA	3408	0	3347	100	0
45	LC	3408	0	3347	98	0
45	LE	3400	0	3335	88	0
45	LG	3408	0	3347	95	0
45	LI	3381	0	3319	114	0
45	LK	3408	0	3347	107	0
45	LM	3408	0	3347	89	0
45	MA	3392	0	3329	104	0
45	MC	3368	0	3305	102	0
45	ME	3372	0	3306	109	0
45	MG	3400	0	3340	112	0
45	MI	3408	0	3347	100	0
45	MK	3384	0	3315	97	0
45	MM	3392	0	3329	99	0
45	NA	3408	0	3347	153	0
45	NC	3364	0	3302	109	0
45	NE	3408	0	3347	106	0
45	NG	3364	0	3302	119	0
45	NI	3408	0	3347	118	0

*Continued on next page...*

*Continued from previous page...*

Mol	Chain	Non-H	H(model)	H(added)	Clashes	Symm-Clashes
45	NK	3364	0	3302	129	0
45	NM	3408	0	3347	134	0
45	OA	3368	0	3305	166	0
45	OC	3368	0	3305	132	0
45	OE	3368	0	3305	133	0
45	OG	3368	0	3305	110	0
45	OI	3368	0	3305	112	0
45	OK	3368	0	3305	127	0
45	OM	3368	0	3305	112	0
45	PA	3342	0	3288	148	0
45	PC	3342	0	3289	132	0
45	PE	3342	0	3289	129	0
45	PG	3342	0	3289	140	0
45	PI	3342	0	3289	115	0
45	PK	3342	0	3289	110	0
45	PM	3342	0	3289	103	0
45	QA	3356	0	3298	102	0
45	QC	3356	0	3298	124	0
45	QE	3356	0	3298	116	0
45	QG	3356	0	3298	153	0
45	QI	3356	0	3298	140	0
45	QK	3356	0	3298	125	0
45	QM	3356	0	3298	115	0
45	RA	3356	0	3298	76	0
45	RC	3356	0	3298	122	0
45	RE	3356	0	3298	128	0
45	RG	3356	0	3298	144	0
45	RI	3356	0	3298	96	0
45	RK	3356	0	3298	110	0
45	RM	3356	0	3298	106	0
45	SA	3350	0	3293	56	0
45	SC	3350	0	3293	124	0
45	SE	3350	0	3293	122	0
45	SG	3350	0	3293	125	0
45	SI	3350	0	3293	110	0
45	SK	3350	0	3293	147	0
45	SM	3350	0	3293	111	0
45	TA	3350	0	3293	67	0
45	TC	3350	0	3293	149	0
45	TE	3350	0	3293	136	0
45	TG	3350	0	3293	117	0
45	TI	3350	0	3293	102	0

*Continued on next page...*



*Continued from previous page...*

Mol	Chain	Non-H	H(model)	H(added)	Clashes	Symm-Clashes
45	TK	3350	0	3293	116	0
45	TM	3350	0	3293	139	0
45	UA	3356	0	3298	108	0
45	UC	3356	0	3298	145	0
45	UE	3356	0	3298	130	0
45	UG	3356	0	3298	120	0
45	UI	3356	0	3298	102	0
45	UK	3356	0	3298	140	0
45	UM	3356	0	3298	135	0
45	VA	3372	0	3306	182	0
45	VC	3408	0	3347	112	0
45	VE	3372	0	3306	121	0
45	VG	3408	0	3347	156	0
45	VI	3372	0	3306	127	0
45	VK	3408	0	3347	152	0
45	VM	3372	0	3306	65	0
45	WA	3356	0	3297	134	0
45	WC	3408	0	3347	150	0
45	WE	3356	0	3298	120	0
45	WG	3408	0	3347	130	0
45	WI	3356	0	3298	102	0
45	WK	3408	0	3347	137	0
45	WM	3356	0	3298	89	0
46	AB	3366	0	3257	118	0
46	AD	3366	0	3257	122	0
46	AF	3366	0	3257	108	0
46	AH	3366	0	3257	105	0
46	AJ	3366	0	3257	91	0
46	AL	3366	0	3257	106	0
46	AN	3366	0	3257	119	0
46	BB	3366	0	3257	83	0
46	BD	3366	0	3257	138	0
46	BF	3366	0	3257	123	0
46	BH	3366	0	3257	142	0
46	BJ	3366	0	3257	106	0
46	BL	3366	0	3257	120	0
46	BN	3366	0	3257	160	0
46	CB	3366	0	3257	168	0
46	CD	3366	0	3257	112	0
46	CF	3366	0	3257	172	0
46	CH	3366	0	3257	111	0
46	CJ	3366	0	3257	123	0

*Continued on next page...*

*Continued from previous page...*

Mol	Chain	Non-H	H(model)	H(added)	Clashes	Symm-Clashes
46	CL	3366	0	3257	130	0
46	CN	3366	0	3257	91	0
46	DB	3366	0	3257	129	0
46	DD	3366	0	3257	118	0
46	DF	3366	0	3257	129	0
46	DH	3366	0	3257	114	0
46	DJ	3366	0	3257	124	0
46	DL	3366	0	3257	154	0
46	DN	3366	0	3257	63	0
46	EB	3366	0	3257	130	0
46	ED	3366	0	3257	121	0
46	EF	3366	0	3257	146	0
46	EH	3366	0	3257	128	0
46	EJ	3366	0	3257	119	0
46	EL	3366	0	3257	142	0
46	EN	3366	0	3257	102	0
46	FB	3366	0	3257	113	0
46	FD	3366	0	3257	132	0
46	FF	3366	0	3257	124	0
46	FH	3366	0	3257	126	0
46	FJ	3366	0	3257	113	0
46	FL	3366	0	3257	126	0
46	FN	3366	0	3257	98	0
46	GB	3366	0	3257	87	0
46	GD	3366	0	3257	126	0
46	GF	3366	0	3257	113	0
46	GH	3366	0	3257	106	0
46	GJ	3366	0	3257	101	0
46	GL	3366	0	3257	97	0
46	GN	3366	0	3257	113	0
46	HB	3366	0	3257	102	0
46	HD	3366	0	3257	121	0
46	HF	3366	0	3257	125	0
46	HH	3366	0	3257	116	0
46	HJ	3366	0	3257	105	0
46	HL	3366	0	3257	117	0
46	HN	3366	0	3257	127	0
46	IB	3366	0	3257	107	0
46	ID	3366	0	3257	118	0
46	IF	3366	0	3257	77	0
46	IH	3366	0	3257	122	0
46	IJ	3366	0	3257	123	0

*Continued on next page...*

*Continued from previous page...*

Mol	Chain	Non-H	H(model)	H(added)	Clashes	Symm-Clashes
46	IL	3366	0	3257	111	0
46	IN	3366	0	3257	133	0
46	JB	3366	0	3257	97	0
46	JD	3366	0	3257	77	0
46	JF	3366	0	3257	98	0
46	JH	3366	0	3257	99	0
46	JJ	3366	0	3257	106	0
46	JL	3366	0	3257	102	0
46	JN	3366	0	3257	137	0
46	KB	3366	0	3257	102	0
46	KD	3366	0	3257	90	0
46	KF	3366	0	3257	104	0
46	KH	3366	0	3257	94	0
46	KJ	3366	0	3257	105	0
46	KL	3366	0	3257	98	0
46	KN	3366	0	3257	115	0
46	LB	3366	0	3257	102	0
46	LD	3366	0	3257	101	0
46	LF	3366	0	3257	95	0
46	LH	3366	0	3257	100	0
46	LJ	3366	0	3257	107	0
46	LL	3366	0	3257	108	0
46	LN	3366	0	3257	96	0
46	MB	3366	0	3257	123	0
46	MD	3366	0	3257	102	0
46	MF	3366	0	3257	108	0
46	MH	3366	0	3257	90	0
46	MJ	3366	0	3257	139	0
46	ML	3366	0	3257	76	0
46	MN	3366	0	3257	101	0
46	NB	3304	0	3197	146	0
46	ND	3366	0	3257	140	0
46	NF	3304	0	3197	89	0
46	NH	3366	0	3257	130	0
46	NJ	3304	0	3197	120	0
46	NL	3366	0	3257	141	0
46	NN	3304	0	3197	113	0
46	OB	3366	0	3257	126	0
46	OD	3366	0	3257	142	0
46	OF	3366	0	3255	123	0
46	OH	3366	0	3257	101	0
46	OJ	3366	0	3257	118	0

*Continued on next page...*

*Continued from previous page...*

Mol	Chain	Non-H	H(model)	H(added)	Clashes	Symm-Clashes
46	OL	3366	0	3257	105	0
46	ON	3366	0	3257	150	0
46	PB	3366	0	3257	90	0
46	PD	3366	0	3255	152	0
46	PF	3366	0	3257	122	0
46	PH	3366	0	3257	122	0
46	PJ	3366	0	3257	124	0
46	PL	3366	0	3257	135	0
46	PN	3366	0	3257	158	0
46	QB	3366	0	3257	150	0
46	QD	3366	0	3257	112	0
46	QF	3366	0	3257	132	0
46	QH	3366	0	3257	142	0
46	QJ	3366	0	3257	121	0
46	QL	3366	0	3257	162	0
46	QN	3366	0	3257	63	0
46	RB	3366	0	3257	136	0
46	RD	3366	0	3257	129	0
46	RF	3366	0	3257	143	0
46	RH	3366	0	3257	130	0
46	RJ	3366	0	3257	125	0
46	RL	3366	0	3257	171	0
46	RN	3366	0	3257	66	0
46	SB	3366	0	3257	138	0
46	SD	3366	0	3257	139	0
46	SF	3366	0	3257	137	0
46	SH	3366	0	3257	125	0
46	SJ	3366	0	3257	134	0
46	SL	3366	0	3257	161	0
46	SN	3366	0	3257	66	0
46	TB	3366	0	3257	144	0
46	TD	3366	0	3257	130	0
46	TF	3366	0	3257	148	0
46	TH	3366	0	3257	125	0
46	TJ	3366	0	3257	135	0
46	TL	3366	0	3257	180	0
46	TN	3366	0	3257	75	0
46	UB	3366	0	3257	163	0
46	UD	3366	0	3257	132	0
46	UF	3366	0	3257	145	0
46	UH	3366	0	3257	136	0
46	UJ	3366	0	3257	161	0

*Continued on next page...*

*Continued from previous page...*

Mol	Chain	Non-H	H(model)	H(added)	Clashes	Symm-Clashes
46	UL	3366	0	3257	168	0
46	UN	3366	0	3257	120	0
46	VB	3366	0	3257	149	0
46	VD	3366	0	3257	147	0
46	VF	3366	0	3257	135	0
46	VH	3366	0	3257	150	0
46	VJ	3366	0	3257	129	0
46	VL	3366	0	3257	154	0
46	VN	3366	0	3257	159	0
46	WB	3366	0	3257	143	0
46	WD	3366	0	3257	144	0
46	WF	3366	0	3257	144	0
46	WH	3366	0	3257	117	0
46	WJ	3366	0	3257	126	0
46	WL	3366	0	3257	123	0
46	WN	3366	0	3257	148	0
47	AA	32	0	12	3	0
47	AC	32	0	12	1	0
47	AE	32	0	12	0	0
47	AG	32	0	12	1	0
47	AI	32	0	12	1	0
47	AK	32	0	12	1	0
47	AM	32	0	12	2	0
47	BA	32	0	12	1	0
47	BC	32	0	12	0	0
47	BE	32	0	12	4	0
47	BG	32	0	12	1	0
47	BI	32	0	12	3	0
47	BK	32	0	12	1	0
47	BM	32	0	12	1	0
47	CA	32	0	12	2	0
47	CC	32	0	12	1	0
47	CE	32	0	12	1	0
47	CG	32	0	12	2	0
47	CI	32	0	12	2	0
47	CK	32	0	12	1	0
47	CM	32	0	12	1	0
47	DA	32	0	12	2	0
47	DC	32	0	12	3	0
47	DE	32	0	12	2	0
47	DG	32	0	12	3	0
47	DI	32	0	12	4	0

*Continued on next page...*

*Continued from previous page...*

Mol	Chain	Non-H	H(model)	H(added)	Clashes	Symm-Clashes
47	DK	32	0	12	3	0
47	DM	32	0	12	2	0
47	EA	32	0	12	2	0
47	EC	32	0	12	3	0
47	EE	32	0	12	1	0
47	EG	32	0	12	2	0
47	EI	32	0	12	1	0
47	EK	32	0	12	3	0
47	EM	32	0	12	2	0
47	FA	32	0	12	3	0
47	FC	32	0	12	2	0
47	FE	32	0	12	1	0
47	FG	32	0	12	0	0
47	FI	32	0	12	0	0
47	FK	32	0	12	1	0
47	FM	32	0	12	2	0
47	GA	32	0	12	0	0
47	GC	32	0	12	1	0
47	GE	32	0	12	1	0
47	GG	32	0	12	1	0
47	GI	32	0	12	1	0
47	GK	32	0	12	1	0
47	GM	32	0	12	2	0
47	HA	32	0	12	1	0
47	HC	32	0	12	0	0
47	HE	32	0	12	2	0
47	HG	32	0	12	1	0
47	HI	32	0	12	0	0
47	HK	32	0	12	0	0
47	HM	32	0	12	1	0
47	IA	32	0	12	0	0
47	IC	32	0	12	0	0
47	IE	32	0	12	3	0
47	IG	32	0	12	2	0
47	II	32	0	12	0	0
47	IK	32	0	12	3	0
47	IM	32	0	12	3	0
47	JA	32	0	12	1	0
47	JC	32	0	12	2	0
47	JE	32	0	12	0	0
47	JG	32	0	12	2	0
47	JI	32	0	12	1	0

*Continued on next page...*

*Continued from previous page...*

Mol	Chain	Non-H	H(model)	H(added)	Clashes	Symm-Clashes
47	JK	32	0	12	2	0
47	JM	32	0	12	0	0
47	KA	32	0	12	2	0
47	KC	32	0	12	2	0
47	KE	32	0	12	2	0
47	KG	32	0	12	2	0
47	KI	32	0	12	1	0
47	KK	32	0	12	0	0
47	KM	32	0	12	3	0
47	LA	32	0	12	1	0
47	LC	32	0	12	3	0
47	LE	32	0	12	0	0
47	LG	32	0	12	2	0
47	LI	32	0	12	1	0
47	LK	32	0	12	2	0
47	LM	32	0	12	1	0
47	MA	32	0	12	0	0
47	MC	32	0	12	1	0
47	ME	32	0	12	1	0
47	MG	32	0	12	0	0
47	MI	32	0	12	0	0
47	MK	32	0	12	0	0
47	MM	32	0	12	4	0
47	NA	32	0	12	3	0
47	NC	32	0	12	0	0
47	NE	32	0	12	1	0
47	NG	32	0	12	1	0
47	NI	32	0	12	1	0
47	NK	32	0	12	1	0
47	NM	32	0	12	2	0
47	OA	32	0	12	0	0
47	OC	32	0	12	1	0
47	OF	32	0	12	4	0
47	OG	32	0	12	4	0
47	OI	32	0	12	3	0
47	OK	32	0	12	1	0
47	OM	32	0	12	1	0
47	PA	32	0	12	2	0
47	PD	32	0	12	3	0
47	PE	32	0	12	1	0
47	PG	32	0	12	3	0
47	PI	32	0	12	4	0

*Continued on next page...*

*Continued from previous page...*

Mol	Chain	Non-H	H(model)	H(added)	Clashes	Symm-Clashes
47	PK	32	0	12	4	0
47	PM	32	0	12	2	0
47	QA	32	0	12	2	0
47	QC	32	0	12	3	0
47	QE	32	0	12	4	0
47	QG	32	0	12	5	0
47	QI	32	0	12	3	0
47	QK	32	0	12	2	0
47	QM	32	0	12	2	0
47	RA	32	0	12	2	0
47	RC	32	0	12	3	0
47	RE	32	0	12	3	0
47	RG	32	0	12	2	0
47	RI	32	0	12	1	0
47	RK	32	0	12	3	0
47	RM	32	0	12	2	0
47	SA	32	0	12	2	0
47	SC	32	0	12	2	0
47	SE	32	0	12	2	0
47	SG	32	0	12	0	0
47	SI	32	0	12	1	0
47	SK	32	0	12	4	0
47	SM	32	0	12	1	0
47	TA	32	0	12	2	0
47	TC	32	0	12	3	0
47	TE	32	0	12	1	0
47	TG	32	0	12	1	0
47	TI	32	0	12	1	0
47	TK	32	0	12	2	0
47	TM	32	0	12	3	0
47	UA	32	0	12	2	0
47	UC	32	0	12	1	0
47	UE	32	0	12	3	0
47	UG	32	0	12	1	0
47	UI	32	0	12	3	0
47	UK	32	0	12	0	0
47	UM	32	0	12	1	0
47	VA	32	0	12	3	0
47	VC	32	0	12	3	0
47	VE	32	0	12	4	0
47	VG	32	0	12	4	0
47	VI	32	0	12	0	0

*Continued on next page...*



*Continued from previous page...*

Mol	Chain	Non-H	H(model)	H(added)	Clashes	Symm-Clashes
47	VK	32	0	12	1	0
47	VM	32	0	12	2	0
47	WA	32	0	12	3	0
47	WC	32	0	12	0	0
47	WE	32	0	12	1	0
47	WG	32	0	12	1	0
47	WI	32	0	12	3	0
47	WK	32	0	12	3	0
47	WM	32	0	12	1	0
48	AA	1	0	0	0	0
48	AC	1	0	0	0	0
48	AE	1	0	0	0	0
48	AG	1	0	0	0	0
48	AI	1	0	0	0	0
48	AK	1	0	0	0	0
48	AM	1	0	0	0	0
48	BA	1	0	0	0	0
48	BC	1	0	0	0	0
48	BE	1	0	0	0	0
48	BG	1	0	0	0	0
48	BI	1	0	0	0	0
48	BK	1	0	0	0	0
48	BM	1	0	0	0	0
48	CA	1	0	0	0	0
48	CC	1	0	0	0	0
48	CE	1	0	0	0	0
48	CG	1	0	0	0	0
48	CI	1	0	0	0	0
48	CK	1	0	0	0	0
48	CM	1	0	0	0	0
48	DA	1	0	0	0	0
48	DC	1	0	0	0	0
48	DE	1	0	0	0	0
48	DG	1	0	0	0	0
48	DI	1	0	0	0	0
48	DK	1	0	0	0	0
48	DM	1	0	0	0	0
48	EA	1	0	0	0	0
48	EC	1	0	0	0	0
48	EE	1	0	0	0	0
48	EG	1	0	0	0	0
48	EI	1	0	0	0	0

*Continued on next page...*

*Continued from previous page...*

Mol	Chain	Non-H	H(model)	H(added)	Clashes	Symm-Clashes
48	EK	1	0	0	0	0
48	EM	1	0	0	0	0
48	FA	1	0	0	0	0
48	FC	1	0	0	0	0
48	FE	1	0	0	0	0
48	FG	1	0	0	0	0
48	FI	1	0	0	0	0
48	FL	1	0	0	0	0
48	FM	1	0	0	0	0
48	GB	1	0	0	0	0
48	GC	1	0	0	0	0
48	GE	1	0	0	0	0
48	GG	1	0	0	0	0
48	GI	1	0	0	0	0
48	GL	1	0	0	0	0
48	GN	1	0	0	0	0
48	HA	1	0	0	0	0
48	HC	1	0	0	0	0
48	HE	1	0	0	0	0
48	HG	1	0	0	0	0
48	HI	1	0	0	0	0
48	HK	1	0	0	0	0
48	HM	1	0	0	0	0
48	IA	1	0	0	0	0
48	IC	1	0	0	0	0
48	IE	1	0	0	0	0
48	IG	1	0	0	0	0
48	II	1	0	0	0	0
48	IK	1	0	0	0	0
48	IM	1	0	0	0	0
48	JA	1	0	0	0	0
48	JC	1	0	0	0	0
48	JE	1	0	0	0	0
48	JG	1	0	0	0	0
48	JI	1	0	0	0	0
48	JK	1	0	0	0	0
48	JM	1	0	0	0	0
48	KA	1	0	0	0	0
48	KC	1	0	0	0	0
48	KE	1	0	0	0	0
48	KG	1	0	0	0	0
48	KI	1	0	0	0	0

*Continued on next page...*

*Continued from previous page...*

Mol	Chain	Non-H	H(model)	H(added)	Clashes	Symm-Clashes
48	KK	1	0	0	0	0
48	KM	1	0	0	0	0
48	LA	1	0	0	0	0
48	LC	1	0	0	0	0
48	LE	1	0	0	0	0
48	LG	1	0	0	0	0
48	LI	1	0	0	0	0
48	LK	1	0	0	0	0
48	LM	1	0	0	0	0
48	MA	1	0	0	0	0
48	MC	1	0	0	0	0
48	ME	1	0	0	0	0
48	MG	1	0	0	0	0
48	MI	1	0	0	0	0
48	MK	1	0	0	0	0
48	MM	1	0	0	0	0
48	NA	1	0	0	0	0
48	ND	1	0	0	0	0
48	NE	1	0	0	0	0
48	NG	1	0	0	0	0
48	NI	1	0	0	0	0
48	NK	1	0	0	0	0
48	NM	1	0	0	0	0
48	OA	1	0	0	0	0
48	OC	1	0	0	0	0
48	OE	1	0	0	0	0
48	OG	1	0	0	0	0
48	OI	1	0	0	0	0
48	OK	1	0	0	0	0
48	OM	1	0	0	0	0
48	PA	1	0	0	0	0
48	PC	1	0	0	0	0
48	PE	1	0	0	0	0
48	PG	1	0	0	0	0
48	PI	1	0	0	0	0
48	PK	1	0	0	0	0
48	PN	1	0	0	0	0
48	QA	1	0	0	0	0
48	QC	1	0	0	0	0
48	QE	1	0	0	0	0
48	QG	1	0	0	0	0
48	QI	1	0	0	0	0

*Continued on next page...*

*Continued from previous page...*

Mol	Chain	Non-H	H(model)	H(added)	Clashes	Symm-Clashes
48	QK	1	0	0	0	0
48	QM	1	0	0	0	0
48	RA	1	0	0	0	0
48	RC	1	0	0	0	0
48	RD	1	0	0	0	0
48	RG	1	0	0	0	0
48	RI	1	0	0	0	0
48	RK	1	0	0	0	0
48	RM	1	0	0	0	0
48	SA	1	0	0	0	0
48	SC	1	0	0	0	0
48	SE	1	0	0	0	0
48	SG	1	0	0	0	0
48	SI	1	0	0	0	0
48	SK	1	0	0	0	0
48	SM	1	0	0	0	0
48	TA	1	0	0	0	0
48	TB	1	0	0	0	0
48	TE	1	0	0	0	0
48	TF	1	0	0	0	0
48	TI	1	0	0	0	0
48	TK	1	0	0	0	0
48	TL	1	0	0	0	0
48	UA	1	0	0	0	0
48	UC	1	0	0	0	0
48	UE	1	0	0	0	0
48	UG	1	0	0	0	0
48	UI	1	0	0	0	0
48	UK	1	0	0	0	0
48	UM	1	0	0	0	0
48	VA	1	0	0	0	0
48	VC	1	0	0	0	0
48	VE	1	0	0	0	0
48	VG	1	0	0	0	0
48	VI	1	0	0	0	0
48	VK	1	0	0	0	0
48	VM	1	0	0	0	0
48	WA	1	0	0	0	0
48	WC	1	0	0	0	0
48	WE	1	0	0	0	0
48	WG	1	0	0	0	0
48	WI	1	0	0	0	0

*Continued on next page...*

*Continued from previous page...*

Mol	Chain	Non-H	H(model)	H(added)	Clashes	Symm-Clashes
48	WK	1	0	0	0	0
48	WM	1	0	0	0	0
49	AB	28	0	12	0	0
49	AD	28	0	12	0	0
49	AF	28	0	12	1	0
49	AH	28	0	12	2	0
49	AJ	28	0	12	2	0
49	AL	28	0	12	1	0
49	AN	28	0	12	1	0
49	BB	28	0	12	0	0
49	BD	28	0	12	2	0
49	BF	28	0	12	4	0
49	BH	28	0	12	2	0
49	BJ	28	0	12	2	0
49	BL	28	0	12	2	0
49	BN	28	0	12	0	0
49	CB	28	0	12	2	0
49	CD	28	0	12	2	0
49	CF	28	0	12	6	0
49	CH	28	0	12	1	0
49	CJ	28	0	12	4	0
49	CL	28	0	12	0	0
49	CN	28	0	12	0	0
49	DB	28	0	12	0	0
49	DD	28	0	12	2	0
49	DF	28	0	12	1	0
49	DH	28	0	12	2	0
49	DJ	28	0	12	2	0
49	DL	28	0	12	1	0
49	DN	28	0	12	1	0
49	EB	28	0	12	0	0
49	ED	28	0	12	1	0
49	EF	28	0	12	1	0
49	EH	28	0	12	4	0
49	EJ	28	0	12	0	0
49	EL	28	0	12	3	0
49	EN	28	0	12	5	0
49	FB	28	0	12	0	0
49	FD	28	0	12	0	0
49	FF	28	0	12	2	0
49	FH	28	0	12	4	0
49	FJ	28	0	12	1	0

*Continued on next page...*

*Continued from previous page...*

Mol	Chain	Non-H	H(model)	H(added)	Clashes	Symm-Clashes
49	FL	28	0	12	2	0
49	FN	28	0	12	1	0
49	GB	28	0	12	0	0
49	GD	28	0	12	2	0
49	GF	28	0	12	1	0
49	GH	28	0	12	0	0
49	GJ	28	0	12	1	0
49	GL	28	0	12	3	0
49	GN	28	0	12	1	0
49	HB	28	0	12	1	0
49	HD	28	0	12	1	0
49	HF	28	0	12	2	0
49	HH	28	0	12	2	0
49	HJ	28	0	12	2	0
49	HL	28	0	12	1	0
49	HN	28	0	12	1	0
49	IB	28	0	12	1	0
49	ID	28	0	12	0	0
49	IF	28	0	12	1	0
49	IH	28	0	12	3	0
49	IJ	28	0	12	3	0
49	IL	28	0	12	4	0
49	IN	28	0	12	3	0
49	JB	28	0	12	0	0
49	JD	28	0	12	1	0
49	JF	28	0	12	1	0
49	JH	28	0	12	1	0
49	JJ	28	0	12	2	0
49	JL	28	0	12	1	0
49	JN	28	0	12	1	0
49	KB	28	0	12	0	0
49	KD	28	0	12	0	0
49	KF	28	0	12	1	0
49	KH	28	0	12	1	0
49	KJ	28	0	12	0	0
49	KL	28	0	12	0	0
49	KN	28	0	12	0	0
49	LB	28	0	12	0	0
49	LD	28	0	12	0	0
49	LF	28	0	12	0	0
49	LH	28	0	12	0	0
49	LJ	28	0	12	2	0

*Continued on next page...*

*Continued from previous page...*

Mol	Chain	Non-H	H(model)	H(added)	Clashes	Symm-Clashes
49	LL	28	0	12	1	0
49	LN	28	0	12	2	0
49	MB	28	0	12	0	0
49	MD	28	0	12	0	0
49	MF	28	0	12	2	0
49	MH	28	0	12	1	0
49	MJ	28	0	12	3	0
49	ML	28	0	12	0	0
49	MN	28	0	12	0	0
49	NB	28	0	12	1	0
49	ND	28	0	12	0	0
49	NF	28	0	12	0	0
49	NH	28	0	12	0	0
49	NJ	28	0	12	1	0
49	NL	28	0	12	0	0
49	NN	28	0	12	0	0
49	OB	28	0	12	2	0
49	OD	28	0	12	2	0
49	OF	28	0	12	3	0
49	OH	28	0	12	0	0
49	OJ	28	0	12	2	0
49	OL	28	0	12	1	0
49	ON	28	0	12	2	0
49	PB	28	0	12	1	0
49	PD	28	0	12	0	0
49	PF	28	0	12	0	0
49	PH	28	0	12	2	0
49	PJ	28	0	12	1	0
49	PL	28	0	12	0	0
49	PN	28	0	12	3	0
49	QB	28	0	12	1	0
49	QD	28	0	12	1	0
49	QF	28	0	12	6	0
49	QH	28	0	12	1	0
49	QJ	28	0	12	3	0
49	QL	28	0	12	1	0
49	QN	28	0	12	1	0
49	RB	28	0	12	1	0
49	RD	28	0	12	0	0
49	RF	28	0	12	0	0
49	RH	28	0	12	1	0
49	RJ	28	0	12	3	0

*Continued on next page...*

*Continued from previous page...*

Mol	Chain	Non-H	H(model)	H(added)	Clashes	Symm-Clashes
49	RL	28	0	12	1	0
49	RN	28	0	12	1	0
49	SB	28	0	12	1	0
49	SD	28	0	12	0	0
49	SF	28	0	12	1	0
49	SH	28	0	12	0	0
49	SJ	28	0	12	1	0
49	SL	28	0	12	0	0
49	SN	28	0	12	1	0
49	TB	28	0	12	0	0
49	TD	28	0	12	1	0
49	TF	28	0	12	1	0
49	TH	28	0	12	1	0
49	TJ	28	0	12	1	0
49	TL	28	0	12	1	0
49	TN	28	0	12	1	0
49	UB	28	0	12	0	0
49	UD	28	0	12	2	0
49	UF	28	0	12	5	0
49	UH	28	0	12	1	0
49	UJ	28	0	12	3	0
49	UL	28	0	12	2	0
49	UN	28	0	12	1	0
49	VB	28	0	12	1	0
49	VD	28	0	12	1	0
49	VF	28	0	12	2	0
49	VH	28	0	12	2	0
49	VJ	28	0	12	4	0
49	VL	28	0	12	3	0
49	VN	28	0	12	2	0
49	WB	28	0	12	0	0
49	WD	28	0	12	3	0
49	WF	28	0	12	1	0
49	WH	28	0	12	2	0
49	WJ	28	0	12	0	0
49	WL	28	0	12	2	0
49	WN	28	0	12	0	0
All	All	1325153	0	1283777	35555	0

The all-atom clashscore is defined as the number of clashes found per 1000 atoms (including hydrogen atoms). The all-atom clashscore for this structure is 14.

The worst 5 of 35555 close contacts within the same asymmetric unit are listed below, sorted by their clash magnitude.



Atom-1	Atom-2	Interatomic distance (Å)	Clash overlap (Å)
46:DF:281:TYR:CD1	46:DF:281:TYR:CG	1.80	1.67
46:DF:281:TYR:CG	46:DF:281:TYR:CD2	1.80	1.65
45:UA:282:TYR:CD1	45:UA:282:TYR:CG	1.83	1.64
45:UA:282:TYR:CG	45:UA:282:TYR:CD2	1.89	1.60
46:DF:281:TYR:CE2	46:DF:281:TYR:CZ	1.91	1.57

There are no symmetry-related clashes.

## 5.3 Torsion angles [i](#)

### 5.3.1 Protein backbone [i](#)

There are no protein backbone outliers to report in this entry.

### 5.3.2 Protein sidechains [i](#)

In the following table, the Percentiles column shows the percent sidechain outliers of the chain as a percentile score with respect to all PDB entries followed by that with respect to all EM entries.

The Analysed column shows the number of residues for which the sidechain conformation was analysed, and the total number of residues.

Mol	Chain	Analysed	Rotameric	Outliers	Percentiles	
1	0A	133/213 (62%)	132 (99%)	1 (1%)	81	88
1	1A	133/213 (62%)	132 (99%)	1 (1%)	81	88
1	2A	133/213 (62%)	131 (98%)	2 (2%)	65	79
1	3A	133/213 (62%)	132 (99%)	1 (1%)	81	88
2	0B	291/301 (97%)	290 (100%)	1 (0%)	92	95
3	0C	81/137 (59%)	81 (100%)	0	100	100
3	1C	81/137 (59%)	81 (100%)	0	100	100
4	0D	175/197 (89%)	174 (99%)	1 (1%)	86	92
4	1D	175/197 (89%)	173 (99%)	2 (1%)	73	84
4	2D	175/197 (89%)	173 (99%)	2 (1%)	73	84
5	0E	172/175 (98%)	170 (99%)	2 (1%)	71	83
5	1E	172/175 (98%)	170 (99%)	2 (1%)	71	83
5	2E	172/175 (98%)	170 (99%)	2 (1%)	71	83

*Continued on next page...*

*Continued from previous page...*

Mol	Chain	Analysed	Rotameric	Outliers	Percentiles	
5	3E	172/175 (98%)	169 (98%)	3 (2%)	60	78
6	0F	182/194 (94%)	180 (99%)	2 (1%)	73	84
7	0G	153/167 (92%)	151 (99%)	2 (1%)	69	81
7	1G	125/167 (75%)	125 (100%)	0	100	100
8	0H	111/413 (27%)	110 (99%)	1 (1%)	78	87
8	1H	392/413 (95%)	385 (98%)	7 (2%)	59	77
9	0N	256/451 (57%)	256 (100%)	0	100	100
9	1N	423/451 (94%)	421 (100%)	2 (0%)	88	93
9	2N	256/451 (57%)	254 (99%)	2 (1%)	81	88
10	0Q	174/182 (96%)	172 (99%)	2 (1%)	73	84
10	1Q	174/182 (96%)	173 (99%)	1 (1%)	86	92
10	2Q	174/182 (96%)	174 (100%)	0	100	100
10	3Q	174/182 (96%)	173 (99%)	1 (1%)	86	92
10	4Q	174/182 (96%)	174 (100%)	0	100	100
10	5Q	174/182 (96%)	173 (99%)	1 (1%)	86	92
10	6Q	174/182 (96%)	173 (99%)	1 (1%)	86	92
11	0S	257/286 (90%)	256 (100%)	1 (0%)	91	94
11	1S	257/286 (90%)	255 (99%)	2 (1%)	81	88
11	2S	257/286 (90%)	256 (100%)	1 (0%)	91	94
11	3S	257/286 (90%)	257 (100%)	0	100	100
12	0T	229/264 (87%)	225 (98%)	4 (2%)	60	78
12	1T	251/264 (95%)	248 (99%)	3 (1%)	71	83
12	2T	251/264 (95%)	247 (98%)	4 (2%)	62	78
12	3T	251/264 (95%)	248 (99%)	3 (1%)	71	83
13	0U	528/571 (92%)	520 (98%)	8 (2%)	65	79
13	1U	528/571 (92%)	526 (100%)	2 (0%)	91	94
13	2U	528/571 (92%)	524 (99%)	4 (1%)	81	88
13	3U	528/571 (92%)	524 (99%)	4 (1%)	81	88
14	0V	196/249 (79%)	194 (99%)	2 (1%)	76	85
14	1V	244/249 (98%)	241 (99%)	3 (1%)	71	83
14	2V	244/249 (98%)	241 (99%)	3 (1%)	71	83

*Continued on next page...*

*Continued from previous page...*

Mol	Chain	Analysed	Rotameric	Outliers	Percentiles	
14	3V	244/249 (98%)	243 (100%)	1 (0%)	91	94
15	0X	98/129 (76%)	97 (99%)	1 (1%)	76	85
15	1X	128/129 (99%)	128 (100%)	0	100	100
15	2X	128/129 (99%)	126 (98%)	2 (2%)	62	78
15	3X	128/129 (99%)	128 (100%)	0	100	100
15	4X	128/129 (99%)	128 (100%)	0	100	100
16	1B	441/441 (100%)	439 (100%)	2 (0%)	88	93
16	2B	264/441 (60%)	263 (100%)	1 (0%)	91	94
16	3B	263/441 (60%)	262 (100%)	1 (0%)	91	94
17	1F	121/157 (77%)	119 (98%)	2 (2%)	60	78
18	1I	172/239 (72%)	171 (99%)	1 (1%)	86	92
19	1J	328/370 (89%)	328 (100%)	0	100	100
20	1K	263/463 (57%)	262 (100%)	1 (0%)	91	94
20	2K	275/463 (59%)	272 (99%)	3 (1%)	73	84
21	1L	771/878 (88%)	766 (99%)	5 (1%)	86	92
21	2L	576/878 (66%)	567 (98%)	9 (2%)	62	78
21	3L	191/878 (22%)	190 (100%)	1 (0%)	88	93
22	1M	323/325 (99%)	320 (99%)	3 (1%)	78	87
22	2M	323/325 (99%)	322 (100%)	1 (0%)	92	95
23	1O	228/458 (50%)	223 (98%)	5 (2%)	52	71
23	2O	346/458 (76%)	340 (98%)	6 (2%)	60	78
23	3O	258/458 (56%)	251 (97%)	7 (3%)	44	66
24	1P	328/471 (70%)	323 (98%)	5 (2%)	65	79
24	2P	173/471 (37%)	169 (98%)	4 (2%)	50	70
25	1R	466/475 (98%)	466 (100%)	0	100	100
25	2R	466/475 (98%)	465 (100%)	1 (0%)	93	96
25	3R	466/475 (98%)	465 (100%)	1 (0%)	93	96
26	1W	211/265 (80%)	211 (100%)	0	100	100
26	2W	109/265 (41%)	107 (98%)	2 (2%)	59	77
27	2C	271/271 (100%)	270 (100%)	1 (0%)	91	94
27	3C	271/271 (100%)	271 (100%)	0	100	100

*Continued on next page...*

*Continued from previous page...*

Mol	Chain	Analysed	Rotameric	Outliers	Percentiles	
27	4C	271/271 (100%)	270 (100%)	1 (0%)	91	94
28	2F	81/90 (90%)	81 (100%)	0	100	100
29	2G	91/91 (100%)	91 (100%)	0	100	100
30	2H	59/212 (28%)	59 (100%)	0	100	100
30	3H	59/212 (28%)	59 (100%)	0	100	100
30	4H	59/212 (28%)	59 (100%)	0	100	100
31	2I	124/259 (48%)	122 (98%)	2 (2%)	62	78
31	3I	80/259 (31%)	79 (99%)	1 (1%)	69	81
32	3D	195/195 (100%)	195 (100%)	0	100	100
33	4F	179/245 (73%)	178 (99%)	1 (1%)	86	92
34	4R	561/568 (99%)	561 (100%)	0	100	100
34	5R	561/568 (99%)	558 (100%)	3 (0%)	88	93
34	6R	561/568 (99%)	559 (100%)	2 (0%)	91	94
34	7R	561/568 (99%)	557 (99%)	4 (1%)	84	90
35	4S	169/222 (76%)	169 (100%)	0	100	100
35	5S	169/222 (76%)	166 (98%)	3 (2%)	59	77
36	5A	140/159 (88%)	139 (99%)	1 (1%)	84	90
36	5B	140/159 (88%)	138 (99%)	2 (1%)	67	80
36	5C	140/159 (88%)	139 (99%)	1 (1%)	84	90
36	5D	101/159 (64%)	97 (96%)	4 (4%)	31	57
37	5E	173/227 (76%)	170 (98%)	3 (2%)	60	78
37	5F	194/227 (86%)	194 (100%)	0	100	100
37	5G	194/227 (86%)	192 (99%)	2 (1%)	76	85
37	5H	132/227 (58%)	131 (99%)	1 (1%)	81	88
39	6F	128/141 (91%)	127 (99%)	1 (1%)	81	88
40	6G	194/329 (59%)	193 (100%)	1 (0%)	88	93
41	6H	150/474 (32%)	147 (98%)	3 (2%)	55	73
44	8R	31/31 (100%)	31 (100%)	0	100	100
45	AA	370/376 (98%)	370 (100%)	0	100	100
45	AC	370/376 (98%)	370 (100%)	0	100	100
45	AE	370/376 (98%)	370 (100%)	0	100	100

*Continued on next page...*

*Continued from previous page...*

Mol	Chain	Analysed	Rotameric	Outliers	Percentiles	
45	AG	370/376 (98%)	369 (100%)	1 (0%)	92	95
45	AI	370/376 (98%)	369 (100%)	1 (0%)	92	95
45	AK	370/376 (98%)	370 (100%)	0	100	100
45	AM	370/376 (98%)	369 (100%)	1 (0%)	92	95
45	BA	366/376 (97%)	365 (100%)	1 (0%)	92	95
45	BC	366/376 (97%)	364 (100%)	2 (0%)	88	93
45	BE	366/376 (97%)	366 (100%)	0	100	100
45	BG	366/376 (97%)	366 (100%)	0	100	100
45	BI	366/376 (97%)	366 (100%)	0	100	100
45	BK	366/376 (97%)	366 (100%)	0	100	100
45	BM	366/376 (97%)	364 (100%)	2 (0%)	88	93
45	CA	370/376 (98%)	370 (100%)	0	100	100
45	CC	370/376 (98%)	369 (100%)	1 (0%)	92	95
45	CE	370/376 (98%)	370 (100%)	0	100	100
45	CG	370/376 (98%)	367 (99%)	3 (1%)	81	88
45	CI	370/376 (98%)	370 (100%)	0	100	100
45	CK	370/376 (98%)	369 (100%)	1 (0%)	92	95
45	CM	370/376 (98%)	370 (100%)	0	100	100
45	DA	367/376 (98%)	367 (100%)	0	100	100
45	DC	368/376 (98%)	365 (99%)	3 (1%)	81	88
45	DE	367/376 (98%)	366 (100%)	1 (0%)	92	95
45	DG	368/376 (98%)	366 (100%)	2 (0%)	88	93
45	DI	367/376 (98%)	365 (100%)	2 (0%)	88	93
45	DK	368/376 (98%)	366 (100%)	2 (0%)	88	93
45	DM	367/376 (98%)	366 (100%)	1 (0%)	92	95
45	EA	370/376 (98%)	369 (100%)	1 (0%)	92	95
45	EC	370/376 (98%)	369 (100%)	1 (0%)	92	95
45	EE	370/376 (98%)	369 (100%)	1 (0%)	92	95
45	EG	370/376 (98%)	370 (100%)	0	100	100
45	EI	370/376 (98%)	367 (99%)	3 (1%)	81	88
45	EK	370/376 (98%)	370 (100%)	0	100	100

*Continued on next page...*

*Continued from previous page...*

Mol	Chain	Analysed	Rotameric	Outliers	Percentiles	
45	EM	370/376 (98%)	368 (100%)	2 (0%)	88	93
45	FA	363/376 (96%)	363 (100%)	0	100	100
45	FC	366/376 (97%)	366 (100%)	0	100	100
45	FE	367/376 (98%)	367 (100%)	0	100	100
45	FG	370/376 (98%)	370 (100%)	0	100	100
45	FI	367/376 (98%)	366 (100%)	1 (0%)	92	95
45	FK	366/376 (97%)	365 (100%)	1 (0%)	92	95
45	FM	363/376 (96%)	362 (100%)	1 (0%)	92	95
45	GA	363/376 (96%)	360 (99%)	3 (1%)	81	88
45	GC	365/376 (97%)	361 (99%)	4 (1%)	73	84
45	GE	365/376 (97%)	365 (100%)	0	100	100
45	GG	365/376 (97%)	363 (100%)	2 (0%)	88	93
45	GI	365/376 (97%)	363 (100%)	2 (0%)	88	93
45	GK	370/376 (98%)	370 (100%)	0	100	100
45	GM	363/376 (96%)	361 (99%)	2 (1%)	86	92
45	HA	365/376 (97%)	363 (100%)	2 (0%)	88	93
45	HC	365/376 (97%)	365 (100%)	0	100	100
45	HE	365/376 (97%)	363 (100%)	2 (0%)	88	93
45	HG	365/376 (97%)	363 (100%)	2 (0%)	88	93
45	HI	365/376 (97%)	365 (100%)	0	100	100
45	HK	365/376 (97%)	364 (100%)	1 (0%)	92	95
45	HM	365/376 (97%)	363 (100%)	2 (0%)	88	93
45	IA	366/376 (97%)	365 (100%)	1 (0%)	92	95
45	IC	370/376 (98%)	369 (100%)	1 (0%)	92	95
45	IE	366/376 (97%)	365 (100%)	1 (0%)	92	95
45	IG	370/376 (98%)	369 (100%)	1 (0%)	92	95
45	II	370/376 (98%)	368 (100%)	2 (0%)	88	93
45	IK	366/376 (97%)	364 (100%)	2 (0%)	88	93
45	IM	366/376 (97%)	365 (100%)	1 (0%)	92	95
45	JA	366/376 (97%)	365 (100%)	1 (0%)	92	95
45	JC	367/376 (98%)	365 (100%)	2 (0%)	88	93

*Continued on next page...*

*Continued from previous page...*

Mol	Chain	Analysed	Rotameric	Outliers	Percentiles	
45	JE	370/376 (98%)	369 (100%)	1 (0%)	92	95
45	JG	370/376 (98%)	370 (100%)	0	100	100
45	JI	369/376 (98%)	369 (100%)	0	100	100
45	JK	370/376 (98%)	368 (100%)	2 (0%)	88	93
45	JM	366/376 (97%)	366 (100%)	0	100	100
45	KA	367/376 (98%)	366 (100%)	1 (0%)	92	95
45	KC	367/376 (98%)	366 (100%)	1 (0%)	92	95
45	KE	368/376 (98%)	365 (99%)	3 (1%)	81	88
45	KG	370/376 (98%)	370 (100%)	0	100	100
45	KI	370/376 (98%)	365 (99%)	5 (1%)	67	80
45	KK	370/376 (98%)	369 (100%)	1 (0%)	92	95
45	KM	367/376 (98%)	365 (100%)	2 (0%)	88	93
45	LA	370/376 (98%)	368 (100%)	2 (0%)	88	93
45	LC	370/376 (98%)	370 (100%)	0	100	100
45	LE	369/376 (98%)	367 (100%)	2 (0%)	88	93
45	LG	370/376 (98%)	370 (100%)	0	100	100
45	LI	368/376 (98%)	367 (100%)	1 (0%)	92	95
45	LK	370/376 (98%)	370 (100%)	0	100	100
45	LM	370/376 (98%)	367 (99%)	3 (1%)	81	88
45	MA	369/376 (98%)	367 (100%)	2 (0%)	88	93
45	MC	366/376 (97%)	365 (100%)	1 (0%)	92	95
45	ME	367/376 (98%)	367 (100%)	0	100	100
45	MG	370/376 (98%)	370 (100%)	0	100	100
45	MI	370/376 (98%)	369 (100%)	1 (0%)	92	95
45	MK	367/376 (98%)	367 (100%)	0	100	100
45	MM	369/376 (98%)	366 (99%)	3 (1%)	81	88
45	NA	370/376 (98%)	367 (99%)	3 (1%)	81	88
45	NC	366/376 (97%)	365 (100%)	1 (0%)	92	95
45	NE	370/376 (98%)	368 (100%)	2 (0%)	88	93
45	NG	366/376 (97%)	364 (100%)	2 (0%)	88	93
45	NI	370/376 (98%)	369 (100%)	1 (0%)	92	95

*Continued on next page...*



*Continued from previous page...*

Mol	Chain	Analysed	Rotameric	Outliers	Percentiles	
45	NK	366/376 (97%)	364 (100%)	2 (0%)	88	93
45	NM	370/376 (98%)	370 (100%)	0	100	100
45	OA	366/376 (97%)	366 (100%)	0	100	100
45	OC	366/376 (97%)	366 (100%)	0	100	100
45	OE	366/376 (97%)	365 (100%)	1 (0%)	92	95
45	OG	366/376 (97%)	366 (100%)	0	100	100
45	OI	366/376 (97%)	366 (100%)	0	100	100
45	OK	366/376 (97%)	365 (100%)	1 (0%)	92	95
45	OM	366/376 (97%)	366 (100%)	0	100	100
45	PA	363/376 (96%)	363 (100%)	0	100	100
45	PC	363/376 (96%)	363 (100%)	0	100	100
45	PE	363/376 (96%)	363 (100%)	0	100	100
45	PG	363/376 (96%)	360 (99%)	3 (1%)	81	88
45	PI	363/376 (96%)	362 (100%)	1 (0%)	92	95
45	PK	363/376 (96%)	363 (100%)	0	100	100
45	PM	363/376 (96%)	362 (100%)	1 (0%)	92	95
45	QA	365/376 (97%)	365 (100%)	0	100	100
45	QC	365/376 (97%)	362 (99%)	3 (1%)	81	88
45	QE	365/376 (97%)	363 (100%)	2 (0%)	88	93
45	QG	365/376 (97%)	364 (100%)	1 (0%)	92	95
45	QI	365/376 (97%)	364 (100%)	1 (0%)	92	95
45	QK	365/376 (97%)	362 (99%)	3 (1%)	81	88
45	QM	365/376 (97%)	363 (100%)	2 (0%)	88	93
45	RA	365/376 (97%)	364 (100%)	1 (0%)	92	95
45	RC	365/376 (97%)	362 (99%)	3 (1%)	81	88
45	RE	365/376 (97%)	364 (100%)	1 (0%)	92	95
45	RG	365/376 (97%)	363 (100%)	2 (0%)	88	93
45	RI	365/376 (97%)	363 (100%)	2 (0%)	88	93
45	RK	365/376 (97%)	361 (99%)	4 (1%)	73	84
45	RM	365/376 (97%)	363 (100%)	2 (0%)	88	93
45	SA	364/376 (97%)	363 (100%)	1 (0%)	92	95

*Continued on next page...*



*Continued from previous page...*

Mol	Chain	Analysed	Rotameric	Outliers	Percentiles	
45	SC	364/376 (97%)	363 (100%)	1 (0%)	92	95
45	SE	364/376 (97%)	363 (100%)	1 (0%)	92	95
45	SG	364/376 (97%)	363 (100%)	1 (0%)	92	95
45	SI	364/376 (97%)	362 (100%)	2 (0%)	88	93
45	SK	364/376 (97%)	363 (100%)	1 (0%)	92	95
45	SM	364/376 (97%)	363 (100%)	1 (0%)	92	95
45	TA	364/376 (97%)	363 (100%)	1 (0%)	92	95
45	TC	364/376 (97%)	362 (100%)	2 (0%)	88	93
45	TE	364/376 (97%)	362 (100%)	2 (0%)	88	93
45	TG	364/376 (97%)	363 (100%)	1 (0%)	92	95
45	TI	364/376 (97%)	363 (100%)	1 (0%)	92	95
45	TK	364/376 (97%)	364 (100%)	0	100	100
45	TM	364/376 (97%)	362 (100%)	2 (0%)	88	93
45	UA	365/376 (97%)	364 (100%)	1 (0%)	92	95
45	UC	365/376 (97%)	364 (100%)	1 (0%)	92	95
45	UE	365/376 (97%)	363 (100%)	2 (0%)	88	93
45	UG	365/376 (97%)	365 (100%)	0	100	100
45	UI	365/376 (97%)	364 (100%)	1 (0%)	92	95
45	UK	365/376 (97%)	365 (100%)	0	100	100
45	UM	365/376 (97%)	364 (100%)	1 (0%)	92	95
45	VA	367/376 (98%)	367 (100%)	0	100	100
45	VC	370/376 (98%)	369 (100%)	1 (0%)	92	95
45	VE	367/376 (98%)	367 (100%)	0	100	100
45	VG	370/376 (98%)	369 (100%)	1 (0%)	92	95
45	VI	367/376 (98%)	365 (100%)	2 (0%)	88	93
45	VK	370/376 (98%)	370 (100%)	0	100	100
45	VM	367/376 (98%)	366 (100%)	1 (0%)	92	95
45	WA	365/376 (97%)	362 (99%)	3 (1%)	81	88
45	WC	370/376 (98%)	367 (99%)	3 (1%)	81	88
45	WE	365/376 (97%)	365 (100%)	0	100	100
45	WG	370/376 (98%)	367 (99%)	3 (1%)	81	88

*Continued on next page...*

*Continued from previous page...*

Mol	Chain	Analysed	Rotameric	Outliers	Percentiles	
45	WI	365/376 (97%)	363 (100%)	2 (0%)	88	93
45	WK	370/376 (98%)	368 (100%)	2 (0%)	88	93
45	WM	365/376 (97%)	364 (100%)	1 (0%)	92	95
46	AB	365/376 (97%)	365 (100%)	0	100	100
46	AD	365/376 (97%)	364 (100%)	1 (0%)	92	95
46	AF	365/376 (97%)	365 (100%)	0	100	100
46	AH	365/376 (97%)	365 (100%)	0	100	100
46	AJ	365/376 (97%)	364 (100%)	1 (0%)	92	95
46	AL	365/376 (97%)	364 (100%)	1 (0%)	92	95
46	AN	365/376 (97%)	365 (100%)	0	100	100
46	BB	365/376 (97%)	364 (100%)	1 (0%)	92	95
46	BD	365/376 (97%)	364 (100%)	1 (0%)	92	95
46	BF	365/376 (97%)	364 (100%)	1 (0%)	92	95
46	BH	365/376 (97%)	364 (100%)	1 (0%)	92	95
46	BJ	365/376 (97%)	365 (100%)	0	100	100
46	BL	365/376 (97%)	363 (100%)	2 (0%)	88	93
46	BN	365/376 (97%)	363 (100%)	2 (0%)	88	93
46	CB	365/376 (97%)	361 (99%)	4 (1%)	73	84
46	CD	365/376 (97%)	365 (100%)	0	100	100
46	CF	365/376 (97%)	363 (100%)	2 (0%)	88	93
46	CH	365/376 (97%)	363 (100%)	2 (0%)	88	93
46	CJ	365/376 (97%)	363 (100%)	2 (0%)	88	93
46	CL	365/376 (97%)	364 (100%)	1 (0%)	92	95
46	CN	365/376 (97%)	365 (100%)	0	100	100
46	DB	365/376 (97%)	365 (100%)	0	100	100
46	DD	365/376 (97%)	364 (100%)	1 (0%)	92	95
46	DF	365/376 (97%)	365 (100%)	0	100	100
46	DH	365/376 (97%)	364 (100%)	1 (0%)	92	95
46	DJ	365/376 (97%)	365 (100%)	0	100	100
46	DL	365/376 (97%)	365 (100%)	0	100	100
46	DN	365/376 (97%)	365 (100%)	0	100	100

*Continued on next page...*

Continued from previous page...

Mol	Chain	Analysed	Rotameric	Outliers	Percentiles	
46	EB	365/376 (97%)	363 (100%)	2 (0%)	88	93
46	ED	365/376 (97%)	365 (100%)	0	100	100
46	EF	365/376 (97%)	364 (100%)	1 (0%)	92	95
46	EH	365/376 (97%)	364 (100%)	1 (0%)	92	95
46	EJ	365/376 (97%)	365 (100%)	0	100	100
46	EL	365/376 (97%)	365 (100%)	0	100	100
46	EN	365/376 (97%)	365 (100%)	0	100	100
46	FB	365/376 (97%)	363 (100%)	2 (0%)	88	93
46	FD	365/376 (97%)	361 (99%)	4 (1%)	73	84
46	FF	365/376 (97%)	363 (100%)	2 (0%)	88	93
46	FH	365/376 (97%)	365 (100%)	0	100	100
46	FJ	365/376 (97%)	364 (100%)	1 (0%)	92	95
46	FL	365/376 (97%)	364 (100%)	1 (0%)	92	95
46	FN	365/376 (97%)	364 (100%)	1 (0%)	92	95
46	GB	365/376 (97%)	363 (100%)	2 (0%)	88	93
46	GD	365/376 (97%)	365 (100%)	0	100	100
46	GF	365/376 (97%)	363 (100%)	2 (0%)	88	93
46	GH	365/376 (97%)	365 (100%)	0	100	100
46	GJ	365/376 (97%)	363 (100%)	2 (0%)	88	93
46	GL	365/376 (97%)	364 (100%)	1 (0%)	92	95
46	GN	365/376 (97%)	363 (100%)	2 (0%)	88	93
46	HB	365/376 (97%)	365 (100%)	0	100	100
46	HD	365/376 (97%)	364 (100%)	1 (0%)	92	95
46	HF	365/376 (97%)	364 (100%)	1 (0%)	92	95
46	HH	365/376 (97%)	365 (100%)	0	100	100
46	HJ	365/376 (97%)	363 (100%)	2 (0%)	88	93
46	HL	365/376 (97%)	364 (100%)	1 (0%)	92	95
46	HN	365/376 (97%)	365 (100%)	0	100	100
46	IB	365/376 (97%)	364 (100%)	1 (0%)	92	95
46	ID	365/376 (97%)	364 (100%)	1 (0%)	92	95
46	IF	365/376 (97%)	365 (100%)	0	100	100

Continued on next page...

*Continued from previous page...*

Mol	Chain	Analysed	Rotameric	Outliers	Percentiles	
46	IH	365/376 (97%)	364 (100%)	1 (0%)	92	95
46	IJ	365/376 (97%)	361 (99%)	4 (1%)	73	84
46	IL	365/376 (97%)	363 (100%)	2 (0%)	88	93
46	IN	365/376 (97%)	365 (100%)	0	100	100
46	JB	365/376 (97%)	364 (100%)	1 (0%)	92	95
46	JD	365/376 (97%)	365 (100%)	0	100	100
46	JF	365/376 (97%)	364 (100%)	1 (0%)	92	95
46	JH	365/376 (97%)	365 (100%)	0	100	100
46	JJ	365/376 (97%)	363 (100%)	2 (0%)	88	93
46	JL	365/376 (97%)	365 (100%)	0	100	100
46	JN	365/376 (97%)	365 (100%)	0	100	100
46	KB	365/376 (97%)	364 (100%)	1 (0%)	92	95
46	KD	365/376 (97%)	364 (100%)	1 (0%)	92	95
46	KF	365/376 (97%)	365 (100%)	0	100	100
46	KH	365/376 (97%)	365 (100%)	0	100	100
46	KJ	365/376 (97%)	365 (100%)	0	100	100
46	KL	365/376 (97%)	365 (100%)	0	100	100
46	KN	365/376 (97%)	365 (100%)	0	100	100
46	LB	365/376 (97%)	365 (100%)	0	100	100
46	LD	365/376 (97%)	365 (100%)	0	100	100
46	LF	365/376 (97%)	365 (100%)	0	100	100
46	LH	365/376 (97%)	363 (100%)	2 (0%)	88	93
46	LJ	365/376 (97%)	365 (100%)	0	100	100
46	LL	365/376 (97%)	364 (100%)	1 (0%)	92	95
46	LN	365/376 (97%)	364 (100%)	1 (0%)	92	95
46	MB	365/376 (97%)	365 (100%)	0	100	100
46	MD	365/376 (97%)	364 (100%)	1 (0%)	92	95
46	MF	365/376 (97%)	365 (100%)	0	100	100
46	MH	365/376 (97%)	365 (100%)	0	100	100
46	MJ	365/376 (97%)	365 (100%)	0	100	100
46	ML	365/376 (97%)	365 (100%)	0	100	100

*Continued on next page...*

*Continued from previous page...*

Mol	Chain	Analysed	Rotameric	Outliers	Percentiles	
46	MN	365/376 (97%)	364 (100%)	1 (0%)	92	95
46	NB	359/376 (96%)	359 (100%)	0	100	100
46	ND	365/376 (97%)	364 (100%)	1 (0%)	92	95
46	NF	359/376 (96%)	358 (100%)	1 (0%)	92	95
46	NH	365/376 (97%)	365 (100%)	0	100	100
46	NJ	359/376 (96%)	358 (100%)	1 (0%)	92	95
46	NL	365/376 (97%)	365 (100%)	0	100	100
46	NN	359/376 (96%)	358 (100%)	1 (0%)	92	95
46	OB	365/376 (97%)	365 (100%)	0	100	100
46	OD	365/376 (97%)	364 (100%)	1 (0%)	92	95
46	OF	365/376 (97%)	363 (100%)	2 (0%)	88	93
46	OH	365/376 (97%)	364 (100%)	1 (0%)	92	95
46	OJ	365/376 (97%)	364 (100%)	1 (0%)	92	95
46	OL	365/376 (97%)	365 (100%)	0	100	100
46	ON	365/376 (97%)	364 (100%)	1 (0%)	92	95
46	PB	365/376 (97%)	364 (100%)	1 (0%)	92	95
46	PD	365/376 (97%)	363 (100%)	2 (0%)	88	93
46	PF	365/376 (97%)	364 (100%)	1 (0%)	92	95
46	PH	365/376 (97%)	364 (100%)	1 (0%)	92	95
46	PJ	365/376 (97%)	365 (100%)	0	100	100
46	PL	365/376 (97%)	365 (100%)	0	100	100
46	PN	365/376 (97%)	364 (100%)	1 (0%)	92	95
46	QB	365/376 (97%)	364 (100%)	1 (0%)	92	95
46	QD	365/376 (97%)	365 (100%)	0	100	100
46	QF	365/376 (97%)	365 (100%)	0	100	100
46	QH	365/376 (97%)	364 (100%)	1 (0%)	92	95
46	QJ	365/376 (97%)	363 (100%)	2 (0%)	88	93
46	QL	365/376 (97%)	365 (100%)	0	100	100
46	QN	365/376 (97%)	365 (100%)	0	100	100
46	RB	365/376 (97%)	365 (100%)	0	100	100
46	RD	365/376 (97%)	365 (100%)	0	100	100

*Continued on next page...*

Continued from previous page...

Mol	Chain	Analysed	Rotameric	Outliers	Percentiles	
46	RF	365/376 (97%)	364 (100%)	1 (0%)	92	95
46	RH	365/376 (97%)	365 (100%)	0	100	100
46	RJ	365/376 (97%)	364 (100%)	1 (0%)	92	95
46	RL	365/376 (97%)	365 (100%)	0	100	100
46	RN	365/376 (97%)	365 (100%)	0	100	100
46	SB	365/376 (97%)	363 (100%)	2 (0%)	88	93
46	SD	365/376 (97%)	365 (100%)	0	100	100
46	SF	365/376 (97%)	365 (100%)	0	100	100
46	SH	365/376 (97%)	364 (100%)	1 (0%)	92	95
46	SJ	365/376 (97%)	364 (100%)	1 (0%)	92	95
46	SL	365/376 (97%)	365 (100%)	0	100	100
46	SN	365/376 (97%)	365 (100%)	0	100	100
46	TB	365/376 (97%)	364 (100%)	1 (0%)	92	95
46	TD	365/376 (97%)	361 (99%)	4 (1%)	73	84
46	TF	365/376 (97%)	364 (100%)	1 (0%)	92	95
46	TH	365/376 (97%)	364 (100%)	1 (0%)	92	95
46	TJ	365/376 (97%)	363 (100%)	2 (0%)	88	93
46	TL	365/376 (97%)	362 (99%)	3 (1%)	81	88
46	TN	365/376 (97%)	365 (100%)	0	100	100
46	UB	365/376 (97%)	364 (100%)	1 (0%)	92	95
46	UD	365/376 (97%)	365 (100%)	0	100	100
46	UF	365/376 (97%)	364 (100%)	1 (0%)	92	95
46	UH	365/376 (97%)	365 (100%)	0	100	100
46	UJ	365/376 (97%)	364 (100%)	1 (0%)	92	95
46	UL	365/376 (97%)	364 (100%)	1 (0%)	92	95
46	UN	365/376 (97%)	364 (100%)	1 (0%)	92	95
46	VB	365/376 (97%)	361 (99%)	4 (1%)	73	84
46	VD	365/376 (97%)	363 (100%)	2 (0%)	88	93
46	VF	365/376 (97%)	364 (100%)	1 (0%)	92	95
46	VH	365/376 (97%)	363 (100%)	2 (0%)	88	93
46	VJ	365/376 (97%)	365 (100%)	0	100	100

Continued on next page...

Continued from previous page...

Mol	Chain	Analysed	Rotameric	Outliers	Percentiles	
46	VL	365/376 (97%)	364 (100%)	1 (0%)	92	95
46	VN	365/376 (97%)	364 (100%)	1 (0%)	92	95
46	WB	365/376 (97%)	365 (100%)	0	100	100
46	WD	365/376 (97%)	365 (100%)	0	100	100
46	WF	365/376 (97%)	364 (100%)	1 (0%)	92	95
46	WH	365/376 (97%)	364 (100%)	1 (0%)	92	95
46	WJ	365/376 (97%)	364 (100%)	1 (0%)	92	95
46	WL	365/376 (97%)	365 (100%)	0	100	100
46	WN	365/376 (97%)	365 (100%)	0	100	100
All	All	142179/152289 (93%)	141673 (100%)	506 (0%)	91	94

5 of 506 residues with a non-rotameric sidechain are listed below:

Mol	Chain	Res	Type
45	DK	373	ARG
46	TD	297	LYS
46	HF	347	ASN
45	TA	326	LYS
46	VB	380	ARG

Sometimes sidechains can be flipped to improve hydrogen bonding and reduce clashes. 5 of 763 such sidechains are listed below:

Mol	Chain	Res	Type
46	ND	426	GLN
46	QJ	99	ASN
45	NK	8	HIS
45	NC	91	GLN
46	ON	227	HIS

### 5.3.3 RNA [i](#)

There are no RNA molecules in this entry.

## 5.4 Non-standard residues in protein, DNA, RNA chains [i](#)

There are no non-standard protein/DNA/RNA residues in this entry.



## 5.5 Carbohydrates [i](#)

There are no monosaccharides in this entry.

## 5.6 Ligand geometry [i](#)

Of 483 ligands modelled in this entry, 161 are monoatomic - leaving 322 for Mogul analysis.

In the following table, the Counts columns list the number of bonds (or angles) for which Mogul statistics could be retrieved, the number of bonds (or angles) that are observed in the model and the number of bonds (or angles) that are defined in the Chemical Component Dictionary. The Link column lists molecule types, if any, to which the group is linked. The Z score for a bond length (or angle) is the number of standard deviations the observed value is removed from the expected value. A bond length (or angle) with  $|Z| > 2$  is considered an outlier worth inspection. RMSZ is the root-mean-square of all Z scores of the bond lengths (or angles).

Mol	Type	Chain	Res	Link	Bond lengths			Bond angles		
					Counts	RMSZ	# Z  > 2	Counts	RMSZ	# Z  > 2
47	GTP	RK	501	48	26,34,34	1.15	2 (7%)	32,54,54	1.60	7 (21%)
47	GTP	AE	501	48	26,34,34	1.18	2 (7%)	32,54,54	1.63	7 (21%)
49	GDP	LL	501	-	24,30,30	0.96	1 (4%)	30,47,47	1.37	4 (13%)
49	GDP	PF	501	-	24,30,30	0.94	1 (4%)	30,47,47	1.30	4 (13%)
47	GTP	QG	501	48	26,34,34	1.17	2 (7%)	32,54,54	1.52	8 (25%)
49	GDP	DL	501	-	24,30,30	0.94	1 (4%)	30,47,47	1.29	4 (13%)
49	GDP	QD	501	-	24,30,30	0.96	1 (4%)	30,47,47	1.30	4 (13%)
47	GTP	VI	501	48	26,34,34	1.15	2 (7%)	32,54,54	1.60	7 (21%)
49	GDP	EN	501	-	24,30,30	0.96	1 (4%)	30,47,47	1.27	4 (13%)
47	GTP	DK	501	48	26,34,34	1.16	2 (7%)	32,54,54	1.53	7 (21%)
49	GDP	QB	501	-	24,30,30	0.94	1 (4%)	30,47,47	1.31	4 (13%)
47	GTP	TC	501	48	26,34,34	1.13	2 (7%)	32,54,54	1.59	6 (18%)
47	GTP	PD	501	46,48	26,34,34	1.14	2 (7%)	32,54,54	1.55	7 (21%)
49	GDP	BD	501	-	24,30,30	0.94	1 (4%)	30,47,47	1.29	4 (13%)
47	GTP	EK	501	48	26,34,34	1.15	2 (7%)	32,54,54	1.59	7 (21%)
47	GTP	VG	501	48	26,34,34	1.15	2 (7%)	32,54,54	1.64	7 (21%)
47	GTP	UI	501	48	26,34,34	1.15	2 (7%)	32,54,54	1.58	7 (21%)
49	GDP	QH	501	-	24,30,30	0.95	1 (4%)	30,47,47	1.27	4 (13%)
49	GDP	AD	501	-	24,30,30	0.95	1 (4%)	30,47,47	1.37	4 (13%)
49	GDP	DF	501	-	24,30,30	0.94	1 (4%)	30,47,47	1.26	4 (13%)
49	GDP	FD	501	-	24,30,30	0.94	1 (4%)	30,47,47	1.38	4 (13%)
47	GTP	TM	501	48	26,34,34	1.12	2 (7%)	32,54,54	1.57	6 (18%)



Mol	Type	Chain	Res	Link	Bond lengths			Bond angles		
					Counts	RMSZ	# Z  > 2	Counts	RMSZ	# Z  > 2
47	GTP	BG	501	48	26,34,34	1.15	2 (7%)	32,54,54	1.65	7 (21%)
47	GTP	AK	501	48	26,34,34	1.20	2 (7%)	32,54,54	1.60	7 (21%)
47	GTP	TG	501	48	26,34,34	1.16	2 (7%)	32,54,54	1.56	7 (21%)
47	GTP	JE	501	48	26,34,34	1.17	2 (7%)	32,54,54	1.69	7 (21%)
49	GDP	OF	502	-	24,30,30	0.94	1 (4%)	30,47,47	1.34	4 (13%)
47	GTP	NC	501	48	26,34,34	1.15	2 (7%)	32,54,54	1.58	7 (21%)
49	GDP	JN	501	-	24,30,30	0.94	1 (4%)	30,47,47	1.34	4 (13%)
47	GTP	MC	501	48	26,34,34	1.18	2 (7%)	32,54,54	1.63	7 (21%)
47	GTP	GI	501	48	26,34,34	1.16	2 (7%)	32,54,54	1.61	7 (21%)
49	GDP	SJ	501	-	24,30,30	0.95	1 (4%)	30,47,47	1.35	5 (16%)
49	GDP	UJ	501	-	24,30,30	0.96	1 (4%)	30,47,47	1.30	4 (13%)
47	GTP	OA	501	48	26,34,34	1.14	2 (7%)	32,54,54	1.56	7 (21%)
47	GTP	PG	501	48	26,34,34	1.14	2 (7%)	32,54,54	1.61	6 (18%)
49	GDP	QN	501	-	24,30,30	0.94	1 (4%)	30,47,47	1.31	4 (13%)
47	GTP	OC	501	48	26,34,34	1.13	2 (7%)	32,54,54	1.54	7 (21%)
47	GTP	GM	501	48	26,34,34	1.11	2 (7%)	32,54,54	1.55	7 (21%)
49	GDP	JJ	501	-	24,30,30	0.96	1 (4%)	30,47,47	1.34	4 (13%)
47	GTP	KI	501	48	26,34,34	1.17	2 (7%)	32,54,54	1.65	7 (21%)
49	GDP	DJ	501	-	24,30,30	0.95	1 (4%)	30,47,47	1.32	4 (13%)
49	GDP	UH	501	-	24,30,30	0.95	1 (4%)	30,47,47	1.32	4 (13%)
49	GDP	OL	501	-	24,30,30	0.93	1 (4%)	30,47,47	1.33	4 (13%)
49	GDP	MD	501	-	24,30,30	0.96	1 (4%)	30,47,47	1.42	4 (13%)
49	GDP	QF	501	-	24,30,30	0.94	1 (4%)	30,47,47	1.28	4 (13%)
47	GTP	SM	501	48	26,34,34	1.14	2 (7%)	32,54,54	1.54	7 (21%)
47	GTP	SC	501	48	26,34,34	1.14	2 (7%)	32,54,54	1.56	7 (21%)
47	GTP	NM	501	48	26,34,34	1.15	2 (7%)	32,54,54	1.52	7 (21%)
49	GDP	IN	501	-	24,30,30	0.95	1 (4%)	30,47,47	1.37	4 (13%)
47	GTP	IA	501	48	26,34,34	1.15	2 (7%)	32,54,54	1.57	7 (21%)
49	GDP	VH	501	-	24,30,30	0.95	1 (4%)	30,47,47	1.36	4 (13%)
49	GDP	VB	501	-	24,30,30	0.95	1 (4%)	30,47,47	1.30	4 (13%)
47	GTP	GA	501	48	26,34,34	1.12	2 (7%)	32,54,54	1.60	7 (21%)
49	GDP	ML	501	-	24,30,30	0.95	1 (4%)	30,47,47	1.33	4 (13%)
47	GTP	BA	501	48	26,34,34	1.13	2 (7%)	32,54,54	1.58	6 (18%)
49	GDP	OJ	501	-	24,30,30	0.94	1 (4%)	30,47,47	1.36	4 (13%)
47	GTP	UC	501	48	26,34,34	1.13	2 (7%)	32,54,54	1.62	7 (21%)

Mol	Type	Chain	Res	Link	Bond lengths			Bond angles		
					Counts	RMSZ	# Z  > 2	Counts	RMSZ	# Z  > 2
47	GTP	VC	501	48	26,34,34	1.15	2 (7%)	32,54,54	1.60	6 (18%)
49	GDP	NB	501	-	24,30,30	0.94	1 (4%)	30,47,47	1.33	4 (13%)
49	GDP	PD	502	-	24,30,30	0.93	1 (4%)	30,47,47	1.27	4 (13%)
49	GDP	FJ	501	-	24,30,30	0.94	1 (4%)	30,47,47	1.36	4 (13%)
49	GDP	LD	501	-	24,30,30	0.95	1 (4%)	30,47,47	1.39	4 (13%)
49	GDP	IJ	501	-	24,30,30	0.95	1 (4%)	30,47,47	1.31	4 (13%)
47	GTP	JM	501	48	26,34,34	1.13	2 (7%)	32,54,54	1.59	7 (21%)
47	GTP	DG	501	48	26,34,34	1.15	2 (7%)	32,54,54	1.59	7 (21%)
49	GDP	MN	501	-	24,30,30	0.92	1 (4%)	30,47,47	1.33	4 (13%)
49	GDP	PB	501	-	24,30,30	0.94	1 (4%)	30,47,47	1.31	4 (13%)
47	GTP	VK	501	48	26,34,34	1.16	2 (7%)	32,54,54	1.54	7 (21%)
47	GTP	RI	501	48	26,34,34	1.17	2 (7%)	32,54,54	1.59	7 (21%)
47	GTP	FK	501	48	26,34,34	1.16	2 (7%)	32,54,54	1.60	7 (21%)
47	GTP	BK	501	48	26,34,34	1.17	2 (7%)	32,54,54	1.63	7 (21%)
49	GDP	CD	501	-	24,30,30	0.95	1 (4%)	30,47,47	1.31	4 (13%)
49	GDP	BB	501	-	24,30,30	0.94	1 (4%)	30,47,47	1.31	4 (13%)
47	GTP	OM	501	48	26,34,34	1.15	2 (7%)	32,54,54	1.54	7 (21%)
47	GTP	VA	501	48	26,34,34	1.15	2 (7%)	32,54,54	1.61	6 (18%)
47	GTP	WE	501	48	26,34,34	1.15	2 (7%)	32,54,54	1.62	6 (18%)
47	GTP	FM	501	48	26,34,34	1.13	2 (7%)	32,54,54	1.54	7 (21%)
47	GTP	CG	501	48	26,34,34	1.15	2 (7%)	32,54,54	1.61	7 (21%)
47	GTP	DM	501	48	26,34,34	1.14	2 (7%)	32,54,54	1.58	7 (21%)
47	GTP	FE	501	48	26,34,34	1.17	2 (7%)	32,54,54	1.64	7 (21%)
49	GDP	NL	501	-	24,30,30	0.94	1 (4%)	30,47,47	1.35	4 (13%)
47	GTP	OK	501	48	26,34,34	1.15	2 (7%)	32,54,54	1.57	7 (21%)
49	GDP	BN	501	-	24,30,30	0.95	1 (4%)	30,47,47	1.38	4 (13%)
47	GTP	HM	501	48	26,34,34	1.13	2 (7%)	32,54,54	1.53	7 (21%)
47	GTP	ME	501	48	26,34,34	1.20	2 (7%)	32,54,54	1.63	7 (21%)
47	GTP	WG	501	48	26,34,34	1.16	2 (7%)	32,54,54	1.61	7 (21%)
49	GDP	FN	501	-	24,30,30	0.95	1 (4%)	30,47,47	1.34	4 (13%)
47	GTP	DC	501	48	26,34,34	1.16	2 (7%)	32,54,54	1.57	7 (21%)
47	GTP	QE	501	48	26,34,34	1.17	2 (7%)	32,54,54	1.58	7 (21%)
47	GTP	VM	501	48	26,34,34	1.12	2 (7%)	32,54,54	1.55	7 (21%)
47	GTP	UE	501	48	26,34,34	1.15	2 (7%)	32,54,54	1.64	7 (21%)
47	GTP	UM	501	48	26,34,34	1.13	2 (7%)	32,54,54	1.57	7 (21%)

Mol	Type	Chain	Res	Link	Bond lengths			Bond angles		
					Counts	RMSZ	# Z  > 2	Counts	RMSZ	# Z  > 2
49	GDP	ID	501	-	24,30,30	0.95	1 (4%)	30,47,47	1.36	4 (13%)
47	GTP	KK	501	48	26,34,34	1.17	2 (7%)	32,54,54	1.64	7 (21%)
47	GTP	OG	501	48	26,34,34	1.14	2 (7%)	32,54,54	1.55	7 (21%)
47	GTP	MK	501	48	26,34,34	1.17	2 (7%)	32,54,54	1.63	7 (21%)
49	GDP	PN	502	-	24,30,30	0.94	1 (4%)	30,47,47	1.30	4 (13%)
47	GTP	QK	501	48	26,34,34	1.18	2 (7%)	32,54,54	1.57	7 (21%)
49	GDP	QJ	501	-	24,30,30	0.95	1 (4%)	30,47,47	1.35	4 (13%)
47	GTP	UA	501	48	26,34,34	1.12	2 (7%)	32,54,54	1.56	7 (21%)
47	GTP	BI	501	48	26,34,34	1.17	2 (7%)	32,54,54	1.63	7 (21%)
49	GDP	EF	501	-	24,30,30	0.94	1 (4%)	30,47,47	1.35	4 (13%)
49	GDP	TB	501	-	24,30,30	0.93	1 (4%)	30,47,47	1.34	4 (13%)
47	GTP	NK	501	48	26,34,34	1.18	2 (7%)	32,54,54	1.63	7 (21%)
47	GTP	SI	501	48	26,34,34	1.16	2 (7%)	32,54,54	1.58	7 (21%)
49	GDP	VN	501	-	24,30,30	0.94	1 (4%)	30,47,47	1.35	4 (13%)
47	GTP	BC	502	48	26,34,34	1.16	2 (7%)	32,54,54	1.63	7 (21%)
47	GTP	GE	501	48	26,34,34	1.17	2 (7%)	32,54,54	1.67	7 (21%)
49	GDP	RJ	501	-	24,30,30	0.97	1 (4%)	30,47,47	1.31	4 (13%)
49	GDP	IH	501	-	24,30,30	0.94	1 (4%)	30,47,47	1.27	4 (13%)
47	GTP	KC	501	48	26,34,34	1.17	2 (7%)	32,54,54	1.61	7 (21%)
47	GTP	AG	501	48	26,34,34	1.16	2 (7%)	32,54,54	1.66	7 (21%)
47	GTP	MI	501	48	26,34,34	1.17	2 (7%)	32,54,54	1.62	7 (21%)
47	GTP	MM	501	48	26,34,34	1.16	2 (7%)	32,54,54	1.62	7 (21%)
49	GDP	RB	501	-	24,30,30	1.00	1 (4%)	30,47,47	1.31	4 (13%)
49	GDP	GN	502	-	24,30,30	0.94	1 (4%)	30,47,47	1.36	4 (13%)
49	GDP	AB	501	-	24,30,30	0.92	1 (4%)	30,47,47	1.38	5 (16%)
49	GDP	IF	501	-	24,30,30	0.95	1 (4%)	30,47,47	1.36	4 (13%)
49	GDP	AH	501	-	24,30,30	0.94	1 (4%)	30,47,47	1.35	4 (13%)
47	GTP	GG	501	48	26,34,34	1.17	2 (7%)	32,54,54	1.64	7 (21%)
49	GDP	MF	501	-	24,30,30	0.95	1 (4%)	30,47,47	1.32	4 (13%)
49	GDP	KN	501	-	24,30,30	0.93	1 (4%)	30,47,47	1.33	4 (13%)
49	GDP	GB	502	-	24,30,30	0.95	1 (4%)	30,47,47	1.32	4 (13%)
47	GTP	BE	501	48	26,34,34	1.18	2 (7%)	32,54,54	1.62	7 (21%)
47	GTP	NI	501	48	26,34,34	1.18	2 (7%)	32,54,54	1.55	7 (21%)
49	GDP	RH	501	-	24,30,30	0.96	1 (4%)	30,47,47	1.29	4 (13%)
49	GDP	DB	501	-	24,30,30	0.94	1 (4%)	30,47,47	1.31	4 (13%)

Mol	Type	Chain	Res	Link	Bond lengths			Bond angles		
					Counts	RMSZ	# Z  > 2	Counts	RMSZ	# Z  > 2
47	GTP	JC	501	48	26,34,34	1.17	2 (7%)	32,54,54	1.49	6 (18%)
49	GDP	LB	501	-	24,30,30	0.94	1 (4%)	30,47,47	1.31	4 (13%)
49	GDP	SF	501	-	24,30,30	0.94	1 (4%)	30,47,47	1.40	4 (13%)
49	GDP	UF	501	-	24,30,30	0.95	1 (4%)	30,47,47	1.36	4 (13%)
49	GDP	TH	501	-	24,30,30	0.95	1 (4%)	30,47,47	1.34	4 (13%)
49	GDP	RN	501	-	24,30,30	0.95	1 (4%)	30,47,47	1.31	4 (13%)
49	GDP	HN	501	-	24,30,30	0.95	1 (4%)	30,47,47	1.34	4 (13%)
47	GTP	LI	501	48	26,34,34	1.18	2 (7%)	32,54,54	1.63	7 (21%)
47	GTP	KA	501	48	26,34,34	1.16	2 (7%)	32,54,54	1.61	7 (21%)
47	GTP	CI	501	48	26,34,34	1.14	2 (7%)	32,54,54	1.63	7 (21%)
47	GTP	QA	501	48	26,34,34	1.13	2 (7%)	32,54,54	1.56	7 (21%)
47	GTP	UK	501	48	26,34,34	1.15	2 (7%)	32,54,54	1.59	7 (21%)
49	GDP	UD	501	-	24,30,30	0.95	1 (4%)	30,47,47	1.34	4 (13%)
49	GDP	HF	501	-	24,30,30	0.94	1 (4%)	30,47,47	1.36	4 (13%)
49	GDP	MH	501	-	24,30,30	0.94	1 (4%)	30,47,47	1.35	4 (13%)
49	GDP	TD	501	-	24,30,30	0.93	1 (4%)	30,47,47	1.34	4 (13%)
49	GDP	NH	501	-	24,30,30	0.95	1 (4%)	30,47,47	1.33	4 (13%)
49	GDP	LN	501	-	24,30,30	0.93	1 (4%)	30,47,47	1.39	4 (13%)
47	GTP	SK	501	48	26,34,34	1.15	2 (7%)	32,54,54	1.58	7 (21%)
49	GDP	KL	501	-	24,30,30	0.95	1 (4%)	30,47,47	1.38	4 (13%)
47	GTP	WI	501	48	26,34,34	1.15	2 (7%)	32,54,54	1.62	7 (21%)
49	GDP	HH	501	-	24,30,30	0.94	1 (4%)	30,47,47	1.35	4 (13%)
47	GTP	IM	501	48	26,34,34	1.14	2 (7%)	32,54,54	1.60	6 (18%)
47	GTP	EM	501	48	26,34,34	1.14	2 (7%)	32,54,54	1.50	6 (18%)
49	GDP	FB	501	-	24,30,30	0.94	1 (4%)	30,47,47	1.31	4 (13%)
47	GTP	KG	501	48	26,34,34	1.17	2 (7%)	32,54,54	1.62	7 (21%)
49	GDP	PJ	501	-	24,30,30	0.93	1 (4%)	30,47,47	1.31	4 (13%)
47	GTP	JK	501	48	26,34,34	1.17	2 (7%)	32,54,54	1.54	7 (21%)
47	GTP	RG	501	48	26,34,34	1.16	2 (7%)	32,54,54	1.57	7 (21%)
49	GDP	TF	501	-	24,30,30	0.94	1 (4%)	30,47,47	1.35	4 (13%)
49	GDP	MJ	501	-	24,30,30	0.97	1 (4%)	30,47,47	1.31	5 (16%)
49	GDP	EL	501	-	24,30,30	0.94	1 (4%)	30,47,47	1.29	4 (13%)
47	GTP	JI	501	48	26,34,34	1.15	2 (7%)	32,54,54	1.65	6 (18%)
49	GDP	GL	502	-	24,30,30	0.96	1 (4%)	30,47,47	1.33	4 (13%)
49	GDP	CN	501	-	24,30,30	0.95	1 (4%)	30,47,47	1.31	4 (13%)

Mol	Type	Chain	Res	Link	Bond lengths			Bond angles		
					Counts	RMSZ	# Z  > 2	Counts	RMSZ	# Z  > 2
47	GTP	KM	501	48	26,34,34	1.16	2 (7%)	32,54,54	1.62	7 (21%)
47	GTP	FC	501	48	26,34,34	1.17	2 (7%)	32,54,54	1.63	7 (21%)
47	GTP	CE	501	48	26,34,34	1.15	2 (7%)	32,54,54	1.63	6 (18%)
49	GDP	BL	501	-	24,30,30	0.95	1 (4%)	30,47,47	1.35	4 (13%)
49	GDP	NN	501	-	24,30,30	0.94	1 (4%)	30,47,47	1.36	4 (13%)
47	GTP	SG	501	48	26,34,34	1.17	2 (7%)	32,54,54	1.60	7 (21%)
49	GDP	SH	501	-	24,30,30	0.96	1 (4%)	30,47,47	1.35	5 (16%)
49	GDP	SN	501	-	24,30,30	0.94	1 (4%)	30,47,47	1.32	4 (13%)
49	GDP	TN	501	-	24,30,30	0.94	1 (4%)	30,47,47	1.31	4 (13%)
47	GTP	QM	501	48	26,34,34	1.13	2 (7%)	32,54,54	1.59	7 (21%)
49	GDP	GD	501	-	24,30,30	0.95	1 (4%)	30,47,47	1.35	4 (13%)
47	GTP	CA	501	48	26,34,34	1.12	2 (7%)	32,54,54	1.56	7 (21%)
49	GDP	HD	501	-	24,30,30	0.95	1 (4%)	30,47,47	1.33	4 (13%)
49	GDP	WL	501	-	24,30,30	0.94	1 (4%)	30,47,47	1.37	4 (13%)
47	GTP	QC	501	48	26,34,34	1.14	2 (7%)	32,54,54	1.59	7 (21%)
47	GTP	FI	501	48	26,34,34	1.17	2 (7%)	32,54,54	1.66	7 (21%)
49	GDP	WD	501	-	24,30,30	0.94	1 (4%)	30,47,47	1.33	4 (13%)
47	GTP	BM	501	48	26,34,34	1.14	2 (7%)	32,54,54	1.62	7 (21%)
49	GDP	HB	501	-	24,30,30	0.94	1 (4%)	30,47,47	1.31	4 (13%)
47	GTP	OF	501	46,48	26,34,34	1.16	2 (7%)	32,54,54	1.57	7 (21%)
49	GDP	BF	501	-	24,30,30	0.96	1 (4%)	30,47,47	1.36	4 (13%)
49	GDP	WB	501	-	24,30,30	0.94	1 (4%)	30,47,47	1.35	4 (13%)
47	GTP	GK	501	48	26,34,34	1.17	2 (7%)	32,54,54	1.64	7 (21%)
49	GDP	BJ	501	-	24,30,30	0.94	1 (4%)	30,47,47	1.38	4 (13%)
47	GTP	TE	501	48	26,34,34	1.14	2 (7%)	32,54,54	1.61	7 (21%)
47	GTP	IE	501	48	26,34,34	1.20	2 (7%)	32,54,54	1.68	7 (21%)
47	GTP	VE	501	48	26,34,34	1.19	2 (7%)	32,54,54	1.59	7 (21%)
49	GDP	OB	501	-	24,30,30	0.93	1 (4%)	30,47,47	1.30	4 (13%)
49	GDP	ED	501	-	24,30,30	0.94	1 (4%)	30,47,47	1.31	4 (13%)
49	GDP	NF	501	-	24,30,30	0.95	1 (4%)	30,47,47	1.37	4 (13%)
47	GTP	SE	501	48	26,34,34	1.15	2 (7%)	32,54,54	1.60	7 (21%)
47	GTP	DI	501	48	26,34,34	1.15	2 (7%)	32,54,54	1.58	6 (18%)
49	GDP	GH	501	-	24,30,30	0.96	1 (4%)	30,47,47	1.38	4 (13%)
47	GTP	MG	501	48	26,34,34	1.17	2 (7%)	32,54,54	1.62	7 (21%)
47	GTP	II	501	48	26,34,34	1.17	2 (7%)	32,54,54	1.60	7 (21%)

Mol	Type	Chain	Res	Link	Bond lengths			Bond angles		
					Counts	RMSZ	# Z  > 2	Counts	RMSZ	# Z  > 2
49	GDP	KD	501	-	24,30,30	0.96	1 (4%)	30,47,47	1.34	5 (16%)
49	GDP	NJ	501	-	24,30,30	0.95	1 (4%)	30,47,47	1.37	4 (13%)
49	GDP	VJ	501	-	24,30,30	0.93	1 (4%)	30,47,47	1.33	4 (13%)
49	GDP	OH	501	-	24,30,30	0.95	1 (4%)	30,47,47	1.34	4 (13%)
47	GTP	IG	501	48	26,34,34	1.18	2 (7%)	32,54,54	1.59	7 (21%)
47	GTP	RM	501	48	26,34,34	1.12	2 (7%)	32,54,54	1.53	6 (18%)
47	GTP	HK	501	48	26,34,34	1.15	2 (7%)	32,54,54	1.67	6 (18%)
49	GDP	HJ	501	-	24,30,30	0.96	1 (4%)	30,47,47	1.34	4 (13%)
47	GTP	EC	501	48	26,34,34	1.13	2 (7%)	32,54,54	1.57	7 (21%)
49	GDP	FF	501	-	24,30,30	0.93	1 (4%)	30,47,47	1.36	4 (13%)
49	GDP	KH	501	-	24,30,30	0.96	1 (4%)	30,47,47	1.32	4 (13%)
47	GTP	EG	501	48	26,34,34	1.15	2 (7%)	32,54,54	1.57	7 (21%)
47	GTP	TI	501	48	26,34,34	1.15	2 (7%)	32,54,54	1.58	7 (21%)
47	GTP	CK	501	48	26,34,34	1.14	2 (7%)	32,54,54	1.61	7 (21%)
49	GDP	SD	501	-	24,30,30	0.95	1 (4%)	30,47,47	1.37	4 (13%)
49	GDP	HL	501	-	24,30,30	0.95	1 (4%)	30,47,47	1.36	4 (13%)
47	GTP	DA	501	-	26,34,34	1.12	2 (7%)	32,54,54	1.53	7 (21%)
49	GDP	IL	501	-	24,30,30	0.96	1 (4%)	30,47,47	1.33	4 (13%)
47	GTP	LE	501	48	26,34,34	1.19	2 (7%)	32,54,54	1.59	7 (21%)
49	GDP	CB	501	-	24,30,30	0.92	1 (4%)	30,47,47	1.30	4 (13%)
49	GDP	AF	501	-	24,30,30	0.95	1 (4%)	30,47,47	1.40	4 (13%)
49	GDP	RF	501	-	24,30,30	0.94	1 (4%)	30,47,47	1.31	4 (13%)
49	GDP	GF	501	-	24,30,30	0.95	1 (4%)	30,47,47	1.33	4 (13%)
47	GTP	LM	501	48	26,34,34	1.16	2 (7%)	32,54,54	1.67	7 (21%)
49	GDP	UB	501	-	24,30,30	0.94	1 (4%)	30,47,47	1.32	4 (13%)
47	GTP	EE	501	48	26,34,34	1.16	2 (7%)	32,54,54	1.60	7 (21%)
49	GDP	CJ	501	-	24,30,30	0.94	1 (4%)	30,47,47	1.31	4 (13%)
49	GDP	EJ	501	-	24,30,30	0.94	1 (4%)	30,47,47	1.33	5 (16%)
49	GDP	LJ	501	-	24,30,30	0.96	1 (4%)	30,47,47	1.35	4 (13%)
47	GTP	AC	501	48	26,34,34	1.17	2 (7%)	32,54,54	1.65	7 (21%)
47	GTP	EI	501	48	26,34,34	1.15	2 (7%)	32,54,54	1.57	7 (21%)
47	GTP	WM	501	48	26,34,34	1.13	2 (7%)	32,54,54	1.58	6 (18%)
49	GDP	PH	501	-	24,30,30	0.96	1 (4%)	30,47,47	1.27	4 (13%)
47	GTP	WA	501	48	26,34,34	1.14	2 (7%)	32,54,54	1.60	7 (21%)
49	GDP	DH	501	-	24,30,30	0.95	1 (4%)	30,47,47	1.28	4 (13%)



Mol	Type	Chain	Res	Link	Bond lengths			Bond angles		
					Counts	RMSZ	# Z  > 2	Counts	RMSZ	# Z  > 2
47	GTP	GC	501	48	26,34,34	1.17	2 (7%)	32,54,54	1.66	7 (21%)
47	GTP	AA	501	48	26,34,34	1.15	2 (7%)	32,54,54	1.60	7 (21%)
47	GTP	OI	501	48	26,34,34	1.15	2 (7%)	32,54,54	1.54	7 (21%)
49	GDP	ND	502	-	24,30,30	0.96	1 (4%)	30,47,47	1.35	4 (13%)
47	GTP	HE	501	48	26,34,34	1.17	2 (7%)	32,54,54	1.65	7 (21%)
47	GTP	WK	501	48	26,34,34	1.15	2 (7%)	32,54,54	1.53	6 (18%)
49	GDP	RD	501	-	24,30,30	0.95	1 (4%)	30,47,47	1.32	4 (13%)
49	GDP	EH	501	-	24,30,30	0.96	1 (4%)	30,47,47	1.24	5 (16%)
47	GTP	JG	501	48	26,34,34	1.17	2 (7%)	32,54,54	1.63	7 (21%)
47	GTP	HG	501	48	26,34,34	1.17	2 (7%)	32,54,54	1.60	7 (21%)
47	GTP	FG	501	48	26,34,34	1.17	2 (7%)	32,54,54	1.64	7 (21%)
47	GTP	CC	501	48	26,34,34	1.13	2 (7%)	32,54,54	1.62	7 (21%)
47	GTP	AI	501	48	26,34,34	1.17	2 (7%)	32,54,54	1.68	7 (21%)
49	GDP	CF	501	-	24,30,30	0.96	1 (4%)	30,47,47	1.25	4 (13%)
49	GDP	SB	501	-	24,30,30	0.89	1 (4%)	30,47,47	1.35	4 (13%)
49	GDP	JB	501	-	24,30,30	0.95	1 (4%)	30,47,47	1.34	4 (13%)
47	GTP	CM	501	48	26,34,34	1.14	2 (7%)	32,54,54	1.60	7 (21%)
49	GDP	UL	501	-	24,30,30	0.94	1 (4%)	30,47,47	1.29	4 (13%)
47	GTP	LC	501	48	26,34,34	1.17	2 (7%)	32,54,54	1.55	7 (21%)
47	GTP	PE	501	48	26,34,34	1.15	2 (7%)	32,54,54	1.60	6 (18%)
49	GDP	FH	501	-	24,30,30	0.95	1 (4%)	30,47,47	1.28	4 (13%)
49	GDP	VF	501	-	24,30,30	0.96	1 (4%)	30,47,47	1.36	4 (13%)
47	GTP	UG	501	48	26,34,34	1.15	2 (7%)	32,54,54	1.59	7 (21%)
49	GDP	CL	501	-	24,30,30	0.93	1 (4%)	30,47,47	1.33	4 (13%)
47	GTP	LG	501	48	26,34,34	1.17	2 (7%)	32,54,54	1.53	7 (21%)
47	GTP	AM	501	48	26,34,34	1.16	2 (7%)	32,54,54	1.63	7 (21%)
47	GTP	PI	501	48	26,34,34	1.14	2 (7%)	32,54,54	1.60	6 (18%)
47	GTP	NG	501	48	26,34,34	1.17	2 (7%)	32,54,54	1.59	7 (21%)
49	GDP	UN	501	-	24,30,30	0.95	1 (4%)	30,47,47	1.34	4 (13%)
49	GDP	VD	501	-	24,30,30	0.95	1 (4%)	30,47,47	1.34	4 (13%)
47	GTP	HI	501	48	26,34,34	1.17	2 (7%)	32,54,54	1.67	7 (21%)
47	GTP	HC	501	48	26,34,34	1.16	2 (7%)	32,54,54	1.67	6 (18%)
49	GDP	OD	501	-	24,30,30	0.93	1 (4%)	30,47,47	1.30	4 (13%)
49	GDP	AJ	501	-	24,30,30	0.96	1 (4%)	30,47,47	1.37	6 (20%)
47	GTP	MA	501	48	26,34,34	1.14	2 (7%)	32,54,54	1.61	7 (21%)

Mol	Type	Chain	Res	Link	Bond lengths			Bond angles		
					Counts	RMSZ	# Z  > 2	Counts	RMSZ	# Z  > 2
49	GDP	QL	501	-	24,30,30	0.94	1 (4%)	30,47,47	1.30	4 (13%)
49	GDP	CH	501	-	24,30,30	0.95	1 (4%)	30,47,47	1.28	4 (13%)
49	GDP	GJ	501	-	24,30,30	0.94	1 (4%)	30,47,47	1.35	4 (13%)
49	GDP	AL	501	-	24,30,30	0.94	1 (4%)	30,47,47	1.37	4 (13%)
49	GDP	VL	501	-	24,30,30	0.96	1 (4%)	30,47,47	1.32	4 (13%)
47	GTP	DE	501	48	26,34,34	1.16	2 (7%)	32,54,54	1.57	7 (21%)
49	GDP	SL	501	-	24,30,30	0.92	1 (4%)	30,47,47	1.39	5 (16%)
49	GDP	WF	501	-	24,30,30	0.94	1 (4%)	30,47,47	1.35	4 (13%)
47	GTP	QI	501	48	26,34,34	1.17	2 (7%)	32,54,54	1.59	7 (21%)
47	GTP	JA	501	48	26,34,34	1.16	2 (7%)	32,54,54	1.63	7 (21%)
49	GDP	MB	501	-	24,30,30	0.93	1 (4%)	30,47,47	1.38	4 (13%)
47	GTP	EA	501	48	26,34,34	1.12	2 (7%)	32,54,54	1.55	7 (21%)
47	GTP	PM	501	48	26,34,34	1.13	2 (7%)	32,54,54	1.61	6 (18%)
47	GTP	WC	501	48	26,34,34	1.16	2 (7%)	32,54,54	1.60	7 (21%)
47	GTP	NA	501	48	26,34,34	1.14	2 (7%)	32,54,54	1.55	7 (21%)
49	GDP	LF	501	-	24,30,30	0.97	1 (4%)	30,47,47	1.35	4 (13%)
49	GDP	WJ	501	-	24,30,30	0.94	1 (4%)	30,47,47	1.32	4 (13%)
49	GDP	JH	501	-	24,30,30	0.94	1 (4%)	30,47,47	1.33	4 (13%)
47	GTP	NE	501	48	26,34,34	1.17	2 (7%)	32,54,54	1.54	7 (21%)
47	GTP	HA	501	48	26,34,34	1.13	2 (7%)	32,54,54	1.58	7 (21%)
47	GTP	LK	501	48	26,34,34	1.18	2 (7%)	32,54,54	1.57	7 (21%)
49	GDP	IB	501	-	24,30,30	0.93	1 (4%)	30,47,47	1.28	4 (13%)
49	GDP	PL	501	-	24,30,30	0.94	1 (4%)	30,47,47	1.31	4 (13%)
47	GTP	PA	501	48	26,34,34	1.13	2 (7%)	32,54,54	1.55	7 (21%)
47	GTP	RA	501	48	26,34,34	1.13	2 (7%)	32,54,54	1.56	7 (21%)
49	GDP	KJ	501	-	24,30,30	0.94	1 (4%)	30,47,47	1.30	4 (13%)
49	GDP	WH	501	-	24,30,30	0.96	1 (4%)	30,47,47	1.31	4 (13%)
47	GTP	TK	501	48	26,34,34	1.15	2 (7%)	32,54,54	1.59	7 (21%)
49	GDP	DN	501	-	24,30,30	0.94	1 (4%)	30,47,47	1.32	4 (13%)
49	GDP	LH	501	-	24,30,30	0.95	1 (4%)	30,47,47	1.38	4 (13%)
49	GDP	AN	501	-	24,30,30	0.95	1 (4%)	30,47,47	1.39	4 (13%)
47	GTP	KE	501	48	26,34,34	1.17	2 (7%)	32,54,54	1.65	7 (21%)
47	GTP	RE	501	48	26,34,34	1.17	2 (7%)	32,54,54	1.60	7 (21%)
49	GDP	WN	501	-	24,30,30	0.95	1 (4%)	30,47,47	1.35	4 (13%)
49	GDP	TJ	501	-	24,30,30	0.93	1 (4%)	30,47,47	1.35	4 (13%)



Mol	Type	Chain	Res	Link	Bond lengths			Bond angles		
					Counts	RMSZ	# Z  > 2	Counts	RMSZ	# Z  > 2
49	GDP	RL	501	-	24,30,30	0.93	1 (4%)	30,47,47	1.31	4 (13%)
49	GDP	JD	501	-	24,30,30	0.95	1 (4%)	30,47,47	1.32	4 (13%)
49	GDP	KB	501	-	24,30,30	0.94	1 (4%)	30,47,47	1.30	4 (13%)
47	GTP	IK	501	48	26,34,34	1.17	2 (7%)	32,54,54	1.68	7 (21%)
49	GDP	JL	501	-	24,30,30	0.95	1 (4%)	30,47,47	1.36	4 (13%)
47	GTP	RC	501	48	26,34,34	1.15	2 (7%)	32,54,54	1.58	7 (21%)
47	GTP	FA	501	48	26,34,34	1.13	2 (7%)	32,54,54	1.57	7 (21%)
49	GDP	TL	501	-	24,30,30	0.94	1 (4%)	30,47,47	1.33	4 (13%)
49	GDP	JF	501	-	24,30,30	0.94	1 (4%)	30,47,47	1.37	4 (13%)
49	GDP	BH	501	-	24,30,30	0.96	1 (4%)	30,47,47	1.36	5 (16%)
47	GTP	IC	501	48	26,34,34	1.17	2 (7%)	32,54,54	1.64	7 (21%)
49	GDP	EB	501	-	24,30,30	0.94	1 (4%)	30,47,47	1.32	4 (13%)
47	GTP	TA	501	48	26,34,34	1.13	2 (7%)	32,54,54	1.56	7 (21%)
49	GDP	ON	501	-	24,30,30	0.95	1 (4%)	30,47,47	1.31	4 (13%)
47	GTP	LA	501	48	26,34,34	1.16	2 (7%)	32,54,54	1.63	7 (21%)
47	GTP	PK	501	48	26,34,34	1.15	2 (7%)	32,54,54	1.63	7 (21%)
47	GTP	SA	501	48	26,34,34	1.12	2 (7%)	32,54,54	1.55	7 (21%)
49	GDP	DD	501	-	24,30,30	0.95	1 (4%)	30,47,47	1.33	4 (13%)
49	GDP	FL	502	-	24,30,30	0.95	1 (4%)	30,47,47	1.34	4 (13%)
49	GDP	KF	501	-	24,30,30	0.95	1 (4%)	30,47,47	1.32	4 (13%)

In the following table, the Chirals column lists the number of chiral outliers, the number of chiral centers analysed, the number of these observed in the model and the number defined in the Chemical Component Dictionary. Similar counts are reported in the Torsion and Rings columns. '-' means no outliers of that kind were identified.

Mol	Type	Chain	Res	Link	Chirals	Torsions	Rings
47	GTP	RK	501	48	-	7/18/38/38	0/3/3/3
47	GTP	AE	501	48	-	9/18/38/38	0/3/3/3
49	GDP	LL	501	-	-	3/12/32/32	0/3/3/3
49	GDP	PF	501	-	-	0/12/32/32	0/3/3/3
47	GTP	QG	501	48	-	4/18/38/38	0/3/3/3
49	GDP	DL	501	-	-	0/12/32/32	0/3/3/3
49	GDP	QD	501	-	-	0/12/32/32	0/3/3/3
47	GTP	VI	501	48	-	6/18/38/38	0/3/3/3
49	GDP	EN	501	-	-	1/12/32/32	0/3/3/3
47	GTP	DK	501	48	-	8/18/38/38	0/3/3/3

Continued on next page...

*Continued from previous page...*

Mol	Type	Chain	Res	Link	Chirals	Torsions	Rings
49	GDP	QB	501	-	-	1/12/32/32	0/3/3/3
47	GTP	TC	501	48	-	8/18/38/38	0/3/3/3
47	GTP	PD	501	46,48	-	9/18/38/38	0/3/3/3
49	GDP	BD	501	-	-	2/12/32/32	0/3/3/3
47	GTP	EK	501	48	-	6/18/38/38	0/3/3/3
47	GTP	VG	501	48	-	8/18/38/38	0/3/3/3
47	GTP	UI	501	48	-	8/18/38/38	0/3/3/3
49	GDP	QH	501	-	-	0/12/32/32	0/3/3/3
49	GDP	AD	501	-	-	0/12/32/32	0/3/3/3
49	GDP	DF	501	-	-	1/12/32/32	0/3/3/3
49	GDP	FD	501	-	-	1/12/32/32	0/3/3/3
47	GTP	TM	501	48	-	8/18/38/38	0/3/3/3
47	GTP	BG	501	48	-	9/18/38/38	0/3/3/3
47	GTP	AK	501	48	-	7/18/38/38	0/3/3/3
47	GTP	TG	501	48	-	7/18/38/38	0/3/3/3
47	GTP	JE	501	48	-	6/18/38/38	0/3/3/3
49	GDP	OF	502	-	-	0/12/32/32	0/3/3/3
47	GTP	NC	501	48	-	5/18/38/38	0/3/3/3
49	GDP	JN	501	-	-	0/12/32/32	0/3/3/3
47	GTP	MC	501	48	-	8/18/38/38	0/3/3/3
47	GTP	GI	501	48	-	8/18/38/38	0/3/3/3
49	GDP	SJ	501	-	-	0/12/32/32	0/3/3/3
49	GDP	UJ	501	-	-	0/12/32/32	0/3/3/3
47	GTP	OA	501	48	-	5/18/38/38	0/3/3/3
47	GTP	PG	501	48	-	7/18/38/38	0/3/3/3
49	GDP	QN	501	-	-	0/12/32/32	0/3/3/3
47	GTP	OC	501	48	-	7/18/38/38	0/3/3/3
47	GTP	GM	501	48	-	9/18/38/38	0/3/3/3
49	GDP	JJ	501	-	-	1/12/32/32	0/3/3/3
47	GTP	KI	501	48	-	7/18/38/38	0/3/3/3
49	GDP	DJ	501	-	-	0/12/32/32	0/3/3/3
49	GDP	UH	501	-	-	0/12/32/32	0/3/3/3
49	GDP	OL	501	-	-	0/12/32/32	0/3/3/3
49	GDP	MD	501	-	-	3/12/32/32	0/3/3/3
49	GDP	QF	501	-	-	0/12/32/32	0/3/3/3
47	GTP	SM	501	48	-	8/18/38/38	0/3/3/3
47	GTP	SC	501	48	-	7/18/38/38	0/3/3/3

*Continued on next page...*

*Continued from previous page...*

Mol	Type	Chain	Res	Link	Chirals	Torsions	Rings
47	GTP	NM	501	48	-	4/18/38/38	0/3/3/3
49	GDP	IN	501	-	-	1/12/32/32	0/3/3/3
47	GTP	IA	501	48	-	7/18/38/38	0/3/3/3
49	GDP	VH	501	-	-	1/12/32/32	0/3/3/3
49	GDP	VB	501	-	-	0/12/32/32	0/3/3/3
47	GTP	GA	501	48	-	8/18/38/38	0/3/3/3
49	GDP	ML	501	-	-	1/12/32/32	0/3/3/3
47	GTP	BA	501	48	-	7/18/38/38	0/3/3/3
49	GDP	OJ	501	-	-	0/12/32/32	0/3/3/3
47	GTP	UC	501	48	-	6/18/38/38	0/3/3/3
47	GTP	VC	501	48	-	9/18/38/38	0/3/3/3
49	GDP	NB	501	-	-	1/12/32/32	0/3/3/3
49	GDP	PD	502	-	-	0/12/32/32	0/3/3/3
49	GDP	FJ	501	-	-	3/12/32/32	0/3/3/3
49	GDP	LD	501	-	-	2/12/32/32	0/3/3/3
49	GDP	IJ	501	-	-	0/12/32/32	0/3/3/3
47	GTP	JM	501	48	-	7/18/38/38	0/3/3/3
47	GTP	DG	501	48	-	6/18/38/38	0/3/3/3
49	GDP	MN	501	-	-	0/12/32/32	0/3/3/3
49	GDP	PB	501	-	-	0/12/32/32	0/3/3/3
47	GTP	VK	501	48	-	9/18/38/38	0/3/3/3
47	GTP	RI	501	48	-	7/18/38/38	0/3/3/3
47	GTP	FK	501	48	-	8/18/38/38	0/3/3/3
47	GTP	BK	501	48	-	9/18/38/38	0/3/3/3
49	GDP	CD	501	-	-	0/12/32/32	0/3/3/3
49	GDP	BB	501	-	-	0/12/32/32	0/3/3/3
47	GTP	OM	501	48	-	4/18/38/38	0/3/3/3
47	GTP	VA	501	48	-	7/18/38/38	0/3/3/3
47	GTP	WE	501	48	-	8/18/38/38	0/3/3/3
47	GTP	FM	501	48	-	8/18/38/38	0/3/3/3
47	GTP	CG	501	48	-	8/18/38/38	0/3/3/3
47	GTP	DM	501	48	-	7/18/38/38	0/3/3/3
47	GTP	FE	501	48	-	9/18/38/38	0/3/3/3
49	GDP	NL	501	-	-	0/12/32/32	0/3/3/3
47	GTP	OK	501	48	-	5/18/38/38	0/3/3/3
49	GDP	BN	501	-	-	3/12/32/32	0/3/3/3
47	GTP	HM	501	48	-	8/18/38/38	0/3/3/3

*Continued on next page...*

*Continued from previous page...*

Mol	Type	Chain	Res	Link	Chirals	Torsions	Rings
47	GTP	ME	501	48	-	8/18/38/38	0/3/3/3
47	GTP	WG	501	48	-	8/18/38/38	0/3/3/3
49	GDP	FN	501	-	-	1/12/32/32	0/3/3/3
47	GTP	DC	501	48	-	8/18/38/38	0/3/3/3
47	GTP	QE	501	48	-	6/18/38/38	0/3/3/3
47	GTP	VM	501	48	-	8/18/38/38	0/3/3/3
47	GTP	UE	501	48	-	8/18/38/38	0/3/3/3
47	GTP	UM	501	48	-	7/18/38/38	0/3/3/3
49	GDP	ID	501	-	-	1/12/32/32	0/3/3/3
47	GTP	KK	501	48	-	6/18/38/38	0/3/3/3
47	GTP	OG	501	48	-	8/18/38/38	0/3/3/3
47	GTP	MK	501	48	-	7/18/38/38	0/3/3/3
49	GDP	PN	502	-	-	0/12/32/32	0/3/3/3
47	GTP	QK	501	48	-	9/18/38/38	0/3/3/3
49	GDP	QJ	501	-	-	0/12/32/32	0/3/3/3
47	GTP	UA	501	48	-	8/18/38/38	0/3/3/3
47	GTP	BI	501	48	-	8/18/38/38	0/3/3/3
49	GDP	EF	501	-	-	0/12/32/32	0/3/3/3
49	GDP	TB	501	-	-	1/12/32/32	0/3/3/3
47	GTP	NK	501	48	-	6/18/38/38	0/3/3/3
47	GTP	SI	501	48	-	5/18/38/38	0/3/3/3
49	GDP	VN	501	-	-	1/12/32/32	0/3/3/3
47	GTP	BC	502	48	-	9/18/38/38	0/3/3/3
47	GTP	GE	501	48	-	7/18/38/38	0/3/3/3
49	GDP	RJ	501	-	-	3/12/32/32	0/3/3/3
49	GDP	IH	501	-	-	0/12/32/32	0/3/3/3
47	GTP	KC	501	48	-	5/18/38/38	0/3/3/3
47	GTP	AG	501	48	-	7/18/38/38	0/3/3/3
47	GTP	MI	501	48	-	7/18/38/38	0/3/3/3
47	GTP	MM	501	48	-	6/18/38/38	0/3/3/3
49	GDP	RB	501	-	-	0/12/32/32	0/3/3/3
49	GDP	GN	502	-	-	0/12/32/32	0/3/3/3
49	GDP	AB	501	-	-	1/12/32/32	0/3/3/3
49	GDP	IF	501	-	-	0/12/32/32	0/3/3/3
49	GDP	AH	501	-	-	0/12/32/32	0/3/3/3
47	GTP	GG	501	48	-	8/18/38/38	0/3/3/3
49	GDP	MF	501	-	-	0/12/32/32	0/3/3/3

*Continued on next page...*

*Continued from previous page...*

Mol	Type	Chain	Res	Link	Chirals	Torsions	Rings
49	GDP	KN	501	-	-	0/12/32/32	0/3/3/3
49	GDP	GB	502	-	-	0/12/32/32	0/3/3/3
47	GTP	BE	501	48	-	9/18/38/38	0/3/3/3
47	GTP	NI	501	48	-	4/18/38/38	0/3/3/3
49	GDP	RH	501	-	-	0/12/32/32	0/3/3/3
49	GDP	DB	501	-	-	0/12/32/32	0/3/3/3
47	GTP	JC	501	48	-	5/18/38/38	0/3/3/3
49	GDP	LB	501	-	-	0/12/32/32	0/3/3/3
49	GDP	SF	501	-	-	1/12/32/32	0/3/3/3
49	GDP	UF	501	-	-	1/12/32/32	0/3/3/3
49	GDP	TH	501	-	-	1/12/32/32	0/3/3/3
49	GDP	RN	501	-	-	0/12/32/32	0/3/3/3
49	GDP	HN	501	-	-	0/12/32/32	0/3/3/3
47	GTP	LI	501	48	-	8/18/38/38	0/3/3/3
47	GTP	KA	501	48	-	8/18/38/38	0/3/3/3
47	GTP	CI	501	48	-	4/18/38/38	0/3/3/3
47	GTP	QA	501	48	-	8/18/38/38	0/3/3/3
47	GTP	UK	501	48	-	5/18/38/38	0/3/3/3
49	GDP	UD	501	-	-	1/12/32/32	0/3/3/3
49	GDP	HF	501	-	-	1/12/32/32	0/3/3/3
49	GDP	MH	501	-	-	1/12/32/32	0/3/3/3
49	GDP	TD	501	-	-	4/12/32/32	0/3/3/3
49	GDP	NH	501	-	-	0/12/32/32	0/3/3/3
49	GDP	LN	501	-	-	0/12/32/32	0/3/3/3
47	GTP	SK	501	48	-	8/18/38/38	0/3/3/3
49	GDP	KL	501	-	-	1/12/32/32	0/3/3/3
47	GTP	WI	501	48	-	6/18/38/38	0/3/3/3
49	GDP	HH	501	-	-	0/12/32/32	0/3/3/3
47	GTP	IM	501	48	-	8/18/38/38	0/3/3/3
47	GTP	EM	501	48	-	8/18/38/38	0/3/3/3
49	GDP	FB	501	-	-	0/12/32/32	0/3/3/3
47	GTP	KG	501	48	-	6/18/38/38	0/3/3/3
49	GDP	PJ	501	-	-	0/12/32/32	0/3/3/3
47	GTP	JK	501	48	-	9/18/38/38	0/3/3/3
47	GTP	RG	501	48	-	8/18/38/38	0/3/3/3
49	GDP	TF	501	-	-	1/12/32/32	0/3/3/3
49	GDP	MJ	501	-	-	1/12/32/32	0/3/3/3
49	GDP	EL	501	-	-	0/12/32/32	0/3/3/3

*Continued on next page...*

*Continued from previous page...*

Mol	Type	Chain	Res	Link	Chirals	Torsions	Rings
47	GTP	JI	501	48	-	7/18/38/38	0/3/3/3
49	GDP	GL	502	-	-	1/12/32/32	0/3/3/3
49	GDP	CN	501	-	-	0/12/32/32	0/3/3/3
47	GTP	KM	501	48	-	6/18/38/38	0/3/3/3
47	GTP	FC	501	48	-	8/18/38/38	0/3/3/3
47	GTP	CE	501	48	-	8/18/38/38	0/3/3/3
49	GDP	BL	501	-	-	0/12/32/32	0/3/3/3
49	GDP	NN	501	-	-	1/12/32/32	0/3/3/3
47	GTP	SG	501	48	-	8/18/38/38	0/3/3/3
49	GDP	SH	501	-	-	1/12/32/32	0/3/3/3
49	GDP	SN	501	-	-	0/12/32/32	0/3/3/3
49	GDP	TN	501	-	-	0/12/32/32	0/3/3/3
47	GTP	QM	501	48	-	8/18/38/38	0/3/3/3
49	GDP	GD	501	-	-	1/12/32/32	0/3/3/3
47	GTP	CA	501	48	-	9/18/38/38	0/3/3/3
49	GDP	HD	501	-	-	1/12/32/32	0/3/3/3
49	GDP	WL	501	-	-	1/12/32/32	0/3/3/3
47	GTP	QC	501	48	-	5/18/38/38	0/3/3/3
47	GTP	FI	501	48	-	7/18/38/38	0/3/3/3
49	GDP	WD	501	-	-	0/12/32/32	0/3/3/3
47	GTP	BM	501	48	-	7/18/38/38	0/3/3/3
49	GDP	HB	501	-	-	0/12/32/32	0/3/3/3
47	GTP	OF	501	46,48	-	6/18/38/38	0/3/3/3
49	GDP	BF	501	-	-	1/12/32/32	0/3/3/3
49	GDP	WB	501	-	-	0/12/32/32	0/3/3/3
47	GTP	GK	501	48	-	8/18/38/38	0/3/3/3
49	GDP	BJ	501	-	-	0/12/32/32	0/3/3/3
47	GTP	TE	501	48	-	8/18/38/38	0/3/3/3
47	GTP	IE	501	48	-	8/18/38/38	0/3/3/3
47	GTP	VE	501	48	-	7/18/38/38	0/3/3/3
49	GDP	OB	501	-	-	0/12/32/32	0/3/3/3
49	GDP	ED	501	-	-	0/12/32/32	0/3/3/3
49	GDP	NF	501	-	-	1/12/32/32	0/3/3/3
47	GTP	SE	501	48	-	8/18/38/38	0/3/3/3
47	GTP	DI	501	48	-	8/18/38/38	0/3/3/3
49	GDP	GH	501	-	-	0/12/32/32	0/3/3/3
47	GTP	MG	501	48	-	7/18/38/38	0/3/3/3
47	GTP	II	501	48	-	8/18/38/38	0/3/3/3

*Continued on next page...*

*Continued from previous page...*

Mol	Type	Chain	Res	Link	Chirals	Torsions	Rings
49	GDP	KD	501	-	-	0/12/32/32	0/3/3/3
49	GDP	NJ	501	-	-	1/12/32/32	0/3/3/3
49	GDP	VJ	501	-	-	0/12/32/32	0/3/3/3
49	GDP	OH	501	-	-	1/12/32/32	0/3/3/3
47	GTP	IG	501	48	-	8/18/38/38	0/3/3/3
47	GTP	RM	501	48	-	9/18/38/38	0/3/3/3
47	GTP	HK	501	48	-	8/18/38/38	0/3/3/3
49	GDP	HJ	501	-	-	1/12/32/32	0/3/3/3
47	GTP	EC	501	48	-	7/18/38/38	0/3/3/3
49	GDP	FF	501	-	-	0/12/32/32	0/3/3/3
49	GDP	KH	501	-	-	0/12/32/32	0/3/3/3
47	GTP	EG	501	48	-	6/18/38/38	0/3/3/3
47	GTP	TI	501	48	-	7/18/38/38	0/3/3/3
47	GTP	CK	501	48	-	7/18/38/38	0/3/3/3
49	GDP	SD	501	-	-	2/12/32/32	0/3/3/3
49	GDP	HL	501	-	-	1/12/32/32	0/3/3/3
47	GTP	DA	501	-	-	8/18/38/38	0/3/3/3
49	GDP	IL	501	-	-	0/12/32/32	0/3/3/3
47	GTP	LE	501	48	-	7/18/38/38	0/3/3/3
49	GDP	CB	501	-	-	0/12/32/32	0/3/3/3
49	GDP	AF	501	-	-	1/12/32/32	0/3/3/3
49	GDP	RF	501	-	-	1/12/32/32	0/3/3/3
49	GDP	GF	501	-	-	1/12/32/32	0/3/3/3
47	GTP	LM	501	48	-	7/18/38/38	0/3/3/3
49	GDP	UB	501	-	-	1/12/32/32	0/3/3/3
47	GTP	EE	501	48	-	7/18/38/38	0/3/3/3
49	GDP	CJ	501	-	-	1/12/32/32	0/3/3/3
49	GDP	EJ	501	-	-	1/12/32/32	0/3/3/3
49	GDP	LJ	501	-	-	2/12/32/32	0/3/3/3
47	GTP	AC	501	48	-	8/18/38/38	0/3/3/3
47	GTP	EI	501	48	-	7/18/38/38	0/3/3/3
47	GTP	WM	501	48	-	8/18/38/38	0/3/3/3
49	GDP	PH	501	-	-	0/12/32/32	0/3/3/3
47	GTP	WA	501	48	-	6/18/38/38	0/3/3/3
49	GDP	DH	501	-	-	0/12/32/32	0/3/3/3
47	GTP	GC	501	48	-	7/18/38/38	0/3/3/3
47	GTP	AA	501	48	-	7/18/38/38	0/3/3/3
47	GTP	OI	501	48	-	5/18/38/38	0/3/3/3

*Continued on next page...*



*Continued from previous page...*

Mol	Type	Chain	Res	Link	Chirals	Torsions	Rings
49	GDP	ND	502	-	-	1/12/32/32	0/3/3/3
47	GTP	HE	501	48	-	8/18/38/38	0/3/3/3
47	GTP	WK	501	48	-	8/18/38/38	0/3/3/3
49	GDP	RD	501	-	-	0/12/32/32	0/3/3/3
49	GDP	EH	501	-	-	1/12/32/32	0/3/3/3
47	GTP	JG	501	48	-	7/18/38/38	0/3/3/3
47	GTP	HG	501	48	-	8/18/38/38	0/3/3/3
47	GTP	FG	501	48	-	8/18/38/38	0/3/3/3
47	GTP	CC	501	48	-	5/18/38/38	0/3/3/3
47	GTP	AI	501	48	-	7/18/38/38	0/3/3/3
49	GDP	CF	501	-	-	0/12/32/32	0/3/3/3
49	GDP	SB	501	-	-	1/12/32/32	0/3/3/3
49	GDP	JB	501	-	-	1/12/32/32	0/3/3/3
47	GTP	CM	501	48	-	7/18/38/38	0/3/3/3
49	GDP	UL	501	-	-	0/12/32/32	0/3/3/3
47	GTP	LC	501	48	-	5/18/38/38	0/3/3/3
47	GTP	PE	501	48	-	6/18/38/38	0/3/3/3
49	GDP	FH	501	-	-	1/12/32/32	0/3/3/3
49	GDP	VF	501	-	-	1/12/32/32	0/3/3/3
47	GTP	UG	501	48	-	8/18/38/38	0/3/3/3
49	GDP	CL	501	-	-	0/12/32/32	0/3/3/3
47	GTP	LG	501	48	-	5/18/38/38	0/3/3/3
47	GTP	AM	501	48	-	8/18/38/38	0/3/3/3
47	GTP	PI	501	48	-	6/18/38/38	0/3/3/3
47	GTP	NG	501	48	-	7/18/38/38	0/3/3/3
49	GDP	UN	501	-	-	1/12/32/32	0/3/3/3
49	GDP	VD	501	-	-	1/12/32/32	0/3/3/3
47	GTP	HI	501	48	-	8/18/38/38	0/3/3/3
47	GTP	HC	501	48	-	6/18/38/38	0/3/3/3
49	GDP	OD	501	-	-	0/12/32/32	0/3/3/3
49	GDP	AJ	501	-	-	1/12/32/32	0/3/3/3
47	GTP	MA	501	48	-	9/18/38/38	0/3/3/3
49	GDP	QL	501	-	-	0/12/32/32	0/3/3/3
49	GDP	CH	501	-	-	1/12/32/32	0/3/3/3
49	GDP	GJ	501	-	-	1/12/32/32	0/3/3/3
49	GDP	AL	501	-	-	1/12/32/32	0/3/3/3
49	GDP	VL	501	-	-	0/12/32/32	0/3/3/3
47	GTP	DE	501	48	-	7/18/38/38	0/3/3/3

*Continued on next page...*



*Continued from previous page...*

Mol	Type	Chain	Res	Link	Chirals	Torsions	Rings
49	GDP	SL	501	-	-	2/12/32/32	0/3/3/3
49	GDP	WF	501	-	-	0/12/32/32	0/3/3/3
47	GTP	QI	501	48	-	8/18/38/38	0/3/3/3
47	GTP	JA	501	48	-	6/18/38/38	0/3/3/3
49	GDP	MB	501	-	-	3/12/32/32	0/3/3/3
47	GTP	EA	501	48	-	8/18/38/38	0/3/3/3
47	GTP	PM	501	48	-	7/18/38/38	0/3/3/3
47	GTP	WC	501	48	-	7/18/38/38	0/3/3/3
47	GTP	NA	501	48	-	8/18/38/38	0/3/3/3
49	GDP	LF	501	-	-	2/12/32/32	0/3/3/3
49	GDP	WJ	501	-	-	2/12/32/32	0/3/3/3
49	GDP	JH	501	-	-	1/12/32/32	0/3/3/3
47	GTP	NE	501	48	-	7/18/38/38	0/3/3/3
47	GTP	HA	501	48	-	7/18/38/38	0/3/3/3
47	GTP	LK	501	48	-	9/18/38/38	0/3/3/3
49	GDP	IB	501	-	-	1/12/32/32	0/3/3/3
49	GDP	PL	501	-	-	0/12/32/32	0/3/3/3
47	GTP	PA	501	48	-	8/18/38/38	0/3/3/3
47	GTP	RA	501	48	-	8/18/38/38	0/3/3/3
49	GDP	KJ	501	-	-	0/12/32/32	0/3/3/3
49	GDP	WH	501	-	-	1/12/32/32	0/3/3/3
47	GTP	TK	501	48	-	8/18/38/38	0/3/3/3
49	GDP	DN	501	-	-	0/12/32/32	0/3/3/3
49	GDP	LH	501	-	-	3/12/32/32	0/3/3/3
49	GDP	AN	501	-	-	1/12/32/32	0/3/3/3
47	GTP	KE	501	48	-	6/18/38/38	0/3/3/3
47	GTP	RE	501	48	-	8/18/38/38	0/3/3/3
49	GDP	WN	501	-	-	1/12/32/32	0/3/3/3
49	GDP	TJ	501	-	-	1/12/32/32	0/3/3/3
49	GDP	RL	501	-	-	0/12/32/32	0/3/3/3
49	GDP	JD	501	-	-	2/12/32/32	0/3/3/3
49	GDP	KB	501	-	-	0/12/32/32	0/3/3/3
47	GTP	IK	501	48	-	7/18/38/38	0/3/3/3
49	GDP	JL	501	-	-	1/12/32/32	0/3/3/3
47	GTP	RC	501	48	-	8/18/38/38	0/3/3/3
47	GTP	FA	501	48	-	8/18/38/38	0/3/3/3
49	GDP	TL	501	-	-	4/12/32/32	0/3/3/3

*Continued on next page...*

Continued from previous page...

Mol	Type	Chain	Res	Link	Chirals	Torsions	Rings
49	GDP	JF	501	-	-	1/12/32/32	0/3/3/3
49	GDP	BH	501	-	-	0/12/32/32	0/3/3/3
47	GTP	IC	501	48	-	9/18/38/38	0/3/3/3
49	GDP	EB	501	-	-	0/12/32/32	0/3/3/3
47	GTP	TA	501	48	-	8/18/38/38	0/3/3/3
49	GDP	ON	501	-	-	0/12/32/32	0/3/3/3
47	GTP	LA	501	48	-	8/18/38/38	0/3/3/3
47	GTP	PK	501	48	-	6/18/38/38	0/3/3/3
47	GTP	SA	501	48	-	7/18/38/38	0/3/3/3
49	GDP	DD	501	-	-	1/12/32/32	0/3/3/3
49	GDP	FL	502	-	-	1/12/32/32	0/3/3/3
49	GDP	KF	501	-	-	0/12/32/32	0/3/3/3

The worst 5 of 483 bond length outliers are listed below:

Mol	Chain	Res	Type	Atoms	Z	Observed(Å)	Ideal(Å)
47	AK	501	GTP	C5-C6	-4.36	1.38	1.47
47	LE	501	GTP	C5-C6	-4.32	1.38	1.47
47	VE	501	GTP	C5-C6	-4.31	1.38	1.47
47	NK	501	GTP	C5-C6	-4.30	1.38	1.47
47	NI	501	GTP	C5-C6	-4.30	1.38	1.47

The worst 5 of 1762 bond angle outliers are listed below:

Mol	Chain	Res	Type	Atoms	Z	Observed(°)	Ideal(°)
47	LM	501	GTP	PB-O3B-PG	-4.64	116.89	132.83
47	IK	501	GTP	PB-O3B-PG	-4.42	117.65	132.83
49	AF	501	GDP	PA-O3A-PB	-4.37	117.84	132.83
47	HK	501	GTP	PB-O3B-PG	-4.33	117.96	132.83
49	LD	501	GDP	PA-O3A-PB	-4.33	117.96	132.83

There are no chirality outliers.

5 of 1272 torsion outliers are listed below:

Mol	Chain	Res	Type	Atoms
47	AA	501	GTP	C5'-O5'-PA-O3A
47	AA	501	GTP	C5'-O5'-PA-O2A
47	AC	501	GTP	C5'-O5'-PA-O1A
47	AC	501	GTP	C5'-O5'-PA-O2A
47	AE	501	GTP	PB-O3A-PA-O5'

There are no ring outliers.

250 monomers are involved in 484 short contacts:

Mol	Chain	Res	Type	Clashes	Symm-Clashes
47	RK	501	GTP	3	0
49	LL	501	GDP	1	0
47	QG	501	GTP	5	0
49	DL	501	GDP	1	0
49	QD	501	GDP	1	0
49	EN	501	GDP	5	0
47	DK	501	GTP	3	0
49	QB	501	GDP	1	0
47	TC	501	GTP	3	0
47	PD	501	GTP	3	0
49	BD	501	GDP	2	0
47	EK	501	GTP	3	0
47	VG	501	GTP	4	0
47	UI	501	GTP	3	0
49	QH	501	GDP	1	0
49	DF	501	GDP	1	0
47	TM	501	GTP	3	0
47	BG	501	GTP	1	0
47	AK	501	GTP	1	0
47	TG	501	GTP	1	0
49	OF	502	GDP	3	0
49	JN	501	GDP	1	0
47	MC	501	GTP	1	0
47	GI	501	GTP	1	0
49	SJ	501	GDP	1	0
49	UJ	501	GDP	3	0
47	PG	501	GTP	3	0
49	QN	501	GDP	1	0
47	OC	501	GTP	1	0
47	GM	501	GTP	2	0
49	JJ	501	GDP	2	0
47	KI	501	GTP	1	0
49	DJ	501	GDP	2	0
49	UH	501	GDP	1	0
49	OL	501	GDP	1	0
49	QF	501	GDP	6	0
47	SM	501	GTP	1	0
47	SC	501	GTP	2	0
47	NM	501	GTP	2	0
49	IN	501	GDP	3	0

*Continued on next page...*

*Continued from previous page...*

Mol	Chain	Res	Type	Clashes	Symm-Clashes
49	VH	501	GDP	2	0
49	VB	501	GDP	1	0
47	BA	501	GTP	1	0
49	OJ	501	GDP	2	0
47	UC	501	GTP	1	0
47	VC	501	GTP	3	0
49	NB	501	GDP	1	0
49	FJ	501	GDP	1	0
49	IJ	501	GDP	3	0
47	DG	501	GTP	3	0
49	PB	501	GDP	1	0
47	VK	501	GTP	1	0
47	RI	501	GTP	1	0
47	FK	501	GTP	1	0
47	BK	501	GTP	1	0
49	CD	501	GDP	2	0
47	OM	501	GTP	1	0
47	VA	501	GTP	3	0
47	WE	501	GTP	1	0
47	FM	501	GTP	2	0
47	CG	501	GTP	2	0
47	DM	501	GTP	2	0
47	FE	501	GTP	1	0
47	OK	501	GTP	1	0
47	HM	501	GTP	1	0
47	ME	501	GTP	1	0
47	WG	501	GTP	1	0
49	FN	501	GDP	1	0
47	DC	501	GTP	3	0
47	QE	501	GTP	4	0
47	VM	501	GTP	2	0
47	UE	501	GTP	3	0
47	UM	501	GTP	1	0
47	OG	501	GTP	4	0
49	PN	502	GDP	3	0
47	QK	501	GTP	2	0
49	QJ	501	GDP	3	0
47	UA	501	GTP	2	0
47	BI	501	GTP	3	0
49	EF	501	GDP	1	0
47	NK	501	GTP	1	0
47	SI	501	GTP	1	0

*Continued on next page...*

*Continued from previous page...*

Mol	Chain	Res	Type	Clashes	Symm-Clashes
49	VN	501	GDP	2	0
47	GE	501	GTP	1	0
49	RJ	501	GDP	3	0
49	IH	501	GDP	3	0
47	KC	501	GTP	2	0
47	AG	501	GTP	1	0
47	MM	501	GTP	4	0
49	RB	501	GDP	1	0
49	GN	502	GDP	1	0
49	IF	501	GDP	1	0
49	AH	501	GDP	2	0
47	GG	501	GTP	1	0
49	MF	501	GDP	2	0
47	BE	501	GTP	4	0
47	NI	501	GTP	1	0
49	RH	501	GDP	1	0
47	JC	501	GTP	2	0
49	SF	501	GDP	1	0
49	UF	501	GDP	5	0
49	TH	501	GDP	1	0
49	RN	501	GDP	1	0
49	HN	501	GDP	1	0
47	LI	501	GTP	1	0
47	KA	501	GTP	2	0
47	CI	501	GTP	2	0
47	QA	501	GTP	2	0
49	UD	501	GDP	2	0
49	HF	501	GDP	2	0
49	MH	501	GDP	1	0
49	TD	501	GDP	1	0
49	LN	501	GDP	2	0
47	SK	501	GTP	4	0
47	WI	501	GTP	3	0
49	HH	501	GDP	2	0
47	IM	501	GTP	3	0
47	EM	501	GTP	2	0
47	KG	501	GTP	2	0
49	PJ	501	GDP	1	0
47	JK	501	GTP	2	0
47	RG	501	GTP	2	0
49	TF	501	GDP	1	0
49	MJ	501	GDP	3	0

*Continued on next page...*

*Continued from previous page...*

Mol	Chain	Res	Type	Clashes	Symm-Clashes
49	EL	501	GDP	3	0
47	JI	501	GTP	1	0
49	GL	502	GDP	3	0
47	KM	501	GTP	3	0
47	FC	501	GTP	2	0
47	CE	501	GTP	1	0
49	BL	501	GDP	2	0
49	SN	501	GDP	1	0
49	TN	501	GDP	1	0
47	QM	501	GTP	2	0
49	GD	501	GDP	2	0
47	CA	501	GTP	2	0
49	HD	501	GDP	1	0
49	WL	501	GDP	2	0
47	QC	501	GTP	3	0
49	WD	501	GDP	3	0
47	BM	501	GTP	1	0
49	HB	501	GDP	1	0
47	OF	501	GTP	4	0
49	BF	501	GDP	4	0
47	GK	501	GTP	1	0
49	BJ	501	GDP	2	0
47	TE	501	GTP	1	0
47	IE	501	GTP	3	0
47	VE	501	GTP	4	0
49	OB	501	GDP	2	0
49	ED	501	GDP	1	0
47	SE	501	GTP	2	0
47	DI	501	GTP	4	0
49	NJ	501	GDP	1	0
49	VJ	501	GDP	4	0
47	IG	501	GTP	2	0
47	RM	501	GTP	2	0
49	HJ	501	GDP	2	0
47	EC	501	GTP	3	0
49	FF	501	GDP	2	0
49	KH	501	GDP	1	0
47	EG	501	GTP	2	0
47	TI	501	GTP	1	0
47	CK	501	GTP	1	0
49	HL	501	GDP	1	0
47	DA	501	GTP	2	0

*Continued on next page...*

*Continued from previous page...*

Mol	Chain	Res	Type	Clashes	Symm-Clashes
49	IL	501	GDP	4	0
49	CB	501	GDP	2	0
49	AF	501	GDP	1	0
49	GF	501	GDP	1	0
47	LM	501	GTP	1	0
47	EE	501	GTP	1	0
49	CJ	501	GDP	4	0
49	LJ	501	GDP	2	0
47	AC	501	GTP	1	0
47	EI	501	GTP	1	0
47	WM	501	GTP	1	0
49	PH	501	GDP	2	0
47	WA	501	GTP	3	0
49	DH	501	GDP	2	0
47	GC	501	GTP	1	0
47	AA	501	GTP	3	0
47	OI	501	GTP	3	0
47	HE	501	GTP	2	0
47	WK	501	GTP	3	0
49	EH	501	GDP	4	0
47	JG	501	GTP	2	0
47	HG	501	GTP	1	0
47	CC	501	GTP	1	0
47	AI	501	GTP	1	0
49	CF	501	GDP	6	0
49	SB	501	GDP	1	0
47	CM	501	GTP	1	0
49	UL	501	GDP	2	0
47	LC	501	GTP	3	0
47	PE	501	GTP	1	0
49	FH	501	GDP	4	0
49	VF	501	GDP	2	0
47	UG	501	GTP	1	0
47	LG	501	GTP	2	0
47	AM	501	GTP	2	0
47	PI	501	GTP	4	0
47	NG	501	GTP	1	0
49	UN	501	GDP	1	0
49	VD	501	GDP	1	0
49	OD	501	GDP	2	0
49	AJ	501	GDP	2	0
49	QL	501	GDP	1	0

*Continued on next page...*

*Continued from previous page...*

Mol	Chain	Res	Type	Clashes	Symm-Clashes
49	CH	501	GDP	1	0
49	GJ	501	GDP	1	0
49	AL	501	GDP	1	0
49	VL	501	GDP	3	0
47	DE	501	GTP	2	0
49	WF	501	GDP	1	0
47	QI	501	GTP	3	0
47	JA	501	GTP	1	0
47	EA	501	GTP	2	0
47	PM	501	GTP	2	0
47	NA	501	GTP	3	0
49	JH	501	GDP	1	0
47	NE	501	GTP	1	0
47	HA	501	GTP	1	0
47	LK	501	GTP	2	0
49	IB	501	GDP	1	0
47	PA	501	GTP	2	0
47	RA	501	GTP	2	0
49	WH	501	GDP	2	0
47	TK	501	GTP	2	0
49	DN	501	GDP	1	0
49	AN	501	GDP	1	0
47	KE	501	GTP	2	0
47	RE	501	GTP	3	0
49	TJ	501	GDP	1	0
49	RL	501	GDP	1	0
49	JD	501	GDP	1	0
47	IK	501	GTP	3	0
49	JL	501	GDP	1	0
47	RC	501	GTP	3	0
47	FA	501	GTP	3	0
49	TL	501	GDP	1	0
49	JF	501	GDP	1	0
49	BH	501	GDP	2	0
47	TA	501	GTP	2	0
49	ON	501	GDP	2	0
47	LA	501	GTP	1	0
47	PK	501	GTP	4	0
47	SA	501	GTP	2	0
49	DD	501	GDP	2	0
49	FL	502	GDP	2	0
49	KF	501	GDP	1	0



The following is a two-dimensional graphical depiction of Mogul quality analysis of bond lengths, bond angles, torsion angles, and ring geometry for all instances of the Ligand of Interest. In addition, ligands with molecular weight > 250 and outliers as shown on the validation Tables will also be included. For torsion angles, if less than 5% of the Mogul distribution of torsion angles is within 10 degrees of the torsion angle in question, then that torsion angle is considered an outlier. Any bond that is central to one or more torsion angles identified as an outlier by Mogul will be highlighted in the graph. For rings, the root-mean-square deviation (RMSD) between the ring in question and similar rings identified by Mogul is calculated over all ring torsion angles. If the average RMSD is greater than 60 degrees and the minimal RMSD between the ring in question and any Mogul-identified rings is also greater than 60 degrees, then that ring is considered an outlier. The outliers are highlighted in purple. The color gray indicates Mogul did not find sufficient equivalents in the CSD to analyse the geometry.

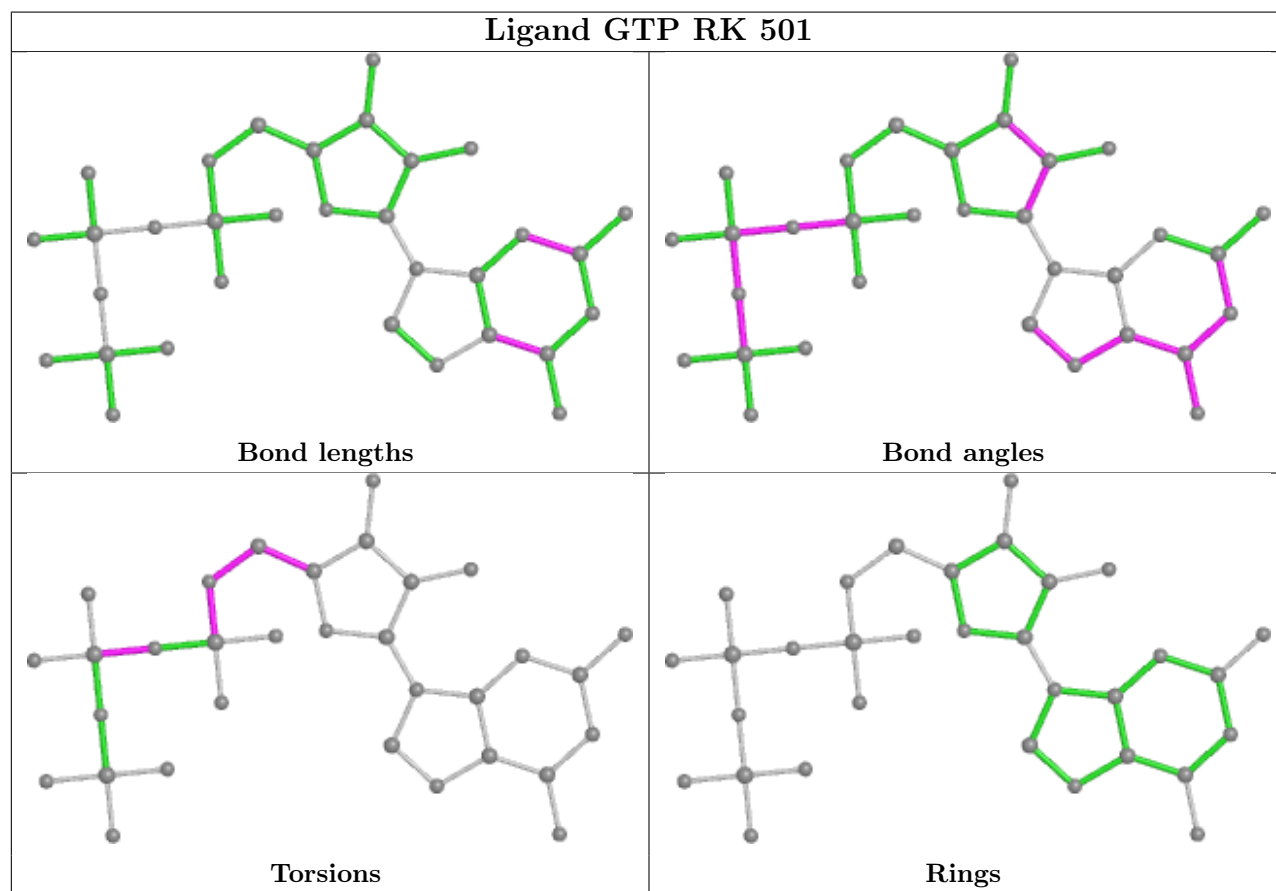

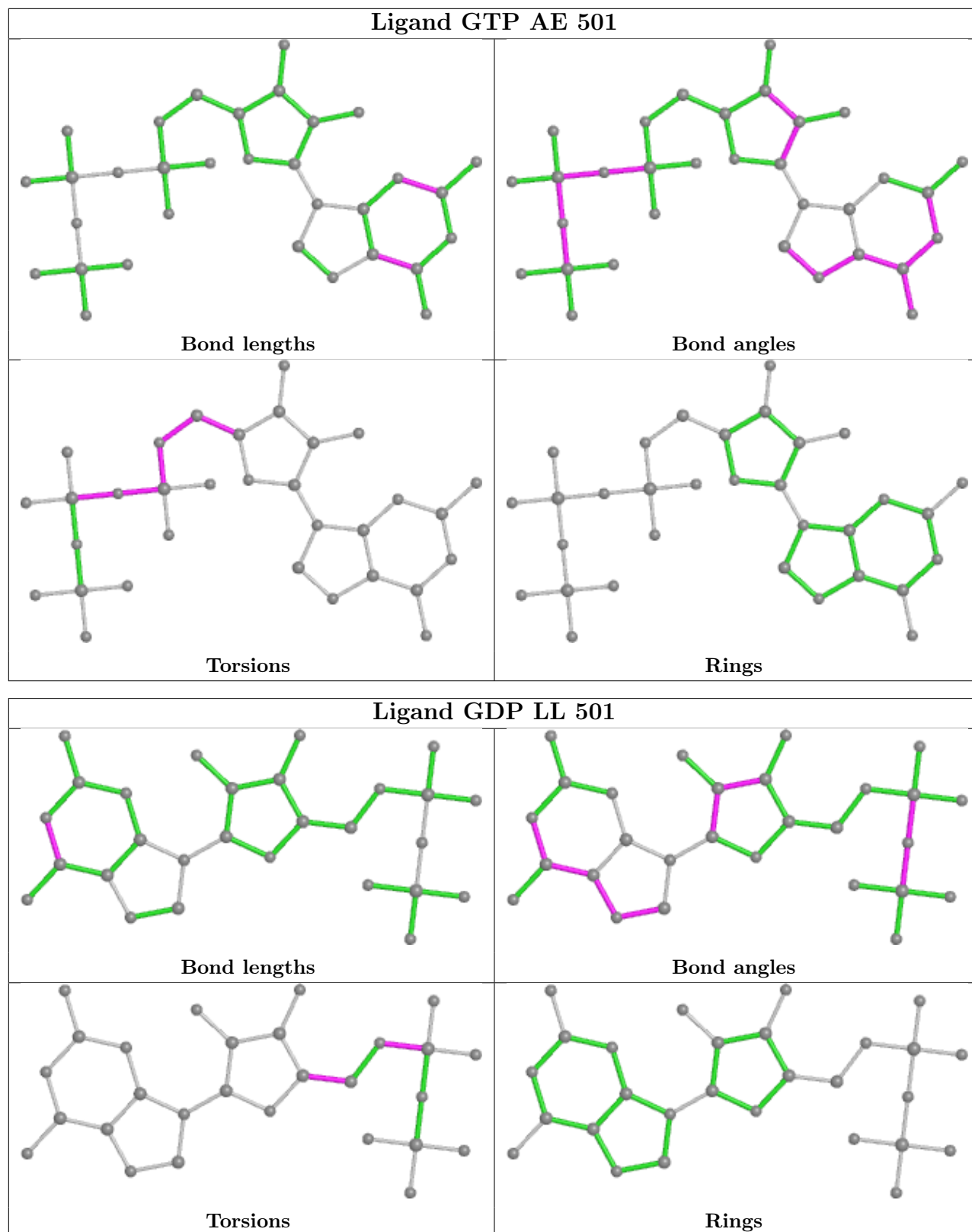

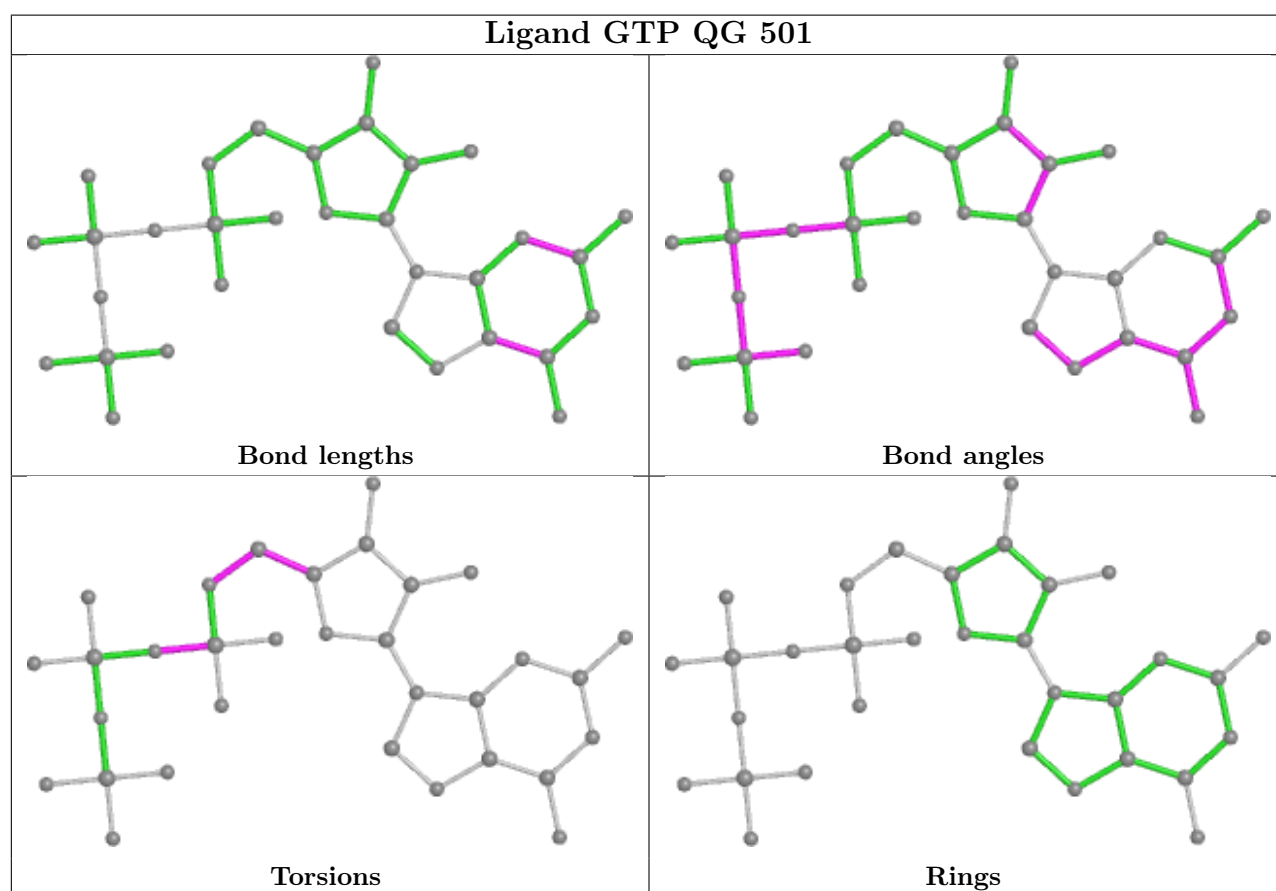
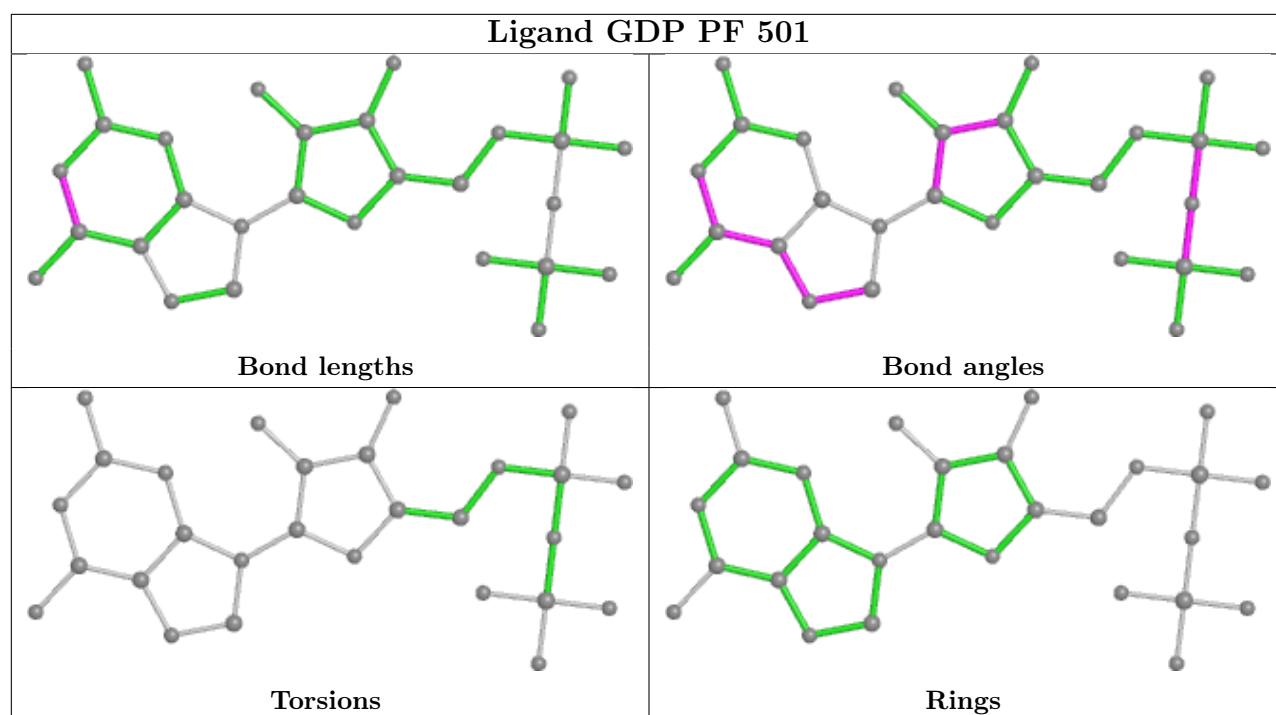

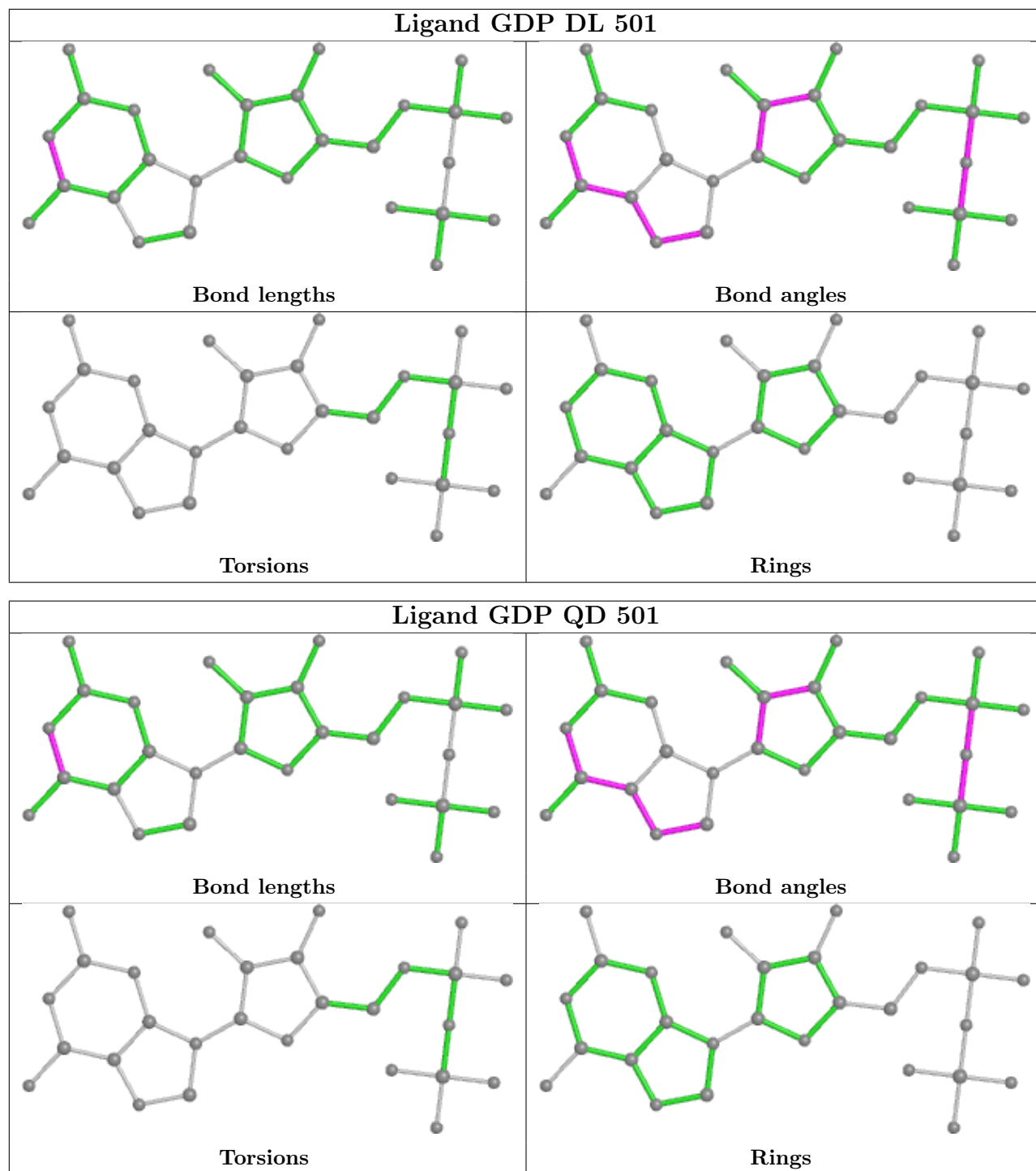

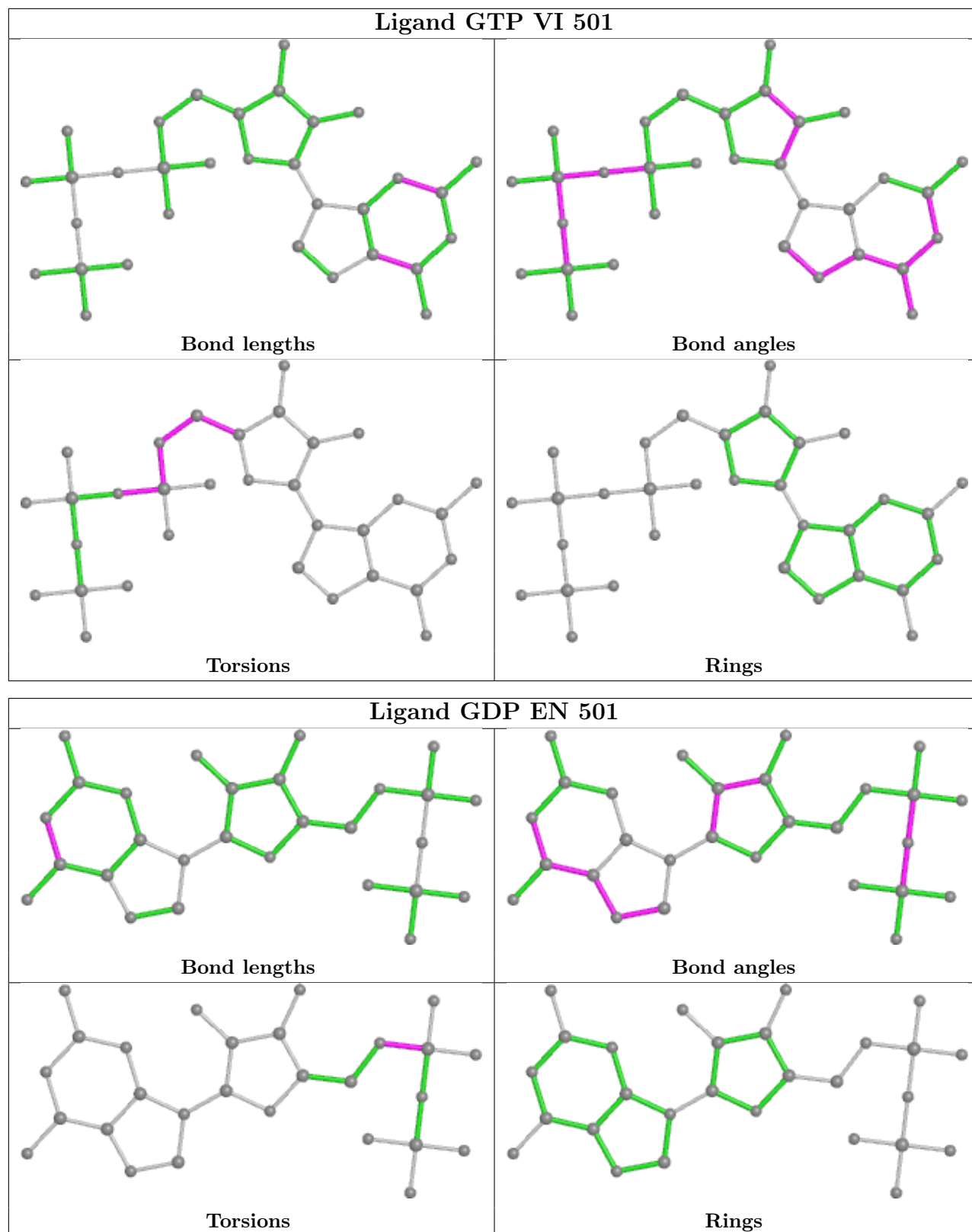

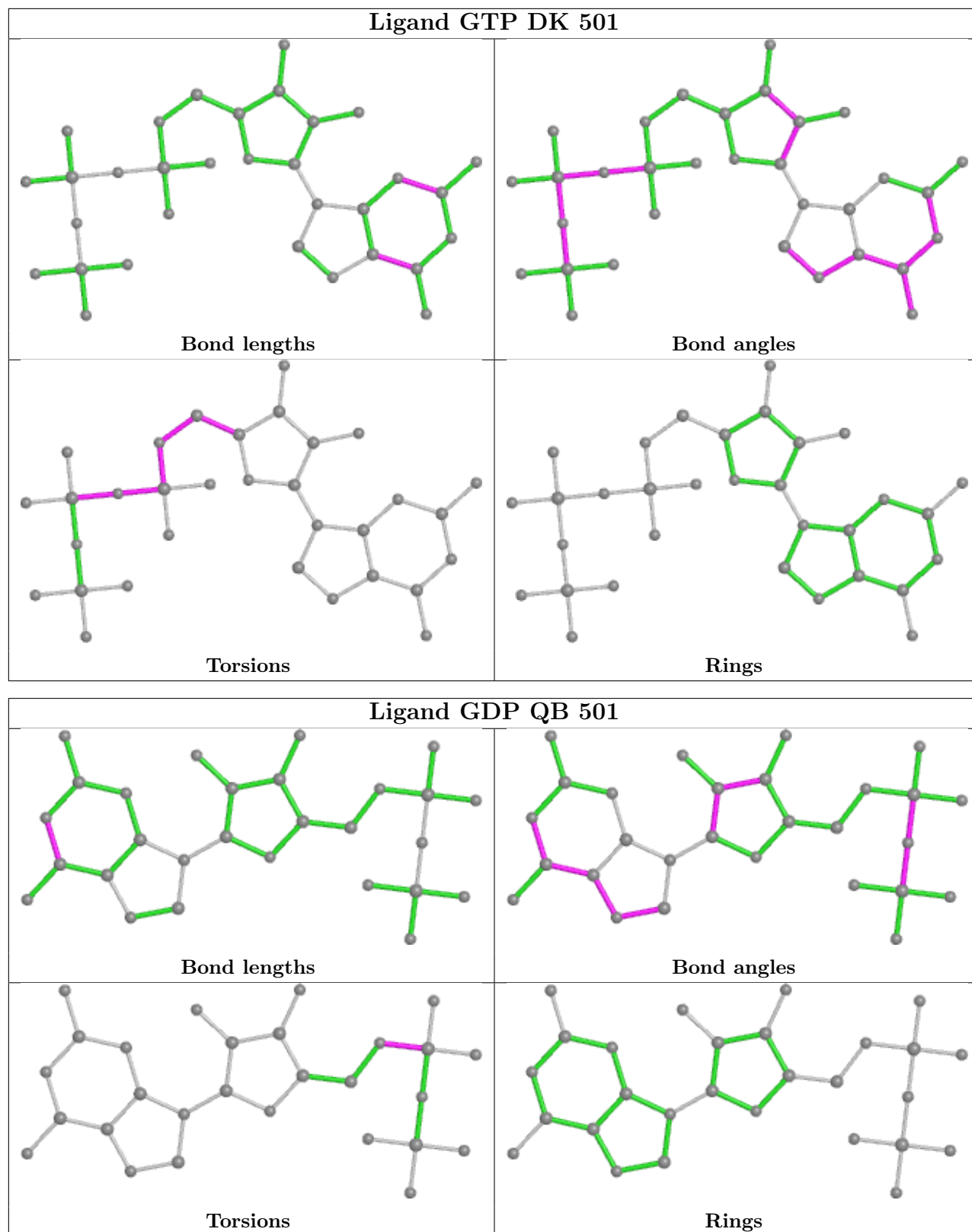

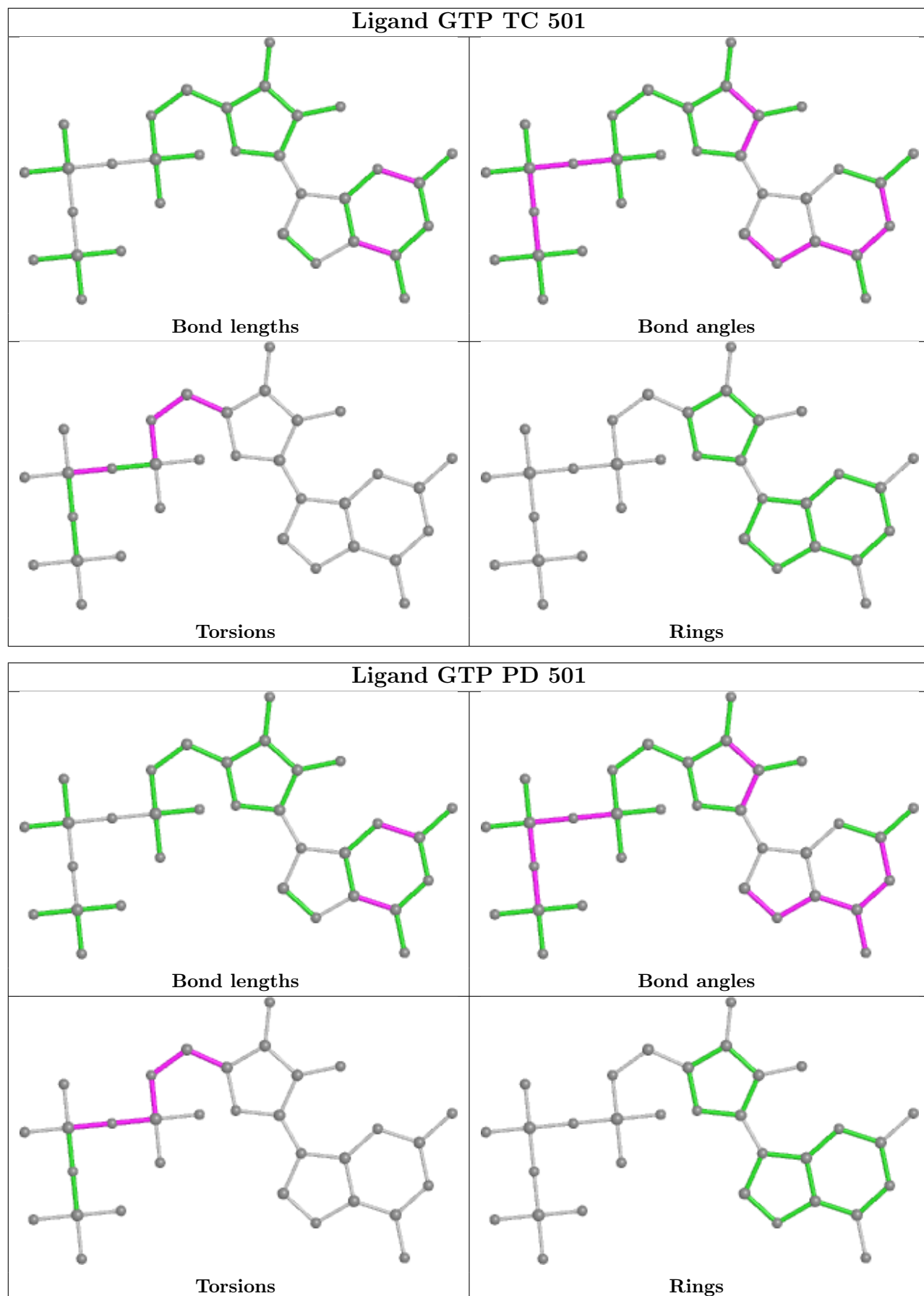

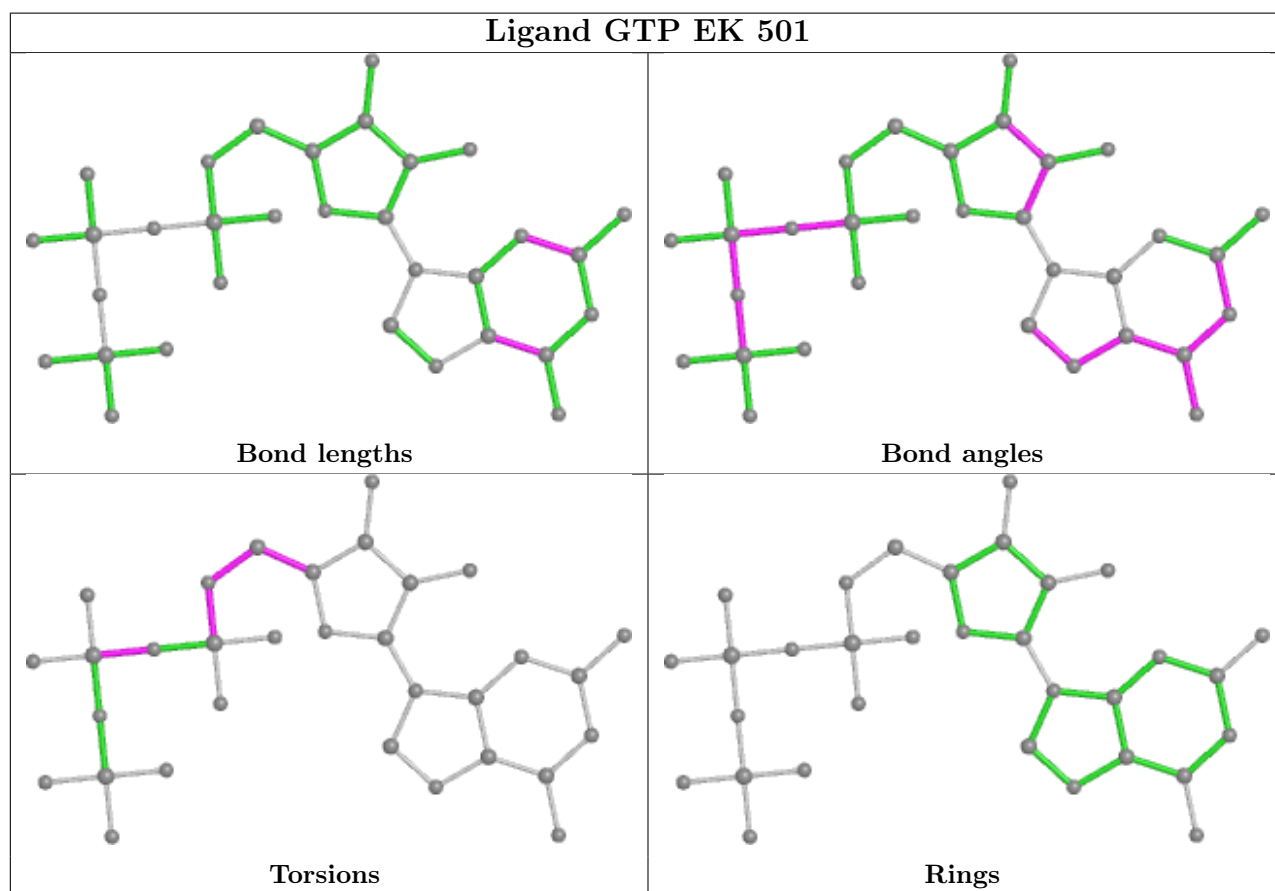
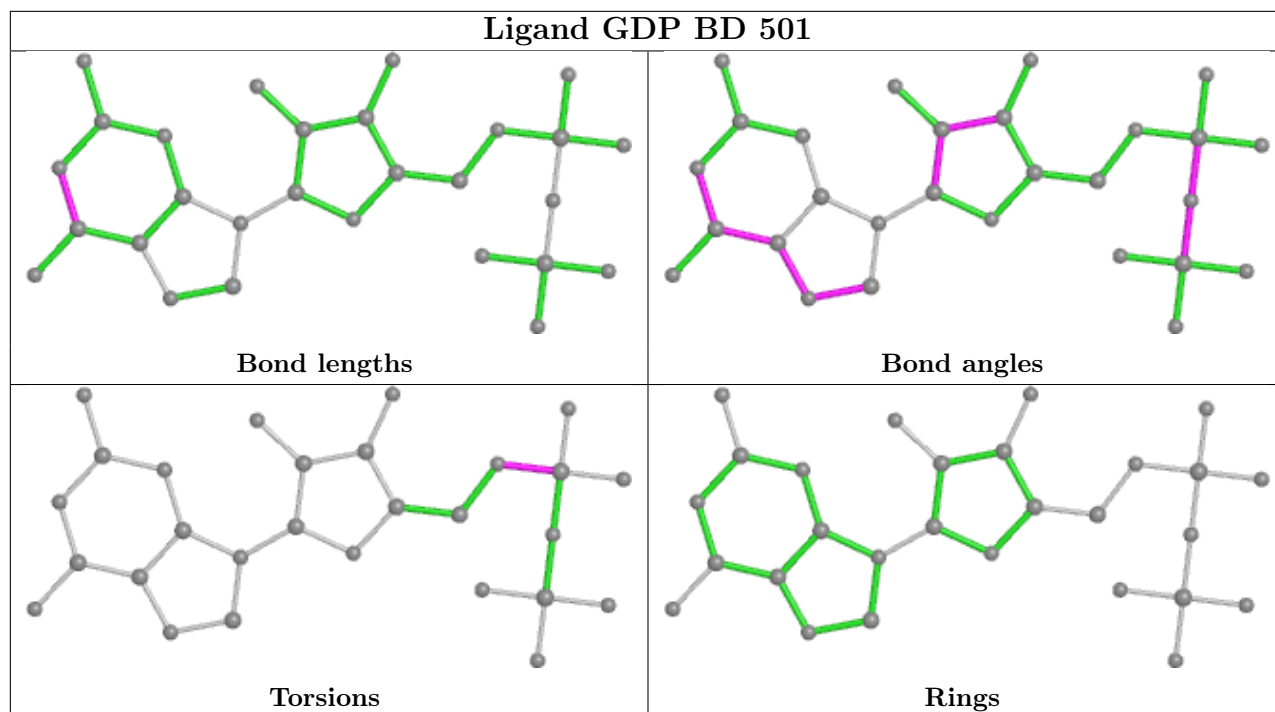



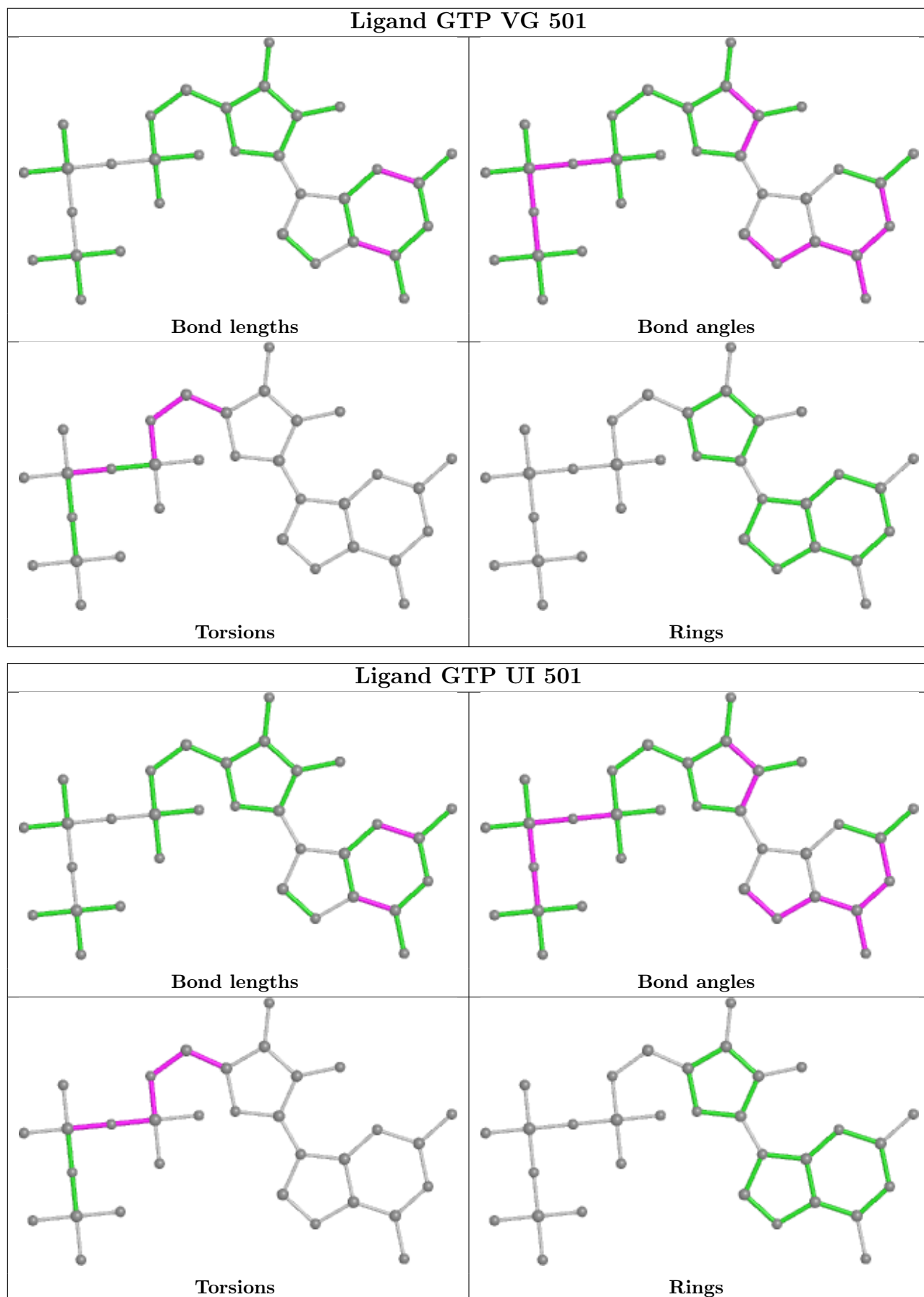

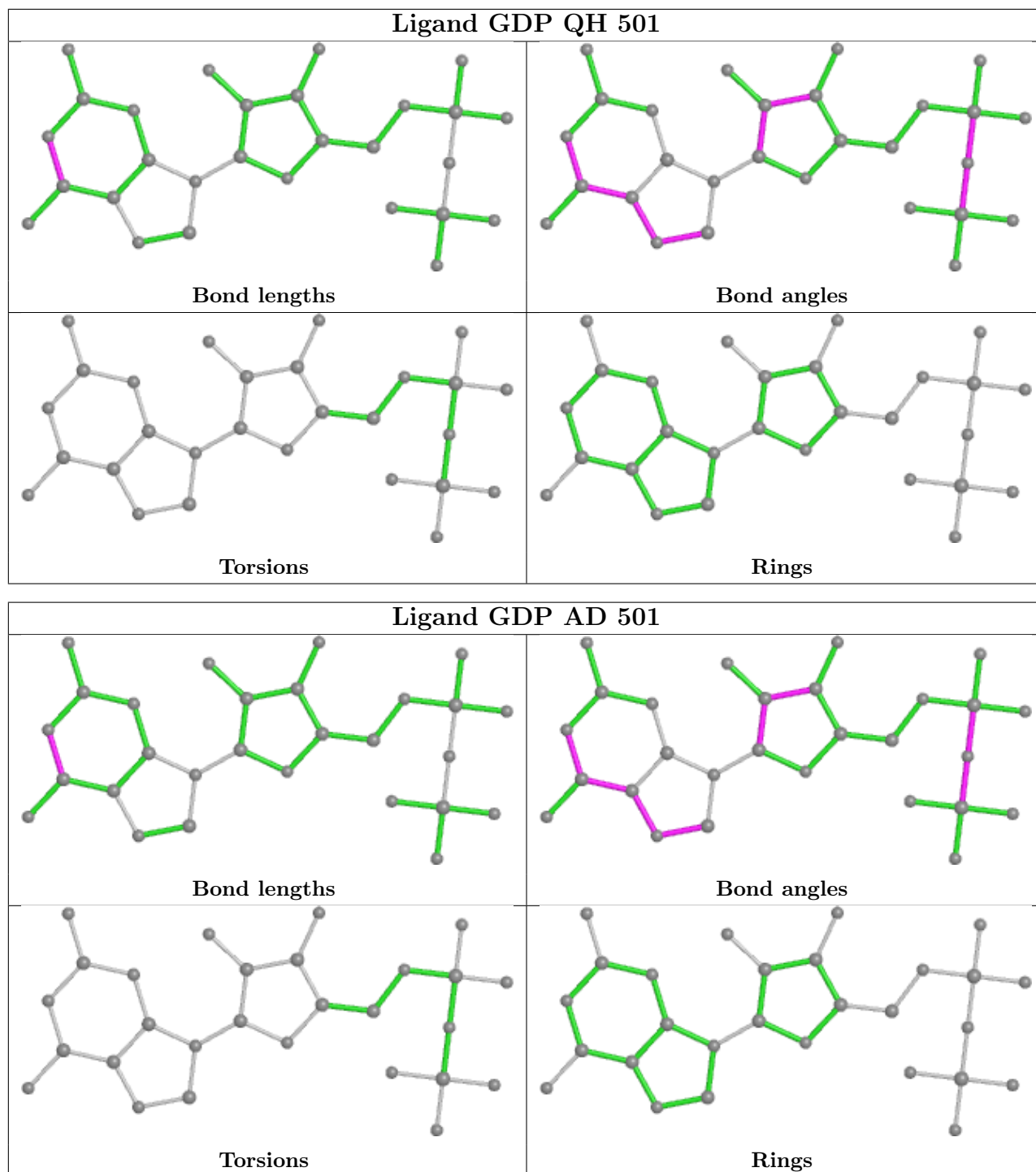

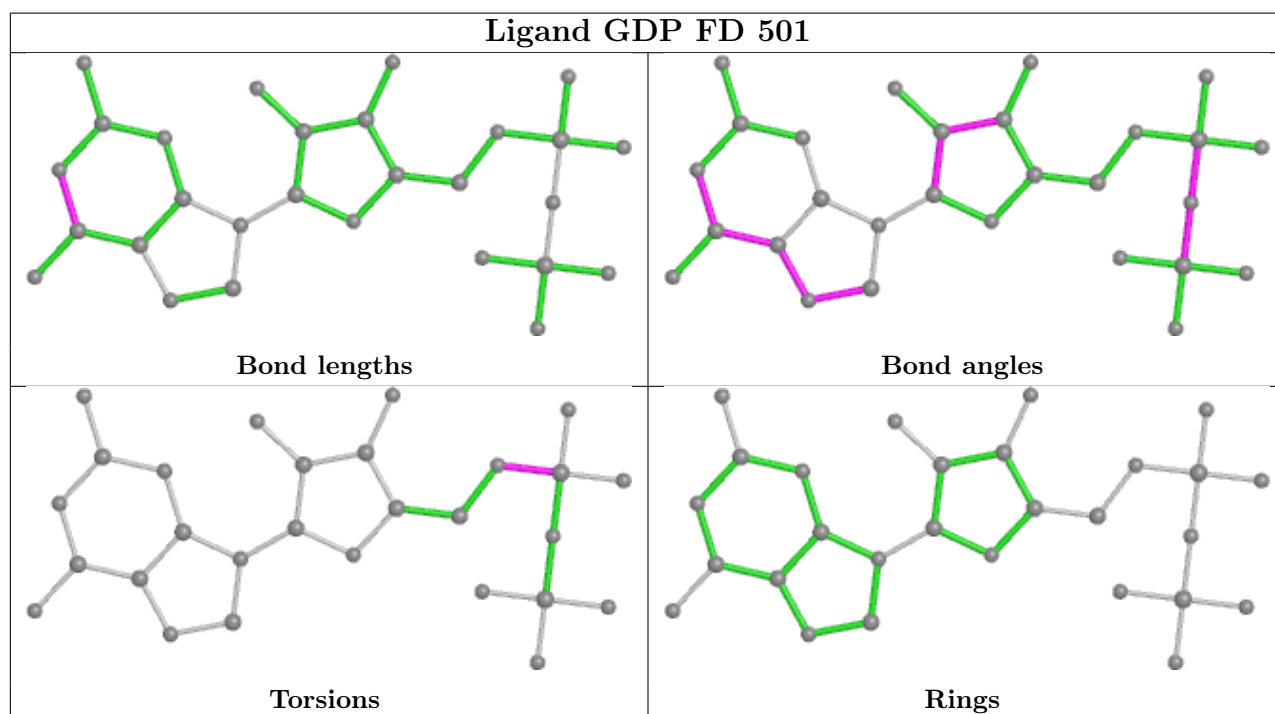
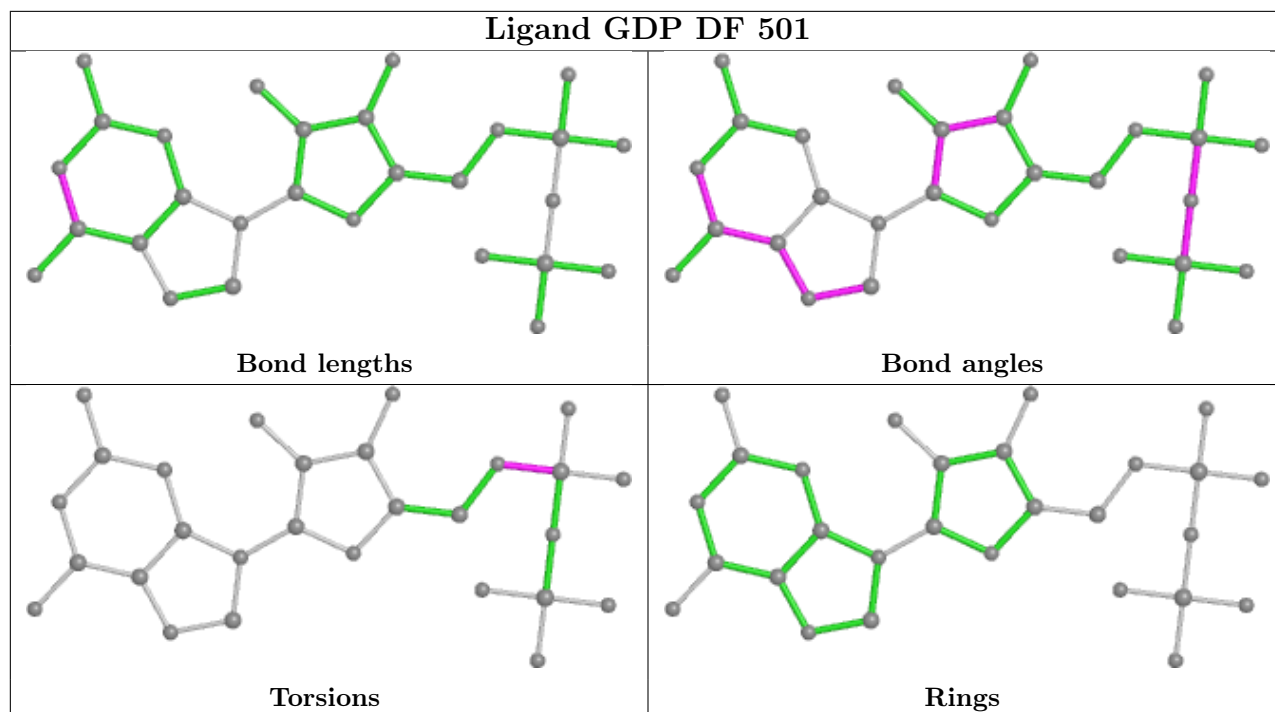

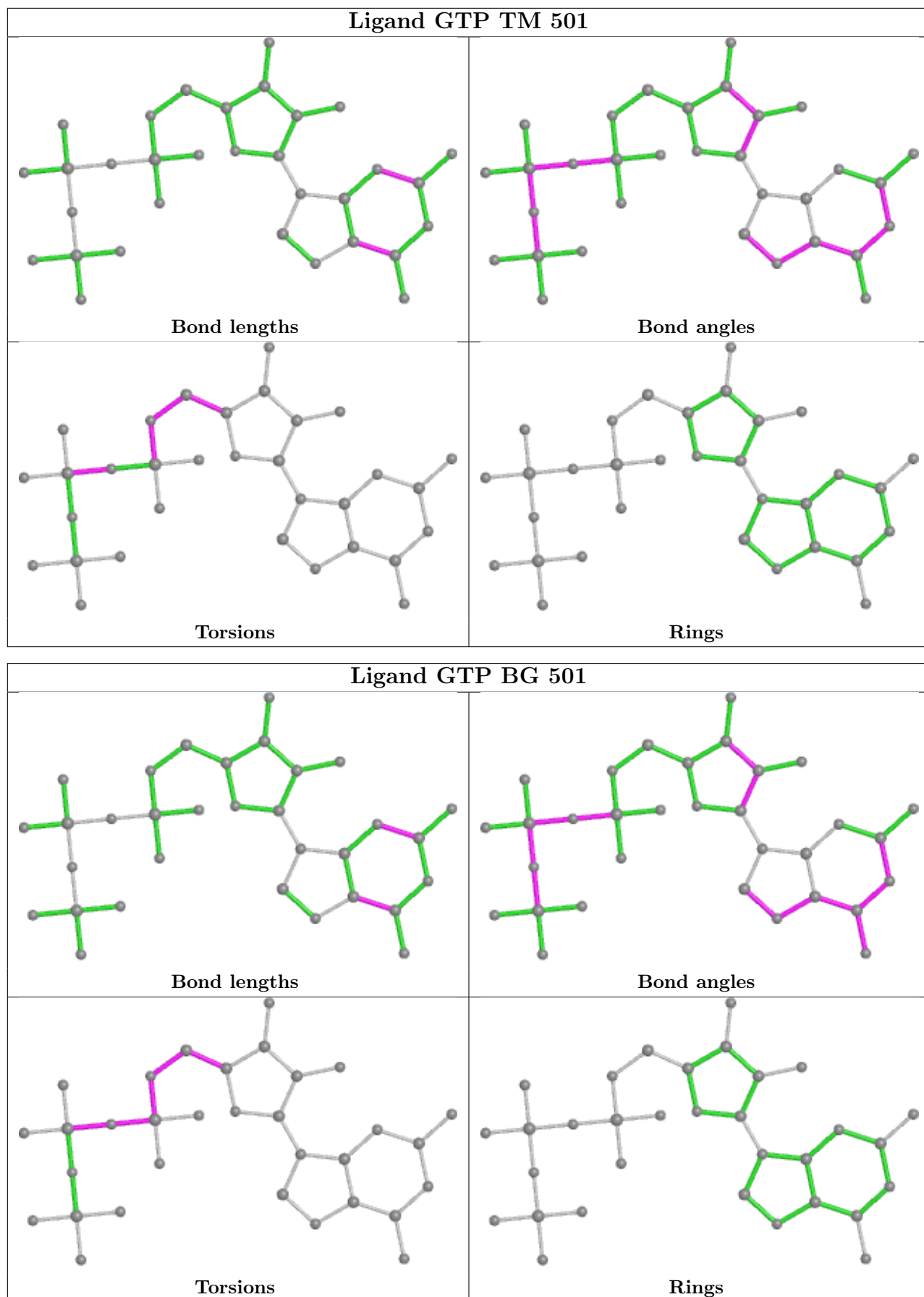

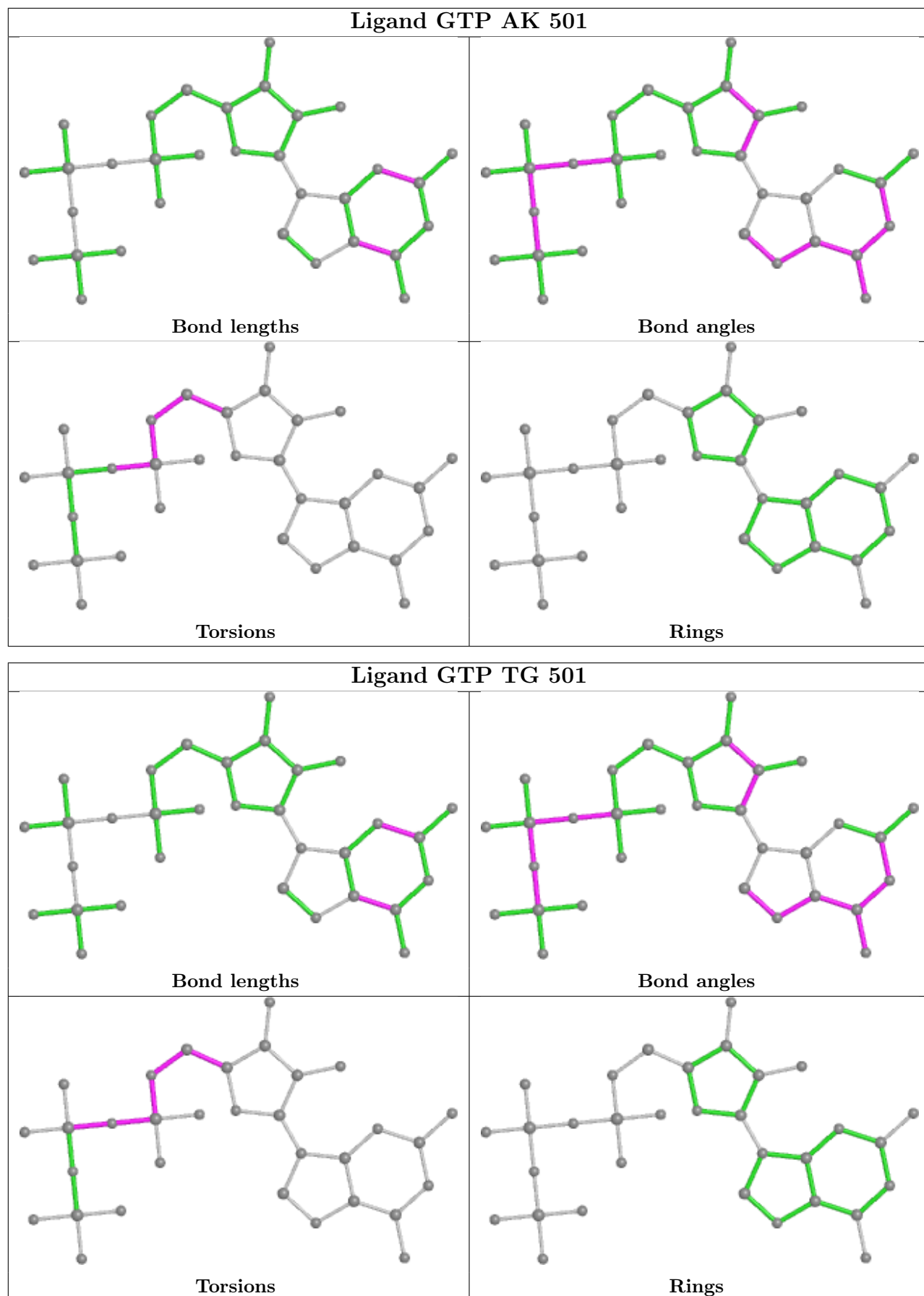

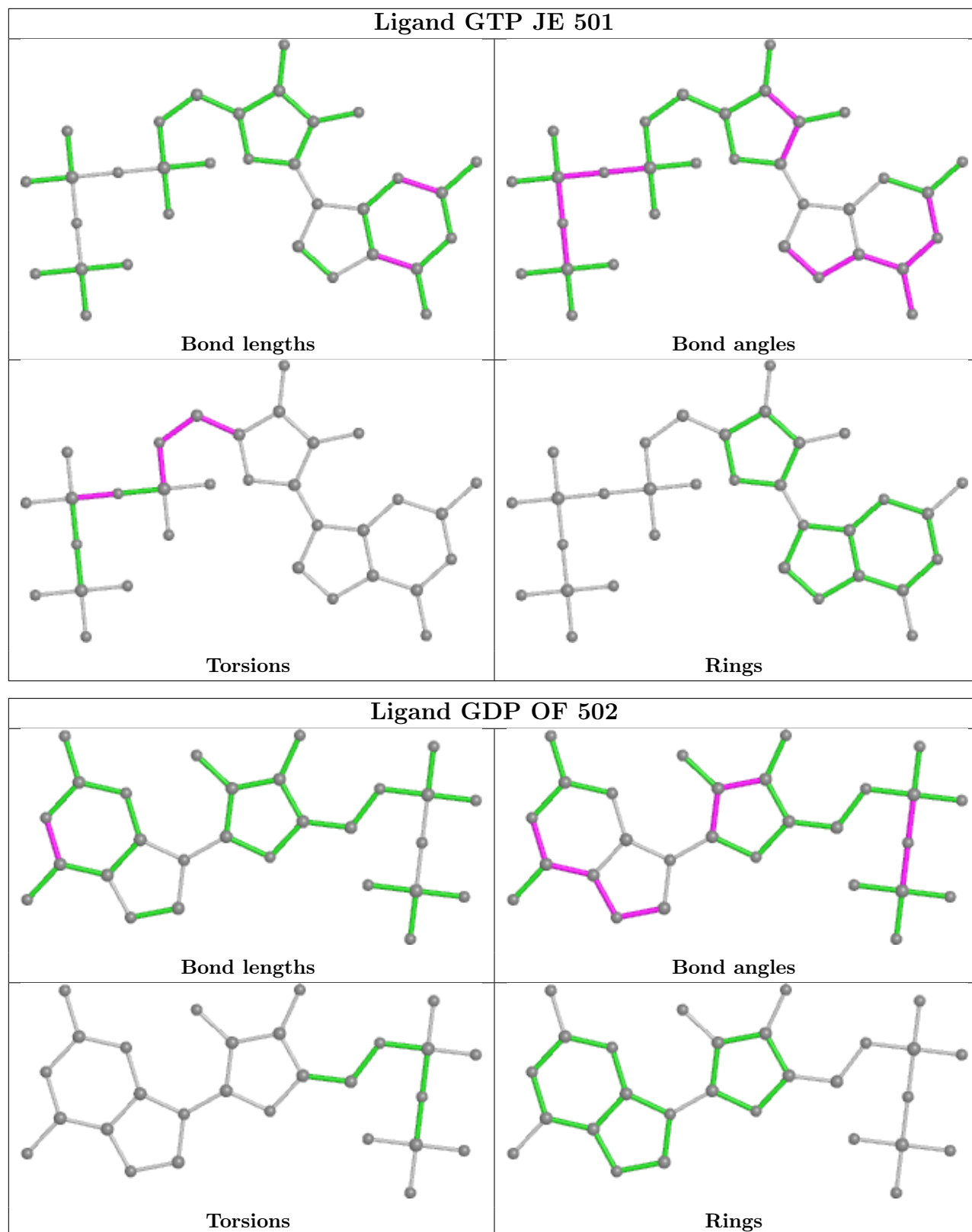

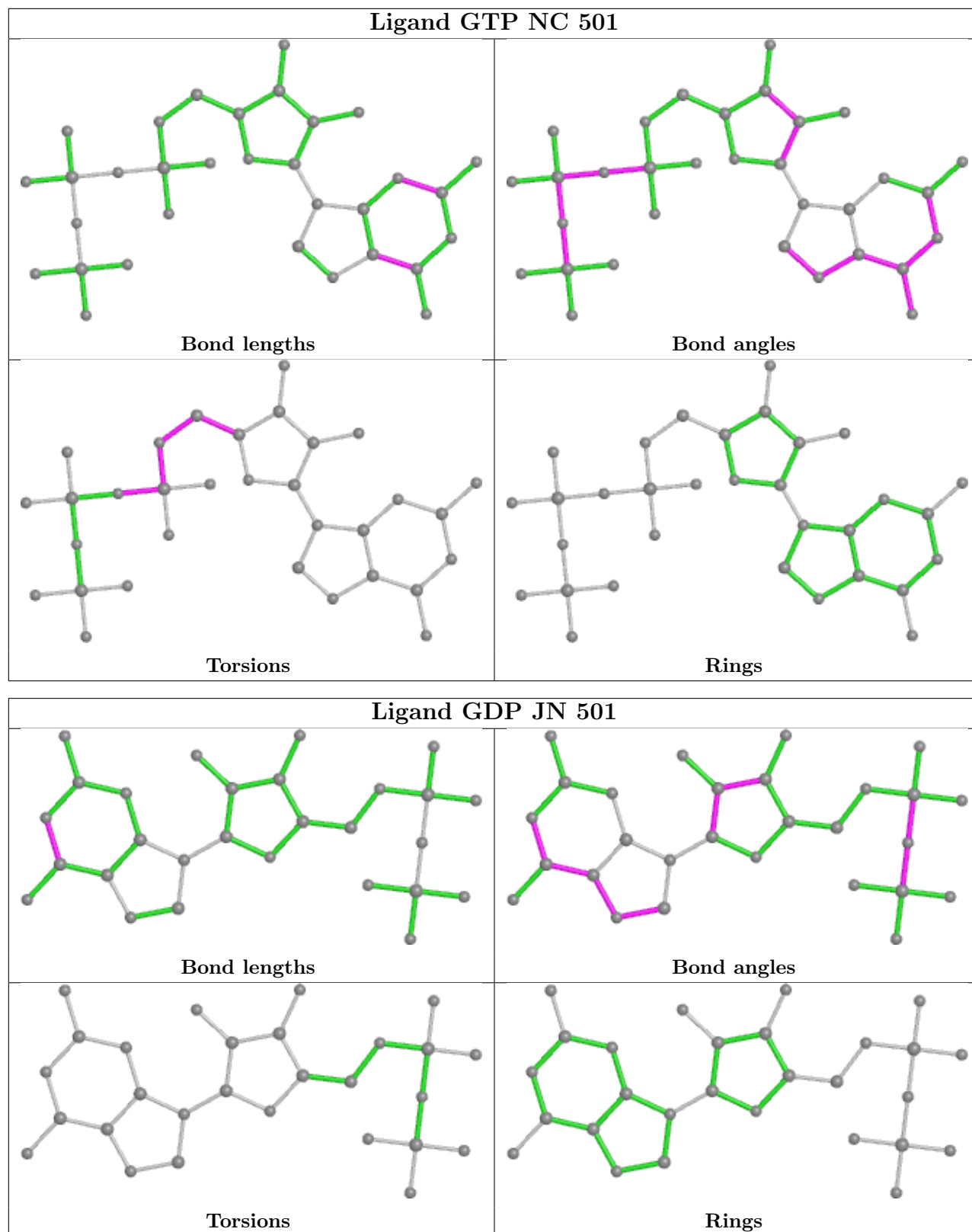

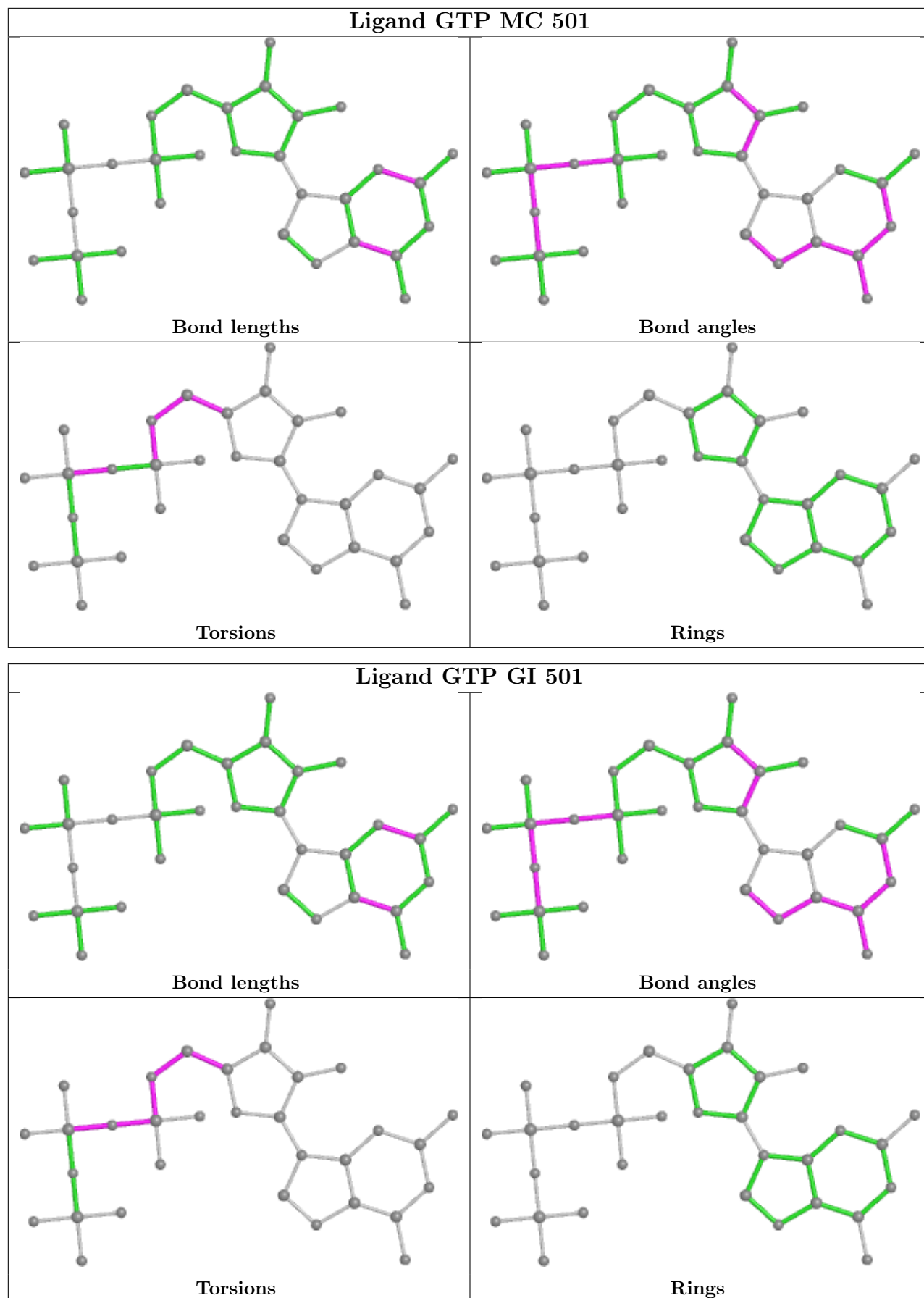



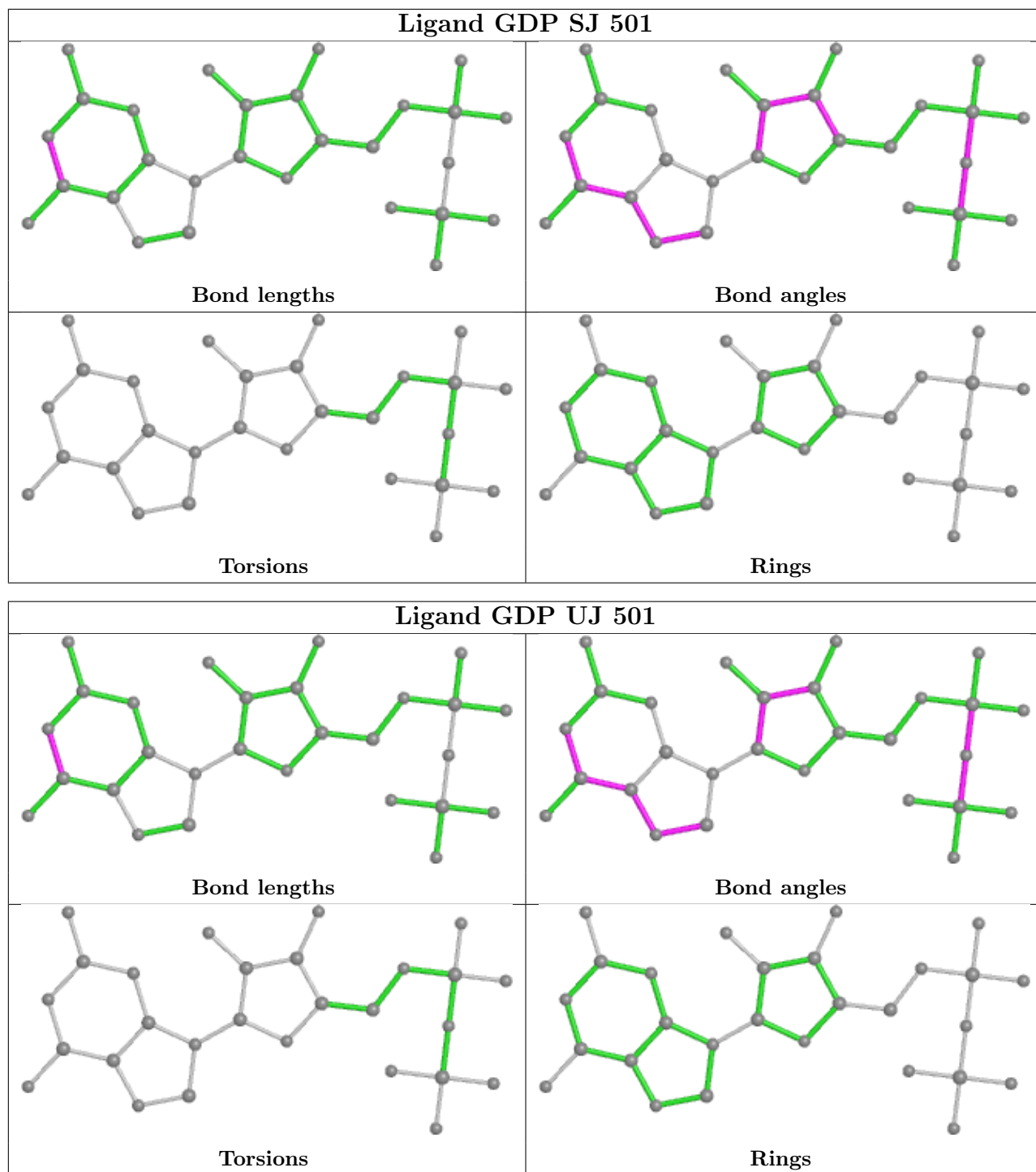

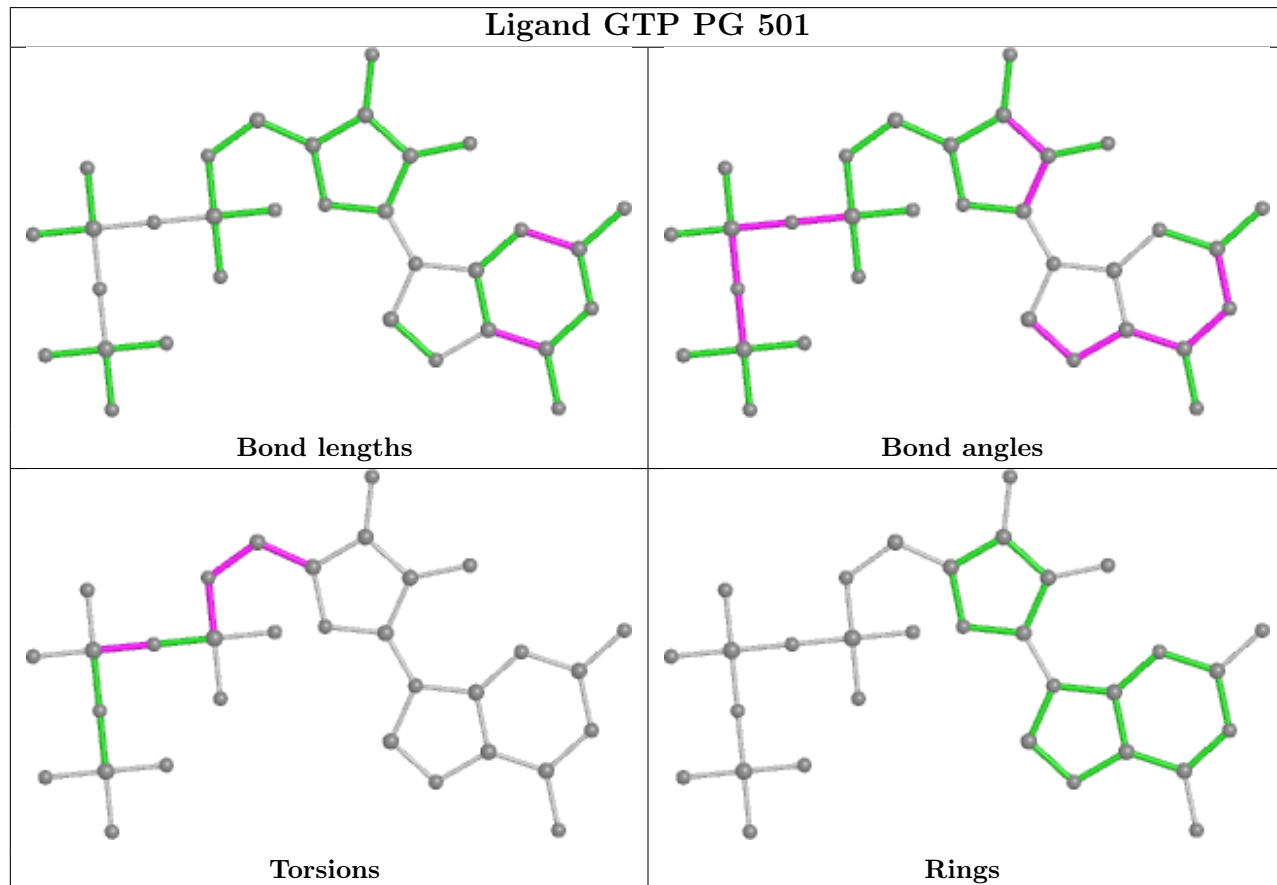
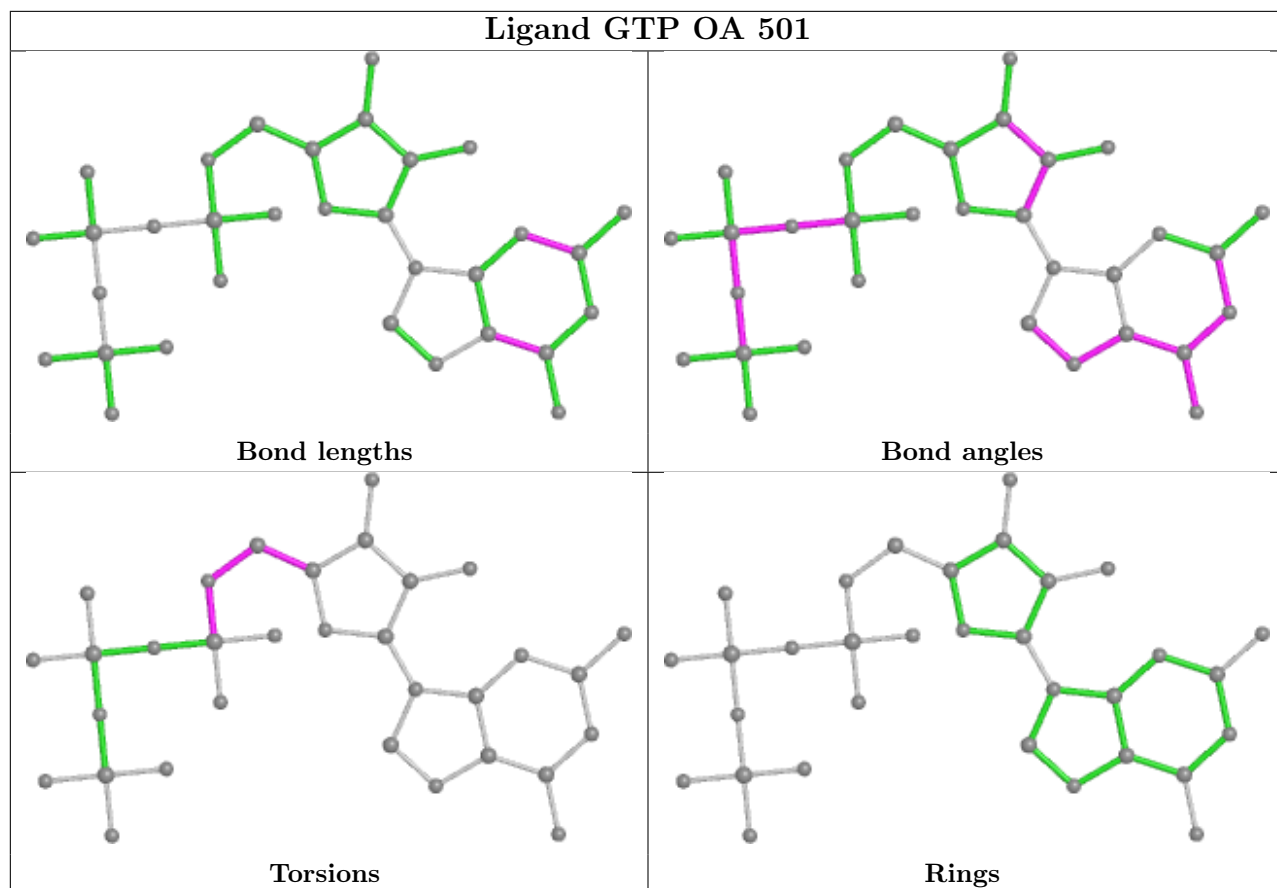

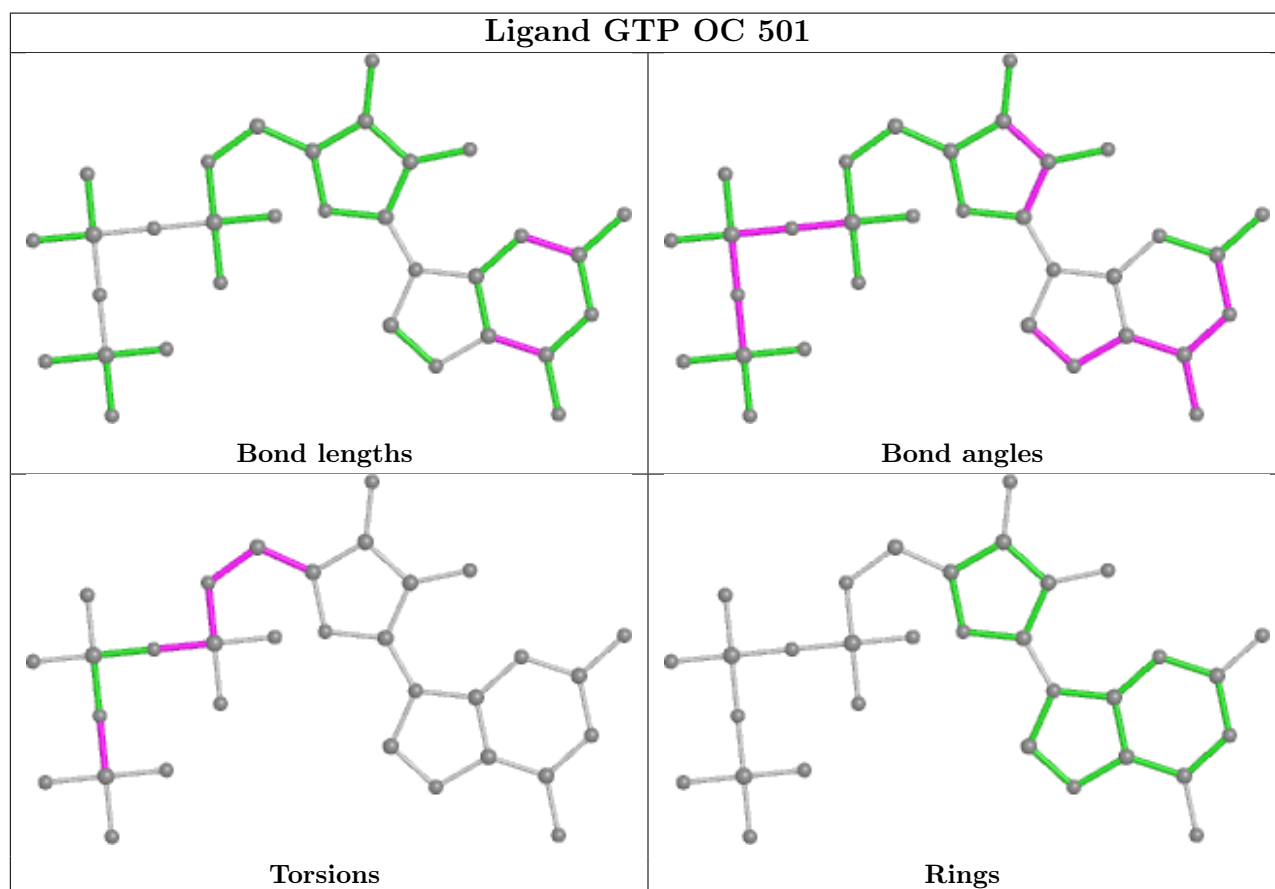
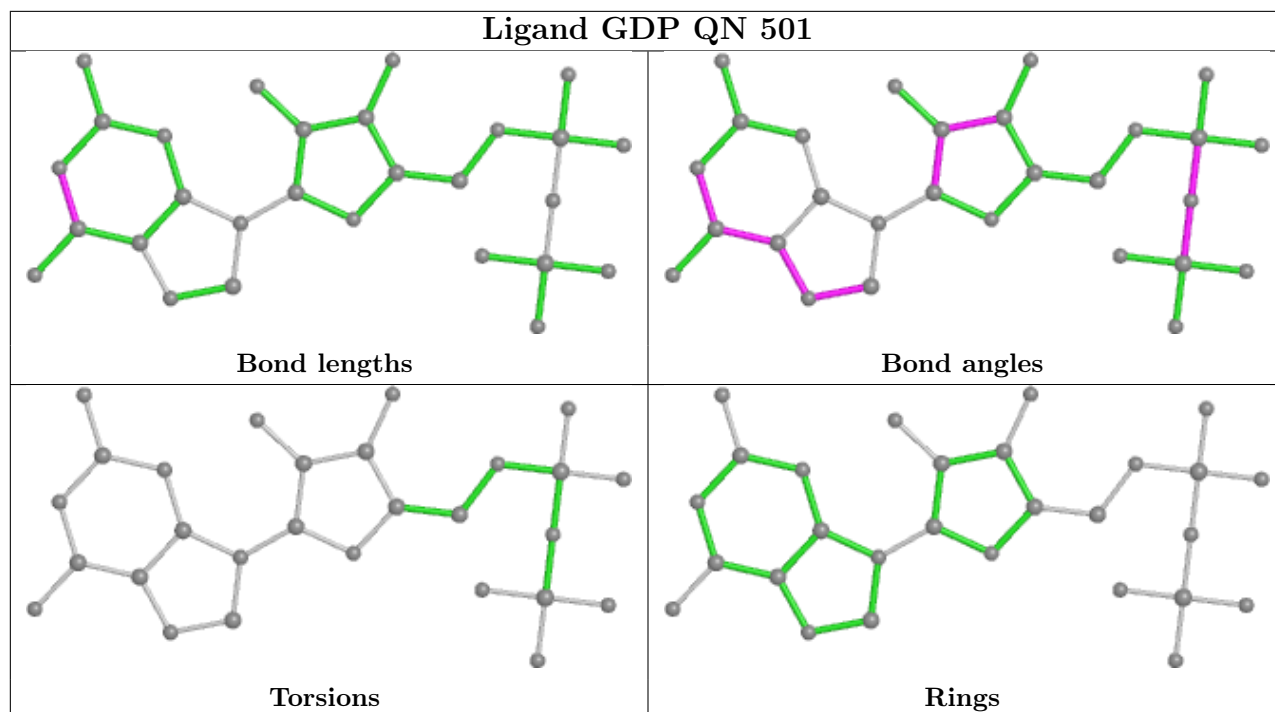

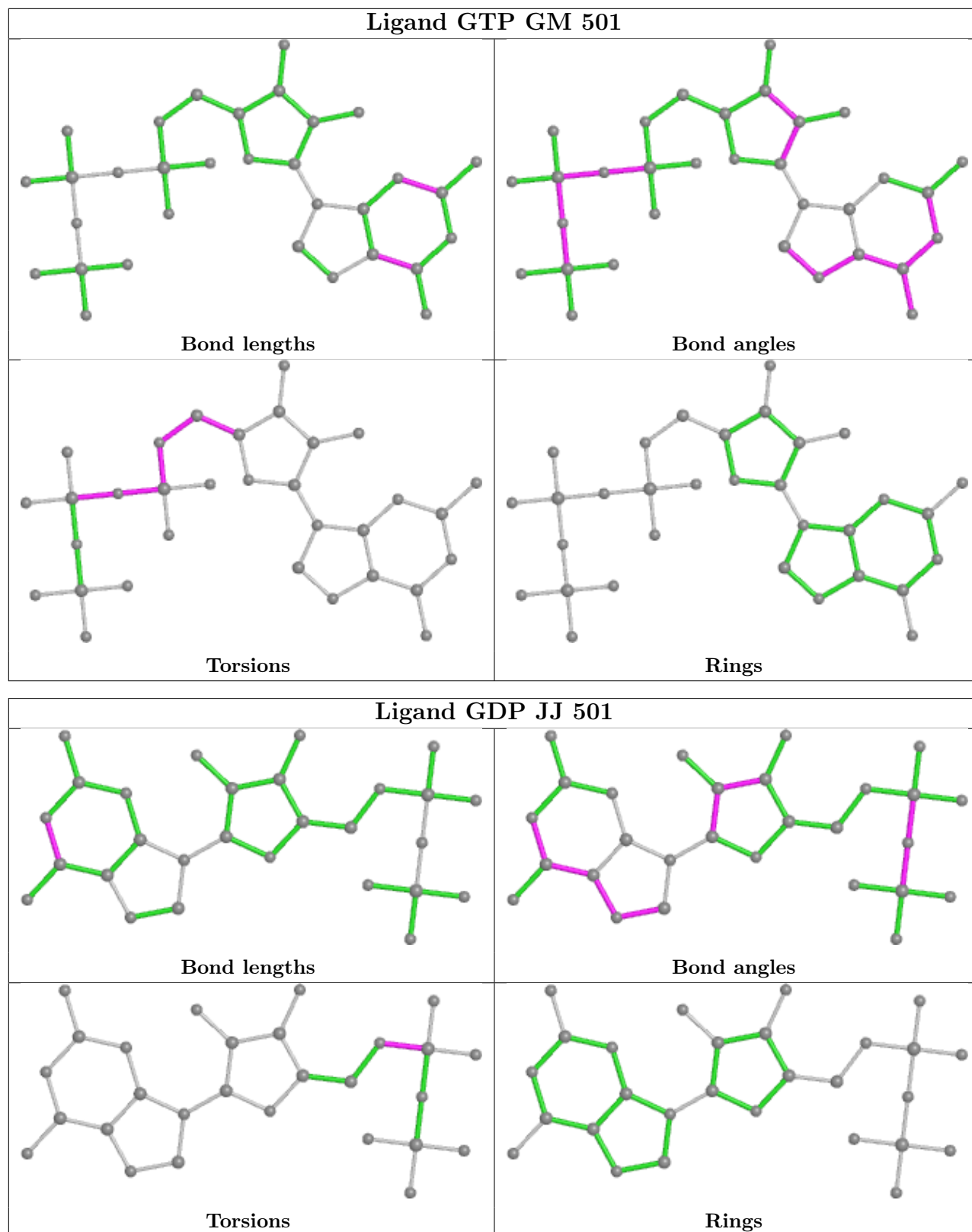

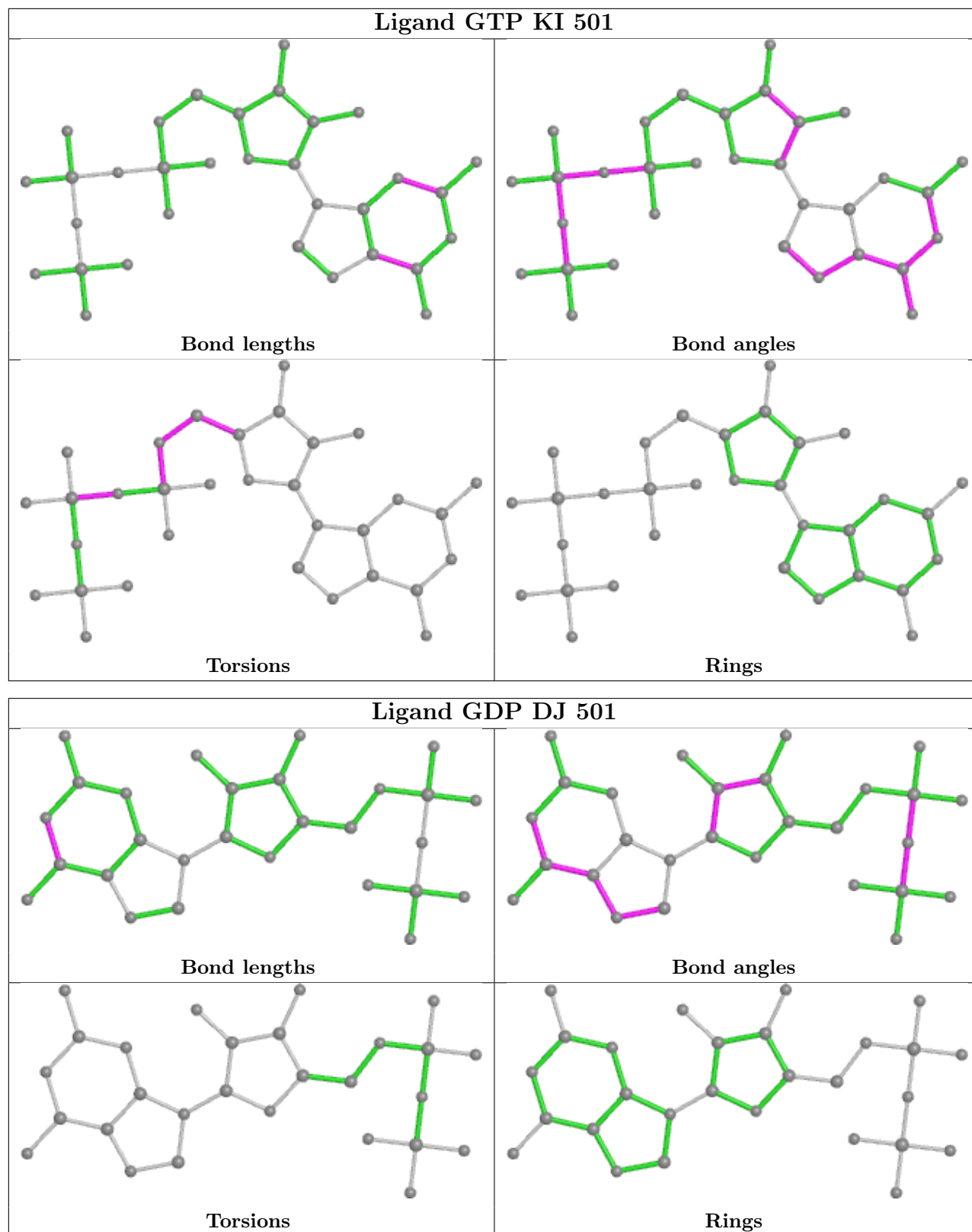

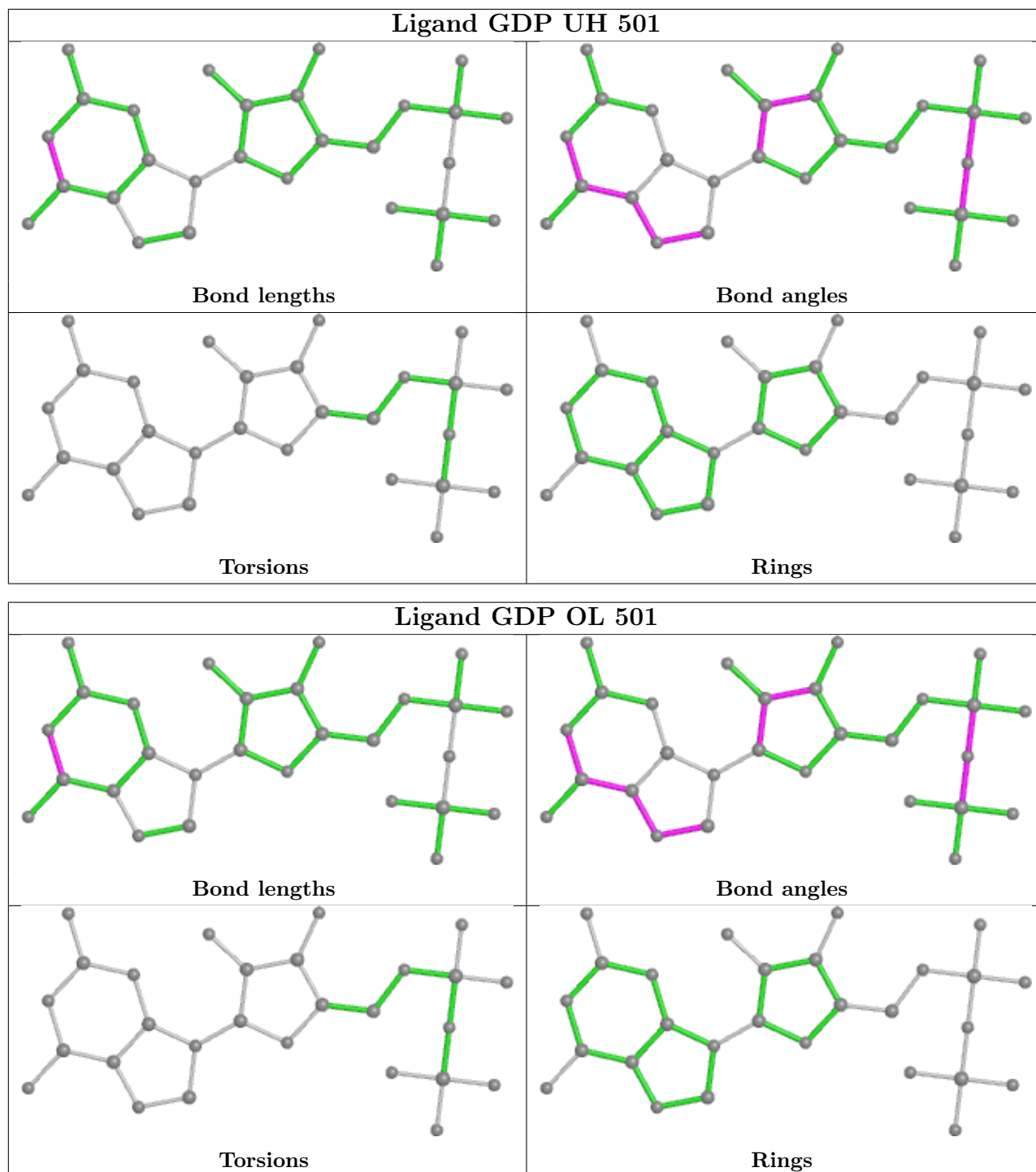

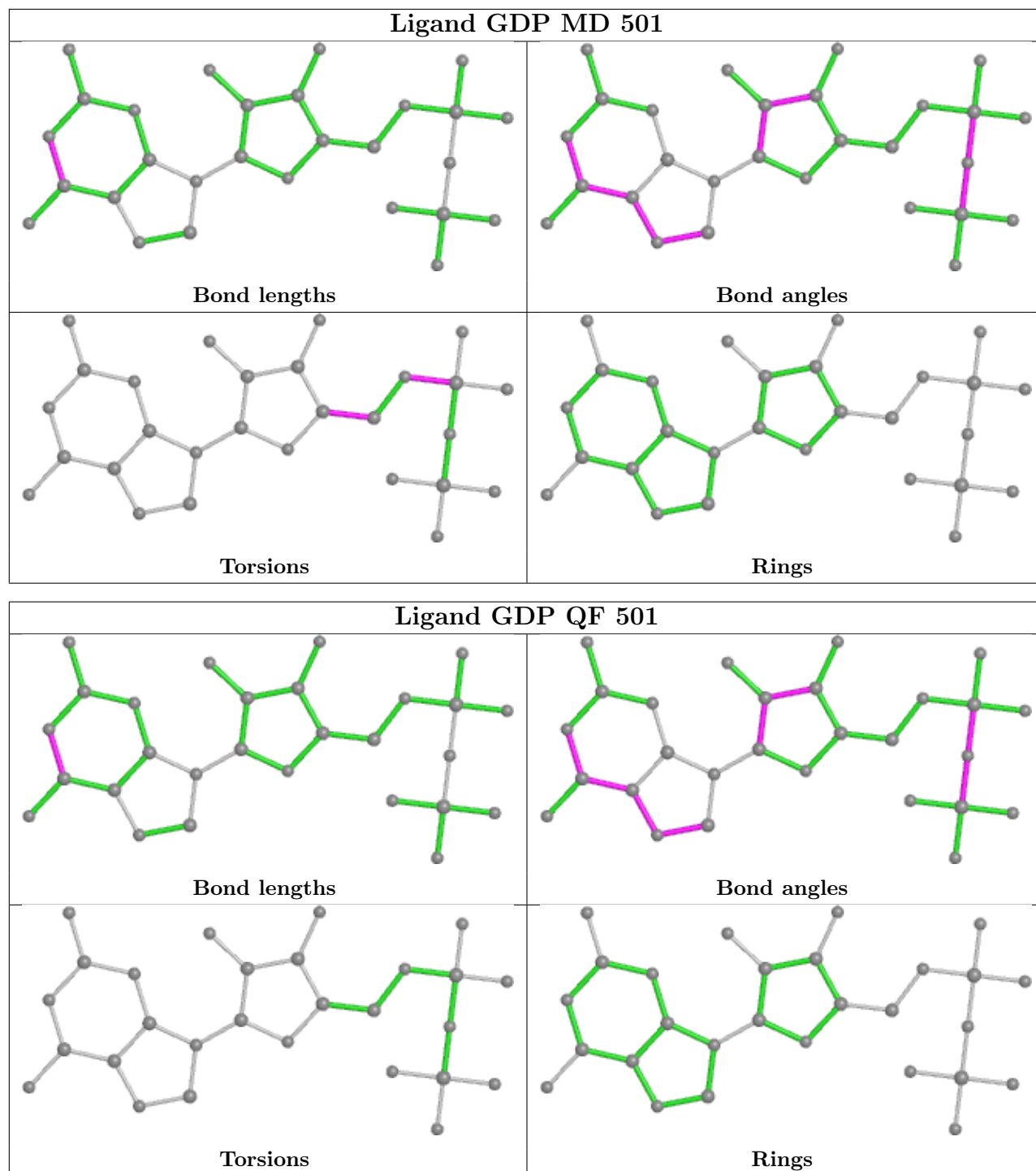

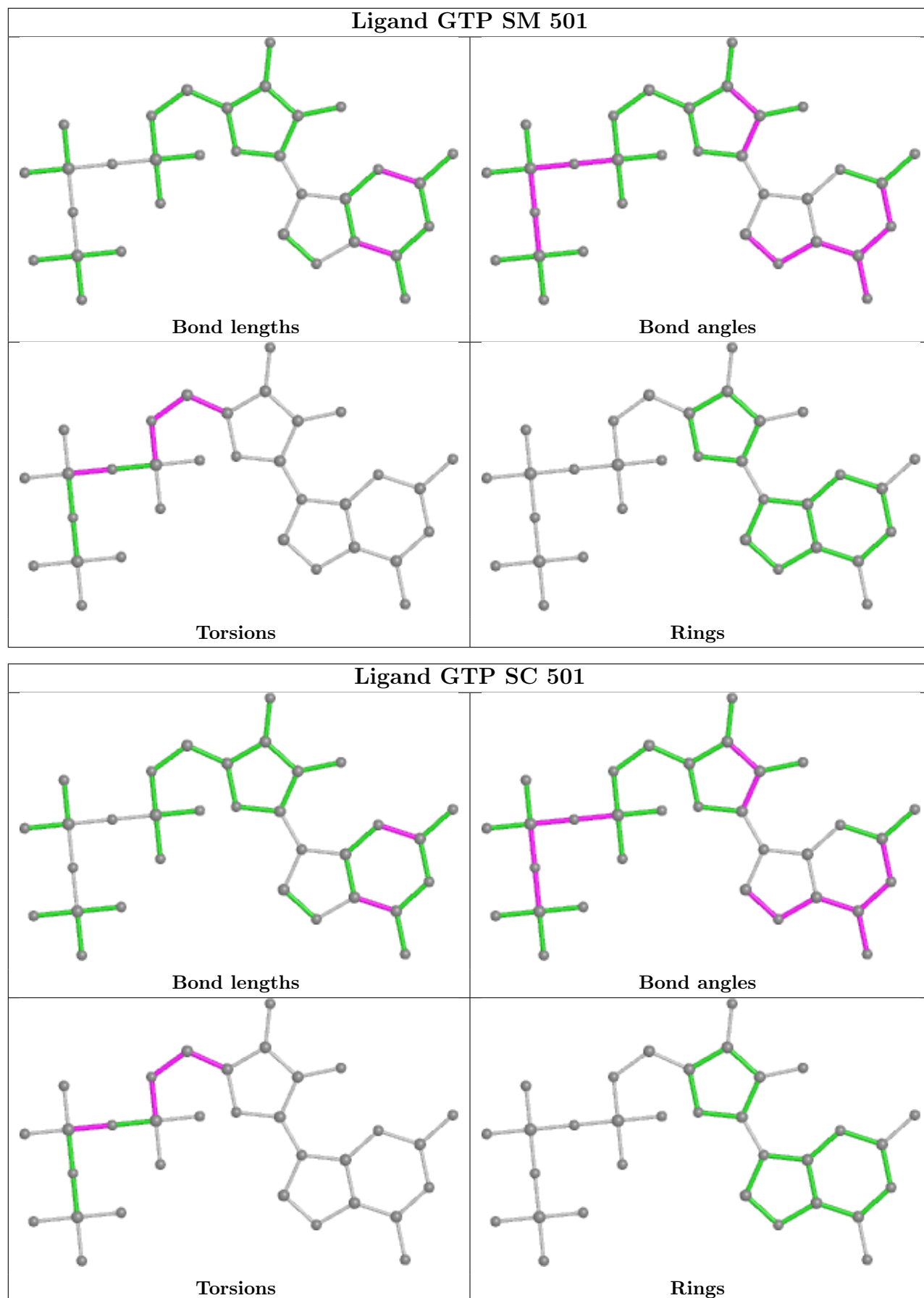



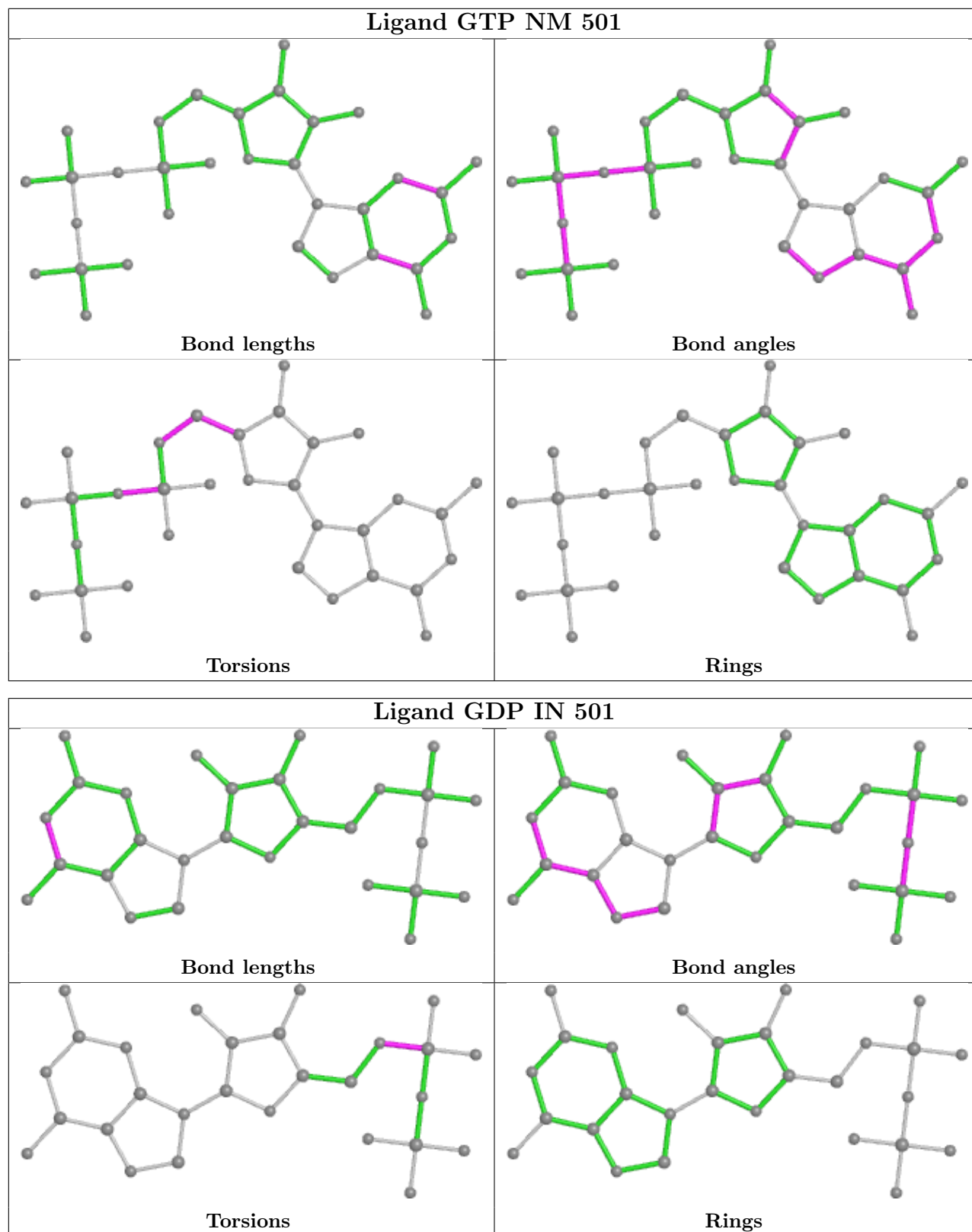

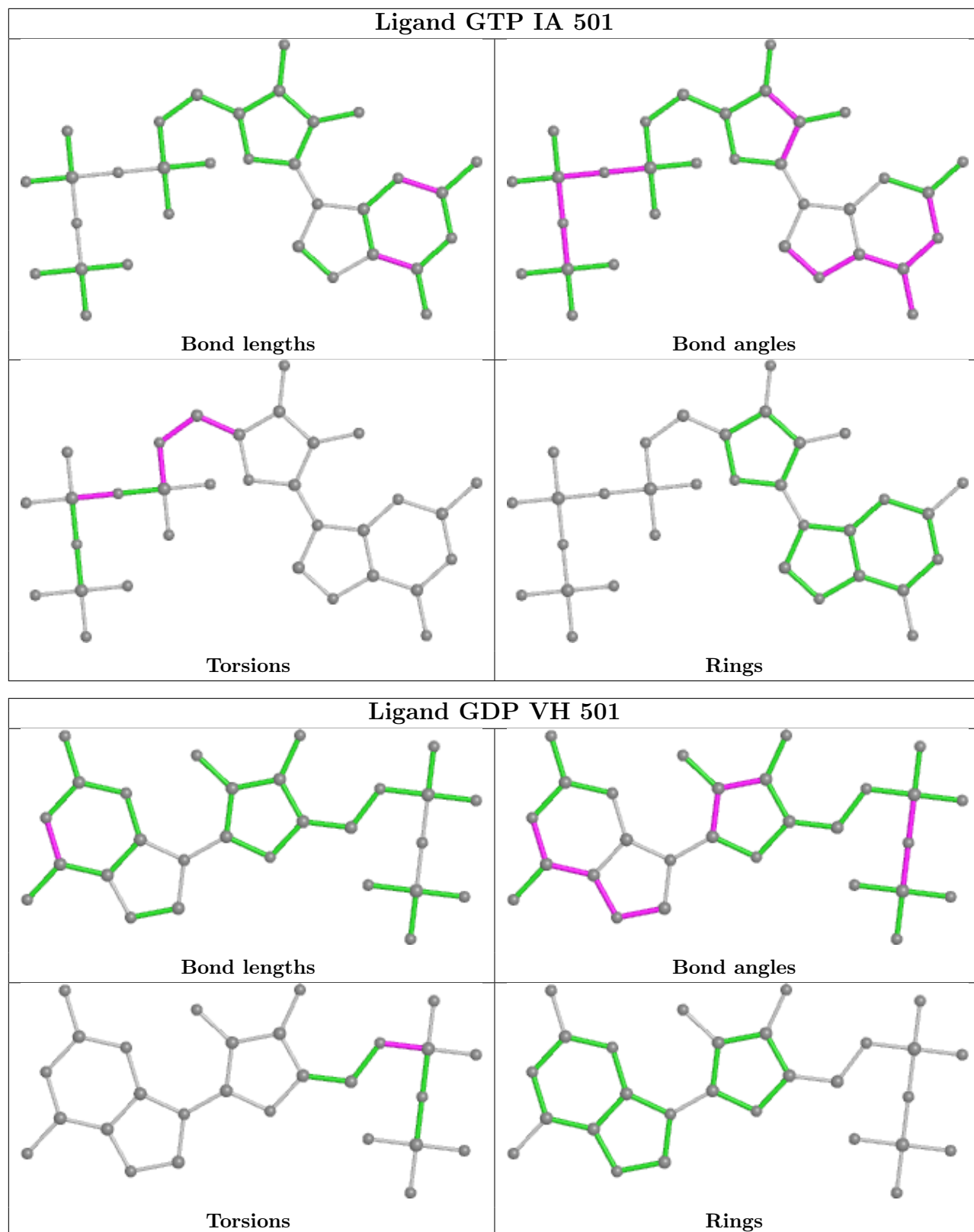

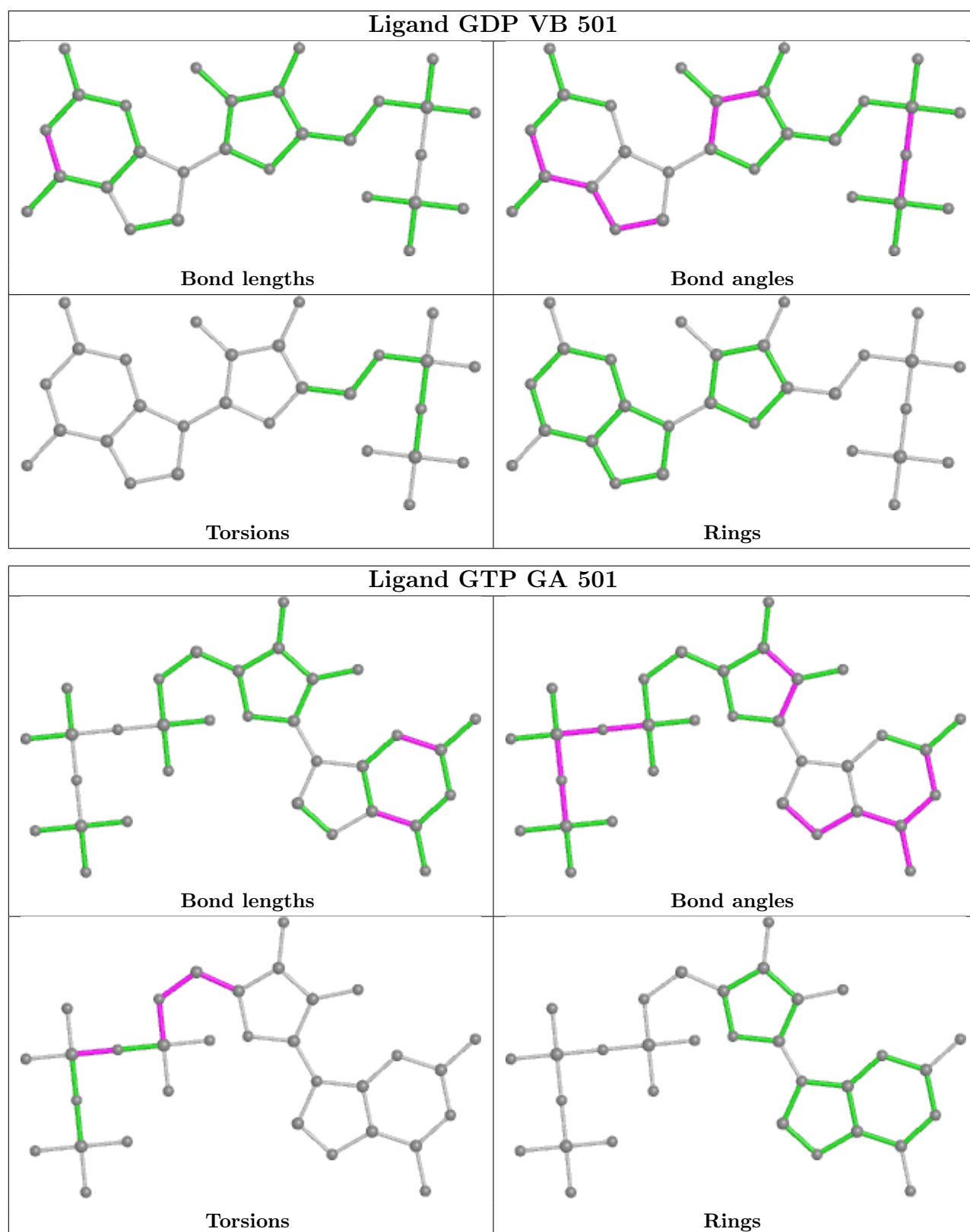

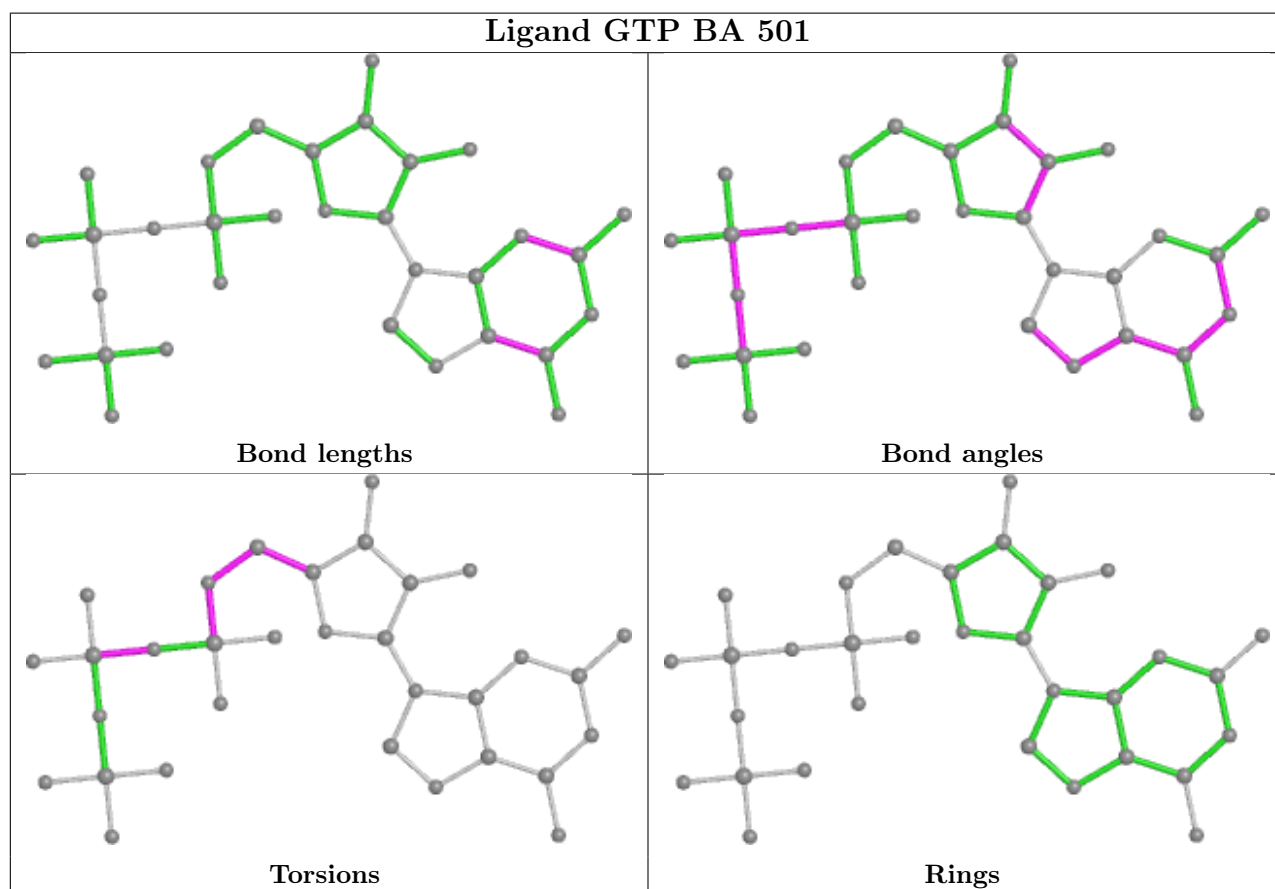
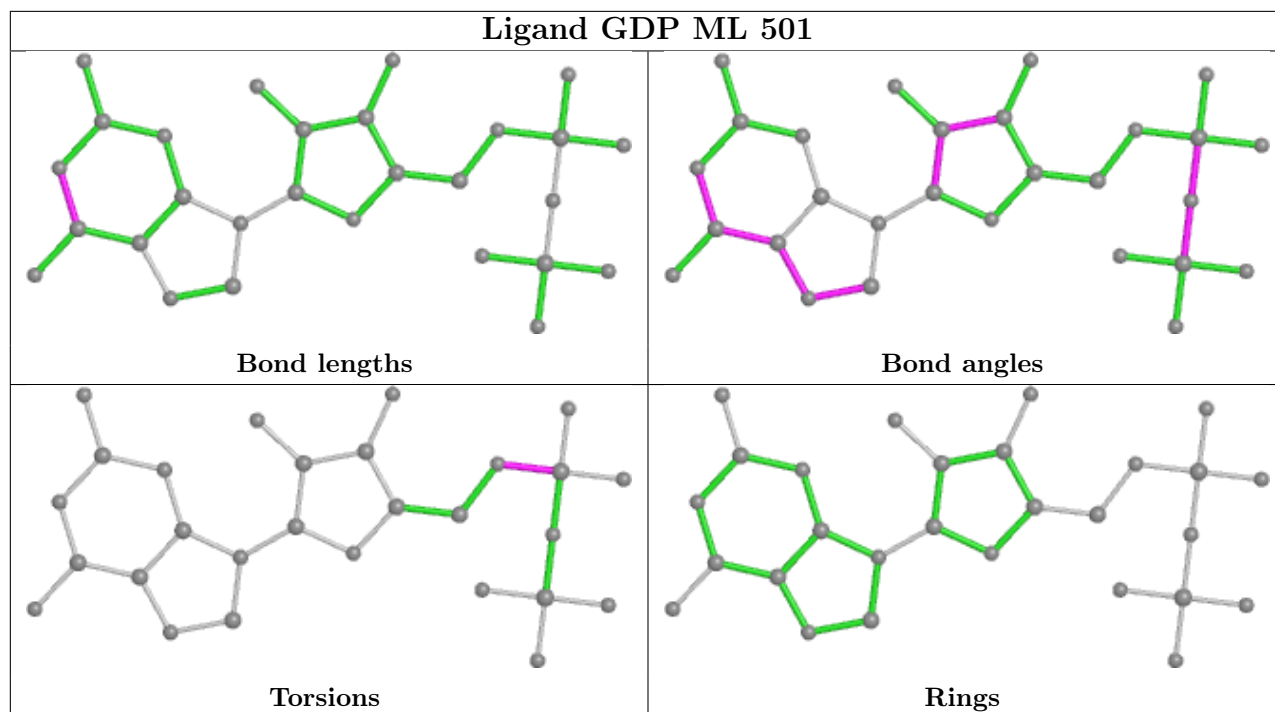

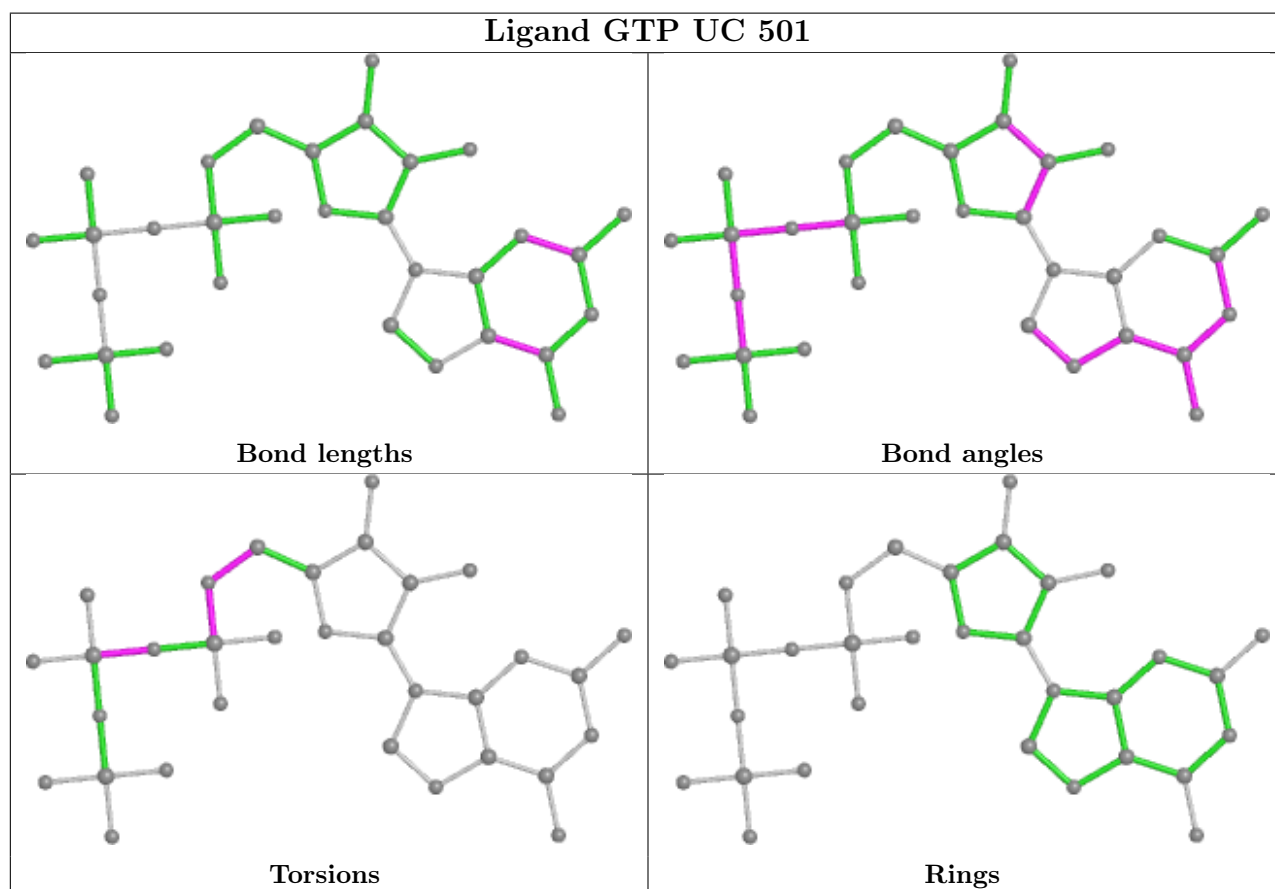
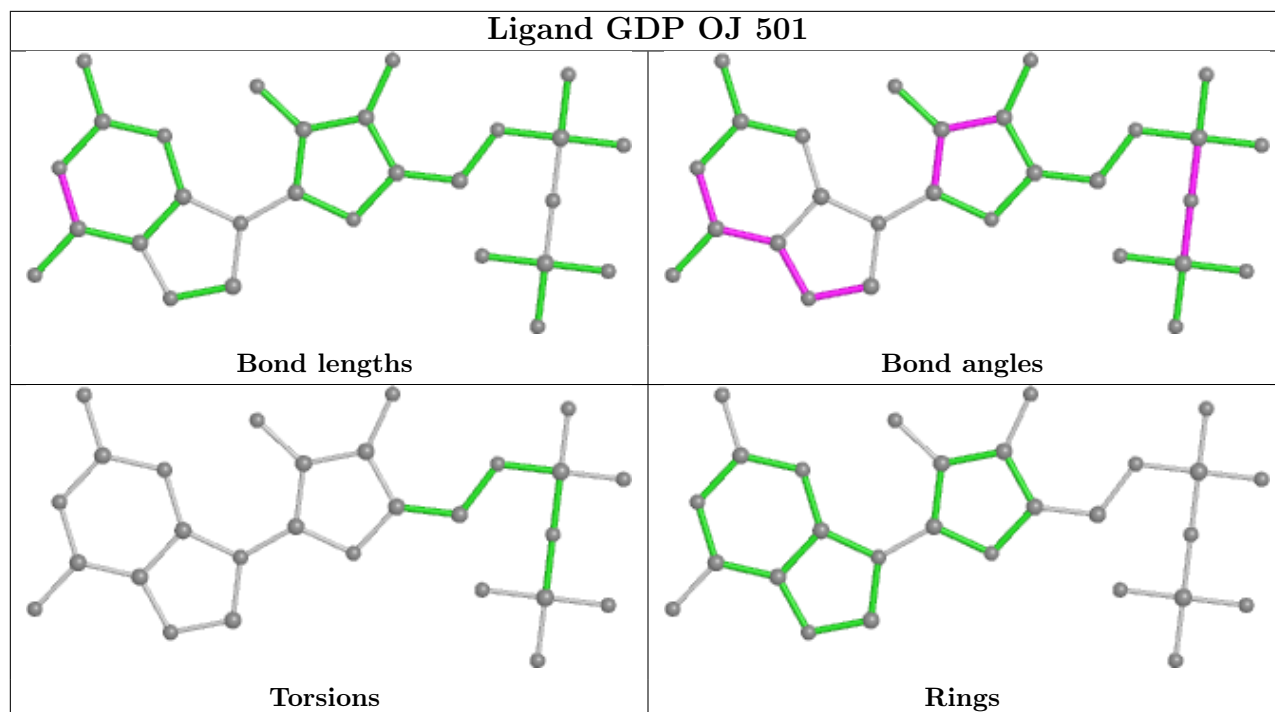

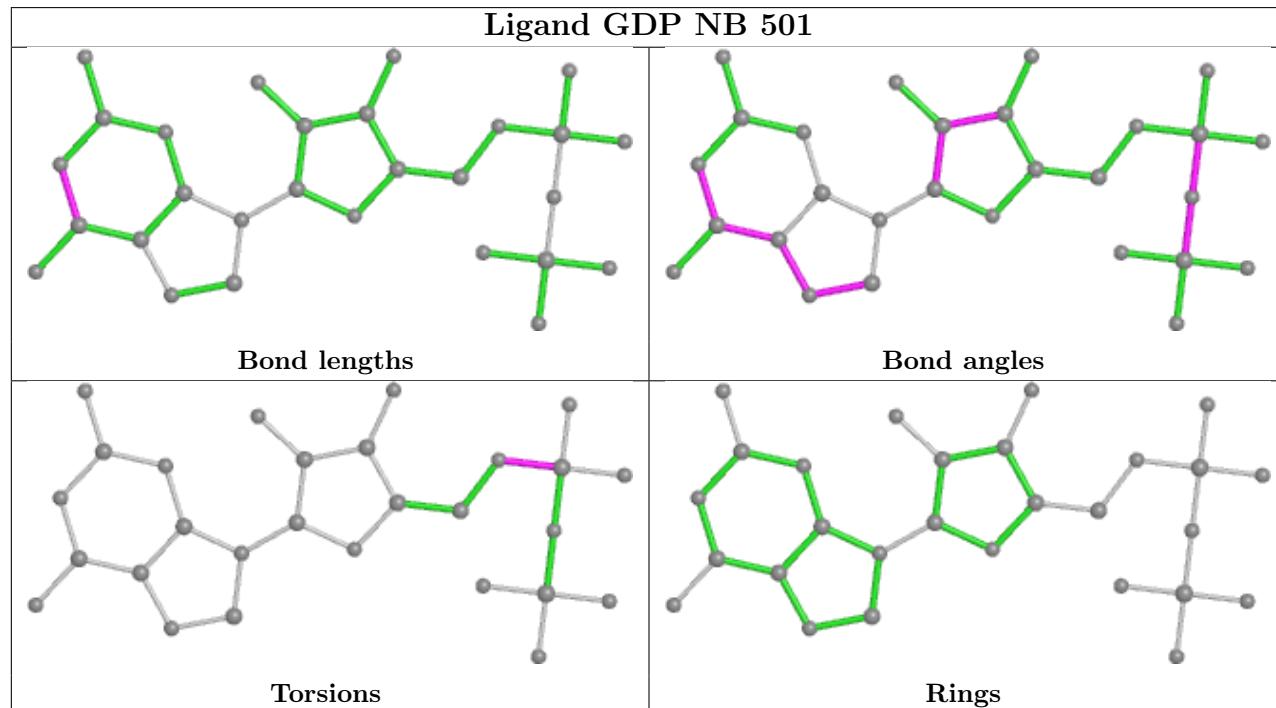
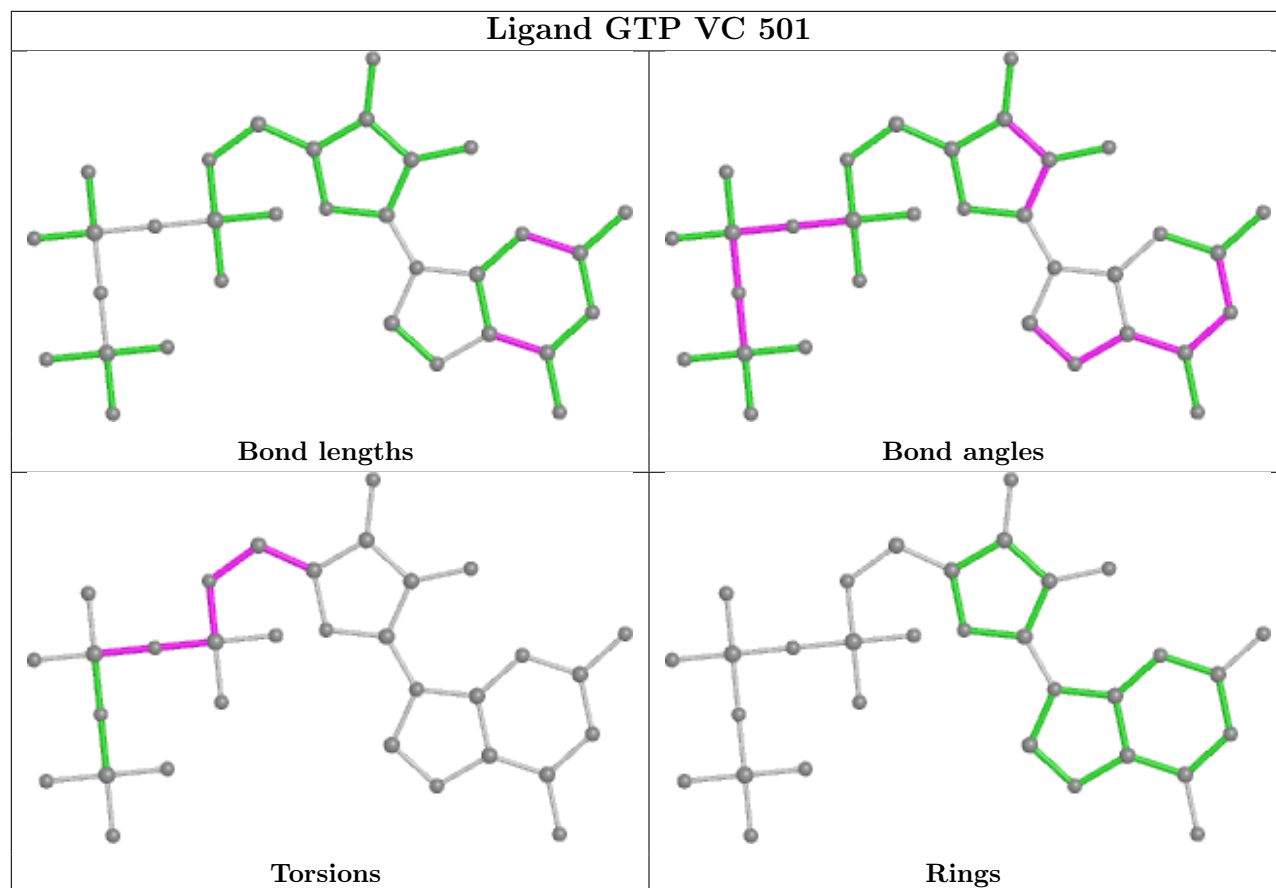

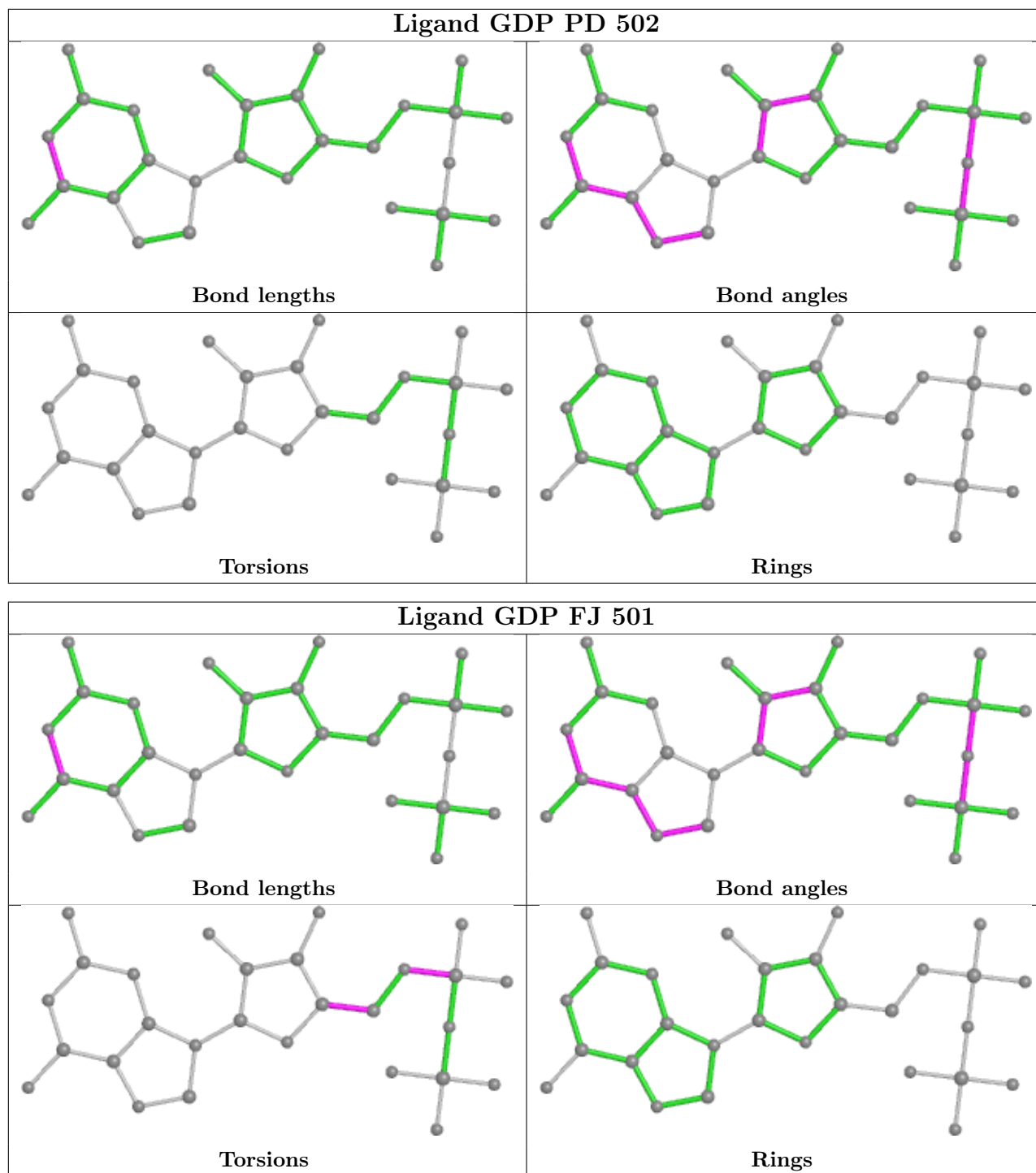

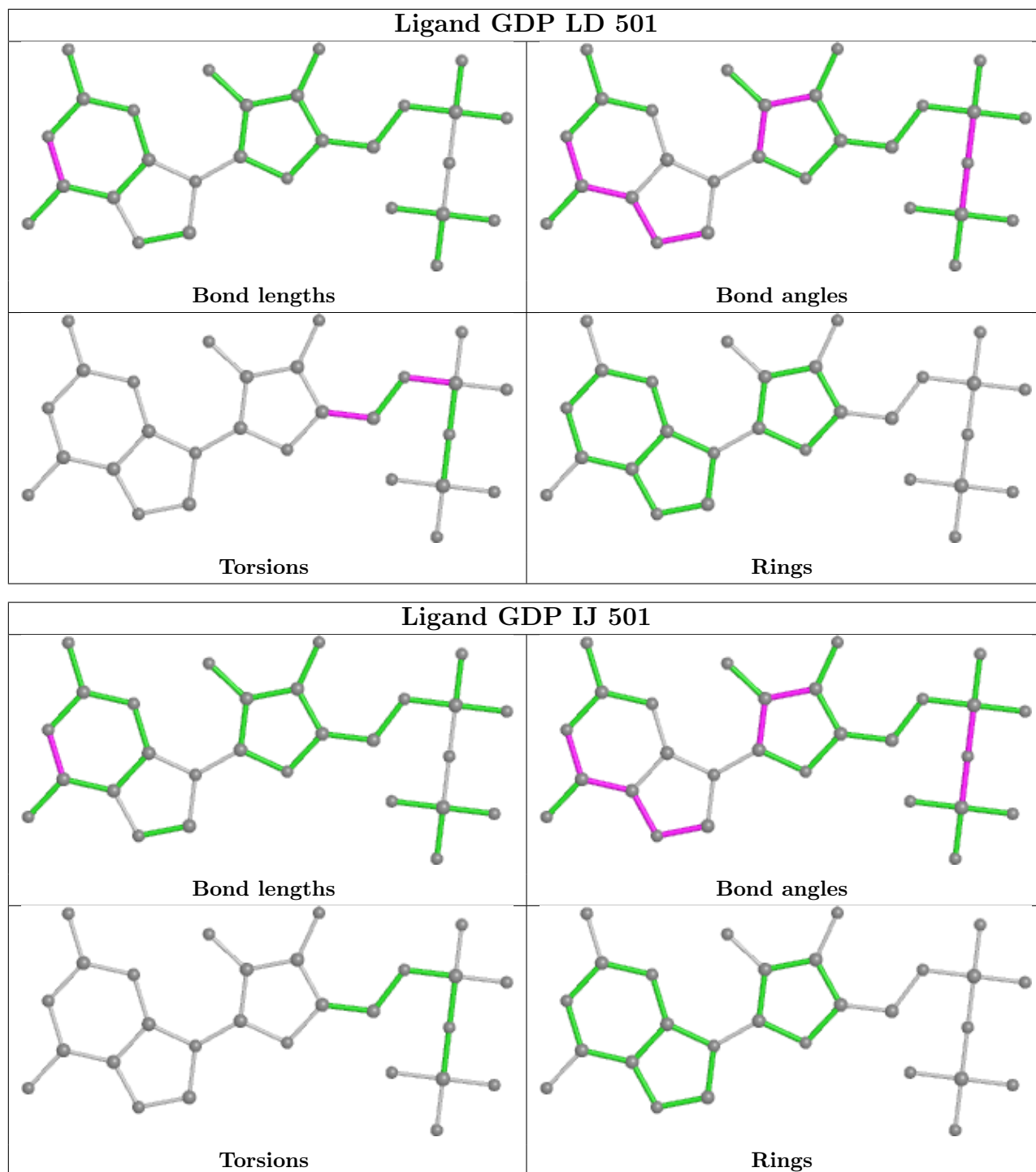



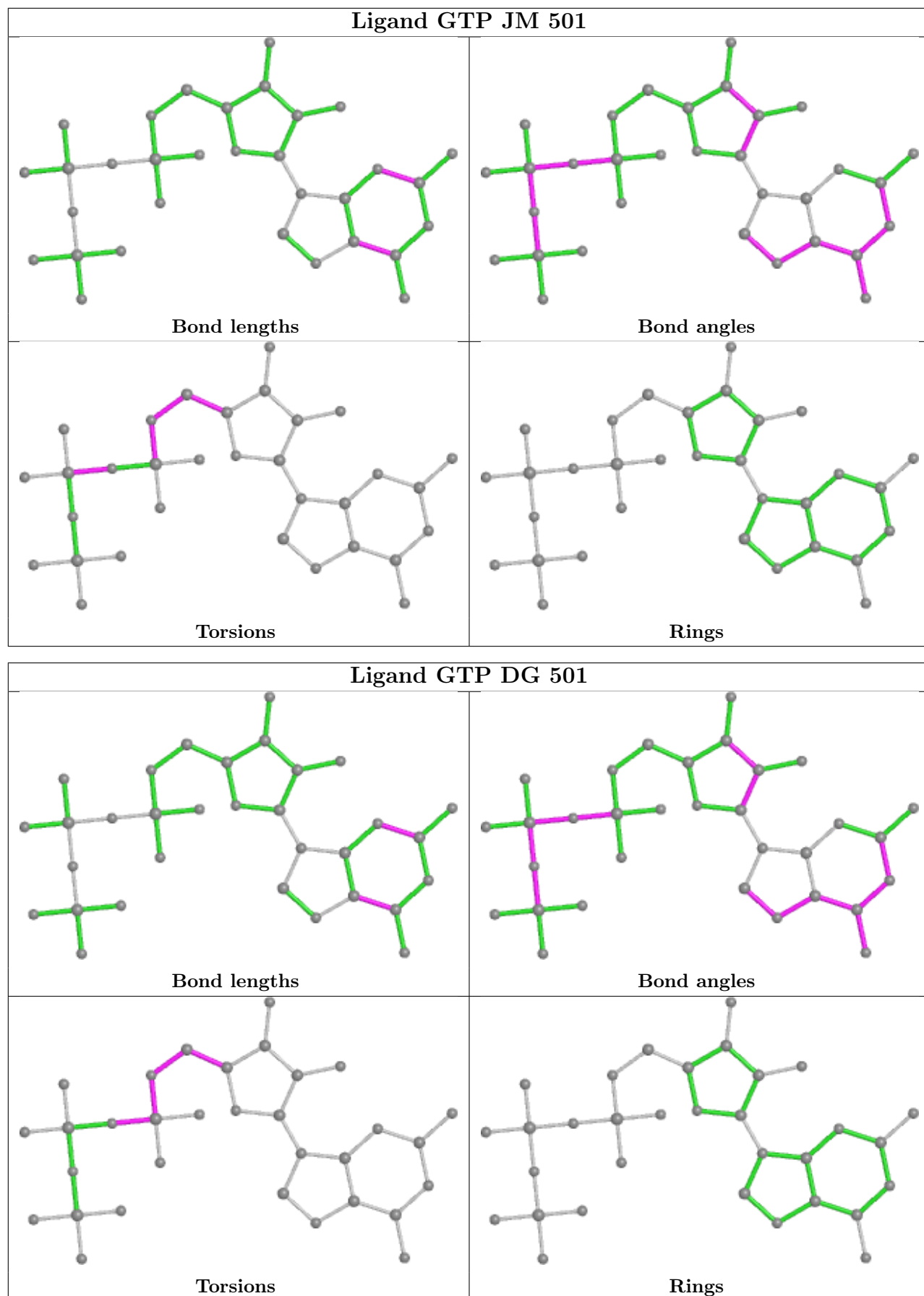

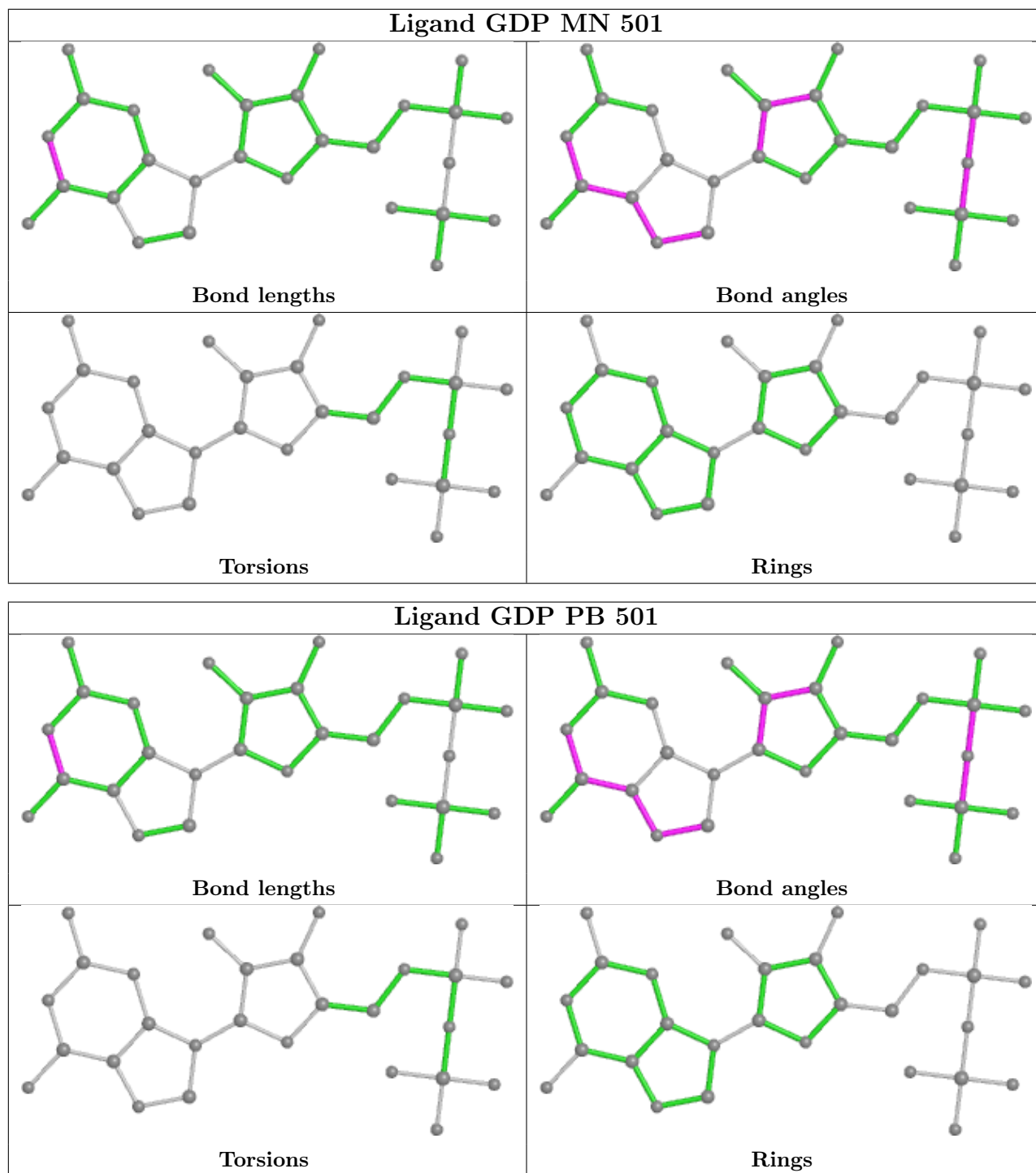

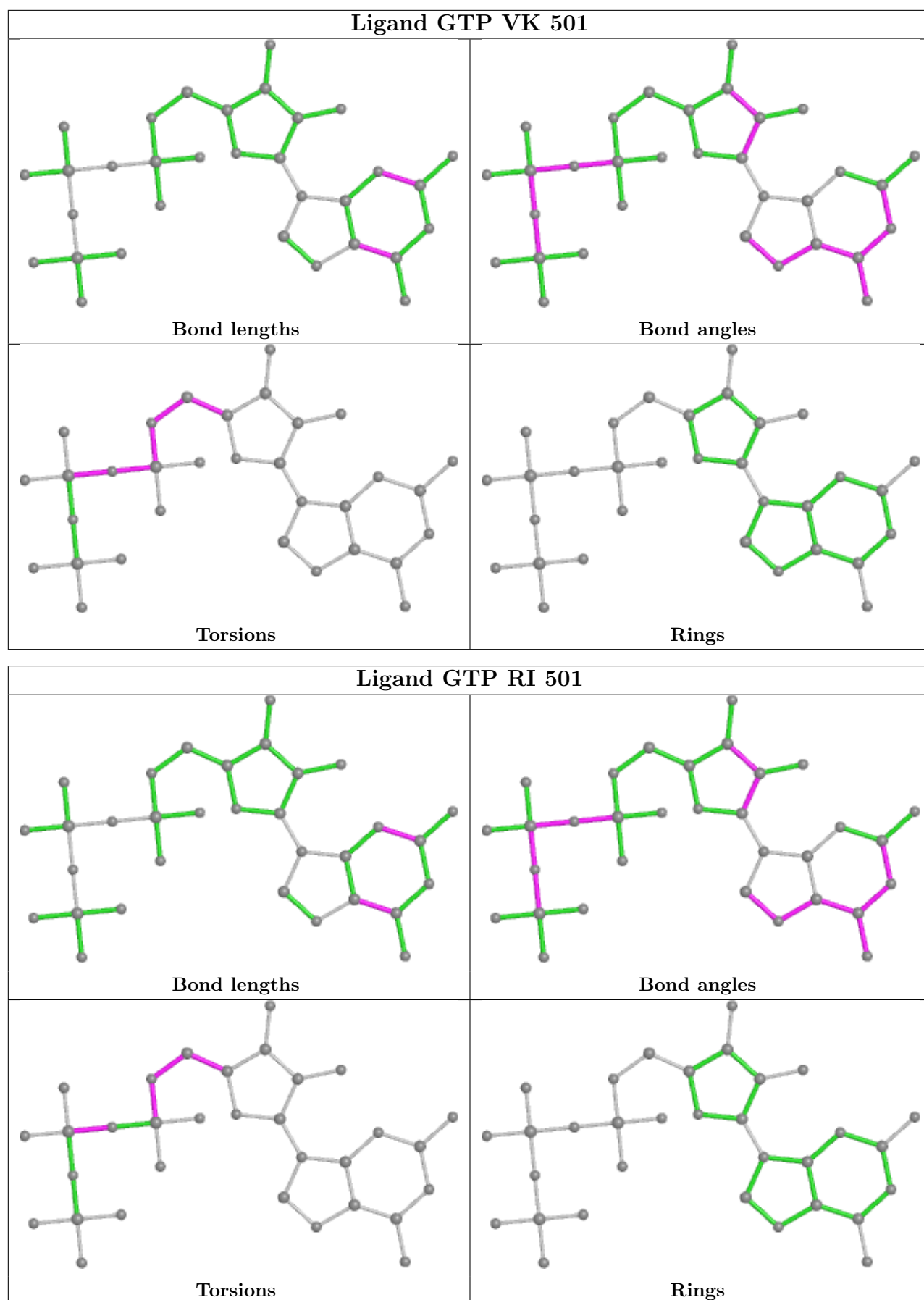

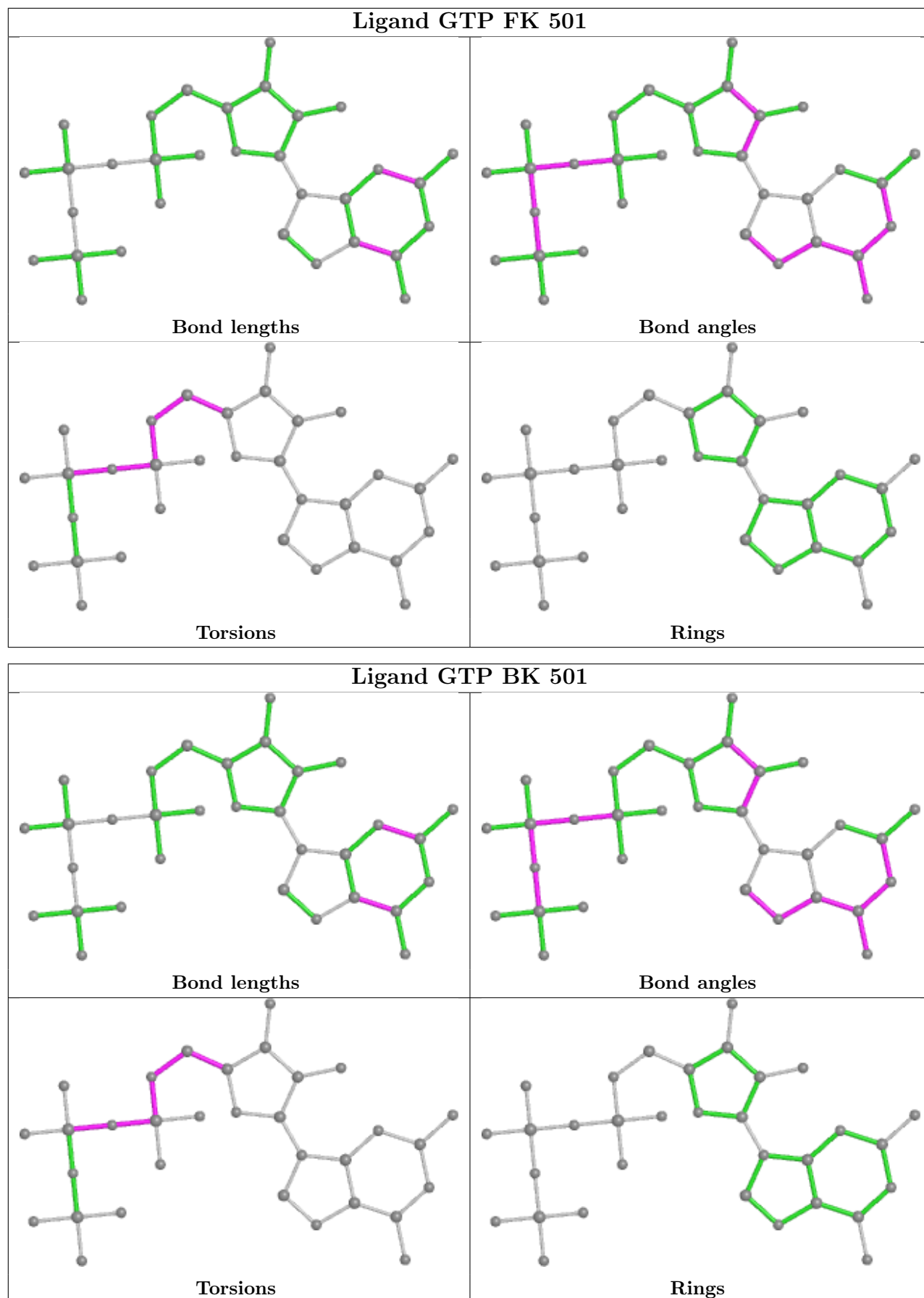

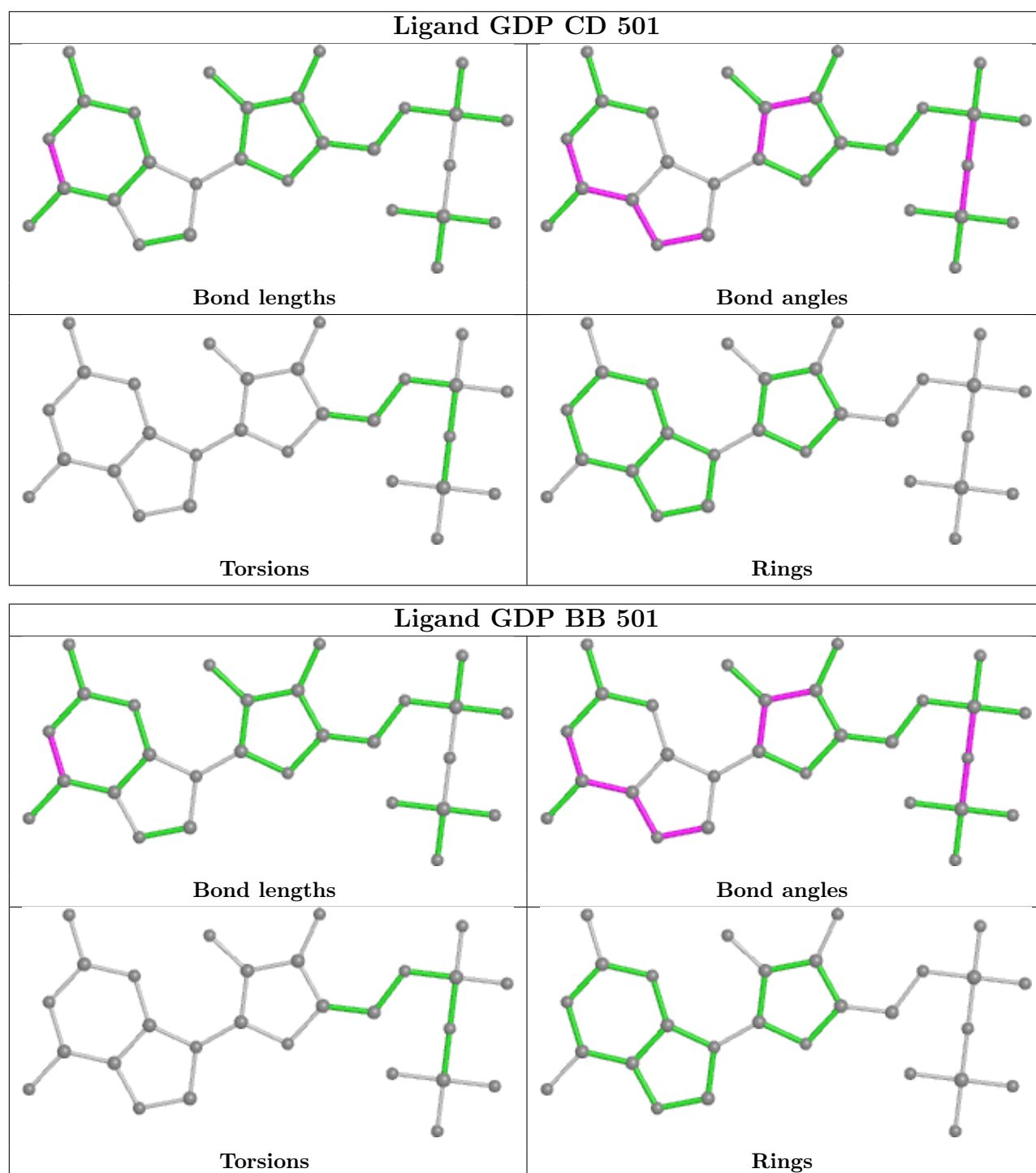

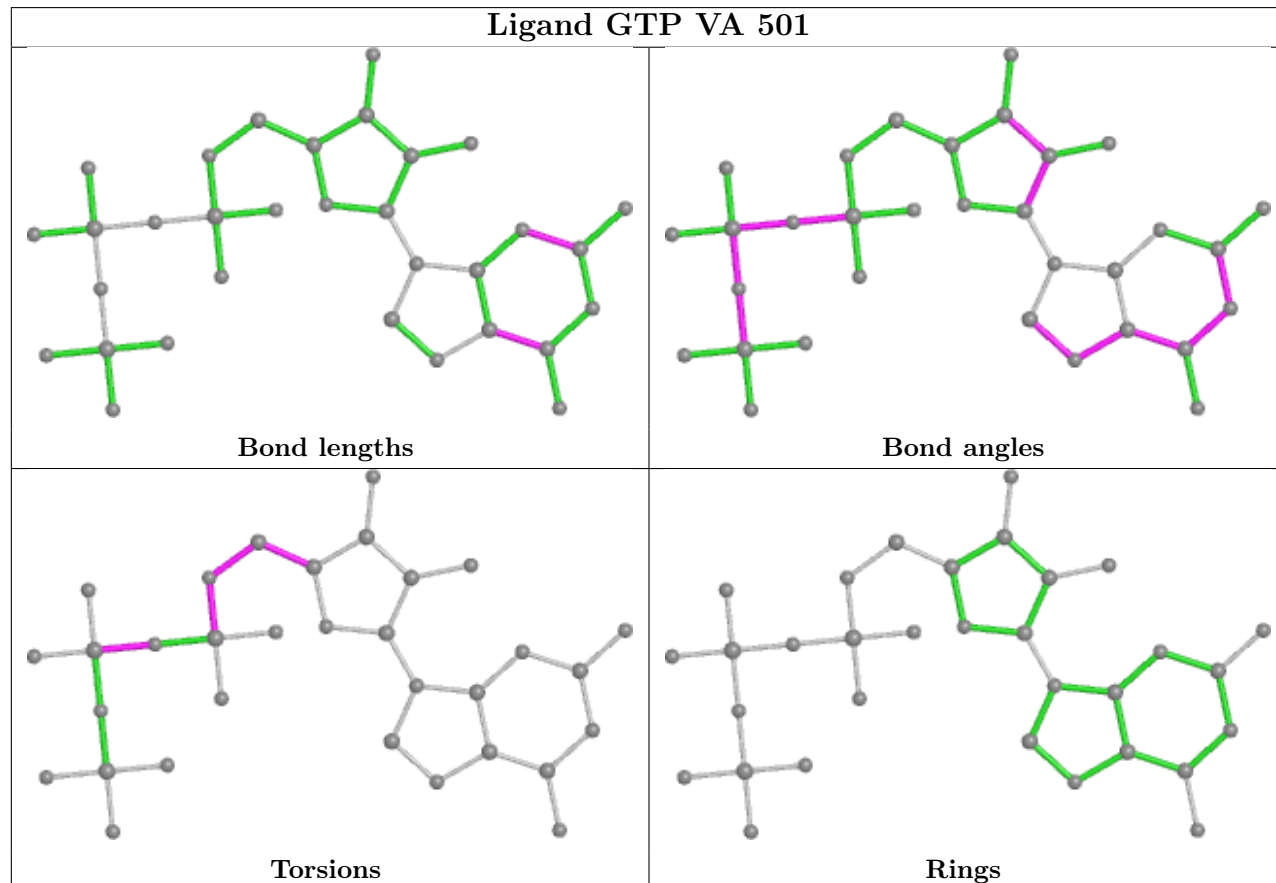
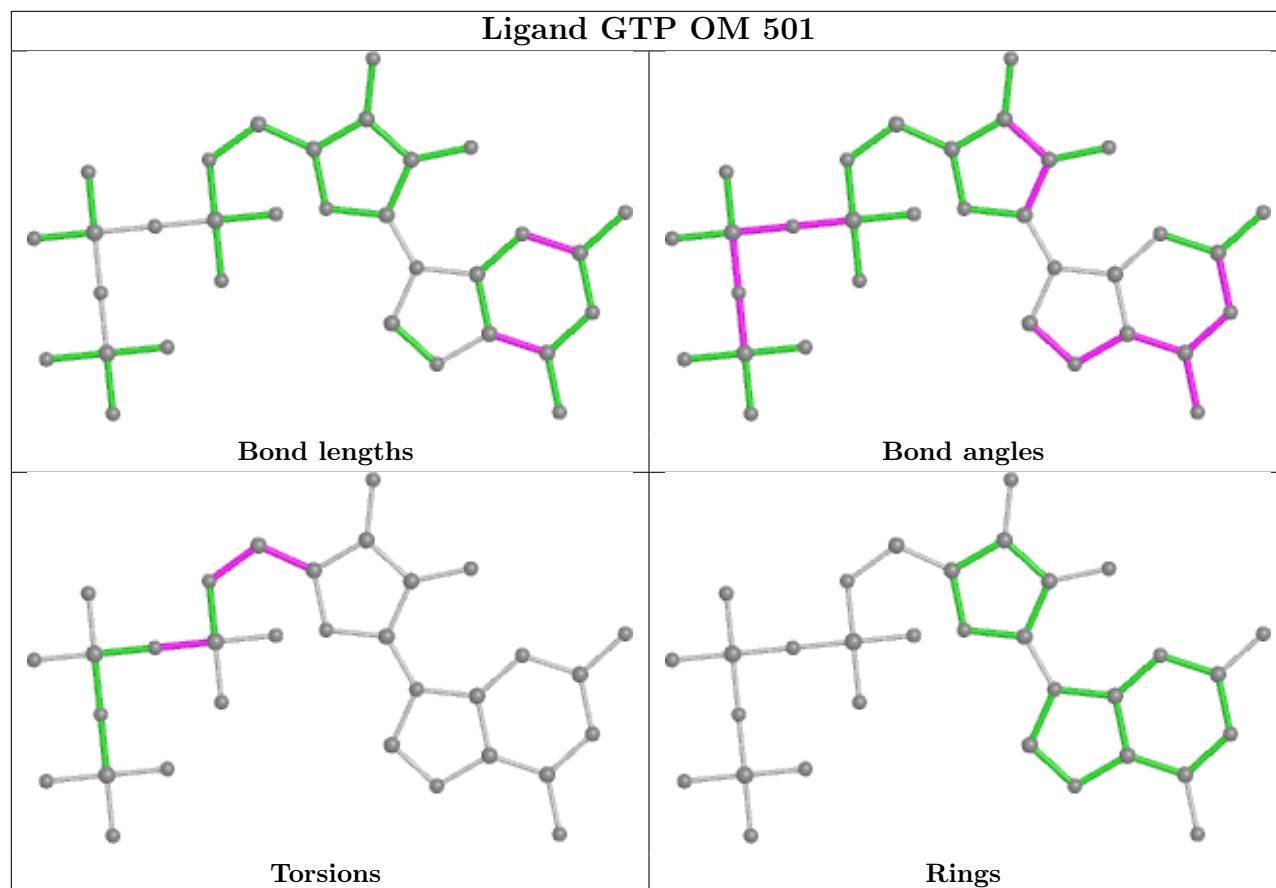

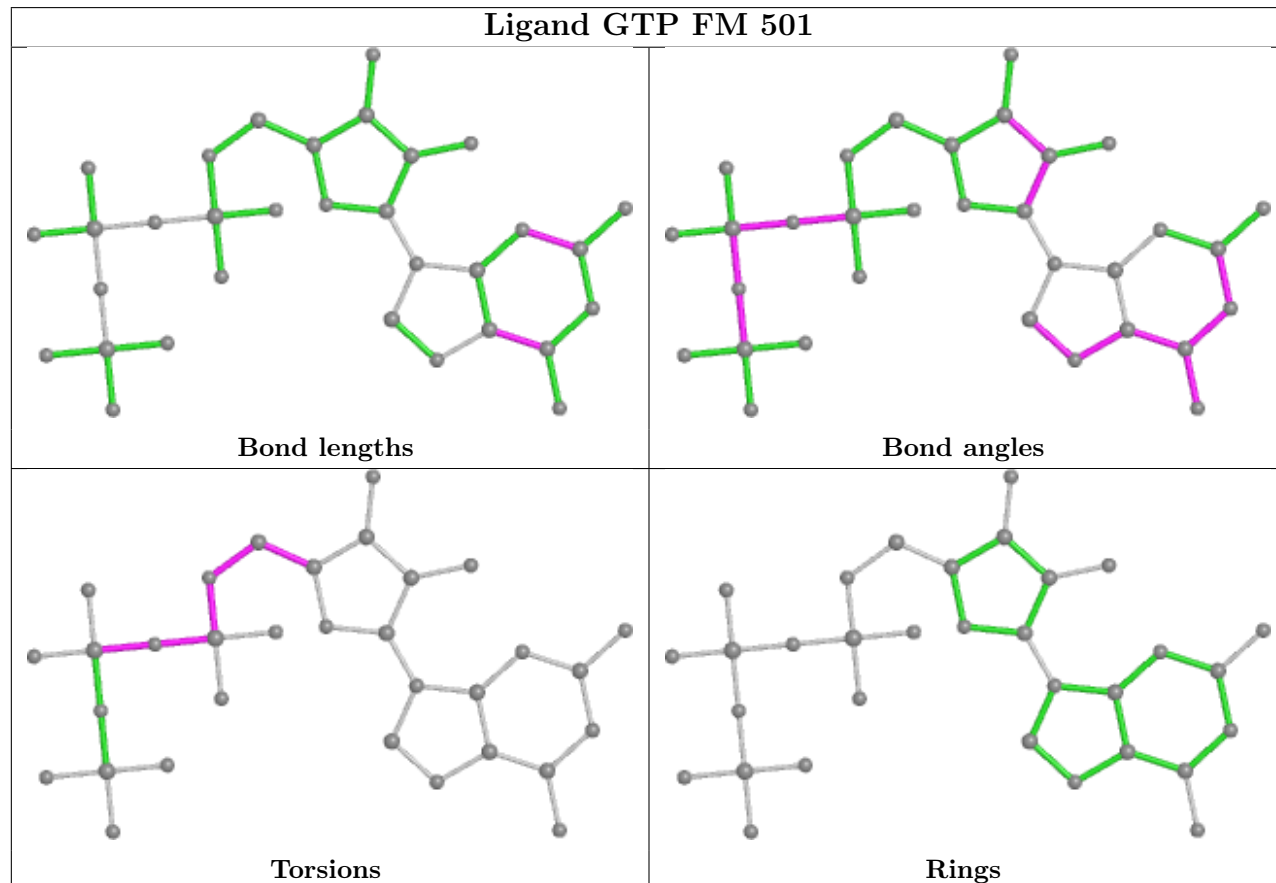
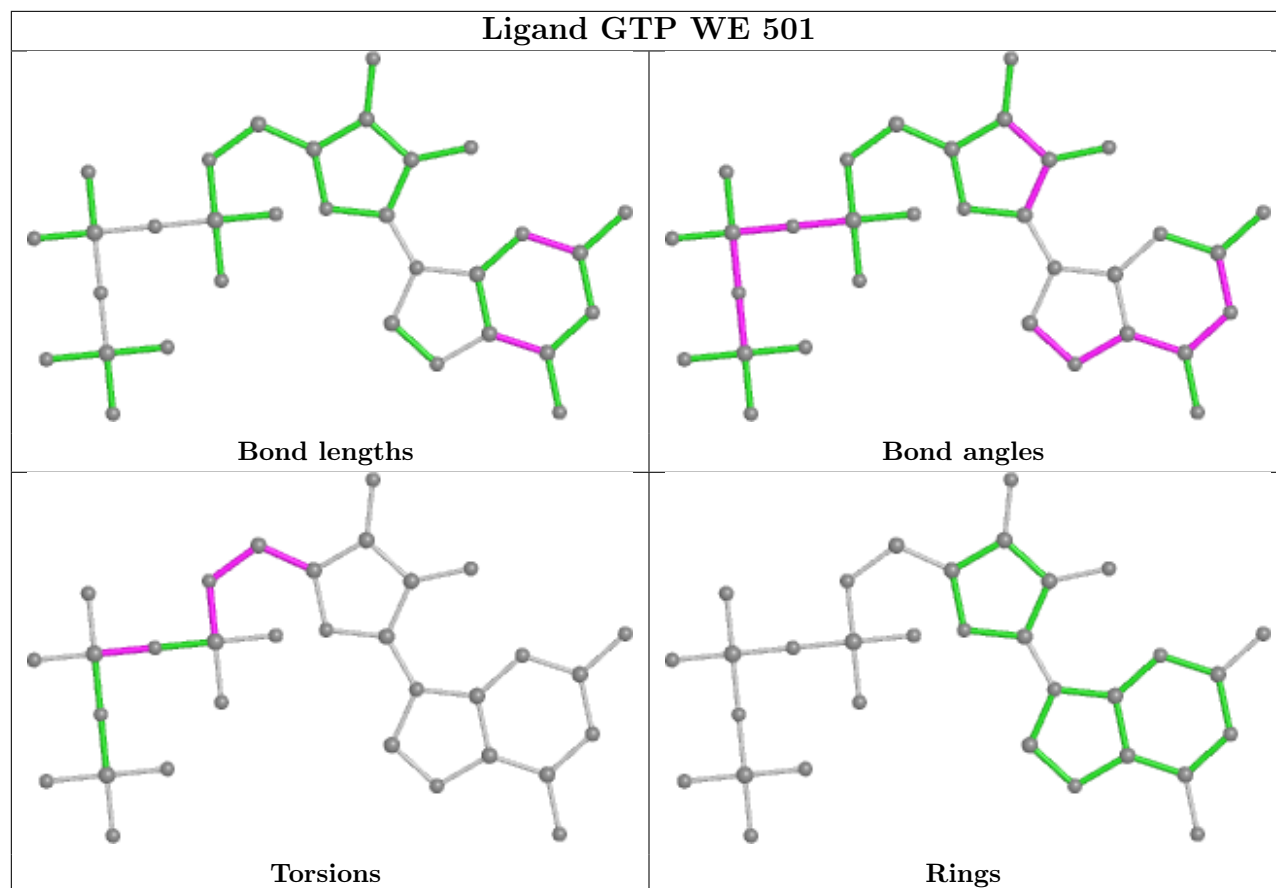

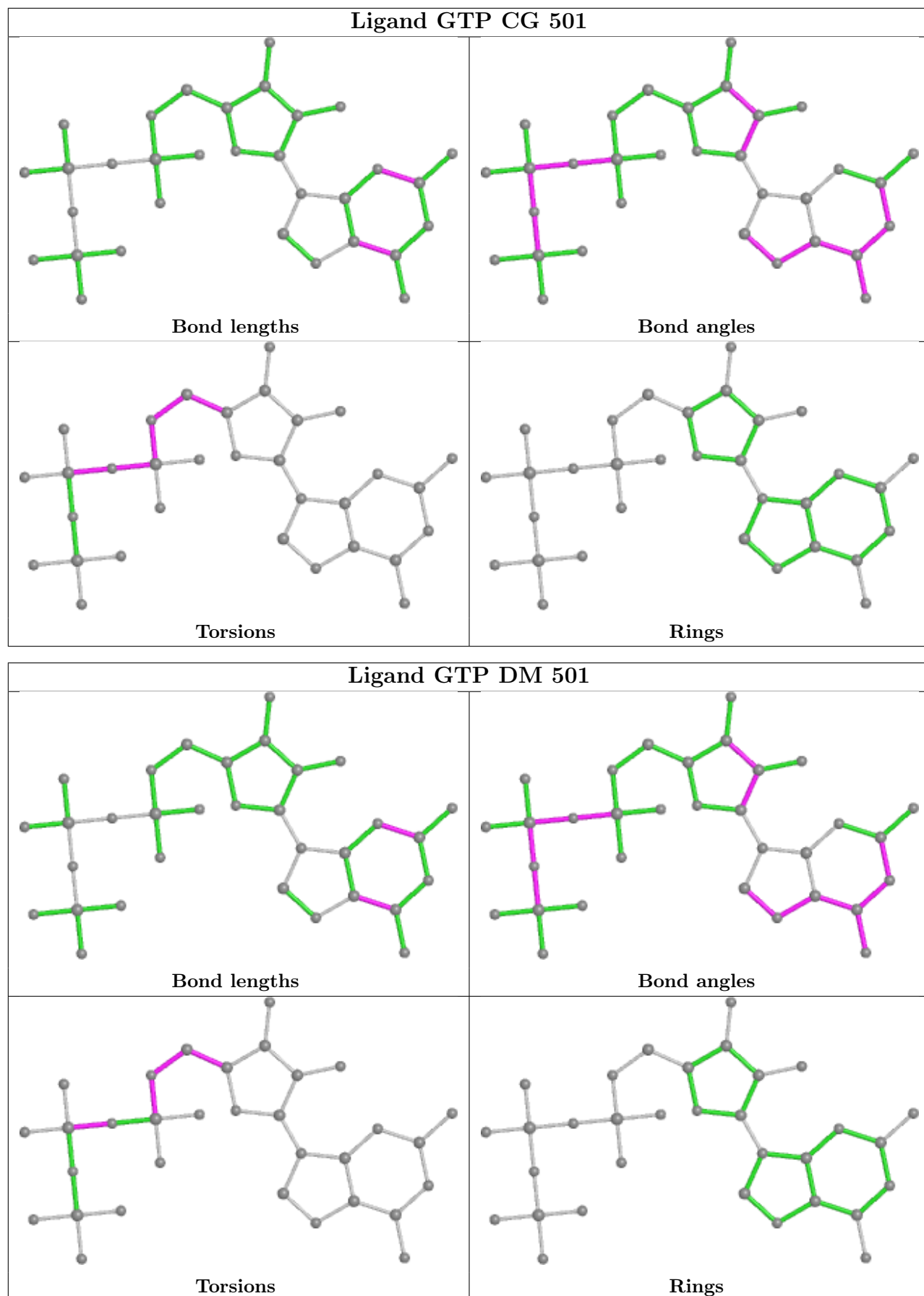



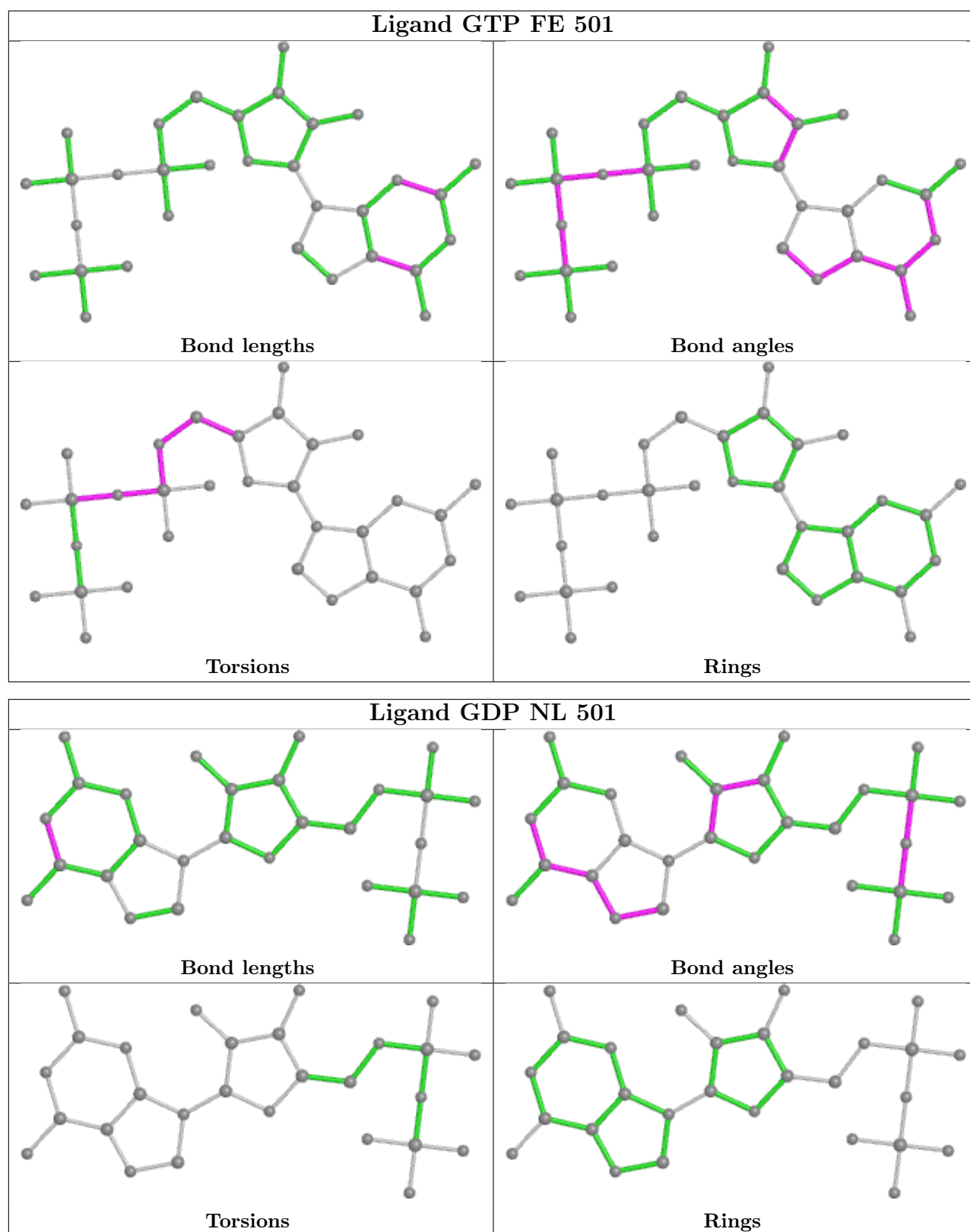

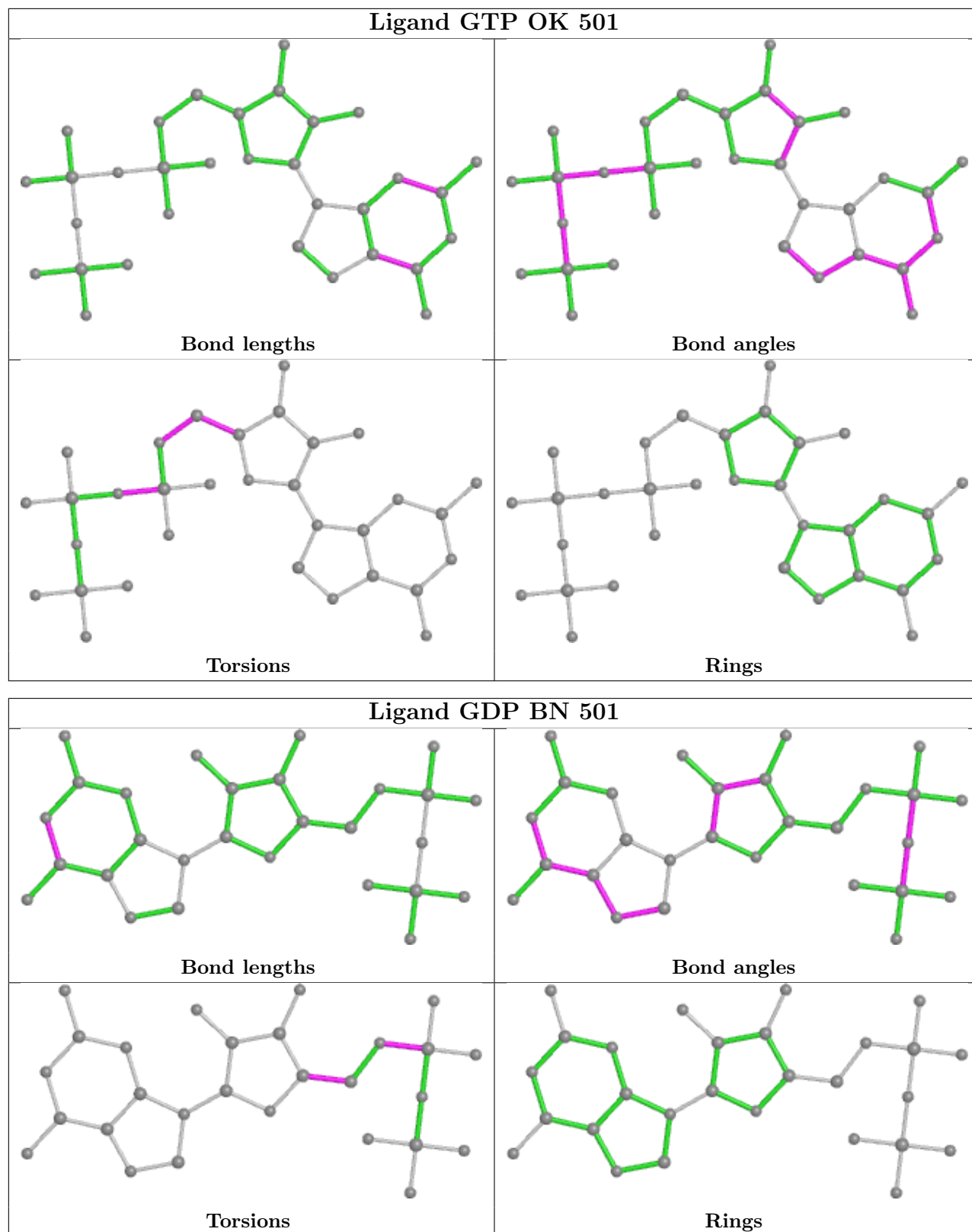

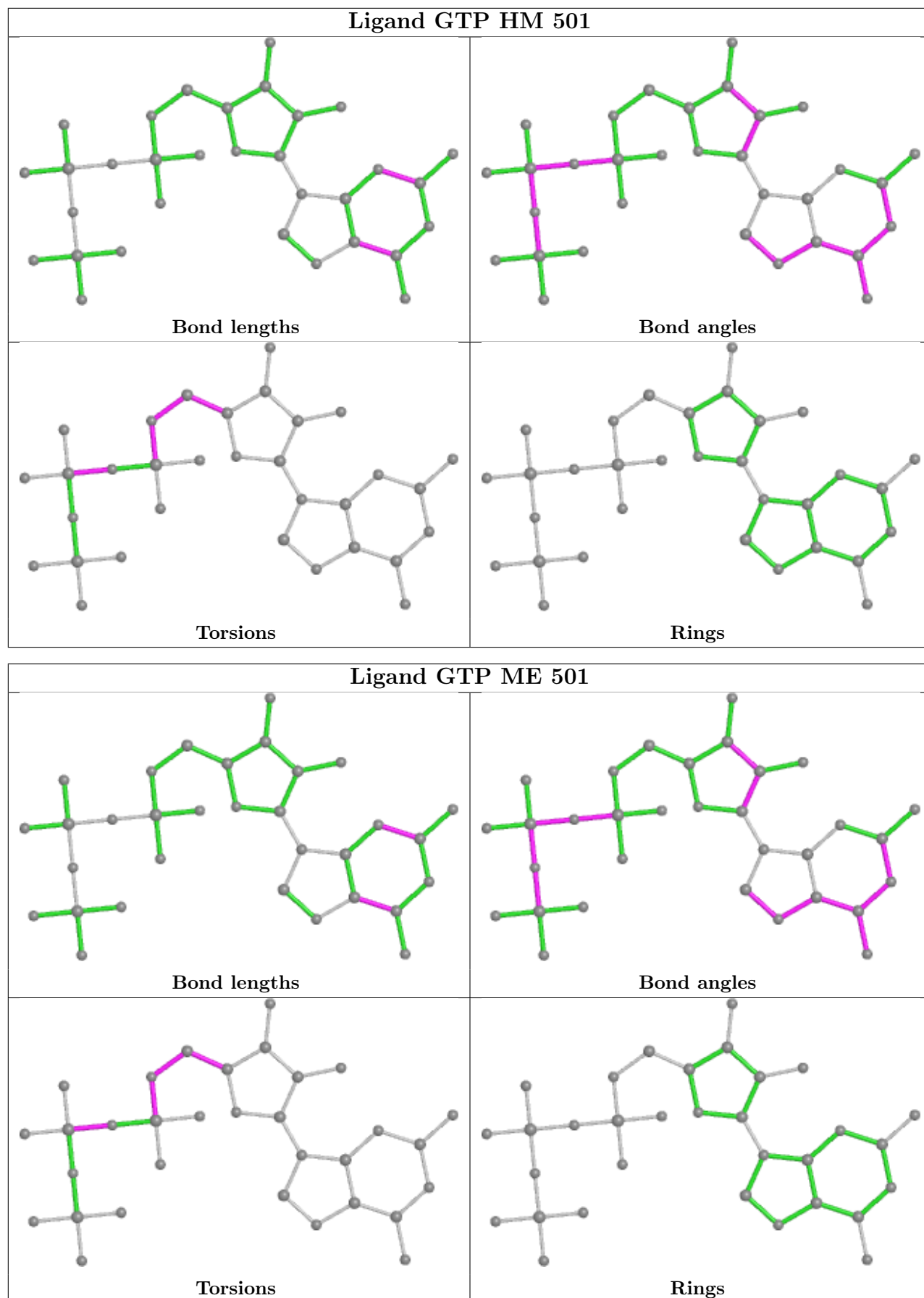

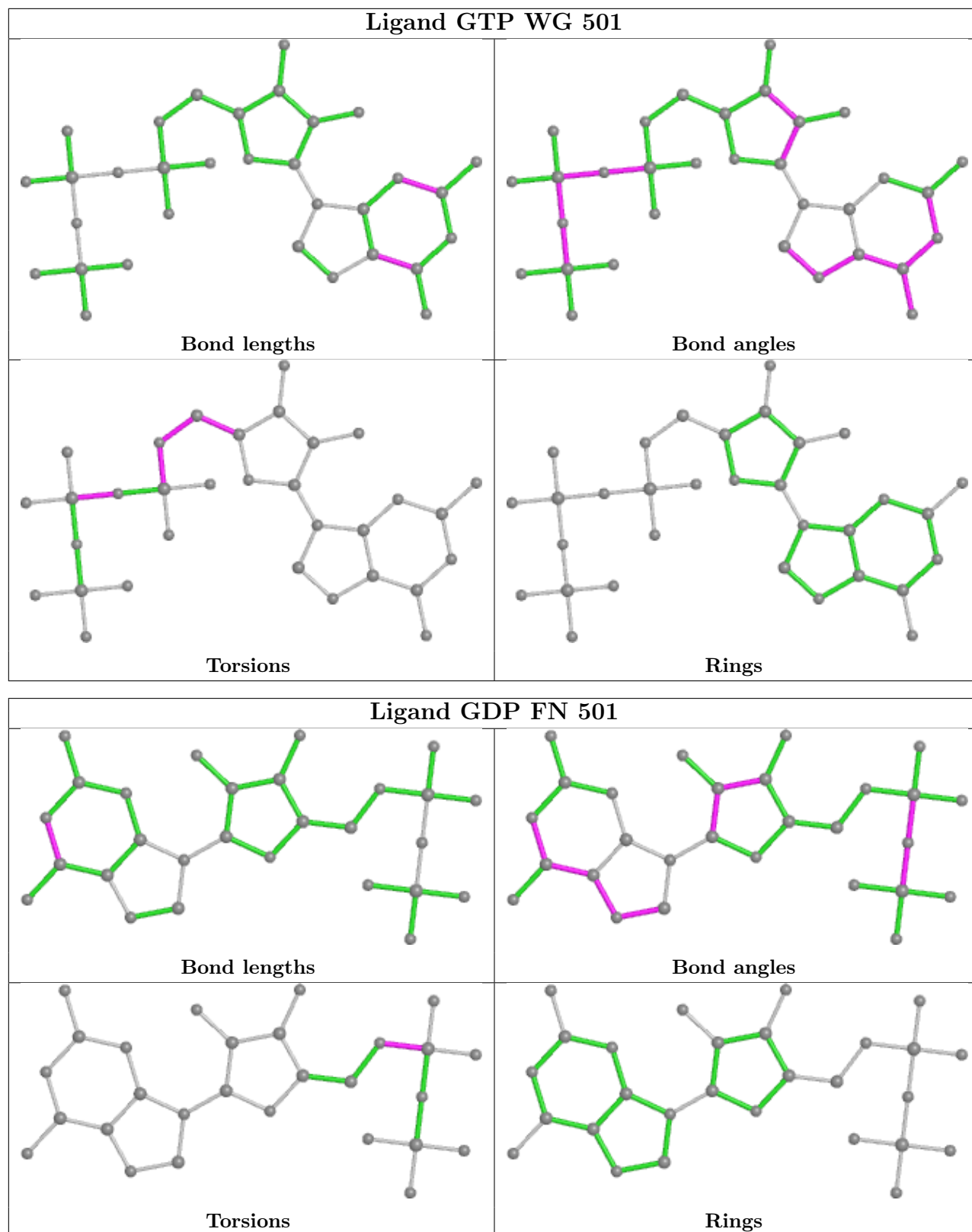

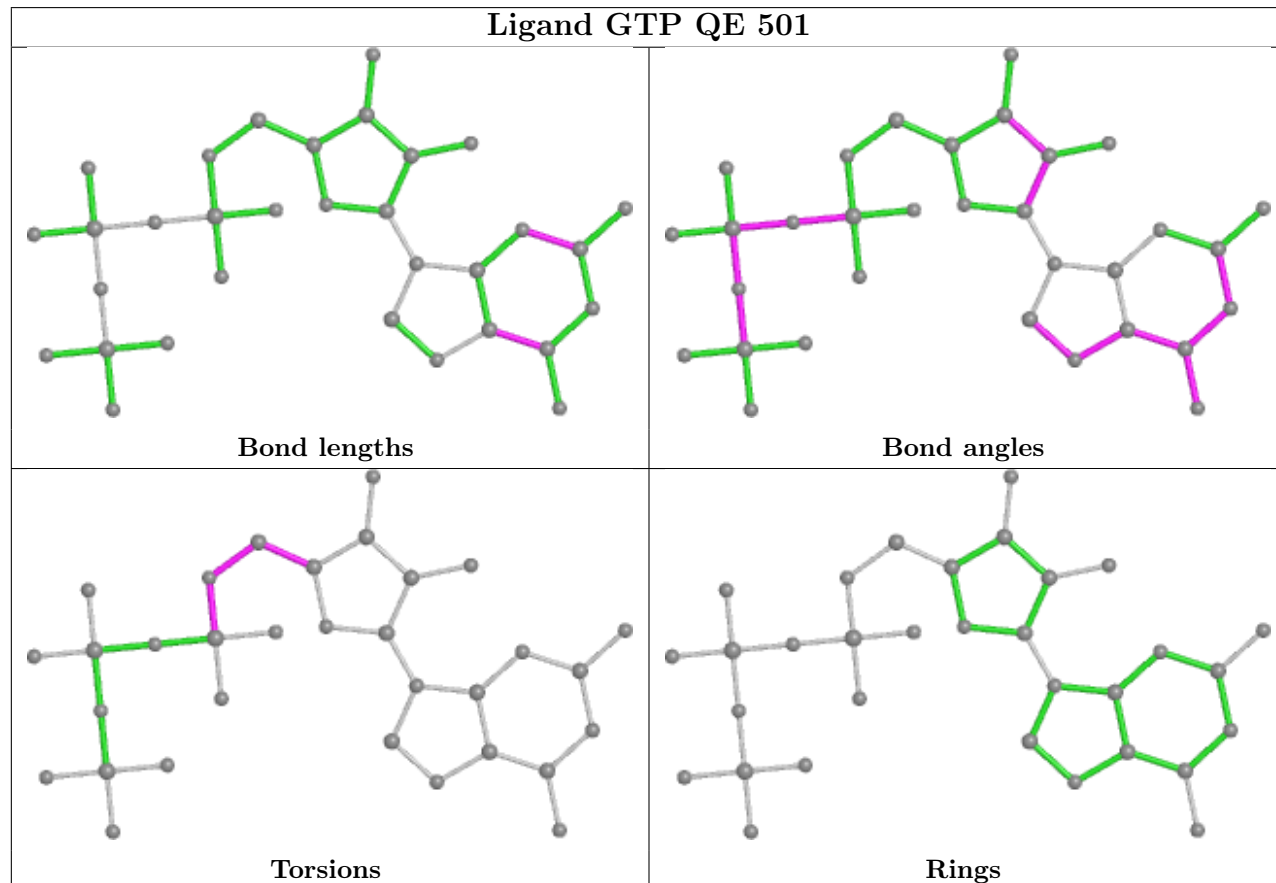
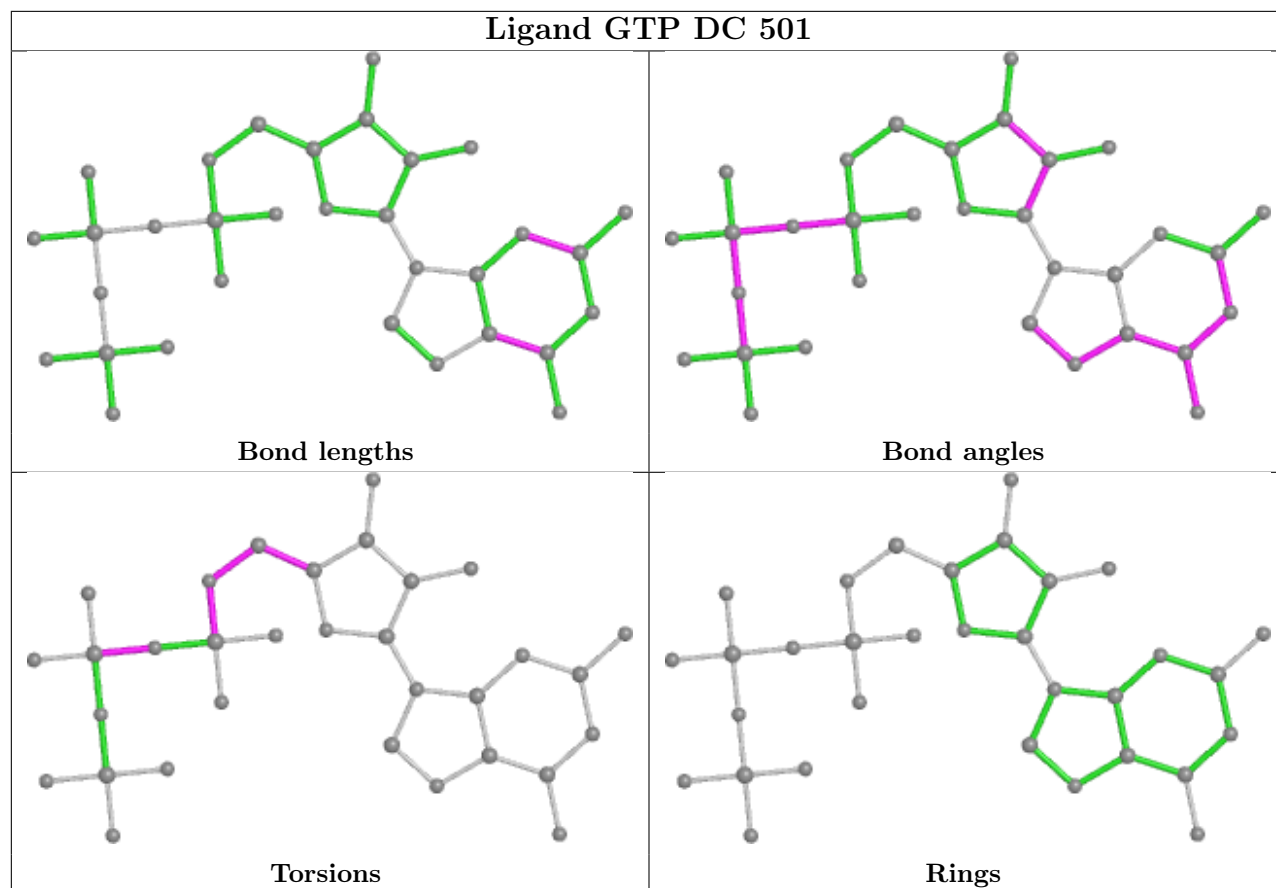

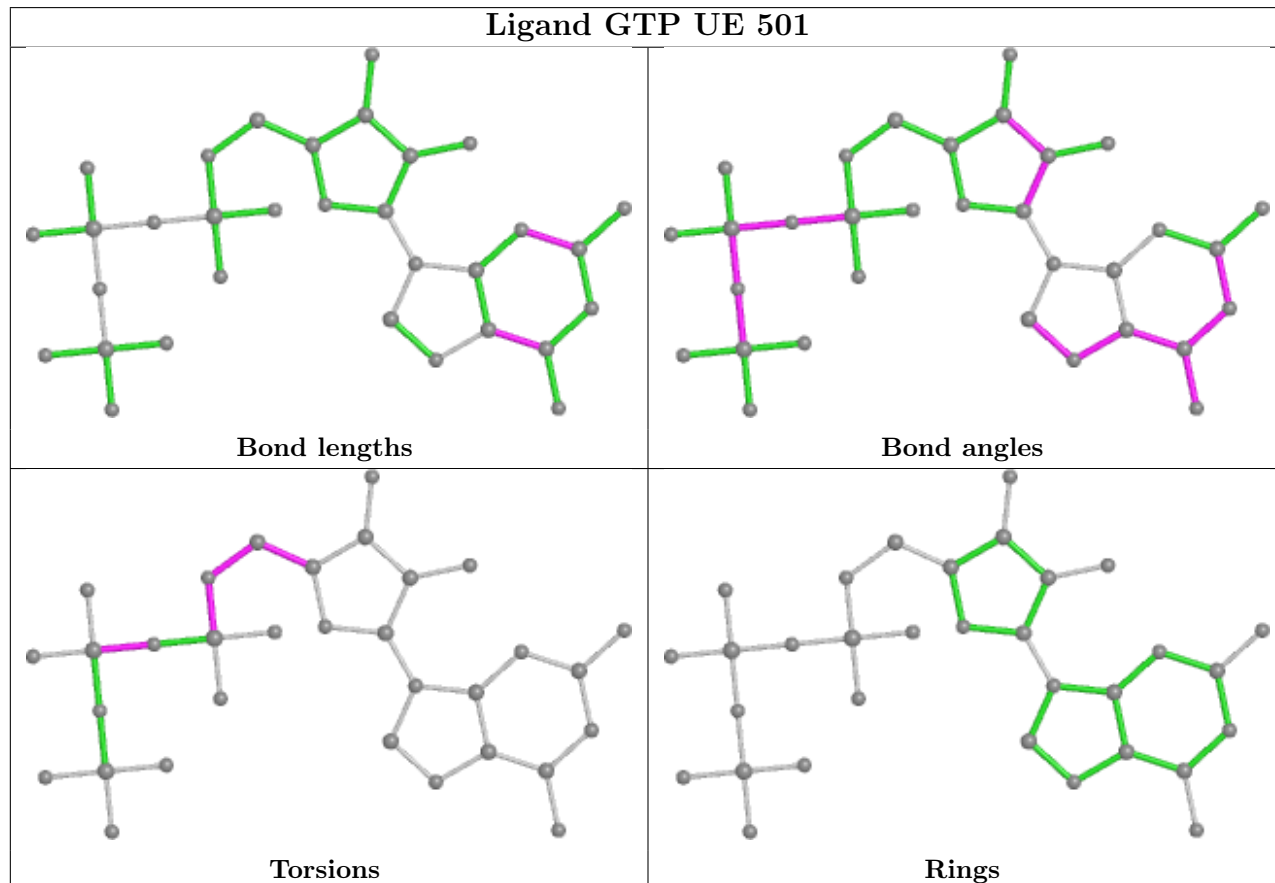
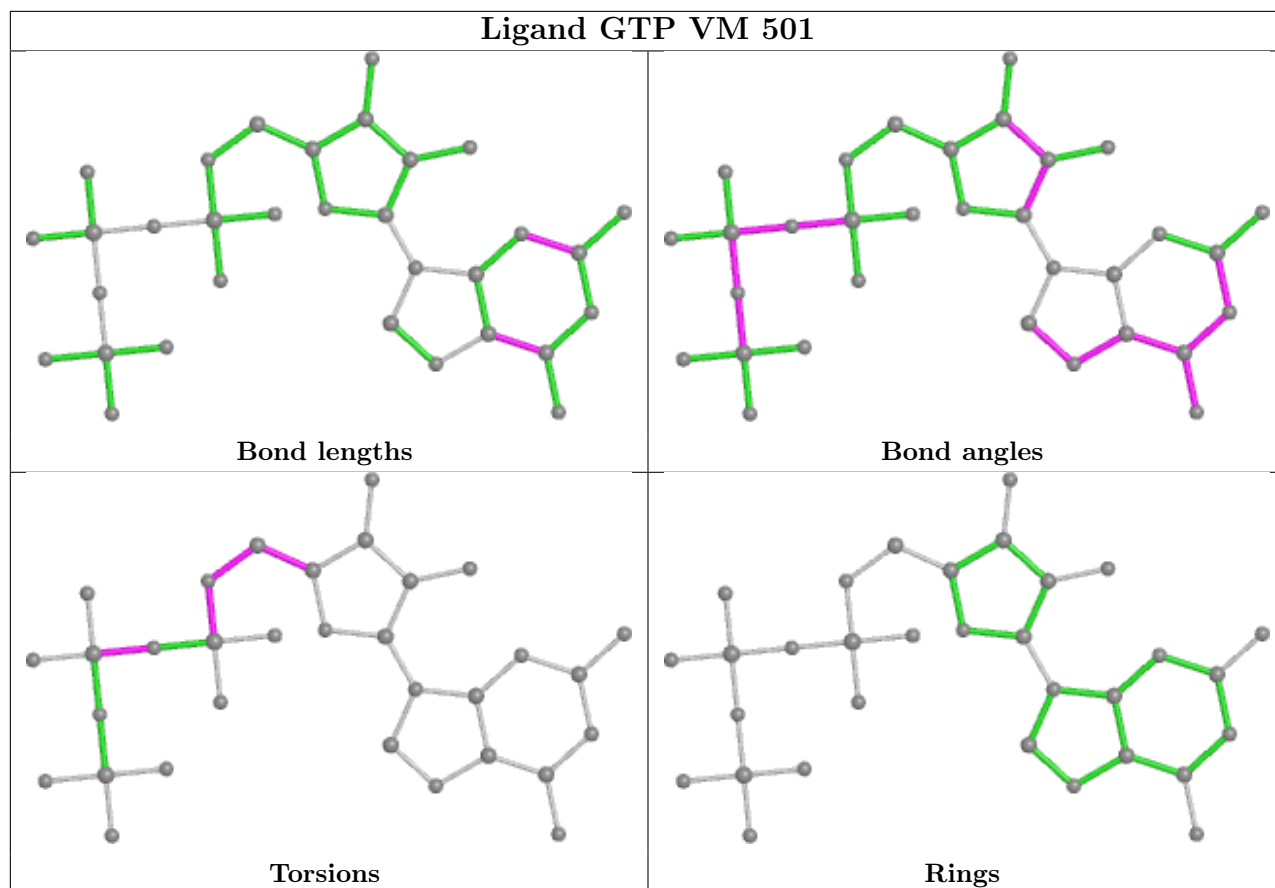

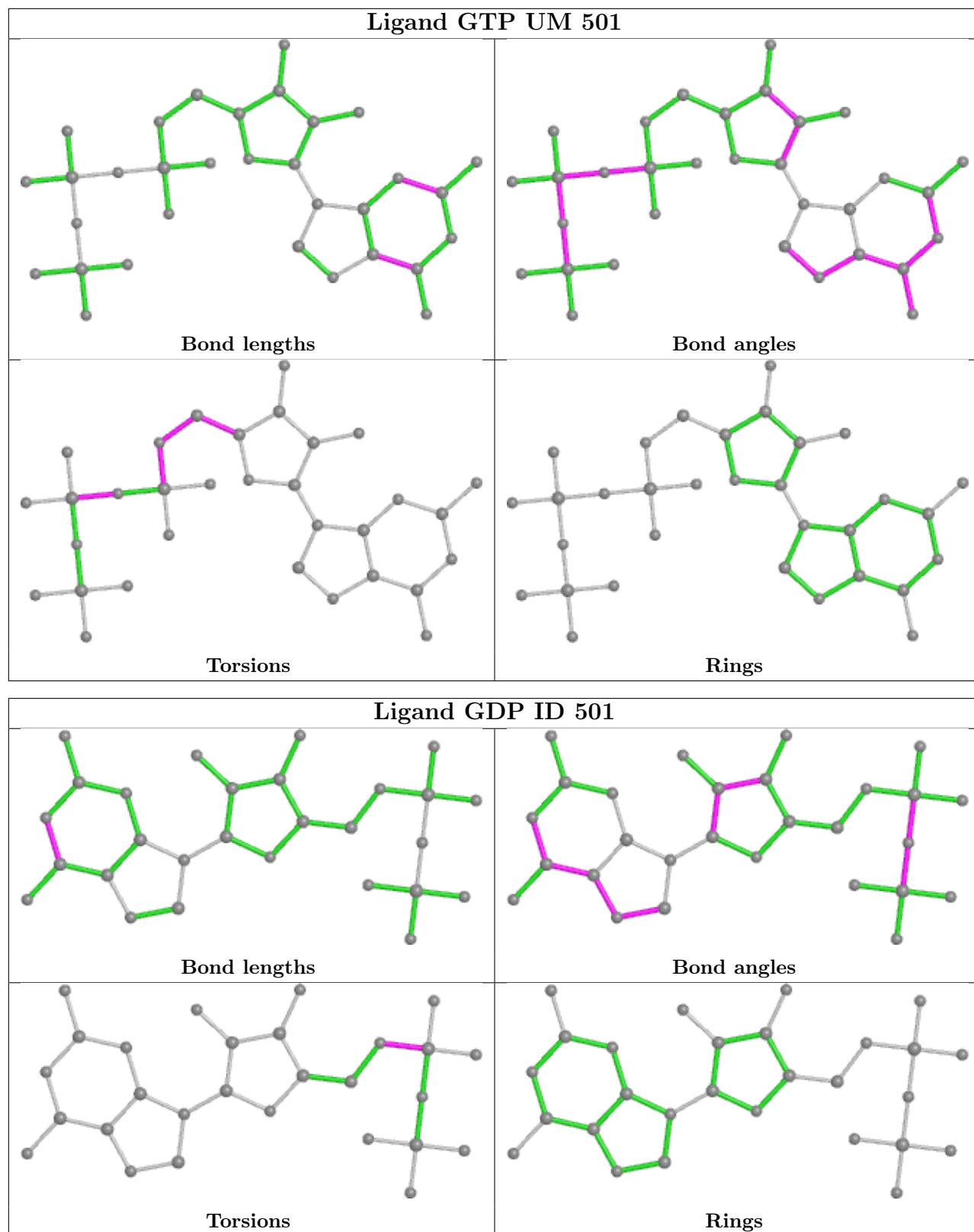

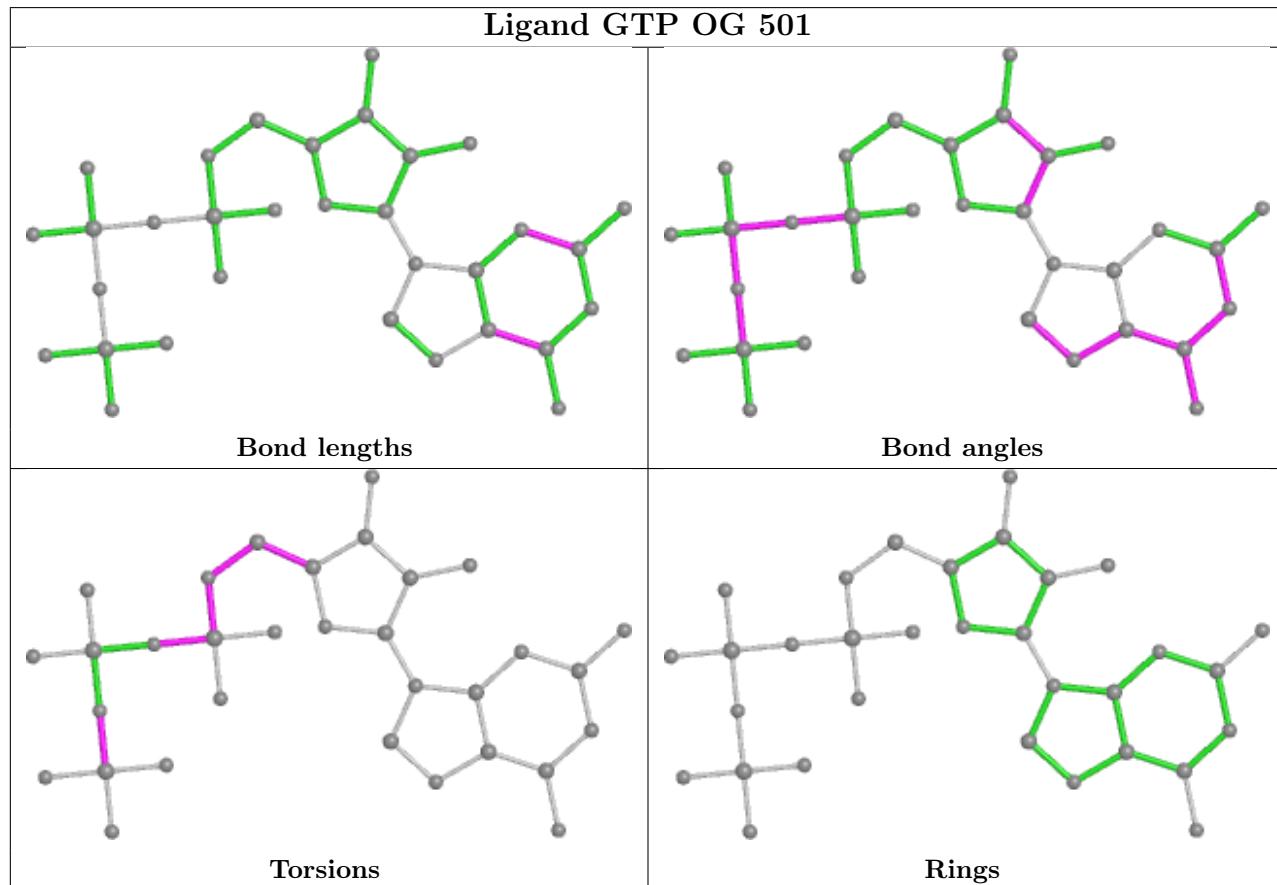
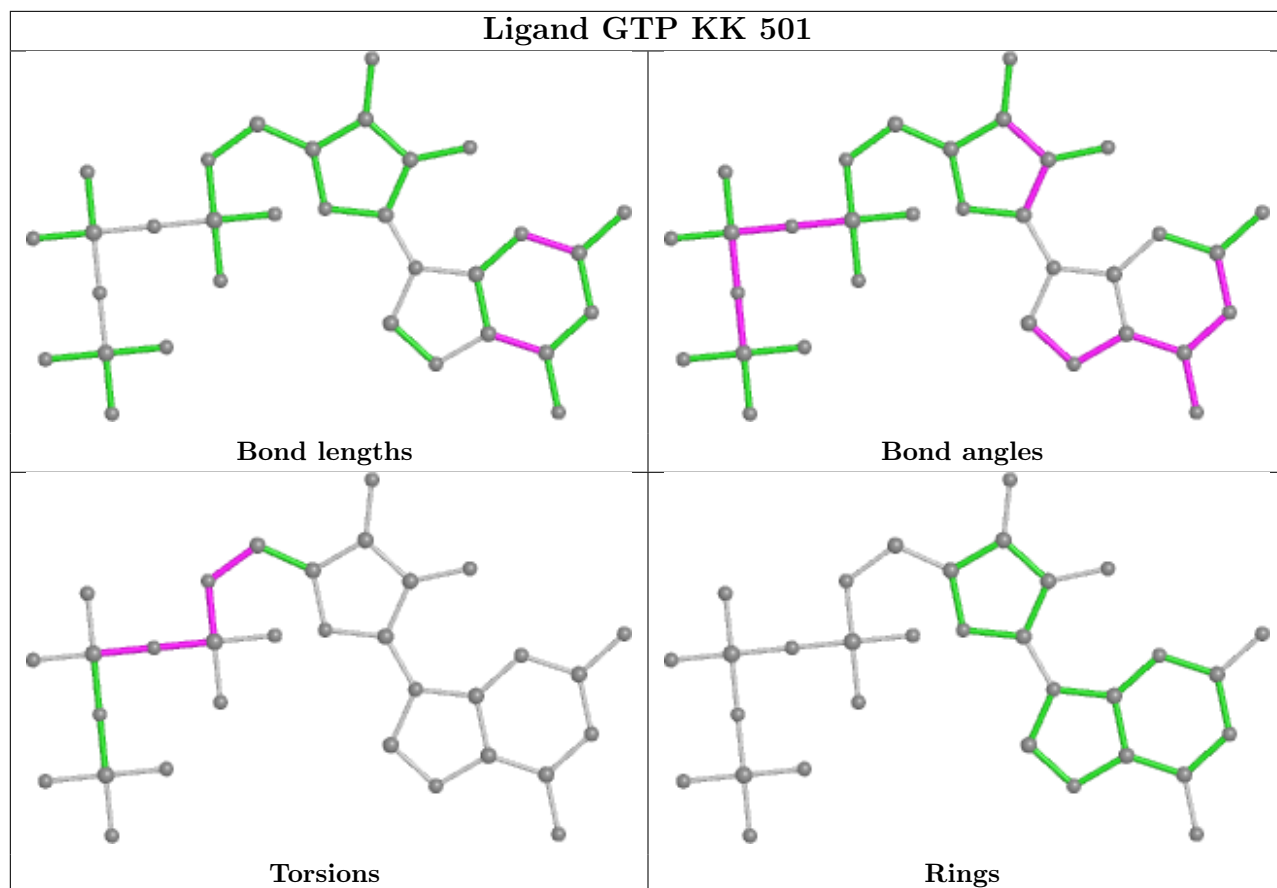



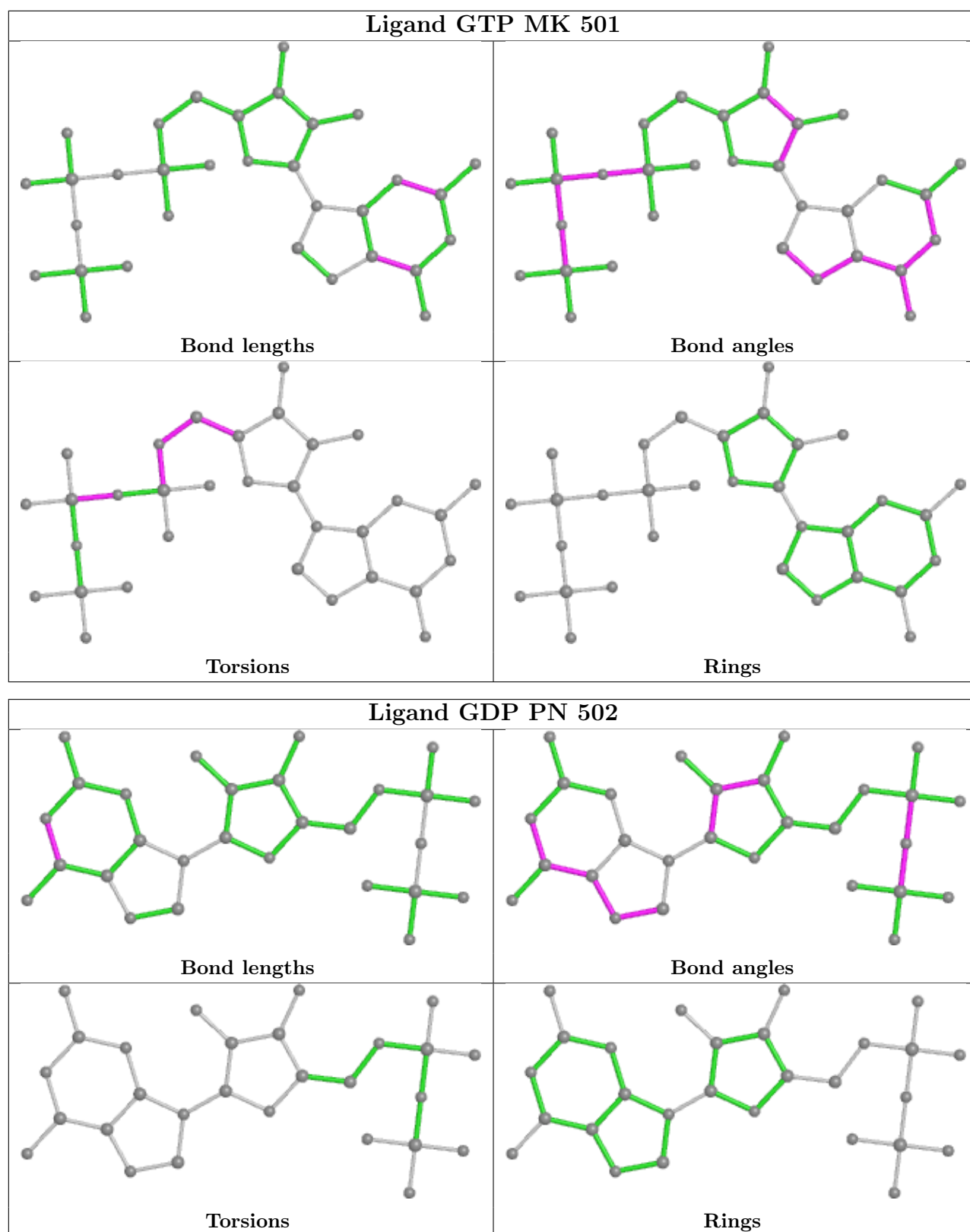

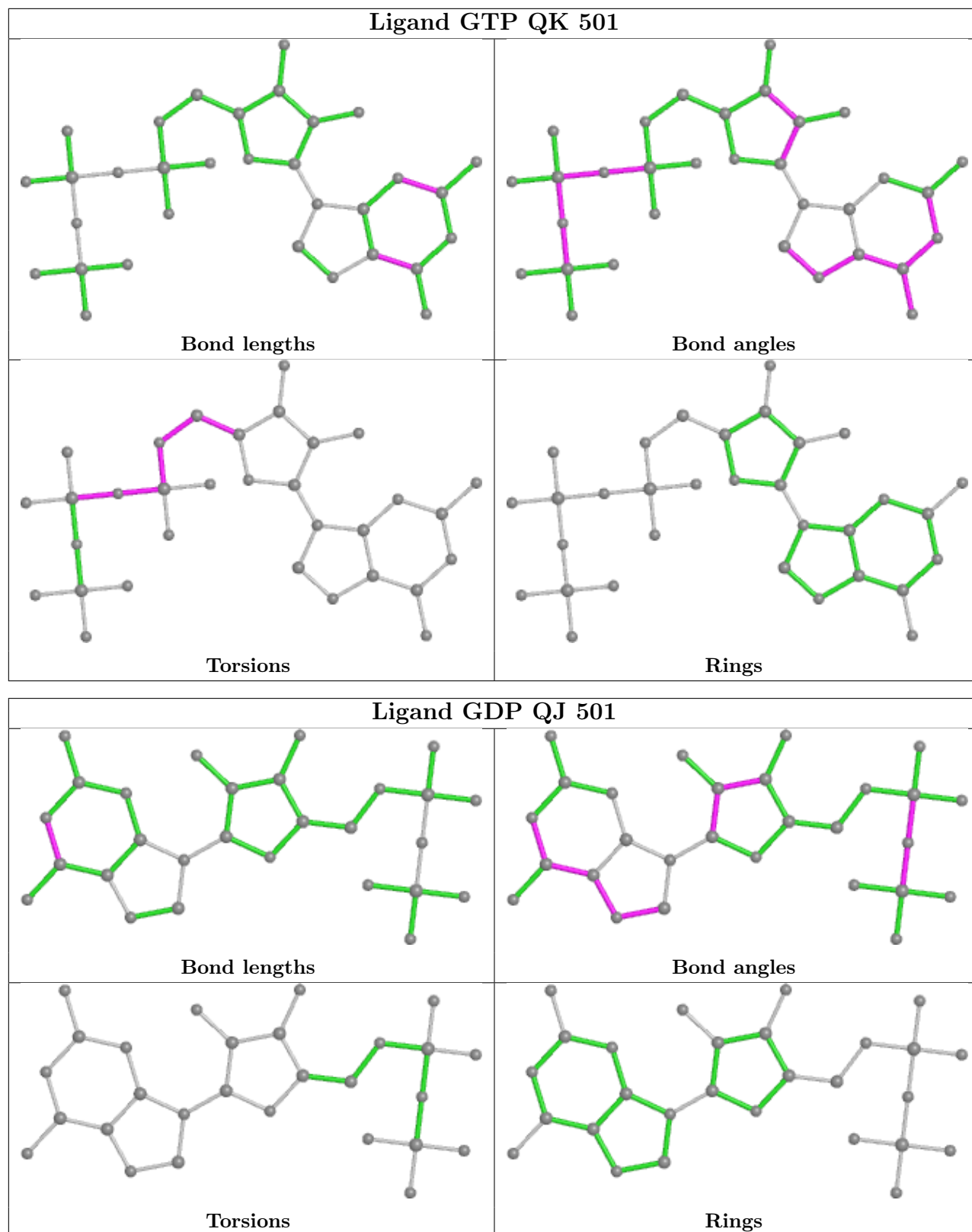

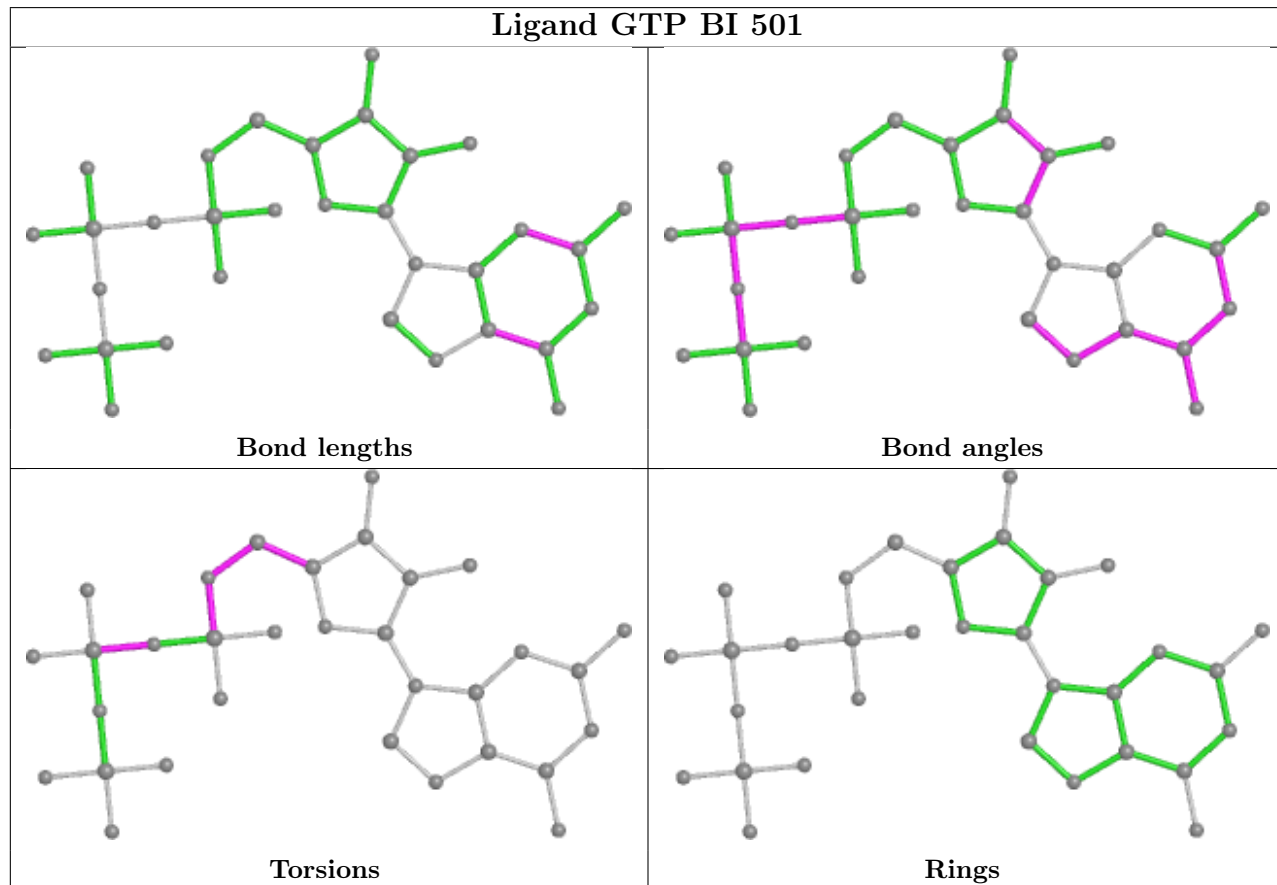
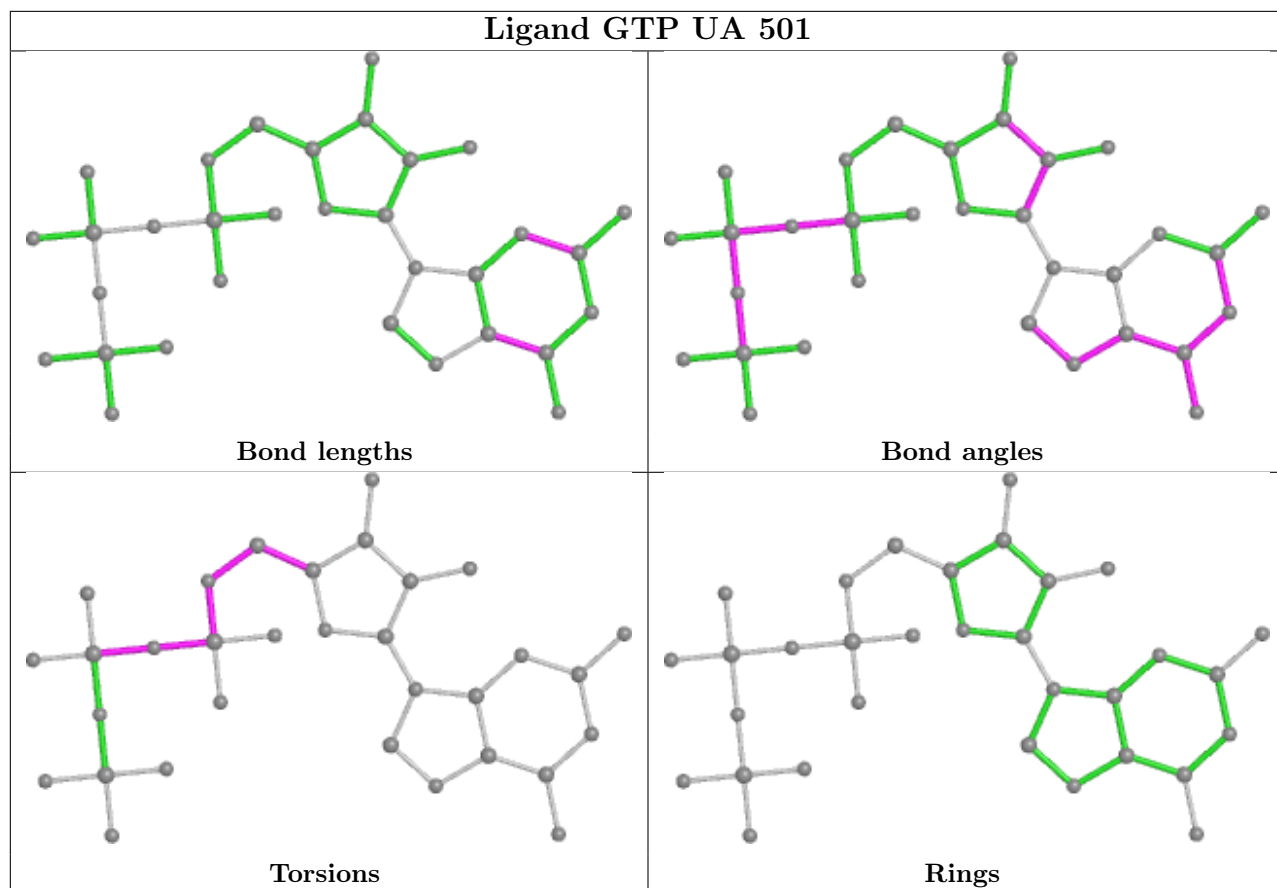

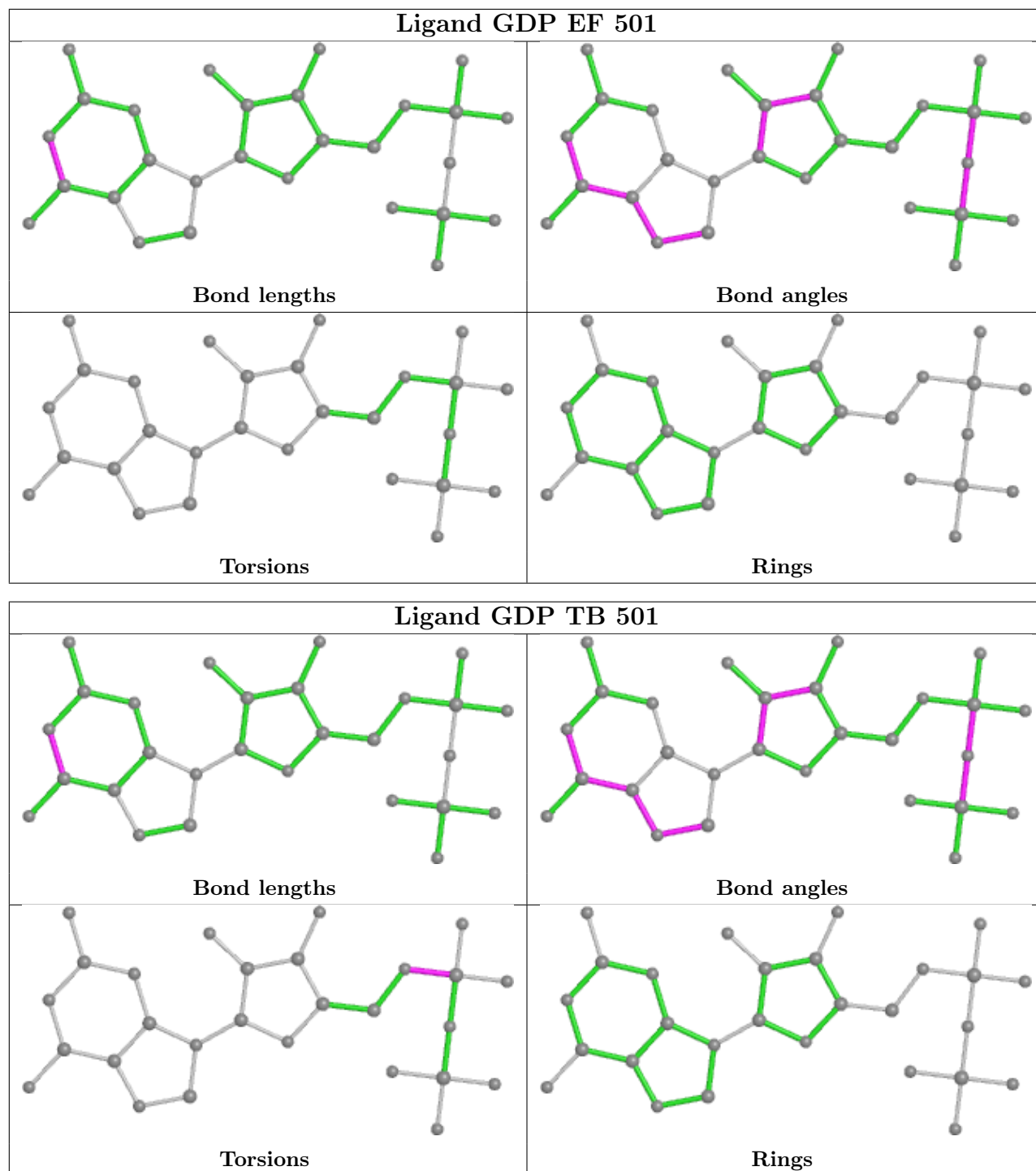

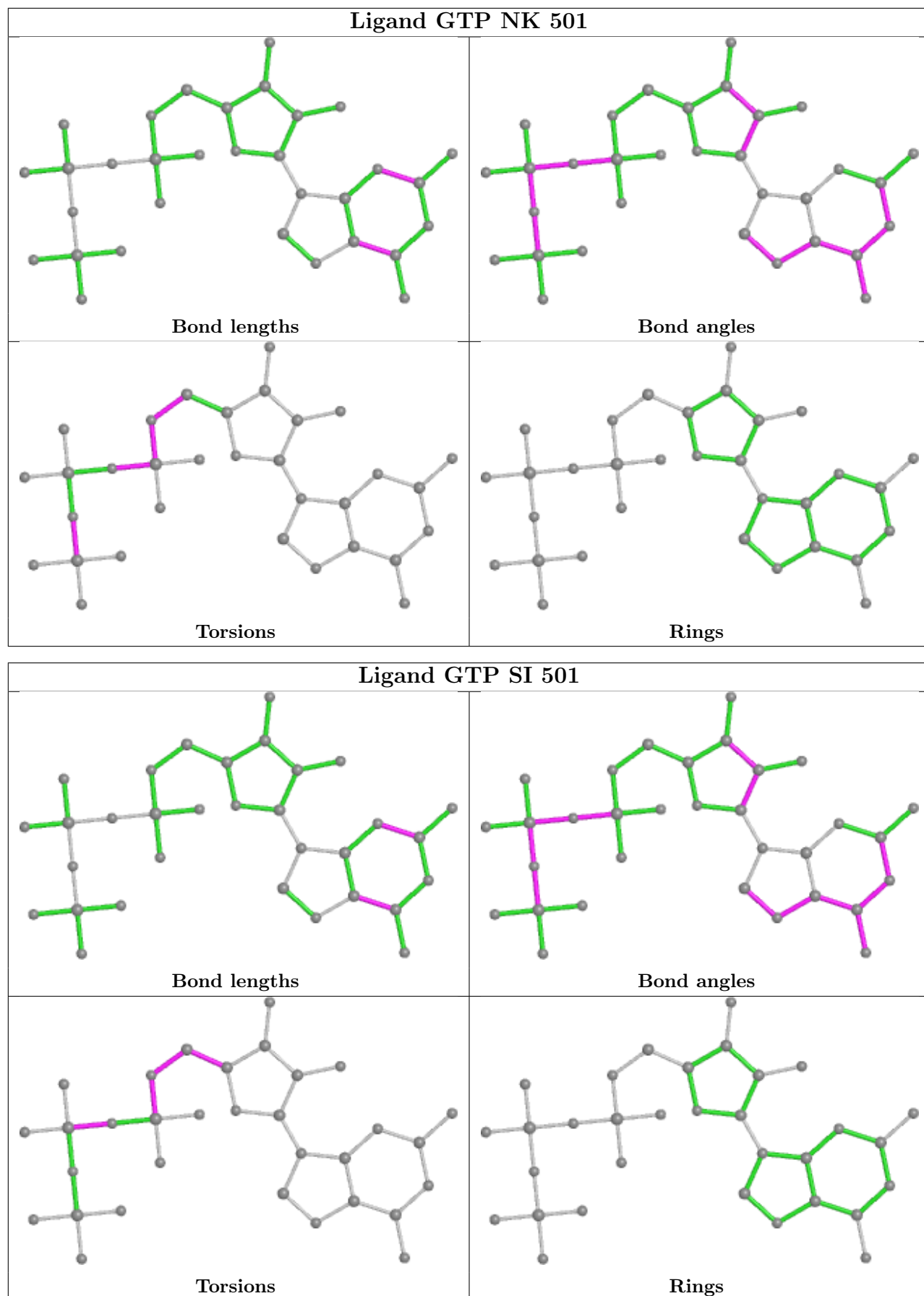

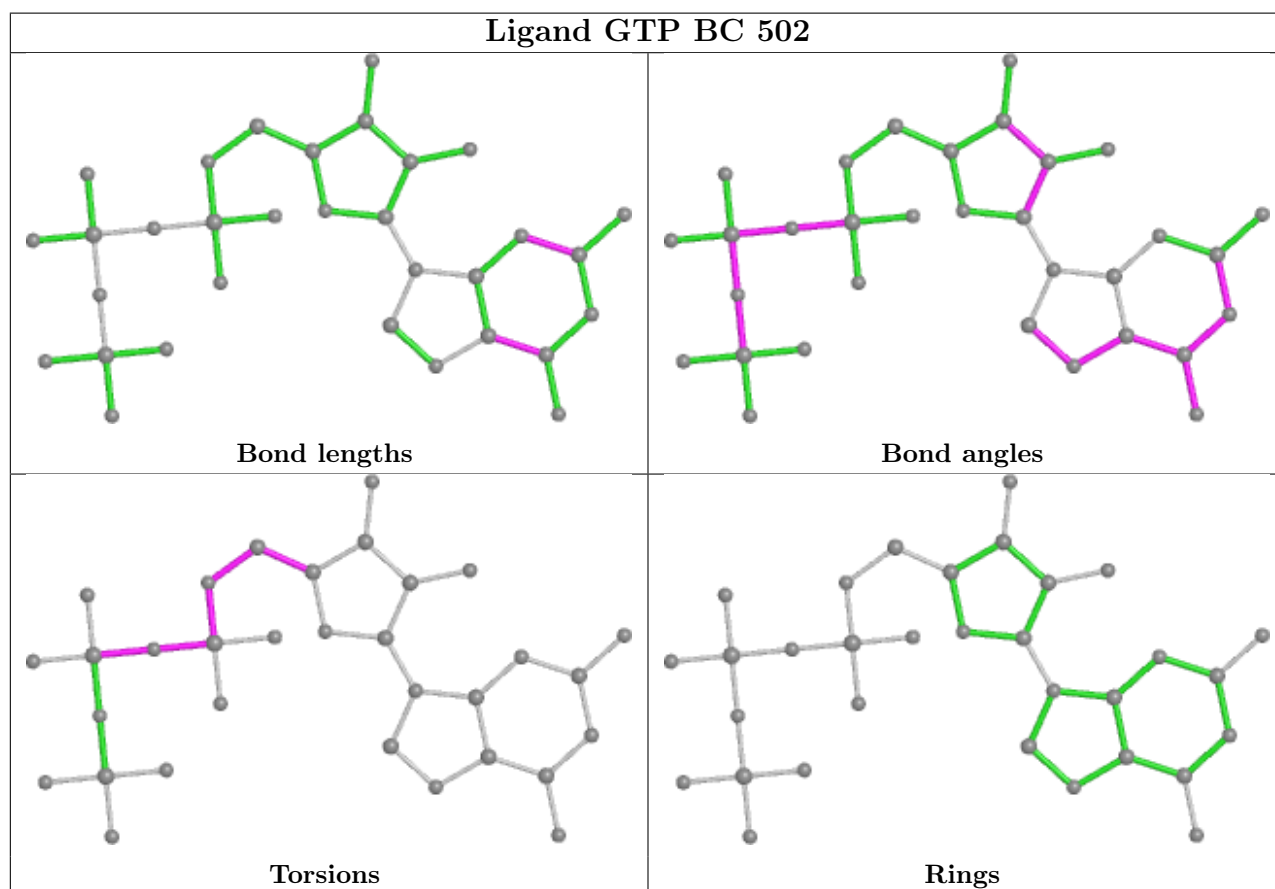
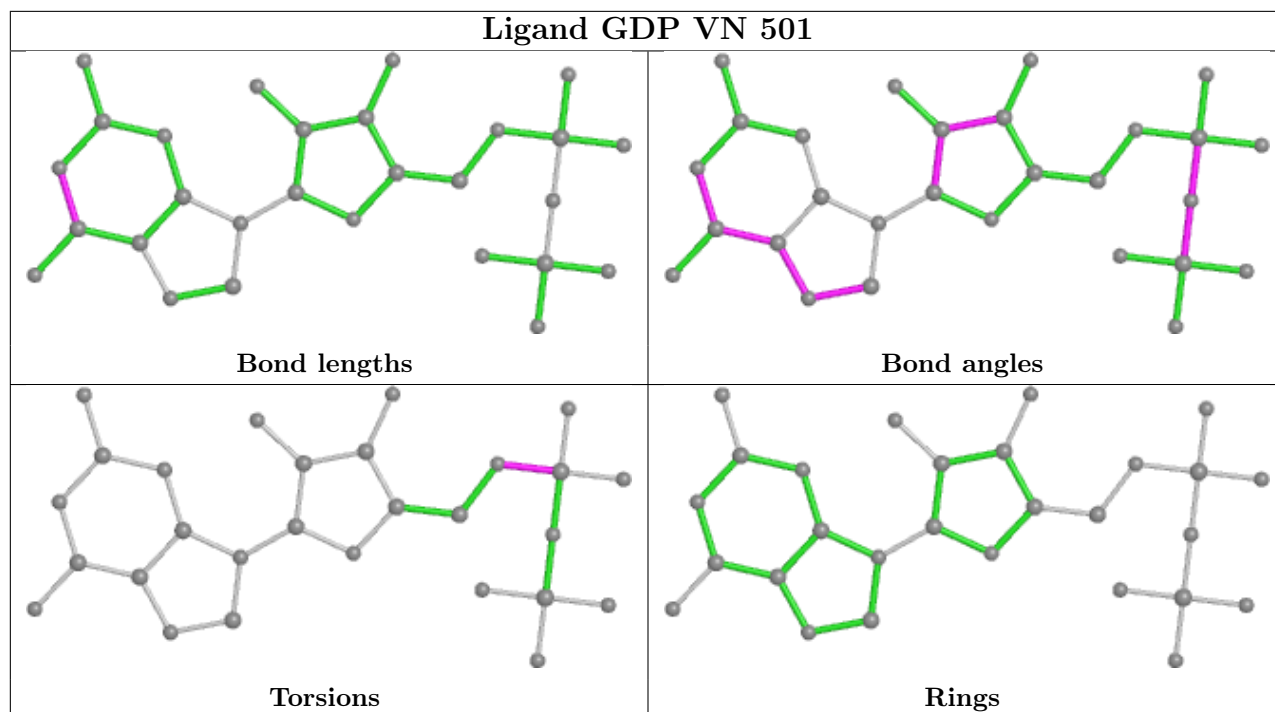

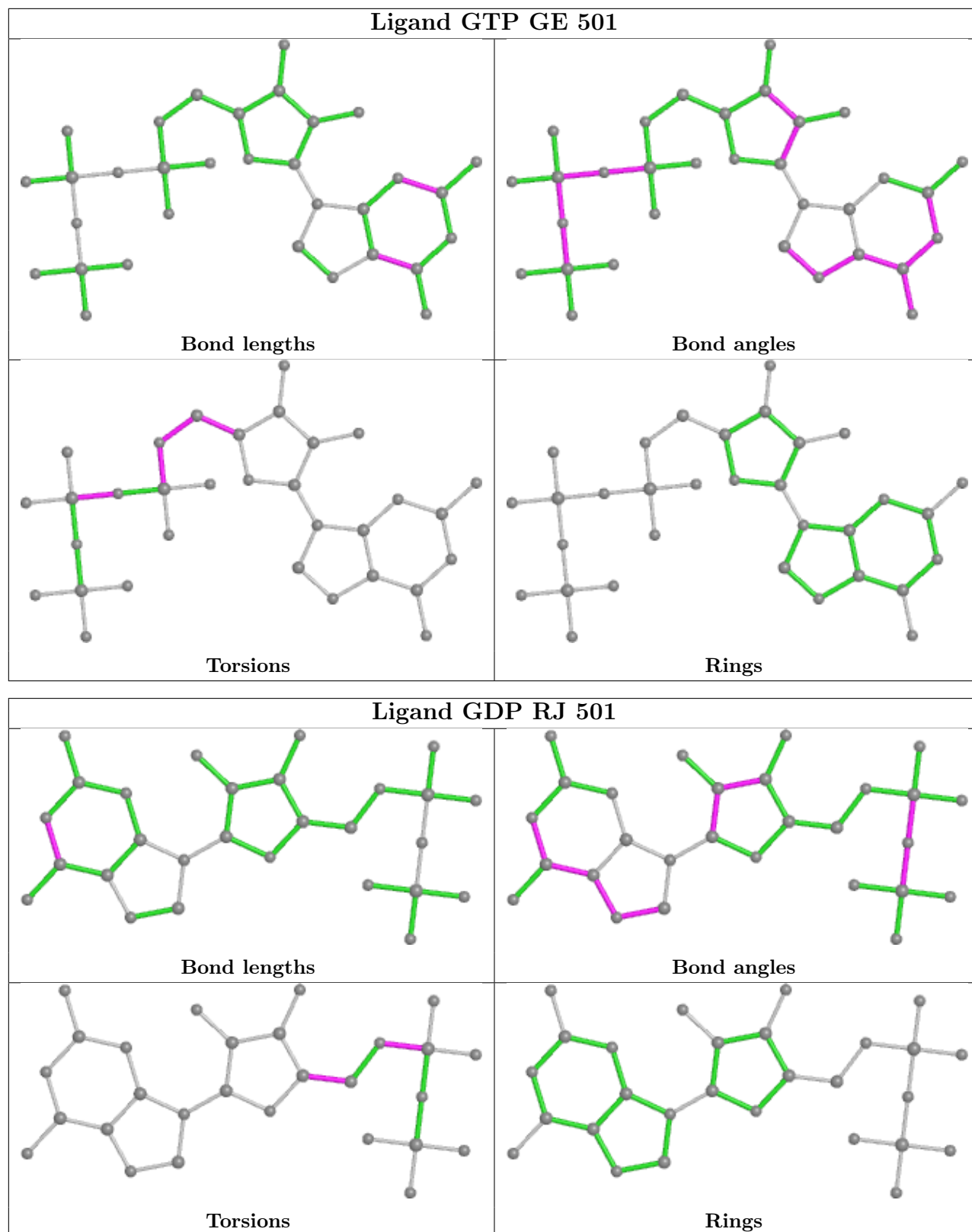

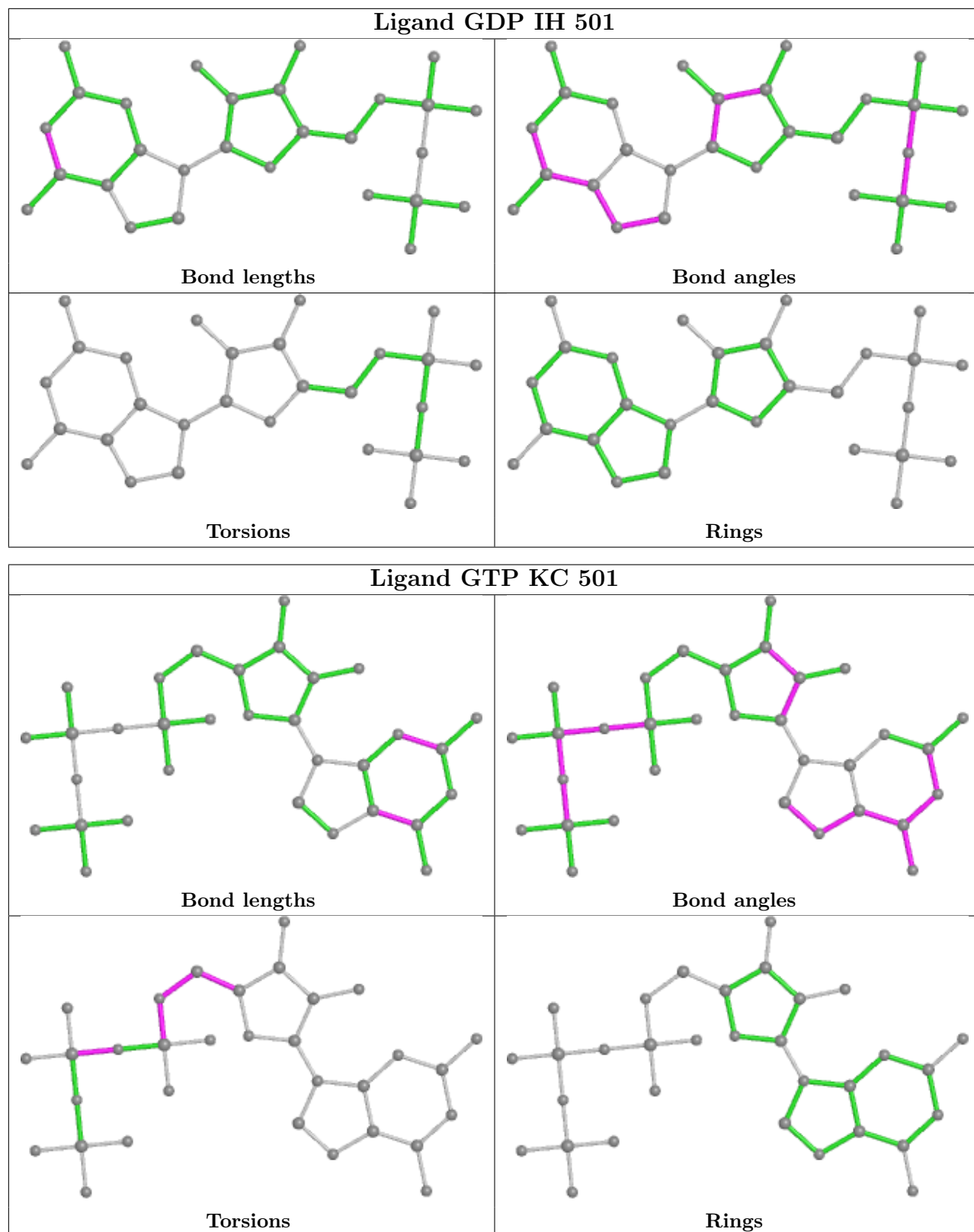



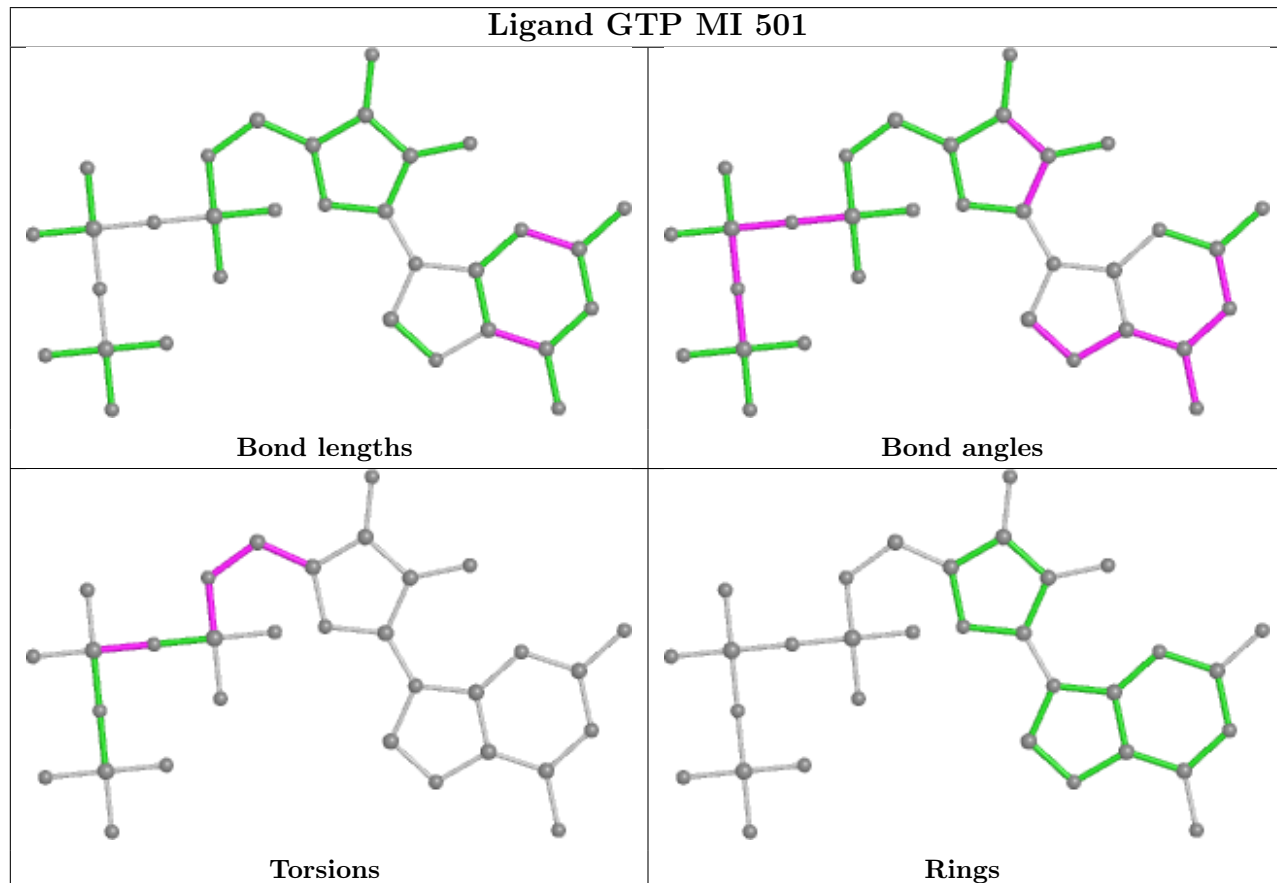
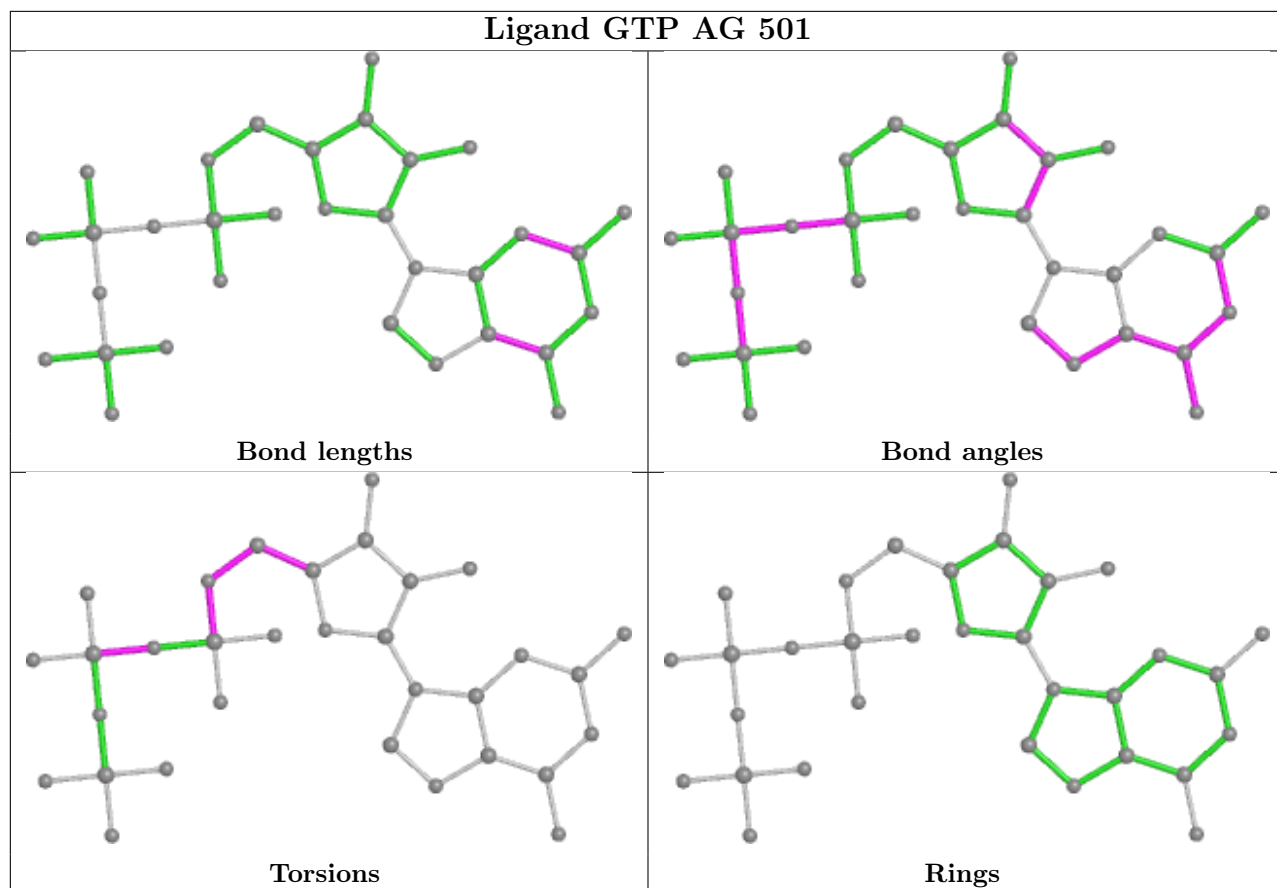

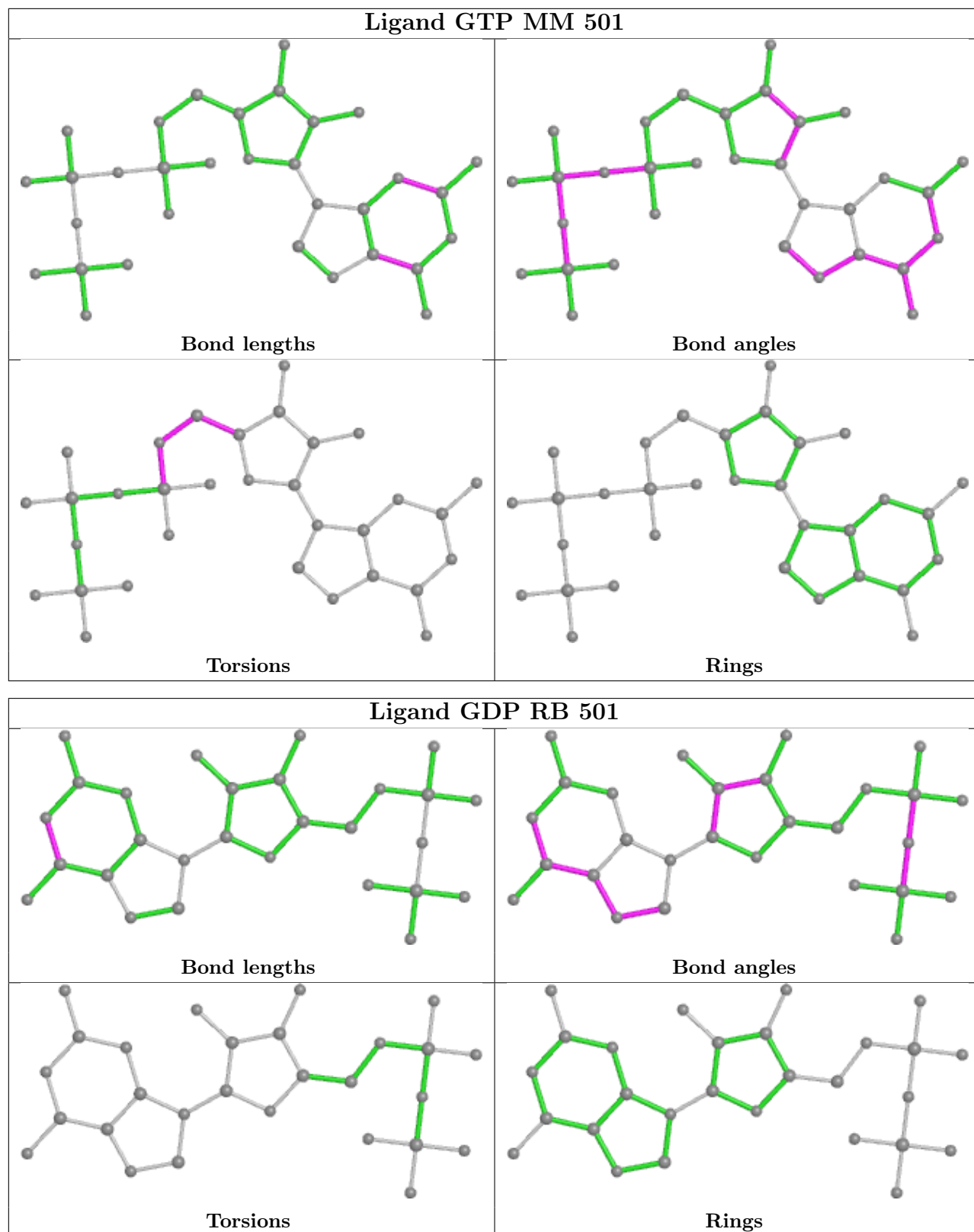

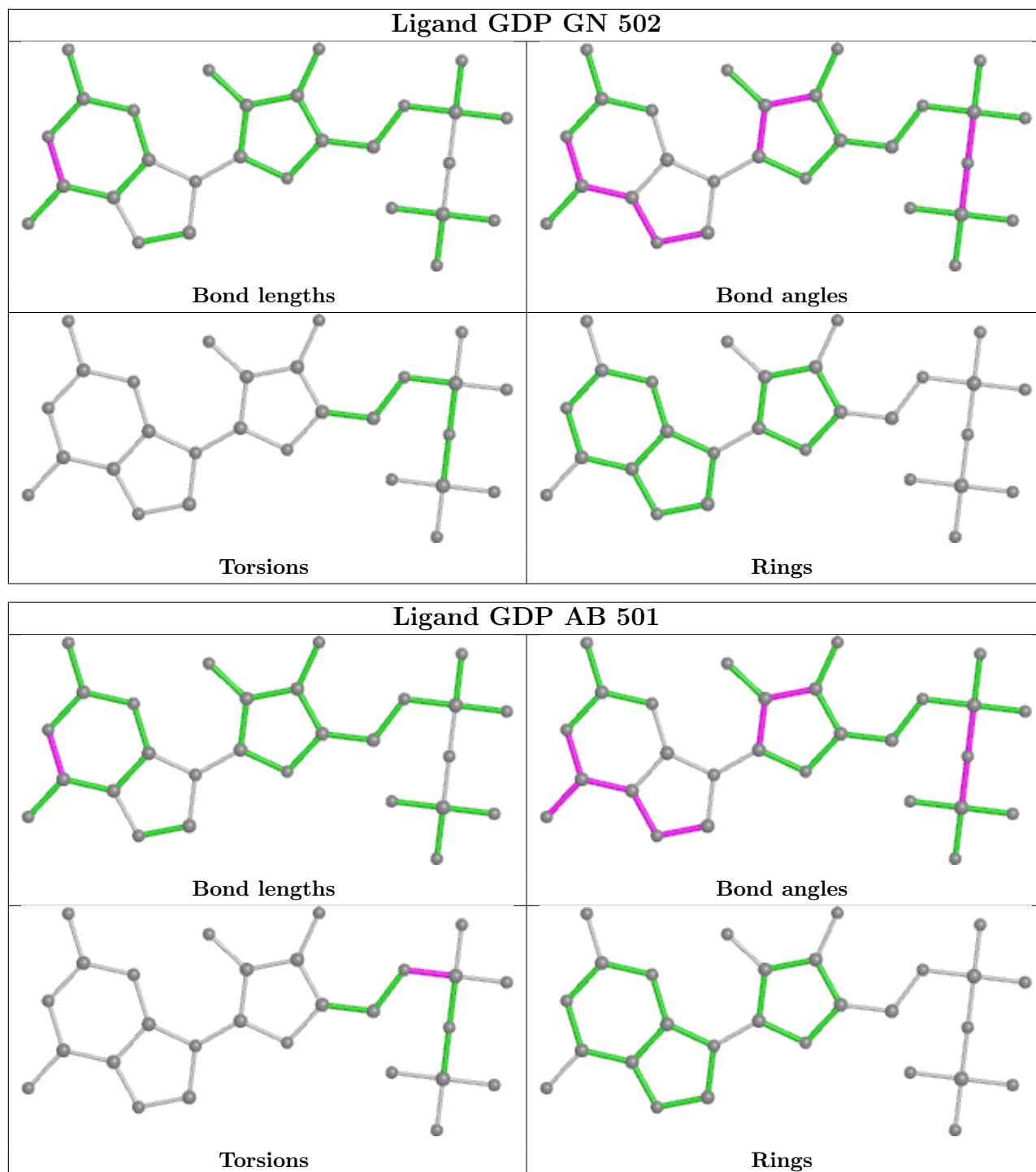

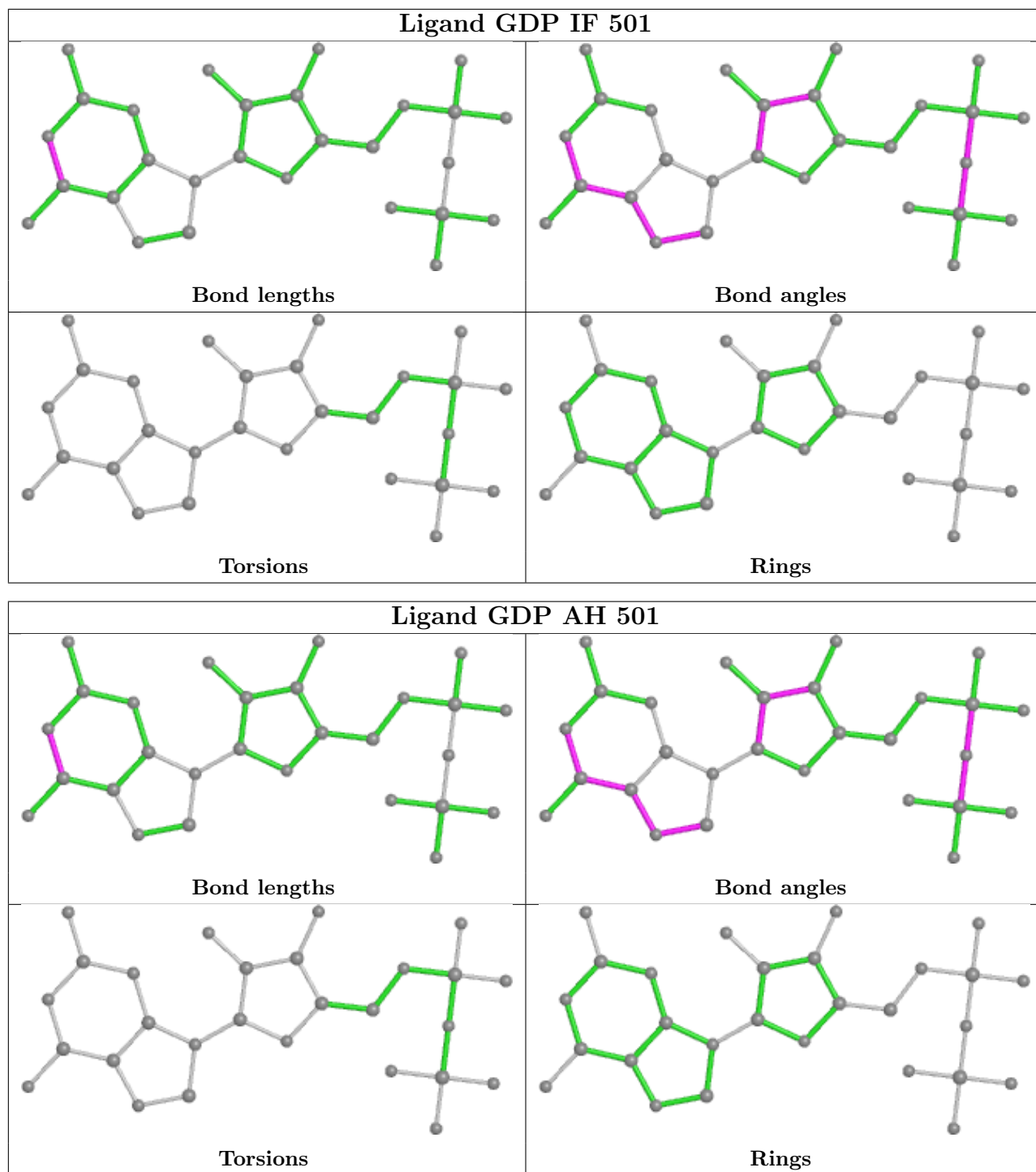

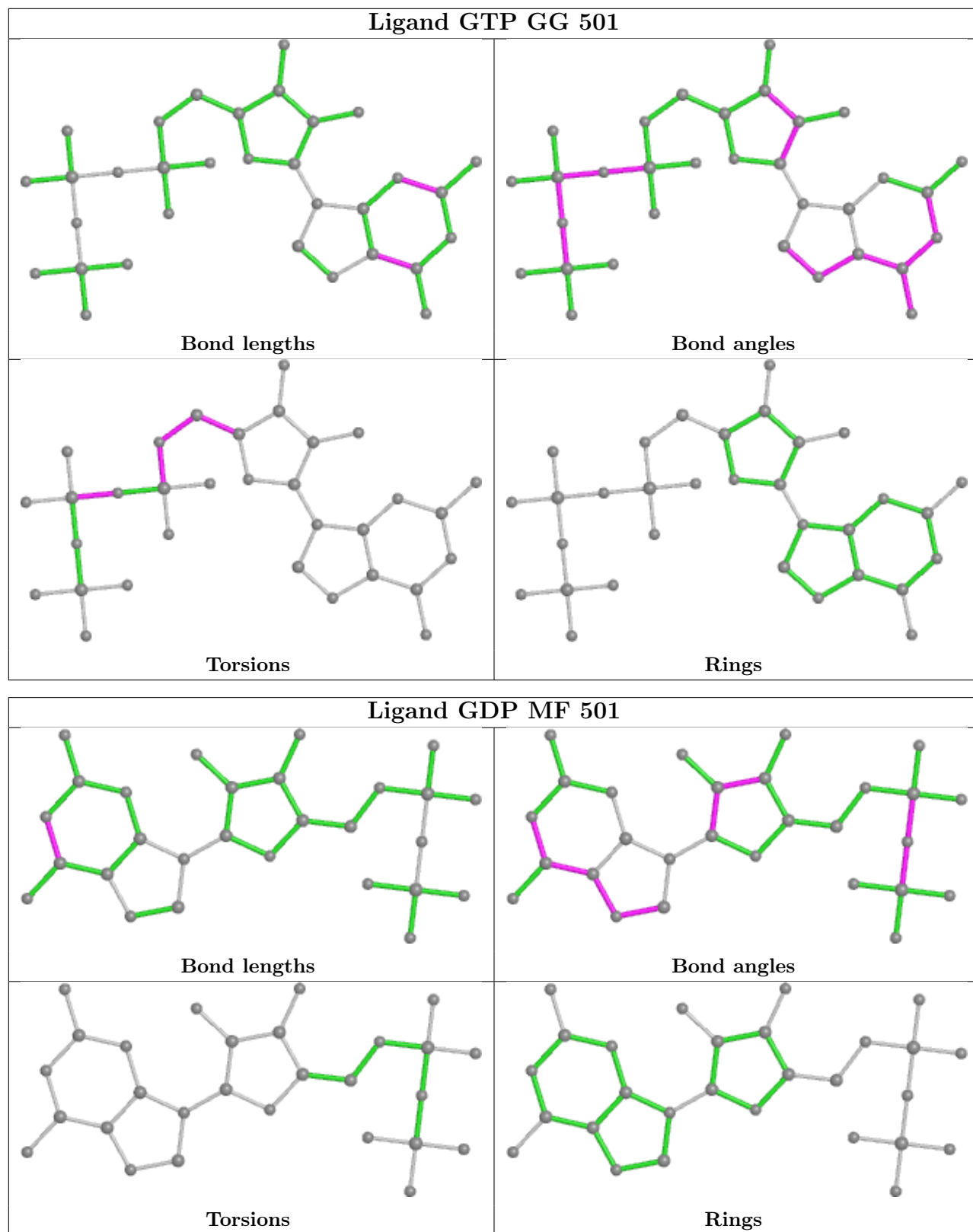

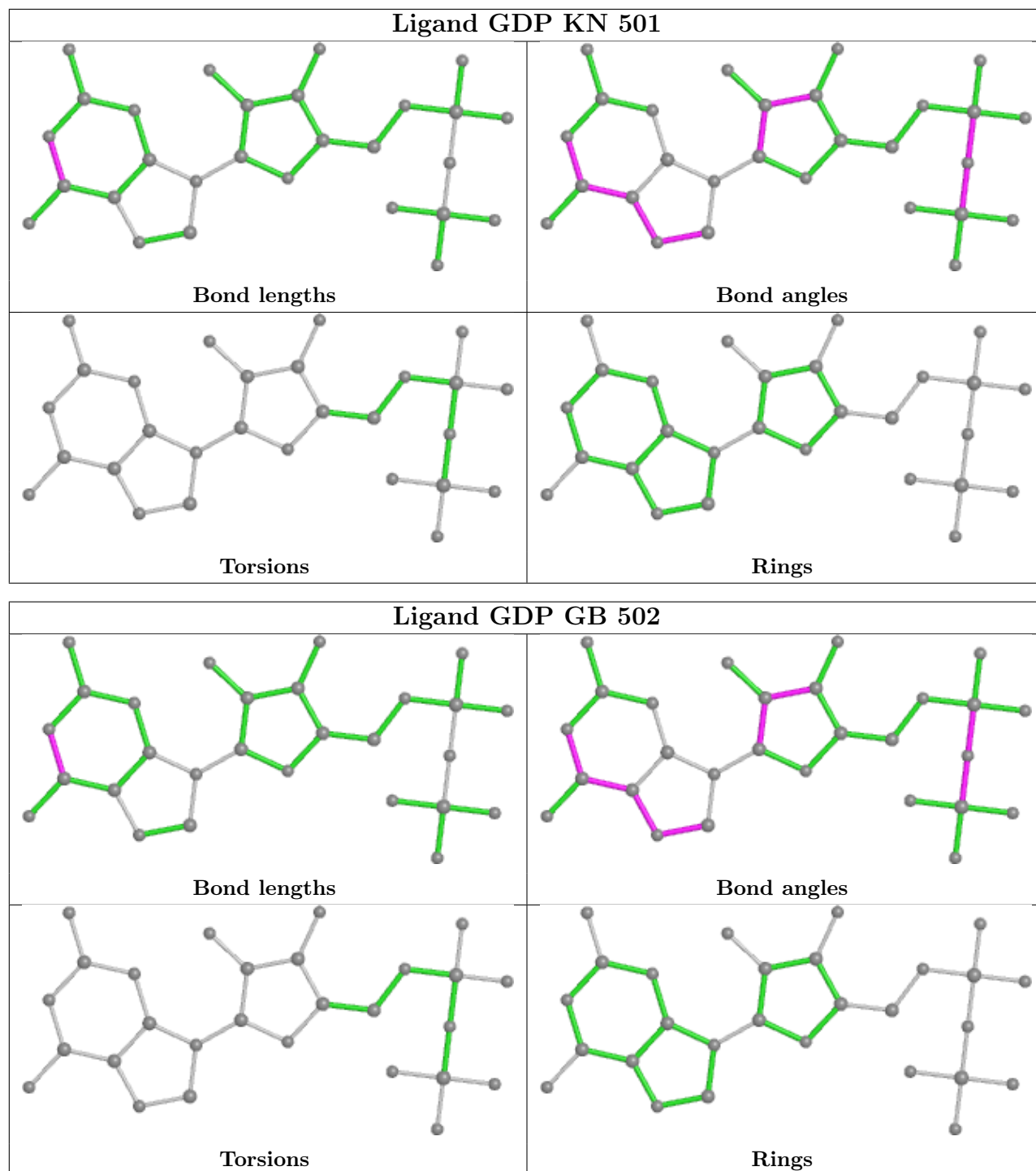

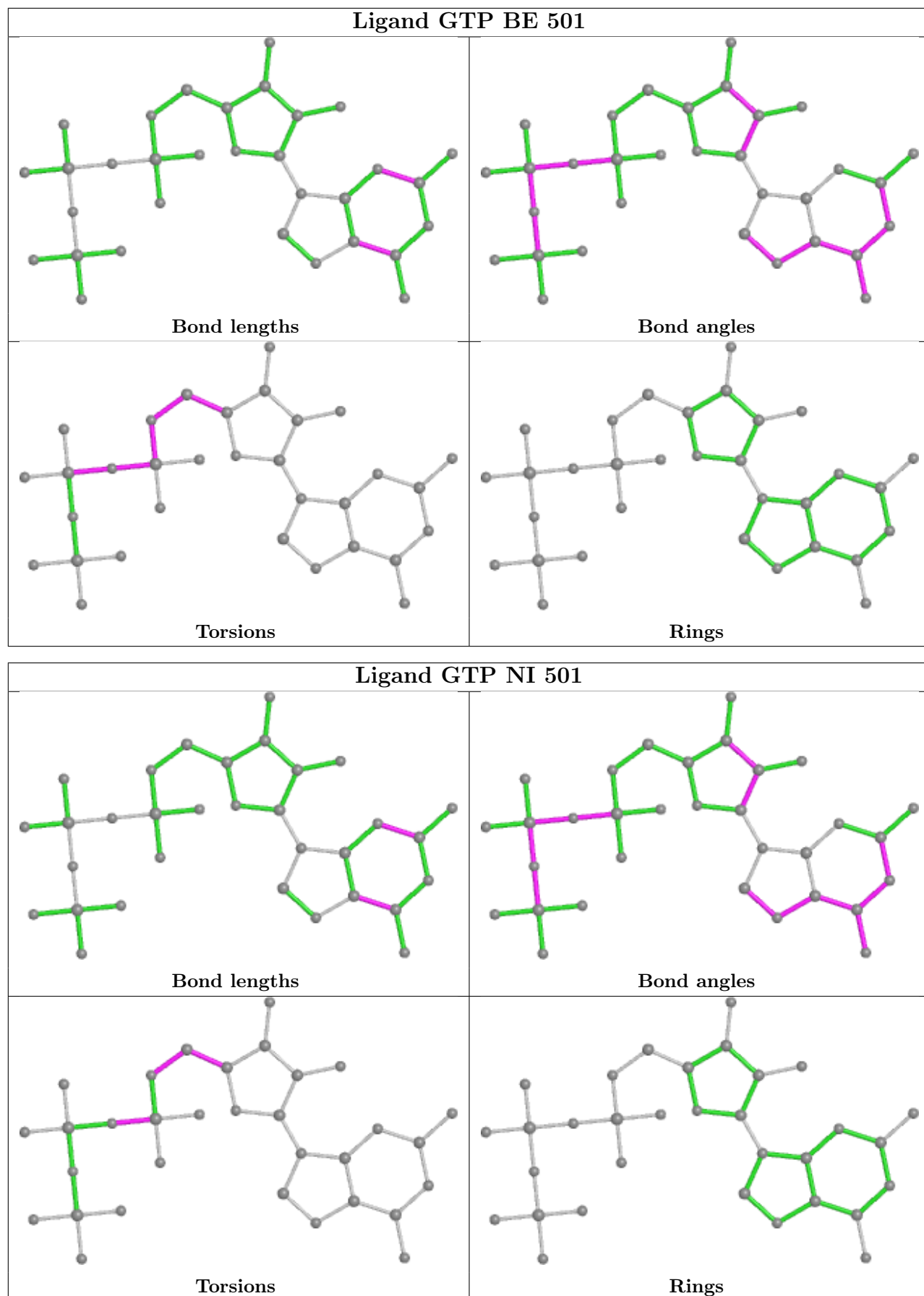

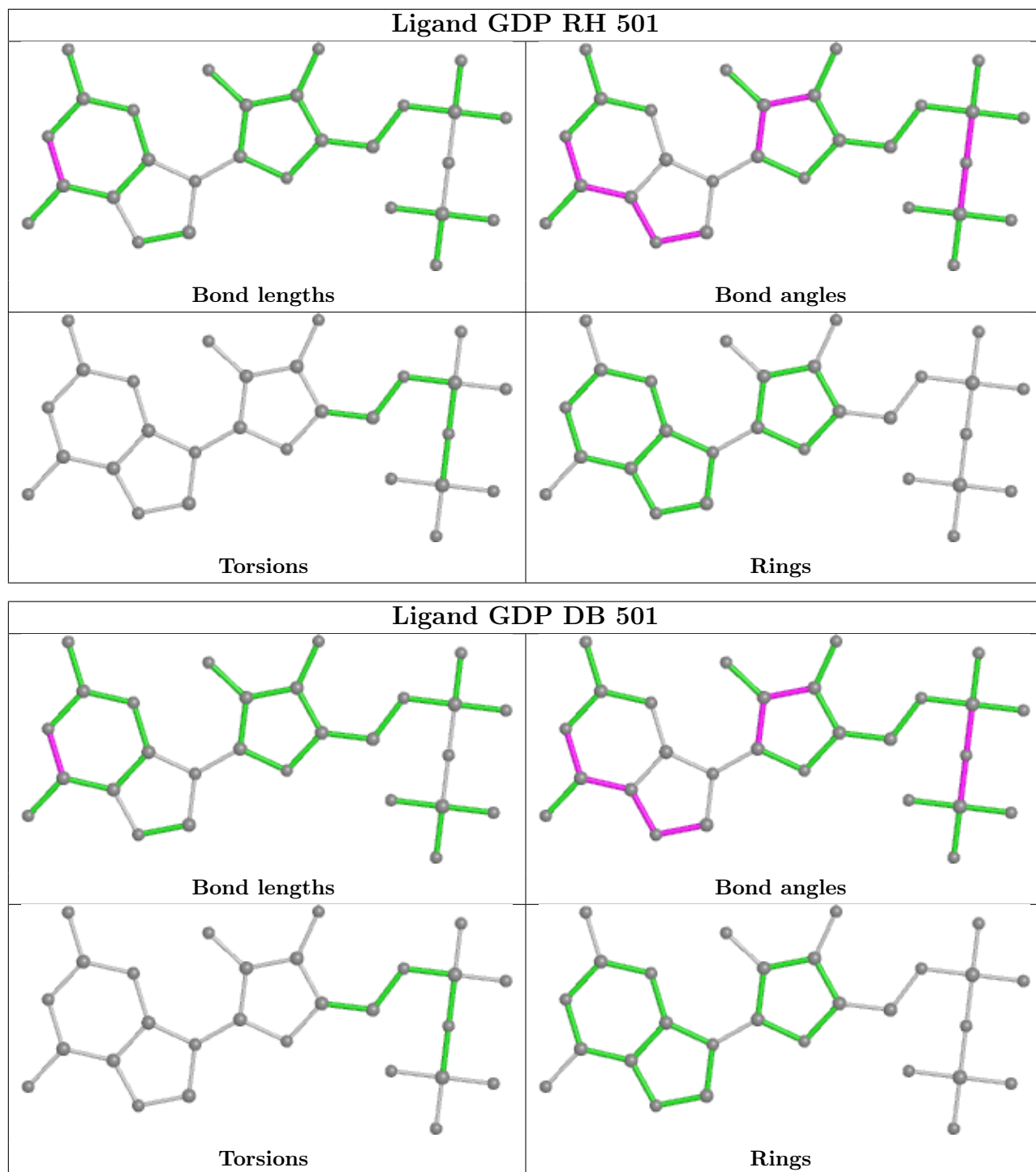



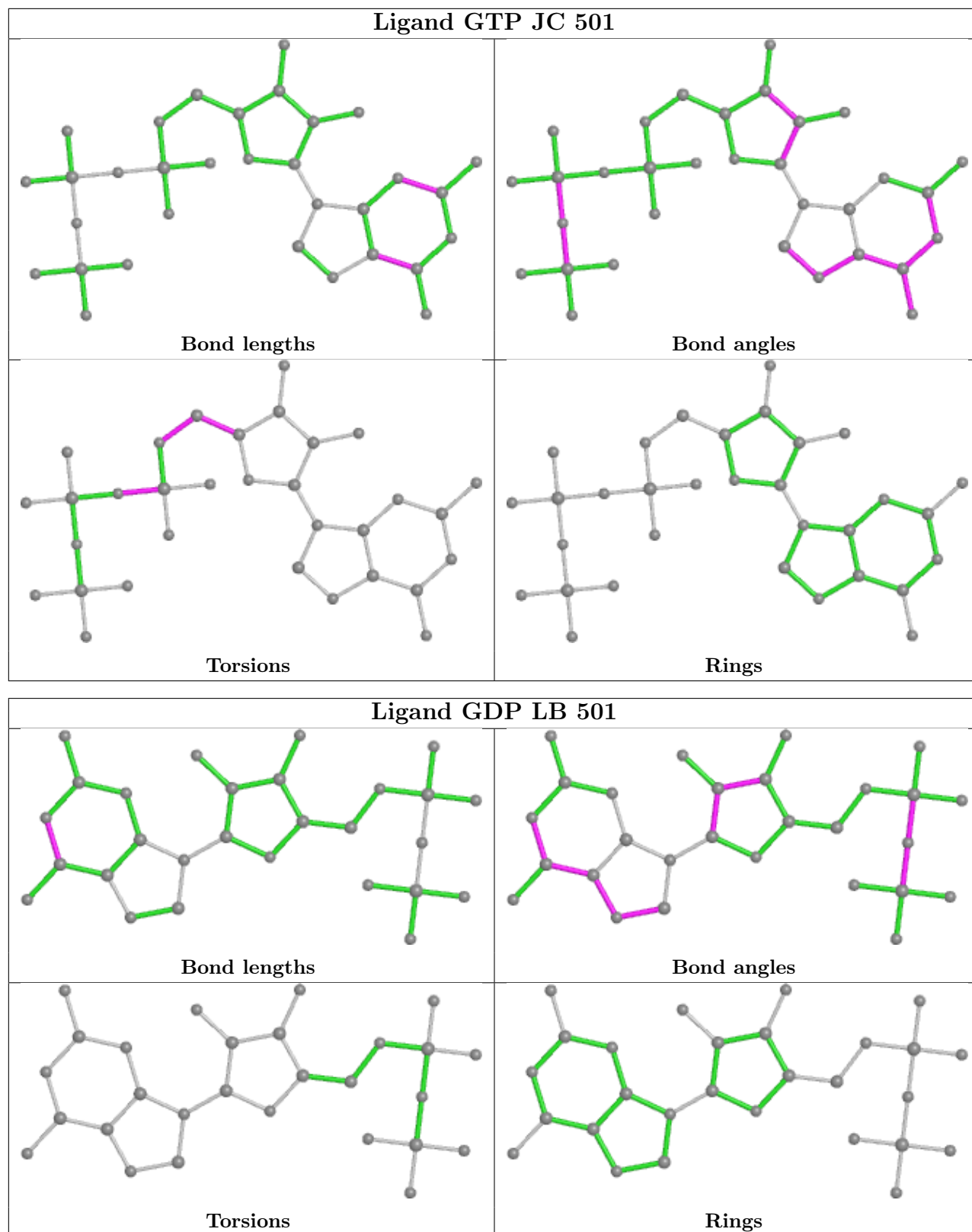

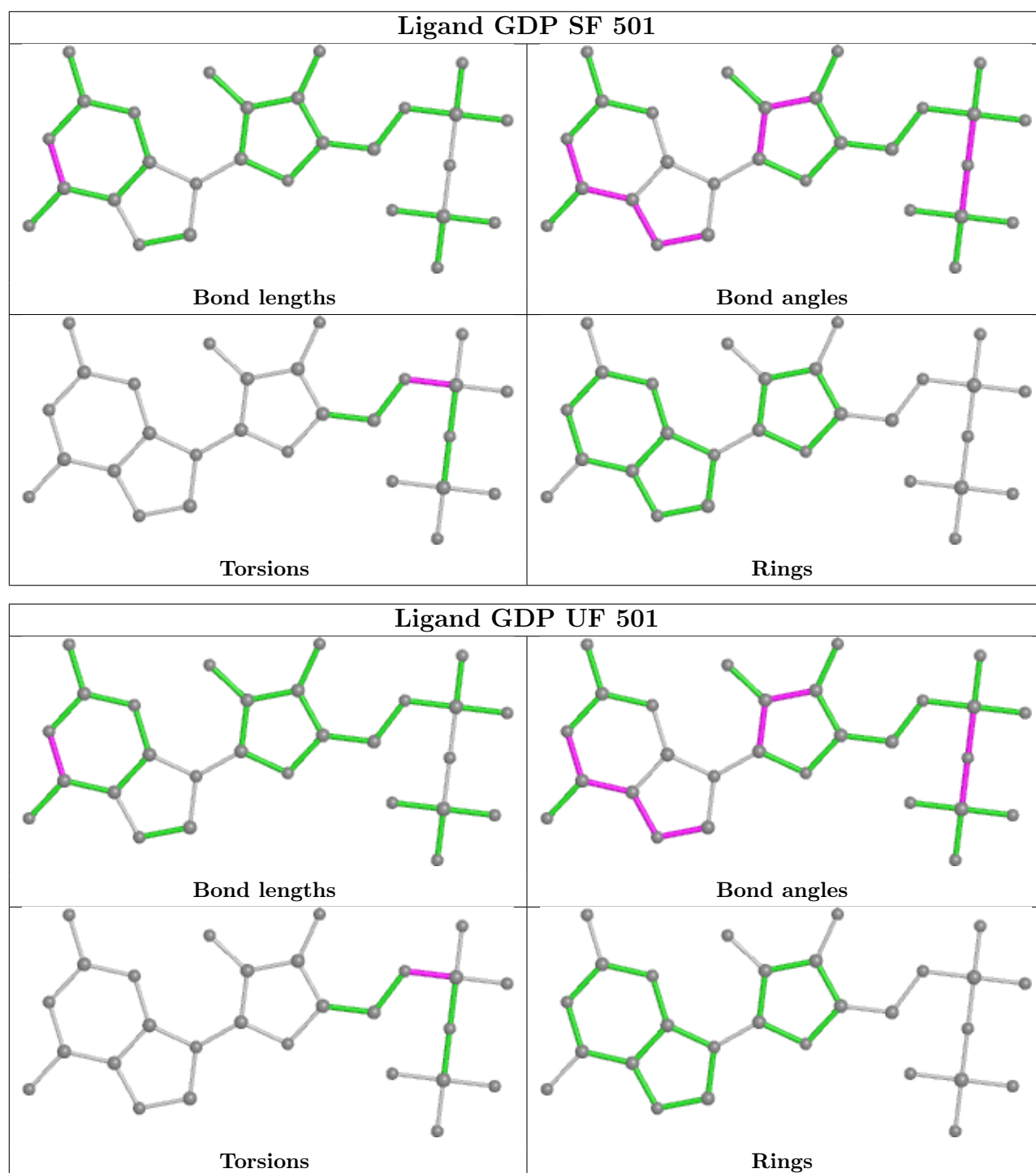

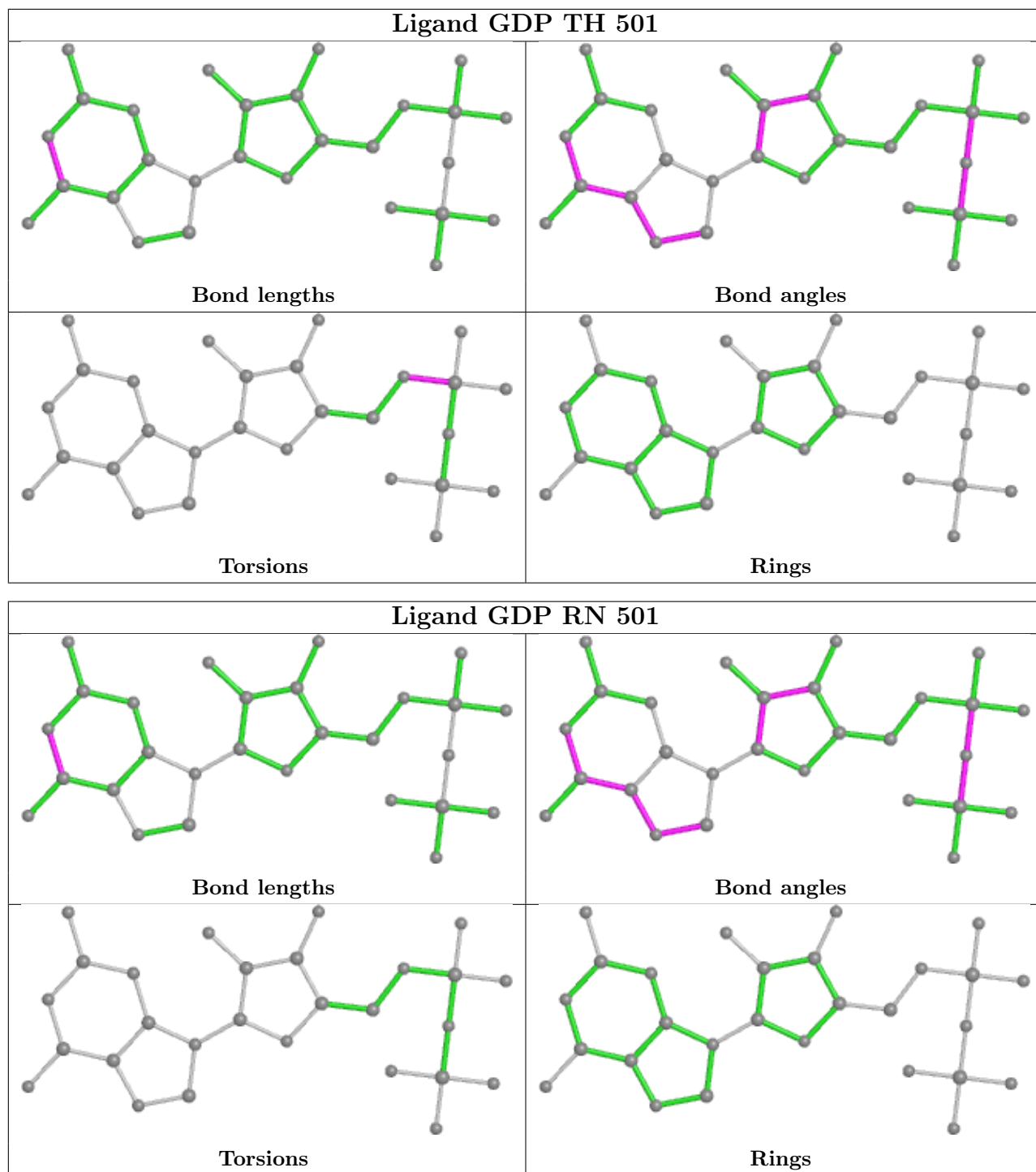

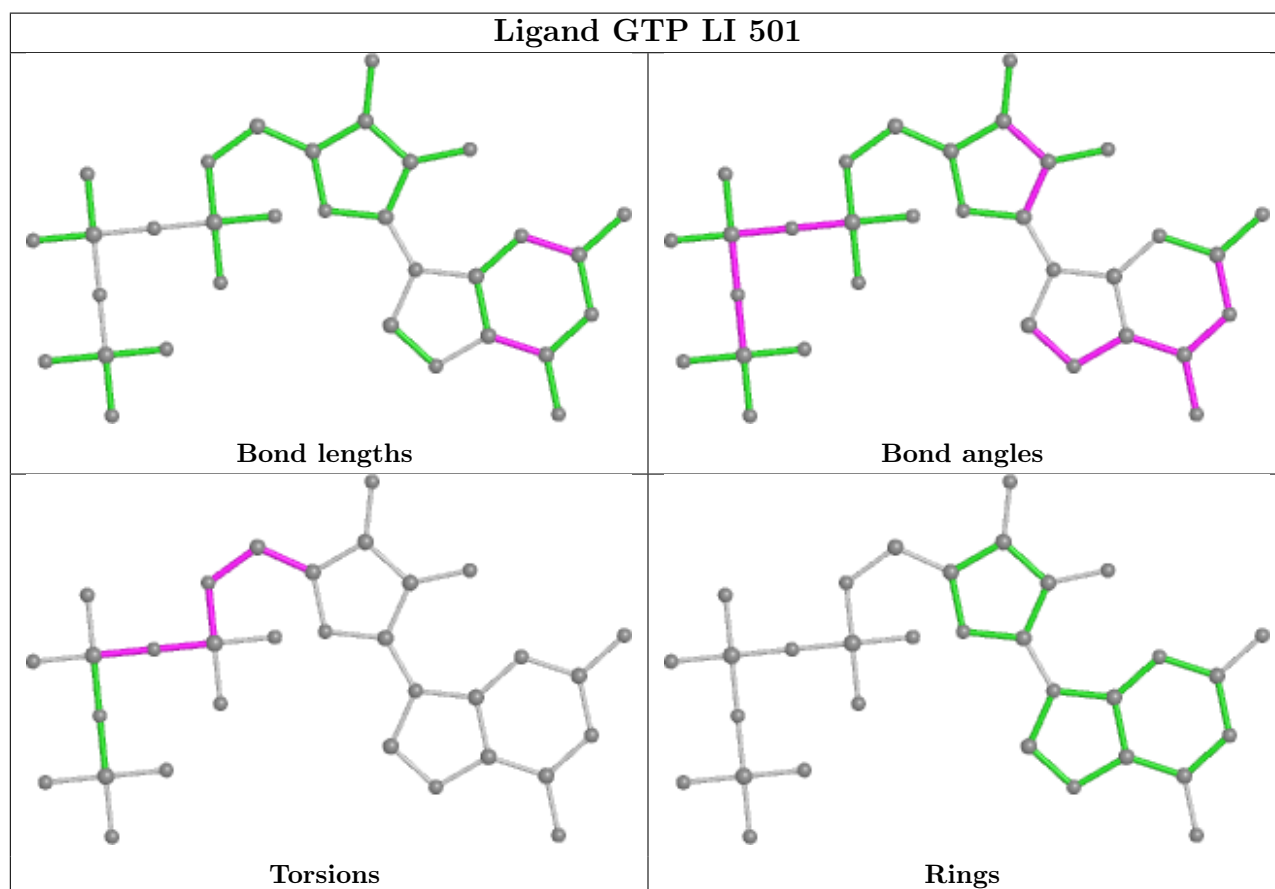
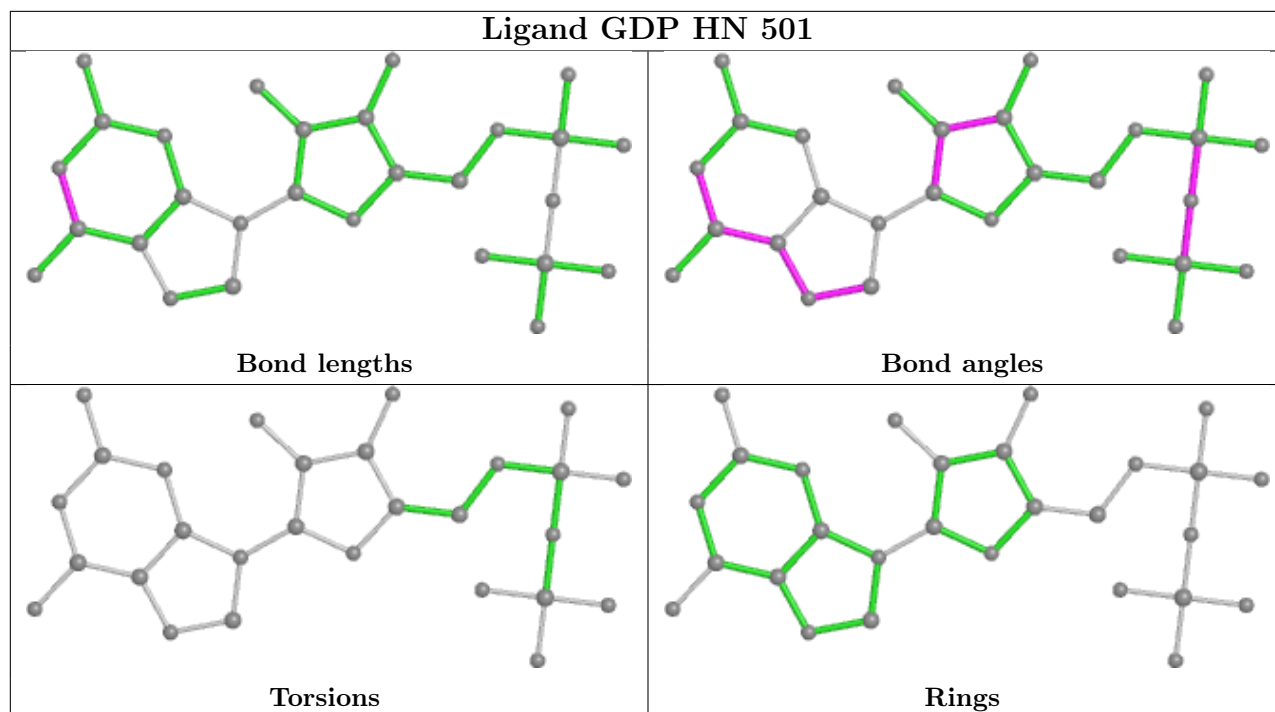

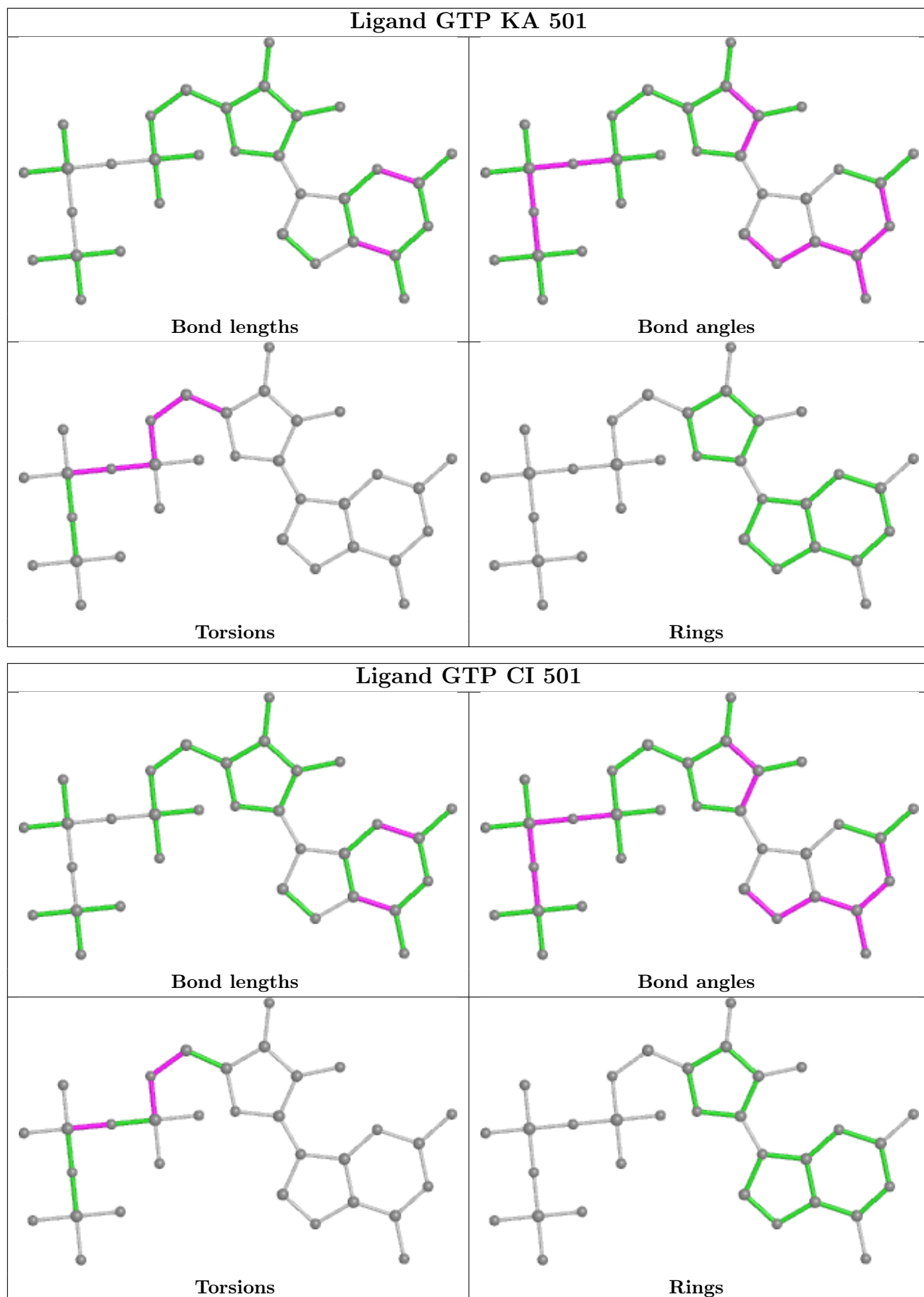

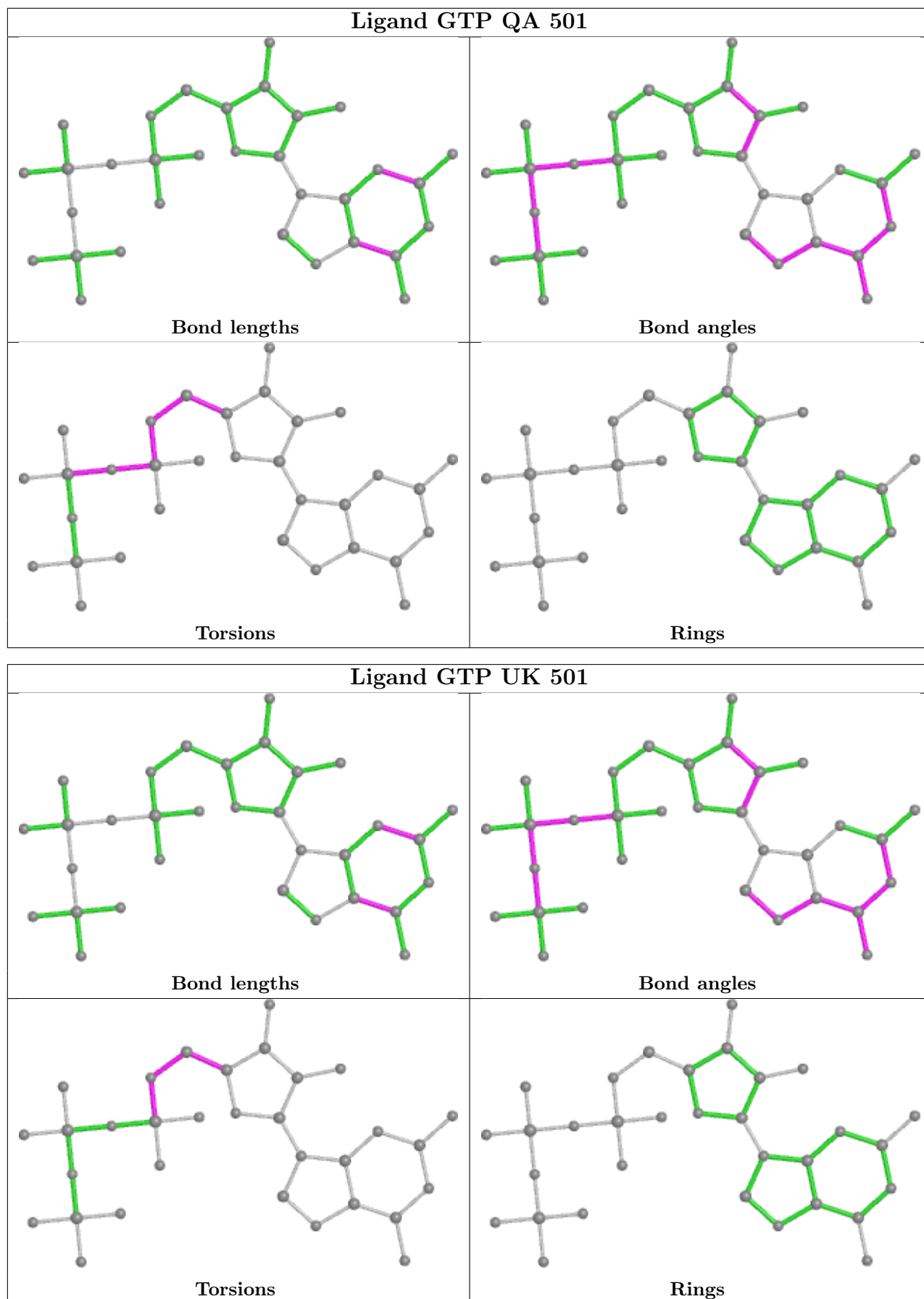

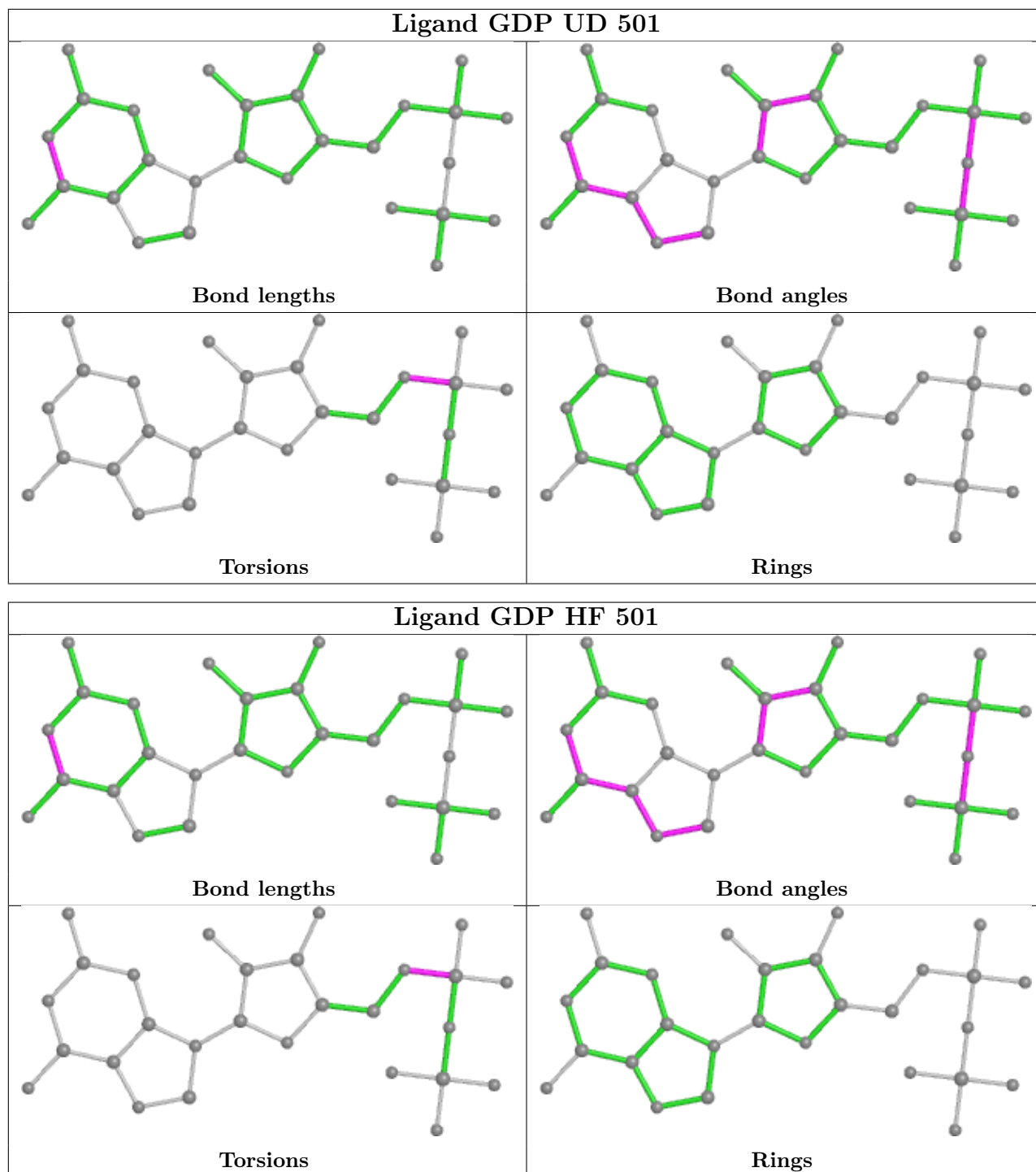

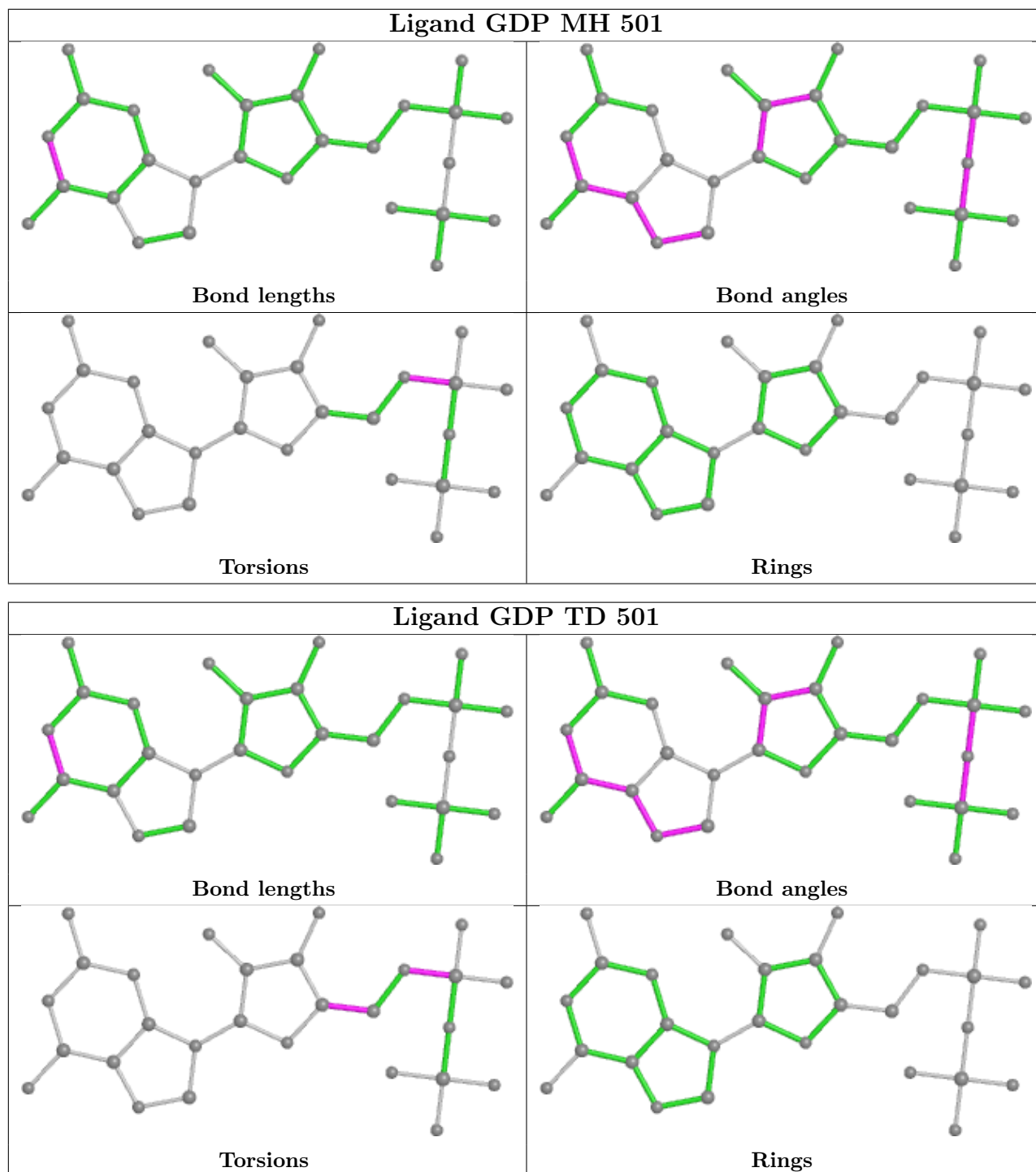



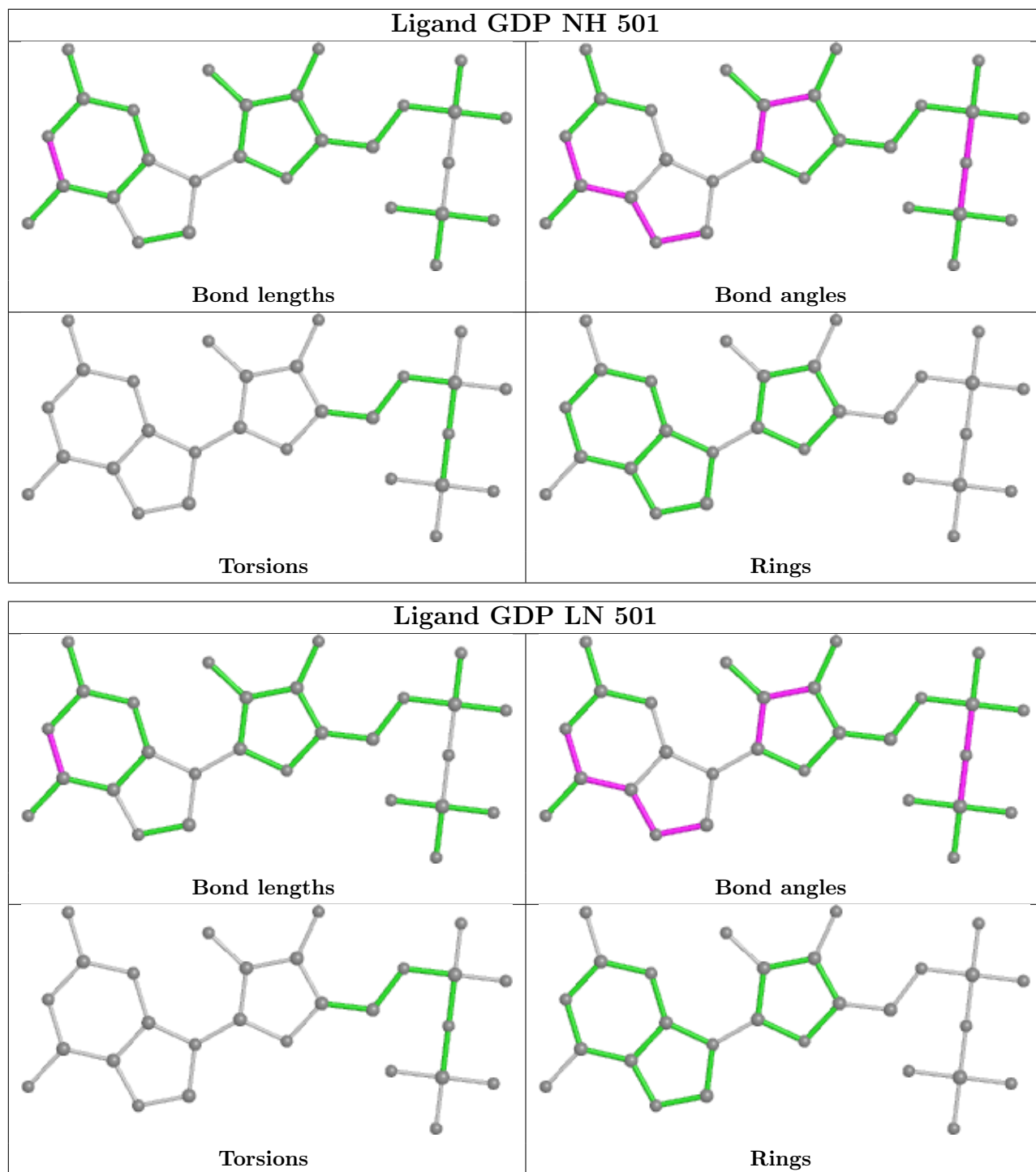

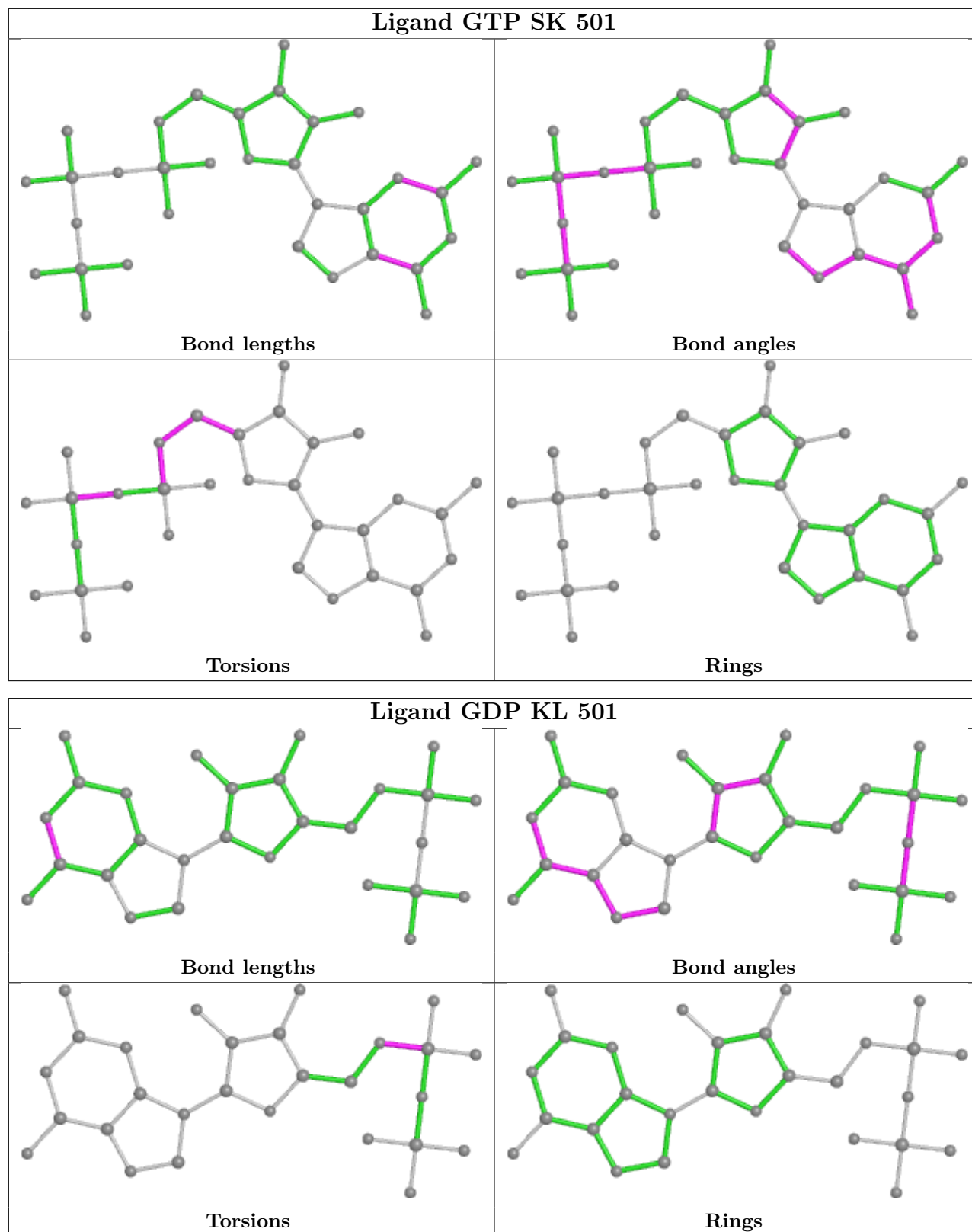

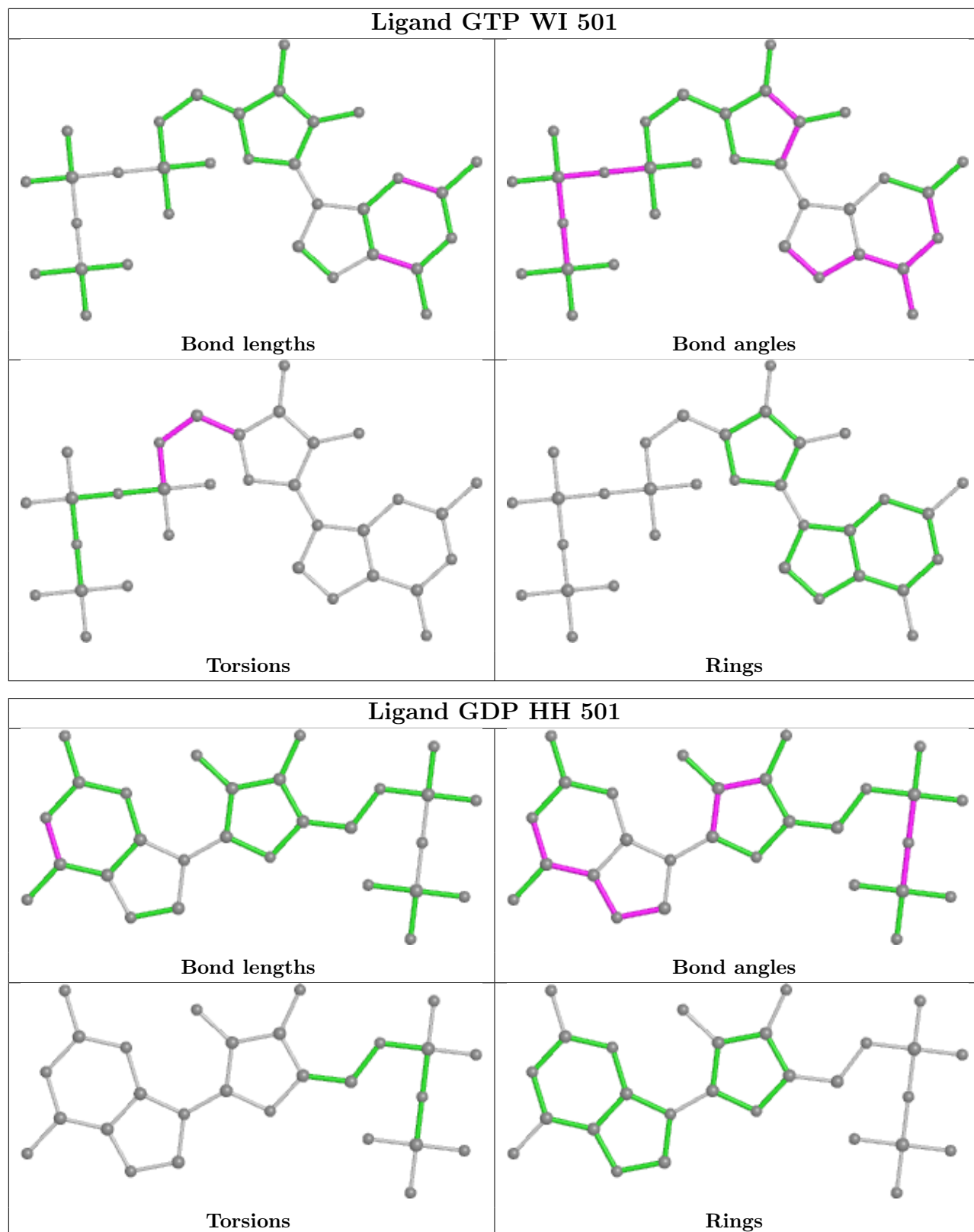

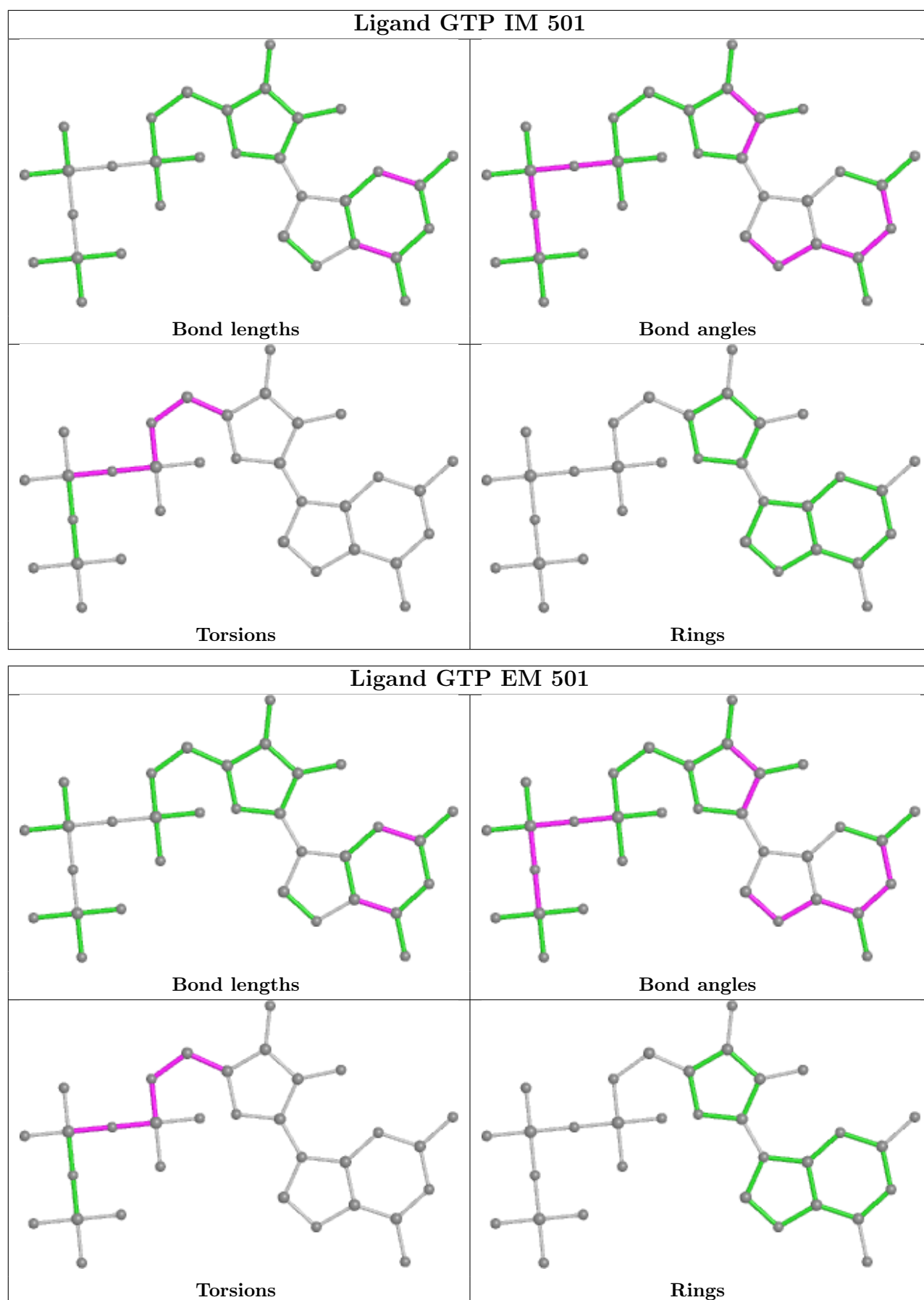

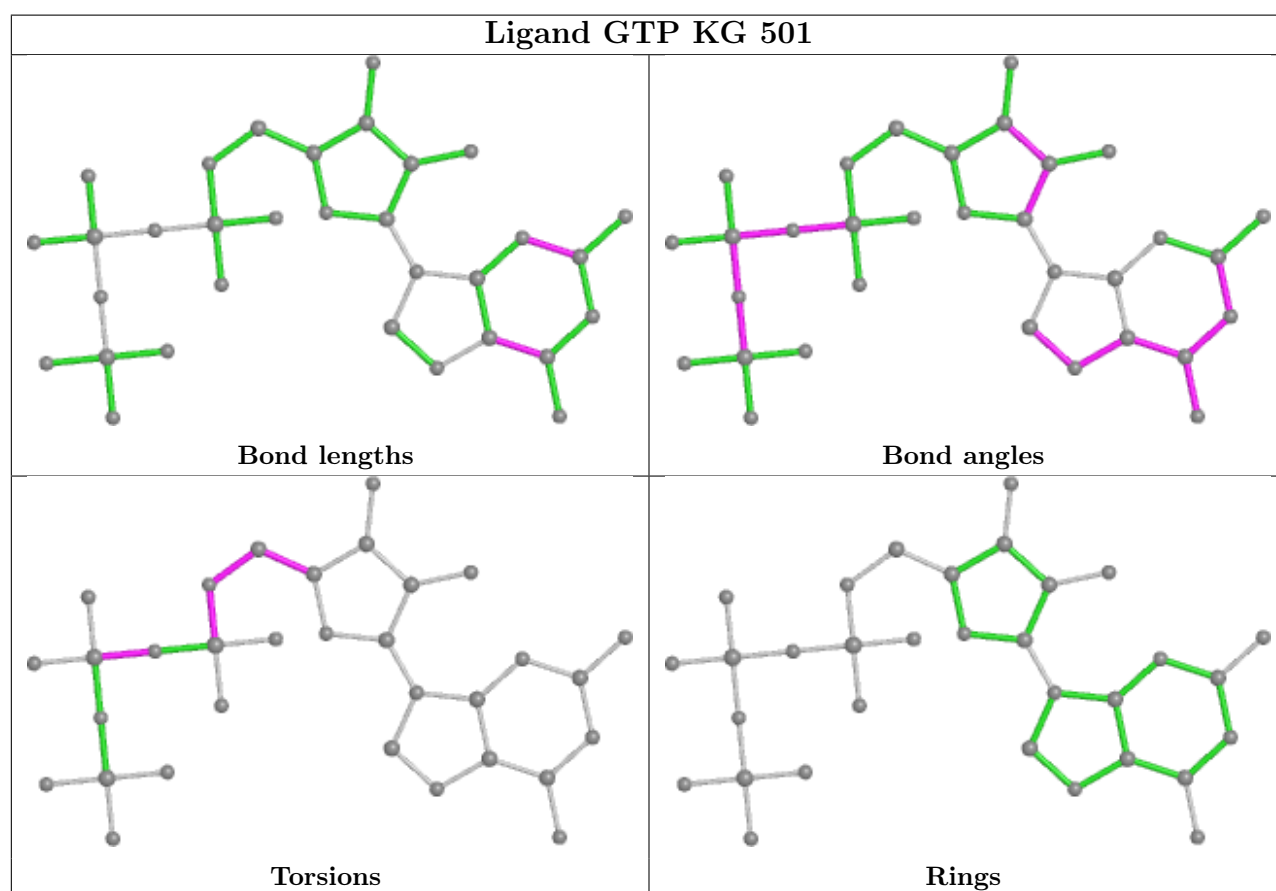
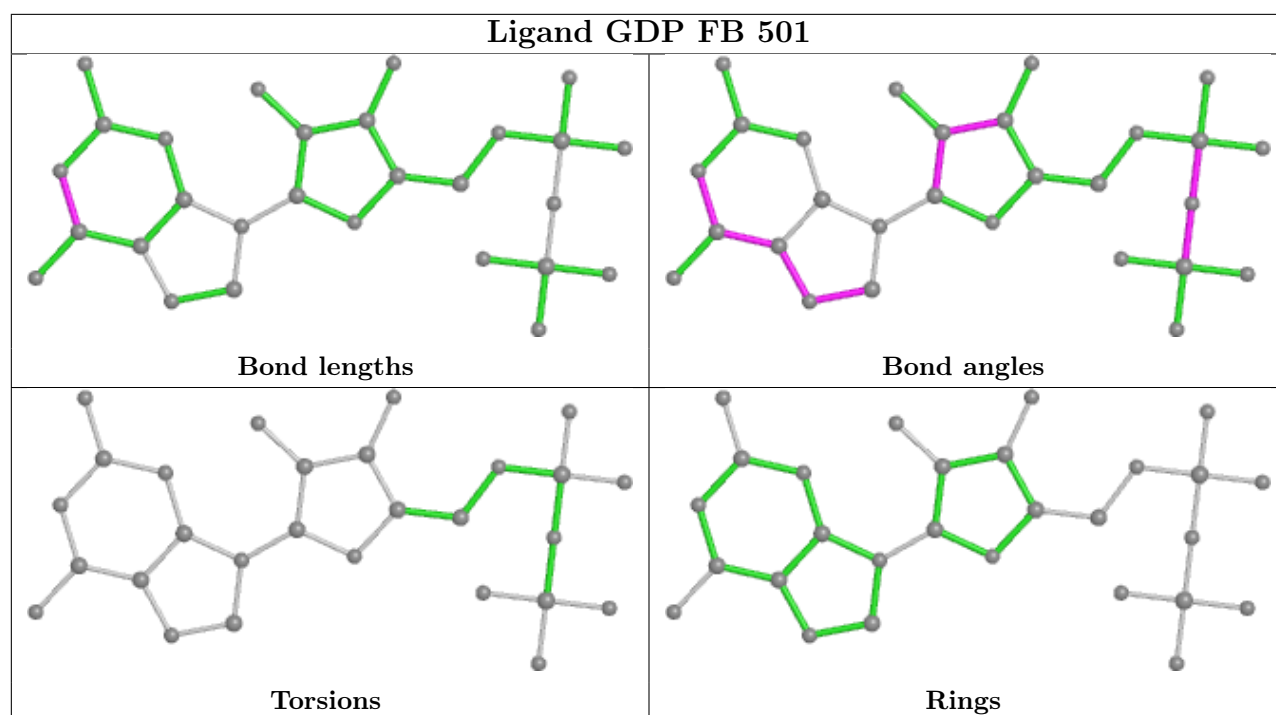

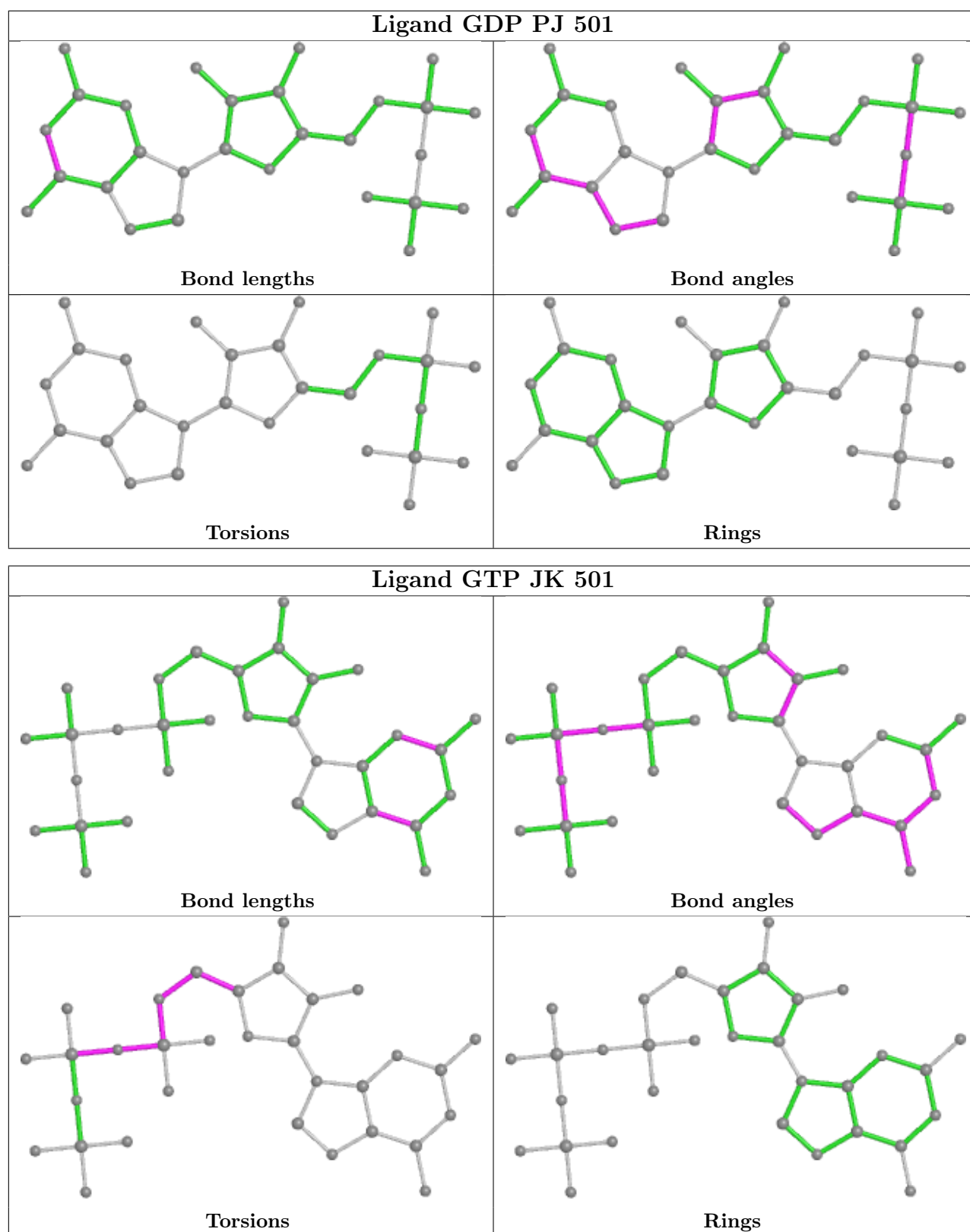

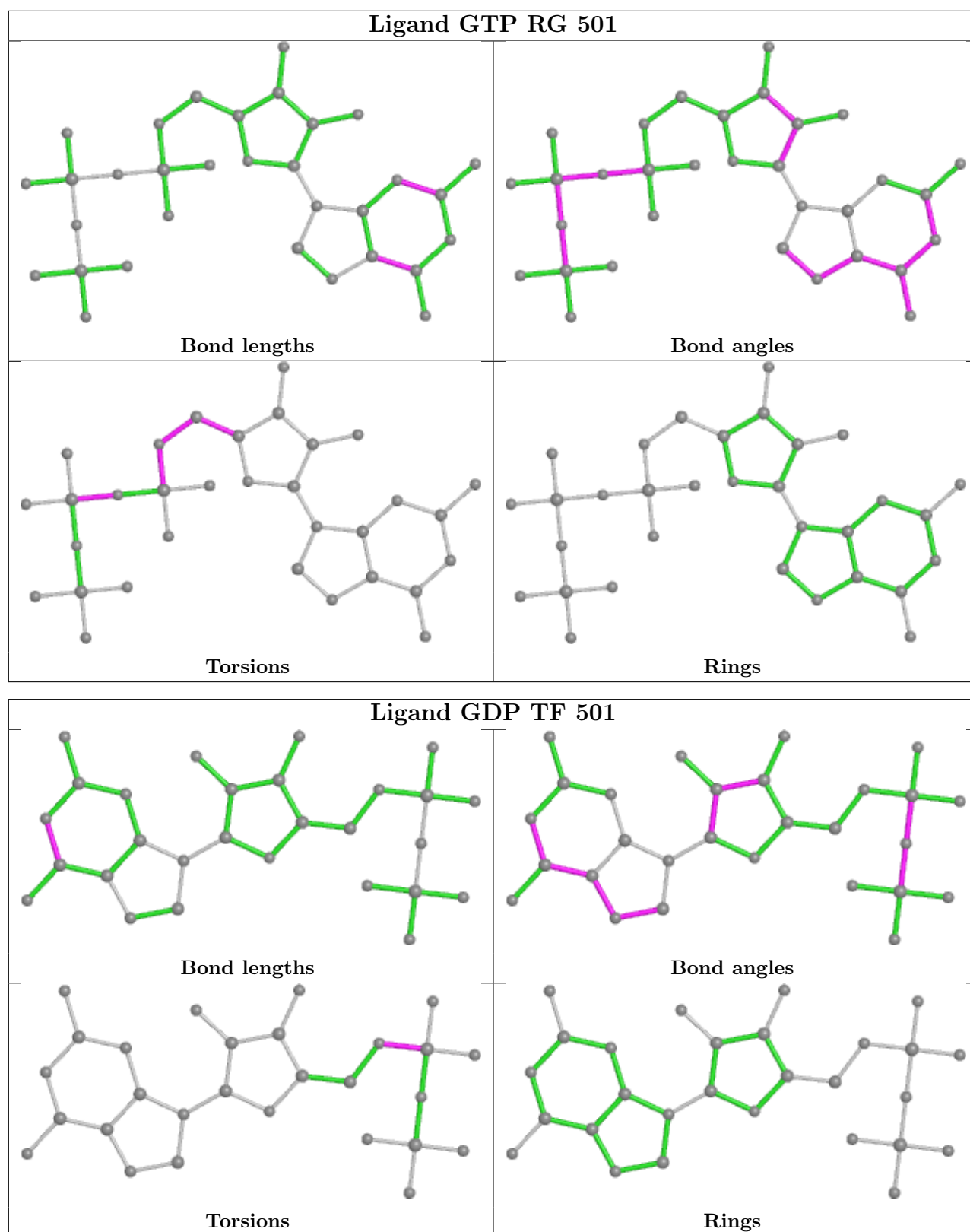

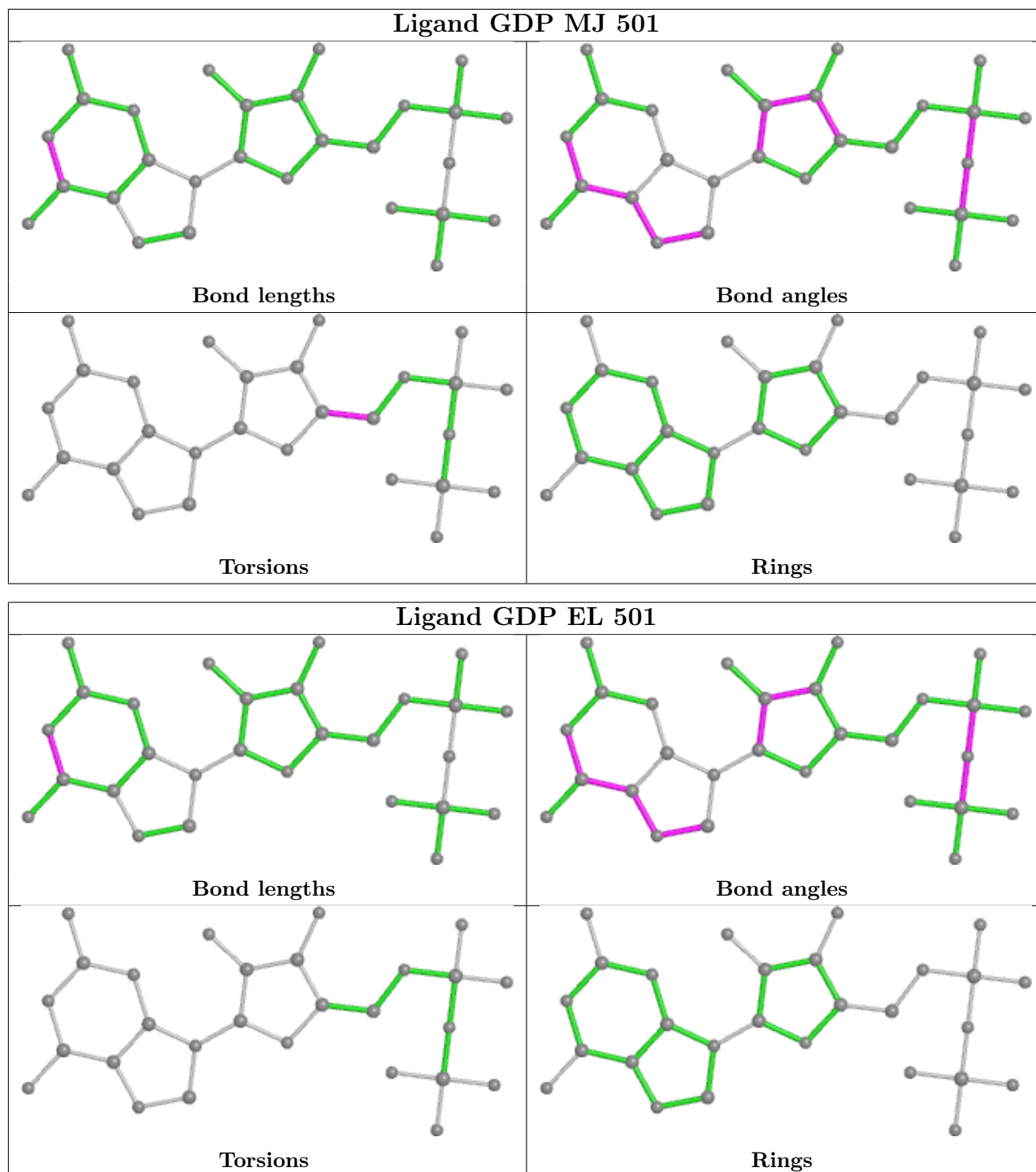



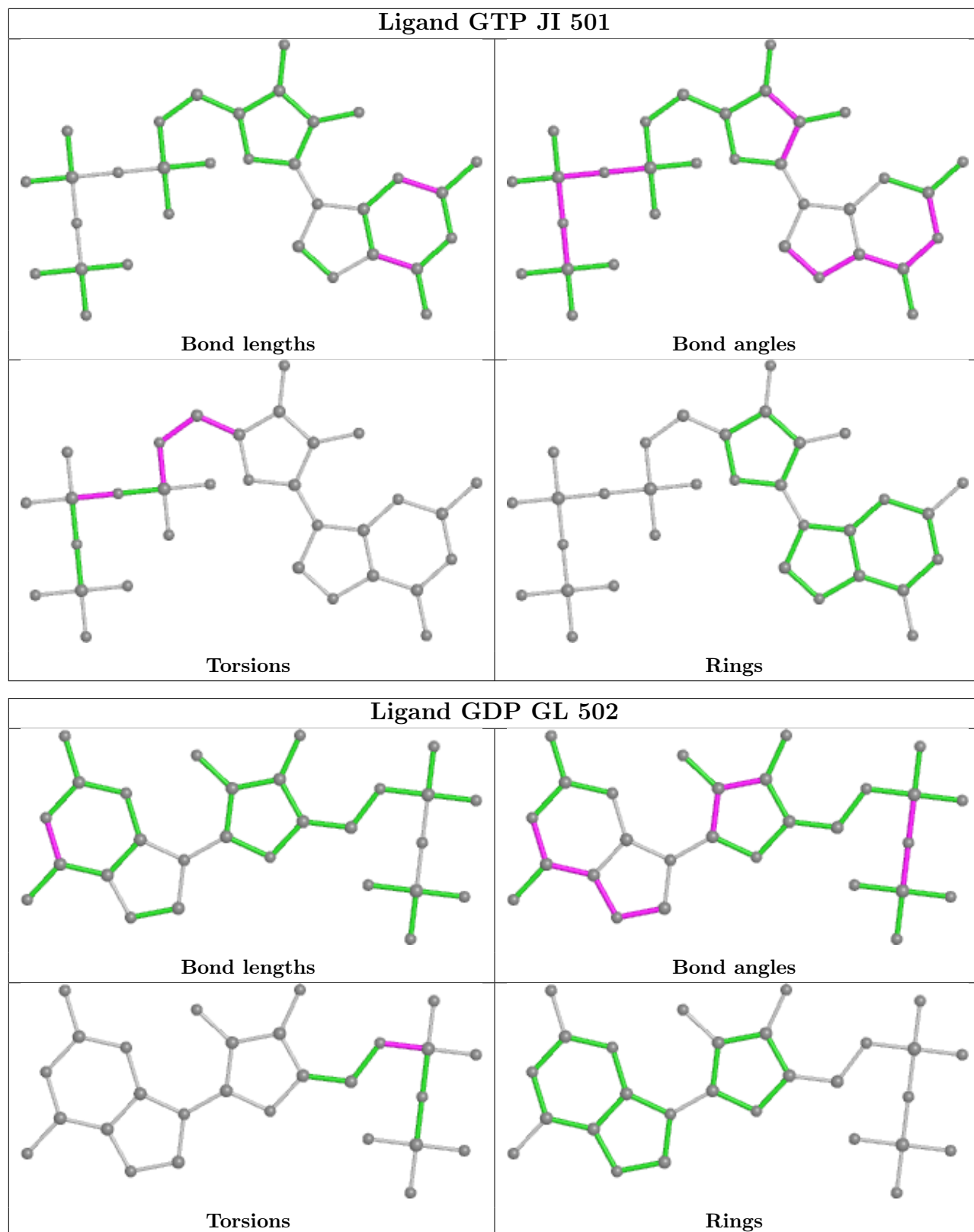

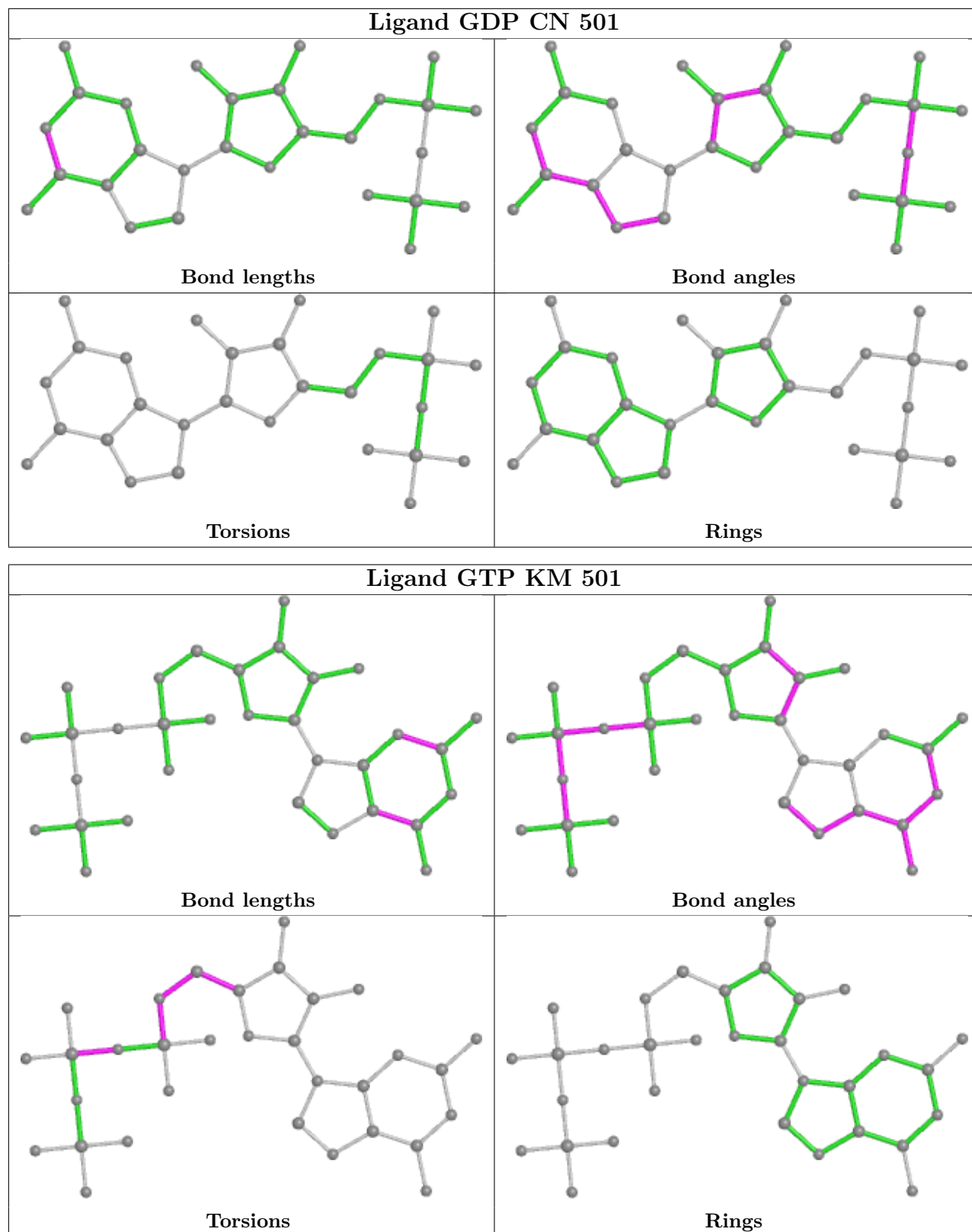

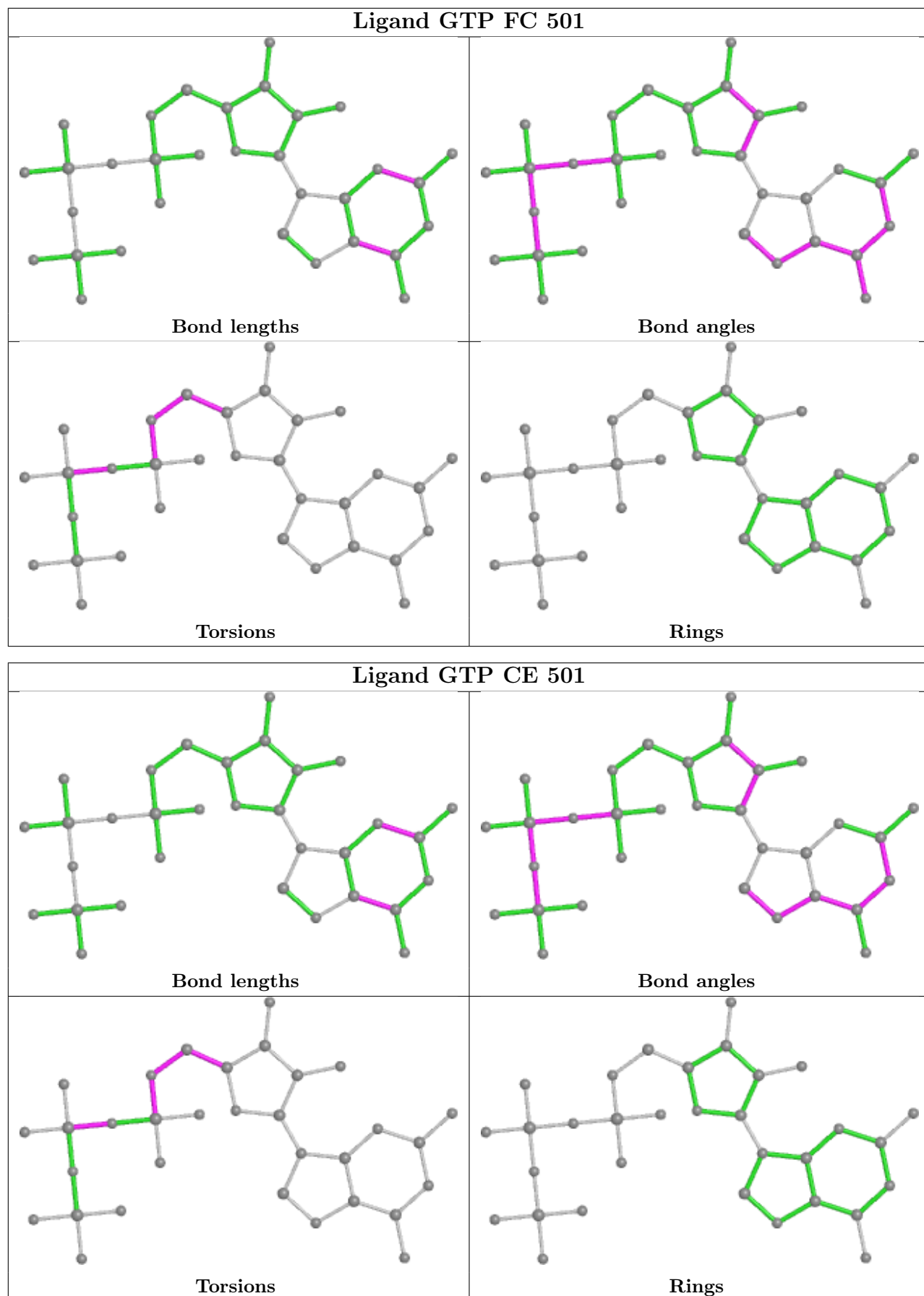

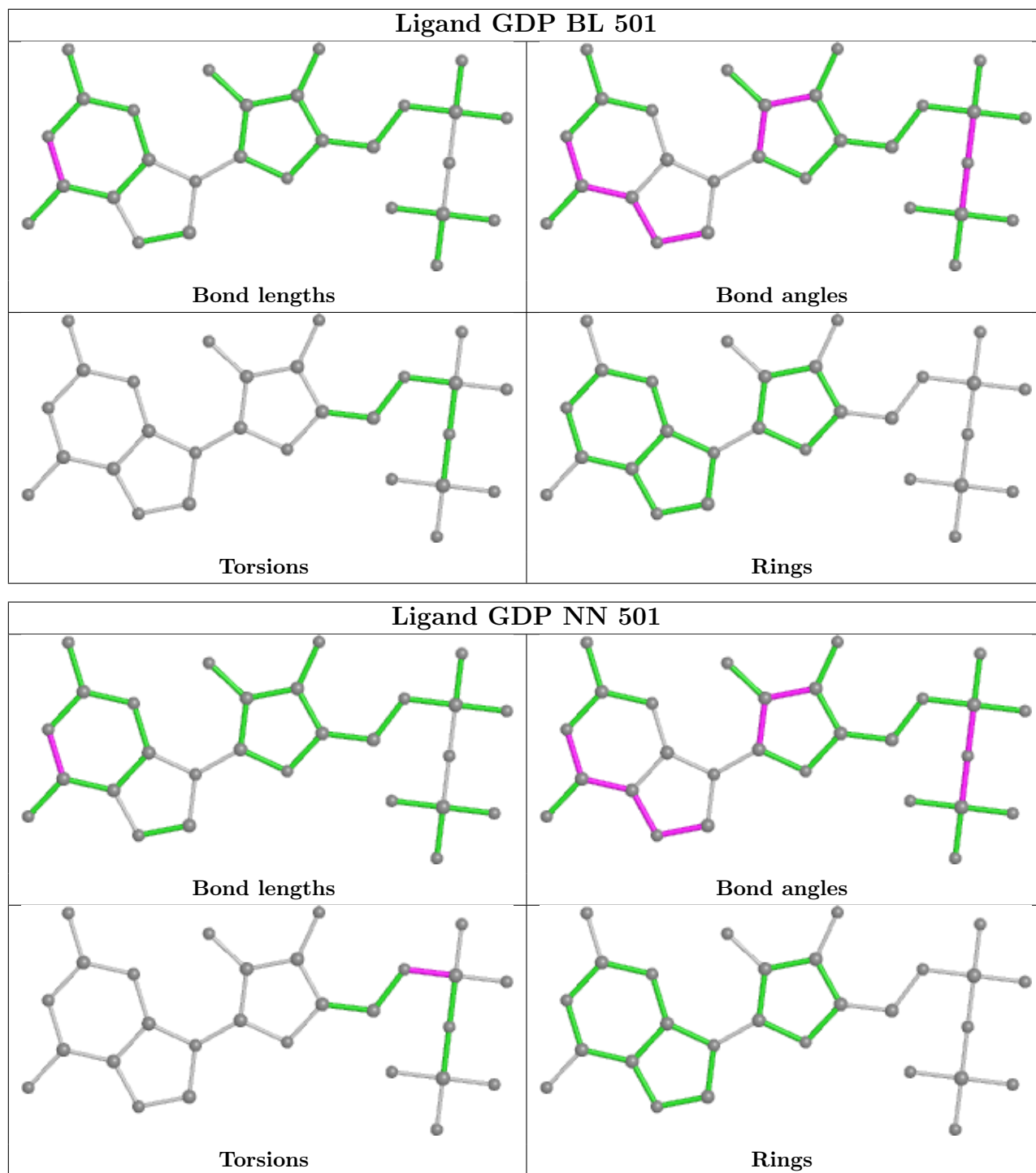

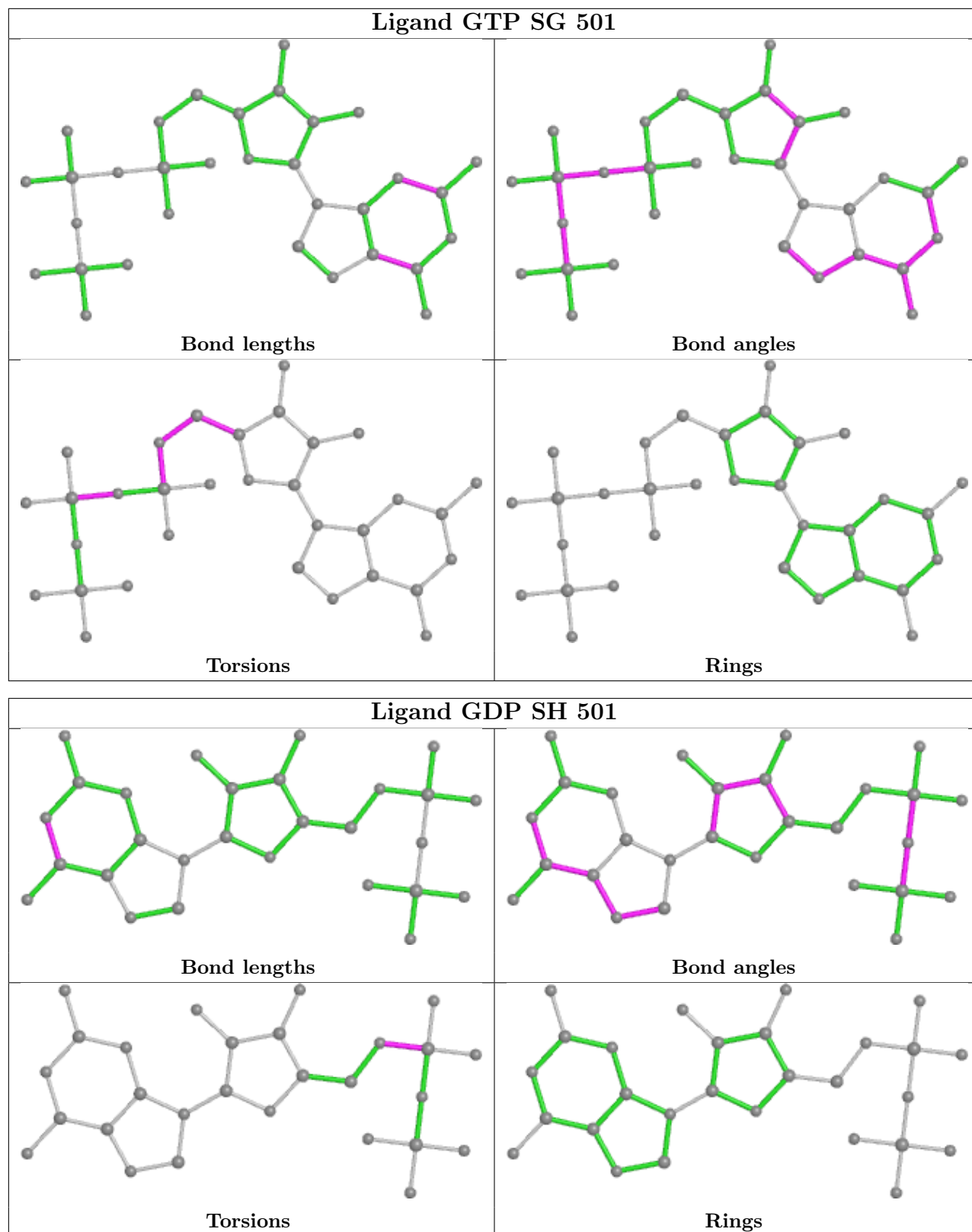

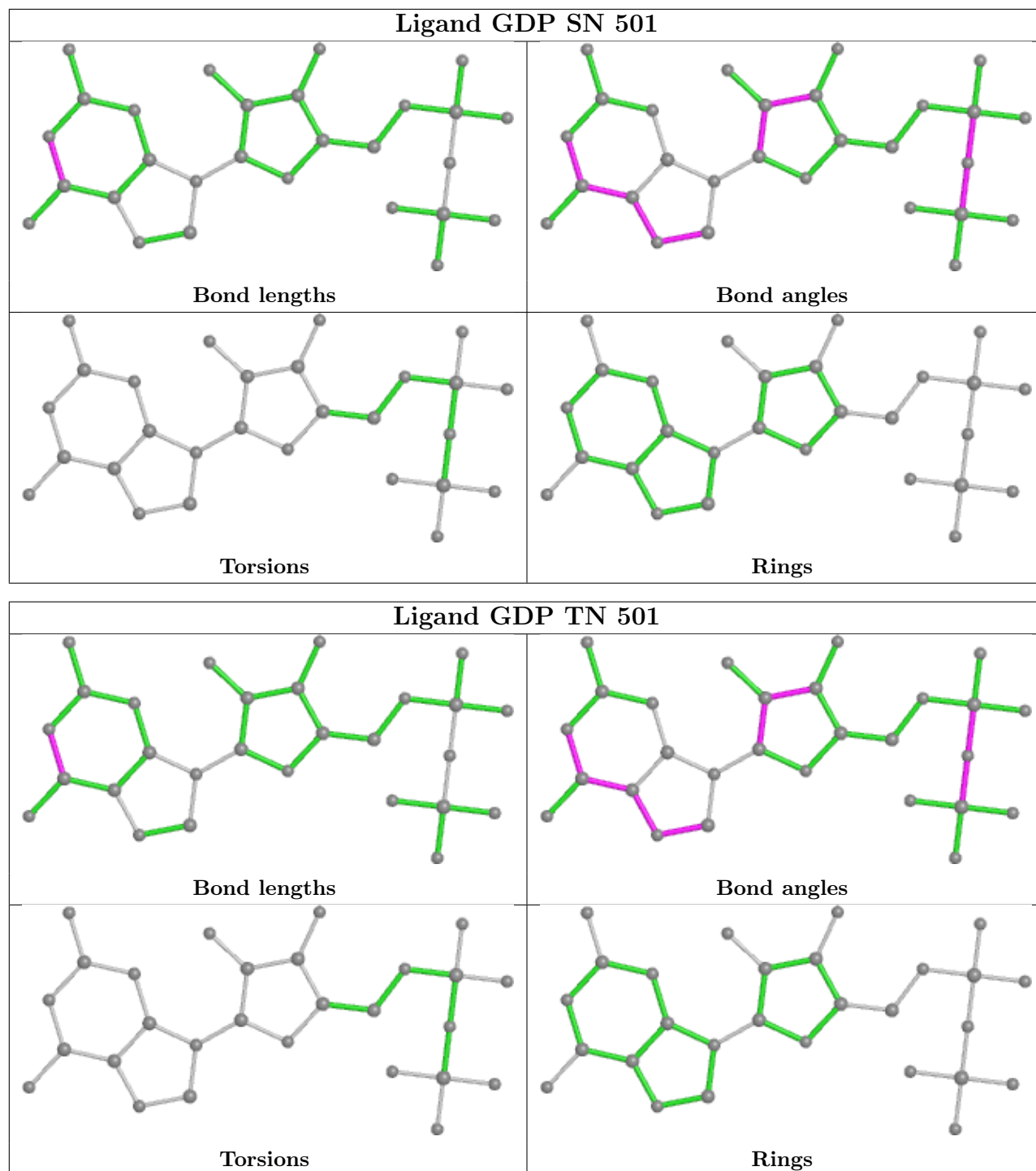

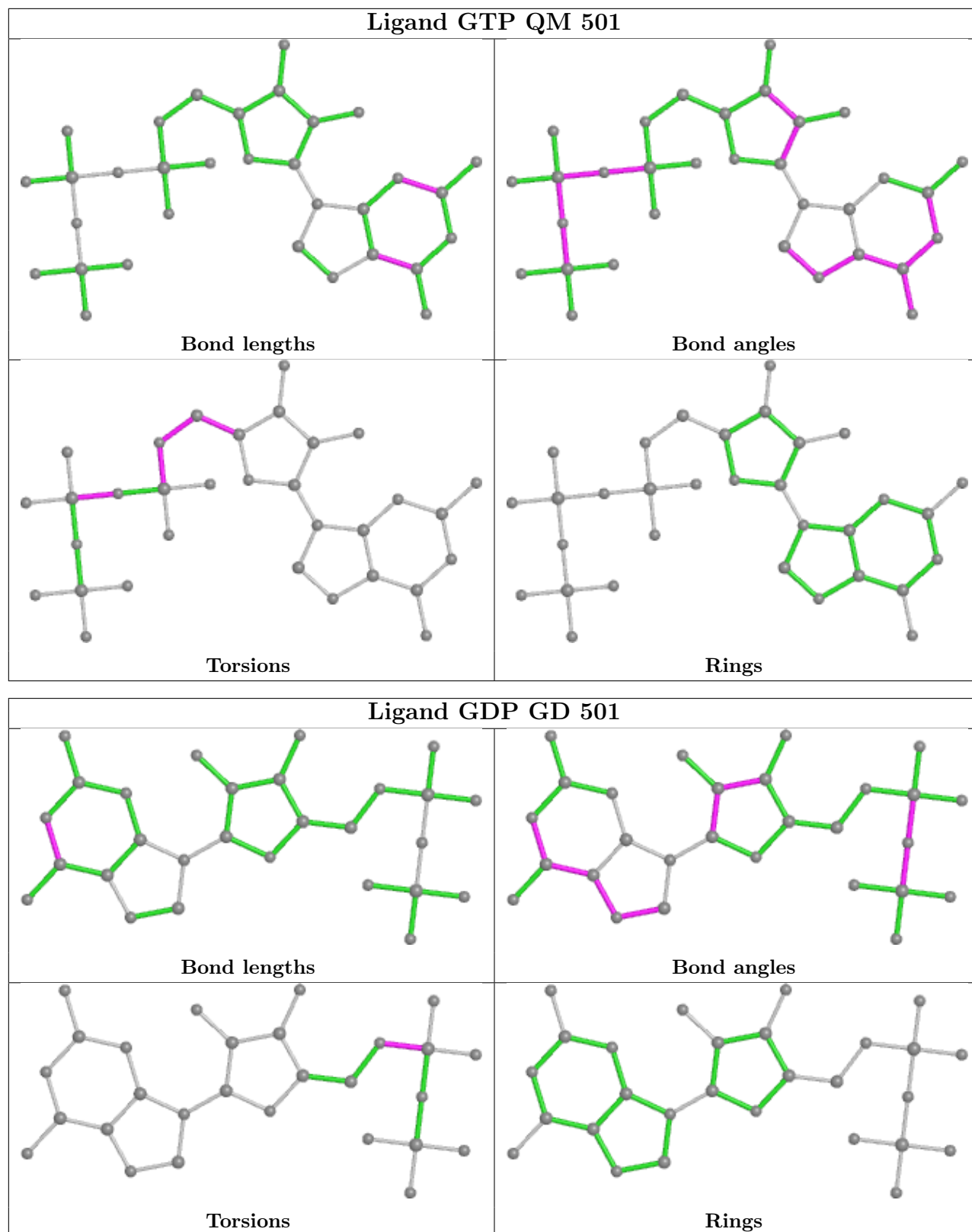

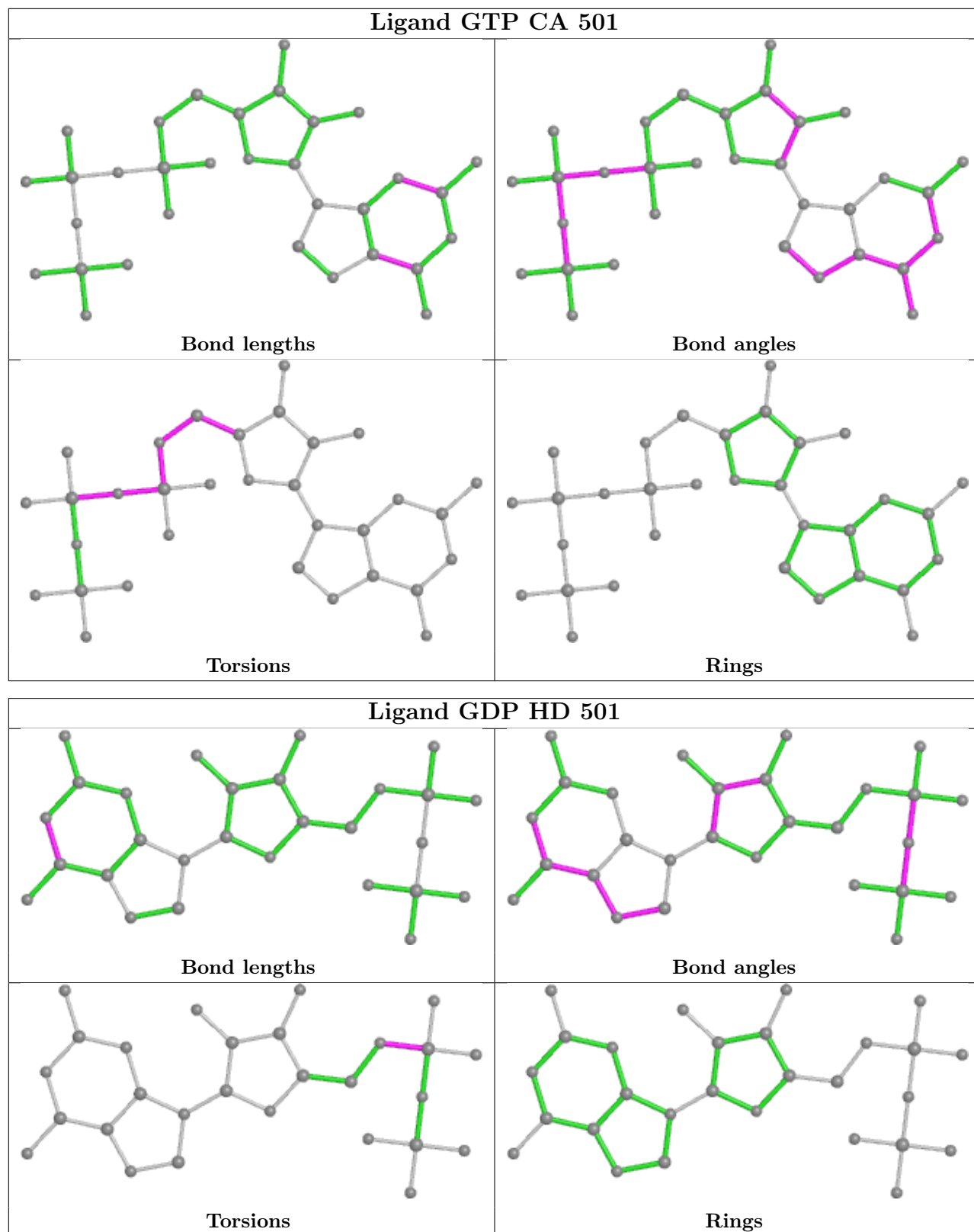



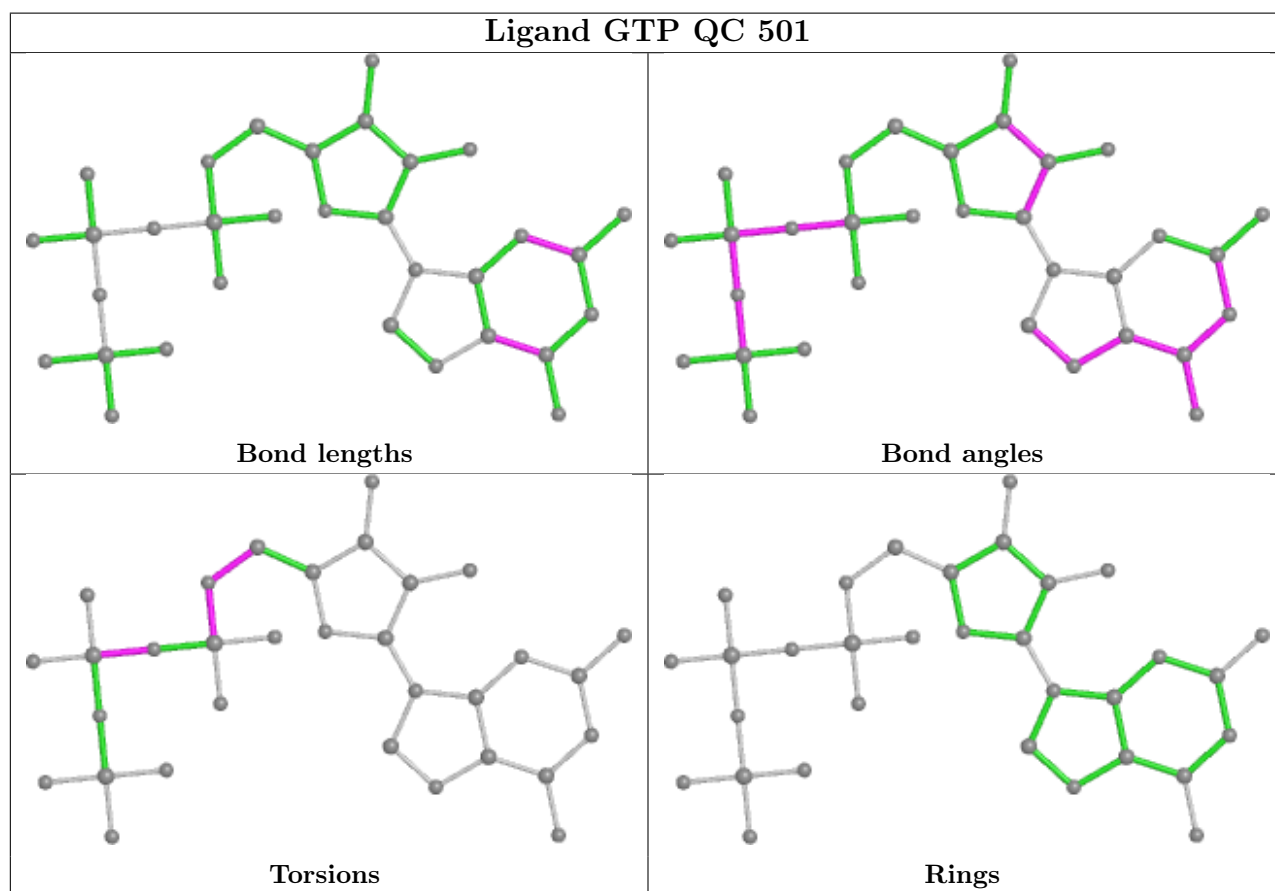
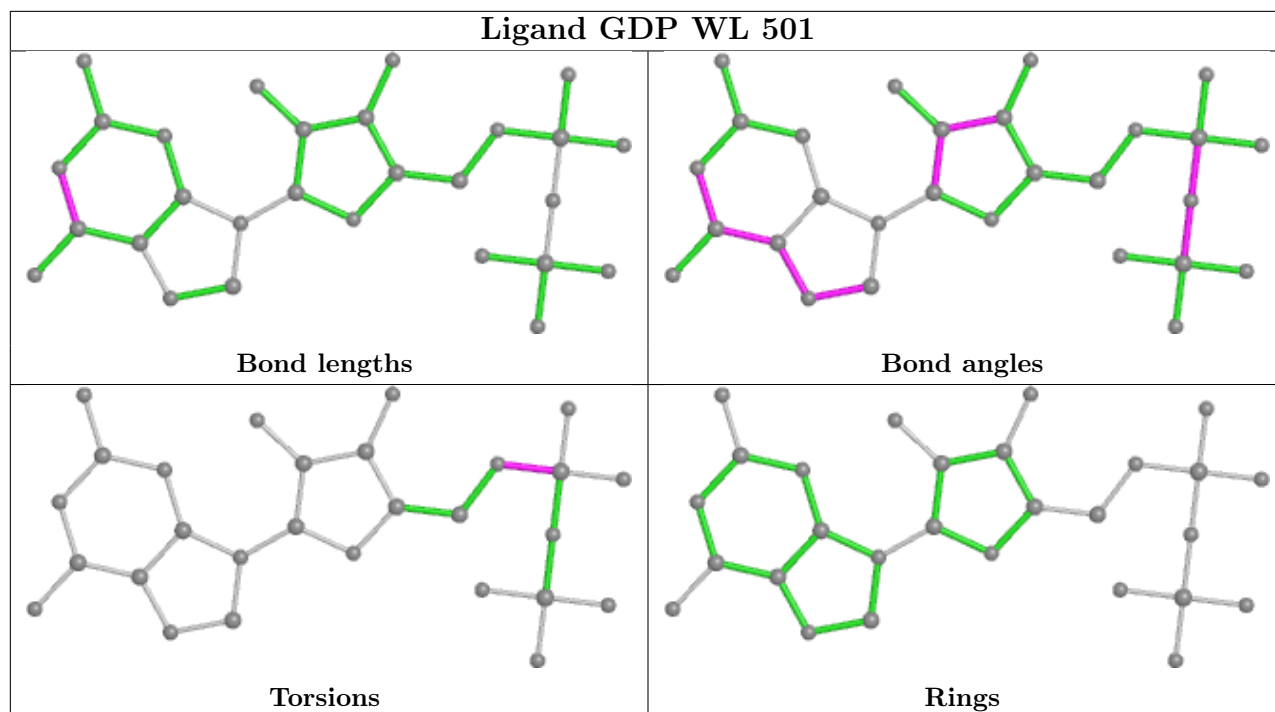

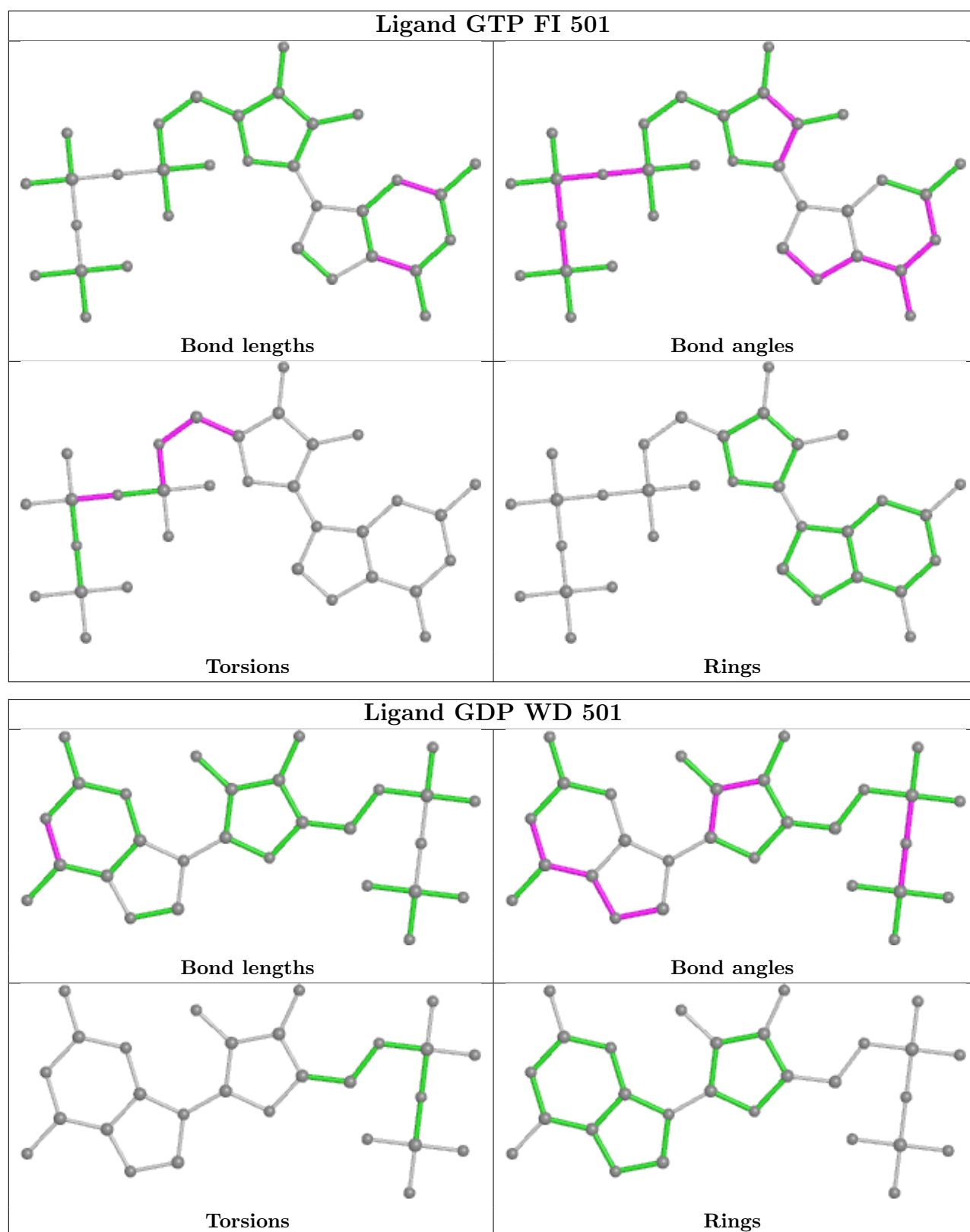

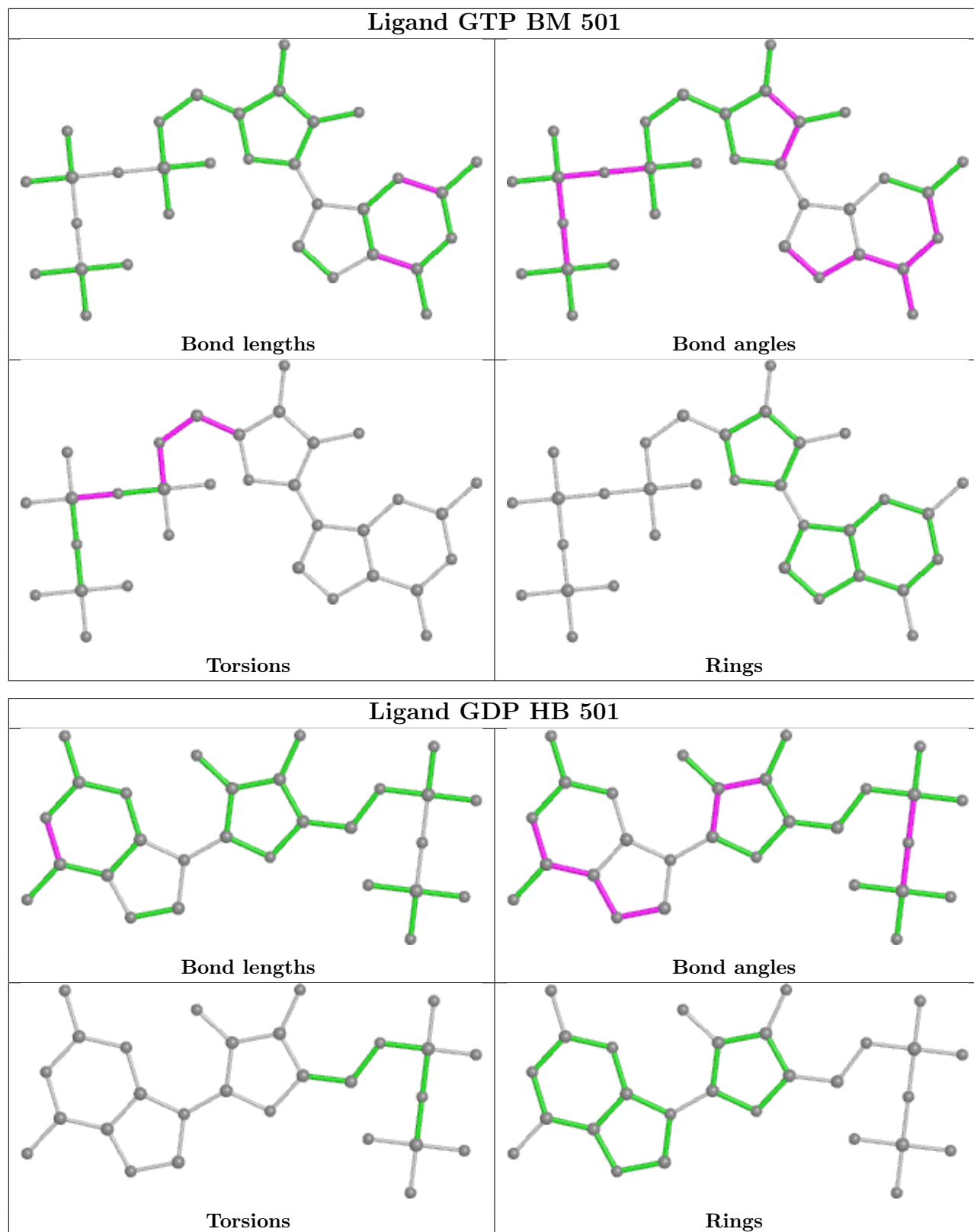

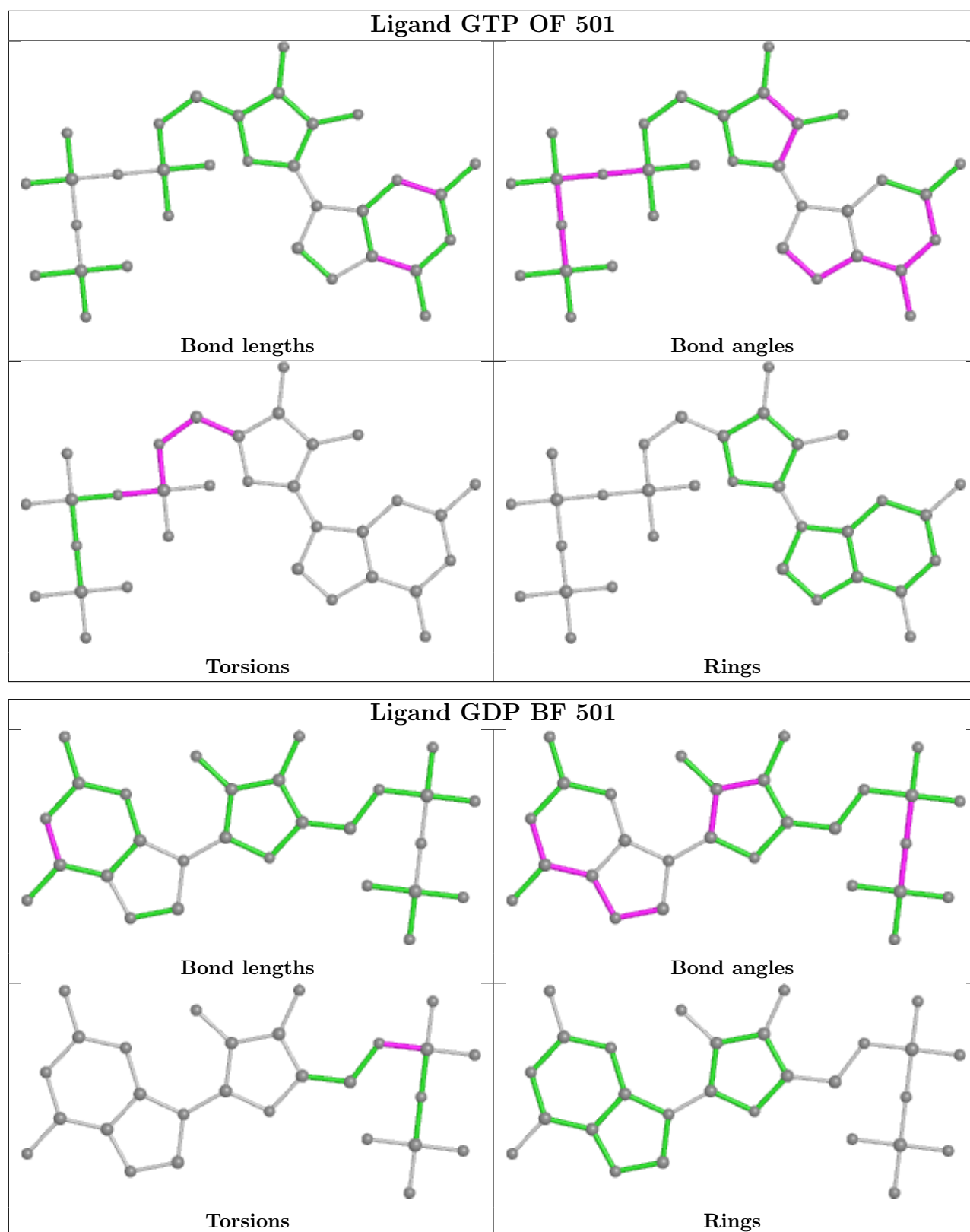

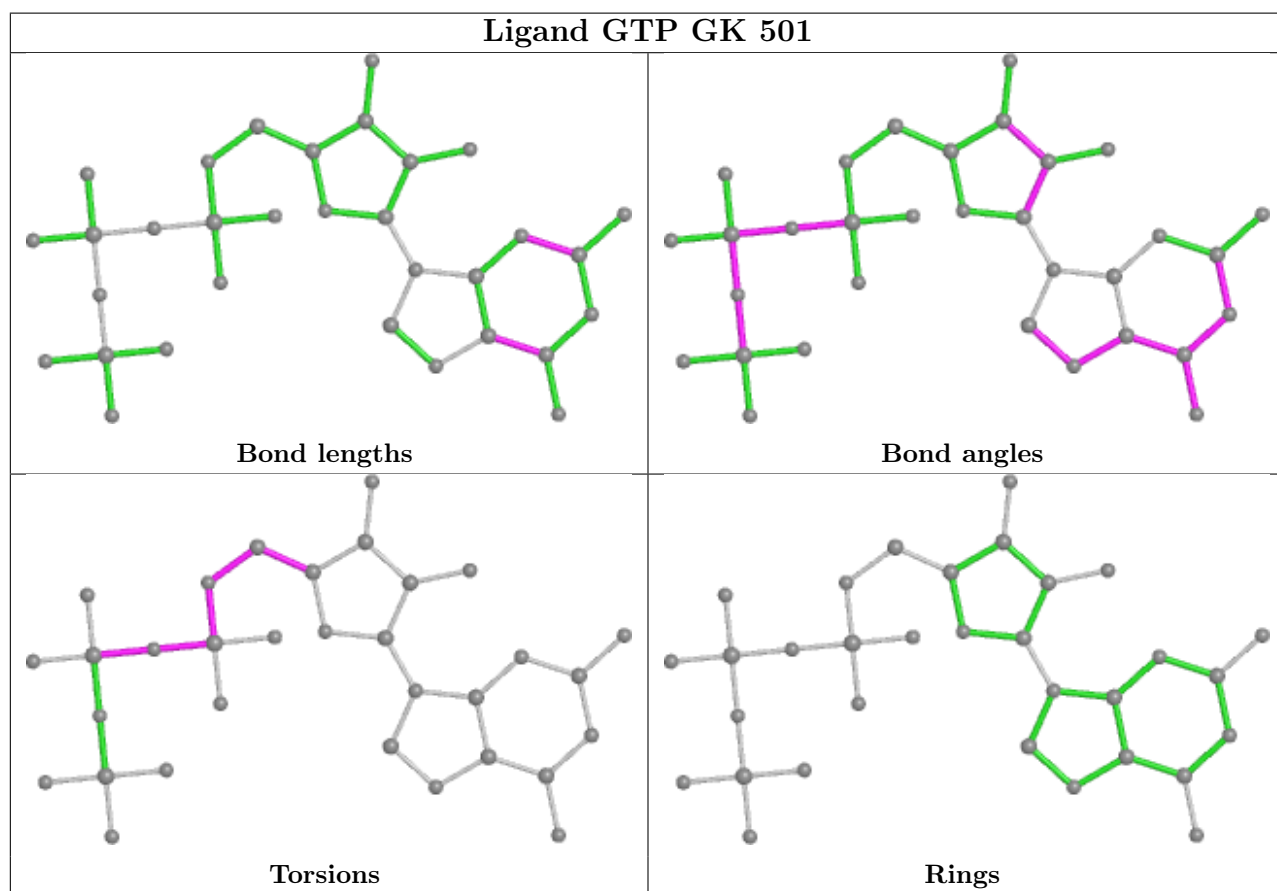
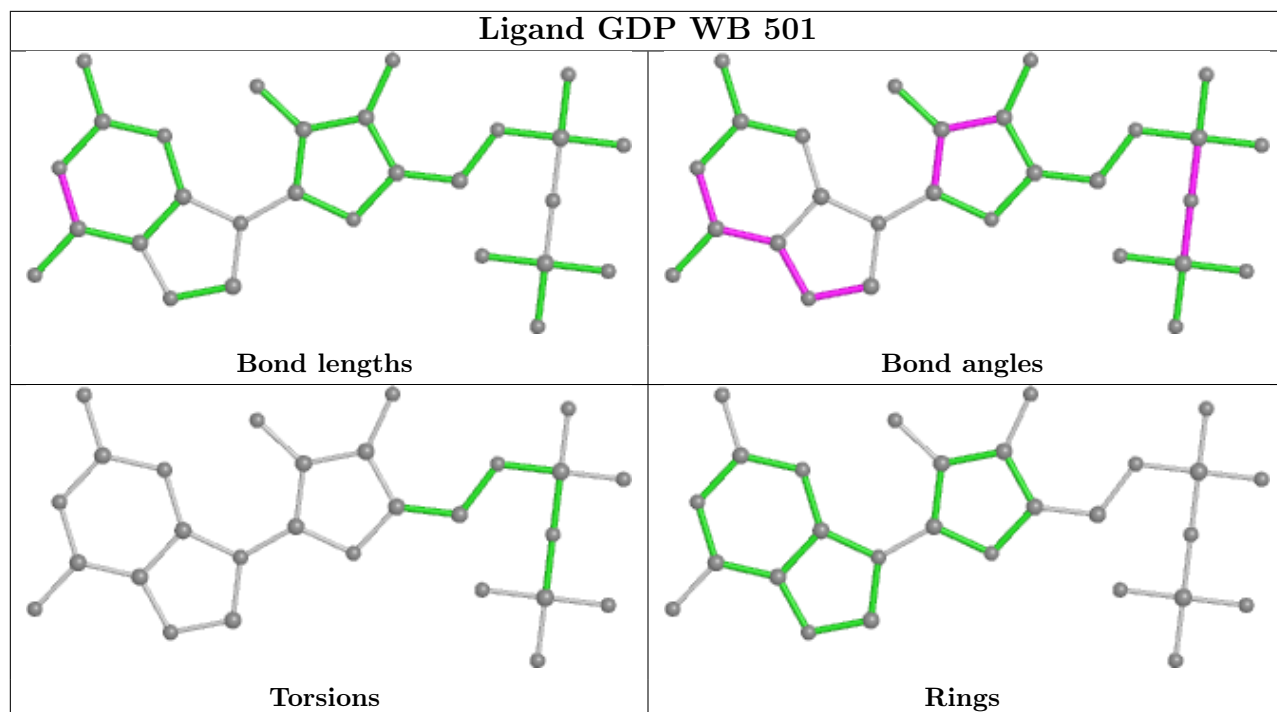

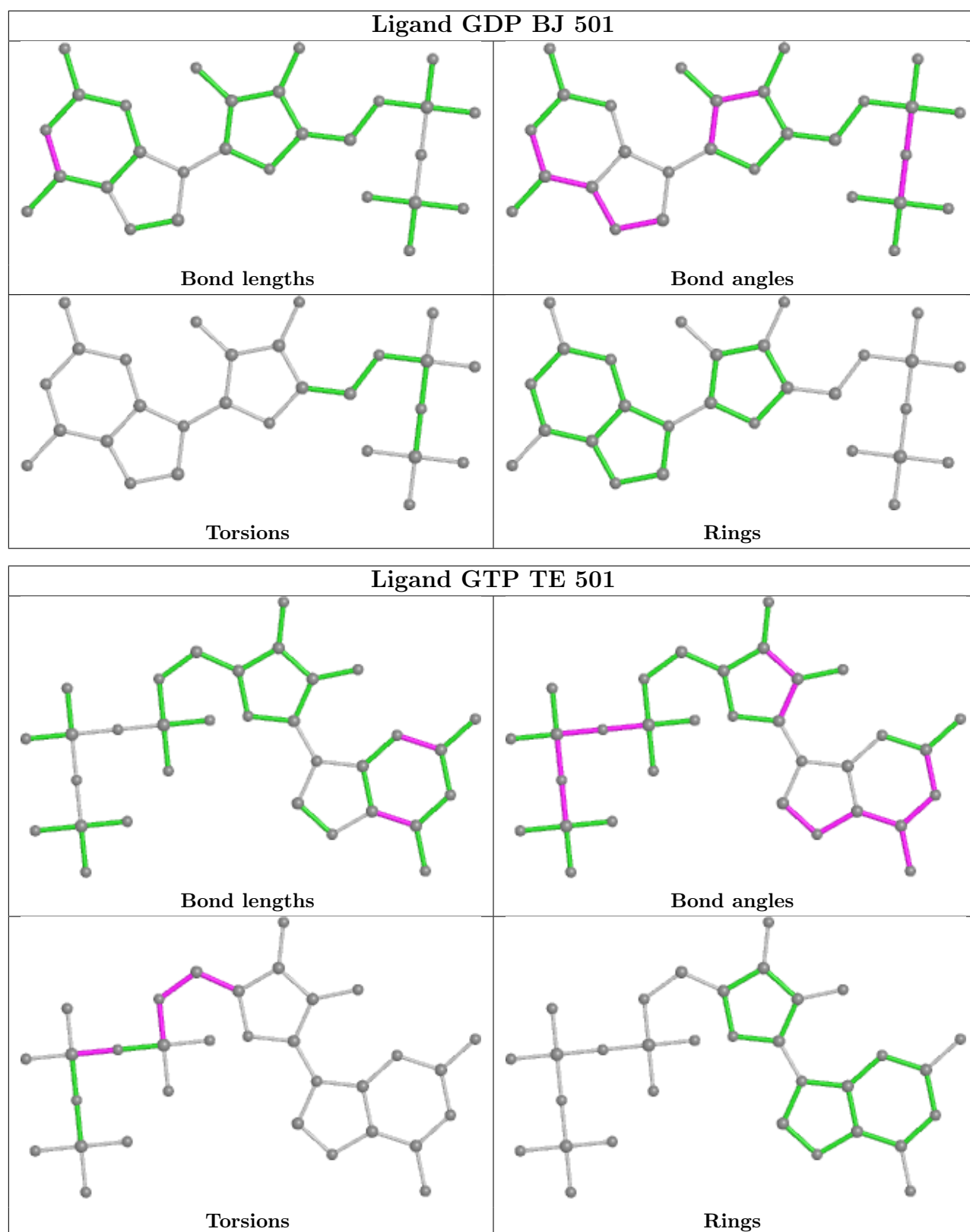

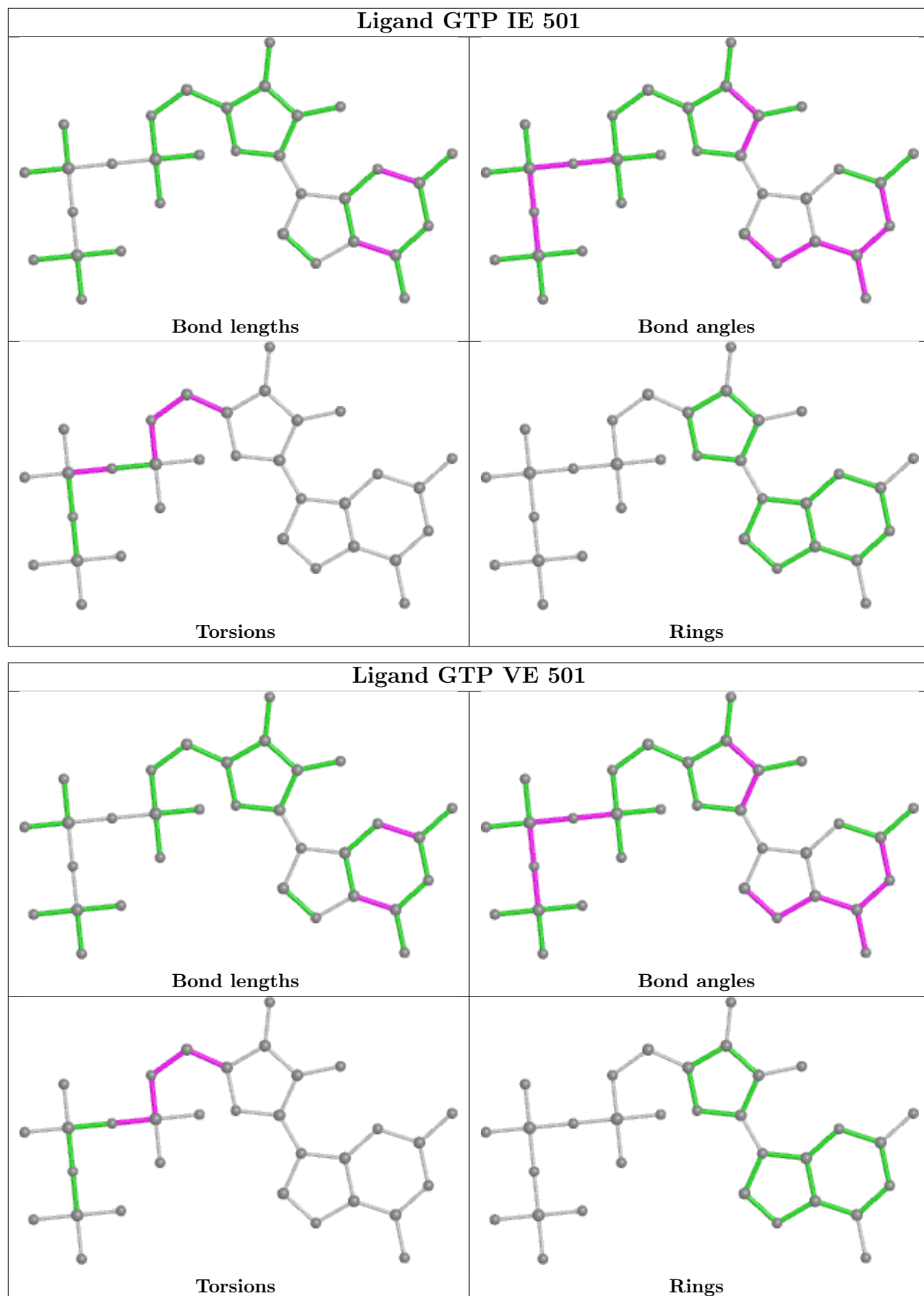

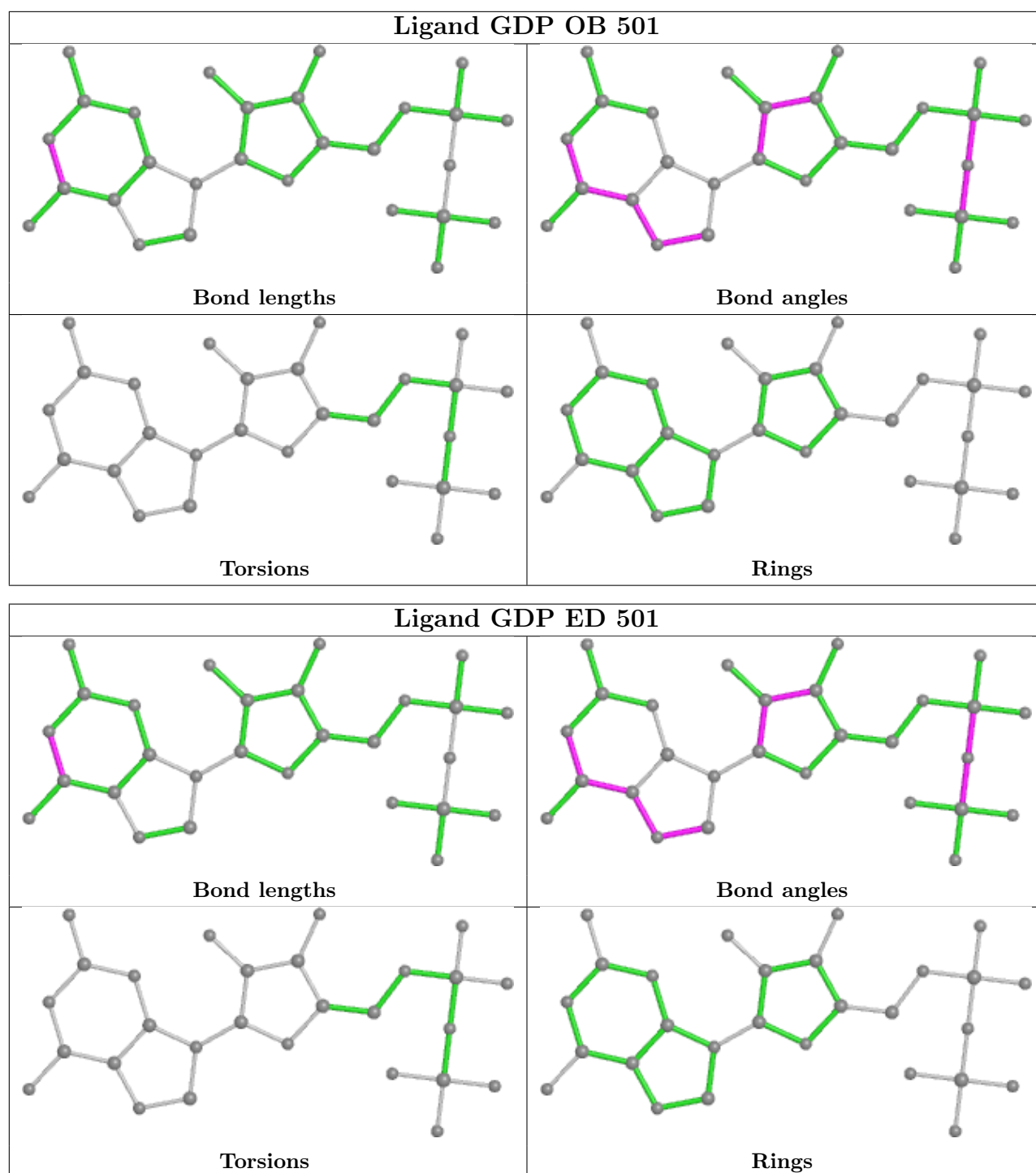



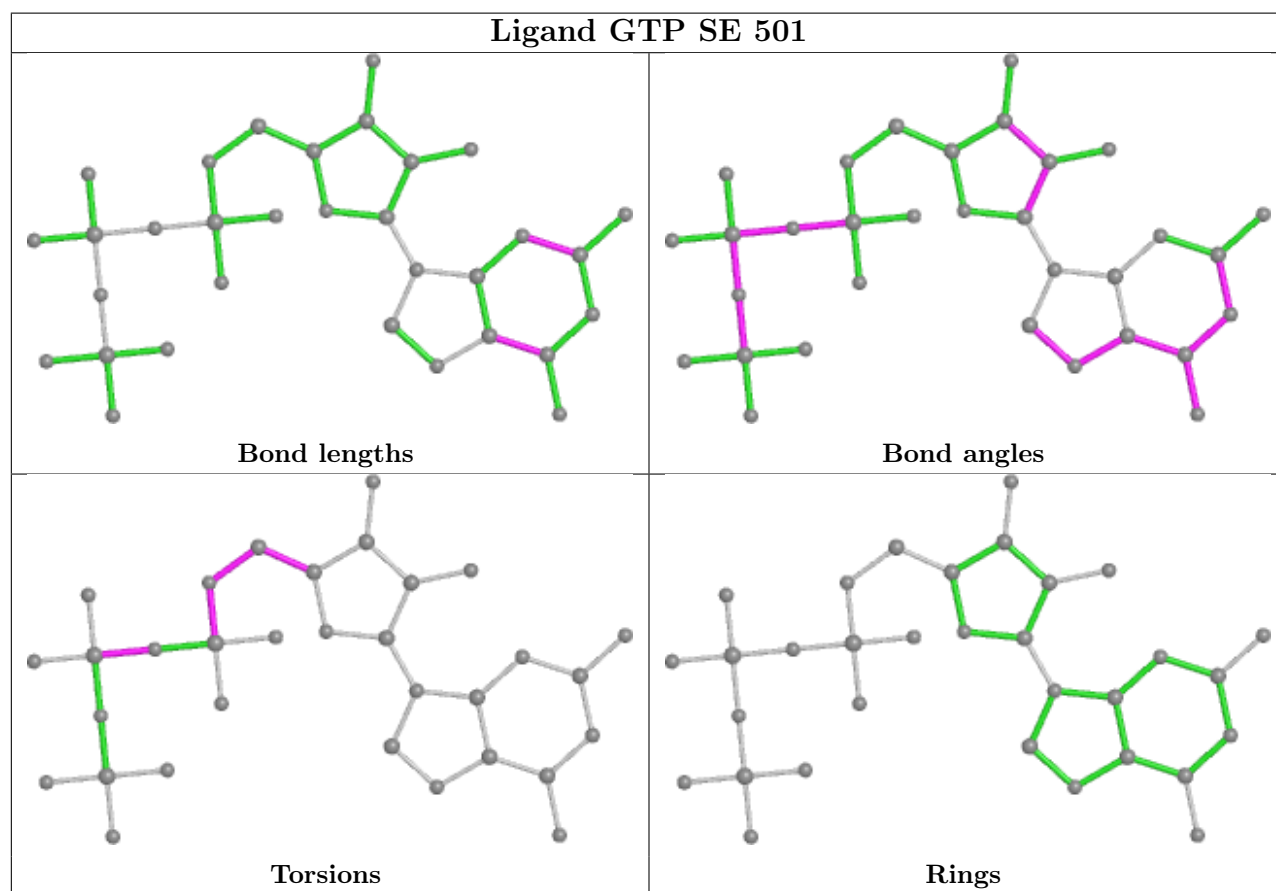
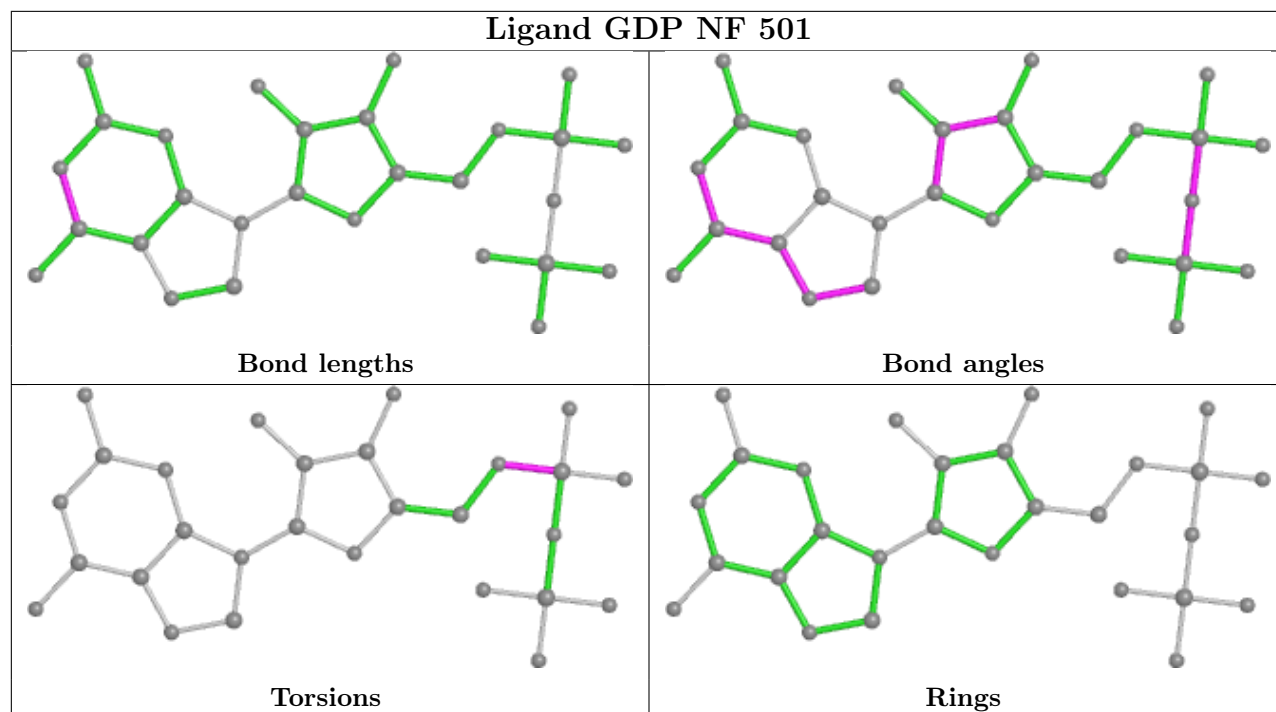

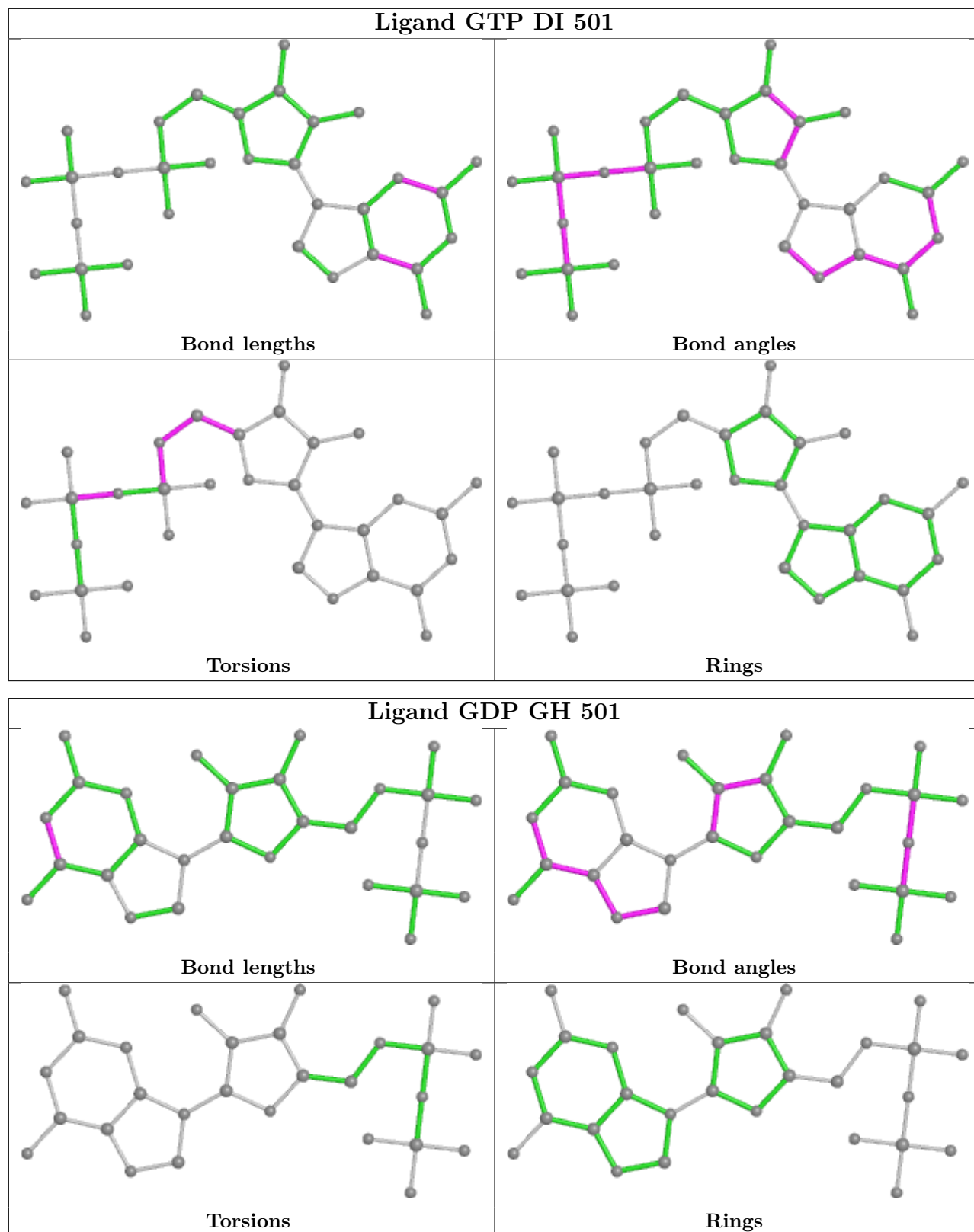

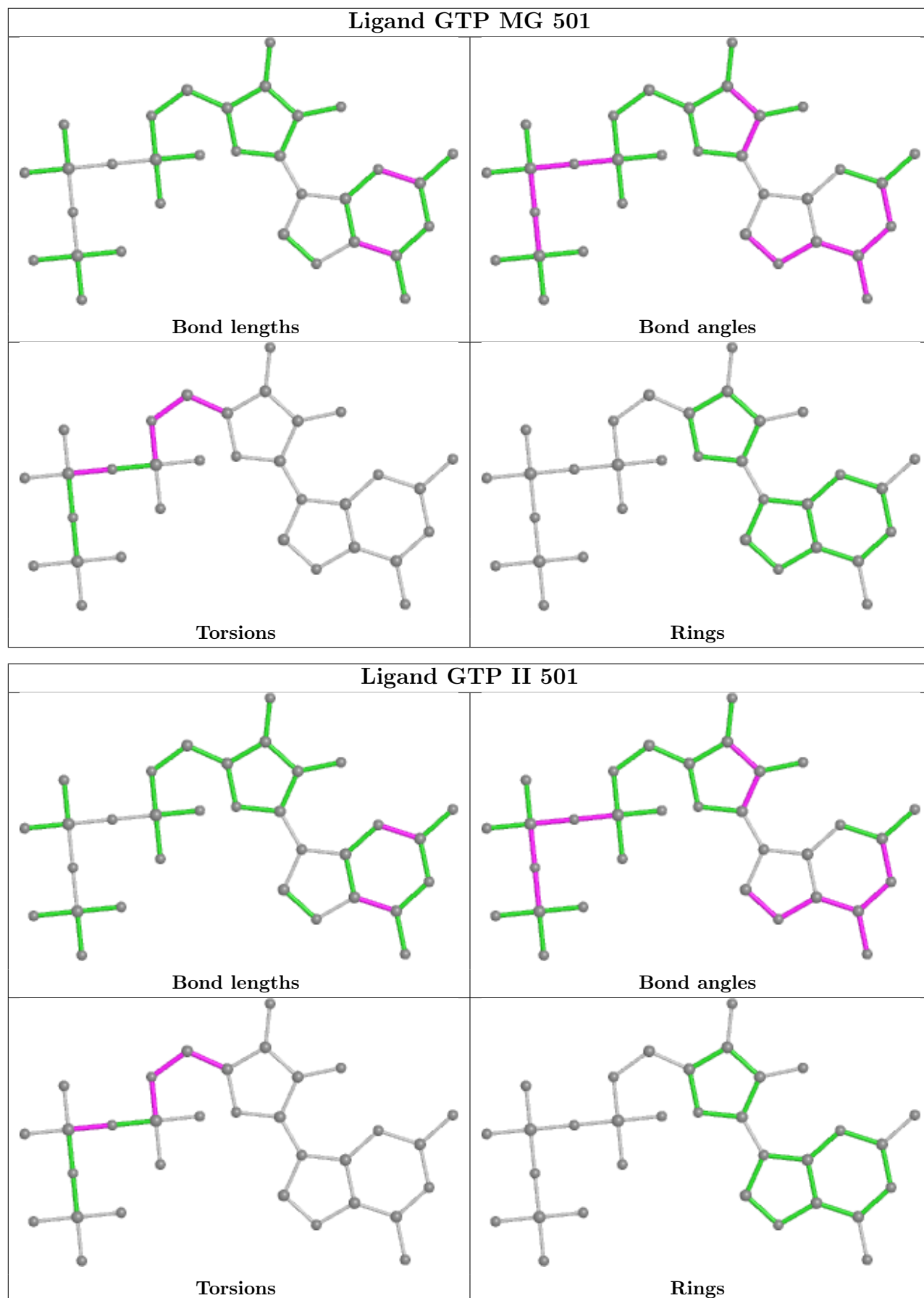

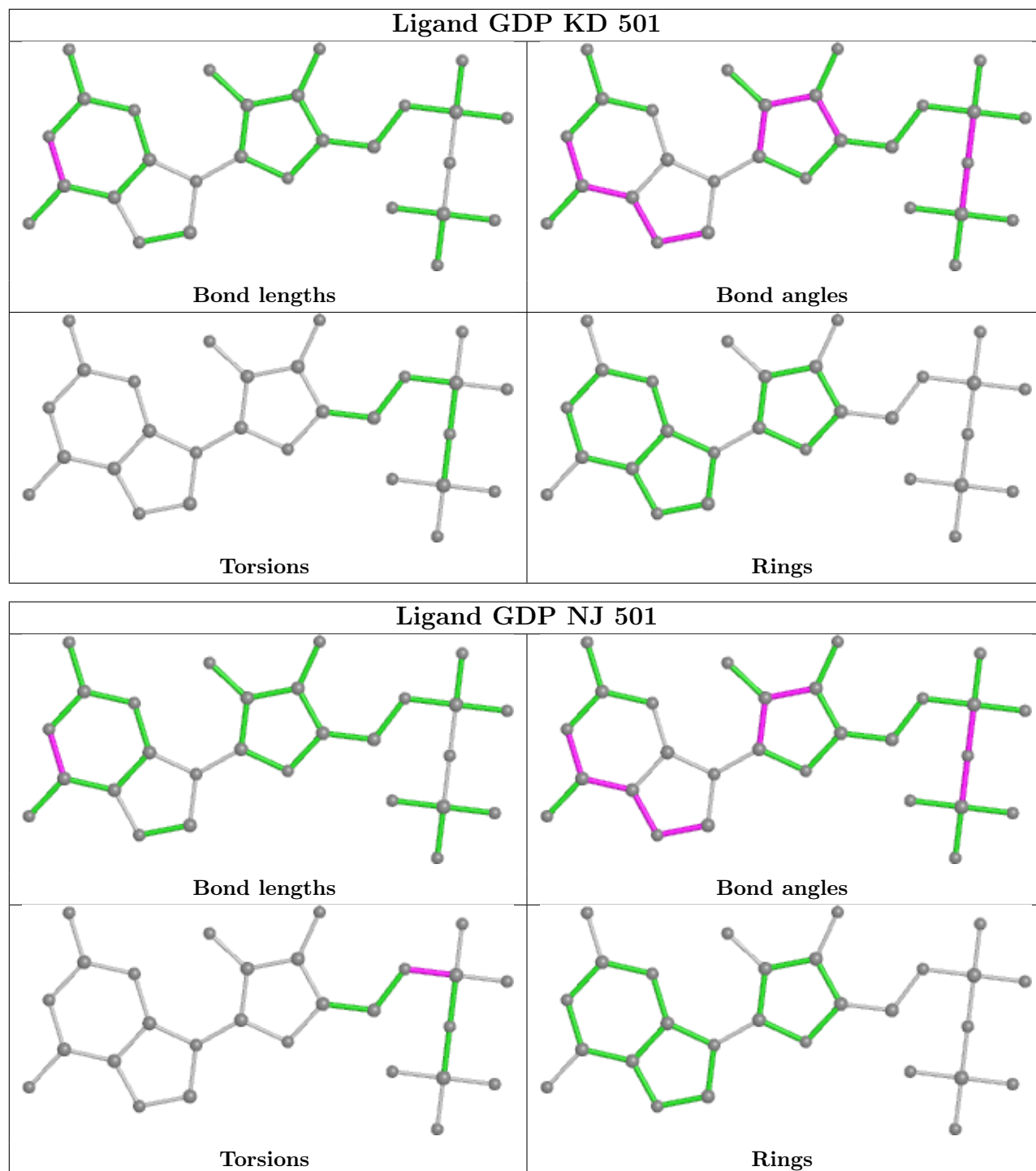

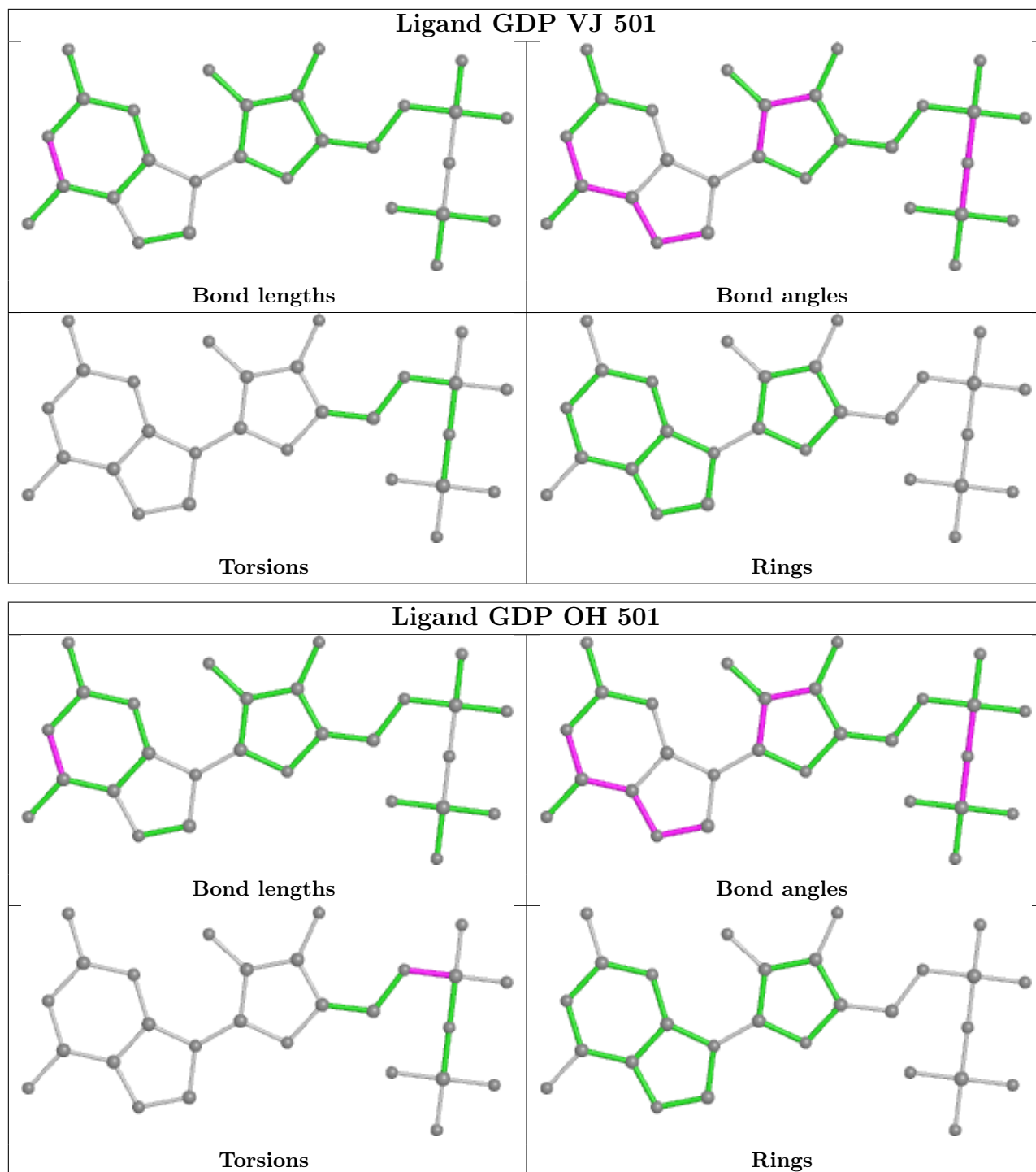

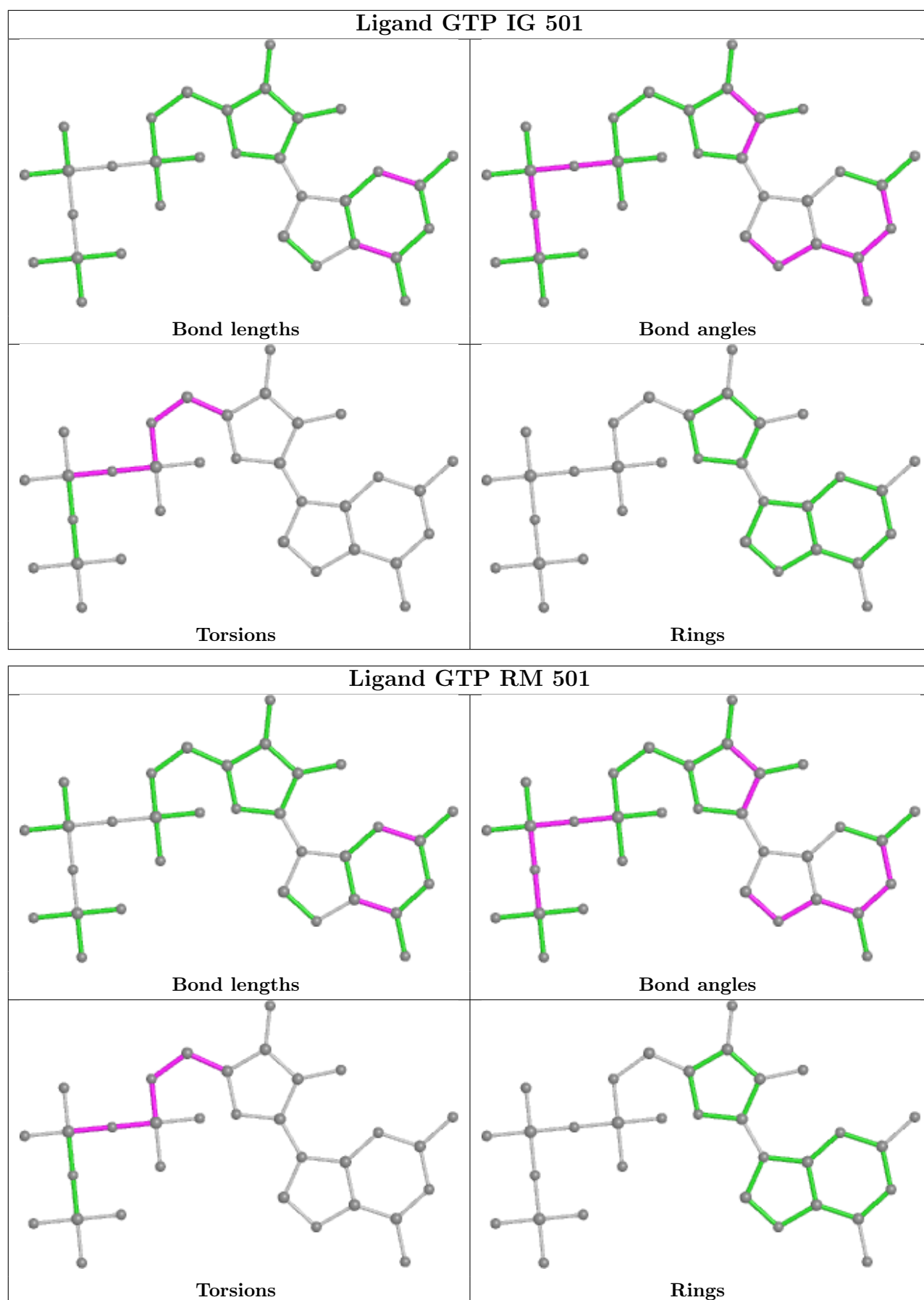

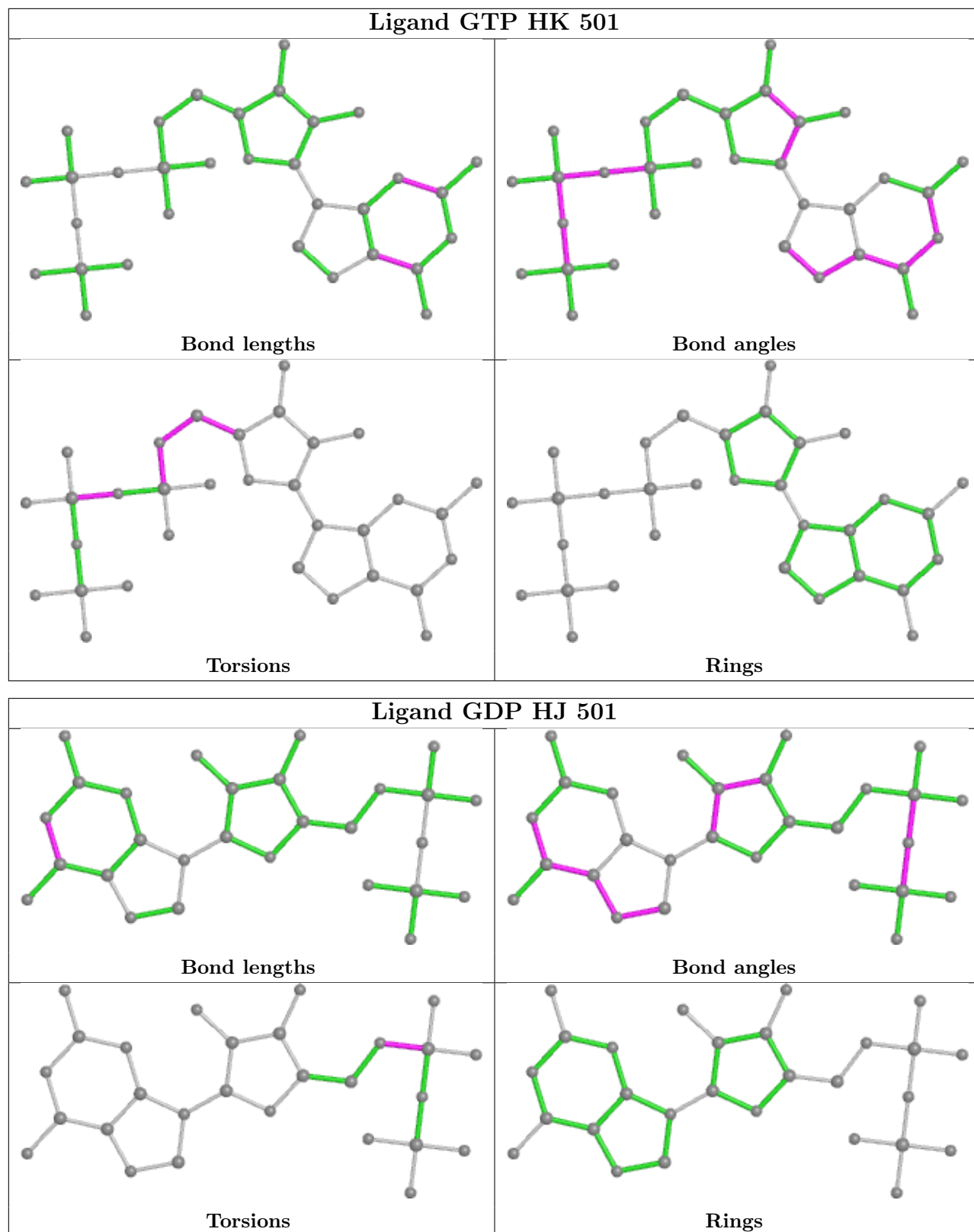

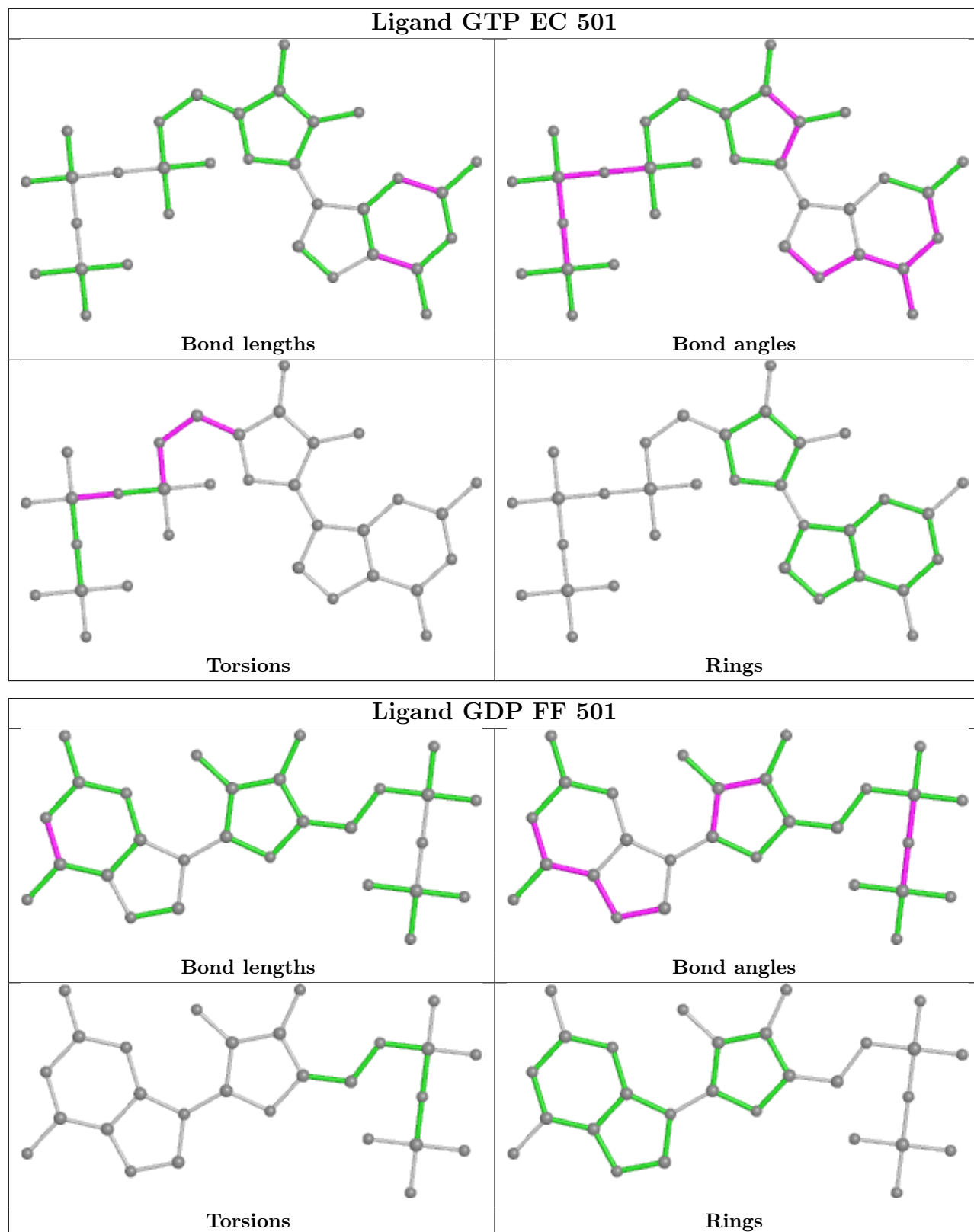



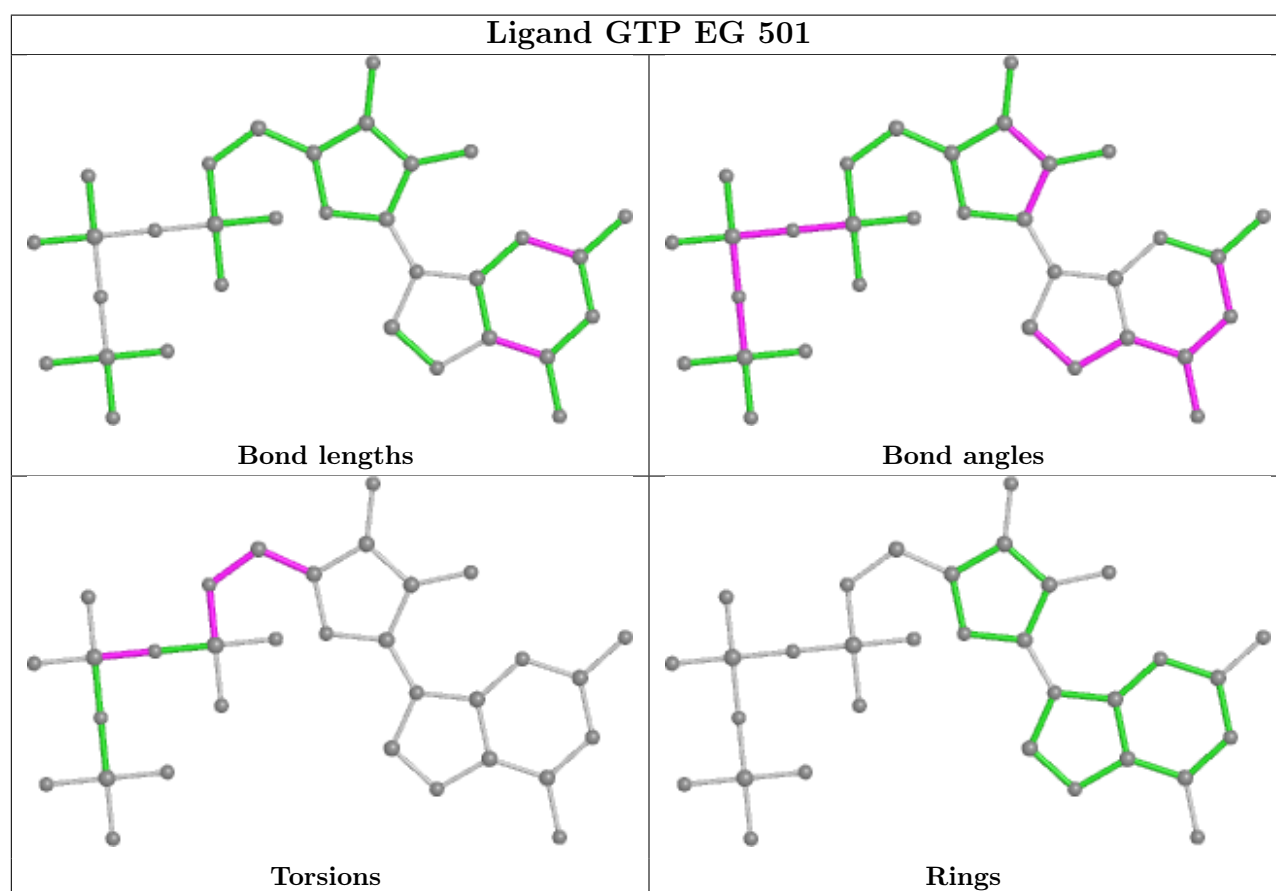
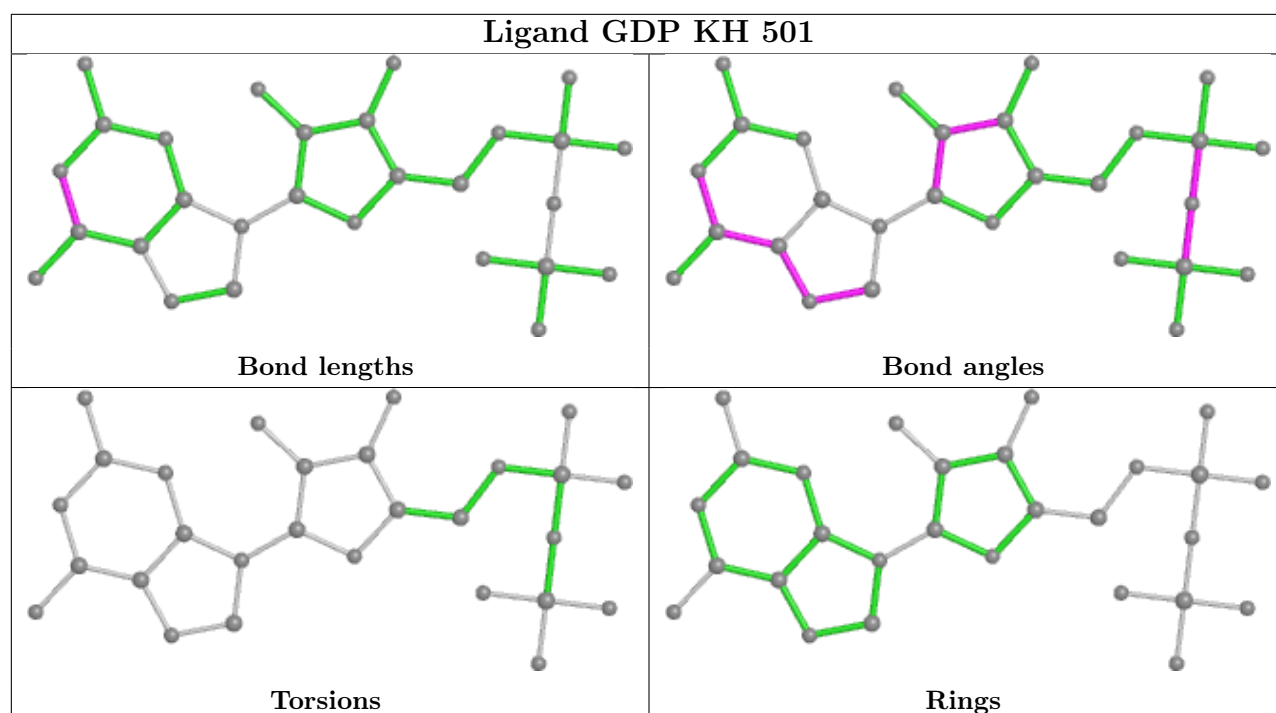

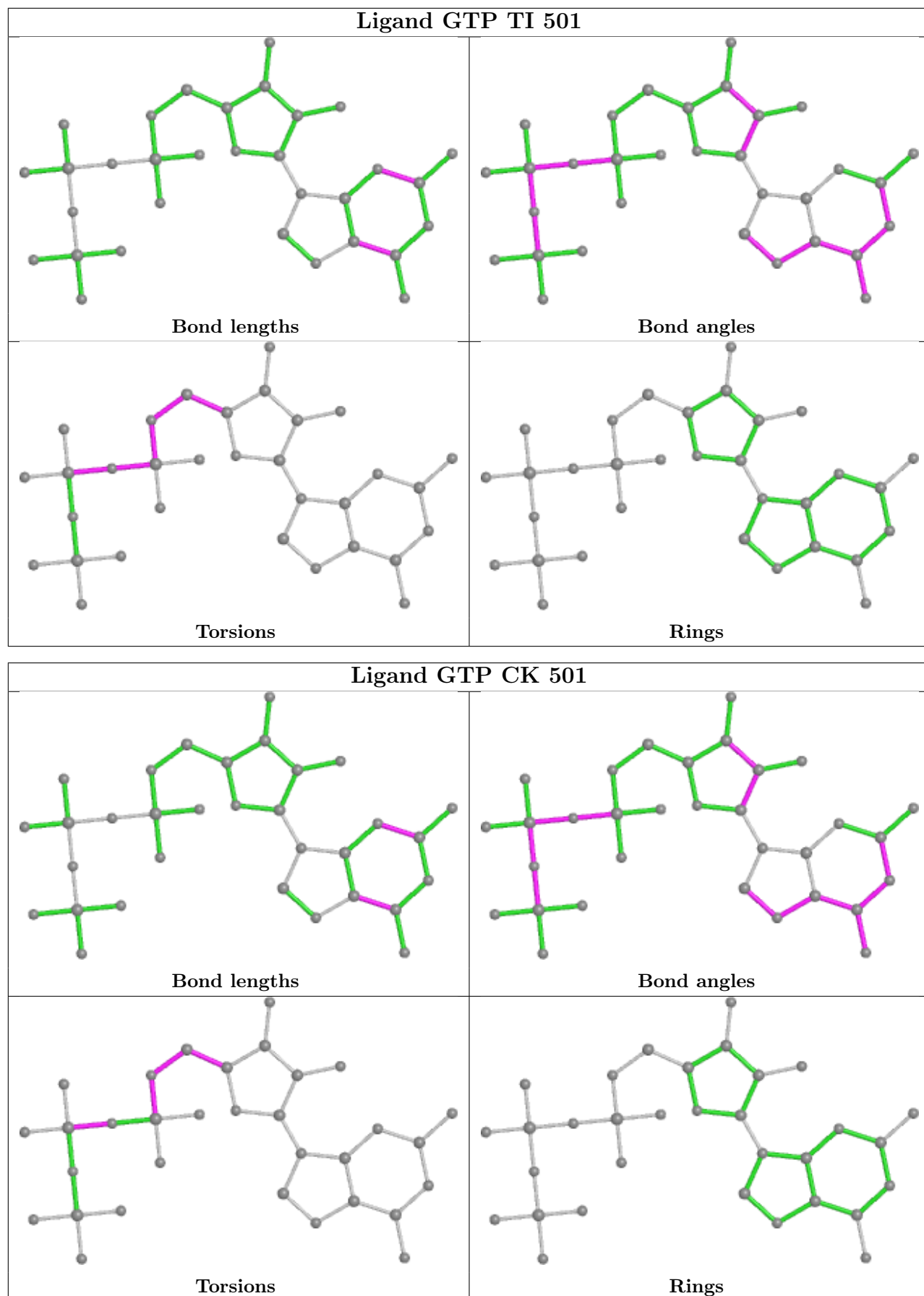

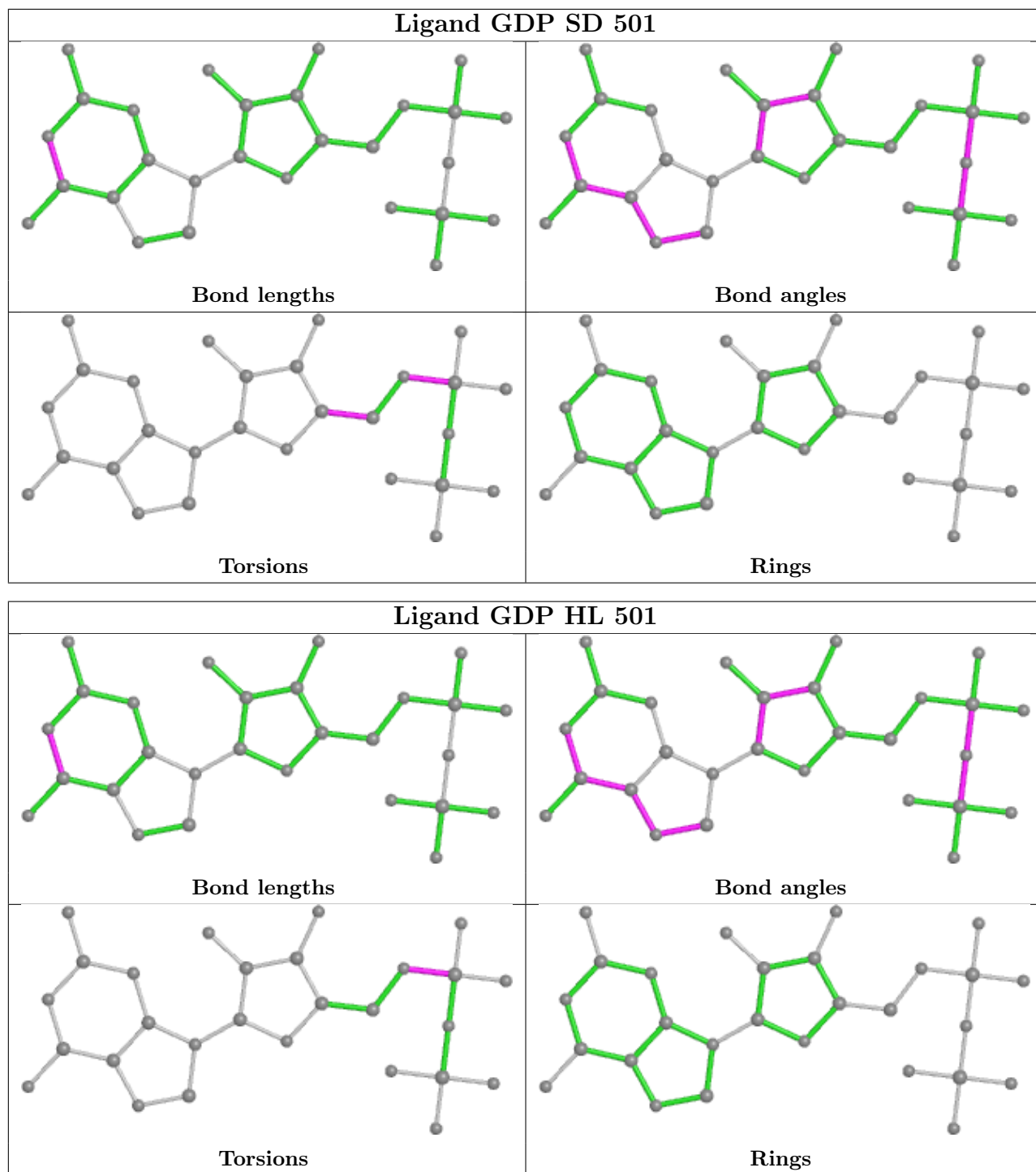

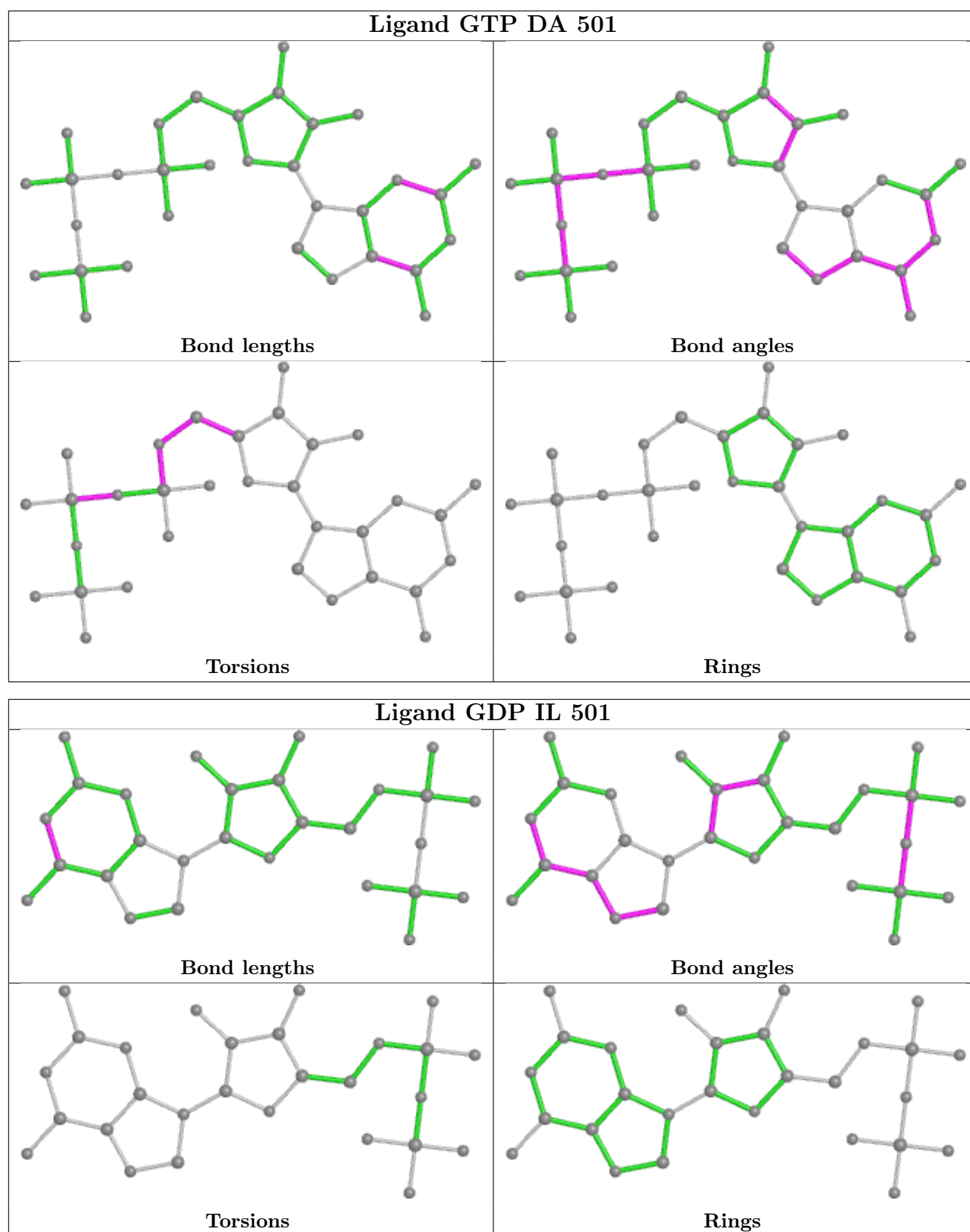

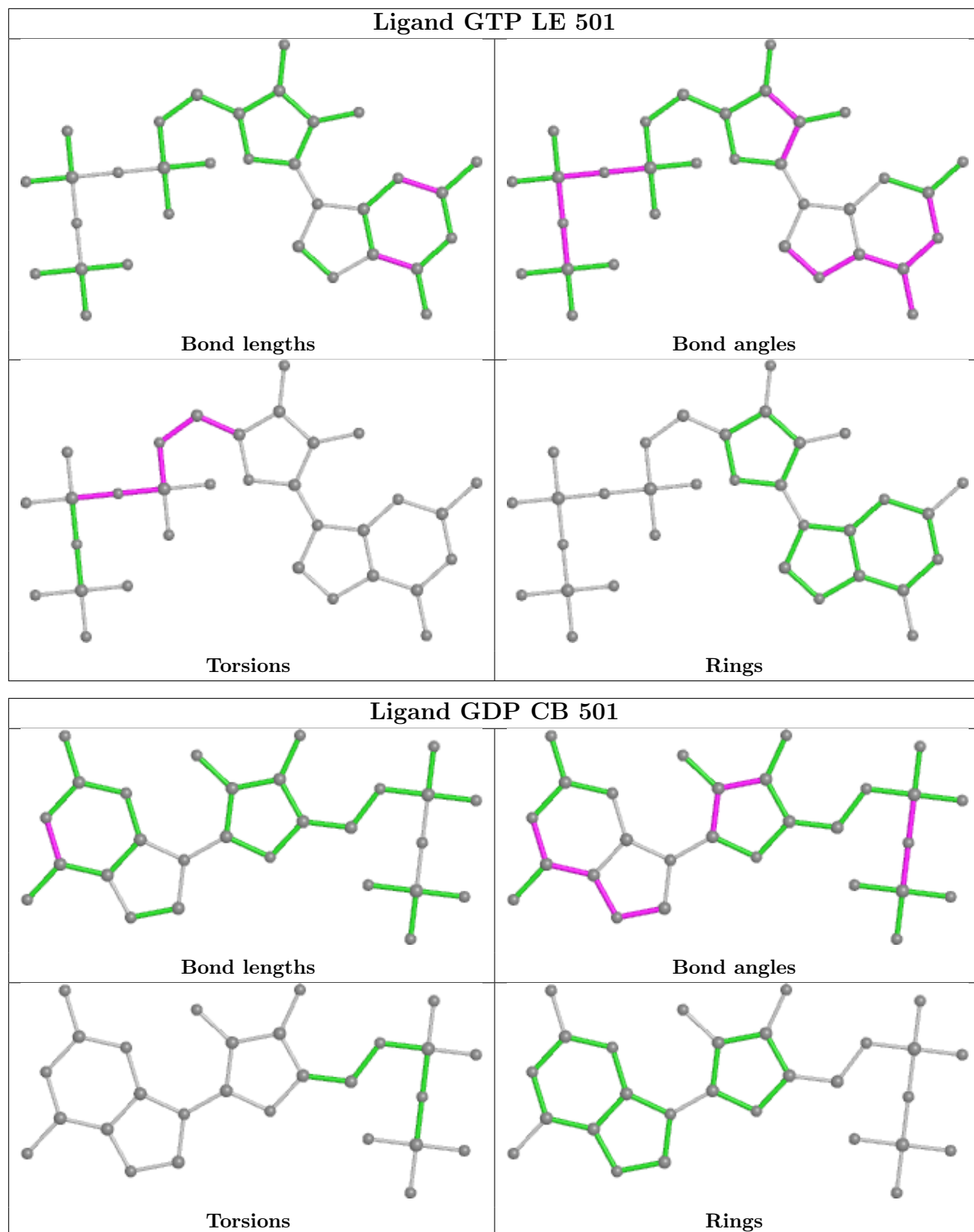

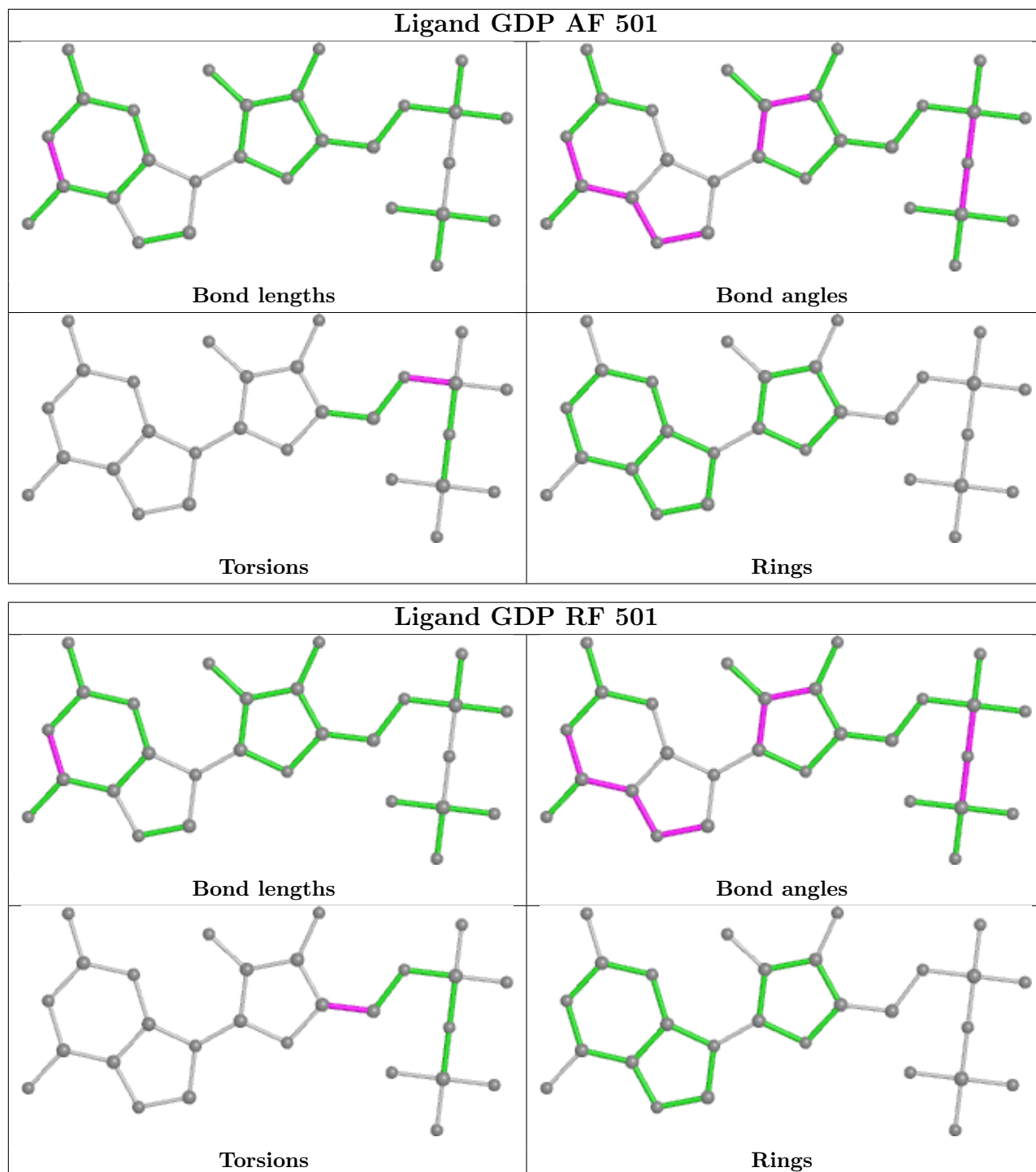

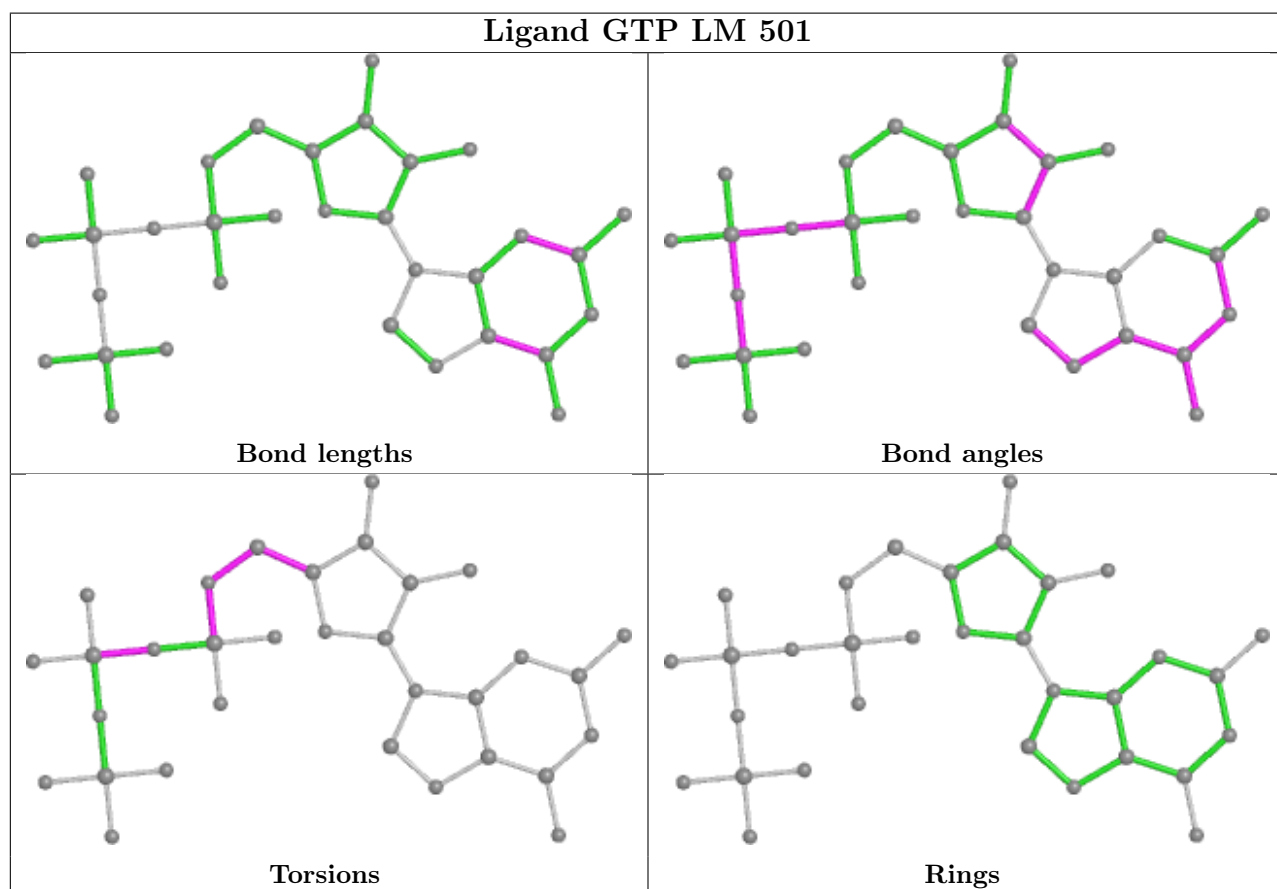
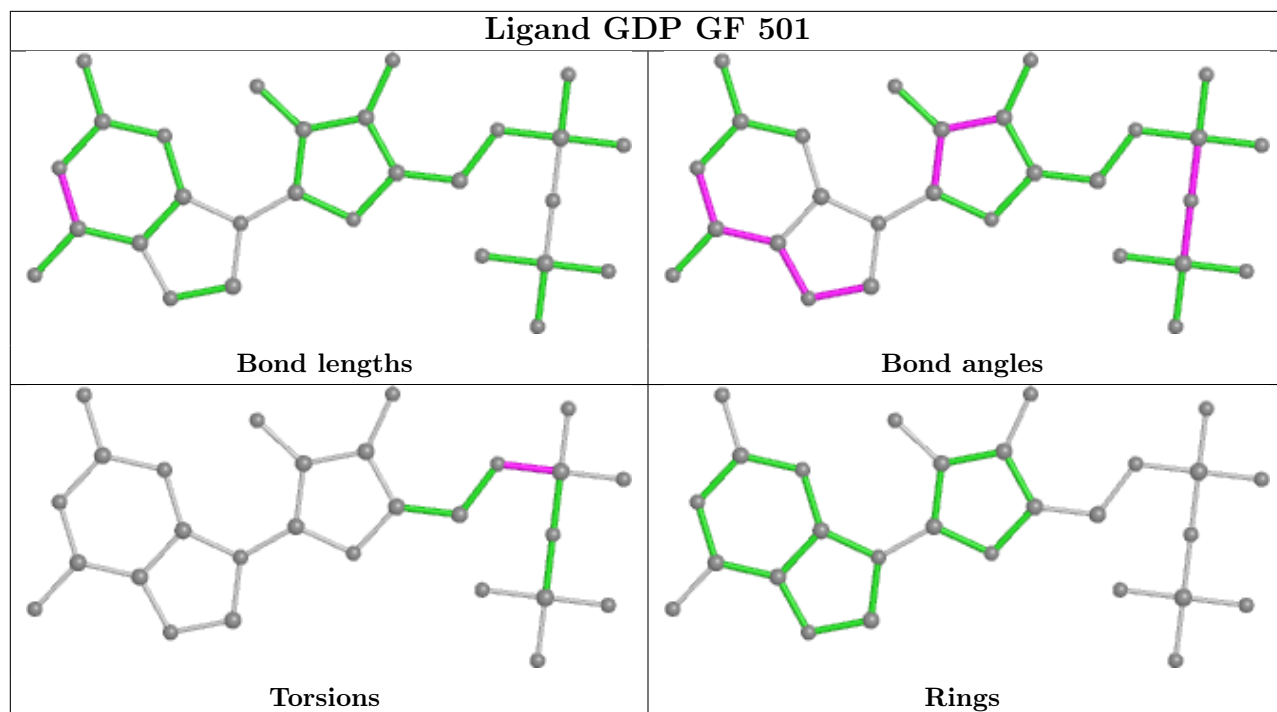

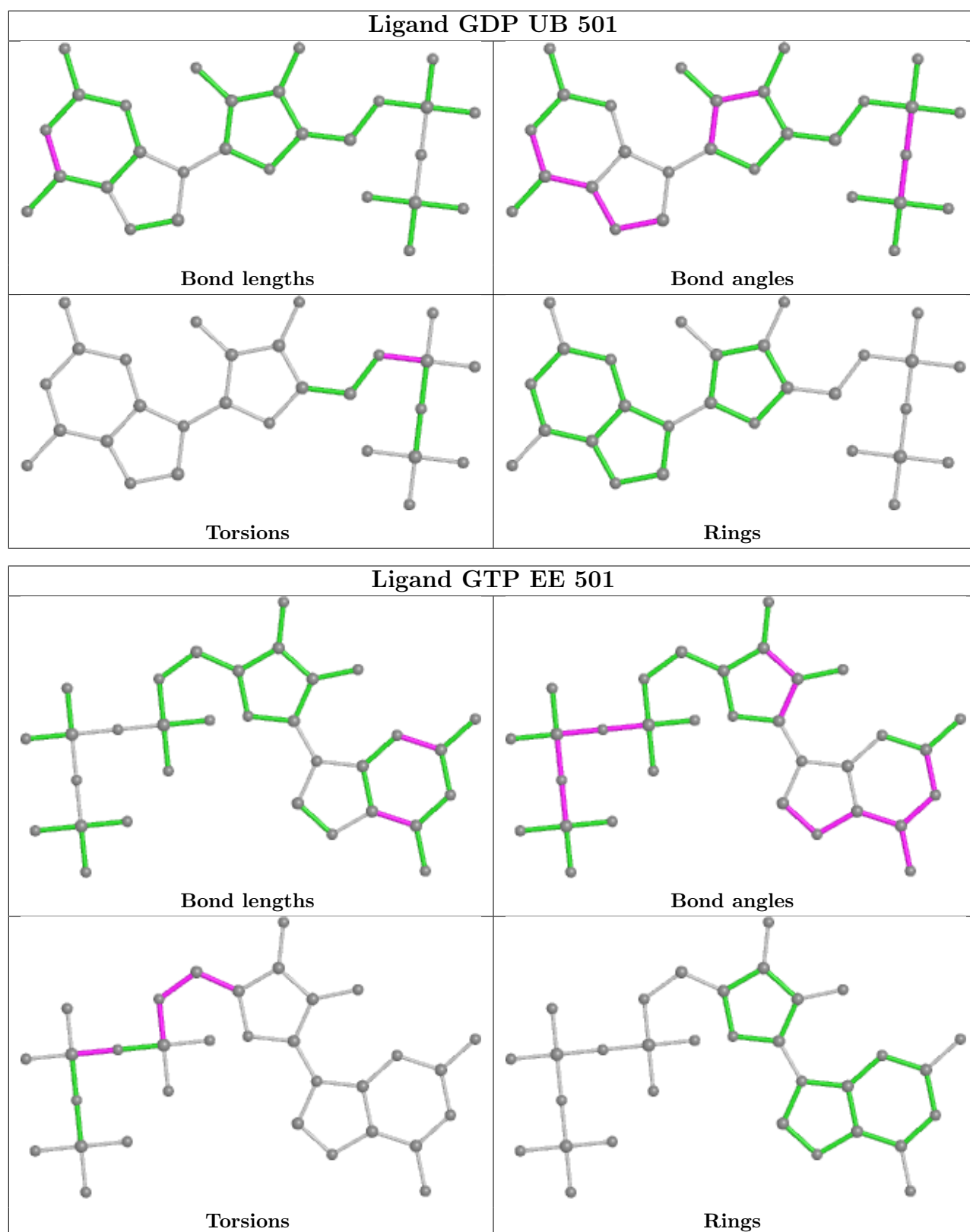



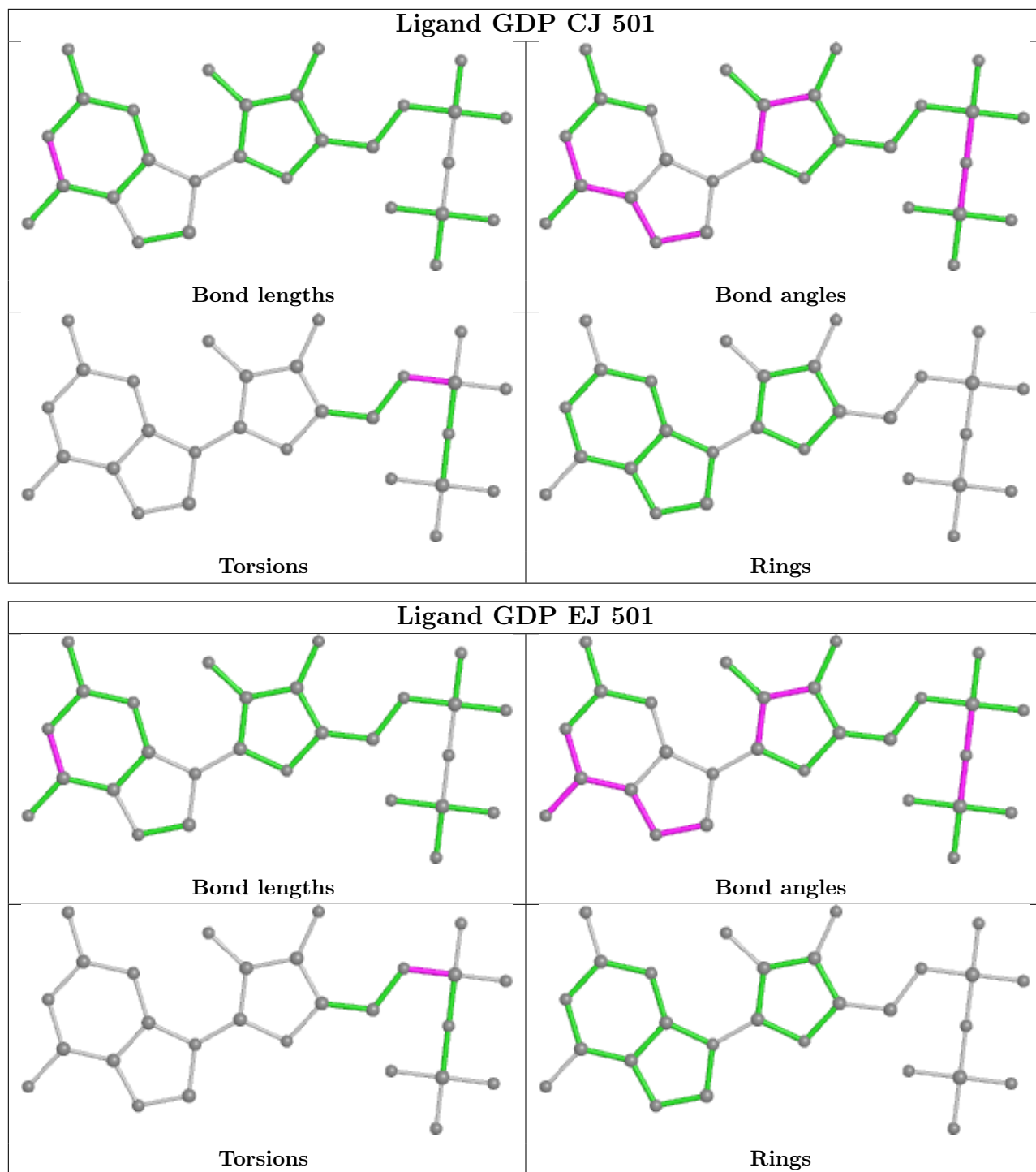

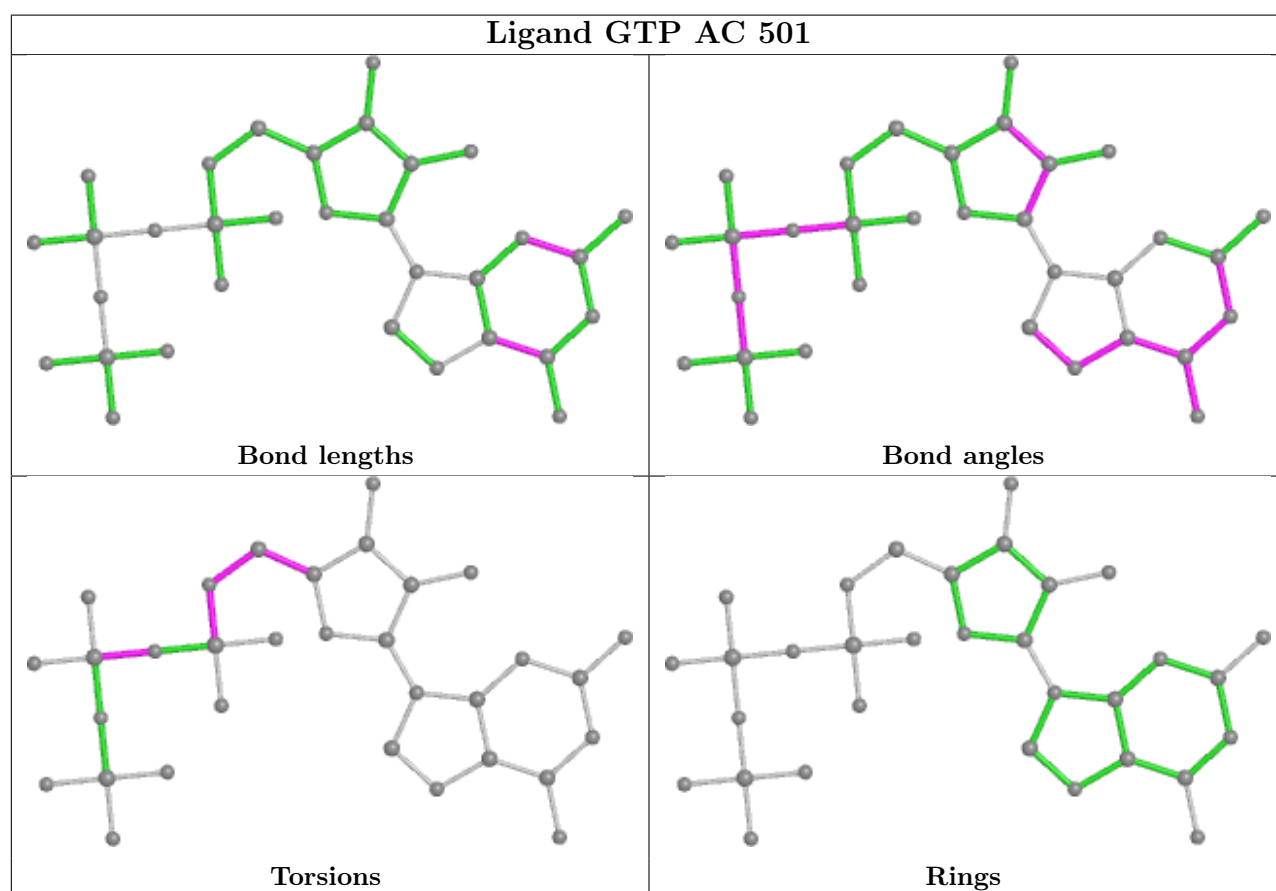
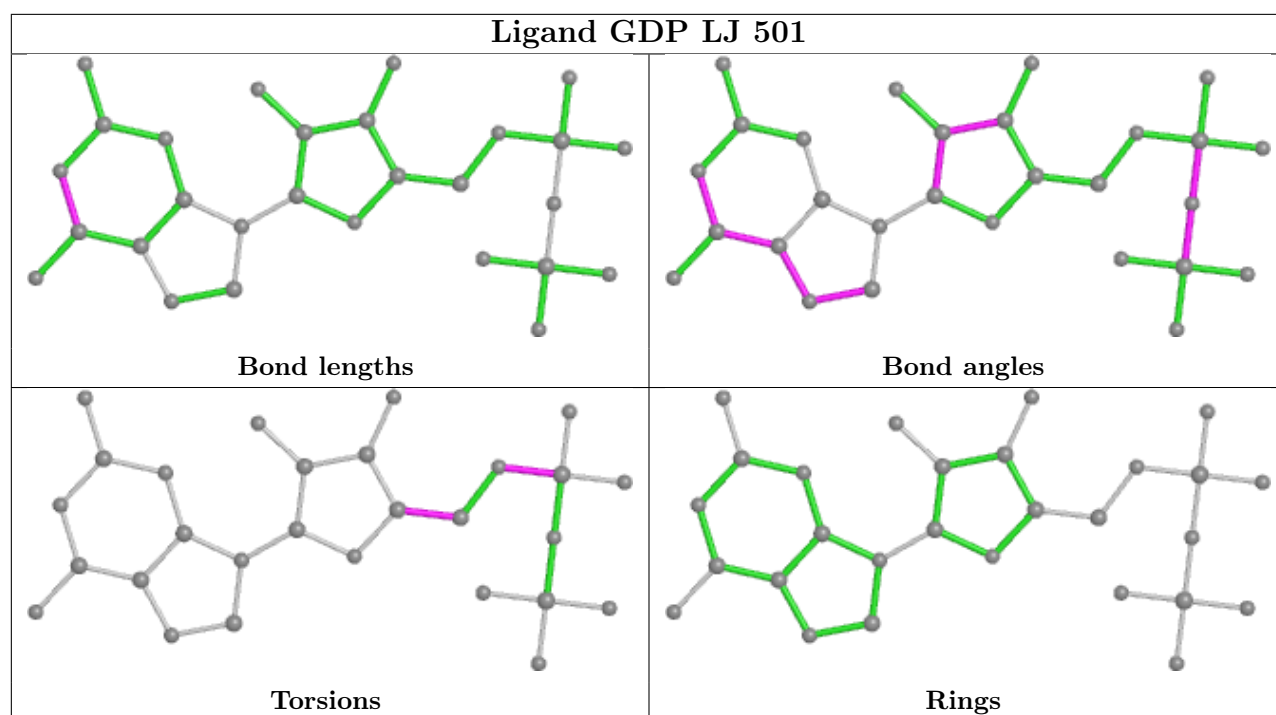

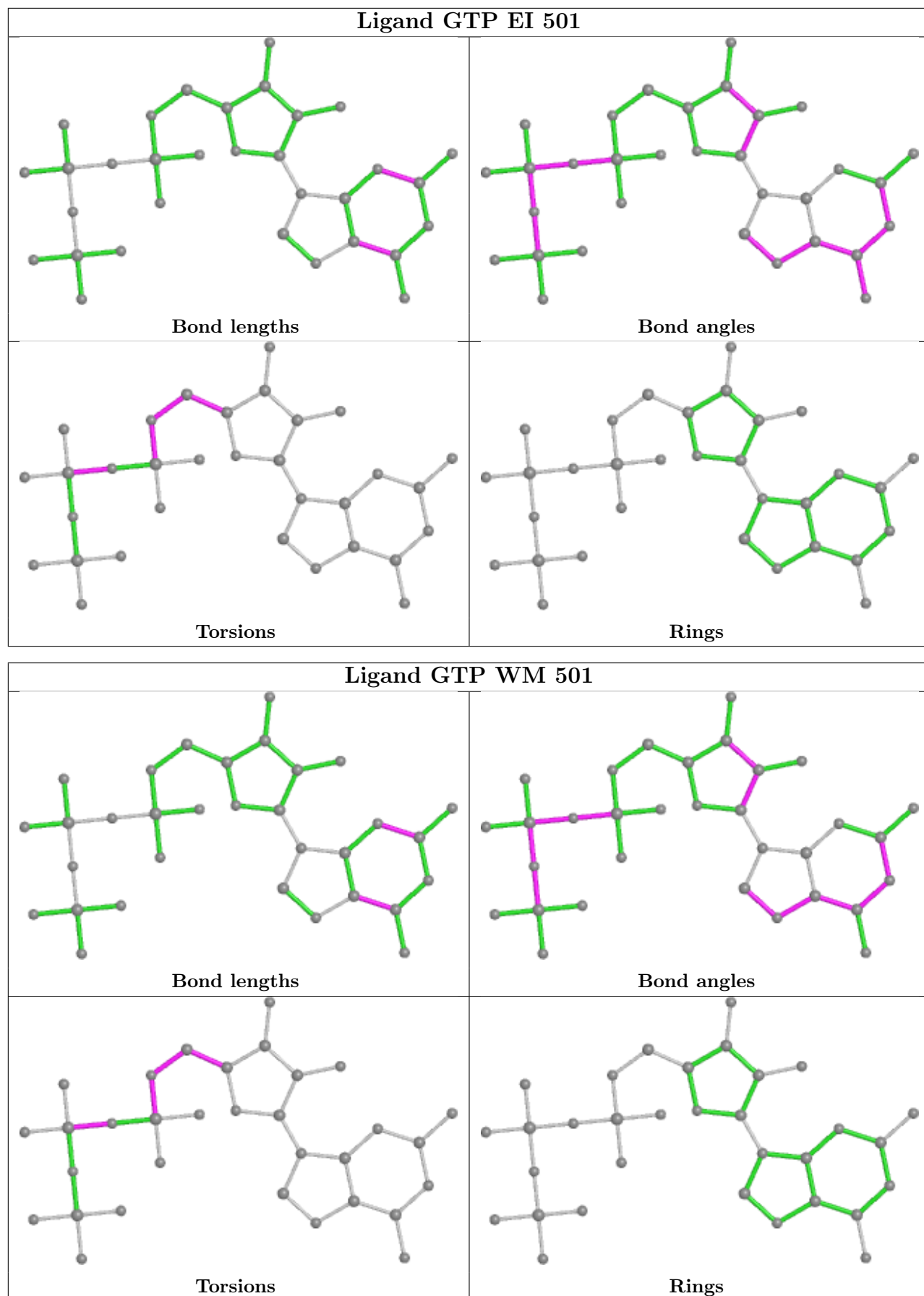

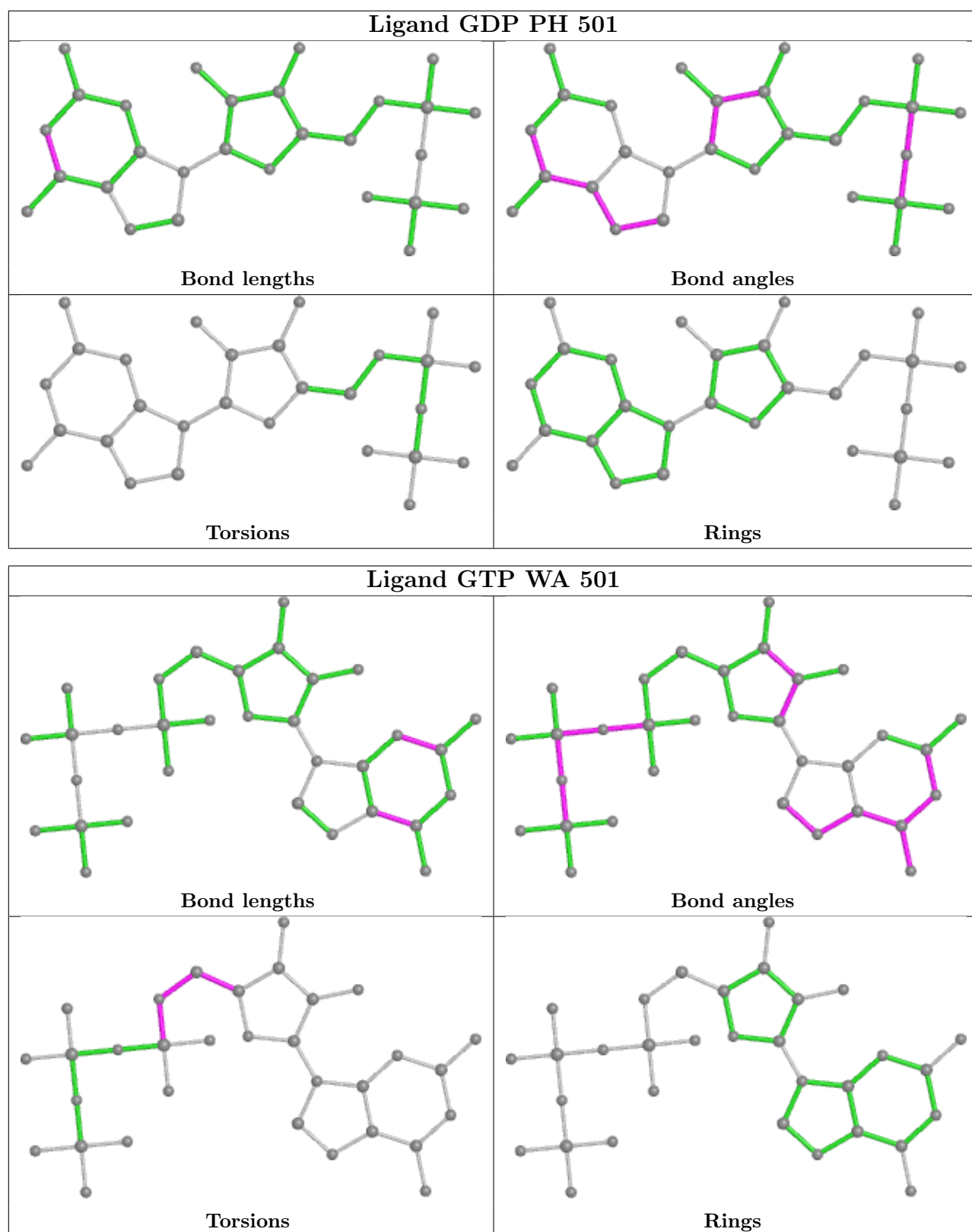

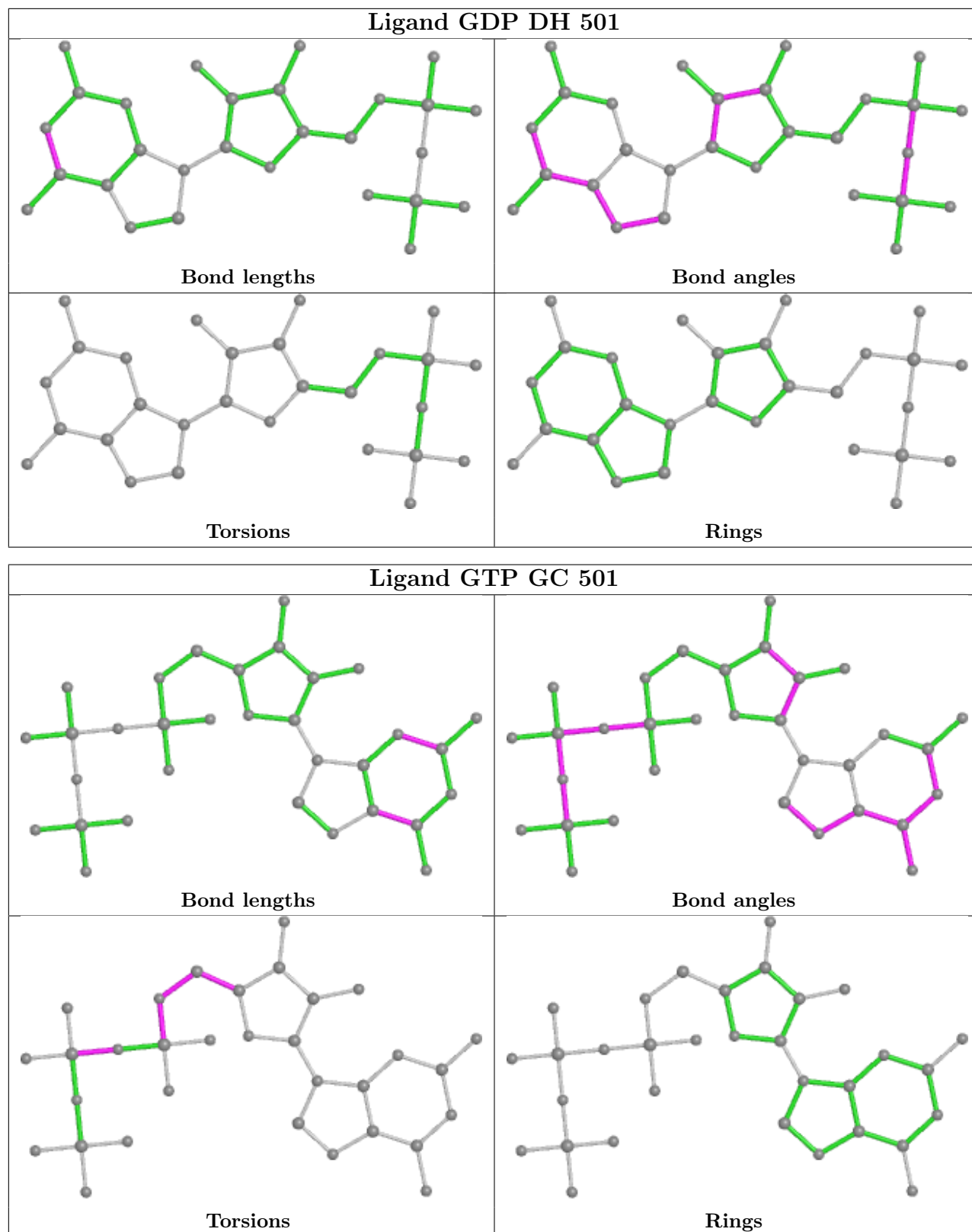

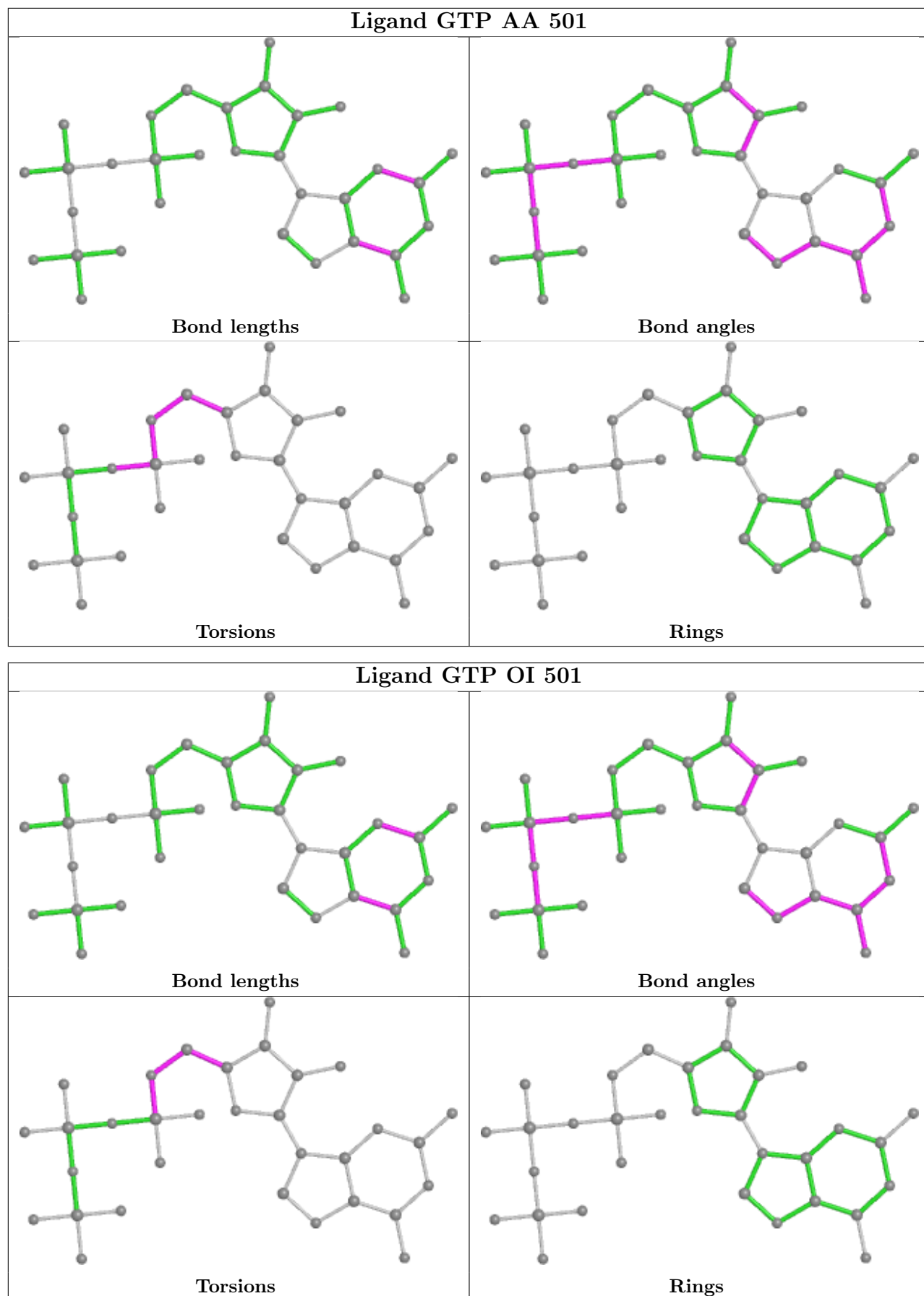

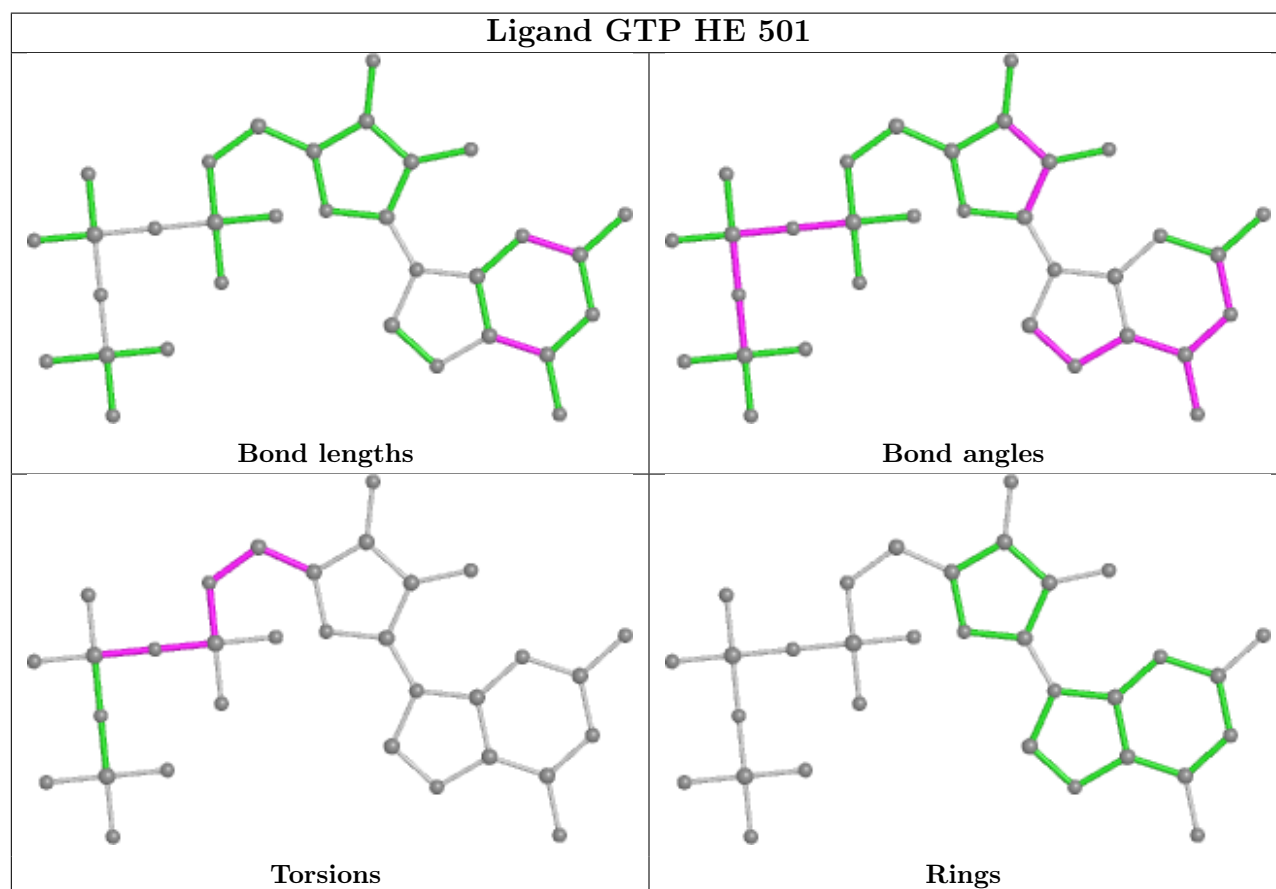
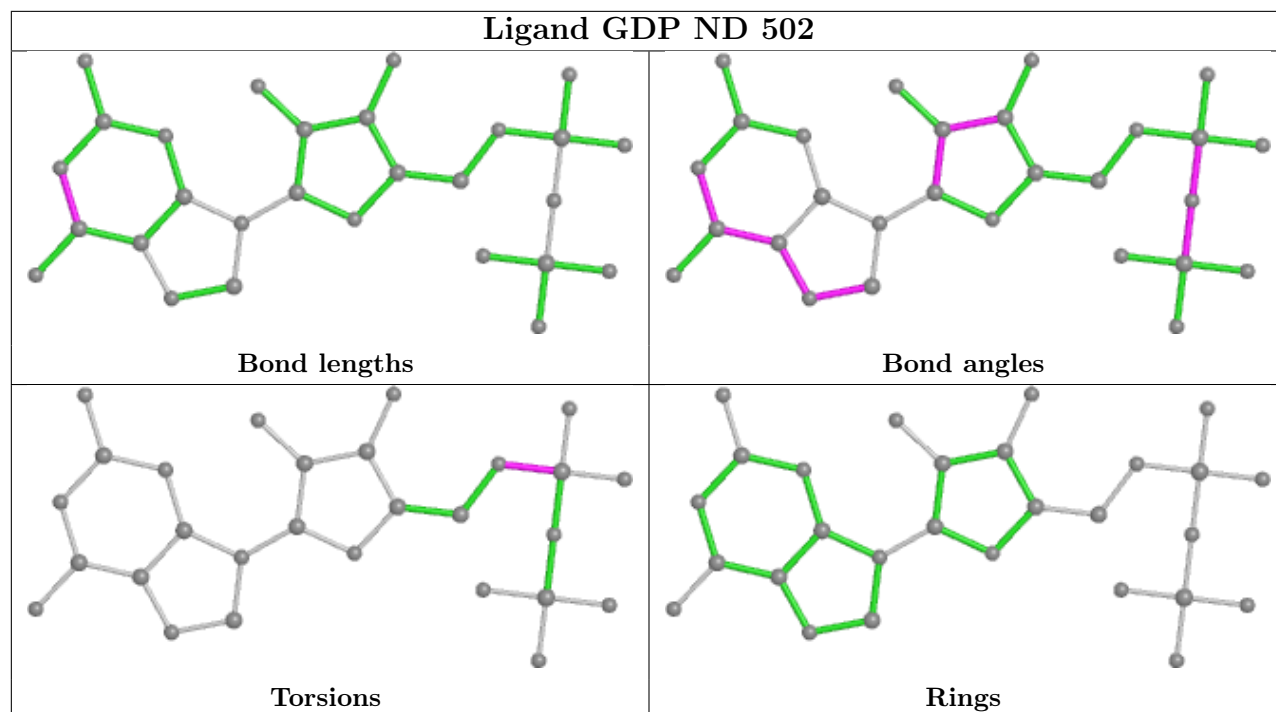

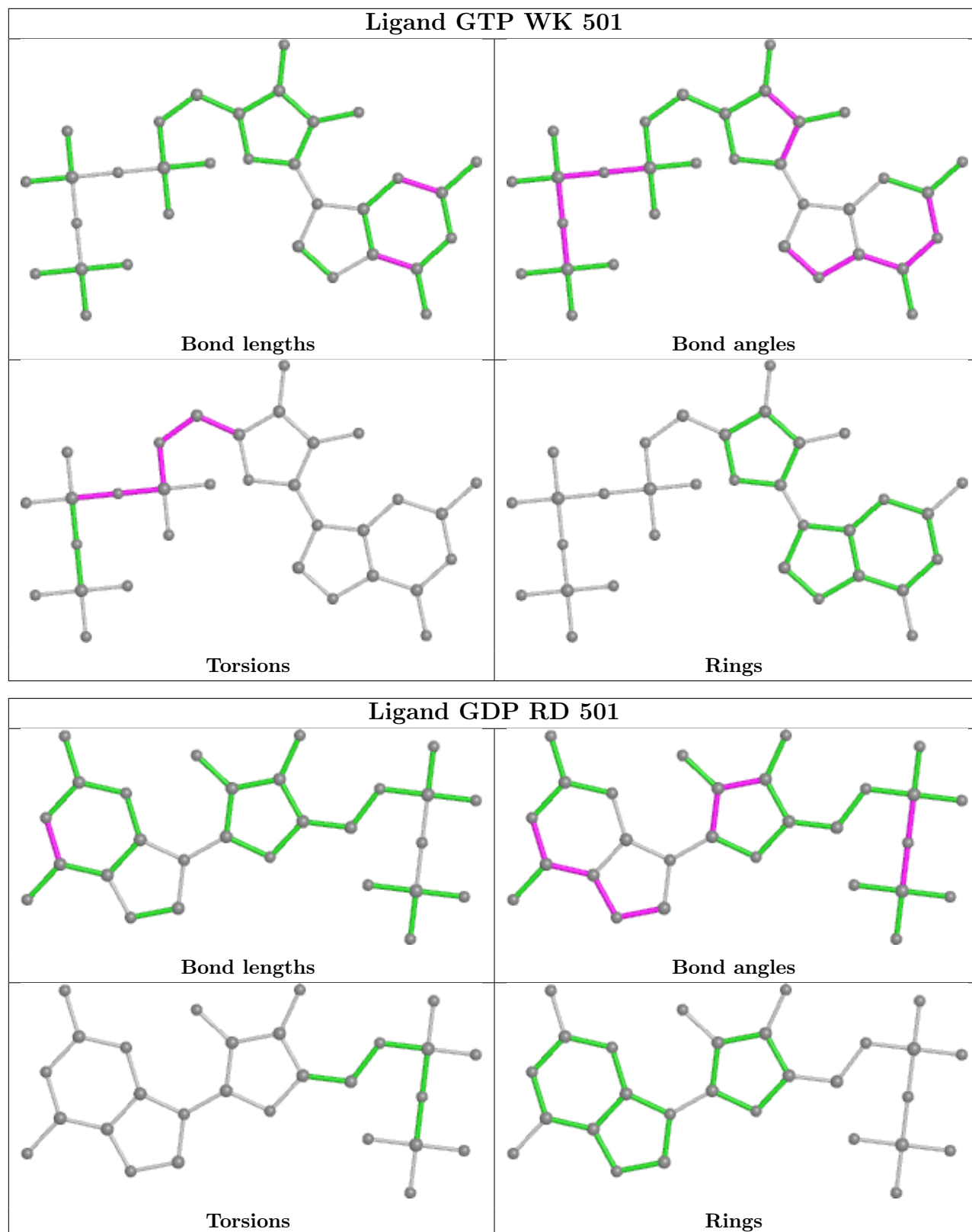



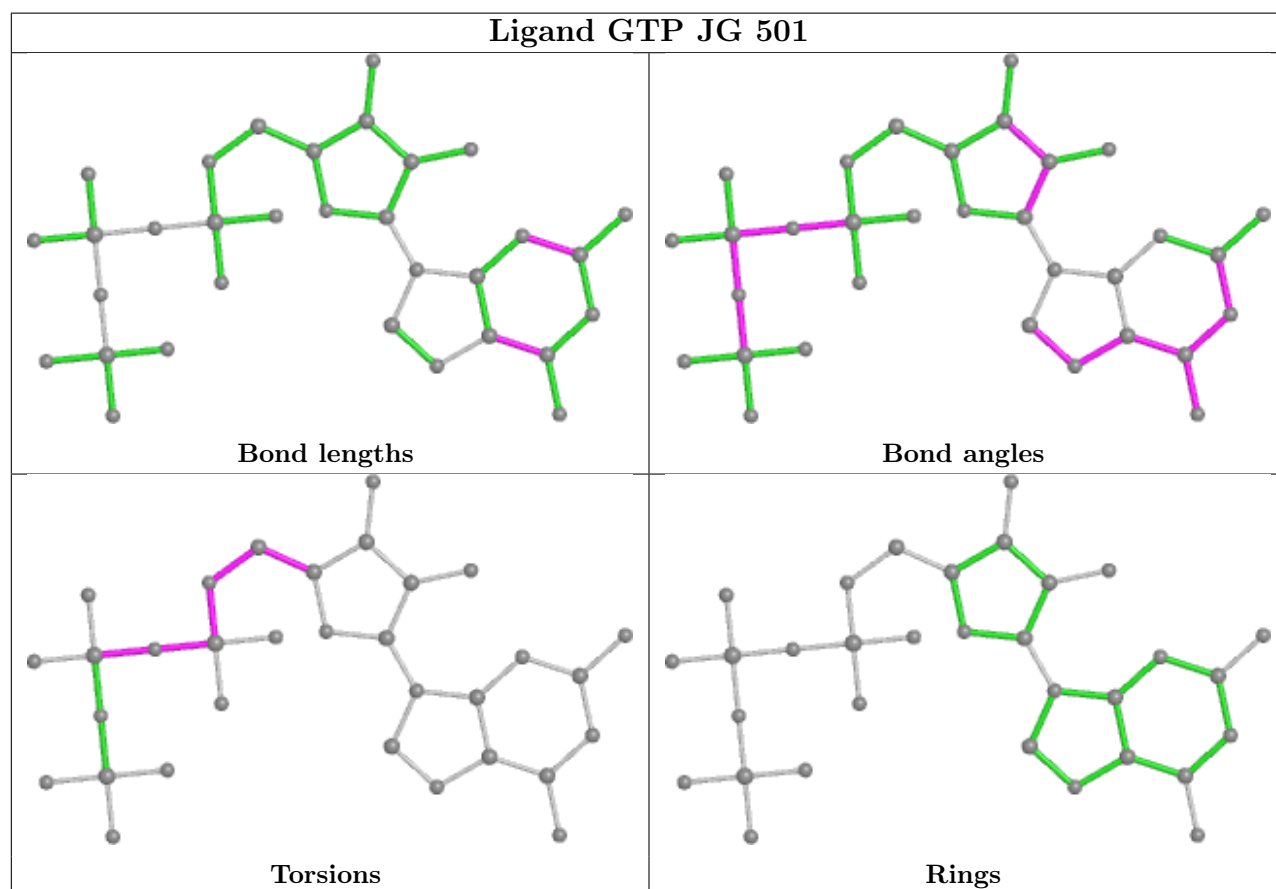
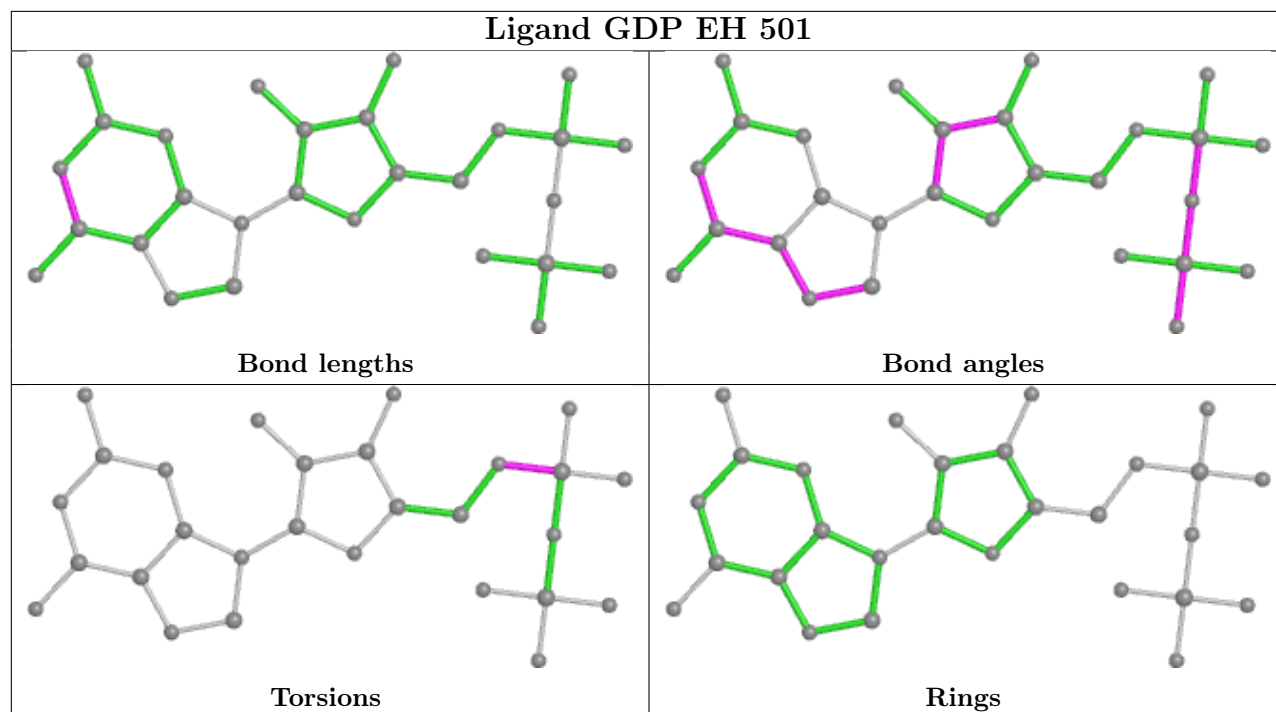

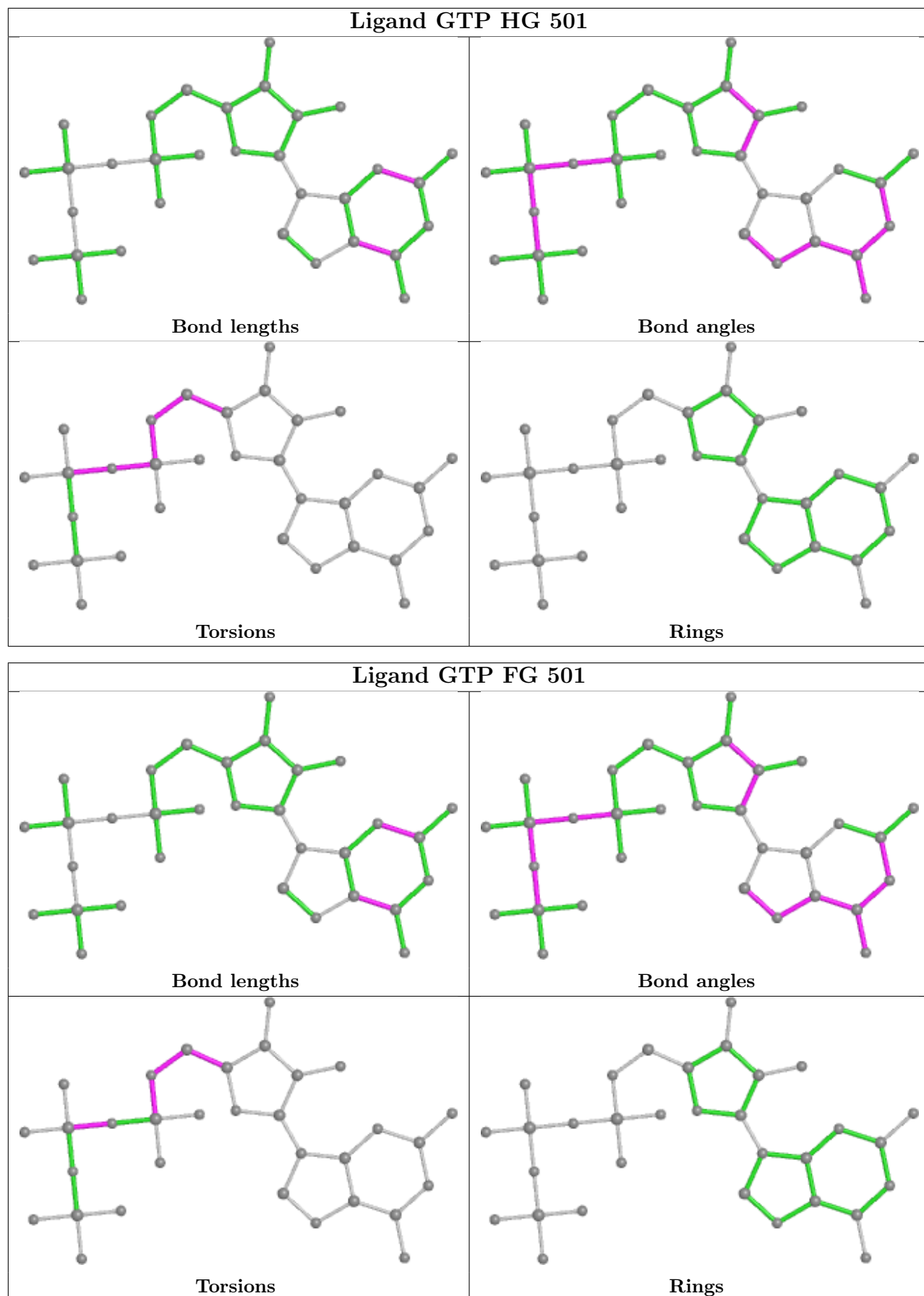

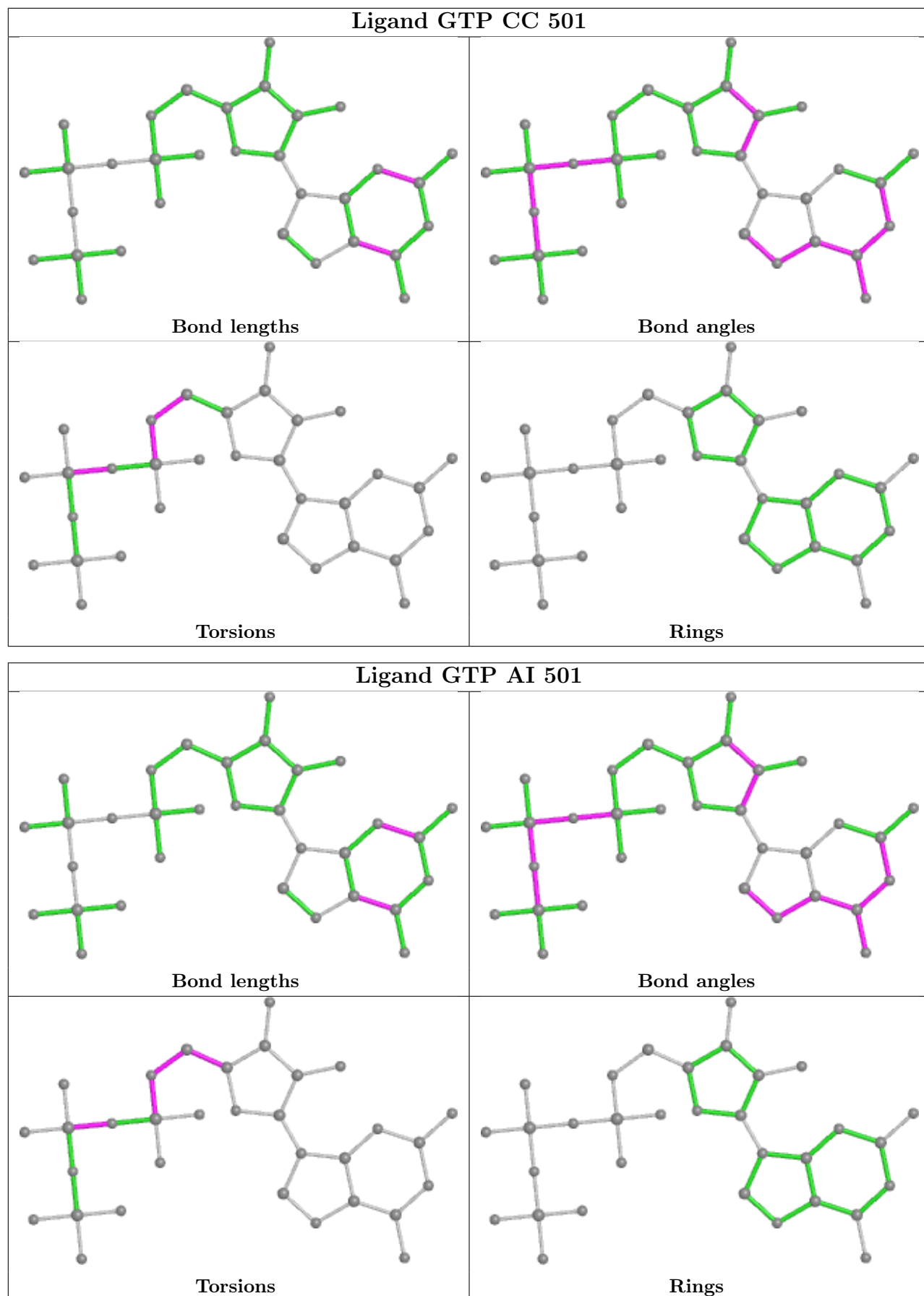

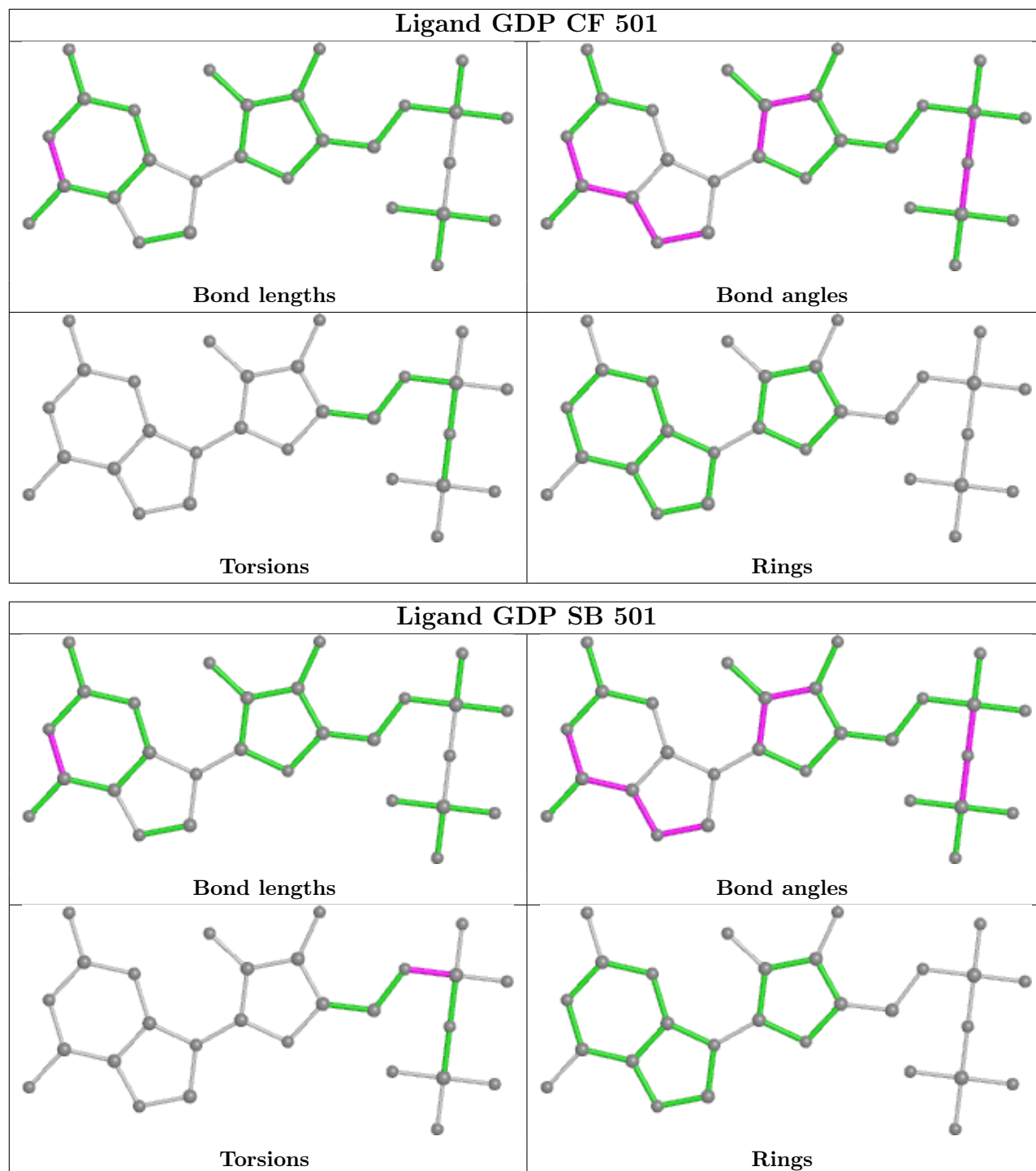

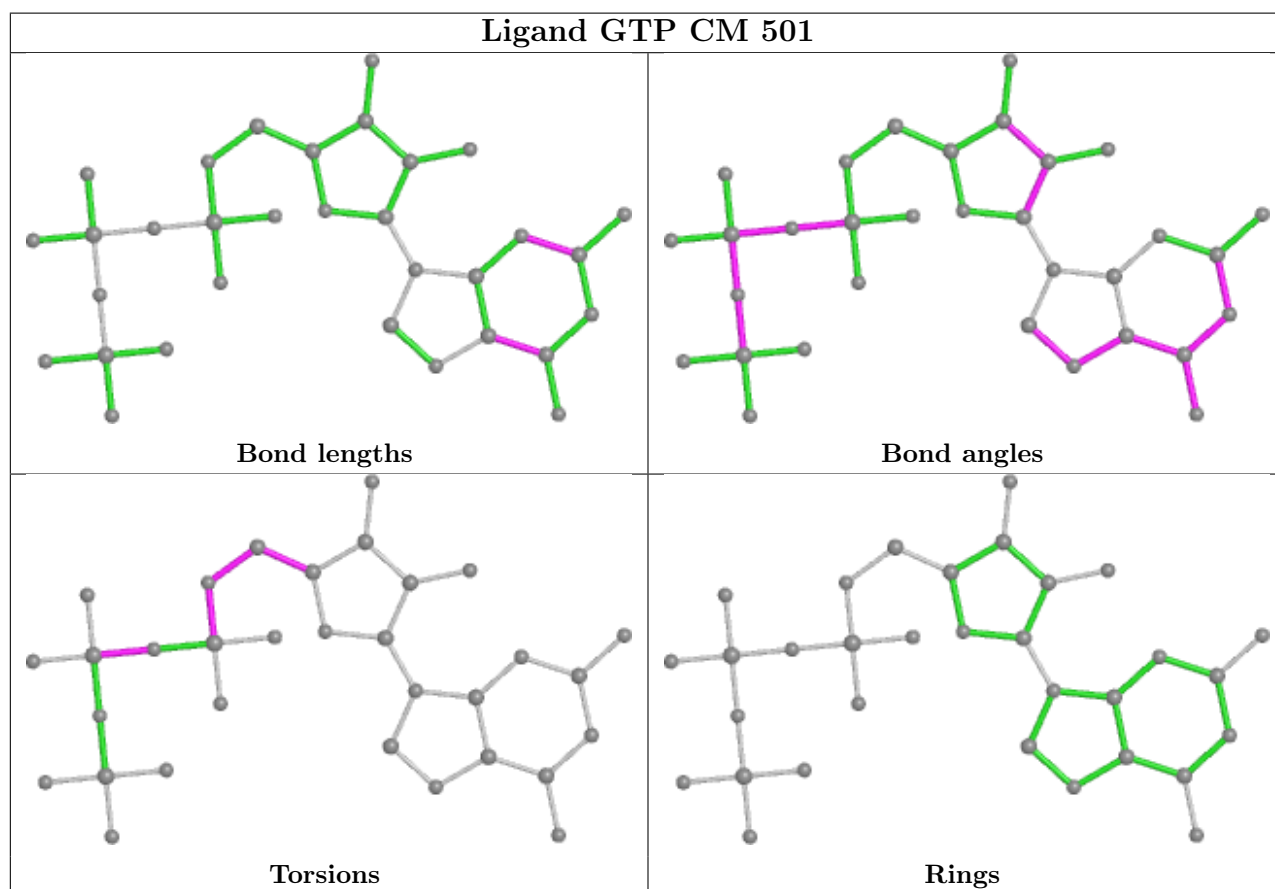
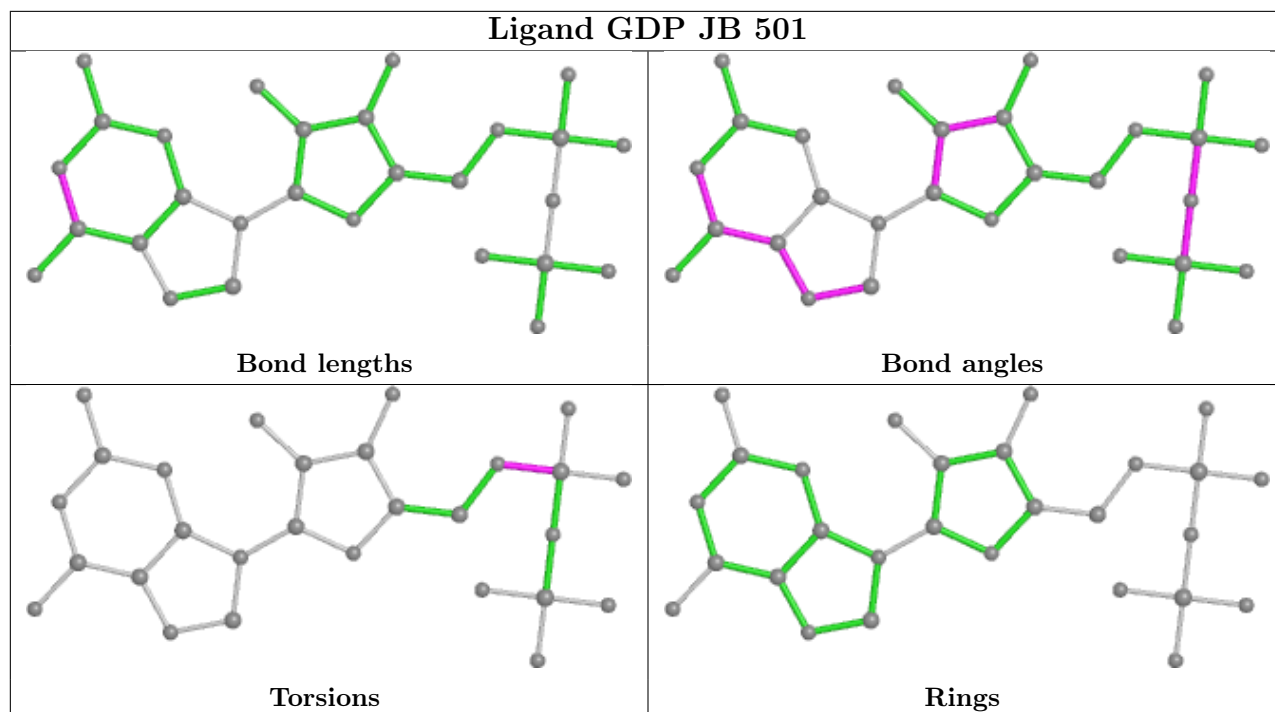

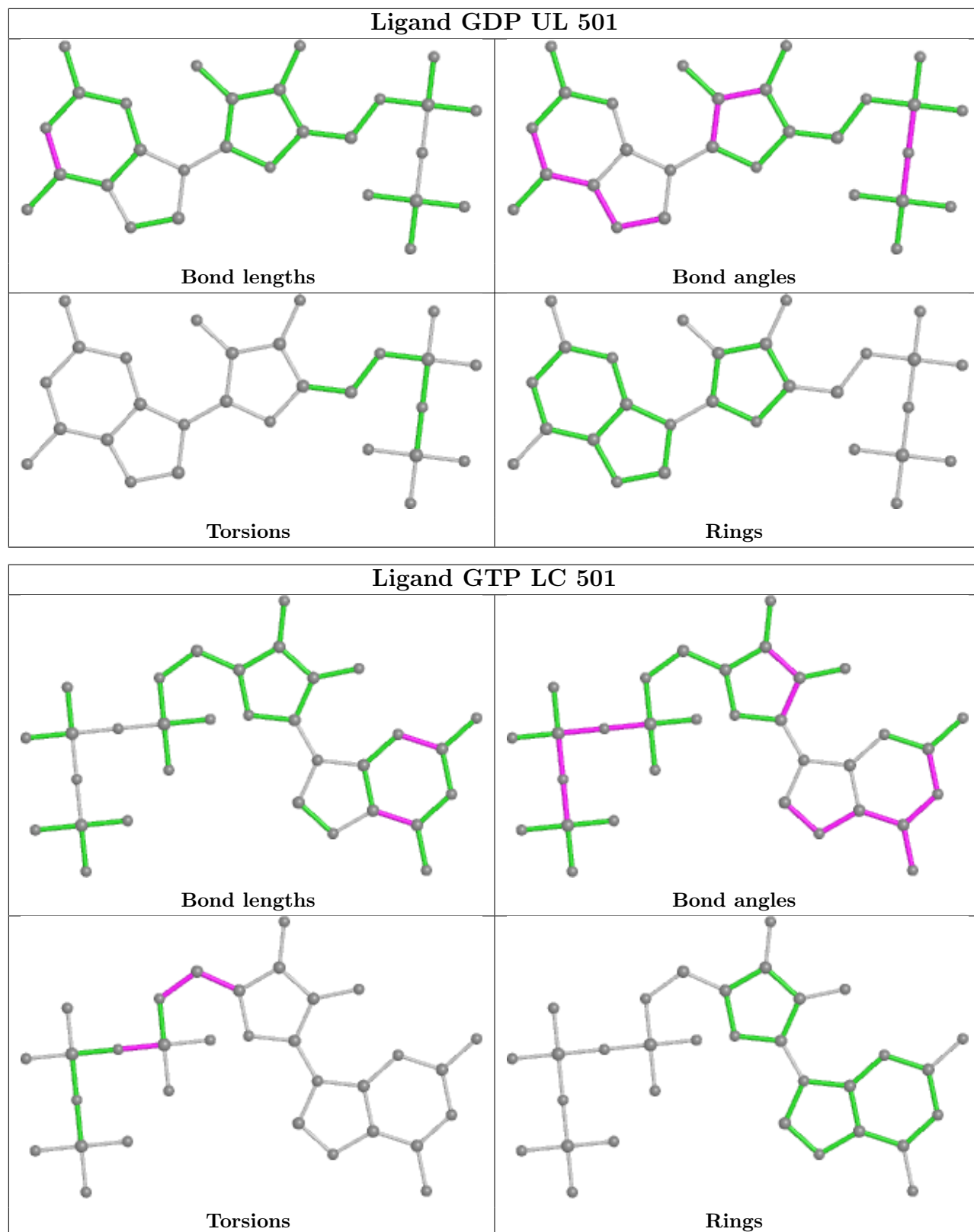

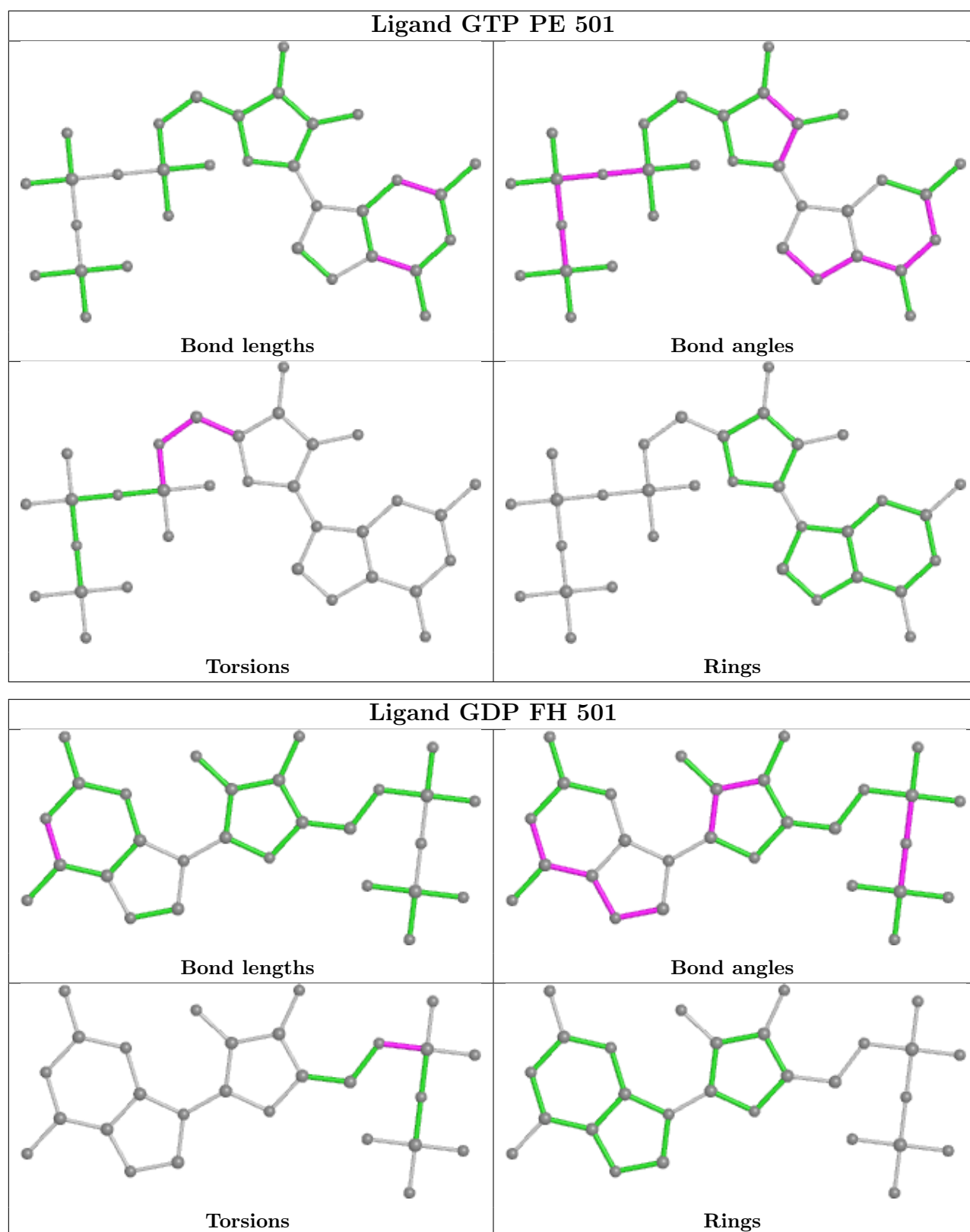

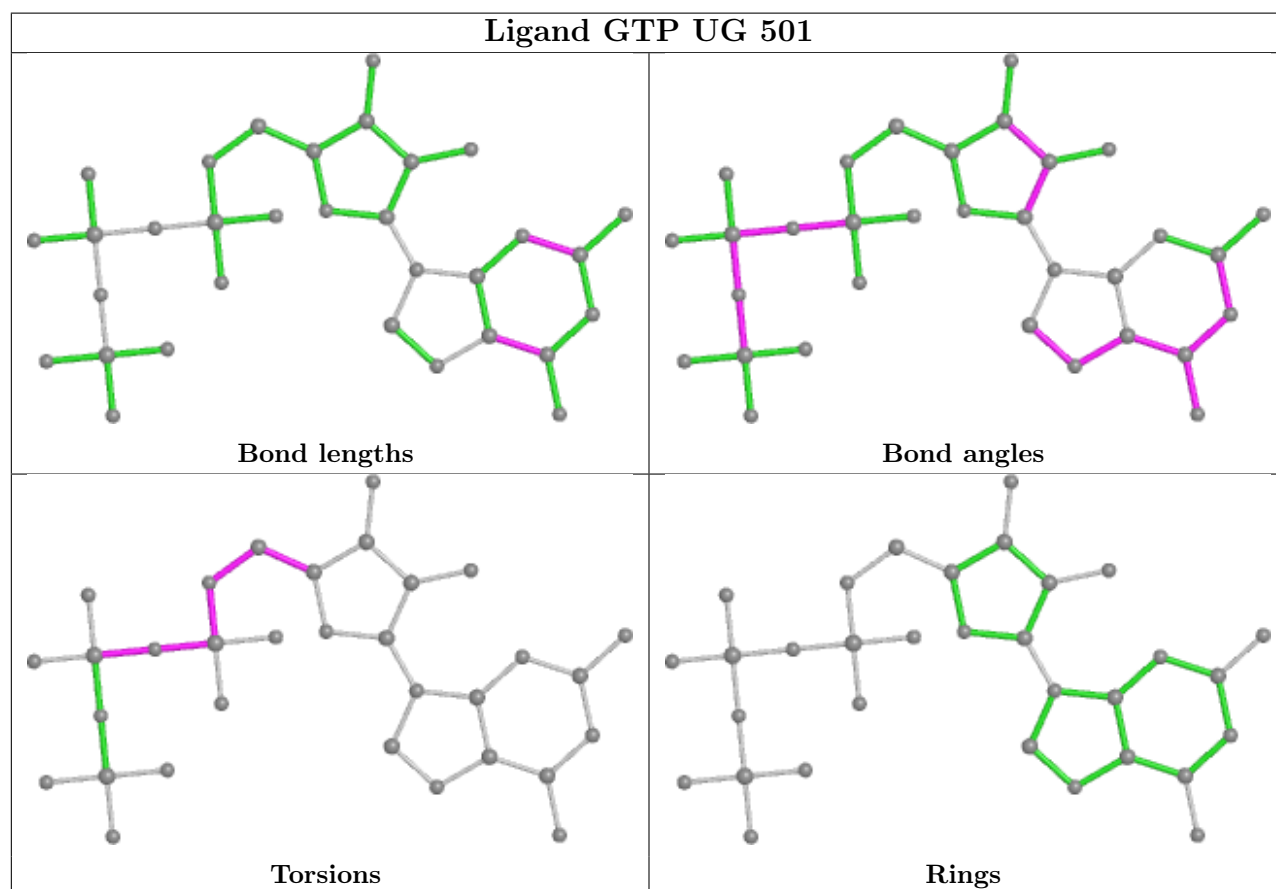
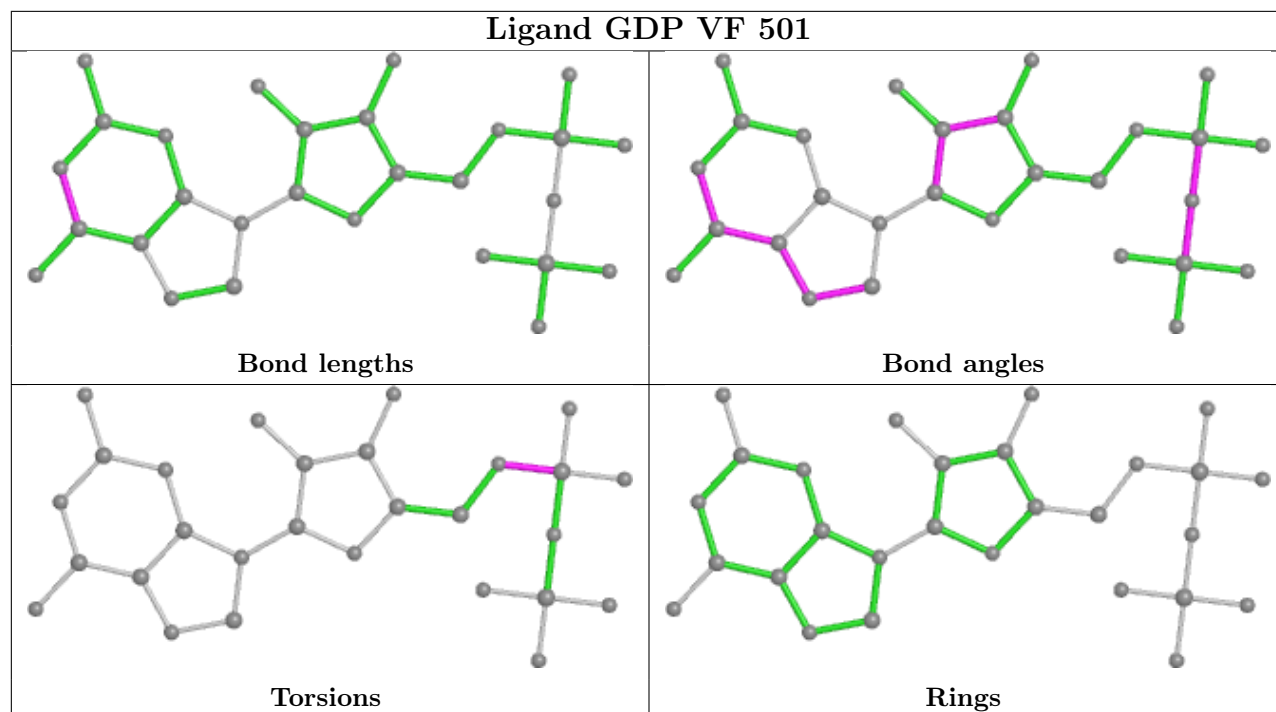



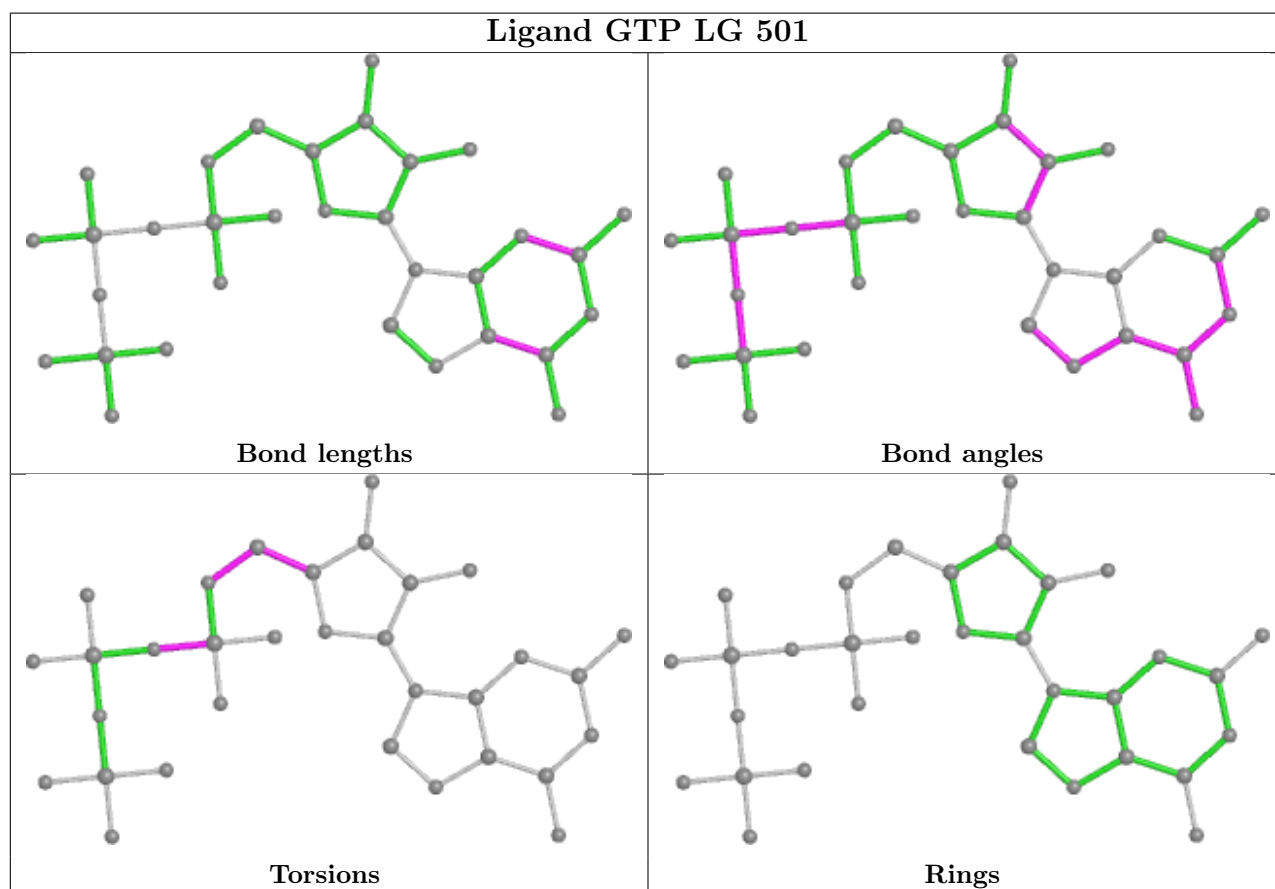
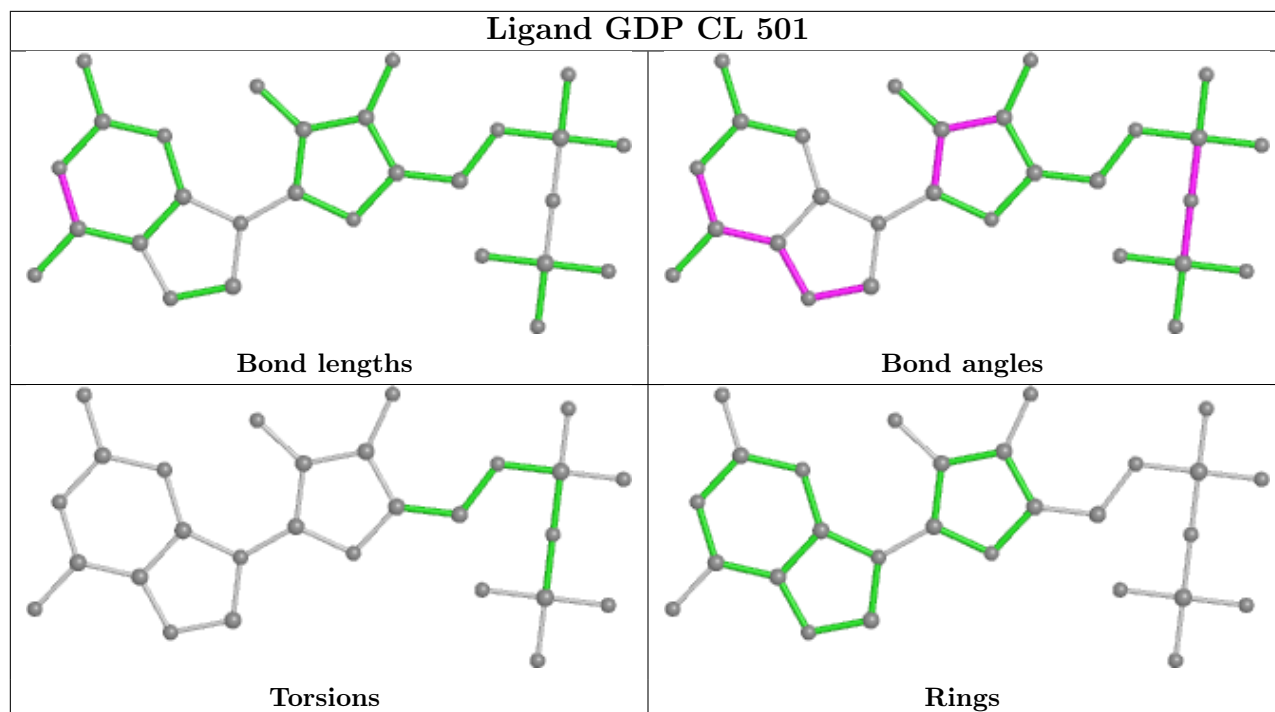

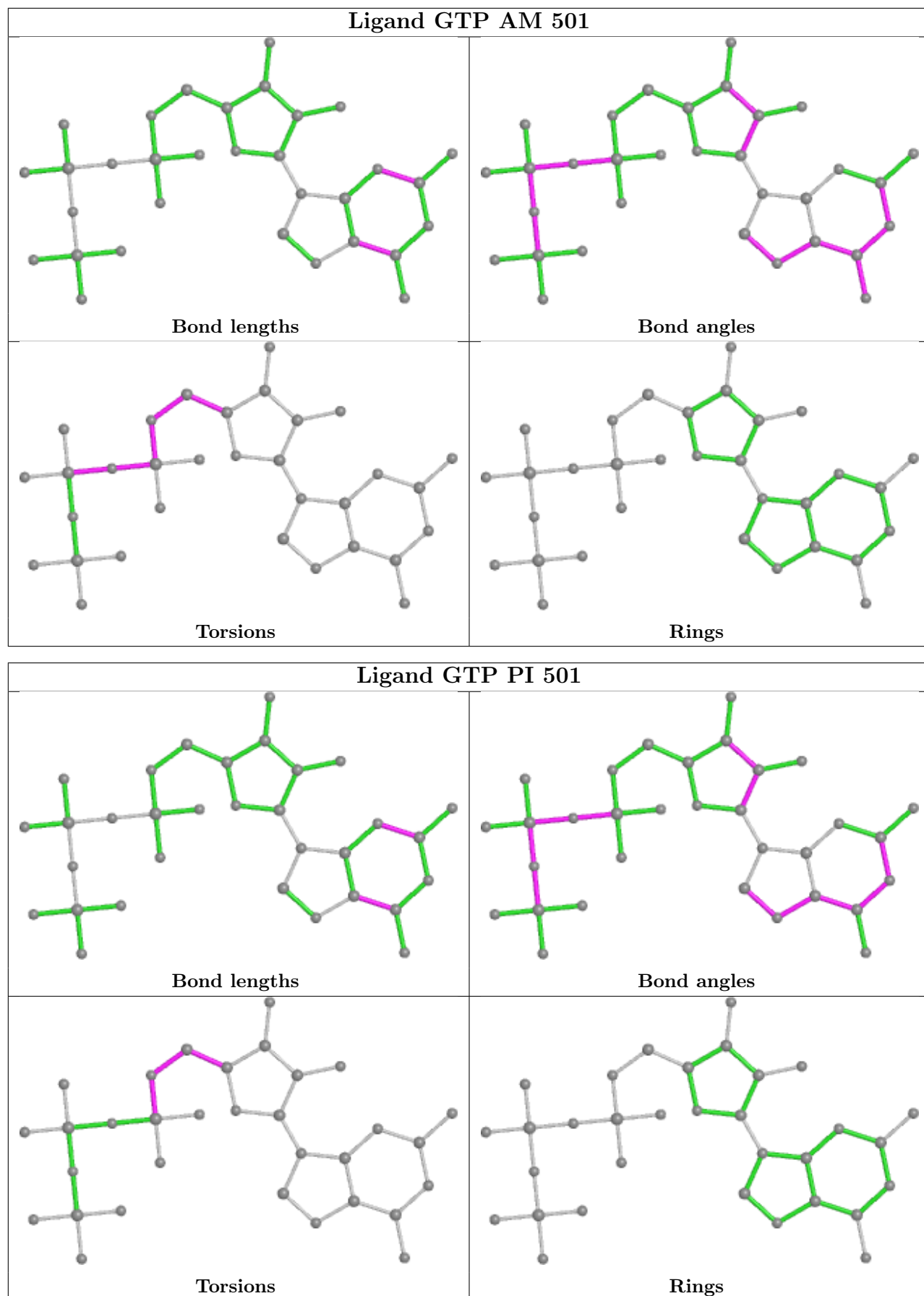

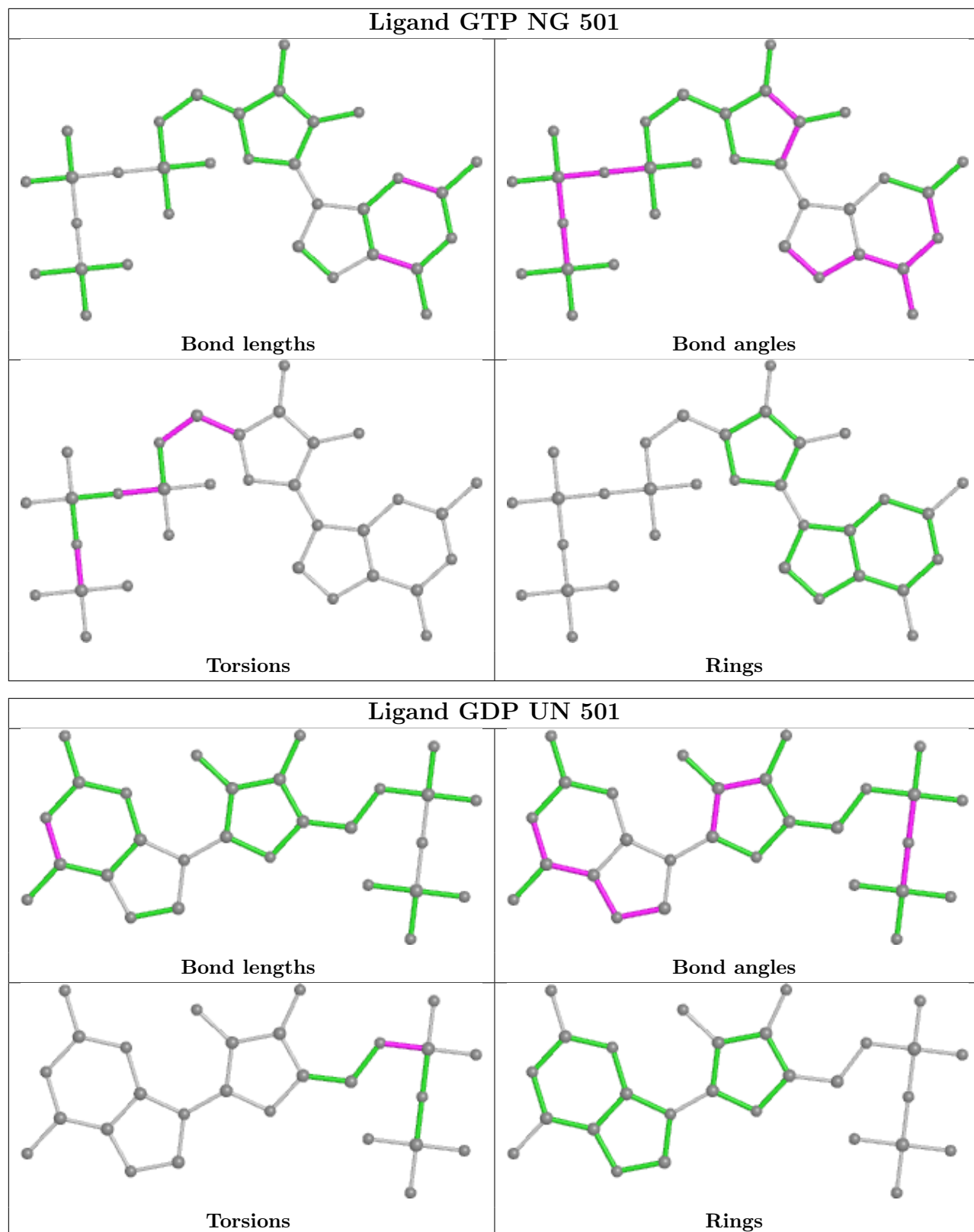

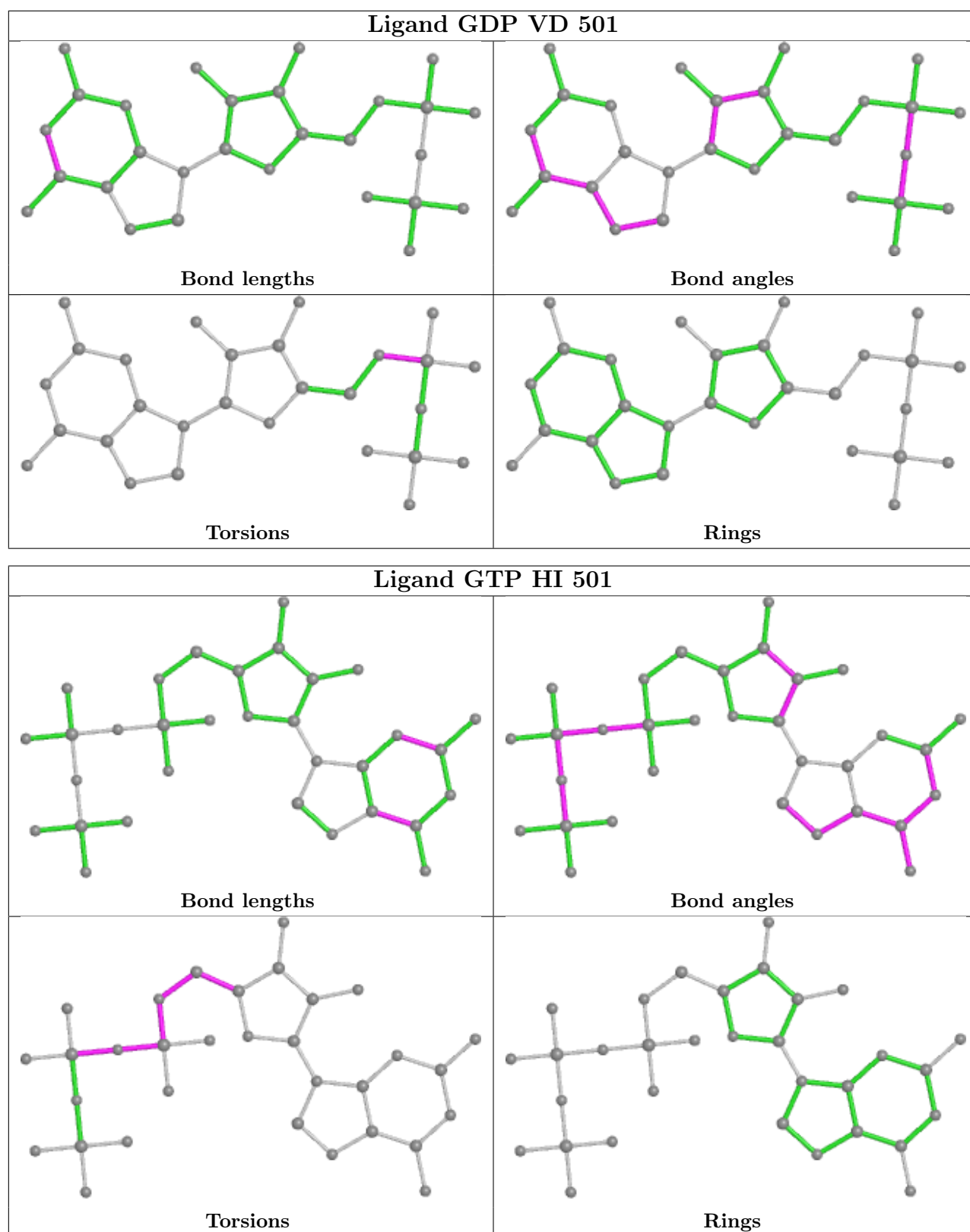

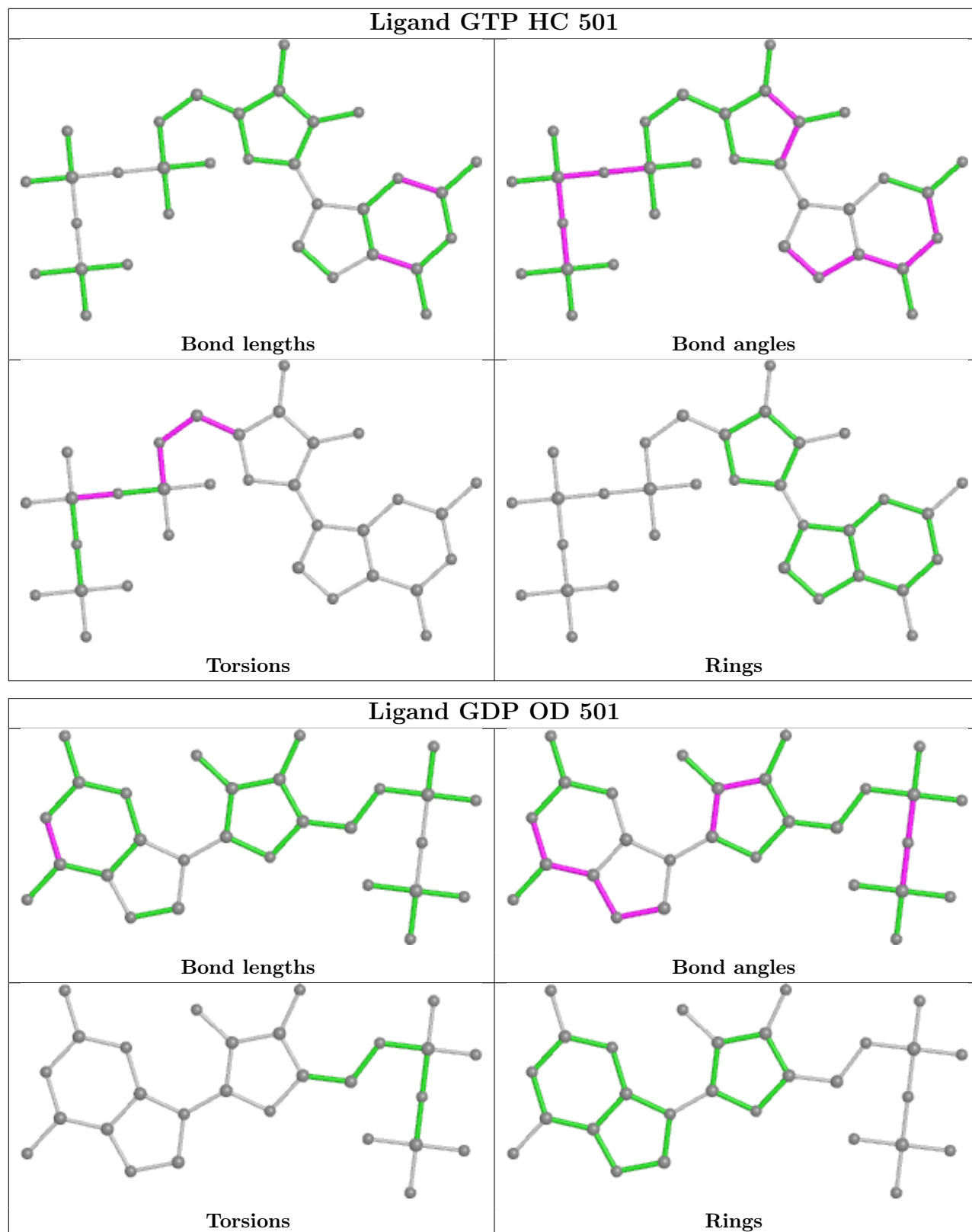

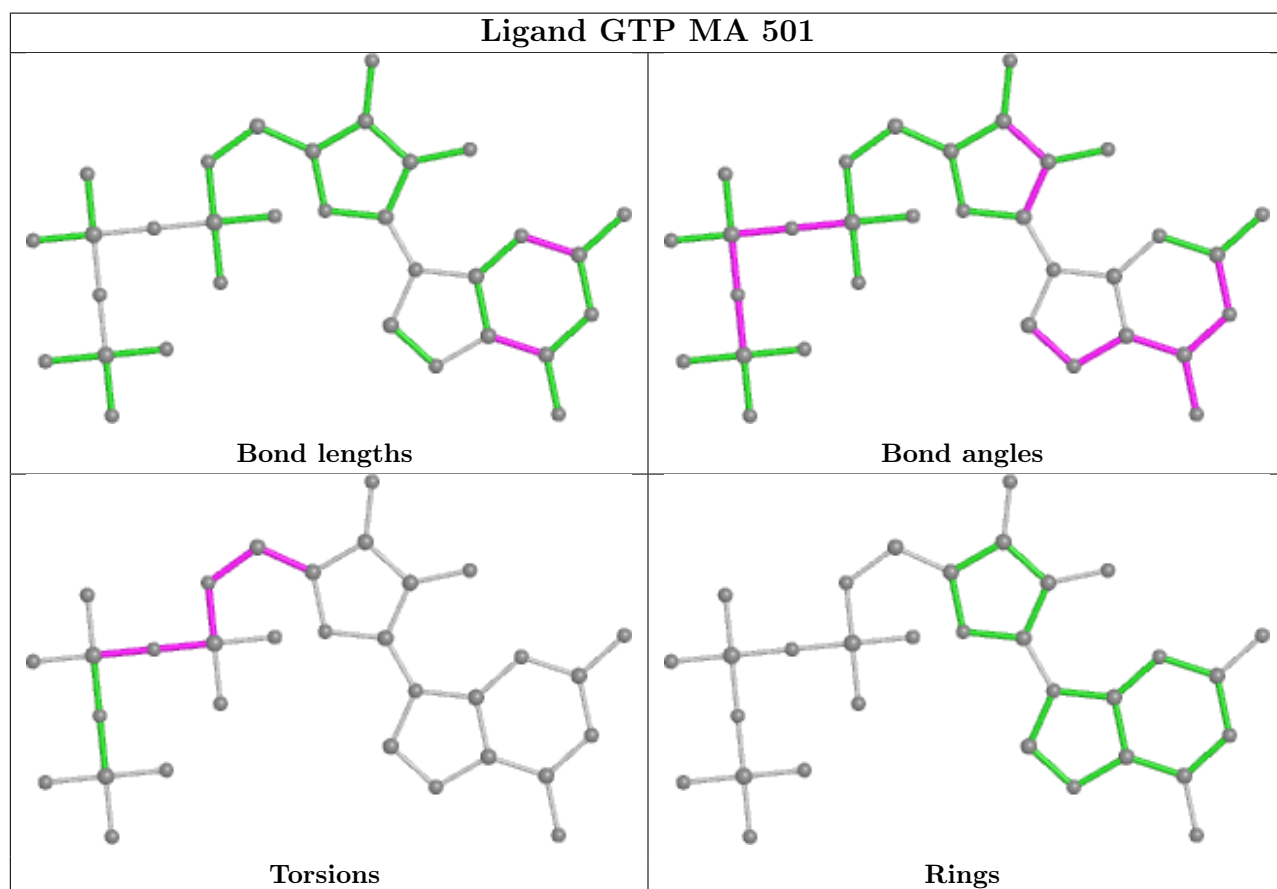
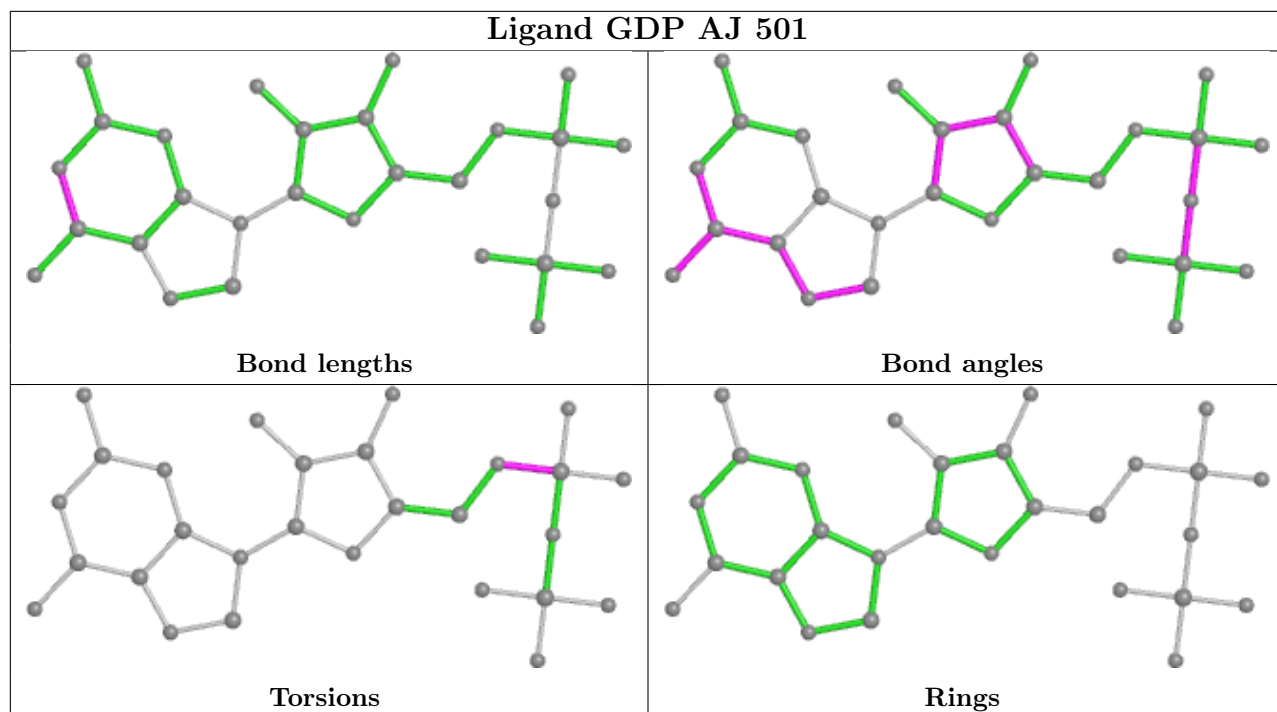

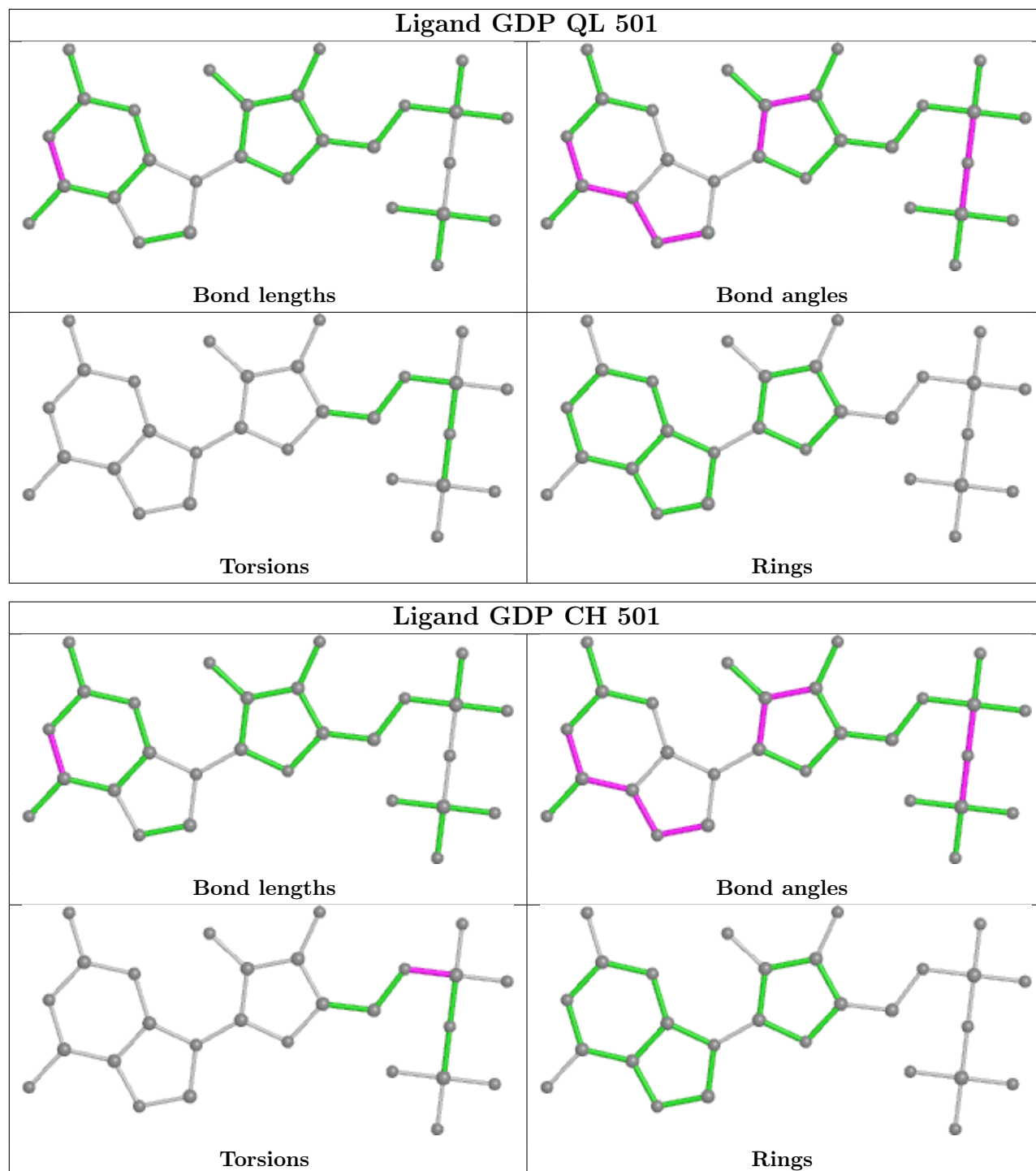

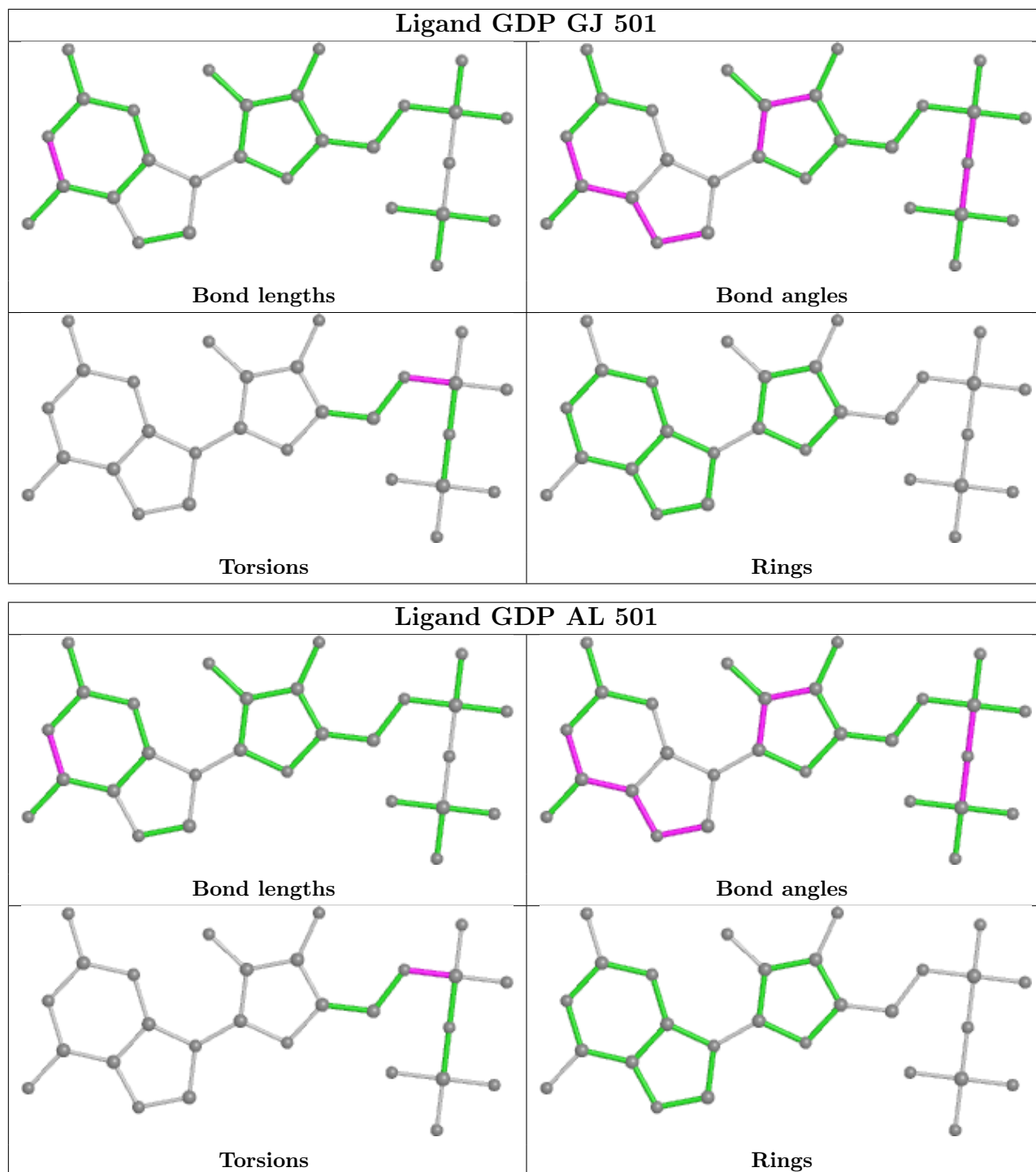



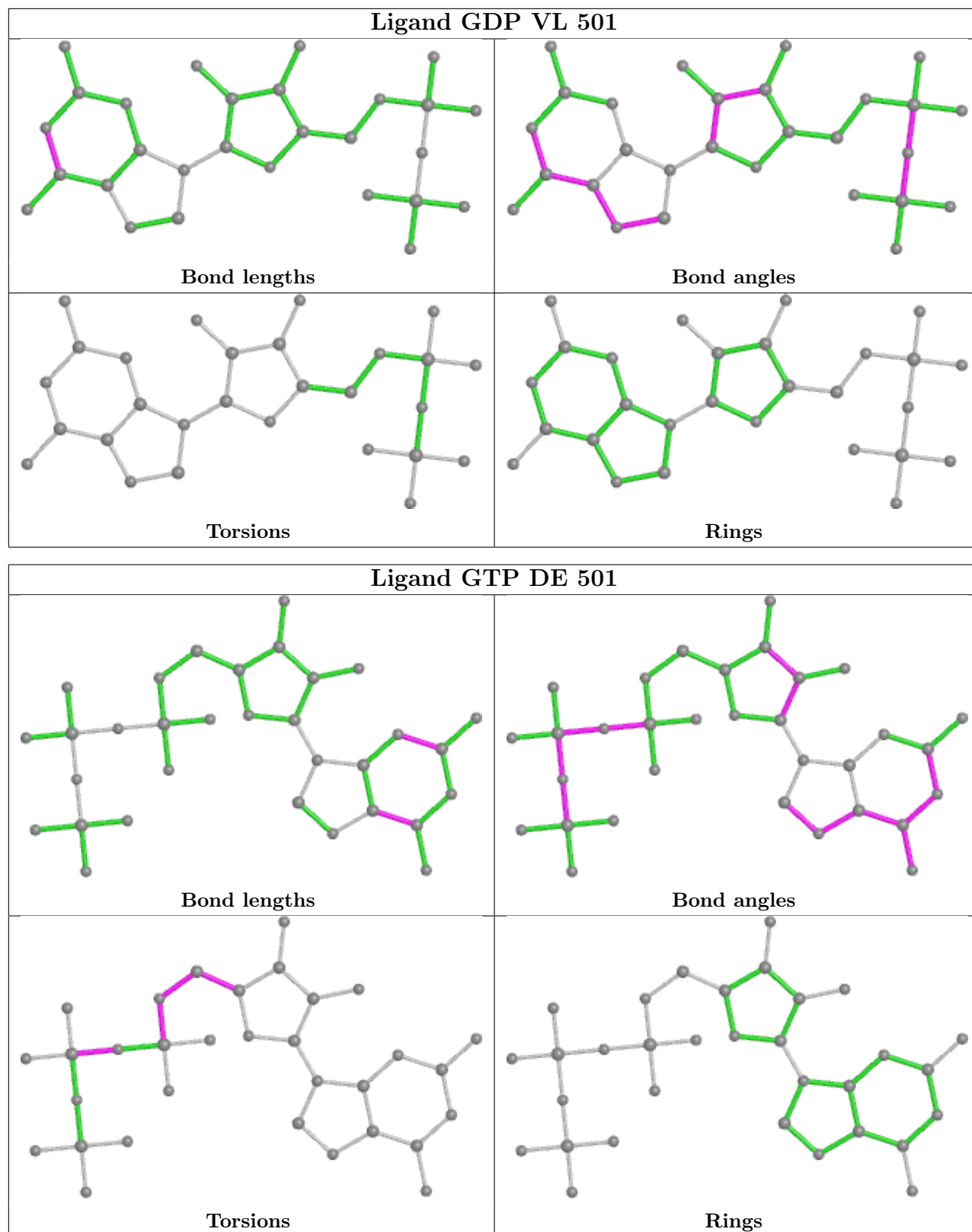

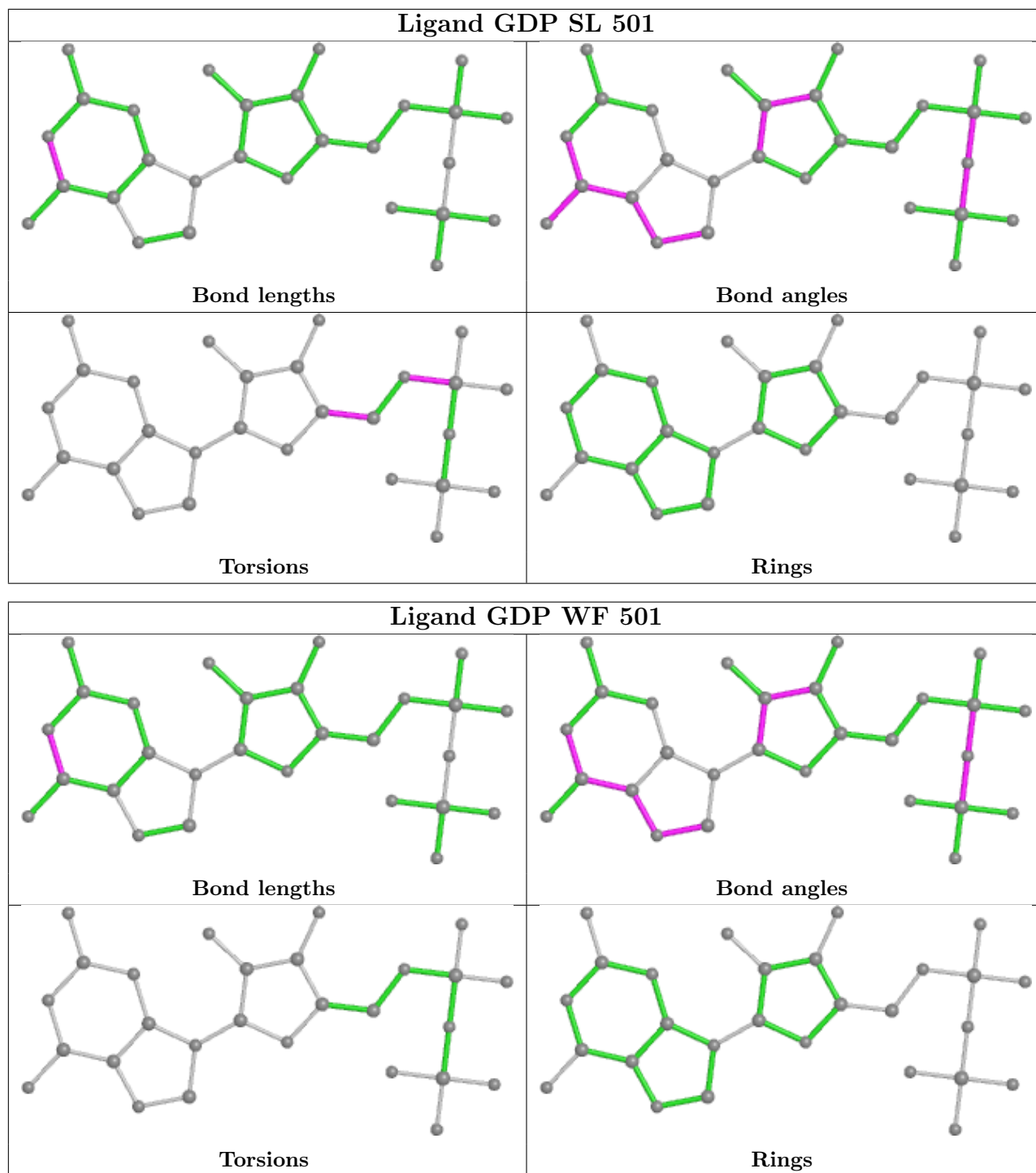

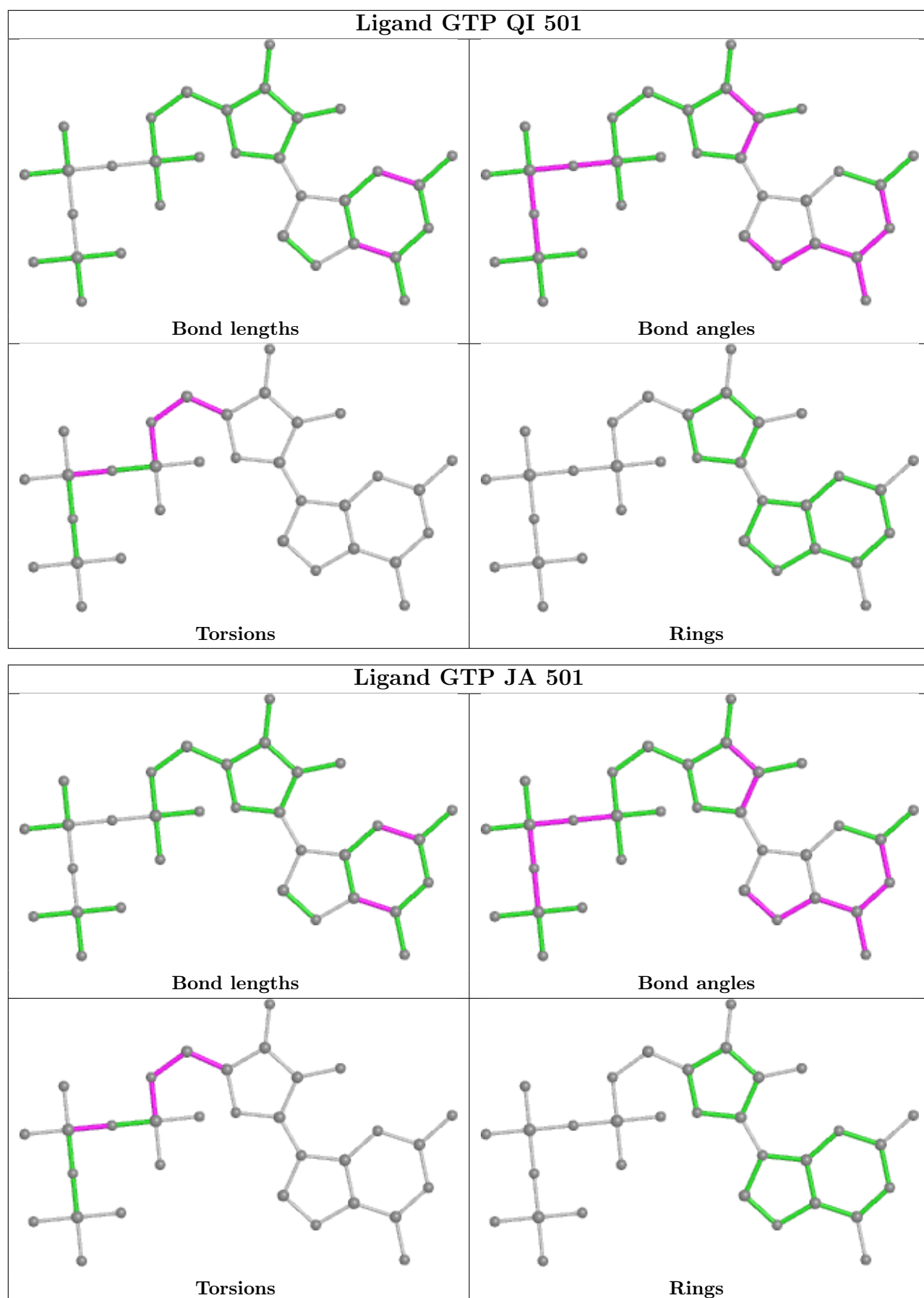

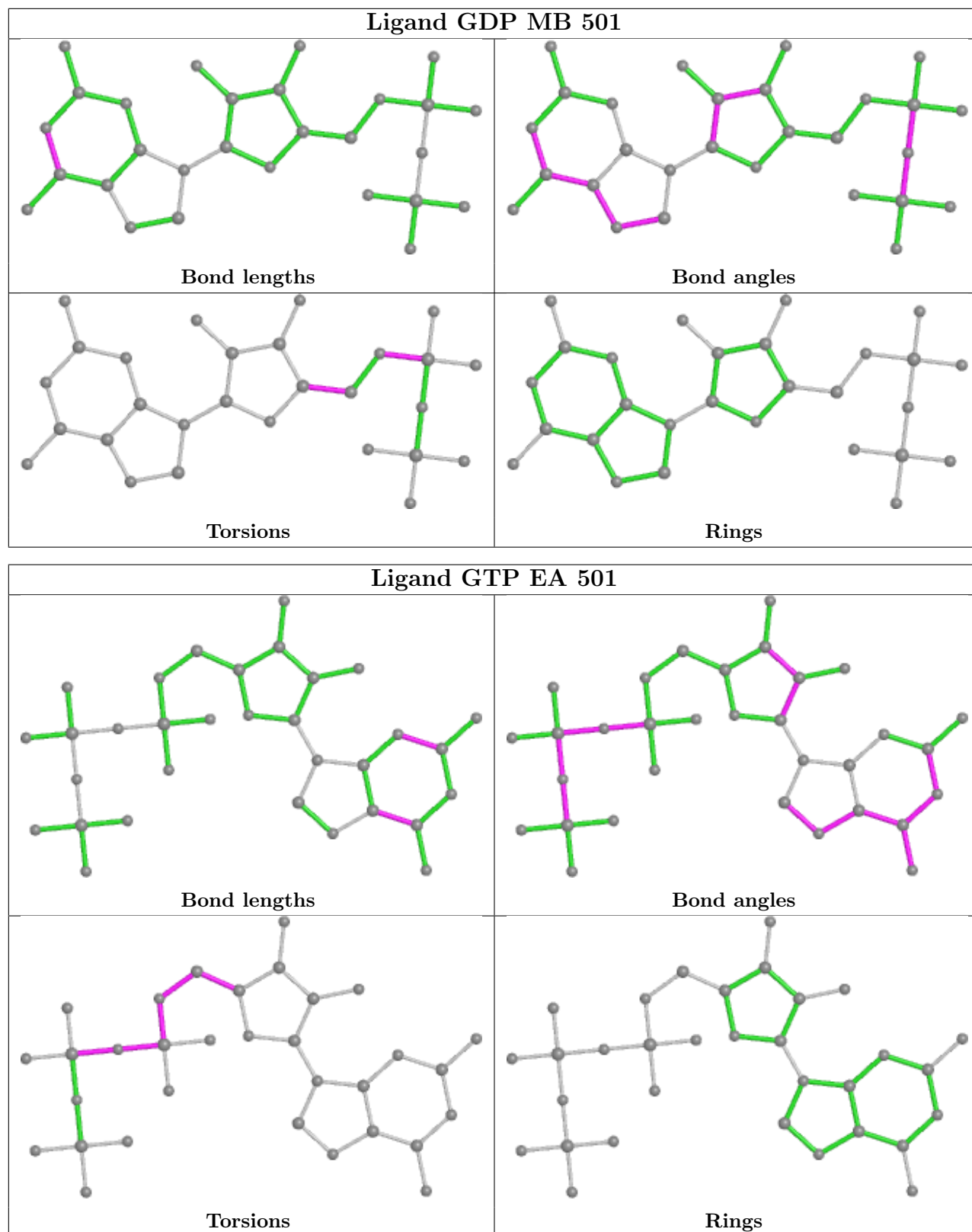

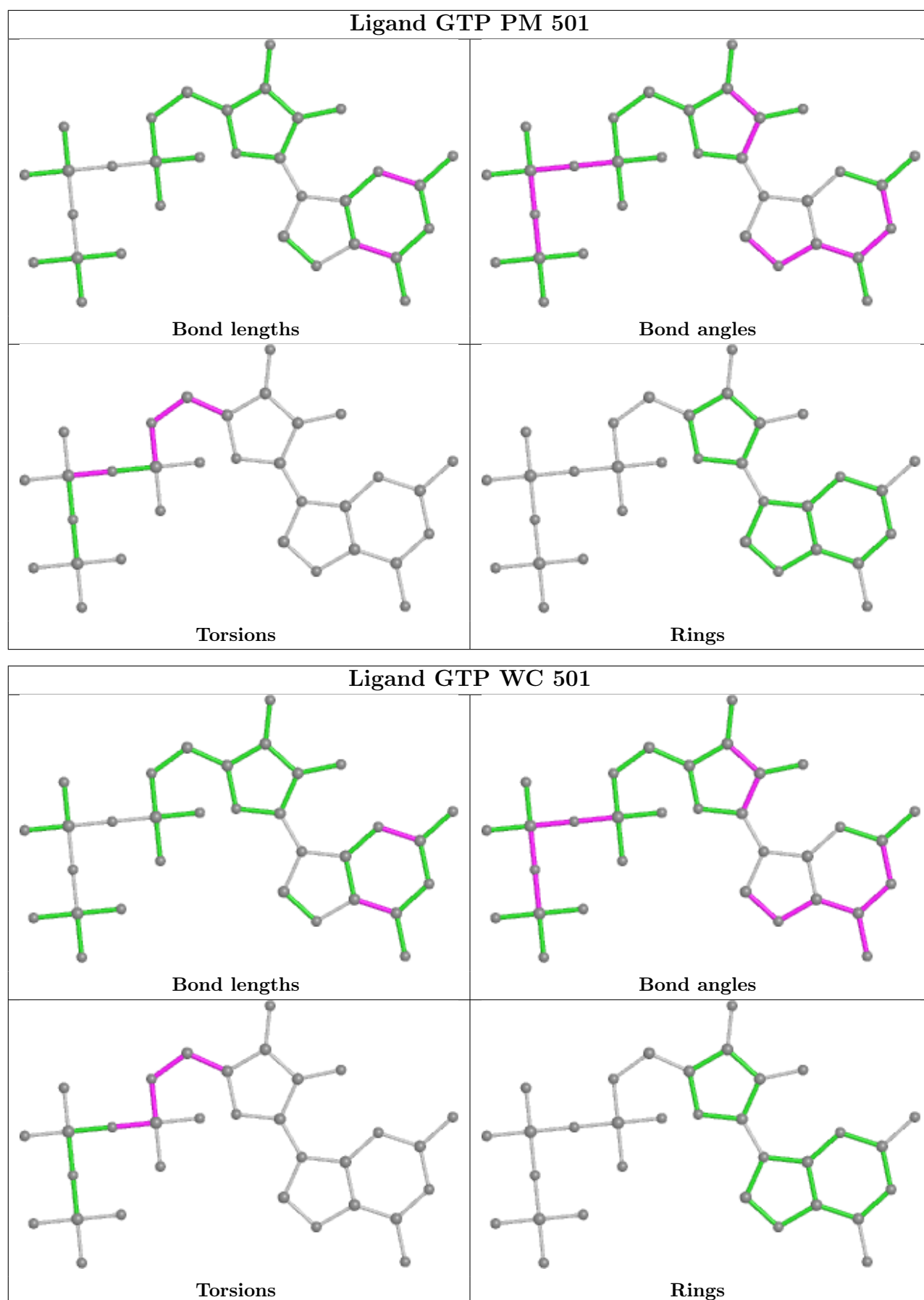

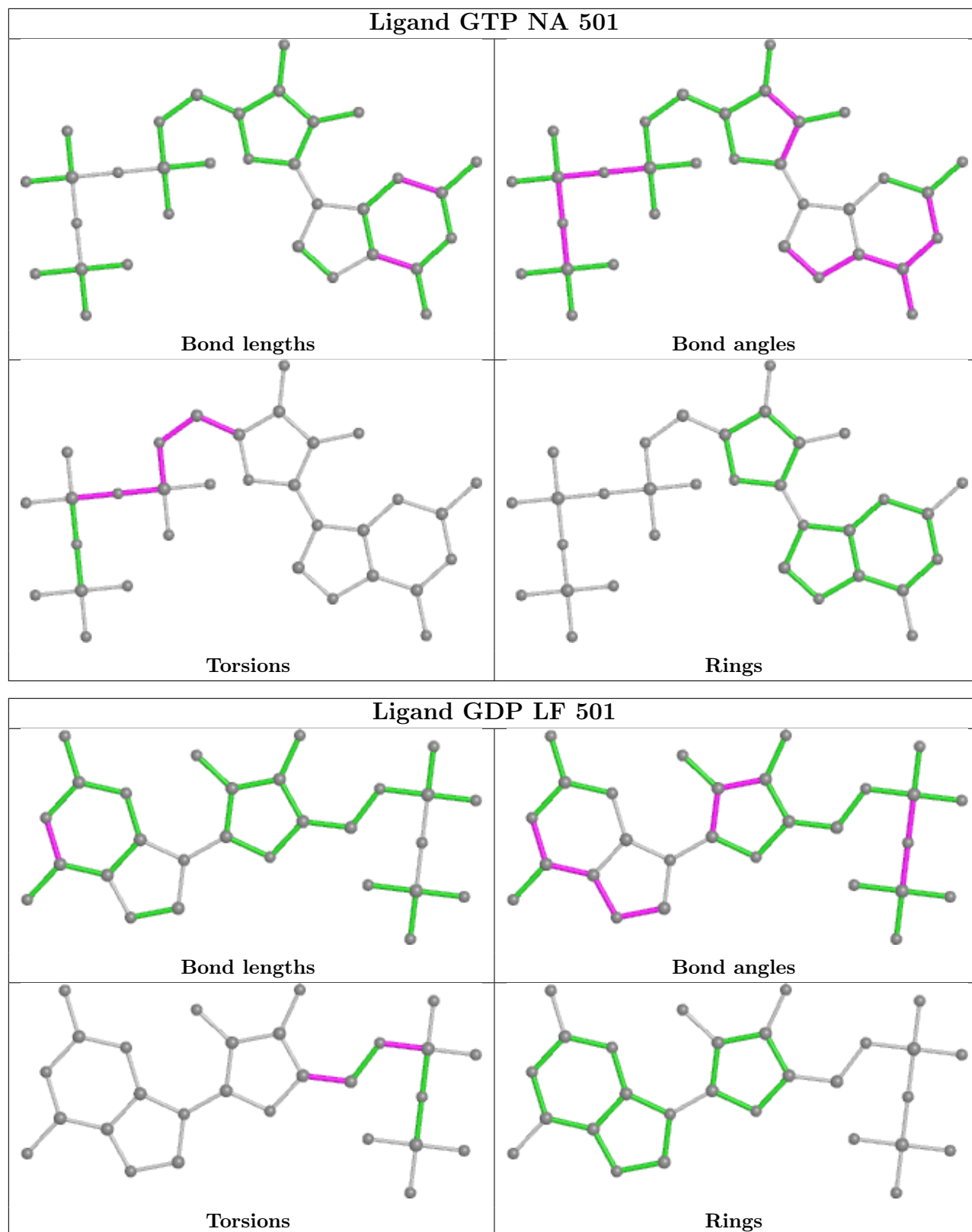

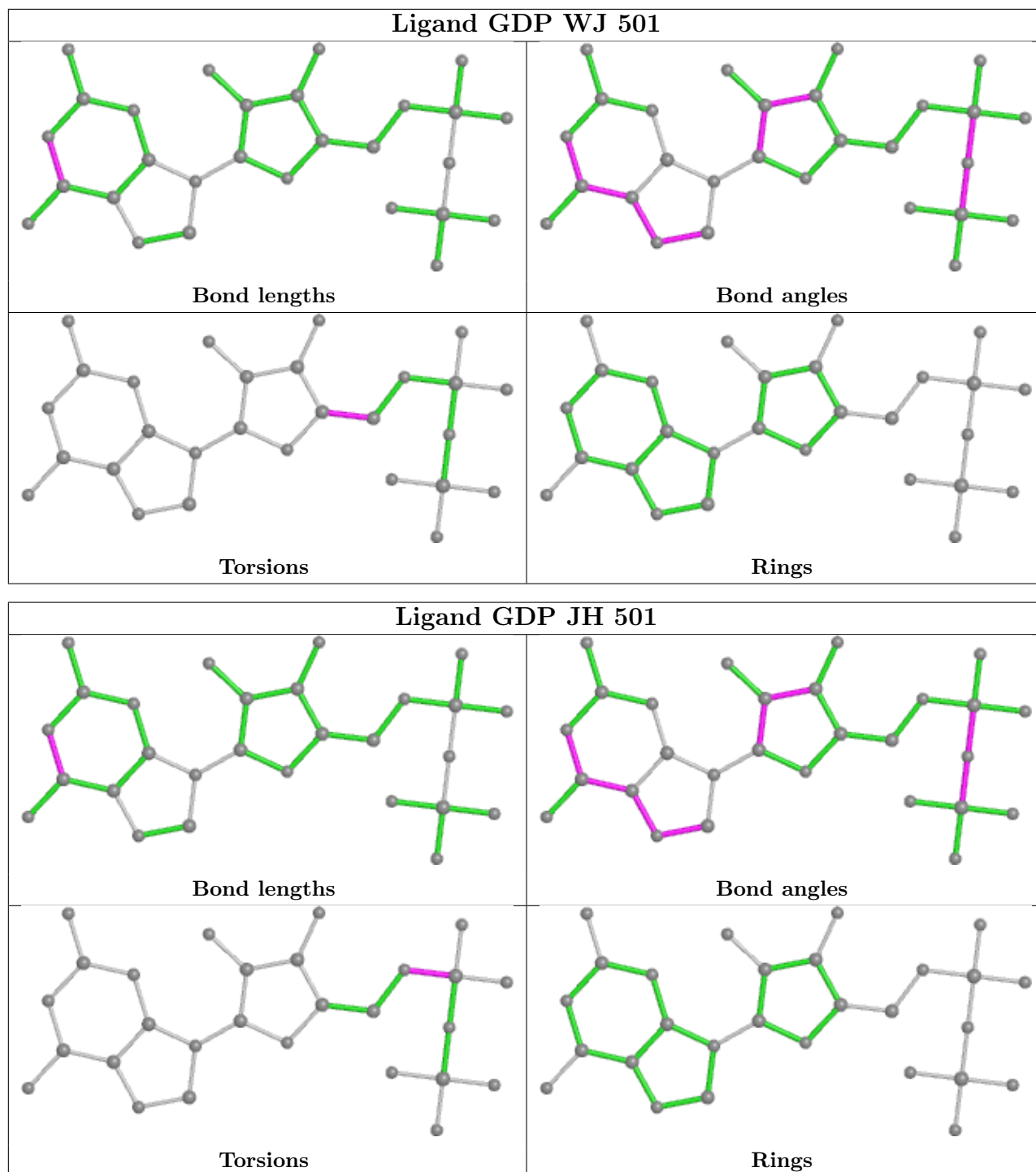

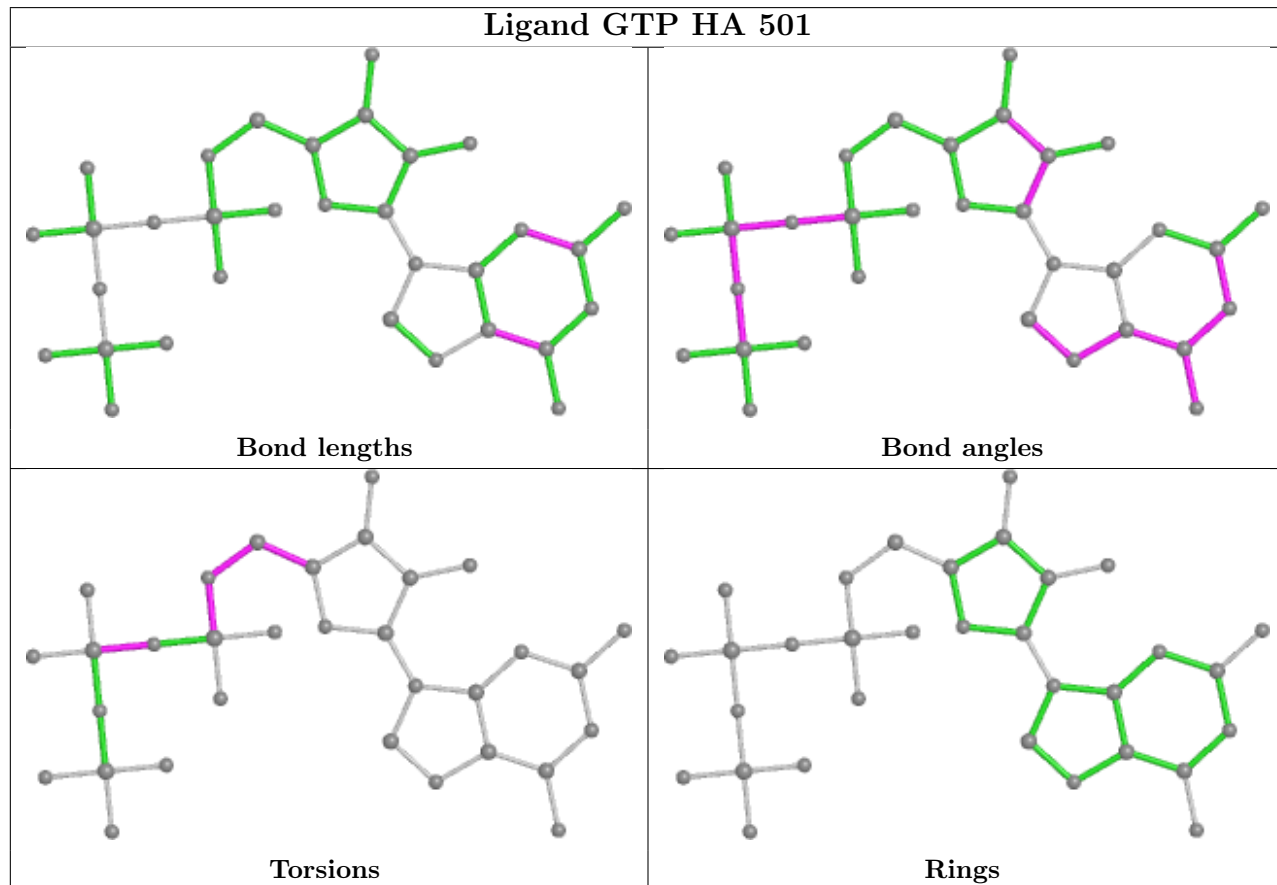
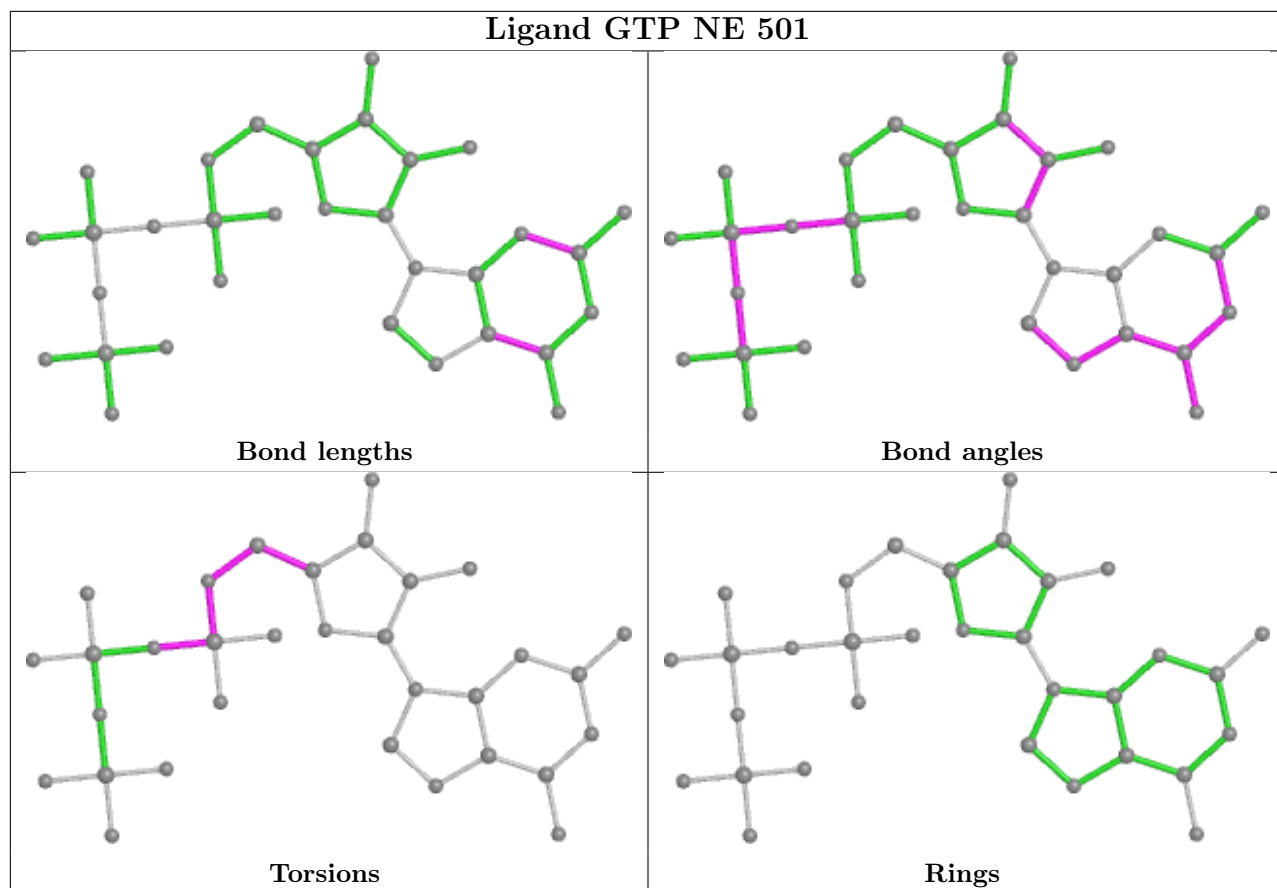



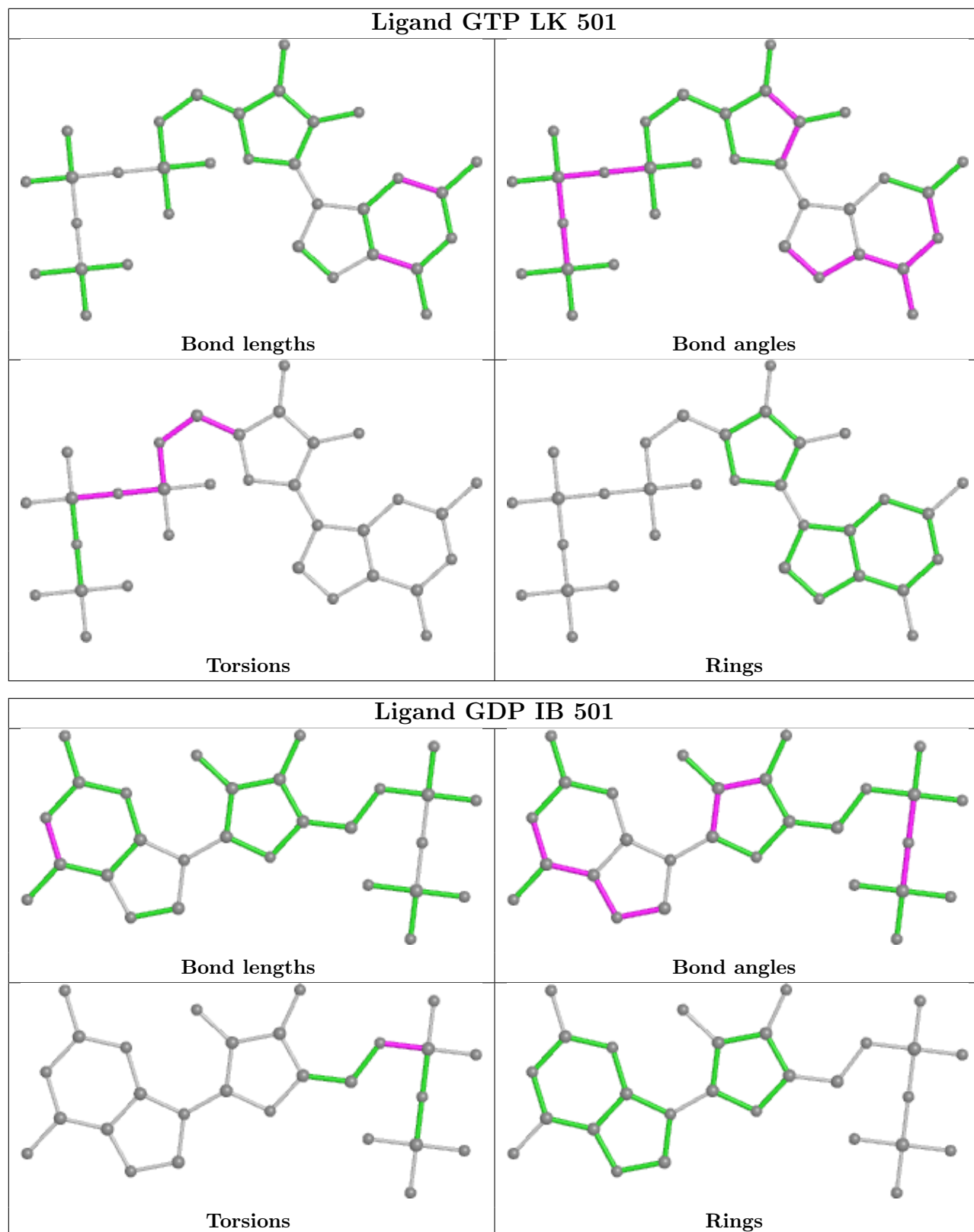

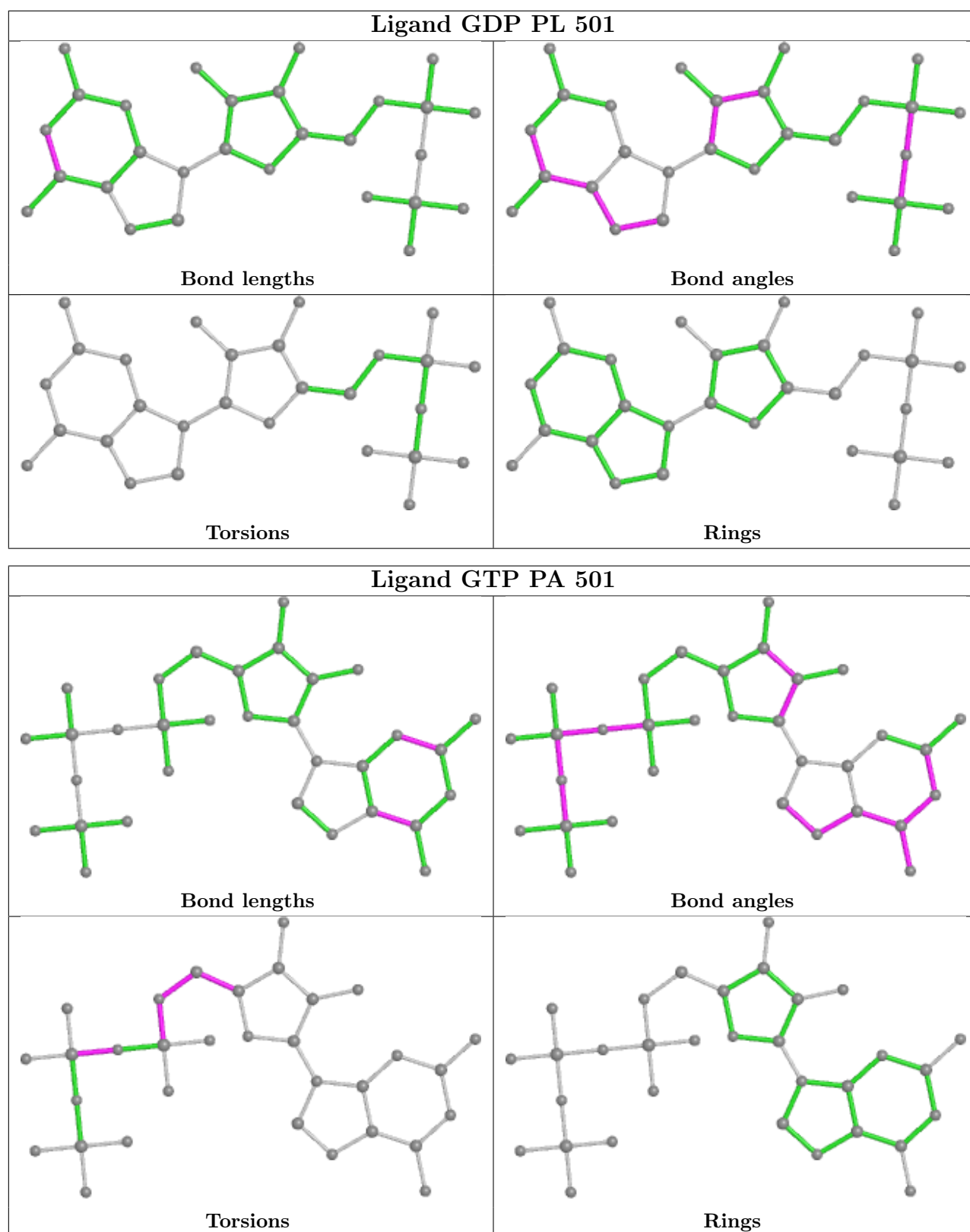

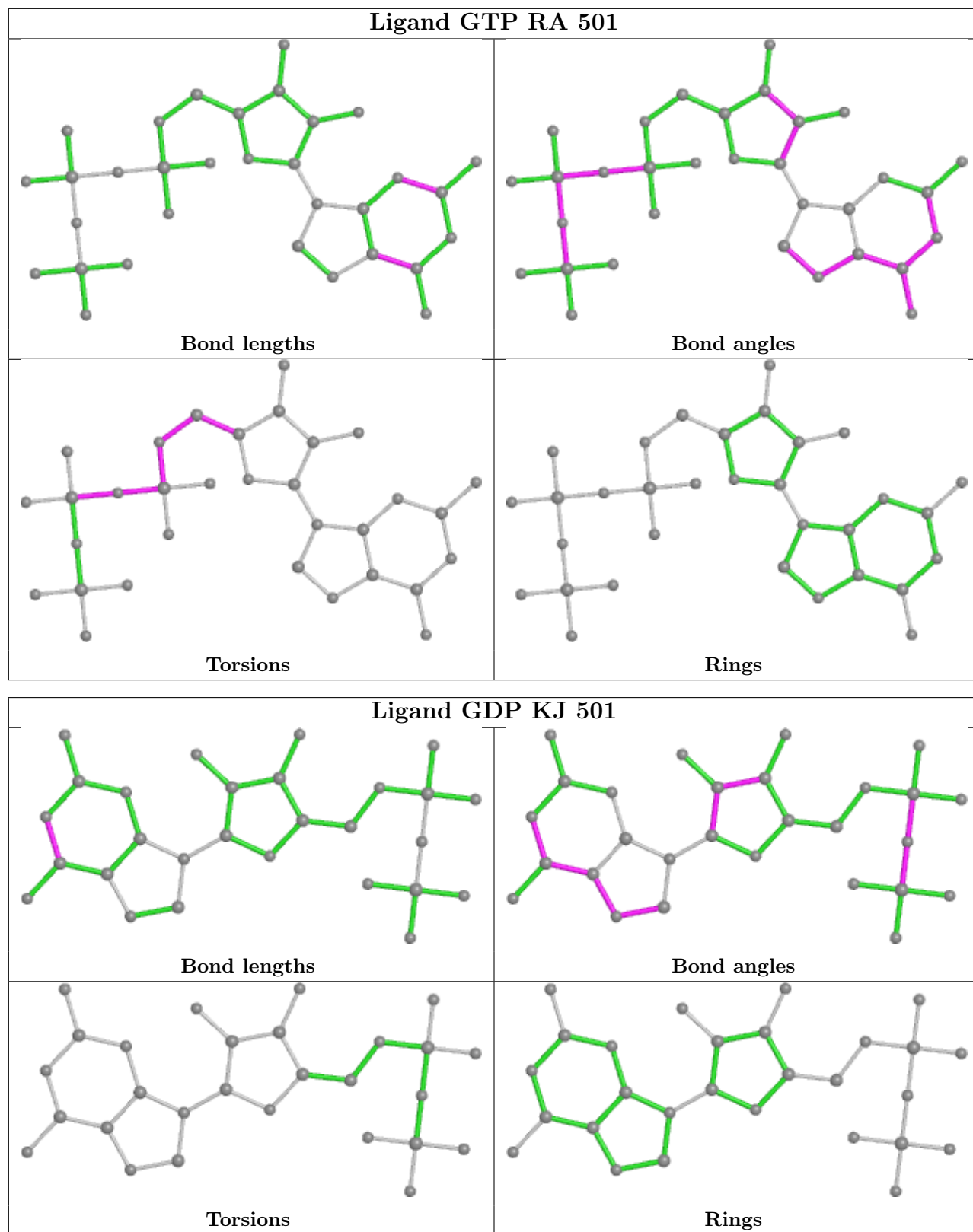

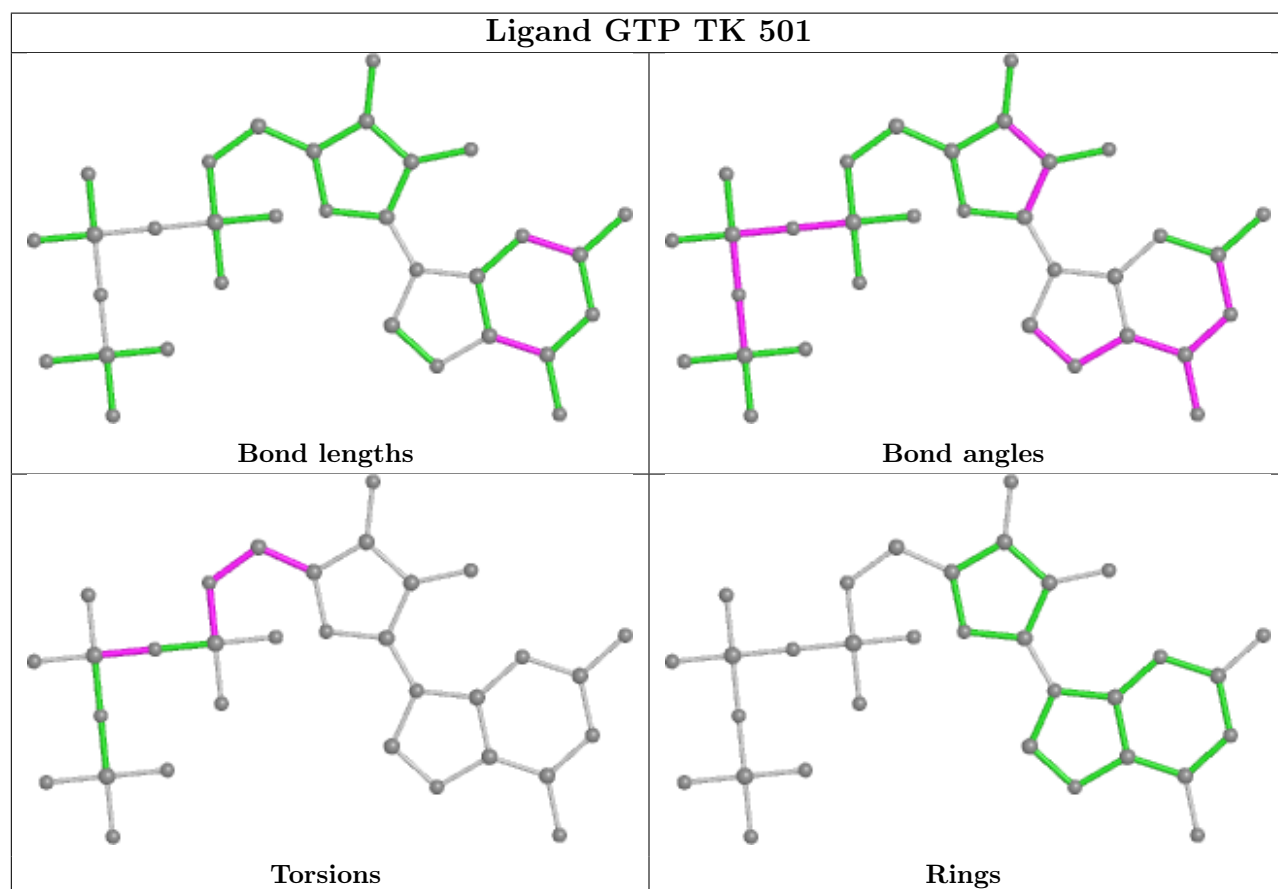
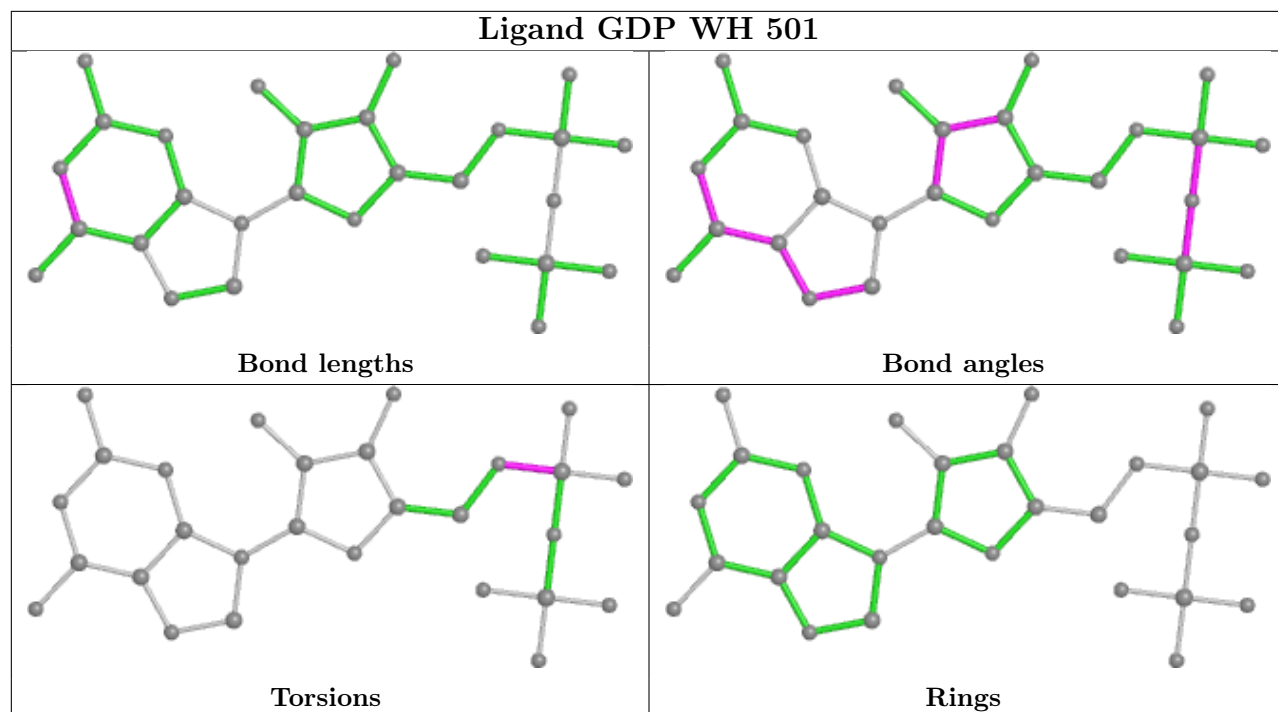

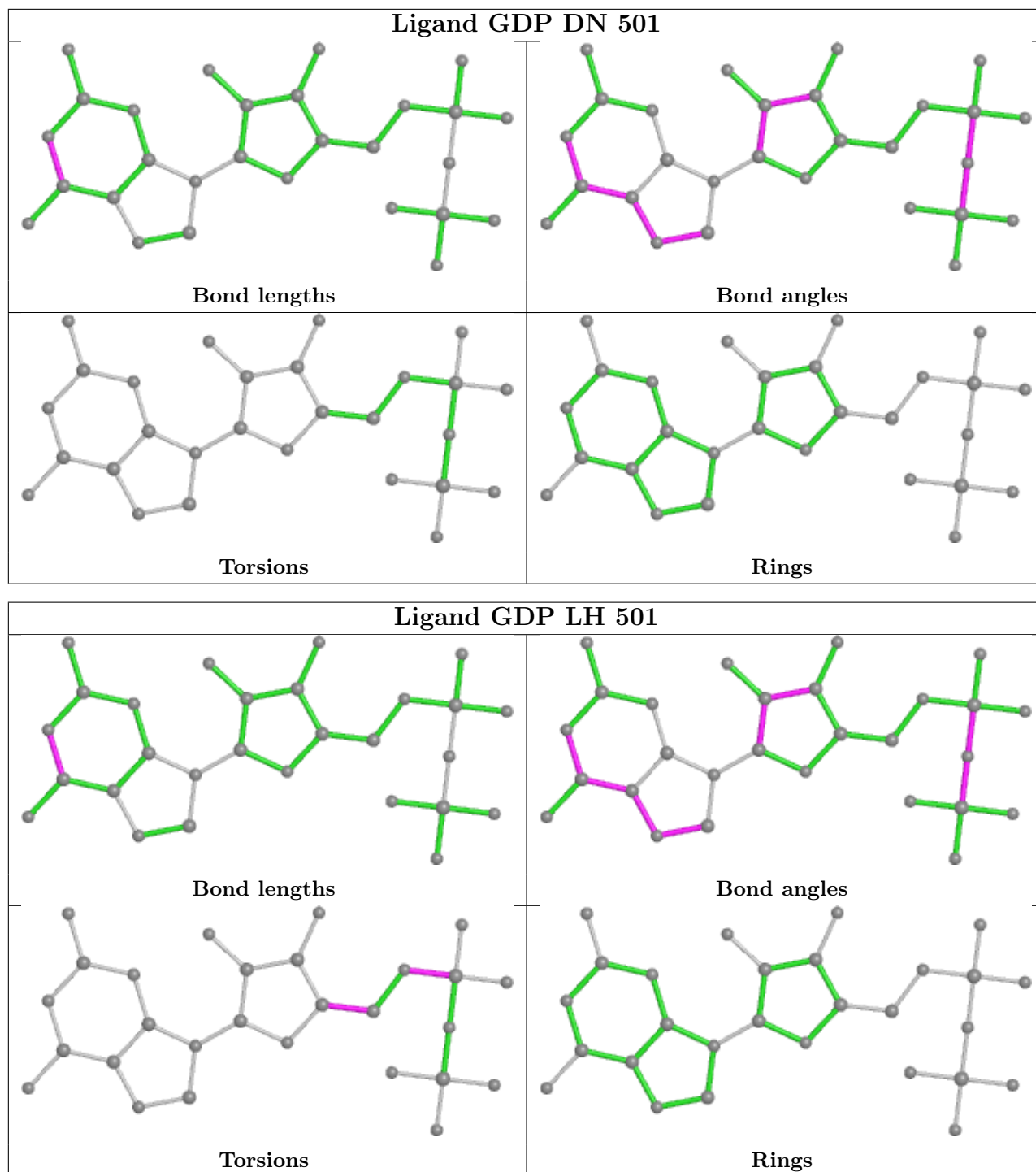

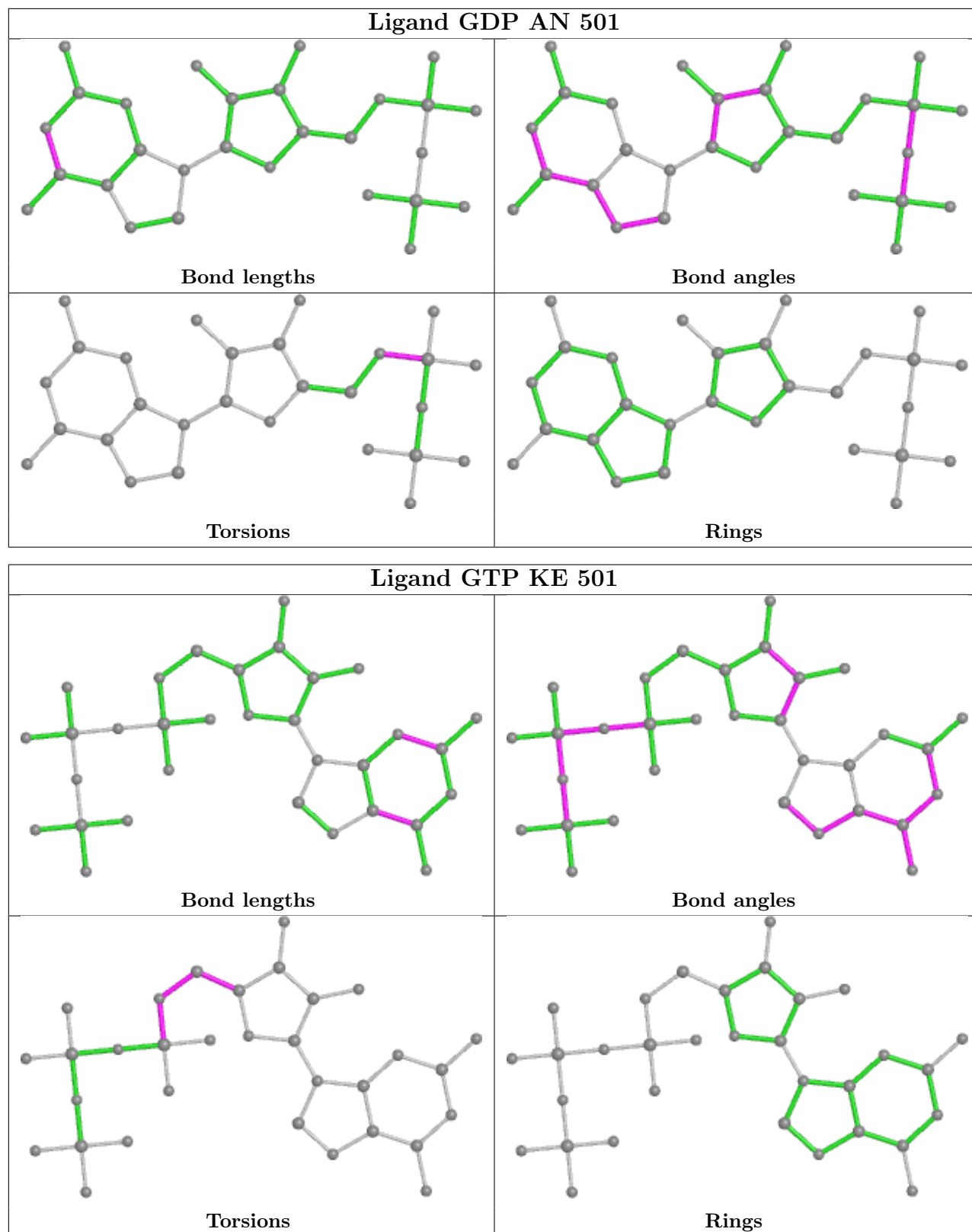

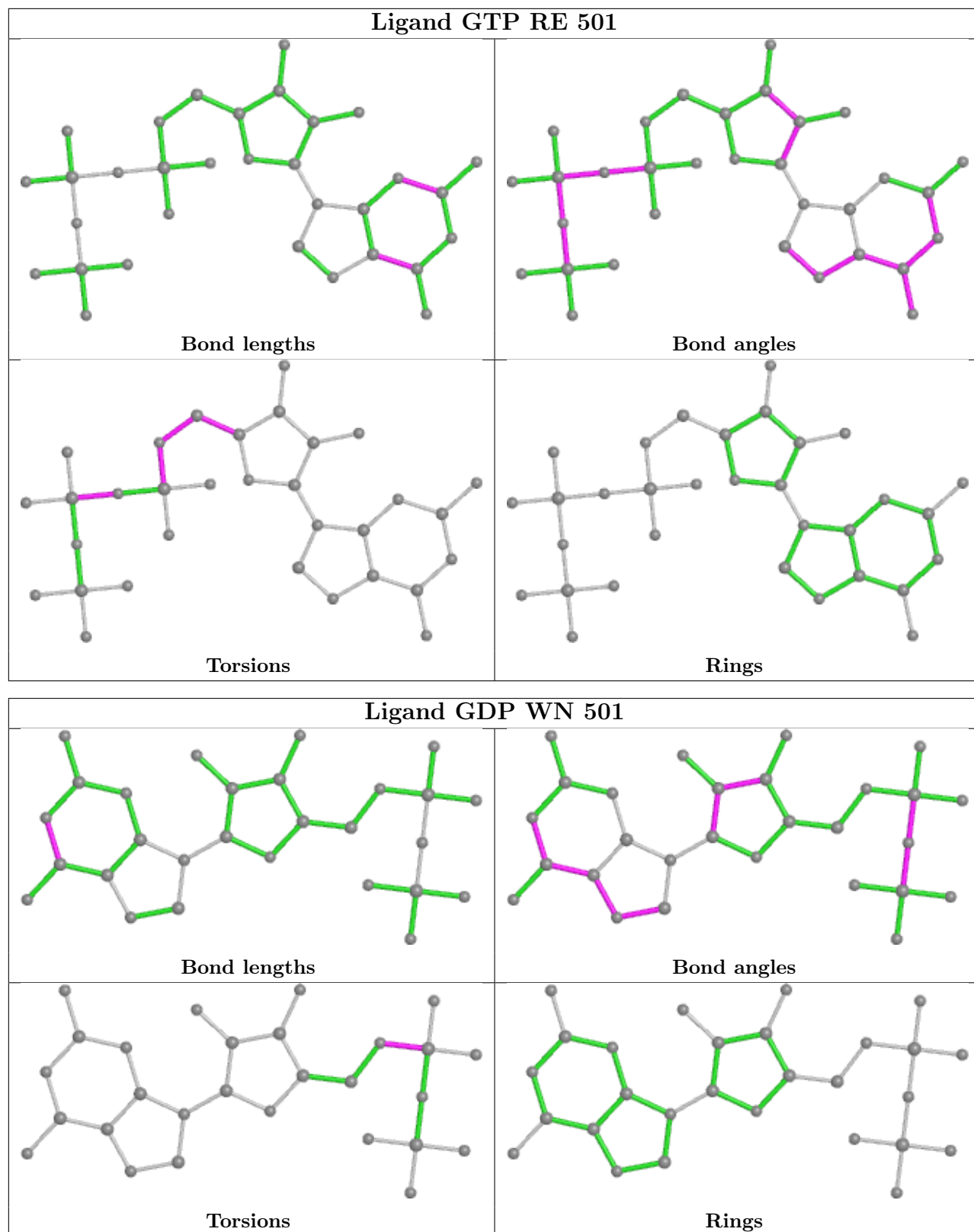

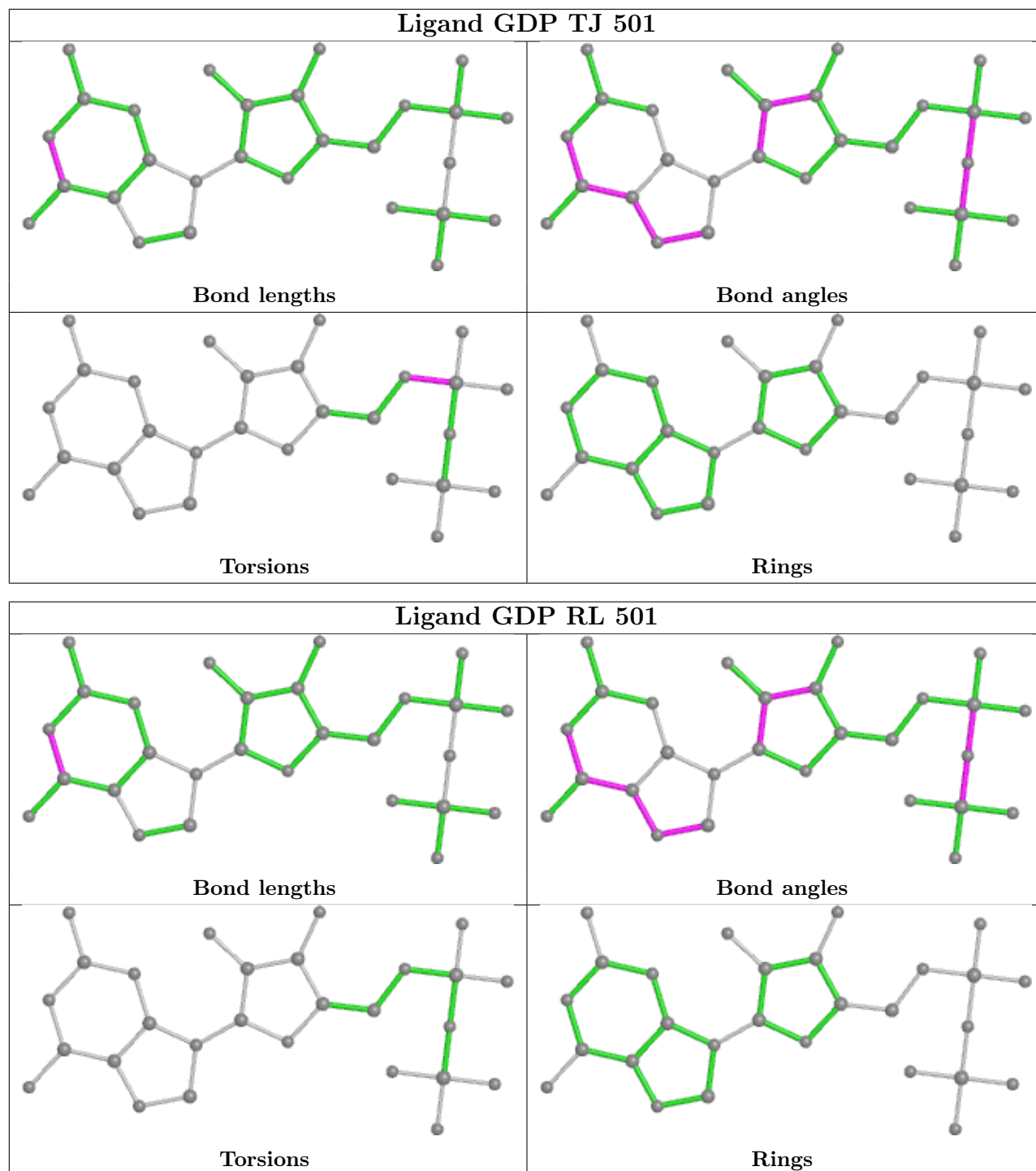



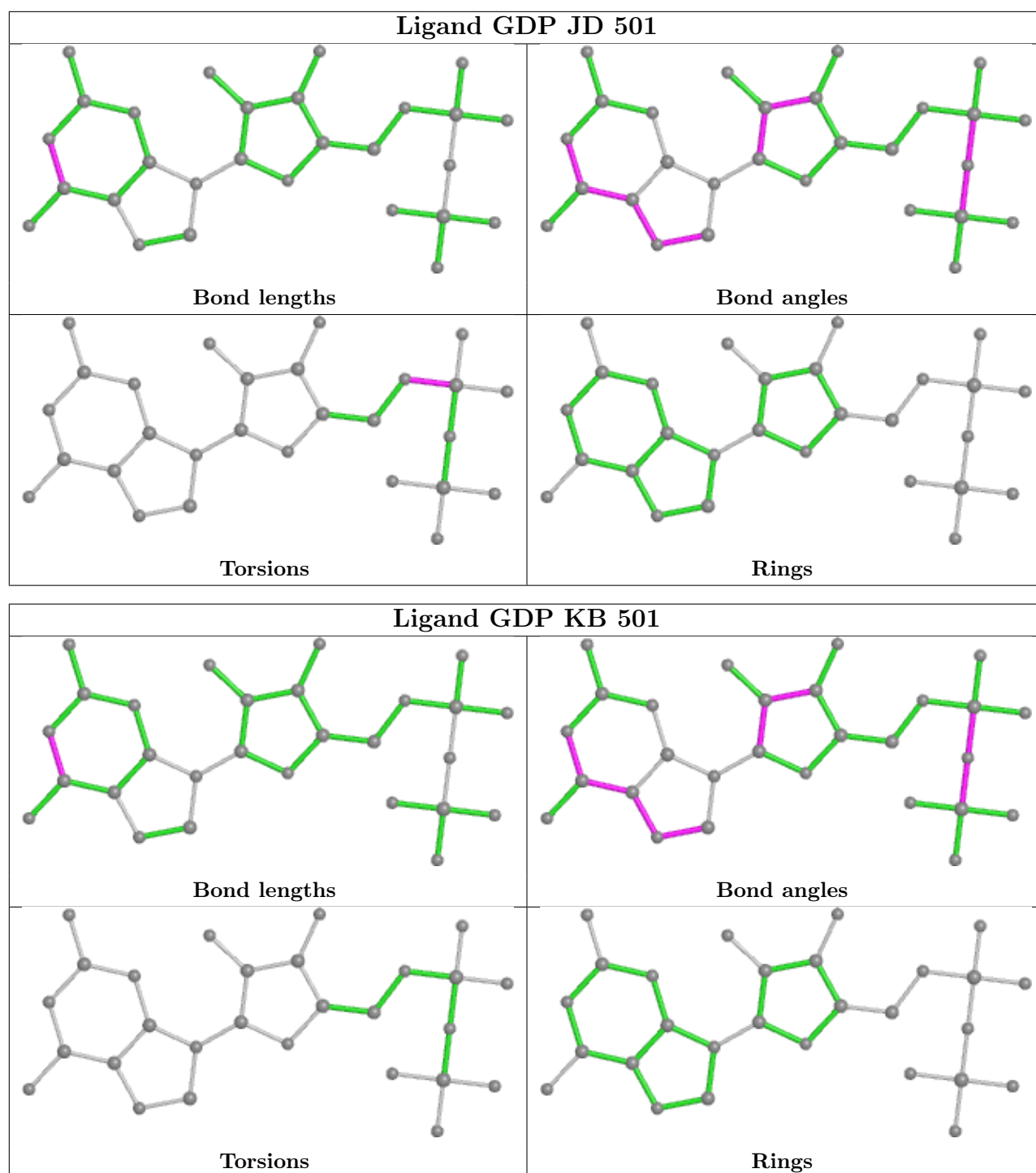

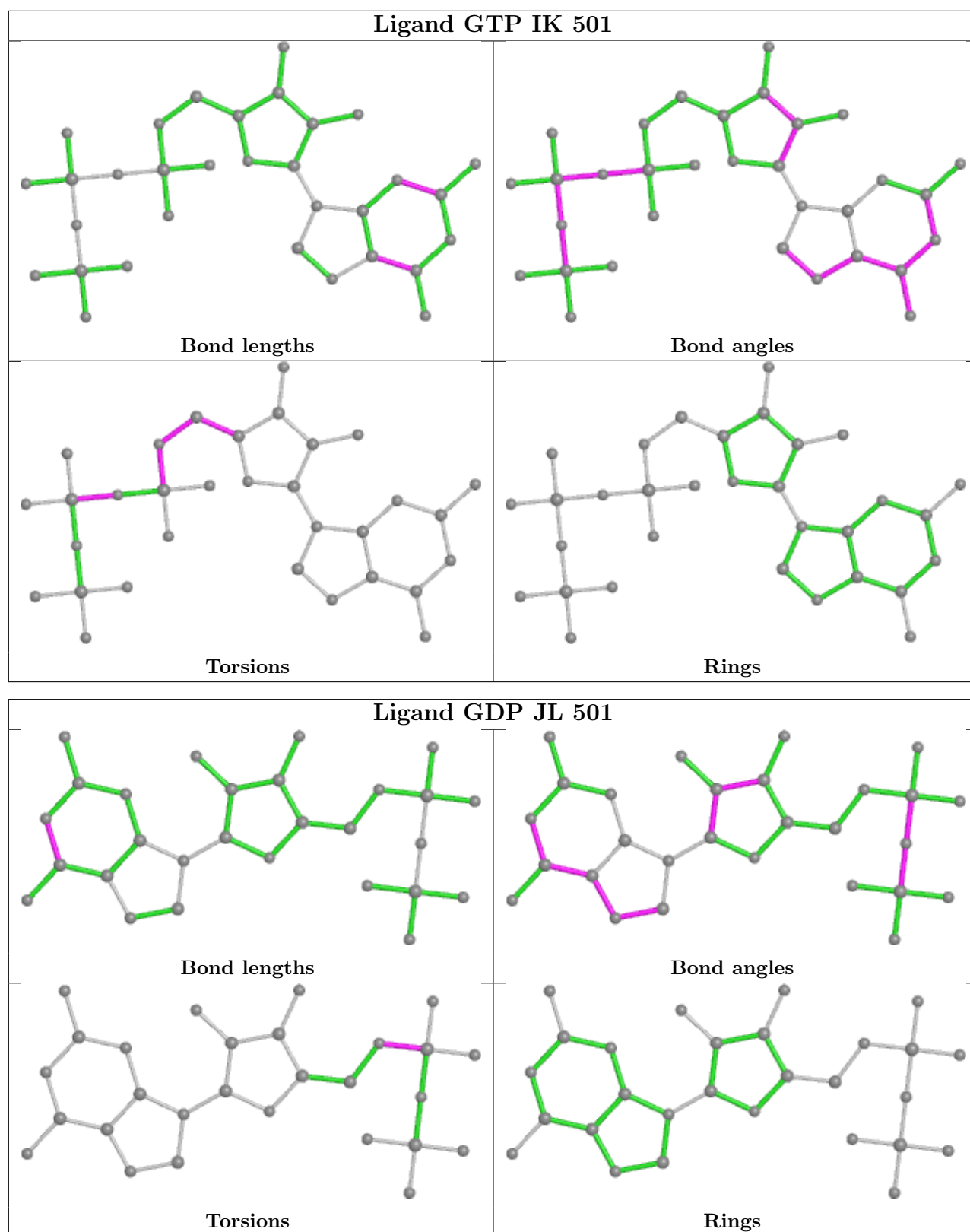

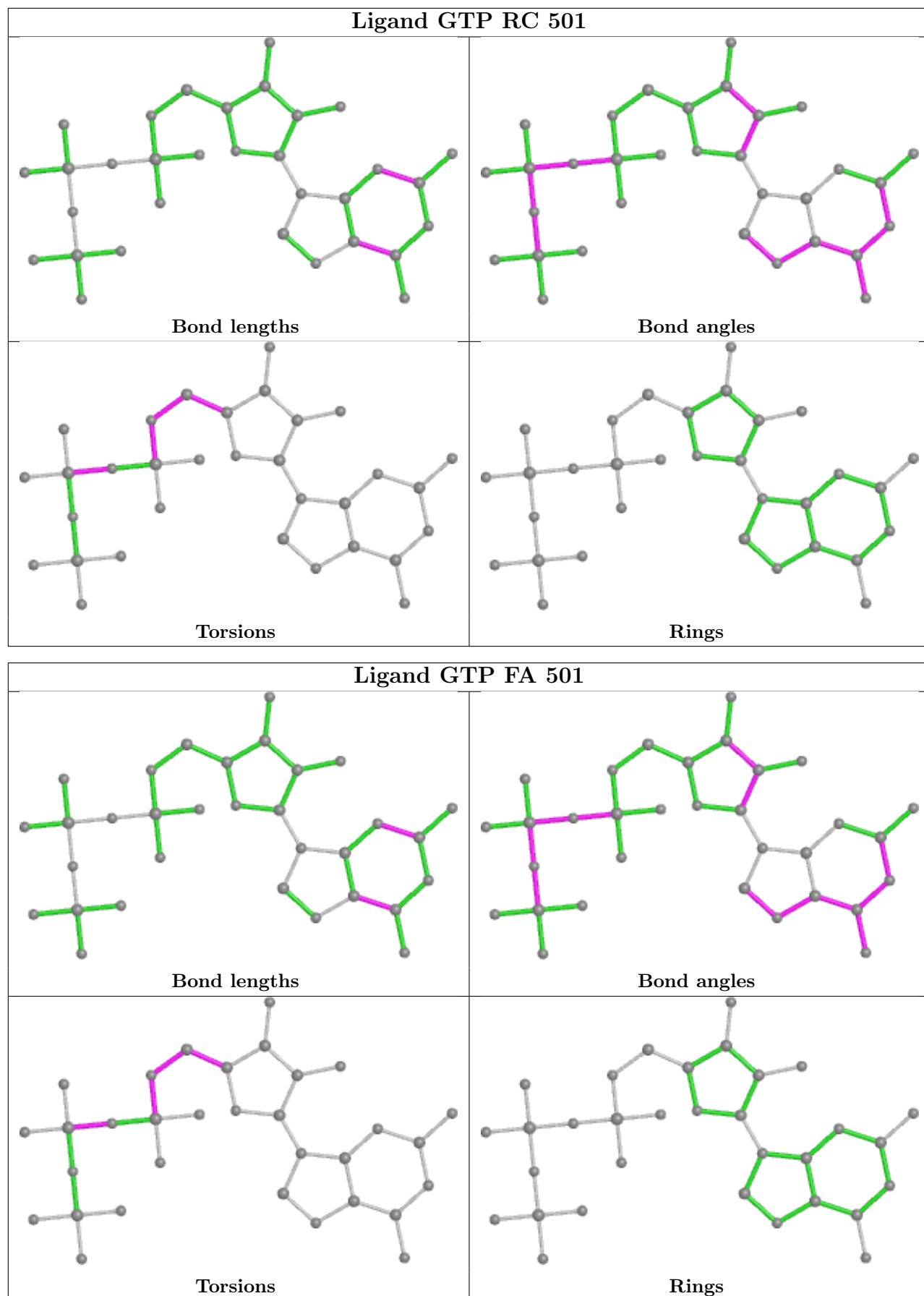

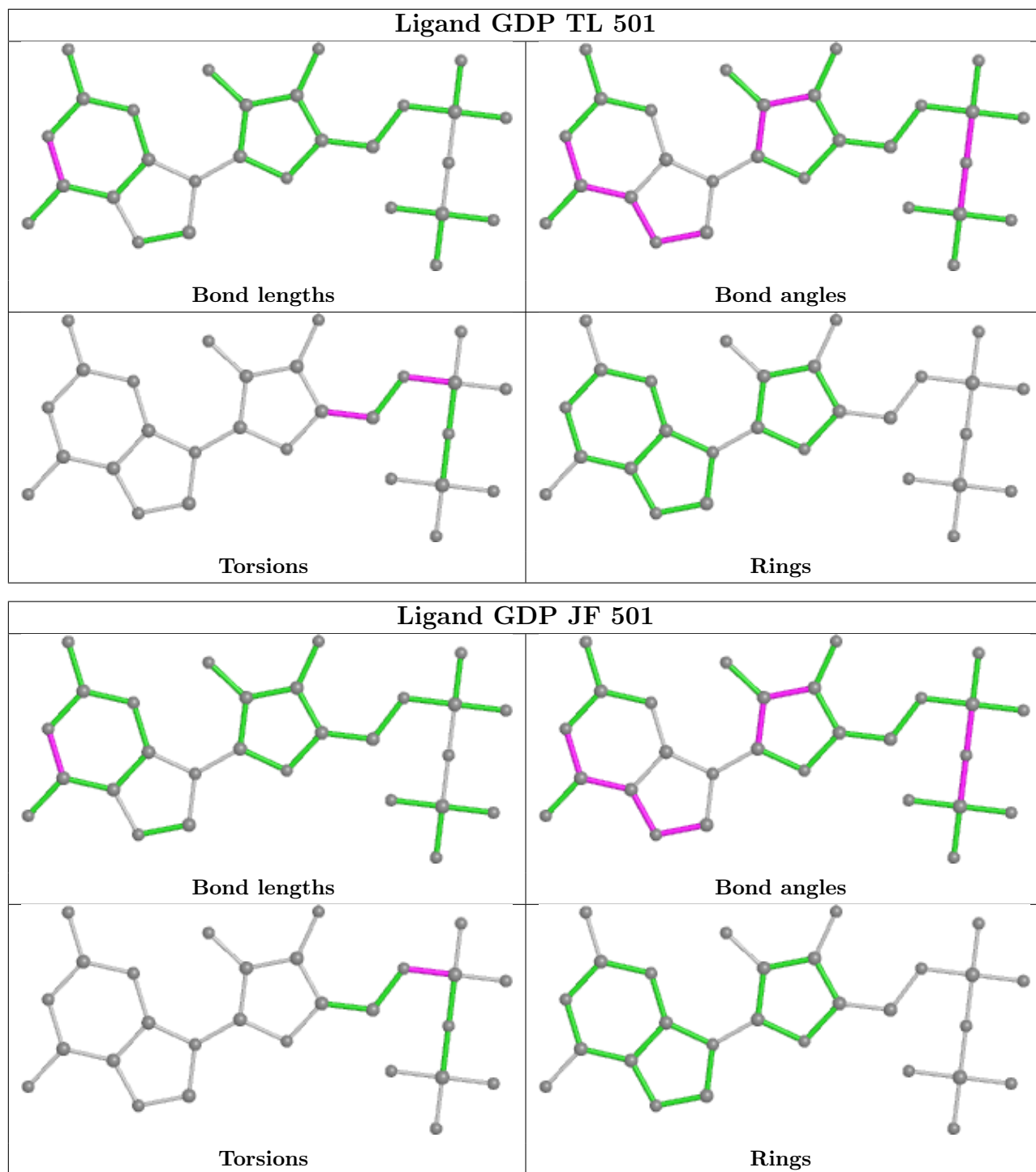

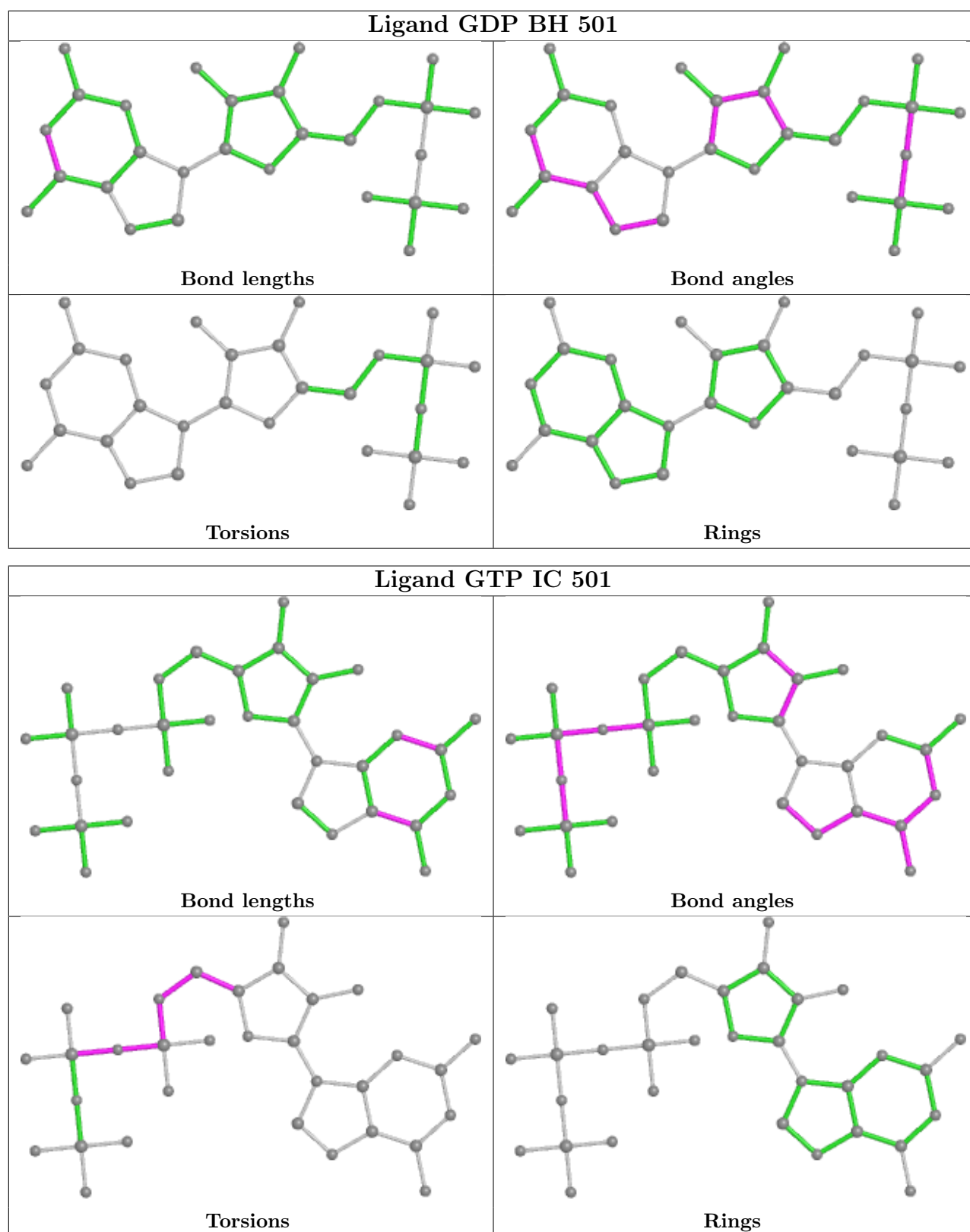

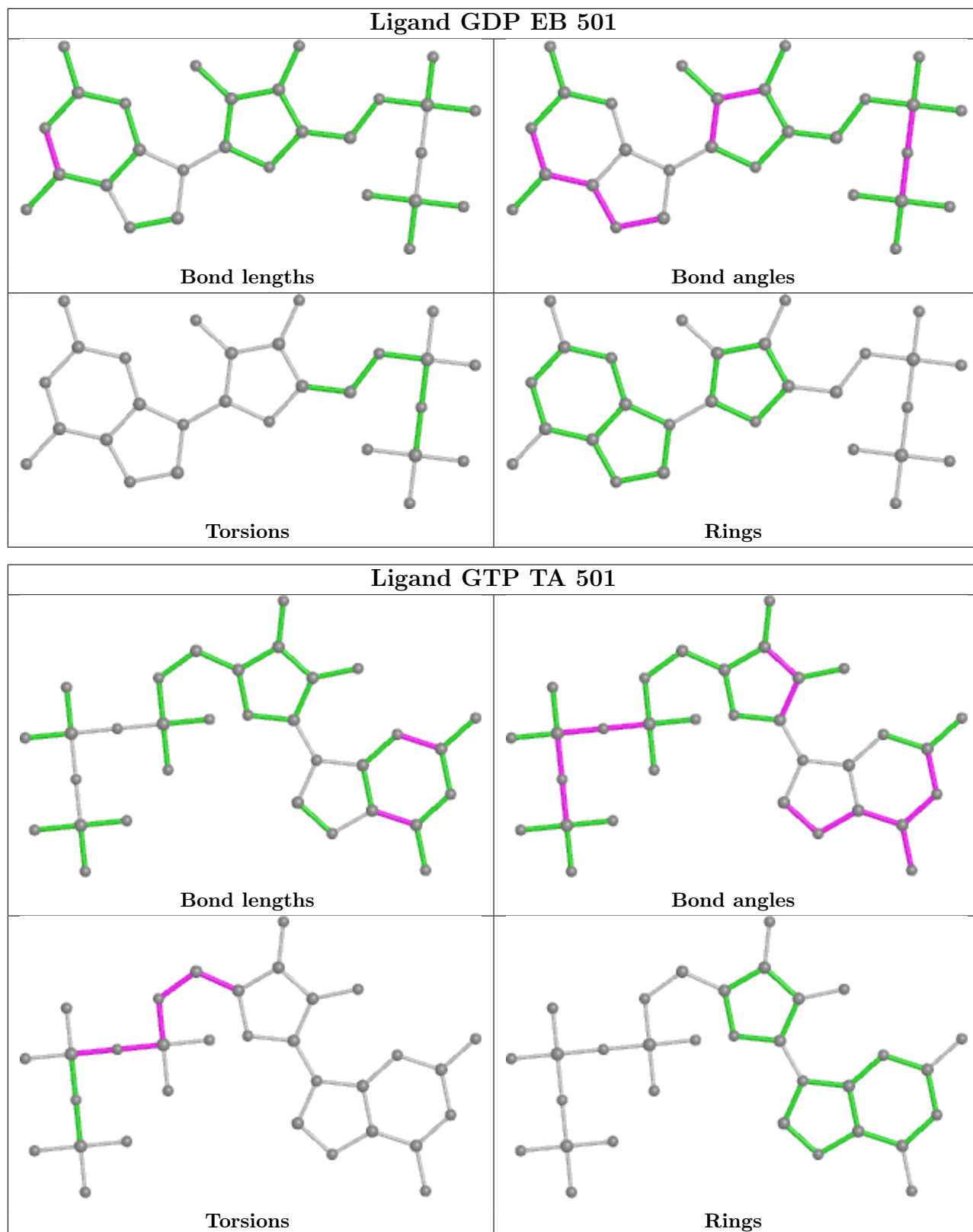

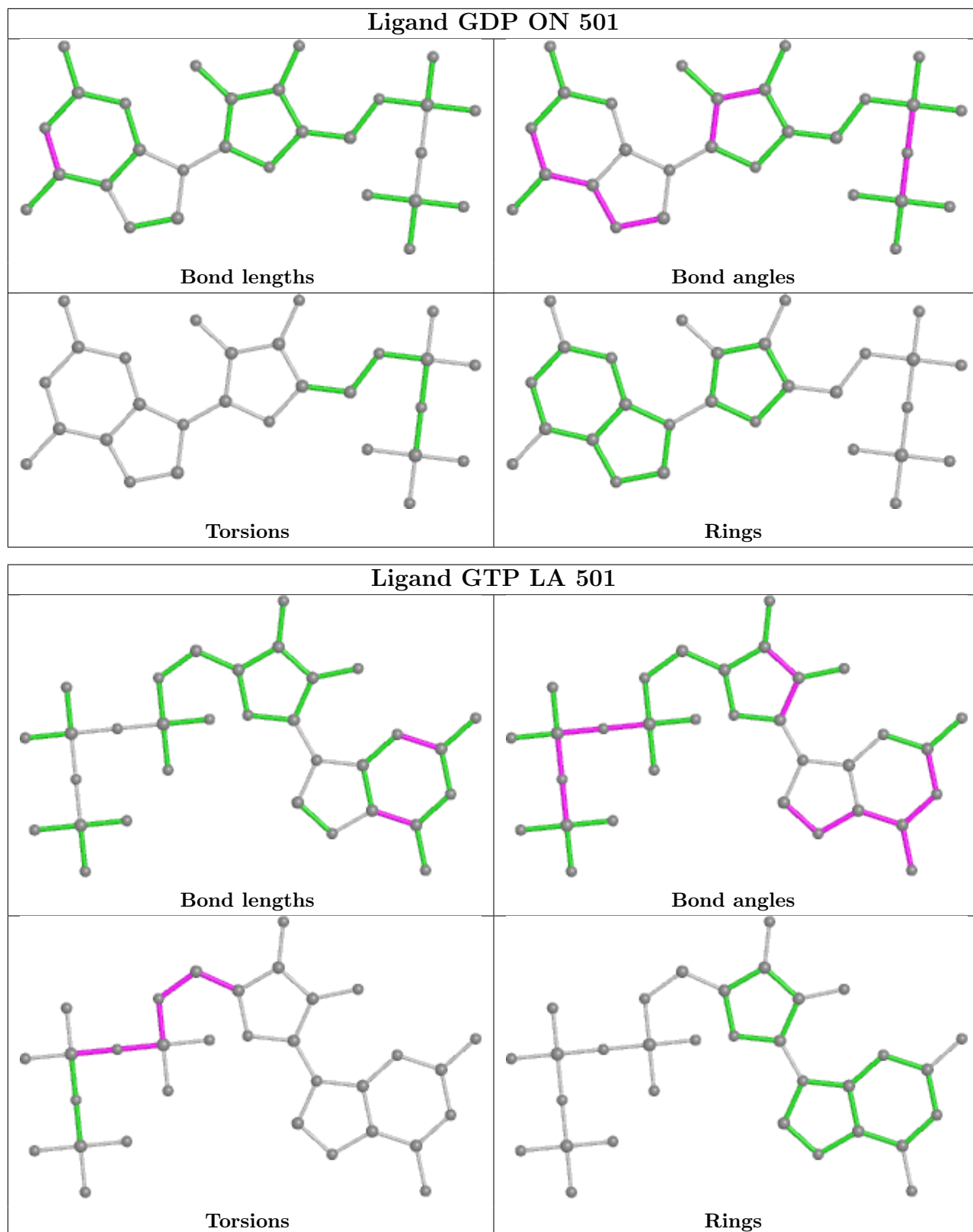

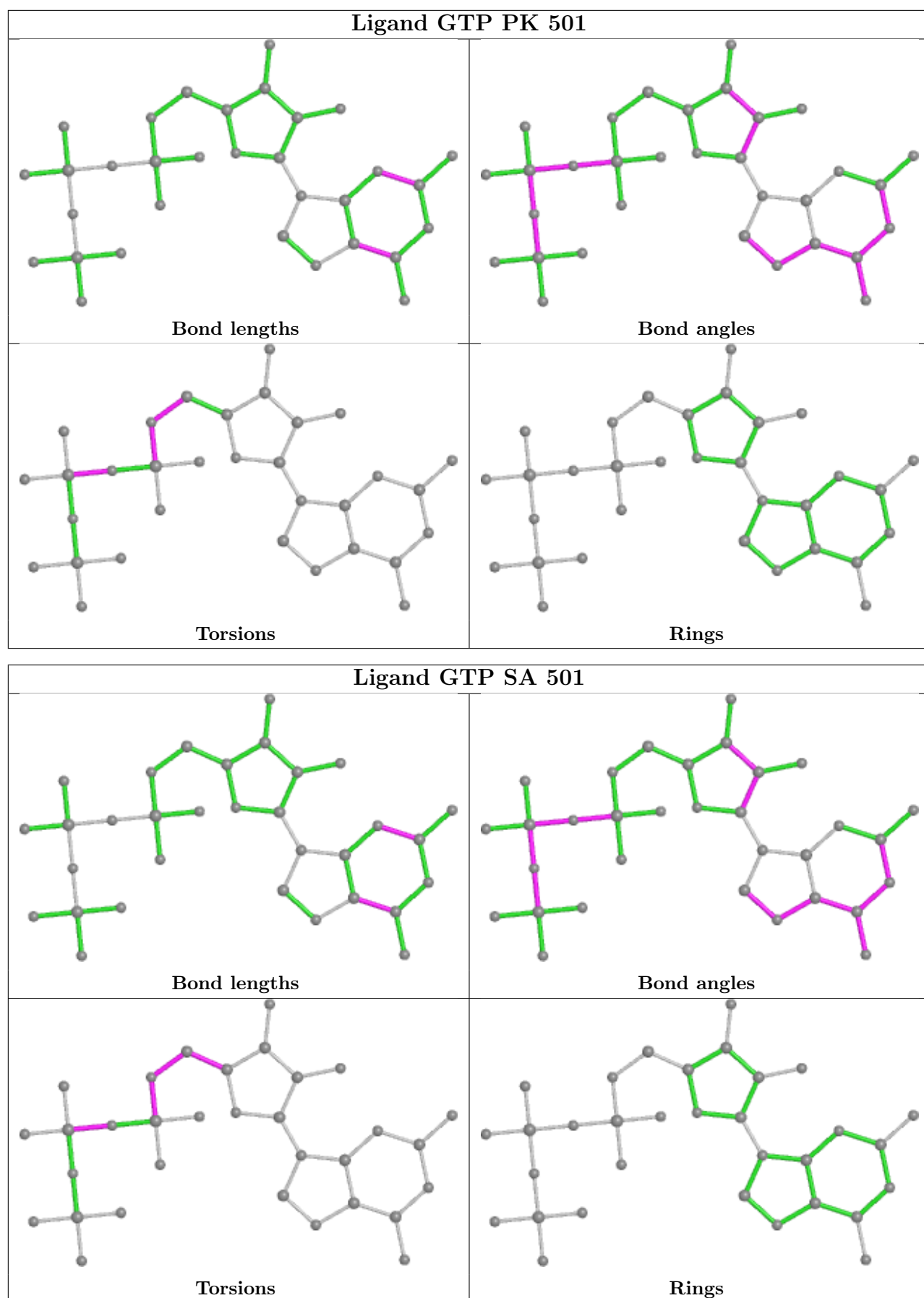



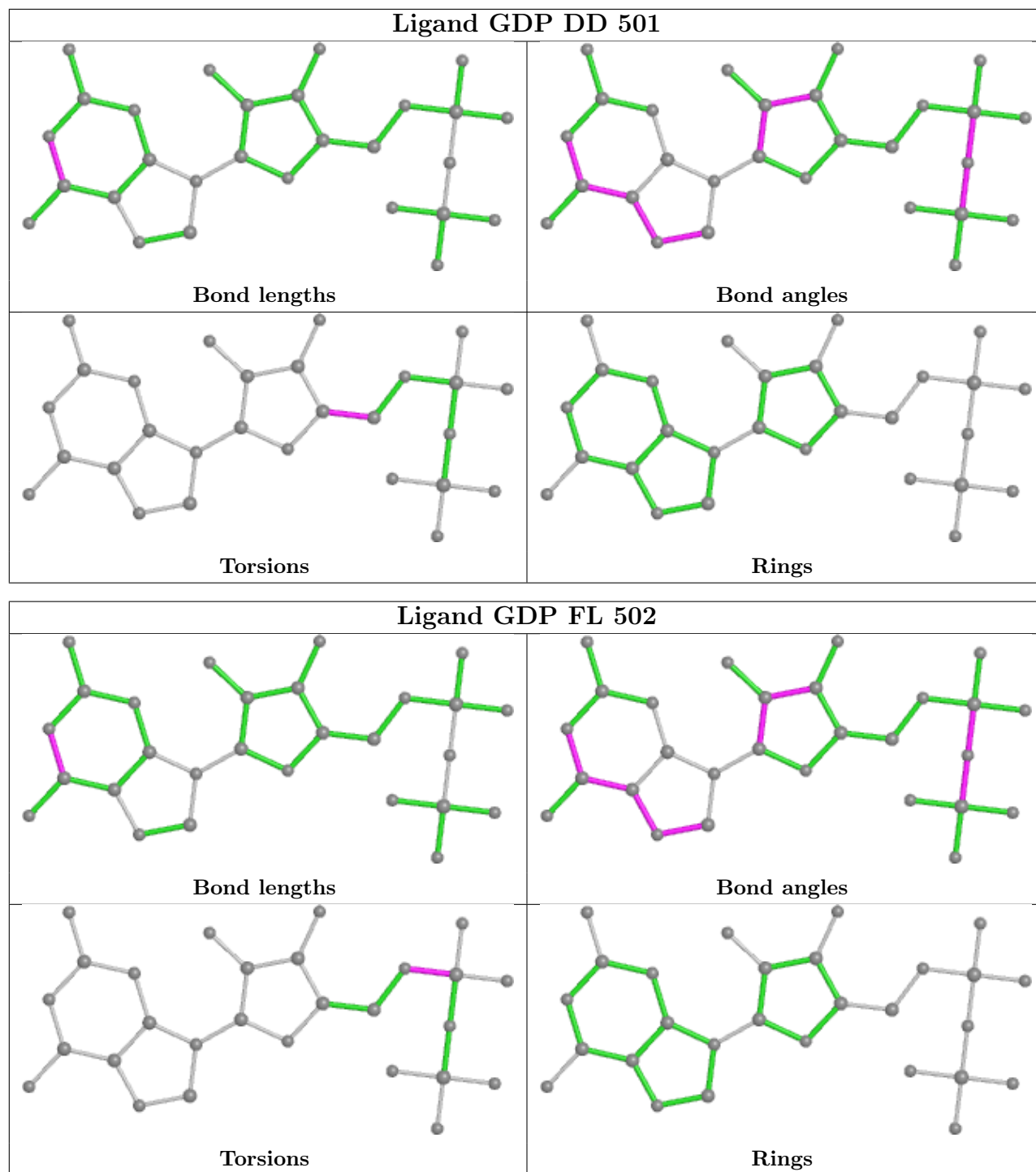

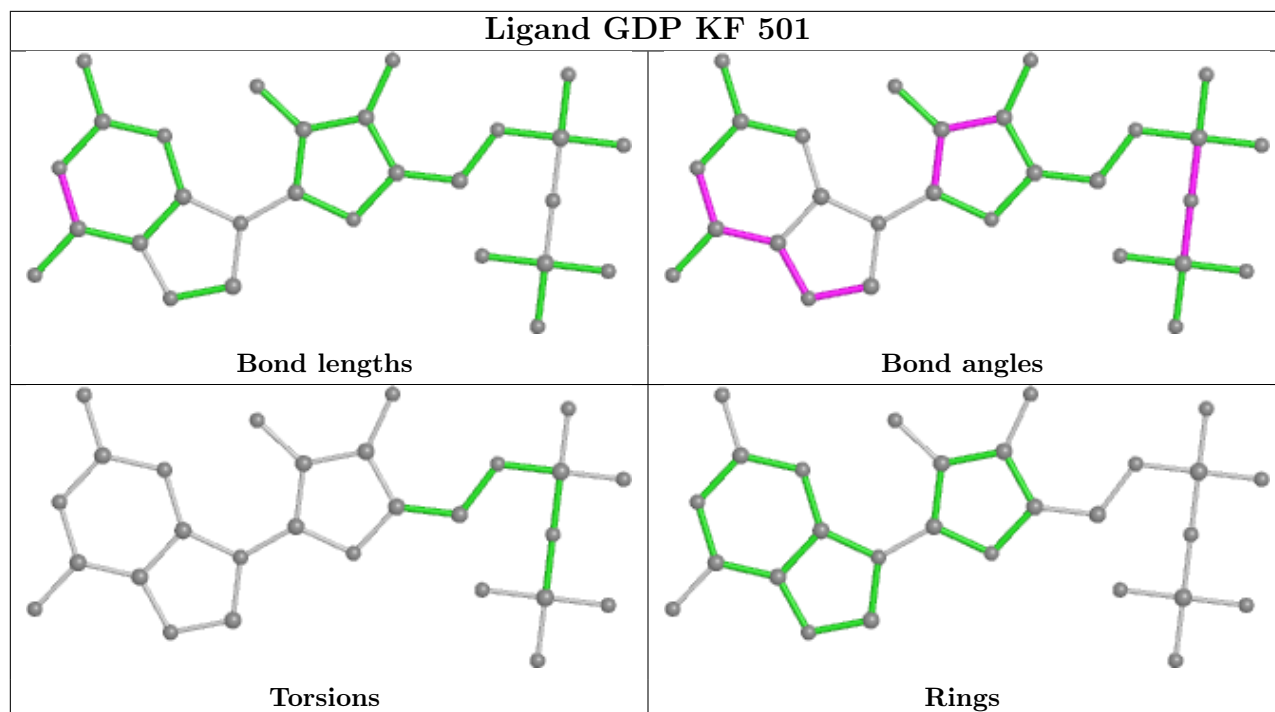

## 5.7 Other polymers [i](#)

There are no such residues in this entry.

## 5.8 Polymer linkage issues [i](#)

The following chains have linkage breaks:

Mol	Chain	Number of breaks
1	2A	1
1	1A	1
1	0A	1
28	2F	1
1	3A	1
12	0T	1
23	2O	1

The worst 5 of 7 chain breaks are listed below:

Model	Chain	Residue-1	Atom-1	Residue-2	Atom-2	Distance (Å)
1	2A	110:PRO	C	111:SER	N	6.11
1	1A	110:PRO	C	111:SER	N	6.07
1	0A	110:PRO	C	111:SER	N	6.00
1	2F	68:THR	C	69:MET	N	5.77
1	3A	110:PRO	C	111:SER	N	5.47

## 6 Map visualisation [i](#)

This section contains visualisations of the EMDB entry EMD-29685. These allow visual inspection of the internal detail of the map and identification of artifacts.

Images derived from a raw map, generated by summing the deposited half-maps, are presented below the corresponding image components of the primary map to allow further visual inspection and comparison with those of the primary map.

### 6.1 Orthogonal projections [i](#)

#### 6.1.1 Primary map

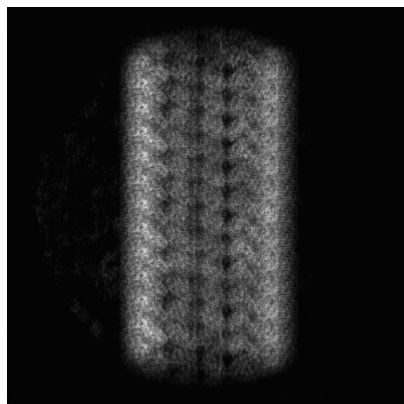

X

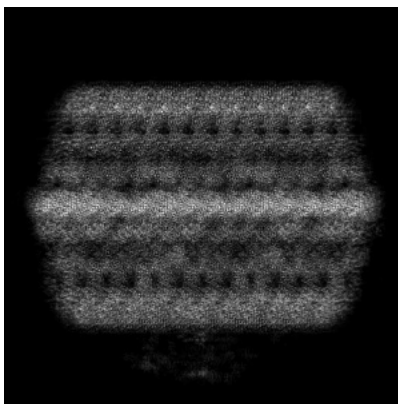

Y

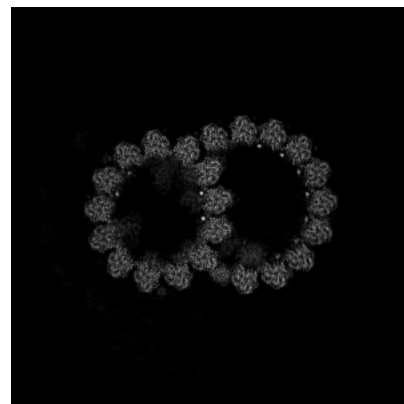

Z

#### 6.1.2 Raw map

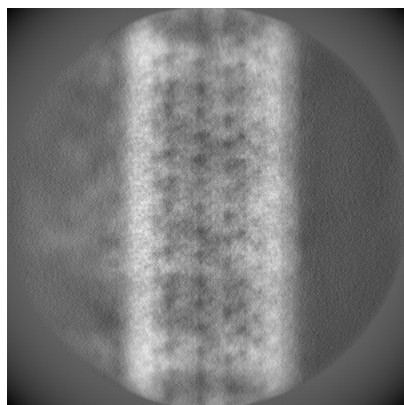

X

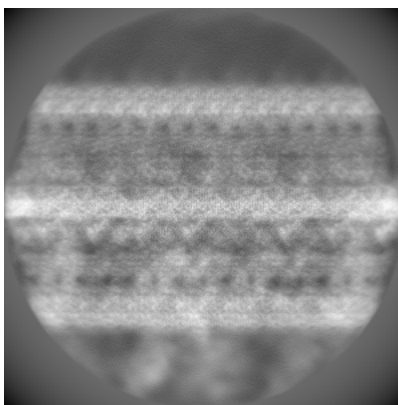

Y

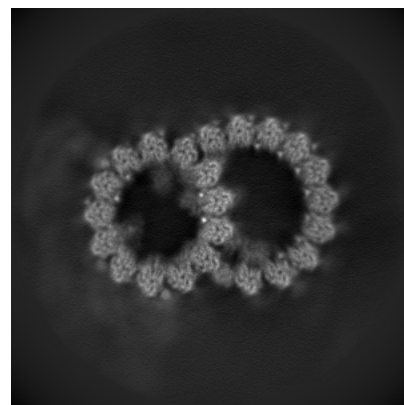

Z

The images above show the map projected in three orthogonal directions.

## 6.2 Central slices [i](#)

### 6.2.1 Primary map

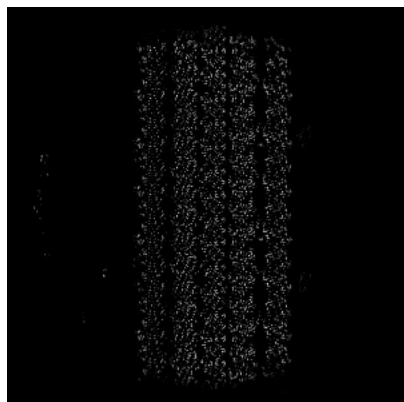

X Index: 256



Y Index: 256

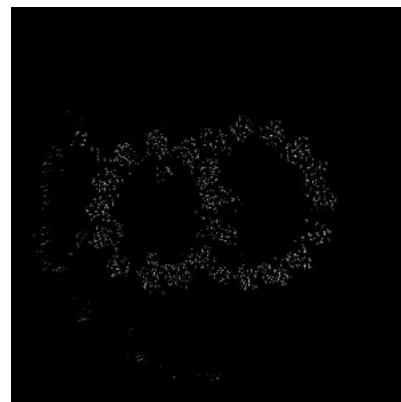

Z Index: 256

### 6.2.2 Raw map

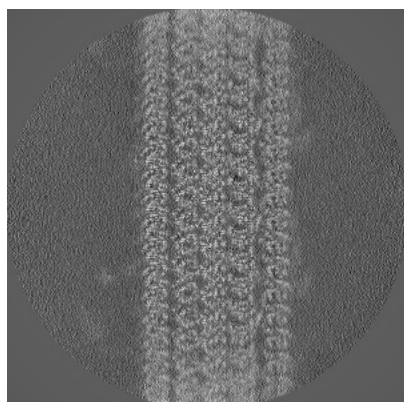

X Index: 256

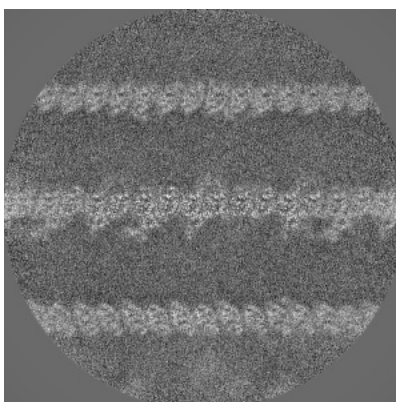

Y Index: 256

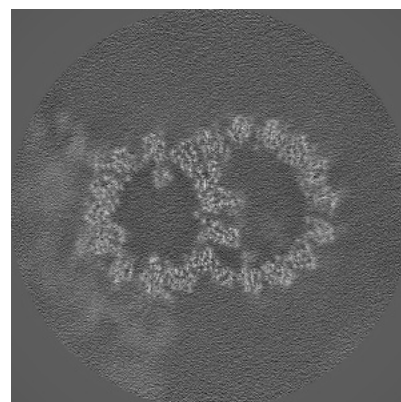

Z Index: 256

The images above show central slices of the map in three orthogonal directions.

## 6.3 Largest variance slices [i](#)

### 6.3.1 Primary map

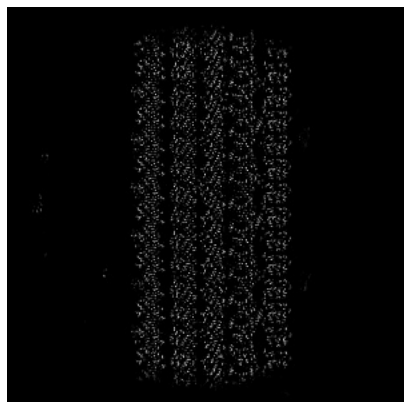

X Index: 258

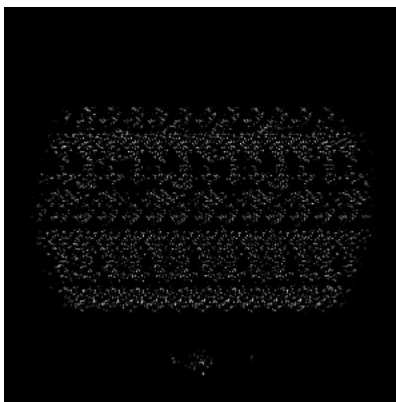

Y Index: 176

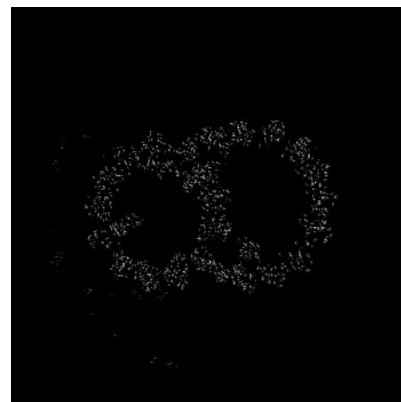

Z Index: 200

### 6.3.2 Raw map

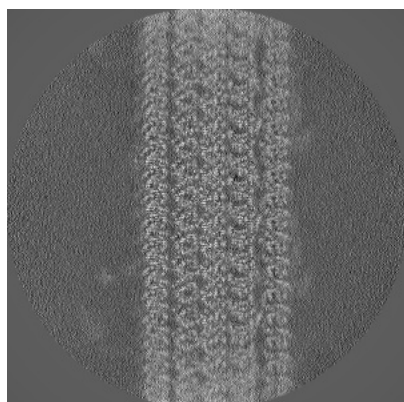

X Index: 256

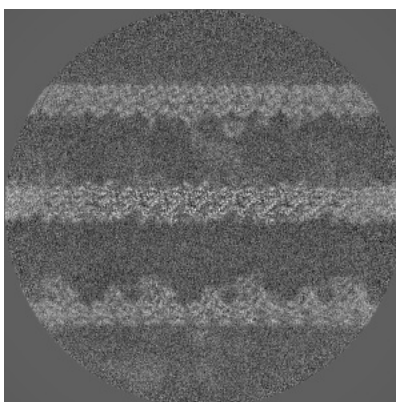

Y Index: 223

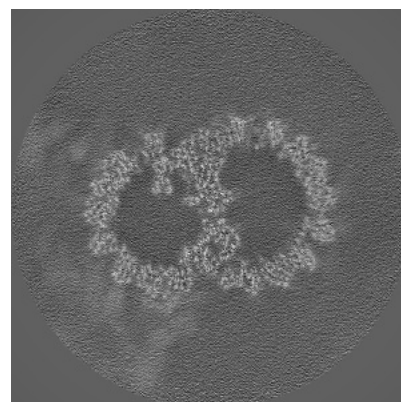

Z Index: 229

The images above show the largest variance slices of the map in three orthogonal directions.



## 6.4 Orthogonal standard-deviation projections (False-color) [i](#)

### 6.4.1 Primary map

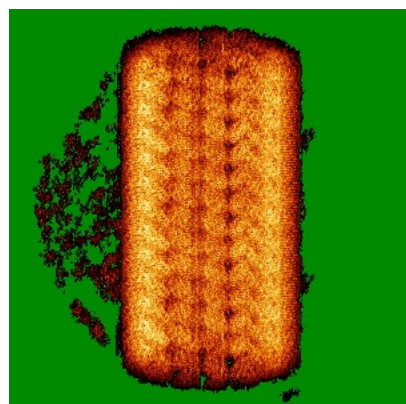

X

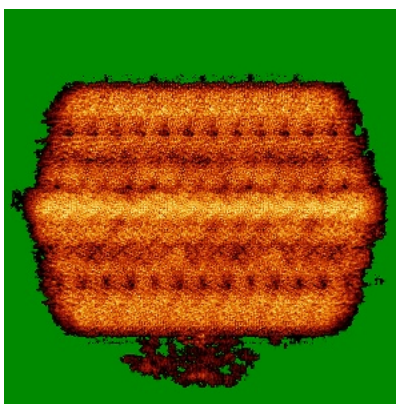

Y



Z

### 6.4.2 Raw map

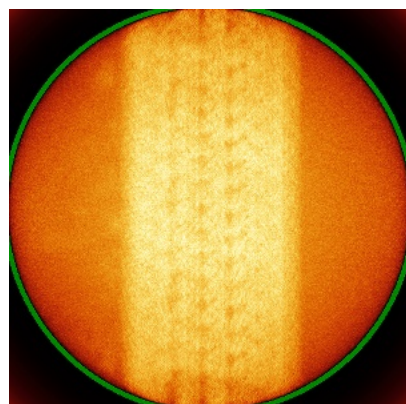

X

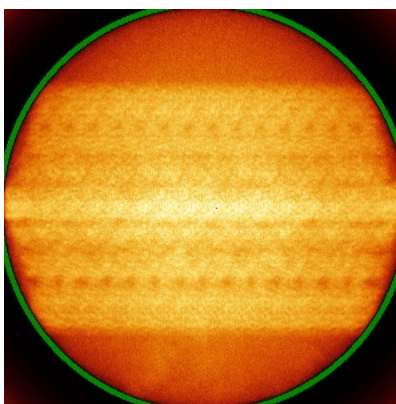

Y

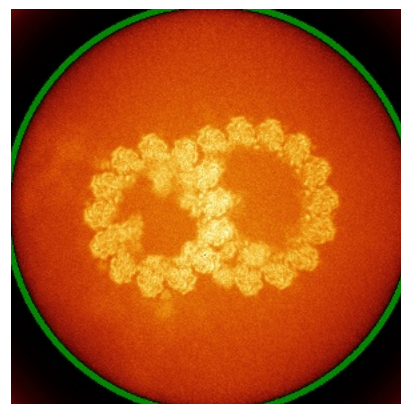

Z

The images above show the map standard deviation projections with false color in three orthogonal directions. Minimum values are shown in green, max in blue, and dark to light orange shades represent small to large values respectively.

## 6.5 Orthogonal surface views [i](#)

### 6.5.1 Primary map

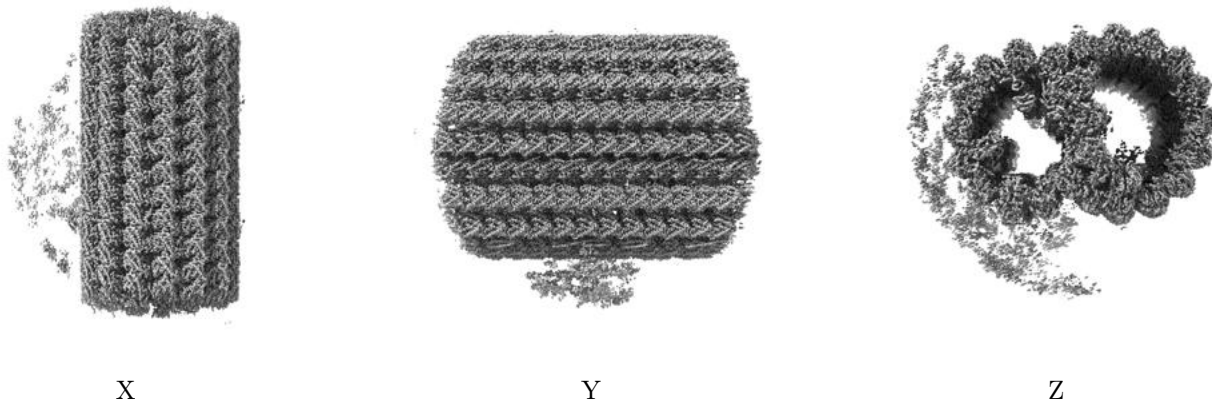

The images above show the 3D surface view of the map at the recommended contour level 0.15. These images, in conjunction with the slice images, may facilitate assessment of whether an appropriate contour level has been provided.

### 6.5.2 Raw map

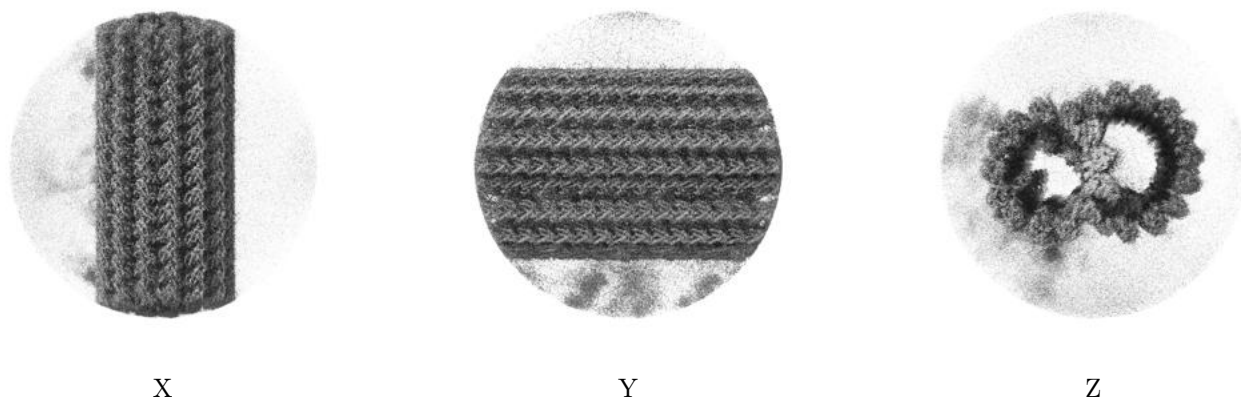

These images show the 3D surface of the raw map. The raw map's contour level was selected so that its surface encloses the same volume as the primary map does at its recommended contour level.

## 6.6 Mask visualisation [i](#)

This section shows the 3D surface view of the primary map at 50% transparency overlaid with the specified mask at 0% transparency

A mask typically either:

- Encompasses the whole structure
- Separates out a domain, a functional unit, a monomer or an area of interest from a larger structure

### 6.6.1 emd\_29685\_msk\_1.map [i](#)

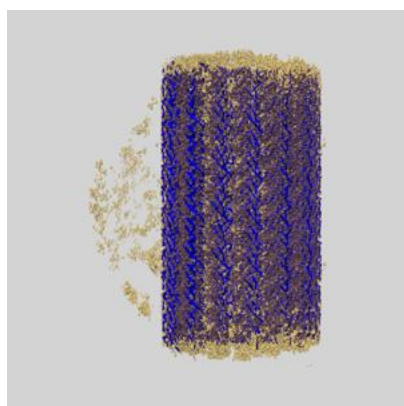

X

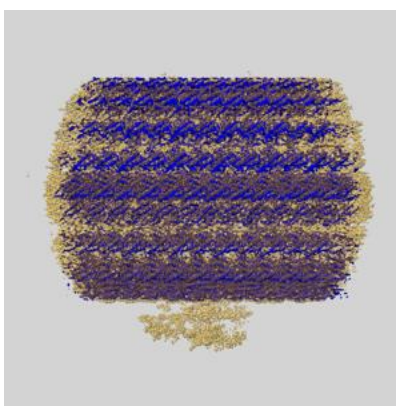

Y

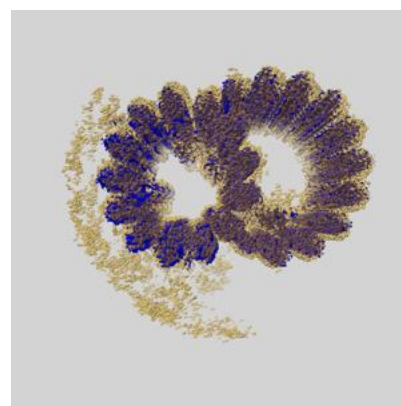

Z



## 7 Map analysis [i](#)

This section contains the results of statistical analysis of the map.

### 7.1 Map-value distribution [i](#)

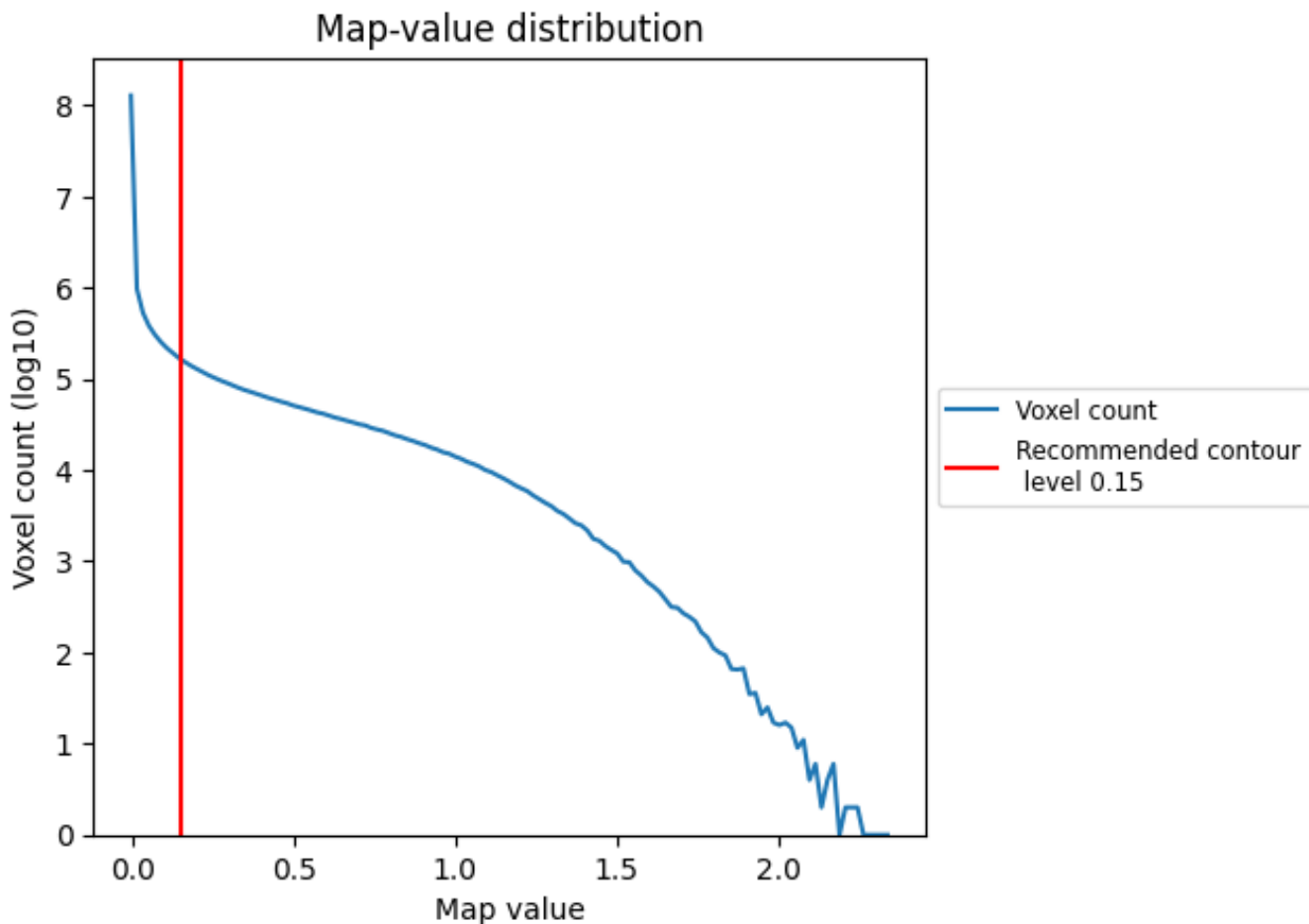

The map-value distribution is plotted in 128 intervals along the x-axis. The y-axis is logarithmic. A spike in this graph at zero usually indicates that the volume has been masked.

## 7.2 Volume estimate [\(i\)](#)

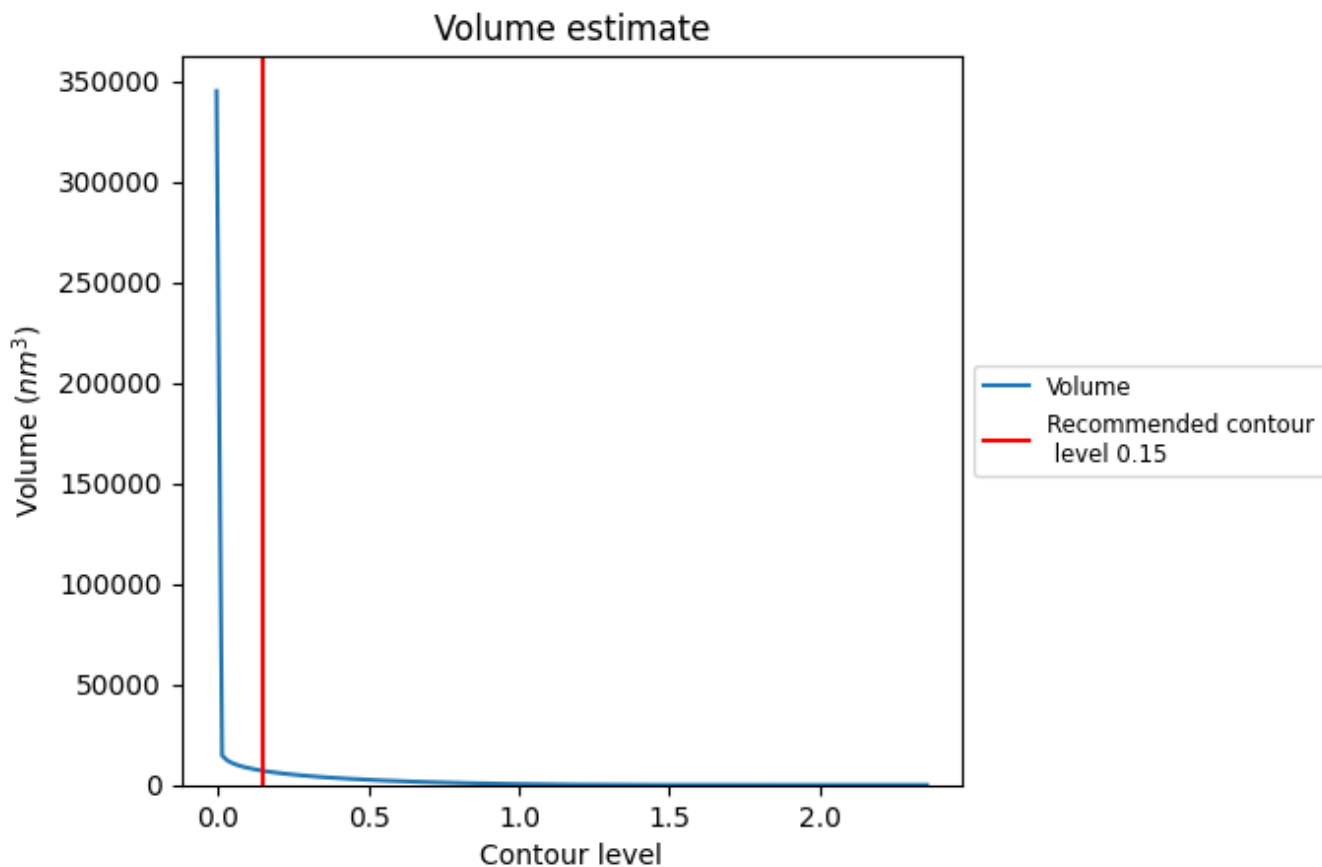

The volume at the recommended contour level is 7038  $\text{nm}^3$ ; this corresponds to an approximate mass of 6357 kDa.

The volume estimate graph shows how the enclosed volume varies with the contour level. The recommended contour level is shown as a vertical line and the intersection between the line and the curve gives the volume of the enclosed surface at the given level.

### 7.3 Rotationally averaged power spectrum i

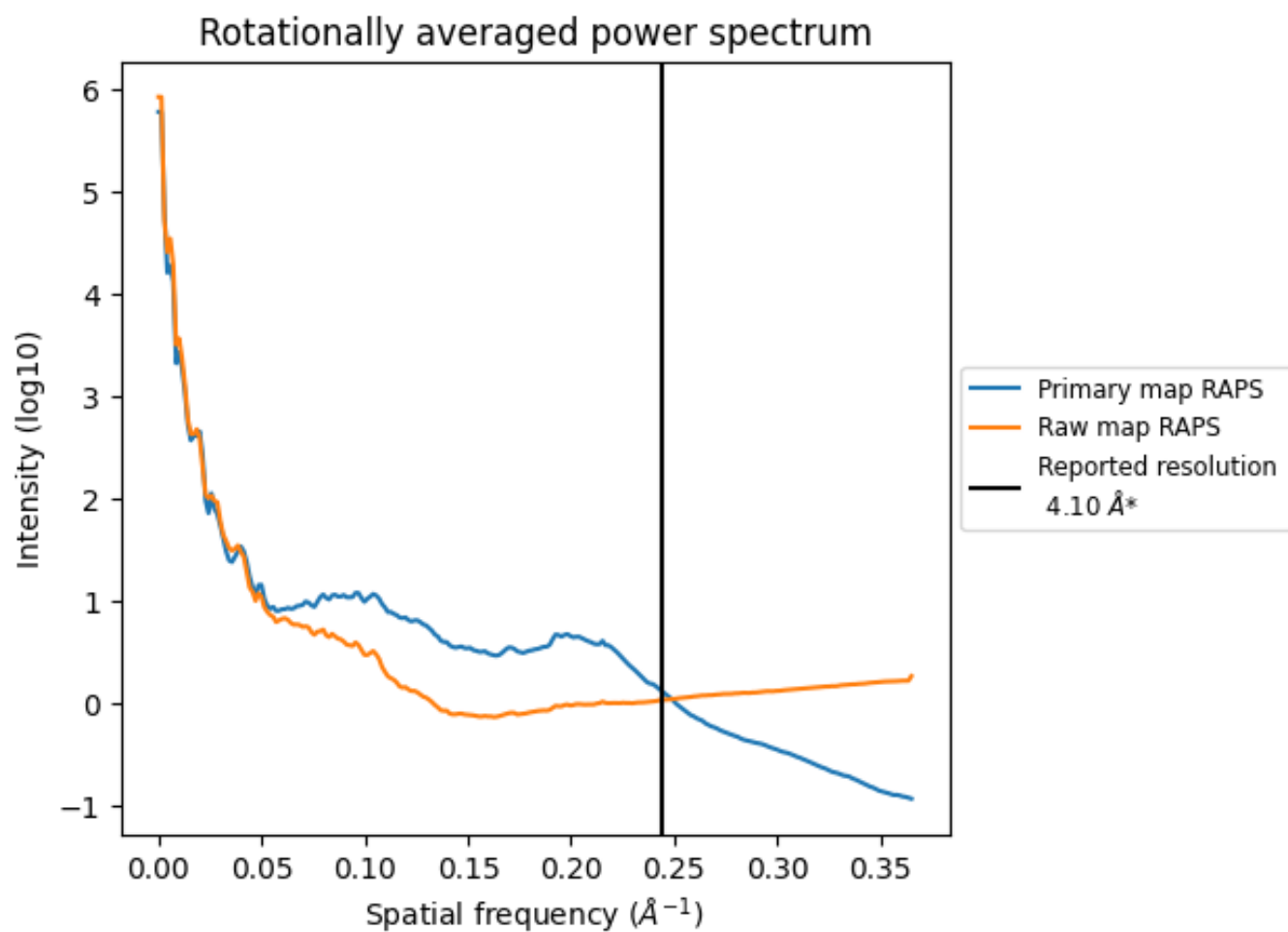

\*Reported resolution corresponds to spatial frequency of  $0.244 \text{ \AA}^{-1}$

## 8 Fourier-Shell correlation [i](#)

Fourier-Shell Correlation (FSC) is the most commonly used method to estimate the resolution of single-particle and subtomogram-averaged maps. The shape of the curve depends on the imposed symmetry, mask and whether or not the two 3D reconstructions used were processed from a common reference. The reported resolution is shown as a black line. A curve is displayed for the half-bit criterion in addition to lines showing the 0.143 gold standard cut-off and 0.5 cut-off.

### 8.1 FSC [i](#)

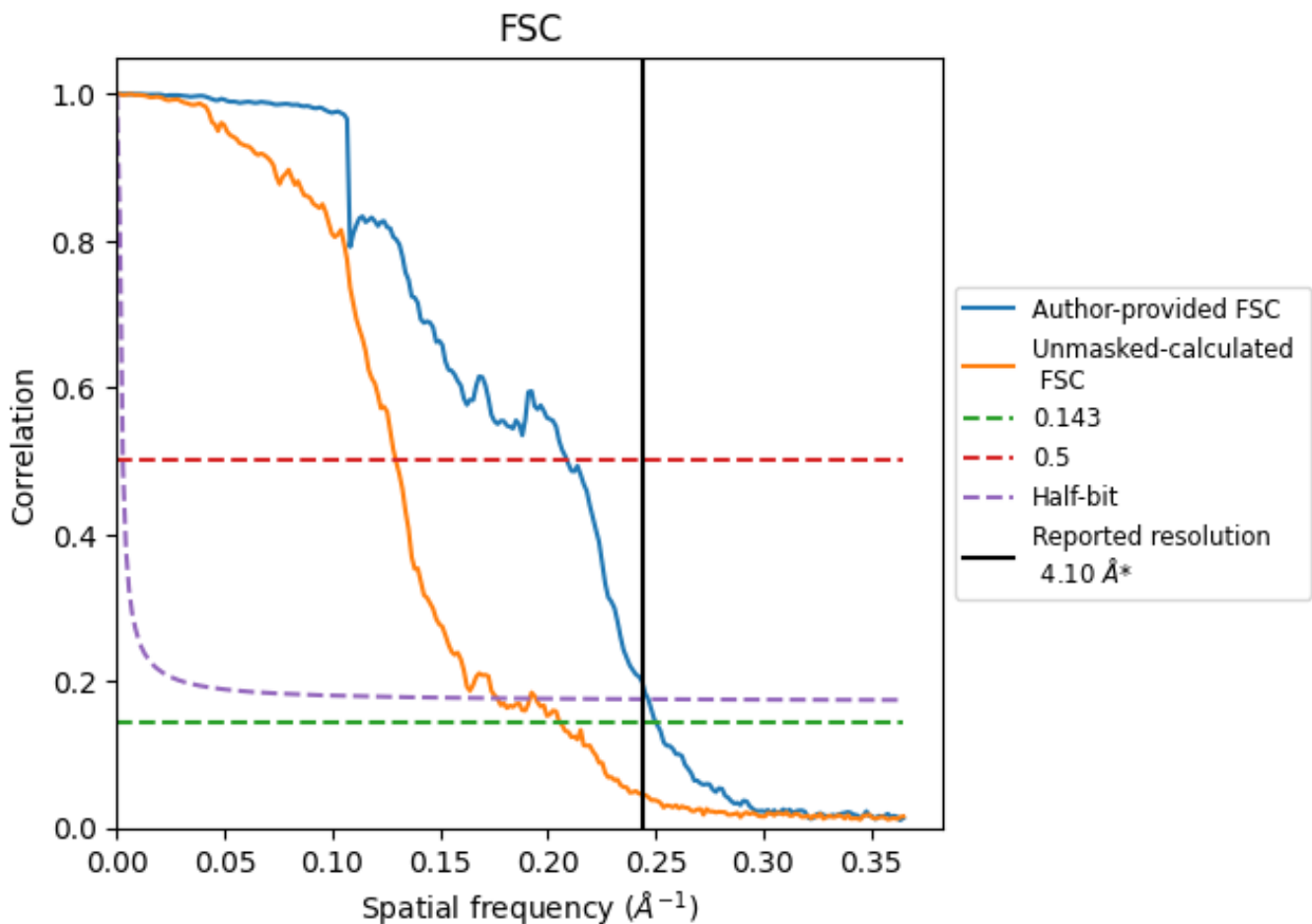

\*Reported resolution corresponds to spatial frequency of 0.244 Å<sup>-1</sup>

## 8.2 Resolution estimates [i](#)

Resolution estimate (Å)	Estimation criterion (FSC cut-off)		
	0.143	0.5	Half-bit
Reported by author	4.10	-	-
Author-provided FSC curve	4.00	4.78	4.05
Unmasked-calculated*	4.86	7.72	5.67

\*Resolution estimate based on FSC curve calculated by comparison of deposited half-maps. The value from deposited half-maps intersecting FSC 0.143 CUT-OFF 4.86 differs from the reported value 4.1 by more than 10 %

## 9 Map-model fit [i](#)

This section contains information regarding the fit between EMDB map EMD-29685 and PDB model 8G2Z. Per-residue inclusion information can be found in section 3 on page 71.

### 9.1 Map-model overlay [i](#)

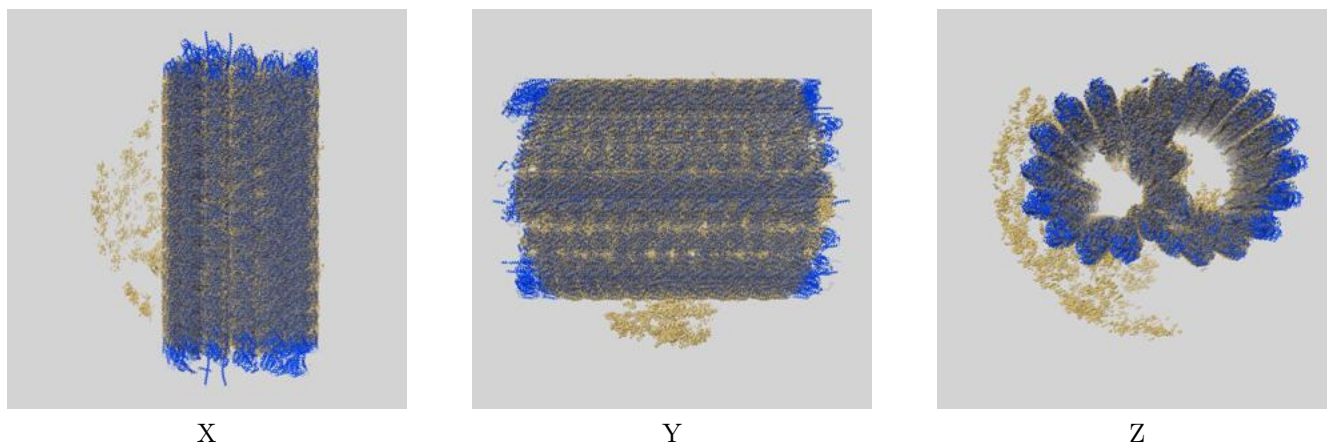

The images above show the 3D surface view of the map at the recommended contour level 0.15 at 50% transparency in yellow overlaid with a ribbon representation of the model coloured in blue. These images allow for the visual assessment of the quality of fit between the atomic model and the map.

## 9.2 Q-score mapped to coordinate model [\(i\)](#)

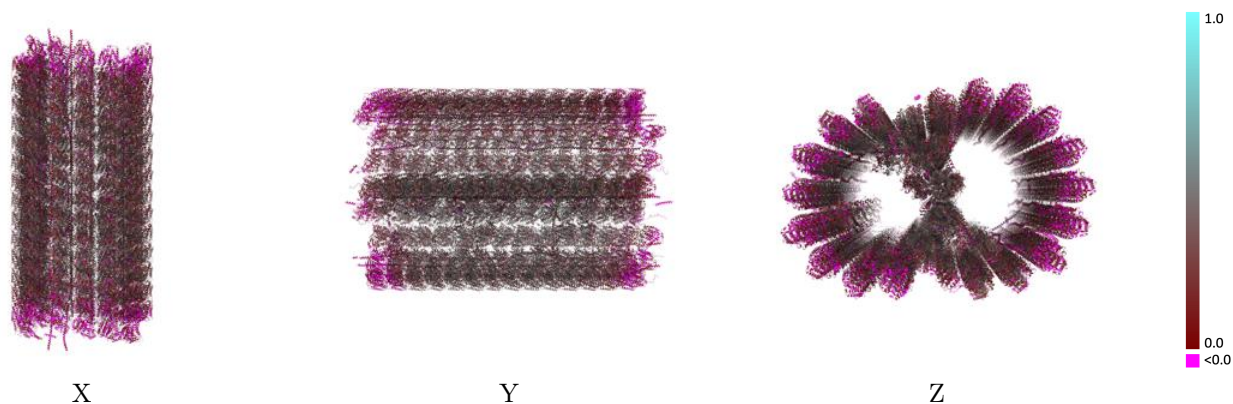

The images above show the model with each residue coloured according its Q-score. This shows their resolvability in the map with higher Q-score values reflecting better resolvability. Please note: Q-score is calculating the resolvability of atoms, and thus high values are only expected at resolutions at which atoms can be resolved. Low Q-score values may therefore be expected for many entries.

## 9.3 Atom inclusion mapped to coordinate model [\(i\)](#)

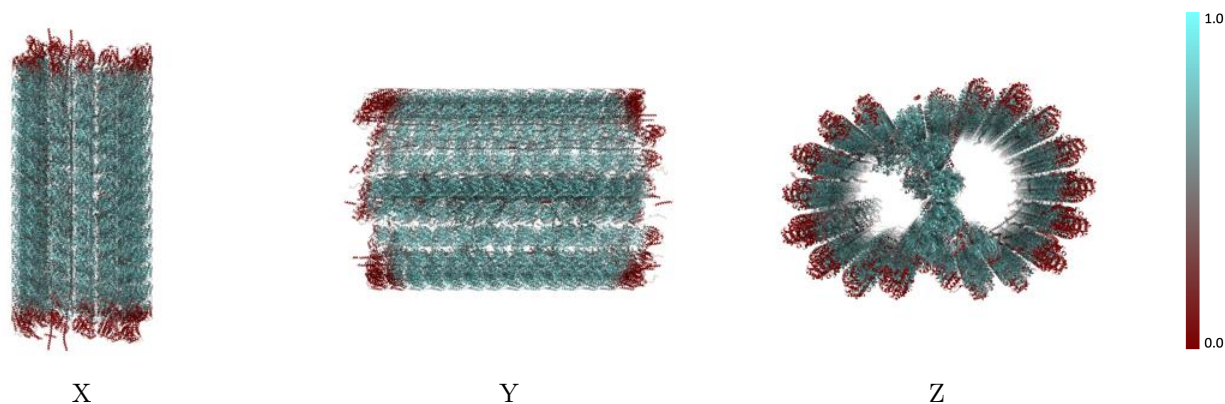

The images above show the model with each residue coloured according to its atom inclusion. This shows to what extent they are inside the map at the recommended contour level (0.15).

## 9.4 Atom inclusion [i](#)

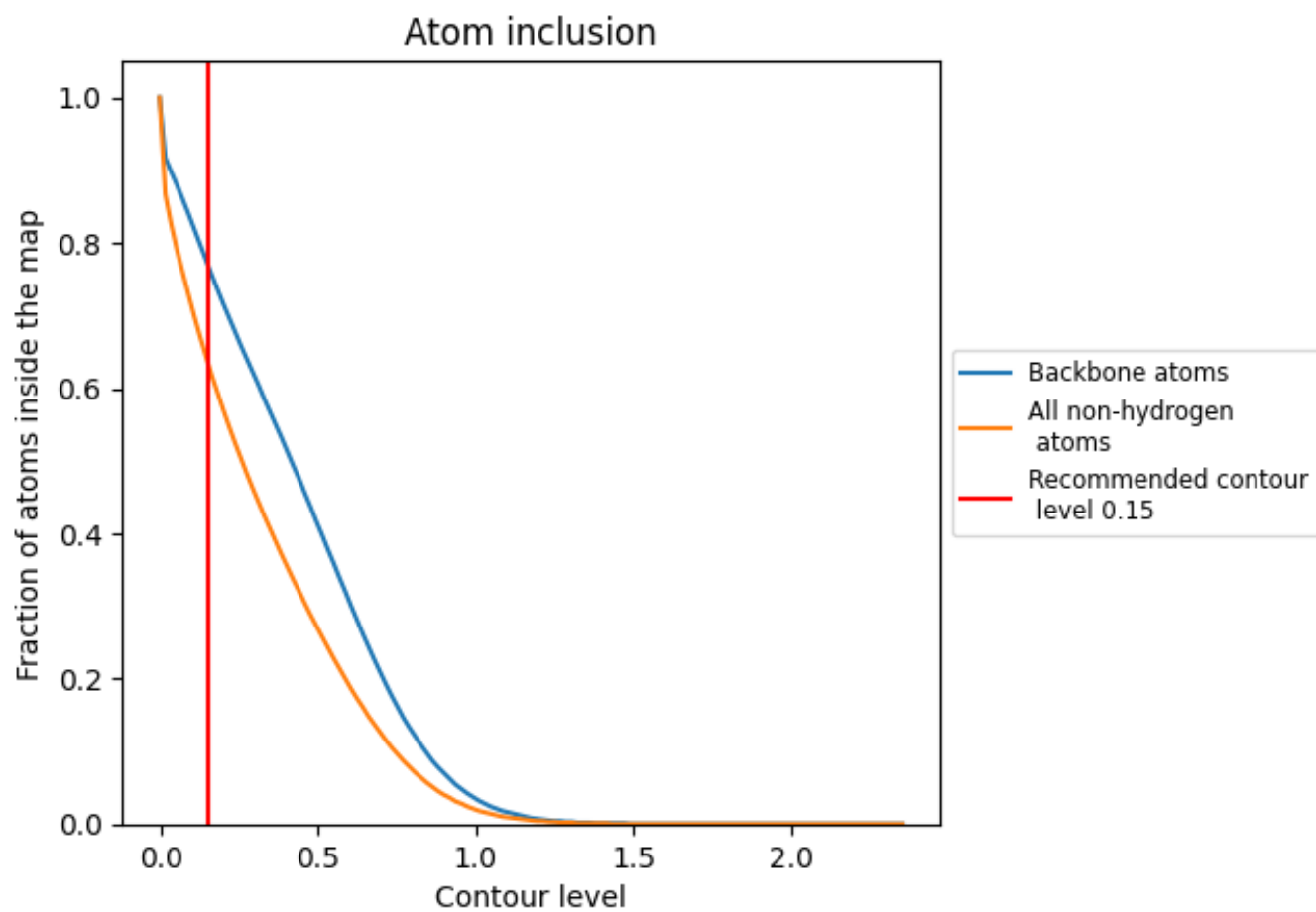







































































At the recommended contour level, 77% of all backbone atoms, 64% of all non-hydrogen atoms, are inside the map.



## 9.5 Map-model fit summary





















































































The table lists the average atom inclusion at the recommended contour level (0.15) and Q-score for the entire model and for each chain.

Chain	Atom inclusion	Q-score
All	 0.6350	 0.2870
0A	 0.6270	 0.2850
0B	 0.7020	 0.3390
0C	 0.6590	 0.2830
0D	 0.4860	 0.1340
0E	 0.4270	 0.1140
0F	 0.6730	 0.2870
0G	 0.5630	 0.2310
0H	 0.3130	 0.0690
0N	 0.6690	 0.2830
0Q	 0.6950	 0.3030
0S	 0.3450	 0.1700
0T	 0.3810	 0.2120
0U	 0.6490	 0.2860
0V	 0.3220	 0.1440
0X	 0.6190	 0.2700
1A	 0.6250	 0.3300
1B	 0.6590	 0.3000
1C	 0.6690	 0.2570
1D	 0.5820	 0.2640
1E	 0.4750	 0.2120
1F	 0.6510	 0.3180
1G	 0.5670	 0.2220
1H	 0.3960	 0.1160
1I	 0.6710	 0.3240
1J	 0.5980	 0.2620
1K	 0.5000	 0.1890
1L	 0.5870	 0.2700
1M	 0.7080	 0.3460
1N	 0.7050	 0.3380
1O	 0.3310	 0.0650
1P	 0.4110	 0.0930
1Q	 0.7350	 0.3550
1R	 0.6960	 0.3450
1S	 0.7010	 0.3410



*Continued on next page...*

*Continued from previous page...*

Chain	Atom inclusion	Q-score
1T	 0.7190	 0.3760
1U	 0.7190	 0.3500
1V	 0.5620	 0.2500
1W	 0.6570	 0.3050
1X	 0.6790	 0.3550
2A	 0.6660	 0.3430
2B	 0.6340	 0.2800
2C	 0.5680	 0.2020
2D	 0.5680	 0.2430
2E	 0.5390	 0.2350
2F	 0.6600	 0.2910
2G	 0.6680	 0.3100
2H	 0.6050	 0.3290
2I	 0.5660	 0.2640
2K	 0.4450	 0.1560
2L	 0.3740	 0.1590
2M	 0.7450	 0.3700
2N	 0.5800	 0.2080
2O	 0.3850	 0.0520
2P	 0.4280	 0.1250
2Q	 0.7370	 0.3520
2R	 0.7090	 0.3620
2S	 0.6930	 0.3390
2T	 0.7380	 0.3700
2U	 0.7200	 0.3410
2V	 0.5600	 0.2450
2W	 0.4220	 0.1170
2X	 0.6870	 0.3440
3A	 0.6540	 0.3140
3B	 0.5800	 0.2380
3C	 0.6340	 0.2710
3D	 0.3550	 0.2420
3E	 0.2920	 0.0800
3H	 0.5950	 0.3190
3I	 0.7040	 0.3220
3L	 0.2740	 0.0410
3O	 0.3560	 0.0500
3Q	 0.7310	 0.3560
3R	 0.6980	 0.3480
3S	 0.6950	 0.3200
3T	 0.7160	 0.3540
3U	 0.6100	 0.2660





















































































*Continued on next page...*

*Continued from previous page...*

Chain	Atom inclusion	Q-score
3V	0.5220	0.2240
3X	0.6450	0.3150
4C	0.6120	0.2600
4F	0.6090	0.2780
4H	0.6190	0.3360
4Q	0.7280	0.3560
4R	0.6910	0.3500
4S	0.6600	0.3150
4X	0.6460	0.2980
5A	0.5170	0.2410
5B	0.6500	0.3190
5C	0.6580	0.3260
5D	0.5100	0.2510
5E	0.3130	0.1210
5F	0.4260	0.2120
5G	0.4780	0.2430
5H	0.3940	0.1430
5I	0.2700	0.1310
5J	0.3190	0.2170
5K	0.1850	0.0640
5Q	0.7190	0.3490
5R	0.7080	0.3460
5S	0.6700	0.3220
6F	0.6980	0.3660
6G	0.5490	0.1970
6H	0.6170	0.2460
6Q	0.6620	0.2980
6R	0.5210	0.2160
7R	0.5490	0.2300
8L	0.6500	0.1740
8N	0.5800	0.1110
8P	0.6570	0.1800
8R	0.6270	0.1770
AA	0.7390	0.3500
AB	0.4970	0.2450
AC	0.7700	0.4050
AD	0.7710	0.3870
AE	0.7780	0.4230
AF	0.7690	0.4050
AG	0.7670	0.4100
AH	0.7600	0.4020
AI	0.7750	0.4080





















































































*Continued on next page...*

*Continued from previous page...*

Chain	Atom inclusion	Q-score
AJ	 0.7620	 0.4030
AK	 0.7740	 0.4080
AL	 0.7730	 0.4090
AM	 0.7420	 0.3490
AN	 0.7690	 0.3820
BA	 0.5690	 0.2260
BB	 0.0830	 0.0170
BC	 0.7410	 0.3410
BD	 0.7260	 0.3190
BE	 0.7490	 0.3730
BF	 0.7460	 0.3660
BG	 0.7480	 0.3710
BH	 0.7350	 0.3510
BI	 0.7730	 0.3870
BJ	 0.7530	 0.3790
BK	 0.7520	 0.3700
BL	 0.7480	 0.3700
BM	 0.6930	 0.2930
BN	 0.7450	 0.3380
CA	 0.2480	 0.0830
CB	 0.6510	 0.2380
CC	 0.7040	 0.3080
CD	 0.7440	 0.3450
CE	 0.7300	 0.3520
CF	 0.7290	 0.3270
CG	 0.7280	 0.3460
CH	 0.7380	 0.3550
CI	 0.7480	 0.3670
CJ	 0.7500	 0.3500
CK	 0.7330	 0.3470
CL	 0.6950	 0.2970
CM	 0.5950	 0.2200
CN	 0.0150	 0.0060
DA	 0.0240	 0.0130
DB	 0.4770	 0.1790
DC	 0.6960	 0.2740
DD	 0.7530	 0.3340
DE	 0.7370	 0.3480
DF	 0.7590	 0.3500
DG	 0.7330	 0.3320
DH	 0.7510	 0.3510
DI	 0.7410	 0.3490





















































































*Continued on next page...*

*Continued from previous page...*

Chain	Atom inclusion	Q-score
DJ	 0.7570	 0.3480
DK	 0.7510	 0.3330
DL	 0.7010	 0.2760
DM	 0.5790	 0.2040
DN	 0.0330	 -0.0070
EA	 0.0000	 0.0450
EB	 0.2380	 0.0770
EC	 0.6040	 0.2260
ED	 0.7040	 0.3040
EE	 0.7220	 0.3390
EF	 0.7180	 0.3380
EG	 0.7080	 0.3380
EH	 0.6980	 0.3200
EI	 0.7260	 0.3510
EJ	 0.7220	 0.3410
EK	 0.7290	 0.3400
EL	 0.6770	 0.2890
EM	 0.5610	 0.2120
EN	 0.0430	 -0.0070
FA	 0.6100	 0.2230
FB	 0.1590	 0.0540
FC	 0.7580	 0.3550
FD	 0.7300	 0.3150
FE	 0.7570	 0.3710
FF	 0.7560	 0.3660
FG	 0.7440	 0.3560
FH	 0.7380	 0.3490
FI	 0.7630	 0.3700
FJ	 0.7580	 0.3650
FK	 0.6930	 0.2910
FL	 0.7440	 0.3340
FM	 0.0000	 0.0090
FN	 0.1680	 0.0210
GA	 0.5900	 0.2170
GB	 0.0800	 -0.0020
GC	 0.7510	 0.3590
GD	 0.7480	 0.3270
GE	 0.7620	 0.3770
GF	 0.7510	 0.3730
GG	 0.7370	 0.3660
GH	 0.7570	 0.3700
GI	 0.7580	 0.3820





















































































*Continued on next page...*

*Continued from previous page...*

Chain	Atom inclusion	Q-score
GJ	 0.7680	 0.3820
GK	 0.7440	 0.3410
GL	 0.7460	 0.3600
GM	 0.0000	 0.0040
GN	 0.4400	 0.1860
HA	 0.6100	 0.2520
HB	 0.1250	 0.0330
HC	 0.7540	 0.3780
HD	 0.7530	 0.3540
HE	 0.7610	 0.3900
HF	 0.7560	 0.3810
HG	 0.7380	 0.3680
HH	 0.7580	 0.3820
HI	 0.7640	 0.3980
HJ	 0.7560	 0.3790
HK	 0.7610	 0.3700
HL	 0.7480	 0.3750
HM	 0.0860	 0.0010
HN	 0.6170	 0.2650
IA	 0.6800	 0.2860
IB	 0.2470	 0.1070
IC	 0.7540	 0.3780
ID	 0.7450	 0.3560
IE	 0.7570	 0.3930
IF	 0.7650	 0.3960
IG	 0.7380	 0.3720
IH	 0.7590	 0.3840
II	 0.7650	 0.3930
IJ	 0.7540	 0.3800
IK	 0.7660	 0.3810
IL	 0.7520	 0.3800
IM	 0.5180	 0.2510
IN	 0.7370	 0.3360
JA	 0.7550	 0.3670
JB	 0.7380	 0.3350
JC	 0.7620	 0.3940
JD	 0.7610	 0.3880
JE	 0.7690	 0.3980
JF	 0.7760	 0.4110
JG	 0.7630	 0.3880
JH	 0.7610	 0.3940
JI	 0.7720	 0.4020





















































































*Continued on next page...*

*Continued from previous page...*

Chain	Atom inclusion	Q-score
JJ	 0.7630	 0.3950
JK	 0.7530	 0.3760
JL	 0.7640	 0.3990
JM	 0.2250	 0.1040
JN	 0.7110	 0.3350
KA	 0.7570	 0.3580
KB	 0.6910	 0.2970
KC	 0.7680	 0.4020
KD	 0.7670	 0.3940
KE	 0.7760	 0.4030
KF	 0.7870	 0.4100
KG	 0.7770	 0.4040
KH	 0.7740	 0.4060
KI	 0.7710	 0.3910
KJ	 0.7760	 0.3980
KK	 0.7900	 0.4020
KL	 0.7830	 0.4120
KM	 0.6410	 0.3100
KN	 0.7710	 0.3780
LA	 0.7530	 0.3740
LB	 0.7300	 0.3370
LC	 0.7680	 0.4130
LD	 0.7750	 0.3990
LE	 0.7630	 0.4010
LF	 0.7590	 0.4020
LG	 0.7620	 0.4080
LH	 0.7760	 0.4050
LI	 0.7560	 0.3930
LJ	 0.7720	 0.4100
LK	 0.7640	 0.4050
LL	 0.7660	 0.4050
LM	 0.7290	 0.3450
LN	 0.7800	 0.3960
MA	 0.7670	 0.3810
MB	 0.7330	 0.3340
MC	 0.7680	 0.4070
MD	 0.7720	 0.4050
ME	 0.7650	 0.4070
MF	 0.7810	 0.4120
MG	 0.7530	 0.3940
MH	 0.7710	 0.4090
MI	 0.7550	 0.3960

*Continued on next page...*





















































































*Continued from previous page...*

Chain	Atom inclusion	Q-score
MJ	 0.7840	 0.4140
MK	 0.7670	 0.4000
ML	 0.7620	 0.4080
MM	 0.7470	 0.3510
MN	 0.7900	 0.3960
NA	 0.6530	 0.2780
NB	 0.5050	 0.1950
NC	 0.7260	 0.3500
ND	 0.7040	 0.3210
NE	 0.7230	 0.3630
NF	 0.7280	 0.3680
NG	 0.7200	 0.3510
NH	 0.7050	 0.3430
NI	 0.7180	 0.3520
NJ	 0.7210	 0.3470
NK	 0.7210	 0.3500
NL	 0.7120	 0.3510
NM	 0.4200	 0.2120
NN	 0.6890	 0.3130
OA	 0.6240	 0.2260
OB	 0.2530	 0.0810
OC	 0.7140	 0.3160
OD	 0.7100	 0.2830
OE	 0.7340	 0.3470
OF	 0.7420	 0.3430
OG	 0.7300	 0.3310
OH	 0.7250	 0.3340
OI	 0.7250	 0.3360
OJ	 0.7240	 0.3270
OK	 0.7310	 0.3360
OL	 0.7370	 0.3410
OM	 0.4040	 0.1940
ON	 0.6890	 0.2870
PA	 0.4570	 0.1270
PB	 0.0730	 0.0150
PC	 0.6880	 0.2650
PD	 0.6350	 0.2110
PE	 0.7190	 0.3070
PF	 0.7030	 0.2940
PG	 0.6980	 0.2950
PH	 0.7030	 0.2940
PI	 0.7150	 0.3160

*Continued on next page...*























































































*Continued from previous page...*

Chain	Atom inclusion	Q-score
PJ	 0.6900	 0.2960
PK	 0.7260	 0.3090
PL	 0.7210	 0.3080
PM	 0.2980	 0.1290
PN	 0.6560	 0.2510
QA	 0.2050	 0.0200
QB	 0.5990	 0.1940
QC	 0.6820	 0.2340
QD	 0.7050	 0.2810
QE	 0.7300	 0.2930
QF	 0.7140	 0.2910
QG	 0.7000	 0.2760
QH	 0.7150	 0.3030
QI	 0.7250	 0.3000
QJ	 0.7160	 0.3010
QK	 0.7040	 0.2820
QL	 0.6440	 0.2260
QM	 0.2160	 0.0710
QN	 0.0000	 0.0310
RA	 0.0870	 0.0150
RB	 0.5350	 0.1860
RC	 0.6590	 0.2270
RD	 0.6940	 0.2710
RE	 0.7010	 0.2870
RF	 0.6990	 0.2800
RG	 0.6830	 0.2670
RH	 0.7000	 0.2800
RI	 0.7060	 0.2980
RJ	 0.6970	 0.2860
RK	 0.6910	 0.2710
RL	 0.6290	 0.2190
RM	 0.2500	 0.0860
RN	 0.0000	 0.0250
SA	 0.0180	 0.0210
SB	 0.4380	 0.1350
SC	 0.6670	 0.2360
SD	 0.7140	 0.2840
SE	 0.7160	 0.2920
SF	 0.7160	 0.2890
SG	 0.7120	 0.2790
SH	 0.7140	 0.2950
SI	 0.7180	 0.3020







































*Continued on next page...*

*Continued from previous page...*

Chain	Atom inclusion	Q-score
SJ	 0.7170	 0.3000
SK	 0.7190	 0.2910
SL	 0.6630	 0.2300
SM	 0.3750	 0.1260
SN	 0.0000	 0.0100
TA	 0.0010	 0.0270
TB	 0.3000	 0.0530
TC	 0.6160	 0.2070
TD	 0.6780	 0.2620
TE	 0.6860	 0.2580
TF	 0.6920	 0.2750
TG	 0.6800	 0.2610
TH	 0.6700	 0.2540
TI	 0.6810	 0.2690
TJ	 0.6900	 0.2710
TK	 0.6830	 0.2740
TL	 0.6420	 0.2200
TM	 0.4850	 0.1300
TN	 0.0480	 0.0030
UA	 0.0170	 0.0260
UB	 0.3530	 0.1120
UC	 0.6310	 0.2310
UD	 0.6630	 0.2510
UE	 0.7050	 0.2890
UF	 0.6710	 0.2670
UG	 0.6830	 0.2680
UH	 0.6490	 0.2400
UI	 0.6810	 0.2710
UJ	 0.6640	 0.2560
UK	 0.6700	 0.2720
UL	 0.6420	 0.2410
UM	 0.5990	 0.2090
UN	 0.1950	 0.0210
VA	 0.6960	 0.2830
VB	 0.4690	 0.1930
VC	 0.7380	 0.3310
VD	 0.7350	 0.3130
VE	 0.7390	 0.3230
VF	 0.7300	 0.3250
VG	 0.7330	 0.3190
VH	 0.7070	 0.2980
VI	 0.7430	 0.3270

*Continued on next page...*

*Continued from previous page...*

Chain	Atom inclusion	Q-score
VJ	 0.7280	 0.3210
VK	 0.6950	 0.2880
VL	 0.7130	 0.2990
VM	 0.0210	 0.0100
VN	 0.4530	 0.1240
WA	 0.7190	 0.3010
WB	 0.5110	 0.2200
WC	 0.7390	 0.3350
WD	 0.7250	 0.3210
WE	 0.7280	 0.3310
WF	 0.7300	 0.3360
WG	 0.7220	 0.3170
WH	 0.7010	 0.3050
WI	 0.7480	 0.3460
WJ	 0.7320	 0.3300
WK	 0.7150	 0.3010
WL	 0.7130	 0.3140
WM	 0.2330	 0.0860
WN	 0.6270	 0.2310