



wwPDB EM Validation Summary Report ⓘ

Oct 21, 2024 – 08:35 AM EDT

PDB ID : 8G3D
EMDB ID : EMD-29692
Title : 48-nm doublet microtubule from Tetrahymena thermophila strain K40R
Authors : Black, C.S.; Kubo, S.; Yang, S.K.; Bui, K.H.
Deposited on : 2023-02-07
Resolution : 3.70 Å(reported)

This is a wwPDB EM Validation Summary Report for a publicly released PDB entry.

We welcome your comments at validation@mail.wwpdb.org

A user guide is available at

<https://www.wwpdb.org/validation/2017/EMValidationReportHelp>

with specific help available everywhere you see the ⓘ symbol.

The types of validation reports are described at

<http://www.wwpdb.org/validation/2017/FAQs#types>.

The following versions of software and data (see [references ⓘ](#)) were used in the production of this report:

EMDB validation analysis : 0.0.1.dev113
Mogul : 2022.3.0, CSD as543be (2022)
MolProbity : 4.02b-467
buster-report : 1.1.7 (2018)
Percentile statistics : 20231227.v01 (using entries in the PDB archive December 27th 2023)
MapQ : 1.9.13
Ideal geometry (proteins) : Engh & Huber (2001)
Ideal geometry (DNA, RNA) : Parkinson et al. (1996)
Validation Pipeline (wwPDB-VP) : 2.39

1 Overall quality at a glance

The following experimental techniques were used to determine the structure:

ELECTRON MICROSCOPY

The reported resolution of this entry is 3.70 Å.

Percentile scores (ranging between 0-100) for global validation metrics of the entry are shown in the following graphic. The table shows the number of entries on which the scores are based.

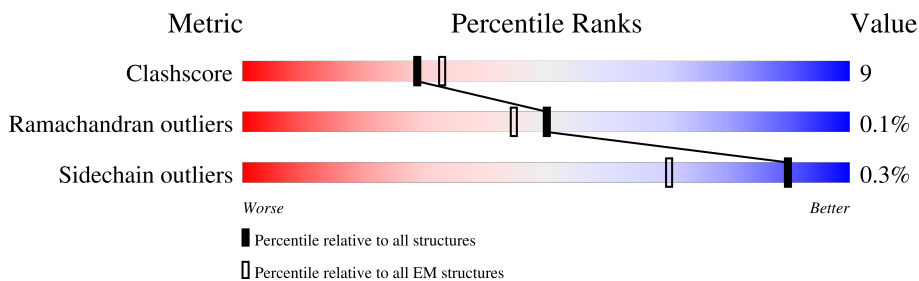

Metric	Whole archive (#Entries)	EM structures (#Entries)
Clashscore	210492	15764
Ramachandran outliers	207382	16835
Sidechain outliers	206894	16415

The table below summarises the geometric issues observed across the polymeric chains and their fit to the map. The red, orange, yellow and green segments of the bar indicate the fraction of residues that contain outliers for ≥ 3 , 2, 1 and 0 types of geometric quality criteria respectively. A grey segment represents the fraction of residues that are not modelled. The numeric value for each fraction is indicated below the corresponding segment, with a dot representing fractions $\leq 5\%$. The upper red bar (where present) indicates the fraction of residues that have poor fit to the EM map (all-atom inclusion $< 40\%$). The numeric value is given above the bar.

Mol	Chain	Length	Quality of chain
1	0A	236	
1	1A	236	
1	2A	236	
1	3A	236	
2	0B	329	
3	0C	156	
3	1C	156	
4	0D	225	

Continued on next page...

Continued from previous page...

Mol	Chain	Length	Quality of chain
4	1D	225	19% 80% 9% 10%
4	2D	225	20% 56% 32% 10%
5	0E	191	18% 95%
5	1E	191	15% 95%
5	2E	191	16% 68% 30%
5	3E	191	36% 66% 31%
6	0F	219	5% 85% 9% 6%
7	0G	183	13% 80% 11% 8%
7	1G	183	16% 66% 7% 27%
8	0H	447	10% 25% 74%
8	1H	447	36% 90% 6%
9	0N	492	7% 55% 43%
9	1N	492	6% 92% 6%
9	2N	492	12% 40% 17% 43%
10	0Q	195	93% 5%
10	1Q	195	90% 6% 5%
10	2Q	195	71% 23% 5%
10	3Q	195	68% 26% 5%
10	4Q	195	5% 73% 22% 5%
10	5Q	195	73% 22% 5%
10	6Q	195	8% 64% 31% 5%
11	0S	319	41% 89% 10%
11	1S	319	7% 74% 16% 10%
11	2S	319	6% 71% 19% 10%
11	3S	319	7% 73% 17% 10%











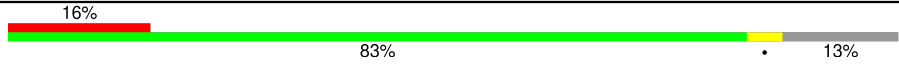

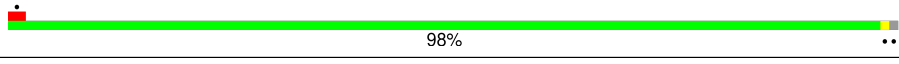
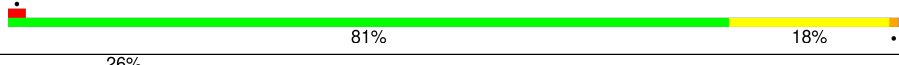
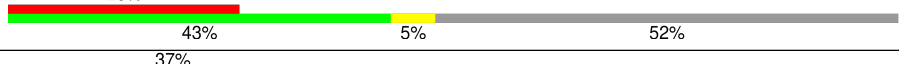
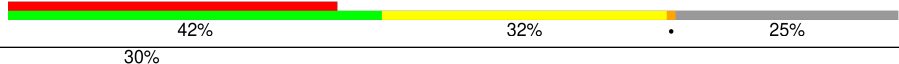
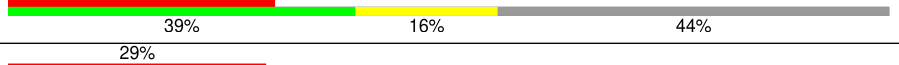
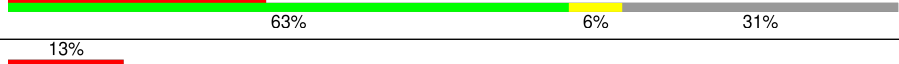
Continued on next page...

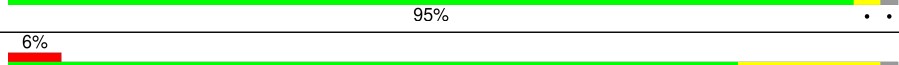
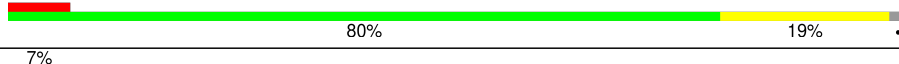
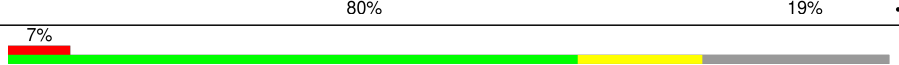
Continued from previous page...

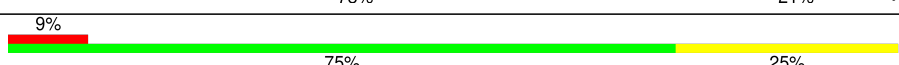
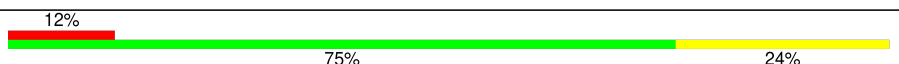
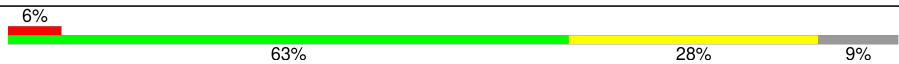
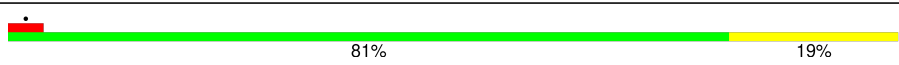
Mol	Chain	Length	Quality of chain
12	0T	298	
12	1T	298	
12	2T	298	
12	3T	298	
13	0U	656	
13	1U	656	
13	2U	656	
13	3U	656	
14	0V	269	
14	1V	269	
14	2V	269	
14	3V	269	
15	0X	142	
15	1X	142	
15	2X	142	
15	3X	142	
15	4X	142	
16	1B	498	
16	2B	498	
16	3B	498	
17	1F	173	
18	1I	263	
19	1J	422	
20	1K	489	
20	2K	489	

Continued on next page...

Continued from previous page...

Mol	Chain	Length	Quality of chain
21	1L	940	
21	2L	940	
21	3L	940	
22	1M	372	
22	2M	372	
23	1O	494	
23	2O	494	
23	3O	494	
24	1P	507	
24	2P	507	
25	1R	516	
25	2R	516	
25	3R	516	
26	1W	280	
26	2W	280	
27	2C	300	
27	3C	300	
27	4C	300	
28	2F	96	
29	2G	99	
30	2H	229	
30	3H	229	
30	4H	229	
31	2I	293	
31	3I	293	

Continued on next page...

Continued from previous page...

Mol	Chain	Length	Quality of chain
32	3D	237	7% 77% 23%
33	4F	276	9% 58% 14% 28%
34	4R	613	78% 21%
34	5R	613	83% 17%
34	6R	613	10% 77% 22%
34	7R	613	13% 80% 19%
35	4S	249	7% 55% 21% 24%
35	5S	249	6% 58% 17% 24%
36	5A	175	35% 63% 25% 10%
36	5B	175	21% 67% 22% 10%
36	5C	175	23% 66% 23% 10%
36	5D	175	19% 49% 13% 38%
37	5E	247	41% 51% 23% 25%
37	5F	247	31% 68% 16% 15%
37	5G	247	30% 60% 25% 15%
37	5H	247	19% 45% 11% 44%
38	5I	168	38% 59% 41%
38	5J	168	41% 65% 35%
38	5K	168	33% 44% 55%
39	6F	145	7% 70% 20% 9%
40	6G	364	8% 38% 21% 41%
41	6H	518	5% 24% 8% 68%
42	8L	507	15% 75% 24%
42	8N	507	15% 70% 29%
43	8P	529	14% 67% 31%

Continued on next page...

Continued from previous page...

Mol	Chain	Length	Quality of chain
44	8R	361	25% 95% 5%
45	AA	449	75% 23%
45	AC	449	79% 18%
45	AE	449	82% 16%
45	AG	449	81% 17%
45	AI	449	83% 15%
45	AK	449	81% 16%
45	AM	449	74% 23%
45	BA	449	5% 73% 23%
45	BC	449	75% 21%
45	BE	449	79% 17%
45	BG	449	76% 20%
45	BI	449	80% 16%
45	BK	449	75% 21%
45	BM	449	76% 20%
45	CA	449	35% 69% 29%
45	CC	449	73% 25%
45	CE	449	73% 25%
45	CG	449	76% 22%
45	CI	449	78% 20%
45	CK	449	80% 18%
45	CM	449	65% 32%
45	DA	449	59% 67% 30%
45	DC	449	68% 29%
45	DE	449	74% 22%

Continued on next page...

Continued from previous page...

Mol	Chain	Length	Quality of chain	
45	DG	449	78%	19%
45	DI	449	75%	21%
45	DK	449	73%	24%
45	DM	449	8%	68%
45	EA	449	68%	70%
45	EC	449	70%	27%
45	EE	449	78%	19%
45	EG	449	79%	19%
45	EI	449	73%	24%
45	EK	449	75%	23%
45	EM	449	5%	72%
45	FA	449	5%	67%
45	FC	449	79%	17%
45	FE	449	77%	20%
45	FG	449	79%	18%
45	FI	449	78%	18%
45	FK	449	73%	23%
45	FM	449	77%	76%
45	GA	449	7%	73%
45	GC	449	77%	19%
45	GE	449	78%	18%
45	GG	449	83%	13%
45	GI	449	79%	16%
45	GK	449	80%	17%
45	GM	449	59%	64%
				31%

Continued on next page...

Continued from previous page...

Mol	Chain	Length	Quality of chain
45	HA	449	 5% 76% 20%
45	HC	449	 78% 18%
45	HE	449	 77% 19%
45	HG	449	 76% 20%
45	HI	449	 81% 15%
45	HK	449	 77% 19%
45	HM	449	 32% 73% 23%
45	IA	449	 74% 22%
45	IC	449	 80% 18%
45	IE	449	 80% 16%
45	IG	449	 82% 16%
45	II	449	 81% 17%
45	IK	449	 78% 18%
45	IM	449	 14% 70% 26%
45	JA	449	 76% 20%
45	JC	449	 79% 18%
45	JE	449	 84% 14%
45	JG	449	 78% 19%
45	JI	449	 78% 20%
45	JK	449	 73% 24%
45	JM	449	 37% 68% 28%
45	KA	449	 79% 17%
45	KC	449	 82% 14%
45	KE	449	 80% 17%
45	KG	449	 80% 18%















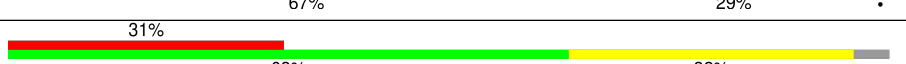
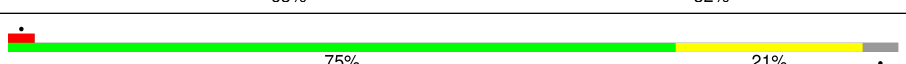
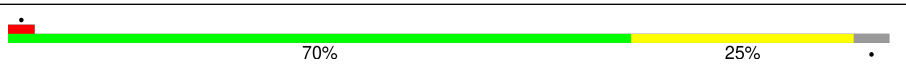

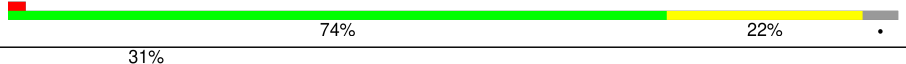
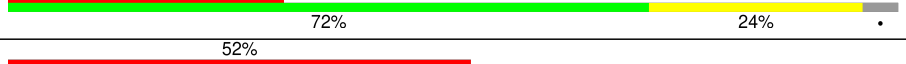

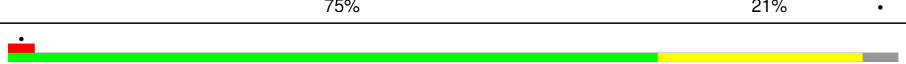
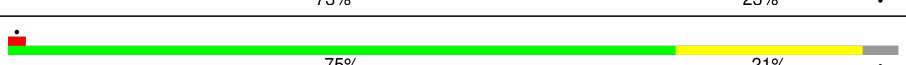
Continued on next page...

Continued from previous page...

Mol	Chain	Length	Quality of chain
45	KI	449	78% 20%
45	KK	449	84% 14%
45	KM	449	8% 79% 17%
45	LA	449	74% 23%
45	LC	449	77% 21%
45	LE	449	76% 22%
45	LG	449	78% 19%
45	LI	449	80% 17%
45	LK	449	78% 20%
45	LM	449	72% 26%
45	MA	449	74% 23%
45	MC	449	82% 15%
45	ME	449	76% 21%
45	MG	449	82% 15%
45	MI	449	77% 21%
45	MK	449	78% 19%
45	MM	449	69% 28%
45	NA	449	6% 71% 26%
45	NC	449	72% 24%
45	NE	449	75% 22%
45	NG	449	73% 23%
45	NI	449	5% 78% 19%
45	NK	449	74% 22%
45	NM	449	21% 71% 27%
45	OA	449	12% 66% 30%















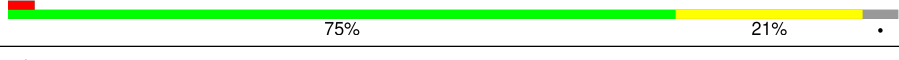

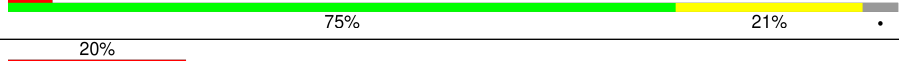
Continued on next page...

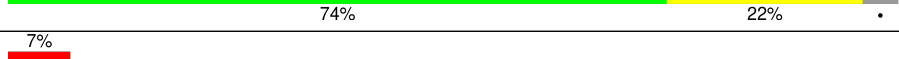
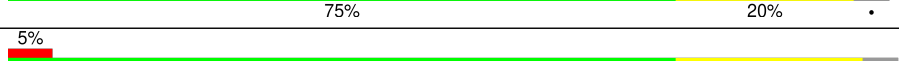
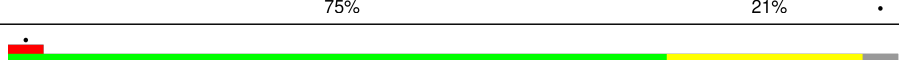
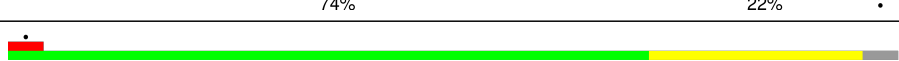
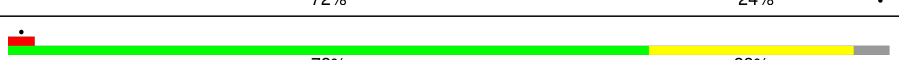
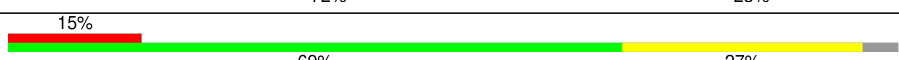
Continued from previous page...

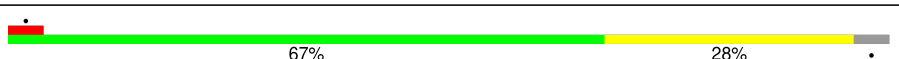
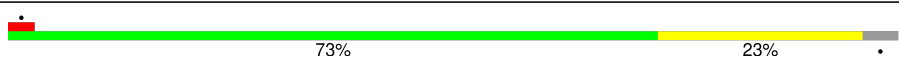
Mol	Chain	Length	Quality of chain
45	OC	449	 74% 23%
45	OE	449	 74% 22%
45	OG	449	 76% 20%
45	OI	449	 75% 21%
45	OK	449	 77% 20%
45	OM	449	 22% 67% 29%
45	PA	449	 31% 63% 32%
45	PC	449	 75% 21%
45	PE	449	 70% 25%
45	PG	449	 76% 19%
45	PI	449	 74% 21%
45	PK	449	 74% 22%
45	PM	449	 31% 72% 24%
45	QA	449	 52% 68% 28%
45	QC	449	 75% 21%
45	QE	449	 73% 23%
45	QG	449	 75% 21%
45	QI	449	 72% 24%
45	QK	449	 73% 22%
45	QM	449	 39% 64% 31%
45	RA	449	 64% 72% 24%
45	RC	449	 5% 68% 27%
45	RE	449	 75% 20%
45	RG	449	 73% 22%
45	RI	449	 5% 75% 21%



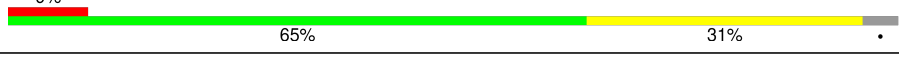
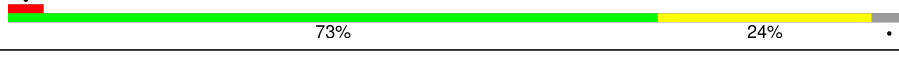
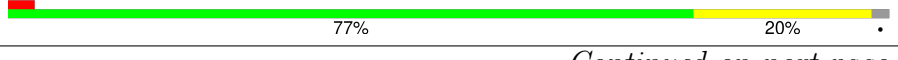















Continued on next page...

Continued from previous page...

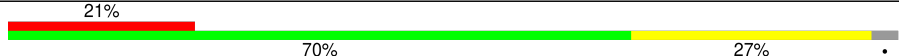
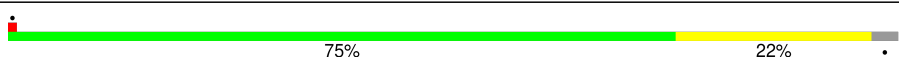
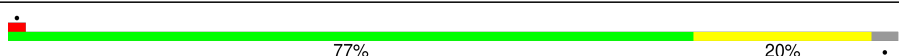
Mol	Chain	Length	Quality of chain
45	RK	449	
45	RM	449	
45	SA	449	
45	SC	449	
45	SE	449	
45	SG	449	
45	SI	449	
45	SK	449	
45	SM	449	
45	TA	449	
45	TC	449	
45	TE	449	
45	TG	449	
45	TI	449	
45	TK	449	
45	TM	449	
45	UA	449	
45	UC	449	
45	UE	449	
45	UG	449	
45	UI	449	
45	UK	449	
45	UM	449	
45	VA	449	
45	VC	449	

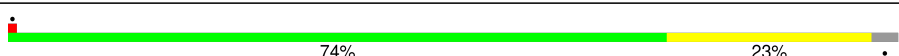
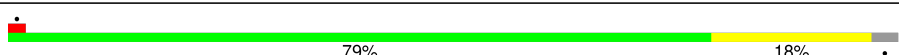
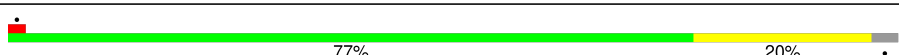
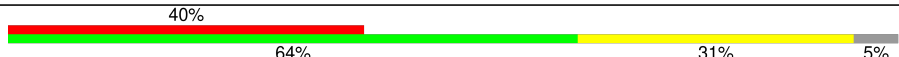
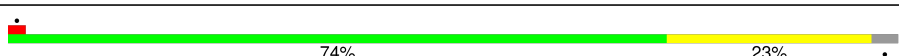



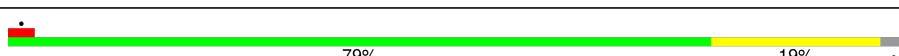







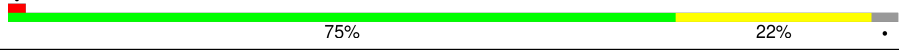
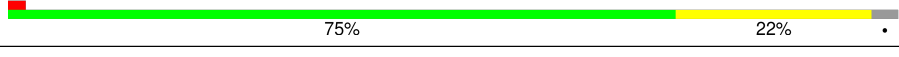



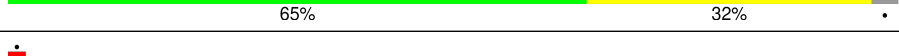
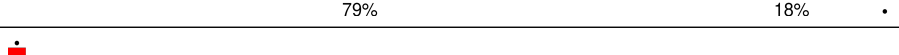
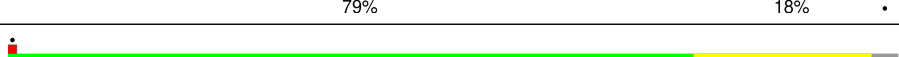
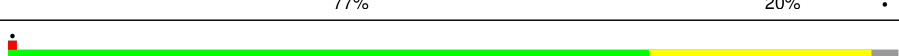

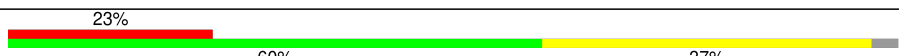
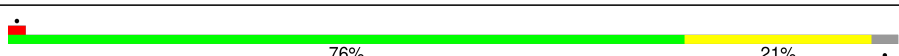
Continued on next page...

Continued from previous page...

Mol	Chain	Length	Quality of chain
45	VE	449	 77% 19%
45	VG	449	 5% 74% 23%
45	VI	449	 77% 20%
45	VK	449	 72% 26%
45	VM	449	 60% 67% 29%
45	WA	449	 77% 19%
45	WC	449	 81% 17%
45	WE	449	 74% 22%
45	WG	449	 77% 20%
45	WI	449	 79% 17%
45	WK	449	 75% 22%
45	WM	449	 41% 63% 33%
46	AB	443	 21% 70% 27%
46	AD	443	 75% 22%
46	AF	443	 77% 20%
46	AH	443	 81% 16%
46	AJ	443	 74% 23%
46	AL	443	 79% 18%
46	AN	443	 77% 20%
46	BB	443	 40% 64% 31% 5%
46	BD	443	 74% 23%
46	BF	443	 74% 23%
46	BH	443	 76% 21%
46	BJ	443	 77% 20%
46	BL	443	 79% 19%

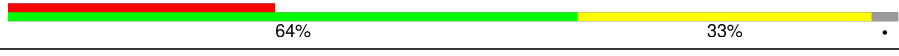

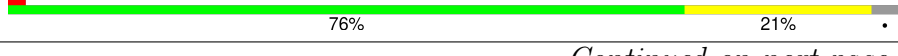











Continued on next page...

Continued from previous page...

Mol	Chain	Length	Quality of chain
46	BN	443	 74% 23%
46	CB	443	 67% 30%
46	CD	443	 74% 23%
46	CF	443	 75% 22%
46	CH	443	 75% 22%
46	CJ	443	 76% 21%
46	CL	443	 74% 23%
46	CN	443	 48% 61% 36%
46	DB	443	 12% 65% 32%
46	DD	443	 79% 18%
46	DF	443	 79% 18%
46	DH	443	 77% 20%
46	DJ	443	 72% 25%
46	DL	443	 70% 27%
46	DN	443	 53% 62% 34%
46	EB	443	 23% 60% 37%
46	ED	443	 76% 21%
46	EF	443	 77% 20%
46	EH	443	 71% 26%
46	EJ	443	 76% 21%
46	EL	443	 70% 27%
46	EN	443	 45% 68% 29%
46	FB	443	 30% 64% 33%
46	FD	443	 75% 22%
46	FF	443	 76% 21%

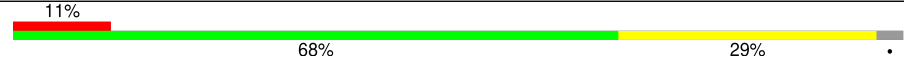
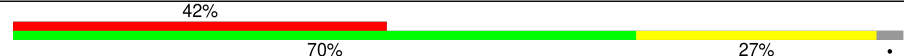

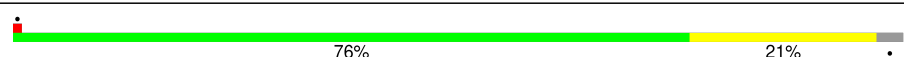
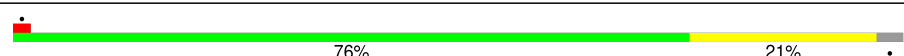
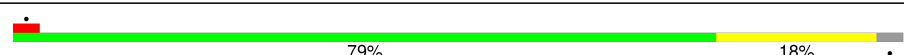
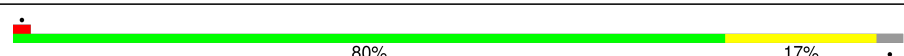
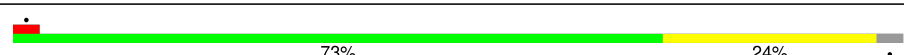
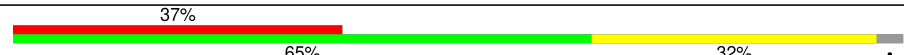
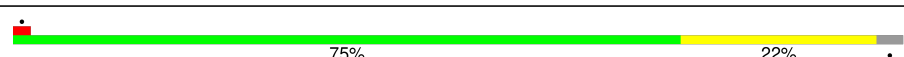

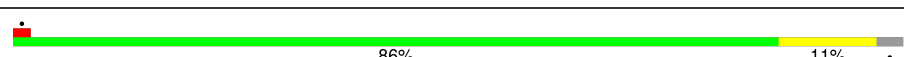
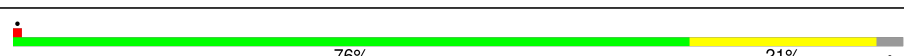
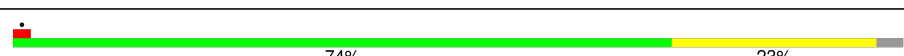







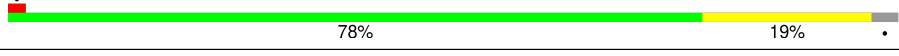
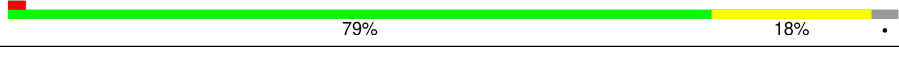



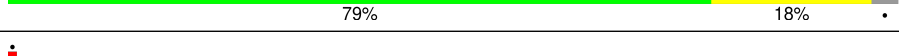
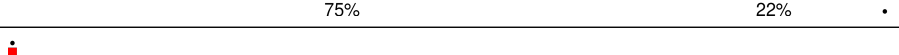
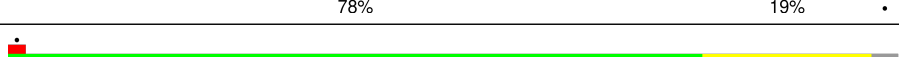
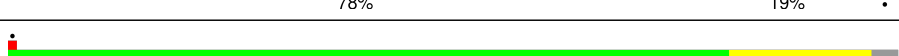

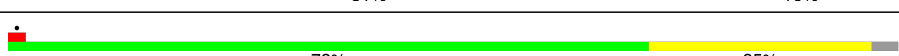
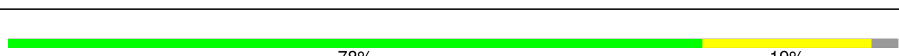
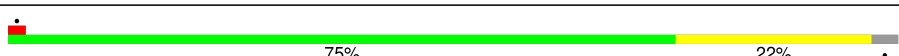
Continued on next page...

Continued from previous page...

Mol	Chain	Length	Quality of chain
46	FH	443	
46	FJ	443	
46	FL	443	
46	FN	443	
46	GB	443	
46	GD	443	
46	GF	443	
46	GH	443	
46	GJ	443	
46	GL	443	
46	GN	443	
46	HB	443	
46	HD	443	
46	HF	443	
46	HH	443	
46	HJ	443	
46	HL	443	
46	HN	443	
46	IB	443	
46	ID	443	
46	IF	443	
46	IH	443	
46	IJ	443	
46	IL	443	
46	IN	443	

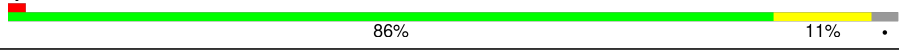

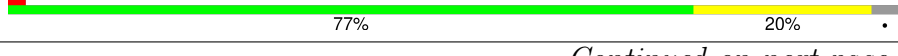















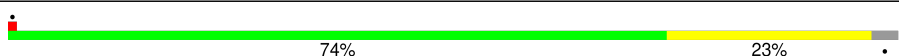
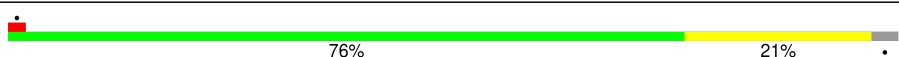
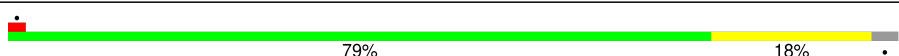

Continued on next page...

Continued from previous page...

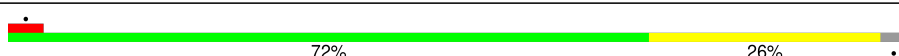
Mol	Chain	Length	Quality of chain
46	JB	443	 72% 25%
46	JD	443	 81% 16%
46	JF	443	 79% 18%
46	JH	443	 78% 19%
46	JJ	443	 79% 18%
46	JL	443	 82% 15%
46	JN	443	 76% 21%
46	KB	443	 77% 20%
46	KD	443	 79% 18%
46	KF	443	 75% 22%
46	KH	443	 78% 19%
46	KJ	443	 78% 19%
46	KL	443	 81% 16%
46	KN	443	 81% 16%
46	LB	443	 72% 25%
46	LD	443	 78% 19%
46	LF	443	 75% 22%
46	LH	443	 79% 18%
46	LJ	443	 77% 21%
46	LL	443	 79% 18%
46	LN	443	 75% 22%
46	MB	443	 72% 25%
46	MD	443	 86% 11%
46	MF	443	 77% 20%
46	MH	443	 77% 20%

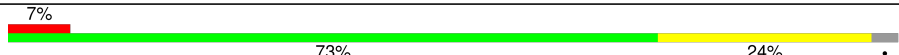
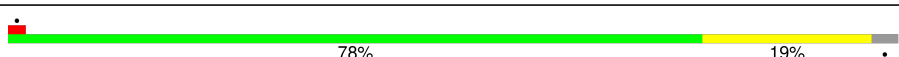
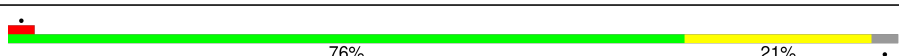



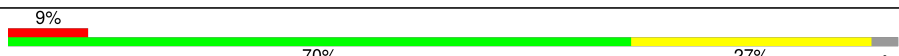







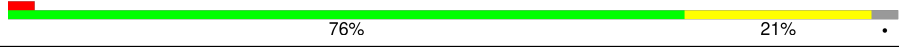
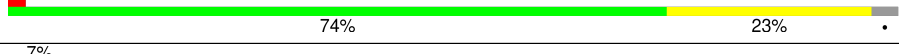



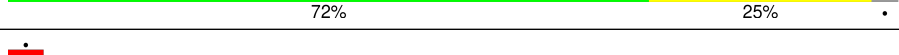
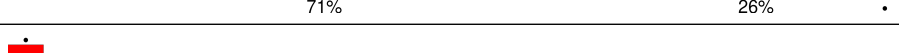
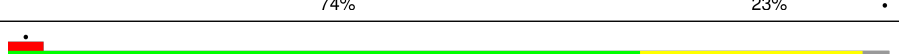
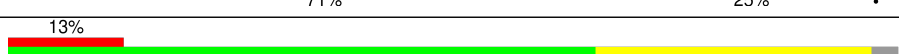

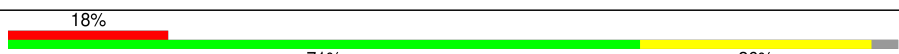
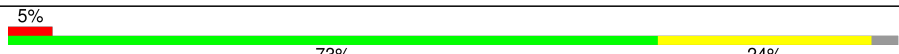
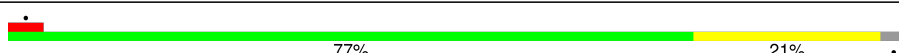
Continued on next page...

Continued from previous page...

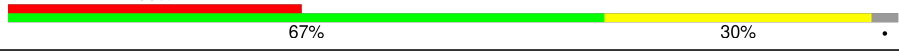
Mol	Chain	Length	Quality of chain
46	MJ	443	 75% 22%
46	ML	443	 77% 21%
46	MN	443	 75% 22%
46	NB	443	 15% 71% 25% 5%
46	ND	443	 5% 69% 28%
46	NF	443	 75% 20% 5%
46	NH	443	 6% 72% 25%
46	NJ	443	 76% 20% 5%
46	NL	443	 5% 75% 22%
46	NN	443	 5% 66% 29% 5%
46	OB	443	 36% 63% 33%
46	OD	443	 74% 23%
46	OF	443	 74% 23%
46	OH	443	 76% 21%
46	OJ	443	 79% 18%
46	OL	443	 77% 20%
46	ON	443	 72% 26%
46	PB	443	 62% 69% 28%
46	PD	443	 7% 73% 24%
46	PF	443	 78% 19%
46	PH	443	 76% 21%
46	PJ	443	 75% 22%
46	PL	443	 79% 18%
46	PN	443	 6% 69% 28%
46	QB	443	 9% 70% 27%

Continued on next page...

Continued from previous page...

Mol	Chain	Length	Quality of chain
46	QD	443	 71% 25%
46	QF	443	 72% 25%
46	QH	443	 76% 21%
46	QJ	443	 74% 23%
46	QL	443	 7% 66% 31%
46	QN	443	 84% 80% 16%
46	RB	443	 15% 69% 28%
46	RD	443	 72% 25%
46	RF	443	 71% 26%
46	RH	443	 74% 23%
46	RJ	443	 71% 25%
46	RL	443	 13% 66% 31%
46	RN	443	 83% 81% 16%
46	SB	443	 18% 71% 26%
46	SD	443	 5% 73% 24%
46	SF	443	 77% 21%
46	SH	443	 72% 25%
46	SJ	443	 5% 71% 26%
46	SL	443	 6% 67% 30%
46	SN	443	 72% 75% 22%
46	TB	443	 33% 67% 30%
46	TD	443	 72% 25%
46	TF	443	 76% 21%
46	TH	443	 5% 75% 22%
46	TJ	443	 6% 72% 25%

Continued on next page...

Continued from previous page...

Mol	Chain	Length	Quality of chain
46	TL	443	<p>5% 69% 28%</p>
46	TN	443	<p>73% 71% 26%</p>
46	UB	443	<p>32% 68% 28%</p>
46	UD	443	<p>5% 73% 24%</p>
46	UF	443	<p>5% 78% 19%</p>
46	UH	443	<p>5% 74% 23%</p>
46	UJ	443	<p>5% 71% 26%</p>
46	UL	443	<p>6% 75% 22%</p>
46	UN	443	<p>51% 67% 30%</p>
46	VB	443	<p>18% 70% 27%</p>
46	VD	443	<p>5% 78% 19%</p>
46	VF	443	<p>5% 76% 21%</p>
46	VH	443	<p>5% 73% 24%</p>
46	VJ	443	<p>5% 76% 21%</p>
46	VL	443	<p>5% 74% 23%</p>
46	VN	443	<p>14% 64% 33%</p>
46	WB	443	<p>19% 73% 24%</p>
46	WD	443	<p>5% 80% 17%</p>
46	WF	443	<p>5% 83% 14%</p>
46	WH	443	<p>5% 74% 23%</p>
46	WJ	443	<p>5% 79% 18%</p>
46	WL	443	<p>5% 75% 22%</p>
46	WN	443	<p>5% 71% 26%</p>

2 Entry composition

There are 49 unique types of molecules in this entry. The entry contains 1324599 atoms, of which 0 are hydrogens and 0 are deuteriums.

In the tables below, the AltConf column contains the number of residues with at least one atom in alternate conformation and the Trace column contains the number of residues modelled with at most 2 atoms.

- Molecule 1 is a protein called RIB27A.

Mol	Chain	Residues	Atoms					AltConf	Trace
			Total	C	N	O	S		
1	0A	152	1229	776	224	228	1	0	0
1	1A	152	1229	776	224	228	1	0	0
1	2A	152	1229	776	224	228	1	0	0
1	3A	152	1229	776	224	228	1	0	0

- Molecule 2 is a protein called RIB38.

Mol	Chain	Residues	Atoms					AltConf	Trace
			Total	C	N	O	S		
2	0B	321	2614	1633	472	503	6	0	0

- Molecule 3 is a protein called CFAM166B.

Mol	Chain	Residues	Atoms					AltConf	Trace
			Total	C	N	O	S		
3	0C	95	747	471	131	143	2	0	0
3	1C	95	747	471	131	143	2	0	0

- Molecule 4 is a protein called CFAM166A.

Mol	Chain	Residues	Atoms					AltConf	Trace
			Total	C	N	O	S		
4	0D	202	1621	1019	293	307	2	1	0
4	1D	202	1621	1019	293	307	2	1	0
4	2D	202	1621	1019	293	307	2	1	0

- Molecule 5 is a protein called RIB22.

Mol	Chain	Residues	Atoms					AltConf	Trace
5	0E	189	Total	C	N	O	S	0	0
			1557	978	280	294	5		
5	1E	189	Total	C	N	O	S	0	0
			1557	978	280	294	5		
5	2E	189	Total	C	N	O	S	0	0
			1557	978	280	294	5		
5	3E	189	Total	C	N	O	S	0	0
			1557	978	280	294	5		

- Molecule 6 is a protein called CFAM166C.

Mol	Chain	Residues	Atoms					AltConf	Trace
6	0F	206	Total	C	N	O	S	0	0
			1665	1048	300	314	3		

- Molecule 7 is a protein called CFAP107.

Mol	Chain	Residues	Atoms					AltConf	Trace
7	0G	168	Total	C	N	O	S	0	0
			1378	872	237	265	4		
7	1G	133	Total	C	N	O	S	0	0
			1089	692	185	210	2		

- Molecule 8 is a protein called CFAP127.

Mol	Chain	Residues	Atoms					AltConf	Trace
8	0H	116	Total	C	N	O	S	0	0
			1006	628	181	192	5		
8	1H	422	Total	C	N	O	S	0	0
			3687	2271	687	715	14		

- Molecule 9 is a protein called CFAP161A.

Mol	Chain	Residues	Atoms					AltConf	Trace
9	0N	280	Total	C	N	O	S	0	0
			2305	1455	396	441	13		
9	1N	463	Total	C	N	O	S	0	0
			3805	2414	653	723	15		
9	2N	280	Total	C	N	O	S	0	0
			2305	1455	396	441	13		

- Molecule 10 is a protein called CFAP20.

Mol	Chain	Residues	Atoms					AltConf	Trace
10	0Q	186	Total	C	N	O	S	0	0
			1548	997	268	276	7		
10	1Q	186	Total	C	N	O	S	0	0
			1548	997	268	276	7		
10	2Q	186	Total	C	N	O	S	0	0
			1548	997	268	276	7		
10	3Q	186	Total	C	N	O	S	0	0
			1548	997	268	276	7		
10	4Q	186	Total	C	N	O	S	0	0
			1548	997	268	276	7		
10	5Q	186	Total	C	N	O	S	0	0
			1548	997	268	276	7		
10	6Q	186	Total	C	N	O	S	0	0
			1548	997	268	276	7		

- Molecule 11 is a protein called Parkin co-regulated protein PACRGA.

Mol	Chain	Residues	Atoms					AltConf	Trace
11	0S	288	Total	C	N	O	S	0	0
			2310	1485	397	422	6		
11	1S	288	Total	C	N	O	S	0	0
			2310	1485	397	422	6		
11	2S	288	Total	C	N	O	S	0	0
			2310	1485	397	422	6		
11	3S	288	Total	C	N	O	S	0	0
			2310	1485	397	422	6		

- Molecule 12 is a protein called IJ34.

Mol	Chain	Residues	Atoms					AltConf	Trace
12	0T	253	Total	C	N	O	S	0	0
			2056	1312	357	378	9		
12	1T	285	Total	C	N	O	S	0	0
			2321	1471	411	430	9		
12	2T	285	Total	C	N	O	S	0	0
			2321	1471	411	430	9		
12	3T	285	Total	C	N	O	S	0	0
			2321	1471	411	430	9		

- Molecule 13 is a protein called Cilia- and flagella-associated protein 52.

Mol	Chain	Residues	Atoms					AltConf	Trace
13	0U	607	Total	C	N	O	S	0	0
			4774	3025	819	906	24		
13	1U	607	Total	C	N	O	S	0	0
			4774	3025	819	906	24		
13	2U	607	Total	C	N	O	S	0	0
			4774	3025	819	906	24		
13	3U	607	Total	C	N	O	S	0	0
			4774	3025	819	906	24		

- Molecule 14 is a protein called DNA polymerase delta C4-type zinc-finger protein.

Mol	Chain	Residues	Atoms					AltConf	Trace
14	0V	212	Total	C	N	O	S	0	0
			1750	1095	317	332	6		
14	1V	263	Total	C	N	O	S	0	0
			2168	1359	388	412	9		
14	2V	263	Total	C	N	O	S	0	0
			2168	1359	388	412	9		
14	3V	263	Total	C	N	O	S	0	0
			2168	1359	388	412	9		

- Molecule 15 is a protein called RIB43A protein.

Mol	Chain	Residues	Atoms					AltConf	Trace
15	0X	106	Total	C	N	O	S	0	0
			903	553	170	175	5		
15	1X	141	Total	C	N	O	S	0	0
			1205	736	229	234	6		
15	2X	141	Total	C	N	O	S	0	0
			1205	736	229	234	6		
15	3X	141	Total	C	N	O	S	0	0
			1205	736	229	234	6		
15	4X	141	Total	C	N	O	S	0	0
			1205	736	229	234	6		

- Molecule 16 is a protein called RIB57.

Mol	Chain	Residues	Atoms					AltConf	Trace
16	1B	498	Total	C	N	O	S	0	0
			4066	2598	692	768	8		
16	2B	295	Total	C	N	O	S	0	0
			2439	1553	416	464	6		

Continued on next page...

Continued from previous page...

Mol	Chain	Residues	Atoms					AltConf	Trace
16	3B	297	Total	C	N	O	S	0	0
			2449	1558	418	467	6		

- Molecule 17 is a protein called CFAP182A.

Mol	Chain	Residues	Atoms					AltConf	Trace
17	1F	136	Total	C	N	O	S	0	0
			1093	696	184	208	5		

- Molecule 18 is a protein called CFAP143.

Mol	Chain	Residues	Atoms					AltConf	Trace
18	1I	188	Total	C	N	O	S	0	0
			1546	951	285	306	4		

- Molecule 19 is a protein called CFAP21A.

Mol	Chain	Residues	Atoms					AltConf	Trace
19	1J	370	Total	C	N	O	S	0	0
			3025	1901	534	579	11		

- Molecule 20 is a protein called Cilia- and flagella-associated protein 53.

Mol	Chain	Residues	Atoms					AltConf	Trace
20	1K	273	Total	C	N	O	S	0	0
			2391	1479	447	458	7		
20	2K	284	Total	C	N	O	S	0	0
			2465	1517	455	486	7		

- Molecule 21 is a protein called CFAP115.

Mol	Chain	Residues	Atoms					AltConf	Trace
21	1L	820	Total	C	N	O	S	0	0
			6841	4357	1186	1280	18		
21	2L	620	Total	C	N	O	S	0	0
			5181	3304	902	963	12		
21	3L	200	Total	C	N	O	S	0	0
			1660	1053	284	317	6		

- Molecule 22 is a protein called Nucleoside diphosphate kinase.

Mol	Chain	Residues	Atoms					AltConf	Trace
22	1M	369	Total	C	N	O	S	0	0
			2978	1910	501	552	15		
22	2M	369	Total	C	N	O	S	0	0
			2978	1910	501	552	15		

- Molecule 23 is a protein called Cilia- and flagella-associated protein 45.

Mol	Chain	Residues	Atoms					AltConf	Trace
23	1O	235	Total	C	N	O	S	0	0
			1983	1235	350	386	12		
23	2O	370	Total	C	N	O	S	0	0
			3173	1948	595	617	13		
23	3O	275	Total	C	N	O	S	0	0
			2358	1447	451	456	4		

- Molecule 24 is a protein called CFAP210.

Mol	Chain	Residues	Atoms					AltConf	Trace
24	1P	351	Total	C	N	O	S	0	0
			3026	1869	567	582	8		
24	2P	186	Total	C	N	O	S	0	0
			1594	983	299	307	5		

- Molecule 25 is a protein called RIB72B.

Mol	Chain	Residues	Atoms					AltConf	Trace
25	1R	508	Total	C	N	O	S	0	0
			4244	2744	711	777	12		
25	2R	508	Total	C	N	O	S	0	0
			4244	2744	711	777	12		
25	3R	508	Total	C	N	O	S	0	0
			4244	2744	711	777	12		

- Molecule 26 is a protein called Protofilament ribbon protein.

Mol	Chain	Residues	Atoms					AltConf	Trace
26	1W	220	Total	C	N	O	S	0	0
			1888	1143	372	364	9		
26	2W	111	Total	C	N	O	S	0	0
			949	585	183	176	5		

- Molecule 27 is a protein called RIB35.

Mol	Chain	Residues	Atoms					AltConf	Trace
27	2C	300	Total	C	N	O	S	0	0
			2467	1581	417	464	5		
27	3C	300	Total	C	N	O	S	0	0
			2467	1581	417	464	5		
27	4C	300	Total	C	N	O	S	0	0
			2467	1581	417	464	5		

- Molecule 28 is a protein called CFAP182B.

Mol	Chain	Residues	Atoms					AltConf	Trace
28	2F	87	Total	C	N	O	S	0	0
			746	469	136	137	4		

- Molecule 29 is a protein called Flagellar FliJ protein.

Mol	Chain	Residues	Atoms					AltConf	Trace
29	2G	99	Total	C	N	O	S	0	0
			848	536	153	155	4		

- Molecule 30 is a protein called RIB27B.

Mol	Chain	Residues	Atoms					AltConf	Trace
30	2H	61	Total	C	N	O	S	0	0
			501	313	92	94	2		
30	3H	61	Total	C	N	O	S	0	0
			501	313	92	94	2		
30	4H	61	Total	C	N	O	S	0	0
			501	313	92	94	2		

- Molecule 31 is a protein called STPG2.

Mol	Chain	Residues	Atoms					AltConf	Trace
31	2I	140	Total	C	N	O	S	0	0
			1132	726	198	207	1		
31	3I	87	Total	C	N	O	S	0	0
			712	451	130	127	4		

- Molecule 32 is a protein called RIB26.

Mol	Chain	Residues	Atoms					AltConf	Trace
32	3D	237	Total	C	N	O	S	0	0
			1835	1174	310	340	11		

- Molecule 33 is a protein called CFAP129.

Mol	Chain	Residues	Atoms					AltConf	Trace
			Total	C	N	O	S		
33	4F	200	1623	1022	286	313	2	0	0

- Molecule 34 is a protein called Flagellar microtugule protofilament ribbon protein.

Mol	Chain	Residues	Atoms					AltConf	Trace
			Total	C	N	O	S		
34	4R	609	5070	3267	847	932	24	0	0
34	5R	609	5070	3267	847	932	24	0	0
34	6R	609	5070	3267	847	932	24	0	0
34	7R	609	5070	3267	847	932	24	0	0

- Molecule 35 is a protein called Parkin co-regulated protein PACRGB.

Mol	Chain	Residues	Atoms					AltConf	Trace
			Total	C	N	O	S		
35	4S	188	1537	999	251	279	8	0	0
35	5S	188	1537	999	251	279	8	0	0

- Molecule 36 is a protein called OJ2.

Mol	Chain	Residues	Atoms					AltConf	Trace
			Total	C	N	O	S		
36	5A	157	1261	795	234	229	3	0	0
36	5B	157	1261	795	234	229	3	0	0
36	5C	157	1261	795	234	229	3	0	0
36	5D	109	872	551	157	161	3	0	0

- Molecule 37 is a protein called CFAP77A.

Mol	Chain	Residues	Atoms					AltConf	Trace
			Total	C	N	O	S		
37	5E	185	1543	977	278	283	5	0	0

Continued on next page...

Continued from previous page...

Mol	Chain	Residues	Atoms					AltConf	Trace
37	5F	210	Total	C	N	O	S	0	0
			1750	1107	316	322	5		
37	5G	210	Total	C	N	O	S	0	0
			1750	1107	316	322	5		
37	5H	139	Total	C	N	O	S	0	0
			1146	725	207	210	4		

- Molecule 38 is a protein called OJ3.

Mol	Chain	Residues	Atoms				AltConf	Trace
38	5I	99	Total	C	N	O	0	0
			495	297	99	99		
38	5J	109	Total	C	N	O	0	0
			545	327	109	109		
38	5K	76	Total	C	N	O	0	0
			380	228	76	76		

- Molecule 39 is a protein called SB1.

Mol	Chain	Residues	Atoms					AltConf	Trace
39	6F	132	Total	C	N	O	S	0	0
			1141	718	197	222	4		

- Molecule 40 is a protein called STPG1A.

Mol	Chain	Residues	Atoms					AltConf	Trace
40	6G	216	Total	C	N	O	S	0	0
			1769	1128	303	333	5		

- Molecule 41 is a protein called Nebulin.

Mol	Chain	Residues	Atoms					AltConf	Trace
41	6H	165	Total	C	N	O	S	0	0
			1361	856	232	267	6		

There are 2 discrepancies between the modelled and reference sequences:

Chain	Residue	Modelled	Actual	Comment	Reference
6H	198	HIS	MET	conflict	UNP Q231B6
6H	199	MET	GLN	conflict	UNP Q231B6

- Molecule 42 is a protein called B5B6_fmIP.

Mol	Chain	Residues	Atoms				AltConf	Trace
42	8L	385	Total	C	N	O	0	0
			1925	1155	385	385		
42	8N	358	Total	C	N	O	0	0
			1790	1074	358	358		

- Molecule 43 is a protein called CFAP112A.

Mol	Chain	Residues	Atoms				AltConf	Trace
43	8P	363	Total	C	N	O	0	0
			1815	1089	363	363		

- Molecule 44 is a protein called B2B3_fMIP.

Mol	Chain	Residues	Atoms				AltConf	Trace
44	8R	361	Total	C	N	O	0	0
			2022	1269	361	392		

- Molecule 45 is a protein called Tubulin alpha chain.

Mol	Chain	Residues	Atoms					AltConf	Trace
45	AA	439	Total	C	N	O	S	0	0
			3410	2155	581	652	22		
45	AC	439	Total	C	N	O	S	0	0
			3410	2155	581	652	22		
45	AE	439	Total	C	N	O	S	0	0
			3410	2155	581	652	22		
45	AG	439	Total	C	N	O	S	0	0
			3410	2155	581	652	22		
45	AI	439	Total	C	N	O	S	0	0
			3410	2155	581	652	22		
45	AK	439	Total	C	N	O	S	0	0
			3410	2155	581	652	22		
45	AM	439	Total	C	N	O	S	0	0
			3410	2155	581	652	22		
45	BA	432	Total	C	N	O	S	0	0
			3364	2129	571	642	22		
45	BC	432	Total	C	N	O	S	0	0
			3364	2129	571	642	22		
45	BE	432	Total	C	N	O	S	0	0
			3364	2129	571	642	22		
45	BG	432	Total	C	N	O	S	0	0
			3364	2129	571	642	22		

Continued on next page...

Continued from previous page...

Mol	Chain	Residues	Atoms					AltConf	Trace
			Total	C	N	O	S		
45	BI	432	Total 3364	C 2129	N 571	O 642	S 22	0	0
45	BK	432	Total 3364	C 2129	N 571	O 642	S 22	0	0
45	BM	432	Total 3364	C 2129	N 571	O 642	S 22	0	0
45	CA	439	Total 3410	C 2155	N 581	O 652	S 22	0	0
45	CC	439	Total 3410	C 2155	N 581	O 652	S 22	0	0
45	CE	439	Total 3410	C 2155	N 581	O 652	S 22	0	0
45	CG	439	Total 3410	C 2155	N 581	O 652	S 22	0	0
45	CI	439	Total 3410	C 2155	N 581	O 652	S 22	0	0
45	CK	439	Total 3410	C 2155	N 581	O 652	S 22	0	0
45	CM	439	Total 3410	C 2155	N 581	O 652	S 22	0	0
45	DA	433	Total 3372	C 2133	N 572	O 645	S 22	0	0
45	DC	436	Total 3391	C 2143	N 578	O 648	S 22	0	0
45	DE	433	Total 3372	C 2133	N 572	O 645	S 22	0	0
45	DG	436	Total 3391	C 2143	N 578	O 648	S 22	0	0
45	DI	433	Total 3372	C 2133	N 572	O 645	S 22	0	0
45	DK	436	Total 3391	C 2143	N 578	O 648	S 22	0	0
45	DM	433	Total 3372	C 2133	N 572	O 645	S 22	0	0
45	EA	439	Total 3410	C 2155	N 581	O 652	S 22	0	0
45	EC	439	Total 3410	C 2155	N 581	O 652	S 22	0	0
45	EE	439	Total 3410	C 2155	N 581	O 652	S 22	0	0
45	EG	439	Total 3410	C 2155	N 581	O 652	S 22	0	0

Continued on next page...

Continued from previous page...

Mol	Chain	Residues	Atoms					AltConf	Trace
			Total	C	N	O	S		
45	EI	439	Total 3410	C 2155	N 581	O 652	S 22	0	0
45	EK	439	Total 3410	C 2155	N 581	O 652	S 22	0	0
45	EM	439	Total 3410	C 2155	N 581	O 652	S 22	0	0
45	FA	429	Total 3342	C 2118	N 568	O 634	S 22	0	0
45	FC	432	Total 3364	C 2129	N 571	O 642	S 22	0	0
45	FE	434	Total 3376	C 2135	N 573	O 646	S 22	0	0
45	FG	439	Total 3410	C 2155	N 581	O 652	S 22	0	0
45	FI	433	Total 3372	C 2133	N 572	O 645	S 22	0	0
45	FK	432	Total 3364	C 2129	N 571	O 642	S 22	0	0
45	FM	429	Total 3342	C 2118	N 568	O 634	S 22	0	0
45	GA	429	Total 3342	C 2118	N 568	O 634	S 22	0	0
45	GC	431	Total 3358	C 2126	N 570	O 640	S 22	0	0
45	GE	431	Total 3358	C 2126	N 570	O 640	S 22	0	0
45	GG	431	Total 3358	C 2126	N 570	O 640	S 22	0	0
45	GI	431	Total 3358	C 2126	N 570	O 640	S 22	0	0
45	GK	439	Total 3410	C 2155	N 581	O 652	S 22	0	0
45	GM	429	Total 3342	C 2118	N 568	O 634	S 22	0	0
45	HA	431	Total 3356	C 2125	N 570	O 639	S 22	0	0
45	HC	431	Total 3356	C 2125	N 570	O 639	S 22	0	0
45	HE	431	Total 3356	C 2125	N 570	O 639	S 22	0	0
45	HG	431	Total 3356	C 2125	N 570	O 639	S 22	0	0

Continued on next page...

Continued from previous page...

Mol	Chain	Residues	Atoms					AltConf	Trace
			Total	C	N	O	S		
45	HI	431	Total 3356	C 2125	N 570	O 639	S 22	0	0
45	HK	431	Total 3356	C 2125	N 570	O 639	S 22	0	0
45	HM	431	Total 3356	C 2125	N 570	O 639	S 22	0	0
45	IA	432	Total 3364	C 2129	N 571	O 642	S 22	0	0
45	IC	439	Total 3410	C 2155	N 581	O 652	S 22	0	0
45	IE	432	Total 3364	C 2129	N 571	O 642	S 22	0	0
45	IG	439	Total 3410	C 2155	N 581	O 652	S 22	0	0
45	II	439	Total 3410	C 2155	N 581	O 652	S 22	0	0
45	IK	432	Total 3364	C 2129	N 571	O 642	S 22	0	0
45	IM	432	Total 3364	C 2129	N 571	O 642	S 22	0	0
45	JA	432	Total 3364	C 2129	N 571	O 642	S 22	0	0
45	JC	434	Total 3376	C 2135	N 573	O 646	S 22	0	0
45	JE	439	Total 3410	C 2155	N 581	O 652	S 22	0	0
45	JG	439	Total 3410	C 2155	N 581	O 652	S 22	0	0
45	JI	439	Total 3406	C 2151	N 581	O 652	S 22	0	0
45	JK	439	Total 3410	C 2155	N 581	O 652	S 22	0	0
45	JM	432	Total 3364	C 2129	N 571	O 642	S 22	0	0
45	KA	434	Total 3376	C 2135	N 573	O 646	S 22	0	0
45	KC	433	Total 3372	C 2133	N 572	O 645	S 22	0	0
45	KE	435	Total 3387	C 2141	N 577	O 647	S 22	0	0
45	KG	439	Total 3410	C 2155	N 581	O 652	S 22	0	0

Continued on next page...

Continued from previous page...

Mol	Chain	Residues	Atoms					AltConf	Trace
			Total	C	N	O	S		
45	KI	439	Total 3410	C 2155	N 581	O 652	S 22	0	0
45	KK	439	Total 3410	C 2155	N 581	O 652	S 22	0	0
45	KM	434	Total 3376	C 2135	N 573	O 646	S 22	0	0
45	LA	439	Total 3410	C 2155	N 581	O 652	S 22	0	0
45	LC	439	Total 3410	C 2155	N 581	O 652	S 22	0	0
45	LE	438	Total 3402	C 2149	N 580	O 651	S 22	0	0
45	LG	439	Total 3410	C 2155	N 581	O 652	S 22	0	0
45	LI	434	Total 3383	C 2139	N 576	O 646	S 22	0	0
45	LK	439	Total 3410	C 2155	N 581	O 652	S 22	0	0
45	LM	439	Total 3410	C 2155	N 581	O 652	S 22	0	0
45	MA	436	Total 3394	C 2145	N 578	O 649	S 22	0	0
45	MC	433	Total 3368	C 2131	N 572	O 643	S 22	0	0
45	ME	433	Total 3372	C 2133	N 572	O 645	S 22	0	0
45	MG	437	Total 3402	C 2151	N 579	O 650	S 22	0	0
45	MI	439	Total 3410	C 2155	N 581	O 652	S 22	0	0
45	MK	436	Total 3384	C 2139	N 575	O 648	S 22	0	0
45	MM	436	Total 3394	C 2145	N 578	O 649	S 22	0	0
45	NA	439	Total 3410	C 2155	N 581	O 652	S 22	0	0
45	NC	432	Total 3364	C 2129	N 571	O 642	S 22	0	0
45	NE	439	Total 3410	C 2155	N 581	O 652	S 22	0	0
45	NG	432	Total 3364	C 2129	N 571	O 642	S 22	0	0

Continued on next page...

Continued from previous page...

Mol	Chain	Residues	Atoms					AltConf	Trace
			Total	C	N	O	S		
45	NI	439	Total 3410	C 2155	N 581	O 652	S 22	0	0
45	NK	432	Total 3364	C 2129	N 571	O 642	S 22	0	0
45	NM	439	Total 3410	C 2155	N 581	O 652	S 22	0	0
45	OA	433	Total 3368	C 2131	N 572	O 643	S 22	0	0
45	OC	433	Total 3368	C 2131	N 572	O 643	S 22	0	0
45	OE	433	Total 3368	C 2131	N 572	O 643	S 22	0	0
45	OG	433	Total 3368	C 2131	N 572	O 643	S 22	0	0
45	OI	433	Total 3368	C 2131	N 572	O 643	S 22	0	0
45	OK	433	Total 3368	C 2131	N 572	O 643	S 22	0	0
45	OM	433	Total 3368	C 2131	N 572	O 643	S 22	0	0
45	PA	429	Total 3342	C 2118	N 568	O 634	S 22	0	0
45	PC	429	Total 3342	C 2118	N 568	O 634	S 22	0	0
45	PE	429	Total 3342	C 2118	N 568	O 634	S 22	0	0
45	PG	429	Total 3342	C 2118	N 568	O 634	S 22	0	0
45	PI	429	Total 3342	C 2118	N 568	O 634	S 22	0	0
45	PK	429	Total 3342	C 2118	N 568	O 634	S 22	0	0
45	PM	429	Total 3342	C 2118	N 568	O 634	S 22	0	0
45	QA	431	Total 3356	C 2125	N 570	O 639	S 22	0	0
45	QC	431	Total 3356	C 2125	N 570	O 639	S 22	0	0
45	QE	431	Total 3356	C 2125	N 570	O 639	S 22	0	0
45	QG	431	Total 3356	C 2125	N 570	O 639	S 22	0	0

Continued on next page...

Continued from previous page...

Mol	Chain	Residues	Atoms					AltConf	Trace
			Total	C	N	O	S		
45	QI	431	Total 3356	C 2125	N 570	O 639	S 22	0	0
45	QK	431	Total 3356	C 2125	N 570	O 639	S 22	0	0
45	QM	431	Total 3356	C 2125	N 570	O 639	S 22	0	0
45	RA	431	Total 3356	C 2125	N 570	O 639	S 22	0	0
45	RC	431	Total 3356	C 2125	N 570	O 639	S 22	0	0
45	RE	431	Total 3356	C 2125	N 570	O 639	S 22	0	0
45	RG	431	Total 3356	C 2125	N 570	O 639	S 22	0	0
45	RI	431	Total 3356	C 2125	N 570	O 639	S 22	0	0
45	RK	431	Total 3356	C 2125	N 570	O 639	S 22	0	0
45	RM	431	Total 3356	C 2125	N 570	O 639	S 22	0	0
45	SA	430	Total 3350	C 2122	N 569	O 637	S 22	0	0
45	SC	430	Total 3350	C 2122	N 569	O 637	S 22	0	0
45	SE	430	Total 3350	C 2122	N 569	O 637	S 22	0	0
45	SG	430	Total 3350	C 2122	N 569	O 637	S 22	0	0
45	SI	430	Total 3350	C 2122	N 569	O 637	S 22	0	0
45	SK	430	Total 3350	C 2122	N 569	O 637	S 22	0	0
45	SM	430	Total 3350	C 2122	N 569	O 637	S 22	0	0
45	TA	430	Total 3350	C 2122	N 569	O 637	S 22	0	0
45	TC	430	Total 3350	C 2122	N 569	O 637	S 22	0	0
45	TE	430	Total 3350	C 2122	N 569	O 637	S 22	0	0
45	TG	430	Total 3350	C 2122	N 569	O 637	S 22	0	0

Continued on next page...

Continued from previous page...

Mol	Chain	Residues	Atoms					AltConf	Trace
			Total	C	N	O	S		
45	TI	430	Total 3350	C 2122	N 569	O 637	S 22	0	0
45	TK	430	Total 3350	C 2122	N 569	O 637	S 22	0	0
45	TM	430	Total 3350	C 2122	N 569	O 637	S 22	0	0
45	UA	431	Total 3356	C 2125	N 570	O 639	S 22	0	0
45	UC	431	Total 3356	C 2125	N 570	O 639	S 22	0	0
45	UE	431	Total 3356	C 2125	N 570	O 639	S 22	0	0
45	UG	431	Total 3356	C 2125	N 570	O 639	S 22	0	0
45	UI	431	Total 3356	C 2125	N 570	O 639	S 22	0	0
45	UK	431	Total 3356	C 2125	N 570	O 639	S 22	0	0
45	UM	431	Total 3356	C 2125	N 570	O 639	S 22	0	0
45	VA	433	Total 3372	C 2133	N 572	O 645	S 22	0	0
45	VC	439	Total 3410	C 2155	N 581	O 652	S 22	0	0
45	VE	433	Total 3372	C 2133	N 572	O 645	S 22	0	0
45	VG	439	Total 3410	C 2155	N 581	O 652	S 22	0	0
45	VI	433	Total 3372	C 2133	N 572	O 645	S 22	0	0
45	VK	439	Total 3410	C 2155	N 581	O 652	S 22	0	0
45	VM	433	Total 3372	C 2133	N 572	O 645	S 22	0	0
45	WA	431	Total 3356	C 2125	N 570	O 639	S 22	0	0
45	WC	439	Total 3410	C 2155	N 581	O 652	S 22	0	0
45	WE	431	Total 3356	C 2125	N 570	O 639	S 22	0	0
45	WG	439	Total 3410	C 2155	N 581	O 652	S 22	0	0

Continued on next page...

Continued from previous page...

Mol	Chain	Residues	Atoms					AltConf	Trace
			Total	C	N	O	S		
45	WI	431	3356	2125	570	639	22	0	0
45	WK	439	3410	2155	581	652	22	0	0
45	WM	431	3356	2125	570	639	22	0	0

There are 161 discrepancies between the modelled and reference sequences:

Chain	Residue	Modelled	Actual	Comment	Reference
AA	40	ARG	LYS	variant	UNP P41351
AC	40	ARG	LYS	variant	UNP P41351
AE	40	ARG	LYS	variant	UNP P41351
AG	40	ARG	LYS	variant	UNP P41351
AI	40	ARG	LYS	variant	UNP P41351
AK	40	ARG	LYS	variant	UNP P41351
AM	40	ARG	LYS	variant	UNP P41351
BA	40	ARG	LYS	variant	UNP P41351
BC	40	ARG	LYS	variant	UNP P41351
BE	40	ARG	LYS	variant	UNP P41351
BG	40	ARG	LYS	variant	UNP P41351
BI	40	ARG	LYS	variant	UNP P41351
BK	40	ARG	LYS	variant	UNP P41351
BM	40	ARG	LYS	variant	UNP P41351
CA	40	ARG	LYS	variant	UNP P41351
CC	40	ARG	LYS	variant	UNP P41351
CE	40	ARG	LYS	variant	UNP P41351
CG	40	ARG	LYS	variant	UNP P41351
CI	40	ARG	LYS	variant	UNP P41351
CK	40	ARG	LYS	variant	UNP P41351
CM	40	ARG	LYS	variant	UNP P41351
DA	40	ARG	LYS	variant	UNP P41351
DC	40	ARG	LYS	variant	UNP P41351
DE	40	ARG	LYS	variant	UNP P41351
DG	40	ARG	LYS	variant	UNP P41351
DI	40	ARG	LYS	variant	UNP P41351
DK	40	ARG	LYS	variant	UNP P41351
DM	40	ARG	LYS	variant	UNP P41351
EA	40	ARG	LYS	variant	UNP P41351
EC	40	ARG	LYS	variant	UNP P41351
EE	40	ARG	LYS	variant	UNP P41351
EG	40	ARG	LYS	variant	UNP P41351

Continued on next page...

Continued from previous page...

Chain	Residue	Modelled	Actual	Comment	Reference
EI	40	ARG	LYS	variant	UNP P41351
EK	40	ARG	LYS	variant	UNP P41351
EM	40	ARG	LYS	variant	UNP P41351
FA	40	ARG	LYS	variant	UNP P41351
FC	40	ARG	LYS	variant	UNP P41351
FE	40	ARG	LYS	variant	UNP P41351
FG	40	ARG	LYS	variant	UNP P41351
FI	40	ARG	LYS	variant	UNP P41351
FK	40	ARG	LYS	variant	UNP P41351
FM	40	ARG	LYS	variant	UNP P41351
GA	40	ARG	LYS	variant	UNP P41351
GC	40	ARG	LYS	variant	UNP P41351
GE	40	ARG	LYS	variant	UNP P41351
GG	40	ARG	LYS	variant	UNP P41351
GI	40	ARG	LYS	variant	UNP P41351
GK	40	ARG	LYS	variant	UNP P41351
GM	40	ARG	LYS	variant	UNP P41351
HA	40	ARG	LYS	variant	UNP P41351
HC	40	ARG	LYS	variant	UNP P41351
HE	40	ARG	LYS	variant	UNP P41351
HG	40	ARG	LYS	variant	UNP P41351
HI	40	ARG	LYS	variant	UNP P41351
HK	40	ARG	LYS	variant	UNP P41351
HM	40	ARG	LYS	variant	UNP P41351
IA	40	ARG	LYS	variant	UNP P41351
IC	40	ARG	LYS	variant	UNP P41351
IE	40	ARG	LYS	variant	UNP P41351
IG	40	ARG	LYS	variant	UNP P41351
II	40	ARG	LYS	variant	UNP P41351
IK	40	ARG	LYS	variant	UNP P41351
IM	40	ARG	LYS	variant	UNP P41351
JA	40	ARG	LYS	variant	UNP P41351
JC	40	ARG	LYS	variant	UNP P41351
JE	40	ARG	LYS	variant	UNP P41351
JG	40	ARG	LYS	variant	UNP P41351
JI	40	ARG	LYS	variant	UNP P41351
JK	40	ARG	LYS	variant	UNP P41351
JM	40	ARG	LYS	variant	UNP P41351
KA	40	ARG	LYS	variant	UNP P41351
KC	40	ARG	LYS	variant	UNP P41351
KE	40	ARG	LYS	variant	UNP P41351
KG	40	ARG	LYS	variant	UNP P41351

Continued on next page...

Continued from previous page...

Chain	Residue	Modelled	Actual	Comment	Reference
KI	40	ARG	LYS	variant	UNP P41351
KK	40	ARG	LYS	variant	UNP P41351
KM	40	ARG	LYS	variant	UNP P41351
LA	40	ARG	LYS	variant	UNP P41351
LC	40	ARG	LYS	variant	UNP P41351
LE	40	ARG	LYS	variant	UNP P41351
LG	40	ARG	LYS	variant	UNP P41351
LI	40	ARG	LYS	variant	UNP P41351
LK	40	ARG	LYS	variant	UNP P41351
LM	40	ARG	LYS	variant	UNP P41351
MA	40	ARG	LYS	variant	UNP P41351
MC	40	ARG	LYS	variant	UNP P41351
ME	40	ARG	LYS	variant	UNP P41351
MG	40	ARG	LYS	variant	UNP P41351
MI	40	ARG	LYS	variant	UNP P41351
MK	40	ARG	LYS	variant	UNP P41351
MM	40	ARG	LYS	variant	UNP P41351
NA	40	ARG	LYS	variant	UNP P41351
NC	40	ARG	LYS	variant	UNP P41351
NE	40	ARG	LYS	variant	UNP P41351
NG	40	ARG	LYS	variant	UNP P41351
NI	40	ARG	LYS	variant	UNP P41351
NK	40	ARG	LYS	variant	UNP P41351
NM	40	ARG	LYS	variant	UNP P41351
OA	40	ARG	LYS	variant	UNP P41351
OC	40	ARG	LYS	variant	UNP P41351
OE	40	ARG	LYS	variant	UNP P41351
OG	40	ARG	LYS	variant	UNP P41351
OI	40	ARG	LYS	variant	UNP P41351
OK	40	ARG	LYS	variant	UNP P41351
OM	40	ARG	LYS	variant	UNP P41351
PA	40	ARG	LYS	variant	UNP P41351
PC	40	ARG	LYS	variant	UNP P41351
PE	40	ARG	LYS	variant	UNP P41351
PG	40	ARG	LYS	variant	UNP P41351
PI	40	ARG	LYS	variant	UNP P41351
PK	40	ARG	LYS	variant	UNP P41351
PM	40	ARG	LYS	variant	UNP P41351
QA	40	ARG	LYS	variant	UNP P41351
QC	40	ARG	LYS	variant	UNP P41351
QE	40	ARG	LYS	variant	UNP P41351
QG	40	ARG	LYS	variant	UNP P41351

Continued on next page...

Continued from previous page...

Chain	Residue	Modelled	Actual	Comment	Reference
QI	40	ARG	LYS	variant	UNP P41351
QK	40	ARG	LYS	variant	UNP P41351
QM	40	ARG	LYS	variant	UNP P41351
RA	40	ARG	LYS	variant	UNP P41351
RC	40	ARG	LYS	variant	UNP P41351
RE	40	ARG	LYS	variant	UNP P41351
RG	40	ARG	LYS	variant	UNP P41351
RI	40	ARG	LYS	variant	UNP P41351
RK	40	ARG	LYS	variant	UNP P41351
RM	40	ARG	LYS	variant	UNP P41351
SA	40	ARG	LYS	variant	UNP P41351
SC	40	ARG	LYS	variant	UNP P41351
SE	40	ARG	LYS	variant	UNP P41351
SG	40	ARG	LYS	variant	UNP P41351
SI	40	ARG	LYS	variant	UNP P41351
SK	40	ARG	LYS	variant	UNP P41351
SM	40	ARG	LYS	variant	UNP P41351
TA	40	ARG	LYS	variant	UNP P41351
TC	40	ARG	LYS	variant	UNP P41351
TE	40	ARG	LYS	variant	UNP P41351
TG	40	ARG	LYS	variant	UNP P41351
TI	40	ARG	LYS	variant	UNP P41351
TK	40	ARG	LYS	variant	UNP P41351
TM	40	ARG	LYS	variant	UNP P41351
UA	40	ARG	LYS	variant	UNP P41351
UC	40	ARG	LYS	variant	UNP P41351
UE	40	ARG	LYS	variant	UNP P41351
UG	40	ARG	LYS	variant	UNP P41351
UI	40	ARG	LYS	variant	UNP P41351
UK	40	ARG	LYS	variant	UNP P41351
UM	40	ARG	LYS	variant	UNP P41351
VA	40	ARG	LYS	variant	UNP P41351
VC	40	ARG	LYS	variant	UNP P41351
VE	40	ARG	LYS	variant	UNP P41351
VG	40	ARG	LYS	variant	UNP P41351
VI	40	ARG	LYS	variant	UNP P41351
VK	40	ARG	LYS	variant	UNP P41351
VM	40	ARG	LYS	variant	UNP P41351
WA	40	ARG	LYS	variant	UNP P41351
WC	40	ARG	LYS	variant	UNP P41351
WE	40	ARG	LYS	variant	UNP P41351
WG	40	ARG	LYS	variant	UNP P41351

Continued on next page...

Continued from previous page...

Chain	Residue	Modelled	Actual	Comment	Reference
WI	40	ARG	LYS	variant	UNP P41351
WK	40	ARG	LYS	variant	UNP P41351
WM	40	ARG	LYS	variant	UNP P41351

- Molecule 46 is a protein called Tubulin beta chain.

Mol	Chain	Residues	Atoms					AltConf	Trace
			Total	C	N	O	S		
46	AB	430	3366	2115	577	646	28	0	0
46	AD	430	3366	2115	577	646	28	0	0
46	AF	430	3366	2115	577	646	28	0	0
46	AH	430	3366	2115	577	646	28	0	0
46	AJ	430	3366	2115	577	646	28	0	0
46	AL	430	3366	2115	577	646	28	0	0
46	AN	430	3366	2115	577	646	28	0	0
46	BB	423	3304	2074	564	638	28	0	0
46	BD	430	3366	2115	577	646	28	0	0
46	BF	430	3366	2115	577	646	28	0	0
46	BH	430	3366	2115	577	646	28	0	0
46	BJ	430	3366	2115	577	646	28	0	0
46	BL	430	3366	2115	577	646	28	0	0
46	BN	430	3366	2115	577	646	28	0	0
46	CB	430	3366	2115	577	646	28	0	0
46	CD	430	3366	2115	577	646	28	0	0
46	CF	430	3366	2115	577	646	28	0	0
46	CH	430	3366	2115	577	646	28	0	0

Continued on next page...

Continued from previous page...

Mol	Chain	Residues	Atoms					AltConf	Trace
			Total	C	N	O	S		
46	CJ	430	3366	2115	577	646	28	0	0
46	CL	430	3366	2115	577	646	28	0	0
46	CN	430	3366	2115	577	646	28	0	0
46	DB	430	3366	2115	577	646	28	0	0
46	DD	430	3366	2115	577	646	28	0	0
46	DF	430	3366	2115	577	646	28	0	0
46	DH	430	3366	2115	577	646	28	0	0
46	DJ	430	3366	2115	577	646	28	0	0
46	DL	430	3366	2115	577	646	28	0	0
46	DN	430	3366	2115	577	646	28	0	0
46	EB	430	3366	2115	577	646	28	0	0
46	ED	430	3366	2115	577	646	28	0	0
46	EF	430	3366	2115	577	646	28	0	0
46	EH	430	3366	2115	577	646	28	0	0
46	EJ	430	3366	2115	577	646	28	0	0
46	EL	430	3366	2115	577	646	28	0	0
46	EN	430	3366	2115	577	646	28	0	0
46	FB	430	3366	2115	577	646	28	0	0
46	FD	430	3366	2115	577	646	28	0	0
46	FF	430	3366	2115	577	646	28	0	0
46	FH	430	3366	2115	577	646	28	0	0

Continued on next page...

Continued from previous page...

Mol	Chain	Residues	Atoms					AltConf	Trace
			Total	C	N	O	S		
46	FJ	430	3366	2115	577	646	28	0	0
46	FL	430	3366	2115	577	646	28	0	0
46	FN	430	3366	2115	577	646	28	0	0
46	GB	430	3366	2115	577	646	28	0	0
46	GD	430	3366	2115	577	646	28	0	0
46	GF	430	3366	2115	577	646	28	0	0
46	GH	430	3366	2115	577	646	28	0	0
46	GJ	430	3366	2115	577	646	28	0	0
46	GL	430	3366	2115	577	646	28	0	0
46	GN	430	3366	2115	577	646	28	0	0
46	HB	430	3366	2115	577	646	28	0	0
46	HD	430	3366	2115	577	646	28	0	0
46	HF	430	3366	2115	577	646	28	0	0
46	HH	430	3366	2115	577	646	28	0	0
46	HJ	430	3366	2115	577	646	28	0	0
46	HL	430	3366	2115	577	646	28	0	0
46	HN	430	3366	2115	577	646	28	0	0
46	IB	430	3366	2115	577	646	28	0	0
46	ID	430	3366	2115	577	646	28	0	0
46	IF	430	3366	2115	577	646	28	0	0
46	IH	430	3366	2115	577	646	28	0	0

Continued on next page...

Continued from previous page...

Mol	Chain	Residues	Atoms					AltConf	Trace
			Total	C	N	O	S		
46	IJ	430	3366	2115	577	646	28	0	0
46	IL	430	3366	2115	577	646	28	0	0
46	IN	430	3366	2115	577	646	28	0	0
46	JB	430	3366	2115	577	646	28	0	0
46	JD	430	3366	2115	577	646	28	0	0
46	JF	430	3366	2115	577	646	28	0	0
46	JH	430	3366	2115	577	646	28	0	0
46	JJ	430	3366	2115	577	646	28	0	0
46	JL	430	3366	2115	577	646	28	0	0
46	JN	430	3366	2115	577	646	28	0	0
46	KB	430	3366	2115	577	646	28	0	0
46	KD	430	3366	2115	577	646	28	0	0
46	KF	430	3366	2115	577	646	28	0	0
46	KH	430	3366	2115	577	646	28	0	0
46	KJ	430	3366	2115	577	646	28	0	0
46	KL	430	3366	2115	577	646	28	0	0
46	KN	430	3366	2115	577	646	28	0	0
46	LB	430	3366	2115	577	646	28	0	0
46	LD	430	3366	2115	577	646	28	0	0
46	LF	430	3366	2115	577	646	28	0	0
46	LH	430	3366	2115	577	646	28	0	0

Continued on next page...

Continued from previous page...

Mol	Chain	Residues	Atoms					AltConf	Trace
			Total	C	N	O	S		
46	LJ	430	Total 3366	C 2115	N 577	O 646	S 28	0	0
46	LL	430	Total 3366	C 2115	N 577	O 646	S 28	0	0
46	LN	430	Total 3366	C 2115	N 577	O 646	S 28	0	0
46	MB	430	Total 3366	C 2115	N 577	O 646	S 28	0	0
46	MD	430	Total 3366	C 2115	N 577	O 646	S 28	0	0
46	MF	430	Total 3366	C 2115	N 577	O 646	S 28	0	0
46	MH	430	Total 3366	C 2115	N 577	O 646	S 28	0	0
46	MJ	430	Total 3366	C 2115	N 577	O 646	S 28	0	0
46	ML	430	Total 3366	C 2115	N 577	O 646	S 28	0	0
46	MN	430	Total 3366	C 2115	N 577	O 646	S 28	0	0
46	NB	423	Total 3304	C 2079	N 562	O 635	S 28	0	0
46	ND	430	Total 3366	C 2115	N 577	O 646	S 28	0	0
46	NF	423	Total 3304	C 2079	N 562	O 635	S 28	0	0
46	NH	430	Total 3366	C 2115	N 577	O 646	S 28	0	0
46	NJ	423	Total 3304	C 2079	N 562	O 635	S 28	0	0
46	NL	430	Total 3366	C 2115	N 577	O 646	S 28	0	0
46	NN	423	Total 3304	C 2079	N 562	O 635	S 28	0	0
46	OB	430	Total 3366	C 2115	N 577	O 646	S 28	0	0
46	OD	430	Total 3366	C 2115	N 577	O 646	S 28	0	0
46	OF	430	Total 3366	C 2115	N 577	O 646	S 28	0	0
46	OH	430	Total 3366	C 2115	N 577	O 646	S 28	0	0

Continued on next page...

Continued from previous page...

Mol	Chain	Residues	Atoms					AltConf	Trace
			Total	C	N	O	S		
46	OJ	430	3366	2115	577	646	28	0	0
46	OL	430	3366	2115	577	646	28	0	0
46	ON	430	3366	2115	577	646	28	0	0
46	PB	430	3366	2115	577	646	28	0	0
46	PD	430	3366	2115	577	646	28	0	0
46	PF	430	3366	2115	577	646	28	0	0
46	PH	430	3366	2115	577	646	28	0	0
46	PJ	430	3366	2115	577	646	28	0	0
46	PL	430	3366	2115	577	646	28	0	0
46	PN	430	3366	2115	577	646	28	0	0
46	QB	430	3366	2115	577	646	28	0	0
46	QD	430	3366	2115	577	646	28	0	0
46	QF	430	3366	2115	577	646	28	0	0
46	QH	430	3366	2115	577	646	28	0	0
46	QJ	430	3366	2115	577	646	28	0	0
46	QL	430	3366	2115	577	646	28	0	0
46	QN	430	3366	2115	577	646	28	0	0
46	RB	430	3366	2115	577	646	28	0	0
46	RD	430	3366	2115	577	646	28	0	0
46	RF	430	3366	2115	577	646	28	0	0
46	RH	430	3366	2115	577	646	28	0	0

Continued on next page...

Continued from previous page...

Mol	Chain	Residues	Atoms					AltConf	Trace
			Total	C	N	O	S		
46	RJ	430	3366	2115	577	646	28	0	0
46	RL	430	3366	2115	577	646	28	0	0
46	RN	430	3366	2115	577	646	28	0	0
46	SB	430	3366	2115	577	646	28	0	0
46	SD	430	3366	2115	577	646	28	0	0
46	SF	430	3366	2115	577	646	28	0	0
46	SH	430	3366	2115	577	646	28	0	0
46	SJ	430	3366	2115	577	646	28	0	0
46	SL	430	3366	2115	577	646	28	0	0
46	SN	430	3366	2115	577	646	28	0	0
46	TB	430	3366	2115	577	646	28	0	0
46	TD	430	3366	2115	577	646	28	0	0
46	TF	430	3366	2115	577	646	28	0	0
46	TH	430	3366	2115	577	646	28	0	0
46	TJ	430	3366	2115	577	646	28	0	0
46	TL	430	3366	2115	577	646	28	0	0
46	TN	430	3366	2115	577	646	28	0	0
46	UB	430	3366	2115	577	646	28	0	0
46	UD	430	3366	2115	577	646	28	0	0
46	UF	430	3366	2115	577	646	28	0	0
46	UH	430	3366	2115	577	646	28	0	0

Continued on next page...

Continued from previous page...

Mol	Chain	Residues	Atoms					AltConf	Trace
			Total	C	N	O	S		
46	UJ	430	3366	2115	577	646	28	0	0
46	UL	430	3366	2115	577	646	28	0	0
46	UN	430	3366	2115	577	646	28	0	0
46	VB	430	3366	2115	577	646	28	0	0
46	VD	430	3366	2115	577	646	28	0	0
46	VF	430	3366	2115	577	646	28	0	0
46	VH	430	3366	2115	577	646	28	0	0
46	VJ	430	3366	2115	577	646	28	0	0
46	VL	430	3366	2115	577	646	28	0	0
46	VN	430	3366	2115	577	646	28	0	0
46	WB	430	3366	2115	577	646	28	0	0
46	WD	430	3366	2115	577	646	28	0	0
46	WF	430	3366	2115	577	646	28	0	0
46	WH	430	3366	2115	577	646	28	0	0
46	WJ	430	3366	2115	577	646	28	0	0
46	WL	430	3366	2115	577	646	28	0	0
46	WN	430	3366	2115	577	646	28	0	0

- Molecule 47 is GUANOSINE-5'-TRIPHOSPHATE (three-letter code: GTP) (formula: $C_{10}H_{16}N_5O_{14}P_3$) (labeled as "Ligand of Interest" by depositor).

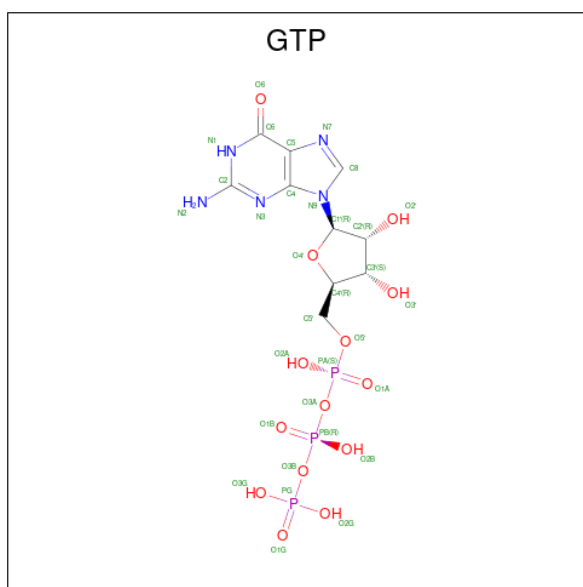

Mol	Chain	Residues	Atoms					AltConf
			Total	C	N	O	P	
47	AA	1	Total 32	C 10	N 5	O 14	P 3	0
47	AC	1	Total 32	C 10	N 5	O 14	P 3	0
47	AE	1	Total 32	C 10	N 5	O 14	P 3	0
47	AG	1	Total 32	C 10	N 5	O 14	P 3	0
47	AI	1	Total 32	C 10	N 5	O 14	P 3	0
47	AK	1	Total 32	C 10	N 5	O 14	P 3	0
47	AM	1	Total 32	C 10	N 5	O 14	P 3	0
47	BA	1	Total 32	C 10	N 5	O 14	P 3	0
47	BC	1	Total 32	C 10	N 5	O 14	P 3	0
47	BE	1	Total 32	C 10	N 5	O 14	P 3	0
47	BG	1	Total 32	C 10	N 5	O 14	P 3	0
47	BI	1	Total 32	C 10	N 5	O 14	P 3	0
47	BK	1	Total 32	C 10	N 5	O 14	P 3	0
47	BM	1	Total 32	C 10	N 5	O 14	P 3	0

Continued on next page...

Continued from previous page...

Mol	Chain	Residues	Atoms					AltConf
			Total	C	N	O	P	
47	CA	1	Total 32	C 10	N 5	O 14	P 3	0
47	CC	1	Total 32	C 10	N 5	O 14	P 3	0
47	CE	1	Total 32	C 10	N 5	O 14	P 3	0
47	CG	1	Total 32	C 10	N 5	O 14	P 3	0
47	CI	1	Total 32	C 10	N 5	O 14	P 3	0
47	CK	1	Total 32	C 10	N 5	O 14	P 3	0
47	CM	1	Total 32	C 10	N 5	O 14	P 3	0
47	DA	1	Total 32	C 10	N 5	O 14	P 3	0
47	DC	1	Total 32	C 10	N 5	O 14	P 3	0
47	DE	1	Total 32	C 10	N 5	O 14	P 3	0
47	DG	1	Total 32	C 10	N 5	O 14	P 3	0
47	DI	1	Total 32	C 10	N 5	O 14	P 3	0
47	DK	1	Total 32	C 10	N 5	O 14	P 3	0
47	DM	1	Total 32	C 10	N 5	O 14	P 3	0
47	EA	1	Total 32	C 10	N 5	O 14	P 3	0
47	EC	1	Total 32	C 10	N 5	O 14	P 3	0
47	EE	1	Total 32	C 10	N 5	O 14	P 3	0
47	EG	1	Total 32	C 10	N 5	O 14	P 3	0
47	EI	1	Total 32	C 10	N 5	O 14	P 3	0
47	EK	1	Total 32	C 10	N 5	O 14	P 3	0
47	EM	1	Total 32	C 10	N 5	O 14	P 3	0

Continued on next page...

Continued from previous page...

Mol	Chain	Residues	Atoms					AltConf
			Total	C	N	O	P	
47	FA	1	Total 32	C 10	N 5	O 14	P 3	0
47	FC	1	Total 32	C 10	N 5	O 14	P 3	0
47	FE	1	Total 32	C 10	N 5	O 14	P 3	0
47	FG	1	Total 32	C 10	N 5	O 14	P 3	0
47	FI	1	Total 32	C 10	N 5	O 14	P 3	0
47	FK	1	Total 32	C 10	N 5	O 14	P 3	0
47	FM	1	Total 32	C 10	N 5	O 14	P 3	0
47	GA	1	Total 32	C 10	N 5	O 14	P 3	0
47	GC	1	Total 32	C 10	N 5	O 14	P 3	0
47	GE	1	Total 32	C 10	N 5	O 14	P 3	0
47	GG	1	Total 32	C 10	N 5	O 14	P 3	0
47	GI	1	Total 32	C 10	N 5	O 14	P 3	0
47	GK	1	Total 32	C 10	N 5	O 14	P 3	0
47	GM	1	Total 32	C 10	N 5	O 14	P 3	0
47	HA	1	Total 32	C 10	N 5	O 14	P 3	0
47	HC	1	Total 32	C 10	N 5	O 14	P 3	0
47	HE	1	Total 32	C 10	N 5	O 14	P 3	0
47	HG	1	Total 32	C 10	N 5	O 14	P 3	0
47	HI	1	Total 32	C 10	N 5	O 14	P 3	0
47	HK	1	Total 32	C 10	N 5	O 14	P 3	0
47	HM	1	Total 32	C 10	N 5	O 14	P 3	0

Continued on next page...

Continued from previous page...

Mol	Chain	Residues	Atoms					AltConf
			Total	C	N	O	P	
47	IA	1	Total 32	C 10	N 5	O 14	P 3	0
47	IC	1	Total 32	C 10	N 5	O 14	P 3	0
47	IE	1	Total 32	C 10	N 5	O 14	P 3	0
47	IG	1	Total 32	C 10	N 5	O 14	P 3	0
47	II	1	Total 32	C 10	N 5	O 14	P 3	0
47	IK	1	Total 32	C 10	N 5	O 14	P 3	0
47	IM	1	Total 32	C 10	N 5	O 14	P 3	0
47	JA	1	Total 32	C 10	N 5	O 14	P 3	0
47	JC	1	Total 32	C 10	N 5	O 14	P 3	0
47	JE	1	Total 32	C 10	N 5	O 14	P 3	0
47	JG	1	Total 32	C 10	N 5	O 14	P 3	0
47	JI	1	Total 32	C 10	N 5	O 14	P 3	0
47	JK	1	Total 32	C 10	N 5	O 14	P 3	0
47	JM	1	Total 32	C 10	N 5	O 14	P 3	0
47	KA	1	Total 32	C 10	N 5	O 14	P 3	0
47	KC	1	Total 32	C 10	N 5	O 14	P 3	0
47	KE	1	Total 32	C 10	N 5	O 14	P 3	0
47	KG	1	Total 32	C 10	N 5	O 14	P 3	0
47	KI	1	Total 32	C 10	N 5	O 14	P 3	0
47	KK	1	Total 32	C 10	N 5	O 14	P 3	0
47	KM	1	Total 32	C 10	N 5	O 14	P 3	0

Continued on next page...

Continued from previous page...

Mol	Chain	Residues	Atoms					AltConf
			Total	C	N	O	P	
47	LA	1	Total 32	C 10	N 5	O 14	P 3	0
47	LC	1	Total 32	C 10	N 5	O 14	P 3	0
47	LE	1	Total 32	C 10	N 5	O 14	P 3	0
47	LG	1	Total 32	C 10	N 5	O 14	P 3	0
47	LI	1	Total 32	C 10	N 5	O 14	P 3	0
47	LK	1	Total 32	C 10	N 5	O 14	P 3	0
47	LM	1	Total 32	C 10	N 5	O 14	P 3	0
47	MA	1	Total 32	C 10	N 5	O 14	P 3	0
47	MC	1	Total 32	C 10	N 5	O 14	P 3	0
47	ME	1	Total 32	C 10	N 5	O 14	P 3	0
47	MG	1	Total 32	C 10	N 5	O 14	P 3	0
47	MI	1	Total 32	C 10	N 5	O 14	P 3	0
47	MK	1	Total 32	C 10	N 5	O 14	P 3	0
47	MM	1	Total 32	C 10	N 5	O 14	P 3	0
47	NA	1	Total 32	C 10	N 5	O 14	P 3	0
47	NC	1	Total 32	C 10	N 5	O 14	P 3	0
47	NE	1	Total 32	C 10	N 5	O 14	P 3	0
47	NG	1	Total 32	C 10	N 5	O 14	P 3	0
47	NI	1	Total 32	C 10	N 5	O 14	P 3	0
47	NK	1	Total 32	C 10	N 5	O 14	P 3	0
47	NM	1	Total 32	C 10	N 5	O 14	P 3	0

Continued on next page...

Continued from previous page...

Mol	Chain	Residues	Atoms					AltConf
			Total	C	N	O	P	
47	OA	1	Total 32	C 10	N 5	O 14	P 3	0
47	OC	1	Total 32	C 10	N 5	O 14	P 3	0
47	OE	1	Total 32	C 10	N 5	O 14	P 3	0
47	OG	1	Total 32	C 10	N 5	O 14	P 3	0
47	OI	1	Total 32	C 10	N 5	O 14	P 3	0
47	OK	1	Total 32	C 10	N 5	O 14	P 3	0
47	OM	1	Total 32	C 10	N 5	O 14	P 3	0
47	PA	1	Total 32	C 10	N 5	O 14	P 3	0
47	PC	1	Total 32	C 10	N 5	O 14	P 3	0
47	PE	1	Total 32	C 10	N 5	O 14	P 3	0
47	PG	1	Total 32	C 10	N 5	O 14	P 3	0
47	PI	1	Total 32	C 10	N 5	O 14	P 3	0
47	PK	1	Total 32	C 10	N 5	O 14	P 3	0
47	PM	1	Total 32	C 10	N 5	O 14	P 3	0
47	QA	1	Total 32	C 10	N 5	O 14	P 3	0
47	QC	1	Total 32	C 10	N 5	O 14	P 3	0
47	QE	1	Total 32	C 10	N 5	O 14	P 3	0
47	QG	1	Total 32	C 10	N 5	O 14	P 3	0
47	QI	1	Total 32	C 10	N 5	O 14	P 3	0
47	QK	1	Total 32	C 10	N 5	O 14	P 3	0
47	QM	1	Total 32	C 10	N 5	O 14	P 3	0

Continued on next page...

Continued from previous page...

Mol	Chain	Residues	Atoms					AltConf
			Total	C	N	O	P	
47	RA	1	Total 32	C 10	N 5	O 14	P 3	0
47	RC	1	Total 32	C 10	N 5	O 14	P 3	0
47	RE	1	Total 32	C 10	N 5	O 14	P 3	0
47	RG	1	Total 32	C 10	N 5	O 14	P 3	0
47	RI	1	Total 32	C 10	N 5	O 14	P 3	0
47	RK	1	Total 32	C 10	N 5	O 14	P 3	0
47	RM	1	Total 32	C 10	N 5	O 14	P 3	0
47	SA	1	Total 32	C 10	N 5	O 14	P 3	0
47	SC	1	Total 32	C 10	N 5	O 14	P 3	0
47	SE	1	Total 32	C 10	N 5	O 14	P 3	0
47	SG	1	Total 32	C 10	N 5	O 14	P 3	0
47	SI	1	Total 32	C 10	N 5	O 14	P 3	0
47	SK	1	Total 32	C 10	N 5	O 14	P 3	0
47	SM	1	Total 32	C 10	N 5	O 14	P 3	0
47	TA	1	Total 32	C 10	N 5	O 14	P 3	0
47	TC	1	Total 32	C 10	N 5	O 14	P 3	0
47	TE	1	Total 32	C 10	N 5	O 14	P 3	0
47	TG	1	Total 32	C 10	N 5	O 14	P 3	0
47	TI	1	Total 32	C 10	N 5	O 14	P 3	0
47	TK	1	Total 32	C 10	N 5	O 14	P 3	0
47	TM	1	Total 32	C 10	N 5	O 14	P 3	0

Continued on next page...

Continued from previous page...

Mol	Chain	Residues	Atoms					AltConf
			Total	C	N	O	P	
47	UA	1	32	10	5	14	3	0
47	UC	1	32	10	5	14	3	0
47	UE	1	32	10	5	14	3	0
47	UG	1	32	10	5	14	3	0
47	UI	1	32	10	5	14	3	0
47	UK	1	32	10	5	14	3	0
47	UM	1	32	10	5	14	3	0
47	VA	1	32	10	5	14	3	0
47	VC	1	32	10	5	14	3	0
47	VE	1	32	10	5	14	3	0
47	VG	1	32	10	5	14	3	0
47	VI	1	32	10	5	14	3	0
47	VK	1	32	10	5	14	3	0
47	VM	1	32	10	5	14	3	0
47	WA	1	32	10	5	14	3	0
47	WC	1	32	10	5	14	3	0
47	WE	1	32	10	5	14	3	0
47	WG	1	32	10	5	14	3	0
47	WI	1	32	10	5	14	3	0
47	WK	1	32	10	5	14	3	0
47	WM	1	32	10	5	14	3	0

- Molecule 48 is MAGNESIUM ION (three-letter code: MG) (formula: Mg) (labeled as "Ligand of Interest" by depositor).

Mol	Chain	Residues	Atoms	AltConf
48	AA	1	Total Mg 1 1	0
48	AC	1	Total Mg 1 1	0
48	AE	1	Total Mg 1 1	0
48	AG	1	Total Mg 1 1	0
48	AI	1	Total Mg 1 1	0
48	AL	1	Total Mg 1 1	0
48	AM	1	Total Mg 1 1	0
48	BB	1	Total Mg 1 1	0
48	BC	1	Total Mg 1 1	0
48	BE	1	Total Mg 1 1	0
48	BG	1	Total Mg 1 1	0
48	BI	1	Total Mg 1 1	0
48	BK	1	Total Mg 1 1	0
48	BM	1	Total Mg 1 1	0
48	CA	1	Total Mg 1 1	0
48	CC	1	Total Mg 1 1	0
48	CE	1	Total Mg 1 1	0
48	CG	1	Total Mg 1 1	0
48	CI	1	Total Mg 1 1	0
48	CK	1	Total Mg 1 1	0

Continued on next page...

Continued from previous page...

Mol	Chain	Residues	Atoms		AltConf
			Total	Mg	
48	CM	1	1	1	0
48	DA	1	1	1	0
48	DC	1	1	1	0
48	DE	1	1	1	0
48	DG	1	1	1	0
48	DI	1	1	1	0
48	DK	1	1	1	0
48	DM	1	1	1	0
48	EA	1	1	1	0
48	EC	1	1	1	0
48	EE	1	1	1	0
48	EG	1	1	1	0
48	EI	1	1	1	0
48	EK	1	1	1	0
48	EM	1	1	1	0
48	FA	1	1	1	0
48	FC	1	1	1	0
48	FE	1	1	1	0
48	FG	1	1	1	0
48	FI	1	1	1	0
48	FK	1	1	1	0

Continued on next page...

Continued from previous page...

Mol	Chain	Residues	Atoms		AltConf
			Total	Mg	
48	FM	1	1	1	0
48	GB	1	1	1	0
48	GC	1	1	1	0
48	GE	1	1	1	0
48	GG	1	1	1	0
48	GI	1	1	1	0
48	GK	1	1	1	0
48	GM	1	1	1	0
48	HA	1	1	1	0
48	HC	1	1	1	0
48	HE	1	1	1	0
48	HG	1	1	1	0
48	HI	1	1	1	0
48	HK	1	1	1	0
48	HM	1	1	1	0
48	IA	1	1	1	0
48	IC	1	1	1	0
48	IE	1	1	1	0
48	IG	1	1	1	0
48	II	1	1	1	0
48	IK	1	1	1	0

Continued on next page...

Continued from previous page...

Mol	Chain	Residues	Atoms		AltConf
			Total	Mg	
48	IM	1	1	1	0
48	JA	1	1	1	0
48	JC	1	1	1	0
48	JE	1	1	1	0
48	JG	1	1	1	0
48	JI	1	1	1	0
48	JK	1	1	1	0
48	JM	1	1	1	0
48	KA	1	1	1	0
48	KC	1	1	1	0
48	KE	1	1	1	0
48	KG	1	1	1	0
48	KI	1	1	1	0
48	KK	1	1	1	0
48	KM	1	1	1	0
48	LA	1	1	1	0
48	LC	1	1	1	0
48	LE	1	1	1	0
48	LG	1	1	1	0
48	LI	1	1	1	0
48	LK	1	1	1	0

Continued on next page...

Continued from previous page...

Mol	Chain	Residues	Atoms		AltConf
			Total	Mg	
48	LM	1	1	1	0
48	MA	1	1	1	0
48	MC	1	1	1	0
48	ME	1	1	1	0
48	MG	1	1	1	0
48	MI	1	1	1	0
48	MK	1	1	1	0
48	MM	1	1	1	0
48	NB	1	1	1	0
48	NC	1	1	1	0
48	NE	1	1	1	0
48	NG	1	1	1	0
48	NI	1	1	1	0
48	NK	1	1	1	0
48	NM	1	1	1	0
48	OA	1	1	1	0
48	OC	1	1	1	0
48	OE	1	1	1	0
48	OG	1	1	1	0
48	OI	1	1	1	0
48	OK	1	1	1	0

Continued on next page...

Continued from previous page...

Mol	Chain	Residues	Atoms		AltConf
			Total	Mg	
48	OM	1	1	1	0
48	PA	1	1	1	0
48	PC	1	1	1	0
48	PE	1	1	1	0
48	PG	1	1	1	0
48	PI	1	1	1	0
48	PK	1	1	1	0
48	PM	1	1	1	0
48	QA	1	1	1	0
48	QC	1	1	1	0
48	QE	1	1	1	0
48	QG	1	1	1	0
48	QI	1	1	1	0
48	QK	1	1	1	0
48	QM	1	1	1	0
48	RA	1	1	1	0
48	RC	1	1	1	0
48	RE	1	1	1	0
48	RF	1	1	1	0
48	RI	1	1	1	0
48	RK	1	1	1	0

Continued on next page...

Continued from previous page...

Mol	Chain	Residues	Atoms		AltConf
			Total	Mg	
48	RM	1	1	1	0
48	SA	1	1	1	0
48	SB	1	1	1	0
48	SE	1	1	1	0
48	SG	1	1	1	0
48	SI	1	1	1	0
48	SK	1	1	1	0
48	SM	1	1	1	0
48	TA	1	1	1	0
48	TC	1	1	1	0
48	TE	1	1	1	0
48	TG	1	1	1	0
48	TI	1	1	1	0
48	TK	1	1	1	0
48	TM	1	1	1	0
48	UA	1	1	1	0
48	UC	1	1	1	0
48	UE	1	1	1	0
48	UG	1	1	1	0
48	UI	1	1	1	0
48	UK	1	1	1	0

Continued on next page...

Continued from previous page...

Mol	Chain	Residues	Atoms		AltConf
48	UM	1	Total 1	Mg 1	0
48	VA	1	Total 1	Mg 1	0
48	VC	1	Total 1	Mg 1	0
48	VE	1	Total 1	Mg 1	0
48	VG	1	Total 1	Mg 1	0
48	VI	1	Total 1	Mg 1	0
48	VK	1	Total 1	Mg 1	0
48	VM	1	Total 1	Mg 1	0
48	WA	1	Total 1	Mg 1	0
48	WC	1	Total 1	Mg 1	0
48	WE	1	Total 1	Mg 1	0
48	WG	1	Total 1	Mg 1	0
48	WI	1	Total 1	Mg 1	0
48	WK	1	Total 1	Mg 1	0
48	WM	1	Total 1	Mg 1	0

- Molecule 49 is GUANOSINE-5'-DIPHOSPHATE (three-letter code: GDP) (formula: $C_{10}H_{15}N_5O_{11}P_2$) (labeled as "Ligand of Interest" by depositor).

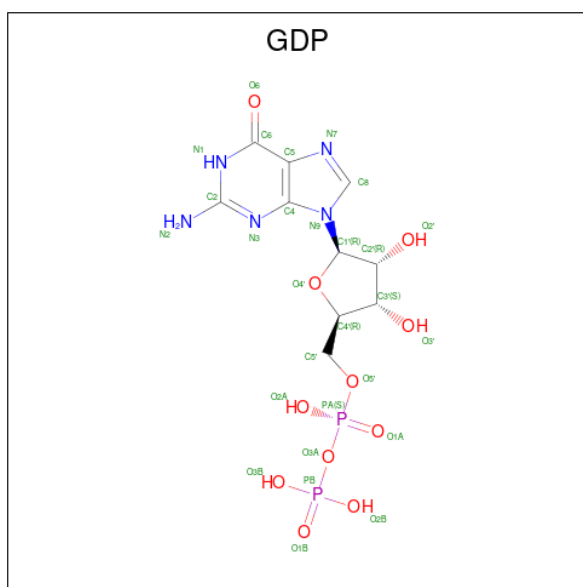

Mol	Chain	Residues	Atoms					AltConf
			Total	C	N	O	P	
49	AB	1	Total 28	C 10	N 5	O 11	P 2	0
49	AD	1	Total 28	C 10	N 5	O 11	P 2	0
49	AF	1	Total 28	C 10	N 5	O 11	P 2	0
49	AH	1	Total 28	C 10	N 5	O 11	P 2	0
49	AJ	1	Total 28	C 10	N 5	O 11	P 2	0
49	AL	1	Total 28	C 10	N 5	O 11	P 2	0
49	AN	1	Total 28	C 10	N 5	O 11	P 2	0
49	BB	1	Total 28	C 10	N 5	O 11	P 2	0
49	BD	1	Total 28	C 10	N 5	O 11	P 2	0
49	BF	1	Total 28	C 10	N 5	O 11	P 2	0
49	BH	1	Total 28	C 10	N 5	O 11	P 2	0
49	BJ	1	Total 28	C 10	N 5	O 11	P 2	0
49	BL	1	Total 28	C 10	N 5	O 11	P 2	0
49	BN	1	Total 28	C 10	N 5	O 11	P 2	0

Continued on next page...

Continued from previous page...

Mol	Chain	Residues	Atoms					AltConf
			Total	C	N	O	P	
49	CB	1	Total 28	C 10	N 5	O 11	P 2	0
49	CD	1	Total 28	C 10	N 5	O 11	P 2	0
49	CF	1	Total 28	C 10	N 5	O 11	P 2	0
49	CH	1	Total 28	C 10	N 5	O 11	P 2	0
49	CJ	1	Total 28	C 10	N 5	O 11	P 2	0
49	CL	1	Total 28	C 10	N 5	O 11	P 2	0
49	CN	1	Total 28	C 10	N 5	O 11	P 2	0
49	DB	1	Total 28	C 10	N 5	O 11	P 2	0
49	DD	1	Total 28	C 10	N 5	O 11	P 2	0
49	DF	1	Total 28	C 10	N 5	O 11	P 2	0
49	DH	1	Total 28	C 10	N 5	O 11	P 2	0
49	DJ	1	Total 28	C 10	N 5	O 11	P 2	0
49	DL	1	Total 28	C 10	N 5	O 11	P 2	0
49	DN	1	Total 28	C 10	N 5	O 11	P 2	0
49	EB	1	Total 28	C 10	N 5	O 11	P 2	0
49	ED	1	Total 28	C 10	N 5	O 11	P 2	0
49	EF	1	Total 28	C 10	N 5	O 11	P 2	0
49	EH	1	Total 28	C 10	N 5	O 11	P 2	0
49	EJ	1	Total 28	C 10	N 5	O 11	P 2	0
49	EL	1	Total 28	C 10	N 5	O 11	P 2	0
49	EN	1	Total 28	C 10	N 5	O 11	P 2	0

Continued on next page...

Continued from previous page...

Mol	Chain	Residues	Atoms					AltConf
			Total	C	N	O	P	
49	FB	1	28	10	5	11	2	0
49	FD	1	28	10	5	11	2	0
49	FF	1	28	10	5	11	2	0
49	FH	1	28	10	5	11	2	0
49	FJ	1	28	10	5	11	2	0
49	FL	1	28	10	5	11	2	0
49	FN	1	28	10	5	11	2	0
49	GB	1	28	10	5	11	2	0
49	GD	1	28	10	5	11	2	0
49	GF	1	28	10	5	11	2	0
49	GH	1	28	10	5	11	2	0
49	GJ	1	28	10	5	11	2	0
49	GL	1	28	10	5	11	2	0
49	GN	1	28	10	5	11	2	0
49	HB	1	28	10	5	11	2	0
49	HD	1	28	10	5	11	2	0
49	HF	1	28	10	5	11	2	0
49	HH	1	28	10	5	11	2	0
49	HJ	1	28	10	5	11	2	0
49	HL	1	28	10	5	11	2	0
49	HN	1	28	10	5	11	2	0

Continued on next page...

Continued from previous page...

Mol	Chain	Residues	Atoms					AltConf
			Total	C	N	O	P	
49	IB	1	28	10	5	11	2	0
49	ID	1	28	10	5	11	2	0
49	IF	1	28	10	5	11	2	0
49	IH	1	28	10	5	11	2	0
49	IJ	1	28	10	5	11	2	0
49	IL	1	28	10	5	11	2	0
49	IN	1	28	10	5	11	2	0
49	JB	1	28	10	5	11	2	0
49	JD	1	28	10	5	11	2	0
49	JF	1	28	10	5	11	2	0
49	JH	1	28	10	5	11	2	0
49	JJ	1	28	10	5	11	2	0
49	JL	1	28	10	5	11	2	0
49	JN	1	28	10	5	11	2	0
49	KB	1	28	10	5	11	2	0
49	KD	1	28	10	5	11	2	0
49	KF	1	28	10	5	11	2	0
49	KH	1	28	10	5	11	2	0
49	KJ	1	28	10	5	11	2	0
49	KL	1	28	10	5	11	2	0
49	KN	1	28	10	5	11	2	0

Continued on next page...

Continued from previous page...

Mol	Chain	Residues	Atoms					AltConf
			Total	C	N	O	P	
49	LB	1	28	10	5	11	2	0
49	LD	1	28	10	5	11	2	0
49	LF	1	28	10	5	11	2	0
49	LH	1	28	10	5	11	2	0
49	LJ	1	28	10	5	11	2	0
49	LL	1	28	10	5	11	2	0
49	LN	1	28	10	5	11	2	0
49	MB	1	28	10	5	11	2	0
49	MD	1	28	10	5	11	2	0
49	MF	1	28	10	5	11	2	0
49	MH	1	28	10	5	11	2	0
49	MJ	1	28	10	5	11	2	0
49	ML	1	28	10	5	11	2	0
49	MN	1	28	10	5	11	2	0
49	NB	1	28	10	5	11	2	0
49	ND	1	28	10	5	11	2	0
49	NF	1	28	10	5	11	2	0
49	NH	1	28	10	5	11	2	0
49	NJ	1	28	10	5	11	2	0
49	NL	1	28	10	5	11	2	0
49	NN	1	28	10	5	11	2	0

Continued on next page...

Continued from previous page...

Mol	Chain	Residues	Atoms					AltConf
			Total	C	N	O	P	
49	OB	1	28	10	5	11	2	0
49	OD	1	28	10	5	11	2	0
49	OF	1	28	10	5	11	2	0
49	OH	1	28	10	5	11	2	0
49	OJ	1	28	10	5	11	2	0
49	OL	1	28	10	5	11	2	0
49	ON	1	28	10	5	11	2	0
49	PB	1	28	10	5	11	2	0
49	PD	1	28	10	5	11	2	0
49	PF	1	28	10	5	11	2	0
49	PH	1	28	10	5	11	2	0
49	PJ	1	28	10	5	11	2	0
49	PL	1	28	10	5	11	2	0
49	PN	1	28	10	5	11	2	0
49	QB	1	28	10	5	11	2	0
49	QD	1	28	10	5	11	2	0
49	QF	1	28	10	5	11	2	0
49	QH	1	28	10	5	11	2	0
49	QJ	1	28	10	5	11	2	0
49	QL	1	28	10	5	11	2	0
49	QN	1	28	10	5	11	2	0

Continued on next page...

Continued from previous page...

Mol	Chain	Residues	Atoms					AltConf
			Total	C	N	O	P	
49	RB	1	28	10	5	11	2	0
49	RD	1	28	10	5	11	2	0
49	RF	1	28	10	5	11	2	0
49	RH	1	28	10	5	11	2	0
49	RJ	1	28	10	5	11	2	0
49	RL	1	28	10	5	11	2	0
49	RN	1	28	10	5	11	2	0
49	SB	1	28	10	5	11	2	0
49	SD	1	28	10	5	11	2	0
49	SF	1	28	10	5	11	2	0
49	SH	1	28	10	5	11	2	0
49	SJ	1	28	10	5	11	2	0
49	SL	1	28	10	5	11	2	0
49	SN	1	28	10	5	11	2	0
49	TB	1	28	10	5	11	2	0
49	TD	1	28	10	5	11	2	0
49	TF	1	28	10	5	11	2	0
49	TH	1	28	10	5	11	2	0
49	TJ	1	28	10	5	11	2	0
49	TL	1	28	10	5	11	2	0
49	TN	1	28	10	5	11	2	0

Continued on next page...

Continued from previous page...

Mol	Chain	Residues	Atoms					AltConf
			Total	C	N	O	P	
49	UB	1	28	10	5	11	2	0
49	UD	1	28	10	5	11	2	0
49	UF	1	28	10	5	11	2	0
49	UH	1	28	10	5	11	2	0
49	UJ	1	28	10	5	11	2	0
49	UL	1	28	10	5	11	2	0
49	UN	1	28	10	5	11	2	0
49	VB	1	28	10	5	11	2	0
49	VD	1	28	10	5	11	2	0
49	VF	1	28	10	5	11	2	0
49	VH	1	28	10	5	11	2	0
49	VJ	1	28	10	5	11	2	0
49	VL	1	28	10	5	11	2	0
49	VN	1	28	10	5	11	2	0
49	WB	1	28	10	5	11	2	0
49	WD	1	28	10	5	11	2	0
49	WF	1	28	10	5	11	2	0
49	WH	1	28	10	5	11	2	0
49	WJ	1	28	10	5	11	2	0
49	WL	1	28	10	5	11	2	0
49	WN	1	28	10	5	11	2	0

3 Residue-property plots [i](#)

These plots are drawn for all protein, RNA, DNA and oligosaccharide chains in the entry. The first graphic for a chain summarises the proportions of the various outlier classes displayed in the second graphic. The second graphic shows the sequence view annotated by issues in geometry and atom inclusion in map density. Residues are color-coded according to the number of geometric quality criteria for which they contain at least one outlier: green = 0, yellow = 1, orange = 2 and red = 3 or more. A red diamond above a residue indicates a poor fit to the EM map for this residue (all-atom inclusion < 40%). Stretches of 2 or more consecutive residues without any outlier are shown as a green connector. Residues present in the sample, but not in the model, are shown in grey.

• Molecule 1: RIB27A

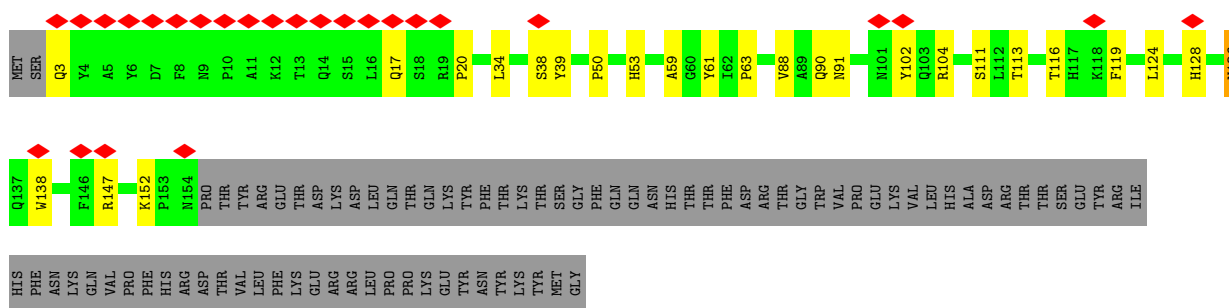

• Molecule 1: RIB27A

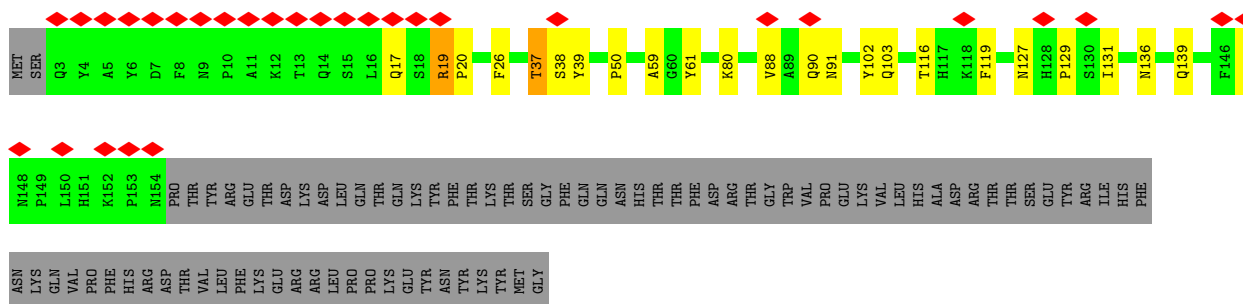

• Molecule 1: RIB27A

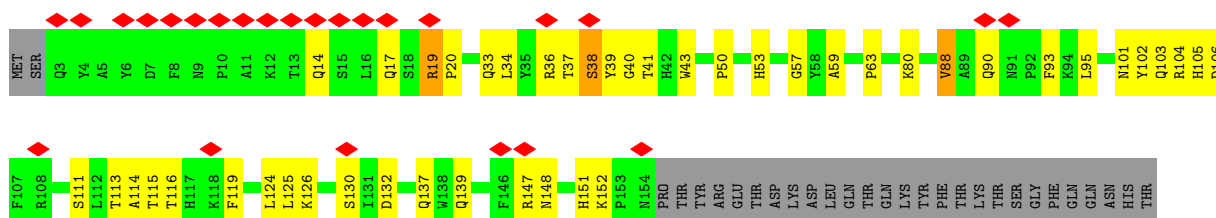

THR PHE ASP ARG THR GLY TRP VAL PRO GLU LYS VAL LEU HIS ALA ASP ARG THR THR SER GLU TYR ARG ILE HIS PHE ASN LYS GLN VAL PRO PHE HIS ASP THR VAL LEU PHE LYS ARG ARG LEU PRO LYS GLU TYR MET GLY

• Molecule 1: RIB27A

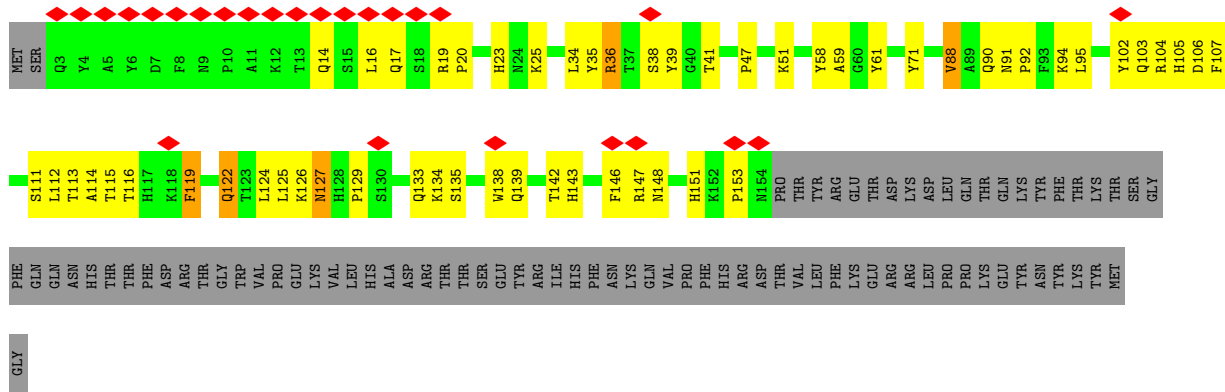

• Molecule 2: RIB38

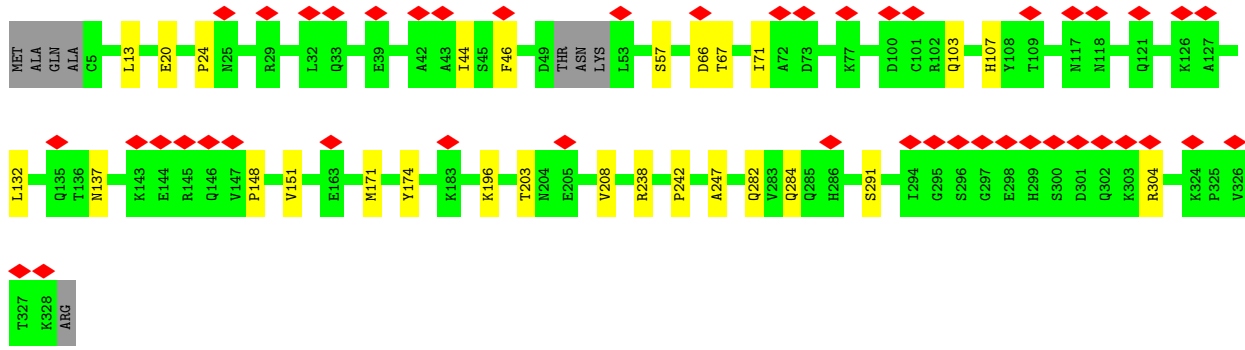
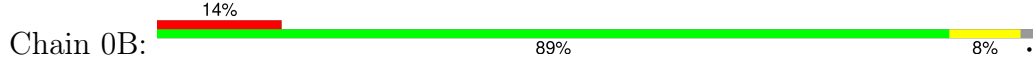

• Molecule 3: CFAM166B

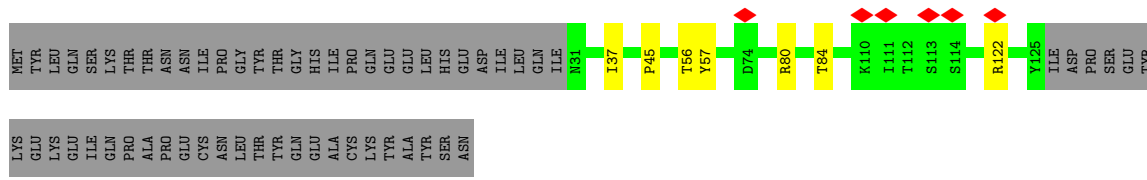

• Molecule 3: CFAM166B

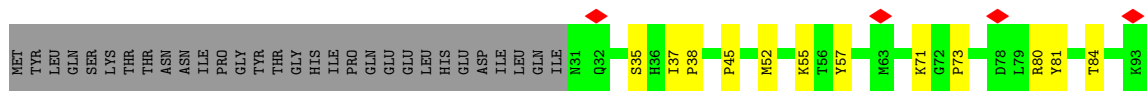

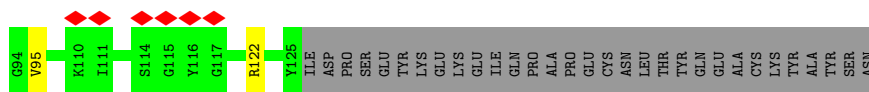

• Molecule 4: CFAM166A

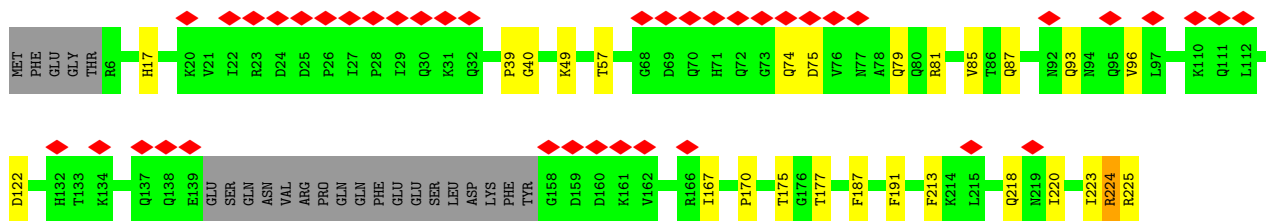
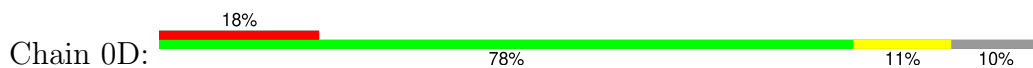

• Molecule 4: CFAM166A

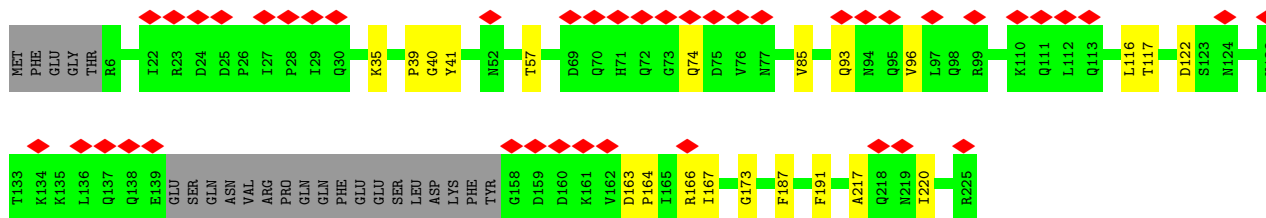
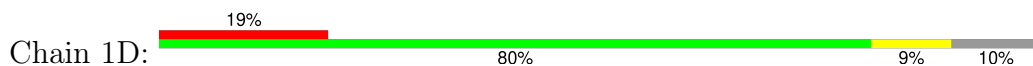

• Molecule 4: CFAM166A

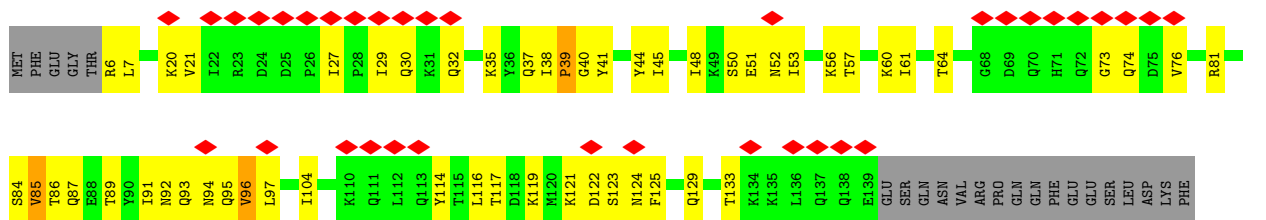

• Molecule 5: RIB22

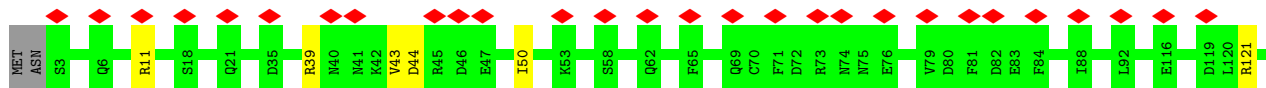

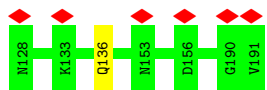

• Molecule 5: RIB22

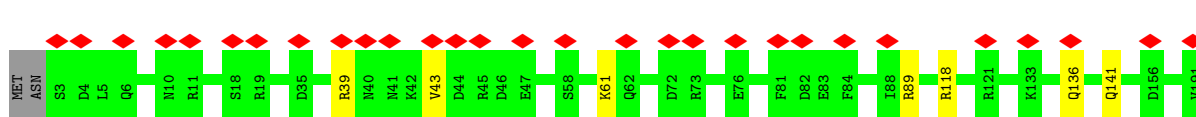

• Molecule 5: RIB22

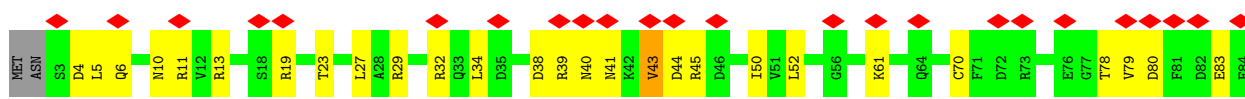

• Molecule 5: RIB22

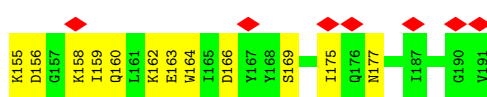
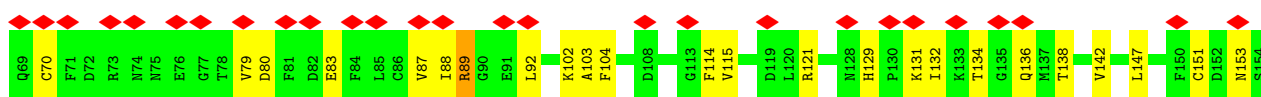
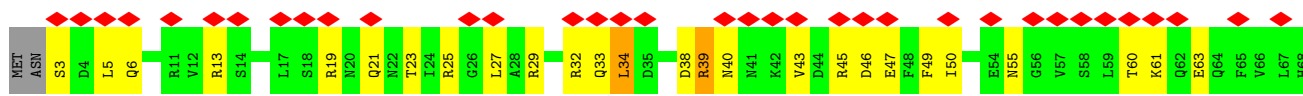

• Molecule 6: CFAM166C

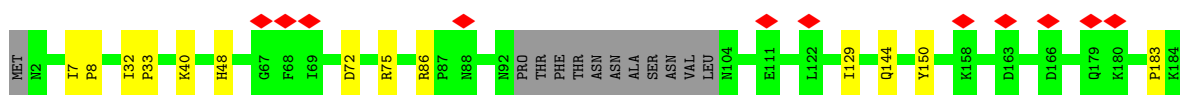
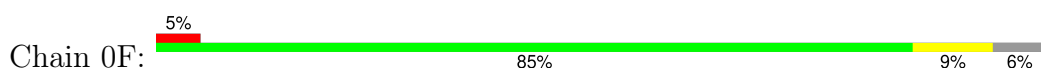

• Molecule 7: CFAP107

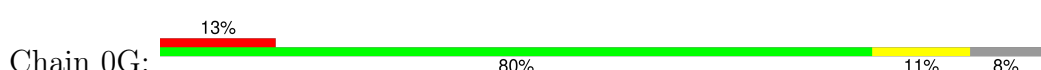

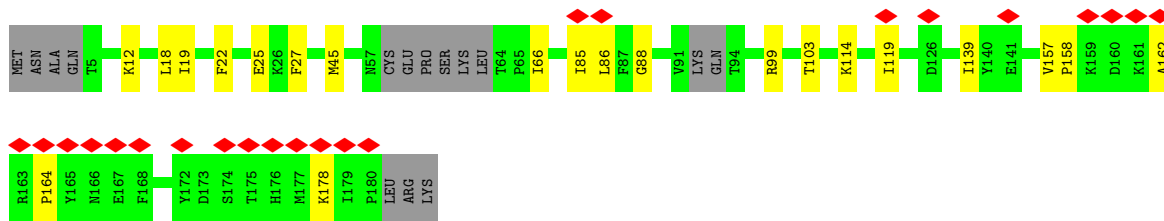

• Molecule 7: CFAP107

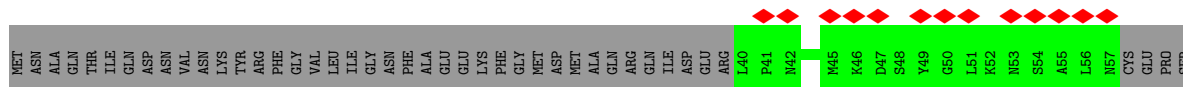

• Molecule 8: CFAP127

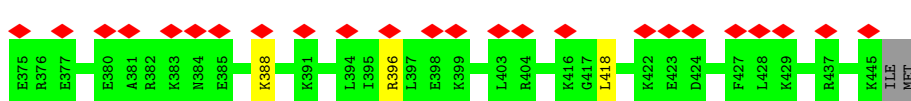
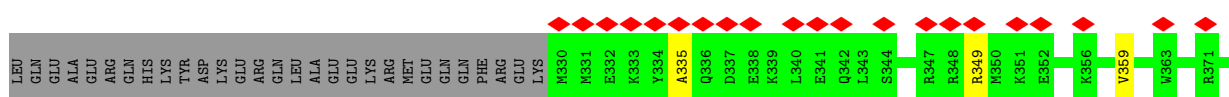
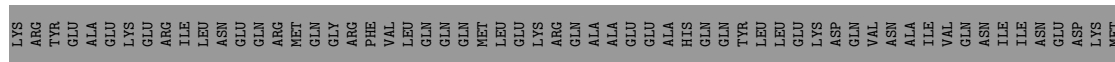
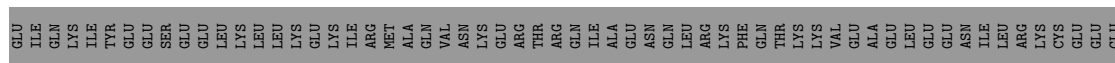
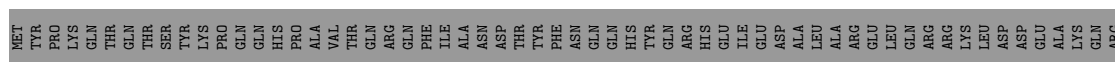

• Molecule 8: CFAP127

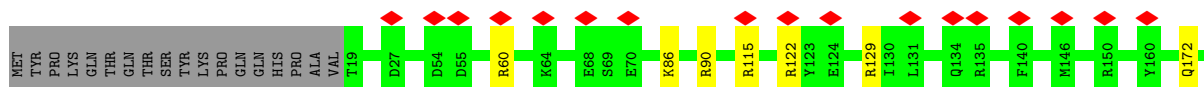



• Molecule 9: CFAP161A

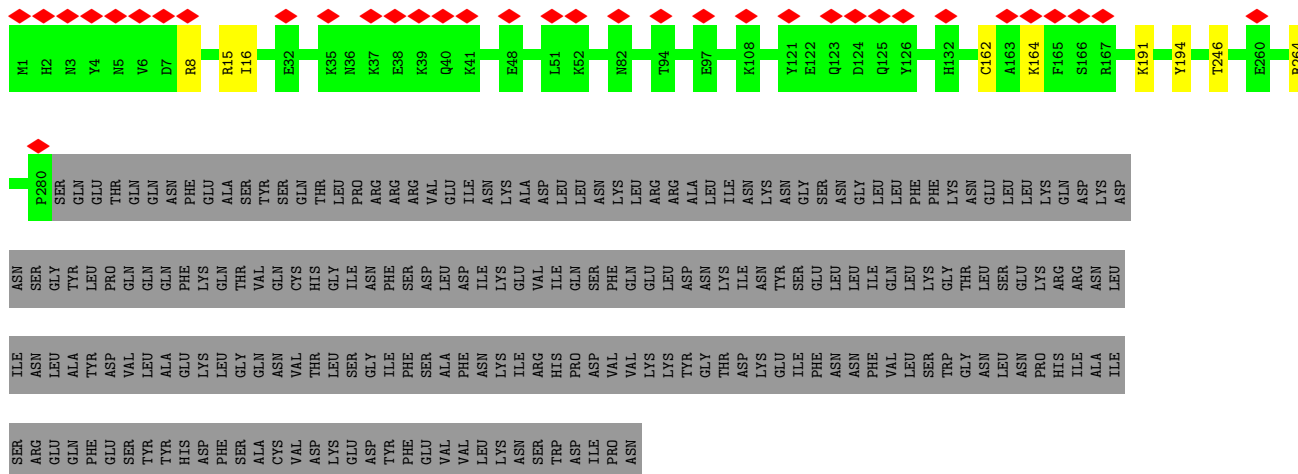

• Molecule 9: CFAP161A

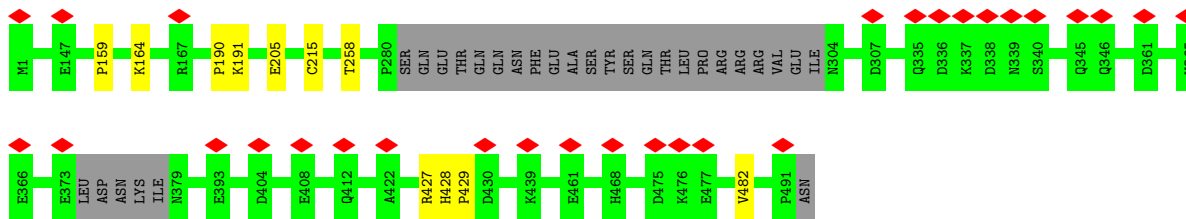

• Molecule 9: CFAP161A

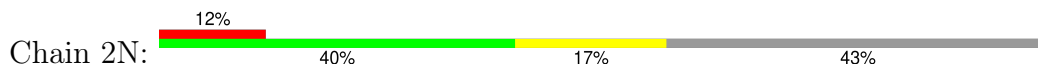

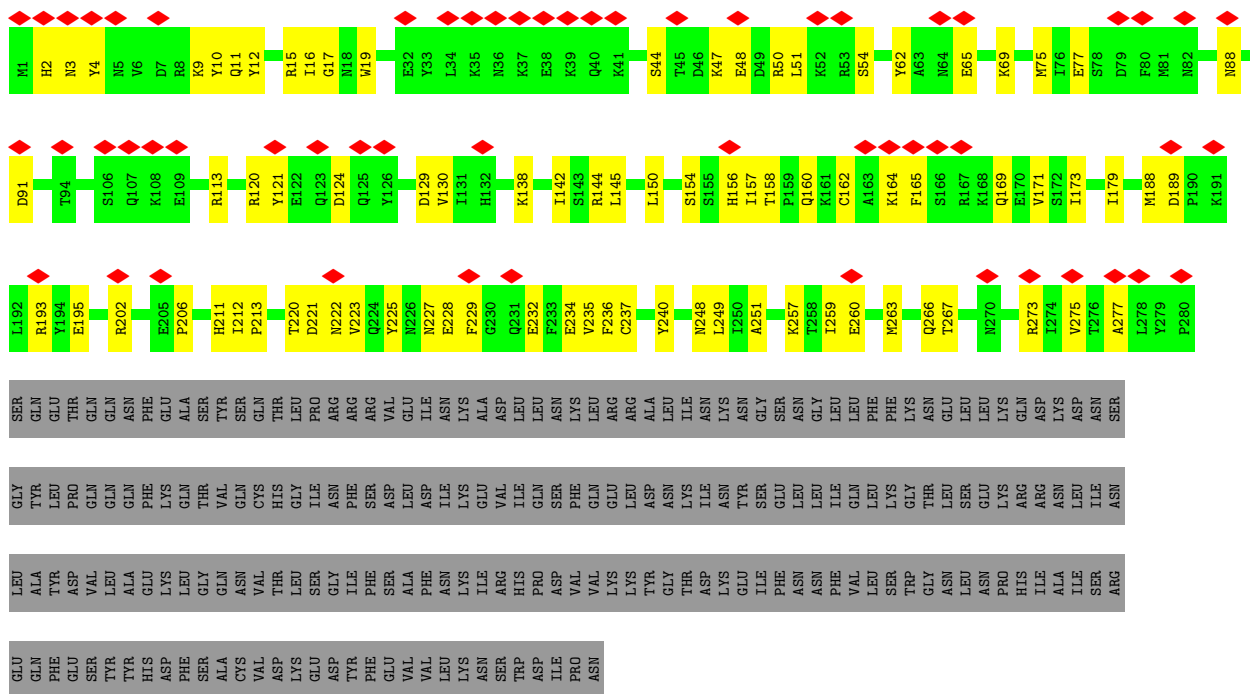

• Molecule 10: CFAP20

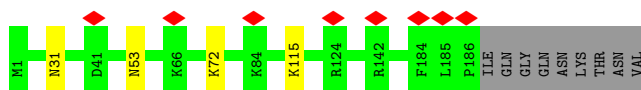

• Molecule 10: CFAP20

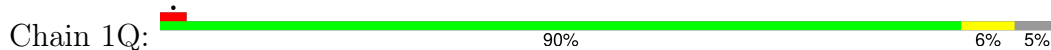

• Molecule 10: CFAP20

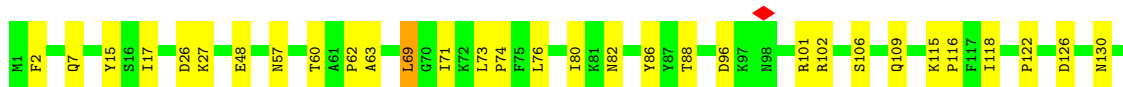

• Molecule 10: CFAP20



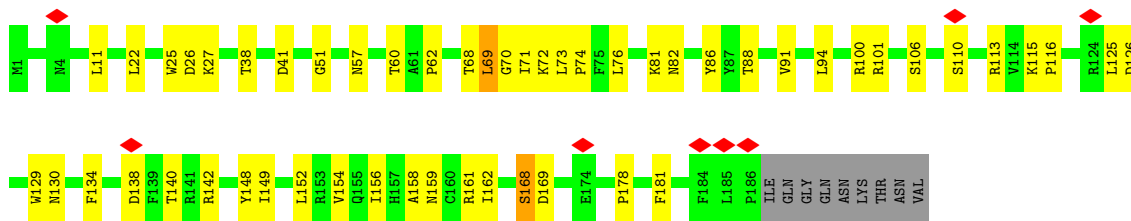

• Molecule 10: CFAP20

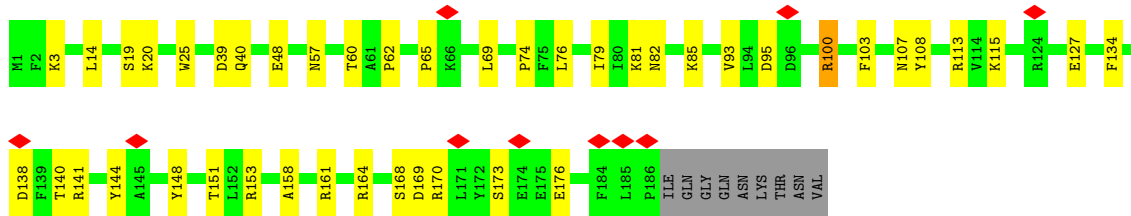
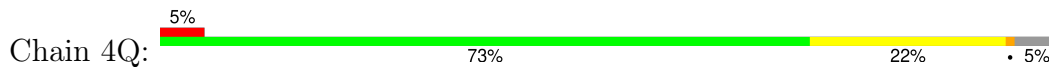

• Molecule 10: CFAP20

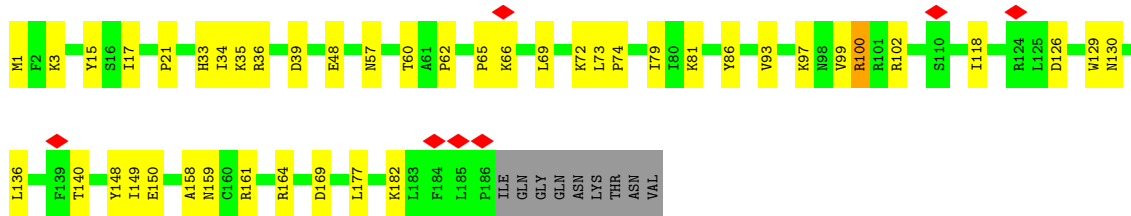
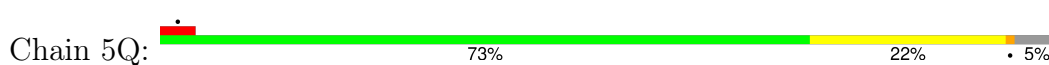

• Molecule 10: CFAP20

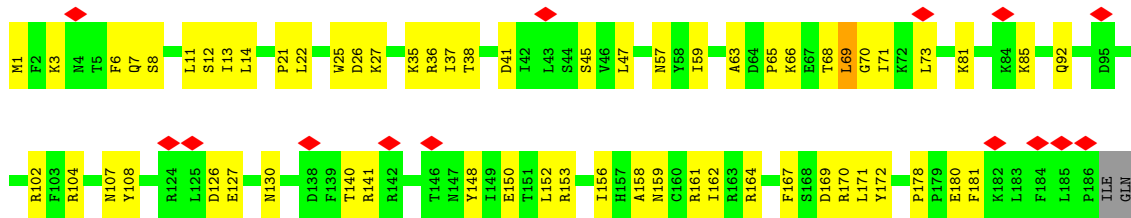

• Molecule 11: Parkin co-regulated protein PACRGA

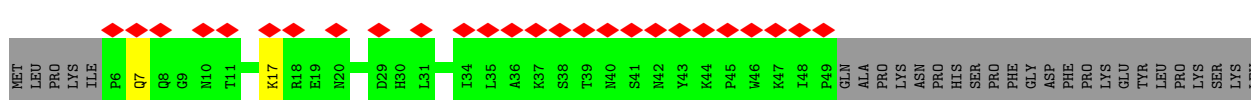
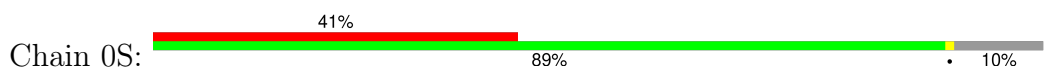

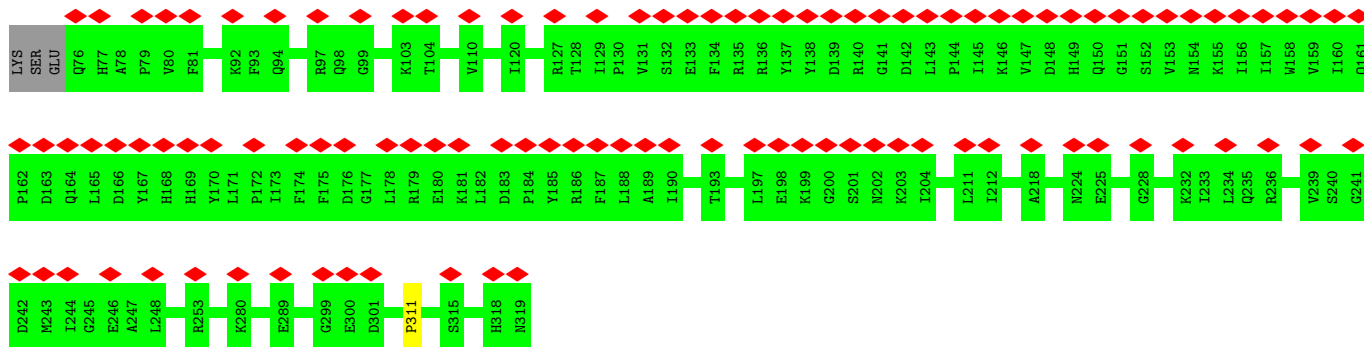

• Molecule 11: Parkin co-regulated protein PACRGA

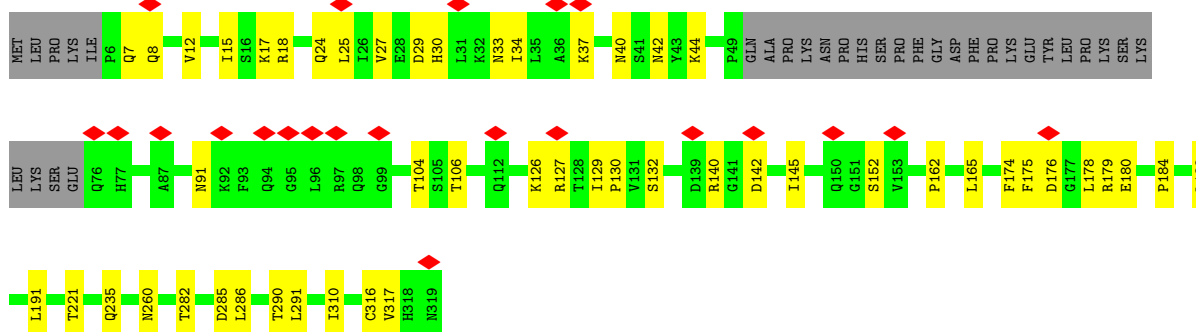
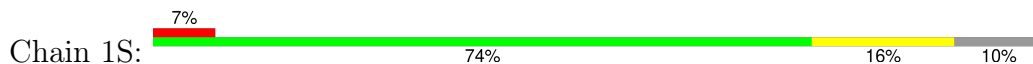

• Molecule 11: Parkin co-regulated protein PACRGA

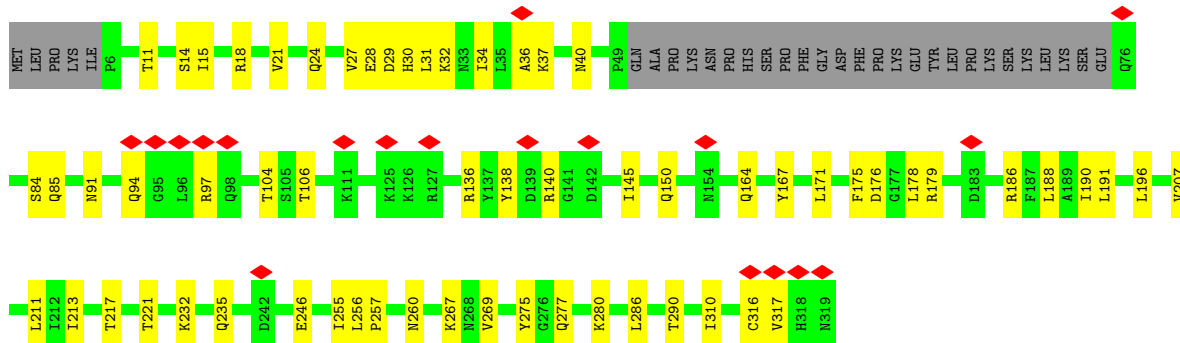

• Molecule 11: Parkin co-regulated protein PACRGA

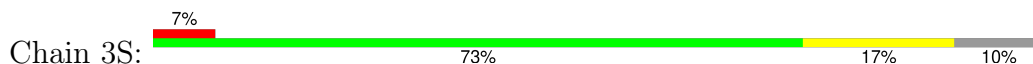

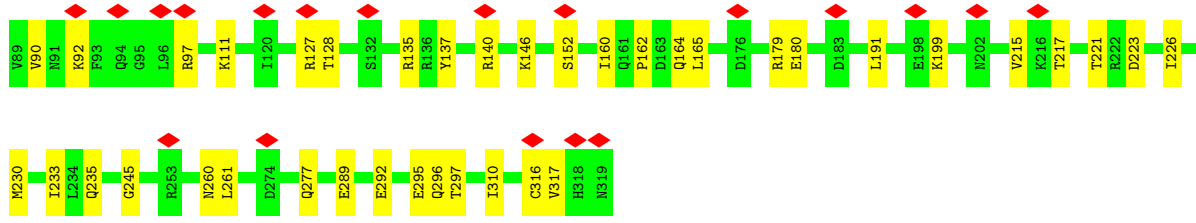

• Molecule 12: IJ34

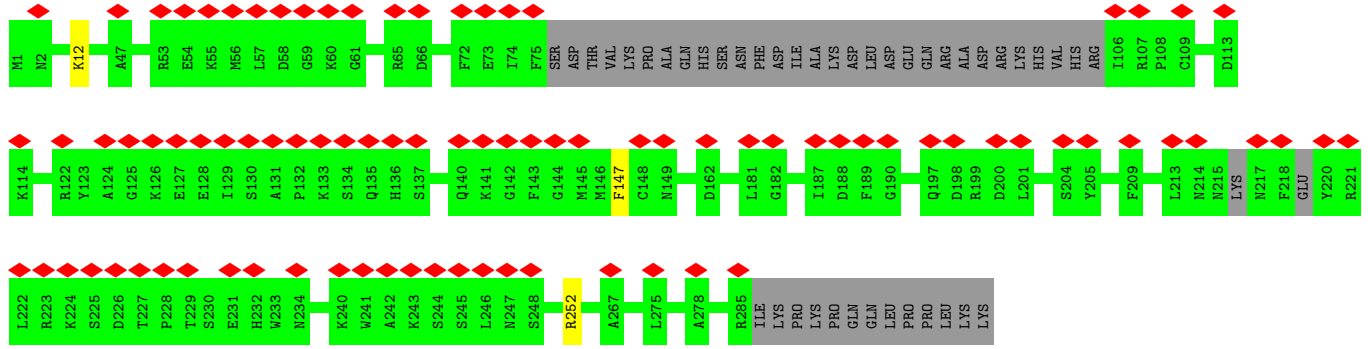
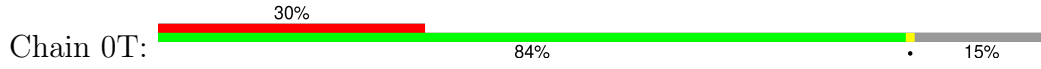

• Molecule 12: IJ34

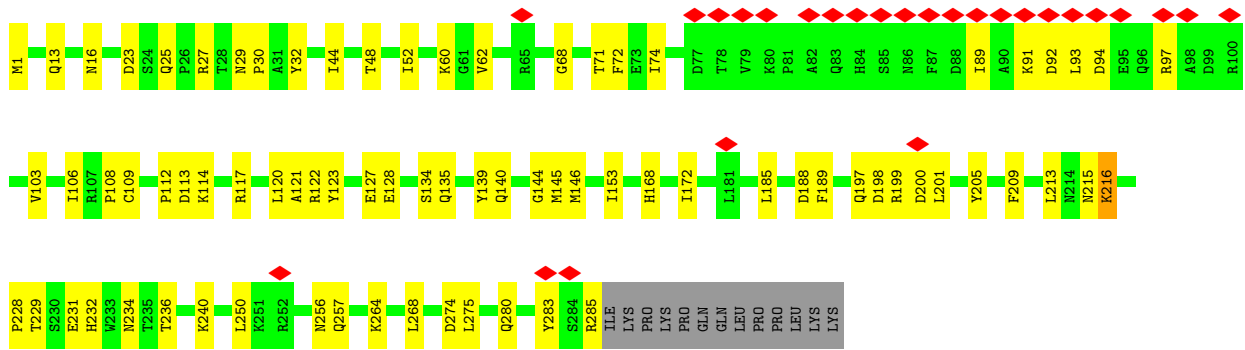

• Molecule 12: IJ34

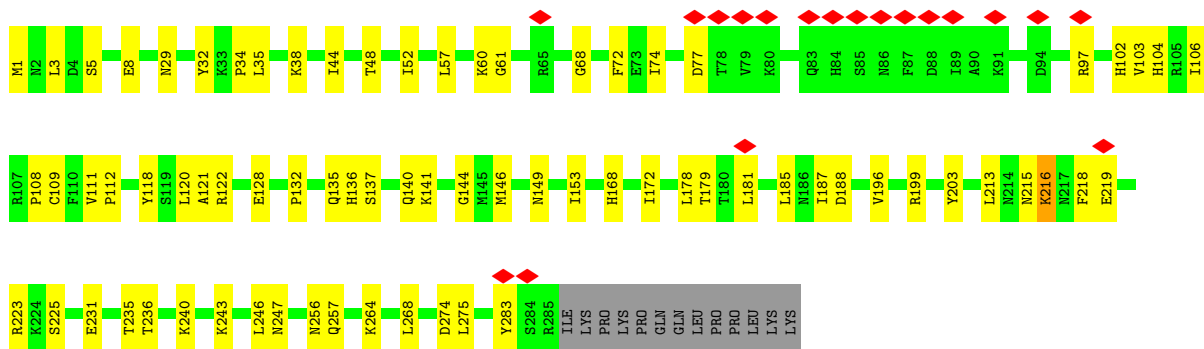

• Molecule 12: IJ34

Chain 3T:

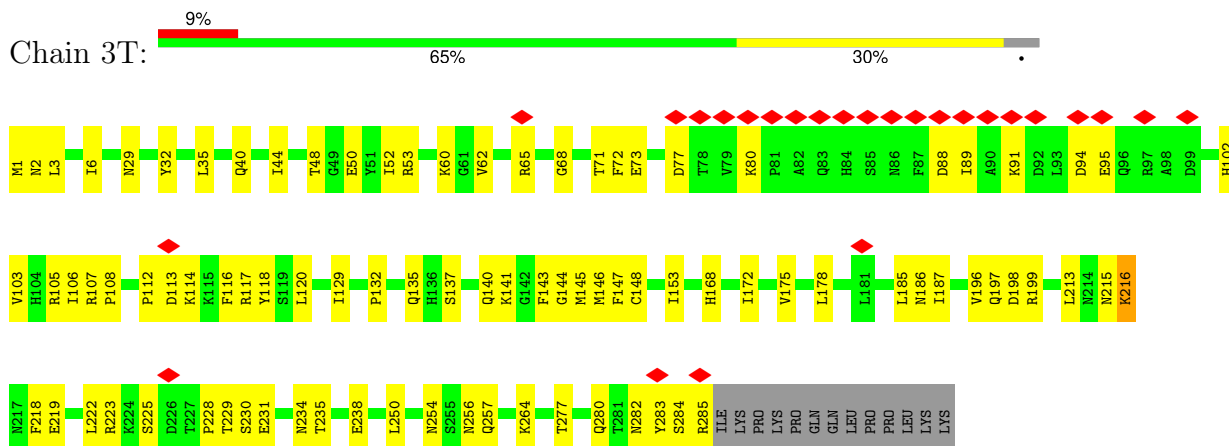

• Molecule 13: Cilia- and flagella-associated protein 52

Chain 0U:

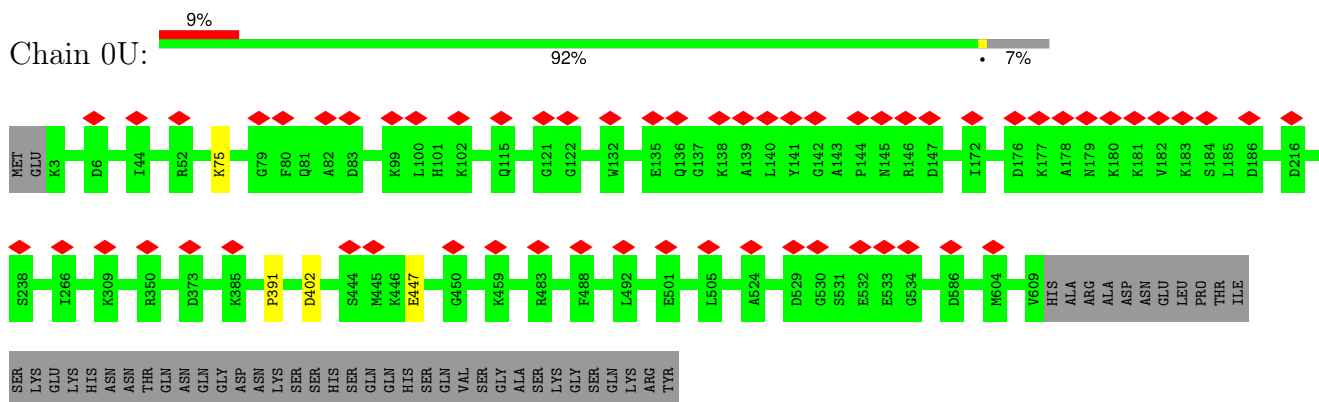

• Molecule 13: Cilia- and flagella-associated protein 52

Chain 1U:

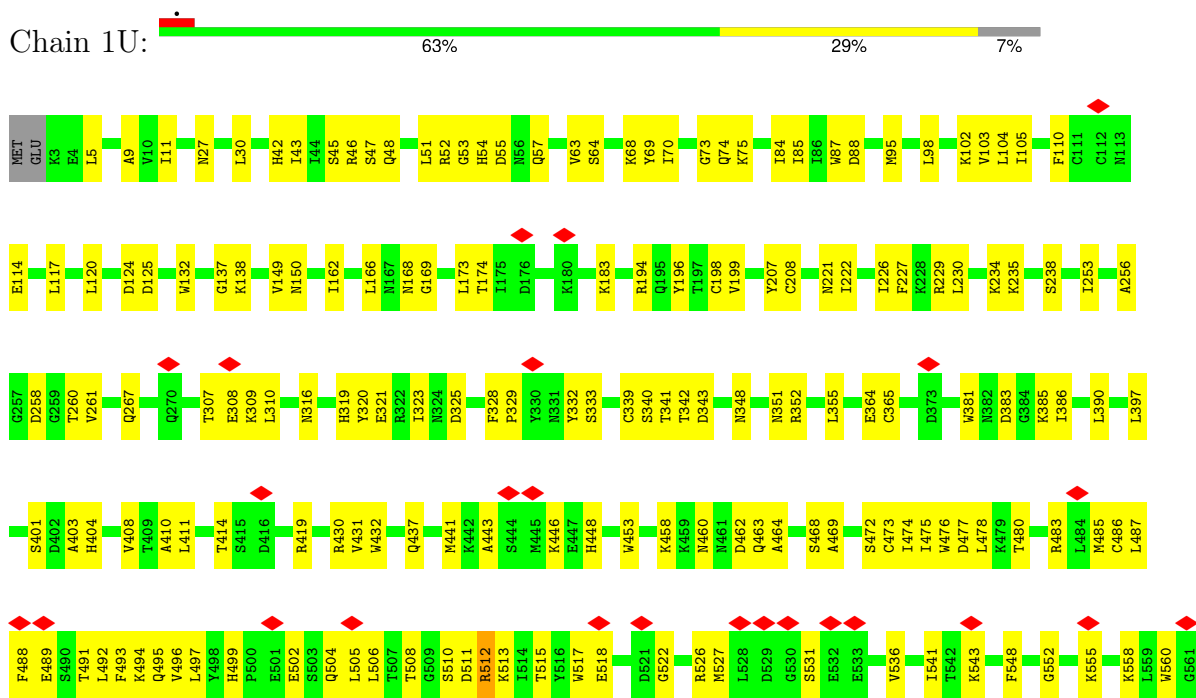

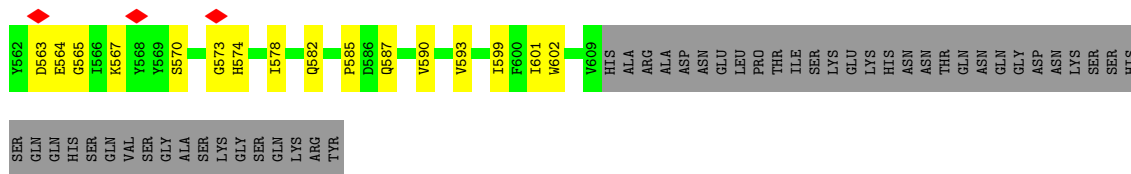

• Molecule 13: Cilia- and flagella-associated protein 52

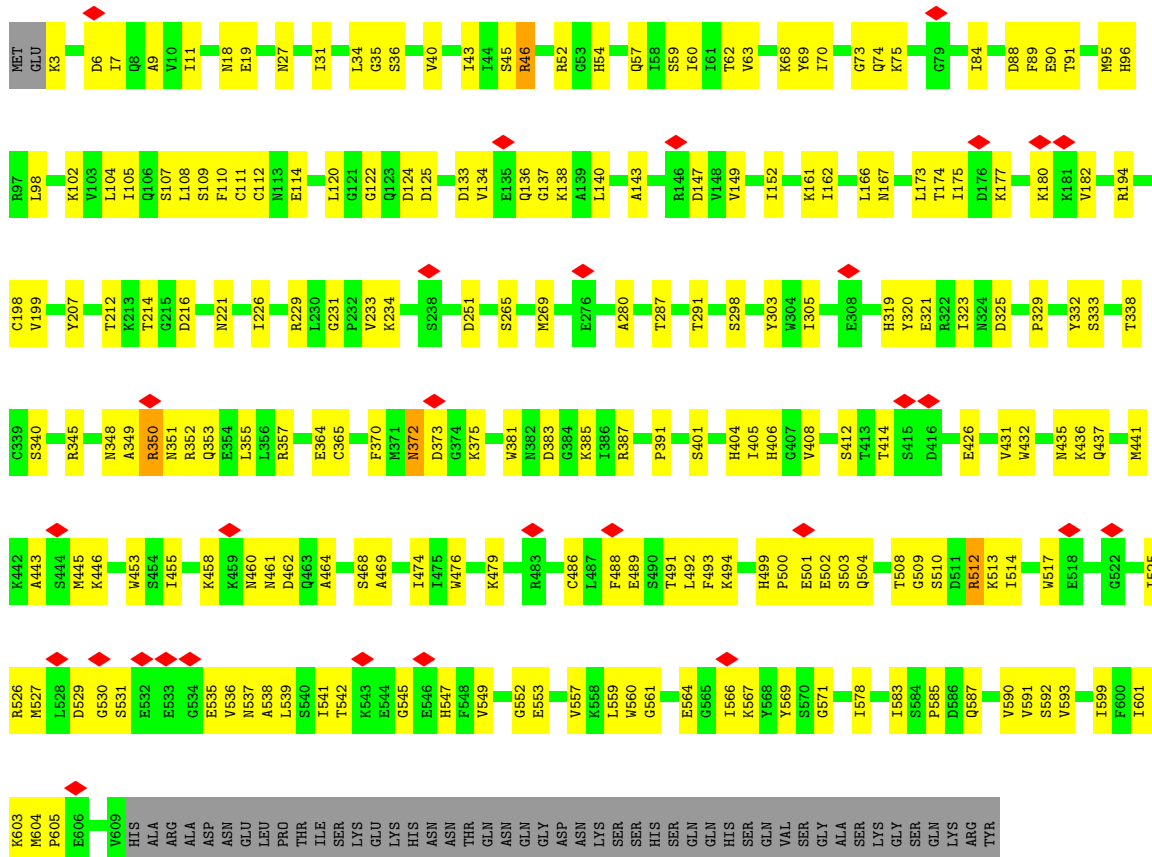

• Molecule 13: Cilia- and flagella-associated protein 52

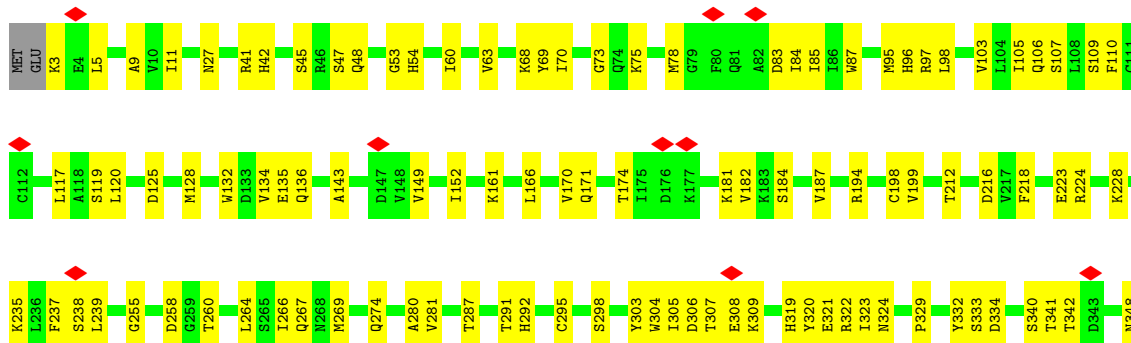

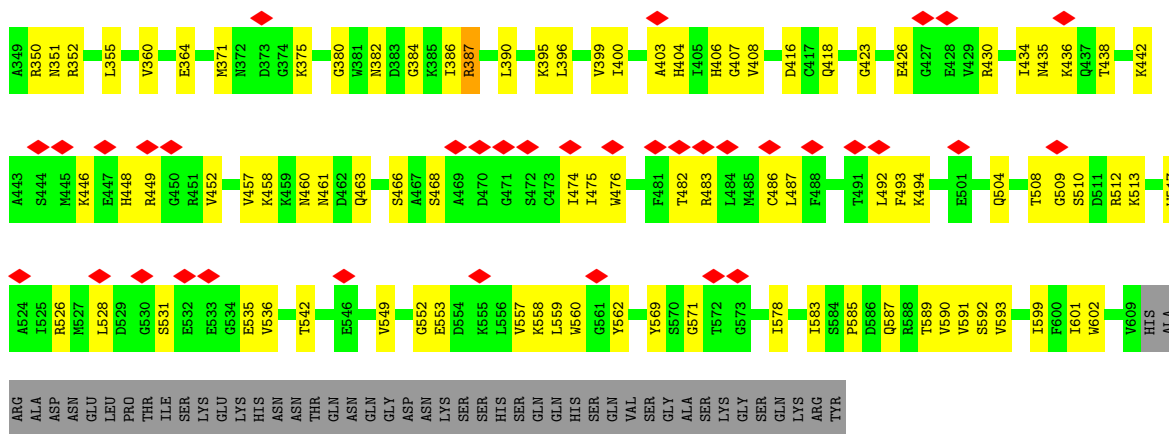

● Molecule 14: DNA polymerase delta C4-type zinc-finger protein

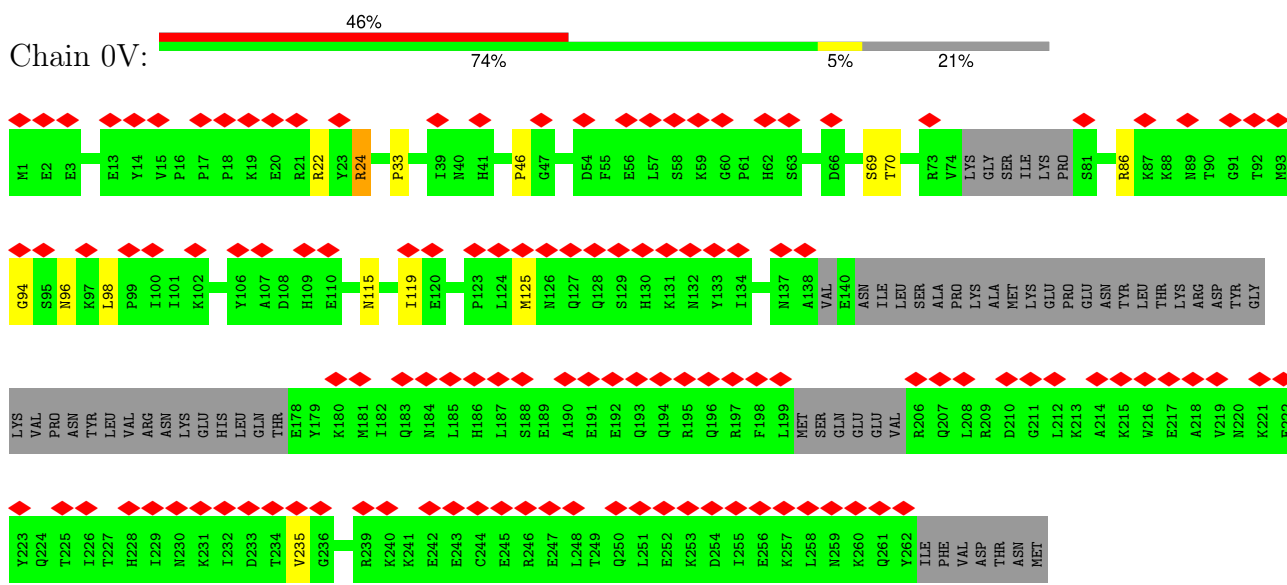

● Molecule 14: DNA polymerase delta C4-type zinc-finger protein

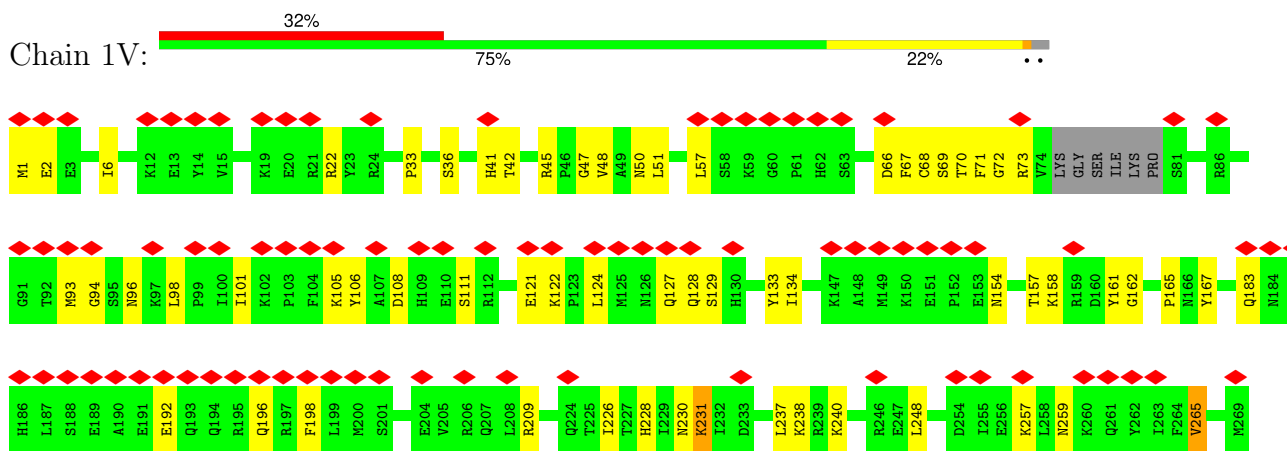

● Molecule 14: DNA polymerase delta C4-type zinc-finger protein



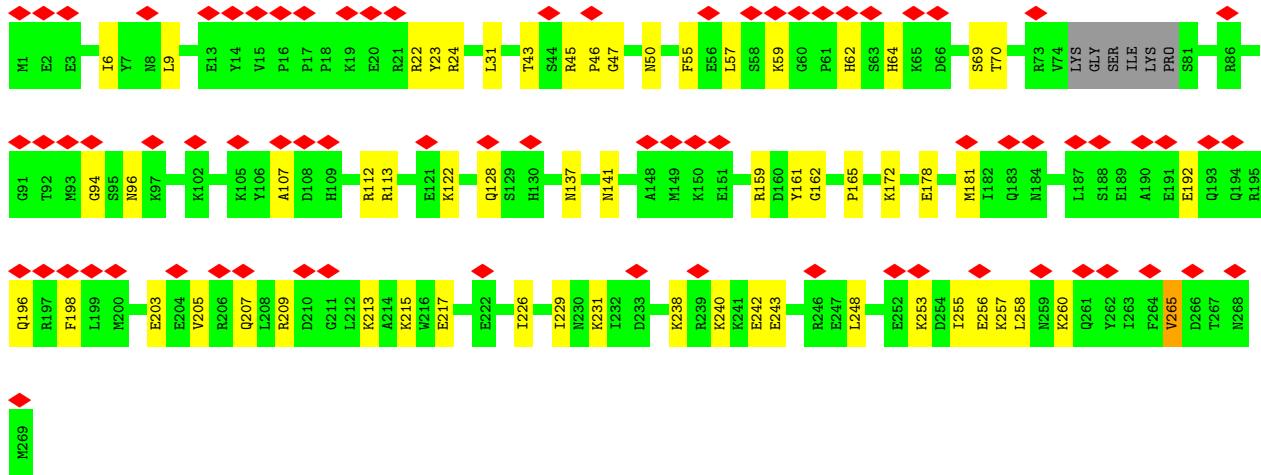

• Molecule 14: DNA polymerase delta C4-type zinc-finger protein

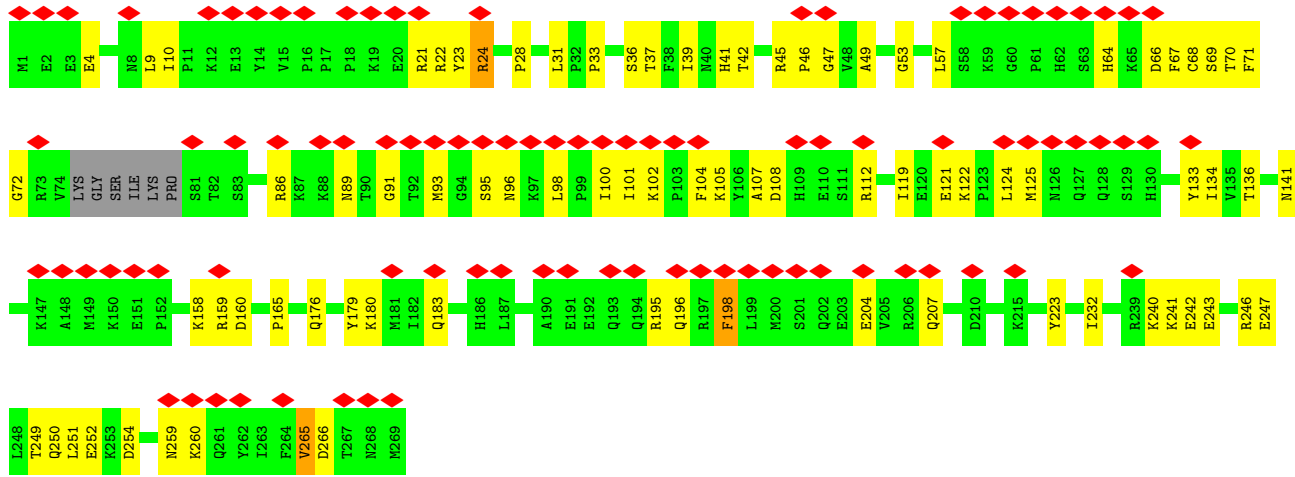

• Molecule 15: RIB43A protein

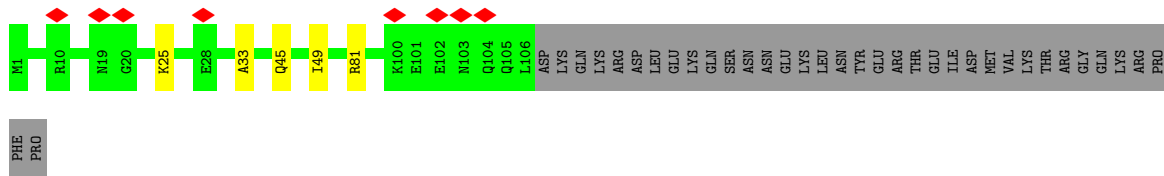

• Molecule 15: RIB43A protein

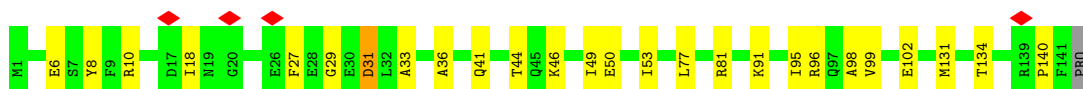
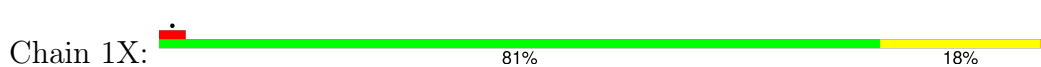

• Molecule 15: RIB43A protein

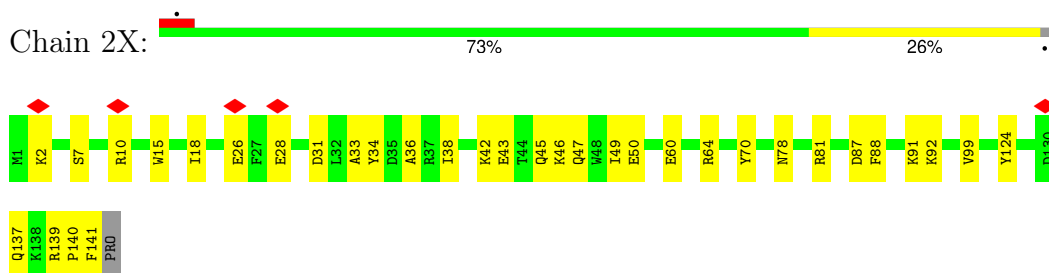

• Molecule 15: RIB43A protein

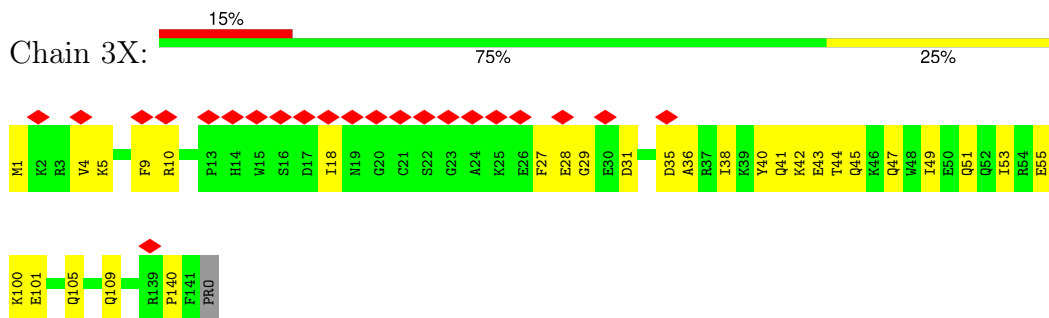

• Molecule 15: RIB43A protein

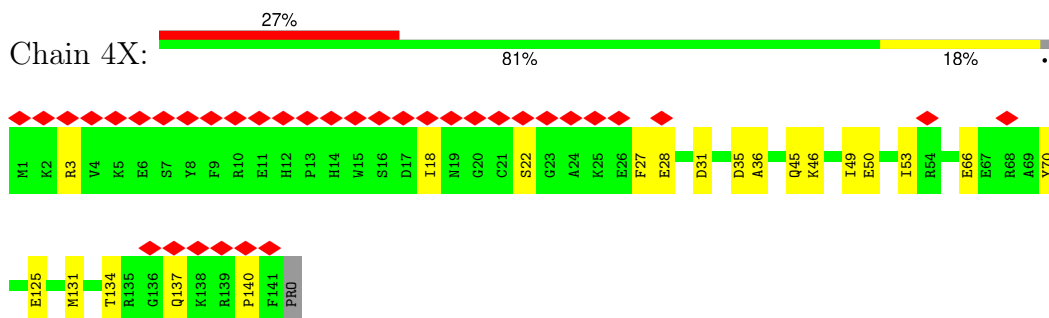

• Molecule 16: RIB57

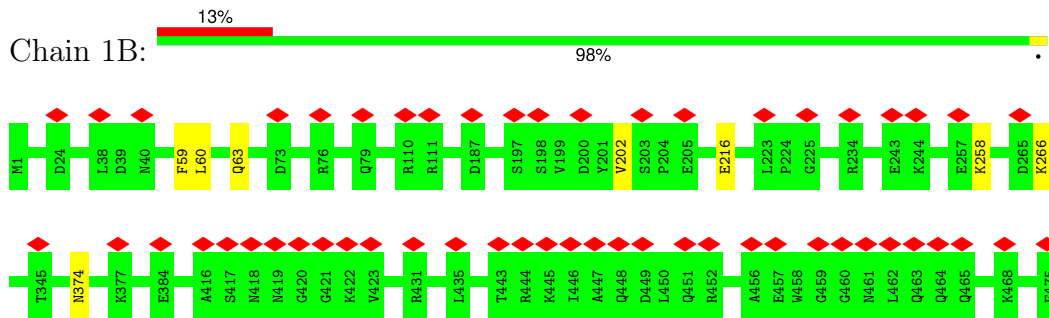

• Molecule 16: RIB57

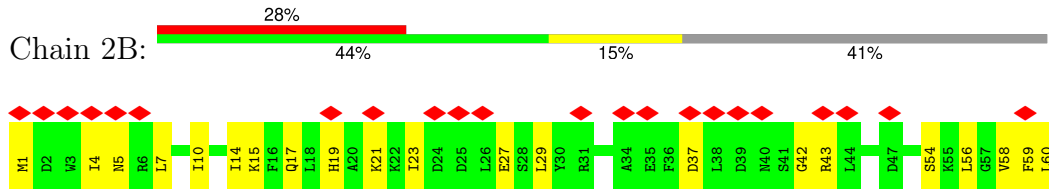

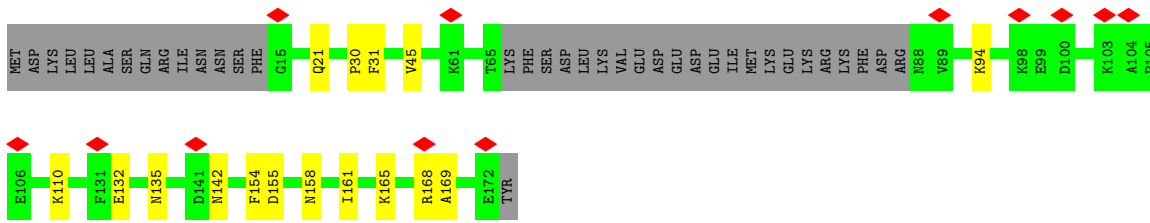

- Molecule 18: CFAP143

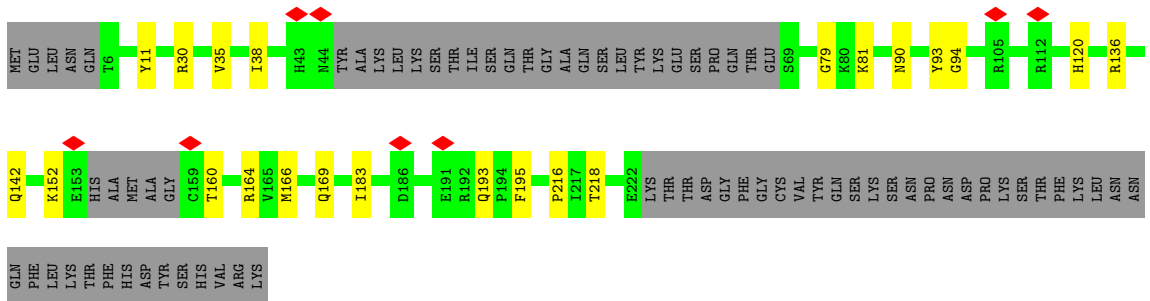

- Molecule 19: CFAP21A

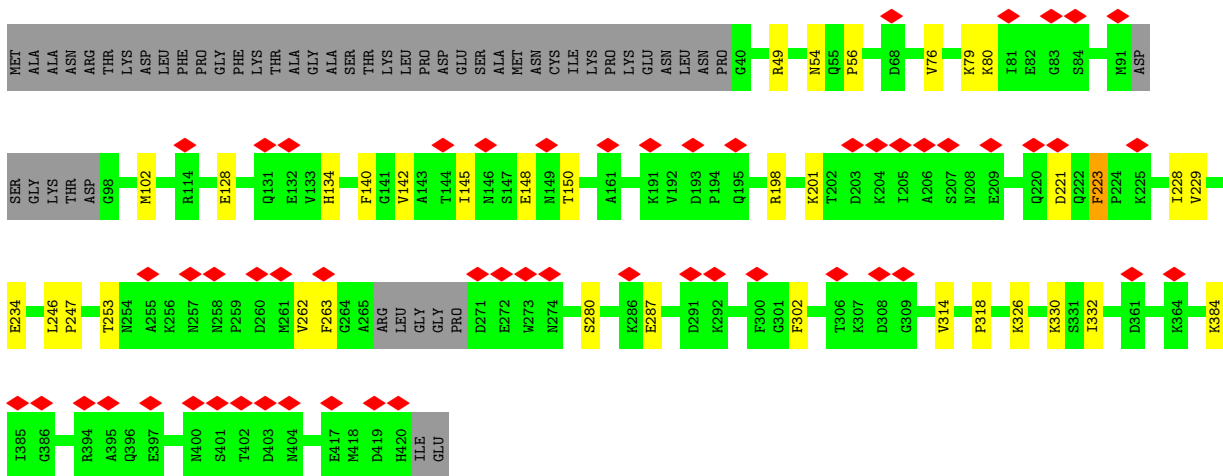
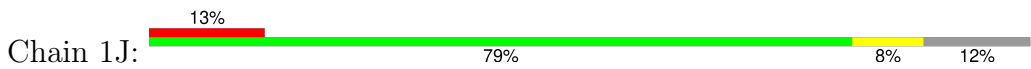

- Molecule 20: Cilia- and flagella-associated protein 53

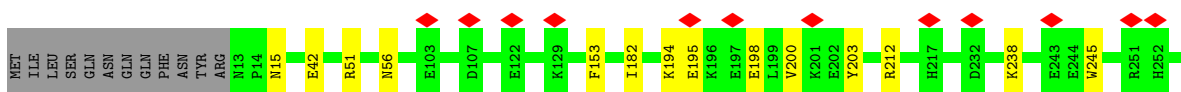

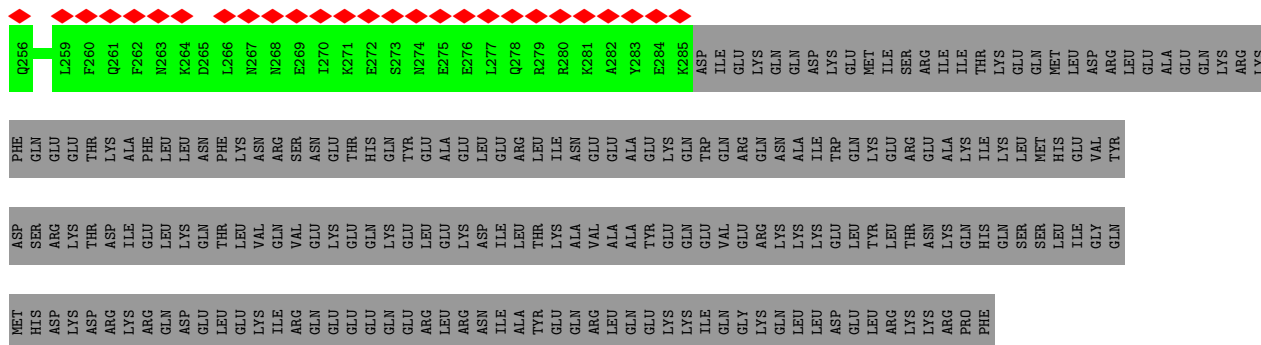

● Molecule 20: Cilia- and flagella-associated protein 53

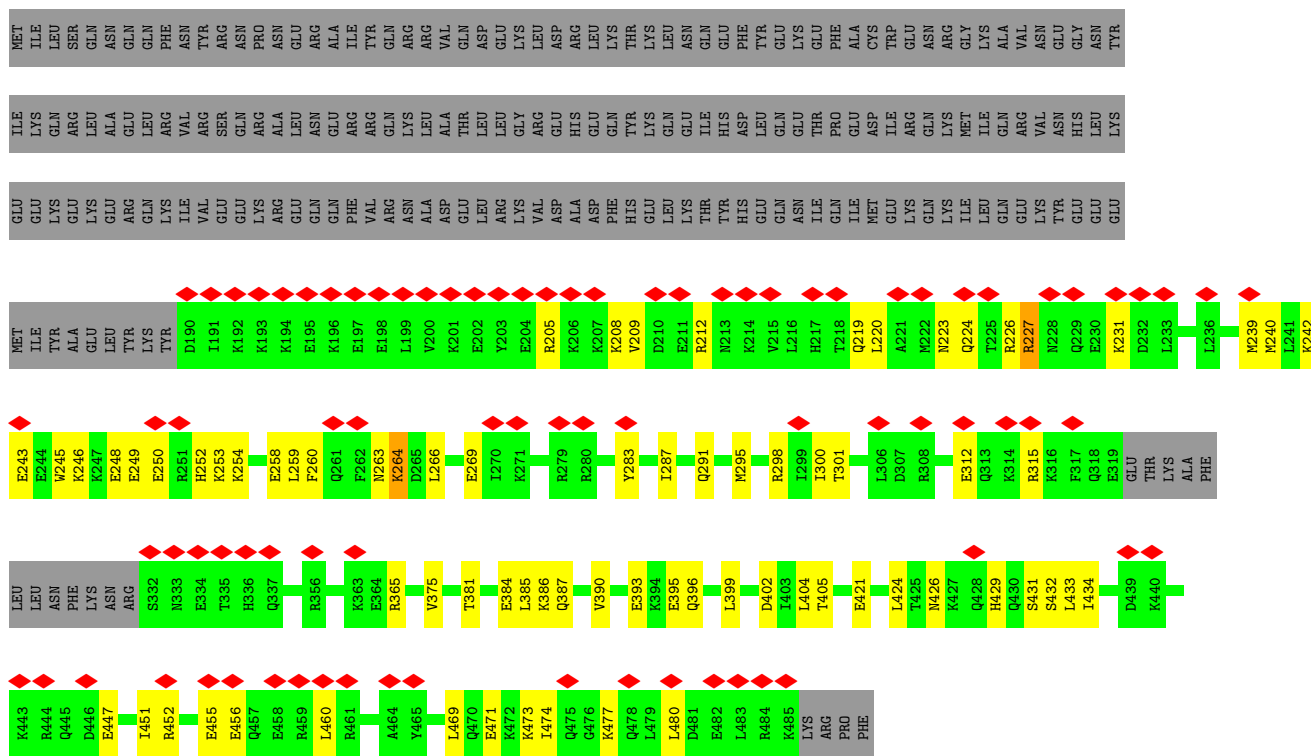
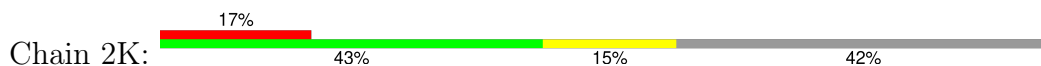

● Molecule 21: CFAP115

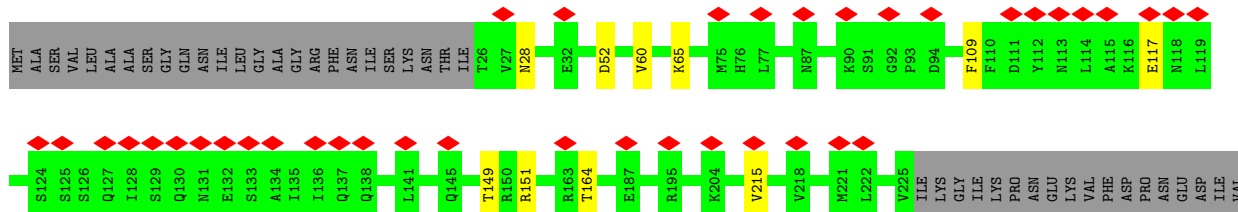
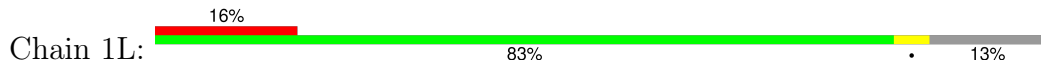

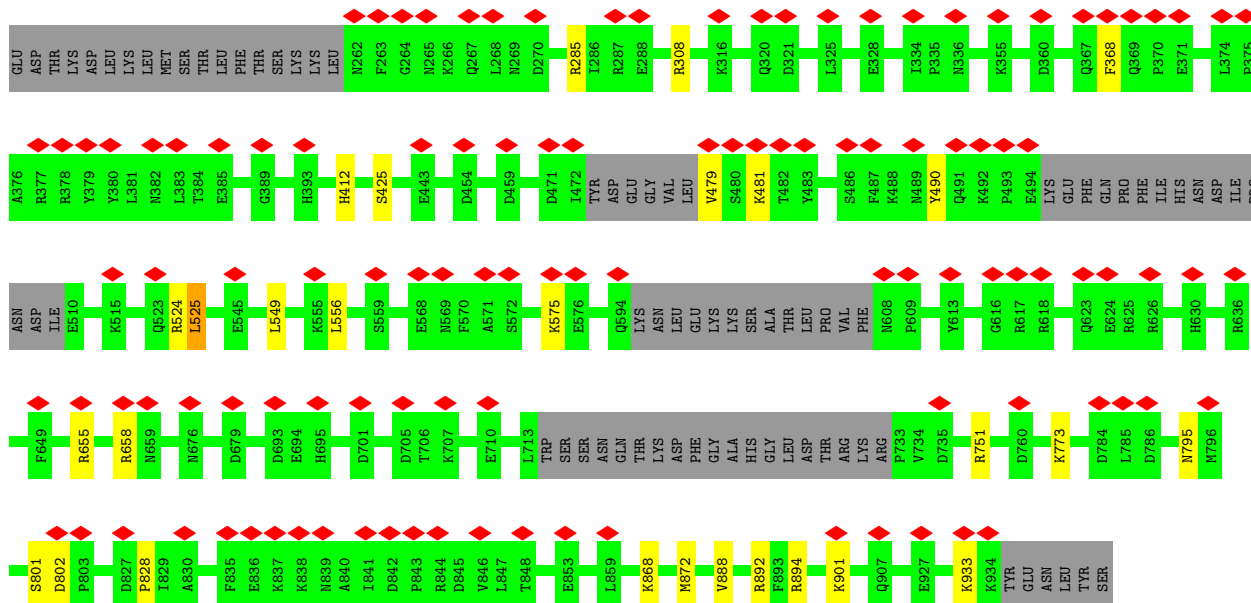

• Molecule 21: CFAP115

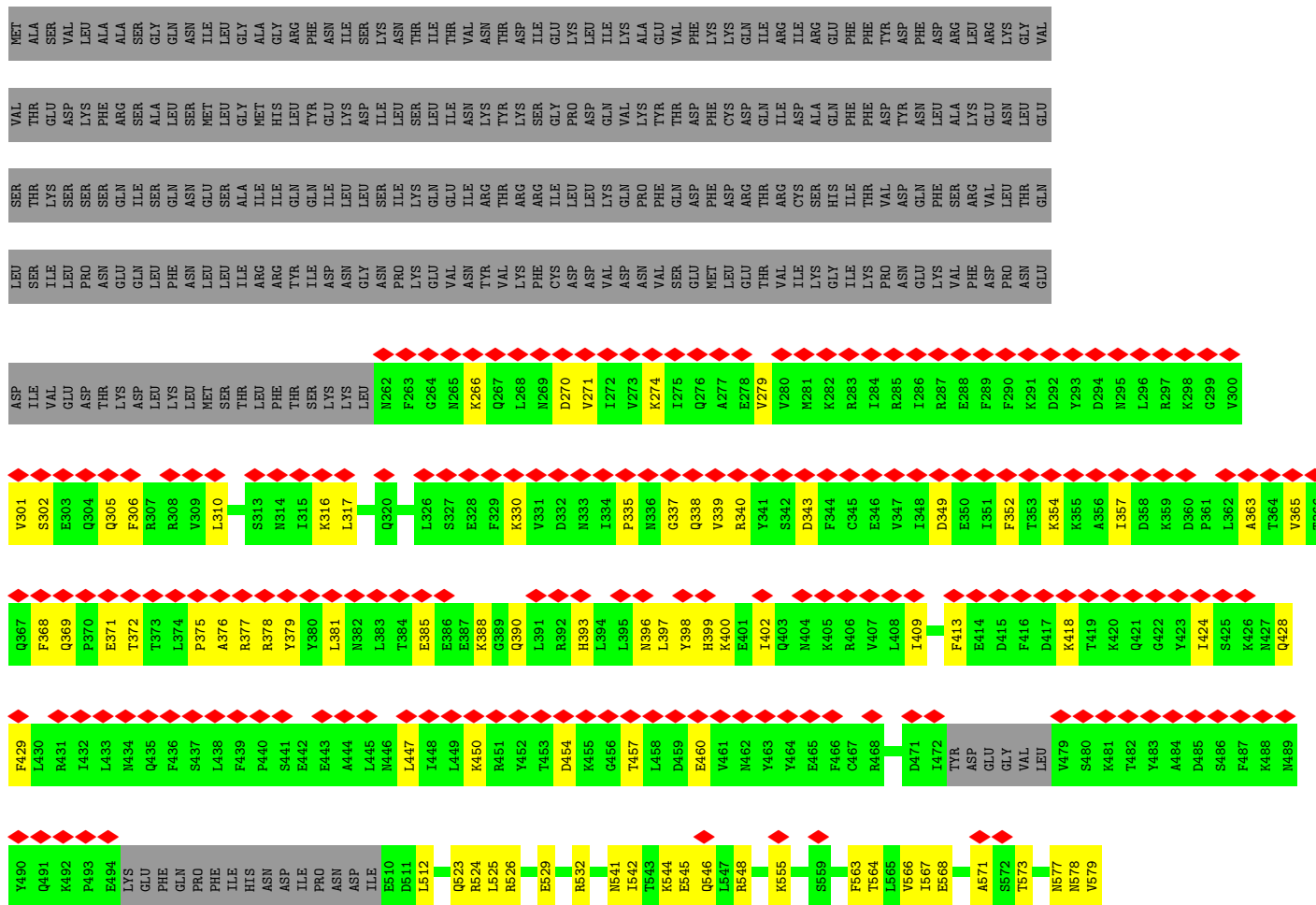

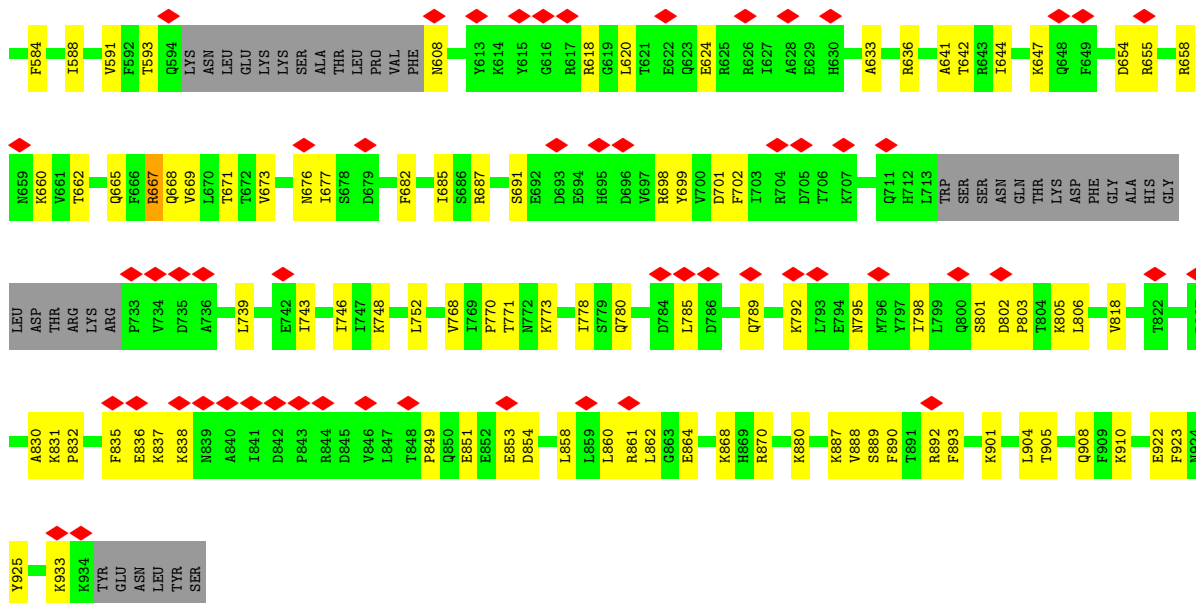

• Molecule 21: CFAP115

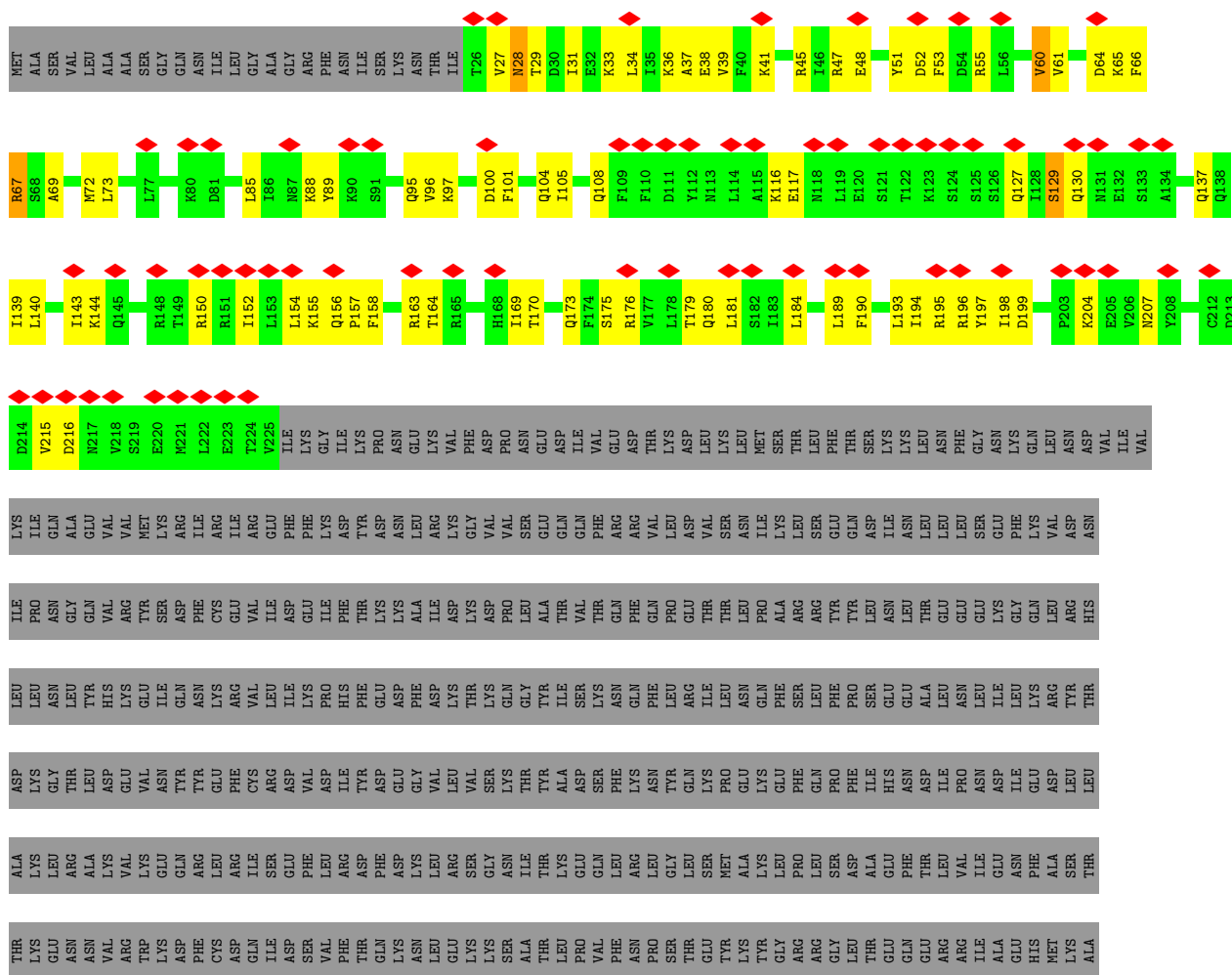

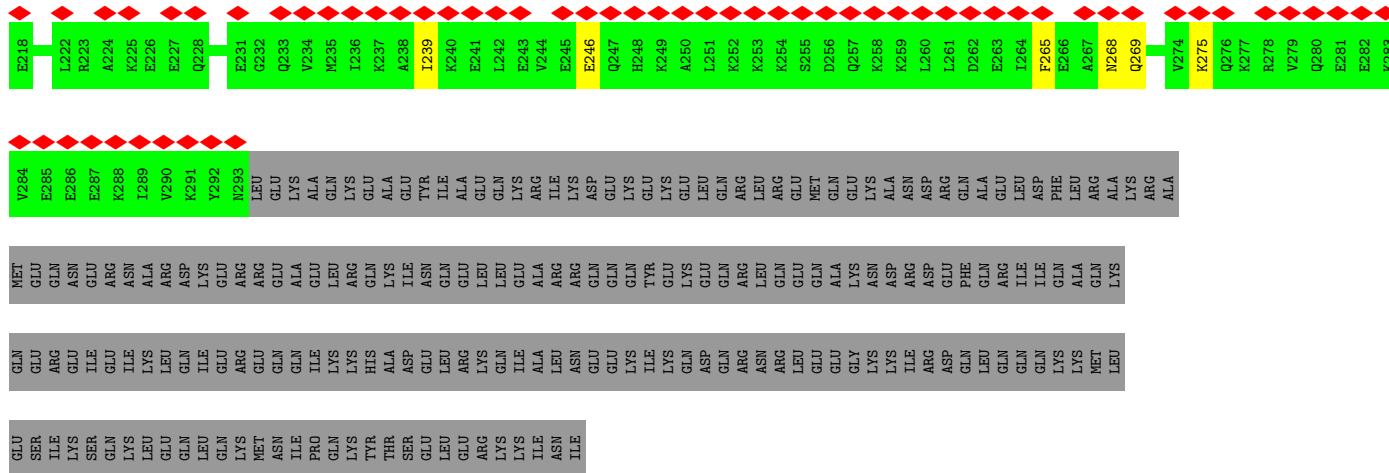

● Molecule 23: Cilia- and flagella-associated protein 45

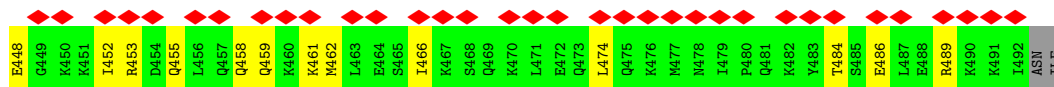
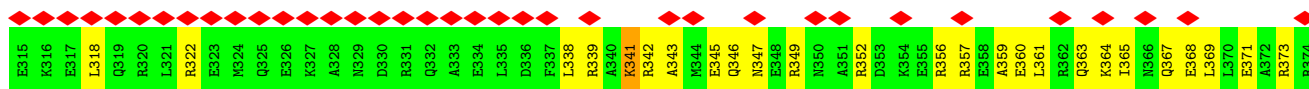
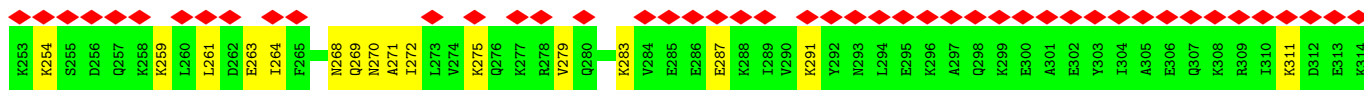
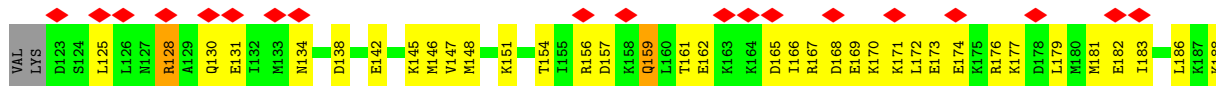
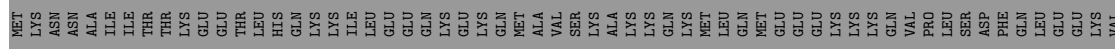
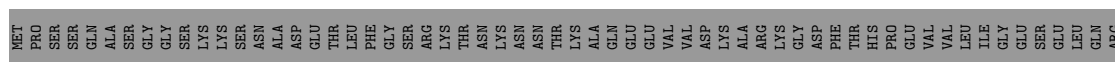

● Molecule 23: Cilia- and flagella-associated protein 45



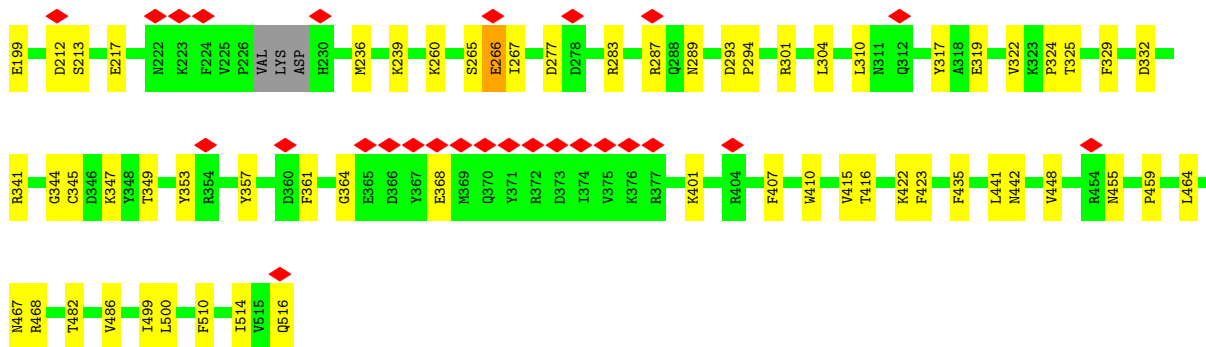

• Molecule 25: RIB72B

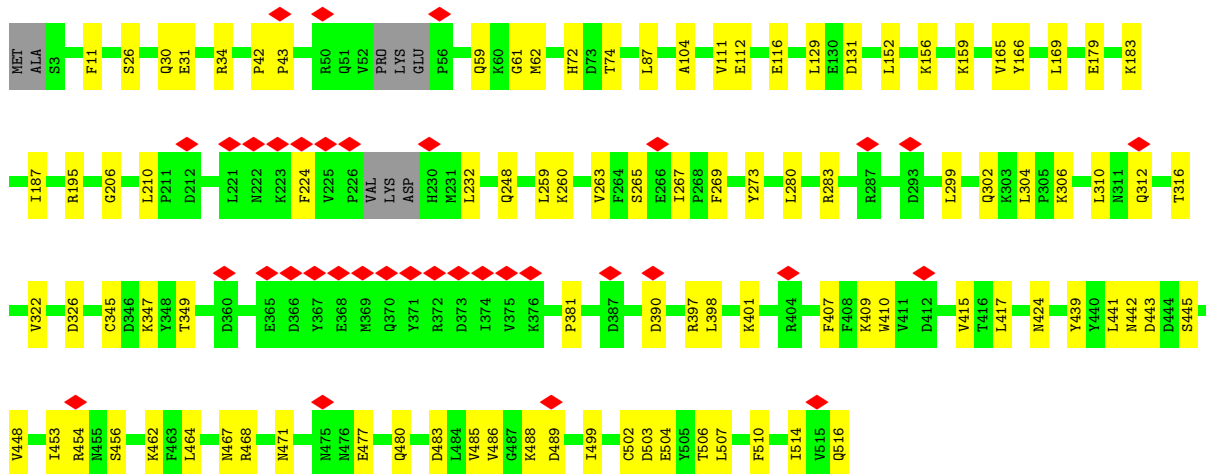
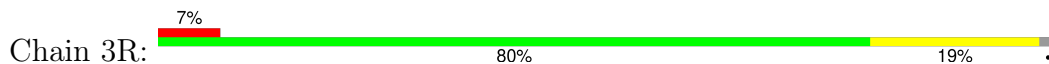

• Molecule 26: Protofilament ribbon protein

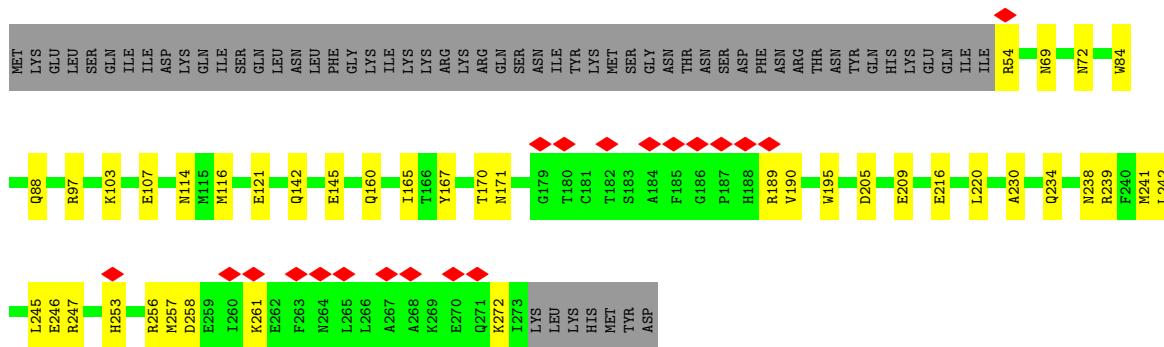

• Molecule 26: Protofilament ribbon protein



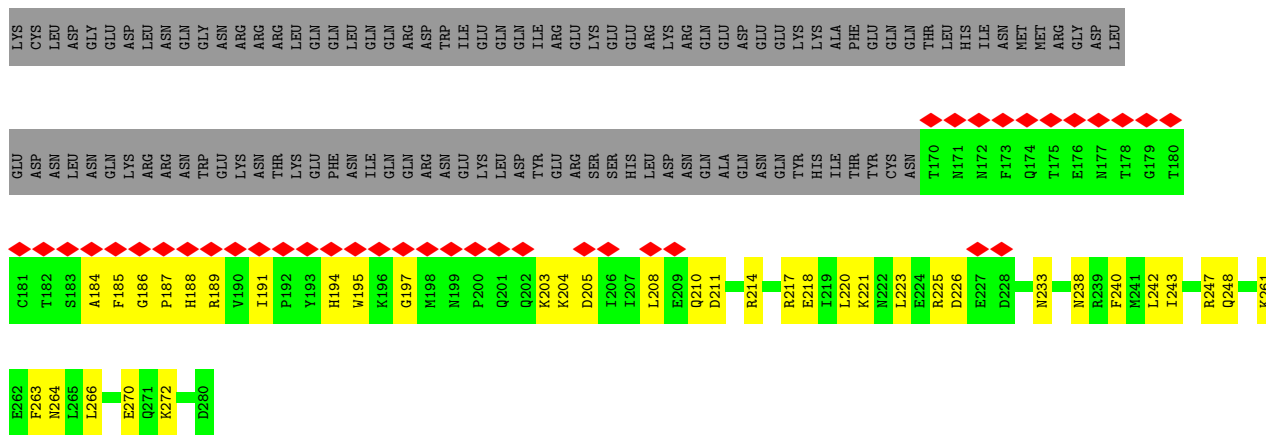

● Molecule 27: RIB35

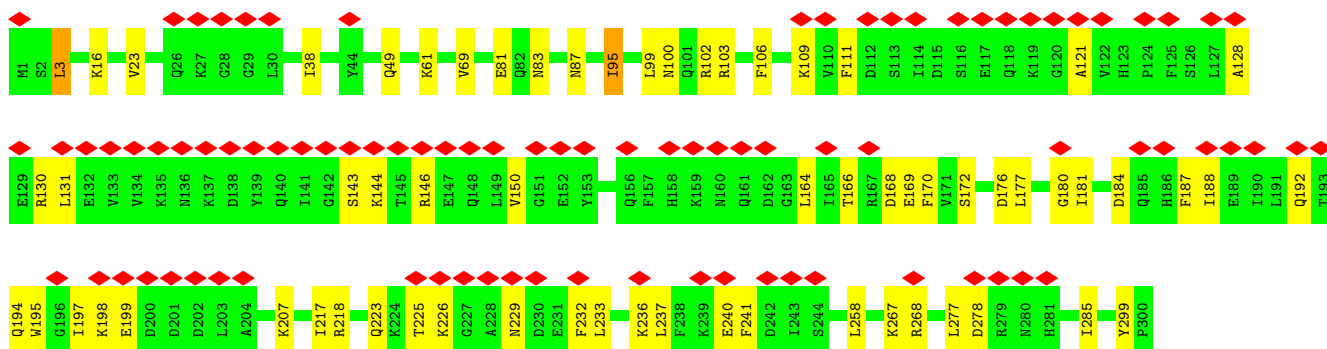
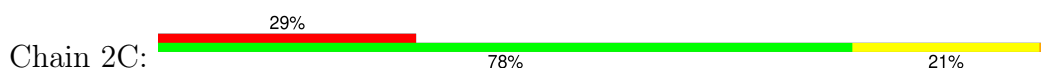

● Molecule 27: RIB35

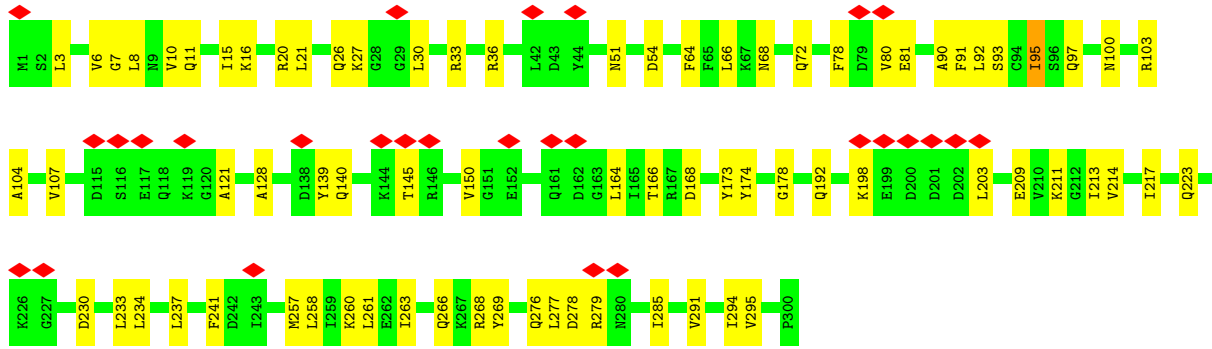
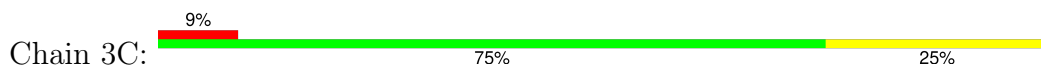

● Molecule 27: RIB35

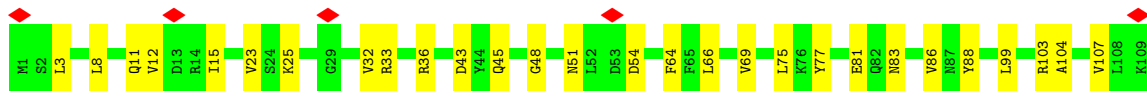
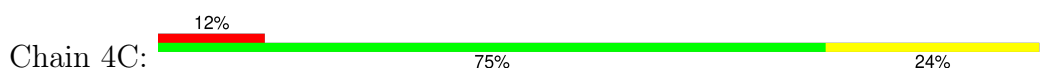

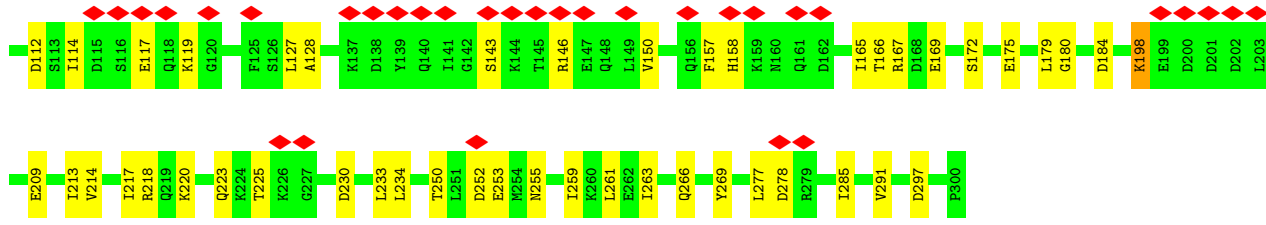

• Molecule 28: CFAP182B



• Molecule 29: Flagellar FliJ protein

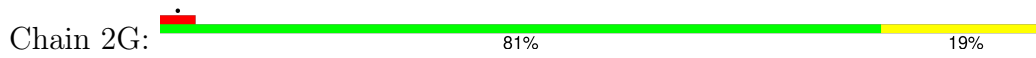

• Molecule 30: RIB27B

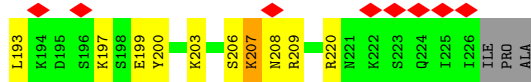
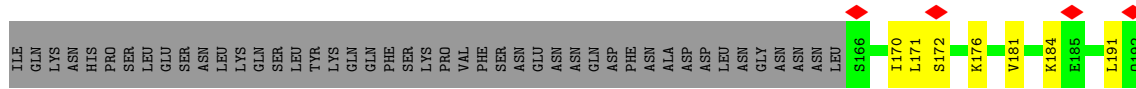

• Molecule 30: RIB27B



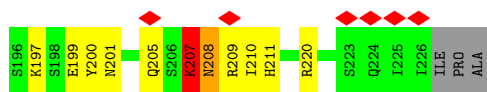

• Molecule 30: RIB27B

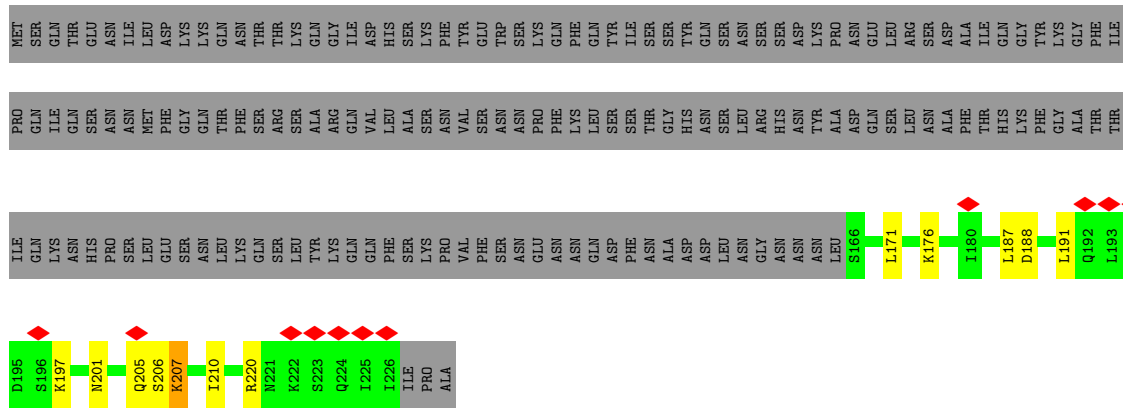

• Molecule 31: STPG2

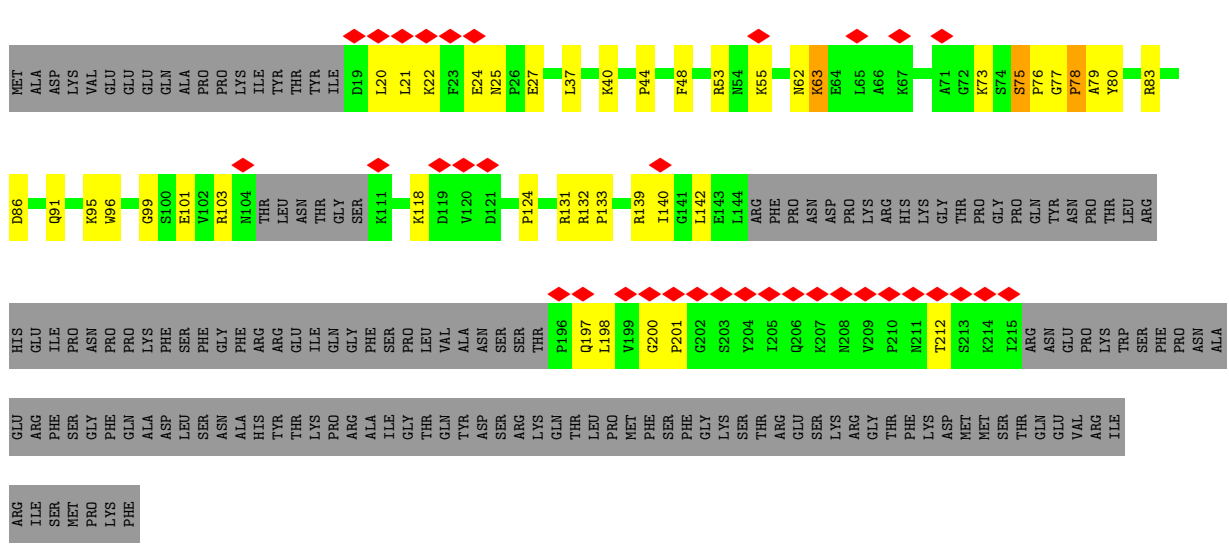
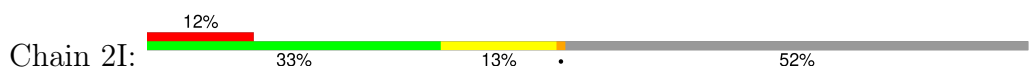

• Molecule 31: STPG2

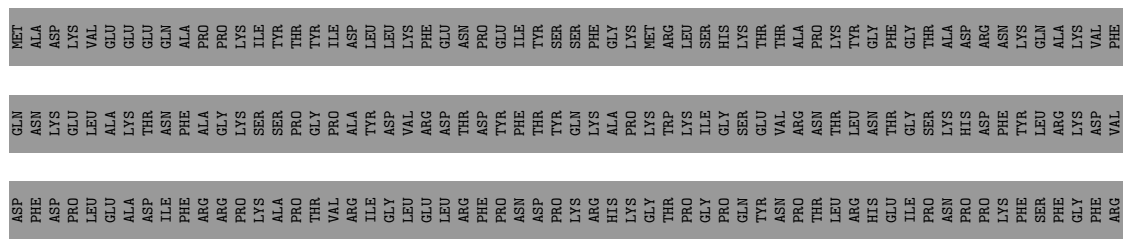

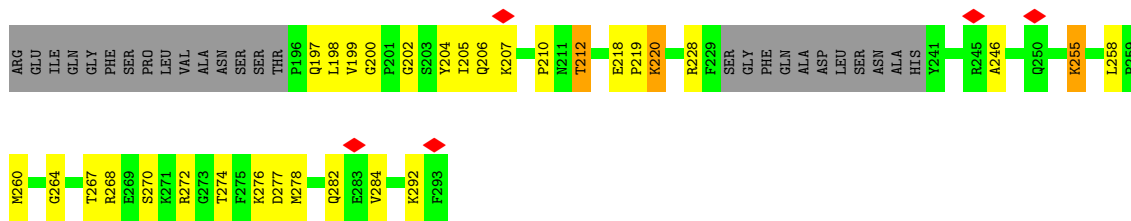

• Molecule 32: RIB26

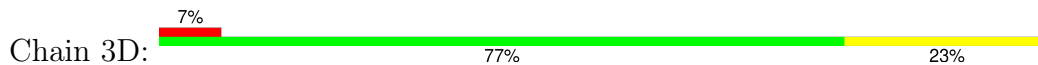

• Molecule 33: CFAP129

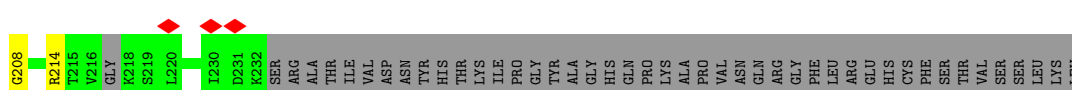
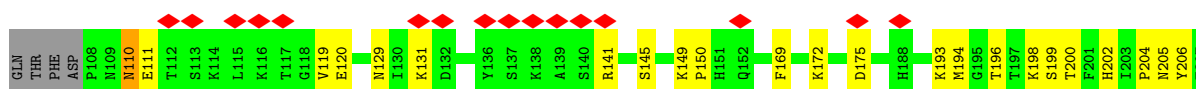
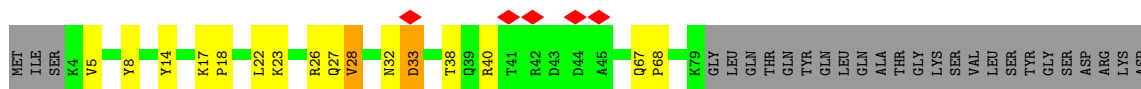

• Molecule 34: Flagellar microtubule protofilament ribbon protein

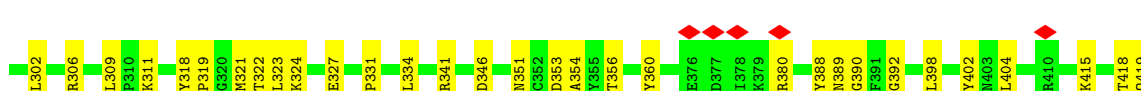
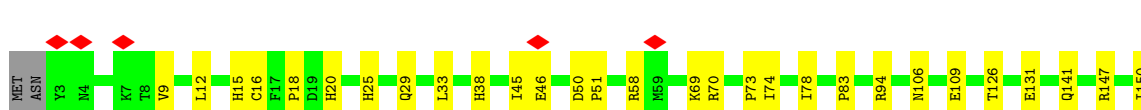
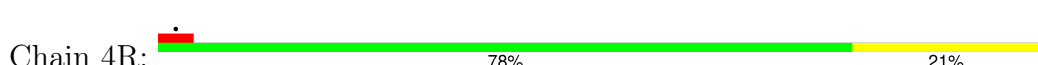

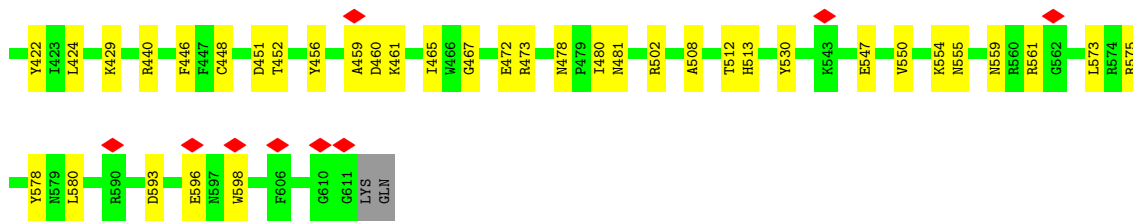

• Molecule 34: Flagellar microtugule protofilament ribbon protein

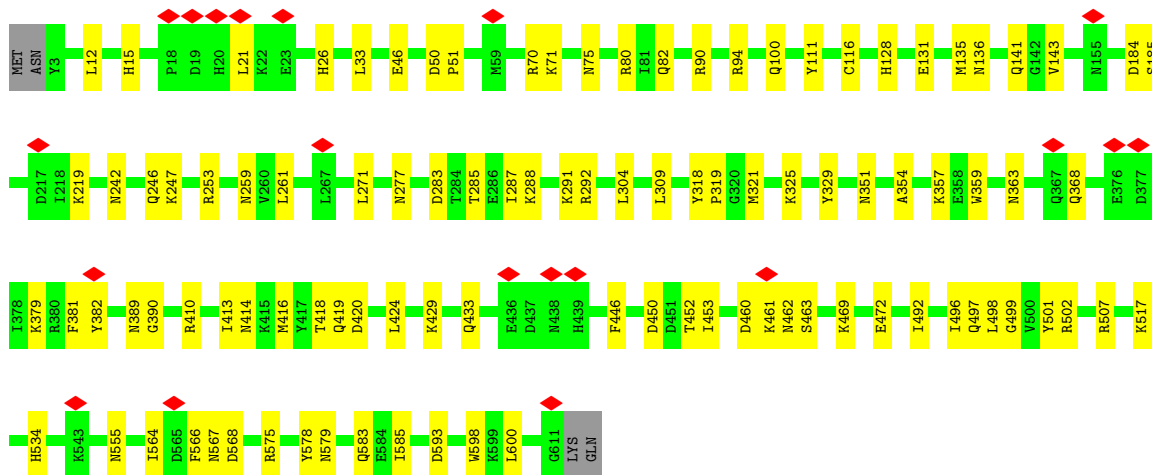
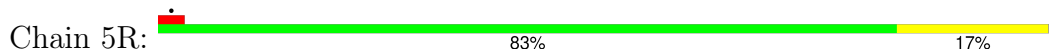

• Molecule 34: Flagellar microtugule protofilament ribbon protein

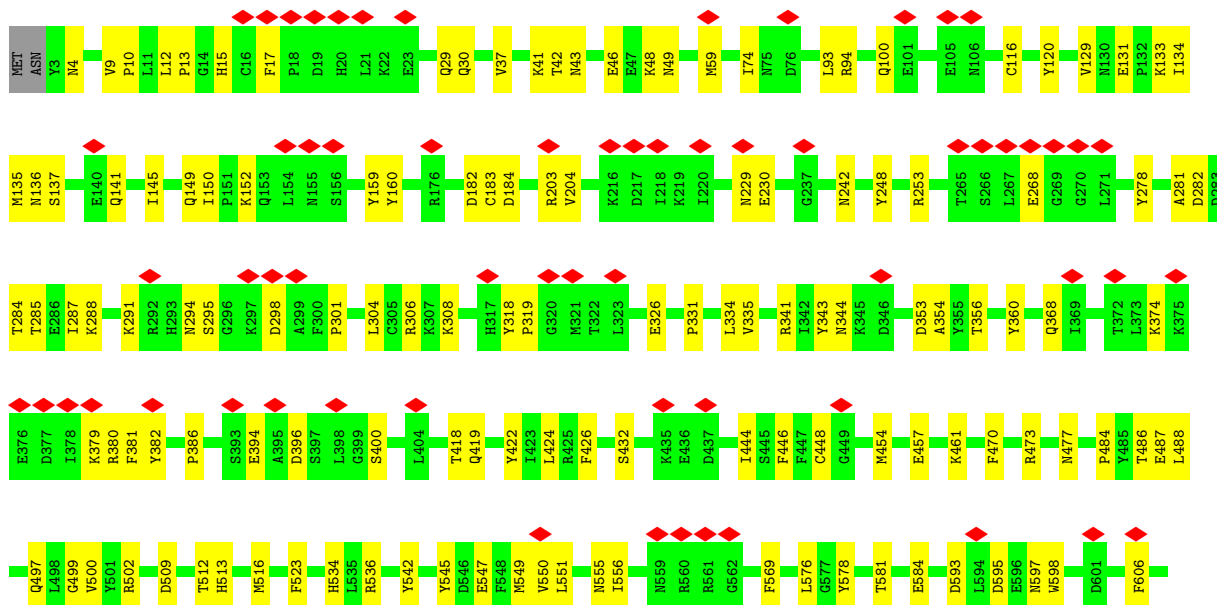
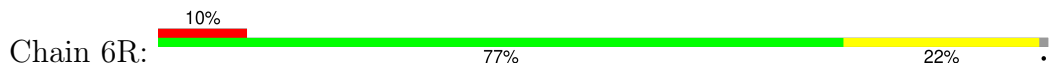

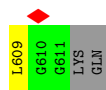

• Molecule 34: Flagellar microtugule protofilament ribbon protein

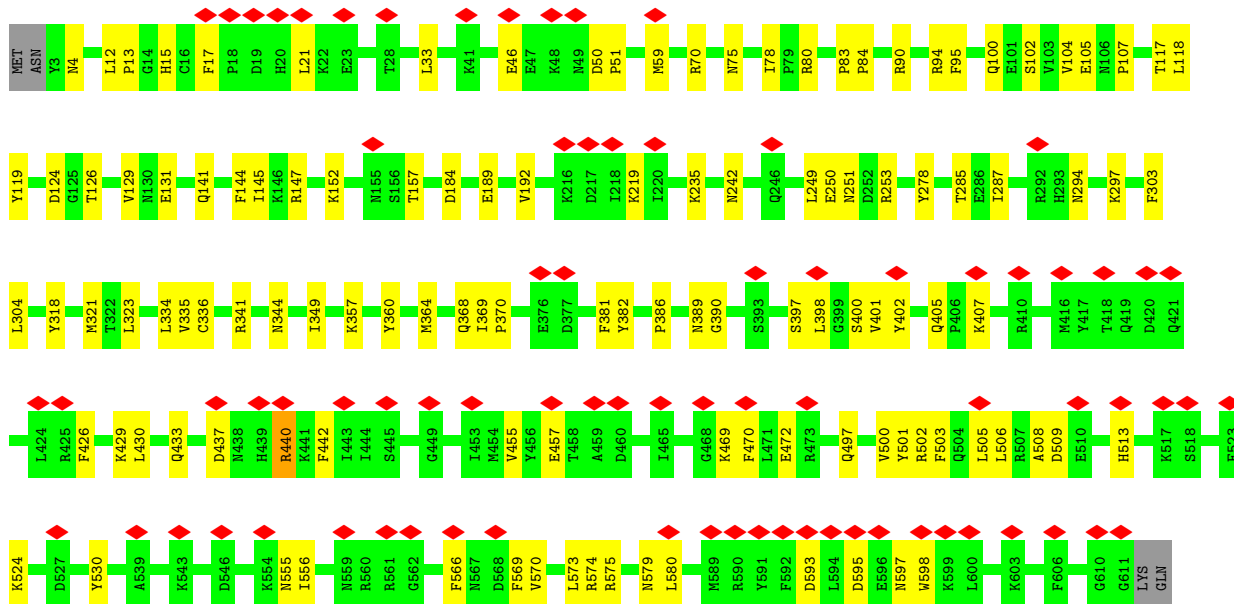
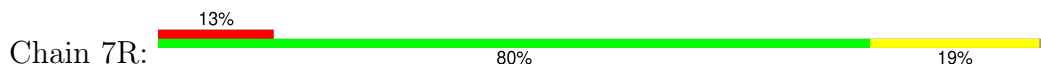

• Molecule 35: Parkin co-regulated protein PACRGB

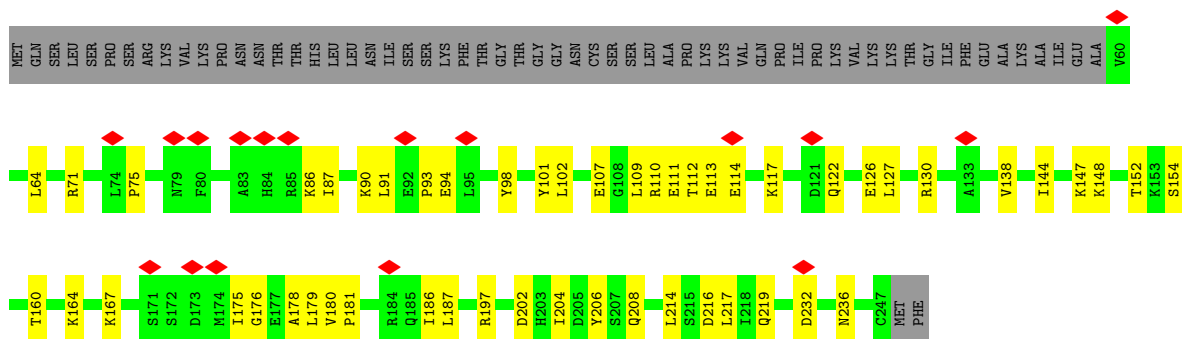

• Molecule 35: Parkin co-regulated protein PACRGB

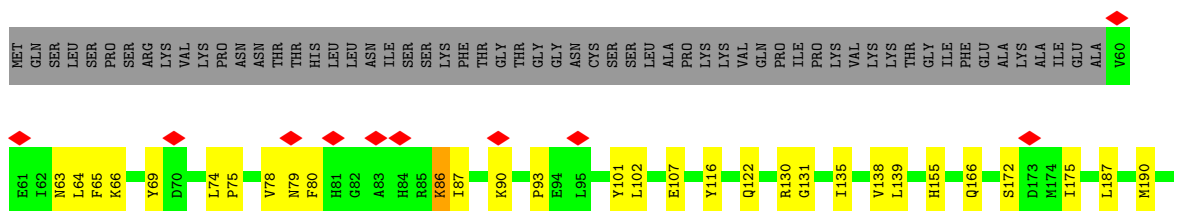

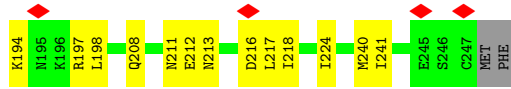

• Molecule 36: OJ2



Chain 5A:

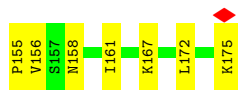
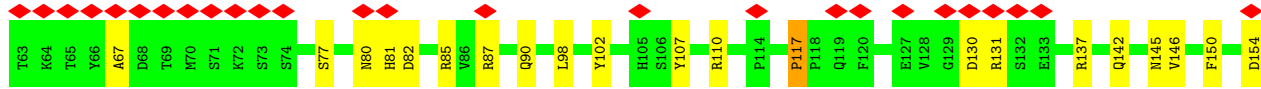
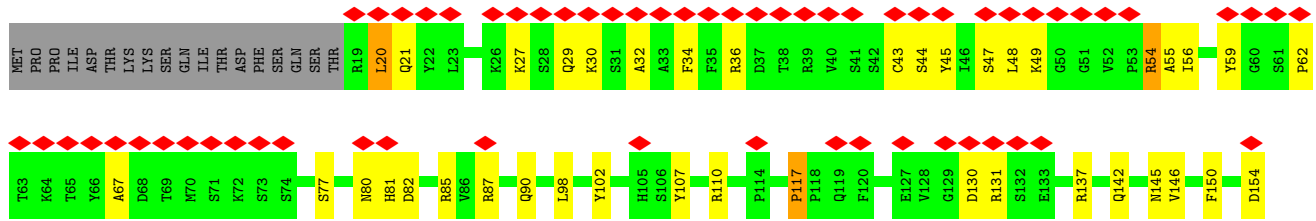

• Molecule 36: OJ2



Chain 5B:

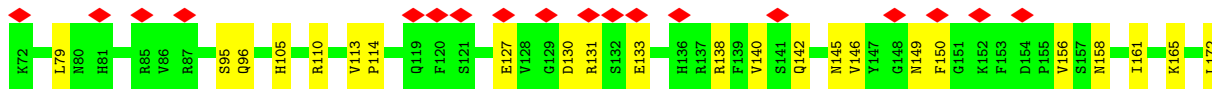

• Molecule 36: OJ2



Chain 5C:

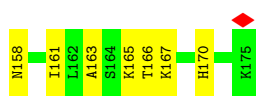
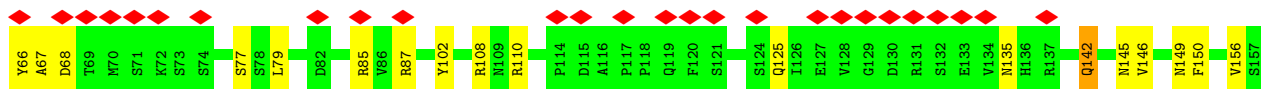
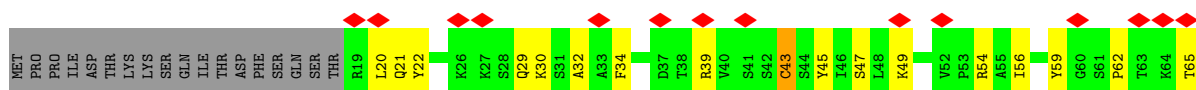

• Molecule 36: OJ2

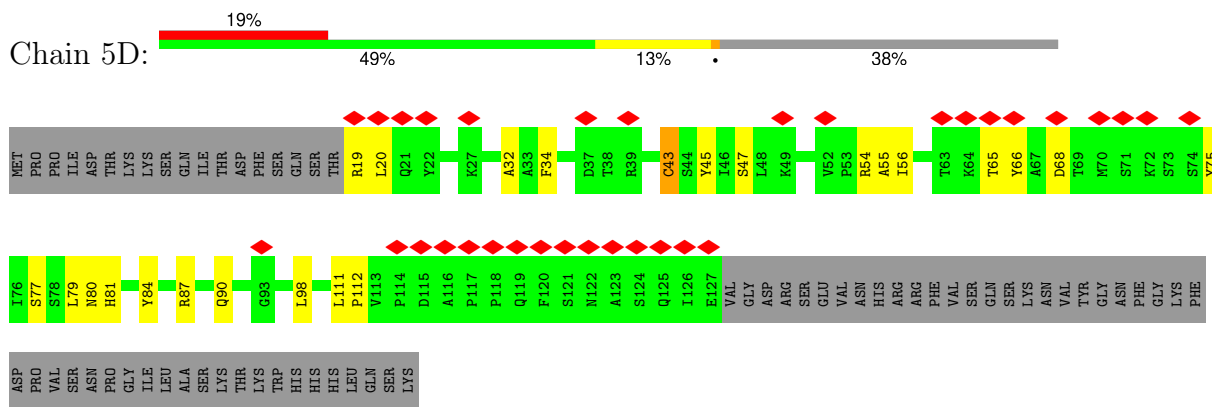

• Molecule 37: CFAP77A

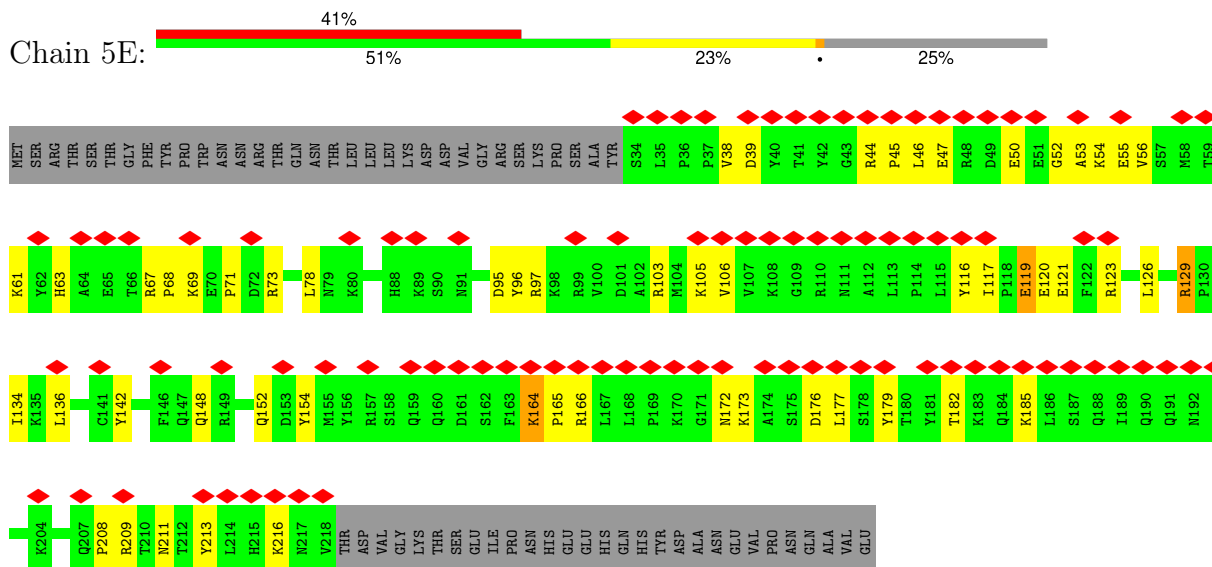

• Molecule 37: CFAP77A

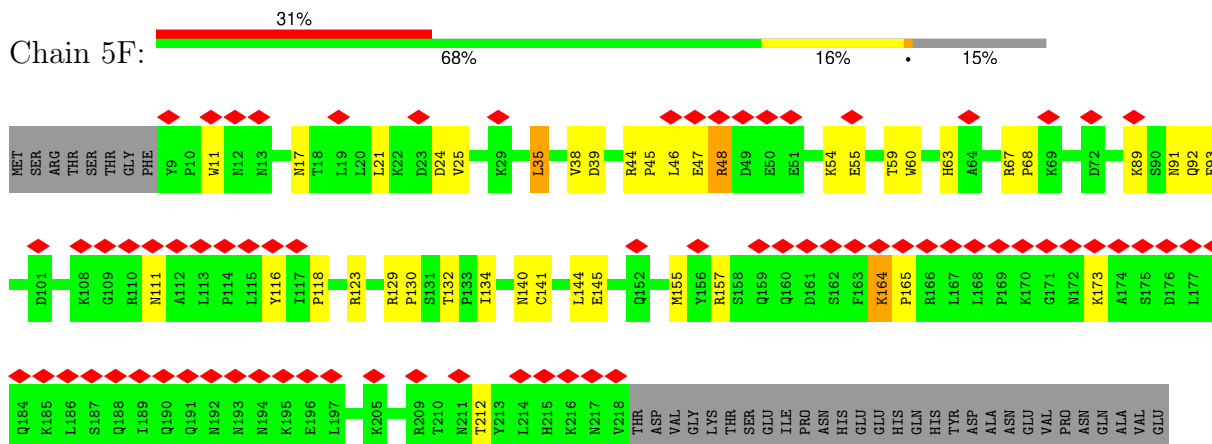

• Molecule 37: CFAP77A



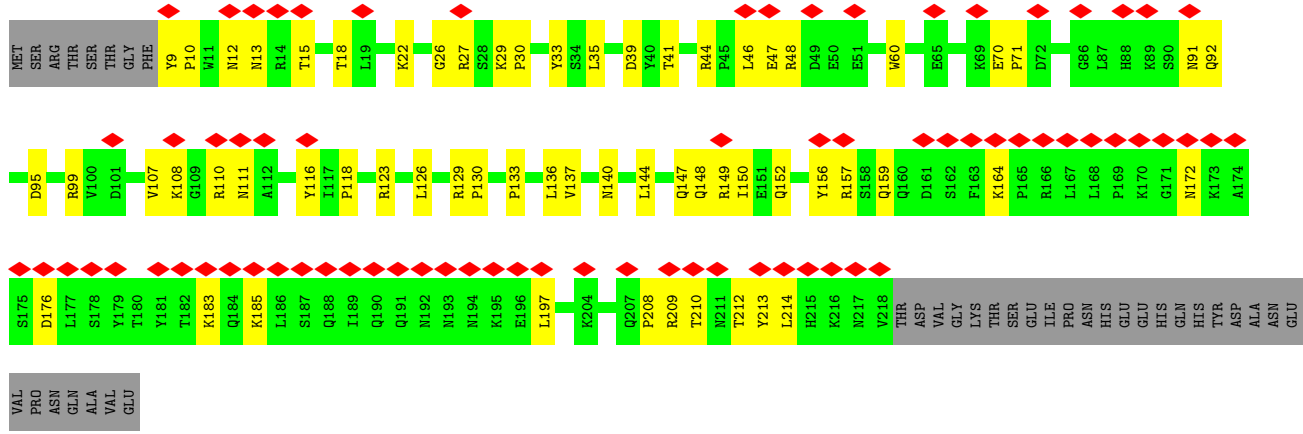

• Molecule 37: CFAP77A

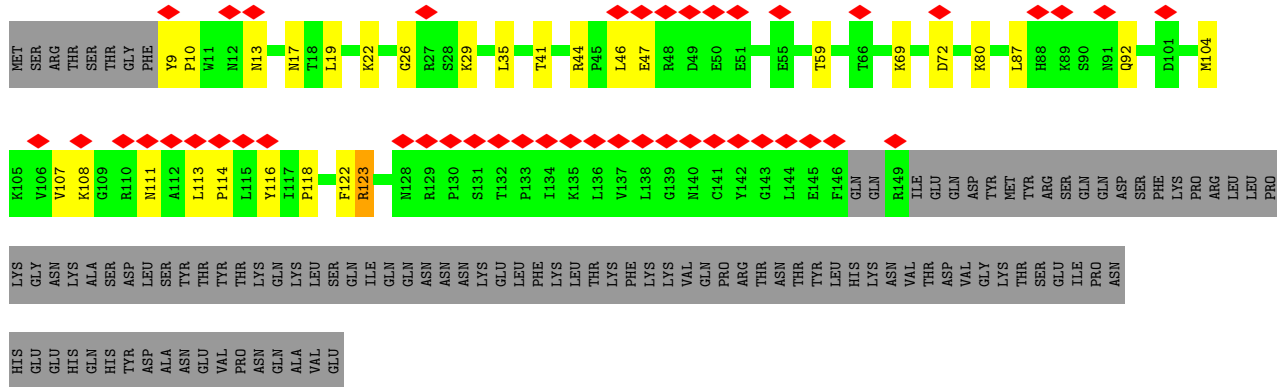

• Molecule 38: OJ3

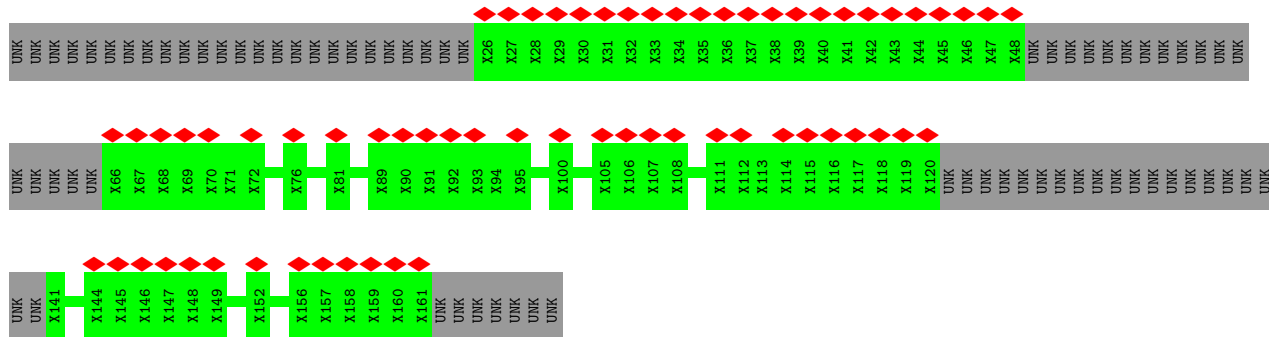

• Molecule 38: OJ3

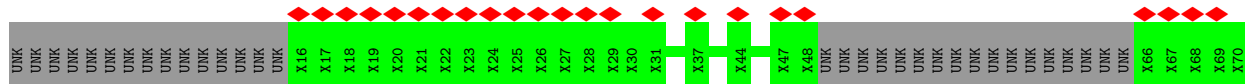
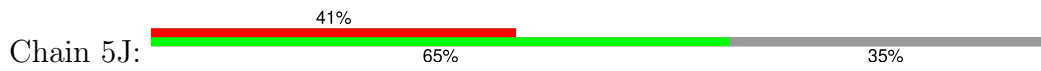

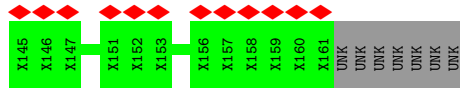
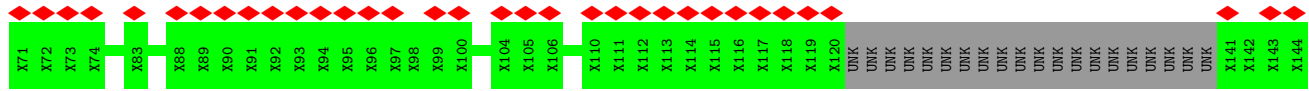

• Molecule 38: OJ3

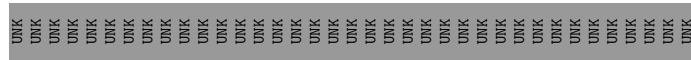
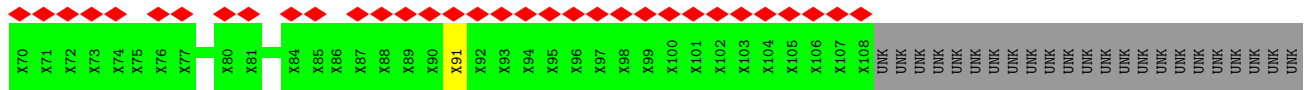
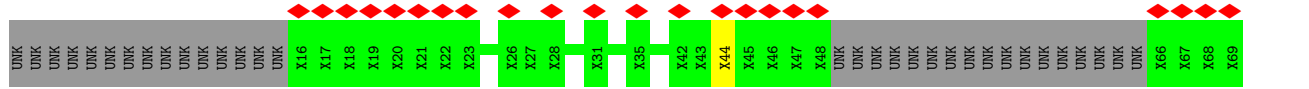
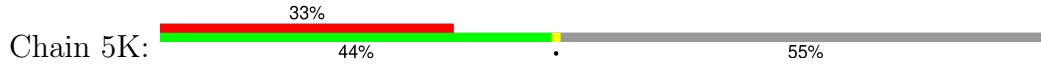

• Molecule 39: SB1

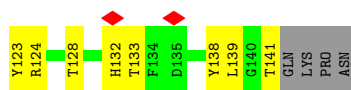
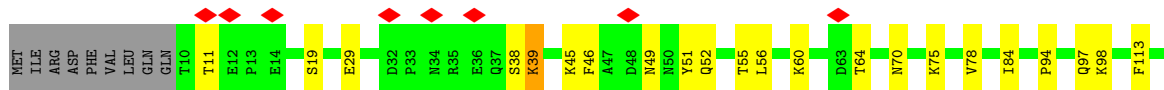

• Molecule 40: STPG1A

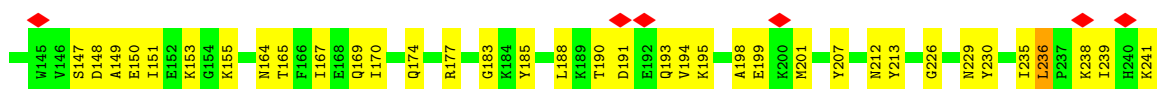
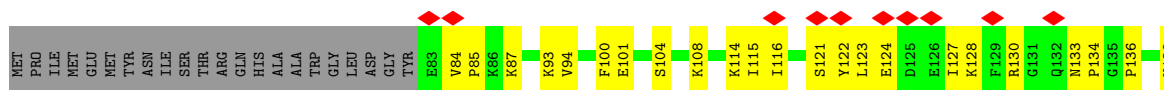
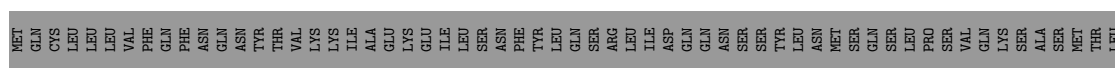

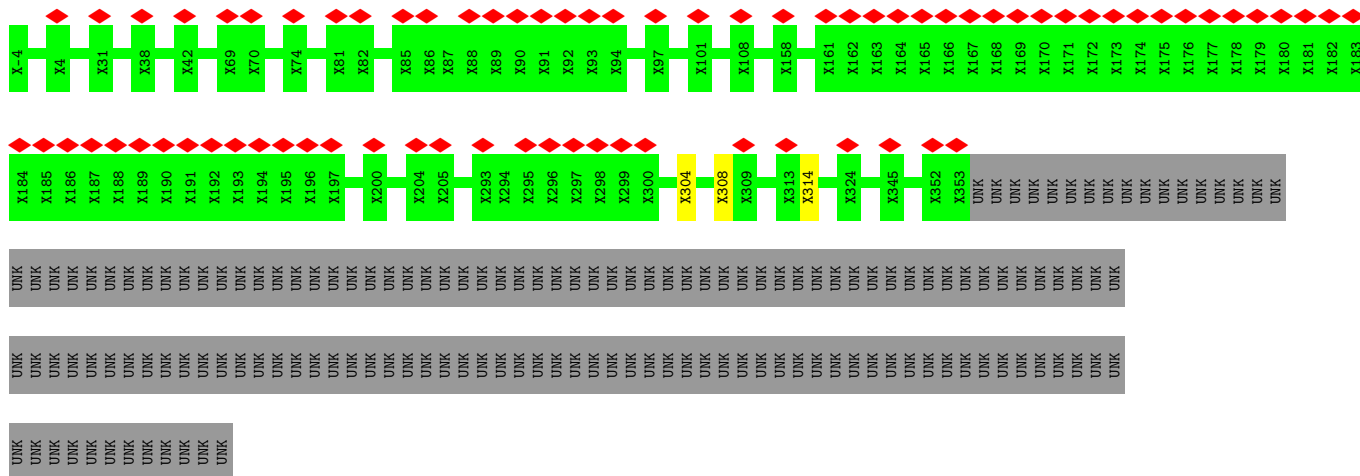

• Molecule 43: CFAP112A

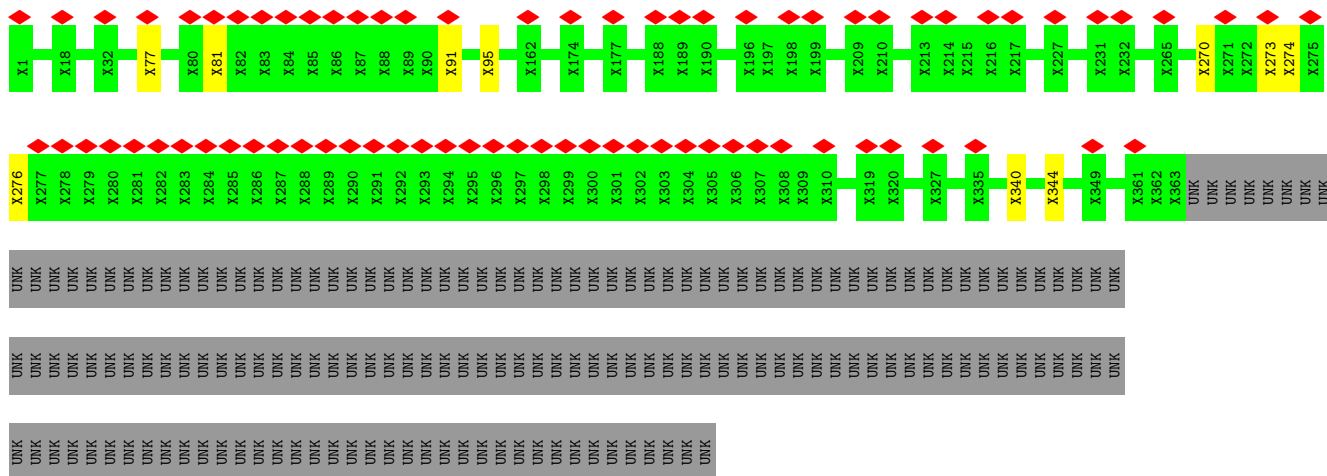

• Molecule 44: B2B3_fmIP

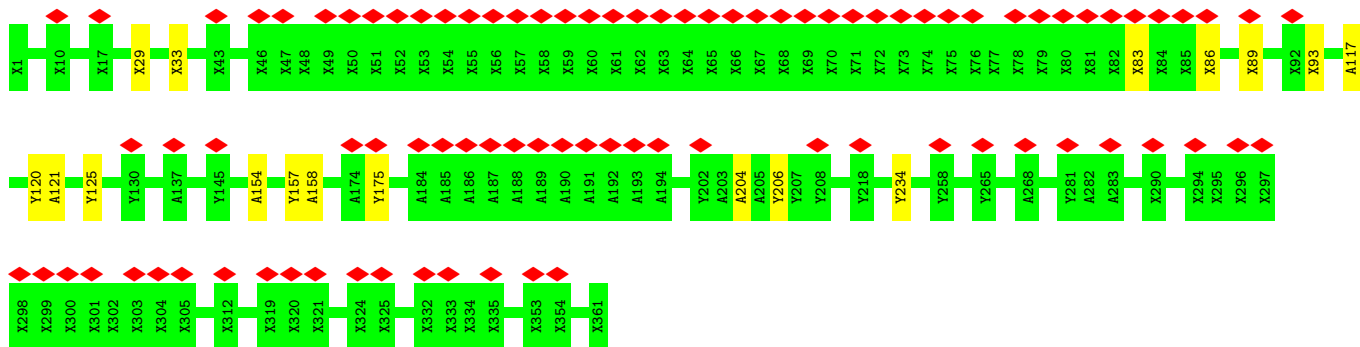

• Molecule 45: Tubulin alpha chain

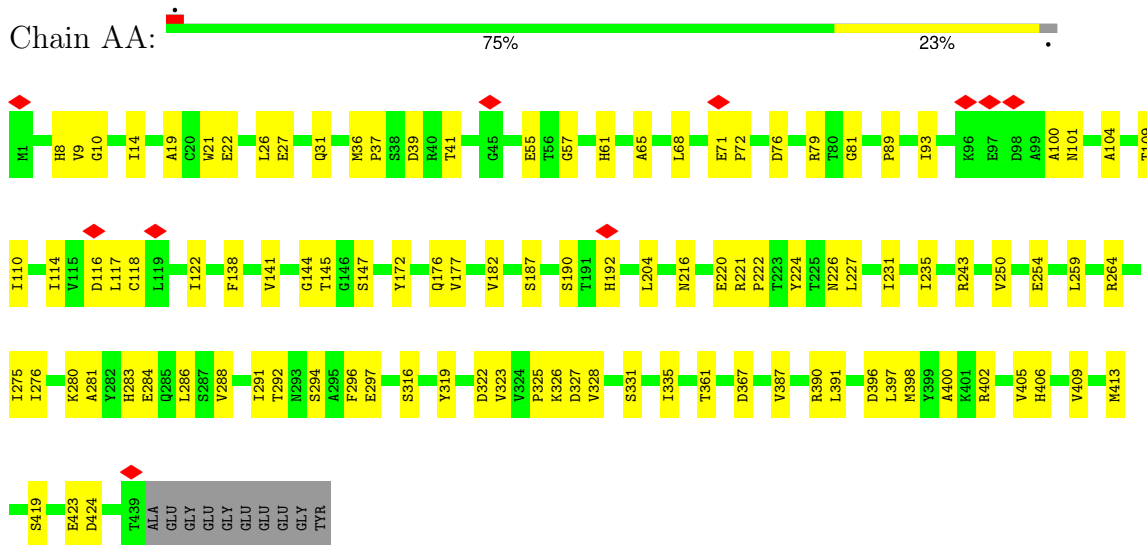

• Molecule 45: Tubulin alpha chain

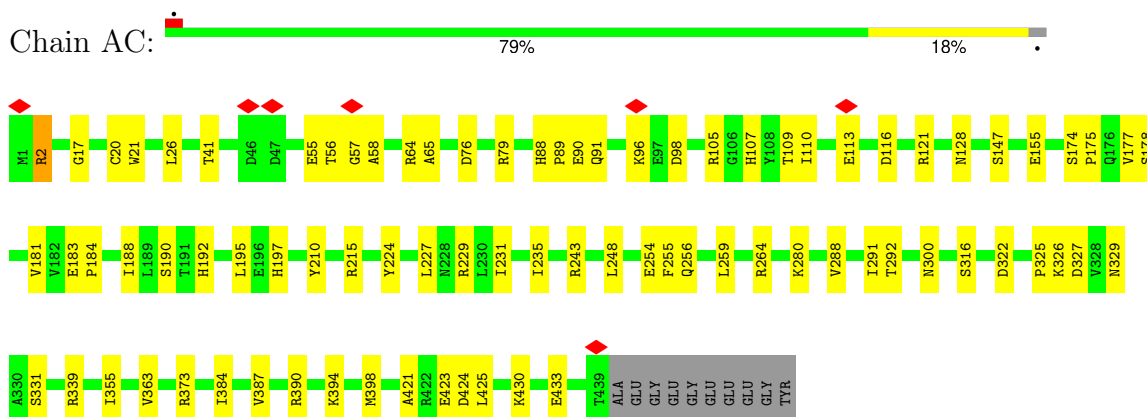

• Molecule 45: Tubulin alpha chain

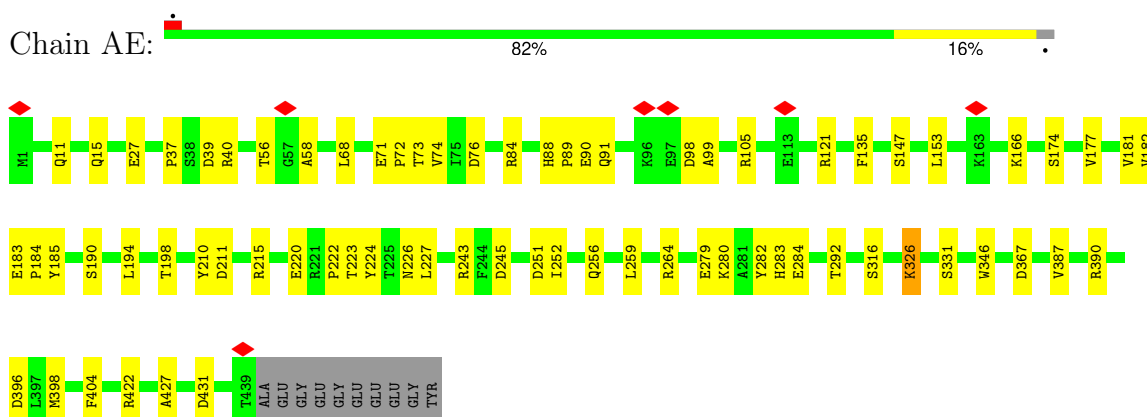

• Molecule 45: Tubulin alpha chain



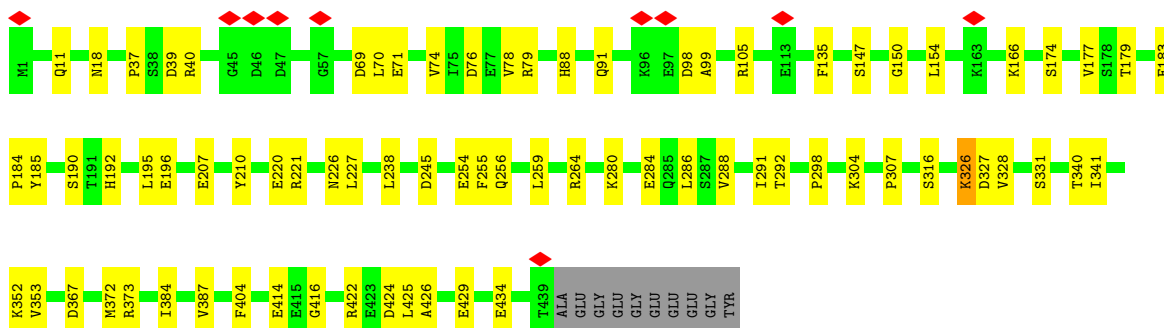

- Molecule 45: Tubulin alpha chain

Chain AI: 83% 15%

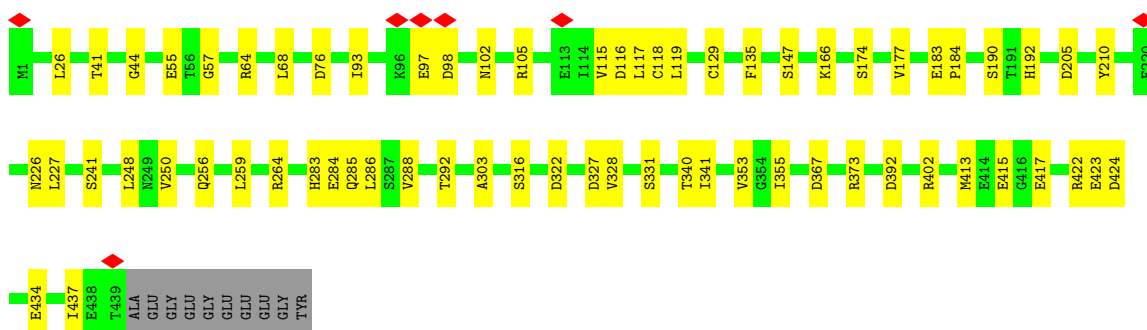

- Molecule 45: Tubulin alpha chain

Chain AK: 81% 16%

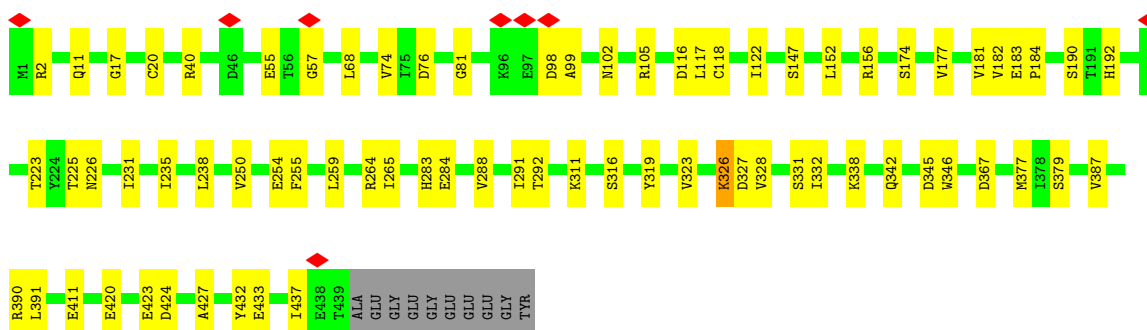

- Molecule 45: Tubulin alpha chain

Chain AM: 74% 23%

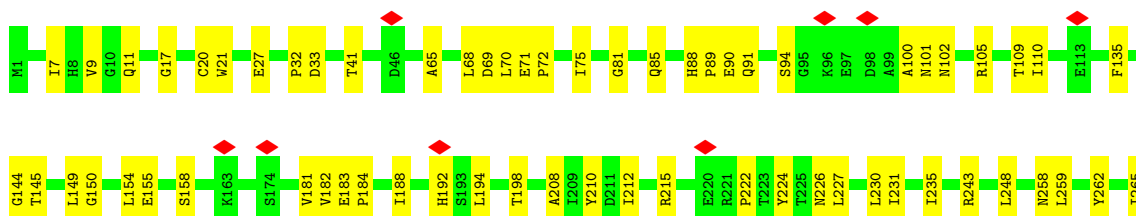

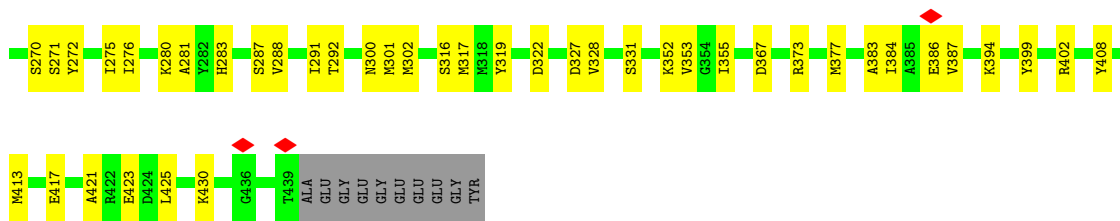

• Molecule 45: Tubulin alpha chain

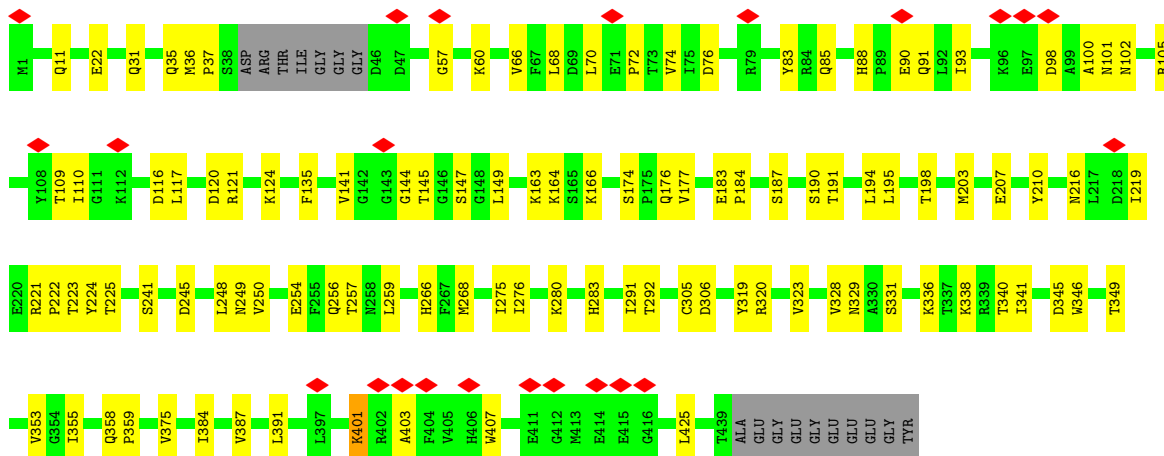
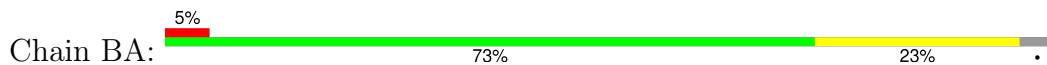

• Molecule 45: Tubulin alpha chain

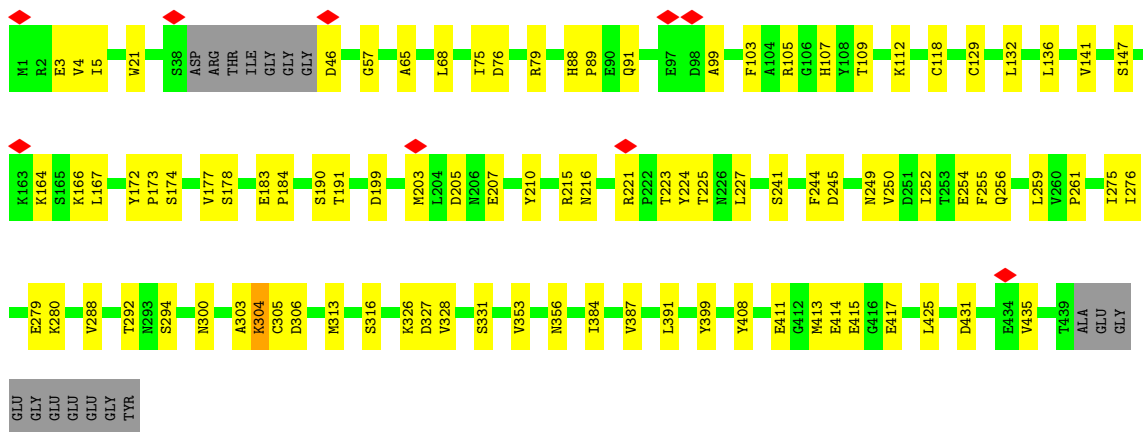
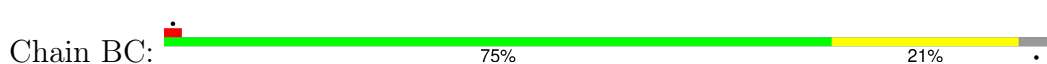

• Molecule 45: Tubulin alpha chain

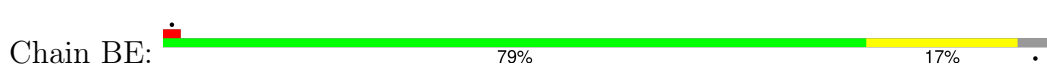

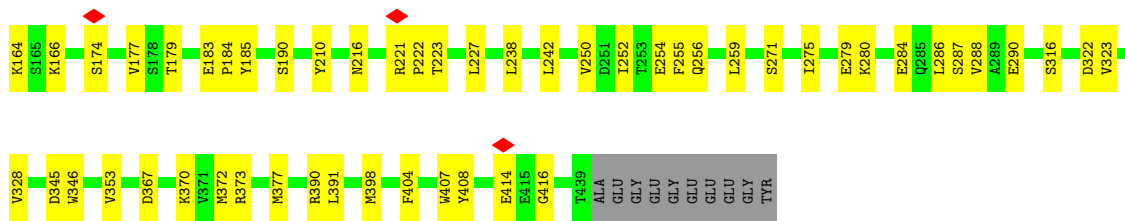

• Molecule 45: Tubulin alpha chain

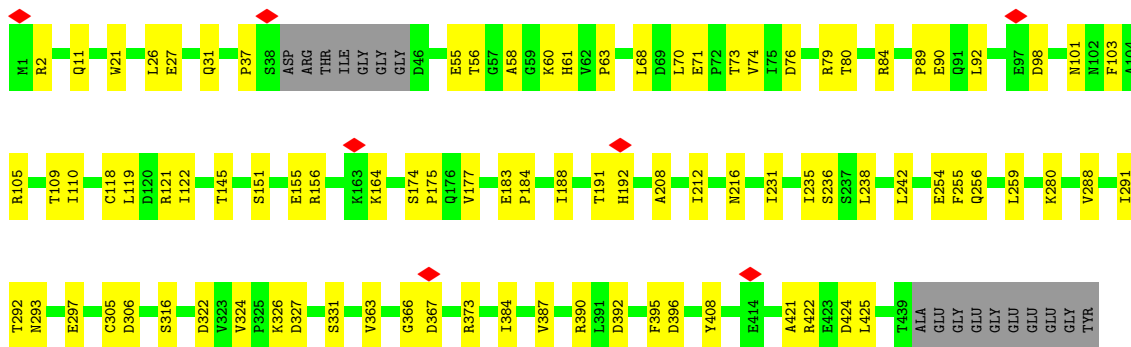
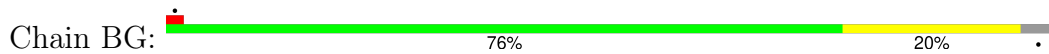

• Molecule 45: Tubulin alpha chain

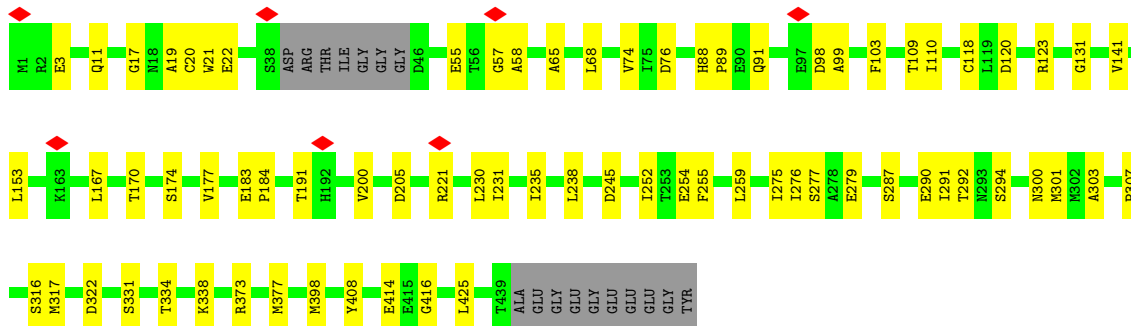
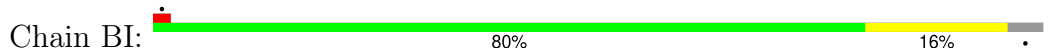

• Molecule 45: Tubulin alpha chain

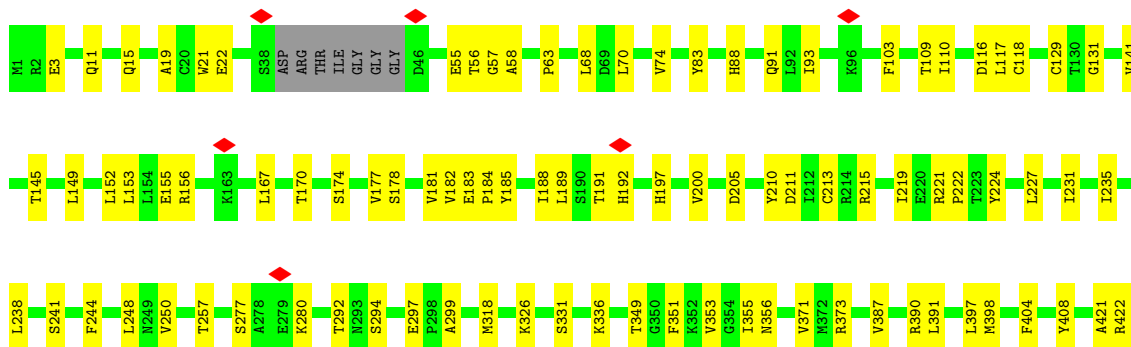
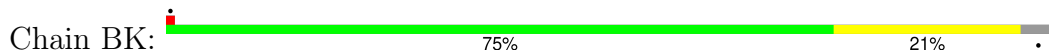

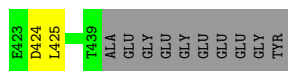

• Molecule 45: Tubulin alpha chain

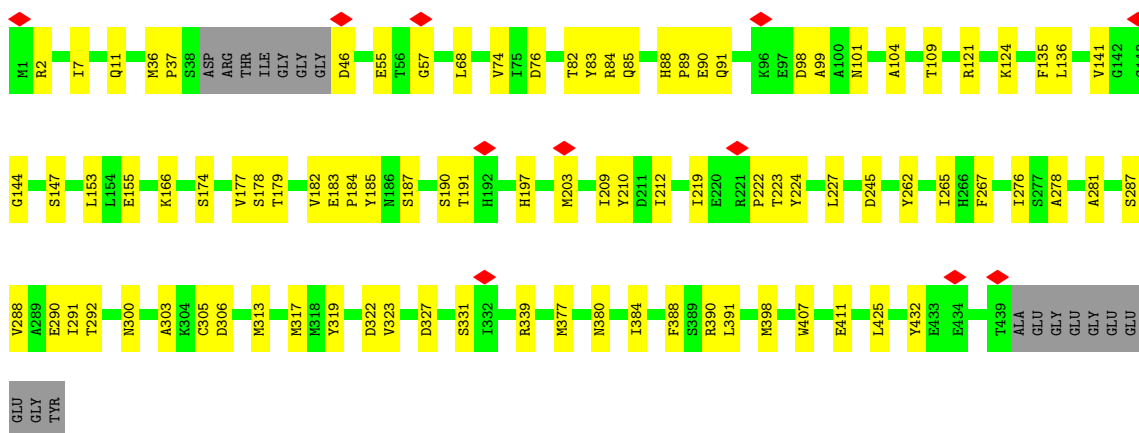
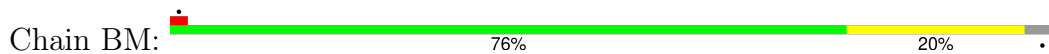

• Molecule 45: Tubulin alpha chain

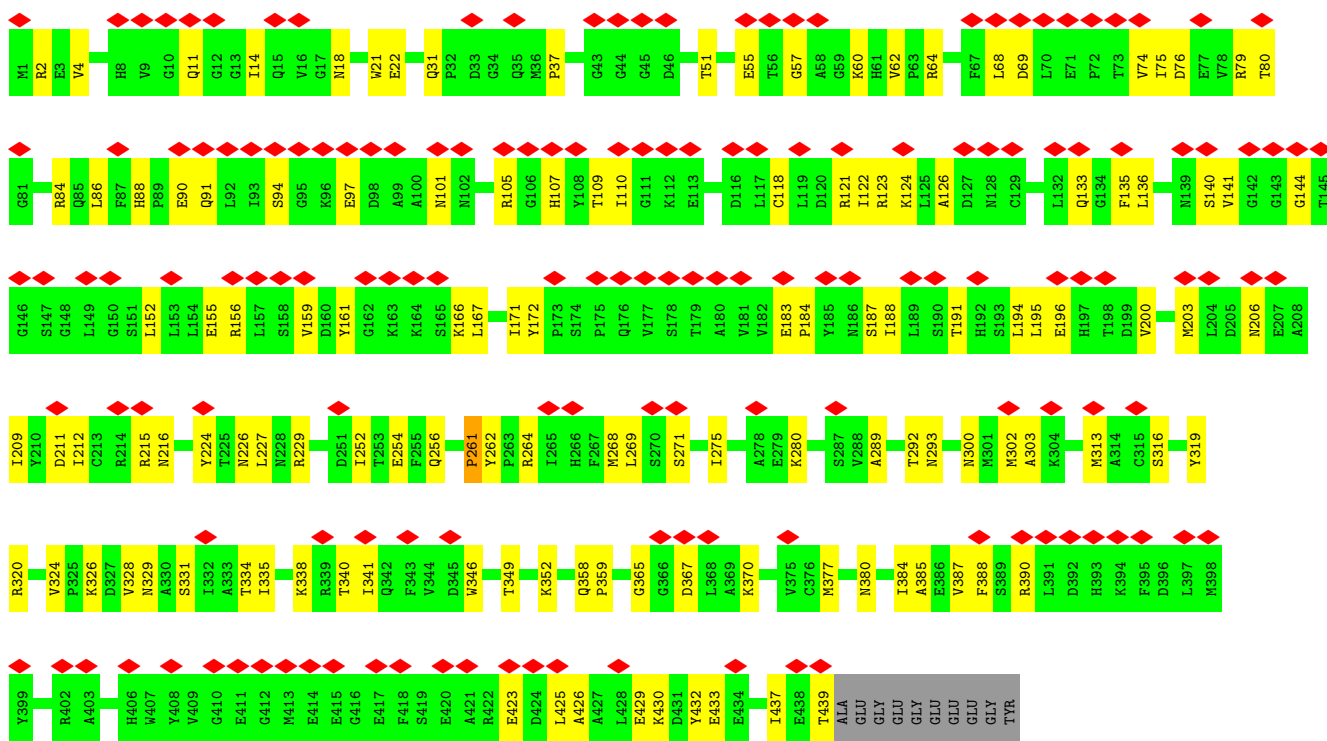

• Molecule 45: Tubulin alpha chain

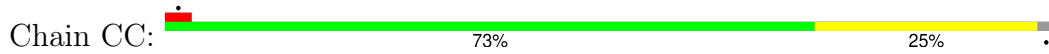

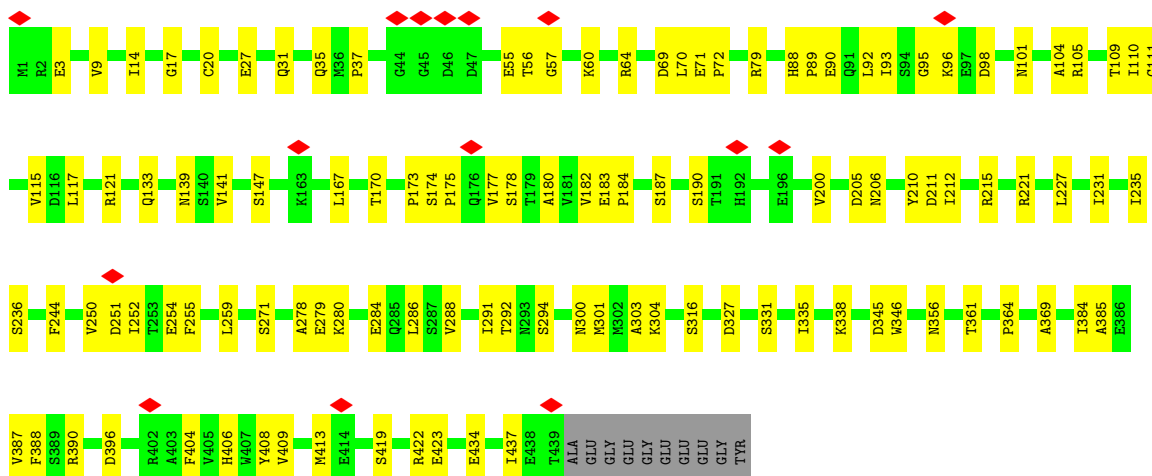

• Molecule 45: Tubulin alpha chain

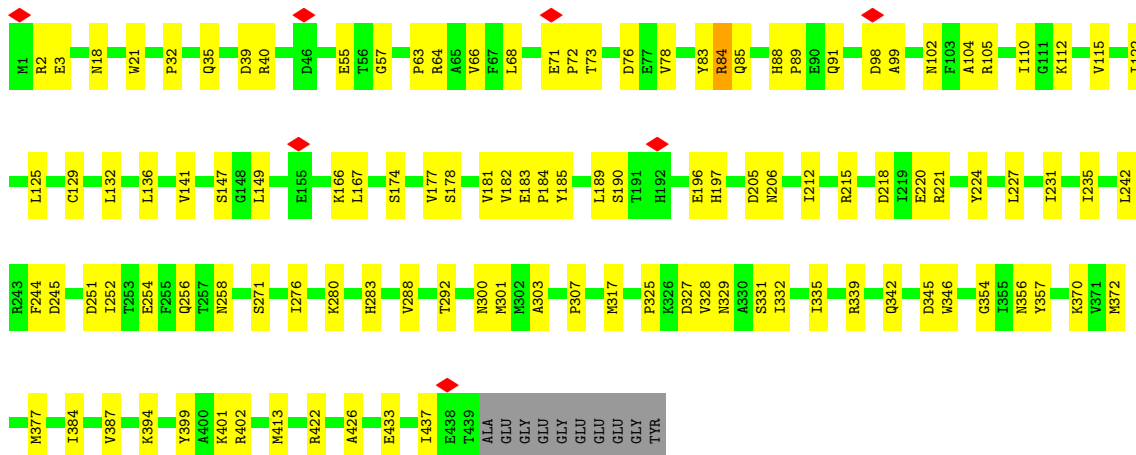

• Molecule 45: Tubulin alpha chain

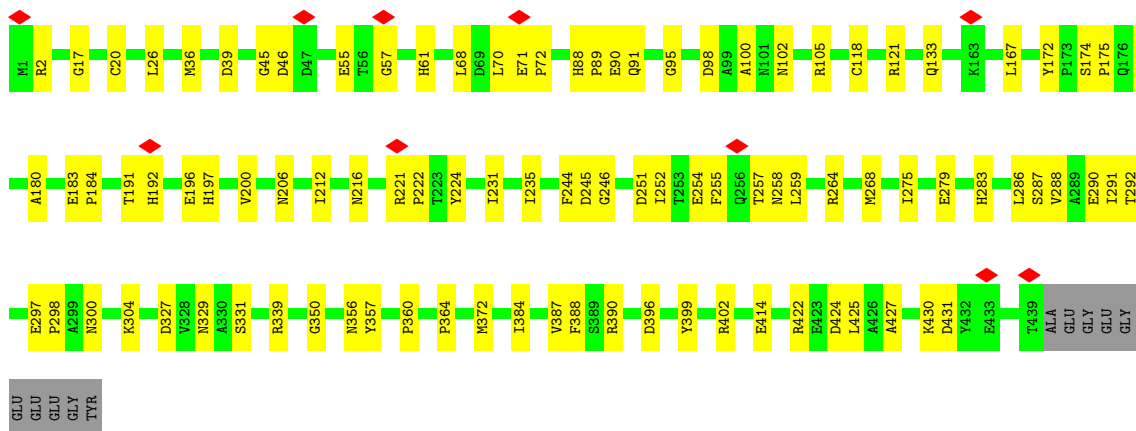
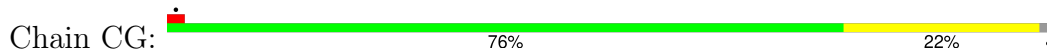

• Molecule 45: Tubulin alpha chain

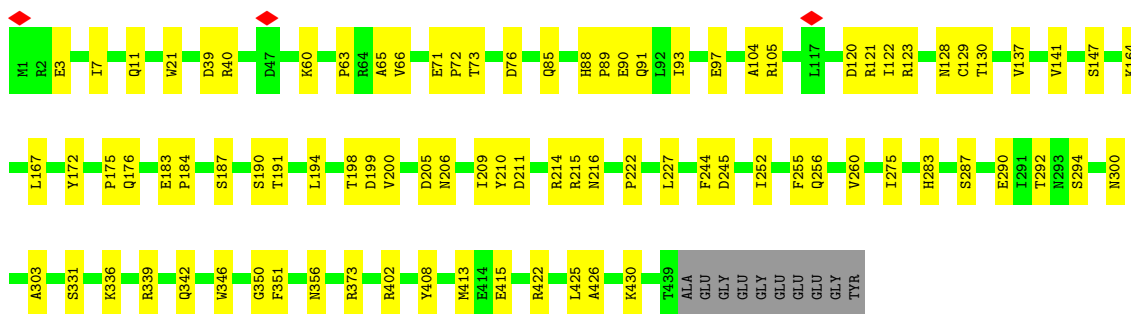
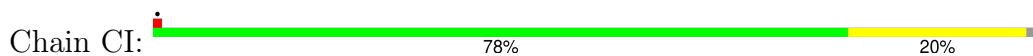

• Molecule 45: Tubulin alpha chain

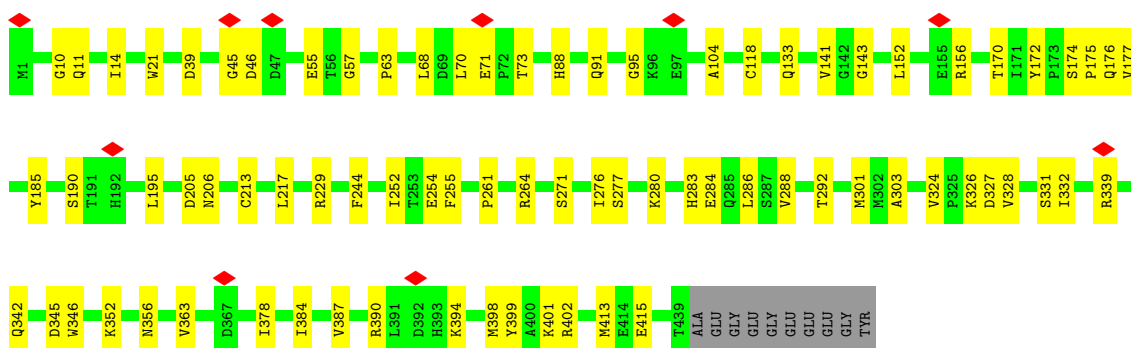
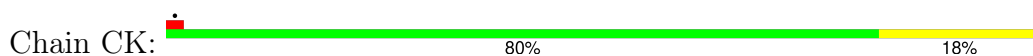

• Molecule 45: Tubulin alpha chain

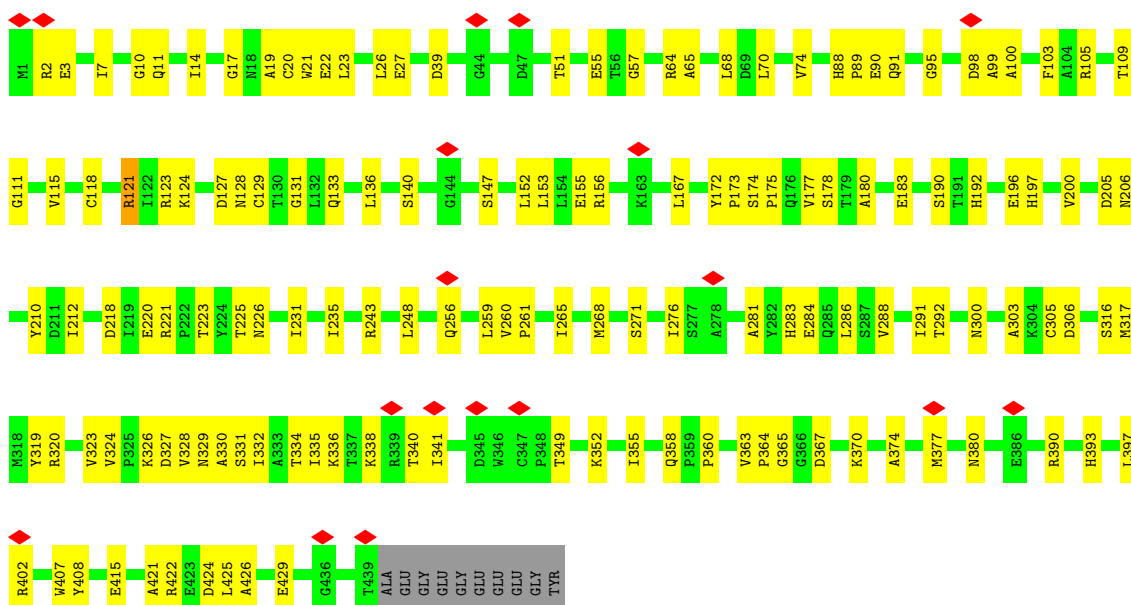

● Molecule 45: Tubulin alpha chain

Chain DA:

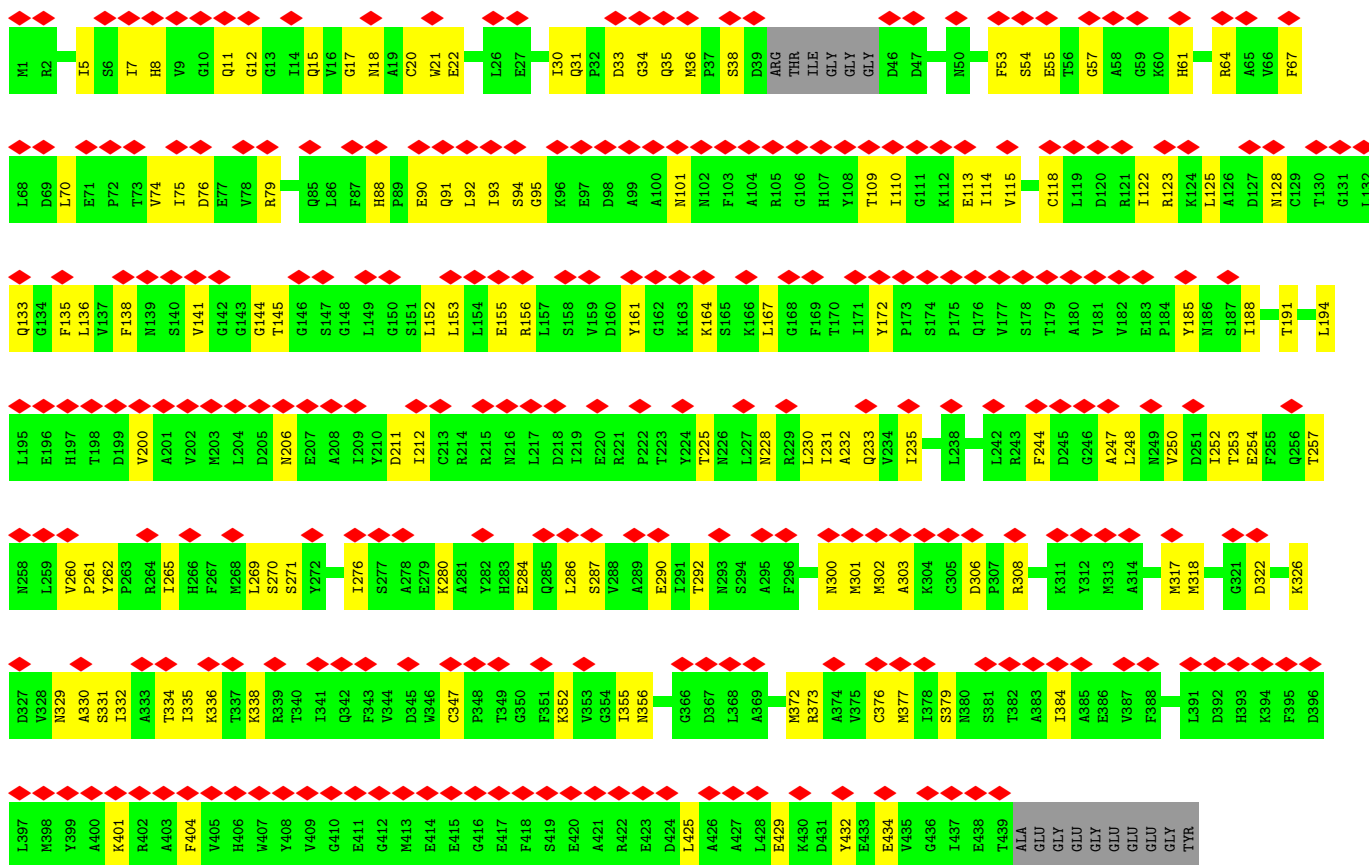

● Molecule 45: Tubulin alpha chain

Chain DC:

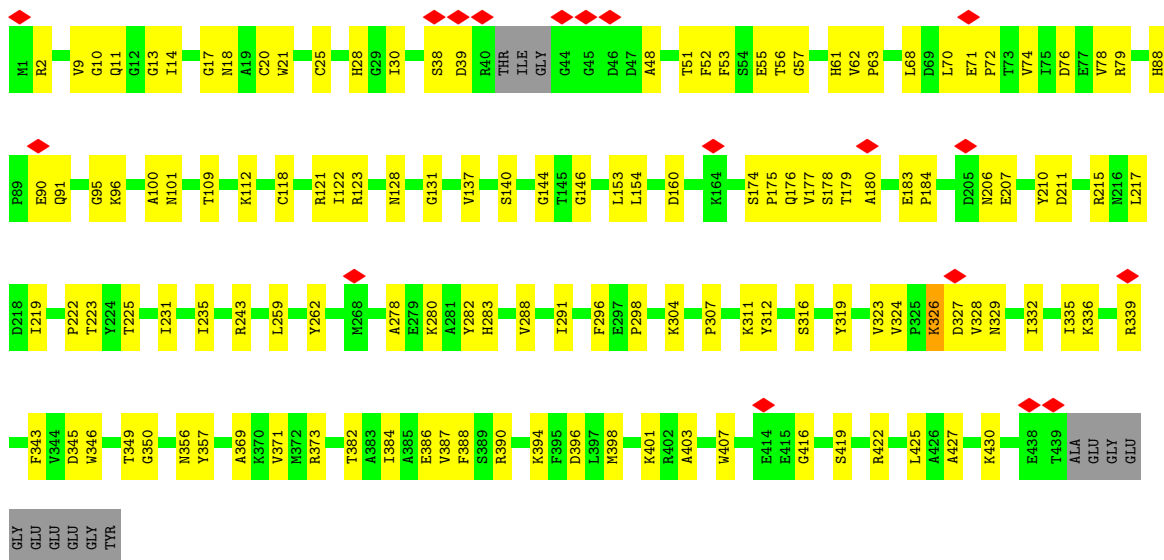

• Molecule 45: Tubulin alpha chain

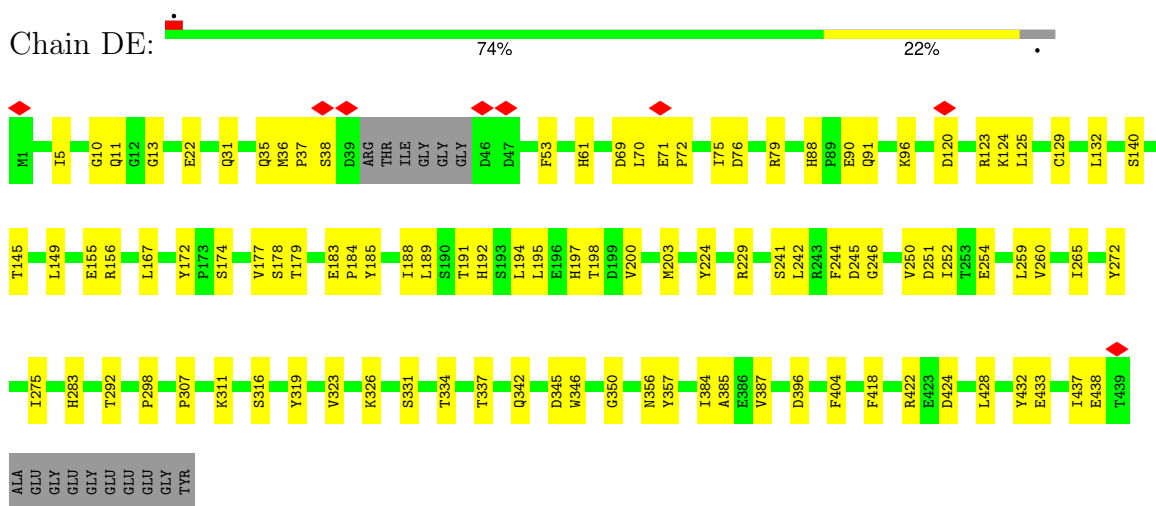

• Molecule 45: Tubulin alpha chain

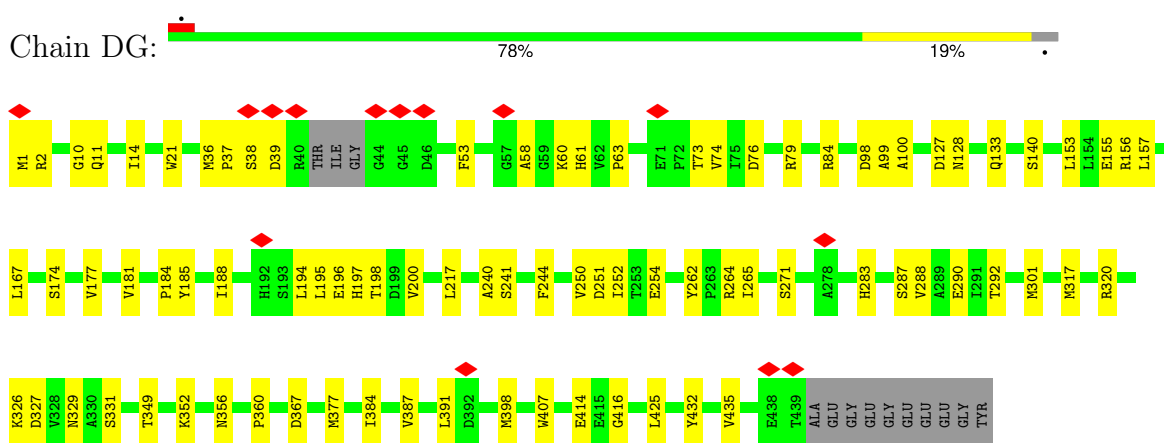

• Molecule 45: Tubulin alpha chain

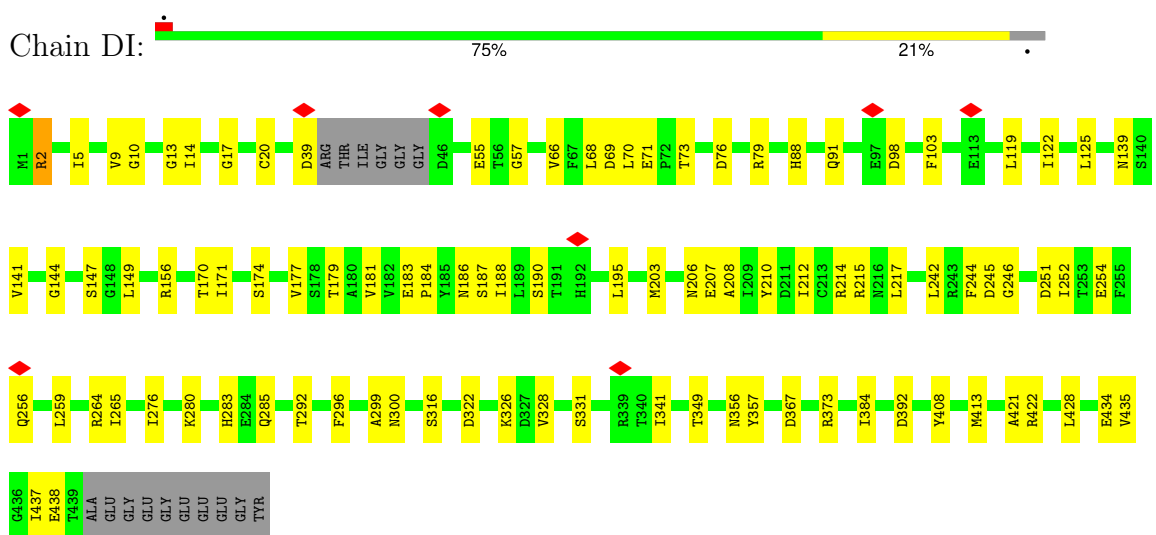

• Molecule 45: Tubulin alpha chain

Chain DK:

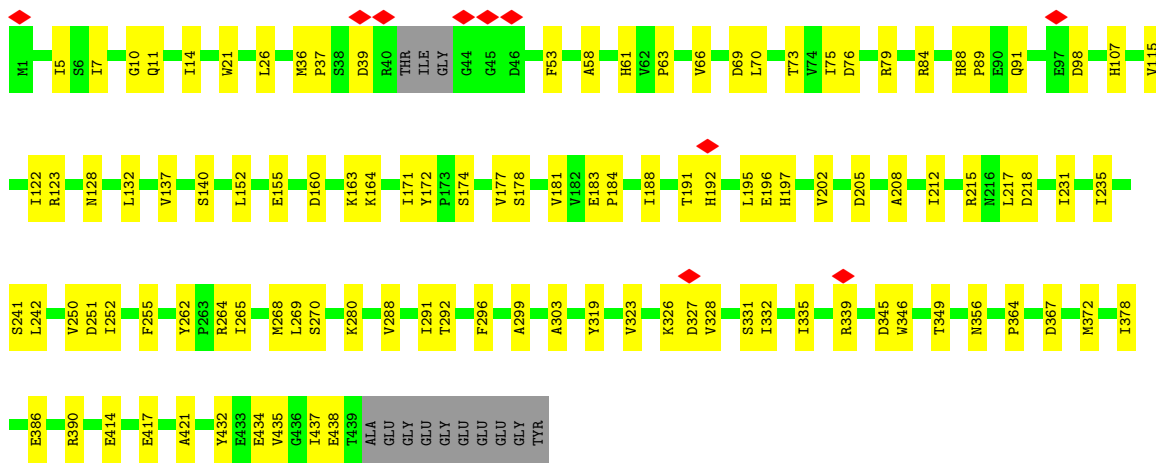

• Molecule 45: Tubulin alpha chain

Chain DM:

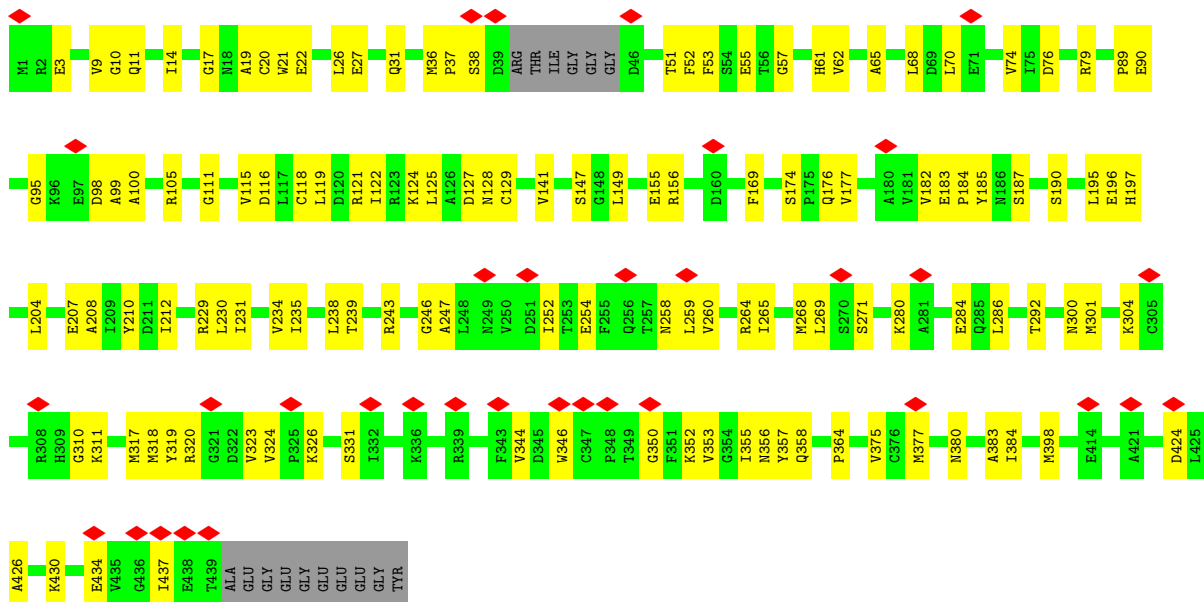

• Molecule 45: Tubulin alpha chain

Chain EA:

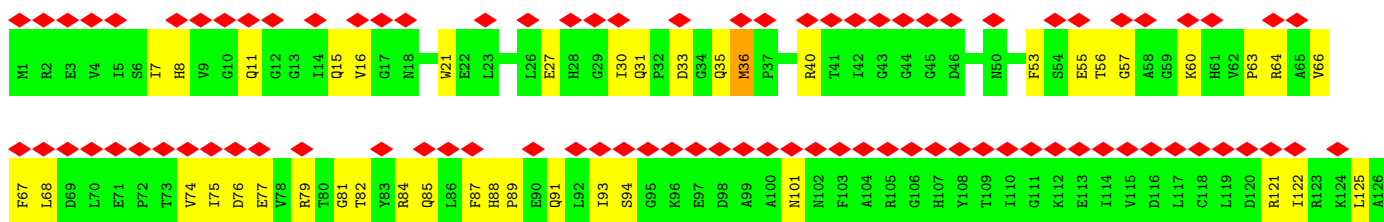

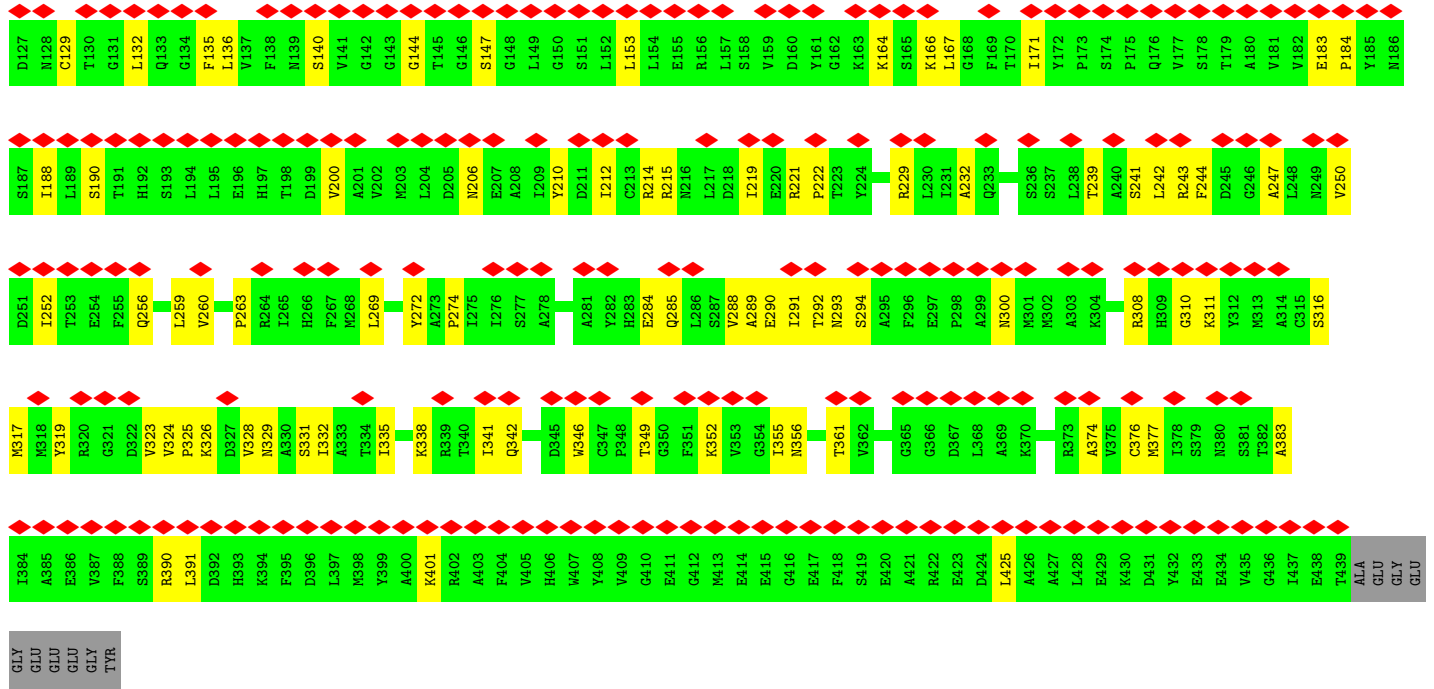

- Molecule 45: Tubulin alpha chain

Chain EC: 70% 27%

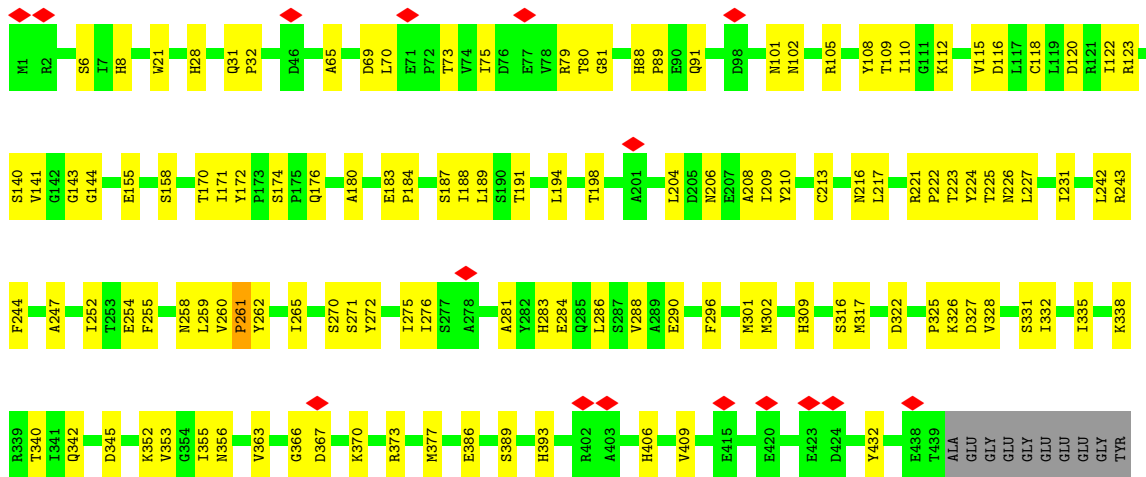

- Molecule 45: Tubulin alpha chain

Chain EE: 78% 19%

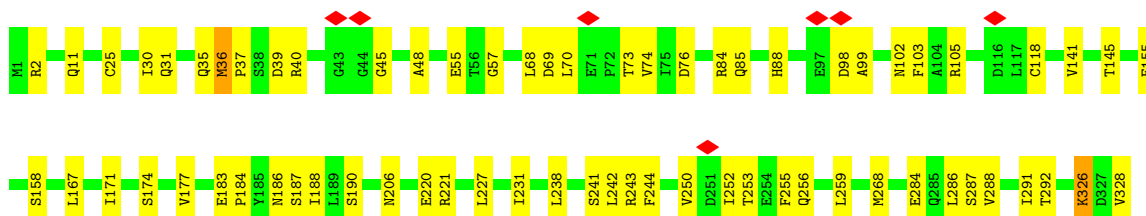

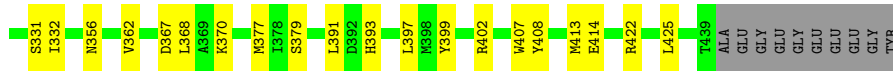

• Molecule 45: Tubulin alpha chain

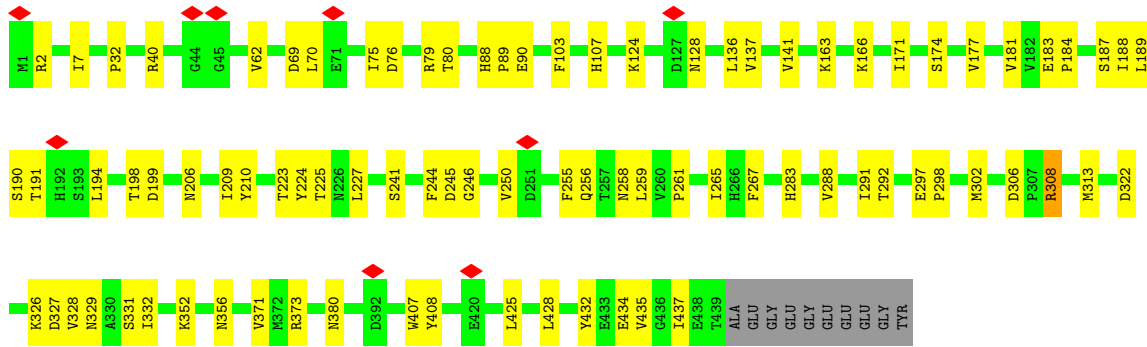
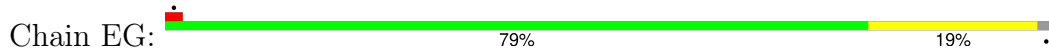

• Molecule 45: Tubulin alpha chain

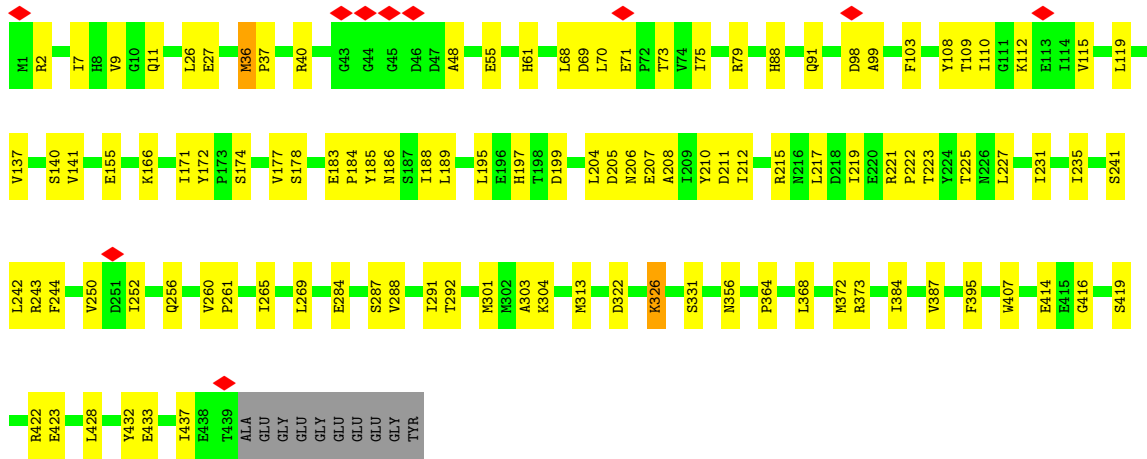

• Molecule 45: Tubulin alpha chain

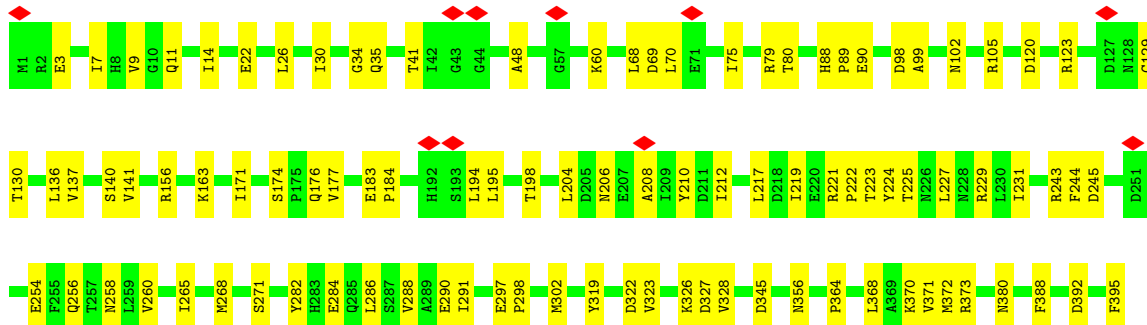
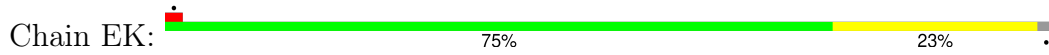

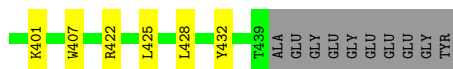

• Molecule 45: Tubulin alpha chain

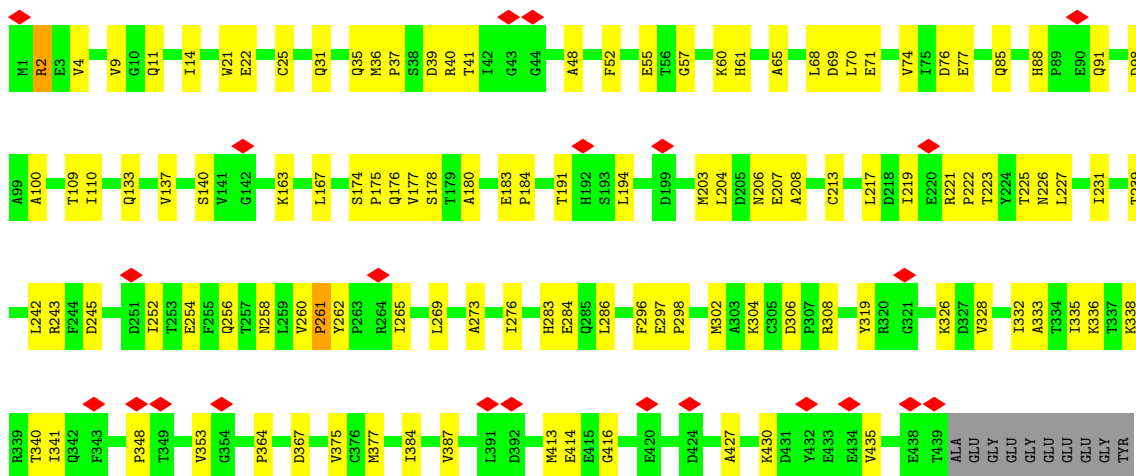
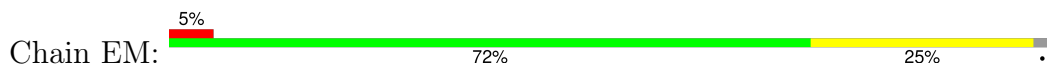

• Molecule 45: Tubulin alpha chain

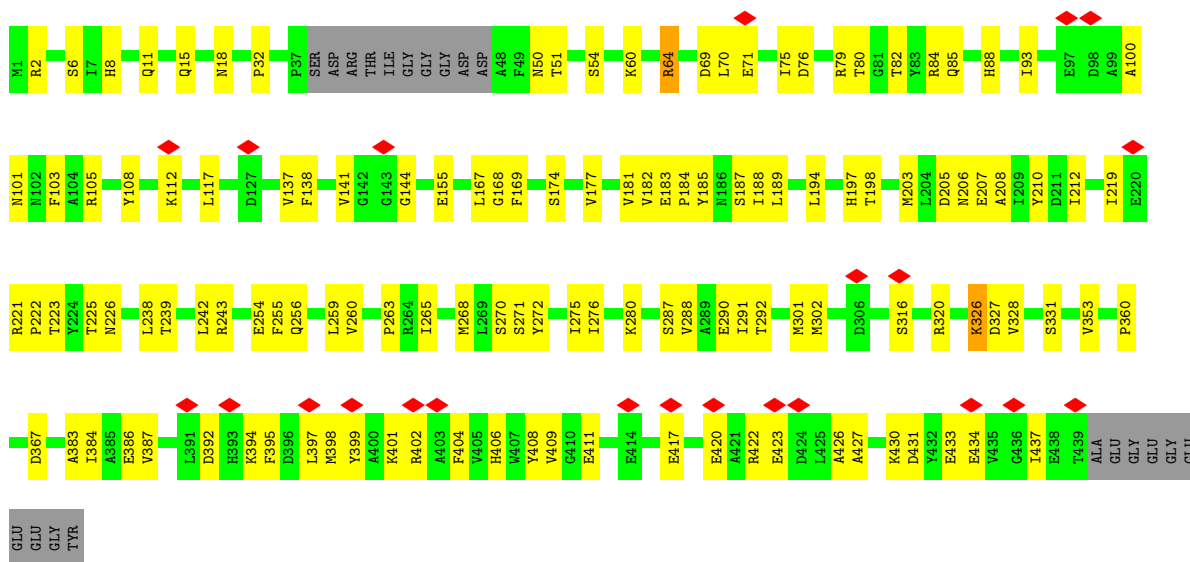

• Molecule 45: Tubulin alpha chain

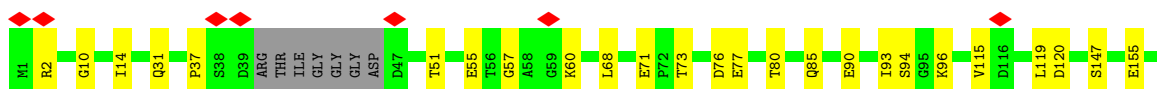
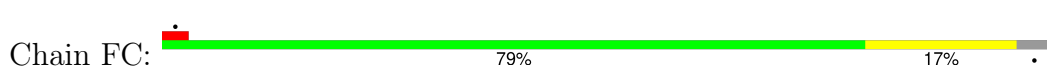

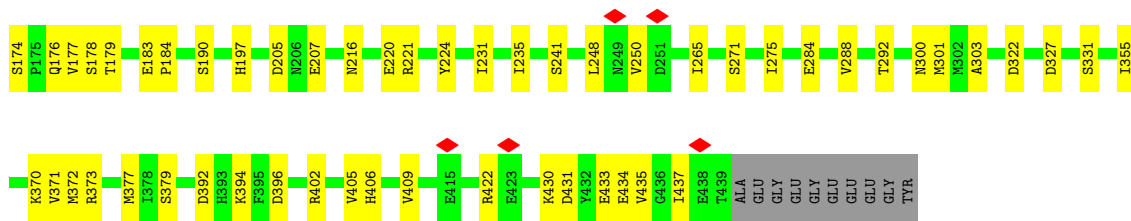

• Molecule 45: Tubulin alpha chain

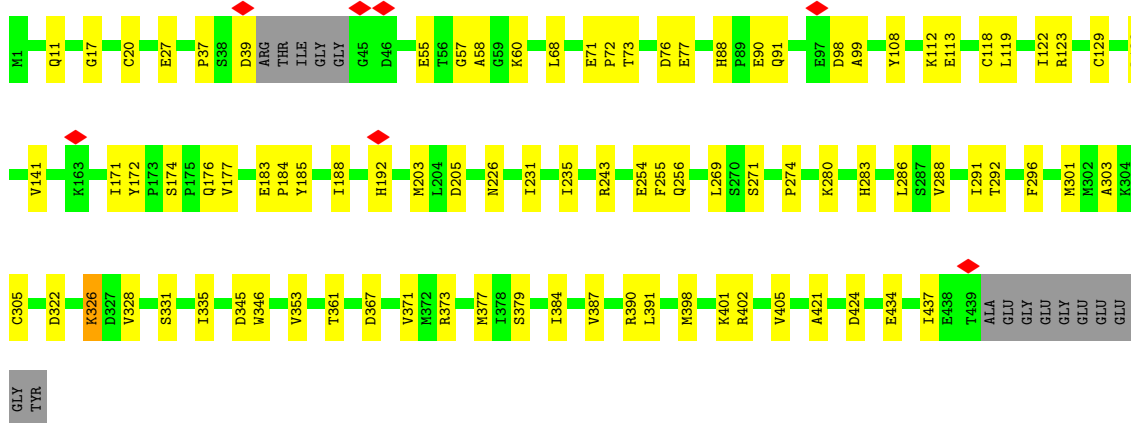
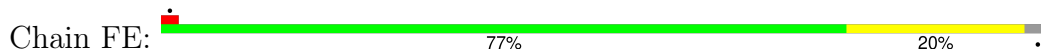

• Molecule 45: Tubulin alpha chain

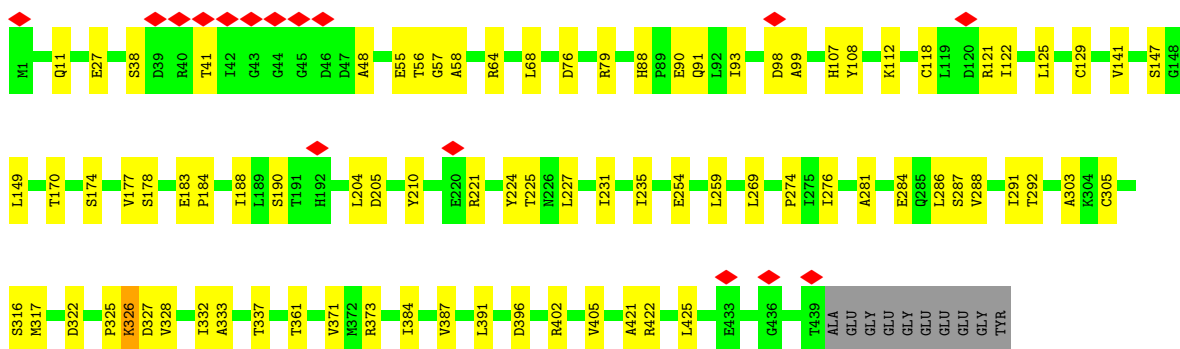
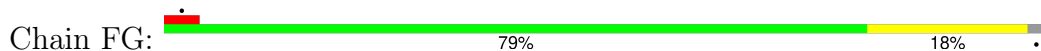

• Molecule 45: Tubulin alpha chain

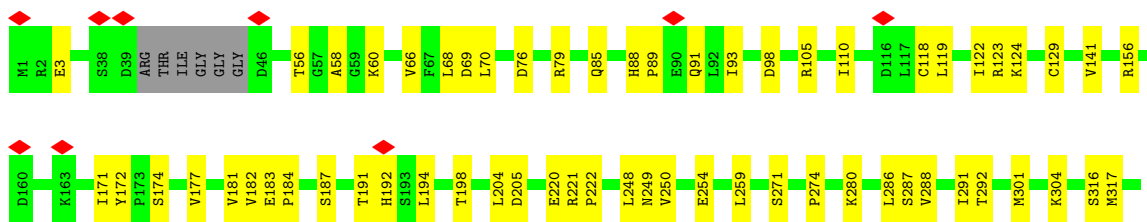
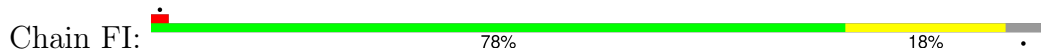



• Molecule 45: Tubulin alpha chain

Chain FK: 73% 23%

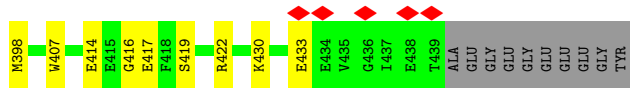
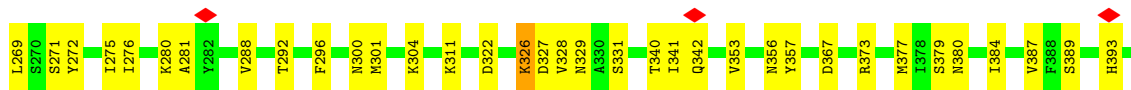
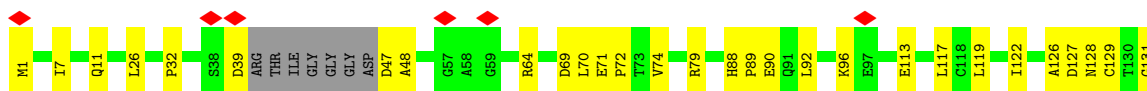

• Molecule 45: Tubulin alpha chain

Chain FM: 77% 76% 19%

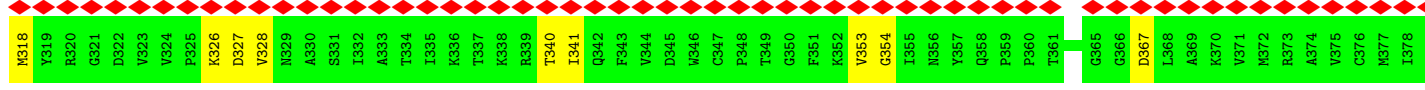
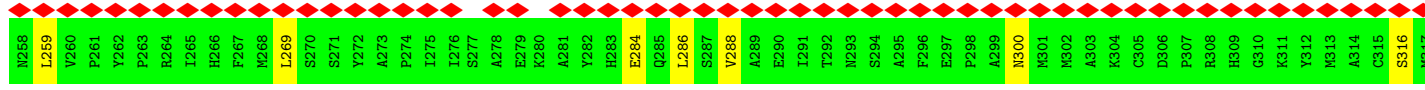
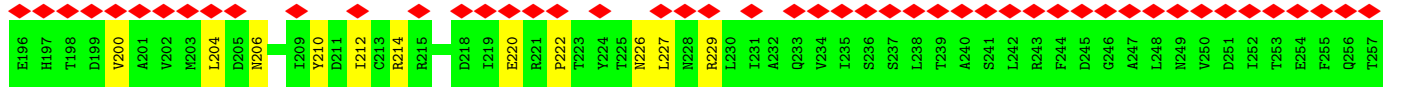
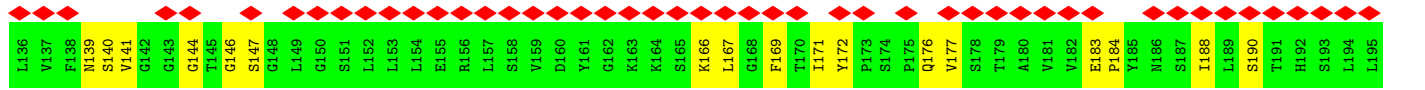
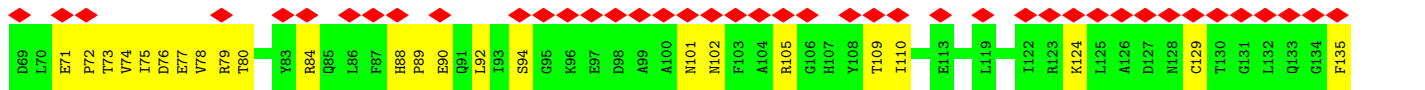
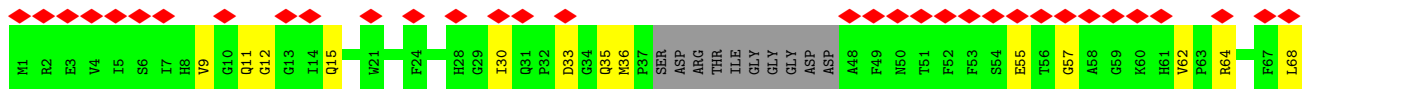



ALA
GLU
GLY
GLY
GLY
GLY
GLY
GLY
TYR

• Molecule 45: Tubulin alpha chain

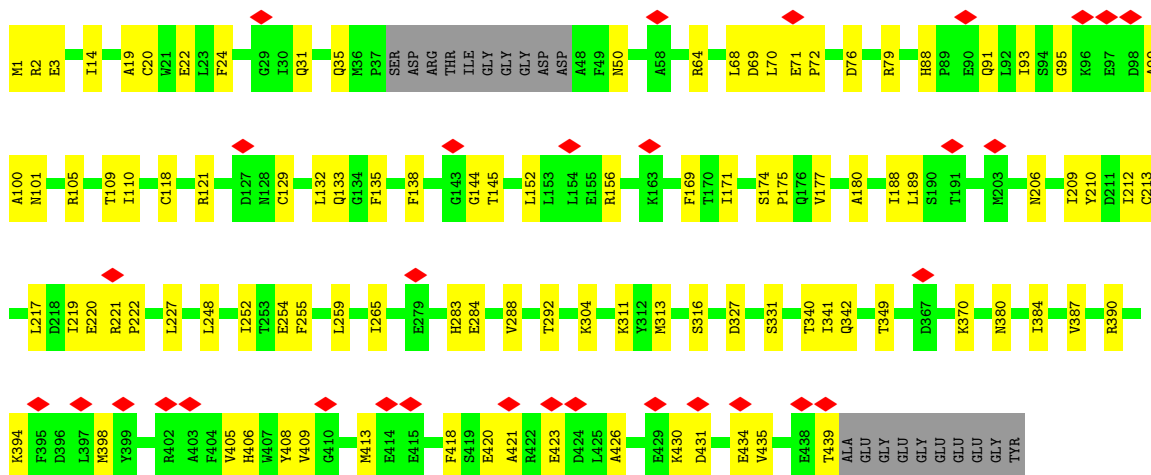
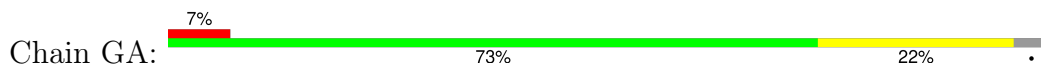

• Molecule 45: Tubulin alpha chain

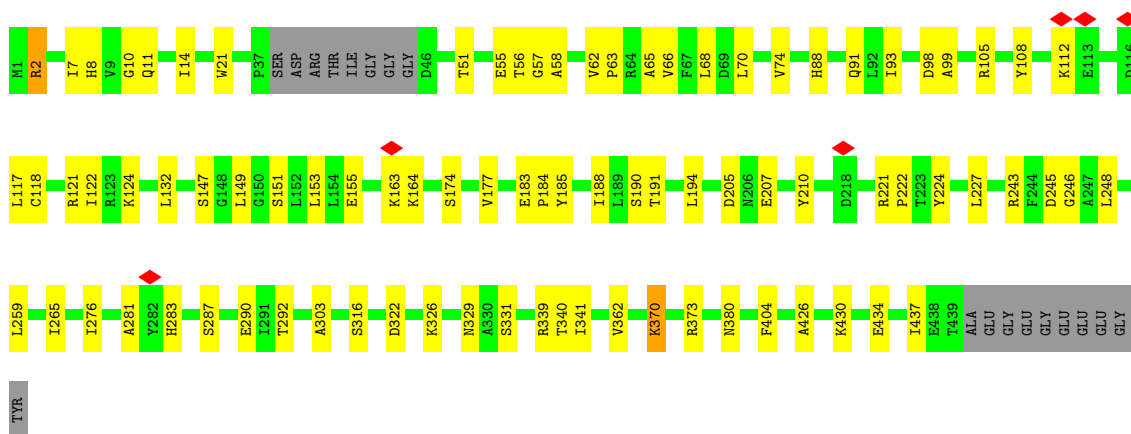
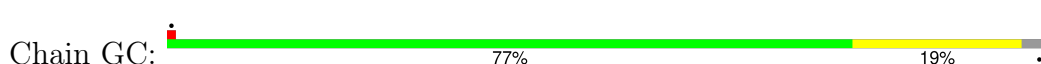

• Molecule 45: Tubulin alpha chain

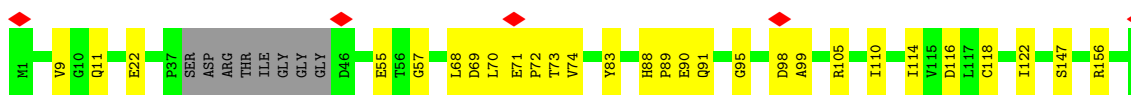
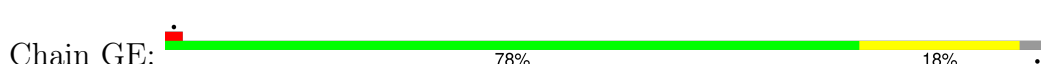

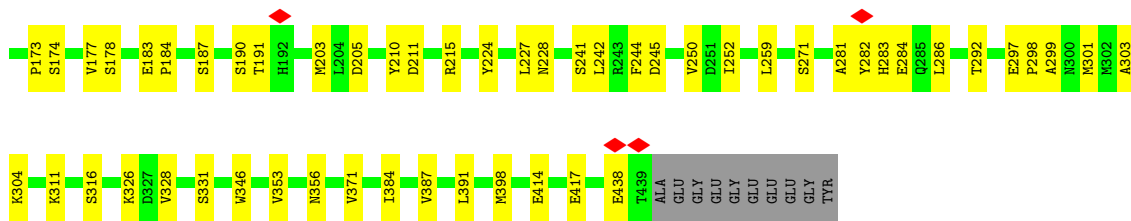

• Molecule 45: Tubulin alpha chain

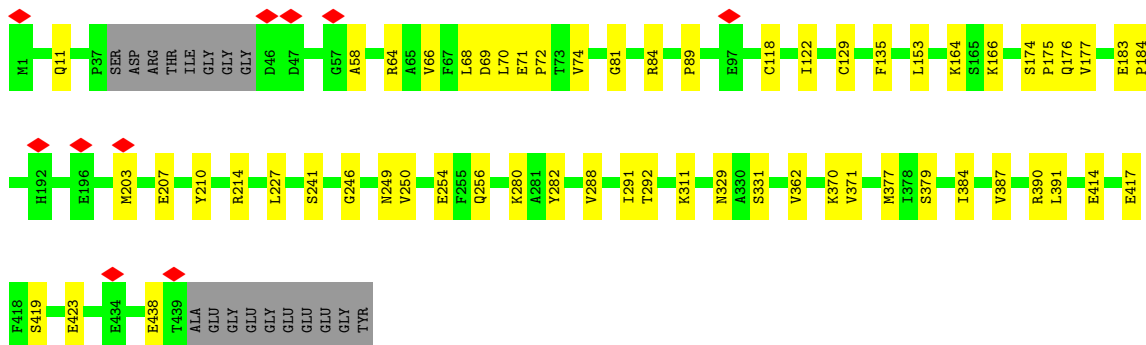
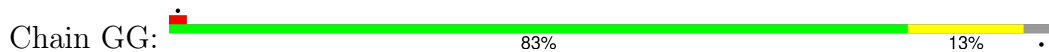

• Molecule 45: Tubulin alpha chain

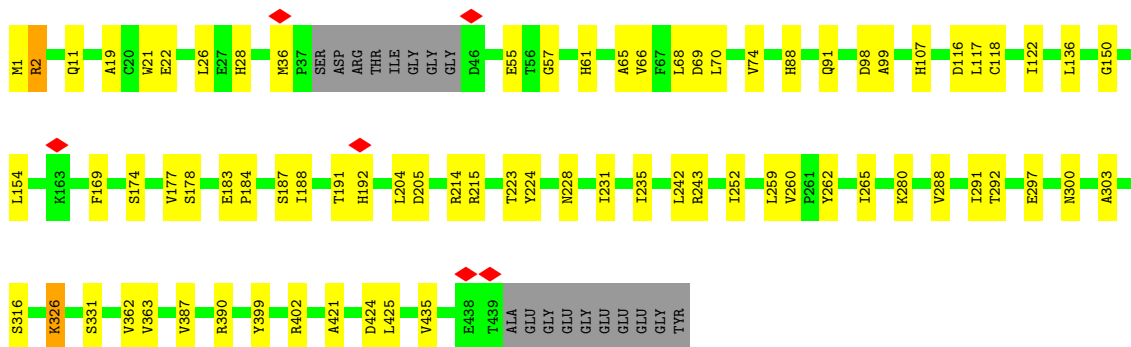
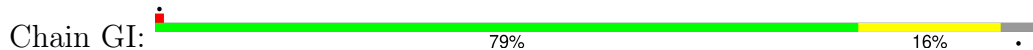

• Molecule 45: Tubulin alpha chain

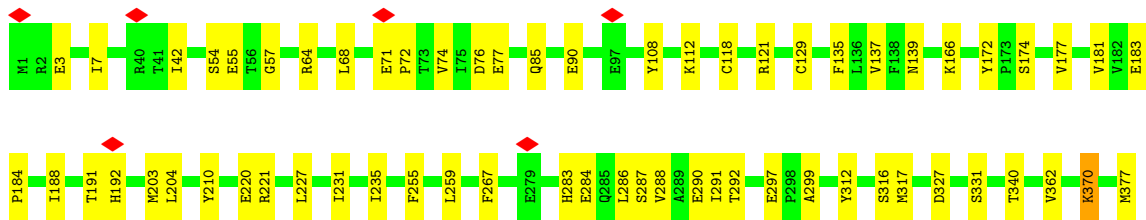
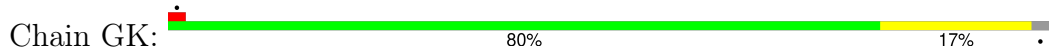



• Molecule 45: Tubulin alpha chain

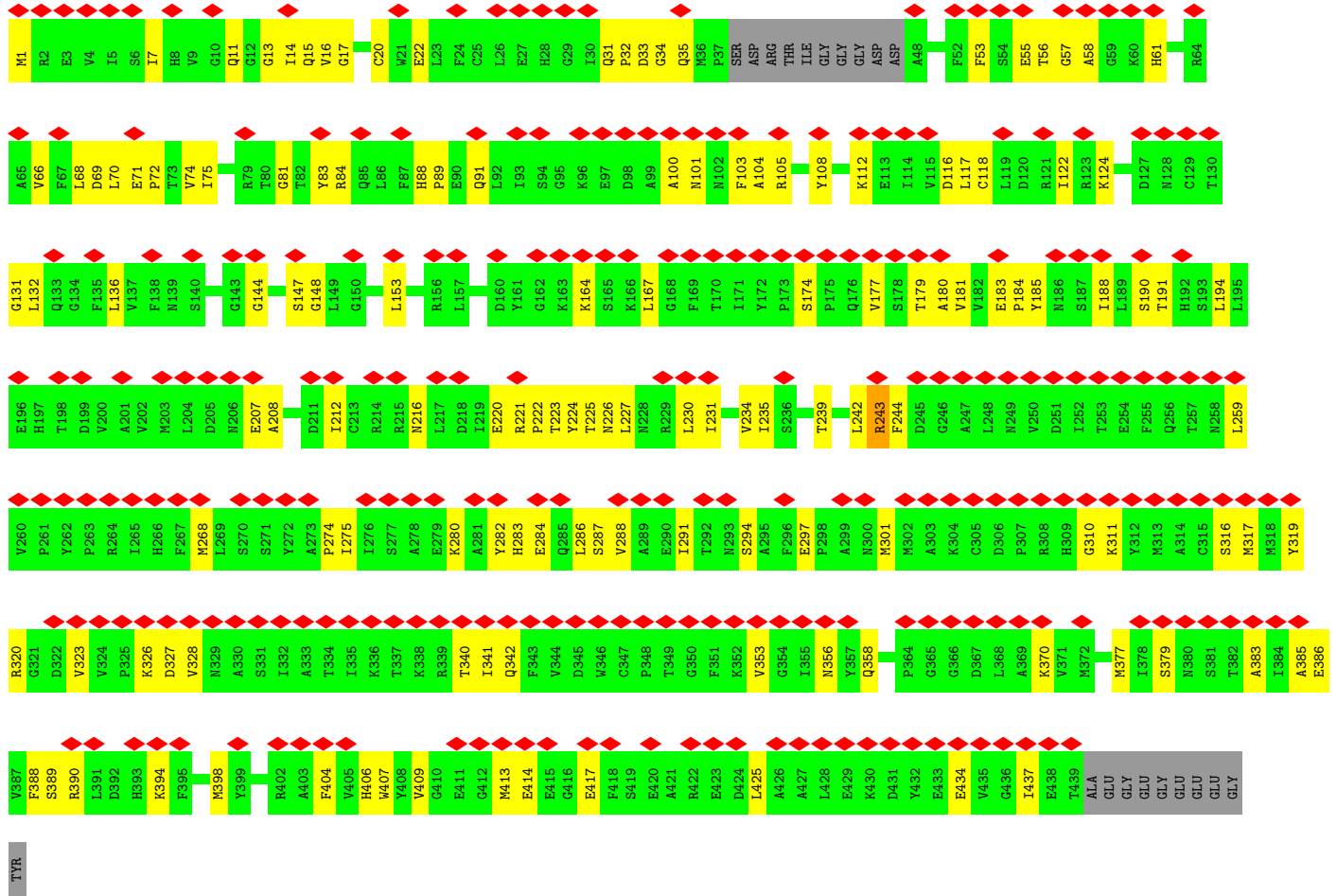

• Molecule 45: Tubulin alpha chain

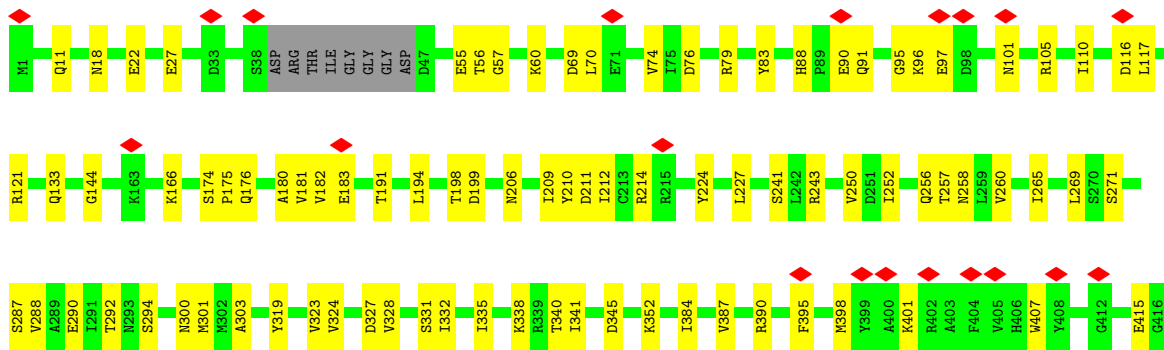
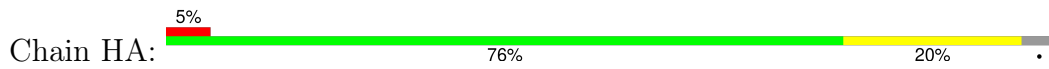

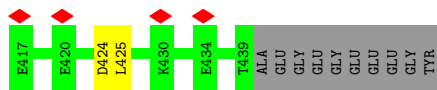

• Molecule 45: Tubulin alpha chain

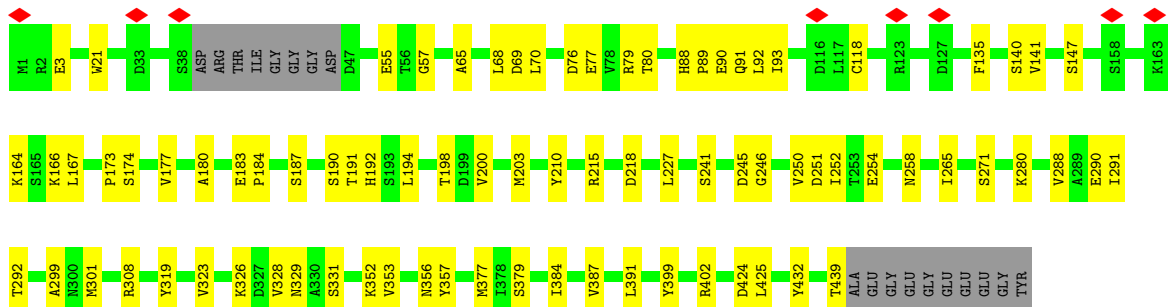
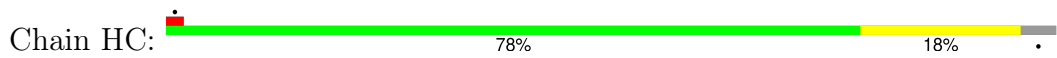

• Molecule 45: Tubulin alpha chain

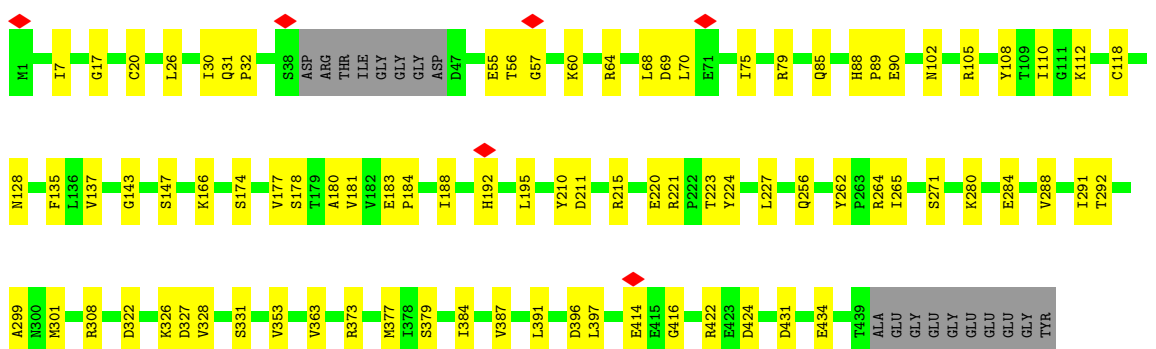
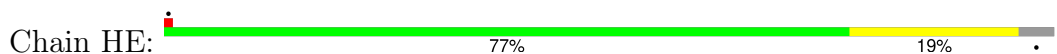

• Molecule 45: Tubulin alpha chain

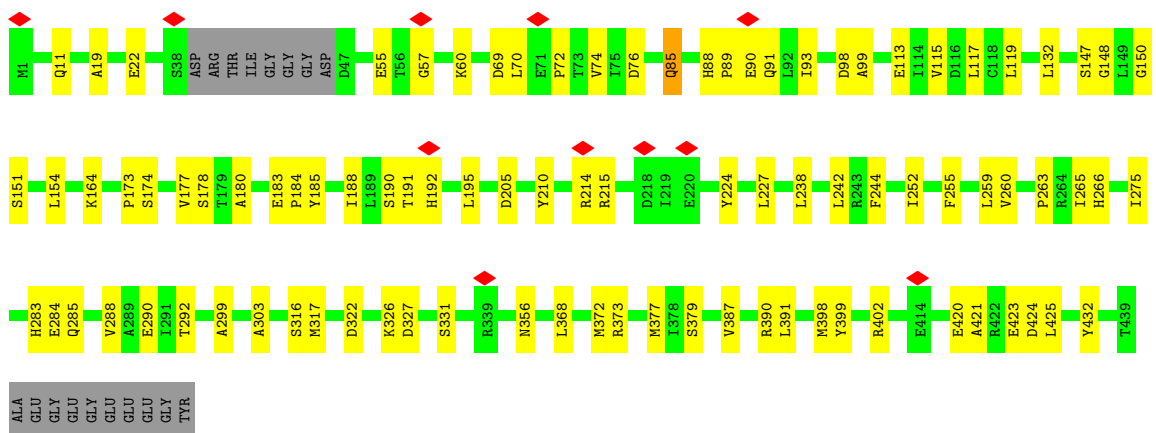
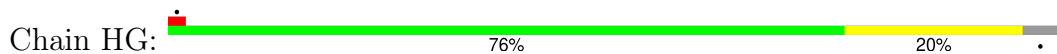

• Molecule 45: Tubulin alpha chain

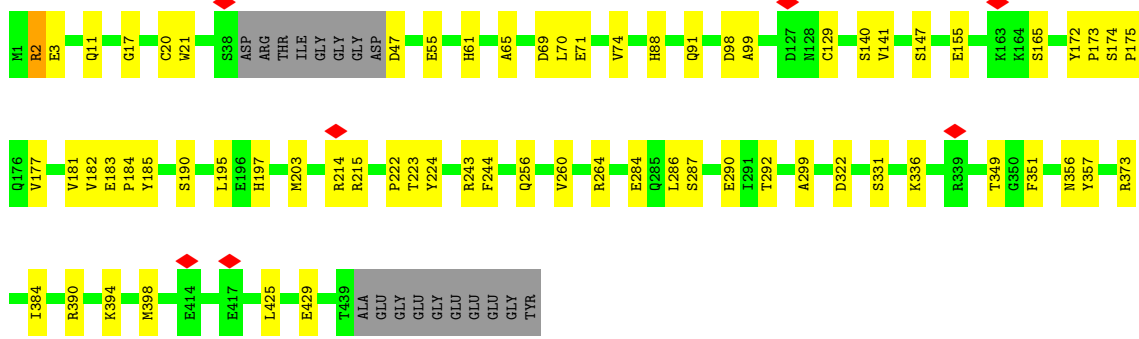
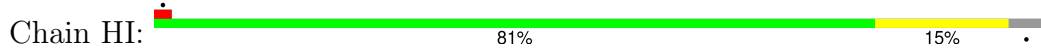

• Molecule 45: Tubulin alpha chain

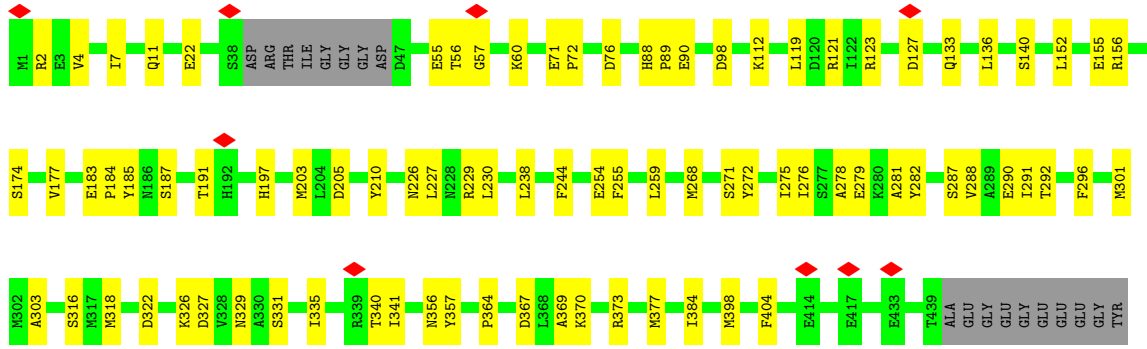
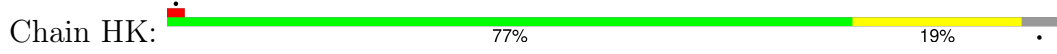

• Molecule 45: Tubulin alpha chain

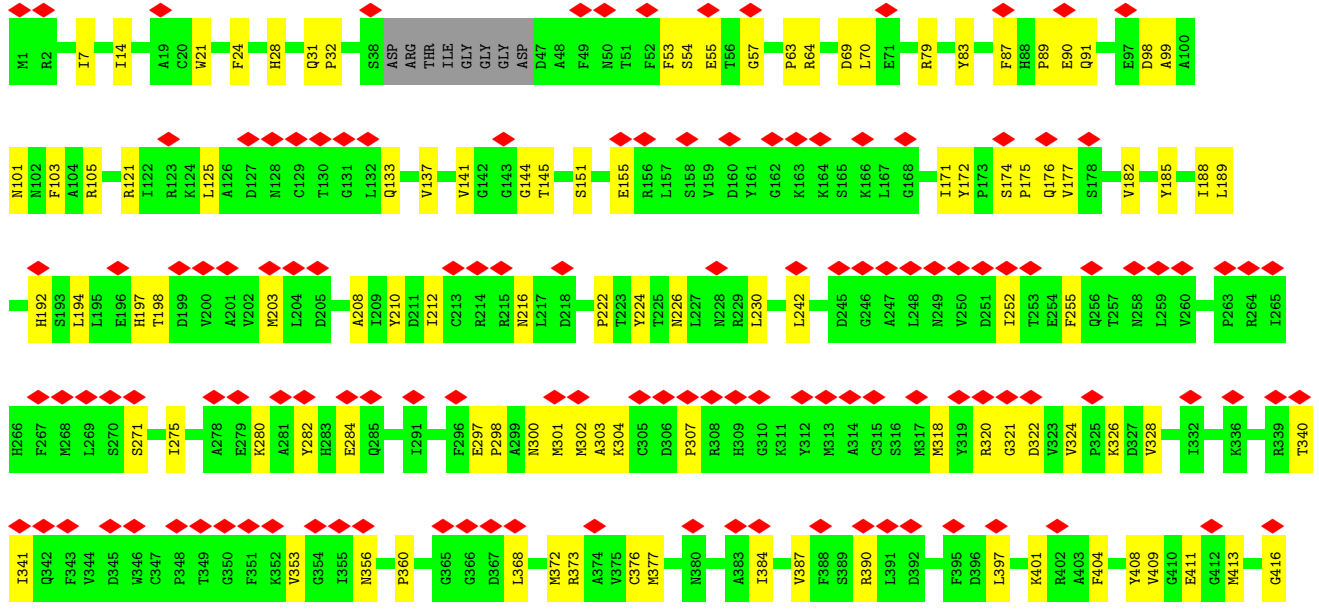
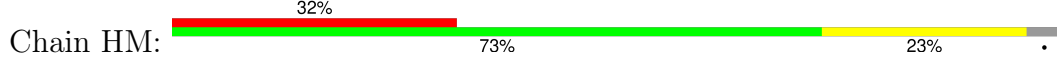

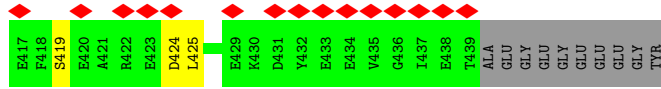

• Molecule 45: Tubulin alpha chain

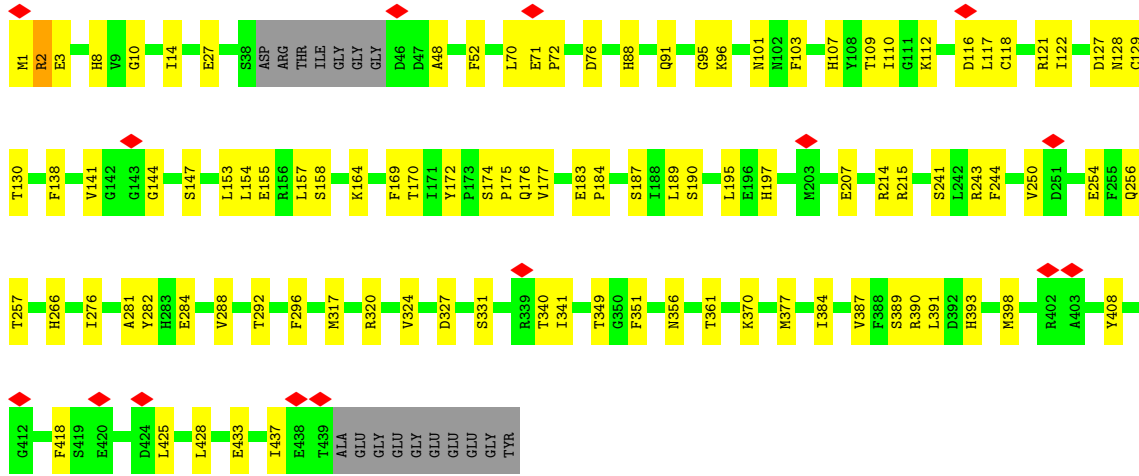
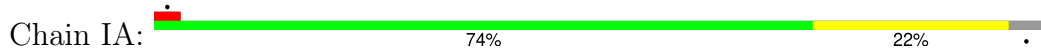

• Molecule 45: Tubulin alpha chain

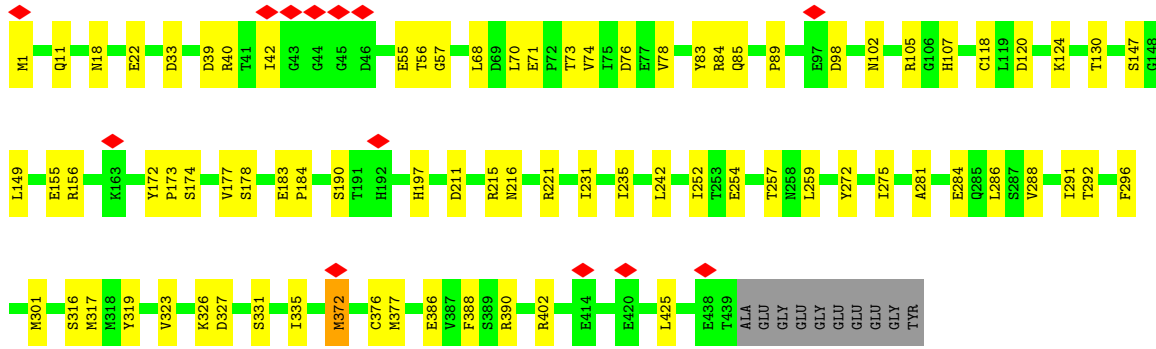
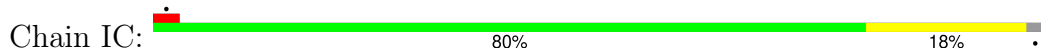

• Molecule 45: Tubulin alpha chain

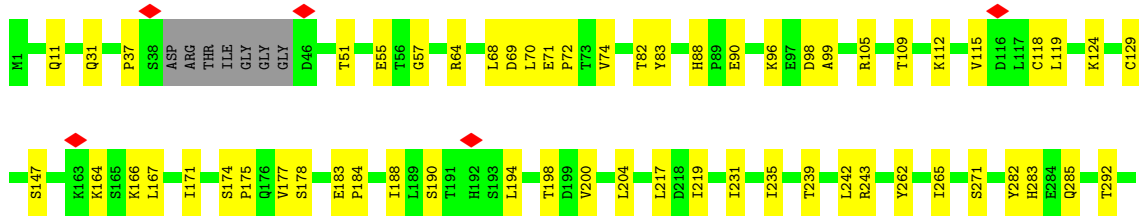
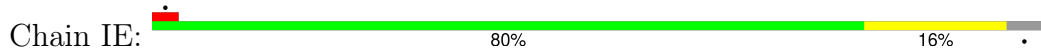



- Molecule 45: Tubulin alpha chain

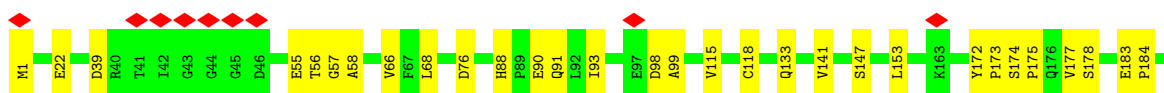
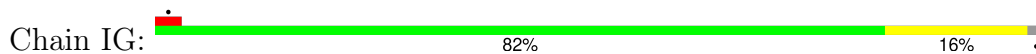

- Molecule 45: Tubulin alpha chain

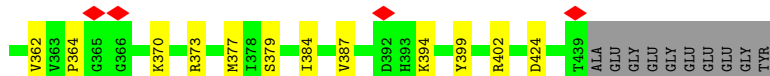
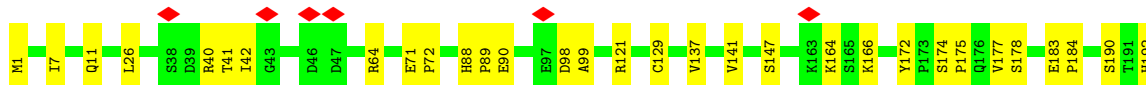
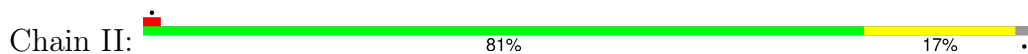

- Molecule 45: Tubulin alpha chain

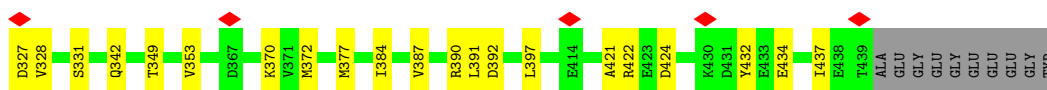
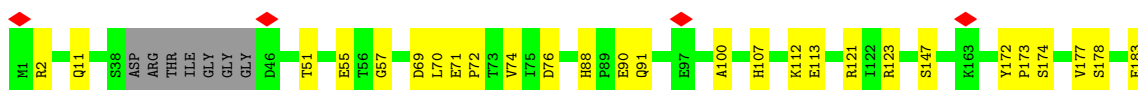
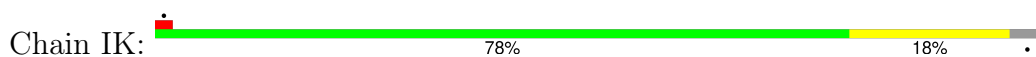

- Molecule 45: Tubulin alpha chain

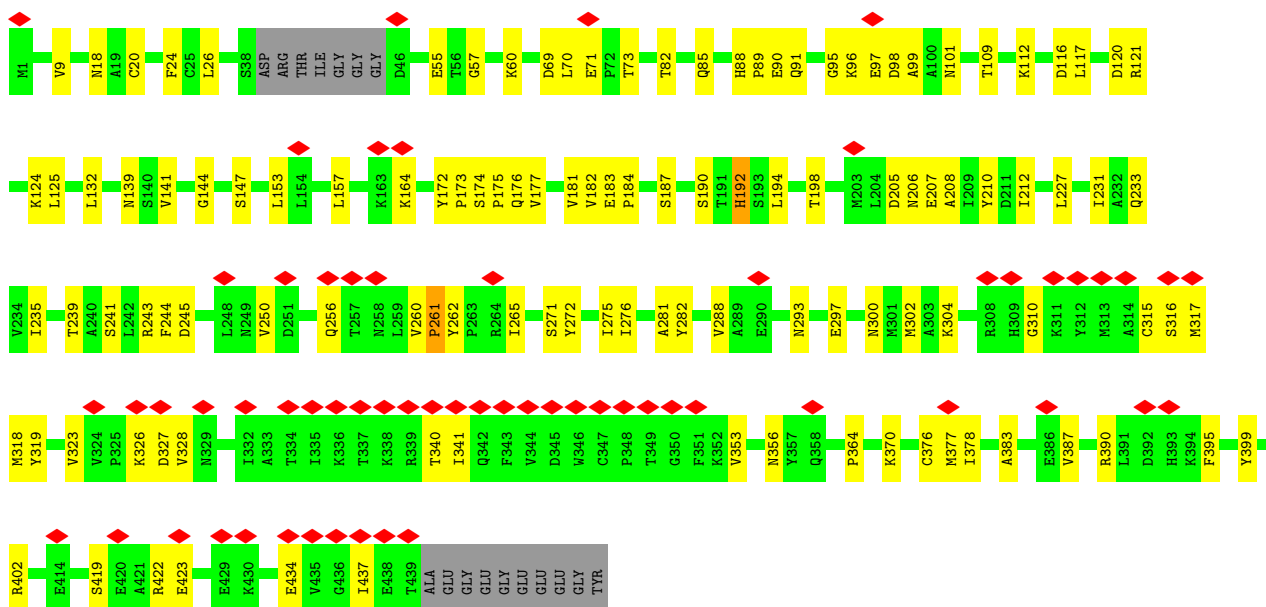

• Molecule 45: Tubulin alpha chain

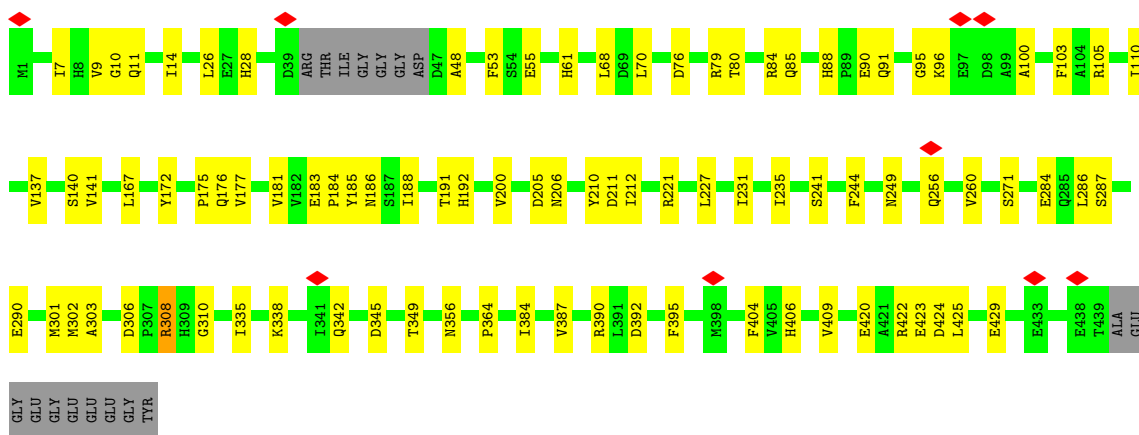
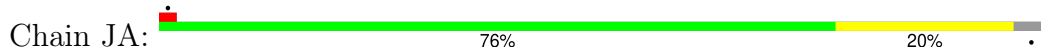

• Molecule 45: Tubulin alpha chain

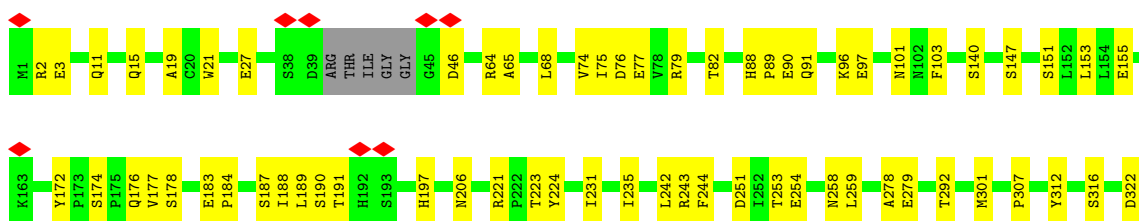
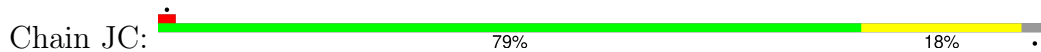



• Molecule 45: Tubulin alpha chain

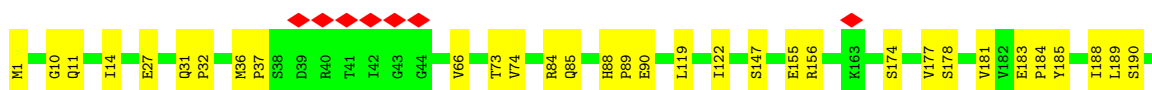
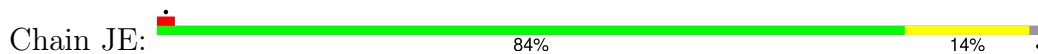

• Molecule 45: Tubulin alpha chain

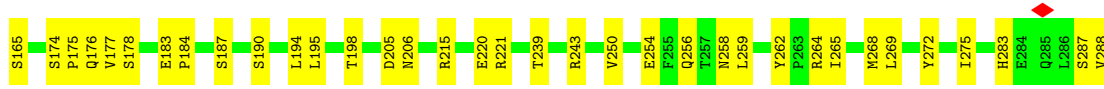
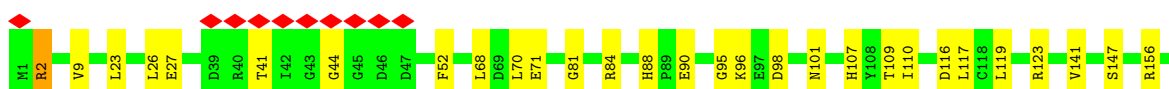
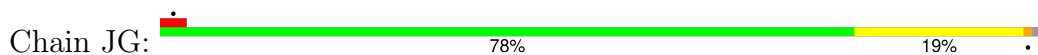

• Molecule 45: Tubulin alpha chain

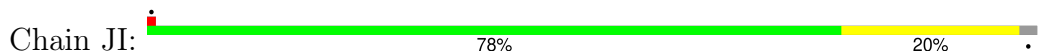

• Molecule 45: Tubulin alpha chain

Chain JK:  73% 24%

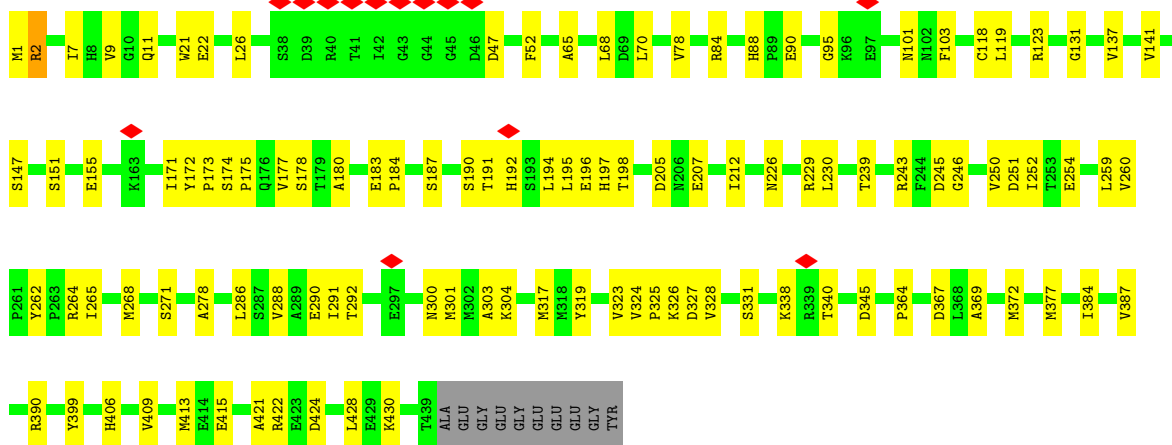

• Molecule 45: Tubulin alpha chain

Chain JM:  37% 68% 28%

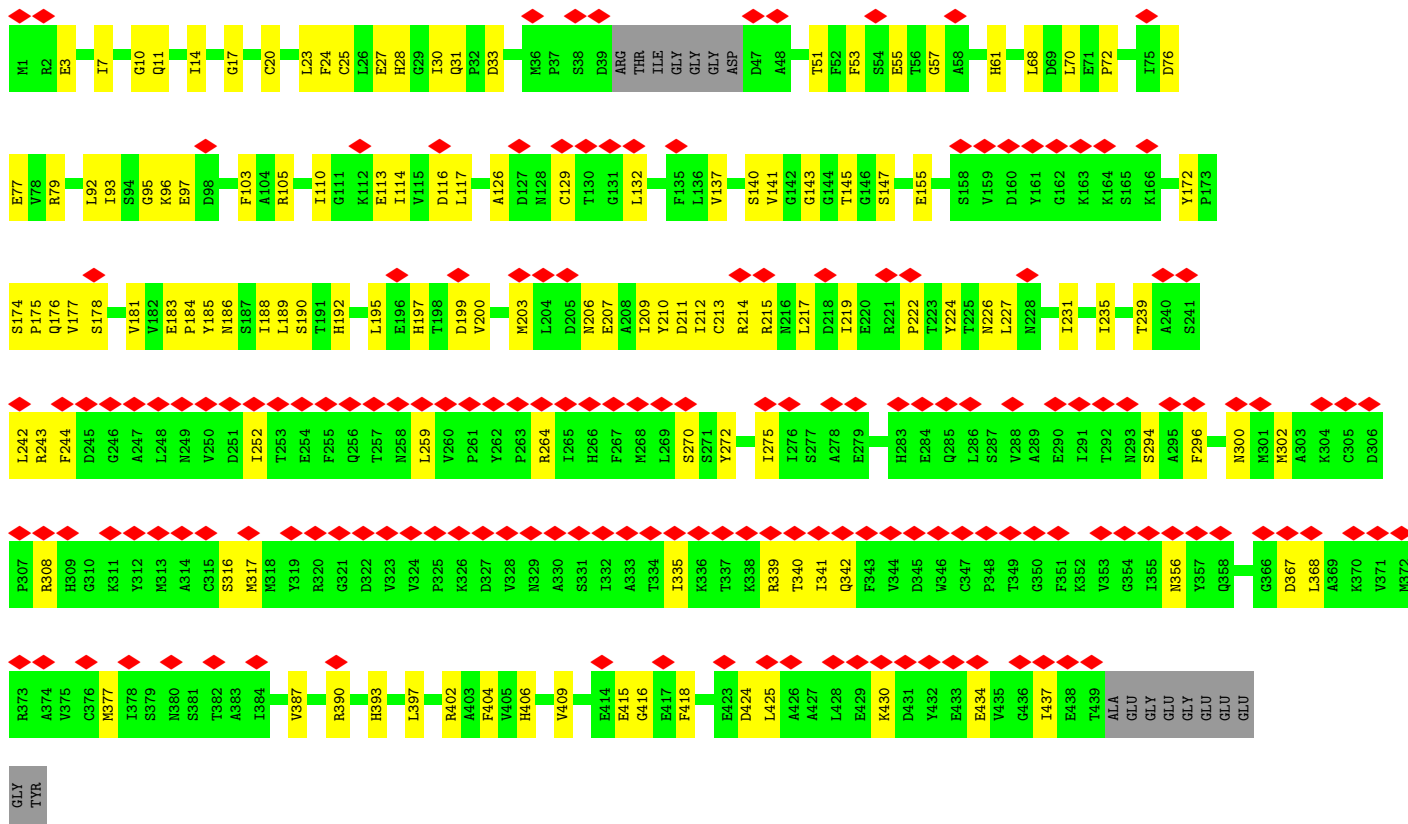

• Molecule 45: Tubulin alpha chain

Chain KA:  79% 17%



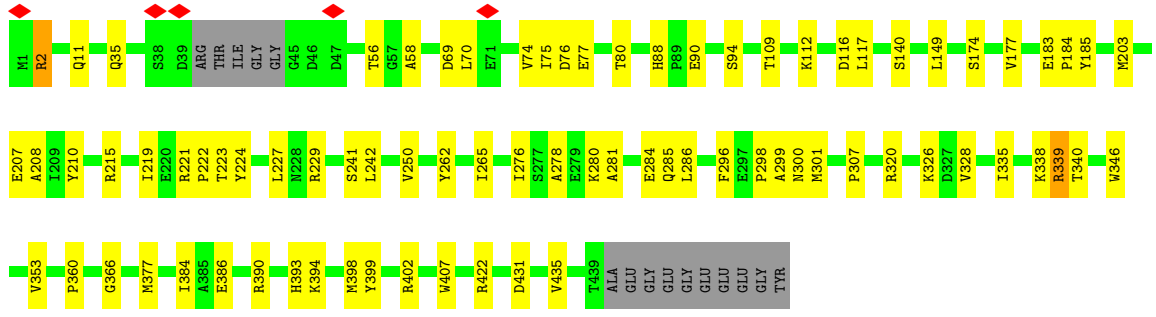

• Molecule 45: Tubulin alpha chain

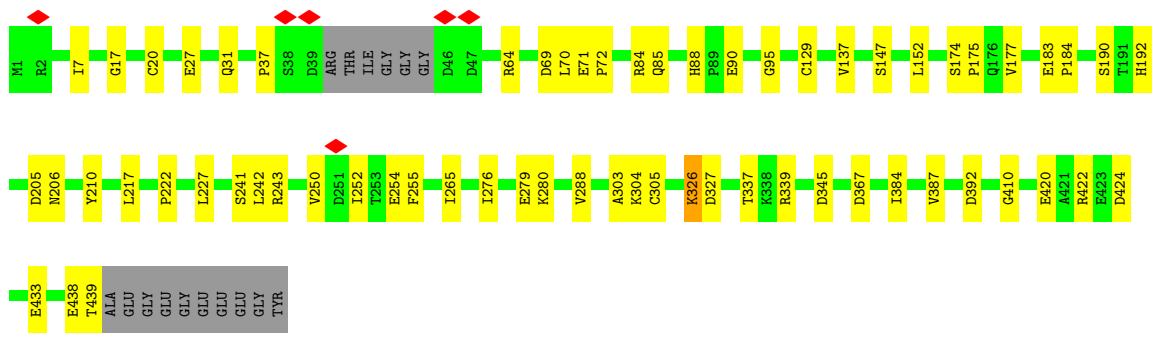
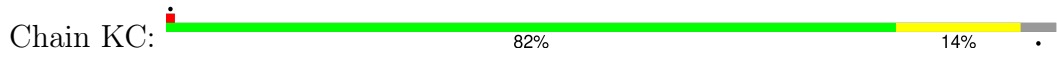

• Molecule 45: Tubulin alpha chain

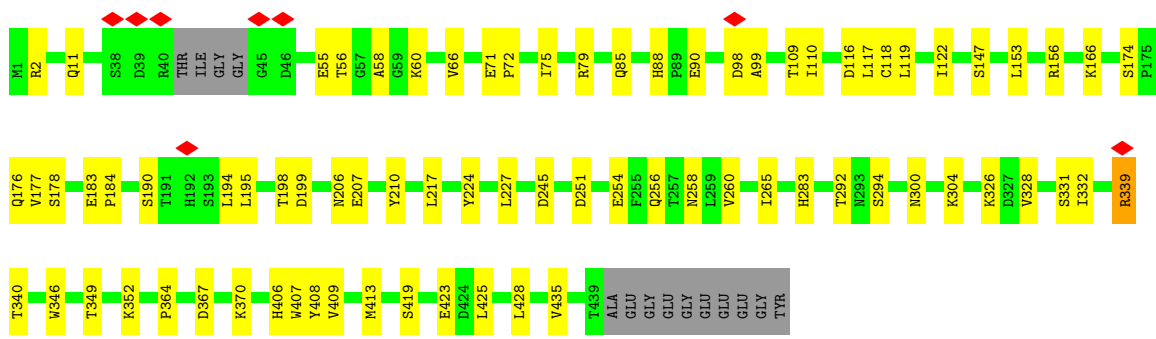
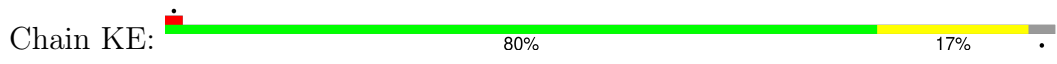

• Molecule 45: Tubulin alpha chain

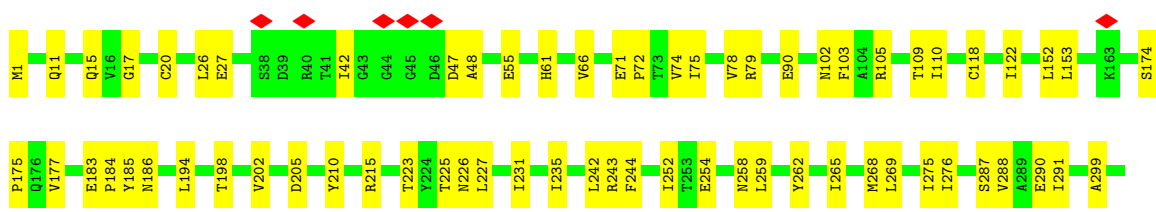
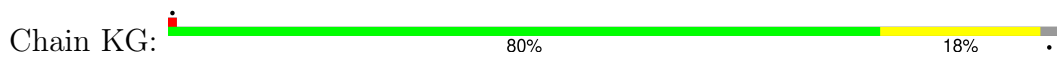



• Molecule 45: Tubulin alpha chain

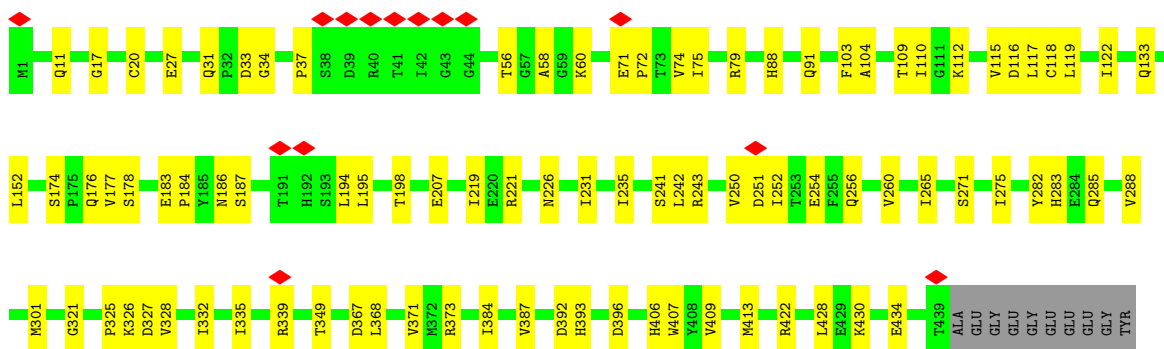
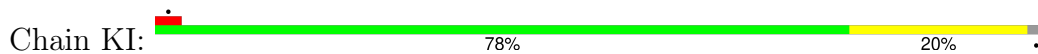

• Molecule 45: Tubulin alpha chain

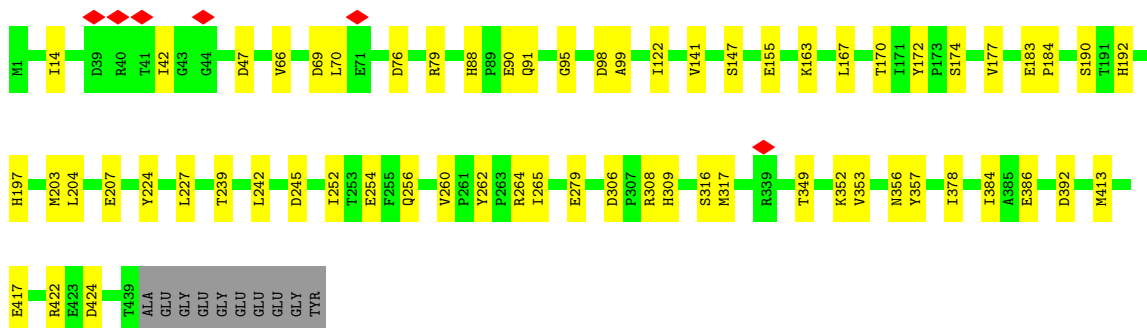
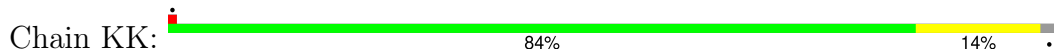

• Molecule 45: Tubulin alpha chain

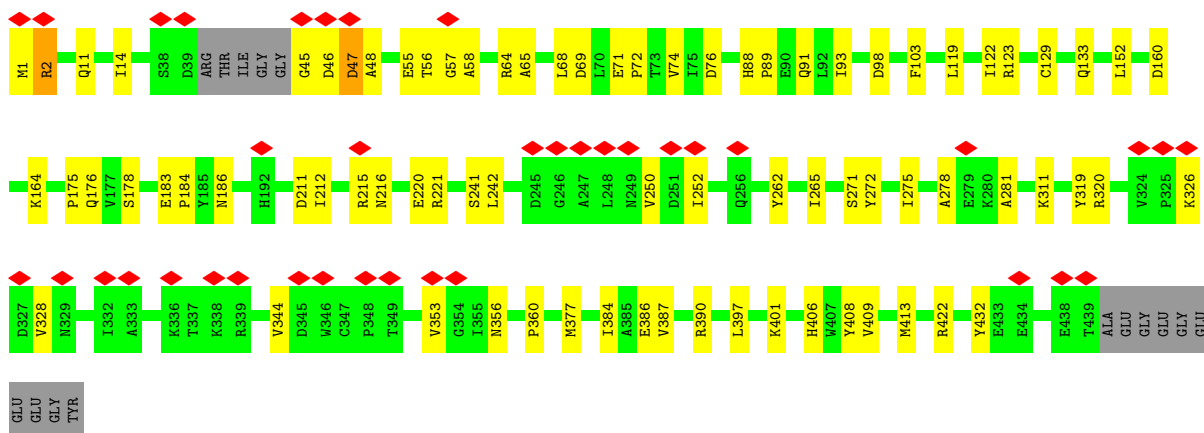
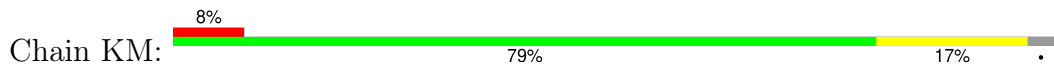

• Molecule 45: Tubulin alpha chain

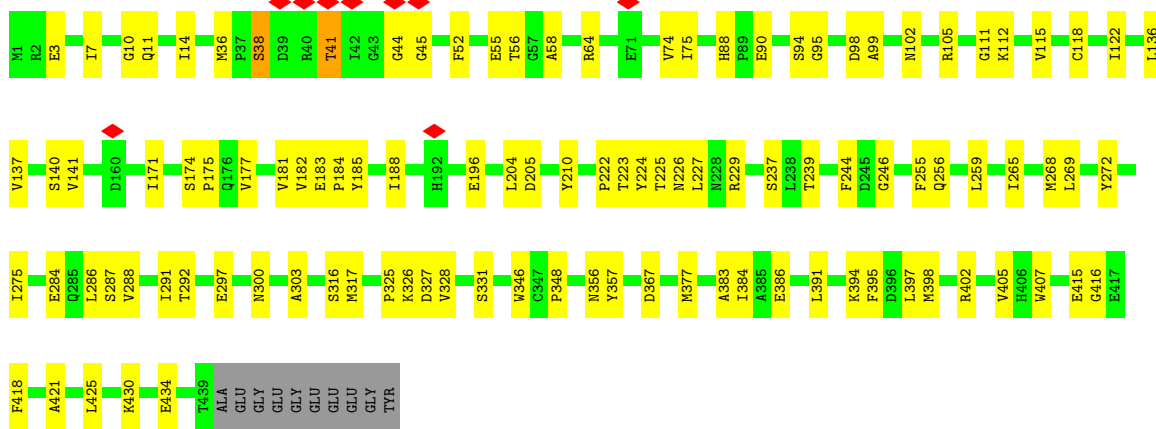
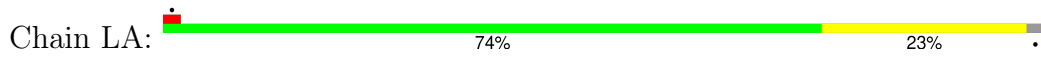

• Molecule 45: Tubulin alpha chain

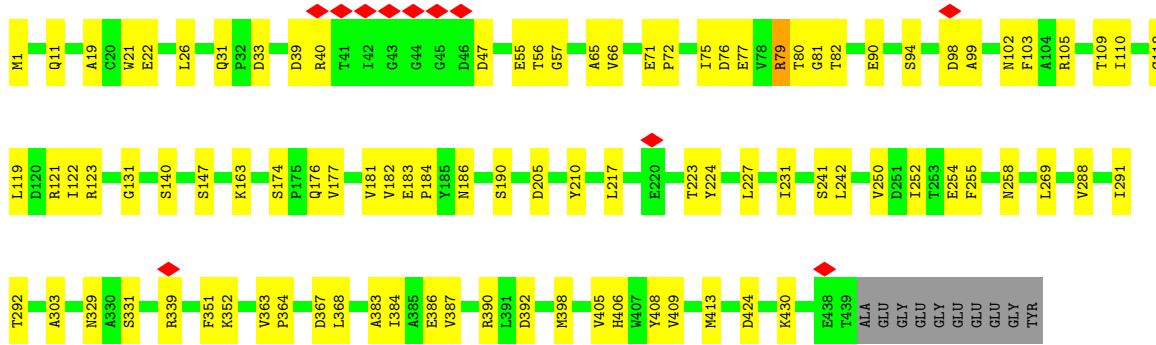
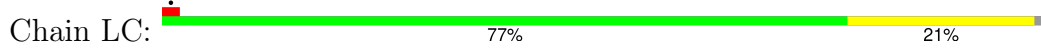

• Molecule 45: Tubulin alpha chain

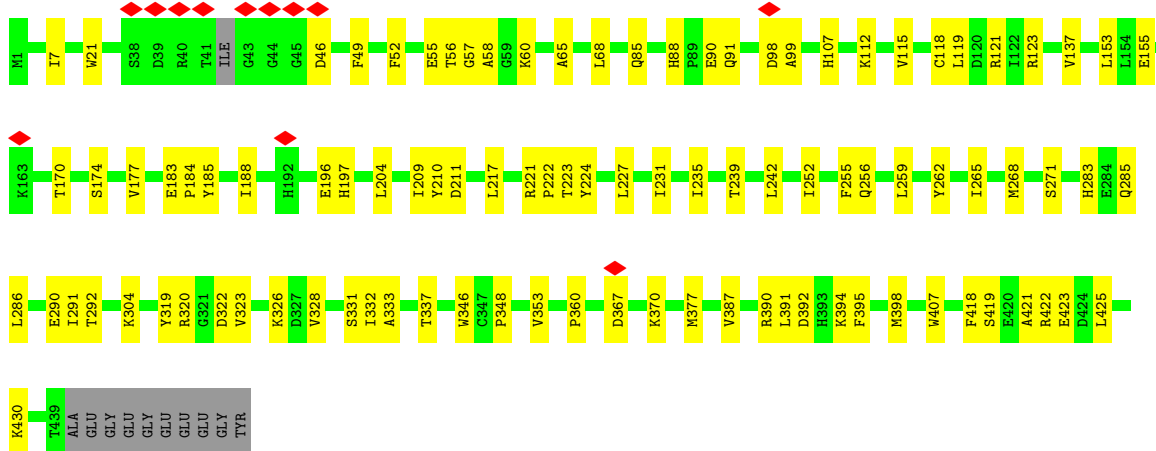
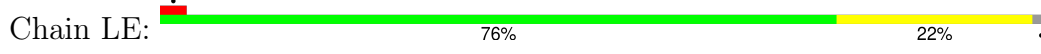

• Molecule 45: Tubulin alpha chain

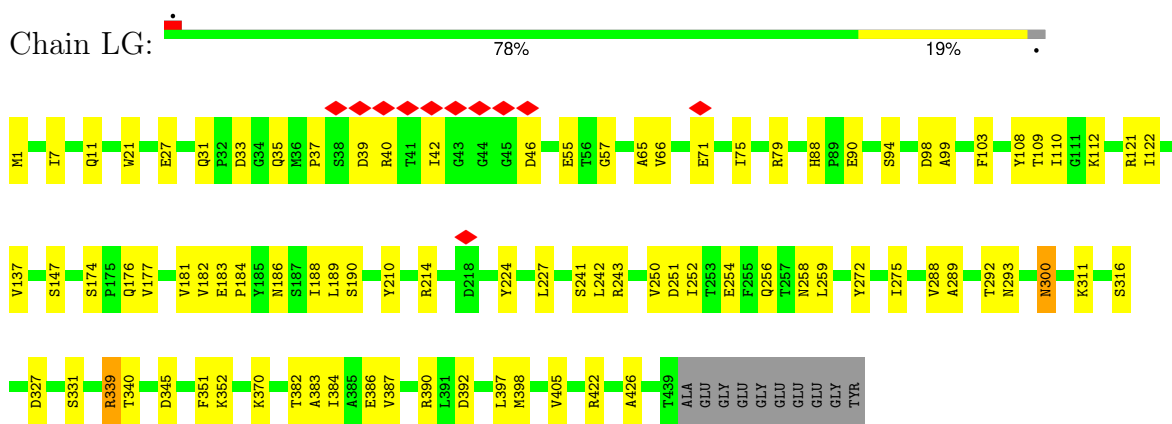

• Molecule 45: Tubulin alpha chain

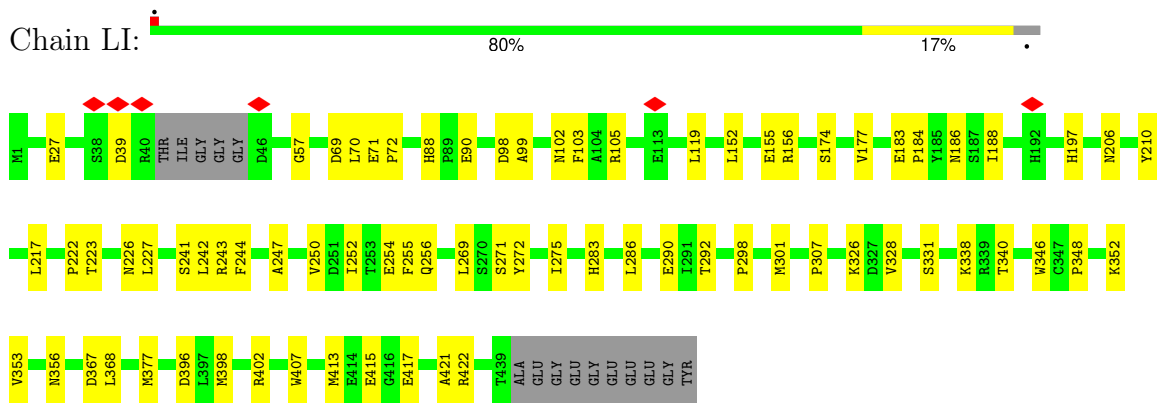

• Molecule 45: Tubulin alpha chain



• Molecule 45: Tubulin alpha chain

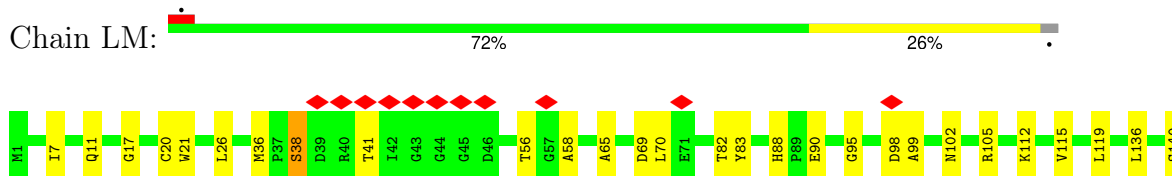

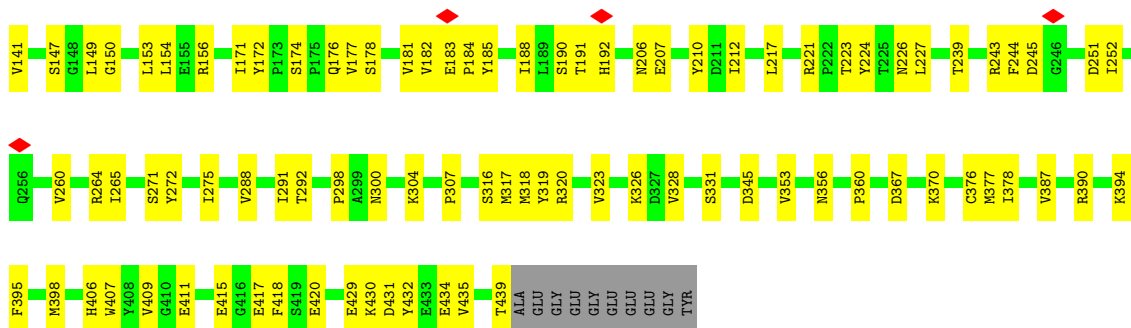

• Molecule 45: Tubulin alpha chain

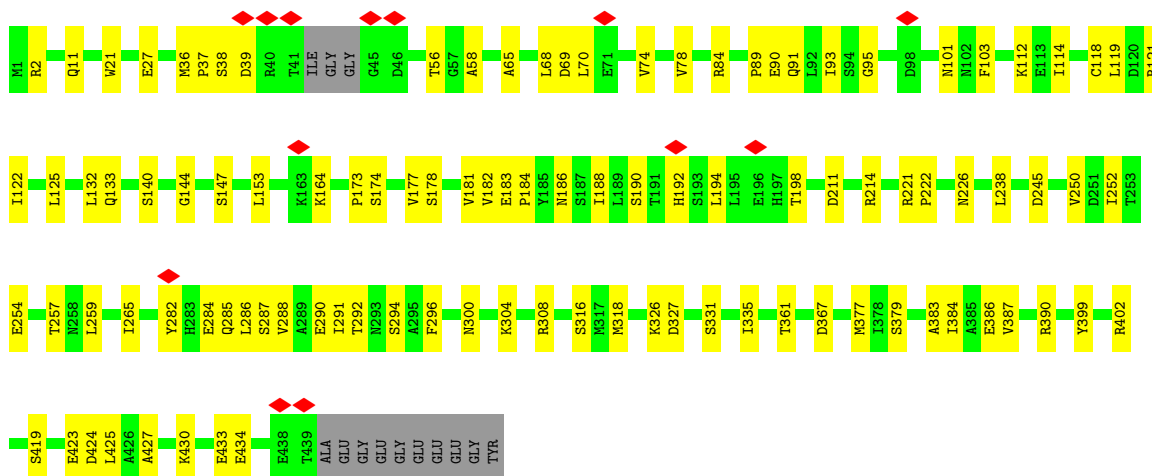
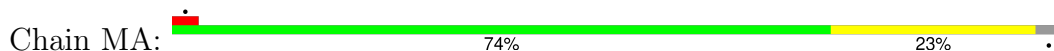

• Molecule 45: Tubulin alpha chain

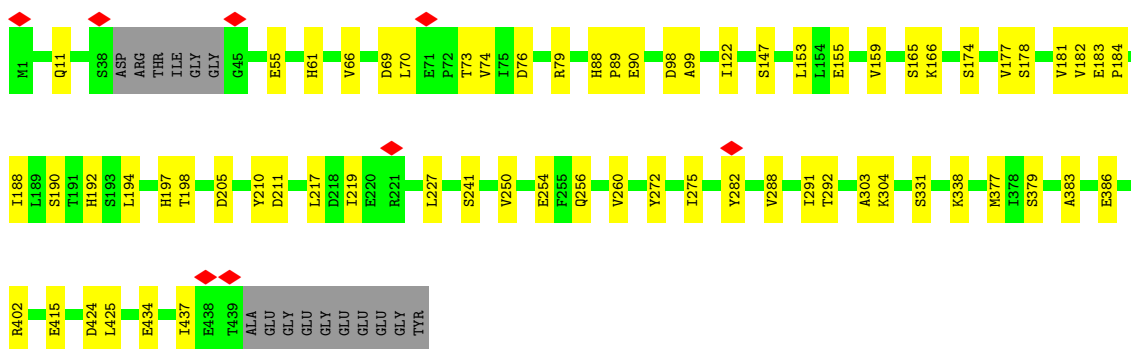
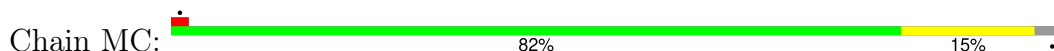

• Molecule 45: Tubulin alpha chain

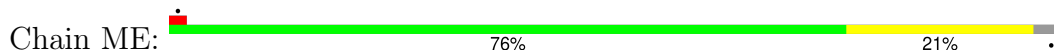

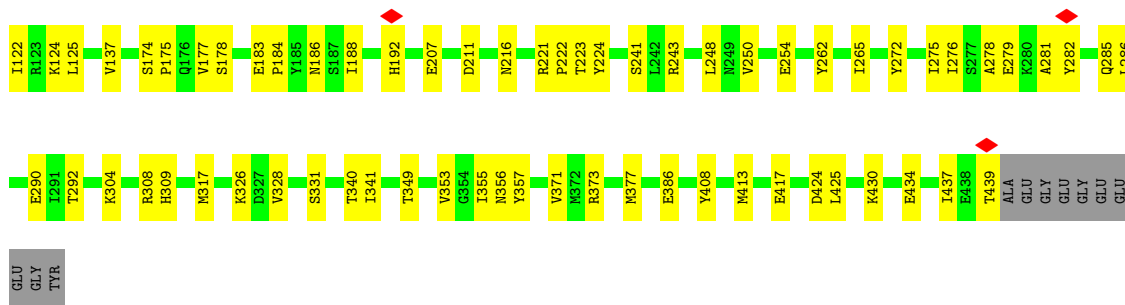

• Molecule 45: Tubulin alpha chain

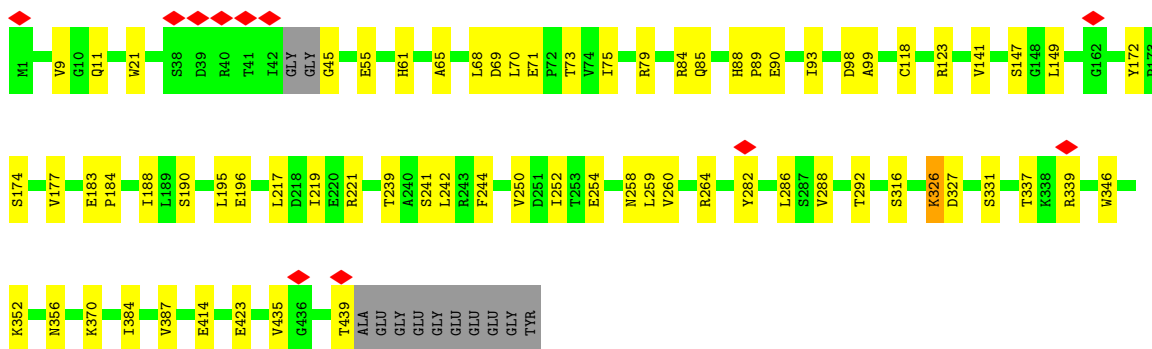
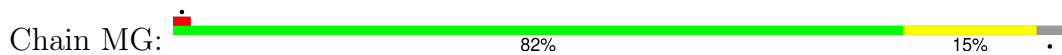

• Molecule 45: Tubulin alpha chain

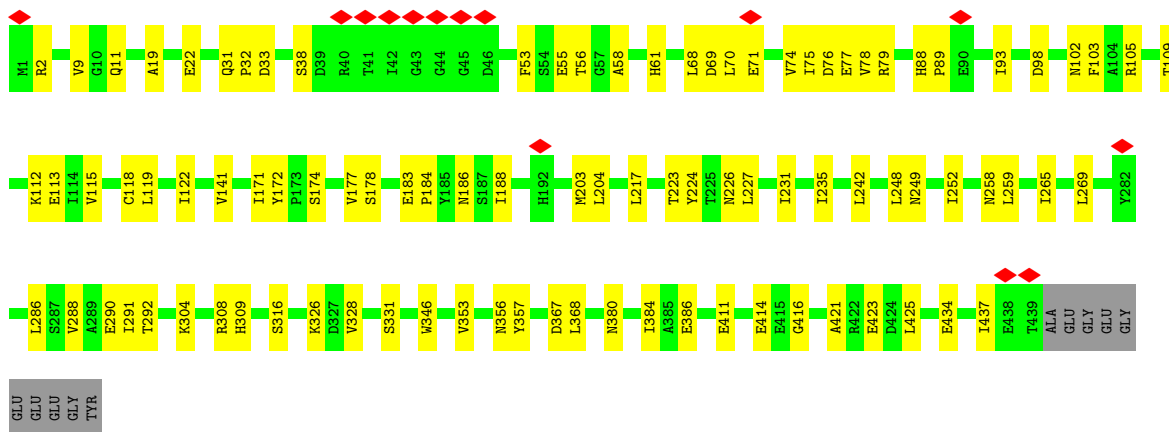
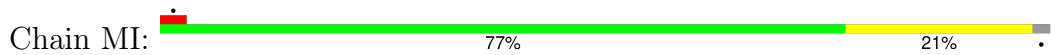

• Molecule 45: Tubulin alpha chain

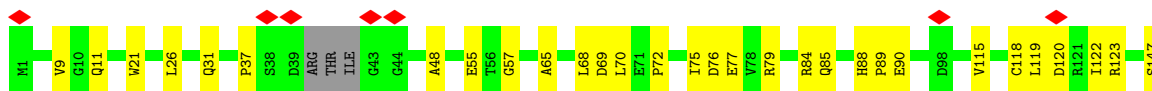
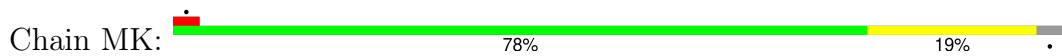

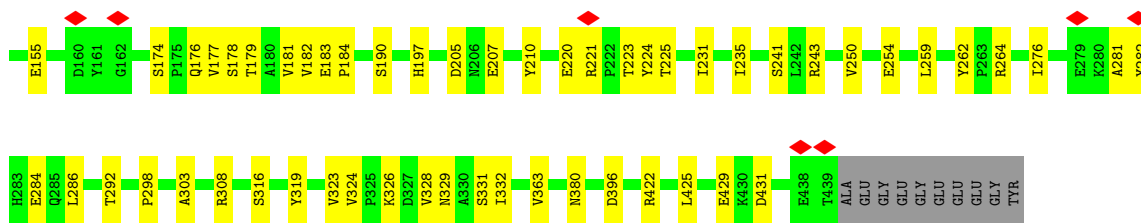

• Molecule 45: Tubulin alpha chain

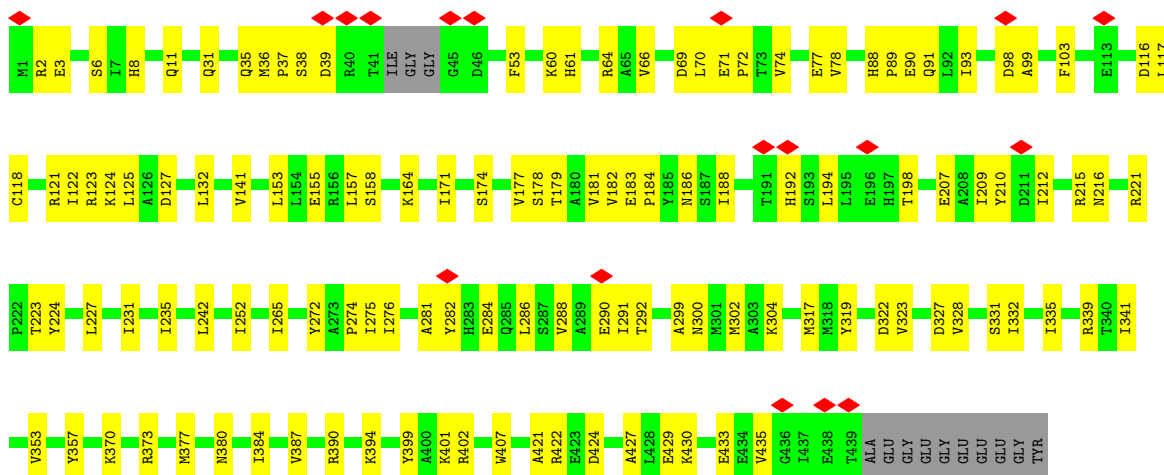

• Molecule 45: Tubulin alpha chain

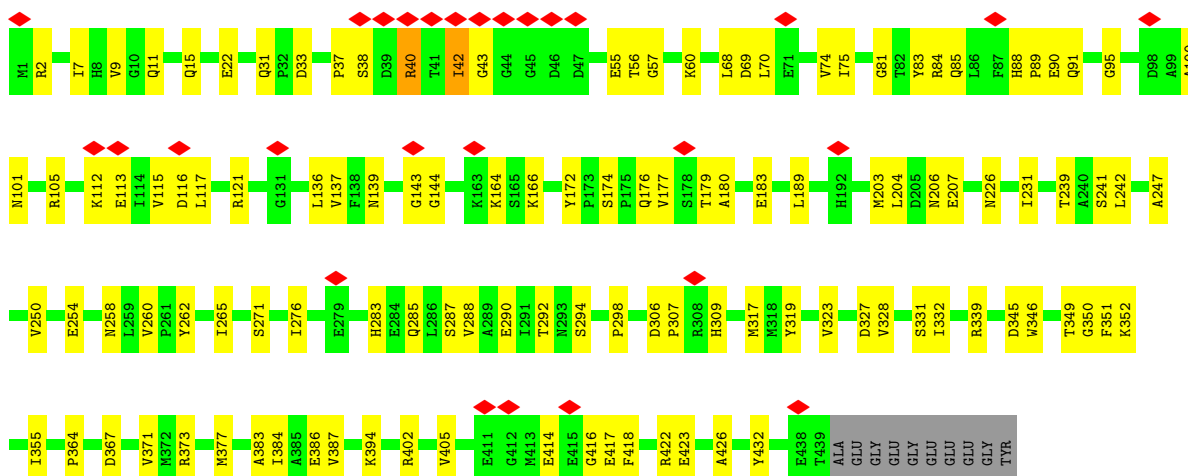
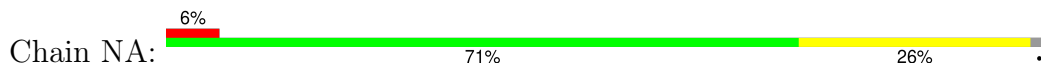

• Molecule 45: Tubulin alpha chain



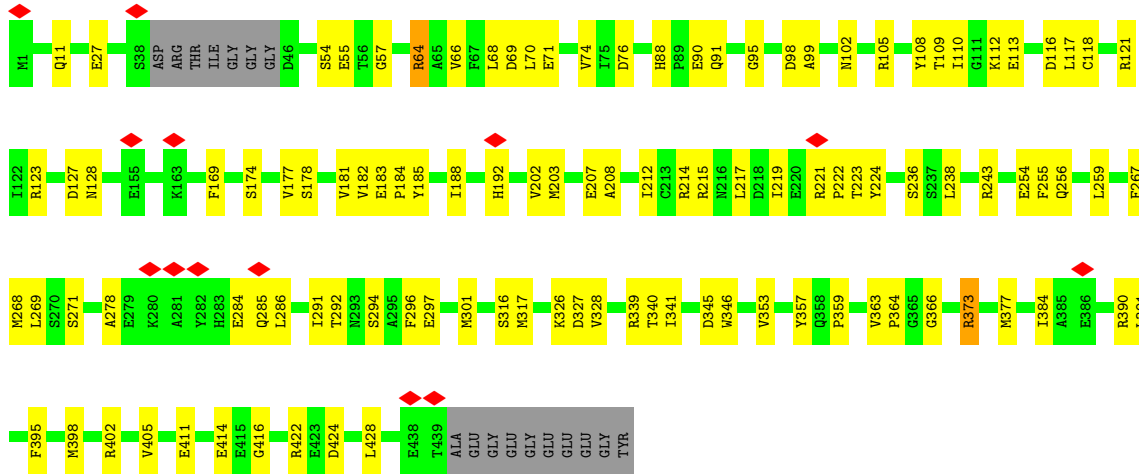

• Molecule 45: Tubulin alpha chain

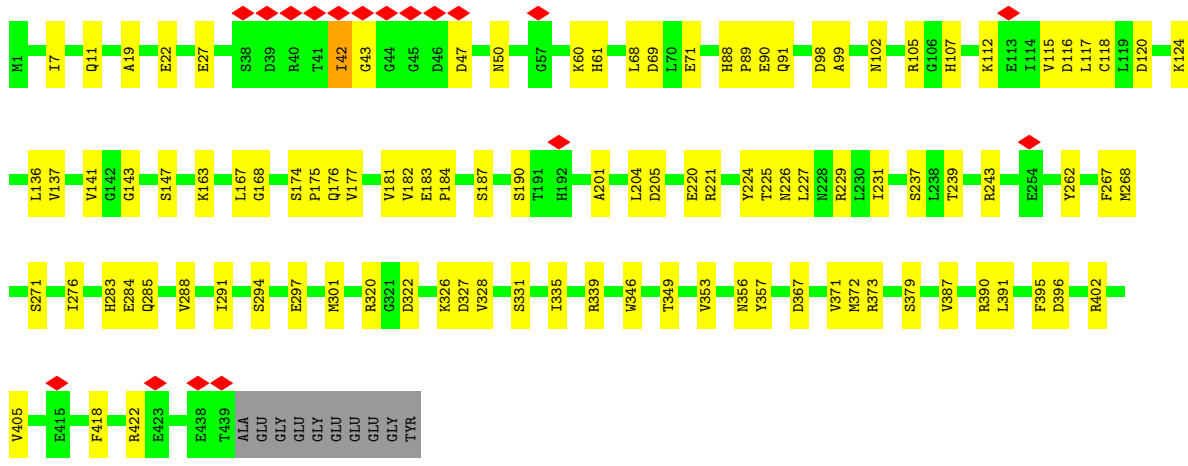
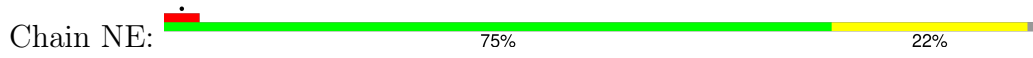

• Molecule 45: Tubulin alpha chain

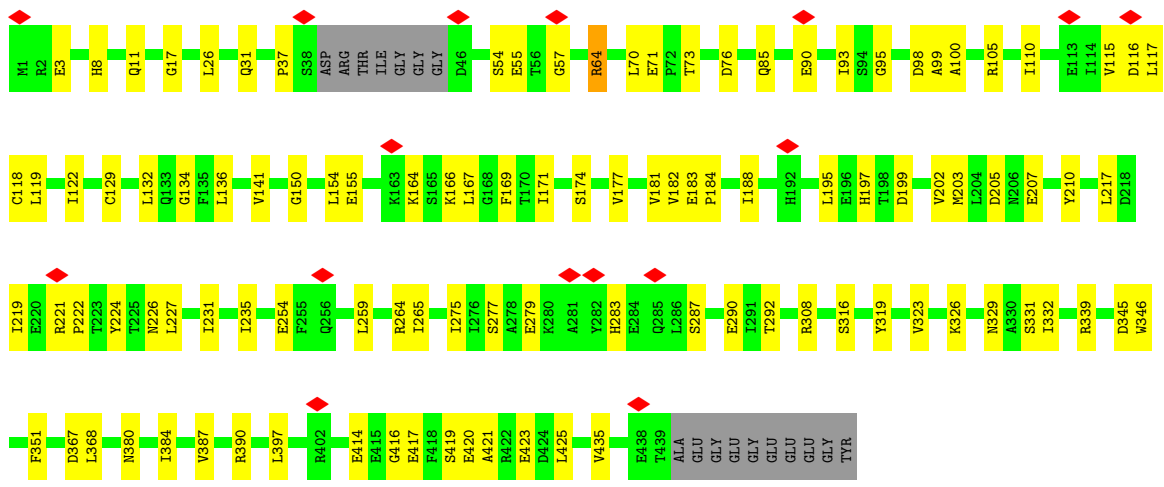
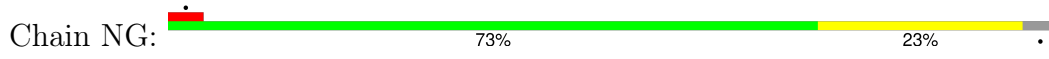

• Molecule 45: Tubulin alpha chain

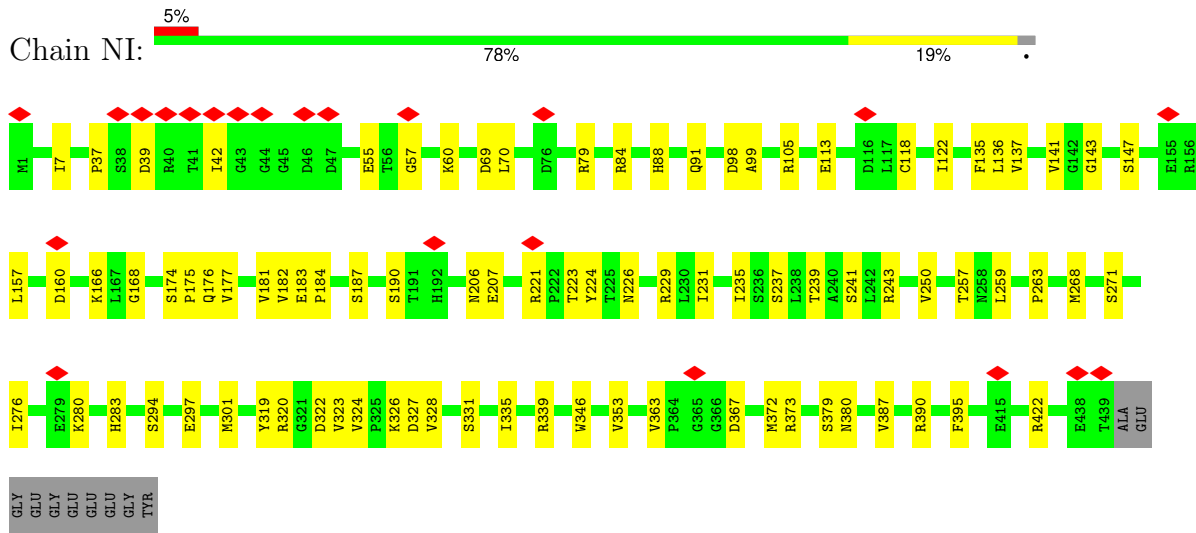

• Molecule 45: Tubulin alpha chain

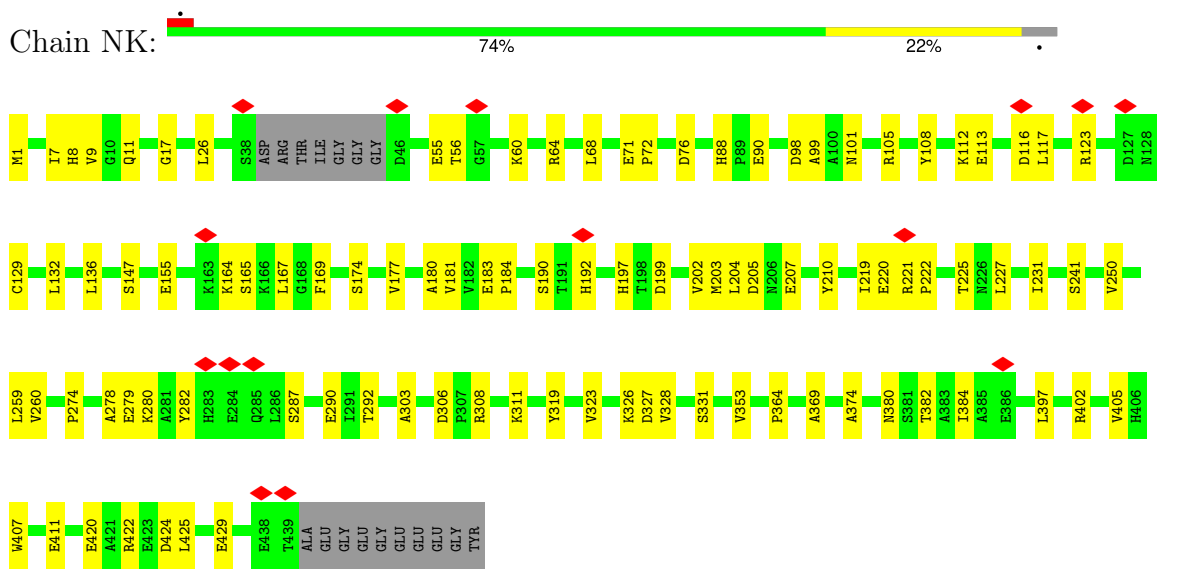

• Molecule 45: Tubulin alpha chain

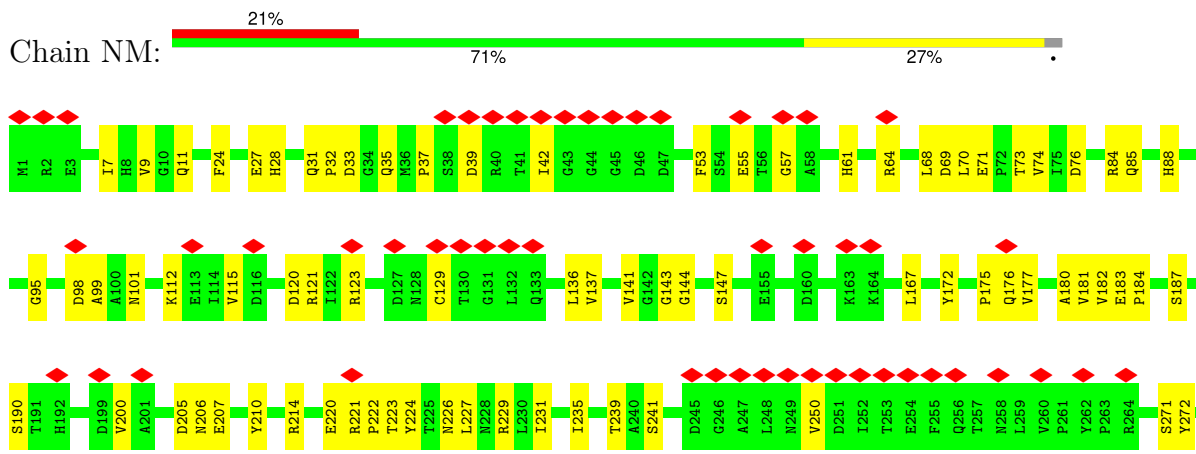

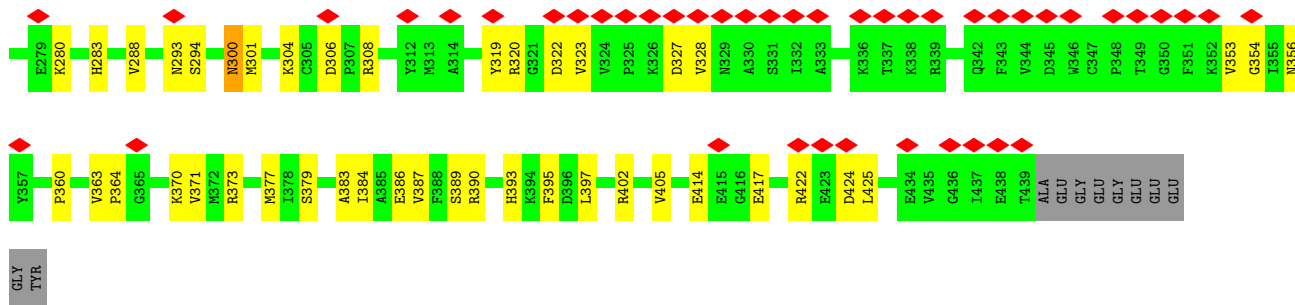

• Molecule 45: Tubulin alpha chain

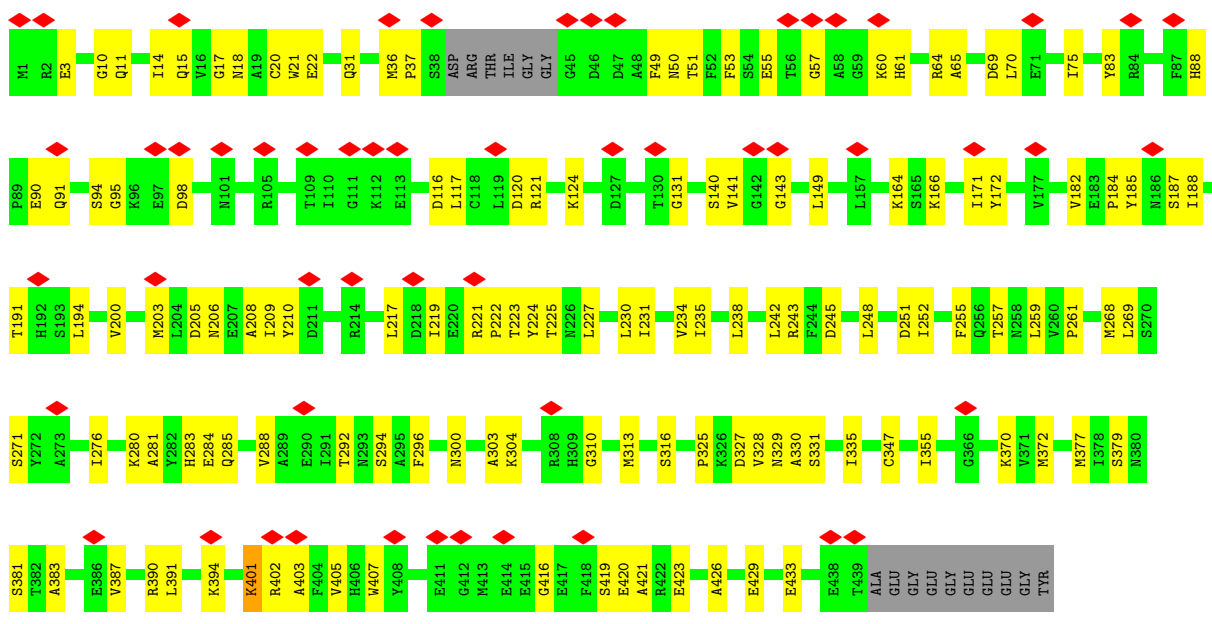

• Molecule 45: Tubulin alpha chain

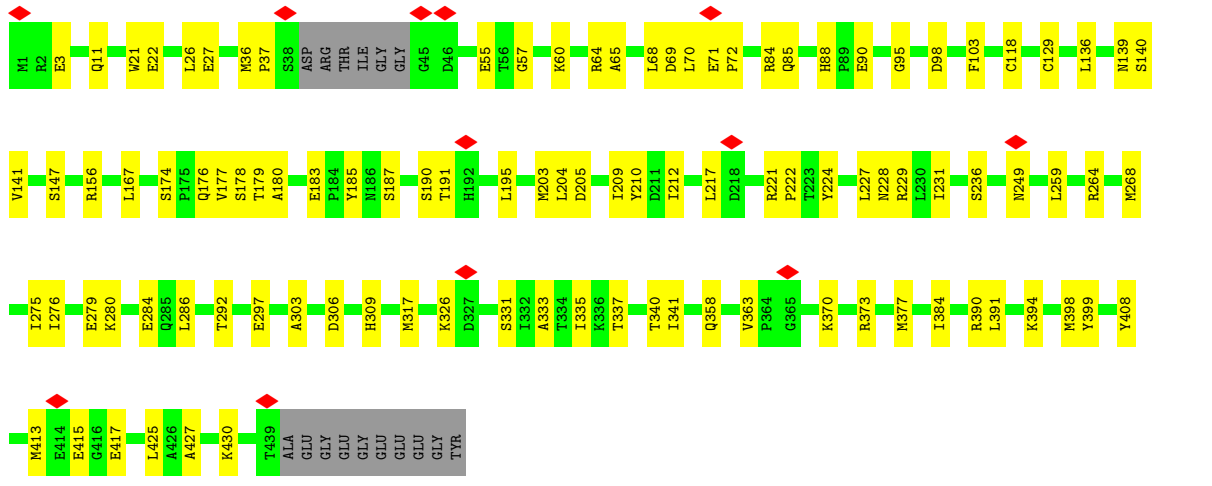
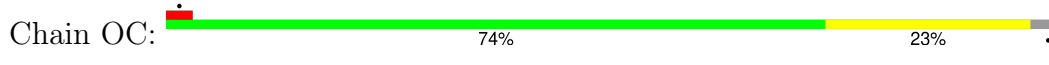

• Molecule 45: Tubulin alpha chain

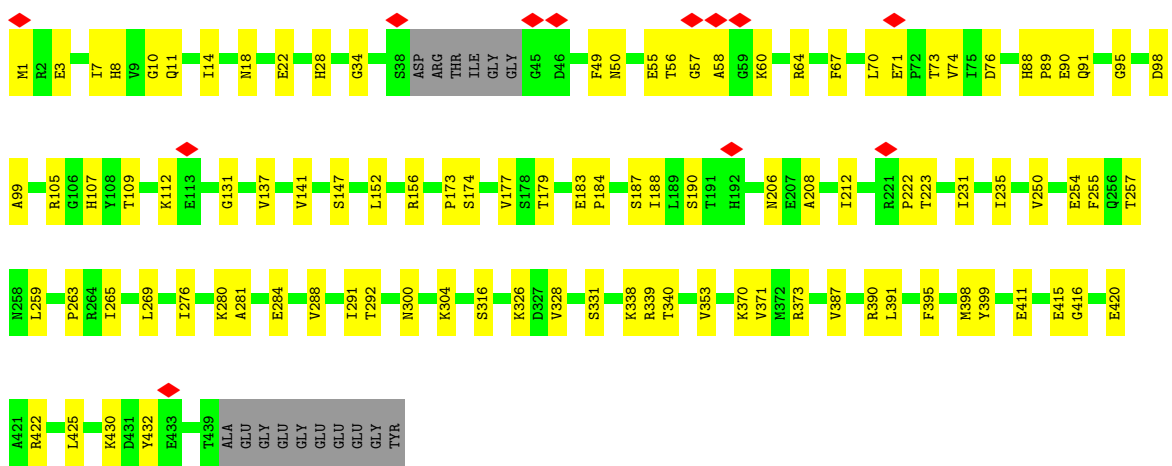
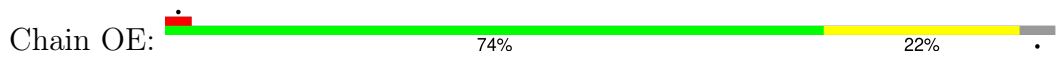

• Molecule 45: Tubulin alpha chain

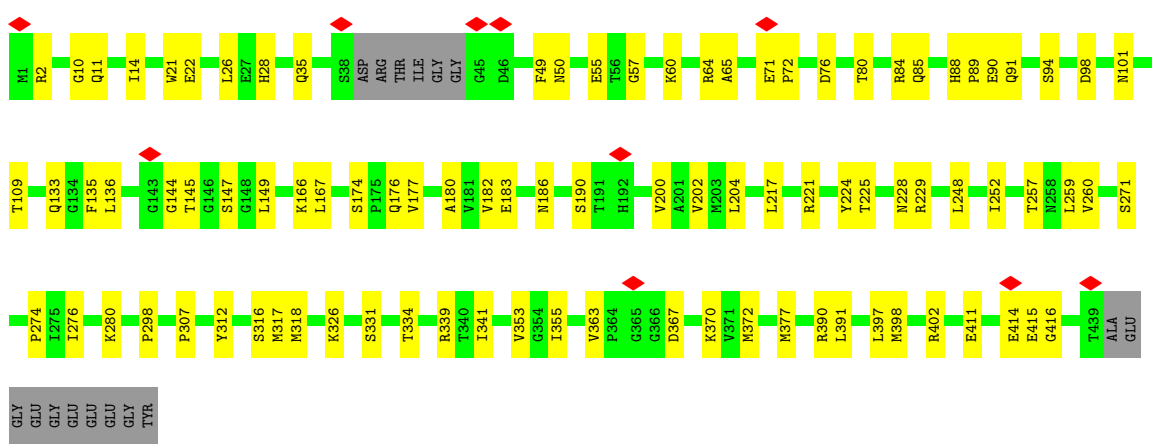
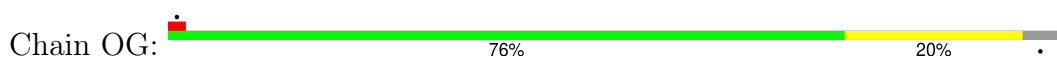

• Molecule 45: Tubulin alpha chain

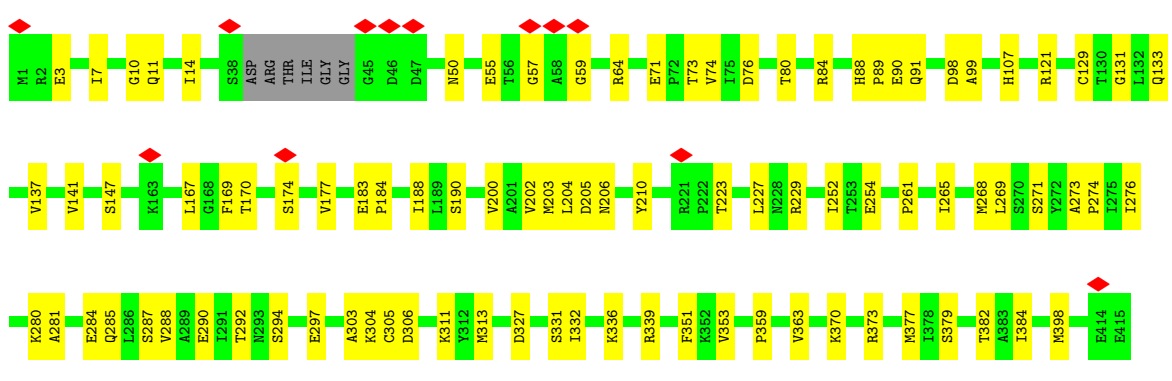
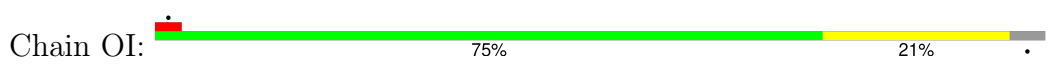

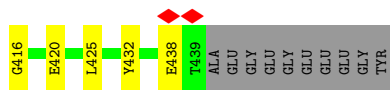

• Molecule 45: Tubulin alpha chain

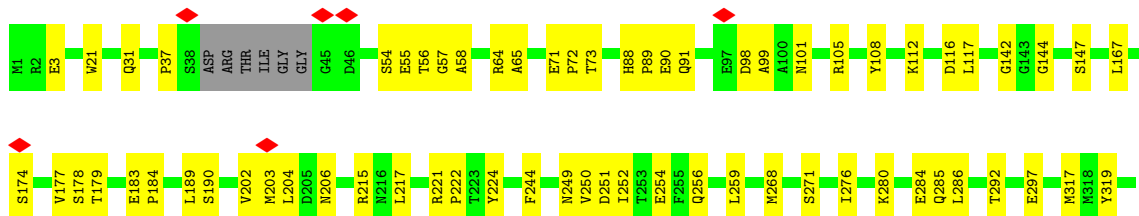
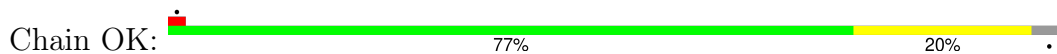

• Molecule 45: Tubulin alpha chain

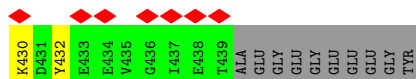
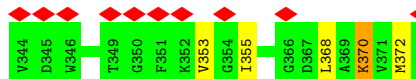
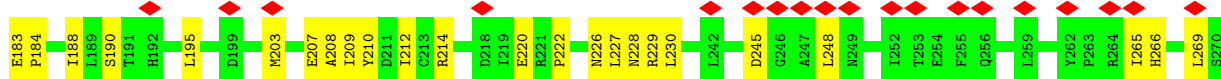
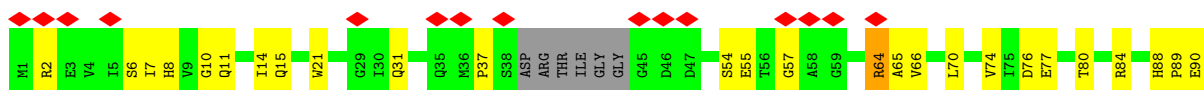

• Molecule 45: Tubulin alpha chain



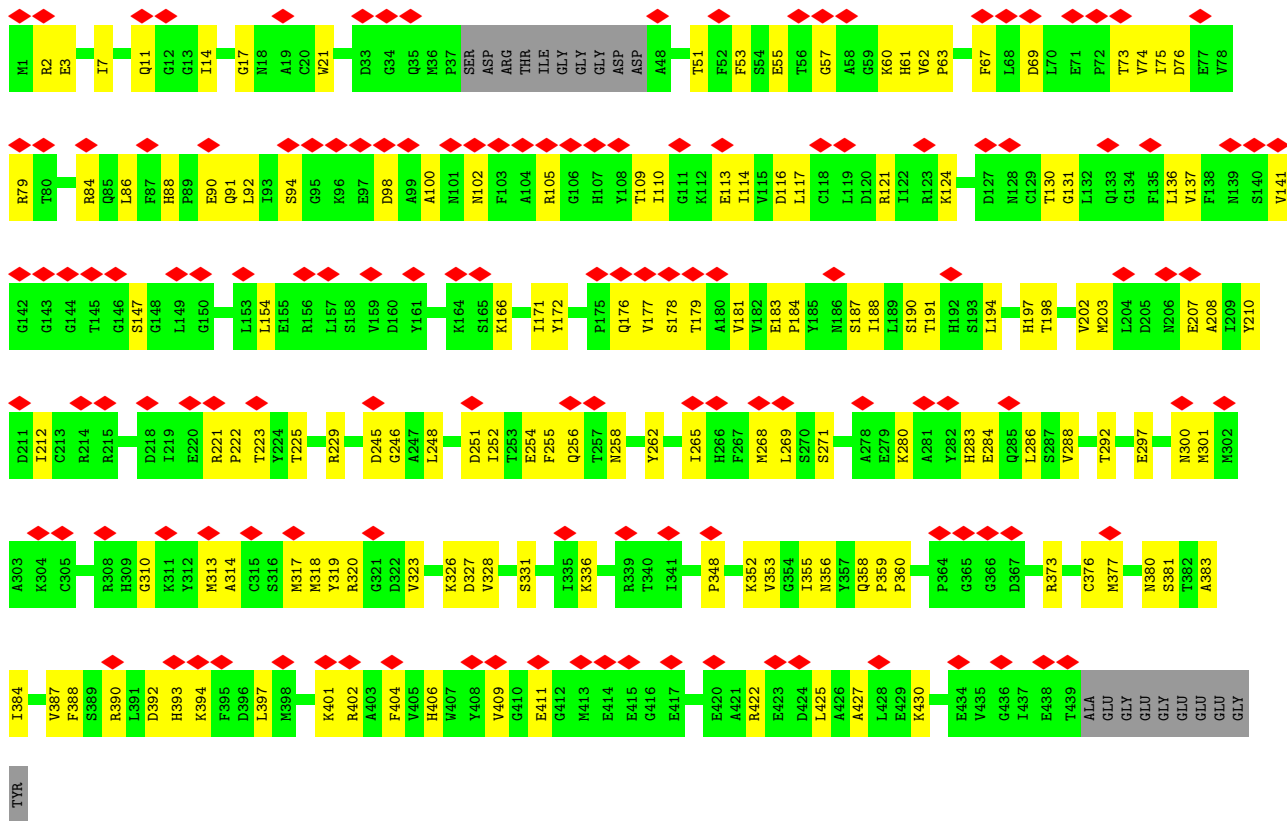

• Molecule 45: Tubulin alpha chain

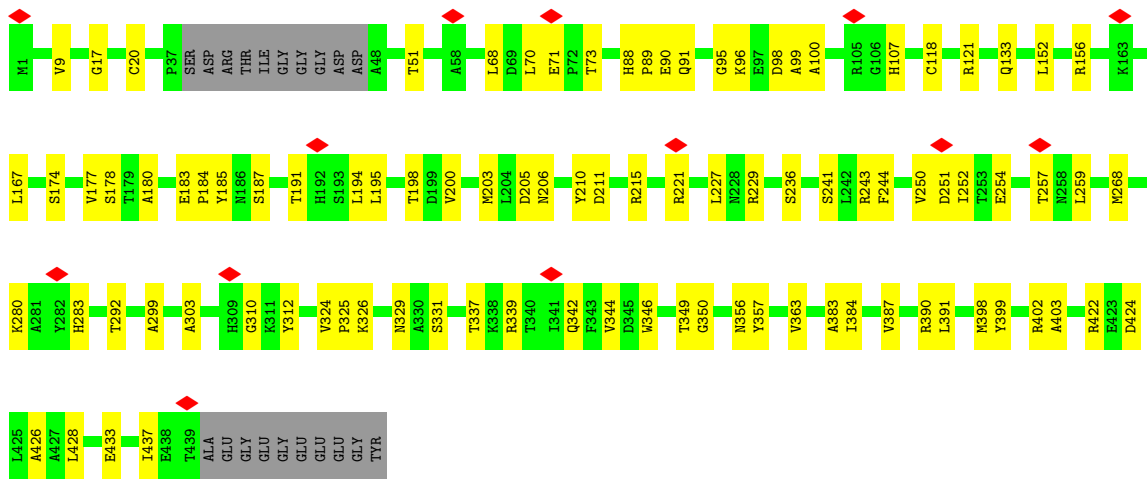
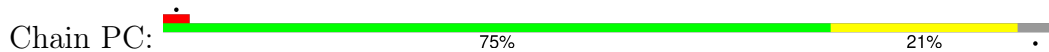

• Molecule 45: Tubulin alpha chain



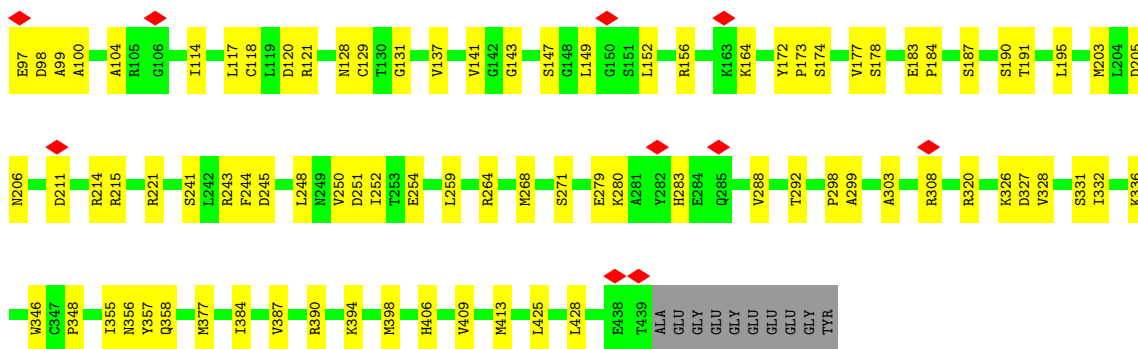

• Molecule 45: Tubulin alpha chain

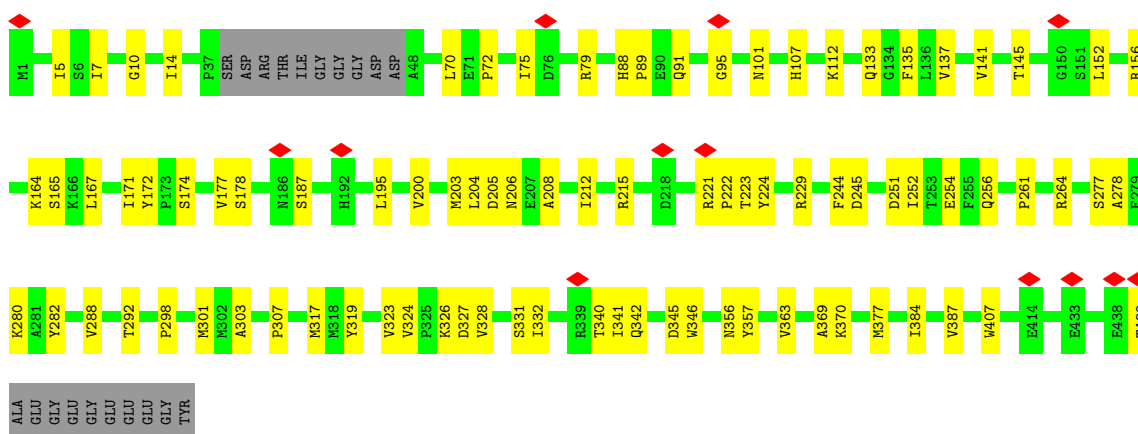
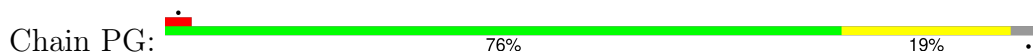

• Molecule 45: Tubulin alpha chain

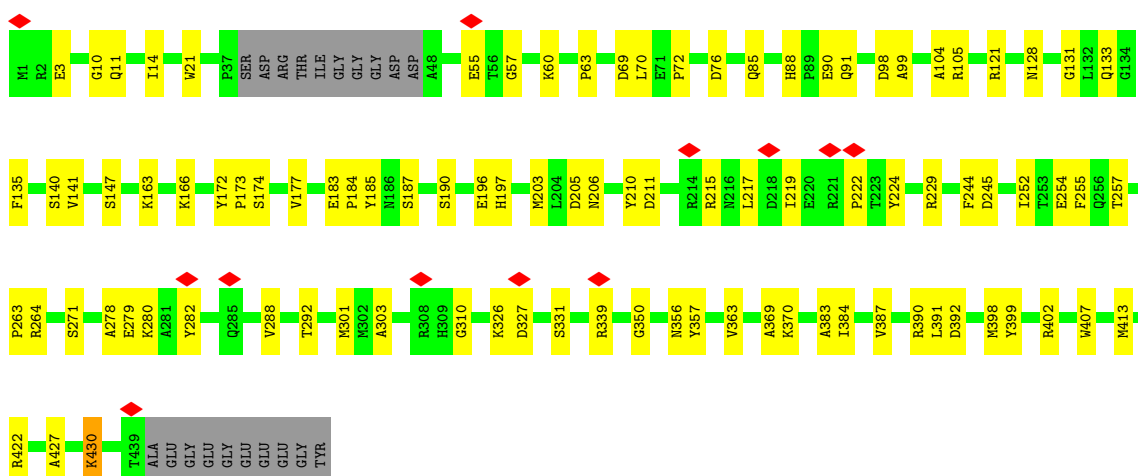

• Molecule 45: Tubulin alpha chain

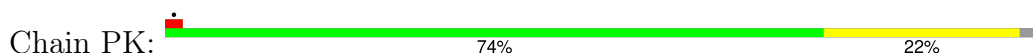

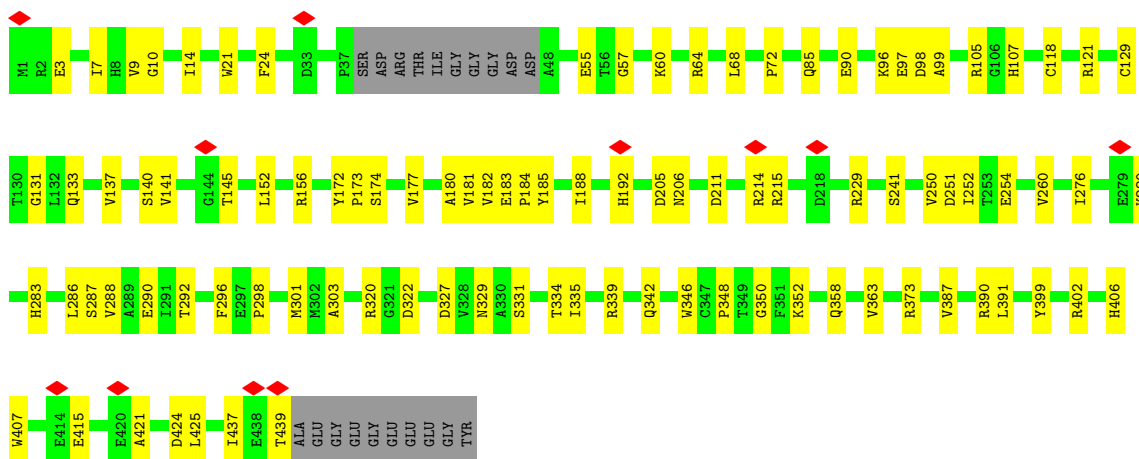

• Molecule 45: Tubulin alpha chain

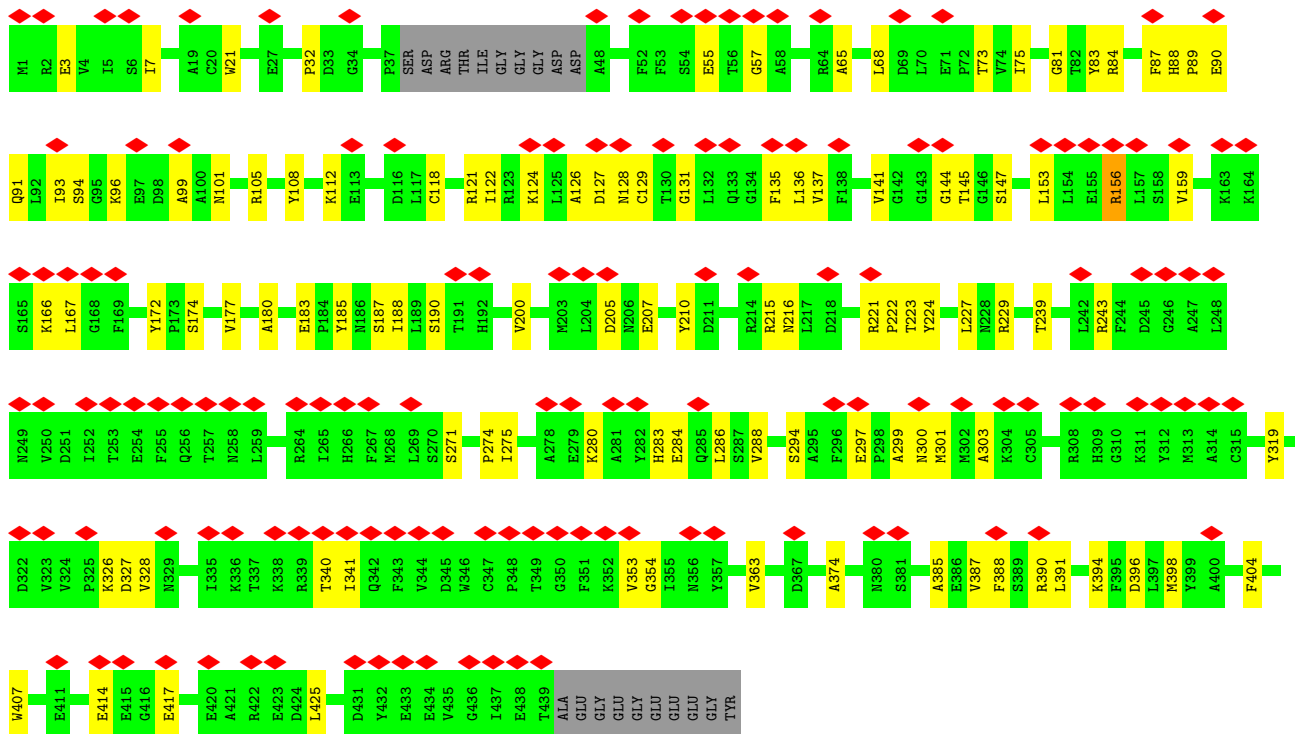
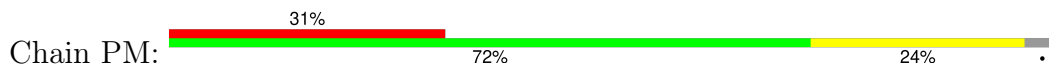

• Molecule 45: Tubulin alpha chain

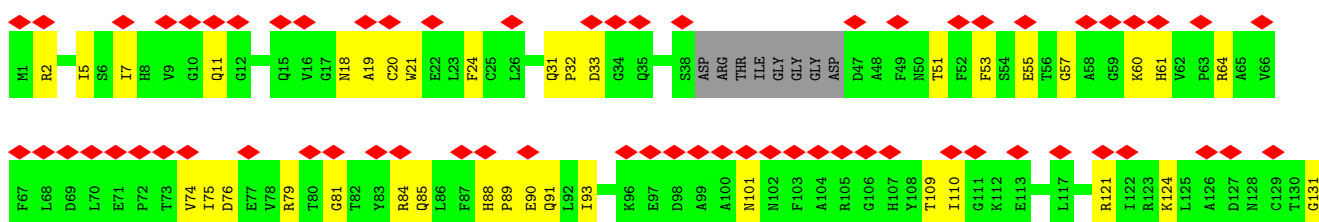

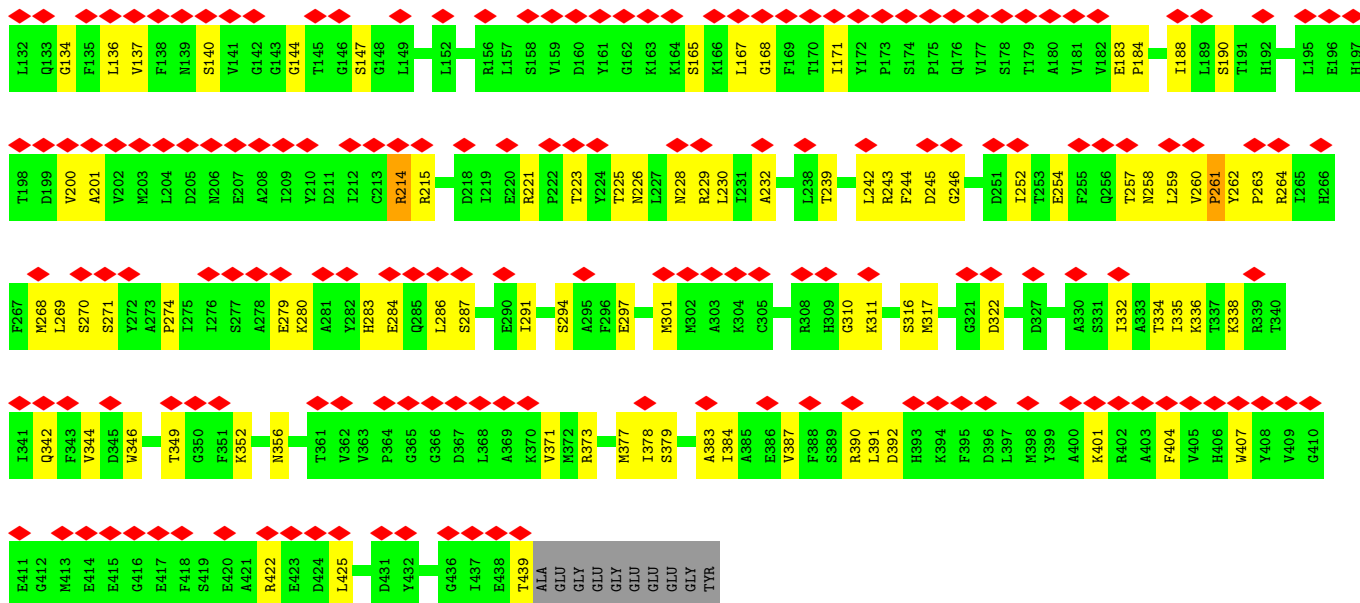

• Molecule 45: Tubulin alpha chain

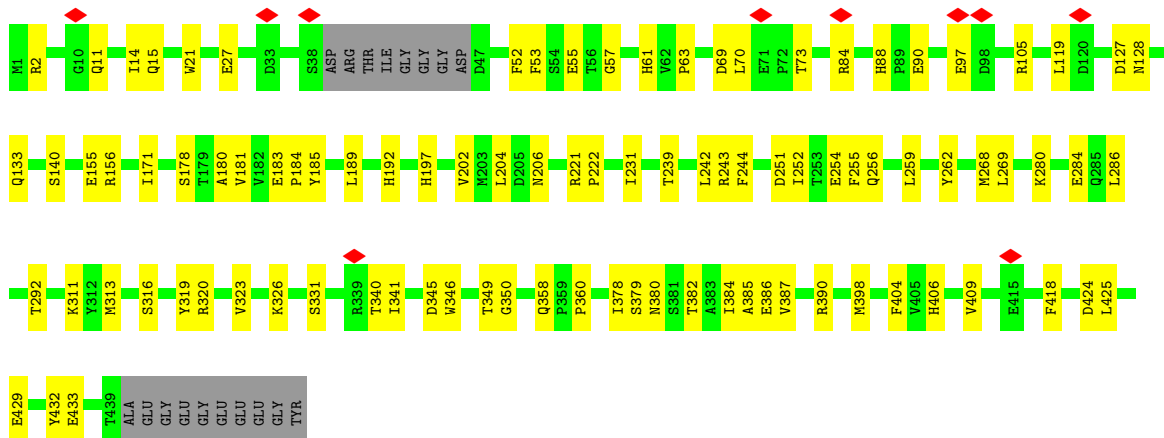
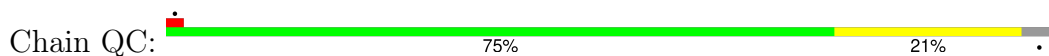

• Molecule 45: Tubulin alpha chain

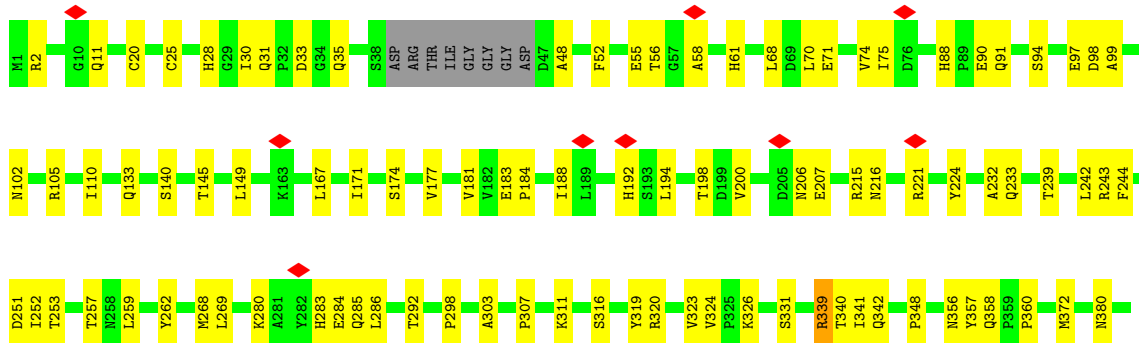
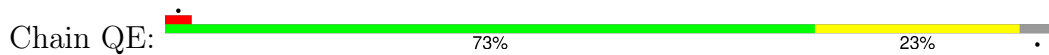



- Molecule 45: Tubulin alpha chain

Chain QG: 75% 21%

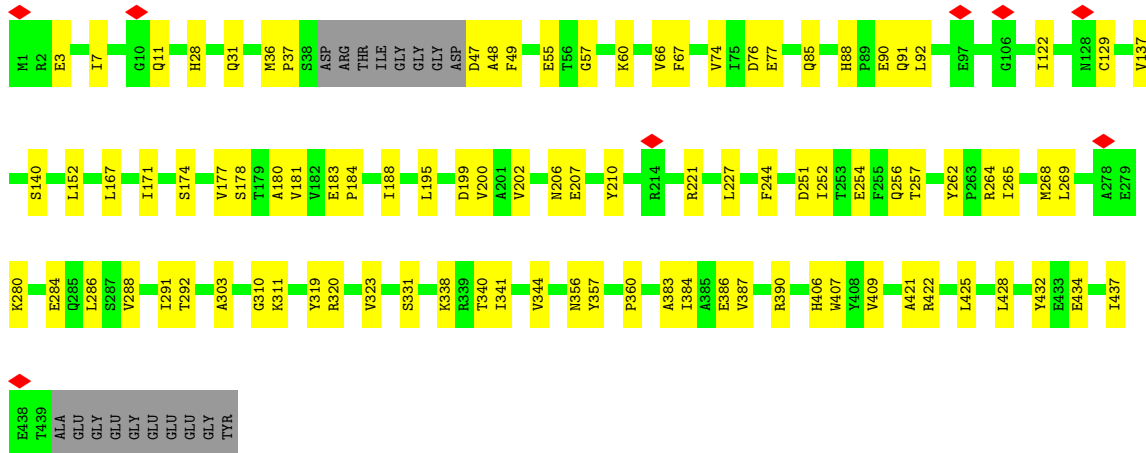

- Molecule 45: Tubulin alpha chain

Chain QI: 72% 24%

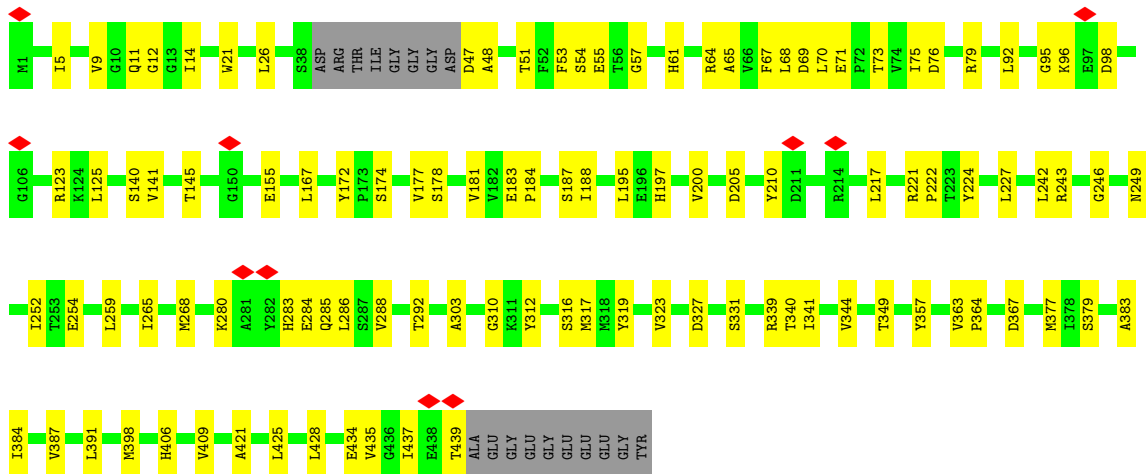

- Molecule 45: Tubulin alpha chain

Chain QK: 73% 22%



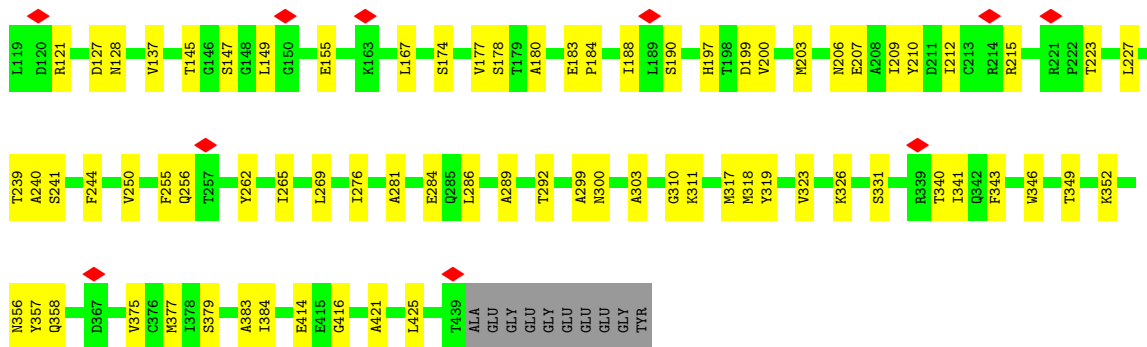

• Molecule 45: Tubulin alpha chain

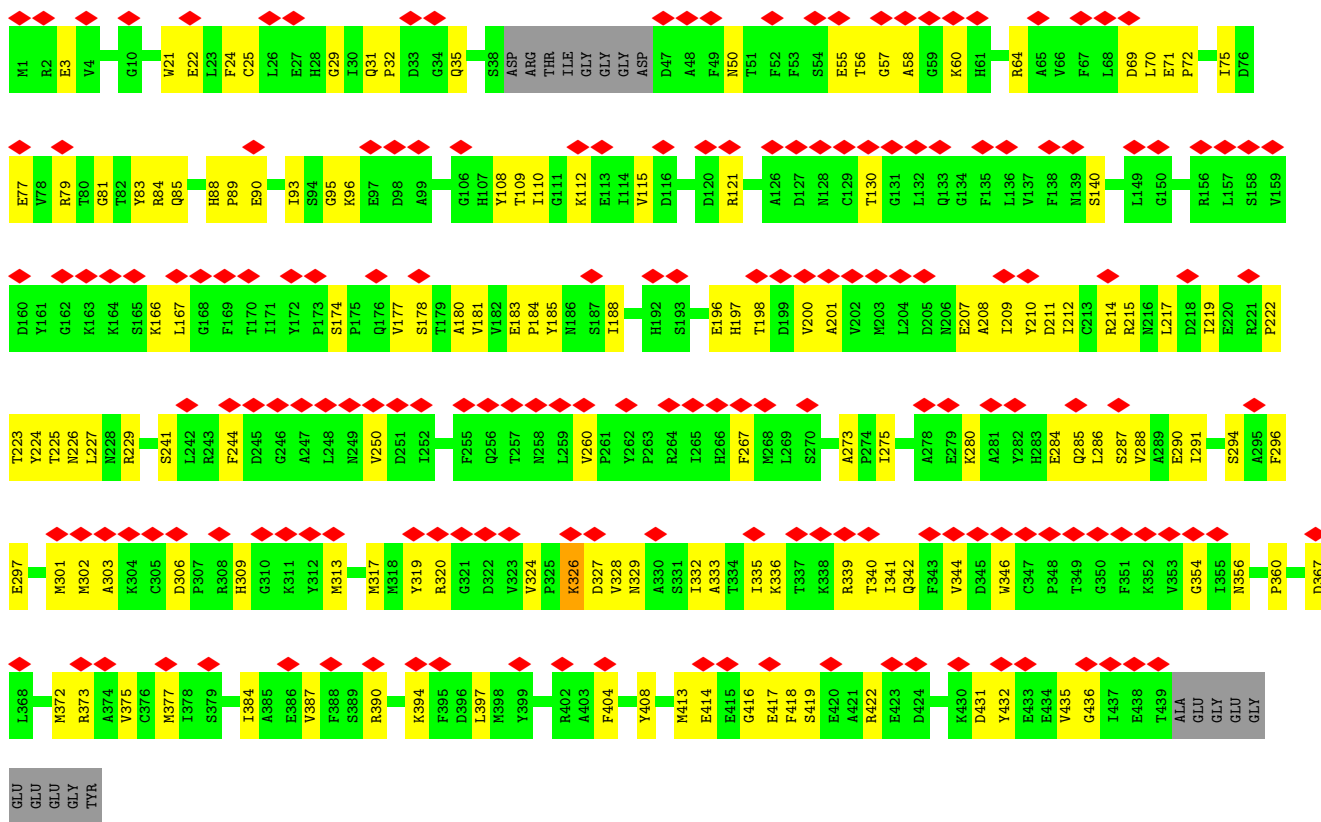
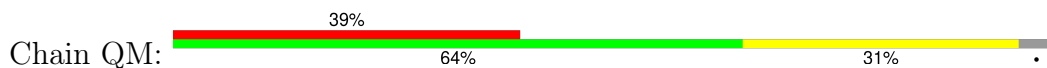

• Molecule 45: Tubulin alpha chain

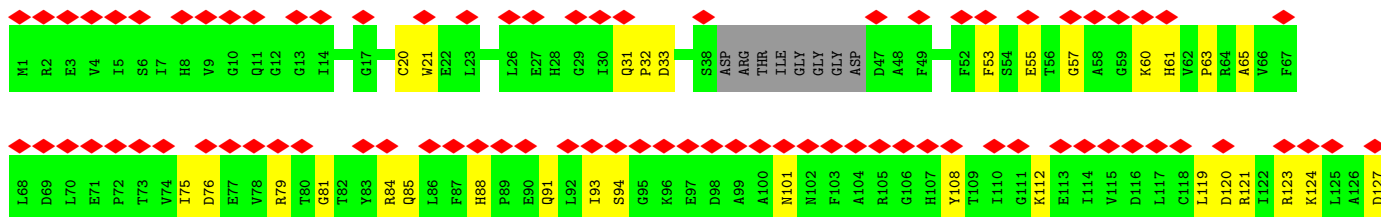
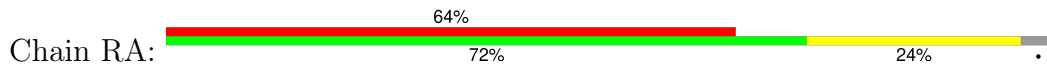

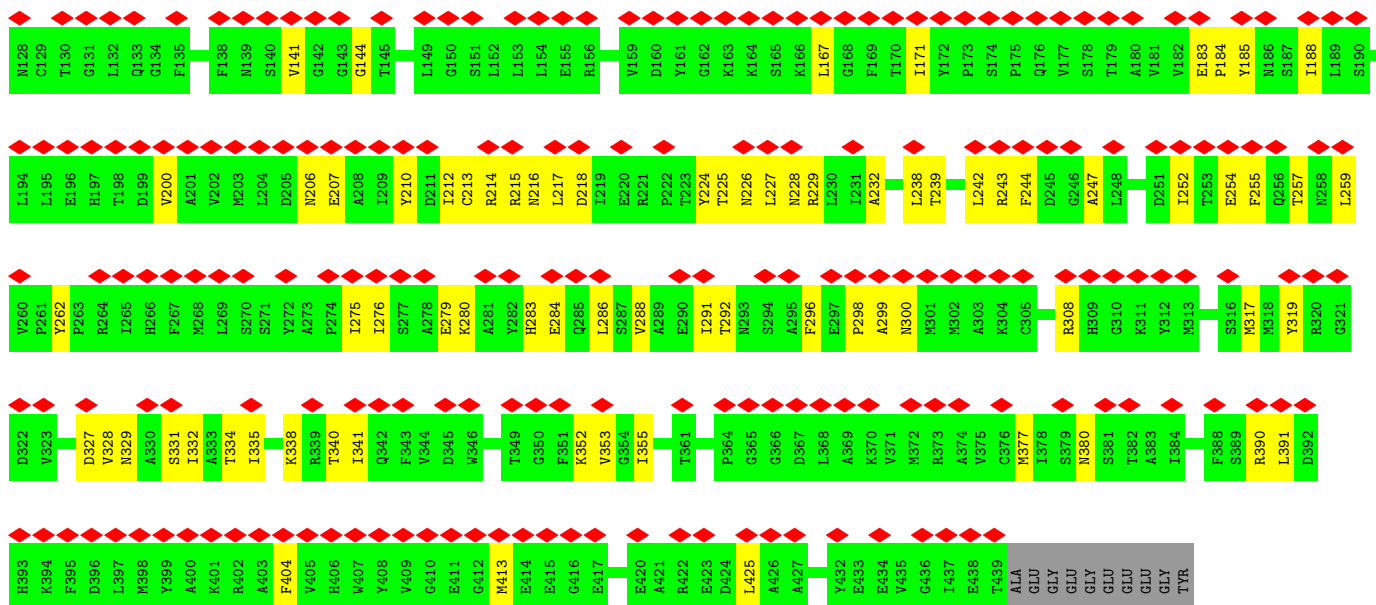

• Molecule 45: Tubulin alpha chain

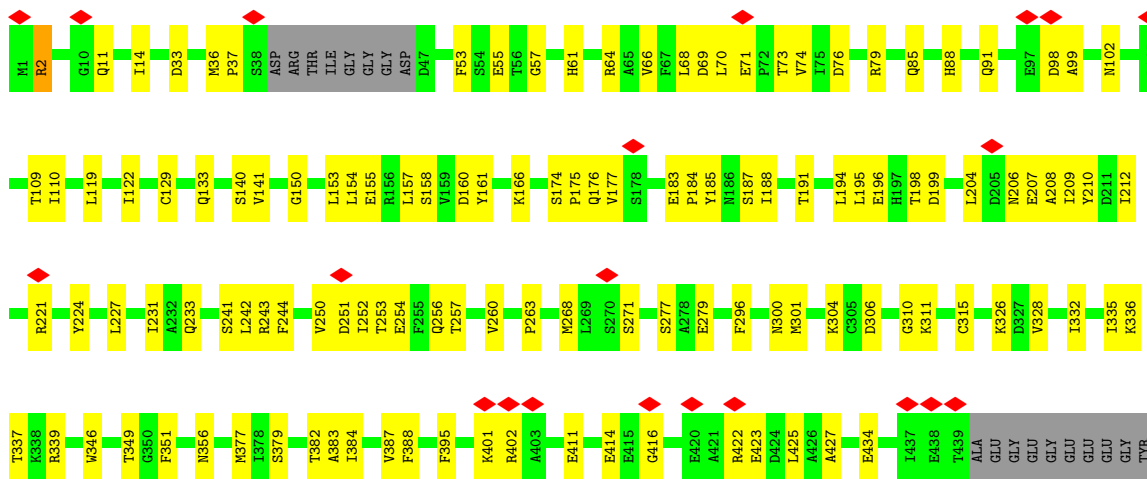

• Molecule 45: Tubulin alpha chain

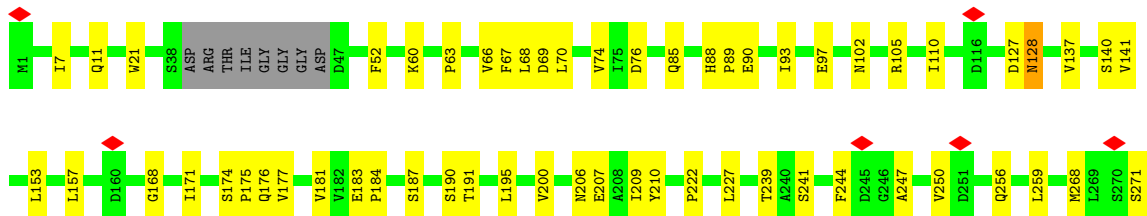
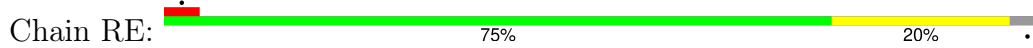

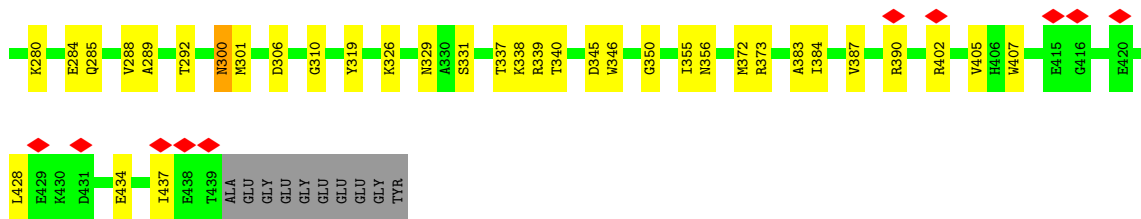

• Molecule 45: Tubulin alpha chain

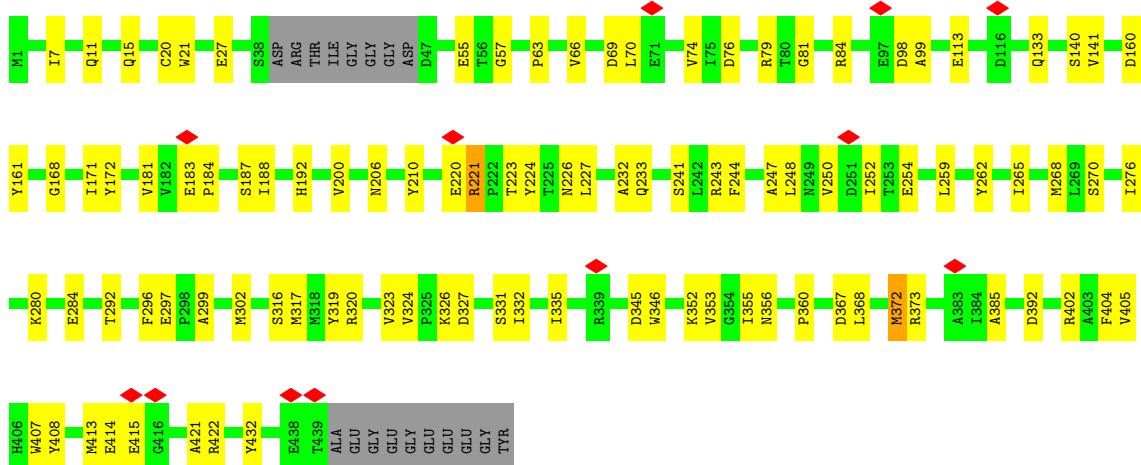
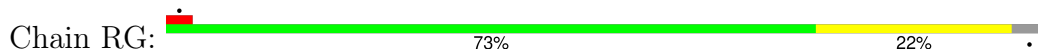

• Molecule 45: Tubulin alpha chain

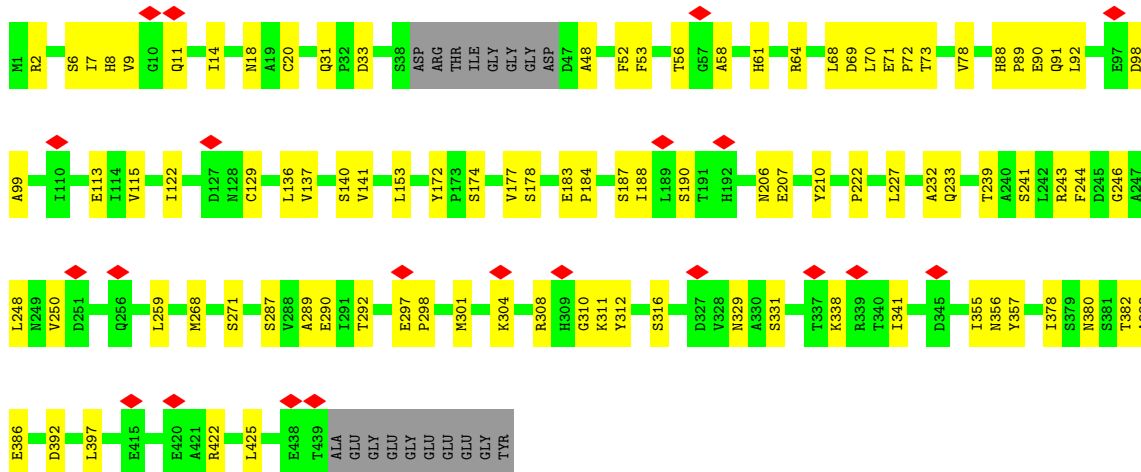
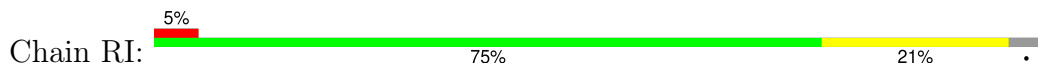

• Molecule 45: Tubulin alpha chain

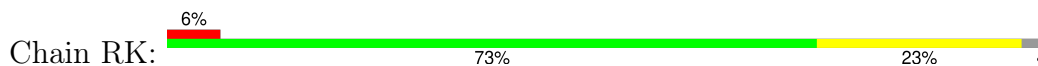

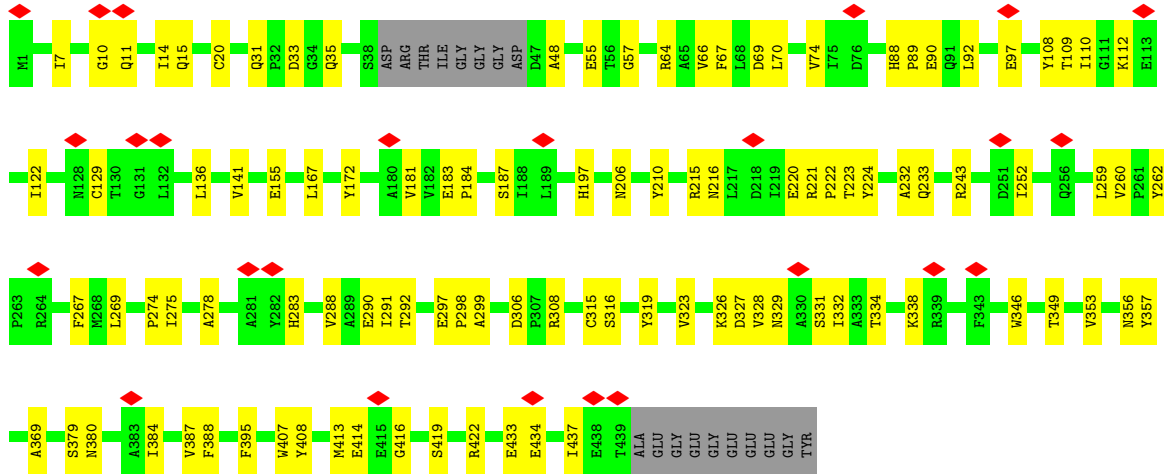

• Molecule 45: Tubulin alpha chain

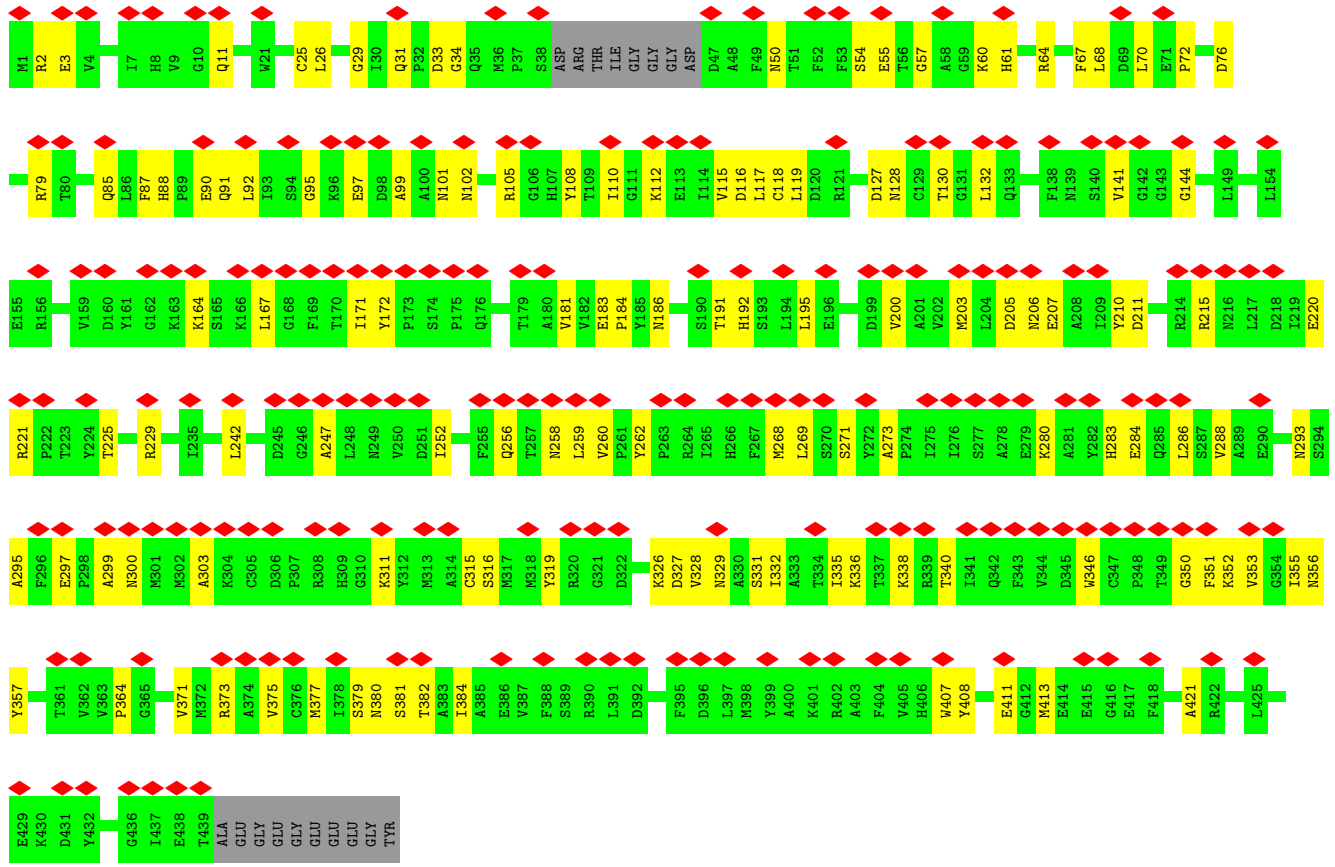

• Molecule 45: Tubulin alpha chain

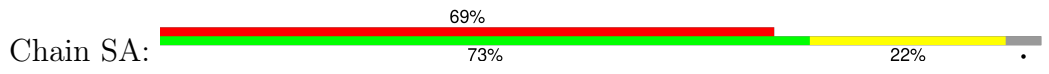

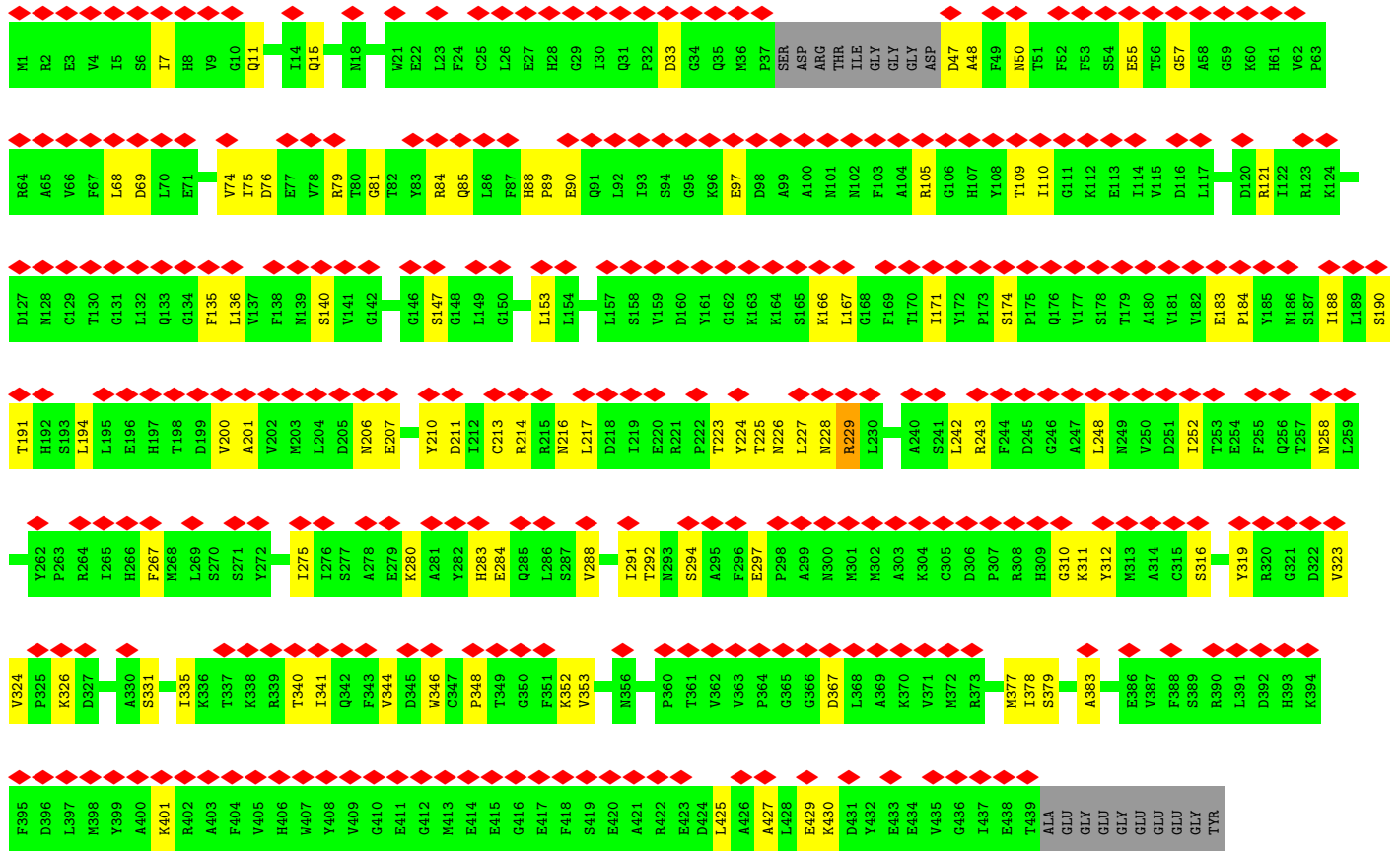

• Molecule 45: Tubulin alpha chain

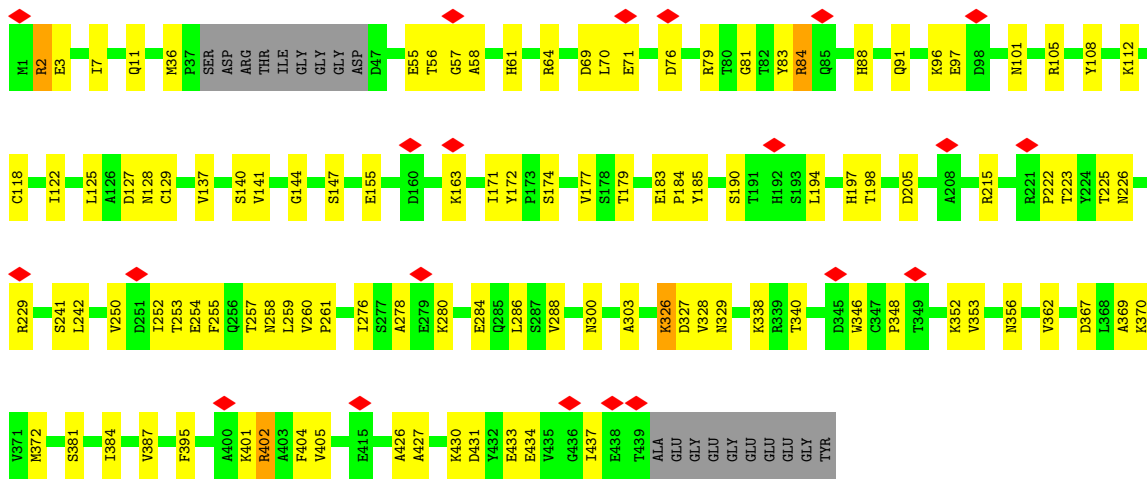
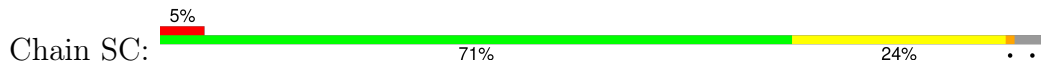

• Molecule 45: Tubulin alpha chain



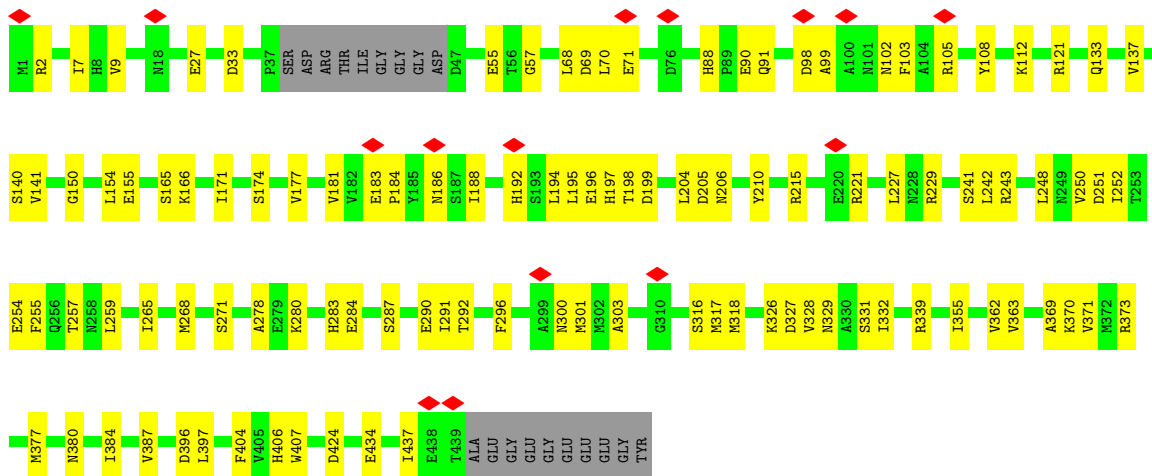

• Molecule 45: Tubulin alpha chain

Chain SG:

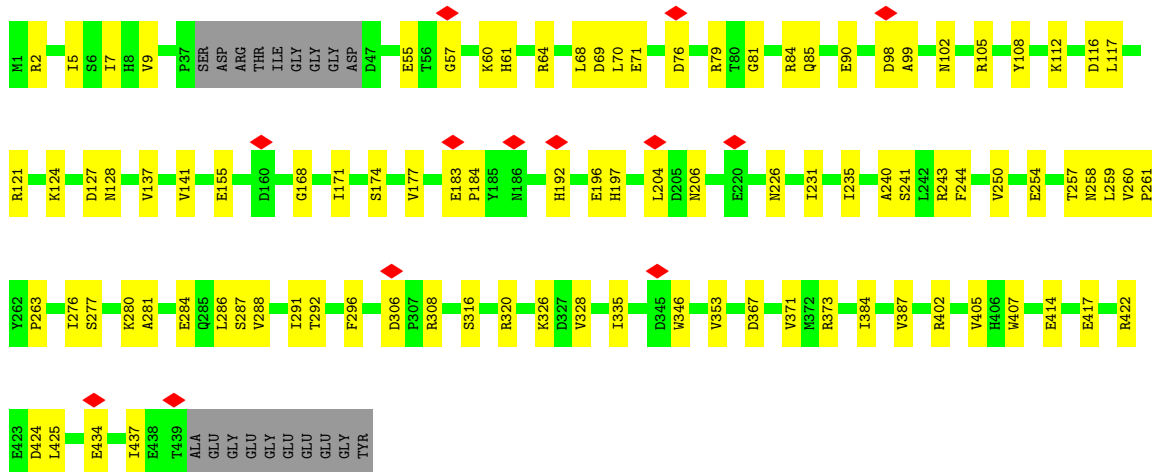

• Molecule 45: Tubulin alpha chain

Chain SI:

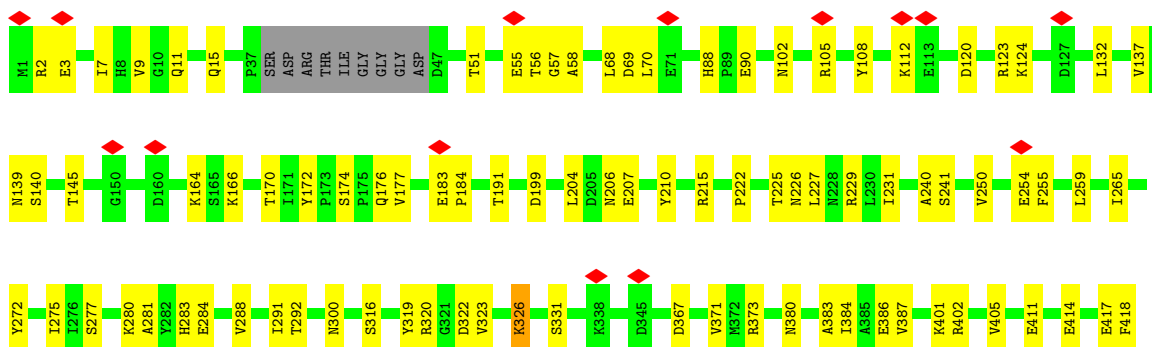

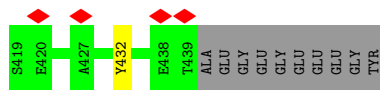

• Molecule 45: Tubulin alpha chain

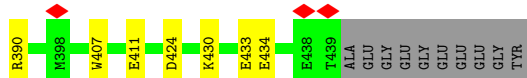
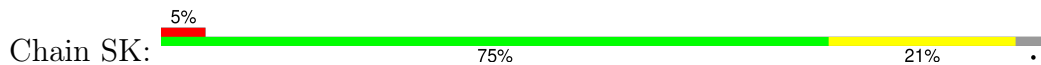

• Molecule 45: Tubulin alpha chain

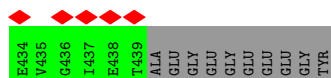
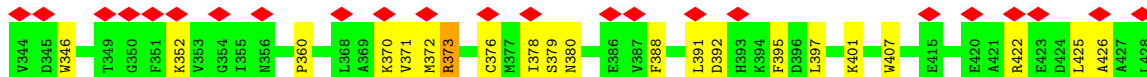
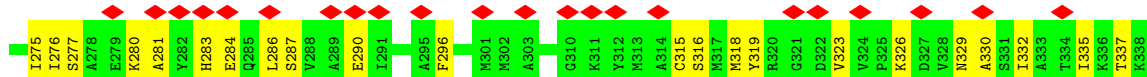
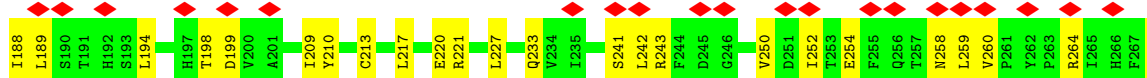

• Molecule 45: Tubulin alpha chain

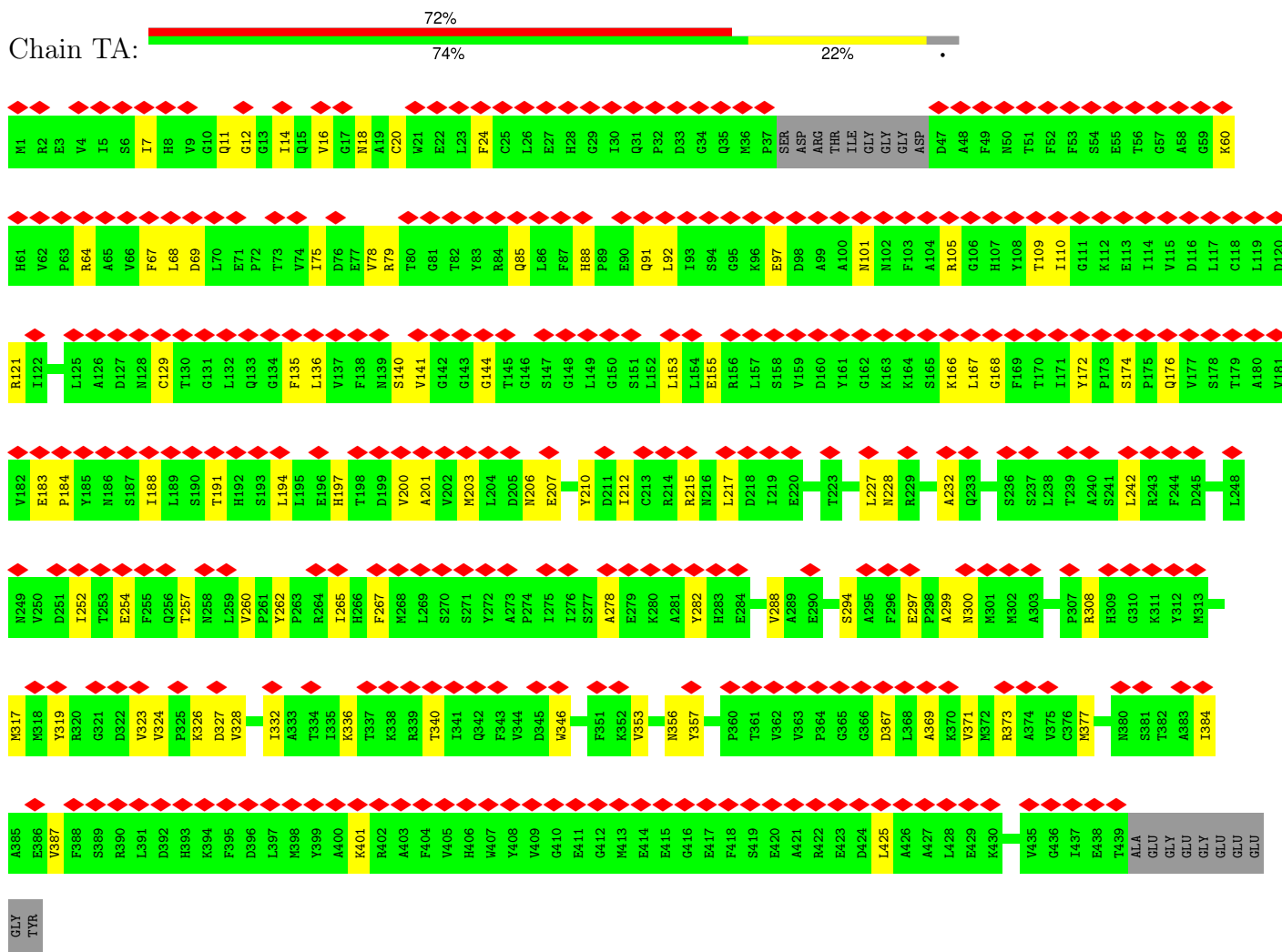

• Molecule 45: Tubulin alpha chain

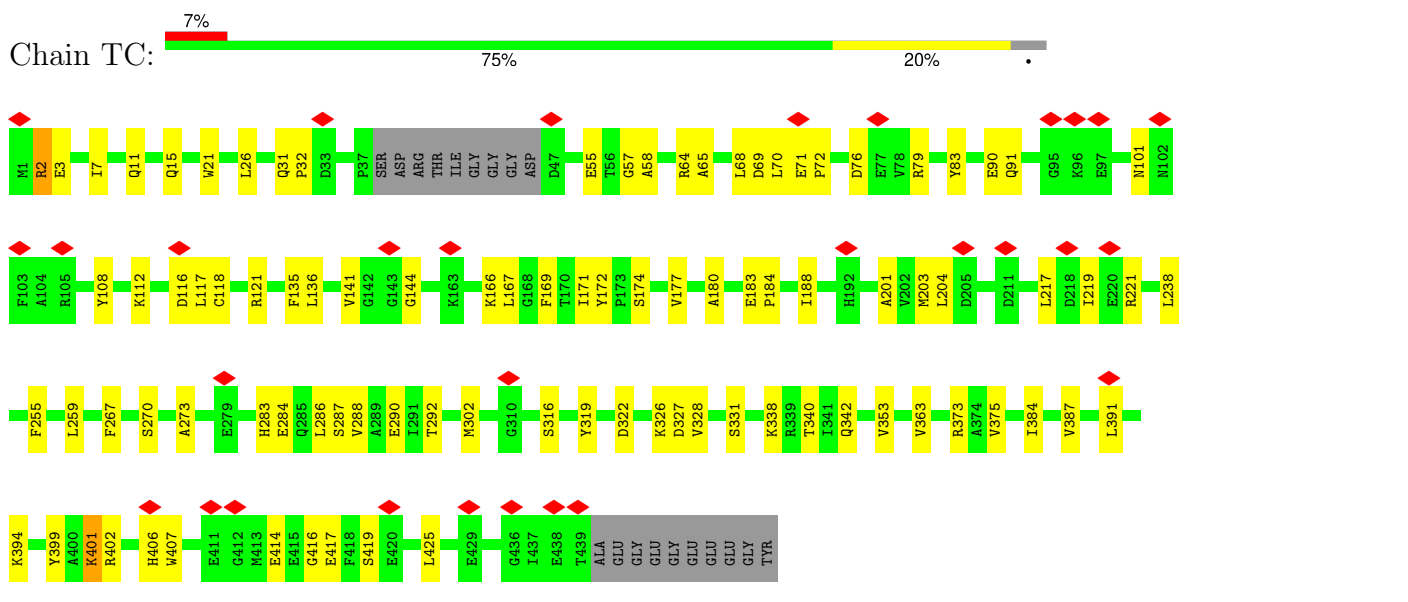

• Molecule 45: Tubulin alpha chain

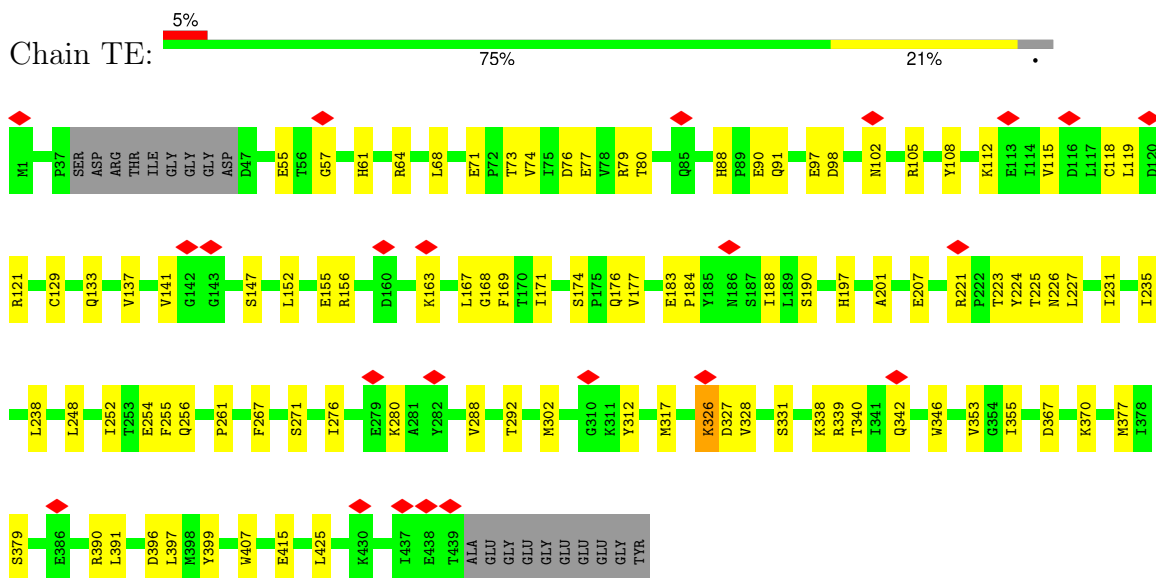

• Molecule 45: Tubulin alpha chain

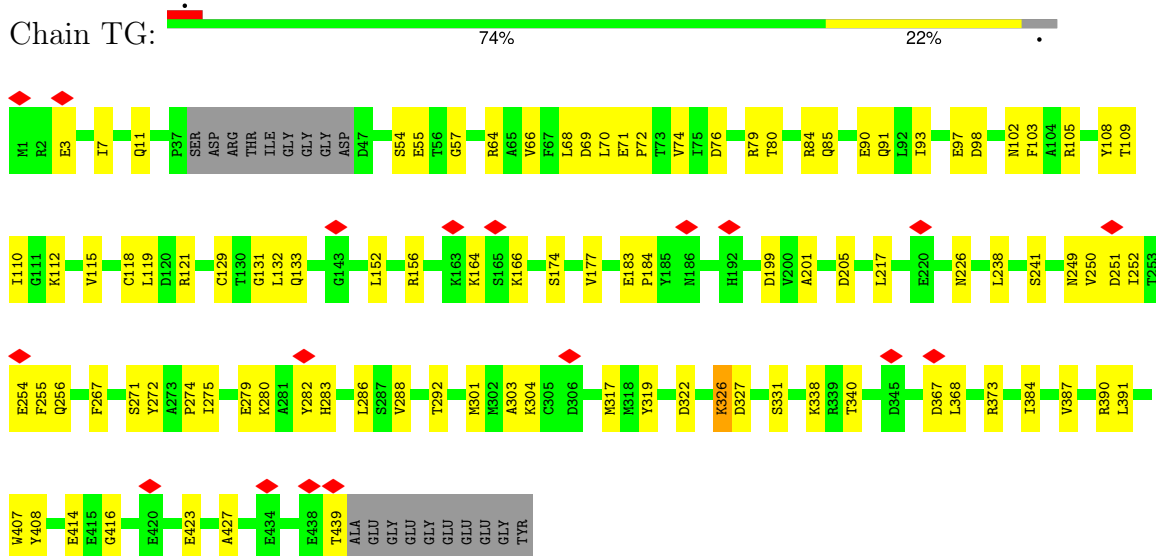

• Molecule 45: Tubulin alpha chain

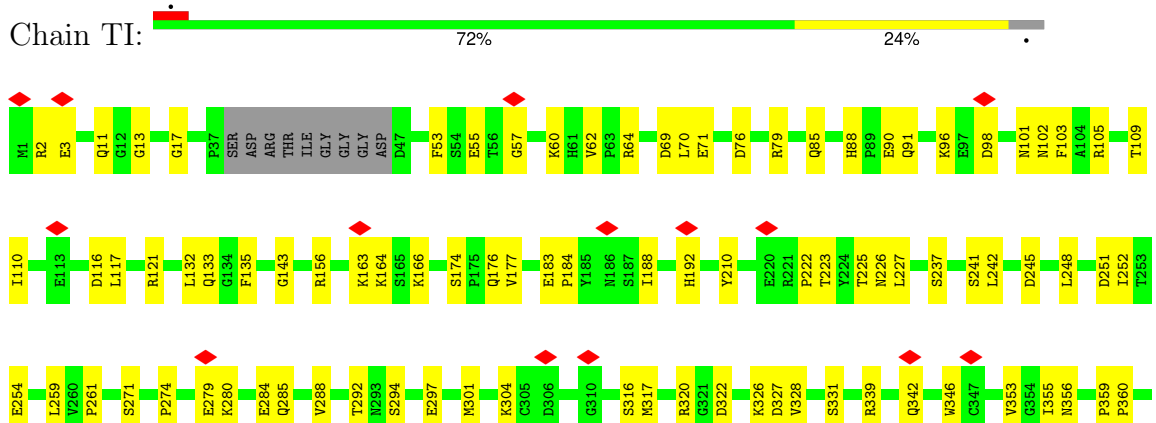

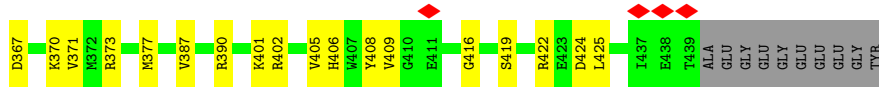

• Molecule 45: Tubulin alpha chain

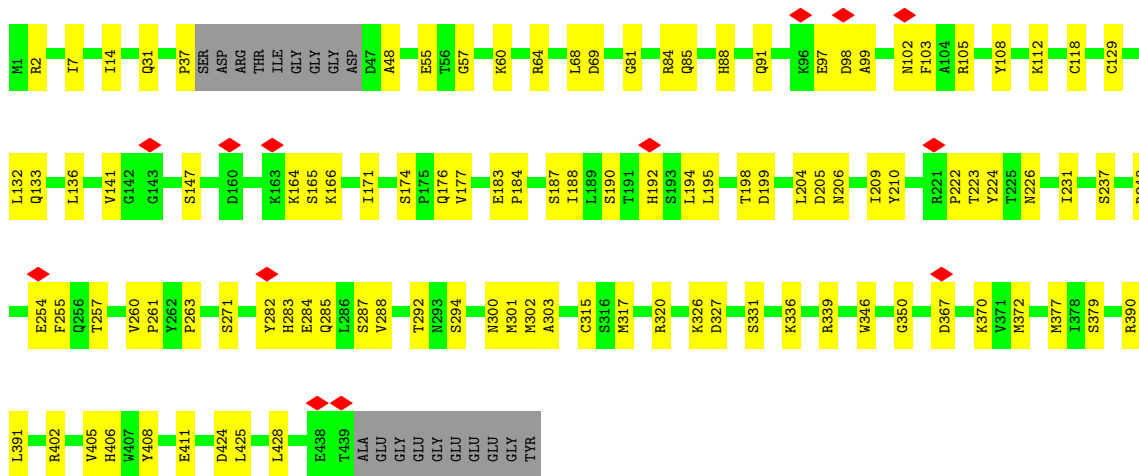
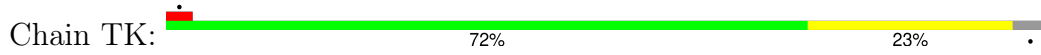

• Molecule 45: Tubulin alpha chain

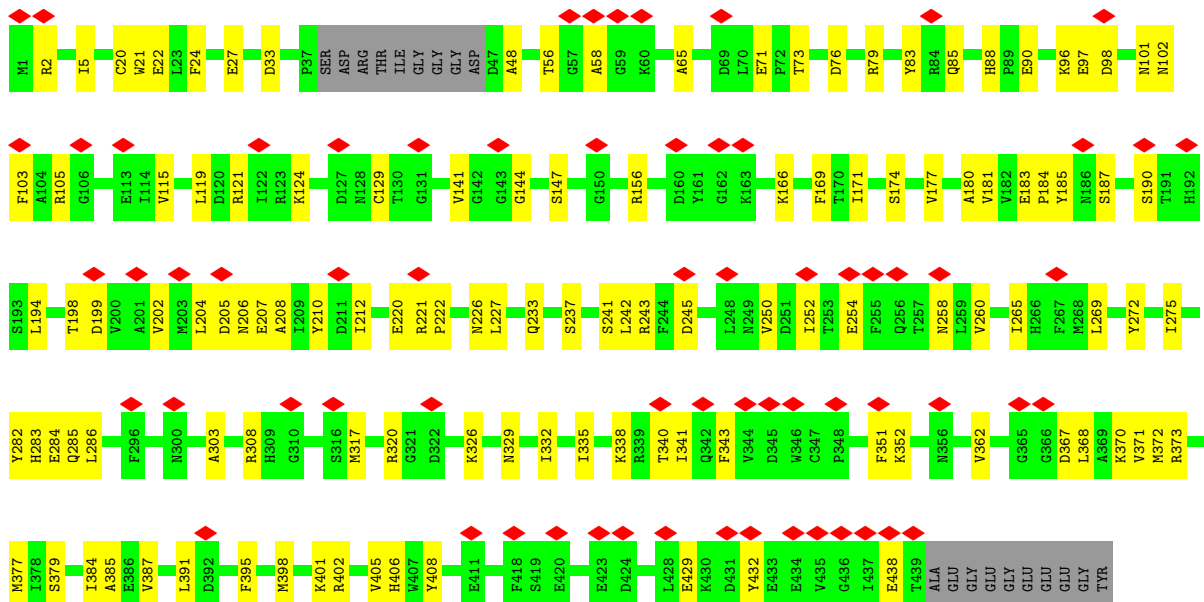

• Molecule 45: Tubulin alpha chain

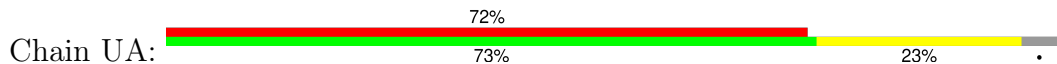

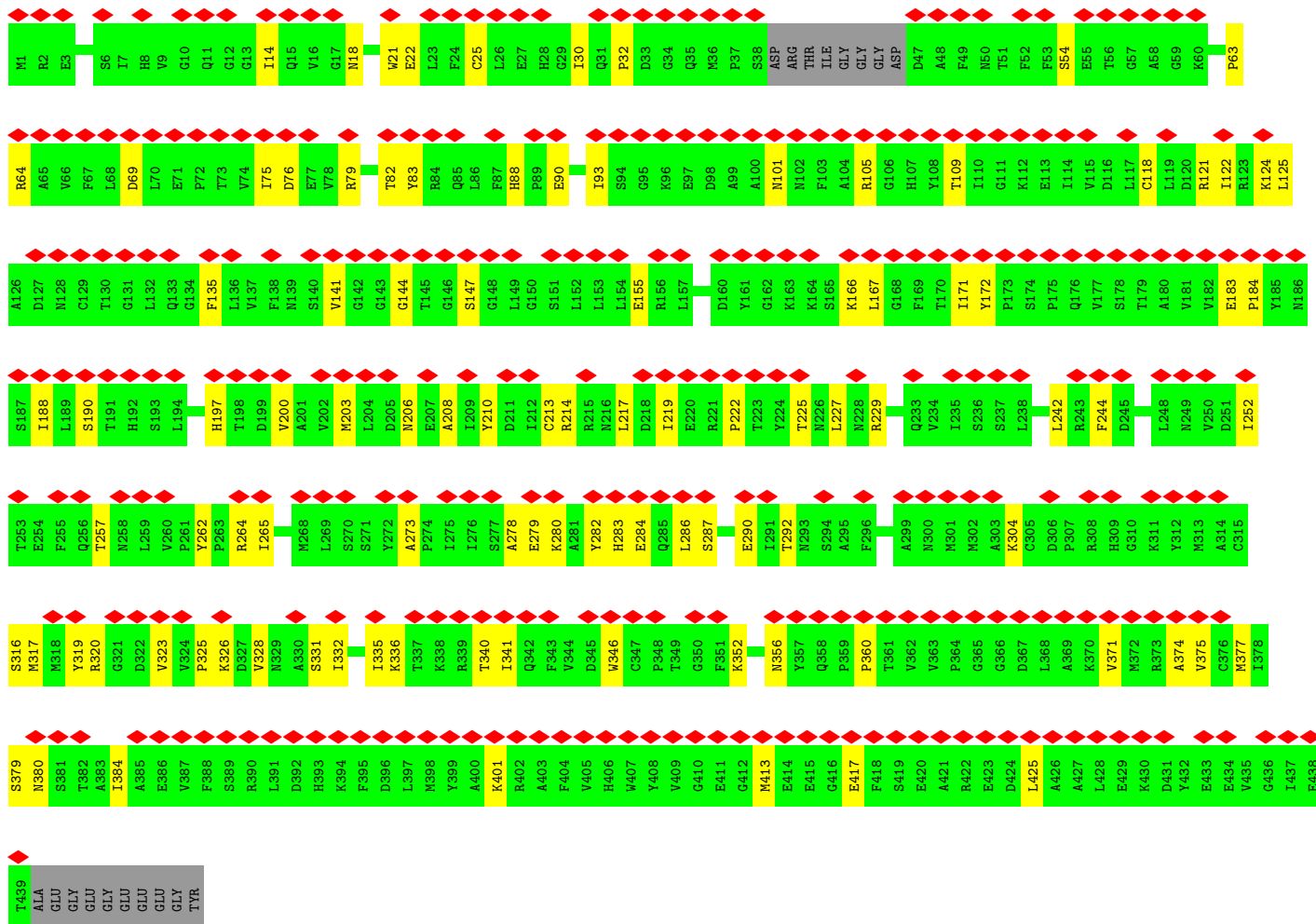

- Molecule 45: Tubulin alpha chain

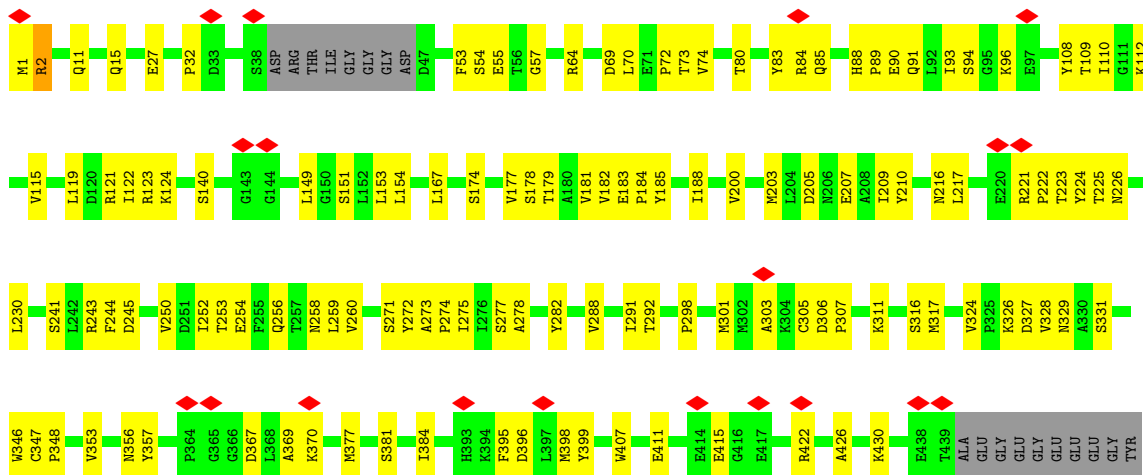

- Molecule 45: Tubulin alpha chain

Chain UE:

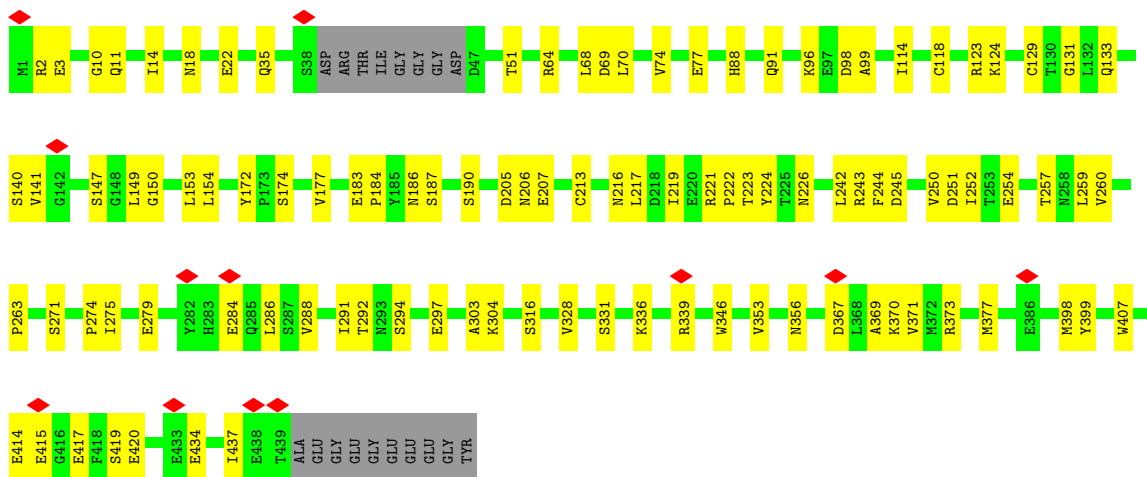

• Molecule 45: Tubulin alpha chain

Chain UG:

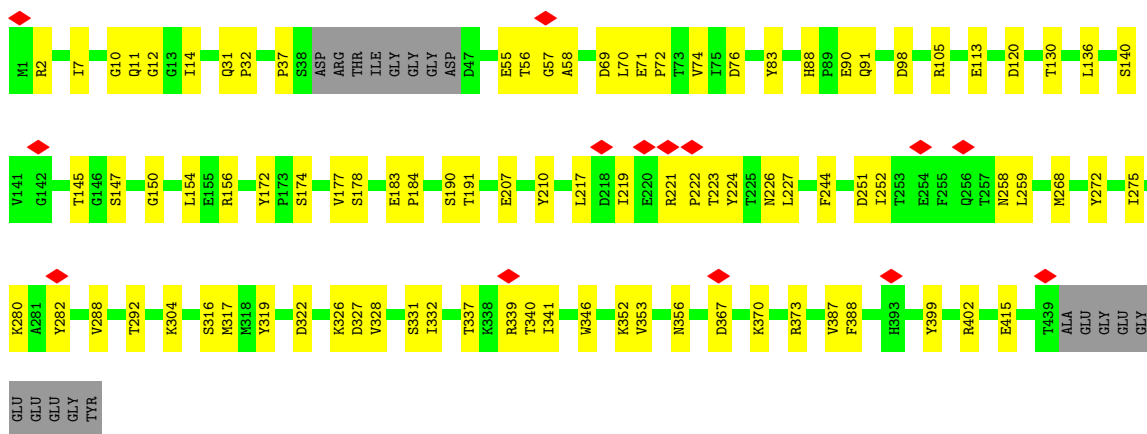

• Molecule 45: Tubulin alpha chain

Chain UI:

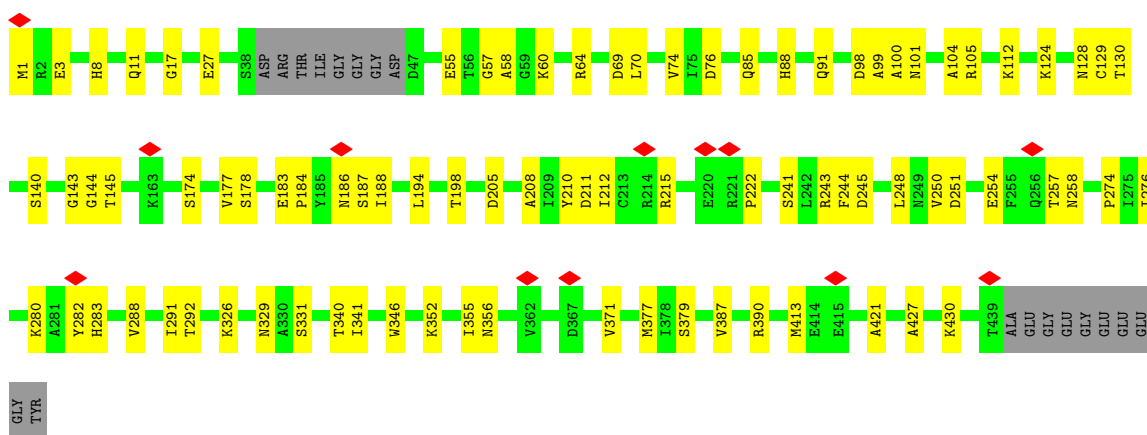

• Molecule 45: Tubulin alpha chain

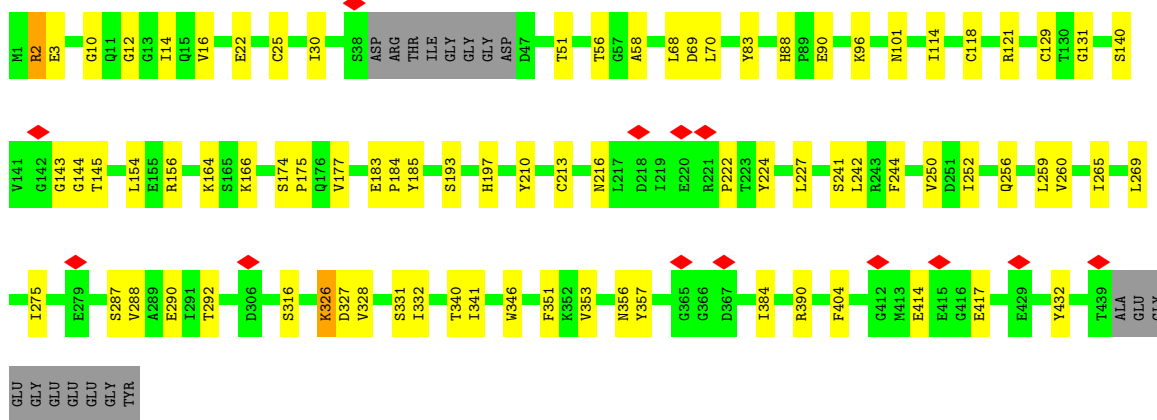
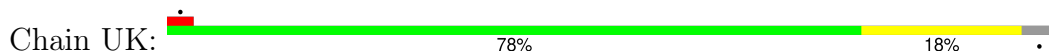

• Molecule 45: Tubulin alpha chain

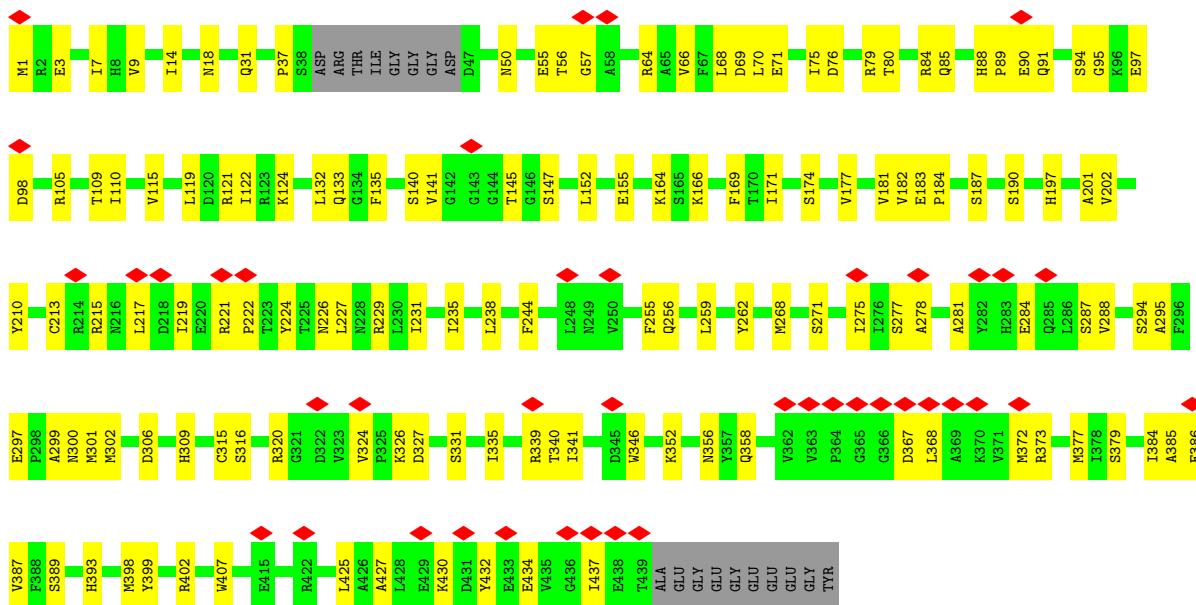

• Molecule 45: Tubulin alpha chain

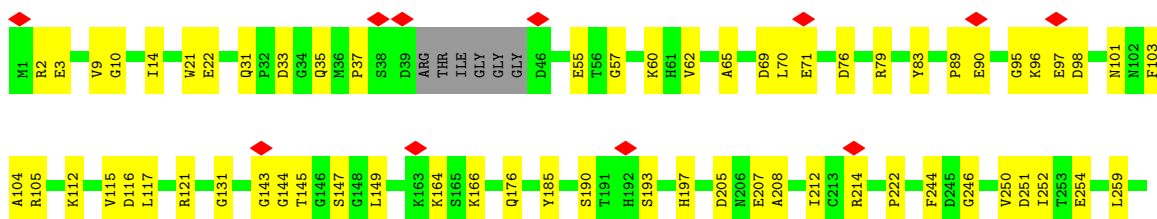
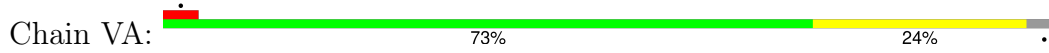

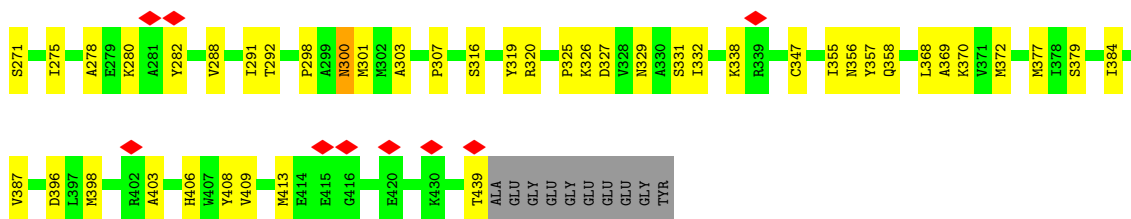

• Molecule 45: Tubulin alpha chain

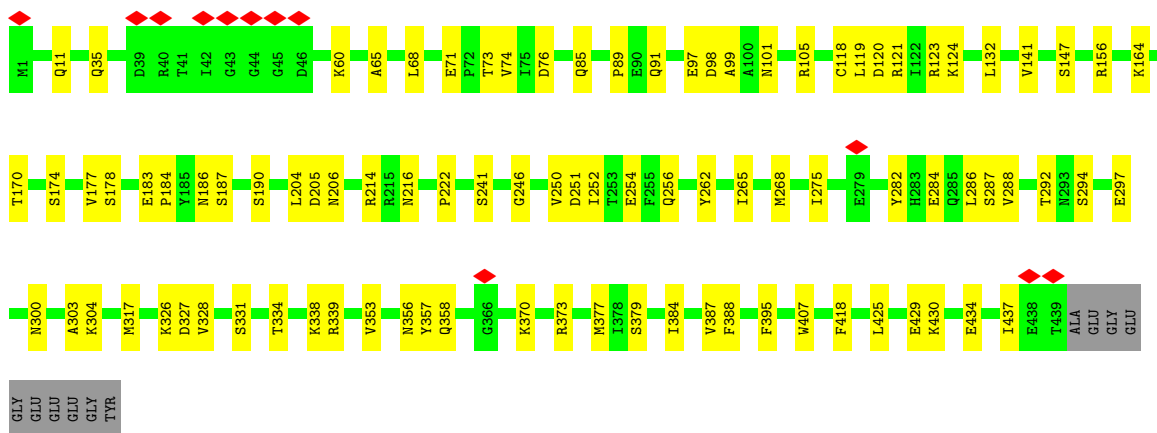
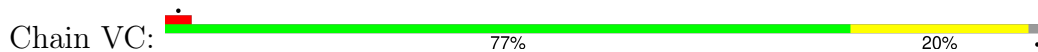

• Molecule 45: Tubulin alpha chain

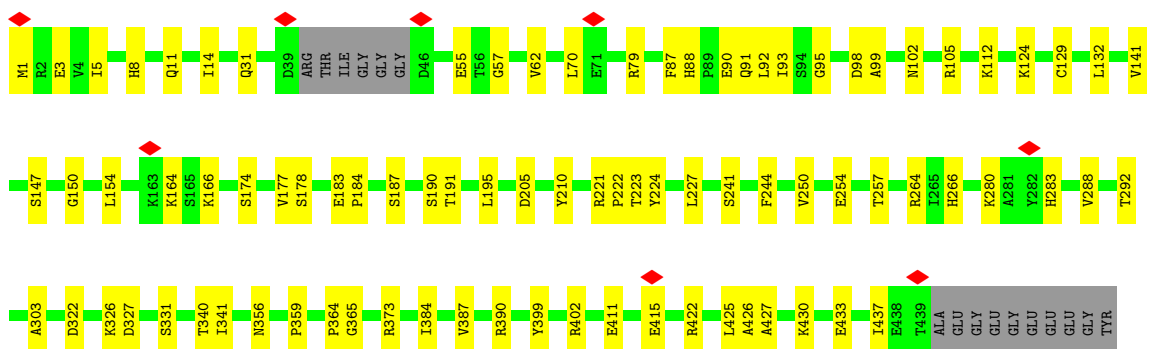
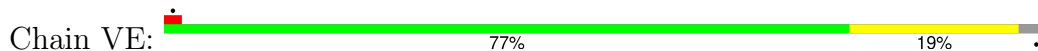

• Molecule 45: Tubulin alpha chain

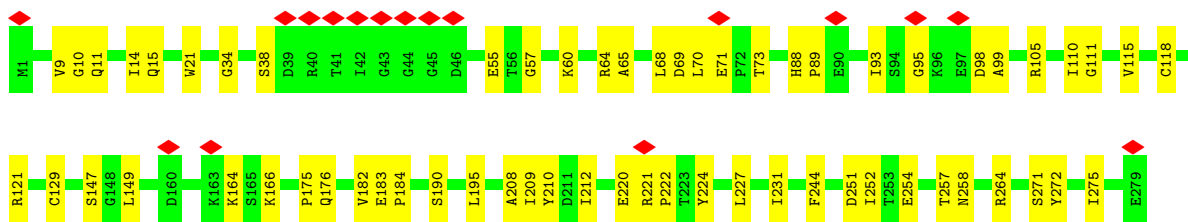
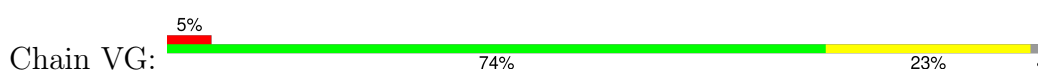

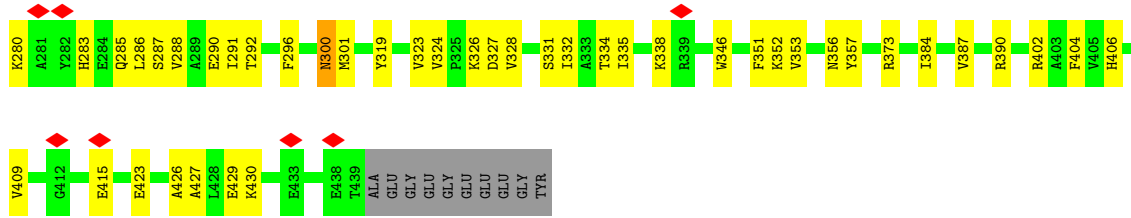

• Molecule 45: Tubulin alpha chain

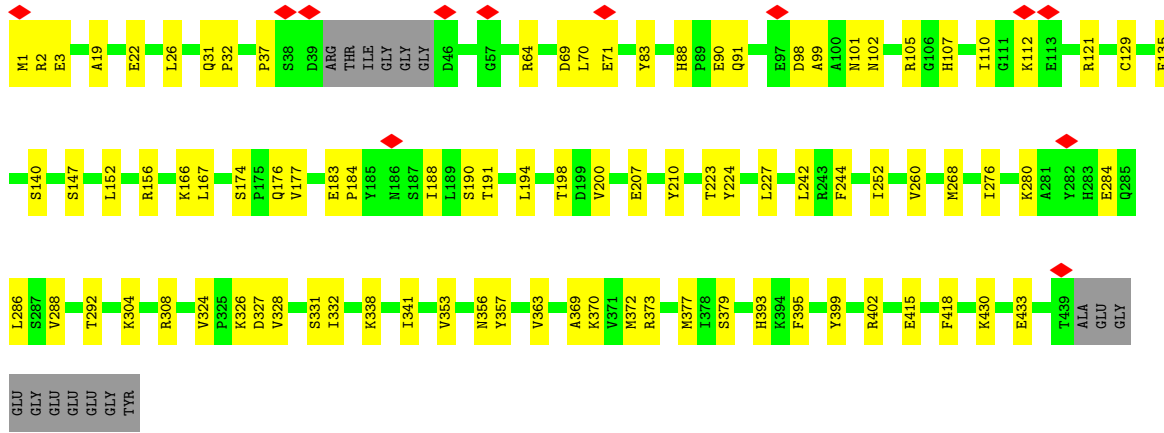
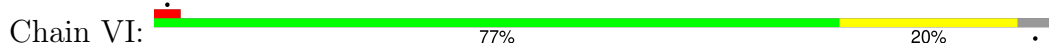

• Molecule 45: Tubulin alpha chain

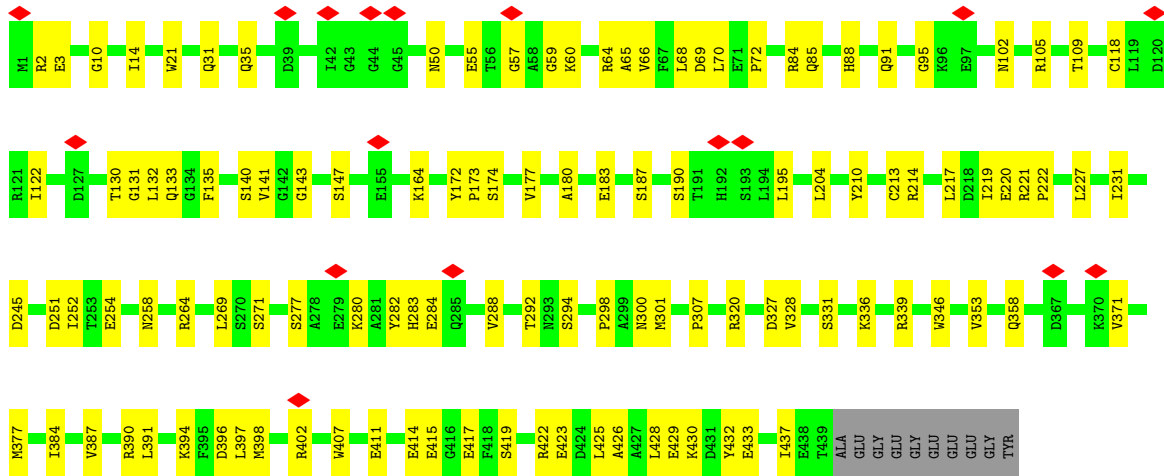

• Molecule 45: Tubulin alpha chain

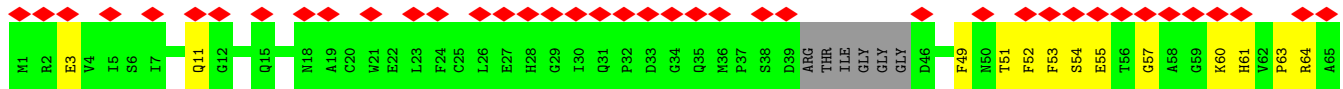

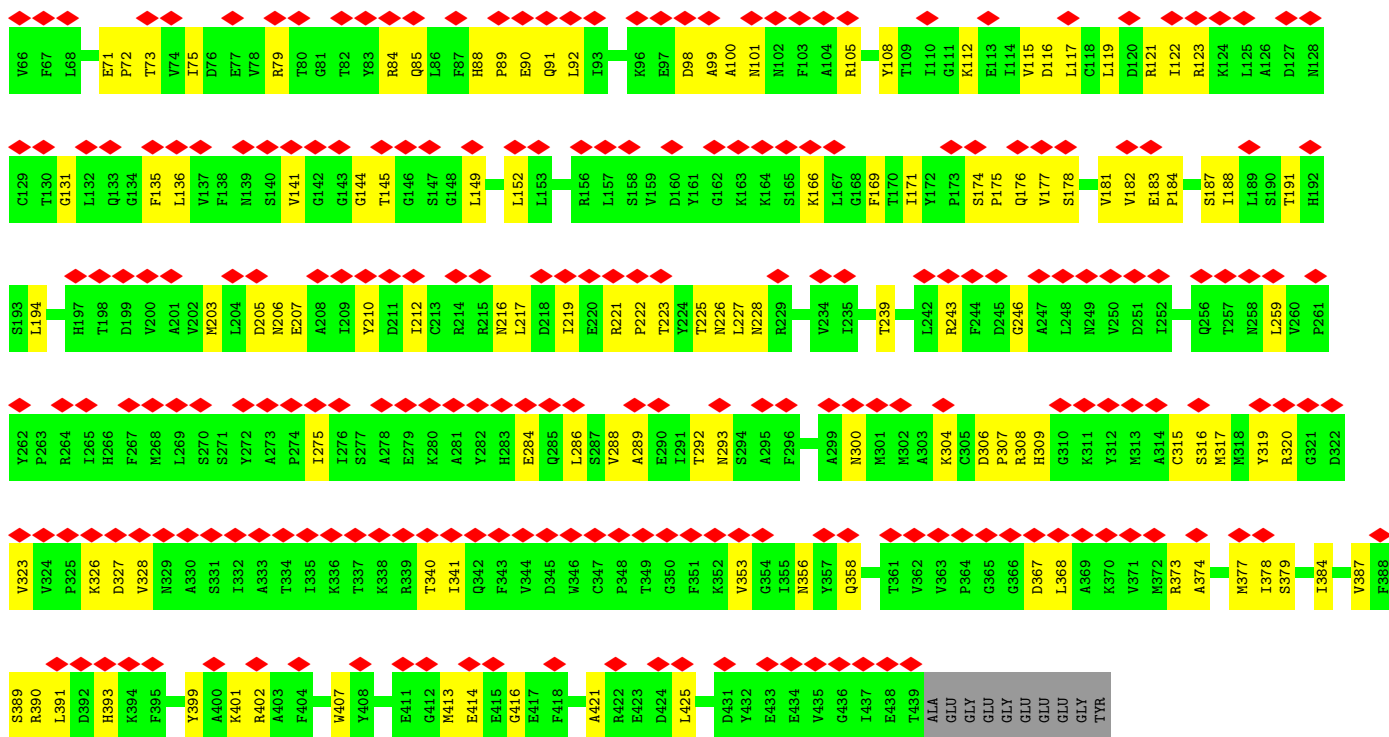

• Molecule 45: Tubulin alpha chain

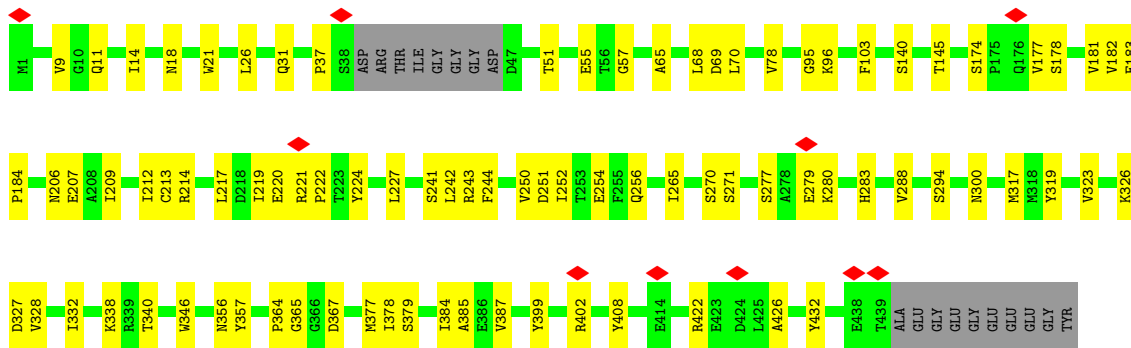
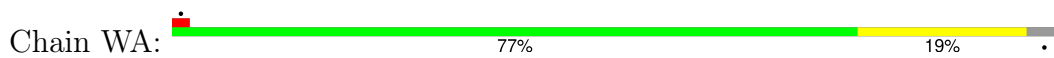

• Molecule 45: Tubulin alpha chain

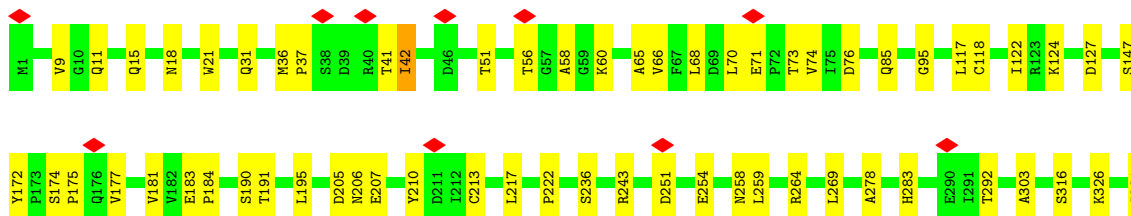
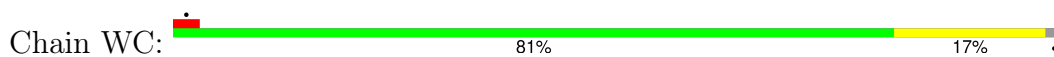

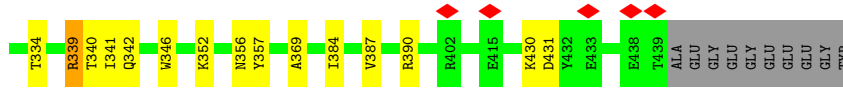

• Molecule 45: Tubulin alpha chain

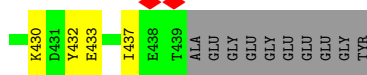
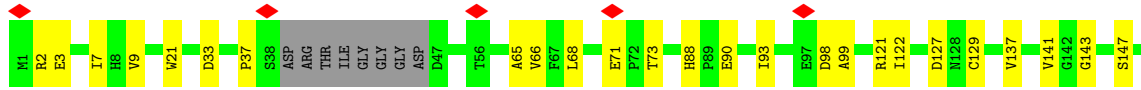
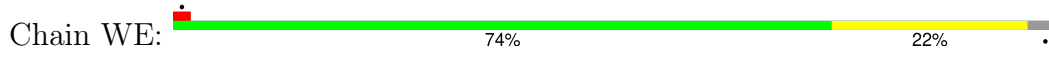

• Molecule 45: Tubulin alpha chain

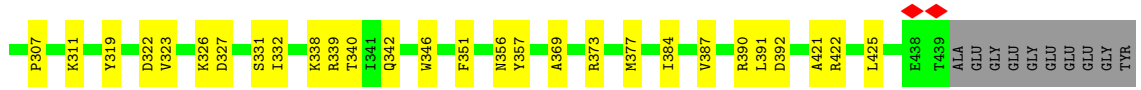
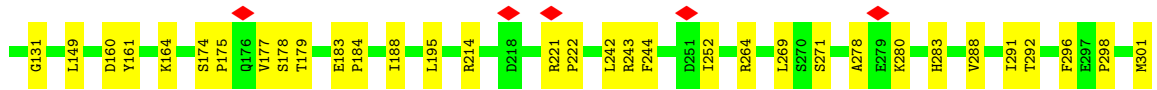
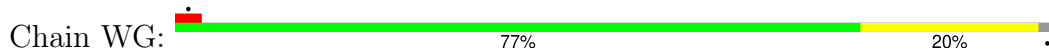

• Molecule 45: Tubulin alpha chain

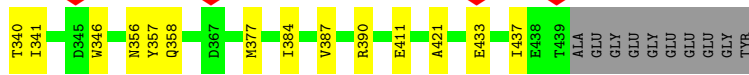
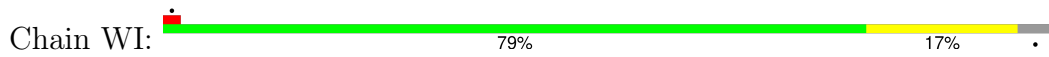

• Molecule 45: Tubulin alpha chain

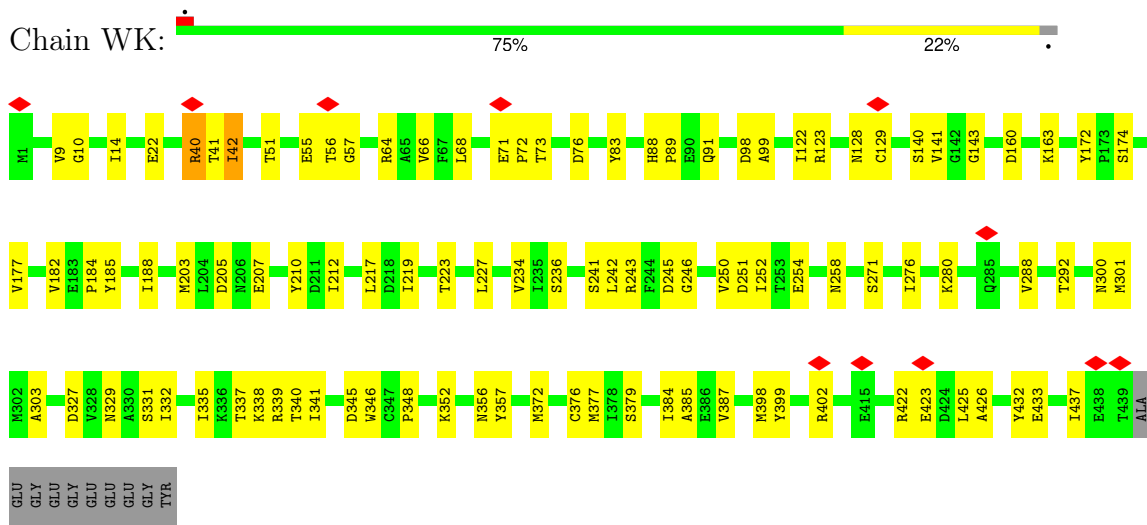

• Molecule 45: Tubulin alpha chain

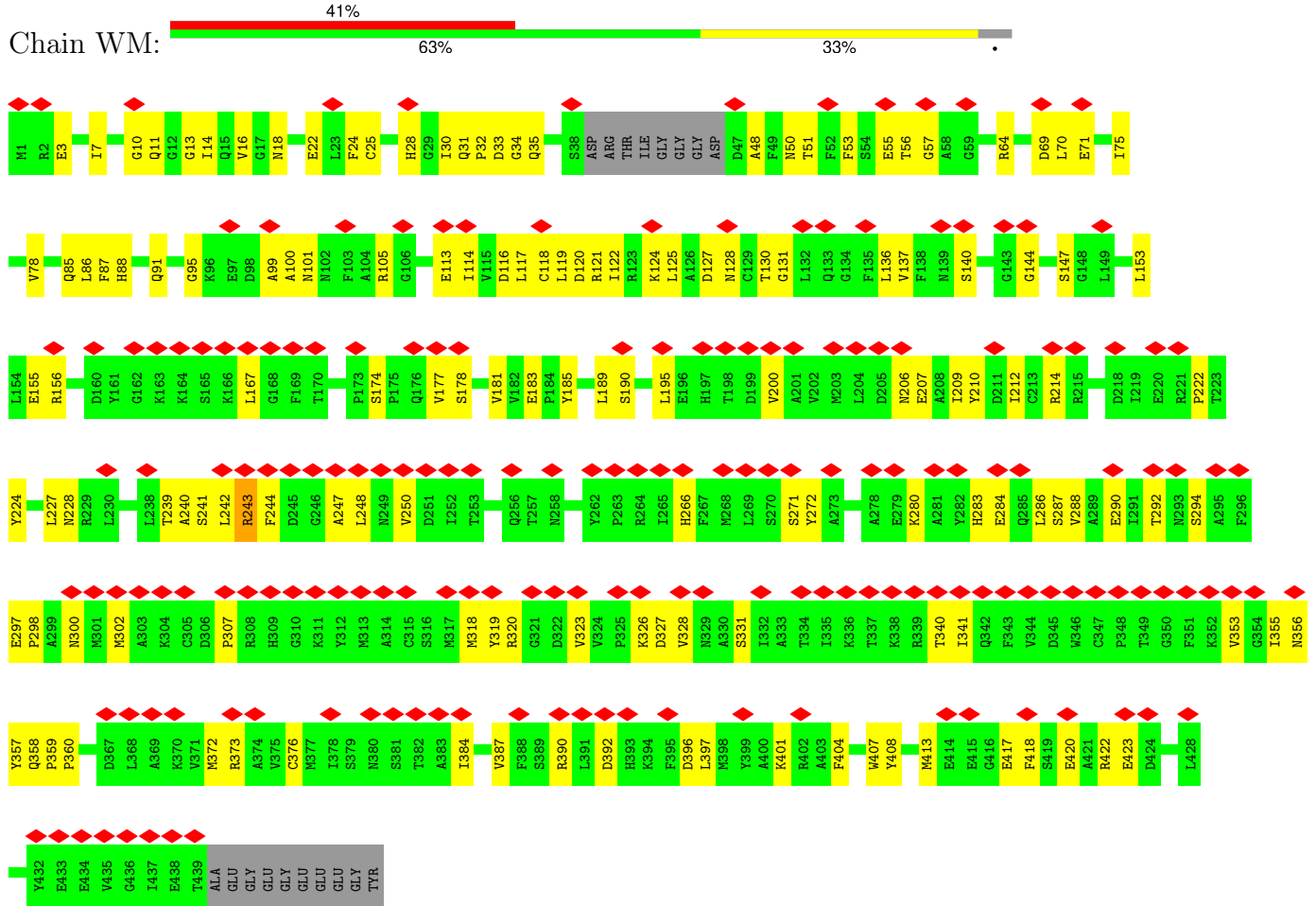

• Molecule 46: Tubulin beta chain



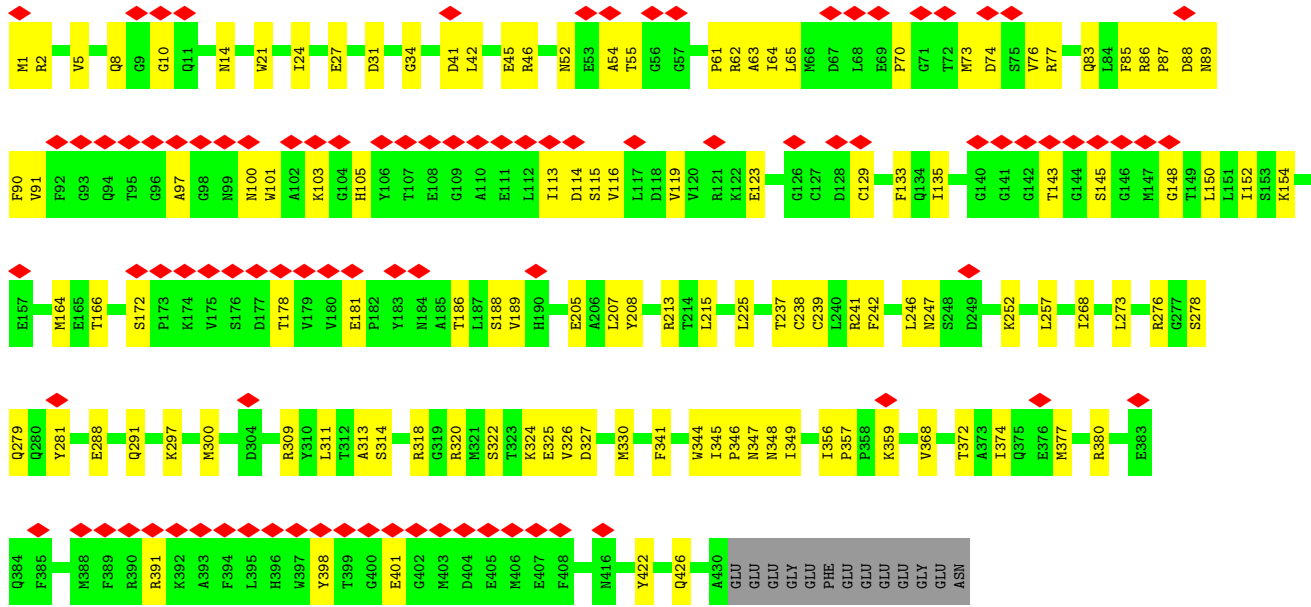

• Molecule 46: Tubulin beta chain

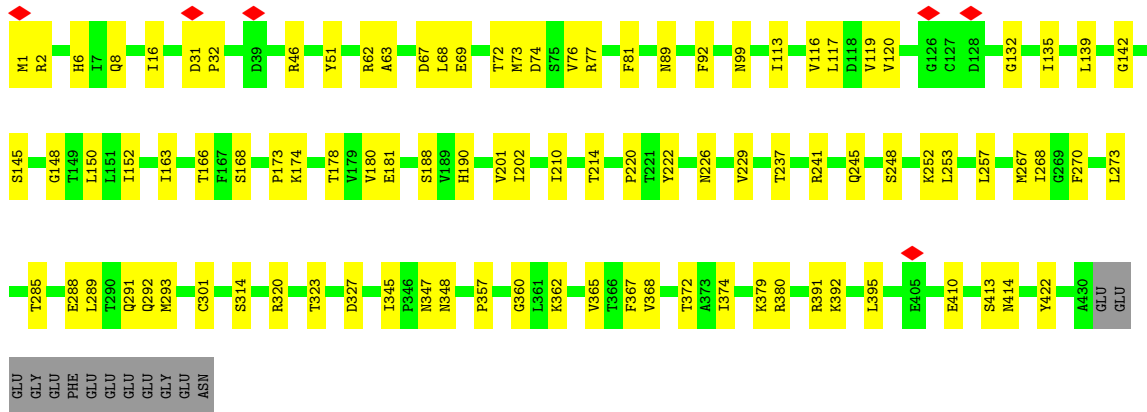
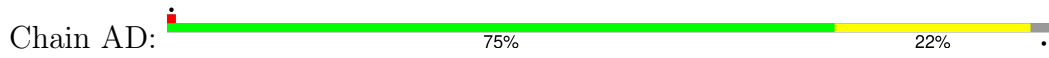

• Molecule 46: Tubulin beta chain

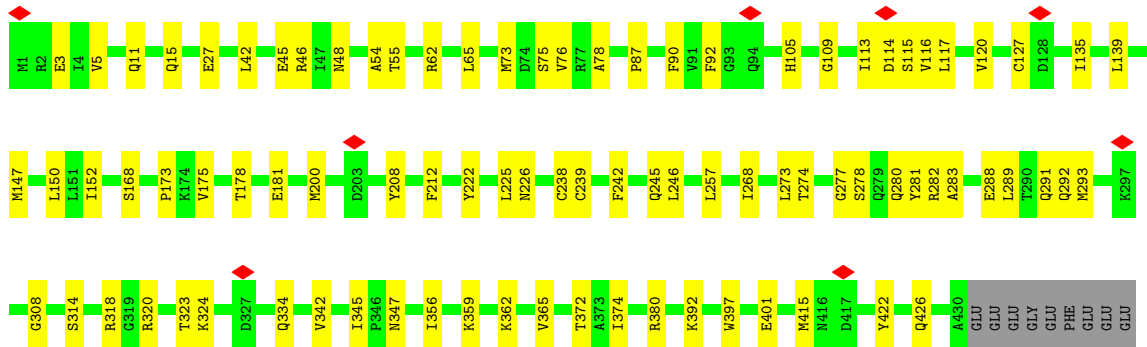
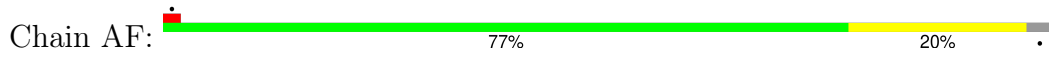

GLU
GLY
GLU
ASN

• Molecule 46: Tubulin beta chain

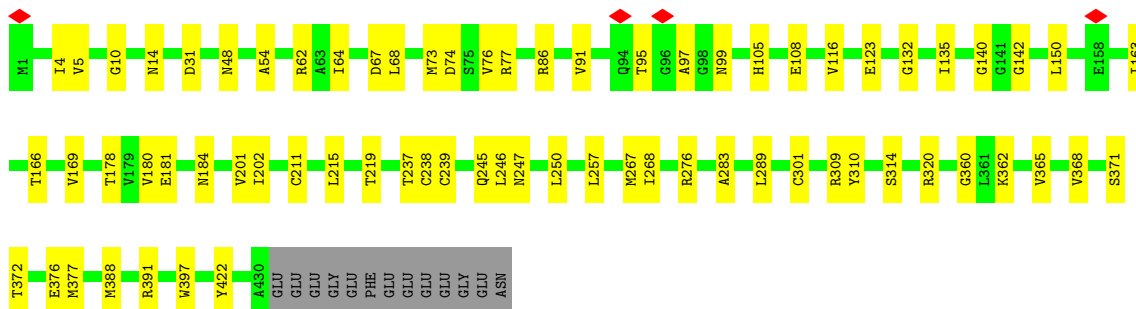
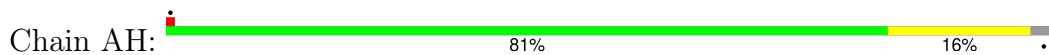

• Molecule 46: Tubulin beta chain

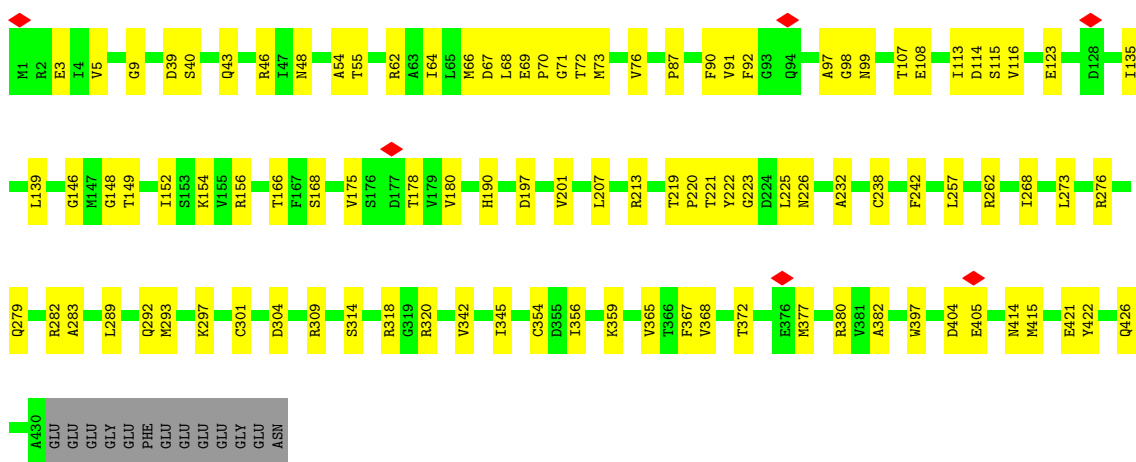
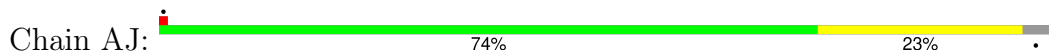

• Molecule 46: Tubulin beta chain

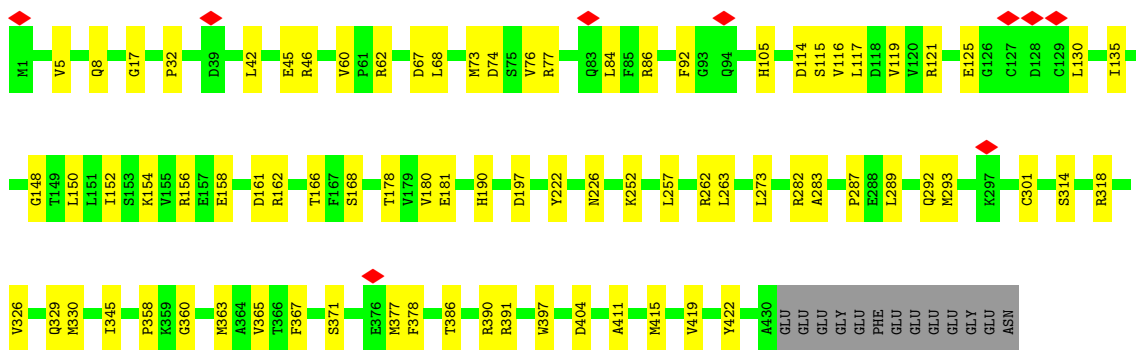
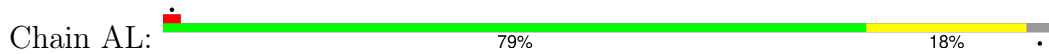

• Molecule 46: Tubulin beta chain

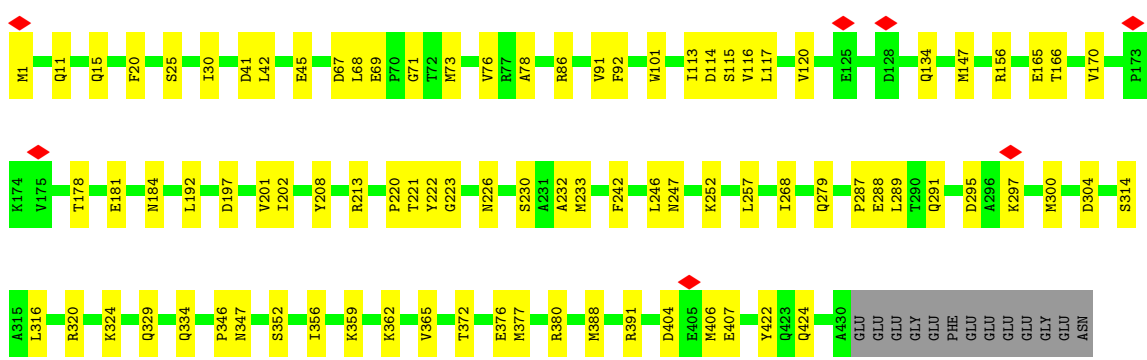
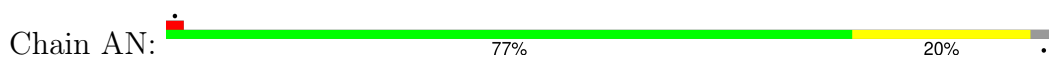

• Molecule 46: Tubulin beta chain

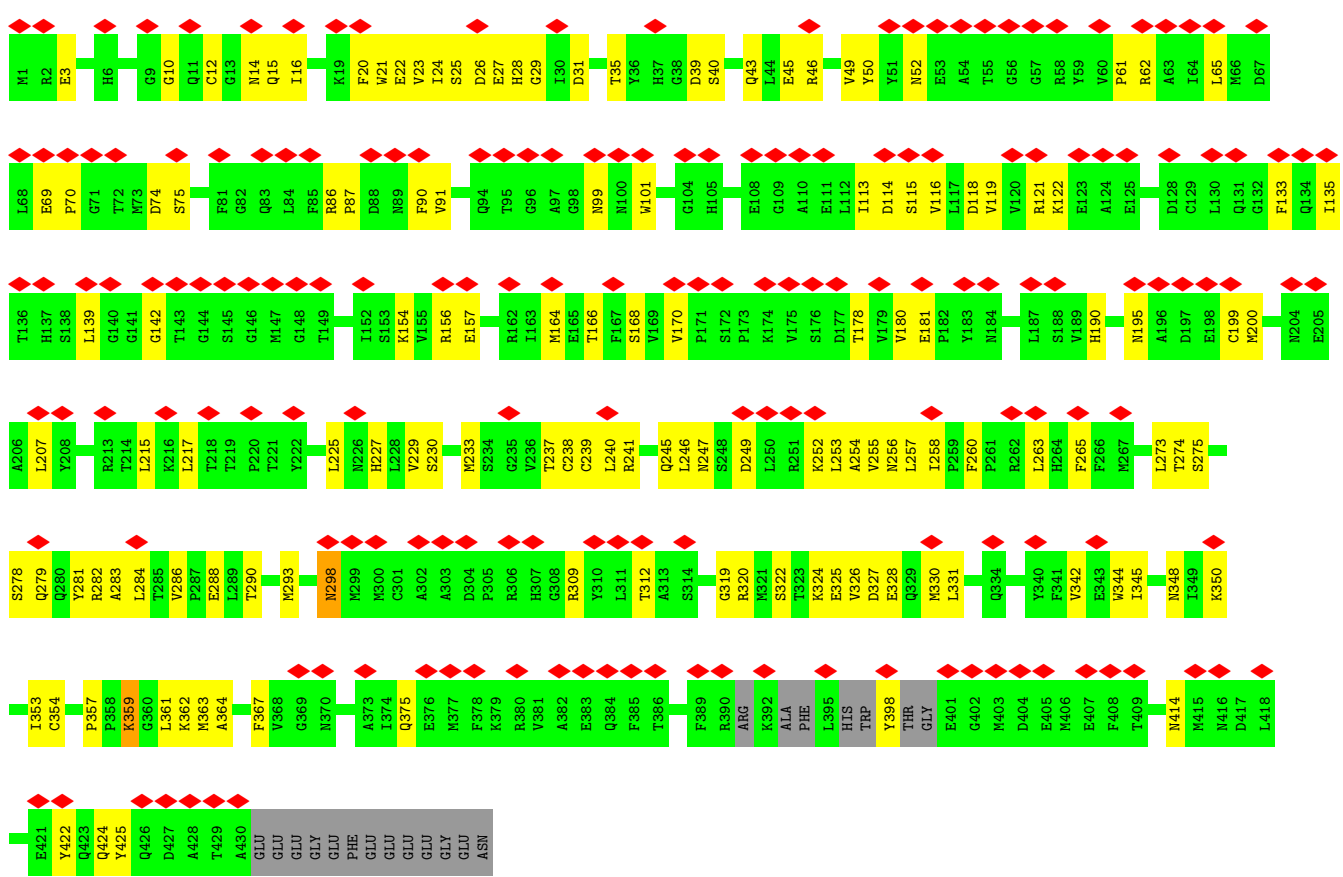
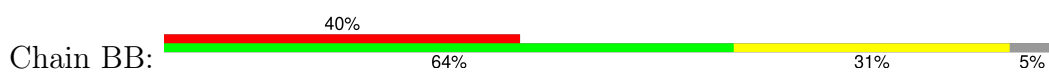

• Molecule 46: Tubulin beta chain

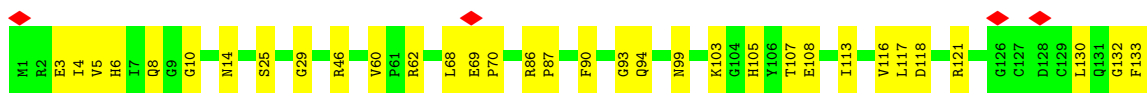
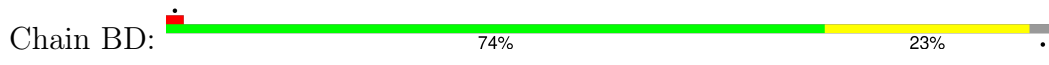

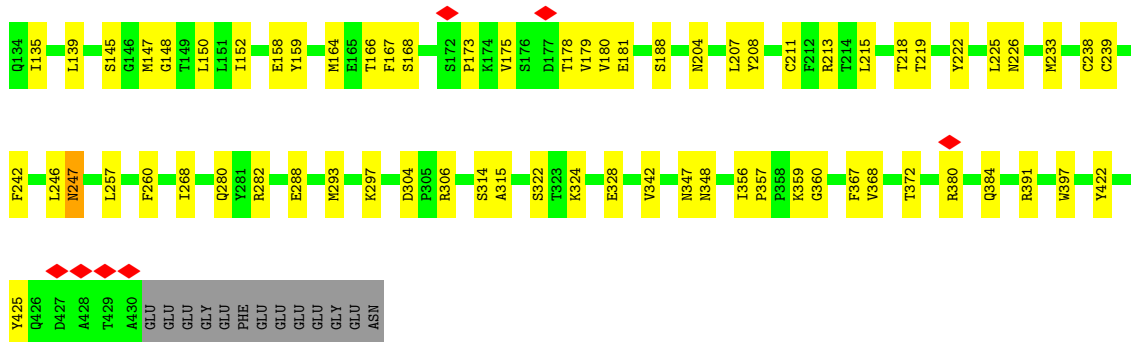

• Molecule 46: Tubulin beta chain

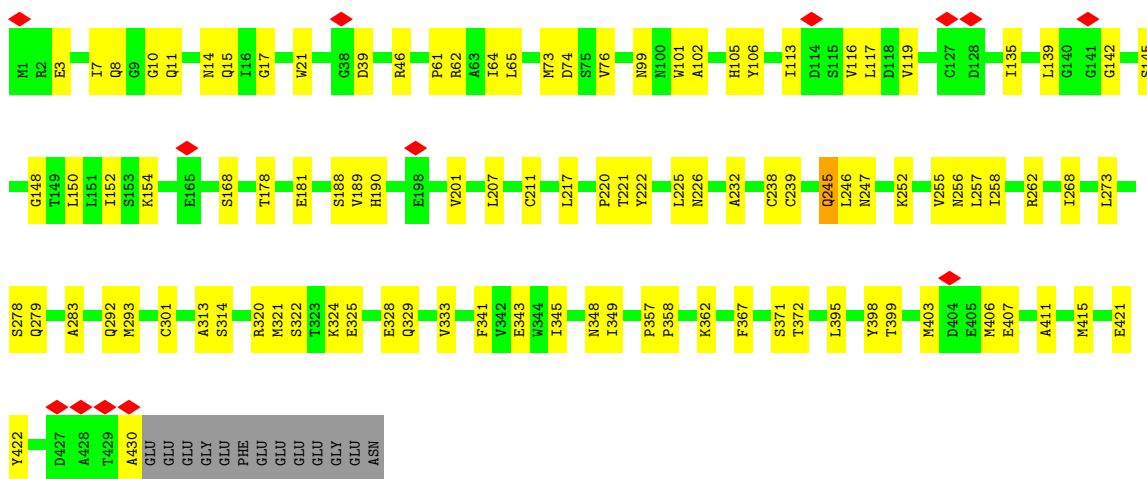
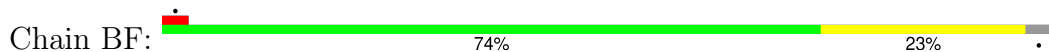

• Molecule 46: Tubulin beta chain

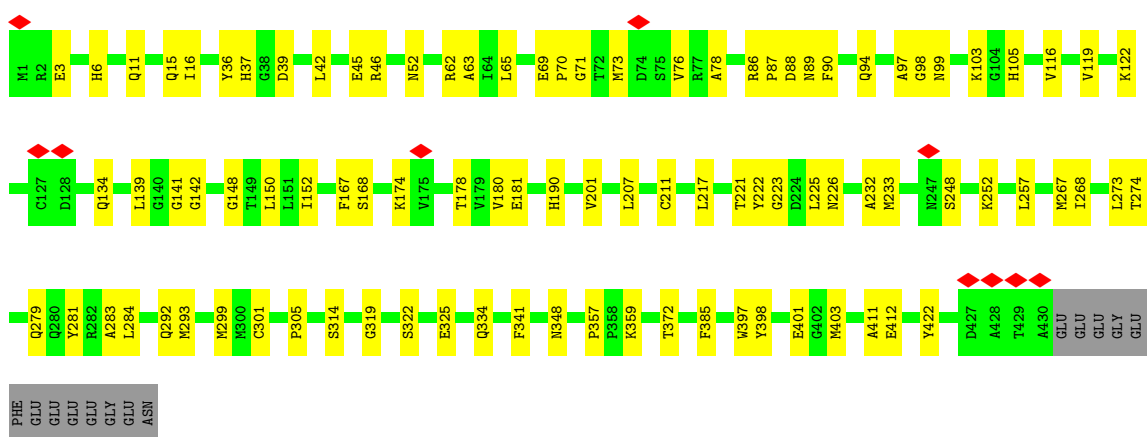
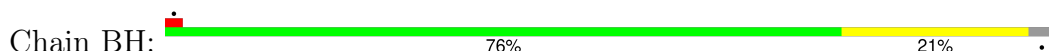

• Molecule 46: Tubulin beta chain



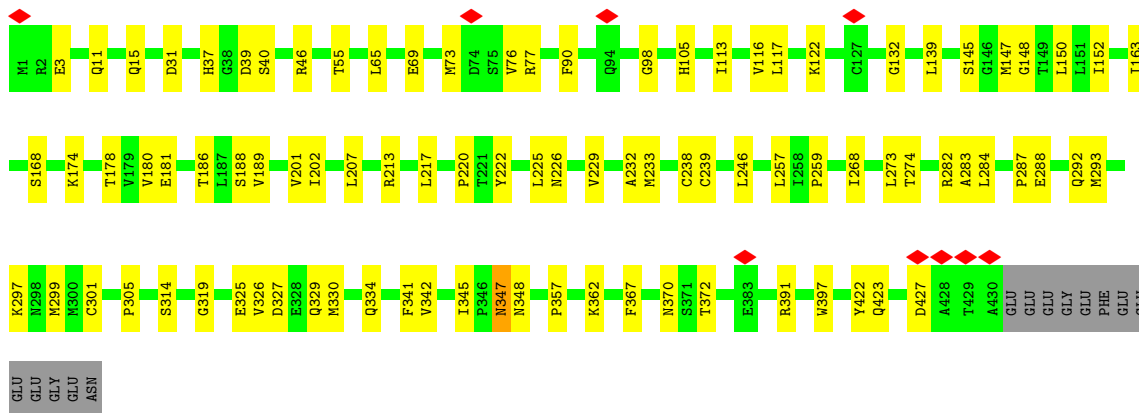

• Molecule 46: Tubulin beta chain

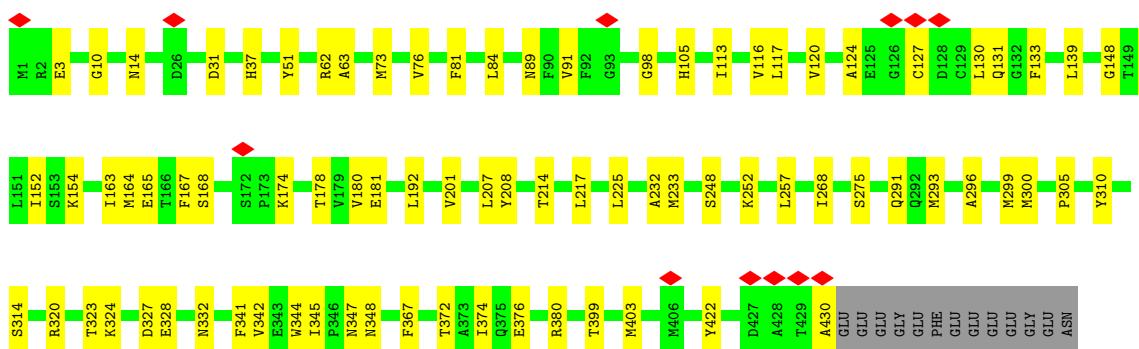
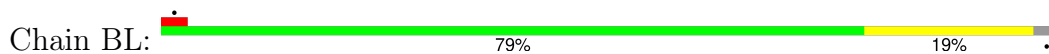

• Molecule 46: Tubulin beta chain

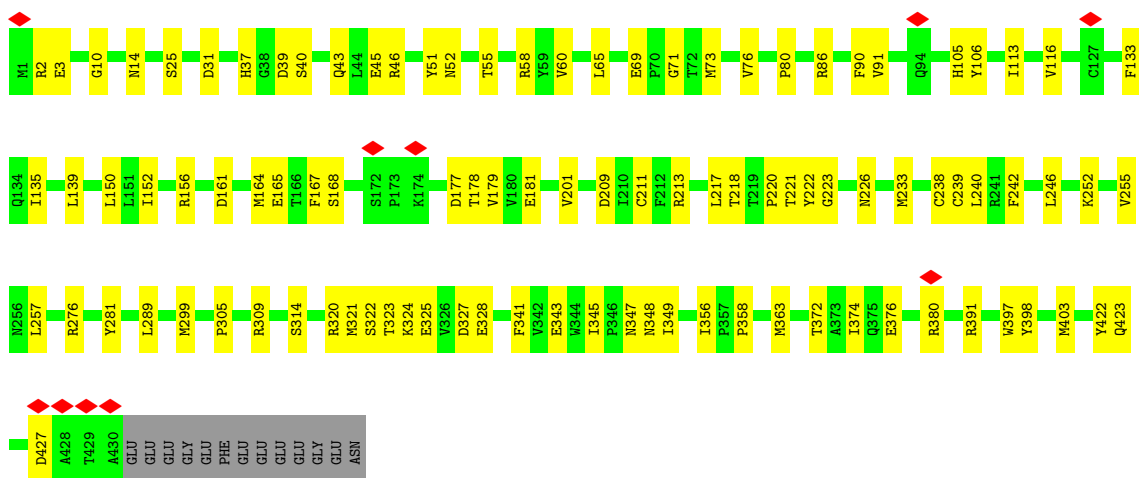
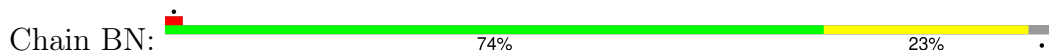

• Molecule 46: Tubulin beta chain



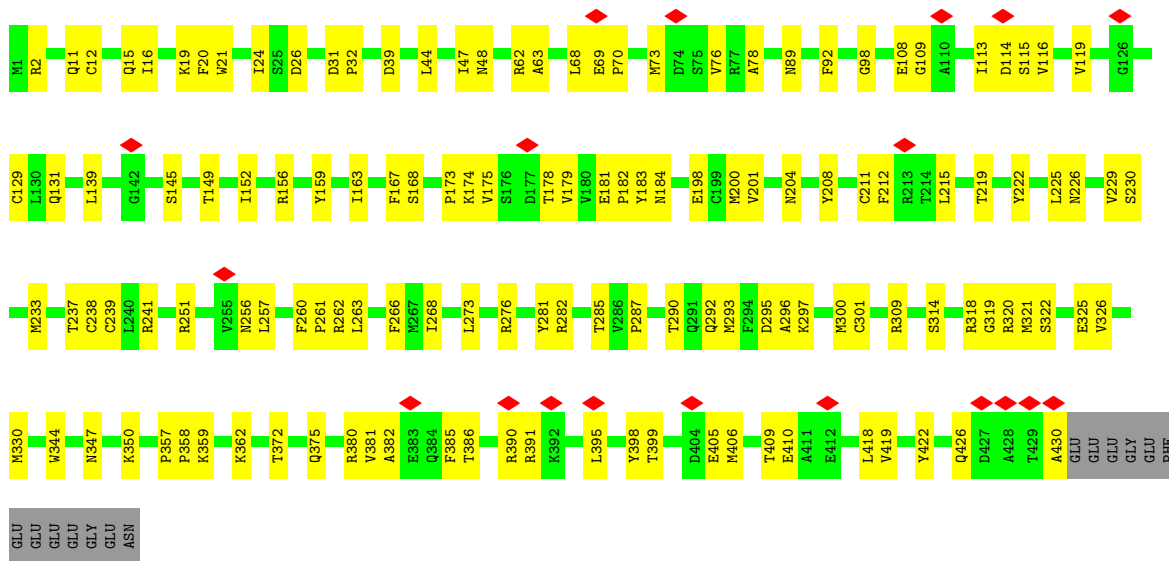

• Molecule 46: Tubulin beta chain

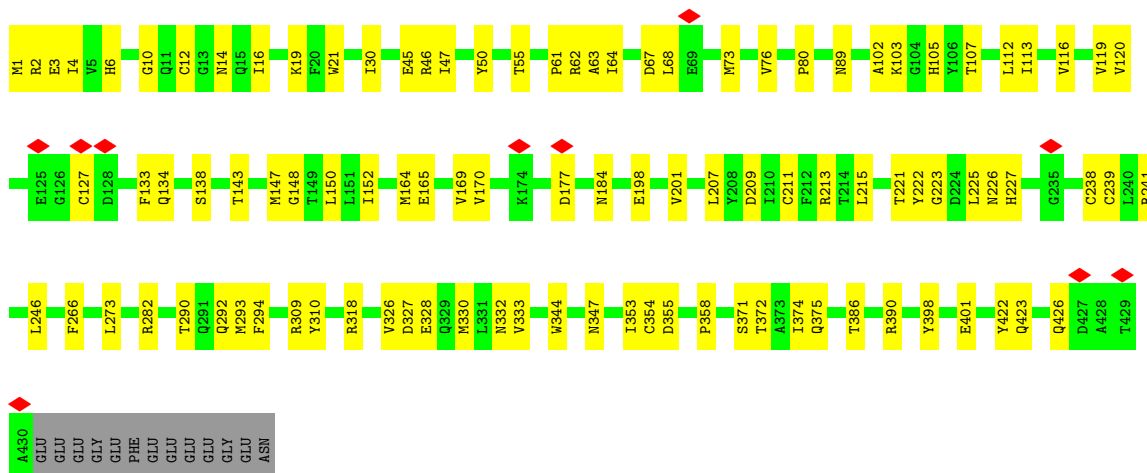
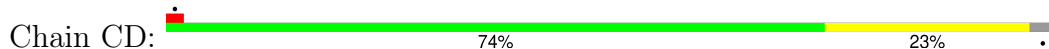

• Molecule 46: Tubulin beta chain

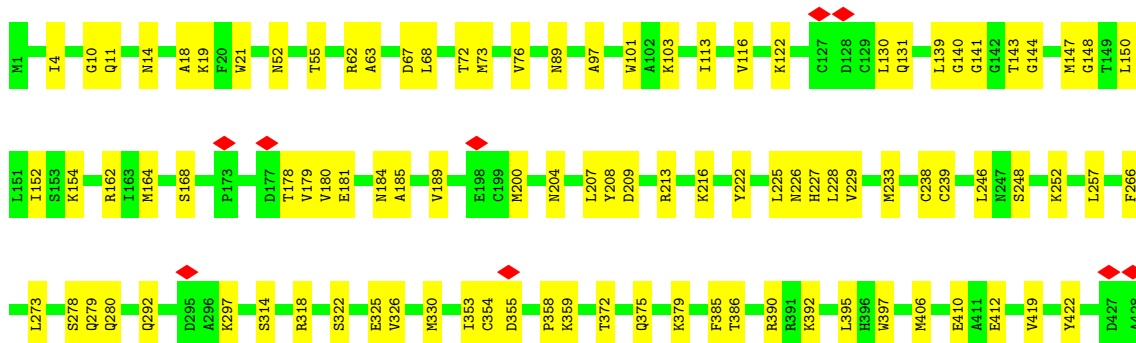
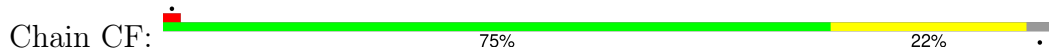

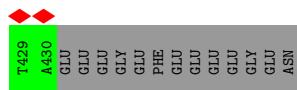

• Molecule 46: Tubulin beta chain

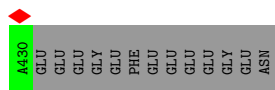
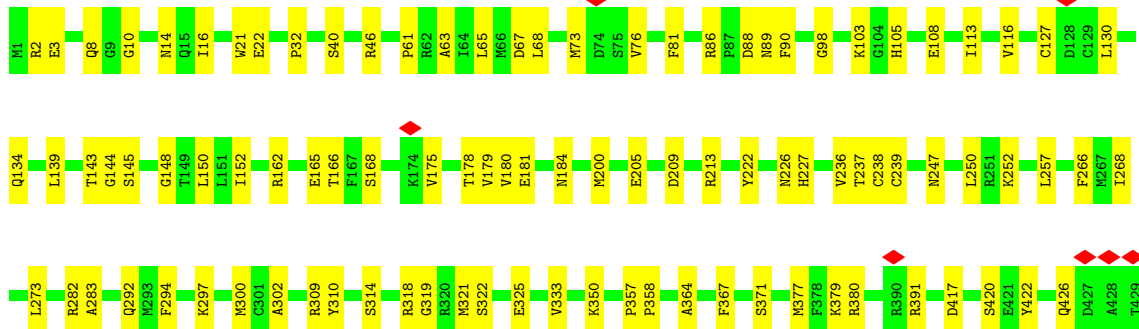
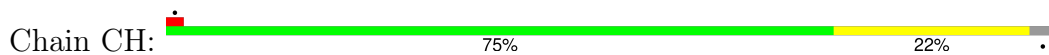

• Molecule 46: Tubulin beta chain

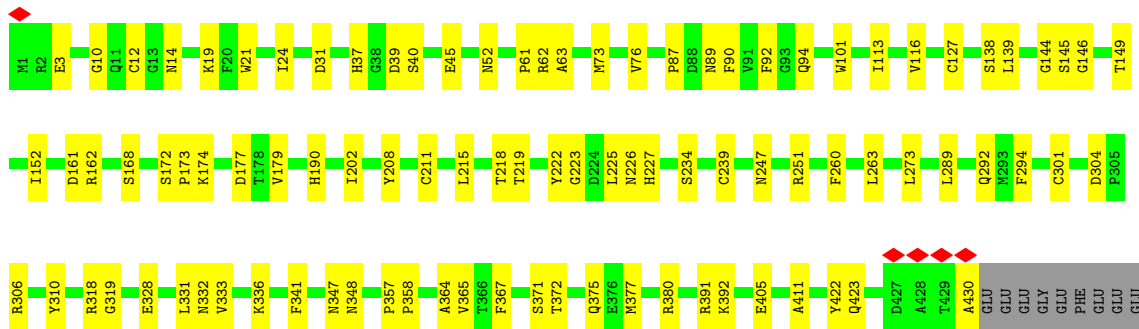
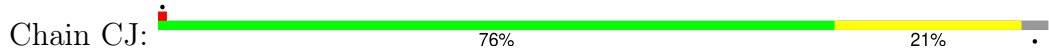

• Molecule 46: Tubulin beta chain

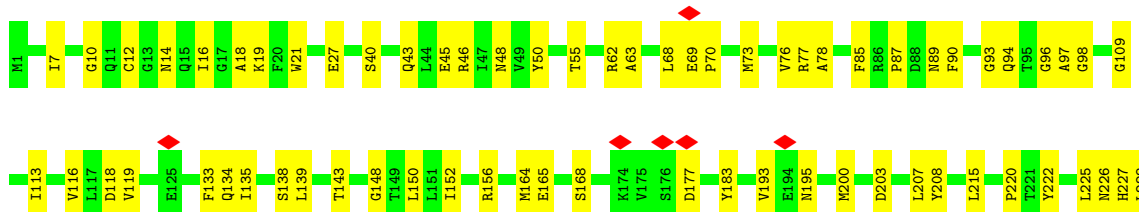
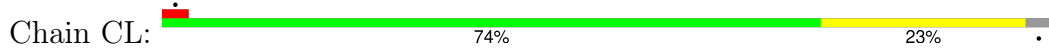

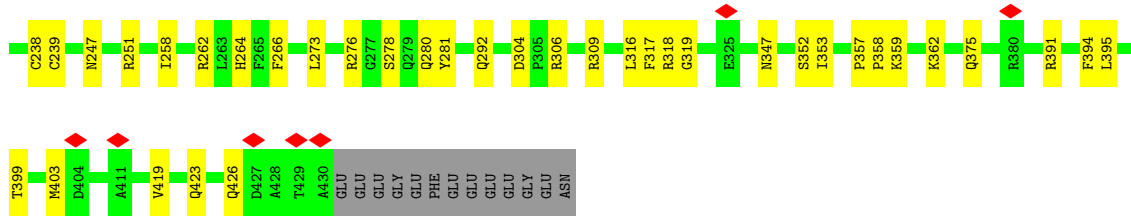

• Molecule 46: Tubulin beta chain

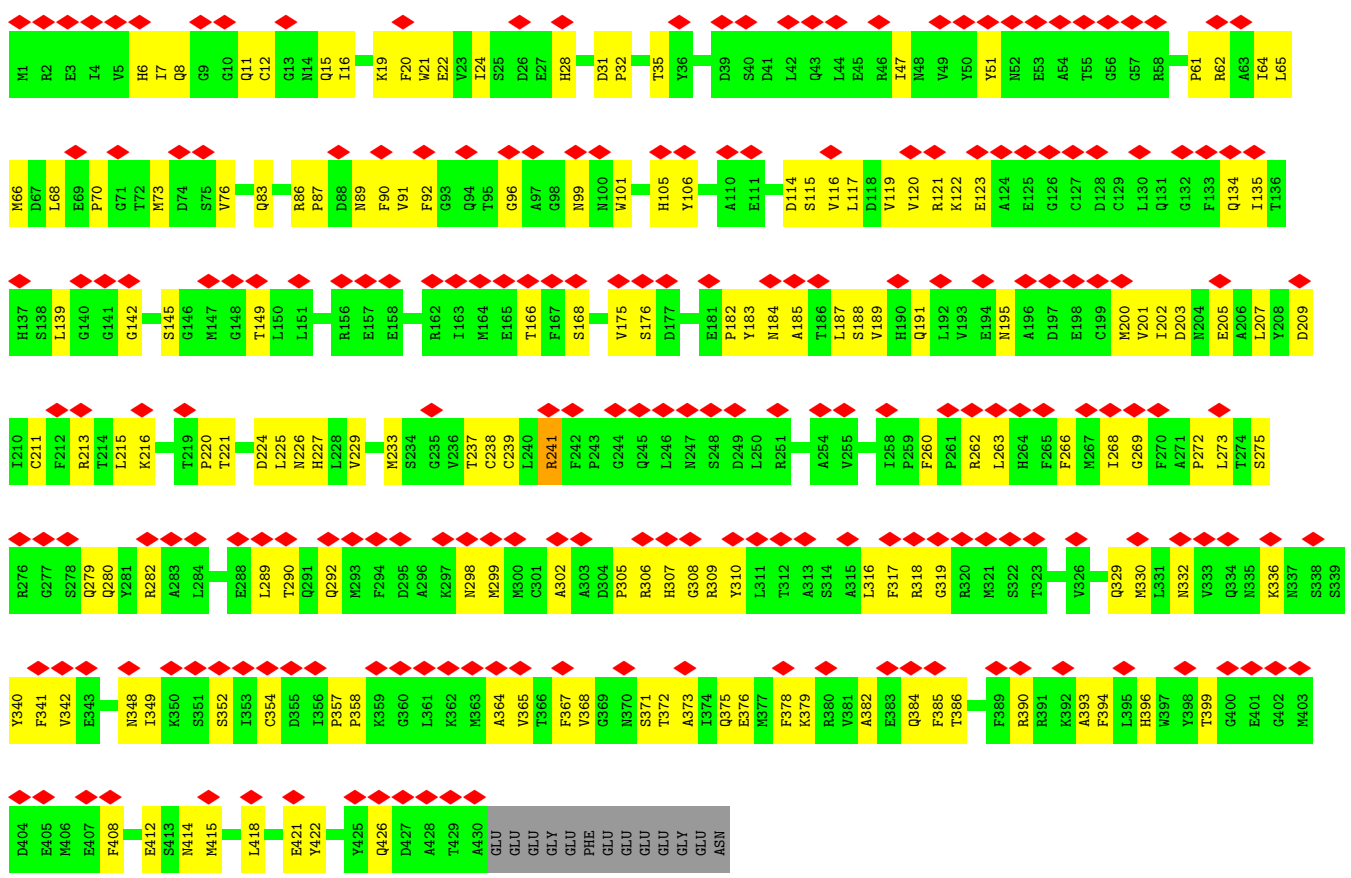

• Molecule 46: Tubulin beta chain

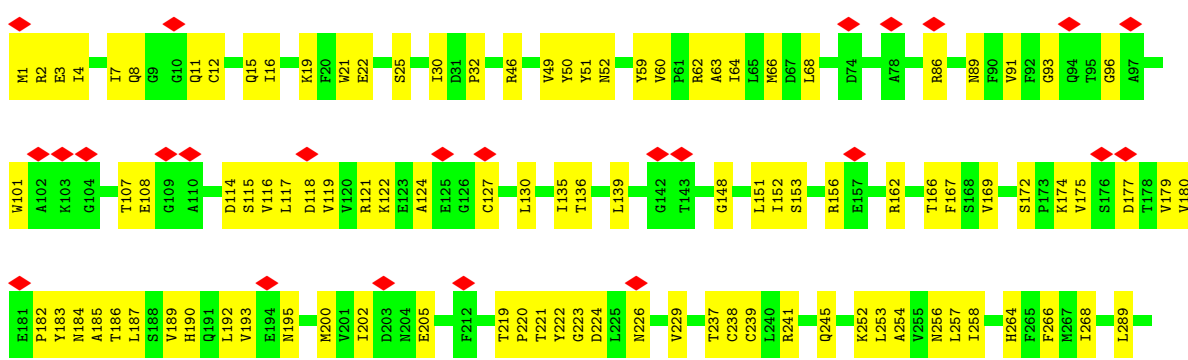

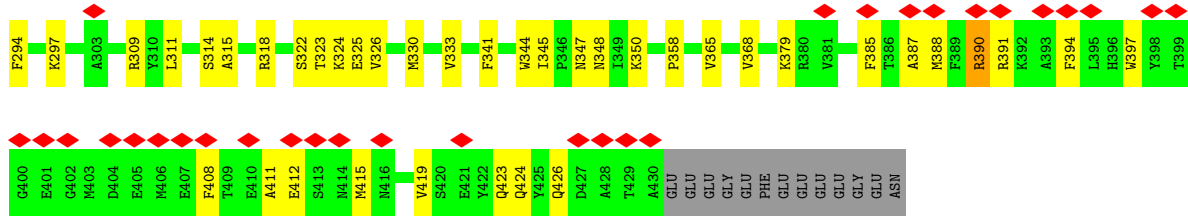

• Molecule 46: Tubulin beta chain

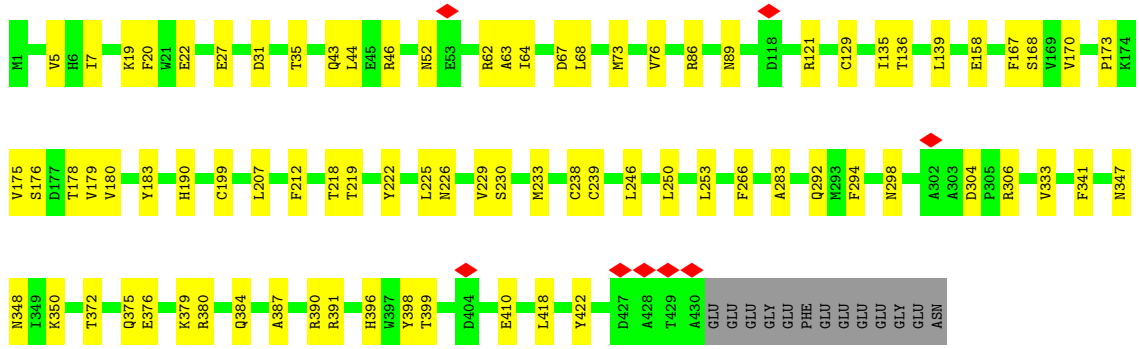
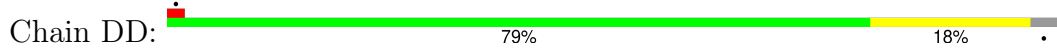

• Molecule 46: Tubulin beta chain

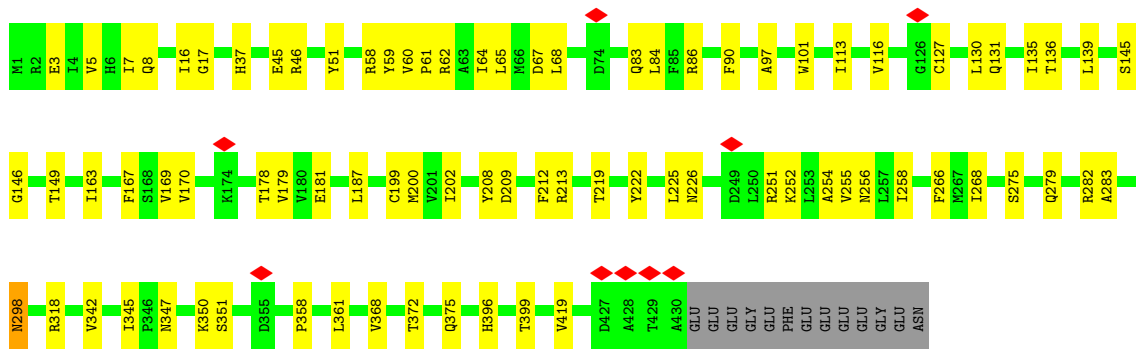
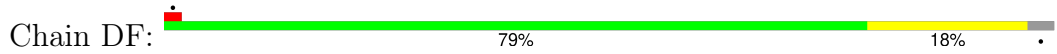

• Molecule 46: Tubulin beta chain

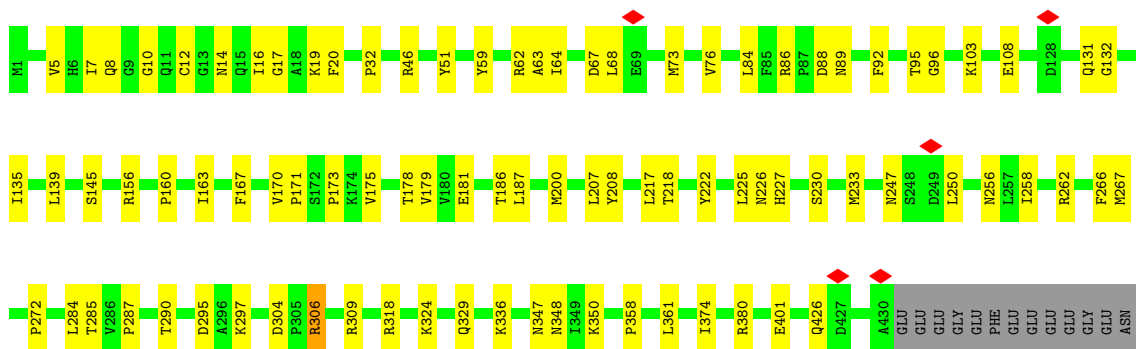
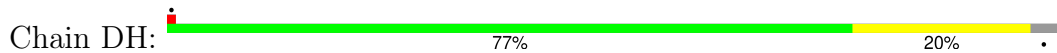

• Molecule 46: Tubulin beta chain

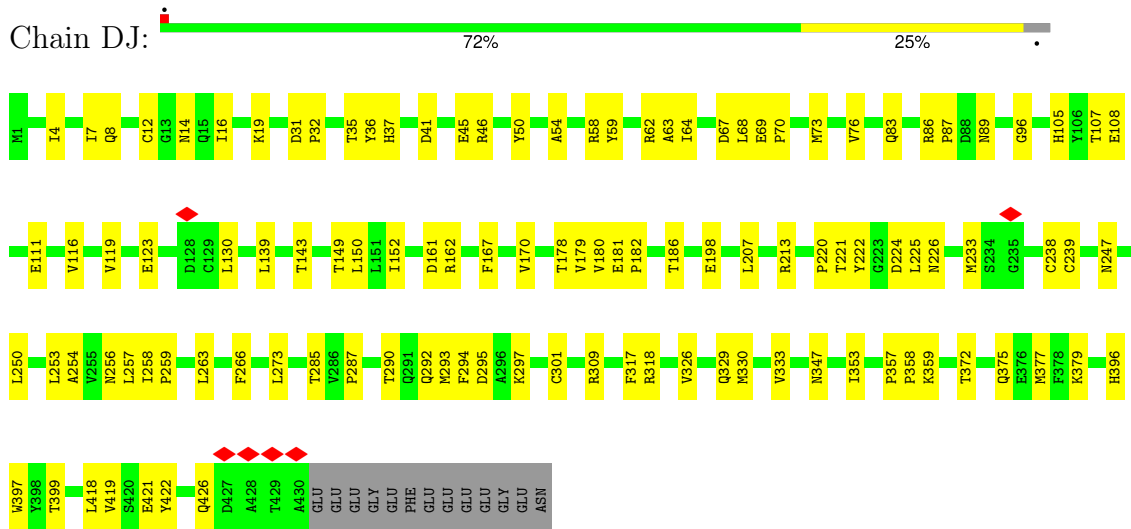

• Molecule 46: Tubulin beta chain

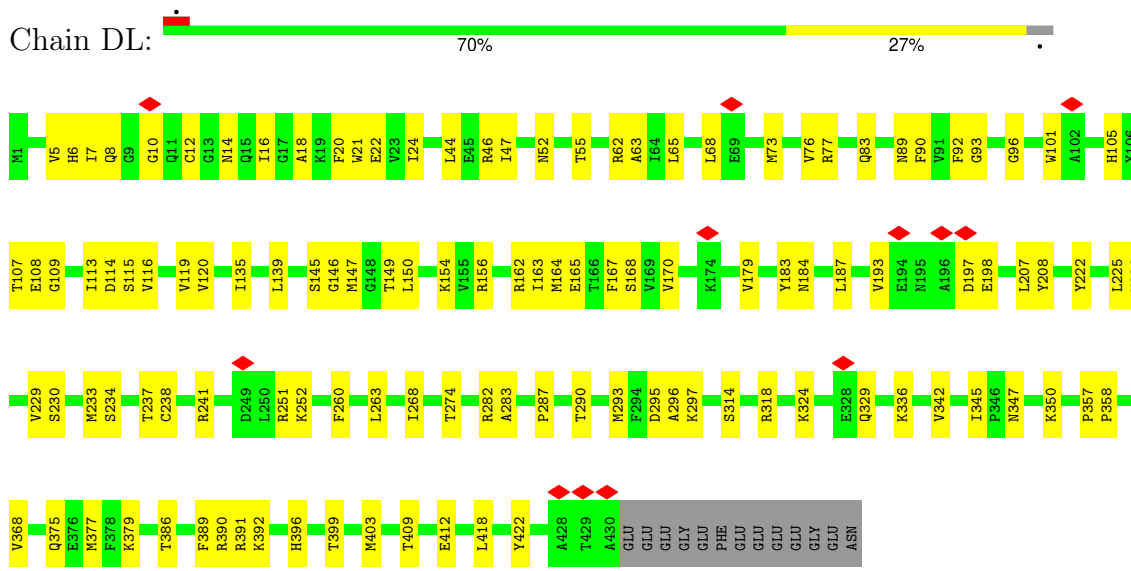

• Molecule 46: Tubulin beta chain

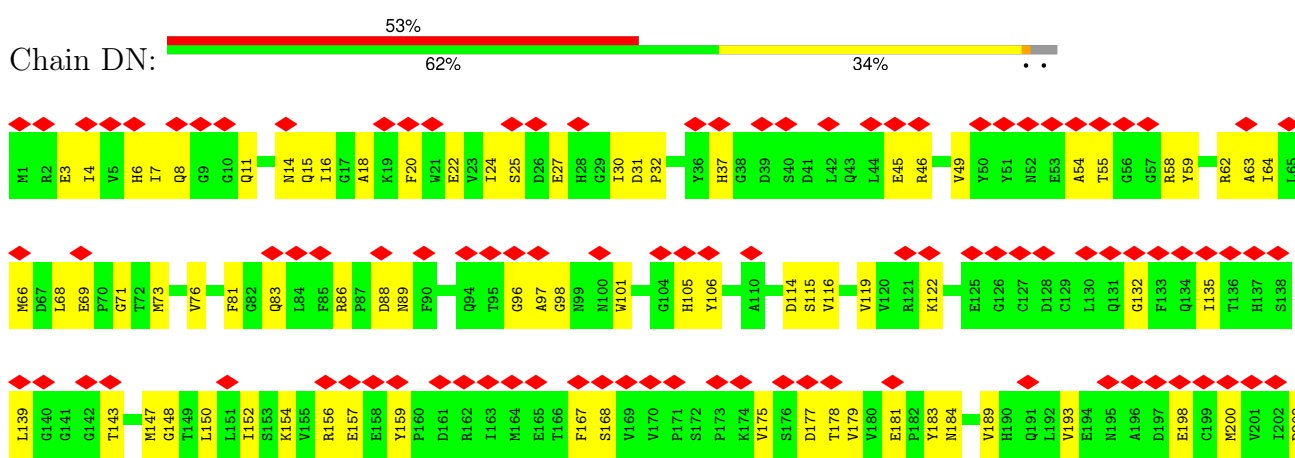

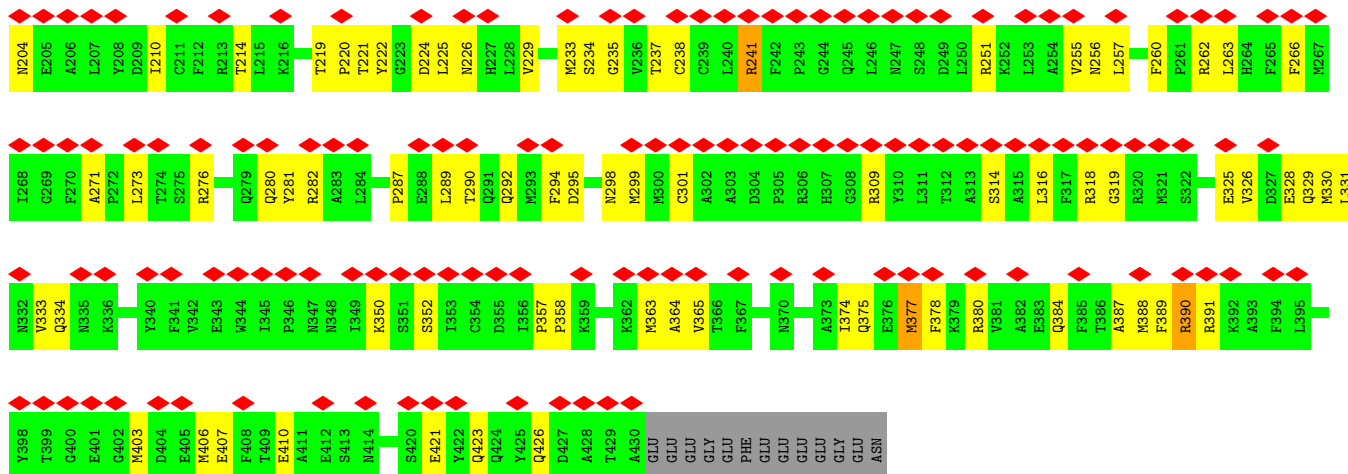

• Molecule 46: Tubulin beta chain

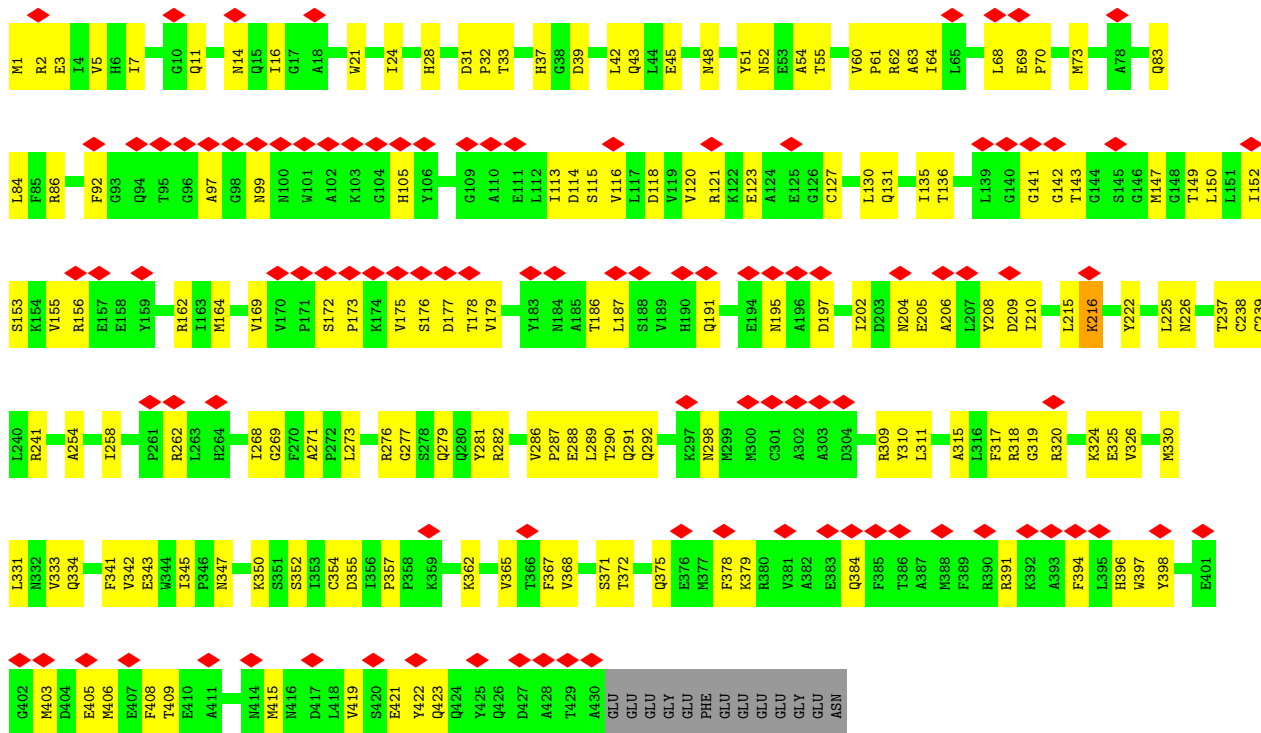

• Molecule 46: Tubulin beta chain

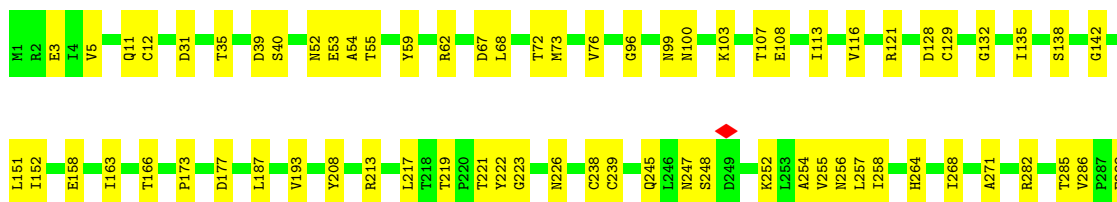
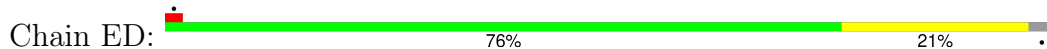

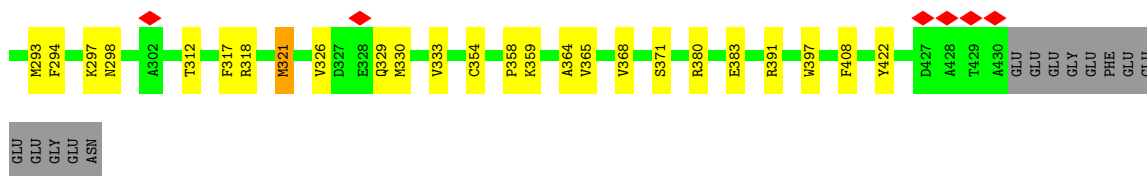

• Molecule 46: Tubulin beta chain

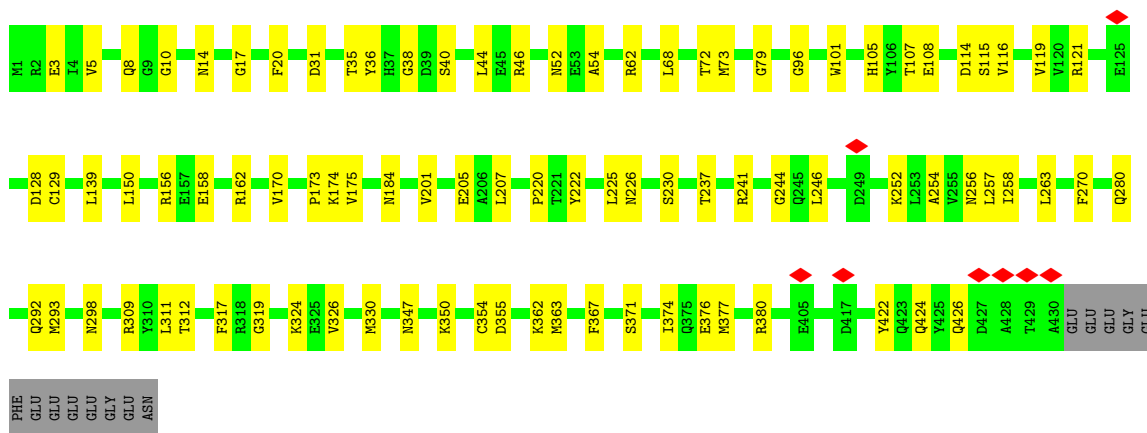
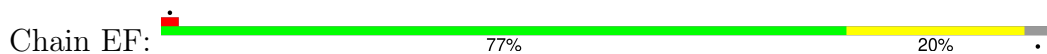

• Molecule 46: Tubulin beta chain

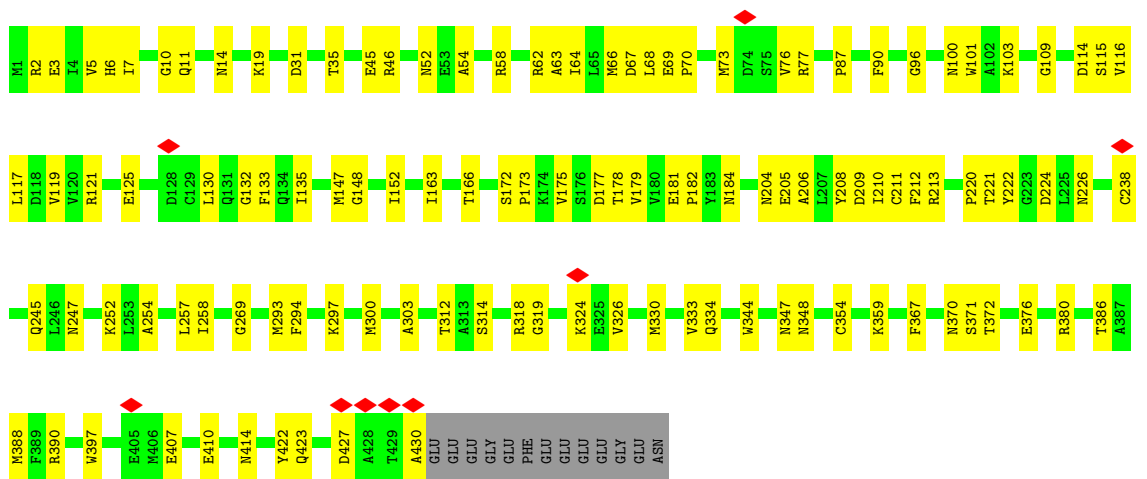

• Molecule 46: Tubulin beta chain

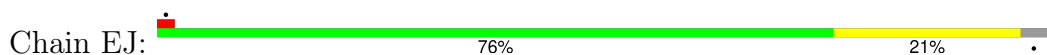

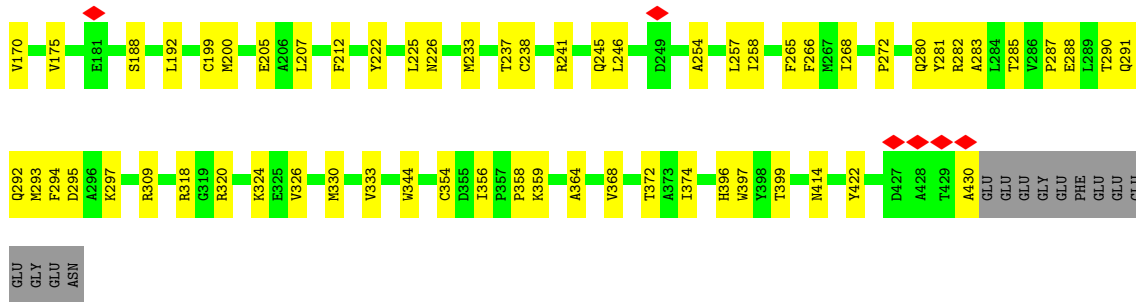

• Molecule 46: Tubulin beta chain

Chain EL:

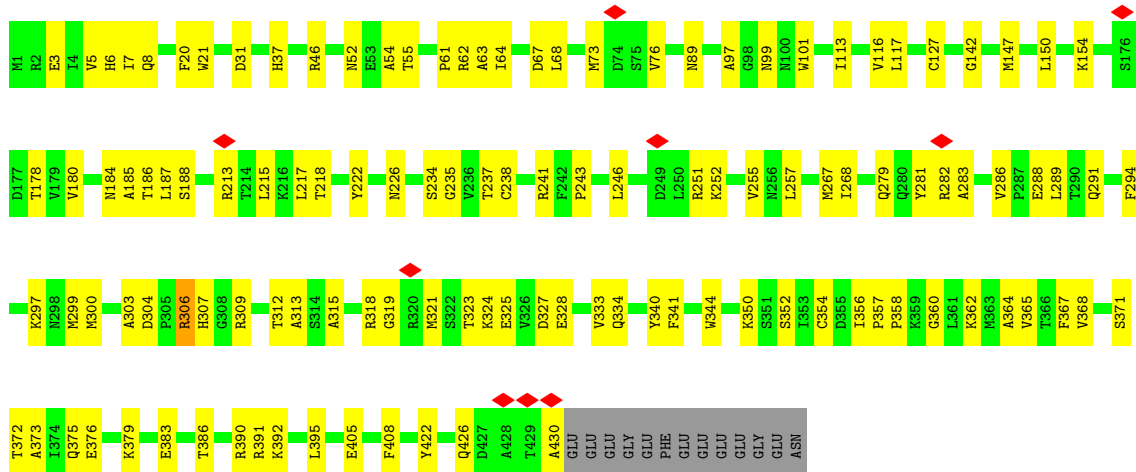

• Molecule 46: Tubulin beta chain

Chain EN:

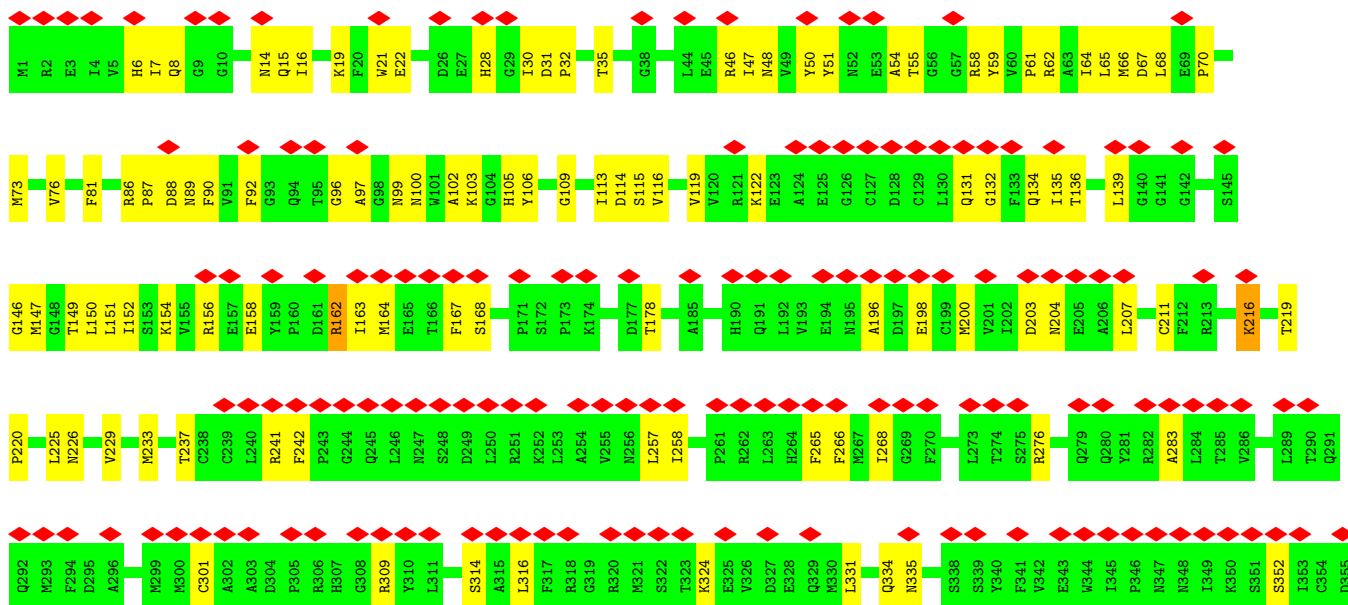

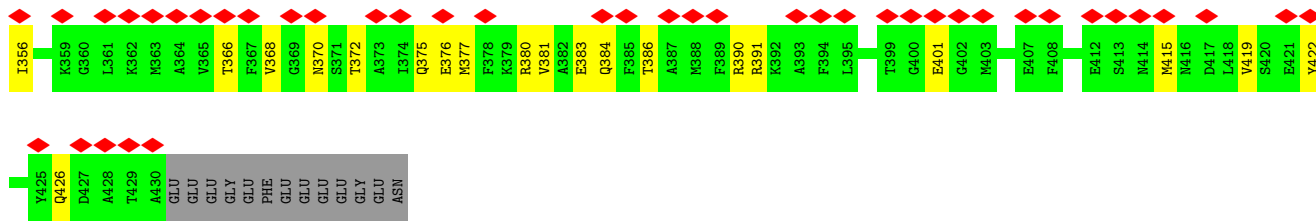

• Molecule 46: Tubulin beta chain

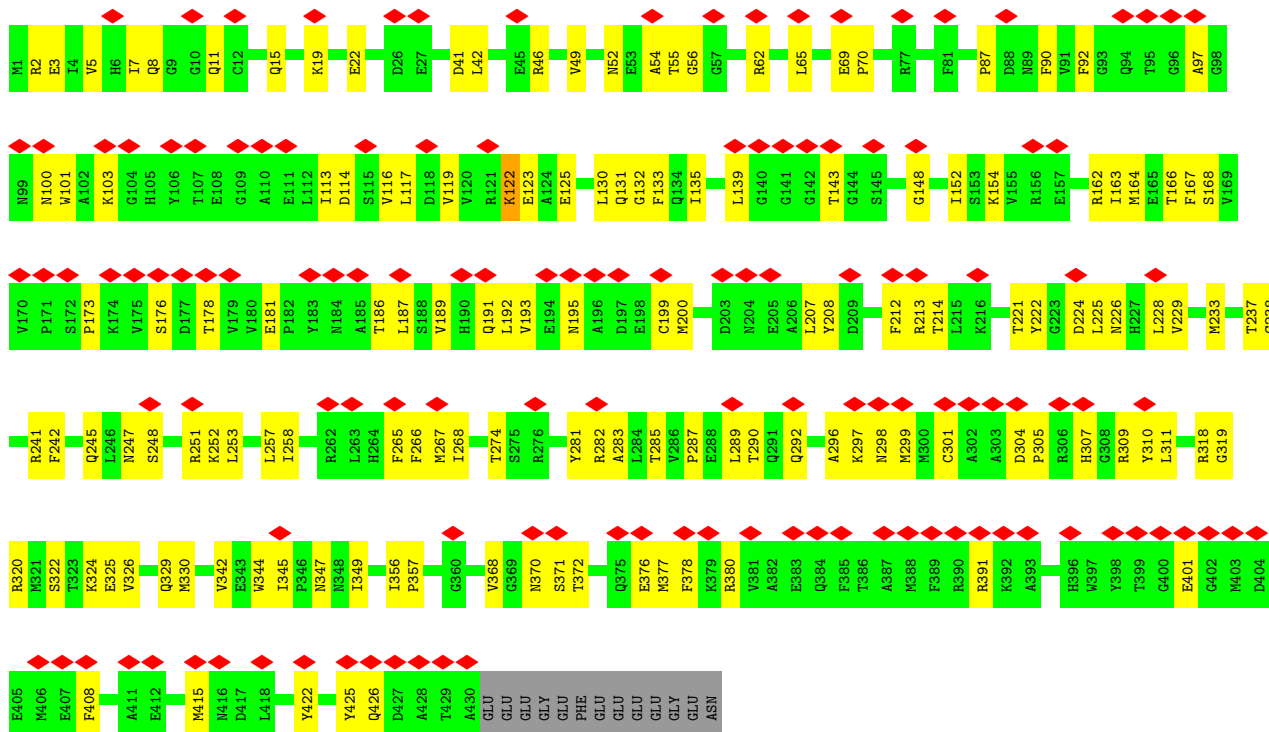

• Molecule 46: Tubulin beta chain

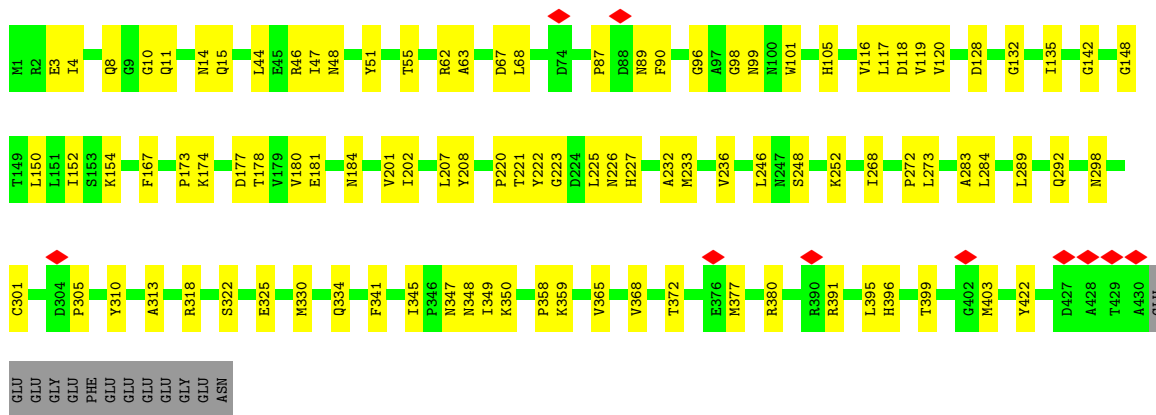
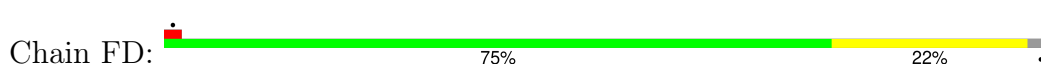

• Molecule 46: Tubulin beta chain

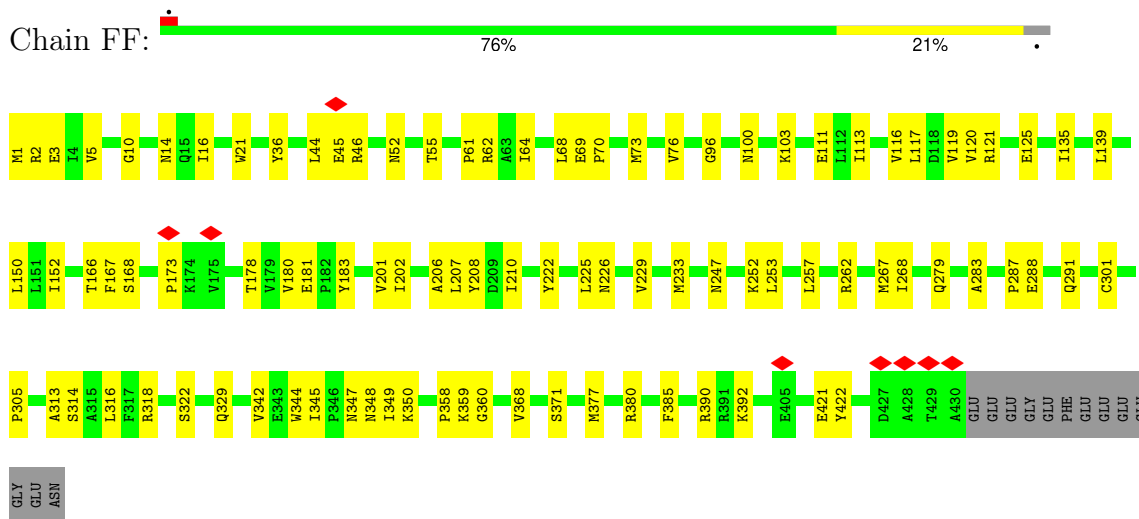

• Molecule 46: Tubulin beta chain

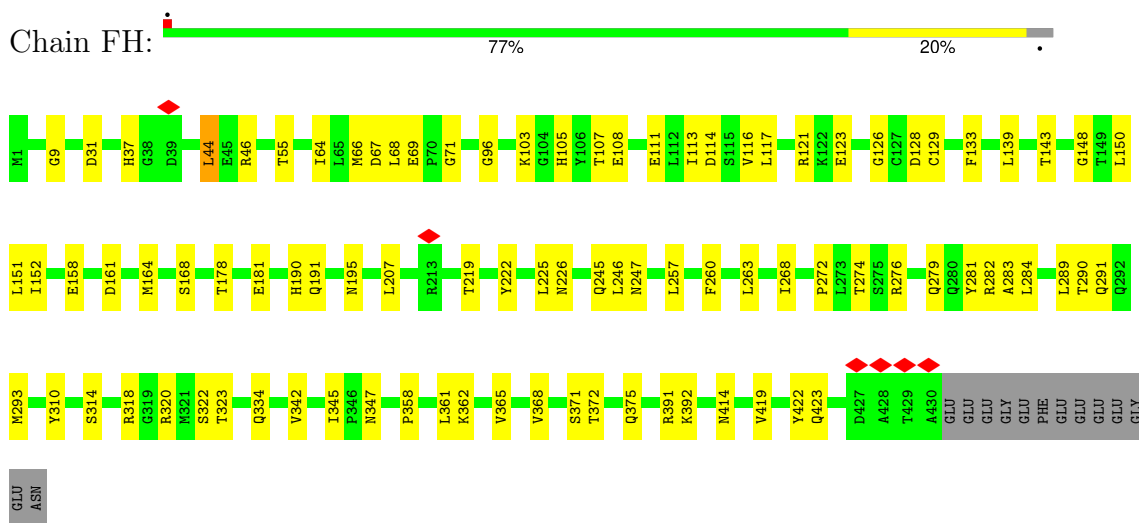

• Molecule 46: Tubulin beta chain

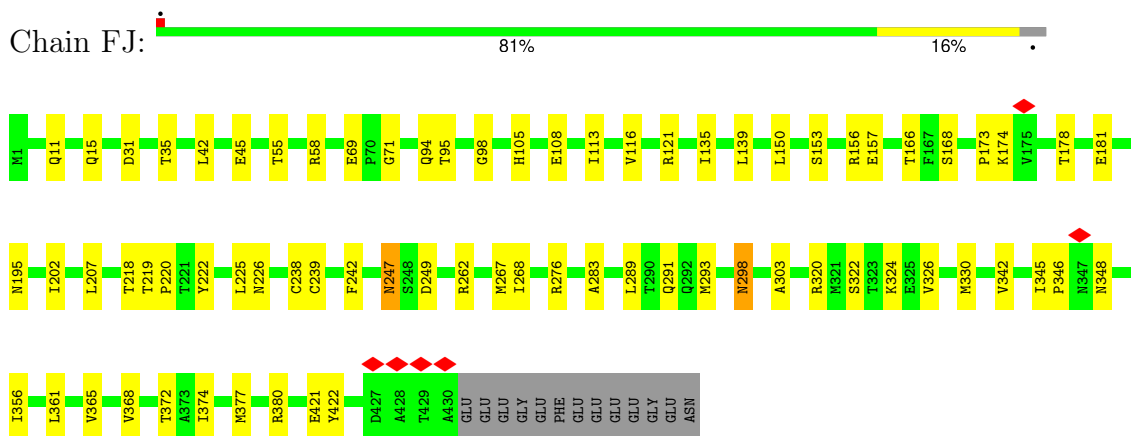

• Molecule 46: Tubulin beta chain



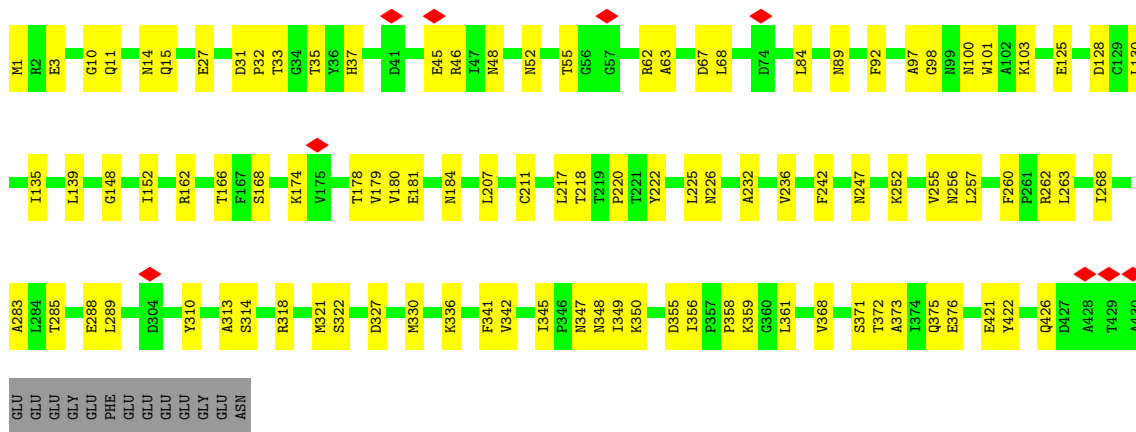

• Molecule 46: Tubulin beta chain

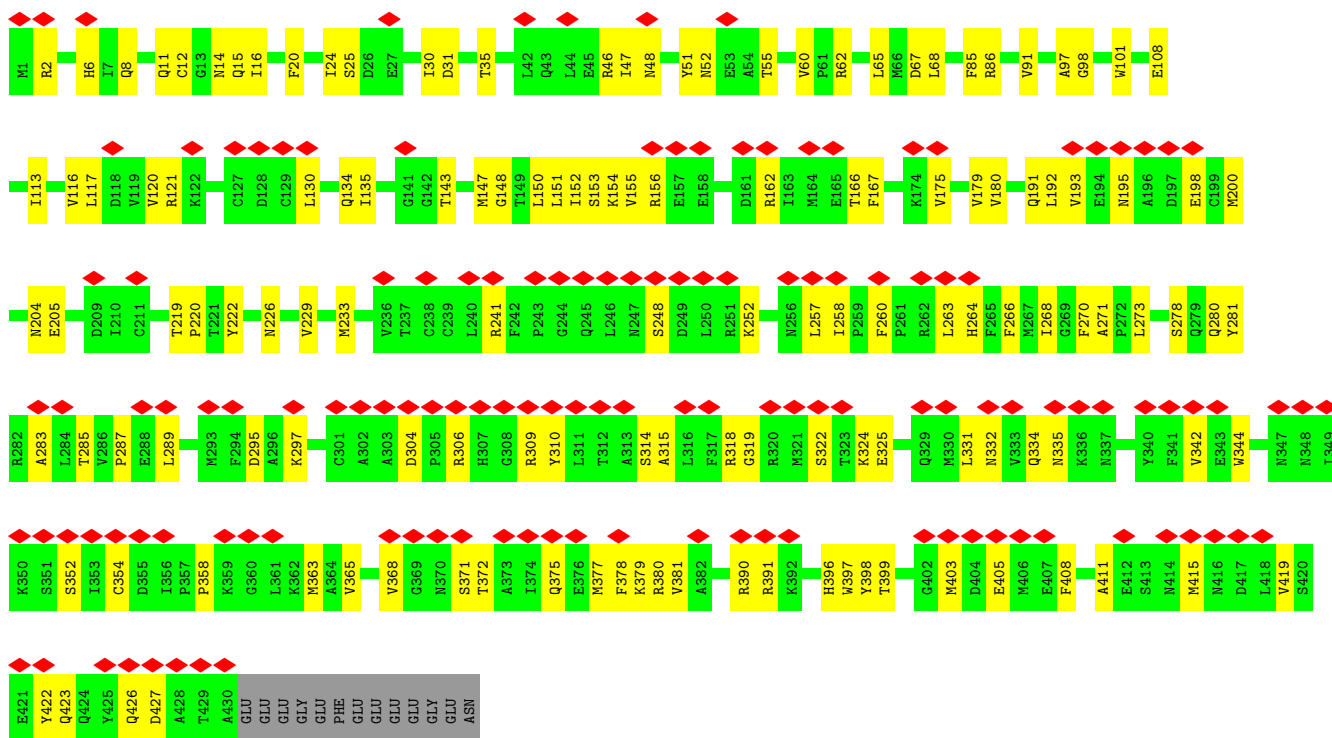

• Molecule 46: Tubulin beta chain

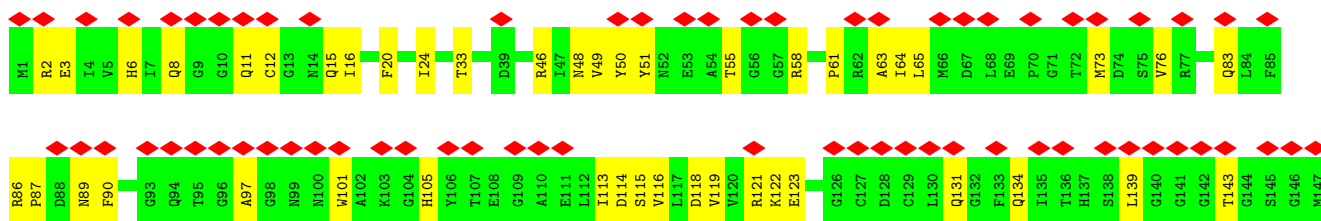
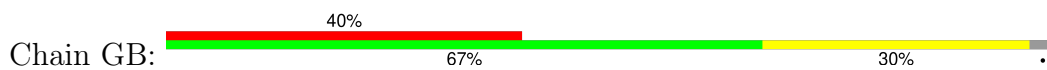

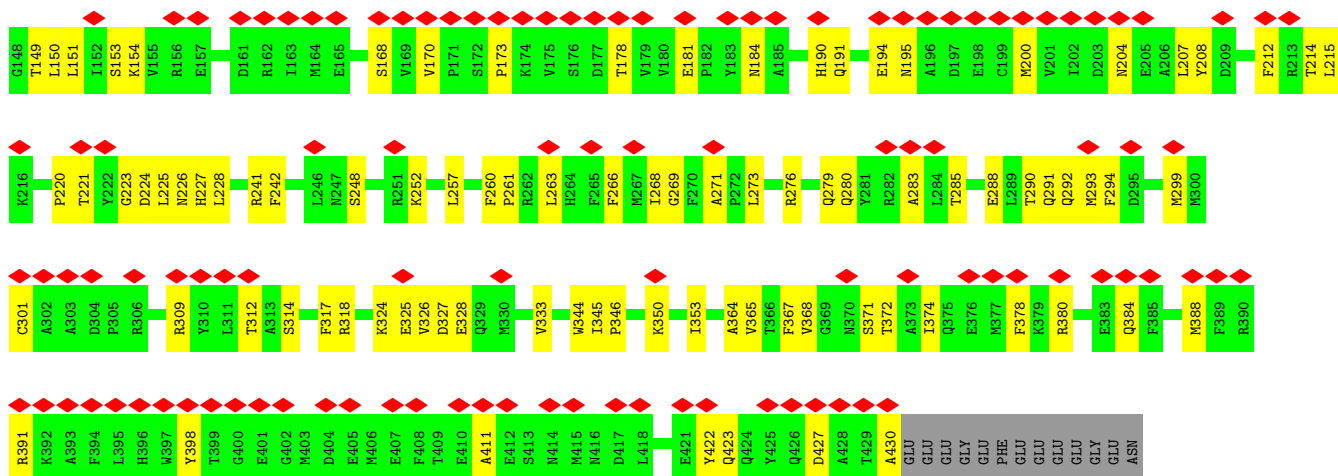

• Molecule 46: Tubulin beta chain

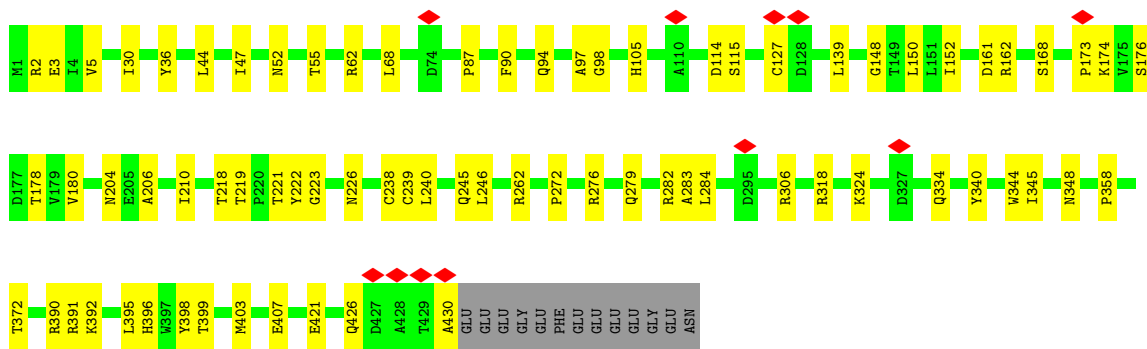
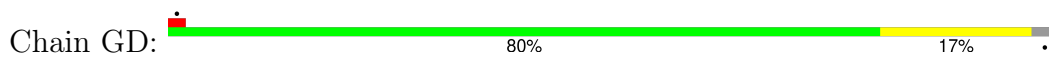

• Molecule 46: Tubulin beta chain

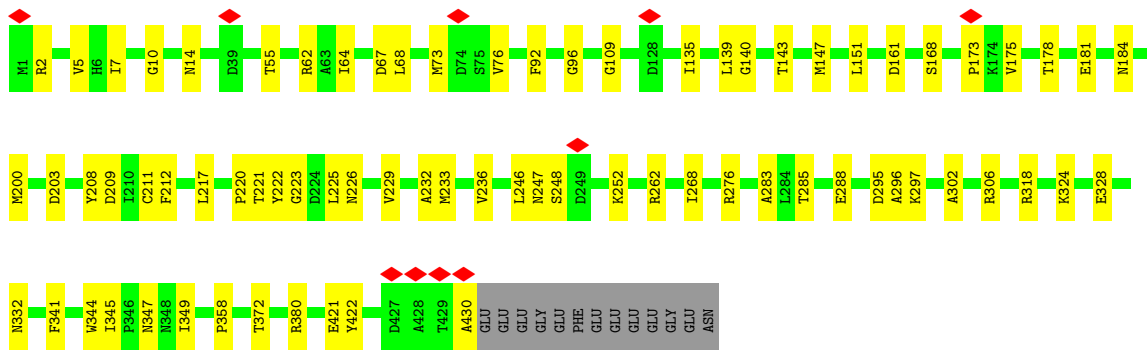
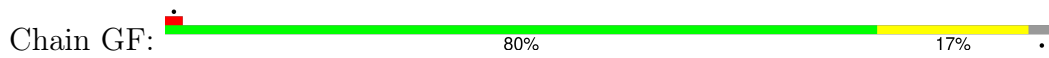

• Molecule 46: Tubulin beta chain

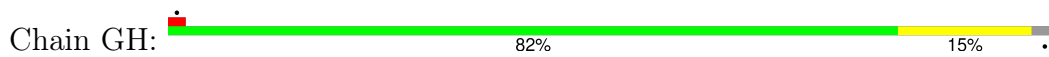

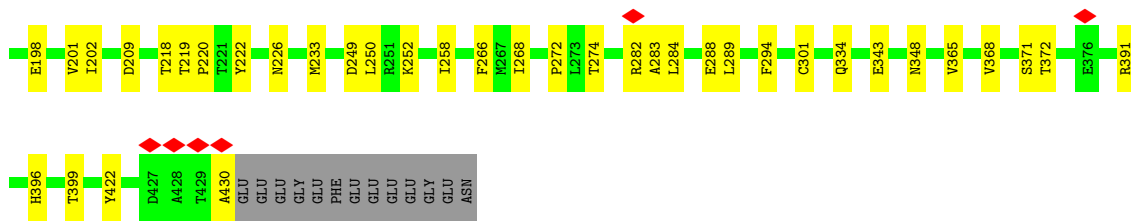

• Molecule 46: Tubulin beta chain

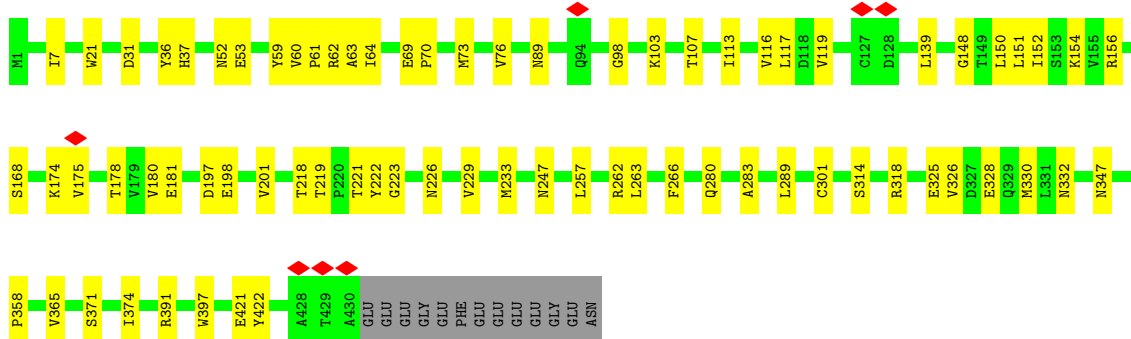
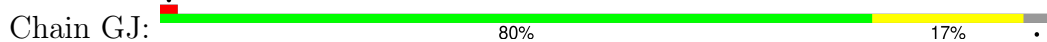

• Molecule 46: Tubulin beta chain

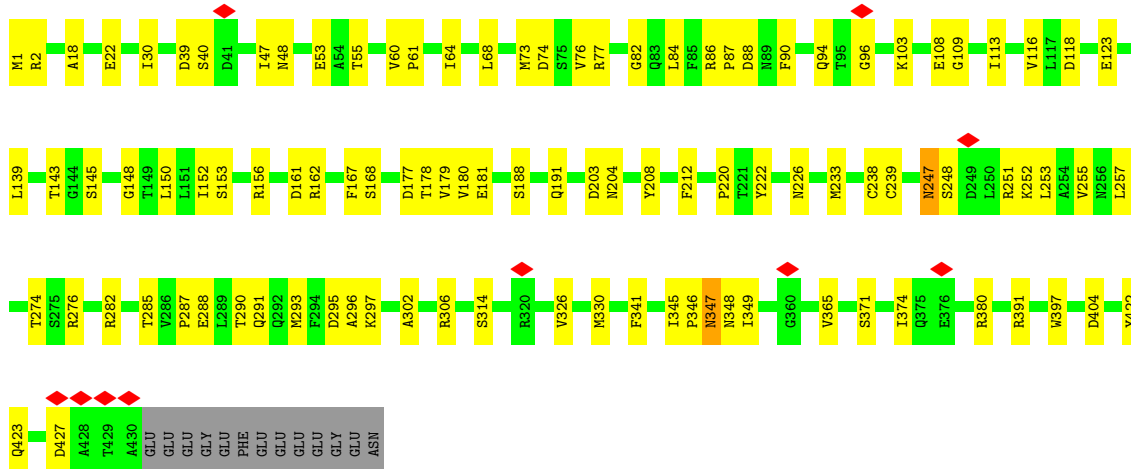

• Molecule 46: Tubulin beta chain

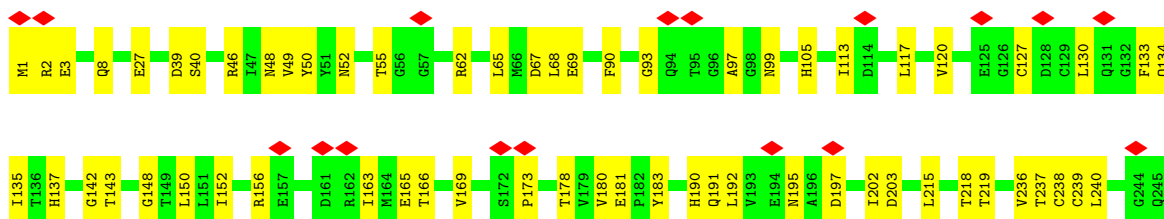

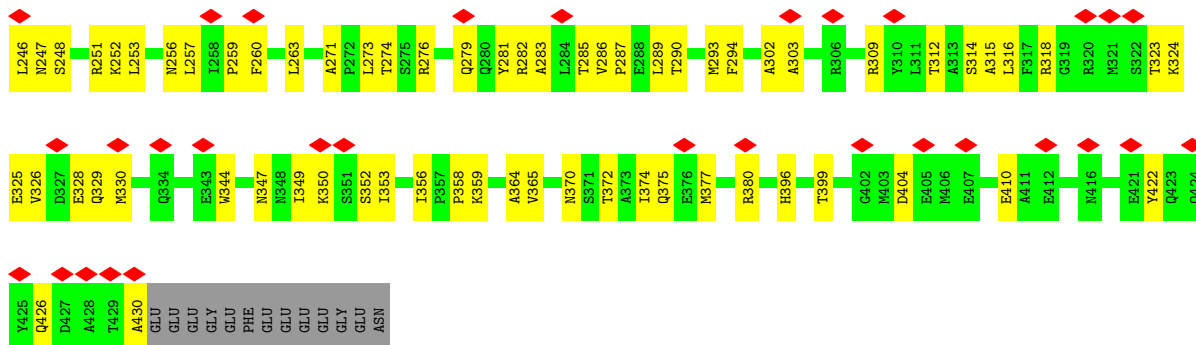

• Molecule 46: Tubulin beta chain

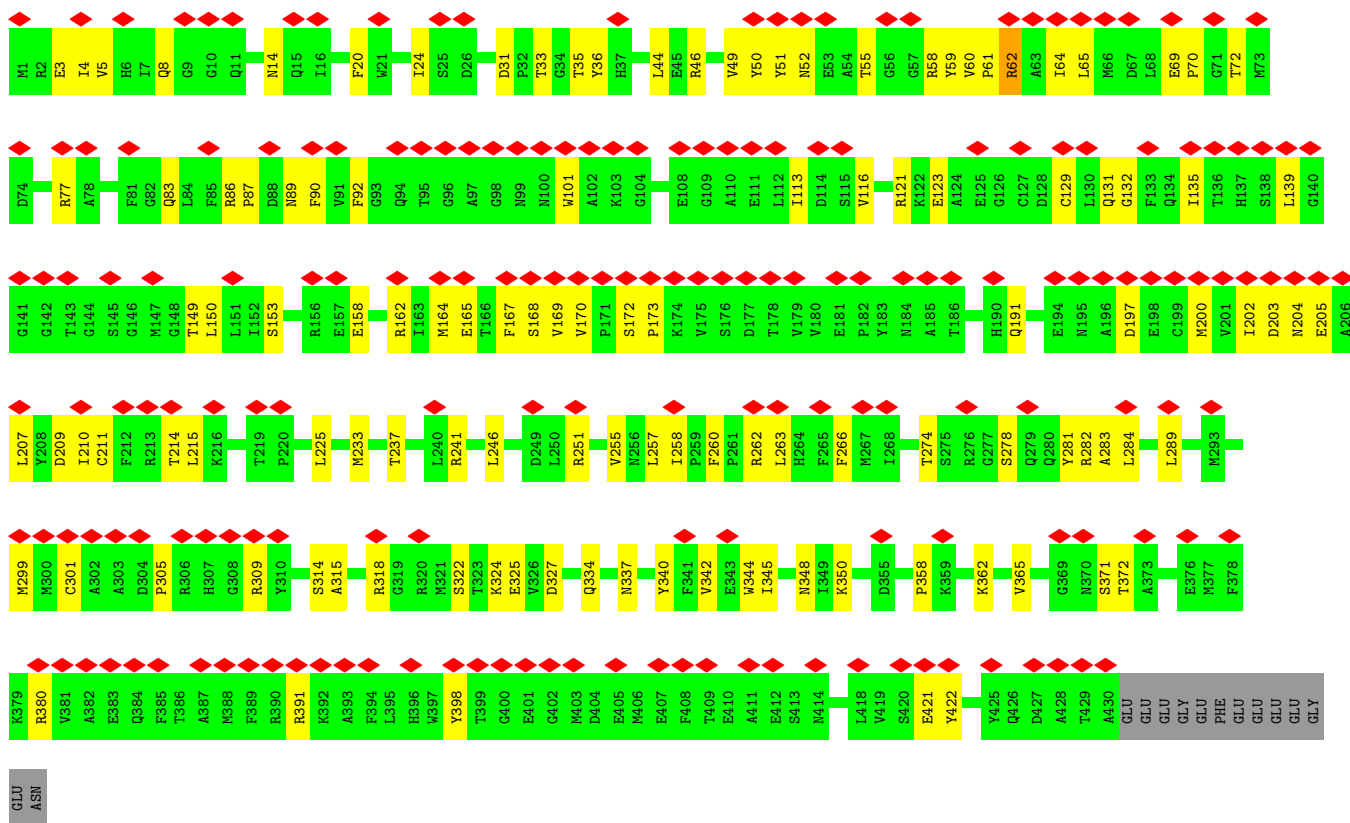
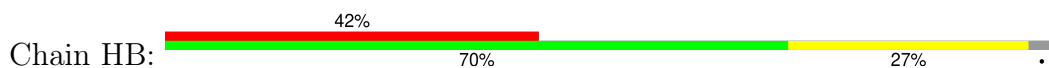

• Molecule 46: Tubulin beta chain

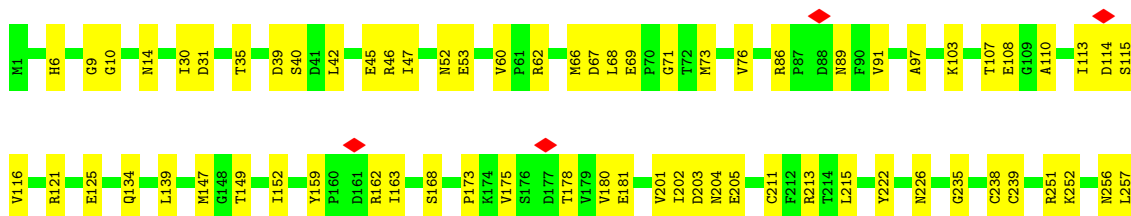
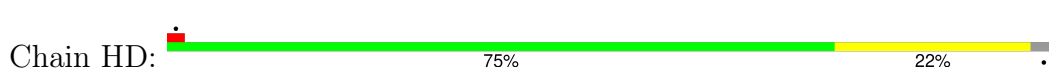

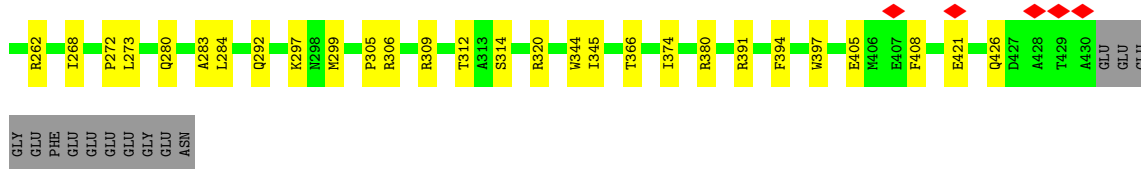

• Molecule 46: Tubulin beta chain

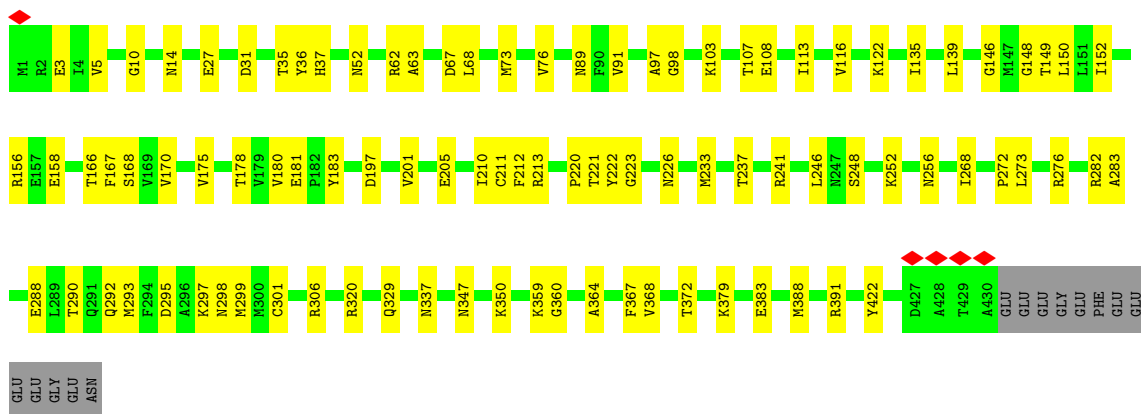
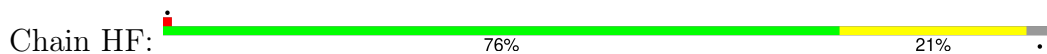

• Molecule 46: Tubulin beta chain

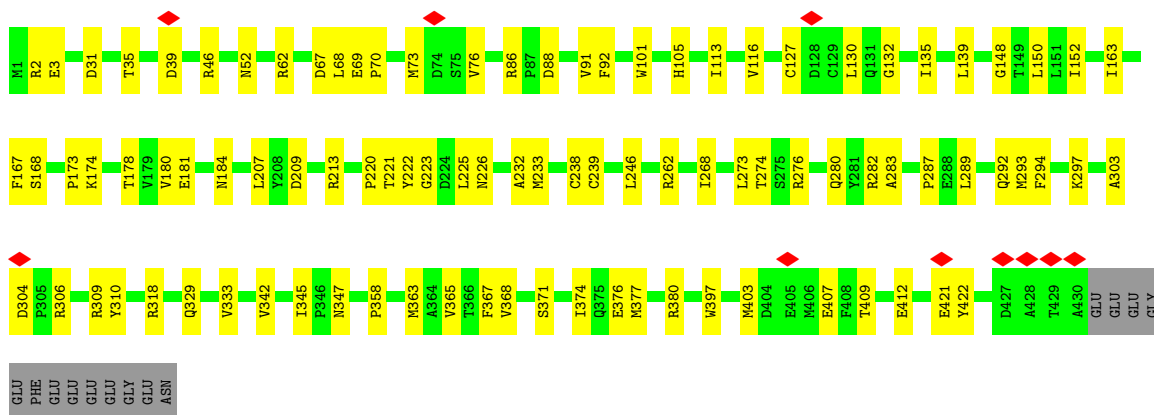
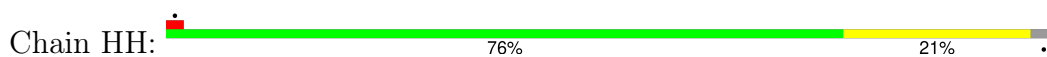

• Molecule 46: Tubulin beta chain

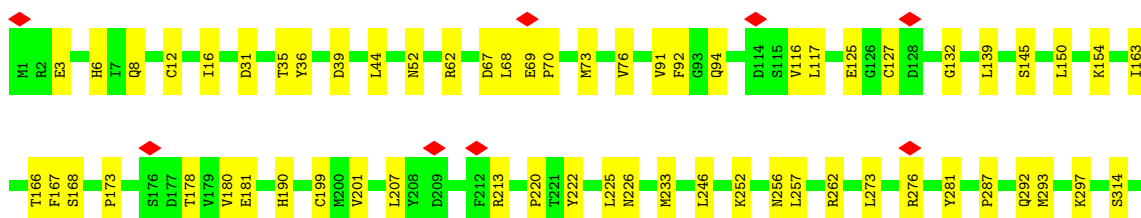
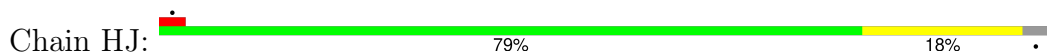



• Molecule 46: Tubulin beta chain

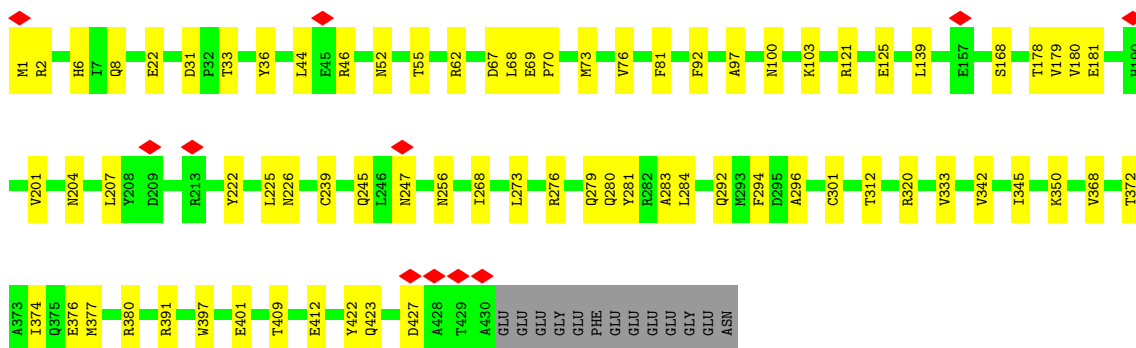
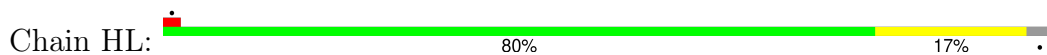

• Molecule 46: Tubulin beta chain

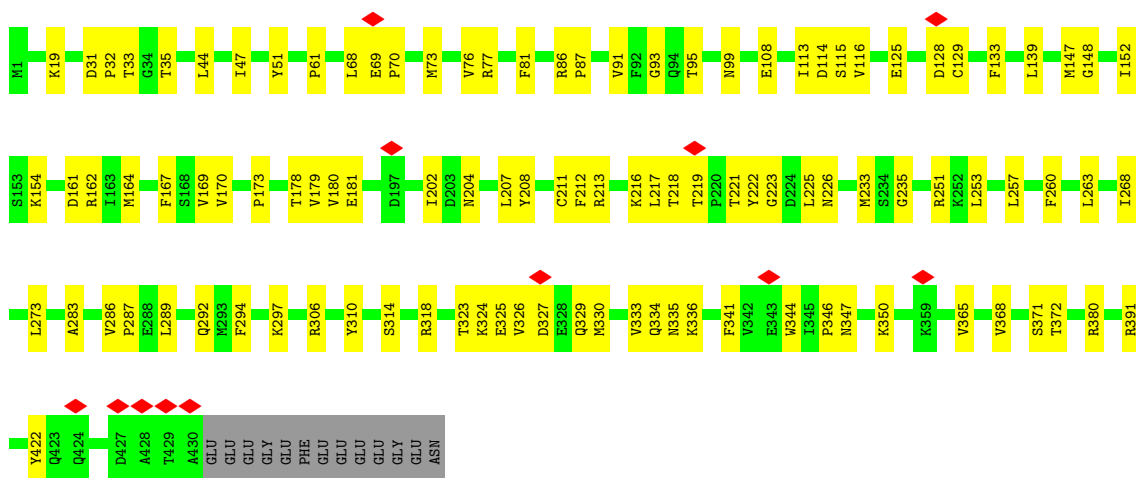
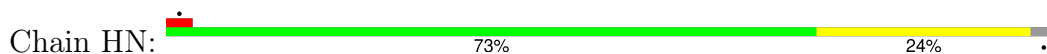

• Molecule 46: Tubulin beta chain

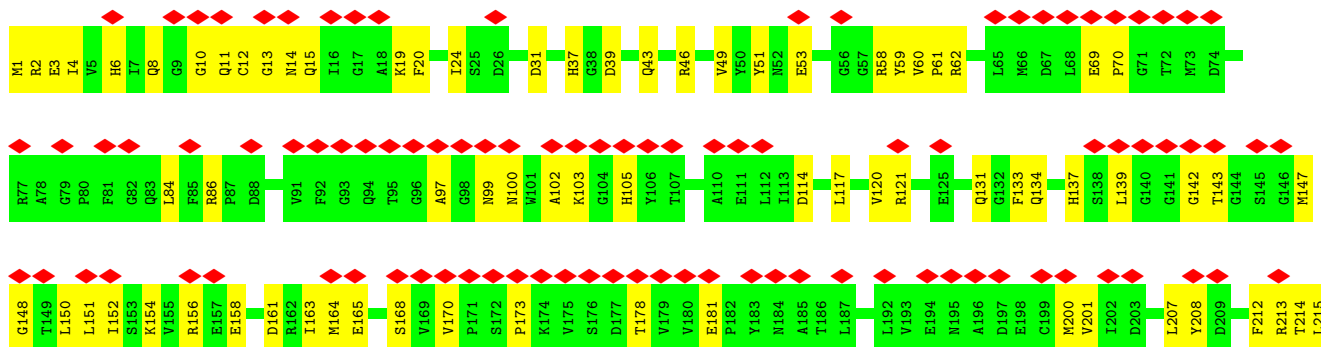

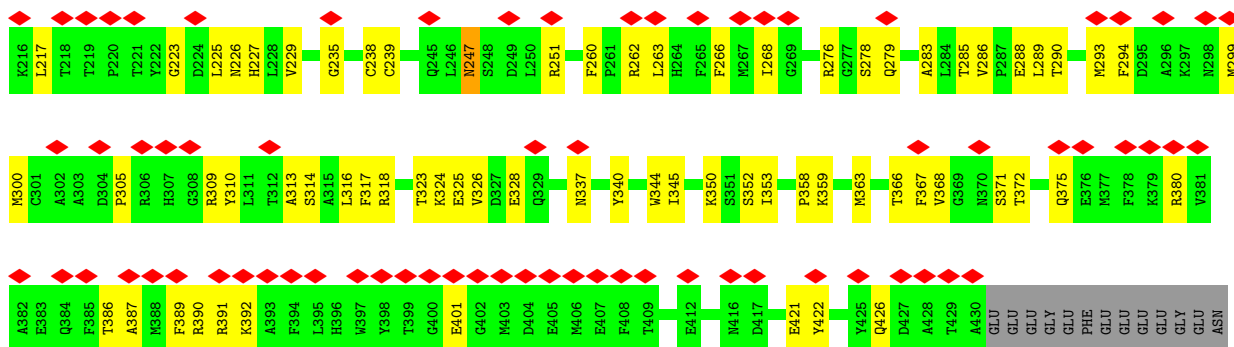

• Molecule 46: Tubulin beta chain

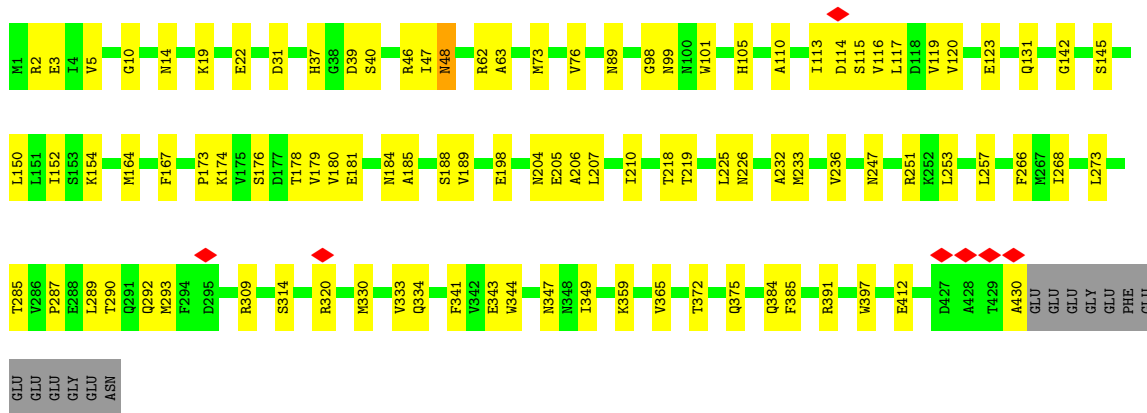
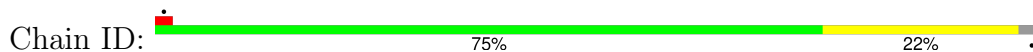

• Molecule 46: Tubulin beta chain

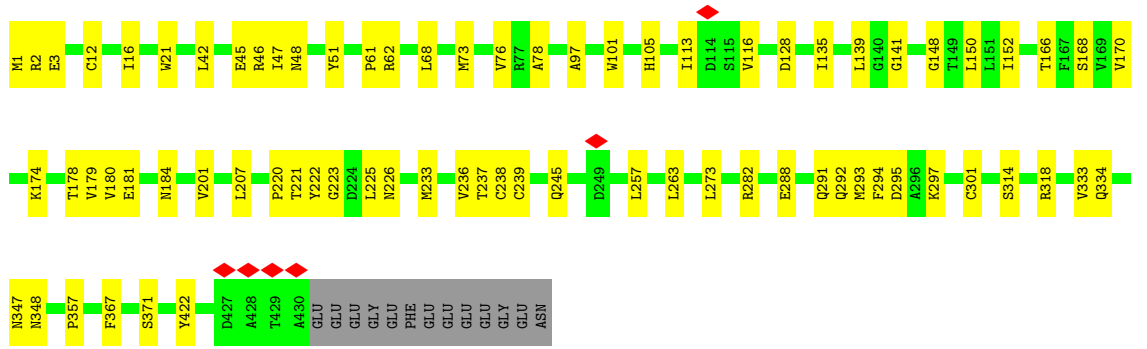
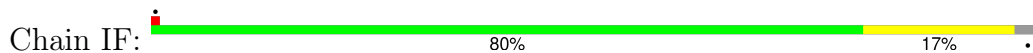

• Molecule 46: Tubulin beta chain

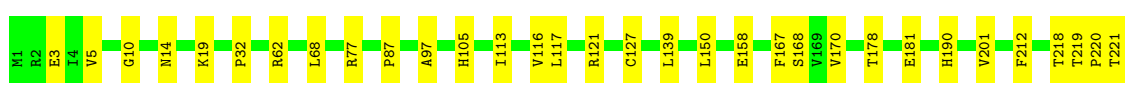
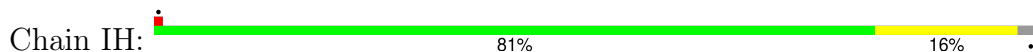

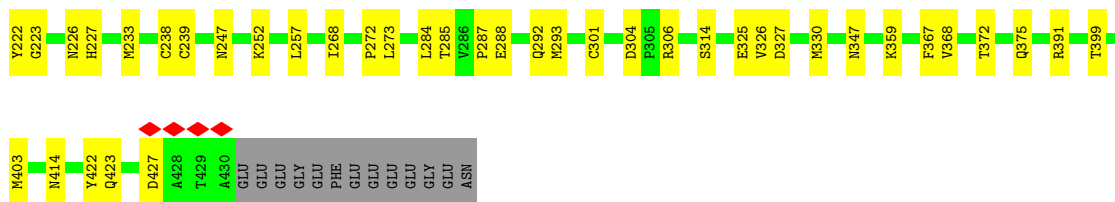

• Molecule 46: Tubulin beta chain

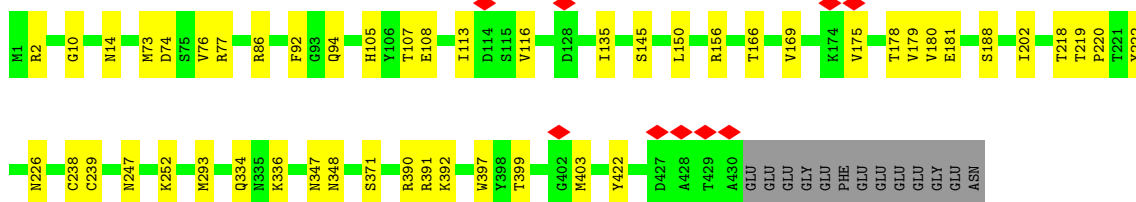
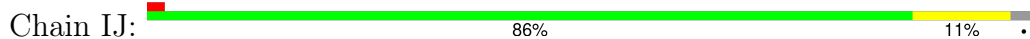

• Molecule 46: Tubulin beta chain

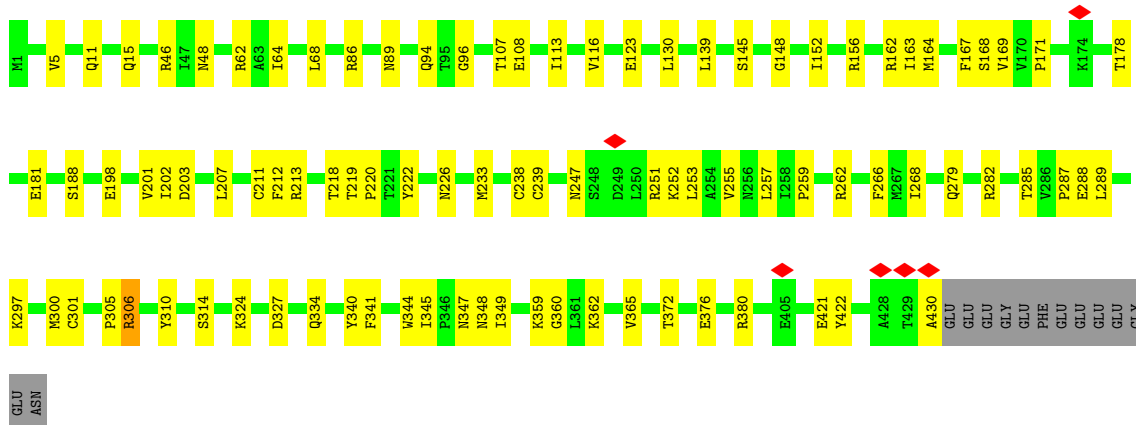
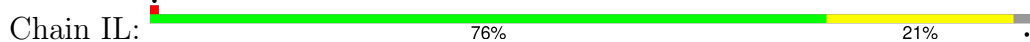

• Molecule 46: Tubulin beta chain

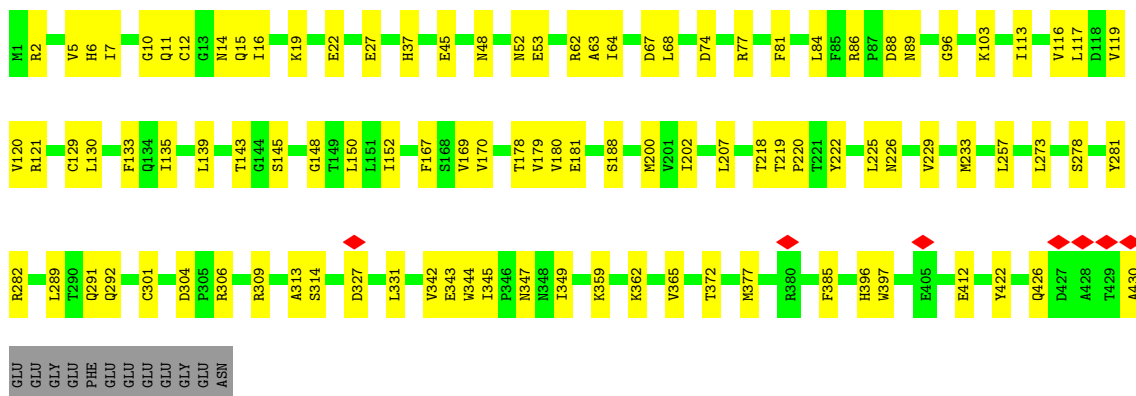

• Molecule 46: Tubulin beta chain

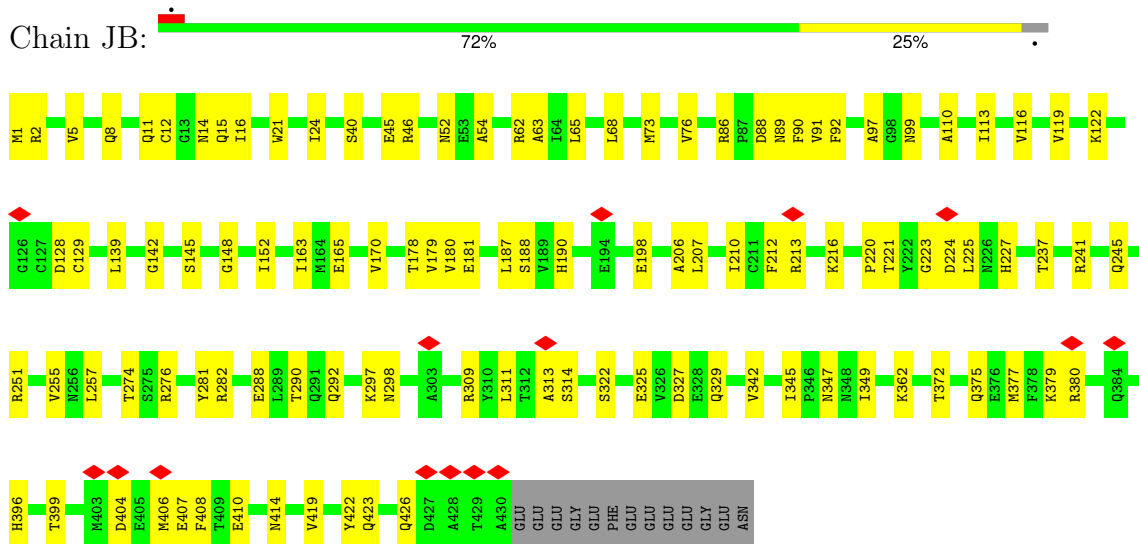

• Molecule 46: Tubulin beta chain

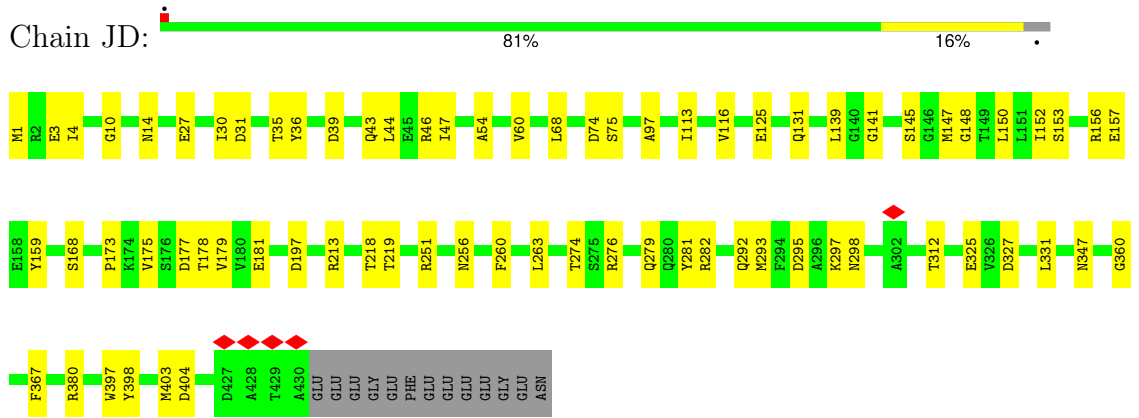

• Molecule 46: Tubulin beta chain

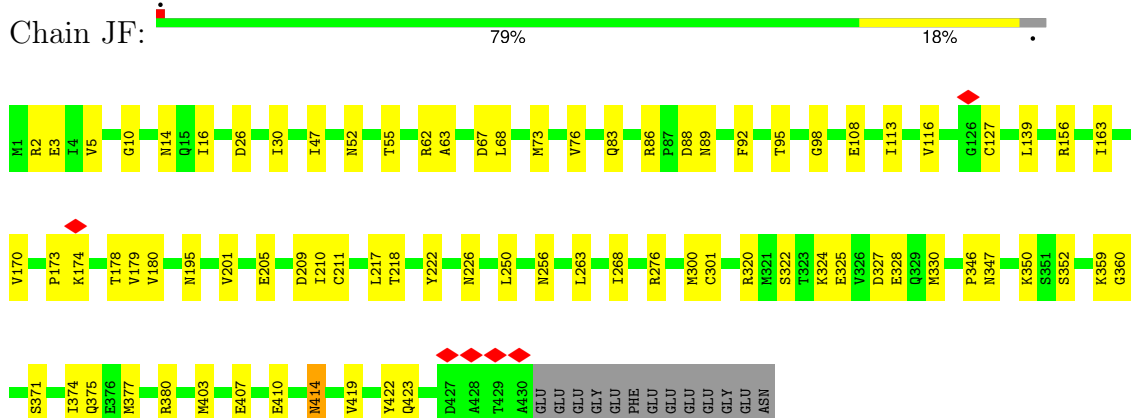

• Molecule 46: Tubulin beta chain



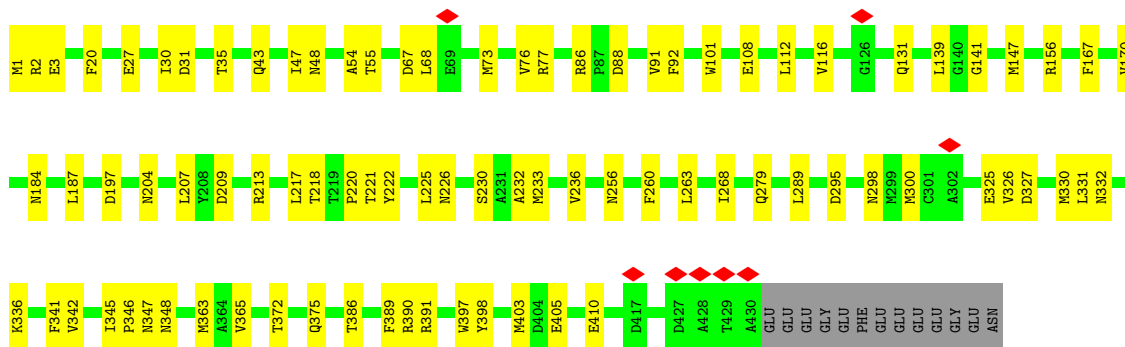

• Molecule 46: Tubulin beta chain

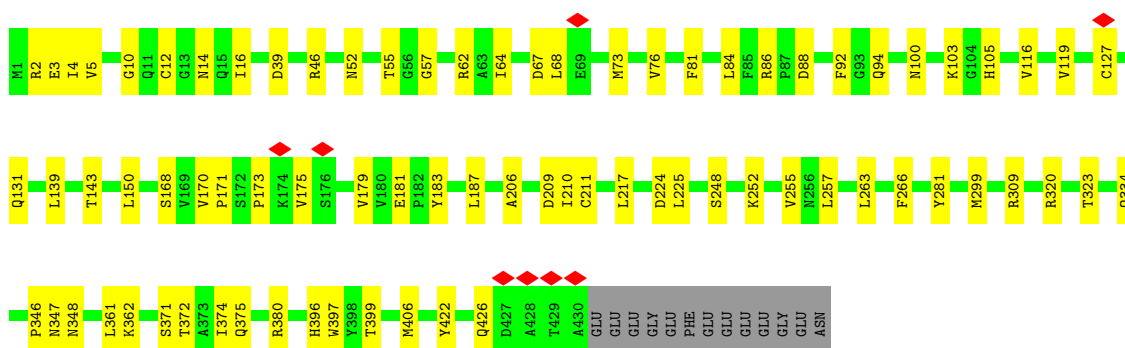
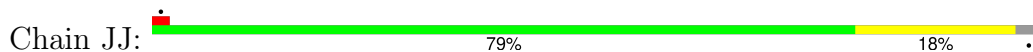

• Molecule 46: Tubulin beta chain

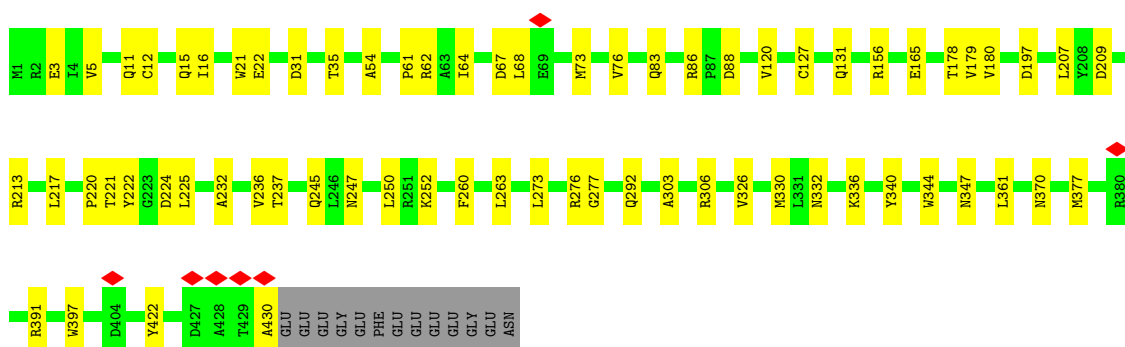
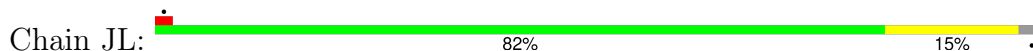

• Molecule 46: Tubulin beta chain

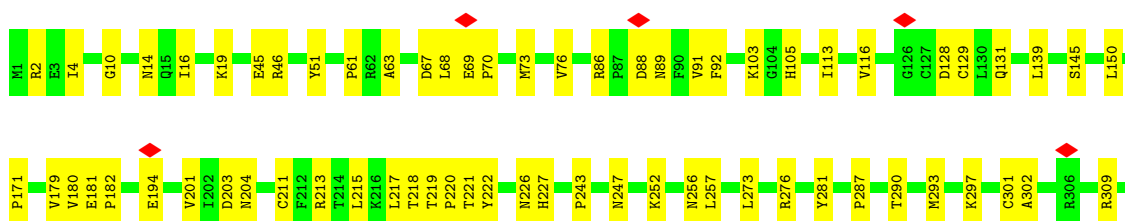
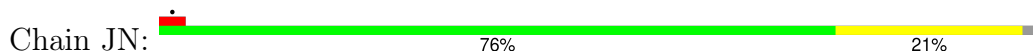

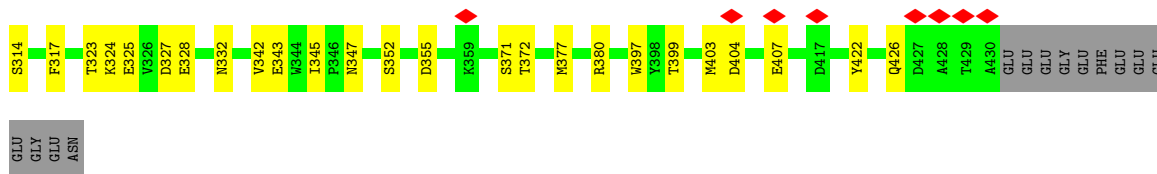

• Molecule 46: Tubulin beta chain

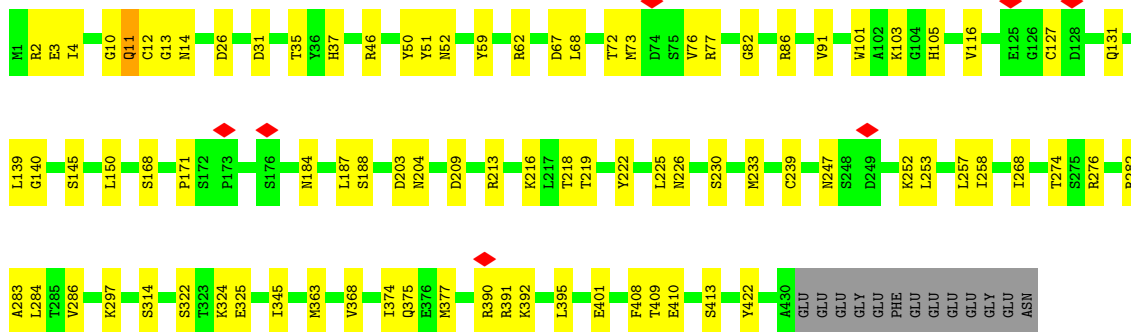
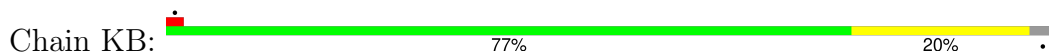

• Molecule 46: Tubulin beta chain

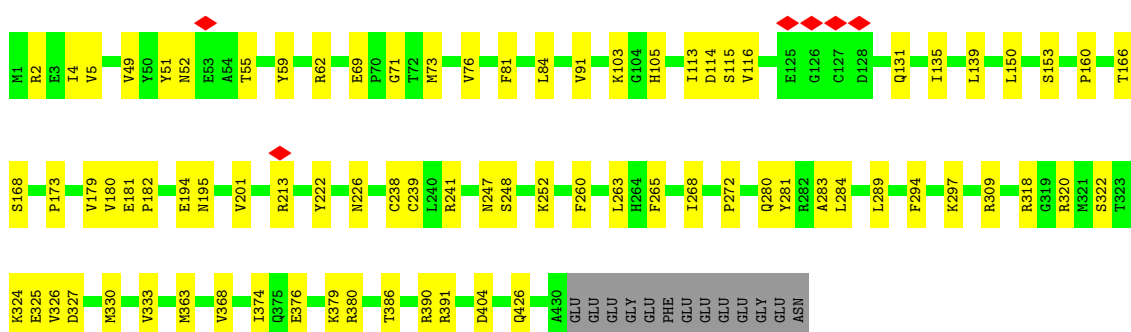
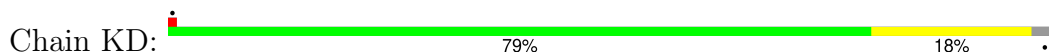

• Molecule 46: Tubulin beta chain

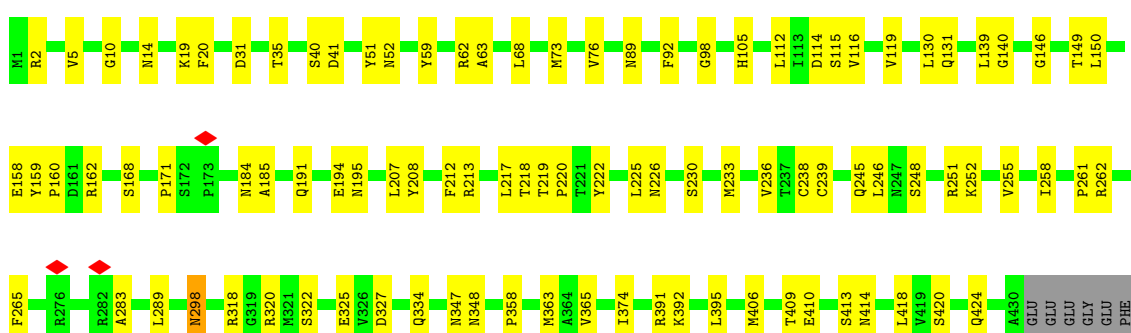
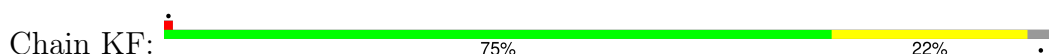

GLU
GLU
GLU
GLU
GLU
GLU
ASN

• Molecule 46: Tubulin beta chain

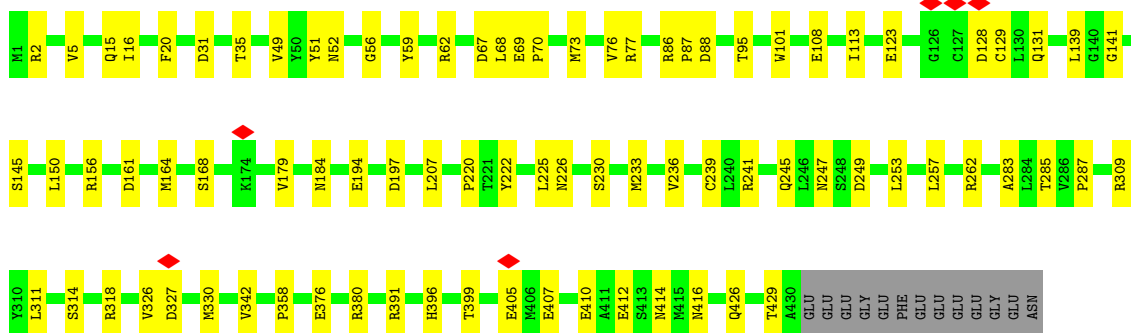
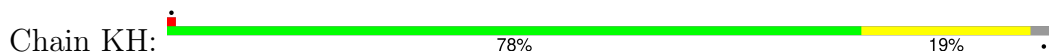

• Molecule 46: Tubulin beta chain

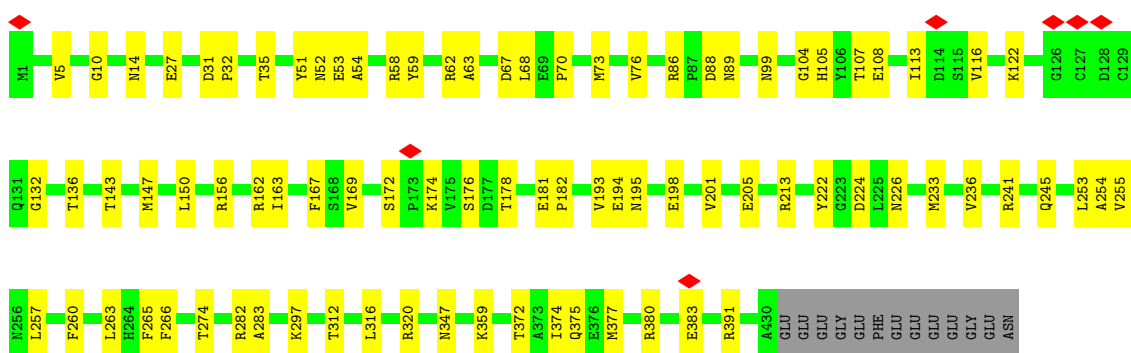
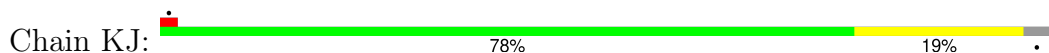

• Molecule 46: Tubulin beta chain

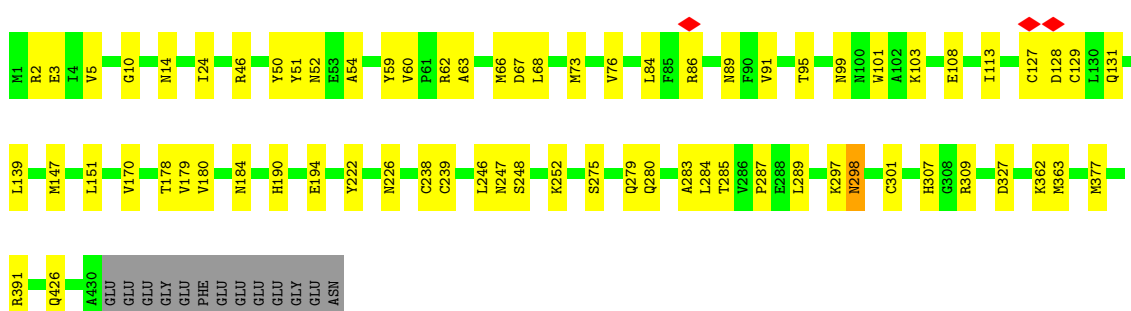
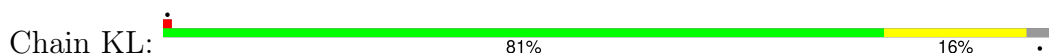

• Molecule 46: Tubulin beta chain

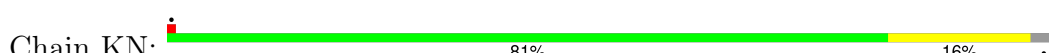

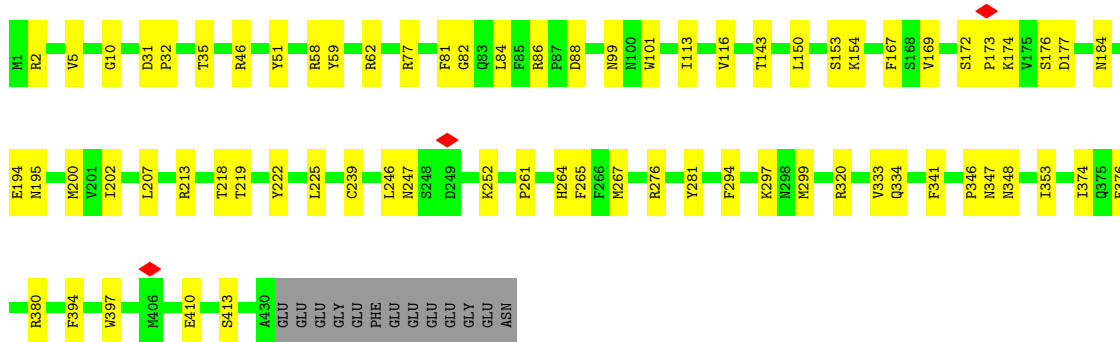

• Molecule 46: Tubulin beta chain

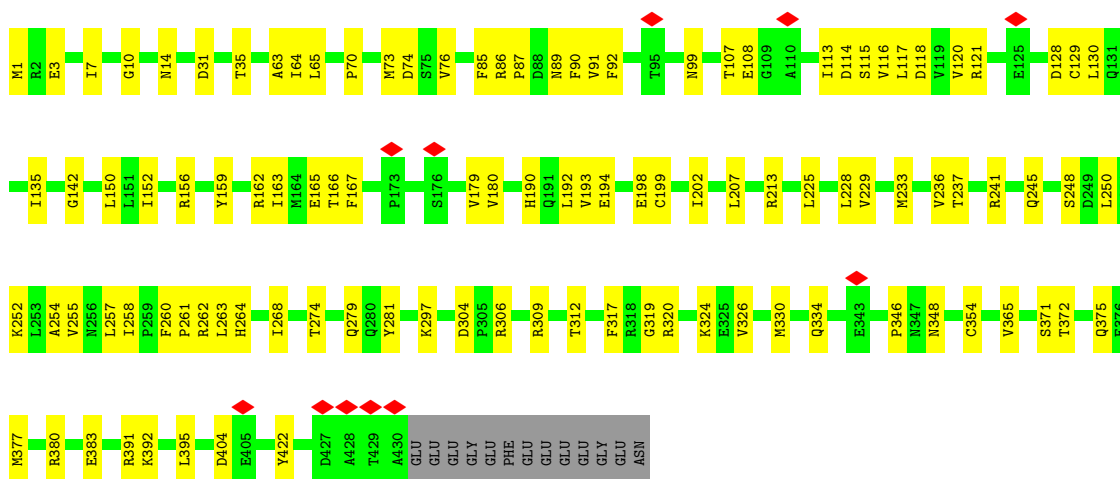

• Molecule 46: Tubulin beta chain

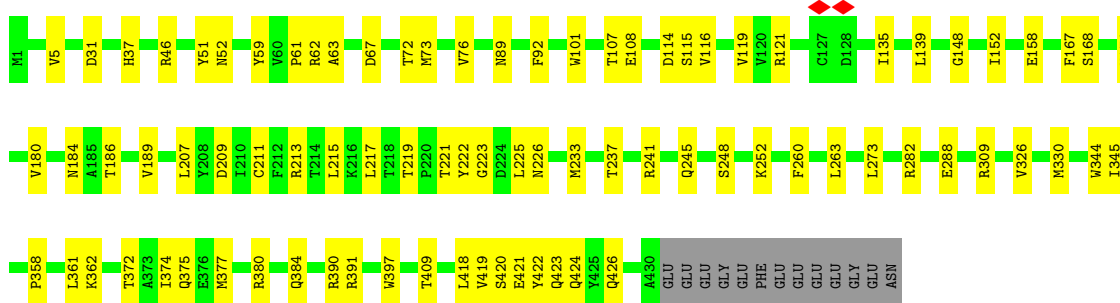
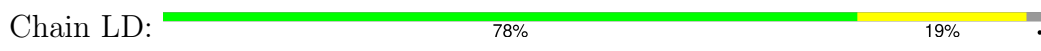

• Molecule 46: Tubulin beta chain

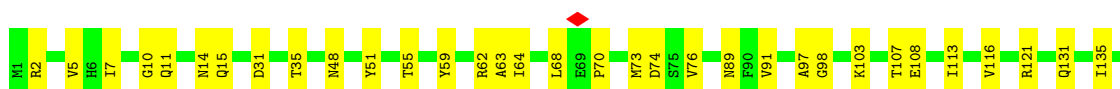
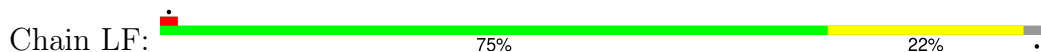

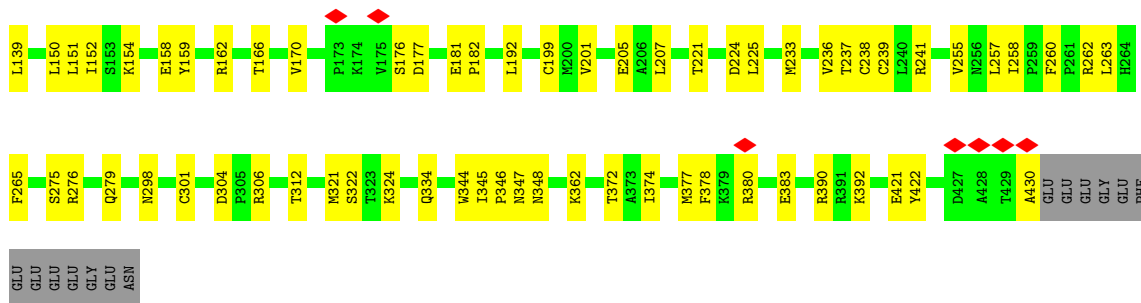

• Molecule 46: Tubulin beta chain

Chain LH:

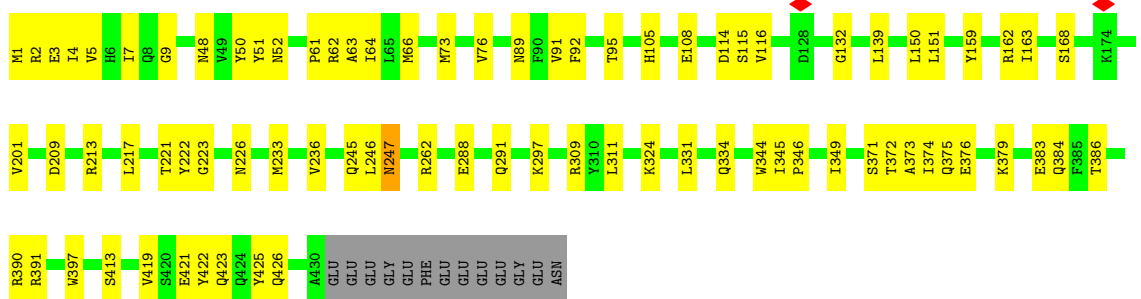

• Molecule 46: Tubulin beta chain

Chain LJ:

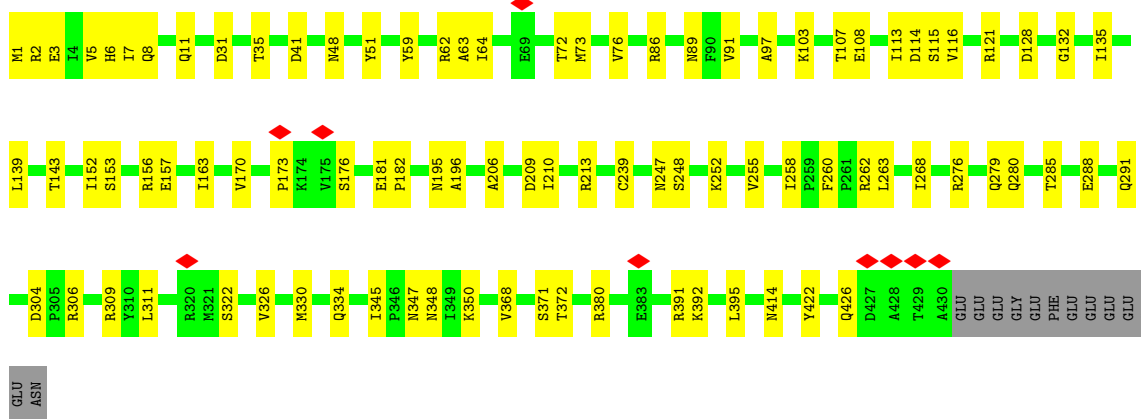

• Molecule 46: Tubulin beta chain

Chain LL:

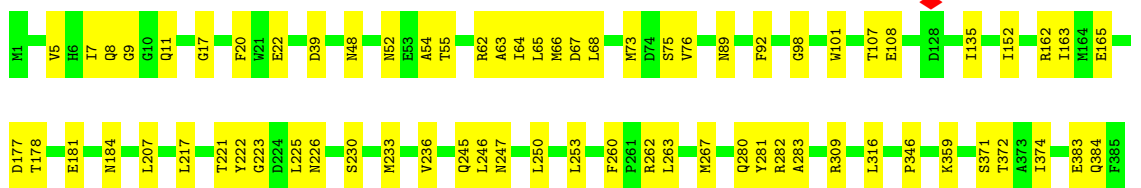

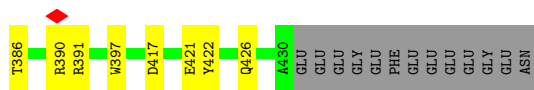

• Molecule 46: Tubulin beta chain

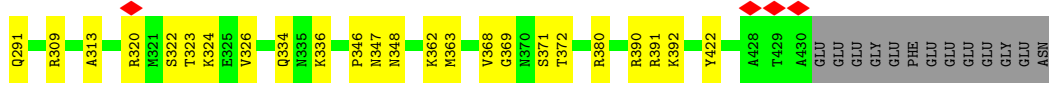
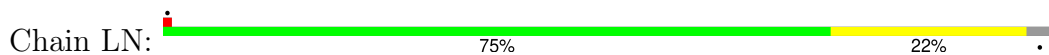

• Molecule 46: Tubulin beta chain

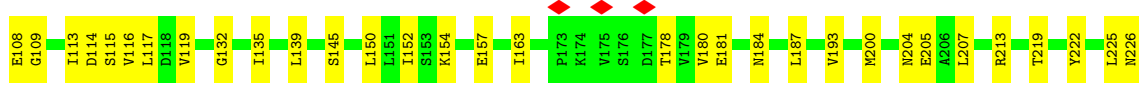
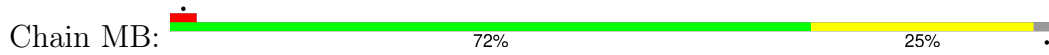

• Molecule 46: Tubulin beta chain

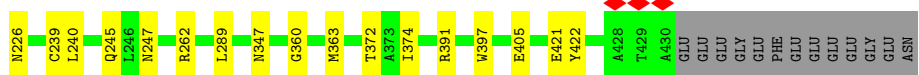
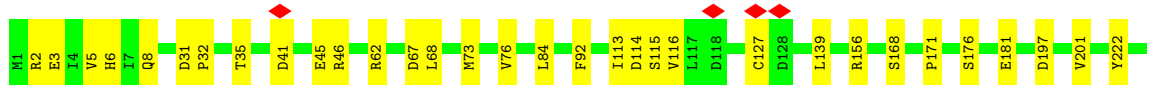
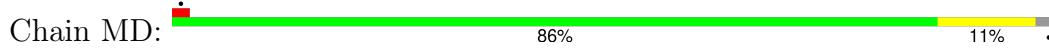

• Molecule 46: Tubulin beta chain

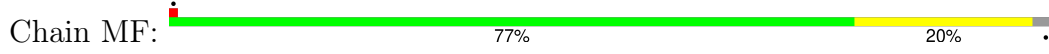

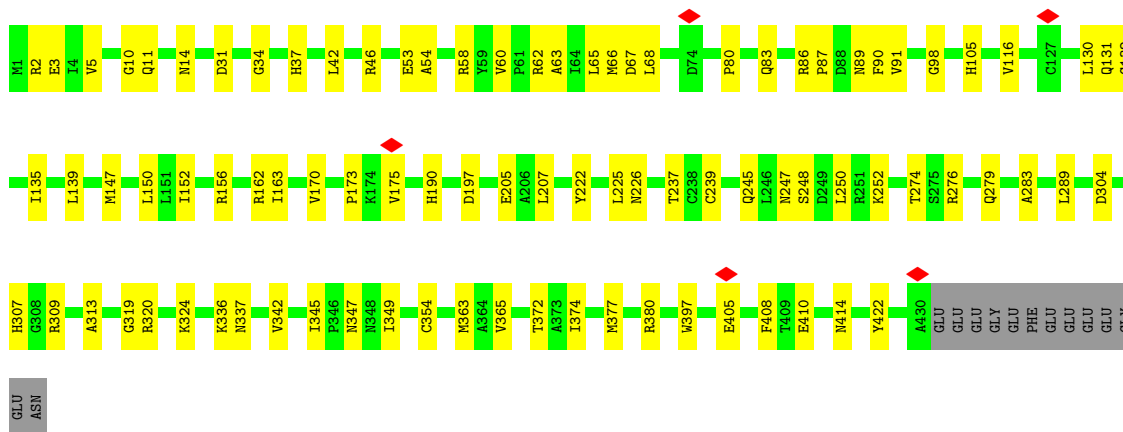

• Molecule 46: Tubulin beta chain

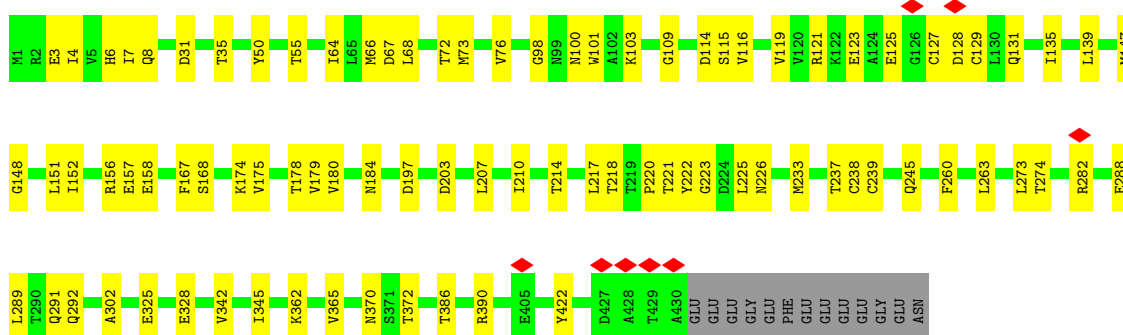
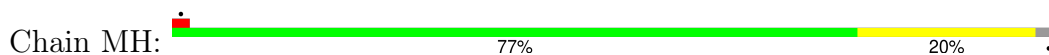

• Molecule 46: Tubulin beta chain

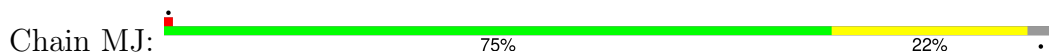

• Molecule 46: Tubulin beta chain

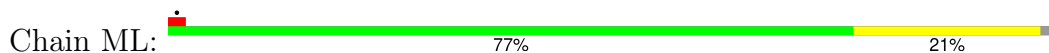

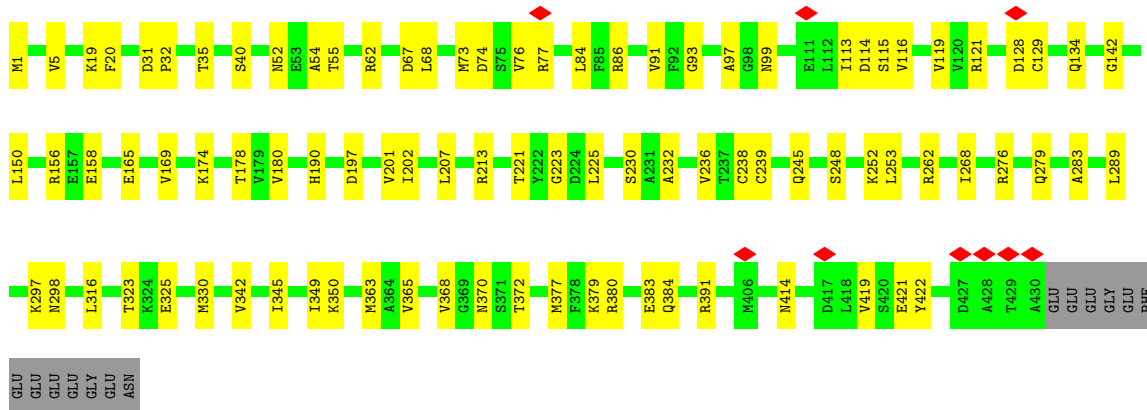

• Molecule 46: Tubulin beta chain

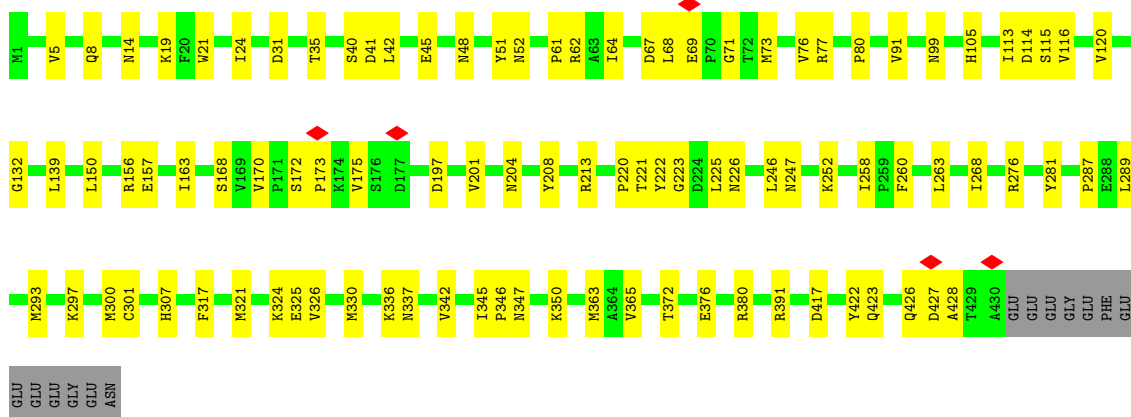
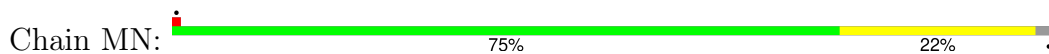

• Molecule 46: Tubulin beta chain

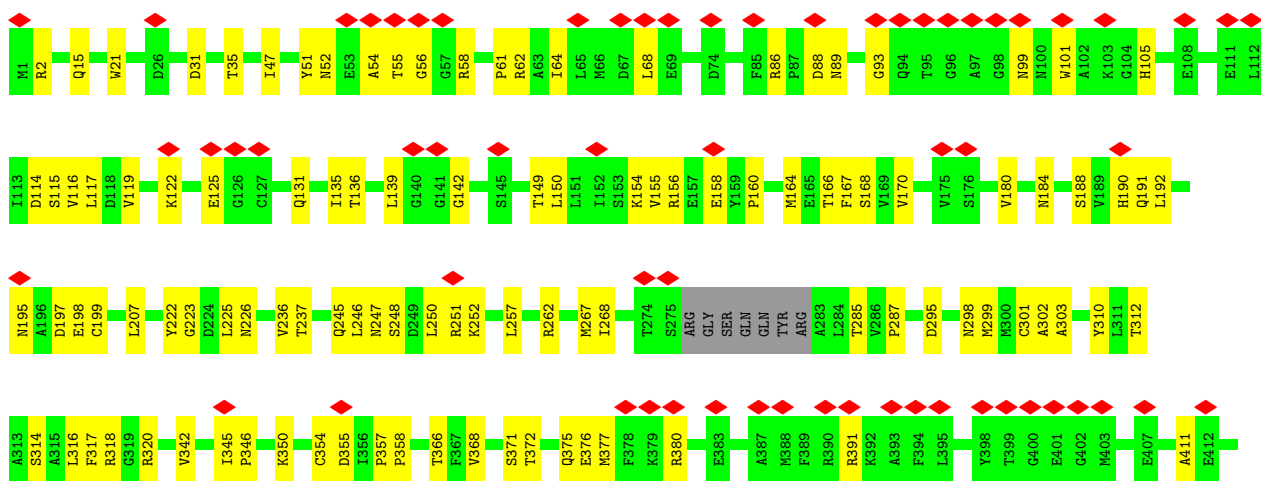

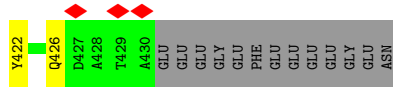

• Molecule 46: Tubulin beta chain

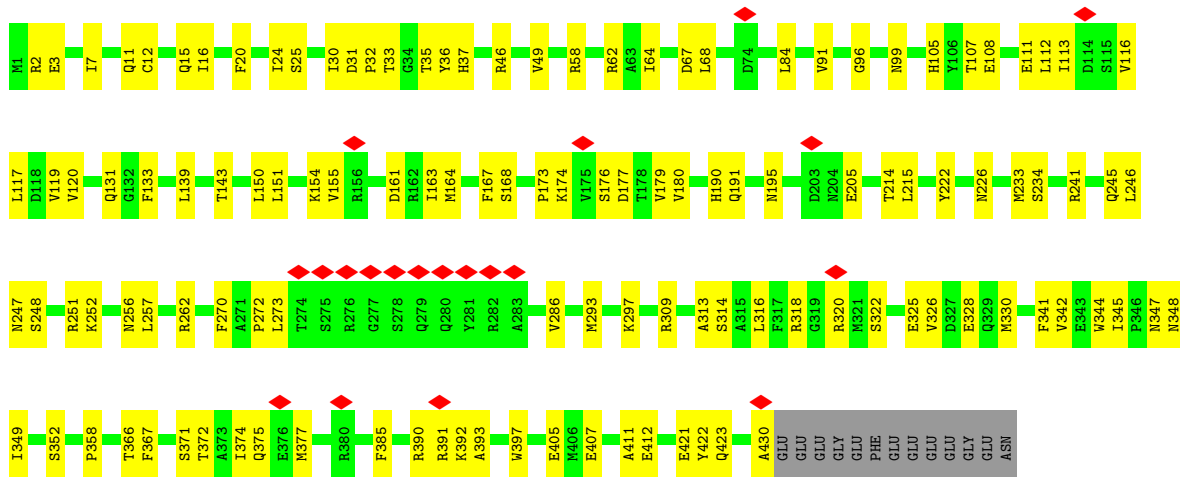

• Molecule 46: Tubulin beta chain

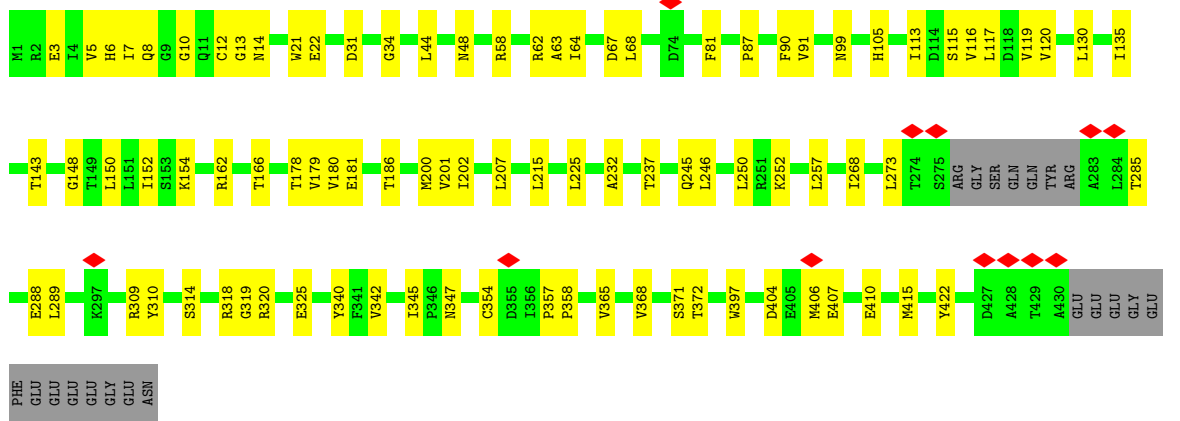
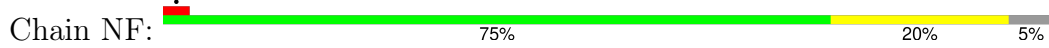

• Molecule 46: Tubulin beta chain

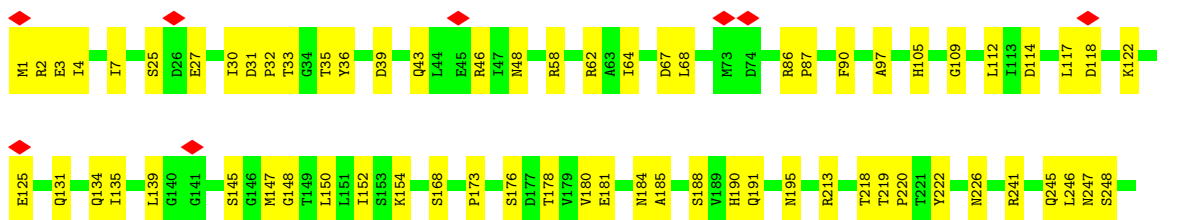
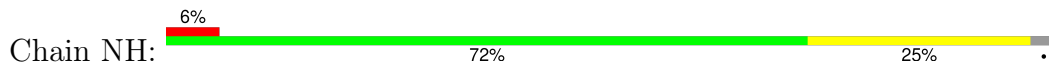

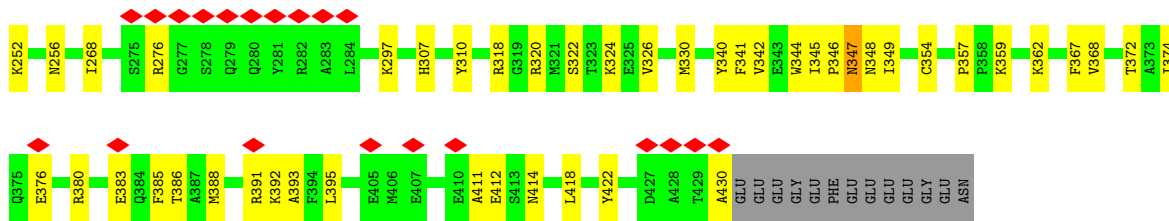

• Molecule 46: Tubulin beta chain

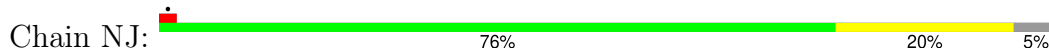

GLU ASN

• Molecule 46: Tubulin beta chain

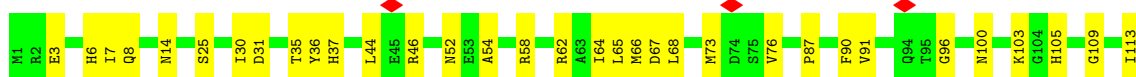
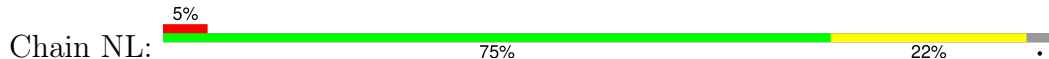

• Molecule 46: Tubulin beta chain

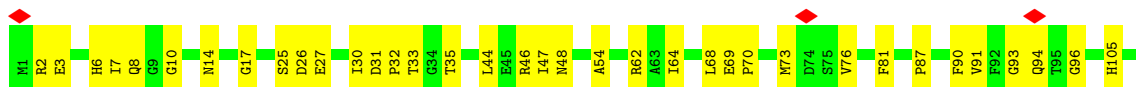

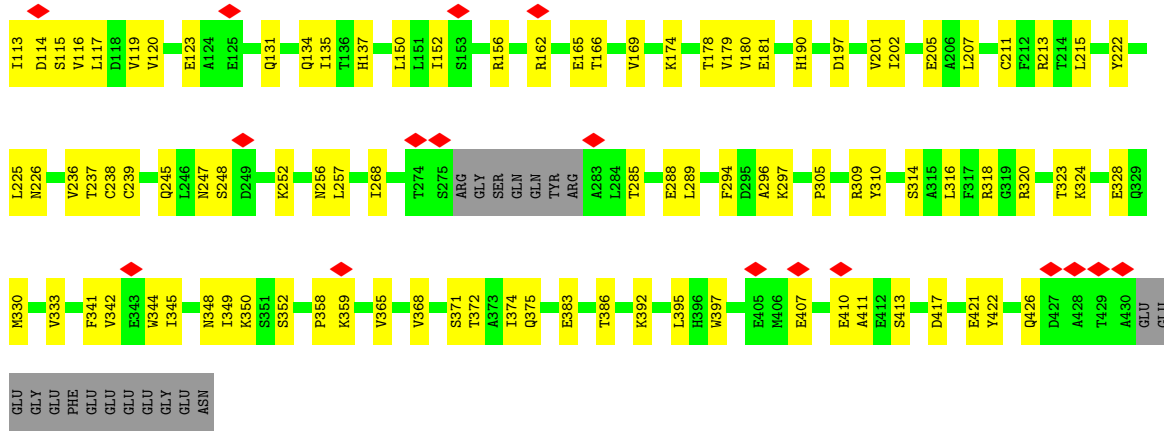

• Molecule 46: Tubulin beta chain

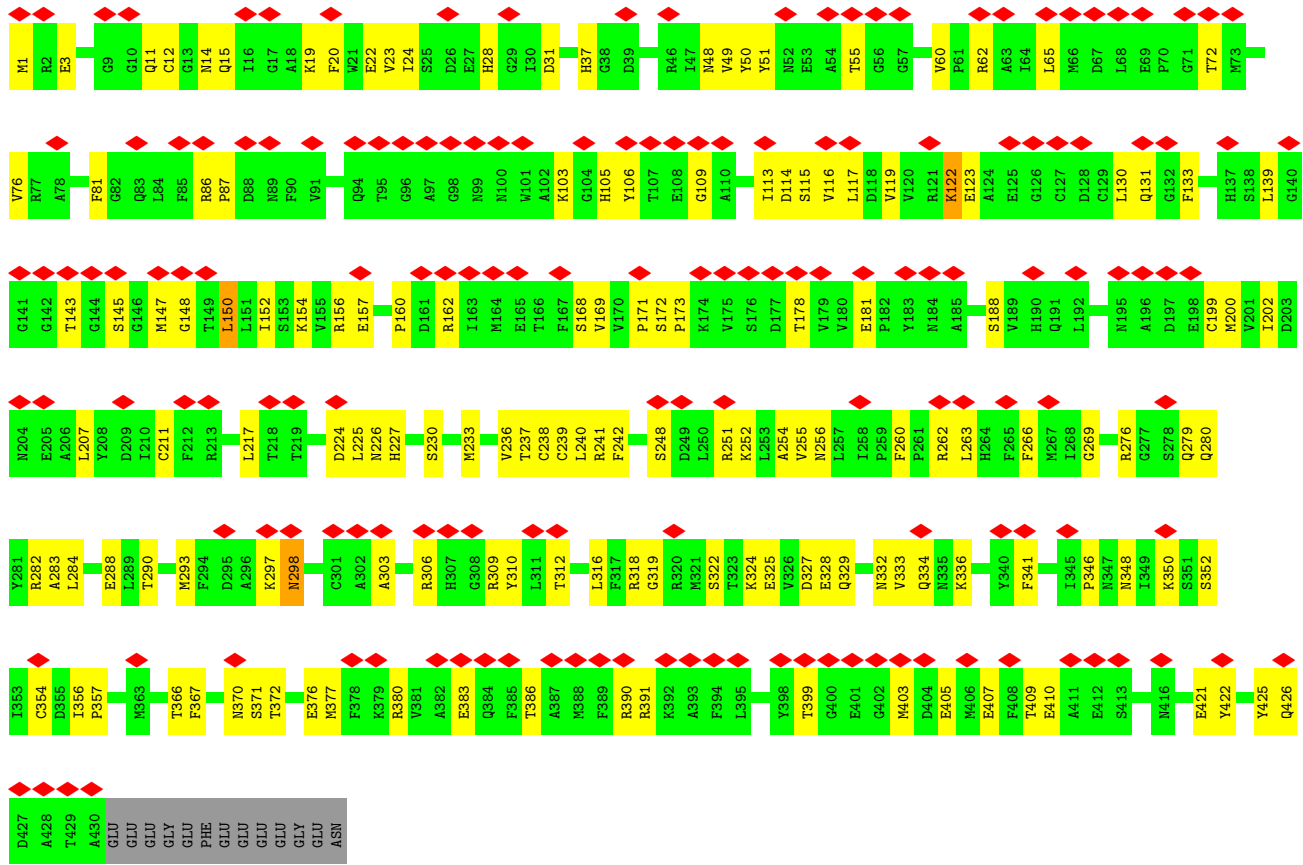

• Molecule 46: Tubulin beta chain

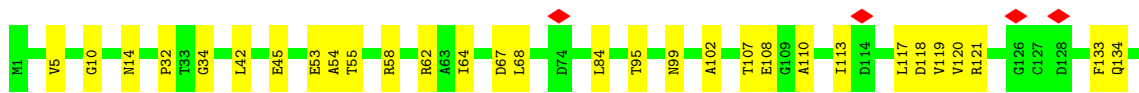
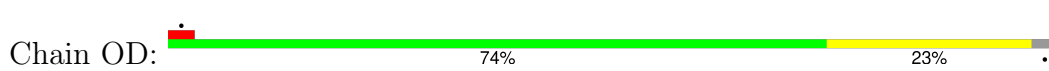

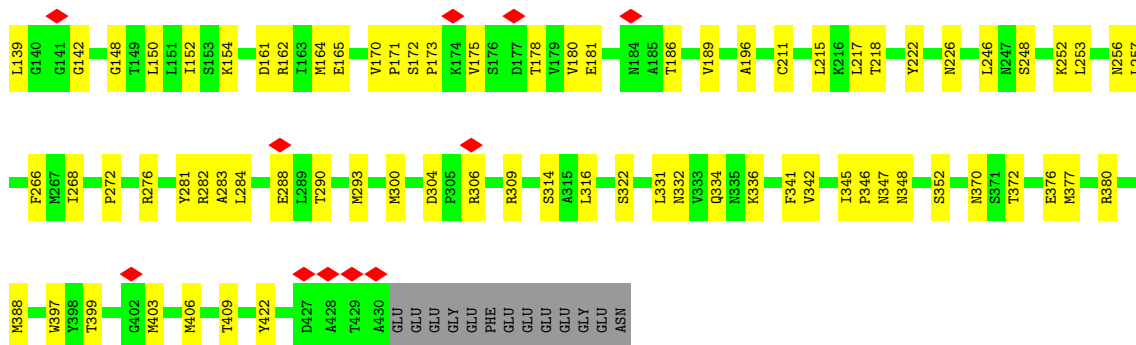

• Molecule 46: Tubulin beta chain

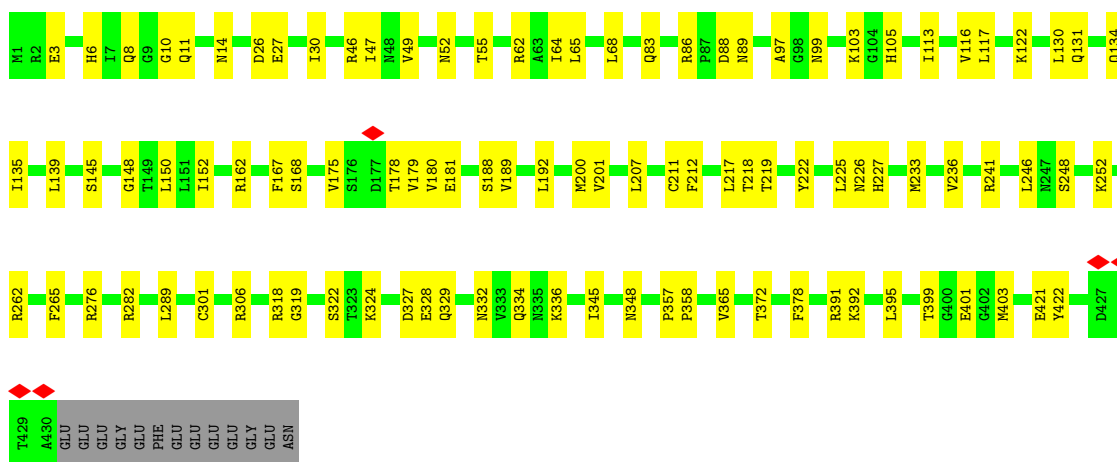
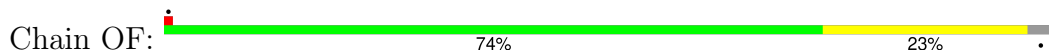

• Molecule 46: Tubulin beta chain

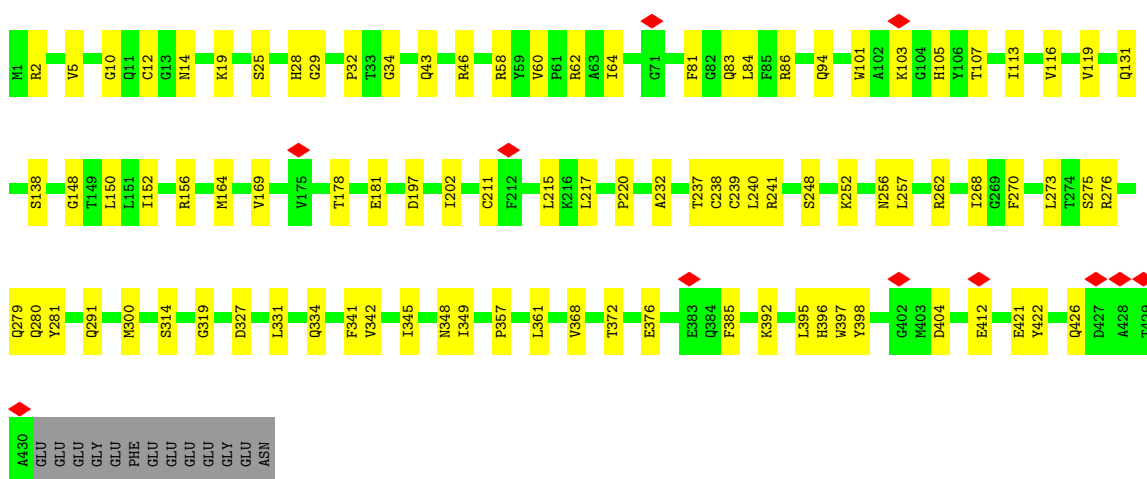
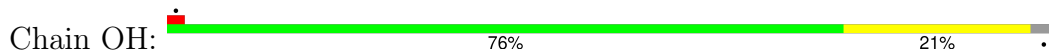

• Molecule 46: Tubulin beta chain

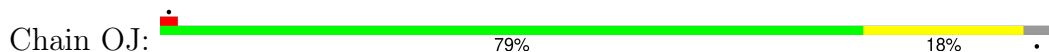

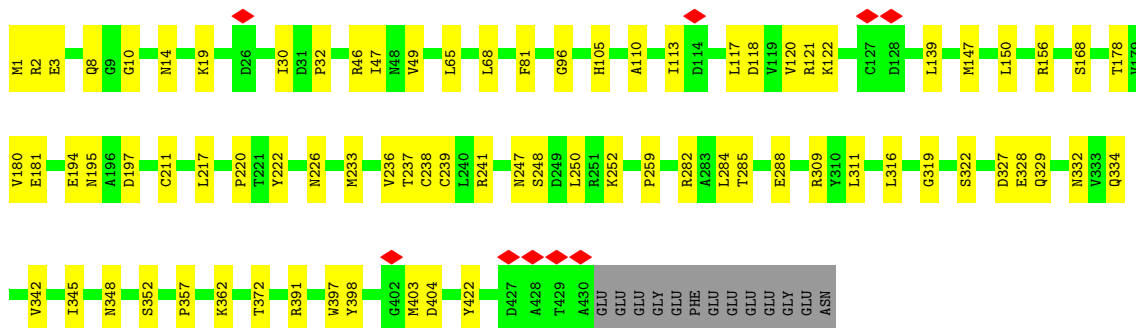

• Molecule 46: Tubulin beta chain

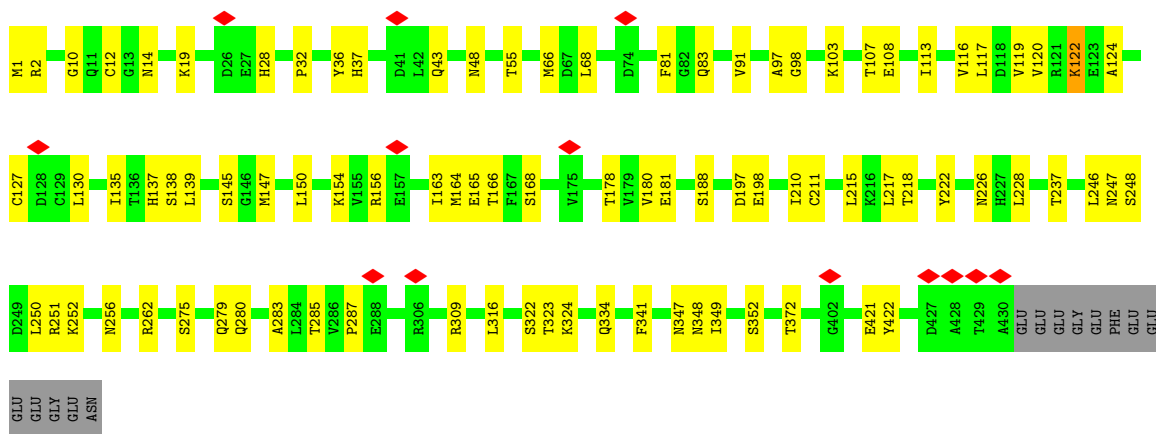
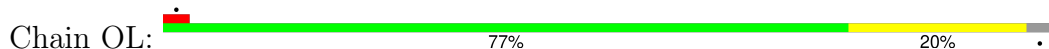

• Molecule 46: Tubulin beta chain

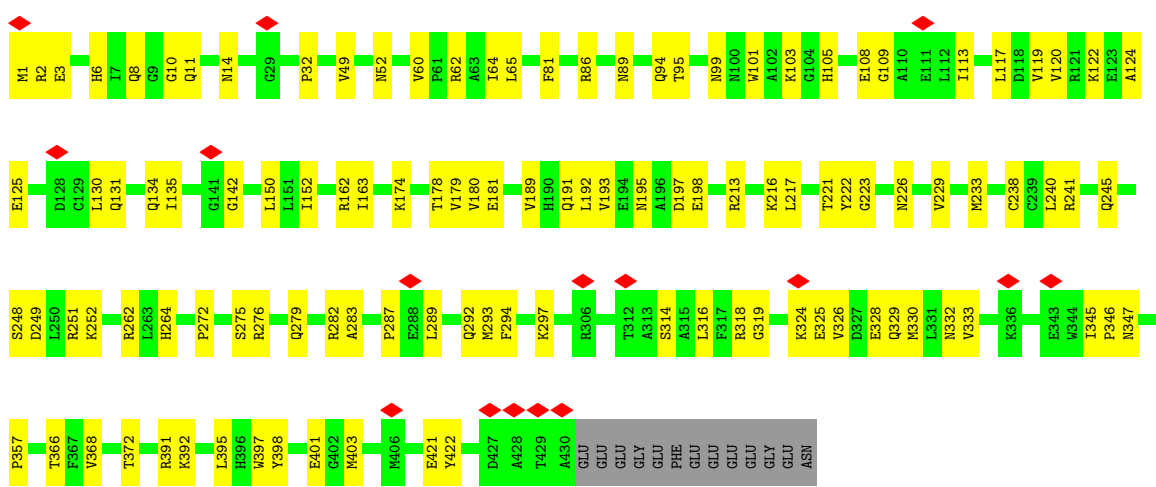

• Molecule 46: Tubulin beta chain



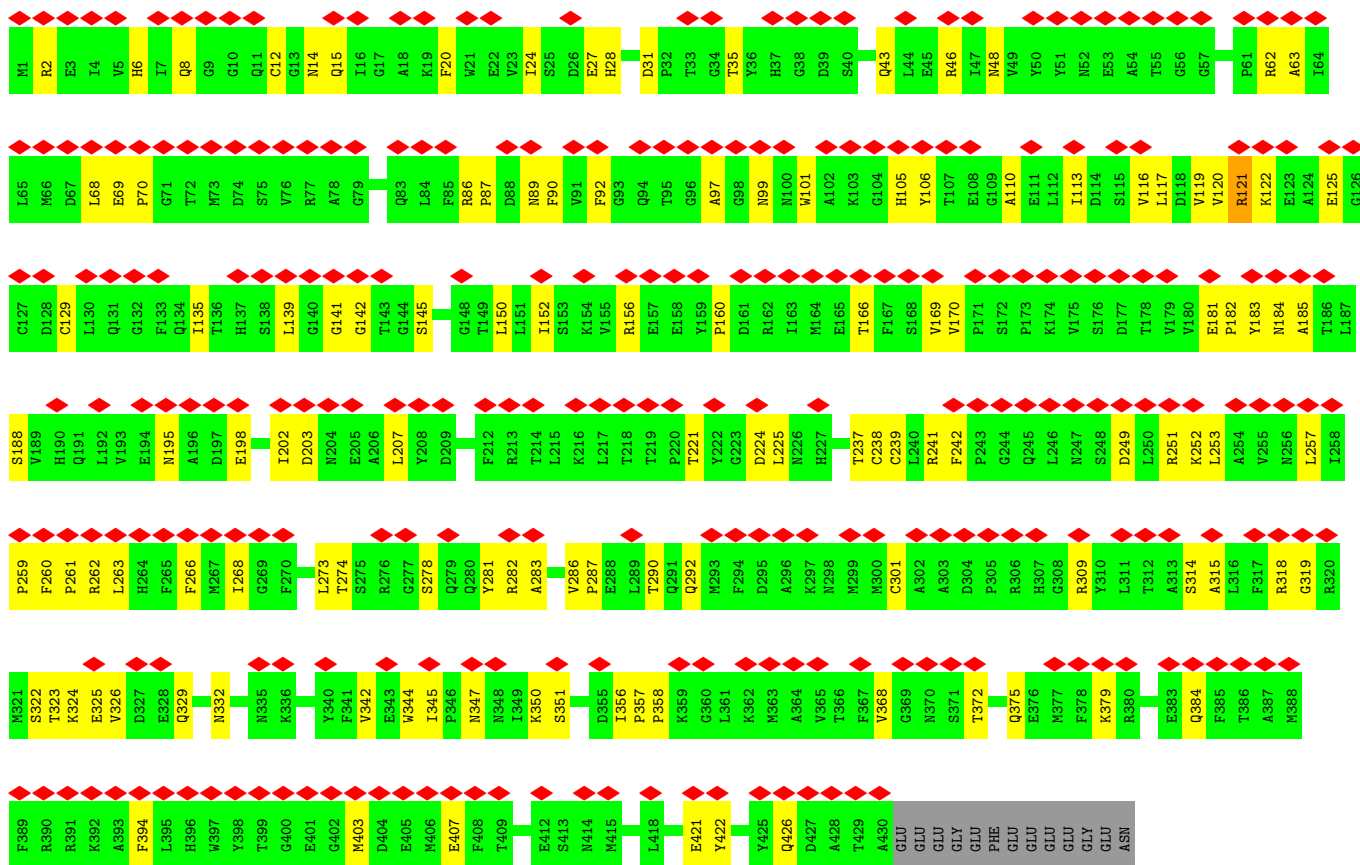

• Molecule 46: Tubulin beta chain

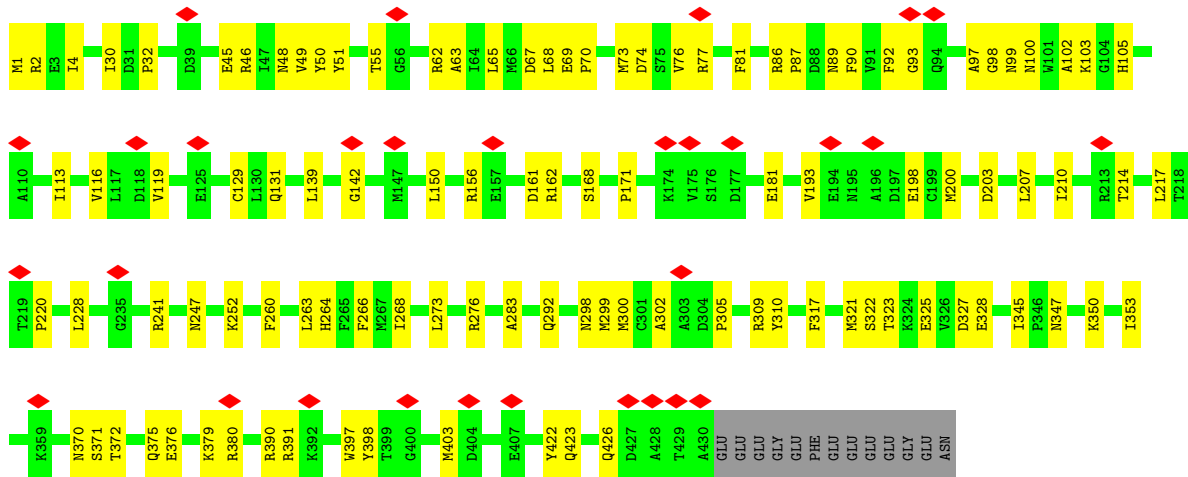
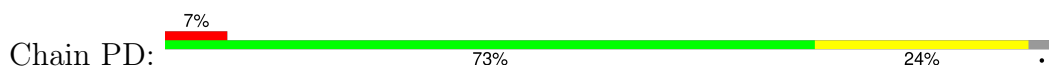

• Molecule 46: Tubulin beta chain

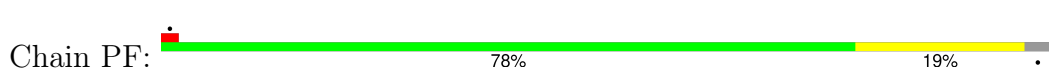

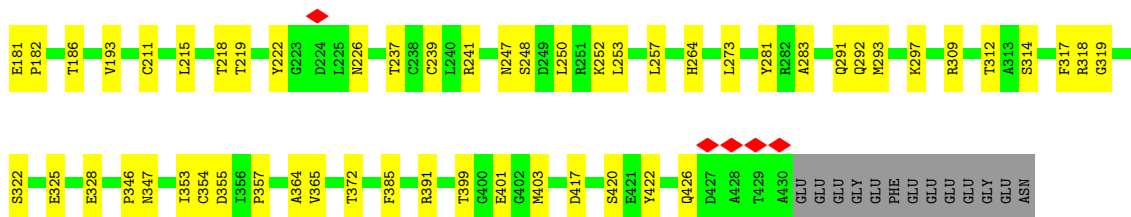

• Molecule 46: Tubulin beta chain

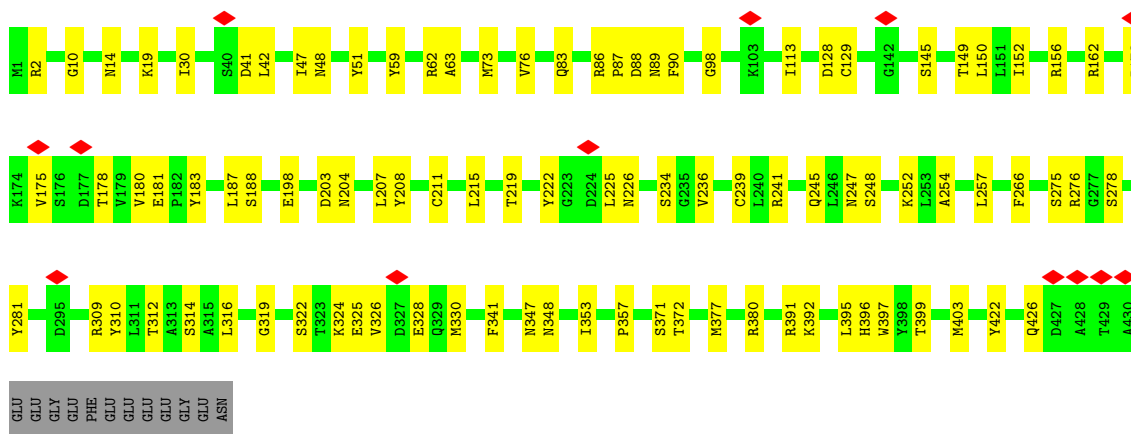
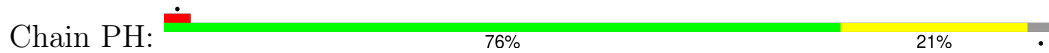

• Molecule 46: Tubulin beta chain

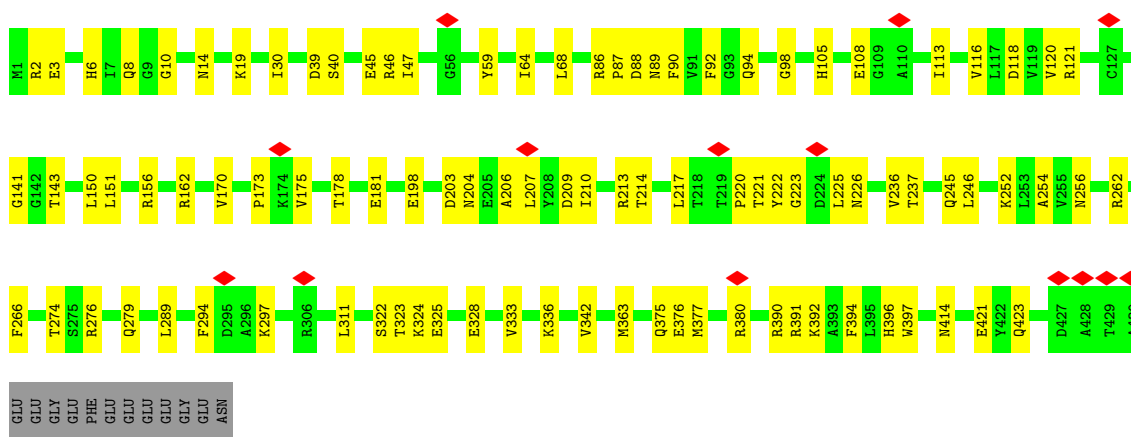
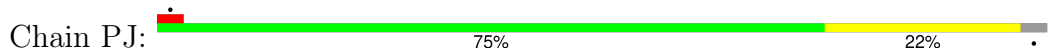

• Molecule 46: Tubulin beta chain

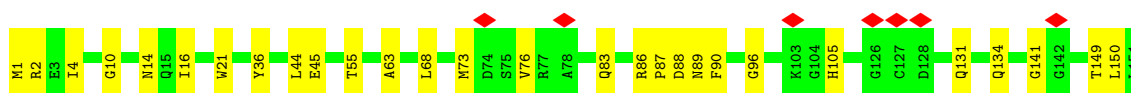
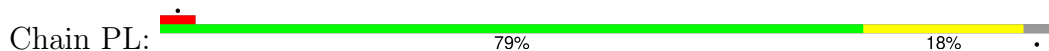

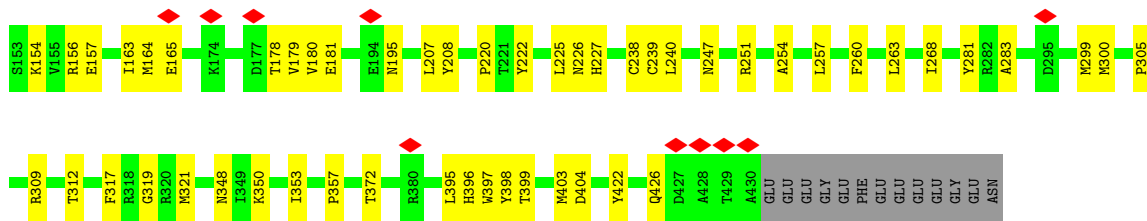

• Molecule 46: Tubulin beta chain

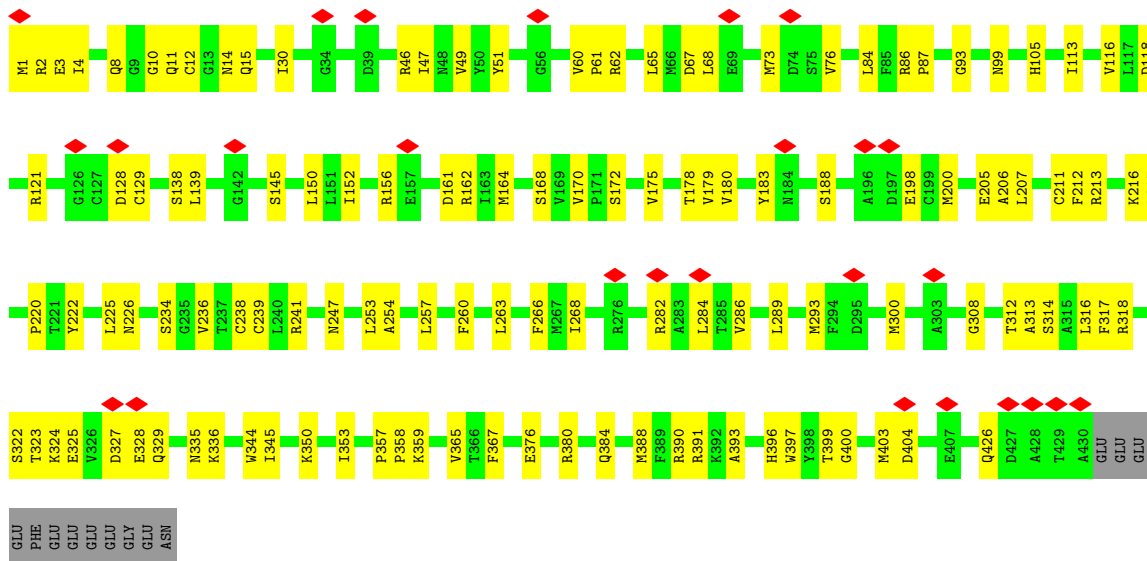

• Molecule 46: Tubulin beta chain

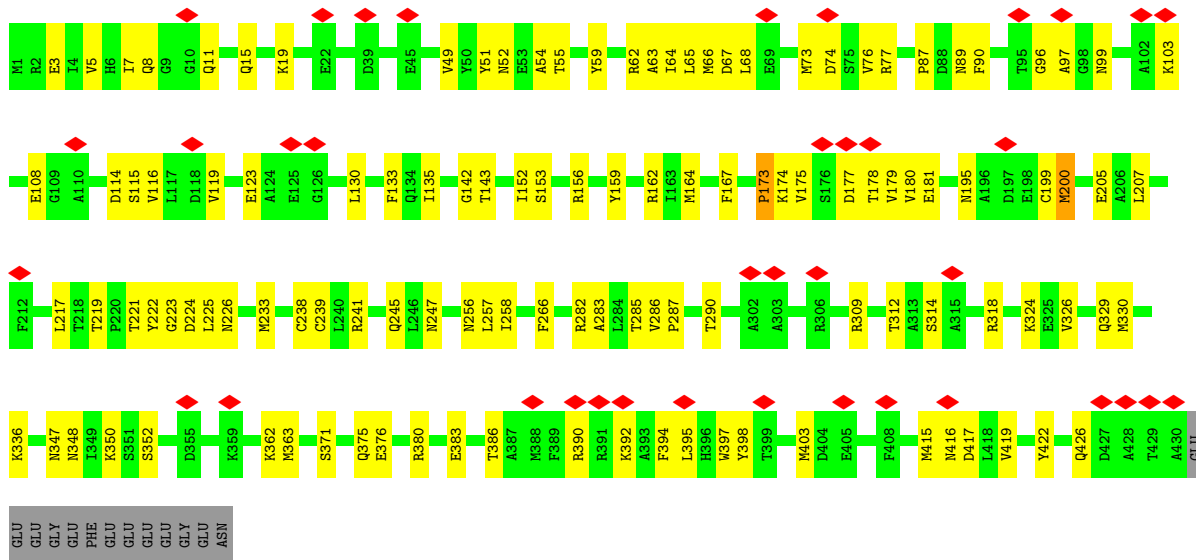

• Molecule 46: Tubulin beta chain

Chain QD:  71% 25%

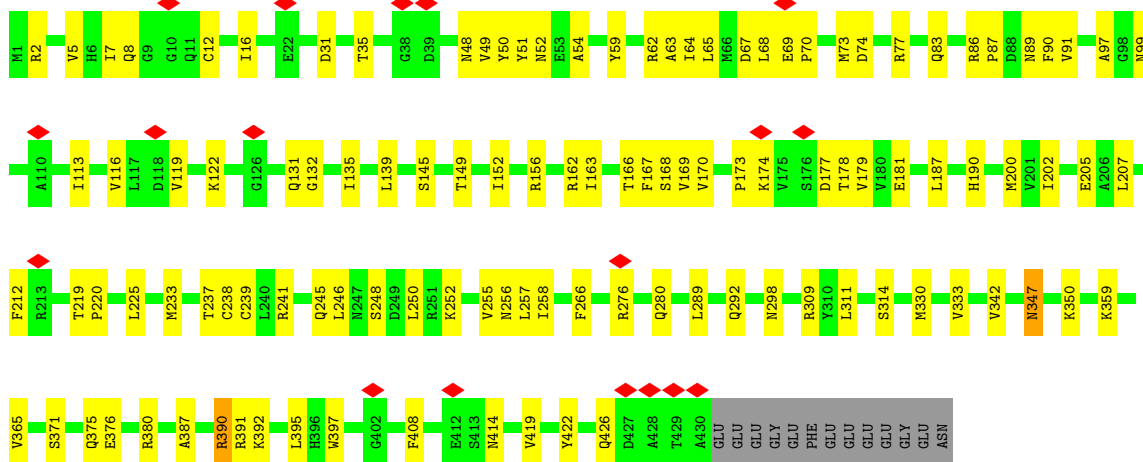

• Molecule 46: Tubulin beta chain

Chain QF:  72% 25%

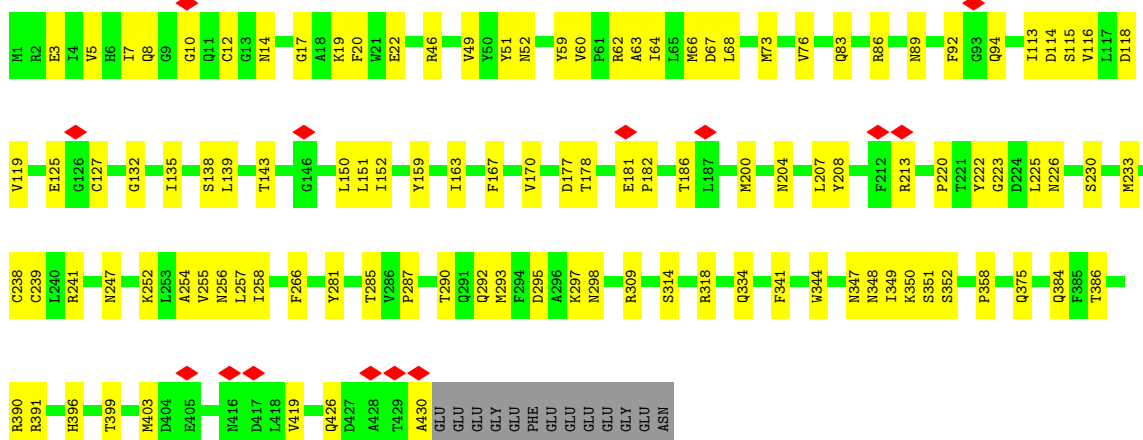

• Molecule 46: Tubulin beta chain

Chain QH:  76% 21%

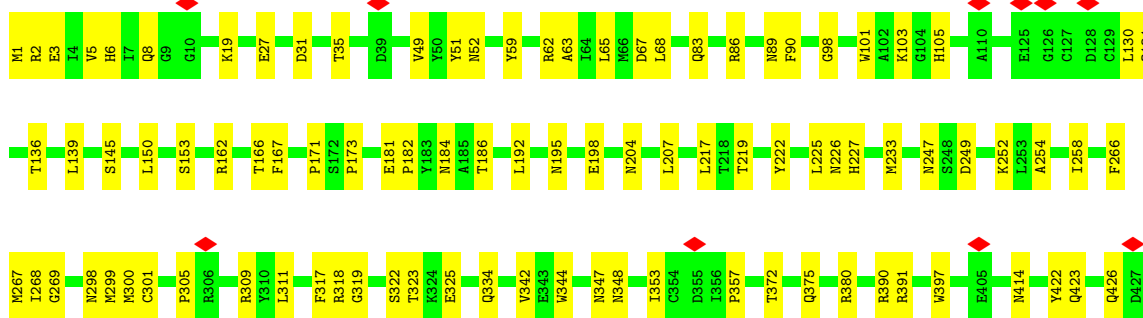

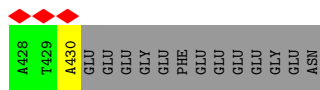

• Molecule 46: Tubulin beta chain

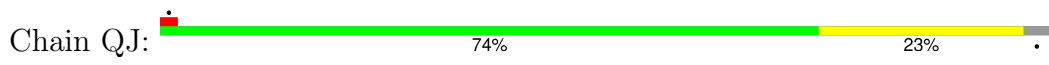

• Molecule 46: Tubulin beta chain

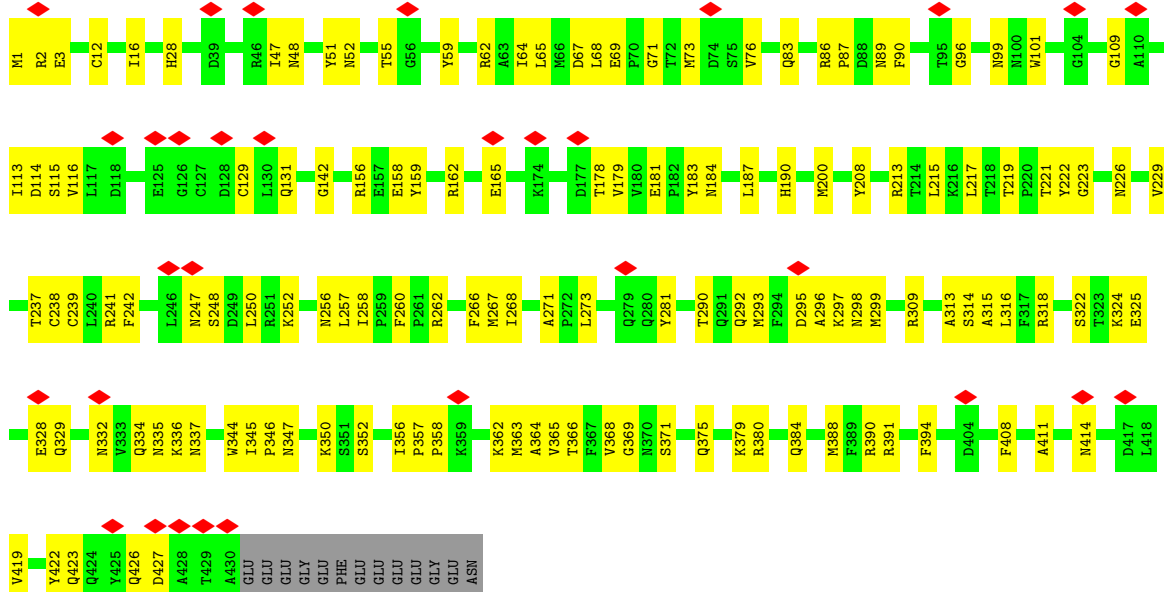

• Molecule 46: Tubulin beta chain

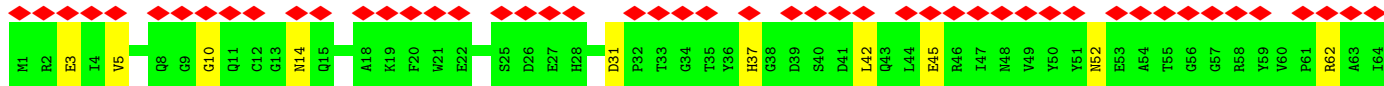
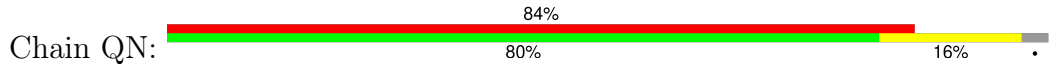

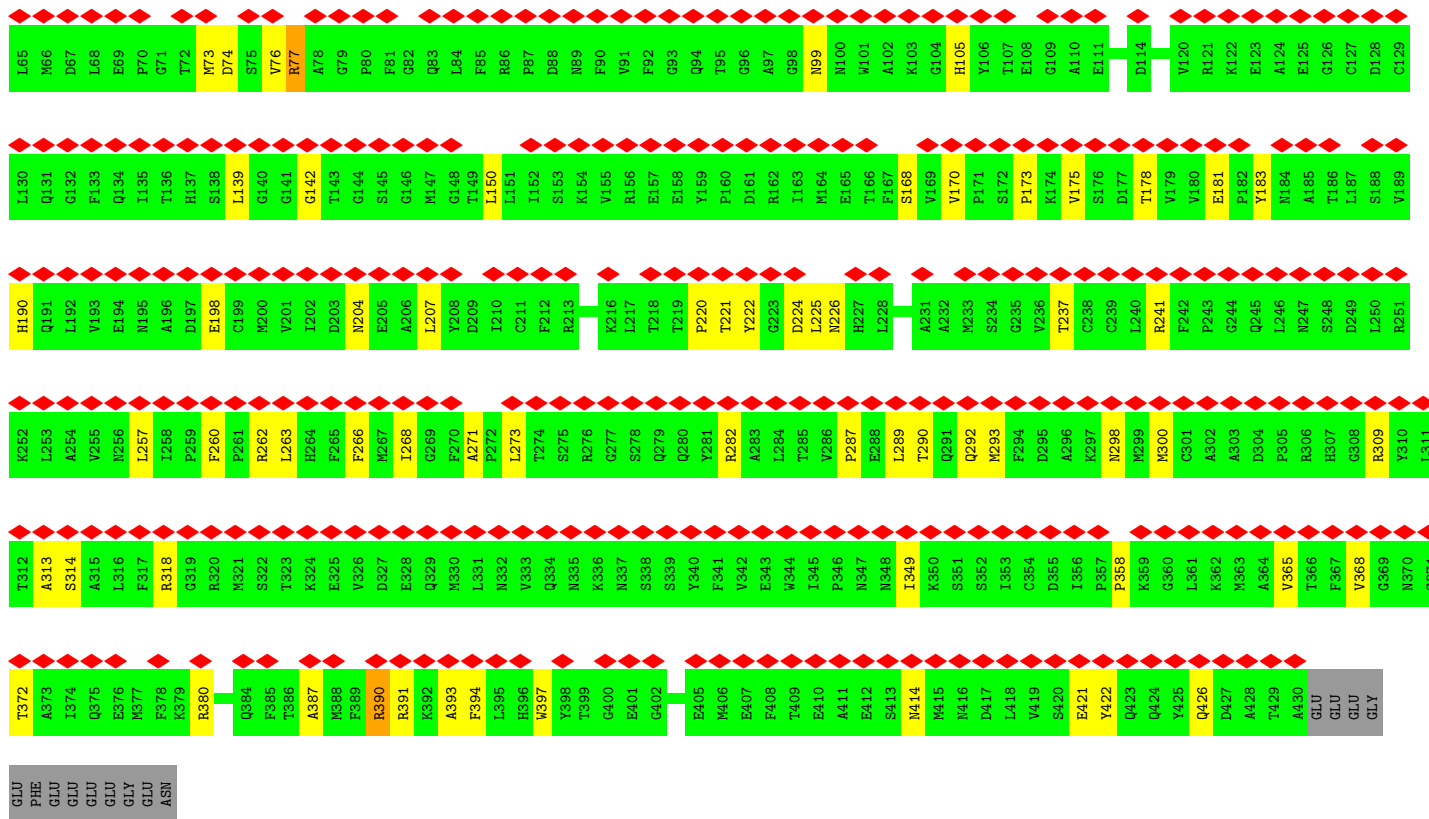

• Molecule 46: Tubulin beta chain

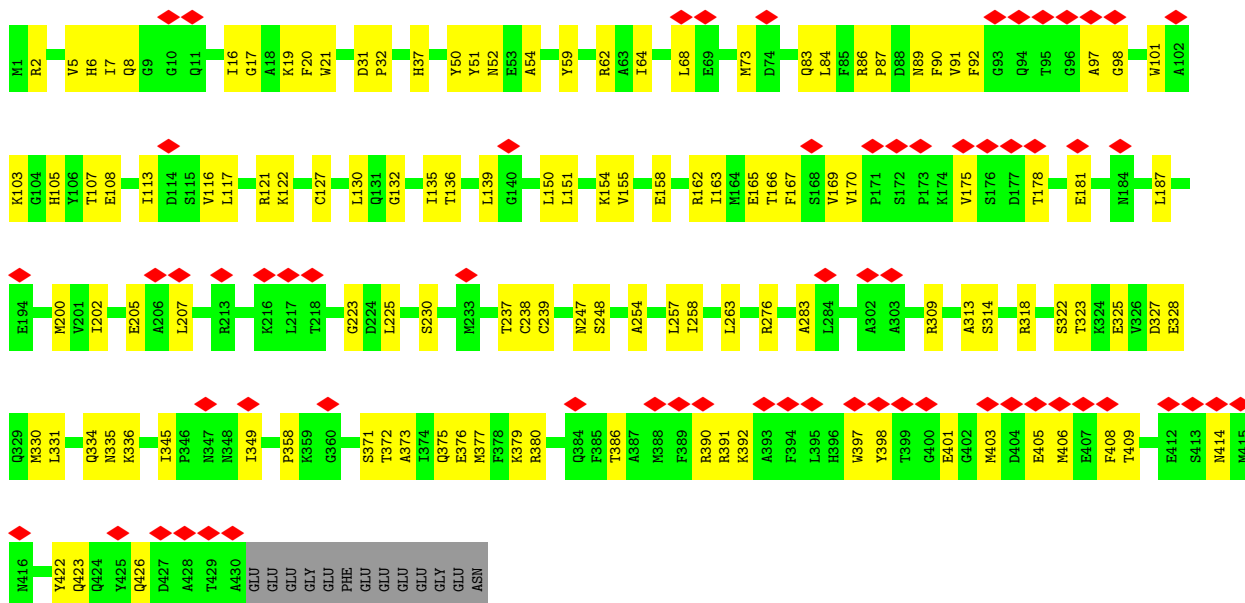

• Molecule 46: Tubulin beta chain



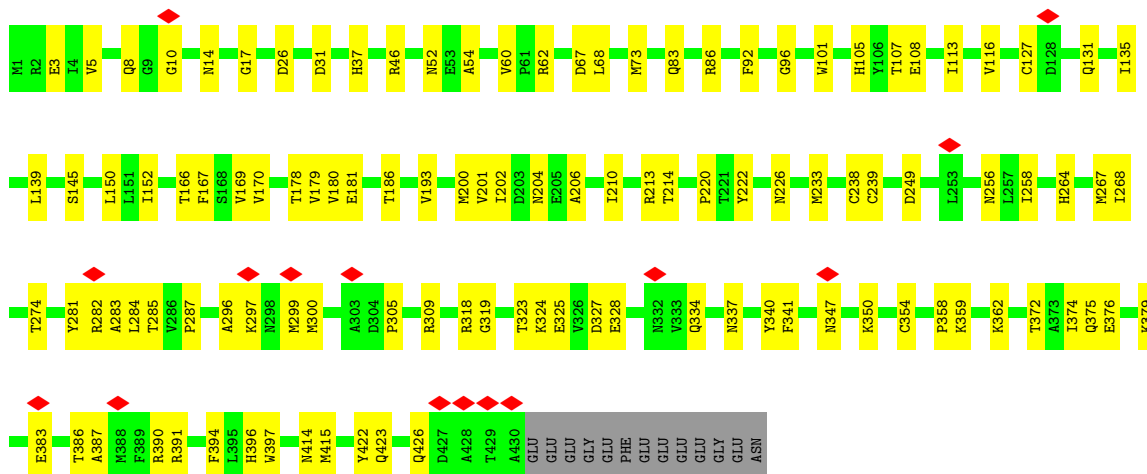

• Molecule 46: Tubulin beta chain

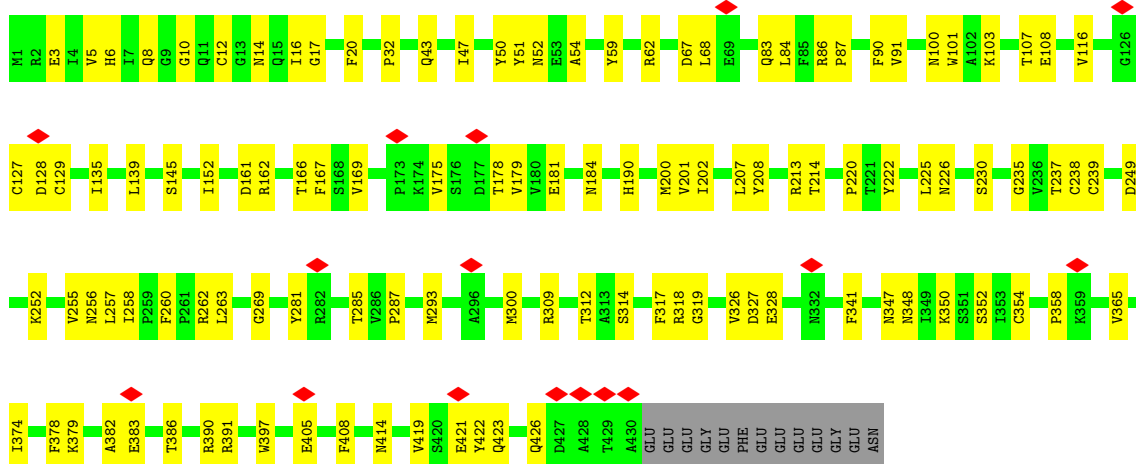

• Molecule 46: Tubulin beta chain

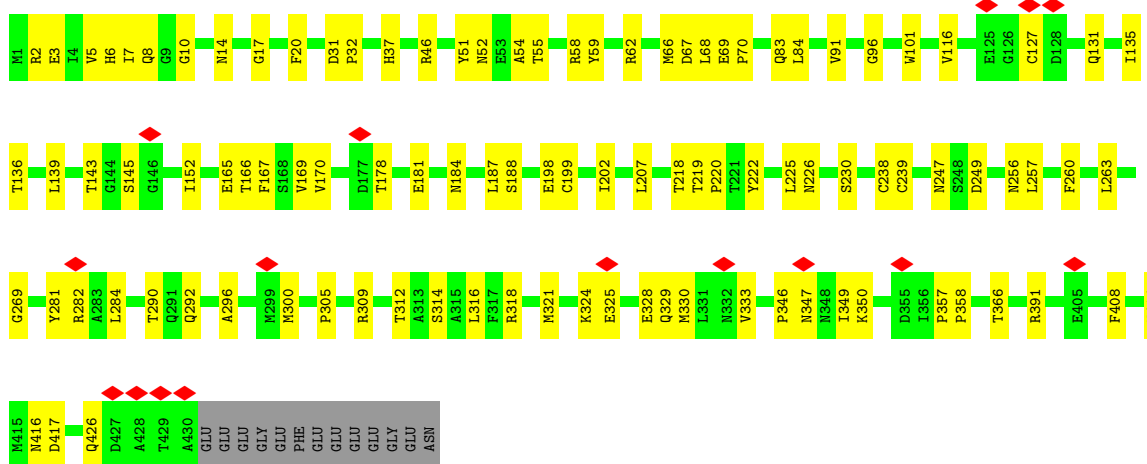
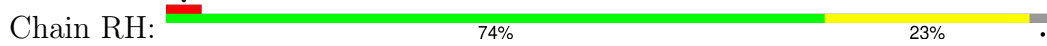

• Molecule 46: Tubulin beta chain

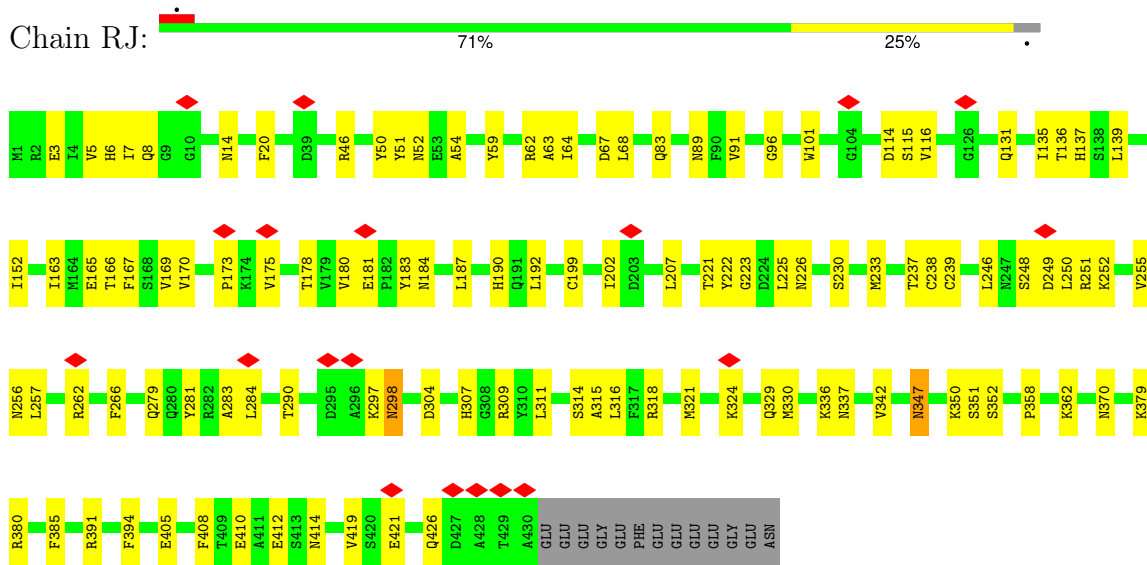

• Molecule 46: Tubulin beta chain

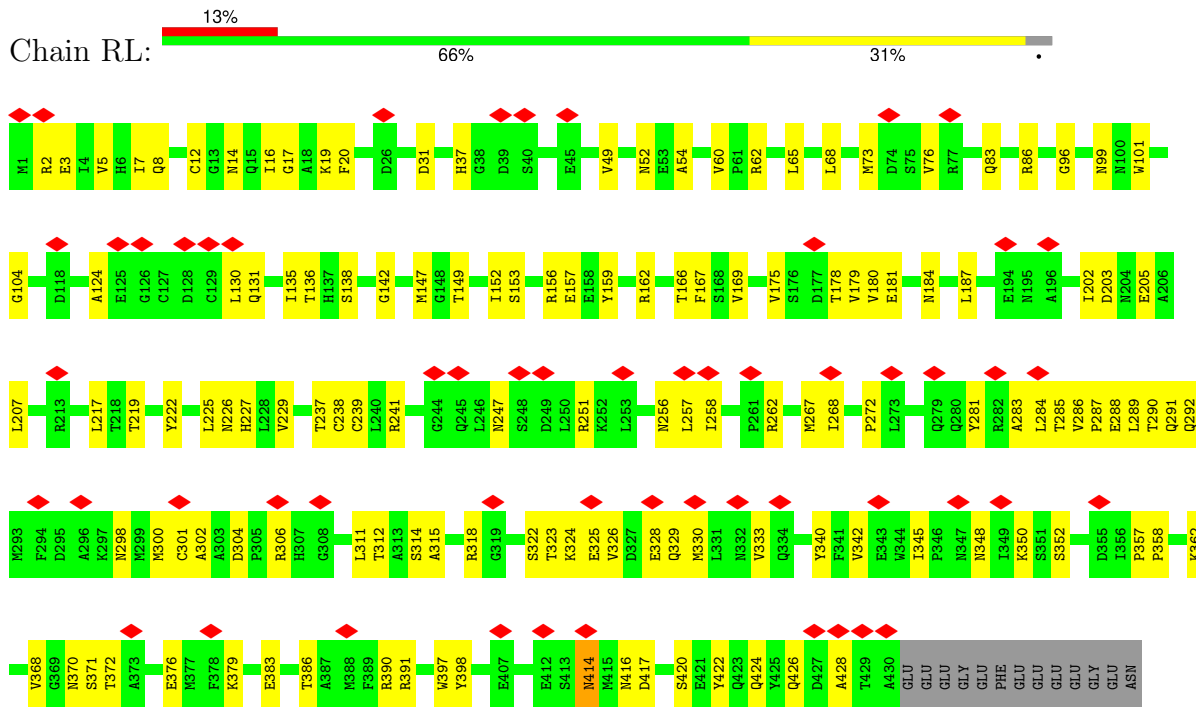

• Molecule 46: Tubulin beta chain

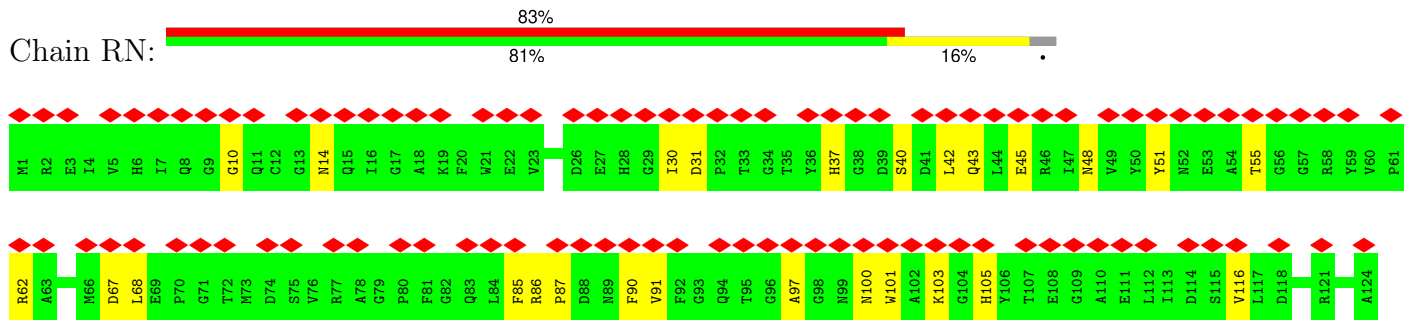

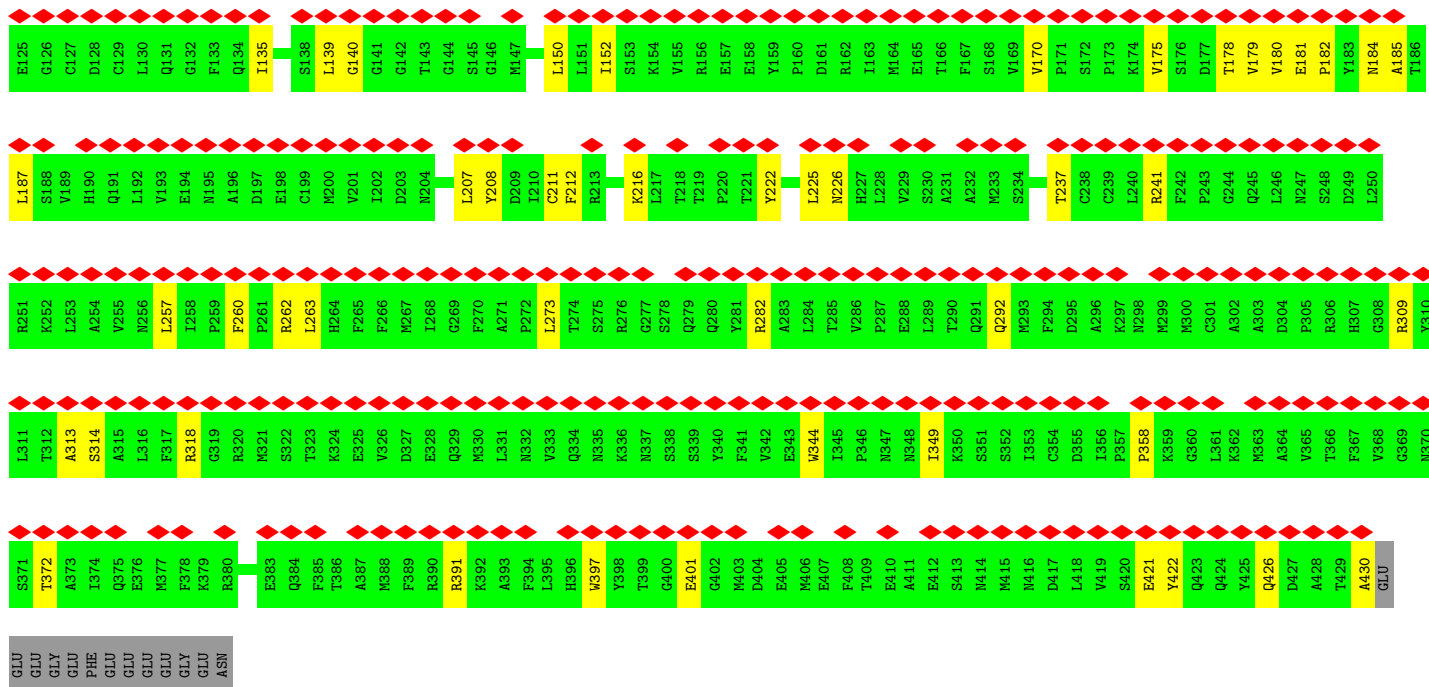

• Molecule 46: Tubulin beta chain

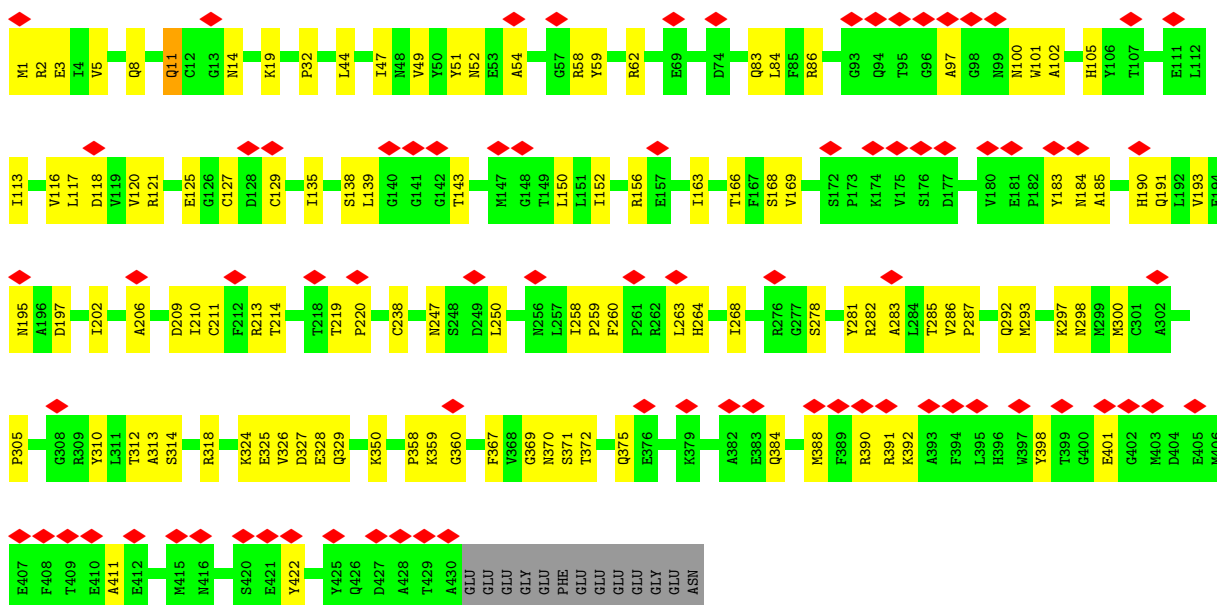

• Molecule 46: Tubulin beta chain

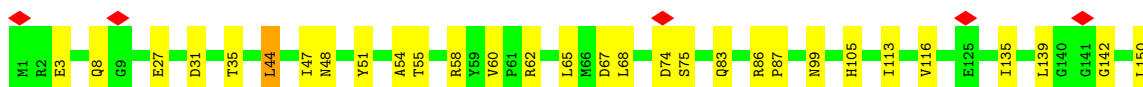
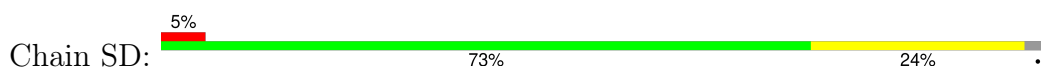

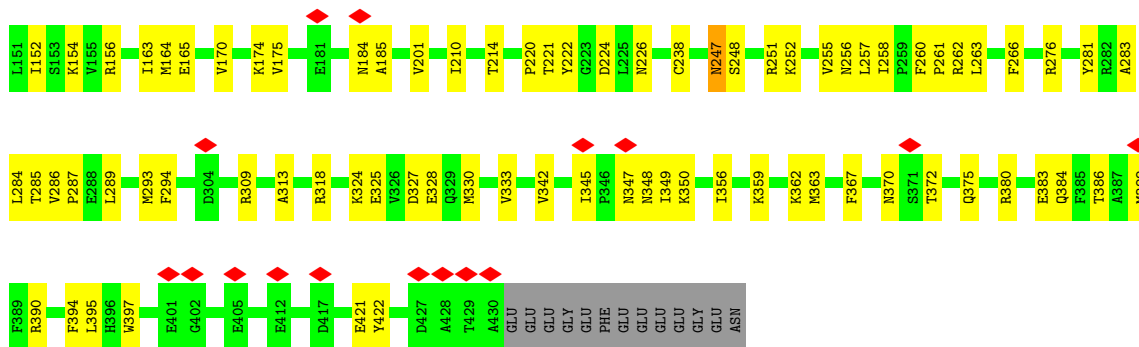

• Molecule 46: Tubulin beta chain

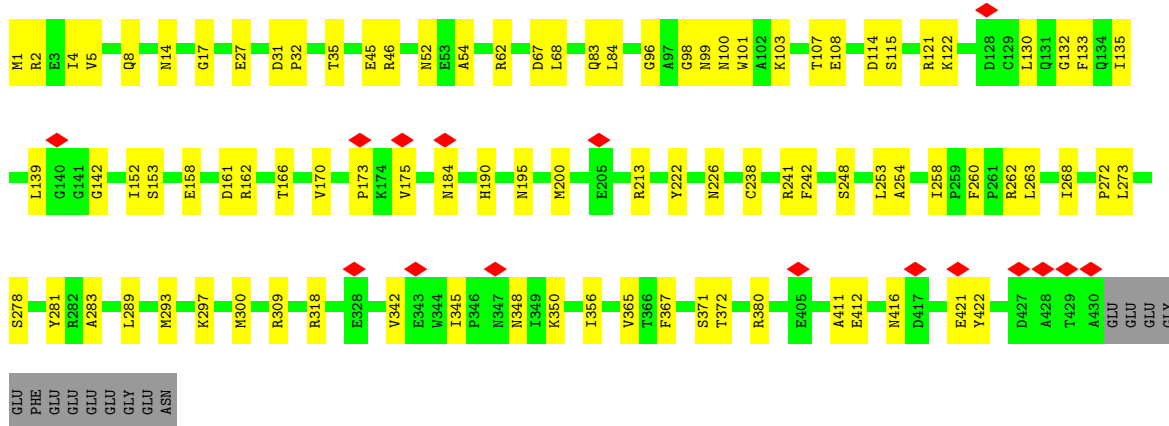
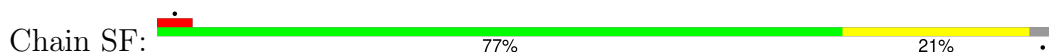

• Molecule 46: Tubulin beta chain

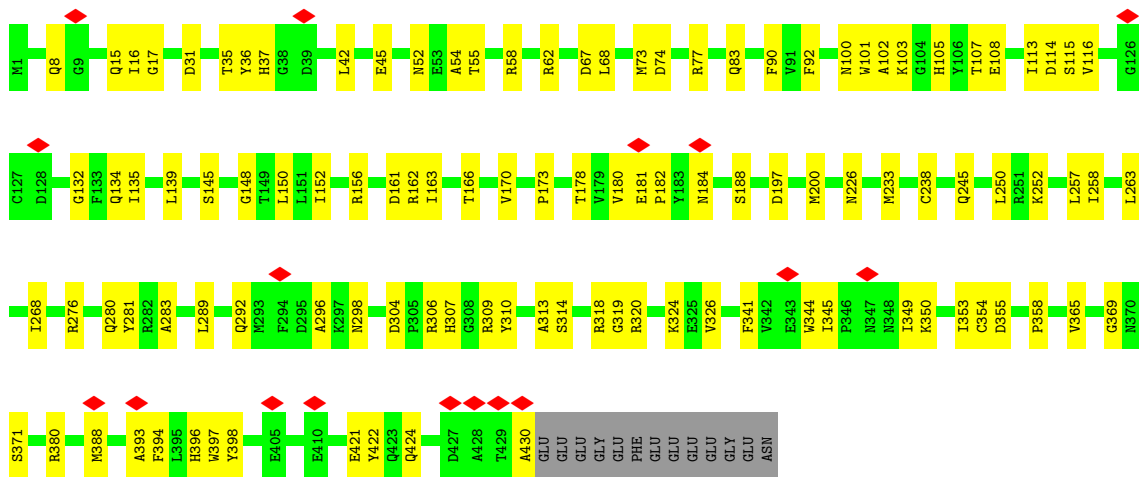

• Molecule 46: Tubulin beta chain



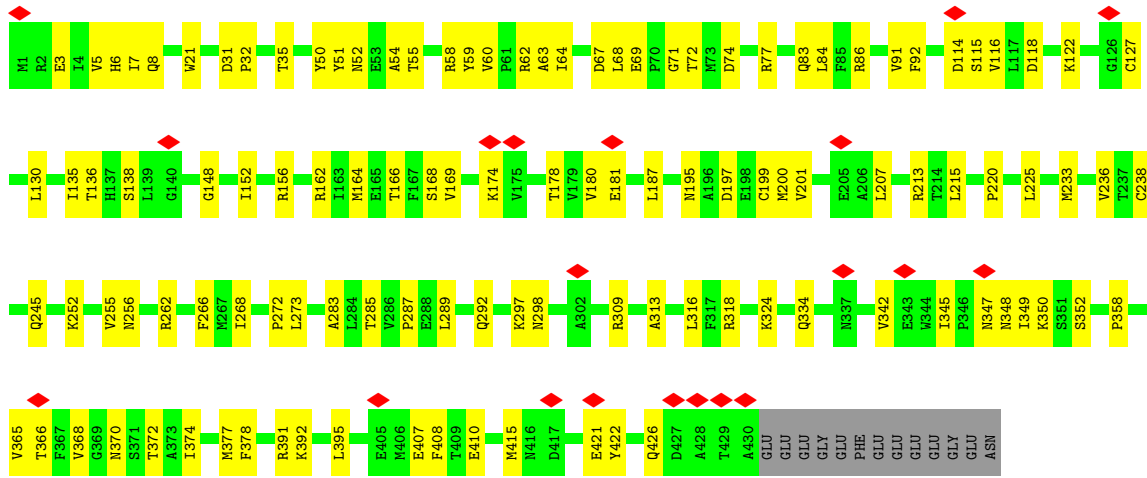

• Molecule 46: Tubulin beta chain

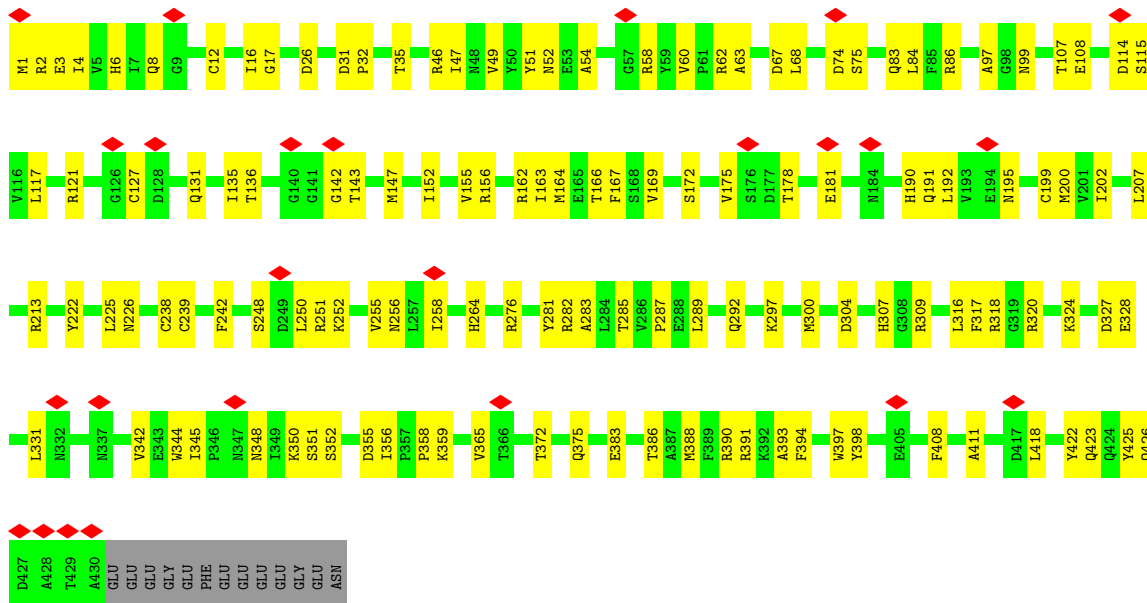

• Molecule 46: Tubulin beta chain

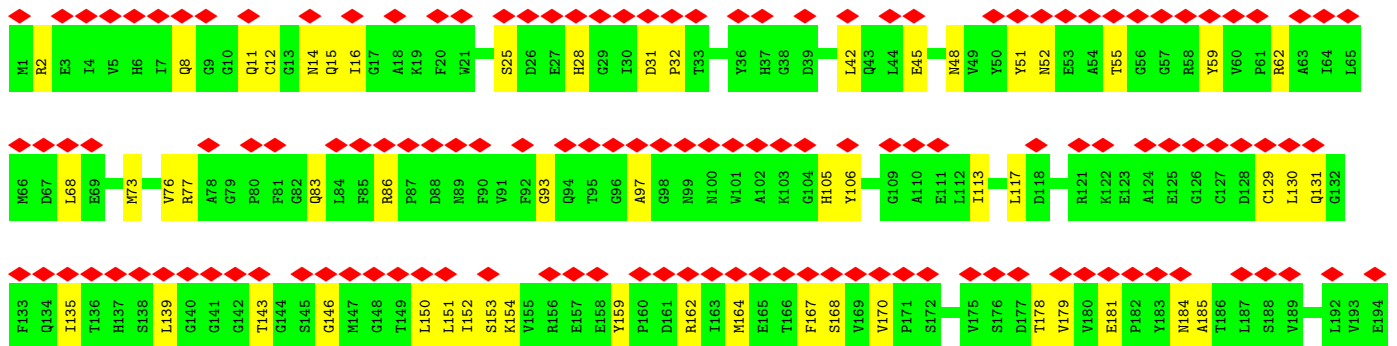
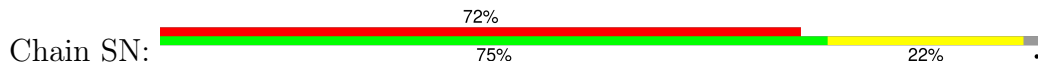

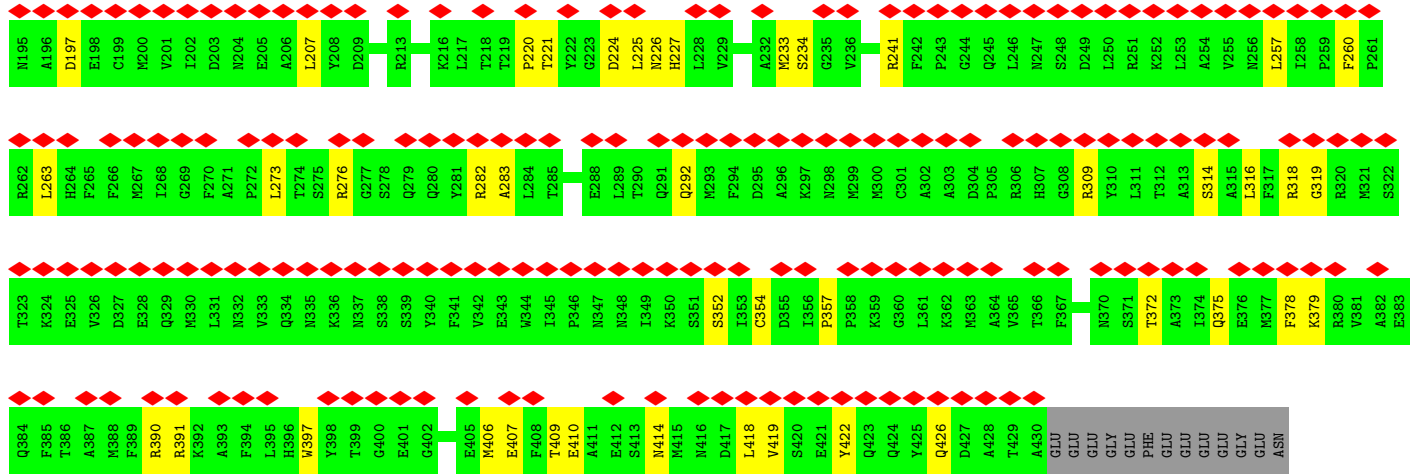

• Molecule 46: Tubulin beta chain

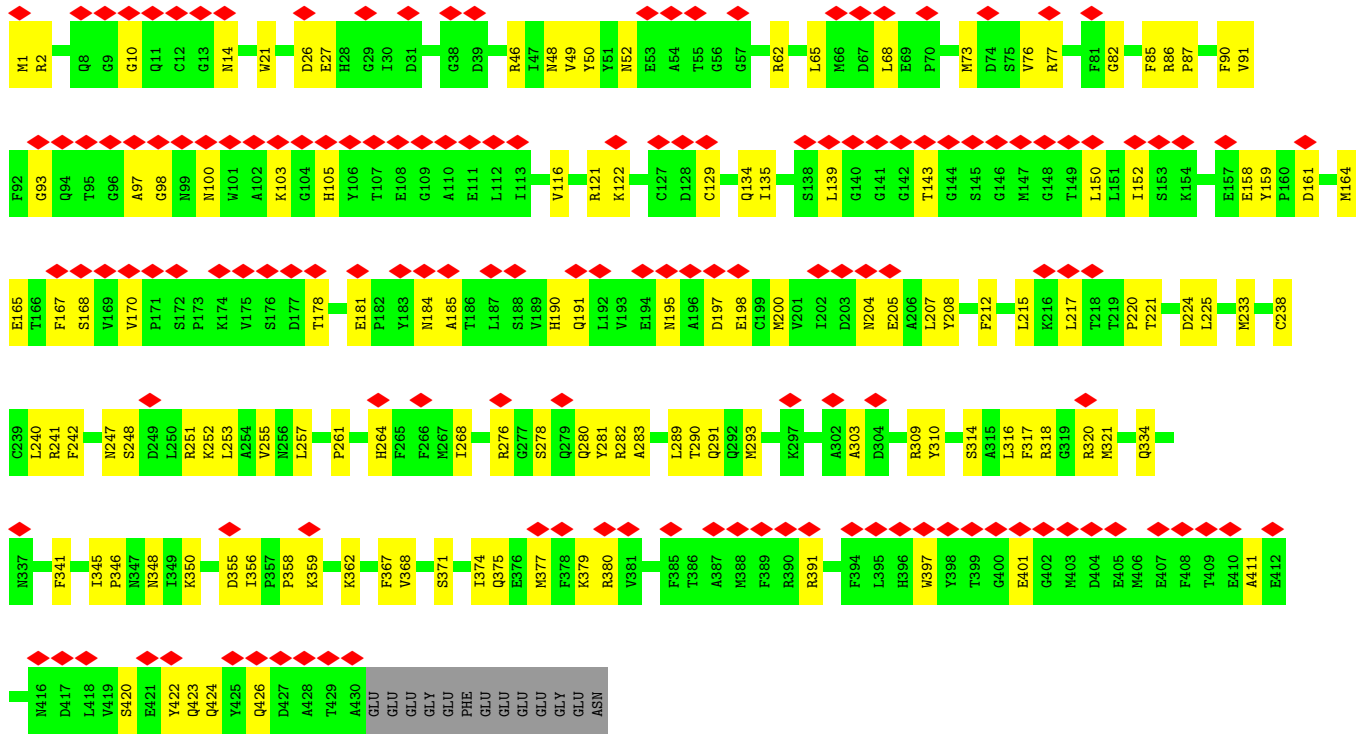

• Molecule 46: Tubulin beta chain

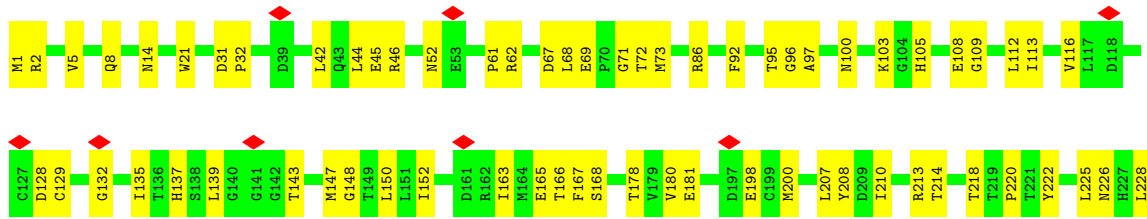
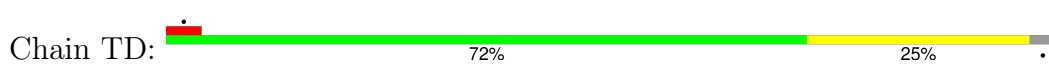

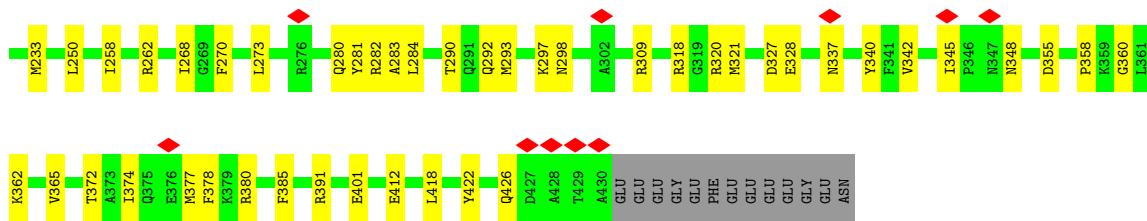

• Molecule 46: Tubulin beta chain

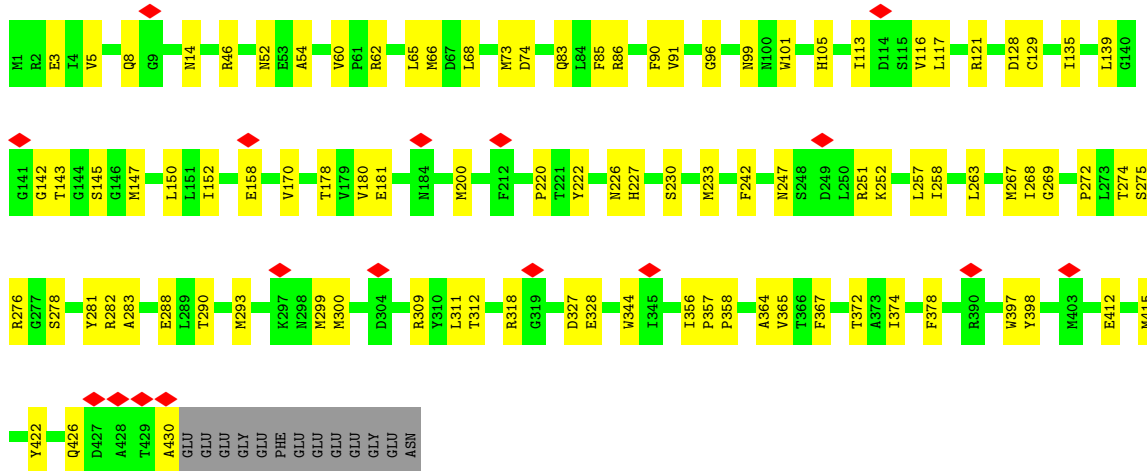
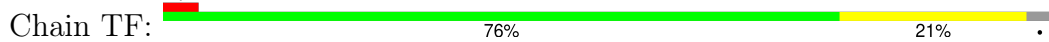

• Molecule 46: Tubulin beta chain

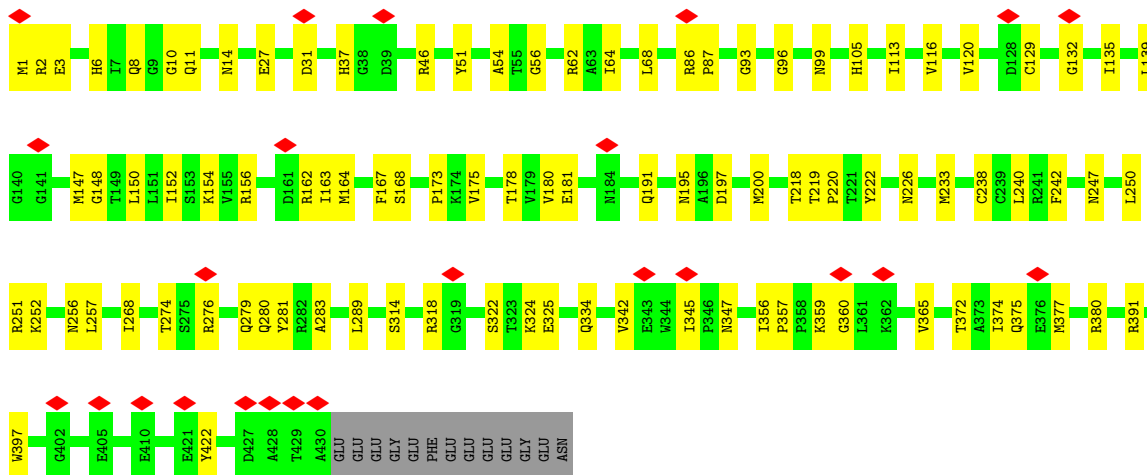
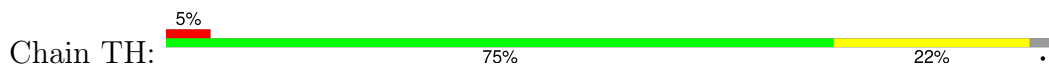

• Molecule 46: Tubulin beta chain



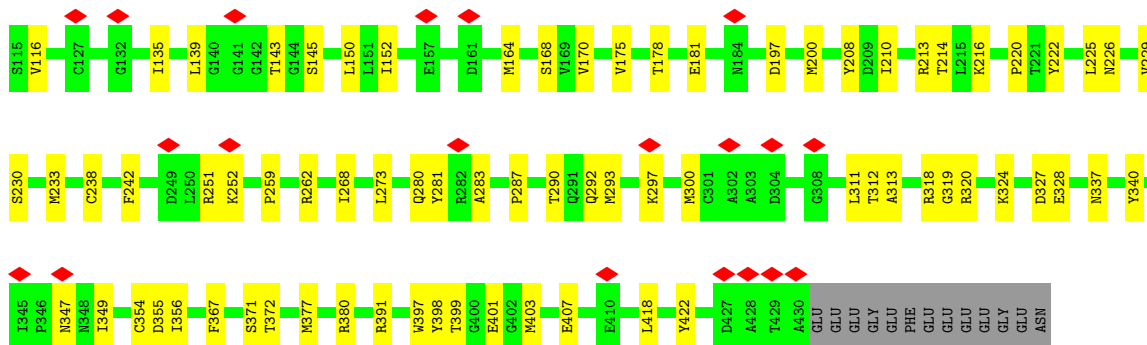

• Molecule 46: Tubulin beta chain

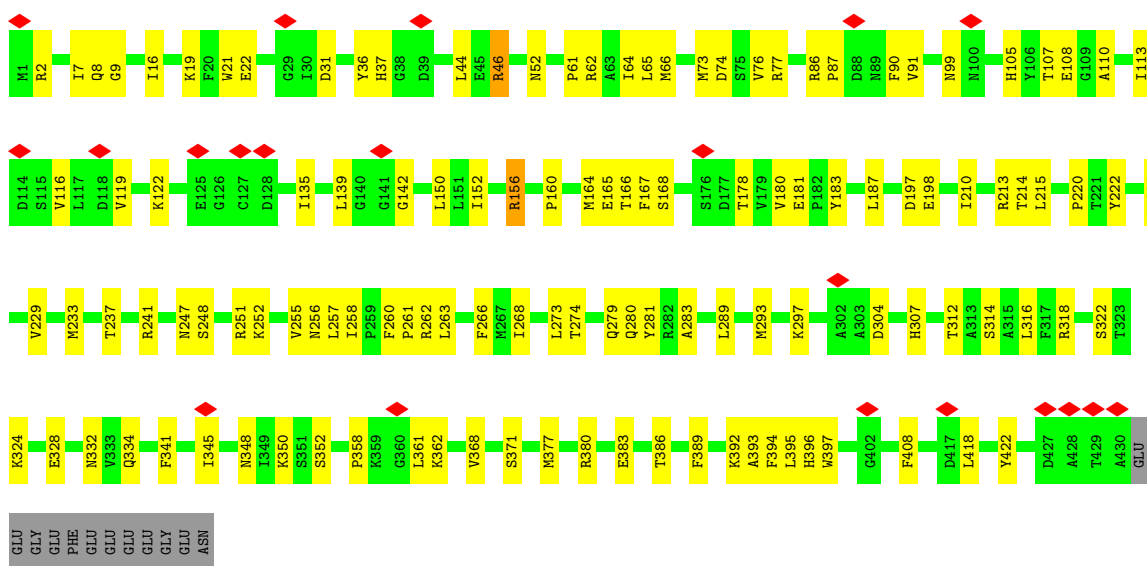

• Molecule 46: Tubulin beta chain

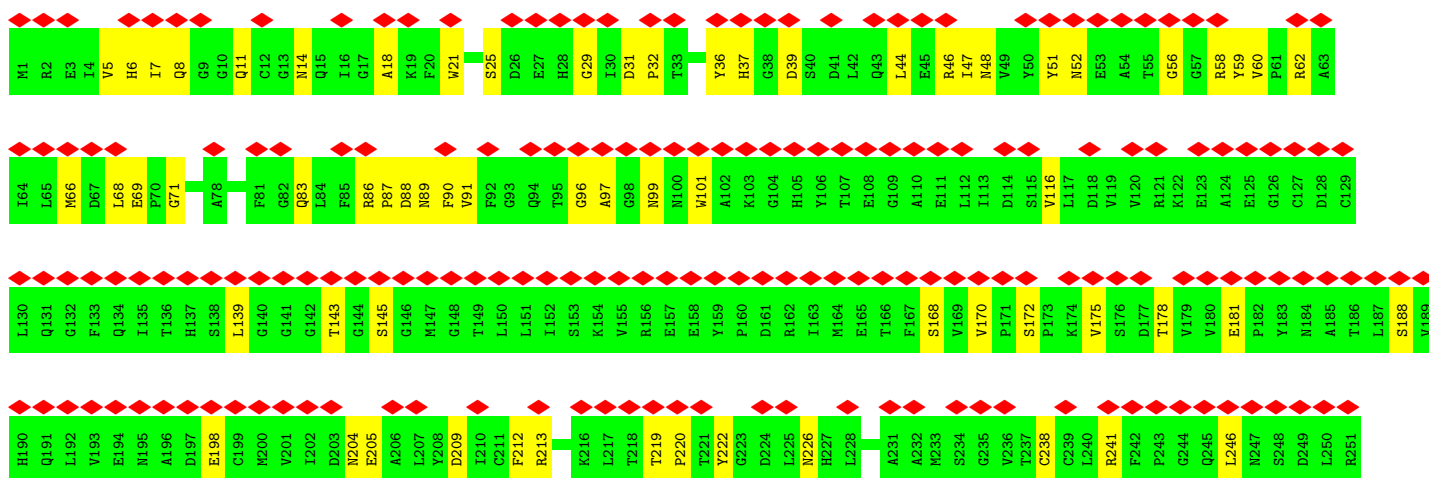
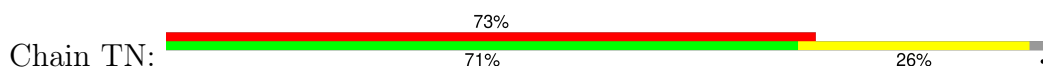

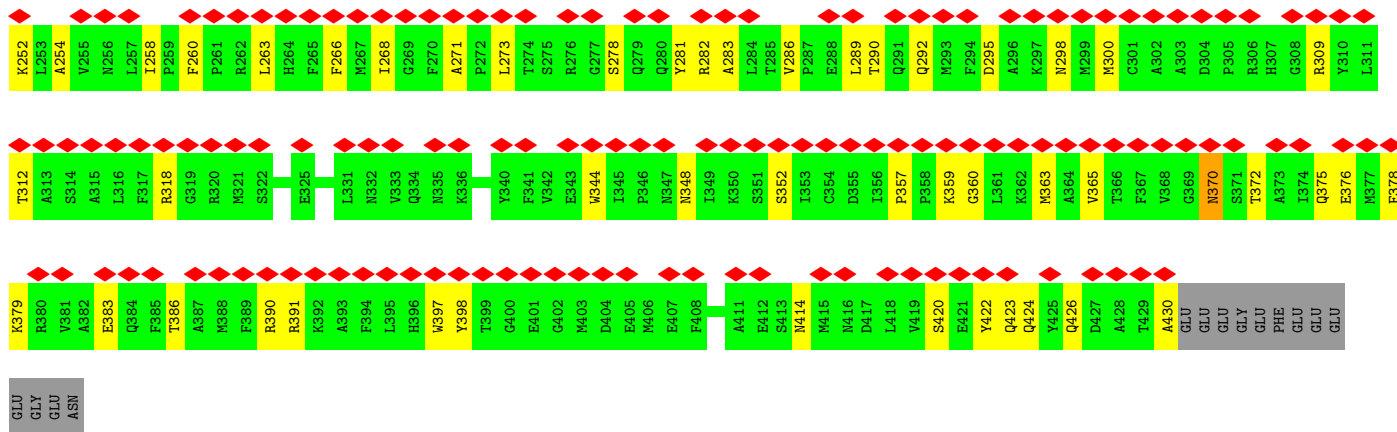

• Molecule 46: Tubulin beta chain

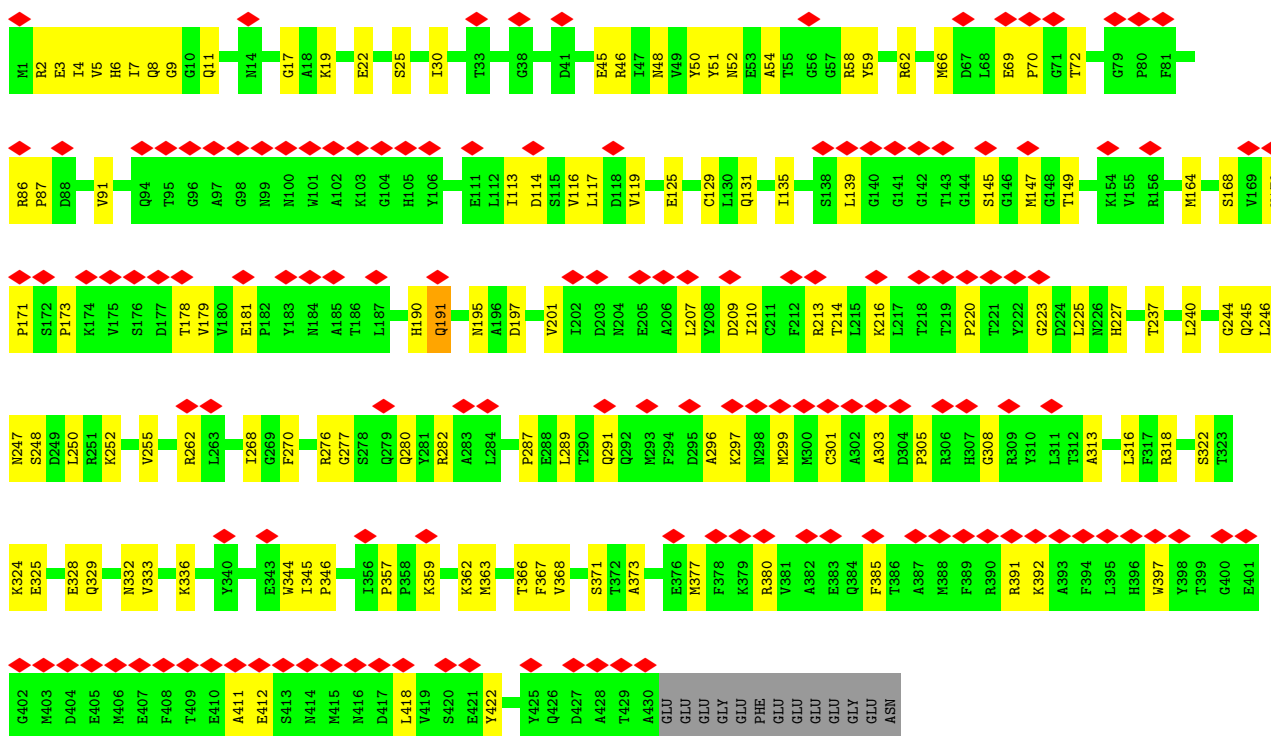

• Molecule 46: Tubulin beta chain

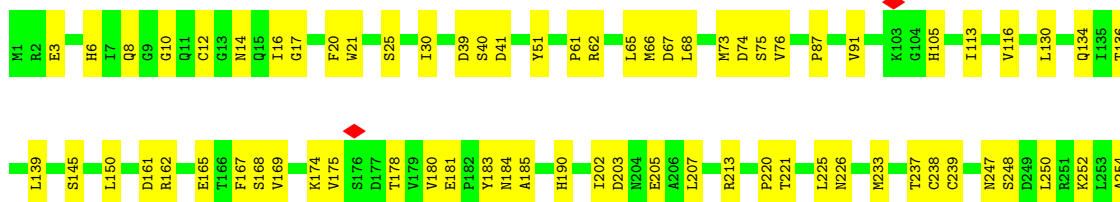
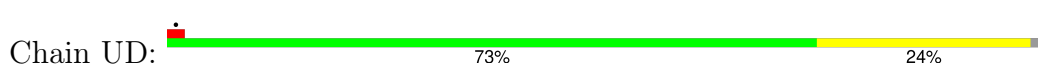

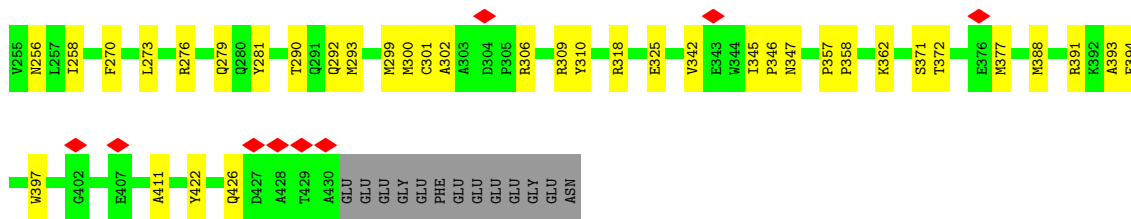

• Molecule 46: Tubulin beta chain

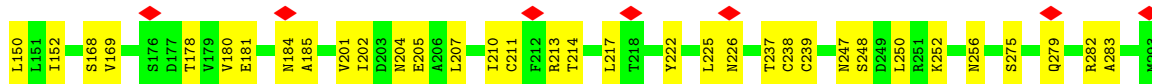
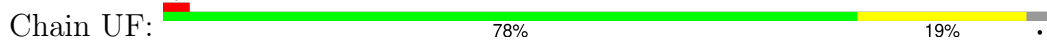

• Molecule 46: Tubulin beta chain

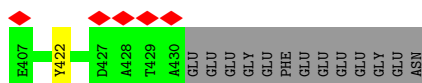
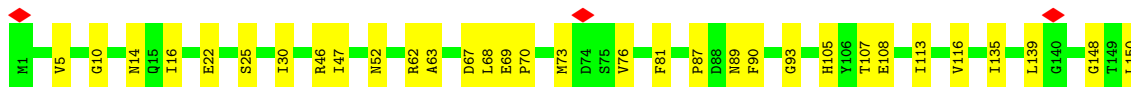
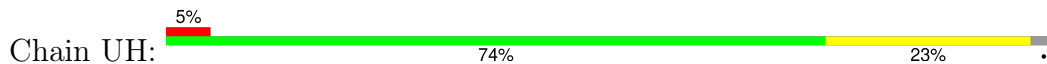

• Molecule 46: Tubulin beta chain

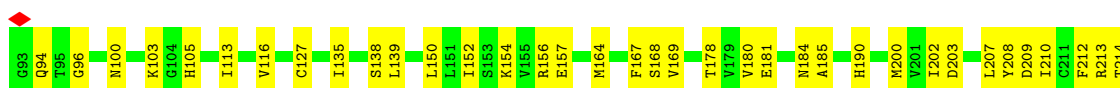
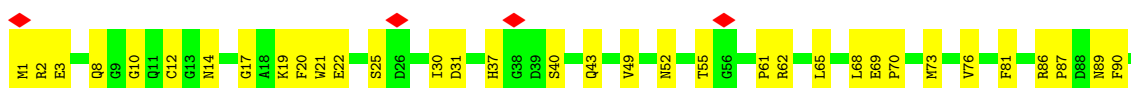

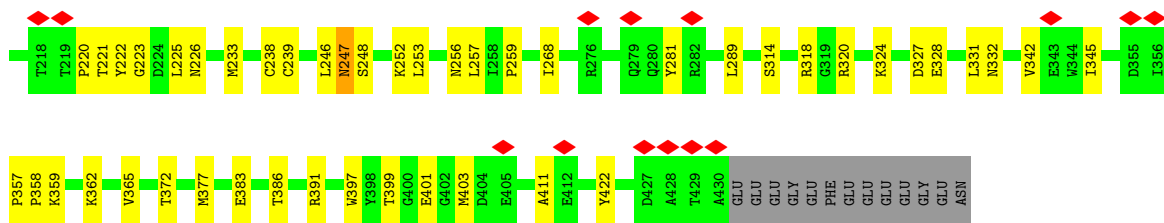

• Molecule 46: Tubulin beta chain

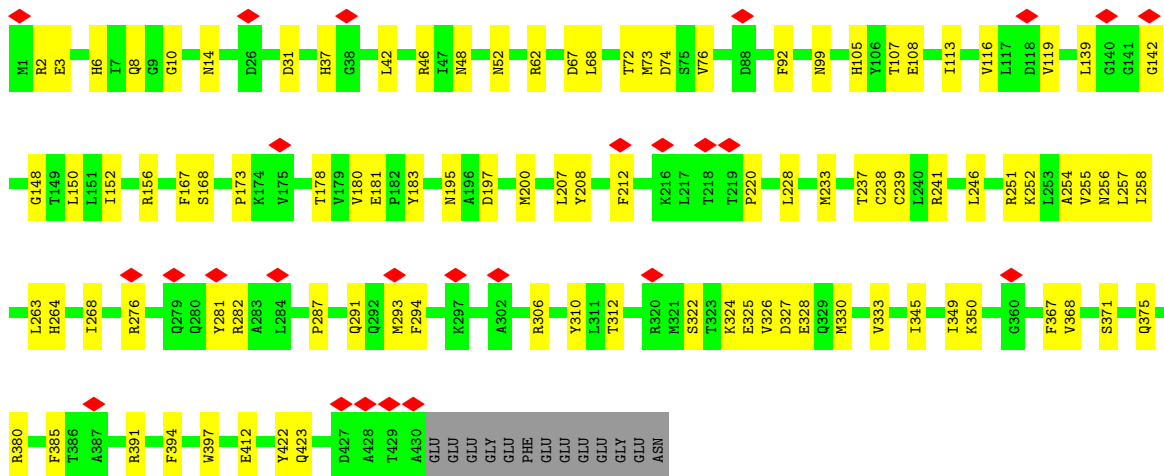
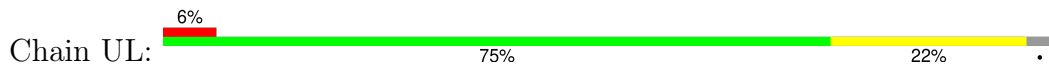

• Molecule 46: Tubulin beta chain

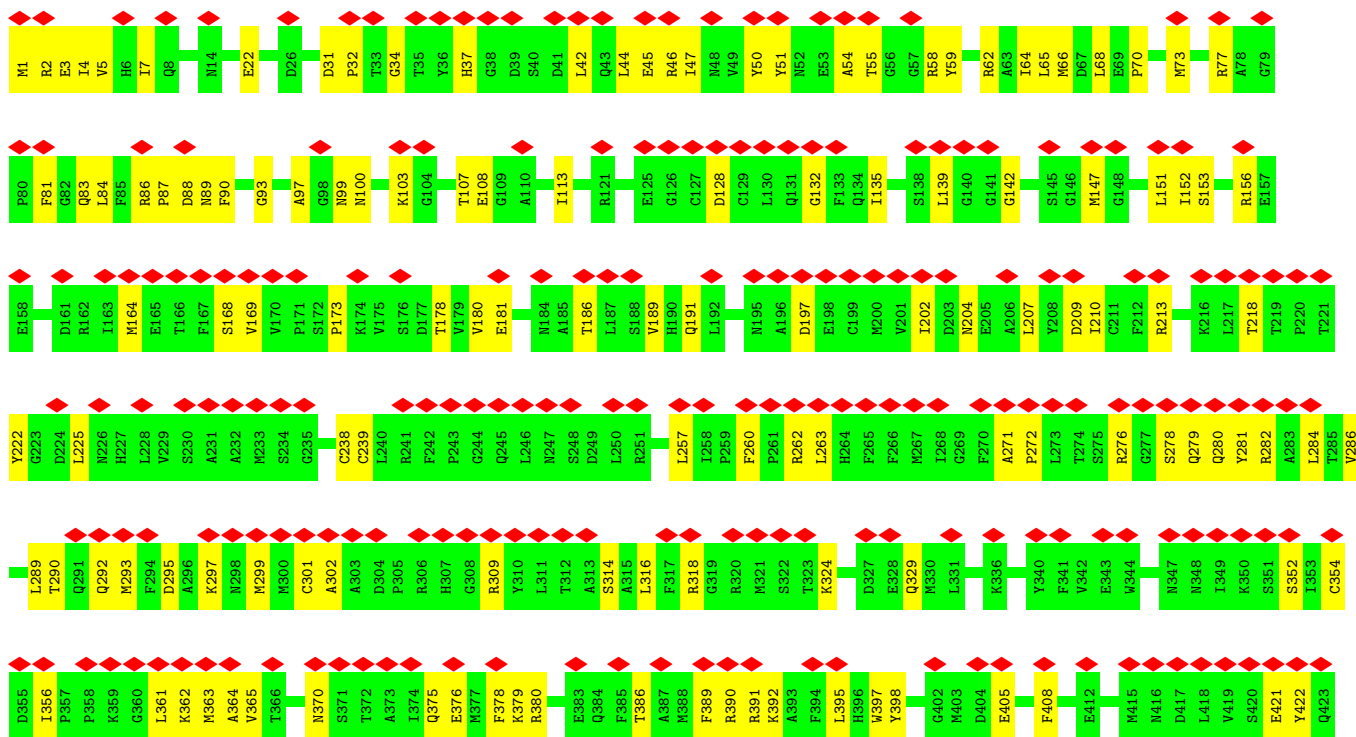

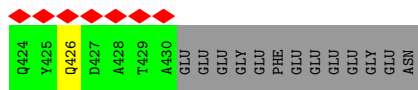

• Molecule 46: Tubulin beta chain

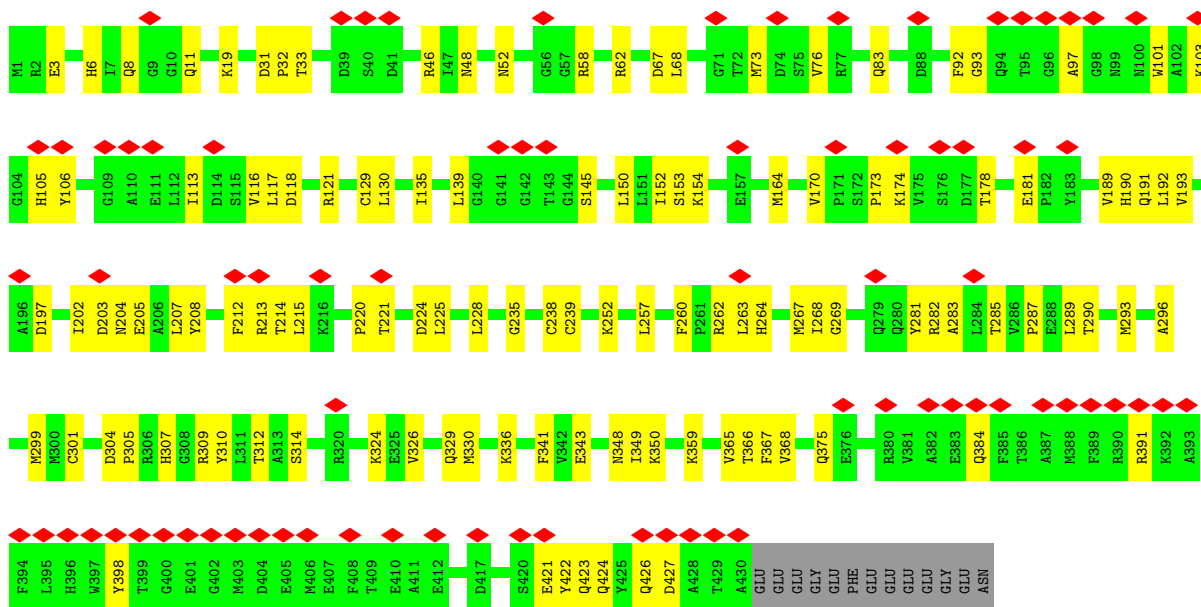

• Molecule 46: Tubulin beta chain

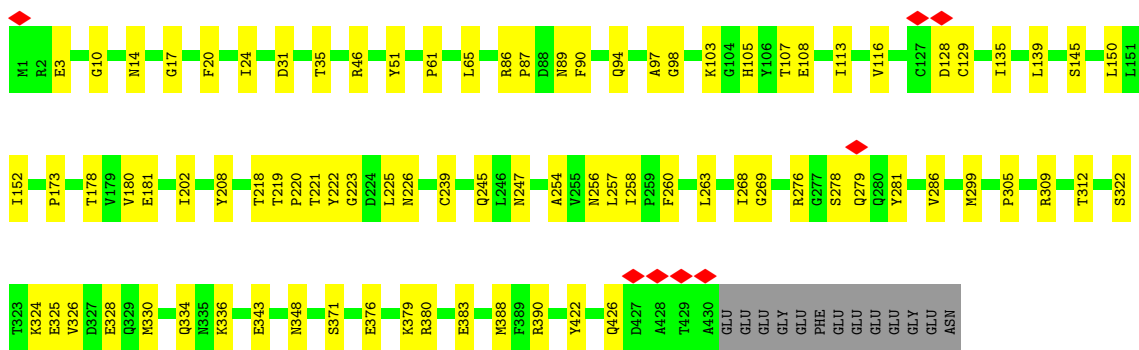
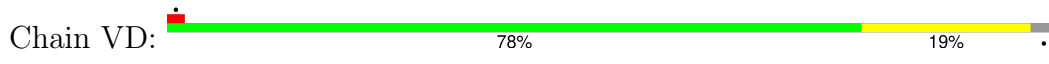

• Molecule 46: Tubulin beta chain

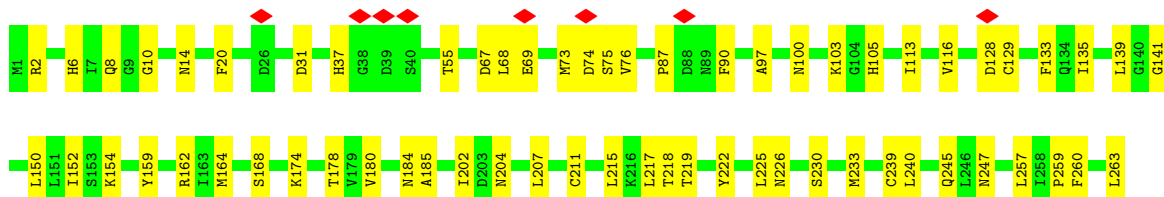
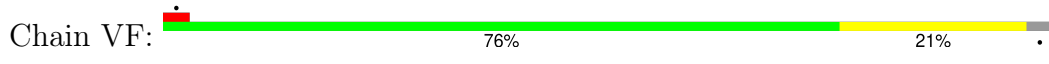

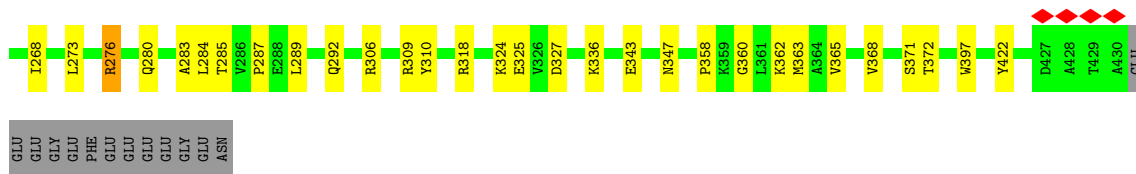

• Molecule 46: Tubulin beta chain

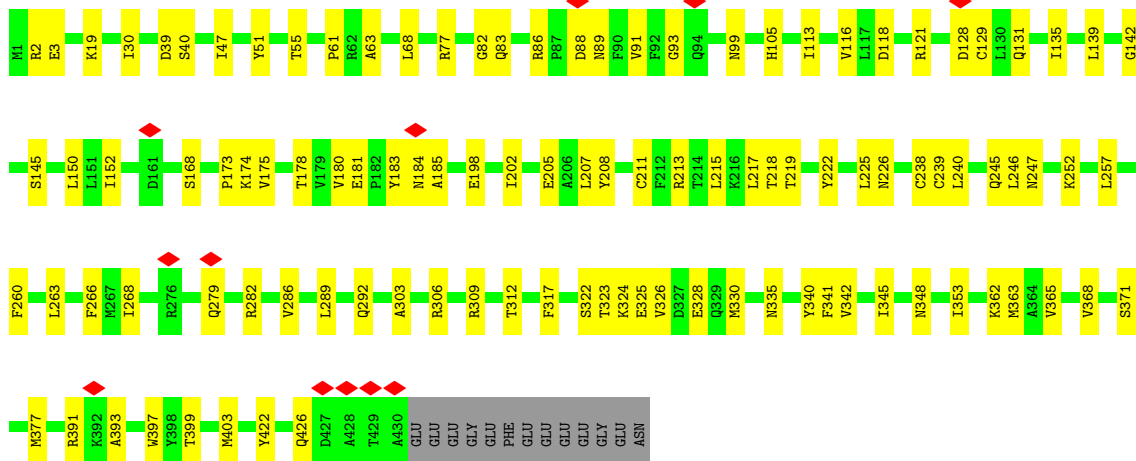
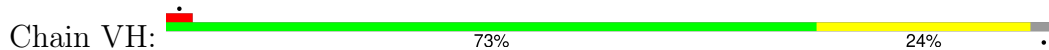

• Molecule 46: Tubulin beta chain

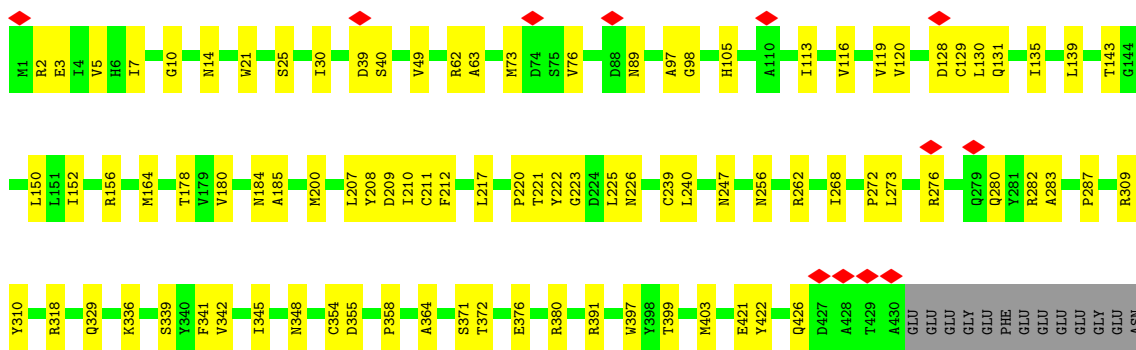

• Molecule 46: Tubulin beta chain

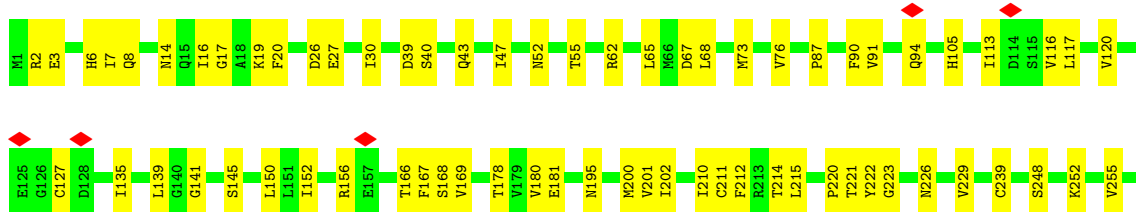
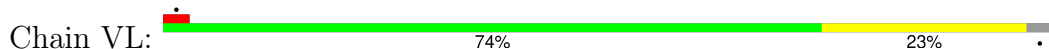

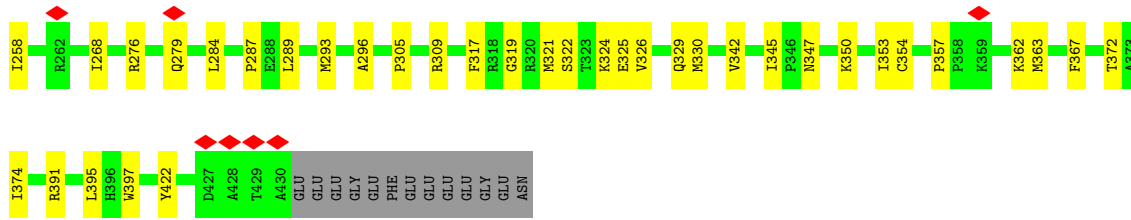

• Molecule 46: Tubulin beta chain

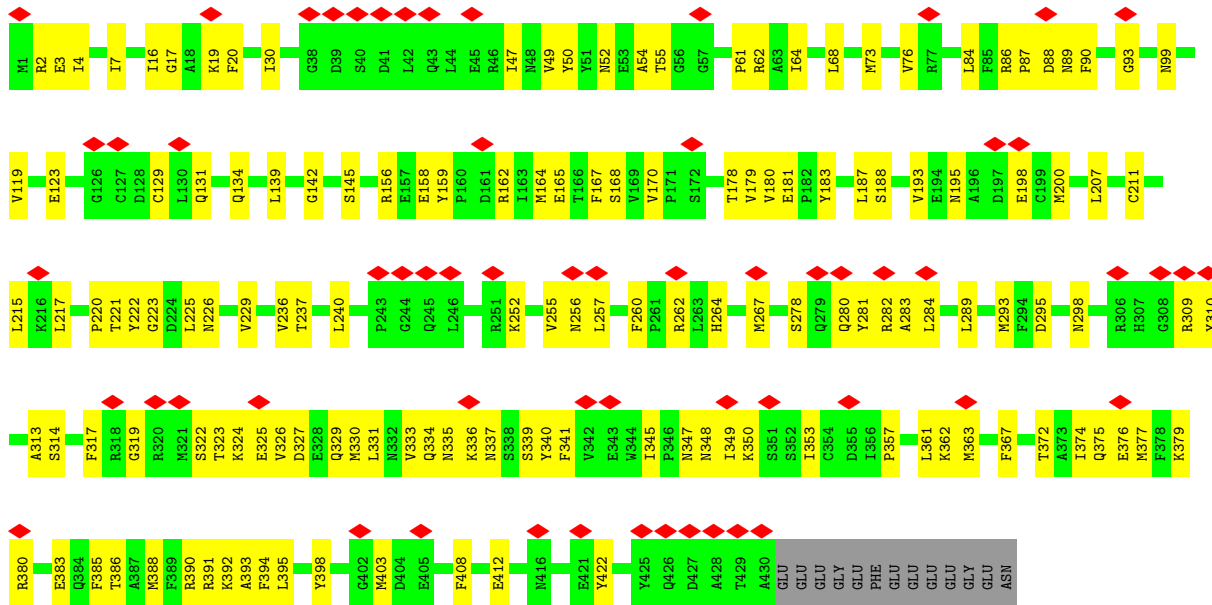

• Molecule 46: Tubulin beta chain

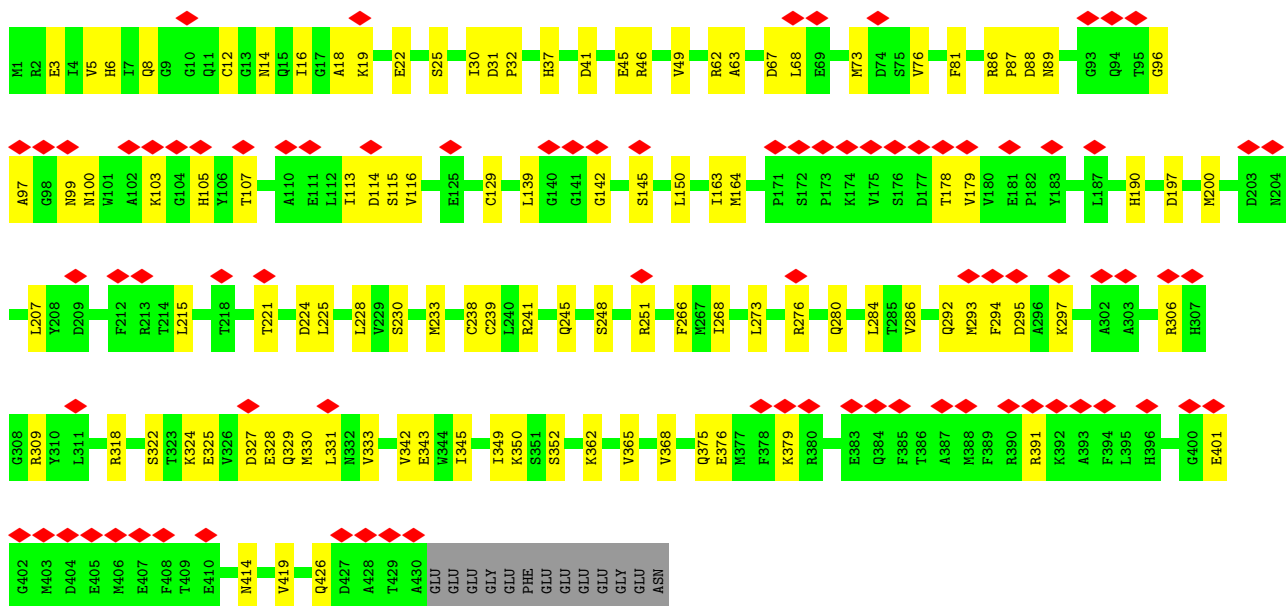
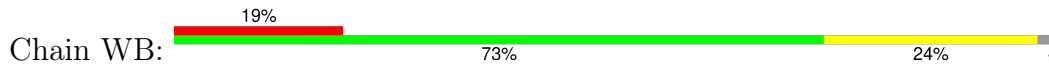

• Molecule 46: Tubulin beta chain

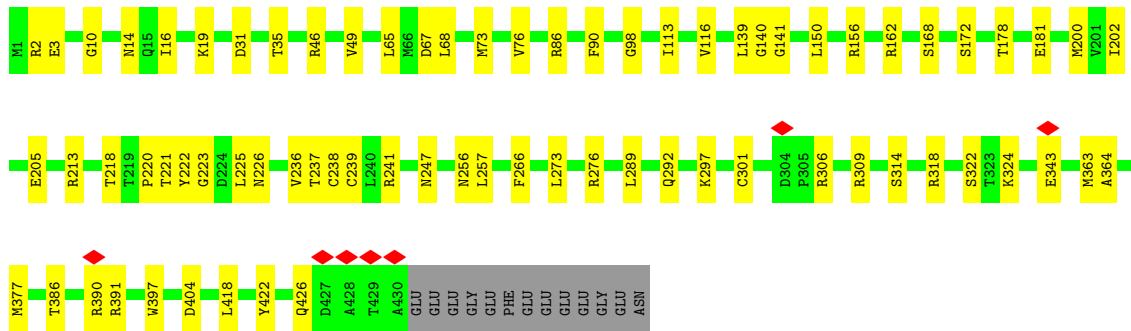
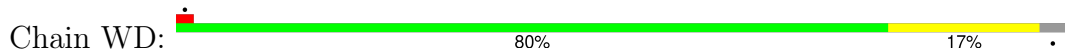

• Molecule 46: Tubulin beta chain

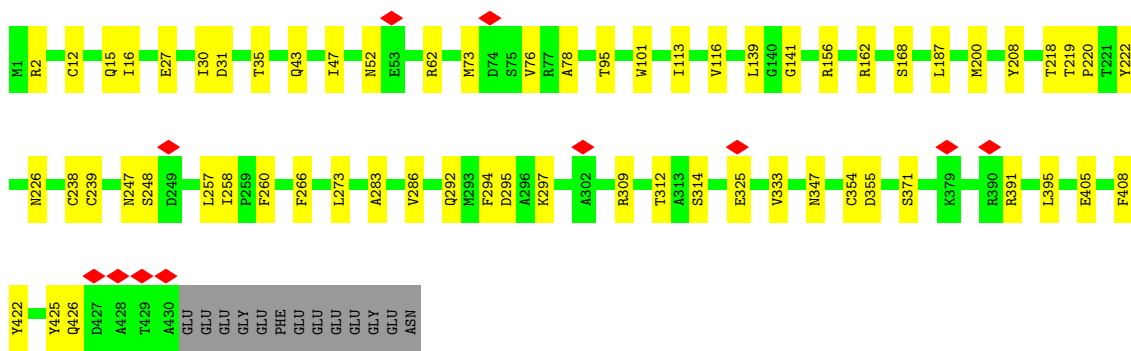
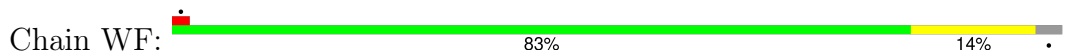

• Molecule 46: Tubulin beta chain

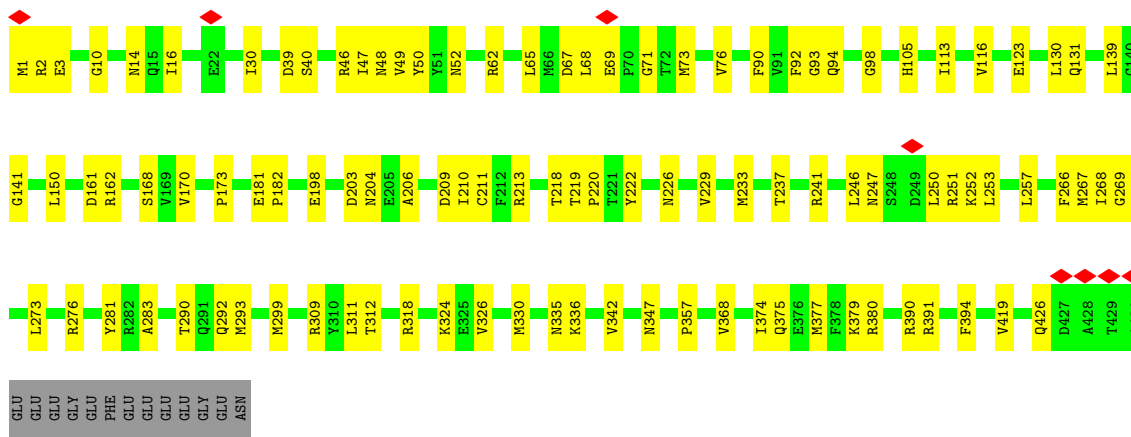
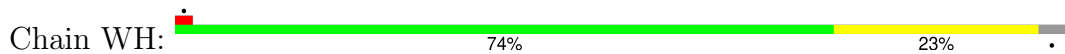

• Molecule 46: Tubulin beta chain

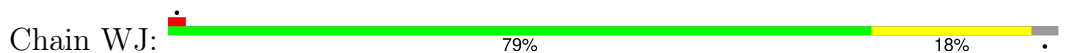

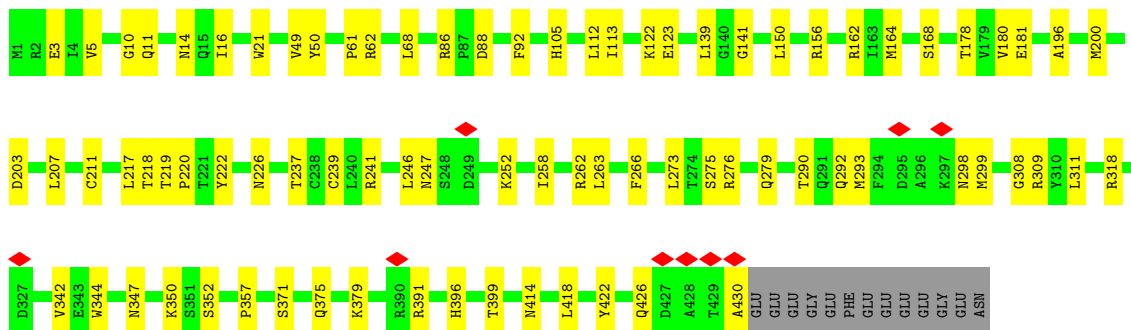

• Molecule 46: Tubulin beta chain

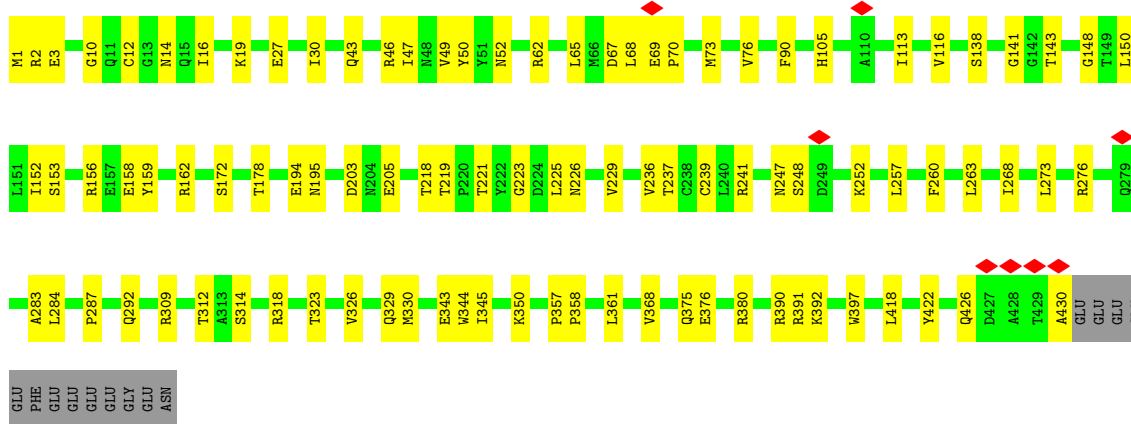
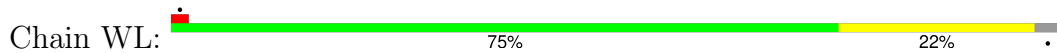

• Molecule 46: Tubulin beta chain

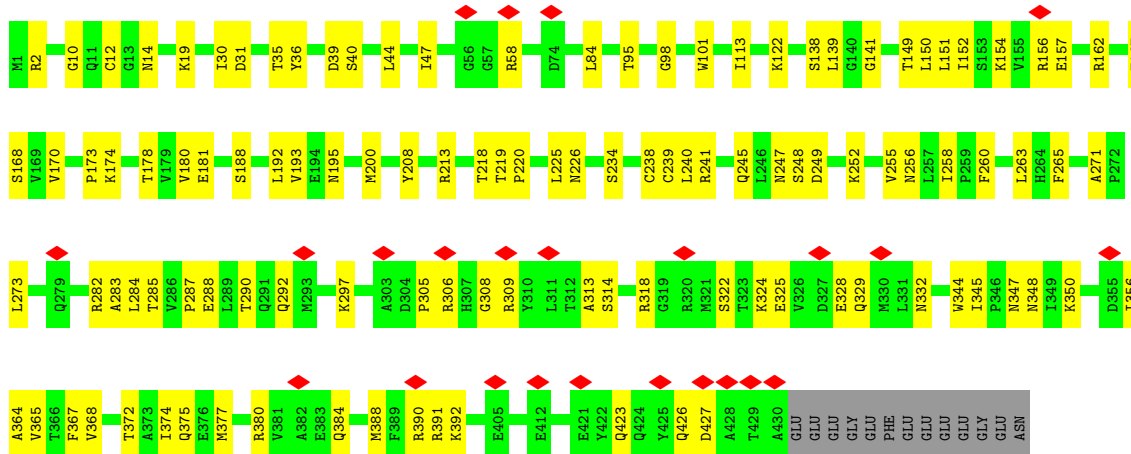

4 Experimental information

Property	Value	Source
EM reconstruction method	SINGLE PARTICLE	Depositor
Imposed symmetry	POINT, Not provided	
Number of particles used	182355	Depositor
Resolution determination method	FSC 0.143 CUT-OFF	Depositor
CTF correction method	NONE	Depositor
Microscope	TFS KRIOS	Depositor
Voltage (kV)	300	Depositor
Electron dose ($e^-/\text{\AA}^2$)	45	Depositor
Minimum defocus (nm)	1000	Depositor
Maximum defocus (nm)	3000	Depositor
Magnification	Not provided	
Image detector	GATAN K3 (6k x 4k)	Depositor
Maximum map value	2.387	Depositor
Minimum map value	-0.003	Depositor
Average map value	0.010	Depositor
Map value standard deviation	0.074	Depositor
Recommended contour level	0.12	Depositor
Map size (\AA)	701.44, 701.44, 701.44	wwPDB
Map dimensions	512, 512, 512	wwPDB
Map angles ($^\circ$)	90.0, 90.0, 90.0	wwPDB
Pixel spacing (\AA)	1.37, 1.37, 1.37	Depositor

5 Model quality i

5.1 Standard geometry i

Bond lengths and bond angles in the following residue types are not validated in this section: MG, GTP, GDP

The Z score for a bond length (or angle) is the number of standard deviations the observed value is removed from the expected value. A bond length (or angle) with $|Z| > 5$ is considered an outlier worth inspection. RMSZ is the root-mean-square of all Z scores of the bond lengths (or angles).

Mol	Chain	Bond lengths		Bond angles	
		RMSZ	# Z >5	RMSZ	# Z >5
1	0A	0.26	0/1273	0.54	0/1733
1	1A	0.27	0/1273	0.59	1/1733 (0.1%)
1	2A	0.26	0/1273	0.57	0/1733
1	3A	0.27	0/1273	0.55	0/1733
2	0B	0.25	0/2673	0.53	0/3619
3	0C	0.27	0/764	0.56	0/1029
3	1C	0.28	0/764	0.60	1/1029 (0.1%)
4	0D	0.27	0/1655	0.56	0/2241
4	1D	0.27	0/1655	0.58	0/2241
4	2D	0.26	0/1655	0.55	0/2241
5	0E	0.25	0/1584	0.49	0/2133
5	1E	0.26	0/1584	0.50	0/2133
5	2E	0.26	0/1584	0.54	1/2133 (0.0%)
5	3E	0.26	0/1584	0.57	1/2133 (0.0%)
6	0F	0.25	0/1699	0.58	0/2294
7	0G	0.27	0/1410	0.57	0/1899
7	1G	0.26	0/1117	0.56	0/1508
8	0H	0.25	0/1019	0.60	0/1351
8	1H	0.25	0/3722	0.56	1/4929 (0.0%)
9	0N	0.26	0/2355	0.49	0/3181
9	1N	0.25	0/3884	0.47	0/5240
9	2N	0.25	0/2355	0.50	0/3181
10	0Q	0.25	0/1583	0.57	0/2138
10	1Q	0.26	0/1583	0.59	2/2138 (0.1%)
10	2Q	0.26	0/1583	0.58	2/2138 (0.1%)
10	3Q	0.26	0/1583	0.60	2/2138 (0.1%)
10	4Q	0.25	0/1583	0.56	0/2138
10	5Q	0.25	0/1583	0.58	0/2138
10	6Q	0.25	0/1583	0.58	1/2138 (0.0%)
11	0S	0.24	0/2361	0.48	0/3199
11	1S	0.25	0/2361	0.49	0/3199
11	2S	0.25	0/2361	0.50	0/3199

Mol	Chain	Bond lengths		Bond angles	
		RMSZ	# Z >5	RMSZ	# Z >5
11	3S	0.25	0/2361	0.49	0/3199
12	0T	0.25	0/2106	0.48	0/2838
12	1T	0.25	0/2379	0.48	0/3209
12	2T	0.25	0/2379	0.49	0/3209
12	3T	0.25	0/2379	0.48	0/3209
13	0U	0.25	0/4866	0.54	0/6583
13	1U	0.25	0/4866	0.54	0/6583
13	2U	0.26	0/4866	0.55	0/6583
13	3U	0.25	0/4866	0.55	0/6583
14	0V	0.24	0/1784	0.51	0/2393
14	1V	0.25	0/2213	0.52	0/2978
14	2V	0.25	0/2213	0.52	0/2978
14	3V	0.26	0/2213	0.53	0/2978
15	0X	0.31	0/916	0.60	0/1218
15	1X	0.30	0/1221	0.52	0/1622
15	2X	0.29	0/1221	0.54	0/1622
15	3X	0.28	0/1221	0.55	0/1622
15	4X	0.29	0/1221	0.55	0/1622
16	1B	0.26	0/4148	0.48	0/5587
16	2B	0.25	0/2483	0.52	0/3339
16	3B	0.25	0/2493	0.50	0/3352
17	1F	0.26	0/1119	0.52	0/1513
18	1I	0.25	0/1574	0.54	0/2125
19	1J	0.26	0/3090	0.53	0/4148
20	1K	0.24	0/2420	0.49	0/3215
20	2K	0.24	0/2485	0.47	0/3293
21	1L	0.26	0/6960	0.55	3/9358 (0.0%)
21	2L	0.25	0/5275	0.53	1/7092 (0.0%)
21	3L	0.30	0/1685	0.65	1/2266 (0.0%)
22	1M	0.25	0/3041	0.52	0/4100
22	2M	0.25	0/3041	0.50	1/4100 (0.0%)
23	1O	0.26	0/1990	0.51	0/2623
23	2O	0.28	0/3186	0.59	0/4207
23	3O	0.23	0/2367	0.46	0/3126
24	1P	0.26	0/3046	0.54	0/4025
24	2P	0.26	0/1610	0.53	0/2136
25	1R	0.26	0/4366	0.49	0/5904
25	2R	0.26	0/4366	0.49	0/5904
25	3R	0.26	0/4366	0.48	0/5904
26	1W	0.24	0/1915	0.49	0/2558
26	2W	0.27	0/966	0.57	0/1291
27	2C	0.25	0/2511	0.50	1/3378 (0.0%)
27	3C	0.25	0/2511	0.48	0/3378

Mol	Chain	Bond lengths		Bond angles	
		RMSZ	# Z >5	RMSZ	# Z >5
27	4C	0.25	0/2511	0.48	0/3378
28	2F	0.30	0/767	0.62	1/1028 (0.1%)
29	2G	0.25	0/861	0.45	0/1146
30	2H	0.25	0/507	0.52	0/672
30	3H	0.26	0/507	0.51	0/672
30	4H	0.26	0/507	0.51	0/672
31	2I	0.27	0/1160	0.59	1/1560 (0.1%)
31	3I	0.25	0/729	0.59	0/975
32	3D	0.25	0/1878	0.45	0/2538
33	4F	0.27	0/1669	0.52	1/2258 (0.0%)
34	4R	0.26	0/5205	0.49	0/7042
34	5R	0.26	0/5205	0.48	0/7042
34	6R	0.25	0/5205	0.48	0/7042
34	7R	0.25	0/5205	0.49	0/7042
35	4S	0.25	0/1572	0.47	0/2122
35	5S	0.25	0/1572	0.48	0/2122
36	5A	0.28	0/1299	0.66	2/1757 (0.1%)
36	5B	0.26	0/1299	0.57	0/1757
36	5C	0.25	0/1299	0.55	0/1757
36	5D	0.27	0/898	0.59	0/1217
37	5E	0.26	0/1579	0.54	0/2124
37	5F	0.26	0/1792	0.55	0/2415
37	5G	0.25	0/1792	0.55	0/2415
37	5H	0.26	0/1175	0.59	1/1586 (0.1%)
39	6F	0.27	0/1171	0.52	0/1573
40	6G	0.27	0/1809	0.55	1/2426 (0.0%)
41	6H	0.27	0/1389	0.58	1/1855 (0.1%)
44	8R	0.26	0/1137	0.33	0/1584
45	AA	0.26	0/3482	0.51	0/4719
45	AC	0.26	0/3482	0.50	0/4719
45	AE	0.25	0/3482	0.49	0/4719
45	AG	0.25	0/3482	0.48	0/4719
45	AI	0.25	0/3482	0.49	0/4719
45	AK	0.26	0/3482	0.51	0/4719
45	AM	0.25	0/3482	0.50	0/4719
45	BA	0.25	0/3435	0.49	0/4655
45	BC	0.25	0/3435	0.48	0/4655
45	BE	0.25	0/3435	0.49	0/4655
45	BG	0.25	0/3435	0.49	0/4655
45	BI	0.26	0/3435	0.49	0/4655
45	BK	0.25	0/3435	0.49	0/4655
45	BM	0.25	0/3435	0.48	0/4655
45	CA	0.27	0/3482	0.55	2/4719 (0.0%)

Mol	Chain	Bond lengths		Bond angles	
		RMSZ	# Z >5	RMSZ	# Z >5
45	CC	0.25	0/3482	0.51	0/4719
45	CE	0.25	0/3482	0.50	0/4719
45	CG	0.26	0/3482	0.50	0/4719
45	CI	0.25	0/3482	0.49	0/4719
45	CK	0.25	0/3482	0.48	0/4719
45	CM	0.25	0/3482	0.51	0/4719
45	DA	0.25	0/3443	0.52	0/4666
45	DC	0.26	0/3462	0.51	0/4690
45	DE	0.25	0/3443	0.50	0/4666
45	DG	0.25	0/3462	0.47	0/4690
45	DI	0.25	0/3443	0.50	0/4666
45	DK	0.25	0/3462	0.49	0/4690
45	DM	0.25	0/3443	0.50	0/4666
45	EA	0.25	0/3482	0.50	0/4719
45	EC	0.25	0/3482	0.51	1/4719 (0.0%)
45	EE	0.25	0/3482	0.50	0/4719
45	EG	0.26	0/3482	0.50	0/4719
45	EI	0.25	0/3482	0.50	0/4719
45	EK	0.25	0/3482	0.49	0/4719
45	EM	0.27	0/3482	0.54	2/4719 (0.0%)
45	FA	0.25	0/3413	0.49	0/4625
45	FC	0.25	0/3435	0.49	0/4655
45	FE	0.25	0/3447	0.49	0/4671
45	FG	0.26	0/3482	0.49	0/4719
45	FI	0.25	0/3443	0.49	0/4666
45	FK	0.25	0/3435	0.48	0/4655
45	FM	0.24	0/3413	0.47	0/4625
45	GA	0.25	0/3413	0.49	0/4625
45	GC	0.25	0/3429	0.49	0/4647
45	GE	0.25	0/3429	0.48	0/4647
45	GG	0.25	0/3429	0.48	0/4647
45	GI	0.25	0/3429	0.49	0/4647
45	GK	0.26	0/3482	0.51	0/4719
45	GM	0.25	0/3413	0.52	0/4625
45	HA	0.25	0/3427	0.48	0/4644
45	HC	0.25	0/3427	0.48	0/4644
45	HE	0.25	0/3427	0.47	0/4644
45	HG	0.25	0/3427	0.49	0/4644
45	HI	0.25	0/3427	0.48	0/4644
45	HK	0.25	0/3427	0.48	0/4644
45	HM	0.25	0/3427	0.50	0/4644
45	IA	0.25	0/3435	0.49	0/4655
45	IC	0.26	0/3482	0.50	0/4719

Mol	Chain	Bond lengths		Bond angles	
		RMSZ	# Z >5	RMSZ	# Z >5
45	IE	0.26	0/3435	0.50	0/4655
45	IG	0.25	0/3482	0.48	0/4719
45	II	0.25	0/3482	0.49	0/4719
45	IK	0.25	0/3435	0.48	0/4655
45	IM	0.26	0/3435	0.52	1/4655 (0.0%)
45	JA	0.25	0/3435	0.49	0/4655
45	JC	0.25	0/3447	0.49	0/4671
45	JE	0.25	0/3482	0.49	0/4719
45	JG	0.25	0/3482	0.49	0/4719
45	JI	0.26	0/3478	0.50	0/4713
45	JK	0.26	0/3482	0.50	0/4719
45	JM	0.25	0/3435	0.51	0/4655
45	KA	0.25	0/3447	0.48	0/4671
45	KC	0.25	0/3443	0.47	0/4666
45	KE	0.26	0/3458	0.50	0/4685
45	KG	0.26	0/3482	0.49	0/4719
45	KI	0.26	0/3482	0.49	0/4719
45	KK	0.25	0/3482	0.48	0/4719
45	KM	0.25	0/3447	0.50	0/4671
45	LA	0.26	0/3482	0.50	0/4719
45	LC	0.25	0/3482	0.50	1/4719 (0.0%)
45	LE	0.25	0/3473	0.50	0/4705
45	LG	0.25	0/3482	0.48	0/4719
45	LI	0.25	0/3454	0.48	0/4680
45	LK	0.25	0/3482	0.48	0/4719
45	LM	0.26	0/3482	0.51	0/4719
45	MA	0.25	0/3465	0.50	0/4695
45	MC	0.25	0/3439	0.47	0/4660
45	ME	0.26	0/3443	0.50	0/4666
45	MG	0.25	0/3473	0.49	0/4706
45	MI	0.26	0/3482	0.51	0/4719
45	MK	0.26	0/3455	0.49	0/4681
45	MM	0.25	0/3465	0.50	0/4695
45	NA	0.25	0/3482	0.50	0/4719
45	NC	0.25	0/3435	0.50	0/4655
45	NE	0.26	0/3482	0.51	0/4719
45	NG	0.25	0/3435	0.50	0/4655
45	NI	0.25	0/3482	0.49	0/4719
45	NK	0.25	0/3435	0.50	0/4655
45	NM	0.25	0/3482	0.50	0/4719
45	OA	0.26	0/3439	0.53	0/4660
45	OC	0.25	0/3439	0.50	0/4660
45	OE	0.25	0/3439	0.50	0/4660

Mol	Chain	Bond lengths		Bond angles	
		RMSZ	# Z >5	RMSZ	# Z >5
45	OG	0.25	0/3439	0.49	0/4660
45	OI	0.25	0/3439	0.49	0/4660
45	OK	0.25	0/3439	0.50	0/4660
45	OM	0.25	0/3439	0.50	0/4660
45	PA	0.25	0/3413	0.51	0/4625
45	PC	0.25	0/3413	0.50	0/4625
45	PE	0.25	0/3413	0.50	0/4625
45	PG	0.25	0/3413	0.49	0/4625
45	PI	0.25	0/3413	0.50	0/4625
45	PK	0.25	0/3413	0.49	0/4625
45	PM	0.25	0/3413	0.50	0/4625
45	QA	0.30	1/3427 (0.0%)	0.55	3/4644 (0.1%)
45	QC	0.25	0/3427	0.49	0/4644
45	QE	0.25	0/3427	0.48	0/4644
45	QG	0.25	0/3427	0.49	0/4644
45	QI	0.25	0/3427	0.50	0/4644
45	QK	0.25	0/3427	0.49	0/4644
45	QM	0.25	0/3427	0.51	0/4644
45	RA	0.24	0/3427	0.48	0/4644
45	RC	0.25	0/3427	0.50	0/4644
45	RE	0.25	0/3427	0.49	0/4644
45	RG	0.25	0/3427	0.49	0/4644
45	RI	0.25	0/3427	0.50	0/4644
45	RK	0.25	0/3427	0.49	0/4644
45	RM	0.26	0/3427	0.50	0/4644
45	SA	0.24	0/3421	0.49	0/4636
45	SC	0.25	0/3421	0.50	0/4636
45	SE	0.25	0/3421	0.49	0/4636
45	SG	0.25	0/3421	0.49	0/4636
45	SI	0.25	0/3421	0.48	0/4636
45	SK	0.25	0/3421	0.49	0/4636
45	SM	0.25	0/3421	0.51	0/4636
45	TA	0.24	0/3421	0.47	0/4636
45	TC	0.25	0/3421	0.50	0/4636
45	TE	0.25	0/3421	0.49	0/4636
45	TG	0.25	0/3421	0.48	0/4636
45	TI	0.25	0/3421	0.50	0/4636
45	TK	0.25	0/3421	0.49	0/4636
45	TM	0.25	0/3421	0.49	0/4636
45	UA	0.24	0/3427	0.49	0/4644
45	UC	0.25	0/3427	0.50	0/4644
45	UE	0.25	0/3427	0.48	0/4644
45	UG	0.25	0/3427	0.48	0/4644

Mol	Chain	Bond lengths		Bond angles	
		RMSZ	# Z >5	RMSZ	# Z >5
45	UI	0.25	0/3427	0.48	0/4644
45	UK	0.25	0/3427	0.49	0/4644
45	UM	0.25	0/3427	0.48	0/4644
45	VA	0.25	0/3443	0.49	0/4666
45	VC	0.25	0/3482	0.48	0/4719
45	VE	0.25	0/3443	0.48	0/4666
45	VG	0.25	0/3482	0.48	0/4719
45	VI	0.26	0/3443	0.51	0/4666
45	VK	0.26	0/3482	0.51	0/4719
45	VM	0.25	0/3443	0.50	0/4666
45	WA	0.25	0/3427	0.49	0/4644
45	WC	0.25	0/3482	0.50	0/4719
45	WE	0.25	0/3427	0.48	0/4644
45	WG	0.25	0/3482	0.50	0/4719
45	WI	0.25	0/3427	0.48	0/4644
45	WK	0.25	0/3482	0.49	0/4719
45	WM	0.25	0/3427	0.51	0/4644
46	AB	0.25	0/3439	0.51	0/4655
46	AD	0.26	0/3439	0.51	0/4655
46	AF	0.26	0/3439	0.50	0/4655
46	AH	0.25	0/3439	0.48	0/4655
46	AJ	0.26	0/3439	0.50	0/4655
46	AL	0.26	0/3439	0.50	0/4655
46	AN	0.26	0/3439	0.49	0/4655
46	BB	0.25	0/3369	0.51	0/4553
46	BD	0.25	0/3439	0.50	0/4655
46	BF	0.26	0/3439	0.50	0/4655
46	BH	0.26	0/3439	0.49	0/4655
46	BJ	0.26	0/3439	0.50	0/4655
46	BL	0.25	0/3439	0.50	0/4655
46	BN	0.25	0/3439	0.49	0/4655
46	CB	0.26	0/3439	0.53	0/4655
46	CD	0.26	0/3439	0.50	0/4655
46	CF	0.26	0/3439	0.50	0/4655
46	CH	0.25	0/3439	0.50	0/4655
46	CJ	0.26	0/3439	0.49	0/4655
46	CL	0.25	0/3439	0.50	0/4655
46	CN	0.26	0/3439	0.56	0/4655
46	DB	0.26	0/3439	0.53	0/4655
46	DD	0.25	0/3439	0.50	0/4655
46	DF	0.25	0/3439	0.50	0/4655
46	DH	0.25	0/3439	0.48	0/4655
46	DJ	0.26	0/3439	0.51	1/4655 (0.0%)

Mol	Chain	Bond lengths		Bond angles	
		RMSZ	# Z >5	RMSZ	# Z >5
46	DL	0.25	0/3439	0.51	0/4655
46	DN	0.27	0/3439	0.54	0/4655
46	EB	0.25	0/3439	0.50	0/4655
46	ED	0.25	0/3439	0.49	0/4655
46	EF	0.26	0/3439	0.51	0/4655
46	EH	0.26	0/3439	0.51	0/4655
46	EJ	0.26	0/3439	0.51	0/4655
46	EL	0.25	0/3439	0.49	0/4655
46	EN	0.25	0/3439	0.52	0/4655
46	FB	0.27	0/3439	0.55	0/4655
46	FD	0.26	0/3439	0.49	0/4655
46	FF	0.26	0/3439	0.52	0/4655
46	FH	0.25	0/3439	0.49	1/4655 (0.0%)
46	FJ	0.25	0/3439	0.49	0/4655
46	FL	0.25	0/3439	0.48	0/4655
46	FN	0.25	0/3439	0.52	0/4655
46	GB	0.26	0/3439	0.53	0/4655
46	GD	0.25	0/3439	0.49	0/4655
46	GF	0.25	0/3439	0.48	0/4655
46	GH	0.25	0/3439	0.47	0/4655
46	GJ	0.26	0/3439	0.50	0/4655
46	GL	0.26	0/3439	0.50	0/4655
46	GN	0.25	0/3439	0.49	0/4655
46	HB	0.26	0/3439	0.51	0/4655
46	HD	0.25	0/3439	0.48	0/4655
46	HF	0.26	0/3439	0.50	0/4655
46	HH	0.26	0/3439	0.49	0/4655
46	HJ	0.26	0/3439	0.49	0/4655
46	HL	0.25	0/3439	0.50	0/4655
46	HN	0.25	0/3439	0.49	0/4655
46	IB	0.25	0/3439	0.52	0/4655
46	ID	0.26	0/3439	0.50	0/4655
46	IF	0.26	0/3439	0.49	0/4655
46	IH	0.25	0/3439	0.47	0/4655
46	IJ	0.25	0/3439	0.47	0/4655
46	IL	0.26	0/3439	0.49	0/4655
46	IN	0.26	0/3439	0.50	0/4655
46	JB	0.26	0/3439	0.50	0/4655
46	JD	0.26	0/3439	0.49	0/4655
46	JF	0.25	0/3439	0.48	0/4655
46	JH	0.26	0/3439	0.50	0/4655
46	JJ	0.26	0/3439	0.50	0/4655
46	JL	0.26	0/3439	0.49	0/4655

Mol	Chain	Bond lengths		Bond angles	
		RMSZ	# Z >5	RMSZ	# Z >5
46	JN	0.25	0/3439	0.50	0/4655
46	KB	0.25	0/3439	0.48	0/4655
46	KD	0.25	0/3439	0.48	0/4655
46	KF	0.26	0/3439	0.50	0/4655
46	KH	0.26	0/3439	0.48	0/4655
46	KJ	0.25	0/3439	0.49	0/4655
46	KL	0.25	0/3439	0.48	0/4655
46	KN	0.25	0/3439	0.48	0/4655
46	LB	0.25	0/3439	0.51	0/4655
46	LD	0.26	0/3439	0.49	0/4655
46	LF	0.26	0/3439	0.50	0/4655
46	LH	0.26	0/3439	0.49	0/4655
46	LJ	0.25	0/3439	0.49	0/4655
46	LL	0.26	0/3439	0.50	0/4655
46	LN	0.26	0/3439	0.51	0/4655
46	MB	0.25	0/3439	0.49	0/4655
46	MD	0.25	0/3439	0.49	0/4655
46	MF	0.25	0/3439	0.49	0/4655
46	MH	0.25	0/3439	0.49	0/4655
46	MJ	0.26	0/3439	0.50	0/4655
46	ML	0.26	0/3439	0.50	0/4655
46	MN	0.25	0/3439	0.49	0/4655
46	NB	0.25	0/3375	0.50	0/4569
46	ND	0.26	0/3439	0.51	0/4655
46	NF	0.26	0/3375	0.50	0/4569
46	NH	0.26	0/3439	0.50	0/4655
46	NJ	0.25	0/3375	0.49	0/4569
46	NL	0.25	0/3439	0.50	0/4655
46	NN	0.25	0/3375	0.50	0/4569
46	OB	0.26	0/3439	0.53	1/4655 (0.0%)
46	OD	0.26	0/3439	0.51	0/4655
46	OF	0.24	0/3439	0.49	0/4655
46	OH	0.25	0/3439	0.50	0/4655
46	OJ	0.25	0/3439	0.48	0/4655
46	OL	0.24	0/3439	0.48	0/4655
46	ON	0.25	0/3439	0.48	0/4655
46	PB	0.25	0/3439	0.49	0/4655
46	PD	0.26	0/3439	0.51	0/4655
46	PF	0.25	0/3439	0.50	0/4655
46	PH	0.25	0/3439	0.49	0/4655
46	PJ	0.25	0/3439	0.50	0/4655
46	PL	0.25	0/3439	0.50	1/4655 (0.0%)
46	PN	0.25	0/3439	0.51	0/4655

Mol	Chain	Bond lengths		Bond angles	
		RMSZ	# Z >5	RMSZ	# Z >5
46	QB	0.26	0/3439	0.52	1/4655 (0.0%)
46	QD	0.25	0/3439	0.50	0/4655
46	QF	0.25	0/3439	0.49	0/4655
46	QH	0.25	0/3439	0.49	0/4655
46	QJ	0.25	0/3439	0.51	0/4655
46	QL	0.25	0/3439	0.51	0/4655
46	QN	0.24	0/3439	0.47	0/4655
46	RB	0.25	0/3439	0.50	0/4655
46	RD	0.25	0/3439	0.49	0/4655
46	RF	0.25	0/3439	0.50	0/4655
46	RH	0.25	0/3439	0.51	0/4655
46	RJ	0.25	0/3439	0.49	0/4655
46	RL	0.25	0/3439	0.51	0/4655
46	RN	0.24	0/3439	0.47	0/4655
46	SB	0.25	0/3439	0.50	0/4655
46	SD	0.25	0/3439	0.51	1/4655 (0.0%)
46	SF	0.25	0/3439	0.50	0/4655
46	SH	0.25	0/3439	0.50	0/4655
46	SJ	0.26	0/3439	0.51	0/4655
46	SL	0.25	0/3439	0.50	0/4655
46	SN	0.24	0/3439	0.47	0/4655
46	TB	0.25	0/3439	0.49	0/4655
46	TD	0.25	0/3439	0.50	0/4655
46	TF	0.25	0/3439	0.50	0/4655
46	TH	0.25	0/3439	0.49	0/4655
46	TJ	0.25	0/3439	0.50	0/4655
46	TL	0.26	0/3439	0.51	0/4655
46	TN	0.24	0/3439	0.49	0/4655
46	UB	0.25	0/3439	0.50	0/4655
46	UD	0.26	0/3439	0.49	0/4655
46	UF	0.25	0/3439	0.49	0/4655
46	UH	0.25	0/3439	0.50	0/4655
46	UJ	0.25	0/3439	0.49	0/4655
46	UL	0.25	0/3439	0.50	0/4655
46	UN	0.25	0/3439	0.53	0/4655
46	VB	0.25	0/3439	0.51	0/4655
46	VD	0.26	0/3439	0.51	0/4655
46	VF	0.25	0/3439	0.49	0/4655
46	VH	0.26	0/3439	0.49	0/4655
46	VJ	0.25	0/3439	0.49	0/4655
46	VL	0.25	0/3439	0.49	0/4655
46	VN	0.26	0/3439	0.52	0/4655
46	WB	0.25	0/3439	0.49	0/4655

Mol	Chain	Bond lengths		Bond angles	
		RMSZ	# Z >5	RMSZ	# Z >5
46	WD	0.25	0/3439	0.49	0/4655
46	WF	0.25	0/3439	0.48	0/4655
46	WH	0.25	0/3439	0.49	0/4655
46	WJ	0.25	0/3439	0.49	0/4655
46	WL	0.25	0/3439	0.49	0/4655
46	WN	0.25	0/3439	0.52	0/4655
All	All	0.25	1/1334739 (0.0%)	0.50	43/1805944 (0.0%)

Chiral center outliers are detected by calculating the chiral volume of a chiral center and verifying if the center is modelled as a planar moiety or with the opposite hand. A planarity outlier is detected by checking planarity of atoms in a peptide group, atoms in a mainchain group or atoms of a sidechain that are expected to be planar.

Mol	Chain	#Chirality outliers	#Planarity outliers
1	0A	0	1
1	1A	0	3
1	2A	0	2
1	3A	0	1
4	0D	0	1
4	1D	0	1
6	0F	0	1
25	1R	0	1
25	2R	0	1
25	3R	0	1
27	3C	0	1
31	2I	0	1
45	BA	0	1
45	EA	0	1
45	EE	0	1
45	EI	0	1
45	EM	0	1
All	All	0	20

All (1) bond length outliers are listed below:

Mol	Chain	Res	Type	Atoms	Z	Observed(Å)	Ideal(Å)
45	QA	261	PRO	CG-CD	-9.16	1.20	1.50

The worst 5 of 43 bond angle outliers are listed below:

Mol	Chain	Res	Type	Atoms	Z	Observed(°)	Ideal(°)
45	QA	261	PRO	CA-N-CD	-10.43	96.90	111.50

Continued on next page...

Continued from previous page...

Mol	Chain	Res	Type	Atoms	Z	Observed(°)	Ideal(°)
45	EM	261	PRO	CA-N-CD	-10.24	97.17	111.50
45	QA	261	PRO	N-CD-CG	-9.91	88.33	103.20
45	CA	261	PRO	CA-N-CD	-9.37	98.38	111.50
36	5A	20	LEU	CA-CB-CG	7.18	131.83	115.30

There are no chirality outliers.

5 of 20 planarity outliers are listed below:

Mol	Chain	Res	Type	Group
1	0A	38	SER	Peptide
4	0D	79	GLN	Peptide
6	0F	7	ILE	Peptide
1	1A	19	ARG	Peptide
1	1A	37	THR	Peptide

5.2 Too-close contacts [i](#)

In the following table, the Non-H and H(model) columns list the number of non-hydrogen atoms and hydrogen atoms in the chain respectively. The H(added) column lists the number of hydrogen atoms added and optimized by MolProbity. The Clashes column lists the number of clashes within the asymmetric unit, whereas Symm-Clashes lists symmetry-related clashes.

Mol	Chain	Non-H	H(model)	H(added)	Clashes	Symm-Clashes
1	0A	1229	0	1157	19	0
1	1A	1229	0	1157	15	0
1	2A	1229	0	1157	36	0
1	3A	1229	0	1157	56	0
2	0B	2614	0	2537	24	0
3	0C	747	0	746	3	0
3	1C	747	0	746	8	0
4	0D	1621	0	1610	18	0
4	1D	1621	0	1610	14	0
4	2D	1621	0	1610	67	0
5	0E	1557	0	1513	3	0
5	1E	1557	0	1513	4	0
5	2E	1557	0	1513	45	0
5	3E	1557	0	1513	45	0
6	0F	1665	0	1658	14	0
7	0G	1378	0	1335	16	0
7	1G	1089	0	1056	9	0
8	0H	1006	0	1010	2	0

Continued on next page...

Continued from previous page...

Mol	Chain	Non-H	H(model)	H(added)	Clashes	Symm-Clashes
8	1H	3687	0	3703	26	0
9	0N	2305	0	2251	9	0
9	1N	3805	0	3734	10	0
9	2N	2305	0	2251	60	0
10	0Q	1548	0	1575	4	0
10	1Q	1548	0	1575	10	0
10	2Q	1548	0	1575	30	0
10	3Q	1548	0	1575	41	0
10	4Q	1548	0	1575	29	0
10	5Q	1548	0	1575	37	0
10	6Q	1548	0	1575	49	0
11	0S	2310	0	2349	2	0
11	1S	2310	0	2349	41	0
11	2S	2310	0	2349	57	0
11	3S	2310	0	2349	49	0
12	0T	2056	0	2010	2	0
12	1T	2321	0	2267	53	0
12	2T	2321	0	2267	57	0
12	3T	2321	0	2267	62	0
13	0U	4774	0	4750	3	0
13	1U	4774	0	4750	134	0
13	2U	4774	0	4750	144	0
13	3U	4774	0	4750	127	0
14	0V	1750	0	1740	19	0
14	1V	2168	0	2164	51	0
14	2V	2168	0	2164	47	0
14	3V	2168	0	2164	78	0
15	0X	903	0	878	7	0
15	1X	1205	0	1184	23	0
15	2X	1205	0	1184	32	0
15	3X	1205	0	1184	30	0
15	4X	1205	0	1184	27	0
16	1B	4066	0	4014	7	0
16	2B	2439	0	2418	62	0
16	3B	2449	0	2426	56	0
17	1F	1093	0	1080	10	0
18	1I	1546	0	1485	18	0
19	1J	3025	0	2938	34	0
20	1K	2391	0	2398	14	0
20	2K	2465	0	2499	58	0
21	1L	6841	0	6886	35	0
21	2L	5181	0	5214	139	0

Continued on next page...

Continued from previous page...

Mol	Chain	Non-H	H(model)	H(added)	Clashes	Symm-Clashes
21	3L	1660	0	1672	69	0
22	1M	2978	0	2957	6	0
22	2M	2978	0	2957	45	0
23	1O	1983	0	2096	26	0
23	2O	3173	0	3303	158	0
23	3O	2358	0	2454	67	0
24	1P	3026	0	3144	30	0
24	2P	1594	0	1605	55	0
25	1R	4244	0	4119	16	0
25	2R	4244	0	4119	67	0
25	3R	4244	0	4119	76	0
26	1W	1888	0	1823	38	0
26	2W	949	0	929	43	0
27	2C	2467	0	2457	47	0
27	3C	2467	0	2457	45	0
27	4C	2467	0	2457	49	0
28	2F	746	0	703	23	0
29	2G	848	0	871	24	0
30	2H	501	0	513	25	0
30	3H	501	0	513	20	0
30	4H	501	0	513	11	0
31	2I	1132	0	1131	40	0
31	3I	712	0	722	24	0
32	3D	1835	0	1817	32	0
33	4F	1623	0	1559	29	0
34	4R	5070	0	4976	100	0
34	5R	5070	0	4976	78	0
34	6R	5070	0	4976	93	0
34	7R	5070	0	4976	99	0
35	4S	1537	0	1565	38	0
35	5S	1537	0	1565	27	0
36	5A	1261	0	1230	41	0
36	5B	1261	0	1230	30	0
36	5C	1261	0	1230	38	0
36	5D	872	0	852	22	0
37	5E	1543	0	1551	54	0
37	5F	1750	0	1753	35	0
37	5G	1750	0	1753	49	0
37	5H	1146	0	1136	30	0
38	5I	495	0	105	0	0
38	5J	545	0	115	0	0
38	5K	380	0	80	2	0

Continued on next page...

Continued from previous page...

Mol	Chain	Non-H	H(model)	H(added)	Clashes	Symm-Clashes
39	6F	1141	0	1077	26	0
40	6G	1769	0	1772	73	0
41	6H	1361	0	1280	40	0
42	8L	1925	0	391	2	0
42	8N	1790	0	362	2	0
43	8P	1815	0	369	6	0
44	8R	2022	0	1200	14	0
45	AA	3410	0	3347	83	0
45	AC	3410	0	3347	62	0
45	AE	3410	0	3347	50	0
45	AG	3410	0	3347	54	0
45	AI	3410	0	3347	45	0
45	AK	3410	0	3347	52	0
45	AM	3410	0	3347	69	0
45	BA	3364	0	3302	79	0
45	BC	3364	0	3302	62	0
45	BE	3364	0	3302	62	0
45	BG	3364	0	3302	63	0
45	BI	3364	0	3302	48	0
45	BK	3364	0	3302	65	0
45	BM	3364	0	3302	59	0
45	CA	3410	0	3347	100	0
45	CC	3410	0	3347	84	0
45	CE	3410	0	3347	78	0
45	CG	3410	0	3347	75	0
45	CI	3410	0	3347	61	0
45	CK	3410	0	3346	58	0
45	CM	3410	0	3347	104	0
45	DA	3372	0	3306	91	0
45	DC	3391	0	3325	102	0
45	DE	3372	0	3306	62	0
45	DG	3391	0	3325	58	0
45	DI	3372	0	3306	68	0
45	DK	3391	0	3325	79	0
45	DM	3372	0	3306	99	0
45	EA	3410	0	3347	90	0
45	EC	3410	0	3346	94	0
45	EE	3410	0	3347	54	0
45	EG	3410	0	3347	62	0
45	EI	3410	0	3347	69	0
45	EK	3410	0	3347	71	0
45	EM	3410	0	3347	89	0

Continued on next page...

Continued from previous page...

Mol	Chain	Non-H	H(model)	H(added)	Clashes	Symm-Clashes
45	FA	3342	0	3289	95	0
45	FC	3364	0	3302	57	0
45	FE	3376	0	3309	65	0
45	FG	3410	0	3347	55	0
45	FI	3372	0	3306	52	0
45	FK	3364	0	3302	72	0
45	FM	3342	0	3289	57	0
45	GA	3342	0	3289	82	0
45	GC	3358	0	3297	56	0
45	GE	3358	0	3297	63	0
45	GG	3358	0	3297	38	0
45	GI	3358	0	3297	49	0
45	GK	3410	0	3347	54	0
45	GM	3342	0	3289	99	0
45	HA	3356	0	3298	70	0
45	HC	3356	0	3298	51	0
45	HE	3356	0	3298	55	0
45	HG	3356	0	3298	61	0
45	HI	3356	0	3298	42	0
45	HK	3356	0	3298	63	0
45	HM	3356	0	3298	74	0
45	IA	3364	0	3302	64	0
45	IC	3410	0	3347	57	0
45	IE	3364	0	3302	50	0
45	IG	3410	0	3347	48	0
45	II	3410	0	3347	48	0
45	IK	3364	0	3302	66	0
45	IM	3364	0	3302	75	0
45	JA	3364	0	3302	64	0
45	JC	3376	0	3309	57	0
45	JE	3410	0	3347	47	0
45	JG	3410	0	3347	59	0
45	JI	3406	0	3337	71	0
45	JK	3410	0	3347	68	0
45	JM	3364	0	3302	88	0
45	KA	3376	0	3309	63	0
45	KC	3372	0	3306	47	0
45	KE	3387	0	3322	53	0
45	KG	3410	0	3347	55	0
45	KI	3410	0	3347	63	0
45	KK	3410	0	3347	48	0
45	KM	3376	0	3309	55	0

Continued on next page...

Continued from previous page...

Mol	Chain	Non-H	H(model)	H(added)	Clashes	Symm-Clashes
45	LA	3410	0	3347	78	0
45	LC	3410	0	3347	65	0
45	LE	3402	0	3335	70	0
45	LG	3410	0	3347	57	0
45	LI	3383	0	3319	55	0
45	LK	3410	0	3347	65	0
45	LM	3410	0	3347	79	0
45	MA	3394	0	3329	87	0
45	MC	3368	0	3305	40	0
45	ME	3372	0	3306	66	0
45	MG	3402	0	3340	53	0
45	MI	3410	0	3347	71	0
45	MK	3384	0	3315	64	0
45	MM	3394	0	3329	93	0
45	NA	3410	0	3347	93	0
45	NC	3364	0	3302	81	0
45	NE	3410	0	3347	72	0
45	NG	3364	0	3302	80	0
45	NI	3410	0	3347	59	0
45	NK	3364	0	3302	69	0
45	NM	3410	0	3347	90	0
45	OA	3368	0	3305	99	0
45	OC	3368	0	3305	64	0
45	OE	3368	0	3305	69	0
45	OG	3368	0	3305	59	0
45	OI	3368	0	3305	68	0
45	OK	3368	0	3305	66	0
45	OM	3368	0	3305	93	0
45	PA	3342	0	3289	120	0
45	PC	3342	0	3289	70	0
45	PE	3342	0	3289	76	0
45	PG	3342	0	3289	59	0
45	PI	3342	0	3289	71	0
45	PK	3342	0	3289	73	0
45	PM	3342	0	3289	75	0
45	QA	3356	0	3298	92	0
45	QC	3356	0	3298	63	0
45	QE	3356	0	3298	75	0
45	QG	3356	0	3298	69	0
45	QI	3356	0	3298	72	0
45	QK	3356	0	3298	70	0
45	QM	3356	0	3298	101	0

Continued on next page...

Continued from previous page...

Mol	Chain	Non-H	H(model)	H(added)	Clashes	Symm-Clashes
45	RA	3356	0	3298	76	0
45	RC	3356	0	3298	84	0
45	RE	3356	0	3298	70	0
45	RG	3356	0	3298	69	0
45	RI	3356	0	3298	65	0
45	RK	3356	0	3298	72	0
45	RM	3356	0	3298	94	0
45	SA	3350	0	3293	73	0
45	SC	3350	0	3293	71	0
45	SE	3350	0	3293	81	0
45	SG	3350	0	3293	62	0
45	SI	3350	0	3293	59	0
45	SK	3350	0	3293	66	0
45	SM	3350	0	3293	111	0
45	TA	3350	0	3293	64	0
45	TC	3350	0	3293	70	0
45	TE	3350	0	3293	65	0
45	TG	3350	0	3293	68	0
45	TI	3350	0	3293	78	0
45	TK	3350	0	3293	72	0
45	TM	3350	0	3293	92	0
45	UA	3356	0	3298	77	0
45	UC	3356	0	3298	99	0
45	UE	3356	0	3298	73	0
45	UG	3356	0	3298	67	0
45	UI	3356	0	3298	62	0
45	UK	3356	0	3298	55	0
45	UM	3356	0	3298	102	0
45	VA	3372	0	3306	78	0
45	VC	3410	0	3347	63	0
45	VE	3372	0	3306	61	0
45	VG	3410	0	3347	73	0
45	VI	3372	0	3306	61	0
45	VK	3410	0	3347	90	0
45	VM	3372	0	3305	111	0
45	WA	3356	0	3298	72	0
45	WC	3410	0	3347	59	0
45	WE	3356	0	3298	64	0
45	WG	3410	0	3347	63	0
45	WI	3356	0	3298	48	0
45	WK	3410	0	3347	71	0
45	WM	3356	0	3298	111	0

Continued on next page...

Continued from previous page...

Mol	Chain	Non-H	H(model)	H(added)	Clashes	Symm-Clashes
46	AB	3366	0	3257	93	0
46	AD	3366	0	3257	69	0
46	AF	3366	0	3257	69	0
46	AH	3366	0	3257	52	0
46	AJ	3366	0	3257	78	0
46	AL	3366	0	3257	51	0
46	AN	3366	0	3257	64	0
46	BB	3304	0	3199	102	0
46	BD	3366	0	3257	67	0
46	BF	3366	0	3257	79	0
46	BH	3366	0	3257	64	0
46	BJ	3366	0	3257	68	0
46	BL	3366	0	3257	51	0
46	BN	3366	0	3257	88	0
46	CB	3366	0	3257	98	0
46	CD	3366	0	3257	69	0
46	CF	3366	0	3257	72	0
46	CH	3366	0	3257	78	0
46	CJ	3366	0	3257	60	0
46	CL	3366	0	3257	83	0
46	CN	3366	0	3257	112	0
46	DB	3366	0	3255	117	0
46	DD	3366	0	3257	51	0
46	DF	3366	0	3257	62	0
46	DH	3366	0	3257	64	0
46	DJ	3366	0	3257	79	0
46	DL	3366	0	3257	82	0
46	DN	3366	0	3257	117	0
46	EB	3366	0	3257	124	0
46	ED	3366	0	3257	67	0
46	EF	3366	0	3257	59	0
46	EH	3366	0	3257	82	0
46	EJ	3366	0	3257	74	0
46	EL	3366	0	3257	86	0
46	EN	3366	0	3257	105	0
46	FB	3366	0	3257	120	0
46	FD	3366	0	3257	73	0
46	FF	3366	0	3257	75	0
46	FH	3366	0	3257	70	0
46	FJ	3366	0	3257	54	0
46	FL	3366	0	3257	76	0
46	FN	3366	0	3257	108	0

Continued on next page...

Continued from previous page...

Mol	Chain	Non-H	H(model)	H(added)	Clashes	Symm-Clashes
46	GB	3366	0	3257	118	0
46	GD	3366	0	3257	53	0
46	GF	3366	0	3257	52	0
46	GH	3366	0	3257	51	0
46	GJ	3366	0	3257	50	0
46	GL	3366	0	3257	76	0
46	GN	3366	0	3257	102	0
46	HB	3366	0	3257	92	0
46	HD	3366	0	3257	60	0
46	HF	3366	0	3257	75	0
46	HH	3366	0	3257	63	0
46	HJ	3366	0	3257	57	0
46	HL	3366	0	3257	54	0
46	HN	3366	0	3257	76	0
46	IB	3366	0	3257	98	0
46	ID	3366	0	3257	65	0
46	IF	3366	0	3257	50	0
46	IH	3366	0	3257	46	0
46	IJ	3366	0	3257	35	0
46	IL	3366	0	3257	64	0
46	IN	3366	0	3257	69	0
46	JB	3366	0	3257	77	0
46	JD	3366	0	3257	51	0
46	JF	3366	0	3257	56	0
46	JH	3366	0	3257	59	0
46	JJ	3366	0	3257	56	0
46	JL	3366	0	3257	47	0
46	JN	3366	0	3257	70	0
46	KB	3366	0	3257	68	0
46	KD	3366	0	3257	50	0
46	KF	3366	0	3257	67	0
46	KH	3366	0	3257	54	0
46	KJ	3366	0	3257	56	0
46	KL	3366	0	3257	47	0
46	KN	3366	0	3257	53	0
46	LB	3366	0	3257	85	0
46	LD	3366	0	3257	63	0
46	LF	3366	0	3257	64	0
46	LH	3366	0	3257	56	0
46	LJ	3366	0	3257	62	0
46	LL	3366	0	3257	68	0
46	LN	3366	0	3257	74	0

Continued on next page...

Continued from previous page...

Mol	Chain	Non-H	H(model)	H(added)	Clashes	Symm-Clashes
46	MB	3366	0	3257	84	0
46	MD	3366	0	3257	31	0
46	MF	3366	0	3257	71	0
46	MH	3366	0	3257	56	0
46	MJ	3366	0	3257	76	0
46	ML	3366	0	3257	64	0
46	MN	3366	0	3257	76	0
46	NB	3304	0	3197	86	0
46	ND	3366	0	3257	97	0
46	NF	3304	0	3197	65	0
46	NH	3366	0	3257	100	0
46	NJ	3304	0	3197	59	0
46	NL	3366	0	3257	75	0
46	NN	3304	0	3197	103	0
46	OB	3366	0	3257	123	0
46	OD	3366	0	3257	70	0
46	OF	3366	0	3257	72	0
46	OH	3366	0	3257	66	0
46	OJ	3366	0	3257	56	0
46	OL	3366	0	3257	70	0
46	ON	3366	0	3257	79	0
46	PB	3366	0	3257	106	0
46	PD	3366	0	3257	77	0
46	PF	3366	0	3257	57	0
46	PH	3366	0	3257	62	0
46	PJ	3366	0	3257	73	0
46	PL	3366	0	3257	54	0
46	PN	3366	0	3257	98	0
46	QB	3366	0	3257	86	0
46	QD	3366	0	3257	84	0
46	QF	3366	0	3257	75	0
46	QH	3366	0	3257	66	0
46	QJ	3366	0	3257	75	0
46	QL	3366	0	3257	100	0
46	QN	3366	0	3257	44	0
46	RB	3366	0	3257	103	0
46	RD	3366	0	3257	85	0
46	RF	3366	0	3257	89	0
46	RH	3366	0	3257	73	0
46	RJ	3366	0	3257	83	0
46	RL	3366	0	3257	99	0
46	RN	3366	0	3257	49	0

Continued on next page...

Continued from previous page...

Mol	Chain	Non-H	H(model)	H(added)	Clashes	Symm-Clashes
46	SB	3366	0	3257	90	0
46	SD	3366	0	3257	82	0
46	SF	3366	0	3257	66	0
46	SH	3366	0	3257	75	0
46	SJ	3366	0	3257	85	0
46	SL	3366	0	3257	99	0
46	SN	3366	0	3257	70	0
46	TB	3366	0	3257	100	0
46	TD	3366	0	3257	77	0
46	TF	3366	0	3257	76	0
46	TH	3366	0	3257	77	0
46	TJ	3366	0	3257	81	0
46	TL	3366	0	3257	97	0
46	TN	3366	0	3257	88	0
46	UB	3366	0	3257	102	0
46	UD	3366	0	3257	77	0
46	UF	3366	0	3257	65	0
46	UH	3366	0	3257	77	0
46	UJ	3366	0	3257	88	0
46	UL	3366	0	3257	69	0
46	UN	3366	0	3257	117	0
46	VB	3366	0	3257	84	0
46	VD	3366	0	3257	70	0
46	VF	3366	0	3257	66	0
46	VH	3366	0	3257	77	0
46	VJ	3366	0	3257	63	0
46	VL	3366	0	3257	91	0
46	VN	3366	0	3257	116	0
46	WB	3366	0	3257	77	0
46	WD	3366	0	3257	60	0
46	WF	3366	0	3257	45	0
46	WH	3366	0	3257	73	0
46	WJ	3366	0	3257	57	0
46	WL	3366	0	3257	66	0
46	WN	3366	0	3257	91	0
47	AA	32	0	12	2	0
47	AC	32	0	12	1	0
47	AE	32	0	12	0	0
47	AG	32	0	12	0	0
47	AI	32	0	12	0	0
47	AK	32	0	12	1	0
47	AM	32	0	12	2	0

Continued on next page...

Continued from previous page...

Mol	Chain	Non-H	H(model)	H(added)	Clashes	Symm-Clashes
47	BA	32	0	12	2	0
47	BC	32	0	12	0	0
47	BE	32	0	12	2	0
47	BG	32	0	12	0	0
47	BI	32	0	12	0	0
47	BK	32	0	12	2	0
47	BM	32	0	12	1	0
47	CA	32	0	12	4	0
47	CC	32	0	12	1	0
47	CE	32	0	12	2	0
47	CG	32	0	12	2	0
47	CI	32	0	12	3	0
47	CK	32	0	12	2	0
47	CM	32	0	12	1	0
47	DA	32	0	12	2	0
47	DC	32	0	12	1	0
47	DE	32	0	12	2	0
47	DG	32	0	12	1	0
47	DI	32	0	12	2	0
47	DK	32	0	12	2	0
47	DM	32	0	12	1	0
47	EA	32	0	12	3	0
47	EC	32	0	12	2	0
47	EE	32	0	12	1	0
47	EG	32	0	12	2	0
47	EI	32	0	12	2	0
47	EK	32	0	12	2	0
47	EM	32	0	12	2	0
47	FA	32	0	12	0	0
47	FC	32	0	12	1	0
47	FE	32	0	12	1	0
47	FG	32	0	12	0	0
47	FI	32	0	12	0	0
47	FK	32	0	12	1	0
47	FM	32	0	12	5	0
47	GA	32	0	12	3	0
47	GC	32	0	12	0	0
47	GE	32	0	12	0	0
47	GG	32	0	12	1	0
47	GI	32	0	12	0	0
47	GK	32	0	12	0	0
47	GM	32	0	12	3	0

Continued on next page...

Continued from previous page...

Mol	Chain	Non-H	H(model)	H(added)	Clashes	Symm-Clashes
47	HA	32	0	12	0	0
47	HC	32	0	12	2	0
47	HE	32	0	12	0	0
47	HG	32	0	12	0	0
47	HI	32	0	12	1	0
47	HK	32	0	12	1	0
47	HM	32	0	12	1	0
47	IA	32	0	12	0	0
47	IC	32	0	12	0	0
47	IE	32	0	12	0	0
47	IG	32	0	12	1	0
47	II	32	0	12	1	0
47	IK	32	0	12	0	0
47	IM	32	0	12	0	0
47	JA	32	0	12	2	0
47	JC	32	0	12	2	0
47	JE	32	0	12	0	0
47	JG	32	0	12	1	0
47	JI	32	0	12	2	0
47	JK	32	0	12	0	0
47	JM	32	0	12	5	0
47	KA	32	0	12	1	0
47	KC	32	0	12	0	0
47	KE	32	0	12	1	0
47	KG	32	0	12	1	0
47	KI	32	0	12	0	0
47	KK	32	0	12	0	0
47	KM	32	0	12	0	0
47	LA	32	0	12	3	0
47	LC	32	0	12	2	0
47	LE	32	0	12	0	0
47	LG	32	0	12	0	0
47	LI	32	0	12	2	0
47	LK	32	0	12	1	0
47	LM	32	0	12	2	0
47	MA	32	0	12	1	0
47	MC	32	0	12	0	0
47	ME	32	0	12	0	0
47	MG	32	0	12	0	0
47	MI	32	0	12	0	0
47	MK	32	0	12	0	0
47	MM	32	0	12	0	0

Continued on next page...

Continued from previous page...

Mol	Chain	Non-H	H(model)	H(added)	Clashes	Symm-Clashes
47	NA	32	0	12	2	0
47	NC	32	0	12	0	0
47	NE	32	0	12	2	0
47	NG	32	0	12	0	0
47	NI	32	0	12	3	0
47	NK	32	0	12	0	0
47	NM	32	0	12	1	0
47	OA	32	0	12	4	0
47	OC	32	0	12	0	0
47	OE	32	0	12	2	0
47	OG	32	0	12	1	0
47	OI	32	0	12	1	0
47	OK	32	0	12	1	0
47	OM	32	0	12	3	0
47	PA	32	0	12	3	0
47	PC	32	0	12	1	0
47	PE	32	0	12	3	0
47	PG	32	0	12	3	0
47	PI	32	0	12	4	0
47	PK	32	0	12	3	0
47	PM	32	0	12	1	0
47	QA	32	0	12	2	0
47	QC	32	0	12	3	0
47	QE	32	0	12	2	0
47	QG	32	0	12	2	0
47	QI	32	0	12	3	0
47	QK	32	0	12	2	0
47	QM	32	0	12	2	0
47	RA	32	0	12	1	0
47	RC	32	0	12	2	0
47	RE	32	0	12	2	0
47	RG	32	0	12	3	0
47	RI	32	0	12	3	0
47	RK	32	0	12	2	0
47	RM	32	0	12	0	0
47	SA	32	0	12	5	0
47	SC	32	0	12	1	0
47	SE	32	0	12	3	0
47	SG	32	0	12	1	0
47	SI	32	0	12	2	0
47	SK	32	0	12	1	0
47	SM	32	0	12	1	0

Continued on next page...

Continued from previous page...

Mol	Chain	Non-H	H(model)	H(added)	Clashes	Symm-Clashes
47	TA	32	0	12	1	0
47	TC	32	0	12	0	0
47	TE	32	0	12	0	0
47	TG	32	0	12	1	0
47	TI	32	0	12	1	0
47	TK	32	0	12	1	0
47	TM	32	0	12	0	0
47	UA	32	0	12	2	0
47	UC	32	0	12	2	0
47	UE	32	0	12	2	0
47	UG	32	0	12	2	0
47	UI	32	0	12	3	0
47	UK	32	0	12	4	0
47	UM	32	0	12	3	0
47	VA	32	0	12	2	0
47	VC	32	0	12	1	0
47	VE	32	0	12	0	0
47	VG	32	0	12	0	0
47	VI	32	0	12	1	0
47	VK	32	0	12	2	0
47	VM	32	0	12	3	0
47	WA	32	0	12	3	0
47	WC	32	0	12	0	0
47	WE	32	0	12	1	0
47	WG	32	0	12	1	0
47	WI	32	0	12	1	0
47	WK	32	0	12	2	0
47	WM	32	0	12	3	0
48	AA	1	0	0	0	0
48	AC	1	0	0	0	0
48	AE	1	0	0	0	0
48	AG	1	0	0	0	0
48	AI	1	0	0	0	0
48	AL	1	0	0	0	0
48	AM	1	0	0	0	0
48	BB	1	0	0	0	0
48	BC	1	0	0	0	0
48	BE	1	0	0	0	0
48	BG	1	0	0	0	0
48	BI	1	0	0	0	0
48	BK	1	0	0	0	0
48	BM	1	0	0	0	0

Continued on next page...

Continued from previous page...

Mol	Chain	Non-H	H(model)	H(added)	Clashes	Symm-Clashes
48	CA	1	0	0	0	0
48	CC	1	0	0	0	0
48	CE	1	0	0	0	0
48	CG	1	0	0	0	0
48	CI	1	0	0	0	0
48	CK	1	0	0	0	0
48	CM	1	0	0	0	0
48	DA	1	0	0	0	0
48	DC	1	0	0	0	0
48	DE	1	0	0	0	0
48	DG	1	0	0	0	0
48	DI	1	0	0	0	0
48	DK	1	0	0	0	0
48	DM	1	0	0	0	0
48	EA	1	0	0	0	0
48	EC	1	0	0	0	0
48	EE	1	0	0	0	0
48	EG	1	0	0	0	0
48	EI	1	0	0	0	0
48	EK	1	0	0	0	0
48	EM	1	0	0	0	0
48	FA	1	0	0	0	0
48	FC	1	0	0	0	0
48	FE	1	0	0	0	0
48	FG	1	0	0	0	0
48	FI	1	0	0	0	0
48	FK	1	0	0	0	0
48	FM	1	0	0	0	0
48	GB	1	0	0	0	0
48	GC	1	0	0	0	0
48	GE	1	0	0	0	0
48	GG	1	0	0	0	0
48	GI	1	0	0	0	0
48	GK	1	0	0	0	0
48	GM	1	0	0	0	0
48	HA	1	0	0	0	0
48	HC	1	0	0	0	0
48	HE	1	0	0	0	0
48	HG	1	0	0	0	0
48	HI	1	0	0	0	0
48	HK	1	0	0	0	0
48	HM	1	0	0	0	0

Continued on next page...

Continued from previous page...

Mol	Chain	Non-H	H(model)	H(added)	Clashes	Symm-Clashes
48	IA	1	0	0	0	0
48	IC	1	0	0	0	0
48	IE	1	0	0	0	0
48	IG	1	0	0	0	0
48	II	1	0	0	0	0
48	IK	1	0	0	0	0
48	IM	1	0	0	0	0
48	JA	1	0	0	0	0
48	JC	1	0	0	0	0
48	JE	1	0	0	0	0
48	JG	1	0	0	0	0
48	JI	1	0	0	0	0
48	JK	1	0	0	0	0
48	JM	1	0	0	0	0
48	KA	1	0	0	0	0
48	KC	1	0	0	0	0
48	KE	1	0	0	0	0
48	KG	1	0	0	0	0
48	KI	1	0	0	0	0
48	KK	1	0	0	0	0
48	KM	1	0	0	0	0
48	LA	1	0	0	0	0
48	LC	1	0	0	0	0
48	LE	1	0	0	0	0
48	LG	1	0	0	0	0
48	LI	1	0	0	0	0
48	LK	1	0	0	0	0
48	LM	1	0	0	0	0
48	MA	1	0	0	0	0
48	MC	1	0	0	0	0
48	ME	1	0	0	0	0
48	MG	1	0	0	0	0
48	MI	1	0	0	0	0
48	MK	1	0	0	0	0
48	MM	1	0	0	0	0
48	NB	1	0	0	0	0
48	NC	1	0	0	0	0
48	NE	1	0	0	0	0
48	NG	1	0	0	0	0
48	NI	1	0	0	0	0
48	NK	1	0	0	0	0
48	NM	1	0	0	0	0

Continued on next page...

Continued from previous page...

Mol	Chain	Non-H	H(model)	H(added)	Clashes	Symm-Clashes
48	OA	1	0	0	0	0
48	OC	1	0	0	0	0
48	OE	1	0	0	0	0
48	OG	1	0	0	0	0
48	OI	1	0	0	0	0
48	OK	1	0	0	0	0
48	OM	1	0	0	0	0
48	PA	1	0	0	0	0
48	PC	1	0	0	0	0
48	PE	1	0	0	0	0
48	PG	1	0	0	0	0
48	PI	1	0	0	0	0
48	PK	1	0	0	0	0
48	PM	1	0	0	0	0
48	QA	1	0	0	0	0
48	QC	1	0	0	0	0
48	QE	1	0	0	0	0
48	QG	1	0	0	0	0
48	QI	1	0	0	0	0
48	QK	1	0	0	0	0
48	QM	1	0	0	0	0
48	RA	1	0	0	0	0
48	RC	1	0	0	0	0
48	RE	1	0	0	0	0
48	RF	1	0	0	0	0
48	RI	1	0	0	0	0
48	RK	1	0	0	0	0
48	RM	1	0	0	0	0
48	SA	1	0	0	0	0
48	SB	1	0	0	0	0
48	SE	1	0	0	0	0
48	SG	1	0	0	0	0
48	SI	1	0	0	0	0
48	SK	1	0	0	0	0
48	SM	1	0	0	0	0
48	TA	1	0	0	0	0
48	TC	1	0	0	0	0
48	TE	1	0	0	0	0
48	TG	1	0	0	0	0
48	TI	1	0	0	0	0
48	TK	1	0	0	0	0
48	TM	1	0	0	0	0

Continued on next page...

Continued from previous page...

Mol	Chain	Non-H	H(model)	H(added)	Clashes	Symm-Clashes
48	UA	1	0	0	0	0
48	UC	1	0	0	0	0
48	UE	1	0	0	0	0
48	UG	1	0	0	0	0
48	UI	1	0	0	0	0
48	UK	1	0	0	0	0
48	UM	1	0	0	0	0
48	VA	1	0	0	0	0
48	VC	1	0	0	0	0
48	VE	1	0	0	0	0
48	VG	1	0	0	0	0
48	VI	1	0	0	0	0
48	VK	1	0	0	0	0
48	VM	1	0	0	0	0
48	WA	1	0	0	0	0
48	WC	1	0	0	0	0
48	WE	1	0	0	0	0
48	WG	1	0	0	0	0
48	WI	1	0	0	0	0
48	WK	1	0	0	0	0
48	WM	1	0	0	0	0
49	AB	28	0	12	0	0
49	AD	28	0	12	1	0
49	AF	28	0	12	1	0
49	AH	28	0	12	0	0
49	AJ	28	0	12	1	0
49	AL	28	0	12	0	0
49	AN	28	0	12	0	0
49	BB	28	0	12	0	0
49	BD	28	0	12	1	0
49	BF	28	0	12	2	0
49	BH	28	0	12	1	0
49	BJ	28	0	12	1	0
49	BL	28	0	12	0	0
49	BN	28	0	12	1	0
49	CB	28	0	12	3	0
49	CD	28	0	12	1	0
49	CF	28	0	12	5	0
49	CH	28	0	12	1	0
49	CJ	28	0	12	1	0
49	CL	28	0	12	1	0
49	CN	28	0	12	1	0

Continued on next page...

Continued from previous page...

Mol	Chain	Non-H	H(model)	H(added)	Clashes	Symm-Clashes
49	DB	28	0	12	1	0
49	DD	28	0	12	0	0
49	DF	28	0	12	0	0
49	DH	28	0	12	0	0
49	DJ	28	0	12	1	0
49	DL	28	0	12	0	0
49	DN	28	0	12	1	0
49	EB	28	0	12	2	0
49	ED	28	0	12	1	0
49	EF	28	0	12	0	0
49	EH	28	0	12	2	0
49	EJ	28	0	12	0	0
49	EL	28	0	12	0	0
49	EN	28	0	12	0	0
49	FB	28	0	12	0	0
49	FD	28	0	12	2	0
49	FF	28	0	12	0	0
49	FH	28	0	12	2	0
49	FJ	28	0	12	0	0
49	FL	28	0	12	0	0
49	FN	28	0	12	1	0
49	GB	28	0	12	0	0
49	GD	28	0	12	2	0
49	GF	28	0	12	2	0
49	GH	28	0	12	2	0
49	GJ	28	0	12	1	0
49	GL	28	0	12	1	0
49	GN	28	0	12	0	0
49	HB	28	0	12	0	0
49	HD	28	0	12	2	0
49	HF	28	0	12	1	0
49	HH	28	0	12	1	0
49	HJ	28	0	12	0	0
49	HL	28	0	12	3	0
49	HN	28	0	12	2	0
49	IB	28	0	12	0	0
49	ID	28	0	12	1	0
49	IF	28	0	12	1	0
49	IH	28	0	12	0	0
49	IJ	28	0	12	0	0
49	IL	28	0	12	0	0
49	IN	28	0	12	0	0

Continued on next page...

Continued from previous page...

Mol	Chain	Non-H	H(model)	H(added)	Clashes	Symm-Clashes
49	JB	28	0	12	0	0
49	JD	28	0	12	0	0
49	JF	28	0	12	2	0
49	JH	28	0	12	3	0
49	JJ	28	0	12	0	0
49	JL	28	0	12	0	0
49	JN	28	0	12	2	0
49	KB	28	0	12	0	0
49	KD	28	0	12	0	0
49	KF	28	0	12	0	0
49	KH	28	0	12	0	0
49	KJ	28	0	12	0	0
49	KL	28	0	12	0	0
49	KN	28	0	12	0	0
49	LB	28	0	12	0	0
49	LD	28	0	12	0	0
49	LF	28	0	12	1	0
49	LH	28	0	12	0	0
49	LJ	28	0	12	0	0
49	LL	28	0	12	0	0
49	LN	28	0	12	2	0
49	MB	28	0	12	0	0
49	MD	28	0	12	0	0
49	MF	28	0	12	1	0
49	MH	28	0	12	0	0
49	MJ	28	0	12	0	0
49	ML	28	0	12	0	0
49	MN	28	0	12	0	0
49	NB	28	0	12	1	0
49	ND	28	0	12	0	0
49	NF	28	0	12	0	0
49	NH	28	0	12	0	0
49	NJ	28	0	12	1	0
49	NL	28	0	12	2	0
49	NN	28	0	12	0	0
49	OB	28	0	12	2	0
49	OD	28	0	12	0	0
49	OF	28	0	12	1	0
49	OH	28	0	12	0	0
49	OJ	28	0	12	1	0
49	OL	28	0	12	1	0
49	ON	28	0	12	1	0

Continued on next page...

Continued from previous page...

Mol	Chain	Non-H	H(model)	H(added)	Clashes	Symm-Clashes
49	PB	28	0	12	1	0
49	PD	28	0	12	0	0
49	PF	28	0	12	1	0
49	PH	28	0	12	0	0
49	PJ	28	0	12	4	0
49	PL	28	0	12	1	0
49	PN	28	0	12	2	0
49	QB	28	0	12	2	0
49	QD	28	0	12	0	0
49	QF	28	0	12	3	0
49	QH	28	0	12	1	0
49	QJ	28	0	12	1	0
49	QL	28	0	12	0	0
49	QN	28	0	12	0	0
49	RB	28	0	12	0	0
49	RD	28	0	12	1	0
49	RF	28	0	12	0	0
49	RH	28	0	12	0	0
49	RJ	28	0	12	0	0
49	RL	28	0	12	0	0
49	RN	28	0	12	0	0
49	SB	28	0	12	0	0
49	SD	28	0	12	0	0
49	SF	28	0	12	0	0
49	SH	28	0	12	0	0
49	SJ	28	0	12	0	0
49	SL	28	0	12	0	0
49	SN	28	0	12	2	0
49	TB	28	0	12	0	0
49	TD	28	0	12	1	0
49	TF	28	0	12	1	0
49	TH	28	0	12	1	0
49	TJ	28	0	12	0	0
49	TL	28	0	12	1	0
49	TN	28	0	12	1	0
49	UB	28	0	12	0	0
49	UD	28	0	12	0	0
49	UF	28	0	12	3	0
49	UH	28	0	12	2	0
49	UJ	28	0	12	1	0
49	UL	28	0	12	0	0
49	UN	28	0	12	0	0

Continued on next page...

Continued from previous page...

Mol	Chain	Non-H	H(model)	H(added)	Clashes	Symm-Clashes
49	VB	28	0	12	1	0
49	VD	28	0	12	2	0
49	VF	28	0	12	4	0
49	VH	28	0	12	2	0
49	VJ	28	0	12	1	0
49	VL	28	0	12	3	0
49	VN	28	0	12	0	0
49	WB	28	0	12	0	0
49	WD	28	0	12	1	0
49	WF	28	0	12	1	0
49	WH	28	0	12	1	0
49	WJ	28	0	12	2	0
49	WL	28	0	12	2	0
49	WN	28	0	12	1	0
All	All	1324599	0	1283181	24056	0

The all-atom clashscore is defined as the number of clashes found per 1000 atoms (including hydrogen atoms). The all-atom clashscore for this structure is 9.

The worst 5 of 24056 close contacts within the same asymmetric unit are listed below, sorted by their clash magnitude.

Atom-1	Atom-2	Interatomic distance (Å)	Clash overlap (Å)
14:1V:122:LYS:HE2	46:LL:390:ARG:HH12	1.30	0.97
15:3X:49:ILE:HD11	45:MM:282:TYR:HD2	1.30	0.95
46:NH:391:ARG:HE	46:NH:393:ALA:HB3	1.33	0.94
21:2L:544:LYS:HA	21:2L:578:ASN:HD22	1.33	0.94
45:CA:261:PRO:HD2	45:CA:262:TYR:H	1.32	0.94

There are no symmetry-related clashes.

5.3 Torsion angles [i](#)

5.3.1 Protein backbone [i](#)

In the following table, the Percentiles column shows the percent Ramachandran outliers of the chain as a percentile score with respect to all PDB entries followed by that with respect to all EM entries.

The Analysed column shows the number of residues for which the backbone conformation was analysed, and the total number of residues.

Mol	Chain	Analysed	Favoured	Allowed	Outliers	Percentiles	
1	0A	150/236 (64%)	112 (75%)	31 (21%)	7 (5%)	2	19
1	1A	150/236 (64%)	115 (77%)	28 (19%)	7 (5%)	2	19
1	2A	150/236 (64%)	118 (79%)	27 (18%)	5 (3%)	3	26
1	3A	150/236 (64%)	114 (76%)	31 (21%)	5 (3%)	3	26
2	0B	317/329 (96%)	256 (81%)	56 (18%)	5 (2%)	8	37
3	0C	93/156 (60%)	77 (83%)	13 (14%)	3 (3%)	3	27
3	1C	93/156 (60%)	74 (80%)	14 (15%)	5 (5%)	1	17
4	0D	198/225 (88%)	145 (73%)	43 (22%)	10 (5%)	1	18
4	1D	198/225 (88%)	145 (73%)	43 (22%)	10 (5%)	1	18
4	2D	198/225 (88%)	143 (72%)	46 (23%)	9 (4%)	2	19
5	0E	187/191 (98%)	172 (92%)	13 (7%)	2 (1%)	12	43
5	1E	187/191 (98%)	174 (93%)	12 (6%)	1 (0%)	25	57
5	2E	187/191 (98%)	174 (93%)	11 (6%)	2 (1%)	12	43
5	3E	187/191 (98%)	177 (95%)	8 (4%)	2 (1%)	12	43
6	0F	202/219 (92%)	159 (79%)	35 (17%)	8 (4%)	2	22
7	0G	162/183 (88%)	121 (75%)	36 (22%)	5 (3%)	3	27
7	1G	127/183 (69%)	97 (76%)	26 (20%)	4 (3%)	3	27
8	0H	114/447 (26%)	105 (92%)	8 (7%)	1 (1%)	14	47
8	1H	420/447 (94%)	404 (96%)	14 (3%)	2 (0%)	25	57
9	0N	278/492 (56%)	265 (95%)	13 (5%)	0	100	100
9	1N	457/492 (93%)	441 (96%)	15 (3%)	1 (0%)	44	72
9	2N	278/492 (56%)	271 (98%)	7 (2%)	0	100	100
10	0Q	184/195 (94%)	173 (94%)	11 (6%)	0	100	100
10	1Q	184/195 (94%)	173 (94%)	11 (6%)	0	100	100
10	2Q	184/195 (94%)	172 (94%)	12 (6%)	0	100	100
10	3Q	184/195 (94%)	172 (94%)	12 (6%)	0	100	100
10	4Q	184/195 (94%)	170 (92%)	14 (8%)	0	100	100
10	5Q	184/195 (94%)	172 (94%)	12 (6%)	0	100	100
10	6Q	184/195 (94%)	170 (92%)	14 (8%)	0	100	100
11	0S	284/319 (89%)	268 (94%)	15 (5%)	1 (0%)	30	62
11	1S	284/319 (89%)	262 (92%)	21 (7%)	1 (0%)	30	62
11	2S	284/319 (89%)	266 (94%)	18 (6%)	0	100	100

Continued on next page...

Continued from previous page...

Mol	Chain	Analysed	Favoured	Allowed	Outliers	Percentiles	
11	3S	284/319 (89%)	266 (94%)	18 (6%)	0	100	100
12	0T	245/298 (82%)	226 (92%)	19 (8%)	0	100	100
12	1T	283/298 (95%)	266 (94%)	17 (6%)	0	100	100
12	2T	283/298 (95%)	257 (91%)	26 (9%)	0	100	100
12	3T	283/298 (95%)	260 (92%)	23 (8%)	0	100	100
13	0U	605/656 (92%)	555 (92%)	50 (8%)	0	100	100
13	1U	605/656 (92%)	548 (91%)	57 (9%)	0	100	100
13	2U	605/656 (92%)	545 (90%)	60 (10%)	0	100	100
13	3U	605/656 (92%)	545 (90%)	60 (10%)	0	100	100
14	0V	203/269 (76%)	178 (88%)	24 (12%)	1 (0%)	25	57
14	1V	259/269 (96%)	223 (86%)	33 (13%)	3 (1%)	11	41
14	2V	259/269 (96%)	223 (86%)	33 (13%)	3 (1%)	11	41
14	3V	259/269 (96%)	225 (87%)	29 (11%)	5 (2%)	6	35
15	0X	104/142 (73%)	100 (96%)	4 (4%)	0	100	100
15	1X	139/142 (98%)	132 (95%)	6 (4%)	1 (1%)	19	51
15	2X	139/142 (98%)	133 (96%)	5 (4%)	1 (1%)	19	51
15	3X	139/142 (98%)	135 (97%)	3 (2%)	1 (1%)	19	51
15	4X	139/142 (98%)	131 (94%)	7 (5%)	1 (1%)	19	51
16	1B	496/498 (100%)	466 (94%)	27 (5%)	3 (1%)	22	54
16	2B	293/498 (59%)	270 (92%)	22 (8%)	1 (0%)	37	67
16	3B	295/498 (59%)	273 (92%)	22 (8%)	0	100	100
17	1F	132/173 (76%)	120 (91%)	8 (6%)	4 (3%)	3	27
18	1I	182/263 (69%)	151 (83%)	28 (15%)	3 (2%)	8	37
19	1J	364/422 (86%)	316 (87%)	40 (11%)	8 (2%)	5	32
20	1K	271/489 (55%)	267 (98%)	4 (2%)	0	100	100
20	2K	280/489 (57%)	277 (99%)	3 (1%)	0	100	100
21	1L	808/940 (86%)	711 (88%)	90 (11%)	7 (1%)	14	47
21	2L	610/940 (65%)	553 (91%)	54 (9%)	3 (0%)	25	57
21	3L	198/940 (21%)	176 (89%)	18 (9%)	4 (2%)	6	34
22	1M	367/372 (99%)	345 (94%)	21 (6%)	1 (0%)	37	67
22	2M	367/372 (99%)	351 (96%)	15 (4%)	1 (0%)	37	67

Continued on next page...

Continued from previous page...

Mol	Chain	Analysed	Favoured	Allowed	Outliers	Percentiles	
23	1O	229/494 (46%)	225 (98%)	4 (2%)	0	100	100
23	2O	368/494 (74%)	363 (99%)	5 (1%)	0	100	100
23	3O	271/494 (55%)	271 (100%)	0	0	100	100
24	1P	349/507 (69%)	347 (99%)	2 (1%)	0	100	100
24	2P	184/507 (36%)	184 (100%)	0	0	100	100
25	1R	502/516 (97%)	474 (94%)	27 (5%)	1 (0%)	44	72
25	2R	502/516 (97%)	480 (96%)	20 (4%)	2 (0%)	30	62
25	3R	502/516 (97%)	478 (95%)	23 (5%)	1 (0%)	44	72
26	1W	218/280 (78%)	213 (98%)	5 (2%)	0	100	100
26	2W	109/280 (39%)	100 (92%)	8 (7%)	1 (1%)	14	47
27	2C	298/300 (99%)	279 (94%)	17 (6%)	2 (1%)	19	51
27	3C	298/300 (99%)	275 (92%)	22 (7%)	1 (0%)	37	67
27	4C	298/300 (99%)	278 (93%)	20 (7%)	0	100	100
28	2F	85/96 (88%)	72 (85%)	13 (15%)	0	100	100
29	2G	97/99 (98%)	91 (94%)	6 (6%)	0	100	100
30	2H	59/229 (26%)	50 (85%)	8 (14%)	1 (2%)	7	36
30	3H	59/229 (26%)	52 (88%)	5 (8%)	2 (3%)	3	26
30	4H	59/229 (26%)	50 (85%)	8 (14%)	1 (2%)	7	36
31	2I	134/293 (46%)	113 (84%)	18 (13%)	3 (2%)	5	32
31	3I	83/293 (28%)	70 (84%)	10 (12%)	3 (4%)	3	24
32	3D	235/237 (99%)	225 (96%)	10 (4%)	0	100	100
33	4F	194/276 (70%)	173 (89%)	19 (10%)	2 (1%)	13	44
34	4R	607/613 (99%)	584 (96%)	23 (4%)	0	100	100
34	5R	607/613 (99%)	580 (96%)	27 (4%)	0	100	100
34	6R	607/613 (99%)	583 (96%)	24 (4%)	0	100	100
34	7R	607/613 (99%)	590 (97%)	17 (3%)	0	100	100
35	4S	186/249 (75%)	180 (97%)	6 (3%)	0	100	100
35	5S	186/249 (75%)	181 (97%)	5 (3%)	0	100	100
36	5A	155/175 (89%)	131 (84%)	24 (16%)	0	100	100
36	5B	155/175 (89%)	126 (81%)	29 (19%)	0	100	100
36	5C	155/175 (89%)	127 (82%)	27 (17%)	1 (1%)	22	54

Continued on next page...

Continued from previous page...

Mol	Chain	Analysed	Favoured	Allowed	Outliers	Percentiles	
36	5D	107/175 (61%)	88 (82%)	18 (17%)	1 (1%)	14	47
37	5E	183/247 (74%)	156 (85%)	24 (13%)	3 (2%)	8	37
37	5F	208/247 (84%)	168 (81%)	38 (18%)	2 (1%)	13	44
37	5G	208/247 (84%)	173 (83%)	33 (16%)	2 (1%)	13	44
37	5H	136/247 (55%)	113 (83%)	22 (16%)	1 (1%)	19	51
39	6F	130/145 (90%)	112 (86%)	17 (13%)	1 (1%)	16	49
40	6G	210/364 (58%)	184 (88%)	25 (12%)	1 (0%)	25	57
41	6H	151/518 (29%)	115 (76%)	32 (21%)	4 (3%)	4	29
44	8R	178/361 (49%)	176 (99%)	2 (1%)	0	100	100
45	AA	437/449 (97%)	423 (97%)	14 (3%)	0	100	100
45	AC	437/449 (97%)	428 (98%)	9 (2%)	0	100	100
45	AE	437/449 (97%)	428 (98%)	9 (2%)	0	100	100
45	AG	437/449 (97%)	423 (97%)	14 (3%)	0	100	100
45	AI	437/449 (97%)	425 (97%)	12 (3%)	0	100	100
45	AK	437/449 (97%)	428 (98%)	9 (2%)	0	100	100
45	AM	437/449 (97%)	430 (98%)	7 (2%)	0	100	100
45	BA	428/449 (95%)	418 (98%)	10 (2%)	0	100	100
45	BC	428/449 (95%)	418 (98%)	10 (2%)	0	100	100
45	BE	428/449 (95%)	415 (97%)	13 (3%)	0	100	100
45	BG	428/449 (95%)	416 (97%)	12 (3%)	0	100	100
45	BI	428/449 (95%)	418 (98%)	10 (2%)	0	100	100
45	BK	428/449 (95%)	417 (97%)	11 (3%)	0	100	100
45	BM	428/449 (95%)	414 (97%)	14 (3%)	0	100	100
45	CA	437/449 (97%)	423 (97%)	14 (3%)	0	100	100
45	CC	437/449 (97%)	428 (98%)	9 (2%)	0	100	100
45	CE	437/449 (97%)	429 (98%)	8 (2%)	0	100	100
45	CG	437/449 (97%)	429 (98%)	8 (2%)	0	100	100
45	CI	437/449 (97%)	426 (98%)	11 (2%)	0	100	100
45	CK	437/449 (97%)	429 (98%)	8 (2%)	0	100	100
45	CM	437/449 (97%)	424 (97%)	13 (3%)	0	100	100
45	DA	429/449 (96%)	416 (97%)	13 (3%)	0	100	100

Continued on next page...

Continued from previous page...

Mol	Chain	Analysed	Favoured	Allowed	Outliers	Percentiles	
45	DC	432/449 (96%)	420 (97%)	11 (2%)	1 (0%)	44	72
45	DE	429/449 (96%)	415 (97%)	14 (3%)	0	100	100
45	DG	432/449 (96%)	420 (97%)	11 (2%)	1 (0%)	44	72
45	DI	429/449 (96%)	419 (98%)	10 (2%)	0	100	100
45	DK	432/449 (96%)	422 (98%)	10 (2%)	0	100	100
45	DM	429/449 (96%)	421 (98%)	8 (2%)	0	100	100
45	EA	437/449 (97%)	418 (96%)	19 (4%)	0	100	100
45	EC	437/449 (97%)	422 (97%)	15 (3%)	0	100	100
45	EE	437/449 (97%)	423 (97%)	13 (3%)	1 (0%)	44	72
45	EG	437/449 (97%)	430 (98%)	7 (2%)	0	100	100
45	EI	437/449 (97%)	418 (96%)	18 (4%)	1 (0%)	44	72
45	EK	437/449 (97%)	425 (97%)	12 (3%)	0	100	100
45	EM	437/449 (97%)	425 (97%)	12 (3%)	0	100	100
45	FA	425/449 (95%)	412 (97%)	13 (3%)	0	100	100
45	FC	428/449 (95%)	417 (97%)	11 (3%)	0	100	100
45	FE	430/449 (96%)	419 (97%)	11 (3%)	0	100	100
45	FG	437/449 (97%)	424 (97%)	12 (3%)	1 (0%)	44	72
45	FI	429/449 (96%)	416 (97%)	13 (3%)	0	100	100
45	FK	428/449 (95%)	418 (98%)	10 (2%)	0	100	100
45	FM	425/449 (95%)	420 (99%)	5 (1%)	0	100	100
45	GA	425/449 (95%)	412 (97%)	13 (3%)	0	100	100
45	GC	427/449 (95%)	417 (98%)	10 (2%)	0	100	100
45	GE	427/449 (95%)	417 (98%)	10 (2%)	0	100	100
45	GG	427/449 (95%)	417 (98%)	10 (2%)	0	100	100
45	GI	427/449 (95%)	413 (97%)	14 (3%)	0	100	100
45	GK	437/449 (97%)	423 (97%)	14 (3%)	0	100	100
45	GM	425/449 (95%)	411 (97%)	14 (3%)	0	100	100
45	HA	427/449 (95%)	417 (98%)	10 (2%)	0	100	100
45	HC	427/449 (95%)	418 (98%)	9 (2%)	0	100	100
45	HE	427/449 (95%)	420 (98%)	7 (2%)	0	100	100
45	HG	427/449 (95%)	414 (97%)	13 (3%)	0	100	100

Continued on next page...

Continued from previous page...

Mol	Chain	Analysed	Favoured	Allowed	Outliers	Percentiles	
45	HI	427/449 (95%)	410 (96%)	17 (4%)	0	100	100
45	HK	427/449 (95%)	416 (97%)	11 (3%)	0	100	100
45	HM	427/449 (95%)	417 (98%)	10 (2%)	0	100	100
45	IA	428/449 (95%)	415 (97%)	13 (3%)	0	100	100
45	IC	437/449 (97%)	427 (98%)	10 (2%)	0	100	100
45	IE	428/449 (95%)	416 (97%)	12 (3%)	0	100	100
45	IG	437/449 (97%)	426 (98%)	11 (2%)	0	100	100
45	II	437/449 (97%)	422 (97%)	15 (3%)	0	100	100
45	IK	428/449 (95%)	415 (97%)	13 (3%)	0	100	100
45	IM	428/449 (95%)	417 (97%)	11 (3%)	0	100	100
45	JA	428/449 (95%)	421 (98%)	7 (2%)	0	100	100
45	JC	430/449 (96%)	422 (98%)	8 (2%)	0	100	100
45	JE	437/449 (97%)	422 (97%)	15 (3%)	0	100	100
45	JG	437/449 (97%)	420 (96%)	17 (4%)	0	100	100
45	JI	437/449 (97%)	419 (96%)	17 (4%)	1 (0%)	44	72
45	JK	437/449 (97%)	427 (98%)	10 (2%)	0	100	100
45	JM	428/449 (95%)	419 (98%)	9 (2%)	0	100	100
45	KA	430/449 (96%)	418 (97%)	12 (3%)	0	100	100
45	KC	429/449 (96%)	419 (98%)	10 (2%)	0	100	100
45	KE	431/449 (96%)	416 (96%)	15 (4%)	0	100	100
45	KG	437/449 (97%)	423 (97%)	14 (3%)	0	100	100
45	KI	437/449 (97%)	420 (96%)	17 (4%)	0	100	100
45	KK	437/449 (97%)	418 (96%)	19 (4%)	0	100	100
45	KM	430/449 (96%)	416 (97%)	13 (3%)	1 (0%)	44	72
45	LA	437/449 (97%)	423 (97%)	12 (3%)	2 (0%)	25	57
45	LC	437/449 (97%)	420 (96%)	17 (4%)	0	100	100
45	LE	434/449 (97%)	420 (97%)	14 (3%)	0	100	100
45	LG	437/449 (97%)	419 (96%)	18 (4%)	0	100	100
45	LI	430/449 (96%)	414 (96%)	16 (4%)	0	100	100
45	LK	437/449 (97%)	422 (97%)	15 (3%)	0	100	100
45	LM	437/449 (97%)	425 (97%)	10 (2%)	2 (0%)	25	57

Continued on next page...

Continued from previous page...

Mol	Chain	Analysed	Favoured	Allowed	Outliers	Percentiles	
45	MA	432/449 (96%)	416 (96%)	16 (4%)	0	100	100
45	MC	429/449 (96%)	422 (98%)	7 (2%)	0	100	100
45	ME	429/449 (96%)	413 (96%)	15 (4%)	1 (0%)	44	72
45	MG	433/449 (96%)	420 (97%)	13 (3%)	0	100	100
45	MI	437/449 (97%)	423 (97%)	14 (3%)	0	100	100
45	MK	432/449 (96%)	418 (97%)	14 (3%)	0	100	100
45	MM	432/449 (96%)	417 (96%)	15 (4%)	0	100	100
45	NA	437/449 (97%)	421 (96%)	15 (3%)	1 (0%)	44	72
45	NC	428/449 (95%)	414 (97%)	14 (3%)	0	100	100
45	NE	437/449 (97%)	425 (97%)	10 (2%)	2 (0%)	25	57
45	NG	428/449 (95%)	417 (97%)	11 (3%)	0	100	100
45	NI	437/449 (97%)	422 (97%)	14 (3%)	1 (0%)	44	72
45	NK	428/449 (95%)	411 (96%)	17 (4%)	0	100	100
45	NM	437/449 (97%)	424 (97%)	12 (3%)	1 (0%)	44	72
45	OA	429/449 (96%)	415 (97%)	14 (3%)	0	100	100
45	OC	429/449 (96%)	417 (97%)	12 (3%)	0	100	100
45	OE	429/449 (96%)	421 (98%)	8 (2%)	0	100	100
45	OG	429/449 (96%)	423 (99%)	6 (1%)	0	100	100
45	OI	429/449 (96%)	419 (98%)	10 (2%)	0	100	100
45	OK	429/449 (96%)	417 (97%)	12 (3%)	0	100	100
45	OM	429/449 (96%)	413 (96%)	16 (4%)	0	100	100
45	PA	425/449 (95%)	416 (98%)	9 (2%)	0	100	100
45	PC	425/449 (95%)	415 (98%)	10 (2%)	0	100	100
45	PE	425/449 (95%)	415 (98%)	10 (2%)	0	100	100
45	PG	425/449 (95%)	412 (97%)	13 (3%)	0	100	100
45	PI	425/449 (95%)	415 (98%)	10 (2%)	0	100	100
45	PK	425/449 (95%)	416 (98%)	9 (2%)	0	100	100
45	PM	425/449 (95%)	417 (98%)	8 (2%)	0	100	100
45	QA	427/449 (95%)	411 (96%)	16 (4%)	0	100	100
45	QC	427/449 (95%)	418 (98%)	9 (2%)	0	100	100
45	QE	427/449 (95%)	420 (98%)	7 (2%)	0	100	100

Continued on next page...

Continued from previous page...

Mol	Chain	Analysed	Favoured	Allowed	Outliers	Percentiles	
45	QG	427/449 (95%)	419 (98%)	8 (2%)	0	100	100
45	QI	427/449 (95%)	418 (98%)	9 (2%)	0	100	100
45	QK	427/449 (95%)	420 (98%)	7 (2%)	0	100	100
45	QM	427/449 (95%)	414 (97%)	13 (3%)	0	100	100
45	RA	427/449 (95%)	421 (99%)	6 (1%)	0	100	100
45	RC	427/449 (95%)	414 (97%)	13 (3%)	0	100	100
45	RE	427/449 (95%)	412 (96%)	15 (4%)	0	100	100
45	RG	427/449 (95%)	412 (96%)	15 (4%)	0	100	100
45	RI	427/449 (95%)	416 (97%)	11 (3%)	0	100	100
45	RK	427/449 (95%)	416 (97%)	11 (3%)	0	100	100
45	RM	427/449 (95%)	417 (98%)	10 (2%)	0	100	100
45	SA	426/449 (95%)	416 (98%)	10 (2%)	0	100	100
45	SC	426/449 (95%)	412 (97%)	14 (3%)	0	100	100
45	SE	426/449 (95%)	412 (97%)	14 (3%)	0	100	100
45	SG	426/449 (95%)	408 (96%)	18 (4%)	0	100	100
45	SI	426/449 (95%)	413 (97%)	13 (3%)	0	100	100
45	SK	426/449 (95%)	414 (97%)	12 (3%)	0	100	100
45	SM	426/449 (95%)	414 (97%)	12 (3%)	0	100	100
45	TA	426/449 (95%)	414 (97%)	12 (3%)	0	100	100
45	TC	426/449 (95%)	416 (98%)	10 (2%)	0	100	100
45	TE	426/449 (95%)	414 (97%)	12 (3%)	0	100	100
45	TG	426/449 (95%)	418 (98%)	8 (2%)	0	100	100
45	TI	426/449 (95%)	412 (97%)	14 (3%)	0	100	100
45	TK	426/449 (95%)	412 (97%)	14 (3%)	0	100	100
45	TM	426/449 (95%)	417 (98%)	9 (2%)	0	100	100
45	UA	427/449 (95%)	417 (98%)	10 (2%)	0	100	100
45	UC	427/449 (95%)	414 (97%)	13 (3%)	0	100	100
45	UE	427/449 (95%)	415 (97%)	12 (3%)	0	100	100
45	UG	427/449 (95%)	418 (98%)	9 (2%)	0	100	100
45	UI	427/449 (95%)	417 (98%)	10 (2%)	0	100	100
45	UK	427/449 (95%)	416 (97%)	11 (3%)	0	100	100

Continued on next page...

Continued from previous page...

Mol	Chain	Analysed	Favoured	Allowed	Outliers	Percentiles	
45	UM	427/449 (95%)	412 (96%)	15 (4%)	0	100	100
45	VA	429/449 (96%)	418 (97%)	11 (3%)	0	100	100
45	VC	437/449 (97%)	421 (96%)	16 (4%)	0	100	100
45	VE	429/449 (96%)	417 (97%)	12 (3%)	0	100	100
45	VG	437/449 (97%)	426 (98%)	11 (2%)	0	100	100
45	VI	429/449 (96%)	417 (97%)	12 (3%)	0	100	100
45	VK	437/449 (97%)	425 (97%)	12 (3%)	0	100	100
45	VM	429/449 (96%)	418 (97%)	11 (3%)	0	100	100
45	WA	427/449 (95%)	414 (97%)	13 (3%)	0	100	100
45	WC	437/449 (97%)	424 (97%)	12 (3%)	1 (0%)	44	72
45	WE	427/449 (95%)	416 (97%)	11 (3%)	0	100	100
45	WG	437/449 (97%)	421 (96%)	15 (3%)	1 (0%)	44	72
45	WI	427/449 (95%)	412 (96%)	15 (4%)	0	100	100
45	WK	437/449 (97%)	419 (96%)	17 (4%)	1 (0%)	44	72
45	WM	427/449 (95%)	416 (97%)	11 (3%)	0	100	100
46	AB	428/443 (97%)	418 (98%)	10 (2%)	0	100	100
46	AD	428/443 (97%)	421 (98%)	7 (2%)	0	100	100
46	AF	428/443 (97%)	417 (97%)	11 (3%)	0	100	100
46	AH	428/443 (97%)	421 (98%)	7 (2%)	0	100	100
46	AJ	428/443 (97%)	417 (97%)	11 (3%)	0	100	100
46	AL	428/443 (97%)	418 (98%)	10 (2%)	0	100	100
46	AN	428/443 (97%)	421 (98%)	7 (2%)	0	100	100
46	BB	416/443 (94%)	408 (98%)	8 (2%)	0	100	100
46	BD	428/443 (97%)	413 (96%)	15 (4%)	0	100	100
46	BF	428/443 (97%)	414 (97%)	14 (3%)	0	100	100
46	BH	428/443 (97%)	415 (97%)	13 (3%)	0	100	100
46	BJ	428/443 (97%)	416 (97%)	12 (3%)	0	100	100
46	BL	428/443 (97%)	416 (97%)	12 (3%)	0	100	100
46	BN	428/443 (97%)	416 (97%)	12 (3%)	0	100	100
46	CB	428/443 (97%)	415 (97%)	13 (3%)	0	100	100
46	CD	428/443 (97%)	421 (98%)	7 (2%)	0	100	100

Continued on next page...

Continued from previous page...

Mol	Chain	Analysed	Favoured	Allowed	Outliers	Percentiles	
46	CF	428/443 (97%)	415 (97%)	13 (3%)	0	100	100
46	CH	428/443 (97%)	419 (98%)	9 (2%)	0	100	100
46	CJ	428/443 (97%)	416 (97%)	12 (3%)	0	100	100
46	CL	428/443 (97%)	419 (98%)	9 (2%)	0	100	100
46	CN	428/443 (97%)	415 (97%)	13 (3%)	0	100	100
46	DB	428/443 (97%)	415 (97%)	13 (3%)	0	100	100
46	DD	428/443 (97%)	419 (98%)	9 (2%)	0	100	100
46	DF	428/443 (97%)	415 (97%)	13 (3%)	0	100	100
46	DH	428/443 (97%)	417 (97%)	11 (3%)	0	100	100
46	DJ	428/443 (97%)	415 (97%)	13 (3%)	0	100	100
46	DL	428/443 (97%)	417 (97%)	11 (3%)	0	100	100
46	DN	428/443 (97%)	417 (97%)	11 (3%)	0	100	100
46	EB	428/443 (97%)	413 (96%)	15 (4%)	0	100	100
46	ED	428/443 (97%)	421 (98%)	7 (2%)	0	100	100
46	EF	428/443 (97%)	415 (97%)	13 (3%)	0	100	100
46	EH	428/443 (97%)	413 (96%)	15 (4%)	0	100	100
46	EJ	428/443 (97%)	414 (97%)	14 (3%)	0	100	100
46	EL	428/443 (97%)	421 (98%)	7 (2%)	0	100	100
46	EN	428/443 (97%)	416 (97%)	12 (3%)	0	100	100
46	FB	428/443 (97%)	415 (97%)	13 (3%)	0	100	100
46	FD	428/443 (97%)	417 (97%)	11 (3%)	0	100	100
46	FF	428/443 (97%)	420 (98%)	8 (2%)	0	100	100
46	FH	428/443 (97%)	418 (98%)	10 (2%)	0	100	100
46	FJ	428/443 (97%)	414 (97%)	14 (3%)	0	100	100
46	FL	428/443 (97%)	413 (96%)	15 (4%)	0	100	100
46	FN	428/443 (97%)	418 (98%)	10 (2%)	0	100	100
46	GB	428/443 (97%)	416 (97%)	12 (3%)	0	100	100
46	GD	428/443 (97%)	419 (98%)	9 (2%)	0	100	100
46	GF	428/443 (97%)	414 (97%)	14 (3%)	0	100	100
46	GH	428/443 (97%)	416 (97%)	12 (3%)	0	100	100
46	GJ	428/443 (97%)	417 (97%)	11 (3%)	0	100	100

Continued on next page...

Continued from previous page...

Mol	Chain	Analysed	Favoured	Allowed	Outliers	Percentiles	
46	GL	428/443 (97%)	415 (97%)	13 (3%)	0	100	100
46	GN	428/443 (97%)	415 (97%)	13 (3%)	0	100	100
46	HB	428/443 (97%)	421 (98%)	7 (2%)	0	100	100
46	HD	428/443 (97%)	425 (99%)	3 (1%)	0	100	100
46	HF	428/443 (97%)	413 (96%)	15 (4%)	0	100	100
46	HH	428/443 (97%)	415 (97%)	13 (3%)	0	100	100
46	HJ	428/443 (97%)	416 (97%)	12 (3%)	0	100	100
46	HL	428/443 (97%)	421 (98%)	7 (2%)	0	100	100
46	HN	428/443 (97%)	417 (97%)	11 (3%)	0	100	100
46	IB	428/443 (97%)	413 (96%)	15 (4%)	0	100	100
46	ID	428/443 (97%)	415 (97%)	13 (3%)	0	100	100
46	IF	428/443 (97%)	415 (97%)	13 (3%)	0	100	100
46	IH	428/443 (97%)	421 (98%)	7 (2%)	0	100	100
46	IJ	428/443 (97%)	419 (98%)	9 (2%)	0	100	100
46	IL	428/443 (97%)	419 (98%)	9 (2%)	0	100	100
46	IN	428/443 (97%)	418 (98%)	10 (2%)	0	100	100
46	JB	428/443 (97%)	416 (97%)	12 (3%)	0	100	100
46	JD	428/443 (97%)	419 (98%)	9 (2%)	0	100	100
46	JF	428/443 (97%)	420 (98%)	8 (2%)	0	100	100
46	JH	428/443 (97%)	414 (97%)	14 (3%)	0	100	100
46	JJ	428/443 (97%)	412 (96%)	16 (4%)	0	100	100
46	JL	428/443 (97%)	414 (97%)	14 (3%)	0	100	100
46	JN	428/443 (97%)	418 (98%)	10 (2%)	0	100	100
46	KB	428/443 (97%)	415 (97%)	13 (3%)	0	100	100
46	KD	428/443 (97%)	422 (99%)	6 (1%)	0	100	100
46	KF	428/443 (97%)	414 (97%)	14 (3%)	0	100	100
46	KH	428/443 (97%)	419 (98%)	9 (2%)	0	100	100
46	KJ	428/443 (97%)	419 (98%)	9 (2%)	0	100	100
46	KL	428/443 (97%)	419 (98%)	9 (2%)	0	100	100
46	KN	428/443 (97%)	413 (96%)	15 (4%)	0	100	100
46	LB	428/443 (97%)	419 (98%)	9 (2%)	0	100	100

Continued on next page...

Continued from previous page...

Mol	Chain	Analysed	Favoured	Allowed	Outliers	Percentiles	
46	LD	428/443 (97%)	417 (97%)	11 (3%)	0	100	100
46	LF	428/443 (97%)	417 (97%)	11 (3%)	0	100	100
46	LH	428/443 (97%)	418 (98%)	10 (2%)	0	100	100
46	LJ	428/443 (97%)	418 (98%)	10 (2%)	0	100	100
46	LL	428/443 (97%)	416 (97%)	12 (3%)	0	100	100
46	LN	428/443 (97%)	416 (97%)	12 (3%)	0	100	100
46	MB	428/443 (97%)	419 (98%)	9 (2%)	0	100	100
46	MD	428/443 (97%)	416 (97%)	12 (3%)	0	100	100
46	MF	428/443 (97%)	416 (97%)	12 (3%)	0	100	100
46	MH	428/443 (97%)	420 (98%)	8 (2%)	0	100	100
46	MJ	428/443 (97%)	415 (97%)	13 (3%)	0	100	100
46	ML	428/443 (97%)	418 (98%)	10 (2%)	0	100	100
46	MN	428/443 (97%)	418 (98%)	10 (2%)	0	100	100
46	NB	419/443 (95%)	410 (98%)	9 (2%)	0	100	100
46	ND	428/443 (97%)	414 (97%)	14 (3%)	0	100	100
46	NF	419/443 (95%)	408 (97%)	11 (3%)	0	100	100
46	NH	428/443 (97%)	410 (96%)	18 (4%)	0	100	100
46	NJ	419/443 (95%)	408 (97%)	11 (3%)	0	100	100
46	NL	428/443 (97%)	412 (96%)	16 (4%)	0	100	100
46	NN	419/443 (95%)	410 (98%)	9 (2%)	0	100	100
46	OB	428/443 (97%)	413 (96%)	15 (4%)	0	100	100
46	OD	428/443 (97%)	413 (96%)	15 (4%)	0	100	100
46	OF	428/443 (97%)	416 (97%)	12 (3%)	0	100	100
46	OH	428/443 (97%)	413 (96%)	15 (4%)	0	100	100
46	OJ	428/443 (97%)	415 (97%)	13 (3%)	0	100	100
46	OL	428/443 (97%)	417 (97%)	11 (3%)	0	100	100
46	ON	428/443 (97%)	417 (97%)	11 (3%)	0	100	100
46	PB	428/443 (97%)	422 (99%)	6 (1%)	0	100	100
46	PD	428/443 (97%)	419 (98%)	9 (2%)	0	100	100
46	PF	428/443 (97%)	421 (98%)	7 (2%)	0	100	100
46	PH	428/443 (97%)	421 (98%)	7 (2%)	0	100	100

Continued on next page...

Continued from previous page...

Mol	Chain	Analysed	Favoured	Allowed	Outliers	Percentiles	
46	PJ	428/443 (97%)	419 (98%)	9 (2%)	0	100	100
46	PL	428/443 (97%)	419 (98%)	9 (2%)	0	100	100
46	PN	428/443 (97%)	418 (98%)	10 (2%)	0	100	100
46	QB	428/443 (97%)	416 (97%)	12 (3%)	0	100	100
46	QD	428/443 (97%)	418 (98%)	10 (2%)	0	100	100
46	QF	428/443 (97%)	423 (99%)	5 (1%)	0	100	100
46	QH	428/443 (97%)	423 (99%)	5 (1%)	0	100	100
46	QJ	428/443 (97%)	421 (98%)	7 (2%)	0	100	100
46	QL	428/443 (97%)	423 (99%)	5 (1%)	0	100	100
46	QN	428/443 (97%)	424 (99%)	4 (1%)	0	100	100
46	RB	428/443 (97%)	418 (98%)	10 (2%)	0	100	100
46	RD	428/443 (97%)	416 (97%)	12 (3%)	0	100	100
46	RF	428/443 (97%)	415 (97%)	13 (3%)	0	100	100
46	RH	428/443 (97%)	419 (98%)	9 (2%)	0	100	100
46	RJ	428/443 (97%)	413 (96%)	15 (4%)	0	100	100
46	RL	428/443 (97%)	419 (98%)	9 (2%)	0	100	100
46	RN	428/443 (97%)	423 (99%)	5 (1%)	0	100	100
46	SB	428/443 (97%)	415 (97%)	13 (3%)	0	100	100
46	SD	428/443 (97%)	420 (98%)	8 (2%)	0	100	100
46	SF	428/443 (97%)	416 (97%)	12 (3%)	0	100	100
46	SH	428/443 (97%)	416 (97%)	12 (3%)	0	100	100
46	SJ	428/443 (97%)	414 (97%)	14 (3%)	0	100	100
46	SL	428/443 (97%)	418 (98%)	10 (2%)	0	100	100
46	SN	428/443 (97%)	422 (99%)	6 (1%)	0	100	100
46	TB	428/443 (97%)	422 (99%)	6 (1%)	0	100	100
46	TD	428/443 (97%)	418 (98%)	10 (2%)	0	100	100
46	TF	428/443 (97%)	419 (98%)	9 (2%)	0	100	100
46	TH	428/443 (97%)	414 (97%)	14 (3%)	0	100	100
46	TJ	428/443 (97%)	418 (98%)	10 (2%)	0	100	100
46	TL	428/443 (97%)	420 (98%)	8 (2%)	0	100	100
46	TN	428/443 (97%)	424 (99%)	4 (1%)	0	100	100

Continued on next page...

Continued from previous page...

Mol	Chain	Analysed	Favoured	Allowed	Outliers	Percentiles	
46	UB	428/443 (97%)	416 (97%)	12 (3%)	0	100	100
46	UD	428/443 (97%)	418 (98%)	10 (2%)	0	100	100
46	UF	428/443 (97%)	420 (98%)	8 (2%)	0	100	100
46	UH	428/443 (97%)	418 (98%)	10 (2%)	0	100	100
46	UJ	428/443 (97%)	414 (97%)	14 (3%)	0	100	100
46	UL	428/443 (97%)	421 (98%)	7 (2%)	0	100	100
46	UN	428/443 (97%)	420 (98%)	8 (2%)	0	100	100
46	VB	428/443 (97%)	421 (98%)	7 (2%)	0	100	100
46	VD	428/443 (97%)	417 (97%)	11 (3%)	0	100	100
46	VF	428/443 (97%)	419 (98%)	9 (2%)	0	100	100
46	VH	428/443 (97%)	420 (98%)	8 (2%)	0	100	100
46	VJ	428/443 (97%)	417 (97%)	11 (3%)	0	100	100
46	VL	428/443 (97%)	419 (98%)	9 (2%)	0	100	100
46	VN	428/443 (97%)	420 (98%)	8 (2%)	0	100	100
46	WB	428/443 (97%)	417 (97%)	11 (3%)	0	100	100
46	WD	428/443 (97%)	423 (99%)	5 (1%)	0	100	100
46	WF	428/443 (97%)	419 (98%)	9 (2%)	0	100	100
46	WH	428/443 (97%)	421 (98%)	7 (2%)	0	100	100
46	WJ	428/443 (97%)	417 (97%)	11 (3%)	0	100	100
46	WL	428/443 (97%)	420 (98%)	8 (2%)	0	100	100
46	WN	428/443 (97%)	423 (99%)	5 (1%)	0	100	100
All	All	164812/178239 (92%)	158863 (96%)	5746 (4%)	203 (0%)	50	78

5 of 203 Ramachandran outliers are listed below:

Mol	Chain	Res	Type
1	0A	20	PRO
1	0A	90	GLN
2	0B	44	ILE
2	0B	67	THR
2	0B	208	VAL

5.3.2 Protein sidechains [i](#)

In the following table, the Percentiles column shows the percent sidechain outliers of the chain as a percentile score with respect to all PDB entries followed by that with respect to all EM entries.

The Analysed column shows the number of residues for which the sidechain conformation was analysed, and the total number of residues.

Mol	Chain	Analysed	Rotameric	Outliers	Percentiles	
1	0A	133/213 (62%)	132 (99%)	1 (1%)	79	85
1	1A	133/213 (62%)	132 (99%)	1 (1%)	79	85
1	2A	133/213 (62%)	132 (99%)	1 (1%)	79	85
1	3A	133/213 (62%)	131 (98%)	2 (2%)	60	75
2	0B	291/301 (97%)	291 (100%)	0	100	100
3	0C	81/137 (59%)	80 (99%)	1 (1%)	67	79
3	1C	81/137 (59%)	81 (100%)	0	100	100
4	0D	176/198 (89%)	175 (99%)	1 (1%)	84	90
4	1D	176/198 (89%)	176 (100%)	0	100	100
4	2D	176/198 (89%)	176 (100%)	0	100	100
5	0E	172/175 (98%)	170 (99%)	2 (1%)	67	79
5	1E	172/175 (98%)	170 (99%)	2 (1%)	67	79
5	2E	172/175 (98%)	171 (99%)	1 (1%)	84	90
5	3E	172/175 (98%)	168 (98%)	4 (2%)	45	64
6	0F	182/194 (94%)	182 (100%)	0	100	100
7	0G	153/167 (92%)	151 (99%)	2 (1%)	65	77
7	1G	123/167 (74%)	123 (100%)	0	100	100
8	0H	107/413 (26%)	104 (97%)	3 (3%)	38	60
8	1H	390/413 (94%)	386 (99%)	4 (1%)	73	82
9	0N	256/451 (57%)	256 (100%)	0	100	100
9	1N	423/451 (94%)	423 (100%)	0	100	100
9	2N	256/451 (57%)	256 (100%)	0	100	100
10	0Q	174/182 (96%)	174 (100%)	0	100	100
10	1Q	174/182 (96%)	174 (100%)	0	100	100
10	2Q	174/182 (96%)	174 (100%)	0	100	100
10	3Q	174/182 (96%)	174 (100%)	0	100	100

Continued on next page...

Continued from previous page...

Mol	Chain	Analysed	Rotameric	Outliers	Percentiles	
10	4Q	174/182 (96%)	173 (99%)	1 (1%)	84	90
10	5Q	174/182 (96%)	173 (99%)	1 (1%)	84	90
10	6Q	174/182 (96%)	174 (100%)	0	100	100
11	0S	257/286 (90%)	257 (100%)	0	100	100
11	1S	257/286 (90%)	256 (100%)	1 (0%)	89	93
11	2S	257/286 (90%)	256 (100%)	1 (0%)	89	93
11	3S	257/286 (90%)	257 (100%)	0	100	100
12	0T	222/264 (84%)	220 (99%)	2 (1%)	75	84
12	1T	251/264 (95%)	249 (99%)	2 (1%)	79	85
12	2T	251/264 (95%)	250 (100%)	1 (0%)	89	93
12	3T	251/264 (95%)	249 (99%)	2 (1%)	79	85
13	0U	528/571 (92%)	527 (100%)	1 (0%)	92	96
13	1U	528/571 (92%)	526 (100%)	2 (0%)	89	93
13	2U	528/571 (92%)	523 (99%)	5 (1%)	75	84
13	3U	528/571 (92%)	524 (99%)	4 (1%)	79	85
14	0V	196/249 (79%)	194 (99%)	2 (1%)	73	82
14	1V	244/249 (98%)	242 (99%)	2 (1%)	79	85
14	2V	244/249 (98%)	243 (100%)	1 (0%)	89	93
14	3V	244/249 (98%)	243 (100%)	1 (0%)	89	93
15	0X	94/129 (73%)	94 (100%)	0	100	100
15	1X	128/129 (99%)	128 (100%)	0	100	100
15	2X	128/129 (99%)	127 (99%)	1 (1%)	79	85
15	3X	128/129 (99%)	128 (100%)	0	100	100
15	4X	128/129 (99%)	128 (100%)	0	100	100
16	1B	441/441 (100%)	440 (100%)	1 (0%)	92	96
16	2B	264/441 (60%)	263 (100%)	1 (0%)	89	93
16	3B	265/441 (60%)	264 (100%)	1 (0%)	89	93
17	1F	121/157 (77%)	117 (97%)	4 (3%)	33	57
18	1I	172/239 (72%)	170 (99%)	2 (1%)	67	79
19	1J	328/370 (89%)	327 (100%)	1 (0%)	91	94
20	1K	259/463 (56%)	258 (100%)	1 (0%)	89	93

Continued on next page...

Continued from previous page...

Mol	Chain	Analysed	Rotameric	Outliers	Percentiles	
20	2K	271/463 (58%)	269 (99%)	2 (1%)	81	88
21	1L	771/878 (88%)	769 (100%)	2 (0%)	91	94
21	2L	580/878 (66%)	575 (99%)	5 (1%)	75	84
21	3L	191/878 (22%)	189 (99%)	2 (1%)	73	82
22	1M	323/325 (99%)	322 (100%)	1 (0%)	91	94
22	2M	323/325 (99%)	323 (100%)	0	100	100
23	1O	223/458 (49%)	219 (98%)	4 (2%)	54	71
23	2O	346/458 (76%)	341 (99%)	5 (1%)	62	76
23	3O	254/458 (56%)	252 (99%)	2 (1%)	79	85
24	1P	325/471 (69%)	319 (98%)	6 (2%)	54	71
24	2P	169/471 (36%)	167 (99%)	2 (1%)	67	79
25	1R	466/475 (98%)	465 (100%)	1 (0%)	92	96
25	2R	466/475 (98%)	466 (100%)	0	100	100
25	3R	466/475 (98%)	466 (100%)	0	100	100
26	1W	207/265 (78%)	206 (100%)	1 (0%)	86	92
26	2W	104/265 (39%)	102 (98%)	2 (2%)	52	70
27	2C	271/271 (100%)	271 (100%)	0	100	100
27	3C	271/271 (100%)	271 (100%)	0	100	100
27	4C	271/271 (100%)	270 (100%)	1 (0%)	89	93
28	2F	81/90 (90%)	81 (100%)	0	100	100
29	2G	91/91 (100%)	91 (100%)	0	100	100
30	2H	59/212 (28%)	59 (100%)	0	100	100
30	3H	59/212 (28%)	58 (98%)	1 (2%)	56	73
30	4H	59/212 (28%)	59 (100%)	0	100	100
31	2I	122/259 (47%)	121 (99%)	1 (1%)	79	85
31	3I	80/259 (31%)	77 (96%)	3 (4%)	28	53
32	3D	195/195 (100%)	195 (100%)	0	100	100
33	4F	180/245 (74%)	180 (100%)	0	100	100
34	4R	561/568 (99%)	560 (100%)	1 (0%)	92	96
34	5R	561/568 (99%)	559 (100%)	2 (0%)	89	93
34	6R	561/568 (99%)	561 (100%)	0	100	100

Continued on next page...

Continued from previous page...

Mol	Chain	Analysed	Rotameric	Outliers	Percentiles	
34	7R	561/568 (99%)	560 (100%)	1 (0%)	92	96
35	4S	169/222 (76%)	167 (99%)	2 (1%)	67	79
35	5S	169/222 (76%)	167 (99%)	2 (1%)	67	79
36	5A	140/159 (88%)	138 (99%)	2 (1%)	62	76
36	5B	140/159 (88%)	140 (100%)	0	100	100
36	5C	140/159 (88%)	139 (99%)	1 (1%)	81	88
36	5D	97/159 (61%)	97 (100%)	0	100	100
37	5E	171/227 (75%)	170 (99%)	1 (1%)	84	90
37	5F	194/227 (86%)	193 (100%)	1 (0%)	86	92
37	5G	194/227 (86%)	192 (99%)	2 (1%)	73	82
37	5H	125/227 (55%)	125 (100%)	0	100	100
39	6F	128/141 (91%)	127 (99%)	1 (1%)	79	85
40	6G	194/329 (59%)	193 (100%)	1 (0%)	86	92
41	6H	150/474 (32%)	150 (100%)	0	100	100
44	8R	31/31 (100%)	31 (100%)	0	100	100
45	AA	370/376 (98%)	369 (100%)	1 (0%)	91	94
45	AC	370/376 (98%)	369 (100%)	1 (0%)	91	94
45	AE	370/376 (98%)	369 (100%)	1 (0%)	91	94
45	AG	370/376 (98%)	369 (100%)	1 (0%)	91	94
45	AI	370/376 (98%)	370 (100%)	0	100	100
45	AK	370/376 (98%)	368 (100%)	2 (0%)	86	92
45	AM	370/376 (98%)	370 (100%)	0	100	100
45	BA	366/376 (97%)	363 (99%)	3 (1%)	79	85
45	BC	366/376 (97%)	364 (100%)	2 (0%)	86	92
45	BE	366/376 (97%)	366 (100%)	0	100	100
45	BG	366/376 (97%)	366 (100%)	0	100	100
45	BI	366/376 (97%)	366 (100%)	0	100	100
45	BK	366/376 (97%)	365 (100%)	1 (0%)	91	94
45	BM	366/376 (97%)	365 (100%)	1 (0%)	91	94
45	CA	370/376 (98%)	369 (100%)	1 (0%)	91	94
45	CC	370/376 (98%)	370 (100%)	0	100	100

Continued on next page...

Continued from previous page...

Mol	Chain	Analysed	Rotameric	Outliers	Percentiles	
45	CE	370/376 (98%)	368 (100%)	2 (0%)	86	92
45	CG	370/376 (98%)	369 (100%)	1 (0%)	91	94
45	CI	370/376 (98%)	370 (100%)	0	100	100
45	CK	370/376 (98%)	370 (100%)	0	100	100
45	CM	370/376 (98%)	369 (100%)	1 (0%)	91	94
45	DA	367/376 (98%)	367 (100%)	0	100	100
45	DC	368/376 (98%)	367 (100%)	1 (0%)	91	94
45	DE	367/376 (98%)	367 (100%)	0	100	100
45	DG	368/376 (98%)	367 (100%)	1 (0%)	91	94
45	DI	367/376 (98%)	365 (100%)	2 (0%)	86	92
45	DK	368/376 (98%)	367 (100%)	1 (0%)	91	94
45	DM	367/376 (98%)	367 (100%)	0	100	100
45	EA	370/376 (98%)	369 (100%)	1 (0%)	91	94
45	EC	370/376 (98%)	370 (100%)	0	100	100
45	EE	370/376 (98%)	369 (100%)	1 (0%)	91	94
45	EG	370/376 (98%)	367 (99%)	3 (1%)	79	85
45	EI	370/376 (98%)	368 (100%)	2 (0%)	86	92
45	EK	370/376 (98%)	369 (100%)	1 (0%)	91	94
45	EM	370/376 (98%)	369 (100%)	1 (0%)	91	94
45	FA	363/376 (96%)	360 (99%)	3 (1%)	79	85
45	FC	366/376 (97%)	365 (100%)	1 (0%)	91	94
45	FE	367/376 (98%)	366 (100%)	1 (0%)	91	94
45	FG	370/376 (98%)	369 (100%)	1 (0%)	91	94
45	FI	367/376 (98%)	366 (100%)	1 (0%)	91	94
45	FK	366/376 (97%)	364 (100%)	2 (0%)	86	92
45	FM	363/376 (96%)	362 (100%)	1 (0%)	91	94
45	GA	363/376 (96%)	362 (100%)	1 (0%)	91	94
45	GC	365/376 (97%)	362 (99%)	3 (1%)	79	85
45	GE	365/376 (97%)	365 (100%)	0	100	100
45	GG	365/376 (97%)	365 (100%)	0	100	100
45	GI	365/376 (97%)	363 (100%)	2 (0%)	86	92

Continued on next page...

Continued from previous page...

Mol	Chain	Analysed	Rotameric	Outliers	Percentiles	
45	GK	370/376 (98%)	369 (100%)	1 (0%)	91	94
45	GM	363/376 (96%)	360 (99%)	3 (1%)	79	85
45	HA	365/376 (97%)	365 (100%)	0	100	100
45	HC	365/376 (97%)	364 (100%)	1 (0%)	91	94
45	HE	365/376 (97%)	365 (100%)	0	100	100
45	HG	365/376 (97%)	364 (100%)	1 (0%)	91	94
45	HI	365/376 (97%)	364 (100%)	1 (0%)	91	94
45	HK	365/376 (97%)	364 (100%)	1 (0%)	91	94
45	HM	365/376 (97%)	365 (100%)	0	100	100
45	IA	366/376 (97%)	364 (100%)	2 (0%)	86	92
45	IC	370/376 (98%)	369 (100%)	1 (0%)	91	94
45	IE	366/376 (97%)	366 (100%)	0	100	100
45	IG	370/376 (98%)	369 (100%)	1 (0%)	91	94
45	II	370/376 (98%)	370 (100%)	0	100	100
45	IK	366/376 (97%)	366 (100%)	0	100	100
45	IM	366/376 (97%)	363 (99%)	3 (1%)	79	85
45	JA	366/376 (97%)	365 (100%)	1 (0%)	91	94
45	JC	367/376 (98%)	367 (100%)	0	100	100
45	JE	370/376 (98%)	369 (100%)	1 (0%)	91	94
45	JG	370/376 (98%)	367 (99%)	3 (1%)	79	85
45	JI	369/376 (98%)	369 (100%)	0	100	100
45	JK	370/376 (98%)	369 (100%)	1 (0%)	91	94
45	JM	366/376 (97%)	366 (100%)	0	100	100
45	KA	367/376 (98%)	364 (99%)	3 (1%)	79	85
45	KC	367/376 (98%)	366 (100%)	1 (0%)	91	94
45	KE	368/376 (98%)	367 (100%)	1 (0%)	91	94
45	KG	370/376 (98%)	369 (100%)	1 (0%)	91	94
45	KI	370/376 (98%)	368 (100%)	2 (0%)	86	92
45	KK	370/376 (98%)	370 (100%)	0	100	100
45	KM	367/376 (98%)	365 (100%)	2 (0%)	86	92
45	LA	370/376 (98%)	370 (100%)	0	100	100

Continued on next page...

Continued from previous page...

Mol	Chain	Analysed	Rotameric	Outliers	Percentiles	
45	LC	370/376 (98%)	369 (100%)	1 (0%)	91	94
45	LE	369/376 (98%)	368 (100%)	1 (0%)	91	94
45	LG	370/376 (98%)	367 (99%)	3 (1%)	79	85
45	LI	368/376 (98%)	367 (100%)	1 (0%)	91	94
45	LK	370/376 (98%)	370 (100%)	0	100	100
45	LM	370/376 (98%)	370 (100%)	0	100	100
45	MA	369/376 (98%)	368 (100%)	1 (0%)	91	94
45	MC	366/376 (97%)	366 (100%)	0	100	100
45	ME	367/376 (98%)	366 (100%)	1 (0%)	91	94
45	MG	370/376 (98%)	369 (100%)	1 (0%)	91	94
45	MI	370/376 (98%)	368 (100%)	2 (0%)	86	92
45	MK	367/376 (98%)	367 (100%)	0	100	100
45	MM	369/376 (98%)	368 (100%)	1 (0%)	91	94
45	NA	370/376 (98%)	368 (100%)	2 (0%)	86	92
45	NC	366/376 (97%)	364 (100%)	2 (0%)	86	92
45	NE	370/376 (98%)	370 (100%)	0	100	100
45	NG	366/376 (97%)	365 (100%)	1 (0%)	91	94
45	NI	370/376 (98%)	370 (100%)	0	100	100
45	NK	366/376 (97%)	366 (100%)	0	100	100
45	NM	370/376 (98%)	369 (100%)	1 (0%)	91	94
45	OA	366/376 (97%)	365 (100%)	1 (0%)	91	94
45	OC	366/376 (97%)	364 (100%)	2 (0%)	86	92
45	OE	366/376 (97%)	365 (100%)	1 (0%)	91	94
45	OG	366/376 (97%)	366 (100%)	0	100	100
45	OI	366/376 (97%)	366 (100%)	0	100	100
45	OK	366/376 (97%)	365 (100%)	1 (0%)	91	94
45	OM	366/376 (97%)	363 (99%)	3 (1%)	79	85
45	PA	363/376 (96%)	363 (100%)	0	100	100
45	PC	363/376 (96%)	363 (100%)	0	100	100
45	PE	363/376 (96%)	363 (100%)	0	100	100
45	PG	363/376 (96%)	361 (99%)	2 (1%)	84	90

Continued on next page...

Continued from previous page...

Mol	Chain	Analysed	Rotameric	Outliers	Percentiles	
45	PI	363/376 (96%)	362 (100%)	1 (0%)	91	94
45	PK	363/376 (96%)	362 (100%)	1 (0%)	91	94
45	PM	363/376 (96%)	361 (99%)	2 (1%)	84	90
45	QA	365/376 (97%)	362 (99%)	3 (1%)	79	85
45	QC	365/376 (97%)	362 (99%)	3 (1%)	79	85
45	QE	365/376 (97%)	363 (100%)	2 (0%)	86	92
45	QG	365/376 (97%)	365 (100%)	0	100	100
45	QI	365/376 (97%)	363 (100%)	2 (0%)	86	92
45	QK	365/376 (97%)	364 (100%)	1 (0%)	91	94
45	QM	365/376 (97%)	362 (99%)	3 (1%)	79	85
45	RA	365/376 (97%)	365 (100%)	0	100	100
45	RC	365/376 (97%)	363 (100%)	2 (0%)	86	92
45	RE	365/376 (97%)	362 (99%)	3 (1%)	79	85
45	RG	365/376 (97%)	362 (99%)	3 (1%)	79	85
45	RI	365/376 (97%)	363 (100%)	2 (0%)	86	92
45	RK	365/376 (97%)	364 (100%)	1 (0%)	91	94
45	RM	365/376 (97%)	365 (100%)	0	100	100
45	SA	364/376 (97%)	363 (100%)	1 (0%)	91	94
45	SC	364/376 (97%)	359 (99%)	5 (1%)	62	76
45	SE	364/376 (97%)	364 (100%)	0	100	100
45	SG	364/376 (97%)	362 (100%)	2 (0%)	86	92
45	SI	364/376 (97%)	362 (100%)	2 (0%)	86	92
45	SK	364/376 (97%)	362 (100%)	2 (0%)	86	92
45	SM	364/376 (97%)	361 (99%)	3 (1%)	79	85
45	TA	364/376 (97%)	364 (100%)	0	100	100
45	TC	364/376 (97%)	362 (100%)	2 (0%)	86	92
45	TE	364/376 (97%)	363 (100%)	1 (0%)	91	94
45	TG	364/376 (97%)	363 (100%)	1 (0%)	91	94
45	TI	364/376 (97%)	364 (100%)	0	100	100
45	TK	364/376 (97%)	363 (100%)	1 (0%)	91	94
45	TM	364/376 (97%)	361 (99%)	3 (1%)	79	85

Continued on next page...

Continued from previous page...

Mol	Chain	Analysed	Rotameric	Outliers	Percentiles	
45	UA	365/376 (97%)	364 (100%)	1 (0%)	91	94
45	UC	365/376 (97%)	364 (100%)	1 (0%)	91	94
45	UE	365/376 (97%)	365 (100%)	0	100	100
45	UG	365/376 (97%)	365 (100%)	0	100	100
45	UI	365/376 (97%)	364 (100%)	1 (0%)	91	94
45	UK	365/376 (97%)	363 (100%)	2 (0%)	86	92
45	UM	365/376 (97%)	365 (100%)	0	100	100
45	VA	367/376 (98%)	365 (100%)	2 (0%)	86	92
45	VC	370/376 (98%)	368 (100%)	2 (0%)	86	92
45	VE	367/376 (98%)	366 (100%)	1 (0%)	91	94
45	VG	370/376 (98%)	368 (100%)	2 (0%)	86	92
45	VI	367/376 (98%)	364 (99%)	3 (1%)	79	85
45	VK	370/376 (98%)	370 (100%)	0	100	100
45	VM	367/376 (98%)	366 (100%)	1 (0%)	91	94
45	WA	365/376 (97%)	365 (100%)	0	100	100
45	WC	370/376 (98%)	369 (100%)	1 (0%)	91	94
45	WE	365/376 (97%)	362 (99%)	3 (1%)	79	85
45	WG	370/376 (98%)	369 (100%)	1 (0%)	91	94
45	WI	365/376 (97%)	364 (100%)	1 (0%)	91	94
45	WK	370/376 (98%)	368 (100%)	2 (0%)	86	92
45	WM	365/376 (97%)	361 (99%)	4 (1%)	70	80
46	AB	365/376 (97%)	365 (100%)	0	100	100
46	AD	365/376 (97%)	365 (100%)	0	100	100
46	AF	365/376 (97%)	365 (100%)	0	100	100
46	AH	365/376 (97%)	365 (100%)	0	100	100
46	AJ	365/376 (97%)	365 (100%)	0	100	100
46	AL	365/376 (97%)	365 (100%)	0	100	100
46	AN	365/376 (97%)	365 (100%)	0	100	100
46	BB	360/376 (96%)	358 (99%)	2 (1%)	84	90
46	BD	365/376 (97%)	363 (100%)	2 (0%)	86	92
46	BF	365/376 (97%)	364 (100%)	1 (0%)	91	94

Continued on next page...

Continued from previous page...

Mol	Chain	Analysed	Rotameric	Outliers	Percentiles	
46	BH	365/376 (97%)	365 (100%)	0	100	100
46	BJ	365/376 (97%)	363 (100%)	2 (0%)	86	92
46	BL	365/376 (97%)	365 (100%)	0	100	100
46	BN	365/376 (97%)	364 (100%)	1 (0%)	91	94
46	CB	365/376 (97%)	365 (100%)	0	100	100
46	CD	365/376 (97%)	365 (100%)	0	100	100
46	CF	365/376 (97%)	365 (100%)	0	100	100
46	CH	365/376 (97%)	364 (100%)	1 (0%)	91	94
46	CJ	365/376 (97%)	365 (100%)	0	100	100
46	CL	365/376 (97%)	365 (100%)	0	100	100
46	CN	365/376 (97%)	364 (100%)	1 (0%)	91	94
46	DB	365/376 (97%)	364 (100%)	1 (0%)	91	94
46	DD	365/376 (97%)	365 (100%)	0	100	100
46	DF	365/376 (97%)	363 (100%)	2 (0%)	86	92
46	DH	365/376 (97%)	364 (100%)	1 (0%)	91	94
46	DJ	365/376 (97%)	365 (100%)	0	100	100
46	DL	365/376 (97%)	364 (100%)	1 (0%)	91	94
46	DN	365/376 (97%)	362 (99%)	3 (1%)	79	85
46	EB	365/376 (97%)	364 (100%)	1 (0%)	91	94
46	ED	365/376 (97%)	363 (100%)	2 (0%)	86	92
46	EF	365/376 (97%)	365 (100%)	0	100	100
46	EH	365/376 (97%)	364 (100%)	1 (0%)	91	94
46	EJ	365/376 (97%)	364 (100%)	1 (0%)	91	94
46	EL	365/376 (97%)	364 (100%)	1 (0%)	91	94
46	EN	365/376 (97%)	363 (100%)	2 (0%)	86	92
46	FB	365/376 (97%)	364 (100%)	1 (0%)	91	94
46	FD	365/376 (97%)	364 (100%)	1 (0%)	91	94
46	FF	365/376 (97%)	365 (100%)	0	100	100
46	FH	365/376 (97%)	365 (100%)	0	100	100
46	FJ	365/376 (97%)	363 (100%)	2 (0%)	86	92
46	FL	365/376 (97%)	364 (100%)	1 (0%)	91	94

Continued on next page...

Continued from previous page...

Mol	Chain	Analysed	Rotameric	Outliers	Percentiles	
46	FN	365/376 (97%)	365 (100%)	0	100	100
46	GB	365/376 (97%)	364 (100%)	1 (0%)	91	94
46	GD	365/376 (97%)	365 (100%)	0	100	100
46	GF	365/376 (97%)	364 (100%)	1 (0%)	91	94
46	GH	365/376 (97%)	365 (100%)	0	100	100
46	GJ	365/376 (97%)	365 (100%)	0	100	100
46	GL	365/376 (97%)	363 (100%)	2 (0%)	86	92
46	GN	365/376 (97%)	365 (100%)	0	100	100
46	HB	365/376 (97%)	363 (100%)	2 (0%)	86	92
46	HD	365/376 (97%)	365 (100%)	0	100	100
46	HF	365/376 (97%)	365 (100%)	0	100	100
46	HH	365/376 (97%)	365 (100%)	0	100	100
46	HJ	365/376 (97%)	365 (100%)	0	100	100
46	HL	365/376 (97%)	365 (100%)	0	100	100
46	HN	365/376 (97%)	364 (100%)	1 (0%)	91	94
46	IB	365/376 (97%)	363 (100%)	2 (0%)	86	92
46	ID	365/376 (97%)	364 (100%)	1 (0%)	91	94
46	IF	365/376 (97%)	365 (100%)	0	100	100
46	IH	365/376 (97%)	364 (100%)	1 (0%)	91	94
46	IJ	365/376 (97%)	365 (100%)	0	100	100
46	IL	365/376 (97%)	364 (100%)	1 (0%)	91	94
46	IN	365/376 (97%)	365 (100%)	0	100	100
46	JB	365/376 (97%)	365 (100%)	0	100	100
46	JD	365/376 (97%)	365 (100%)	0	100	100
46	JF	365/376 (97%)	364 (100%)	1 (0%)	91	94
46	JH	365/376 (97%)	365 (100%)	0	100	100
46	JJ	365/376 (97%)	365 (100%)	0	100	100
46	JL	365/376 (97%)	365 (100%)	0	100	100
46	JN	365/376 (97%)	365 (100%)	0	100	100
46	KB	365/376 (97%)	364 (100%)	1 (0%)	91	94
46	KD	365/376 (97%)	365 (100%)	0	100	100

Continued on next page...

Continued from previous page...

Mol	Chain	Analysed	Rotameric	Outliers	Percentiles	
46	KF	365/376 (97%)	364 (100%)	1 (0%)	91	94
46	KH	365/376 (97%)	365 (100%)	0	100	100
46	KJ	365/376 (97%)	365 (100%)	0	100	100
46	KL	365/376 (97%)	363 (100%)	2 (0%)	86	92
46	KN	365/376 (97%)	365 (100%)	0	100	100
46	LB	365/376 (97%)	365 (100%)	0	100	100
46	LD	365/376 (97%)	365 (100%)	0	100	100
46	LF	365/376 (97%)	361 (99%)	4 (1%)	70	80
46	LH	365/376 (97%)	364 (100%)	1 (0%)	91	94
46	LJ	365/376 (97%)	364 (100%)	1 (0%)	91	94
46	LL	365/376 (97%)	365 (100%)	0	100	100
46	LN	365/376 (97%)	364 (100%)	1 (0%)	91	94
46	MB	365/376 (97%)	365 (100%)	0	100	100
46	MD	365/376 (97%)	365 (100%)	0	100	100
46	MF	365/376 (97%)	365 (100%)	0	100	100
46	MH	365/376 (97%)	365 (100%)	0	100	100
46	MJ	365/376 (97%)	365 (100%)	0	100	100
46	ML	365/376 (97%)	363 (100%)	2 (0%)	86	92
46	MN	365/376 (97%)	364 (100%)	1 (0%)	91	94
46	NB	359/376 (96%)	358 (100%)	1 (0%)	91	94
46	ND	365/376 (97%)	365 (100%)	0	100	100
46	NF	359/376 (96%)	359 (100%)	0	100	100
46	NH	365/376 (97%)	364 (100%)	1 (0%)	91	94
46	NJ	359/376 (96%)	358 (100%)	1 (0%)	91	94
46	NL	365/376 (97%)	365 (100%)	0	100	100
46	NN	359/376 (96%)	359 (100%)	0	100	100
46	OB	365/376 (97%)	361 (99%)	4 (1%)	70	80
46	OD	365/376 (97%)	365 (100%)	0	100	100
46	OF	365/376 (97%)	364 (100%)	1 (0%)	91	94
46	OH	365/376 (97%)	365 (100%)	0	100	100
46	OJ	365/376 (97%)	365 (100%)	0	100	100

Continued on next page...

Continued from previous page...

Mol	Chain	Analysed	Rotameric	Outliers	Percentiles	
46	OL	365/376 (97%)	364 (100%)	1 (0%)	91	94
46	ON	365/376 (97%)	365 (100%)	0	100	100
46	PB	365/376 (97%)	364 (100%)	1 (0%)	91	94
46	PD	365/376 (97%)	364 (100%)	1 (0%)	91	94
46	PF	365/376 (97%)	365 (100%)	0	100	100
46	PH	365/376 (97%)	365 (100%)	0	100	100
46	PJ	365/376 (97%)	364 (100%)	1 (0%)	91	94
46	PL	365/376 (97%)	364 (100%)	1 (0%)	91	94
46	PN	365/376 (97%)	365 (100%)	0	100	100
46	QB	365/376 (97%)	364 (100%)	1 (0%)	91	94
46	QD	365/376 (97%)	363 (100%)	2 (0%)	86	92
46	QF	365/376 (97%)	365 (100%)	0	100	100
46	QH	365/376 (97%)	363 (100%)	2 (0%)	86	92
46	QJ	365/376 (97%)	365 (100%)	0	100	100
46	QL	365/376 (97%)	365 (100%)	0	100	100
46	QN	365/376 (97%)	363 (100%)	2 (0%)	86	92
46	RB	365/376 (97%)	364 (100%)	1 (0%)	91	94
46	RD	365/376 (97%)	364 (100%)	1 (0%)	91	94
46	RF	365/376 (97%)	365 (100%)	0	100	100
46	RH	365/376 (97%)	363 (100%)	2 (0%)	86	92
46	RJ	365/376 (97%)	362 (99%)	3 (1%)	79	85
46	RL	365/376 (97%)	364 (100%)	1 (0%)	91	94
46	RN	365/376 (97%)	365 (100%)	0	100	100
46	SB	365/376 (97%)	364 (100%)	1 (0%)	91	94
46	SD	365/376 (97%)	364 (100%)	1 (0%)	91	94
46	SF	365/376 (97%)	365 (100%)	0	100	100
46	SH	365/376 (97%)	365 (100%)	0	100	100
46	SJ	365/376 (97%)	365 (100%)	0	100	100
46	SL	365/376 (97%)	365 (100%)	0	100	100
46	SN	365/376 (97%)	363 (100%)	2 (0%)	86	92
46	TB	365/376 (97%)	364 (100%)	1 (0%)	91	94

Continued on next page...

Continued from previous page...

Mol	Chain	Analysed	Rotameric	Outliers	Percentiles	
46	TD	365/376 (97%)	365 (100%)	0	100	100
46	TF	365/376 (97%)	365 (100%)	0	100	100
46	TH	365/376 (97%)	365 (100%)	0	100	100
46	TJ	365/376 (97%)	365 (100%)	0	100	100
46	TL	365/376 (97%)	363 (100%)	2 (0%)	86	92
46	TN	365/376 (97%)	362 (99%)	3 (1%)	79	85
46	UB	365/376 (97%)	363 (100%)	2 (0%)	86	92
46	UD	365/376 (97%)	364 (100%)	1 (0%)	91	94
46	UF	365/376 (97%)	365 (100%)	0	100	100
46	UH	365/376 (97%)	364 (100%)	1 (0%)	91	94
46	UJ	365/376 (97%)	364 (100%)	1 (0%)	91	94
46	UL	365/376 (97%)	364 (100%)	1 (0%)	91	94
46	UN	365/376 (97%)	365 (100%)	0	100	100
46	VB	365/376 (97%)	364 (100%)	1 (0%)	91	94
46	VD	365/376 (97%)	365 (100%)	0	100	100
46	VF	365/376 (97%)	364 (100%)	1 (0%)	91	94
46	VH	365/376 (97%)	365 (100%)	0	100	100
46	VJ	365/376 (97%)	365 (100%)	0	100	100
46	VL	365/376 (97%)	364 (100%)	1 (0%)	91	94
46	VN	365/376 (97%)	365 (100%)	0	100	100
46	WB	365/376 (97%)	365 (100%)	0	100	100
46	WD	365/376 (97%)	365 (100%)	0	100	100
46	WF	365/376 (97%)	365 (100%)	0	100	100
46	WH	365/376 (97%)	364 (100%)	1 (0%)	91	94
46	WJ	365/376 (97%)	364 (100%)	1 (0%)	91	94
46	WL	365/376 (97%)	365 (100%)	0	100	100
46	WN	365/376 (97%)	365 (100%)	0	100	100
All	All	142117/152292 (93%)	141699 (100%)	418 (0%)	90	94

5 of 418 residues with a non-rotameric sidechain are listed below:

Mol	Chain	Res	Type
45	JE	300	ASN

Continued on next page...

Continued from previous page...

Mol	Chain	Res	Type
46	OB	391	ARG
45	VI	2	ARG
45	KA	326	LYS
46	LH	247	ASN

Sometimes sidechains can be flipped to improve hydrogen bonding and reduce clashes. 5 of 508 such sidechains are listed below:

Mol	Chain	Res	Type
46	GH	334	GLN
45	SE	380	ASN
45	KE	11	GLN
46	SB	134	GLN
46	UH	347	ASN

5.3.3 RNA [i](#)

There are no RNA molecules in this entry.

5.4 Non-standard residues in protein, DNA, RNA chains [i](#)

There are no non-standard protein/DNA/RNA residues in this entry.

5.5 Carbohydrates [i](#)

There are no oligosaccharides in this entry.

5.6 Ligand geometry [i](#)

Of 483 ligands modelled in this entry, 161 are monoatomic - leaving 322 for Mogul analysis.

In the following table, the Counts columns list the number of bonds (or angles) for which Mogul statistics could be retrieved, the number of bonds (or angles) that are observed in the model and the number of bonds (or angles) that are defined in the Chemical Component Dictionary. The Link column lists molecule types, if any, to which the group is linked. The Z score for a bond length (or angle) is the number of standard deviations the observed value is removed from the expected value. A bond length (or angle) with $|Z| > 2$ is considered an outlier worth inspection. RMSZ is the root-mean-square of all Z scores of the bond lengths (or angles).

Mol	Type	Chain	Res	Link	Bond lengths			Bond angles		
					Counts	RMSZ	# Z > 2	Counts	RMSZ	# Z > 2
47	GTP	CI	501	48	29,34,34	1.24	2 (6%)	35,54,54	1.32	4 (11%)
49	GDP	WH	501	-	25,30,30	0.98	1 (4%)	30,47,47	1.11	2 (6%)
47	GTP	DI	501	48	29,34,34	1.27	4 (13%)	35,54,54	1.32	4 (11%)
49	GDP	RB	501	-	25,30,30	0.99	1 (4%)	30,47,47	1.06	2 (6%)
47	GTP	BC	501	48	29,34,34	1.22	2 (6%)	35,54,54	1.28	4 (11%)
47	GTP	OE	501	48	29,34,34	1.24	2 (6%)	35,54,54	1.28	4 (11%)
47	GTP	LM	501	48	29,34,34	1.21	2 (6%)	35,54,54	1.27	4 (11%)
47	GTP	FA	501	48	29,34,34	1.20	2 (6%)	35,54,54	1.29	3 (8%)
49	GDP	DL	501	-	25,30,30	0.98	1 (4%)	30,47,47	1.09	2 (6%)
49	GDP	CJ	501	-	25,30,30	0.95	1 (4%)	30,47,47	1.09	2 (6%)
47	GTP	VA	501	48	29,34,34	1.25	2 (6%)	35,54,54	1.27	4 (11%)
47	GTP	BE	501	48	29,34,34	1.25	2 (6%)	35,54,54	1.28	4 (11%)
47	GTP	NE	501	48	29,34,34	1.26	3 (10%)	35,54,54	1.27	4 (11%)
49	GDP	BD	501	-	25,30,30	0.97	1 (4%)	30,47,47	1.07	2 (6%)
47	GTP	NC	501	48	29,34,34	1.25	2 (6%)	35,54,54	1.26	4 (11%)
49	GDP	PN	501	-	25,30,30	0.97	1 (4%)	30,47,47	1.05	2 (6%)
47	GTP	CK	501	48	29,34,34	1.27	3 (10%)	35,54,54	1.27	4 (11%)
49	GDP	OF	501	-	25,30,30	0.96	1 (4%)	30,47,47	1.06	2 (6%)
47	GTP	ME	501	48	29,34,34	1.22	2 (6%)	35,54,54	1.28	4 (11%)
47	GTP	DM	501	48	29,34,34	1.25	2 (6%)	35,54,54	1.29	3 (8%)
47	GTP	UK	501	48	29,34,34	1.24	2 (6%)	35,54,54	1.28	4 (11%)
49	GDP	HB	501	-	25,30,30	0.98	1 (4%)	30,47,47	1.07	2 (6%)
49	GDP	NB	502	-	25,30,30	1.00	1 (4%)	30,47,47	1.09	2 (6%)
47	GTP	RK	501	48	29,34,34	1.23	2 (6%)	35,54,54	1.24	4 (11%)
47	GTP	TI	501	48	29,34,34	1.20	2 (6%)	35,54,54	1.28	3 (8%)
47	GTP	NG	501	48	29,34,34	1.25	2 (6%)	35,54,54	1.26	4 (11%)
47	GTP	TG	501	48	29,34,34	1.23	2 (6%)	35,54,54	1.26	4 (11%)
49	GDP	IJ	501	-	25,30,30	0.96	1 (4%)	30,47,47	1.09	2 (6%)
49	GDP	DJ	501	-	25,30,30	0.97	1 (4%)	30,47,47	1.11	2 (6%)
47	GTP	SI	501	48	29,34,34	1.21	2 (6%)	35,54,54	1.26	4 (11%)
47	GTP	MM	501	48	29,34,34	1.23	2 (6%)	35,54,54	1.28	4 (11%)
47	GTP	SC	501	48	29,34,34	1.20	2 (6%)	35,54,54	1.28	4 (11%)
47	GTP	DE	501	48	29,34,34	1.25	2 (6%)	35,54,54	1.30	4 (11%)
49	GDP	BL	501	-	25,30,30	0.95	1 (4%)	30,47,47	1.07	2 (6%)
47	GTP	WC	501	48	29,34,34	1.22	2 (6%)	35,54,54	1.29	4 (11%)

Mol	Type	Chain	Res	Link	Bond lengths			Bond angles		
					Counts	RMSZ	# Z > 2	Counts	RMSZ	# Z > 2
47	GTP	DC	501	48	29,34,34	1.24	2 (6%)	35,54,54	1.30	4 (11%)
49	GDP	VJ	501	-	25,30,30	0.95	1 (4%)	30,47,47	1.08	2 (6%)
49	GDP	HL	501	-	25,30,30	0.95	1 (4%)	30,47,47	1.08	2 (6%)
47	GTP	HC	501	48	29,34,34	1.27	3 (10%)	35,54,54	1.30	4 (11%)
47	GTP	PI	501	48	29,34,34	1.21	2 (6%)	35,54,54	1.26	4 (11%)
49	GDP	PD	501	-	25,30,30	0.98	1 (4%)	30,47,47	1.08	2 (6%)
47	GTP	DK	501	48	29,34,34	1.22	2 (6%)	35,54,54	1.29	4 (11%)
47	GTP	PE	501	48	29,34,34	1.22	2 (6%)	35,54,54	1.30	4 (11%)
49	GDP	MF	501	-	25,30,30	0.95	1 (4%)	30,47,47	1.09	2 (6%)
49	GDP	EH	501	-	25,30,30	0.96	1 (4%)	30,47,47	1.09	2 (6%)
47	GTP	DG	501	48	29,34,34	1.23	2 (6%)	35,54,54	1.29	4 (11%)
49	GDP	RD	501	-	25,30,30	0.98	1 (4%)	30,47,47	1.11	2 (6%)
47	GTP	RA	501	48	29,34,34	1.26	2 (6%)	35,54,54	1.29	4 (11%)
47	GTP	JA	501	48	29,34,34	1.21	2 (6%)	35,54,54	1.28	4 (11%)
47	GTP	JE	501	48	29,34,34	1.22	2 (6%)	35,54,54	1.29	4 (11%)
49	GDP	QF	501	-	25,30,30	0.97	1 (4%)	30,47,47	1.08	2 (6%)
49	GDP	GD	501	-	25,30,30	0.96	1 (4%)	30,47,47	1.10	2 (6%)
49	GDP	NF	501	-	25,30,30	0.97	1 (4%)	30,47,47	1.07	2 (6%)
47	GTP	MK	501	48	29,34,34	1.22	2 (6%)	35,54,54	1.28	4 (11%)
47	GTP	RI	501	48	29,34,34	1.24	2 (6%)	35,54,54	1.31	4 (11%)
47	GTP	KC	501	48	29,34,34	1.23	2 (6%)	35,54,54	1.29	4 (11%)
49	GDP	FJ	501	-	25,30,30	0.94	1 (4%)	30,47,47	1.06	2 (6%)
49	GDP	QN	501	-	25,30,30	0.97	1 (4%)	30,47,47	1.06	2 (6%)
47	GTP	QA	501	48	29,34,34	1.23	2 (6%)	35,54,54	1.26	4 (11%)
49	GDP	SD	501	-	25,30,30	0.96	1 (4%)	30,47,47	1.11	3 (10%)
49	GDP	MB	501	-	25,30,30	0.97	1 (4%)	30,47,47	1.07	2 (6%)
49	GDP	NN	501	-	25,30,30	0.97	1 (4%)	30,47,47	1.08	2 (6%)
47	GTP	VI	501	48	29,34,34	1.27	2 (6%)	35,54,54	1.29	4 (11%)
49	GDP	FD	501	-	25,30,30	0.96	1 (4%)	30,47,47	1.03	2 (6%)
49	GDP	EB	501	-	25,30,30	0.98	1 (4%)	30,47,47	1.07	2 (6%)
49	GDP	FF	501	-	25,30,30	0.95	1 (4%)	30,47,47	1.07	2 (6%)
49	GDP	DN	501	-	25,30,30	1.00	1 (4%)	30,47,47	1.08	3 (10%)
47	GTP	BK	501	48	29,34,34	1.25	3 (10%)	35,54,54	1.26	4 (11%)
49	GDP	QL	501	-	25,30,30	0.96	1 (4%)	30,47,47	1.07	2 (6%)
49	GDP	RN	501	-	25,30,30	0.98	1 (4%)	30,47,47	1.05	2 (6%)

Mol	Type	Chain	Res	Link	Bond lengths			Bond angles		
					Counts	RMSZ	# Z > 2	Counts	RMSZ	# Z > 2
49	GDP	NL	501	-	25,30,30	0.96	1 (4%)	30,47,47	1.10	2 (6%)
47	GTP	HA	501	48	29,34,34	1.21	2 (6%)	35,54,54	1.27	4 (11%)
47	GTP	HG	501	48	29,34,34	1.20	2 (6%)	35,54,54	1.28	4 (11%)
47	GTP	TM	501	48	29,34,34	1.21	2 (6%)	35,54,54	1.26	4 (11%)
49	GDP	NJ	501	-	25,30,30	0.97	1 (4%)	30,47,47	1.07	2 (6%)
49	GDP	BN	501	-	25,30,30	0.95	1 (4%)	30,47,47	1.06	2 (6%)
47	GTP	II	501	48	29,34,34	1.24	2 (6%)	35,54,54	1.28	4 (11%)
49	GDP	BB	502	-	25,30,30	0.99	1 (4%)	30,47,47	1.05	2 (6%)
49	GDP	KH	501	-	25,30,30	0.96	1 (4%)	30,47,47	1.07	2 (6%)
47	GTP	HM	501	48	29,34,34	1.21	2 (6%)	35,54,54	1.26	4 (11%)
49	GDP	RJ	501	-	25,30,30	0.99	1 (4%)	30,47,47	1.09	2 (6%)
49	GDP	GF	501	-	25,30,30	0.96	1 (4%)	30,47,47	1.06	2 (6%)
47	GTP	FG	501	48	29,34,34	1.22	2 (6%)	35,54,54	1.28	4 (11%)
47	GTP	UE	501	48	29,34,34	1.23	2 (6%)	35,54,54	1.28	4 (11%)
47	GTP	GK	501	48	29,34,34	1.22	2 (6%)	35,54,54	1.28	4 (11%)
49	GDP	UN	501	-	25,30,30	0.97	1 (4%)	30,47,47	1.06	2 (6%)
49	GDP	DB	501	-	25,30,30	0.98	1 (4%)	30,47,47	1.03	2 (6%)
49	GDP	DF	501	-	25,30,30	0.96	1 (4%)	30,47,47	1.06	2 (6%)
49	GDP	CB	501	-	25,30,30	0.98	1 (4%)	30,47,47	1.06	2 (6%)
49	GDP	LD	501	-	25,30,30	0.97	1 (4%)	30,47,47	1.06	2 (6%)
49	GDP	TF	501	-	25,30,30	0.95	1 (4%)	30,47,47	1.05	2 (6%)
49	GDP	IB	501	-	25,30,30	0.98	1 (4%)	30,47,47	1.04	2 (6%)
49	GDP	IN	501	-	25,30,30	0.96	1 (4%)	30,47,47	1.10	2 (6%)
47	GTP	NI	501	48	29,34,34	1.26	3 (10%)	35,54,54	1.27	4 (11%)
49	GDP	LJ	501	-	25,30,30	0.95	1 (4%)	30,47,47	1.09	2 (6%)
49	GDP	IF	501	-	25,30,30	0.94	1 (4%)	30,47,47	1.07	2 (6%)
47	GTP	NM	501	48	29,34,34	1.27	3 (10%)	35,54,54	1.27	4 (11%)
49	GDP	KF	501	-	25,30,30	0.94	1 (4%)	30,47,47	1.09	2 (6%)
49	GDP	BJ	501	-	25,30,30	0.95	1 (4%)	30,47,47	1.06	2 (6%)
49	GDP	PH	501	-	25,30,30	0.96	1 (4%)	30,47,47	1.07	2 (6%)
47	GTP	QG	501	48	29,34,34	1.24	2 (6%)	35,54,54	1.25	4 (11%)
47	GTP	LI	501	48	29,34,34	1.24	2 (6%)	35,54,54	1.28	4 (11%)
47	GTP	TE	501	48	29,34,34	1.21	2 (6%)	35,54,54	1.27	4 (11%)
47	GTP	JM	501	48	29,34,34	1.27	4 (13%)	35,54,54	1.28	3 (8%)
49	GDP	MH	501	-	25,30,30	0.96	1 (4%)	30,47,47	1.10	2 (6%)

Mol	Type	Chain	Res	Link	Bond lengths			Bond angles		
					Counts	RMSZ	# Z > 2	Counts	RMSZ	# Z > 2
49	GDP	SB	501	-	25,30,30	0.98	1 (4%)	30,47,47	1.09	2 (6%)
49	GDP	VF	501	-	25,30,30	0.96	1 (4%)	30,47,47	1.05	2 (6%)
47	GTP	KI	501	48	29,34,34	1.20	2 (6%)	35,54,54	1.26	4 (11%)
49	GDP	TL	501	-	25,30,30	0.97	1 (4%)	30,47,47	1.06	2 (6%)
47	GTP	EM	501	48	29,34,34	1.25	2 (6%)	35,54,54	1.28	4 (11%)
49	GDP	AL	502	-	25,30,30	0.95	1 (4%)	30,47,47	1.05	2 (6%)
47	GTP	JC	501	48	29,34,34	1.20	2 (6%)	35,54,54	1.27	4 (11%)
49	GDP	IH	501	-	25,30,30	0.95	1 (4%)	30,47,47	1.09	2 (6%)
47	GTP	TK	501	48	29,34,34	1.24	2 (6%)	35,54,54	1.26	4 (11%)
47	GTP	GA	501	48	29,34,34	1.23	2 (6%)	35,54,54	1.27	4 (11%)
47	GTP	PC	501	48	29,34,34	1.21	2 (6%)	35,54,54	1.27	3 (8%)
47	GTP	MG	501	48	29,34,34	1.22	2 (6%)	35,54,54	1.28	4 (11%)
49	GDP	DH	501	-	25,30,30	0.96	1 (4%)	30,47,47	1.13	3 (10%)
49	GDP	QB	501	-	25,30,30	0.98	1 (4%)	30,47,47	1.07	2 (6%)
49	GDP	AN	501	-	25,30,30	0.95	1 (4%)	30,47,47	1.06	2 (6%)
47	GTP	VM	501	48	29,34,34	1.23	2 (6%)	35,54,54	1.26	4 (11%)
49	GDP	SN	501	-	25,30,30	1.01	1 (4%)	30,47,47	1.11	2 (6%)
47	GTP	CE	501	48	29,34,34	1.24	2 (6%)	35,54,54	1.30	4 (11%)
47	GTP	FC	501	48	29,34,34	1.24	2 (6%)	35,54,54	1.27	4 (11%)
47	GTP	PA	501	48	29,34,34	1.24	2 (6%)	35,54,54	1.28	4 (11%)
47	GTP	KG	501	48	29,34,34	1.22	2 (6%)	35,54,54	1.26	4 (11%)
49	GDP	JB	501	-	25,30,30	0.98	1 (4%)	30,47,47	1.08	2 (6%)
47	GTP	LK	501	48	29,34,34	1.25	3 (10%)	35,54,54	1.28	4 (11%)
49	GDP	SF	501	-	25,30,30	0.95	1 (4%)	30,47,47	1.09	2 (6%)
49	GDP	OH	501	-	25,30,30	0.97	1 (4%)	30,47,47	1.05	2 (6%)
49	GDP	JN	501	-	25,30,30	0.96	1 (4%)	30,47,47	1.07	1 (3%)
49	GDP	JH	501	-	25,30,30	0.96	1 (4%)	30,47,47	1.06	2 (6%)
47	GTP	OM	501	48	29,34,34	1.26	2 (6%)	35,54,54	1.26	4 (11%)
47	GTP	MI	501	48	29,34,34	1.25	2 (6%)	35,54,54	1.27	4 (11%)
49	GDP	CL	501	-	25,30,30	0.96	1 (4%)	30,47,47	1.07	2 (6%)
49	GDP	HD	501	-	25,30,30	0.96	1 (4%)	30,47,47	1.08	2 (6%)
49	GDP	EL	501	-	25,30,30	0.96	1 (4%)	30,47,47	1.08	2 (6%)
49	GDP	AD	501	-	25,30,30	0.96	1 (4%)	30,47,47	1.03	2 (6%)
49	GDP	MD	501	-	25,30,30	0.97	1 (4%)	30,47,47	1.08	2 (6%)
47	GTP	IA	501	48	29,34,34	1.23	2 (6%)	35,54,54	1.28	4 (11%)

Mol	Type	Chain	Res	Link	Bond lengths			Bond angles		
					Counts	RMSZ	# Z > 2	Counts	RMSZ	# Z > 2
47	GTP	OK	501	48	29,34,34	1.25	3 (10%)	35,54,54	1.27	4 (11%)
49	GDP	GB	502	-	25,30,30	0.99	1 (4%)	30,47,47	1.06	2 (6%)
47	GTP	CC	501	48	29,34,34	1.25	2 (6%)	35,54,54	1.31	4 (11%)
49	GDP	VD	501	-	25,30,30	0.95	1 (4%)	30,47,47	1.07	2 (6%)
49	GDP	WJ	501	-	25,30,30	0.97	1 (4%)	30,47,47	1.09	2 (6%)
49	GDP	KN	501	-	25,30,30	0.94	1 (4%)	30,47,47	1.08	2 (6%)
47	GTP	GE	501	48	29,34,34	1.24	2 (6%)	35,54,54	1.30	4 (11%)
49	GDP	UF	501	-	25,30,30	0.96	1 (4%)	30,47,47	1.05	2 (6%)
49	GDP	UH	501	-	25,30,30	0.96	1 (4%)	30,47,47	1.08	2 (6%)
49	GDP	OD	501	-	25,30,30	0.96	1 (4%)	30,47,47	1.04	2 (6%)
49	GDP	EF	501	-	25,30,30	0.95	1 (4%)	30,47,47	1.06	2 (6%)
47	GTP	CM	501	48	29,34,34	1.22	2 (6%)	35,54,54	1.26	4 (11%)
47	GTP	JI	501	48	29,34,34	1.19	2 (6%)	35,54,54	1.30	3 (8%)
49	GDP	NH	501	-	25,30,30	0.95	1 (4%)	30,47,47	1.06	2 (6%)
47	GTP	KM	501	48	29,34,34	1.25	2 (6%)	35,54,54	1.28	4 (11%)
49	GDP	HH	501	-	25,30,30	0.96	1 (4%)	30,47,47	1.06	2 (6%)
49	GDP	ID	501	-	25,30,30	0.95	1 (4%)	30,47,47	1.07	2 (6%)
47	GTP	KA	501	48	29,34,34	1.23	2 (6%)	35,54,54	1.27	4 (11%)
47	GTP	QK	501	48	29,34,34	1.23	2 (6%)	35,54,54	1.29	4 (11%)
49	GDP	RL	501	-	25,30,30	0.97	1 (4%)	30,47,47	1.08	2 (6%)
49	GDP	KD	501	-	25,30,30	0.95	1 (4%)	30,47,47	1.07	2 (6%)
47	GTP	TC	501	48	29,34,34	1.22	2 (6%)	35,54,54	1.27	4 (11%)
47	GTP	RG	501	48	29,34,34	1.23	2 (6%)	35,54,54	1.25	4 (11%)
49	GDP	JJ	501	-	25,30,30	0.96	1 (4%)	30,47,47	1.07	2 (6%)
47	GTP	BI	501	48	29,34,34	1.21	2 (6%)	35,54,54	1.29	4 (11%)
47	GTP	VE	501	48	29,34,34	1.22	2 (6%)	35,54,54	1.27	4 (11%)
49	GDP	FB	501	-	25,30,30	0.99	1 (4%)	30,47,47	1.09	2 (6%)
49	GDP	TH	501	-	25,30,30	0.96	1 (4%)	30,47,47	1.06	2 (6%)
49	GDP	VB	501	-	25,30,30	0.98	1 (4%)	30,47,47	1.06	2 (6%)
49	GDP	UJ	501	-	25,30,30	0.97	1 (4%)	30,47,47	1.05	2 (6%)
47	GTP	RM	501	48	29,34,34	1.23	2 (6%)	35,54,54	1.26	4 (11%)
49	GDP	DD	501	-	25,30,30	0.97	1 (4%)	30,47,47	1.09	2 (6%)
47	GTP	MC	501	48	29,34,34	1.22	2 (6%)	35,54,54	1.28	4 (11%)
49	GDP	RF	501	-	25,30,30	0.97	1 (4%)	30,47,47	1.12	2 (6%)
47	GTP	BG	501	48	29,34,34	1.22	2 (6%)	35,54,54	1.31	4 (11%)

Mol	Type	Chain	Res	Link	Bond lengths			Bond angles		
					Counts	RMSZ	# Z > 2	Counts	RMSZ	# Z > 2
47	GTP	OG	501	48	29,34,34	1.25	2 (6%)	35,54,54	1.30	3 (8%)
47	GTP	IG	501	48	29,34,34	1.21	2 (6%)	35,54,54	1.27	4 (11%)
47	GTP	HE	501	48	29,34,34	1.23	2 (6%)	35,54,54	1.28	4 (11%)
47	GTP	AK	501	48	29,34,34	1.22	2 (6%)	35,54,54	1.28	4 (11%)
47	GTP	PK	501	48	29,34,34	1.25	2 (6%)	35,54,54	1.30	3 (8%)
47	GTP	AM	501	48	29,34,34	1.27	2 (6%)	35,54,54	1.26	4 (11%)
47	GTP	SE	501	48	29,34,34	1.22	2 (6%)	35,54,54	1.25	4 (11%)
49	GDP	IL	501	-	25,30,30	0.94	1 (4%)	30,47,47	1.06	2 (6%)
49	GDP	FL	501	-	25,30,30	0.95	1 (4%)	30,47,47	1.05	2 (6%)
47	GTP	LG	501	48	29,34,34	1.22	2 (6%)	35,54,54	1.27	4 (11%)
47	GTP	AA	501	48	29,34,34	1.27	3 (10%)	35,54,54	1.28	4 (11%)
47	GTP	MA	501	48	29,34,34	1.24	2 (6%)	35,54,54	1.27	4 (11%)
47	GTP	QI	501	48	29,34,34	1.24	2 (6%)	35,54,54	1.28	4 (11%)
47	GTP	UI	501	48	29,34,34	1.26	2 (6%)	35,54,54	1.26	4 (11%)
49	GDP	AB	501	-	25,30,30	0.99	1 (4%)	30,47,47	1.09	2 (6%)
47	GTP	EG	501	48	29,34,34	1.23	2 (6%)	35,54,54	1.28	4 (11%)
49	GDP	PF	501	-	25,30,30	0.97	1 (4%)	30,47,47	1.05	2 (6%)
49	GDP	GL	501	-	25,30,30	0.94	1 (4%)	30,47,47	1.08	2 (6%)
47	GTP	QM	501	48	29,34,34	1.23	2 (6%)	35,54,54	1.27	4 (11%)
47	GTP	QE	501	48	29,34,34	1.23	2 (6%)	35,54,54	1.27	4 (11%)
47	GTP	LC	501	48	29,34,34	1.24	2 (6%)	35,54,54	1.29	4 (11%)
49	GDP	ON	501	-	25,30,30	0.97	1 (4%)	30,47,47	1.05	2 (6%)
47	GTP	IE	501	48	29,34,34	1.21	2 (6%)	35,54,54	1.27	4 (11%)
49	GDP	BF	501	-	25,30,30	0.94	1 (4%)	30,47,47	1.04	1 (3%)
49	GDP	VN	501	-	25,30,30	0.98	1 (4%)	30,47,47	1.06	2 (6%)
47	GTP	AG	501	48	29,34,34	1.24	2 (6%)	35,54,54	1.28	4 (11%)
47	GTP	IC	501	48	29,34,34	1.24	2 (6%)	35,54,54	1.31	4 (11%)
49	GDP	SH	501	-	25,30,30	0.97	1 (4%)	30,47,47	1.06	2 (6%)
49	GDP	JL	501	-	25,30,30	0.96	1 (4%)	30,47,47	1.08	2 (6%)
47	GTP	EC	501	48	29,34,34	1.21	2 (6%)	35,54,54	1.28	4 (11%)
47	GTP	UA	501	48	29,34,34	1.27	3 (10%)	35,54,54	1.25	4 (11%)
49	GDP	CF	501	-	25,30,30	0.98	1 (4%)	30,47,47	1.08	2 (6%)
47	GTP	FI	501	48	29,34,34	1.25	2 (6%)	35,54,54	1.29	4 (11%)
47	GTP	WE	501	48	29,34,34	1.24	3 (10%)	35,54,54	1.30	4 (11%)
47	GTP	EK	501	48	29,34,34	1.22	2 (6%)	35,54,54	1.26	4 (11%)

Mol	Type	Chain	Res	Link	Bond lengths			Bond angles		
					Counts	RMSZ	# Z > 2	Counts	RMSZ	# Z > 2
49	GDP	AF	501	-	25,30,30	0.94	1 (4%)	30,47,47	1.06	2 (6%)
49	GDP	KB	501	-	25,30,30	0.97	1 (4%)	30,47,47	1.05	2 (6%)
49	GDP	AJ	501	-	25,30,30	0.95	1 (4%)	30,47,47	1.04	2 (6%)
47	GTP	JK	501	48	29,34,34	1.25	2 (6%)	35,54,54	1.28	4 (11%)
47	GTP	OA	501	48	29,34,34	1.26	2 (6%)	35,54,54	1.26	4 (11%)
47	GTP	PM	501	48	29,34,34	1.21	2 (6%)	35,54,54	1.26	4 (11%)
49	GDP	HF	501	-	25,30,30	0.96	1 (4%)	30,47,47	1.07	2 (6%)
47	GTP	FE	501	48	29,34,34	1.24	2 (6%)	35,54,54	1.28	4 (11%)
47	GTP	VG	501	48	29,34,34	1.23	2 (6%)	35,54,54	1.30	3 (8%)
49	GDP	CN	501	-	25,30,30	0.99	1 (4%)	30,47,47	1.06	2 (6%)
49	GDP	BH	501	-	25,30,30	0.94	1 (4%)	30,47,47	1.07	2 (6%)
47	GTP	QC	501	48	29,34,34	1.25	3 (10%)	35,54,54	1.28	3 (8%)
49	GDP	PJ	501	-	25,30,30	0.96	1 (4%)	30,47,47	1.08	2 (6%)
49	GDP	UB	501	-	25,30,30	0.99	1 (4%)	30,47,47	1.05	2 (6%)
47	GTP	UM	501	48	29,34,34	1.20	2 (6%)	35,54,54	1.28	3 (8%)
47	GTP	FM	501	48	29,34,34	1.23	2 (6%)	35,54,54	1.33	4 (11%)
49	GDP	GN	501	-	25,30,30	0.96	1 (4%)	30,47,47	1.06	2 (6%)
47	GTP	FK	501	48	29,34,34	1.23	2 (6%)	35,54,54	1.28	4 (11%)
47	GTP	UG	501	48	29,34,34	1.20	2 (6%)	35,54,54	1.30	3 (8%)
49	GDP	KL	501	-	25,30,30	0.96	1 (4%)	30,47,47	1.07	2 (6%)
49	GDP	QJ	501	-	25,30,30	0.97	1 (4%)	30,47,47	1.07	2 (6%)
49	GDP	LF	501	-	25,30,30	0.95	1 (4%)	30,47,47	1.11	3 (10%)
49	GDP	TD	501	-	25,30,30	0.96	1 (4%)	30,47,47	1.05	2 (6%)
47	GTP	AI	501	48	29,34,34	1.22	2 (6%)	35,54,54	1.27	4 (11%)
47	GTP	RC	501	48	29,34,34	1.21	2 (6%)	35,54,54	1.25	4 (11%)
49	GDP	ND	501	-	25,30,30	0.97	1 (4%)	30,47,47	1.07	2 (6%)
49	GDP	PB	501	-	25,30,30	0.99	1 (4%)	30,47,47	1.07	2 (6%)
49	GDP	HJ	501	-	25,30,30	0.95	1 (4%)	30,47,47	1.06	2 (6%)
49	GDP	OB	501	-	25,30,30	0.98	1 (4%)	30,47,47	1.10	2 (6%)
47	GTP	PG	501	48	29,34,34	1.23	2 (6%)	35,54,54	1.26	4 (11%)
49	GDP	RH	501	-	25,30,30	0.98	1 (4%)	30,47,47	1.06	2 (6%)
49	GDP	LN	501	-	25,30,30	0.96	1 (4%)	30,47,47	1.06	2 (6%)
49	GDP	SJ	501	-	25,30,30	0.95	1 (4%)	30,47,47	1.09	2 (6%)
47	GTP	GC	501	48	29,34,34	1.25	2 (6%)	35,54,54	1.28	4 (11%)
49	GDP	WL	501	-	25,30,30	0.97	1 (4%)	30,47,47	1.07	2 (6%)

Mol	Type	Chain	Res	Link	Bond lengths			Bond angles		
					Counts	RMSZ	# Z > 2	Counts	RMSZ	# Z > 2
47	GTP	HI	501	48	29,34,34	1.24	2 (6%)	35,54,54	1.28	4 (11%)
47	GTP	RE	501	48	29,34,34	1.22	2 (6%)	35,54,54	1.26	4 (11%)
49	GDP	WD	501	-	25,30,30	0.96	1 (4%)	30,47,47	1.07	2 (6%)
49	GDP	HN	501	-	25,30,30	0.97	1 (4%)	30,47,47	1.07	2 (6%)
49	GDP	QD	501	-	25,30,30	0.98	1 (4%)	30,47,47	1.11	2 (6%)
47	GTP	AC	501	48	29,34,34	1.22	2 (6%)	35,54,54	1.29	4 (11%)
49	GDP	UL	501	-	25,30,30	0.96	1 (4%)	30,47,47	1.06	2 (6%)
49	GDP	FN	501	-	25,30,30	0.97	1 (4%)	30,47,47	1.04	2 (6%)
49	GDP	QH	501	-	25,30,30	0.98	1 (4%)	30,47,47	1.08	2 (6%)
47	GTP	VK	501	48	29,34,34	1.25	2 (6%)	35,54,54	1.31	4 (11%)
47	GTP	KE	501	48	29,34,34	1.22	2 (6%)	35,54,54	1.28	4 (11%)
49	GDP	ML	501	-	25,30,30	0.96	1 (4%)	30,47,47	1.09	2 (6%)
47	GTP	UC	501	48	29,34,34	1.23	2 (6%)	35,54,54	1.28	4 (11%)
49	GDP	LH	501	-	25,30,30	0.95	1 (4%)	30,47,47	1.06	2 (6%)
49	GDP	EJ	501	-	25,30,30	0.96	1 (4%)	30,47,47	1.10	2 (6%)
49	GDP	PL	501	-	25,30,30	0.98	1 (4%)	30,47,47	1.07	2 (6%)
49	GDP	TB	501	-	25,30,30	0.98	1 (4%)	30,47,47	1.05	2 (6%)
49	GDP	JF	501	-	25,30,30	0.95	1 (4%)	30,47,47	1.08	2 (6%)
49	GDP	OL	501	-	25,30,30	0.96	1 (4%)	30,47,47	1.05	2 (6%)
49	GDP	WN	501	-	25,30,30	0.96	1 (4%)	30,47,47	1.07	2 (6%)
47	GTP	OC	501	48	29,34,34	1.24	2 (6%)	35,54,54	1.29	3 (8%)
49	GDP	GH	501	-	25,30,30	0.95	1 (4%)	30,47,47	1.06	2 (6%)
49	GDP	FH	501	-	25,30,30	0.95	1 (4%)	30,47,47	1.06	2 (6%)
49	GDP	SL	501	-	25,30,30	0.98	1 (4%)	30,47,47	1.08	2 (6%)
47	GTP	NA	501	48	29,34,34	1.28	3 (10%)	35,54,54	1.26	4 (11%)
47	GTP	KK	501	48	29,34,34	1.24	2 (6%)	35,54,54	1.28	4 (11%)
49	GDP	OJ	501	-	25,30,30	0.95	1 (4%)	30,47,47	1.05	1 (3%)
49	GDP	WB	501	-	25,30,30	0.98	1 (4%)	30,47,47	1.07	2 (6%)
47	GTP	CG	501	48	29,34,34	1.23	2 (6%)	35,54,54	1.30	3 (8%)
47	GTP	SA	501	48	29,34,34	1.26	2 (6%)	35,54,54	1.26	4 (11%)
47	GTP	WG	501	48	29,34,34	1.23	2 (6%)	35,54,54	1.29	4 (11%)
47	GTP	GG	501	48	29,34,34	1.23	2 (6%)	35,54,54	1.29	4 (11%)
47	GTP	IM	501	48	29,34,34	1.21	2 (6%)	35,54,54	1.26	4 (11%)
47	GTP	GI	501	48	29,34,34	1.21	2 (6%)	35,54,54	1.29	4 (11%)
49	GDP	TJ	501	-	25,30,30	0.95	1 (4%)	30,47,47	1.08	2 (6%)

Mol	Type	Chain	Res	Link	Bond lengths			Bond angles		
					Counts	RMSZ	# Z > 2	Counts	RMSZ	# Z > 2
49	GDP	EN	501	-	25,30,30	1.01	2 (8%)	30,47,47	1.10	2 (6%)
47	GTP	WM	501	48	29,34,34	1.27	3 (10%)	35,54,54	1.28	5 (14%)
49	GDP	AH	501	-	25,30,30	0.96	1 (4%)	30,47,47	1.04	2 (6%)
47	GTP	JG	501	48	29,34,34	1.21	2 (6%)	35,54,54	1.27	4 (11%)
47	GTP	DA	501	48	29,34,34	1.25	2 (6%)	35,54,54	1.25	4 (11%)
47	GTP	EI	501	48	29,34,34	1.22	2 (6%)	35,54,54	1.26	4 (11%)
47	GTP	TA	501	48	29,34,34	1.24	2 (6%)	35,54,54	1.28	4 (11%)
47	GTP	GM	501	48	29,34,34	1.24	2 (6%)	35,54,54	1.26	4 (11%)
47	GTP	CA	501	48	29,34,34	1.23	2 (6%)	35,54,54	1.24	4 (11%)
47	GTP	BA	501	48	29,34,34	1.21	2 (6%)	35,54,54	1.27	4 (11%)
47	GTP	AE	501	48	29,34,34	1.26	2 (6%)	35,54,54	1.30	4 (11%)
49	GDP	CH	501	-	25,30,30	0.95	1 (4%)	30,47,47	1.09	2 (6%)
47	GTP	SM	501	48	29,34,34	1.25	2 (6%)	35,54,54	1.31	4 (11%)
49	GDP	ED	501	-	25,30,30	0.96	1 (4%)	30,47,47	1.06	2 (6%)
47	GTP	WI	501	48	29,34,34	1.22	2 (6%)	35,54,54	1.29	4 (11%)
47	GTP	HK	501	48	29,34,34	1.25	2 (6%)	35,54,54	1.27	4 (11%)
49	GDP	TN	501	-	25,30,30	0.98	1 (4%)	30,47,47	1.05	2 (6%)
47	GTP	BM	501	48	29,34,34	1.20	2 (6%)	35,54,54	1.30	4 (11%)
49	GDP	KJ	501	-	25,30,30	0.94	1 (4%)	30,47,47	1.07	2 (6%)
47	GTP	NK	501	48	29,34,34	1.26	3 (10%)	35,54,54	1.26	4 (11%)
47	GTP	WA	501	48	29,34,34	1.20	2 (6%)	35,54,54	1.24	4 (11%)
47	GTP	WK	501	48	29,34,34	1.23	2 (6%)	35,54,54	1.27	4 (11%)
49	GDP	WF	501	-	25,30,30	0.96	1 (4%)	30,47,47	1.07	2 (6%)
47	GTP	LA	501	48	29,34,34	1.27	2 (6%)	35,54,54	1.27	4 (11%)
47	GTP	SG	501	48	29,34,34	1.24	2 (6%)	35,54,54	1.25	4 (11%)
49	GDP	VL	501	-	25,30,30	0.97	1 (4%)	30,47,47	1.04	2 (6%)
49	GDP	CD	501	-	25,30,30	0.95	1 (4%)	30,47,47	1.08	2 (6%)
49	GDP	GJ	501	-	25,30,30	0.95	1 (4%)	30,47,47	1.08	2 (6%)
49	GDP	JD	501	-	25,30,30	0.96	1 (4%)	30,47,47	1.07	2 (6%)
47	GTP	EE	501	48	29,34,34	1.21	2 (6%)	35,54,54	1.26	4 (11%)
47	GTP	IK	502	48	29,34,34	1.22	2 (6%)	35,54,54	1.27	4 (11%)
47	GTP	VC	501	48	29,34,34	1.23	2 (6%)	35,54,54	1.30	3 (8%)
49	GDP	VH	501	-	25,30,30	0.96	1 (4%)	30,47,47	1.07	2 (6%)
49	GDP	LB	501	-	25,30,30	0.97	1 (4%)	30,47,47	1.05	2 (6%)
47	GTP	SK	501	48	29,34,34	1.22	2 (6%)	35,54,54	1.27	4 (11%)

Mol	Type	Chain	Res	Link	Bond lengths			Bond angles		
					Counts	RMSZ	# Z > 2	Counts	RMSZ	# Z > 2
47	GTP	LE	501	48	29,34,34	1.21	2 (6%)	35,54,54	1.27	4 (11%)
47	GTP	OI	501	48	29,34,34	1.25	2 (6%)	35,54,54	1.27	4 (11%)
47	GTP	EA	501	48	29,34,34	1.25	2 (6%)	35,54,54	1.24	4 (11%)
49	GDP	MJ	501	-	25,30,30	0.95	1 (4%)	30,47,47	1.09	2 (6%)
49	GDP	MN	501	-	25,30,30	0.96	1 (4%)	30,47,47	1.11	2 (6%)
49	GDP	LL	501	-	25,30,30	0.94	1 (4%)	30,47,47	1.07	2 (6%)
49	GDP	UD	501	-	25,30,30	0.95	1 (4%)	30,47,47	1.07	2 (6%)

In the following table, the Chirals column lists the number of chiral outliers, the number of chiral centers analysed, the number of these observed in the model and the number defined in the Chemical Component Dictionary. Similar counts are reported in the Torsion and Rings columns. '-' means no outliers of that kind were identified.

Mol	Type	Chain	Res	Link	Chirals	Torsions	Rings
47	GTP	CI	501	48	-	7/18/38/38	0/3/3/3
49	GDP	WH	501	-	-	2/12/32/32	0/3/3/3
47	GTP	DI	501	48	-	6/18/38/38	0/3/3/3
49	GDP	RB	501	-	-	0/12/32/32	0/3/3/3
47	GTP	BC	501	48	-	8/18/38/38	0/3/3/3
47	GTP	OE	501	48	-	3/18/38/38	0/3/3/3
47	GTP	LM	501	48	-	6/18/38/38	0/3/3/3
47	GTP	FA	501	48	-	8/18/38/38	0/3/3/3
49	GDP	DL	501	-	-	0/12/32/32	0/3/3/3
49	GDP	CJ	501	-	-	1/12/32/32	0/3/3/3
47	GTP	VA	501	48	-	5/18/38/38	0/3/3/3
47	GTP	BE	501	48	-	5/18/38/38	0/3/3/3
47	GTP	NE	501	48	-	5/18/38/38	0/3/3/3
49	GDP	BD	501	-	-	1/12/32/32	0/3/3/3
47	GTP	NC	501	48	-	5/18/38/38	0/3/3/3
49	GDP	PN	501	-	-	0/12/32/32	0/3/3/3
47	GTP	CK	501	48	-	5/18/38/38	0/3/3/3
49	GDP	OF	501	-	-	0/12/32/32	0/3/3/3
47	GTP	ME	501	48	-	8/18/38/38	0/3/3/3
47	GTP	DM	501	48	-	6/18/38/38	0/3/3/3
47	GTP	UK	501	48	-	5/18/38/38	0/3/3/3
49	GDP	HB	501	-	-	0/12/32/32	0/3/3/3
49	GDP	NB	502	-	-	0/12/32/32	0/3/3/3

Continued on next page...

Continued from previous page...

Mol	Type	Chain	Res	Link	Chirals	Torsions	Rings
47	GTP	RK	501	48	-	7/18/38/38	0/3/3/3
47	GTP	TI	501	48	-	9/18/38/38	0/3/3/3
47	GTP	NG	501	48	-	6/18/38/38	0/3/3/3
47	GTP	TG	501	48	-	7/18/38/38	0/3/3/3
49	GDP	IJ	501	-	-	1/12/32/32	0/3/3/3
49	GDP	DJ	501	-	-	1/12/32/32	0/3/3/3
47	GTP	SI	501	48	-	7/18/38/38	0/3/3/3
47	GTP	MM	501	48	-	6/18/38/38	0/3/3/3
47	GTP	SC	501	48	-	6/18/38/38	0/3/3/3
47	GTP	DE	501	48	-	7/18/38/38	0/3/3/3
49	GDP	BL	501	-	-	1/12/32/32	0/3/3/3
47	GTP	WC	501	48	-	6/18/38/38	0/3/3/3
47	GTP	DC	501	48	-	6/18/38/38	0/3/3/3
49	GDP	VJ	501	-	-	0/12/32/32	0/3/3/3
49	GDP	HL	501	-	-	0/12/32/32	0/3/3/3
47	GTP	HC	501	48	-	5/18/38/38	0/3/3/3
47	GTP	PI	501	48	-	6/18/38/38	0/3/3/3
49	GDP	PD	501	-	-	0/12/32/32	0/3/3/3
47	GTP	DK	501	48	-	6/18/38/38	0/3/3/3
47	GTP	PE	501	48	-	8/18/38/38	0/3/3/3
49	GDP	MF	501	-	-	0/12/32/32	0/3/3/3
49	GDP	EH	501	-	-	1/12/32/32	0/3/3/3
47	GTP	DG	501	48	-	7/18/38/38	0/3/3/3
49	GDP	RD	501	-	-	1/12/32/32	0/3/3/3
47	GTP	RA	501	48	-	7/18/38/38	0/3/3/3
47	GTP	JA	501	48	-	5/18/38/38	0/3/3/3
47	GTP	JE	501	48	-	6/18/38/38	0/3/3/3
49	GDP	QF	501	-	-	0/12/32/32	0/3/3/3
49	GDP	GD	501	-	-	1/12/32/32	0/3/3/3
49	GDP	NF	501	-	-	1/12/32/32	0/3/3/3
47	GTP	MK	501	48	-	8/18/38/38	0/3/3/3
47	GTP	RI	501	48	-	8/18/38/38	0/3/3/3
47	GTP	KC	501	48	-	5/18/38/38	0/3/3/3
49	GDP	FJ	501	-	-	1/12/32/32	0/3/3/3
49	GDP	QN	501	-	-	0/12/32/32	0/3/3/3
47	GTP	QA	501	48	-	8/18/38/38	0/3/3/3
49	GDP	SD	501	-	-	1/12/32/32	0/3/3/3

Continued on next page...

Continued from previous page...

Mol	Type	Chain	Res	Link	Chirals	Torsions	Rings
49	GDP	MB	501	-	-	0/12/32/32	0/3/3/3
49	GDP	NN	501	-	-	1/12/32/32	0/3/3/3
47	GTP	VI	501	48	-	8/18/38/38	0/3/3/3
49	GDP	FD	501	-	-	0/12/32/32	0/3/3/3
49	GDP	EB	501	-	-	0/12/32/32	0/3/3/3
49	GDP	FF	501	-	-	1/12/32/32	0/3/3/3
49	GDP	DN	501	-	-	1/12/32/32	0/3/3/3
47	GTP	BK	501	48	-	4/18/38/38	0/3/3/3
49	GDP	QL	501	-	-	0/12/32/32	0/3/3/3
49	GDP	RN	501	-	-	0/12/32/32	0/3/3/3
49	GDP	NL	501	-	-	3/12/32/32	0/3/3/3
47	GTP	HA	501	48	-	6/18/38/38	0/3/3/3
47	GTP	HG	501	48	-	4/18/38/38	0/3/3/3
47	GTP	TM	501	48	-	8/18/38/38	0/3/3/3
49	GDP	NJ	501	-	-	1/12/32/32	0/3/3/3
49	GDP	BN	501	-	-	1/12/32/32	0/3/3/3
47	GTP	II	501	48	-	8/18/38/38	0/3/3/3
49	GDP	BB	502	-	-	0/12/32/32	0/3/3/3
49	GDP	KH	501	-	-	1/12/32/32	0/3/3/3
47	GTP	HM	501	48	-	8/18/38/38	0/3/3/3
49	GDP	RJ	501	-	-	1/12/32/32	0/3/3/3
49	GDP	GF	501	-	-	1/12/32/32	0/3/3/3
47	GTP	FG	501	48	-	8/18/38/38	0/3/3/3
47	GTP	UE	501	48	-	8/18/38/38	0/3/3/3
47	GTP	GK	501	48	-	7/18/38/38	0/3/3/3
49	GDP	UN	501	-	-	1/12/32/32	0/3/3/3
49	GDP	DB	501	-	-	1/12/32/32	0/3/3/3
49	GDP	DF	501	-	-	0/12/32/32	0/3/3/3
49	GDP	CB	501	-	-	1/12/32/32	0/3/3/3
49	GDP	LD	501	-	-	1/12/32/32	0/3/3/3
49	GDP	TF	501	-	-	1/12/32/32	0/3/3/3
49	GDP	IB	501	-	-	0/12/32/32	0/3/3/3
49	GDP	IN	501	-	-	1/12/32/32	0/3/3/3
47	GTP	NI	501	48	-	7/18/38/38	0/3/3/3
49	GDP	LJ	501	-	-	2/12/32/32	0/3/3/3
49	GDP	IF	501	-	-	1/12/32/32	0/3/3/3
47	GTP	NM	501	48	-	8/18/38/38	0/3/3/3
49	GDP	KF	501	-	-	1/12/32/32	0/3/3/3
49	GDP	BJ	501	-	-	1/12/32/32	0/3/3/3

Continued on next page...

Continued from previous page...

Mol	Type	Chain	Res	Link	Chirals	Torsions	Rings
49	GDP	PH	501	-	-	0/12/32/32	0/3/3/3
47	GTP	QG	501	48	-	8/18/38/38	0/3/3/3
47	GTP	LI	501	48	-	7/18/38/38	0/3/3/3
47	GTP	TE	501	48	-	9/18/38/38	0/3/3/3
47	GTP	JM	501	48	-	6/18/38/38	0/3/3/3
49	GDP	MH	501	-	-	3/12/32/32	0/3/3/3
49	GDP	SB	501	-	-	3/12/32/32	0/3/3/3
49	GDP	VF	501	-	-	1/12/32/32	0/3/3/3
47	GTP	KI	501	48	-	5/18/38/38	0/3/3/3
49	GDP	TL	501	-	-	1/12/32/32	0/3/3/3
47	GTP	EM	501	48	-	8/18/38/38	0/3/3/3
49	GDP	AL	502	-	-	1/12/32/32	0/3/3/3
47	GTP	JC	501	48	-	6/18/38/38	0/3/3/3
49	GDP	IH	501	-	-	2/12/32/32	0/3/3/3
47	GTP	TK	501	48	-	5/18/38/38	0/3/3/3
47	GTP	GA	501	48	-	7/18/38/38	0/3/3/3
47	GTP	PC	501	48	-	7/18/38/38	0/3/3/3
47	GTP	MG	501	48	-	7/18/38/38	0/3/3/3
49	GDP	DH	501	-	-	1/12/32/32	0/3/3/3
49	GDP	QB	501	-	-	0/12/32/32	0/3/3/3
49	GDP	AN	501	-	-	1/12/32/32	0/3/3/3
47	GTP	VM	501	48	-	5/18/38/38	0/3/3/3
49	GDP	SN	501	-	-	1/12/32/32	0/3/3/3
47	GTP	CE	501	48	-	7/18/38/38	0/3/3/3
47	GTP	FC	501	48	-	7/18/38/38	0/3/3/3
47	GTP	PA	501	48	-	8/18/38/38	0/3/3/3
47	GTP	KG	501	48	-	7/18/38/38	0/3/3/3
49	GDP	JB	501	-	-	0/12/32/32	0/3/3/3
47	GTP	LK	501	48	-	5/18/38/38	0/3/3/3
49	GDP	SF	501	-	-	2/12/32/32	0/3/3/3
49	GDP	OH	501	-	-	1/12/32/32	0/3/3/3
49	GDP	JN	501	-	-	1/12/32/32	0/3/3/3
49	GDP	JH	501	-	-	1/12/32/32	0/3/3/3
47	GTP	OM	501	48	-	3/18/38/38	0/3/3/3
47	GTP	MI	501	48	-	8/18/38/38	0/3/3/3
49	GDP	CL	501	-	-	1/12/32/32	0/3/3/3
49	GDP	HD	501	-	-	1/12/32/32	0/3/3/3

Continued on next page...

Continued from previous page...

Mol	Type	Chain	Res	Link	Chirals	Torsions	Rings
49	GDP	EL	501	-	-	1/12/32/32	0/3/3/3
49	GDP	AD	501	-	-	1/12/32/32	0/3/3/3
49	GDP	MD	501	-	-	2/12/32/32	0/3/3/3
47	GTP	IA	501	48	-	7/18/38/38	0/3/3/3
47	GTP	OK	501	48	-	5/18/38/38	0/3/3/3
49	GDP	GB	502	-	-	1/12/32/32	0/3/3/3
47	GTP	CC	501	48	-	5/18/38/38	0/3/3/3
49	GDP	VD	501	-	-	0/12/32/32	0/3/3/3
49	GDP	WJ	501	-	-	0/12/32/32	0/3/3/3
49	GDP	KN	501	-	-	0/12/32/32	0/3/3/3
47	GTP	GE	501	48	-	5/18/38/38	0/3/3/3
49	GDP	UF	501	-	-	1/12/32/32	0/3/3/3
49	GDP	UH	501	-	-	1/12/32/32	0/3/3/3
49	GDP	OD	501	-	-	1/12/32/32	0/3/3/3
49	GDP	EF	501	-	-	1/12/32/32	0/3/3/3
47	GTP	CM	501	48	-	8/18/38/38	0/3/3/3
47	GTP	JI	501	48	-	7/18/38/38	0/3/3/3
49	GDP	NH	501	-	-	1/12/32/32	0/3/3/3
47	GTP	KM	501	48	-	5/18/38/38	0/3/3/3
49	GDP	HH	501	-	-	1/12/32/32	0/3/3/3
49	GDP	ID	501	-	-	0/12/32/32	0/3/3/3
47	GTP	KA	501	48	-	7/18/38/38	0/3/3/3
47	GTP	QK	501	48	-	7/18/38/38	0/3/3/3
49	GDP	RL	501	-	-	1/12/32/32	0/3/3/3
49	GDP	KD	501	-	-	0/12/32/32	0/3/3/3
47	GTP	TC	501	48	-	9/18/38/38	0/3/3/3
47	GTP	RG	501	48	-	7/18/38/38	0/3/3/3
49	GDP	JJ	501	-	-	2/12/32/32	0/3/3/3
47	GTP	BI	501	48	-	7/18/38/38	0/3/3/3
47	GTP	VE	501	48	-	6/18/38/38	0/3/3/3
49	GDP	FB	501	-	-	0/12/32/32	0/3/3/3
49	GDP	TH	501	-	-	1/12/32/32	0/3/3/3
49	GDP	VB	501	-	-	0/12/32/32	0/3/3/3
49	GDP	UJ	501	-	-	1/12/32/32	0/3/3/3
47	GTP	RM	501	48	-	7/18/38/38	0/3/3/3
49	GDP	DD	501	-	-	1/12/32/32	0/3/3/3
47	GTP	MC	501	48	-	7/18/38/38	0/3/3/3
49	GDP	RF	501	-	-	3/12/32/32	0/3/3/3

Continued on next page...

Continued from previous page...

Mol	Type	Chain	Res	Link	Chirals	Torsions	Rings
47	GTP	BG	501	48	-	8/18/38/38	0/3/3/3
47	GTP	OG	501	48	-	5/18/38/38	0/3/3/3
47	GTP	IG	501	48	-	8/18/38/38	0/3/3/3
47	GTP	HE	501	48	-	8/18/38/38	0/3/3/3
47	GTP	AK	501	48	-	9/18/38/38	0/3/3/3
47	GTP	PK	501	48	-	7/18/38/38	0/3/3/3
47	GTP	AM	501	48	-	4/18/38/38	0/3/3/3
47	GTP	SE	501	48	-	5/18/38/38	0/3/3/3
49	GDP	IL	501	-	-	1/12/32/32	0/3/3/3
49	GDP	FL	501	-	-	1/12/32/32	0/3/3/3
47	GTP	LG	501	48	-	8/18/38/38	0/3/3/3
47	GTP	AA	501	48	-	4/18/38/38	0/3/3/3
47	GTP	MA	501	48	-	7/18/38/38	0/3/3/3
47	GTP	QI	501	48	-	5/18/38/38	0/3/3/3
47	GTP	UI	501	48	-	5/18/38/38	0/3/3/3
49	GDP	AB	501	-	-	1/12/32/32	0/3/3/3
47	GTP	EG	501	48	-	4/18/38/38	0/3/3/3
49	GDP	PF	501	-	-	1/12/32/32	0/3/3/3
49	GDP	GL	501	-	-	0/12/32/32	0/3/3/3
47	GTP	QM	501	48	-	8/18/38/38	0/3/3/3
47	GTP	QE	501	48	-	7/18/38/38	0/3/3/3
47	GTP	LC	501	48	-	7/18/38/38	0/3/3/3
49	GDP	ON	501	-	-	0/12/32/32	0/3/3/3
47	GTP	IE	501	48	-	8/18/38/38	0/3/3/3
49	GDP	BF	501	-	-	1/12/32/32	0/3/3/3
49	GDP	VN	501	-	-	0/12/32/32	0/3/3/3
47	GTP	AG	501	48	-	6/18/38/38	0/3/3/3
47	GTP	IC	501	48	-	8/18/38/38	0/3/3/3
49	GDP	SH	501	-	-	0/12/32/32	0/3/3/3
49	GDP	JL	501	-	-	2/12/32/32	0/3/3/3
47	GTP	EC	501	48	-	8/18/38/38	0/3/3/3
47	GTP	UA	501	48	-	5/18/38/38	0/3/3/3
49	GDP	CF	501	-	-	1/12/32/32	0/3/3/3
47	GTP	FI	501	48	-	5/18/38/38	0/3/3/3
47	GTP	WE	501	48	-	3/18/38/38	0/3/3/3
47	GTP	EK	501	48	-	6/18/38/38	0/3/3/3

Continued on next page...

Continued from previous page...

Mol	Type	Chain	Res	Link	Chirals	Torsions	Rings
49	GDP	AF	501	-	-	0/12/32/32	0/3/3/3
49	GDP	KB	501	-	-	0/12/32/32	0/3/3/3
49	GDP	AJ	501	-	-	0/12/32/32	0/3/3/3
47	GTP	JK	501	48	-	6/18/38/38	0/3/3/3
47	GTP	OA	501	48	-	3/18/38/38	0/3/3/3
47	GTP	PM	501	48	-	8/18/38/38	0/3/3/3
49	GDP	HF	501	-	-	1/12/32/32	0/3/3/3
47	GTP	FE	501	48	-	9/18/38/38	0/3/3/3
47	GTP	VG	501	48	-	8/18/38/38	0/3/3/3
49	GDP	CN	501	-	-	0/12/32/32	0/3/3/3
49	GDP	BH	501	-	-	1/12/32/32	0/3/3/3
47	GTP	QC	501	48	-	7/18/38/38	0/3/3/3
49	GDP	PJ	501	-	-	1/12/32/32	0/3/3/3
49	GDP	UB	501	-	-	0/12/32/32	0/3/3/3
47	GTP	UM	501	48	-	7/18/38/38	0/3/3/3
47	GTP	FM	501	48	-	6/18/38/38	0/3/3/3
49	GDP	GN	501	-	-	1/12/32/32	0/3/3/3
47	GTP	FK	501	48	-	7/18/38/38	0/3/3/3
47	GTP	UG	501	48	-	7/18/38/38	0/3/3/3
49	GDP	KL	501	-	-	1/12/32/32	0/3/3/3
49	GDP	QJ	501	-	-	0/12/32/32	0/3/3/3
49	GDP	LF	501	-	-	0/12/32/32	0/3/3/3
49	GDP	TD	501	-	-	1/12/32/32	0/3/3/3
47	GTP	AI	501	48	-	9/18/38/38	0/3/3/3
47	GTP	RC	501	48	-	7/18/38/38	0/3/3/3
49	GDP	ND	501	-	-	1/12/32/32	0/3/3/3
49	GDP	PB	501	-	-	0/12/32/32	0/3/3/3
49	GDP	HJ	501	-	-	0/12/32/32	0/3/3/3
49	GDP	OB	501	-	-	0/12/32/32	0/3/3/3
47	GTP	PG	501	48	-	8/18/38/38	0/3/3/3
49	GDP	RH	501	-	-	0/12/32/32	0/3/3/3
49	GDP	LN	501	-	-	0/12/32/32	0/3/3/3
49	GDP	SJ	501	-	-	1/12/32/32	0/3/3/3
47	GTP	GC	501	48	-	5/18/38/38	0/3/3/3
49	GDP	WL	501	-	-	1/12/32/32	0/3/3/3
47	GTP	HI	501	48	-	4/18/38/38	0/3/3/3
47	GTP	RE	501	48	-	7/18/38/38	0/3/3/3
49	GDP	WD	501	-	-	0/12/32/32	0/3/3/3

Continued on next page...

Continued from previous page...

Mol	Type	Chain	Res	Link	Chirals	Torsions	Rings
49	GDP	HN	501	-	-	1/12/32/32	0/3/3/3
49	GDP	QD	501	-	-	0/12/32/32	0/3/3/3
47	GTP	AC	501	48	-	9/18/38/38	0/3/3/3
49	GDP	UL	501	-	-	1/12/32/32	0/3/3/3
49	GDP	FN	501	-	-	1/12/32/32	0/3/3/3
49	GDP	QH	501	-	-	0/12/32/32	0/3/3/3
47	GTP	VK	501	48	-	7/18/38/38	0/3/3/3
47	GTP	KE	501	48	-	7/18/38/38	0/3/3/3
49	GDP	ML	501	-	-	3/12/32/32	0/3/3/3
47	GTP	UC	501	48	-	7/18/38/38	0/3/3/3
49	GDP	LH	501	-	-	2/12/32/32	0/3/3/3
49	GDP	EJ	501	-	-	2/12/32/32	0/3/3/3
49	GDP	PL	501	-	-	1/12/32/32	0/3/3/3
49	GDP	TB	501	-	-	1/12/32/32	0/3/3/3
49	GDP	JF	501	-	-	2/12/32/32	0/3/3/3
49	GDP	OL	501	-	-	0/12/32/32	0/3/3/3
49	GDP	WN	501	-	-	0/12/32/32	0/3/3/3
47	GTP	OC	501	48	-	2/18/38/38	0/3/3/3
49	GDP	GH	501	-	-	0/12/32/32	0/3/3/3
49	GDP	FH	501	-	-	1/12/32/32	0/3/3/3
49	GDP	SL	501	-	-	3/12/32/32	0/3/3/3
47	GTP	NA	501	48	-	8/18/38/38	0/3/3/3
47	GTP	KK	501	48	-	4/18/38/38	0/3/3/3
49	GDP	OJ	501	-	-	0/12/32/32	0/3/3/3
49	GDP	WB	501	-	-	1/12/32/32	0/3/3/3
47	GTP	CG	501	48	-	7/18/38/38	0/3/3/3
47	GTP	SA	501	48	-	6/18/38/38	0/3/3/3
47	GTP	WG	501	48	-	8/18/38/38	0/3/3/3
47	GTP	GG	501	48	-	8/18/38/38	0/3/3/3
47	GTP	IM	501	48	-	9/18/38/38	0/3/3/3
47	GTP	GI	501	48	-	7/18/38/38	0/3/3/3
49	GDP	TJ	501	-	-	1/12/32/32	0/3/3/3
49	GDP	EN	501	-	-	0/12/32/32	0/3/3/3
47	GTP	WM	501	48	-	3/18/38/38	0/3/3/3
49	GDP	AH	501	-	-	1/12/32/32	0/3/3/3
47	GTP	JG	501	48	-	8/18/38/38	0/3/3/3
47	GTP	DA	501	48	-	5/18/38/38	0/3/3/3

Continued on next page...

Continued from previous page...

Mol	Type	Chain	Res	Link	Chirals	Torsions	Rings
47	GTP	EI	501	48	-	5/18/38/38	0/3/3/3
47	GTP	TA	501	48	-	8/18/38/38	0/3/3/3
47	GTP	GM	501	48	-	6/18/38/38	0/3/3/3
47	GTP	CA	501	48	-	6/18/38/38	0/3/3/3
47	GTP	BA	501	48	-	7/18/38/38	0/3/3/3
47	GTP	AE	501	48	-	5/18/38/38	0/3/3/3
49	GDP	CH	501	-	-	2/12/32/32	0/3/3/3
47	GTP	SM	501	48	-	8/18/38/38	0/3/3/3
49	GDP	ED	501	-	-	2/12/32/32	0/3/3/3
47	GTP	WI	501	48	-	6/18/38/38	0/3/3/3
47	GTP	HK	501	48	-	5/18/38/38	0/3/3/3
49	GDP	TN	501	-	-	1/12/32/32	0/3/3/3
47	GTP	BM	501	48	-	8/18/38/38	0/3/3/3
49	GDP	KJ	501	-	-	1/12/32/32	0/3/3/3
47	GTP	NK	501	48	-	6/18/38/38	0/3/3/3
47	GTP	WA	501	48	-	8/18/38/38	0/3/3/3
47	GTP	WK	501	48	-	8/18/38/38	0/3/3/3
49	GDP	WF	501	-	-	1/12/32/32	0/3/3/3
47	GTP	LA	501	48	-	5/18/38/38	0/3/3/3
47	GTP	SG	501	48	-	4/18/38/38	0/3/3/3
49	GDP	VL	501	-	-	1/12/32/32	0/3/3/3
49	GDP	CD	501	-	-	1/12/32/32	0/3/3/3
49	GDP	GJ	501	-	-	1/12/32/32	0/3/3/3
49	GDP	JD	501	-	-	1/12/32/32	0/3/3/3
47	GTP	EE	501	48	-	9/18/38/38	0/3/3/3
47	GTP	IK	502	48	-	7/18/38/38	0/3/3/3
47	GTP	VC	501	48	-	7/18/38/38	0/3/3/3
49	GDP	VH	501	-	-	0/12/32/32	0/3/3/3
49	GDP	LB	501	-	-	0/12/32/32	0/3/3/3
47	GTP	SK	501	48	-	5/18/38/38	0/3/3/3
47	GTP	LE	501	48	-	8/18/38/38	0/3/3/3
47	GTP	OI	501	48	-	4/18/38/38	0/3/3/3
47	GTP	EA	501	48	-	6/18/38/38	0/3/3/3
49	GDP	MJ	501	-	-	1/12/32/32	0/3/3/3
49	GDP	MN	501	-	-	2/12/32/32	0/3/3/3
49	GDP	LL	501	-	-	1/12/32/32	0/3/3/3

Continued on next page...

Continued from previous page...

Mol	Type	Chain	Res	Link	Chirals	Torsions	Rings
49	GDP	UD	501	-	-	1/12/32/32	0/3/3/3

The worst 5 of 503 bond length outliers are listed below:

Mol	Chain	Res	Type	Atoms	Z	Observed(Å)	Ideal(Å)
47	EA	501	GTP	C5-C6	-4.32	1.38	1.47
47	AE	501	GTP	C5-C6	-4.31	1.38	1.47
47	AM	501	GTP	C5-C6	-4.29	1.39	1.47
47	AA	501	GTP	C5-C6	-4.28	1.39	1.47
47	AG	501	GTP	C5-C6	-4.28	1.39	1.47

The worst 5 of 953 bond angle outliers are listed below:

Mol	Chain	Res	Type	Atoms	Z	Observed(°)	Ideal(°)
47	RI	501	GTP	C8-N7-C5	3.72	108.89	102.55
47	FM	501	GTP	C8-N7-C5	3.72	108.88	102.55
47	DC	501	GTP	C8-N7-C5	3.71	108.87	102.55
47	RK	501	GTP	C8-N7-C5	3.71	108.86	102.55
47	VC	501	GTP	C8-N7-C5	3.69	108.83	102.55

There are no chirality outliers.

5 of 1178 torsion outliers are listed below:

Mol	Chain	Res	Type	Atoms
47	AC	501	GTP	C5'-O5'-PA-O3A
47	AC	501	GTP	C5'-O5'-PA-O1A
47	AC	501	GTP	C5'-O5'-PA-O2A
47	AG	501	GTP	PB-O3A-PA-O5'
47	AI	501	GTP	PB-O3A-PA-O5'

There are no ring outliers.

196 monomers are involved in 350 short contacts:

Mol	Chain	Res	Type	Clashes	Symm-Clashes
47	CI	501	GTP	3	0
49	WH	501	GDP	1	0
47	DI	501	GTP	2	0
47	OE	501	GTP	2	0
47	LM	501	GTP	2	0
49	CJ	501	GDP	1	0
47	VA	501	GTP	2	0

Continued on next page...

Continued from previous page...

Mol	Chain	Res	Type	Clashes	Symm-Clashes
47	BE	501	GTP	2	0
47	NE	501	GTP	2	0
49	BD	501	GDP	1	0
49	PN	501	GDP	2	0
47	CK	501	GTP	2	0
49	OF	501	GDP	1	0
47	DM	501	GTP	1	0
47	UK	501	GTP	4	0
49	NB	502	GDP	1	0
47	RK	501	GTP	2	0
47	TI	501	GTP	1	0
47	TG	501	GTP	1	0
49	DJ	501	GDP	1	0
47	SI	501	GTP	2	0
47	SC	501	GTP	1	0
47	DE	501	GTP	2	0
47	DC	501	GTP	1	0
49	VJ	501	GDP	1	0
49	HL	501	GDP	3	0
47	HC	501	GTP	2	0
47	PI	501	GTP	4	0
47	DK	501	GTP	2	0
47	PE	501	GTP	3	0
49	MF	501	GDP	1	0
49	EH	501	GDP	2	0
47	DG	501	GTP	1	0
49	RD	501	GDP	1	0
47	RA	501	GTP	1	0
47	JA	501	GTP	2	0
49	QF	501	GDP	3	0
49	GD	501	GDP	2	0
47	RI	501	GTP	3	0
47	QA	501	GTP	2	0
47	VI	501	GTP	1	0
49	FD	501	GDP	2	0
49	EB	501	GDP	2	0
49	DN	501	GDP	1	0
47	BK	501	GTP	2	0
49	NL	501	GDP	2	0
49	NJ	501	GDP	1	0
49	BN	501	GDP	1	0
47	II	501	GTP	1	0

Continued on next page...

Continued from previous page...

Mol	Chain	Res	Type	Clashes	Symm-Clashes
47	HM	501	GTP	1	0
49	GF	501	GDP	2	0
47	UE	501	GTP	2	0
49	DB	501	GDP	1	0
49	CB	501	GDP	3	0
49	TF	501	GDP	1	0
47	NI	501	GTP	3	0
49	IF	501	GDP	1	0
47	NM	501	GTP	1	0
49	BJ	501	GDP	1	0
47	QG	501	GTP	2	0
47	LI	501	GTP	2	0
47	JM	501	GTP	5	0
49	VF	501	GDP	4	0
49	TL	501	GDP	1	0
47	EM	501	GTP	2	0
47	JC	501	GTP	2	0
47	TK	501	GTP	1	0
47	GA	501	GTP	3	0
47	PC	501	GTP	1	0
49	QB	501	GDP	2	0
47	VM	501	GTP	3	0
49	SN	501	GDP	2	0
47	CE	501	GTP	2	0
47	FC	501	GTP	1	0
47	PA	501	GTP	3	0
47	KG	501	GTP	1	0
47	LK	501	GTP	1	0
49	JN	501	GDP	2	0
49	JH	501	GDP	3	0
47	OM	501	GTP	3	0
49	CL	501	GDP	1	0
49	HD	501	GDP	2	0
49	AD	501	GDP	1	0
47	OK	501	GTP	1	0
47	CC	501	GTP	1	0
49	VD	501	GDP	2	0
49	WJ	501	GDP	2	0
49	UF	501	GDP	3	0
49	UH	501	GDP	2	0
47	CM	501	GTP	1	0
47	JI	501	GTP	2	0

Continued on next page...

Continued from previous page...

Mol	Chain	Res	Type	Clashes	Symm-Clashes
49	HH	501	GDP	1	0
49	ID	501	GDP	1	0
47	KA	501	GTP	1	0
47	QK	501	GTP	2	0
47	RG	501	GTP	3	0
49	TH	501	GDP	1	0
49	VB	501	GDP	1	0
49	UJ	501	GDP	1	0
47	OG	501	GTP	1	0
47	IG	501	GTP	1	0
47	AK	501	GTP	1	0
47	PK	501	GTP	3	0
47	AM	501	GTP	2	0
47	SE	501	GTP	3	0
47	AA	501	GTP	2	0
47	MA	501	GTP	1	0
47	QI	501	GTP	3	0
47	UI	501	GTP	3	0
47	EG	501	GTP	2	0
49	PF	501	GDP	1	0
49	GL	501	GDP	1	0
47	QM	501	GTP	2	0
47	QE	501	GTP	2	0
47	LC	501	GTP	2	0
49	ON	501	GDP	1	0
49	BF	501	GDP	2	0
47	EC	501	GTP	2	0
47	UA	501	GTP	2	0
49	CF	501	GDP	5	0
47	WE	501	GTP	1	0
47	EK	501	GTP	2	0
49	AF	501	GDP	1	0
49	AJ	501	GDP	1	0
47	OA	501	GTP	4	0
47	PM	501	GTP	1	0
49	HF	501	GDP	1	0
47	FE	501	GTP	1	0
49	CN	501	GDP	1	0
49	BH	501	GDP	1	0
47	QC	501	GTP	3	0
49	PJ	501	GDP	4	0
47	UM	501	GTP	3	0

Continued on next page...

Continued from previous page...

Mol	Chain	Res	Type	Clashes	Symm-Clashes
47	FM	501	GTP	5	0
47	FK	501	GTP	1	0
47	UG	501	GTP	2	0
49	QJ	501	GDP	1	0
49	LF	501	GDP	1	0
49	TD	501	GDP	1	0
47	RC	501	GTP	2	0
49	PB	501	GDP	1	0
49	OB	501	GDP	2	0
47	PG	501	GTP	3	0
49	LN	501	GDP	2	0
49	WL	501	GDP	2	0
47	HI	501	GTP	1	0
47	RE	501	GTP	2	0
49	WD	501	GDP	1	0
49	HN	501	GDP	2	0
47	AC	501	GTP	1	0
49	FN	501	GDP	1	0
49	QH	501	GDP	1	0
47	VK	501	GTP	2	0
47	KE	501	GTP	1	0
47	UC	501	GTP	2	0
49	PL	501	GDP	1	0
49	JF	501	GDP	2	0
49	OL	501	GDP	1	0
49	WN	501	GDP	1	0
49	GH	501	GDP	2	0
49	FH	501	GDP	2	0
47	NA	501	GTP	2	0
49	OJ	501	GDP	1	0
47	CG	501	GTP	2	0
47	SA	501	GTP	5	0
47	WG	501	GTP	1	0
47	GG	501	GTP	1	0
47	WM	501	GTP	3	0
47	JG	501	GTP	1	0
47	DA	501	GTP	2	0
47	EI	501	GTP	2	0
47	TA	501	GTP	1	0
47	GM	501	GTP	3	0
47	CA	501	GTP	4	0
47	BA	501	GTP	2	0

Continued on next page...

Continued from previous page...

Mol	Chain	Res	Type	Clashes	Symm-Clashes
49	CH	501	GDP	1	0
47	SM	501	GTP	1	0
49	ED	501	GDP	1	0
47	WI	501	GTP	1	0
47	HK	501	GTP	1	0
49	TN	501	GDP	1	0
47	BM	501	GTP	1	0
47	WA	501	GTP	3	0
47	WK	501	GTP	2	0
49	WF	501	GDP	1	0
47	LA	501	GTP	3	0
47	SG	501	GTP	1	0
49	VL	501	GDP	3	0
49	CD	501	GDP	1	0
49	GJ	501	GDP	1	0
47	EE	501	GTP	1	0
47	VC	501	GTP	1	0
49	VH	501	GDP	2	0
47	SK	501	GTP	1	0
47	OI	501	GTP	1	0
47	EA	501	GTP	3	0

The following is a two-dimensional graphical depiction of Mogul quality analysis of bond lengths, bond angles, torsion angles, and ring geometry for all instances of the Ligand of Interest. In addition, ligands with molecular weight > 250 and outliers as shown on the validation Tables will also be included. For torsion angles, if less than 5% of the Mogul distribution of torsion angles is within 10 degrees of the torsion angle in question, then that torsion angle is considered an outlier. Any bond that is central to one or more torsion angles identified as an outlier by Mogul will be highlighted in the graph. For rings, the root-mean-square deviation (RMSD) between the ring in question and similar rings identified by Mogul is calculated over all ring torsion angles. If the average RMSD is greater than 60 degrees and the minimal RMSD between the ring in question and any Mogul-identified rings is also greater than 60 degrees, then that ring is considered an outlier. The outliers are highlighted in purple. The color gray indicates Mogul did not find sufficient equivalents in the CSD to analyse the geometry.

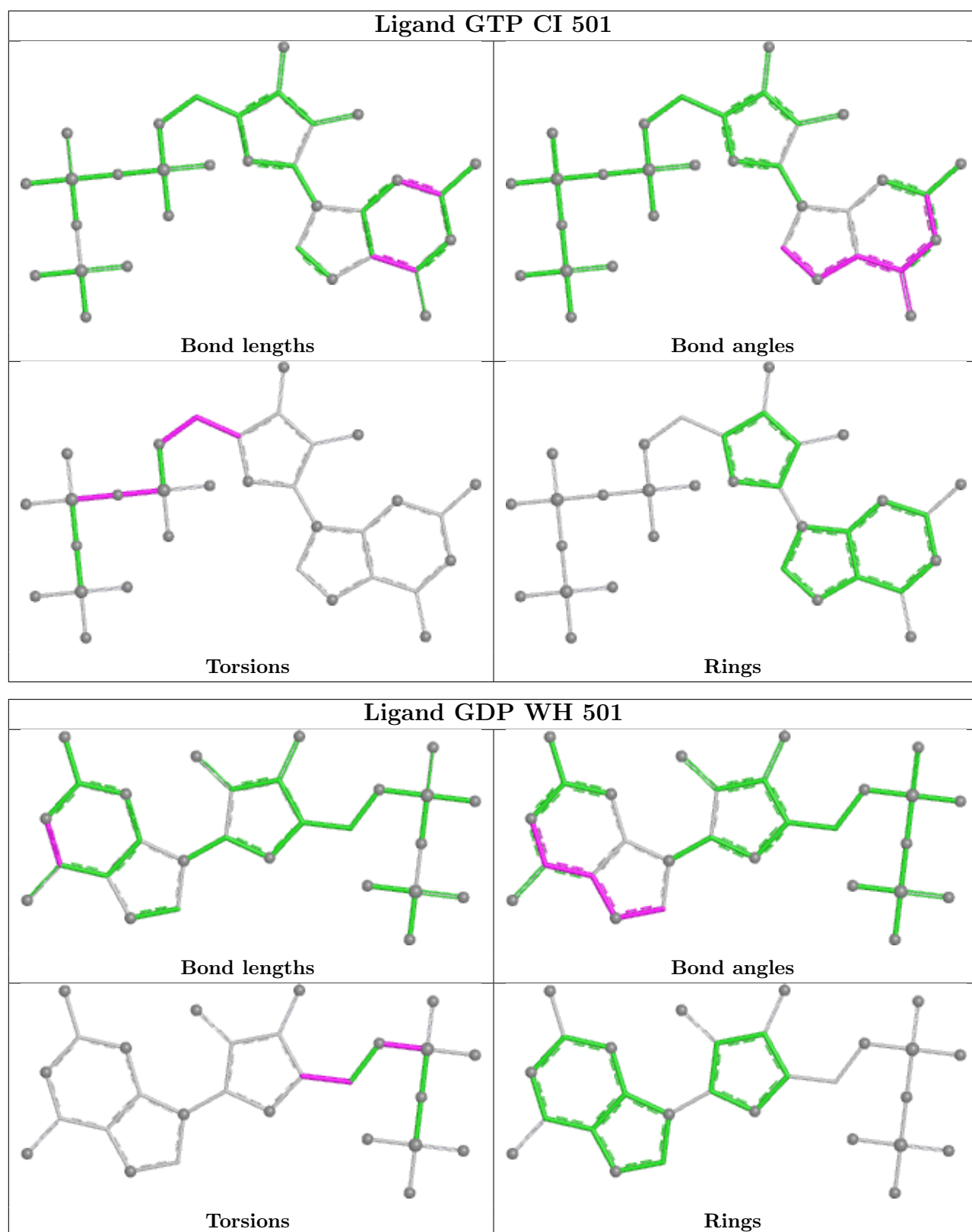

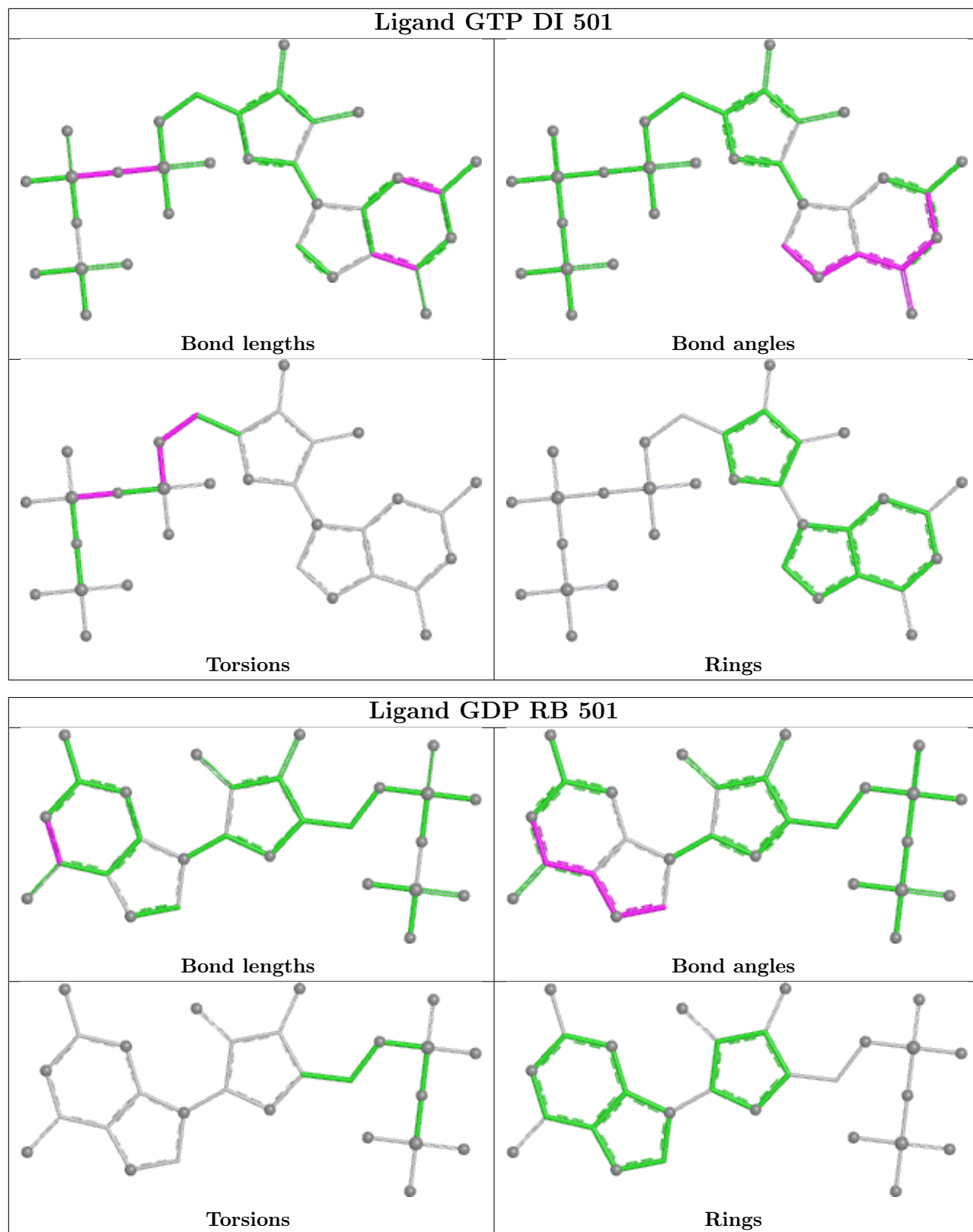

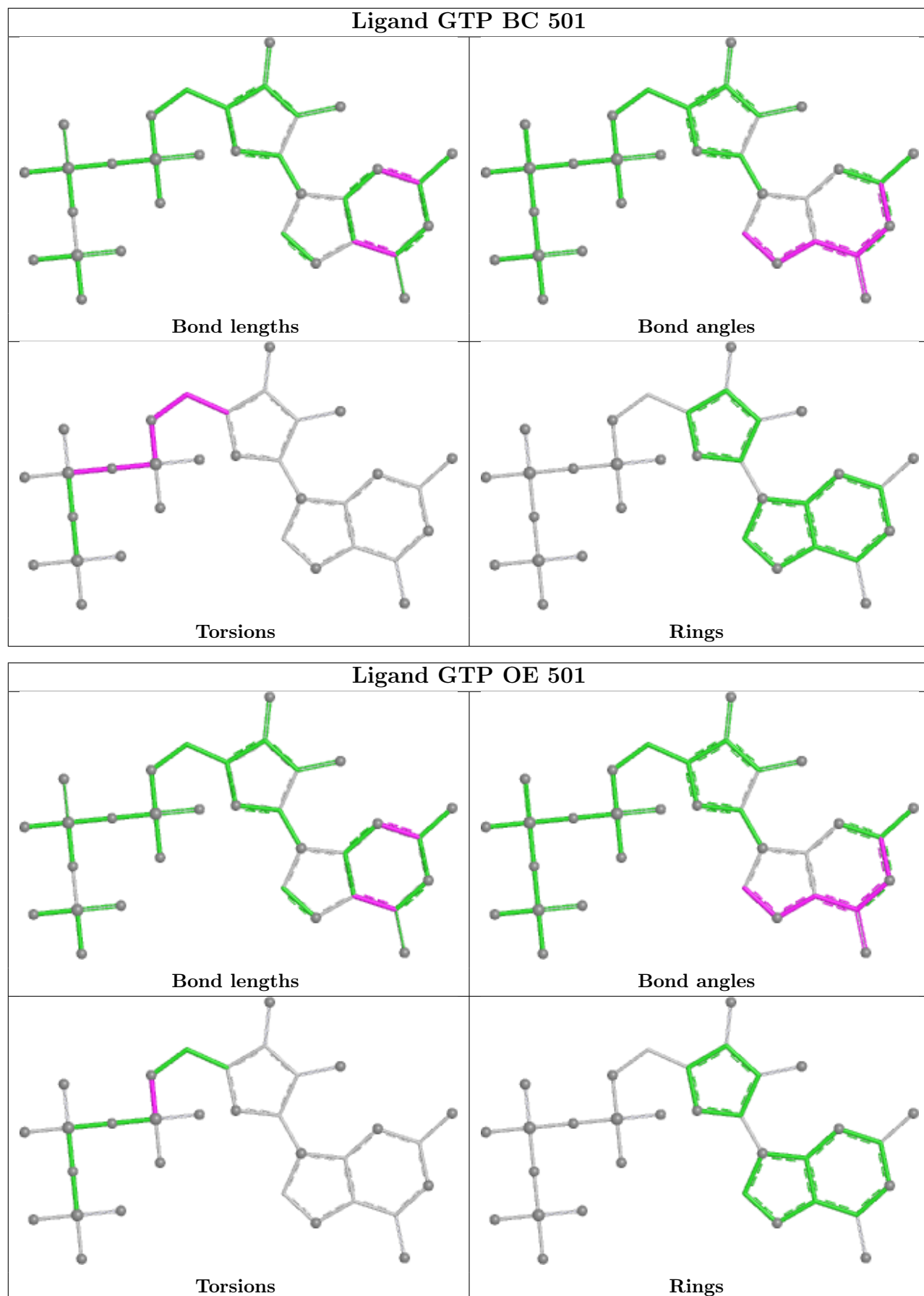

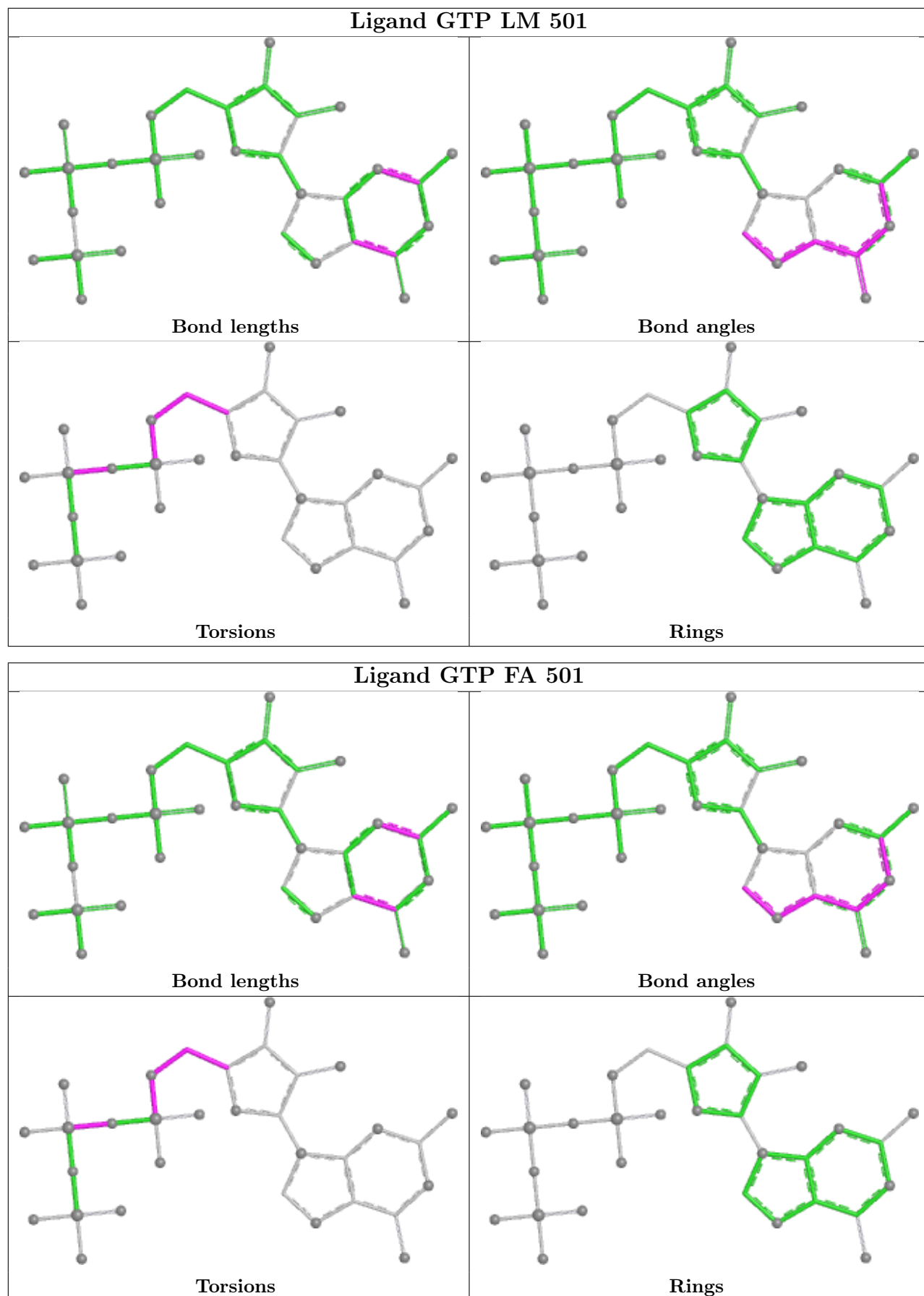

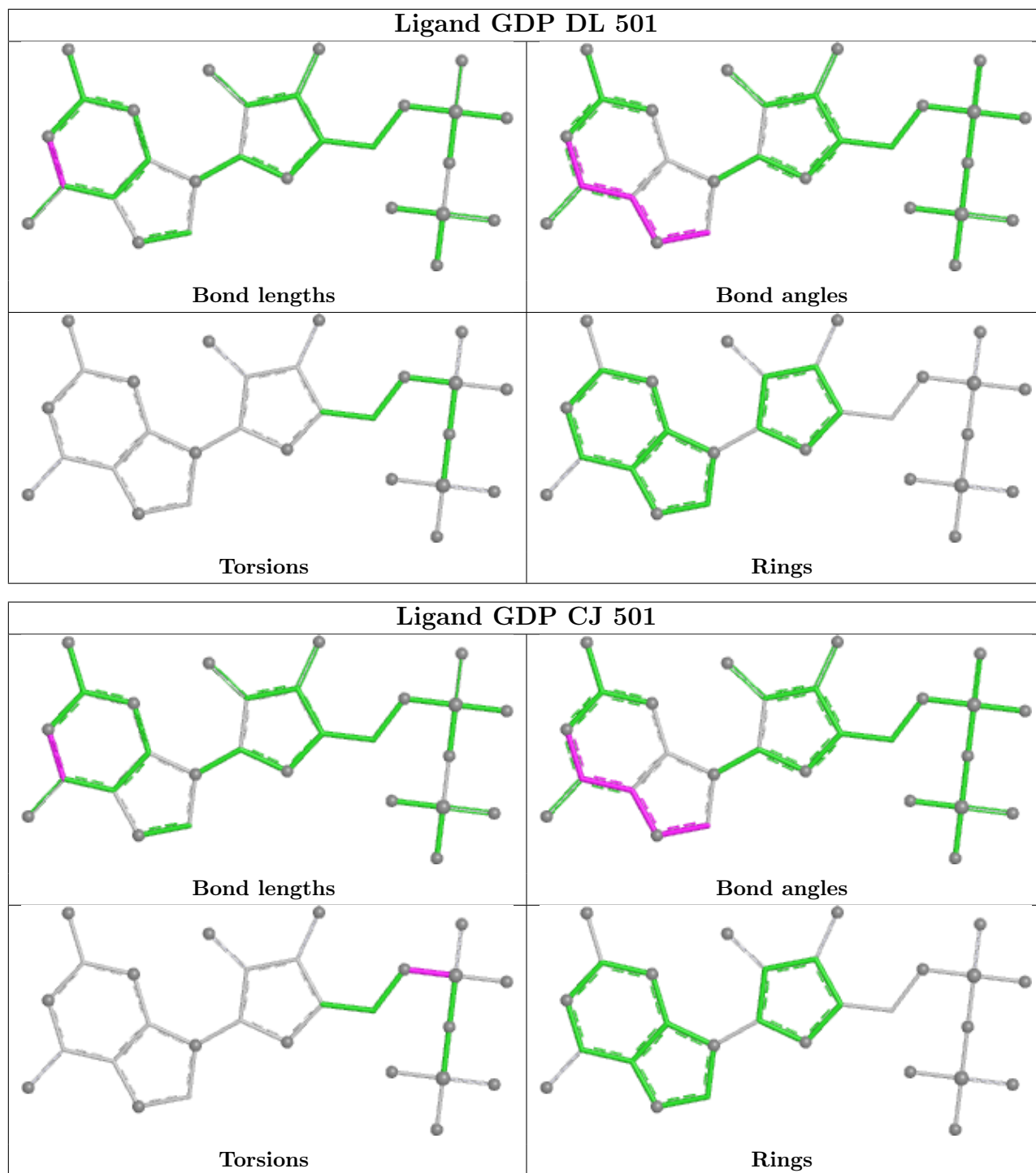

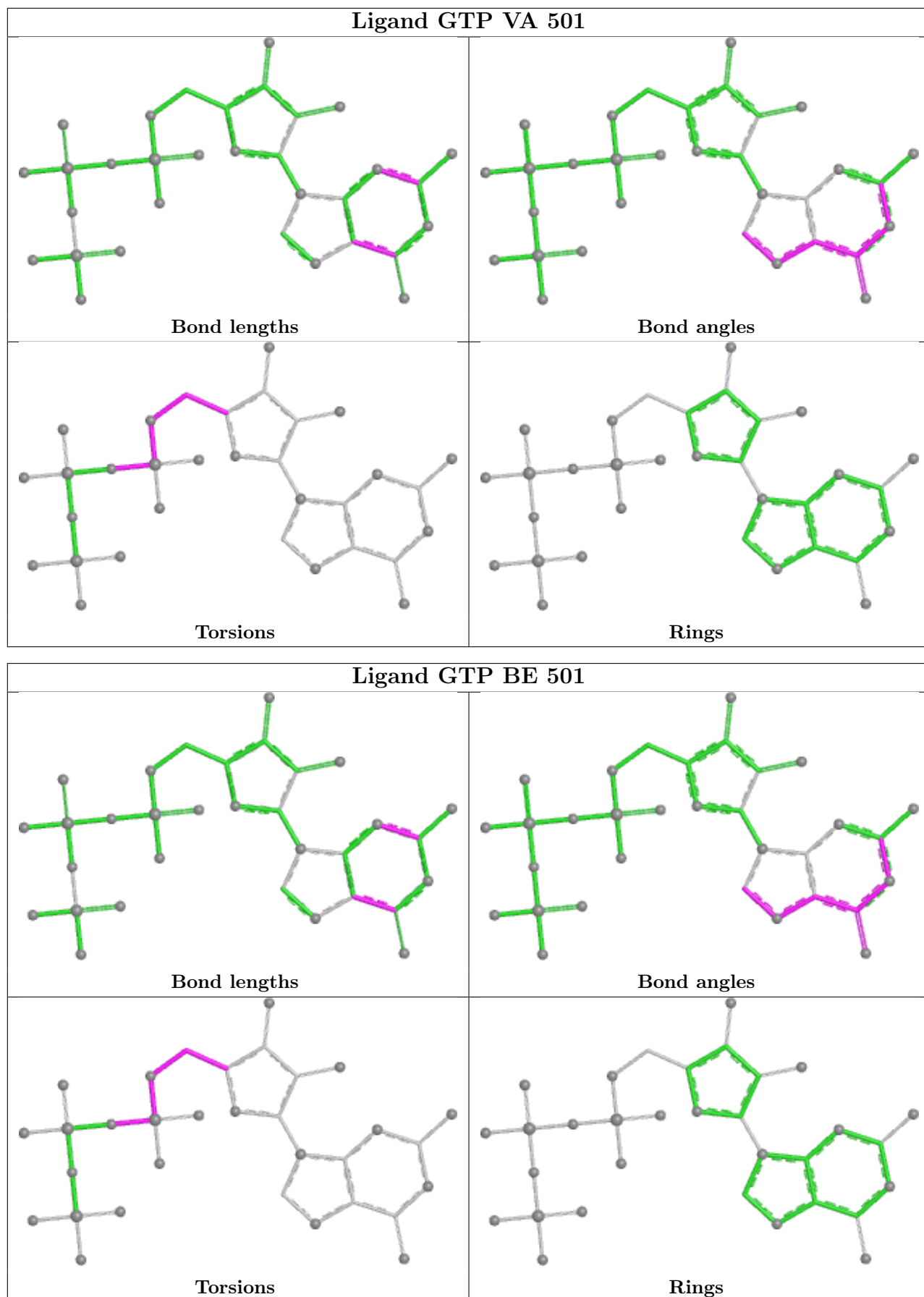

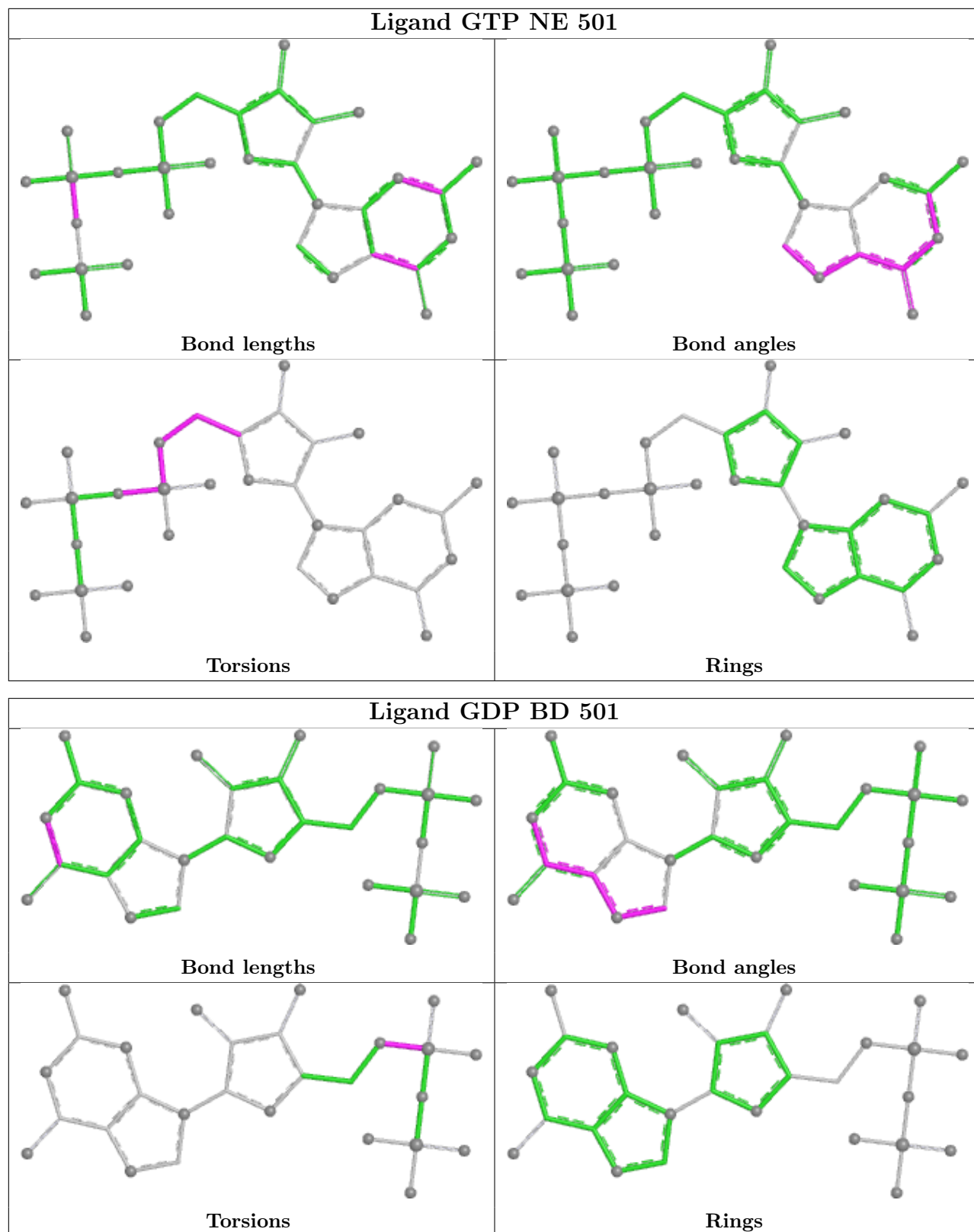

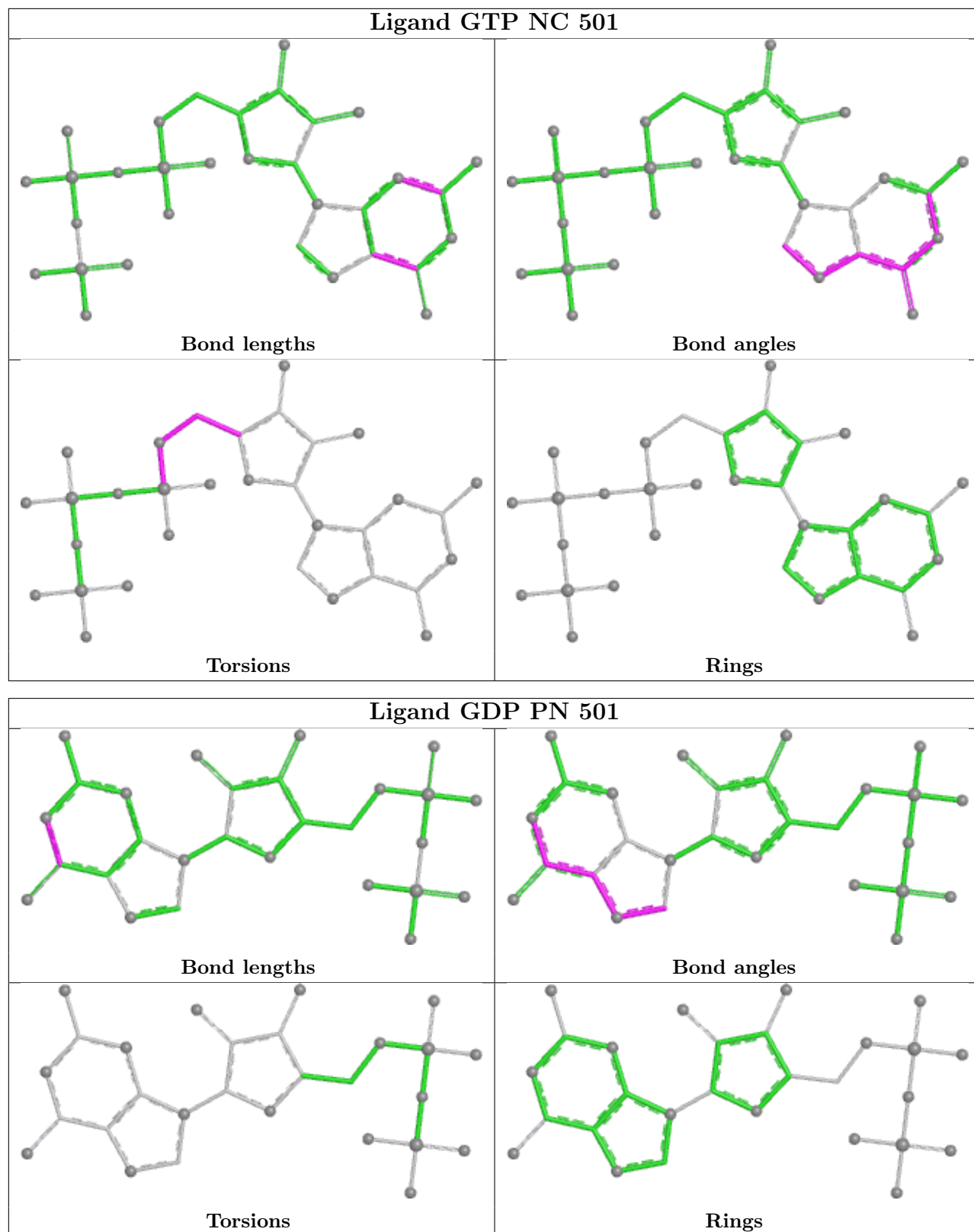

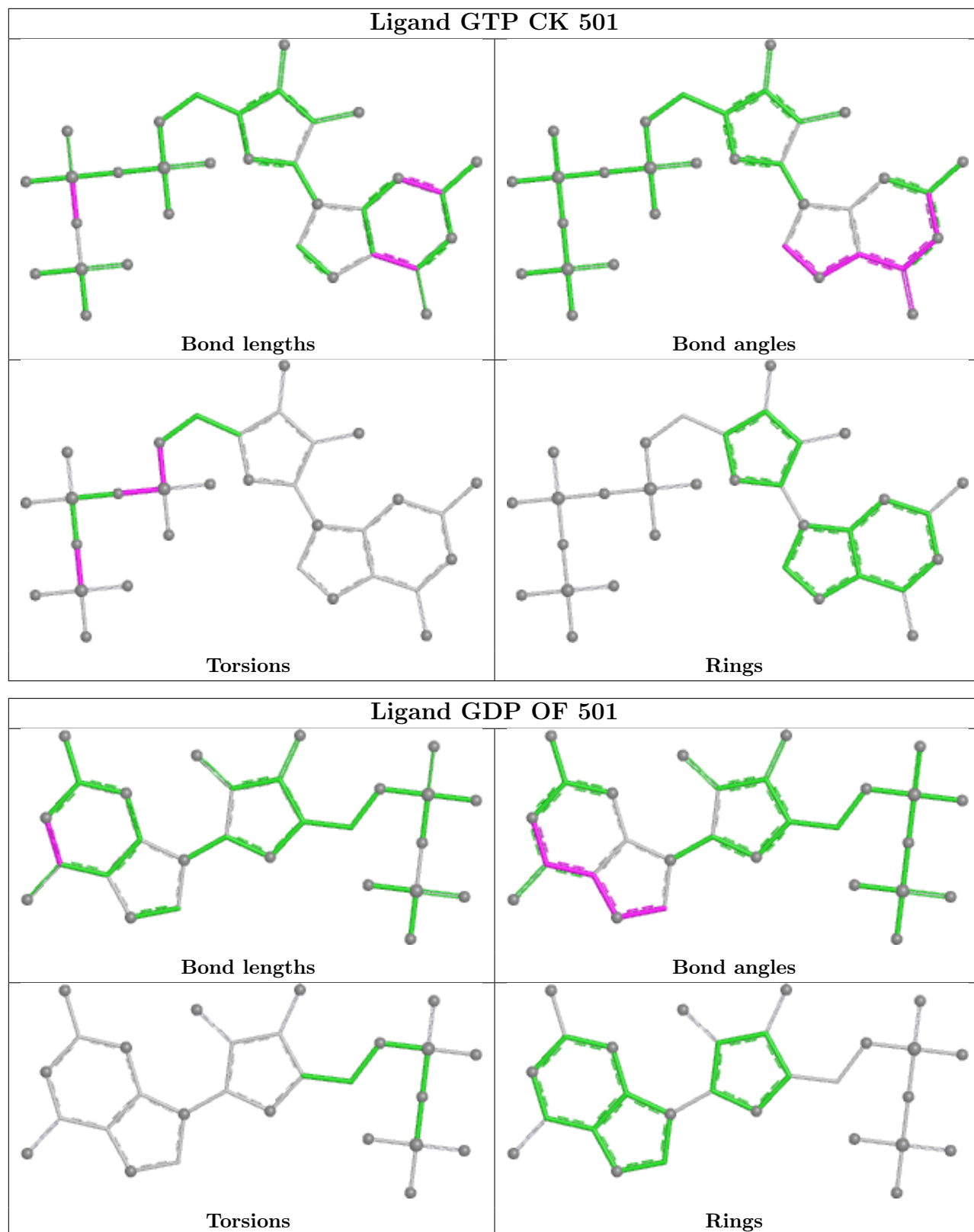

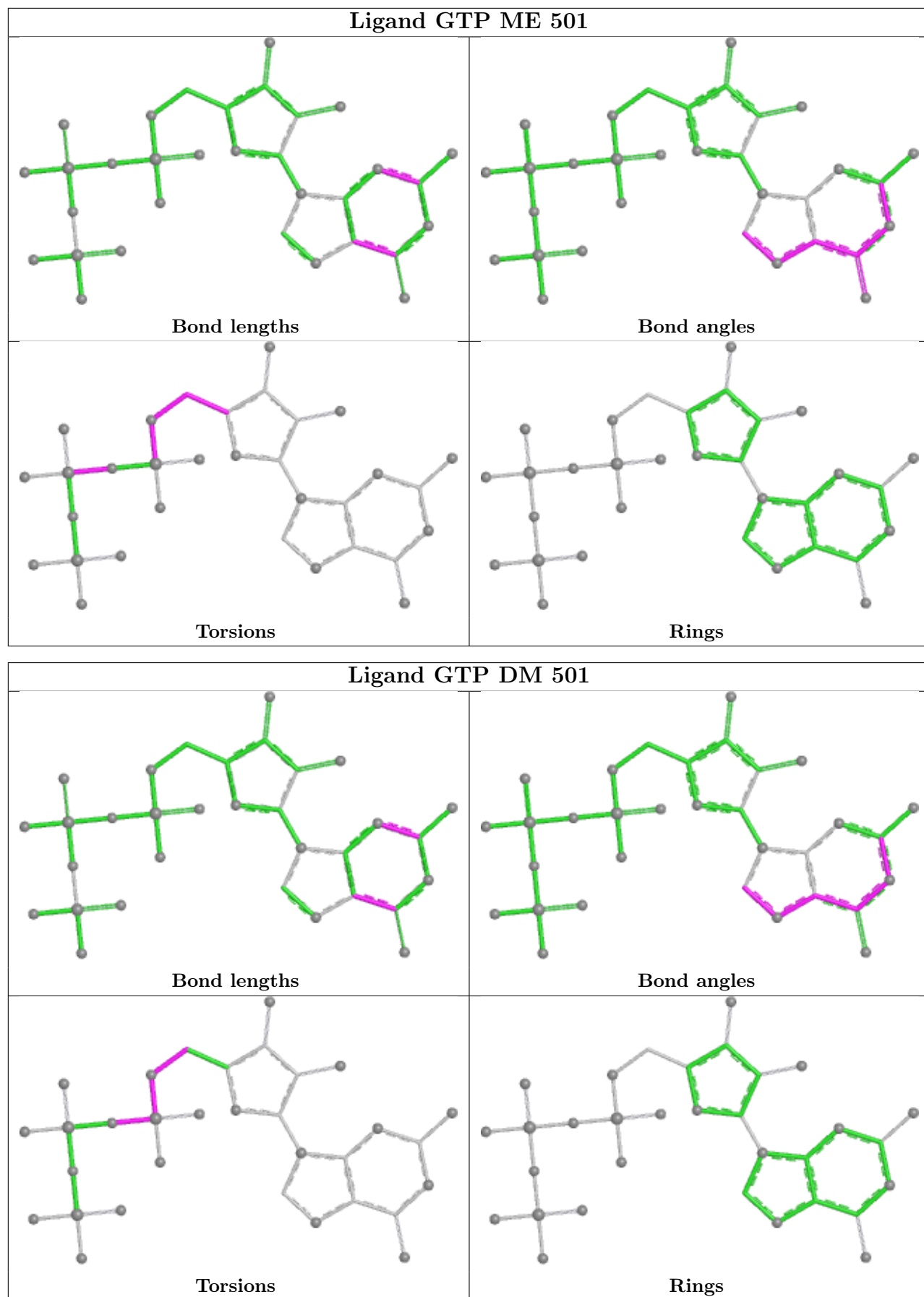

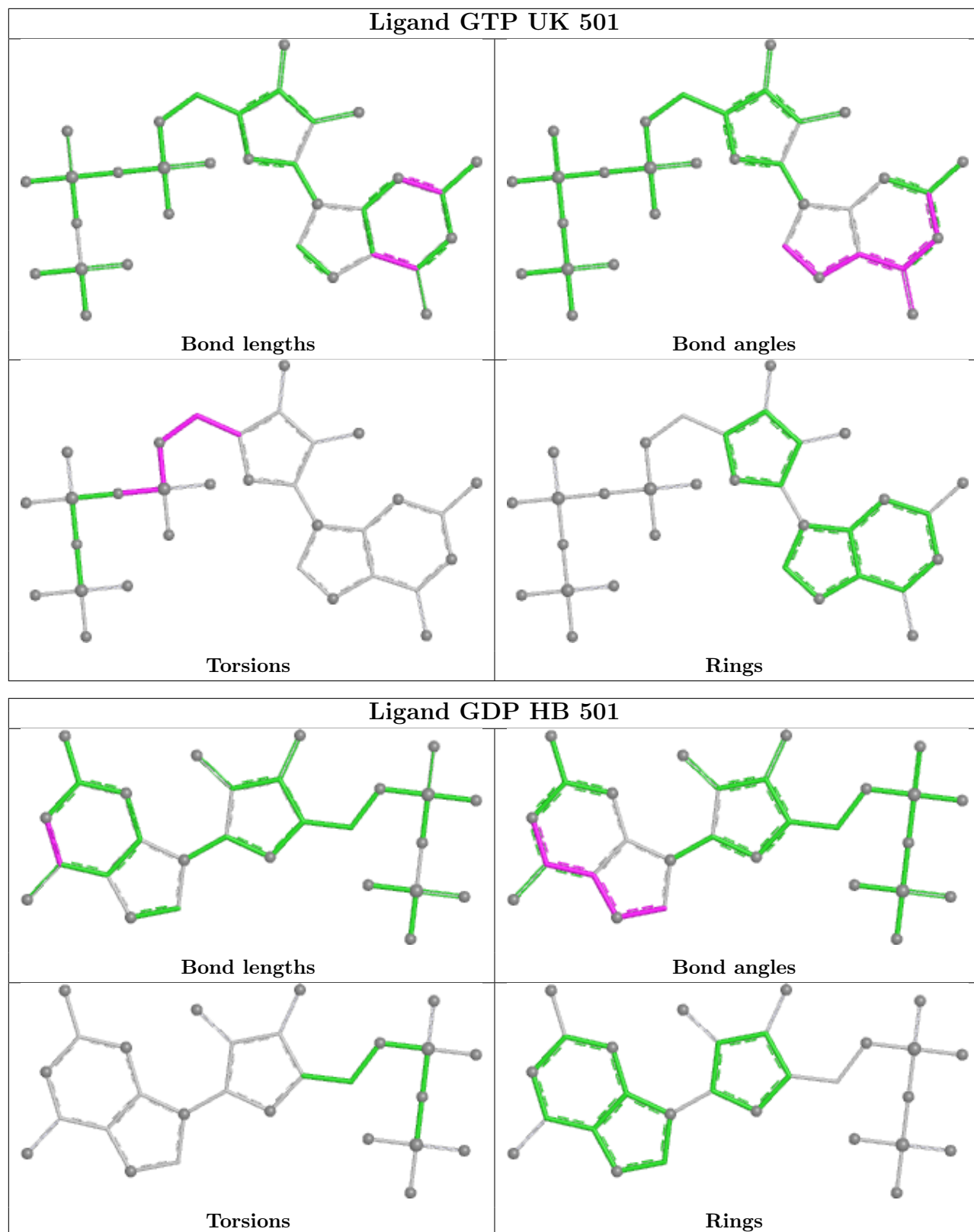

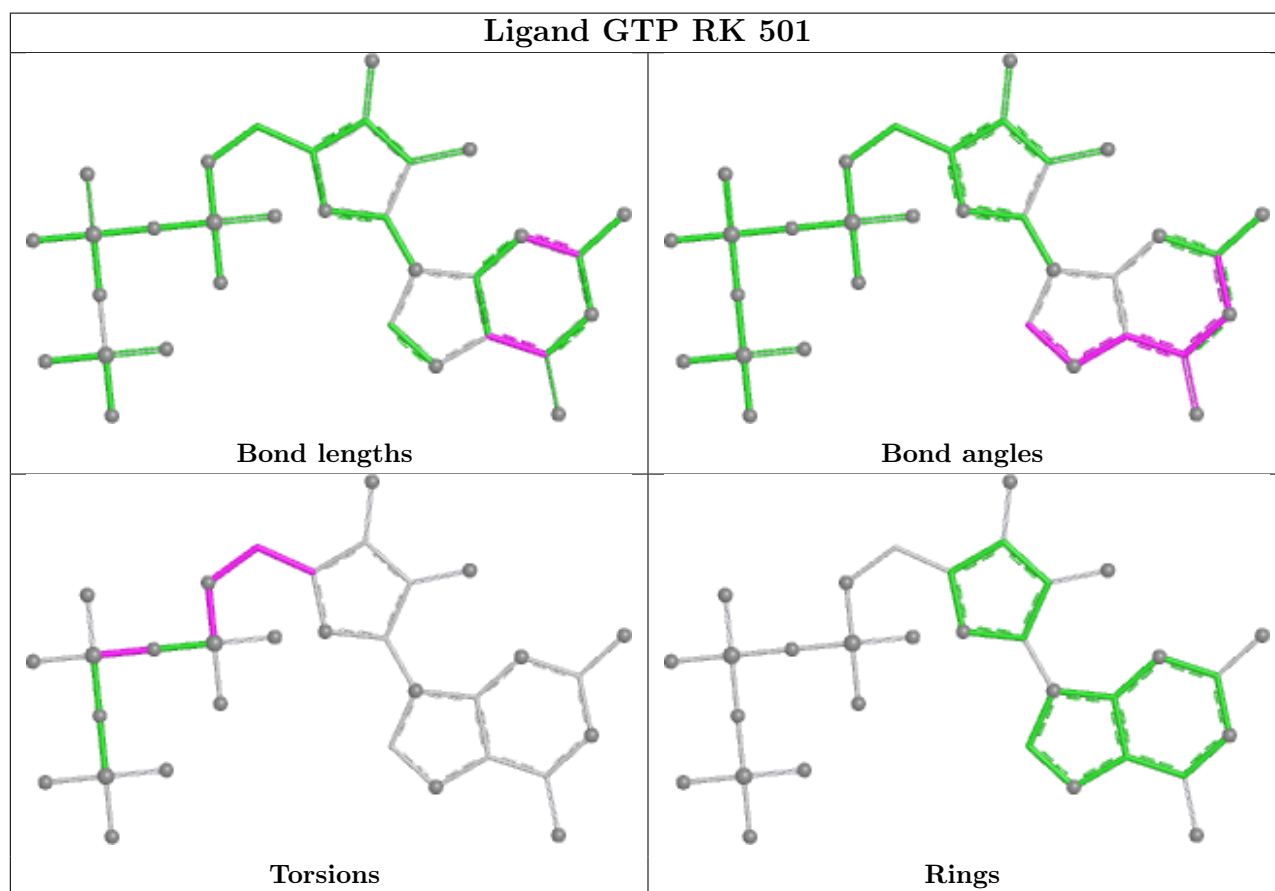
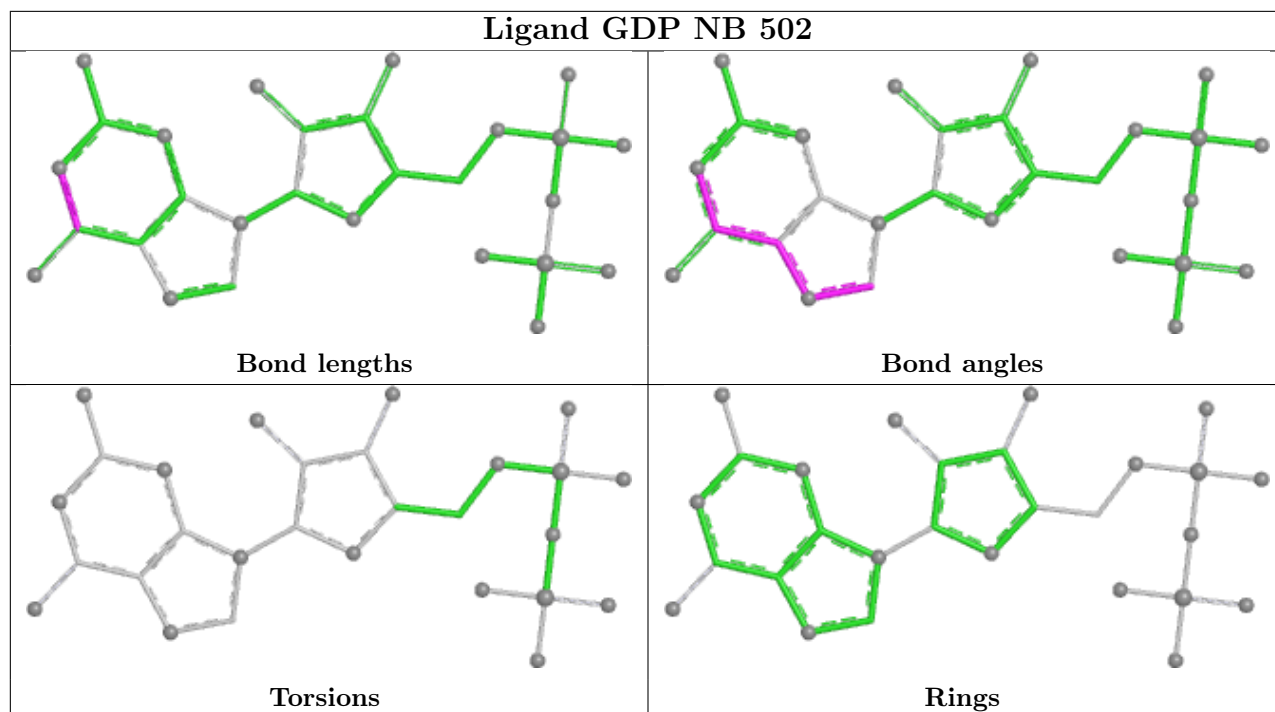

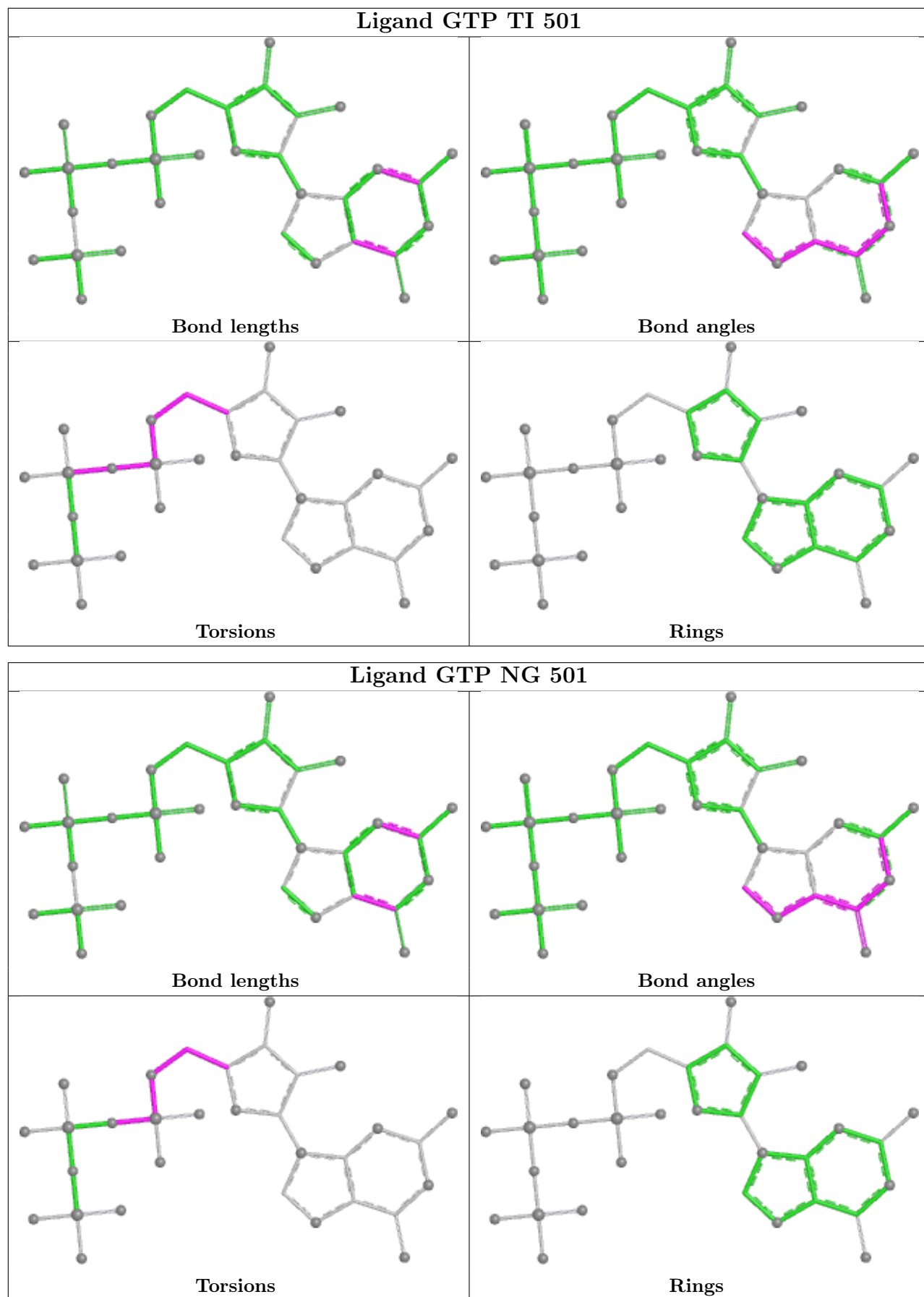

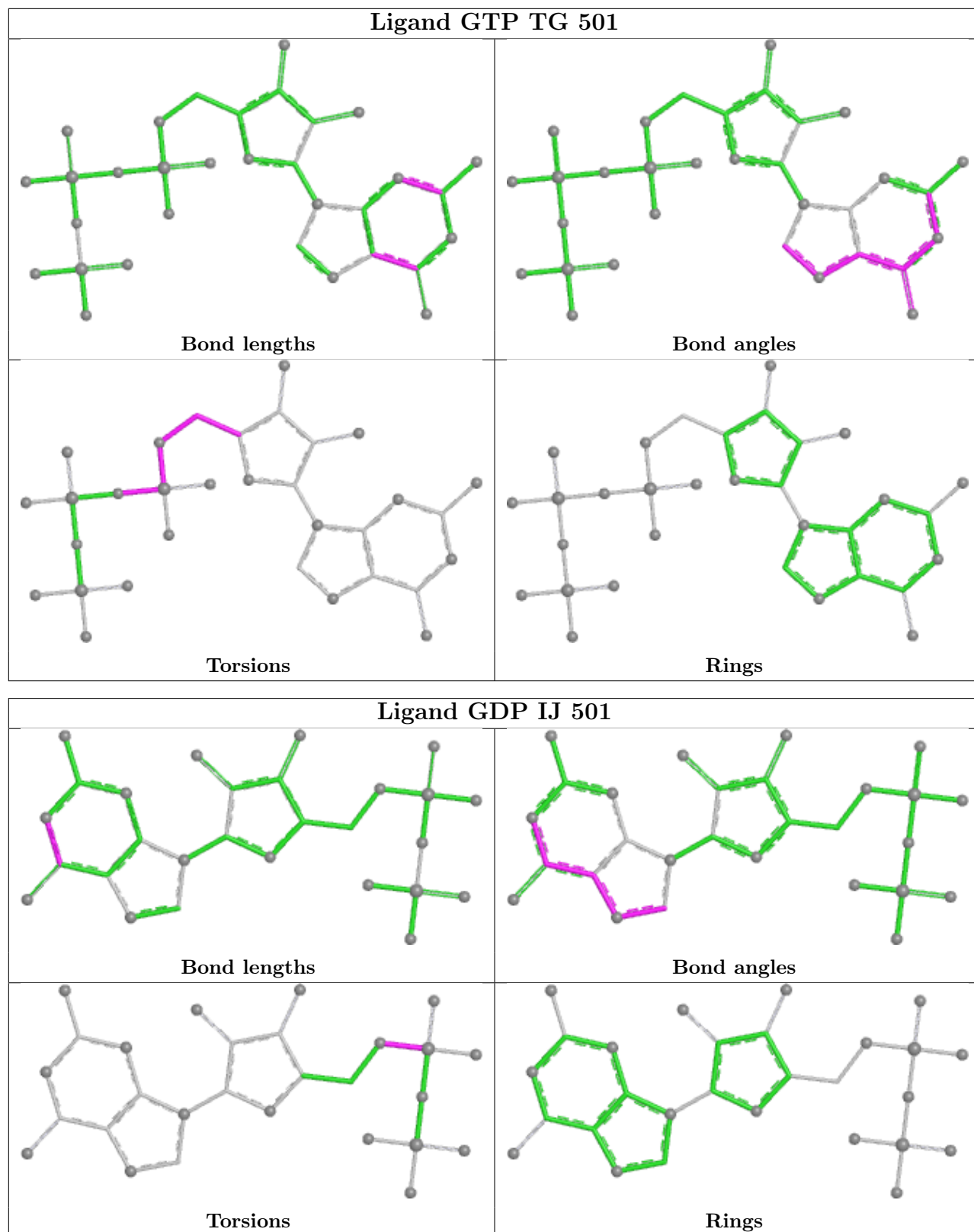

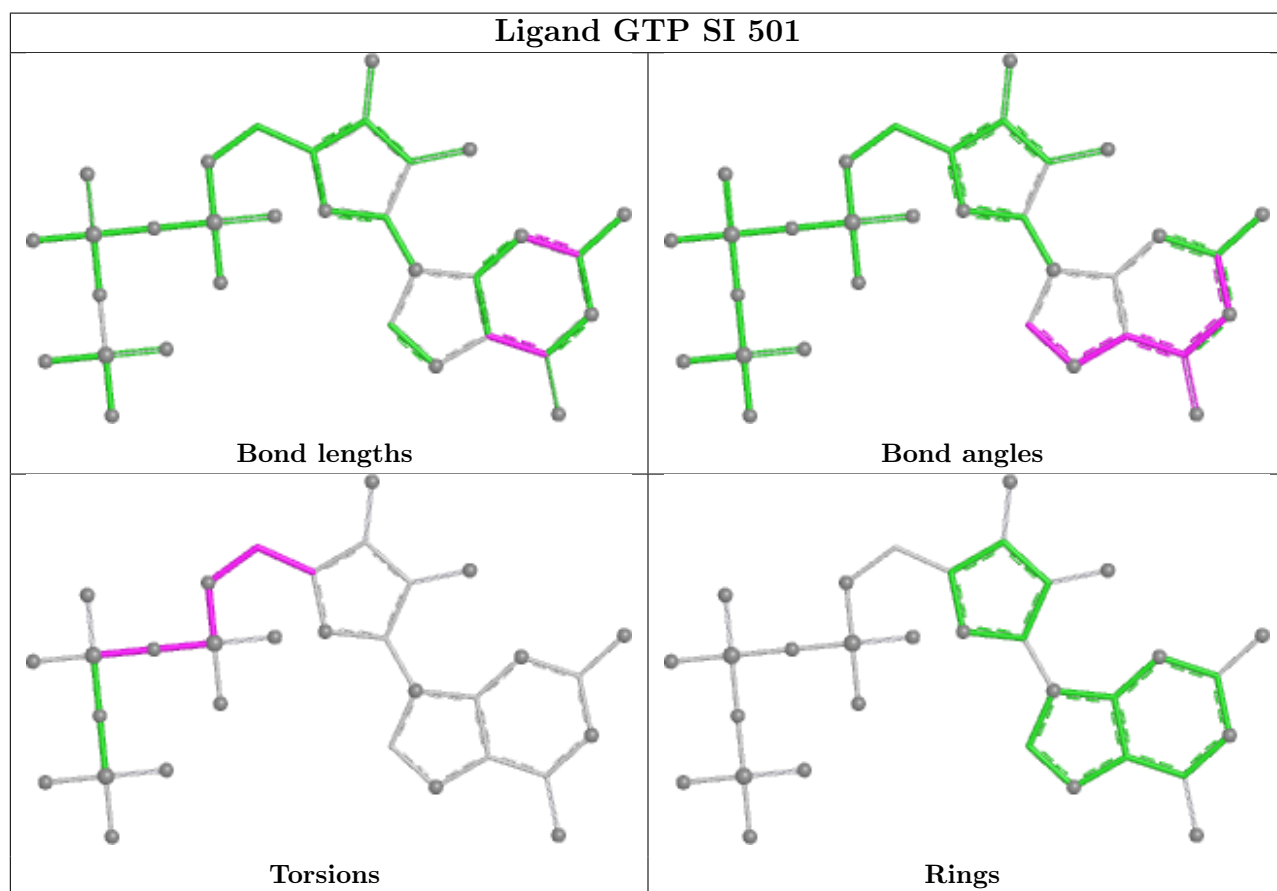
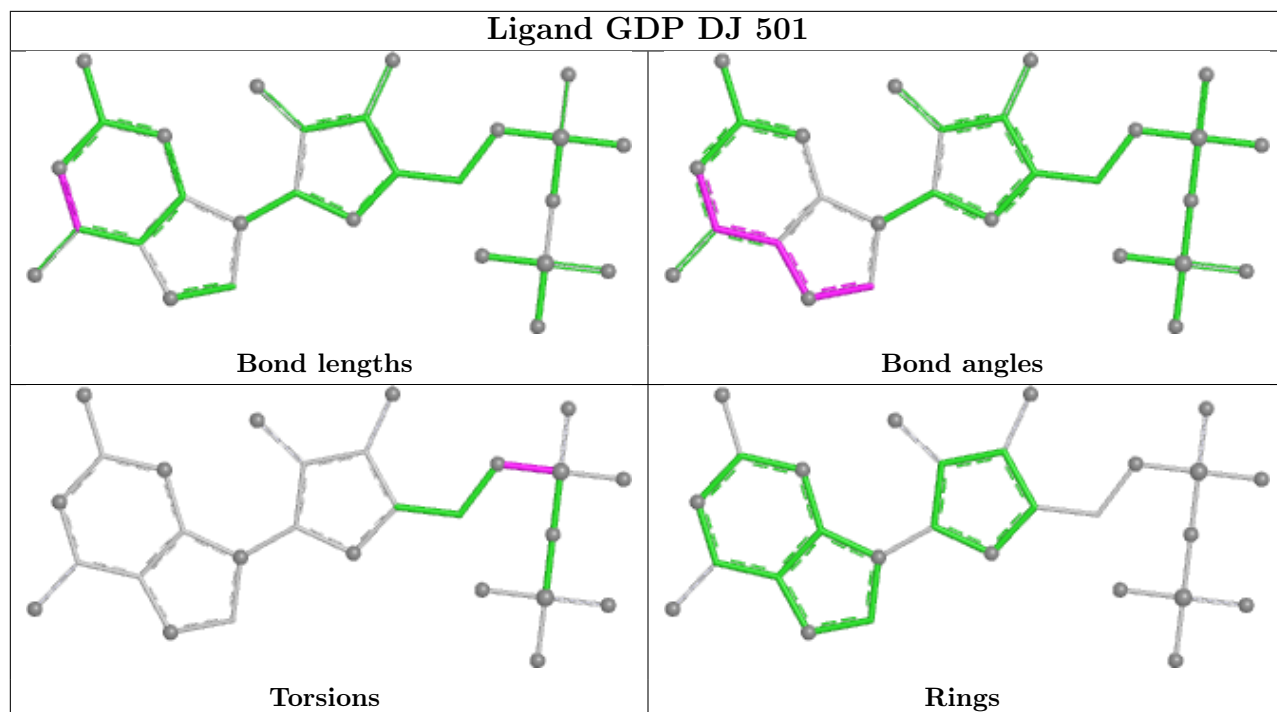

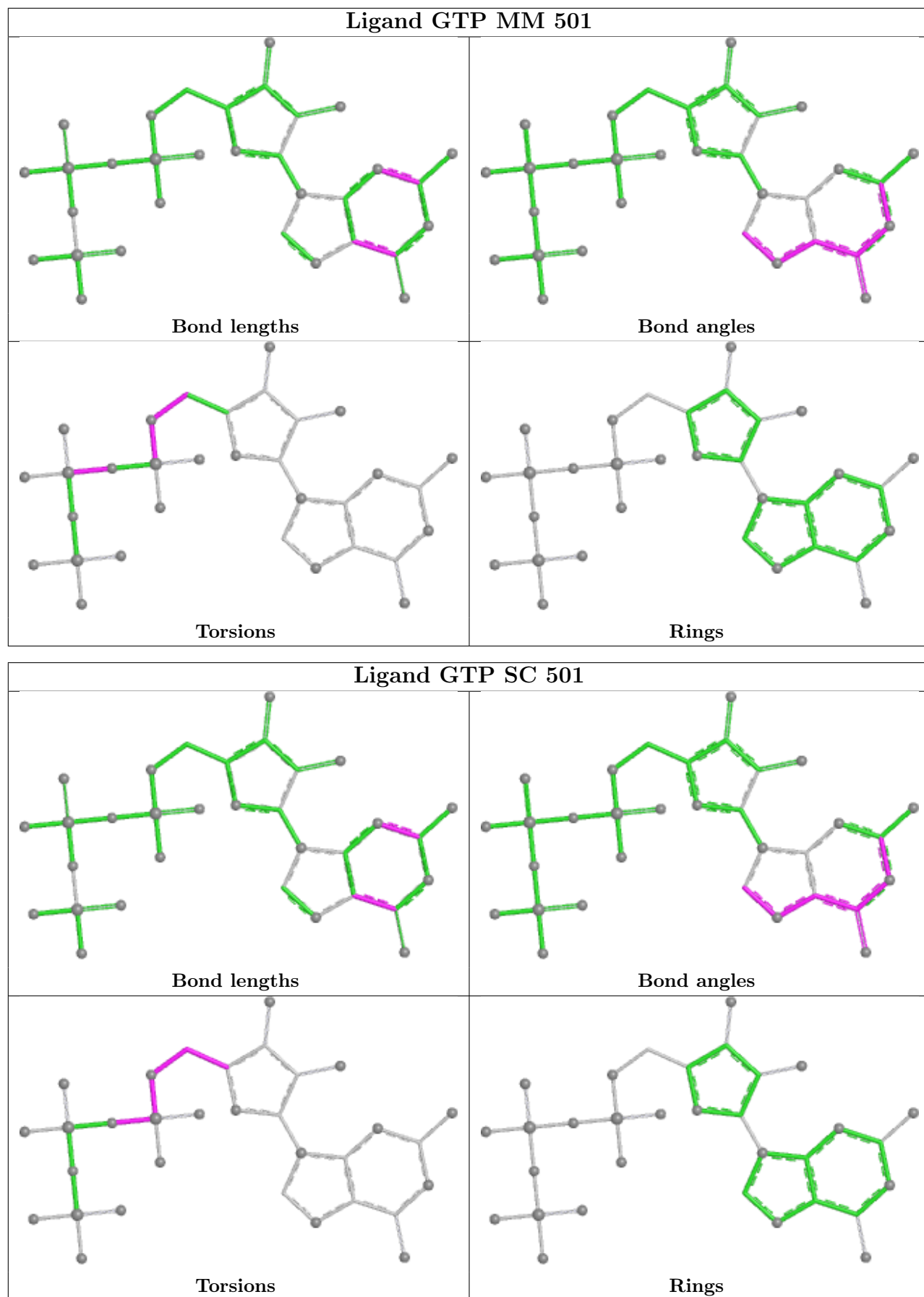

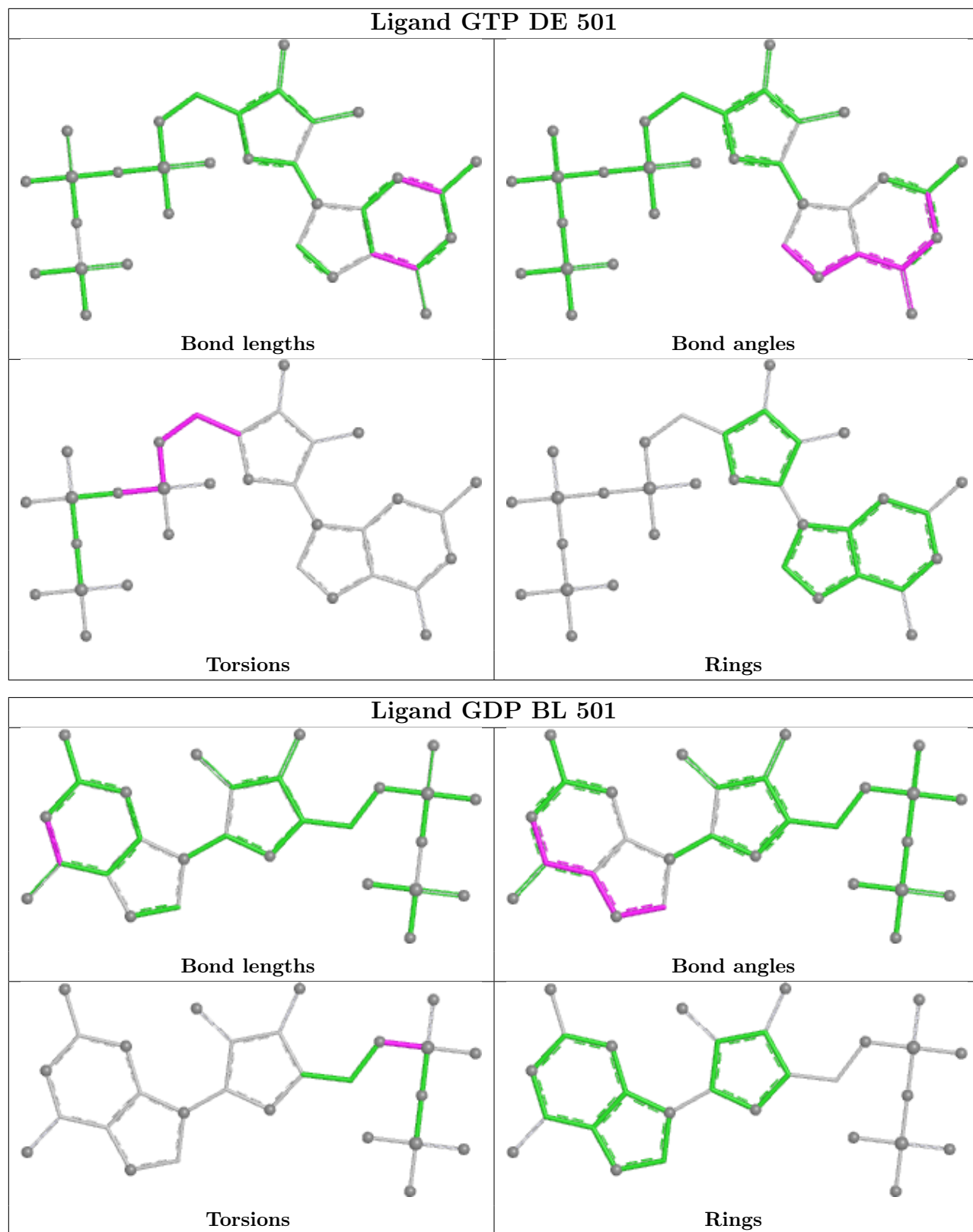

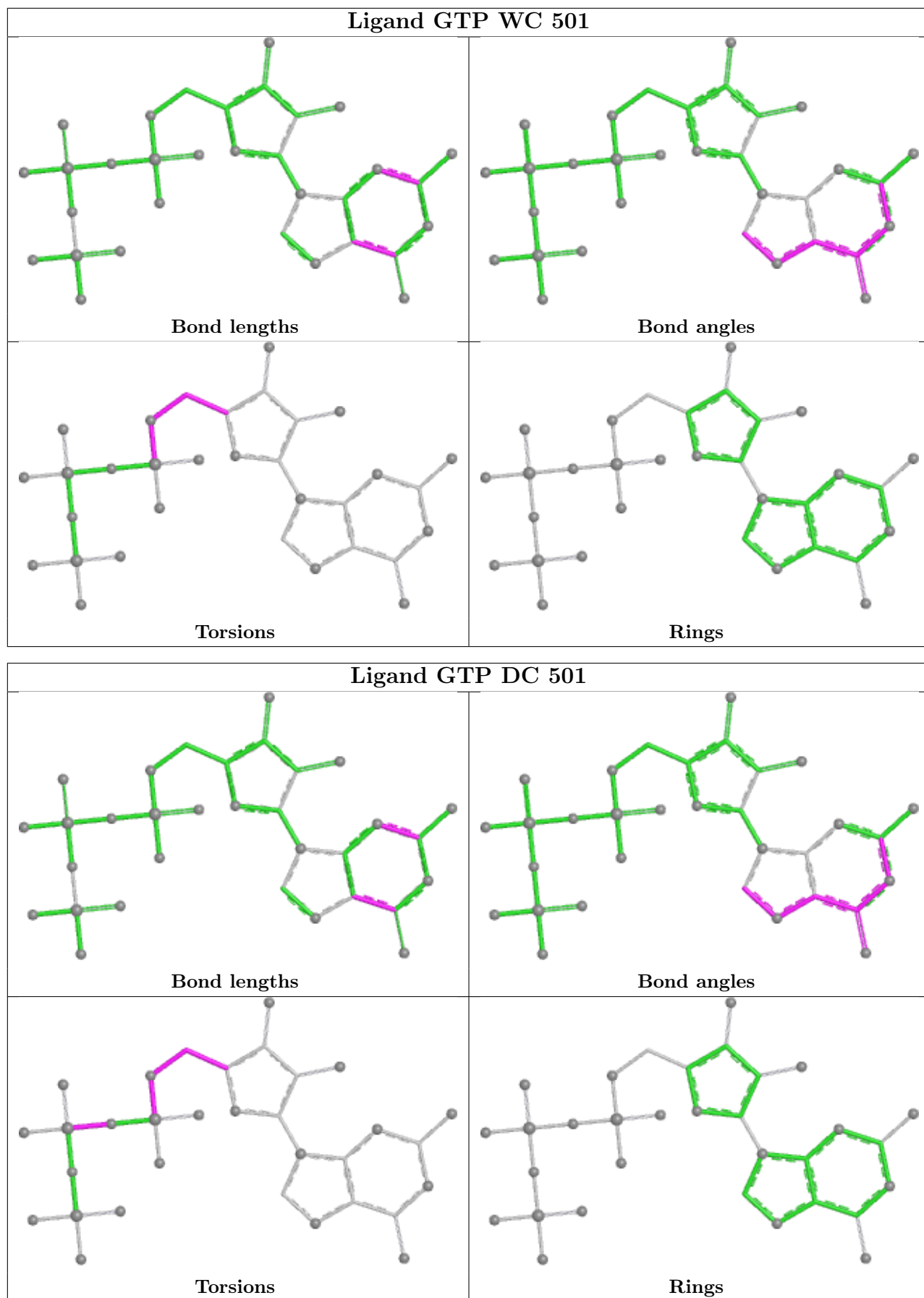

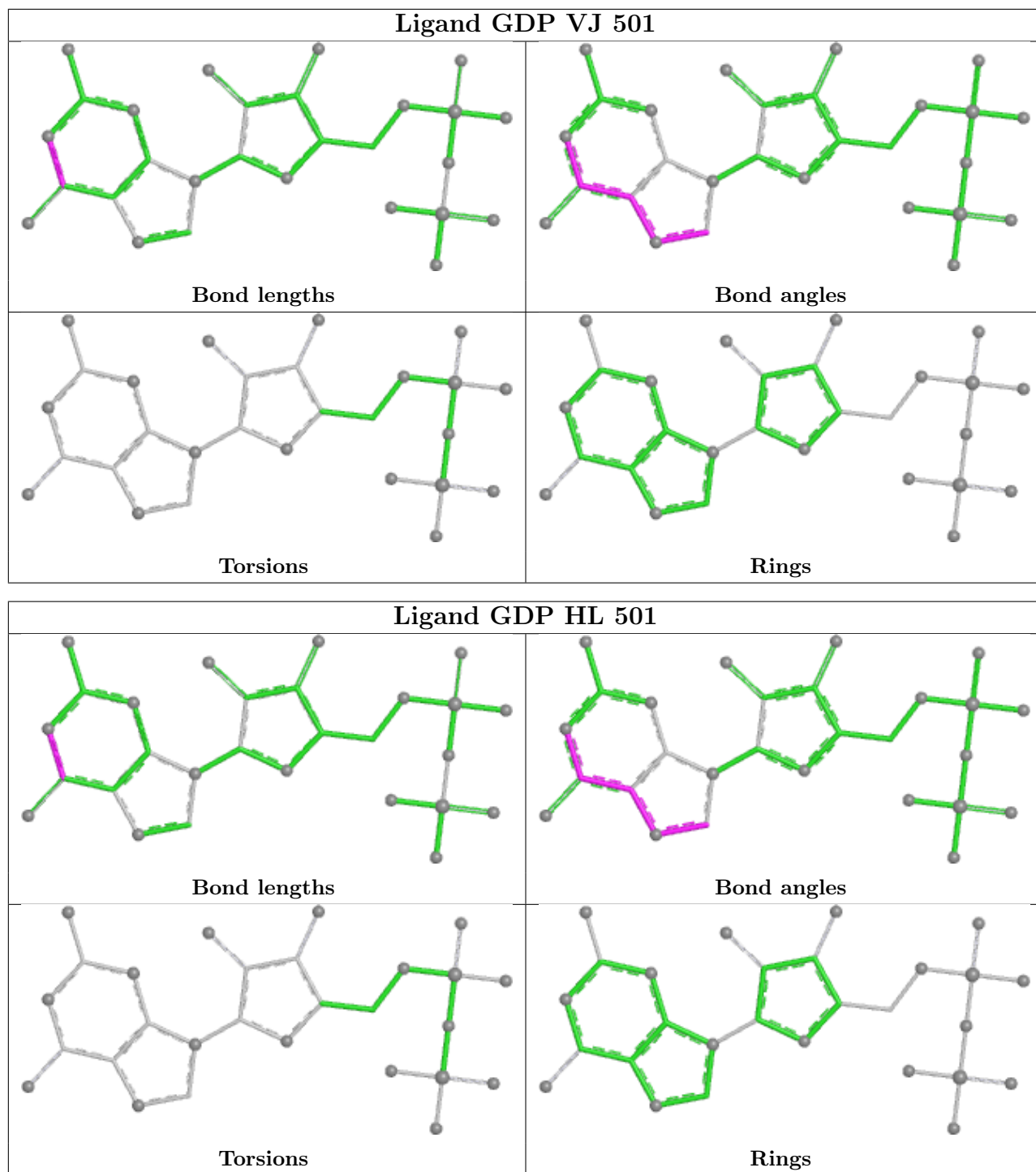

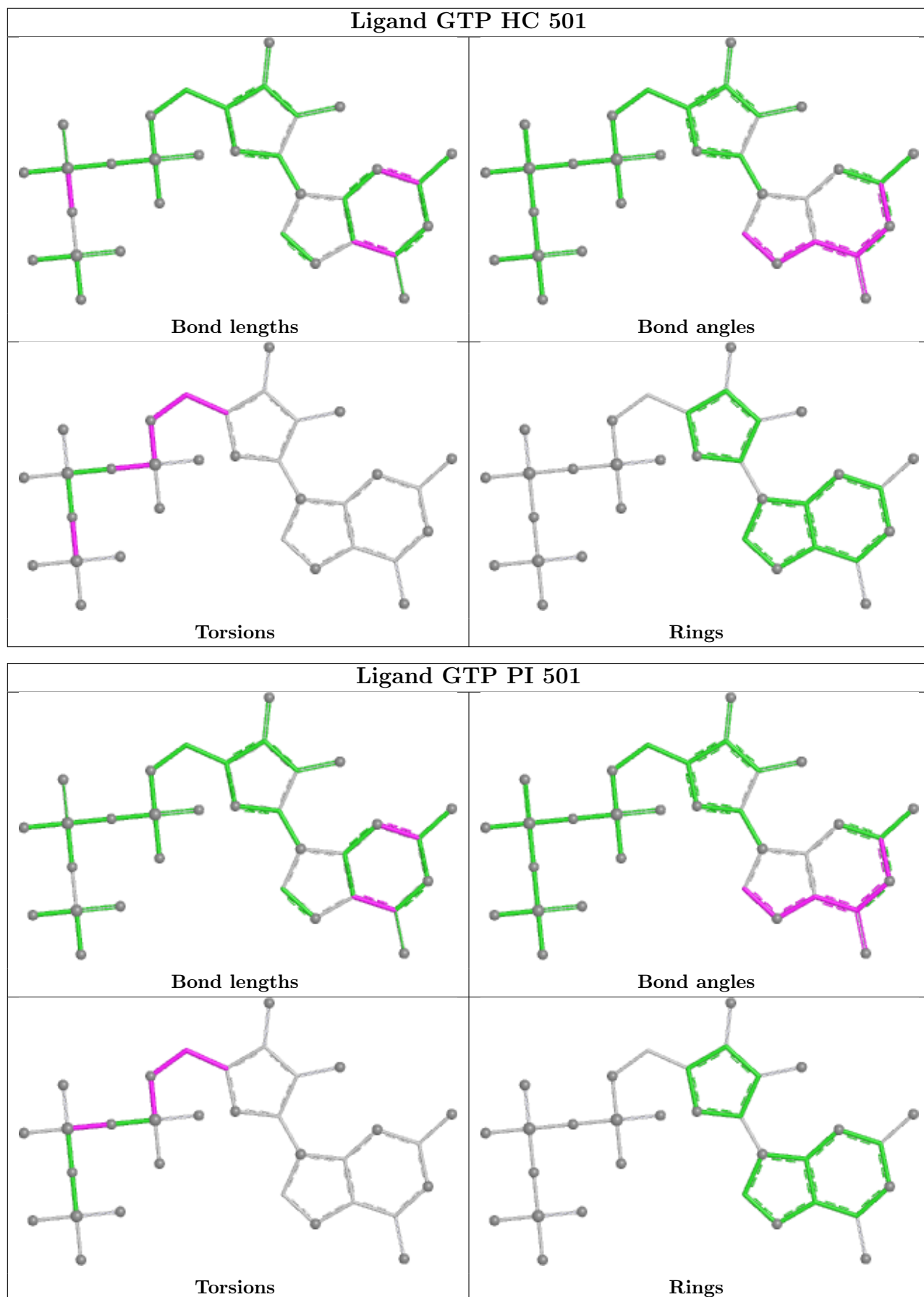

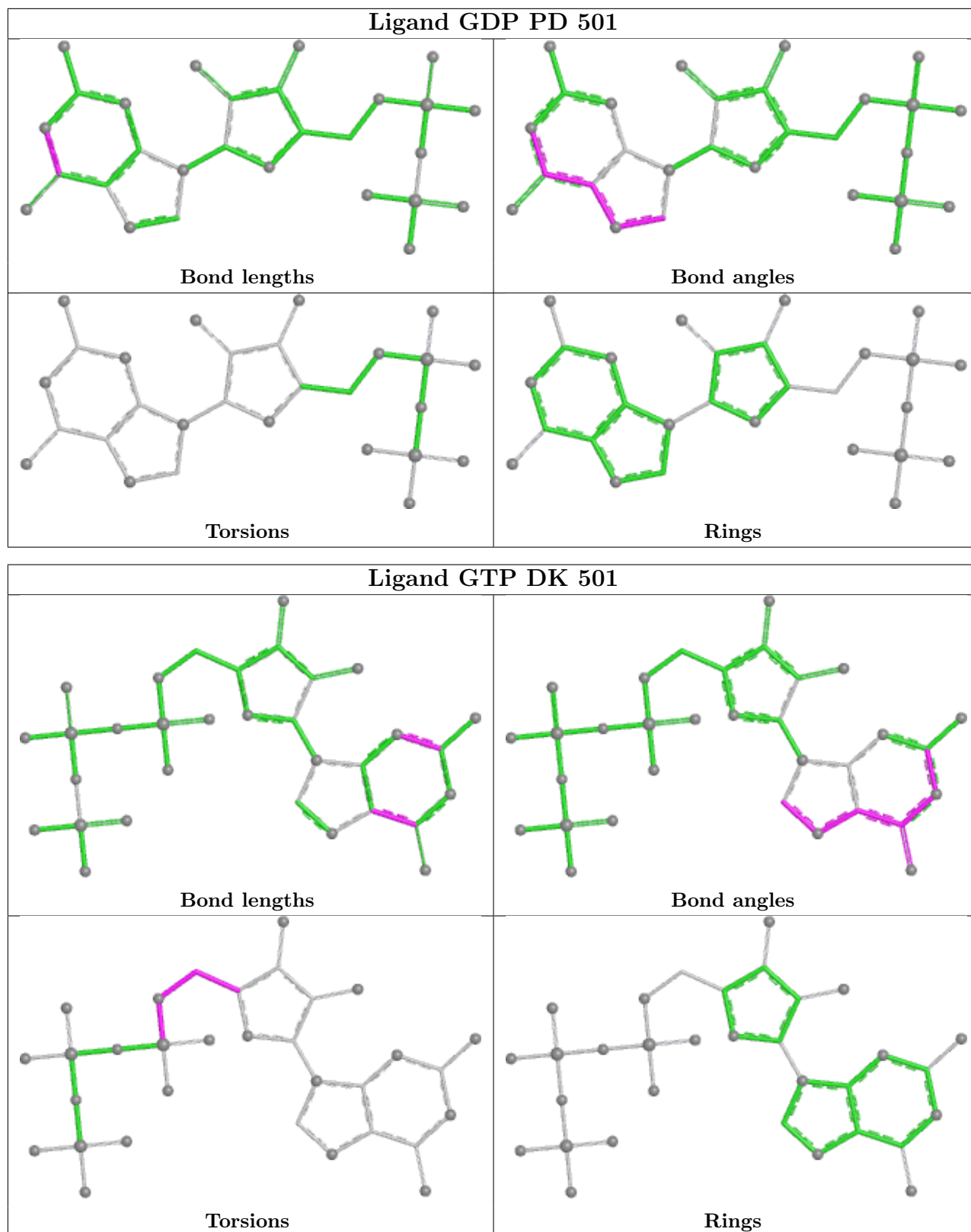

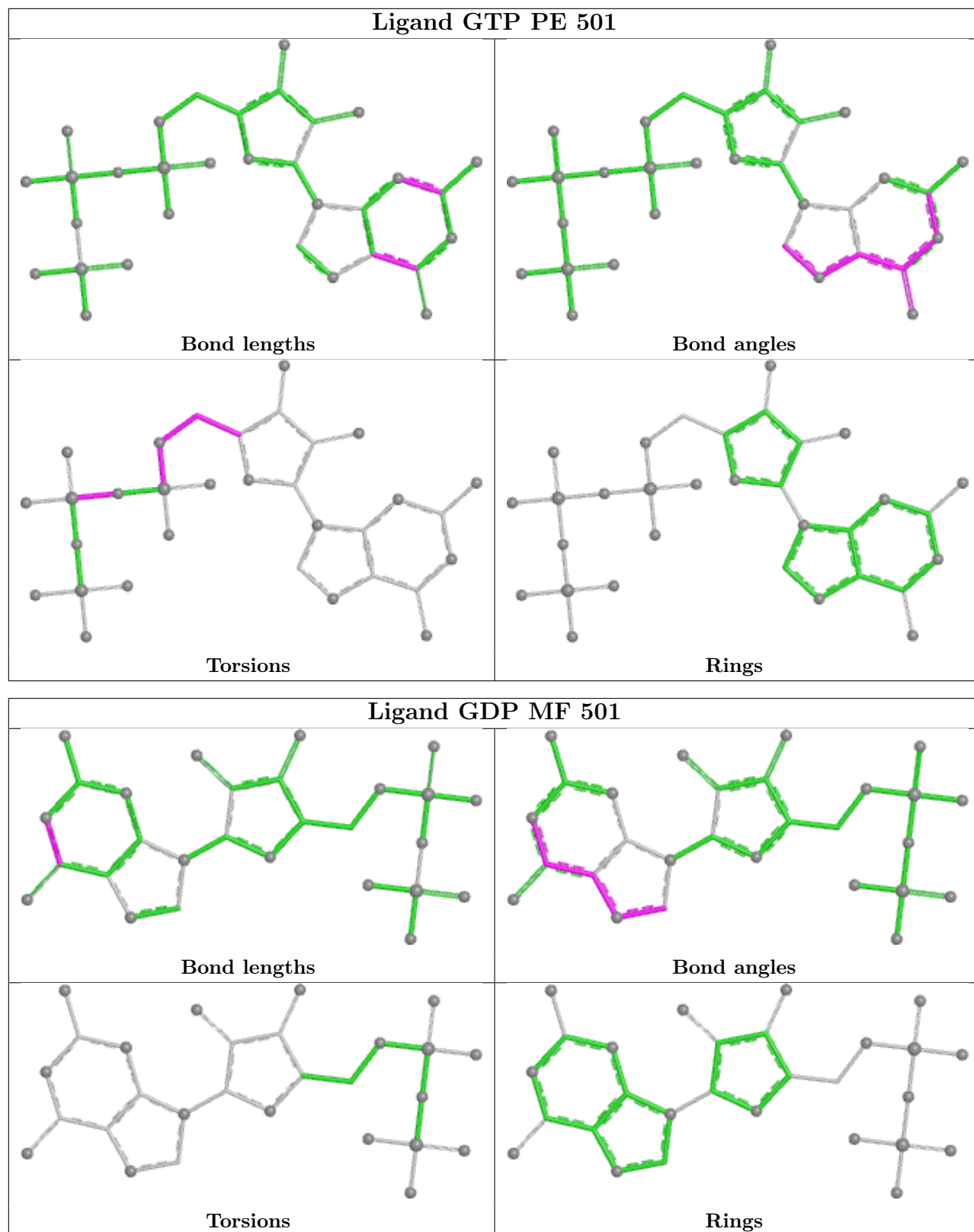

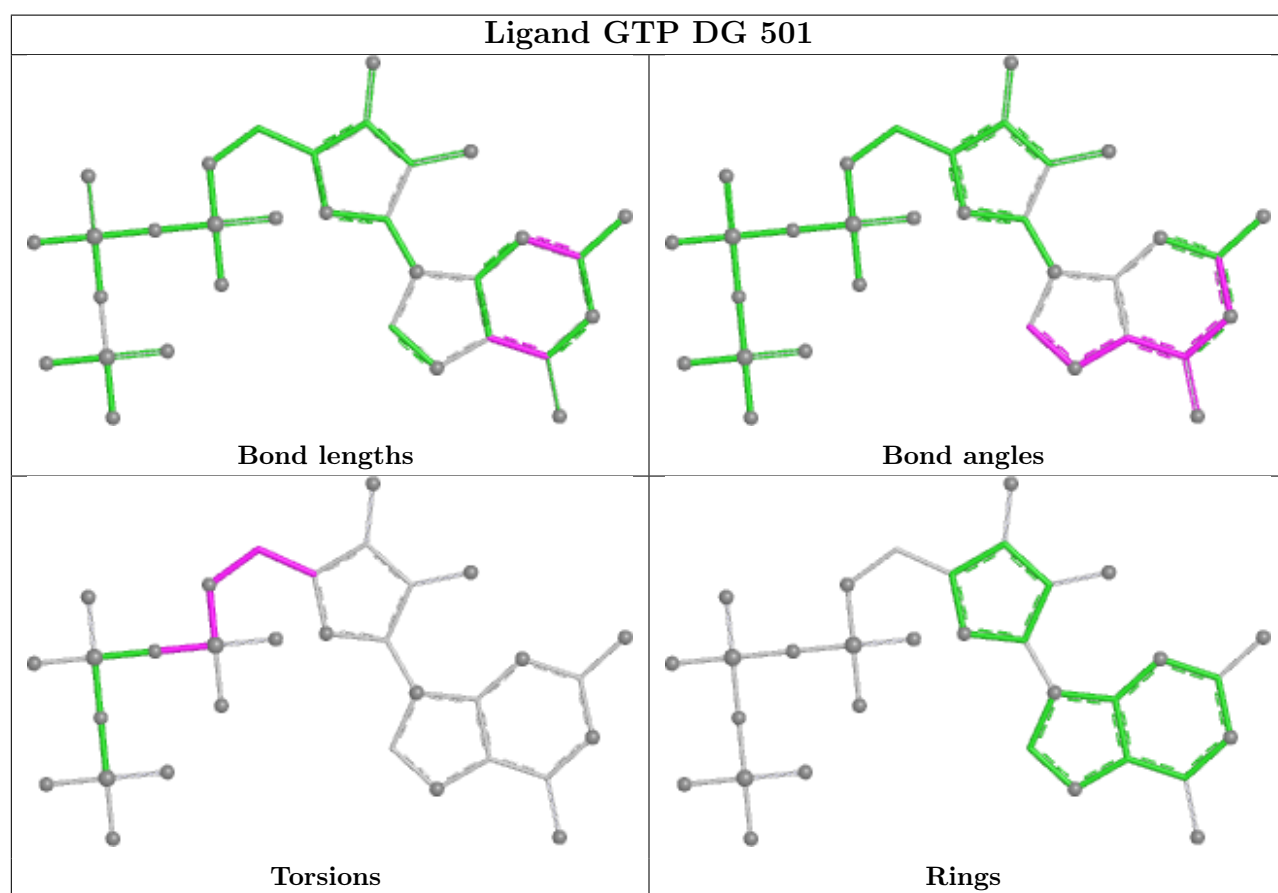
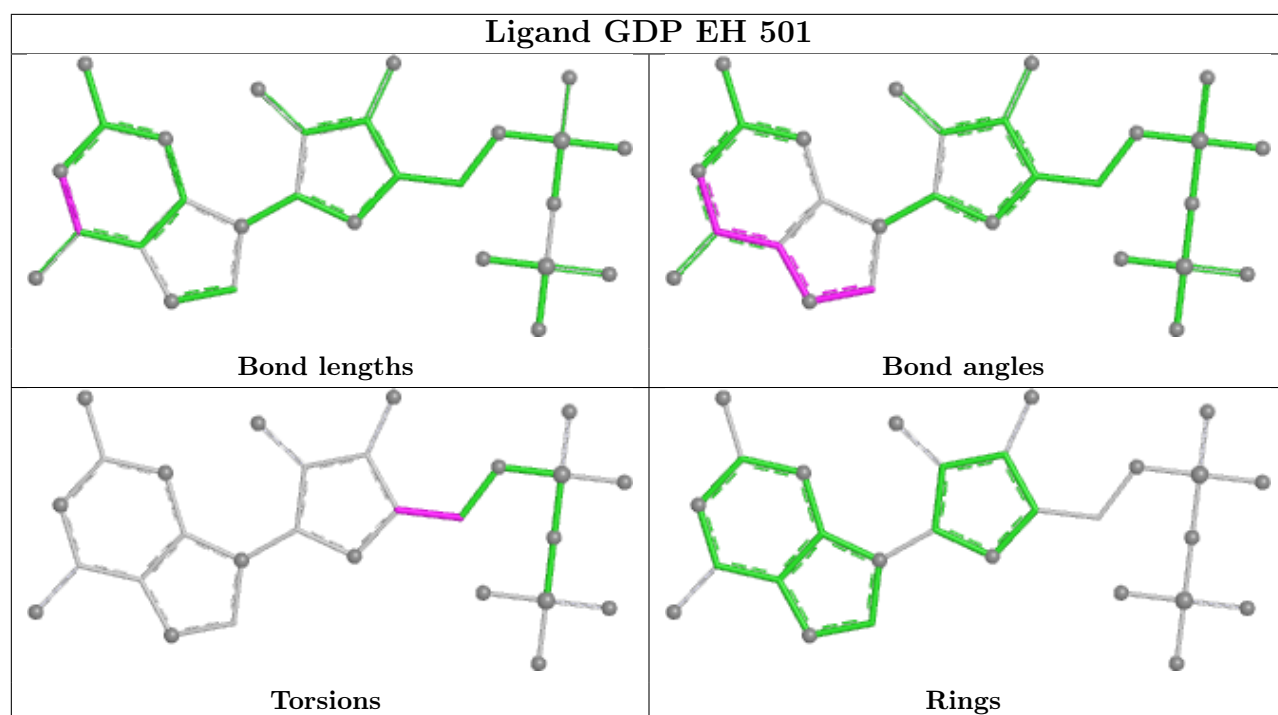

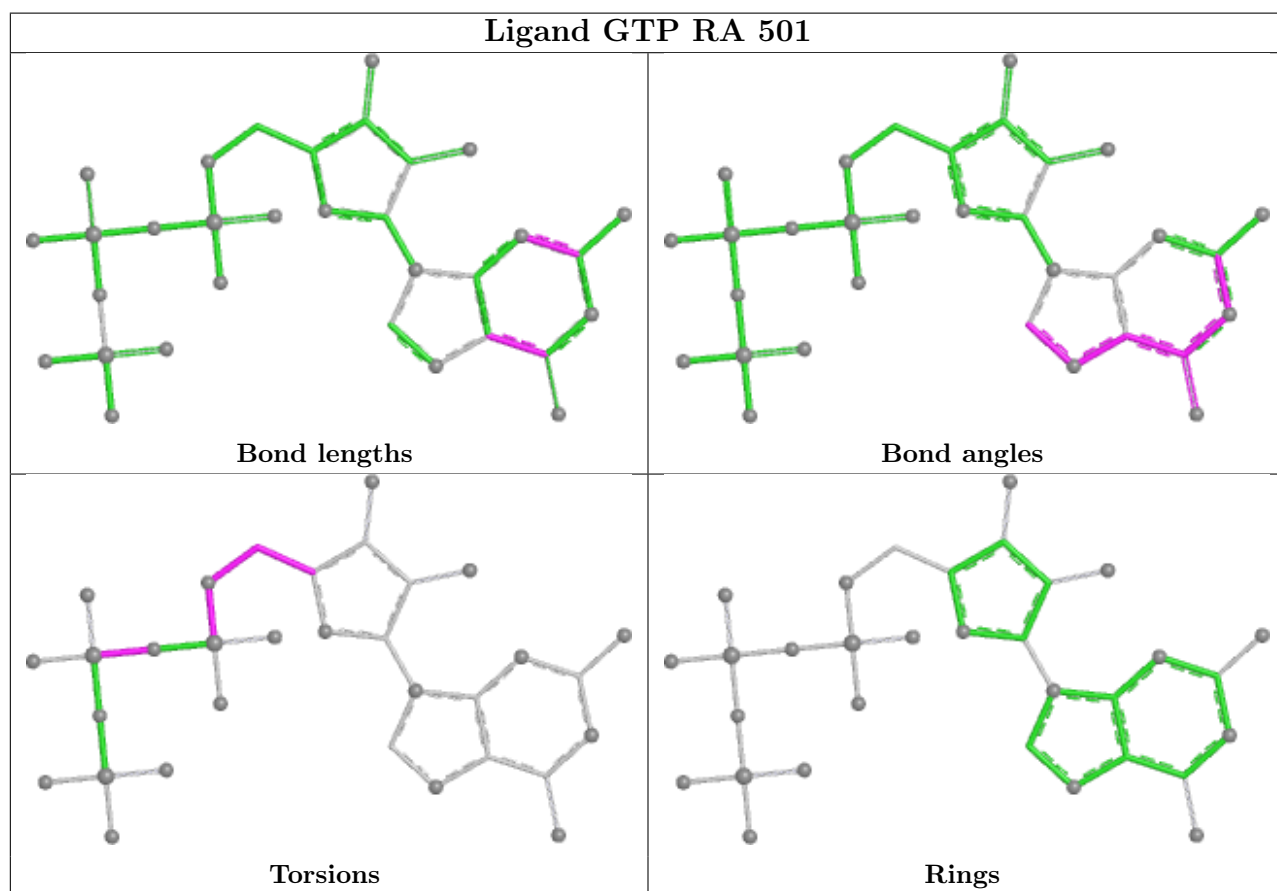
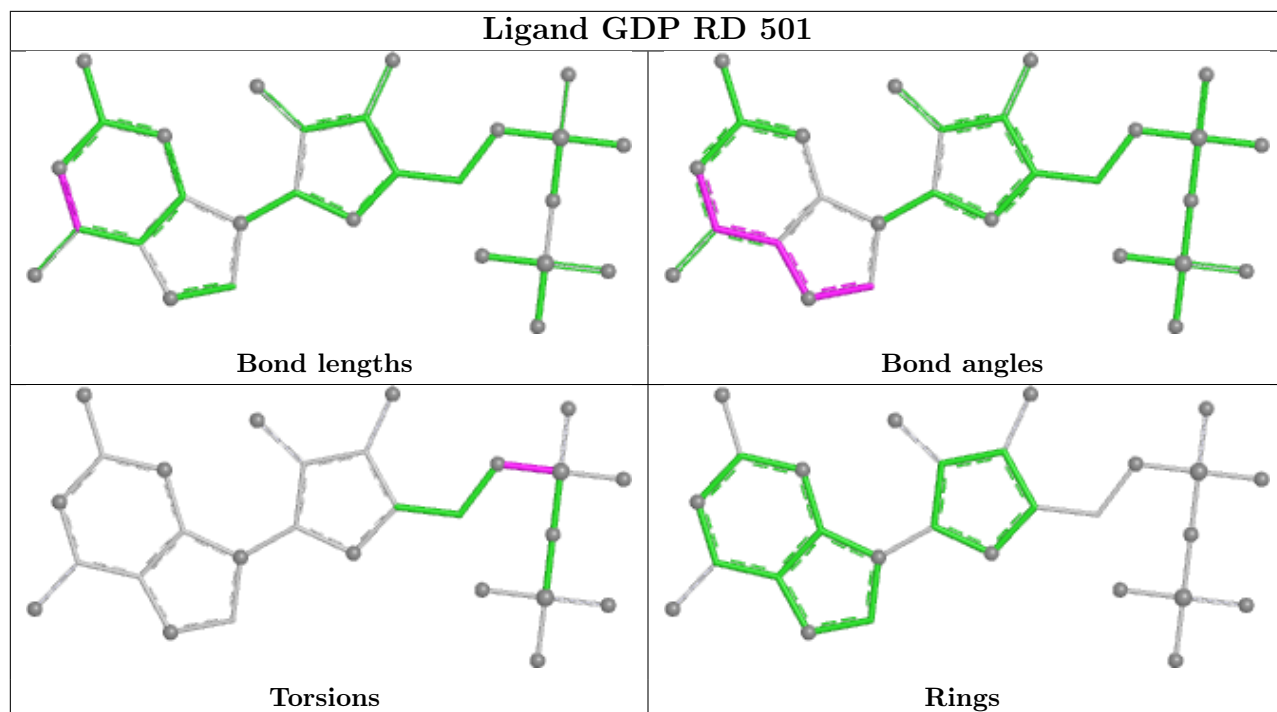

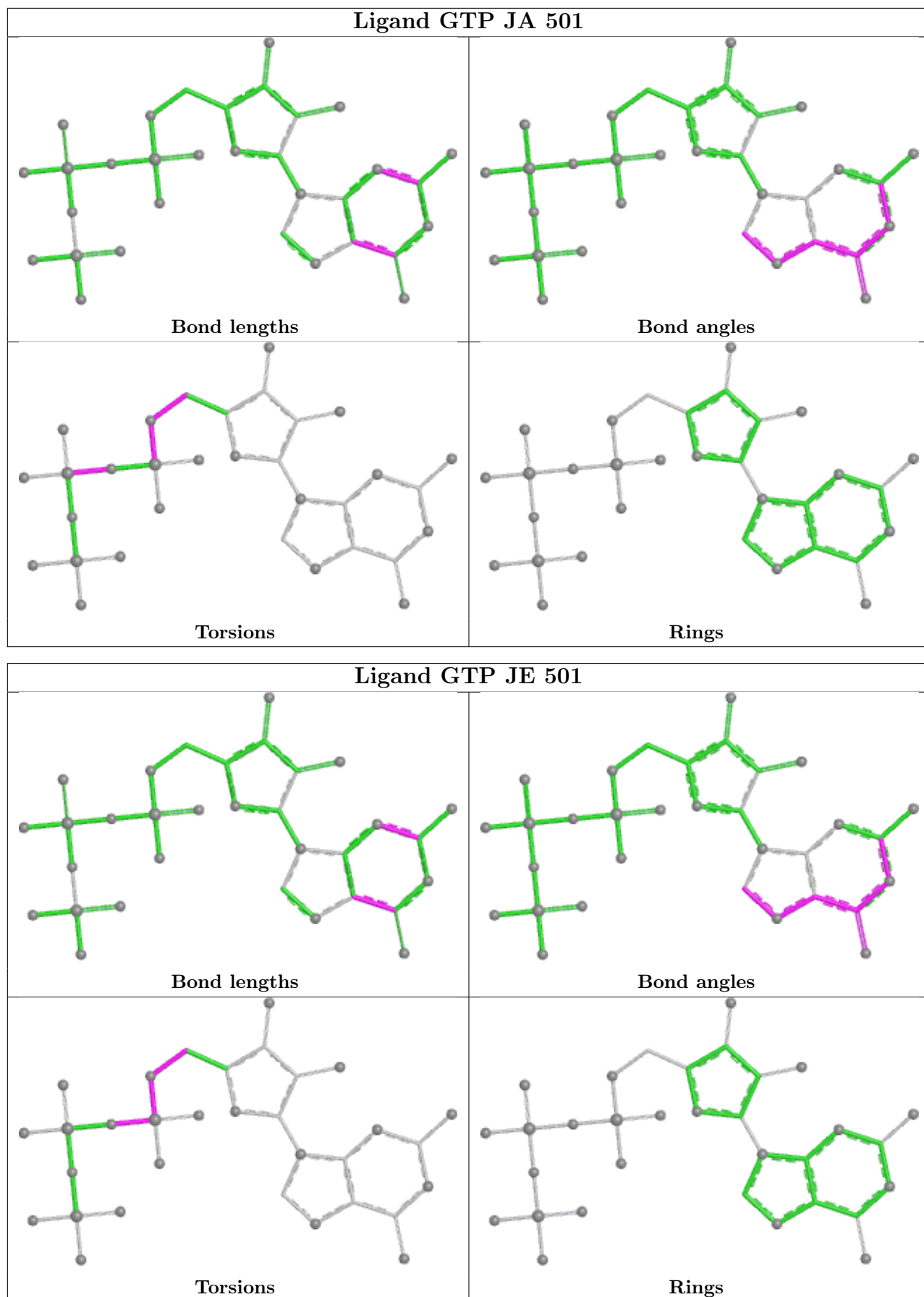

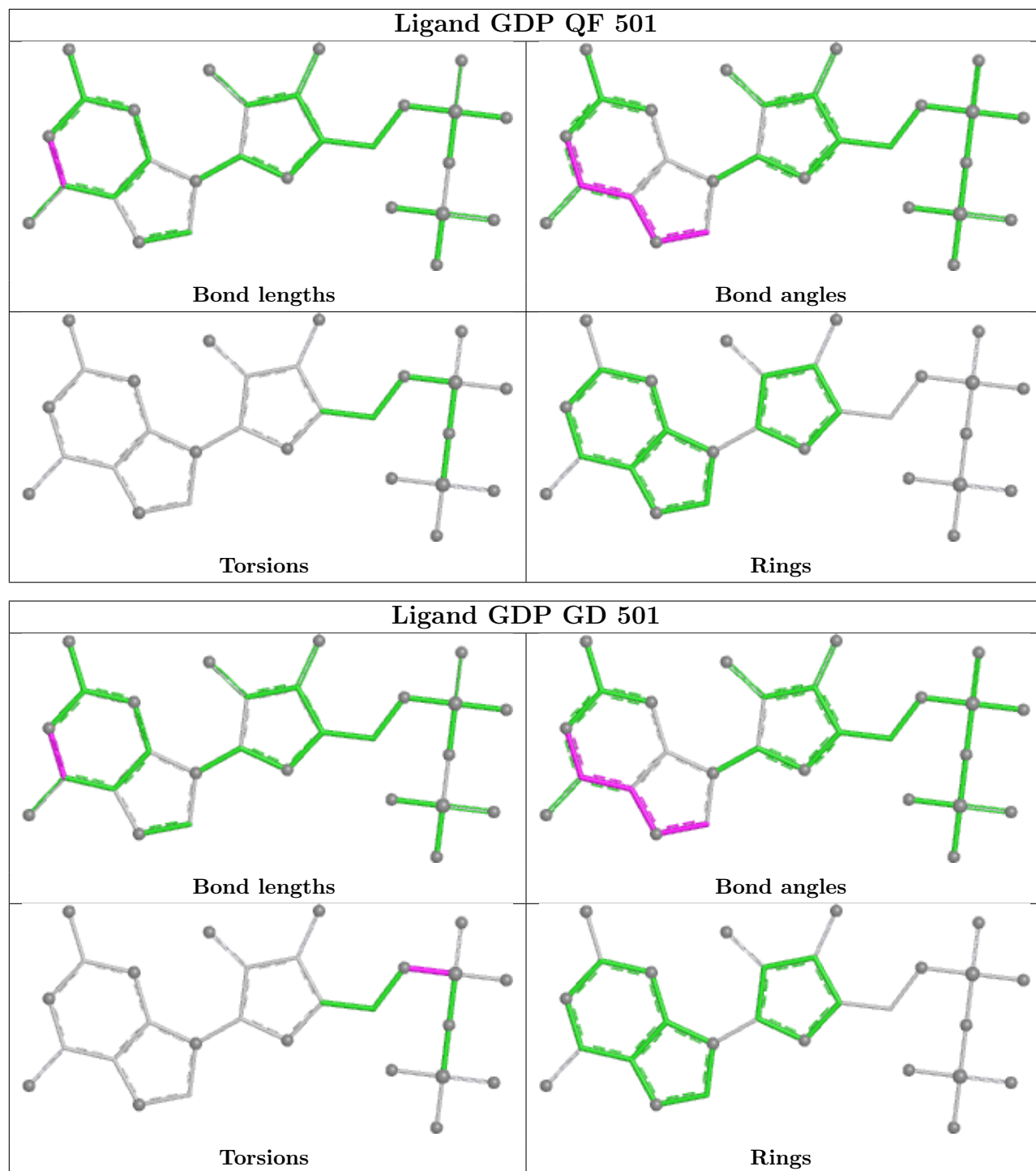

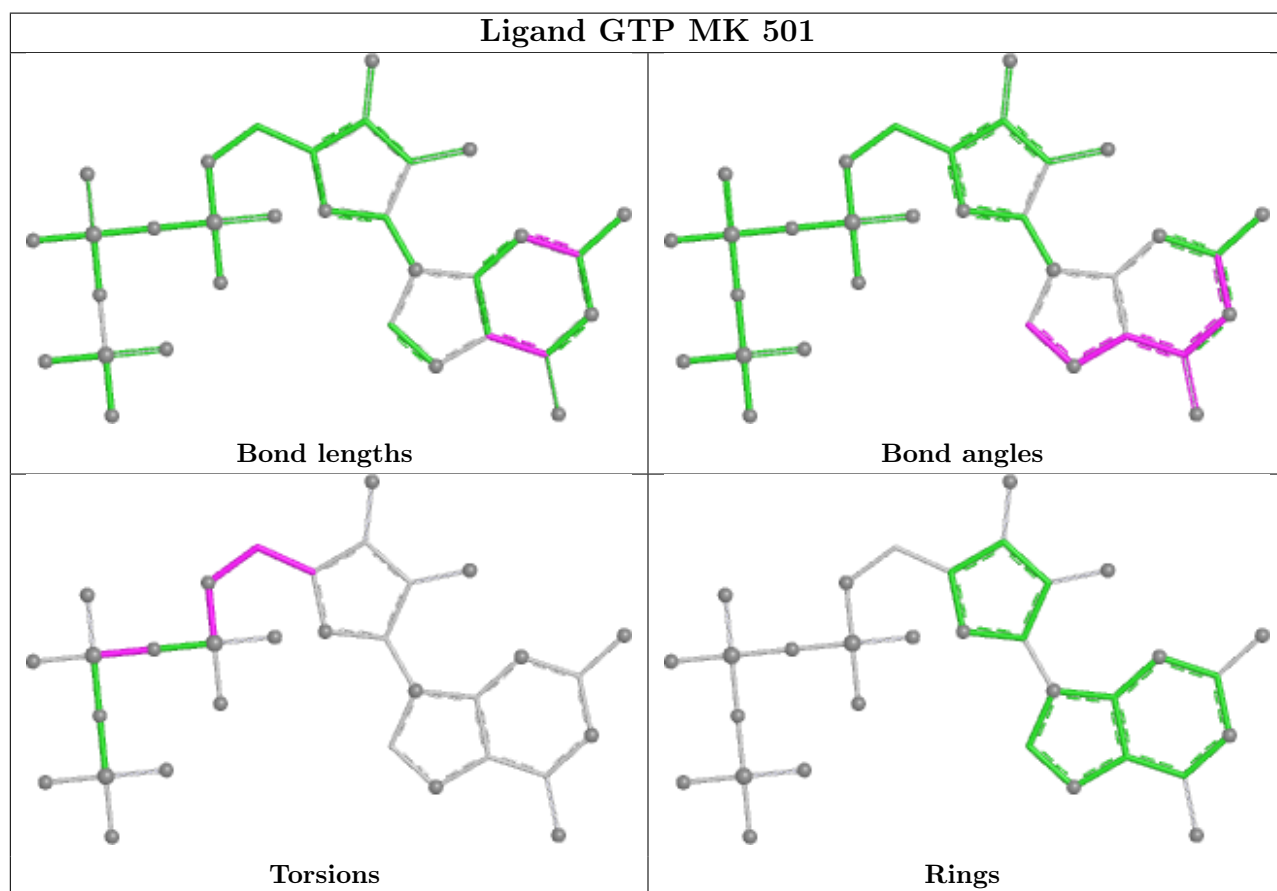
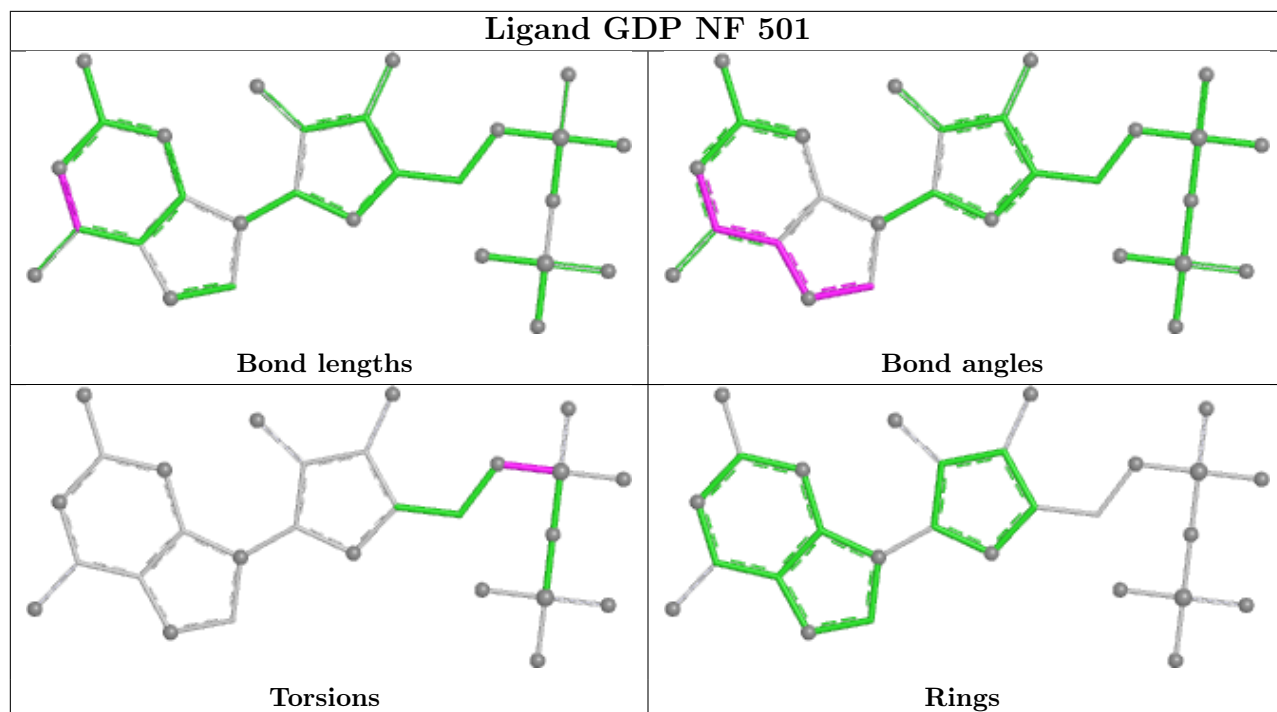

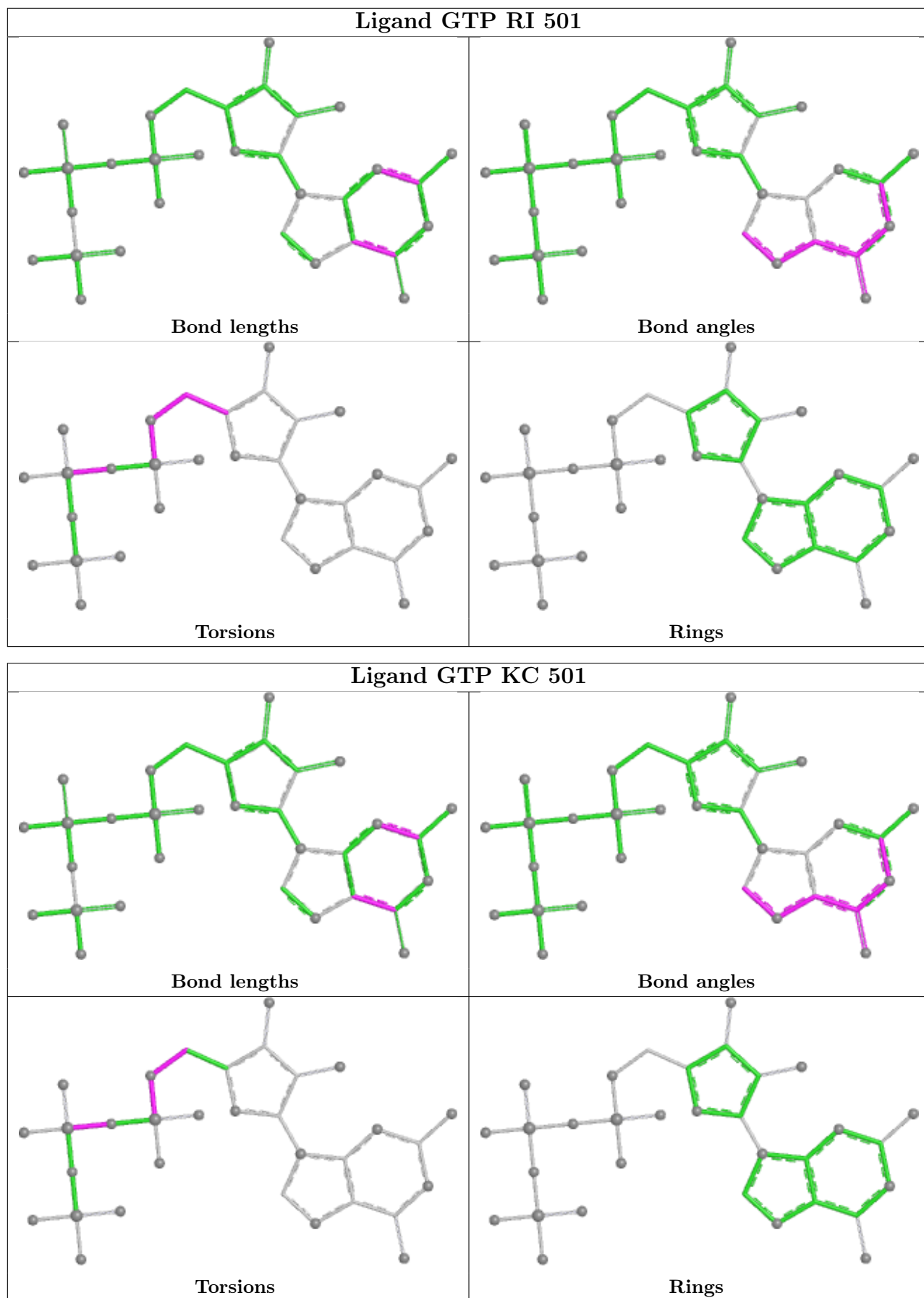

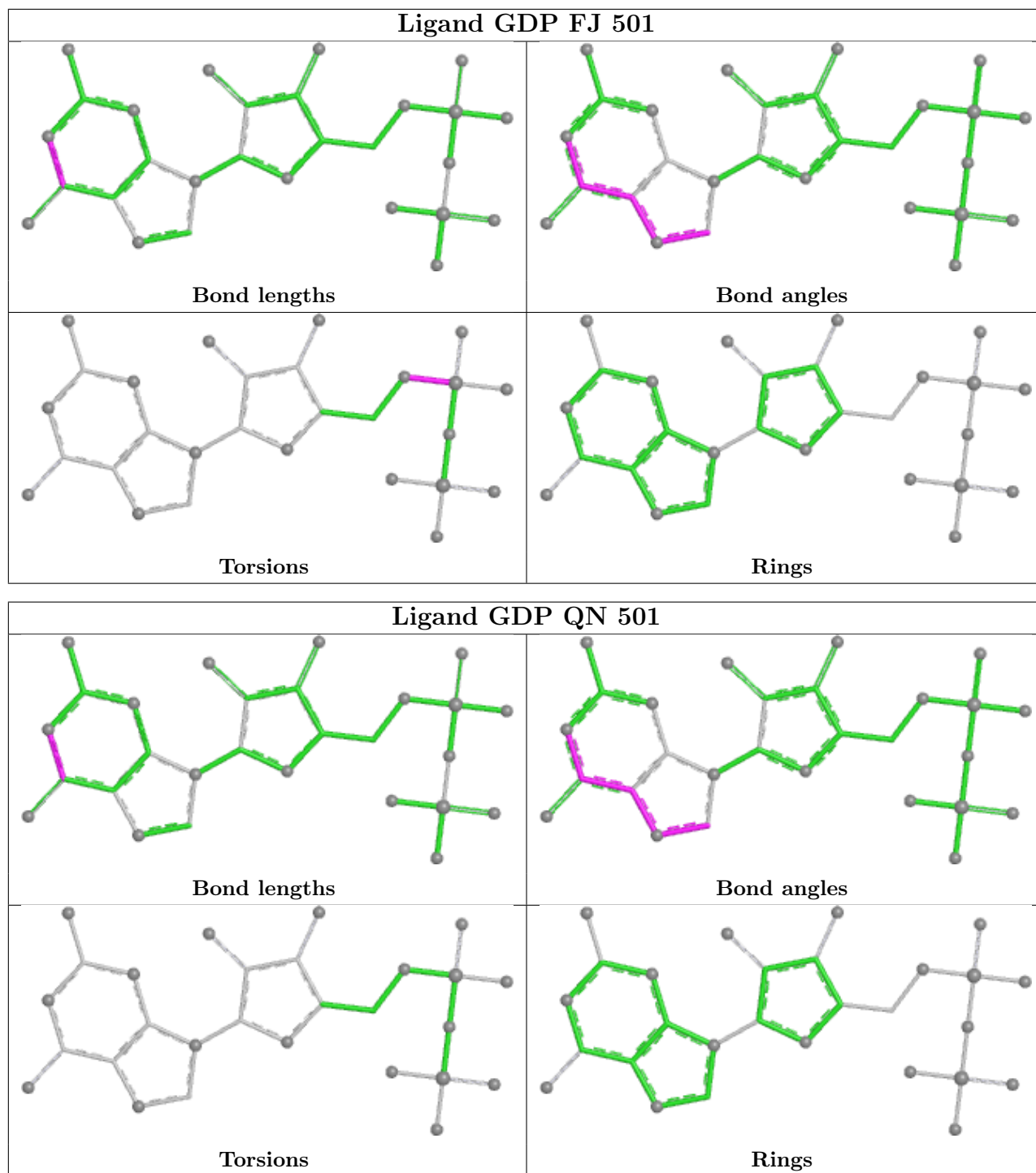

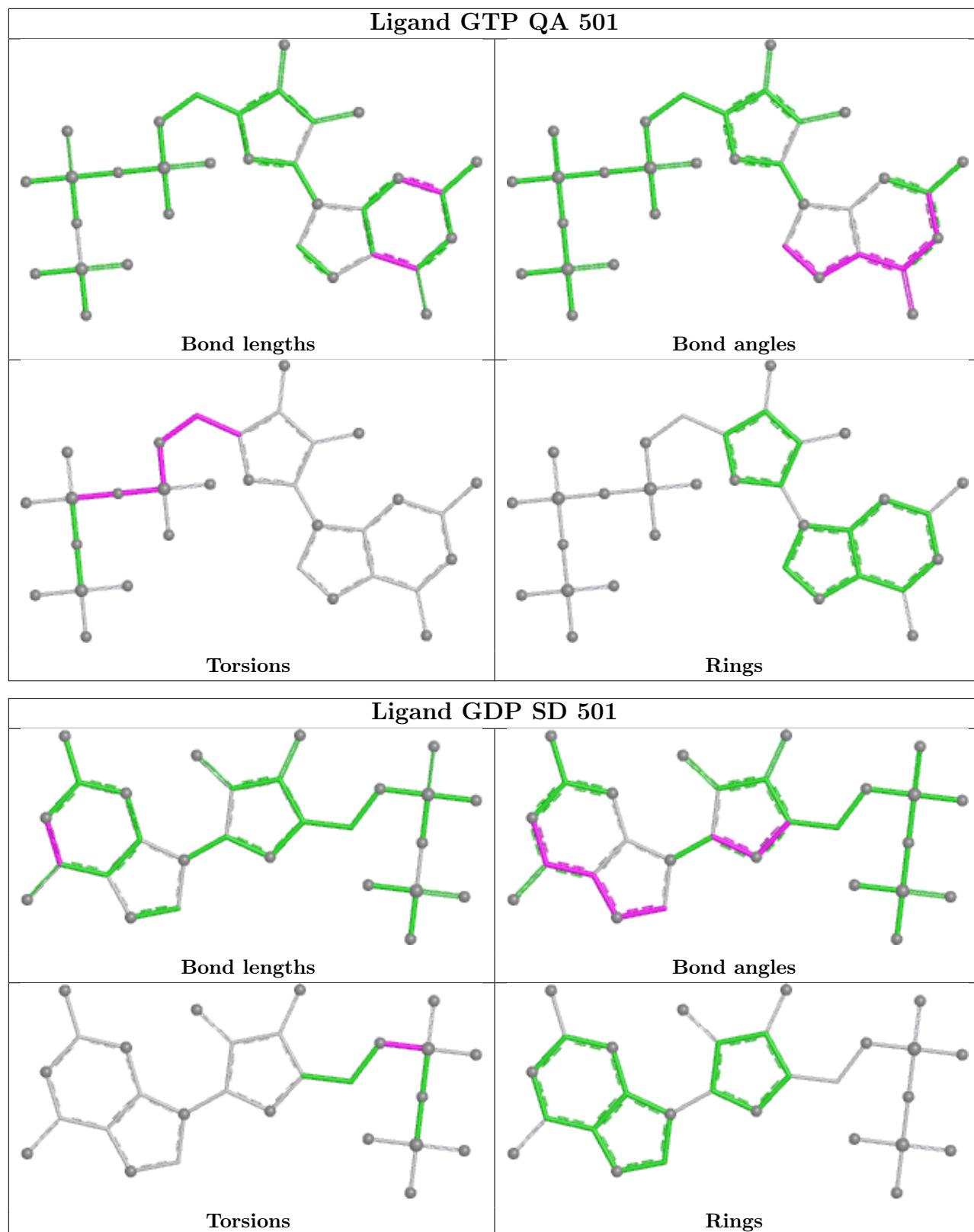

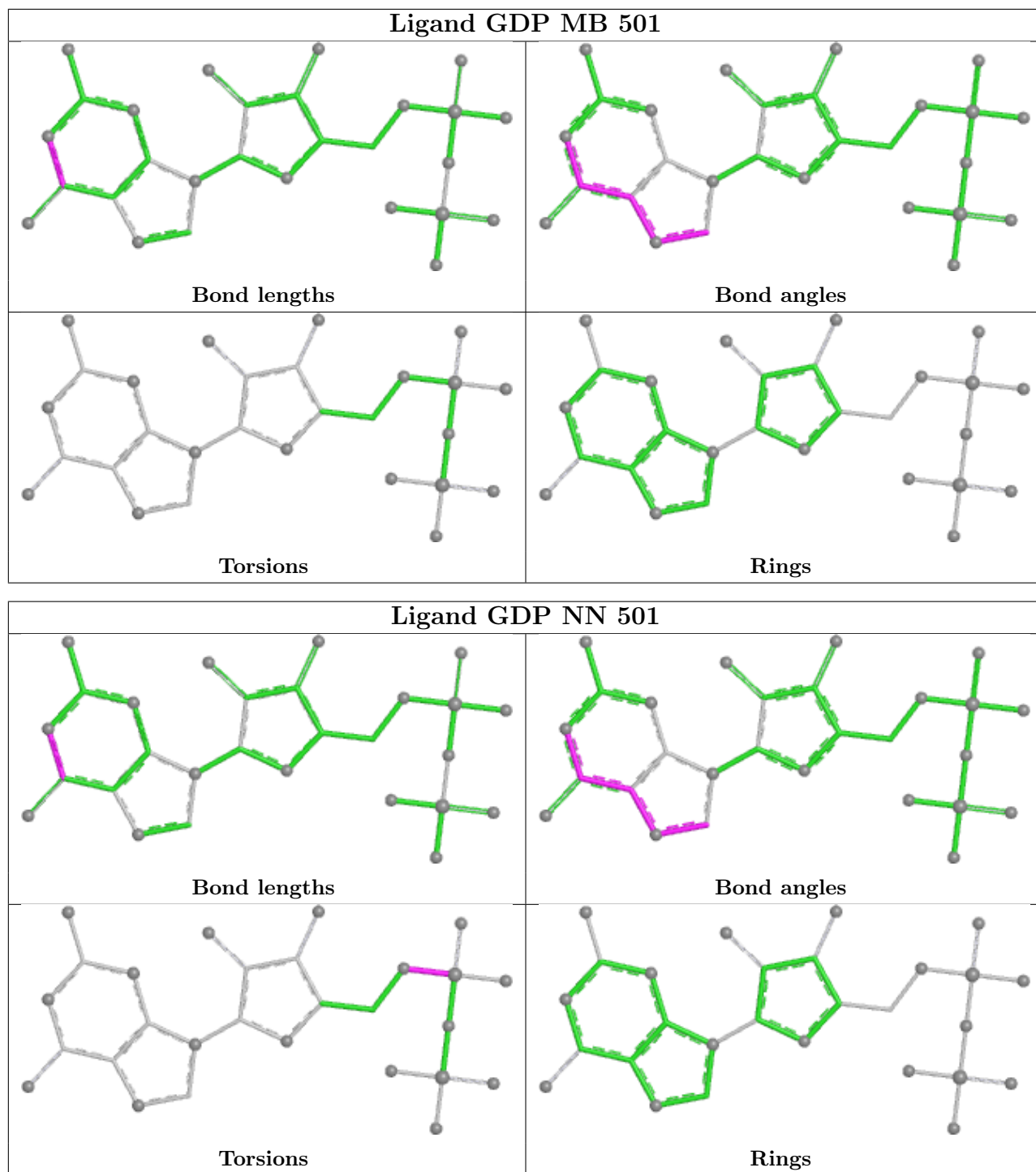

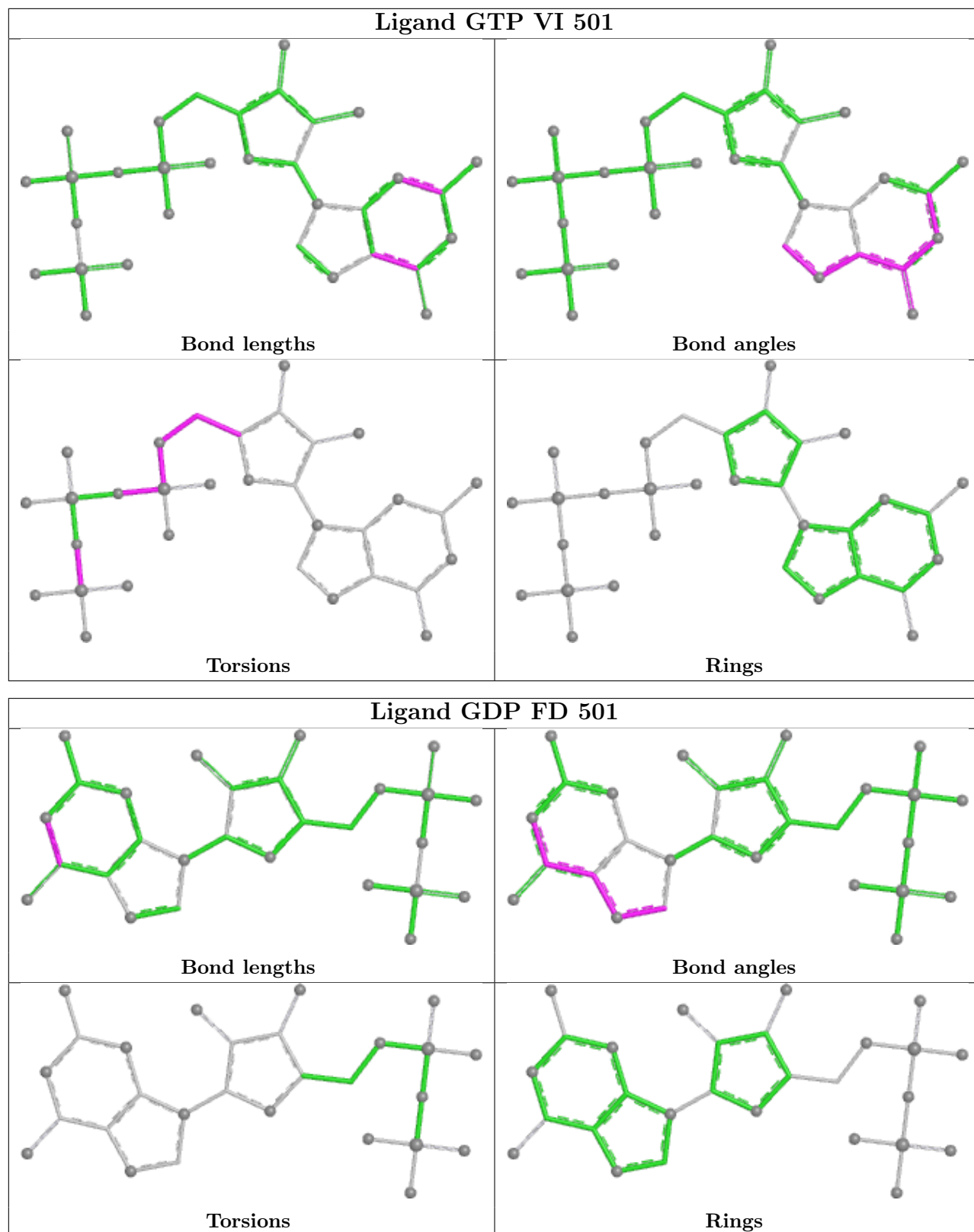

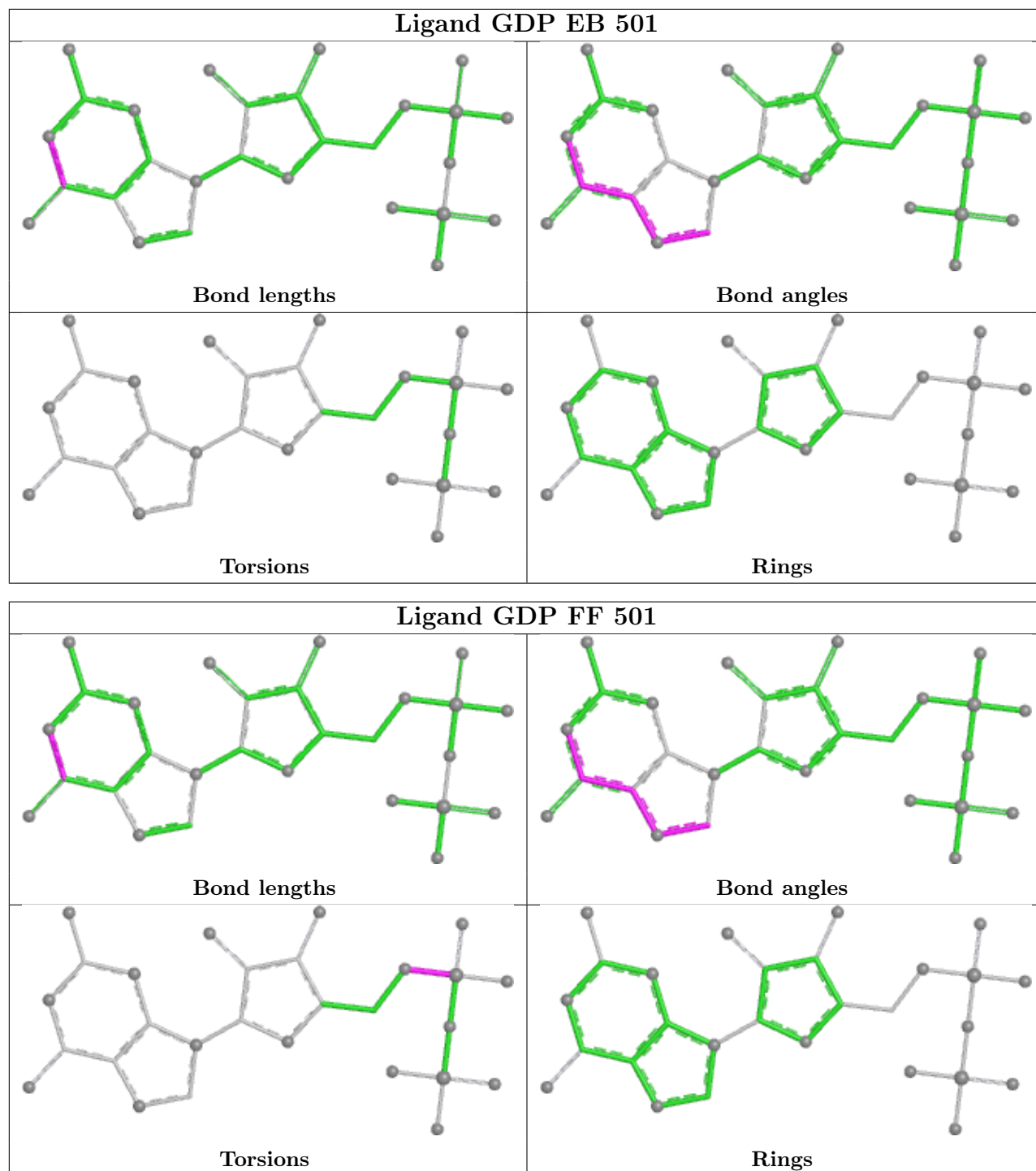

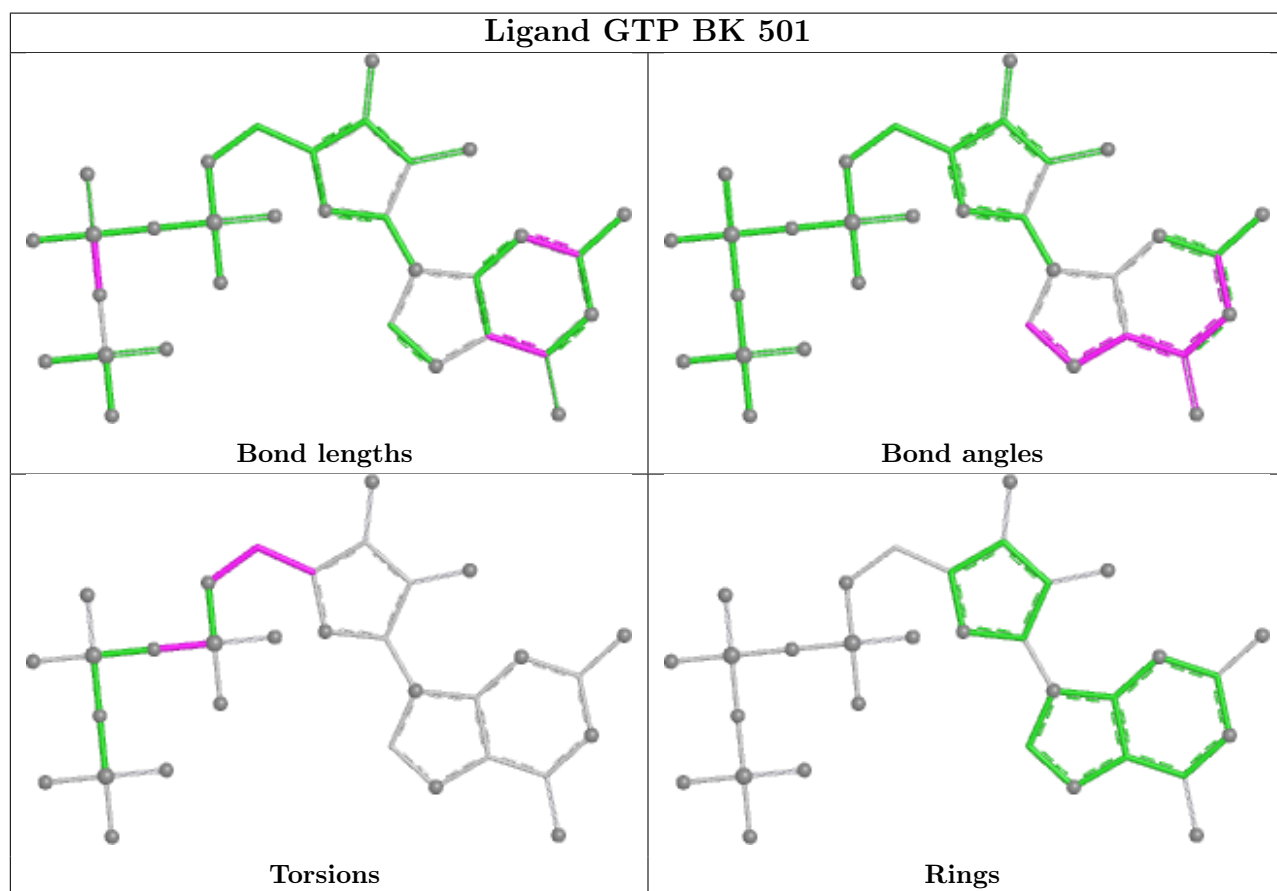
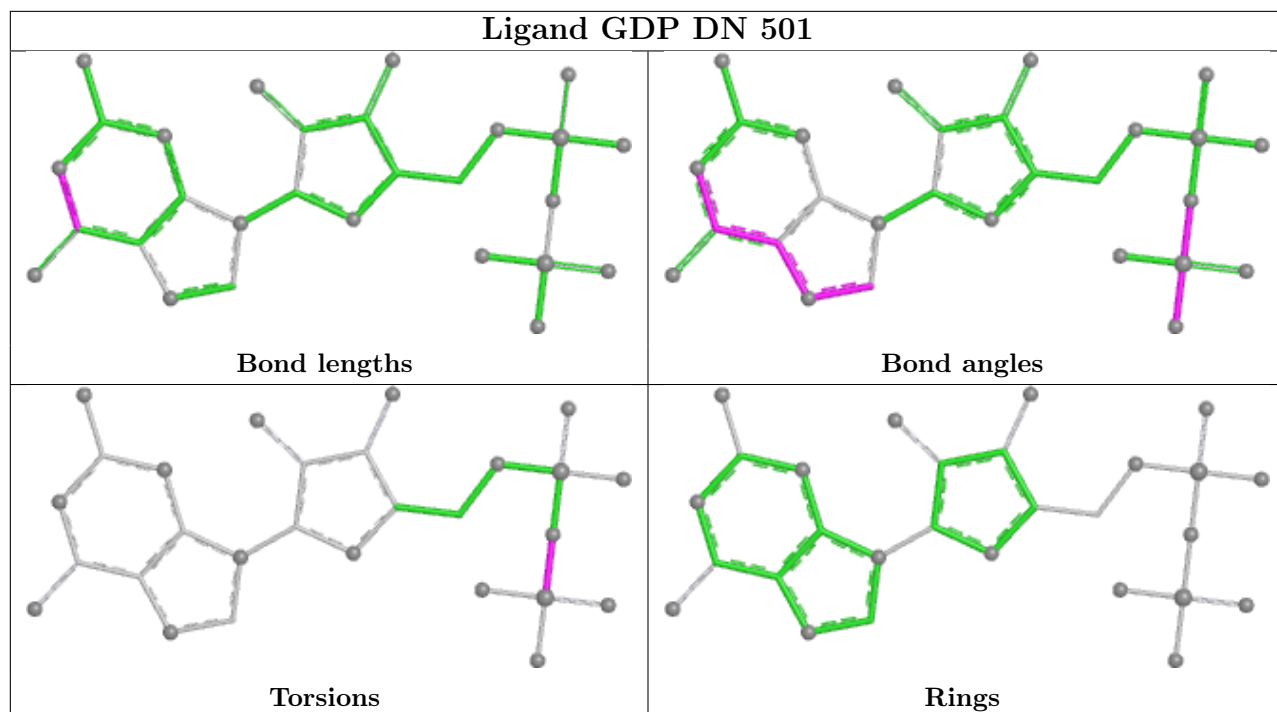

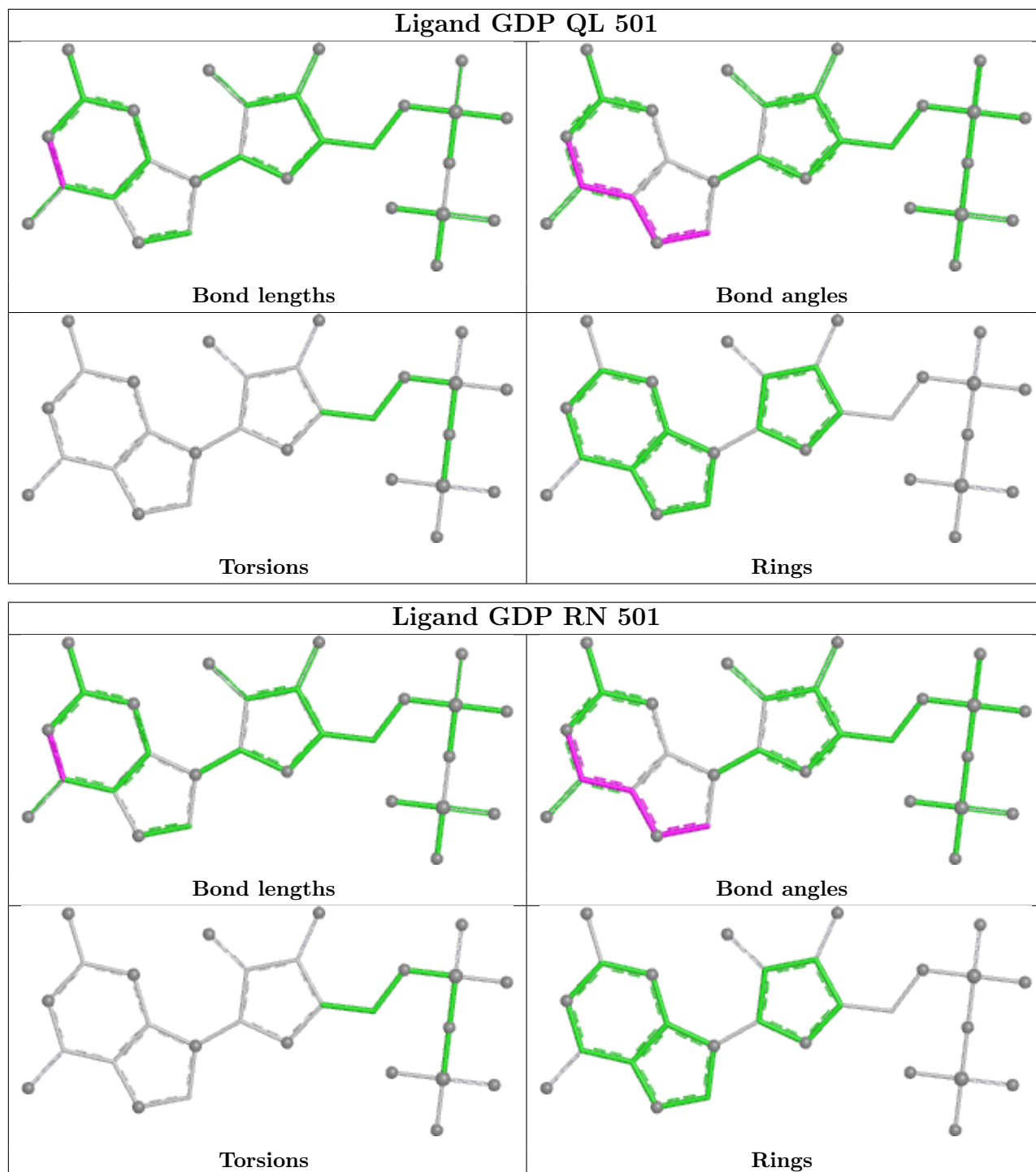

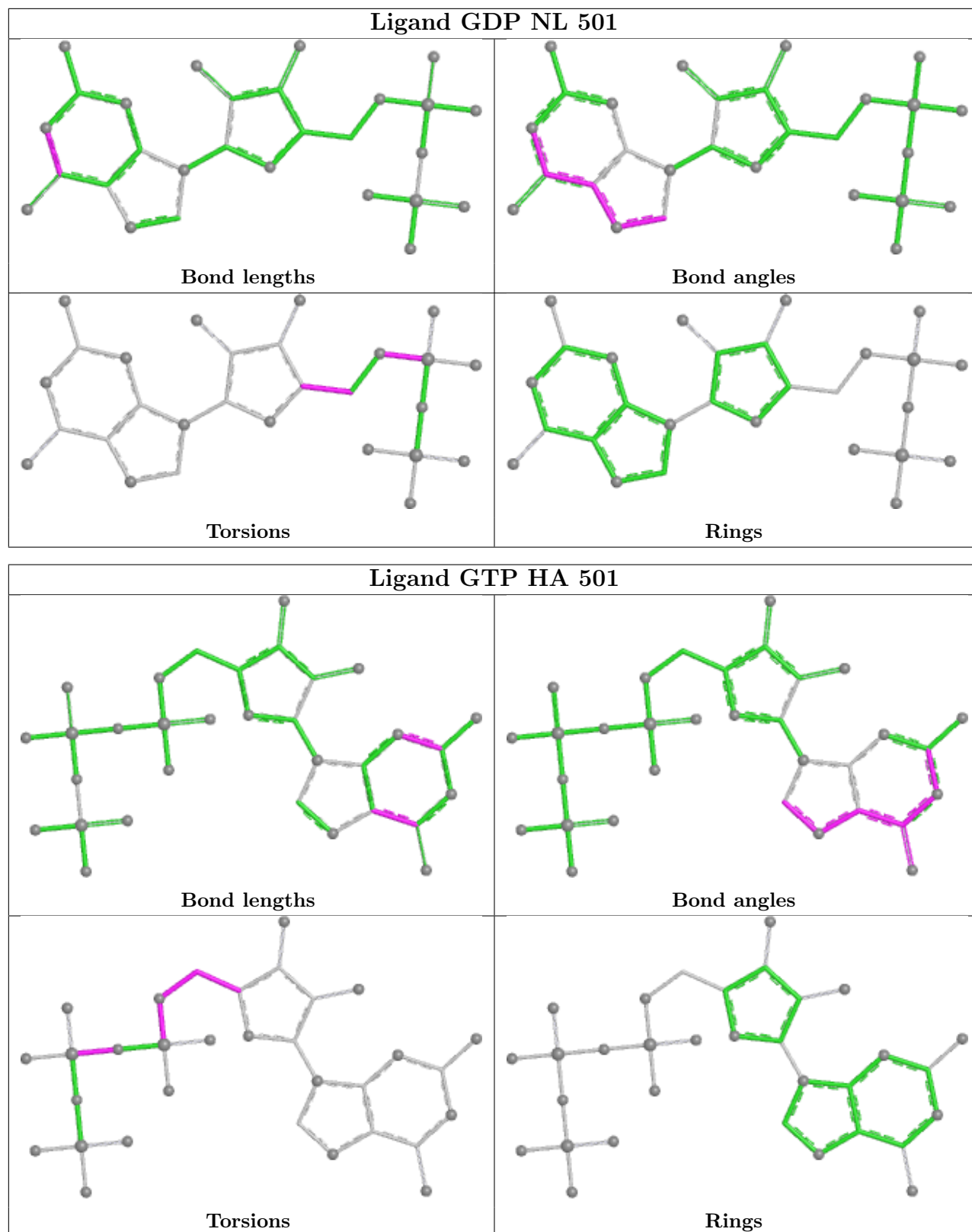

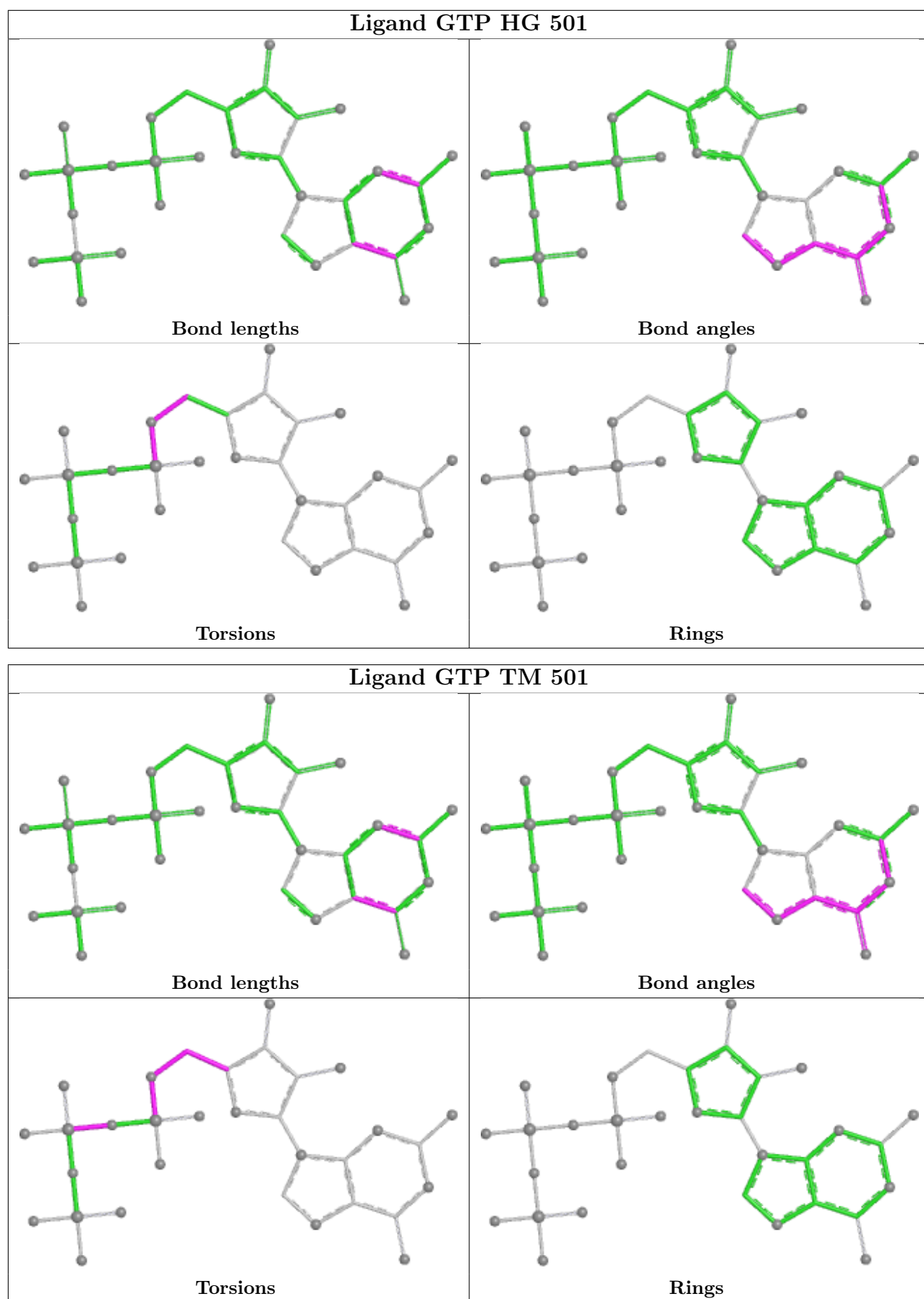

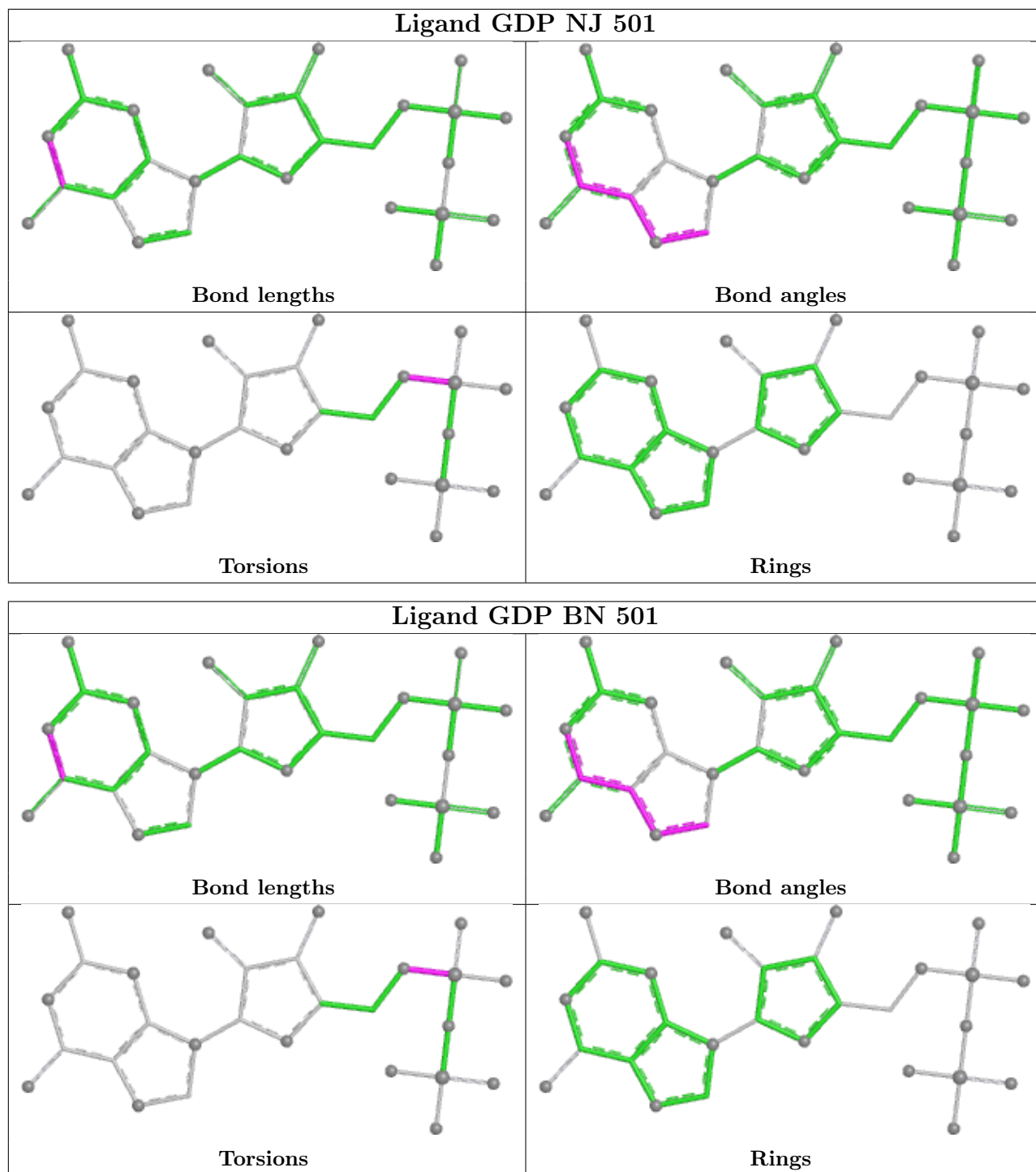

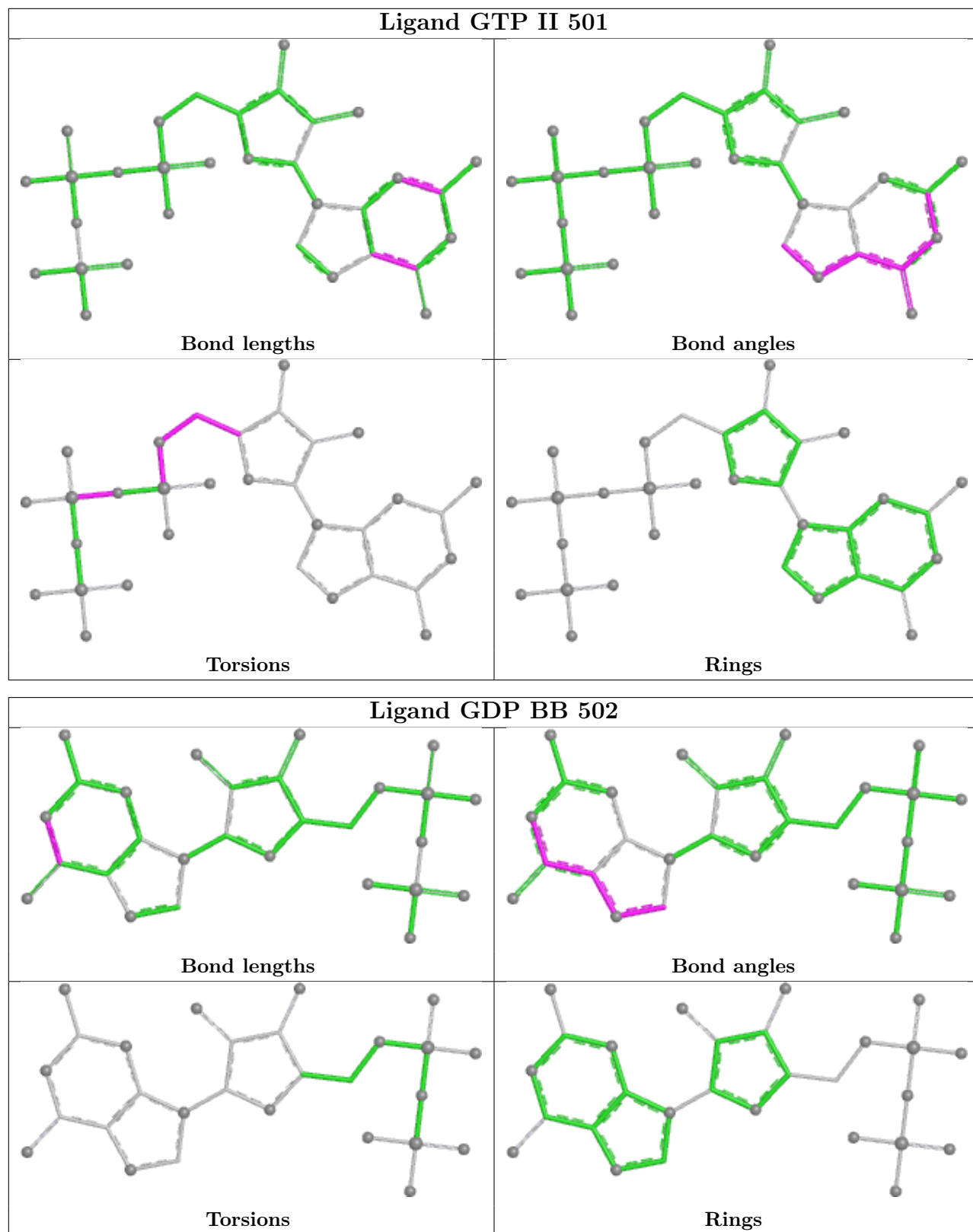

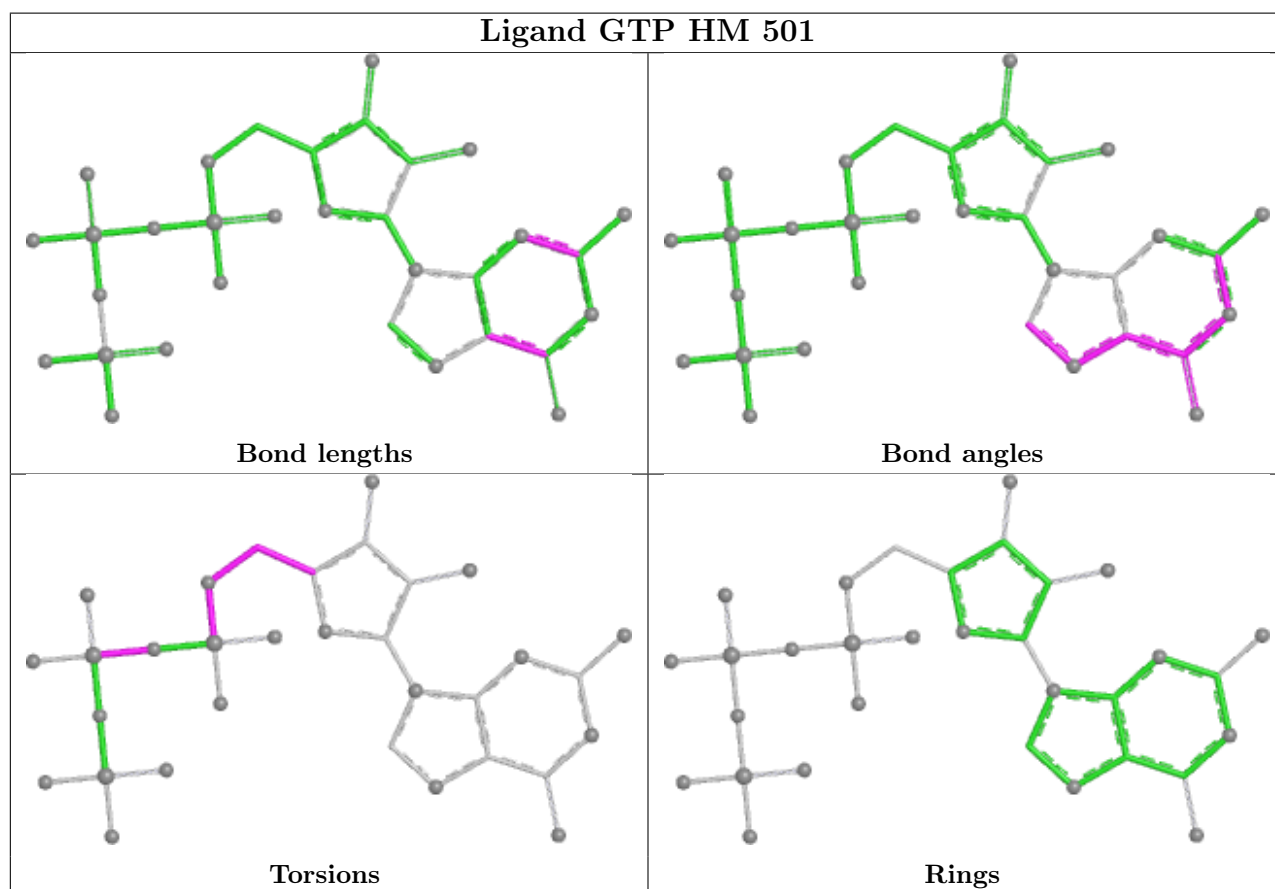
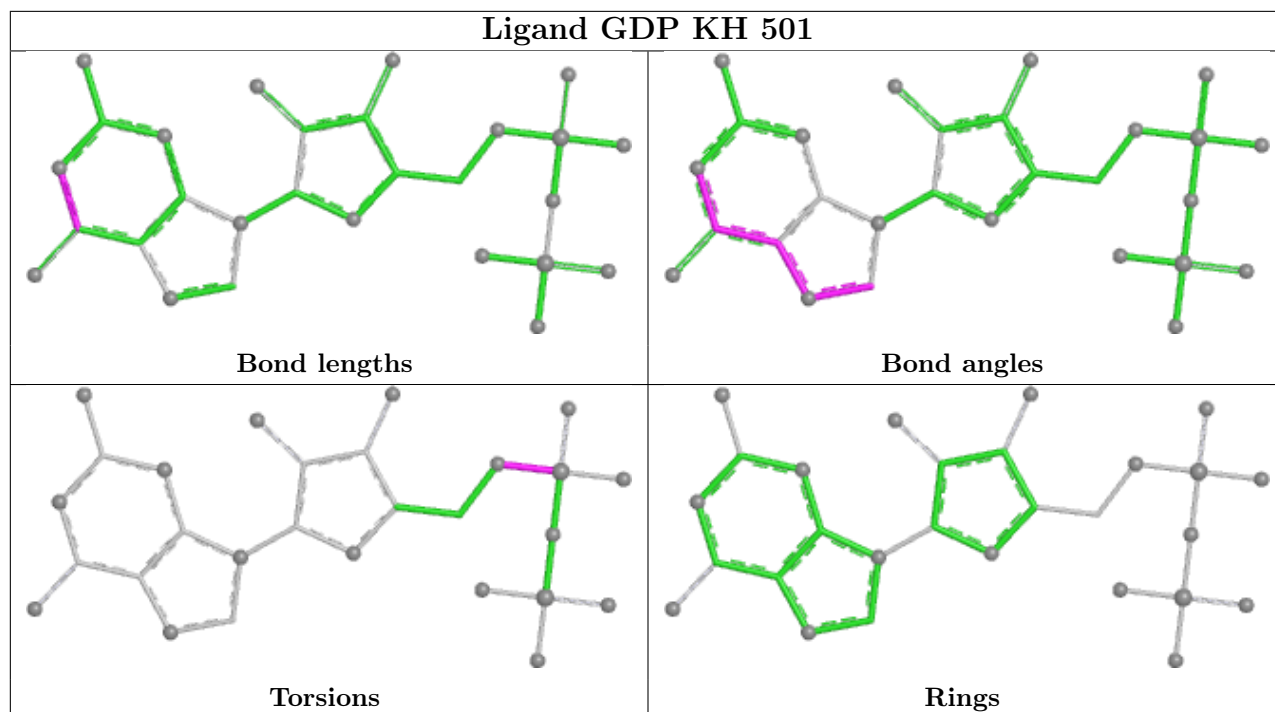

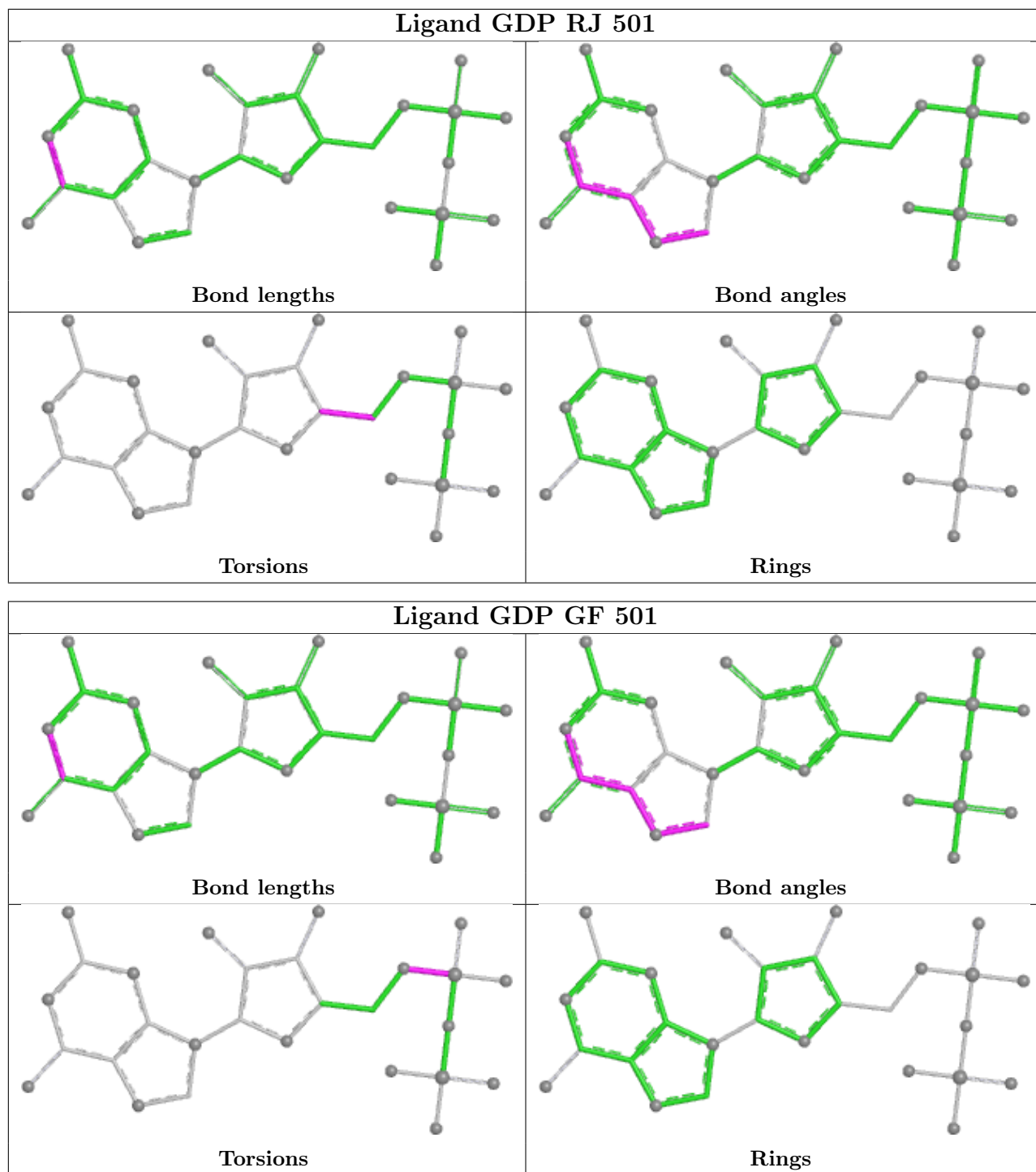

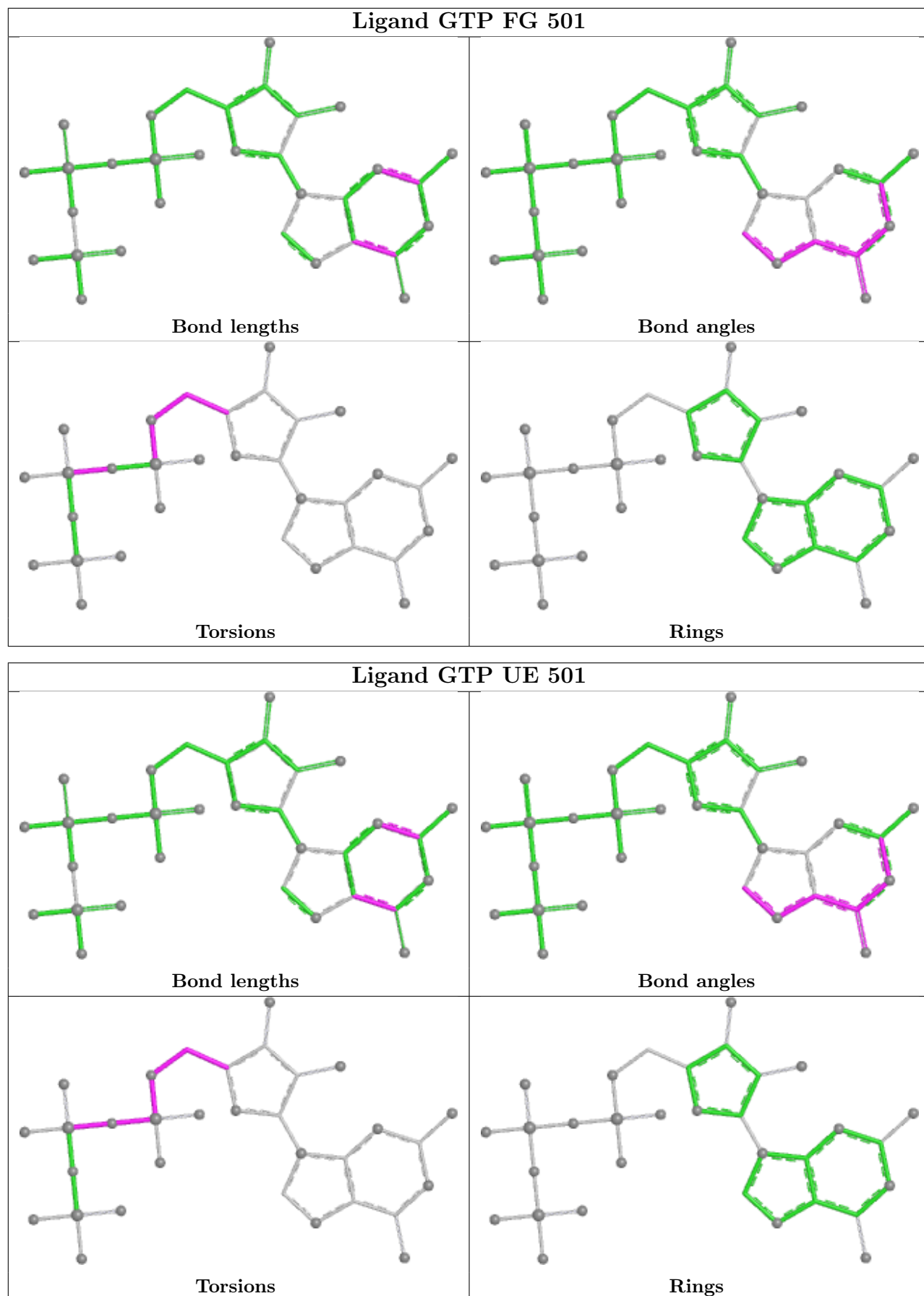

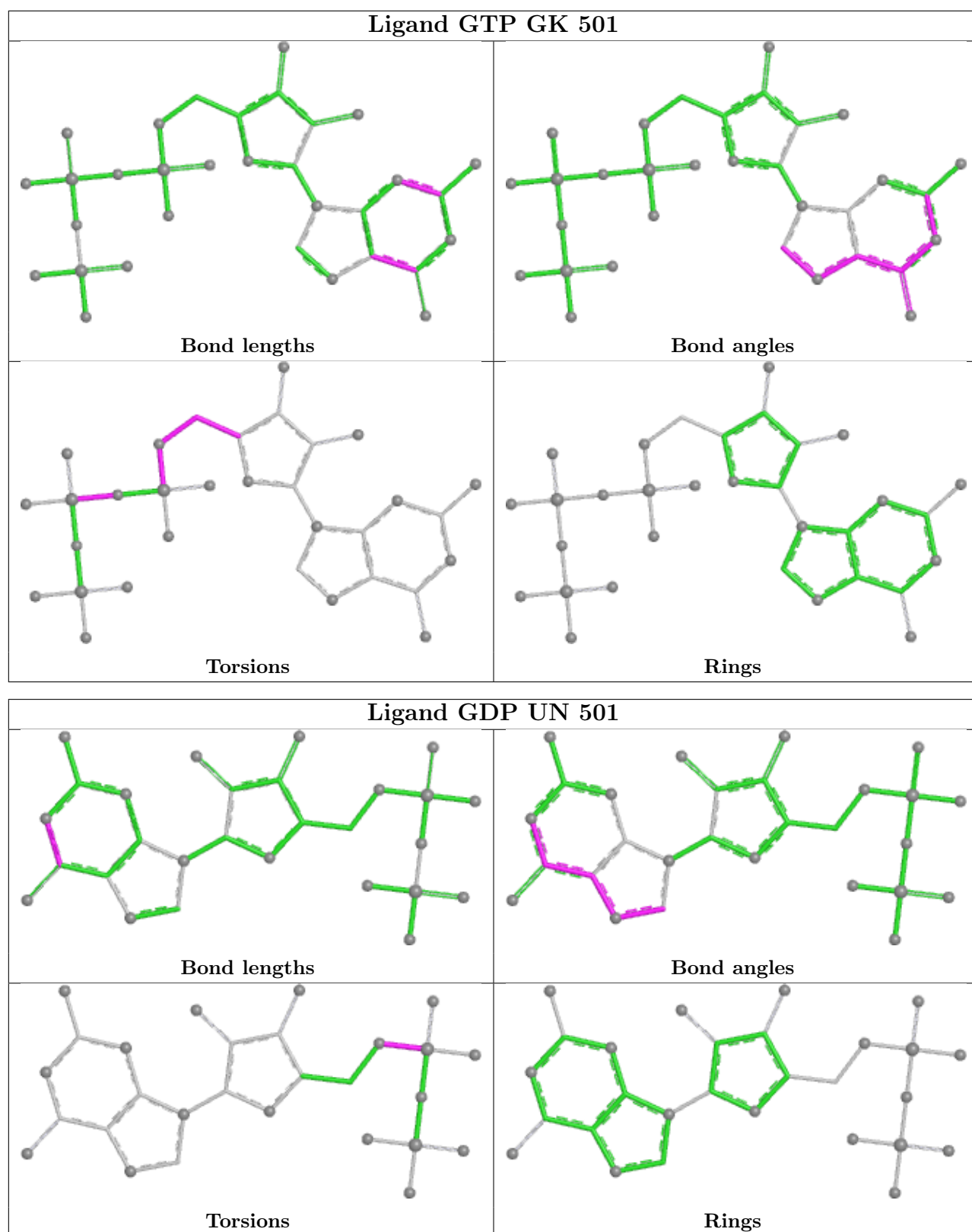

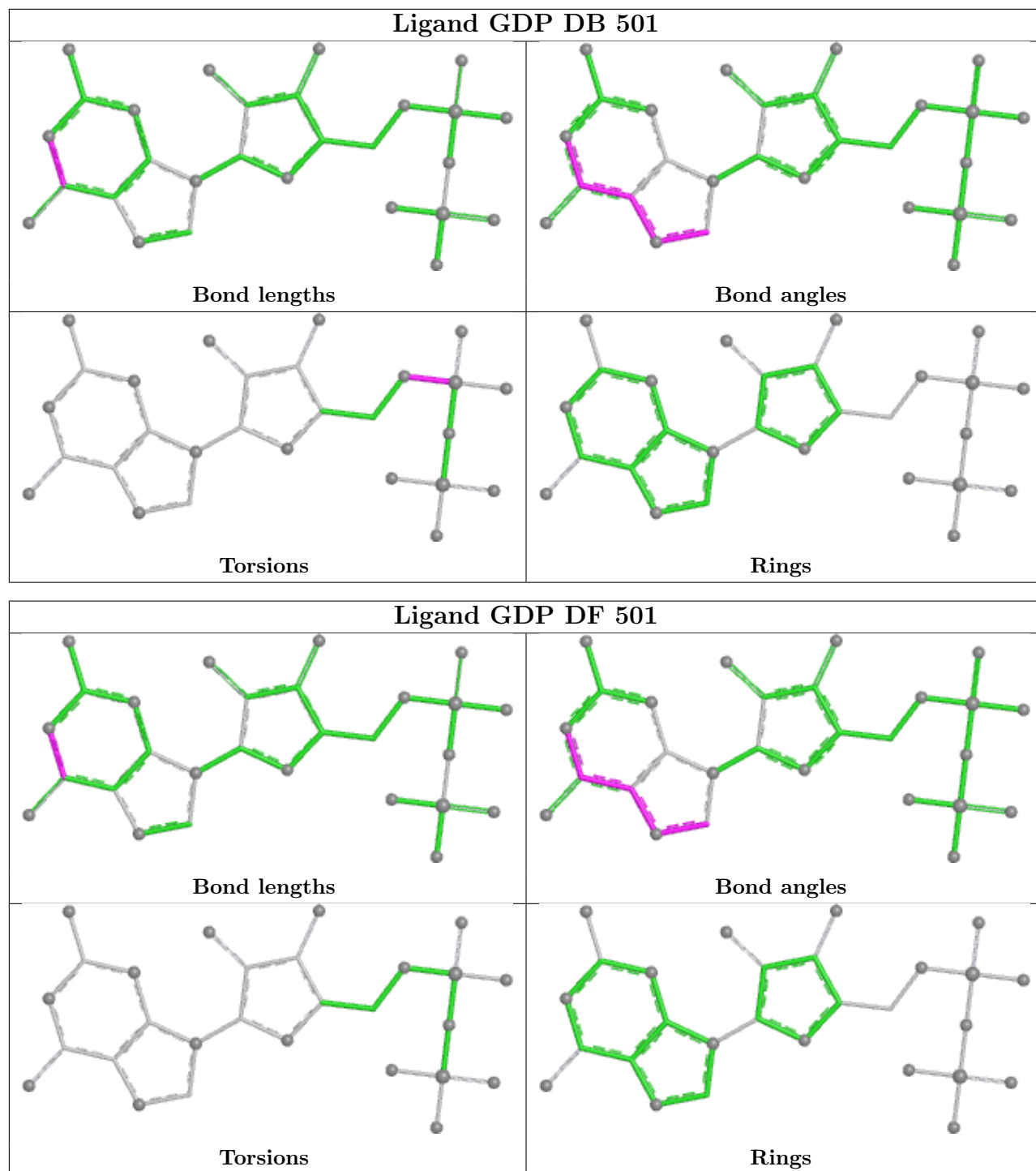

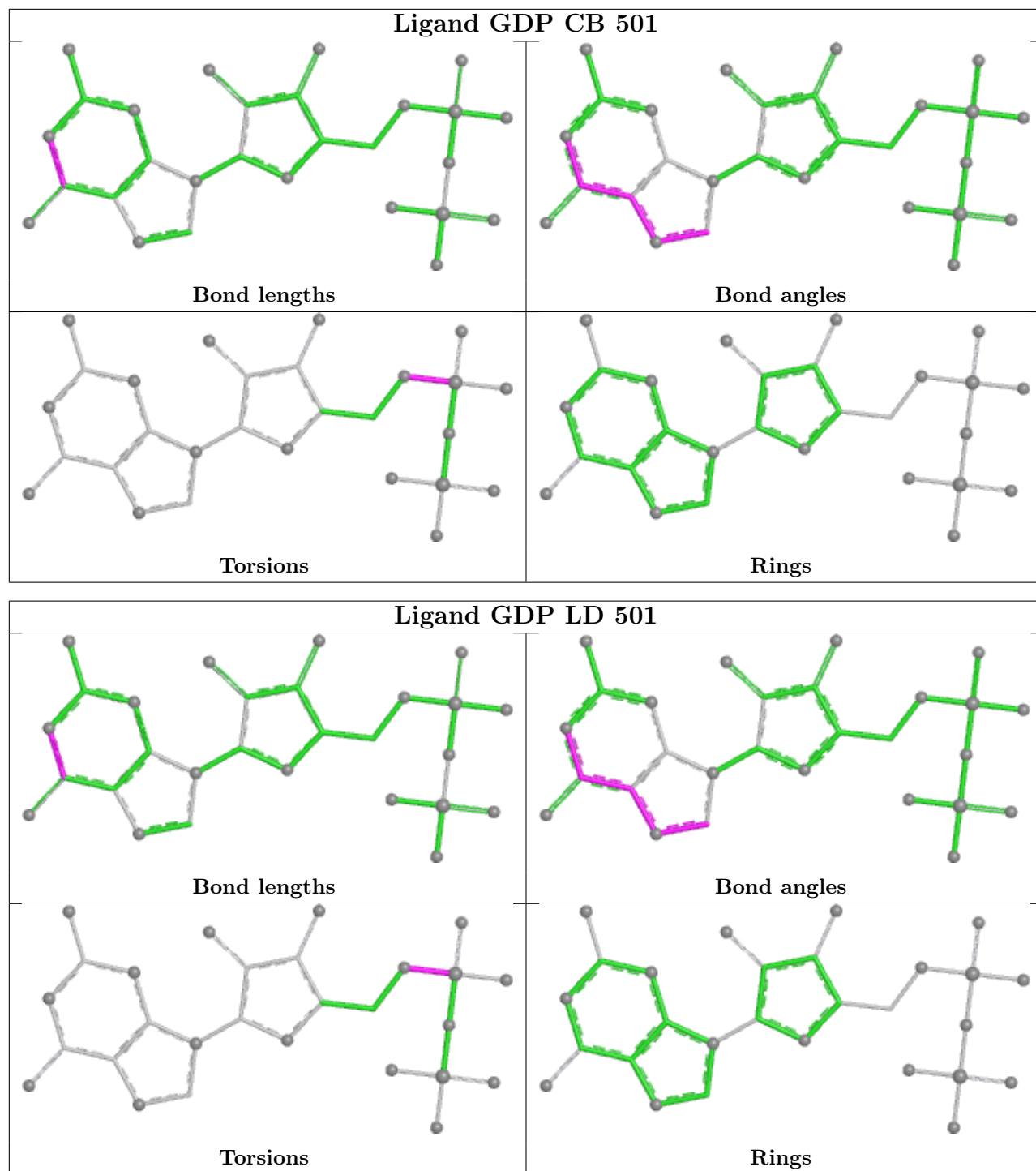

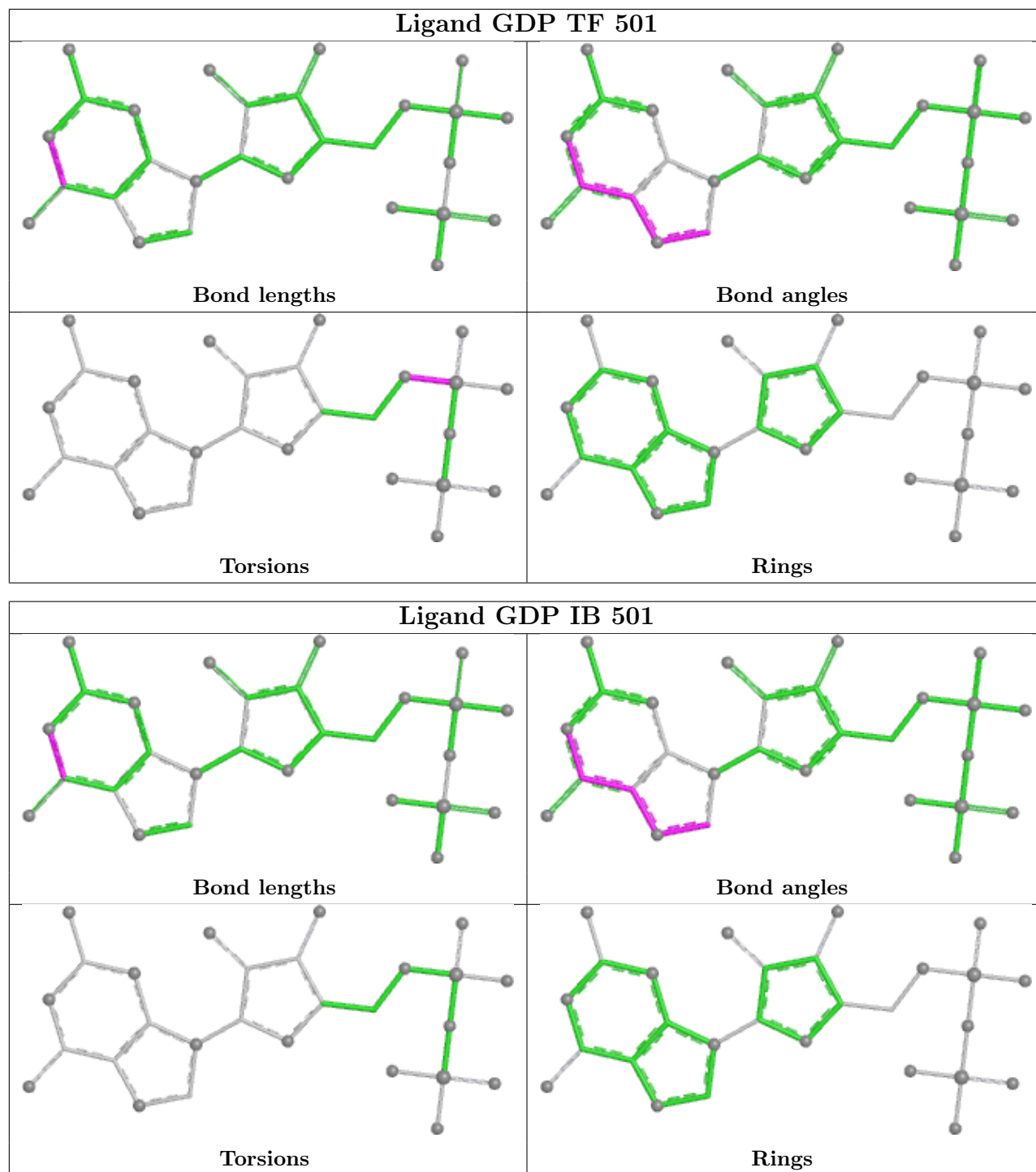

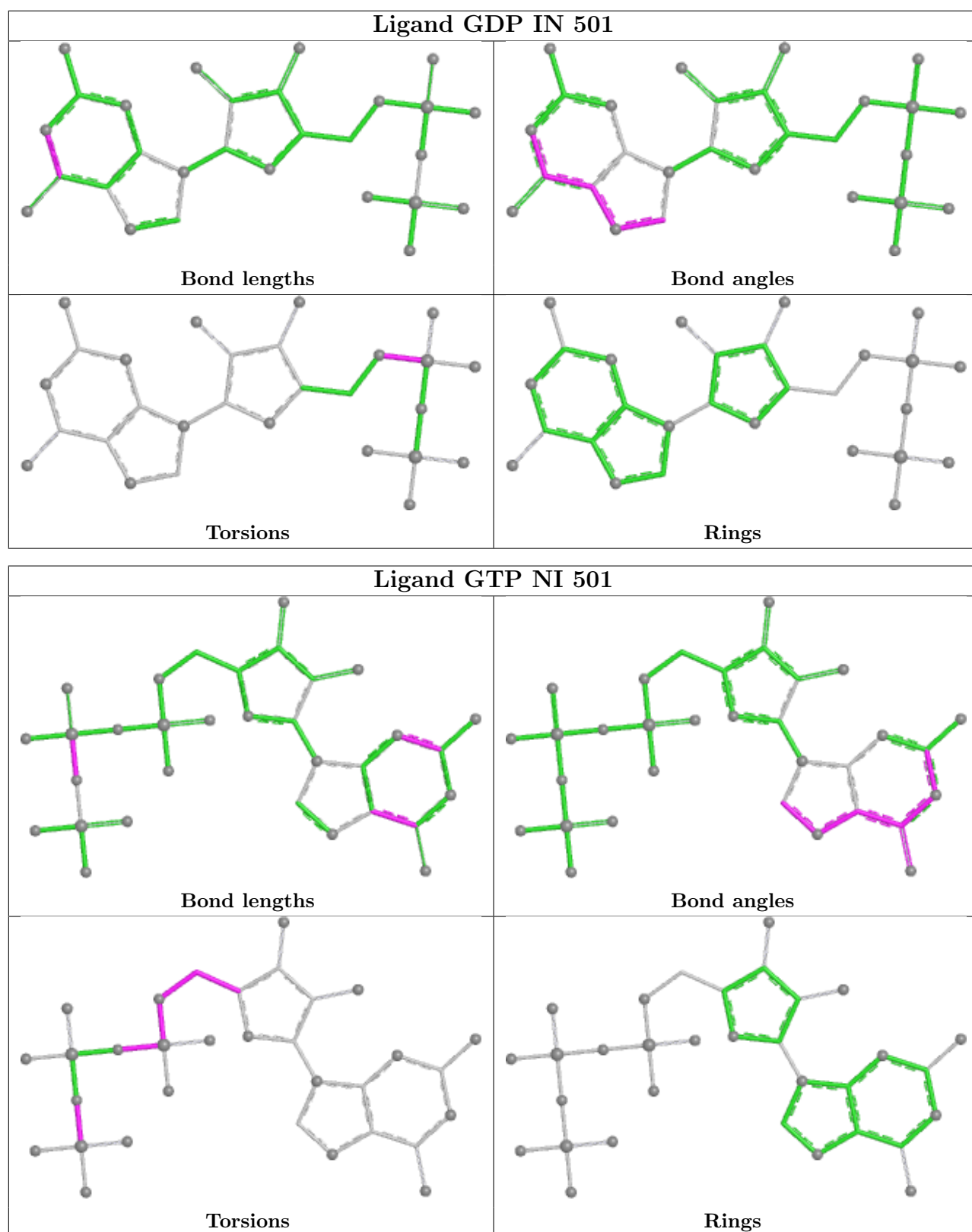

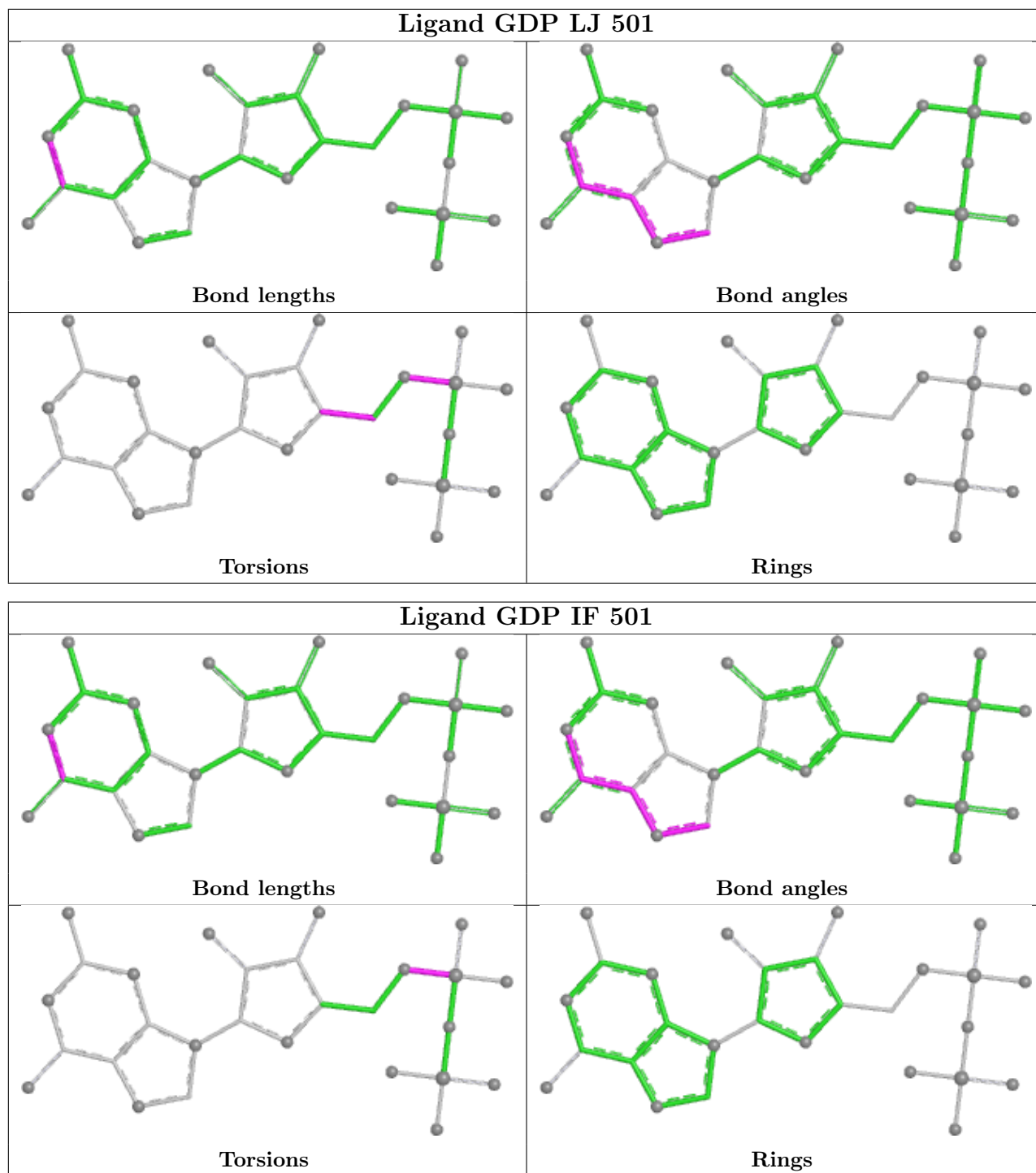

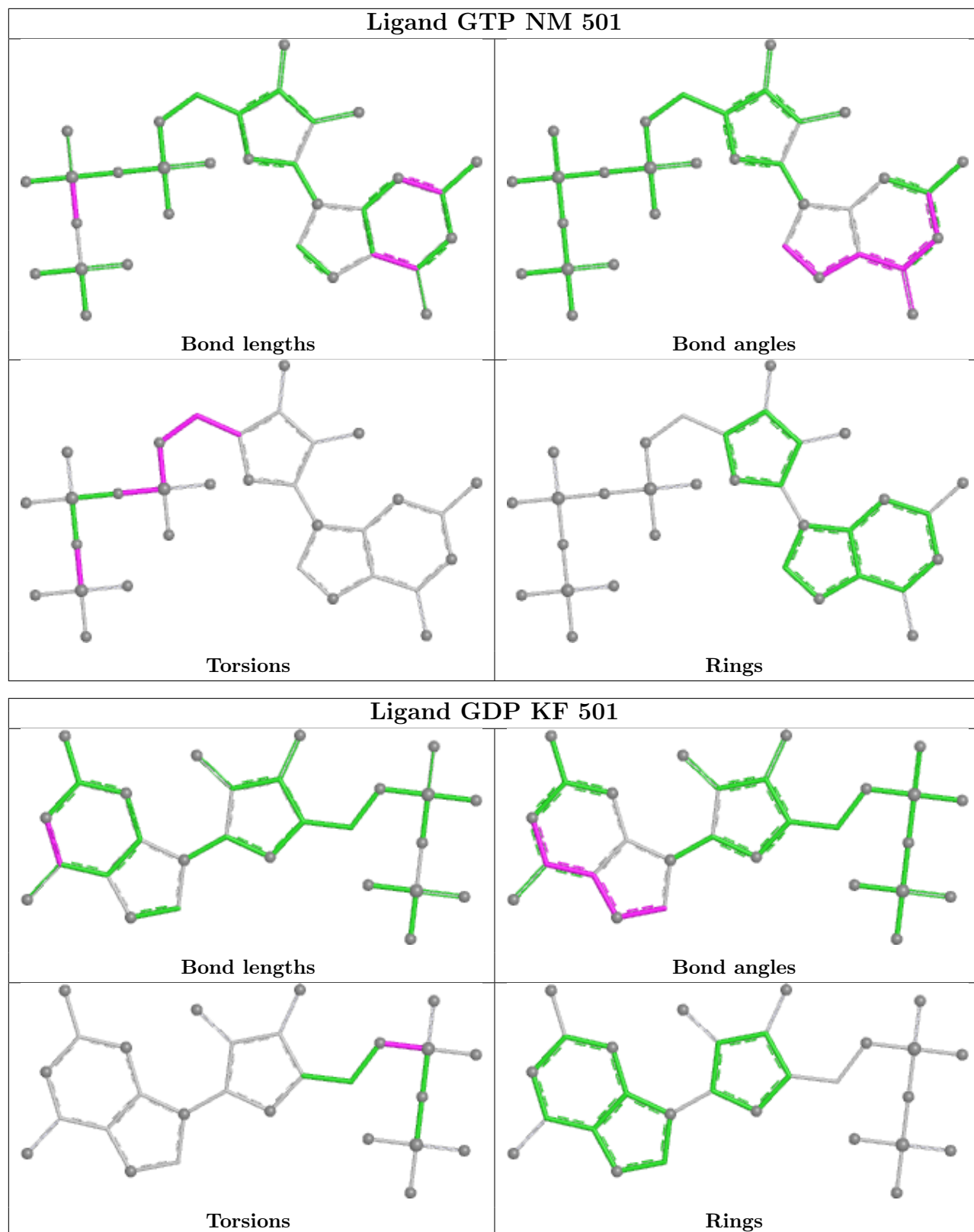

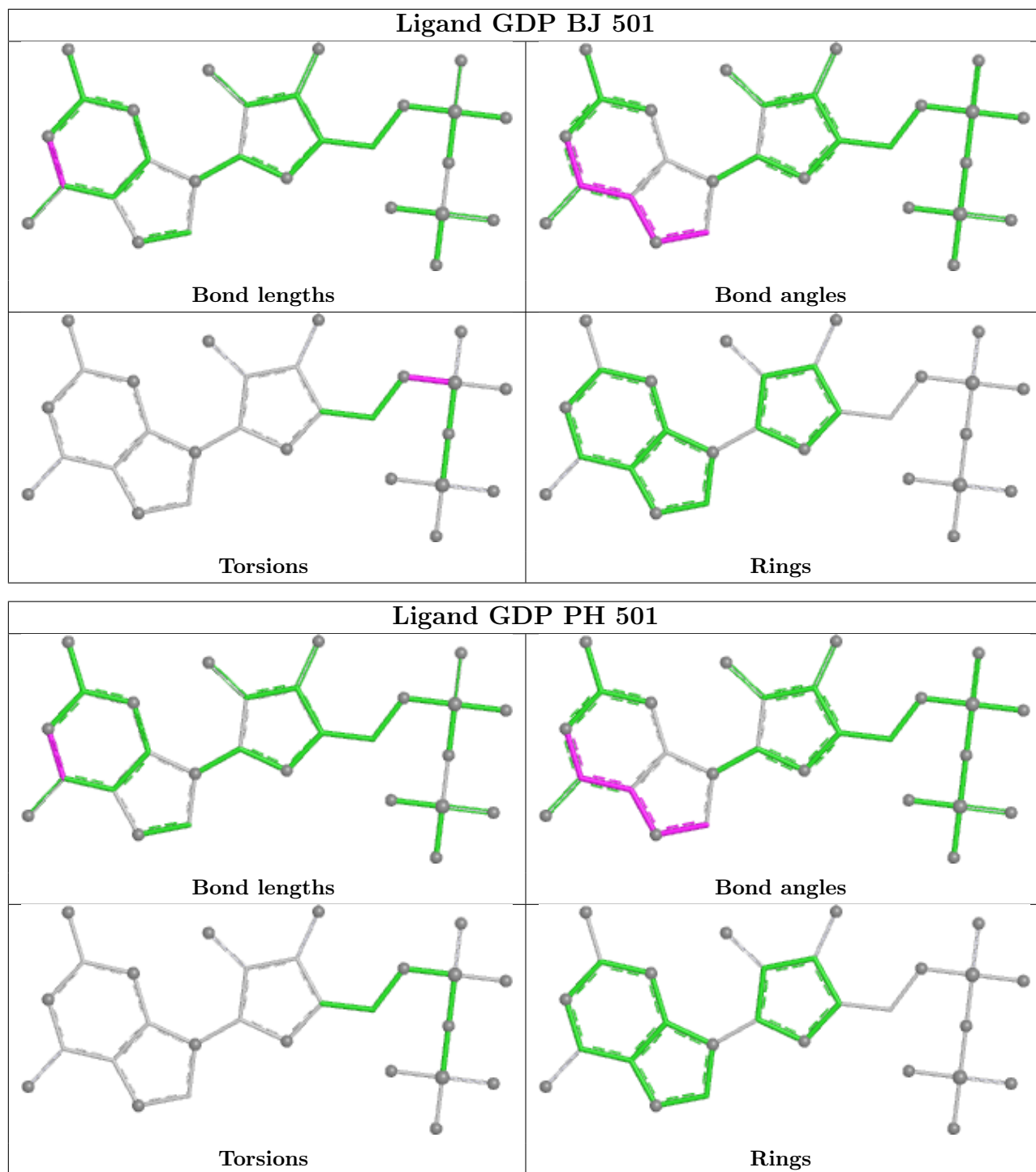

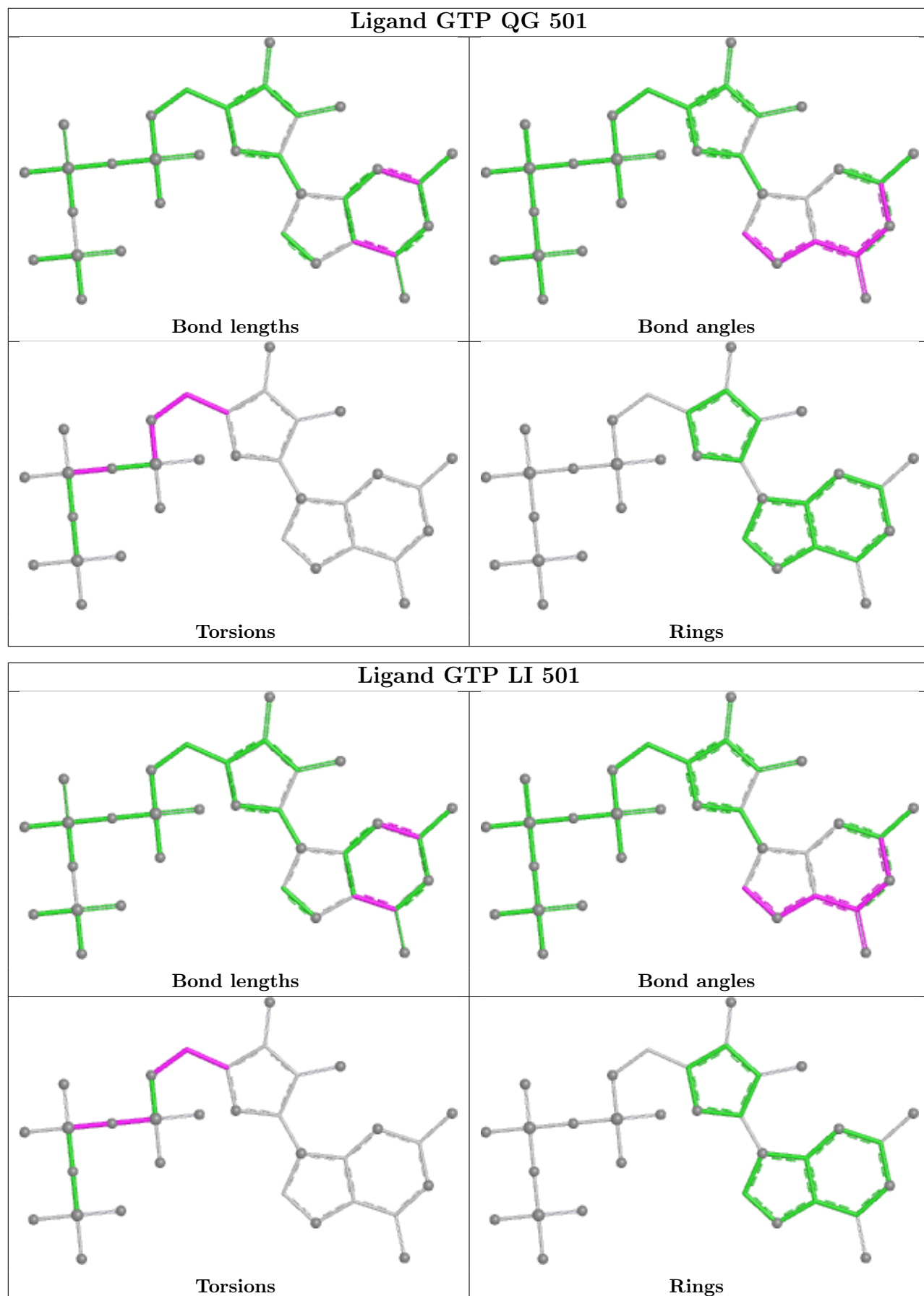

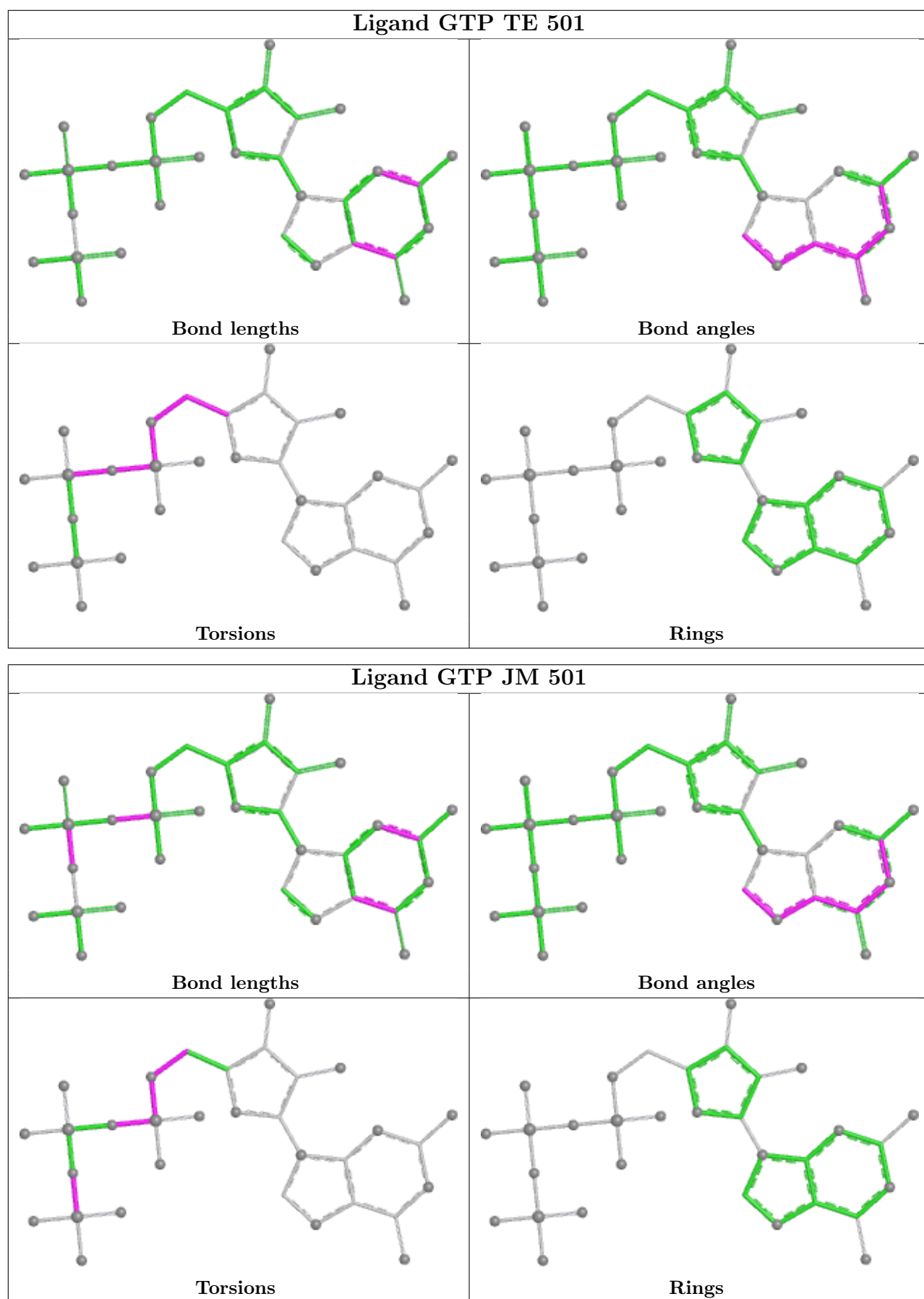

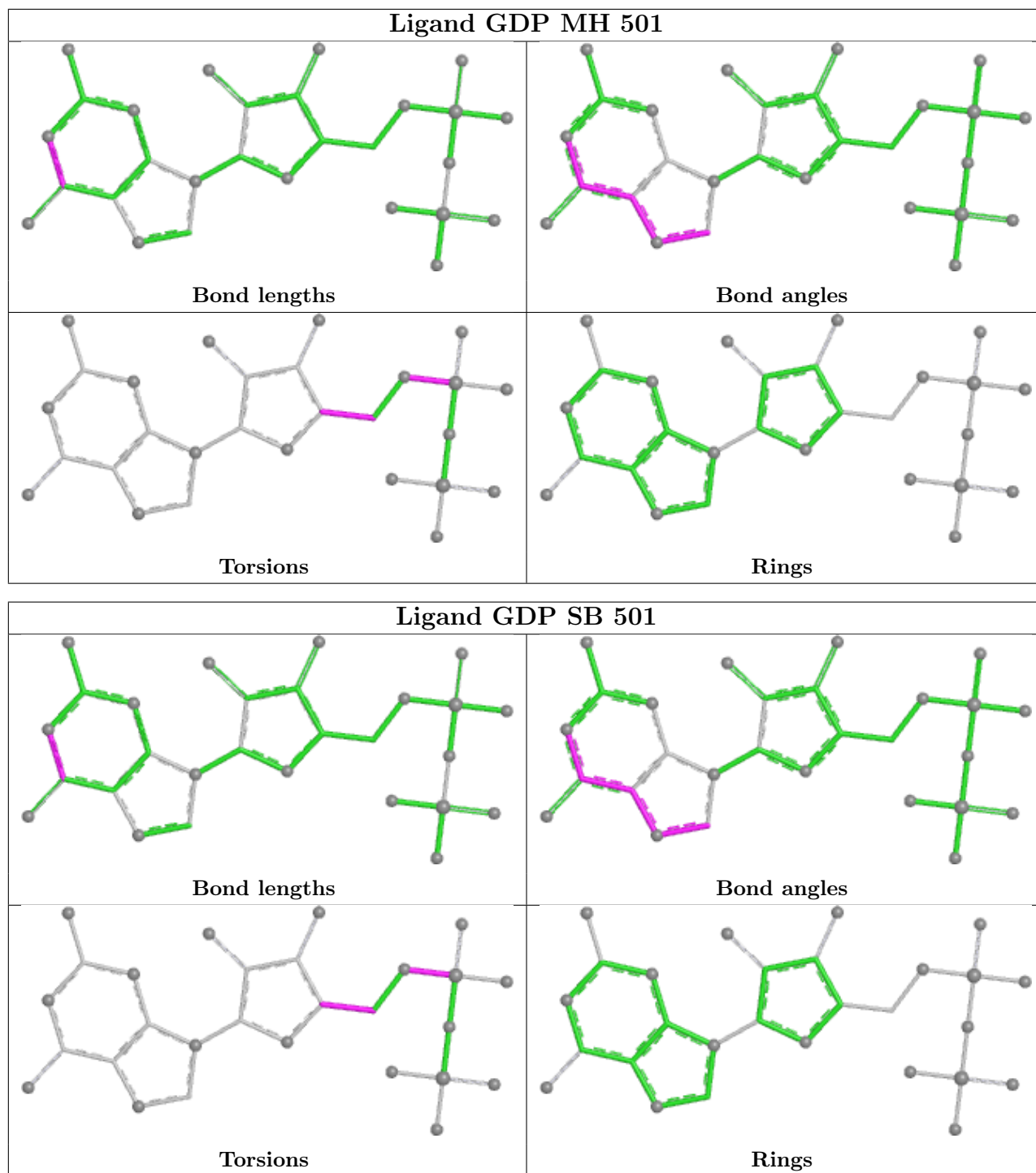

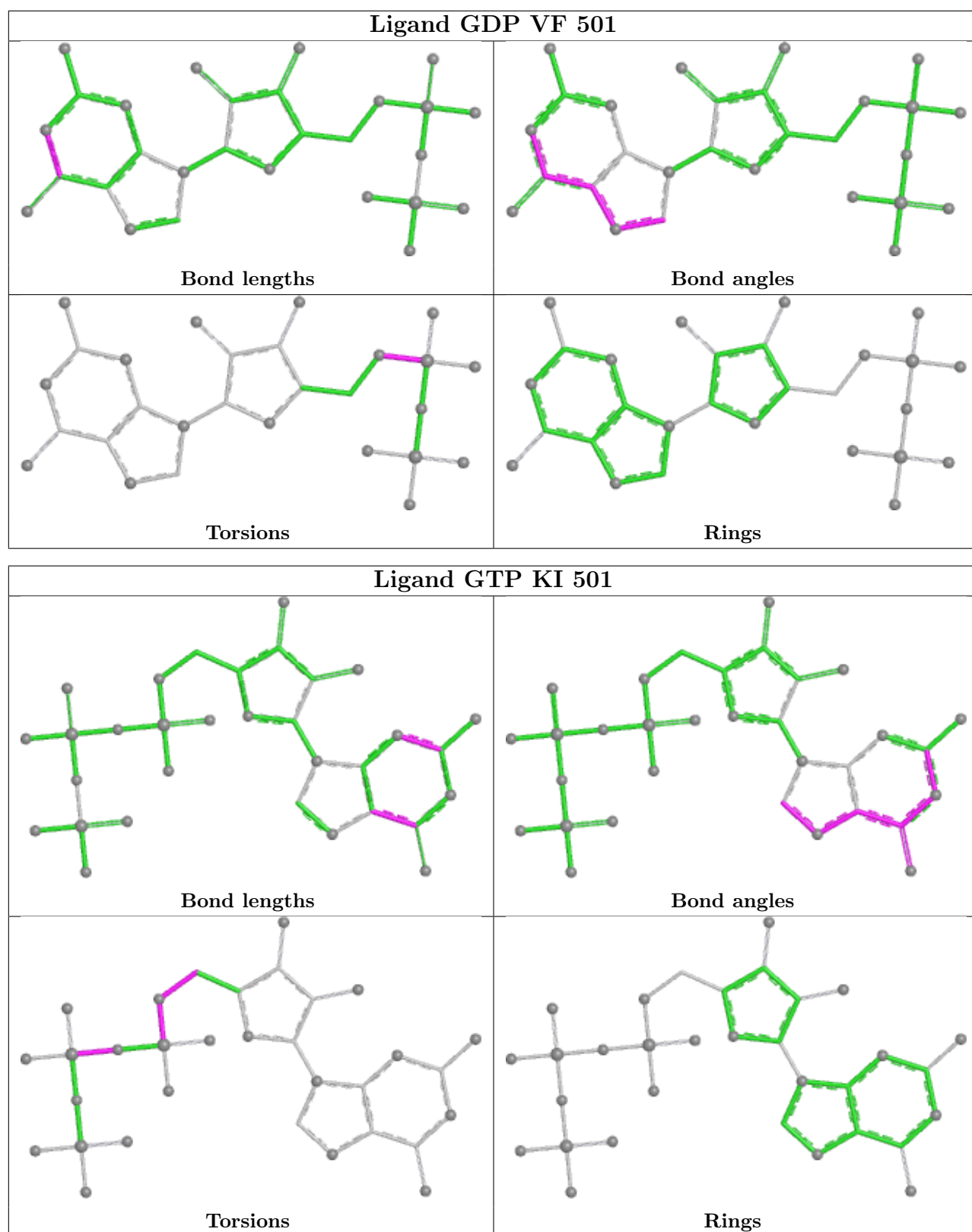

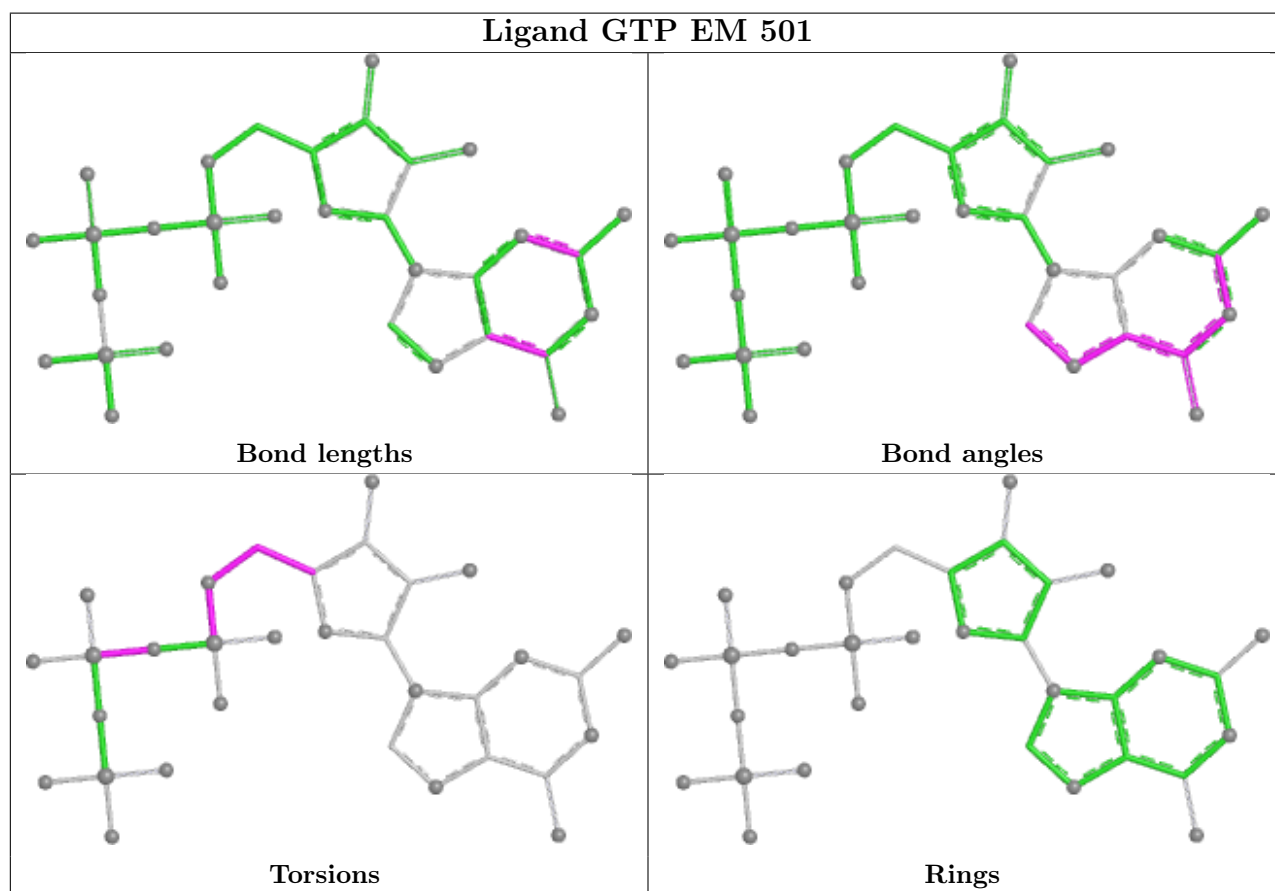
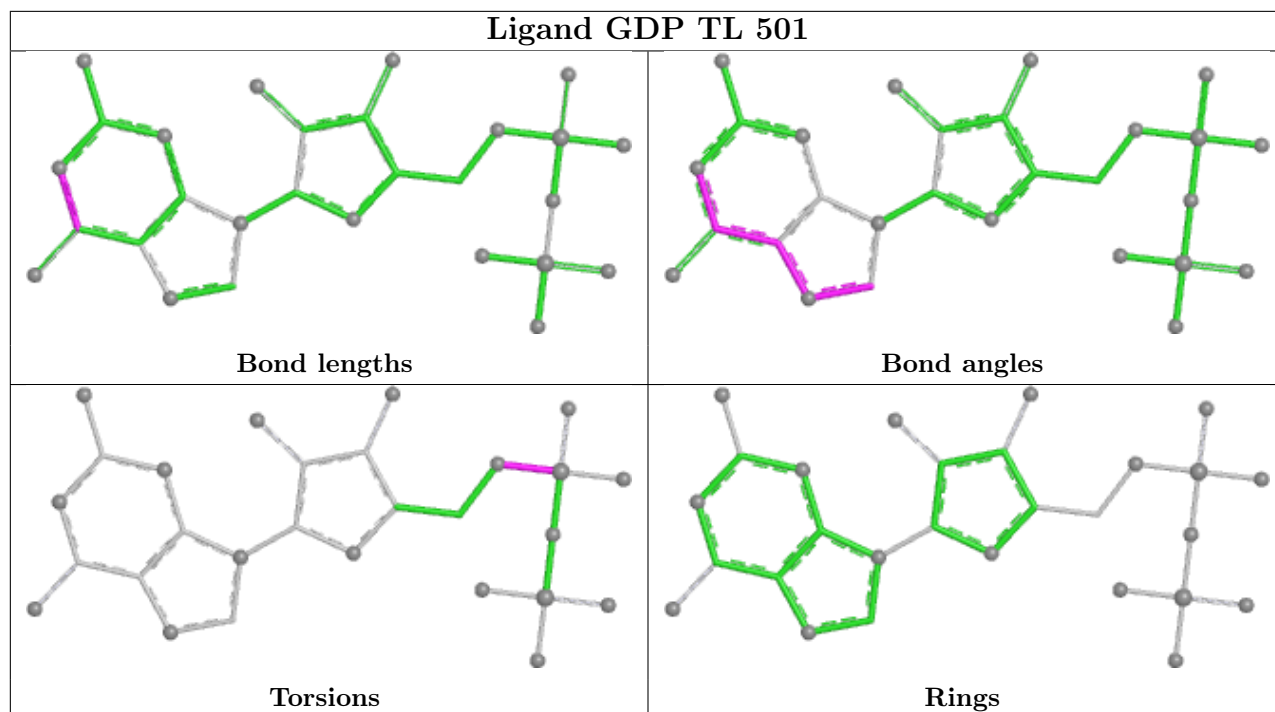

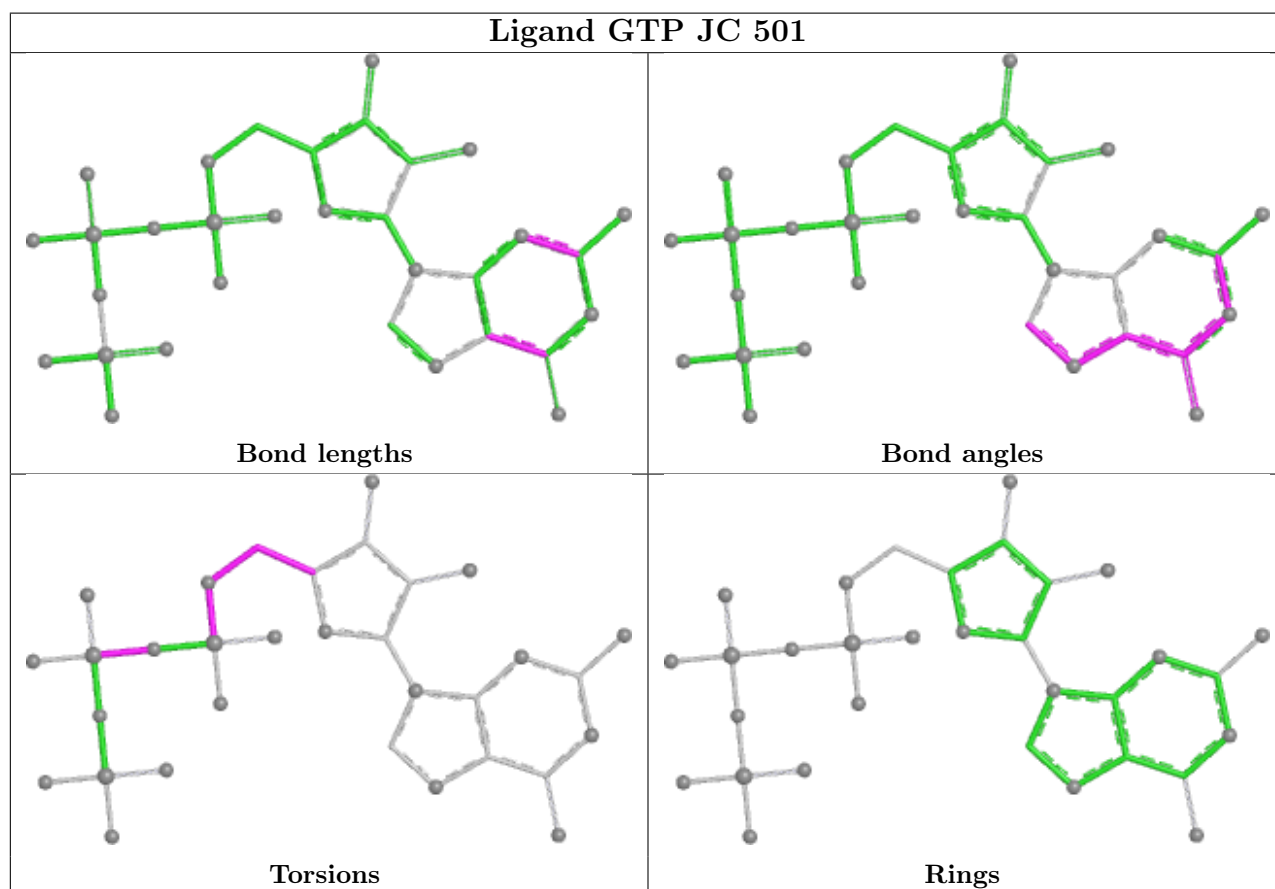
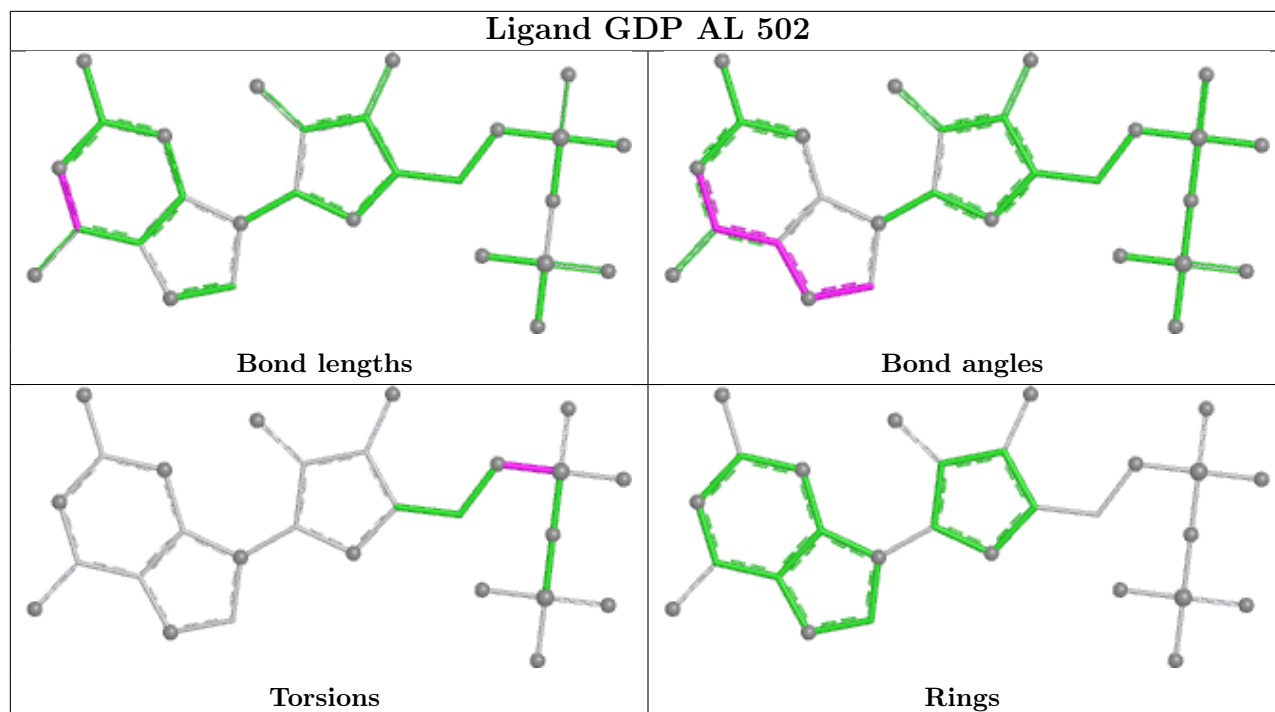

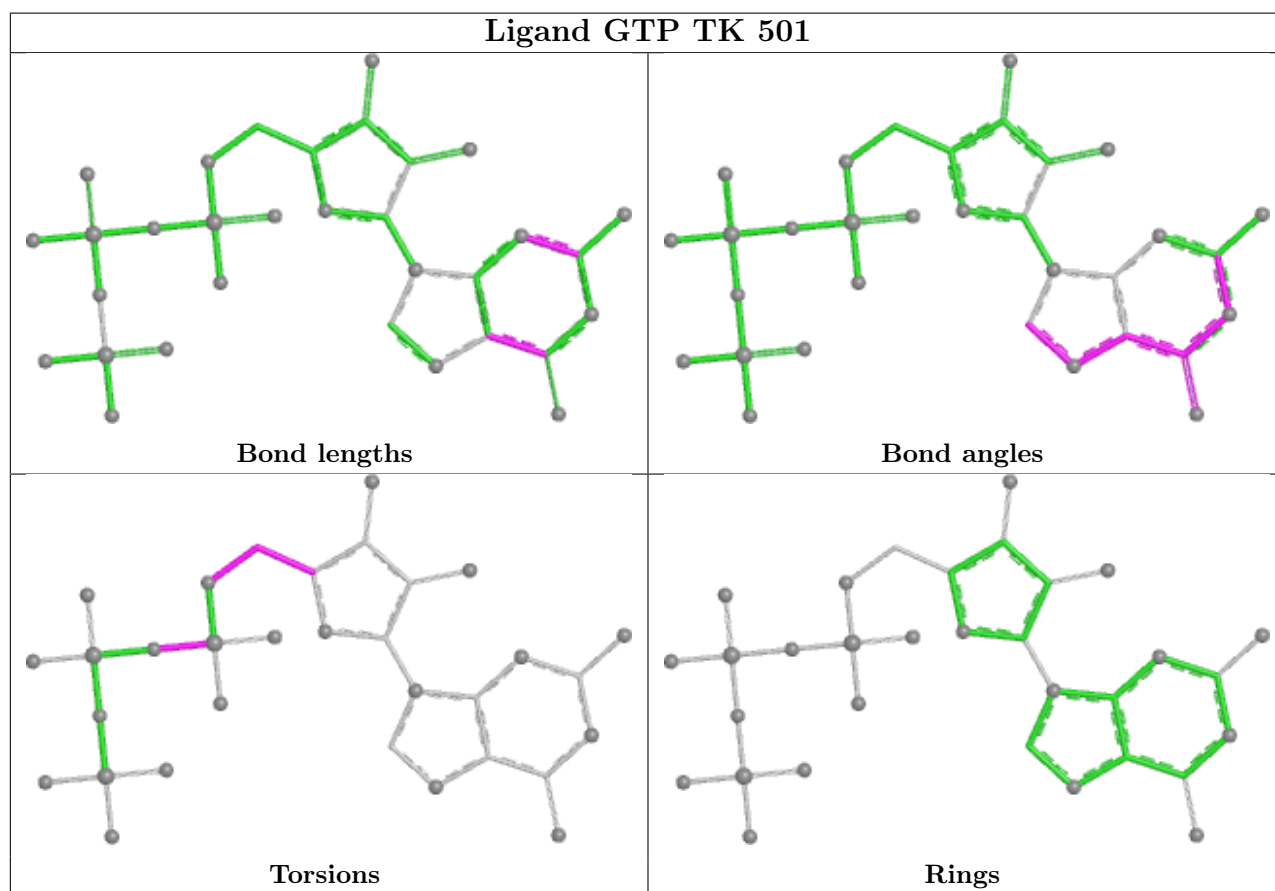
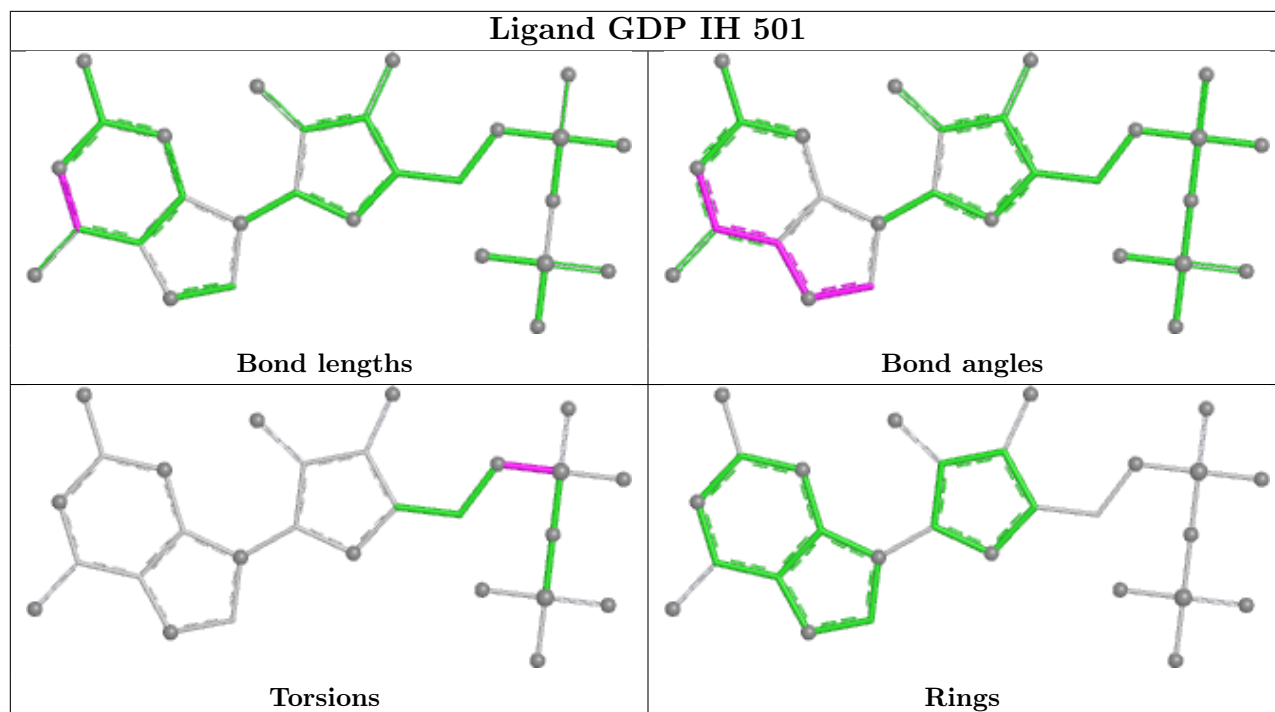

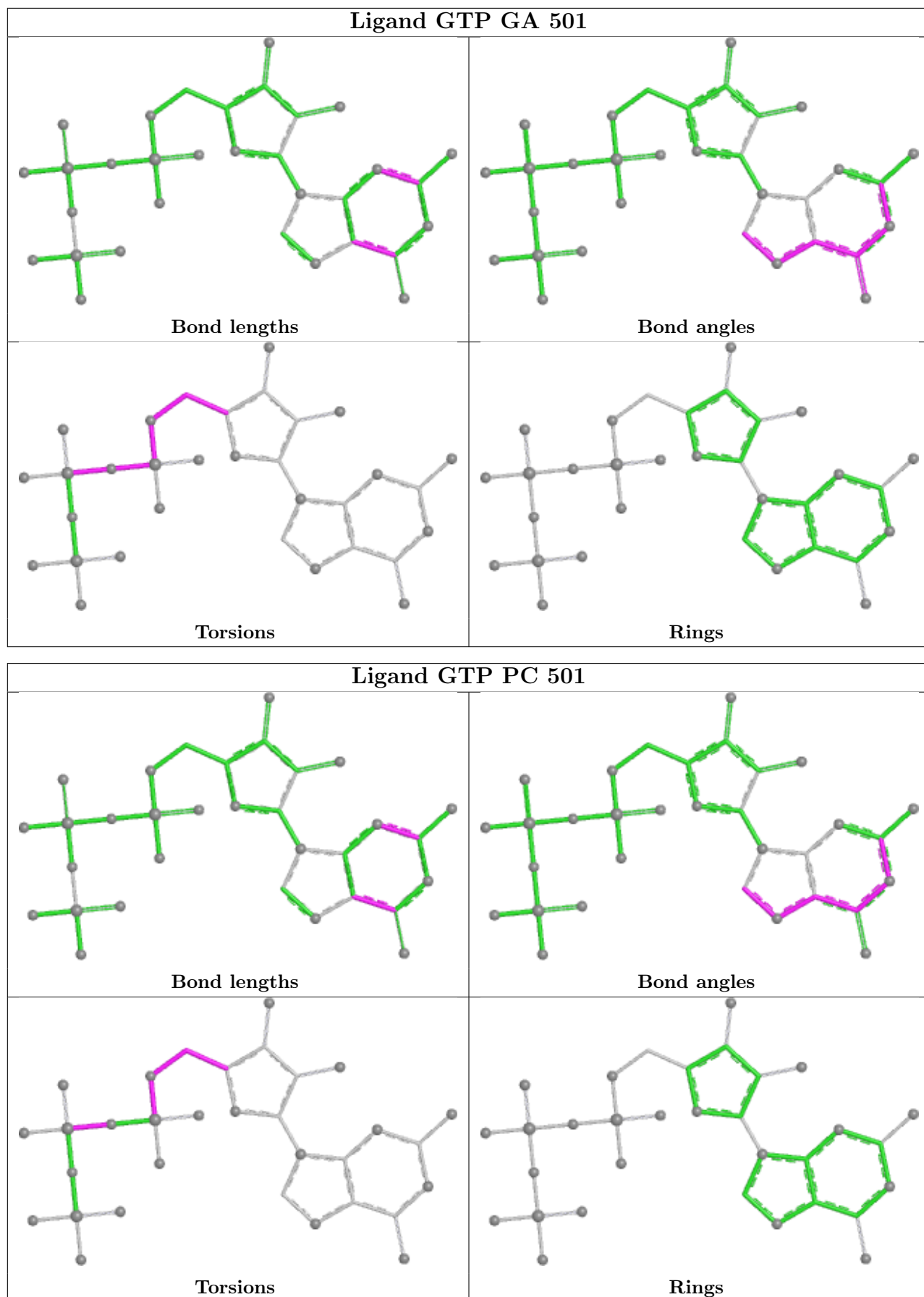

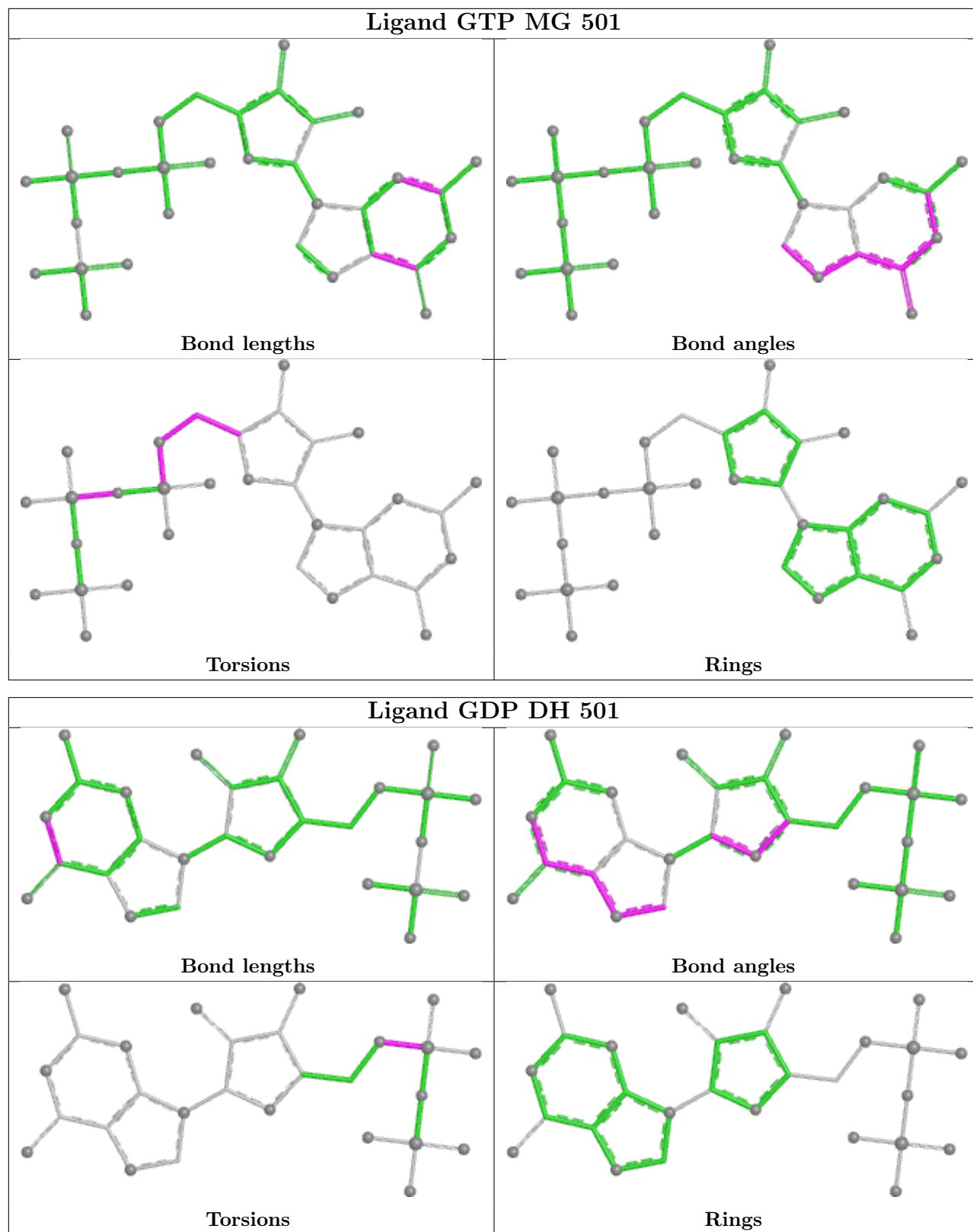

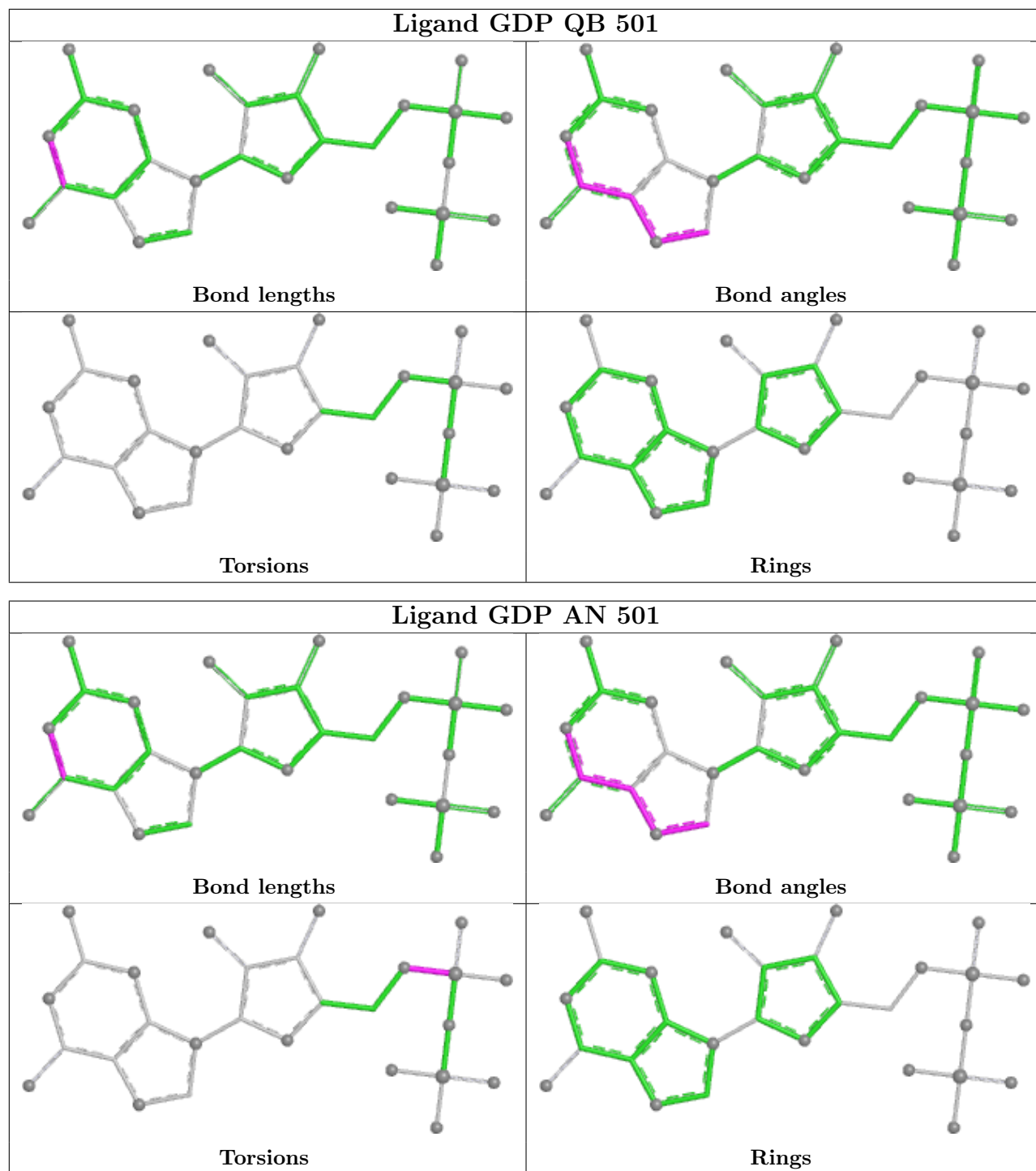

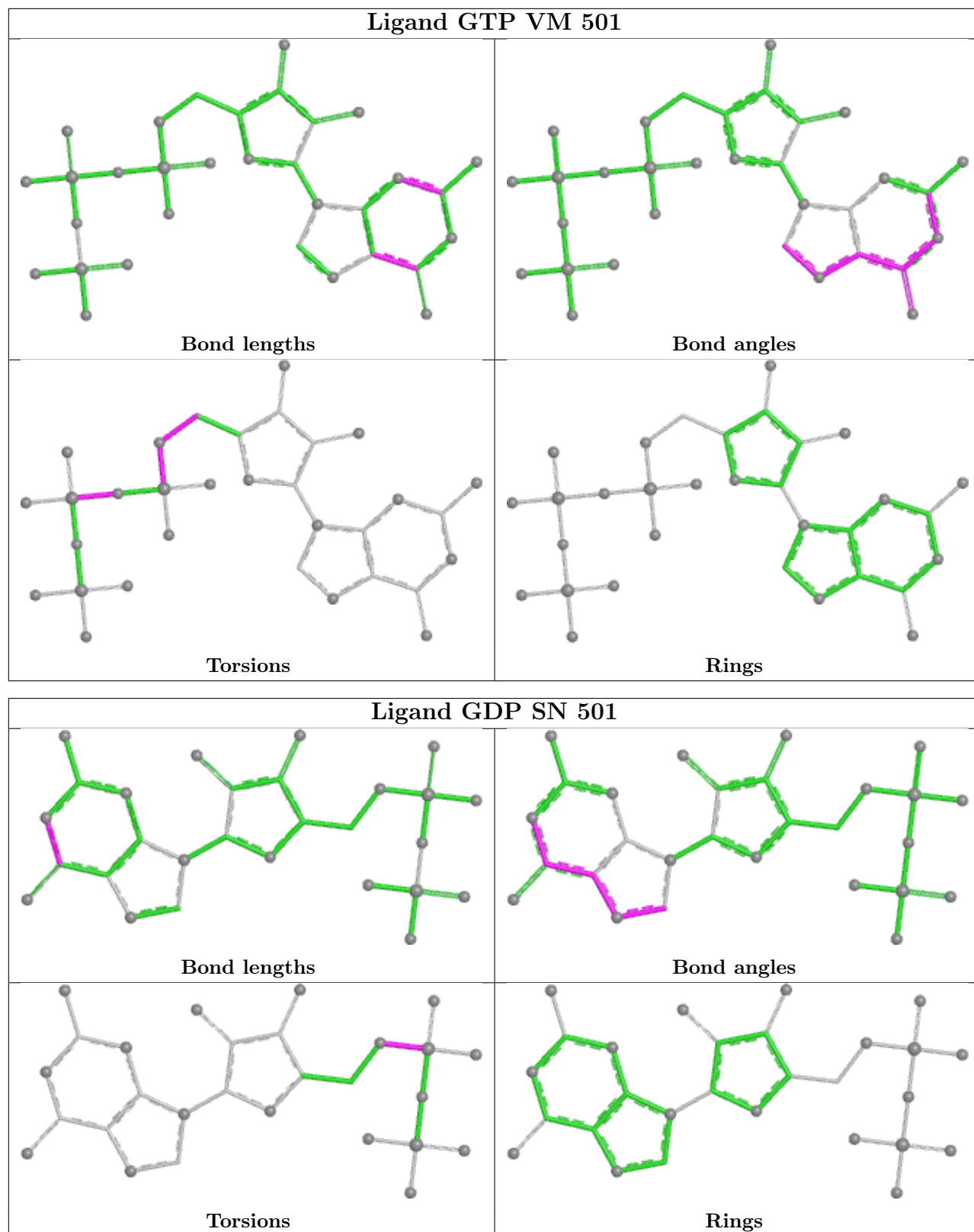

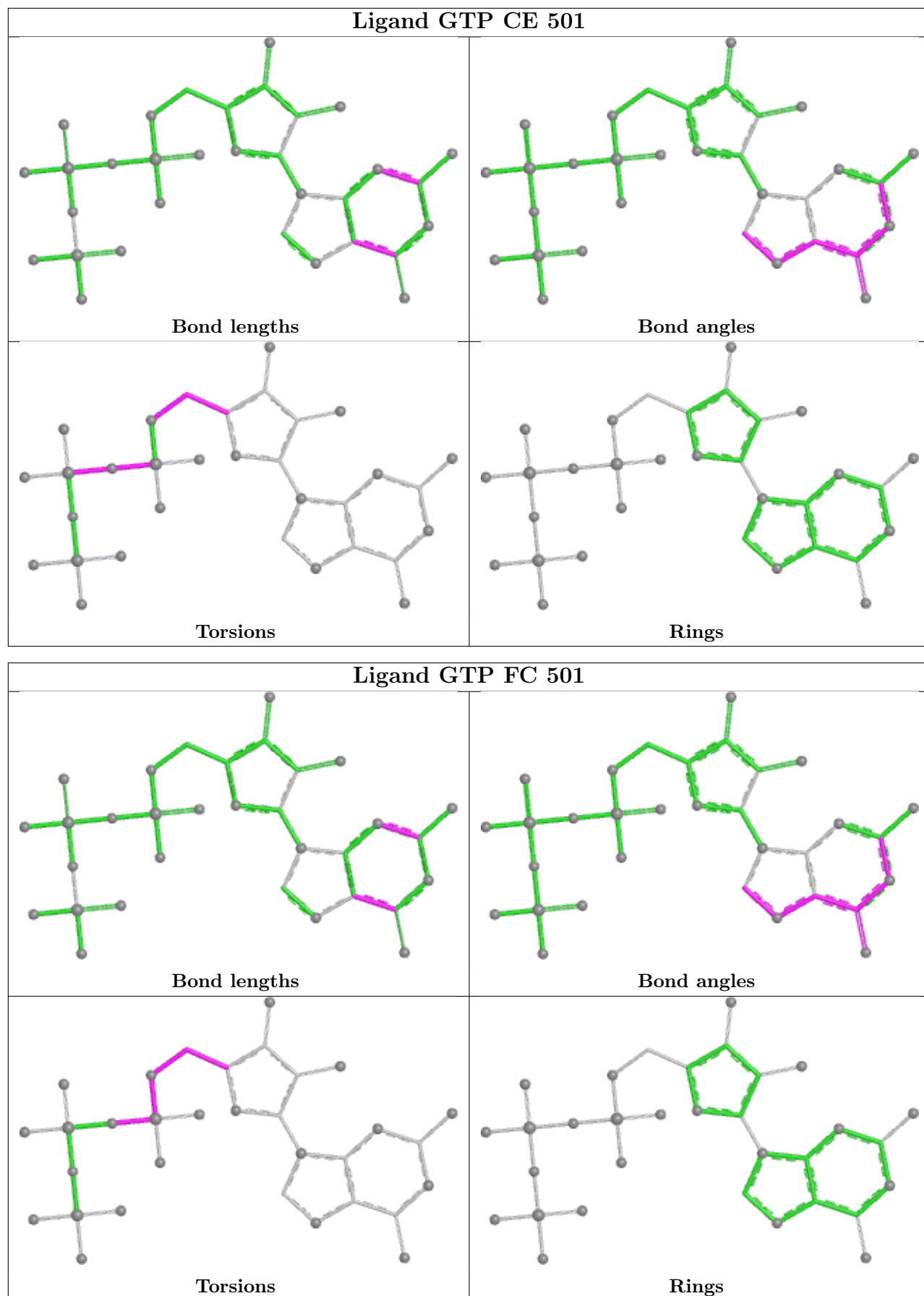

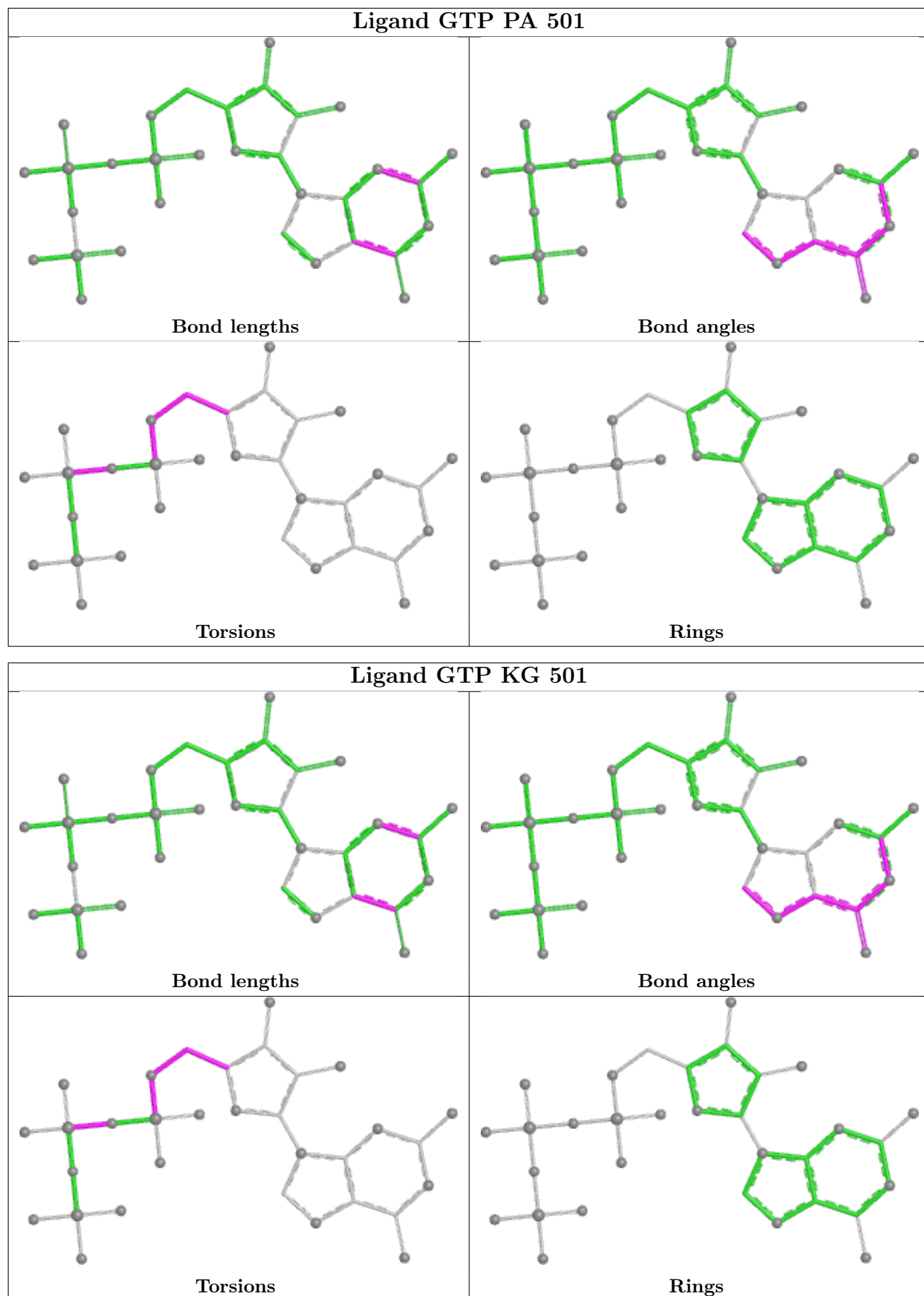

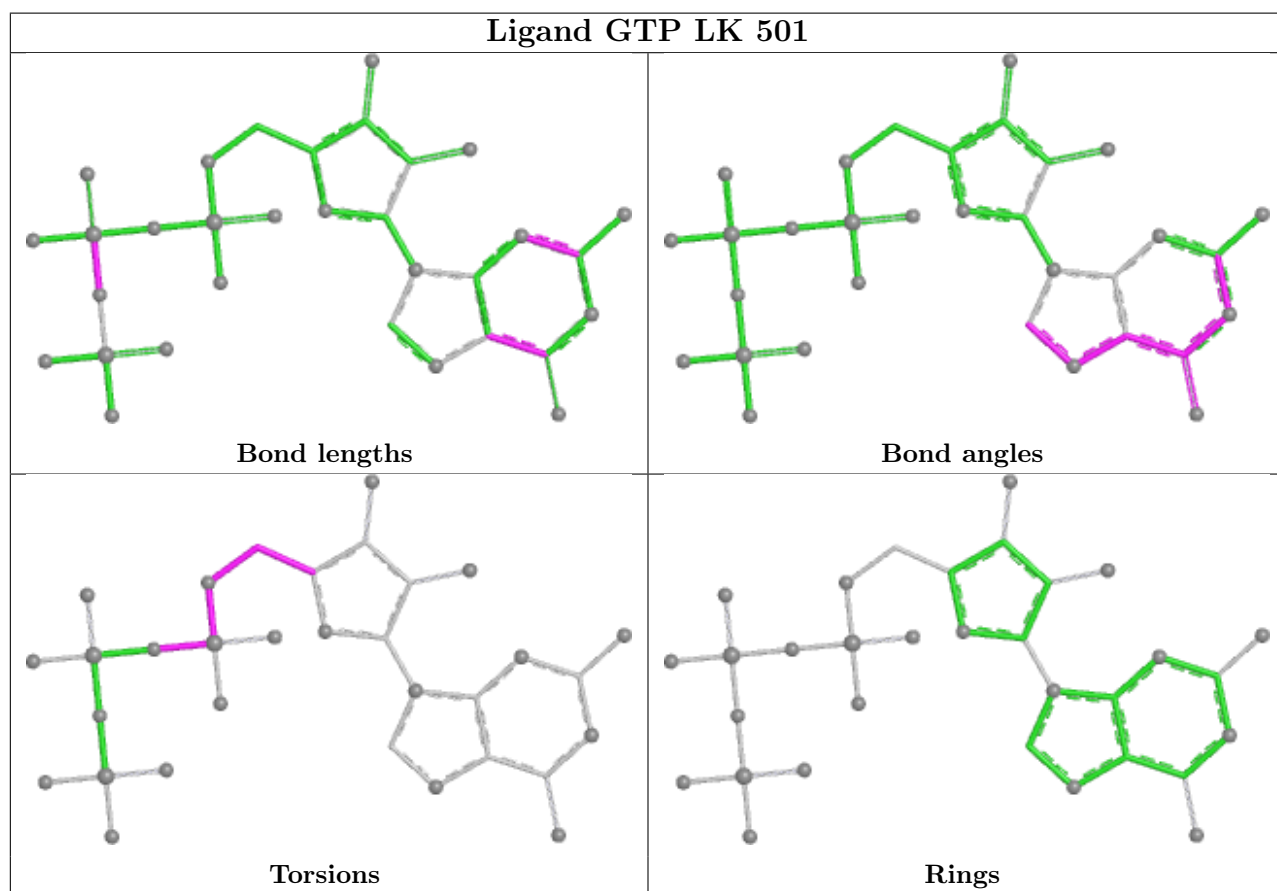
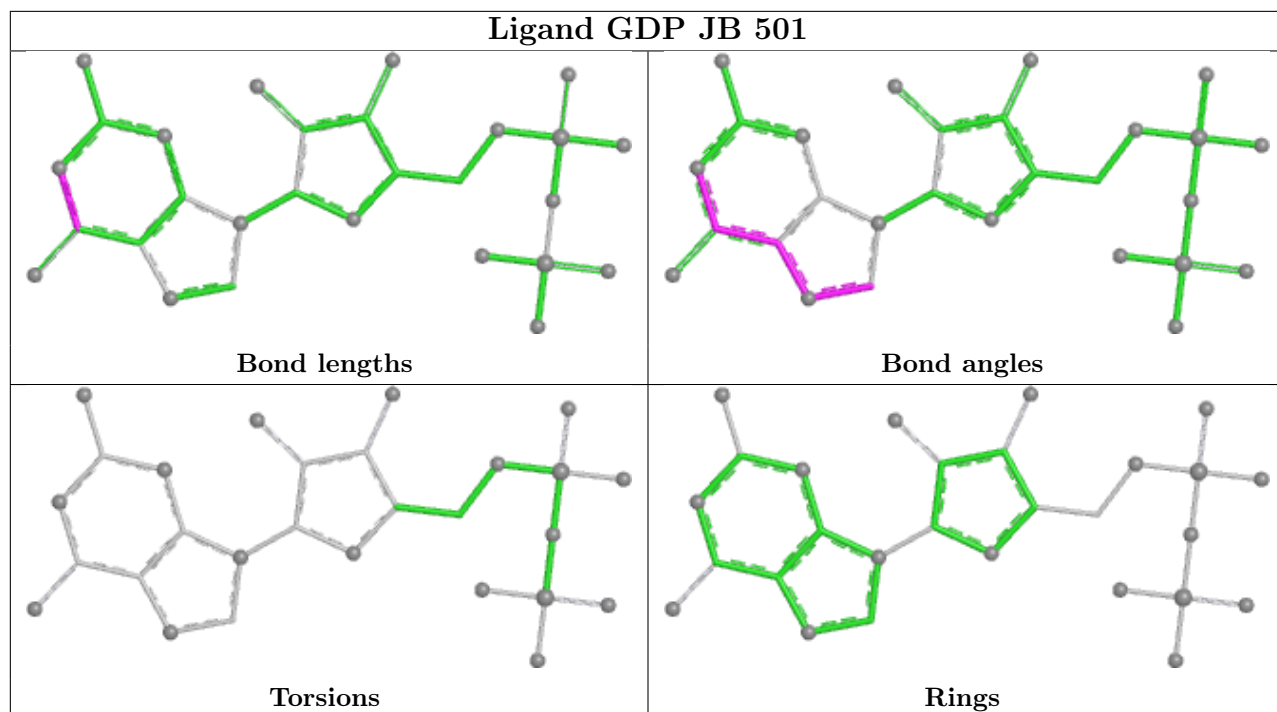

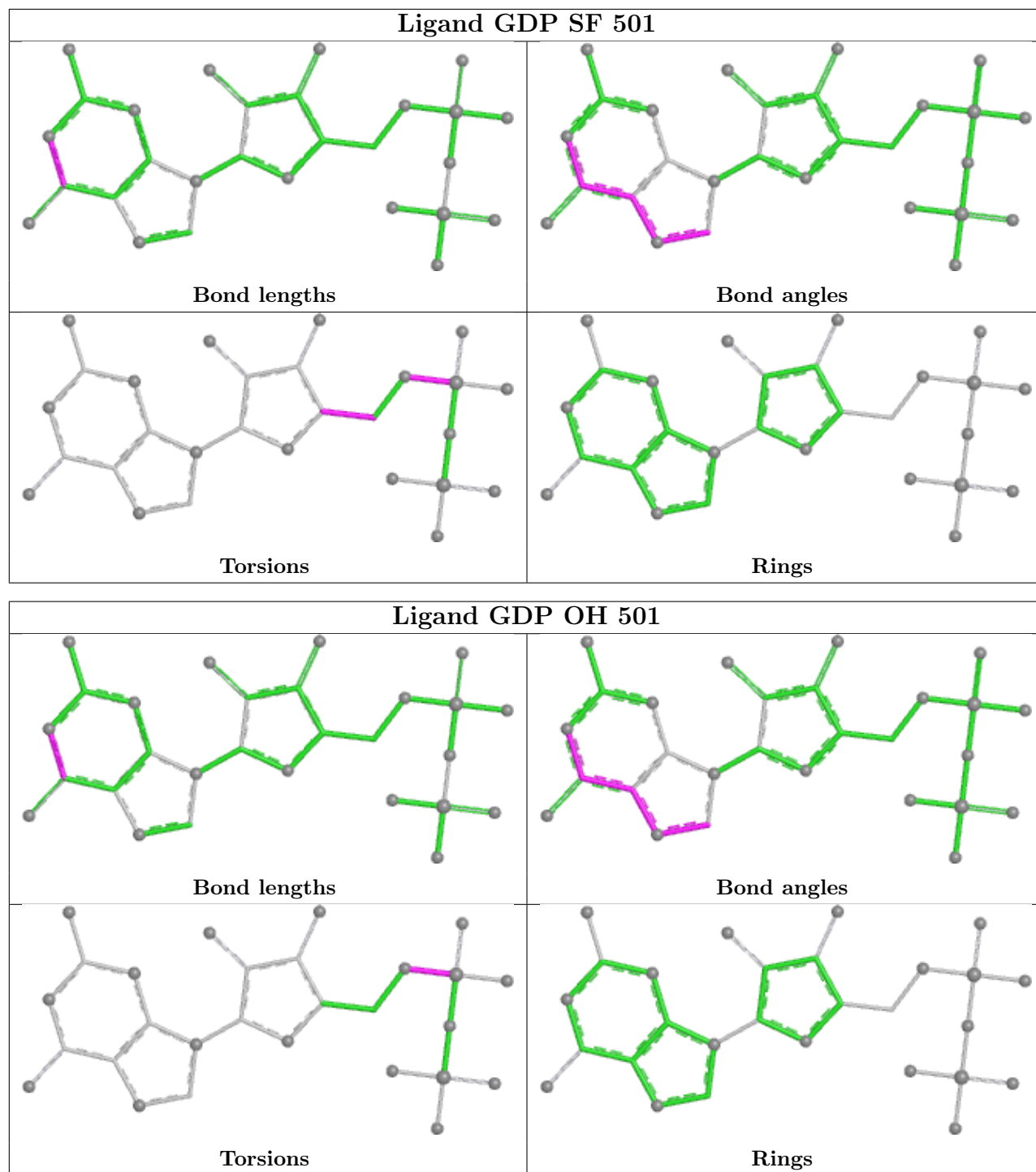

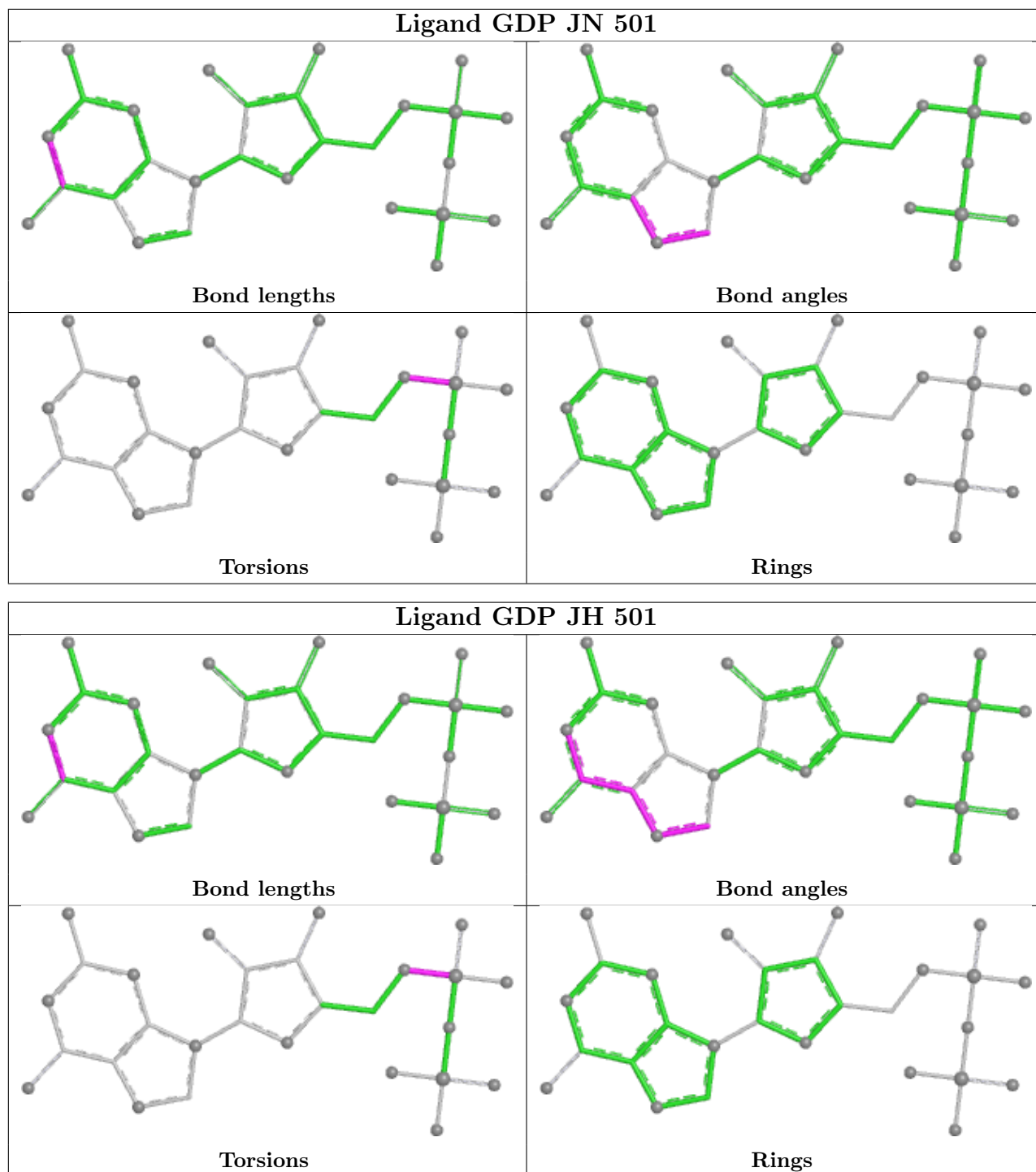

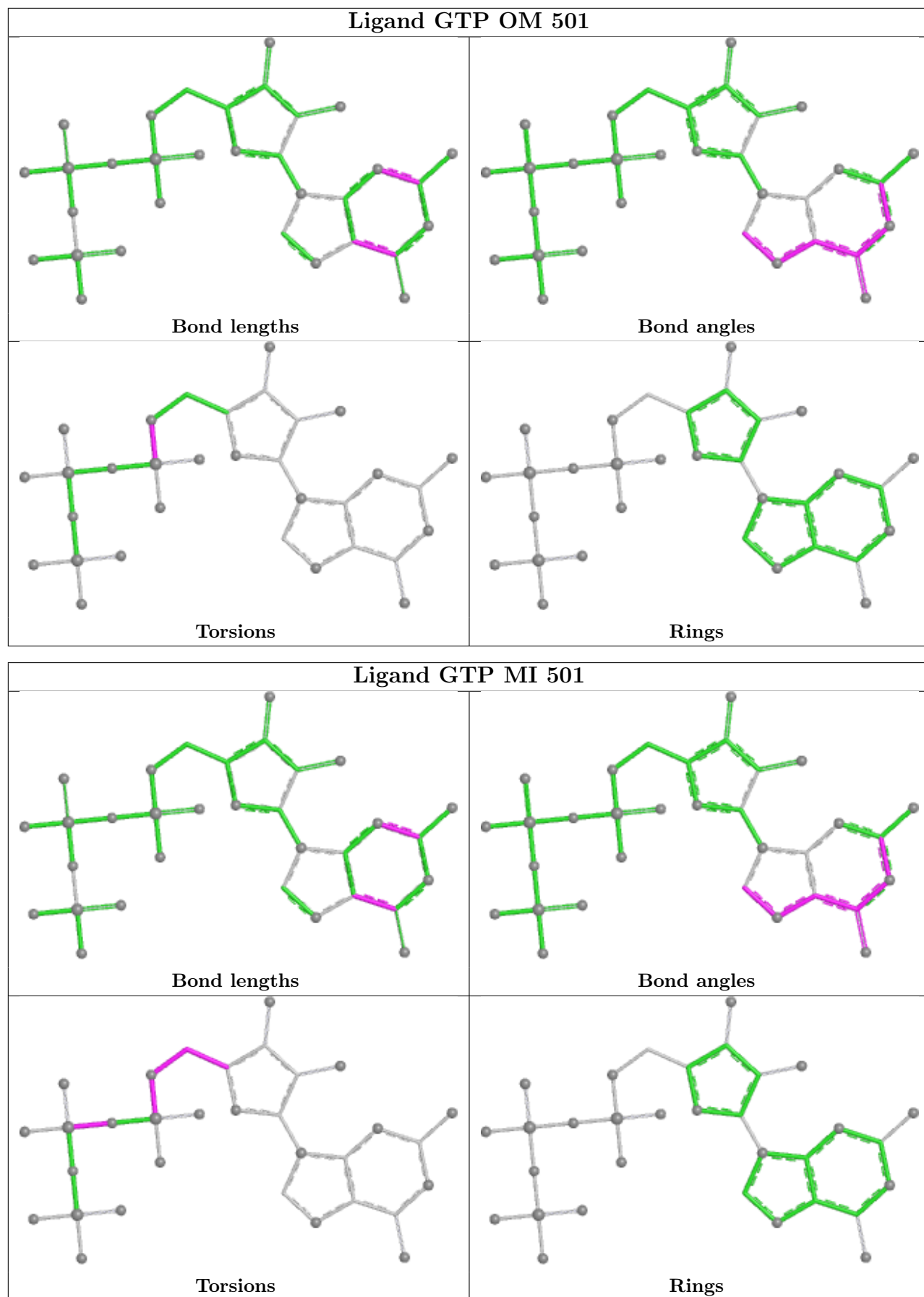

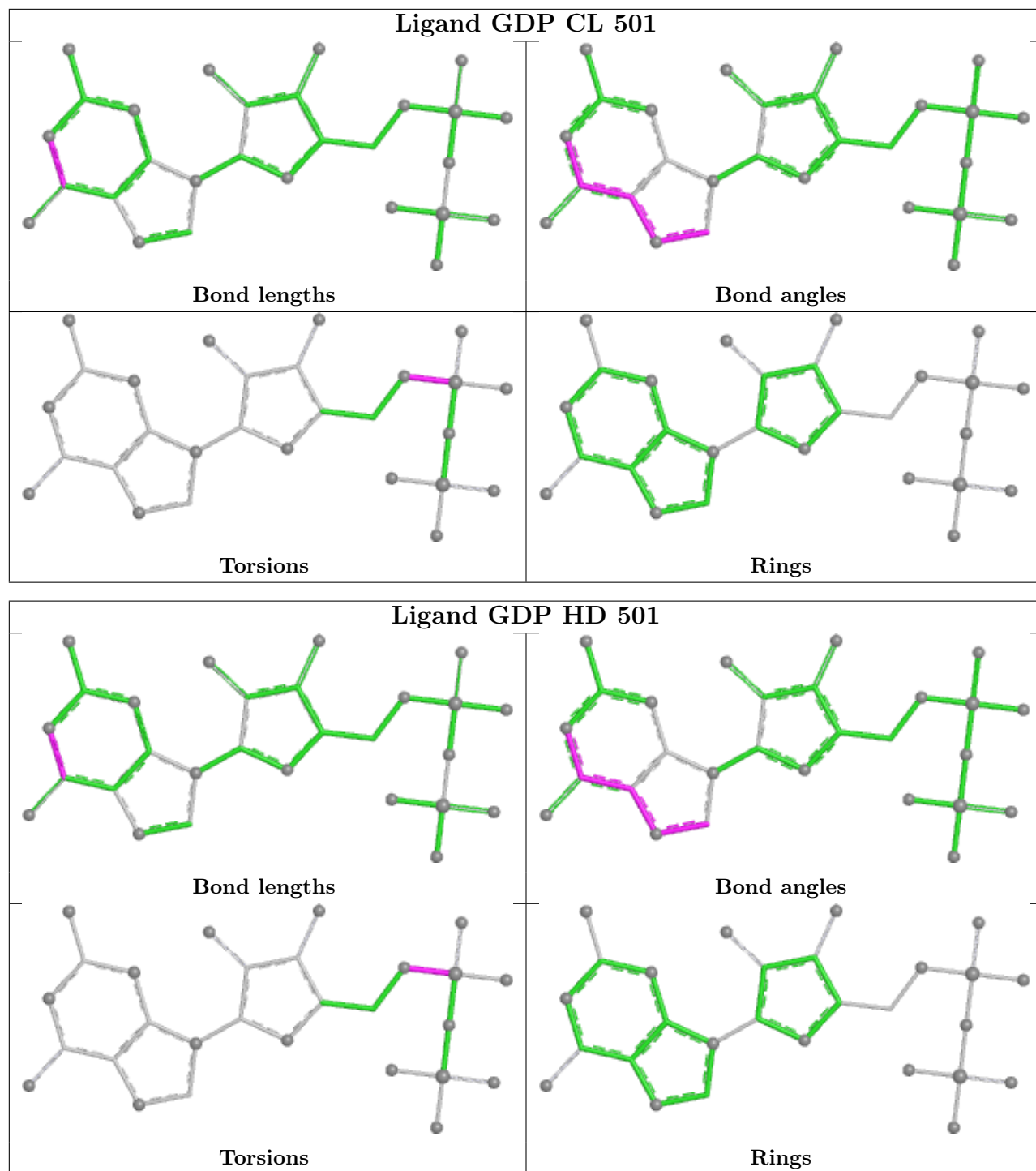

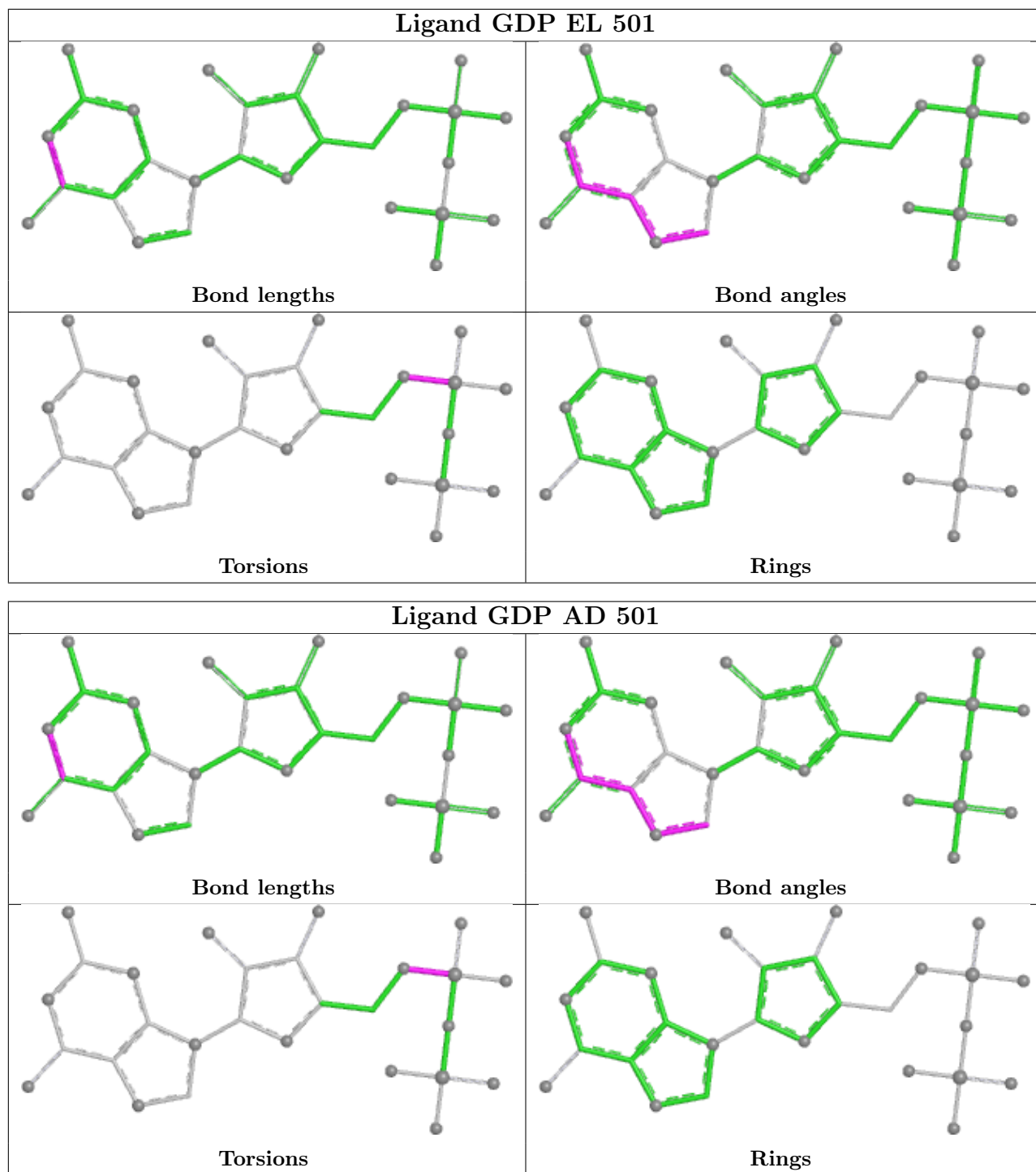

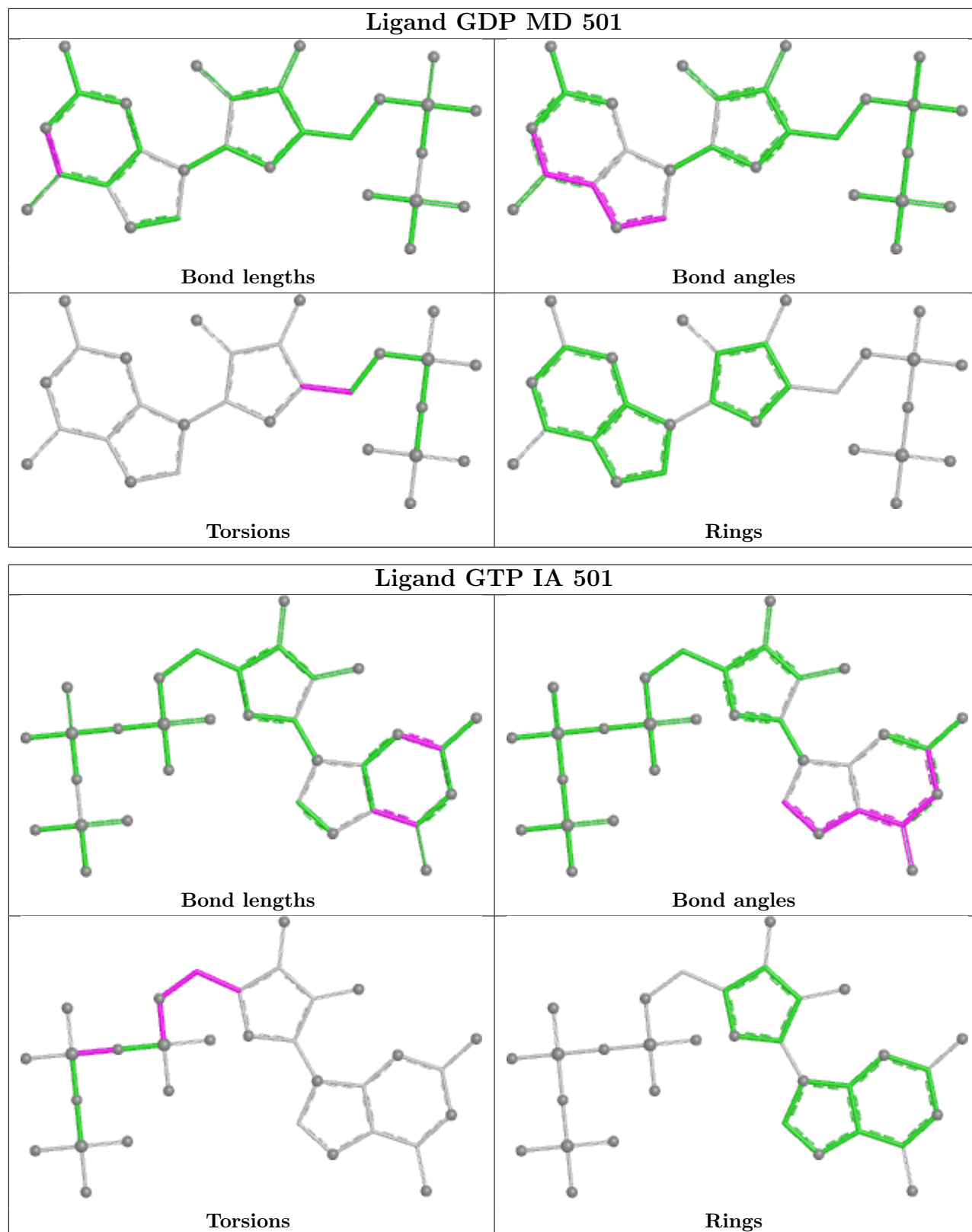

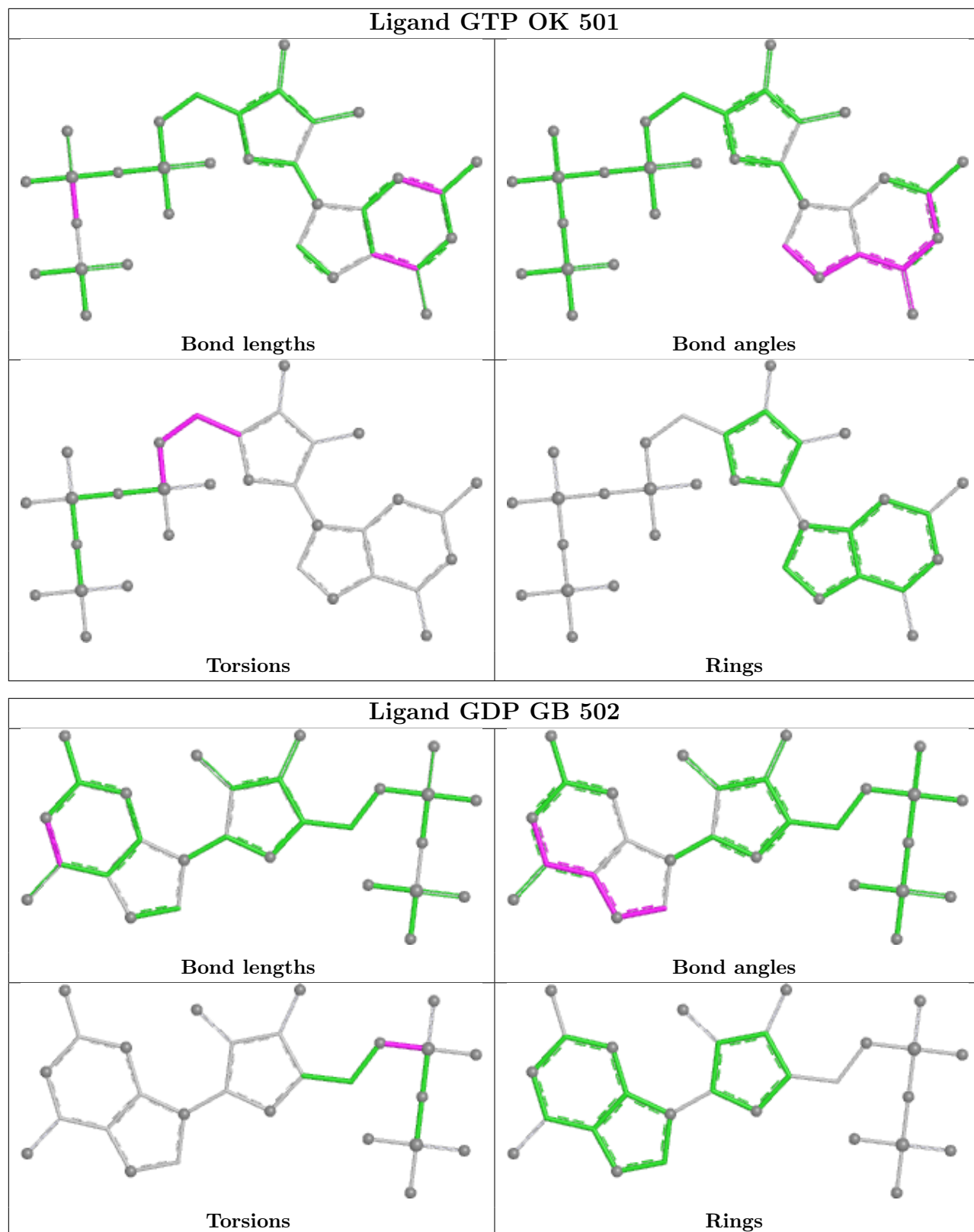

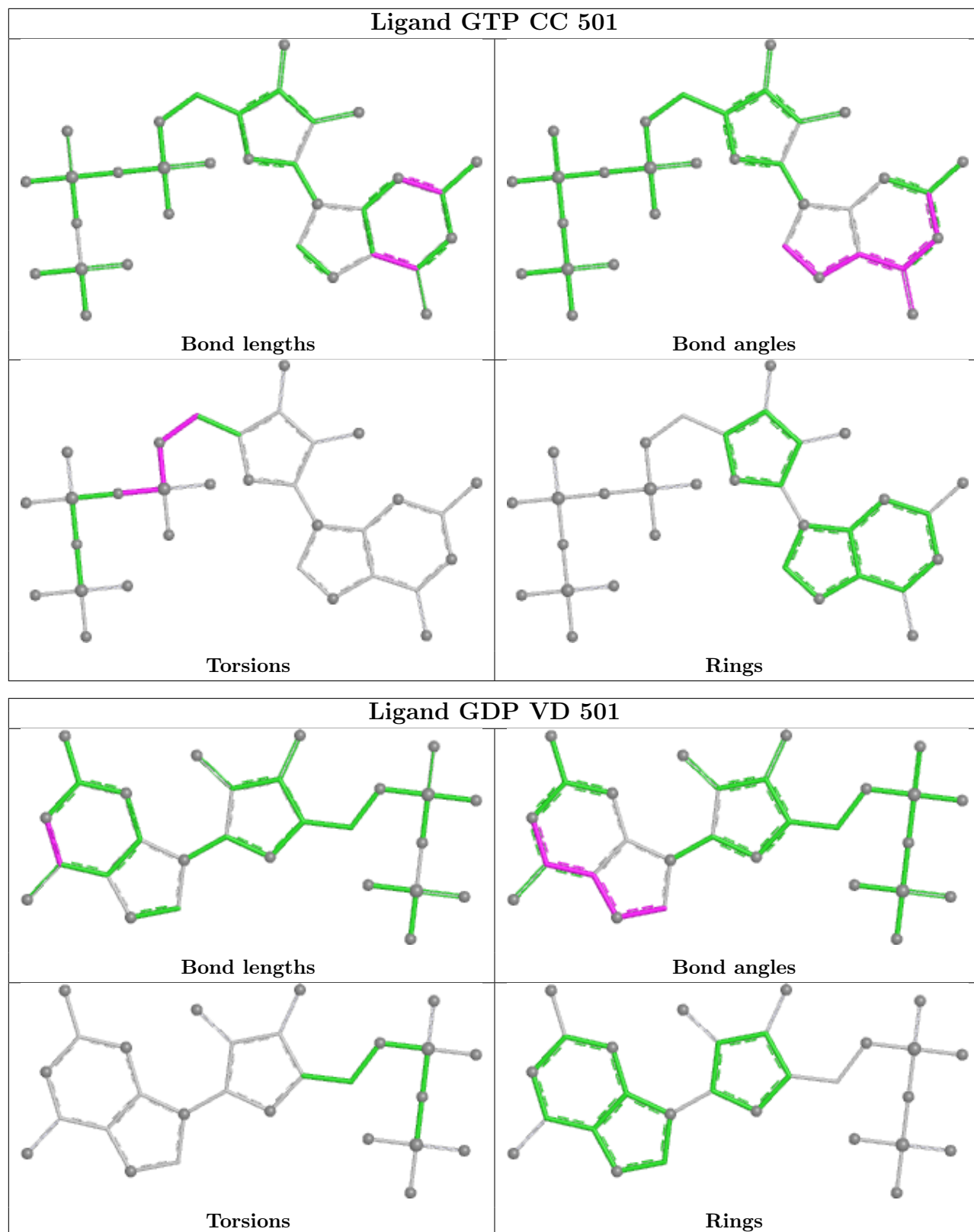

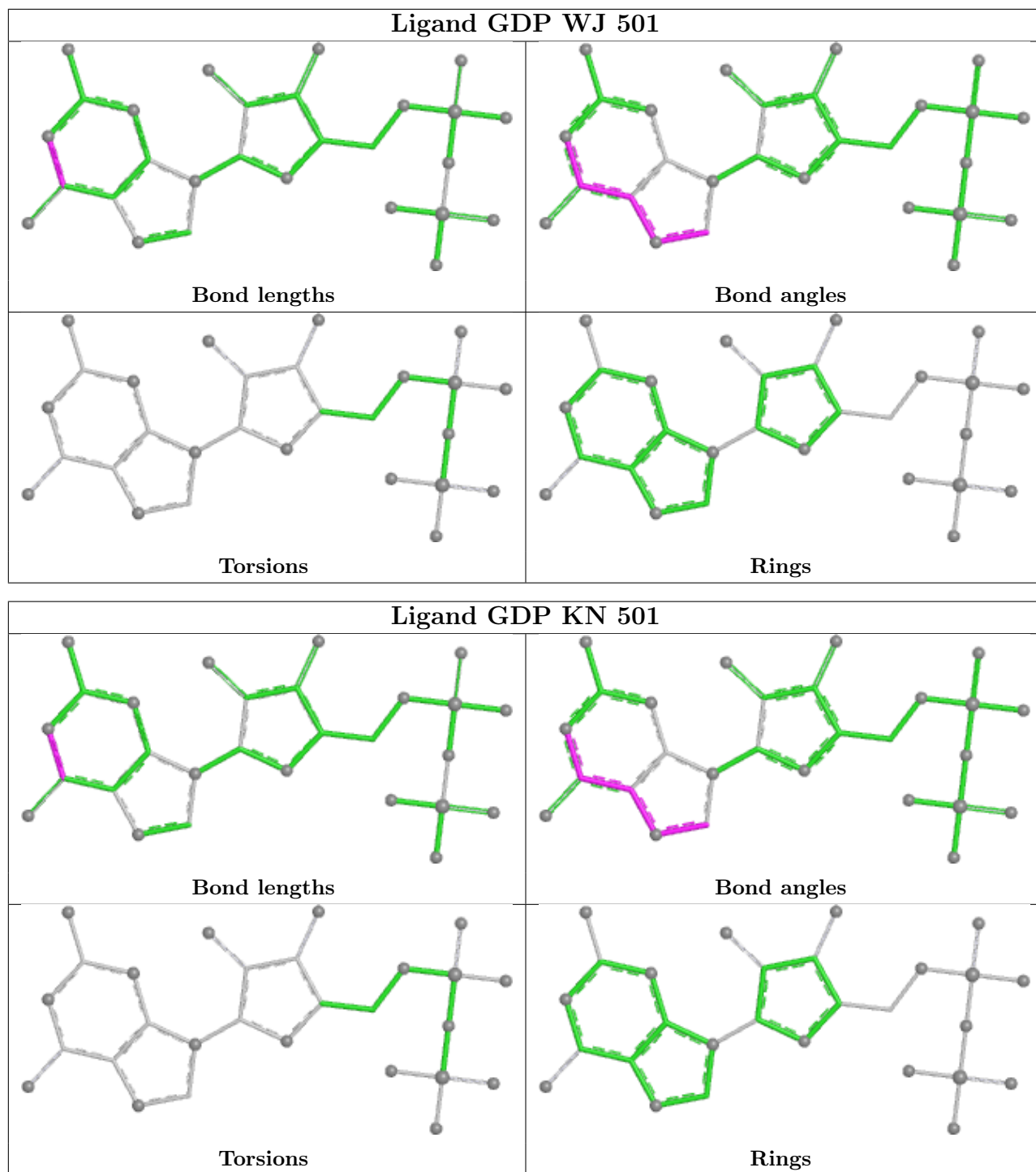

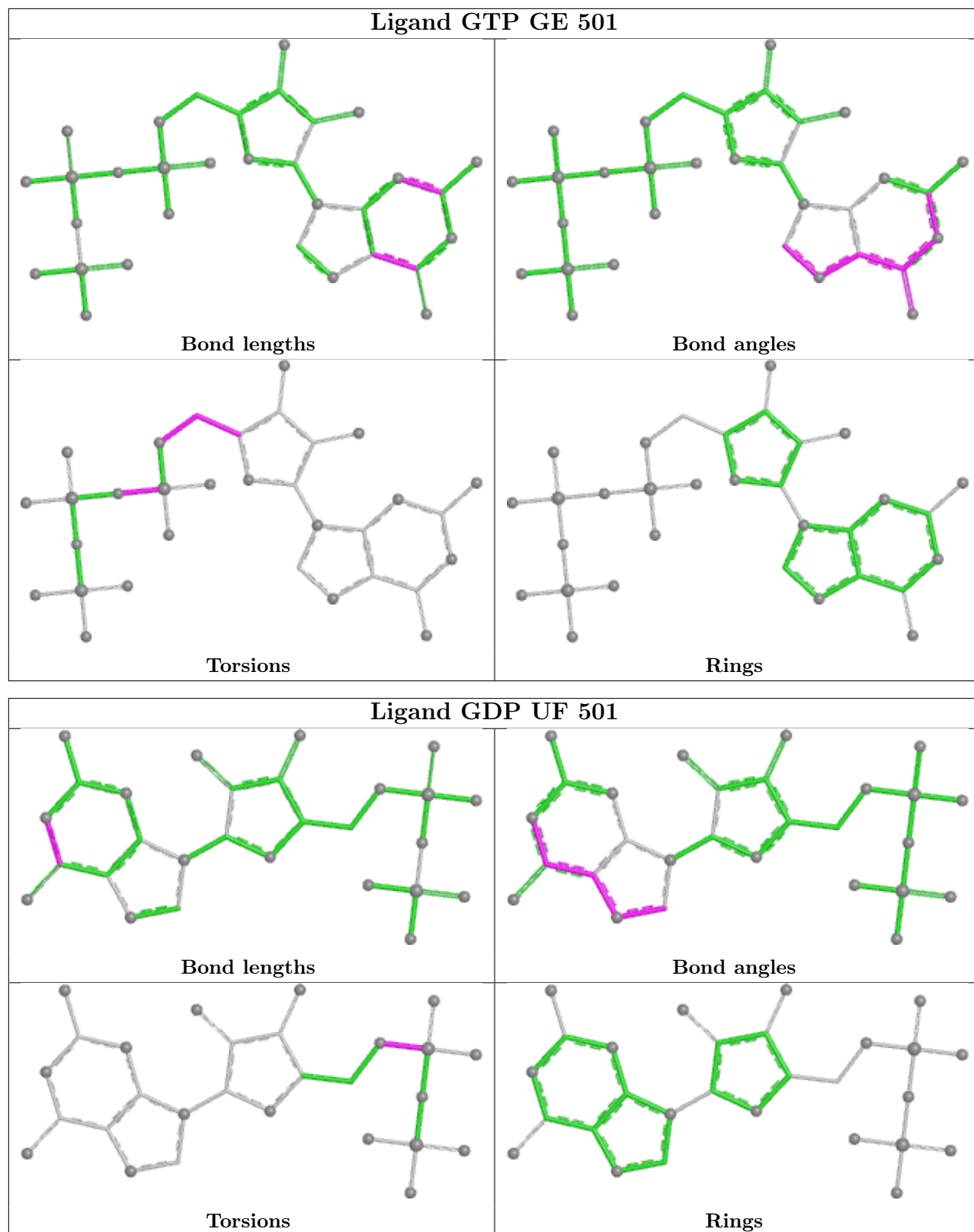

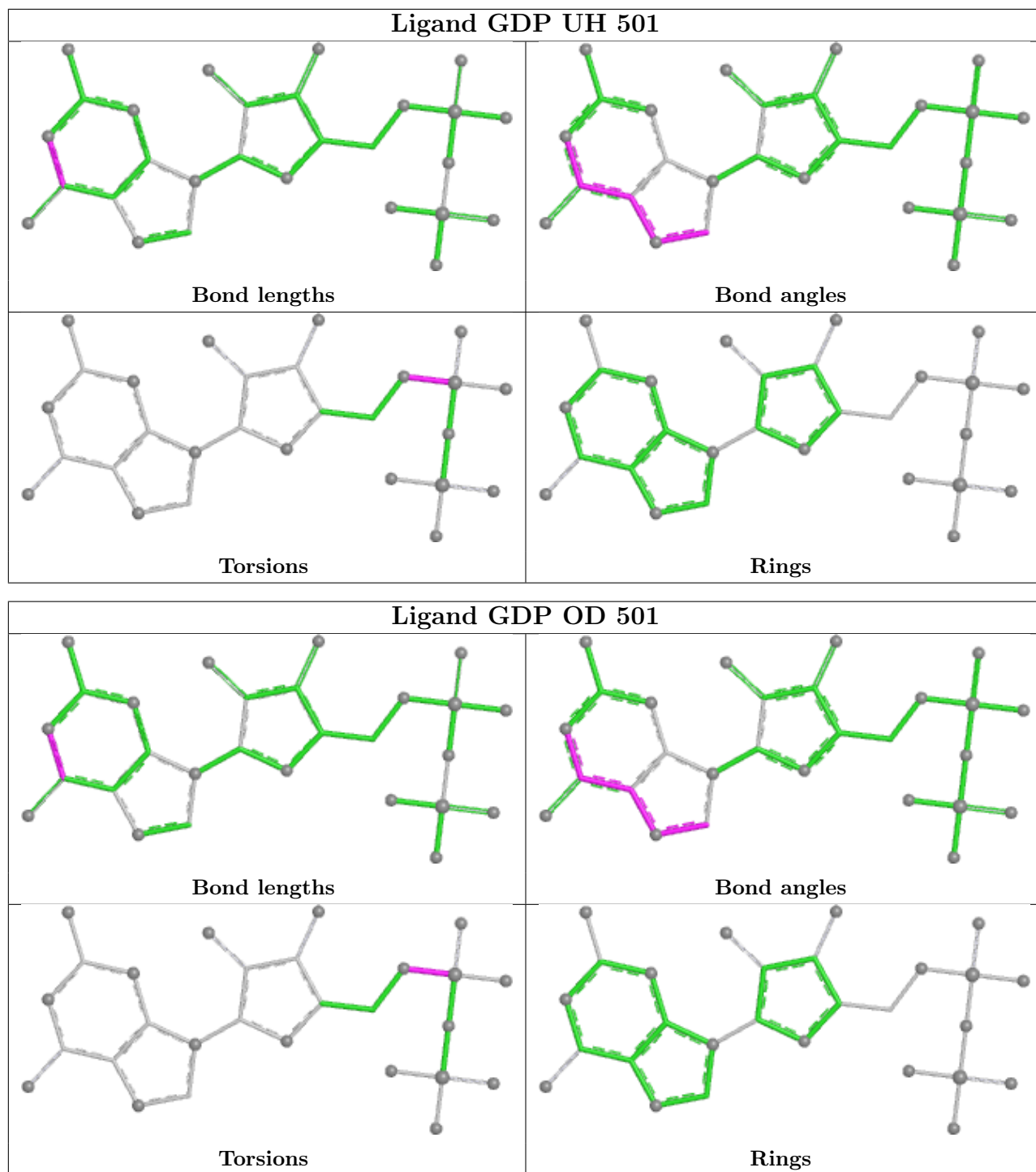

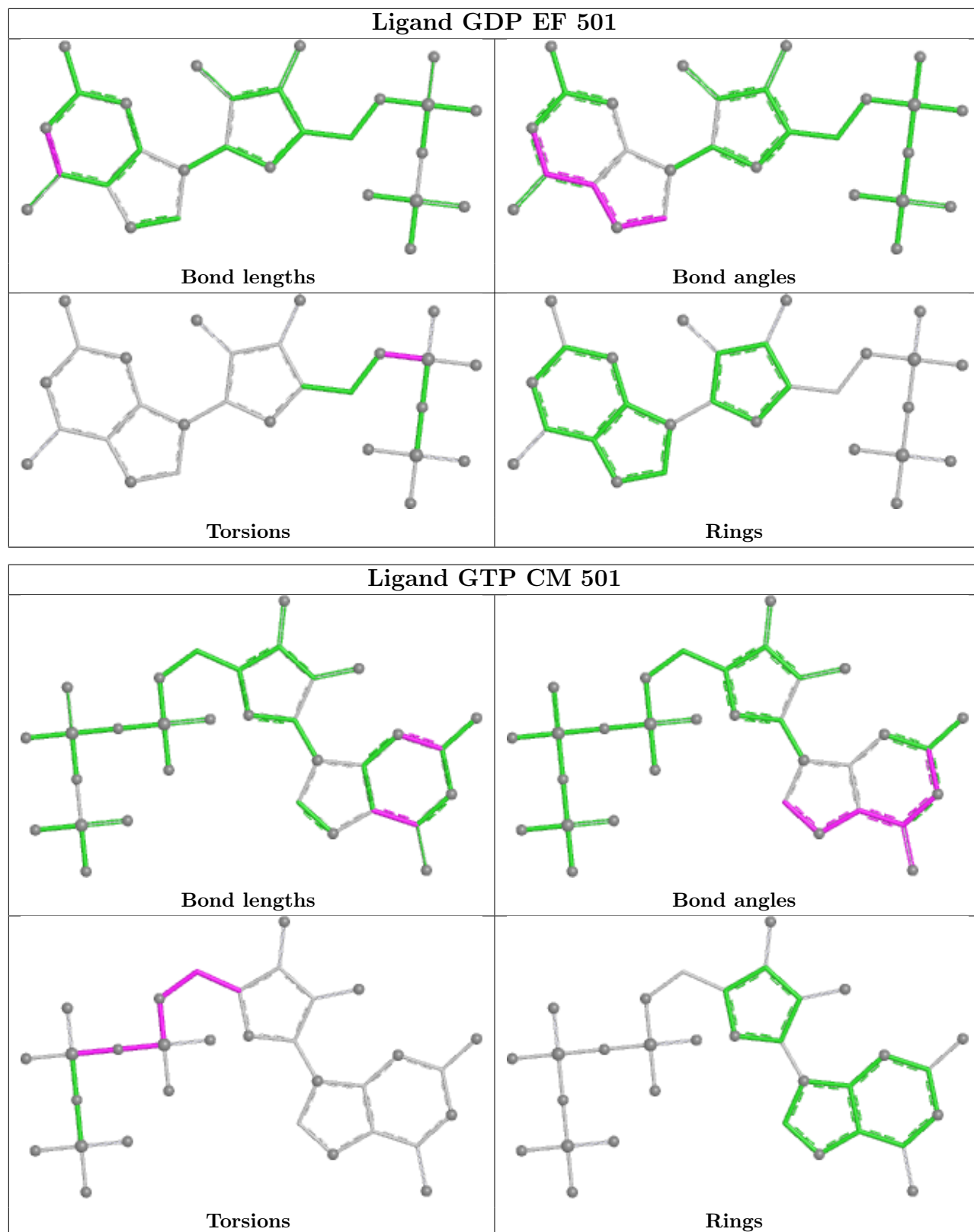

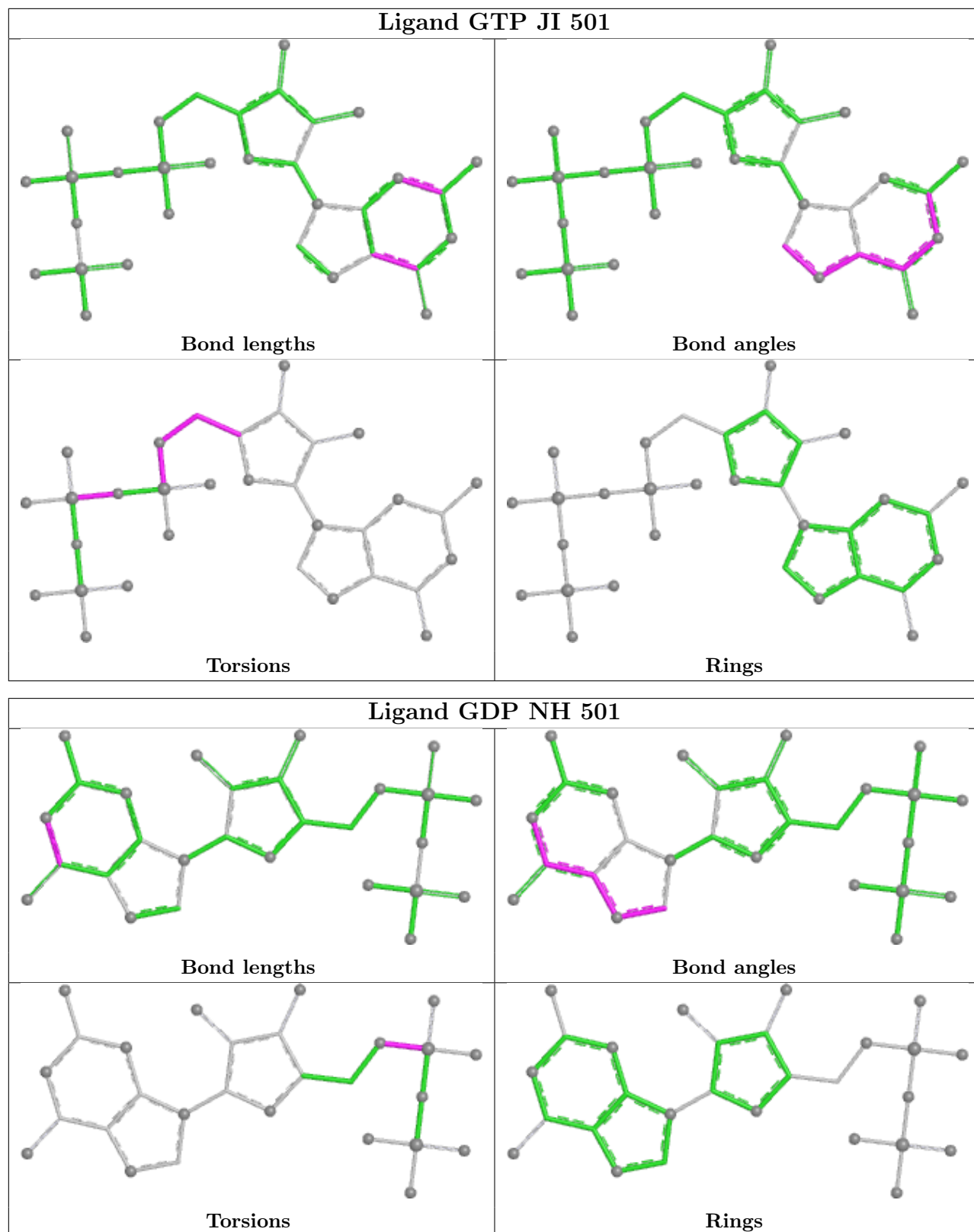

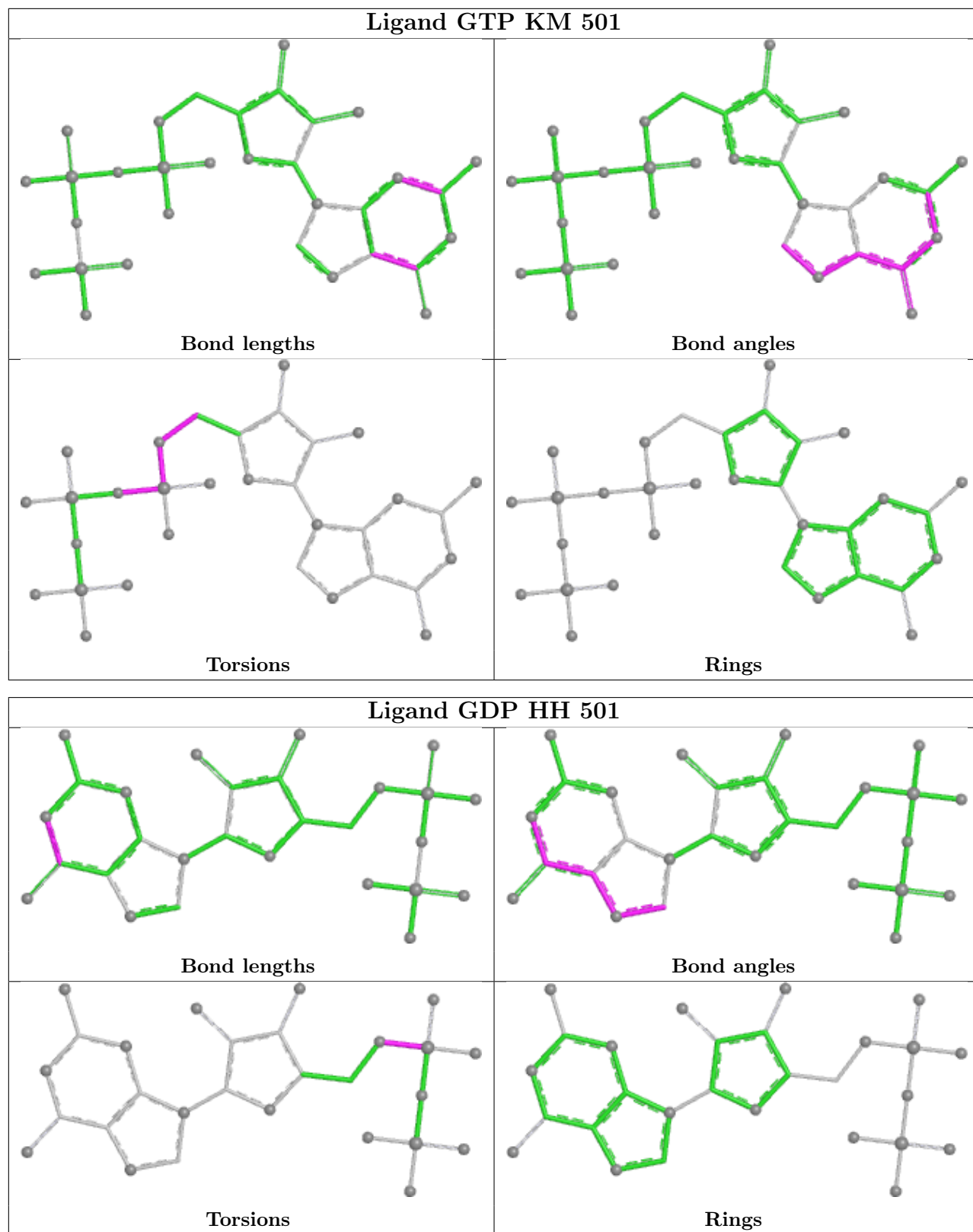

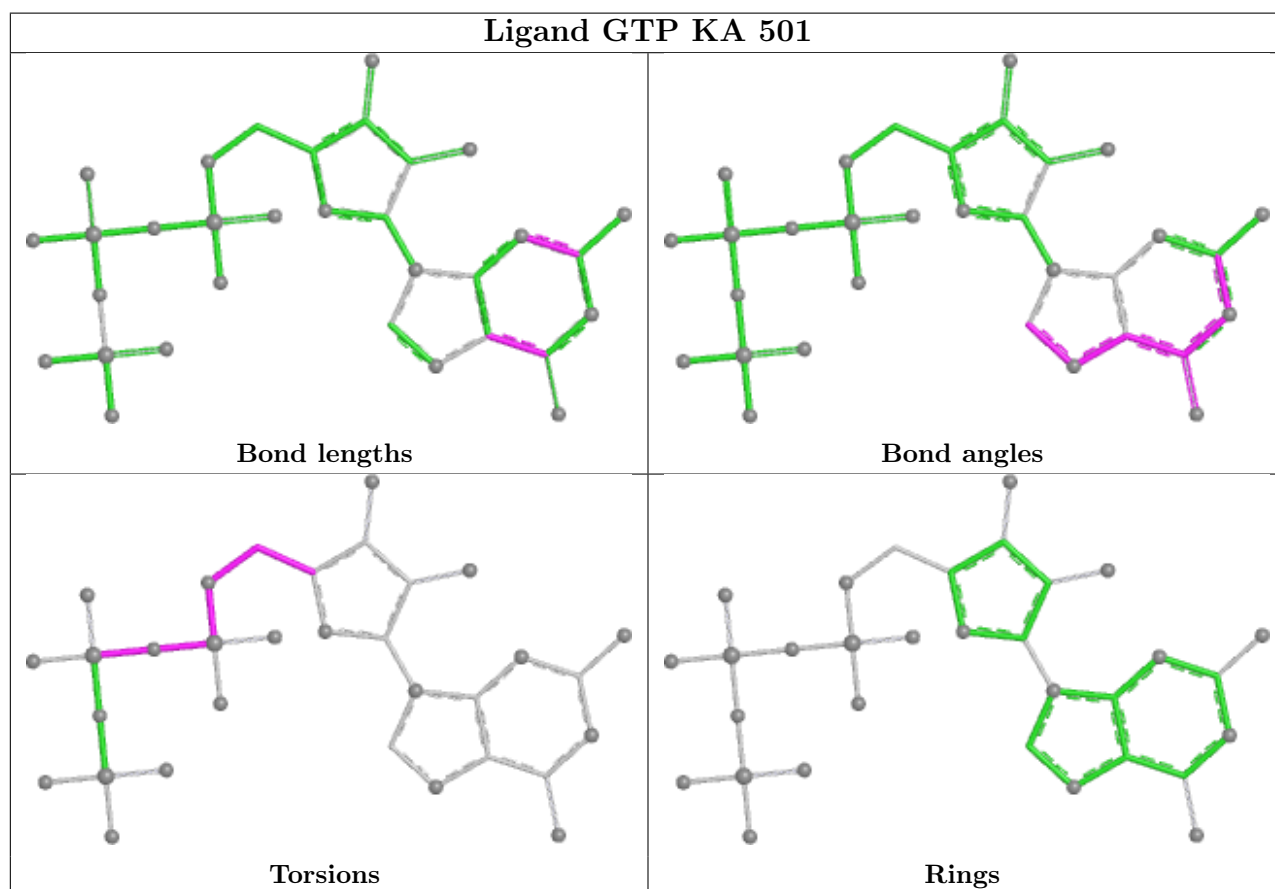
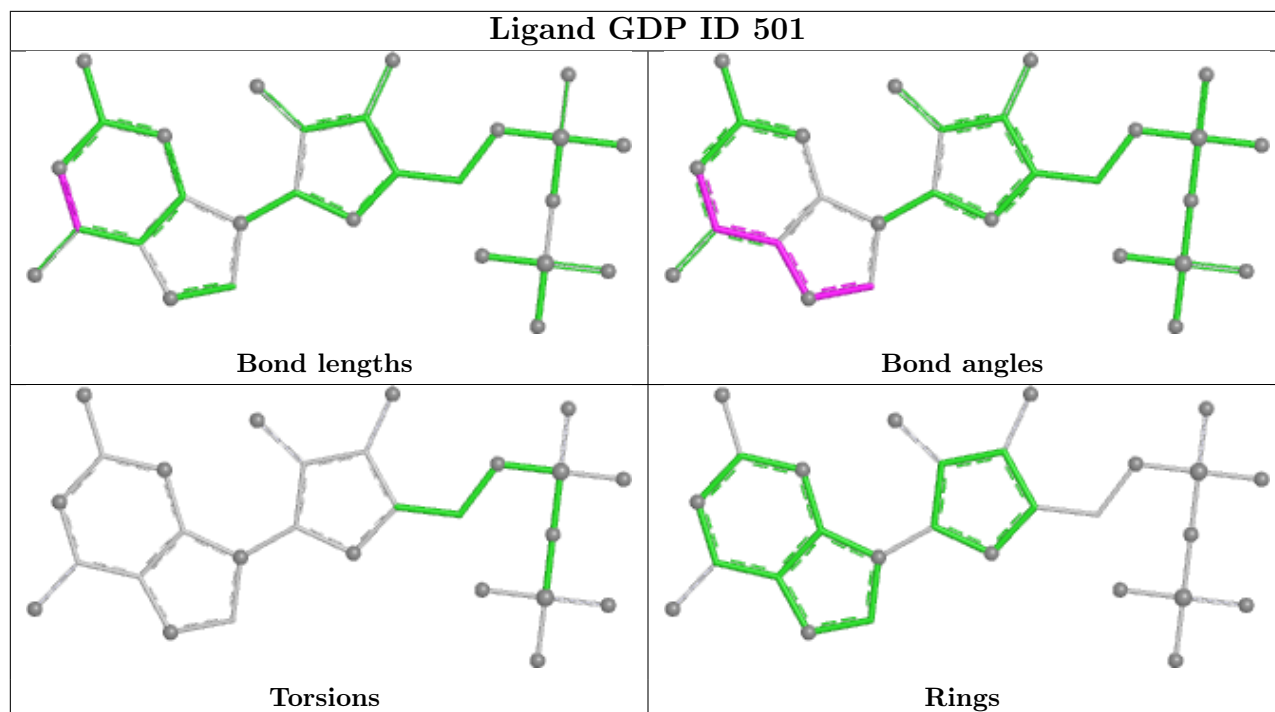

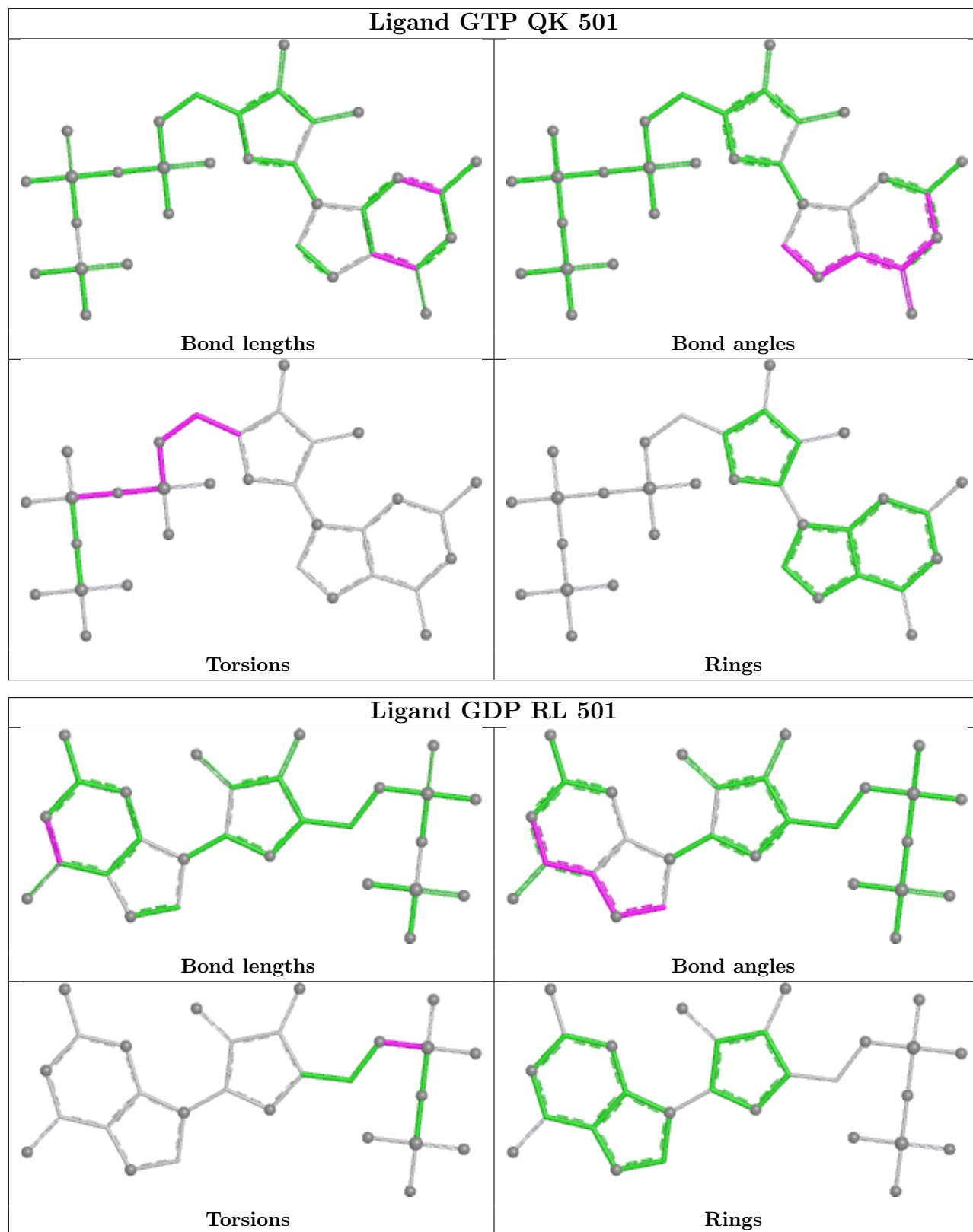

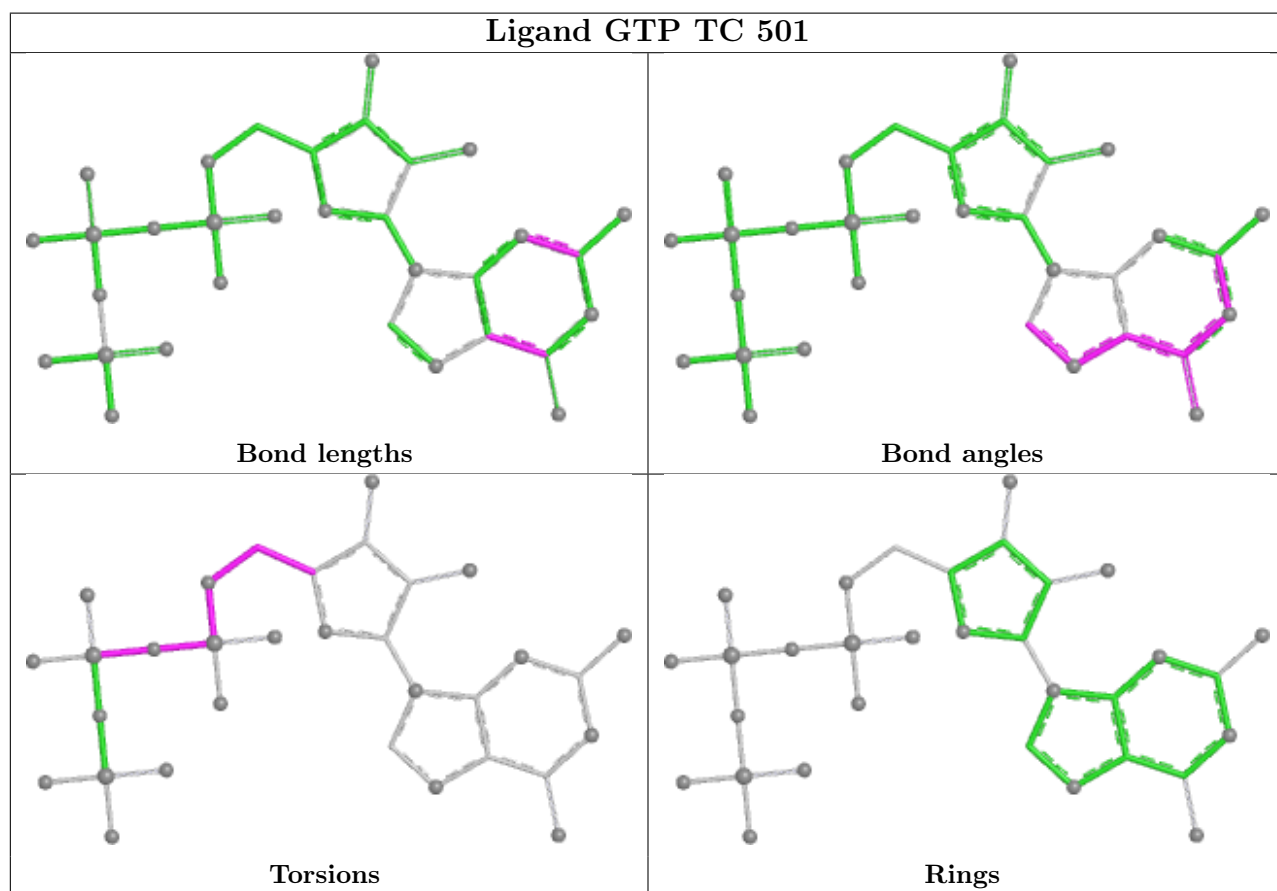
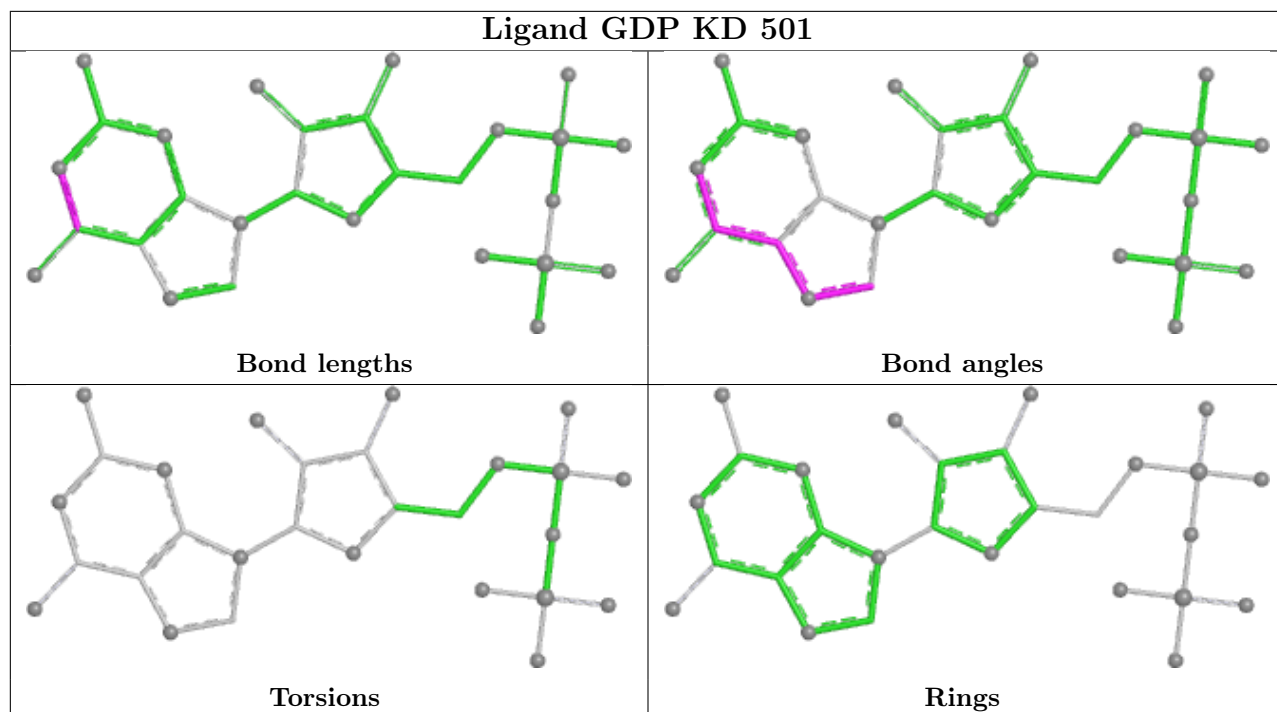

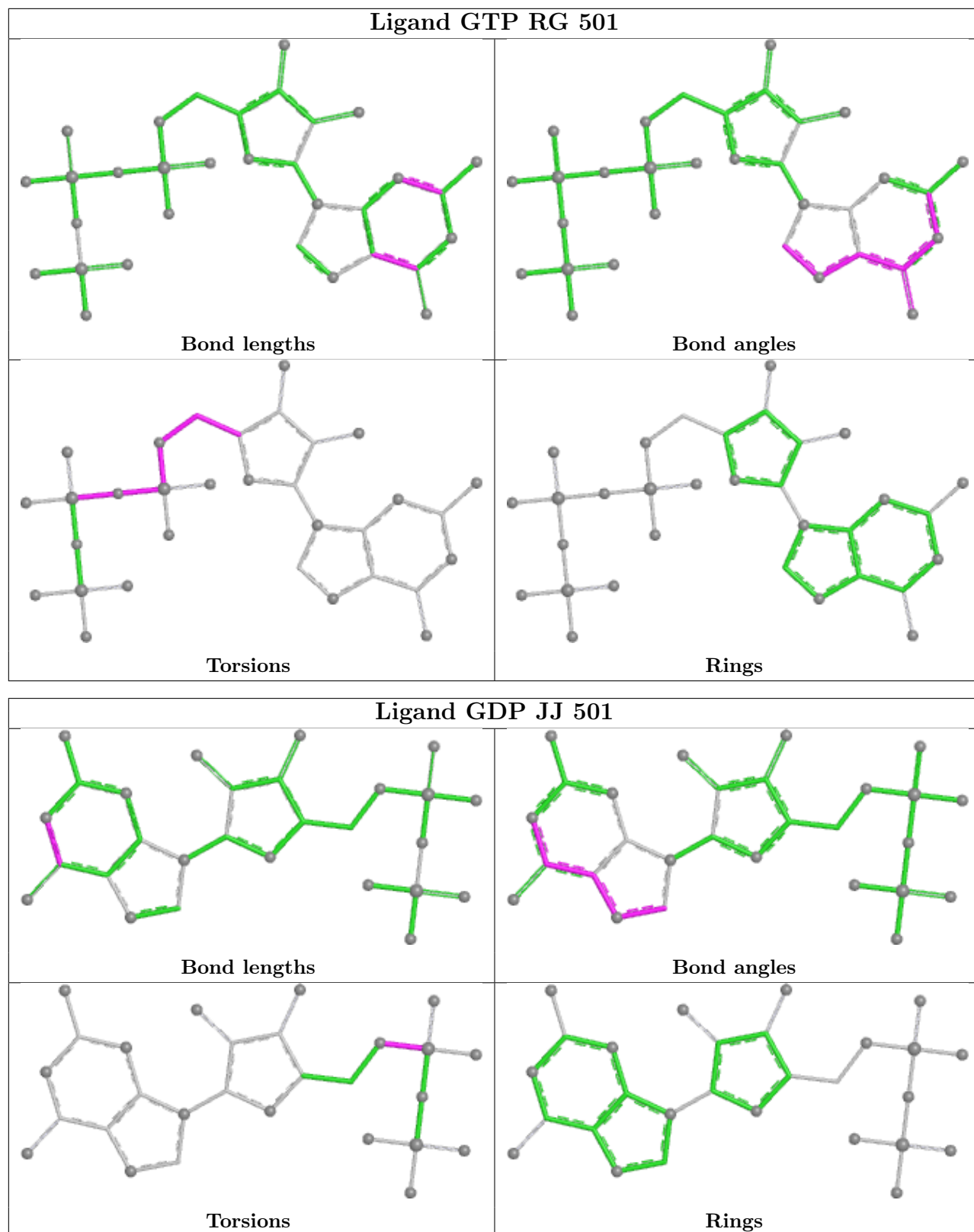

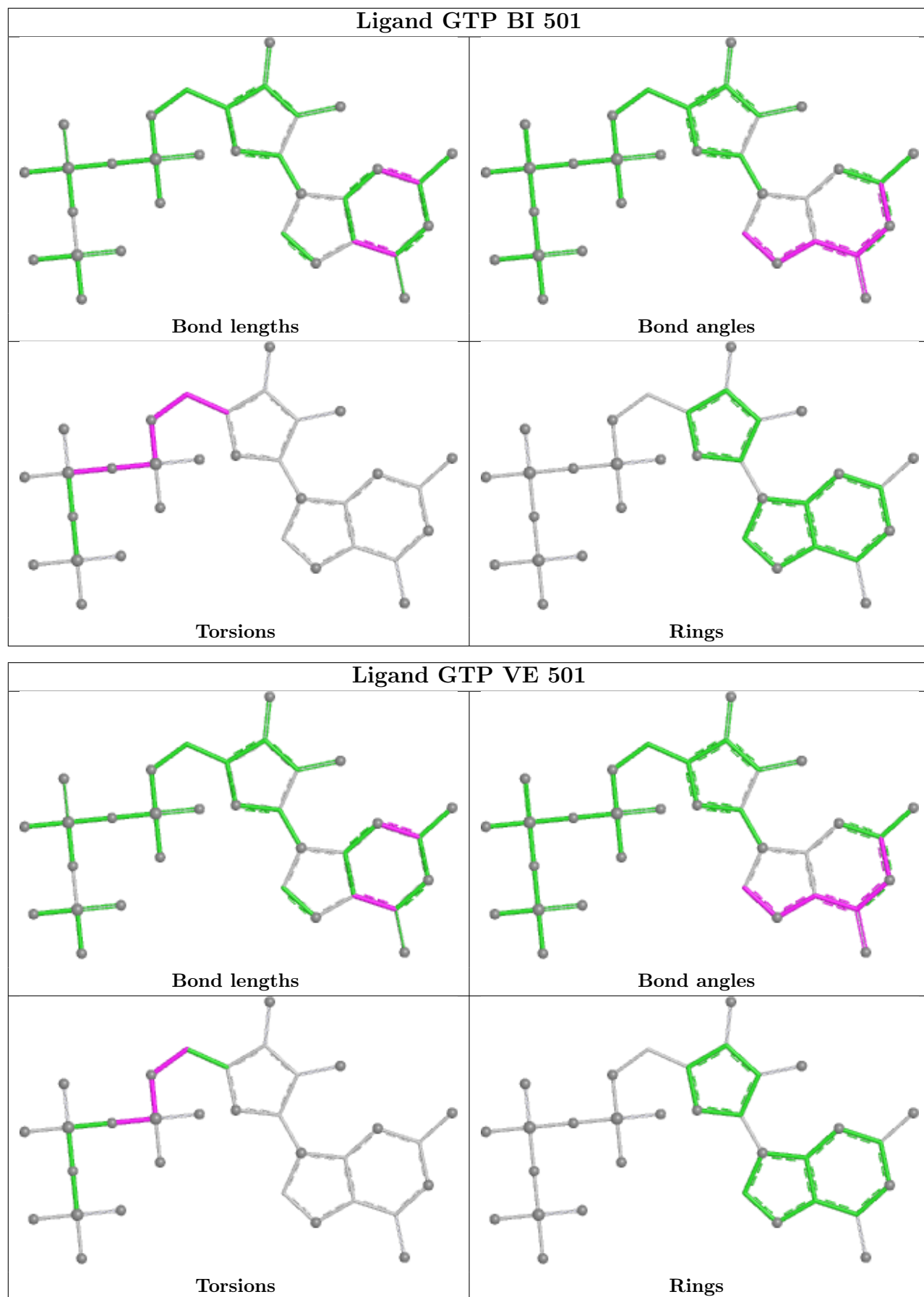

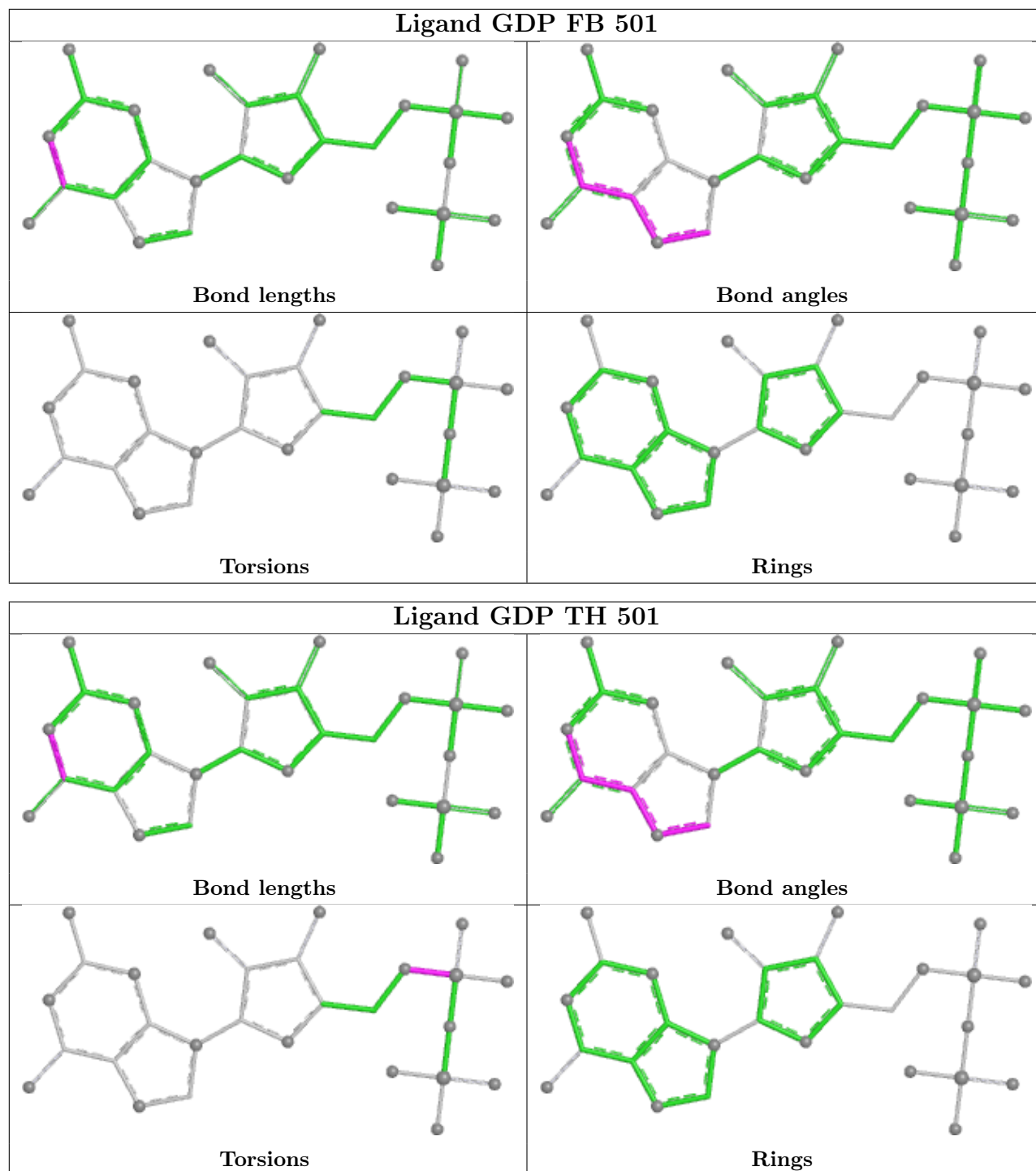

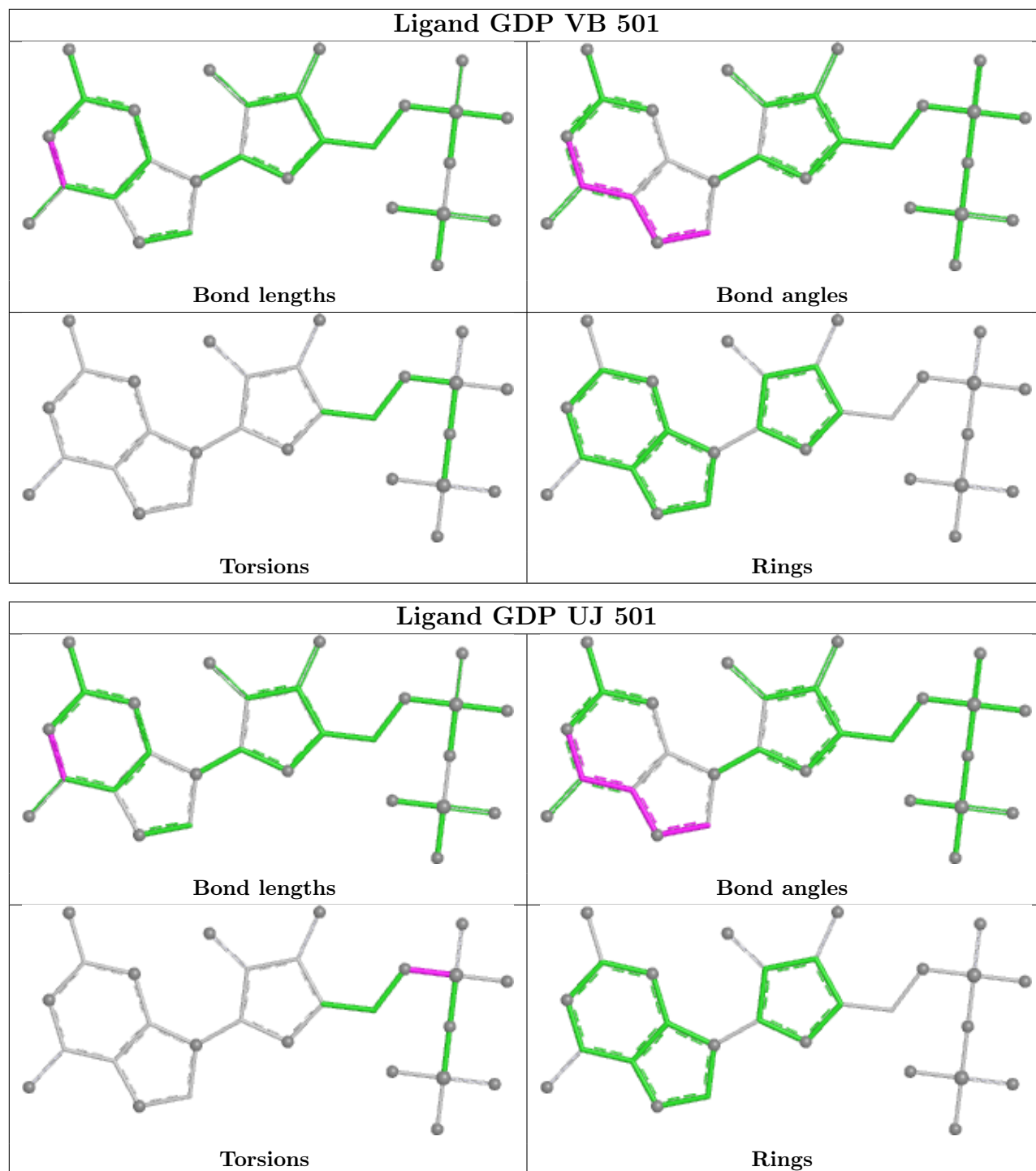

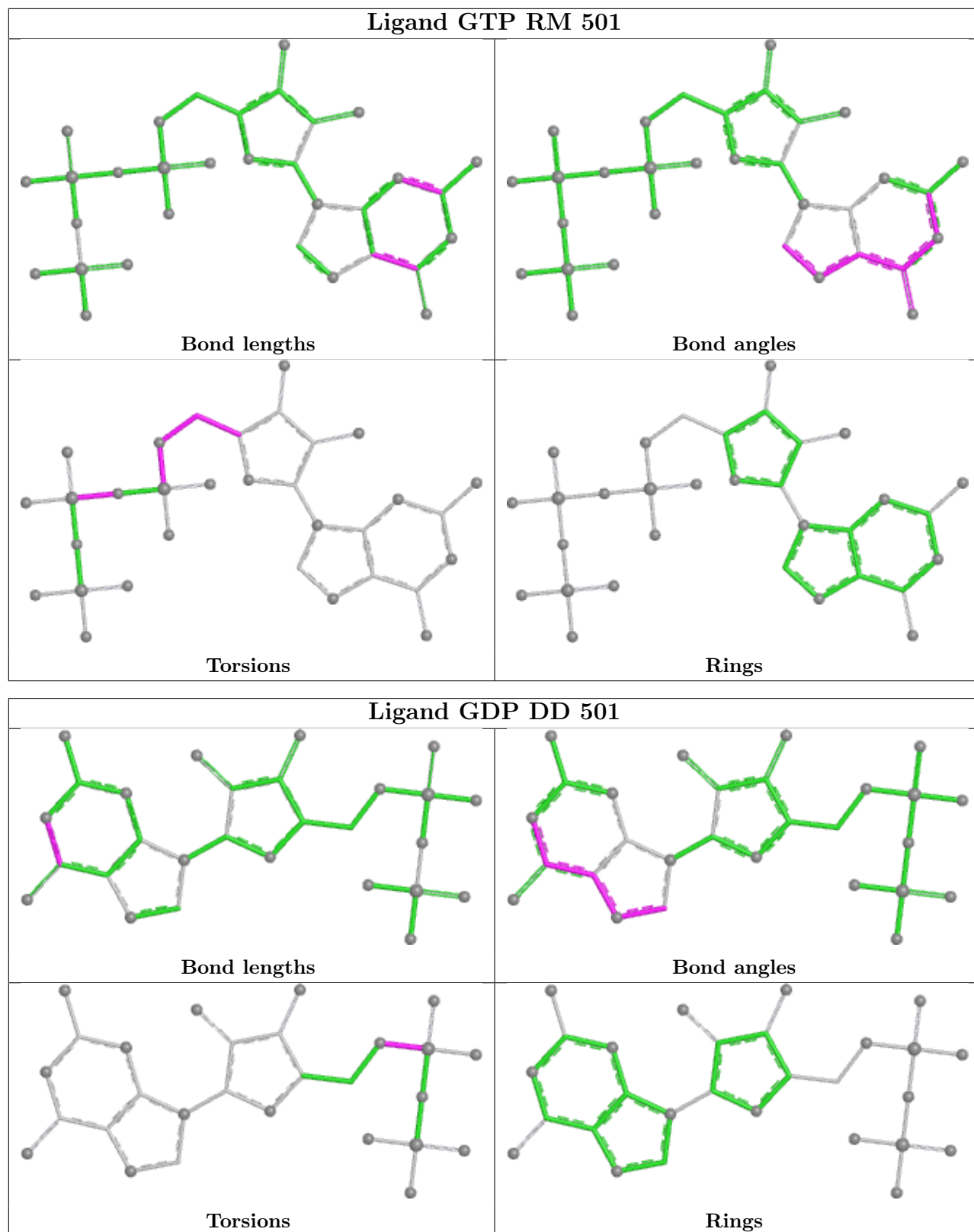

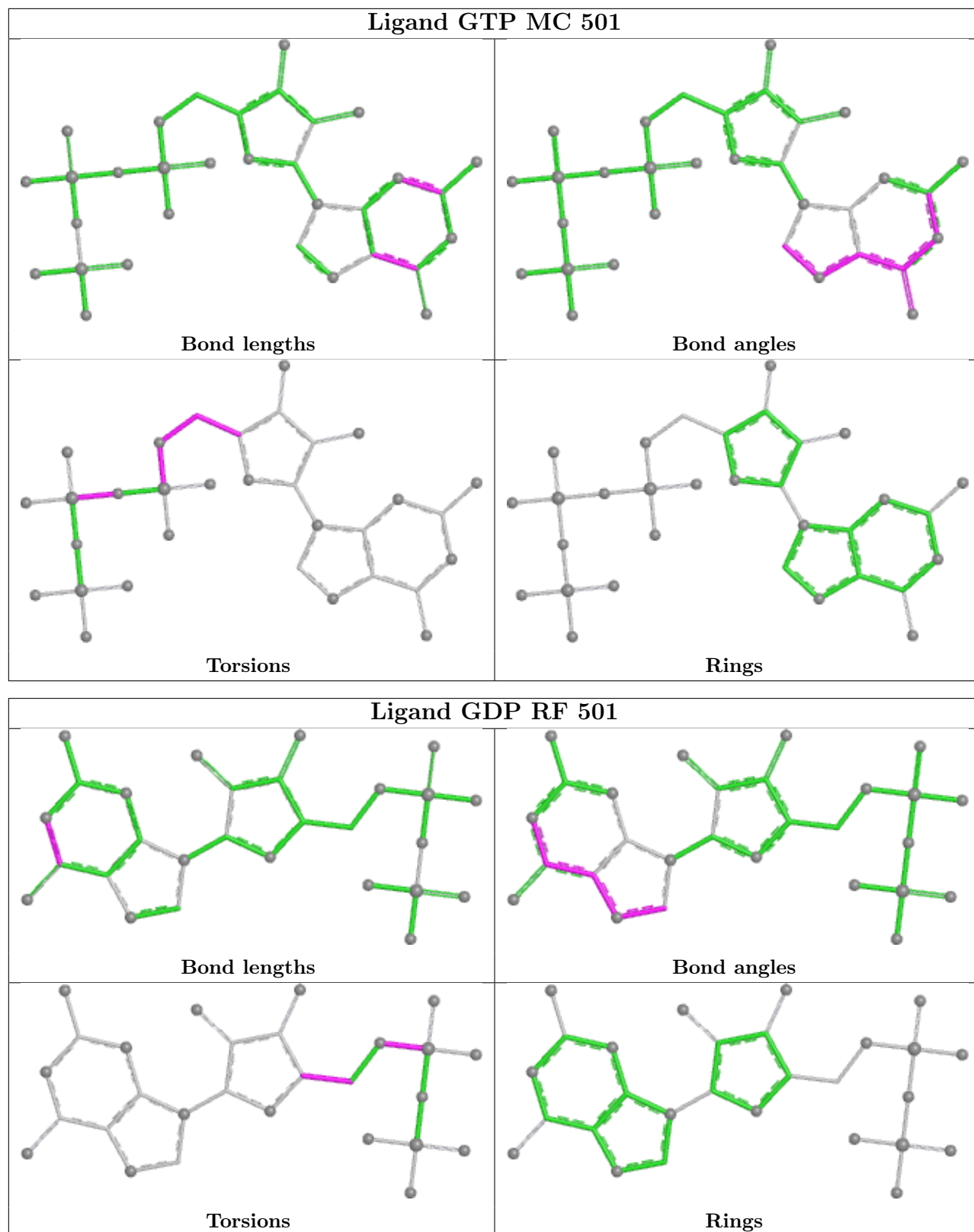

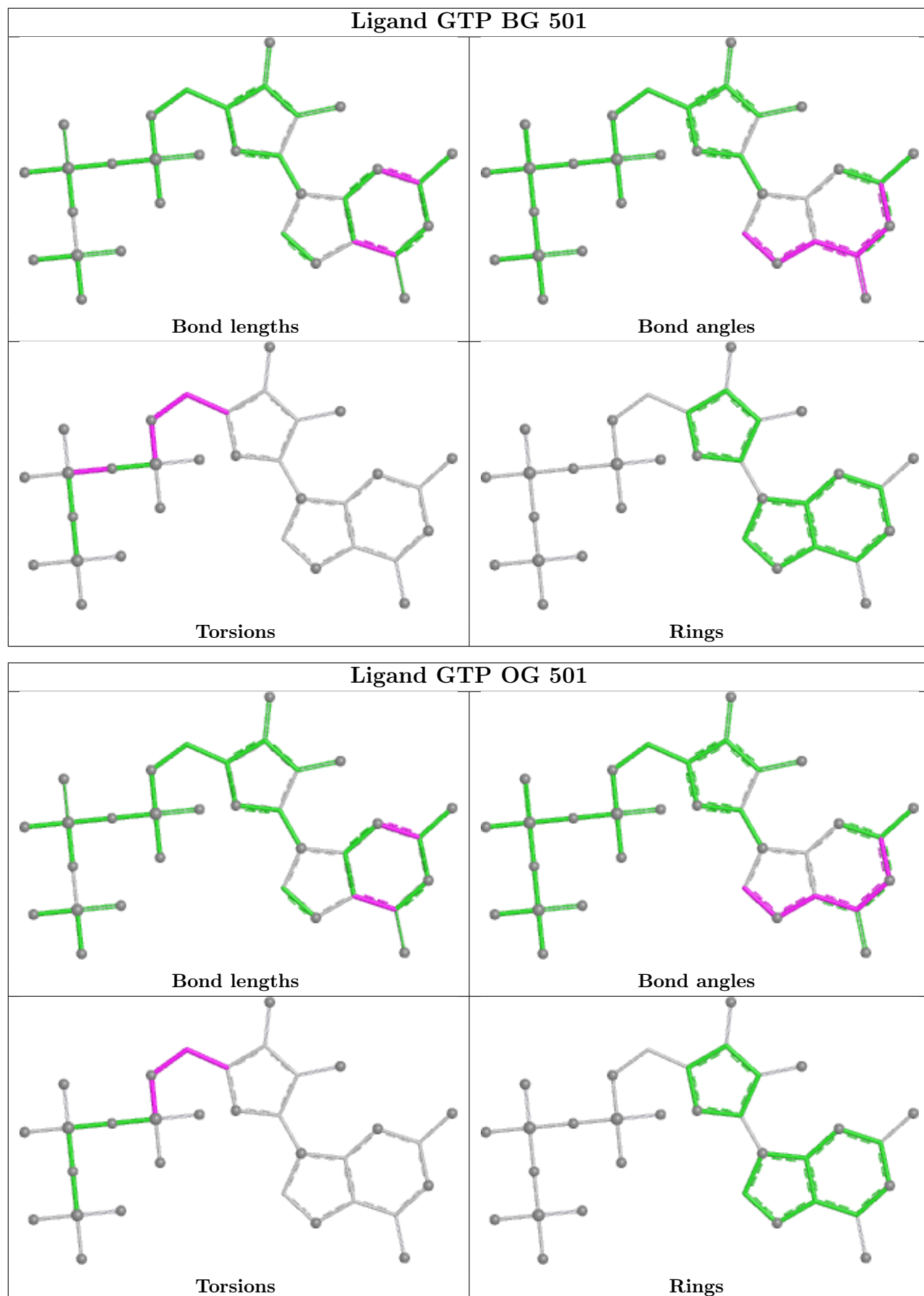

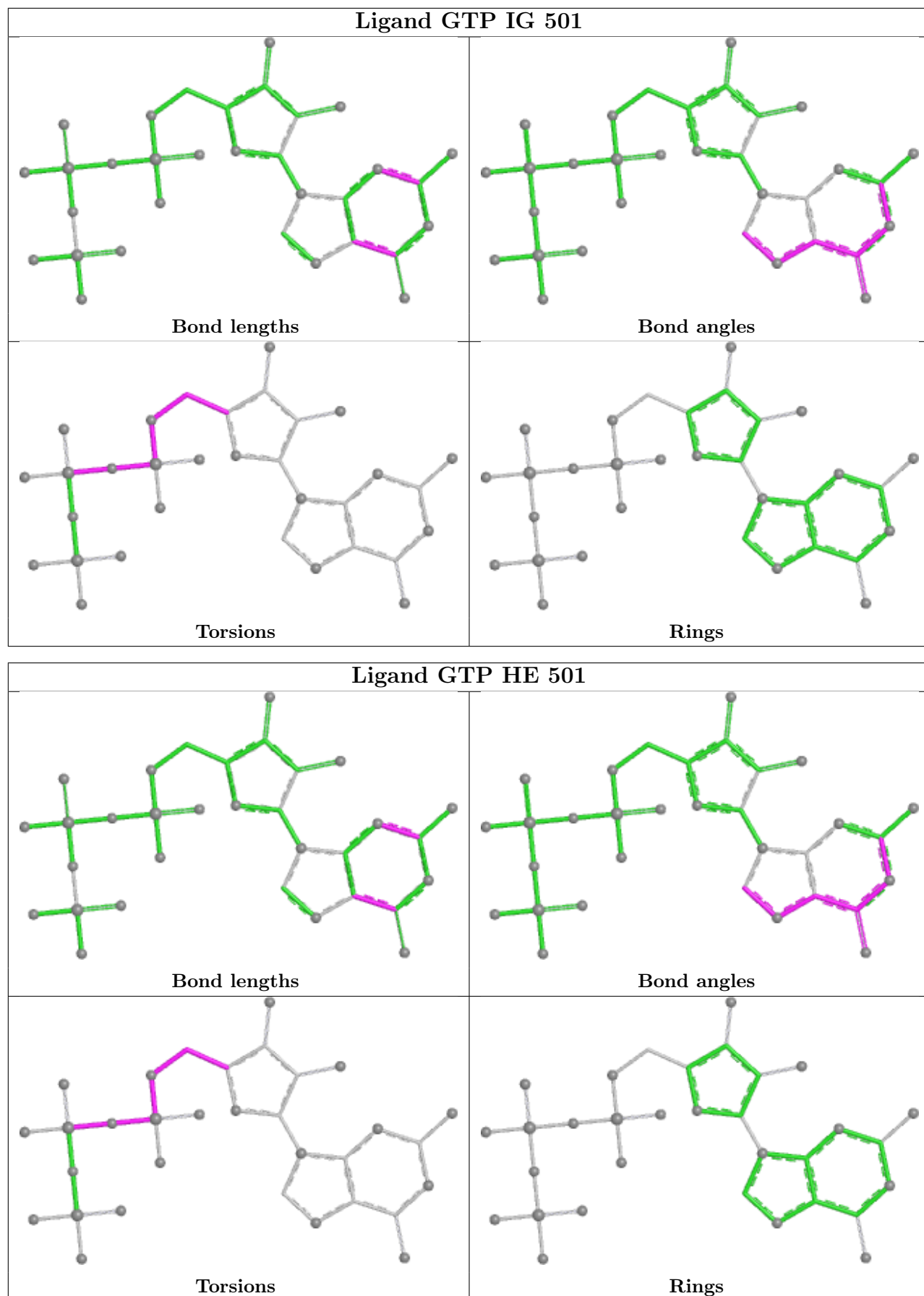

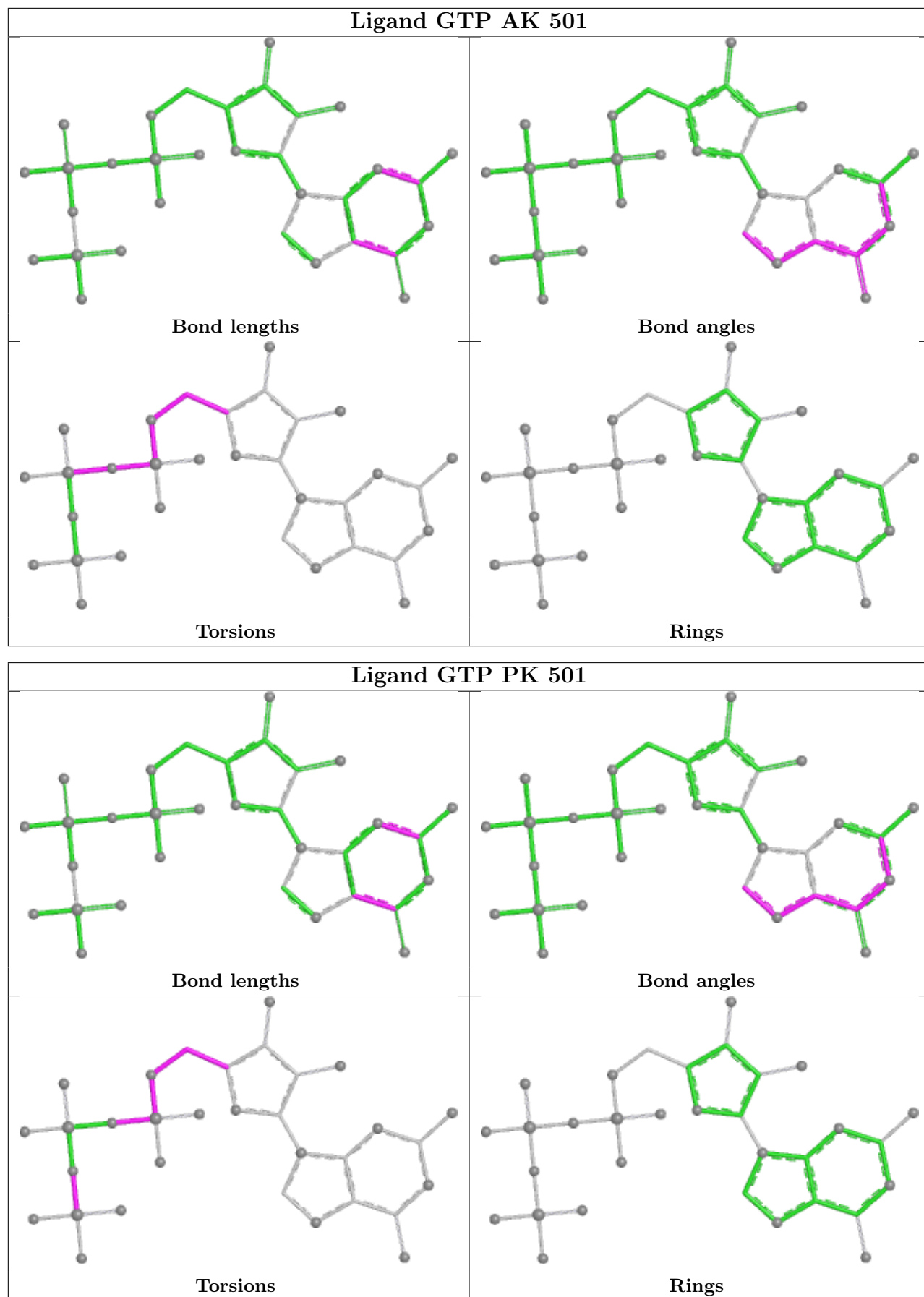

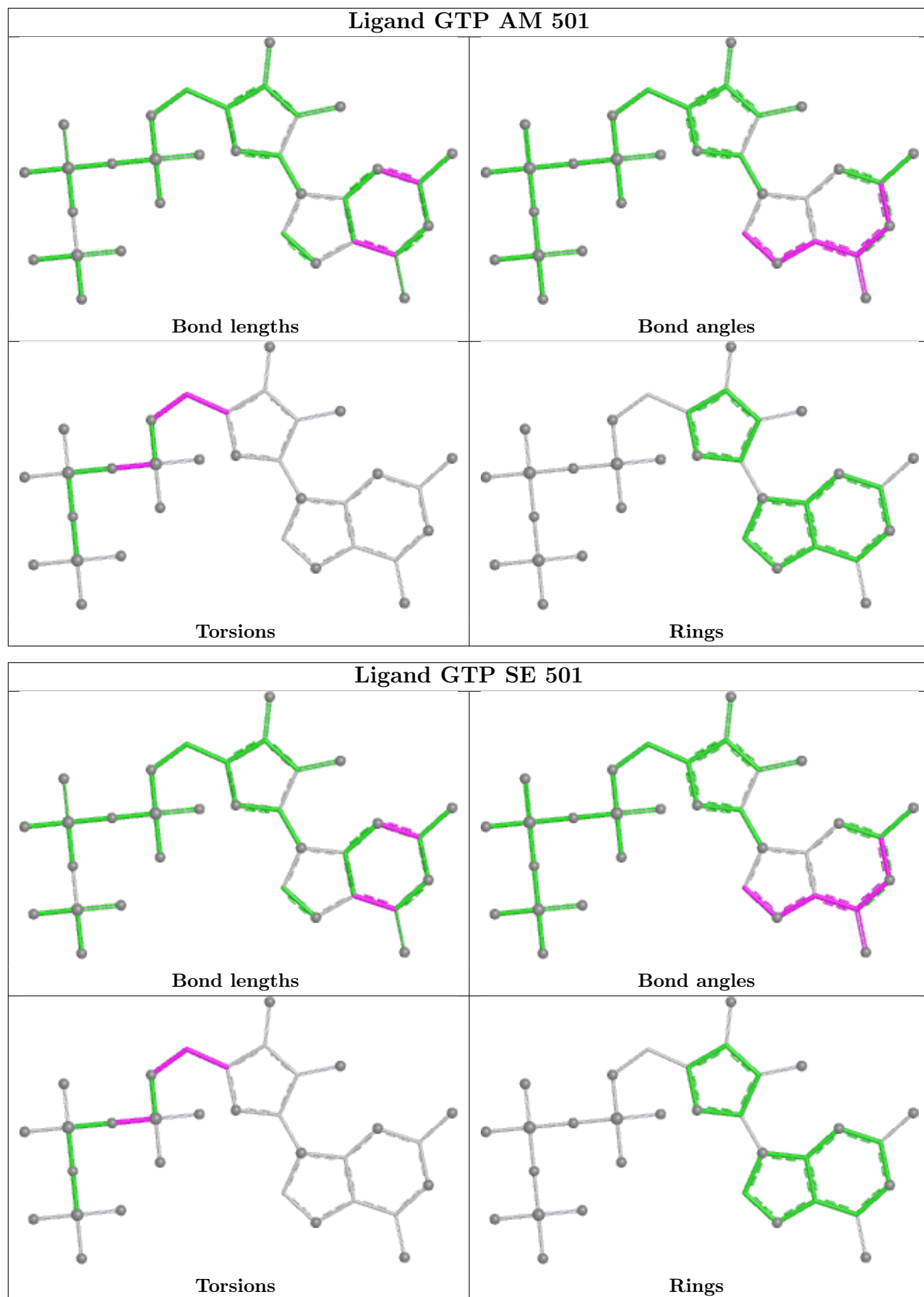

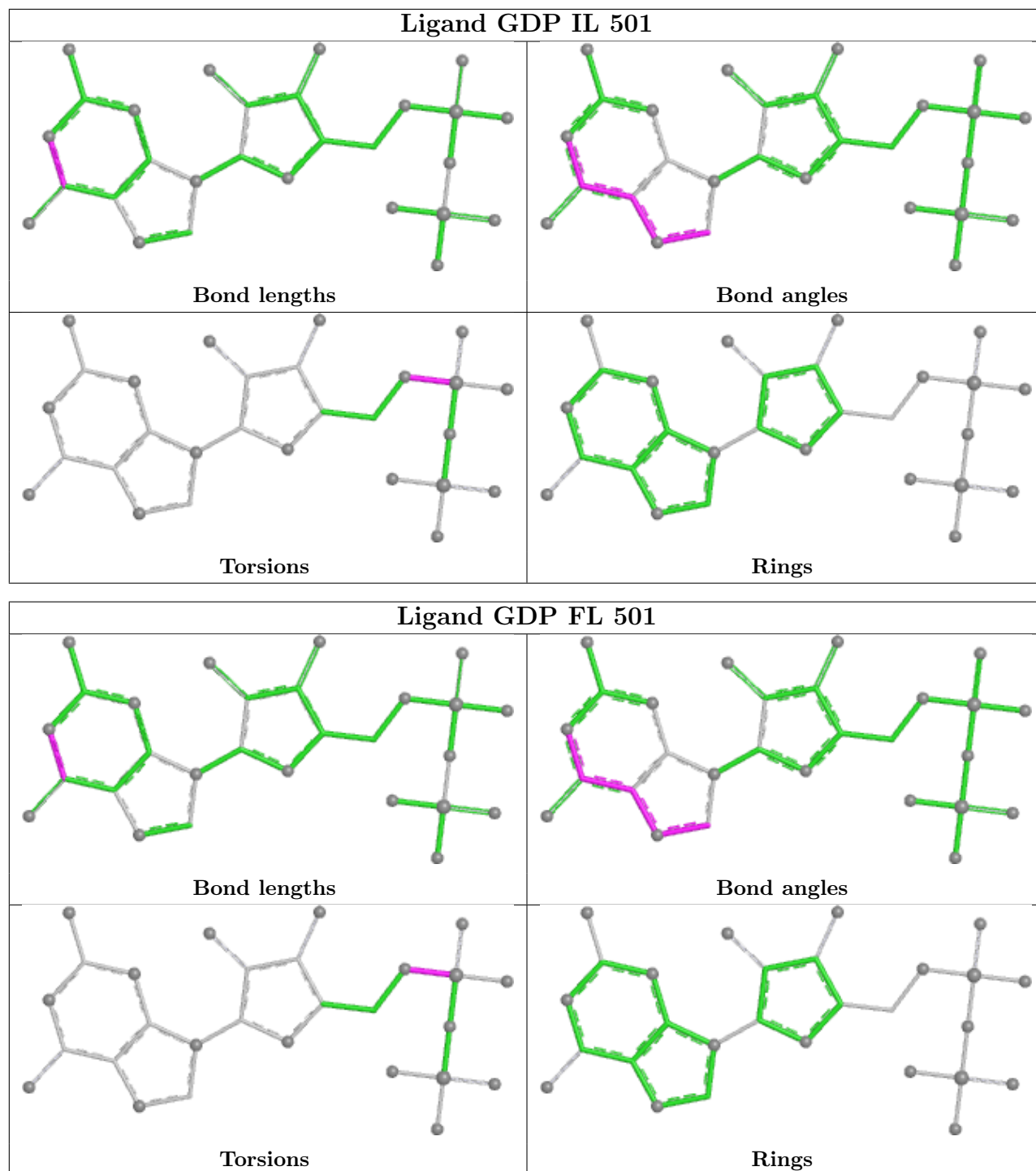

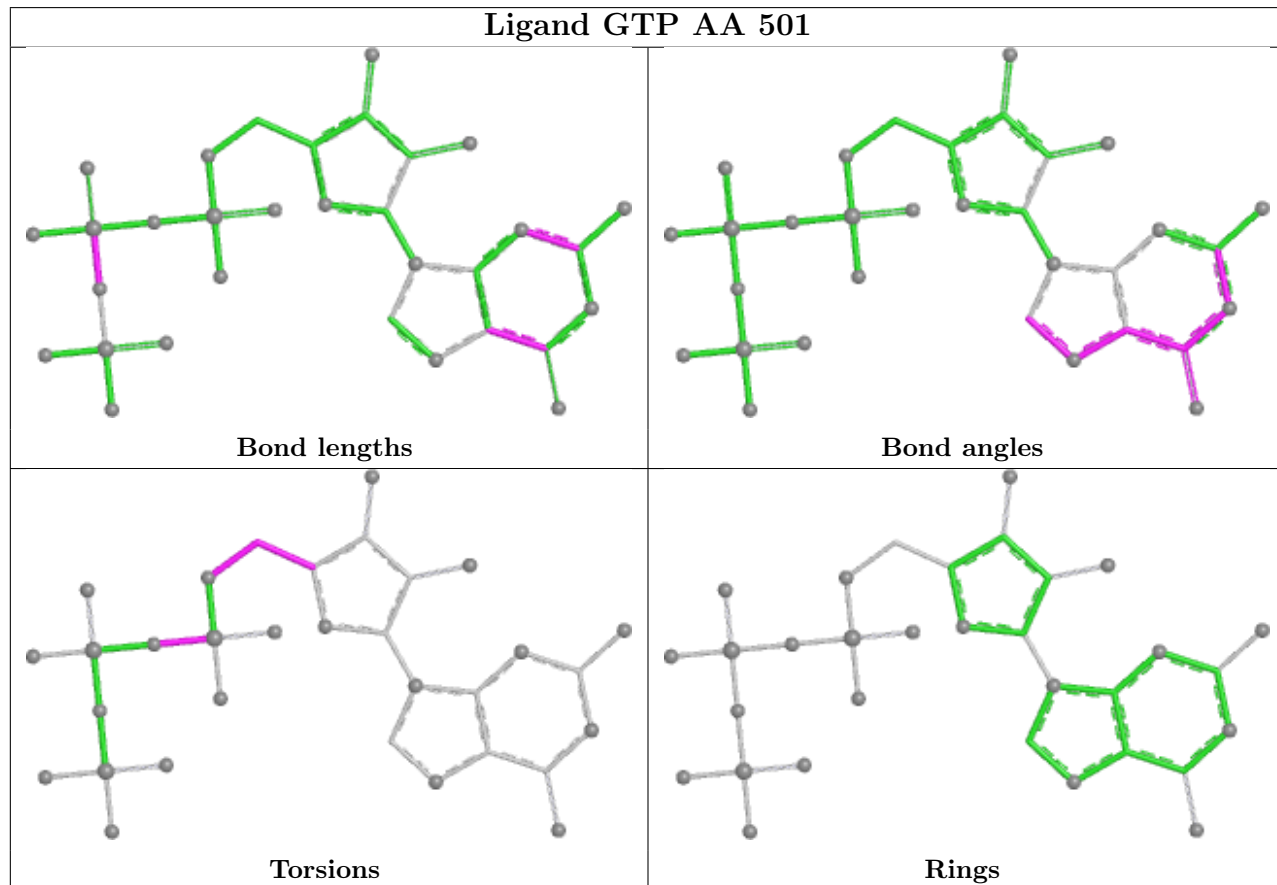
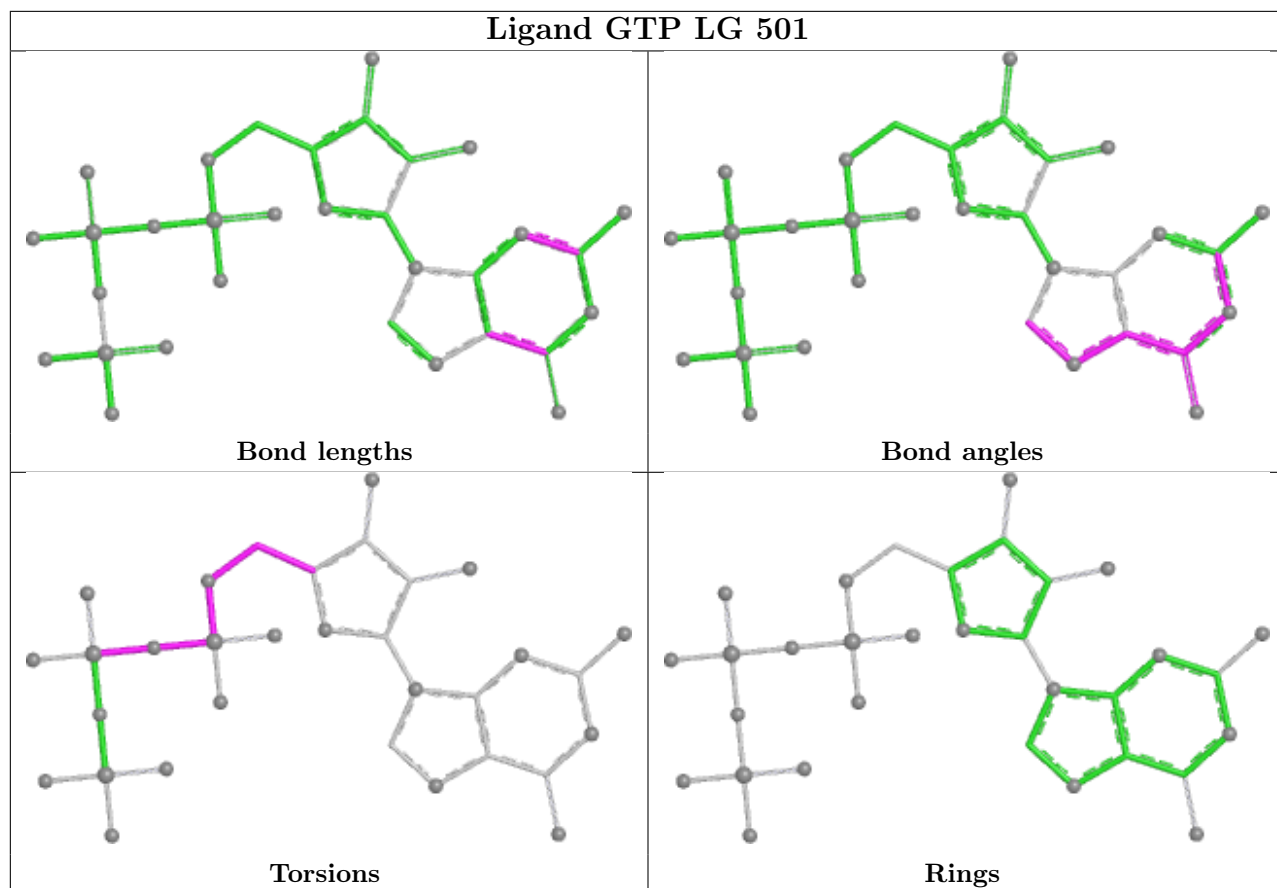

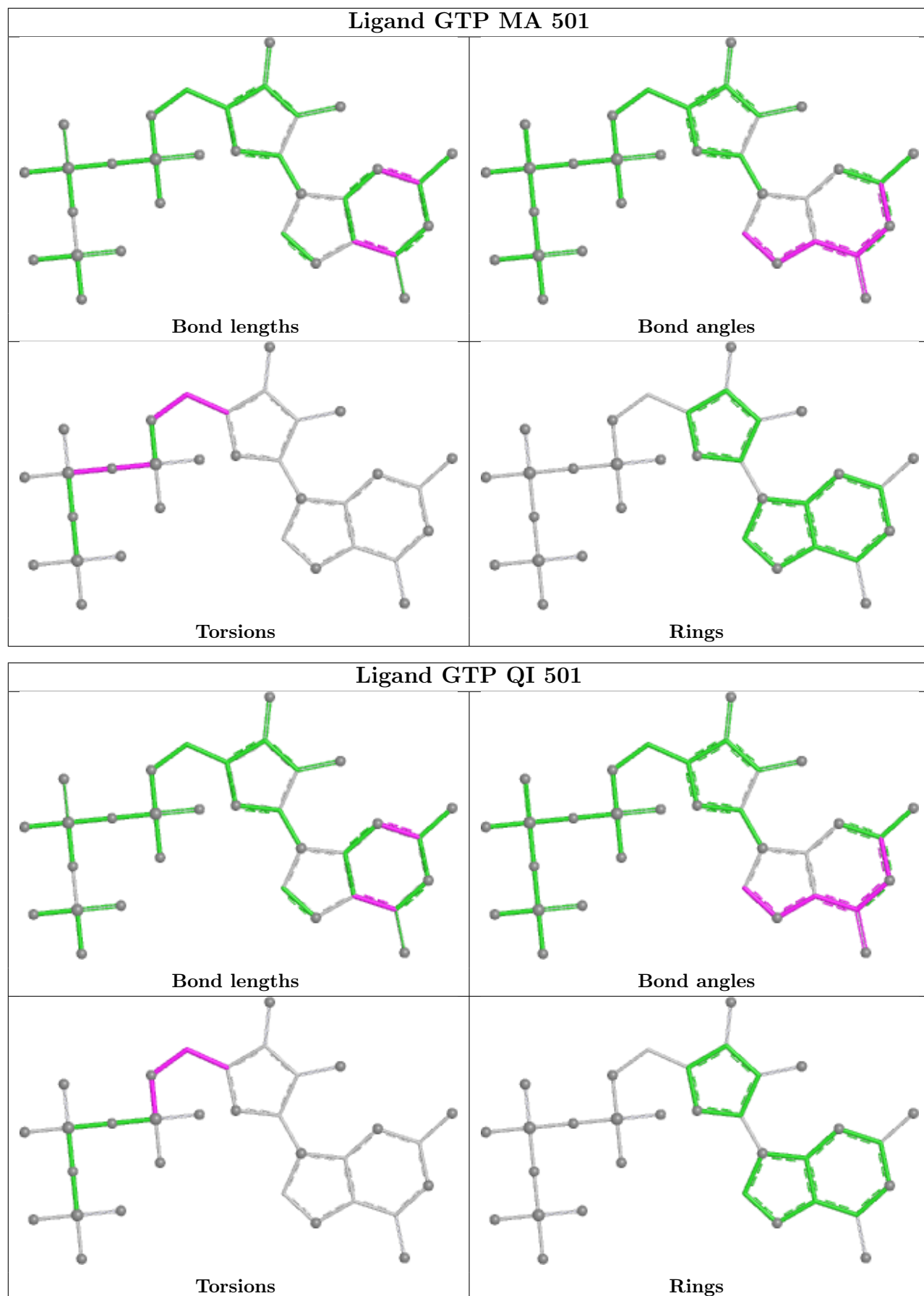

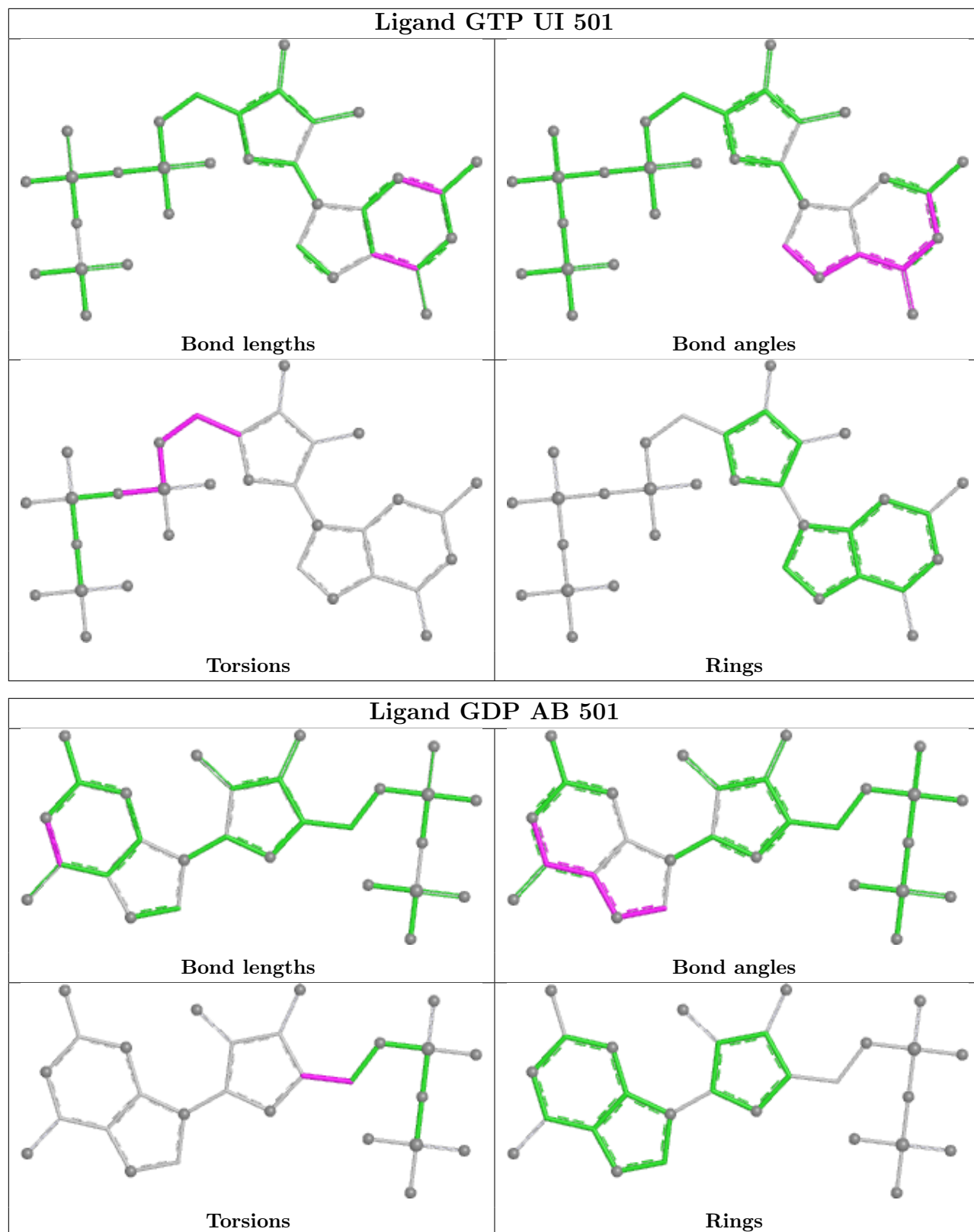

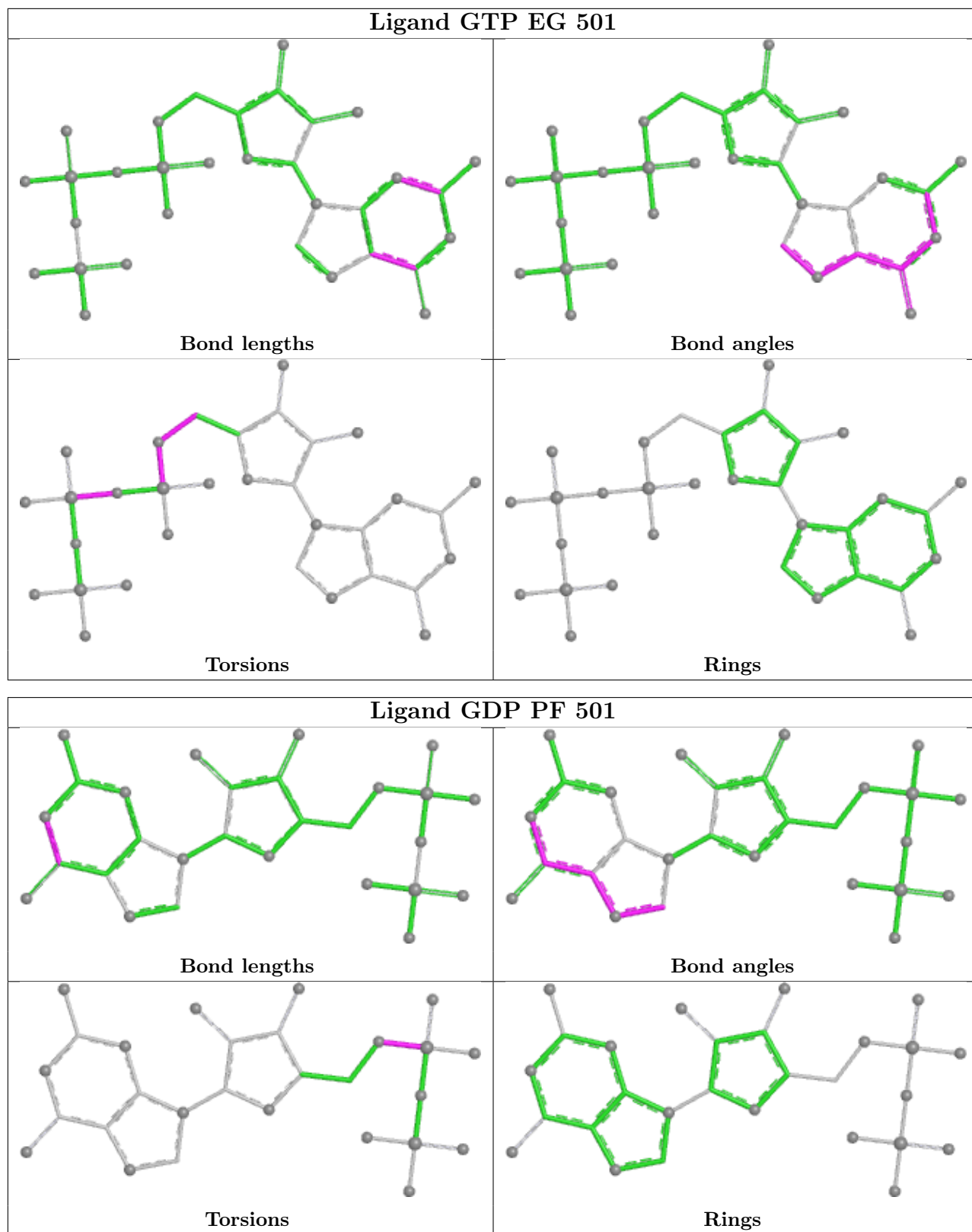

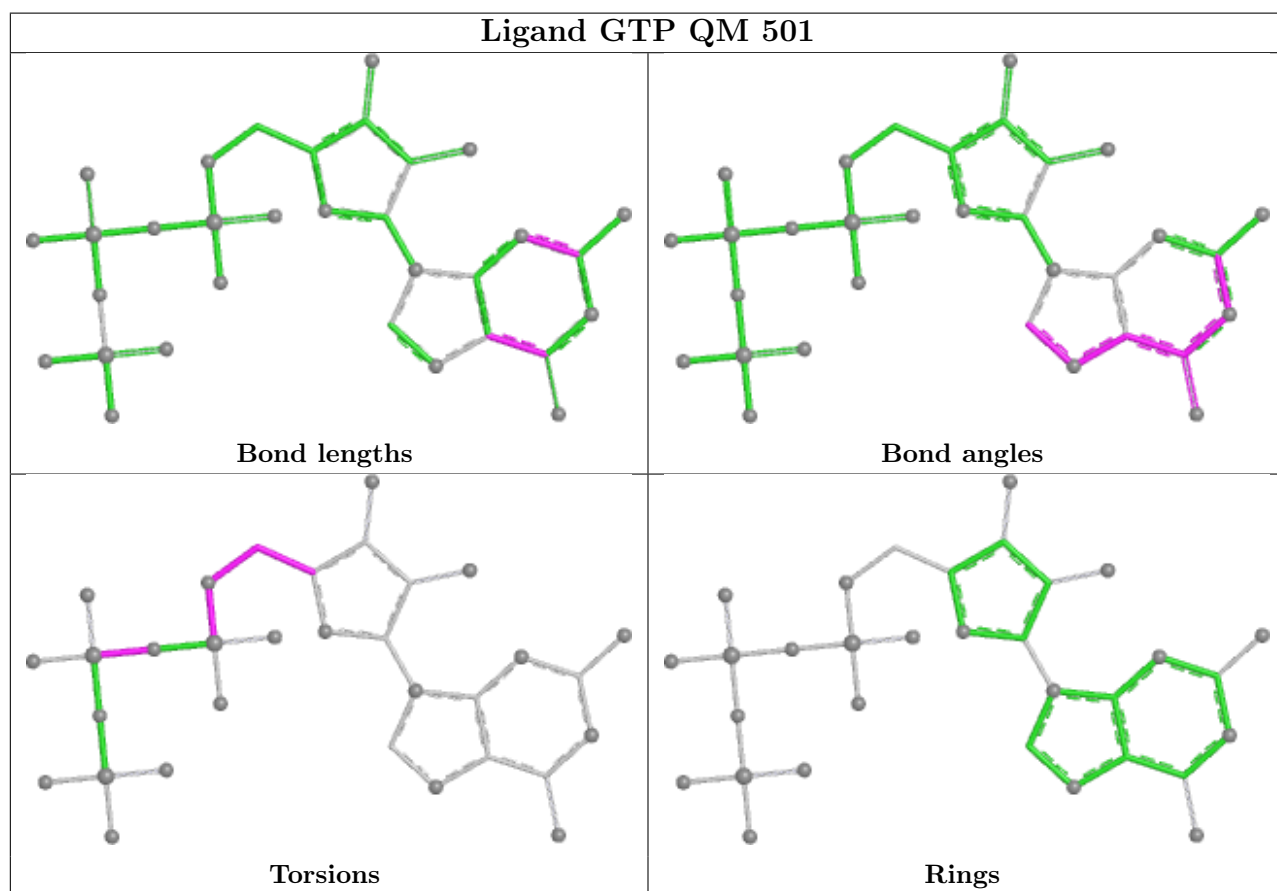
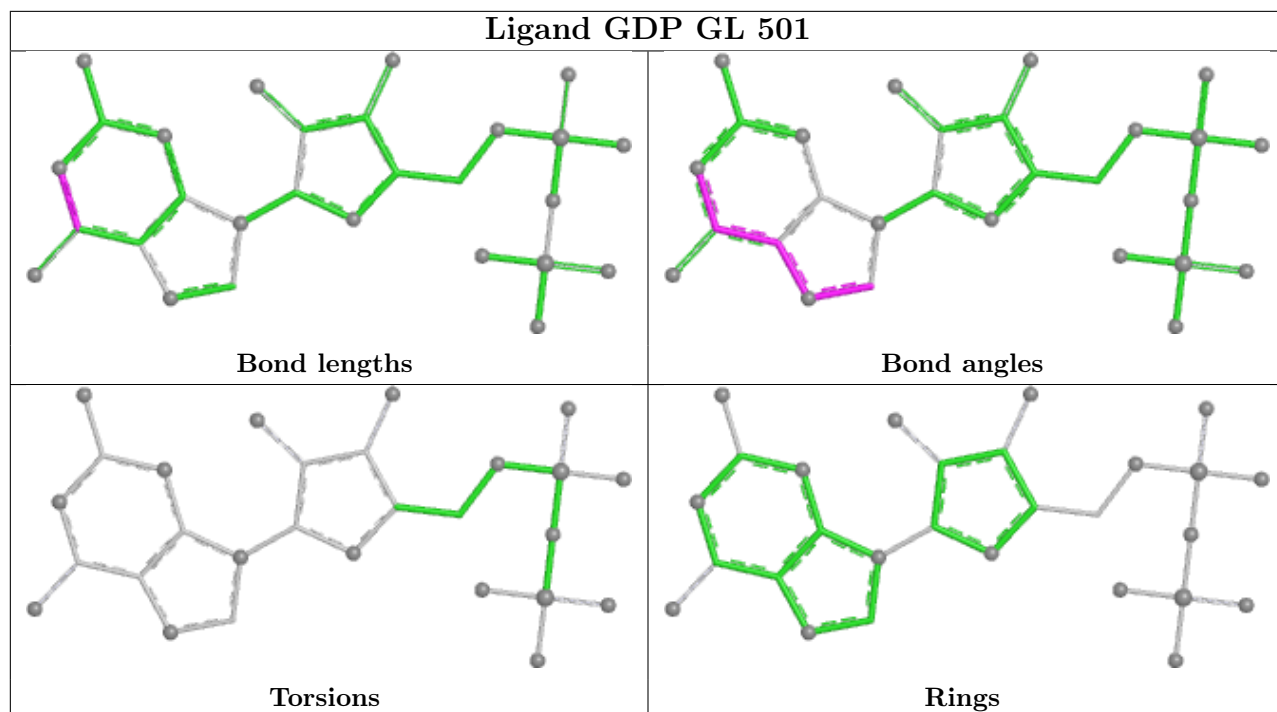

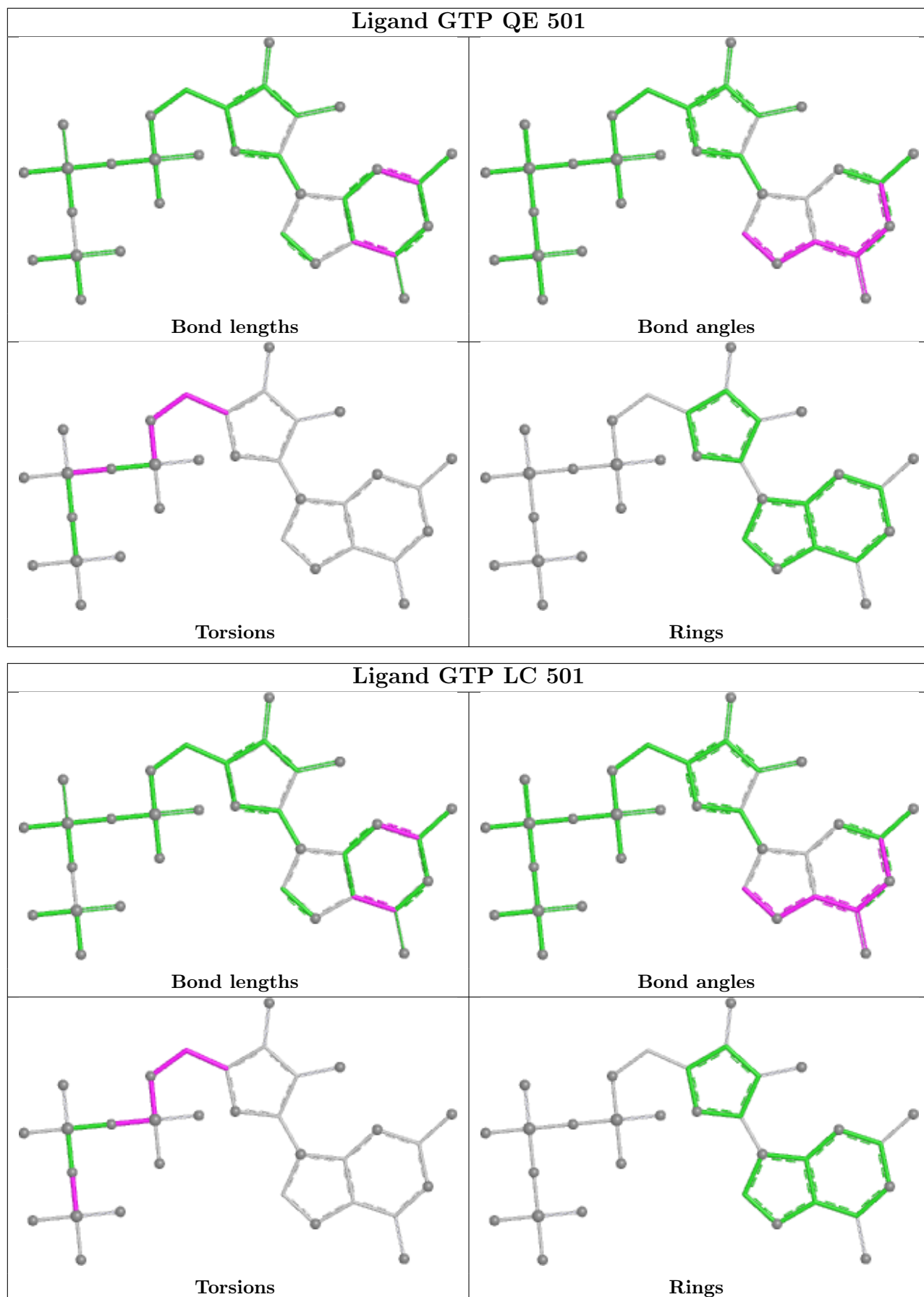

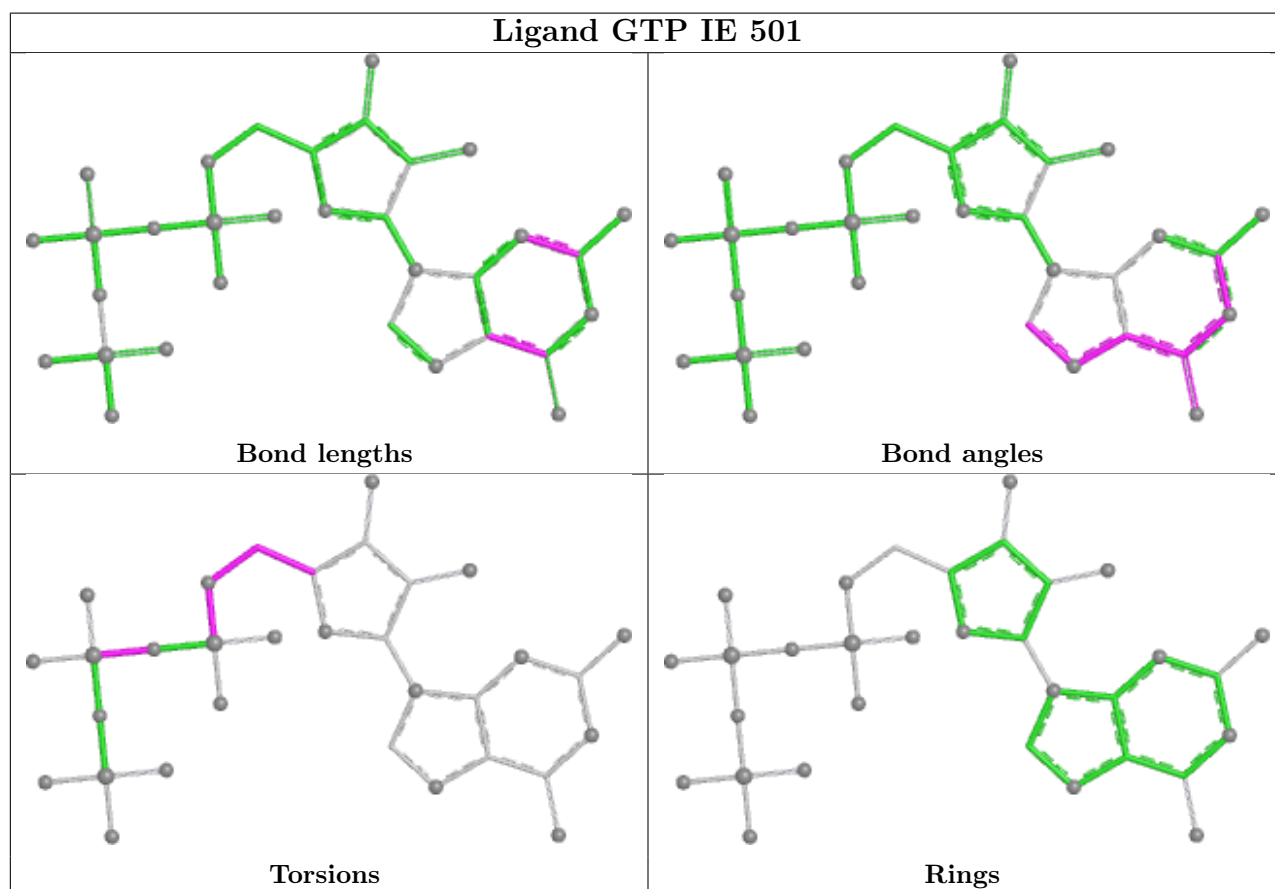
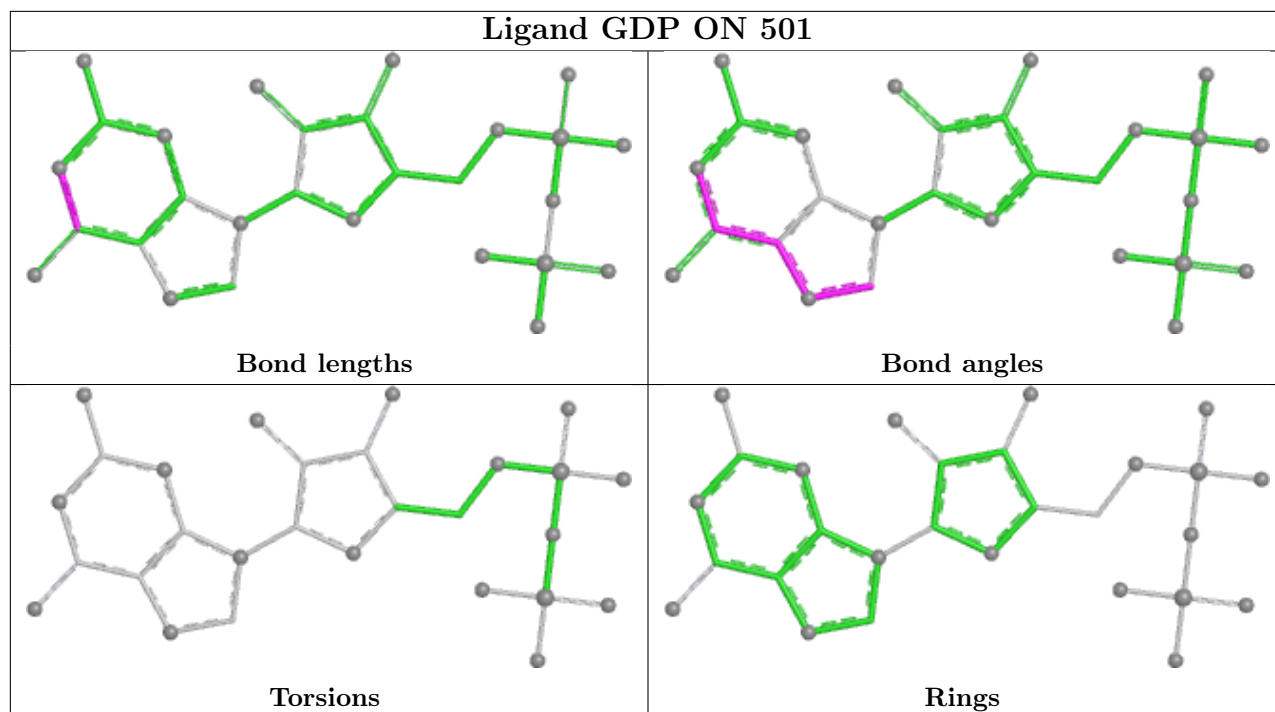

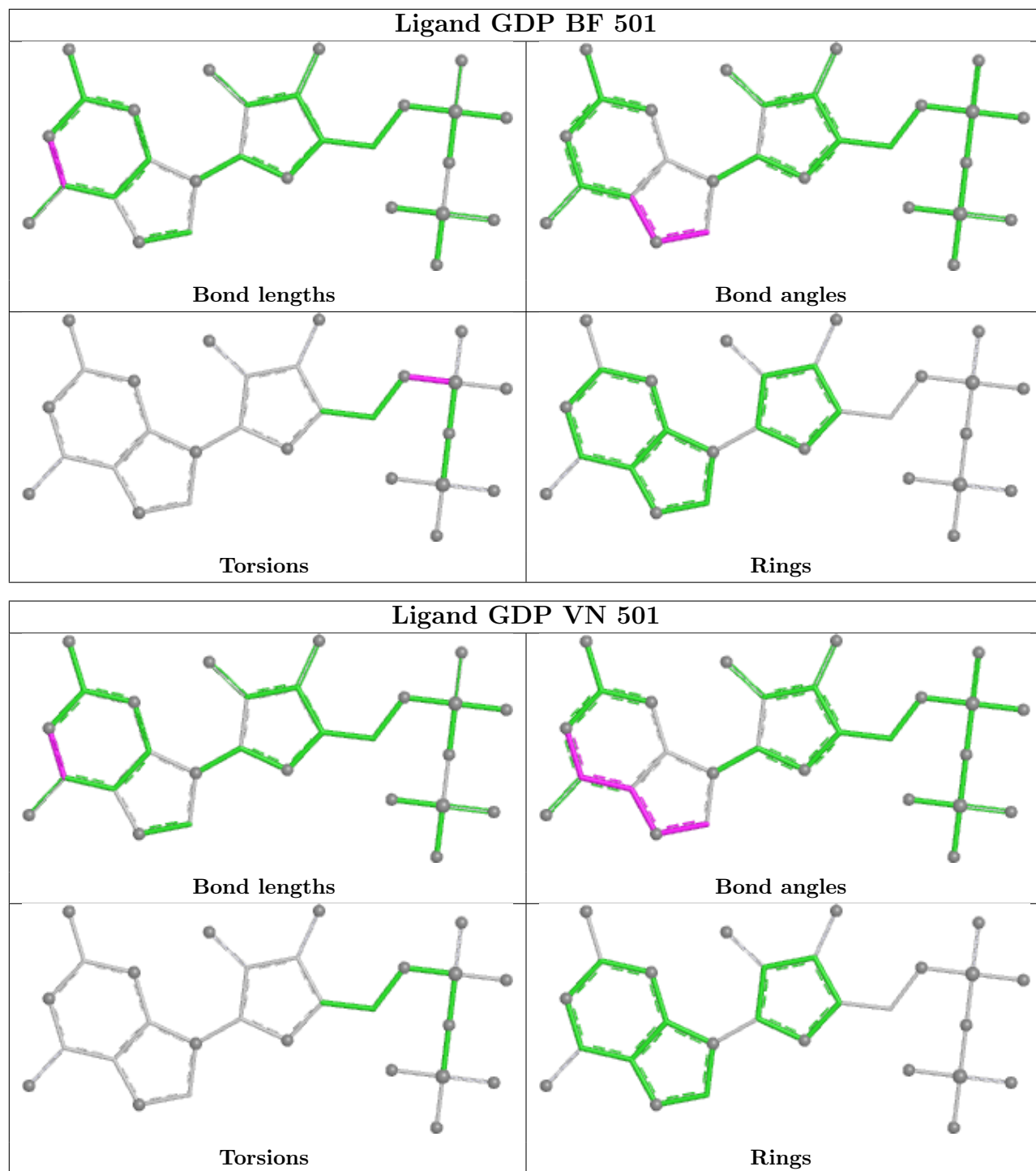

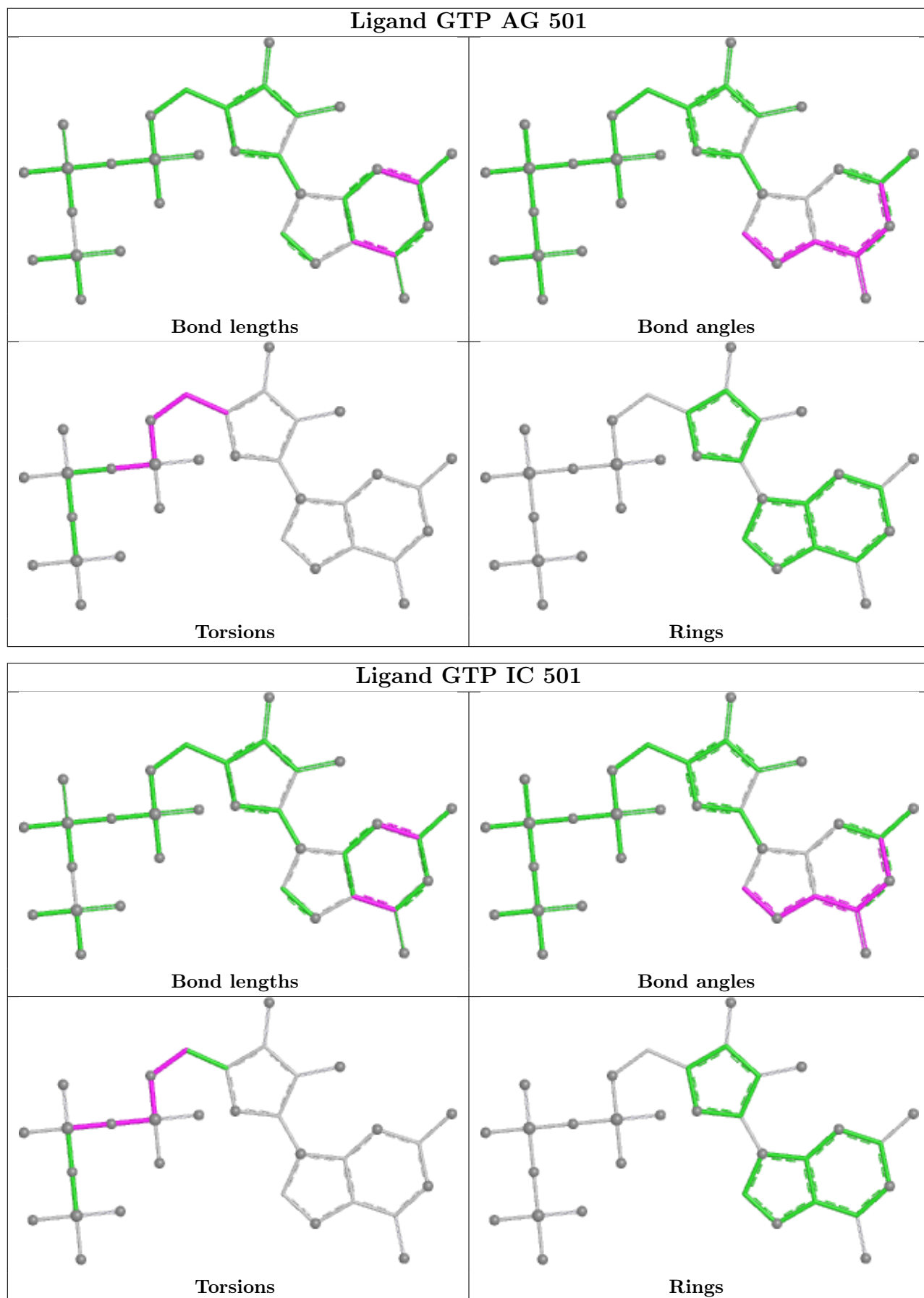

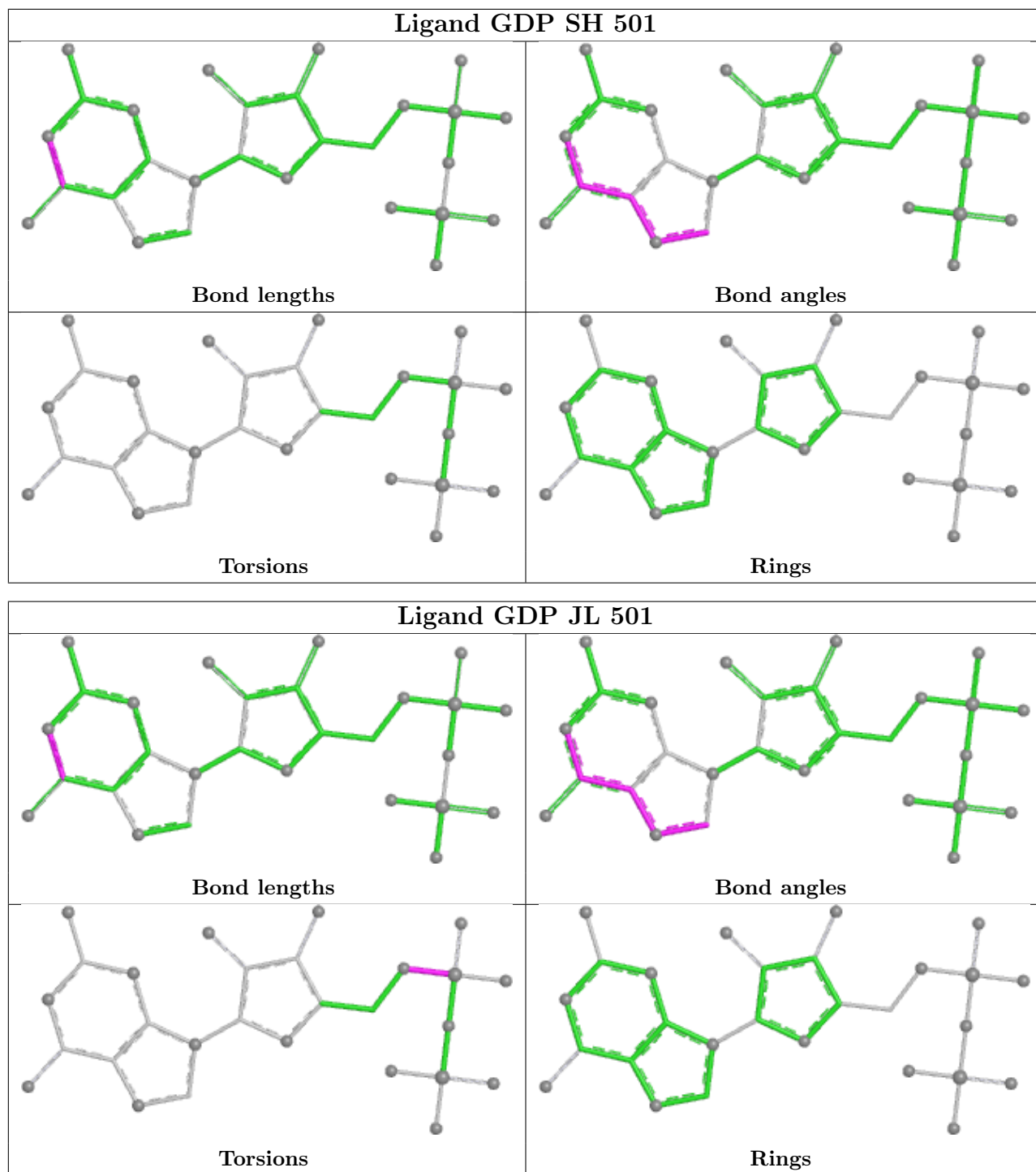

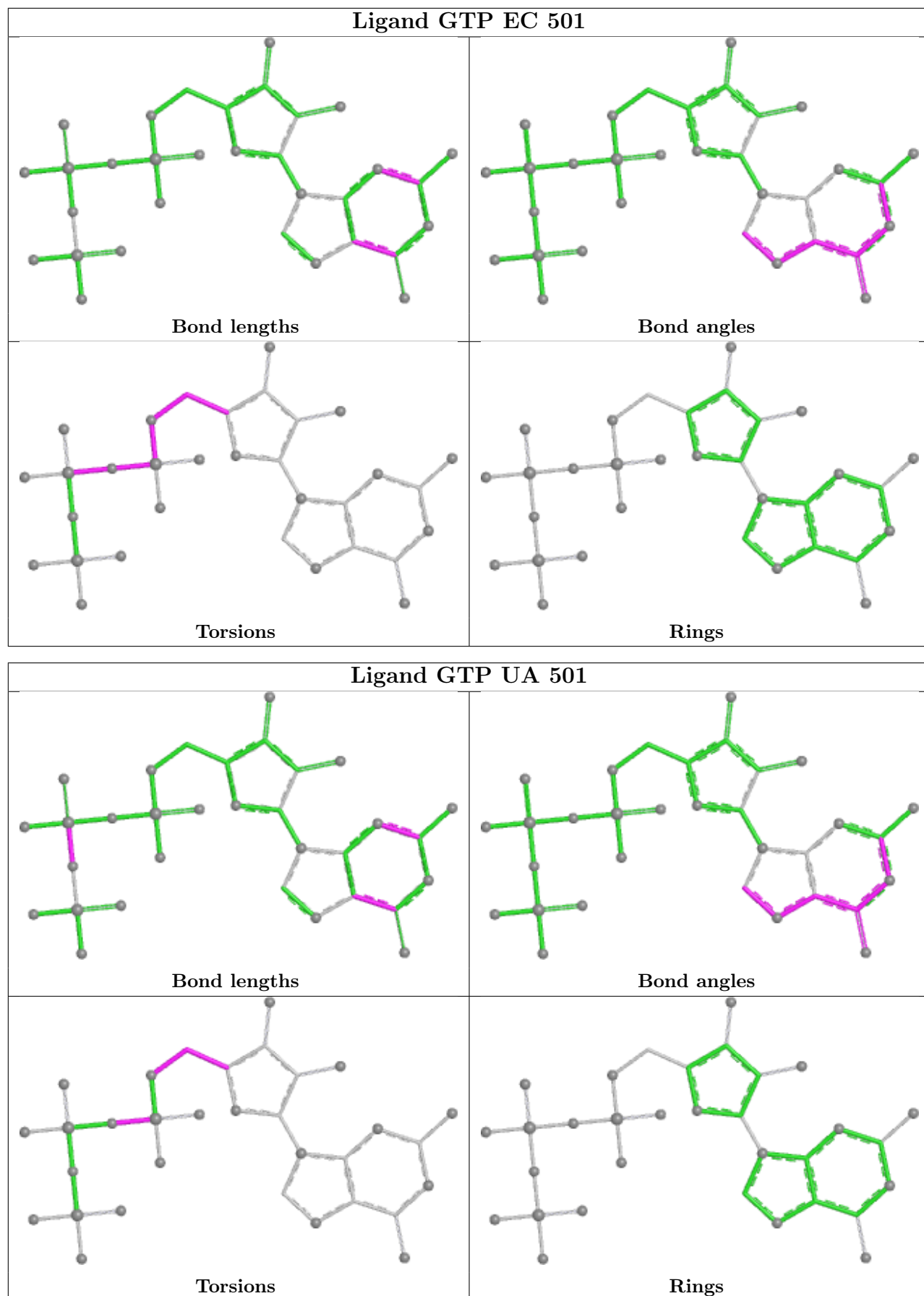

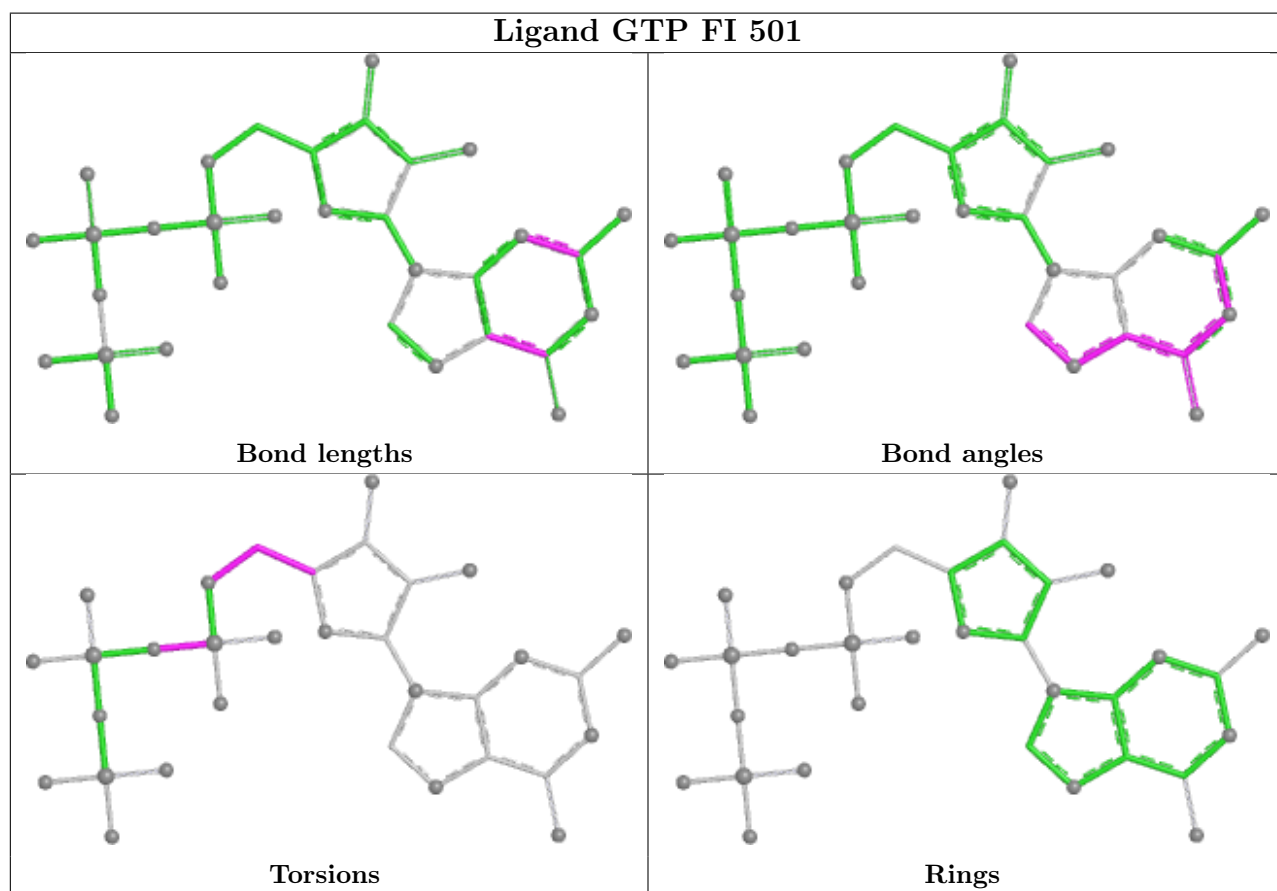
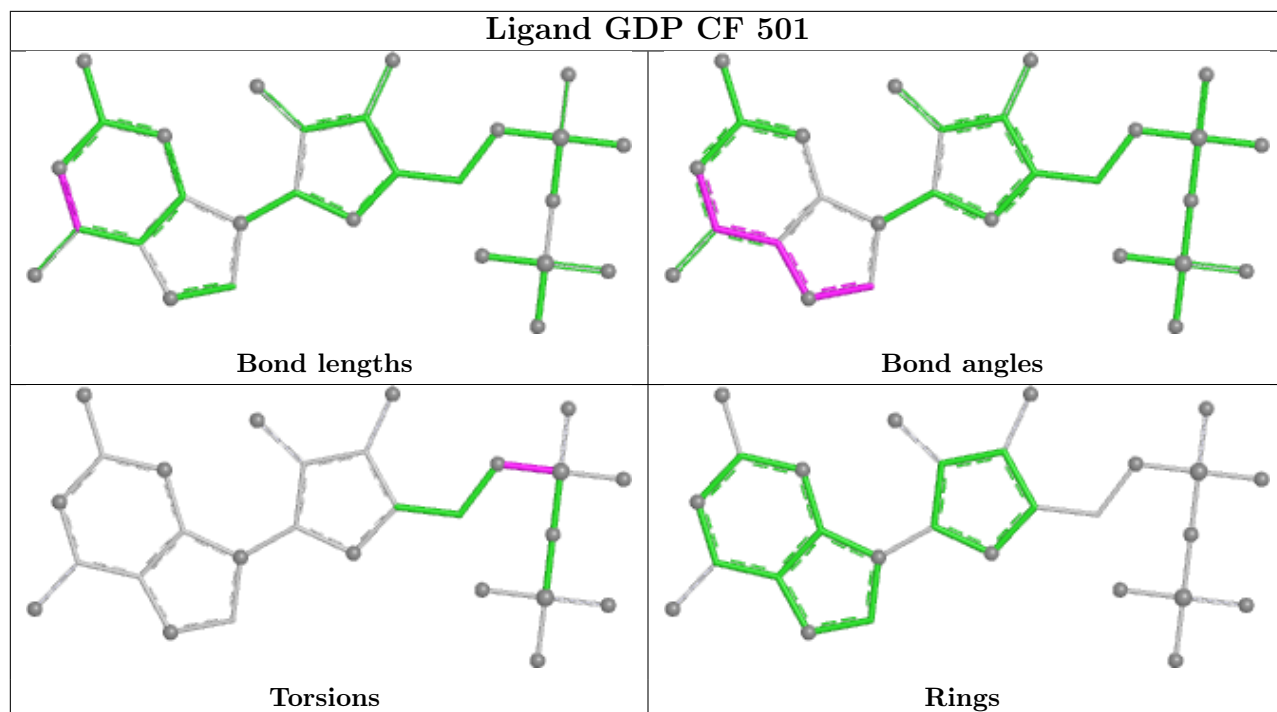

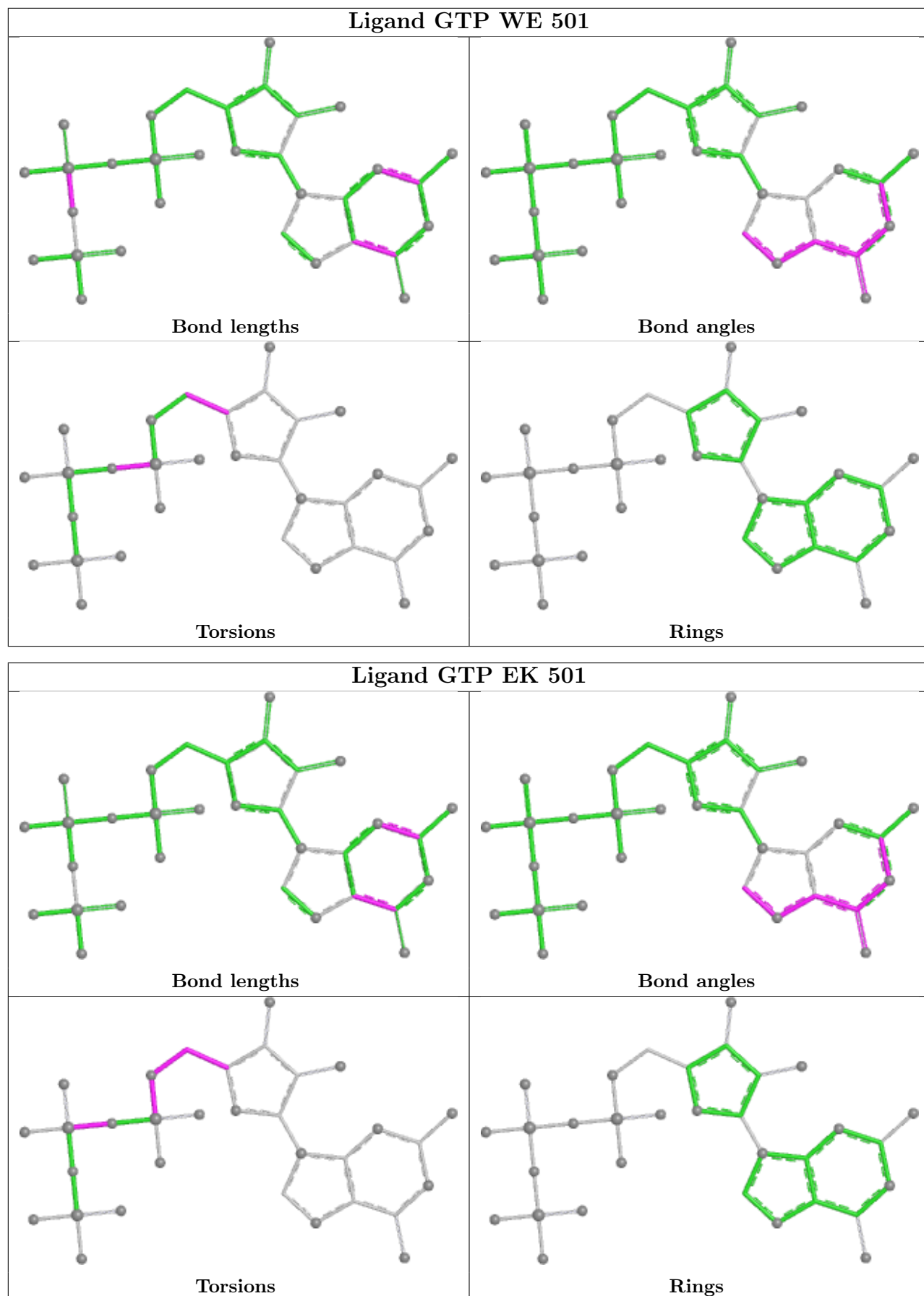

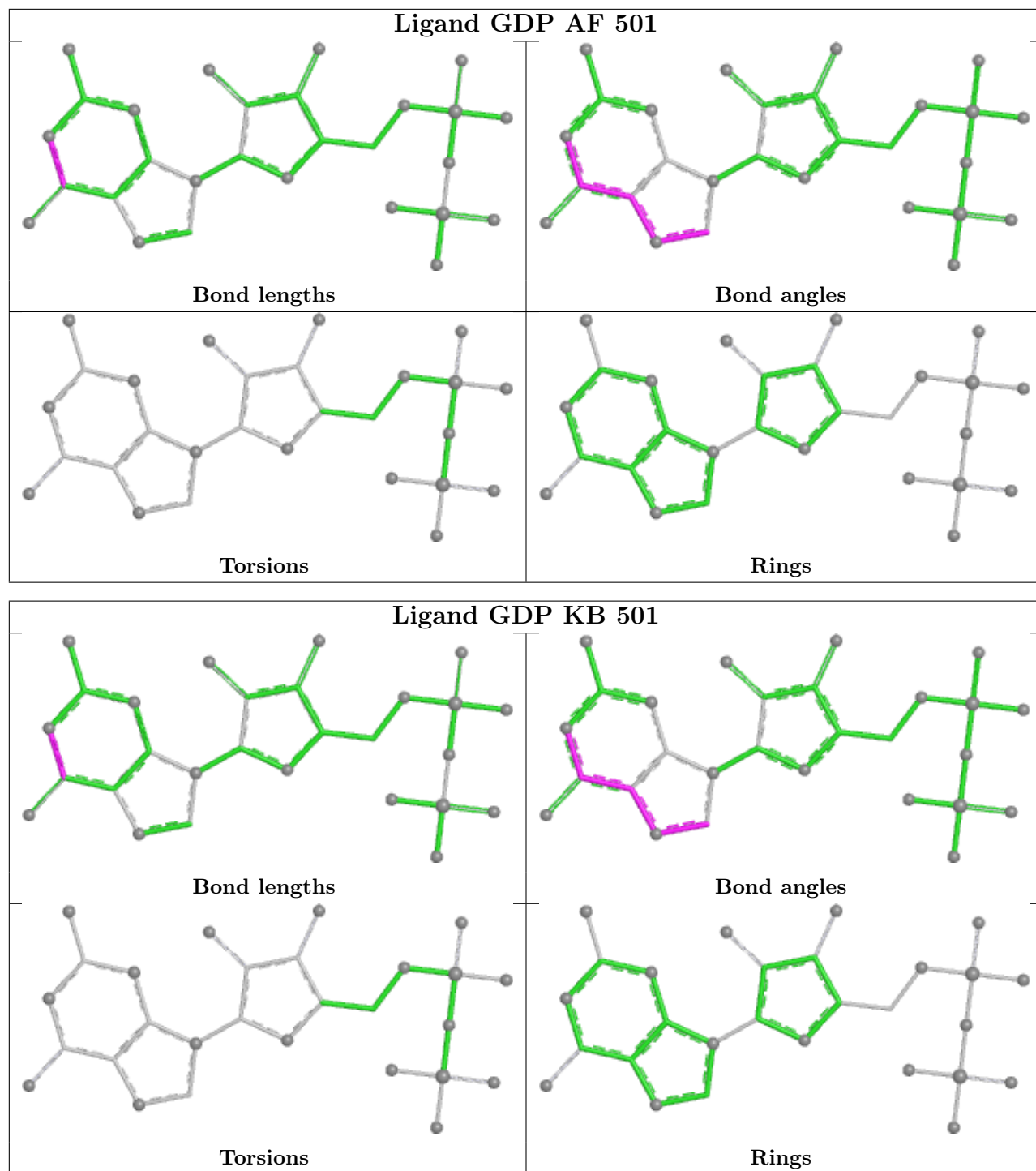

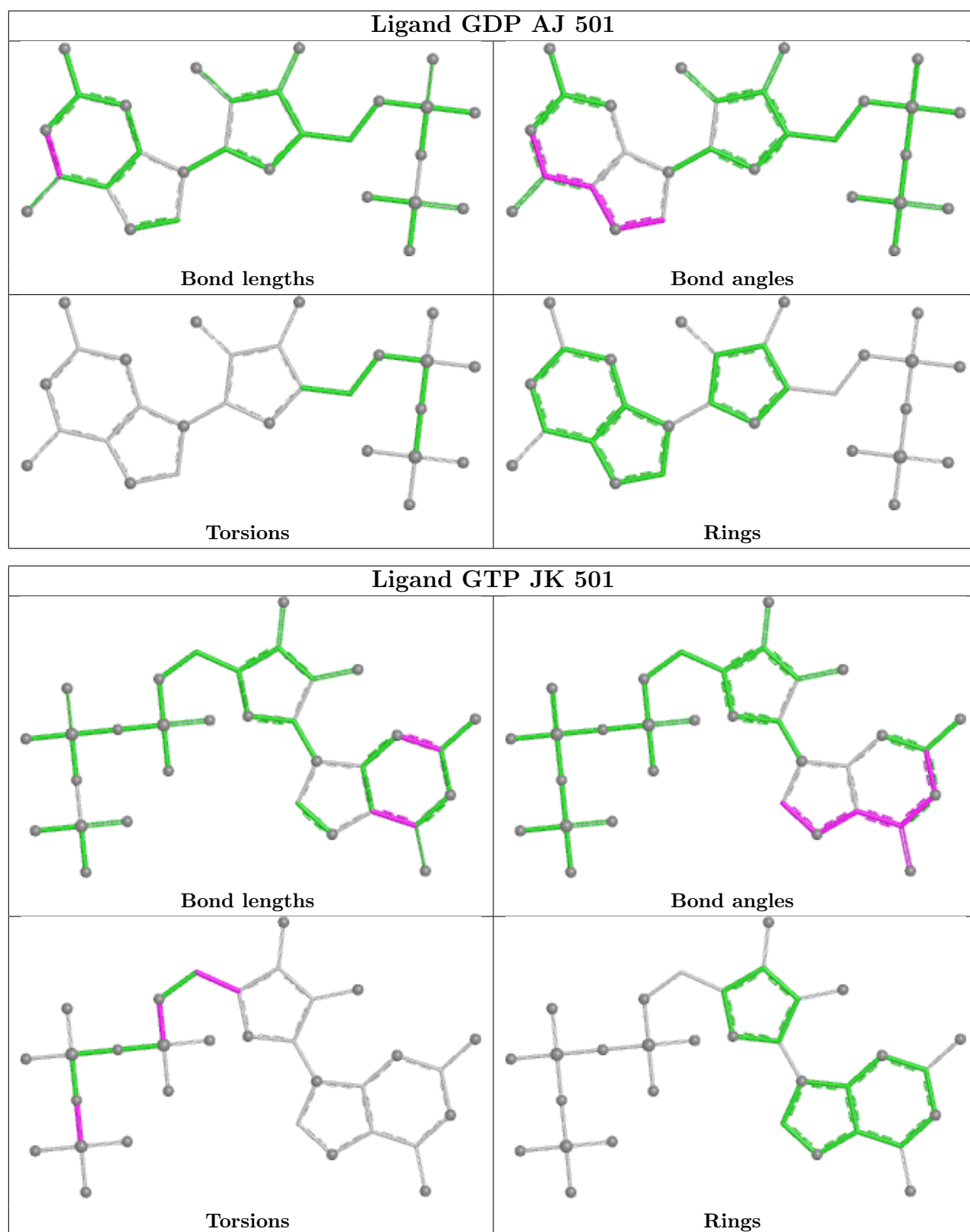

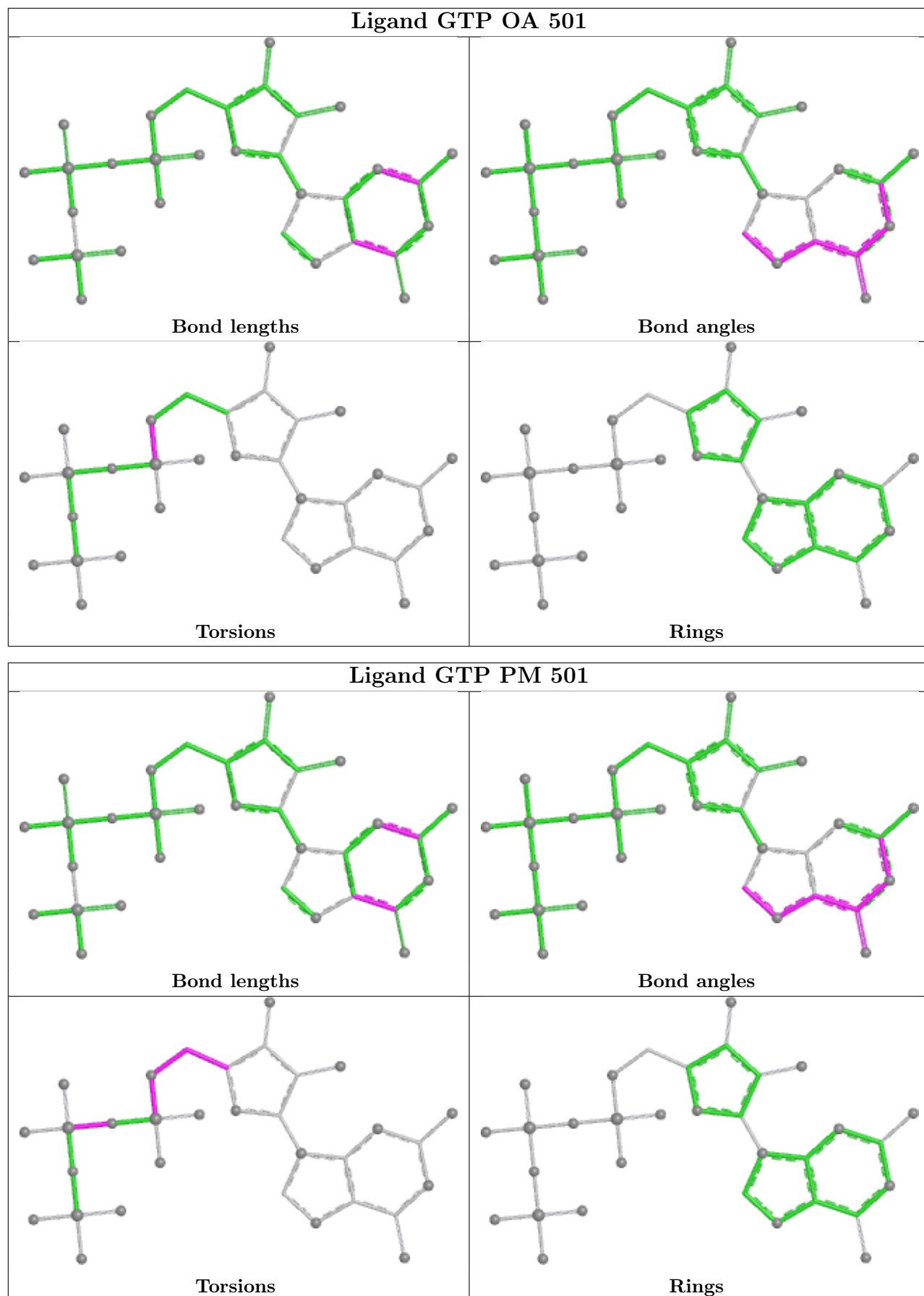

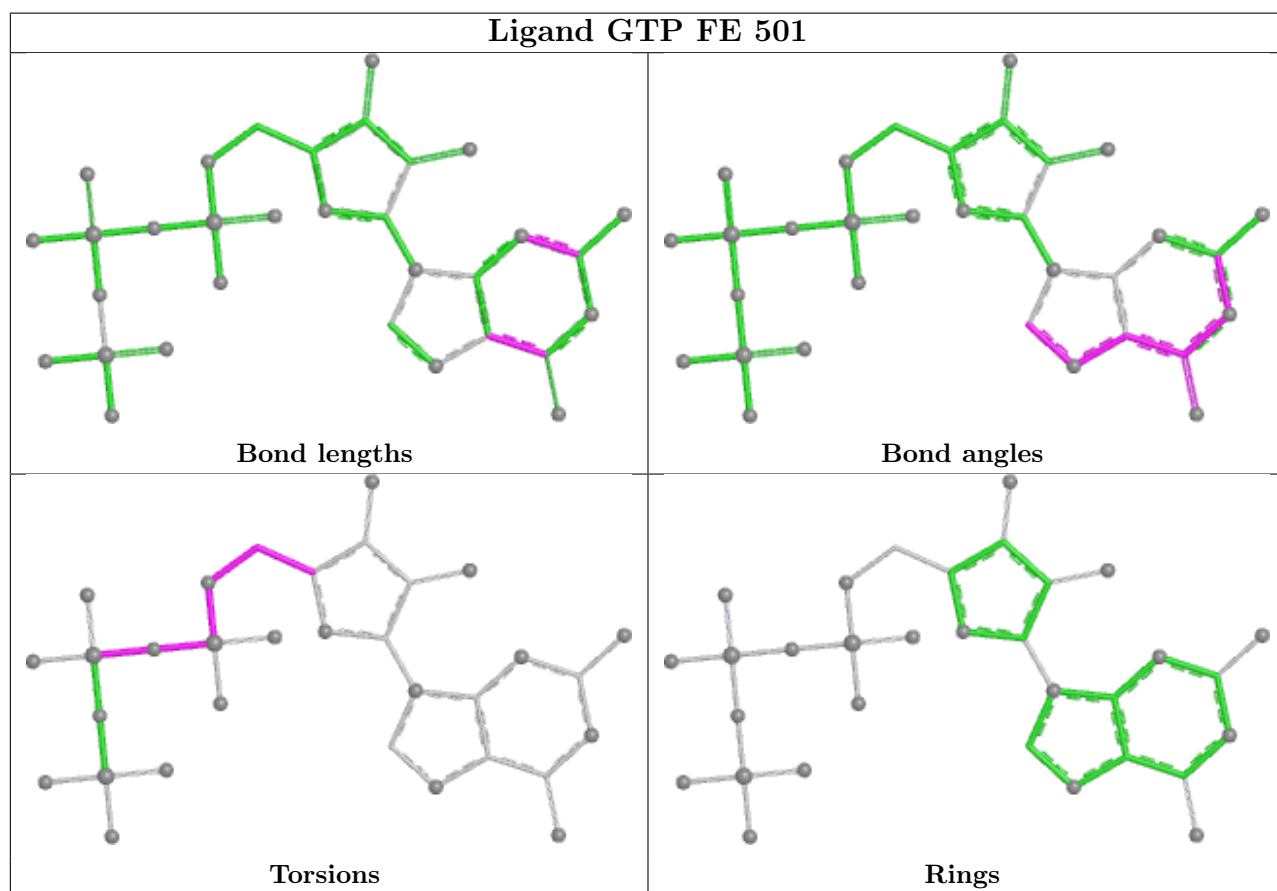
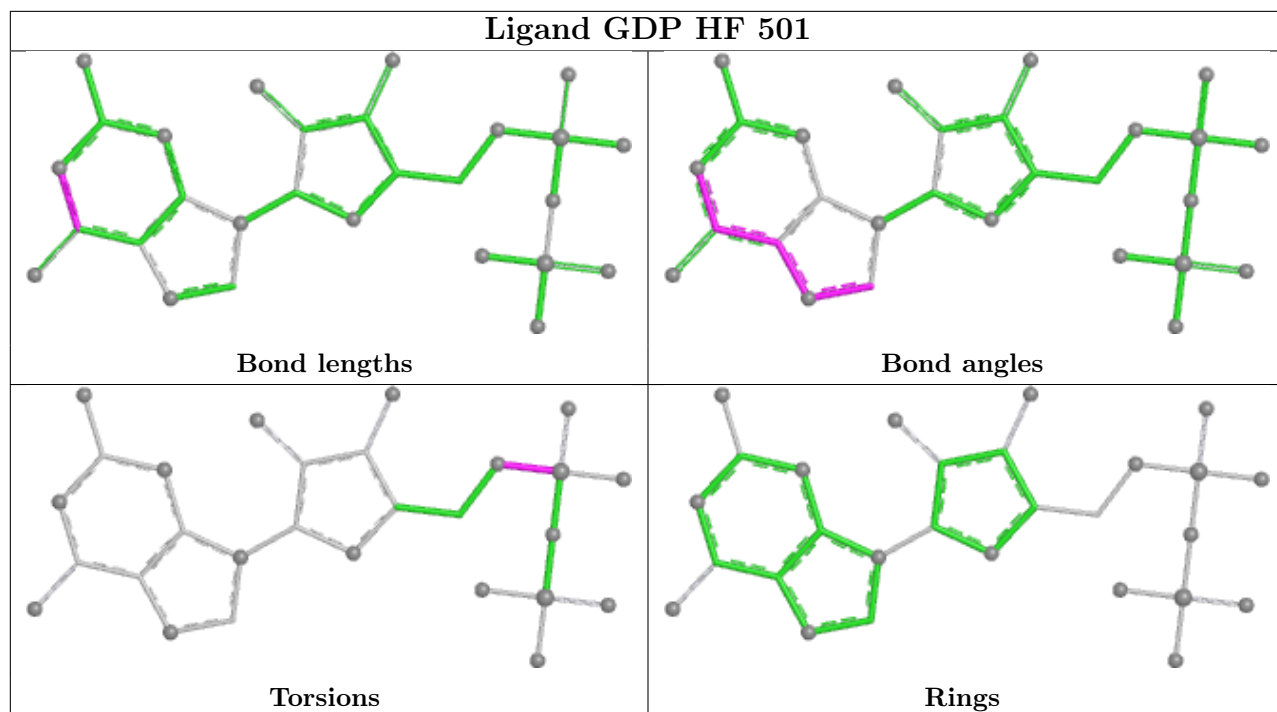

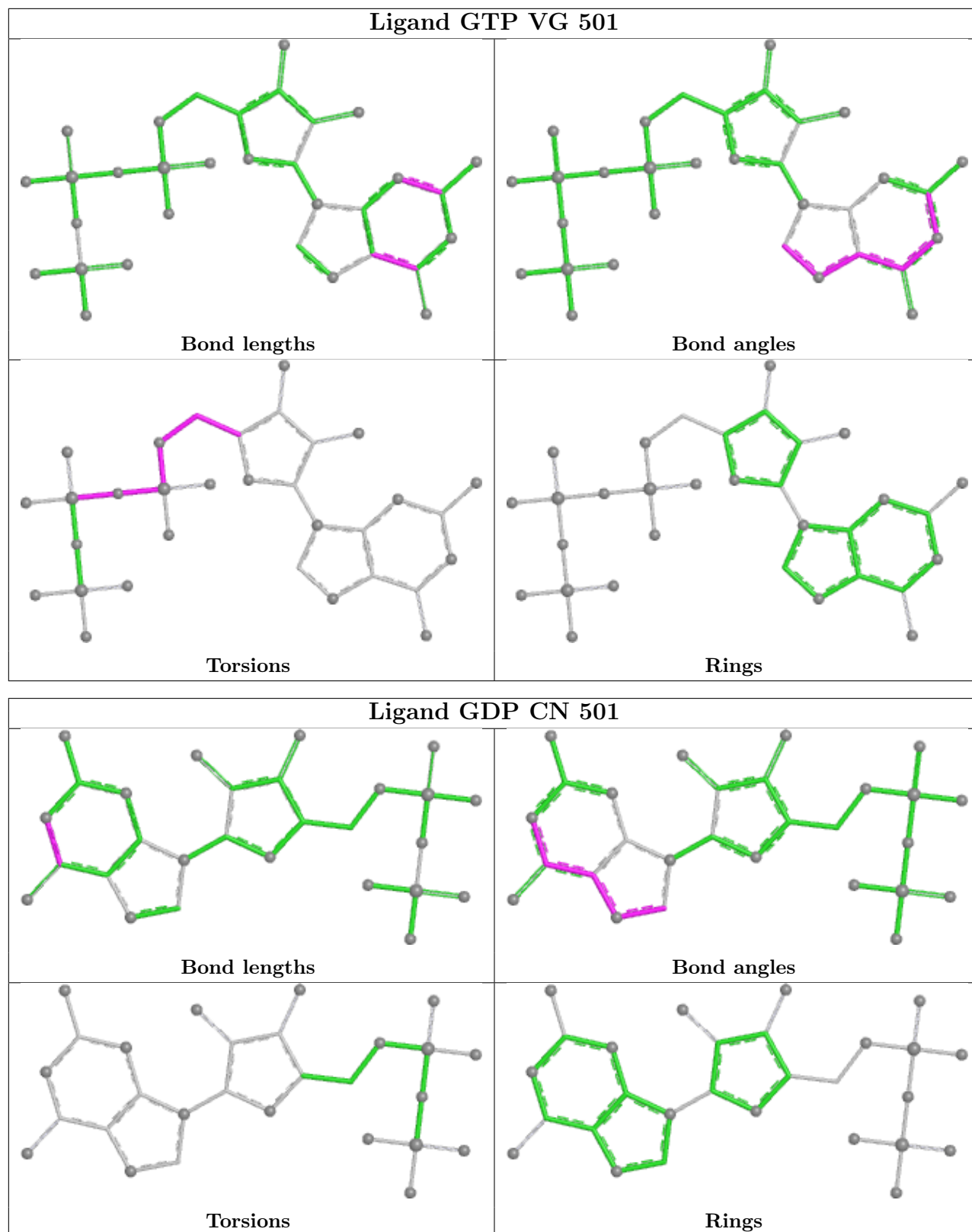

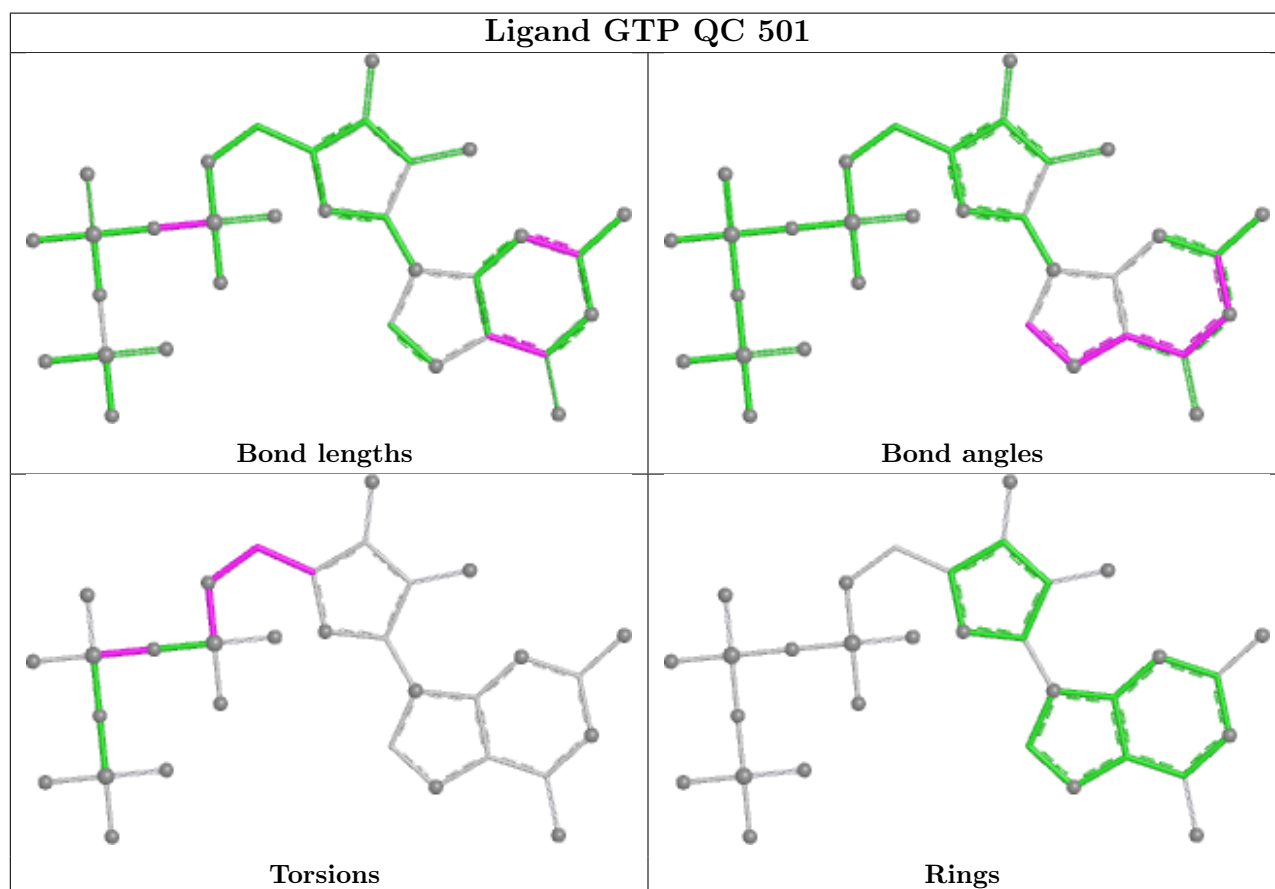
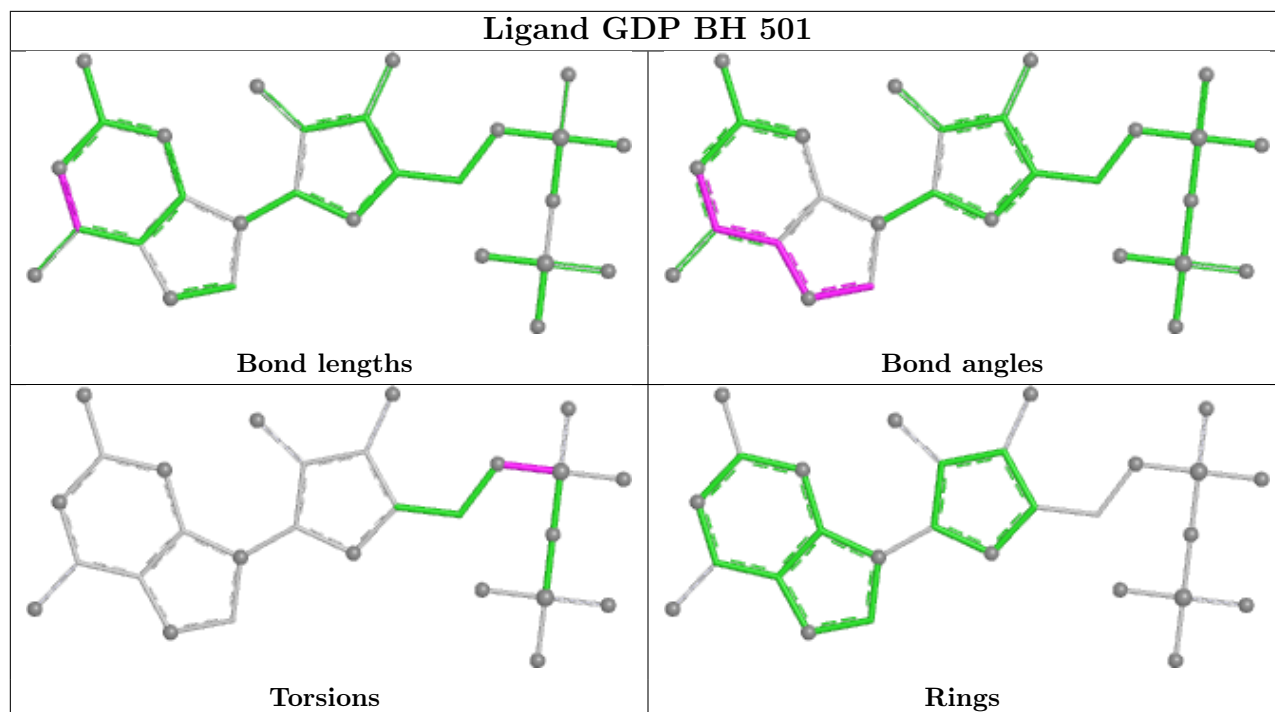

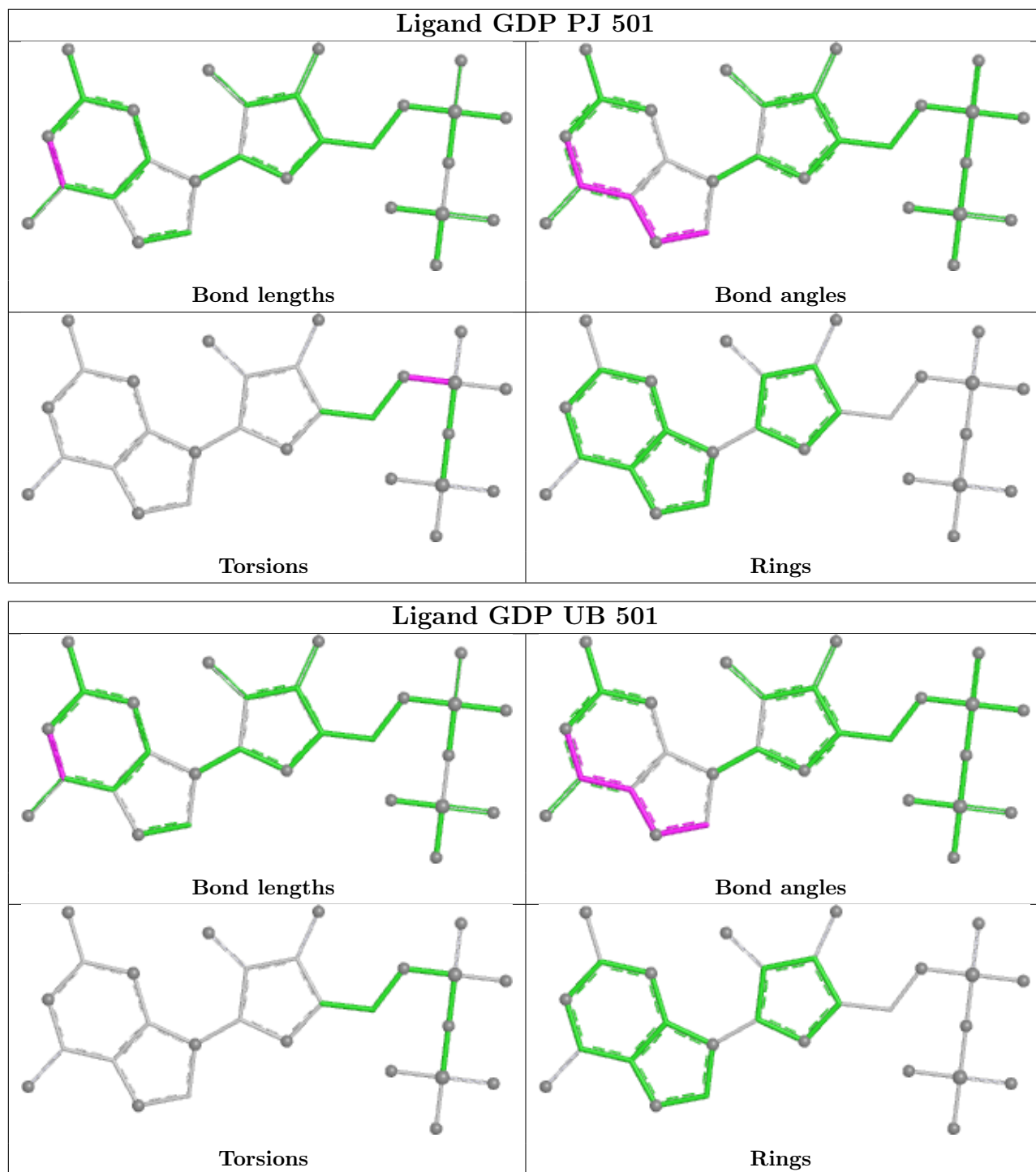

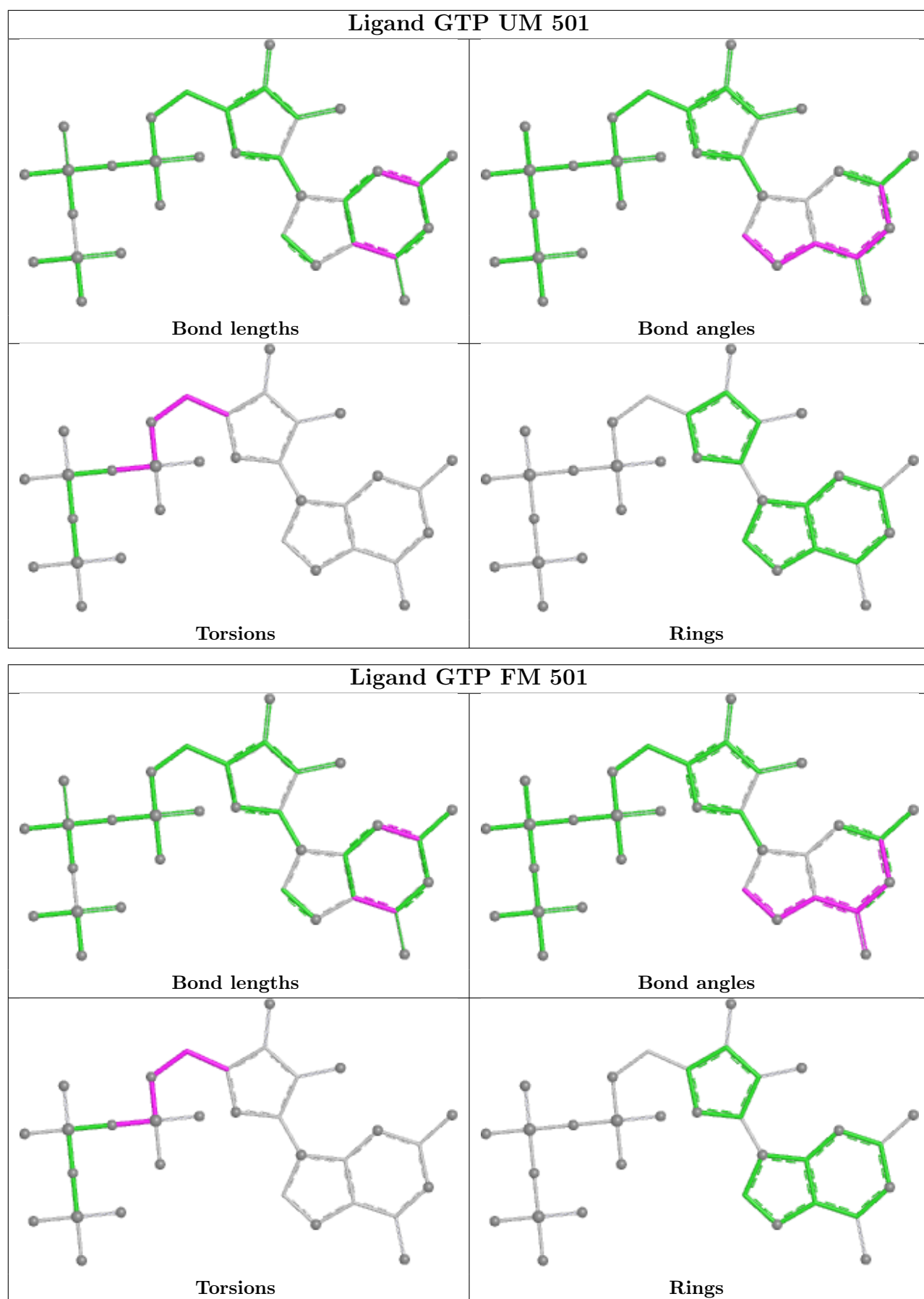

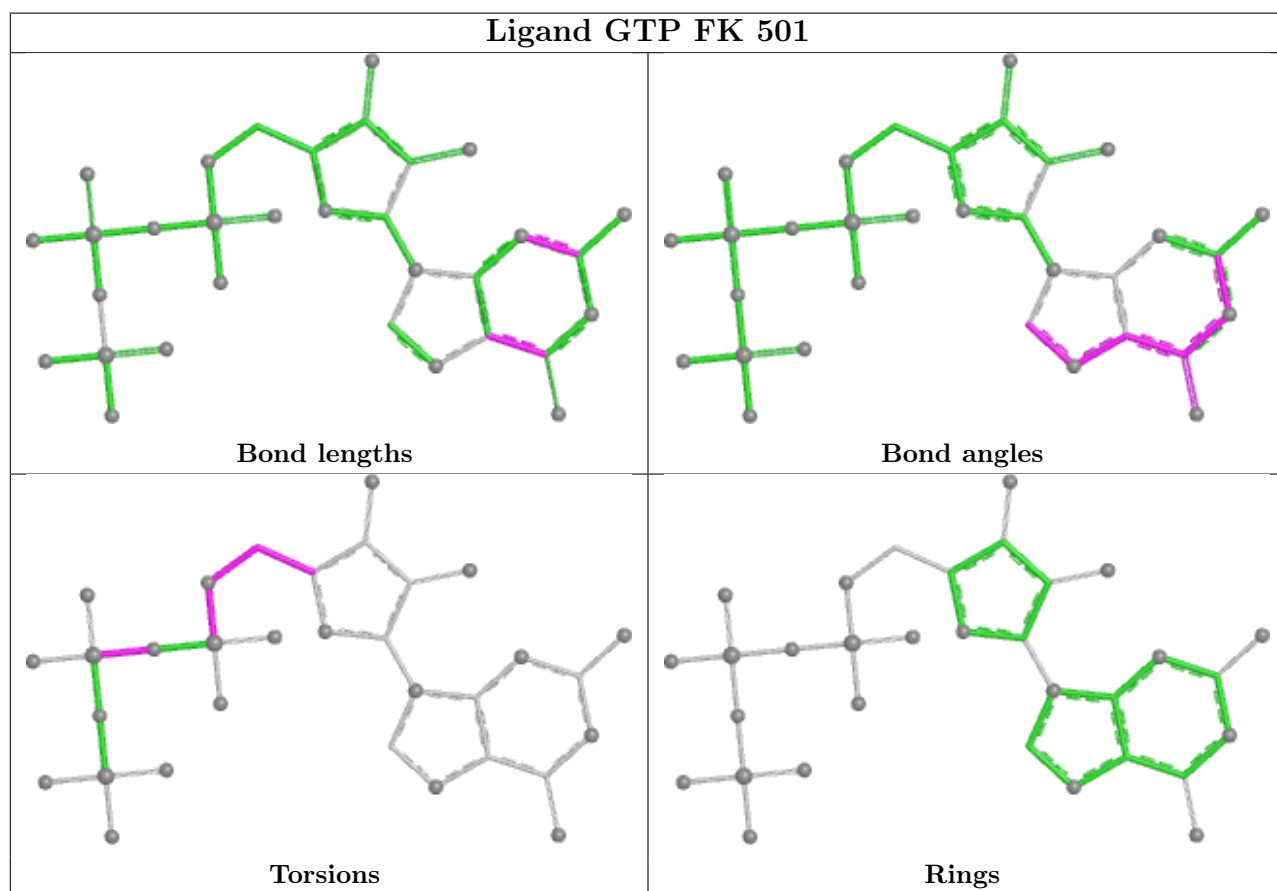
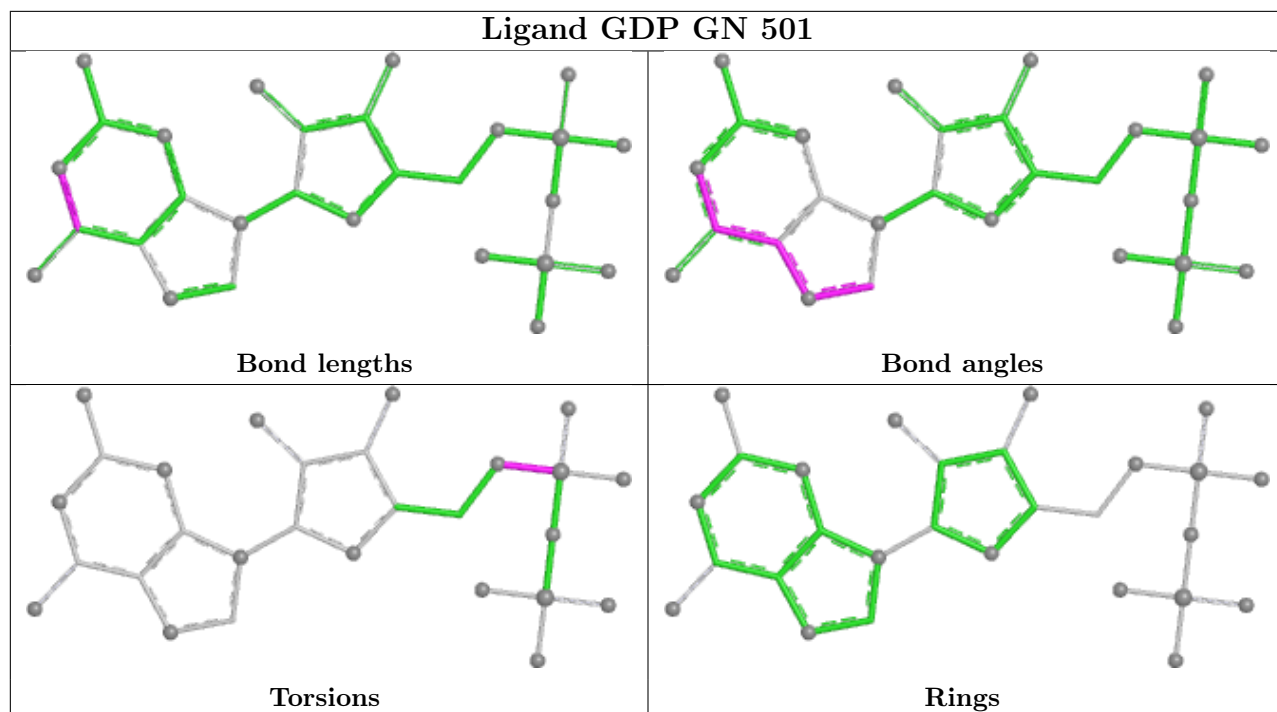

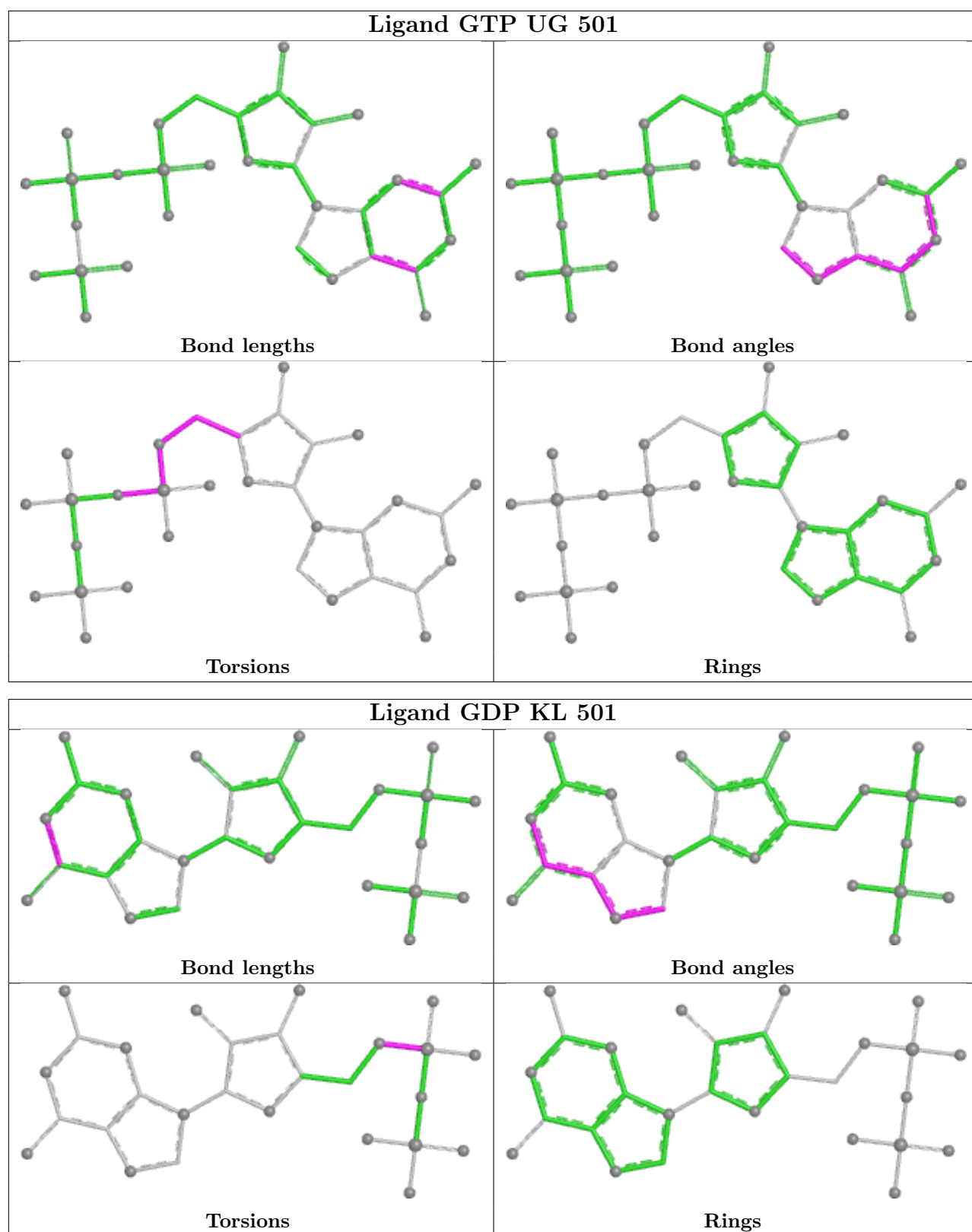

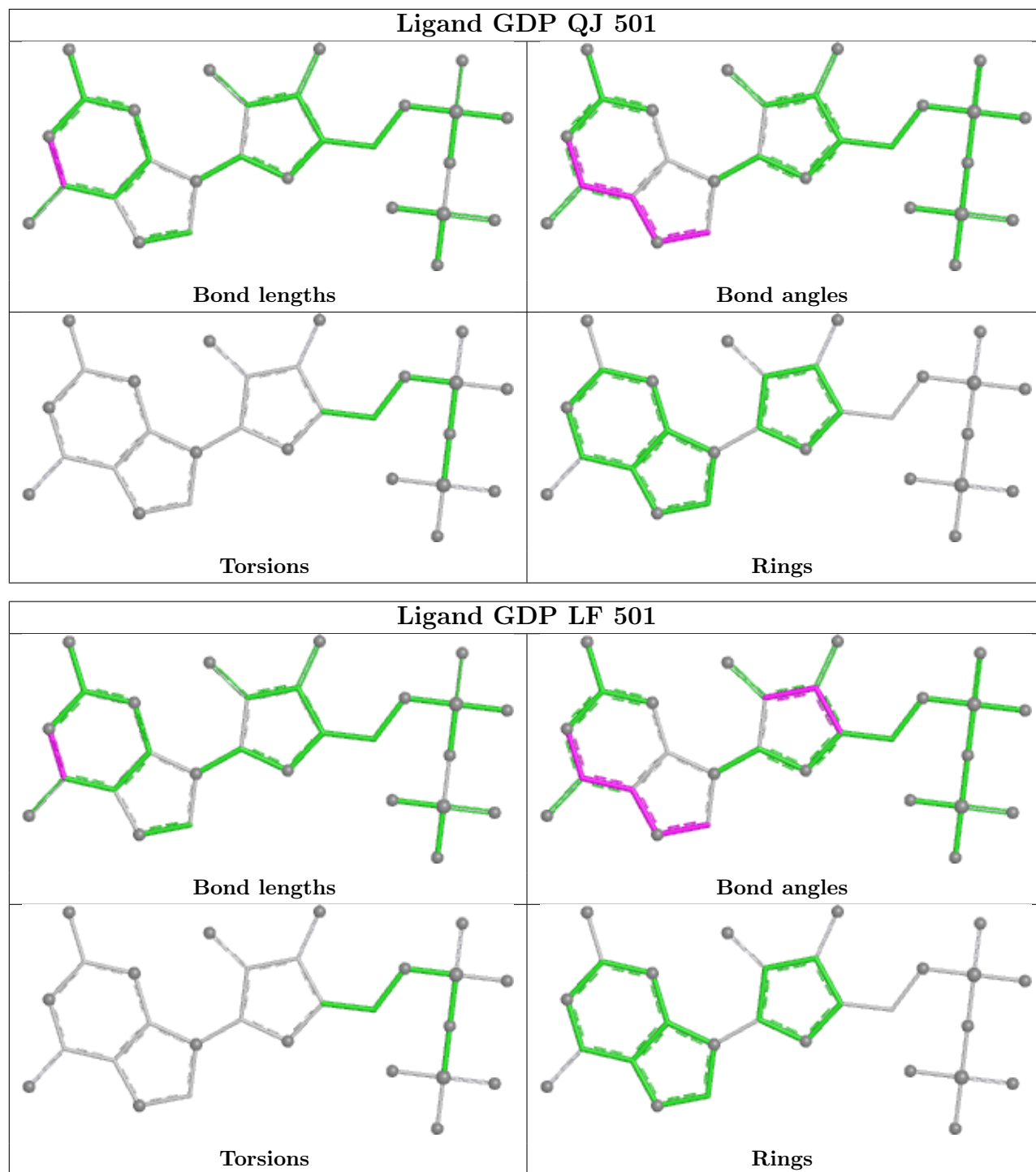

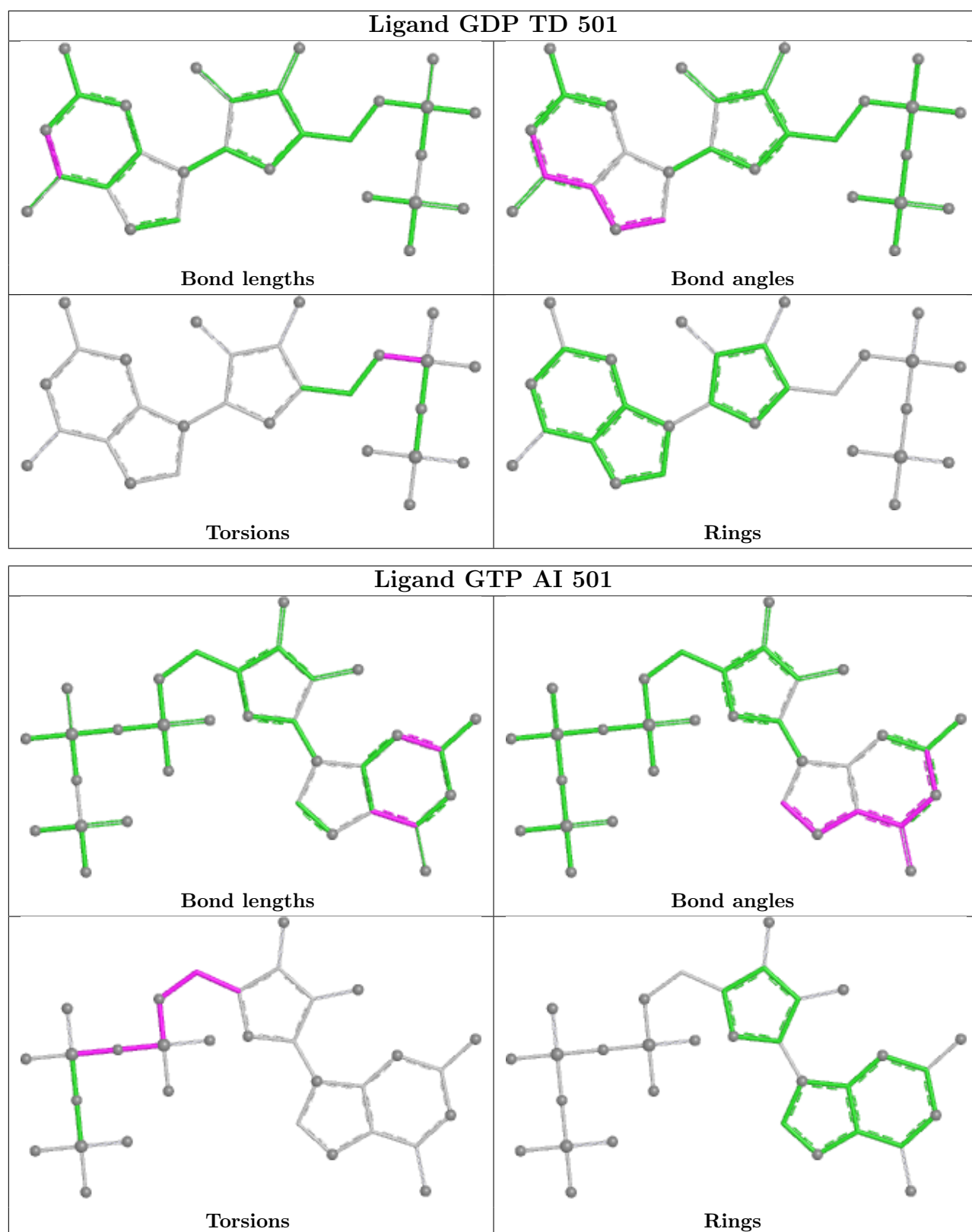

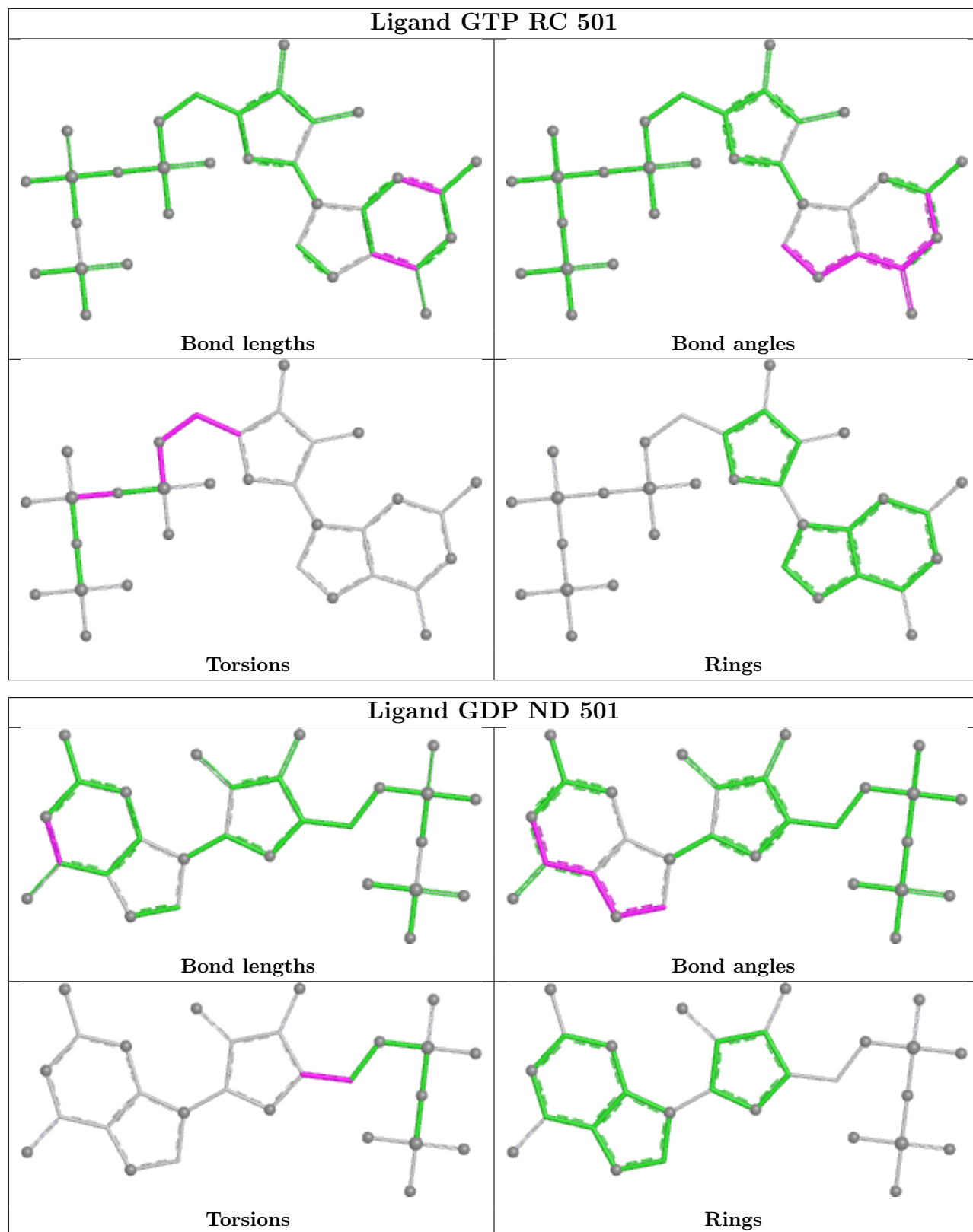

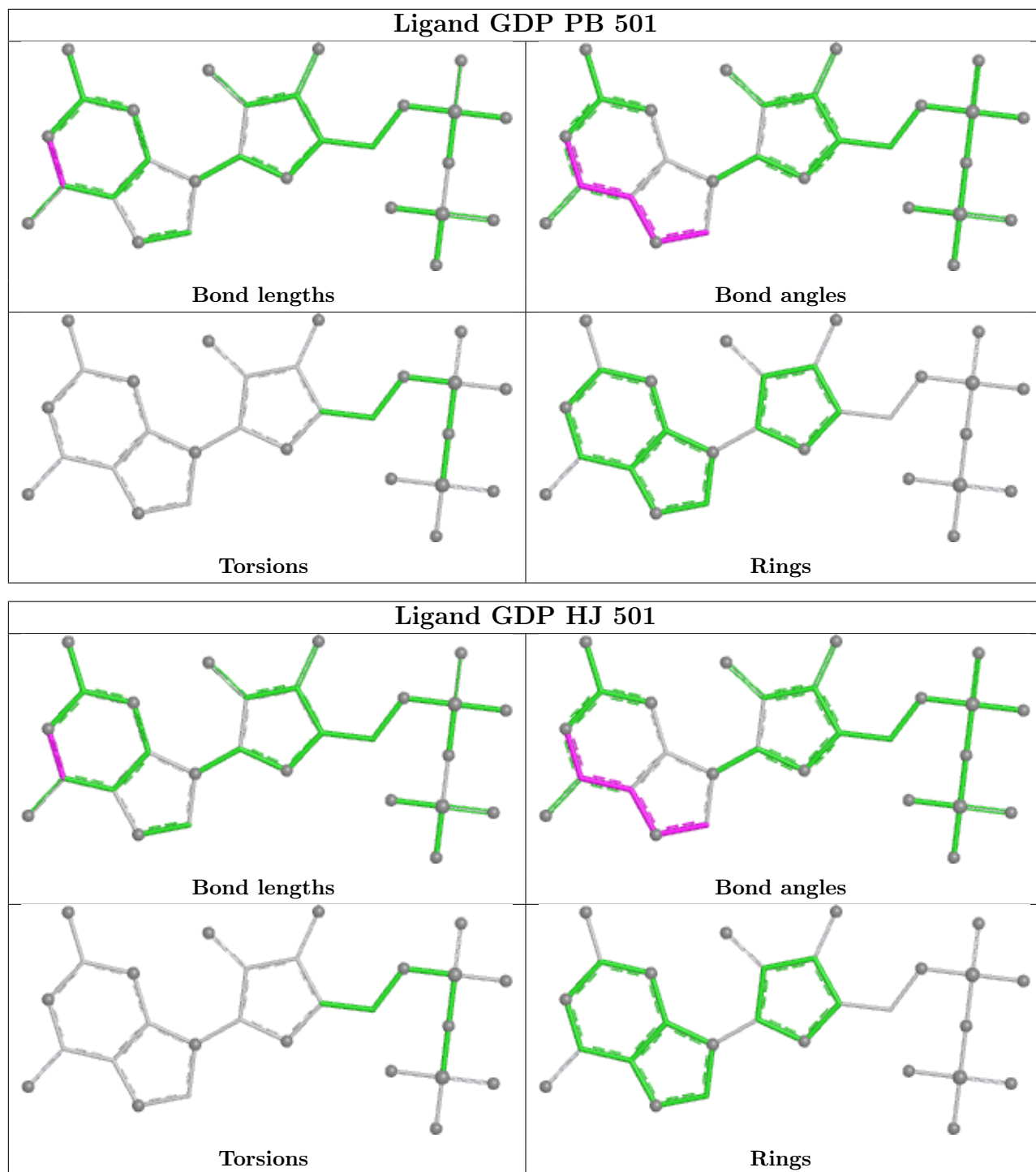

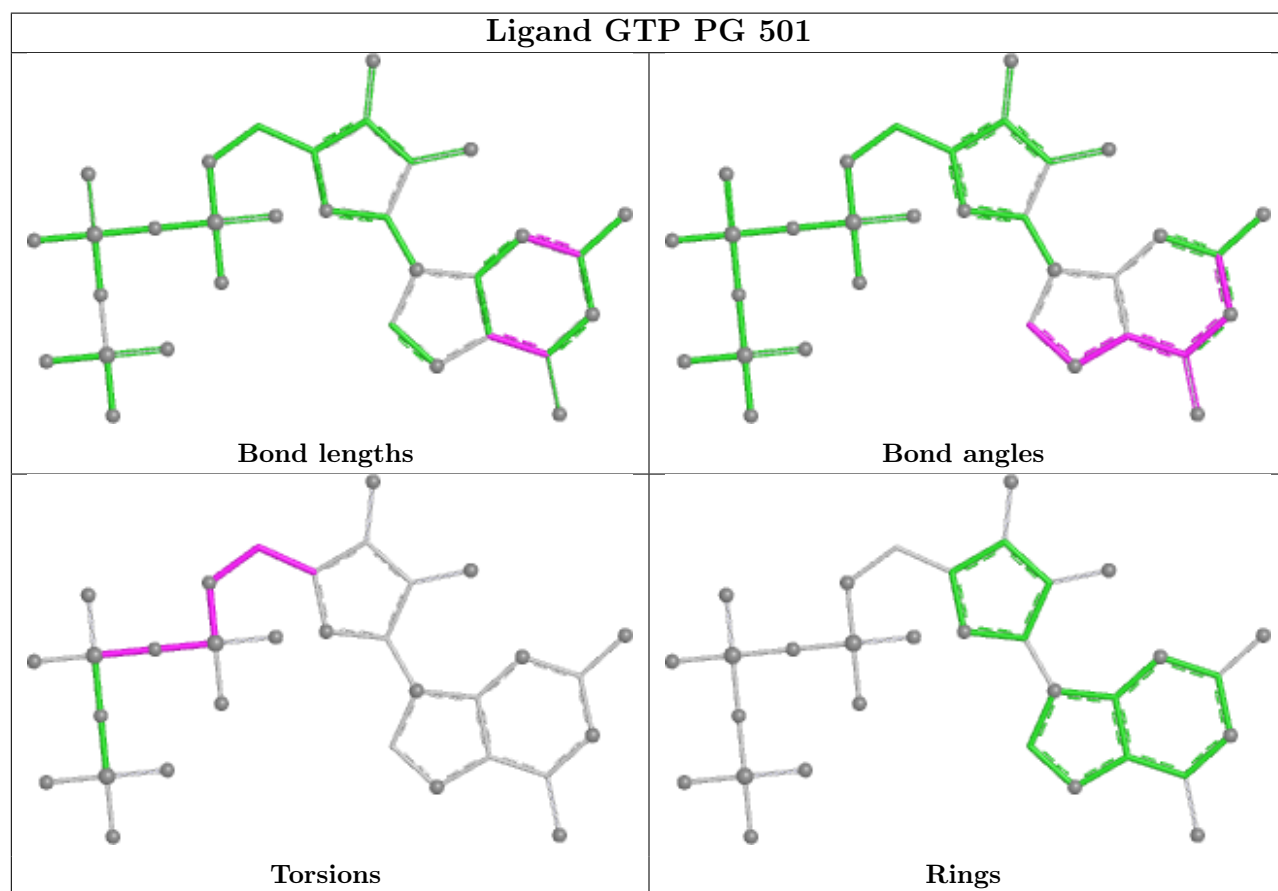
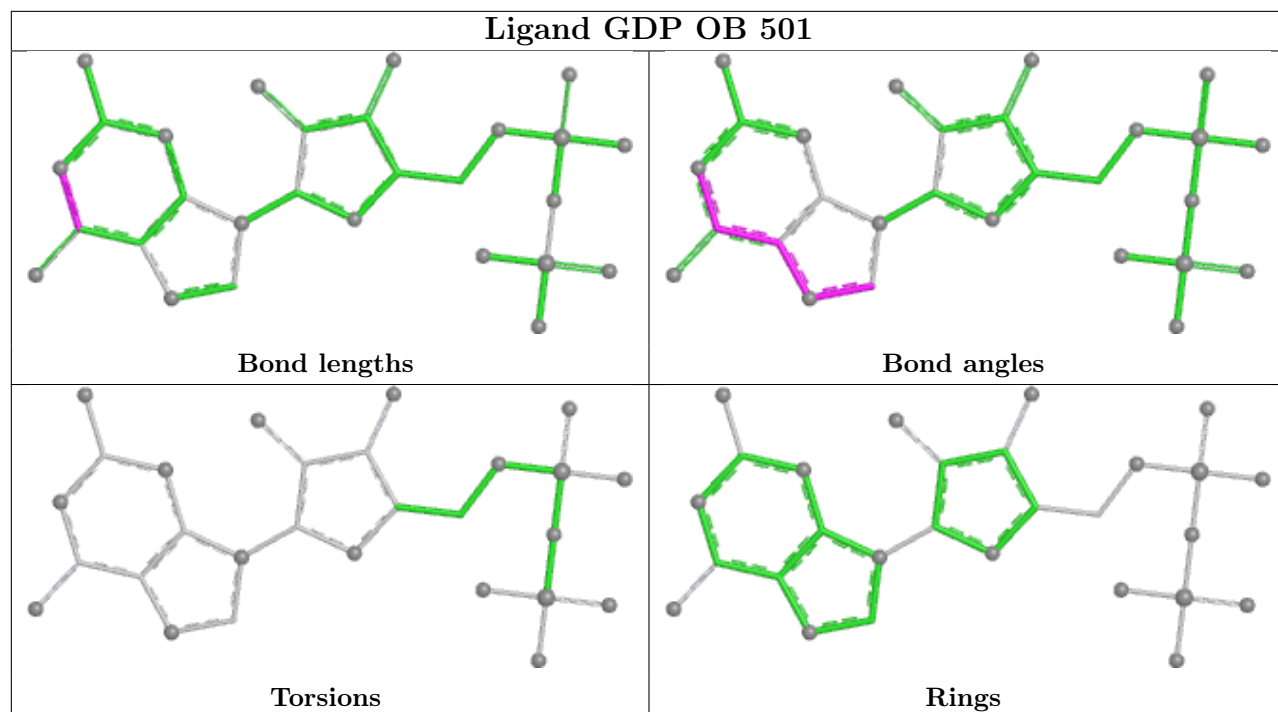

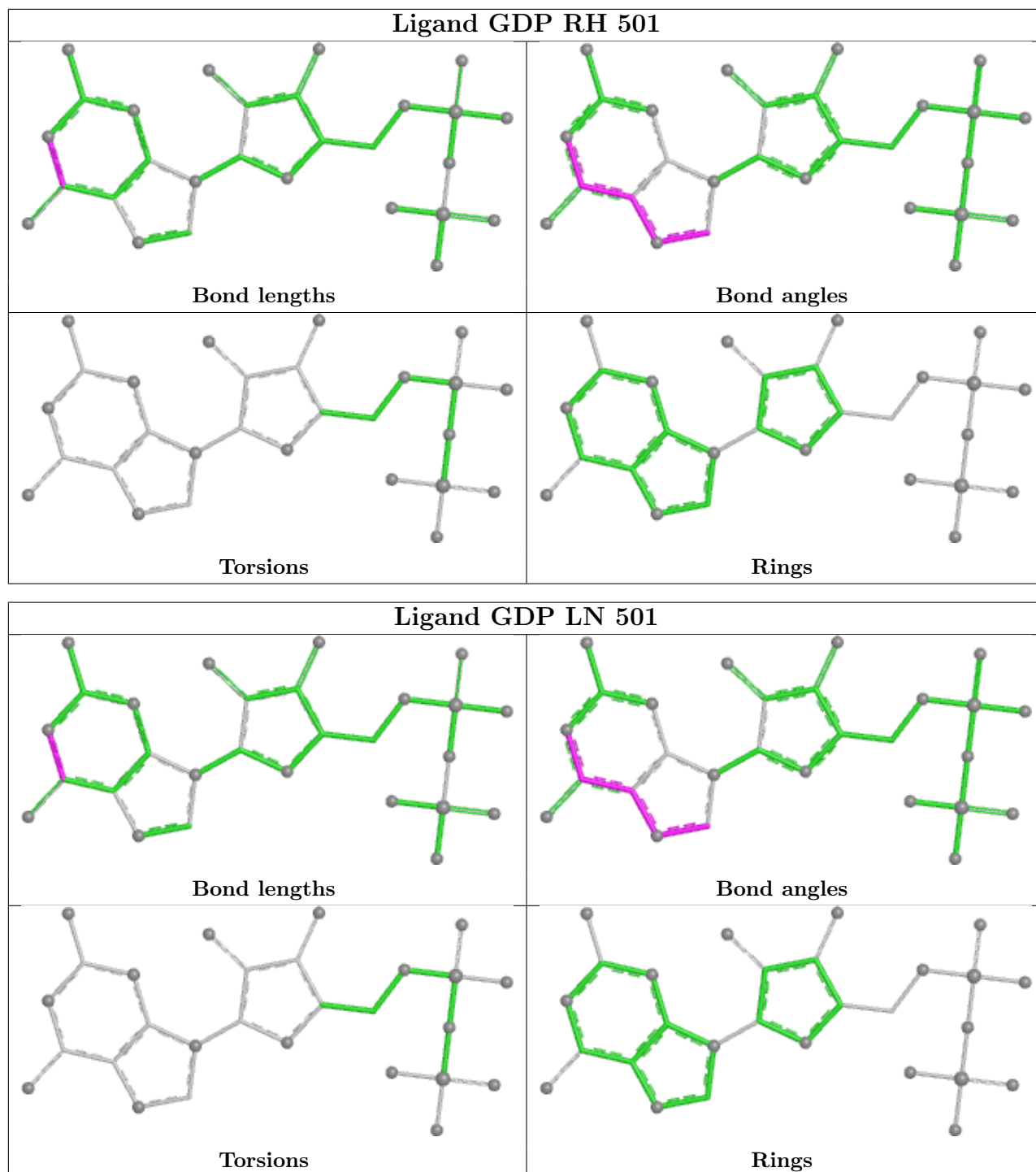

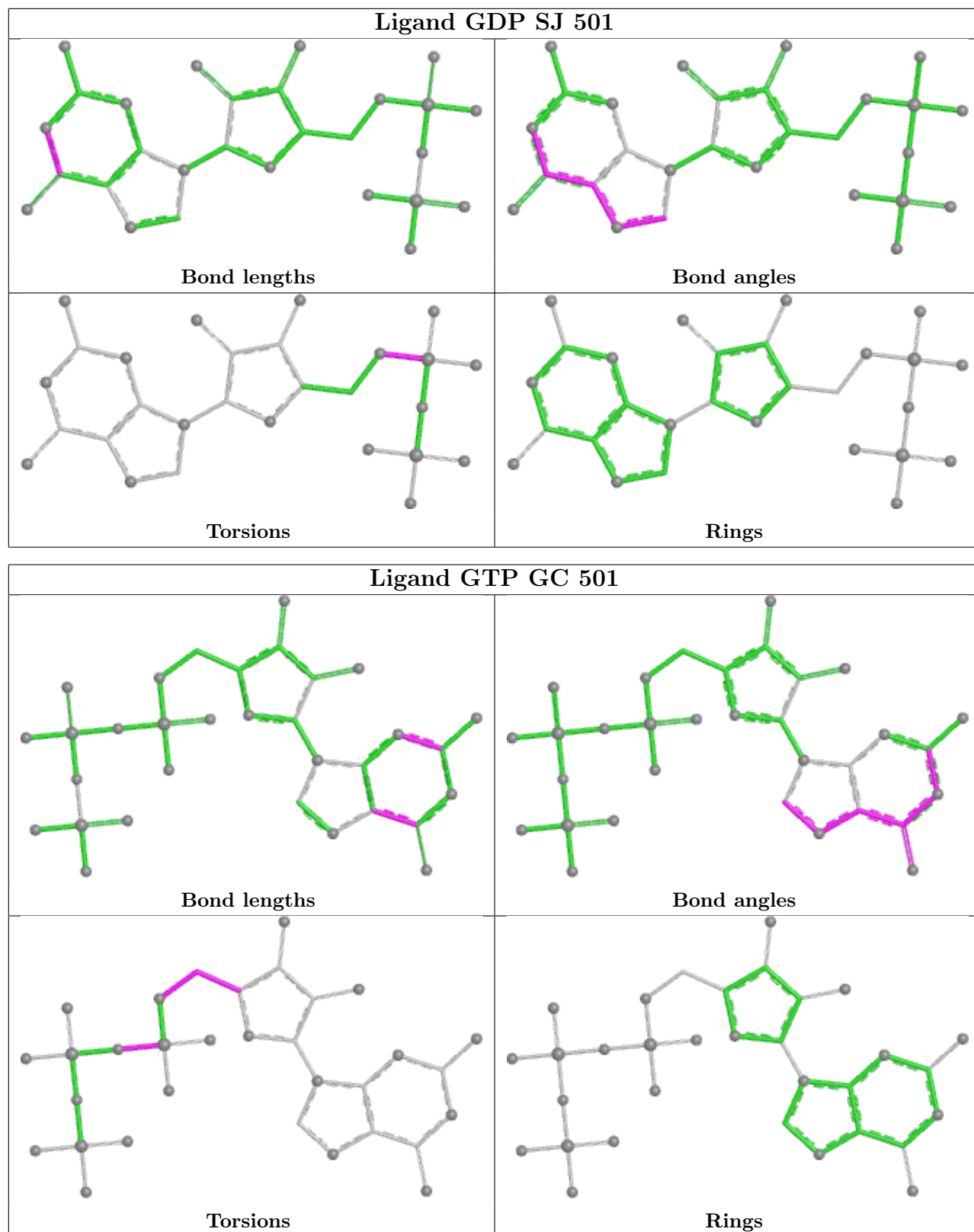

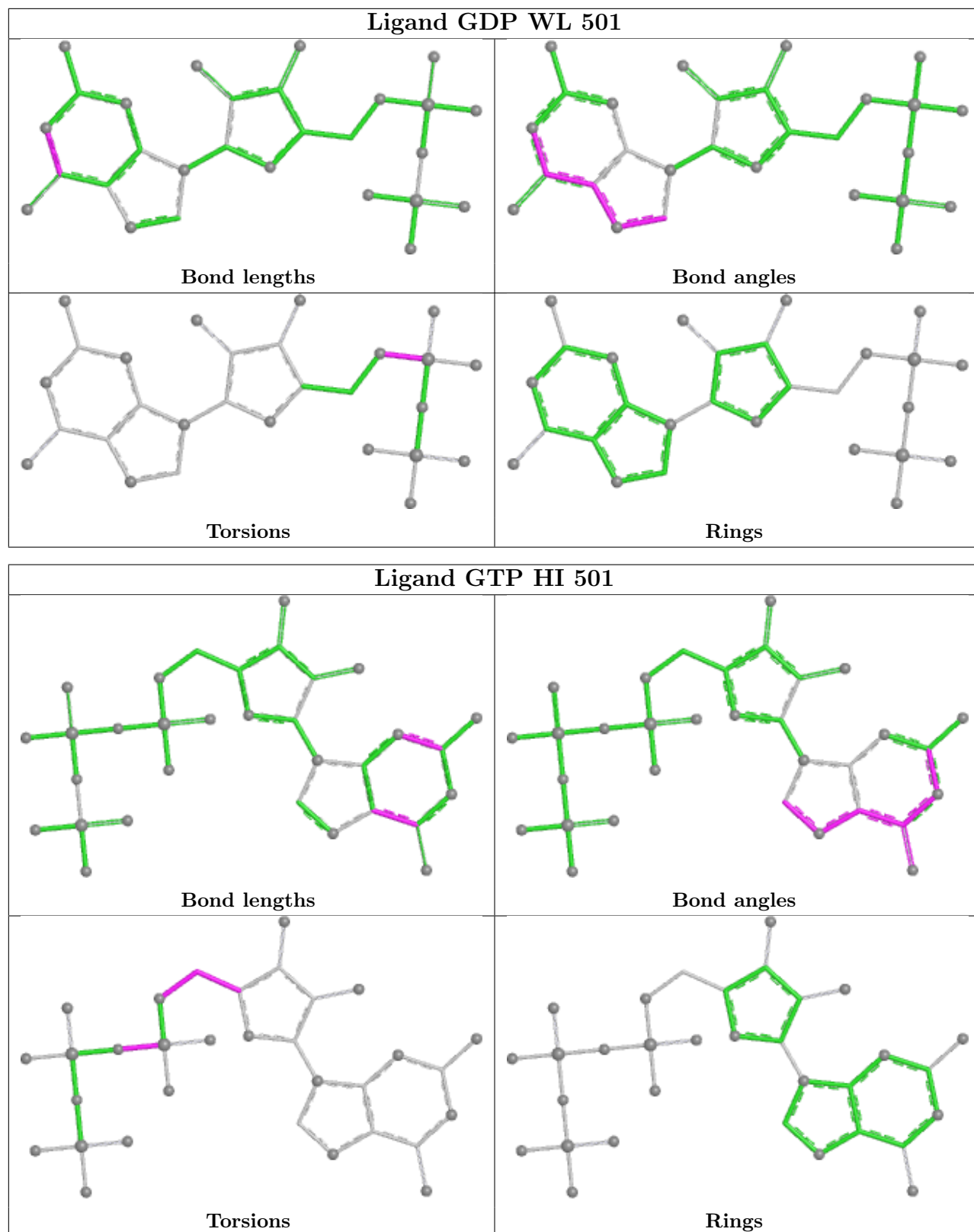

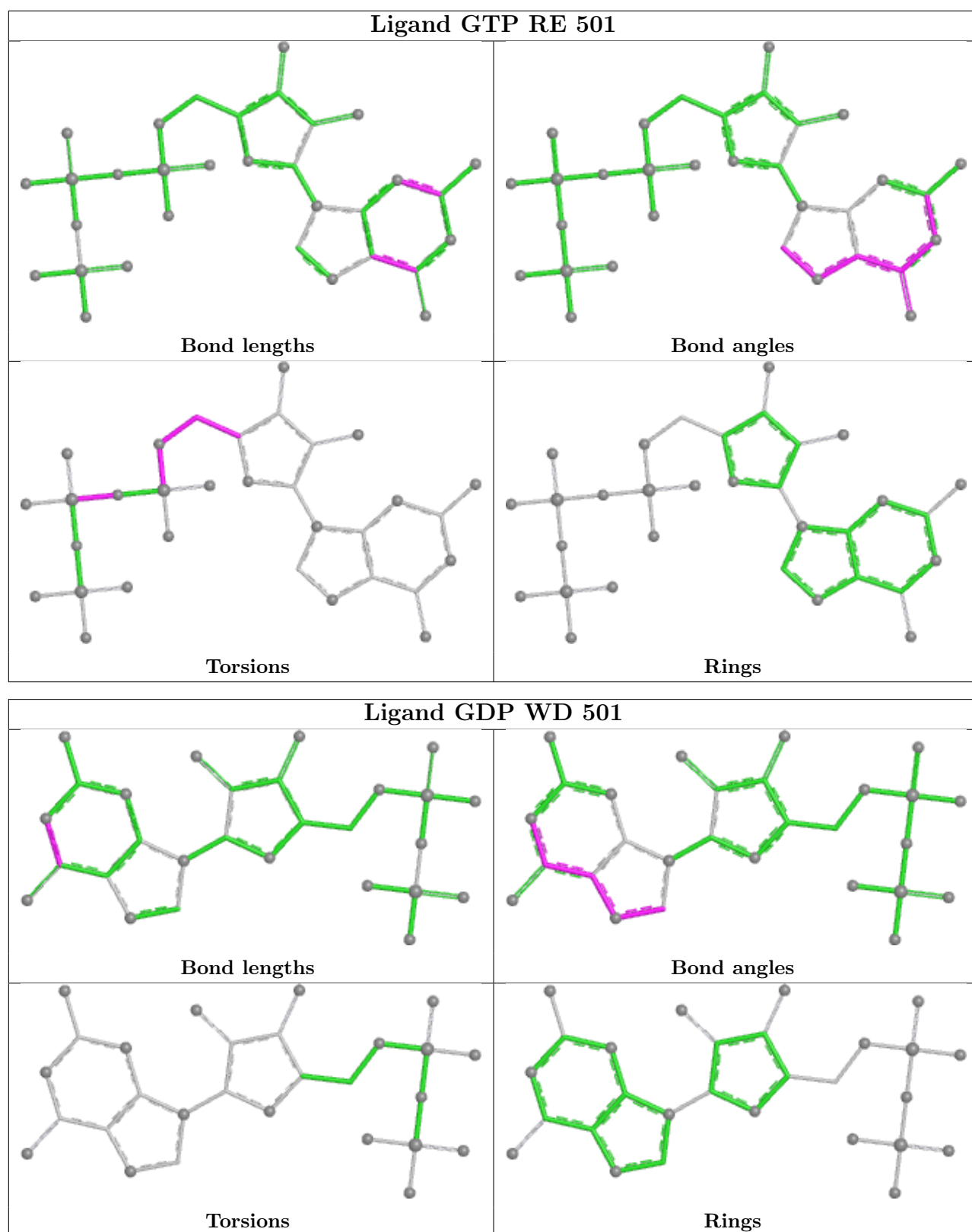

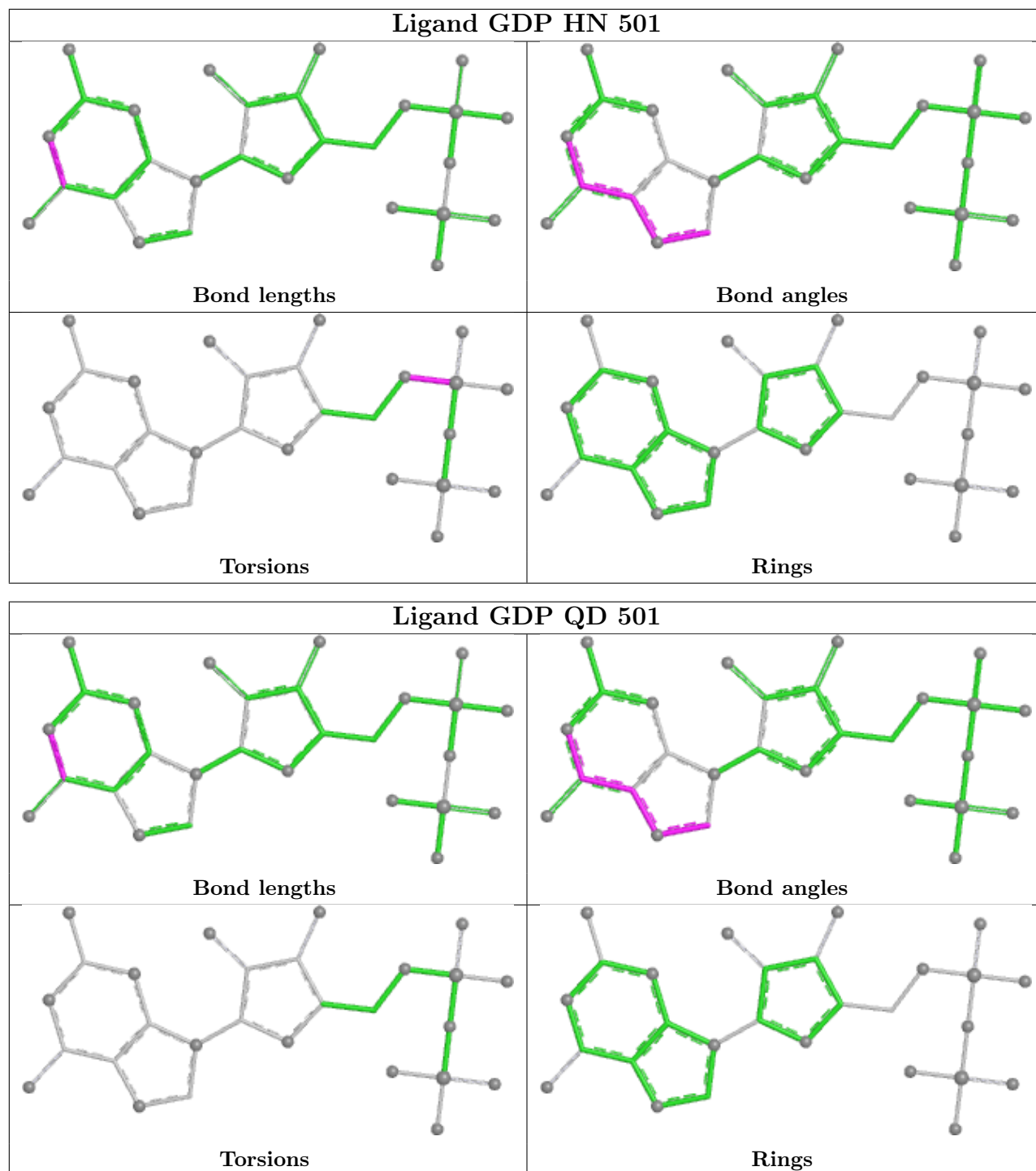

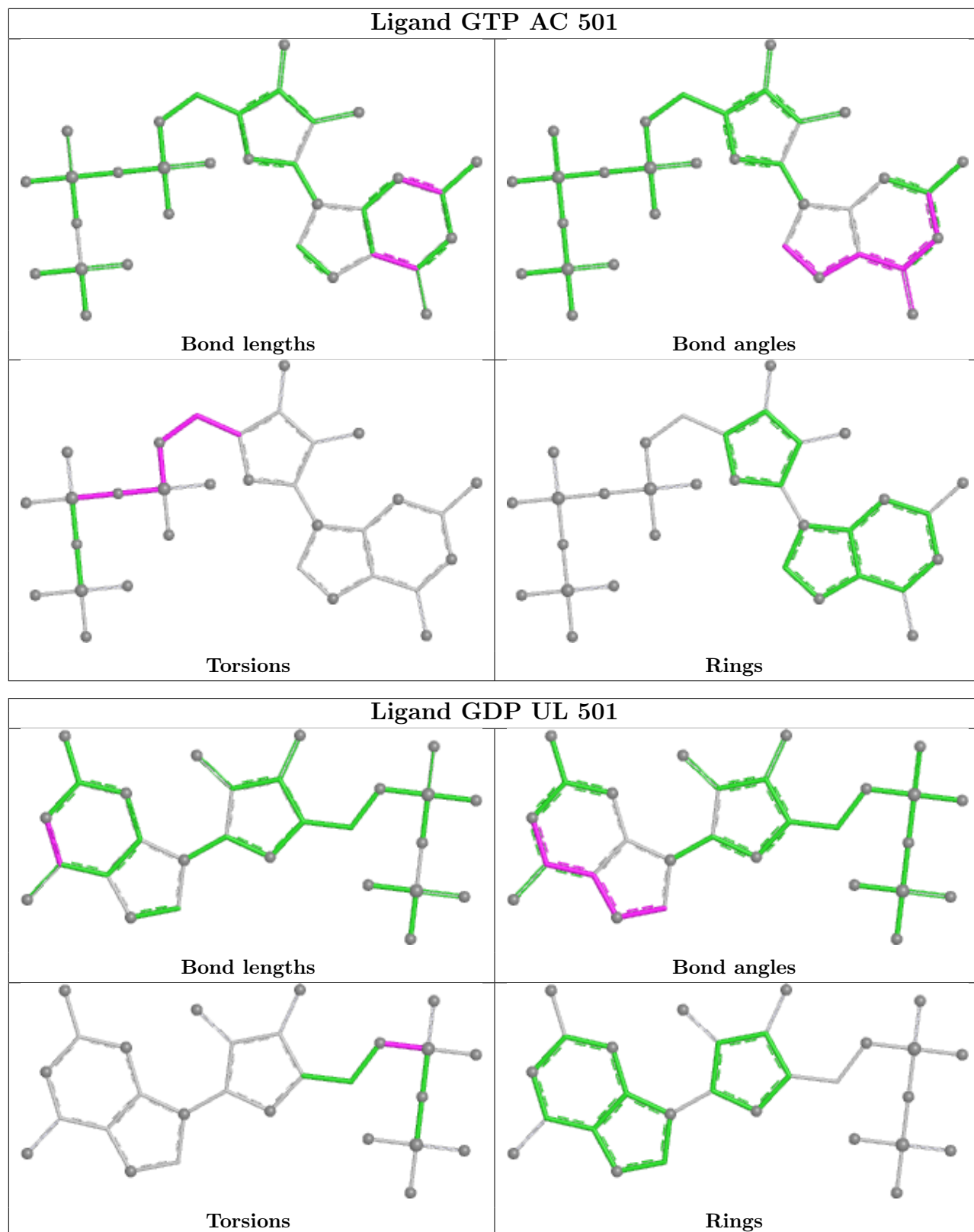

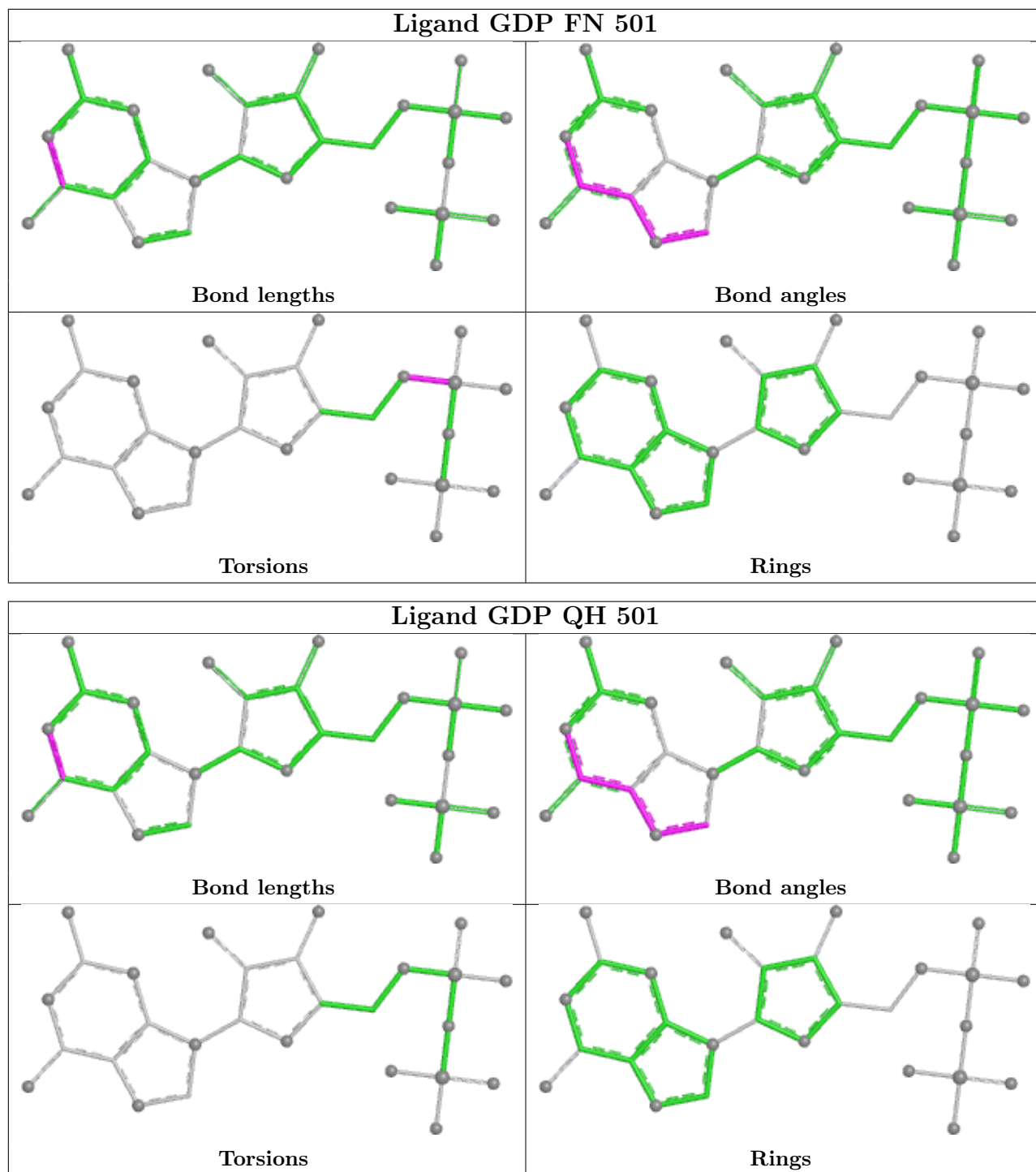

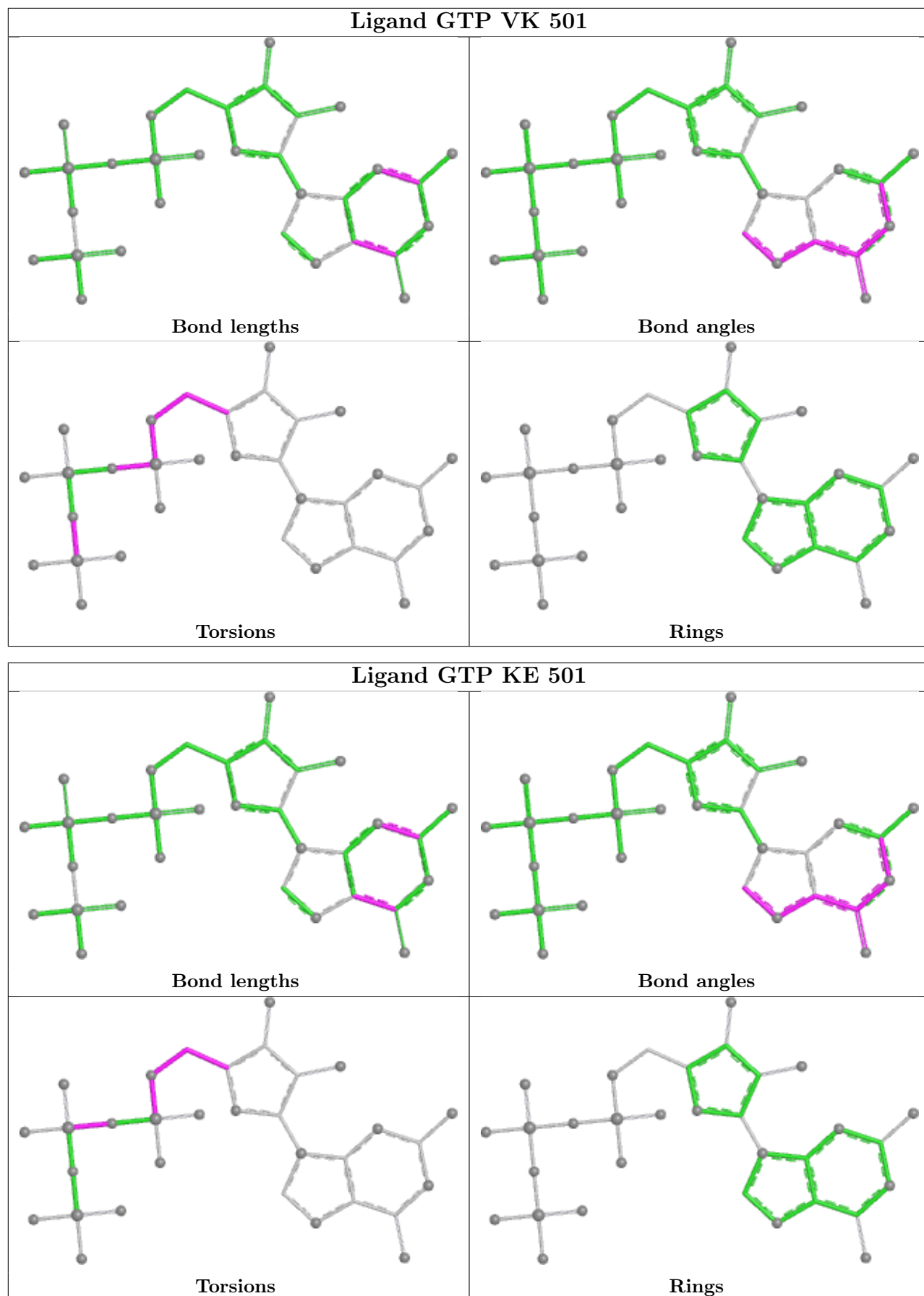

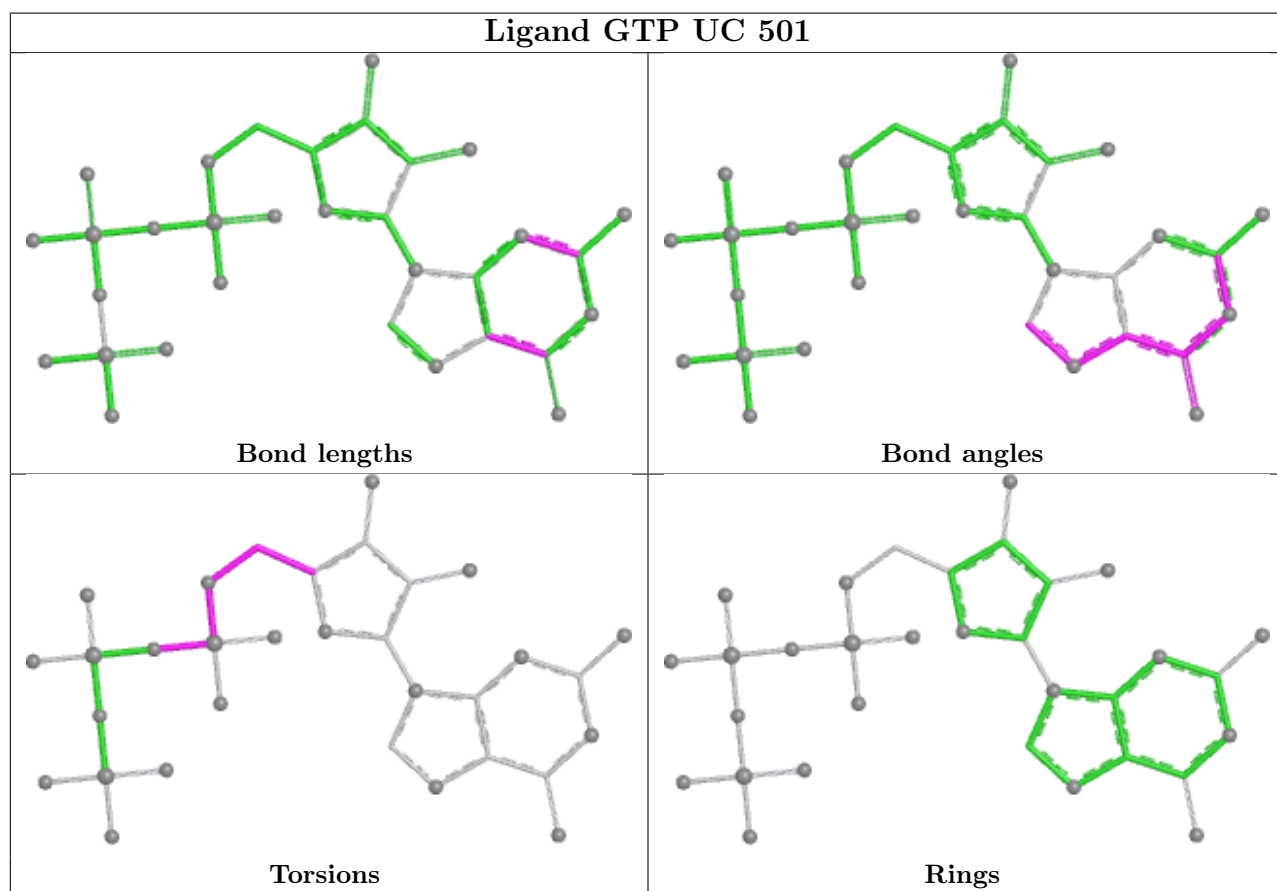
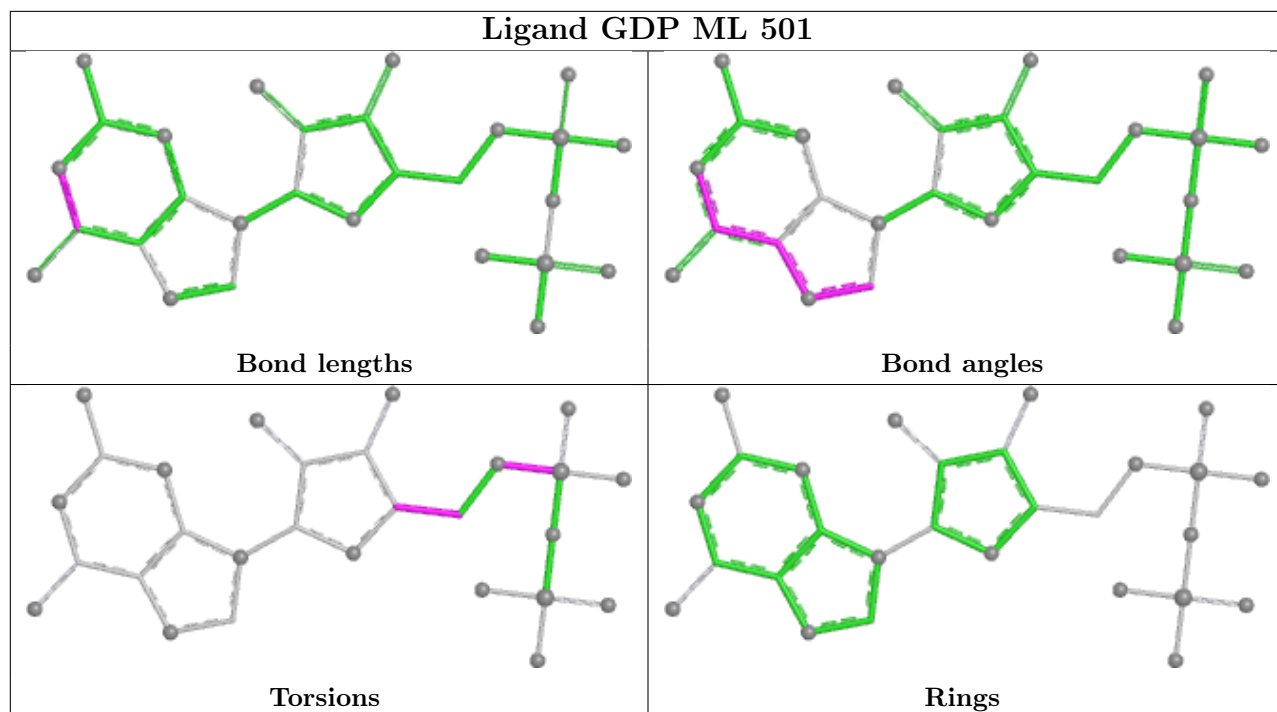

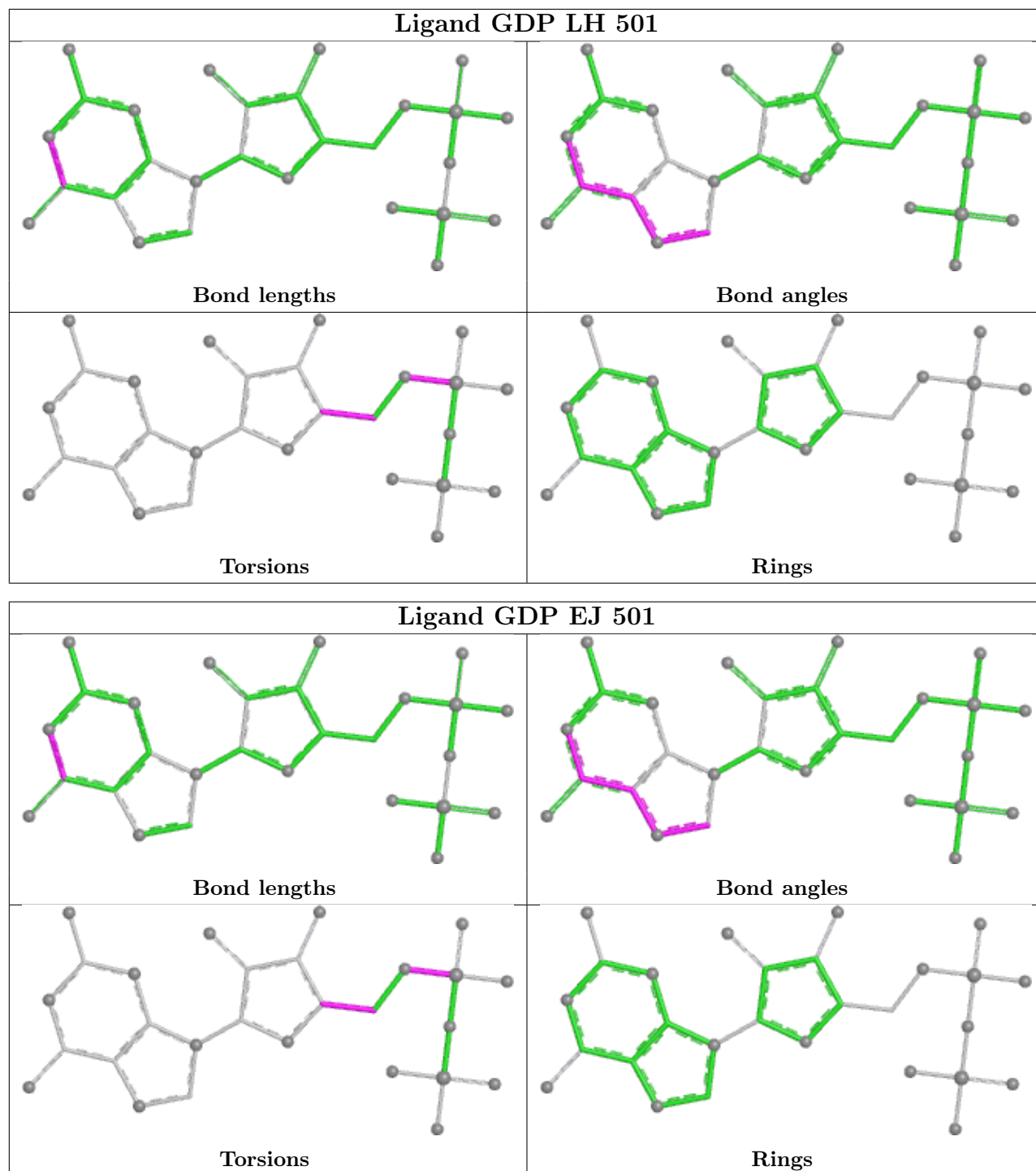

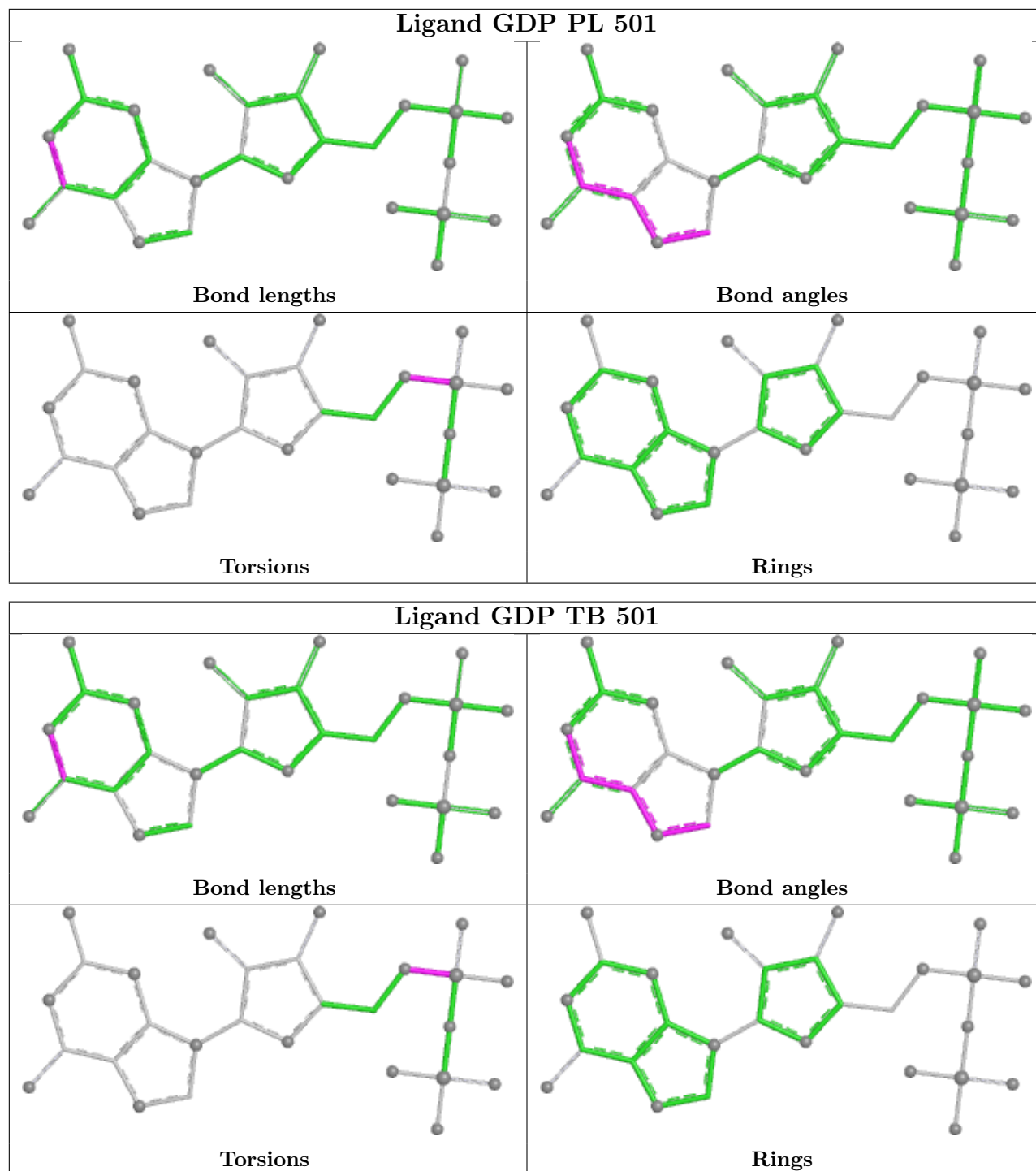

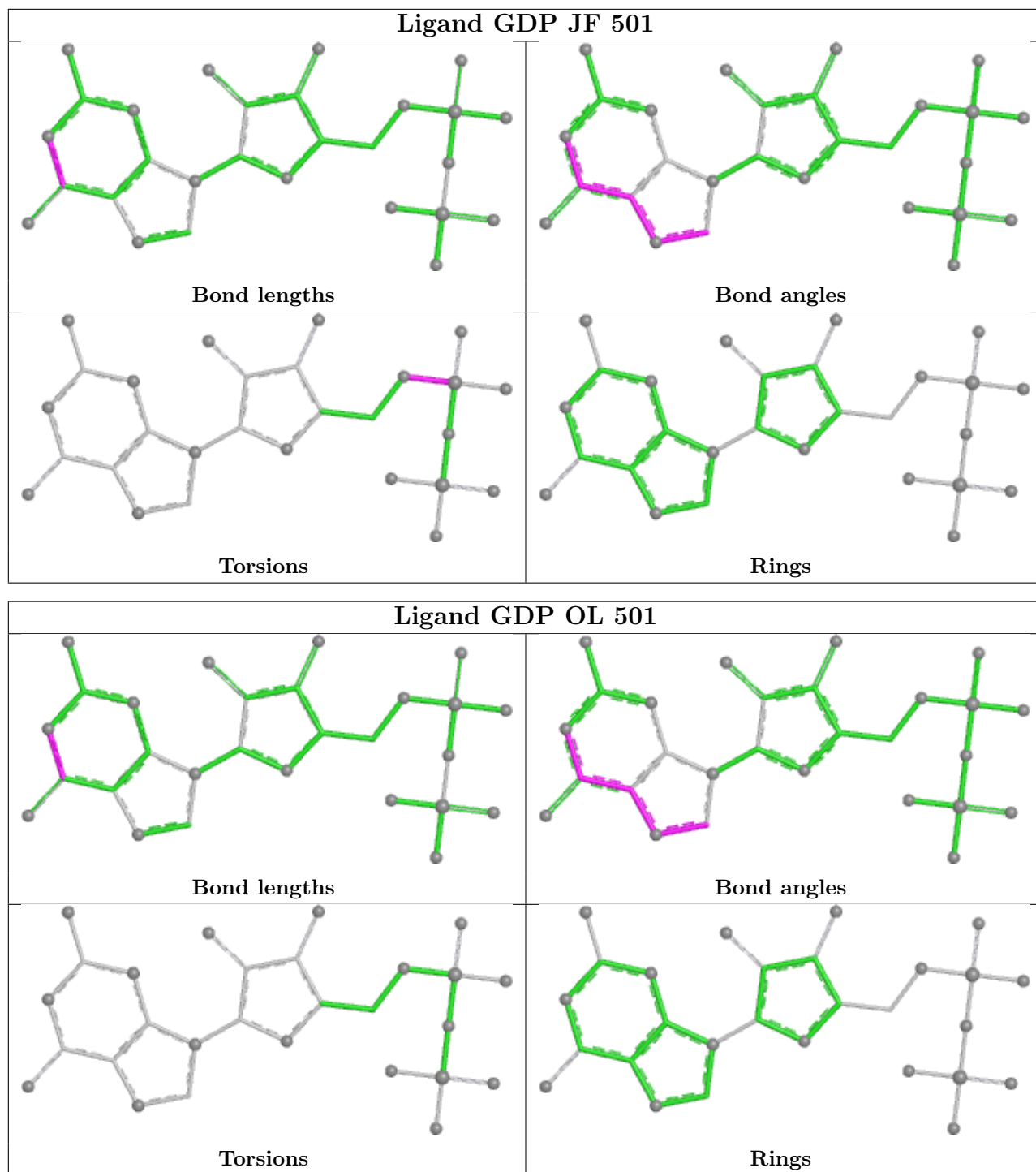

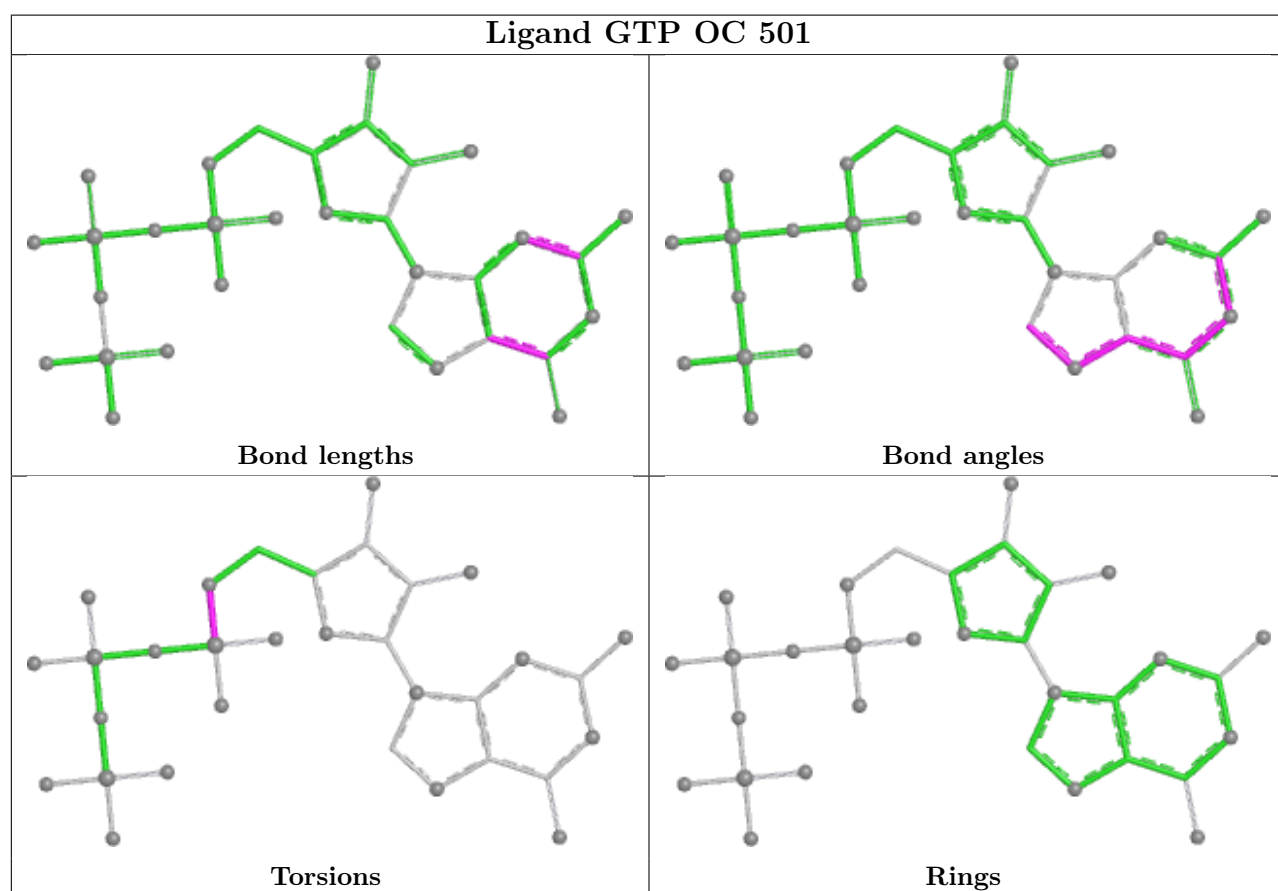
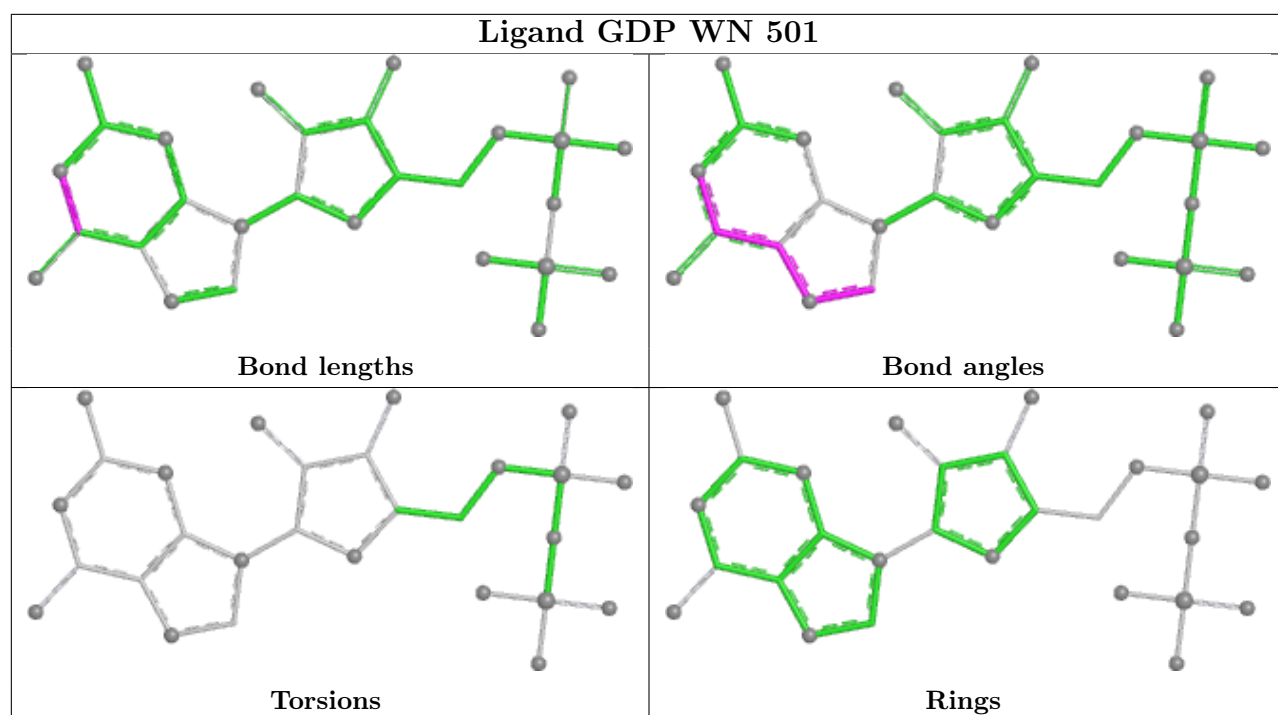

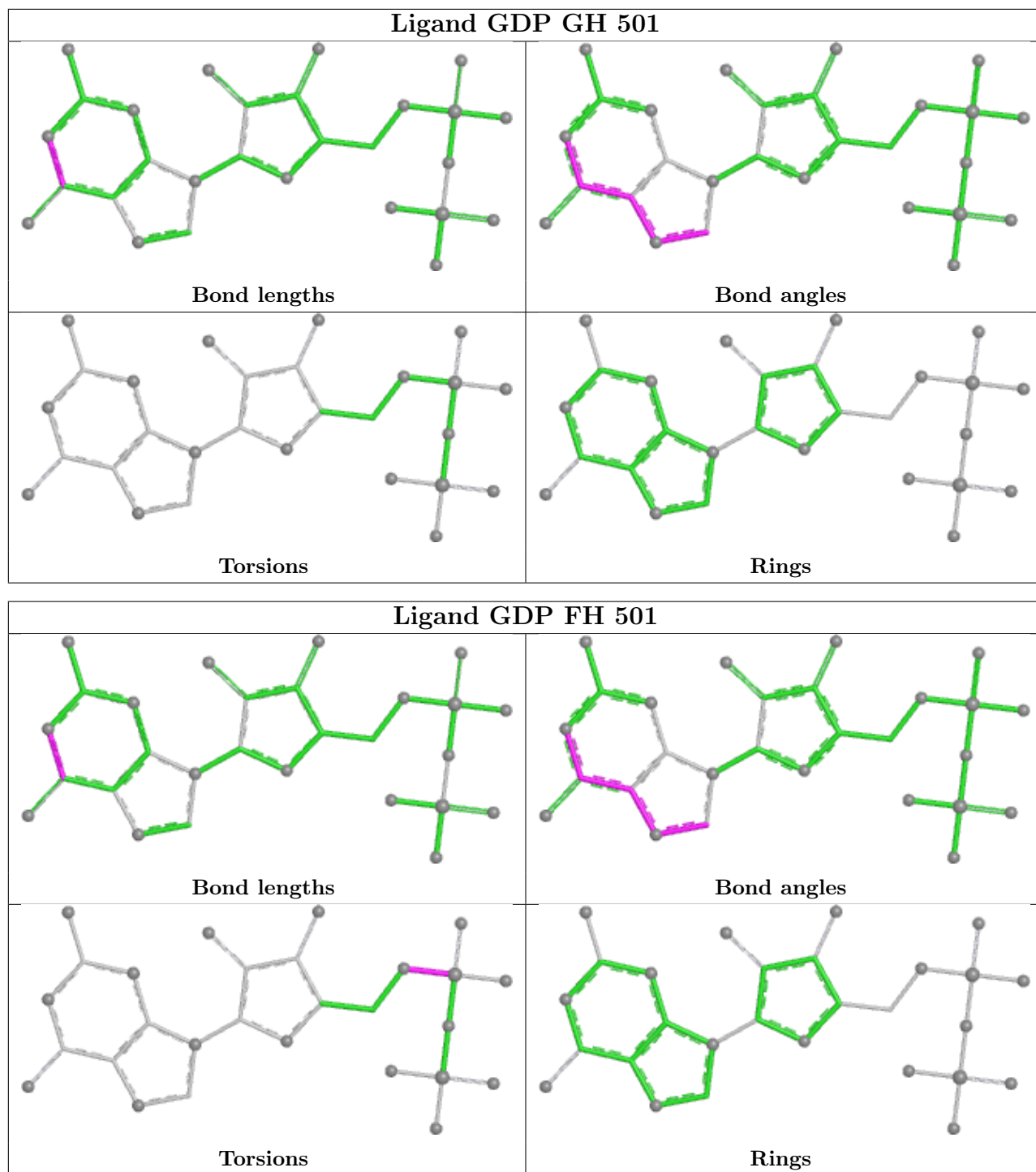

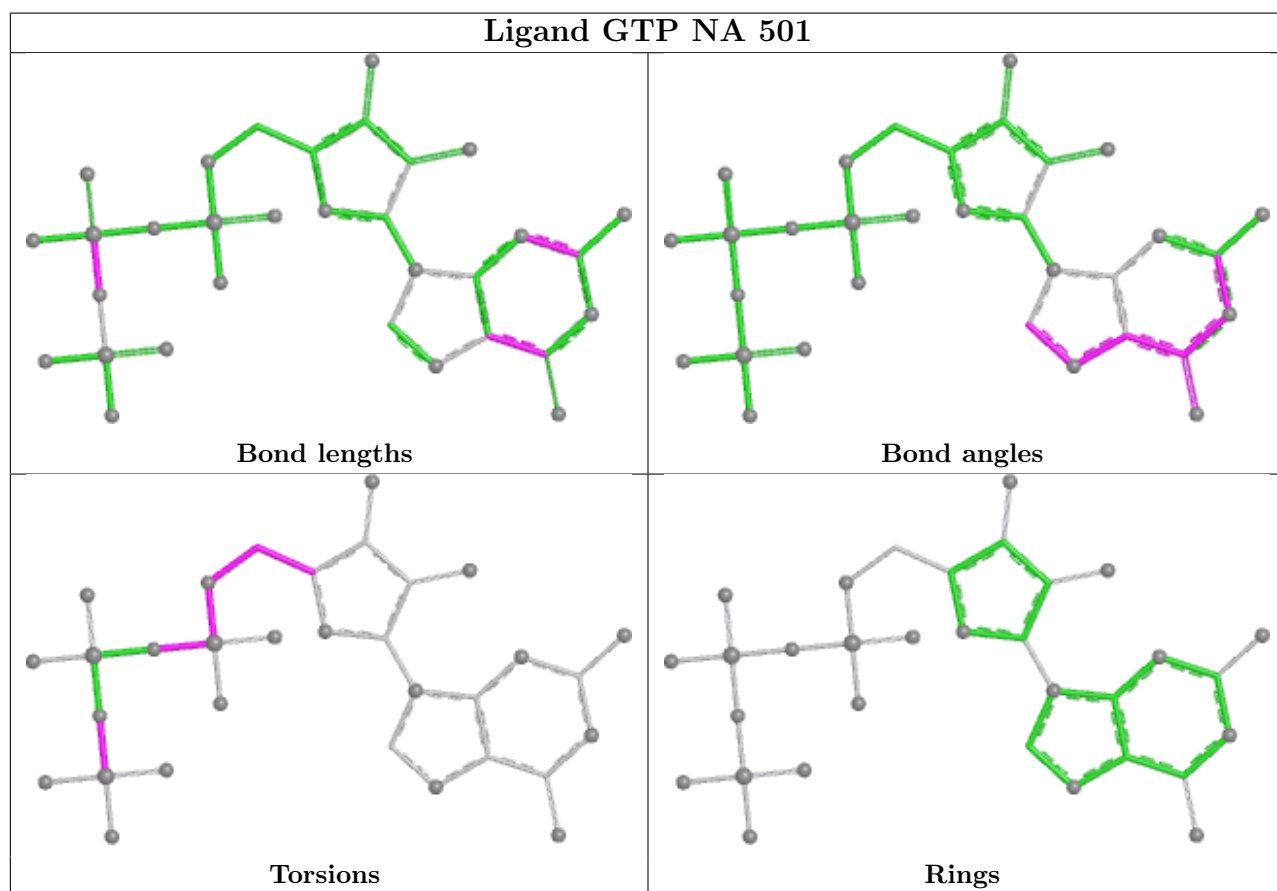
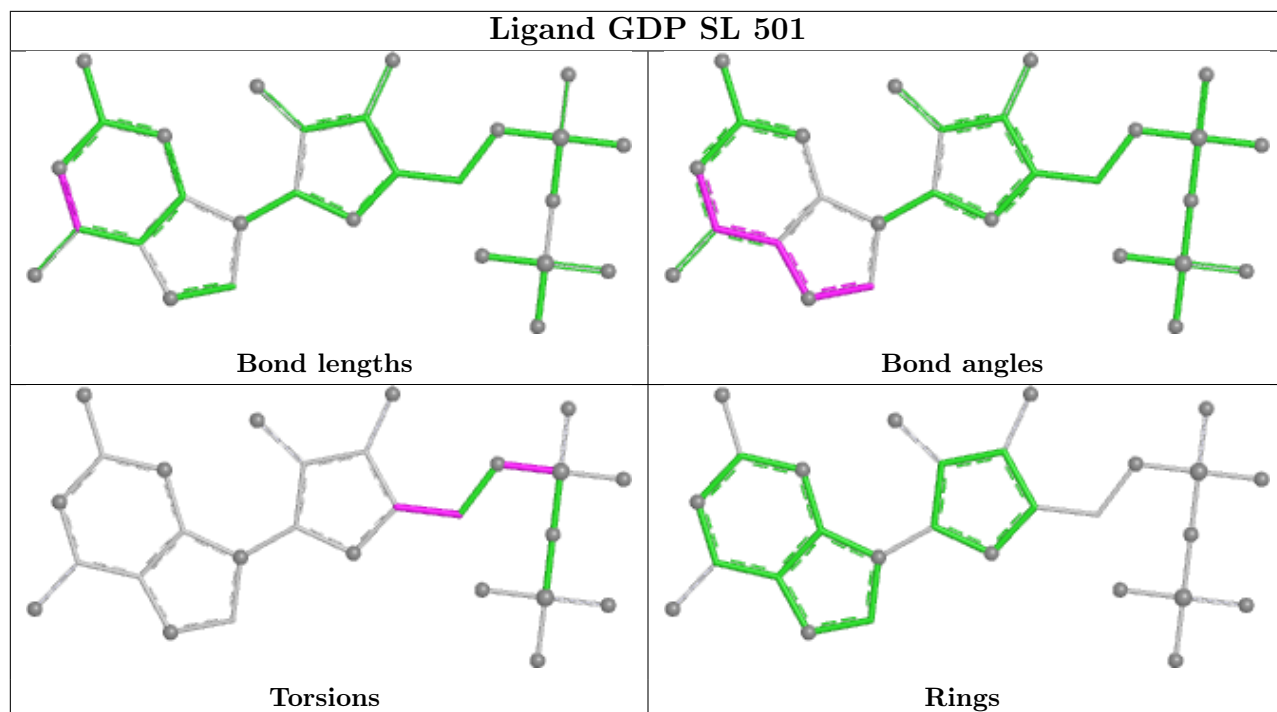

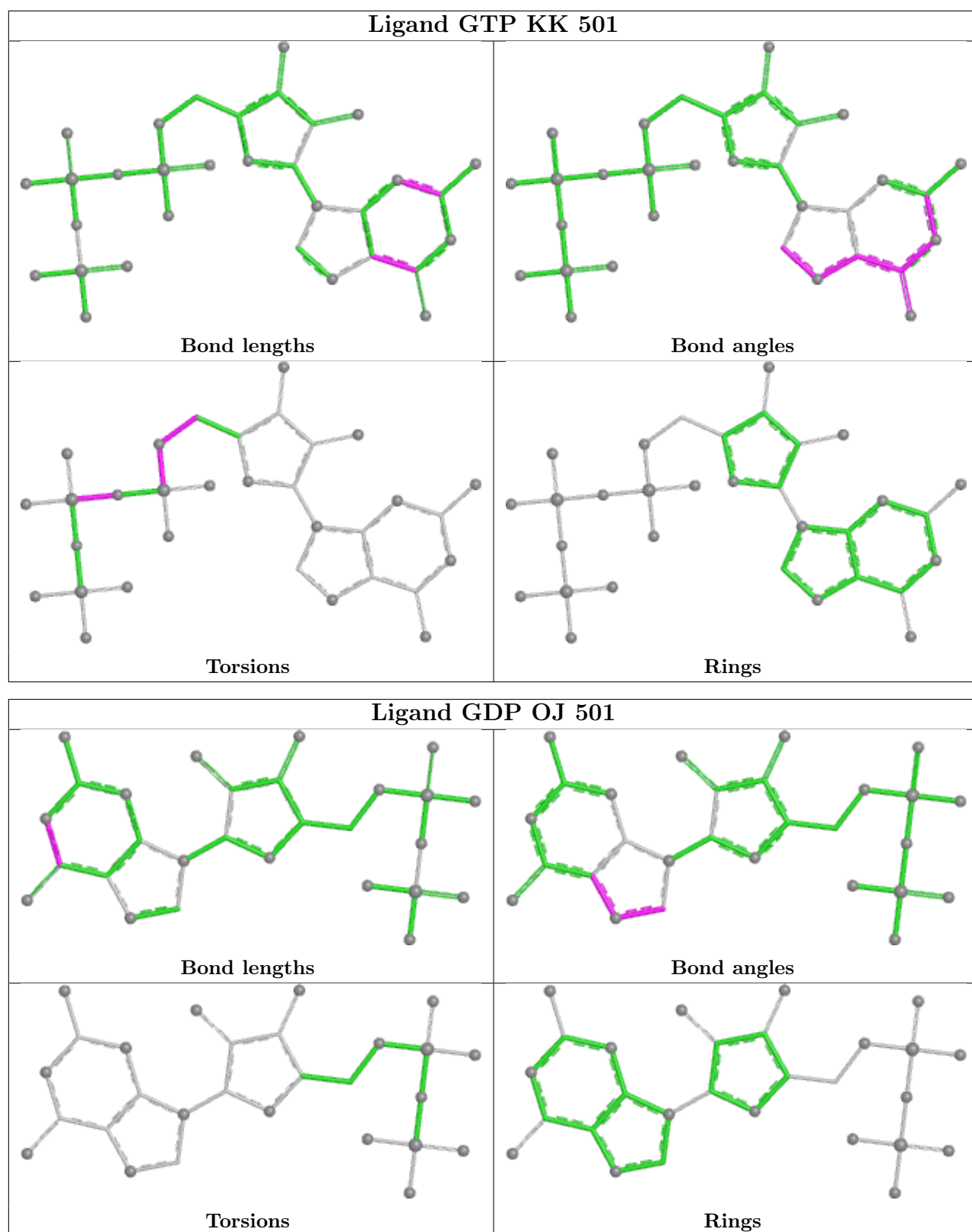

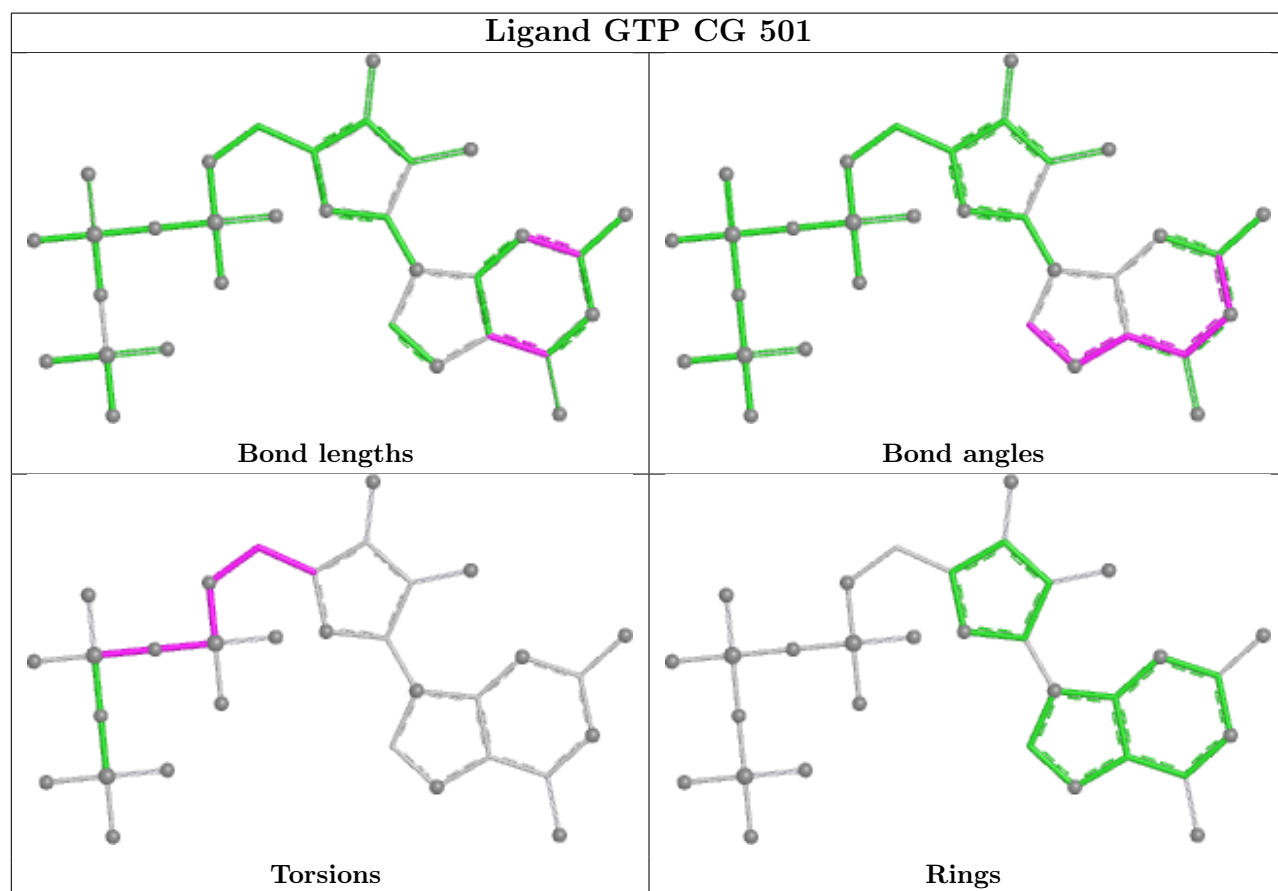
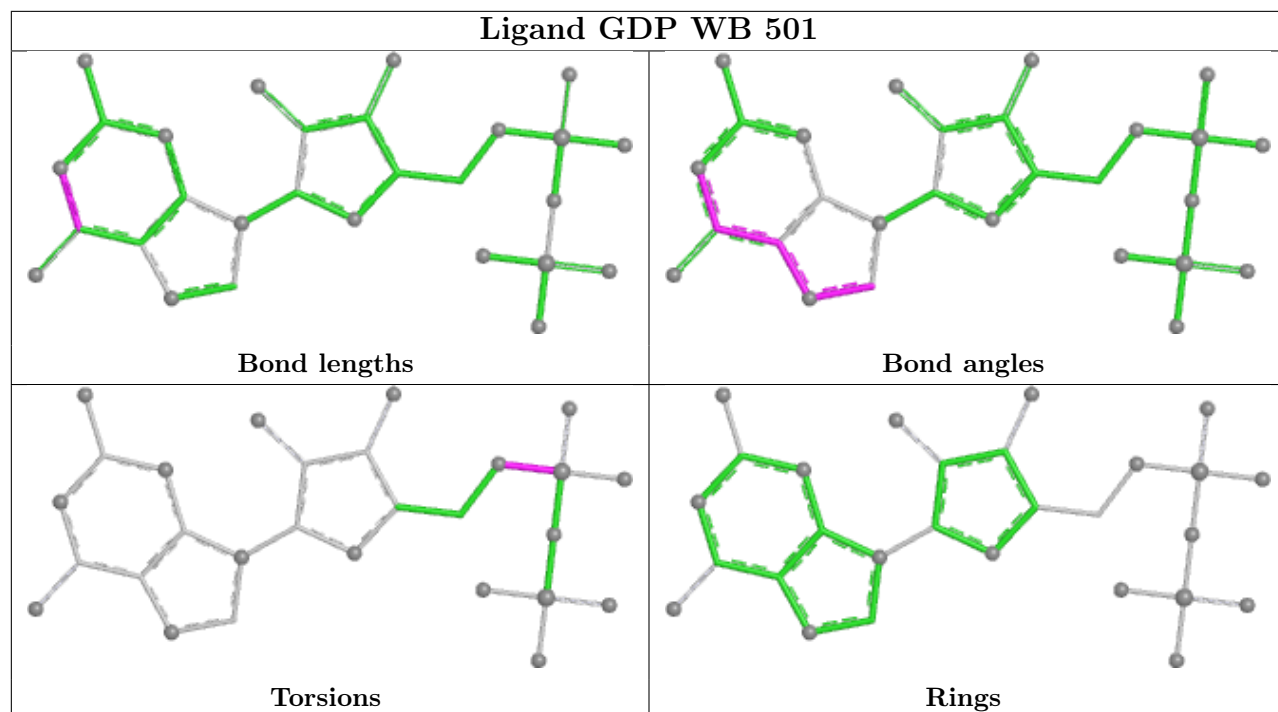

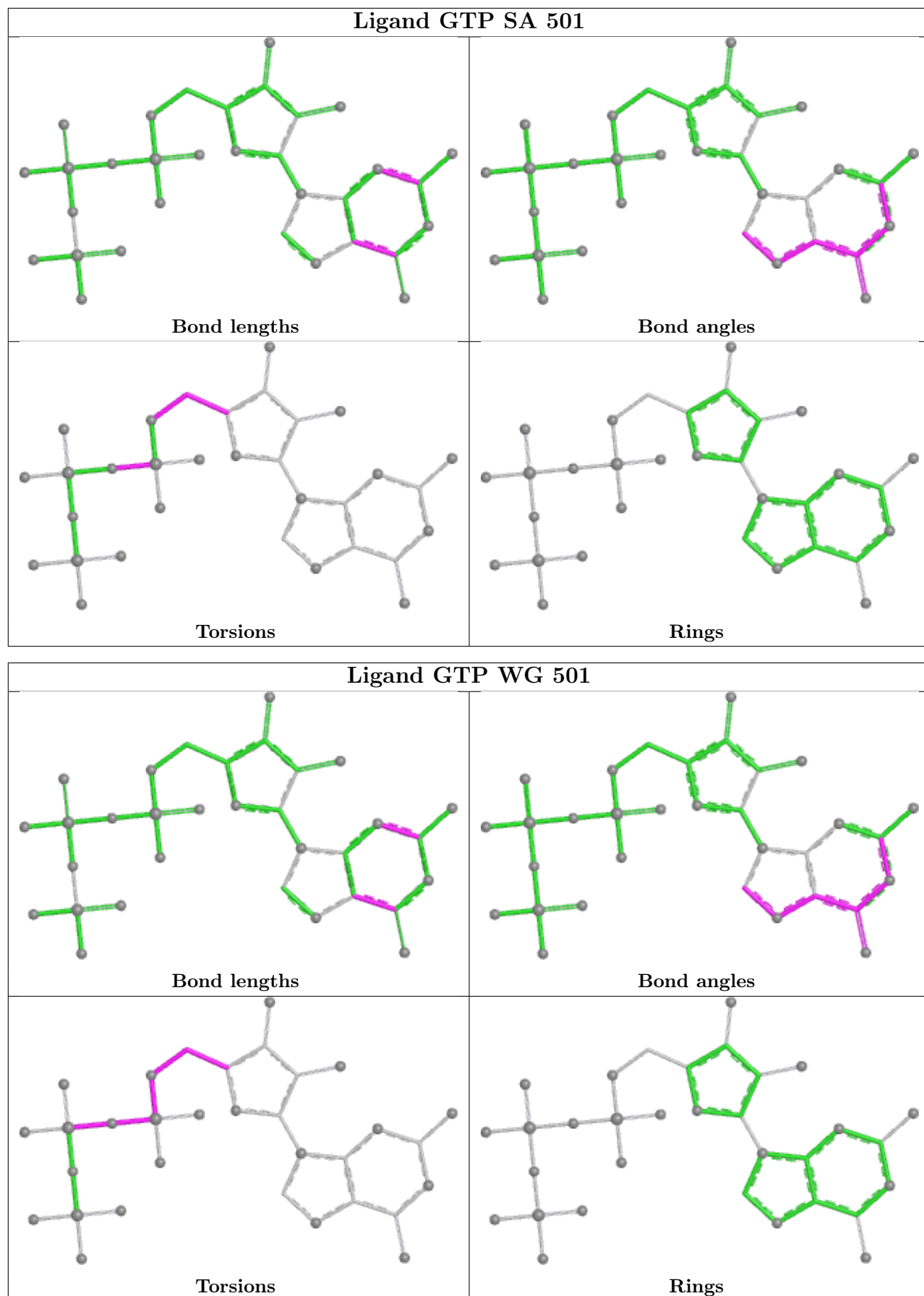

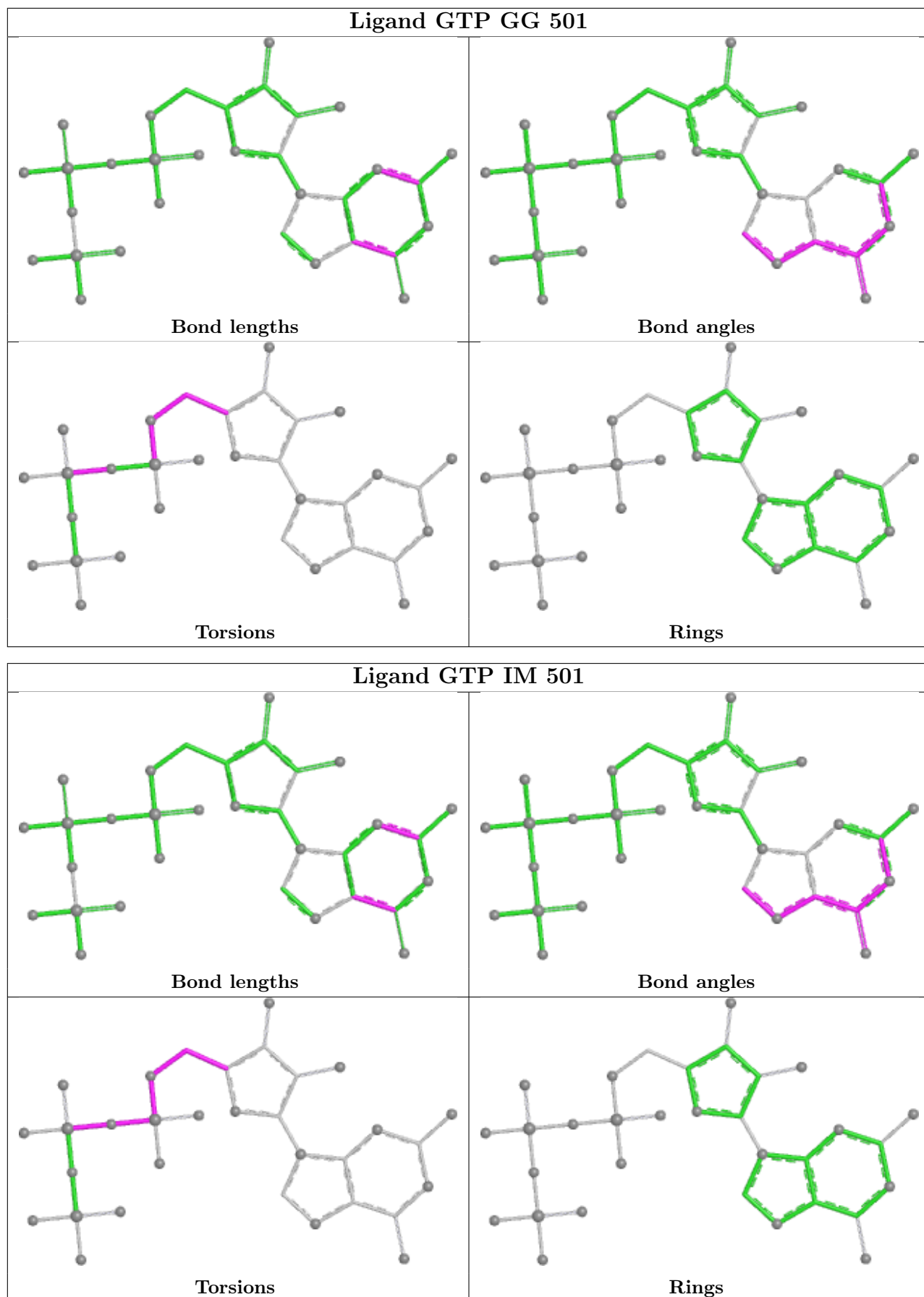

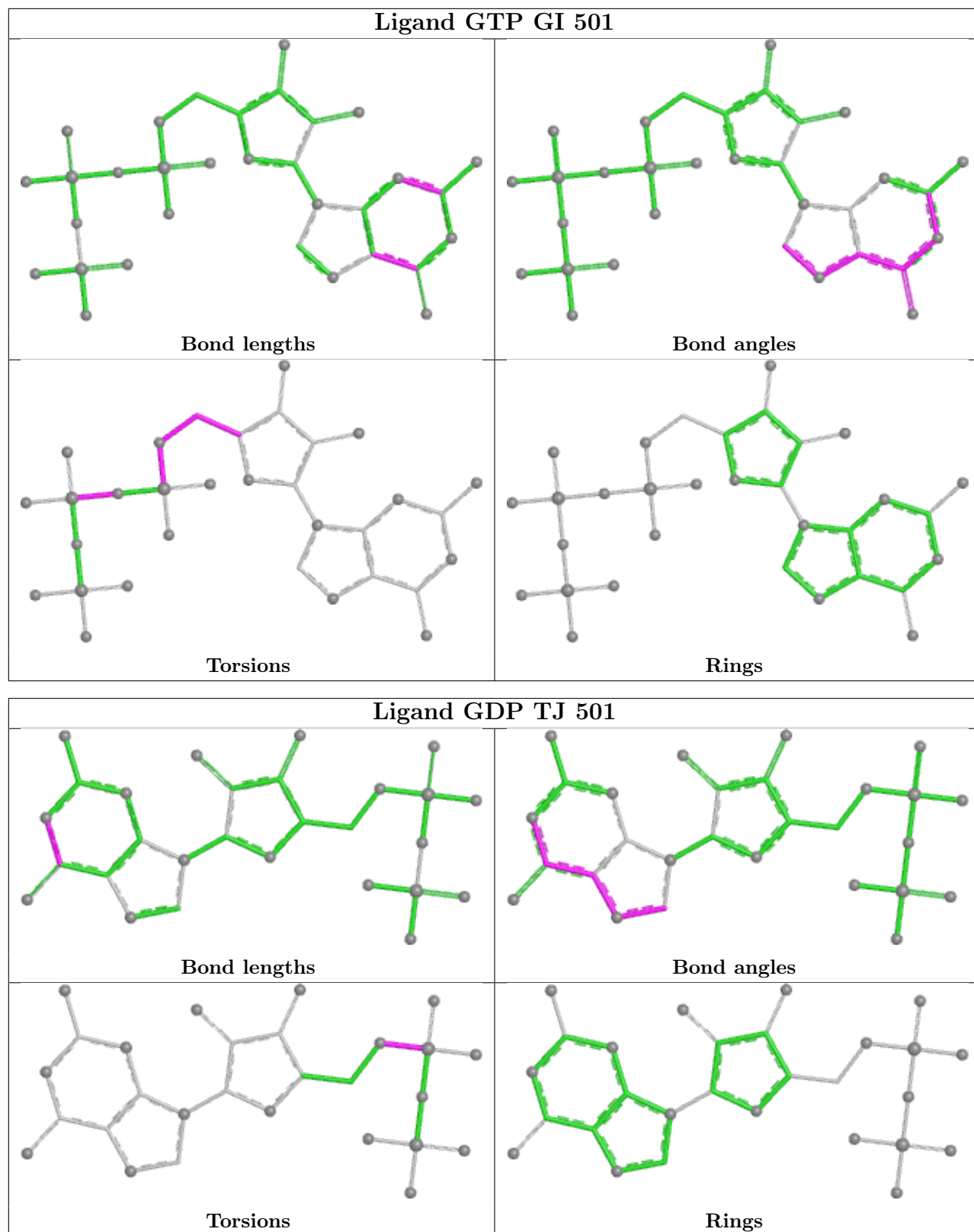

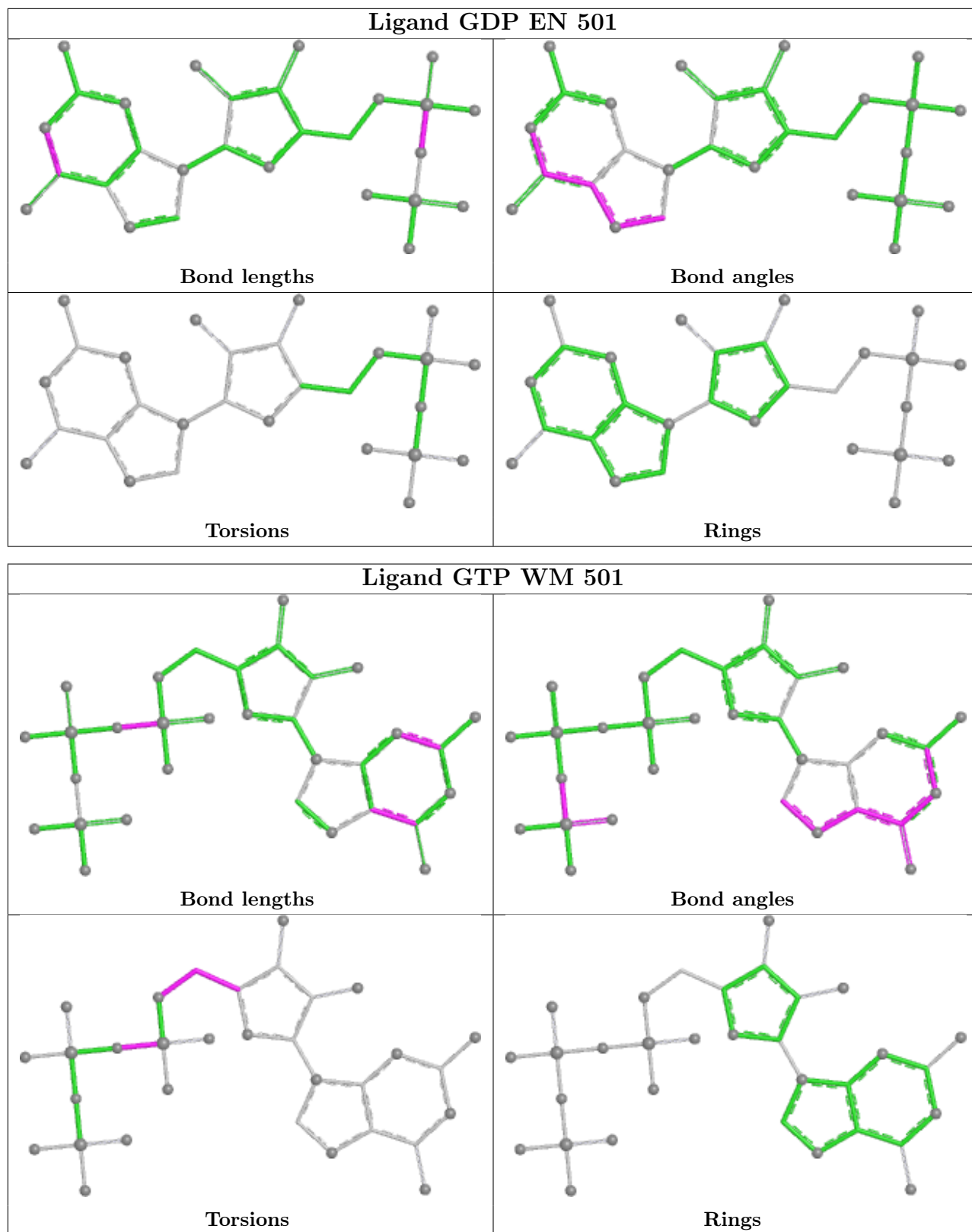

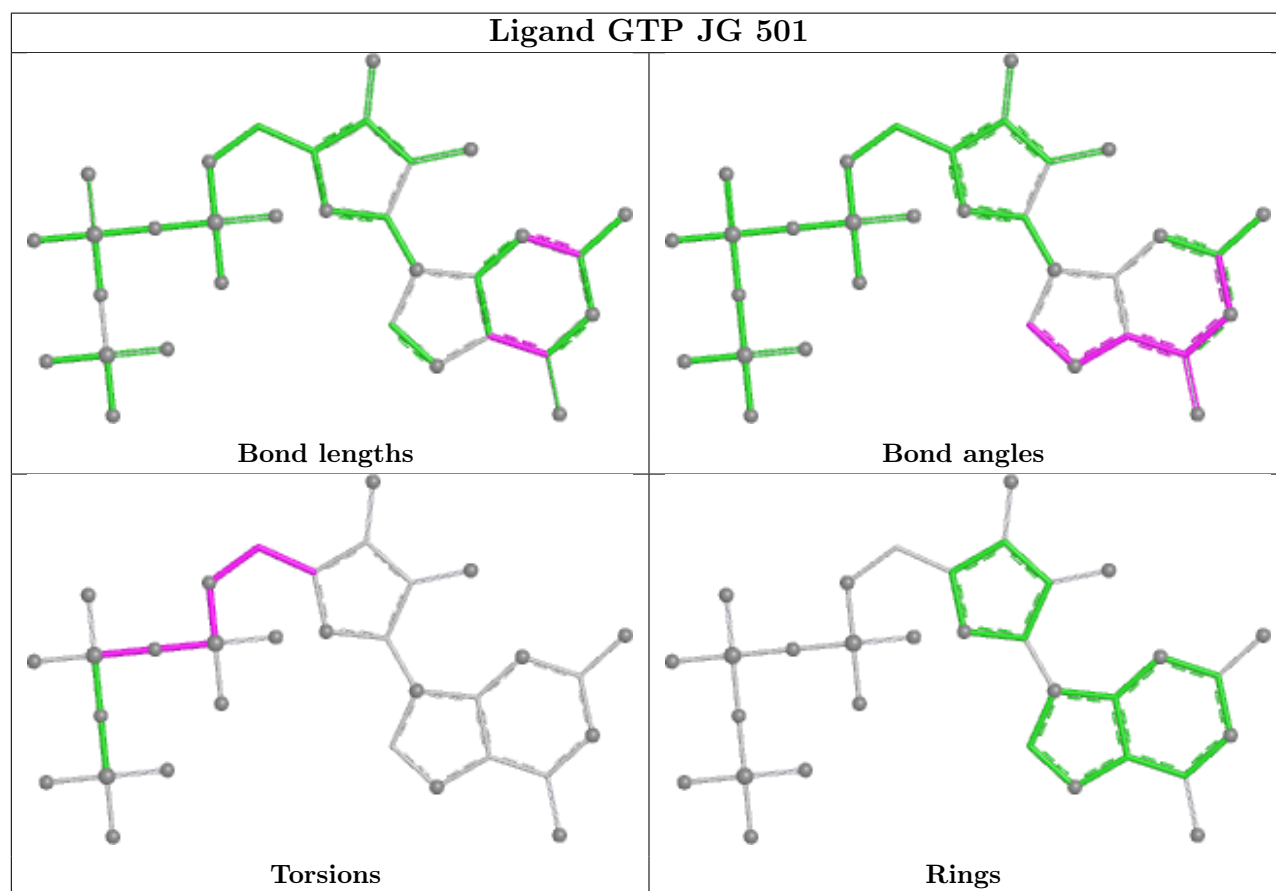
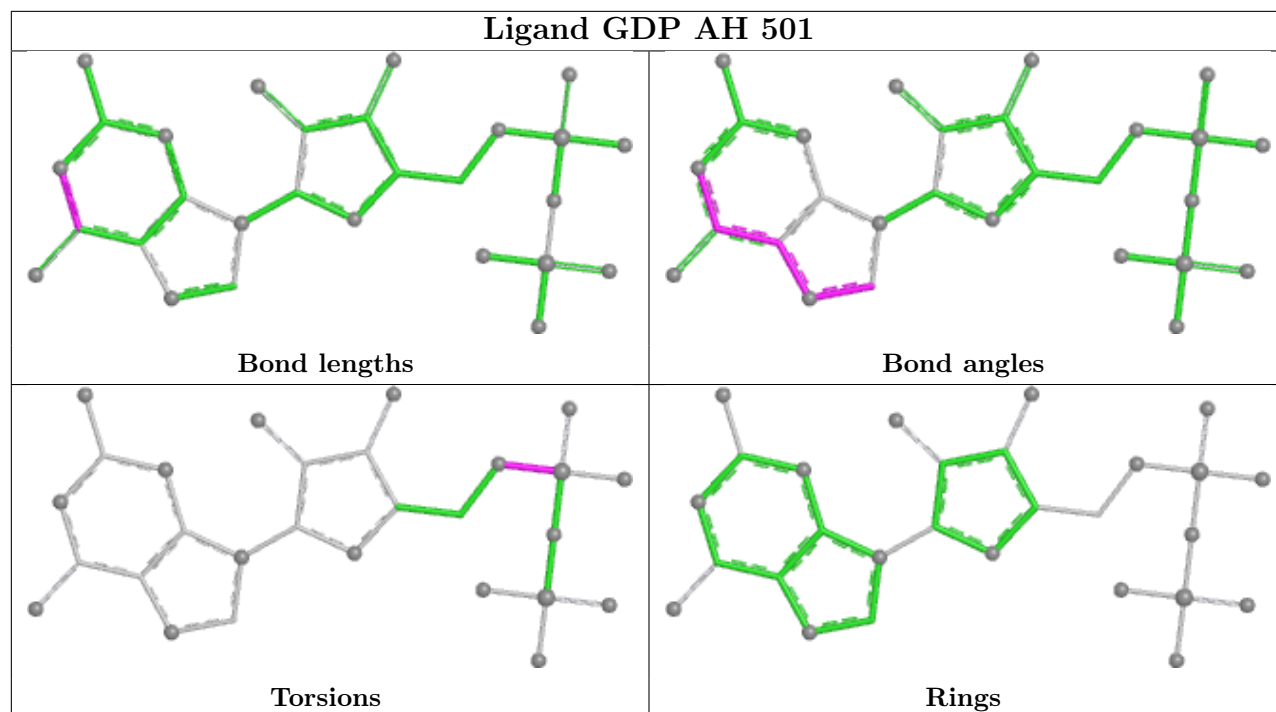

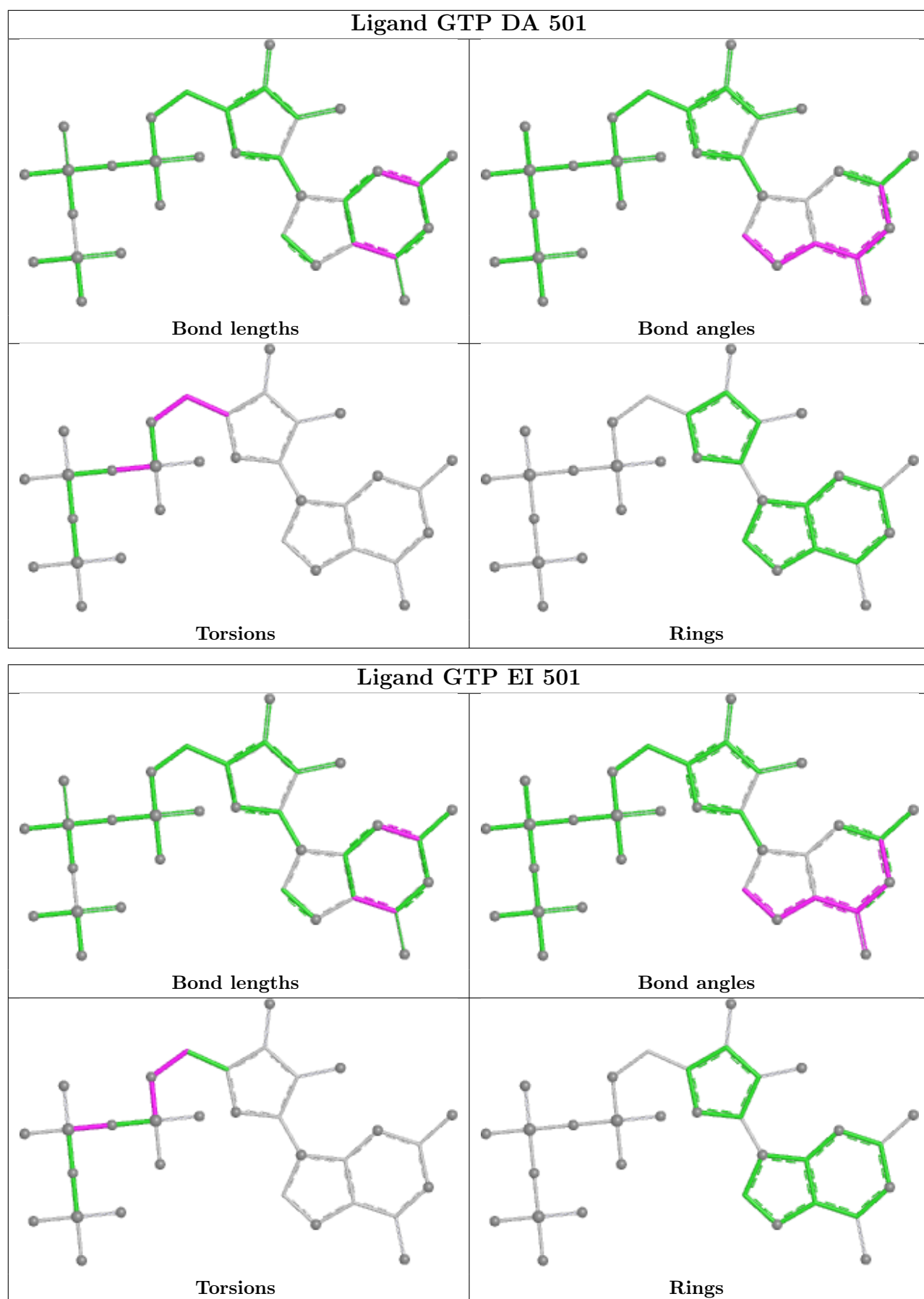

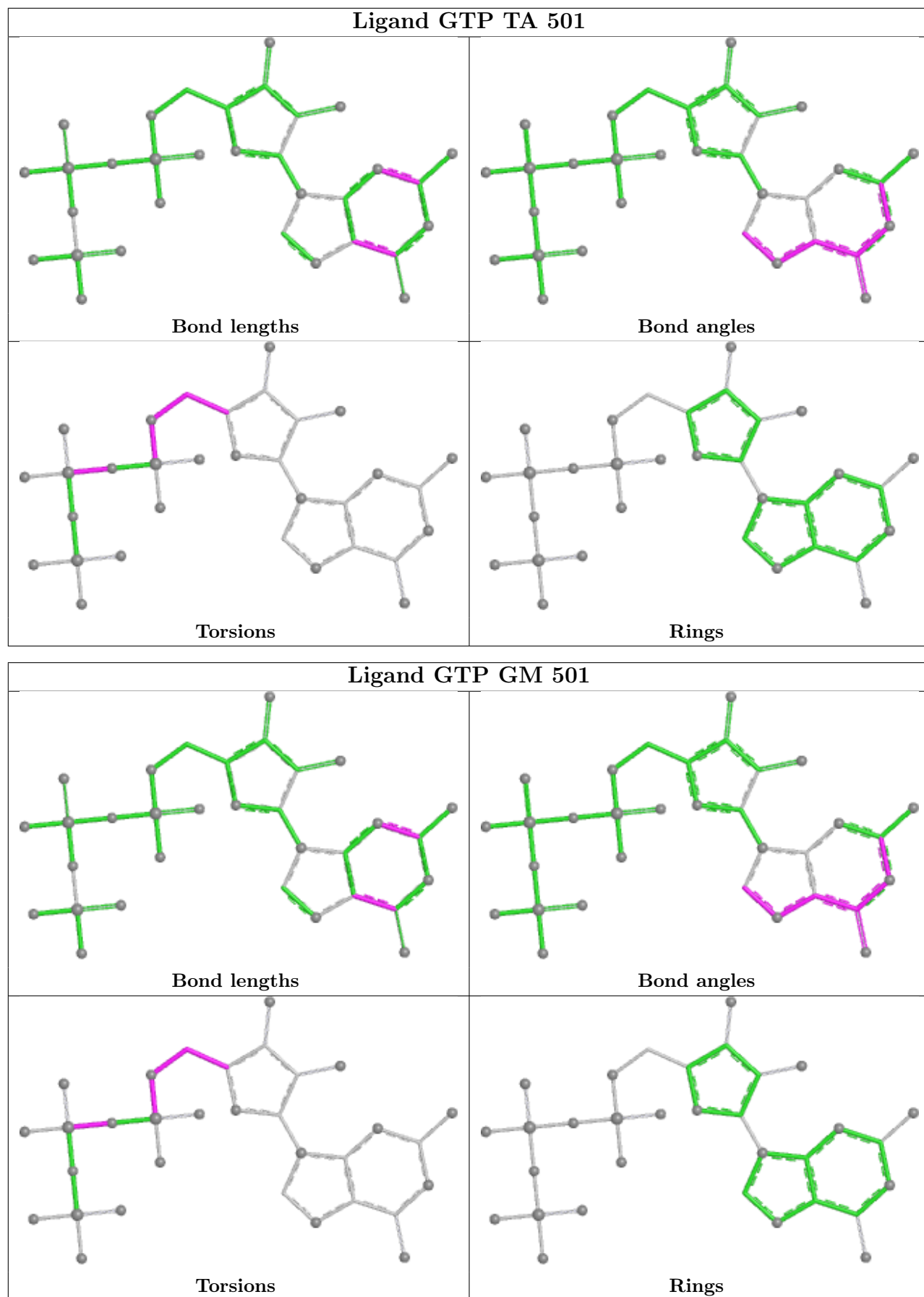

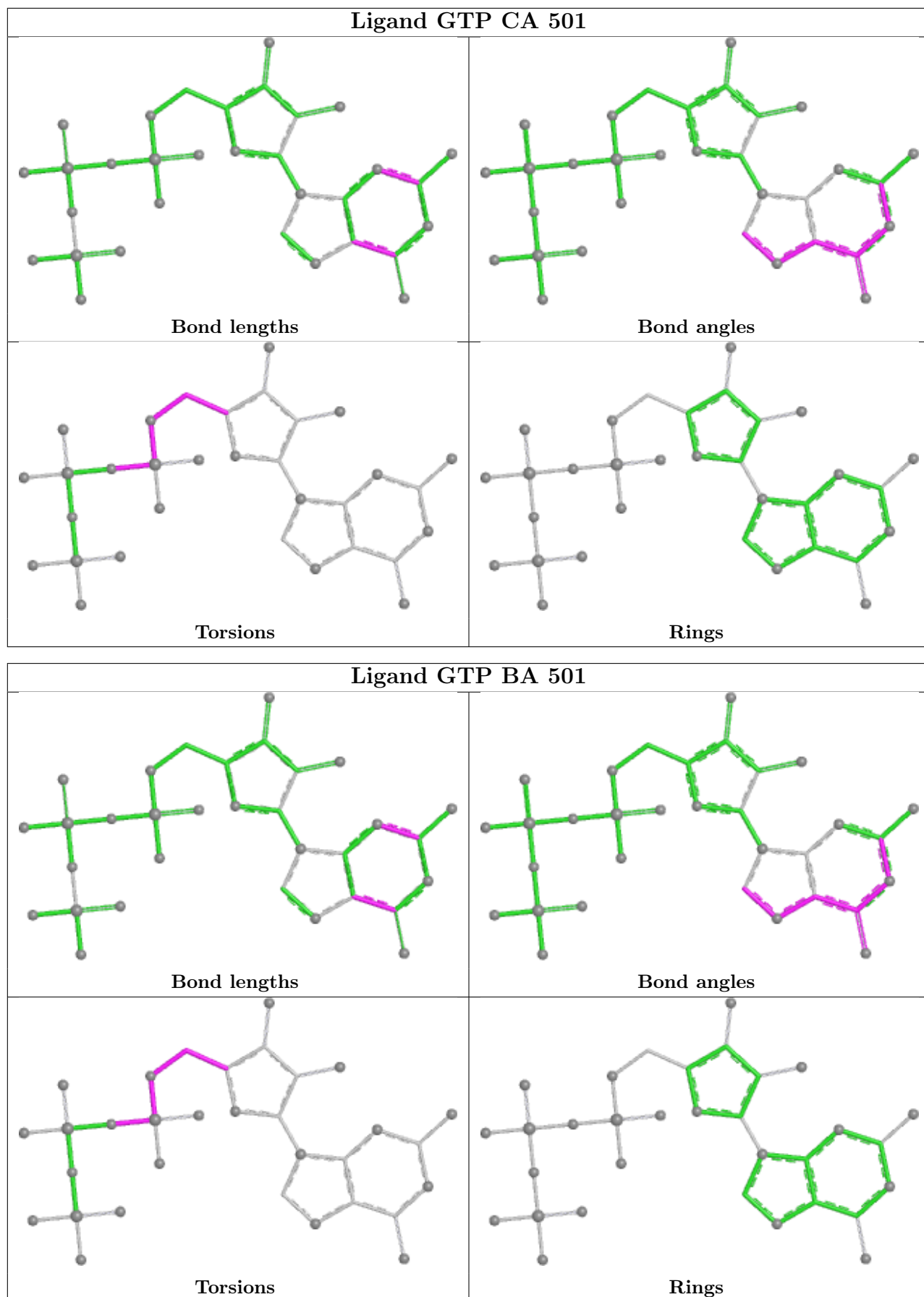

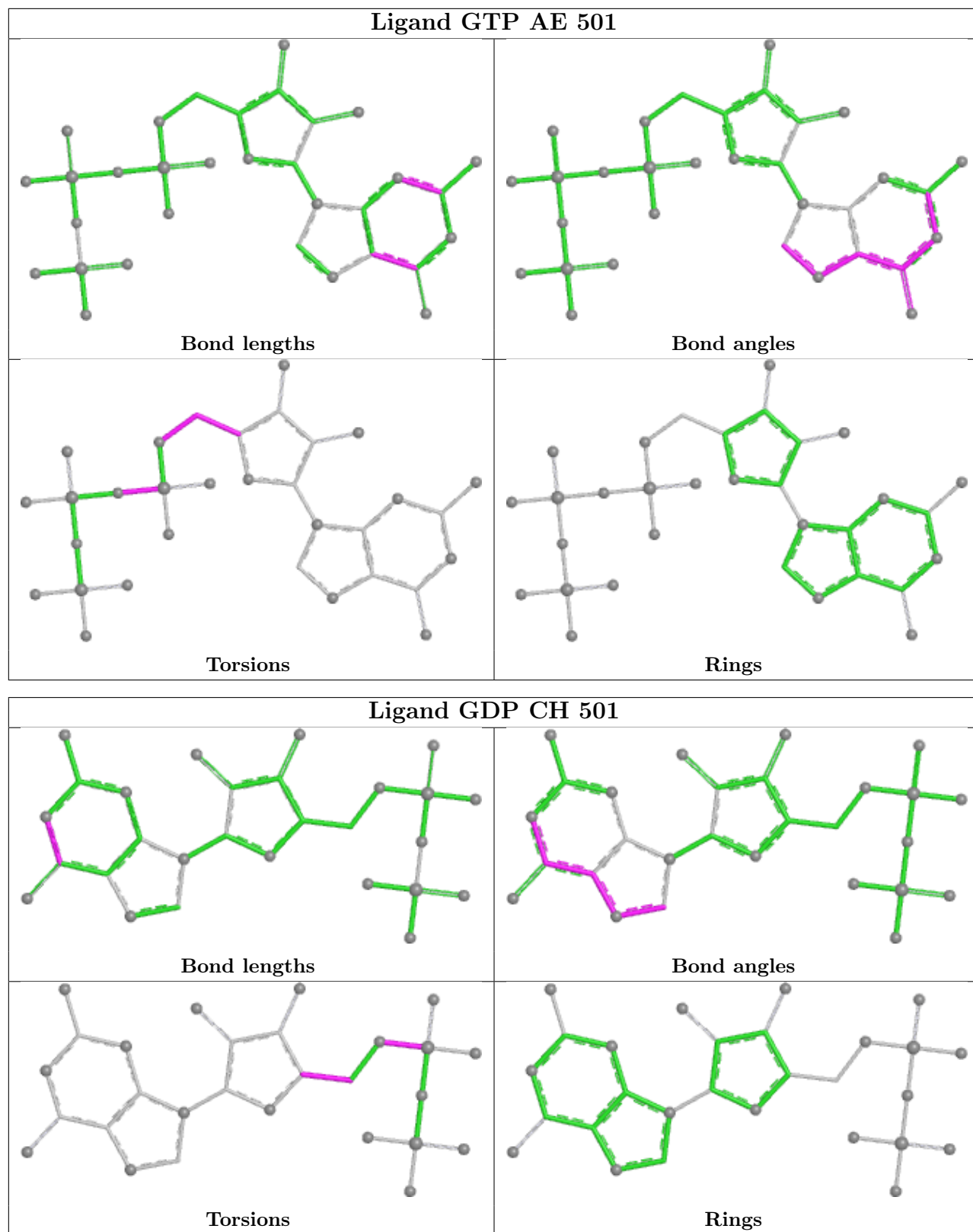

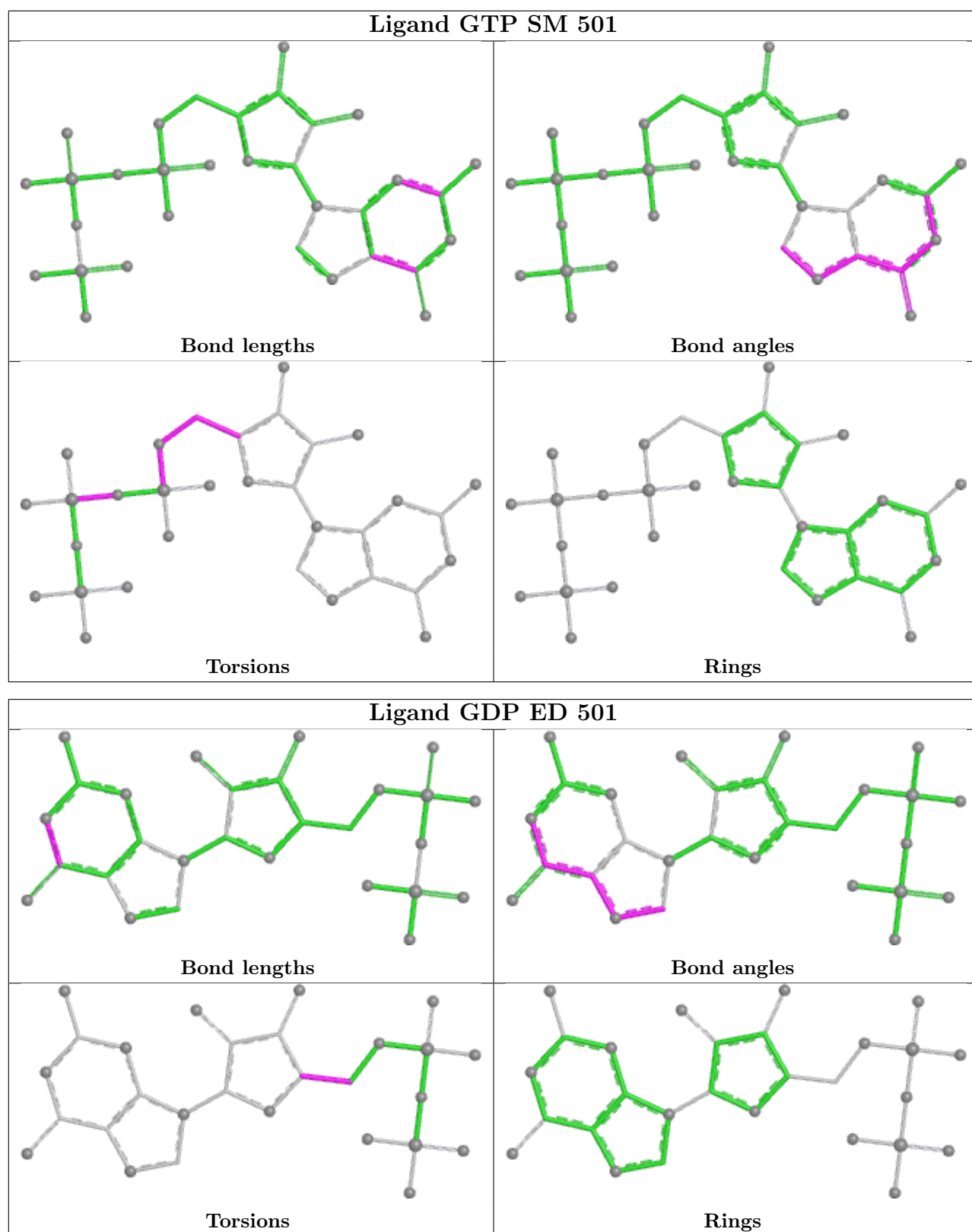

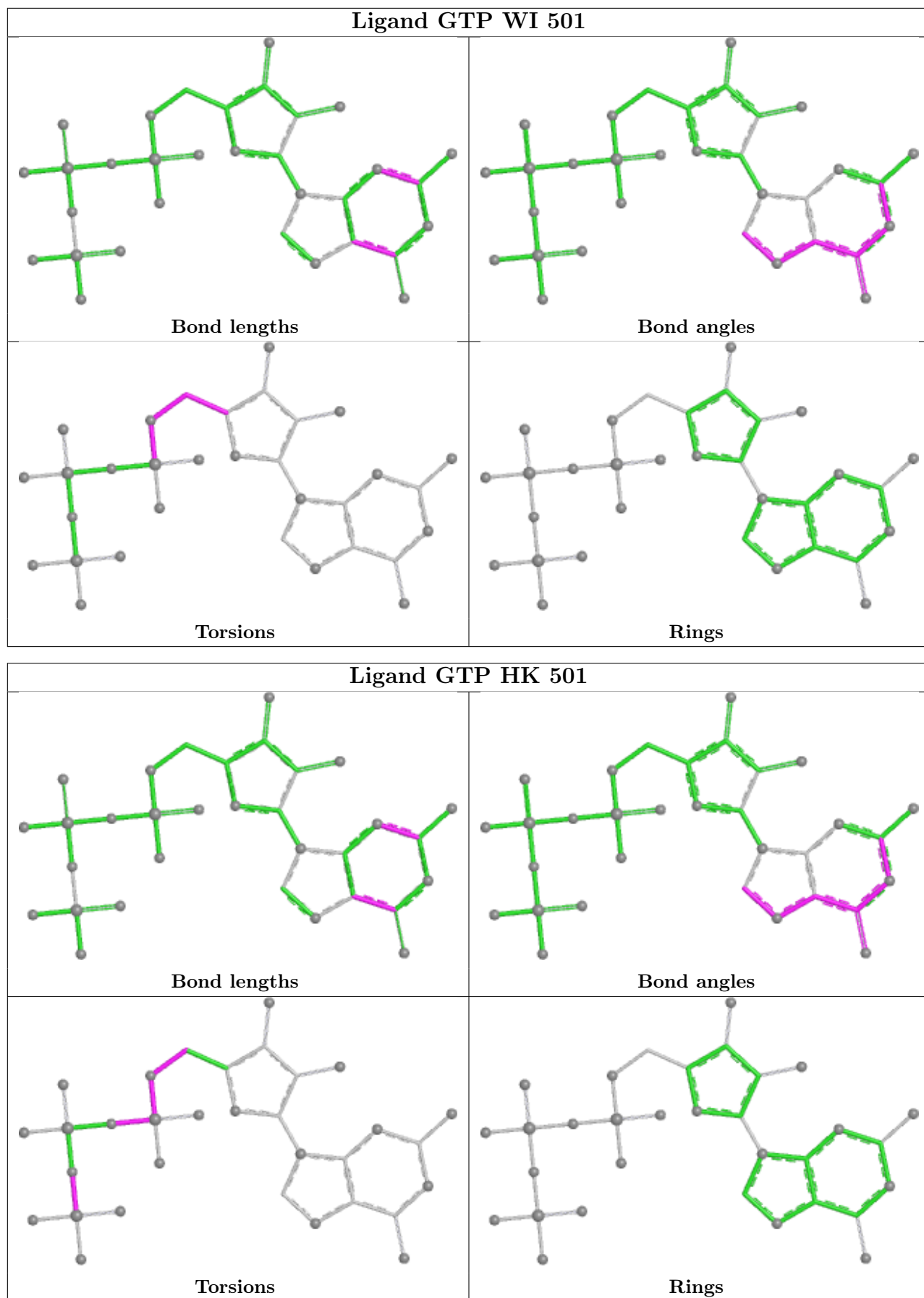

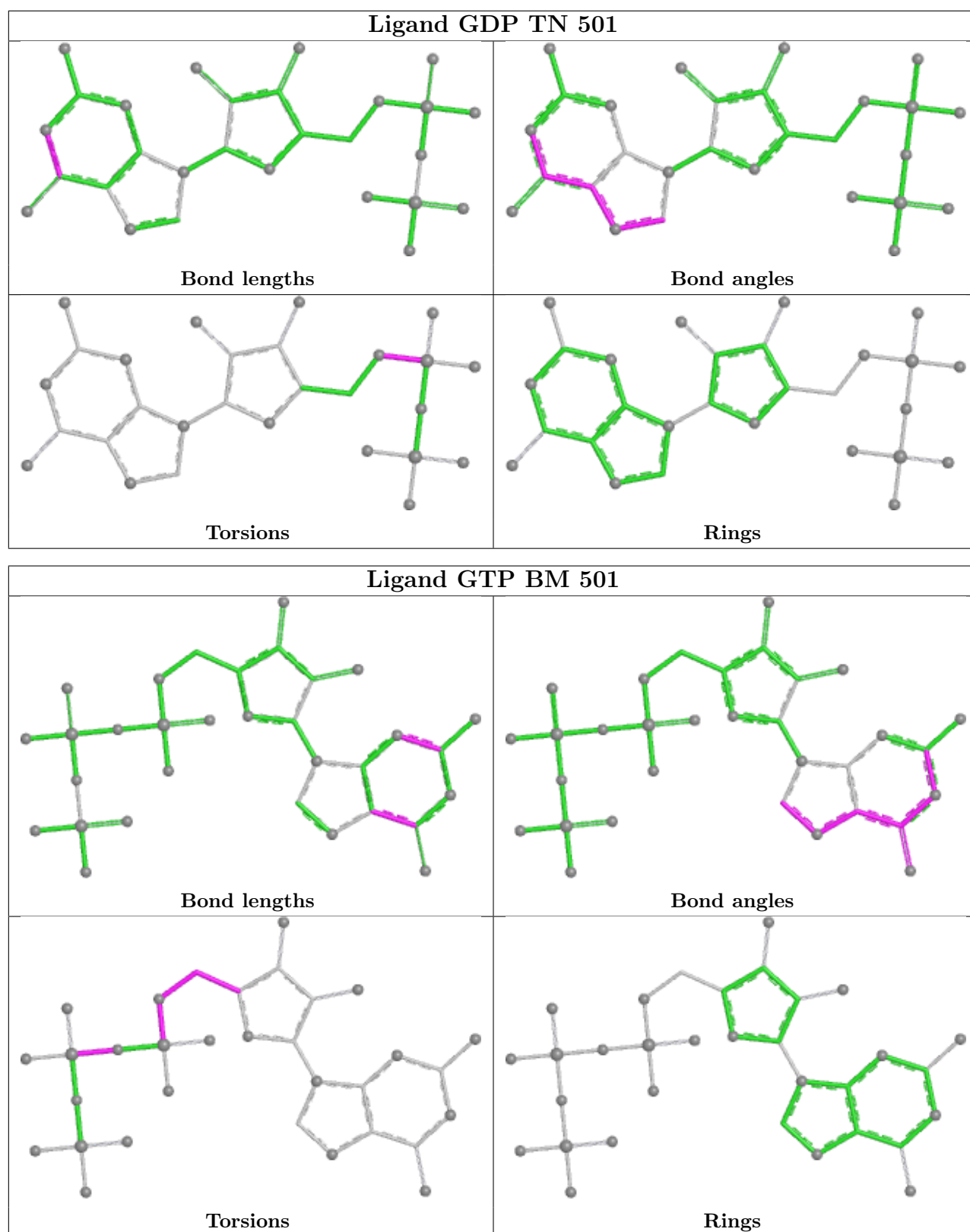

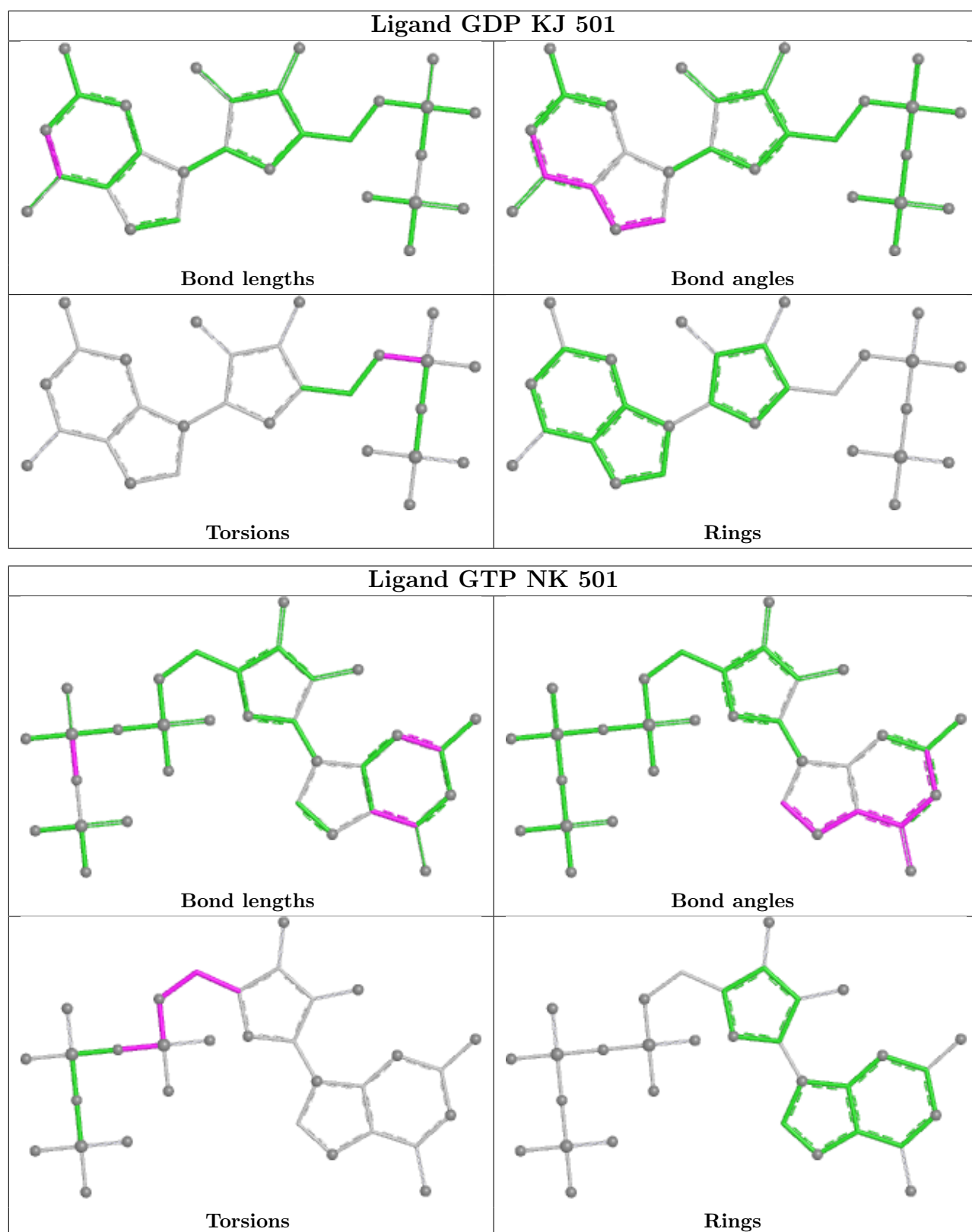

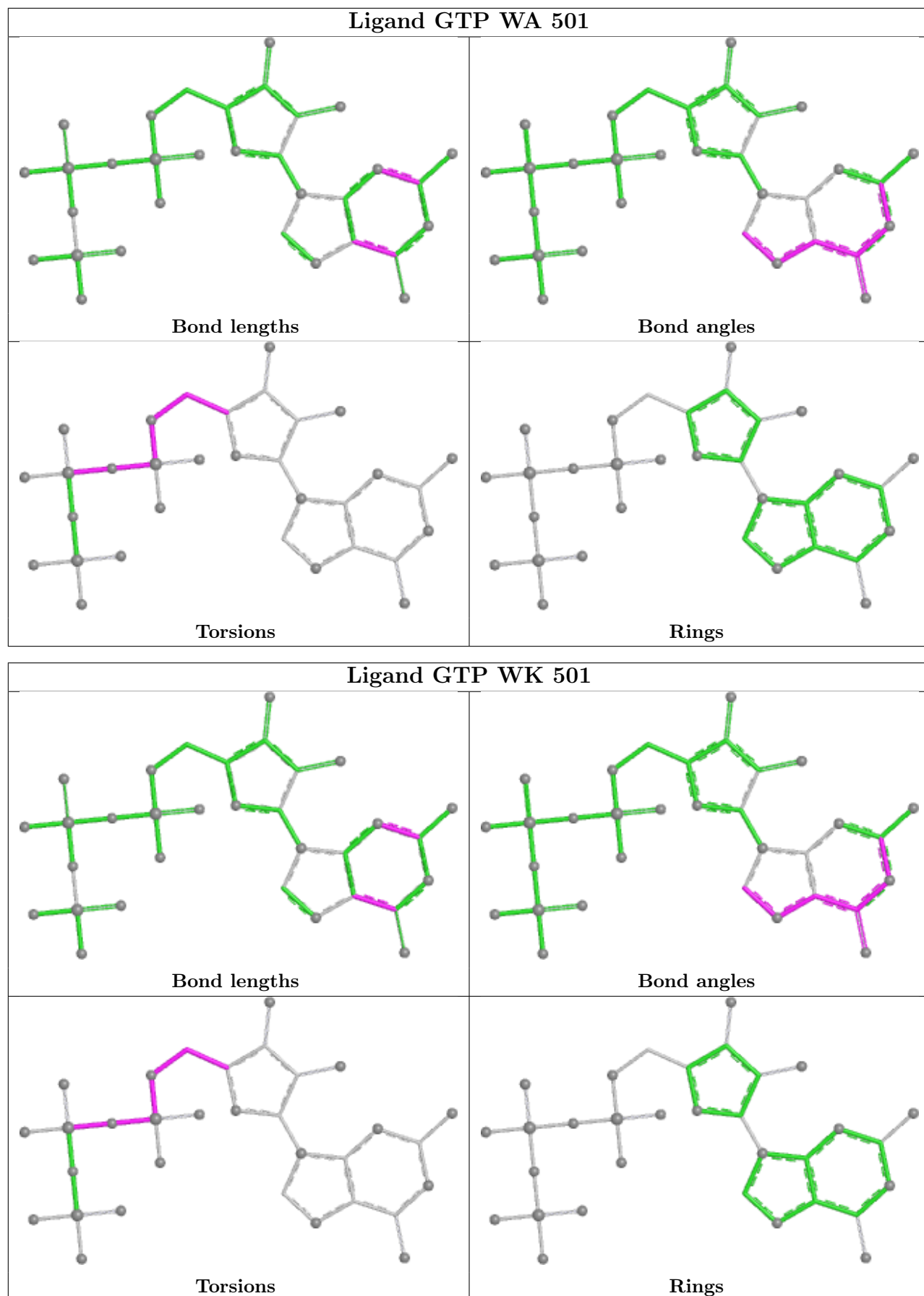

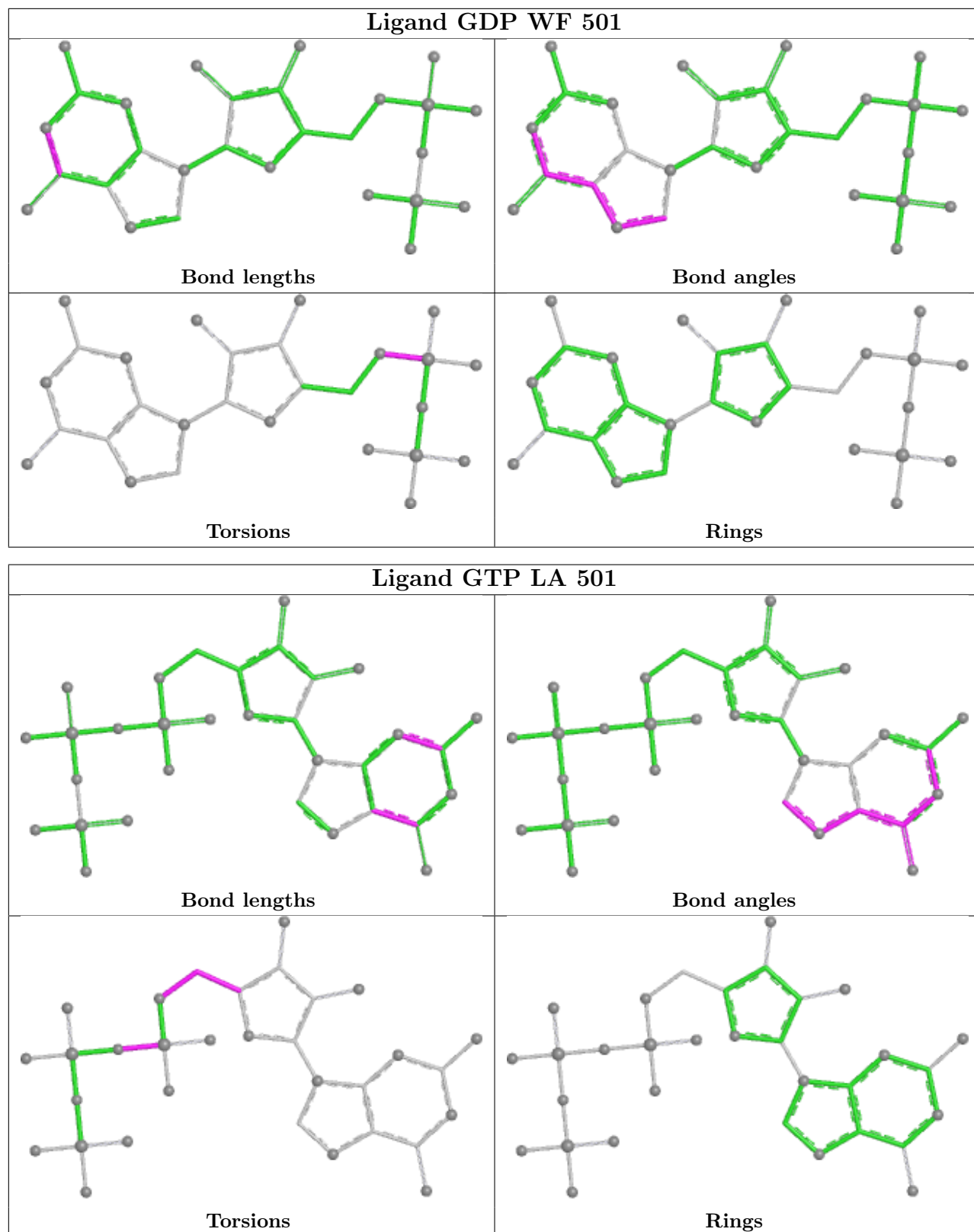

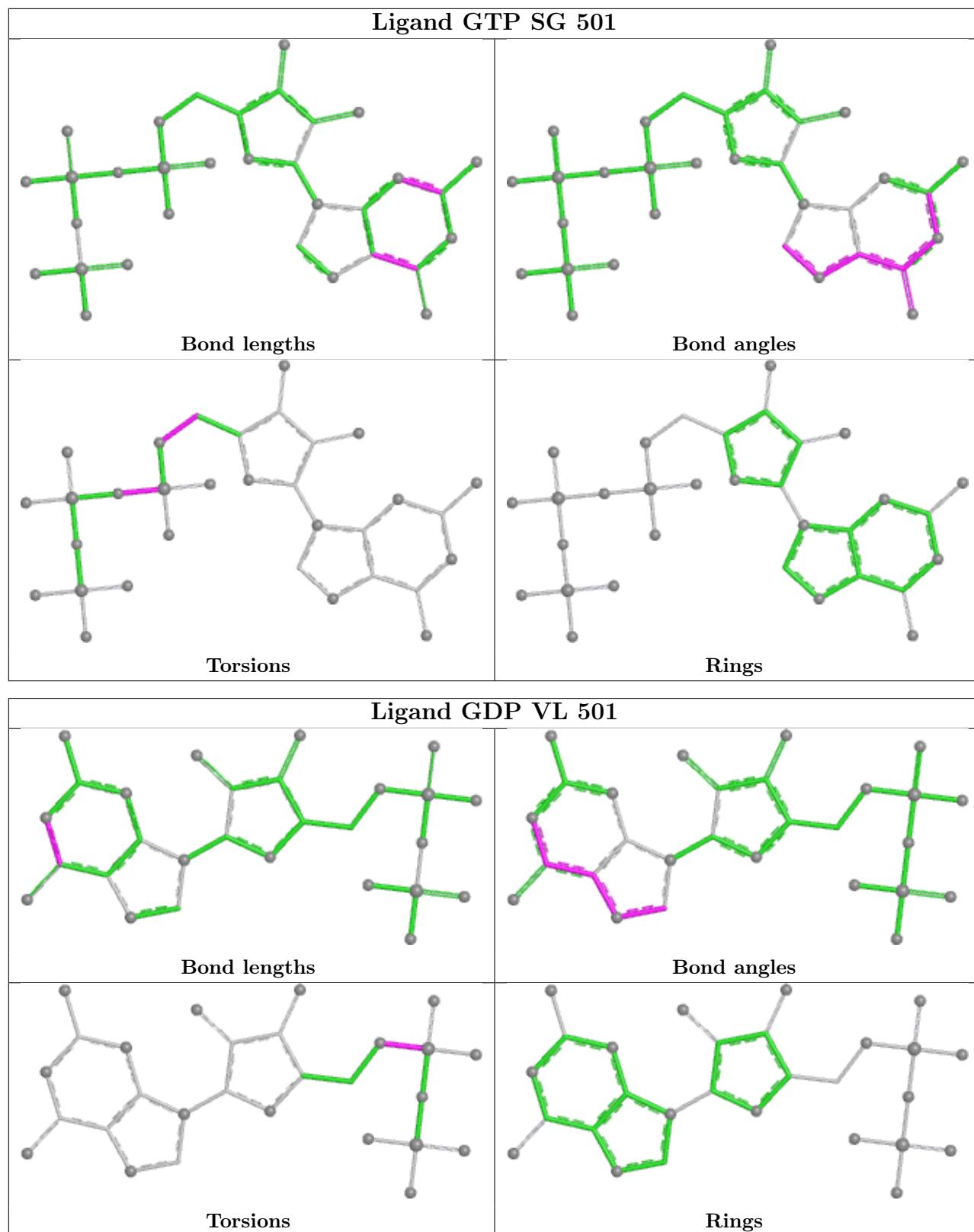

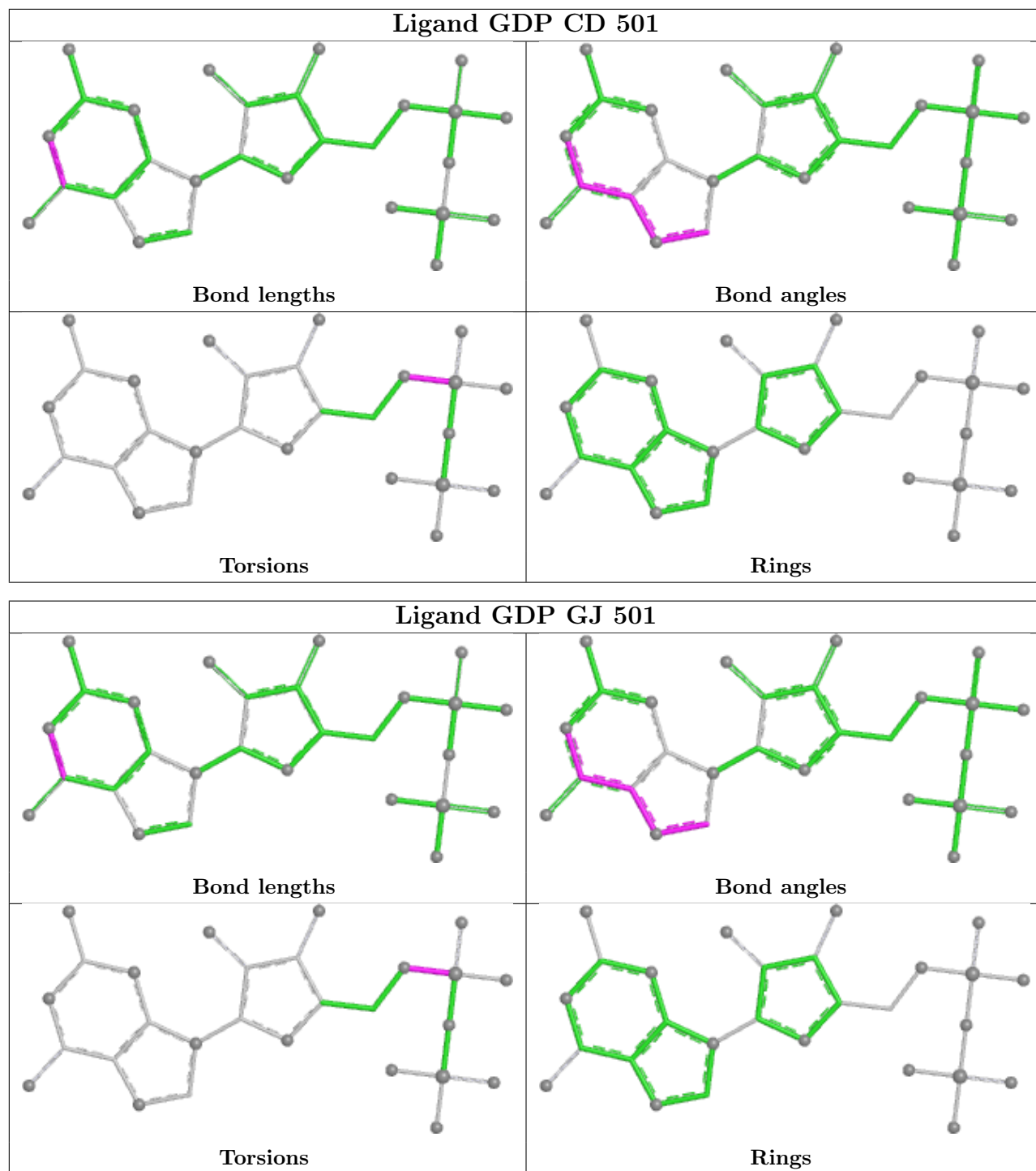

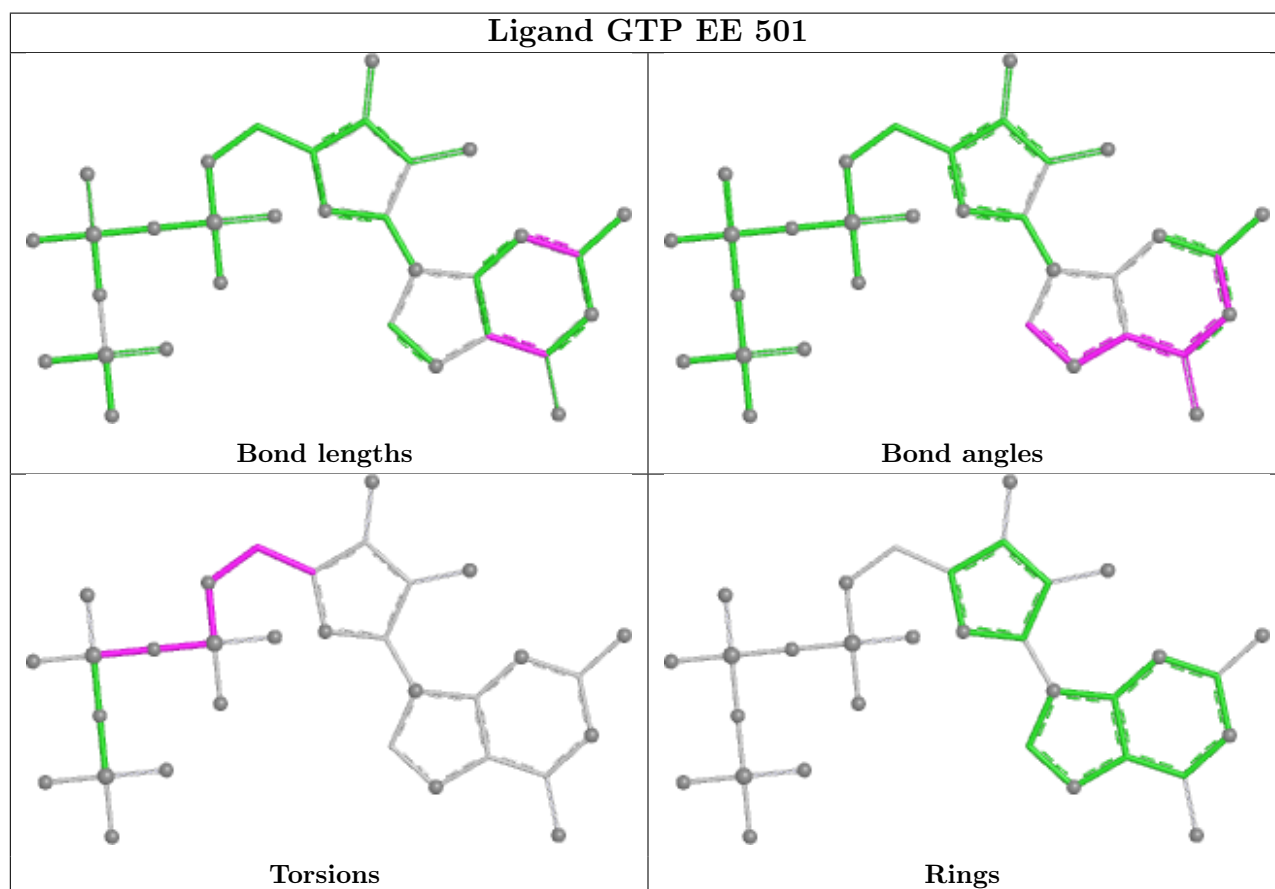
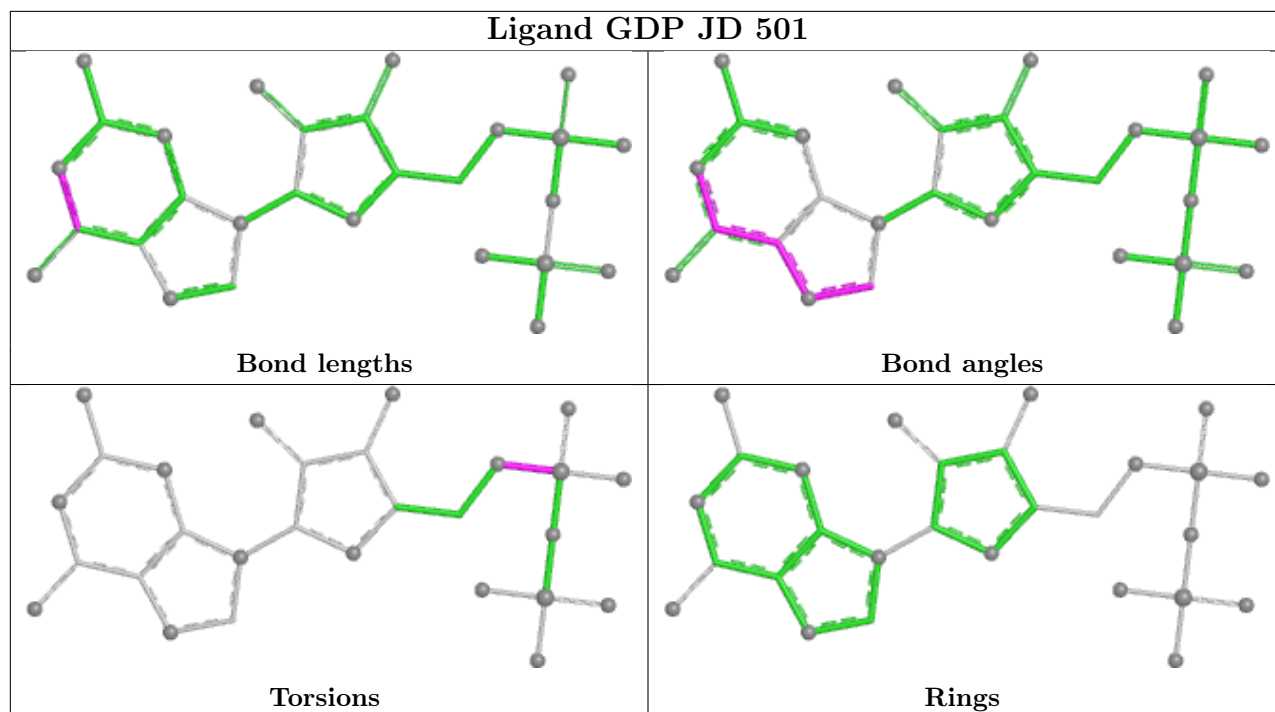

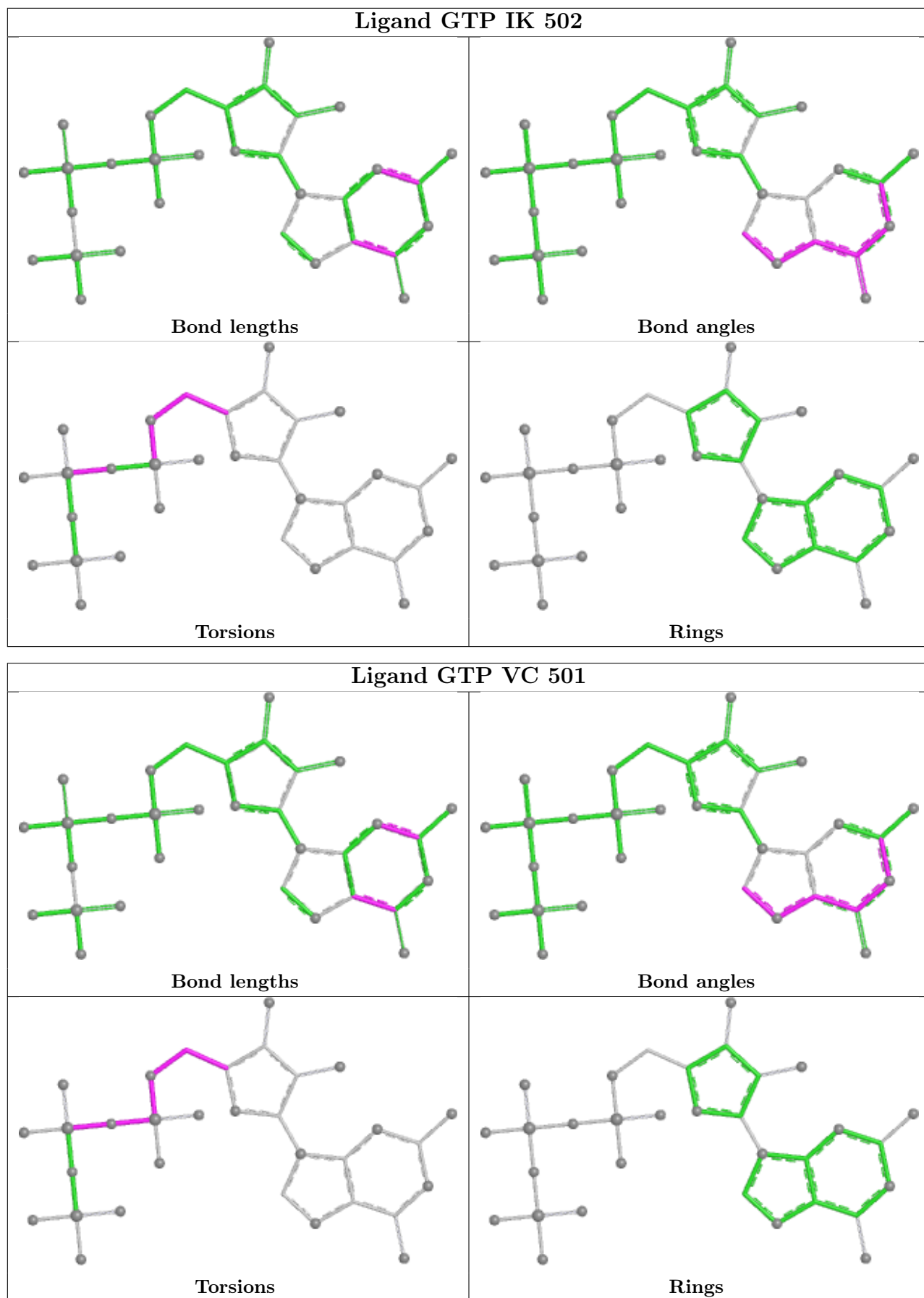

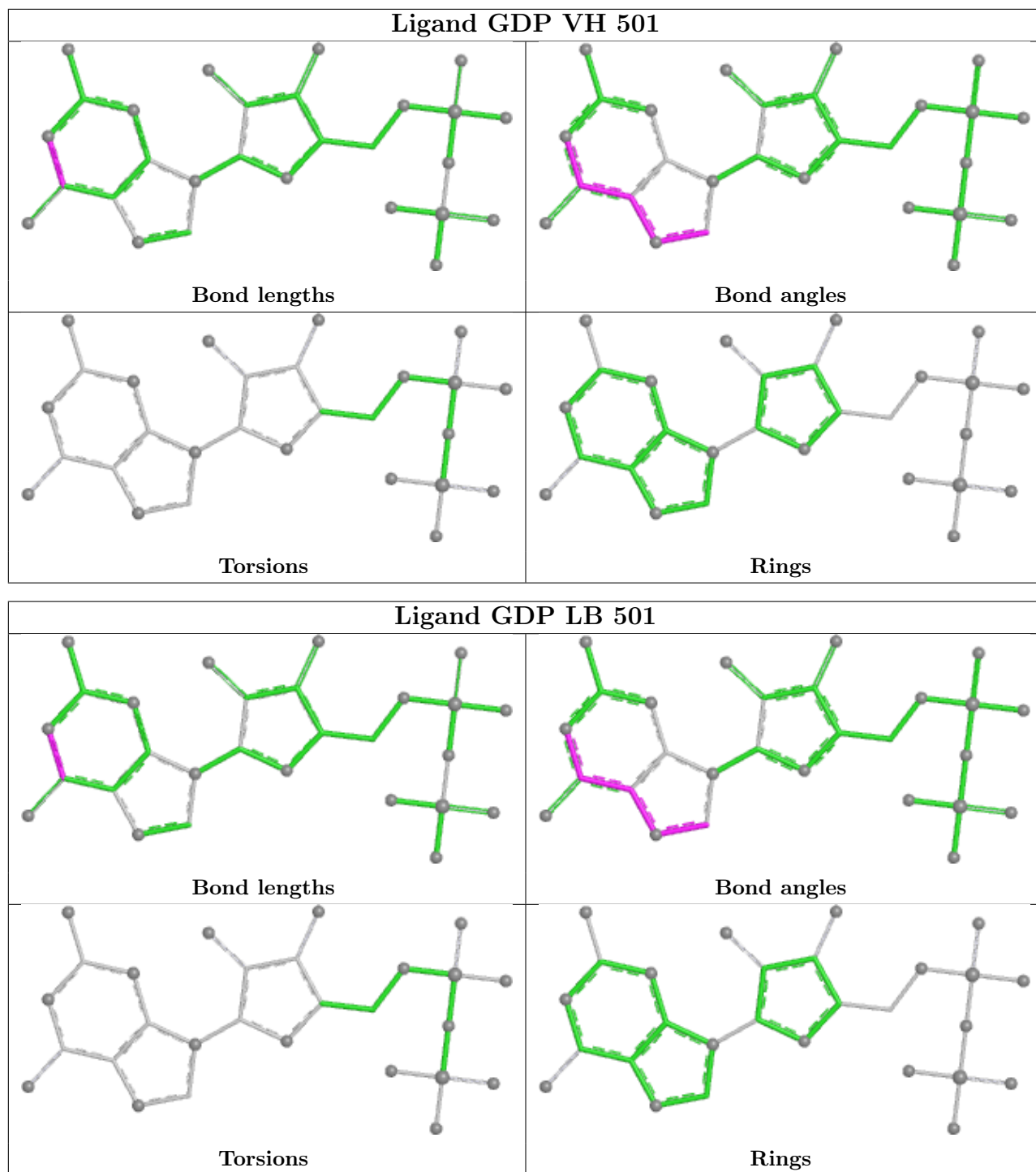

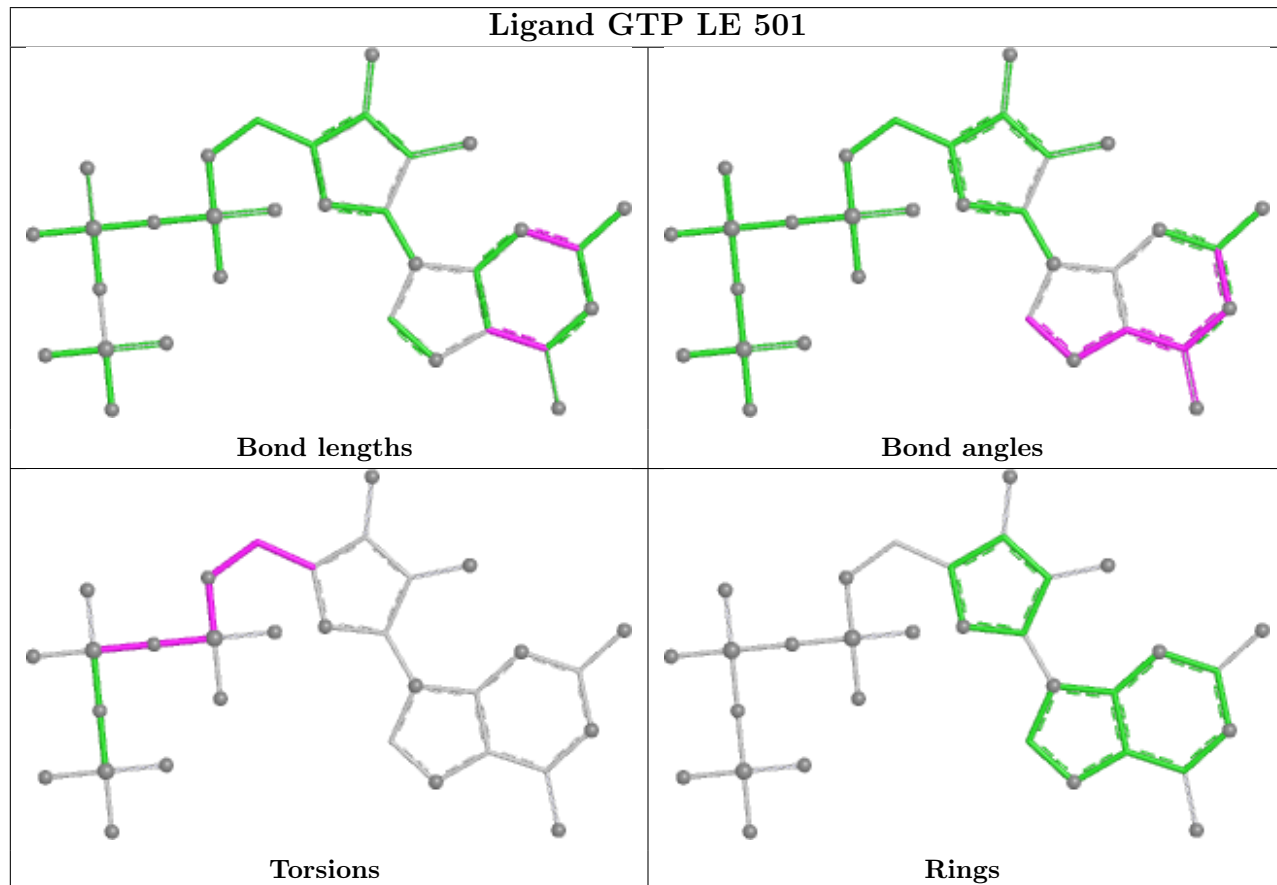
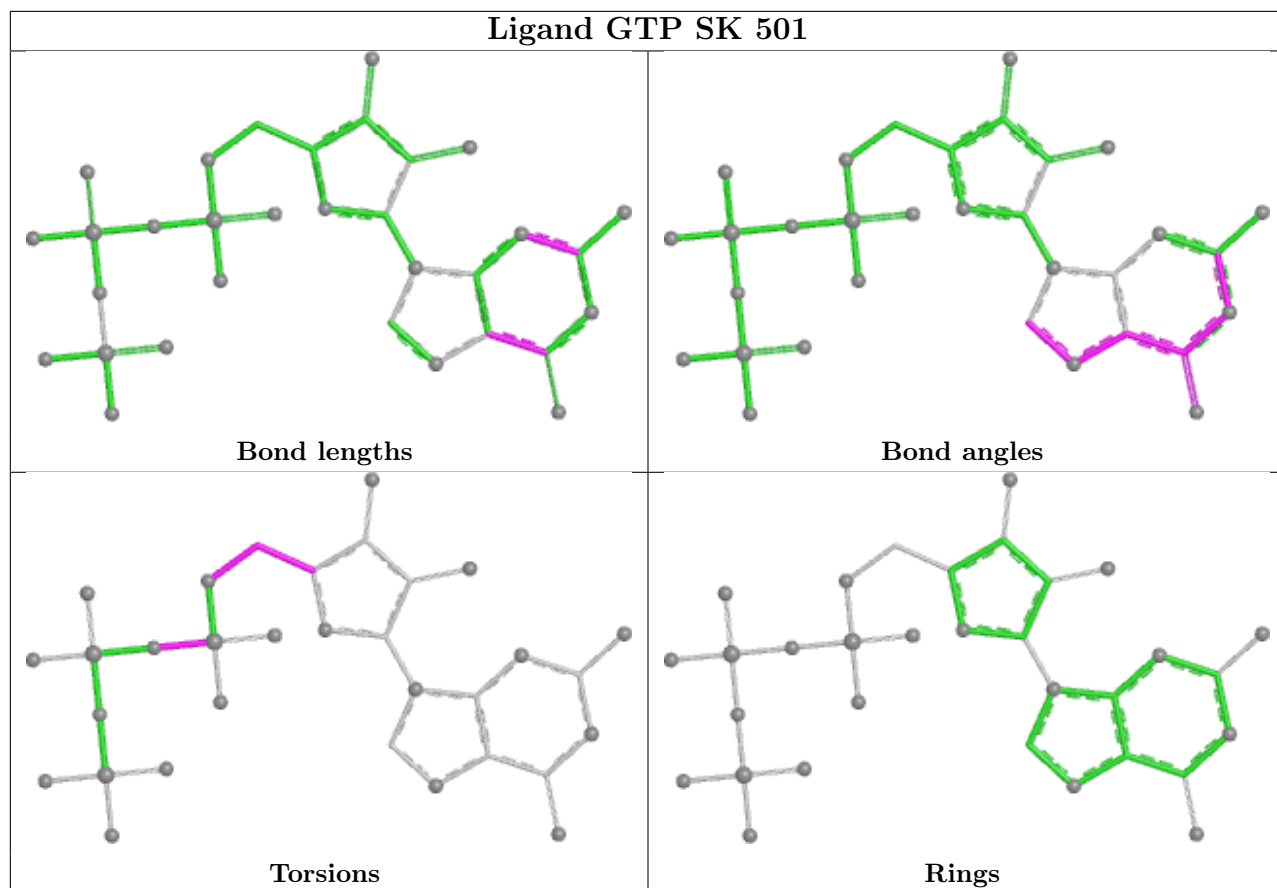

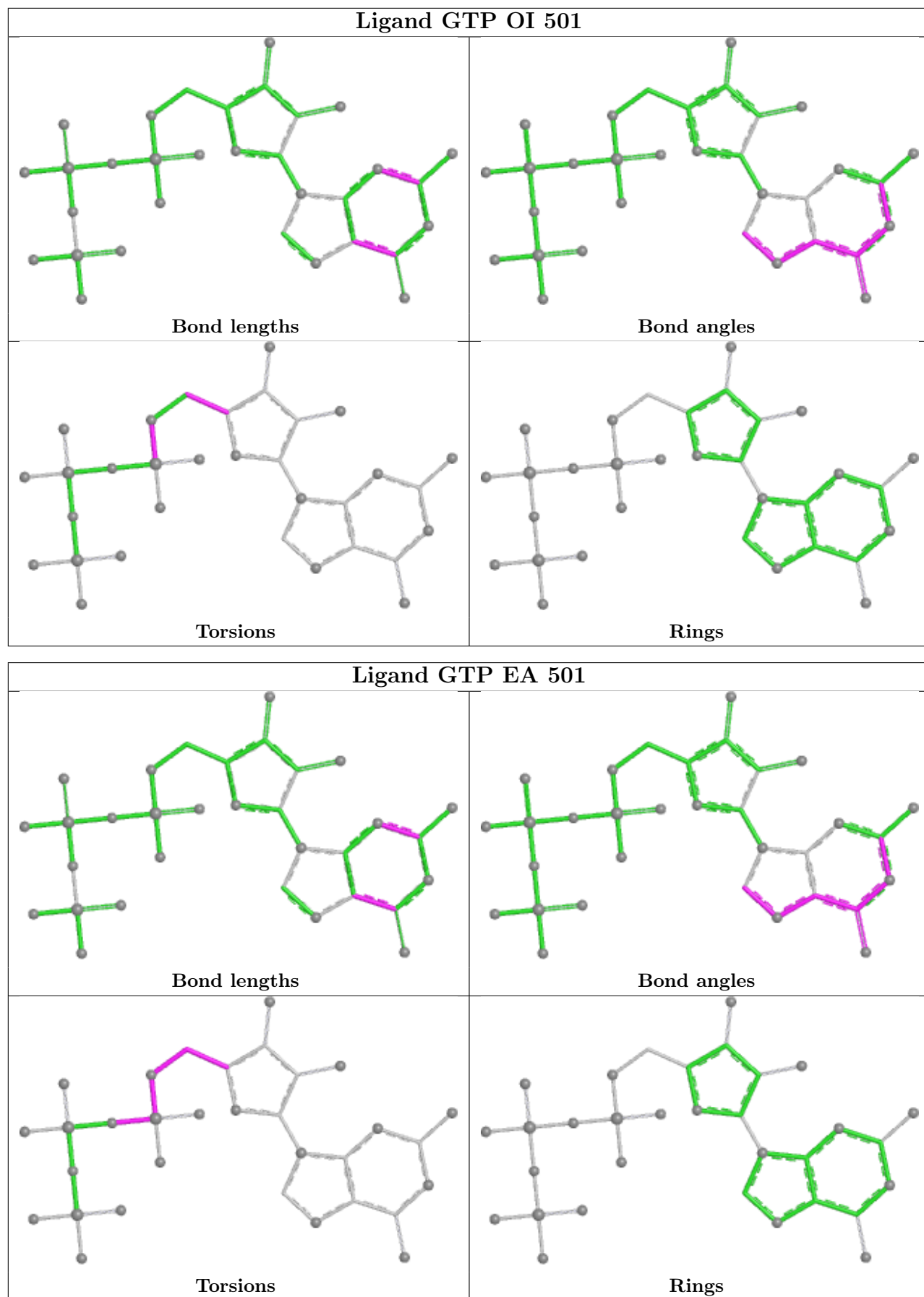

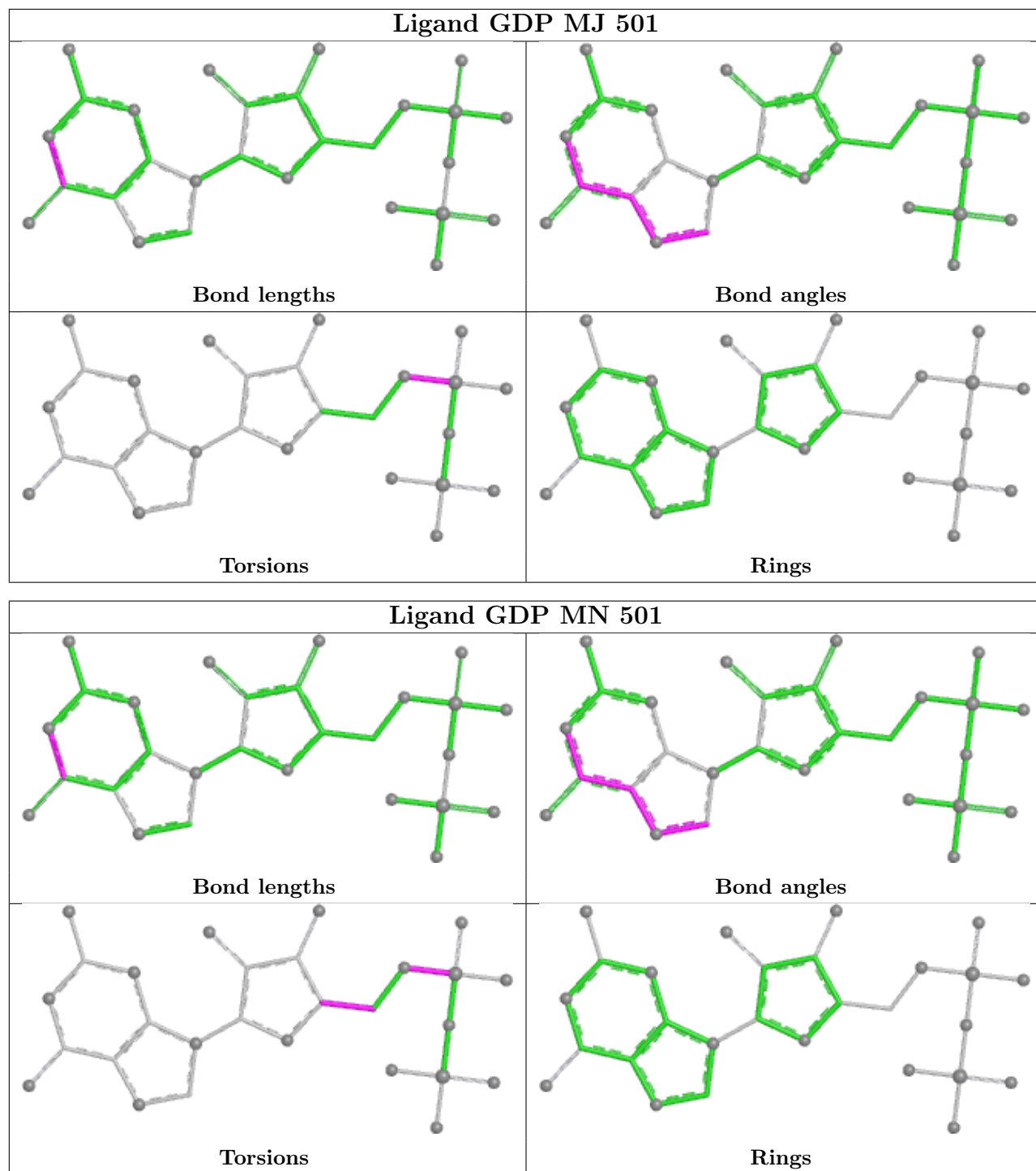

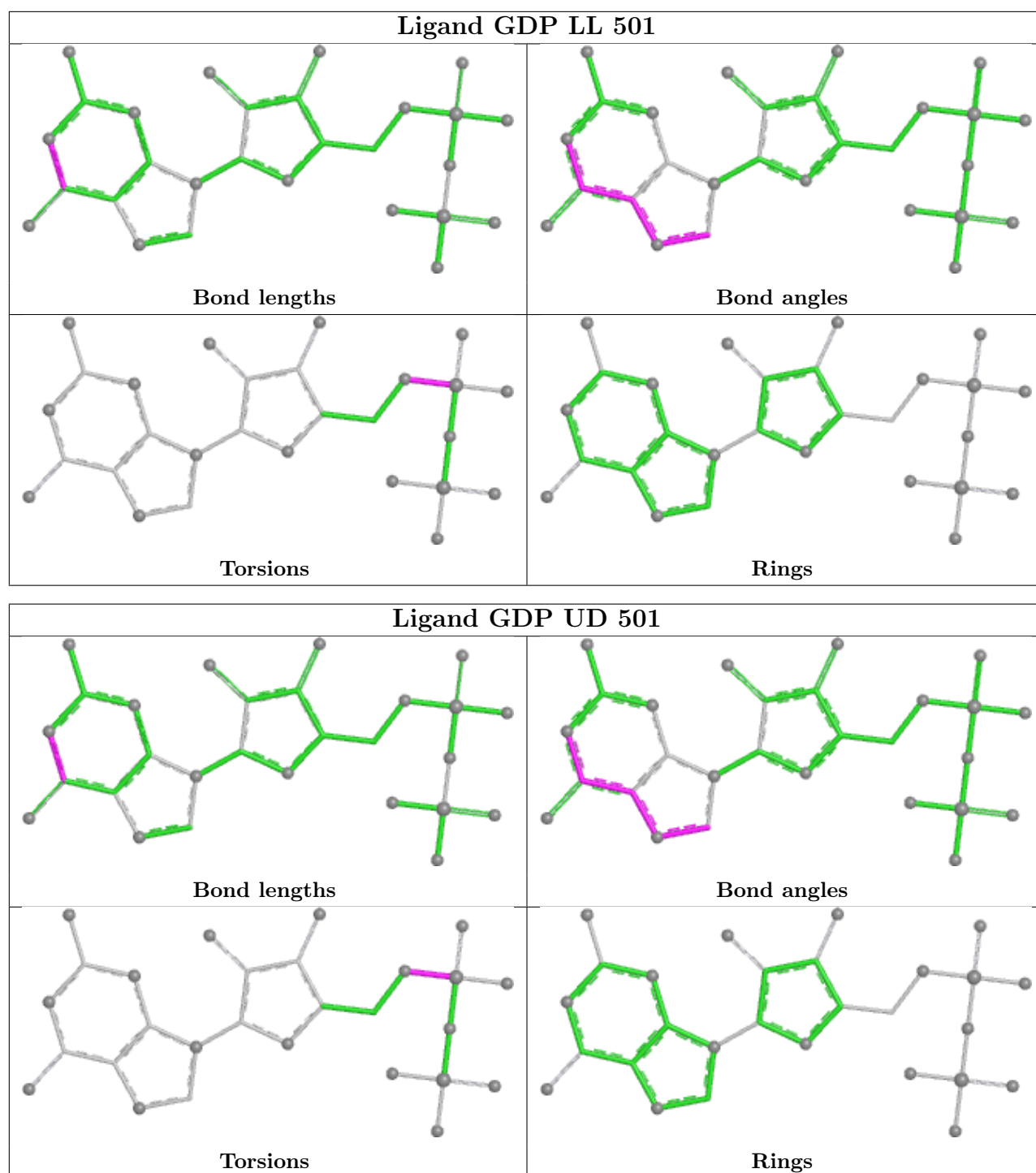

5.7 Other polymers [i](#)

There are no such residues in this entry.

5.8 Polymer linkage issues [i](#)

There are no chain breaks in this entry.

6 Map visualisation [i](#)

This section contains visualisations of the EMDB entry EMD-29692. These allow visual inspection of the internal detail of the map and identification of artifacts.

Images derived from a raw map, generated by summing the deposited half-maps, are presented below the corresponding image components of the primary map to allow further visual inspection and comparison with those of the primary map.

6.1 Orthogonal projections [i](#)

6.1.1 Primary map

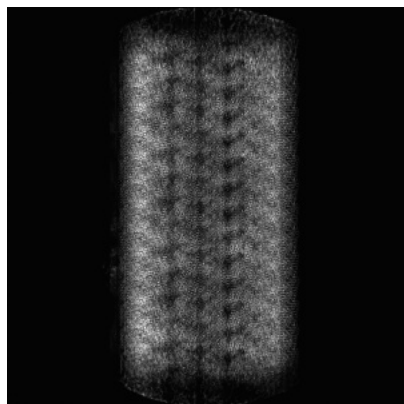

X

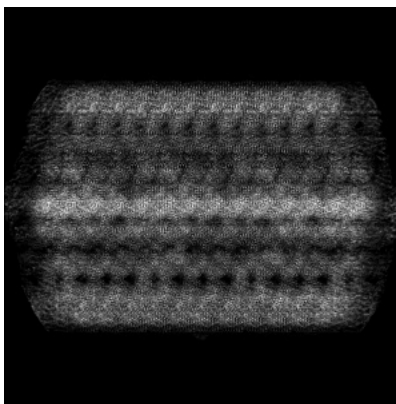

Y

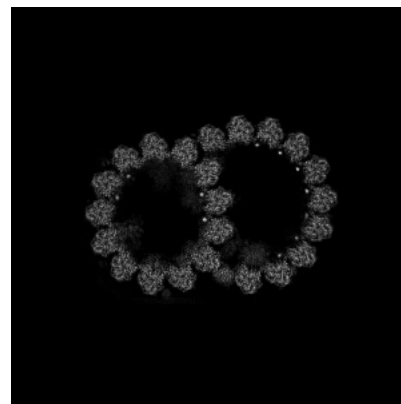

Z

6.1.2 Raw map

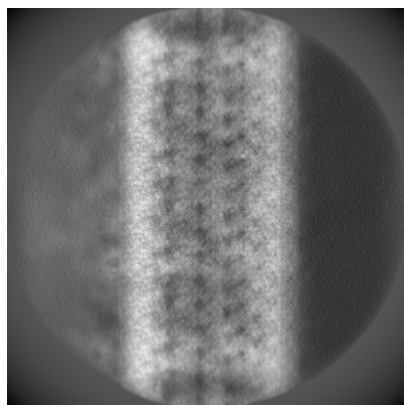

X

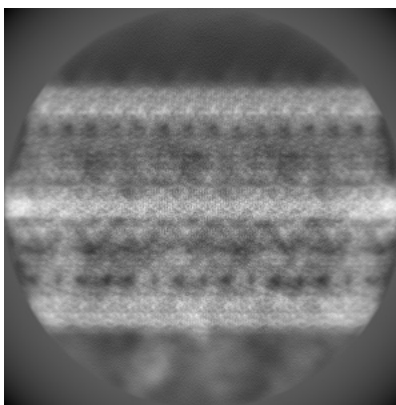

Y

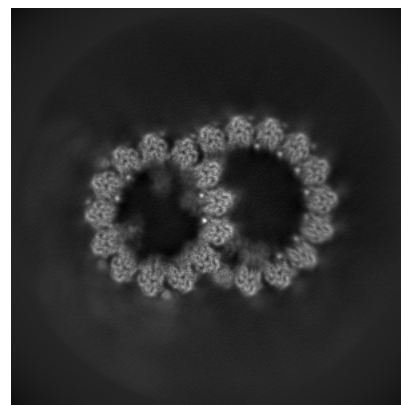

Z

The images above show the map projected in three orthogonal directions.

6.2 Central slices [i](#)

6.2.1 Primary map

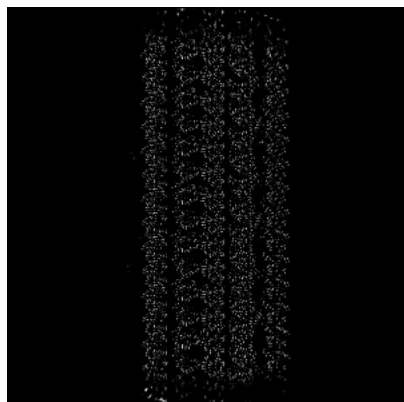

X Index: 256

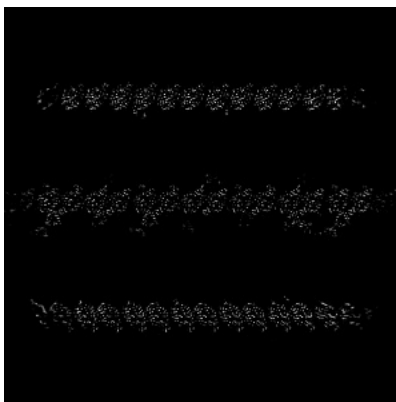

Y Index: 256

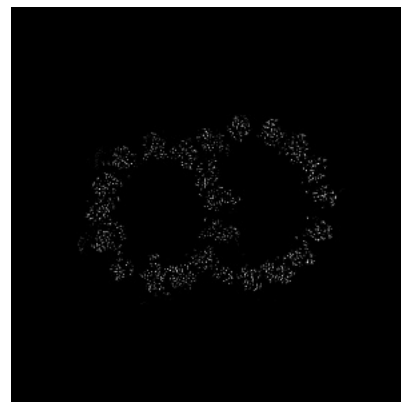

Z Index: 256

6.2.2 Raw map

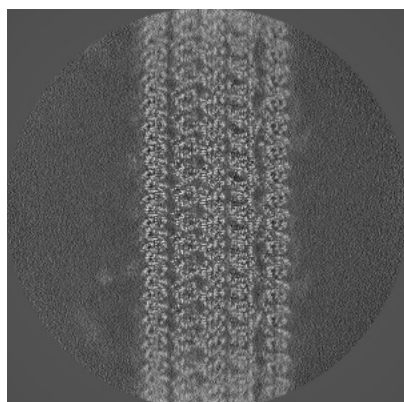

X Index: 256

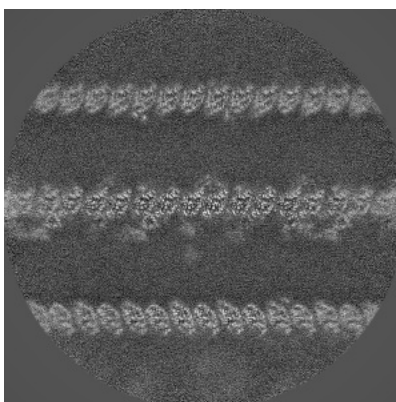

Y Index: 256

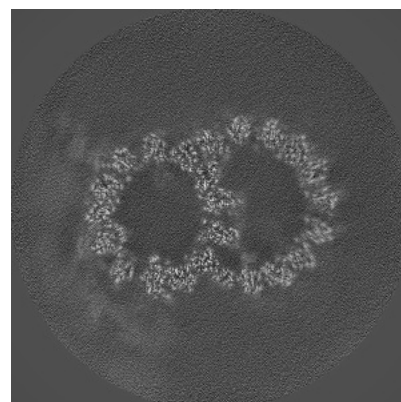

Z Index: 256

The images above show central slices of the map in three orthogonal directions.

6.3 Largest variance slices [i](#)

6.3.1 Primary map

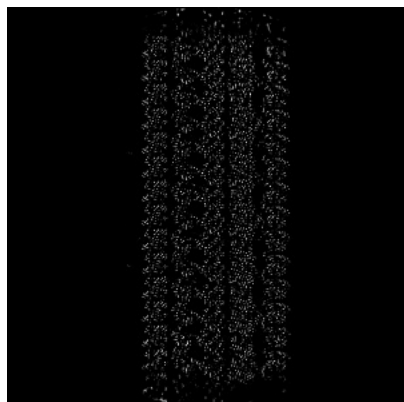

X Index: 255

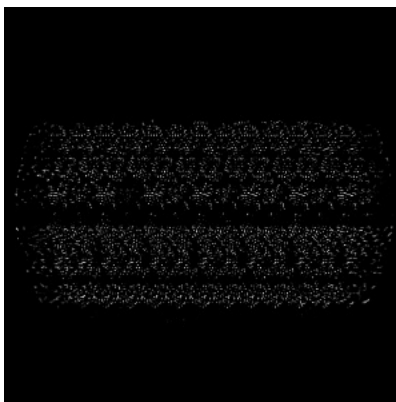

Y Index: 172

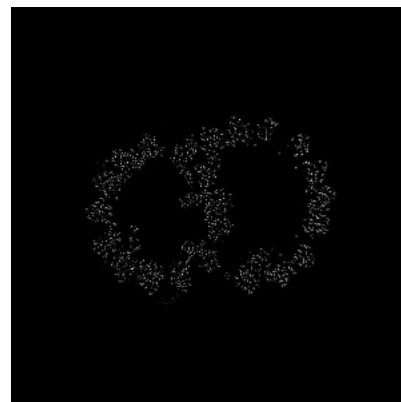

Z Index: 421

6.3.2 Raw map

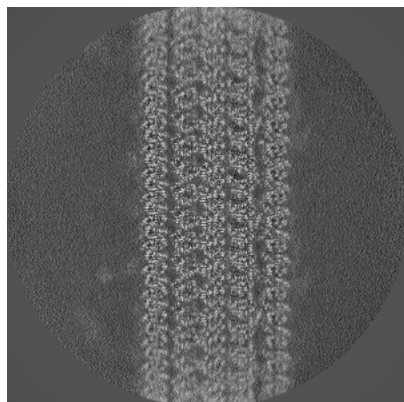

X Index: 256

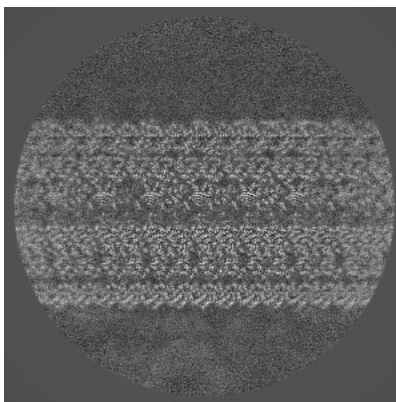

Y Index: 172

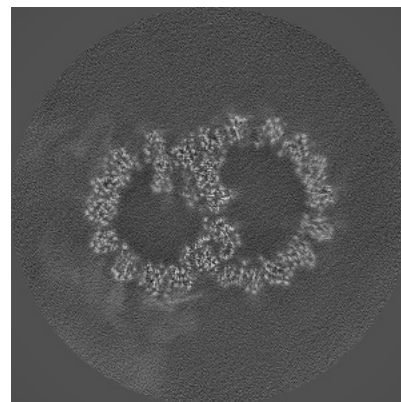

Z Index: 228

The images above show the largest variance slices of the map in three orthogonal directions.

6.4 Orthogonal standard-deviation projections (False-color) [i](#)

6.4.1 Primary map

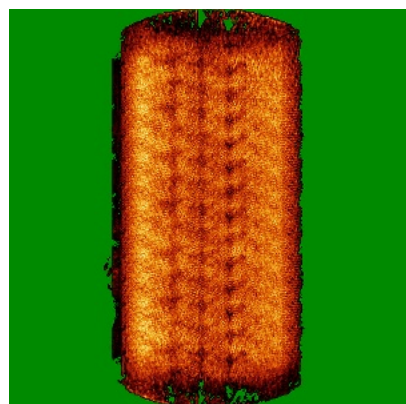

X

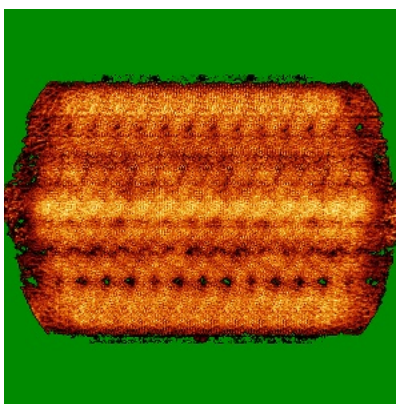

Y

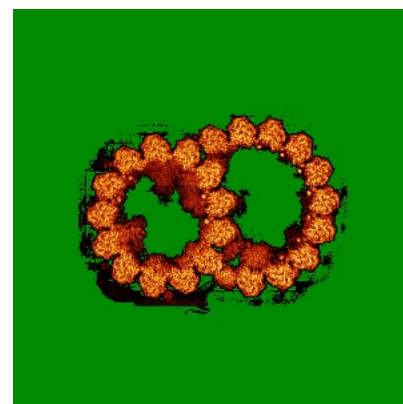

Z

6.4.2 Raw map

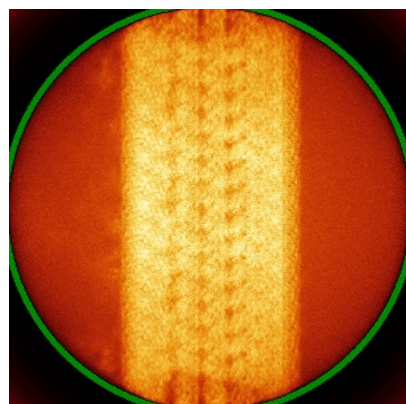

X

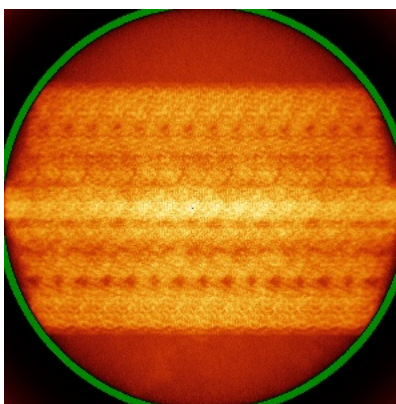

Y

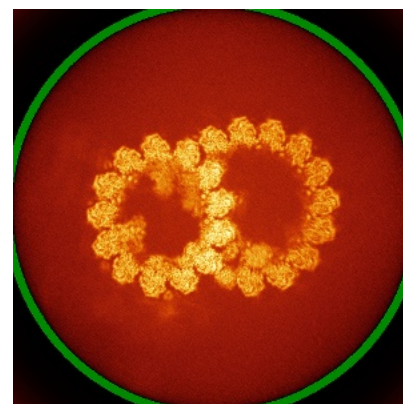

Z

The images above show the map standard deviation projections with false color in three orthogonal directions. Minimum values are shown in green, max in blue, and dark to light orange shades represent small to large values respectively.

6.5 Orthogonal surface views [i](#)

6.5.1 Primary map

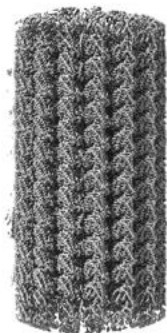

X

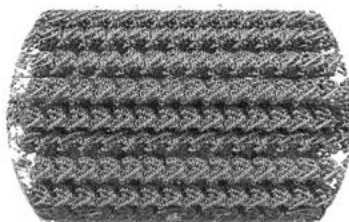

Y

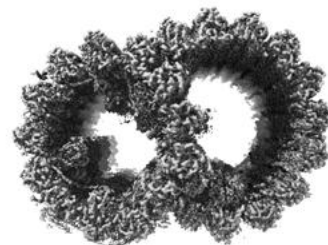

Z

The images above show the 3D surface view of the map at the recommended contour level 0.12. These images, in conjunction with the slice images, may facilitate assessment of whether an appropriate contour level has been provided.

6.5.2 Raw map

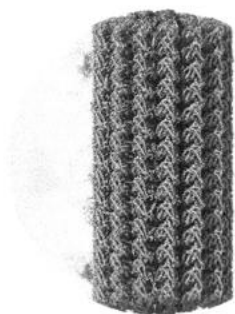

X

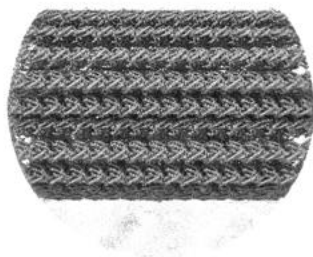

Y

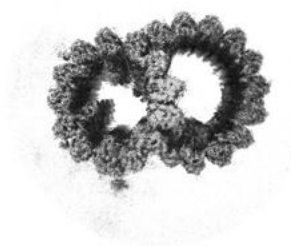

Z

These images show the 3D surface of the raw map. The raw map's contour level was selected so that its surface encloses the same volume as the primary map does at its recommended contour level.

6.6 Mask visualisation [i](#)

This section shows the 3D surface view of the primary map at 50% transparency overlaid with the specified mask at 0% transparency

A mask typically either:

- Encompasses the whole structure
- Separates out a domain, a functional unit, a monomer or an area of interest from a larger structure

6.6.1 emd_29692_msk_1.map [i](#)

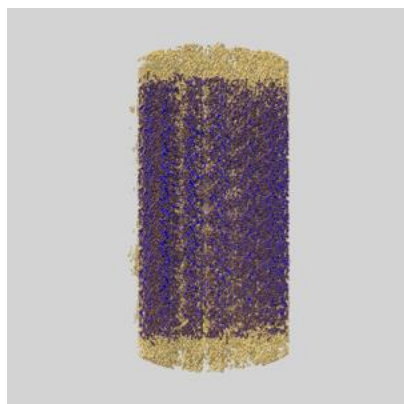

X

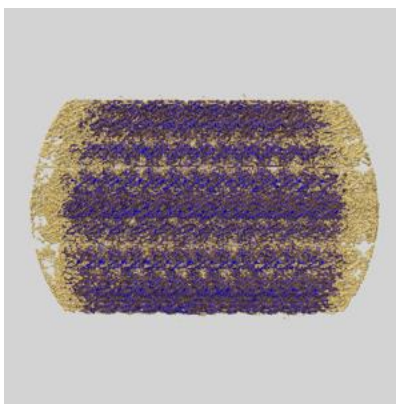

Y

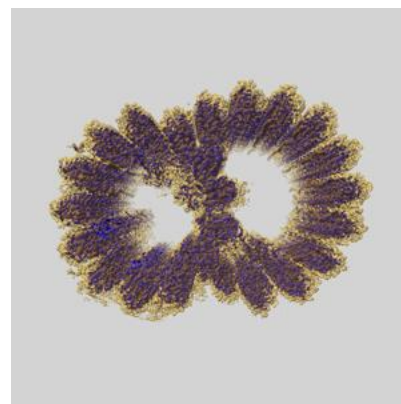

Z

7 Map analysis [i](#)

This section contains the results of statistical analysis of the map.

7.1 Map-value distribution [i](#)

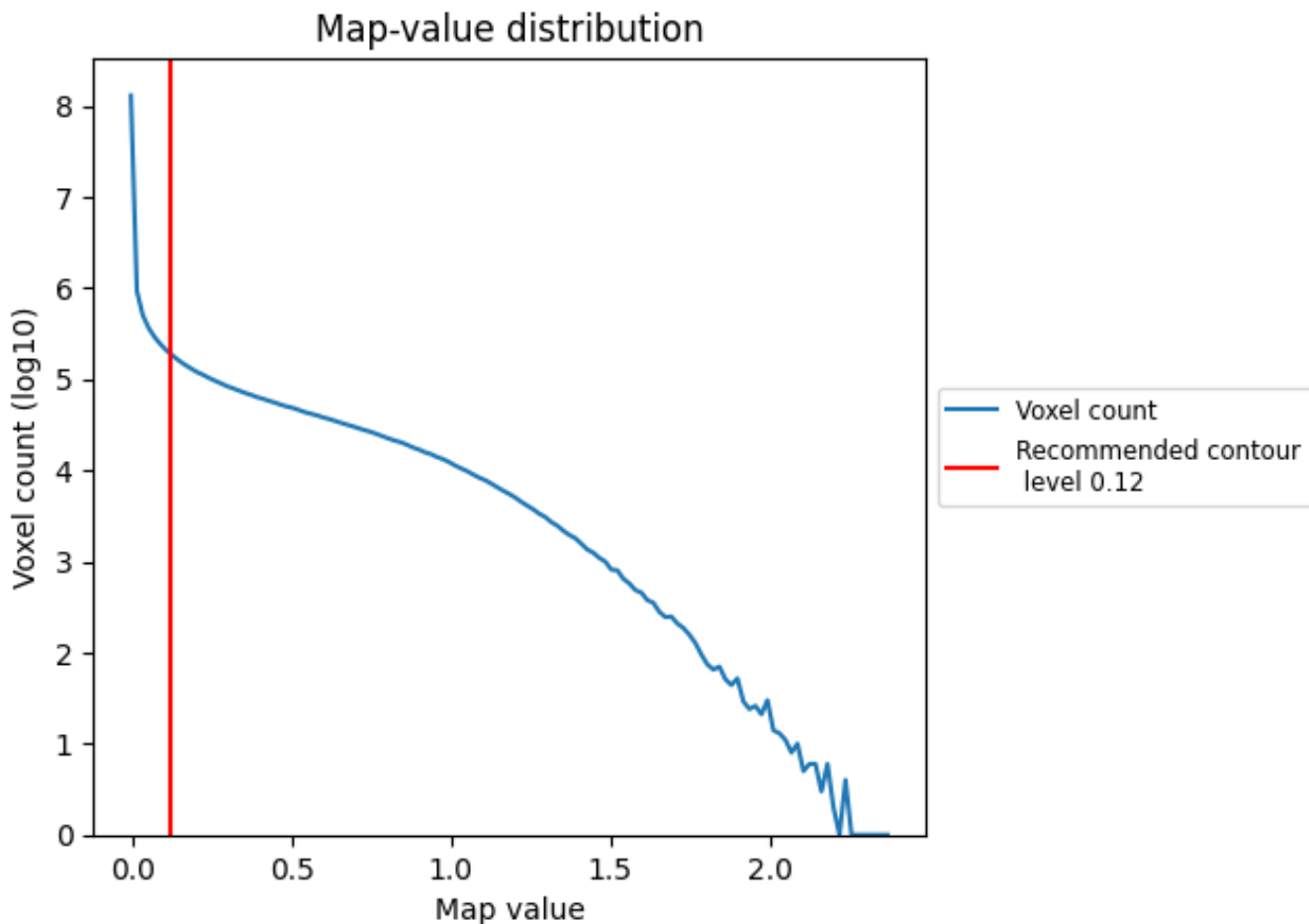

The map-value distribution is plotted in 128 intervals along the x-axis. The y-axis is logarithmic. A spike in this graph at zero usually indicates that the volume has been masked.

7.2 Volume estimate [i](#)

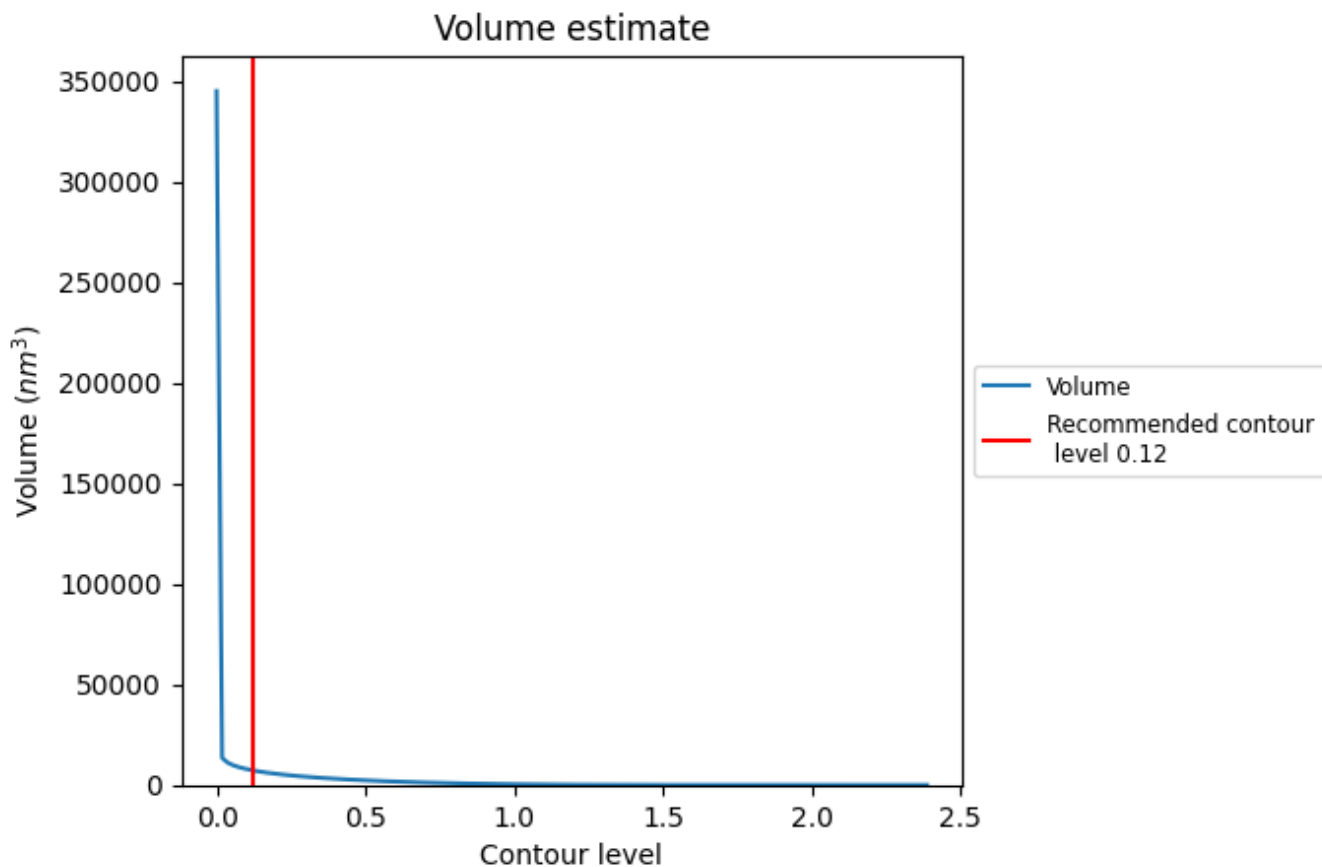

The volume at the recommended contour level is 7236 nm³; this corresponds to an approximate mass of 6536 kDa.

The volume estimate graph shows how the enclosed volume varies with the contour level. The recommended contour level is shown as a vertical line and the intersection between the line and the curve gives the volume of the enclosed surface at the given level.

7.3 Rotationally averaged power spectrum i

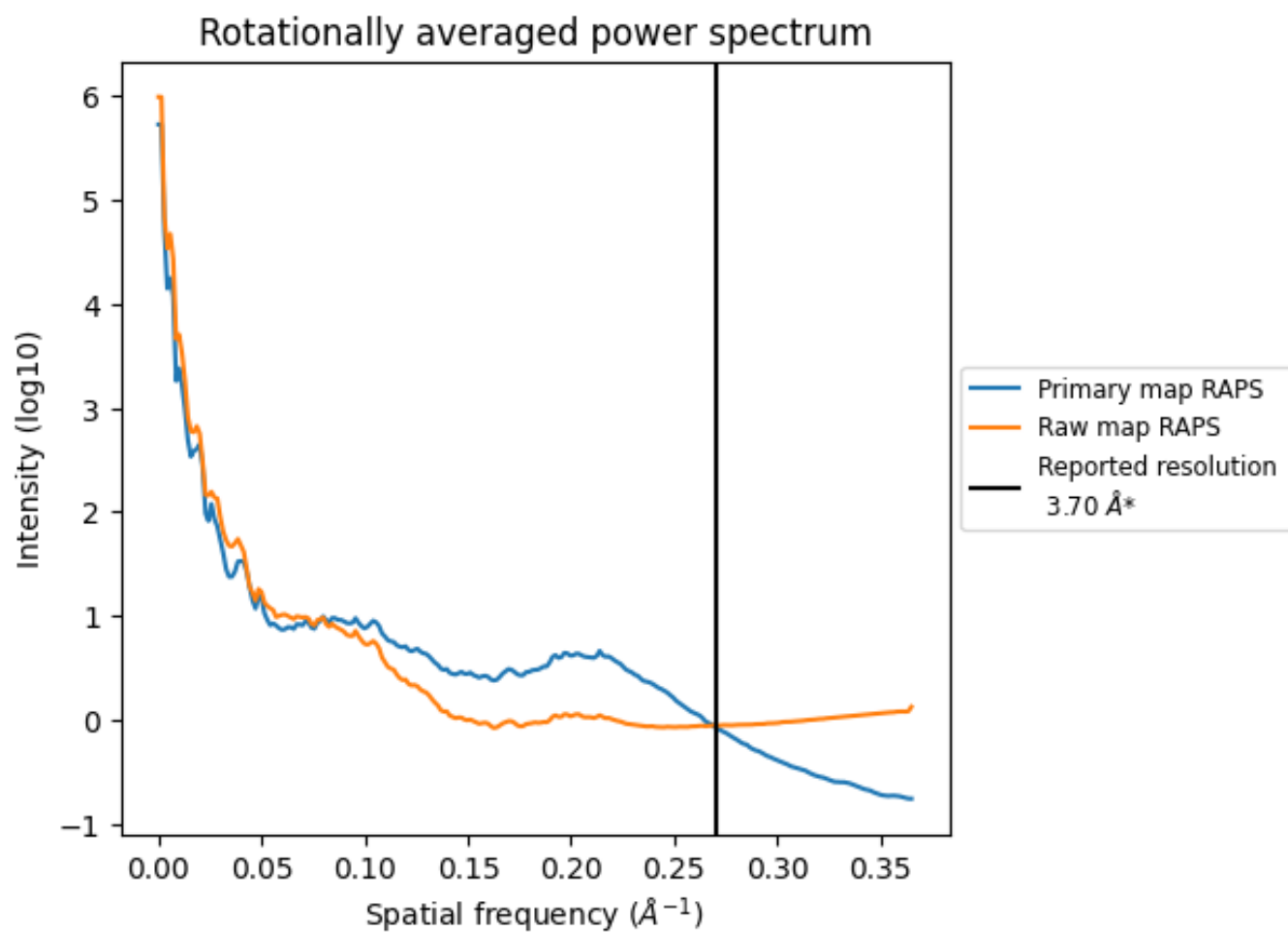

*Reported resolution corresponds to spatial frequency of 0.270 Å⁻¹

8 Fourier-Shell correlation [i](#)

Fourier-Shell Correlation (FSC) is the most commonly used method to estimate the resolution of single-particle and subtomogram-averaged maps. The shape of the curve depends on the imposed symmetry, mask and whether or not the two 3D reconstructions used were processed from a common reference. The reported resolution is shown as a black line. A curve is displayed for the half-bit criterion in addition to lines showing the 0.143 gold standard cut-off and 0.5 cut-off.

8.1 FSC [i](#)

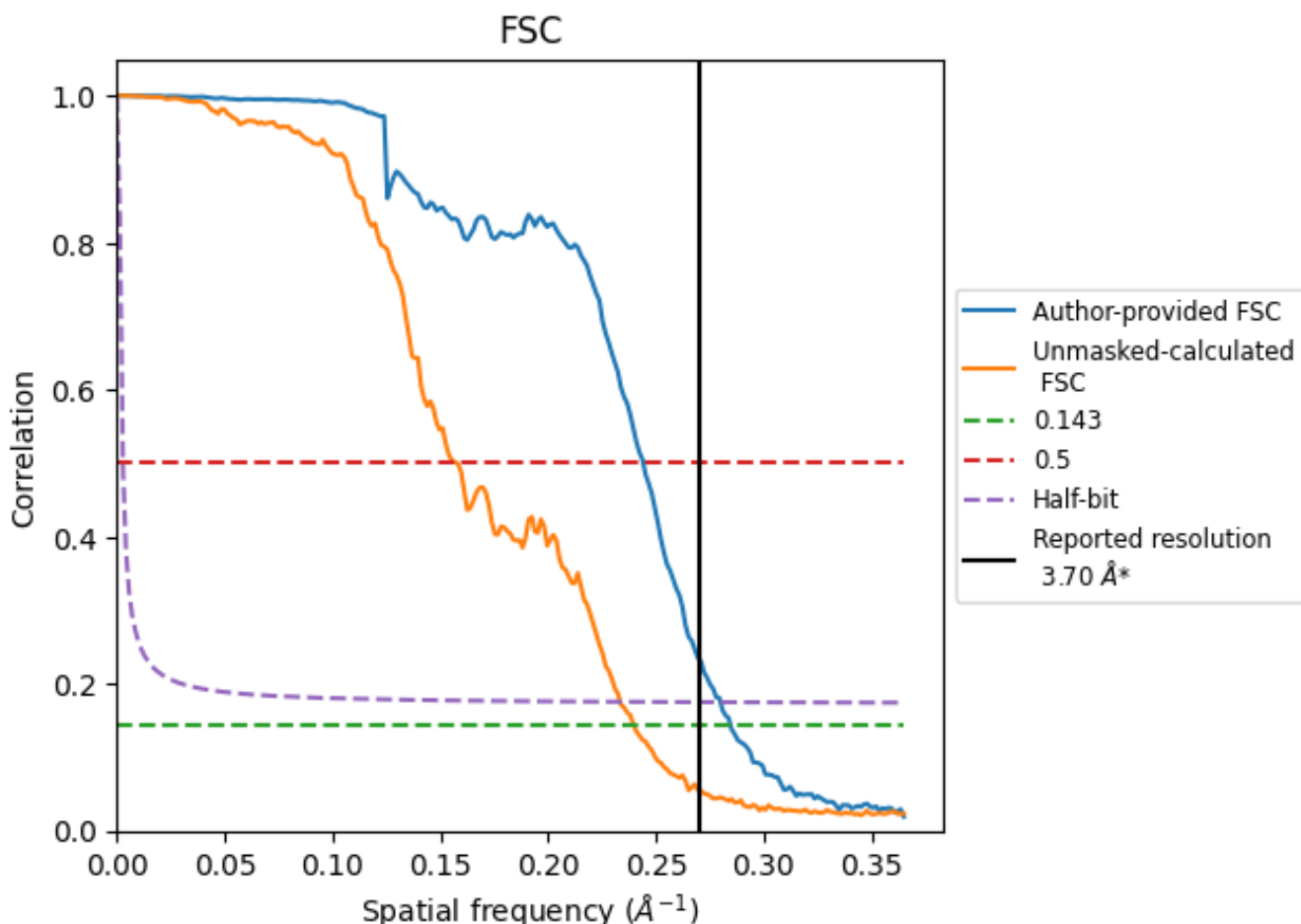

*Reported resolution corresponds to spatial frequency of 0.270 Å⁻¹

8.2 Resolution estimates [i](#)

Resolution estimate (Å)	Estimation criterion (FSC cut-off)		
	0.143	0.5	Half-bit
Reported by author	3.70	-	-
Author-provided FSC curve	3.51	4.10	3.57
Unmasked-calculated*	4.17	6.34	4.28

*Resolution estimate based on FSC curve calculated by comparison of deposited half-maps. The value from deposited half-maps intersecting FSC 0.143 CUT-OFF 4.17 differs from the reported value 3.7 by more than 10 %

9 Map-model fit [i](#)

This section contains information regarding the fit between EMDB map EMD-29692 and PDB model 8G3D. Per-residue inclusion information can be found in section 3 on page 73.

9.1 Map-model overlay [i](#)

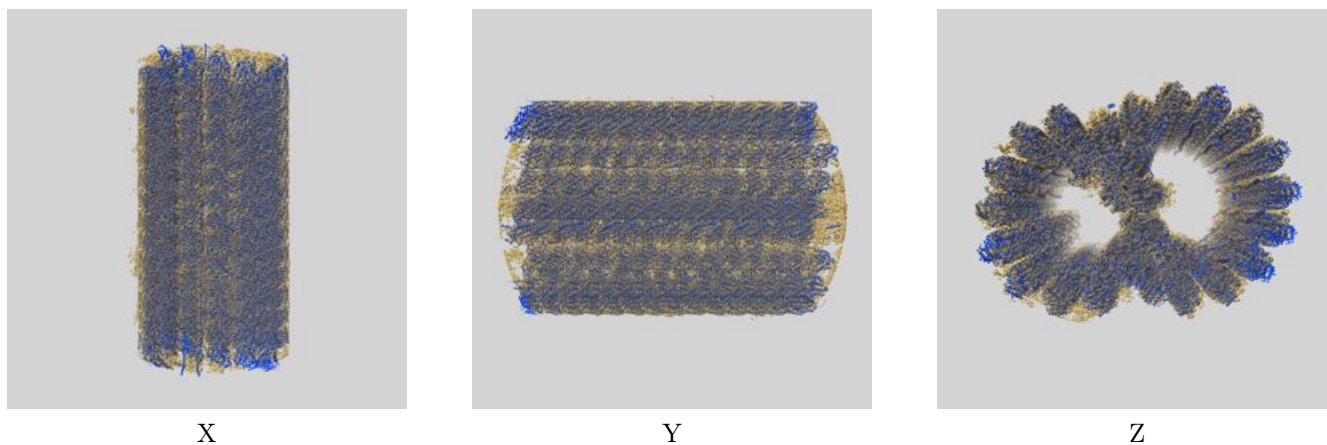

The images above show the 3D surface view of the map at the recommended contour level 0.12 at 50% transparency in yellow overlaid with a ribbon representation of the model coloured in blue. These images allow for the visual assessment of the quality of fit between the atomic model and the map.

9.2 Q-score mapped to coordinate model [i](#)

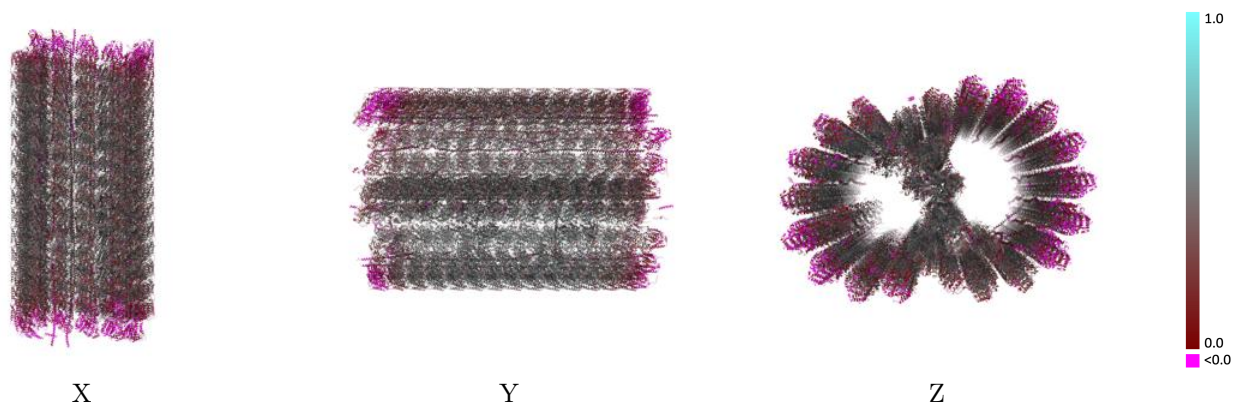

The images above show the model with each residue coloured according to its Q-score. This shows their resolvability in the map with higher Q-score values reflecting better resolvability. Please note: Q-score is calculating the resolvability of atoms, and thus high values are only expected at resolutions at which atoms can be resolved. Low Q-score values may therefore be expected for many entries.

9.3 Atom inclusion mapped to coordinate model [i](#)

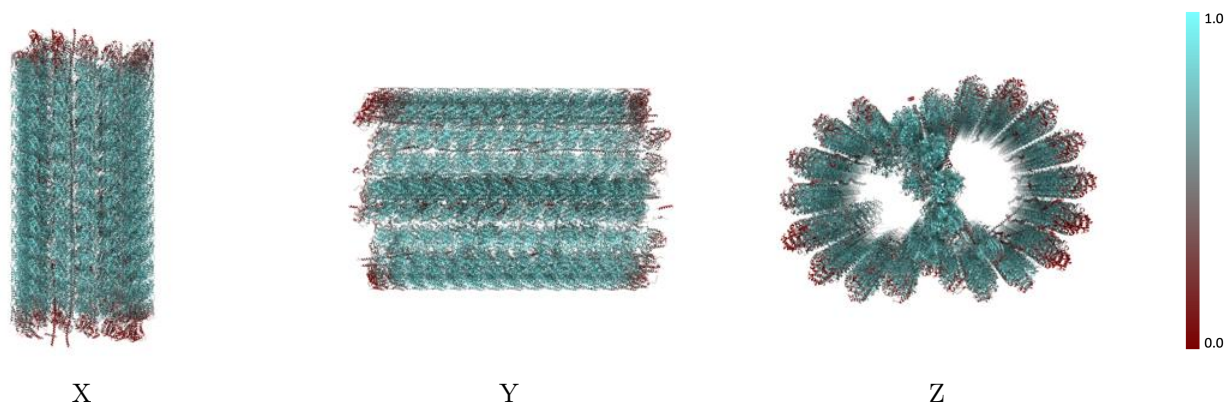

The images above show the model with each residue coloured according to its atom inclusion. This shows to what extent they are inside the map at the recommended contour level (0.12).



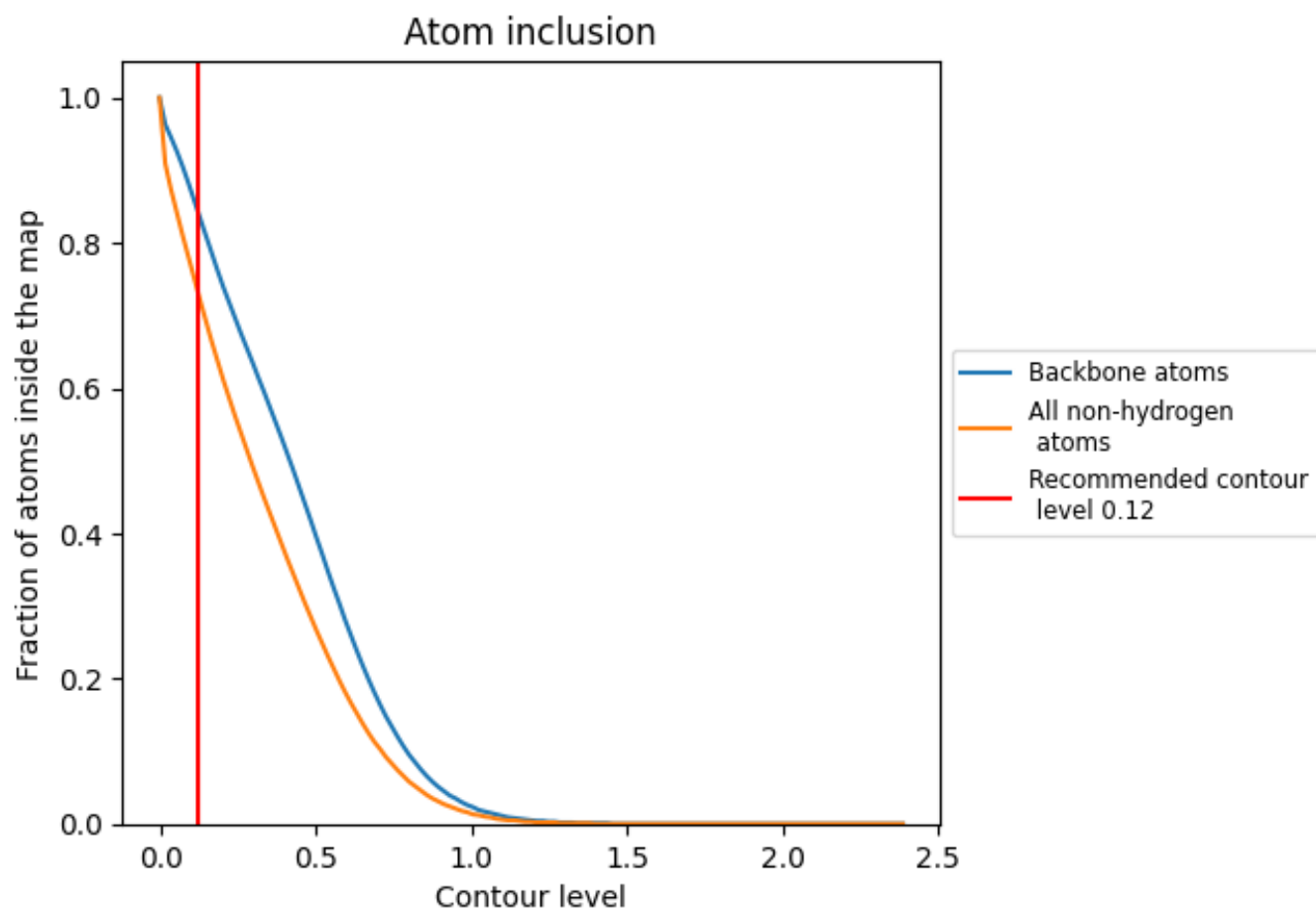



































































9.4 Atom inclusion [i](#)



At the recommended contour level, 84% of all backbone atoms, 73% of all non-hydrogen atoms, are inside the map.

9.5 Map-model fit summary





















































































The table lists the average atom inclusion at the recommended contour level (0.12) and Q-score for the entire model and for each chain.

Chain	Atom inclusion	Q-score
All	 0.7330	 0.3750
0A	 0.6480	 0.3110
0B	 0.6760	 0.4100
0C	 0.7220	 0.3910
0D	 0.6170	 0.2560
0E	 0.5970	 0.2200
0F	 0.7420	 0.3900
0G	 0.6560	 0.3440
0H	 0.4610	 0.1240
0N	 0.7200	 0.3390
0Q	 0.7640	 0.3630
0S	 0.4210	 0.2380
0T	 0.5000	 0.2970
0U	 0.6910	 0.3150
0V	 0.3380	 0.1270
0X	 0.7270	 0.4000
1A	 0.6510	 0.3700
1B	 0.6980	 0.3840
1C	 0.7160	 0.3200
1D	 0.6440	 0.3160
1E	 0.6600	 0.3320
1F	 0.7210	 0.4220
1G	 0.6060	 0.2790
1H	 0.4680	 0.1810
1I	 0.7620	 0.4350
1J	 0.6640	 0.3700
1K	 0.6190	 0.3230
1L	 0.6440	 0.3360
1M	 0.8170	 0.4520
1N	 0.7590	 0.4500
1O	 0.3520	 0.1010
1P	 0.4340	 0.1370
1Q	 0.8080	 0.4410
1R	 0.7860	 0.4410
1S	 0.7500	 0.4240



Continued on next page...

Continued from previous page...

Chain	Atom inclusion	Q-score
1T	 0.7500	 0.4370
1U	 0.7610	 0.3980
1V	 0.5250	 0.2990
1W	 0.7070	 0.4040
1X	 0.7480	 0.4440
2A	 0.6810	 0.3780
2B	 0.4370	 0.2970
2C	 0.5630	 0.2820
2D	 0.6260	 0.2940
2E	 0.6860	 0.3580
2F	 0.7180	 0.4100
2G	 0.7240	 0.4260
2H	 0.6420	 0.3780
2I	 0.5970	 0.3360
2K	 0.5270	 0.2680
2L	 0.4680	 0.2170
2M	 0.8120	 0.4580
2N	 0.6260	 0.2640
2O	 0.3730	 0.0880
2P	 0.4590	 0.1770
2Q	 0.7920	 0.4350
2R	 0.7720	 0.4480
2S	 0.7480	 0.4140
2T	 0.7600	 0.4300
2U	 0.7670	 0.3900
2V	 0.5640	 0.3040
2W	 0.4770	 0.2110
2X	 0.7470	 0.4330
3A	 0.6610	 0.3380
3B	 0.3860	 0.2130
3C	 0.7240	 0.3560
3D	 0.7610	 0.4200
3E	 0.4810	 0.1490
3H	 0.6240	 0.3980
3I	 0.7050	 0.4080
3L	 0.4770	 0.1650
3O	 0.3560	 0.1200
3Q	 0.8000	 0.4350
3R	 0.7770	 0.4320
3S	 0.7380	 0.3850
3T	 0.7400	 0.4020
3U	 0.7210	 0.3300





















































































Continued on next page...

Continued from previous page...

Chain	Atom inclusion	Q-score
3V	0.5190	0.2670
3X	0.6780	0.3790
4C	0.6980	0.3540
4F	0.7090	0.4140
4H	0.6840	0.4140
4Q	0.7980	0.4300
4R	0.7760	0.4350
4S	0.7180	0.3780
4X	0.5340	0.3180
5A	0.4880	0.2770
5B	0.6180	0.3920
5C	0.5970	0.3620
5D	0.5640	0.3170
5E	0.3540	0.1830
5F	0.5020	0.2980
5G	0.4920	0.2900
5H	0.5040	0.2600
5I	0.2930	0.1980
5J	0.3450	0.3140
5K	0.2470	0.1430
5Q	0.7900	0.4150
5R	0.7940	0.4460
5S	0.7240	0.4110
6F	0.7330	0.4310
6G	0.6600	0.3210
6H	0.6700	0.3570
6Q	0.7490	0.3690
6R	0.6920	0.3330
7R	0.6850	0.3280
8L	0.7020	0.2430
8N	0.6540	0.1780
8P	0.6670	0.2070
8R	0.6250	0.2020
AA	0.8240	0.4360
AB	0.6240	0.3510
AC	0.8310	0.4750
AD	0.8350	0.4700
AE	0.8360	0.4850
AF	0.8340	0.4850
AG	0.8320	0.4890
AH	0.8400	0.4870
AI	0.8420	0.4910





















































































Continued on next page...

Continued from previous page...

Chain	Atom inclusion	Q-score
AJ	 0.8300	 0.4790
AK	 0.8340	 0.4780
AL	 0.8270	 0.4770
AM	 0.8190	 0.4300
AN	 0.8320	 0.4640
BA	 0.7480	 0.3540
BB	 0.4340	 0.1290
BC	 0.8210	 0.4480
BD	 0.8260	 0.4330
BE	 0.8210	 0.4600
BF	 0.8170	 0.4580
BG	 0.8210	 0.4550
BH	 0.8240	 0.4630
BI	 0.8280	 0.4650
BJ	 0.8200	 0.4580
BK	 0.8280	 0.4590
BL	 0.8330	 0.4710
BM	 0.8120	 0.4080
BN	 0.8240	 0.4350
CA	 0.4990	 0.1790
CB	 0.7800	 0.3760
CC	 0.7950	 0.4090
CD	 0.8250	 0.4470
CE	 0.8190	 0.4500
CF	 0.8090	 0.4510
CG	 0.8190	 0.4460
CH	 0.8230	 0.4580
CI	 0.8320	 0.4600
CJ	 0.8350	 0.4630
CK	 0.8370	 0.4550
CL	 0.8220	 0.4170
CM	 0.7680	 0.3560
CN	 0.4020	 0.0980
DA	 0.3160	 0.0290
DB	 0.6960	 0.2900
DC	 0.7790	 0.3630
DD	 0.8360	 0.4470
DE	 0.8330	 0.4480
DF	 0.8260	 0.4520
DG	 0.8190	 0.4470
DH	 0.8340	 0.4570
DI	 0.8150	 0.4390





















































































Continued on next page...

Continued from previous page...

Chain	Atom inclusion	Q-score
DJ	 0.8310	 0.4440
DK	 0.8170	 0.4260
DL	 0.7970	 0.3900
DM	 0.7310	 0.3280
DN	 0.3610	 0.0690
EA	 0.2500	 0.0270
EB	 0.5730	 0.2210
EC	 0.7810	 0.3580
ED	 0.8160	 0.4220
EE	 0.8260	 0.4430
EF	 0.8070	 0.4320
EG	 0.8090	 0.4340
EH	 0.8080	 0.4250
EI	 0.8150	 0.4350
EJ	 0.8050	 0.4310
EK	 0.8140	 0.4390
EL	 0.7970	 0.3970
EM	 0.7650	 0.3550
EN	 0.4180	 0.1220
FA	 0.7740	 0.3540
FB	 0.5270	 0.2070
FC	 0.8240	 0.4540
FD	 0.8270	 0.4300
FE	 0.8220	 0.4590
FF	 0.8200	 0.4510
FG	 0.8130	 0.4470
FH	 0.8270	 0.4600
FI	 0.8260	 0.4620
FJ	 0.8400	 0.4620
FK	 0.8200	 0.4220
FL	 0.8170	 0.4360
FM	 0.1680	 -0.0030
FN	 0.5420	 0.2460
GA	 0.7520	 0.3390
GB	 0.4480	 0.1510
GC	 0.8260	 0.4610
GD	 0.8300	 0.4350
GE	 0.8340	 0.4780
GF	 0.8340	 0.4730
GG	 0.8280	 0.4700
GH	 0.8280	 0.4750
GI	 0.8300	 0.4700





















































































Continued on next page...

Continued from previous page...

Chain	Atom inclusion	Q-score
GJ	 0.8310	 0.4750
GK	 0.8280	 0.4440
GL	 0.8250	 0.4570
GM	 0.3100	 0.0560
GN	 0.7090	 0.3620
HA	 0.7590	 0.3620
HB	 0.4410	 0.1400
HC	 0.8130	 0.4600
HD	 0.8240	 0.4410
HE	 0.8390	 0.4850
HF	 0.8370	 0.4710
HG	 0.8140	 0.4680
HH	 0.8210	 0.4600
HI	 0.8290	 0.4740
HJ	 0.8230	 0.4680
HK	 0.8320	 0.4620
HL	 0.8250	 0.4700
HM	 0.5100	 0.2400
HN	 0.7870	 0.4130
IA	 0.7770	 0.3670
IB	 0.4800	 0.2120
IC	 0.8220	 0.4570
ID	 0.8320	 0.4480
IE	 0.8370	 0.4840
IF	 0.8360	 0.4800
IG	 0.8290	 0.4790
IH	 0.8570	 0.4890
II	 0.8400	 0.4890
IJ	 0.8530	 0.4950
IK	 0.8390	 0.4740
IL	 0.8370	 0.4730
IM	 0.7080	 0.3950
IN	 0.8320	 0.4500
JA	 0.8230	 0.4340
JB	 0.8090	 0.3960
JC	 0.8370	 0.4780
JD	 0.8500	 0.4750
JE	 0.8350	 0.4790
JF	 0.8410	 0.4830
JG	 0.8280	 0.4700
JH	 0.8360	 0.4760
JI	 0.8370	 0.4660





















































































Continued on next page...

Continued from previous page...

Chain	Atom inclusion	Q-score
JJ	 0.8400	 0.4720
JK	 0.8140	 0.4440
JL	 0.8400	 0.4780
JM	 0.5030	 0.2960
JN	 0.8170	 0.4350
KA	 0.8420	 0.4500
KB	 0.8240	 0.4080
KC	 0.8410	 0.4840
KD	 0.8530	 0.4830
KE	 0.8390	 0.4820
KF	 0.8540	 0.4910
KG	 0.8310	 0.4730
KH	 0.8350	 0.4810
KI	 0.8300	 0.4750
KJ	 0.8470	 0.4840
KK	 0.8480	 0.4830
KL	 0.8460	 0.4920
KM	 0.7500	 0.4160
KN	 0.8550	 0.4690
LA	 0.8170	 0.4420
LB	 0.7960	 0.4120
LC	 0.8350	 0.4860
LD	 0.8460	 0.4800
LE	 0.8310	 0.4840
LF	 0.8360	 0.4850
LG	 0.8410	 0.4860
LH	 0.8420	 0.4890
LI	 0.8260	 0.4790
LJ	 0.8420	 0.4860
LK	 0.8330	 0.4860
LL	 0.8340	 0.4790
LM	 0.7960	 0.4180
LN	 0.8400	 0.4650
MA	 0.8200	 0.4430
MB	 0.8050	 0.4240
MC	 0.8410	 0.4960
MD	 0.8450	 0.4950
ME	 0.8230	 0.4870
MF	 0.8410	 0.4960
MG	 0.8320	 0.4850
MH	 0.8350	 0.4870
MI	 0.8210	 0.4700





















































































Continued on next page...

Continued from previous page...

Chain	Atom inclusion	Q-score
MJ	 0.8470	 0.4940
MK	 0.8330	 0.4820
ML	 0.8180	 0.4790
MM	 0.8070	 0.4250
MN	 0.8460	 0.4840
NA	 0.7420	 0.3530
NB	 0.6380	 0.2690
NC	 0.8010	 0.4360
ND	 0.7780	 0.4050
NE	 0.7930	 0.4360
NF	 0.7850	 0.4310
NG	 0.7950	 0.4290
NH	 0.7680	 0.4160
NI	 0.7780	 0.4210
NJ	 0.8000	 0.4330
NK	 0.7900	 0.4210
NL	 0.7710	 0.4220
NM	 0.5910	 0.3350
NN	 0.7700	 0.4070
OA	 0.6790	 0.2760
OB	 0.4700	 0.1150
OC	 0.8070	 0.4110
OD	 0.7980	 0.3820
OE	 0.8110	 0.4340
OF	 0.8220	 0.4310
OG	 0.8110	 0.4220
OH	 0.7990	 0.4140
OI	 0.8100	 0.4250
OJ	 0.8110	 0.4200
OK	 0.8040	 0.4120
OL	 0.8020	 0.4200
OM	 0.5880	 0.2970
ON	 0.7930	 0.3800
PA	 0.5030	 0.1510
PB	 0.3080	 0.0130
PC	 0.7860	 0.3730
PD	 0.7300	 0.3180
PE	 0.7950	 0.3900
PF	 0.7950	 0.3900
PG	 0.7910	 0.3970
PH	 0.7910	 0.3930
PI	 0.7980	 0.4000





















































































Continued on next page...

Continued from previous page...

Chain	Atom inclusion	Q-score
PJ	 0.7890	 0.3890
PK	 0.8010	 0.3900
PL	 0.7910	 0.3910
PM	 0.5140	 0.2230
PN	 0.7570	 0.3380
QA	 0.3770	 0.0860
QB	 0.7180	 0.3050
QC	 0.7650	 0.3460
QD	 0.7860	 0.3760
QE	 0.7760	 0.3730
QF	 0.7910	 0.3780
QG	 0.7740	 0.3670
QH	 0.7850	 0.3820
QI	 0.7850	 0.3670
QJ	 0.7870	 0.3710
QK	 0.7650	 0.3570
QL	 0.7160	 0.3020
QM	 0.4560	 0.1380
QN	 0.1310	 -0.0040
RA	 0.2780	 0.0410
RB	 0.6570	 0.2830
RC	 0.7570	 0.3470
RD	 0.7580	 0.3640
RE	 0.7600	 0.3720
RF	 0.7620	 0.3690
RG	 0.7660	 0.3710
RH	 0.7650	 0.3650
RI	 0.7480	 0.3600
RJ	 0.7530	 0.3560
RK	 0.7420	 0.3370
RL	 0.6520	 0.2620
RM	 0.4230	 0.0620
RN	 0.1440	 -0.0230
SA	 0.2440	 0.0110
SB	 0.6460	 0.2670
SC	 0.7760	 0.3420
SD	 0.7810	 0.3690
SE	 0.7840	 0.3820
SF	 0.7810	 0.3840
SG	 0.7980	 0.3860
SH	 0.7810	 0.3770
SI	 0.7850	 0.3860







































Continued on next page...

Continued from previous page...

Chain	Atom inclusion	Q-score
SJ	 0.7720	 0.3620
SK	 0.7750	 0.3550
SL	 0.7650	 0.3220
SM	 0.6080	 0.2230
SN	 0.2210	 -0.0100
TA	 0.2060	 0.0060
TB	 0.5180	 0.2280
TC	 0.7400	 0.3240
TD	 0.7860	 0.3630
TE	 0.7860	 0.3820
TF	 0.7910	 0.3800
TG	 0.7690	 0.3650
TH	 0.7640	 0.3540
TI	 0.7680	 0.3650
TJ	 0.7790	 0.3660
TK	 0.7790	 0.3590
TL	 0.7530	 0.3100
TM	 0.6470	 0.2460
TN	 0.2170	 0.0080
UA	 0.2230	 0.0110
UB	 0.5200	 0.2270
UC	 0.7490	 0.3300
UD	 0.7910	 0.3850
UE	 0.8030	 0.4130
UF	 0.8020	 0.4060
UG	 0.8020	 0.4020
UH	 0.7790	 0.3880
UI	 0.8030	 0.4010
UJ	 0.7860	 0.3910
UK	 0.8020	 0.3930
UL	 0.7510	 0.3400
UM	 0.7120	 0.2950
UN	 0.3860	 0.1030
VA	 0.7890	 0.3830
VB	 0.6350	 0.3080
VC	 0.8070	 0.4370
VD	 0.8140	 0.4240
VE	 0.8160	 0.4290
VF	 0.8030	 0.4260
VG	 0.7910	 0.4090
VH	 0.7920	 0.4140
VI	 0.8090	 0.4190

Continued on next page...

Continued from previous page...

Chain	Atom inclusion	Q-score
VJ	 0.8040	 0.4170
VK	 0.7860	 0.3700
VL	 0.8010	 0.3930
VM	 0.3210	 0.0300
VN	 0.6710	 0.2870
WA	 0.7860	 0.3850
WB	 0.6300	 0.3150
WC	 0.8060	 0.4280
WD	 0.8160	 0.4310
WE	 0.8050	 0.4250
WF	 0.8010	 0.4340
WG	 0.7970	 0.4080
WH	 0.7990	 0.4240
WI	 0.8030	 0.4300
WJ	 0.8050	 0.4280
WK	 0.7980	 0.3840
WL	 0.7990	 0.4100
WM	 0.4440	 0.1380
WN	 0.7340	 0.3270