



# Full wwPDB X-ray Structure Validation Report ⓘ

Sep 20, 2023 – 11:06 AM EDT

PDB ID : 5IRQ  
Title : Human cytochrome P450 17A1 bound to inhibitors (R)- and (S)- orteronel  
Authors : Scott, E.E.; Petrunak, E.M.  
Deposited on : 2016-03-14  
Resolution : 2.20 Å(reported)

This is a Full wwPDB X-ray Structure Validation Report for a publicly released PDB entry.

We welcome your comments at [validation@mail.wwpdb.org](mailto:validation@mail.wwpdb.org)

A user guide is available at

<https://www.wwpdb.org/validation/2017/XrayValidationReportHelp>

with specific help available everywhere you see the ⓘ symbol.

The types of validation reports are described at

<http://www.wwpdb.org/validation/2017/FAQs#types>.

---

The following versions of software and data (see [references ⓘ](#)) were used in the production of this report:

MolProbity : 4.02b-467  
Mogul : 1.8.5 (274361), CSD as541be (2020)  
Xtriage (Phenix) : 1.13  
EDS : 2.35.1  
buster-report : 1.1.7 (2018)  
Percentile statistics : 20191225.v01 (using entries in the PDB archive December 25th 2019)  
Refmac : 5.8.0158  
CCP4 : 7.0.044 (Gargrove)  
Ideal geometry (proteins) : Engh & Huber (2001)  
Ideal geometry (DNA, RNA) : Parkinson et al. (1996)  
Validation Pipeline (wwPDB-VP) : 2.35.1

# 1 Overall quality at a glance

The following experimental techniques were used to determine the structure:

*X-RAY DIFFRACTION*

The reported resolution of this entry is 2.20 Å.

Percentile scores (ranging between 0-100) for global validation metrics of the entry are shown in the following graphic. The table shows the number of entries on which the scores are based.

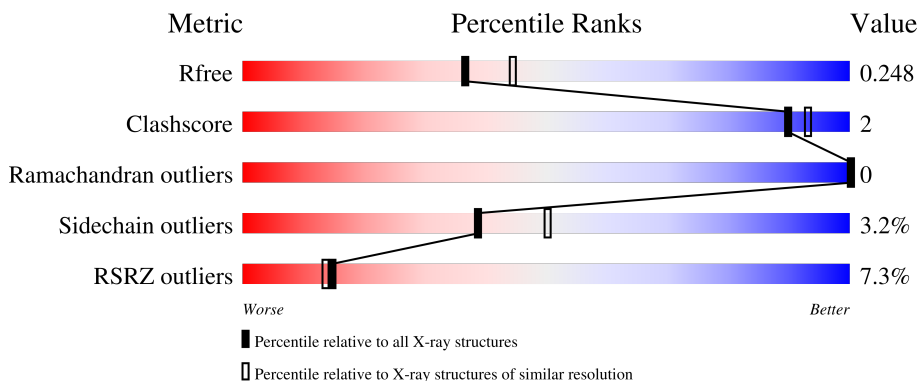

Metric	Whole archive (#Entries)	Similar resolution (#Entries, resolution range(Å))
$R_{free}$	130704	4898 (2.20-2.20)
Clashscore	141614	5594 (2.20-2.20)
Ramachandran outliers	138981	5503 (2.20-2.20)
Sidechain outliers	138945	5504 (2.20-2.20)
RSRZ outliers	127900	4800 (2.20-2.20)

The table below summarises the geometric issues observed across the polymeric chains and their fit to the electron density. The red, orange, yellow and green segments of the lower bar indicate the fraction of residues that contain outliers for  $\geq 3$ , 2, 1 and 0 types of geometric quality criteria respectively. A grey segment represents the fraction of residues that are not modelled. The numeric value for each fraction is indicated below the corresponding segment, with a dot representing fractions  $\leq 5\%$ . The upper red bar (where present) indicates the fraction of residues that have poor fit to the electron density. The numeric value is given above the bar.

Mol	Chain	Length	Quality of chain
1	A	494	 5% 88% 6% 6%
1	B	494	 4% 90% 5% 5%
1	C	494	 7% 89% 6% 5%
1	D	494	 11% 86% 8% 6%

## 2 Entry composition i

There are 5 unique types of molecules in this entry. The entry contains 31054 atoms, of which 15364 are hydrogens and 0 are deuteriums.

In the tables below, the ZeroOcc column contains the number of atoms modelled with zero occupancy, the AltConf column contains the number of residues with at least one atom in alternate conformation and the Trace column contains the number of residues modelled with at most 2 atoms.

- Molecule 1 is a protein called Steroid 17-alpha-hydroxylase/17,20 lyase.

Mol	Chain	Residues	Atoms					ZeroOcc	AltConf	Trace	
			Total	C	H	N	O				S
1	A	466	7503	2384	3787	643	674	15	0	0	0
1	B	467	7519	2389	3794	645	676	15	0	0	0
1	C	472	7567	2404	3815	650	683	15	0	0	0
1	D	465	7488	2380	3780	641	672	15	0	0	0

There are 36 discrepancies between the modelled and reference sequences:

Chain	Residue	Modelled	Actual	Comment	Reference
A	19	MET	-	expression tag	UNP P05093
A	20	ALA	-	expression tag	UNP P05093
A	21	LYS	-	expression tag	UNP P05093
A	22	LYS	-	expression tag	UNP P05093
A	23	THR	-	expression tag	UNP P05093
A	509	HIS	-	expression tag	UNP P05093
A	510	HIS	-	expression tag	UNP P05093
A	511	HIS	-	expression tag	UNP P05093
A	512	HIS	-	expression tag	UNP P05093
B	19	MET	-	expression tag	UNP P05093
B	20	ALA	-	expression tag	UNP P05093
B	21	LYS	-	expression tag	UNP P05093
B	22	LYS	-	expression tag	UNP P05093
B	23	THR	-	expression tag	UNP P05093
B	509	HIS	-	expression tag	UNP P05093
B	510	HIS	-	expression tag	UNP P05093
B	511	HIS	-	expression tag	UNP P05093
B	512	HIS	-	expression tag	UNP P05093
C	19	MET	-	expression tag	UNP P05093
C	20	ALA	-	expression tag	UNP P05093
C	21	LYS	-	expression tag	UNP P05093

*Continued on next page...*



Continued from previous page...

Mol	Chain	Residues	Atoms					ZeroOcc	AltConf	
			Total	C	Fe	H	N			O
2	D	1	73	34	1	30	4	4	0	0

- Molecule 3 is (R)-orteronel (three-letter code: 6D7) (formula: C<sub>18</sub>H<sub>17</sub>N<sub>3</sub>O<sub>2</sub>).

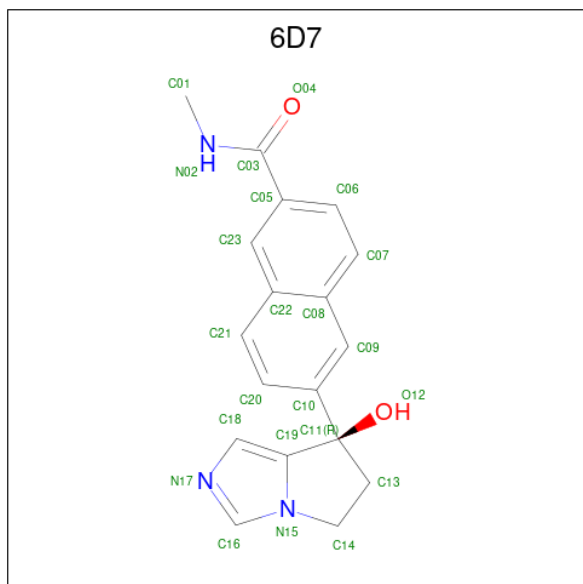

Mol	Chain	Residues	Atoms					ZeroOcc	AltConf
			Total	C	H	N	O		
3	A	1	40	18	17	3	2	0	0
3	B	1	40	18	17	3	2	0	0

- Molecule 4 is (S)-orteronel (three-letter code: 7D6) (formula: C<sub>18</sub>H<sub>17</sub>N<sub>3</sub>O<sub>2</sub>).

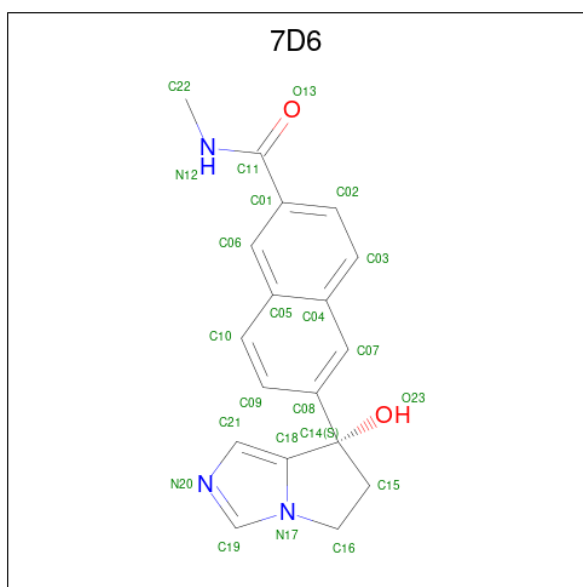

Mol	Chain	Residues	Atoms				ZeroOcc	AltConf	
			Total	C	H	N			O
4	C	1	40	18	17	3	2	0	0
4	D	1	40	18	17	3	2	0	0

- Molecule 5 is water.

Mol	Chain	Residues	Atoms		ZeroOcc	AltConf
5	A	148	Total	O	0	0
			148	148		
5	B	143	Total	O	0	0
			143	143		
5	C	135	Total	O	0	0
			135	135		
5	D	99	Total	O	0	0
			99	99		

### 3 Residue-property plots [i](#)

These plots are drawn for all protein, RNA, DNA and oligosaccharide chains in the entry. The first graphic for a chain summarises the proportions of the various outlier classes displayed in the second graphic. The second graphic shows the sequence view annotated by issues in geometry and electron density. Residues are color-coded according to the number of geometric quality criteria for which they contain at least one outlier: green = 0, yellow = 1, orange = 2 and red = 3 or more. A red dot above a residue indicates a poor fit to the electron density ( $RSRZ > 2$ ). Stretches of 2 or more consecutive residues without any outlier are shown as a green connector. Residues present in the sample, but not in the model, are shown in grey.

- Molecule 1: Steroid 17-alpha-hydroxylase/17,20 lyase

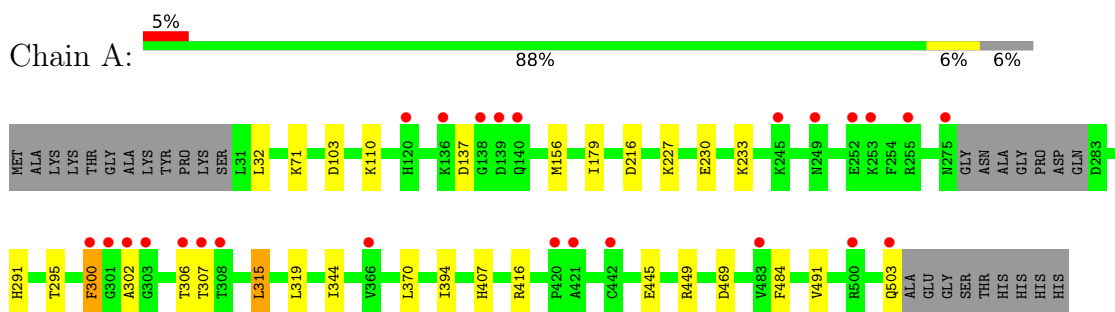

- Molecule 1: Steroid 17-alpha-hydroxylase/17,20 lyase

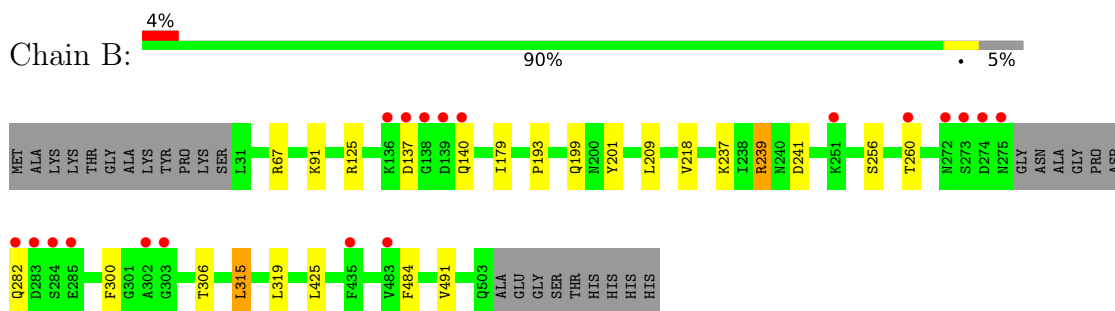

- Molecule 1: Steroid 17-alpha-hydroxylase/17,20 lyase

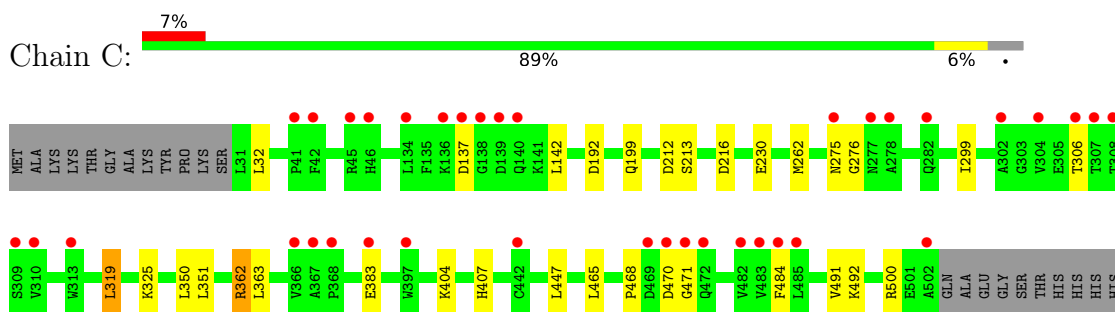

- Molecule 1: Steroid 17-alpha-hydroxylase/17,20 lyase

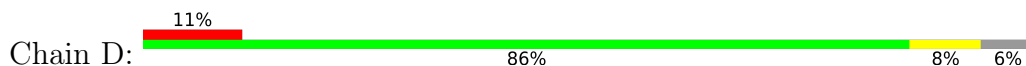

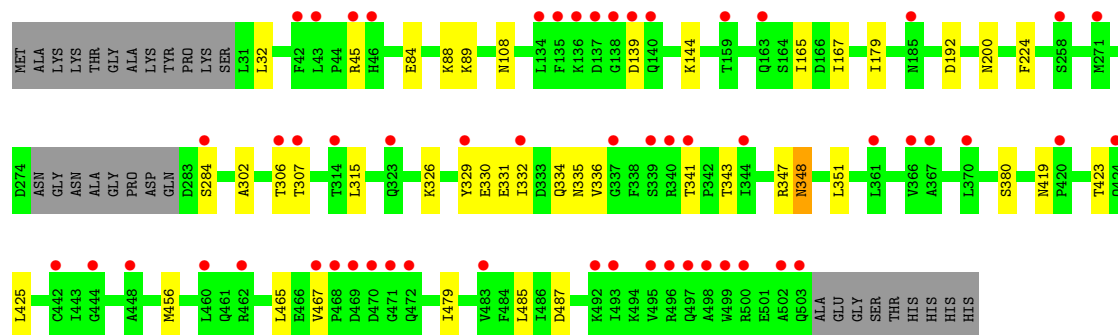



## 4 Data and refinement statistics

Property	Value	Source
Space group	P 21 21 21	Depositor
Cell constants a, b, c, $\alpha$ , $\beta$ , $\gamma$	90.17Å 153.20Å 168.12Å 90.00° 90.00° 90.00°	Depositor
Resolution (Å)	39.28 – 2.20 39.28 – 2.20	Depositor EDS
% Data completeness (in resolution range)	99.8 (39.28-2.20) 99.8 (39.28-2.20)	Depositor EDS
$R_{merge}$	(Not available)	Depositor
$R_{sym}$	0.13	Depositor
$\langle I/\sigma(I) \rangle$ <sup>1</sup>	1.80 (at 2.20Å)	Xtrriage
Refinement program	PHENIX (1.10pre_2124: ???)	Depositor
R, $R_{free}$	0.201 , 0.249 0.202 , 0.248	Depositor DCC
$R_{free}$ test set	5915 reflections (5.01%)	wwPDB-VP
Wilson B-factor (Å <sup>2</sup> )	37.9	Xtrriage
Anisotropy	0.421	Xtrriage
Bulk solvent $k_{sol}$ (e/Å <sup>3</sup> ), $B_{sol}$ (Å <sup>2</sup> )	0.39 , 42.1	EDS
L-test for twinning <sup>2</sup>	$\langle  L  \rangle = 0.48$ , $\langle L^2 \rangle = 0.31$	Xtrriage
Estimated twinning fraction	No twinning to report.	Xtrriage
$F_o, F_c$ correlation	0.95	EDS
Total number of atoms	31054	wwPDB-VP
Average B, all atoms (Å <sup>2</sup> )	52.0	wwPDB-VP

Xtrriage's analysis on translational NCS is as follows: *The largest off-origin peak in the Patterson function is 3.04% of the height of the origin peak. No significant pseudotranslation is detected.*

<sup>1</sup>Intensities estimated from amplitudes.

<sup>2</sup>Theoretical values of  $\langle |L| \rangle$ ,  $\langle L^2 \rangle$  for acentric reflections are 0.5, 0.333 respectively for untwinned datasets, and 0.375, 0.2 for perfectly twinned datasets.

## 5 Model quality [i](#)

### 5.1 Standard geometry [i](#)

Bond lengths and bond angles in the following residue types are not validated in this section: 7D6, HEM, 6D7

The Z score for a bond length (or angle) is the number of standard deviations the observed value is removed from the expected value. A bond length (or angle) with  $|Z| > 5$  is considered an outlier worth inspection. RMSZ is the root-mean-square of all Z scores of the bond lengths (or angles).

Mol	Chain	Bond lengths		Bond angles	
		RMSZ	# Z  >5	RMSZ	# Z  >5
1	A	0.26	0/3796	0.42	0/5139
1	B	0.28	1/3805 (0.0%)	0.43	0/5151
1	C	0.26	0/3834	0.43	0/5193
1	D	0.28	1/3788 (0.0%)	0.44	0/5128
All	All	0.27	2/15223 (0.0%)	0.43	0/20611

All (2) bond length outliers are listed below:

Mol	Chain	Res	Type	Atoms	Z	Observed(Å)	Ideal(Å)
1	B	218	VAL	C-N	8.01	1.49	1.34
1	D	224	PHE	C-N	6.25	1.46	1.34

There are no bond angle outliers.

There are no chirality outliers.

There are no planarity outliers.

### 5.2 Too-close contacts [i](#)

In the following table, the Non-H and H(model) columns list the number of non-hydrogen atoms and hydrogen atoms in the chain respectively. The H(added) column lists the number of hydrogen atoms added and optimized by MolProbity. The Clashes column lists the number of clashes within the asymmetric unit, whereas Symm-Clashes lists symmetry-related clashes.

Mol	Chain	Non-H	H(model)	H(added)	Clashes	Symm-Clashes
1	A	3716	3787	3786	16	0
1	B	3725	3794	3793	11	0
1	C	3752	3815	3815	12	0
1	D	3708	3780	3779	14	0
2	A	43	30	30	1	0

*Continued on next page...*

Continued from previous page...

Mol	Chain	Non-H	H(model)	H(added)	Clashes	Symm-Clashes
2	B	43	30	30	2	0
2	C	43	30	30	1	0
2	D	43	30	30	2	0
3	A	23	17	0	0	0
3	B	23	17	0	0	0
4	C	23	17	0	0	0
4	D	23	17	0	0	0
5	A	148	0	0	5	0
5	B	143	0	0	4	0
5	C	135	0	0	2	0
5	D	99	0	0	2	0
All	All	15690	15364	15293	55	0

The all-atom clashscore is defined as the number of clashes found per 1000 atoms (including hydrogen atoms). The all-atom clashscore for this structure is 2.

All (55) close contacts within the same asymmetric unit are listed below, sorted by their clash magnitude.

Atom-1	Atom-2	Interatomic distance (Å)	Clash overlap (Å)
1:D:326:LYS:NZ	1:D:330:GLU:OE2	2.07	0.87
1:A:445:GLU:OE2	1:A:449:ARG:NH2	2.22	0.73
1:D:192:ASP:OD2	5:D:701:HOH:O	2.10	0.68
1:B:425:LEU:O	5:B:701:HOH:O	2.10	0.68
1:A:295:THR:OG1	5:A:701:HOH:O	2.13	0.67
1:C:470:ASP:OD1	1:C:471:GLY:N	2.29	0.66
1:C:216:ASP:OD1	5:C:701:HOH:O	2.14	0.65
1:B:125:ARG:NH1	5:B:705:HOH:O	2.30	0.65
1:A:227:LYS:NZ	1:A:230:GLU:OE1	2.30	0.65
1:A:407:HIS:O	1:A:416:ARG:NH1	2.29	0.64
1:C:275:ASN:OD1	1:C:276:GLY:N	2.31	0.64
1:B:239:ARG:NH2	5:B:703:HOH:O	2.27	0.63
1:D:487:ASP:OD2	5:D:702:HOH:O	2.15	0.62
1:C:325:LYS:NZ	1:C:465:LEU:O	2.30	0.62
2:C:600:HEM:HHC	2:C:600:HEM:HBB2	1.84	0.59
1:C:192:ASP:OD2	5:C:702:HOH:O	2.17	0.58
2:B:600:HEM:HBB2	2:B:600:HEM:HHC	1.85	0.58
1:D:331:GLU:OE2	1:D:351:LEU:N	2.36	0.57
2:D:602:HEM:HBB2	2:D:602:HEM:HHC	1.85	0.57
1:D:89:LYS:NZ	1:D:380:SER:OG	2.38	0.56
1:D:139:ASP:O	1:D:144:LYS:NZ	2.33	0.54
1:A:306:THR:HG21	2:A:600:HEM:CHC	2.38	0.53

Continued on next page...

Continued from previous page...

Atom-1	Atom-2	Interatomic distance (Å)	Clash overlap (Å)
1:A:179:ILE:HG21	1:A:300:PHE:HA	1.92	0.52
1:D:479:ILE:N	1:D:485:LEU:O	2.42	0.52
1:D:302:ALA:O	1:D:306:THR:HG22	2.10	0.51
1:A:291:HIS:O	5:A:701:HOH:O	2.19	0.51
1:D:306:THR:HG21	2:D:602:HEM:CHC	2.41	0.50
1:B:319:LEU:HD11	1:B:491:VAL:HG12	1.94	0.48
1:A:319:LEU:HD11	1:A:491:VAL:HG12	1.95	0.48
1:B:140:GLN:NE2	1:B:260:THR:O	2.48	0.47
1:C:468:PRO:HA	1:C:492:LYS:HB2	1.98	0.46
1:A:103:ASP:OD1	5:A:702:HOH:O	2.20	0.46
1:A:469:ASP:OD2	5:A:703:HOH:O	2.21	0.45
1:D:329:TYR:O	1:D:332:ILE:HG22	2.17	0.44
1:B:199:GLN:OE1	5:B:702:HOH:O	2.21	0.44
1:C:212:ASP:OD1	1:C:213:SER:N	2.44	0.44
1:D:167:ILE:HD11	1:D:315:LEU:HD22	2.00	0.44
1:B:179:ILE:HG21	1:B:300:PHE:HA	2.00	0.43
1:C:319:LEU:HD21	1:C:491:VAL:HG12	2.00	0.43
1:D:348:ASN:OD1	1:D:348:ASN:N	2.49	0.43
1:A:156:MET:SD	1:B:193:PRO:HB3	2.58	0.43
1:D:84:GLU:HG3	1:D:88:LYS:HD3	2.00	0.43
1:C:142:LEU:HD11	1:C:447:LEU:HD13	2.01	0.43
1:C:262:MET:SD	1:C:299:ILE:HG13	2.59	0.43
1:C:362:ARG:HG3	1:C:363:LEU:N	2.34	0.43
1:D:306:THR:HG23	1:D:307:THR:N	2.34	0.43
1:A:370:LEU:HD22	1:A:394:ILE:HB	2.01	0.42
1:B:315:LEU:HD23	1:B:491:VAL:HG11	2.00	0.42
1:B:306:THR:HG21	2:B:600:HEM:C4B	2.53	0.42
1:A:302:ALA:O	1:A:306:THR:HG22	2.19	0.41
1:A:306:THR:CG2	1:A:307:THR:N	2.83	0.41
1:C:230:GLU:OE1	1:C:230:GLU:N	2.45	0.41
1:A:315:LEU:HD23	1:A:491:VAL:HG11	2.02	0.41
1:A:110:LYS:NZ	5:A:719:HOH:O	2.53	0.40
1:B:237:LYS:NZ	1:B:241:ASP:OD2	2.52	0.40

There are no symmetry-related clashes.

## 5.3 Torsion angles [i](#)

### 5.3.1 Protein backbone [i](#)

In the following table, the Percentiles column shows the percent Ramachandran outliers of the chain as a percentile score with respect to all X-ray entries followed by that with respect to entries of similar resolution.

The Analysed column shows the number of residues for which the backbone conformation was analysed, and the total number of residues.

Mol	Chain	Analysed	Favoured	Allowed	Outliers	Percentiles	
1	A	462/494 (94%)	449 (97%)	13 (3%)	0	100	100
1	B	463/494 (94%)	449 (97%)	14 (3%)	0	100	100
1	C	470/494 (95%)	447 (95%)	23 (5%)	0	100	100
1	D	461/494 (93%)	438 (95%)	23 (5%)	0	100	100
All	All	1856/1976 (94%)	1783 (96%)	73 (4%)	0	100	100

There are no Ramachandran outliers to report.

### 5.3.2 Protein sidechains [i](#)

In the following table, the Percentiles column shows the percent sidechain outliers of the chain as a percentile score with respect to all X-ray entries followed by that with respect to entries of similar resolution.

The Analysed column shows the number of residues for which the sidechain conformation was analysed, and the total number of residues.

Mol	Chain	Analysed	Rotameric	Outliers	Percentiles	
1	A	416/436 (95%)	406 (98%)	10 (2%)	49	62
1	B	417/436 (96%)	407 (98%)	10 (2%)	49	62
1	C	419/436 (96%)	406 (97%)	13 (3%)	40	51
1	D	415/436 (95%)	395 (95%)	20 (5%)	25	32
All	All	1667/1744 (96%)	1614 (97%)	53 (3%)	39	50

All (53) residues with a non-rotameric sidechain are listed below:

Mol	Chain	Res	Type
1	A	32	LEU
1	A	71	LYS

*Continued on next page...*

*Continued from previous page...*

<b>Mol</b>	<b>Chain</b>	<b>Res</b>	<b>Type</b>
1	A	137	ASP
1	A	216	ASP
1	A	233	LYS
1	A	300	PHE
1	A	315	LEU
1	A	344	ILE
1	A	484	PHE
1	A	503	GLN
1	B	67	ARG
1	B	91	LYS
1	B	137	ASP
1	B	201	TYR
1	B	209	LEU
1	B	239	ARG
1	B	256	SER
1	B	282	GLN
1	B	315	LEU
1	B	484	PHE
1	C	32	LEU
1	C	137	ASP
1	C	199	GLN
1	C	306	THR
1	C	319	LEU
1	C	350	LEU
1	C	351	LEU
1	C	362	ARG
1	C	383	GLU
1	C	404	LYS
1	C	407	HIS
1	C	484	PHE
1	C	500	ARG
1	D	32	LEU
1	D	45	ARG
1	D	108	ASN
1	D	165	ILE
1	D	179	ILE
1	D	200	ASN
1	D	284	SER
1	D	334	GLN
1	D	335	ASN
1	D	336	VAL
1	D	341	THR

*Continued on next page...*

*Continued from previous page...*

Mol	Chain	Res	Type
1	D	343	THR
1	D	347	ARG
1	D	348	ASN
1	D	419	ASN
1	D	423	THR
1	D	425	LEU
1	D	456	MET
1	D	465	LEU
1	D	467	VAL

Sometimes sidechains can be flipped to improve hydrogen bonding and reduce clashes. All (2) such sidechains are listed below:

Mol	Chain	Res	Type
1	A	48	HIS
1	B	291	HIS

### 5.3.3 RNA [i](#)

There are no RNA molecules in this entry.

## 5.4 Non-standard residues in protein, DNA, RNA chains [i](#)

There are no non-standard protein/DNA/RNA residues in this entry.

## 5.5 Carbohydrates [i](#)

There are no monosaccharides in this entry.

## 5.6 Ligand geometry [i](#)

8 ligands are modelled in this entry.

In the following table, the Counts columns list the number of bonds (or angles) for which Mogul statistics could be retrieved, the number of bonds (or angles) that are observed in the model and the number of bonds (or angles) that are defined in the Chemical Component Dictionary. The Link column lists molecule types, if any, to which the group is linked. The Z score for a bond length (or angle) is the number of standard deviations the observed value is removed from the expected value. A bond length (or angle) with  $|Z| > 2$  is considered an outlier worth inspection. RMSZ is the root-mean-square of all Z scores of the bond lengths (or angles).

Mol	Type	Chain	Res	Link	Bond lengths			Bond angles		
					Counts	RMSZ	# Z  > 2	Counts	RMSZ	# Z  > 2
4	7D6	C	601	2	20,26,26	2.67	7 (35%)	29,39,39	1.59	3 (10%)
3	6D7	B	601	2	20,26,26	5.98	14 (70%)	29,39,39	2.00	6 (20%)
2	HEM	A	600	3	41,50,50	1.46	4 (9%)	45,82,82	1.57	7 (15%)
2	HEM	B	600	3	41,50,50	1.48	5 (12%)	45,82,82	1.60	7 (15%)
3	6D7	A	601	2	20,26,26	5.96	14 (70%)	29,39,39	2.00	6 (20%)
4	7D6	D	601	2	20,26,26	2.70	7 (35%)	29,39,39	1.52	3 (10%)
2	HEM	C	600	4	41,50,50	1.46	4 (9%)	45,82,82	1.62	8 (17%)
2	HEM	D	602	4	41,50,50	1.47	5 (12%)	45,82,82	1.65	9 (20%)

In the following table, the Chirals column lists the number of chiral outliers, the number of chiral centers analysed, the number of these observed in the model and the number defined in the Chemical Component Dictionary. Similar counts are reported in the Torsion and Rings columns. '-' means no outliers of that kind were identified.

Mol	Type	Chain	Res	Link	Chirals	Torsions	Rings
4	7D6	C	601	2	-	0/12/24/24	0/4/4/4
3	6D7	B	601	2	-	0/12/24/24	0/4/4/4
2	HEM	A	600	3	-	0/12/54/54	-
2	HEM	B	600	3	-	1/12/54/54	-
3	6D7	A	601	2	-	0/12/24/24	0/4/4/4
4	7D6	D	601	2	-	0/12/24/24	0/4/4/4
2	HEM	C	600	4	-	3/12/54/54	-
2	HEM	D	602	4	-	4/12/54/54	-

All (60) bond length outliers are listed below:

Mol	Chain	Res	Type	Atoms	Z	Observed(Å)	Ideal(Å)
3	A	601	6D7	C09-C10	9.69	1.55	1.38
3	B	601	6D7	C09-C10	9.65	1.55	1.38
3	B	601	6D7	C03-N02	9.04	1.45	1.33
3	A	601	6D7	C06-C05	8.95	1.54	1.39
3	B	601	6D7	C06-C05	8.91	1.54	1.39
3	A	601	6D7	C03-N02	8.88	1.44	1.33
4	C	601	7D6	C11-N12	8.32	1.44	1.33
4	D	601	7D6	C11-N12	8.29	1.44	1.33
3	A	601	6D7	C20-C10	8.26	1.52	1.39
3	B	601	6D7	C20-C10	8.23	1.52	1.39
3	B	601	6D7	C23-C05	8.20	1.51	1.37
3	A	601	6D7	C23-C05	8.13	1.51	1.37
3	B	601	6D7	C21-C20	7.76	1.53	1.36

Continued on next page...



*Continued from previous page...*

Mol	Chain	Res	Type	Atoms	Z	Observed(Å)	Ideal(Å)
3	A	601	6D7	C21-C20	7.72	1.52	1.36
3	B	601	6D7	C07-C06	7.63	1.52	1.36
3	A	601	6D7	C07-C06	7.61	1.52	1.36
3	B	601	6D7	C11-C10	-7.32	1.45	1.53
3	A	601	6D7	C11-C10	-7.22	1.46	1.53
3	B	601	6D7	C21-C22	6.42	1.57	1.41
3	A	601	6D7	C21-C22	6.36	1.57	1.41
3	B	601	6D7	C07-C08	5.65	1.55	1.41
3	A	601	6D7	C07-C08	5.61	1.55	1.41
3	B	601	6D7	C23-C22	5.52	1.54	1.42
3	A	601	6D7	C23-C22	5.49	1.54	1.42
3	B	601	6D7	C09-C08	5.09	1.53	1.42
3	A	601	6D7	C09-C08	5.07	1.53	1.42
4	C	601	7D6	C15-C16	4.21	1.60	1.52
4	D	601	7D6	C15-C16	4.17	1.60	1.52
4	D	601	7D6	C03-C02	4.00	1.45	1.36
2	B	600	HEM	C3C-CAC	3.87	1.55	1.47
2	A	600	HEM	C3C-CAC	3.85	1.55	1.47
2	D	602	HEM	C3C-CAC	3.85	1.55	1.47
4	C	601	7D6	C03-C02	3.82	1.44	1.36
2	C	600	HEM	C3C-CAC	3.79	1.55	1.47
3	A	601	6D7	C08-C22	3.61	1.50	1.42
2	B	600	HEM	C3C-C2C	-3.60	1.35	1.40
3	B	601	6D7	C08-C22	3.58	1.50	1.42
2	A	600	HEM	C3C-C2C	-3.56	1.35	1.40
4	D	601	7D6	C01-C11	3.55	1.57	1.50
2	D	602	HEM	C3C-C2C	-3.54	1.35	1.40
2	C	600	HEM	C3C-C2C	-3.54	1.35	1.40
4	C	601	7D6	C01-C11	3.45	1.57	1.50
2	D	602	HEM	CAB-C3B	3.04	1.55	1.47
2	C	600	HEM	CAB-C3B	3.01	1.55	1.47
2	A	600	HEM	CAB-C3B	3.00	1.55	1.47
2	B	600	HEM	CAB-C3B	2.96	1.55	1.47
4	D	601	7D6	C05-C04	-2.68	1.36	1.42
4	C	601	7D6	C05-C04	-2.65	1.36	1.42
4	D	601	7D6	C06-C05	2.63	1.48	1.42
4	C	601	7D6	C06-C05	2.55	1.47	1.42
4	D	601	7D6	C07-C08	2.38	1.43	1.38
3	B	601	6D7	C16-N17	2.35	1.40	1.34
3	A	601	6D7	C16-N17	2.30	1.39	1.34
2	B	600	HEM	CMB-C2B	2.17	1.55	1.50
4	C	601	7D6	C07-C08	2.16	1.42	1.38

*Continued on next page...*

*Continued from previous page...*

Mol	Chain	Res	Type	Atoms	Z	Observed(Å)	Ideal(Å)
2	D	602	HEM	FE-ND	2.11	2.07	1.96
2	A	600	HEM	CMB-C2B	2.11	1.55	1.50
2	B	600	HEM	FE-ND	2.07	2.07	1.96
2	D	602	HEM	CMB-C2B	2.06	1.55	1.50
2	C	600	HEM	CMB-C2B	2.04	1.55	1.50

All (49) bond angle outliers are listed below:

Mol	Chain	Res	Type	Atoms	Z	Observed(°)	Ideal(°)
3	B	601	6D7	C16-N15-C19	-6.18	107.96	110.81
3	A	601	6D7	C16-N15-C19	-5.91	108.09	110.81
4	C	601	7D6	C19-N17-C18	-5.48	108.29	110.81
4	D	601	7D6	C19-N17-C18	-5.38	108.33	110.81
3	A	601	6D7	O12-C11-C10	-4.43	101.83	110.68
3	B	601	6D7	O12-C11-C10	-4.36	101.96	110.68
2	D	602	HEM	C4B-CHC-C1C	4.08	127.94	122.56
2	A	600	HEM	C4B-CHC-C1C	3.84	127.62	122.56
2	D	602	HEM	CMC-C2C-C3C	3.77	131.73	124.68
2	C	600	HEM	CMC-C2C-C3C	3.67	131.55	124.68
2	C	600	HEM	C4B-CHC-C1C	3.53	127.22	122.56
2	A	600	HEM	CMC-C2C-C3C	3.49	131.21	124.68
3	A	601	6D7	O12-C11-C19	3.44	117.75	111.60
2	B	600	HEM	C1B-NB-C4B	3.43	108.62	105.07
2	B	600	HEM	CMC-C2C-C3C	3.43	131.09	124.68
2	C	600	HEM	C1B-NB-C4B	3.40	108.59	105.07
2	B	600	HEM	C4B-CHC-C1C	3.38	127.03	122.56
3	B	601	6D7	O12-C11-C19	3.38	117.64	111.60
2	D	602	HEM	C1B-NB-C4B	3.38	108.56	105.07
2	B	600	HEM	C4C-CHD-C1D	3.20	126.78	122.56
2	D	602	HEM	C4D-ND-C1D	3.00	108.17	105.07
2	A	600	HEM	C4C-CHD-C1D	2.97	126.48	122.56
2	A	600	HEM	C4D-ND-C1D	2.97	108.14	105.07
2	C	600	HEM	C3B-C2B-C1B	2.85	108.60	106.49
2	A	600	HEM	CMB-C2B-C1B	-2.84	120.71	125.04
2	B	600	HEM	C4D-ND-C1D	2.83	108.00	105.07
2	C	600	HEM	C4D-ND-C1D	2.83	107.99	105.07
3	A	601	6D7	N17-C16-N15	-2.83	108.06	112.26
2	D	602	HEM	C4C-CHD-C1D	2.82	126.28	122.56
2	A	600	HEM	C1B-NB-C4B	2.79	107.96	105.07
3	B	601	6D7	N17-C16-N15	-2.76	108.17	112.26
2	C	600	HEM	C4C-CHD-C1D	2.75	126.18	122.56
2	C	600	HEM	CHC-C4B-C3B	2.69	128.68	124.57

*Continued on next page...*

Continued from previous page...

Mol	Chain	Res	Type	Atoms	Z	Observed(°)	Ideal(°)
4	D	601	7D6	C16-N17-C18	-2.68	105.90	115.46
2	B	600	HEM	CHC-C4B-C3B	2.67	128.66	124.57
2	D	602	HEM	C3B-C2B-C1B	2.66	108.46	106.49
3	A	601	6D7	C01-N02-C03	-2.57	118.98	121.89
2	B	600	HEM	C3B-C2B-C1B	2.54	108.37	106.49
4	C	601	7D6	C16-N17-C18	-2.49	106.59	115.46
2	D	602	HEM	CHC-C4B-C3B	2.31	128.11	124.57
2	D	602	HEM	CAD-CBD-CGD	-2.26	108.73	113.60
3	B	601	6D7	C01-N02-C03	-2.19	119.41	121.89
2	D	602	HEM	CMA-C3A-C4A	-2.10	125.23	128.46
3	A	601	6D7	C14-N15-C19	-2.07	108.08	115.46
4	D	601	7D6	C21-N20-C19	2.06	109.00	105.78
2	C	600	HEM	C3D-C4D-ND	-2.05	107.88	110.17
4	C	601	7D6	C21-N20-C19	2.04	108.97	105.78
3	B	601	6D7	C14-N15-C19	-2.03	108.24	115.46
2	A	600	HEM	CAA-CBA-CGA	-2.03	108.08	113.76

There are no chirality outliers.

All (8) torsion outliers are listed below:

Mol	Chain	Res	Type	Atoms
2	B	600	HEM	C4B-C3B-CAB-CBB
2	C	600	HEM	C4B-C3B-CAB-CBB
2	D	602	HEM	CAA-CBA-CGA-O2A
2	D	602	HEM	C4B-C3B-CAB-CBB
2	D	602	HEM	CAA-CBA-CGA-O1A
2	D	602	HEM	CAD-CBD-CGD-O2D
2	C	600	HEM	CAA-CBA-CGA-O1A
2	C	600	HEM	CAA-CBA-CGA-O2A

There are no ring outliers.

4 monomers are involved in 6 short contacts:

Mol	Chain	Res	Type	Clashes	Symm-Clashes
2	A	600	HEM	1	0
2	B	600	HEM	2	0
2	C	600	HEM	1	0
2	D	602	HEM	2	0

The following is a two-dimensional graphical depiction of Mogul quality analysis of bond lengths, bond angles, torsion angles, and ring geometry for all instances of the Ligand of Interest. In

addition, ligands with molecular weight  $> 250$  and outliers as shown on the validation Tables will also be included. For torsion angles, if less than 5% of the Mogul distribution of torsion angles is within 10 degrees of the torsion angle in question, then that torsion angle is considered an outlier. Any bond that is central to one or more torsion angles identified as an outlier by Mogul will be highlighted in the graph. For rings, the root-mean-square deviation (RMSD) between the ring in question and similar rings identified by Mogul is calculated over all ring torsion angles. If the average RMSD is greater than 60 degrees and the minimal RMSD between the ring in question and any Mogul-identified rings is also greater than 60 degrees, then that ring is considered an outlier. The outliers are highlighted in purple. The color gray indicates Mogul did not find sufficient equivalents in the CSD to analyse the geometry.

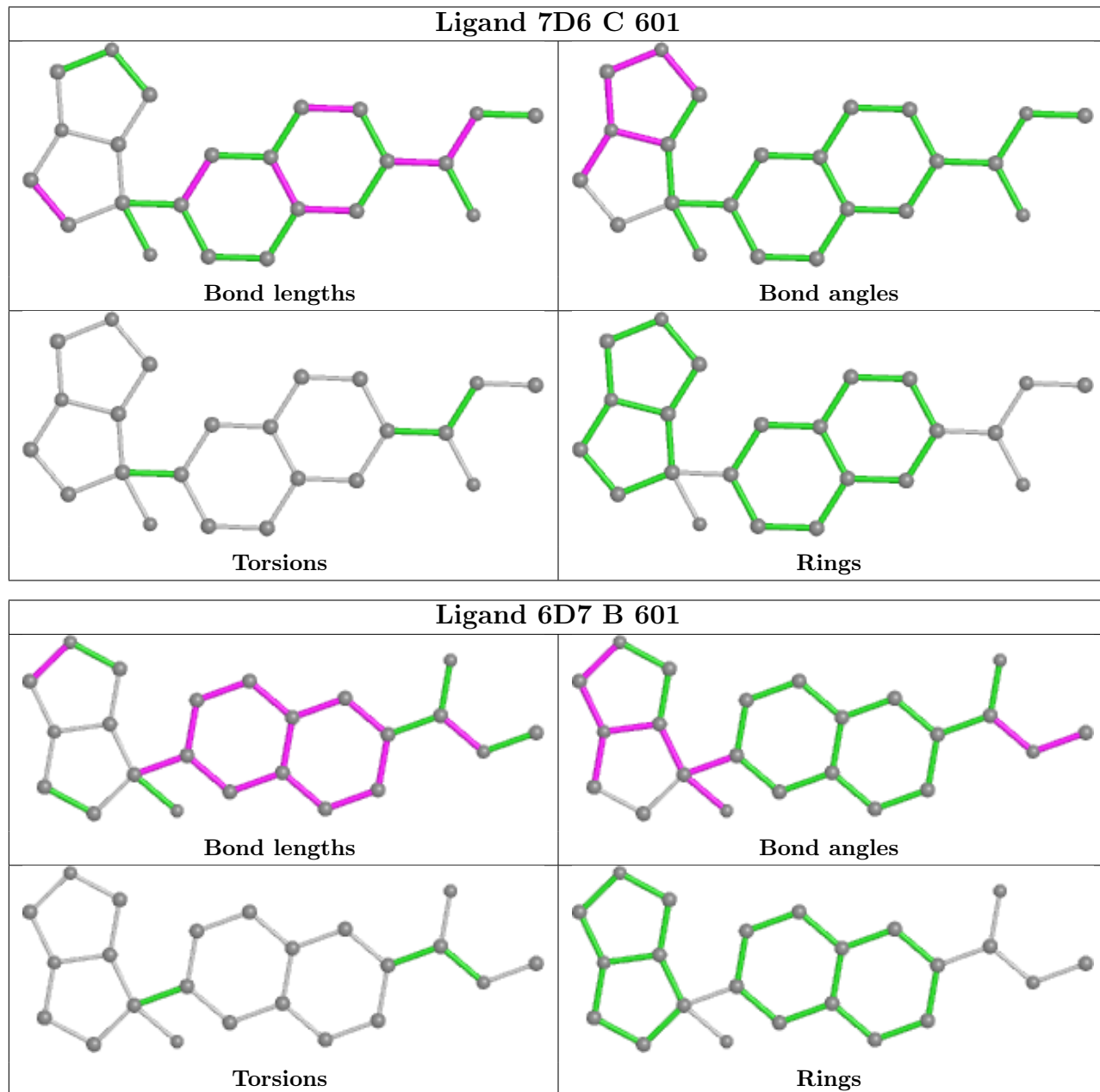

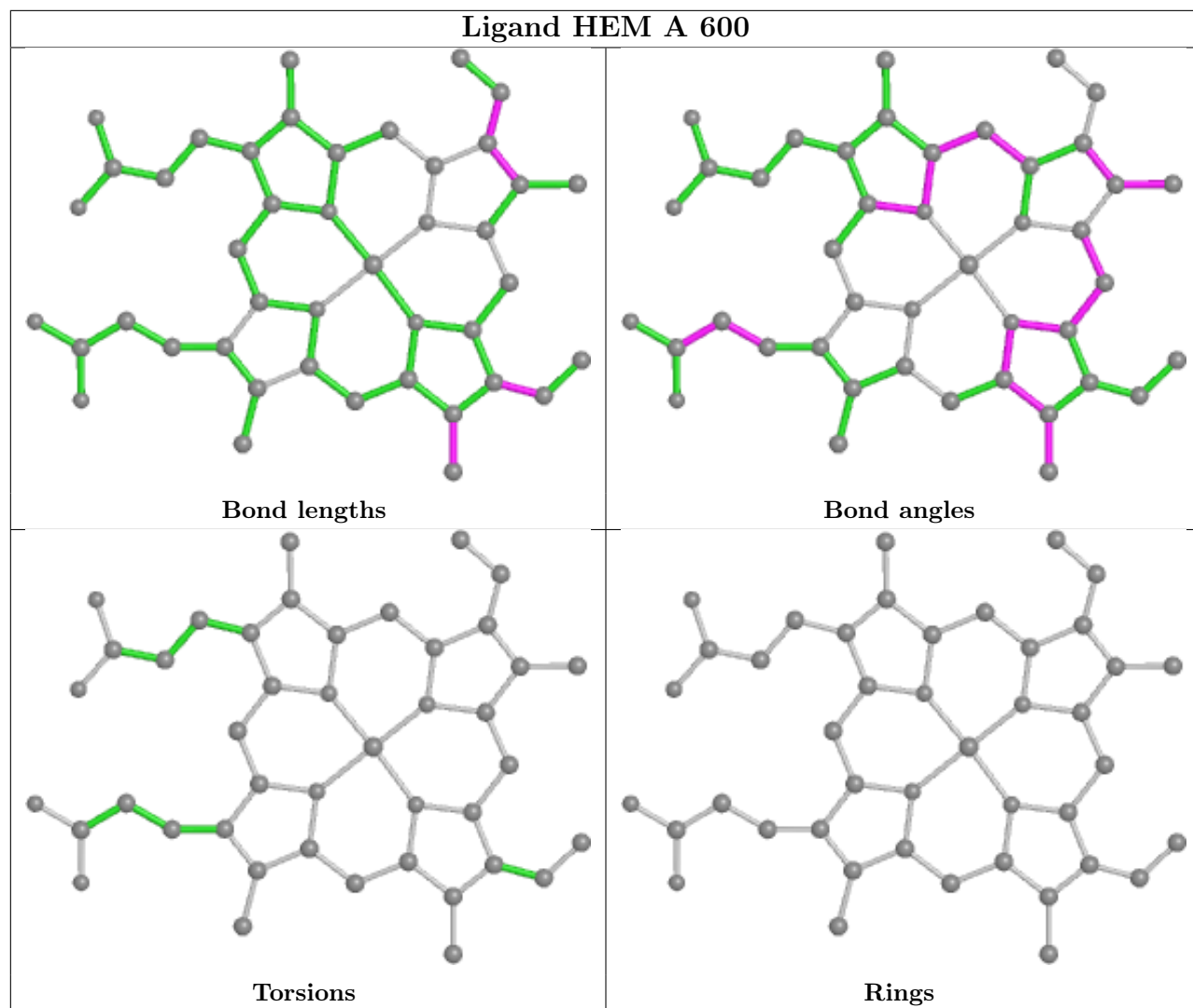

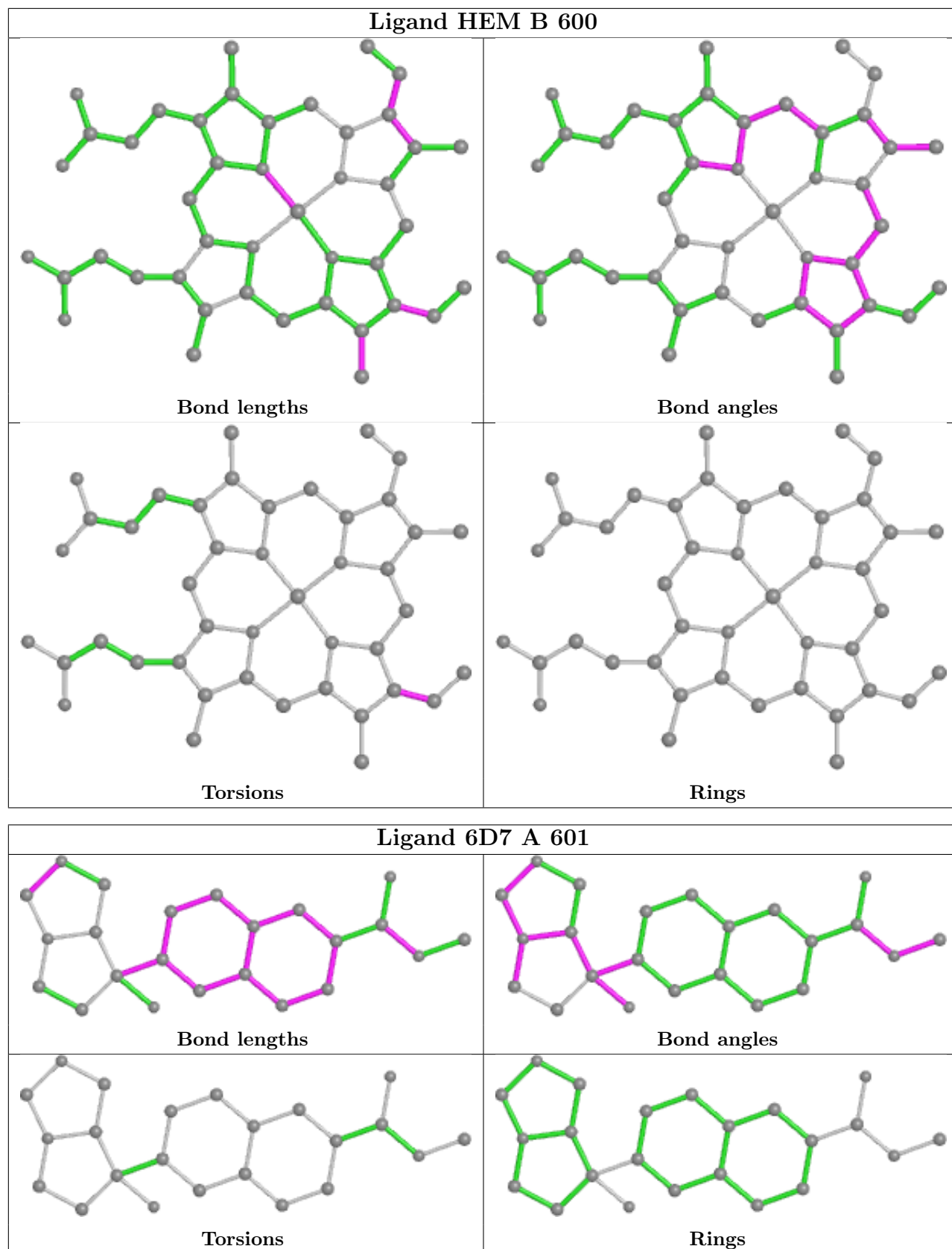

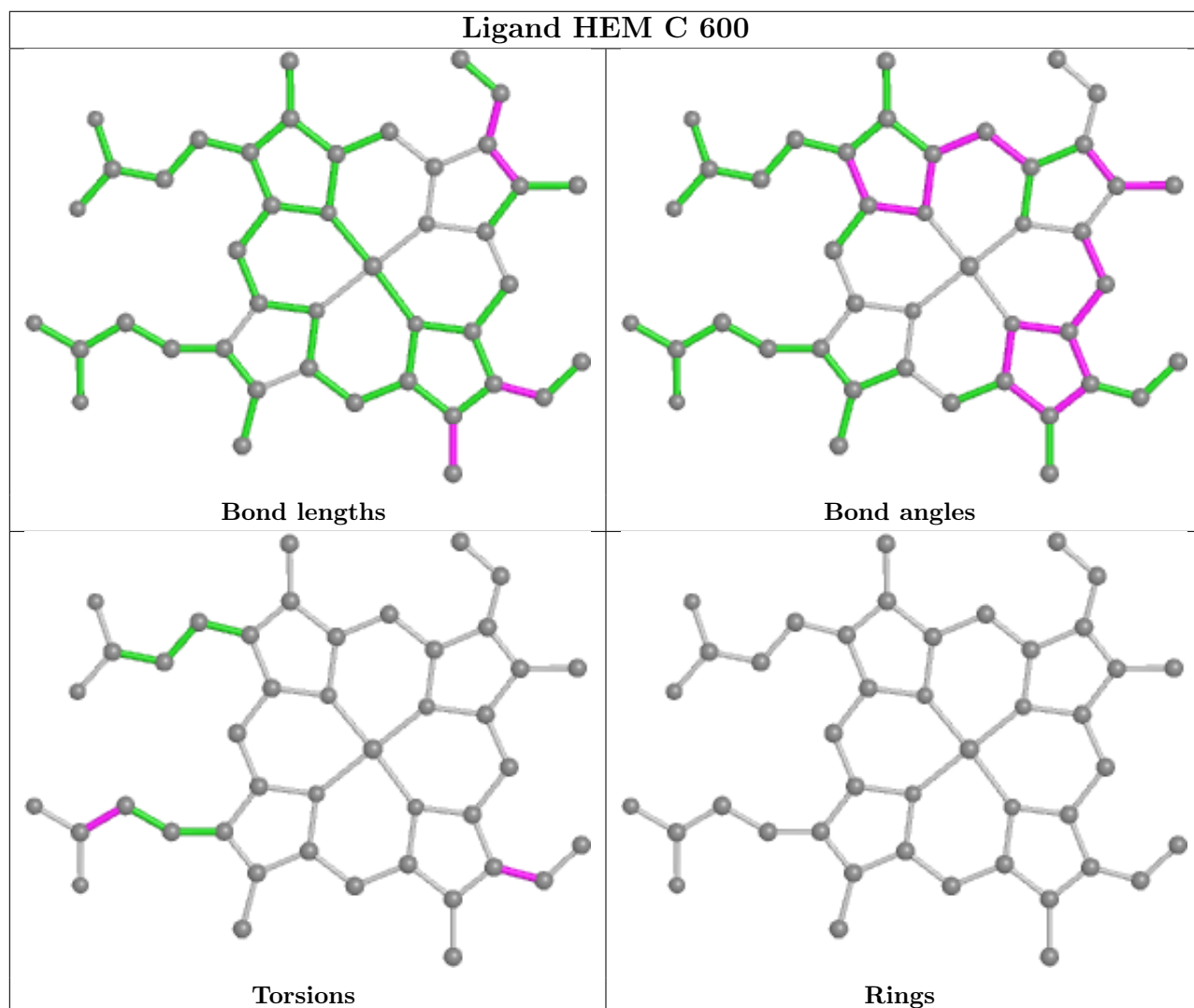
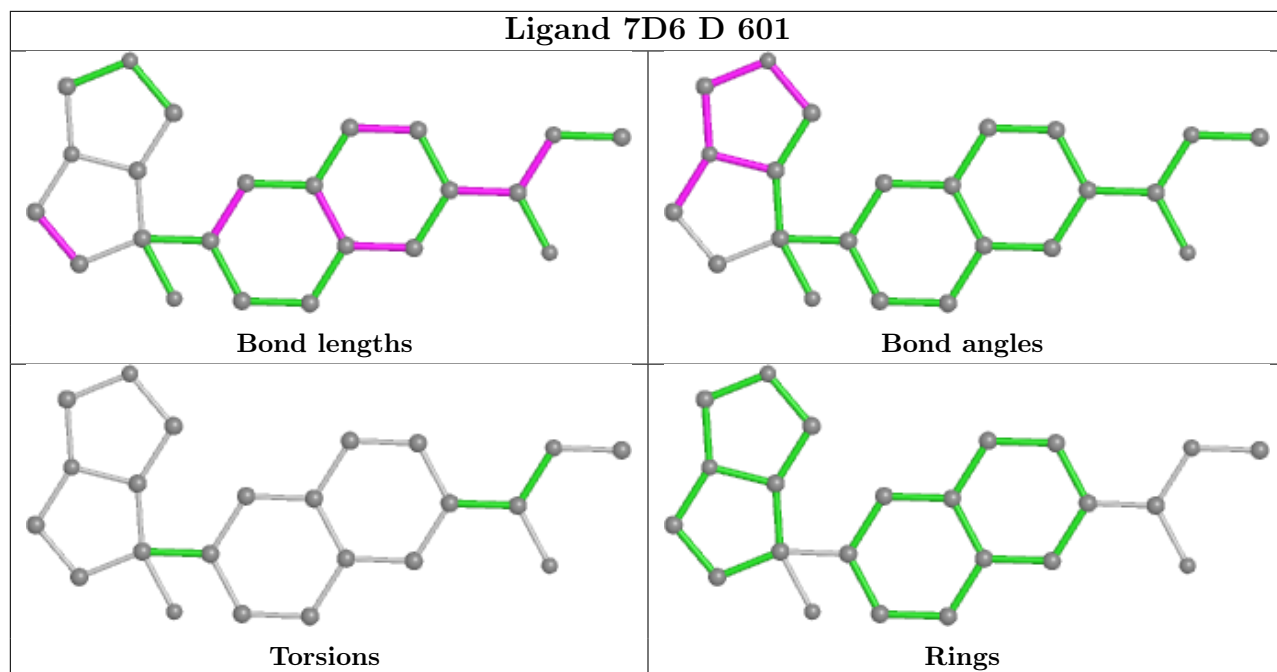

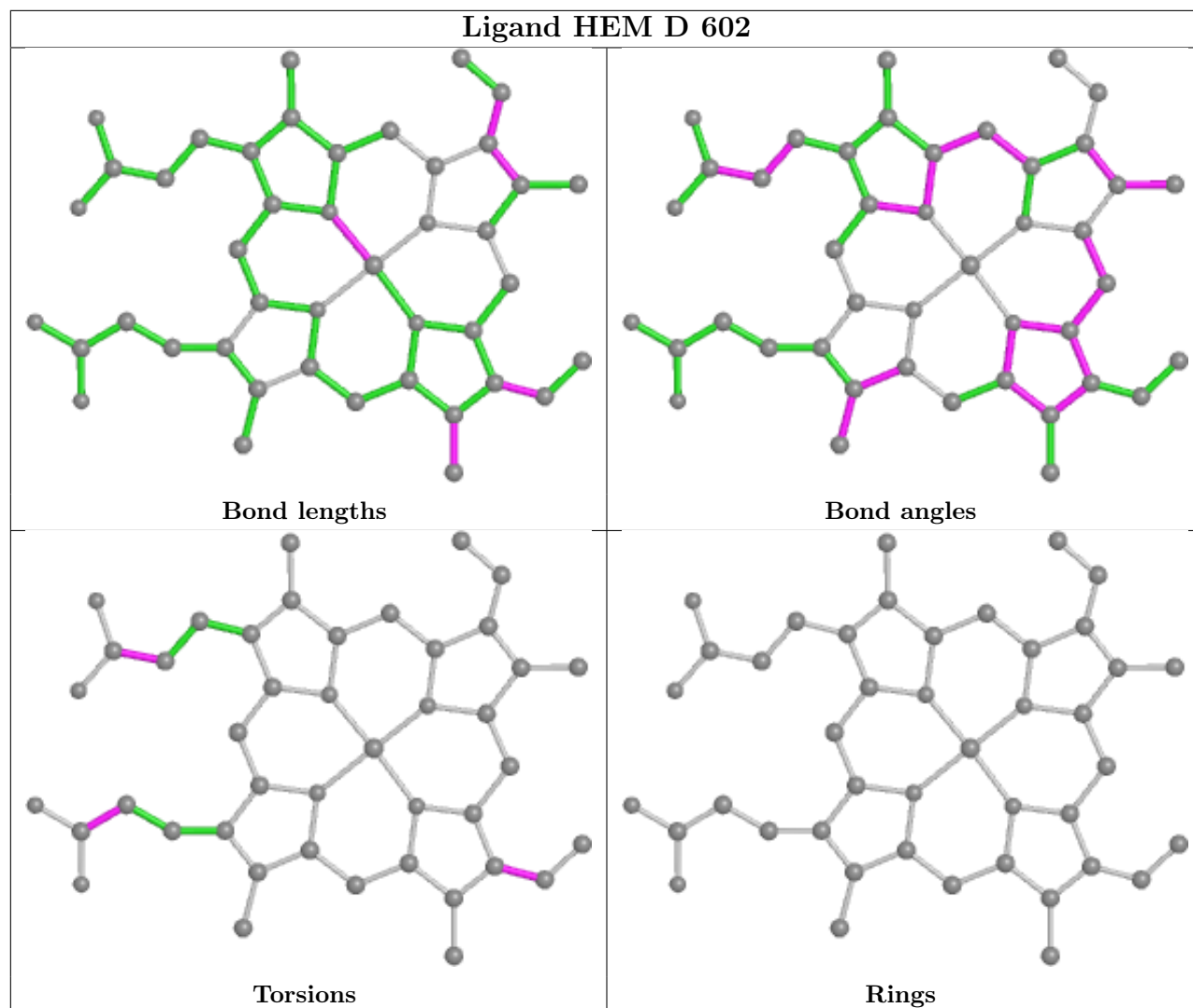

## 5.7 Other polymers [i](#)

There are no such residues in this entry.

## 5.8 Polymer linkage issues [i](#)

There are no chain breaks in this entry.



## 6 Fit of model and data

### 6.1 Protein, DNA and RNA chains

In the following table, the column labelled ‘#RSRZ > 2’ contains the number (and percentage) of RSRZ outliers, followed by percent RSRZ outliers for the chain as percentile scores relative to all X-ray entries and entries of similar resolution. The OWAB column contains the minimum, median, 95<sup>th</sup> percentile and maximum values of the occupancy-weighted average B-factor per residue. The column labelled ‘Q < 0.9’ lists the number of (and percentage) of residues with an average occupancy less than 0.9.

Mol	Chain	Analysed	<RSRZ>	#RSRZ>2	OWAB(Å <sup>2</sup> )	Q<0.9
1	A	466/494 (94%)	0.17	25 (5%) 25 24	28, 40, 71, 112	0
1	B	467/494 (94%)	0.18	19 (4%) 37 35	29, 41, 71, 127	0
1	C	472/494 (95%)	0.28	37 (7%) 13 11	28, 41, 74, 109	0
1	D	465/494 (94%)	0.61	56 (12%) 4 3	28, 48, 90, 122	0
All	All	1870/1976 (94%)	0.31	137 (7%) 15 14	28, 42, 81, 127	0

All (137) RSRZ outliers are listed below:

Mol	Chain	Res	Type	RSRZ
1	D	139	ASP	8.2
1	B	139	ASP	7.0
1	D	499	TRP	6.9
1	C	139	ASP	6.7
1	D	503	GLN	6.0
1	A	275	ASN	5.8
1	D	471	GLY	5.7
1	C	45	ARG	5.5
1	C	137	ASP	5.5
1	C	278	ALA	5.3
1	B	138	GLY	5.2
1	B	137	ASP	5.1
1	B	275	ASN	4.8
1	D	502	ALA	4.7
1	A	139	ASP	4.7
1	D	45	ARG	4.6
1	C	277	ASN	4.4
1	B	140	GLN	4.4
1	B	285	GLU	4.3
1	D	469	ASP	4.2
1	D	137	ASP	4.2

*Continued on next page...*

*Continued from previous page...*

<b>Mol</b>	<b>Chain</b>	<b>Res</b>	<b>Type</b>	<b>RSRZ</b>
1	D	140	GLN	4.1
1	C	469	ASP	4.1
1	C	46	HIS	3.9
1	A	503	GLN	3.9
1	D	468	PRO	3.9
1	C	140	GLN	3.9
1	D	496	ARG	3.8
1	D	42	PHE	3.8
1	D	340	ARG	3.7
1	D	337	GLY	3.6
1	D	493	ILE	3.6
1	C	138	GLY	3.6
1	D	271	MET	3.5
1	D	460	LEU	3.4
1	B	282	GLN	3.4
1	B	283	ASP	3.3
1	D	163	GLN	3.3
1	D	46	HIS	3.3
1	D	135	PHE	3.3
1	D	138	GLY	3.2
1	A	301	GLY	3.2
1	B	302	ALA	3.2
1	C	302	ALA	3.1
1	C	282	GLN	3.1
1	A	252	GLU	3.1
1	B	284	SER	3.1
1	D	366	VAL	3.1
1	C	484	PHE	3.1
1	C	306	THR	3.0
1	D	500	ARG	3.0
1	C	134	LEU	2.9
1	D	344	ILE	2.9
1	A	306	THR	2.9
1	C	307	THR	2.9
1	C	308	THR	2.9
1	C	310	VAL	2.9
1	C	483	VAL	2.9
1	A	253	LYS	2.9
1	D	134	LEU	2.9
1	A	249	ASN	2.8
1	C	471	GLY	2.8
1	D	323	GLN	2.8

*Continued on next page...*

*Continued from previous page...*

<b>Mol</b>	<b>Chain</b>	<b>Res</b>	<b>Type</b>	<b>RSRZ</b>
1	C	367	ALA	2.8
1	D	498	ALA	2.8
1	D	284	SER	2.7
1	C	304	VAL	2.7
1	C	275	ASN	2.7
1	D	420	PRO	2.7
1	C	502	ALA	2.7
1	D	497	GLN	2.7
1	D	367	ALA	2.6
1	D	361	LEU	2.6
1	A	442	CYS	2.6
1	D	332	ILE	2.6
1	C	42	PHE	2.6
1	A	136	LYS	2.6
1	C	136	LYS	2.5
1	D	442	CYS	2.5
1	A	302	ALA	2.5
1	A	140	GLN	2.5
1	B	274	ASP	2.5
1	D	314	THR	2.5
1	D	306	THR	2.4
1	D	341	THR	2.4
1	C	366	VAL	2.4
1	A	245	LYS	2.4
1	D	329	TYR	2.4
1	D	370	LEU	2.4
1	C	313	TRP	2.4
1	D	307	THR	2.4
1	C	482	VAL	2.4
1	B	272	ASN	2.4
1	A	500	ARG	2.3
1	D	159	THR	2.3
1	D	448	ALA	2.3
1	B	273	SER	2.3
1	D	339	SER	2.3
1	C	41	PRO	2.3
1	B	136	LYS	2.3
1	D	467	VAL	2.3
1	B	483	VAL	2.3
1	D	495	VAL	2.3
1	C	442	CYS	2.3
1	D	136	LYS	2.3

*Continued on next page...*

*Continued from previous page...*

Mol	Chain	Res	Type	RSRZ
1	C	309	SER	2.3
1	A	483	VAL	2.2
1	D	472	GLN	2.2
1	B	435	PHE	2.2
1	A	120	HIS	2.2
1	C	470	ASP	2.2
1	D	462	ARG	2.2
1	A	300	PHE	2.2
1	B	303	GLY	2.2
1	D	444	GLY	2.2
1	A	307	THR	2.2
1	A	255	ARG	2.2
1	A	303	GLY	2.2
1	A	421	ALA	2.2
1	C	383	GLU	2.2
1	A	366	VAL	2.1
1	B	260	THR	2.1
1	A	420	PRO	2.1
1	D	43	LEU	2.1
1	A	138	GLY	2.1
1	D	492	LYS	2.1
1	C	485	LEU	2.1
1	C	368	PRO	2.1
1	D	258	SER	2.0
1	C	472	GLN	2.0
1	D	483	VAL	2.0
1	D	424	GLN	2.0
1	C	397	TRP	2.0
1	D	185	ASN	2.0
1	A	308	THR	2.0
1	B	251	LYS	2.0
1	D	470	ASP	2.0

## 6.2 Non-standard residues in protein, DNA, RNA chains [i](#)

There are no non-standard protein/DNA/RNA residues in this entry.

## 6.3 Carbohydrates [i](#)

There are no monosaccharides in this entry.

## 6.4 Ligands [i](#)

In the following table, the Atoms column lists the number of modelled atoms in the group and the number defined in the chemical component dictionary. The B-factors column lists the minimum, median, 95<sup>th</sup> percentile and maximum values of B factors of atoms in the group. The column labelled 'Q<0.9' lists the number of atoms with occupancy less than 0.9.

Mol	Type	Chain	Res	Atoms	RSCC	RSR	B-factors(Å <sup>2</sup> )	Q<0.9
3	6D7	A	601	23/23	0.73	0.40	30,48,78,79	0
3	6D7	B	601	23/23	0.73	0.39	33,50,69,76	0
4	7D6	C	601	23/23	0.91	0.26	30,43,58,59	0
4	7D6	D	601	23/23	0.91	0.22	32,46,56,61	0
2	HEM	D	602	43/43	0.96	0.25	24,39,54,65	0
2	HEM	C	600	43/43	0.97	0.26	19,31,42,50	0
2	HEM	A	600	43/43	0.97	0.25	20,35,50,60	0
2	HEM	B	600	43/43	0.98	0.28	26,37,50,58	0

The following is a graphical depiction of the model fit to experimental electron density of all instances of the Ligand of Interest. In addition, ligands with molecular weight > 250 and outliers as shown on the geometry validation Tables will also be included. Each fit is shown from different orientation to approximate a three-dimensional view.

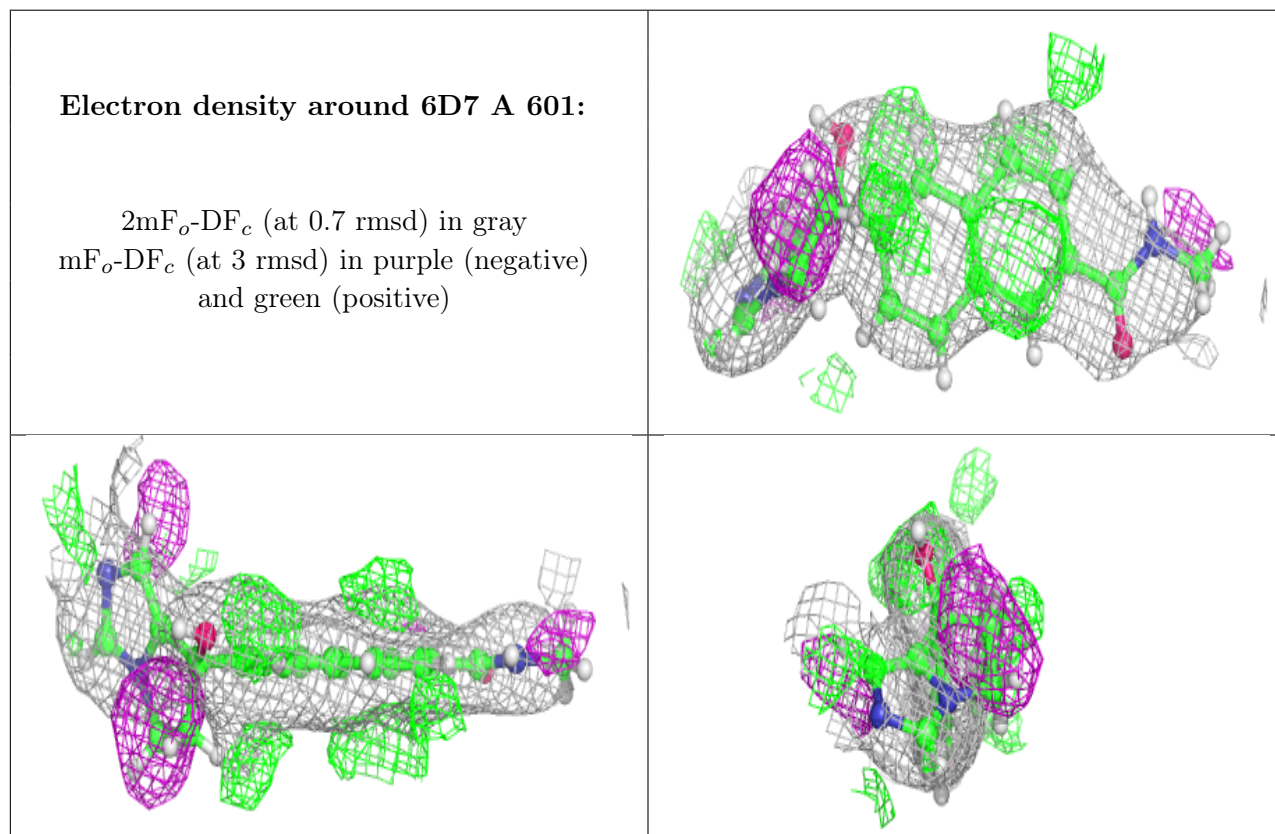

**Electron density around 6D7 B 601:**

$2mF_o-DF_c$  (at 0.7 rmsd) in gray  
 $mF_o-DF_c$  (at 3 rmsd) in purple (negative)  
and green (positive)

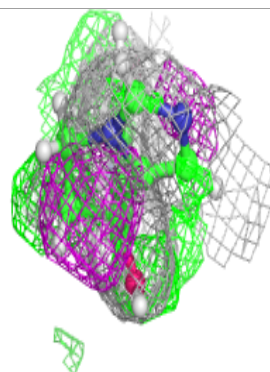
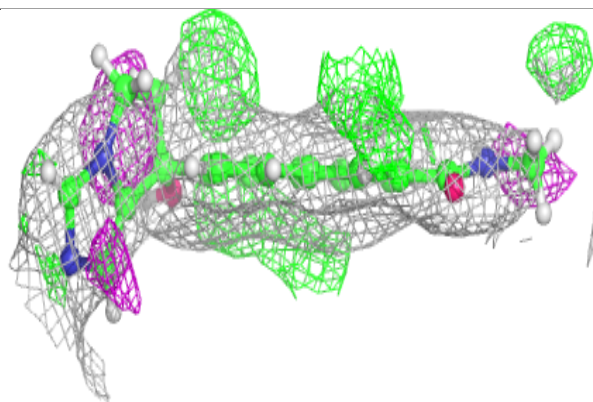
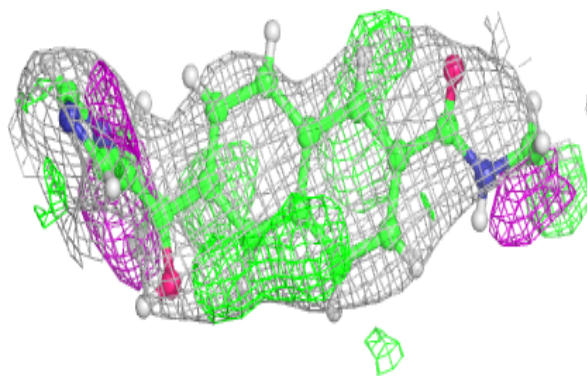
**Electron density around 7D6 C 601:**

$2mF_o-DF_c$  (at 0.7 rmsd) in gray  
 $mF_o-DF_c$  (at 3 rmsd) in purple (negative)  
and green (positive)

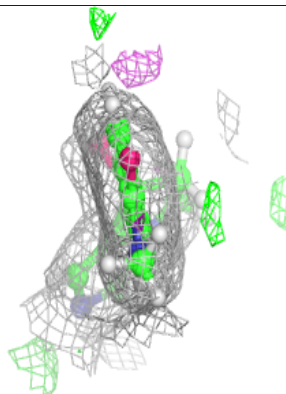
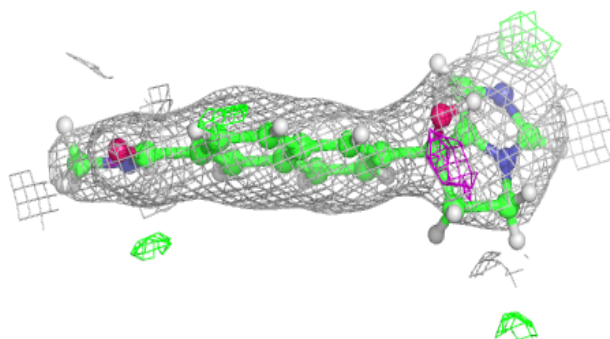
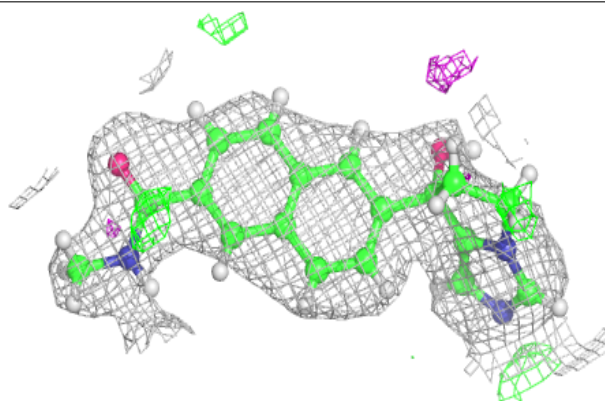

**Electron density around 7D6 D 601:**

$2mF_o-DF_c$  (at 0.7 rmsd) in gray  
 $mF_o-DF_c$  (at 3 rmsd) in purple (negative)  
and green (positive)

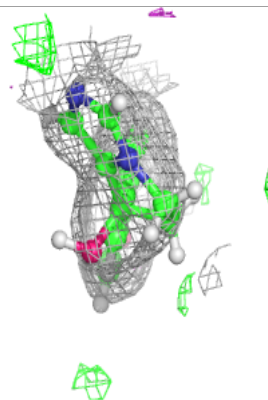
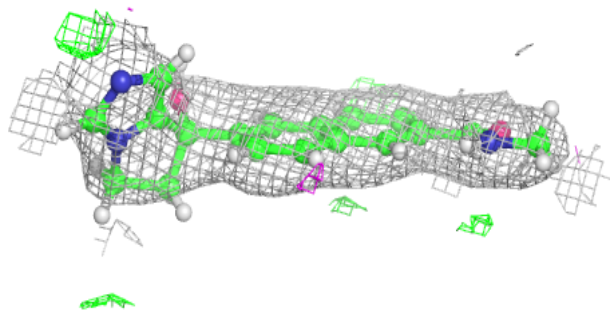
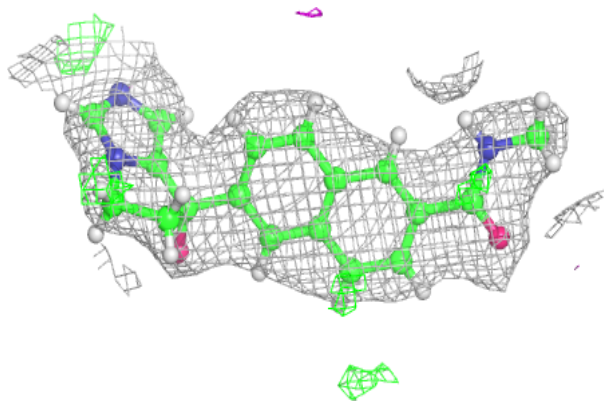

**Electron density around HEM D 602:**

$2mF_o-DF_c$  (at 0.7 rmsd) in gray  
 $mF_o-DF_c$  (at 3 rmsd) in purple (negative)  
and green (positive)

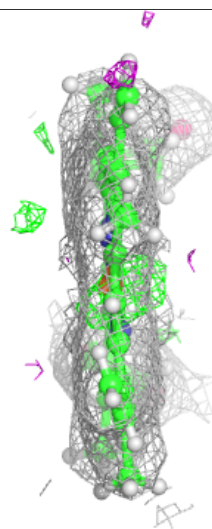
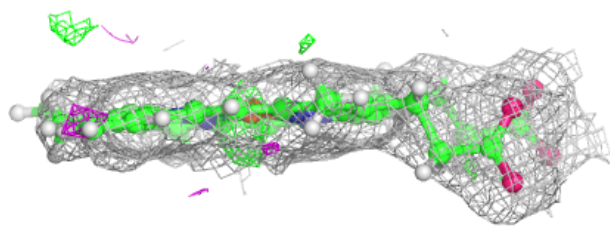
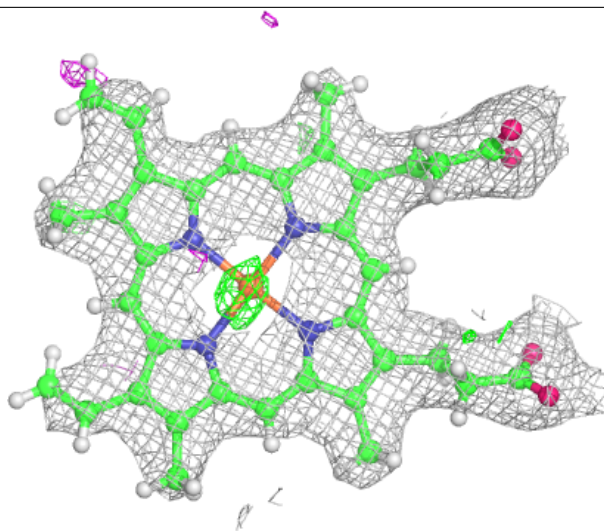



**Electron density around HEM C 600:**

$2mF_o-DF_c$  (at 0.7 rmsd) in gray  
 $mF_o-DF_c$  (at 3 rmsd) in purple (negative)  
and green (positive)

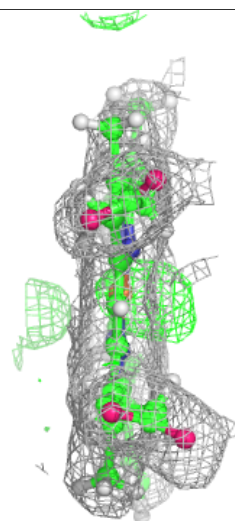
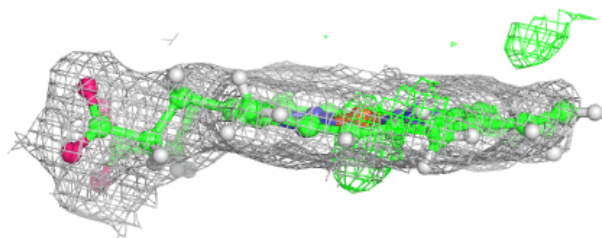
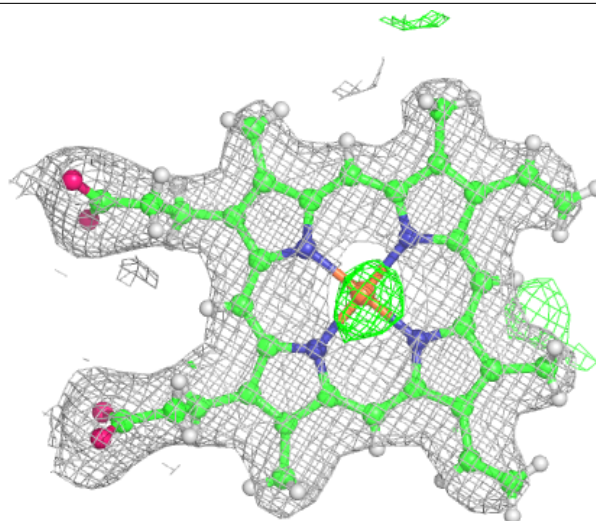

**Electron density around HEM A 600:**

$2mF_o-DF_c$  (at 0.7 rmsd) in gray  
 $mF_o-DF_c$  (at 3 rmsd) in purple (negative)  
and green (positive)

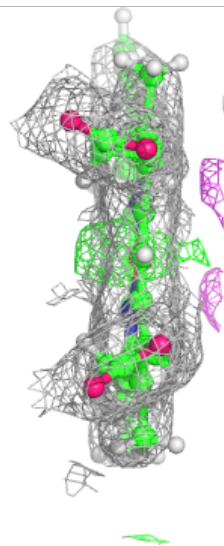
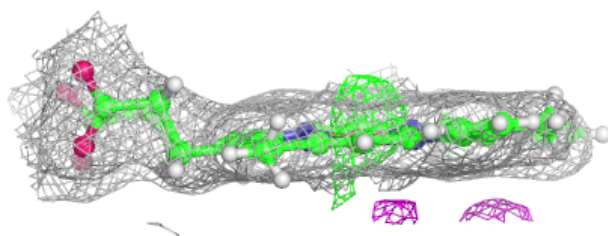
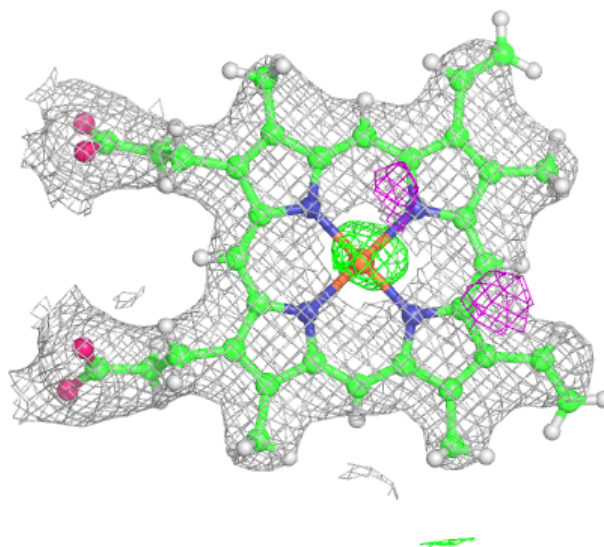

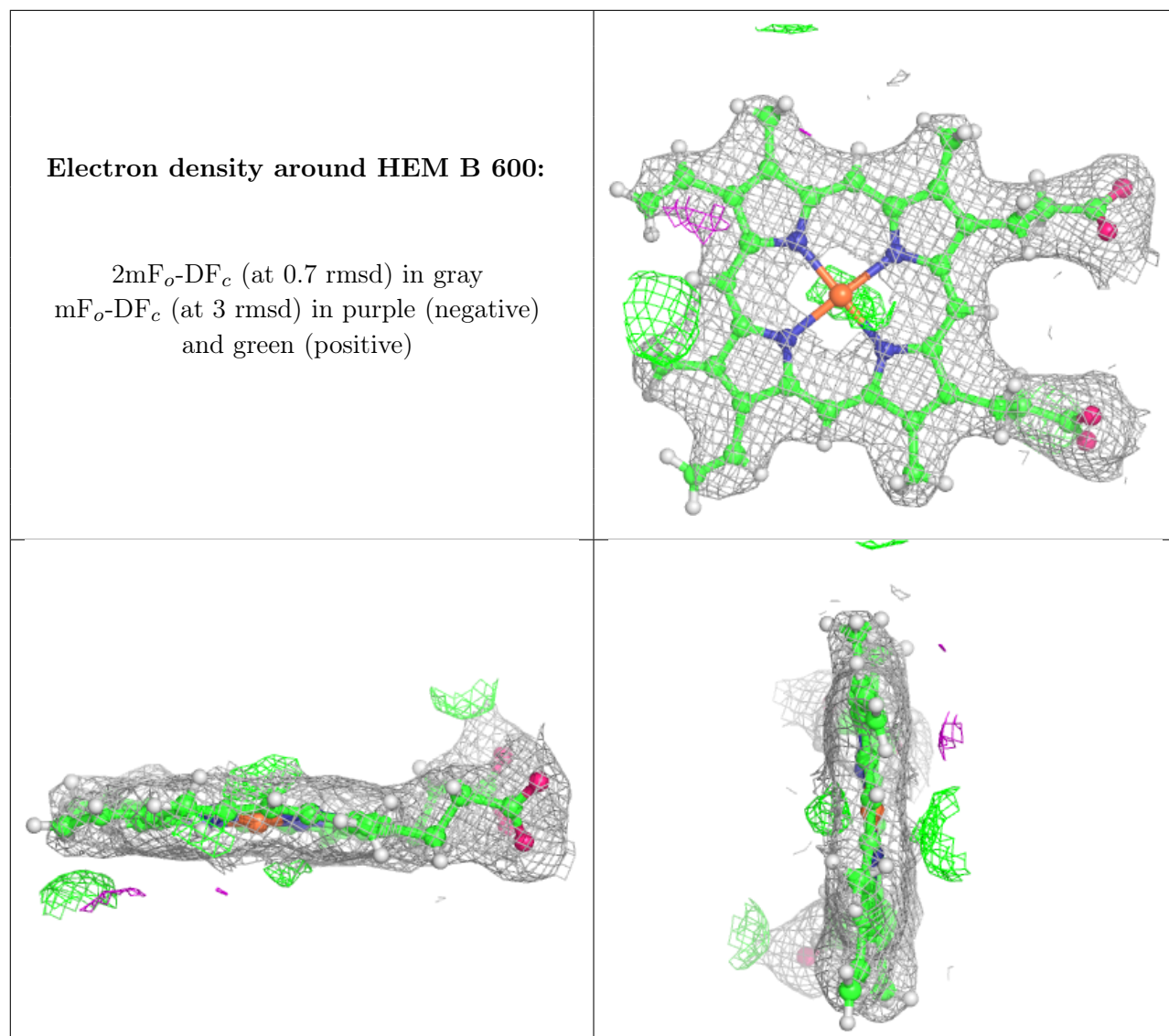

## 6.5 Other polymers [i](#)

There are no such residues in this entry.