



# Full wwPDB EM Validation Report ⓘ

Jan 28, 2024 – 12:41 AM JST

PDB ID : 8IT1  
EMDB ID : EMD-35703  
Title : Cryo-EM structure of Crt-SPARTA-gRNA-tDNA tetramer (NADase active form)  
Authors : Gao, X.; Shang, K.; Zhu, K.; Wang, L.; Mu, Z.; Fu, X.; Yu, X.; Qin, B.; Zhu, H.; Ding, W.; Cui, S.  
Deposited on : 2023-03-21  
Resolution : 3.41 Å(reported)

This is a Full wwPDB EM Validation Report for a publicly released PDB entry.

We welcome your comments at [validation@mail.wwpdb.org](mailto:validation@mail.wwpdb.org)

A user guide is available at

<https://www.wwpdb.org/validation/2017/EMValidationReportHelp>

with specific help available everywhere you see the ⓘ symbol.

The types of validation reports are described at

<http://www.wwpdb.org/validation/2017/FAQs#types>.

---

The following versions of software and data (see [references ⓘ](#)) were used in the production of this report:

EMDB validation analysis : 0.0.1.dev70  
MolProbity : 4.02b-467  
Percentile statistics : 20191225.v01 (using entries in the PDB archive December 25th 2019)  
MapQ : 1.9.9  
Ideal geometry (proteins) : Engh & Huber (2001)  
Ideal geometry (DNA, RNA) : Parkinson et al. (1996)  
Validation Pipeline (wwPDB-VP) : 2.36

# 1 Overall quality at a glance i

The following experimental techniques were used to determine the structure:

*ELECTRON MICROSCOPY*

The reported resolution of this entry is 3.41 Å.

Percentile scores (ranging between 0-100) for global validation metrics of the entry are shown in the following graphic. The table shows the number of entries on which the scores are based.

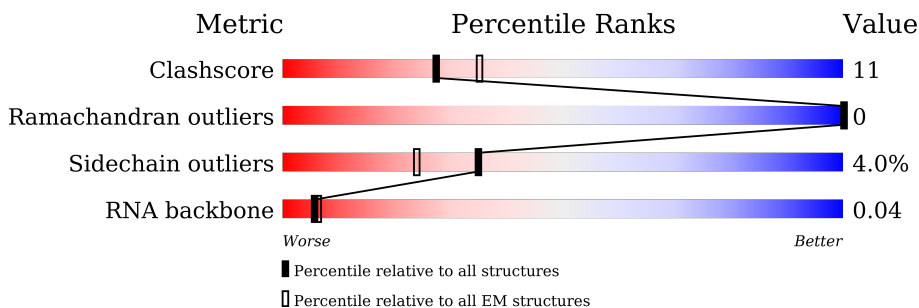

Metric	Whole archive (#Entries)	EM structures (#Entries)
Clashscore	158937	4297
Ramachandran outliers	154571	4023
Sidechain outliers	154315	3826
RNA backbone	4643	859

The table below summarises the geometric issues observed across the polymeric chains and their fit to the map. The red, orange, yellow and green segments of the bar indicate the fraction of residues that contain outliers for  $\geq 3$ , 2, 1 and 0 types of geometric quality criteria respectively. A grey segment represents the fraction of residues that are not modelled. The numeric value for each fraction is indicated below the corresponding segment, with a dot representing fractions  $\leq 5\%$ . The upper red bar (where present) indicates the fraction of residues that have poor fit to the EM map (all-atom inclusion  $< 40\%$ ). The numeric value is given above the bar.

Mol	Chain	Length	Quality of chain
1	A	507	
1	E	507	
1	I	507	
1	M	507	
2	B	450	
2	F	450	
2	J	450	

Continued on next page...

*Continued from previous page...*

Mol	Chain	Length	Quality of chain
2	N	450	
3	C	45	
3	G	45	
3	K	45	
3	O	45	
4	D	21	
4	H	21	
4	L	21	
4	P	21	

## 2 Entry composition [i](#)

There are 4 unique types of molecules in this entry. The entry contains 33844 atoms, of which 0 are hydrogens and 0 are deuteriums.

In the tables below, the AltConf column contains the number of residues with at least one atom in alternate conformation and the Trace column contains the number of residues modelled with at most 2 atoms.

- Molecule 1 is a protein called Piwi domain-containing protein.

Mol	Chain	Residues	Atoms					AltConf	Trace
			Total	C	N	O	S		
1	A	465	3771	2446	626	687	12	0	0
1	E	465	3771	2446	626	687	12	0	0
1	I	465	3771	2446	626	687	12	0	0
1	M	465	3771	2446	626	687	12	0	0

- Molecule 2 is a protein called TIR domain-containing protein.

Mol	Chain	Residues	Atoms					AltConf	Trace
			Total	C	N	O	S		
2	B	450	3754	2421	625	697	11	0	0
2	F	450	3754	2421	625	697	11	0	0
2	J	450	3754	2421	625	697	11	0	0
2	N	450	3754	2421	625	697	11	0	0

- Molecule 3 is a DNA chain called DNA (45-mer).

Mol	Chain	Residues	Atoms					AltConf	Trace
			Total	C	N	O	P		
3	K	24	482	232	86	140	24	0	0
3	O	24	482	232	86	140	24	0	0
3	C	24	482	232	86	140	24	0	0
3	G	24	482	232	86	140	24	0	0

- Molecule 4 is a RNA chain called RNA (5'-R(P\*UP\*GP\*AP\*GP\*GP\*UP\*AP\*GP\*UP\*AP

\*GP\*GP\*UP\*UP\*GP\*UP\*AP\*UP\*AP\*GP\*U)-3').

Mol	Chain	Residues	Atoms					AltConf	Trace
4	L	21	Total 454	C 202	N 81	O 150	P 21	0	0
4	P	21	Total 454	C 202	N 81	O 150	P 21	0	0
4	D	21	Total 454	C 202	N 81	O 150	P 21	0	0
4	H	21	Total 454	C 202	N 81	O 150	P 21	0	0

### 3 Residue-property plots [i](#)

These plots are drawn for all protein, RNA, DNA and oligosaccharide chains in the entry. The first graphic for a chain summarises the proportions of the various outlier classes displayed in the second graphic. The second graphic shows the sequence view annotated by issues in geometry and atom inclusion in map density. Residues are color-coded according to the number of geometric quality criteria for which they contain at least one outlier: green = 0, yellow = 1, orange = 2 and red = 3 or more. A red diamond above a residue indicates a poor fit to the EM map for this residue (all-atom inclusion < 40%). Stretches of 2 or more consecutive residues without any outlier are shown as a green connector. Residues present in the sample, but not in the model, are shown in grey.

- Molecule 1: Piwi domain-containing protein

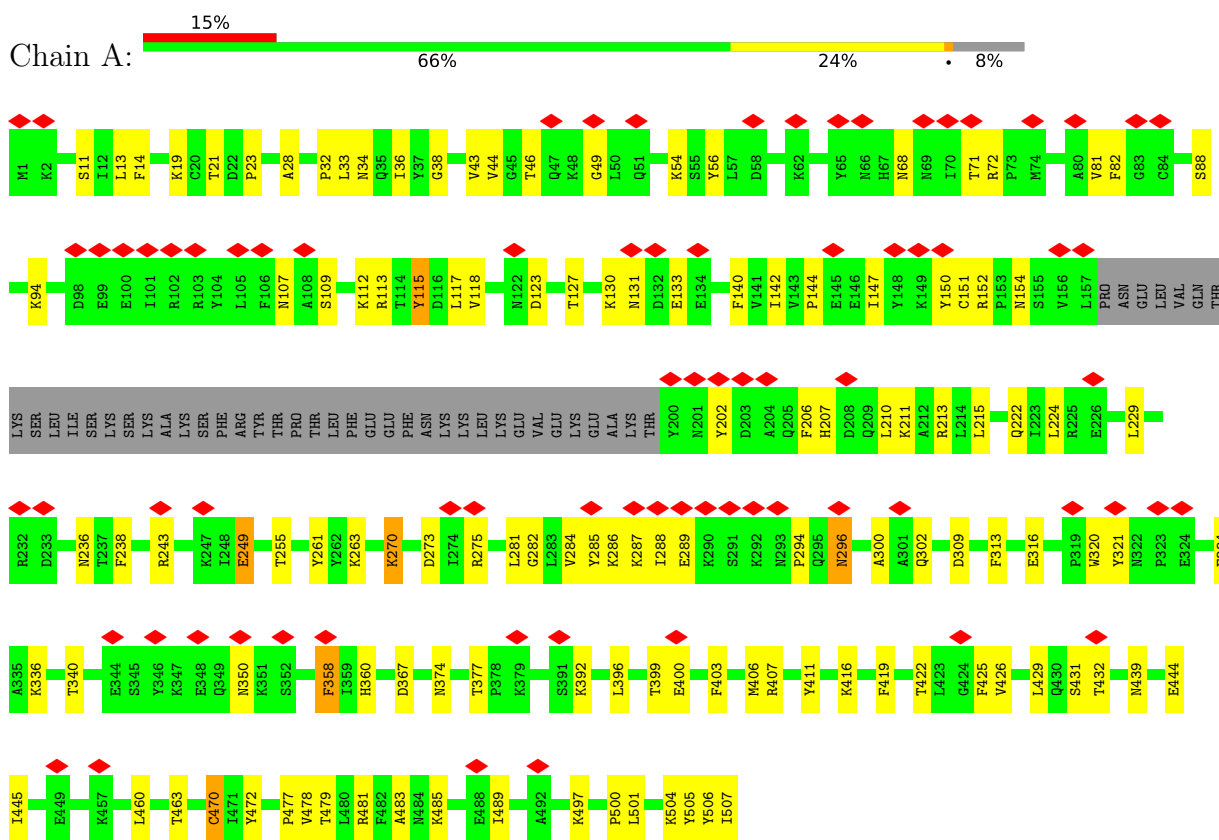

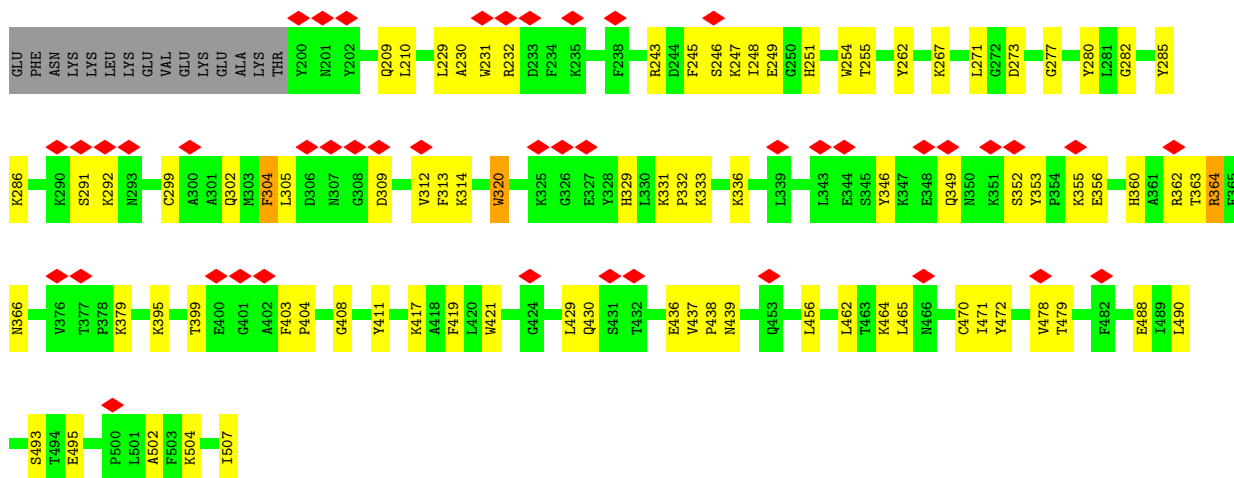

• Molecule 1: Piwi domain-containing protein

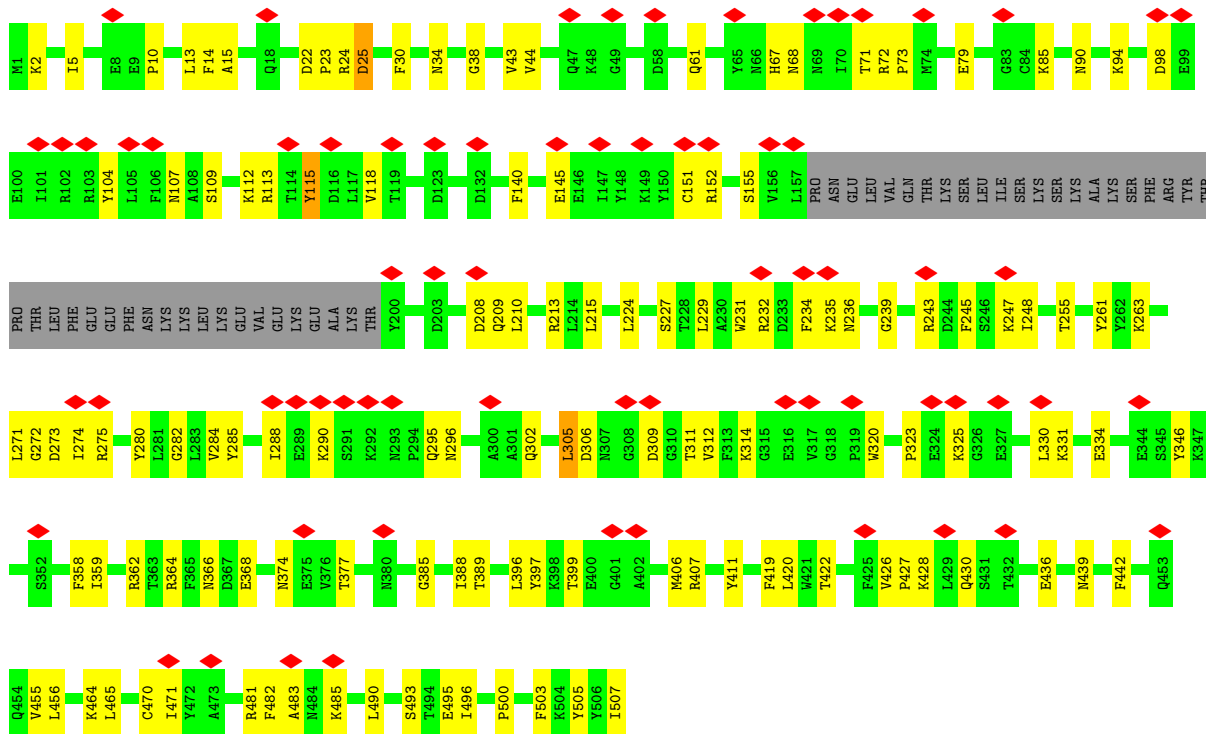

• Molecule 1: Piwi domain-containing protein

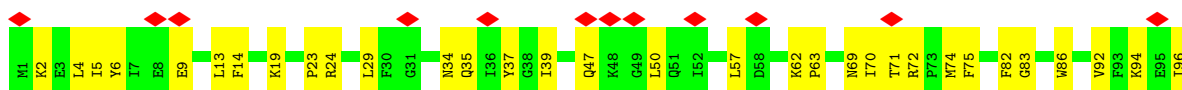

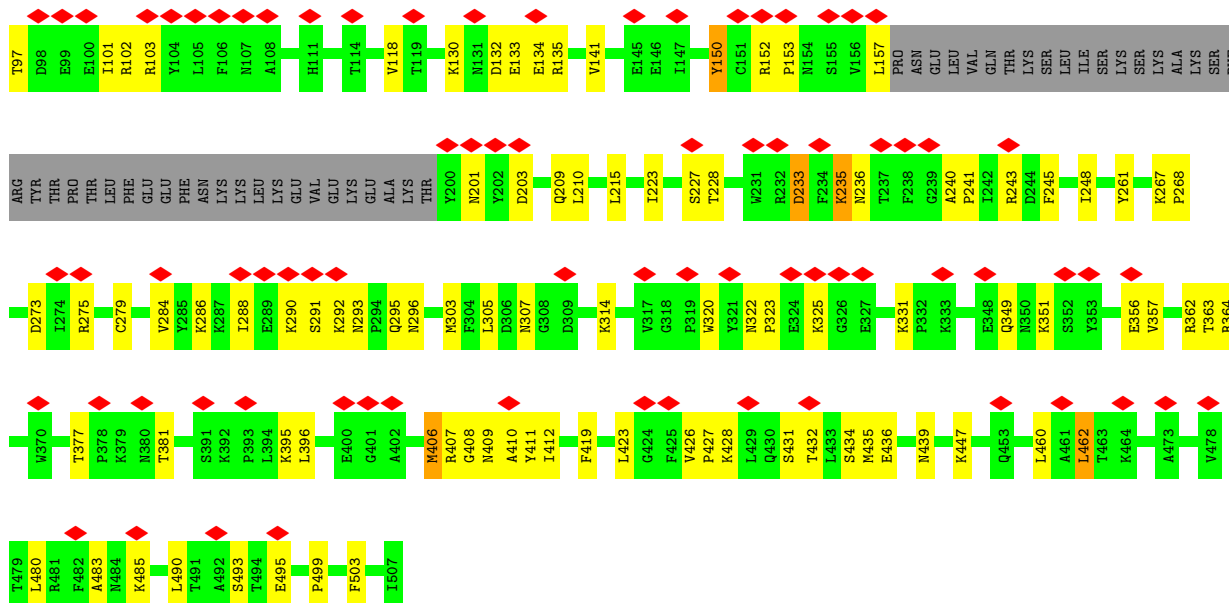

• Molecule 2: TIR domain-containing protein

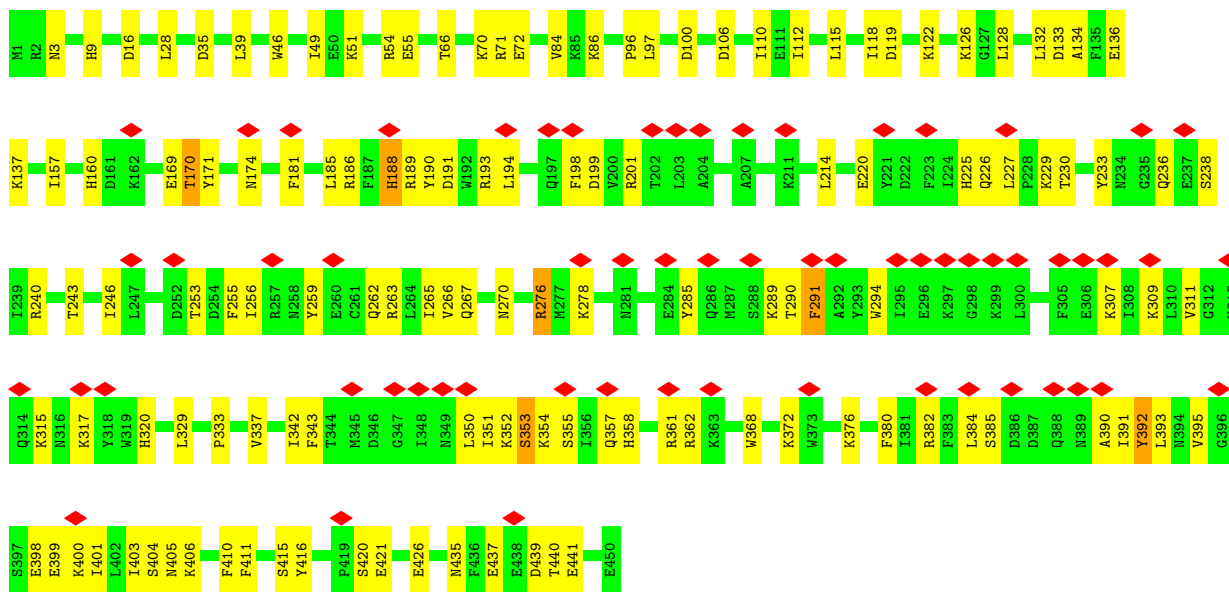

• Molecule 2: TIR domain-containing protein

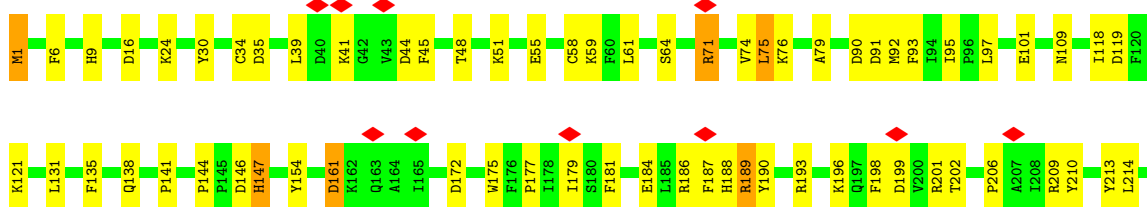



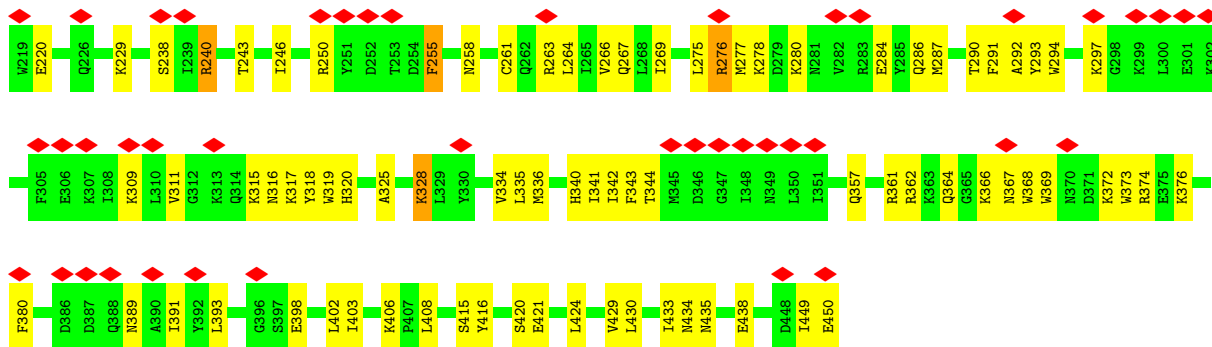

• Molecule 2: TIR domain-containing protein

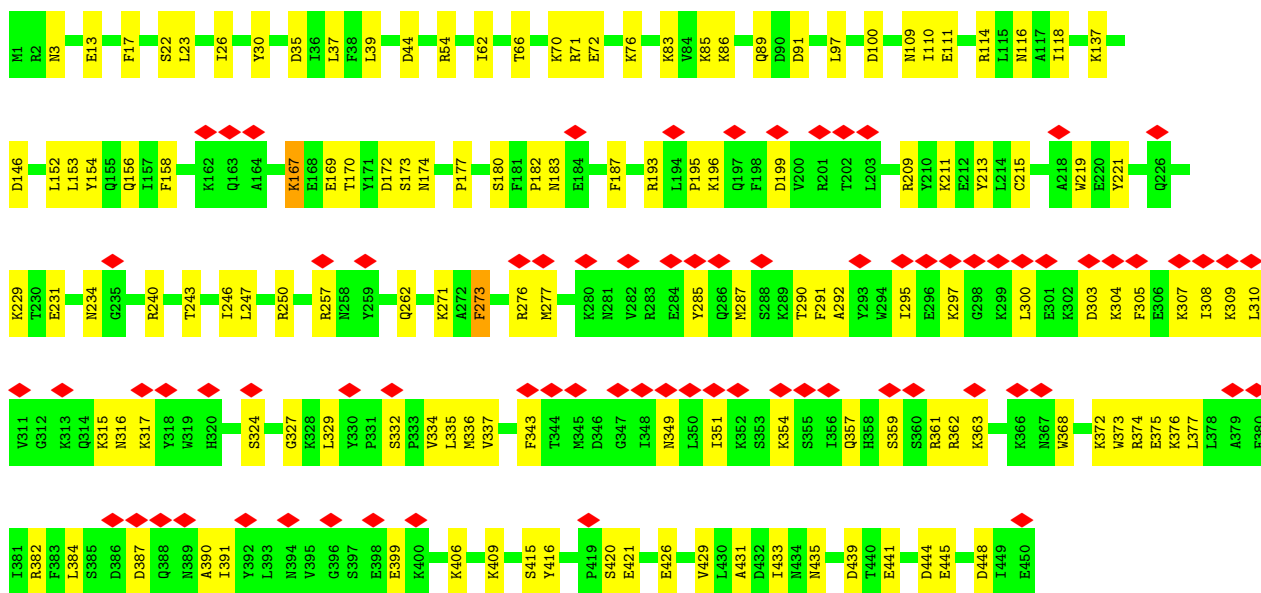

• Molecule 2: TIR domain-containing protein

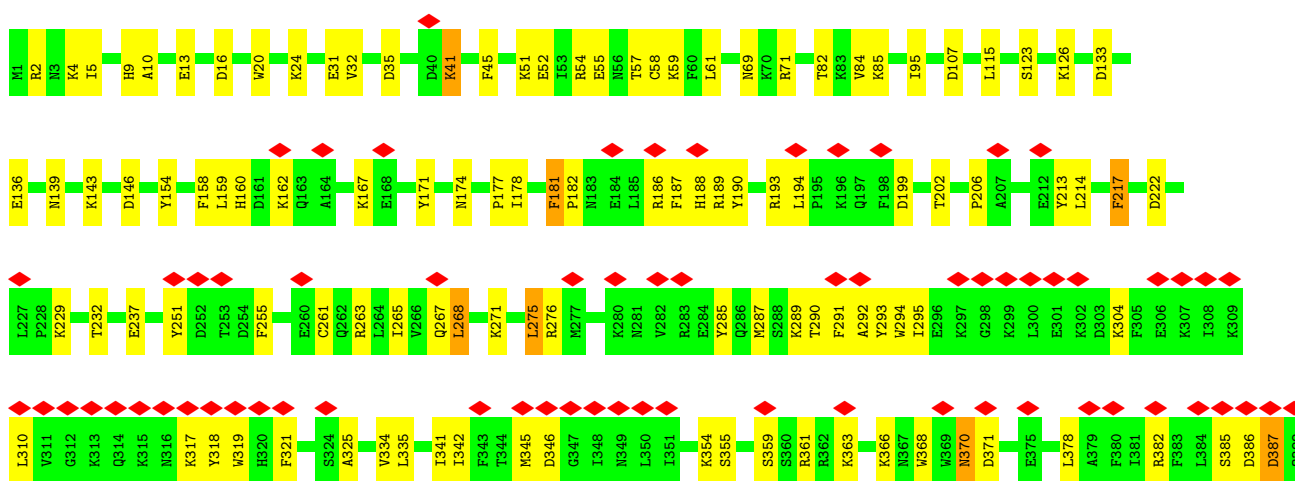



• Molecule 3: DNA (45-mer)

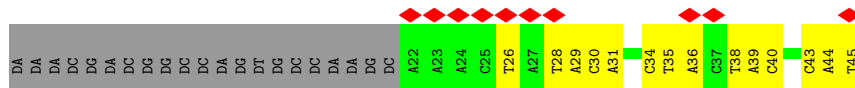
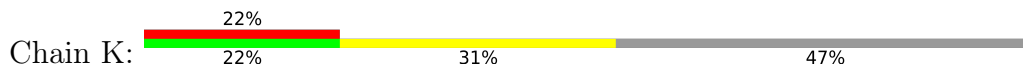

• Molecule 3: DNA (45-mer)

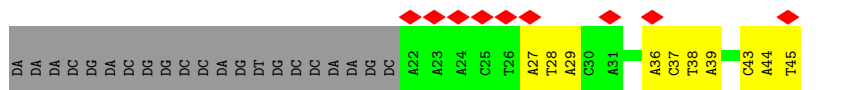
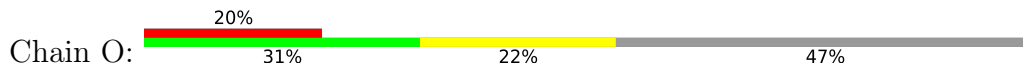

• Molecule 3: DNA (45-mer)

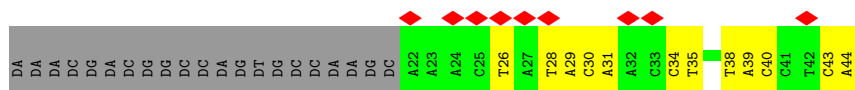
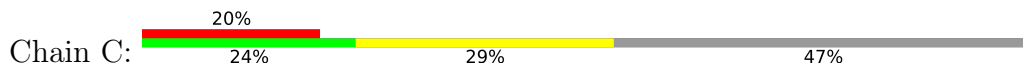

• Molecule 3: DNA (45-mer)

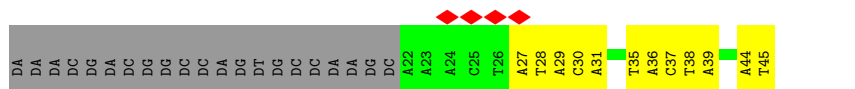
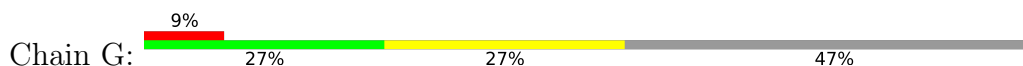

• Molecule 4: RNA (5'-R(P\*UP\*GP\*AP\*GP\*GP\*UP\*AP\*GP\*UP\*AP\*GP\*GP\*UP\*UP\*GP\*U P\*AP\*UP\*AP\*GP\*U)-3')

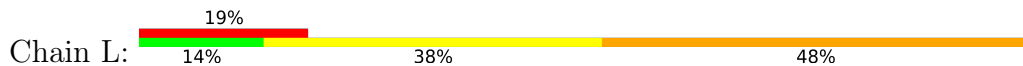

• Molecule 4: RNA (5'-R(P\*UP\*GP\*AP\*GP\*GP\*UP\*AP\*GP\*UP\*AP\*GP\*GP\*UP\*UP\*GP\*U P\*AP\*UP\*AP\*GP\*U)-3')



- Molecule 4: RNA (5'-R(P\*UP\*GP\*AP\*GP\*GP\*UP\*AP\*GP\*UP\*AP\*GP\*GP\*UP\*UP\*GP\*U P\*AP\*UP\*AP\*GP\*U)-3')



- Molecule 4: RNA (5'-R(P\*UP\*GP\*AP\*GP\*GP\*UP\*AP\*GP\*UP\*AP\*GP\*GP\*UP\*UP\*GP\*U P\*AP\*UP\*AP\*GP\*U)-3')



## 4 Experimental information

Property	Value	Source
EM reconstruction method	SINGLE PARTICLE	Depositor
Imposed symmetry	POINT, C1	Depositor
Number of particles used	1119433	Depositor
Resolution determination method	FSC 0.143 CUT-OFF	Depositor
CTF correction method	PHASE FLIPPING AND AMPLITUDE CORRECTION	Depositor
Microscope	FEI TITAN KRIOS	Depositor
Voltage (kV)	300	Depositor
Electron dose ( $e^-/\text{\AA}^2$ )	66	Depositor
Minimum defocus (nm)	1800	Depositor
Maximum defocus (nm)	2500	Depositor
Magnification	Not provided	
Image detector	GATAN K3 (6k x 4k)	Depositor
Maximum map value	2.393	Depositor
Minimum map value	-0.008	Depositor
Average map value	0.002	Depositor
Map value standard deviation	0.031	Depositor
Recommended contour level	0.2	Depositor
Map size (Å)	432.63998, 432.63998, 432.63998	wwPDB
Map dimensions	416, 416, 416	wwPDB
Map angles (°)	90.0, 90.0, 90.0	wwPDB
Pixel spacing (Å)	1.04, 1.04, 1.04	Depositor

## 5 Model quality [i](#)

### 5.1 Standard geometry [i](#)

The Z score for a bond length (or angle) is the number of standard deviations the observed value is removed from the expected value. A bond length (or angle) with  $|Z| > 5$  is considered an outlier worth inspection. RMSZ is the root-mean-square of all Z scores of the bond lengths (or angles).

Mol	Chain	Bond lengths		Bond angles	
		RMSZ	# Z  >5	RMSZ	# Z  >5
1	A	0.31	0/3868	0.50	0/5237
1	E	0.31	0/3868	0.51	0/5237
1	I	0.32	0/3868	0.53	2/5237 (0.0%)
1	M	0.31	0/3868	0.53	1/5237 (0.0%)
2	B	0.30	0/3843	0.51	0/5182
2	F	0.30	0/3843	0.55	3/5182 (0.1%)
2	J	0.31	0/3843	0.51	0/5182
2	N	0.31	0/3843	0.54	2/5182 (0.0%)
3	C	0.72	0/539	0.96	0/826
3	G	0.73	0/539	0.99	0/826
3	K	0.74	0/539	0.95	0/826
3	O	0.76	0/539	0.99	0/826
4	D	0.56	0/508	0.88	0/791
4	H	0.56	0/508	0.87	0/791
4	L	0.55	0/508	0.88	0/791
4	P	0.57	0/508	0.90	0/791
All	All	0.37	0/35032	0.59	8/48144 (0.0%)

Chiral center outliers are detected by calculating the chiral volume of a chiral center and verifying if the center is modelled as a planar moiety or with the opposite hand. A planarity outlier is detected by checking planarity of atoms in a peptide group, atoms in a mainchain group or atoms of a sidechain that are expected to be planar.

Mol	Chain	#Chirality outliers	#Planarity outliers
1	M	0	1

There are no bond length outliers.

All (8) bond angle outliers are listed below:

Mol	Chain	Res	Type	Atoms	Z	Observed(°)	Ideal(°)
1	I	210	LEU	CA-CB-CG	8.96	135.91	115.30
2	N	268	LEU	CA-CB-CG	7.03	131.48	115.30

*Continued on next page...*

Continued from previous page...

Mol	Chain	Res	Type	Atoms	Z	Observed(°)	Ideal(°)
2	F	277	MET	CA-CB-CG	6.52	124.38	113.30
1	M	462	LEU	CA-CB-CG	5.95	128.97	115.30
2	N	275	LEU	CA-CB-CG	5.62	128.23	115.30
2	F	92	MET	CA-CB-CG	5.59	122.81	113.30
1	I	305	LEU	CA-CB-CG	5.47	127.89	115.30
2	F	75	LEU	CA-CB-CG	5.33	127.57	115.30

There are no chirality outliers.

All (1) planarity outliers are listed below:

Mol	Chain	Res	Type	Group
1	M	406	MET	Peptide

## 5.2 Too-close contacts

In the following table, the Non-H and H(model) columns list the number of non-hydrogen atoms and hydrogen atoms in the chain respectively. The H(added) column lists the number of hydrogen atoms added and optimized by MolProbity. The Clashes column lists the number of clashes within the asymmetric unit, whereas Symm-Clashes lists symmetry-related clashes.

Mol	Chain	Non-H	H(model)	H(added)	Clashes	Symm-Clashes
1	A	3771	0	3780	76	0
1	E	3771	0	3780	79	0
1	I	3771	0	3780	92	0
1	M	3771	0	3780	90	0
2	B	3754	0	3731	94	0
2	F	3754	0	3731	92	0
2	J	3754	0	3731	106	0
2	N	3754	0	3731	81	0
3	C	482	0	271	21	0
3	G	482	0	271	12	0
3	K	482	0	271	20	0
3	O	482	0	271	16	0
4	D	454	0	224	15	0
4	H	454	0	224	8	0
4	L	454	0	224	14	0
4	P	454	0	224	6	0
All	All	33844	0	32024	704	0

The all-atom clashscore is defined as the number of clashes found per 1000 atoms (including hydrogen atoms). The all-atom clashscore for this structure is 11.

All (704) close contacts within the same asymmetric unit are listed below, sorted by their clash magnitude.

Atom-1	Atom-2	Interatomic distance (Å)	Clash overlap (Å)
2:N:51:LYS:O	2:N:55:GLU:HB3	1.79	0.82
3:K:26:DT:H3	4:L:20:G:H1	0.82	0.79
3:C:26:DT:H3	4:D:20:G:H1	0.82	0.79
2:B:51:LYS:O	2:B:55:GLU:HB3	1.87	0.75
2:J:327:GLY:HA2	2:J:336:MET:H	1.53	0.73
2:F:51:LYS:O	2:F:55:GLU:HB3	1.87	0.73
1:A:255:THR:HG22	1:A:470:CYS:H	1.54	0.72
1:M:408:GLY:HA2	1:M:460:LEU:HD11	1.71	0.72
2:B:263:ARG:NH2	3:C:35:DT:O2	2.25	0.69
1:I:152:ARG:HH12	2:J:441:GLU:HB3	1.57	0.69
2:J:435:ASN:HA	3:K:45:DT:H72	1.75	0.67
2:N:435:ASN:HA	3:O:45:DT:H72	1.75	0.67
3:K:35:DT:H3	4:L:11:G:H22	1.41	0.67
1:A:107:ASN:ND2	1:A:109:SER:O	2.28	0.67
1:I:389:THR:HB	1:I:442:PHE:HB3	1.76	0.67
1:A:501:LEU:HB2	1:E:131:ASN:HB3	1.75	0.66
2:F:362:ARG:NH2	4:H:2:G:N3	2.42	0.66
1:I:273:ASP:HB2	1:I:275:ARG:HH22	1.61	0.66
1:M:436:GLU:OE1	2:N:361:ARG:NH2	2.29	0.66
1:E:255:THR:HG22	1:E:470:CYS:H	1.60	0.66
3:G:44:DA:C4	3:G:45:DT:H72	2.31	0.65
1:A:127:THR:O	1:A:131:ASN:ND2	2.29	0.65
1:I:224:LEU:HD23	1:I:229:LEU:HD11	1.78	0.65
1:E:151:CYS:SG	1:E:152:ARG:NH2	2.70	0.64
1:M:57:LEU:HD21	1:M:86:TRP:HE1	1.62	0.64
2:F:193:ARG:HA	2:F:229:LYS:HE3	1.78	0.64
2:N:382:ARG:HA	2:N:405:ASN:HD21	1.61	0.64
1:I:104:TYR:O	1:I:107:ASN:ND2	2.31	0.64
1:M:296:ASN:H	1:M:323:PRO:HD3	1.60	0.64
2:J:86:LYS:O	2:J:89:GLN:NE2	2.30	0.64
2:B:106:ASP:O	2:J:54:ARG:NH1	2.31	0.64
2:F:201:ARG:NH2	3:G:35:DT:OP2	2.31	0.63
1:A:46:THR:HG23	1:A:49:GLY:H	1.63	0.63
2:F:76:LYS:HD3	2:J:110:ILE:HG22	1.80	0.63
1:A:109:SER:HB3	1:A:112:LYS:HE3	1.79	0.63
1:I:396:LEU:HA	2:J:173:SER:HA	1.79	0.63
3:O:39:DA:H2	4:P:7:A:H61	1.45	0.63
2:B:97:LEU:HA	2:B:118:ILE:HG22	1.82	0.62
2:B:435:ASN:HD21	3:C:45:DT:H3'	1.63	0.62
1:M:411:TYR:HB3	1:M:419:PHE:HB2	1.80	0.62

*Continued on next page...*

*Continued from previous page...*

Atom-1	Atom-2	Interatomic distance (Å)	Clash overlap (Å)
2:J:363:LYS:NZ	3:K:45:DT:OP1	2.31	0.62
1:M:284:VAL:HG22	1:M:483:ALA:HB1	1.81	0.62
1:A:416:LYS:NZ	1:A:445:ILE:O	2.32	0.62
1:M:314:LYS:HD3	1:M:490:LEU:HD13	1.82	0.62
1:E:439:ASN:ND2	4:H:3:A:OP2	2.33	0.62
2:F:276:ARG:HH12	2:F:280:LYS:HB3	1.64	0.62
1:A:152:ARG:NH1	1:A:154:ASN:OD1	2.33	0.62
3:C:38:DT:H3	4:D:8:G:H22	1.48	0.62
1:E:229:LEU:O	1:E:232:ARG:NH1	2.33	0.62
2:J:285:TYR:HB3	2:J:292:ALA:HB3	1.82	0.62
1:E:113:ARG:HH12	1:E:117:LEU:HD22	1.65	0.61
1:A:504:LYS:NZ	1:E:132:ASP:O	2.33	0.61
1:A:478:VAL:HA	1:A:481:ARG:HB3	1.82	0.61
1:M:35:GLN:HE22	1:M:83:GLY:HA3	1.64	0.61
2:J:196:LYS:NZ	4:L:15:G:OP2	2.33	0.61
1:M:439:ASN:ND2	4:P:3:A:OP2	2.32	0.61
2:B:358:HIS:NE2	3:C:43:DC:O2	2.32	0.61
1:M:203:ASP:O	1:M:209:GLN:NE2	2.33	0.61
1:A:302:GLN:NE2	1:A:479:THR:O	2.34	0.61
2:B:267:GLN:NE2	3:C:35:DT:O3'	2.33	0.61
2:J:177:PRO:HA	2:J:334:VAL:HA	1.83	0.61
2:J:372:LYS:HE2	2:J:376:LYS:HZ1	1.65	0.61
2:N:361:ARG:HH21	4:P:3:A:H4'	1.66	0.61
2:F:177:PRO:HA	2:F:334:VAL:HA	1.83	0.60
1:I:271:LEU:HD21	1:I:465:LEU:HD11	1.83	0.60
2:F:238:SER:O	2:F:240:ARG:NH2	2.34	0.60
1:M:431:SER:OG	1:M:432:THR:N	2.34	0.60
3:C:38:DT:H2'	3:C:39:DA:C8	2.36	0.60
2:B:119:ASP:OD2	2:B:122:LYS:NZ	2.34	0.60
2:F:364:GLN:OE1	2:F:367:ASN:ND2	2.31	0.60
1:I:263:LYS:NZ	1:I:507:ILE:O	2.31	0.60
2:B:9:HIS:NE2	2:B:35:ASP:OD1	2.34	0.60
2:N:13:GLU:OE1	2:N:71:ARG:NH2	2.34	0.60
2:N:159:LEU:O	2:N:160:HIS:ND1	2.34	0.60
1:E:464:LYS:NZ	1:E:472:TYR:O	2.35	0.60
2:J:167:LYS:HG2	2:J:415:SER:HB3	1.83	0.60
1:A:44:VAL:HG12	1:A:94:LYS:HB2	1.84	0.60
2:B:393:LEU:HD23	2:B:401:ILE:HB	1.84	0.60
2:N:5:ILE:HB	2:N:32:VAL:HG23	1.84	0.60
1:I:10:PRO:O	1:I:464:LYS:NZ	2.34	0.60
2:J:308:ILE:HG12	2:J:375:GLU:HB3	1.84	0.60

*Continued on next page...*



*Continued from previous page...*

Atom-1	Atom-2	Interatomic distance (Å)	Clash overlap (Å)
1:M:432:THR:HG22	1:M:434:SER:H	1.66	0.60
2:B:309:LYS:O	2:B:376:LYS:NZ	2.34	0.59
1:E:74:MET:O	1:E:254:TRP:NE1	2.35	0.59
1:I:407:ARG:NH1	1:I:422:THR:O	2.35	0.59
2:J:362:ARG:NH2	4:L:3:A:O4'	2.35	0.59
1:M:364:ARG:NH2	3:O:38:DT:OP2	2.35	0.59
1:M:436:GLU:O	2:N:370:ASN:ND2	2.35	0.59
3:K:38:DT:H2'	3:K:39:DA:C8	2.37	0.59
1:E:248:ILE:HD13	2:F:433:ILE:HG23	1.83	0.59
1:I:38:GLY:O	1:M:135:ARG:NH2	2.36	0.59
2:J:70:LYS:NZ	2:J:72:GLU:OE2	2.36	0.59
1:M:406:MET:HE1	2:N:416:TYR:HB3	1.83	0.59
1:M:24:ARG:HH11	1:M:24:ARG:HB2	1.67	0.59
2:F:315:LYS:HD2	2:F:317:LYS:HZ1	1.68	0.59
1:A:426:VAL:HG13	1:A:429:LEU:HB2	1.84	0.59
3:C:44:DA:C4	3:C:45:DT:H72	2.38	0.59
2:B:174:ASN:HB2	2:B:337:VAL:HB	1.84	0.59
2:B:188:HIS:NE2	2:B:220:GLU:OE1	2.36	0.59
2:F:366:LYS:NZ	3:G:45:DT:O3'	2.36	0.58
1:E:411:TYR:HB3	1:E:419:PHE:HB2	1.85	0.58
1:A:211:LYS:HB2	1:A:489:ILE:HD12	1.84	0.58
1:E:11:SER:HB2	1:E:19:LYS:HB2	1.86	0.58
2:N:295:ILE:HD12	2:N:310:LEU:HD21	1.85	0.58
1:A:236:ASN:HD21	1:A:238:PHE:HB2	1.67	0.58
1:A:282:GLY:HA3	1:A:479:THR:HB	1.85	0.58
1:E:66:ASN:ND2	1:E:72:ARG:O	2.36	0.58
1:E:282:GLY:HA2	1:E:360:HIS:HB2	1.86	0.58
2:N:182:PRO:HD3	2:N:401:ILE:HD11	1.86	0.58
2:B:440:THR:HG22	2:B:441:GLU:HG2	1.86	0.58
1:M:9:GLU:HG3	1:M:407:ARG:HH21	1.68	0.57
2:B:351:ILE:HB	2:B:357:GLN:HE21	1.70	0.57
2:B:71:ARG:NH1	2:B:72:GLU:OE2	2.38	0.57
2:B:350:LEU:O	2:B:352:LYS:NZ	2.37	0.57
2:N:189:ARG:HD3	2:N:237:GLU:HB3	1.86	0.57
2:B:294:TRP:HB3	2:B:342:ILE:HD13	1.85	0.57
1:M:275:ARG:NH2	1:M:356:GLU:OE1	2.37	0.57
1:A:367:ASP:OD1	1:A:367:ASP:N	2.35	0.57
2:B:185:LEU:HD21	2:B:265:ILE:HD11	1.85	0.57
1:I:362:ARG:HH12	3:K:39:DA:P	2.27	0.57
2:J:351:ILE:HD11	2:J:357:GLN:HB2	1.87	0.57
1:A:71:THR:OG1	1:A:72:ARG:NH1	2.38	0.57

*Continued on next page...*

*Continued from previous page...*

Atom-1	Atom-2	Interatomic distance (Å)	Clash overlap (Å)
2:B:350:LEU:HD12	2:B:357:GLN:HE22	1.68	0.57
1:E:302:GLN:NE2	1:E:479:THR:O	2.37	0.57
2:N:188:HIS:HB2	2:N:214:LEU:HB3	1.86	0.57
2:N:439:ASP:N	2:N:439:ASP:OD1	2.38	0.57
3:K:26:DT:O4	4:L:20:G:O6	2.23	0.57
1:I:411:TYR:HB3	1:I:419:PHE:HB2	1.86	0.57
2:J:209:ARG:NH1	2:J:213:TYR:O	2.38	0.57
2:N:430:LEU:HA	2:N:433:ILE:HD12	1.87	0.57
1:A:286:LYS:NZ	1:A:287:LYS:O	2.38	0.56
2:N:10:ALA:HB1	2:N:71:ARG:HH21	1.69	0.56
1:M:96:ILE:HD11	1:M:101:ILE:HD11	1.86	0.56
1:A:32:PRO:HG3	1:A:82:PHE:HD1	1.69	0.56
2:B:420:SER:OG	2:B:421:GLU:N	2.39	0.56
1:E:47:GLN:NE2	1:E:95:GLU:OE1	2.38	0.56
1:I:366:ASN:ND2	1:I:368:GLU:OE2	2.39	0.56
1:M:434:SER:OG	1:M:435:MET:N	2.37	0.56
3:C:26:DT:O4	4:D:20:G:O6	2.23	0.56
1:E:246:SER:OG	1:E:247:LYS:NZ	2.39	0.56
2:N:69:ASN:ND2	2:N:107:ASP:OD2	2.36	0.56
2:N:420:SER:OG	2:N:421:GLU:N	2.39	0.56
1:A:309:ASP:OD1	1:A:309:ASP:N	2.39	0.56
1:M:423:LEU:HD21	1:M:434:SER:HB2	1.87	0.56
2:N:363:LYS:NZ	3:O:45:DT:OP1	2.39	0.56
2:F:430:LEU:HA	2:F:433:ILE:HG12	1.87	0.56
1:I:72:ARG:NH2	2:J:426:GLU:OE2	2.33	0.56
2:F:198:PHE:O	2:F:209:ARG:NH2	2.38	0.56
3:C:26:DT:O2	4:D:20:G:N2	2.29	0.55
2:N:385:SER:HA	2:N:391:ILE:HB	1.88	0.55
3:C:34:DC:H42	4:D:12:G:H22	1.54	0.55
2:F:343:PHE:O	2:F:357:GLN:NE2	2.40	0.55
1:I:34:ASN:O	1:I:261:TYR:OH	2.25	0.55
2:F:325:ALA:HB1	2:F:335:LEU:HD11	1.88	0.55
1:I:305:LEU:HD22	1:I:346:TYR:HD1	1.71	0.55
2:J:295:ILE:HD12	2:J:310:LEU:HD11	1.88	0.55
2:J:297:LYS:NZ	2:J:303:ASP:OD2	2.39	0.55
2:B:276:ARG:NH2	2:B:384:LEU:O	2.39	0.55
1:M:314:LYS:HE2	1:M:490:LEU:HD22	1.88	0.55
1:A:411:TYR:HB3	1:A:419:PHE:HB2	1.88	0.55
2:B:118:ILE:HA	2:F:41:LYS:HG2	1.87	0.55
1:I:311:THR:O	1:I:311:THR:OG1	2.25	0.55
2:J:420:SER:OG	2:J:421:GLU:N	2.40	0.55

*Continued on next page...*

*Continued from previous page...*

Atom-1	Atom-2	Interatomic distance (Å)	Clash overlap (Å)
1:M:72:ARG:NH1	2:N:426:GLU:OE2	2.39	0.55
1:A:485:LYS:NZ	1:A:506:TYR:O	2.36	0.55
2:B:259:TYR:HD1	2:B:262:GLN:HE21	1.55	0.55
2:B:276:ARG:HG3	2:B:393:LEU:HA	1.88	0.55
1:E:363:THR:OG1	1:E:364:ARG:NH1	2.40	0.55
1:M:203:ASP:OD1	1:M:290:LYS:NZ	2.27	0.55
3:G:38:DT:H2'	3:G:39:DA:C8	2.42	0.55
1:I:243:ARG:NH2	2:J:439:ASP:OD1	2.40	0.55
1:M:279:CYS:HB3	1:M:357:VAL:HA	1.90	0.54
2:F:141:PRO:HG2	2:F:144:PRO:HG3	1.89	0.54
2:J:444:ASP:O	2:J:448:ASP:HB2	2.08	0.54
2:F:30:TYR:OH	2:F:138:GLN:O	2.25	0.54
1:A:286:LYS:HD2	3:C:40:DC:H5''	1.90	0.54
2:B:415:SER:OG	2:B:416:TYR:N	2.39	0.54
1:E:1:MET:SD	1:E:1:MET:N	2.70	0.54
1:I:109:SER:HB3	1:I:112:LYS:HG2	1.90	0.54
1:A:215:LEU:HG	1:A:500:PRO:HD2	1.88	0.54
2:B:385:SER:HB2	2:B:391:ILE:HG22	1.89	0.54
2:J:439:ASP:OD1	2:J:439:ASP:N	2.40	0.54
2:N:167:LYS:HG2	2:N:415:SER:HB3	1.89	0.54
3:K:34:DC:H42	4:L:12:G:H22	1.56	0.54
1:E:71:THR:HA	1:E:429:LEU:HG	1.89	0.54
1:M:215:LEU:HD21	1:M:499:PRO:HB3	1.88	0.54
3:K:38:DT:H3	4:L:8:G:H22	1.54	0.54
1:A:151:CYS:HB2	1:A:206:PHE:HZ	1.70	0.54
1:M:62:LYS:NZ	1:M:63:PRO:O	2.35	0.54
1:I:284:VAL:HG13	1:I:483:ALA:HB1	1.89	0.54
2:J:273:PHE:HE2	2:J:335:LEU:HD21	1.73	0.54
2:B:110:ILE:HG21	2:J:76:LYS:HB3	1.89	0.54
1:I:359:ILE:HB	1:I:385:GLY:HA2	1.89	0.54
2:J:276:ARG:O	2:J:276:ARG:NH1	2.41	0.54
1:M:152:ARG:HE	1:M:153:PRO:HD2	1.73	0.54
2:F:172:ASP:OD2	2:F:374:ARG:NE	2.39	0.53
2:B:226:GLN:HG2	2:B:227:LEU:HG	1.90	0.53
1:E:305:LEU:HD11	1:E:349:GLN:HB2	1.90	0.53
2:N:193:ARG:O	2:N:229:LYS:NZ	2.41	0.53
1:E:395:LYS:HE3	1:E:437:VAL:HB	1.90	0.53
2:N:59:LYS:NZ	2:N:136:GLU:OE1	2.40	0.53
1:M:396:LEU:HD22	2:N:171:TYR:HB3	1.91	0.53
1:E:248:ILE:HB	1:E:251:HIS:HB3	1.91	0.53
1:M:92:VAL:HG11	1:M:134:GLU:HG3	1.91	0.53

*Continued on next page...*

*Continued from previous page...*

Atom-1	Atom-2	Interatomic distance (Å)	Clash overlap (Å)
2:N:319:TRP:HB2	2:N:341:ILE:HD11	1.90	0.53
2:N:9:HIS:NE2	2:N:35:ASP:OD1	2.42	0.53
2:N:415:SER:OG	2:N:416:TYR:N	2.41	0.53
2:J:154:TYR:HA	2:J:158:PHE:HD2	1.73	0.53
1:A:281:LEU:N	1:A:358:PHE:O	2.41	0.53
2:F:309:LYS:HE3	2:F:376:LYS:HZ1	1.73	0.53
2:J:193:ARG:HG3	2:J:229:LYS:HZ2	1.73	0.53
2:N:186:ARG:NH2	2:N:217:PHE:O	2.42	0.53
1:M:284:VAL:HG12	1:M:286:LYS:H	1.74	0.52
1:M:39:ILE:HA	1:M:135:ARG:HH12	1.75	0.52
1:M:428:LYS:HA	2:N:162:LYS:HB3	1.90	0.52
1:I:118:VAL:HG11	1:I:209:GLN:HG3	1.91	0.52
2:J:66:THR:OG1	2:J:100:ASP:OD2	2.25	0.52
2:N:177:PRO:HA	2:N:334:VAL:HA	1.91	0.52
1:A:273:ASP:OD1	1:A:273:ASP:N	2.39	0.52
2:J:13:GLU:OE2	2:J:71:ARG:NH2	2.37	0.52
3:G:39:DA:H2	4:H:7:A:H61	1.56	0.52
1:A:113:ARG:HE	1:A:117:LEU:HD22	1.75	0.52
1:I:358:PHE:HZ	1:I:455:VAL:HG23	1.74	0.52
2:B:391:ILE:HG12	2:B:403:ILE:HB	1.90	0.52
2:F:292:ALA:HB2	2:F:340:HIS:HD2	1.74	0.52
2:N:385:SER:OG	2:N:387:ASP:O	2.24	0.52
1:A:14:PHE:HZ	1:A:23:PRO:HA	1.75	0.52
1:I:43:VAL:HG12	1:I:140:PHE:HB2	1.92	0.52
1:I:305:LEU:HD12	1:I:306:ASP:HB2	1.91	0.52
1:I:426:VAL:HG22	1:I:428:LYS:H	1.75	0.52
2:J:387:ASP:OD1	2:J:390:ALA:N	2.43	0.52
1:M:293:ASN:O	1:M:295:GLN:NE2	2.43	0.52
1:I:232:ARG:O	1:I:235:LYS:NZ	2.38	0.51
1:M:201:ASN:O	1:M:290:LYS:NZ	2.40	0.51
2:B:225:HIS:ND1	2:B:226:GLN:OE1	2.44	0.51
2:F:118:ILE:HG21	2:F:131:LEU:HD13	1.92	0.51
1:I:439:ASN:ND2	4:L:3:A:OP2	2.28	0.51
1:M:377:THR:OG1	1:M:381:THR:OG1	2.28	0.51
2:B:276:ARG:NE	2:B:392:TYR:O	2.43	0.51
2:F:16:ASP:OD1	2:F:16:ASP:N	2.43	0.51
2:F:434:ASN:ND2	4:H:1:U:O4'	2.43	0.51
1:E:404:PRO:HD3	2:F:369:TRP:HZ2	1.73	0.51
1:I:374:ASN:O	1:I:377:THR:OG1	2.28	0.51
3:C:35:DT:H3	4:D:11:G:H22	1.59	0.51
2:B:243:THR:HA	2:B:246:ILE:HD12	1.93	0.51

*Continued on next page...*

*Continued from previous page...*

Atom-1	Atom-2	Interatomic distance (Å)	Clash overlap (Å)
3:K:26:DT:O2	4:L:20:G:N2	2.29	0.51
1:E:430:GLN:NE2	2:F:161:ASP:OD2	2.43	0.51
1:A:243:ARG:NH2	2:B:437:GLU:O	2.43	0.50
1:E:27:LEU:HD23	1:E:254:TRP:HZ3	1.76	0.50
2:F:420:SER:OG	2:F:421:GLU:N	2.44	0.50
1:M:29:LEU:O	2:N:20:TRP:NE1	2.38	0.50
1:A:284:VAL:HB	1:A:300:ALA:H	1.76	0.50
1:I:280:TYR:HA	1:I:358:PHE:HB3	1.94	0.50
2:J:180:SER:O	2:J:180:SER:OG	2.28	0.50
1:I:314:LYS:HD3	1:I:490:LEU:HD13	1.94	0.50
2:B:190:TYR:O	2:B:193:ARG:NE	2.44	0.50
2:F:187:PHE:HB3	2:F:213:TYR:HD2	1.75	0.50
2:N:263:ARG:NH1	3:O:37:DC:OP1	2.44	0.50
2:N:285:TYR:HB3	2:N:292:ALA:HB3	1.93	0.50
3:C:34:DC:H42	4:D:12:G:N2	2.10	0.50
2:F:250:ARG:O	2:F:250:ARG:NE	2.43	0.50
1:I:90:ASN:OD1	1:M:37:TYR:OH	2.23	0.50
2:J:290:THR:OG1	2:J:291:PHE:N	2.44	0.50
1:A:133:GLU:O	1:E:504:LYS:NZ	2.37	0.50
2:B:115:LEU:HD23	2:F:44:ASP:HB3	1.94	0.50
2:B:134:ALA:HA	2:B:137:LYS:HG2	1.92	0.50
1:E:320:TRP:CD1	1:E:331:LYS:HB2	2.46	0.50
1:M:152:ARG:HH12	2:N:441:GLU:HG3	1.77	0.50
1:M:228:THR:OG1	1:M:243:ARG:NH1	2.45	0.50
3:C:28:DT:H2'	3:C:29:DA:C8	2.47	0.50
1:E:57:LEU:HA	1:E:60:ILE:HG12	1.94	0.50
1:I:24:ARG:HE	1:I:73:PRO:HD2	1.77	0.50
1:E:291:SER:OG	1:E:292:LYS:N	2.45	0.49
1:I:493:SER:OG	1:I:495:GLU:OE1	2.25	0.49
2:J:271:LYS:NZ	3:K:36:DA:OP1	2.45	0.49
4:L:6:U:O2'	4:L:7:A:N7	2.40	0.49
1:E:7:ILE:HD11	1:E:456:LEU:HD13	1.93	0.49
1:E:331:LYS:HD2	1:E:332:PRO:HD2	1.93	0.49
1:I:67:HIS:HB2	1:I:247:LYS:HB3	1.94	0.49
2:N:199:ASP:OD2	2:N:202:THR:N	2.43	0.49
4:D:9:U:O2'	4:D:11:G:O6	2.31	0.49
2:J:363:LYS:HD2	3:K:45:DT:H5'	1.93	0.49
2:B:266:VAL:O	2:B:270:ASN:ND2	2.45	0.49
2:F:196:LYS:HA	2:F:209:ARG:HH12	1.78	0.49
1:I:330:LEU:HD11	1:I:334:GLU:HB3	1.94	0.49
2:N:187:PHE:HB3	2:N:213:TYR:HB3	1.95	0.49

*Continued on next page...*

*Continued from previous page...*

Atom-1	Atom-2	Interatomic distance (Å)	Clash overlap (Å)
1:A:21:THR:HG1	1:A:472:TYR:HH	1.60	0.49
2:J:44:ASP:OD1	2:J:44:ASP:N	2.41	0.49
1:E:66:ASN:ND2	1:E:73:PRO:O	2.46	0.49
2:F:61:LEU:HG	2:F:95:ILE:HB	1.94	0.49
2:F:101:GLU:HG3	2:F:121:LYS:HB3	1.95	0.49
2:F:263:ARG:NH2	2:F:267:GLN:OE1	2.45	0.49
1:I:109:SER:H	1:I:112:LYS:HE2	1.78	0.49
1:I:288:ILE:HD13	1:I:290:LYS:HE3	1.95	0.49
1:A:222:GLN:OE1	1:A:263:LYS:NZ	2.33	0.49
2:B:188:HIS:O	2:B:214:LEU:N	2.44	0.49
2:B:201:ARG:HH22	3:C:35:DT:H5'	1.78	0.49
1:I:13:LEU:HD23	1:I:272:GLY:HA2	1.94	0.49
1:A:316:GLU:HG3	1:A:334:GLU:HG2	1.94	0.49
2:J:152:LEU:O	2:J:156:GLN:HB3	2.13	0.49
2:J:354:LYS:HB3	4:L:5:G:OP1	2.12	0.49
2:F:90:ASP:HB3	2:F:93:PHE:HB2	1.93	0.49
1:M:493:SER:OG	1:M:495:GLU:OE1	2.29	0.49
2:J:273:PHE:O	2:J:277:MET:HG2	2.13	0.49
2:B:16:ASP:N	2:B:16:ASP:OD1	2.46	0.48
2:B:227:LEU:O	2:B:230:THR:OG1	2.28	0.48
1:I:366:ASN:N	1:I:366:ASN:OD1	2.46	0.48
2:J:219:TRP:HH2	2:J:399:GLU:H	1.61	0.48
2:J:343:PHE:HD2	2:J:357:GLN:HG2	1.78	0.48
2:B:361:ARG:O	2:B:361:ARG:NH1	2.43	0.48
1:E:329:HIS:CG	1:E:366:ASN:HD22	2.31	0.48
2:B:351:ILE:HG22	2:B:353:SER:H	1.78	0.48
1:E:14:PHE:HZ	1:E:23:PRO:HA	1.78	0.48
2:J:209:ARG:NH2	2:J:211:LYS:O	2.40	0.48
2:B:66:THR:OG1	2:B:100:ASP:OD2	2.29	0.48
2:B:390:ALA:HA	2:B:404:SER:HA	1.95	0.48
2:F:243:THR:HA	2:F:246:ILE:HD12	1.95	0.48
3:G:38:DT:H3	4:H:8:G:H22	1.60	0.48
1:M:150:TYR:OH	1:M:157:LEU:O	2.32	0.48
3:K:39:DA:H2'	3:K:40:DC:C6	2.48	0.48
1:A:68:ASN:OD1	1:A:68:ASN:N	2.44	0.48
1:A:207:HIS:HE2	1:A:485:LYS:HE2	1.78	0.48
1:E:245:PHE:HD1	1:E:248:ILE:HD11	1.79	0.48
2:F:206:PRO:HD3	2:F:275:LEU:HD21	1.95	0.48
1:I:227:SER:HB3	1:I:243:ARG:HG3	1.95	0.48
1:M:362:ARG:NH1	3:O:39:DA:OP2	2.36	0.48
1:A:336:LYS:O	1:A:340:THR:OG1	2.28	0.48

*Continued on next page...*

*Continued from previous page...*

Atom-1	Atom-2	Interatomic distance (Å)	Clash overlap (Å)
1:A:392:LYS:HD2	1:A:392:LYS:HA	1.64	0.48
2:B:441:GLU:HG3	3:C:43:DC:OP2	2.12	0.48
2:J:172:ASP:OD1	2:J:172:ASP:N	2.46	0.48
1:A:399:THR:OG1	1:A:400:GLU:OE1	2.31	0.48
2:B:189:ARG:NH2	2:B:191:ASP:OD1	2.45	0.48
2:F:438:GLU:OE1	4:H:1:U:N3	2.46	0.48
1:M:70:ILE:HG13	1:M:71:THR:HG23	1.95	0.48
2:F:188:HIS:HB2	2:F:214:LEU:HB3	1.95	0.48
2:J:118:ILE:HG13	2:N:41:LYS:HZ2	1.79	0.48
1:M:35:GLN:NE2	1:M:82:PHE:O	2.47	0.48
2:N:82:THR:HA	2:N:85:LYS:HB3	1.95	0.48
3:O:28:DT:H2 <sup>?</sup>	3:O:29:DA:C8	2.49	0.48
1:E:280:TYR:HB2	1:E:304:PHE:HB3	1.95	0.47
2:F:109:ASN:N	2:F:109:ASN:OD1	2.46	0.47
2:F:146:ASP:OD1	2:F:147:HIS:ND1	2.41	0.47
1:I:282:GLY:N	1:I:302:GLN:O	2.40	0.47
1:E:231:TRP:NE1	1:E:249:GLU:OE1	2.39	0.47
1:M:288:ILE:HD11	1:M:290:LYS:HD2	1.95	0.47
2:F:258:ASN:OD1	2:F:258:ASN:N	2.42	0.47
1:I:236:ASN:OD1	1:I:239:GLY:N	2.43	0.47
2:J:193:ARG:HA	2:J:229:LYS:HZ2	1.78	0.47
2:J:429:VAL:O	2:J:433:ILE:HG23	2.13	0.47
1:M:236:ASN:OD1	1:M:240:ALA:N	2.46	0.47
2:F:415:SER:OG	2:F:416:TYR:N	2.46	0.47
1:M:14:PHE:HZ	1:M:23:PRO:HA	1.78	0.47
2:B:290:THR:OG1	2:B:291:PHE:N	2.46	0.47
1:I:399:THR:OG1	2:J:170:THR:O	2.33	0.47
2:B:329:LEU:HD22	2:B:333:PRO:HA	1.97	0.47
1:E:399:THR:O	2:F:374:ARG:NH1	2.46	0.47
2:J:182:PRO:O	2:J:243:THR:OG1	2.25	0.47
2:J:361:ARG:HH22	4:L:3:A:H5 <sup>?</sup>	1.79	0.47
2:N:404:SER:OG	2:N:406:LYS:O	2.28	0.47
3:G:28:DT:H2 <sup>?</sup>	3:G:29:DA:C8	2.49	0.47
1:A:425:PHE:HA	1:A:432:THR:HA	1.96	0.47
2:B:54:ARG:HA	2:B:84:VAL:HG21	1.97	0.47
2:B:289:LYS:NZ	4:D:8:G:O6	2.40	0.47
2:B:317:LYS:HG3	2:B:343:PHE:HD2	1.80	0.47
1:I:320:TRP:CD2	1:I:331:LYS:HE3	2.50	0.47
2:B:263:ARG:NH1	2:B:267:GLN:OE1	2.48	0.47
2:B:382:ARG:HE	2:B:405:ASN:HB2	1.80	0.47
1:I:248:ILE:HD13	2:J:433:ILE:HG22	1.97	0.47

*Continued on next page...*

*Continued from previous page...*

Atom-1	Atom-2	Interatomic distance (Å)	Clash overlap (Å)
1:M:362:ARG:HH12	3:O:39:DA:P	2.38	0.47
2:J:290:THR:HG21	2:J:324:SER:HB2	1.97	0.47
2:N:294:TRP:HB3	2:N:342:ILE:HD13	1.97	0.47
2:N:378:LEU:HB3	2:N:382:ARG:NH2	2.30	0.47
3:K:28:DT:H2'	3:K:29:DA:C8	2.49	0.47
2:B:133:ASP:HA	2:B:136:GLU:HG3	1.97	0.46
1:I:232:ARG:HA	1:I:232:ARG:HD3	1.69	0.46
3:K:30:DC:H2'	3:K:31:DA:C8	2.50	0.46
1:A:33:LEU:HD13	1:A:270:LYS:HZ3	1.79	0.46
1:A:320:TRP:HE3	1:A:321:TYR:HB2	1.80	0.46
1:E:52:ILE:HG12	1:E:230:ALA:HB2	1.97	0.46
1:A:439:ASN:ND2	4:D:3:A:OP2	2.49	0.46
1:A:460:LEU:O	1:A:463:THR:OG1	2.33	0.46
2:B:35:ASP:OD1	2:B:35:ASP:N	2.45	0.46
1:E:493:SER:OG	1:E:495:GLU:OE1	2.30	0.46
2:F:76:LYS:HE2	2:J:111:GLU:HA	1.96	0.46
2:F:184:GLU:OE1	2:F:186:ARG:NH1	2.44	0.46
1:I:302:GLN:HG3	1:I:312:VAL:HG12	1.96	0.46
2:N:267:GLN:O	2:N:271:LYS:HG2	2.15	0.46
2:N:317:LYS:HA	2:N:345:MET:HA	1.96	0.46
1:A:396:LEU:HD21	2:B:410:PHE:HD2	1.80	0.46
2:B:110:ILE:HD12	2:B:110:ILE:H	1.81	0.46
1:M:227:SER:HB2	1:M:243:ARG:HG3	1.97	0.46
1:I:471:ILE:HD12	1:I:471:ILE:HA	1.84	0.46
2:J:169:GLU:HB2	2:J:415:SER:HB2	1.96	0.46
3:G:27:DA:H2'	3:G:28:DT:C6	2.50	0.46
1:I:113:ARG:HH21	1:I:151:CYS:HA	1.80	0.46
2:J:199:ASP:OD1	2:J:199:ASP:N	2.39	0.46
2:N:325:ALA:HB1	2:N:335:LEU:HD11	1.97	0.46
1:I:22:ASP:OD2	1:I:24:ARG:NH2	2.49	0.46
1:I:247:LYS:HB2	1:I:247:LYS:HE2	1.74	0.46
1:M:13:LEU:HD23	1:M:19:LYS:HB3	1.97	0.46
2:F:1:MET:SD	2:F:1:MET:N	2.87	0.46
2:F:175:TRP:CD1	2:F:336:MET:HG3	2.51	0.46
2:N:133:ASP:OD1	2:N:139:ASN:ND2	2.41	0.46
2:N:354:LYS:HB3	4:P:5:G:H5'	1.98	0.46
4:H:6:U:HO2'	4:H:7:A:H8	1.61	0.46
2:B:233:TYR:OH	2:B:238:SER:OG	2.26	0.46
1:E:320:TRP:HE3	1:E:320:TRP:H	1.63	0.46
2:F:76:LYS:HE3	2:J:114:ARG:HG3	1.97	0.46
2:F:24:LYS:HD3	2:F:24:LYS:HA	1.79	0.46

*Continued on next page...*



*Continued from previous page...*

Atom-1	Atom-2	Interatomic distance (Å)	Clash overlap (Å)
2:J:3:ASN:OD1	2:J:3:ASN:N	2.48	0.46
2:B:311:VAL:HG12	2:B:320:HIS:HA	1.98	0.45
1:E:286:LYS:HE2	1:E:488:GLU:HG3	1.98	0.45
1:I:145:GLU:HG2	1:I:234:PHE:HE2	1.81	0.45
1:M:141:VAL:HB	1:M:223:ILE:HA	1.98	0.45
2:B:395:VAL:HG11	2:B:401:ILE:HG12	1.97	0.45
1:E:262:TYR:HD2	1:E:507:ILE:HD11	1.81	0.45
2:F:188:HIS:O	2:F:214:LEU:N	2.46	0.45
2:F:286:GLN:NE2	2:F:287:MET:O	2.36	0.45
1:I:364:ARG:HE	1:I:364:ARG:HB2	1.59	0.45
1:I:420:LEU:HD13	1:I:456:LEU:HD22	1.98	0.45
1:M:102:ARG:O	1:M:102:ARG:NE	2.44	0.45
3:G:36:DA:H2 <sup>?</sup>	3:G:37:DC:C5	2.52	0.45
1:A:284:VAL:HG13	1:A:483:ALA:HB1	1.97	0.45
2:N:386:ASP:OD1	2:N:387:ASP:N	2.47	0.45
1:E:118:VAL:HG21	1:E:209:GLN:HG3	1.99	0.45
1:E:135:ARG:NH2	1:E:137:ASP:OD1	2.41	0.45
2:F:290:THR:OG1	2:F:291:PHE:N	2.48	0.45
2:F:336:MET:SD	2:F:336:MET:N	2.90	0.45
2:F:368:TRP:HB2	2:F:372:LYS:HG3	1.98	0.45
1:I:22:ASP:HB3	1:I:25:ASP:HB2	1.99	0.45
2:N:54:ARG:HA	2:N:84:VAL:HG21	1.97	0.45
3:O:27:DA:H2 <sup>?</sup>	3:O:28:DT:C6	2.51	0.45
3:C:30:DC:H2 <sup>?</sup>	3:C:31:DA:C8	2.51	0.45
2:J:362:ARG:HA	2:J:362:ARG:HD3	1.65	0.45
1:A:374:ASN:O	1:A:377:THR:OG1	2.29	0.45
2:B:439:ASP:N	2:B:439:ASP:OD1	2.50	0.45
2:J:300:LEU:HD21	2:J:305:PHE:HB2	1.98	0.45
1:M:34:ASN:O	1:M:261:TYR:OH	2.35	0.45
1:M:233:ASP:OD1	1:M:233:ASP:N	2.34	0.45
1:I:25:ASP:OD2	2:J:154:TYR:OH	2.34	0.45
1:I:295:GLN:H	1:I:295:GLN:HG2	1.64	0.45
2:J:262:GLN:HB3	2:J:329:LEU:HD21	1.99	0.45
2:J:368:TRP:HB2	2:J:372:LYS:HG3	1.97	0.45
1:M:47:GLN:HA	1:M:50:LEU:HD12	1.98	0.45
2:N:193:ARG:NH1	2:N:232:THR:OG1	2.35	0.45
1:A:43:VAL:HG12	1:A:140:PHE:HB2	1.98	0.45
1:I:68:ASN:OD1	1:I:68:ASN:N	2.50	0.45
2:J:250:ARG:H	2:J:250:ARG:HG3	1.61	0.45
2:N:441:GLU:HB2	3:O:43:DC:OP2	2.17	0.45
1:I:215:LEU:HD23	1:I:496:ILE:HG12	1.98	0.45

*Continued on next page...*

*Continued from previous page...*

Atom-1	Atom-2	Interatomic distance (Å)	Clash overlap (Å)
2:N:52:GLU:O	2:N:57:THR:N	2.49	0.45
1:A:28:ALA:HA	1:A:81:VAL:HG23	1.99	0.44
1:I:500:PRO:HA	1:M:130:LYS:HD2	1.98	0.44
2:J:362:ARG:NE	4:L:2:G:H21	2.15	0.44
1:M:118:VAL:HG13	1:M:210:LEU:HD23	1.98	0.44
2:B:70:LYS:HA	2:B:70:LYS:HD3	1.81	0.44
2:F:311:VAL:HG22	2:F:320:HIS:HA	1.99	0.44
1:I:115:TYR:HE1	1:I:213:ARG:HH22	1.65	0.44
2:J:83:LYS:HA	2:J:83:LYS:HD3	1.82	0.44
1:A:54:LYS:NZ	1:A:88:SER:O	2.38	0.44
1:A:320:TRP:CE3	1:A:321:TYR:HB2	2.53	0.44
1:E:314:LYS:HG3	1:E:490:LEU:HD13	1.98	0.44
2:F:391:ILE:HG12	2:F:403:ILE:HB	1.99	0.44
1:I:427:PRO:O	1:I:430:GLN:NE2	2.51	0.44
1:M:118:VAL:HG21	1:M:209:GLN:HG3	1.98	0.44
1:M:235:LYS:HA	1:M:241:PRO:HA	1.99	0.44
1:M:273:ASP:OD1	1:M:273:ASP:N	2.49	0.44
1:M:395:LYS:N	2:N:174:ASN:OD1	2.50	0.44
1:A:130:LYS:O	1:E:502:ALA:N	2.49	0.44
2:B:372:LYS:HB3	2:B:376:LYS:HE2	2.00	0.44
1:I:245:PHE:HA	1:I:248:ILE:HD11	1.98	0.44
2:J:22:SER:HB3	2:J:37:LEU:HD11	1.98	0.44
2:J:172:ASP:HA	2:J:409:LYS:HA	1.98	0.44
2:J:317:LYS:HE2	2:J:343:PHE:HB3	1.99	0.44
2:N:16:ASP:N	2:N:16:ASP:OD1	2.49	0.44
2:B:39:LEU:HD23	2:B:39:LEU:HA	1.82	0.44
1:I:61:GLN:NE2	1:I:79:GLU:OE2	2.33	0.44
1:I:98:ASP:OD1	1:I:98:ASP:N	2.51	0.44
2:J:85:LYS:HE3	2:J:91:ASP:HA	1.99	0.44
2:J:174:ASN:HB2	2:J:337:VAL:HG12	1.99	0.44
1:M:4:LEU:HD12	1:M:409:ASN:HD21	1.83	0.44
2:N:359:SER:HA	3:O:44:DA:H5'	2.00	0.44
1:A:142:ILE:HD13	1:A:224:LEU:HB2	1.99	0.44
2:F:79:ALA:HB2	2:J:114:ARG:HH22	1.83	0.44
2:J:116:ASN:ND2	2:N:41:LYS:HA	2.33	0.44
2:J:187:PHE:HD1	2:J:215:CYS:HA	1.83	0.44
2:N:276:ARG:HA	2:N:276:ARG:HD2	1.74	0.44
2:B:28:LEU:HD21	2:B:132:LEU:HD22	1.99	0.44
2:B:354:LYS:HA	2:B:357:GLN:HG3	1.98	0.44
2:F:408:LEU:HD12	2:F:408:LEU:HA	1.87	0.44
4:L:9:U:O2'	4:L:11:G:O6	2.34	0.44

*Continued on next page...*

*Continued from previous page...*

Atom-1	Atom-2	Interatomic distance (Å)	Clash overlap (Å)
2:B:46:TRP:HA	2:B:49:ILE:HD12	2.00	0.44
1:E:309:ASP:N	1:E:309:ASP:OD1	2.50	0.44
3:C:39:DA:H2'	3:C:40:DC:C6	2.53	0.44
2:B:169:GLU:OE1	2:B:171:TYR:OH	2.34	0.44
1:E:124:LYS:HA	1:E:127:THR:HG22	2.00	0.44
2:F:9:HIS:CE1	2:F:35:ASP:HB3	2.53	0.44
1:I:436:GLU:OE1	2:J:373:TRP:NE1	2.43	0.44
2:B:435:ASN:ND2	3:C:45:DT:H3'	2.31	0.43
1:E:417:LYS:HB3	1:E:417:LYS:HE2	1.77	0.43
1:E:462:LEU:HD23	1:E:462:LEU:HA	1.85	0.43
2:J:116:ASN:OD1	2:J:116:ASN:N	2.46	0.43
1:M:261:TYR:HD2	1:M:268:PRO:HG3	1.82	0.43
2:B:362:ARG:NH2	4:D:2:G:N3	2.66	0.43
2:F:179:ILE:HD12	2:F:402:LEU:HB3	2.00	0.43
2:F:210:TYR:OH	2:F:255:PHE:O	2.33	0.43
2:F:276:ARG:HD2	2:F:393:LEU:HD23	2.01	0.43
1:I:107:ASN:HB2	1:I:112:LYS:HE3	2.00	0.43
1:A:38:GLY:HA3	1:E:37:TYR:HB2	1.99	0.43
1:E:40:LYS:HE2	1:E:90:ASN:HD22	1.82	0.43
1:E:277:GLY:O	1:E:356:GLU:N	2.51	0.43
1:E:305:LEU:HD13	1:E:346:TYR:HA	2.00	0.43
1:A:36:ILE:HA	1:A:36:ILE:HD12	1.82	0.43
2:B:86:LYS:HB2	2:B:86:LYS:HE2	1.85	0.43
2:B:96:PRO:HB3	2:B:112:ILE:HG23	1.99	0.43
2:B:253:THR:HG23	2:B:256:ILE:H	1.83	0.43
2:B:361:ARG:HE	4:D:3:A:H4'	1.82	0.43
2:F:48:THR:HA	2:F:51:LYS:HG2	2.00	0.43
2:F:429:VAL:O	2:F:433:ILE:HG12	2.19	0.43
2:J:23:LEU:HD13	2:J:26:ILE:HD11	2.00	0.43
3:K:43:DC:H6	3:K:43:DC:H2'	1.66	0.43
1:E:69:ASN:HB3	1:E:73:PRO:HA	2.00	0.43
1:I:362:ARG:HA	1:I:388:ILE:H	1.84	0.43
1:A:477:PRO:O	1:A:481:ARG:N	2.48	0.43
1:M:6:TYR:HA	1:M:409:ASN:HA	2.00	0.43
2:B:170:THR:HA	2:B:411:PHE:HA	1.99	0.43
1:E:40:LYS:HE2	1:E:90:ASN:HB2	2.01	0.43
2:F:318:TYR:N	2:F:344:THR:O	2.42	0.43
1:I:397:TYR:HE2	2:J:377:LEU:HD23	1.83	0.43
2:J:183:ASN:OD1	2:J:183:ASN:N	2.52	0.43
2:J:234:ASN:OD1	2:J:234:ASN:N	2.49	0.43
1:M:71:THR:OG1	1:M:72:ARG:N	2.51	0.43

*Continued on next page...*

*Continued from previous page...*

Atom-1	Atom-2	Interatomic distance (Å)	Clash overlap (Å)
1:E:408:GLY:N	1:E:421:TRP:O	2.41	0.43
2:F:449:ILE:HG23	2:F:450:GLU:HG2	2.00	0.43
2:J:39:LEU:HD23	2:J:39:LEU:HA	1.92	0.43
2:J:243:THR:HA	2:J:246:ILE:HG12	2.00	0.43
1:I:331:LYS:HZ2	1:I:334:GLU:H	1.66	0.43
2:J:70:LYS:NZ	2:J:70:LYS:O	2.38	0.43
2:J:276:ARG:HA	2:J:276:ARG:HD2	1.73	0.43
1:M:447:LYS:HA	1:M:447:LYS:HD2	1.86	0.43
2:N:4:LYS:NZ	2:N:31:GLU:OE2	2.51	0.43
2:B:186:ARG:NH2	2:B:399:GLU:OE1	2.52	0.43
2:B:226:GLN:OE1	2:B:226:GLN:N	2.52	0.43
1:E:23:PRO:O	1:E:27:LEU:HB2	2.19	0.43
1:E:436:GLU:HB2	1:E:437:VAL:H	1.58	0.43
1:I:255:THR:HG22	1:I:470:CYS:H	1.84	0.43
2:J:304:LYS:NZ	2:J:307:LYS:H	2.17	0.43
1:M:291:SER:OG	1:M:292:LYS:N	2.51	0.43
1:M:322:ASN:O	1:M:325:LYS:N	2.51	0.43
3:C:34:DC:H5'	3:C:34:DC:C6	2.54	0.43
4:D:6:U:O2'	4:D:7:A:N7	2.40	0.43
2:F:91:ASP:OD1	2:F:91:ASP:N	2.51	0.42
1:M:97:THR:O	1:M:97:THR:OG1	2.37	0.42
2:N:194:LEU:HD23	2:N:194:LEU:HA	1.84	0.42
2:B:118:ILE:HD12	2:F:41:LYS:HB3	2.01	0.42
1:I:296:ASN:H	1:I:323:PRO:HG3	1.84	0.42
1:M:57:LEU:HD12	1:M:57:LEU:HA	1.94	0.42
2:N:178:ILE:HG21	2:N:181:PHE:HD1	1.84	0.42
1:A:123:ASP:O	1:A:127:THR:OG1	2.30	0.42
2:B:392:TYR:HE1	2:B:400:LYS:HE2	1.83	0.42
2:F:59:LYS:HD3	2:F:59:LYS:HA	1.82	0.42
2:F:278:LYS:NZ	2:F:284:GLU:HB2	2.34	0.42
1:M:320:TRP:CD1	1:M:331:LYS:HG2	2.54	0.42
1:M:362:ARG:HB2	1:M:480:LEU:HD11	2.01	0.42
2:B:285:TYR:HB2	2:B:294:TRP:HE1	1.83	0.42
2:F:199:ASP:O	2:F:202:THR:OG1	2.30	0.42
1:I:397:TYR:N	2:J:172:ASP:O	2.53	0.42
2:J:359:SER:HB2	3:K:44:DA:H5'	2.01	0.42
1:M:24:ARG:HB2	1:M:24:ARG:NH1	2.32	0.42
3:O:37:DC:H2''	3:O:38:DT:H5''	2.02	0.42
2:B:157:ILE:O	2:B:160:HIS:ND1	2.52	0.42
2:F:189:ARG:HA	2:F:213:TYR:HA	2.01	0.42
2:F:319:TRP:HB2	2:F:341:ILE:HD11	2.02	0.42

*Continued on next page...*

*Continued from previous page...*

Atom-1	Atom-2	Interatomic distance (Å)	Clash overlap (Å)
2:F:406:LYS:HA	2:F:406:LYS:HD3	1.75	0.42
2:J:153:LEU:HA	2:J:156:GLN:HG2	2.01	0.42
2:F:9:HIS:HE1	2:F:35:ASP:HB3	1.84	0.42
1:I:152:ARG:HB2	1:I:155:SER:HB3	2.00	0.42
1:A:11:SER:HB2	1:A:19:LYS:HG3	2.00	0.42
1:E:267:LYS:HB3	1:E:267:LYS:HE3	1.89	0.42
1:I:397:TYR:CG	2:J:374:ARG:HB2	2.55	0.42
1:M:94:LYS:NZ	1:M:132:ASP:OD2	2.45	0.42
2:N:290:THR:OG1	2:N:291:PHE:N	2.53	0.42
2:N:346:ASP:OD1	2:N:346:ASP:N	2.53	0.42
1:A:71:THR:OG1	2:B:426:GLU:OE2	2.28	0.42
1:E:362:ARG:NH2	3:G:39:DA:H5'	2.35	0.42
1:M:210:LEU:HD23	1:M:210:LEU:HA	1.89	0.42
1:M:363:THR:OG1	1:M:364:ARG:N	2.51	0.42
2:N:2:ARG:NH2	2:N:54:ARG:O	2.46	0.42
2:N:24:LYS:HA	2:N:24:LYS:HD3	1.82	0.42
1:E:243:ARG:HB3	1:E:245:PHE:CE2	2.55	0.42
1:E:332:PRO:O	1:E:336:LYS:HG2	2.19	0.42
2:F:266:VAL:HA	2:F:269:ILE:HG12	2.01	0.42
2:F:328:LYS:HE3	2:F:336:MET:HE3	2.02	0.42
2:F:389:ASN:OD1	2:F:389:ASN:N	2.51	0.42
2:F:424:LEU:HD23	2:F:424:LEU:HA	1.81	0.42
2:N:206:PRO:HG2	2:N:395:VAL:HG23	2.02	0.42
2:N:434:ASN:HB3	3:O:45:DT:C4	2.55	0.42
4:P:6:U:HO2'	4:P:7:A:H8	1.64	0.42
1:A:431:SER:OG	1:A:432:THR:N	2.53	0.42
1:E:61:GLN:NE2	1:E:79:GLU:OE1	2.53	0.42
2:F:190:TYR:HB3	2:F:193:ARG:HB2	2.01	0.42
1:I:71:THR:HG21	2:J:426:GLU:HG2	2.02	0.42
1:I:208:ASP:N	1:I:208:ASP:OD1	2.53	0.42
1:I:295:GLN:H	1:I:323:PRO:HG3	1.85	0.42
1:M:245:PHE:HD1	1:M:248:ILE:HB	1.84	0.42
1:E:352:SER:OG	1:E:353:TYR:N	2.53	0.41
1:I:44:VAL:HG13	1:I:94:LYS:HB2	2.02	0.41
1:I:406:MET:HE1	2:J:416:TYR:HB3	2.02	0.41
1:A:407:ARG:NH1	1:A:422:THR:O	2.43	0.41
1:E:436:GLU:OE1	2:F:373:TRP:NE1	2.38	0.41
1:E:465:LEU:H	1:E:478:VAL:HG21	1.85	0.41
2:N:354:LYS:H	2:N:354:LYS:HG2	1.72	0.41
1:A:118:VAL:HG13	1:A:210:LEU:HD12	2.02	0.41
1:A:249:GLU:H	1:A:249:GLU:HG3	1.57	0.41

*Continued on next page...*

*Continued from previous page...*

Atom-1	Atom-2	Interatomic distance (Å)	Clash overlap (Å)
2:B:3:ASN:OD1	2:B:3:ASN:N	2.52	0.41
1:E:271:LEU:HD12	1:E:271:LEU:HA	1.87	0.41
1:I:68:ASN:ND2	2:J:426:GLU:OE1	2.53	0.41
2:J:35:ASP:OD1	2:J:35:ASP:N	2.45	0.41
1:M:34:ASN:OD1	1:M:34:ASN:N	2.48	0.41
1:A:282:GLY:HA2	1:A:360:HIS:HB2	2.02	0.41
2:B:362:ARG:NE	4:D:2:G:H21	2.18	0.41
2:F:71:ARG:HD2	2:F:74:VAL:HG23	2.03	0.41
2:J:153:LEU:HA	2:J:153:LEU:HD23	1.85	0.41
2:N:61:LEU:HG	2:N:95:ILE:HB	2.01	0.41
2:N:189:ARG:NE	2:N:237:GLU:OE1	2.48	0.41
1:A:115:TYR:HE1	1:A:213:ARG:HH22	1.68	0.41
1:I:2:LYS:HD2	1:I:411:TYR:HE1	1.85	0.41
2:J:62:ILE:O	2:J:97:LEU:N	2.48	0.41
2:J:307:LYS:HE2	2:J:307:LYS:HB2	1.95	0.41
2:J:359:SER:O	2:J:363:LYS:HG2	2.20	0.41
2:N:276:ARG:HG2	2:N:393:LEU:HD12	2.02	0.41
3:K:34:DC:H5'	3:K:34:DC:C6	2.55	0.41
1:E:66:ASN:H	1:E:69:ASN:HD21	1.67	0.41
2:F:64:SER:OG	2:F:97:LEU:O	2.28	0.41
2:F:188:HIS:CE1	2:F:220:GLU:HG3	2.55	0.41
1:M:69:ASN:HD22	2:N:154:TYR:HD2	1.69	0.41
3:O:36:DA:C8	3:O:36:DA:H5''	2.55	0.41
1:E:421:TRP:HZ3	1:E:438:PRO:HG2	1.86	0.41
1:I:274:ILE:HD13	1:I:274:ILE:HA	1.97	0.41
1:M:5:ILE:HG22	1:M:410:ALA:HB3	2.02	0.41
3:G:30:DC:H1'	3:G:31:DA:H5'	2.02	0.41
2:B:193:ARG:HB2	2:B:229:LYS:HG3	2.02	0.41
2:B:406:LYS:HB2	2:B:406:LYS:HE2	1.88	0.41
2:F:39:LEU:HD21	2:F:45:PHE:HB3	2.03	0.41
1:I:231:TRP:CG	1:I:245:PHE:HB2	2.55	0.41
2:N:222:ASP:OD1	2:N:222:ASP:N	2.38	0.41
2:N:265:ILE:HA	2:N:268:LEU:HD12	2.03	0.41
4:P:19:A:H1'	4:P:20:G:N7	2.36	0.41
1:A:416:LYS:NZ	1:A:444:GLU:OE2	2.51	0.41
1:E:28:ALA:HA	1:E:81:VAL:HG23	2.03	0.41
1:E:118:VAL:HG23	1:E:210:LEU:HG	2.03	0.41
2:F:362:ARG:HD3	2:F:362:ARG:HA	1.69	0.41
2:F:435:ASN:HA	3:G:45:DT:C7	2.50	0.41
1:I:5:ILE:HD13	1:I:5:ILE:HA	1.87	0.41
1:I:14:PHE:HZ	1:I:23:PRO:HA	1.85	0.41

*Continued on next page...*

*Continued from previous page...*

Atom-1	Atom-2	Interatomic distance (Å)	Clash overlap (Å)
1:I:309:ASP:HB2	1:M:133:GLU:HG2	2.03	0.41
2:J:17:PHE:HZ	2:J:97:LEU:HD12	1.85	0.41
2:J:315:LYS:HB2	2:J:316:ASN:H	1.65	0.41
1:A:294:PRO:HB2	1:A:296:ASN:HD21	1.85	0.41
1:A:406:MET:HB2	2:B:416:TYR:CD2	2.56	0.41
2:F:261:CYS:HA	2:F:264:LEU:HG	2.02	0.41
1:I:15:ALA:HB3	1:I:30:PHE:HB3	2.03	0.41
1:M:307:ASN:HD21	1:M:349:GLN:NE2	2.19	0.41
1:M:485:LYS:HE3	1:M:485:LYS:HB3	1.87	0.41
1:A:207:HIS:HA	1:A:210:LEU:HB2	2.01	0.40
2:F:294:TRP:CD1	2:F:342:ILE:HG13	2.55	0.40
1:I:482:PHE:HD1	1:I:485:LYS:HD3	1.86	0.40
2:J:221:TYR:OH	2:J:231:GLU:O	2.24	0.40
2:J:384:LEU:HB3	2:J:391:ILE:HD12	2.03	0.40
2:J:431:ALA:O	3:K:45:DT:H2'	2.22	0.40
1:M:303:MET:HG2	1:M:305:LEU:HD22	2.02	0.40
2:N:406:LYS:HA	2:N:406:LYS:HD3	1.96	0.40
3:K:39:DA:H2'	3:K:40:DC:H6	1.86	0.40
4:D:4:G:O2'	4:D:5:G:H8	2.03	0.40
2:B:190:TYR:HB2	2:B:194:LEU:HD23	2.03	0.40
2:B:285:TYR:HB2	2:B:294:TRP:NE1	2.36	0.40
1:E:302:GLN:HA	1:E:312:VAL:HG22	2.03	0.40
2:F:186:ARG:NH2	2:F:220:GLU:OE2	2.51	0.40
2:J:116:ASN:HB3	2:N:45:PHE:CE1	2.55	0.40
2:N:190:TYR:HB3	2:N:193:ARG:HB2	2.02	0.40
3:O:36:DA:H5''	3:O:36:DA:H8	1.86	0.40
4:H:9:U:O2'	4:H:11:G:O6	2.24	0.40
1:A:34:ASN:O	1:A:261:TYR:OH	2.39	0.40
1:A:144:PRO:HD2	1:A:147:ILE:HD12	2.03	0.40
1:A:288:ILE:HG12	1:A:289:GLU:H	1.86	0.40
2:B:201:ARG:HA	2:B:201:ARG:HD3	1.95	0.40
1:E:124:LYS:HB3	1:E:124:LYS:HE3	1.75	0.40
1:M:2:LYS:NZ	1:M:412:ILE:O	2.46	0.40
1:M:267:LYS:HB3	1:M:267:LYS:HE3	1.86	0.40
1:M:426:VAL:HA	1:M:427:PRO:HD3	1.97	0.40
2:N:126:LYS:HA	2:N:126:LYS:HD2	1.89	0.40
2:N:287:MET:HE3	2:N:289:LYS:H	1.87	0.40
1:A:263:LYS:NZ	1:A:507:ILE:O	2.53	0.40
2:B:236:GLN:O	2:B:236:GLN:NE2	2.51	0.40
2:B:307:LYS:HE2	2:B:307:LYS:HB2	1.88	0.40
1:E:285:TYR:OH	1:E:329:HIS:O	2.31	0.40

*Continued on next page...*

Continued from previous page...

Atom-1	Atom-2	Interatomic distance (Å)	Clash overlap (Å)
1:M:103:ARG:HD2	1:M:103:ARG:HA	1.81	0.40
1:A:13:LEU:HD23	1:A:13:LEU:HA	1.93	0.40
1:E:232:ARG:HD2	1:E:232:ARG:H	1.87	0.40
1:E:471:ILE:HD12	1:E:471:ILE:HA	1.90	0.40
1:I:399:THR:HA	2:J:374:ARG:CZ	2.52	0.40
2:J:187:PHE:HB3	2:J:213:TYR:HB3	2.03	0.40
2:J:382:ARG:HA	2:J:382:ARG:HD3	1.91	0.40
2:N:366:LYS:HD2	3:O:45:DT:H4'	2.03	0.40

There are no symmetry-related clashes.

## 5.3 Torsion angles [i](#)

### 5.3.1 Protein backbone [i](#)

In the following table, the Percentiles column shows the percent Ramachandran outliers of the chain as a percentile score with respect to all PDB entries followed by that with respect to all EM entries.

The Analysed column shows the number of residues for which the backbone conformation was analysed, and the total number of residues.

Mol	Chain	Analysed	Favoured	Allowed	Outliers	Percentiles	
1	A	461/507 (91%)	431 (94%)	30 (6%)	0	100	100
1	E	461/507 (91%)	436 (95%)	25 (5%)	0	100	100
1	I	461/507 (91%)	431 (94%)	30 (6%)	0	100	100
1	M	461/507 (91%)	433 (94%)	28 (6%)	0	100	100
2	B	448/450 (100%)	431 (96%)	17 (4%)	0	100	100
2	F	448/450 (100%)	417 (93%)	31 (7%)	0	100	100
2	J	448/450 (100%)	431 (96%)	17 (4%)	0	100	100
2	N	448/450 (100%)	420 (94%)	28 (6%)	0	100	100
All	All	3636/3828 (95%)	3430 (94%)	206 (6%)	0	100	100

There are no Ramachandran outliers to report.



### 5.3.2 Protein sidechains [i](#)

In the following table, the Percentiles column shows the percent sidechain outliers of the chain as a percentile score with respect to all PDB entries followed by that with respect to all EM entries.

The Analysed column shows the number of residues for which the sidechain conformation was analysed, and the total number of residues.

Mol	Chain	Analysed	Rotameric	Outliers	Percentiles	
1	A	406/446 (91%)	389 (96%)	17 (4%)	30	62
1	E	406/446 (91%)	389 (96%)	17 (4%)	30	62
1	I	406/446 (91%)	398 (98%)	8 (2%)	55	79
1	M	406/446 (91%)	398 (98%)	8 (2%)	55	79
2	B	414/415 (100%)	395 (95%)	19 (5%)	27	60
2	F	414/415 (100%)	391 (94%)	23 (6%)	21	53
2	J	414/415 (100%)	398 (96%)	16 (4%)	32	64
2	N	414/415 (100%)	391 (94%)	23 (6%)	21	53
All	All	3280/3444 (95%)	3149 (96%)	131 (4%)	35	63

All (131) residues with a non-rotameric sidechain are listed below:

Mol	Chain	Res	Type
1	A	56	TYR
1	A	115	TYR
1	A	150	TYR
1	A	202	TYR
1	A	229	LEU
1	A	249	GLU
1	A	270	LYS
1	A	275	ARG
1	A	285	TYR
1	A	296	ASN
1	A	313	PHE
1	A	350	ASN
1	A	358	PHE
1	A	403	PHE
1	A	470	CYS
1	A	497	LYS
1	A	505	TYR
2	B	126	LYS
2	B	128	LEU

*Continued on next page...*

*Continued from previous page...*

<b>Mol</b>	<b>Chain</b>	<b>Res</b>	<b>Type</b>
2	B	170	THR
2	B	181	PHE
2	B	188	HIS
2	B	198	PHE
2	B	199	ASP
2	B	240	ARG
2	B	255	PHE
2	B	276	ARG
2	B	278	LYS
2	B	291	PHE
2	B	315	LYS
2	B	353	SER
2	B	355	SER
2	B	368	TRP
2	B	380	PHE
2	B	392	TYR
2	B	398	GLU
1	E	1	MET
1	E	24	ARG
1	E	74	MET
1	E	115	TYR
1	E	132	ASP
1	E	148	TYR
1	E	155	SER
1	E	273	ASP
1	E	299	CYS
1	E	304	PHE
1	E	313	PHE
1	E	320	TRP
1	E	333	LYS
1	E	355	LYS
1	E	364	ARG
1	E	379	LYS
1	E	403	PHE
2	F	1	MET
2	F	6	PHE
2	F	34	CYS
2	F	58	CYS
2	F	71	ARG
2	F	75	LEU
2	F	119	ASP
2	F	135	PHE

*Continued on next page...*

*Continued from previous page...*

<b>Mol</b>	<b>Chain</b>	<b>Res</b>	<b>Type</b>
2	F	147	HIS
2	F	154	TYR
2	F	161	ASP
2	F	181	PHE
2	F	189	ARG
2	F	240	ARG
2	F	255	PHE
2	F	276	ARG
2	F	293	TYR
2	F	297	LYS
2	F	316	ASN
2	F	328	LYS
2	F	361	ARG
2	F	380	PHE
2	F	398	GLU
1	I	25	ASP
1	I	85	LYS
1	I	115	TYR
1	I	285	TYR
1	I	325	LYS
1	I	481	ARG
1	I	503	PHE
1	I	505	TYR
2	J	30	TYR
2	J	109	ASN
2	J	137	LYS
2	J	146	ASP
2	J	167	LYS
2	J	195	PRO
2	J	240	ARG
2	J	247	LEU
2	J	257	ARG
2	J	273	PHE
2	J	287	MET
2	J	309	LYS
2	J	332	SER
2	J	349	ASN
2	J	406	LYS
2	J	445	GLU
1	M	74	MET
1	M	75	PHE
1	M	150	TYR

*Continued on next page...*

*Continued from previous page...*

Mol	Chain	Res	Type
1	M	233	ASP
1	M	235	LYS
1	M	351	LYS
1	M	462	LEU
1	M	503	PHE
2	N	41	LYS
2	N	58	CYS
2	N	115	LEU
2	N	123	SER
2	N	143	LYS
2	N	146	ASP
2	N	158	PHE
2	N	181	PHE
2	N	217	PHE
2	N	251	TYR
2	N	255	PHE
2	N	261	CYS
2	N	275	LEU
2	N	293	TYR
2	N	304	LYS
2	N	318	TYR
2	N	321	PHE
2	N	355	SER
2	N	368	TRP
2	N	370	ASN
2	N	371	ASP
2	N	387	ASP
2	N	409	LYS

Sometimes sidechains can be flipped to improve hydrogen bonding and reduce clashes. All (7) such sidechains are listed below:

Mol	Chain	Res	Type
1	A	107	ASN
2	B	262	GLN
1	E	90	ASN
1	E	209	GLN
1	M	35	GLN
1	M	307	ASN
2	N	405	ASN

### 5.3.3 RNA

Mol	Chain	Analysed	Backbone Outliers	Pucker Outliers
4	D	20/21 (95%)	16 (80%)	0
4	H	20/21 (95%)	12 (60%)	0
4	L	20/21 (95%)	17 (85%)	0
4	P	20/21 (95%)	14 (70%)	0
All	All	80/84 (95%)	59 (73%)	0

All (59) RNA backbone outliers are listed below:

Mol	Chain	Res	Type
4	L	2	G
4	L	4	G
4	L	5	G
4	L	6	U
4	L	7	A
4	L	8	G
4	L	9	U
4	L	10	A
4	L	11	G
4	L	12	G
4	L	13	U
4	L	14	U
4	L	15	G
4	L	16	U
4	L	18	U
4	L	20	G
4	L	21	U
4	P	3	A
4	P	4	G
4	P	5	G
4	P	6	U
4	P	7	A
4	P	8	G
4	P	10	A
4	P	12	G
4	P	13	U
4	P	14	U
4	P	15	G
4	P	16	U
4	P	18	U
4	P	21	U
4	D	2	G
4	D	4	G
4	D	5	G

*Continued on next page...*

*Continued from previous page...*

Mol	Chain	Res	Type
4	D	6	U
4	D	7	A
4	D	8	G
4	D	9	U
4	D	10	A
4	D	11	G
4	D	13	U
4	D	14	U
4	D	15	G
4	D	16	U
4	D	18	U
4	D	20	G
4	D	21	U
4	H	4	G
4	H	5	G
4	H	6	U
4	H	7	A
4	H	8	G
4	H	10	A
4	H	11	G
4	H	13	U
4	H	14	U
4	H	16	U
4	H	18	U
4	H	21	U

There are no RNA pucker outliers to report.

#### 5.4 Non-standard residues in protein, DNA, RNA chains [i](#)

There are no non-standard protein/DNA/RNA residues in this entry.

#### 5.5 Carbohydrates [i](#)

There are no monosaccharides in this entry.

#### 5.6 Ligand geometry [i](#)

There are no ligands in this entry.

## 5.7 Other polymers [i](#)

There are no such residues in this entry.

## 5.8 Polymer linkage issues [i](#)

There are no chain breaks in this entry.

## 6 Map visualisation [i](#)

This section contains visualisations of the EMDB entry EMD-35703. These allow visual inspection of the internal detail of the map and identification of artifacts.

Images derived from a raw map, generated by summing the deposited half-maps, are presented below the corresponding image components of the primary map to allow further visual inspection and comparison with those of the primary map.

### 6.1 Orthogonal projections [i](#)

#### 6.1.1 Primary map



X

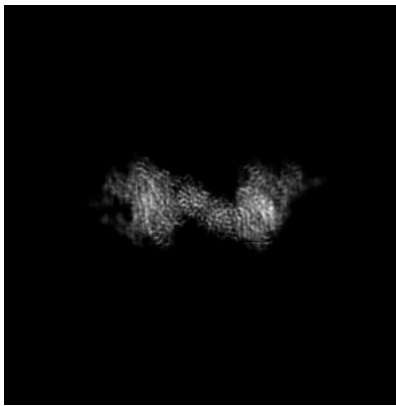

Y

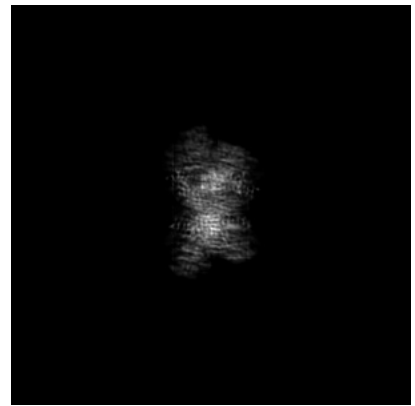

Z

#### 6.1.2 Raw map

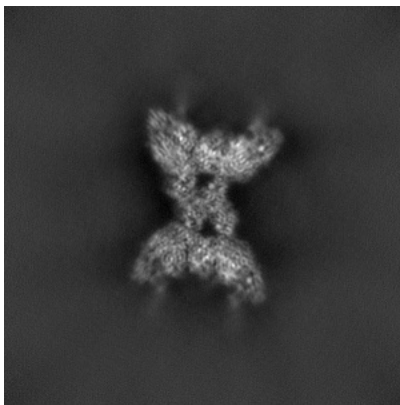

X

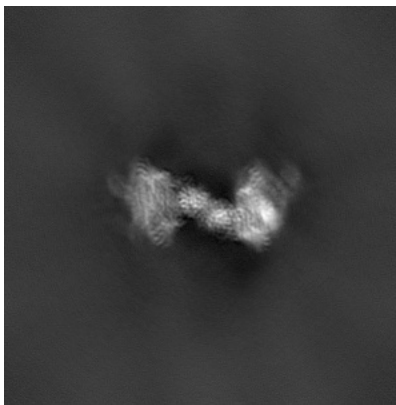

Y

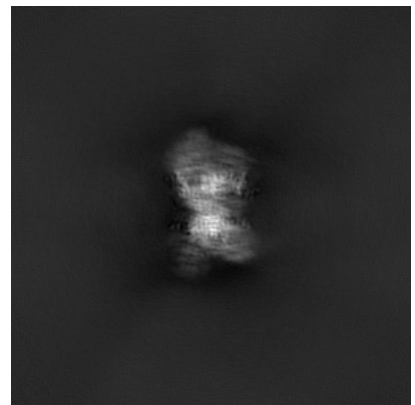

Z

The images above show the map projected in three orthogonal directions.



## 6.2 Central slices [i](#)

### 6.2.1 Primary map



X Index: 208



Y Index: 208

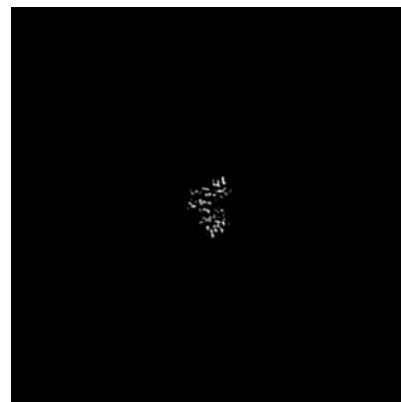

Z Index: 208

### 6.2.2 Raw map

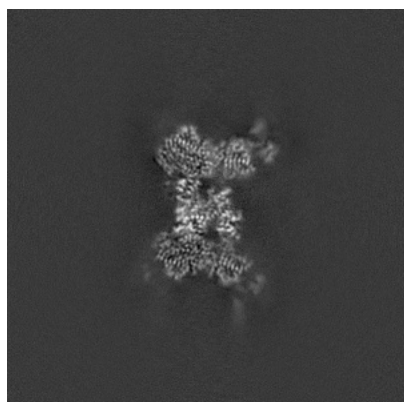

X Index: 208

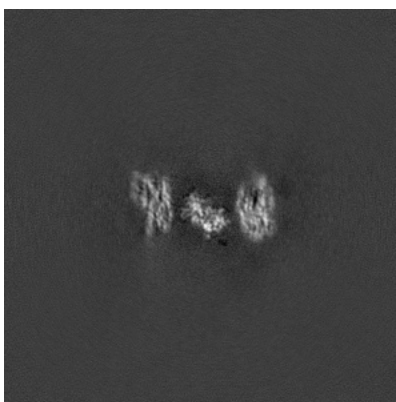

Y Index: 208

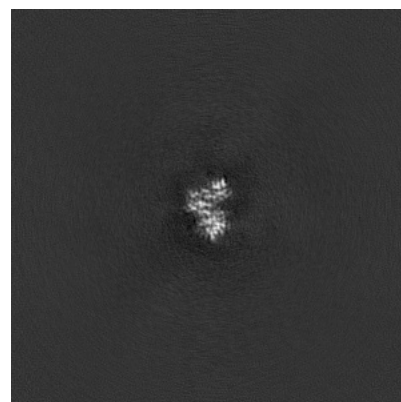

Z Index: 208

The images above show central slices of the map in three orthogonal directions.

## 6.3 Largest variance slices [i](#)

### 6.3.1 Primary map

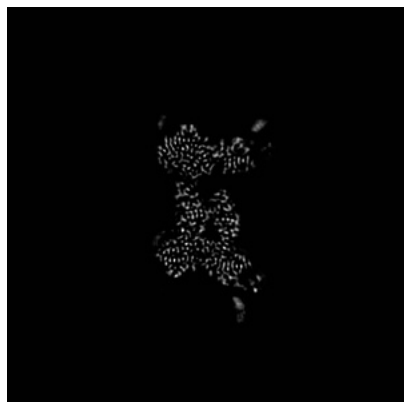

X Index: 211

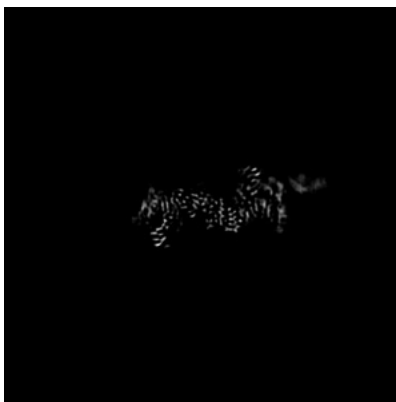

Y Index: 187

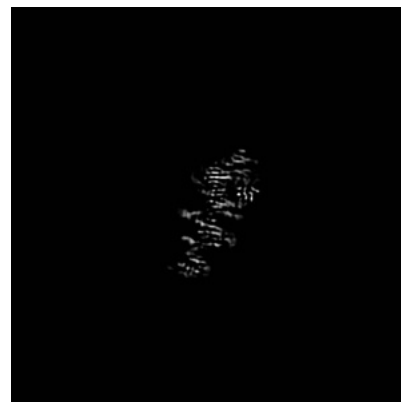

Z Index: 145

### 6.3.2 Raw map

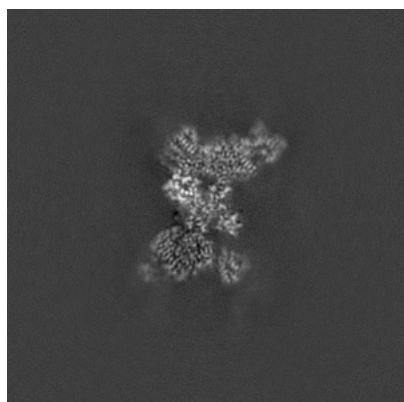

X Index: 202

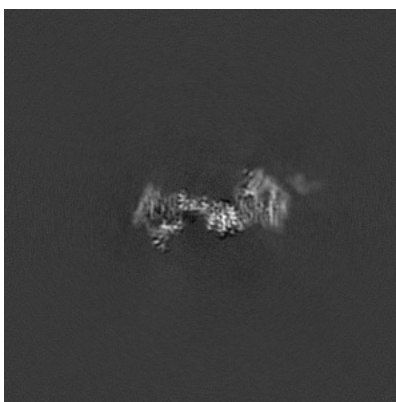

Y Index: 183

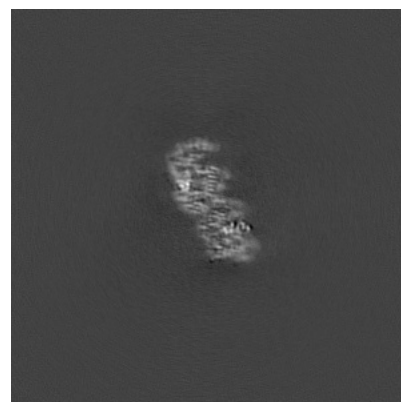

Z Index: 259

The images above show the largest variance slices of the map in three orthogonal directions.

## 6.4 Orthogonal standard-deviation projections (False-color) [i](#)

### 6.4.1 Primary map

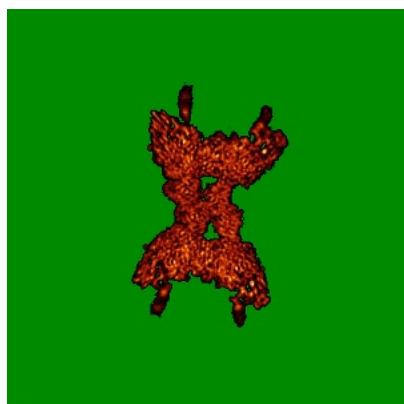

X

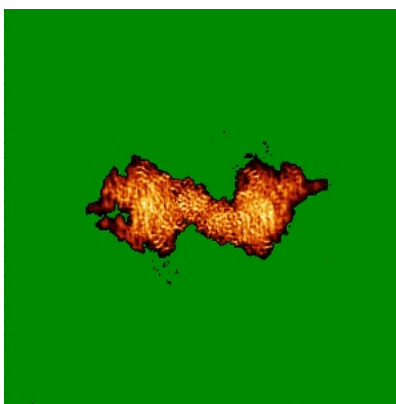

Y

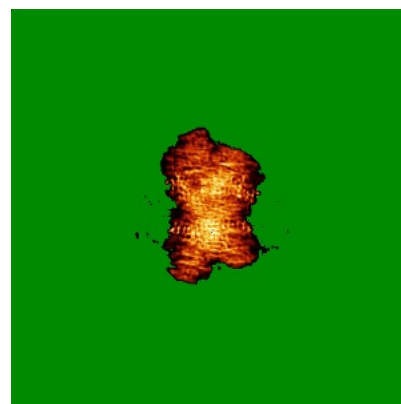

Z

### 6.4.2 Raw map

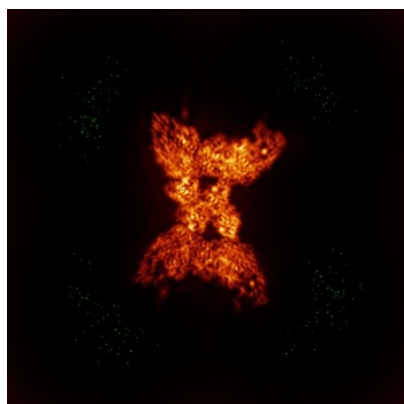

X

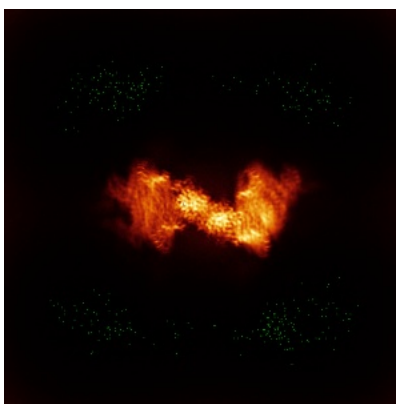

Y

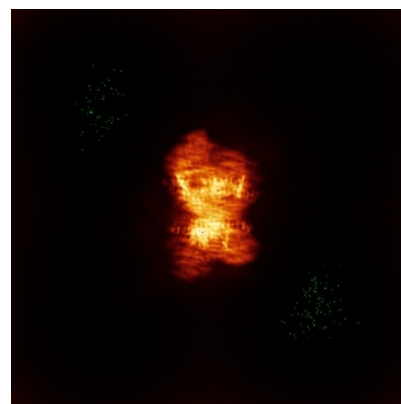

Z

The images above show the map standard deviation projections with false color in three orthogonal directions. Minimum values are shown in green, max in blue, and dark to light orange shades represent small to large values respectively.

## 6.5 Orthogonal surface views [i](#)

### 6.5.1 Primary map

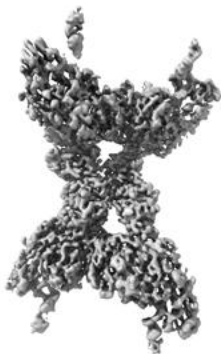

X

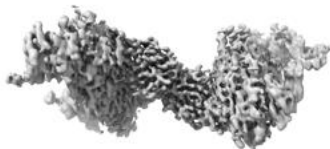

Y

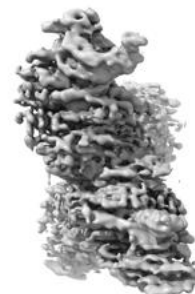

Z

The images above show the 3D surface view of the map at the recommended contour level 0.2. These images, in conjunction with the slice images, may facilitate assessment of whether an appropriate contour level has been provided.

### 6.5.2 Raw map

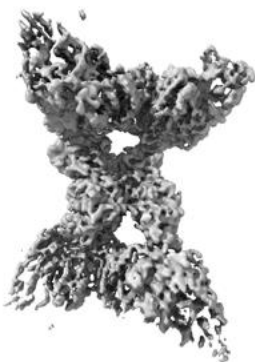

X



Y



Z

These images show the 3D surface of the raw map. The raw map's contour level was selected so that its surface encloses the same volume as the primary map does at its recommended contour level.

## 6.6 Mask visualisation [i](#)

This section was not generated. No masks/segmentation were deposited.

## 7 Map analysis [i](#)

This section contains the results of statistical analysis of the map.

### 7.1 Map-value distribution [i](#)

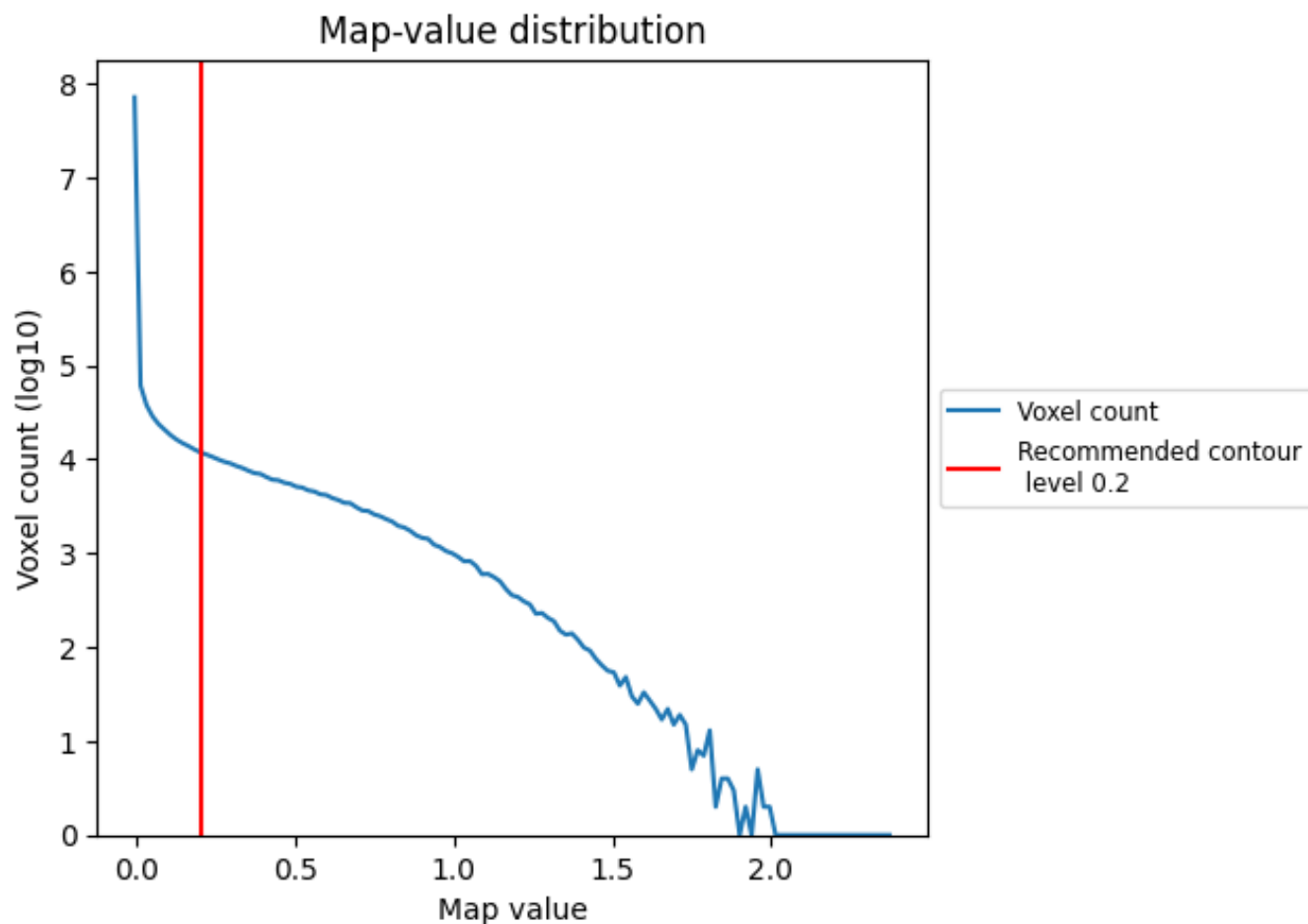

The map-value distribution is plotted in 128 intervals along the x-axis. The y-axis is logarithmic. A spike in this graph at zero usually indicates that the volume has been masked.

## 7.2 Volume estimate [i](#)

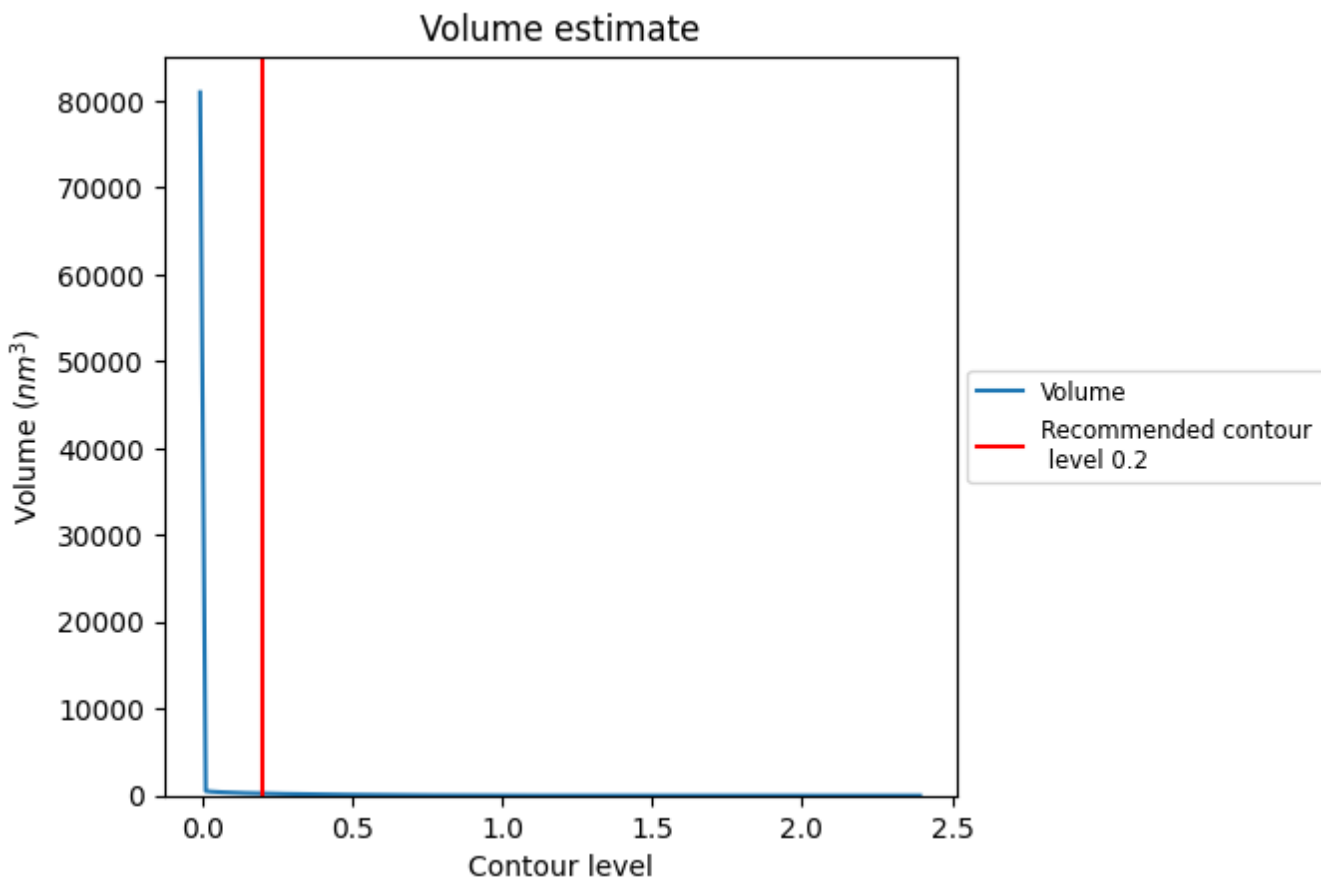

The volume at the recommended contour level is 241 nm<sup>3</sup>; this corresponds to an approximate mass of 218 kDa.

The volume estimate graph shows how the enclosed volume varies with the contour level. The recommended contour level is shown as a vertical line and the intersection between the line and the curve gives the volume of the enclosed surface at the given level.

### 7.3 Rotationally averaged power spectrum [i](#)

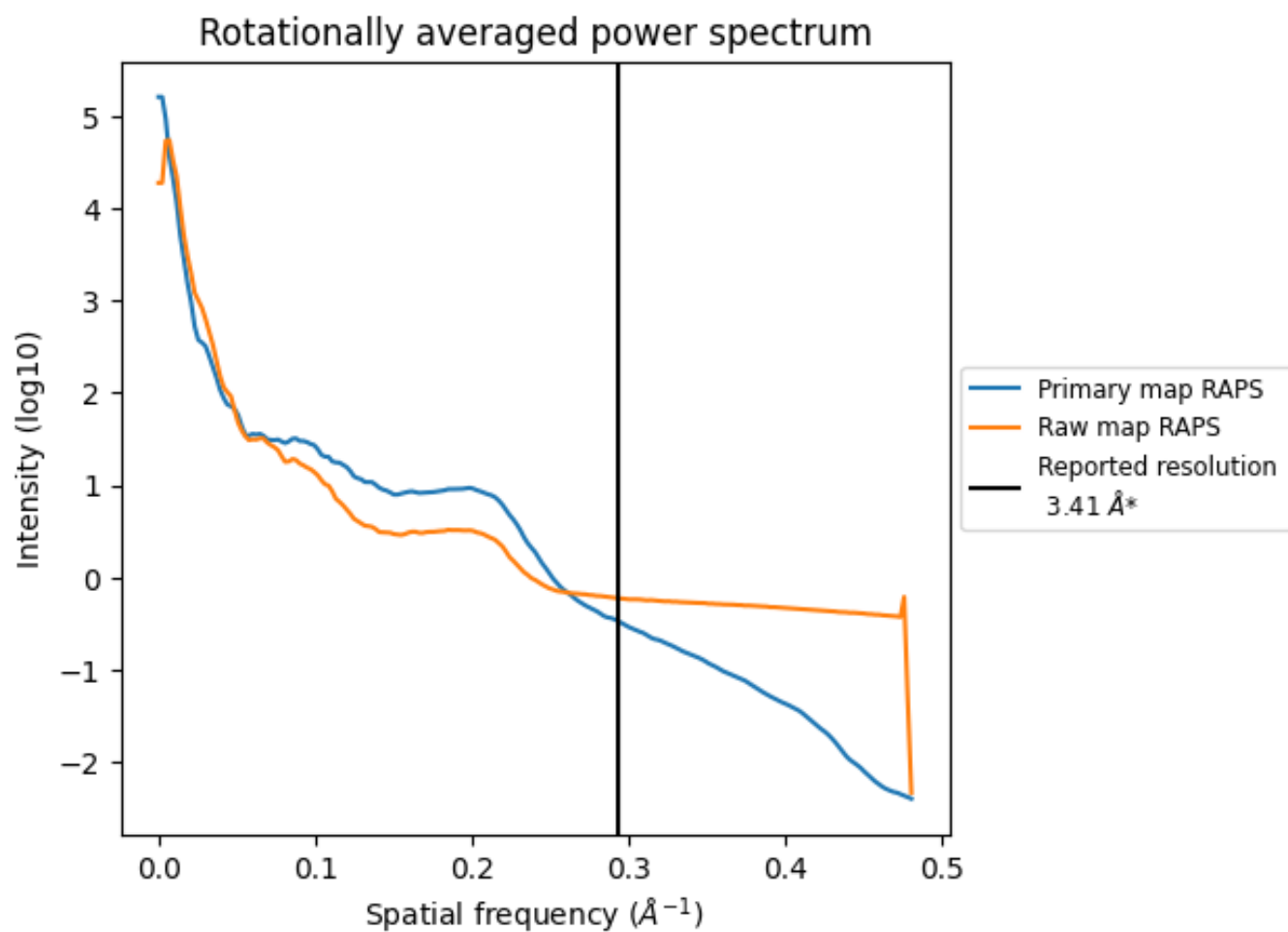

\*Reported resolution corresponds to spatial frequency of 0.293 Å<sup>-1</sup>

## 8 Fourier-Shell correlation [i](#)

Fourier-Shell Correlation (FSC) is the most commonly used method to estimate the resolution of single-particle and subtomogram-averaged maps. The shape of the curve depends on the imposed symmetry, mask and whether or not the two 3D reconstructions used were processed from a common reference. The reported resolution is shown as a black line. A curve is displayed for the half-bit criterion in addition to lines showing the 0.143 gold standard cut-off and 0.5 cut-off.

### 8.1 FSC [i](#)

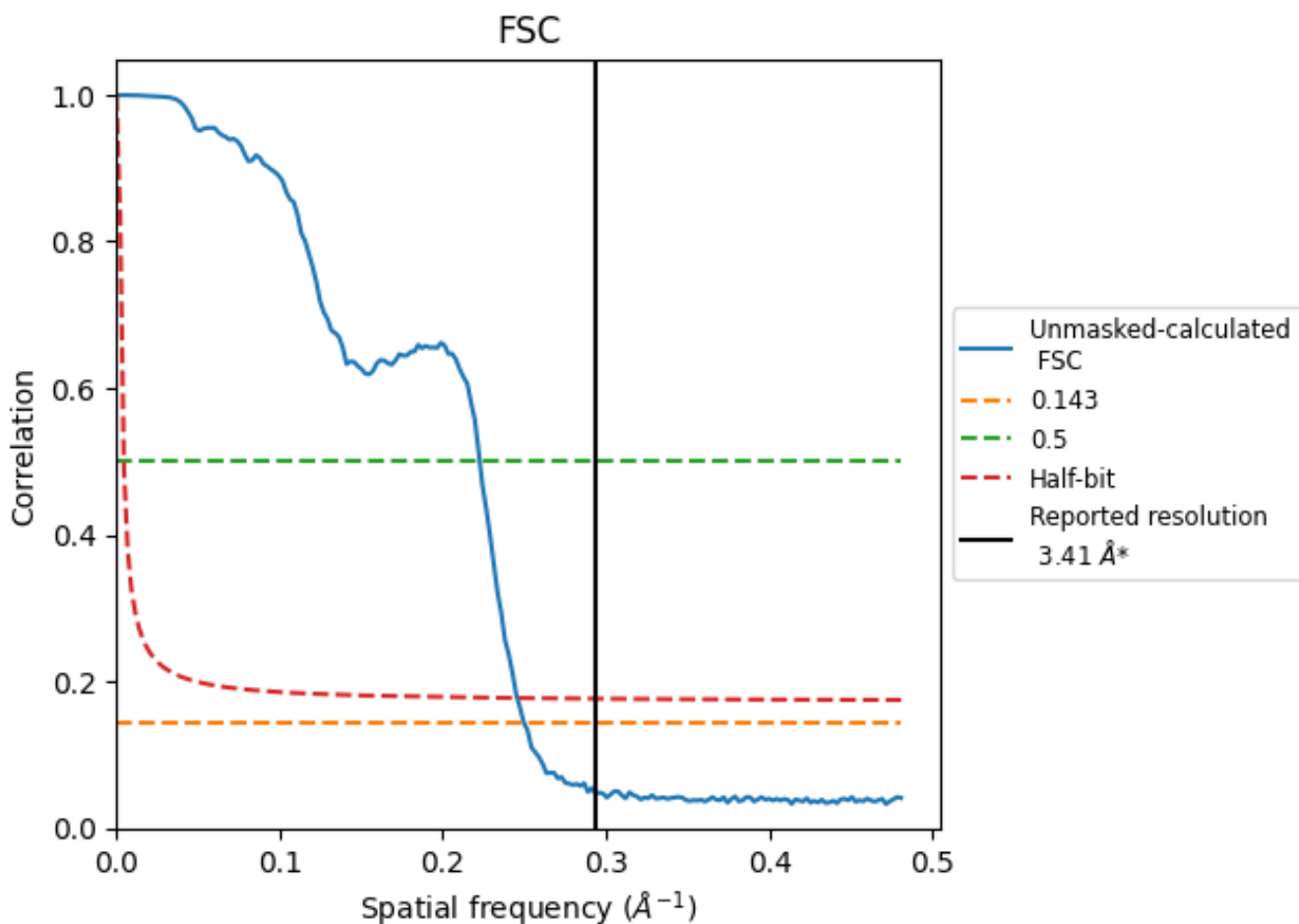

\*Reported resolution corresponds to spatial frequency of 0.293 Å<sup>-1</sup>



## 8.2 Resolution estimates [i](#)

Resolution estimate (Å)	Estimation criterion (FSC cut-off)		
	0.143	0.5	Half-bit
Reported by author	3.41	-	-
Author-provided FSC curve	-	-	-
Unmasked-calculated*	4.00	4.49	4.07

\*Resolution estimate based on FSC curve calculated by comparison of deposited half-maps. The value from deposited half-maps intersecting FSC 0.143 CUT-OFF 4.00 differs from the reported value 3.41 by more than 10 %

## 9 Map-model fit [i](#)

This section contains information regarding the fit between EMDB map EMD-35703 and PDB model 8IT1. Per-residue inclusion information can be found in section 3 on page 6.

### 9.1 Map-model overlay [i](#)

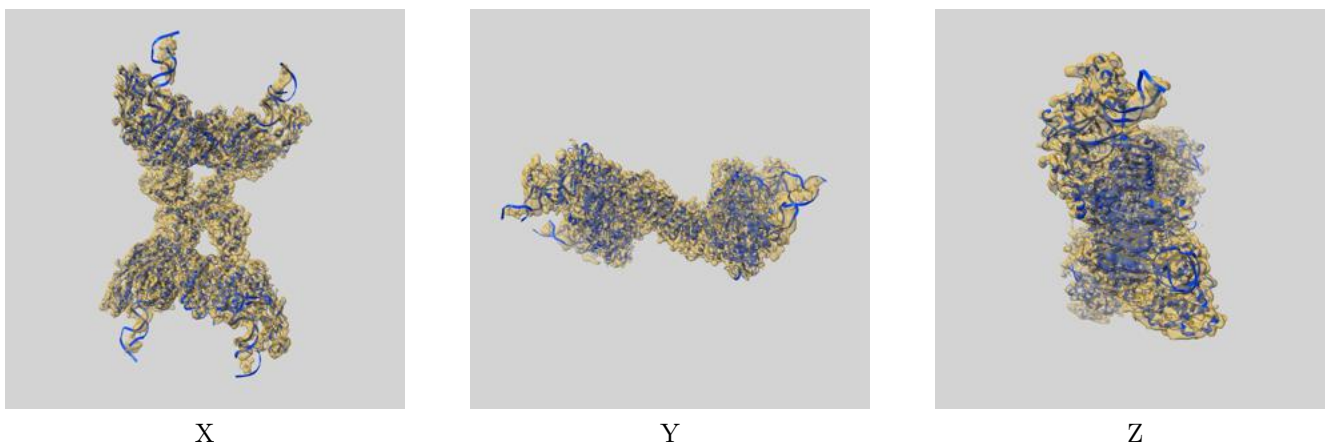

The images above show the 3D surface view of the map at the recommended contour level 0.2 at 50% transparency in yellow overlaid with a ribbon representation of the model coloured in blue. These images allow for the visual assessment of the quality of fit between the atomic model and the map.

## 9.2 Q-score mapped to coordinate model [i](#)

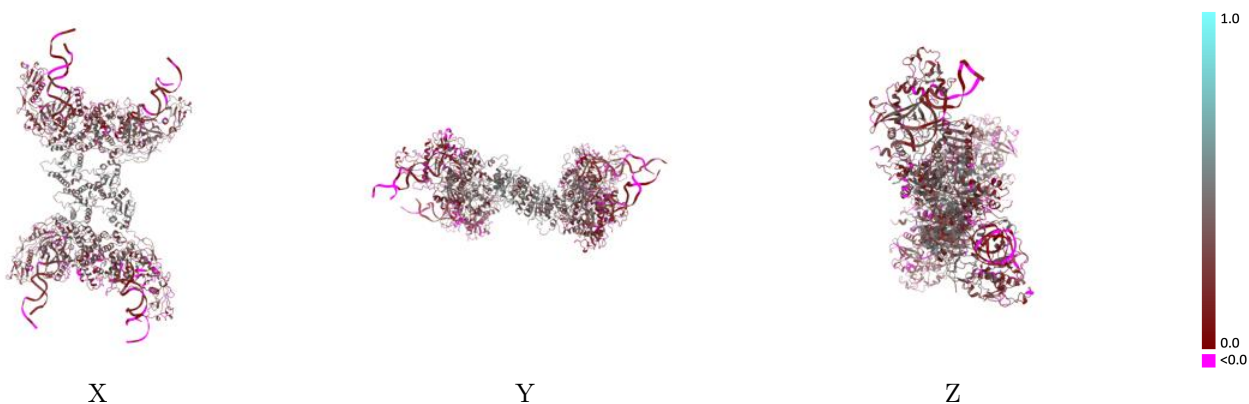

The images above show the model with each residue coloured according to its Q-score. This shows their resolvability in the map with higher Q-score values reflecting better resolvability. Please note: Q-score is calculating the resolvability of atoms, and thus high values are only expected at resolutions at which atoms can be resolved. Low Q-score values may therefore be expected for many entries.

## 9.3 Atom inclusion mapped to coordinate model [i](#)

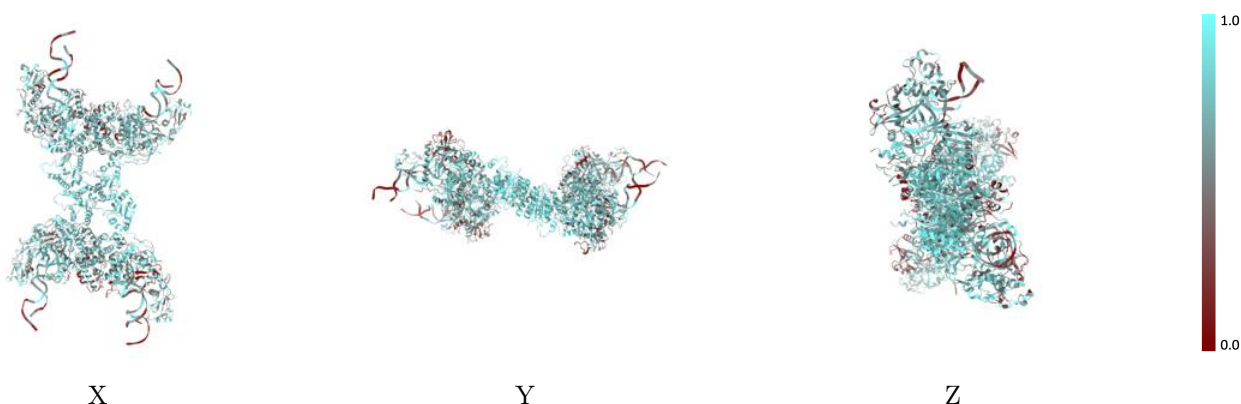

The images above show the model with each residue coloured according to its atom inclusion. This shows to what extent they are inside the map at the recommended contour level (0.2).



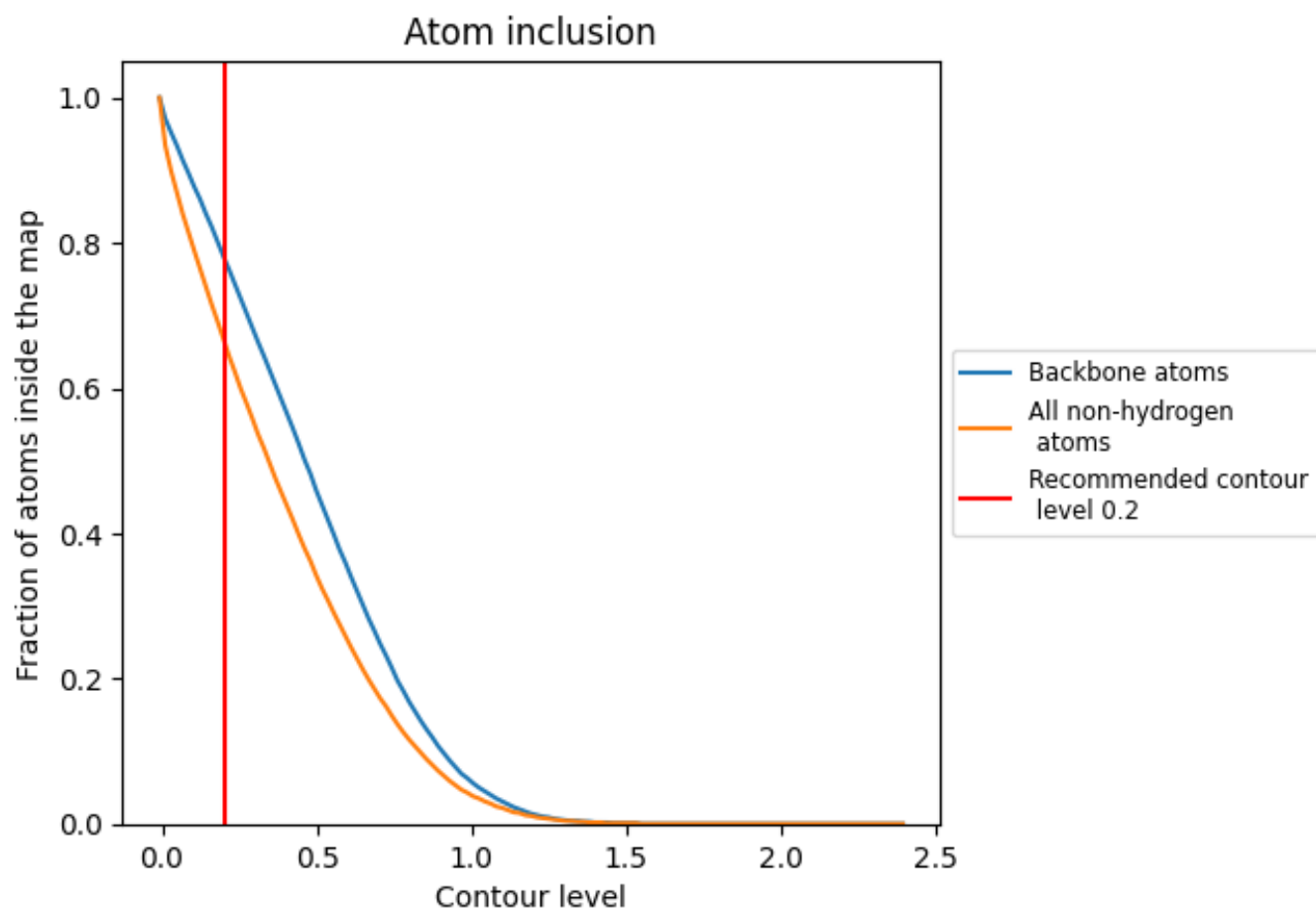































## 9.4 Atom inclusion [i](#)



At the recommended contour level, 78% of all backbone atoms, 67% of all non-hydrogen atoms, are inside the map.

## 9.5 Map-model fit summary [i](#)

The table lists the average atom inclusion at the recommended contour level (0.2) and Q-score for the entire model and for each chain.

Chain	Atom inclusion	Q-score
All	 0.6660	 0.2710
A	 0.6610	 0.2830
B	 0.7200	 0.3150
C	 0.5040	 0.0970
D	 0.5220	 0.0870
E	 0.6660	 0.2800
F	 0.7130	 0.3100
G	 0.6000	 0.1550
H	 0.5750	 0.1000
I	 0.6750	 0.2900
J	 0.6780	 0.2890
K	 0.4880	 0.0670
L	 0.5660	 0.1320
M	 0.6480	 0.2740
N	 0.6990	 0.2940
O	 0.5210	 0.1000
P	 0.5020	 0.0630

