



# Full wwPDB X-ray Structure Validation Report ⓘ

Mar 9, 2018 – 10:42 am GMT

PDB ID : 4J6R  
Title : Crystal structure of broadly and potently neutralizing antibody VRC23 in complex with HIV-1 gp120  
Authors : Zhou, T.; Moquin, S.; Kwong, P.D.  
Deposited on : 2013-02-11  
Resolution : 1.64 Å(reported)

This is a Full wwPDB X-ray Structure Validation Report for a publicly released PDB entry.

We welcome your comments at [validation@mail.wwpdb.org](mailto:validation@mail.wwpdb.org)

A user guide is available at

<https://www.wwpdb.org/validation/2017/XrayValidationReportHelp>

with specific help available everywhere you see the ⓘ symbol.

---

The following versions of software and data (see [references ⓘ](#)) were used in the production of this report:

MolProbity : 4.02b-467  
Mogul : 1.7.3 (157068), CSD as539be (2018)  
Xtriage (Phenix) : 1.13  
EDS : trunk30967  
Percentile statistics : 20171227.v01 (using entries in the PDB archive December 27th 2017)  
Refmac : 5.8.0158  
CCP4 : 7.0 (Gargrove)  
Ideal geometry (proteins) : Engh & Huber (2001)  
Ideal geometry (DNA, RNA) : Parkinson et al. (1996)  
Validation Pipeline (wwPDB-VP) : trunk30967

# 1 Overall quality at a glance

The following experimental techniques were used to determine the structure:

*X-RAY DIFFRACTION*

The reported resolution of this entry is 1.64 Å.

Percentile scores (ranging between 0-100) for global validation metrics of the entry are shown in the following graphic. The table shows the number of entries on which the scores are based.

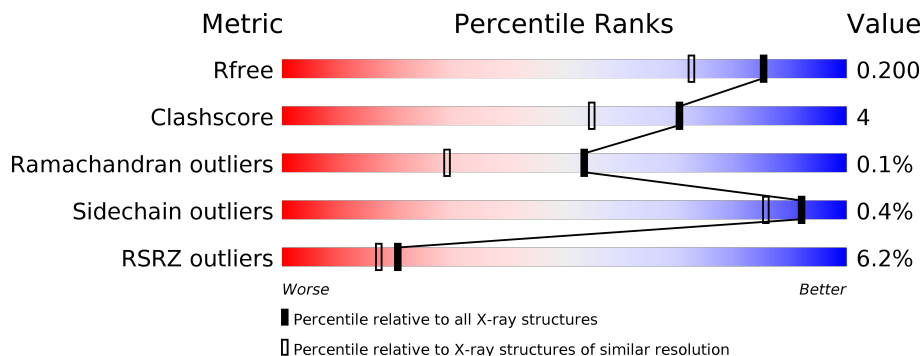

Metric	Whole archive (#Entries)	Similar resolution (#Entries, resolution range(Å))
$R_{free}$	111664	2539 (1.66-1.62)
Clashscore	122126	2672 (1.66-1.62)
Ramachandran outliers	120053	2629 (1.66-1.62)
Sidechain outliers	120020	2629 (1.66-1.62)
RSRZ outliers	108989	2498 (1.66-1.62)

The table below summarises the geometric issues observed across the polymeric chains and their fit to the electron density. The red, orange, yellow and green segments on the lower bar indicate the fraction of residues that contain outliers for  $\geq 3$ , 2, 1 and 0 types of geometric quality criteria. A grey segment represents the fraction of residues that are not modelled. The numeric value for each fraction is indicated below the corresponding segment, with a dot representing fractions  $\leq 5\%$ . The upper red bar (where present) indicates the fraction of residues that have poor fit to the electron density. The numeric value is given above the bar.

Mol	Chain	Length	Quality of chain
1	G	359	
2	H	224	
3	L	210	

The following table lists non-polymeric compounds, carbohydrate monomers and non-standard residues in protein, DNA, RNA chains that are outliers for geometric or electron-density-fit criteria:

Mol	Type	Chain	Res	Chirality	Geometry	Clashes	Electron density
4	NAG	G	509	-	-	-	X
9	BU3	L	305	-	-	X	-

## 2 Entry composition [i](#)

There are 10 unique types of molecules in this entry. The entry contains 13345 atoms, of which 6100 are hydrogens and 0 are deuteriums.

In the tables below, the ZeroOcc column contains the number of atoms modelled with zero occupancy, the AltConf column contains the number of residues with at least one atom in alternate conformation and the Trace column contains the number of residues modelled with at most 2 atoms.

- Molecule 1 is a protein called Envelope glycoprotein gp160.

Mol	Chain	Residues	Atoms					ZeroOcc	AltConf	Trace	
			Total	C	H	N	O				S
1	G	343	5340	1698	2640	471	511	20	0	0	0

- Molecule 2 is a protein called HEAVY CHAIN OF ANTIBODY VRC23.

Mol	Chain	Residues	Atoms					ZeroOcc	AltConf	Trace	
			Total	C	H	N	O				S
2	H	222	3385	1088	1675	293	323	6	0	0	0

- Molecule 3 is a protein called LIGHT CHAIN OF ANTIBODY VRC23.

Mol	Chain	Residues	Atoms					ZeroOcc	AltConf	Trace	
			Total	C	H	N	O				S
3	L	210	3166	1002	1561	274	323	6	0	0	0

- Molecule 4 is N-ACETYL-D-GLUCOSAMINE (three-letter code: NAG) (formula:  $C_8H_{15}NO_6$ ).

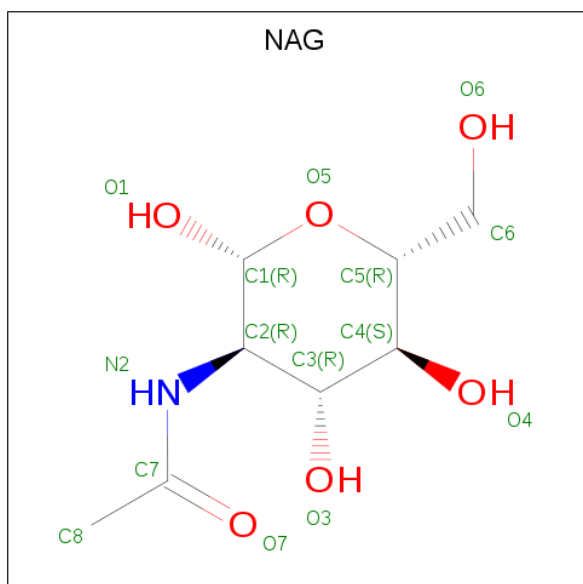

Mol	Chain	Residues	Atoms	ZeroOcc	AltConf
4	G	1	Total C H N O 28 8 14 1 5	0	0
4	G	1	Total C N O 14 8 1 5	0	0
4	G	1	Total C H N O 28 8 14 1 5	0	0
4	G	1	Total C N O 14 8 1 5	0	0
4	G	1	Total C H N O 28 8 14 1 5	0	0
4	G	1	Total C H N O 28 8 14 1 5	0	0
4	G	1	Total C H N O 28 8 14 1 5	0	0
4	G	1	Total C H N O 28 8 14 1 5	0	0
4	G	1	Total C H N O 28 8 14 1 5	0	0
4	G	1	Total C H N O 28 8 14 1 5	0	0

- Molecule 5 is CALCIUM ION (three-letter code: CA) (formula: Ca).

Mol	Chain	Residues	Atoms	ZeroOcc	AltConf
5	G	1	Total Ca 1 1	0	0
5	L	1	Total Ca 1 1	0	0

- Molecule 6 is 1,2-ETHANEDIOL (three-letter code: EDO) (formula: C<sub>2</sub>H<sub>6</sub>O<sub>2</sub>).

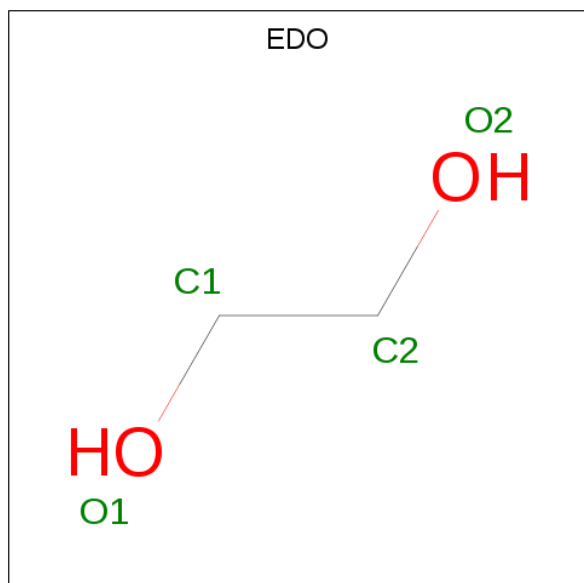

Mol	Chain	Residues	Atoms				ZeroOcc	AltConf
6	G	1	Total	C	H	O	0	0
			10	2	6	2		
6	G	1	Total	C	H	O	0	0
			10	2	6	2		
6	G	1	Total	C	H	O	0	0
			10	2	6	2		
6	G	1	Total	C	H	O	0	0
			10	2	6	2		
6	H	1	Total	C	H	O	0	0
			10	2	6	2		
6	H	1	Total	C	H	O	0	0
			10	2	6	2		
6	H	1	Total	C	H	O	0	0
			10	2	6	2		
6	H	1	Total	C	H	O	0	0
			10	2	6	2		
6	H	1	Total	C	H	O	0	0
			10	2	6	2		
6	H	1	Total	C	H	O	0	0
			10	2	6	2		
6	H	1	Total	C	H	O	0	0
			10	2	6	2		
6	L	1	Total	C	H	O	0	0
			10	2	6	2		
6	L	1	Total	C	H	O	0	0
			10	2	6	2		
6	L	1	Total	C	H	O	0	0
			10	2	6	2		

- Molecule 7 is (4S)-2-METHYL-2,4-PENTANEDIOL (three-letter code: MPD) (formula: C<sub>6</sub>H<sub>14</sub>O<sub>2</sub>).

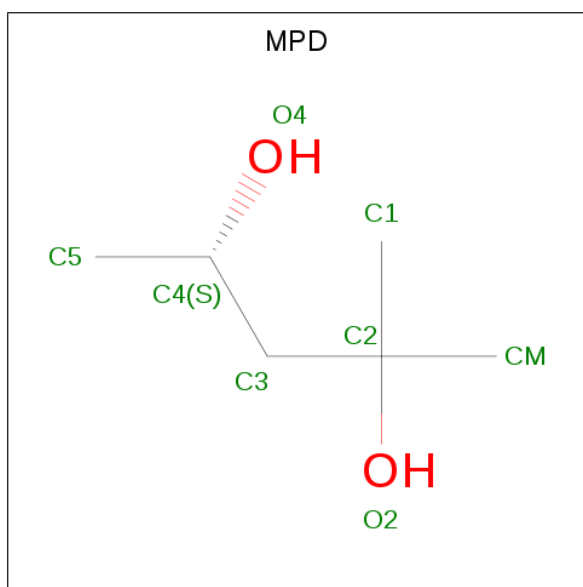

Mol	Chain	Residues	Atoms				ZeroOcc	AltConf
			Total	C	H	O		
7	H	1	22	6	14	2	0	0

- Molecule 8 is 2-AMINO-2-HYDROXYMETHYL-PROPANE-1,3-DIOL (three-letter code: TRS) (formula:  $C_4H_{12}NO_3$ ).

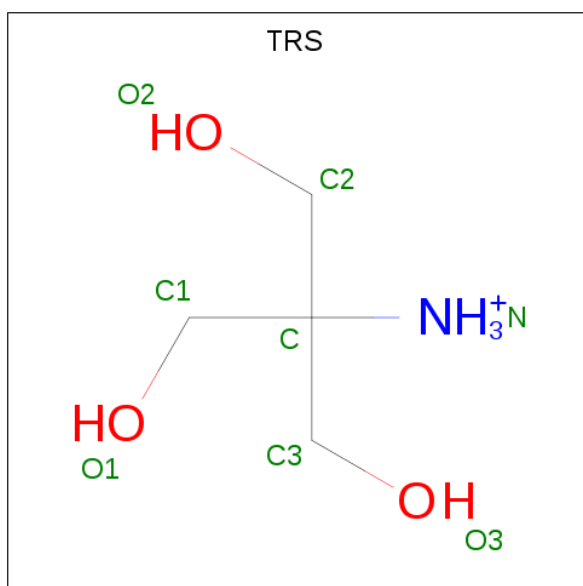

Mol	Chain	Residues	Atoms					ZeroOcc	AltConf
			Total	C	H	N	O		
8	H	1	20	4	12	1	3	0	0

- Molecule 9 is (R,R)-2,3-BUTANEDIOL (three-letter code: BU3) (formula:  $C_4H_{10}O_2$ ).

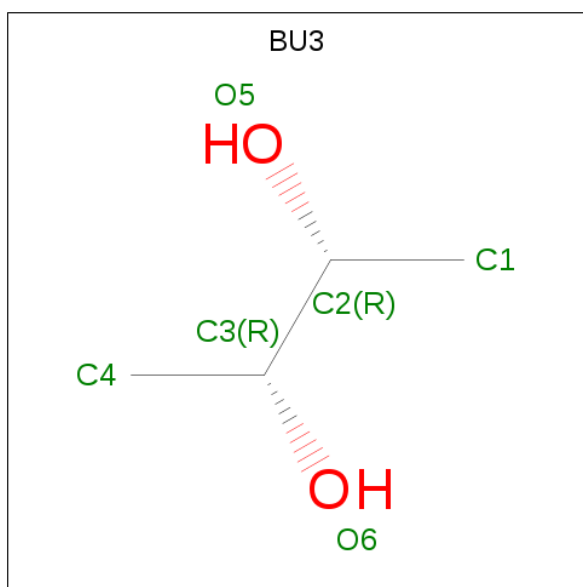

Mol	Chain	Residues	Atoms				ZeroOcc	AltConf
			Total	C	H	O		
9	L	1	16	4	10	2	0	0

- Molecule 10 is water.

Mol	Chain	Residues	Atoms		ZeroOcc	AltConf
10	G	326	Total	O	0	0
			326	326		
10	H	339	Total	O	0	0
			339	339		
10	L	355	Total	O	0	0
			355	355		



### 3 Residue-property plots [i](#)

These plots are drawn for all protein, RNA and DNA chains in the entry. The first graphic for a chain summarises the proportions of the various outlier classes displayed in the second graphic. The second graphic shows the sequence view annotated by issues in geometry and electron density. Residues are color-coded according to the number of geometric quality criteria for which they contain at least one outlier: green = 0, yellow = 1, orange = 2 and red = 3 or more. A red dot above a residue indicates a poor fit to the electron density ( $RSRZ > 2$ ). Stretches of 2 or more consecutive residues without any outlier are shown as a green connector. Residues present in the sample, but not in the model, are shown in grey.

- Molecule 1: Envelope glycoprotein gp160

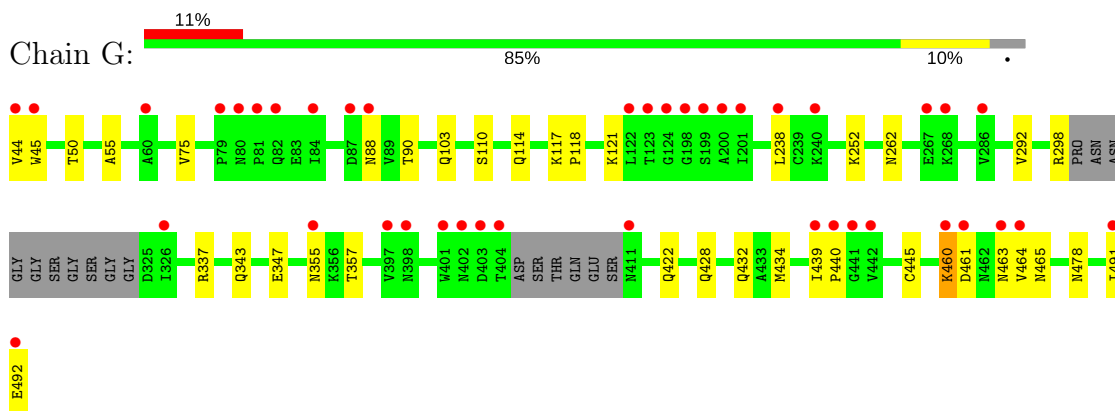

- Molecule 2: HEAVY CHAIN OF ANTIBODY VRC23

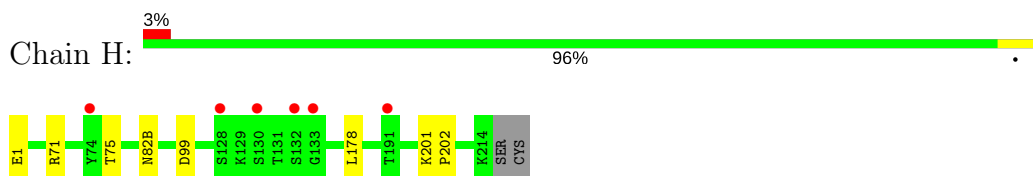

- Molecule 3: LIGHT CHAIN OF ANTIBODY VRC23

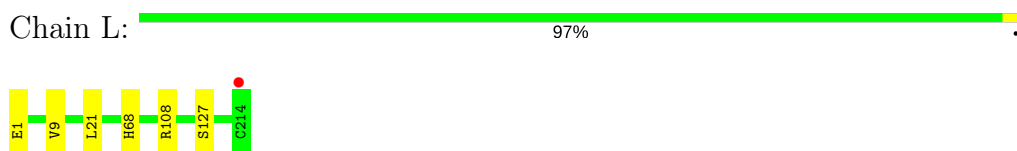

## 4 Data and refinement statistics

Property	Value	Source
Space group	P 21 21 21	Depositor
Cell constants a, b, c, $\alpha$ , $\beta$ , $\gamma$	62.04Å 68.69Å 214.53Å 90.00° 90.00° 90.00°	Depositor
Resolution (Å)	23.17 – 1.64 23.17 – 1.64	Depositor EDS
% Data completeness (in resolution range)	94.6 (23.17-1.64) 94.6 (23.17-1.64)	Depositor EDS
$R_{merge}$	0.07	Depositor
$R_{sym}$	0.07	Depositor
$\langle I/\sigma(I) \rangle$ <sup>1</sup>	1.25 (at 1.63Å)	Xtrriage
Refinement program	PHENIX (phenix.refine: 1.8_1069)	Depositor
R, $R_{free}$	0.164 , 0.198 0.166 , 0.200	Depositor DCC
$R_{free}$ test set	5396 reflections (5.00%)	wwPDB-VP
Wilson B-factor (Å <sup>2</sup> )	23.3	Xtrriage
Anisotropy	0.398	Xtrriage
Bulk solvent $k_{sol}$ (e/Å <sup>3</sup> ), $B_{sol}$ (Å <sup>2</sup> )	0.40 , 56.6	EDS
L-test for twinning <sup>2</sup>	$\langle  L  \rangle = 0.46$ , $\langle L^2 \rangle = 0.29$	Xtrriage
Estimated twinning fraction	No twinning to report.	Xtrriage
$F_o, F_c$ correlation	0.97	EDS
Total number of atoms	13345	wwPDB-VP
Average B, all atoms (Å <sup>2</sup> )	38.0	wwPDB-VP

Xtrriage's analysis on translational NCS is as follows: *The largest off-origin peak in the Patterson function is 3.44% of the height of the origin peak. No significant pseudotranslation is detected.*

<sup>1</sup>Intensities estimated from amplitudes.

<sup>2</sup>Theoretical values of  $\langle |L| \rangle$ ,  $\langle L^2 \rangle$  for acentric reflections are 0.5, 0.333 respectively for untwinned datasets, and 0.375, 0.2 for perfectly twinned datasets.

## 5 Model quality

### 5.1 Standard geometry

Bond lengths and bond angles in the following residue types are not validated in this section: MPD, NAG, BU3, CA, EDO, TRS, PCA

The Z score for a bond length (or angle) is the number of standard deviations the observed value is removed from the expected value. A bond length (or angle) with  $|Z| > 5$  is considered an outlier worth inspection. RMSZ is the root-mean-square of all Z scores of the bond lengths (or angles).

Mol	Chain	Bond lengths		Bond angles	
		RMSZ	# Z  >5	RMSZ	# Z  >5
1	G	0.28	0/2758	0.49	0/3746
2	H	0.34	0/1751	0.54	0/2389
3	L	0.37	0/1639	0.53	0/2225
All	All	0.33	0/6148	0.52	0/8360

Chiral center outliers are detected by calculating the chiral volume of a chiral center and verifying if the center is modelled as a planar moiety or with the opposite hand. A planarity outlier is detected by checking planarity of atoms in a peptide group, atoms in a mainchain group or atoms of a sidechain that are expected to be planar.

Mol	Chain	#Chirality outliers	#Planarity outliers
1	G	0	1

There are no bond length outliers.

There are no bond angle outliers.

There are no chirality outliers.

All (1) planarity outliers are listed below:

Mol	Chain	Res	Type	Group
1	G	428	GLN	Peptide

### 5.2 Too-close contacts

In the following table, the Non-H and H(model) columns list the number of non-hydrogen atoms and hydrogen atoms in the chain respectively. The H(added) column lists the number of hydrogen atoms added and optimized by MolProbity. The Clashes column lists the number of clashes within the asymmetric unit, whereas Symm-Clashes lists symmetry related clashes.

Mol	Chain	Non-H	H(model)	H(added)	Clashes	Symm-Clashes
1	G	2700	2640	2632	29	0
2	H	1710	1675	1672	7	0
3	L	1605	1561	1557	5	0
4	G	126	98	117	1	0
5	G	1	0	0	0	0
5	L	1	0	0	0	0
6	G	16	24	24	0	0
6	H	32	48	48	1	0
6	L	12	18	18	0	0
7	H	8	14	14	4	0
8	H	8	12	12	0	0
9	L	6	10	10	4	0
10	G	326	0	0	11	1
10	H	339	0	0	5	3
10	L	355	0	0	5	3
All	All	7245	6100	6104	48	4

The all-atom clashscore is defined as the number of clashes found per 1000 atoms (including hydrogen atoms). The all-atom clashscore for this structure is 4.

All (48) close contacts within the same asymmetric unit are listed below, sorted by their clash magnitude.

Atom-1	Atom-2	Interatomic distance (Å)	Clash overlap (Å)
1:G:461:ASP:OD1	10:G:902:HOH:O	1.77	1.02
1:G:460:LYS:O	10:G:793:HOH:O	1.92	0.88
1:G:88:ASN:ND2	10:G:739:HOH:O	2.11	0.82
1:G:461:ASP:OD1	10:G:903:HOH:O	1.99	0.80
1:G:460:LYS:HD2	10:H:435:HOH:O	1.80	0.79
3:L:127:SER:OG	10:L:624:HOH:O	2.08	0.71
1:G:445:CYS:SG	10:G:874:HOH:O	2.48	0.71
1:G:465:ASN:OD1	10:G:924:HOH:O	2.10	0.69
2:H:82(B):ASN:ND2	10:H:684:HOH:O	2.25	0.69
3:L:108:ARG:HB2	9:L:305:BU3:H2	1.74	0.68
1:G:50:THR:O	1:G:103:GLN:NE2	2.30	0.63
10:G:883:HOH:O	3:L:1:GLU:HG3	2.03	0.59
1:G:44:VAL:HG12	1:G:45:TRP:CE3	2.38	0.58
7:H:301:MPD:HM1	10:H:505:HOH:O	2.04	0.58
9:L:305:BU3:C1	10:L:537:HOH:O	2.52	0.57
1:G:355:ASN:ND2	10:G:817:HOH:O	2.38	0.56
1:G:491:ILE:O	10:G:836:HOH:O	2.18	0.55
1:G:298:ARG:HD2	1:G:298:ARG:C	2.27	0.55
1:G:463:ASN:O	1:G:464:VAL:HB	2.10	0.51

*Continued on next page...*

Continued from previous page...

Atom-1	Atom-2	Interatomic distance (Å)	Clash overlap (Å)
2:H:75:THR:O	7:H:301:MPD:CM	2.60	0.50
1:G:439:ILE:HG23	1:G:440:PRO:HD2	1.94	0.49
2:H:201:LYS:N	2:H:202:PRO:CD	2.76	0.49
1:G:90:THR:HG22	1:G:238:LEU:HD22	1.94	0.48
2:H:1:PCA:N	10:H:689:HOH:O	2.46	0.47
9:L:305:BU3:H13	10:L:537:HOH:O	2.14	0.47
9:L:305:BU3:H11	10:L:537:HOH:O	2.12	0.47
1:G:343:GLN:O	1:G:347:GLU:HG2	2.15	0.46
1:G:44:VAL:CG1	1:G:45:TRP:CE3	2.99	0.46
1:G:118:PRO:HG2	1:G:121:LYS:HG2	1.99	0.45
7:H:301:MPD:H53	7:H:301:MPD:H11	1.98	0.44
2:H:99:ASP:OD2	10:H:669:HOH:O	2.21	0.44
1:G:357:THR:HB	1:G:465:ASN:HB3	1.98	0.44
1:G:491:ILE:O	1:G:492:GLU:C	2.56	0.44
1:G:463:ASN:O	1:G:464:VAL:CB	2.65	0.44
4:G:505:NAG:O4	10:G:881:HOH:O	2.20	0.43
1:G:117:LYS:HA	1:G:118:PRO:HD3	1.91	0.43
1:G:422:GLN:O	1:G:434:MET:HA	2.19	0.43
3:L:9:VAL:HG12	10:L:691:HOH:O	2.19	0.42
2:H:202:PRO:HG3	6:H:305:EDO:H11	2.02	0.41
3:L:21:LEU:HD12	3:L:21:LEU:N	2.35	0.41
1:G:478:ASN:OD1	10:G:784:HOH:O	2.21	0.41
2:H:178:LEU:HD12	2:H:178:LEU:C	2.39	0.41
1:G:55:ALA:HA	1:G:75:VAL:O	2.21	0.41
1:G:44:VAL:HG12	1:G:45:TRP:N	2.36	0.41
1:G:292:VAL:HG22	1:G:337:ARG:HG2	2.03	0.41
1:G:110:SER:O	1:G:114:GLN:HG2	2.21	0.40
7:H:301:MPD:H11	7:H:301:MPD:C5	2.51	0.40
1:G:252:LYS:CE	1:G:262:ASN:HB3	2.51	0.40

All (4) symmetry-related close contacts are listed below. The label for Atom-2 includes the symmetry operator and encoded unit-cell translations to be applied.

Atom-1	Atom-2	Interatomic distance (Å)	Clash overlap (Å)
10:H:402:HOH:O	10:L:610:HOH:O[4_545]	1.76	0.44
10:L:605:HOH:O	10:L:611:HOH:O[4_435]	1.88	0.32
10:G:882:HOH:O	10:H:728:HOH:O[3_555]	1.93	0.27
10:H:593:HOH:O	10:L:681:HOH:O[4_545]	2.12	0.08

## 5.3 Torsion angles [i](#)

### 5.3.1 Protein backbone [i](#)

In the following table, the Percentiles column shows the percent Ramachandran outliers of the chain as a percentile score with respect to all X-ray entries followed by that with respect to entries of similar resolution.

The Analysed column shows the number of residues for which the backbone conformation was analysed, and the total number of residues.

Mol	Chain	Analysed	Favoured	Allowed	Outliers	Percentiles	
1	G	337/359 (94%)	327 (97%)	10 (3%)	0	100	100
2	H	220/224 (98%)	217 (99%)	3 (1%)	0	100	100
3	L	208/210 (99%)	201 (97%)	6 (3%)	1 (0%)	31	11
All	All	765/793 (96%)	745 (97%)	19 (2%)	1 (0%)	53	29

All (1) Ramachandran outliers are listed below:

Mol	Chain	Res	Type
3	L	68	HIS

### 5.3.2 Protein sidechains [i](#)

In the following table, the Percentiles column shows the percent sidechain outliers of the chain as a percentile score with respect to all X-ray entries followed by that with respect to entries of similar resolution.

The Analysed column shows the number of residues for which the sidechain conformation was analysed, and the total number of residues.

Mol	Chain	Analysed	Rotameric	Outliers	Percentiles	
1	G	303/314 (96%)	301 (99%)	2 (1%)	85	73
2	H	187/189 (99%)	186 (100%)	1 (0%)	90	82
3	L	181/181 (100%)	181 (100%)	0	100	100
All	All	671/684 (98%)	668 (100%)	3 (0%)	92	86

All (3) residues with a non-rotameric sidechain are listed below:

Mol	Chain	Res	Type
1	G	432	GLN
1	G	460	LYS

*Continued on next page...*

*Continued from previous page...*

Mol	Chain	Res	Type
2	H	71	ARG

Some sidechains can be flipped to improve hydrogen bonding and reduce clashes. All (1) such sidechains are listed below:

Mol	Chain	Res	Type
1	G	377	ASN

### 5.3.3 RNA [i](#)

There are no RNA molecules in this entry.

## 5.4 Non-standard residues in protein, DNA, RNA chains [i](#)

1 non-standard protein/DNA/RNA residue is modelled in this entry.

In the following table, the Counts columns list the number of bonds (or angles) for which Mogul statistics could be retrieved, the number of bonds (or angles) that are observed in the model and the number of bonds (or angles) that are defined in the Chemical Component Dictionary. The Link column lists molecule types, if any, to which the group is linked. The Z score for a bond length (or angle) is the number of standard deviations the observed value is removed from the expected value. A bond length (or angle) with  $|Z| > 2$  is considered an outlier worth inspection. RMSZ is the root-mean-square of all Z scores of the bond lengths (or angles).

Mol	Type	Chain	Res	Link	Bond lengths			Bond angles		
					Counts	RMSZ	# Z  > 2	Counts	RMSZ	# Z  > 2
2	PCA	H	1	2	8,8,9	1.97	2 (25%)	9,10,12	2.39	6 (66%)

In the following table, the Chirals column lists the number of chiral outliers, the number of chiral centers analysed, the number of these observed in the model and the number defined in the Chemical Component Dictionary. Similar counts are reported in the Torsion and Rings columns. '-' means no outliers of that kind were identified.

Mol	Type	Chain	Res	Link	Chirals	Torsions	Rings
2	PCA	H	1	2	-	0/0/11/13	0/1/1/1

All (2) bond length outliers are listed below:

Mol	Chain	Res	Type	Atoms	Z	Observed(Å)	Ideal(Å)
2	H	1	PCA	CA-N	3.08	1.50	1.46
2	H	1	PCA	CD-N	4.39	1.46	1.34

All (6) bond angle outliers are listed below:

Mol	Chain	Res	Type	Atoms	Z	Observed(°)	Ideal(°)
2	H	1	PCA	CB-CA-C	-4.19	106.94	112.70
2	H	1	PCA	CA-N-CD	-3.04	103.17	113.58
2	H	1	PCA	OE-CD-CG	-2.88	121.64	126.83
2	H	1	PCA	O-C-CA	-2.09	120.22	125.09
2	H	1	PCA	CG-CD-N	2.24	114.47	108.35
2	H	1	PCA	CB-CA-N	2.50	110.49	103.30

There are no chirality outliers.

There are no torsion outliers.

There are no ring outliers.

1 monomer is involved in 1 short contact:

Mol	Chain	Res	Type	Clashes	Symm-Clashes
2	H	1	PCA	1	0

## 5.5 Carbohydrates [i](#)

There are no carbohydrates in this entry.

## 5.6 Ligand geometry [i](#)

Of 29 ligands modelled in this entry, 2 are monoatomic - leaving 27 for Mogul analysis.

In the following table, the Counts columns list the number of bonds (or angles) for which Mogul statistics could be retrieved, the number of bonds (or angles) that are observed in the model and the number of bonds (or angles) that are defined in the Chemical Component Dictionary. The Link column lists molecule types, if any, to which the group is linked. The Z score for a bond length (or angle) is the number of standard deviations the observed value is removed from the expected value. A bond length (or angle) with  $|Z| > 2$  is considered an outlier worth inspection. RMSZ is the root-mean-square of all Z scores of the bond lengths (or angles).

Mol	Type	Chain	Res	Link	Bond lengths			Bond angles		
					Counts	RMSZ	$\# Z  > 2$	Counts	RMSZ	$\# Z  > 2$
4	NAG	G	501	1	14,14,15	0.54	0	17,19,21	0.93	0
4	NAG	G	502	1	14,14,15	0.48	0	17,19,21	0.66	0
4	NAG	G	503	1	14,14,15	0.48	0	17,19,21	0.92	1 (5%)
4	NAG	G	504	1	14,14,15	0.48	0	17,19,21	0.78	0
4	NAG	G	505	1	14,14,15	0.45	0	17,19,21	0.83	0
4	NAG	G	506	1	14,14,15	0.47	0	17,19,21	1.08	2 (11%)



Mol	Type	Chain	Res	Link	Bond lengths			Bond angles		
					Counts	RMSZ	# Z  > 2	Counts	RMSZ	# Z  > 2
4	NAG	G	507	1	14,14,15	0.51	0	17,19,21	0.76	0
4	NAG	G	508	1	14,14,15	0.55	0	17,19,21	0.78	0
4	NAG	G	509	1	14,14,15	0.44	0	17,19,21	1.19	2 (11%)
6	EDO	G	511	-	3,3,3	0.44	0	2,2,2	0.67	0
6	EDO	G	512	-	3,3,3	0.47	0	2,2,2	0.32	0
6	EDO	G	513	-	3,3,3	0.51	0	2,2,2	0.20	0
6	EDO	G	514	-	3,3,3	0.48	0	2,2,2	0.33	0
7	MPD	H	301	-	7,7,7	0.29	0	9,10,10	0.46	0
6	EDO	H	302	-	3,3,3	0.45	0	2,2,2	0.47	0
6	EDO	H	303	-	3,3,3	0.43	0	2,2,2	0.41	0
6	EDO	H	304	-	3,3,3	0.51	0	2,2,2	0.26	0
6	EDO	H	305	-	3,3,3	0.53	0	2,2,2	0.05	0
6	EDO	H	306	-	3,3,3	0.53	0	2,2,2	0.40	0
6	EDO	H	307	-	3,3,3	0.46	0	2,2,2	0.38	0
6	EDO	H	308	-	3,3,3	0.45	0	2,2,2	0.44	0
6	EDO	H	309	-	3,3,3	0.45	0	2,2,2	0.42	0
8	TRS	H	310	-	7,7,7	0.83	1 (14%)	9,9,9	0.81	0
6	EDO	L	302	-	3,3,3	0.46	0	2,2,2	0.29	0
6	EDO	L	303	-	3,3,3	0.48	0	2,2,2	0.55	0
6	EDO	L	304	-	3,3,3	0.48	0	2,2,2	0.36	0
9	BU3	L	305	-	4,5,5	1.15	0	6,6,6	0.41	0

In the following table, the Chirals column lists the number of chiral outliers, the number of chiral centers analysed, the number of these observed in the model and the number defined in the Chemical Component Dictionary. Similar counts are reported in the Torsion and Rings columns. '-' means no outliers of that kind were identified.

Mol	Type	Chain	Res	Link	Chirals	Torsions	Rings
4	NAG	G	501	1	-	0/6/23/26	0/1/1/1
4	NAG	G	502	1	-	0/6/23/26	0/1/1/1
4	NAG	G	503	1	-	0/6/23/26	0/1/1/1
4	NAG	G	504	1	-	0/6/23/26	0/1/1/1
4	NAG	G	505	1	-	0/6/23/26	0/1/1/1
4	NAG	G	506	1	-	0/6/23/26	0/1/1/1
4	NAG	G	507	1	-	0/6/23/26	0/1/1/1
4	NAG	G	508	1	-	0/6/23/26	0/1/1/1
4	NAG	G	509	1	-	0/6/23/26	0/1/1/1
6	EDO	G	511	-	-	0/1/1/1	0/0/0/0
6	EDO	G	512	-	-	0/1/1/1	0/0/0/0
6	EDO	G	513	-	-	0/1/1/1	0/0/0/0
6	EDO	G	514	-	-	0/1/1/1	0/0/0/0
7	MPD	H	301	-	-	0/5/5/5	0/0/0/0

Continued on next page...

Continued from previous page...

Mol	Type	Chain	Res	Link	Chirals	Torsions	Rings
6	EDO	H	302	-	-	0/1/1/1	0/0/0/0
6	EDO	H	303	-	-	0/1/1/1	0/0/0/0
6	EDO	H	304	-	-	0/1/1/1	0/0/0/0
6	EDO	H	305	-	-	0/1/1/1	0/0/0/0
6	EDO	H	306	-	-	0/1/1/1	0/0/0/0
6	EDO	H	307	-	-	0/1/1/1	0/0/0/0
6	EDO	H	308	-	-	0/1/1/1	0/0/0/0
6	EDO	H	309	-	-	0/1/1/1	0/0/0/0
8	TRS	H	310	-	-	0/9/9/9	0/0/0/0
6	EDO	L	302	-	-	0/1/1/1	0/0/0/0
6	EDO	L	303	-	-	0/1/1/1	0/0/0/0
6	EDO	L	304	-	-	0/1/1/1	0/0/0/0
9	BU3	L	305	-	-	0/4/4/4	0/0/0/0

All (1) bond length outliers are listed below:

Mol	Chain	Res	Type	Atoms	Z	Observed(Å)	Ideal(Å)
8	H	310	TRS	C-N	-2.14	1.46	1.50

All (5) bond angle outliers are listed below:

Mol	Chain	Res	Type	Atoms	Z	Observed(°)	Ideal(°)
4	G	509	NAG	O5-C1-C2	-2.89	107.53	111.52
4	G	506	NAG	O5-C1-C2	-2.30	108.35	111.52
4	G	503	NAG	C1-O5-C5	2.03	114.98	112.19
4	G	506	NAG	C1-O5-C5	2.14	115.13	112.19
4	G	509	NAG	O5-C5-C6	2.26	110.73	107.15

There are no chirality outliers.

There are no torsion outliers.

There are no ring outliers.

4 monomers are involved in 10 short contacts:

Mol	Chain	Res	Type	Clashes	Symm-Clashes
4	G	505	NAG	1	0
7	H	301	MPD	4	0
6	H	305	EDO	1	0
9	L	305	BU3	4	0

## 5.7 Other polymers [i](#)

There are no such residues in this entry.

## 5.8 Polymer linkage issues [i](#)

There are no chain breaks in this entry.

## 6 Fit of model and data

### 6.1 Protein, DNA and RNA chains

In the following table, the column labelled ‘#RSRZ > 2’ contains the number (and percentage) of RSRZ outliers, followed by percent RSRZ outliers for the chain as percentile scores relative to all X-ray entries and entries of similar resolution. The OWAB column contains the minimum, median, 95<sup>th</sup> percentile and maximum values of the occupancy-weighted average B-factor per residue. The column labelled ‘Q < 0.9’ lists the number of (and percentage) of residues with an average occupancy less than 0.9.

Mol	Chain	Analysed	<RSRZ>	#RSRZ>2	OWAB(Å <sup>2</sup> )	Q<0.9
1	G	343/359 (95%)	0.40	41 (11%) 4 3	21, 39, 75, 105	0
2	H	221/224 (98%)	-0.25	6 (2%) 54 53	17, 23, 41, 60	0
3	L	210/210 (100%)	-0.28	1 (0%) 90 91	17, 24, 39, 80	0
All	All	774/793 (97%)	0.03	48 (6%) 20 17	17, 28, 64, 105	0

All (48) RSRZ outliers are listed below:

Mol	Chain	Res	Type	RSRZ
1	G	198	GLY	9.2
1	G	44	VAL	8.4
1	G	404	THR	7.2
1	G	199	SER	6.5
1	G	200	ALA	5.6
1	G	124	GLY	5.2
2	H	132	SER	5.0
1	G	88	ASN	4.8
3	L	214	CYS	4.7
2	H	133	GLY	4.5
1	G	123	THR	4.4
2	H	74	TYR	4.4
1	G	492	GLU	4.3
1	G	201	ILE	4.2
1	G	82	GLN	4.2
1	G	442	VAL	4.0
1	G	401	TRP	3.9
1	G	441	GLY	3.9
1	G	84	ILE	3.7
1	G	238	LEU	3.7
1	G	122	LEU	3.5
1	G	81	PRO	3.4
1	G	268	LYS	3.4

*Continued on next page...*

*Continued from previous page...*

Mol	Chain	Res	Type	RSRZ
1	G	439	ILE	3.3
1	G	460	LYS	3.3
1	G	398	ASN	3.3
1	G	464	VAL	3.2
1	G	411	ASN	3.2
1	G	491	ILE	3.2
1	G	461	ASP	3.1
2	H	191	THR	3.1
1	G	79	PRO	3.0
1	G	267	GLU	2.8
1	G	80	ASN	2.7
1	G	355	ASN	2.6
1	G	240	LYS	2.5
1	G	440	PRO	2.4
1	G	403	ASP	2.4
1	G	326	ILE	2.4
1	G	397	VAL	2.3
1	G	286	VAL	2.3
2	H	130	SER	2.3
1	G	87	ASP	2.2
1	G	60	ALA	2.2
1	G	45	TRP	2.1
1	G	402	ASN	2.1
1	G	463	ASN	2.1
2	H	128	SER	2.0

## 6.2 Non-standard residues in protein, DNA, RNA chains [i](#)

In the following table, the Atoms column lists the number of modelled atoms in the group and the number defined in the chemical component dictionary. The B-factors column lists the minimum, median, 95<sup>th</sup> percentile and maximum values of B factors of atoms in the group. The column labelled 'Q<0.9' lists the number of atoms with occupancy less than 0.9.

Mol	Type	Chain	Res	Atoms	RSCC	RSR	B-factors(Å <sup>2</sup> )	Q<0.9
2	PCA	H	1	8/9	0.90	0.14	30,44,55,55	0

## 6.3 Carbohydrates [i](#)

There are no carbohydrates in this entry.

## 6.4 Ligands [i](#)

In the following table, the Atoms column lists the number of modelled atoms in the group and the number defined in the chemical component dictionary. The B-factors column lists the minimum, median, 95<sup>th</sup> percentile and maximum values of B factors of atoms in the group. The column labelled 'Q< 0.9' lists the number of atoms with occupancy less than 0.9.

Mol	Type	Chain	Res	Atoms	RSCC	RSR	B-factors(Å <sup>2</sup> )	Q<0.9
4	NAG	G	509	14/15	0.59	0.46	72,95,113,121	0
6	EDO	L	304	4/4	0.69	0.24	57,68,74,75	0
6	EDO	H	304	4/4	0.71	0.25	50,61,62,68	0
4	NAG	G	502	14/15	0.74	0.35	64,74,82,87	0
4	NAG	G	508	14/15	0.75	0.36	54,69,81,90	0
6	EDO	H	309	4/4	0.78	0.15	55,67,69,76	0
9	BU3	L	305	6/6	0.79	0.20	35,64,69,69	0
7	MPD	H	301	8/8	0.79	0.34	62,79,86,89	0
8	TRS	H	310	8/8	0.85	0.15	30,40,49,54	0
6	EDO	L	303	4/4	0.87	0.12	38,48,58,63	0
4	NAG	G	507	14/15	0.88	0.14	35,50,59,62	0
6	EDO	H	305	4/4	0.88	0.21	30,38,45,47	0
6	EDO	H	307	4/4	0.89	0.13	29,35,48,48	0
6	EDO	G	514	4/4	0.90	0.07	66,79,82,82	0
6	EDO	H	308	4/4	0.90	0.20	26,54,65,68	0
4	NAG	G	503	14/15	0.91	0.09	24,36,57,71	0
4	NAG	G	506	14/15	0.92	0.22	42,52,76,87	0
6	EDO	G	511	4/4	0.92	0.10	32,39,46,53	0
4	NAG	G	501	14/15	0.94	0.16	42,53,73,82	0
6	EDO	L	302	4/4	0.94	0.08	35,42,50,50	0
6	EDO	G	512	4/4	0.94	0.14	36,58,75,81	0
4	NAG	G	505	14/15	0.94	0.26	38,56,69,69	0
6	EDO	G	513	4/4	0.94	0.08	28,40,43,50	0
4	NAG	G	504	14/15	0.94	0.12	25,38,48,53	0
6	EDO	H	303	4/4	0.95	0.12	27,34,42,42	0
6	EDO	H	306	4/4	0.96	0.07	21,25,26,32	0
6	EDO	H	302	4/4	0.97	0.19	32,38,54,65	0
5	CA	L	301	1/1	0.97	0.10	61,61,61,61	0
5	CA	G	510	1/1	0.98	0.03	39,39,39,39	0

## 6.5 Other polymers [i](#)

There are no such residues in this entry.