



Full wwPDB X-ray Structure Validation Report ⓘ

Jan 30, 2024 – 09:30 PM EST

PDB ID : 1JCX
Title : Aquifex aeolicus KDO8P synthase in complex with API and Cadmium
Authors : Wang, J.; Duewel, H.S.; Woodard, R.W.; Gatti, D.L.
Deposited on : 2001-06-11
Resolution : 1.80 Å(reported)

This is a Full wwPDB X-ray Structure Validation Report for a publicly released PDB entry.

We welcome your comments at validation@mail.wwpdb.org

A user guide is available at

<https://www.wwpdb.org/validation/2017/XrayValidationReportHelp>

with specific help available everywhere you see the ⓘ symbol.

The types of validation reports are described at

<http://www.wwpdb.org/validation/2017/FAQs#types>.

The following versions of software and data (see [references ⓘ](#)) were used in the production of this report:

MolProbity : 4.02b-467
Mogul : 1.8.5 (274361), CSD as541be (2020)
Xtriage (Phenix) : 1.13
EDS : 2.36
buster-report : 1.1.7 (2018)
Percentile statistics : 20191225.v01 (using entries in the PDB archive December 25th 2019)
Refmac : 5.8.0158
CCP4 : 7.0.044 (Gargrove)
Ideal geometry (proteins) : Engh & Huber (2001)
Ideal geometry (DNA, RNA) : Parkinson et al. (1996)
Validation Pipeline (wwPDB-VP) : 2.36

1 Overall quality at a glance

The following experimental techniques were used to determine the structure:

X-RAY DIFFRACTION

The reported resolution of this entry is 1.80 Å.

Percentile scores (ranging between 0-100) for global validation metrics of the entry are shown in the following graphic. The table shows the number of entries on which the scores are based.

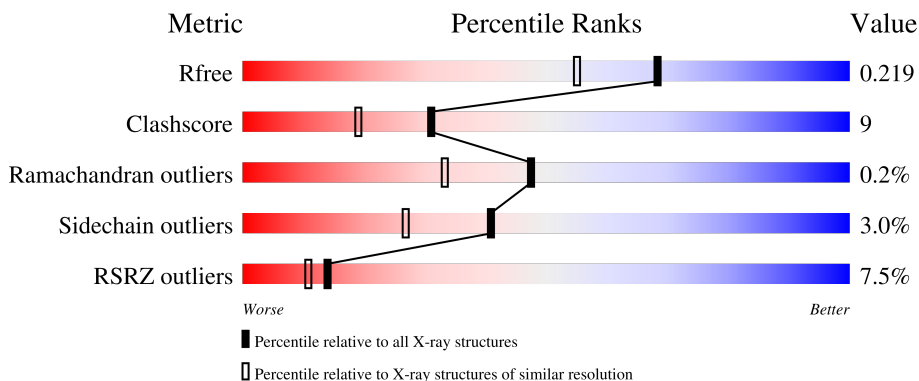

Metric	Whole archive (#Entries)	Similar resolution (#Entries, resolution range(Å))
R_{free}	130704	5950 (1.80-1.80)
Clashscore	141614	6793 (1.80-1.80)
Ramachandran outliers	138981	6697 (1.80-1.80)
Sidechain outliers	138945	6696 (1.80-1.80)
RSRZ outliers	127900	5850 (1.80-1.80)

The table below summarises the geometric issues observed across the polymeric chains and their fit to the electron density. The red, orange, yellow and green segments of the lower bar indicate the fraction of residues that contain outliers for ≥ 3 , 2, 1 and 0 types of geometric quality criteria respectively. A grey segment represents the fraction of residues that are not modelled. The numeric value for each fraction is indicated below the corresponding segment, with a dot representing fractions $\leq 5\%$. The upper red bar (where present) indicates the fraction of residues that have poor fit to the electron density. The numeric value is given above the bar.

Mol	Chain	Length	Quality of chain
1	A	267	 4% (red), 81% (green), 14% (yellow), . . (grey)
1	B	267	 10% (red), 70% (green), 24% (yellow), . 5% (grey)

The following table lists non-polymeric compounds, carbohydrate monomers and non-standard residues in protein, DNA, RNA chains that are outliers for geometric or electron-density-fit criteria:

Mol	Type	Chain	Res	Chirality	Geometry	Clashes	Electron density
3	PAI	A	1300	-	X	-	-

2 Entry composition [i](#)

There are 4 unique types of molecules in this entry. The entry contains 4307 atoms, of which 0 are hydrogens and 0 are deuteriums.

In the tables below, the ZeroOcc column contains the number of atoms modelled with zero occupancy, the AltConf column contains the number of residues with at least one atom in alternate conformation and the Trace column contains the number of residues modelled with at most 2 atoms.

- Molecule 1 is a protein called 2-DEHYDRO-3-DEOXYPHOSPHOCTONATE ALDOLASE.

Mol	Chain	Residues	Atoms					ZeroOcc	AltConf	Trace
			Total	C	N	O	S			
1	A	255	Total 2018	C 1304	N 336	O 372	S 6	0	0	0
1	B	254	Total 2009	C 1299	N 335	O 369	S 6	0	0	0

- Molecule 2 is CADMIUM ION (three-letter code: CD) (formula: Cd).

Mol	Chain	Residues	Atoms		ZeroOcc	AltConf
2	A	1	Total 1	Cd 1	0	0
2	B	1	Total 1	Cd 1	0	0

- Molecule 3 is {(2,2-DIHYDROXY-ETHYL)-(2,3,4,5-TETRAHYDROXY-6-PHOSPHONOXY-HEXYL)-AMINO}-METHYL}-PHOSPHONIC ACID (three-letter code: PAI) (formula: C₉H₂₃NO₁₃P₂).

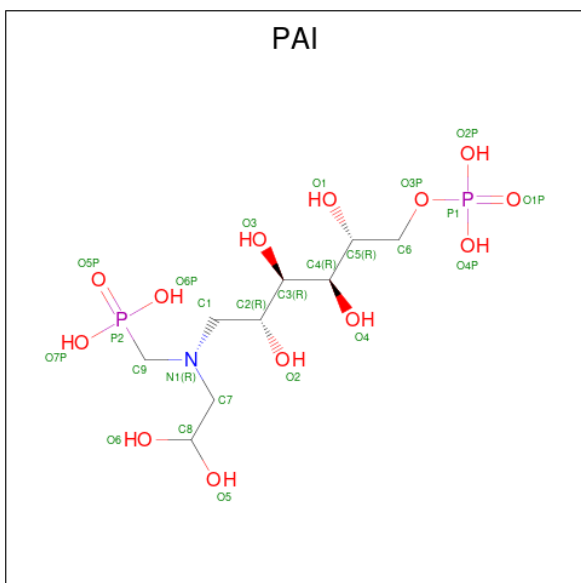

Mol	Chain	Residues	Atoms					ZeroOcc	AltConf
3	A	1	Total	C	N	O	P	0	0
			25	9	1	13	2		
3	B	1	Total	C	N	O	P	0	0
			25	9	1	13	2		

- Molecule 4 is water.

Mol	Chain	Residues	Atoms		ZeroOcc	AltConf
4	A	130	Total	O	0	0
			130	130		
4	B	98	Total	O	0	0
			98	98		

3 Residue-property plots [i](#)

These plots are drawn for all protein, RNA, DNA and oligosaccharide chains in the entry. The first graphic for a chain summarises the proportions of the various outlier classes displayed in the second graphic. The second graphic shows the sequence view annotated by issues in geometry and electron density. Residues are color-coded according to the number of geometric quality criteria for which they contain at least one outlier: green = 0, yellow = 1, orange = 2 and red = 3 or more. A red dot above a residue indicates a poor fit to the electron density ($RSRZ > 2$). Stretches of 2 or more consecutive residues without any outlier are shown as a green connector. Residues present in the sample, but not in the model, are shown in grey.

- Molecule 1: 2-DEHYDRO-3-DEOXYPHOSPHOCTONATE ALDOLASE

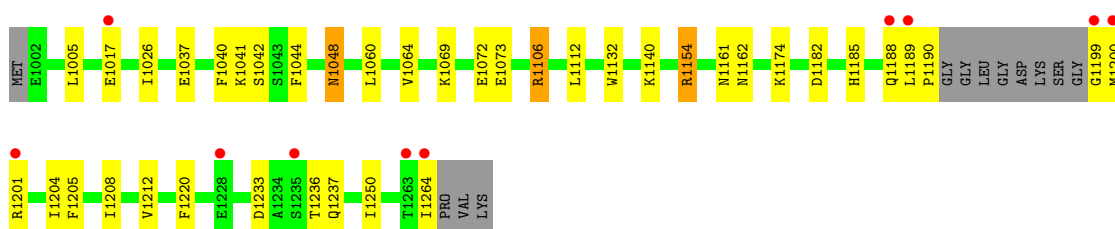
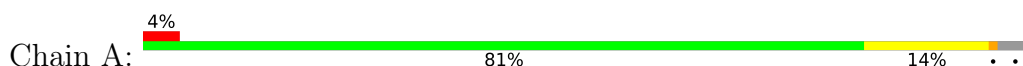

- Molecule 1: 2-DEHYDRO-3-DEOXYPHOSPHOCTONATE ALDOLASE

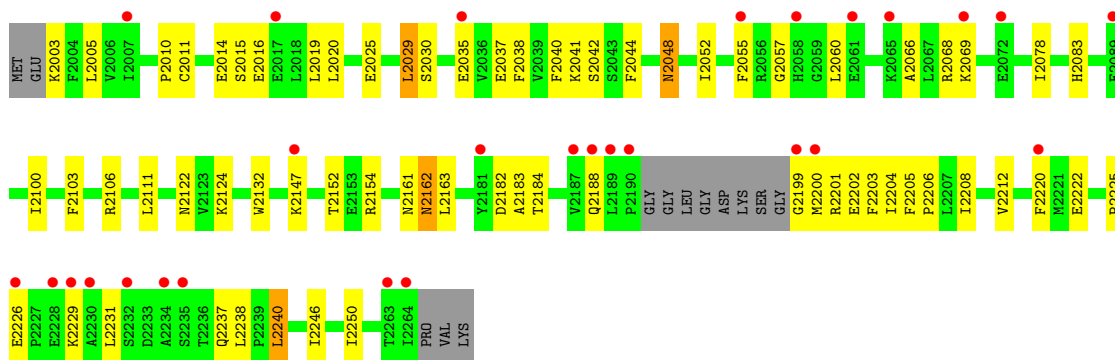

4 Data and refinement statistics

Property	Value	Source
Space group	P 31 2 1	Depositor
Cell constants a, b, c, α , β , γ	84.53Å 84.53Å 160.20Å 90.00° 90.00° 120.00°	Depositor
Resolution (Å)	27.27 – 1.80 27.27 – 1.80	Depositor EDS
% Data completeness (in resolution range)	94.2 (27.27-1.80) 94.3 (27.27-1.80)	Depositor EDS
R_{merge}	0.06	Depositor
R_{sym}	(Not available)	Depositor
$\langle I/\sigma(I) \rangle$ ¹	1.72 (at 1.80Å)	Xtrriage
Refinement program	CNS	Depositor
R, R_{free}	0.206 , 0.229 0.194 , 0.219	Depositor DCC
R_{free} test set	5302 reflections (8.84%)	wwPDB-VP
Wilson B-factor (Å ²)	30.8	Xtrriage
Anisotropy	0.034	Xtrriage
Bulk solvent k_{sol} (e/Å ³), B_{sol} (Å ²)	0.37 , 42.2	EDS
L-test for twinning ²	$\langle L \rangle = 0.50$, $\langle L^2 \rangle = 0.33$	Xtrriage
Estimated twinning fraction	0.022 for -h,-k,l	Xtrriage
F_o, F_c correlation	0.96	EDS
Total number of atoms	4307	wwPDB-VP
Average B, all atoms (Å ²)	34.0	wwPDB-VP

Xtrriage's analysis on translational NCS is as follows: *The largest off-origin peak in the Patterson function is 3.75% of the height of the origin peak. No significant pseudotranslation is detected.*

¹Intensities estimated from amplitudes.

²Theoretical values of $\langle |L| \rangle$, $\langle L^2 \rangle$ for acentric reflections are 0.5, 0.333 respectively for untwinned datasets, and 0.375, 0.2 for perfectly twinned datasets.

5 Model quality [i](#)

5.1 Standard geometry [i](#)

Bond lengths and bond angles in the following residue types are not validated in this section: PAI, CD

The Z score for a bond length (or angle) is the number of standard deviations the observed value is removed from the expected value. A bond length (or angle) with $|Z| > 5$ is considered an outlier worth inspection. RMSZ is the root-mean-square of all Z scores of the bond lengths (or angles).

Mol	Chain	Bond lengths		Bond angles	
		RMSZ	# $ Z > 5$	RMSZ	# $ Z > 5$
1	A	0.37	1/2058 (0.0%)	0.58	0/2776
1	B	0.32	0/2049	0.56	0/2764
All	All	0.34	1/4107 (0.0%)	0.57	0/5540

All (1) bond length outliers are listed below:

Mol	Chain	Res	Type	Atoms	Z	Observed(Å)	Ideal(Å)
1	A	1072	GLU	CD-OE2	7.13	1.33	1.25

There are no bond angle outliers.

There are no chirality outliers.

There are no planarity outliers.

5.2 Too-close contacts [i](#)

In the following table, the Non-H and H(model) columns list the number of non-hydrogen atoms and hydrogen atoms in the chain respectively. The H(added) column lists the number of hydrogen atoms added and optimized by MolProbity. The Clashes column lists the number of clashes within the asymmetric unit, whereas Symm-Clashes lists symmetry-related clashes.

Mol	Chain	Non-H	H(model)	H(added)	Clashes	Symm-Clashes
1	A	2018	0	2054	31	0
1	B	2009	0	2048	47	0
2	A	1	0	0	0	0
2	B	1	0	0	0	0
3	A	25	0	16	1	0
3	B	25	0	16	1	0
4	A	130	0	0	3	0
4	B	98	0	0	1	0

Continued on next page...

Continued from previous page...

Mol	Chain	Non-H	H(model)	H(added)	Clashes	Symm-Clashes
All	All	4307	0	4134	75	0

The all-atom clashscore is defined as the number of clashes found per 1000 atoms (including hydrogen atoms). The all-atom clashscore for this structure is 9.

All (75) close contacts within the same asymmetric unit are listed below, sorted by their clash magnitude.

Atom-1	Atom-2	Interatomic distance (Å)	Clash overlap (Å)
1:A:1174:LYS:HG3	1:A:1264:ILE:HD13	1.55	0.88
1:A:1161:ASN:HD21	1:B:2132:TRP:HE1	1.18	0.84
1:A:1132:TRP:HE1	1:B:2161:ASN:HD21	1.26	0.80
1:B:2238:LEU:HD21	1:B:2246:ILE:HD12	1.66	0.77
1:B:2025:GLU:HG2	1:B:2240:LEU:HD22	1.69	0.75
1:B:2011:CYS:H	1:B:2237:GLN:NE2	1.89	0.71
1:A:1048:ASN:H	1:A:1048:ASN:HD22	1.45	0.65
1:B:2068:ARG:HG3	1:B:2068:ARG:HH11	1.60	0.65
1:A:1185:HIS:O	1:A:1188:GLN:HG2	1.97	0.64
1:B:2204:ILE:O	1:B:2208:ILE:HG13	2.01	0.61
4:A:3041:HOH:O	1:B:2083:HIS:HD2	1.83	0.60
1:B:2020:LEU:HD21	1:B:2069:LYS:HG3	1.84	0.59
1:B:2025:GLU:O	1:B:2029:LEU:HD22	2.03	0.59
1:A:1205:PHE:O	1:A:1208:ILE:HG22	2.03	0.59
1:A:1041:LYS:HD3	1:A:1041:LYS:C	2.24	0.58
1:B:2048:ASN:H	1:B:2048:ASN:HD22	1.51	0.57
1:B:2041:LYS:HD3	1:B:2041:LYS:C	2.25	0.57
1:A:1005:LEU:HD12	1:A:1037:GLU:HB3	1.87	0.56
1:B:2019:LEU:HD12	1:B:2066:ALA:HB1	1.87	0.56
1:A:1189:LEU:HD21	1:A:1200:MET:HE1	1.87	0.55
1:A:1060:LEU:C	1:A:1060:LEU:HD13	2.27	0.54
1:B:2188:GLN:HA	1:B:2199:GLY:HA3	1.90	0.54
1:B:2205:PHE:HB3	1:B:2206:PRO:HD3	1.89	0.53
1:B:2225:PRO:HG3	1:B:2240:LEU:HD12	1.90	0.52
1:A:1174:LYS:HG3	1:A:1264:ILE:HG21	1.92	0.52
1:B:2068:ARG:HG3	1:B:2068:ARG:NH1	2.24	0.52
1:B:2147:LYS:HB3	1:B:2147:LYS:NZ	2.25	0.52
1:A:1189:LEU:HD21	1:A:1200:MET:CE	2.41	0.51
1:B:2014:GLU:HG2	1:B:2231:LEU:HD12	1.93	0.51
1:A:1048:ASN:HD22	1:A:1048:ASN:N	2.06	0.51
1:B:2041:LYS:HD3	1:B:2042:SER:N	2.25	0.51
1:A:1188:GLN:HB3	1:A:1236:THR:HG21	1.92	0.51
1:B:2044:PHE:CZ	1:B:2060:LEU:HD13	2.45	0.50

Continued on next page...

Continued from previous page...

Atom-1	Atom-2	Interatomic distance (Å)	Clash overlap (Å)
1:B:2200:MET:HB3	1:B:2202:GLU:HG2	1.93	0.49
1:B:2016:GLU:O	1:B:2020:LEU:HG	2.13	0.49
1:A:1188:GLN:O	1:A:1190:PRO:HD3	2.13	0.48
1:A:1233:ASP:O	1:A:1237:GLN:HG3	2.14	0.48
1:B:2212:VAL:HG11	1:B:2250:ILE:HB	1.96	0.47
1:A:1140:LYS:HG2	1:B:2052:ILE:HB	1.96	0.47
1:A:1212:VAL:HG11	1:A:1250:ILE:HB	1.97	0.47
1:B:2010:PRO:HA	1:B:2237:GLN:HE22	1.79	0.47
1:B:2182:ASP:HA	1:B:2220:PHE:HB3	1.96	0.47
1:B:2183:ALA:HB2	1:B:2208:ILE:HG12	1.96	0.47
1:B:2124:LYS:HD3	1:B:2152:THR:HB	1.97	0.47
1:A:1188:GLN:HA	1:A:1199:GLY:HA2	1.96	0.46
1:B:2184:THR:HG21	1:B:2222:GLU:H	1.80	0.46
1:B:2208:ILE:CG2	1:B:2250:ILE:HG21	2.46	0.46
3:A:1300:PAI:HC92	4:A:3056:HOH:O	2.15	0.46
1:A:1041:LYS:HD3	1:A:1042:SER:N	2.31	0.45
1:B:2003:LYS:HD2	1:B:2037:GLU:HB2	1.98	0.45
1:A:1182:ASP:HA	1:A:1220:PHE:HB3	1.98	0.45
1:B:2200:MET:HB2	1:B:2203:PHE:CD2	2.52	0.45
1:A:1106:ARG:NH1	1:B:2103:PHE:HE2	2.15	0.44
1:A:1017:GLU:HG3	4:A:3210:HOH:O	2.18	0.44
1:A:1106:ARG:HH11	1:A:1106:ARG:HB3	1.81	0.44
1:B:2040:PHE:HB3	1:B:2078:ILE:HD13	2.00	0.44
1:B:2201:ARG:HG3	1:B:2204:ILE:HD12	1.98	0.44
1:B:2011:CYS:H	1:B:2237:GLN:HE22	1.62	0.43
1:B:2055:PHE:CZ	1:B:2057:GLY:HA2	2.53	0.43
1:A:1154:ARG:O	1:A:1154:ARG:HD3	2.18	0.43
1:B:2226:GLU:OE1	1:B:2229:LYS:HD2	2.18	0.43
1:A:1026:ILE:HD12	1:A:1040:PHE:CD1	2.54	0.42
1:B:2010:PRO:HA	1:B:2237:GLN:NE2	2.34	0.42
3:B:2300:PAI:HC92	4:B:3105:HOH:O	2.19	0.42
1:A:1060:LEU:HD22	1:A:1064:VAL:HG23	2.02	0.42
1:B:2030:SER:HA	1:B:2038:PHE:CE1	2.55	0.42
1:A:1106:ARG:NH1	1:B:2048:ASN:O	2.52	0.42
1:A:1201:ARG:HG3	1:A:1204:ILE:HD12	2.02	0.42
1:A:1044:PHE:CZ	1:A:1060:LEU:HD23	2.55	0.42
1:B:2183:ALA:CB	1:B:2208:ILE:HG12	2.49	0.42
1:B:2162:ASN:HD22	1:B:2163:LEU:H	1.67	0.41
1:B:2100:ILE:HG13	1:B:2111:LEU:HD23	2.02	0.41
1:A:1069:LYS:HE3	1:A:1073:GLU:OE1	2.21	0.41
1:B:2188:GLN:HA	1:B:2199:GLY:CA	2.52	0.40

Continued on next page...

Continued from previous page...

Atom-1	Atom-2	Interatomic distance (Å)	Clash overlap (Å)
1:B:2005:LEU:HD12	1:B:2037:GLU:HB3	2.02	0.40

There are no symmetry-related clashes.

5.3 Torsion angles [i](#)

5.3.1 Protein backbone [i](#)

In the following table, the Percentiles column shows the percent Ramachandran outliers of the chain as a percentile score with respect to all X-ray entries followed by that with respect to entries of similar resolution.

The Analysed column shows the number of residues for which the backbone conformation was analysed, and the total number of residues.

Mol	Chain	Analysed	Favoured	Allowed	Outliers	Percentiles	
1	A	251/267 (94%)	249 (99%)	2 (1%)	0	100	100
1	B	250/267 (94%)	246 (98%)	3 (1%)	1 (0%)	34	21
All	All	501/534 (94%)	495 (99%)	5 (1%)	1 (0%)	47	33

All (1) Ramachandran outliers are listed below:

Mol	Chain	Res	Type
1	B	2015	SER

5.3.2 Protein sidechains [i](#)

In the following table, the Percentiles column shows the percent sidechain outliers of the chain as a percentile score with respect to all X-ray entries followed by that with respect to entries of similar resolution.

The Analysed column shows the number of residues for which the sidechain conformation was analysed, and the total number of residues.

Mol	Chain	Analysed	Rotameric	Outliers	Percentiles	
1	A	216/224 (96%)	211 (98%)	5 (2%)	50	37
1	B	215/224 (96%)	207 (96%)	8 (4%)	34	19
All	All	431/448 (96%)	418 (97%)	13 (3%)	41	27

All (13) residues with a non-rotameric sidechain are listed below:

Mol	Chain	Res	Type
1	A	1048	ASN
1	A	1106	ARG
1	A	1112	LEU
1	A	1154	ARG
1	A	1162	ASN
1	B	2029	LEU
1	B	2035	GLU
1	B	2048	ASN
1	B	2106	ARG
1	B	2122	ASN
1	B	2154	ARG
1	B	2162	ASN
1	B	2240	LEU

Sometimes sidechains can be flipped to improve hydrogen bonding and reduce clashes. All (15) such sidechains are listed below:

Mol	Chain	Res	Type
1	A	1048	ASN
1	A	1058	HIS
1	A	1099	GLN
1	A	1161	ASN
1	A	1162	ASN
1	B	2048	ASN
1	B	2053	HIS
1	B	2083	HIS
1	B	2099	GLN
1	B	2122	ASN
1	B	2136	ASN
1	B	2161	ASN
1	B	2162	ASN
1	B	2188	GLN
1	B	2237	GLN

5.3.3 RNA [i](#)

There are no RNA molecules in this entry.

5.4 Non-standard residues in protein, DNA, RNA chains [i](#)

There are no non-standard protein/DNA/RNA residues in this entry.

5.5 Carbohydrates [i](#)

There are no monosaccharides in this entry.

5.6 Ligand geometry [i](#)

Of 4 ligands modelled in this entry, 2 are monoatomic - leaving 2 for Mogul analysis.

In the following table, the Counts columns list the number of bonds (or angles) for which Mogul statistics could be retrieved, the number of bonds (or angles) that are observed in the model and the number of bonds (or angles) that are defined in the Chemical Component Dictionary. The Link column lists molecule types, if any, to which the group is linked. The Z score for a bond length (or angle) is the number of standard deviations the observed value is removed from the expected value. A bond length (or angle) with $|Z| > 2$ is considered an outlier worth inspection. RMSZ is the root-mean-square of all Z scores of the bond lengths (or angles).

Mol	Type	Chain	Res	Link	Bond lengths			Bond angles		
					Counts	RMSZ	# Z > 2	Counts	RMSZ	# Z > 2
3	PAI	A	1300	2	24,24,24	3.79	7 (29%)	34,35,35	2.79	14 (41%)
3	PAI	B	2300	2	24,24,24	3.79	7 (29%)	34,35,35	2.89	11 (32%)

In the following table, the Chirals column lists the number of chiral outliers, the number of chiral centers analysed, the number of these observed in the model and the number defined in the Chemical Component Dictionary. Similar counts are reported in the Torsion and Rings columns. '-' means no outliers of that kind were identified.

Mol	Type	Chain	Res	Link	Chirals	Torsions	Rings
3	PAI	A	1300	2	-	16/31/31/31	-
3	PAI	B	2300	2	-	15/31/31/31	-

All (14) bond length outliers are listed below:

Mol	Chain	Res	Type	Atoms	Z	Observed(Å)	Ideal(Å)
3	A	1300	PAI	P2-C9	-11.36	1.55	1.81
3	B	2300	PAI	P2-C9	-11.26	1.55	1.81
3	B	2300	PAI	O6-C8	-9.42	1.19	1.40
3	A	1300	PAI	O6-C8	-9.41	1.19	1.40
3	B	2300	PAI	O5-C8	-5.71	1.27	1.40
3	A	1300	PAI	O5-C8	-5.68	1.27	1.40
3	B	2300	PAI	C1-N1	-5.58	1.36	1.47
3	A	1300	PAI	C1-N1	-5.55	1.37	1.47
3	B	2300	PAI	C7-N1	-5.18	1.37	1.47
3	A	1300	PAI	C7-N1	-5.08	1.37	1.47

Continued on next page...

Continued from previous page...

Mol	Chain	Res	Type	Atoms	Z	Observed(Å)	Ideal(Å)
3	A	1300	PAI	C9-N1	-4.61	1.37	1.48
3	B	2300	PAI	C9-N1	-4.52	1.38	1.48
3	A	1300	PAI	P2-O6P	-2.39	1.49	1.54
3	B	2300	PAI	P2-O6P	-2.35	1.49	1.54

All (25) bond angle outliers are listed below:

Mol	Chain	Res	Type	Atoms	Z	Observed(°)	Ideal(°)
3	B	2300	PAI	C8-C7-N1	9.70	129.97	112.55
3	A	1300	PAI	O6-C8-O5	8.70	127.37	111.36
3	B	2300	PAI	O6-C8-O5	7.92	125.93	111.36
3	A	1300	PAI	C8-C7-N1	7.58	126.16	112.55
3	B	2300	PAI	P1-O3P-C6	4.69	131.21	118.30
3	B	2300	PAI	O6-C8-C7	4.01	119.45	109.76
3	A	1300	PAI	C2-C3-C4	-4.01	106.19	112.47
3	A	1300	PAI	O6-C8-C7	3.85	119.05	109.76
3	B	2300	PAI	O7P-P2-O5P	3.40	121.39	112.39
3	A	1300	PAI	P1-O3P-C6	3.35	127.53	118.30
3	B	2300	PAI	C2-C3-C4	-3.19	107.48	112.47
3	B	2300	PAI	C5-C4-C3	-3.15	107.54	112.47
3	B	2300	PAI	O4-C4-C5	2.99	116.02	108.81
3	A	1300	PAI	O6P-P2-C9	2.87	112.80	106.66
3	A	1300	PAI	O4-C4-C5	2.85	115.69	108.81
3	A	1300	PAI	C5-C4-C3	-2.79	108.10	112.47
3	A	1300	PAI	O7P-P2-O5P	2.68	119.48	112.39
3	A	1300	PAI	O2-C2-C3	2.67	115.60	109.10
3	A	1300	PAI	C6-C5-C4	-2.56	107.26	112.20
3	A	1300	PAI	C2-C1-N1	-2.49	107.68	112.21
3	A	1300	PAI	O5P-P2-C9	-2.35	97.25	108.37
3	A	1300	PAI	O3P-C6-C5	2.25	115.37	109.36
3	B	2300	PAI	O2-C2-C3	2.14	114.31	109.10
3	B	2300	PAI	C2-C1-N1	-2.14	108.31	112.21
3	B	2300	PAI	O7P-P2-C9	-2.06	102.23	106.66

There are no chirality outliers.

All (31) torsion outliers are listed below:

Mol	Chain	Res	Type	Atoms
3	A	1300	PAI	C6-O3P-P1-O1P
3	A	1300	PAI	C6-O3P-P1-O2P
3	A	1300	PAI	C6-O3P-P1-O4P
3	A	1300	PAI	O1-C5-C6-O3P

Continued on next page...

Continued from previous page...

Mol	Chain	Res	Type	Atoms
3	A	1300	PAI	C4-C5-C6-O3P
3	A	1300	PAI	N1-C7-C8-O6
3	B	2300	PAI	C6-O3P-P1-O2P
3	B	2300	PAI	C6-O3P-P1-O4P
3	B	2300	PAI	O1-C5-C6-O3P
3	B	2300	PAI	C4-C5-C6-O3P
3	B	2300	PAI	N1-C1-C2-C3
3	B	2300	PAI	N1-C1-C2-O2
3	B	2300	PAI	N1-C7-C8-O6
3	A	1300	PAI	C2-C1-N1-C9
3	B	2300	PAI	C2-C1-N1-C7
3	B	2300	PAI	C6-O3P-P1-O1P
3	A	1300	PAI	C2-C1-N1-C7
3	A	1300	PAI	N1-C9-P2-O6P
3	A	1300	PAI	N1-C9-P2-O7P
3	B	2300	PAI	N1-C9-P2-O6P
3	B	2300	PAI	N1-C9-P2-O7P
3	A	1300	PAI	N1-C9-P2-O5P
3	B	2300	PAI	N1-C9-P2-O5P
3	A	1300	PAI	N1-C1-C2-C3
3	B	2300	PAI	C2-C1-N1-C9
3	A	1300	PAI	P2-C9-N1-C7
3	B	2300	PAI	P2-C9-N1-C7
3	A	1300	PAI	C5-C6-O3P-P1
3	A	1300	PAI	P2-C9-N1-C1
3	B	2300	PAI	P2-C9-N1-C1
3	A	1300	PAI	N1-C1-C2-O2

There are no ring outliers.

2 monomers are involved in 2 short contacts:

Mol	Chain	Res	Type	Clashes	Symm-Clashes
3	A	1300	PAI	1	0
3	B	2300	PAI	1	0

The following is a two-dimensional graphical depiction of Mogul quality analysis of bond lengths, bond angles, torsion angles, and ring geometry for all instances of the Ligand of Interest. In addition, ligands with molecular weight > 250 and outliers as shown on the validation Tables will also be included. For torsion angles, if less than 5% of the Mogul distribution of torsion angles is within 10 degrees of the torsion angle in question, then that torsion angle is considered an outlier. Any bond that is central to one or more torsion angles identified as an outlier by Mogul will be highlighted in the graph. For rings, the root-mean-square deviation (RMSD) between the ring

in question and similar rings identified by Mogul is calculated over all ring torsion angles. If the average RMSD is greater than 60 degrees and the minimal RMSD between the ring in question and any Mogul-identified rings is also greater than 60 degrees, then that ring is considered an outlier. The outliers are highlighted in purple. The color gray indicates Mogul did not find sufficient equivalents in the CSD to analyse the geometry.

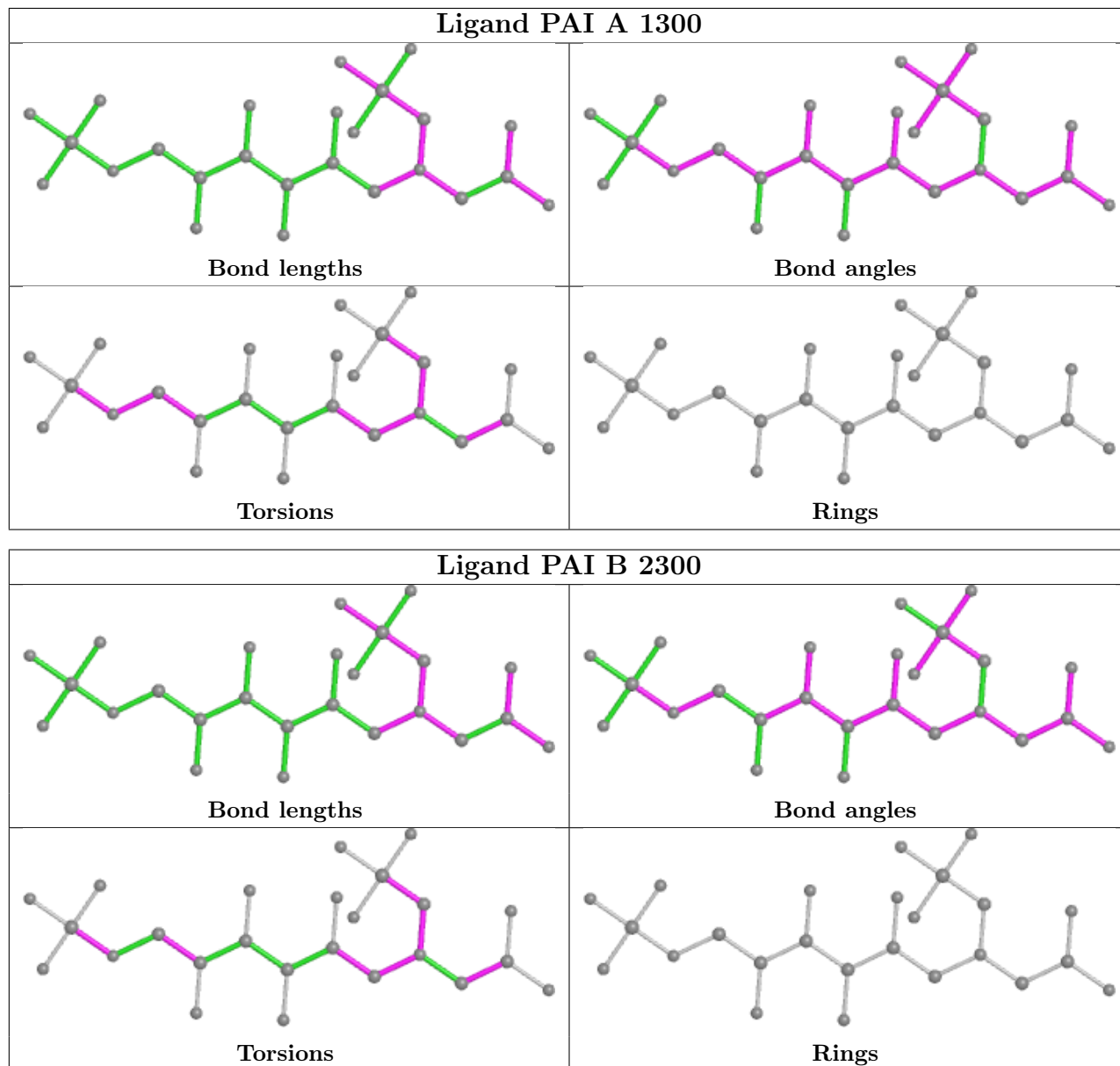

5.7 Other polymers [i](#)

There are no such residues in this entry.

5.8 Polymer linkage issues [i](#)

There are no chain breaks in this entry.

6 Fit of model and data

6.1 Protein, DNA and RNA chains

In the following table, the column labelled ‘#RSRZ > 2’ contains the number (and percentage) of RSRZ outliers, followed by percent RSRZ outliers for the chain as percentile scores relative to all X-ray entries and entries of similar resolution. The OWAB column contains the minimum, median, 95th percentile and maximum values of the occupancy-weighted average B-factor per residue. The column labelled ‘Q < 0.9’ lists the number of (and percentage) of residues with an average occupancy less than 0.9.

Mol	Chain	Analysed	<RSRZ>	#RSRZ>2	OWAB(Å ²)	Q<0.9
1	A	255/267 (95%)	0.16	10 (3%) 39 33	20, 28, 52, 60	0
1	B	254/267 (95%)	0.56	28 (11%) 5 4	21, 33, 58, 73	0
All	All	509/534 (95%)	0.36	38 (7%) 14 11	20, 31, 55, 73	0

All (38) RSRZ outliers are listed below:

Mol	Chain	Res	Type	RSRZ
1	A	1199	GLY	7.7
1	A	1200	MET	7.6
1	B	2264	ILE	6.7
1	B	2199	GLY	5.5
1	B	2200	MET	5.5
1	B	2234	ALA	4.4
1	A	1264	ILE	4.3
1	A	1235	SER	4.1
1	B	2228	GLU	4.1
1	A	1228	GLU	3.9
1	A	1263	THR	3.9
1	B	2189	LEU	3.7
1	B	2263	THR	3.7
1	B	2229	LYS	3.6
1	B	2147	LYS	3.6
1	B	2061	GLU	3.3
1	A	1189	LEU	3.2
1	B	2007	ILE	3.1
1	B	2055	PHE	3.1
1	B	2220	PHE	3.1
1	B	2226	GLU	3.1
1	A	1188	GLN	3.0
1	B	2230	ALA	2.9
1	B	2188	GLN	2.8

Continued on next page...

Continued from previous page...

Mol	Chain	Res	Type	RSRZ
1	B	2072	GLU	2.8
1	A	1017	GLU	2.8
1	B	2089	GLU	2.6
1	B	2232	SER	2.5
1	B	2187	VAL	2.4
1	B	2190	PRO	2.4
1	B	2035	GLU	2.4
1	B	2069	LYS	2.4
1	A	1201	ARG	2.3
1	B	2017	GLU	2.3
1	B	2235	SER	2.3
1	B	2065	LYS	2.1
1	B	2058	HIS	2.1
1	B	2181	TYR	2.0

6.2 Non-standard residues in protein, DNA, RNA chains [i](#)

There are no non-standard protein/DNA/RNA residues in this entry.

6.3 Carbohydrates [i](#)

There are no monosaccharides in this entry.

6.4 Ligands [i](#)

In the following table, the Atoms column lists the number of modelled atoms in the group and the number defined in the chemical component dictionary. The B-factors column lists the minimum, median, 95th percentile and maximum values of B factors of atoms in the group. The column labelled 'Q<0.9' lists the number of atoms with occupancy less than 0.9.

Mol	Type	Chain	Res	Atoms	RSCC	RSR	B-factors(Å ²)	Q<0.9
2	CD	B	2270	1/1	0.83	0.17	101,101,101,101	1
2	CD	A	1270	1/1	0.89	0.14	77,77,77,77	1
3	PAI	A	1300	25/25	0.90	0.19	31,57,61,62	0
3	PAI	B	2300	25/25	0.92	0.17	36,58,62,63	0

The following is a graphical depiction of the model fit to experimental electron density of all instances of the Ligand of Interest. In addition, ligands with molecular weight > 250 and outliers as shown on the geometry validation Tables will also be included. Each fit is shown from different orientation to approximate a three-dimensional view.

Electron density around PAI A 1300:

$2mF_o-DF_c$ (at 0.7 rmsd) in gray
 mF_o-DF_c (at 3 rmsd) in purple (negative)
and green (positive)

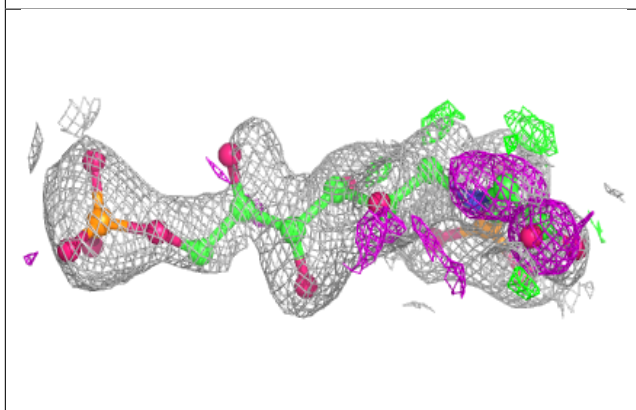
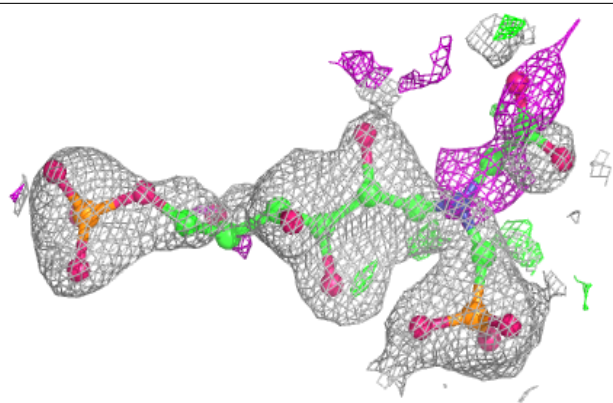
**Electron density around PAI B 2300:**

$2mF_o-DF_c$ (at 0.7 rmsd) in gray
 mF_o-DF_c (at 3 rmsd) in purple (negative)
and green (positive)

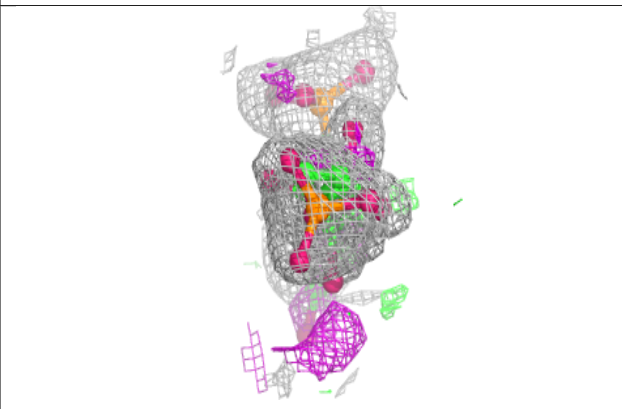
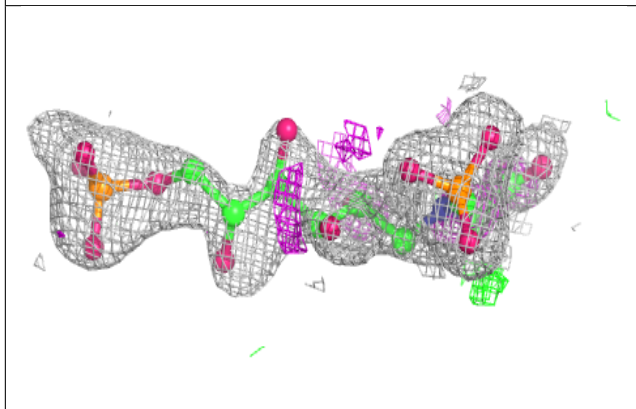
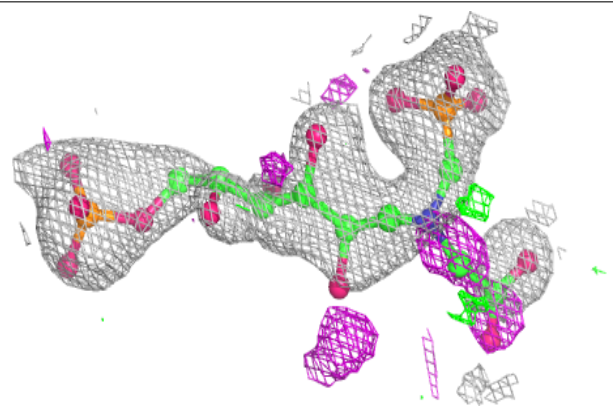

6.5 Other polymers [i](#)

There are no such residues in this entry.