



Full wwPDB EM Validation Report ⓘ

Mar 13, 2024 – 01:48 PM JST

PDB ID : 3JCP
EMDB ID : EMD-6575
Title : Structure of yeast 26S proteasome in M2 state derived from Titan dataset
Authors : Luan, B.; Huang, X.L.; Wu, J.P.; Shi, Y.G.; Wang, F.
Deposited on : 2016-01-06
Resolution : 4.60 Å (reported)
Based on initial model : 4CR2

This is a Full wwPDB EM Validation Report for a publicly released PDB entry.

We welcome your comments at validation@mail.wwpdb.org

A user guide is available at

<https://www.wwpdb.org/validation/2017/EMValidationReportHelp>

with specific help available everywhere you see the ⓘ symbol.

The types of validation reports are described at

<http://www.wwpdb.org/validation/2017/FAQs#types>.

The following versions of software and data (see [references ⓘ](#)) were used in the production of this report:

EMDB validation analysis : 0.0.1.dev70
MolProbity : 4.02b-467
Percentile statistics : 20191225.v01 (using entries in the PDB archive December 25th 2019)
MapQ : 1.9.13
Ideal geometry (proteins) : Engh & Huber (2001)
Ideal geometry (DNA, RNA) : Parkinson et al. (1996)
Validation Pipeline (wwPDB-VP) : 2.36

1 Overall quality at a glance

The following experimental techniques were used to determine the structure:
ELECTRON MICROSCOPY

The reported resolution of this entry is 4.60 Å.

Percentile scores (ranging between 0-100) for global validation metrics of the entry are shown in the following graphic. The table shows the number of entries on which the scores are based.

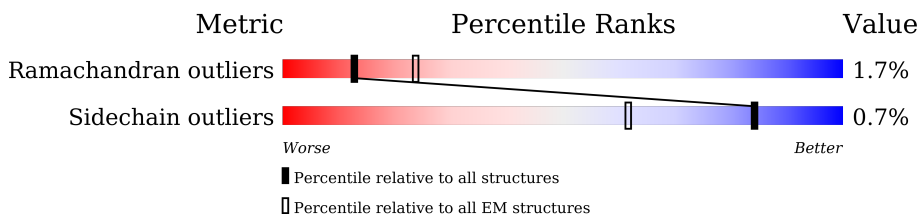

Metric	Whole archive (#Entries)	EM structures (#Entries)
Ramachandran outliers	154571	4023
Sidechain outliers	154315	3826

The table below summarises the geometric issues observed across the polymeric chains and their fit to the map. The red, orange, yellow and green segments of the bar indicate the fraction of residues that contain outliers for ≥ 3 , 2, 1 and 0 types of geometric quality criteria respectively. A grey segment represents the fraction of residues that are not modelled. The numeric value for each fraction is indicated below the corresponding segment, with a dot representing fractions $\leq 5\%$. The upper red bar (where present) indicates the fraction of residues that have poor fit to the EM map (all-atom inclusion $< 40\%$). The numeric value is given above the bar.

Mol	Chain	Length	Quality of chain
1	1	241	
1	8	241	
2	2	266	
2	9	266	
3	3	215	
3	h	215	
4	4	261	
4	i	261	
5	5	205	

Continued on next page...

Continued from previous page...

Mol	Chain	Length	Quality of chain
5	j	205	5% 99%
6	6	198	8% 99%
6	k	198	8% 99%
7	7	287	74% 26%
7	l	287	74% 26%
8	A	252	9% 96%
8	a	252	8% 96%
9	B	250	8% 100%
9	b	250	10% 100%
10	C	258	7% 95% 5%
10	c	258	14% 95% 5%
11	D	254	8% 94% 5%
11	d	254	8% 94% 5%
12	E	260	10% 93% 7%
12	e	260	10% 93% 7%
13	F	234	5% 100%
13	f	234	6% 100%
14	G	288	5% 83% 15%
14	g	288	5% 84% 15%
15	H	467	22% 76% 18%
16	I	437	24% 77% 19%
17	J	405	31% 90% 8%
18	K	428	25% 79% 16%
19	L	437	20% 79% 18%
20	M	434	25% 81% 18%

Continued on next page...

Continued from previous page...

Mol	Chain	Length	Quality of chain
21	N	945	
22	O	393	
23	P	445	
24	Q	434	
25	R	429	
26	S	523	
27	T	274	
28	U	338	
29	V	306	
30	W	268	
31	X	156	
32	Y	89	
33	Z	993	

2 Entry composition [i](#)

There are 33 unique types of molecules in this entry. The entry contains 104170 atoms, of which 0 are hydrogens and 0 are deuteriums.

In the tables below, the AltConf column contains the number of residues with at least one atom in alternate conformation and the Trace column contains the number of residues modelled with at most 2 atoms.

- Molecule 1 is a protein called Proteasome subunit beta type-6.

Mol	Chain	Residues	Atoms					AltConf	Trace
			Total	C	N	O	S		
1	1	222	Total	C	N	O	S	0	0
			1757	1115	303	335	4		
1	8	222	Total	C	N	O	S	0	0
			1757	1115	303	335	4		

- Molecule 2 is a protein called Proteasome subunit beta type-7.

Mol	Chain	Residues	Atoms					AltConf	Trace
			Total	C	N	O	S		
2	2	233	Total	C	N	O	S	0	0
			1824	1154	312	351	7		
2	9	233	Total	C	N	O	S	0	0
			1824	1154	312	351	7		

- Molecule 3 is a protein called Proteasome subunit beta type-1.

Mol	Chain	Residues	Atoms					AltConf	Trace
			Total	C	N	O	S		
3	3	205	Total	C	N	O	S	0	0
			1573	995	260	311	7		
3	h	205	Total	C	N	O	S	0	0
			1574	995	261	311	7		

- Molecule 4 is a protein called Proteasome subunit beta type-2.

Mol	Chain	Residues	Atoms					AltConf	Trace
			Total	C	N	O	S		
4	4	222	Total	C	N	O	S	0	0
			1684	1061	293	323	7		
4	i	222	Total	C	N	O	S	0	0
			1684	1061	293	323	7		

- Molecule 5 is a protein called Proteasome subunit beta type-3.

Mol	Chain	Residues	Atoms					AltConf	Trace
5	5	204	Total	C	N	O	S	0	0
			1581	1010	258	305	8		
5	j	204	Total	C	N	O	S	0	0
			1578	1009	257	304	8		

- Molecule 6 is a protein called Proteasome subunit beta type-4.

Mol	Chain	Residues	Atoms					AltConf	Trace
6	6	198	Total	C	N	O	S	0	0
			1585	1005	269	305	6		
6	k	198	Total	C	N	O	S	0	0
			1585	1005	269	305	6		

- Molecule 7 is a protein called Proteasome subunit beta type-5.

Mol	Chain	Residues	Atoms					AltConf	Trace
7	7	212	Total	C	N	O	S	0	0
			1644	1045	280	312	7		
7	l	212	Total	C	N	O	S	0	0
			1644	1045	280	312	7		

- Molecule 8 is a protein called Proteasome subunit alpha type-1.

Mol	Chain	Residues	Atoms					AltConf	Trace
8	A	243	Total	C	N	O	S	0	0
			1921	1221	322	370	8		
8	a	243	Total	C	N	O	S	0	0
			1921	1221	322	370	8		

- Molecule 9 is a protein called Proteasome subunit alpha type-2.

Mol	Chain	Residues	Atoms					AltConf	Trace
9	B	250	Total	C	N	O	S	0	0
			1915	1219	315	377	4		
9	b	250	Total	C	N	O	S	0	0
			1915	1219	315	377	4		

- Molecule 10 is a protein called Proteasome subunit alpha type-3.

Mol	Chain	Residues	Atoms					AltConf	Trace
10	C	244	Total	C	N	O	S	0	0
			1904	1201	321	379	3		

Continued on next page...

Continued from previous page...

Mol	Chain	Residues	Atoms					AltConf	Trace
10	c	244	Total	C	N	O	S	0	0
			1904	1201	321	379	3		

- Molecule 11 is a protein called Proteasome subunit alpha type-4.

Mol	Chain	Residues	Atoms					AltConf	Trace
11	D	241	Total	C	N	O	S	0	0
			1890	1181	331	374	4		
11	d	241	Total	C	N	O	S	0	0
			1890	1181	331	374	4		

- Molecule 12 is a protein called Proteasome subunit alpha type-5.

Mol	Chain	Residues	Atoms					AltConf	Trace
12	E	242	Total	C	N	O	S	0	0
			1861	1162	314	378	7		
12	e	242	Total	C	N	O	S	0	0
			1861	1162	314	378	7		

- Molecule 13 is a protein called Proteasome subunit alpha type-6.

Mol	Chain	Residues	Atoms					AltConf	Trace
13	F	233	Total	C	N	O	S	0	0
			1795	1129	312	350	4		
13	f	233	Total	C	N	O	S	0	0
			1795	1129	312	350	4		

- Molecule 14 is a protein called Probable proteasome subunit alpha type-7.

Mol	Chain	Residues	Atoms					AltConf	Trace
14	G	244	Total	C	N	O	S	0	0
			1896	1205	330	357	4		
14	g	244	Total	C	N	O	S	0	0
			1896	1205	330	357	4		

- Molecule 15 is a protein called 26S protease regulatory subunit 7 homolog.

Mol	Chain	Residues	Atoms					AltConf	Trace
15	H	381	Total	C	N	O	S	0	0
			2877	1806	519	537	15		

- Molecule 16 is a protein called 26S protease regulatory subunit 4 homolog.

Mol	Chain	Residues	Atoms					AltConf	Trace
			Total	C	N	O	S		
16	I	354	2652	1655	453	531	13	0	0

- Molecule 17 is a protein called 26S protease regulatory subunit 8 homolog.

Mol	Chain	Residues	Atoms					AltConf	Trace
			Total	C	N	O	S		
17	J	373	2914	1824	526	547	17	0	0

- Molecule 18 is a protein called 26S protease regulatory subunit 6B homolog.

Mol	Chain	Residues	Atoms					AltConf	Trace
			Total	C	N	O	S		
18	K	361	2835	1777	506	542	10	0	0

- Molecule 19 is a protein called 26S protease subunit RPT4.

Mol	Chain	Residues	Atoms					AltConf	Trace
			Total	C	N	O	S		
19	L	358	2829	1782	501	534	12	0	0

- Molecule 20 is a protein called 26S protease regulatory subunit 6A.

Mol	Chain	Residues	Atoms					AltConf	Trace
			Total	C	N	O	S		
20	M	357	2754	1723	473	548	10	0	0

- Molecule 21 is a protein called 26S proteasome regulatory subunit RPN2.

Mol	Chain	Residues	Atoms					AltConf	Trace
			Total	C	N	O	S		
21	N	850	6570	4178	1100	1264	28	0	0

- Molecule 22 is a protein called 26S proteasome regulatory subunit RPN9.

Mol	Chain	Residues	Atoms					AltConf	Trace
			Total	C	N	O	S		
22	O	376	2912	1867	481	557	7	0	0

- Molecule 23 is a protein called 26S proteasome regulatory subunit RPN5.

Mol	Chain	Residues	Atoms					AltConf	Trace
			Total	C	N	O	S		
23	P	431	3470	2210	585	667	8	0	0

- Molecule 24 is a protein called 26S proteasome regulatory subunit RPN6.

Mol	Chain	Residues	Atoms					AltConf	Trace
			Total	C	N	O	S		
24	Q	431	3469	2203	574	676	16	0	0

- Molecule 25 is a protein called 26S proteasome regulatory subunit RPN7.

Mol	Chain	Residues	Atoms					AltConf	Trace
			Total	C	N	O	S		
25	R	400	3187	2028	525	624	10	0	0

- Molecule 26 is a protein called 26S proteasome regulatory subunit RPN3.

Mol	Chain	Residues	Atoms					AltConf	Trace
			Total	C	N	O	S		
26	S	439	3384	2155	575	637	17	0	0

- Molecule 27 is a protein called 26S proteasome regulatory subunit RPN12.

Mol	Chain	Residues	Atoms					AltConf	Trace
			Total	C	N	O	S		
27	T	267	2201	1410	350	435	6	0	0

- Molecule 28 is a protein called 26S proteasome regulatory subunit RPN8.

Mol	Chain	Residues	Atoms					AltConf	Trace
			Total	C	N	O	S		
28	U	254	2049	1304	350	389	6	0	0

- Molecule 29 is a protein called Ubiquitin carboxyl-terminal hydrolase RPN11.

Mol	Chain	Residues	Atoms					AltConf	Trace
			Total	C	N	O	S		
29	V	245	1912	1206	322	371	13	0	0

- Molecule 30 is a protein called 26S proteasome regulatory subunit RPN10.

Mol	Chain	Residues	Atoms					AltConf	Trace
			Total	C	N	O	S		
30	W	197	1534	962	269	300	3	0	0

- Molecule 31 is a protein called 26S proteasome regulatory subunit RPN13.

Mol	Chain	Residues	Atoms					AltConf	Trace
			Total	C	N	O	S		
31	X	127	1032	664	169	195	4	0	0

- Molecule 32 is a protein called 26S proteasome complex subunit SEM1.

Mol	Chain	Residues	Atoms				AltConf	Trace
			Total	C	N	O		
32	Y	34	243	146	45	52	0	0

- Molecule 33 is a protein called 26S proteasome regulatory subunit RPN1.

Mol	Chain	Residues	Atoms					AltConf	Trace
			Total	C	N	O	S		
33	Z	746	5688	3616	940	1106	26	0	0

3 Residue-property plots [i](#)

These plots are drawn for all protein, RNA, DNA and oligosaccharide chains in the entry. The first graphic for a chain summarises the proportions of the various outlier classes displayed in the second graphic. The second graphic shows the sequence view annotated by issues in geometry and atom inclusion in map density. Residues are color-coded according to the number of geometric quality criteria for which they contain at least one outlier: green = 0, yellow = 1, orange = 2 and red = 3 or more. A red diamond above a residue indicates a poor fit to the EM map for this residue (all-atom inclusion < 40%). Stretches of 2 or more consecutive residues without any outlier are shown as a green connector. Residues present in the sample, but not in the model, are shown in grey.

- Molecule 1: Proteasome subunit beta type-6

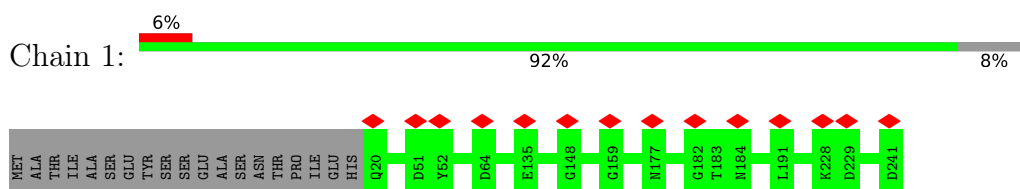

- Molecule 1: Proteasome subunit beta type-6

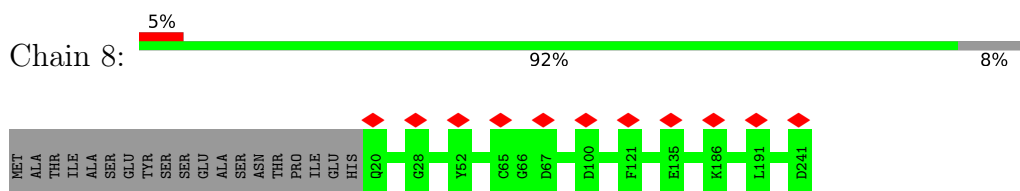

- Molecule 2: Proteasome subunit beta type-7

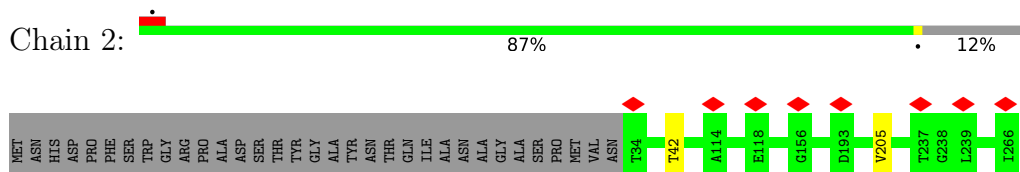

- Molecule 2: Proteasome subunit beta type-7

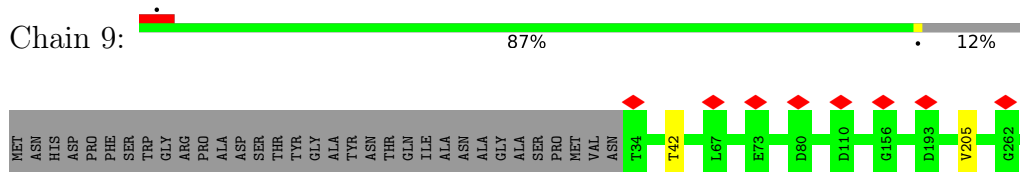

- Molecule 3: Proteasome subunit beta type-1

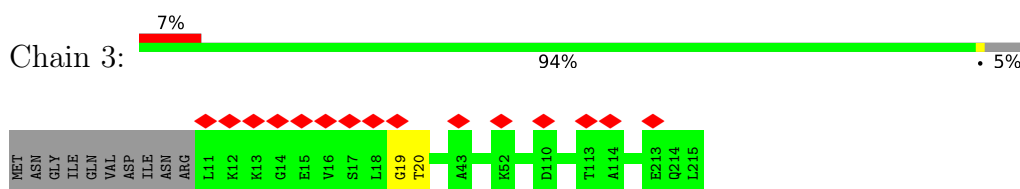

• Molecule 3: Proteasome subunit beta type-1

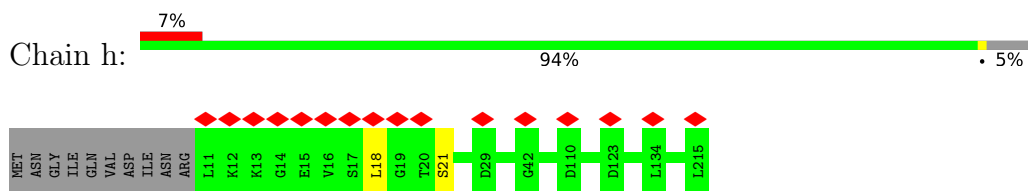

• Molecule 4: Proteasome subunit beta type-2

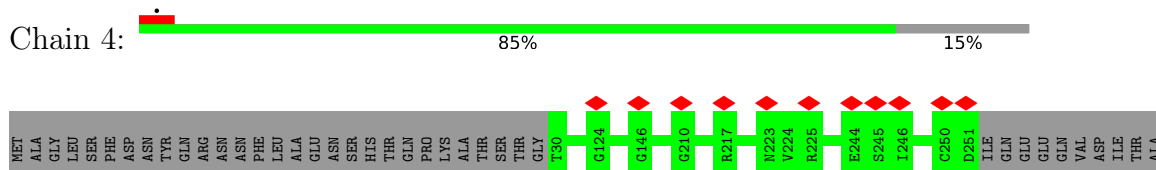

• Molecule 4: Proteasome subunit beta type-2

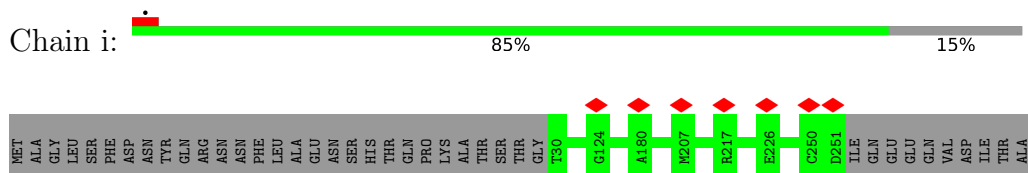

• Molecule 5: Proteasome subunit beta type-3

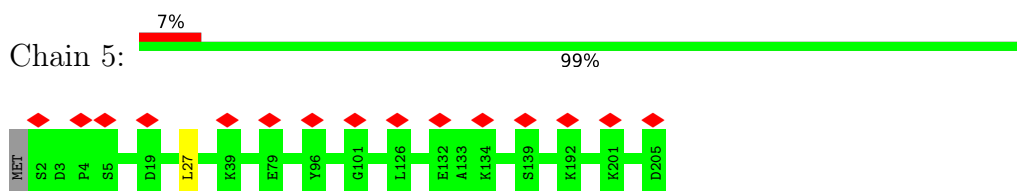

• Molecule 5: Proteasome subunit beta type-3

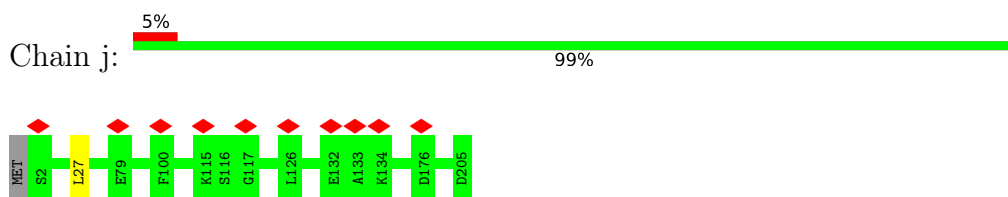

• Molecule 6: Proteasome subunit beta type-4

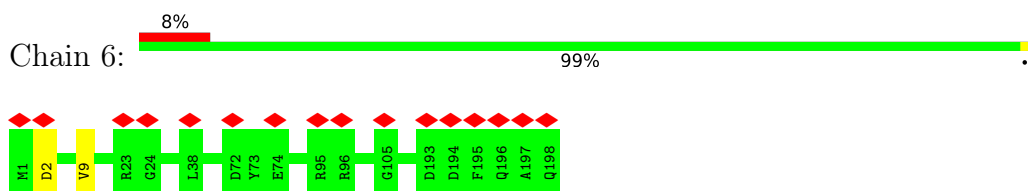

• Molecule 6: Proteasome subunit beta type-4



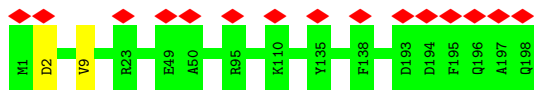

• Molecule 7: Proteasome subunit beta type-5

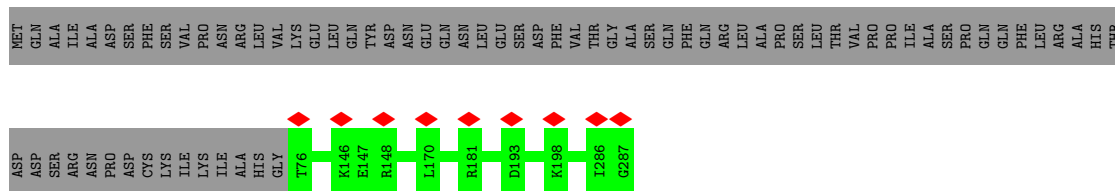
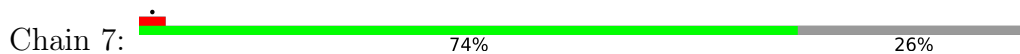

• Molecule 7: Proteasome subunit beta type-5

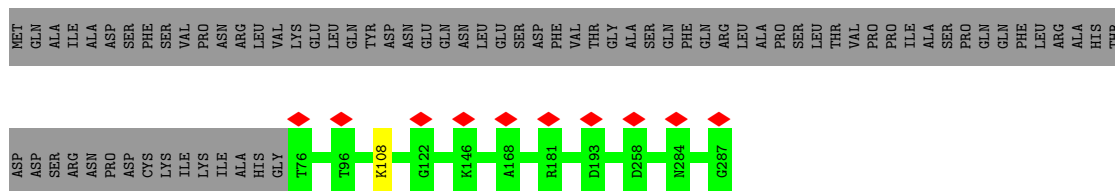

• Molecule 8: Proteasome subunit alpha type-1

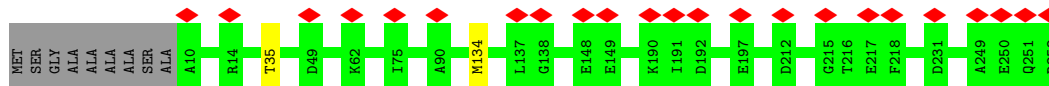

• Molecule 8: Proteasome subunit alpha type-1

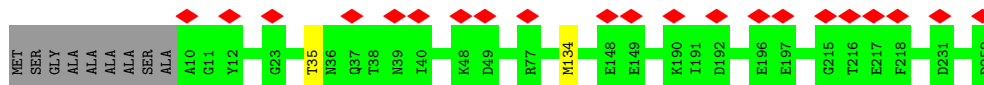

• Molecule 9: Proteasome subunit alpha type-2



• Molecule 9: Proteasome subunit alpha type-2



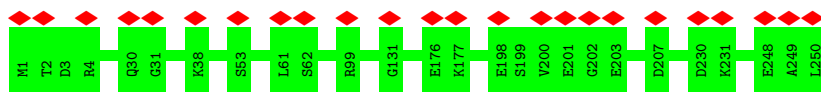

- Molecule 10: Proteasome subunit alpha type-3

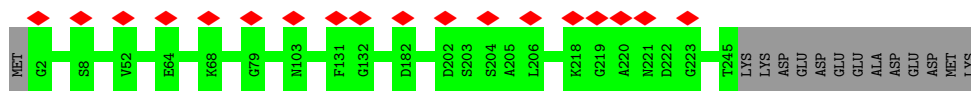
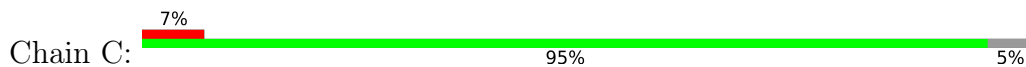

- Molecule 10: Proteasome subunit alpha type-3

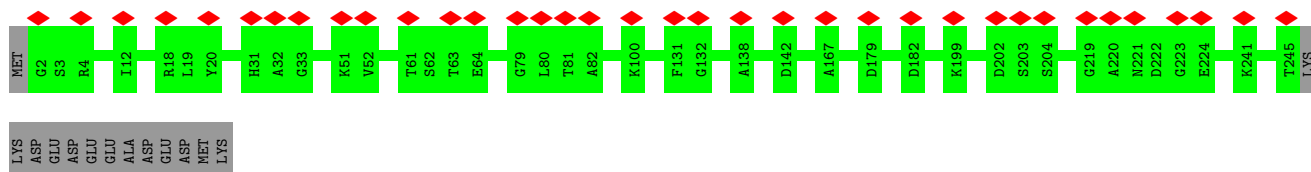
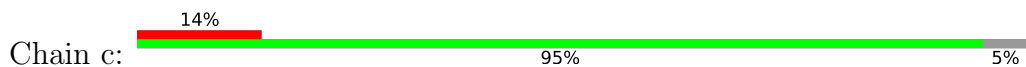

- Molecule 11: Proteasome subunit alpha type-4

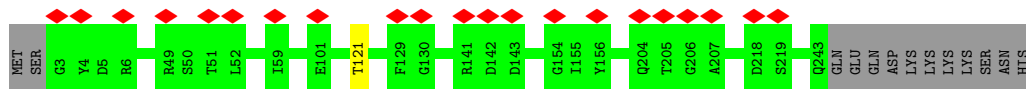

- Molecule 11: Proteasome subunit alpha type-4

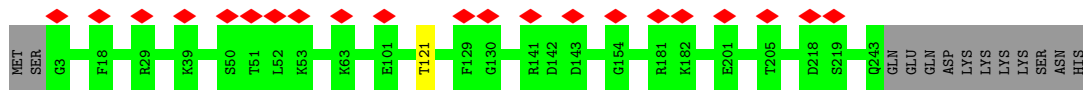

- Molecule 12: Proteasome subunit alpha type-5

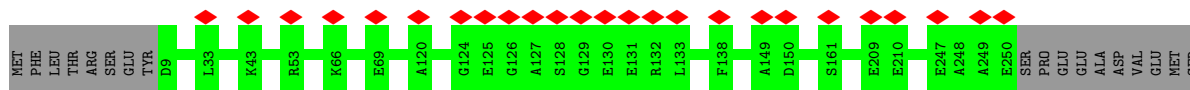

- Molecule 12: Proteasome subunit alpha type-5

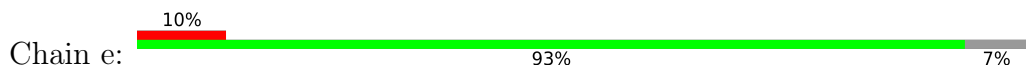

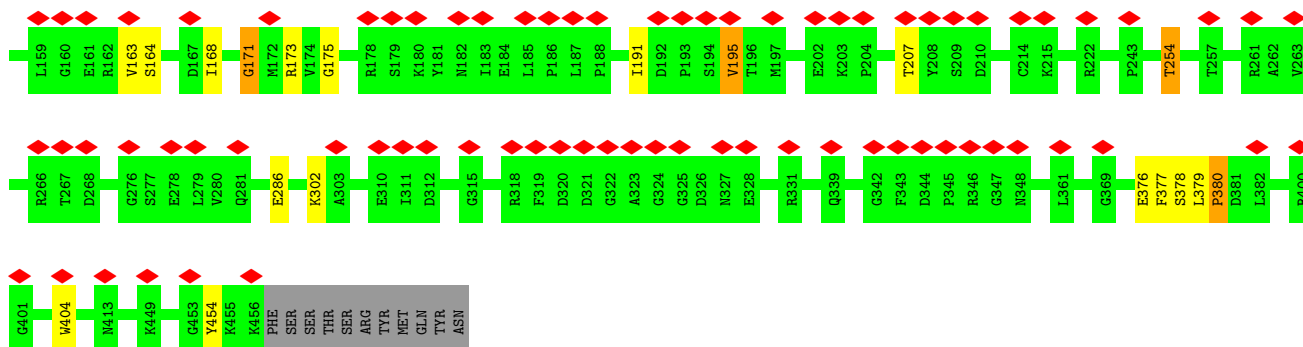

• Molecule 16: 26S protease regulatory subunit 4 homolog

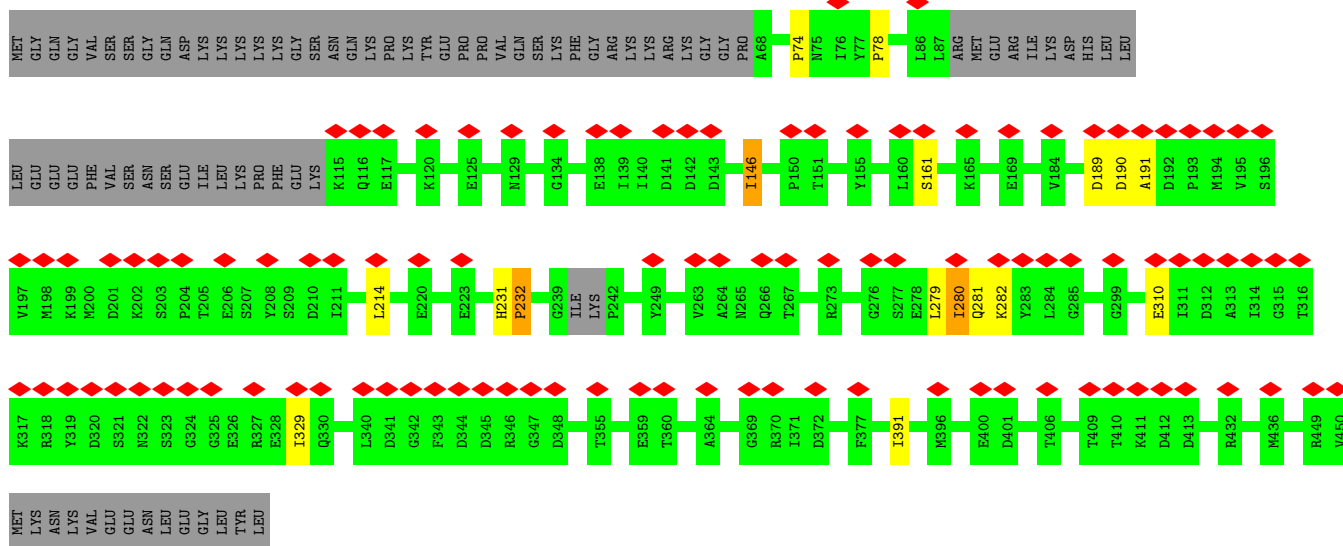
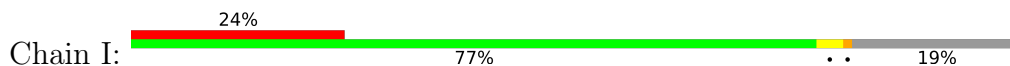

• Molecule 17: 26S protease regulatory subunit 8 homolog

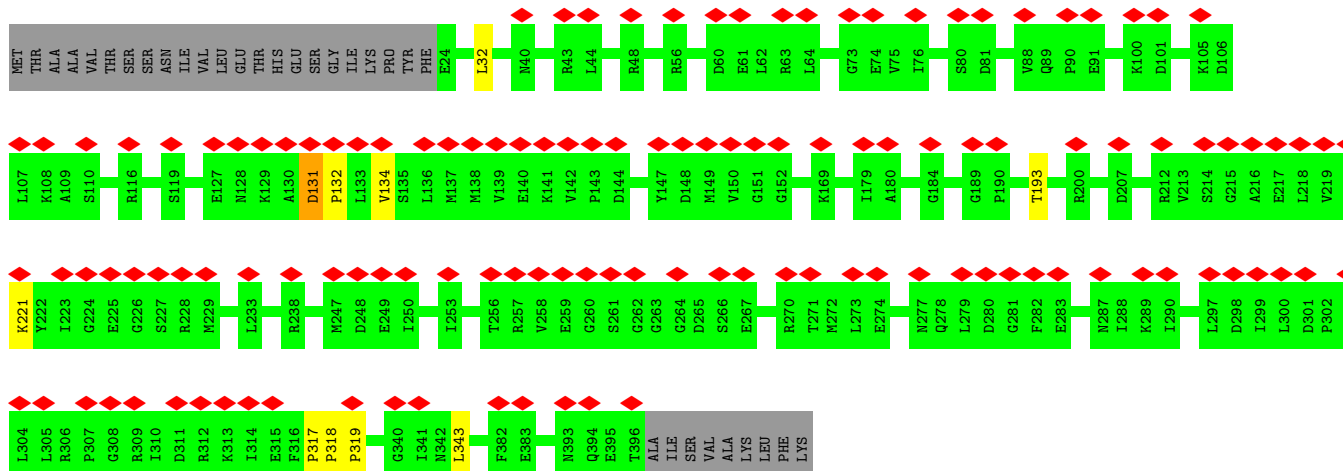

• Molecule 18: 26S protease regulatory subunit 6B homolog

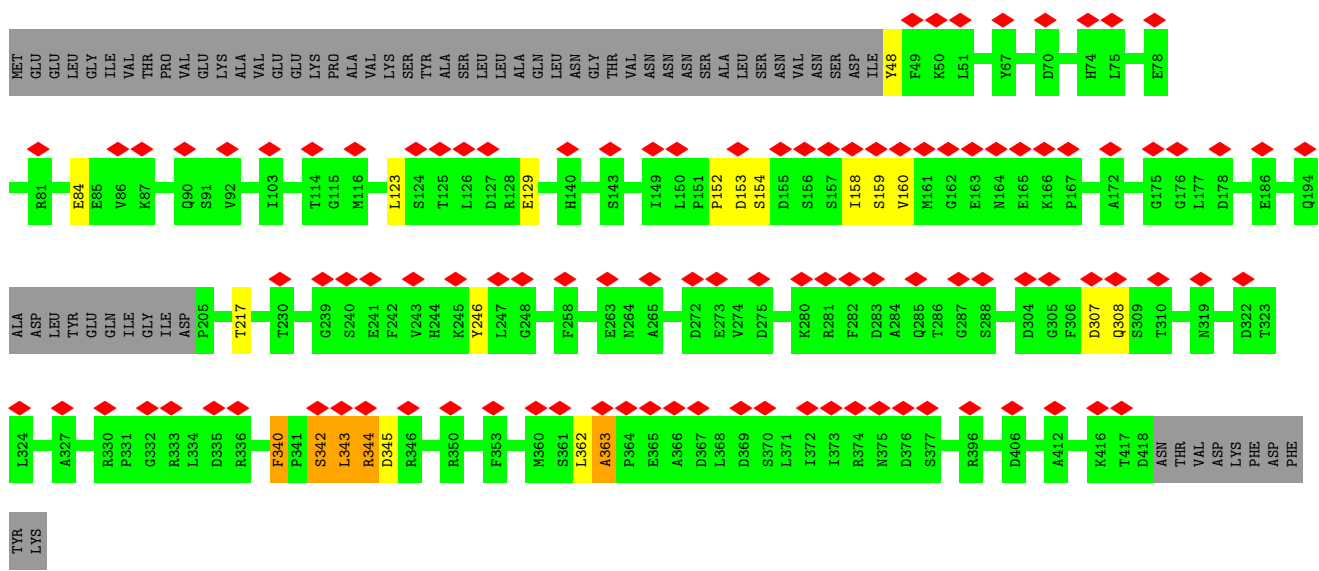
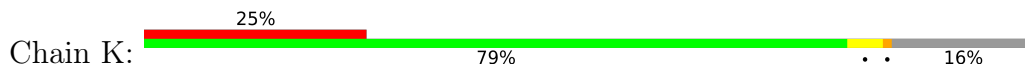

• Molecule 19: 26S protease subunit RPT4

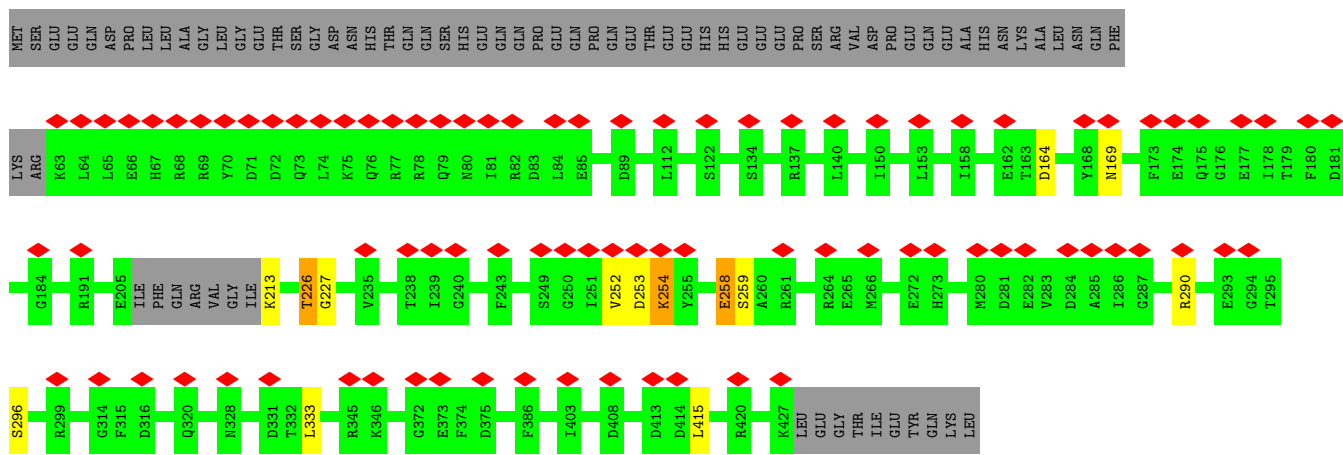

• Molecule 20: 26S protease regulatory subunit 6A

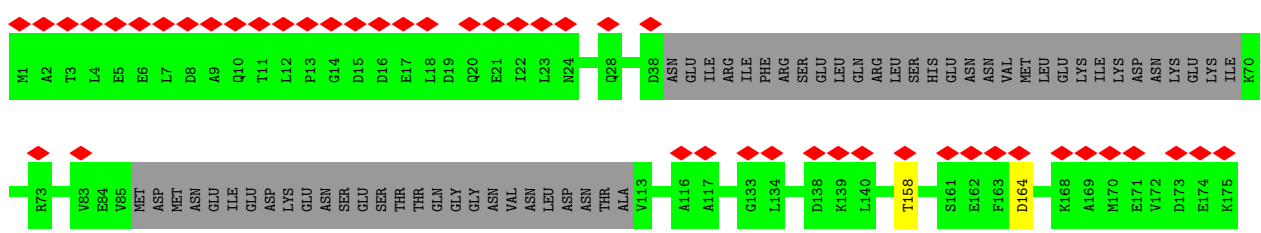
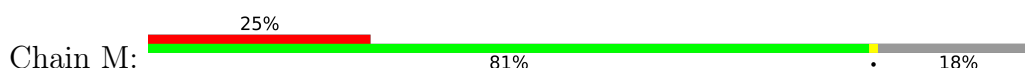

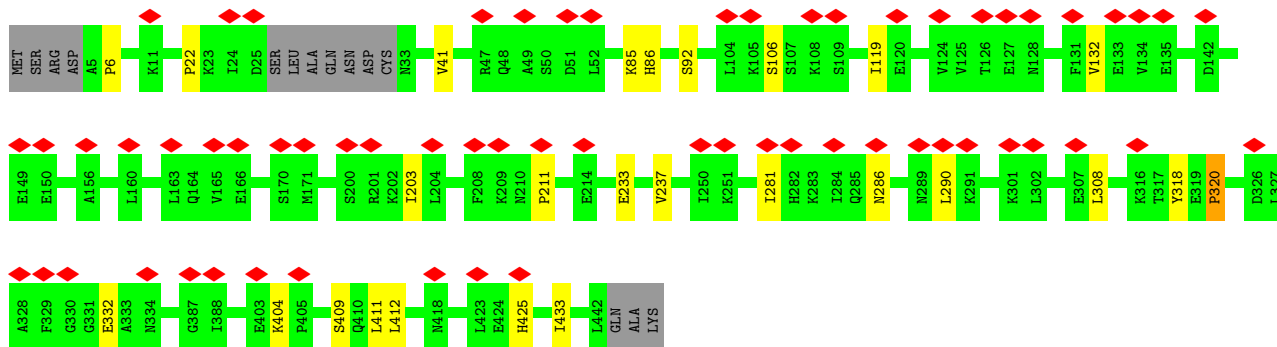

• Molecule 24: 26S proteasome regulatory subunit RPN6

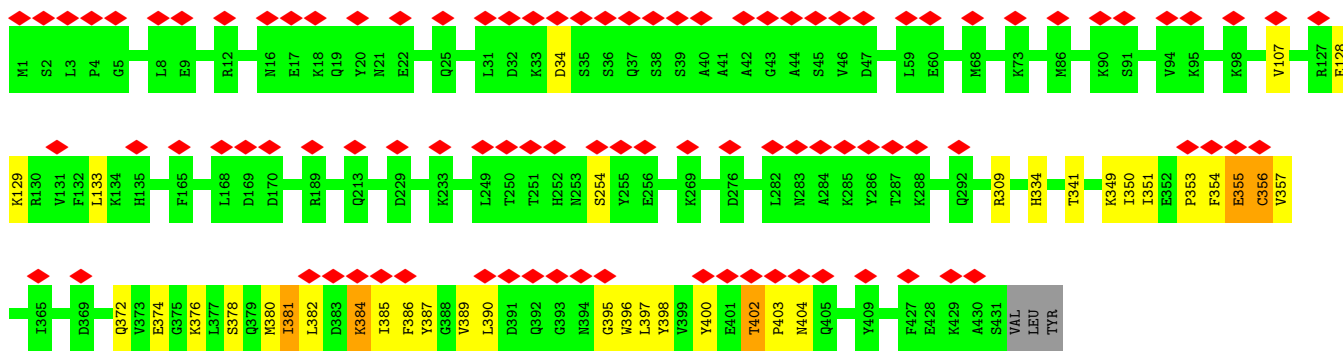
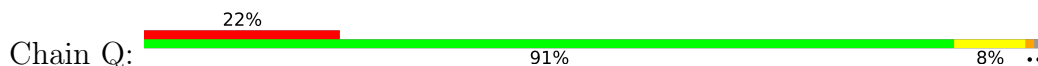

• Molecule 25: 26S proteasome regulatory subunit RPN7

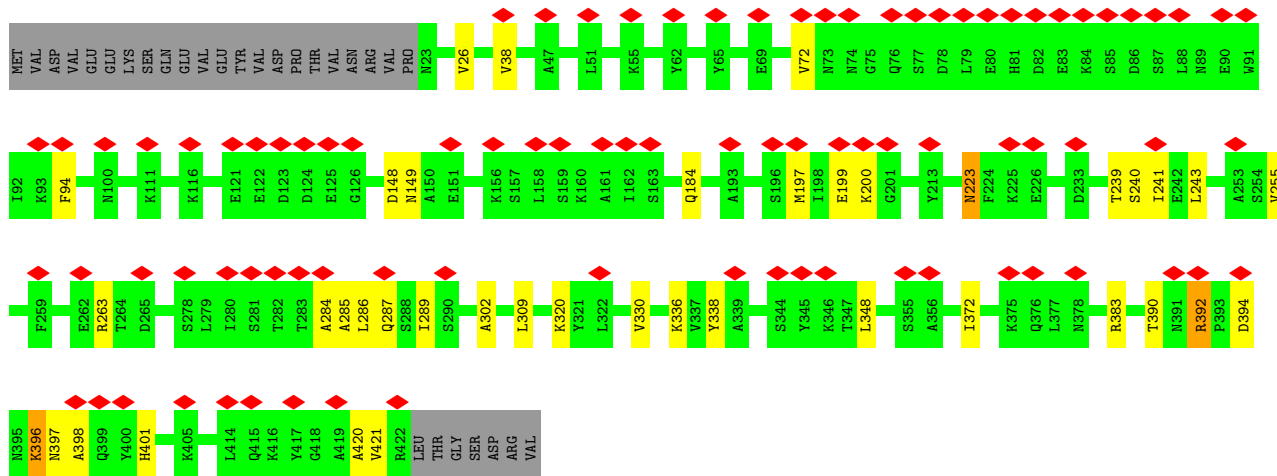
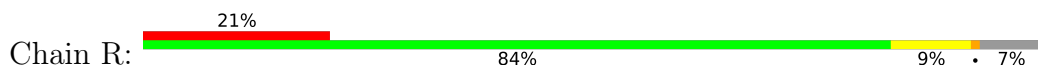

• Molecule 26: 26S proteasome regulatory subunit RPN3

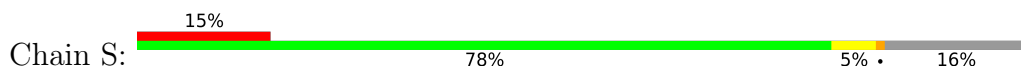

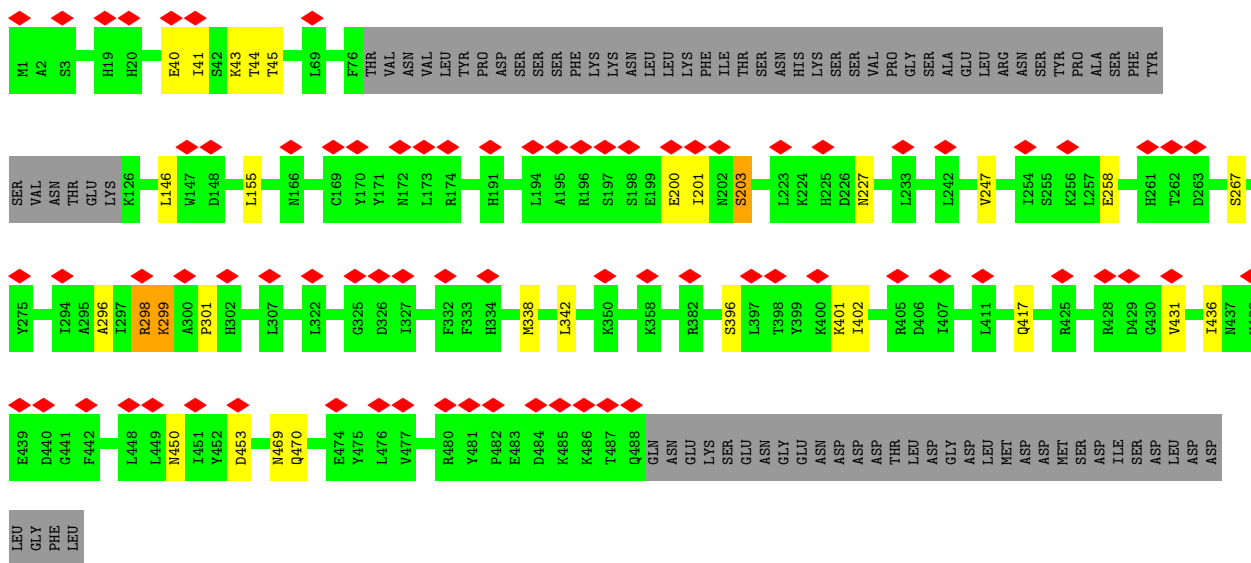

• Molecule 27: 26S proteasome regulatory subunit RPN12

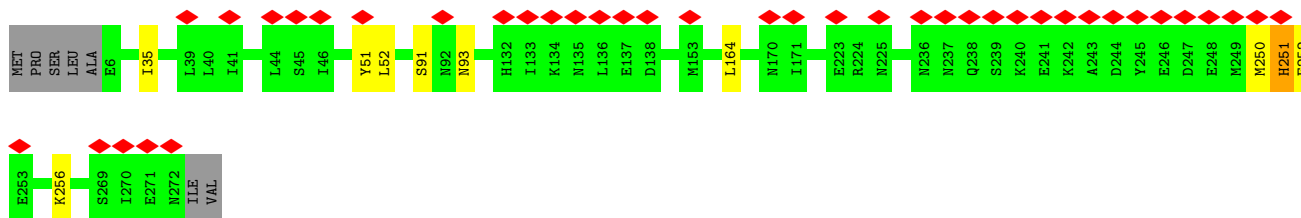

• Molecule 28: 26S proteasome regulatory subunit RPN8

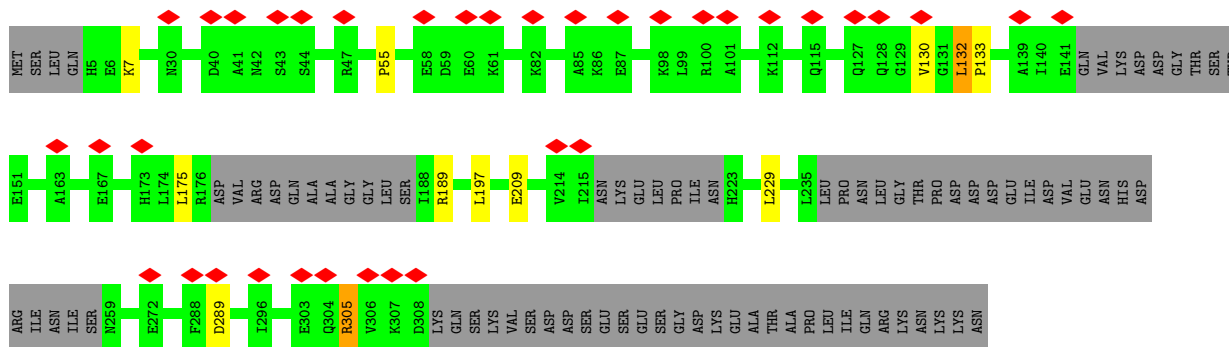

• Molecule 29: Ubiquitin carboxyl-terminal hydrolase RPN11

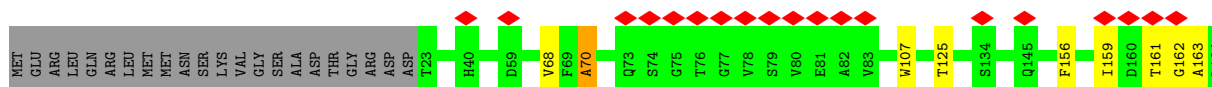
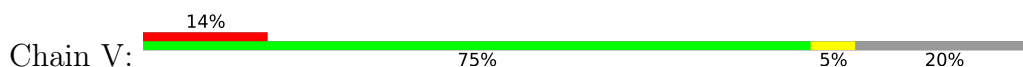

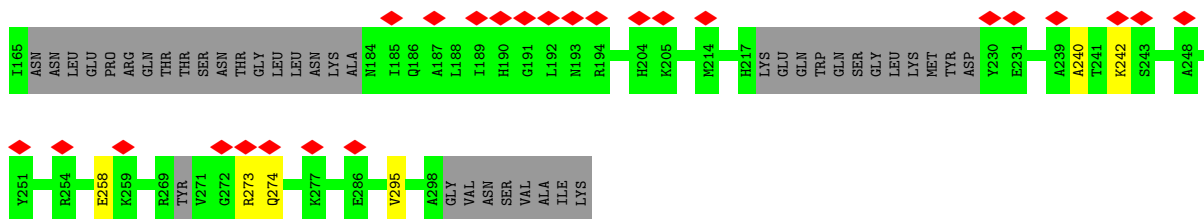

• Molecule 30: 26S proteasome regulatory subunit RPN10

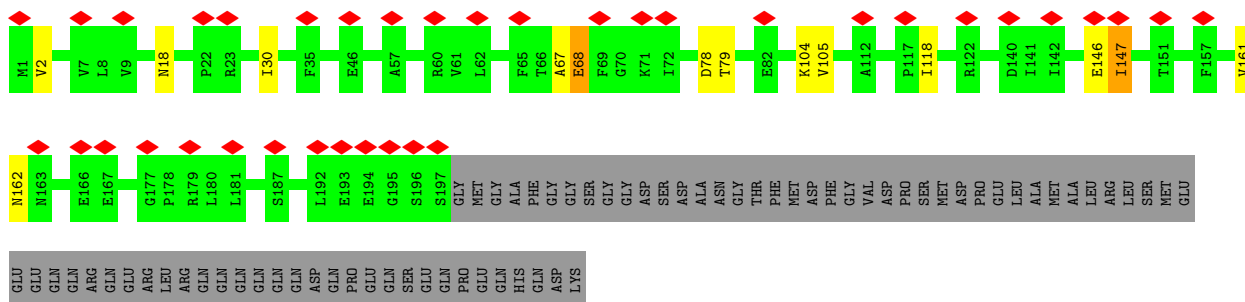

• Molecule 31: 26S proteasome regulatory subunit RPN13

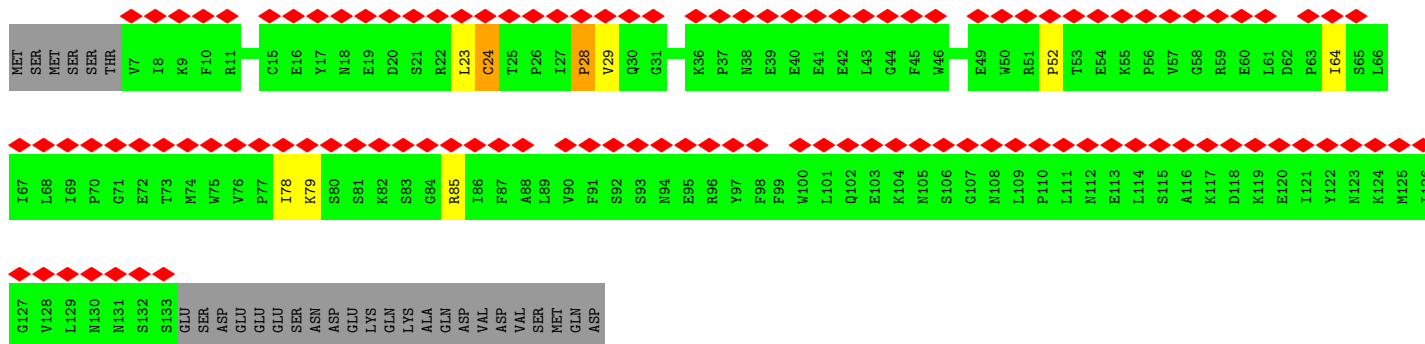
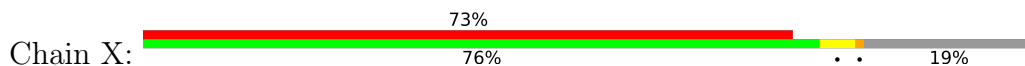

• Molecule 32: 26S proteasome complex subunit SEM1

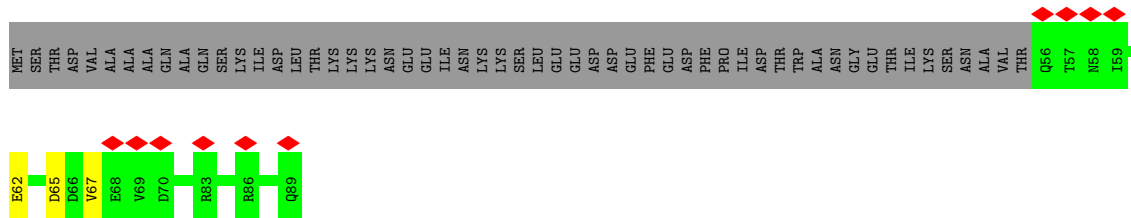

• Molecule 33: 26S proteasome regulatory subunit RPN1



4 Experimental information

Property	Value	Source
EM reconstruction method	SINGLE PARTICLE	Depositor
Imposed symmetry	POINT, C1	Depositor
Number of particles used	25151	Depositor
Resolution determination method	FSC 0.143 CUT-OFF	Depositor
CTF correction method	Each micrographs	Depositor
Microscope	FEI TITAN KRIOS	Depositor
Voltage (kV)	300	Depositor
Electron dose ($e^-/\text{\AA}^2$)	Not provided	
Minimum defocus (nm)	1.5	Depositor
Maximum defocus (nm)	2.5	Depositor
Magnification	75000	Depositor
Image detector	FEI FALCON II (4k x 4k)	Depositor
Maximum map value	0.292	Depositor
Minimum map value	-0.121	Depositor
Average map value	0.001	Depositor
Map value standard deviation	0.015	Depositor
Recommended contour level	0.095	Depositor
Map size (\AA)	537.6, 537.6, 537.6	wwPDB
Map dimensions	256, 256, 256	wwPDB
Map angles ($^\circ$)	90.0, 90.0, 90.0	wwPDB
Pixel spacing (\AA)	2.1, 2.1, 2.1	Depositor

5 Model quality

5.1 Standard geometry

The Z score for a bond length (or angle) is the number of standard deviations the observed value is removed from the expected value. A bond length (or angle) with $|Z| > 5$ is considered an outlier worth inspection. RMSZ is the root-mean-square of all Z scores of the bond lengths (or angles).

Mol	Chain	Bond lengths		Bond angles	
		RMSZ	# Z >5	RMSZ	# Z >5
1	1	0.55	0/1795	0.60	0/2420
1	8	0.55	0/1795	0.60	0/2420
2	2	0.55	0/1855	0.61	0/2514
2	9	0.55	0/1855	0.61	0/2514
3	3	0.59	0/1602	0.59	0/2166
3	h	0.59	0/1603	0.59	0/2168
4	4	0.54	0/1715	0.61	0/2326
4	i	0.54	0/1715	0.61	0/2326
5	5	0.53	0/1611	0.61	1/2174 (0.0%)
5	j	0.53	0/1608	0.61	1/2170 (0.0%)
6	6	0.53	0/1613	0.60	0/2173
6	k	0.53	0/1613	0.60	0/2173
7	7	0.55	0/1681	0.60	0/2274
7	l	0.55	0/1681	0.60	0/2274
8	A	0.56	0/1959	0.61	1/2652 (0.0%)
8	a	0.56	0/1959	0.61	1/2652 (0.0%)
9	B	0.53	0/1952	0.59	0/2642
9	b	0.53	0/1952	0.59	0/2642
10	C	0.54	0/1934	0.60	0/2618
10	c	0.54	0/1934	0.60	0/2618
11	D	0.50	0/1919	0.58	0/2598
11	d	0.50	0/1919	0.58	0/2598
12	E	0.48	0/1886	0.59	0/2541
12	e	0.48	0/1886	0.59	0/2541
13	F	0.49	0/1823	0.58	0/2463
13	f	0.49	0/1823	0.58	0/2463
14	G	0.54	1/1936 (0.1%)	0.58	0/2614
14	g	0.55	1/1936 (0.1%)	0.59	1/2614 (0.0%)
15	H	0.53	1/2915 (0.0%)	0.74	7/3927 (0.2%)
16	I	0.46	0/2681	0.73	4/3620 (0.1%)
17	J	0.48	0/2945	0.67	2/3952 (0.1%)
18	K	0.52	0/2872	0.75	3/3874 (0.1%)
19	L	0.50	0/2870	0.70	4/3858 (0.1%)
20	M	0.48	0/2785	0.69	1/3763 (0.0%)

Mol	Chain	Bond lengths		Bond angles	
		RMSZ	# Z >5	RMSZ	# Z >5
21	N	0.44	0/6679	0.62	2/9037 (0.0%)
22	O	0.50	1/2958 (0.0%)	0.78	5/4005 (0.1%)
23	P	0.53	0/3520	0.74	4/4752 (0.1%)
24	Q	0.48	0/3525	0.61	0/4745
25	R	0.59	1/3240 (0.0%)	0.95	8/4371 (0.2%)
26	S	0.46	0/3439	0.76	4/4657 (0.1%)
27	T	0.46	0/2244	0.65	1/3029 (0.0%)
28	U	0.48	0/2075	0.69	2/2795 (0.1%)
29	V	0.50	0/1939	0.77	2/2613 (0.1%)
30	W	0.41	0/1557	0.67	0/2111
31	X	0.41	0/1058	0.66	0/1432
32	Y	0.44	0/244	0.68	0/328
33	Z	0.41	0/5787	0.68	4/7857 (0.1%)
All	All	0.51	5/105893 (0.0%)	0.66	58/143074 (0.0%)

Chiral center outliers are detected by calculating the chiral volume of a chiral center and verifying if the center is modelled as a planar moiety or with the opposite hand. A planarity outlier is detected by checking planarity of atoms in a peptide group, atoms in a mainchain group or atoms of a sidechain that are expected to be planar.

Mol	Chain	#Chirality outliers	#Planarity outliers
15	H	0	11
16	I	0	4
17	J	0	1
18	K	0	7
19	L	0	5
20	M	0	4
21	N	0	6
22	O	0	17
23	P	0	11
24	Q	0	6
25	R	0	5
26	S	0	16
27	T	0	4
28	U	0	7
29	V	0	6
30	W	0	6
31	X	0	6
32	Y	0	2
33	Z	0	7
All	All	0	131

All (5) bond length outliers are listed below:

Mol	Chain	Res	Type	Atoms	Z	Observed(Å)	Ideal(Å)
25	R	330	VAL	C-N	15.59	1.69	1.34
15	H	380	PRO	N-CD	5.39	1.55	1.47
14	G	131	PRO	N-CD	5.26	1.55	1.47
14	g	131	PRO	N-CD	5.26	1.55	1.47
22	O	34	GLU	C-N	5.07	1.45	1.34

All (58) bond angle outliers are listed below:

Mol	Chain	Res	Type	Atoms	Z	Observed(°)	Ideal(°)
25	R	330	VAL	O-C-N	27.20	166.22	122.70
25	R	330	VAL	CA-C-N	-21.39	70.15	117.20
25	R	330	VAL	C-N-CA	-19.67	72.53	121.70
25	R	338	TYR	CB-CA-C	11.26	132.92	110.40
21	N	152	LEU	CA-CB-CG	9.73	137.68	115.30
33	Z	140	LEU	CA-CB-CG	-8.69	95.31	115.30
26	S	299	LYS	CB-CG-CD	-7.99	90.83	111.60
25	R	309	LEU	CA-CB-CG	-7.92	97.07	115.30
26	S	155	LEU	CA-CB-CG	-7.83	97.29	115.30
26	S	299	LYS	CA-CB-CG	7.10	129.02	113.40
33	Z	284	LEU	CA-CB-CG	-6.78	99.70	115.30
27	T	164	LEU	CA-CB-CG	-6.74	99.80	115.30
23	P	290	LEU	CA-CB-CG	6.64	130.57	115.30
28	U	175	LEU	CA-CB-CG	6.33	129.85	115.30
17	J	32	LEU	CA-CB-CG	-6.32	100.77	115.30
19	L	415	LEU	CB-CG-CD2	-6.30	100.29	111.00
25	R	243	LEU	CA-CB-CG	-6.21	101.01	115.30
18	K	340	PHE	C-N-CD	6.17	141.36	128.40
23	P	22	PRO	N-CA-CB	6.06	110.57	103.30
25	R	372	ILE	C-N-CD	6.05	141.11	128.40
15	H	95	HIS	C-N-CD	6.05	141.10	128.40
25	R	392	ARG	C-N-CD	6.04	141.08	128.40
18	K	363	ALA	C-N-CD	6.04	141.08	128.40
20	M	158	THR	C-N-CA	-5.98	106.75	121.70
18	K	152	PRO	C-N-CA	5.97	136.63	121.70
22	O	193	LEU	CA-CB-CG	5.95	128.97	115.30
15	H	28	PRO	N-CA-CB	5.82	110.29	103.30
29	V	70	ALA	C-N-CA	-5.75	107.32	121.70
22	O	225	ASP	CB-CG-OD1	5.72	123.45	118.30
23	P	6	PRO	N-CA-CB	5.69	110.13	103.30
19	L	333	LEU	CA-CB-CG	-5.67	102.27	115.30
14	g	130	ARG	C-N-CD	5.58	140.12	128.40
8	A	134	MET	C-N-CA	-5.53	107.88	121.70
22	O	41	LEU	CB-CG-CD1	-5.51	101.62	111.00

Continued on next page...

Continued from previous page...

Mol	Chain	Res	Type	Atoms	Z	Observed(°)	Ideal(°)
22	O	226	LYS	N-CA-C	-5.51	96.12	111.00
33	Z	827	LEU	CB-CG-CD2	-5.51	101.63	111.00
15	H	380	PRO	N-CA-C	5.51	126.42	112.10
16	I	189	ASP	CB-CG-OD1	5.51	123.26	118.30
15	H	44	PRO	N-CA-CB	5.50	109.90	103.30
8	a	134	MET	C-N-CA	-5.50	107.96	121.70
16	I	74	PRO	N-CA-CB	5.49	109.89	103.30
16	I	78	PRO	N-CA-CB	5.39	109.76	103.30
15	H	380	PRO	CA-N-CD	-5.36	104.00	111.50
5	j	27	LEU	CA-CB-CG	-5.29	103.14	115.30
5	5	27	LEU	CA-CB-CG	-5.28	103.17	115.30
16	I	232	PRO	N-CA-CB	5.22	109.56	103.30
19	L	164	ASP	CB-CG-OD1	5.21	122.99	118.30
23	P	412	LEU	CA-CB-CG	5.20	127.27	115.30
21	N	177	ASP	CB-CG-OD2	5.14	122.93	118.30
19	L	227	GLY	N-CA-C	-5.11	100.33	113.10
17	J	343	LEU	CA-CB-CG	-5.09	103.58	115.30
15	H	404	TRP	CA-CB-CG	-5.07	104.07	113.70
26	S	402	ILE	N-CA-C	-5.06	97.34	111.00
33	Z	269	TYR	CA-CB-CG	5.06	123.01	113.40
28	U	229	LEU	CB-CG-CD2	5.05	119.58	111.00
29	V	107	TRP	CA-CB-CG	-5.04	104.13	113.70
22	O	240	GLU	N-CA-C	5.01	124.54	111.00
15	H	379	LEU	C-N-CD	5.00	138.91	128.40

There are no chirality outliers.

All (131) planarity outliers are listed below:

Mol	Chain	Res	Type	Group
15	H	102	CYS	Peptide
15	H	164	SER	Peptide
15	H	171	GLY	Peptide
15	H	173	ARG	Peptide
15	H	175	GLY	Peptide
15	H	191	ILE	Peptide
15	H	195	VAL	Peptide
15	H	207	THR	Peptide
15	H	254	THR	Peptide
15	H	302	LYS	Peptide
15	H	376	GLU	Peptide
16	I	146	ILE	Peptide
16	I	161	SER	Peptide

Continued on next page...

Continued from previous page...

Mol	Chain	Res	Type	Group
16	I	190	ASP	Peptide
16	I	214	LEU	Peptide
17	J	193	THR	Peptide
18	K	123	LEU	Peptide
18	K	153	ASP	Peptide
18	K	154	SER	Peptide
18	K	217	THR	Peptide
18	K	307	ASP	Peptide
18	K	308	GLN	Peptide
18	K	48	TYR	Peptide
19	L	169	ASN	Peptide
19	L	213	LYS	Peptide
19	L	226	THR	Peptide
19	L	290	ARG	Peptide
19	L	296	SER	Peptide
20	M	164	ASP	Peptide
20	M	291	PHE	Peptide
20	M	372	ASP	Peptide
20	M	374	ILE	Peptide
21	N	217	MET	Peptide
21	N	322	ASP	Peptide
21	N	352	ASN	Peptide
21	N	693	GLY	Peptide
21	N	765	ASP	Peptide
21	N	778	LYS	Peptide
22	O	164	PRO	Peptide
22	O	223	LEU	Peptide
22	O	226	LYS	Peptide
22	O	240	GLU	Peptide
22	O	244	ASN	Peptide
22	O	301	PHE	Peptide
22	O	302	VAL	Peptide
22	O	306	ARG	Peptide
22	O	308	LEU	Peptide
22	O	309	SER	Peptide
22	O	310	PHE	Peptide
22	O	34	GLU	Peptide
22	O	383	LYS	Peptide
22	O	41	LEU	Peptide
22	O	51	ASP	Peptide
22	O	52	ALA	Peptide
22	O	53	LYS	Peptide

Continued on next page...

Continued from previous page...

Mol	Chain	Res	Type	Group
23	P	106	SER	Peptide
23	P	203	ILE	Peptide
23	P	211	PRO	Peptide
23	P	233	GLU	Peptide
23	P	286	ASN	Peptide
23	P	308	LEU	Peptide
23	P	318	TYR	Peptide
23	P	320	PRO	Peptide
23	P	332	GLU	Peptide
23	P	409	SER	Peptide
23	P	86	HIS	Peptide
24	Q	107	VAL	Peptide
24	Q	128	GLU	Peptide
24	Q	129	LYS	Peptide
24	Q	133	LEU	Peptide
24	Q	254	SER	Peptide
24	Q	34	ASP	Peptide
25	R	184	GLN	Peptide
25	R	223	ASN	Peptide
25	R	240	SER	Peptide
25	R	302	ALA	Peptide
25	R	94	PHE	Peptide
26	S	146	LEU	Peptide
26	S	203	SER	Peptide
26	S	227	ASN	Peptide
26	S	247	VAL	Peptide
26	S	258	GLU	Peptide
26	S	296	ALA	Peptide
26	S	298	ARG	Peptide
26	S	338	MET	Peptide
26	S	342	LEU	Peptide
26	S	396	SER	Peptide
26	S	401	LYS	Peptide
26	S	417	GLN	Peptide
26	S	436	ILE	Peptide
26	S	44	THR	Peptide
26	S	450	ASN	Peptide
26	S	469	ASN	Peptide
27	T	51	TYR	Peptide
27	T	52	LEU	Peptide
27	T	91	SER	Peptide
27	T	93	ASN	Peptide

Continued on next page...

Continued from previous page...

Mol	Chain	Res	Type	Group
28	U	132	LEU	Peptide
28	U	189	ARG	Peptide
28	U	197	LEU	Peptide
28	U	289	ASP	Peptide
28	U	305	ARG	Peptide
28	U	55	PRO	Peptide
28	U	7	LYS	Peptide
29	V	156	PHE	Peptide
29	V	161	THR	Peptide
29	V	162	GLY	Peptide
29	V	273	ARG	Peptide
29	V	295	VAL	Peptide
29	V	70	ALA	Peptide
30	W	104	LYS	Peptide
30	W	146	GLU	Peptide
30	W	147	ILE	Peptide
30	W	161	VAL	Peptide
30	W	162	ASN	Peptide
30	W	2	VAL	Peptide
31	X	23	LEU	Peptide
31	X	24	CYS	Peptide
31	X	28	PRO	Peptide
31	X	52	PRO	Peptide
31	X	79	LYS	Peptide
31	X	85	ARG	Peptide
32	Y	62	GLU	Peptide
32	Y	65	ASP	Peptide
33	Z	132	HIS	Peptide
33	Z	142	ASP	Peptide
33	Z	265	LEU	Peptide
33	Z	325	GLY	Peptide
33	Z	839	SER	Peptide
33	Z	891	PRO	Peptide
33	Z	920	GLY	Peptide

5.2 Too-close contacts [\(i\)](#)

Due to software issues we are unable to calculate clashes - this section is therefore empty.

5.3 Torsion angles

5.3.1 Protein backbone

In the following table, the Percentiles column shows the percent Ramachandran outliers of the chain as a percentile score with respect to all PDB entries followed by that with respect to all EM entries.

The Analysed column shows the number of residues for which the backbone conformation was analysed, and the total number of residues.

Mol	Chain	Analysed	Favoured	Allowed	Outliers	Percentiles	
1	1	220/241 (91%)	207 (94%)	13 (6%)	0	100	100
1	8	220/241 (91%)	207 (94%)	13 (6%)	0	100	100
2	2	231/266 (87%)	222 (96%)	7 (3%)	2 (1%)	17	56
2	9	231/266 (87%)	222 (96%)	7 (3%)	2 (1%)	17	56
3	3	203/215 (94%)	189 (93%)	12 (6%)	2 (1%)	15	54
3	h	203/215 (94%)	188 (93%)	13 (6%)	2 (1%)	15	54
4	4	220/261 (84%)	211 (96%)	9 (4%)	0	100	100
4	i	220/261 (84%)	211 (96%)	9 (4%)	0	100	100
5	5	202/205 (98%)	194 (96%)	8 (4%)	0	100	100
5	j	202/205 (98%)	194 (96%)	8 (4%)	0	100	100
6	6	196/198 (99%)	186 (95%)	8 (4%)	2 (1%)	15	54
6	k	196/198 (99%)	186 (95%)	8 (4%)	2 (1%)	15	54
7	7	210/287 (73%)	203 (97%)	7 (3%)	0	100	100
7	l	210/287 (73%)	203 (97%)	7 (3%)	0	100	100
8	A	241/252 (96%)	227 (94%)	13 (5%)	1 (0%)	34	72
8	a	241/252 (96%)	227 (94%)	13 (5%)	1 (0%)	34	72
9	B	248/250 (99%)	235 (95%)	13 (5%)	0	100	100
9	b	248/250 (99%)	235 (95%)	13 (5%)	0	100	100
10	C	242/258 (94%)	232 (96%)	10 (4%)	0	100	100
10	c	242/258 (94%)	232 (96%)	10 (4%)	0	100	100
11	D	239/254 (94%)	224 (94%)	14 (6%)	1 (0%)	34	72
11	d	239/254 (94%)	224 (94%)	14 (6%)	1 (0%)	34	72
12	E	240/260 (92%)	228 (95%)	12 (5%)	0	100	100
12	e	240/260 (92%)	228 (95%)	12 (5%)	0	100	100
13	F	231/234 (99%)	221 (96%)	10 (4%)	0	100	100

Continued on next page...

Continued from previous page...

Mol	Chain	Analysed	Favoured	Allowed	Outliers	Percentiles	
13	f	231/234 (99%)	221 (96%)	10 (4%)	0	100	100
14	G	242/288 (84%)	224 (93%)	14 (6%)	4 (2%)	9	43
14	g	242/288 (84%)	226 (93%)	15 (6%)	1 (0%)	34	72
15	H	373/467 (80%)	301 (81%)	60 (16%)	12 (3%)	4	30
16	I	348/437 (80%)	297 (85%)	42 (12%)	9 (3%)	5	34
17	J	371/405 (92%)	325 (88%)	39 (10%)	7 (2%)	8	40
18	K	357/428 (83%)	300 (84%)	45 (13%)	12 (3%)	3	29
19	L	354/437 (81%)	291 (82%)	58 (16%)	5 (1%)	11	47
20	M	349/434 (80%)	310 (89%)	38 (11%)	1 (0%)	41	76
21	N	846/945 (90%)	665 (79%)	173 (20%)	8 (1%)	17	56
22	O	372/393 (95%)	263 (71%)	83 (22%)	26 (7%)	1	16
23	P	427/445 (96%)	315 (74%)	100 (23%)	12 (3%)	5	33
24	Q	429/434 (99%)	325 (76%)	92 (21%)	12 (3%)	5	33
25	R	398/429 (93%)	280 (70%)	95 (24%)	23 (6%)	1	20
26	S	435/523 (83%)	332 (76%)	89 (20%)	14 (3%)	4	30
27	T	265/274 (97%)	202 (76%)	60 (23%)	3 (1%)	14	52
28	U	244/338 (72%)	202 (83%)	37 (15%)	5 (2%)	7	40
29	V	237/306 (78%)	185 (78%)	44 (19%)	8 (3%)	3	29
30	W	195/268 (73%)	154 (79%)	33 (17%)	8 (4%)	3	25
31	X	125/156 (80%)	96 (77%)	24 (19%)	5 (4%)	3	26
32	Y	32/89 (36%)	21 (66%)	10 (31%)	1 (3%)	4	31
33	Z	738/993 (74%)	589 (80%)	119 (16%)	30 (4%)	3	25
All	All	13225/15139 (87%)	11460 (87%)	1543 (12%)	222 (2%)	13	43

All (222) Ramachandran outliers are listed below:

Mol	Chain	Res	Type
14	G	130	ARG
14	G	131	PRO
15	H	377	PHE
15	H	378	SER
15	H	380	PRO
16	I	231	HIS
16	I	282	LYS

Continued on next page...

Continued from previous page...

Mol	Chain	Res	Type
17	J	317	PRO
17	J	319	PRO
18	K	246	TYR
18	K	340	PHE
18	K	342	SER
18	K	343	LEU
18	K	345	ASP
18	K	363	ALA
19	L	252	VAL
19	L	253	ASP
19	L	254	LYS
21	N	176	GLN
22	O	12	SER
22	O	18	ALA
22	O	24	PRO
22	O	142	ASP
22	O	143	LEU
22	O	302	VAL
22	O	358	ILE
24	Q	357	VAL
24	Q	402	THR
25	R	149	ASN
25	R	239	THR
25	R	284	ALA
26	S	201	ILE
26	S	203	SER
26	S	431	VAL
26	S	453	ASP
29	V	242	LYS
30	W	67	ALA
30	W	68	GLU
30	W	105	VAL
31	X	64	ILE
31	X	78	ILE
33	Z	219	ASP
33	Z	244	ARG
33	Z	273	LEU
33	Z	274	SER
33	Z	288	LEU
33	Z	289	GLY
33	Z	467	VAL
33	Z	591	ILE

Continued on next page...

Continued from previous page...

Mol	Chain	Res	Type
33	Z	595	MET
3	3	19	GLY
3	3	20	THR
6	6	2	ASP
14	G	129	VAL
15	H	96	PRO
15	H	98	GLN
16	I	280	ILE
16	I	281	GLN
18	K	158	ILE
18	K	160	VAL
18	K	344	ARG
21	N	761	ILE
22	O	11	LEU
22	O	65	PHE
24	Q	355	GLU
24	Q	381	ILE
25	R	396	LYS
25	R	397	ASN
25	R	401	HIS
26	S	200	GLU
27	T	250	MET
29	V	159	ILE
31	X	24	CYS
33	Z	243	GLN
33	Z	272	TYR
33	Z	592	GLU
33	Z	749	GLY
33	Z	787	ASP
6	k	2	ASP
15	H	168	ILE
15	H	195	VAL
16	I	191	ALA
19	L	258	GLU
21	N	874	ILE
22	O	16	MET
22	O	140	LYS
22	O	141	ASN
22	O	303	LYS
23	P	85	LYS
23	P	411	LEU
24	Q	356	CYS

Continued on next page...

Continued from previous page...

Mol	Chain	Res	Type
24	Q	384	LYS
24	Q	387	TYR
24	Q	389	VAL
24	Q	403	PRO
25	R	287	GLN
25	R	289	ILE
26	S	43	LYS
26	S	298	ARG
26	S	299	LYS
28	U	305	ARG
29	V	240	ALA
33	Z	215	ASN
33	Z	359	LYS
33	Z	594	PRO
3	h	21	SER
18	K	129	GLU
18	K	159	SER
21	N	741	TYR
21	N	903	VAL
21	N	913	PRO
22	O	83	LEU
22	O	226	LYS
22	O	352	TRP
22	O	353	VAL
23	P	92	SER
23	P	132	VAL
23	P	425	HIS
24	Q	395	GLY
25	R	223	ASN
25	R	241	ILE
25	R	398	ALA
25	R	420	ALA
25	R	421	VAL
26	S	40	GLU
26	S	45	THR
26	S	470	GLN
27	T	251	HIS
29	V	125	THR
29	V	163	ALA
30	W	78	ASP
30	W	79	THR
30	W	147	ILE

Continued on next page...

Continued from previous page...

Mol	Chain	Res	Type
31	X	29	VAL
32	Y	67	VAL
33	Z	757	SER
33	Z	802	ASP
3	h	18	LEU
2	2	42	THR
2	9	42	THR
8	A	35	THR
11	D	121	THR
16	I	310	GLU
16	I	329	ILE
17	J	221	LYS
18	K	84	GLU
20	M	300	GLU
22	O	13	THR
22	O	70	TYR
22	O	94	GLU
22	O	233	LEU
22	O	289	GLN
22	O	307	MET
22	O	357	ILE
24	Q	334	HIS
25	R	197	MET
25	R	285	ALA
25	R	286	LEU
25	R	320	LYS
25	R	348	LEU
25	R	394	ASP
26	S	267	SER
28	U	130	VAL
28	U	209	GLU
29	V	68	VAL
29	V	258	GLU
29	V	274	GLN
33	Z	217	GLU
33	Z	218	GLU
33	Z	364	ASN
33	Z	434	GLN
33	Z	483	THR
33	Z	577	GLN
8	a	35	THR
11	d	121	THR

Continued on next page...

Continued from previous page...

Mol	Chain	Res	Type
14	G	12	ASN
15	H	60	GLU
15	H	286	GLU
15	H	454	TYR
17	J	131	ASP
19	L	226	THR
23	P	41	VAL
23	P	119	ILE
24	Q	353	PRO
26	S	301	PRO
28	U	132	LEU
31	X	28	PRO
33	Z	524	ALA
33	Z	925	VAL
14	g	12	ASN
21	N	914	VAL
15	H	171	GLY
23	P	237	VAL
23	P	281	ILE
23	P	320	PRO
23	P	404	LYS
23	P	433	ILE
25	R	72	VAL
15	H	163	VAL
16	I	232	PRO
17	J	134	VAL
22	O	144	VAL
22	O	344	VAL
25	R	26	VAL
25	R	38	VAL
30	W	118	ILE
33	Z	286	VAL
16	I	391	ILE
17	J	132	PRO
17	J	318	PRO
21	N	904	VAL
25	R	255	VAL
27	T	35	ILE
30	W	30	ILE
33	Z	480	ASN
2	2	205	VAL
6	6	9	VAL

Continued on next page...

Continued from previous page...

Mol	Chain	Res	Type
2	9	205	VAL
26	S	41	ILE
28	U	133	PRO
33	Z	955	VAL
6	k	9	VAL

5.3.2 Protein sidechains [i](#)

In the following table, the Percentiles column shows the percent sidechain outliers of the chain as a percentile score with respect to all PDB entries followed by that with respect to all EM entries.

The Analysed column shows the number of residues for which the sidechain conformation was analysed, and the total number of residues.

Mol	Chain	Analysed	Rotameric	Outliers	Percentiles	
1	1	185/201 (92%)	185 (100%)	0	100	100
1	8	185/201 (92%)	185 (100%)	0	100	100
2	2	199/224 (89%)	199 (100%)	0	100	100
2	9	199/224 (89%)	199 (100%)	0	100	100
3	3	167/178 (94%)	167 (100%)	0	100	100
3	h	168/178 (94%)	168 (100%)	0	100	100
4	4	181/214 (85%)	181 (100%)	0	100	100
4	i	181/214 (85%)	181 (100%)	0	100	100
5	5	172/173 (99%)	172 (100%)	0	100	100
5	j	171/173 (99%)	171 (100%)	0	100	100
6	6	175/175 (100%)	175 (100%)	0	100	100
6	k	175/175 (100%)	175 (100%)	0	100	100
7	7	169/235 (72%)	169 (100%)	0	100	100
7	l	169/235 (72%)	168 (99%)	1 (1%)	86	92
8	A	207/210 (99%)	207 (100%)	0	100	100
8	a	207/210 (99%)	207 (100%)	0	100	100
9	B	209/209 (100%)	209 (100%)	0	100	100
9	b	209/209 (100%)	209 (100%)	0	100	100
10	C	203/216 (94%)	203 (100%)	0	100	100
10	c	203/216 (94%)	203 (100%)	0	100	100

Continued on next page...

Continued from previous page...

Mol	Chain	Analysed	Rotameric	Outliers	Percentiles	
11	D	213/226 (94%)	213 (100%)	0	100	100
11	d	213/226 (94%)	213 (100%)	0	100	100
12	E	198/215 (92%)	198 (100%)	0	100	100
12	e	198/215 (92%)	198 (100%)	0	100	100
13	F	192/193 (100%)	192 (100%)	0	100	100
13	f	192/193 (100%)	192 (100%)	0	100	100
14	G	201/239 (84%)	200 (100%)	1 (0%)	88	93
14	g	201/239 (84%)	201 (100%)	0	100	100
15	H	296/399 (74%)	292 (99%)	4 (1%)	67	81
16	I	282/385 (73%)	279 (99%)	3 (1%)	73	85
17	J	319/352 (91%)	318 (100%)	1 (0%)	92	95
18	K	313/374 (84%)	309 (99%)	4 (1%)	69	82
19	L	306/377 (81%)	303 (99%)	3 (1%)	76	86
20	M	303/375 (81%)	303 (100%)	0	100	100
21	N	714/797 (90%)	712 (100%)	2 (0%)	92	95
22	O	306/368 (83%)	300 (98%)	6 (2%)	55	73
23	P	384/415 (92%)	384 (100%)	0	100	100
24	Q	387/391 (99%)	362 (94%)	25 (6%)	17	44
25	R	342/379 (90%)	333 (97%)	9 (3%)	46	67
26	S	349/489 (71%)	349 (100%)	0	100	100
27	T	250/256 (98%)	247 (99%)	3 (1%)	71	84
28	U	232/308 (75%)	232 (100%)	0	100	100
29	V	211/268 (79%)	211 (100%)	0	100	100
30	W	171/230 (74%)	169 (99%)	2 (1%)	71	84
31	X	116/144 (81%)	116 (100%)	0	100	100
32	Y	18/81 (22%)	18 (100%)	0	100	100
33	Z	606/850 (71%)	588 (97%)	18 (3%)	41	63
All	All	11247/13054 (86%)	11165 (99%)	82 (1%)	84	90

All (82) residues with a non-rotameric sidechain are listed below:

Mol	Chain	Res	Type
14	G	129	VAL

Continued on next page...

Continued from previous page...

Mol	Chain	Res	Type
15	H	95	HIS
15	H	97	LEU
15	H	98	GLN
15	H	254	THR
16	I	146	ILE
16	I	279	LEU
16	I	280	ILE
17	J	131	ASP
18	K	342	SER
18	K	343	LEU
18	K	344	ARG
18	K	362	LEU
19	L	254	LYS
19	L	258	GLU
19	L	259	SER
21	N	174	LEU
21	N	176	GLN
22	O	97	LYS
22	O	130	ASP
22	O	140	LYS
22	O	142	ASP
22	O	356	ARG
22	O	357	ILE
24	Q	309	ARG
24	Q	341	THR
24	Q	349	LYS
24	Q	350	ILE
24	Q	351	ILE
24	Q	354	PHE
24	Q	355	GLU
24	Q	356	CYS
24	Q	372	GLN
24	Q	374	GLU
24	Q	376	LYS
24	Q	378	SER
24	Q	380	MET
24	Q	381	ILE
24	Q	382	LEU
24	Q	384	LYS
24	Q	385	ILE
24	Q	386	PHE
24	Q	390	LEU

Continued on next page...

Continued from previous page...

Mol	Chain	Res	Type
24	Q	396	TRP
24	Q	397	LEU
24	Q	398	TYR
24	Q	400	TYR
24	Q	402	THR
24	Q	404	ASN
25	R	148	ASP
25	R	199	GLU
25	R	200	LYS
25	R	263	ARG
25	R	336	LYS
25	R	383	ARG
25	R	390	THR
25	R	392	ARG
25	R	396	LYS
27	T	251	HIS
27	T	252	GLU
27	T	256	LYS
30	W	18	ASN
30	W	68	GLU
33	Z	214	HIS
33	Z	217	GLU
33	Z	273	LEU
33	Z	277	GLU
33	Z	291	GLU
33	Z	293	MET
33	Z	365	SER
33	Z	366	LYS
33	Z	367	SER
33	Z	583	ASP
33	Z	605	SER
33	Z	757	SER
33	Z	758	LEU
33	Z	759	ARG
33	Z	761	PHE
33	Z	790	MET
33	Z	959	HIS
33	Z	962	ARG
7	l	108	LYS

Sometimes sidechains can be flipped to improve hydrogen bonding and reduce clashes. All (238) such sidechains are listed below:

Mol	Chain	Res	Type
1	1	171	ASN
1	1	178	GLN
2	2	51	ASN
2	2	70	ASN
2	2	227	ASN
2	2	246	GLN
3	3	125	ASN
3	3	164	ASN
3	3	180	GLN
4	4	115	HIS
4	4	122	HIS
4	4	143	HIS
4	4	194	ASN
5	5	72	ASN
5	5	157	ASN
6	6	37	GLN
6	6	55	GLN
6	6	118	GLN
6	6	146	HIS
7	7	141	HIS
7	7	251	ASN
7	7	283	ASN
2	9	51	ASN
2	9	70	ASN
2	9	227	ASN
2	9	246	GLN
8	A	92	ASN
8	A	123	ASN
9	B	190	HIS
10	C	21	GLN
10	C	31	HIS
10	C	94	HIS
10	C	96	GLN
10	C	103	ASN
10	C	147	GLN
11	D	16	HIS
11	D	19	GLN
11	D	94	GLN
11	D	162	GLN
12	E	23	GLN
12	E	91	HIS
12	E	114	GLN
12	E	147	HIS

Continued on next page...

Continued from previous page...

Mol	Chain	Res	Type
12	E	215	ASN
12	E	233	ASN
13	F	119	ASN
13	F	148	GLN
13	F	199	GLN
14	G	23	GLN
14	G	62	GLN
14	G	64	ASN
14	G	90	ASN
14	G	121	GLN
14	G	127	ASN
14	G	237	GLN
14	G	248	ASN
15	H	95	HIS
15	H	98	GLN
15	H	265	ASN
15	H	281	GLN
15	H	339	GLN
16	I	265	ASN
16	I	301	ASN
16	I	330	GLN
16	I	338	ASN
16	I	420	GLN
16	I	437	GLN
17	J	103	ASN
17	J	111	GLN
17	J	156	GLN
17	J	205	HIS
17	J	269	GLN
17	J	277	ASN
17	J	393	ASN
18	K	180	GLN
18	K	182	GLN
18	K	244	HIS
18	K	285	GLN
18	K	293	GLN
18	K	302	GLN
18	K	404	GLN
19	L	67	HIS
19	L	103	GLN
19	L	169	ASN
19	L	175	GLN

Continued on next page...

Continued from previous page...

Mol	Chain	Res	Type
19	L	311	GLN
20	M	250	GLN
20	M	311	GLN
20	M	359	GLN
20	M	364	HIS
20	M	377	GLN
20	M	405	ASN
21	N	176	GLN
21	N	182	ASN
21	N	226	ASN
21	N	268	GLN
21	N	308	ASN
21	N	360	GLN
21	N	378	ASN
21	N	614	ASN
21	N	666	GLN
21	N	688	ASN
21	N	716	GLN
21	N	747	HIS
21	N	870	ASN
21	N	922	GLN
22	O	75	GLN
22	O	236	HIS
22	O	244	ASN
22	O	256	ASN
22	O	323	ASN
22	O	326	HIS
22	O	374	ASN
23	P	38	GLN
23	P	113	ASN
23	P	210	ASN
23	P	242	GLN
23	P	288	ASN
23	P	289	ASN
23	P	342	GLN
23	P	349	ASN
23	P	410	GLN
23	P	440	HIS
24	Q	19	GLN
24	Q	80	HIS
24	Q	114	GLN
24	Q	135	HIS

Continued on next page...

Continued from previous page...

Mol	Chain	Res	Type
24	Q	226	HIS
24	Q	283	ASN
24	Q	308	ASN
24	Q	336	ASN
24	Q	372	GLN
25	R	100	ASN
25	R	114	ASN
25	R	323	ASN
25	R	366	ASN
25	R	374	ASN
25	R	378	ASN
25	R	391	ASN
25	R	395	ASN
25	R	399	GLN
26	S	20	HIS
26	S	159	ASN
26	S	235	ASN
26	S	314	ASN
26	S	317	HIS
26	S	339	GLN
26	S	458	GLN
26	S	459	GLN
27	T	37	ASN
27	T	118	ASN
27	T	135	ASN
27	T	204	ASN
27	T	258	ASN
28	U	71	ASN
28	U	117	ASN
28	U	127	GLN
28	U	156	HIS
28	U	192	ASN
28	U	193	GLN
28	U	223	HIS
28	U	230	GLN
28	U	259	ASN
28	U	297	GLN
28	U	298	ASN
29	V	184	ASN
29	V	190	HIS
30	W	18	ASN
30	W	29	GLN

Continued on next page...

Continued from previous page...

Mol	Chain	Res	Type
30	W	38	GLN
30	W	42	ASN
30	W	44	ASN
30	W	92	GLN
30	W	143	ASN
30	W	149	GLN
31	X	105	ASN
33	Z	132	HIS
33	Z	156	HIS
33	Z	168	GLN
33	Z	240	ASN
33	Z	364	ASN
33	Z	396	ASN
33	Z	435	GLN
33	Z	475	GLN
33	Z	549	ASN
33	Z	618	GLN
33	Z	622	HIS
33	Z	763	HIS
33	Z	789	GLN
33	Z	801	HIS
33	Z	833	GLN
33	Z	926	ASN
8	a	92	ASN
8	a	123	ASN
9	b	190	HIS
10	c	21	GLN
10	c	31	HIS
10	c	94	HIS
10	c	96	GLN
10	c	147	GLN
11	d	16	HIS
11	d	19	GLN
11	d	70	HIS
11	d	94	GLN
11	d	162	GLN
12	e	23	GLN
12	e	91	HIS
12	e	114	GLN
12	e	147	HIS
12	e	215	ASN
12	e	233	ASN

Continued on next page...

Continued from previous page...

Mol	Chain	Res	Type
13	f	117	GLN
13	f	119	ASN
13	f	148	GLN
13	f	199	GLN
14	g	23	GLN
14	g	62	GLN
14	g	90	ASN
14	g	121	GLN
14	g	127	ASN
14	g	237	GLN
14	g	248	ASN
3	h	125	ASN
3	h	164	ASN
3	h	180	GLN
4	i	115	HIS
4	i	122	HIS
4	i	143	HIS
4	i	194	ASN
5	j	72	ASN
5	j	157	ASN
6	k	37	GLN
6	k	55	GLN
6	k	118	GLN
6	k	146	HIS
7	l	141	HIS
7	l	251	ASN
7	l	283	ASN

5.3.3 RNA [i](#)

There are no RNA molecules in this entry.

5.4 Non-standard residues in protein, DNA, RNA chains [i](#)

There are no non-standard protein/DNA/RNA residues in this entry.

5.5 Carbohydrates [i](#)

There are no monosaccharides in this entry.

5.6 Ligand geometry [i](#)

There are no ligands in this entry.

5.7 Other polymers [i](#)

There are no such residues in this entry.

5.8 Polymer linkage issues [i](#)

The following chains have linkage breaks:

Mol	Chain	Number of breaks
25	R	1

All chain breaks are listed below:

Model	Chain	Residue-1	Atom-1	Residue-2	Atom-2	Distance (Å)
1	R	330:VAL	C	331:ARG	N	1.69

6 Map visualisation [i](#)

This section contains visualisations of the EMDB entry EMD-6575. These allow visual inspection of the internal detail of the map and identification of artifacts.

No raw map or half-maps were deposited for this entry and therefore no images, graphs, etc. pertaining to the raw map can be shown.

6.1 Orthogonal projections [i](#)

6.1.1 Primary map

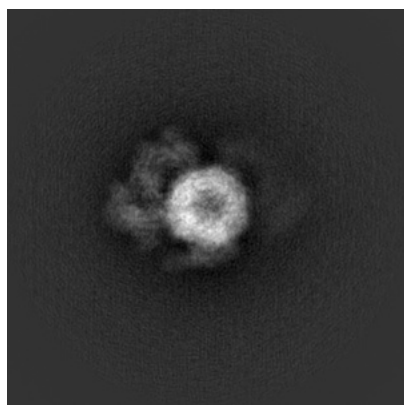

X



Y

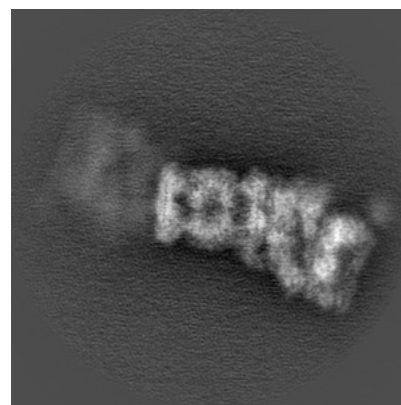

Z

The images above show the map projected in three orthogonal directions.

6.2 Central slices [i](#)

6.2.1 Primary map

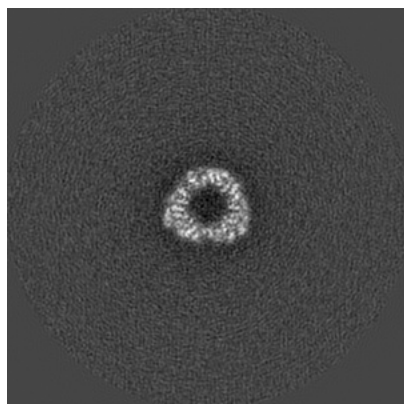

X Index: 128

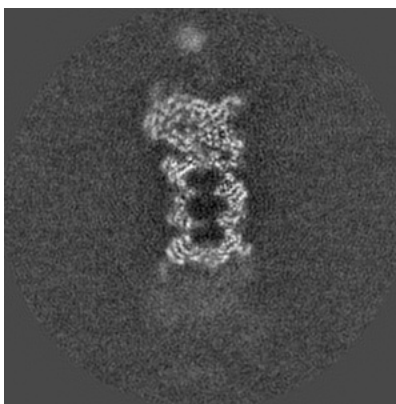

Y Index: 128

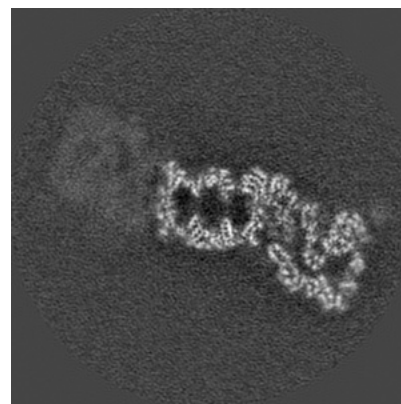

Z Index: 128

The images above show central slices of the map in three orthogonal directions.

6.3 Largest variance slices [i](#)

6.3.1 Primary map

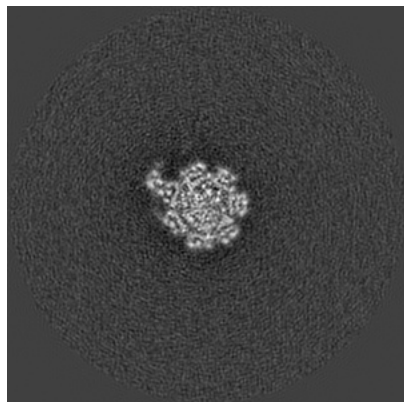

X Index: 155

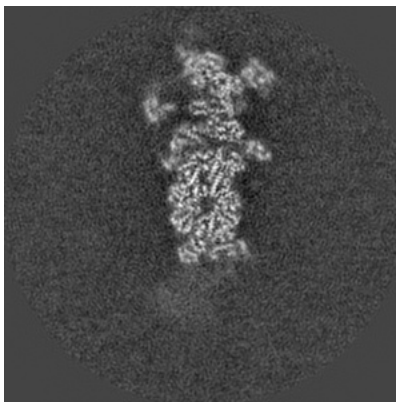

Y Index: 116

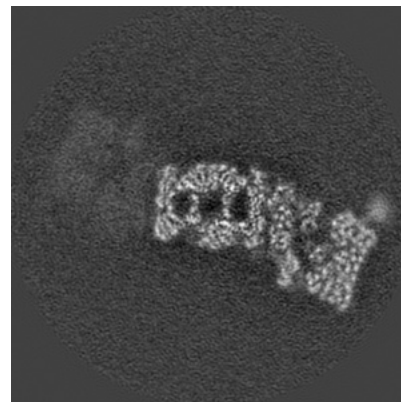

Z Index: 122

The images above show the largest variance slices of the map in three orthogonal directions.

6.4 Orthogonal standard-deviation projections (False-color) [i](#)

6.4.1 Primary map

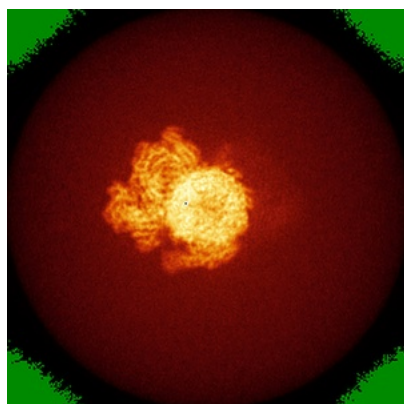

X

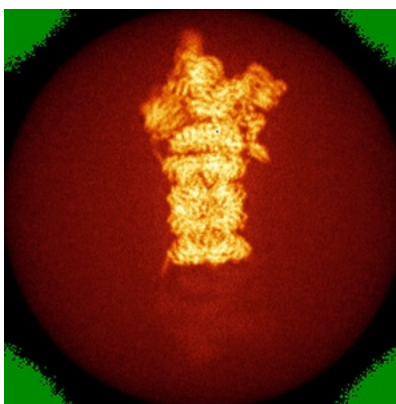

Y

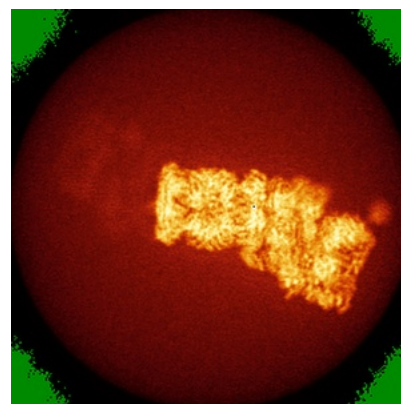

Z

The images above show the map standard deviation projections with false color in three orthogonal directions. Minimum values are shown in green, max in blue, and dark to light orange shades represent small to large values respectively.

6.5 Orthogonal surface views [i](#)

6.5.1 Primary map

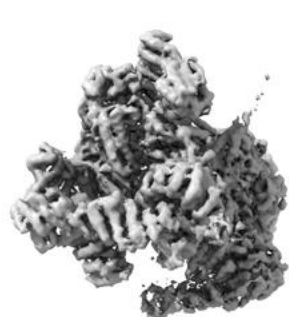

X



Y



Z

The images above show the 3D surface view of the map at the recommended contour level 0.095. These images, in conjunction with the slice images, may facilitate assessment of whether an appropriate contour level has been provided.

6.6 Mask visualisation [i](#)

This section was not generated. No masks/segmentation were deposited.

7 Map analysis [i](#)

This section contains the results of statistical analysis of the map.

7.1 Map-value distribution [i](#)

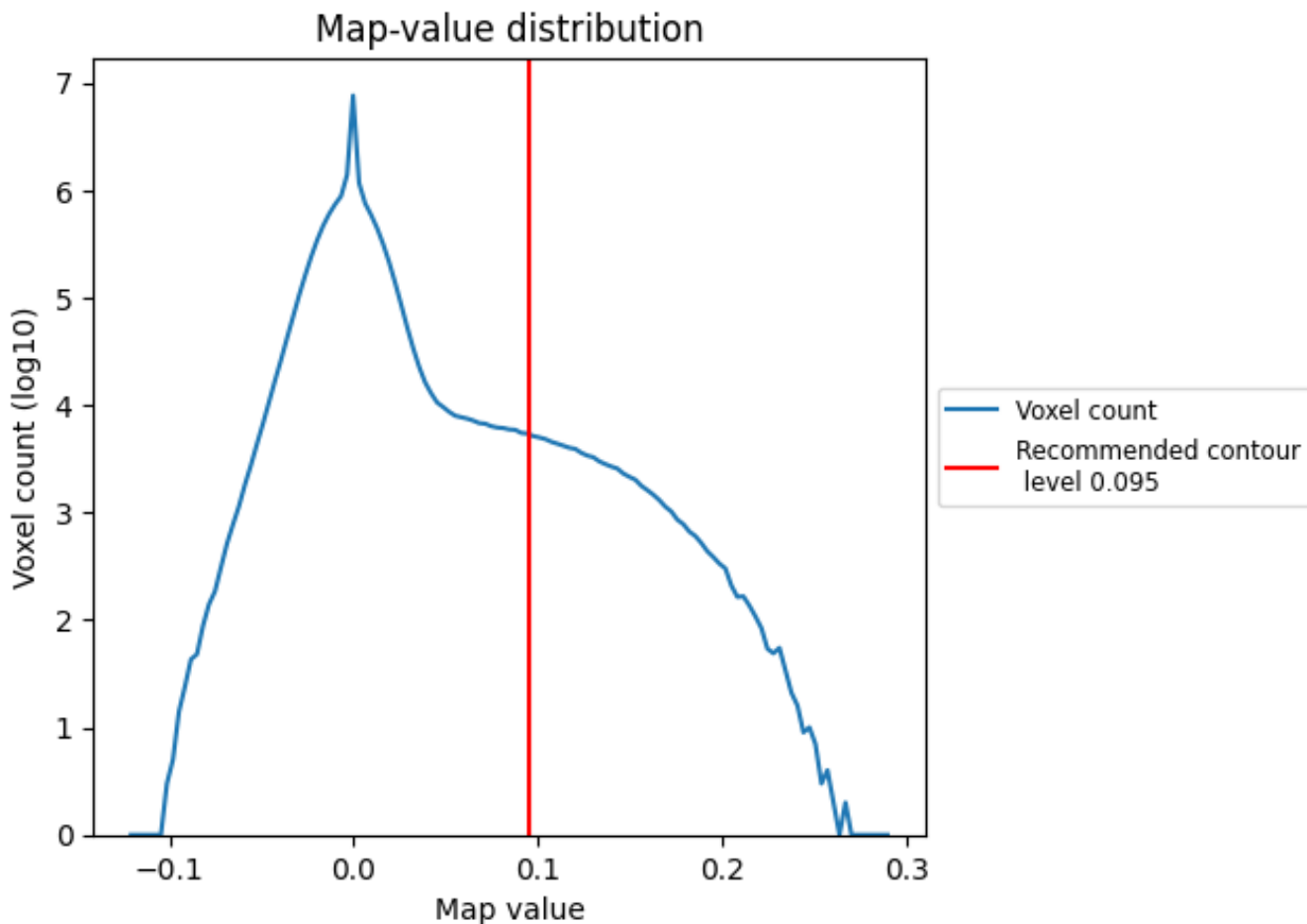

The map-value distribution is plotted in 128 intervals along the x-axis. The y-axis is logarithmic. A spike in this graph at zero usually indicates that the volume has been masked.

7.2 Volume estimate [i](#)

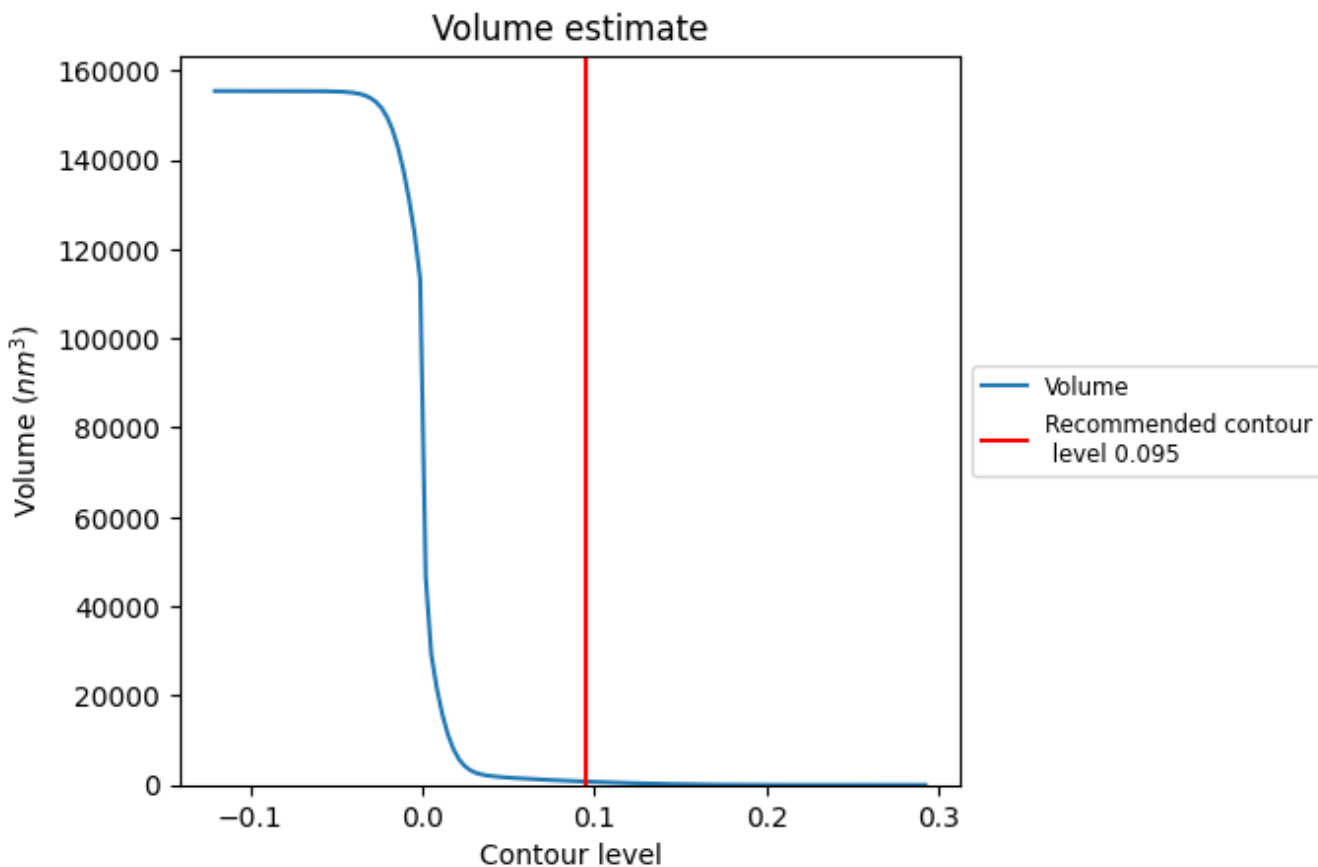

The volume at the recommended contour level is 758 nm^3 ; this corresponds to an approximate mass of 685 kDa.

The volume estimate graph shows how the enclosed volume varies with the contour level. The recommended contour level is shown as a vertical line and the intersection between the line and the curve gives the volume of the enclosed surface at the given level.

7.3 Rotationally averaged power spectrum i

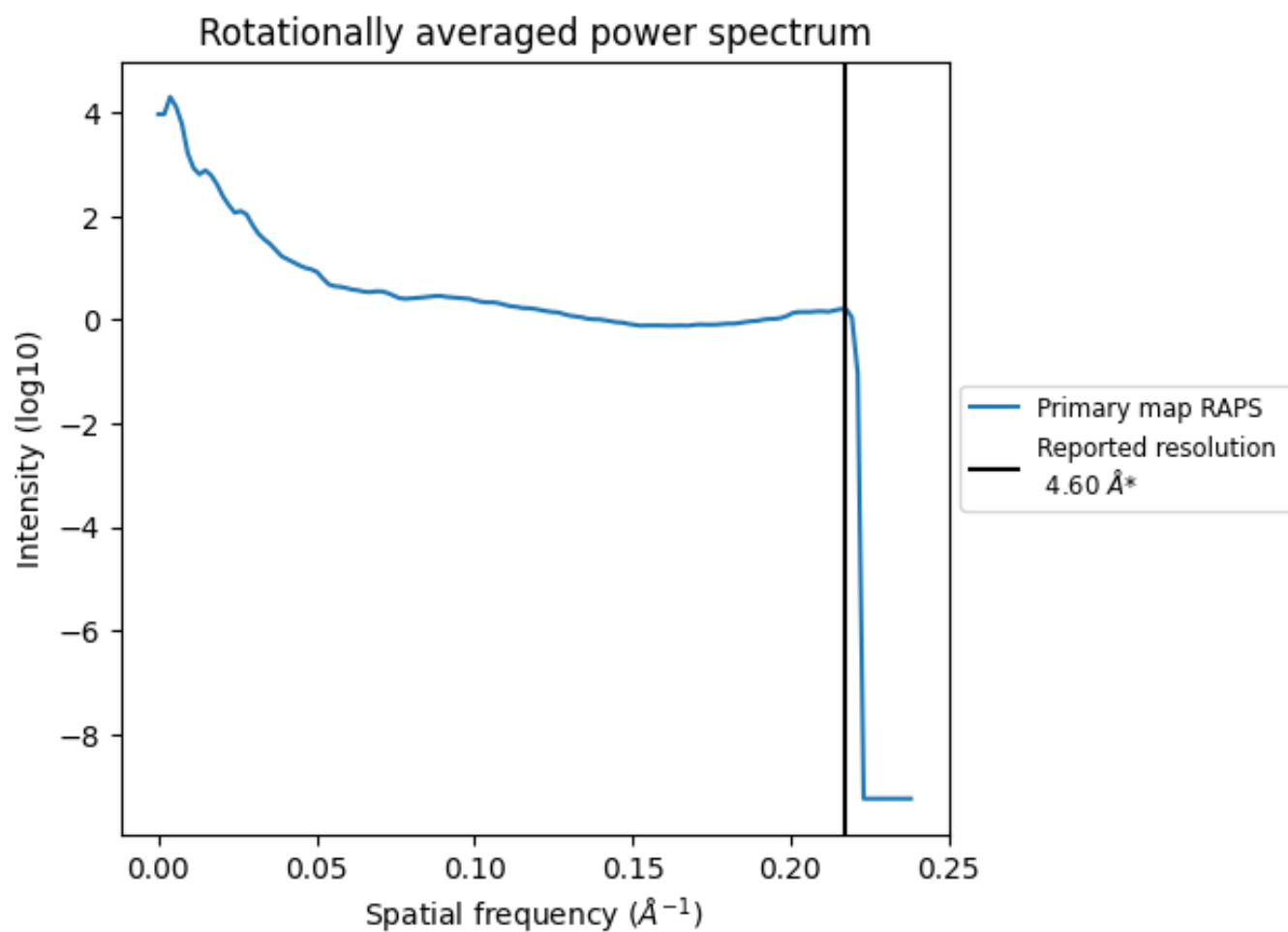

*Reported resolution corresponds to spatial frequency of 0.217 Å⁻¹

8 Fourier-Shell correlation

This section was not generated. No FSC curve or half-maps provided.

9 Map-model fit [i](#)

This section contains information regarding the fit between EMDB map EMD-6575 and PDB model 3JCP. Per-residue inclusion information can be found in section 3 on page 11.

9.1 Map-model overlay [i](#)

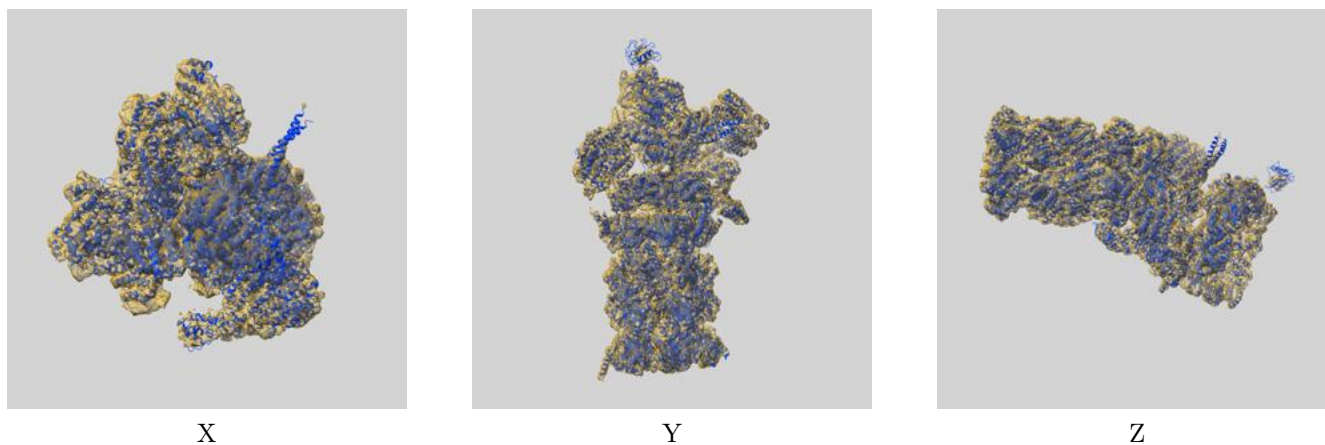

The images above show the 3D surface view of the map at the recommended contour level 0.095 at 50% transparency in yellow overlaid with a ribbon representation of the model coloured in blue. These images allow for the visual assessment of the quality of fit between the atomic model and the map.

9.2 Q-score mapped to coordinate model [i](#)

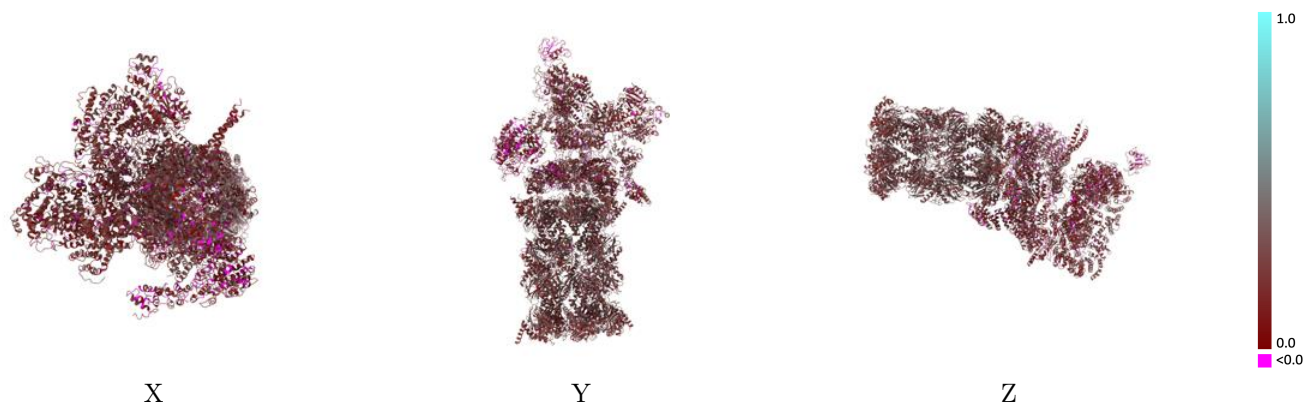

The images above show the model with each residue coloured according to its Q-score. This shows their resolvability in the map with higher Q-score values reflecting better resolvability. Please note: Q-score is calculating the resolvability of atoms, and thus high values are only expected at resolutions at which atoms can be resolved. Low Q-score values may therefore be expected for many entries.

9.3 Atom inclusion mapped to coordinate model [i](#)

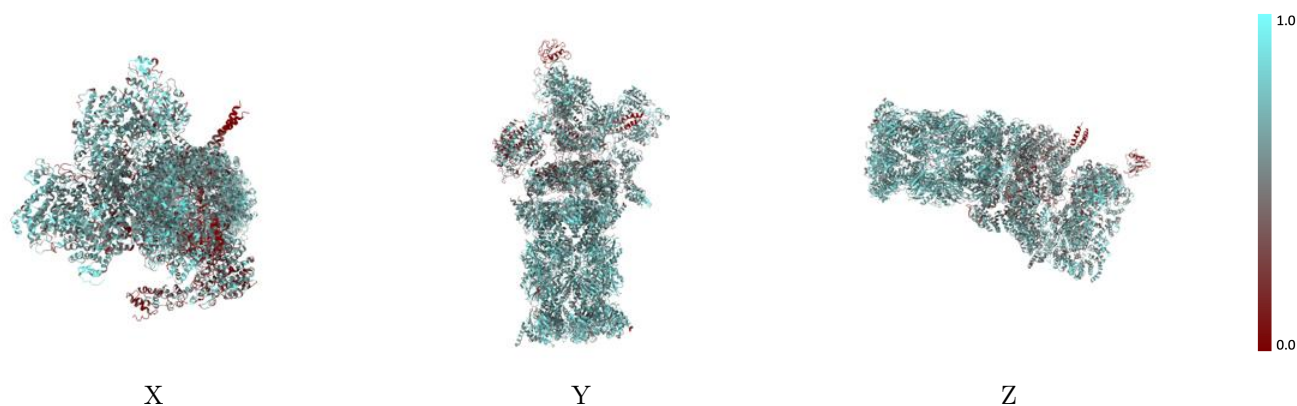

The images above show the model with each residue coloured according to its atom inclusion. This shows to what extent they are inside the map at the recommended contour level (0.095).



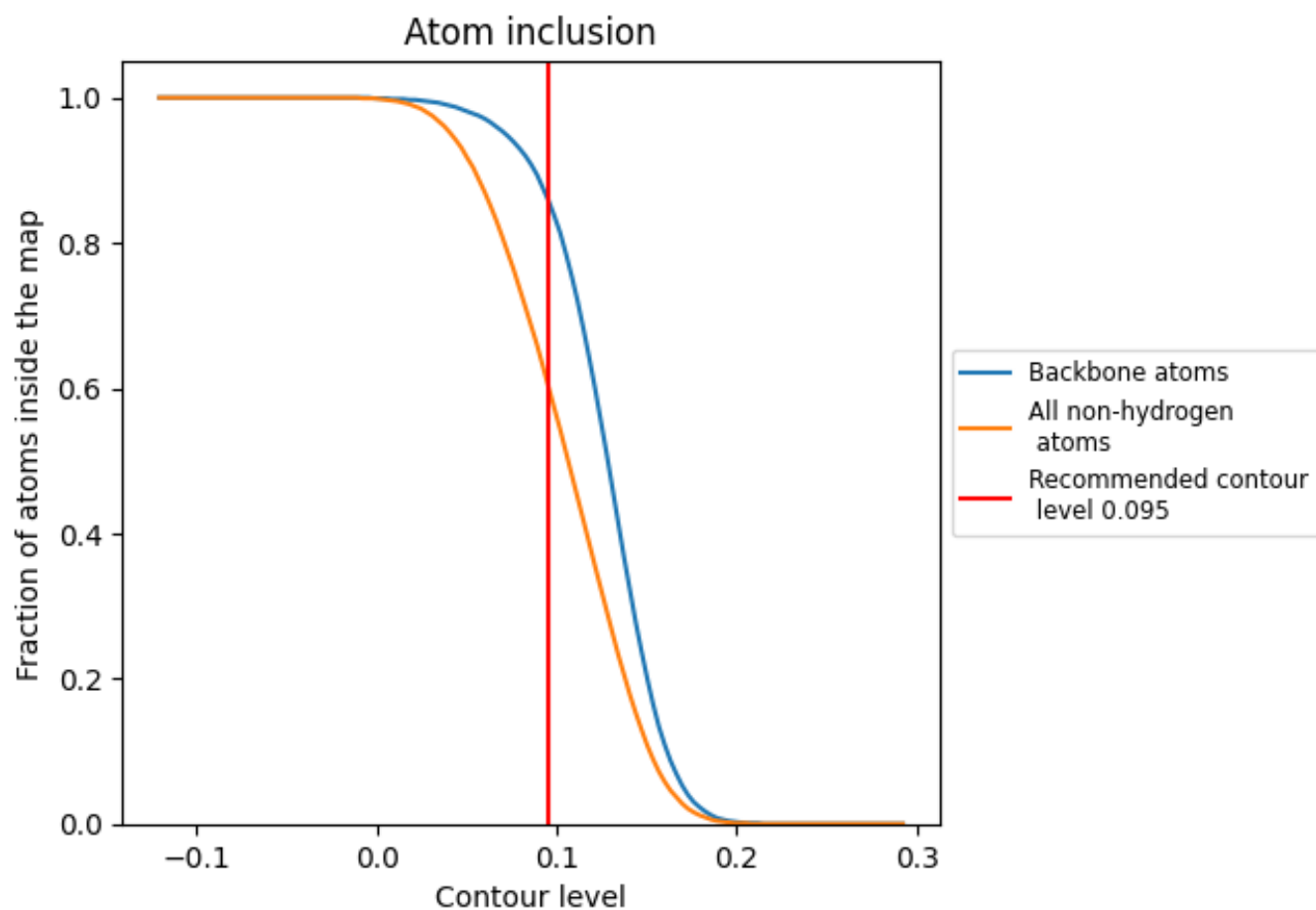



































































9.4 Atom inclusion [i](#)



At the recommended contour level, 86% of all backbone atoms, 61% of all non-hydrogen atoms, are inside the map.

9.5 Map-model fit summary



























The table lists the average atom inclusion at the recommended contour level (0.095) and Q-score for the entire model and for each chain.

Chain	Atom inclusion	Q-score
All	 0.6060	 0.2320
1	 0.6860	 0.2810
2	 0.7010	 0.2900
3	 0.7000	 0.2710
4	 0.6700	 0.2910
5	 0.6580	 0.2800
6	 0.6540	 0.2870
7	 0.7200	 0.2800
8	 0.7010	 0.2930
9	 0.6950	 0.2810
A	 0.6730	 0.2680
B	 0.6500	 0.2630
C	 0.6620	 0.2530
D	 0.6620	 0.2550
E	 0.6550	 0.2470
F	 0.6870	 0.2530
G	 0.6860	 0.2620
H	 0.5420	 0.2040
I	 0.5020	 0.1970
J	 0.4720	 0.1920
K	 0.5220	 0.2180
L	 0.5290	 0.2170
M	 0.5310	 0.2080
N	 0.6350	 0.2160
O	 0.6170	 0.1860
P	 0.6190	 0.1910
Q	 0.5470	 0.1840
R	 0.5590	 0.1890
S	 0.6110	 0.1980
T	 0.5940	 0.1930
U	 0.6260	 0.2280
V	 0.5860	 0.2200
W	 0.6070	 0.1900
X	 0.1030	 0.0880
Y	 0.5290	 0.2170



Continued on next page...

Continued from previous page...

Chain	Atom inclusion	Q-score
Z	 0.4240	 0.1300
a	 0.6470	 0.2870
b	 0.6240	 0.2890
c	 0.6070	 0.2680
d	 0.6340	 0.2620
e	 0.6150	 0.2620
f	 0.6700	 0.2800
g	 0.6640	 0.2820
h	 0.6920	 0.2850
i	 0.6880	 0.3040
j	 0.6900	 0.2980
k	 0.6750	 0.2860
l	 0.7120	 0.2810