



Full wwPDB X-ray Structure Validation Report ⓘ

Mar 9, 2018 – 08:38 am GMT

PDB ID : 4K5E
Title : Structure of neuronal nitric oxide synthase heme domain in complex with (R)-1,2-bis((2-amino-4-methylpyridin-6-yl)-methoxy)-propan-3-amine
Authors : Li, H.; Poulos, T.L.
Deposited on : 2013-04-14
Resolution : 1.89 Å(reported)

This is a Full wwPDB X-ray Structure Validation Report for a publicly released PDB entry.

We welcome your comments at validation@mail.wwpdb.org

A user guide is available at

<https://www.wwpdb.org/validation/2017/XrayValidationReportHelp>

with specific help available everywhere you see the ⓘ symbol.

The following versions of software and data (see [references ⓘ](#)) were used in the production of this report:

MolProbity : 4.02b-467
Mogul : 1.7.3 (157068), CSD as539be (2018)
Xtriage (Phenix) : 1.13
EDS : trunk30967
Percentile statistics : 20171227.v01 (using entries in the PDB archive December 27th 2017)
Refmac : 5.8.0158
CCP4 : 7.0 (Gargrove)
Ideal geometry (proteins) : Engh & Huber (2001)
Ideal geometry (DNA, RNA) : Parkinson et al. (1996)
Validation Pipeline (wwPDB-VP) : trunk30967

1 Overall quality at a glance

The following experimental techniques were used to determine the structure:

X-RAY DIFFRACTION

The reported resolution of this entry is 1.89 Å.

Percentile scores (ranging between 0-100) for global validation metrics of the entry are shown in the following graphic. The table shows the number of entries on which the scores are based.

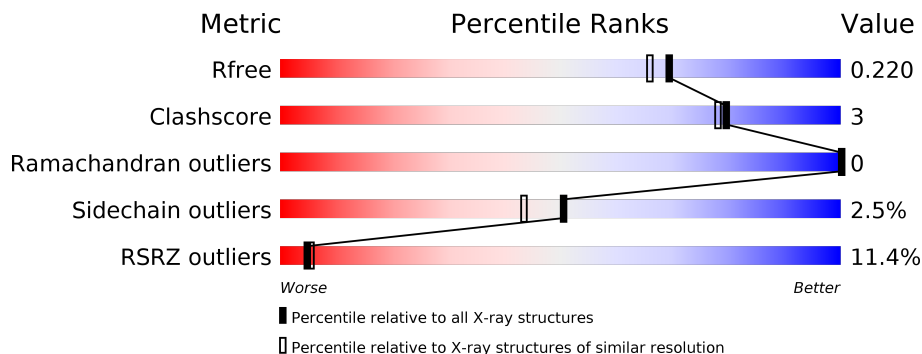

Metric	Whole archive (#Entries)	Similar resolution (#Entries, resolution range(Å))
R_{free}	111664	5502 (1.90-1.90)
Clashscore	122126	6115 (1.90-1.90)
Ramachandran outliers	120053	6048 (1.90-1.90)
Sidechain outliers	120020	6048 (1.90-1.90)
RSRZ outliers	108989	5379 (1.90-1.90)

The table below summarises the geometric issues observed across the polymeric chains and their fit to the electron density. The red, orange, yellow and green segments on the lower bar indicate the fraction of residues that contain outliers for ≥ 3 , 2, 1 and 0 types of geometric quality criteria. A grey segment represents the fraction of residues that are not modelled. The numeric value for each fraction is indicated below the corresponding segment, with a dot representing fractions $\leq 5\%$. The upper red bar (where present) indicates the fraction of residues that have poor fit to the electron density. The numeric value is given above the bar.

Mol	Chain	Length	Quality of chain
1	A	422	
1	B	422	

2 Entry composition [i](#)

There are 7 unique types of molecules in this entry. The entry contains 7308 atoms, of which 0 are hydrogens and 0 are deuteriums.

In the tables below, the ZeroOcc column contains the number of atoms modelled with zero occupancy, the AltConf column contains the number of residues with at least one atom in alternate conformation and the Trace column contains the number of residues modelled with at most 2 atoms.

- Molecule 1 is a protein called Nitric oxide synthase, brain.

Mol	Chain	Residues	Atoms					ZeroOcc	AltConf	Trace
			Total	C	N	O	S			
1	A	407	Total 3316	C 2121	N 567	O 606	S 22	0	2	0
1	B	411	Total 3353	C 2143	N 575	O 612	S 23	0	4	0

There are 2 discrepancies between the modelled and reference sequences:

Chain	Residue	Modelled	Actual	Comment	Reference
A	598	CYS	TYR	CLONING ARTIFACT	UNP P29476
B	598	CYS	TYR	CLONING ARTIFACT	UNP P29476

- Molecule 2 is PROTOPORPHYRIN IX CONTAINING FE (three-letter code: HEM) (formula: $C_{34}H_{32}FeN_4O_4$).

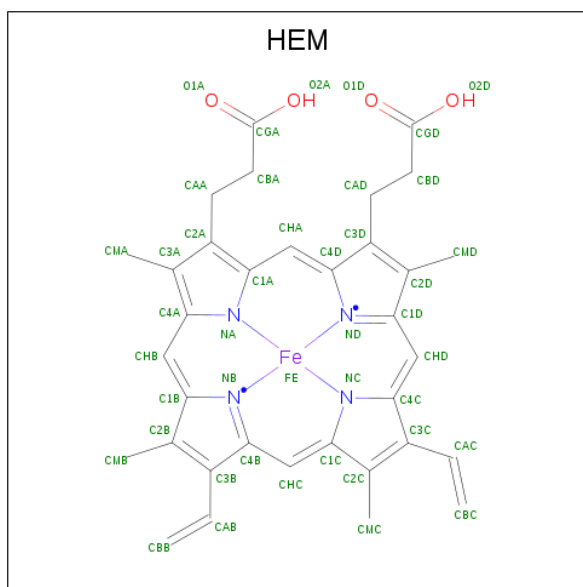

Mol	Chain	Residues	Atoms					ZeroOcc	AltConf
			Total	C	Fe	N	O		
2	A	1	Total 43	C 34	Fe 1	N 4	O 4	0	0

Continued on next page...

Continued from previous page...

Mol	Chain	Residues	Atoms				ZeroOcc	AltConf	
			Total	C	Fe	N			O
2	B	1	43	34	1	4	4	0	0

- Molecule 3 is 5,6,7,8-TETRAHYDROBIOPTERIN (three-letter code: H4B) (formula: $C_9H_{15}N_5O_3$).

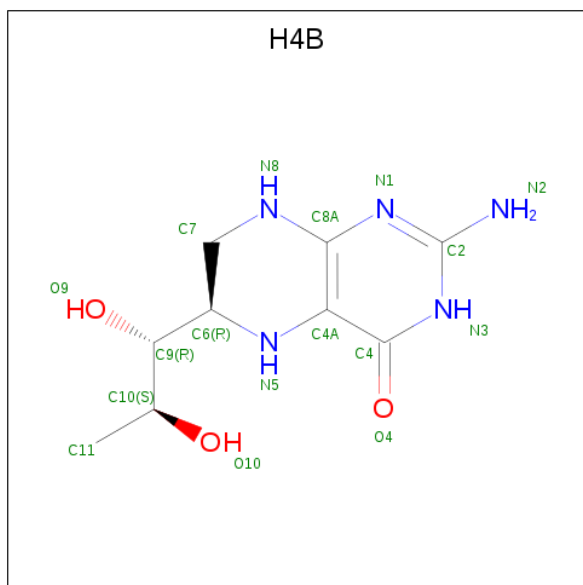

Mol	Chain	Residues	Atoms				ZeroOcc	AltConf
			Total	C	N	O		
3	A	1	17	9	5	3	0	0
3	B	1	17	9	5	3	0	0

- Molecule 4 is 6,6'-{[(2R)-3-aminopropane-1,2-diyl]bis(oxymethanediyl)}bis(4-methylpyridin-2-amine) (three-letter code: 1Q7) (formula: $C_{17}H_{25}N_5O_2$).

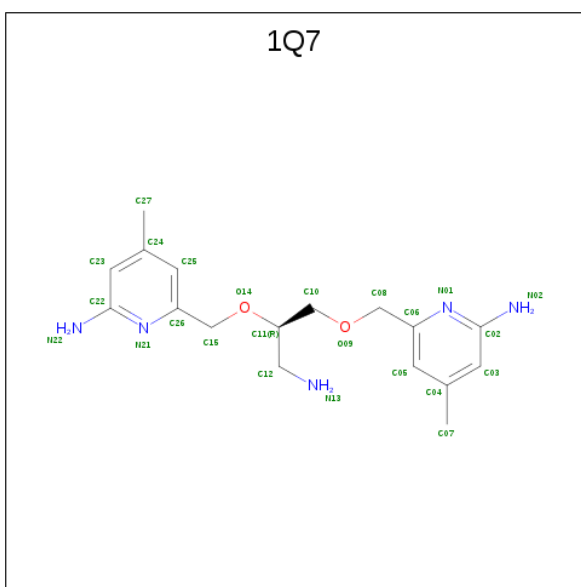

Mol	Chain	Residues	Atoms			ZeroOcc	AltConf	
			Total	C	N			O
4	A	1	24	17	5	2	0	0
4	B	1	24	17	5	2	0	0

- Molecule 5 is ACETATE ION (three-letter code: ACT) (formula: $C_2H_3O_2$).

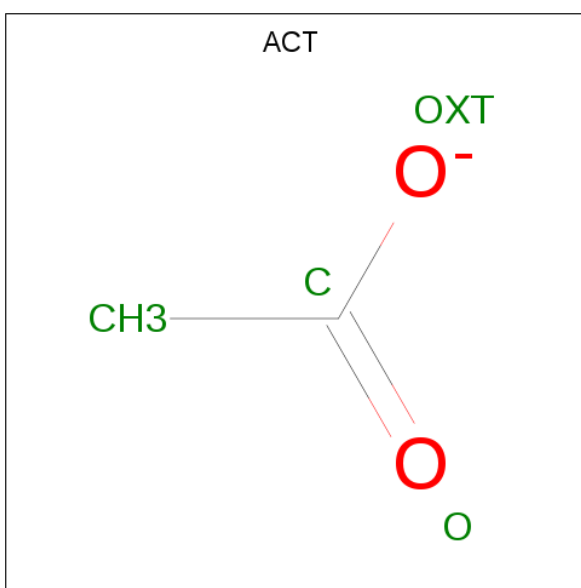

Mol	Chain	Residues	Atoms			ZeroOcc	AltConf
			Total	C	O		
5	A	1	4	2	2	0	0
5	B	1	4	2	2	0	0

- Molecule 6 is ZINC ION (three-letter code: ZN) (formula: Zn).

Mol	Chain	Residues	Atoms		ZeroOcc	AltConf
6	A	1	Total 1	Zn 1	0	0

- Molecule 7 is water.

Mol	Chain	Residues	Atoms		ZeroOcc	AltConf
7	A	178	Total 178	O 178	0	0
7	B	284	Total 284	O 284	0	0

3 Residue-property plots [i](#)

These plots are drawn for all protein, RNA and DNA chains in the entry. The first graphic for a chain summarises the proportions of the various outlier classes displayed in the second graphic. The second graphic shows the sequence view annotated by issues in geometry and electron density. Residues are color-coded according to the number of geometric quality criteria for which they contain at least one outlier: green = 0, yellow = 1, orange = 2 and red = 3 or more. A red dot above a residue indicates a poor fit to the electron density ($RSRZ > 2$). Stretches of 2 or more consecutive residues without any outlier are shown as a green connector. Residues present in the sample, but not in the model, are shown in grey.

- Molecule 1: Nitric oxide synthase, brain

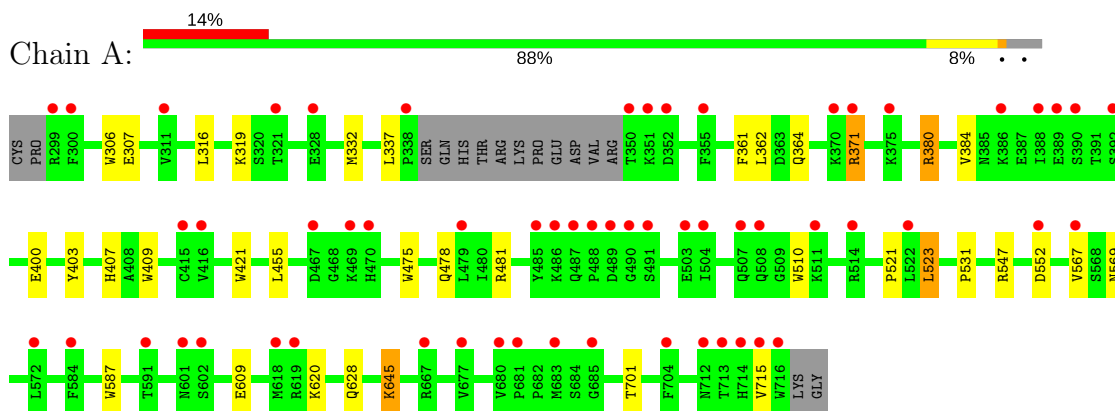

- Molecule 1: Nitric oxide synthase, brain

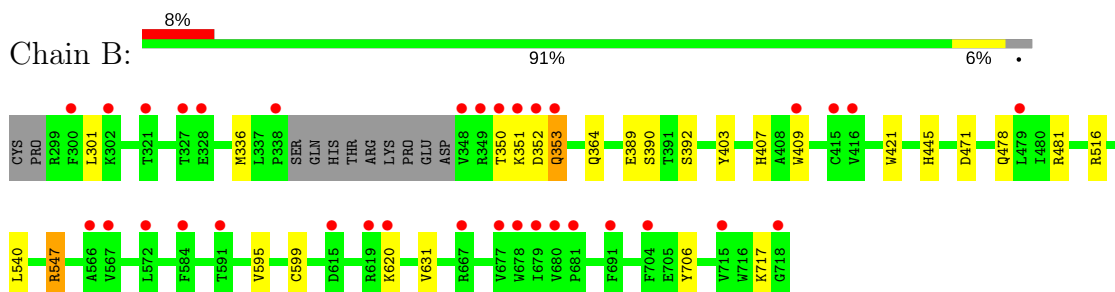

4 Data and refinement statistics i

Property	Value	Source
Space group	P 21 21 21	Depositor
Cell constants a, b, c, α , β , γ	52.00Å 110.67Å 164.39Å 90.00° 90.00° 90.00°	Depositor
Resolution (Å)	32.24 – 1.89 33.65 – 1.89	Depositor EDS
% Data completeness (in resolution range)	98.9 (32.24-1.89) 98.9 (33.65-1.89)	Depositor EDS
R_{merge}	0.05	Depositor
R_{sym}	0.05	Depositor
$\langle I/\sigma(I) \rangle$ ¹	2.45 (at 1.89Å)	Xtrriage
Refinement program	REFMAC	Depositor
R, R_{free}	0.180 , 0.212 0.192 , 0.220	Depositor DCC
R_{free} test set	3761 reflections (4.97%)	wwPDB-VP
Wilson B-factor (Å ²)	29.6	Xtrriage
Anisotropy	0.606	Xtrriage
Bulk solvent k_{sol} (e/Å ³), B_{sol} (Å ²)	0.37 , 42.2	EDS
L-test for twinning ²	$\langle L \rangle = 0.48$, $\langle L^2 \rangle = 0.31$	Xtrriage
Estimated twinning fraction	No twinning to report.	Xtrriage
F_o, F_c correlation	0.96	EDS
Total number of atoms	7308	wwPDB-VP
Average B, all atoms (Å ²)	37.0	wwPDB-VP

Xtrriage's analysis on translational NCS is as follows: *The largest off-origin peak in the Patterson function is 4.58% of the height of the origin peak. No significant pseudotranslation is detected.*

¹Intensities estimated from amplitudes.

²Theoretical values of $\langle |L| \rangle$, $\langle L^2 \rangle$ for acentric reflections are 0.5, 0.333 respectively for untwinned datasets, and 0.375, 0.2 for perfectly twinned datasets.

5 Model quality [i](#)

5.1 Standard geometry [i](#)

Bond lengths and bond angles in the following residue types are not validated in this section: HEM, ZN, ACT, H4B, 1Q7

The Z score for a bond length (or angle) is the number of standard deviations the observed value is removed from the expected value. A bond length (or angle) with $|Z| > 5$ is considered an outlier worth inspection. RMSZ is the root-mean-square of all Z scores of the bond lengths (or angles).

Mol	Chain	Bond lengths		Bond angles	
		RMSZ	# Z >5	RMSZ	# Z >5
1	A	0.65	0/3414	0.66	0/4633
1	B	0.73	0/3457	0.71	2/4686 (0.0%)
All	All	0.69	0/6871	0.69	2/9319 (0.0%)

There are no bond length outliers.

All (2) bond angle outliers are listed below:

Mol	Chain	Res	Type	Atoms	Z	Observed(°)	Ideal(°)
1	B	547	ARG	NE-CZ-NH2	-5.35	117.62	120.30
1	B	471	ASP	CB-CG-OD2	5.25	123.03	118.30

There are no chirality outliers.

There are no planarity outliers.

5.2 Too-close contacts [i](#)

In the following table, the Non-H and H(model) columns list the number of non-hydrogen atoms and hydrogen atoms in the chain respectively. The H(added) column lists the number of hydrogen atoms added and optimized by MolProbity. The Clashes column lists the number of clashes within the asymmetric unit, whereas Symm-Clashes lists symmetry related clashes.

Mol	Chain	Non-H	H(model)	H(added)	Clashes	Symm-Clashes
1	A	3316	0	3230	24	0
1	B	3353	0	3276	14	0
2	A	43	0	30	3	0
2	B	43	0	30	4	0
3	A	17	0	15	0	0
3	B	17	0	15	0	0
4	A	24	0	25	2	0

Continued on next page...

Continued from previous page...

Mol	Chain	Non-H	H(model)	H(added)	Clashes	Symm-Clashes
4	B	24	0	25	2	0
5	A	4	0	3	0	0
5	B	4	0	3	0	0
6	A	1	0	0	0	0
7	A	178	0	0	2	0
7	B	284	0	0	4	0
All	All	7308	0	6652	41	0

The all-atom clashscore is defined as the number of clashes found per 1000 atoms (including hydrogen atoms). The all-atom clashscore for this structure is 3.

All (41) close contacts within the same asymmetric unit are listed below, sorted by their clash magnitude.

Atom-1	Atom-2	Interatomic distance (Å)	Clash overlap (Å)
2:A:801:HEM:HMC2	2:A:801:HEM:HBC2	1.67	0.76
1:A:371:ARG:HH21	1:A:371:ARG:CG	2.03	0.71
1:A:316:LEU:HD12	1:A:319:LYS:HD2	1.82	0.61
2:B:801:HEM:HBA2	4:B:803:1Q7:H18	1.83	0.60
1:A:478:GLN:HB2	1:A:481:ARG:HG3	1.84	0.59
1:A:371:ARG:CG	1:A:371:ARG:NH2	2.67	0.56
1:A:371:ARG:HH21	1:A:371:ARG:HG3	1.71	0.56
1:B:351:LYS:HE3	1:B:392:SER:OG	2.05	0.56
1:A:523:LEU:HD22	1:A:531:PRO:HB2	1.87	0.55
2:B:801:HEM:HBB2	2:B:801:HEM:HHC	1.89	0.55
1:A:380:ARG:HD3	1:A:400:GLU:OE1	2.06	0.54
1:A:475:TRP:HB2	1:A:523:LEU:HB3	1.92	0.51
1:A:628:GLN:HG2	1:B:631:VAL:HG11	1.93	0.50
1:B:403:TYR:CE1	1:B:407:HIS:CE1	3.00	0.49
1:A:371:ARG:HG2	1:A:371:ARG:NH2	2.27	0.49
2:A:801:HEM:HHC	2:A:801:HEM:HBB2	1.96	0.48
1:A:567:VAL:HG22	4:A:803:1Q7:H16	1.94	0.48
1:A:609:GLU:HG3	7:A:903:HOH:O	2.14	0.47
1:B:478:GLN:HB2	1:B:481:ARG:HG3	1.98	0.46
1:B:706:TYR:OH	2:B:801:HEM:O1D	2.20	0.45
1:A:332:MET:HE2	1:B:301:LEU:HD13	1.98	0.45
1:A:455:LEU:HD12	1:A:587:TRP:HB3	1.99	0.45
1:B:717:LYS:NZ	7:B:1176:HOH:O	2.49	0.45
1:A:567:VAL:CG2	4:A:803:1Q7:H16	2.46	0.45
1:A:306:TRP:CD1	1:B:336:MET:HE2	2.52	0.45
1:A:307:GLU:HG3	7:B:902:HOH:O	2.17	0.45
1:A:510:TRP:CE2	1:A:521:PRO:HD3	2.53	0.44

Continued on next page...

Continued from previous page...

Atom-1	Atom-2	Interatomic distance (Å)	Clash overlap (Å)
1:A:701[A]:THR:HG23	7:A:1014:HOH:O	2.17	0.43
2:A:801:HEM:CMC	2:A:801:HEM:HBC2	2.44	0.42
1:A:362:LEU:HD11	1:A:384:VAL:HG21	2.01	0.42
1:A:409:TRP:CE3	1:A:421:TRP:HA	2.54	0.42
1:B:595:VAL:O	1:B:599:CYS:HB2	2.20	0.42
1:B:409:TRP:CE3	1:B:421:TRP:HA	2.55	0.42
1:A:361:PHE:O	1:A:364:GLN:HG2	2.20	0.41
1:B:516:ARG:HD2	7:B:946:HOH:O	2.20	0.41
1:B:445:HIS:C	1:B:445:HIS:CD2	2.93	0.41
1:B:353:GLN:HB3	1:B:353:GLN:HE21	1.69	0.41
2:B:801:HEM:C1C	4:B:803:1Q7:H26	2.55	0.41
1:A:403:TYR:CE1	1:A:407:HIS:CE1	3.09	0.41
1:B:364:GLN:NE2	7:B:1061:HOH:O	2.46	0.41
1:A:645:LYS:HB2	1:A:645:LYS:HE3	1.63	0.41

There are no symmetry-related clashes.

5.3 Torsion angles [i](#)

5.3.1 Protein backbone [i](#)

In the following table, the Percentiles column shows the percent Ramachandran outliers of the chain as a percentile score with respect to all X-ray entries followed by that with respect to entries of similar resolution.

The Analysed column shows the number of residues for which the backbone conformation was analysed, and the total number of residues.

Mol	Chain	Analysed	Favoured	Allowed	Outliers	Percentiles	
1	A	405/422 (96%)	393 (97%)	12 (3%)	0	100	100
1	B	411/422 (97%)	406 (99%)	5 (1%)	0	100	100
All	All	816/844 (97%)	799 (98%)	17 (2%)	0	100	100

There are no Ramachandran outliers to report.

5.3.2 Protein sidechains [i](#)

In the following table, the Percentiles column shows the percent sidechain outliers of the chain as a percentile score with respect to all X-ray entries followed by that with respect to entries of similar resolution.

The Analysed column shows the number of residues for which the sidechain conformation was analysed, and the total number of residues.

Mol	Chain	Analysed	Rotameric	Outliers	Percentiles	
1	A	365/377 (97%)	355 (97%)	10 (3%)	48	40
1	B	370/377 (98%)	362 (98%)	8 (2%)	55	49
All	All	735/754 (98%)	717 (98%)	18 (2%)	50	45

All (18) residues with a non-rotameric sidechain are listed below:

Mol	Chain	Res	Type
1	A	337	LEU
1	A	371	ARG
1	A	380	ARG
1	A	523	LEU
1	A	547	ARG
1	A	552	ASP
1	A	569	ASN
1	A	620	LYS
1	A	645	LYS
1	A	715	VAL
1	B	350	THR
1	B	352	ASP
1	B	353	GLN
1	B	389	GLU
1	B	390	SER
1	B	540	LEU
1	B	547	ARG
1	B	620	LYS

Some sidechains can be flipped to improve hydrogen bonding and reduce clashes. All (16) such sidechains are listed below:

Mol	Chain	Res	Type
1	A	353	GLN
1	A	425	GLN
1	A	454	ASN
1	A	487	GLN
1	A	507	GLN
1	A	569	ASN
1	A	605	ASN
1	A	628	GLN
1	A	697	ASN

Continued on next page...

Continued from previous page...

Mol	Chain	Res	Type
1	B	364	GLN
1	B	440	ASN
1	B	454	ASN
1	B	507	GLN
1	B	605	ASN
1	B	642	GLN
1	B	697	ASN

5.3.3 RNA [i](#)

There are no RNA molecules in this entry.

5.4 Non-standard residues in protein, DNA, RNA chains [i](#)

There are no non-standard protein/DNA/RNA residues in this entry.

5.5 Carbohydrates [i](#)

There are no carbohydrates in this entry.

5.6 Ligand geometry [i](#)

Of 9 ligands modelled in this entry, 1 is monoatomic - leaving 8 for Mogul analysis.

In the following table, the Counts columns list the number of bonds (or angles) for which Mogul statistics could be retrieved, the number of bonds (or angles) that are observed in the model and the number of bonds (or angles) that are defined in the Chemical Component Dictionary. The Link column lists molecule types, if any, to which the group is linked. The Z score for a bond length (or angle) is the number of standard deviations the observed value is removed from the expected value. A bond length (or angle) with $|Z| > 2$ is considered an outlier worth inspection. RMSZ is the root-mean-square of all Z scores of the bond lengths (or angles).

Mol	Type	Chain	Res	Link	Bond lengths			Bond angles		
					Counts	RMSZ	# Z > 2	Counts	RMSZ	# Z > 2
2	HEM	A	801	1	27,50,50	2.17	7 (25%)	17,82,82	2.19	5 (29%)
3	H4B	A	802	-	15,18,18	0.81	0	11,26,26	2.52	5 (45%)
4	1Q7	A	803	-	24,25,25	0.65	0	29,33,33	2.00	7 (24%)
5	ACT	A	804	-	1,3,3	1.37	0	0,3,3	0.00	-
2	HEM	B	801	1	27,50,50	2.13	8 (29%)	17,82,82	2.00	2 (11%)
3	H4B	B	802	-	15,18,18	1.09	0	11,26,26	2.58	4 (36%)

Mol	Type	Chain	Res	Link	Bond lengths			Bond angles		
					Counts	RMSZ	# Z > 2	Counts	RMSZ	# Z > 2
4	1Q7	B	803	-	24,25,25	0.71	0	29,33,33	1.86	11 (37%)
5	ACT	B	804	-	1,3,3	1.70	0	0,3,3	0.00	-

In the following table, the Chirals column lists the number of chiral outliers, the number of chiral centers analysed, the number of these observed in the model and the number defined in the Chemical Component Dictionary. Similar counts are reported in the Torsion and Rings columns. '-' means no outliers of that kind were identified.

Mol	Type	Chain	Res	Link	Chirals	Torsions	Rings
2	HEM	A	801	1	-	0/6/54/54	0/0/8/8
3	H4B	A	802	-	-	0/8/17/17	0/2/2/2
4	1Q7	A	803	-	-	0/13/13/13	0/2/2/2
5	ACT	A	804	-	-	0/0/0/0	0/0/0/0
2	HEM	B	801	1	-	0/6/54/54	0/0/8/8
3	H4B	B	802	-	-	0/8/17/17	0/2/2/2
4	1Q7	B	803	-	-	0/13/13/13	0/2/2/2
5	ACT	B	804	-	-	0/0/0/0	0/0/0/0

All (15) bond length outliers are listed below:

Mol	Chain	Res	Type	Atoms	Z	Observed(Å)	Ideal(Å)
2	A	801	HEM	C3B-C2B	-5.20	1.33	1.40
2	B	801	HEM	C3B-C2B	-4.48	1.34	1.40
2	B	801	HEM	C3C-C2C	-4.29	1.34	1.40
2	A	801	HEM	C3C-C2C	-3.69	1.35	1.40
2	A	801	HEM	CMC-C2C	2.12	1.56	1.51
2	A	801	HEM	CMD-C2D	2.14	1.56	1.51
2	B	801	HEM	CMD-C2D	2.31	1.56	1.51
2	B	801	HEM	CAD-C3D	2.53	1.57	1.52
2	B	801	HEM	CMA-C3A	2.82	1.57	1.51
2	B	801	HEM	C3B-CAB	2.90	1.53	1.47
2	A	801	HEM	C3B-CAB	3.41	1.54	1.47
2	A	801	HEM	C3C-CAC	3.81	1.55	1.47
2	B	801	HEM	C3C-CAC	3.95	1.55	1.47
2	B	801	HEM	C3D-C2D	4.18	1.50	1.37
2	A	801	HEM	C3D-C2D	4.95	1.52	1.37

All (34) bond angle outliers are listed below:

Mol	Chain	Res	Type	Atoms	Z	Observed(°)	Ideal(°)
2	A	801	HEM	CBA-CAA-C2A	-5.16	102.62	112.48
2	A	801	HEM	CBD-CAD-C3D	-5.13	102.68	112.47

Continued on next page...

Continued from previous page...

Mol	Chain	Res	Type	Atoms	Z	Observed(°)	Ideal(°)
2	B	801	HEM	CBA-CAA-C2A	-5.03	102.88	112.48
2	B	801	HEM	CBD-CAD-C3D	-4.58	103.73	112.47
4	A	803	1Q7	C24-C25-C26	-4.35	117.53	120.26
3	A	802	H4B	N3-C2-N1	-3.47	119.92	125.43
3	B	802	H4B	N3-C2-N1	-3.09	120.51	125.43
4	A	803	1Q7	C05-C06-N01	-3.07	119.68	122.91
4	B	803	1Q7	C05-C06-N01	-2.76	120.00	122.91
4	B	803	1Q7	C24-C25-C26	-2.52	118.68	120.26
4	A	803	1Q7	C07-C04-C05	-2.42	117.43	120.96
4	B	803	1Q7	C08-C06-C05	-2.34	117.83	121.08
4	B	803	1Q7	C07-C04-C05	-2.22	117.72	120.96
4	B	803	1Q7	C15-C26-C25	-2.11	118.14	121.08
4	A	803	1Q7	C08-C06-C05	-2.08	118.19	121.08
2	A	801	HEM	C1D-C2D-C3D	-2.03	105.58	107.00
3	A	802	H4B	N2-C2-N3	2.04	120.45	117.25
4	B	803	1Q7	N22-C22-N21	2.22	120.18	116.56
2	A	801	HEM	C4C-C3C-C2C	2.24	108.46	106.90
4	B	803	1Q7	O09-C10-C11	2.42	114.92	109.34
4	B	803	1Q7	C15-C26-N21	2.45	120.78	115.74
3	B	802	H4B	C2-N1-C8A	2.52	120.16	114.50
2	A	801	HEM	CMC-C2C-C3C	2.97	130.29	124.88
3	A	802	H4B	C2-N1-C8A	3.04	121.32	114.50
4	A	803	1Q7	C08-C06-N01	3.11	122.13	115.74
4	B	803	1Q7	C08-C06-N01	3.13	122.17	115.74
3	A	802	H4B	C4-N3-C2	3.61	121.26	116.06
4	B	803	1Q7	C22-N21-C26	3.71	120.78	118.17
3	B	802	H4B	C4-N3-C2	3.78	121.50	116.06
4	B	803	1Q7	C02-N01-C06	3.93	120.93	118.17
3	A	802	H4B	C4-C4A-C8A	4.83	118.94	114.56
4	A	803	1Q7	C22-N21-C26	4.88	121.60	118.17
4	A	803	1Q7	C02-N01-C06	5.17	121.80	118.17
3	B	802	H4B	C4-C4A-C8A	5.58	119.61	114.56

There are no chirality outliers.

There are no torsion outliers.

There are no ring outliers.

4 monomers are involved in 9 short contacts:

Mol	Chain	Res	Type	Clashes	Symm-Clashes
2	A	801	HEM	3	0
4	A	803	1Q7	2	0

Continued on next page...

Continued from previous page...

Mol	Chain	Res	Type	Clashes	Symm-Clashes
2	B	801	HEM	4	0
4	B	803	1Q7	2	0

5.7 Other polymers [i](#)

There are no such residues in this entry.

5.8 Polymer linkage issues [i](#)

There are no chain breaks in this entry.

6 Fit of model and data

6.1 Protein, DNA and RNA chains

In the following table, the column labelled ‘#RSRZ > 2’ contains the number (and percentage) of RSRZ outliers, followed by percent RSRZ outliers for the chain as percentile scores relative to all X-ray entries and entries of similar resolution. The OWAB column contains the minimum, median, 95th percentile and maximum values of the occupancy-weighted average B-factor per residue. The column labelled ‘Q < 0.9’ lists the number of (and percentage) of residues with an average occupancy less than 0.9.

Mol	Chain	Analysed	<RSRZ>	#RSRZ>2	OWAB(Å ²)	Q<0.9
1	A	407/422 (96%)	0.77	59 (14%) 2 2	23, 40, 67, 85	0
1	B	411/422 (97%)	0.37	34 (8%) 11 13	20, 31, 52, 77	0
All	All	818/844 (96%)	0.57	93 (11%) 5 5	20, 35, 62, 85	0

All (93) RSRZ outliers are listed below:

Mol	Chain	Res	Type	RSRZ
1	A	351	LYS	7.1
1	B	300	PHE	6.7
1	A	352	ASP	6.7
1	A	715	VAL	6.5
1	A	488	PRO	6.4
1	A	350	THR	6.2
1	A	716	TRP	6.0
1	B	350	THR	5.7
1	A	486	LYS	4.8
1	B	348	VAL	4.6
1	B	718	GLY	4.4
1	B	619	ARG	4.2
1	A	489	ASP	4.2
1	A	713	THR	4.0
1	A	355	PHE	3.9
1	A	619	ARG	3.8
1	A	712	ASN	3.8
1	A	299	ARG	3.8
1	B	338	PRO	3.8
1	A	388	ILE	3.6
1	A	392	SER	3.4
1	A	507	GLN	3.4
1	A	389	GLU	3.4
1	B	416	VAL	3.3

Continued on next page...

Continued from previous page...

Mol	Chain	Res	Type	RSRZ
1	A	490	GLY	3.3
1	A	321	THR	3.2
1	B	352	ASP	3.2
1	A	469	LYS	3.2
1	A	491	SER	3.1
1	B	321	THR	3.0
1	A	572	LEU	3.0
1	A	714	HIS	3.0
1	A	467	ASP	3.0
1	B	591	THR	3.0
1	A	390	SER	3.0
1	B	328	GLU	2.9
1	A	300	PHE	2.8
1	B	567	VAL	2.8
1	A	503	GLU	2.8
1	B	679	ILE	2.8
1	B	704	PHE	2.8
1	B	415	CYS	2.8
1	B	572	LEU	2.7
1	B	409	TRP	2.7
1	A	602	SER	2.7
1	A	487	GLN	2.7
1	A	370	LYS	2.7
1	A	680	VAL	2.7
1	B	584	PHE	2.6
1	A	601[A]	ASN	2.6
1	A	567	VAL	2.6
1	B	349	ARG	2.6
1	B	715	VAL	2.6
1	A	386	LYS	2.6
1	A	479	LEU	2.5
1	B	681	PRO	2.5
1	B	327	THR	2.5
1	B	691	PHE	2.4
1	A	338	PRO	2.4
1	B	620	LYS	2.4
1	A	514	ARG	2.4
1	B	677	VAL	2.4
1	B	615	ASP	2.4
1	A	470	HIS	2.4
1	A	591	THR	2.4
1	A	375	LYS	2.3

Continued on next page...

Continued from previous page...

Mol	Chain	Res	Type	RSRZ
1	A	683	MET	2.3
1	B	680	VAL	2.3
1	B	353	GLN	2.3
1	A	504	ILE	2.2
1	A	415	CYS	2.2
1	A	371	ARG	2.2
1	A	508	GLN	2.2
1	B	667	ARG	2.2
1	A	704	PHE	2.2
1	B	351	LYS	2.2
1	A	511	LYS	2.1
1	A	677	VAL	2.1
1	A	584	PHE	2.1
1	B	479	LEU	2.1
1	B	566	ALA	2.1
1	A	681	PRO	2.1
1	A	328	GLU	2.1
1	A	311	VAL	2.1
1	A	416	VAL	2.1
1	A	522	LEU	2.1
1	B	678	TRP	2.1
1	A	685	GLY	2.1
1	A	618	MET	2.0
1	A	667	ARG	2.0
1	A	485	TYR	2.0
1	A	552	ASP	2.0
1	B	302	LYS	2.0

6.2 Non-standard residues in protein, DNA, RNA chains [i](#)

There are no non-standard protein/DNA/RNA residues in this entry.

6.3 Carbohydrates [i](#)

There are no carbohydrates in this entry.

6.4 Ligands [i](#)

In the following table, the Atoms column lists the number of modelled atoms in the group and the number defined in the chemical component dictionary. The B-factors column lists the minimum,

median, 95th percentile and maximum values of B factors of atoms in the group. The column labelled 'Q< 0.9' lists the number of atoms with occupancy less than 0.9.

Mol	Type	Chain	Res	Atoms	RSCC	RSR	B-factors(Å ²)	Q<0.9
4	1Q7	B	803	24/24	0.82	0.28	26,43,75,75	0
4	1Q7	A	803	24/24	0.84	0.25	28,49,72,73	0
3	H4B	B	802	17/17	0.96	0.11	26,29,32,33	0
3	H4B	A	802	17/17	0.96	0.11	28,31,36,36	0
5	ACT	A	804	4/4	0.97	0.13	45,45,46,47	0
5	ACT	B	804	4/4	0.97	0.09	33,36,36,37	0
2	HEM	B	801	43/43	0.98	0.21	20,23,31,32	0
2	HEM	A	801	43/43	0.98	0.17	22,26,33,37	0
6	ZN	A	805	1/1	1.00	0.05	29,29,29,29	0

6.5 Other polymers [i](#)

There are no such residues in this entry.